

NASA/CR-20220014586

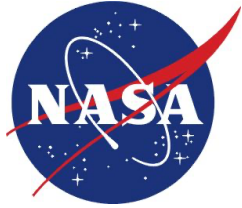

Henrich Focke — Inventor of the First Successful Helicopter

*Edited by
Berend G. van der Wall, German Aerospace Center (DLR)
Franklin D. Harris, F.D. Harris & Associates*

September 2022

NASA STI Program ... in Profile

Since its founding, NASA has been dedicated to the advancement of aeronautics and space science. The NASA scientific and technical information (STI) program plays a key part in helping NASA maintain this important role.

The NASA STI program operates under the auspices of the Agency Chief Information Officer. It collects, organizes, provides for archiving, and disseminates NASA's STI. The NASA STI program provides access to the NTRS Registered and its public interface, the NASA Technical Reports Server, thus providing one of the largest collections of aeronautical and space science STI in the world. Results are published in both non-NASA channels and by NASA in the NASA STI Report Series, which includes the following report types:

- **TECHNICAL PUBLICATION.** Reports of completed research or a major significant phase of research that present the results of NASA Programs and include extensive data or theoretical analysis. Includes compilations of significant scientific and technical data and information deemed to be of continuing reference value. NASA counter-part of peer-reviewed formal professional papers but has less stringent limitations on manuscript length and extent of graphic presentations.
- **TECHNICAL MEMORANDUM.** Scientific and technical findings that are preliminary or of specialized interest, e.g., quick release reports, working papers, and bibliographies that contain minimal annotation. Does not contain extensive analysis.
- **CONTRACTOR REPORT.** Scientific and technical findings by NASA-sponsored contractors and grantees.

- **CONFERENCE PUBLICATION.** Collected papers from scientific and technical conferences, symposia, seminars, or other meetings sponsored or co-sponsored by NASA.
- **SPECIAL PUBLICATION.** Scientific, technical, or historical information from NASA programs, projects, and missions, often concerned with subjects having substantial public interest.
- **TECHNICAL TRANSLATION.** English-language translations of foreign scientific and technical material pertinent to NASA's mission.

Specialized services also include organizing and publishing research results, distributing specialized research announcements and feeds, providing information desk and personal search support, and enabling data exchange services.

For more information about the NASA STI program, see the following:

- Access the NASA STI program home page at <http://www.sti.nasa.gov>
- E-mail your question to help@sti.nasa.gov
- Write to:
NASA STI Information Desk
Mail Stop 148
NASA Langley Research Center
Hampton, VA 23681-2199

NASA/CR-20220014586

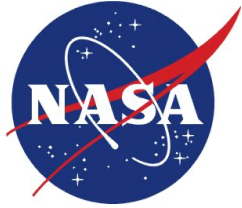

Henrich Focke — Inventor of the First Successful Helicopter

*Edited by
Berend G. van der Wall, German Aerospace Center (DLR)
Franklin D. Harris, F.D. Harris & Associates*

National Aeronautics and
Space Administration

*Ames Research Center
Moffett Field, CA 94035-1000*

September 2022

This report is available in electronic form at
<http://ntrs.nasa.gov>

Overview

In 1924, Henrich Focke, Georg Wulf and Dr. Werner Naumann started Focke-Wulf Flugzeugbau GmbH (Focke-Wulf Aircraft Manufacturing Ltd.). Focke-Wulf constructed Juan de la Cierva's C.19 and C.30 Autogiros under license from 1930 until 1937. This led Focke to design the first successful and fully controllable helicopter, the Fw-61. Model tests in his wind tunnel supported the configuration and in 1932 Focke proposed a helicopter project to the ministry with drawings and calculations, which was granted in that same year. Impressed with the success of the Fw-61, the German Air Ministry suggested that Focke establish a new company dedicated to helicopter development and issued him a requirement for an improved design, capable of carrying a 700 kg (1,500 lbs) payload. Focke and Gerd Achgelis (a test pilot) partnered to establish the Focke-Achgelis company in 1938. The Fw-61 became the Fa-61.

Historically, Henrich Focke and his Focke-Achgelis company must surely be considered as the developer of the world's first successful helicopter. They began development of the Focke Wulf company's Model Fw-61 helicopter, which had a side-by-side rotor system, in 1932. First flight was achieved on June 26, 1936 with test pilot Ewald Rohlf's at the controls. With the Fw-61's flight demonstrated success, Professor Focke went on to present three early papers:

1. Das Trag- und Hubschrauberproblem (Autogyro and Helicopter Problems), November 1937
2. Forschung und Entwicklung der Drehflügelflugzeuge (Research and Development of Rotating Wing Aircraft), April 1942
3. Fortschritte des Hubschraubers (Progress of the Helicopter), October 1943

The first paper was also published by the German Museum (Munich) in 1938 and it was translated into English on the order of the Ministry of Aircraft Production by J. Helledoren as R.T.P No. 2128 at the end of 1937. The other two reports, however, appear not to have been translated during or after World War II and thus are made public here – probably for the first time.

Translations of the three Focke papers are provided in this report. A careful translation from German to English of the papers has been made. Many of original photos have been recovered from the German Museum (Munich). In several cases, the original graphs have been redrawn to enhance each paper's technical value. The editors have added footnotes where appropriate.

The editors consider Focke's papers to be of such immense technical and historical value that they deserve wide distribution to the rotorcraft industry. Finally, the editors believe that readers of the many technical points Henrich Focke makes about his development program will see that Focke's program anticipated even today's best rotorcraft industry efforts.



A handwritten signature in black ink, appearing to read 'H. K. Focke'. The signature is written in a cursive style with large, sweeping loops.

Henrich Karl Johann Focke, Prof. Dr. h.c. (8 October 1890 — 25 February 1979)
Photo at age 40, dated 1930 (Source: DLR central archive)

Table of Contents

| | |
|-----------------------------|-----|
| Overview | i |
| Table of Contents | iii |
| Henrich Focke's Biography | 1 |
| Focke's First Paper (1937) | 7 |
| Focke's Second Paper (1942) | 53 |
| Focke's Third Paper (1943) | 57 |
| List of Symbols | 101 |

HENRICH KARL JOHANN FOCKE

Professor, Diploma-Engineer, Dr. hc.
Technical Chief of Focke, Achgelis & Co., GmbH
in Delmenhorst near Bremen
Bremen, Straßburger Straße 30
Phone 455 79

The aeronautical pioneer Henrich Carl Johann Focke was born Oct. 8, 1890 in Bremen, Germany. He was interested in any kind of aeronautics even as a schoolboy. Together with his older brother Wilhelm he began his first aeronautical experiments with gliders. In 1908 he designed a canard aircraft named Ente (= duck) with the elevator in the front wing. His canard was unsuccessful at that time. Focke was always inspired by failures, which just made him increase his efforts. After a practical year at a railway repair shop in Bremen he began to study mechanical engineering at the TH Hanover in 1910. Here he met Hans Kolthoff and Georg Wulf who became his friends. They developed and built their first motorized aircraft in 1912 called A-IV. This aircraft made several successful flights. At the beginning of World War I Focke and Wulf volunteered for military service, but Focke initially was rejected due to a heart disease; later he was assigned to a local infantry regiment. After having served at the East front, Focke was sent to the German Army Air Service aircraft battalion 5 of the German Air Force in Hanover and finally served until the end of the war as a teacher at the German Test Institute of Aeronautics (DVL) in Berlin.

After the war he finished his studies at the TH Hanover with a diploma engineer with honors in 1920 and took a position in the Franke Company in Bremen as a designer of water-gas systems. During that time – despite the general prohibition of aeronautical manufacturing in Germany – he, together with Georg Wulf, developed and built the monoplane A-VII, a small commercial aircraft flown by Wulf in 1921. This successful design was certified for civil flight in 1923 and formed the beginning of production of their aircraft in a private society. On Jan. 2, 1924, Focke, Wulf and Dr. Werner Naumann started the business as the Focke-Wulf Flugzeugbau GmbH (=Focke-Wulf Aircraft Manufacturing Ltd.). The first order came from the local Air Traffic Society of Bremen for a small commercial monoplane with closed cabin for pilot and three passengers, A-16. Before production started a small model was tested at the AVA Göttingen by Prandtl and confirmed the superior aerodynamic quality of the design. Twenty-two vehicles were built in various versions and Focke-Wulf tried to get the confidence of the German Lufthansa as potential customer, who ordered the A-17 (= Seagull) in considerable numbers.

The development of the canard wing configuration was continued in 1926 with wind tunnel measurements at the AVA Göttingen before the start of flight tests. However, Georg Wulf crashed during one of these flight tests with the aircraft called A 19 Ente on Sept. 30, 1927, and Focke lost a very close friend and an excellent test pilot. Focke in his obituary about Wulf described the aeronautical pioneer's spirit of the time quite accurately as:

Whoever spoke of flying in the years 1908 to 1912, especially in a conservative city like Bremen, was – in the eyes of the brave citizen – surrounded by an atmosphere spookily mixed of adventure, circus, madhouse and graveyard.

After he declined a call for professorship at the University of Danzig, Focke was appointed a professor in Bremen in 1931 and gave lectures at the Technischen Lehranstalt (= Technical School for Applied Sciences) of Bremen. In the following years a series of smaller airplanes was manufactured in larger numbers, totaling to almost 140, amongst them the models Stieglitz, Stößer, Weihe (= goldfinch, hawk, harrier) and the two-engine Falke (= falcon). The merger with the Albatross Aircraft Manufacturers of Berlin in 1930, as a consequence of the world economic crisis and pressure imposed by the government, generated a company of high military relevance. This was very disappointing for Focke since he opposed mass production of military aircraft. Due to pressure by the Nazis he was pushed out of his own company. He managed to get a small team of high-skilled engineers, a wind tunnel and offices in Hemelingen close to Bremen.

However, this paved the way to focus on other subjects and he concentrated on rotating wing aircraft. Already in 1930, he had bought a license of the Cierva Autogiro Company in Southampton, England for manufacturing of the autogiro models C 19 Heuschrecke (= grasshopper) and later for the C 30. Focke-Wulf built a small series of these until 1937. Their performances and handling qualities were investigated intensively and also with their own development of an autogiro, the Fw-186, which was built as competitor to the short take-off Fieseler Fi-156 Storch, but it could not convince anybody. The principle of autorotation, driven by the speed of flying, was not satisfactory to Focke, in part due to the take-off and landing still requiring some runway, albeit of short length.

With a small but efficient team of engineers and technicians Focke began with the development of a vertical take-off and landing helicopter in a separate building in Bremen-Hemelingen. The development of a helicopter was a big step and similar to his development of fixed-wing aircraft Focke started to research and understand the fundamentals of helicopter flight. In short, he and his team performed detailed scientific investigations of the aerodynamic problems, the performances and the dynamical stability. He got a contract for development of a helicopter from the Ministry of Traffic and at that time became involved with Ernst Udet, famous WW I pilot and important advisor for the Nazis, who supported Focke until the end of WW II.

Extensive wind tunnel testing and flight testing with models were executed before he decided to focus on the side-by-side arrangements of rotors so that helicopter yawing moment was zero. He also saw that the side-by-side configuration removed the fuselage from being in the downwash of the rotors and also guaranteed satisfying flight stability. His priorities in designing a fully operational helicopter were defined by him in the following order:

1. Capability of emergency landing in case of engine failure
2. Good stability and control characteristics
3. Reliability
4. Simplicity of control
5. Acceptable flight performances
6. Simple maintenance

Safety was his biggest concern. Therefore, his Fw-61 helicopter had an automatic switch from the helicopter mode into the autogiro mode allowing for a safe landing for the pilot.

The first vehicle was finished in 1935 and first tethered ground tests were performed. The maiden flight followed on June 26, 1936, with Ewald Rohlf's as test pilot at the airport Bremen. Just one year later Rohlf's had broken all official world records of helicopters by far with the Fw-61. Another milestone was the first switching from the helicopter mode into the autogiro mode with a safe landing thereafter on May 10, 1937. For Focke, this was the starting point of the age of helicopters. Some stardom was obtained also by the demonstration flights of Hanna Reitsch in the Deutschlandhalle in Berlin 1938 during a world exhibition, which the Nazis used as propaganda demonstrating their supremacy in aeronautics.

The Focke-Achgelis & Co. GmbH was founded April 27, 1937, in Hoykenkamp at Delmenhorst in the vicinity of Bremen. A two-seater variant of the Fw-61 for training purposes and named the Fa-224 was built into 10 vehicles until 1939, but the project was not followed any further. An order of the Reichsluftfahrtministerium (RLM, = Reichs Ministry of Aeronautics) to develop a utility helicopter named the Fa-266 with 700 kg payload for the German Lufthansa got priority. At the beginning of WW II this order was changed into a military one and the vehicle was renamed to the Fa-223. Also, in order to get this contract, Focke had to join the Nazi Party (the National Socialist German Workers Party) in 1940. This new helicopter had its maiden flight on June 12, 1940, with Karl Bode at the controls. It reached a maximum speed of 182 km/hr, a ceiling height of 7100 m within 30 minutes and could lift payloads up to 1600 kg. An order for series production of 100 vehicles was issued in 1941. However, the impact of World War II hindered the series production significantly and on July 4, 1942 the plant at Delmenhorst was destroyed by bombing during an air raid. Only the series production of 200 Fa-330 Bachstelze (= wagtail) rotating wing kites for submarines remained in Hoykenkamp, because these light-weight vehicles could be carried by hand into the shelters during air raid warnings.

The production of the Fa-223 was transferred to Laupheim in southern Germany and re-started at the beginning of 1943. But in July 1944, production of Fa-223s again became the victim of an air raid, when just 17 machines were finished. The plant was again relocated to Ochsenhausen, and the order enhanced by a further 30 Fa-223s. Under these circumstances the series production could not be finished and at the end of the war only 40 machines were finished. Only three of them were captured in operational condition by the Allies and one of these performed the first crossing of the British Channel by a helicopter during the transfer flight to England. Nevertheless, the helicopter was intensively used during the war to salvage crashed planes from the country side. Additionally, the Weser-Flugzeugbau GmbH (Weser Aircraft Manufacturing Ltd.) had taken over the company on order of the RLM and Focke had to hand over the manufacturing plant as well as the staff for manufacturing of the Me 163, which then had a higher priority.

In Autumn of 1944 the order was enhanced to 400 Fa-223 to be manufactured in Berlin, but shortly after that the Focke team was relocated to Obermaiselstein close to the Alps and this location was occupied by French troops in May 1945. After the end of the war, Focke and his team were forced to contract with the French and they moved to southern France from 1945-1948 in order to work for SNCASE and to develop the SE 3000 for them. The SE 3000 was in principle a replica of the Fa-223, which had its first flight in 1948. In parallel, a small helicopter, the SE 3101 was developed that later became the very

successful Alouette II. Focke in his auto-biography considered this helicopter as his grandchild.

Focke and his team were released in 1948 and returned to Germany, where aircraft manufacturing was forbidden and he turned his knowledge towards shipbuilding and construction. In parallel, he acted as consultant engineer in helicopter technology for the British Ministry of Aeronautics until 1958. Focke built his own house by the method of prefabrication in 1949, a method developed by Prof. Messerschmitt. After a short period as designer for light-weight streamlined busses at the Nordwestdeutsche Fahrzeugwerke (= North-West German Car Manufacturers) in Wilhelmshaven in 1950, he moved to Amsterdam, Netherlands, in 1951 where he was asked to develop a quad-tilt-rotor vertical take-off aircraft named Convertiplan. This was inspired by his own design of the Fa-269. However, due to problems with funding it remained on the drawing board status.

Focke then, in 1952, accepted an invitation from the Centro Technico da Aeronautica in Sao Paulo, Brazil. He was contracted for the further development of the Heliconair – the former Dutch Convertiplan –, but the project was stopped shortly thereafter due to a failure in the main gear box and the impossibility of getting a new one. Another contract was given thereafter for the development of a small light-weight helicopter named Beija-Flor (hummingbird). It was finished 1958, had its first flight in 1959 and had remarkable static and dynamic self-stability, which made obsolete the usual complex and expansive stabilizing controllers.

From 1954 on, Focke for a few months every year returned to Germany, where he started to give lectures in the winter semester 1954/1955 at the Technical University of Stuttgart. This university had offered him a position as ordinary professor and director of the newly to be founded Institute of Aircraft Design, but the institute's establishment was delayed on and on¹, the contract with the Ministry of Education could not be signed, and Focke finally declined in 1956.

In 1956, Focke moved back to Germany where the car manufacturer Borgward had offered him a contract to develop a small three-seated helicopter, while still allowing him to travel to Brazil for a few months each year to continue supervising the work on the Beija-Flor, which lasted until 1960 with a last visit. At Borgward, he began to work on the Kolibri (Kolibri = hummingbird) with several of his former team on May 2, 1956 and the design was similar to the Beija-Flor. In order to avoid patent violations, the construction was modified in several details and the two-seated prototypes Kolibri V1 and V2 were built. Immediately before to the certification flights, Borgward became bankrupt and Focke again had to start newly as a consultant engineer for the Vereinigte Flugtechnische Werke (VFW = United Flight-Technical Manufacturers) in Bremen as well as for the Deutsche Forschungs- und Versuchsanstalt für Luft- und Raumfahrt (DFVLR = German Research and Test Establishment for Aerospace, today's DLR = German Aerospace Center).

After his retirement Focke continued privately to work on problems of helicopter theory and helicopter technique. For this purpose, he built – unnoticed by the public – a small wind tunnel in the backyard of his home in Bremen. At the end of the 1950s on into the beginning of the 1960s he performed aerodynamic measurements on small-scale helicopter

¹ Until 1959. Ulrich Hütter, who also was lecturer from 1952/53 on, then took the position as director.

models. This laboratory was found in bad condition as late as 1997 and was rebuilt into its original condition by sponsors, amongst them Airbus Germany. Today it is a small publicly accessible museum. Henrich Focke died on Feb. 25, 1979, in Bremen at an age of 88 years.

Numerous honors and awards were given to Henrich Focke for his achievements. He became honorary member of the DVL in 1933, an ordinary member of the Academy of German Aeronautics in 1937, and an honorary doctor of engineering of the TH Hanover in 1938. He was given the Lilienthal-Memorial Coin in 1938 and became Wehrwirtschaftsführer (= a title, may be translated as: military industrial leader) in 1940. He got the Verdienstorden (= Order of Merit) of Germany in 1960. In 1961 he was awarded the Prandtl-Ring of the Wissenschaftliche Gesellschaft für Luftfahrt (WGL = Scientific Society for Aeronautics). He received the Howard C. Potts-Medal of the Franklin Institute in 1968 and he was a founding member of the Helicopter Museum in Bückeburg, Germany, in 1970.

Sources:

German National Archive Berlin; *Mein Lebensweg* (Autobiographies, Deutsche Luft- und Raumfahrt, Mitteilung 77-01, 1977)

Aeronautical Research in Germany - from Lilienthal until Today (Springer, 2004); private communication with Dr. Wolfgang Geißler

Focke, Henrich Karl Johann, Jahrbuch 1937/1938 der Deutschen Akademie der Luftfahrtforschung, Vol. 1, pp. 63-64, (1938)

Berend G. van der Wall, "Göttinger Monograph N" published in the AIAA Library of Flight

Writings²
of the German Academy
of Aeronautical Research

Volume 22

R.T.P. Translation
No. 2128
Issued by the
Ministry
of Aircraft
Production.

² Transcript, edited by Berend G. van der Wall, German Aerospace Center, Braunschweig, Germany, 2020

Autogyro and Helicopter Problems

by Henrich Focke

Translated by J. Helledoren.

Lecture

presented at the 3rd science meeting of the
orderly members on November 26, 1937

Period 1937/38

AUTOGYRO AND HELICOPTER PROBLEMS

By Henrich Focke

The development of modern aircraft is subject to certain inherent limitations, which are not easily overcome since they result from the applied physical principle of fixed wing flight. The chief limitations originate in the impossibility of keeping an aircraft stationary (hovering) in the air or making it take-off (rise) and land vertically. Owing to this, the use of aircraft is considerably limited, while further disadvantages are the manifold dangers at taking-off and landing, the large area required for airports and the perils involved in flight with poor visibility or over country unsuitable for landing.

All of us are acquainted with the means whereby the minimum speed of an aircraft to keep it in the air can be successfully reduced. Yet, due to their inherent characteristics, they are incapable of reducing this speed to a zero value. Firstly, because in fixed wing aircraft, the downward acceleration of the air required for supplying the lift is produced by the speed of forward flight and furthermore, since a downward deflection of the air masses at an angle up to 90° constitutes an ideal but unattainable limit.

Thirty years ago³ it was not at all certain which method of aerodynamic flight would be the first to lead to the practical realization of human flight: the fixed-wing aircraft, the wing-flapping machine (ornithopter), the helicopter, or perhaps other machines of an intermediate type.

It is easily understood why, in spite of all, the fixed wing aircraft proved the first successful means, the cause being its simplicity of construction. In those by-gone days when the difficult problem of aerodynamic flight was an entirely new field of research, it was only too tempting to assume that the ideal flying machine did not require any movable components, rudder excepted.

The first visible results obtained between the years 1907 and 1909 created a mode of thought, however, which was regrettable from the point of view of more profound observation and the cause of avoidable stagnation: There arose an almost exclusive support for this first successful form of construction – the fixed-wing aircraft – and all previous efforts along parallel lines passed into oblivion. For 20 to 30 years it was overlooked that the practical realization of only one specific solution did not provide proof that other methods were useless.

This clinging to the means whereby the first flights were successfully achieved is understandable; also, the fact that the fundamental shortcomings of this first solution were accepted.

We are fully aware of the limitations of modern aircraft. We allow for them in our calculations and continuously add improvements within the limits of its performance. This is correct and only natural.

Yet, from the aspect of future development, we must not forget that we can only conquer wider fields of application, barred to us at present, by going back to the roots of acknowledged technical fundamentals and exploring new avenues.

When facing the problem of making an aircraft independent of forward speed, we are inevitably driven to one principle; the wings must have a movement of their own. For practical reasons the mechanism required for this purpose must be as simple as possible. Technically tempting are ornithopters and paddle-wheel aircraft but sober reasoning will bring home the fact that the airscrew

³ 1907, since this report is from 1937

(propeller) provides the most suitable solution, which is one of the simplest engineering elements and simultaneously also well known in its theoretical treatment.

The idea of using a power-driven airscrew with vertical axis as a means of flight is very old. Leonardo da Vinci already sketched a helicopter prototype. I shall pass by the interesting subsequent development of the helicopter. We all know that until recently the helicopter had not passed beyond the laboratory stage.

Interest in this type of aircraft has been strongly revived in recent years owing to two impulses of a totally different origin. One of these was created by a present need: The substitution of captive balloons, guidance from the air of tank battalions, used on board of ships devoid of special fittings such as flight decks or catapults, or use as liaison aircraft, in mountain and colonial warfare, for aerial survey etc.; all these functions called for a machine which could not only use a short runway and landing space but could dispense with these altogether. A machine, consequently, that could remain stationary in the air, and take-off and land at all angles up to the vertical. Future expansion of private aerial traffic would also be made impossible by the need of large spaces for take-off and landing purposes if airplanes were used. In the case of an improved helicopter, however, roof and garden landing grounds are no longer a mere utopia.

The second impulse had a technical origin: De la Cierva's autogyro (Fig. 1) had given practical demonstration that, apart from minor shortcomings, a large rotating airscrew constituted a lifting device which was safe in operation – the principle was argued multiple times before his demonstration. It must be admitted that this machine is no helicopter and consequently – apart from the subsequently discussed jumping take-off – is unable to rise or land vertically in steady flight. Neither can it remain stationary in the air, since the lifting propeller is not driven by the engine but autorotates under the influence of, again, the relative wind. The forward movement is produced in the usual manner by an engine with an airscrew. In this respect the helicopter and Cierva's autogyro are only loosely related, especially when we remember that Cierva himself rejected the helicopter principle.



Fig. 1: Cierva C30 autogyro

All the same, the autogyro undoubtedly represents an interesting intermediate solution between fixed wing aircraft and the helicopter. Although its take-off is no better than that of the former, its landing speed, which is ca. 40 km/hr, is already very low and it has another very valuable characteristic: Since its rotating propeller blades have their own motion relative to the air this aircraft cannot stall and retains its lateral controllability. This common characteristic of rotating blades has led to a general term for helicopters and autogyros, namely, “rotating wing aircraft”.

The mere existence of the autogyro has been instrumental in supplying us with theoretical information which would have been much retarded otherwise. The licensing authorities in Great Britain, charged with testing Cierva's autogyro, engaged aerodynamic experts like Glauert and Lock

to explain mathematically the peculiar progress of autorotation, i.e. the fact that the large airscrew, which is wind-driven only, at a small angle of incidence, rotates freely by the action of the relative wind.

We shall see later, that the Glauert (Ref. 1) – Lock (Ref. 2) method of calculation (Ref. 3) can be extended (and applied) to the forward flight of a helicopter down to extremely low speeds. If we add to this that, in the case of a lifting screw with purely axial flow (hovering flight) numerous methods of calculation and experiments were already available [e.g. von Kármán (Ref. 4), Flachsbart (Ref. 5), Helmbold (Ref. 6)], also methods for obtaining the best radial distribution of thrust, and a stability analysis by Kármán with pessimistic perspective, we have a rough outline of the theoretical development of autogyros and helicopters up to about 1932.

Regarding practical experience, Pescara's (Ref. 7) (France), d'Ascanio's (Ref. 8) (Italy) and Ehmichen's (Ref. 9) (France) performances with helicopters up to 1932, officially or semi-officially acknowledged, were approximately as follows:

| | |
|--------------------|--------|
| Distance covered | 1 km |
| Duration of flight | 10 min |
| Height attained | 18 m |

Continuous, if only experimental, practice in helicopter flight did not exist, however.

In contrast hereto, the autogyro was already in common use as other aircraft of the period. Its performances were, and still are today, short to those of corresponding fixed wing aircraft.

Owing to the existing conditions and general state of aeronautical engineering and science 5 years ago, the construction of a real helicopter - unhampered by the restrictions peculiar to autogyros - would merely have represented an addition to the many already existing machines by another aircraft which might perhaps have flown a few meters higher and farther and yet have been of no practical use.

The real need was to construct an aircraft, actually worthy of the name, if only an experimental model. But this problem had to be approached with all our available technical knowledge and ability. Inventive thoughts are useful and essential, but a most sober consideration of all important aspects of the problem and the subsequent working out of all technical details is better.

These considerations must be based solely on the practical requirements to be made on a finished flying machine. Arranged in order of importance these design requirements are:

1. Emergency landing after engine failure.

No helicopter has ever fulfilled this most important and fundamental requirement in practice (which is a standard requirement for fixed-wing aircraft since long), although the possible transformation of the lifting action of the screw into autorotation had been indicated theoretically many years ago, even before Cierva. For this it is necessary to reduce all blade's pitch angle of the airscrew compared to the helicopter operational condition, since autorotation can only be assured in this manner. This introduces an unavoidable mechanical complication, but an aircraft incapable of a smooth landing in the case of engine failure, or of the power transmitting gear, is useless for practical flight.

The next important design requirement is:

2. Maneuverability and stability.

The aircraft must at least be maneuverable with ordinary skills under all conditions of flight, including hovering flight. Static stability about all axes is better; and dynamic stability, if possible,

still more desirable. This was one of the most vulnerable issues of all previous helicopter experiments. Usually it was reported that to maintain the helicopter in the required position in the air for a matter of minutes was only possible by continuous, accurate and rapid action of the controls. Regarding other designs, which later proved disappointing for other reasons, it is simply stated that they possessed sufficient stability without further explanation. Kármán's pessimistic conclusion has often led to the opinion that it was impossible to design a permanently and practical to control helicopter.

At normal speeds, autogyros do not cause any particular difficulties in this respect in spite of the fact that they do not always prove stable about all axes. At low speeds – from 60 to 70 km/hr, agreeing in theory and practice – they too become unstable at least dynamically about some axes, and partly about all. In practice no major difficulties have been caused by this, since low speeds usually occur for short periods only. With helicopters however, whose major value lies in hovering flight, this issue has to be judged more critically. Even if no complete static and dynamic stability can be assured, normal control must be possible for periods running into hours and not only during good weather.

A further very important design requirement is:

3. General safety in operation.

This is again a very weak point of the helicopter up to the present. So long as flying time was counted in minutes, safety in operation was hardly more than theoretical. The nonrotating components of the aircraft are subjected to conditions that hardly differ from those applying to any aircraft. But the safety of operation of the transmission components must at least be equal to that of the engines, which is, and will presumably remain, less than that of the fuselage. It must be understood that this concerns the principle of general safety which determines the practical usefulness of a design. The possibility of making an emergency landing, dealt with in item 1 of this list, is absolutely essential, as already stated, and must be assured together with the operational safety of the airframe.

In direct association with practical usefulness is:

4. Simplicity of control by the pilot.

The technical side of a new problem is always only one part – perhaps a minor part – of the problem as a whole. The other part is a matter for the pilot who will fly the new machine. One of the most urgent requirements, consequently, is to make his task as easy as possible. The controls and other operating components must be of familiar type and shall not require more than a few additional manipulations compared to flying a fixed wing aircraft. The controls must work not only in the habitual direction but also shall have accustomed effect in their effectiveness.

Neither can we do without:

5. The requirement of reasonable performance.

It is obvious that we cannot, especially at the beginning, expect to attain the highest performances of fixed wing aircraft. For the special advantages of rotating wing aircraft in low-speed flight a price has to be paid on their high-speed performances. The specific advantages of a helicopter would, of course, be considerably reduced if it can *only* hover in the air. It is therefore necessary to insist on forward flight performance being at least *comparable* to that of a fixed wing aircraft.

Finally, the sixth design requirement that is not unimportant is:

6. The requirement of reasonably ease of maintenance.

It is, of course, essential that anyone operating the new machine should familiarize himself with it by constant practice. Despite this it is necessary to emphasize that it must be possible to service the airframe of the new machine in a somewhat similar manner to that of an ordinary aircraft, and that the maintenance of the power-driven gears must approximately be like that of the engine. Then, apart from an initial period, major difficulties need not be anticipated in practice.

This above summary of only the six major requirements shows that there exists no “surprise solution” for the problem of the ideal rotating wing aircraft (or more universally: for the speed range $1: \infty$)⁴. Rather, only *one* method is practical: to get to the bottom of the many different issues with *equal* care and then to accommodate *all* of them in the design. Some of the extensive investigations into stability are purely theoretical. Others, like the question of simplicity of handling and control, are predominantly of a practical nature. In between these are the difficult mechanical engineering design aspects.

To summarize:

In 1932 we find on the one hand the practicable autogyro, wherein the autorotating wings are not engine-driven, and which already permits flight at rather low speeds. On the other hand, barely out of the laboratory stage, we find the engine-driven helicopters with which only slight practical experience has been gained. It has been realized that in spite of this, for hovering flight and continuous steep or absolutely vertical climb, for take-off and landing in the smallest possible space, the solution of the helicopter problem was bound to include the use of autorotation to assure the possibility of emergency landing.

Given this introduction we will now examine the scientific and technical means of solving the problem of designing a helicopter that meets all of the six design requirements.

I. The Generation of Lift of an Airscrew, Engine-driven and in Autorotation.

The developed thrust (in this case thrust is identical with the lift) of an airscrew does not present any unusual features, the related theory is assumed common knowledge. So far, aspects of power economy were in the foreground. The general endeavor has been to secure an optimum thrust distribution over the radius giving maximum lift for the lowest possible engine power. Since the principal requirement is the ability to make an emergency landing, however, we have to make certain compromises: It is essential that the airscrew will autorotate in case of engine failure. That a somewhat higher engine performance is consequently required may be neglected for the time being. At the commencement of my own experiments with helicopters 5 years ago, the rotor blades of all successful autogyros with proven autorotation were completely untwisted. When it is not permissible to obtain the desired lift distribution by twisting the blades, the only remaining means is to vary the blade chord. This results in a pronouncedly trapezoid blade planform, connected to the hub by a universal joint so as to relieve it of all the more considerable bending moments. This principle was applied by Colonel Renard (Ref. 10) in 1904 and holds good today for most autogyros and helicopters.

The blades were of course also subjected to exhaustive analytical and experimental tests for the conditions of autorotation and helicopter flight. Fig. 2 shows a model of this three-bladed propeller, driven by a 3 HP electric motor. The framework is suspended in a wind-tunnel balance which measures all aerodynamic forces and moments. Fig. 3 shows an example of a test result in which

⁴ Focke wrote it exactly this way with the intent to cover the entire speed range thinkable.

the non-dimensional values of the power absorbed by the airscrew $k_d = N/[(\rho/2)Fu^3]$ and the thrust (lift) $k_n = S/[(\rho/2)Fu^2]$ are plotted versus the blade pitch angle (ϑ).⁵

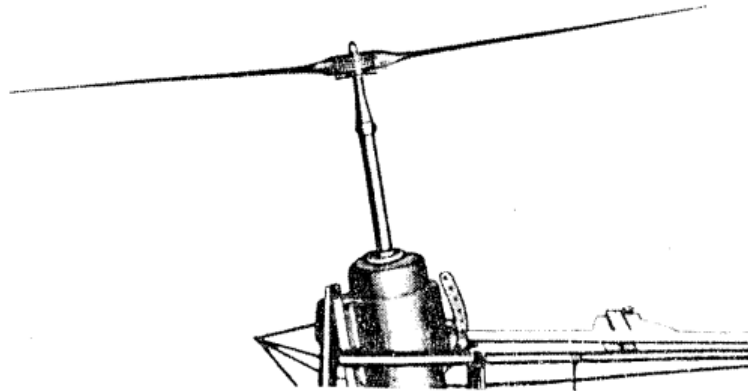

Fig. 2: Model of the three-bladed airscrew in the wind tunnel

According to Bendemann, the figure of merit for the airscrew in hover is $FM = \frac{1}{2}\sqrt{k_n^3/k_d}$.⁶ The optimum value of this factor lies in the present case at a collective pitch of $\vartheta = 12^\circ$ where FM equals 0.71. This is a satisfactory figure in spite of the flatness of the blade.

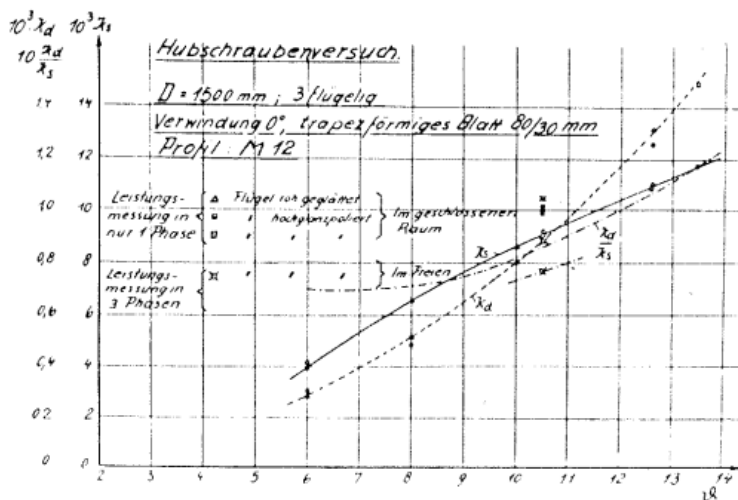

Fig. 3: Power and thrust coefficients versus blade pitch angle

We shall now examine the same airscrew from the aspect of autorotation. It is now only started up by its motor. The wind tunnel is put into operation, and, beginning with a certain wind speed, the airscrew autorotates when a free-wheeling clutch is released and the electric motor switched off. As in the case of a fixed wing a polar can now be measured, varying the wind speed and blade pitch angle ϑ as well as the mean angle of attack α_π of the airscrew relative to the direction of the wind. Fig. 6 exemplarily shows one of the many recorded curves, here for a blade pitch angle $\vartheta = 4^\circ$. When the value of ϑ is increased, autorotation becomes impeded at a smaller value of α_π , (i.e. at high speed of flight). When conversely the value of ϑ is decreased, the airscrew rotates more rapidly at the same angle of attack α_π , while the polar becomes worse.

⁵ Most of Focke's 1937 symbols are different from what we use today. The essential difference is the division by $\rho/2$ instead of today ρ only. Thus, $k_d = 2C_p$ and $k_n = 2C_T$.

⁶ Converted by the above into today's notation: $FM = \sqrt{C_T^3/2/C_p}$.

Keeping the blade pitch angle of $\vartheta = 4^\circ$, we note that at the transition from helicopter flight, for which $\vartheta = 12^\circ$, to autorotation the blade pitch angle must be reduced by 8° , a fairly considerable amount.

It is of course assumed that the airscrew's diameter has been pre-determined. In regard to helicopter properties a large, slowly rotating rotor is of course preferable. The attainable limits are merely a matter of mechanical design. However, the ability to land by autorotation is again decisive. The polars of the autorotation condition increase to approximately $c_a = 1$. Putting the minimum velocity for a steady autorotation condition to about 50 km/hr and considering that, according to American full-scale tests, the value of c_a for unsteady autorotation during landing (flare) rises up to about 2, resulting into only 35 km/hr, then disc loadings of approximately 10 kg/m² can be used. Such disc loadings are also suitable for helicopter operation since they allow for thrust values of roughly 6 to 8 kg/HP, and the rotor diameter is still manageable.

For the analytical treatment of autorotation, I will briefly recall the essentials (Fig. 4) of the Glauert – Lock method without discussing the complete derivation.

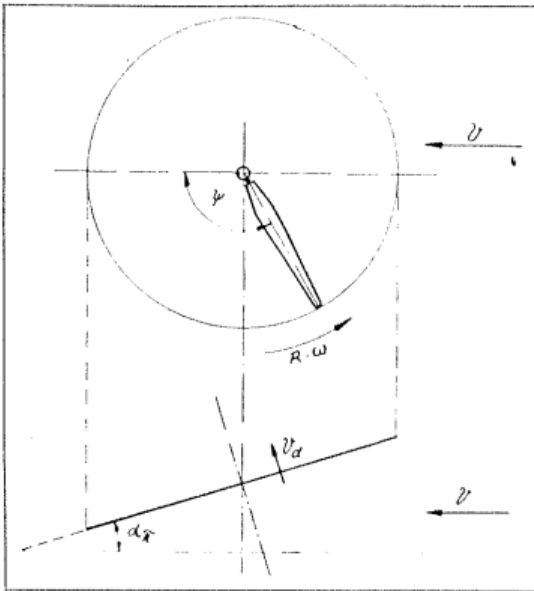

Fig. 4: Velocity components in Glauert's theory

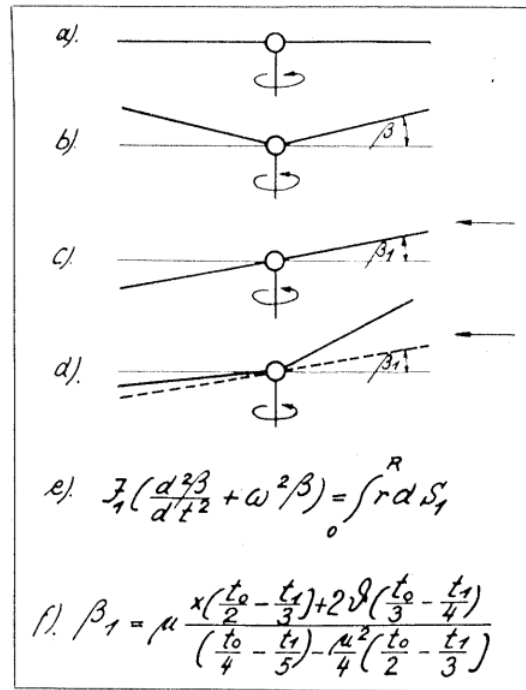

Fig. 5: Glauert's approach to the autogyro theory

At each radial station on the blade Glauert combines the forward speed v geometrically with the peripheral speed $R\omega$ and assumes that only the speed component normal to the axis of the blade spar is a measure of the aerodynamic forces. Of course, the local angles of incidence vary simultaneously according to the instantaneous position of the blade during its rotation which he denotes by ψ and counts from the rear most point of the blade path. In his analysis Glauert utilizes the air velocities in the form of 2 advance ratios, the first being an axial component $x = v_d/(R\omega)$ in which $R\omega$ represents the peripheral speed and v_d the axial velocity through the disc while the second is a tangential advance ratio $\mu = v \cdot \cos \alpha_\pi / (R\omega)$; $\cos \alpha_\pi$ being used on account of the inclination of the propeller plane to the flow through the angle of attack α_π . Since the blades, which are connected to the hub by a universal joint adjust themselves freely to the resultant of the inertia (mainly therefore centrifugal) and aerodynamic (mainly thrust S) forces, Glauert was forced to

introduce into his calculation the blade motion resulting from these respective influences. This blade motion makes possible forward motion of the airscrew without lateral moments, while in the case of blades rigidly attached to the hub the airscrew would always tilt in the direction of the returning blade on account of the smaller lift of the latter.⁷ The centrifugal force by itself would align the blades in a plane normal to the axis of rotation (Fig. 5a). Under the influence of thrust or lift, they will be deflected upwards by the angle β (Fig. 5b). They therefore describe a figure resembling a wide-angled conical envelope for which reason β is termed the coning angle. Glauert now applies an equation of moments for the inertia and aerodynamic forces with respect to the flapping hinge and obtains

$$I_1 \cdot \left(\frac{d^2 \beta}{dt^2} + \omega^2 \cdot \beta \right) = \int_{r=0}^{r=R} r \cdot dS_1 \quad (1)$$

in which I_1 is the mass moment of inertia and S_1 is the thrust of the blade. The first term in parenthesis includes the moment of the blade inertia forces with respect to a vertical⁸ up and down motion called the flapping motion. The second term is the moment of the centrifugal forces acting on the blade. On the right we have the moments of the aerodynamic forces in the form of the integrated moments of the elementary thrusts. Quite correctly, Glauert neglects the moment of the blade weight as being negligible relatively to the aerodynamic and centrifugal forces. He then

develops β and $\int_{r=0}^{r=R} r \cdot dS_1$ in a Fourier series and arrives (after some contrivance and omissions,

which will at present be ignored) at the result that the entire cone of blade rotation is inclined backwards at an angle of β_1 , i.e. that consequently β varies periodically within a revolution, with a maximum in front in the direction of flight where $\psi = 180^\circ$ and a minimum behind at $\psi = 0^\circ$, and represented by the conical angle [(Fig. 5c), and further including the coning angle β_0 in (Fig. 5d)]. Glauert provides all formulae for rectangular blades only, i.e. for a constant blade chord length t . The entire Glauert-Lock theory was further elaborated by my employee Bansemir for a trapezoidal blade in which the blade chord was set to $t = t_0 - t_1 \cdot r/R$. Here t_0 represents the chord at the blade root and $t_0 - t_1$ the chord at the tip. The chord therefore decreases outwards proportional to the radius. After integrating the right hand side of equation (1), or Fig. 5e, we have⁹:

$$\beta_1 = \mu \frac{x \cdot \left(\frac{t_0}{2} - \frac{t_1}{3} \right) + 2\mathcal{G} \left(\frac{t_0}{3} - \frac{t_1}{4} \right)}{\left(\frac{t_0}{4} - \frac{t_1}{5} \right) - \frac{\mu^2}{4} \left(\frac{t_0}{2} - \frac{t_1}{3} \right)} \quad (2)$$

The upward tilt of the entire conical blade path therefore implies that the advancing blade always rises and the returning blade falls. We now obtain an important explanation of the true reason why a hinged blade does not generate a moment about the longitudinal axis of the aircraft. Owing to its upwards motion the advancing blade has a smaller angle of attack and thus compensates for the increased lift due to the sum of the forward and peripheral speeds. The opposite happens at the retreating blade. The explanation of this process is found in the centrifugal force, which must be the same everywhere since all blades have the same speed of rotation and weight.

⁷ This effect was experienced by de la Cierva in his first design, leading to the introduction of flapping hinges.

⁸ "Vertical" is not fully correct, "rotational about the hinge" would be more appropriate.

⁹ x is the inflow ratio

After the angle β_1 , the backwards tilt, has been ascertained, the further aerodynamic values of the rotor can be determined. Once again details of the derivation are omitted, and merely the formulae given. First of all, the torque equation:

$$M = z \frac{\rho}{2} c'_a R^4 \omega^2 \left[\frac{\delta}{c'_a} \left(\frac{t_0}{4} - \frac{t_1}{5} \right) + \frac{1}{2} \frac{\delta}{c'_a} \mu^2 \left(\frac{t_0}{2} - \frac{t_1}{3} \right) - \mathcal{G}x \left(\frac{t_0}{3} - \frac{t_1}{4} \right) - x^2 \left(\frac{t_0}{2} - \frac{t_1}{3} \right) - \frac{1}{2} \beta_1^2 \left(\frac{t_0}{4} - \frac{t_1}{5} \right) - \mu x \beta_1 \left(\frac{t_0}{2} - \frac{t_1}{3} \right) - \frac{3}{8} \mu^2 \beta_1^2 \left(\frac{t_0}{2} - \frac{t_1}{3} \right) \right] \quad (3)$$

In addition to the already used symbols, here z represents the blade number and δ is the mean airfoil drag coefficient of the blade sections. From the sign and existence of δ it is seen that the first two terms in brackets are torque-consuming while the remaining terms are torque-promoting. In the process of calculation, we also note the appearance of harmonic terms which, although they do not contribute to the mean torque, demonstrate that the torque of an individual blade fluctuates during rotation. It consequently also causes slight oscillations in the plane of rotation when a blade is hinged at the hub. These excitations cause the blade to move forward and backward relative to the exactly radial position which the centrifugal force is trying to establish. I have proposed to call this the inplane motion the lead-lag motion, in contrast to the out of plane flapping motion.

The mean torque of an autogyro must be zero, as defined by the condition of autorotation. Introducing the previously calculated value for β_1 we have:

$$M = z \frac{\rho}{2} c'_a R^4 \omega^2 \left[\frac{\delta}{c'_a} \left(\frac{t_0}{4} - \frac{t_1}{5} \right) + \frac{1}{2} \frac{\delta}{c'_a} \mu^2 \left(\frac{t_0}{2} - \frac{t_1}{3} \right) - \mathcal{G}x \left(\frac{t_0}{3} - \frac{t_1}{4} \right) - x^2 \left(\frac{t_0}{2} - \frac{t_1}{3} \right) - \left(\frac{x \left(\frac{t_0}{2} - \frac{t_1}{3} \right) + 2\mathcal{G} \left(\frac{t_0}{3} - \frac{t_1}{4} \right)}{\left(\frac{t_0}{4} - \frac{t_1}{5} \right) - \frac{\mu^2}{4} \left(\frac{t_0}{2} - \frac{t_1}{3} \right)} \right)^2 \left\{ \frac{1}{2} \left(\frac{t_0}{4} - \frac{t_1}{5} \right) + \frac{3}{8} \mu^2 \left(\frac{t_0}{2} - \frac{t_1}{3} \right) \right\} - \mu^2 x \frac{x \left(\frac{t_0}{2} - \frac{t_1}{3} \right) + 2\mathcal{G} \left(\frac{t_0}{3} - \frac{t_1}{4} \right)}{\left(\frac{t_0}{4} - \frac{t_1}{5} \right) - \frac{\mu^2}{4} \left(\frac{t_0}{2} - \frac{t_1}{3} \right)} \left(\frac{t_0}{2} - \frac{t_1}{3} \right) \right] \quad (4)$$

Glauert uses this equation to determine the axial velocity ratio x in dependence of the tangential advance ratio μ . Physically, or better from an energy point of view, this involves ascertaining the airflow through the disc required to maintain autorotation in opposition to the blade drag. We find that

$$x_{free\ run} = \frac{-\bar{B} + \sqrt{\bar{B}^2 - 4\bar{A}\bar{C}}}{2\bar{A}} \quad (5)$$

in which the values \bar{A} , \bar{B} , and \bar{C} represent the abbreviations of longer expressions occurring in the preceding formulae.

We can now calculate the thrust as

$$S = z \frac{\rho}{2} c'_a R^3 \omega^2 \left[x \left(\frac{t_0}{2} - \frac{t_1}{3} \right) + \mathcal{G} \left(\frac{t_0}{3} - \frac{t_1}{4} \right) + \frac{\mu^2 \mathcal{G}}{2} \left(t_0 - \frac{t_1}{2} \right) \right] \quad (6)$$

For many purposes, such as for stress analysis, we need the radial thrust distribution for the different azimuth angles ψ of one blade during its revolution:

$$\begin{aligned} \frac{dS_1}{dr} = \frac{\rho}{2} c'_a \omega^2 t \left[xrR + \mathcal{G}r^2 + \frac{1}{2} \mu^2 \mathcal{G}R^2 \right. \\ \left. + \left(x\mu R^2 - \beta_1 r^2 + 2\mathcal{G}\mu rR + \frac{1}{4} \mu^2 \beta_1 R^2 \right) \sin \psi \right. \\ \left. + \left(\mu \beta_1 rR - \frac{1}{2} \mathcal{G}\mu^2 R^2 \right) \cos 2\psi + \frac{1}{4} \mu^2 \beta_1 R^2 \sin 3\psi \right] \end{aligned} \quad (7)$$

In this equation the harmonic terms, of course, reappear. What is more, the thrust distribution changes very markedly with ψ , (i.e. with the different blade azimuth positions) and the more the higher the forward speed.

Further, the expression of the longitudinal force H is given below. This is equivalent to the tangential force of a wing, and therefore lies, in the actual case, in a plane normal to the axis of rotation, and in the plane of the direction of flight:

$$\begin{aligned} H = z \frac{\rho}{2} c'_a R^3 \omega^2 \left[\frac{\delta}{c'_a} \mu \left(\frac{t_0}{2} - \frac{t_1}{3} \right) - \frac{1}{2} \mu \mathcal{G} x \left(t_0 - \frac{t_1}{2} \right) \right. \\ \left. + \frac{3}{2} \beta_1 x \left(\frac{t_0}{2} - \frac{t_1}{3} \right) + \beta_1 \mathcal{G} \left(\frac{t_0}{3} - \frac{t_1}{4} \right) + \frac{1}{2} \beta_1^2 \mu \left(\frac{t_0}{2} - \frac{t_1}{3} \right) \right] \end{aligned} \quad (8)$$

The rest is simple. With the normal force, i.e. the thrust, and the longitudinal force, i.e. the tangential force, the rotor system lift and drag are known and the lift and drag coefficients of the rotor in autorotation can be calculated, usually referred to the swept disc area $R^2 \cdot \pi$. We now have also the polar, as shown in Fig. 6. Previously, wind tunnel measurements were mentioned. It can now be seen how well the improved English calculation method corresponds to the actual facts, despite of its various assumptions and simplifications.

It only fails in one respect and it is consequently (in view of the requirement 1: safe emergency landing) impossible to escape the necessity for experiment. It does not show the dangerous cessation of autorotation because the calculation is based on a constant blade element airfoil lift curve slope $c'_a = dc_a/d\alpha$, and the particular reason why autorotation ceases is that large sections of the blades – near the stalling condition – experience a considerable increase in drag combined with a significantly less increase of lift. Since wind tunnel tests are usually made at lower values of the coefficients (Mach, and especially Reynolds numbers) than in actual flight, determination of the limits of autorotation in this manner affords a safety factor. The danger line runs within very narrow limits of the blade pitch angle. Below $\vartheta = 4.5^\circ$, counting upwards from zero lift, autorotation is completely assured with usual blade thicknesses at all conditions of flight occurring in practice. When ϑ approaches 6° conditions become very dangerous, as accidents unfortunately show, especially in the case of high speeds and low flying weight. It will therefore be noted that the risk of cessation of autorotation develops in a completely opposite manner to the danger of stalling in the case of fixed wing aircraft.

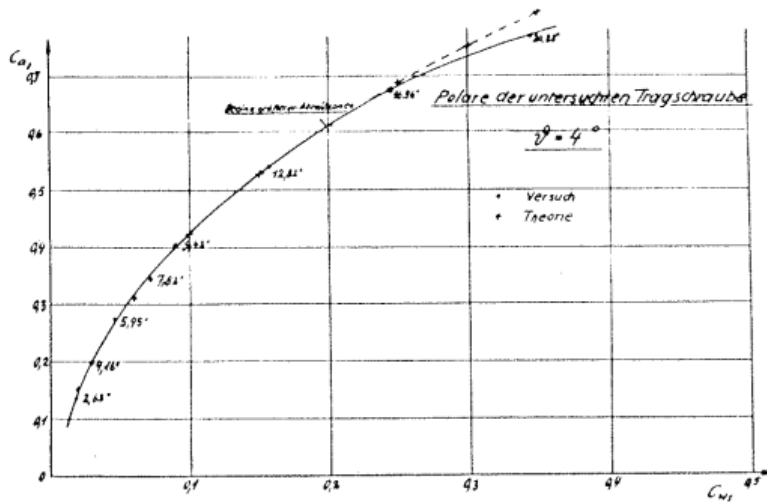

Fig. 6: Polar of the autorotating airscrew, comparison of calculation with wind tunnel measurements

The limit of autorotation is not of much interest in connection with our problem of a helicopter capable of emergency landing as an autogyro the boundaries of autorotation do not play a role. If there was any doubt in this respect we would simply reduce the value of ϑ by some degree, in which case we would completely have fulfilled our requirement for a safe emergency landing.

We have now dealt with the generation of lift of a hovering helicopter and of an autogyro. The discussion of the third condition, (i.e. the helicopter in forward flight) has been intentionally been held back by me. Lock has already commenced extending the Glauert theory to this condition. After having discussed the autogyro condition we shall therefore next examine the calculations for helicopter conditions and later describe the experiments.

We only need to replace the zero torque in the torque equation by a finite torque in order to obtain helicopter conditions. All other relationships remain valid and the calculations proceed as usual. Instead of the usual aerodynamic coefficients it is more suitable to use thrust coefficients, since for the hovering helicopter the c_a value would become ∞ since the transition from forward flight to hovering is of special interest. Following Flachsbart, instead of c_a , we introduce the coefficient of the vertical thrust component K_{sv} referred to the peripheral tip speed instead of the aircraft's forward speed. Similarly, the horizontal component of the thrust is denoted by K_{sh} .

In the helicopter condition the value the axial advance ratio x , of course, changes its sign; the flow during operation of the rotor being downwards across the disc. This condition persists in forward flight.

The rotor disc angle of attack α_π of the airscrew itself relative to the flight path (or to the airflow in a wind tunnel) does not make sense in hovering flight. It can assume any value between 0° and $\pm 180^\circ$ in helicopter forward flight since backward flight is also possible. It is noteworthy that α_π amounts to -90° for vertical climb from hover and to $+90^\circ$ at a corresponding vertical descent.

In a helicopter (without any other propulsive force components) in forward flight the angle of attack α_π must always be negative. The axis of the helicopter rotor must therefore be inclined in a forward direction so as to produce the thrust component required to overcome its own and parasitic drag.

I will later show how the complete calculation for a helicopter in forward flight compares with results obtained by experiments. The measurements were obtained by means of the test rig used for

the autorotating airscrew. The freewheel clutch was disconnected and the helicopter blade pitch angle was applied. The rotor power was measured electrically but cross-checked by the measured moment about the vertical axis, combined with the anyway mandatory measurement of the speed of rotation.

The execution of the measurements required great care because of the presence of many sources of error which will not be discussed here in detail, with the exception of one important factor that also affects practical helicopter flying: the ground effect. When the approaching a horizontal surface (ground surface) of sufficient area, the lift (and in a slight degree also the absorbed torque of the rotor) increases considerably as soon as the distance becomes of the order of the rotor diameter. In practice this is demonstrated very definitely by the fact that at a given engine throttle setting the helicopter will take off, but refuses to rise above a few meters height without increasing the throttle setting. A helicopter without sufficient excess power may in some cases fail ever to rise above this "floating height". This phenomenon supplies on the other hand a welcome cushioning effect during landing. It interferes, however, with laboratory work (in the wind tunnel), since it is rarely possible to experiment at a sufficient distance from solid objects. Until now only a few test results were available for this "ground effect". Those of Flachsbart, obtained in 1928, were the best and have been satisfactorily confirmed by our own measurements. The upper curve in Fig. 7 shows the increase of the lift and the lower one the increase in torque near the ground, expressed in terms of the ratio of height above ground to rotor diameter. The three individual crosses represent our own cross-check measurements.

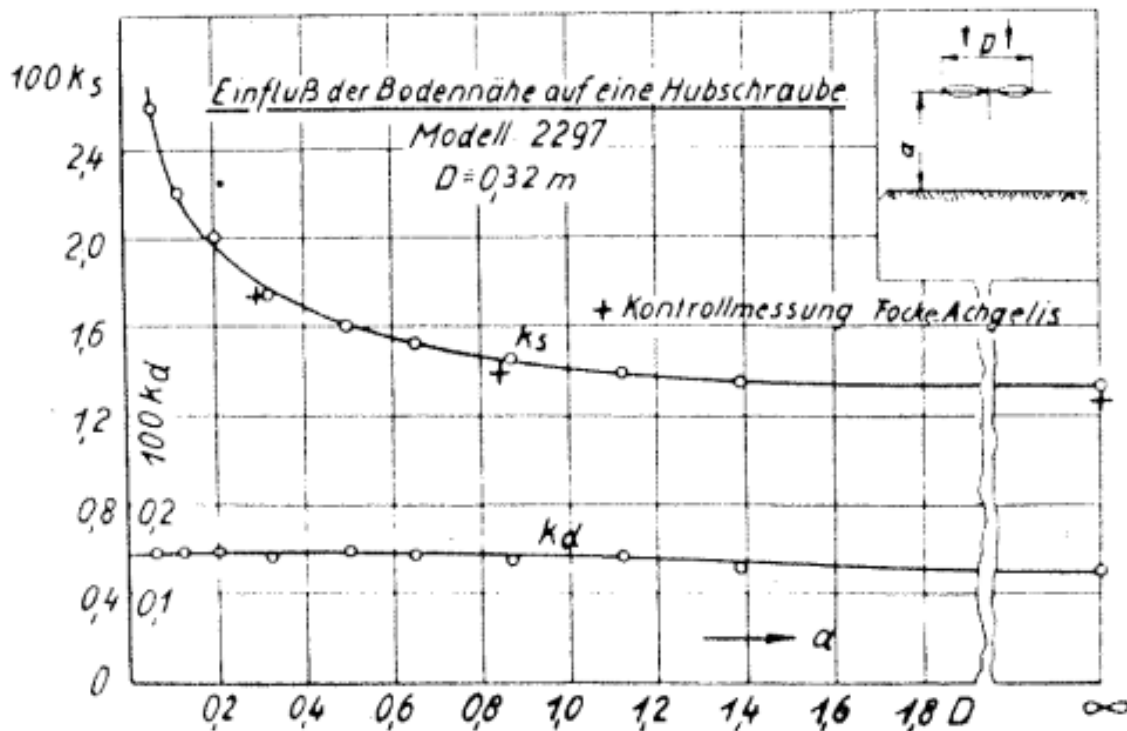

Fig. 7: Ground effect on the lifting airscrew, experiments by Flachsbart

Fig. 8 shows an example of a measurement result almost free from all detrimental influences. As mentioned before, the corresponding calculation has also been drawn for comparison. The vertical thrust coefficient K_{sv} is plotted versus the tangential-advance ratio μ for a blade pitch angle of $\vartheta = 11^\circ$. The family of curves resembles different rotor angles of attack α_π . It can be recognized, in the case of angles of attack above -15° , after a small drop, the thrust coefficient shows a considerable rise with the increase of the advance ratio, i.e. with forward flight speed. Where the

value of α_π is below -15° , on the other hand, the thrust diminishes at once, first more slowly, and then more rapidly. It will also be noted that the calculation satisfactorily reproduces the character of the actually measured curves; even the small drop at the beginning is prominently shown. The transition to the hovering condition is also flawless. In contrast to the calculation, the measured curves show a more rapid downward trend at maximum advance ratios, presumably because portions of the blades operate at too high angles of attack and partial stall takes place.

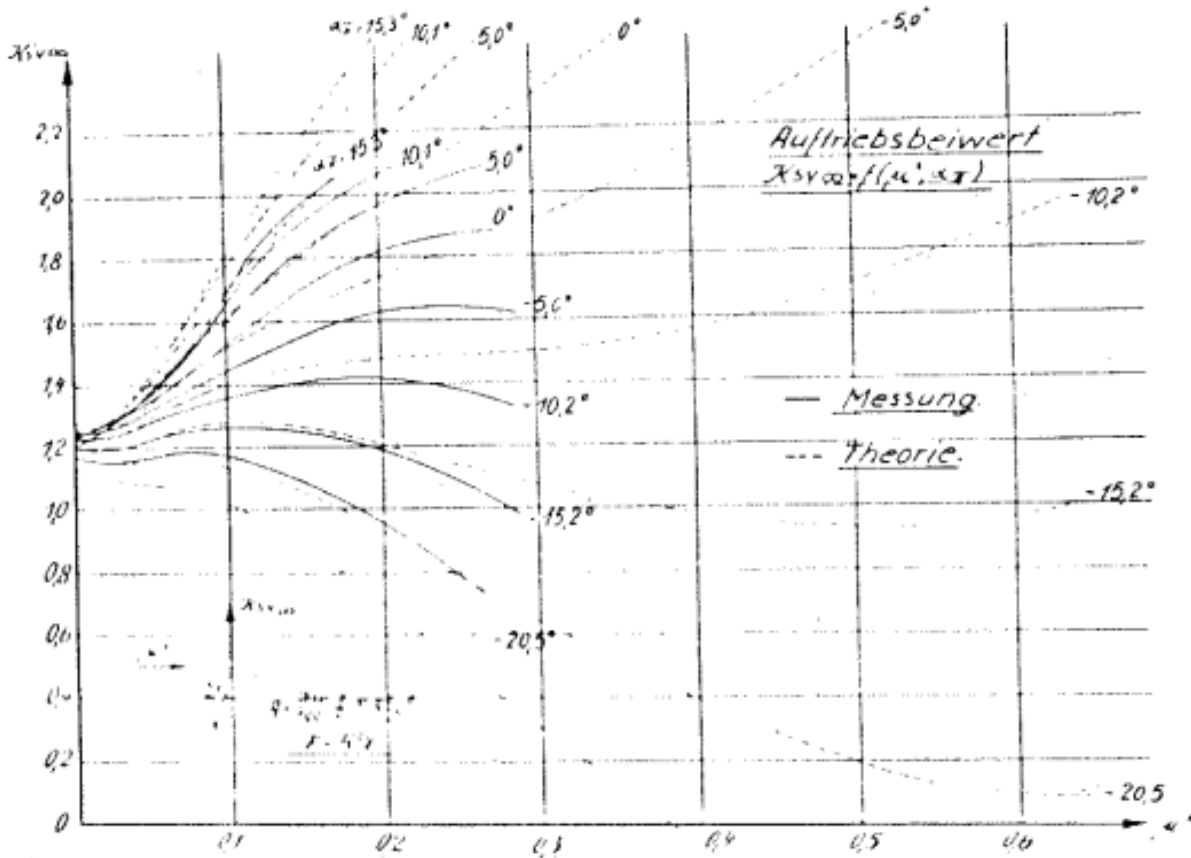

Fig. 8: Vertical thrust coefficient as function of advance ratio.

The counterparts to this are the curves of the horizontal thrust coefficient K_{sh} plotted in the same manner, see Fig. 9. For the most frequent angles of attack $\alpha_\pi = 0^\circ$ to -10° the drag coefficients generally develop almost linearly, again with the exception of the extreme values.

Without doubt the great thrust and lift increase in forward flight is caused by the increased volume of air contributing the total momentum. In hovering condition, only the air flowing through the rotor disc is involved. In forward flight a certain amount of “wing-equivalent” lift is added, that is, part of the lift is caused by the deflection of the air coming in from the front.

Having obtained an insight into the generation and keeping up of lift in different conditions of flight, we shall now discuss the second requirement of satisfactory control and stability.

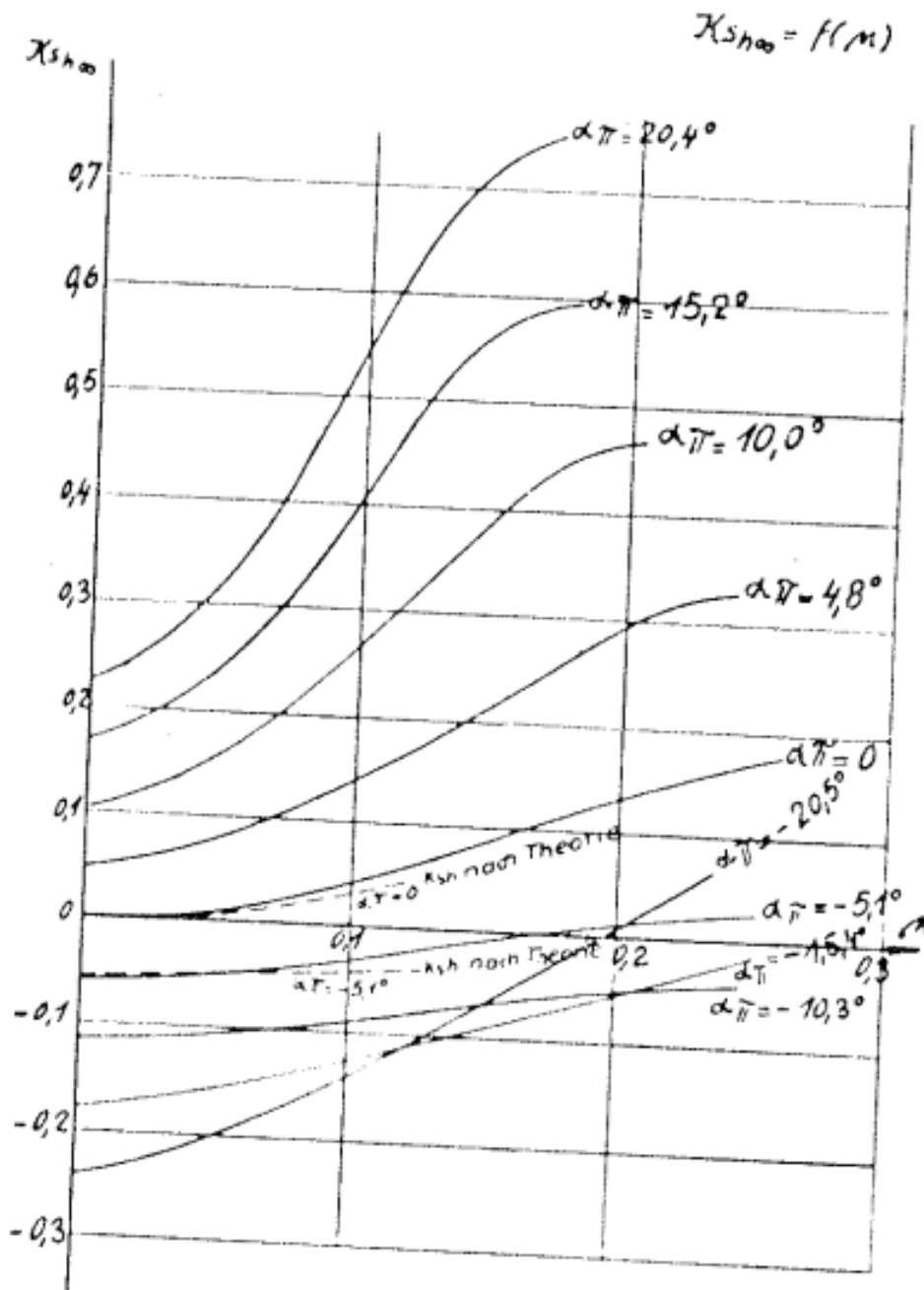

Fig. 9: Horizontal thrust coefficient as function of the advance ratio.

II. Control and stability.

No helicopter control is possible without previously obtaining a full equilibrium of torque moments. In the case of the helicopter we are faced with the well-known difficulty which so largely affects the problem of helicopter flight; i.e. the large slowly rotating rotor exerts a free torque on the aircraft of an order of hundreds to thousands of meter-kilograms¹⁰. The method of its elimination determines the whole structural design of the helicopter. It will be seen from Fig. 10 that many means of affecting this have been proposed, such as:

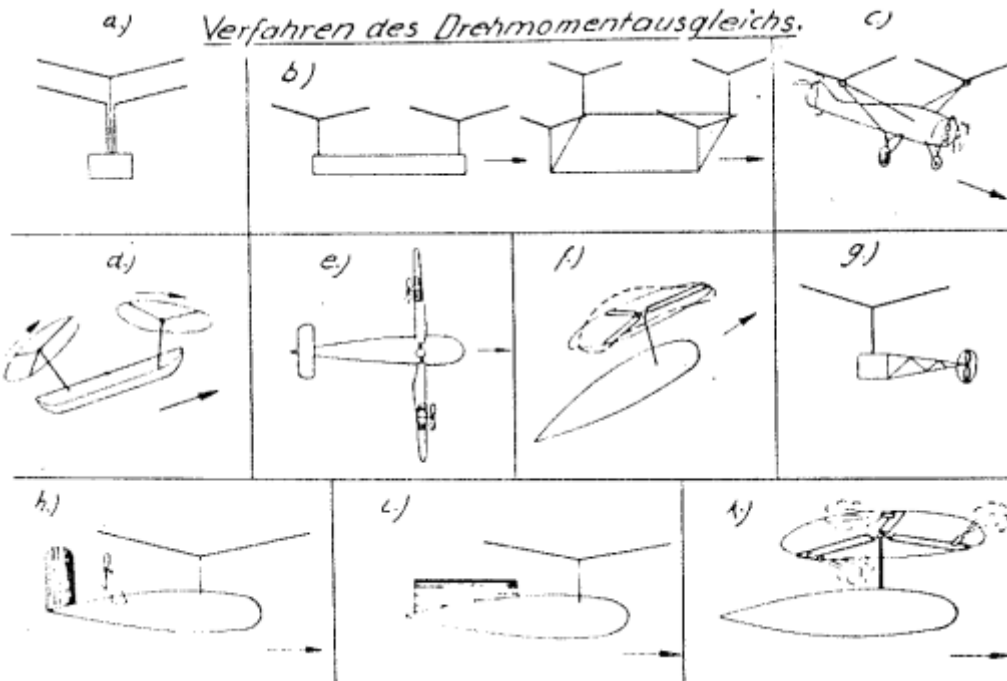

Fig. 10: Methods of torque compensation with a helicopter.

- a) Two airscrews one above the other (coaxial) rotating in opposite direction (Bréguet, d'Ascanio, Pescara, Asboth),
- b) Two airscrews arranged behind each other (Cornu) or even four at the corners of a square (de Bothezat, Ehmichen),
- c) Two airscrews arranged side by side and rotating in opposite direction (Berliner, Focke),
- d) Two even, apparently paradoxically, airscrews which rotate in the same direction. Their axes are so inclined relative to each other that the total torque is neutralized by the generated lateral components (Florine, Belgian Government),
- e) A single large rotor with small propellers mounted on its blades (Isacco, Curtiss-Bleeker),
- f) A single large rotor with blades forced into flapping motion individually, so that no free torque can arise (proposed by Küssner).¹¹
- g) A single rotor for lift and one or more further propellers mounted on long outriggers of the fuselage whose thrust neutralizes the torque (von Baumhauer, Dutch Government Investigation Bureau),

¹⁰ In the 1930s the usual unit for a moment was mkg, instead of today's Nm, and forces were given in kg instead of N

¹¹ This is an application of the ornithopter motion to rotate a blade. Also tried earlier by Passat, see: The Passat „Helithopter“, Flight, Vol. 13, no. 16, p. 277, April, (1921)

- h) A propeller with aft directed slipstream striking on guide vanes in rear of it (Hirtenberger Patronenfabrik, Austria),
- i) Similar surfaces arranged in the slipstream of a lifting rotor itself acting as guide vanes were tried (Hafner and Nagler in Austria experimented with these),
- k) Finally, a reaction jet drive is suggested (Dornier Patents; Papin and Rouilly, France, even with a balanced single bladed rotor and compressed air).

Cierva evades the question by his jumping take-off. He stores up energy by increasing the rotational speed of his rotor on the ground and uses it for a short vertical ascent and subsequent transition to autogyro forward flight. In this case also no free torque is exerted on the fuselage but the method, of course, fails to solve the helicopter problem. Of all these proposals we can reject those that require considerable additional power or involve increased power losses. They are:

- (e) in which the efficiency of the small propellers is included in power consumed by the rotor (i.e. approximately a loss of 30 %).
- (g) and (h) in which the production of a reactive force also continuously absorbs power to the extent of 20 to 30 %, assuming reasonable and technically possible conditions.

Further, from the aspect of present practicability we must also reject those methods of which the fundamental principles have not yet been sufficiently explored. These are:

- (f) and (k), the forced flapping and the reaction (jet) drive, respectively. Both may perhaps be destined to play a role in future. The method (d) shows no advantages over (b) and (c). Its inventor desired to retain the gyroscopic effects which are lost in the case of counter rotating airscrews. Later, we will come back to these gyroscopic moments. We shall also reject for the present such methods that use more than two propellers due to their added mechanical complexity. There remain, therefore, 3 cases: two counter rotating rotors arranged above each other, behind one another, or side by side, respectively. Constructively the first case has been most widely applied. The most successful helicopter up to last year, i.e. the Bréguet-Dorand (France), is constructed along these lines (Fig. 11).

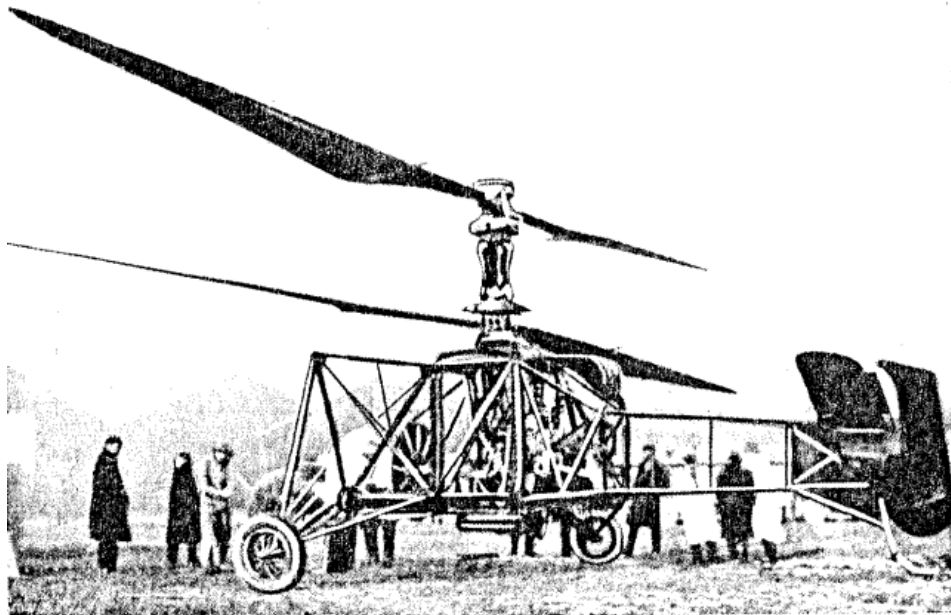

Fig. 11: The Bréguet-Dorand helicopter

Studying the conditions more closely, however, and tracing the reason why so many designs were pre-destined to failure, the above solution cannot be fully approved. In the first place, designers constantly report on the almost unsurpassable difficulties caused by vibrations that are excited by blade passages. The efficiency of coaxial rotors is moreover in most cases inferior to that of the individual rotor alone. In the actual case the rotor slipstream strikes the entire surface of the airframe, fuselage and tail and the effective lift is further reduced. A rough calculation will show that the weight saved by using coaxial rotors instead of rotors mounted side by side is lost again in consequence of the above fact. For emergency landing by autorotation a smaller disc area is available, but this would not be the most serious drawback so long as the autorotation characteristics were perfect. It is just in connection with this most important requirement, however, that considerable difficulties arise with coaxial rotors. There is a tendency that either the top or the lower rotor alone will autorotate, the other rotor only participating in the movement at a very slow rate. As recently pointed out by the DVL¹², uniform autorotation of both screws will only take place under very special conditions in a few cases. Also, with two rotors mounted one behind the other, the aft rotor is considerably influenced by the one in the front, at least in forward flight. It has to be remembered that the downwash of a lifting rotor is directed very differently to that of an ordinary fixed wing aircraft and sets up impracticable conditions with respect to the longitudinal moments.

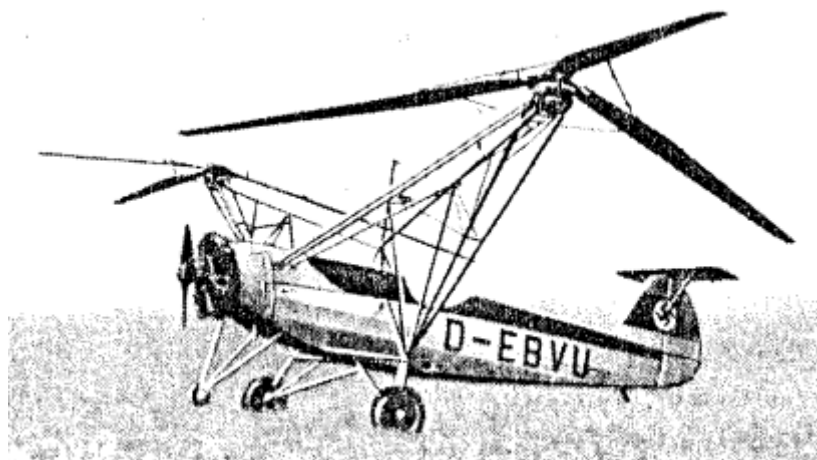

Fig. 12: The Focke helicopter

The only arrangement which does not cause any unfavorable influence on either rotor is the one where by the rotors are mounted at each side of the fuselage, Fig. 12. Oscillatory excitations like blade passages in a coaxial rotor are eliminated. The entire disc area of both rotors is available for emergency landing while their mutual induction acts to increase the aspect ratio.¹³ Autorotation is assured and the total efficiency is equal to that of the individual rotors. The slipstream of each is practically unimpeded while their downwash only acts on the outriggers. The final decision to select this arrangement was given by the prospect of establishing static and dynamic stability about the longitudinal axis even in hovering flight, as will be discussed. The space required by the arrangement is not very different since the saving in span compared with coaxial rotors is partly counterbalanced by their increase in length and especially in height. One important objection to the above arrangement is that the power transmission requires longer shafting. When developing the design, we discovered, however, that the shafting only represented about 1.3 % of the total aircraft

¹² Investigations of the DVL after two crashes of the Rieseler R I and R II coaxial rotor helicopters. Schoppe, G.: Vorversuche über die Autorotation der gegenläufigen Tragschraube (Pretests About the Autorotation of the Counter-Rotating Lifting Airscrew), Zentrale für Wissenschaftliches Berichtswesen (ZWB), DVL FB 895, 1937.

¹³ Each rotor operates in the upwash of the other one, similar to close formation flight of fixed-wing aircraft.

weight. The greater part of this increase can be recovered since subdivision of the power transmission immediately behind the motor has proved favorable for the gear design.

Even if we assume that the adoption of any of the above systems will eliminate free torque, the possibility of perfect control is not assured by this. We are dealing with large and radially largely extending rotating masses which will respond to any change of attitude of the aircraft with large precession moments, turning the machine in a plane at right angles to the intended motion. From the pilot's point of view, cause and effect in the operation of the controls appear confused. This occurs to a slight but nevertheless undesirable degree with the ordinary, large diameter propellers on small aircraft as has long been known. It is therefore hard to understand how the idea of utilizing the gyroscopic moments of *rigid* rotor blades for the stabilization of a helicopter can have been seriously contemplated. Yet, this unhappy idea has played a fatal role for a long time. Stability can be attained (as Küssner has proved¹⁴) but an adequate control is impossible.

The use of hinged rotor blades also removes the difficulty regarding the gyroscopic moments of large lifting rotors. It has been observed that the blades adjust themselves in the direction of the resultants of all inertia and aerodynamic forces and are incapable of transmitting moments at the hinge. We now realize the futility of Renard's idea since the adoption of a hinge also eliminates the third of our difficulties: Firstly, in respect to the principal bending moments in the blades and therewith significantly reduce their weight; secondly the lateral moments in forward flight and also the gyroscopic moments.

We are now at least in a position to review the actual possibilities for stabilization and control. Many autogyros were controlled and stabilized by tail units on the same principle as in fixed-wing aircraft. In the case of a hovering helicopter, this is no longer directly possible. It is of course possible to arrange fixed surfaces or rudders in the slipstream of the lifting rotor or of an ordinary propeller, and both have been tried, also by us, but with little success.

Control and stabilization by use of the rotor blades themselves is more appropriate to the nature of the helicopter. To achieve this, we must again study the mathematical side of the question and examine first of all:

II. A. Longitudinal stability and control.

According to the appropriate formula, the longitudinal flapping β_1 of the rotor blades increases with the tangential advance ratio μ , i.e. in general with the flight speed (see Fig. 13). Since the force in the blade axis direction is the only force capable of being transmitted through the hinge to the hub (and this force is the same on all blades), the parallelogram of forces is, for reasons of symmetry, a rhomboid of which the diagonal represents the resulting direction of this force. It tilts by an angle β_1 relative to the fixed material axis of rotation (= shaft axis). This can be expressed in the way that it represents the new virtual axis of rotation about which, after tilt by the angle β_1 , the entire movement of the blade takes place. Strictly speaking, this is only approximately correct since the thrust distribution and the air drag on the blades influence the position of the latter. This does not however contradict the principle of the process. Consequently, when the general center of gravity of the aircraft is below the rotor, it is obvious that its static longitudinal stability is given already due to the rotor: An increase in speed (i.e. a forward inclination) causes the line of thrust to come in front of the center of gravity owing to the increase in β_1 . The reverse happens when the speed decreases. Since the formal relationships are identical, the above phenomenon occurs in both the autogyro and the helicopter alike. The longitudinal moment of the rotor can therefore be

¹⁴ Küssner, H.G.: Probleme des Hubschraubers, Jahrbuch 1937 der deutschen Luftfahrtforschung, pp. I241-I253, (1937); translated in: NACA TM 827

calculated mathematically in either case or ascertained by wind tunnel tests which will determine the resultant by magnitude and direction. Furthermore, since it is difficult to measure the drag component accurately enough, owing to the numerous necessary corrections and the amount of wire drag to be deducted, other methods have also been applied. We were also prompted by the desire to determine the blade positions over a complete revolution, since this is necessary for many design details, such as the kinematics of the blade pitch mechanism. In Great Britain this has been done by a method of mirroring. I wish to thank Messrs. Schering, Finsterwalder and Flachsbart for the suggestion and execution of a method of stereo-photogrammetry for this purpose which, in the case of a model rotor of 1.5 m \emptyset , indicates the blade position in space with approximately 1 mm accuracy at half radius (Fig. 14).

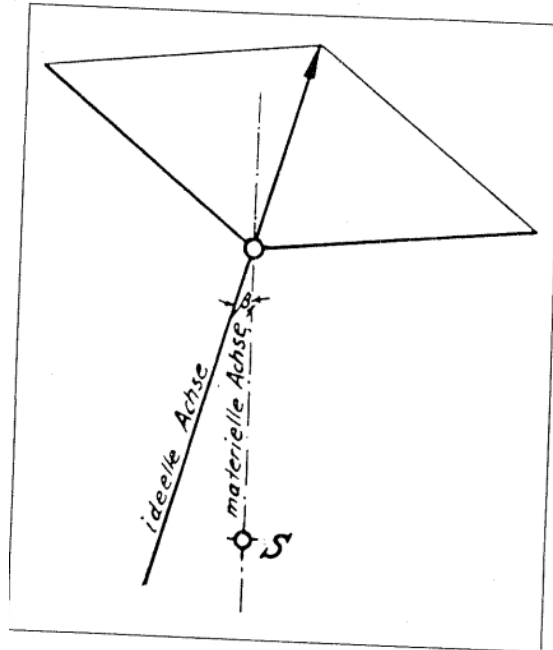

Fig. 13: Static longitudinal stability of the hinged lifting screw

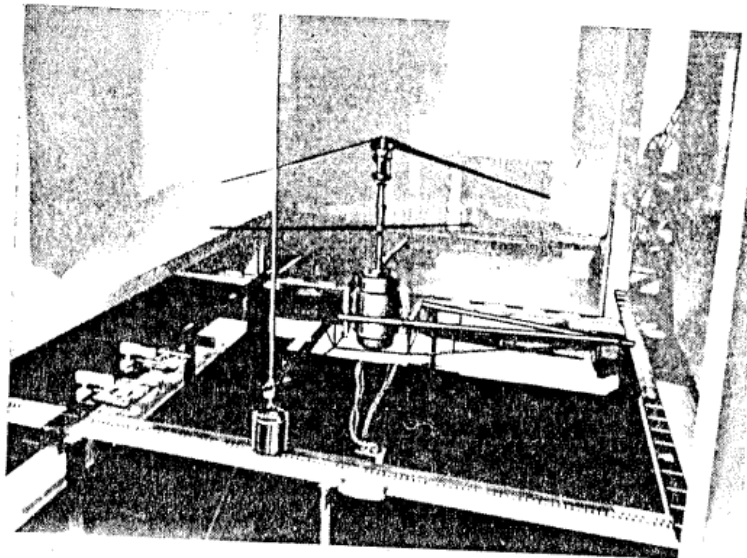

Fig. 14: Stereo-photogrammetric blade path measurements with spark illumination by Schering, Finsterwalder, Flachsbart

Arranged between the lenses of a stereoscopic camera is located an illuminating spark device with $1/1,000,000$ sec exposures. It thus becomes possible to obtain perfectly defined exposures of a series of white spots painted on the rotor which rotates at a rate of 1,700 rpm. After the rotor has been started and the wind tunnel put into operation, a series of 20 to 30 sparks are generated. The room in which the experiment is carried out is of course darkened. The camera shutter is then closed. We then obtain on the same pair of plates a series of exposures, which are, in spite of being taken at random azimuth positions, in most cases sufficiently distributed over the periphery to give a complete picture of all blade positions after evaluation in the stereo comparator. The reference system is a rectangle of graduated scales on the floor of the wind tunnel. Figure 15 shows one example of such a series of exposures. The star-shaped figure is merely due to blade surface glare and can be ignored. The principal advantage of this method is that it can be suitably adapted tis well suited for the examination of the so-called phase delay, i.e. the actual misalignment of the highest and lowest blade path points relative to the direction of flight, owing to the inertia forces of the blades during their flapping motion.

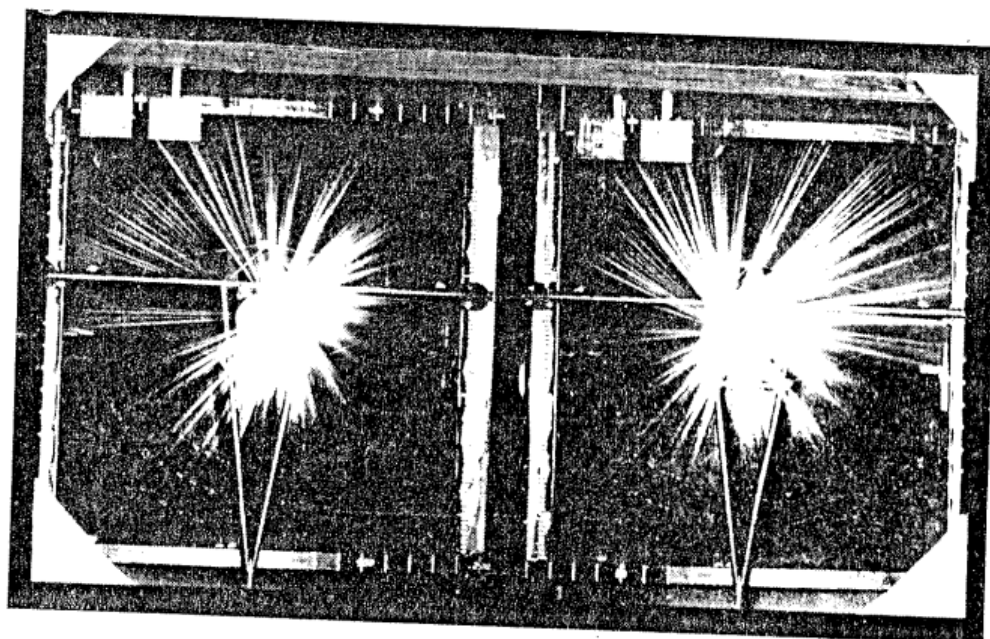

Fig. 15: Stereo-photogrammetric blade path measurements

Figure 16 shows the characteristic of the curves of β_1 plotted versus the advance ratio for an autogyro, as calculated by Glauert and Lock, by the measurement of the forces in the wind tunnel and finally by the photogrammetric exposures. Even if for the reasons already mentioned the curves may diverge in detail, their general characteristics are undoubtedly the same. The longitudinal moments for a known position of the center of gravity can now be easily calculated.

Figure 17 shows a numerical example for a helicopter, in which the moment coefficients K_{ms} are plotted versus the advance ratio μ for different angles of attack α_π . In the case of the helicopter, it is very important for the restoring moments to begin to increase immediately from zero speed.

The rotor behaves like a wing, but with inherent stability as well as a fixed center of pressure.

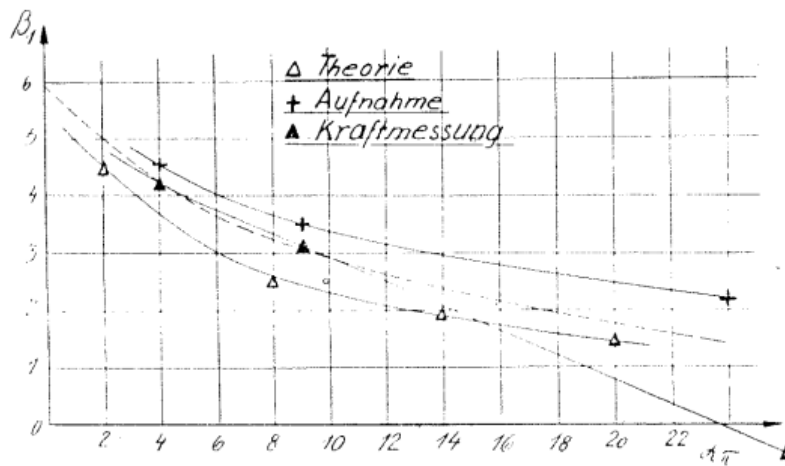

Fig. 16: Longitudinal flapping angle versus advance ratio

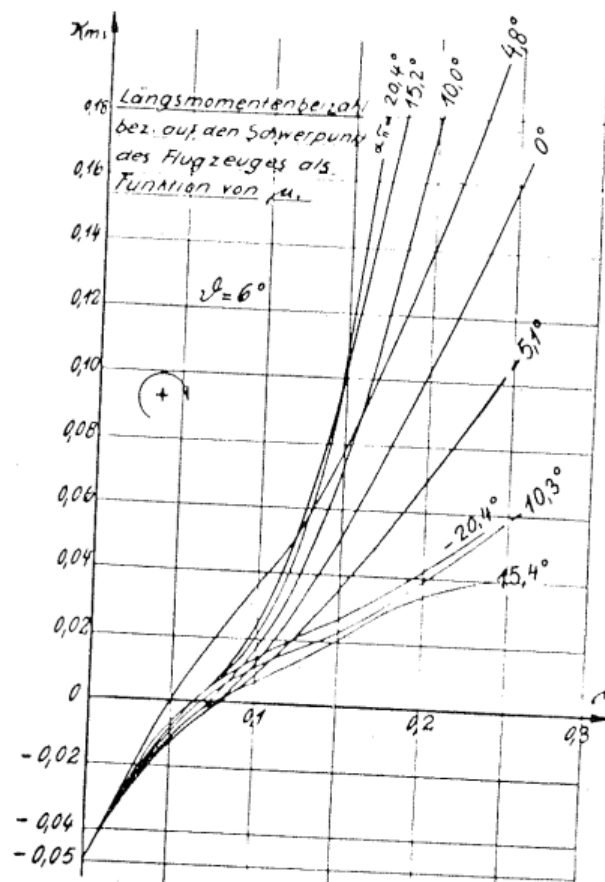

Fig. 17: Moment coefficient versus advance ratio

This stability being caused by the instantaneous direction of the resultant force, the obvious inference is to use an intentional variation of the direction of this force for the control of rotating wing aircraft. Cierva carried this principle into practice with his autogyro C.30 by tilting the entire rotor hub mounted to the pylon forward and backward, and even sideways for lateral control, as shown in Fig. 18. Although the purpose of control was realized, some accidents in attaining high speeds such as in steep diving raised a doubt about whether longitudinal stability would always be

assured under such conditions. I pointed out in a short paper delivered to interested parties¹⁵ that this was certainly so, but that another peculiar danger arises under such conditions: which is a control reversal at high speeds such as in a dive, or at least the resultant dynamic pressure becomes independent of the position of the controls with the result that the pilot loses the feeling of control. If he decides to pull up, the aircraft should finally pitch up again, although his action will at first seem to have the opposite effect. The actual danger, however, lies in the fact that during the short period of apparent state of uncontrollability very high diving speeds may have developed that autorotation ceases. Consequently, the thrust diminishes, the longitudinal restoring moment remains insufficient even after the control stick has been pulled back, and further steepening of the dive can no longer be prevented.

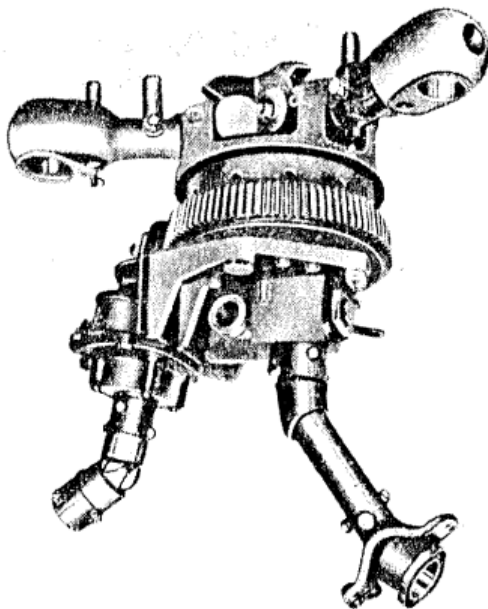

Fig. 18: Rotor hub of the Cierva C.30

To save time I shall omit details of these investigations and merely call attention to the fact that the fixed tail plane is the real cause of the trouble. Cierva erred when he thought that his hub control was a pure control of the center of gravity. At high speeds very large moments are caused by the tail plane. I therefore proposed to use a movable control surface in all rotating wing aircraft, enabling moment stabilization under all circumstances of an emergency. This eliminates any danger from this aspect. I may add that the DVL has independently tested these conditions and arrived at the same conclusions on all important points.¹⁶

But in spite of this, Cierva's control system is not practicable for helicopters. It generates already large control forces, being furnished by the whole flying weight with the by no means negligible lever arms due to the angle β_1 . If the rotor would be powered by a motor, as a rough calculation shows, the very high gear and bearing loads varying with the power applied, can hardly be absorbed without setting up reactive forces in the controls by the action of the movable rotor head.

Whilst it is impossible to tilt the material (= shaft) axis of the rotor, it is possible to do so with the virtual axis given by β_1 . It has been shown that the position of the hinged rotor blades during rotation is defined by the equilibrium of aerodynamic and inertia forces, since the blades adjust

¹⁵ That must be an unknown unpublished internal report for authorities

¹⁶ Schrenk, M.: Statische Längsstabilität und Höhensteuerung von Tragschraubern, Luftfahrt-Forschung, Vol. 15, no. 6, pp. 283-289, June, (1938); translated in: NACA TM 879

themselves to the according angle of attack. Since we must, apart from all other considerations, change the blade pitch angle when transitioning from helicopter to autogyro mode we can also reverse this method: we can force the blades by introducing an angle of attack that they will describe the path desired for control purposes. When for example we decrease the pitch angles in the advancing side of the blade path, and increase them on the retreating side, the blades will run lower in front and higher in the rear. The resultant – which is shown as a dashed line in Fig. 19 – moves behind the center of gravity, and the desired result, which in this case is a dive through pushing the controls, has been obtained. The reverse occurs during pulling the controls. The process has been described rather schematically, however, and varies owing to different influences but remains fundamentally correct. Lock has already proved that the condition of a sinusoidally varying pitch angle produces the same results as inclinations of the whole rotor hub. Control by means of the imaginary and material (= shaft) axes is consequently of equal value in this respect. A very important fact, however, is that control by means of the blade pitch angle, when a blade profile with fixed center of pressure is used, creates zero (in theory) and (in practice) only slight inertia forces as well as frictional forces to act on the control. Changing the blade pitch angle therefore constitutes an ideal operating control. Of almost greater importance is the fact that the blade pitch mechanism – to which objection might perhaps be raised in principle – is hardly subjected to any stress and can therefore be of a light construction and remain safe in operation.¹⁷

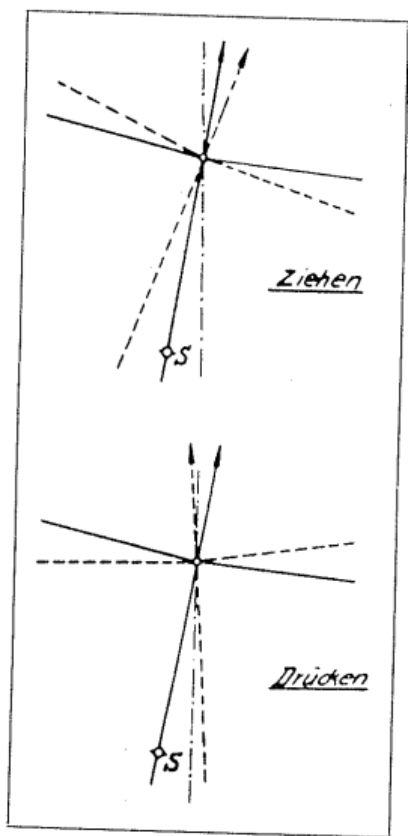

Fig. 19: Longitudinal control

So far everything has been comparatively simple but now arises the most difficult question, which is that of dynamic stability. When we started designing my machine, there was hardly anything useful available for practical purposes, not even with regard to the autogyro, and

¹⁷ Due to this, some autogyro companies introduced cyclic blade pitch, despite its mechanical complexity, as the “direct control autogyro” in the mid-1930s, e.g. Cierva C-30, Pitcairn PA-36, Kellett KD-1.

especially not for the helicopter. We explored two lines of approach at the same time: Firstly, we revised the usual methods of analysis for fixed-wing aircraft and adapted it to helicopters, and secondly, we newly derived our calculation accounting for all active forces and moments first of all for a helicopter in hovering flight. After careful consideration of their reliability numerical values were taken partly from Glauert's calculations and partly from measurements obtained in the wind tunnel. After a lengthy calculation, the values obtained can then be introduced into the equations of motion. The results found excellent confirmation in a number of test flights, principally performed by Hanna Reitsch.

II. B Lateral stability and control.

I have already assumed that in the case of two rotors arranged abreast that conditions were favorable. Let us start by examining the lateral stability of such an arrangement. For this purpose, it is permissible to use the dihedral principle, as in the usual fixed wing aircraft. Brief consideration suffices to show that at the start of a lateral inclination and subsequent lateral motion the air flow on the two airscrews varies in exactly the same way as on the two halves of a dihedral fixed wing, and since the aerodynamic forces increase with the angle of incidence, the same static stabilization takes place. Disregarding mutual induction for the time being, the lateral moments can be directly calculated with the aid of the known relationships. Figure 20 shows an example of a side wind with yaw angles ranging from 0° to 90° , regularly occurring in hovering flight, for different angles of incidence.

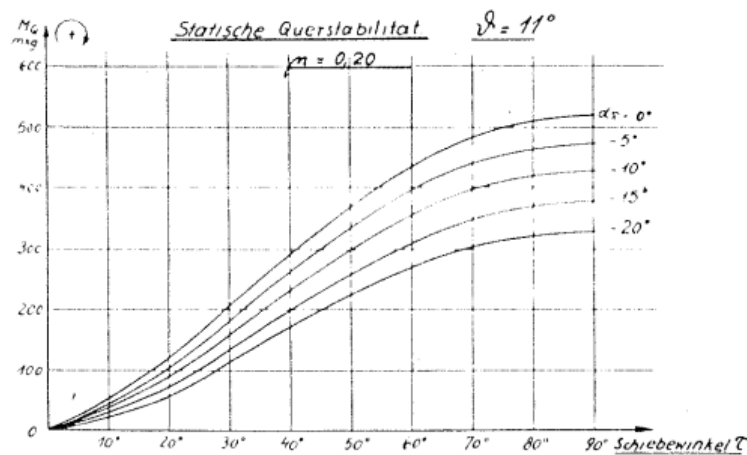

Fig. 20: Lateral moments due to side wind

As in the case of longitudinal stability, the dynamic lateral stability can be analyzed in exactly the same manner, in which case we assume that for the time being the path of flight remains constant and rectilinear, so far as forward flight is concerned.

My collaborators Schweym and Spanger, who carried out the above and most of the remaining troublesome calculations, finally succeeded in eliminating the linear path restriction, incorporating the dynamic directional stability and thus proving the lateral stability. In lateral stability the absolute values of the moments are relatively small. Consequently, starting from low speeds, the moments of the remaining aircraft components can no longer be ignored in forward flight. The mathematical calculation of these components being unreliable, we acquired "six-component measurements" using a complete aircraft model without lifting rotors and thereby obtained the required aerodynamic and moment coefficients. The model is shown in Fig. 21.

There remains the discussion of lateral control. In the case where the rotors are mounted side by side, this is extraordinary simple. Since the blade pitch angle is anyway changed for the transition

from helicopter to autogyro conditions, it is only necessary to introduce suitable kinematic devices in the control gear such that a control stick deflection to port slightly increases the blade pitch angle of the starboard rotor whilst decreasing that of the port rotor. The important fact of this is again, that the actual adjusting mechanism on the hub experiences no further complication. The existing mechanism is inversely applied to port and starboard only. The judgement of its effect from the magnitude of the change of thrust with that of the blade pitch angle ϑ is simple and requires no further explanation.

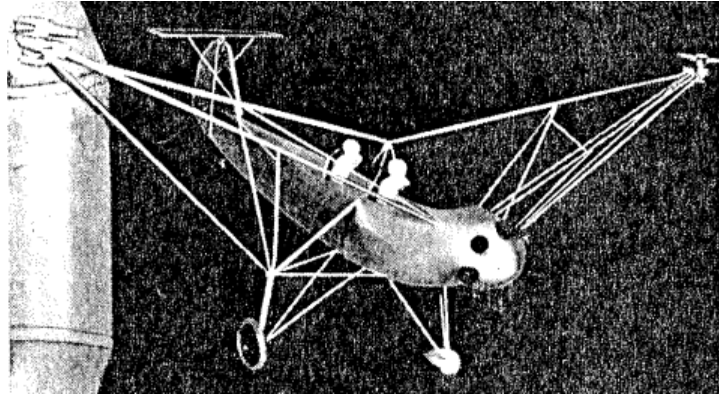

Fig. 21: Model of the complete Focke helicopter in the wind tunnel

II. C. Directional stability and lateral control.

In hovering flight directional stability does not make sense. Any helicopter, when not controlled by the pilot, will slowly rotate about its vertical axis during hovering in a direction determined by some small residual moment; and as any fixed wing aircraft when left uncontrolled, will describe a slight curve to port or starboard. On the other hand, the helicopter has and is expected to have directional stability even at a very low speed. The methods for ascertaining it are of the usual kind, obviously also for autogyros. In the case of my helicopter, Fw 61, the required coefficients were obtained with the model previously shown.

Lateral control of autogyros has so far been affected with a normal rudder or a fixed vertical fin instead of it, as was the case with the Cierva C.30. In flight only lateral control is used, which is obtained by lateral tilting the entire rotor as stated before. Whether this is to be regarded as progress for practical flight is under discussion.

With the helicopter, which must also be able to turn during hovering, a lateral control is indispensable. In the arrangement with two rotors mounted side by side we have made use of the longitudinal control, on the principle of avoiding additional complication. This appears peculiar at first glance, but is easily explained (see Fig. 22). It will be remembered that the longitudinal control displaces the resultant line of force forwards and backwards, of course always in the same sense for both rotors. It is quite possible, however, to link the longitudinal controls to the pilot's pedals in such a manner that, for example, a left pedal pressure tilts the port rotor aft and the starboard rotor forward. In a side view, therefore, the directions of the resultant forces are mutually displaced. The starboard screw produces a horizontal forward component and the port screw a similar backward component. The result is a turn to port as desired, while the changes of the vertical forces neutralize each other. It is therefore again only necessary to introduce a suitable linkage in the controls without introducing additional complications in the hub. Before the machine made the first flight I calculated the duration of a 360° turn at 3 seconds. At the time I could not believe it, but quite recently Hanna Reitsch completed a full turn during hovering in $2\frac{1}{2}$ seconds measured by a stop-watch.

We gave particular attention to the stability and control at the instant of transition from helicopter operation to autorotation. It was consequently possible to give the pilot accurate instructions particularly regarding the possible manipulation of the controls and the trimming of the tail plane. Actually, the behavior was exactly as calculated and the very first test finished with a perfect three-point landing from a height of 400 meters. About 2 seconds after the initiation the machine was already in a normal glide. It may be stated that, starting with this performance – which was first accomplished by pilot Rohlf on May 10th 1937 and repeated by him multiple times – a beginning was made with the solution of the problem of practical helicopter flight. The bogey of engine failure had lost its terror.

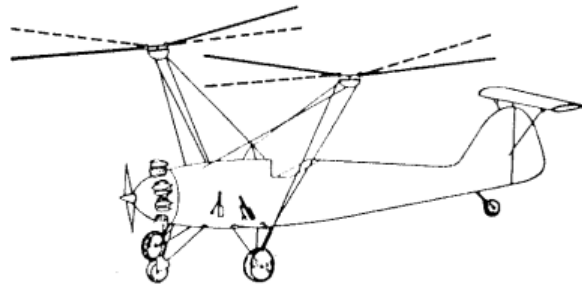

Fig. 22: Lateral control to the left (solid) and to the right (dashed)

The requirements for hovering and forward flight fulfilled by us so far are adequate and in its magnitude predictable controllability and static stability about all axes. It has also been proven that normal gliding can be obtained a few seconds after changing from helicopter flight to autorotation. The controls have been made as safe and simple as possible, with two principal movements of the rotor hubs assuring four different control effects: Two of these (transition to autorotation and roll control) are rectilinear, and the remaining two (longitudinal and lateral control) are sinusoidal. Finally, the requirement of simplicity in operation has been met by adding only one more control movement to the three usual manual and pedal controls, which is a lever on the right of the pilot's seat: controlling the transition from helicopter to autorotation operation. It is only used for take-off and in special, rare emergencies.

I shall not keep quiet about the fact that, before the above result was achieved, a large amount of mathematical and experimental work had to be done. The stability calculations in particular were very voluminous. Since all was new ground; a conscientious approach required the avoidance of all abbreviated methods and simplifying omissions. Where this could not be avoided, however – partly owing to the fact that the possibilities of mathematical analysis had been exhausted – special, protracted experimental investigations were required. The result has, however, justified all the trouble taken: The first free flight of my machine lasted 28 seconds, the fourth already 16 minutes. Although this was attributed mainly to Rohlf's skill and ability as a pilot, it is improbable that such test results could have been obtained without a thorough technical analysis of the problem because many unavoidable dangers accompany such a novel problem.

We now turn to our fifth requirement – The requirement of reasonable performance.

III Performance.

Here I must draw a distinction between what may at present be considered as directly attainable or already proven and what we may anticipate in the far future from the typical features of rotating wing aircraft.

III. A. Autogyros.

Examining the polars of an autogyro (Fig. 23) we observe that for a high value of c_a the drag becomes very large, a multiple of that of a well-designed fixed wing. This is due not only to the small unsatisfactory aspect ratio which is unchangeable and amounts to $f/b^2 = (\pi b^2/4)/b^2 = 0.79^{18}$ but is, as will be seen from c_{wp} , also typical for the lifting airscrews. In contrast to this, the values of c_w are very small with the low lift coefficients at high speeds. These conditions are particularly brought into prominence by the low disc loadings of rotating wings, when referred to the total disc area. With low lift the gliding ratios approximate to those of satisfactory fixed wing shapes and lie between 1:8 and 1:10. Even 1:12 appears to be attainable. In contrast to fixed wing designs however, these are at the same time the absolute peak performances. Consequently, autogyros must be somewhat inferior to fixed wing aircraft with regard to maximum speed. This is still the case today and it is permissible to say that the autogyro possibly has a maximum speed 15 % below that of a corresponding fixed wing aircraft. Schrenk¹⁹ has compiled comparative characteristics shown in Fig. 24²⁰. The actually existing difference is, however, partly due to the less favorable conditions in respect to parasite drag as part of the overall aerodynamics of the aircraft, which could be improved in the future by fairing the rotor hub, pre-rotation²¹ gear etc. A reasonable estimate, therefore, is that the speed of an autogyro will be approximately 10 % below that of a fixed wing aircraft but its minimum flying speed only about half that of the latter.

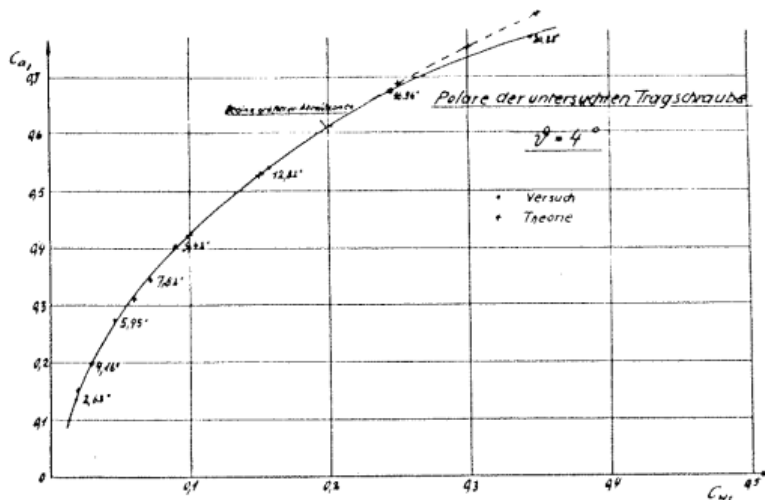

Fig. 23: Polar of an autorotating rotor with parabola of induced drag

¹⁸ Focke's definition of an aspect ratio is inverse to the usual, i.e. $\lambda = 4/\pi = 1.27$.

¹⁹ Martin Schrenk worked at the DVL and was a strong promoter of rotating wing aircraft with many publications from 1932 on. He died during a gas balloon excursion 1934. See: Die aerodynamischen Grundlagen der Tragschraube, DVL-Jahrbuch 1933: IX 17-37, 1933 (translation in NACA TM 733)

²⁰ Fig. 24 derived from Fig. 5 in Schrenk, M.: Entwicklungsrichtungen im gegenwärtigen Flugzeugbau, Zeitschrift für Flugtechnik und Motorluftschiffahrt, 24 (10): 273-279, May, 1933. A two-seat monoplane of 11 m span was compared to a two-seat autogyro with 10,4 m diameter.

²¹ The gear for pre-rotation of autogyro rotors was located underneath the hub and contributed to the hub drag

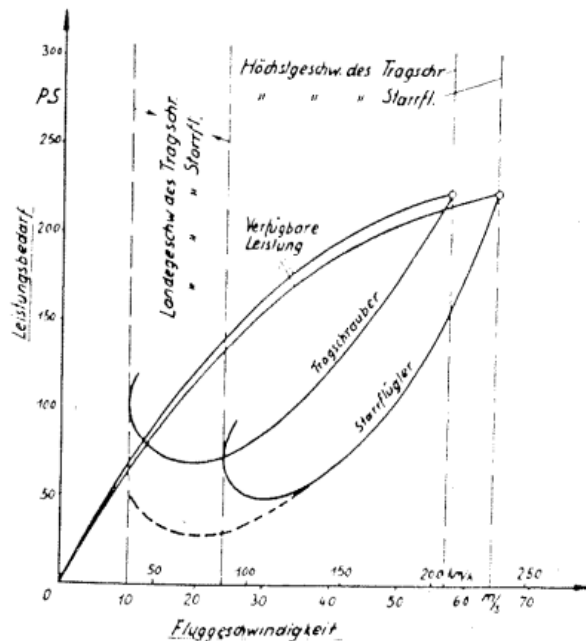

Fig. 24: Comparison between autogyro and fixed wing aircraft, from Schrenk

The climbing performance is less favorable. Since we now operate in the upper region of the polar, the drag values become very high. The minimum level flight power is considerably higher than that of the fixed wing aircraft and is also accompanied by lower speeds which is undesirable for reasons of propeller efficiency. Especially this confirms our previous opinion that the autogyro is only an intermediate stage to the helicopter. It does not even solve half the problem by allowing landing in a smaller space, but it does not permit flight at zero forward speed, and take-off and climbing performance, in general, are worse than before²². The question of weight at least is no drawback. In fact, the reduction of weight due to the rotor blades being free of pressure forces and kept straight by the centrifugal forces, would, especially in large dimensions, more than counterbalance the increased weight caused by the heavy rotor hub and pre-rotation gear. This is a very valuable characteristic of aircraft with rotating wings, therefore also of the helicopter.

III. B. Helicopters.

In spite of this we must, in the case of helicopters, make the relatively greatest sacrifice in regard to weight; in future presumably, the only one. With helicopters, the gear drives must transmit the full maximum engine output power to the rotors with sufficient safety of operation. Despite of the favorable low weight of the outrigger and rotating wing structure, a helicopter of 1,000 kg gross weight will experience a 30 % weight increase compared to a fixed wing aircraft, if the design of my helicopter Fw 61 is used as a basis. This is calculated rather unfavorable since in the above prototype large safety margins were introduced on account of the lack of previous experience. Although prophecies of this kind are unsatisfactory, it may be conjectured that another 5 % could be saved, leaving a balance of 25 %. A very carefully checked project of a 3-ton helicopter, based on present day knowledge, brings this down to 17 %. It is certainly permissible to conjecture that even this figure may be reduced to 12 % in the coming 5 years. Bréguet has worked out an amphibious helicopter of 16 tons gross weight and claims to have arrived at a further saving and even higher speed in comparison to a corresponding seaplane. Admitting that this appears rather optimistic, it generally reveals the fact that with growing dimensions the impact of the transmission gear weight becomes considerably less important in comparison to the very low weights of the

²² "than before" refers to the fixed-wing aircraft already existing before the autogyro became operational.

rotating wing and outriggers. We shall base our further considerations, however, on the less disputable basis of equality of weight, i.e., we assume that the useful load of the helicopter is correspondingly reduced.

In regard to the maximum possible speed, the following question logically arises right at the beginning: Is it preferable to operate any rotating wing aircraft as an autogyro or as a helicopter, i.e. without a propeller developing the propulsive force. In the sense of our initial requirements it is, in fact, worthy of consideration whether a helicopter, i.e. a machine specifically designed for hovering flight at zero forward speed and which is needed there to achieve its tasks, could not be flown at high speeds as an autogyro, or in some intermediate condition. This question has been exhaustively analyzed by us and was confirmed by extensive experimental data, arriving at the interesting conclusion that the same machine is considerably faster when it is operated as a helicopter (compared to being operated as an autogyro) in spite of the fact that 10 % of the engine power had to be deducted for the motor cooling. This was fully confirmed by experiments with my helicopter. After fitting an ordinary propeller in place of the cooling fan the machine could be flown as an autogyro, and after fairing all tubes etc., it attained a speed of 120 km/hr versus 126 km/hr by calculation. Used as a helicopter *without* that fairing the speed attained was 122 km/hr. So far it has unfortunately been found impossible to construct the particular type of fairings required for a helicopter owing to its different orientations relative to the air. It was proved possible, however, to accurately determine the power consumption of the non-streamlined outrigger frame in special tests. At a given speed of 120 km/hr the frame absorbed 46 HP so that a helicopter with streamlined fairing would have an approximately 25 km/hr higher speed. This would give a total speed of 147 km/hr, which nearly corresponds to the calculated speed of 152 km/hr. When investigating the prime cause of this it must first be remembered that an autogyro transmits its power to the air by means of a propeller, which may show 60 % efficiency at the low speed in the above example, 40 % being therefore lost. This leaves only 60 % available for level flight of the rotor in autorotation. On the other hand, a helicopter about 85 % of the engine power is transmitted directly to the rotor, only cooling and gear friction losses being wasted. Assuming as a first approximation that the aerodynamic processes on the rotors develop similarly in both cases, we find that in the case of the helicopter effectively 25 % more power is available. This is, of course, only a general indication, but it can be stated that helicopter propulsion is superior to autogyro flight by the amount of loss in its propeller. Which prospects of high-speed flight in future are indicated by these relationships? We have already seen that in regard to speed the autogyro is but little inferior to fixed wing aircraft and, consequently, the helicopter should, at least from a principal point of view, equal the latter in this respect. Here as well the reduction of parasite drag is the principal factor in the development. However, one restriction we have to accept: Since we hardly can count on an advance ratio exceeding 0.5, the blade tips of a rotorcraft will already reach the speed of sound at half the speed of a fixed wing aircraft. To this has to be added the speed of flight for the advancing blade²³. Taking all this into account the prospects of the helicopter become worse for speeds exceeding 400 km/hr²⁴. However, we must not overlook the fact that in the case of a fixed wing aircraft corresponding difficulties occur with its propeller in the same speed region. In this case therefore everything depends on supersonic research.

²³ Appears erroneous, since the addition of flight speed and tip speed leads to the speed of sound at the advancing blade's tip. Assuming a fixed-wing aircraft flying at Mach 1, a helicopter at half of that speed, i.e. Mach 0.5, must have a blade tip Mach number of 0.5 to obtain Mach = 1 on the advancing blade tip. This, however, is an advance ratio of 1, not 0.5. An advance ratio of 0.5 requires a tip Mach number of 0.666, thus a flight speed with Mach 0.333. The Fw 61 had a mean blade tip Mach number of ca. 0.37, the Fa 223 – not in mind at that time - had ca. 0.46.

²⁴ The helicopter world speed record obtained with the Lynx reached these 400 km/hr in 1986 – almost 50 years after Focke's prognosis, with a tip Mach of ca. 0.65.

Performing the power calculation for a helicopter for different speeds of flight results in Fig. 25. It is seen that, as is the case with fixed wing aircraft, the power curve of a helicopter also has a pronounced minimum at relatively low forward speeds. This indicates favorable prospects for the climbing performance which we shall now examine. The afore-mentioned rise of the thrust curves k_s with forward speed is accompanied by an initially small increase, followed by a considerable decrease in power consumption, as shown in Figure 26. The two phenomena together cause a rapid decrease of the power required in level forward flight, compared to the power in hover. To be added to this is the small power consumption due to parasite drag during climbing, since the optimum²⁵ is attained at low speeds. All these factors combined give the helicopter a considerable superiority in climbing performance, as compared to a fixed wing aircraft of equal power and weight.

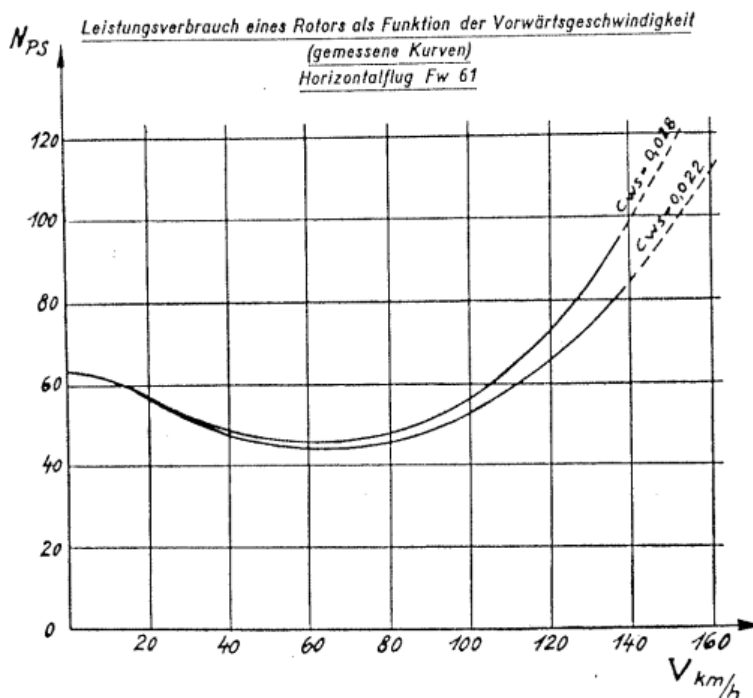

Fig. 25: Power consumption of the helicopter

This has been prominently demonstrated in practice by my helicopter Fw 61. Figure 27 shows the rate of climb from the ground and the gross weights of the Fw 44 Stieglitz, the Cierva C.30 autogyro and the helicopter Fw 61, operated as an autogyro and as a helicopter, the same engine Sh 14A²⁶ being used in all cases. I wish to stress the point that in this instance there was no equality of weight, the helicopter being the heaviest. In spite of this it showed the highest climbing performance, the autogyros being well behind in this respect. It must be emphasized, however, that it is unnecessary for the helicopter to justify its existence by any claims to superiority over the fixed-wing aircraft in respect to speed and rate of climb. Its specific characteristics provide it with its special tasks. It is even more valuable that it is at least not inferior in performances by order of magnitude to those of the fixed-wing type.

²⁵ "optimum" means the optimal speed for maximum climb performance, i.e. speed of minimum power.

²⁶ Sh14A = Siemens & Halske 14 A was a prominent air-cooled radial engine with 7 cylinders and 128 HP permanent power. The Cierva C.30 was built by Focke in license production. Fw 44 is the Focke-Wulf "Stieglitz" biplane.

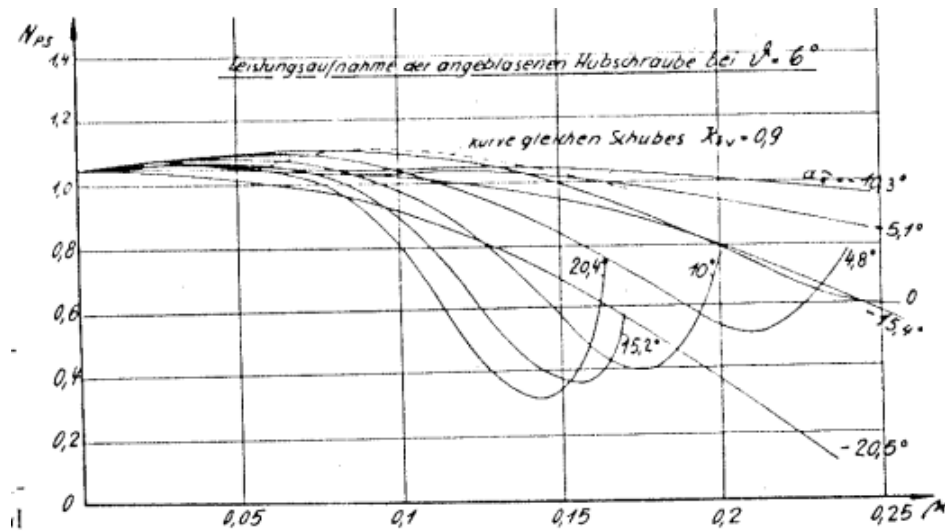

Fig. 26: Power consumption of a lifting screw versus advance ratio

| | Climbing speed m/s | Flying mass kg |
|-----------------------------|-----------------------|-------------------|
| Fw 44 Stieglitz, fixed-wing | 3.5 | 870 |
| Cierva C.30 autogyro | 1.5 | 815 |
| Fw 61 flown as autogyro | 1.3 | 950 |
| Fw 61 flown as helicopter | 3.6 | 950 |

Fig. 27: Comparison of climbing speeds – fixed-wing versus rotating wing

It is hardly necessary to discuss the take-off and landing performances of helicopters. In this respect the desired ideal has been attained, at least technically. The full utilization of all further possibilities will undoubtedly lay added demands on the skill and training of the pilot, the personal factor largely entering into the matter. On the other hand, I am in a position to state that, contrary to sometimes assumed, it is not altogether necessary for the pilot to have the acrobatic skill only possessed by a test pilot. Hanna Reitsch as well as Franke and Ballerstedt have excellently flown my helicopter without trouble after a short course of technical training, and made smooth landings. Figure 28 shows Mr. Franke during a vertical take-off.

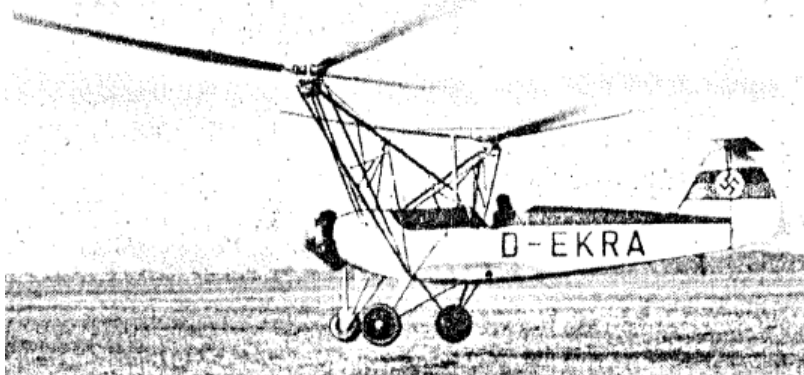

Fig. 28: Vertical take-off performed by Mr. Franke

On account of accidents, which occurred with autogyros due to reduced autorotation at small angles of attack and excessive blade pitch angles ϑ and the consideration that small angles of attack

are also unintentionally caused by gusts of wind, an opinion has arisen that all rotating wing aircraft are sensitive to gusts. It has already been shown in discussing autorotation that this conclusion does not apply at all to helicopters and that no such danger exists in the case of autogyros if provided with an adjustable elevator. Owing to the rotor blades' flapping degree of freedom, we may rather expect the influence of gusts on a rotating wing to be less. When a fixed wing aircraft and my helicopter were flown simultaneously, it was discovered that the former reported considerable gustiness while the helicopter pilot even denied the existence of any gustiness. On other occasions, however, in the case of bad weather and higher wind velocities (about 40 km/hr), the presence of gusts was experienced. The gust structure therefore appears to be of importance.

We have dealt so far with the indispensable considerations necessary for the development of a helicopter. It cannot be sufficiently stressed as to what extent science has provided the basis for new ideas. The second and even more difficult stage of our work lay in translating these ideas into designs and workshop trials and tests into actual practice. To describe this part of the work would supply sufficient material for another lecture. I shall therefore confine myself to a very short resume.

IV. Key Aspects of the Development Program

The first step was to construct a model for free flight as shown in Fig. 29. It was driven by a 0.7 HP, two stroke, twin cylinder engine. Its flying weight, including 50 grams of petrol, was 4.9 kg. It will be easy to understand that it was more often broken than operational but, in spite of this, it gave us much valuable experience. In November 1934 it attained a height of 18 meters, exactly equaling the world record of those days for full size manned helicopters.

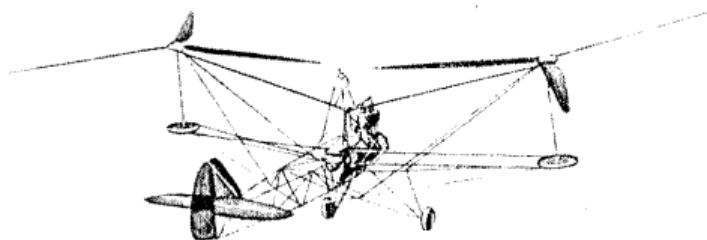

Fig. 29: Freely flying model of the helicopter

We furthermore adopted the principle of submitting the gearing as well as the clutch and blade pitch control to a test somewhat similar to bench test of a new motor. For this purpose, the Brandenburg Engine Co. who, under the personal guidance of Mr. Wolff, so carefully and extraordinary successfully carried out the construction of the above gear and the modification of the Sh 14A engine. They first only built one half of the arrangement (Fig. 30). It was mounted with one lifting rotor and its outrigger to a dummy fuselage. It was electrically driven with a Ward-Leonard control so that the power of the rotor could be approximately measured at the same time. The thrust was measured by attaching ballast to the hub and making the fuselage rotatable about its longitudinal axis, the ground influence being considered, which formed a valuable complement to the wind tunnel test with full-scale data. A 50-hour run was made, while, after the gearing had been dismantled, a further 10-hour run was made, while the pitch control was continuously tested throughout.

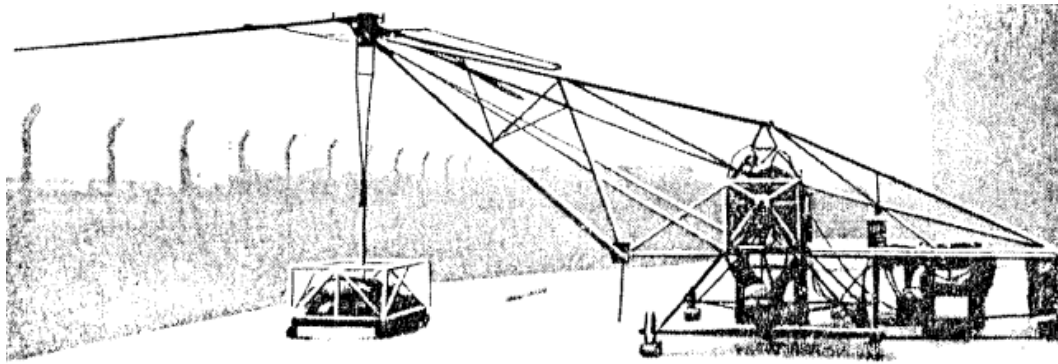

Fig. 30: Full-scale testing of a rotor

The remote drive assembly was analyzed for vibrations by Lürenbaum and his collaborators (DVL²⁷). The results of their numerical analysis were confirmed at a later date in captive flight by means of torsigrams. This was all the more essential since during the ground test runs the electric drive gave no accurate indications of oscillation²⁸. Figure 31 shows a torsigram with regard to which I only say that the point subjected to the highest permissible stress is always found on the engine crank shaft and not in any helicopter component.

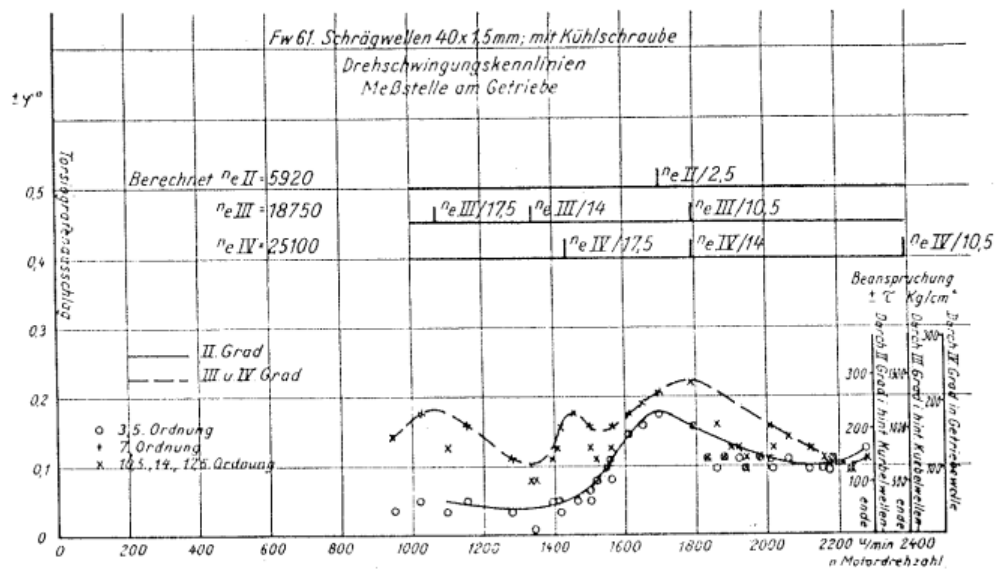

Fig. 31: Torsigram of the gear box of the Focke helicopter

Figure 32 shows the bevel gear with friction clutch and safety devices, which, in case of engine or gear failure or if the rotor RPM drops below a certain minimum, automatically switches over to autorotation.

²⁷ DVL = Deutsche Versuchsanstalt für Luftfahrt in Berlin.

²⁸ as compared to the oscillations introduced by the Sh 14A combustion engine.

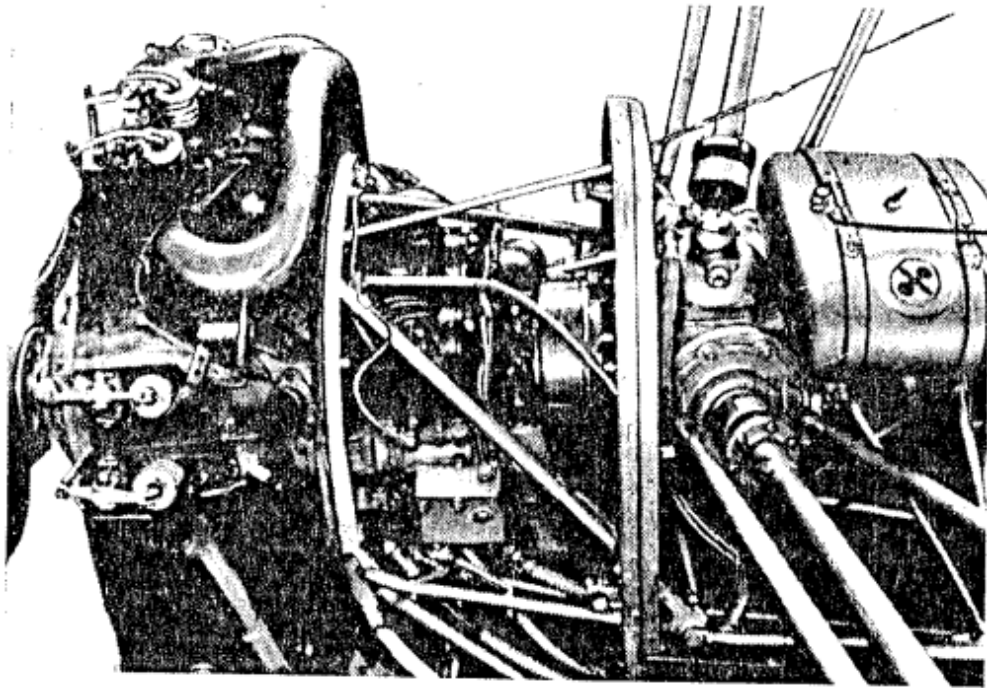

Fig. 32: Bevel gear with friction clutch of the Focke Fw-61 helicopter

Figure 33 shows one of the rotors hubs with the parts controlling the blade movement.

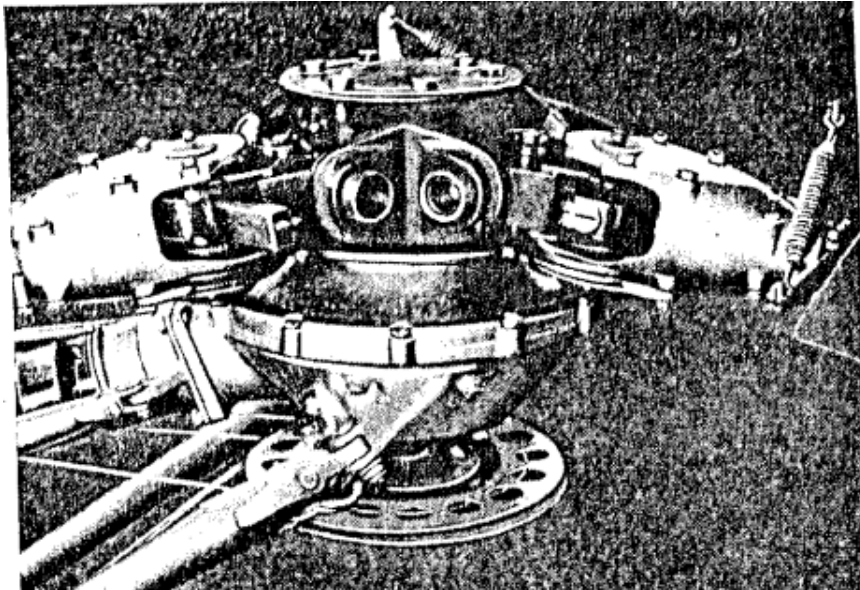

Fig. 33: Rotor hub with the parts controlling the blade pitch of the Focke Fw-61.

The design of the fuselage and rotors was the same as that of an ordinary aircraft with the goal of obtaining a type certificate for the prototype immediately, which actually happened, and this was also done for the gearing by the Brandenburg Engine Co. The novel features of the design and the unusual components required from the workshop, carried out by my employee Mr. Körper, rendered his work not any the easier. It is not surprising that under such conditions our last design requirement for easy maintenance has not yet been properly fulfilled, even if to some extent satisfactory.

Similarly, with the quite new method of calculating the strength of the arrangement, we partly used the previously mentioned theoretical and practical test results, partly extended both where necessary. I would draw particular attention to the fact that many components are subjected to alternating stresses. In the majority of cases the loading cases were first worked out in permanent collaboration with the DVL and the certification authorities.

For engine cooling during hovering flight we developed a propeller fan (Fig. 34) the efficiency of which was checked by cylinder temperature measurements in collaboration with the Brandenburg Engine Co.

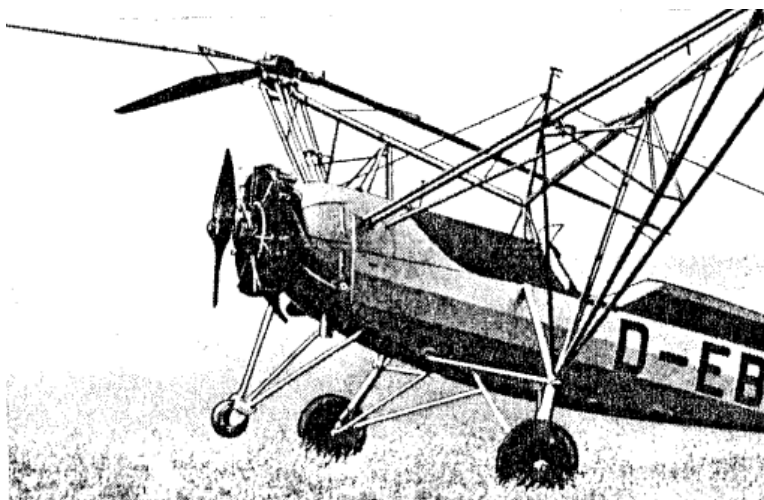

Fig. 34: Cooling fan of the Focke Fw-61 helicopter.

The complete experimental machine was at first tried out several times in captive flight (Fig. 35). These captive flights constitute an excellent test since they are conducted under actual flying conditions while the machine is only at a height of 1/2 to 1 m off the ground. We did not enter any further test stage until the preliminary conditions had been made clear either theoretically or by experiment. On June 26, 1936, pilot Rohlf made the first free flight (Fig. 36). On June 25 and 26, 1937, he succeeded in breaking all helicopter world records, partly exceeding the official recorded performances 15-fold. The height of 2,439 m attained – which did not by any means represent the highest possible ceiling – drew forth a rather blunt accusation of deception published in a foreign technical journal by Mr. Asboth²⁹. This performance is, however, physically explained by the power-curve development already discussed.

²⁹ Le Focke-Wulf (or: Fw-61 Focke), est-il vraiment un hélicoptère?, *Les Ailes*, 17(839):7-8, 1937. Oskar Asboth was a Hungarian helicopter pioneer, developing and flying a coaxial design with rigid propellers and vanes in the downwash in 1928, but lacking control and stability.

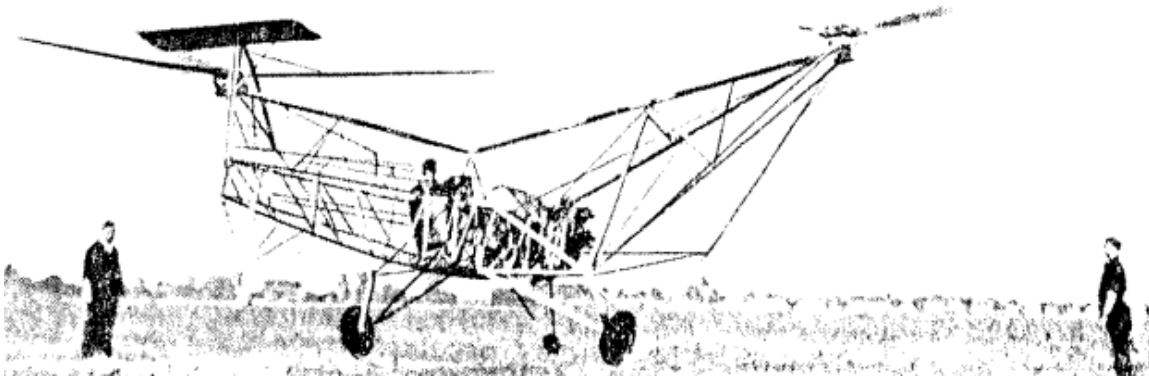

Fig. 35: Tethered flight

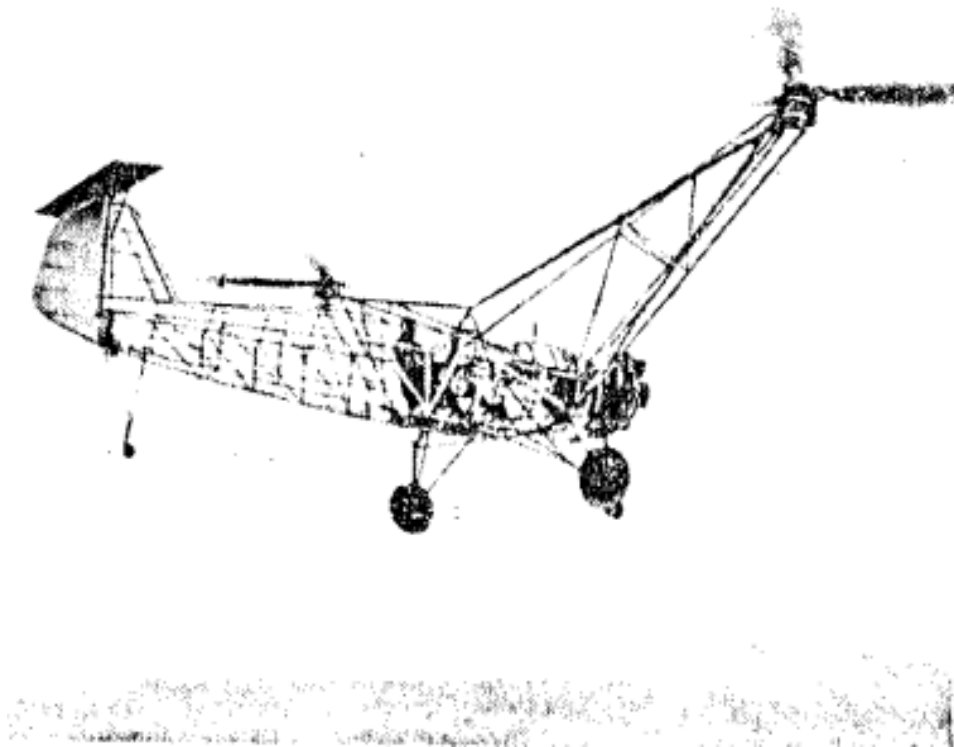

Fig. 36: First free flights of the Focke Fw-61 helicopter

In June 1937 the Government took over the first, and in October the second machine. In October 1937 Hanna Reitsch flew the second machine (Fig. 37) from Bremen to Berlin for a series of exhibition flights³⁰, further raising the existing world record for the distance flown to 108 km (the last segment of the trip from Stendal to Tempelhof).

I trust I have succeeded in giving a rough outline of the rotating wing problem together with some indication of my own work on the subject. Perhaps I have also succeeded in convincing you that a helicopter with autogyro capabilities for emergency landing indicates the direction in which future development will take place. We are, in any case, in a position to state that an aircraft of the above type is qualified to fill existing gaps in present day flying tasks, not as a competitor but as a supplement to other types for fulfilling the great tasks of aeronautics.

³⁰ In February 1938 a Colonial show took place in Berlin with Hanna Reitsch flying the Fw 61 in the Deutschlandhalle.



Fig. 37. Focke's second Fw-61 flown by Hanna Reitsch to Berlin for exhibition flights.

Discussion.

Betz.³¹ In his interesting lecture Mr. Focke has included a survey of the different methods of driving the rotors of rotating wing aircraft. Two of these were free from reaction. In one arrangement, engines with auxiliary propellers were mounted on the blades while the second represents a drive with flapping blades. To begin with I would like to say a few words on these two drives, in particular the latter, since one of my collaborators³² concerned himself with it, and the method was actually tested.

The first drive, in which engines with auxiliary propellers were mounted on the rotor blades, has received my rather brief consideration in the special case of a captive rotor which could perhaps be used instead of a captive observation balloon. In this instance electric motors were considered as engines. It surprised me to find how simple the design proved to be. In the case of auxiliary propellers, we have a very high rpm and consequently very small engines running at high speed. I am of the opinion that this simplicity deserves due credit and to a certain extent compensates for the low efficiency stressed by Mr. Focke. Drives of this kind may yet be favorably considered perhaps for special purposes.

I have not yet taken into consideration the stability conditions of a captive rotor which will cause a number of difficulties.

When the subject of driving the rotor blades by forced flapping is mentioned, one is generally inclined to be of the opinion that such a motion is accompanied by very considerable inertia forces which are unwelcome from the design aspect. In the case of a lifting rotor such forces do not occur, however, if the period of flapping is made to coincide exactly with the period of rotation³³. In that case the rotor blade moves in an inclined plane as shown in Figure 1, i.e. as it would travel without flapping motion but an inclined shaft axis.

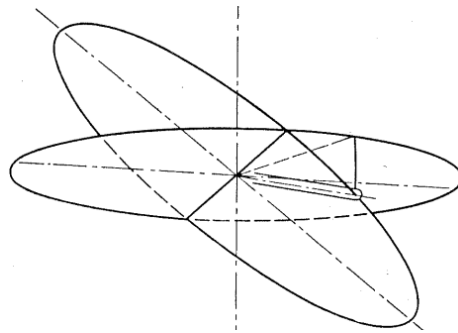

Figure 1: Path of a lifting screw's blade with flapping motion

The difficult problem of inertia forces arising with a flapping wing airplane consequently disappears in the case of a rotating wing. This fact formed the chief reason why my colleague Küssner has interested himself to some extent in this drive. We carried out a number of tests with the result that we obtained an efficiency of 90 % and higher. The losses in this case are therefore

³¹ Director AVA Göttingen from 1937 on, successor to Prof. Dr. Prandtl

³² Prof. Dr. Küssner, from 1939 on was head of the Institute of Unsteady Processes, AVA Göttingen. He theoretically developed (1934), then executed tests in the wind tunnel (1936-7) and published the results in AVA research reports FB 145, 523/1-3 (1936-7); Luftfahrt-Forschung 14(1):1-13, 1937; errata in 14(6):313 (= NACA TM 827). Küssner was a prominent aeroelastician with profound knowledge of unsteady aerodynamics ("Küssner function" = step response to a vertical gust) and knew that a forced flapping motion generates a propulsive force at the flapping wing, especially when pitching and flapping motion are properly combined in magnitude and phase.

³³ The natural frequency of rotor blade flapping of a centrally articulated blade is equal to the rotational frequency, i.e. it is in resonance, and in vacuo only very small forces at that frequency are needed to excite the motion.

less than with a drive by auxiliary propellers, where, according to Mr. Focke's opinion, a 30 % loss must be considered. All the same a 10% loss still exceeds that of a direct drive. The mechanical side of the driving gear is of course a separate problem which is unwelcome but should not be insurmountable.³⁴

Satisfactory efficiency can only be obtained when, simultaneously with their flapping movement, the blades also rotate about their longitudinal axis and therefore continuously place themselves at the proper angle of attack relatively to the direction of motion. When the rotary movement is omitted it is consequently necessary to limit the flapping movement to very small dimensions owing to the resulting angles of attack³⁵. Satisfactory efficiency is only obtained, however, when the flapping movement is relatively large.

Additionally, I will report a few observations regarding our general investigations on helicopter rotors. We carried out six-component measurements of normal propellers without flapping degree of freedom. We developed a special apparatus for the purpose. Although it is not very accurate, relatively speaking, it enables rapid execution of the required measurements. With this method the measured forces are made to act on elastic boxes, the change of their volume being indicated by a multiple pressure gauge and photographed. Figure 2 shows the arrangement mounted in a wind tunnel. The power drive is contained in the streamlined casing above the propeller. It is the same apparatus as the one used for testing the forced flapping drive. The mechanism of the latter is partly visible on the propellers. It was rigidly clamped when six-component measurements were being made. The whole arrangement, propeller and drive, is suspended by wires connected to the corresponding pressure boxes.

With regard to the theoretical analysis of helicopter rotors I can tell the following: A normal helicopter rotor can be theoretically computed with rather good accuracy. Last year I derived a theory of the ground influence which, although rather primitive in nature, yet reproduces the essentials³⁶. According to this the power for constant lifting force becomes zero when there is direct contact with the ground. It then increases linearly with the distance from the ground up to a distance of half the propeller radius when it reaches its final value and remains steady (Figure 3, full line)³⁷. In reality, the curve is rounded (as shown by the broken line in Figure 3) and shows an influence, which, in accordance with experience, extends approximately to a distance from the ground equal to the rotor radius. Considering how very short the range of this ground influence is, it is practically of no importance, since the usual helicopter operation exceeds this distance. Despite this, Mr. Focke called special attention to the fact that this ground influence was particularly advantageous for the final landing approach in landing.

³⁴ Küssner was using a separate swashplate and wires pulling the blades up and down, but reported frequent ruptures of them. Aerodynamic forces due to flapping motion (damping) were not considered in the purely mechanical view.

³⁵ A pure flapping motion increases and reduces the angle of attack by the flapping angle, adding to the angles required to lift the helicopter and therefore larger flapping angles quickly result into local stall, limiting the possibilities of this approach. Also, the periodic flapping at the rotational frequency interferes directly with the pilot's cyclic controls of the same frequency.

³⁶ A. Betz: Die Hubschraube in Bodennähe, Zeitschrift für angewandte Mathematik und Mechanik, **17**(2): 68-72, 1937

³⁷ Today, the ground effect is considered vanishing at a separation of 3 radii off the ground. At one radius above ground about 94 % of the inflow has developed.

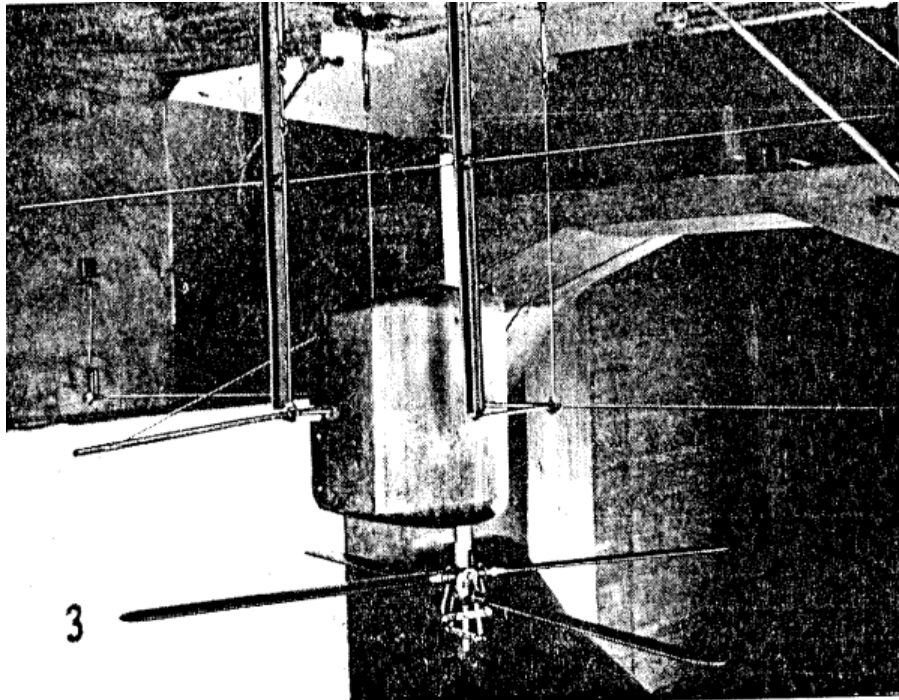

Figure 2: Test installation in the wind tunnel

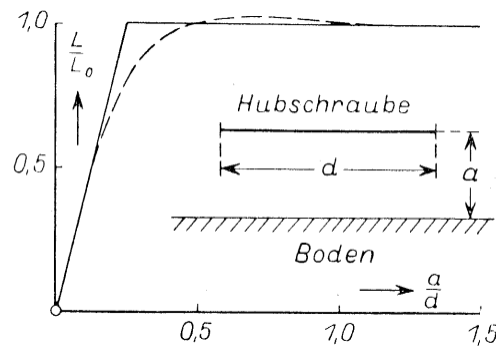

Figure 3: Influence of ground effect on power consumption of a lifting screw at low thrust

The theory of the helicopter rotor in lateral motion through the air has not yet been fully explored. It is generally assumed that the flow velocity through the disc is approximately constant which assumption is often made in the case of a normal propeller with approximately axial motion; and has been proven to be reasonable. In the case of lateral motion this assumption is much less admissible, however. On one side the blade moves with the wind and on the other side against it, producing an asymmetry transversely to the direction of flight. Furthermore, the induced downwash inside the disc increases from front to rear, causing an irregular thrust distribution in the direction of flight. The effects of these unsymmetrical influences on the thrust can be admittedly reduced to such an extent by using universal joints at the blade root such that no moments are produced, but considerable deviations from a uniform distribution of thrust along the blade still persist and the assumption of a constant inflow velocity through the disc therefore appears to agree badly with actual conditions.

Another difficulty in theoretical analysis is that the flow about the blades is in most azimuthal positions like that about a yawed wing. Even for the case of fixed wing aircraft the theory of this phenomenon is still far from being elaborated. Particularly at the wing tips we find forces of which

there is practically no knowledge. With the aid of facts gained by experience, however, it should be possible in my opinion to arrive at a fairly accurate theoretical treatment.

Lusser³⁸, Rostock (visitor). I like to ask Mr. Focke if the transition from helicopter to autogyro conditions could be achieved in less than 2 seconds. What I have particularly in mind is the possible failure of the engine after a take-off when the machine has possibly climbed to a height between 10 and 20 meters and autorotation cannot be enabled in time.

Berger. I would welcome information regarding the diameter of the rotor, its rpm during climb and in autorotation without engine drive³⁹, and also regarding the approximate required engine power for lifting a specified number of kilograms.

Wieselsberger⁴⁰. With regard to the arrangement resembling Bréguet's helicopter in which two rotors are superimposed, I would like to point out that about two years ago, while testing the Asboth helicopter, we also carried out experiments to ascertain the behavior of these rotors in autorotative vertical descent (without engine power). We found that under such conditions the upper rotor was almost entirely screened by the lower one and only rotated at a very low speed. The major part of the lift therefore was carried by the lower rotor⁴¹. Whether it is possible to design arrangements of a nature whereby the lift is about equally shared by both rotors, as mentioned by Mr. Focke, is a question that I cannot answer on basis of our tests.

Prandtl⁴². To the last statements I wish to point out that by the momentum theory if the lower rotor is screening the flow of the other, the other rotor is not needed. Because the entirety of the available momentum having been absorbed, no harm is done if the upper rotor remains inactive. Or does the speaker refer to forward flight?

Wieselsberger⁴³. I could imagine that, in consideration of the blade stresses, the designer might consider it desirable to give both rotors the same lift.

E. Schmidt⁴⁴. It was stated during the lecture that a transition from helicopter conditions to autorotation is also possible when defects develop in the gearing. I am interested to know how this can be done.

Seewald⁴⁵. Various other attempts have been made to solve the helicopter problem. Can anyone present supply any information regarding researches on these parallel lines of development? Personally, I have not sufficient knowledge of these. I only know that attempts have been made. The other participants probably have the same lack of information.

³⁸ Robert Lusser, designer of the He 71 sports aircraft during his employment with Heinkel 1932-1934, then moved to the Bavarian Aircraft Manufacturers that later became Messerschmitt, where he became head of the development. In 1938 he became technical director back at Heinkel in Rostock.

³⁹ Thrust control of the Fw 61, in the absence of collective control, was achieved by variation of rpm. This was relatively slow in reaction to the pilot's throttle commands, as the entire rotor inertia has to be accelerated.

⁴⁰ Prof. Dr. Wieselsberger, worked at AVA Göttingen until 1930, became director of the Institute of Mechanics at the Technical University Aachen from 1931 on, later also director of the Aerodynamic Institute, succeeding Prof. Dr. von Kármán

⁴¹ The same was found by investigations of the DVL regarding the Rieseler coaxial helicopter design, where the DVL performed small model-scale tests in the wind tunnel.

⁴² Founder and director of the AVA Göttingen from 1907 to 1937, followed by Prof. Dr. Betz

⁴³ Dr. Carl Wieselsberger worked at the AVA Göttingen under Prandtl, became chair of Mechanics at the TH Aachen in 1931, also head of the Aerodynamics Institute as successor of Theodor von Kármán in 1934.

⁴⁴ Ernst Schmidt was deputy director of the German Research Establishment for Aeronautics (DFL) in Braunschweig from 1936 on, also director of the institute of engine research and expert for thermodynamics, from 1943 on head of the research network for solid booster rocket development.

⁴⁵ Friedrich Seewald, director of the DVL Berlin from 1936-1941

Focke. I will first of all briefly deal with Mr. Betz's remarks. When propellers are mounted on rotor blades – let us say, driven by electric motors – a fundamental difficulty emerges. The small propellers are subjected to very high gyroscopic moments since they themselves describe a continuous circular path with a very small radius. Up to now this has caused great difficulties. It is fundamentally correct to imagine that motors with a relatively high speed of rotation may supply a simple solution with helicopter rotors which are allowed to run at a high speed by their own. The gyroscopic moments can be compensated by strengthening the rotor blades and the rotor shaft. When combustion engines are used, very considerable difficulties arise in connection with regular fuel supply. Several attempts have failed on account of this. It is impossible in practice to use float carburetors for this purpose since the fuel level would be almost at right angles to its desired position.

In the case of a forced flapping drive something similar happens. I expressed this by the conception of the “virtual” axis, i.e. blades rotating about that new axis. One very considerable practical difficulty cannot be avoided, however: the very high moments in the blade spars. It would be interesting to learn whether discussions on these bending moments in the blade roots have taken place at Göttingen. I must confess that I consider a loss of only 10 % in the case of a forced flapping rotor to be a highly satisfactory performance. This is because with the existing drive 6 % are lost in any case. A new type of drive with 90 % efficiency may be considered very satisfactory if the other difficulties can be controlled.

Mr. Betz correctly considers the assumption of a constant inflow velocity⁴⁶ as one of the biggest deficits of the present theory. It is at least a remarkable fact that the simple considerations based on the assumption of a constant inflow velocity through the plane of the rotor apply relatively well to the total polar of the rotor since the errors due to the different velocities of flow on the blade can of course compensate each other in the polar.

So far, we have dealt with the flow about the wing tips according to Professor Prandtl's theory⁴⁷ concerning the diminution in lift towards the wing tips, which should generally be applicable for the case of the rotating blade. The final result is at least not contradictory.

The assumption that the transition to the autogyro condition requires 2 seconds is based on a misapprehension. I stated that a condition of normal gliding flight, i.e. with constant rectilinear path, was established within 2 seconds. The switching itself is very abruptly performed in about 1/10 second because the mechanism is subjected to a dual spring force, which is only released.

Mr. Berger has asked for various figures. I can only say in reply that the rotary speeds under helicopter and autogyro conditions must be in almost complete coincidence if difficulties during transition are to be avoided. This is now easily achieved by accurate calculation. At the moment the pilot changes over, the rotary speed actually increases to a slight extent, which favorably reacts on the pilot psychologically.

The coaxial rotors would have to be rigidly coupled. Such coupling would be feasible if its disadvantageous were accepted. It is even possible to calculate the power transmitted from one rotor to the other. In that case, however, when the momentum theory is applied it is essential to

⁴⁶ Glauert and Lock have already suggested and introduced a linear variation in 1926/1927. Focke, Betz and Küssner were all aware of this. For simple power estimations it usually is not a matter and Focke did know it very well. The main impact is on calculating correct lateral cyclic control angles for trim in forward flight, and to a less extent this applies to the longitudinal cyclic control angles. Higher order distributions or models of that were not at hand, they appeared first with Mangler/Squire after WW II in 1948/1950. If the subject of interest is vibration, then the higher order downwash models play a major role, but that was out of capabilities in the 1930s.

⁴⁷ A. Betz, Schraubenpropeller mit geringstem Energieverlust, Göttinger Nachrichten, p. 193, 1919.

state that actually only the area of *one* rotor comes into effect but that it has to carry the weight of *two* rotors. If the rotors operate properly, a landing is possible.

I must have to disappoint Mr. Schmidt. I may not give a detailed explanation of the switching mechanism since it is currently being patented. It is a fact, however, that when the release is manually operated, or the rpm drops below a certain predetermined value, autogyro conditions are established in about 1/10 second, and after a few seconds the aircraft will be in a gliding flight with constant angle of descent.

With Rieseler's experiments⁴⁸ we have an arrangement in which opposed blades within one rotor are interconnected such that a positive pitch of one blade cause a negative pitch of the other⁴⁹. If the reports I received are correct the machine appears to have reached a height of 40 m.

References

1. Glauert: "A General Theory of the Autogyro", ARC R&M 1111, 1926 (= Journal of the Royal Aeronautical Society 31(198):483-508 1927) and many ARC R&M reports about airscrews from 1919 on; ARC R&M reports about helicopter from 1927 on
2. Lock: "Further Development of the Autogyro Theory", ARC R&M 1127, 1927; many ARC R&M reports about helicopter from 1923 on
3. Glauert & Lock: "A Summary of the Experimental and Theoretical Investigations of the Characteristics of an Autogyro", ARC R&M 1162, 1928
4. von Kármán: "Theoretische Bemerkungen zur Frage des Schraubenfliegers", Zeitschrift für Flugtechnik und Motorluftschiffahrt 12(24):345-354, 1921. Also Bienen & von Kármán; "Zur Theorie der Luftschrauben" Zeitschrift des Vereins Deutscher Ingenieure 68(48):1237-1242, 1924
5. Flachsbart: "Theorie der Hubschraube", Zeitschrift für Flugtechnik und Motorluftschiffahrt 19(8):177-183, 1928. Also Flachsbart & Krober: Experimentelle Untersuchungen an schräg angeblasenen Schraubenpropellern", Zeitschrift für Flugtechnik und Motorluftschiffahrt 20(23):605-614, 1929
6. Helmbold: "Zur Aerodynamik der Treibschraube", Zeitschrift für Flugtechnik und Motorluftschiffahrt, 15(13/14):150-153 and (15/16): 170-173, 1924,, Also "Über die Goldsteinsche Lösung des Problems der Luftschraube mit endlicher Flügelzahl", Zeitschrift für Flugtechnik und Motorluftschiffahrt, 22(14):429-432, 1931 (see NACA TM 652)
7. "Pescara vole 10 minutes", L'Aérophile, 32(1-2):18, 1924.
8. "The d'Ascanio helicopter", Flight 22(45):1249, 1930.
9. "Le Premier circuit fermé d'un kilomètre par Ehmichen", L'Aérophile, 32(9-10):161-162, 1924
10. "Sur un nouveau de construction des helices aériennes", Comptes Rendus Hebdomadaires des Séances de l'Académie des Sciences, Paris, Séance du 7 Novembre, 139:721-724, 1904; "Über die Güte der Tragschrauben", Illustrierte Aeronautische Mitteilungen, 8(3):104-107, 1904

⁴⁸ Walter Rieseler performed secret development and flight tests on two machines R I in 1936 and R II in 1937, both having coaxial rotor arrangement with large wings in the downwash for steering, similar to Asboth's helicopter. Both vehicles crashed during testing. DVL investigated the autorotative capability of freely rotating coaxial rotors and discovered what Focke stated above. A gear ensuring the same rpm for both rotors was recommended.

⁴⁹ In-depth details about Rieseler's helicopter designs are given in: van der Wall, B.G.: The Aircraft, the Rotorcraft and the Life of Walter Rieseler 1890-1937, VFS 76th Annual Forum & Technology Display, online, Oct. 6-8, 2020.

Memorandum of the German Academy of Aviation Research on Air Force Day in 1942

The task of the German Academy of Aviation Research is set in § 2 c) of the statutes "Working Methods of the Academy":

Once a year, the full members (§ 6) together or through individual reports by the full members submit a Memorandum to the President of the Academy, containing suggestions about the possibilities, goals and paths of German aviation research and general aviation technology for the coming period.

For the first time after the end of the first five-year working period of the Academy, the following Memorandum was drawn up on German aviation research.

Editor Notes

Henrich Focke was a contributor to this first German Academy of Aviation Research memorandum. His contribution was a section of the chapter "Technical Research and Development of Aircraft". He was in good company because other contributors to that chapter were Messerschmitt, Prandtl, Georgii, Betz, Blenk, Bock, von Doepp. Each contributor provided a summary plus a supporting attachment. Focke's summary read as follows:

The helicopter will continue to gain in importance as a supplement to the close-up reconnaissance vehicle and for lifting and moving loads. All measures should therefore be taken to maintain the lead that Germany has today over other countries also in the future. In addition to the practical tests and the use of the existing prototypes, this requires further intensive technical development of the helicopter aircraft and the completion of the extremely small design foundations by research work. (Focke, see Attachment 3)

Attachment 3 contained Focke's report entitled "Research and Development of Rotating Wing Aircraft" that was dated: Berlin, April 1942.

Further chapters of the Memorandum Report were: "Technical Research and Development of Aeronautical Engines", "Technical Research and Development of Navigation Aids", "Technical Research and Development of Onboard Firearms and Airdrop Weapons", and "The Physiological-Medical Research Supporting Aeronautical Developments".

Research and Development of Rotating Wing Aircraft

by Henrich Focke

In the field of rotating wing aircraft, the development of the last five years has been characterized by the appearance of practically useful helicopters, initially in Germany (Focke, Flettner), and more recently in the USA (Sikorsky)⁵⁰. The approaches in the USA make all efforts appear necessary in order to maintain our considerable lead in practice and further development of this type of aircraft. Three main directions of progress would have to be called for to this end:

1. Research on rotating wing aircraft.
2. Intensive technical development of the helicopter.
3. Practical tests and use of the existing prototypes.

1. Research on Rotating Wing Aircraft.

It has to be emphasized again and again: an area like the one in question, which lagged 30 years behind the development of the fixed wing aircraft, needs research like no other. It is true that the science that was built up almost exclusively for the fixed wing aircraft can be made fruitful for the rotating wing aircraft very quickly, much faster than in the years of its own creation. There are, however, a myriad of questions in the new field, and more are added every day which, because they were the first, had not yet been tackled.

Contrary to frequently voiced opinions, the requirements for the helicopter airframe are often quite different from those for normal aircraft. This is only partly due to the other operating states (e.g. with the landing gear). Above all, it is the vibrational phenomena caused by several parts rotating at different speeds, but also due to the peculiar coupling relationships between the rotating blades and the fixed parts of the aircraft, which require further investigation. In-flight stress measurements are urgent here. Some of them are already in preparation.

Most of the tasks still remain unsolved in aerodynamics. What has been built up with an enormous amount of work in the last 10 years is not much more than a first research skeleton, just enough to be able to provide performance information with some certainty and to be able to provide the static loads department with the loading documents needed for design. Extensive tests, especially in large wind tunnels, are necessary on the downwash flow fields and their environment with helicopter and autogyro rotors, on the true air force distribution on the blades, on the stability, the influence of the ground, the transient processes when switching from helicopter to autogyro operation, the fluctuation in air forces, to mention just a few. The supersonic research will also become very important, because due to the addition of the forward speed and the rotational speed of the blades, the speed performance of the future helicopters in the areas above 400 km/hr depends to a large extent on the solution of these problems. Although the main tasks of the helicopter are in the area of low speeds, a good top speed remains of great value for practical use.

Of course, all these issues must be supported not only experimentally but also theoretically; but they will then be of great use, which will have a practical effect on the performance and safety of the helicopters.

⁵⁰ The developments of Igor Sikorsky resulted in the first U.S. series production R-4 helicopter that had its first flight in January 1942. The Bell Model 30 was a prototype still in development, that had its first flight in December 1942. It led to the Bell 47, that was built in series production after its first flight from 1945 on. The Platt-LePage XR-1, also a prototype, followed Focke's side-by-side arrangement and flew 1941. The Piasecki PV-2 single rotor helicopter was a prototype under development, the HRP with tandem rotor design was developed later in 1943, first flight 1945.

Half of the whole helicopter problem is currently a mechanical one: the engine. Much has already been done here, mainly by BMW. But much remains to be explored. The vibration phenomena, mainly the torsional vibrations, form a main problem. For the control parts of the engine, close cooperation with aerodynamics is again necessary.

2. Intensive Technical Development of the Helicopter.

For the basic structure of the helicopter, i.e. essentially the number and arrangement of the rotors, there is no more complete clarity today, such as e.g. 20 years ago regarding the decision between monoplane and biplane. It is also correct that this decision is not brought about by force, but that every reasonable arrangement is tried out and thus clarification is sought from within. Test aircraft of this type should, however, be developed independently from any intended use, because otherwise progress will be too slow. Such aircraft must be flexible in their construction and easily modifiable, so they must be built quickly and relatively cheap.

It is already becoming apparent today that there will be different designs for different purposes. Combined arrangements of helicopter and fixed wing should also be encouraged, as far as war conditions permit⁵¹. They offer particular difficulties, but also the prospect of reaching very high speeds. Despite these various possibilities, one main line of progress is unmistakably emerging for the future: The single-rotor helicopter, aerodynamically just as high-quality as today's fixed-wing aircraft, with a tip-jet driven rotor and therefore completely free of reaction torque⁵². One can make this statement, although an important prerequisite, fuel-efficient jet propulsion is still missing today. However, that should not prevent you from paying full attention to helicopter work of this type today. It goes without saying that the development in terms of aircraft size, which, according to previous experience and forecasts, does not present any fundamental difficulties, but poses a great many individual tasks, must not be neglected.

3. Practical Tests and Use of the Existing Prototypes.

Practical tests and use are all the more necessary as, for the first time since the beginning of aviation, completely new areas of application are opening up for the helicopter due to its basic properties: standstill in the air and landing possibility practically everywhere, without any fundamental restrictions other than the dimensions of the aircraft. The consequences of these properties for the military forces as well as for its peaceful use cannot be completely overlooked today.

But what it means for the technical war, which always and everywhere has to use heavy loads in difficult situations, if a flying crane with a lifting capacity of 1000 kg is available, is at the discretion of every soldier in the field. A crane hook can appear over any point on the site in a few minutes and which, depending on its air resistance, can fly the load at speeds of 50, 100, 200 km/hr, but also at 10 cm/sec speed, to a location of 2 m, but also 50, 200, 500 km away and drop either

⁵¹ This hints at Focke's Fa 269 tiltrotor aircraft currently under development that begun 1941 on demand of the Reichs Ministry of Aeronautics. Comprehensive small-scale wind tunnel experiments were performed, a wooden full-scale mock-up was built that was destroyed 1943 during a bomb raid and the project was cancelled 1944, when it was estimated a prototype would be available no earlier than 1947.

⁵² This hints at the Baron Friedrich von Doblhoff experiments with the WNF 342 helicopter that was under development at the time, first flight occurred later in 1943. Focke's statement is surprising, because he rejected the on-blade propeller drive of the rotor by the power loss due to the inferior efficiency of the small propellers, and jet propulsion has even smaller dimensions. Also, the entire rotor design is much heavier and more complicated due to fuel provision, and jet engines were excessively in fuel consumption.

from the air or place it there as gently as necessary. With all of this, the aircraft doesn't need to land, but it can.

This is the current status. In a few years, the lifting capacity of the "crane" will probably have increased to 3,000 kg⁵³. Joint actions of several helicopters for carrying very large loads are also conceivable in the future. Using the helicopter as a crane should therefore be pursued by all means.

For the navy, the helicopter will – on the one hand – become the "elevated observation post" without the need to create a large landing deck like fixed wing aircraft require, and – on the other hand – it will be an effective weapon against submarines, since it can be fully adapted to their low speeds. It is also an ideal aid for sea rescue.

The helicopter will also become the eye of the army, like the tethered balloon that appears obsolete today. It will also provide a much better opportunity for observation than the balloon, which is restless in wind. On the other hand, under enemy influence it can disappear with considerable speed, or, because hardly visible, land in a well-camouflaged place. Practical experiments in this direction therefore appear necessary.

In many of the cases mentioned, the helicopter will need fighter aircraft protection, like some other aircraft today, but that will not prevent its use in view of the advantages achieved.

In peacetime use, the helicopter will appear wherever airfields cannot be created (mountains, urban areas) or where a connection to a larger airfield is not possible, as in private air traffic. Preparatory work of this kind will have to rest until the war is over. The helicopter work for the Air Force, on the other hand, will provide an excellent basis for helicopter use in peace time.

As far as the autogyro is concerned, it seems to be receding in importance at the moment, as one might suspect, since the helicopter represents the more fundamental solution. However, it was not useless as a forerunner and will perhaps still exist in some forms. Technical interest will remain in the state of autorotation, because of its importance as an emergency landing option for helicopters.

In summary it can be said that the field of rotating wing aircraft, especially helicopters, has a great future ahead of it, but it also requires great efforts in research and practice in order to progress successfully.

⁵³ This hints at plans for an upscaling of the Fa 223, which was started 1943 as the Fa 284 "flying crane" with 3,000 kg payload. Work was partly done at Bréguet in France, but ended 1944 due to bombing raids and increasing difficulties due to wartime shortages.

Writings
of the German Academy of Aeronautical Research
Volume 1070/43 g.⁵⁴

Progress of the Helicopter
by Henrich Focke

Lecture
presented at the 7th science meeting of the
orderly members on October 1, 1943
Period 1943/44

⁵⁴ g. = geheim (secret)

Progress of the Helicopter

by Henrich Focke

More than four years ago I reported to the academy about the development and the first successful attempts of a helicopter, the F 61 (Fig. 1)⁵⁵. As I can recall from this illustration, it is a high-wing aircraft, the wings of which were replaced by two three-bladed rotors arranged side-by-side, which are driven by cardan shafts from a Sh 14A motor⁵⁶ on the front of the fuselage. In case of drive failure, the rotors are automatically or manually disconnected from the motor and the pitch angle of the blades is reduced to such an extent that autorotation and thus a safe gliding landing is possible. The aircraft is therefore able to fly as a helicopter as well as a gyroplane⁵⁷.

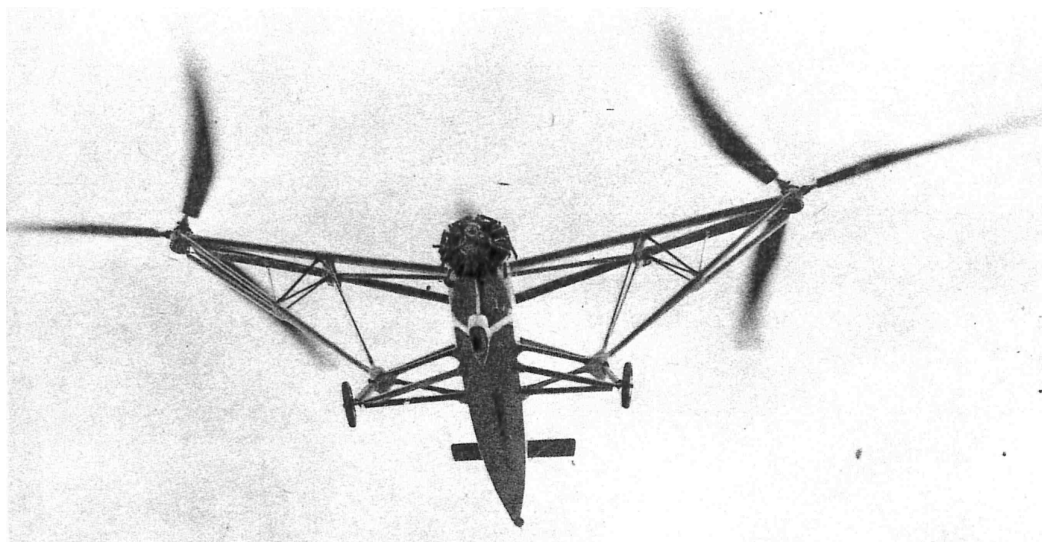

Fig. 1: F 61 helicopter

This prototype was originally only intended for the first implementation and testing of the principle, as it did not carry any significant payload. The two aircraft that were built also fulfilled the task of serving as vehicle of the first real helicopter flight practice, as test objects for numerous flight measurements for further development, as well as training aircraft for the retraining of fixed wing pilots on helicopters. Of the two machines, which together hold all helicopter world records, one was destroyed during the British air raid on my plant on June 1st last year⁵⁸, the other is now destined for the German Museum⁵⁹ after six years of flight service.

Today I would like to briefly report on what has been done in the meantime in terms of research, construction, manufacturing and testing. Given the variety of tasks, I have to limit myself to describing a few problems and suggesting ways of solving them.

Since in 1939 a payload of 700 kg was considered to be the minimum for an aircraft of military interest, considerable dimensions, weights and engine power were already considered for a helicopter: The Focke – Achgelis Fa 223 has 2 rotors, each having 12 m in diameter, a gross weight of around 4 tons and an engine of about 1,000 HP. It was foreseeable that a great deal of further

⁵⁵ The first (1937/38) of Focke's three reports beginning on page 7

⁵⁶ Sh 14A = Siemens & Halske 7-cylinder radial engine, 150 HP permanent performance, short term: 160 HP

⁵⁷ Not really, as it lacks the propulsive force needed for level flight. It only can glide in autorotation.

⁵⁸ 1942

⁵⁹ 1943, German Museum in Munich

research would be necessary in order to realize such a machine having one order of magnitude increase in power from 160 to 1,000 HP.

First, the investigation of the existing F 61 was tackled by measurements in flight in order to collect knowledge of everything that could be gathered. In view of the fact that there was no knowledge foundation at all, the aim was not to achieve highest scientific accuracy but to quickly grasp the important technical parameters. The F 61 was equipped with a camera system that accommodated the instrument panel, which was supplemented by a number of additional measuring devices (Fig. 2). The control position of the three controls and the switch between helicopter and gyroplane, the total angle of attack of the rotors and the vertical acceleration were added to the usual measured values (Fig. 3).

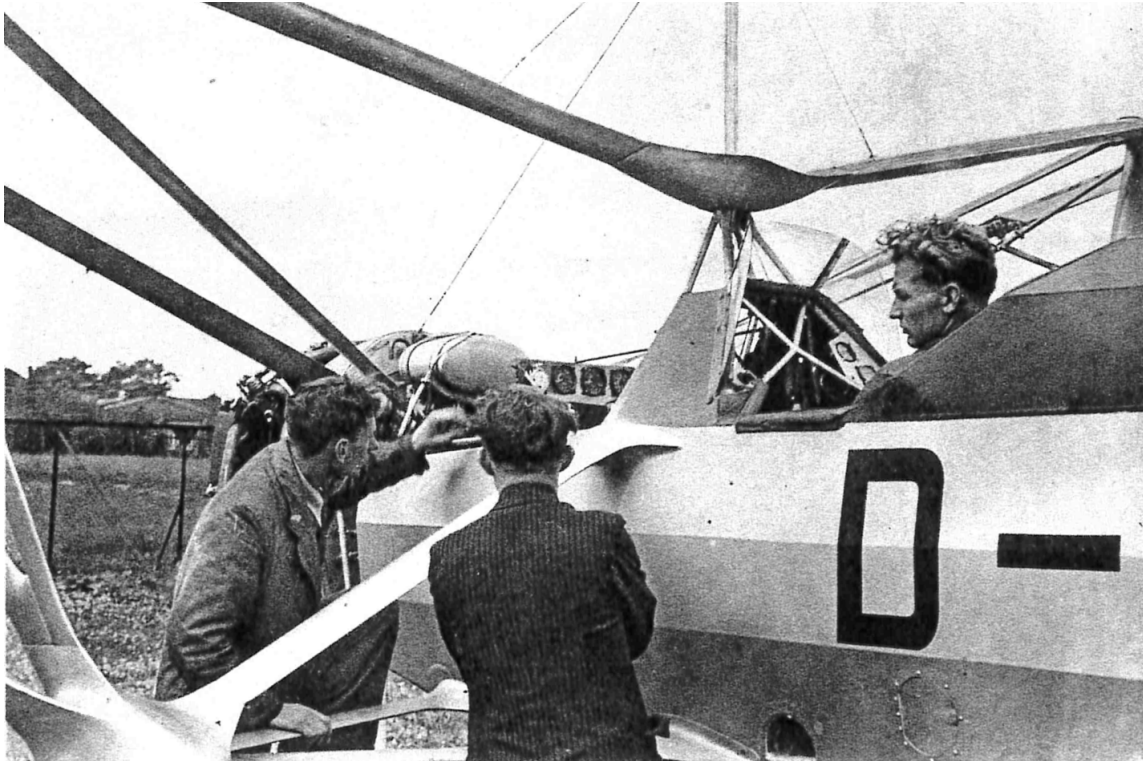

Fig. 2: F 61 with camera equipment

By this, for the first time it was possible to measure the relationships for the helicopter that are so familiar to us with fixed wing aircraft and to compare them with theory. The agreement was quite good except for one value, that is the angle of attack of the entire rotor α_{π} , which shows unsystematic deviations that are still not fully understood today. Here you can see the evaluation of such a film, namely the important case of the so-called *one-sided switchover*⁶⁰ has been extracted (Fig. 4).

⁶⁰ Switching from helicopter to autogyro mode

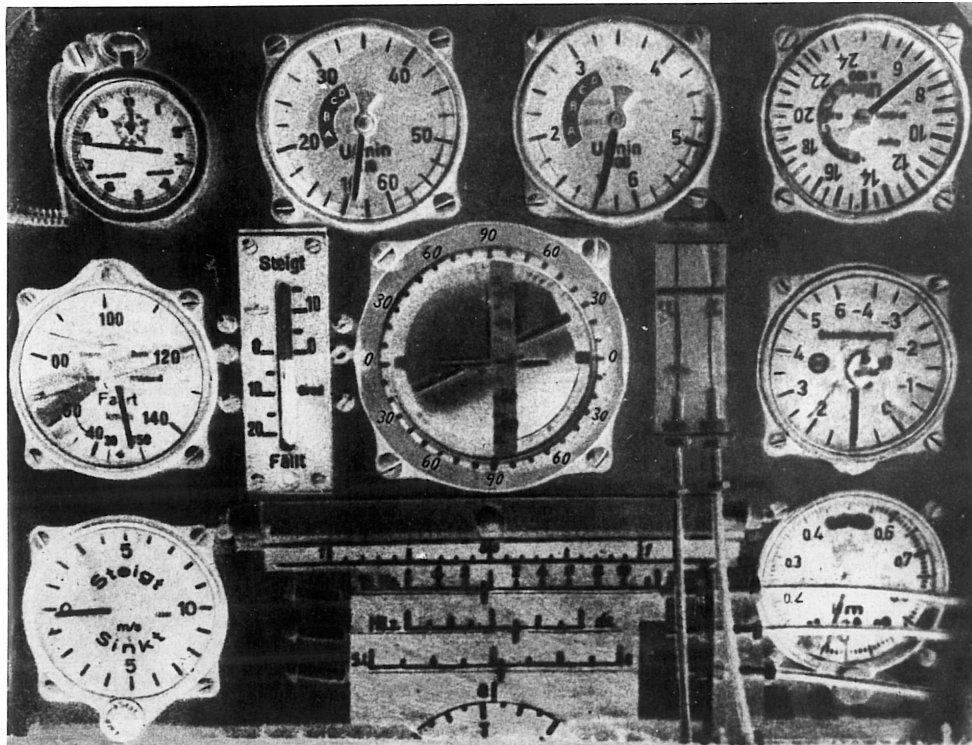

Fig. 3: Instrument panel of the F 61 with additional measuring devices

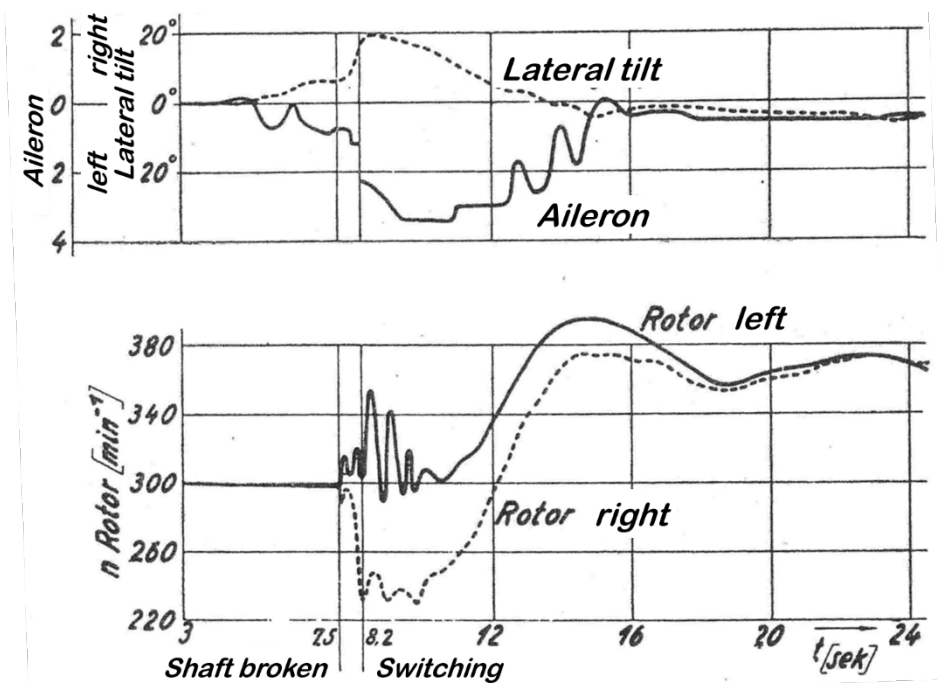

Fig. 4: Fw 61. One-sided switchover after shaft break from $V = 40$ km/hr

The biggest criticism that can be made against the system of the two side-by-side rotors is that of one-sided malfunctions in the transmission; which seems inevitably to lead to a serious accident due to the cessation of lift on one side. We countered this by the fact that in the event of a one-sided failure of the drive, (i.e. one rotor dropping in rotational speed), then a rotational speed comparator becomes effective, the motor is decoupled, and both rotors brought into the autorotative state. This then enables a normal glide landing again. In the figure you recognize the instance of

breakage, the development of both rotor's rpm, the instance of switching when their rpm differs significantly, the rolling angle (lateral tilt) and the aileron deflection. The process was actually brought about by flight captain Bode at an altitude of 2,000 meters through an artificial breakage in one of the drive shafts and ended with a perfect autorotation landing. Of course, there were a lot of tests on the ground beforehand in order to ensure the greatest possible safety. The event recently occurred for the first time as an emergency and led to a smooth emergency landing from a height of 900 meters near Potsdam.

From the many flights I will pick out another one, the one for determining the *longitudinal stability* (Fig. 5). Last time, I mentioned that the calculation showed static stability throughout the flight envelope, but resulted in dynamic instability below 80 km/hr forward speed. You can see how the oscillation process begins after an intentional disturbance of the elevator control, here at 60 km/hr. The oscillation period can be determined to be 8 seconds, the theory had resulted in 7.2 seconds. The pilot had to intervene after just one period because α_{π} had reached 40° , which clearly shows the strong build-up of pitch angle. According to flight practice, it becomes imperceptible, i.e. dynamic stability occurs at ~ 110 km/hr, which is at a higher speed than the theory indicated. However, the agreement is in general satisfactory. The dynamic longitudinal instability has practically not led to any particular difficulties in the case of 25 pilots of various previous training and disposition and it only exists at flight speeds where a fixed wing aircraft can hardly be flown. Nevertheless, the elimination of this characteristic must be sought in the future because it is currently the most fundamental flight characteristic deficit most peculiar to all rotating wing aircraft.

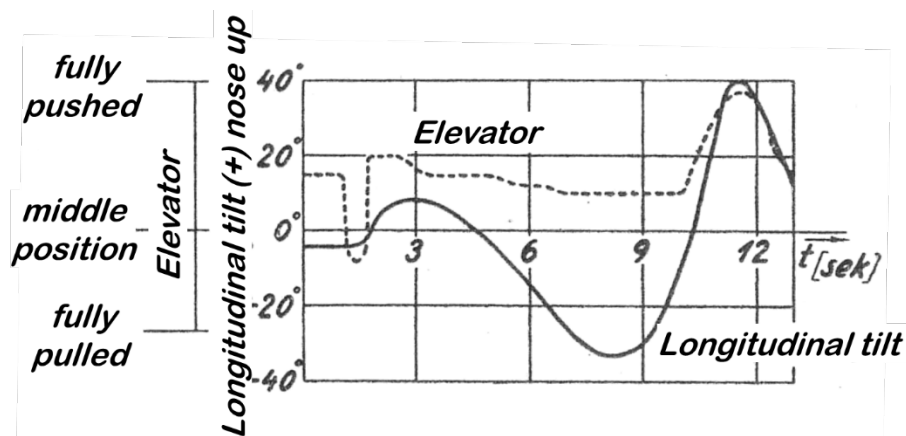

Fig. 5: Fw 61. Dynamic longitudinal stability. Flight test. From a speed of 60 km/hr

These two examples may be sufficient, but almost every flight brought a wealth of important and interesting first-time results.

In the meantime, of course, research on the ground has also been advanced by calculations and wind tunnel tests. As far as the wind tunnel tests are concerned, they were used wherever the aerodynamic foundations had revealed gaps that could not be closed solely by theory.

Already for the F 61, which, as is well known, initially flew with untwisted blades with respect to autorotation, an extensive series of tests⁶¹ was carried out with *twisted blades*, which were

⁶¹ Josef Käufl, group leader of the large wind tunnel VI at AVA Göttingen: Kraftmessungen an einer kombinierten Trag-Hubschraube, Projekt J 1098, AVA/37/43, 1937; Vermessung des Strahlfeldes um eine kombinierte Trag-Hubschraube, Projekt J 1098, AVA/37/21, 1937

designed according to the more recent methods which largely consider all the refinements of Betz⁶² and Helmbold⁶³. It was found that adequate autorotation characteristics can be obtained when appropriate precautionary measures are taken. The set of twisted blades built for the F 61 resulted in an additional lift of over 7 % and allowed Dipl.-Ing. Bode by increased fuel supply to set the world record for range in 1938 to 230 km (Fig. 6).

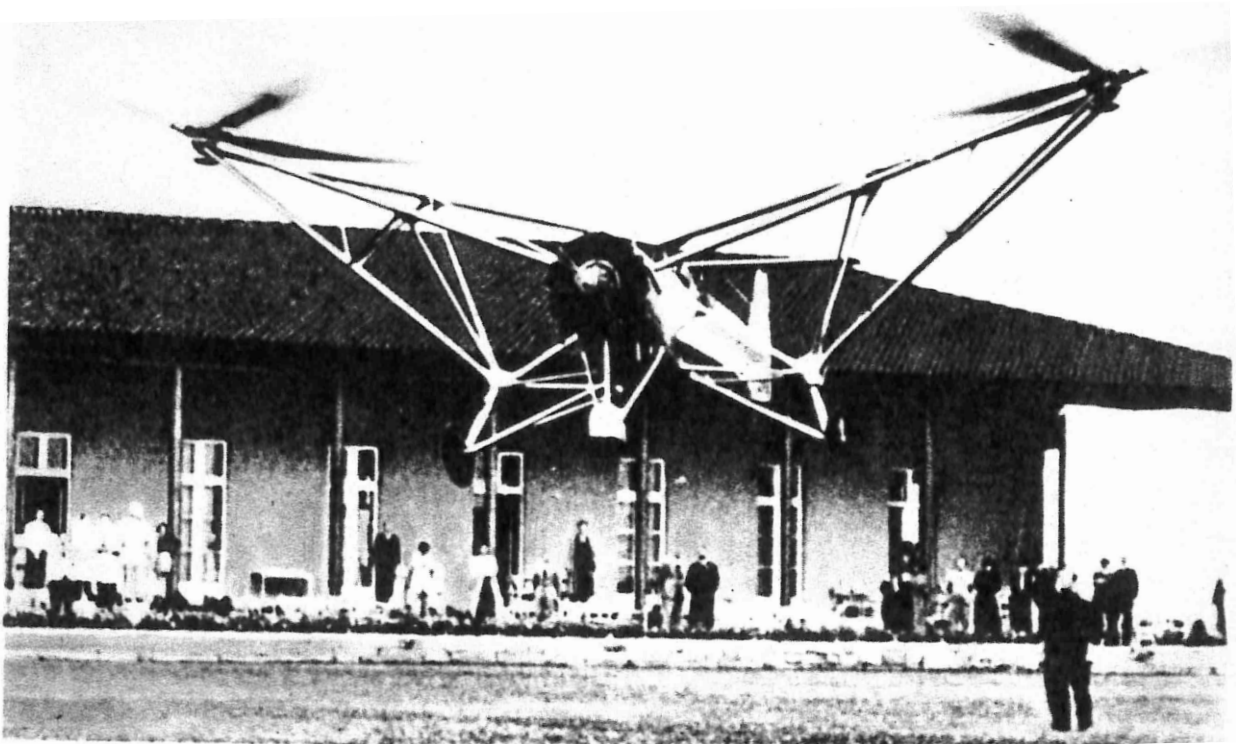

Fig. 6: F 61 helicopter

The creation of sufficient bases for the stress on the hinged blades attached to the hub was also very important. The autogiro had provided some preliminary information with regard to the oscillating *blade bending* due to the changing air loads during the revolution (Fig. 7). However, the process was still very crude, in that only the static radial blade bending distribution was calculated from its own elastic constants and the air forces and centrifugal forces as a distributed load. On the other hand, it was known that resonance conditions between the bending mode of the blade and the rotational speed were possible. Of course, these are the very reasons for breaking. In order to recognize it, the conception of blade bending as an oscillation had to occur. It presents many difficulties, in particular the calculation of the damping, which becomes decisive in the case of resonance. Today we have not yet reached to the point where we can allow a resonance case between rotational speed and blade bending modes in flight and must therefore largely exclude the resonance cases from the operating rotational speeds, at least up to the 5th harmonic. This is reliably possible, since the resonance points themselves can be specified safely, but not the amplitudes occurring there. In order to check the accuracy of the calculation, the flight measurement was also

⁶² Eine Erweiterung der Schraubenstrahl-Theorie, Zeitschrift für Flugtechnik und Motorluftschiffahrt, 11(7/8):105-110, 1920; Der Wirkungsgradbegriff beim Propeller, Zeitschrift für Flugtechnik und Motorluftschiffahrt, 19(8):171-177, 1928 (translation in: NACA TM 481)

⁶³ Zur Aerodynamik der Treibschraube, Zeitschrift für Flugtechnik und Motorluftschiffahrt, 15(13/14):150-153 und (15/16):170-173, 1924; Über die Goldsteinsche Lösung des Problems der Luftschraube mit endlicher Flügelzahl, Zeitschrift für Flugtechnik und Motorluftschiffahrt, 22(14)429-432, 1931

used here. A camera rotating on the hub filmed the rotor blade in radial direction, on which white markers are applied.

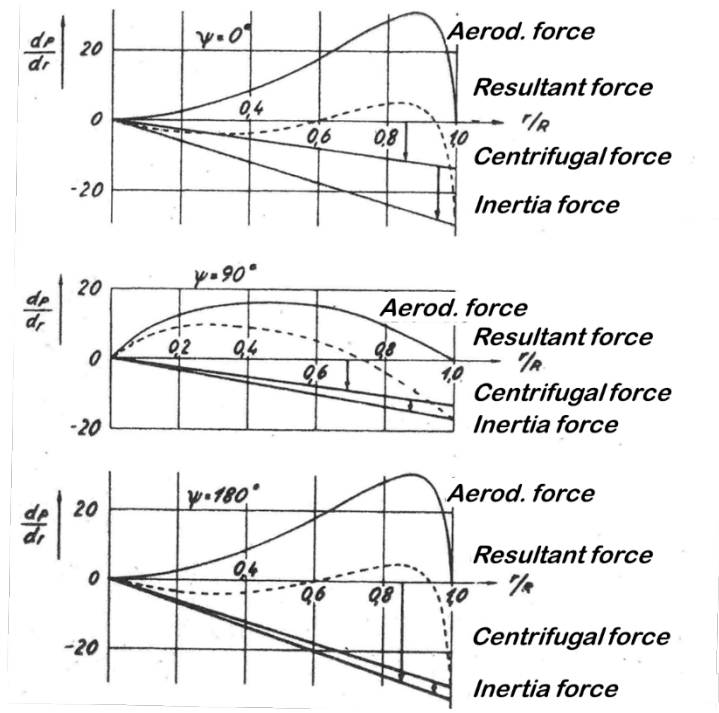

Fig. 7: Fa 330. Air and mass force distributions over the radius.
Rectangular blade Mass = 125 kg, V = 80 km/h, $\mu = 0.32$

The rectification of the camera image, considering the position of the lens and the blade, the lagging and flapping angles of which were also photographed on scales, resulted in the respective bending line. The passage of the vertical tail unit of the aircraft through the middle of the image window served for the azimuthal definition of the film images. Fig. 8 shows a comparison of the calculated and recorded bending line for a flight condition of 138 km/hr speed at 3,223 kg gross weight, load factor $n = 1$, $\psi = 43^\circ$ (azimuth angle counted from the rear blade position). This data is for the big machine, the Fa 223.

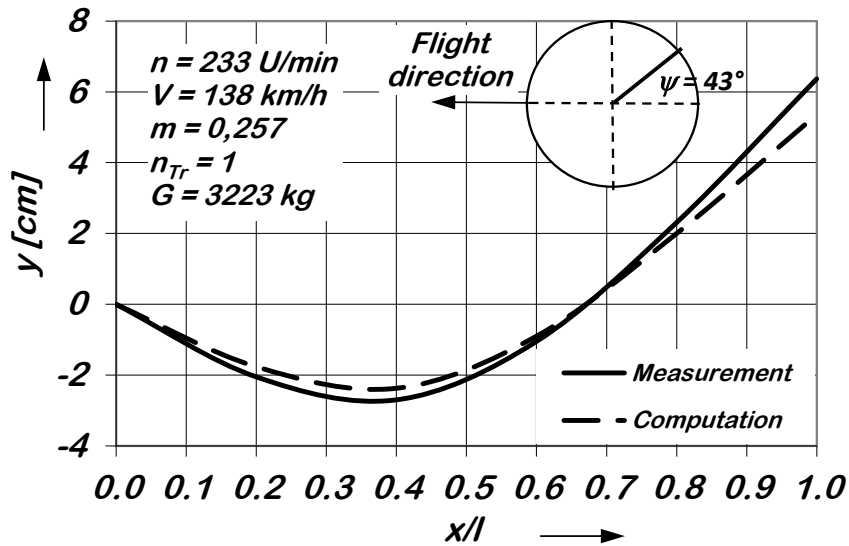

Fig. 8: Bending line of the rotor blade.

There was still no documentation at all about the *torsion* of the blades and their torsional vibration possibilities and ultimately their flutter safety. It is actually simple, albeit an extensive calculation, to calculate the blade torque from the air forces and mass moments at every point of the revolution and thus to determine both the static torsion angle and the total torsion moment of the individual blade delivered to the blade control in the hub. It is well known, however, that there are areas on the rotor disc where the flow undoubtedly separates from the blades. As a result, the lift in these areas is unknown and it is not possible to say without a doubt where the flow separation begins. Of course, this still applies to a much greater degree for the aerodynamic moments. If the moments have been balanced as far as possible by choosing the position of the center of gravity of the blade for attached flow conditions and an airfoil with a constant center of pressure, they can easily reach a multiple of the initial value when stall occurs. Since the blades pass through the areas of attached and separated flow with each revolution, a violent torsional vibration excitation would be possible if the natural torsion frequencies were close to the rotor speed of rotation⁶⁴.

Above all, a *measurement of the blade torsional moments in flight was needed*. It was only conceivable by a force measurement in the parts of the control that transmit the blade torsion moment, but which also rotate. After very great metrological difficulties, Mr. Löffler from BMW succeeded in doing this by means of an inductive strain gauge with oscillographic recording. You can see here (Fig. 9) an example showing the variation of the blade torsion moment in an intercept case at 100 km/hr; gross weight 3,600 kg; load factor $n = 1.7$, $\alpha_\pi = 40^\circ$, i.e. an already very high angle of attack.

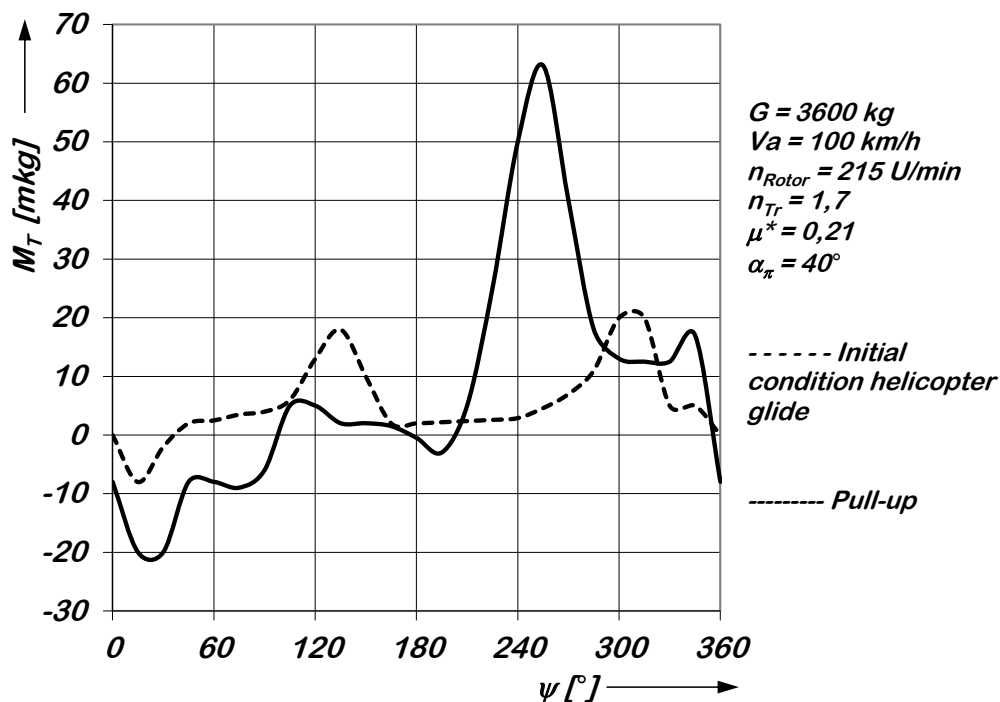

Fig. 9: Fa 223. Blade torsion moment during a high load maneuver

I owe the execution of the torsional vibration calculation to Mr. Dirksen⁶⁵, Braunschweig, and his colleagues. As you can see in Fig. 10, it resulted in excellent margins both in hover and in forward flight, including the torsional elasticity of the blade attachment. I would like to refrain

⁶⁴ The mean rotor speed of the Fa 223 was 250 rpm

⁶⁵ Prof. Dr. B. Dirksen was director of the Institute of Material Strength at LFA Braunschweig, starting activities in 1938. This institute was also responsible for flutter computations, see below.

from further explanations about the very interesting calculation method here, since they appear in a secret doctoral thesis by Mr. Ficker⁶⁶, Braunschweig, which will be accessible to everyone here.

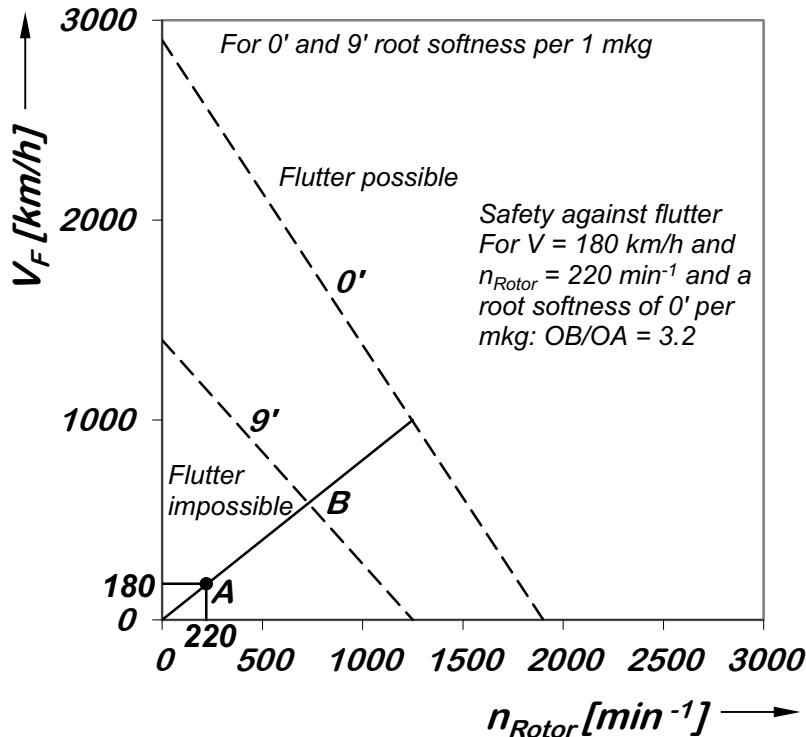

Fig. 10: Flutter boundaries of the rotating wing aircraft

Another fundamentally very important question is that of *gust sensitivity and gust loads* of rotating wing aircraft. Although physical reasoning and theory stated that the gust effect on a rotating wing aircraft must be less than that of a fixed wing aircraft due to the nature of the increase in lift with respect to both the angle of attack and the flight speed, the opposite claim was stubbornly maintained on many sides. It is to the merit of Mr. Stüper⁶⁷ in Göttingen to have clarified this matter in measurement flights with a Fa 223 by means of the gust comparison measurement procedure worked out by him and his employees. Fig. 11 shows a comparison flight between a Bücker 181 (upper recording) and the Fa 223 (lower recording) at a gust differential velocity of about 8 m/sec. The accelerations of the helicopter, which are usually only half of those of the fixed wing, can be recognized immediately. But, although the aircraft always flew as close together as possible, there are also events recognizable where a gust response of the fixed wing aircraft hardly shows a reaction of the helicopter or even an opposite reaction of it. This was also predicted theoretically by us and is based on the very different behavior of a fixed wing and a rotor with respect to horizontal and vertical gusts, as my colleague Mr. Just⁶⁸ firstly has proven.

⁶⁶ Ficker, G.: Flatterrechnung Fa 223, ZWB, LFA Bericht, 1940; Flatterrechnung Fa 223 (Zwischenbericht 2), ZWB, LFA Bericht, 1941; Bericht über Flatterverhalten der Fa 223, ZWB, LFA Bericht, 1942; Das Flattern von Drehflüglern, Technische Berichte I.C. 011, LFA Bericht, 1943 (translation in: MOS Translation GDC 10/13029T, 1943)

⁶⁷ Prof. Josef Stüper, director of the Institute of Flight Testing and Aviation, AVA Göttingen since 1939

⁶⁸ Head of aerodynamics at Focke since 1938, from 1943 on at Messerschmitt in the fighter program, later director of the DSH in Stuttgart from 1953 on.

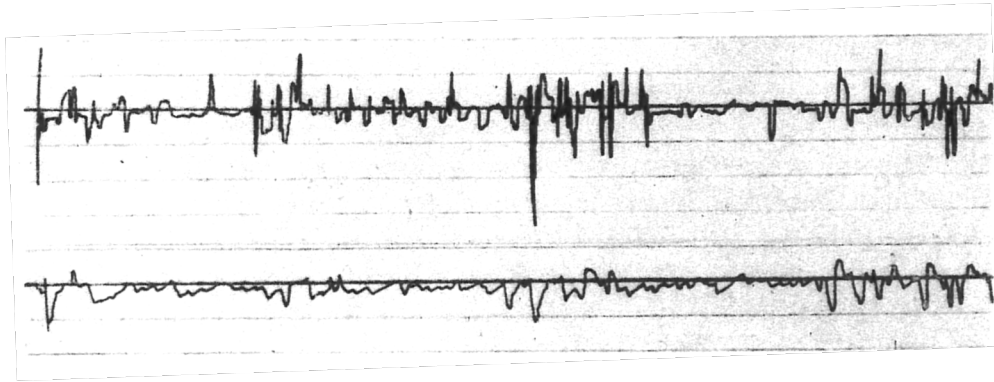

Fig. 11: Gust flight comparison Bü 181 and FA 223, $V = 125$ km/hr

At constant speed, an increase in the angle of attack results in an increase of the air force in both lifting devices. In the case of the rotor, on the other hand, at higher speeds and constant rotational speed, i.e. also higher advance ratios, it causes an air force decrease, as Fig. 12 shows: The air force coefficient⁶⁹ k_a is plotted versus the angle of attack of the rotor α_π purely according to the calculation.

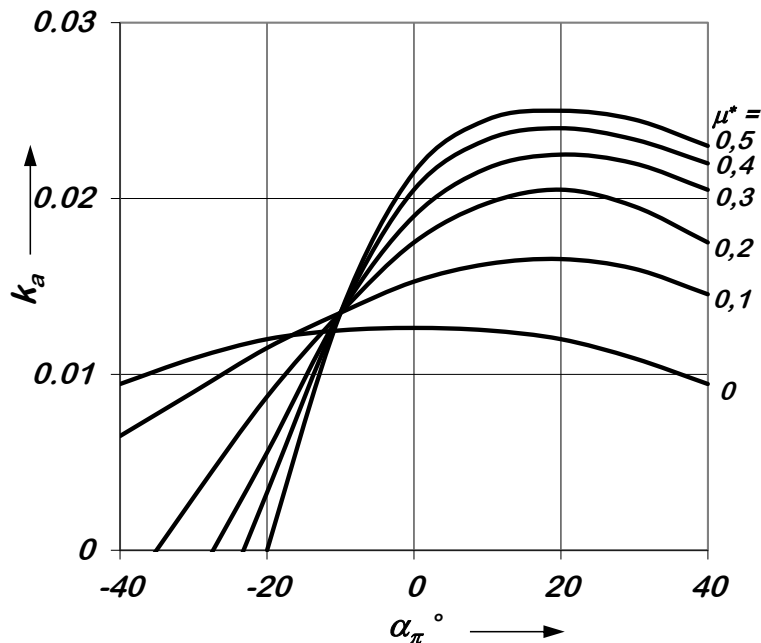

Fig. 12: Wind tunnel measurements k_a versus α_π , $D = 1.5$ m, $\vartheta = 10^\circ$

Going to larger angles of attack with the same advance ratio, i.e. also the same speed, the air force factor always increases, even if only slightly at low speeds and low advance ratios. Going up (vertically) at a fixed angle of attack, you will find at the right side of the graph, i.e. for large angles of attack (i.e. in areas of small flight speed), increasing advance ratios: the air force grows here with increasing speed just like with the fixed wing. But it is the other way around in areas of high speed, where the air force falls with increasing speed. There is an area where the force of the air is almost independent of speed.

⁶⁹ Thrust coefficient (referenced to $\rho/2$), thus twice as large as today when referenced to ρ only. The variation at $\mu = 0$ will be due to the ground effect of the wind tunnel, otherwise a horizontal line would be expected.

This result of the theory, which was initially considered to be implausible, is at least qualitatively ensured by the gust measurements, although I would also like to emphasize that only gust flight statistics of many hours under the most varied of weather conditions, as it is available for fixed wing aircraft, will allow final conclusions. Incidentally, on closer examination, this finding is not as astonishing as it appears at first if you just get rid of fixed wing ideas: A propeller reduces its thrust when its cross-flow speed is increased, and when the plane of the propeller is blown at very inclined angles from above the same effect remains. The *computational* result of the comparison between a Fi 156 and a Fa 223 is shown in Fig. 13.

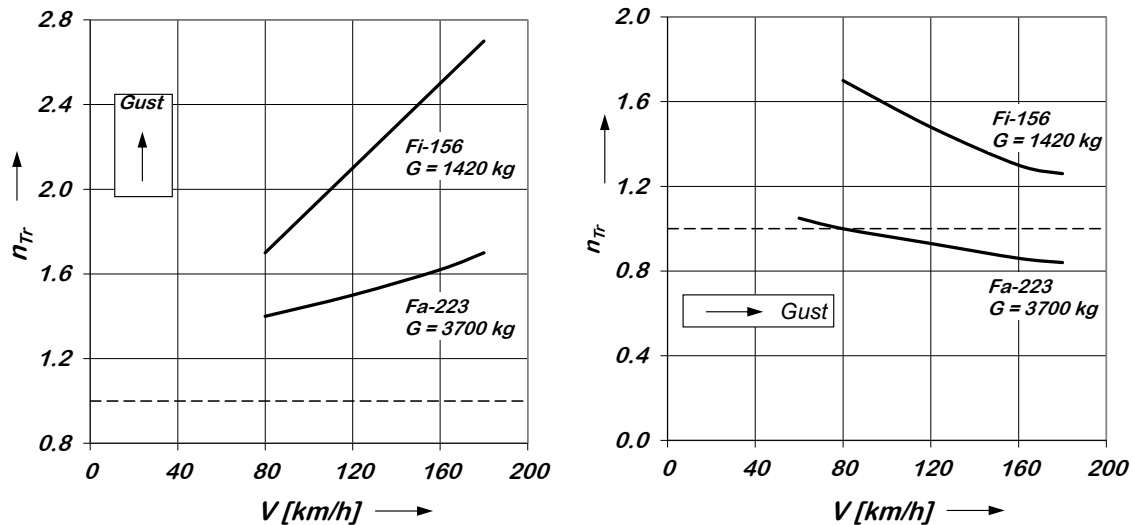

Fig. 13: Gust load factors, $v_B = 10$ m/s. Comparison Fa 223 with Fi 156, calculated.

A reduction in the load of vertical gusts compared to fixed wing (left), and the trend for higher speeds almost a reversal to horizontal gusts, will be extremely valuable for the load assumptions of rotating wing aircraft.

A chapter that demands even more attention with rotating wing aircraft than with normal aircraft are the *oscillations*. It is true that the part of which this was most feared, namely the engine located far away from the rotors, and its torsional vibrations, caused the fewest problems. Careful calculation and torsiongrams of the implemented system have so far protected us against surprises. I will come back to this in the description of the engine.

The main vibration problems, the clarification of which is mostly thanks to the head of my static department, Mr. Papenhausen, occur on the rotor itself and are a consequence of its many degrees of freedom due to the articulated blade attachment. I do not mean the elastic vibrations already mentioned here, but those that the blades would execute relative to each other and against the hub, even if they were themselves absolutely rigid. This is where the regular lagging and flapping movement of the blades belongs, which I mentioned in my earlier lecture and which has long been known from the autogyro, and which must always occur during forward flight. It does not in itself have any harmful consequences.

As my colleague Mr. Gigling discovered purely by calculation, there is a very dangerous form of vibration between the blades, which is of self-exciting nature and can therefore quickly lead to destructively large amplitudes (Fig. 14).

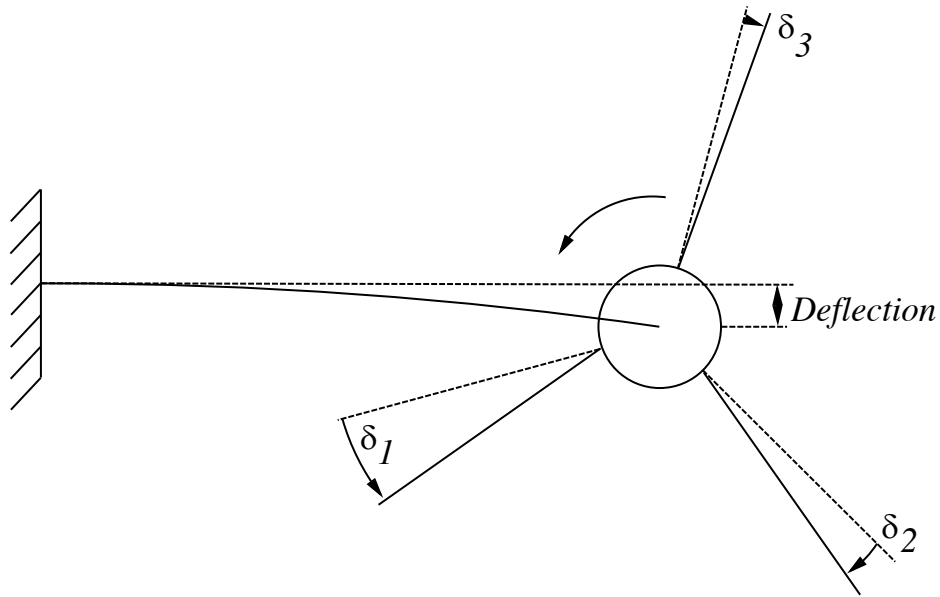

Fig. 14: Rotor hub-blade-oscillations. Rotor hub constrained by springs with blades allowing for lag motion in oscillating condition

We have named it *centric angle oscillation*⁷⁰ because the blade separation angle at the hub, which is normally 120° between the three blades, changes periodically in a peculiar way continuously, but not with the rotor rotational frequency and also not at a simple ratio of it. It is a little difficult to get a proper idea of this oscillatory mode; it can best be seen on the movie to be shown later. The centric angle between two blades periodically becomes more narrow and wider. The elastic restoring force is the never completely rigid mounting of the hub in connection with the centrifugal forces of the blades. On the other hand, however, the frequency of the blade's oscillation depends on the rotational speed and is higher at a higher rotor speed, but in practical cases the centric angle frequency is, in absolute terms, significantly lower than that⁷¹. The result of the calculation of a rotor for centric angle vibration can be seen in Fig. 15.⁷² The frequency is plotted versus the rotational speed ω , so that resonance cases are on a straight line of 45° . The curves represent the solutions⁷³ of the frequency equations, i.e. the various possible forms of oscillation modes. In the indicated area, self-excitation of the centric angle oscillation is possible. So here self-excitation would start with an ω of 37 [1/s]. The usual case of resonance with the rotational speed is just before that. Further up, the possibility of self-excitement ceases.

⁷⁰ Today called ground resonance

⁷¹ This hints to the low-frequency mode of articulated rotors with small hinge offset, which is mostly of regressive nature

⁷² Have a look at the publications of: Coleman, R.P.: Theory of Self-Excited Mechanical Oscillations of Hinged Rotor Blades, NACA ARR 3G29, 1943; therein cited with the same title as ARR of July 1942. Fig. 7 of it is almost identical with Figure 15 here!

⁷³ Eigen values

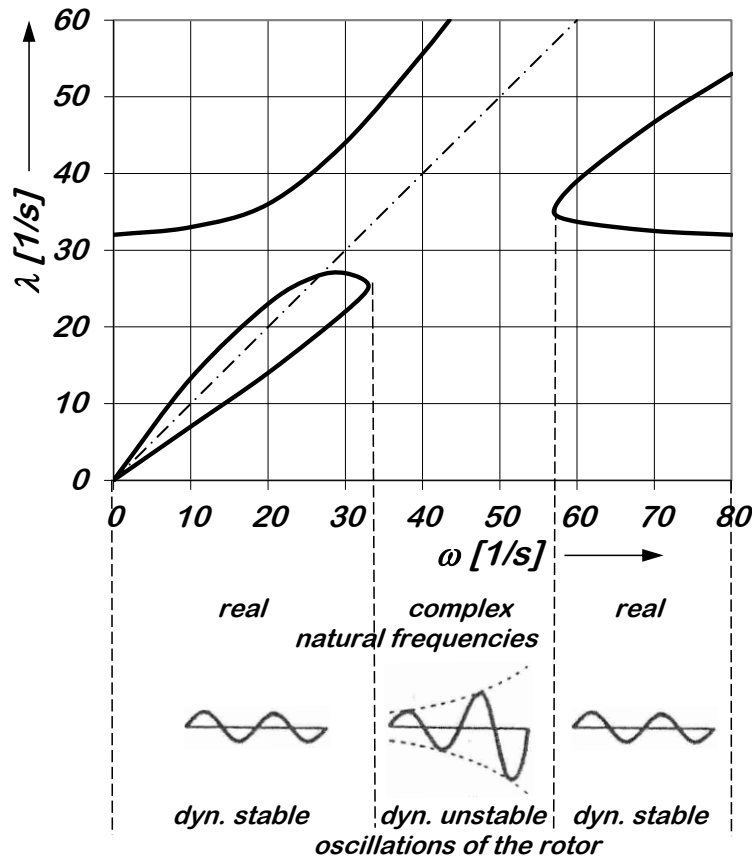

Fig. 15: Rotor hub-blade-oscillations. Frequency diagram

I have to mention that the whole process has nothing to do with aerodynamics, because the three blades represent nothing more than a triple rotating pendulum whose coupling oscillations we observe. We have it e.g. simulated with three simple articulated steel rods instead of the blades that revolve around an elastically mounted hub (Fig. 16). The oscillation starts right at the calculated rotational speed, and so violently that the heavy test facility would be destroyed or dancing around in the room if it is not switched off immediately.

Of course, we asked ourselves why this dangerous form of oscillation never occurred⁷⁴ in the numerous rotating wing aircraft types built all over the world and why it was only determined theoretically by us⁷⁵. A rough recalculation has shown the strange fact that none of the foreign and our own vehicles with their operational speeds of rotation had fallen into the endangered range just by chance. But just when this was elaborated, we experienced the centric angle oscillation in its pure nature with our Fa 330, a new type with unusually small dimensions. Fortunately, the aircraft was tethered in the wind tunnel, so that it happened without an accident.⁷⁶

⁷⁴ This is not true since many autogyros were destroyed by this phenomenon, but usually and conveniently that was mistaken as pilot error. When in 1937 a Kellett YG-1 autogyro without a pilot was destroyed in the NACA Langley wind tunnel it became obvious that it was an inherent problem of rotating wings and following that event Coleman began to tackle it.

⁷⁵ Not completely true: in parallel this problem was solved by Coleman, see footnote 72.

⁷⁶ The autogyro kite Fa 330 was tested in the large wind tunnel of Chalais-Meudon from spring 1942 on and the mentioned accident must be from that time. Later pilot training on it was performed in that wind tunnel.

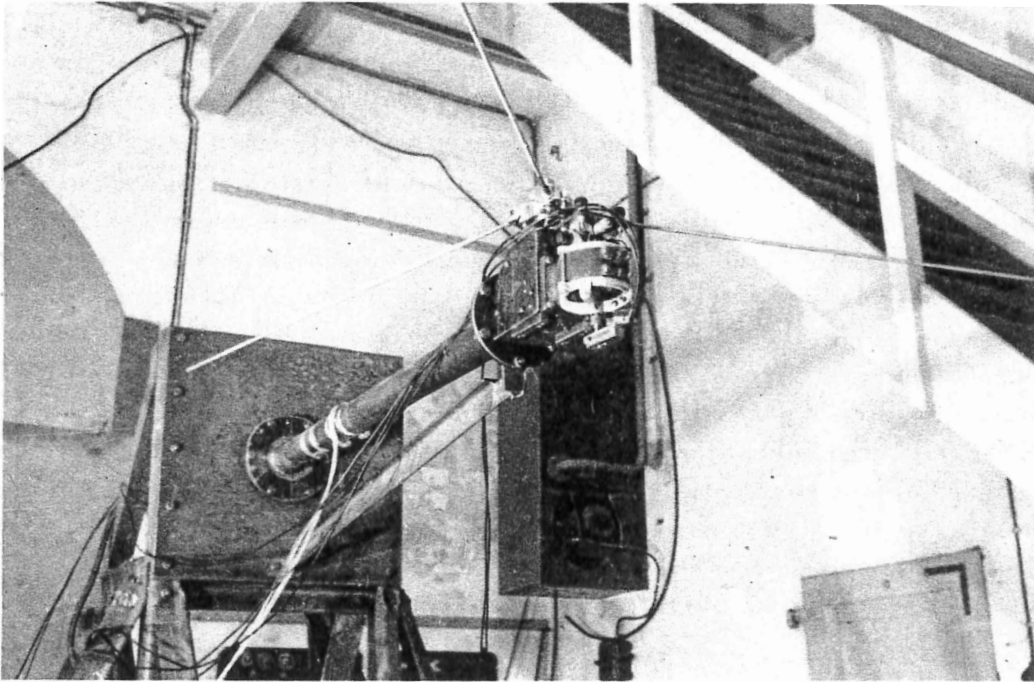

Fig. 16: Model scale experiment for centric angle oscillation

The movie shows the first attempts with this full-size aircraft in the Chalais-Meudon wind tunnel. If you try to detect a centric angle between two blades by eye, you can clearly see how it increases and decreases, but slower than the rotor rotational speed. Of course, this only works out to the good because the self-excitation starts here at a low rotational speed. But it is impossible to increase it. Once the phenomenon was understood and computationally manageable, it was not too difficult to shift it out of the operational range by modification of the blade mass or the restoring moments. It was only after that event that Mr. Hohenemser drew my attention to the fact that Prewitt⁷⁷ had already tackled the phenomenon in England. Mr. Hohenemser himself recently published an article in the *Ingenieur-Archiv* with results similar to ours⁷⁸.

Different from this oscillation was a phenomenon that we have christened *air force fluctuation*. It was first observed by the vibration of the rotor hubs at a frequency of rotational speed times the number of blades, and only then theoretically clarified by the head of my aerodynamic department, Dr. Just⁷⁹. If a helicopter with a finite number of blades hovers with no wind, the thrust of its rotors is undoubtedly constant over time for reasons of symmetry. But if it flies forwards, this is no longer the case. For example, with three blades the rotor lift is smaller when a blade points straight ahead and greater when it is over the tail. The *direction* of the respective thrust also fluctuates with the same frequency. This can be determined from the air forces on the individual blades by simple, albeit lengthy, calculations.

⁷⁷ Prewitt, R.H., Wagner, R.A. (Kellett Autogiro Corporation): Frequency and Vibration Problems of Rotors, Second Annual Rotating Wing Aircraft Meeting Held at The Franklin Institute, Institute of the Aeronautical Sciences, Philadelphia, Nov. 30-Dec. 1, 1939; also in: *Journal of the Aeronautical Sciences*, 7(10):444-450, 1940. In that article the phenomenon was already named “ground resonance”.

⁷⁸ Hohenemser, K. (Anton Flettner Flugzeugbau GmbH): Zur Dynamik von umlaufenden, gelenkig an die Nabe angeschlossenen und in der Umlaufebene schwingenden Stäben, *Ingenieur-Archiv*, 14(2):83-85, 1943.

⁷⁹ In Focke's lecture “Mr. Schweym” was mistakenly named. Dr. Just later made a hand note in his copy correcting that.

As you can see in Fig. 17, the fluctuations are sometimes considerable and require careful consideration for the fatigue strength of the aircraft structure. It therefore makes sense to ask what influence the number of blades has. We checked this question for 2, 3 and 4 blades and found that the variation for 2 blades is very large, on the order of the weight in flight. However, it disappears towards an infinite number of blades, where it must of course be 0, unfortunately not proportional to the number of blades. With 3 blades, as you can see, it is larger in the x-direction than in the z-direction. With 4 blades it is the other way around, without any significant structural advantage emerging. It would be interesting, but not yet possible due to a lack of staff, to investigate the issue for five and more blades.

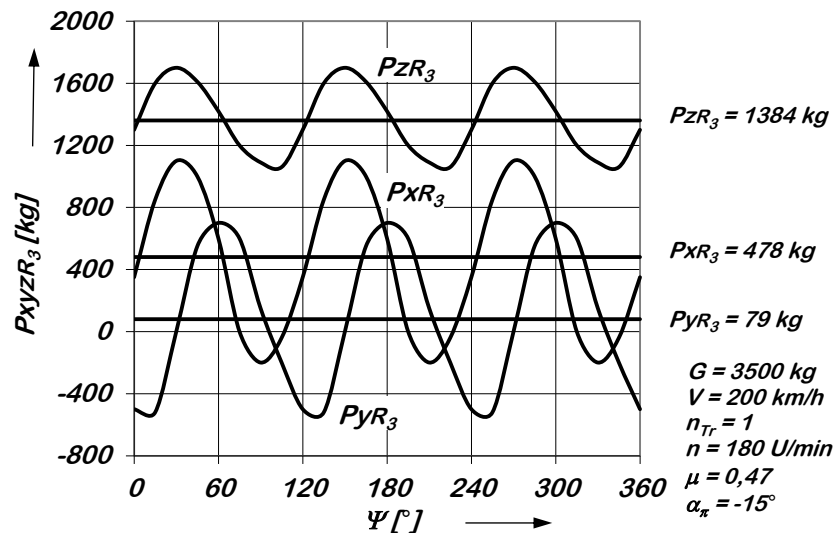

Fig. 17: Fa 223. Forces of all three blades in x_R , y_R and z_R direction

The fluctuation of air force has forced us to make careful *measurements of the stresses* during flight in the struts of the rotor support structure, again electrically with oscillographic recording, as with the moment measurements of the blades.

Fig. 18 shows a characteristic case of the Fa 223 for a gross weight of 3,700 kg, a speed of 160 km/hr, a rotor speed of 266 rpm, i.e. 4.4 revolutions per second. You can clearly count the three periods between the marks of a revolution.

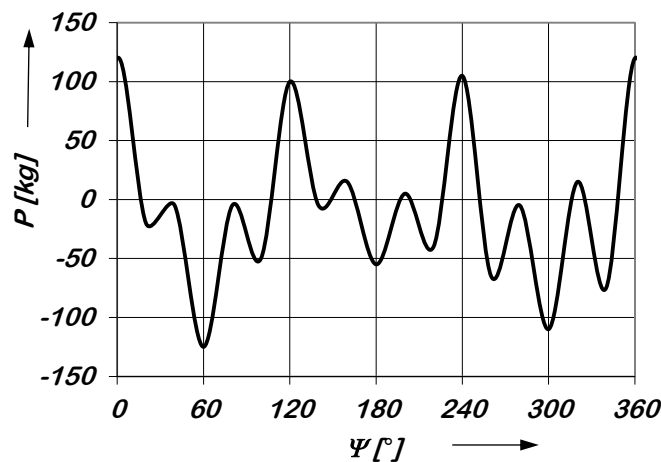

Fig. 18: Measured fluctuation in force of the rear tension strut of the rotor support from the Fa 223. Flight condition: helicopter horizontal flight, $V = 160 \text{ km/hr}$, $n_{Rotor} = 266 \text{ min}^{-1}$, $\mu = 0.266$.

In general, it has been found that the other rare peak loads relate to the ones in question roughly like the static breaking strength of steels relate to their fatigue strength, so that the use of more than three blades from this point of view, even if they considerably reduced air force fluctuations, would not appear justified. Of course, this can change for example with different masses of the rotor hubs that reduce a large portion of the fluctuating loads by acting as a mass damper; therefore, this is not generally valid for all designs.

All of the things mentioned so far have surely brought all sorts of difficulties and required lengthy theoretical, constructive and workshop efforts, but none of the problems in the development of *large* helicopters came close to an apparently simple and primitive problem: the very *common imbalance* of such large rotors. It is true that it is relatively insensitive in terms of mass, and on the other hand, a set of such rotor blades can easily be precisely adjusted in terms of weight and center of gravity. What is decisive, however, is the imbalance that is indirectly caused by aerodynamics. Since the blades are articulated, e.g. a blade with a slightly larger angle of attack immediately lags the other blades due to increased drag. The centric angle in front of it in the direction of rotation becomes larger, the one behind it becomes smaller, and the symmetrical star of blades is disturbed. This process is extremely sensitive. Even an angular error of 2 arc minutes (0.033°) on a blade makes a slight fluctuation of the whole machine noticeable in the rotational frequency of the rotors. 10 arc minutes (0.167°) are uncomfortable and with an error of 20 arc minutes (0.333°) nobody will fly anymore. If such an accuracy would place high technical demands on the blade itself, the joints and the hub with a blade that is fixed in the angle of attack, this is all the truer if the blades of a helicopter are controlled both collectively and periodically with the rotor rotation in the angle of attack. The entire control mechanism must apply exactly the same sinusoidal angle of attack variation to each individual blade with an accuracy of 2 arc minutes to at most 5 arc minutes (0.083°) during one revolution. In the course of countless reconstructions and conversions, it has been shown, for example, that in helicopters of the size of the Fa 223 no slide bearing, no matter how well made, meets this requirement, because the change in the lubricating film thickness of several consecutive bearings in the linkage already leads to greater inaccuracies. Only the best rolling bearings with their very narrow tolerances meet the requirements, combined with careful design of the stiffness of all components. It was only around 1½ years ago (spring 1942) that this problem was fully mastered, and practically usable methods were also found for the precise basic setting required during the first assembly.

Although a lot more could be mentioned, I would like to conclude the overview of the theoretical and experimental preparatory work. You are right to ask what has now been achieved in practice.

The preparations for the *construction* of the largest helicopter, the Fa 223, were already under way during the theoretical investigations, where possible. In order to get a usable prototype as soon as possible (that means in a few years), it was decided in agreement with the authorities not to change the *basic shape* compared to the F 61, although the aerodynamically unfavorable rotor outriggers had to be accepted (Fig. 19). It would now have been logical to at least put the long drive shafts next to the main strut and place a fairing around both. But that would have required the development of a special motor with upright shaft if it were to be housed in the fuselage. This also had to be rejected in the interest of using a standard engine. It was also investigated whether at least the large strut framework of the outriggers could be given up in favor of an aerodynamically better solution of a cantilever design. With regard to the elastic deformation, which is vital for the drive issue, there was also a negative answer here, if one did not want to take the risk of the development failing for such reasons. That explains why this machine still looks aerodynamically unpleasant.



Fig. 19: Fa 223

The development of the *mechanical engineering part* was again taken over by the Brandenburgische Motorenwerke, later BMW development plant in Spandau under the direction of Mr. Wolff. The step from 160 to 1,000 HP posed difficult tasks here too. Of course, a great advantage could be used, which was that the engine was relocated into the fuselage behind the passenger cabin, because on the one hand artificial cooling is necessary, on the other hand the autorotative flight with the propeller in front was proven by the F 61 and did not need to be repeated here. At the same time this poses the possibility of a cockpit and therefore the best view even with a single-engine aircraft (Fig. 20).

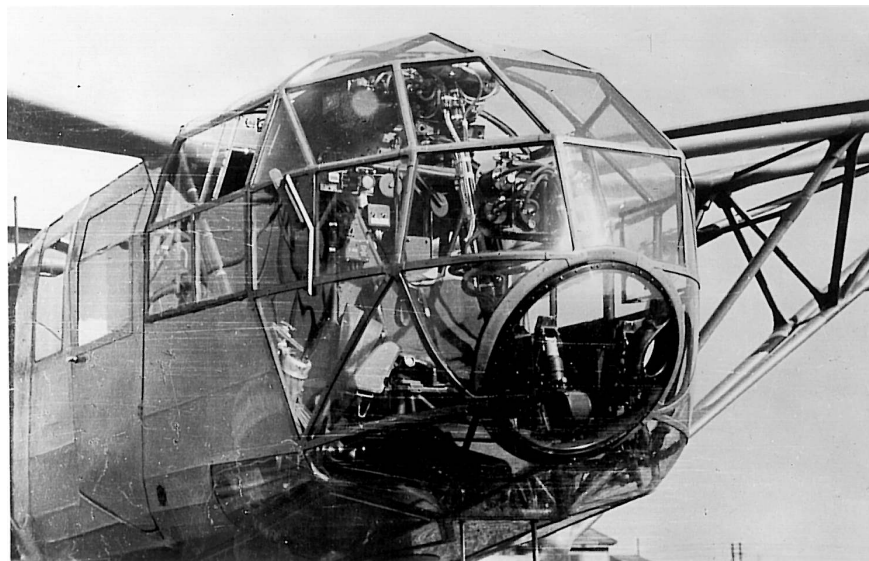

Fig. 20: Glass cockpit of the Fa 223

In the F 61, as you will remember, the two shafts operated at rpm higher than the first bending critical [natural frequency] and therefore only had a simple friction vibration damper in the middle.

The critical bending [frequency] was passed without risk when spinning up. When calculating the large machine, it turned out that this was no longer possible. You either had to allow the operation beyond the 2nd critical bending, which would have been passed through at quite high rotational speeds, or divide the shaft by a fixed bearing at the bracket and the two halves would run between the 1st and 2nd critical bending with two centrally placed dampers. The latter solution was chosen as the safer one, as you can see in Fig. 21.

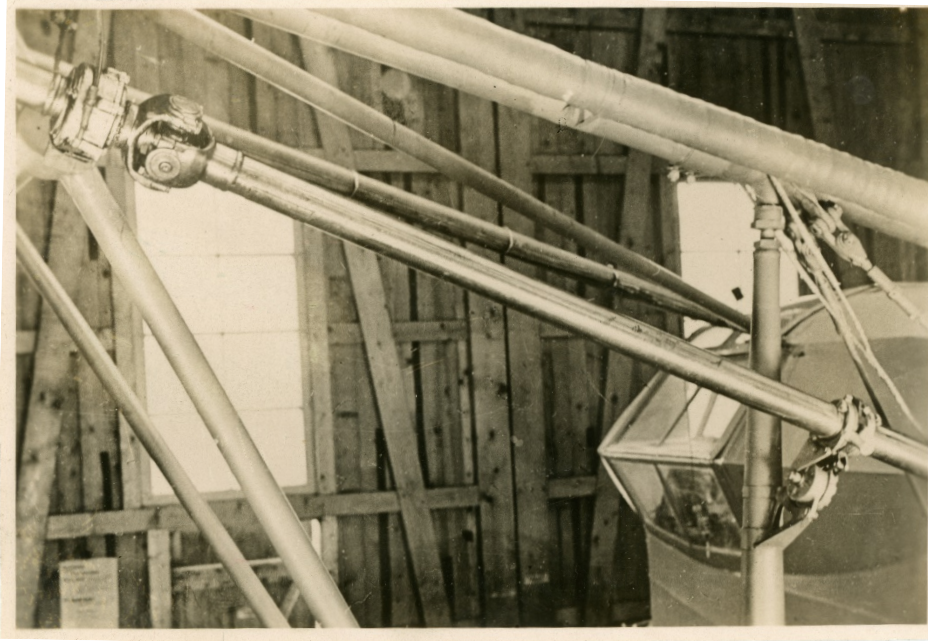

Fig. 21: Shaft bearings (Photo: Steve Coates)

Even mastering the *torsional oscillations* of the entire drive system was not that easy. At first it seemed as if it could only be achieved by using oscillating counterweights, i.e. mass damping, on the crankshaft of the BMW-323 engine, which would have required modifications compared to the series production engine. Ultimately, however, this could be dispensed with, due to perfectly permissible vibration stresses that were proven by torsionography.

Another deviation had to be made in the *construction of the rotor hubs*: The reduction to the low rotor speed could still be managed in one step with the F 61. Here a bevel gears and a pair of spur gears had to be used one behind the other, hence the elongated design of the rotor hub housing (Fig. 22).

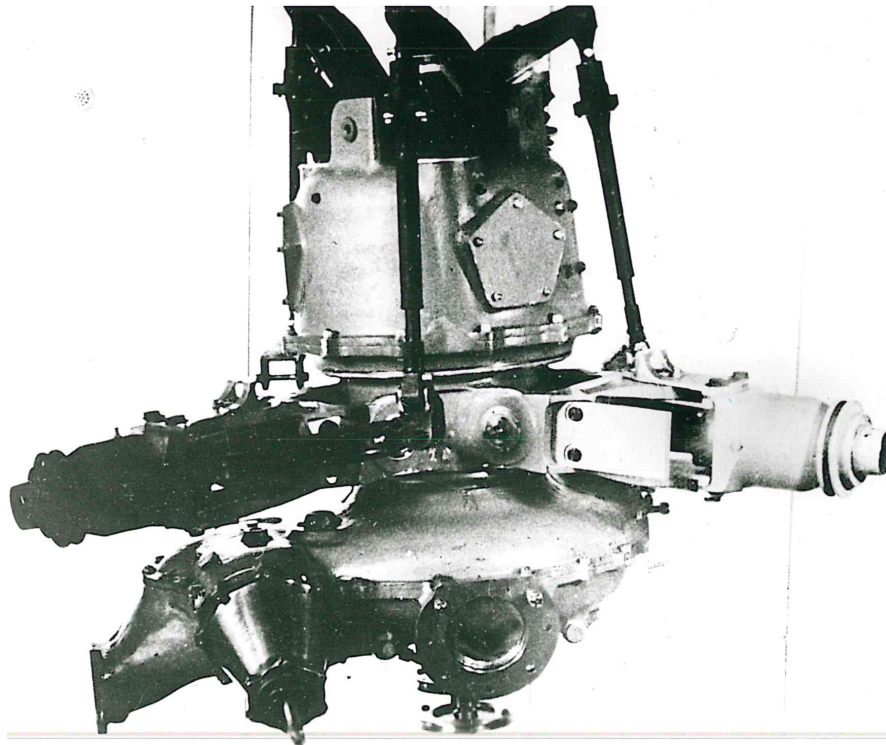

Fig. 22: Rotor hub

The motor installation with cooling jacket and cooling air duct to the oil coolers is shown in Fig. 23.

Finally, because of the greater forces, the *switching processes*⁸⁰ could no longer be carried out manually, as with the F 61, but had to be carried out hydraulically. Although the arrangement became more complex, the advantage was that the coupling speed can be precisely adjusted by regulating the oil flow. Operated manually, rough coupling can easily damage the vital, articulated blade connections, which cannot possibly be designed and built for arbitrary high rotational accelerations.

After completion, the Fa 223 was also subjected to an *endurance run* tied down to the ground, namely 100 hours, according to a new engine model, each 4 ½ hours with 90 % power, 27 minutes with 100 %, 3 minutes with 110 % in a five hours schedule. Several incidents, mostly due to the imbalance and vibration reasons mentioned before, repeatedly prompted a restart of the endurance run. After many successful flights in 1940/41, a serious accident occurred in February 1941 due to the breakage of a faulty weld, as would of course have occurred on any normal aircraft⁸¹. The final version was flown for the first time in May 1942, but after almost the entire type test had been carried out, it was destroyed by the British air raid on my Delmenhorst plant on June 4, 1942, together with the first seven machines of the series production⁸² that was just ramping up. After the reconstruction, the first new machines rolled out in February of this year.

⁸⁰ From helicopter to autogyro mode

⁸¹ More details about this accident see: Göttinger Monograph N, AIAA Library of Flight.

⁸² The Fa 223 was the first series production helicopter, shortly before the Flettner Fl 282, see footnote 87.

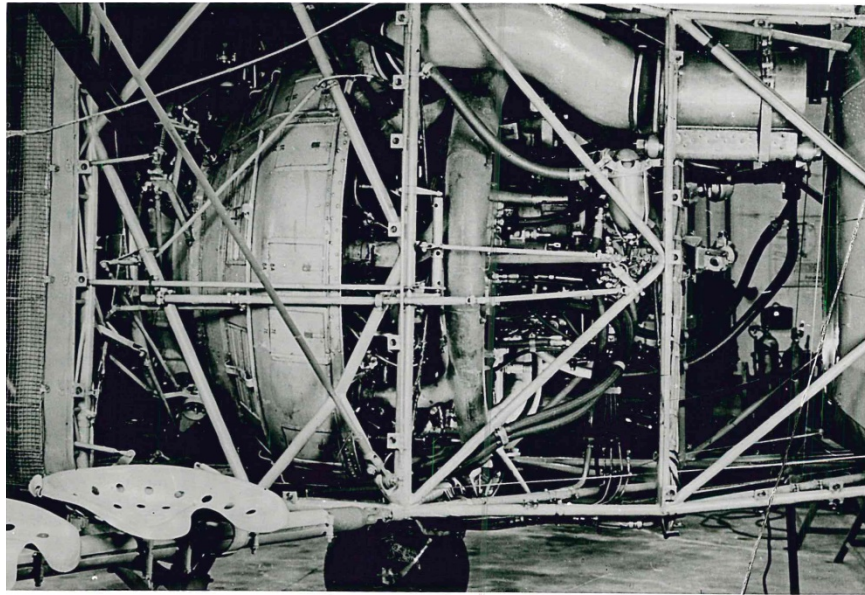

Fig. 23: Installation of the BMW 323 motor

I owe Flight Captain Bode many thanks for the tireless and often dangerous *test flying* of this prototype to a maturity that can at least compete with the 30 years older normal fixed wing aircraft.

Fig. 24 shows the cockpit. It no longer differs significantly from a normal aircraft.

In terms of performance, the expectations have been significantly exceeded. Instead of the required 700 kg payload, the final model carries 1,150 kg with a maximum gross weight of 4,300 kg, with an empty weight of 3,150 kg. The top speed was measured by the Rechlin flight test center at 182 km/hr without streamlined fairing of the outrigger tubes, which leads to around 210 km/hr with fairing. With the normal load of 3,700 kg, a summit height of 7,100 m was reached, although the machine was not yet fully flown out. While the take-off and landing speed as a helicopter is of course 0, the landing speed in autorotation is only 54 km/hr, such that the risks of an emergency landing are much smaller than with a fixed wing aircraft. The machine can be flown backwards at around 30 km/hr. The best rate of climb at sea level is 10 m/sec, the vertical (with zero forward speed) about 8 m/sec.

The pilot question has so far hardly caused any difficulties. 25 pilots with a wide range of previous training learned to master the helicopter mostly in a few hours, mostly without using a dual control. The entire behavior of the machine and the flight characteristics are at least so well developed that when you fly in it as a passenger, for which the Fa 223 as a helicopter offers the first opportunity, you don't feel any difference in high-speed flight compared to the fixed wing aircraft, not even in the pilot's control movements. The impression of hovering stationary in the air, on the other hand, is of course very strange at first, especially at low heights.

Since I wrote down this lecture, the distance covered in cross-country flights has grown to several thousand kilometers.

The following movie shows some sequences of the Fa 223 in flight.

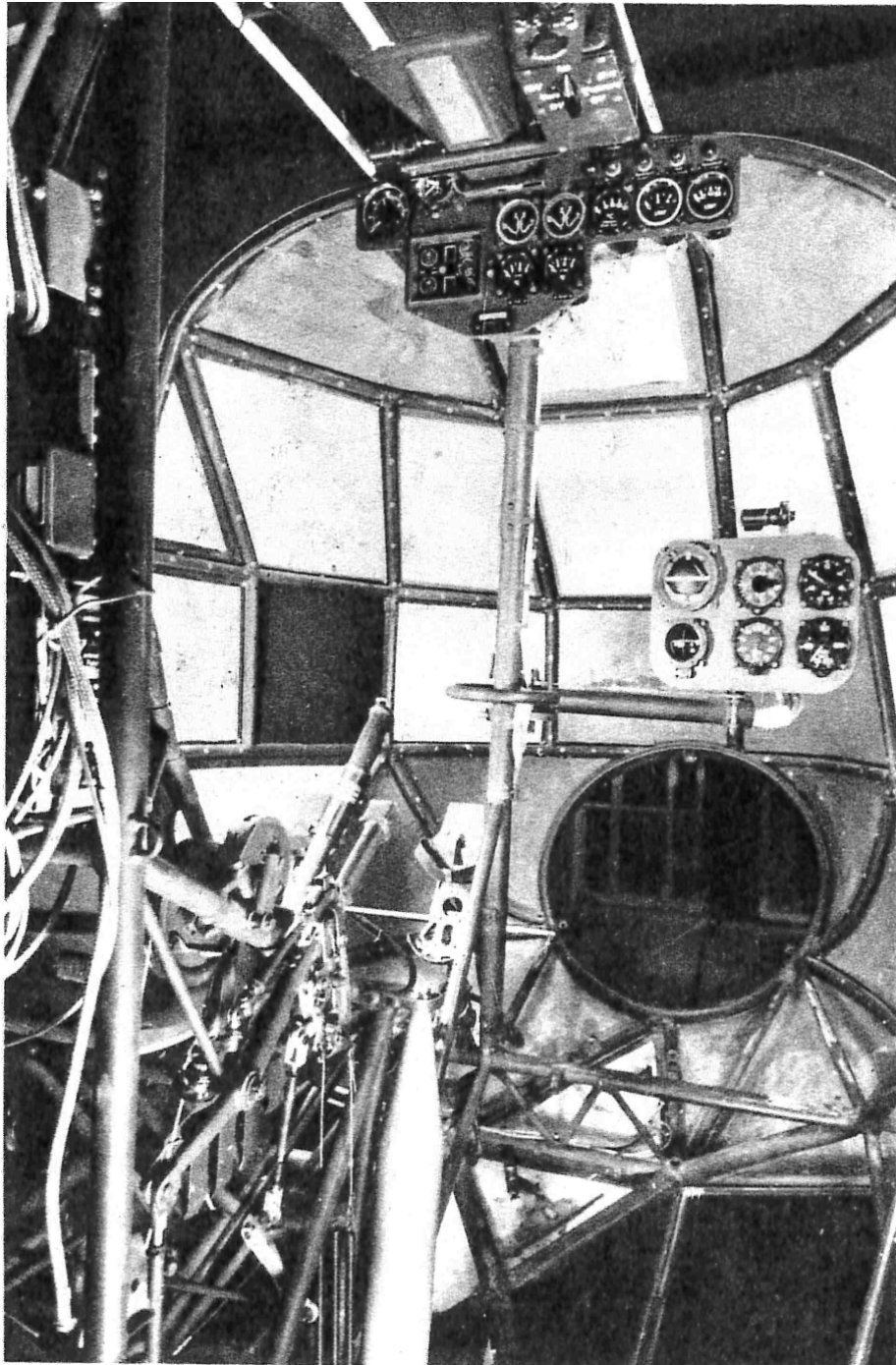

Fig. 24: Cockpit of the Fa 223

To a certain extent, as a by-product of the helicopter development, we designed two other vehicles, both of which are towed *gyrocopters*. The success of the cargo sailers in the western campaign prompted the authorities to commission my company to equip a D.F.S. 230⁸³ with a rotor instead of its fixed wing in order to achieve even lower landing speeds while accepting the worse glide angle of the rotor of about 1:5 (Fig. 25).

⁸³ D.F.S. = German Research Institute for Sailplane Flight in Darmstadt. The 230 was a transport glider with a MTOM of 2.1 tons that was built in large numbers and was used in WW II from 1940 on. The wheeled gear was dropped after take-off, a spring-supported ski was used for landing. Capacity: pilot plus 9 troops in row.



Fig. 25: Towed gyrocopter

The calculation, construction and conversion were completed in 7 weeks by simply placing a rotor from the Fa 223 on a tubular frame, which in turn was carried by the fuselage of D.F.S. 230⁸⁴. I mentioned that we control the altitude of the helicopters by sinusoidally changing the blade pitch angle during the revolution. The height control of the rotor heads of the Fa 223 was made here by turning them by 90° in the top view for rolling control, while the longitudinal and lateral control are performed by the normal tail unit. When towing during start, a wire rope attached to the ground is unwound from a drum that pre-rotates the rotor. The trials were immediately successful; thus, the technical problem was quickly solved, and in addition to our own pilots, various D.F.S. pilots used this gyroplane to be towed by an He 46⁸⁵ (Fig. 26) and a Ju 52⁸⁶ (Fig. 27), they disengaged and performed perfect landings. However, the tactical value or the changed war situation did not seem to justify such a construction, because series production was abandoned.



Fig. 26: Gyrocopter towed by a He 46

⁸⁴ Instead of the normal wing.

⁸⁵ He = Heinkel. High wing airplane, MTOM = 2.3 tons, in operation since 1936. Pilot plus observer/gunman.

⁸⁶ Ju = Junkers. Low wing airplane, MTOM = 10.5 tons, in operation since 1932. Staff: 3, up to 17 passengers.

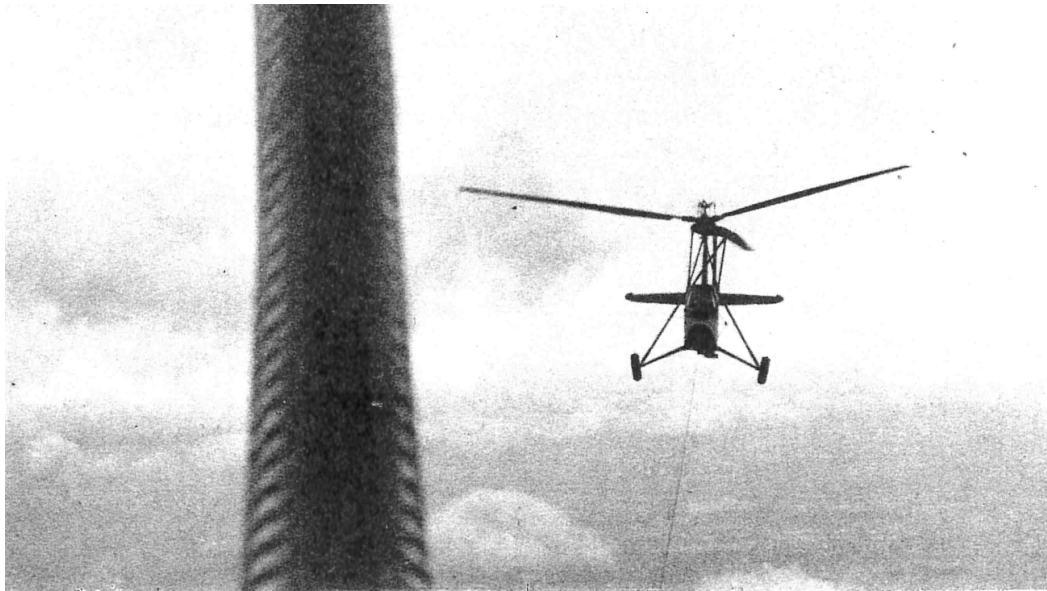

Fig. 27: Gyroplane tow behind a Ju 52

But indirectly, this work bore very important fruit. The engineers who were involved in this, Messrs. Klages, Gensel and Bode, didn't want to give up the idea and suggested creating a very small, easily dismantled, towed gyroplane for the submarine weapon, whose constant complaint since WW I has been the impossibility of a far view and therefore already considered the use of helicopters. This became the Fa 330, of which I already spoke on the occasion of the centric angle oscillation (Fig. 28). The goal was, even when there was no wind, to use only the highest speed of the boat to bring a single man about 200 meters high up on the tow rope, whose task was to steer the aircraft and at the same time to observe the horizon for ships.



Fig. 28: Fa 330. Small gyroplane that can be taken apart for submarines.

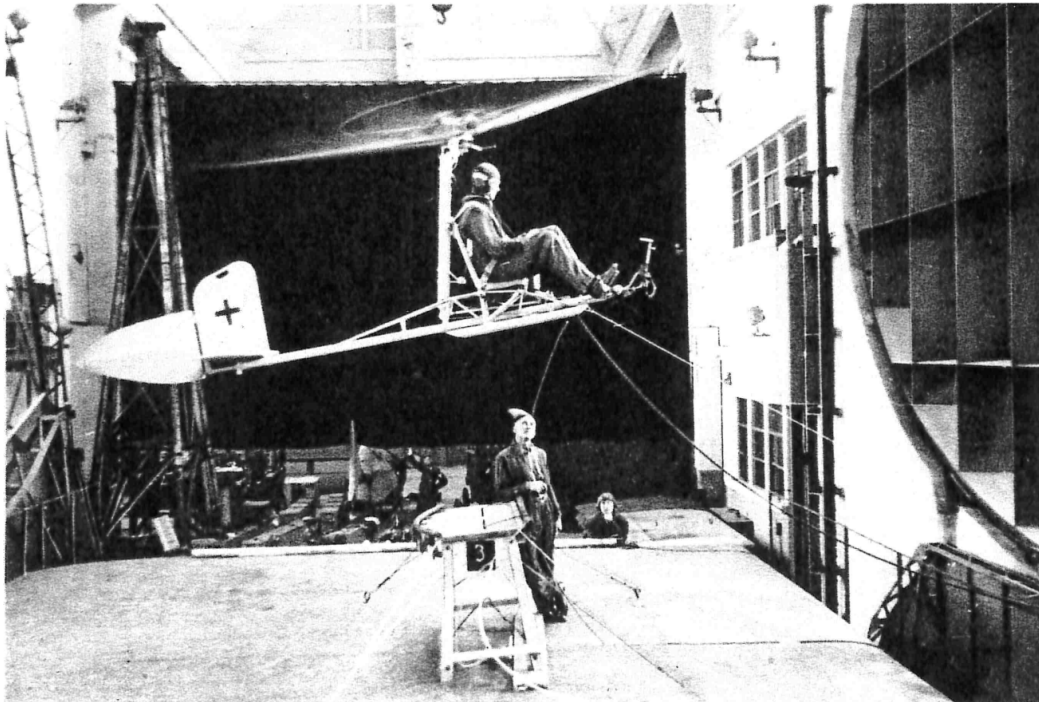

Fig. 29: Wind tunnel tests of the Fa 330

The idea came up in autumn 1941, in the winter the wind tunnel tests were carried out with the first full-size model in Paris and it was also flown in that tunnel in the spring of 1942 (Fig. 29). The first free flights on the experimental ship “Greiff” took place in Travemünde in June 1942 (Fig. 30). The series production began in autumn 1942, and the first auxiliary cruiser was already equipped with it at that time, the first submarine at the beginning of 1943. Incidentally, all series aircraft are also flown in the wind tunnel in Paris and the numerous pilots, mostly simple sailors and mates that have never flown before are given initial training there.

The small gyroplane has a simple, foldable tubular steel frame and a three-bladed rotor of 7.3 meters diameter, the blades of which, like the tail unit, can be quickly removed (Fig. 31). The pilot sits freely as if on a school glider (Fig. 32). The empty weight is only 70 kg, the gross weight 170 kg. For this weight, a minimum flight speed of 7.9 m/sec or a little more than 15 nautical miles/hour were measured. The design is based on a maximum speed of 80 km/hr, since wind speeds over 22 m/sec need not be assumed in weather suitable for observation purposes. With this small weight, lateral and longitudinal control could easily be achieved by directly tilting the rotor hub, while the heading is controlled in the usual way (Fig. 33).



Fig. 30: Free flight of the Fa 330 towed by an experimental vessel

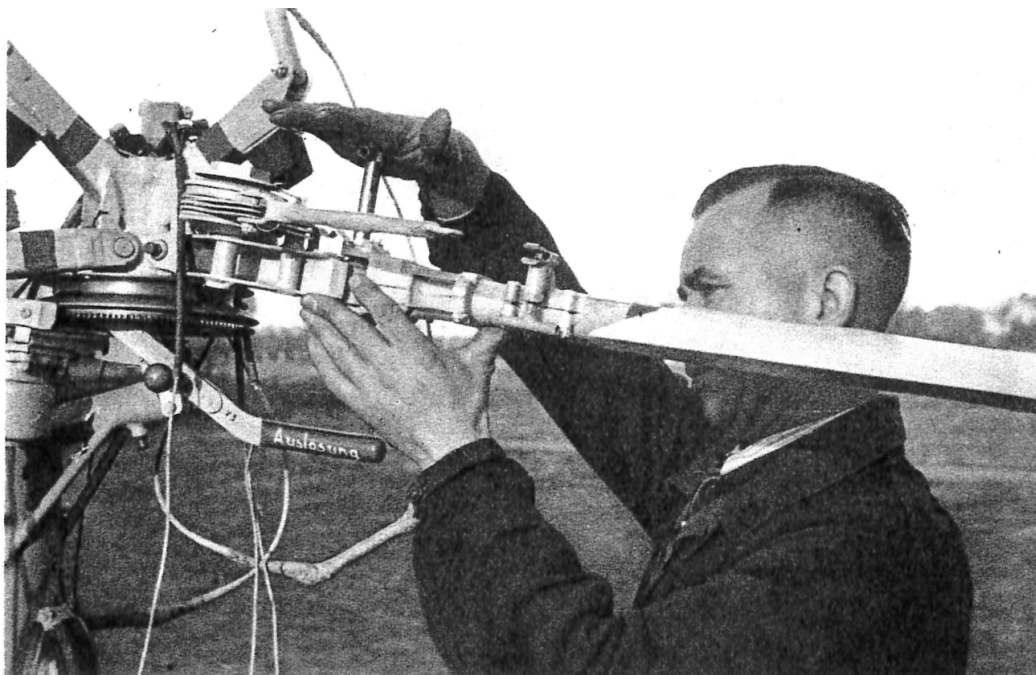

Fig. 31: Rotor hub of the Fa 330

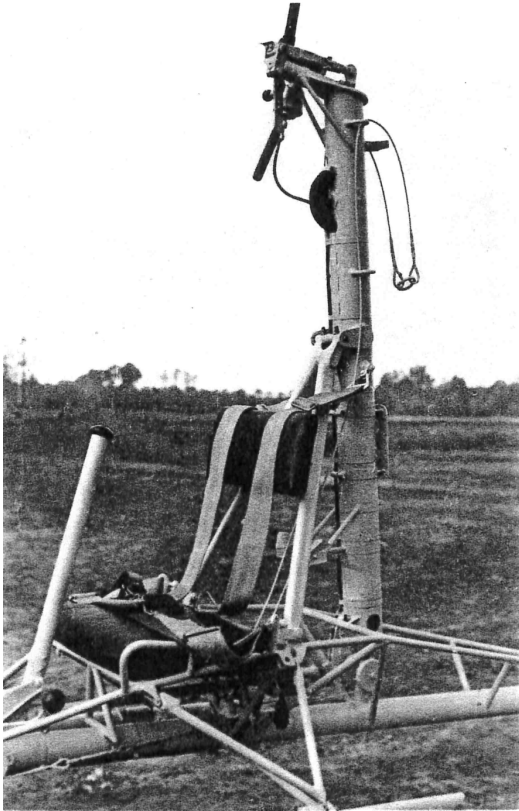

Fig. 32: Pilot seat of the Fa 330

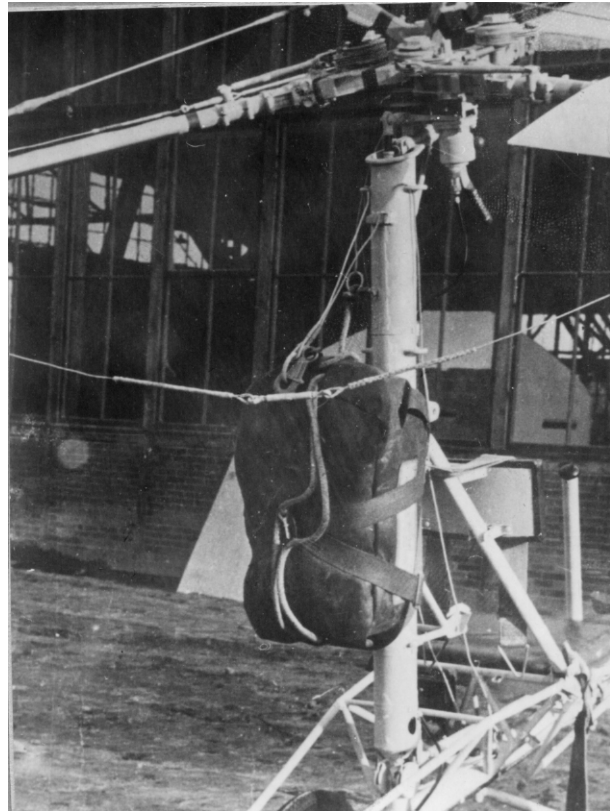

Fig. 33: Rotor hub tilt control

As with the known towing of aircraft, the pilot can talk with the submarine commander using a telephone cable and, in addition to his messages, also announces the speed level required for his flight, which of course depends on the wind speed.

In the event of danger, the pilot can release the rotor so that – while in the water – he is not hit by the blades that are still rotating. With the release of the rotor, the parachute opens at the same time, which carries down the whole machine, then weighing only 40 kg, together with the pilot.

The accommodation on the submarine takes place in a watertight tube (Fig. 34). The rope is pulled in and extended by a small electric or compressed air winch, while take-off and landing take place on a spring-supported table next to the tower of the submarine, so that take-off and landing devices on the aircraft can be omitted in the interests of saving weight. Two men aid and, on command, loosen a mooring during take-off, which they fasten again immediately upon landing. The rotor is started like a children's spinning top by pulling a rope from a drum underneath the rotor hub.

Removing the aircraft from the tube and setting it up on the take-off table takes just a few minutes if the crew is properly trained, as does the stowage.

The first reports from the South Atlantic tell of the successful usage of this aircraft, so we can hope that the submarine has been given one of its most urgent needs, the high-flying observation post. This is probably the first time that a rotating wing aircraft has successfully solved a task that remains beyond grasp of the fixed wing aircraft. This is due to the fact that the rotor with three slim, easily stowed blades is able to represent a very large rotor disc area, which - as a wing of a fixed wing aircraft - is no longer controllable, and thus enables the small minimum speeds required.

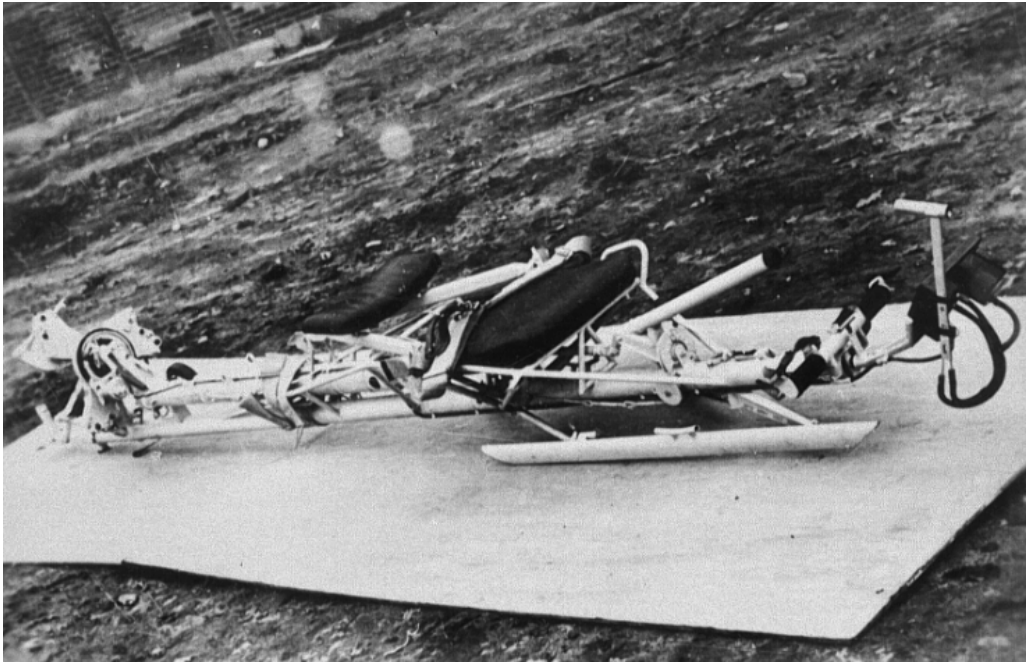

Fig. 34: Fa 330, folded

As regards the future development, we are currently still in a good position in Germany. In addition to the above-mentioned models, the Flettner helicopter⁸⁷ has also demonstrated practical success and has already been operationally used on a trial basis. A helicopter the size of the Fa 223 is not yet available in any country with anything similar in performance⁸⁸. But by no means can we be satisfied with that. News is already coming from America that the very small Sikorsky helicopter⁸⁹ with 90 HP is doing an apparently similar service on warships as our Fa 330. It will take every effort to stay ahead because of our known difficulties in personnel and material such new things are particularly hard hit. It is precisely for this reason that we must not be deceived by the fact that the introduction of rotating wing aircraft in the troops will still bring up difficulties and setbacks.

The *progress of research* is therefore of the utmost importance. One of the greatest shortcomings of the previous theory, the assumption of uniform inflow through the rotor disc, should soon be eliminated by theoretical aerodynamics⁹⁰.

Furthermore, extensive measurements would have to be carried out and, in connection with this, the extension of the corresponding calculation methods for the distribution of air forces and moments on the rotor blades, questions that are closely related to the first point mentioned. I already mentioned the need for statistical analysis of acceleration measurements during flight.

⁸⁷ Fl 282 with intermeshing Flettner rotor, MTOM = 1 ton. Crew: 1 pilot. Reconnaissance helicopter, worldwide second series production of a helicopter from 1942 on.

⁸⁸ The Sikorsky S-55 had about 1-ton payload and was produced from 1952 on.

⁸⁹ This hints at the Sikorsky VS-300 experimental helicopter, that was tested for use on water in 1941 with floats at the landing gear. A series production achieved the Sikorsky R-4 end of 1942/begin of 1943, which was also used for securing ship convoys against submarines.

⁹⁰ It is surprising that Focke still assumes constant inflow. Glauert and Lock in 1926/27 already suggested a linear longitudinal inflow variation with a magnitude on the order of the mean. Wheatley in NACA TR 487 of 1934 took that up again by using $v_i/v_{i0} = 1 + K x/R$, with $K = 0$ in hover and 0.5 in forward flight. Sissingh in *Luftfahrtforschung* 15(6), 1938, applied a linear radial variation in hover in the form $v_i/v_{i0} = r/(0.7R)$.

We also need to get extensive measurements of the flow fields in the vicinity of helicopters and autogyros.

The wind tunnel corrections are still very unclear, namely the large flow deflections that are caused by helicopter models in the test section.

Furthermore, some unsteady processes, e.g. when switching from helicopter to autorotation mode and back, are to be clarified.

An extension of the theory of the ground effect and, in connection with it, stability near the ground would also be desirable. And for the future the question of the blade tips approaching the speed of sound arises almost threatening at the horizon, because due to the constant transition from subsonic to supersonic areas during the revolution, the prospects here still seem particularly dark today, so that the construction of helicopters with speeds over 400 km/hr⁹¹ with today's knowledge would encounter great difficulties due to the strong alternation of air forces and moments.

As far as the design is concerned, it would be time to develop a single-rotor, high-speed helicopter with a speed of around 400 km/hr (216 knots) and a modern aerodynamic shape, as shown in this project, but this task has been postponed at this time. My company is asked to upscale the large twin-engine crane helicopter, which, in the form of the Fa 284, will carry around 3 tons of payload with 3,200 HP at a speed of around 200 km/hr. Also, for the Navy the Fa 336, a small 60 HP single-rotor helicopter weighing around 300 kg intended to replace the Fa 330, which of course has to accept some restrictions in operational use due to the connection to the tow rope. It will hardly need more space on the submarine than this one (Fig. 35).

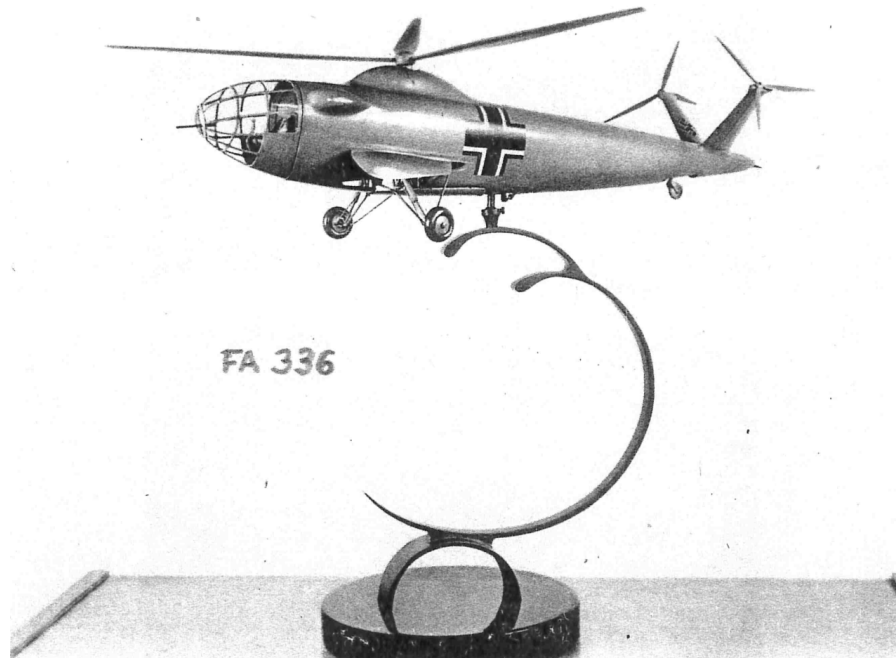

Fig. 35: Project Fa 336

⁹¹ 400 km/hr = 111.1 m/s. The blade tip speed of the Fa 223 in average was only 157 m/s, such that an advance ratio of 0.7 would have been obtained, otherwise the maximum velocity on the advancing side would be 268 m/s, or a Mach number of 0.8 would have been reached. Today's helicopters have blade tip speeds of about 220 m/s, thus reducing the advance ratio to 0.5, but increasing the maximum Mach number to 0.97. Therefore, one could not speak of supersonic speeds yet, but of proximity to the speed of sound, especially the inclusion of compressibility effects.

I don't need to say much more about the *use of helicopters and gyrocopters*. In his comprehensive lecture on the impact of new technical developments on warfare, our Mr. Chancellor has already stated the most essential points in this area as well. Perhaps it is also worth mentioning that the use of the helicopter as an army device is clearly beginning to emerge. In addition to the well-known task of replacing tethered balloons for artillery observation, the commanders also think about direct troop leadership by use of helicopters. You saw examples of pioneering tasks, such as river crossings etc., already shown in the movie about the Fa 223. The artillery in mountain warfare can be made very much easier by transporting artillery and ammunition to points that are otherwise not at all possible, or with a great deal of time and effort.

During a demonstration of the Fa 223 in the narrow courtyard of the *H*-barracks on Obersalzberg, the Führer himself described the use of the mountains as one of the most important, especially for supplies⁹².

On the other hand, the Fa 223 is also equipped with two 250 kg bombs for naval use, firstly for fighting submarines, since it can constantly adapt to the low speeds, and secondly it is used as a sea rescue aircraft to pick up four castaways by means of an electric winch. Since the rescue cage is set up in such a way that even the most exhausted man can easily get in and the aircraft can really stand still at a height of about 20 meters, the prospects of a successful rescue are particularly good (Fig. 36).



Fig. 36: Lift cage for Fa 223 - sea rescue aircraft

⁹² This event happened on June 12, 1943.

As a disadvantage of the use of helicopters, one has sometimes argued a lower bulletproof safety. Probability considerations suggest, however, that the rapidly rotating blades, the vital cross-sections of which are only the thin spar tubes, tend to have lower probabilities of impact. The rest of the aircraft is not significantly more endangered, but the defense as a result of the possibility of completely different flight movements – e.g. turning on the spot – is a particular advantage if, of course, a helicopter mission that is endangered by the enemy cannot be left without fighter protection due to the inferior speed. Above all, however, one thing is often overlooked when discussing the purposes of use: Many applications are *unveiling* only after a new device is available. For years, even after the first tangible successes, the helicopter has met with rejection in many circles due to a wrong attitude that compared its performance with the maximum performance of the fixed wing aircraft, as if it were a competitor of it. That is not the case at all, although one has to consider that the development of the helicopter has been neglected and fallen back compared to the fixed wing aircraft for 30 years. Rather, it is a matter of the rotating wing aircraft – and especially the helicopter – opening up wide areas of application that are not accessible to the fixed wing aircraft.

For our nation, which today cannot think of anything other than the total war, the most important thing is to create special military opportunities that otherwise could not be created. But for a moment we can modestly state the general fact that the helicopter is the third type of aircraft, next to airship and fixed wing aircraft, and the second type of “heavier than air” that has come into practical life.

Although the rotating wing aircraft has achieved a great mental breakthrough during the last year and is the subject of urgent requirements particularly on the part of the army, today, of course, the extensive production of *large* rotating wing aircraft faces considerable obstacles in terms of working capacity.

With my employees and myself, all those men who have lent their imaginary and active support to the cause for a long time will feel great satisfaction with the complete *technical* success with regard to the future. In addition to these and the responsible gentlemen of the authorities, I also express my binding thanks to many members of the Academy, headed by our Chancellor.

Discussion

Hohenemser, Berlin (as a guest): The Chancellor of the Academy was kind enough asking me to give you a short report on the Flettner device and also to address some questions about helicopter flying that I consider important in general.

From the Flettner helicopter with the crossing wing trajectories, the rotor arrangement of which is shown schematically in three views in Fig. 1, 20 aircraft have so far been flown by over 20 pilots, summing up to around 400 hours of flight and almost 1,000 hours of operation.

The order for the first two prototypes⁹³ was placed in May 1938 after a preliminary development of only 3 months, during which the autorotation capability of the system was essentially demonstrated by a wind tunnel model on a scale of 1:4 in the large wind tunnel of the DVL. No other test documents were available for such a design, neither wind tunnel model nor full-scale flight tests. It was not until a year later, in March 1939, that the first air force measurements could be carried out on a wind tunnel model; they coincided with the beginning of flight testing of the first test aircraft. Despite the fact that the design was carried out without test documents or previous aircraft of this kind, it has not been necessary to this day, apart from small constructional details, to make changes to the rotor system with its complicated control apparatus for the control about all three axes, neither in the structure nor in the lengths of the control paths, phase angles, blade flapping amplitudes, etc. The further development since 1939, which had to suffer severe inhibitions due to the war, extended partly to the fuselage – driver's seat arrangement, tail and rudder positions and their sizes – partly to components that were unrelated to the special features of the Flettner helicopter but are applicable to all helicopter systems, e.g. devices to enable the transition from helicopter flight with the rotor propelled by the engine to the autorotating condition with the rotor driven by the airflow and the reverse transition, or equipment to ensure the ability to fly in the event of engine failure, or improvement to the starter systems of the rotor system, etc.

I would now like to draw your attention to some special flight mechanical characteristics of the helicopter with the crossing paths of its wings.

First of all, on the question of roll stability:

At first glance, you will initially assume that the negative V-positioning of the two rotor planes would also result in negative rolling stability. Actually, this is not the case and the rolling stability is particularly large, so that even in very gusty weather there are hardly any bank angles developing. The explanation for this is as follows: The rotor hubs are so close to each other and the negative V-positioning of the rotor disc planes is so large that the rotor axis still intersects near the center of gravity inside the fuselage. The forces, that are created by the negative V-position when the aircraft is yawing, pass with their resultant in the vicinity of the aircraft's center of gravity and consequently only generate a small rolling moment.

Second, on the question of longitudinal stability:

Since the axis of the rotors are not parallel, but rather inclined to one another, the torques of the rotors do not balance each other completely and a pitching moment remains, the direction of which depends on the direction of rotation of the rotors. With the selected direction of rotation, the reaction torques of the rotors combine to form a nose-up pitching moment on the aircraft. To compensate, the thrust resulting from both rotors must be acting *behind* the aircraft's center of gravity in order to generate a compensating nose-down moment. The rotor system then provides a

⁹³ The Fl-265 was the first Flettner helicopter with counterrotating intermeshing rotors. Its tip Mach number was 0.32

positive contribution to the static longitudinal stability, since a nose-down moment arises when the thrust is increased due to an increase in the angle of attack of the rotor discs. The static and dynamic longitudinal stability is excellent with suitable settings of the horizontal stabilizer in the normal speed range, forced disturbances subside immediately. At low speeds, disturbances are greatly excited, but the oscillation period time is so long that a free oscillation does not occur at all. A comparison of the calculated oscillation period time of about 10 seconds with the flight test result was therefore not possible. In contrast to the result of the calculation, the aircraft is stable to small disturbances also at low flight speeds. The reason is likely to be found in the elastic softness of the rotor blades and the control linkages, which was not considered by theory.

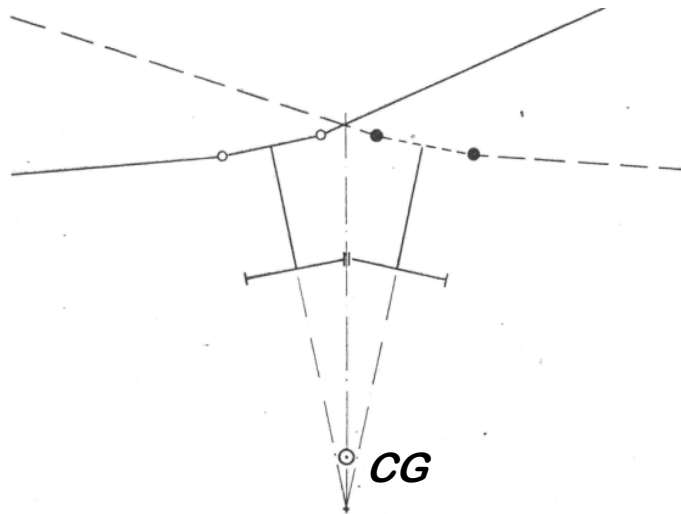

a) Viewed from the back (center of gravity CG is close to the intersection of the rotor axes, the right rotor is shown rotated by 90° in dashed lines)

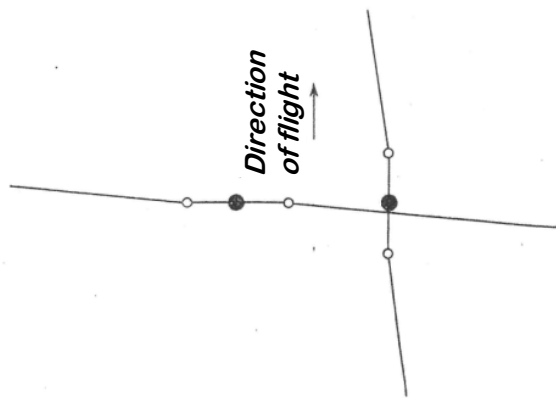

b) Top view (the left rotor is transverse, the right is in the direction of flight)

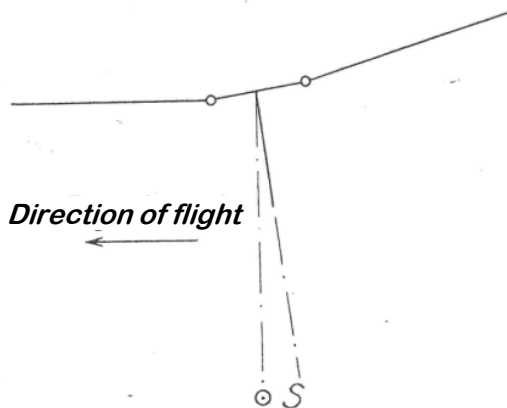

c) Side view (center of gravity S is in front of the rotor axis)

Fig. 1: Scheme of the rotor arrangement of the Flettner device

Thirdly, on the question of lateral control:

While the longitudinal and roll control is carried out by means of blade pitch angle adjustment which is periodic during the rotation and the longitudinal and lateral rotor tilt angles caused by it, similar to the Cierva autogyros, here the pedal control generates a differential blade pitch angle and thus difference in the thrust and torque of both rotors. This type of rudder control has proven itself very well in helicopter flight. There is not only a yawing moment due to the different reaction torques of the two rotors, but the asymmetry of the air flow condition and the resulting rotor tilts result in a rolling moment that fits well with the yawing moment and enables you to fly a perfect curve with almost no lateral control deflection. In autorotating flight, on the other hand, a strange effect occurs in a certain speed range, which we first observed in March 1939 during air force measurements on a wind tunnel model. In that operational area, namely, an increase in the blade pitch angle does not cause an increase in the aerodynamic torque as usual, but on the contrary a reduction in the torque or the generation of propulsion by the airflow. There is therefore a reversal of the rudder control effect in that area. I do not know whether there are blade shapes in which this effect does not occur; it should also be noticeable in other helicopter systems. For example, Bréguet⁹⁴ also controls the yawing moments of his helicopter by means of a differential change in the blade pitch angle. I would be interested to find out whether a decrease in the control effect or even a control reversal was observed in certain flight areas. After results of the first wind tunnel model tests were available, we equipped our aircraft with rudders that they did not have before and dimensioned these rudders in such a way that the rudder effect always remains positive.

The flight tests then confirmed the wind tunnel tests insofar as the control effect in the autorotation flight still proved to be too low and therefore the rudder size had to be increased.

To conclude this brief description of some of the special features of the Flettner vehicle's flight mechanics I would like to mention that the aircraft was extremely maneuverable due to the concentrated masses and the peculiarity of the controls installed. Anyone who has had the opportunity to attend flight demonstrations of the Flettner vehicle will confirm that it made a lasting impression on him how well this aircraft, which looks so sad on the ground with its drooping blades, dominates the airspace, how quickly the transition from stationary flight to high-speed flight happens, how quickly the change from one banked curve to the other takes place. All of us, who are involved in the creation of the vehicle, were just as deeply impressed when Ludwig Hofmann demonstrated a kind of helicopter aerobatics for us for the first time. I hope that you as well will see some good aerial pictures in the movie about landings and take-offs of the Flettner vehicle on board a ship that Mr. Antz will show you afterwards.

I would now like to address two questions of general importance to which we have made a positive contribution in the course of our development, namely the question of regulating the speed of the rotors and the question of high-speed flight.

The question of rotational speed control has to be solved somehow by every helicopter designer, because working with one and the same blade pitch angle in helicopter flight and in autorotation results in a considerable loss of performance, as autorotation-capable blade pitch settings develop a very poor degree of efficiency when they are also used for helicopter flight. Secondly, there is

⁹⁴ Bréguet-Dorand Gyroplane-Laboratoire experimental helicopter with a coaxial rotor system. First flight June 1935, exactly one year before the Fa 61.

then a very large difference in speed between helicopter and gyroplane flight, because when driven by the engine, the speed is much higher than when driven by the airstream⁹⁵.

In principle, the simplest way appears to be the automatic regulation of the blade pitch angle for a constant rotational speed, as has been proposed in various patents for a long time. Unfortunately, this results in fundamental difficulties that are based on the torque characteristics of the rotors, and it is the same phenomenon in certain flight areas when controlling by differential blade pitch angles leads to a control reversal. In these areas, as already mentioned, an increase in the blade pitch angle does not result in an increase in the reaction torque of the rotors, as in helicopter flight, but on the contrary a reduction of it or even a drive by the airstream. In normal flight, the rotational speed control now works in such a way that the blade pitch angle is increased as the rotational speed increases; as a result of the increase in the reaction torque the rotor is then retarded and the speed decreases again. In those autorotative conditions, however, the reaction torque initially decreases, so the increase in rotational speed is greater due to the influence of the controller.

However, this does not go arbitrarily far, since the autorotation finally stops when the blade angle is increased, and there must be a constant strong oscillation of the control process with every type of rotational speed control.

This phenomenon could be predicted from our wind tunnel tests in 1939, and for this reason an automatic control to constant rotational speed was initially avoided. In a different context, namely to check the influence of handling errors, autorotation flights were made this summer with such a control device. Although the control process was very strongly dampened, the expected oscillations occurred to such an extent that there was permanent switching from the autorotation position to the full helicopter position and vice versa. In terms of flight, the condition could be handled perfectly, since the oscillation period time was about 8 seconds, but the flight loads developing are very high.

As a result of this knowledge, we did not plan the rotational speed control automatically from the beginning, but rather manually. The manual lever for the blade pitch adjustment is right next to the throttle, so that when operated at the same time, an approximately constant rotational speed occurs in approximately the entire flight range between helicopter position and autorotation position.

Now the question arises as to the protection against a sudden failure of the engine, because one cannot absolutely rely on the presence of mind of the pilot, who in this case would have to switch to autorotation position in a short time. If he is only about 4 seconds late with this action, then the rotational speed has already dropped so much that it is no longer possible to increase it again by the airstream. In our first prototypes, we had, similar to Prof. Focke, a safety device that automatically switched from helicopter to autorotation mode when the engine speed fell below a certain level. At the same time, however, we also had to uncouple the blade pitch adjustment lever so that the pilot could no longer shift up the blade pitch⁹⁶. We tormented ourselves very much with this safety device, because when the automatic rotational speed for switching was set too low, it caused severe sagging and high vibration loads. When the rotational speed for switching was set higher, the automatic system would occasionally fall out without the engine being disturbed, namely, when the pilot withdrew gas to compensate for a gust, in order to not to rise in the intended

⁹⁵ As Focke had explained before, the helicopter pitch angle was 12° and the autorotation setting was 4°. That loss of pitch angle would have to be compensated for by a significant increase of rpm, roughly $\sqrt{3} = 1.7$, increasing the tip Mach number from 0.37 to 0.64.

⁹⁶ In contrast to Focke's Fa 223 and in the earlier Fw 61 with thrust control via rotor rpm, Flettner had constant rpm and collective control, which had to be disabled for autorotation.

flight near the ground. Switching the automatic system close to the ground could easily lead to a 100 percent crash probability.

In the course of development, we then decided to install an automatic control system for constant rotational speed. In order to avoid the previously mentioned inconveniences of this kind of control, we continuously let it be overridden by the manual adjustment in normal flight. As long as the engine is working properly, the automatic control cannot intervene; the automatic control is overridden even in case of engine malfunctions, if the pilot makes the switching in a timely manner.

The automatic system only comes into effect in the event of an operating error, and only until the pilot has made up for the switching from helicopter to autorotation position at the same time as releasing the throttle.

For direct rotational speed control, this seems like a kind of final solution.

In addition, indirect rotational speed controls using the thrust and torque have also been proposed, the rotor blades being attached to the hub with inclined hinges and changing their pitch angle when flapping up and down and when lagging in the plane of rotation⁹⁷. If the reports are reliable, the Sikorsky helicopter operates with such a control. According to our own investigations about this, a small adjustment angle can be achieved in this way if one adheres to the requirement of a certain static stability of the helicopter and its damping by the rotor system. However, this small adjustment angle could perhaps be sufficient for the design with a tail rotor, such as that used by Sikorsky, since small blade pitch angles of the tail rotor will be selected anyway to reduce its power.

Finally, a few remarks about the high-speed flight. Our test aircraft with the Sh 14A (150 HP) engine reached horizontal speeds of 150 km/hr even though it was not designed for high-speed flight. In helicopters, the fuselage drag has a dual detrimental effect: firstly, due to the power caused by its own drag and secondly, due to the deterioration in helicopter efficiency, which occurs when the helicopter not only has to carry a vertical load, but also has to overcome resistance against the direction of flight⁹⁸. An aerodynamic refinement of the fuselage is therefore also successful in this twofold respect. The Flettner vehicle with its relatively small frontal area is therefore a good starting point for high-speed flight. However, one thing needs to be emphasized. Even with an increase in engine power the limits for increasing the speed of the helicopter are reached relatively soon. Firstly, high Mach numbers are reached very soon, since the circumferential speed and the forward speed add up on the advancing blade, and secondly, the ratio of forward speed to circumferential speed of the blade tips must remain relatively small (approximately below 0.5), such that level flight is possible at all even with a low fuselage drag.

Moreover, not only performance aspects are decisive for high-speed flight. With increasing airspeed, (1) the alternating forces on the rotating wings increase, (2) the static stability of the rotor control decreases, (3) the tendency to oscillations increases in the entire vehicle, (4) the transition from helicopter to autorotation state becomes more critical, and (5) the autorotation flight itself comes closer to its limits. In short, a host of problems must be kept in mind with any increase in speed. Even if the current technical possibilities have been misjudged in certain phantastic helicopter projects that want to turn the helicopter into a long-haul and high-speed aircraft, the

⁹⁷ Inclined flapping and lagging hinges, where due to the kinematics flapping and lagging angles generate a pitch angle (Δ_3 and Δ_4 hinges).

⁹⁸ The forward tilt of the rotor disc to overcome the fuselage drag generates a normal inflow of the rotor, which requires power due to inflow.

helicopter (now that it has happily survived childhood with all its illnesses and dangers) will certainly experience a rich and varied life in future.

von Doblhoff, Ober-Grafendorf (as a guest): Following Mr. Focke's lecture, I would like to tell you a few more things about a new helicopter development that has just left the laboratory stage.

As a result of the careful theoretical treatment of the power requirement, stability and strength of the helicopters by the gentlemen who have been working on this problem in recent years, it is already possible today to make reliable predictions about these properties, so that regarding further flight tests the occurrence of fundamental deficits of the construction described below can hardly be expected.

It is an attempt to turn the rotor by jet propulsion at the blade tips. The particular advantage of this design lies in the fact that there is no reaction torque and thus, firstly, the dual rotor arrangement can be abandoned and, secondly, no gear boxes are required, which plays an important role in terms of both weight and technology in today's helicopter designs.

The jet propulsion – on the one hand – and the problem of the helicopter – on the other hand – are undoubtedly among the most difficult tasks of modern aeronautical research. It is therefore understandable that there are great difficulties, both in terms of research and construction, to build an aircraft which requires a simultaneous solution to these two problems.

Fig. 1 shows such a reaction rotor during a test run at night to illustrate the drive principle. The glowing circle stems from the exhaust gas jets and marks the path of the reaction nozzles. During the relatively long exposure time during the production of this image, the rotor performed a larger number of turns and was also subjected to control movements, which explains the double contour of the luminous circle.

In the following, the most important difficulties that arise in the course of this development will be discussed briefly. Subsequently, information is given about the design that has now been carried out.

The greatest difficulty undoubtedly lies in the drive element, the combustion nozzle. It differs fundamentally from the jet engines developed so far by the special fact that the volume of the combustion chamber cannot be made as large as desired in order not to cause excessive external resistance. The amount of fuel and therefore calories required to generate the thrust is known, and the two conditions: largest combustion chamber and smallest amount of calories result in the lowest possible combustion chamber load, which in the case of such a rotor is several hundred million calories per cubic meter per hour. Since the cooling conditions at the tip of the blade are naturally particularly favorable, the high wall temperature was not the decisive factor in controlling these combustion chamber loads. Rather, the greatest difficulties arose from the incomplete combustion of the fuel-air mixture in the unusually small volume of the combustion chamber.

The use of reaction-accelerating chemical additives in the fuel and the use of additional oxygen were deliberately avoided. It has been shown to be possible to develop a combustion chamber that is suitable for the special conditions, mainly through empirical work.

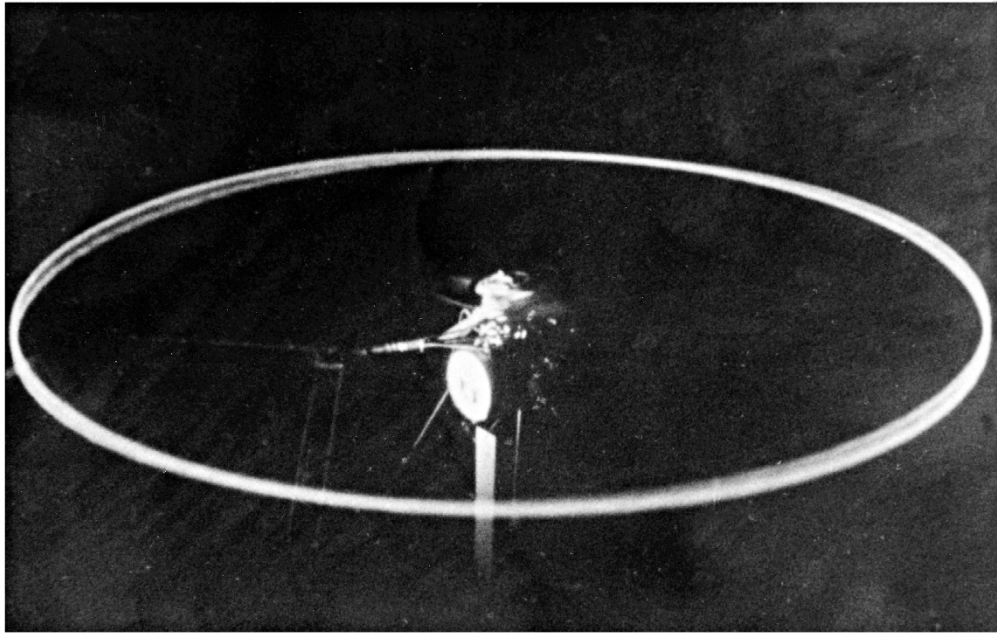

Fig. 1: Test run of a reaction driven rotor

In its current form it has a volume of 1.25 liters and generates a thrust of 18 kg at an overpressure of one atmosphere. The weight is 1.5 kg and the power at the highest rotational speed of the rotor is around 30 HP. The mentioned pressure of one atmosphere is generated partly in a motor-driven aircraft engine loader of the type AS 411 and partly in the revolving rotor blades themselves by the centrifugal force of the enclosed gas column.

The second particular difficulty arose in the construction of these rotor blades. The combustion air supplied by the compressor motor must be fed to the radiant heaters through the hollow rotor blades. The cross-section required for this is so large that the entire cross-section of the rotor blade has to be designed to be hollow and that it is also necessary to use an airfoil of exceptional thickness. This is currently the NACA 23018.

In addition to the most well-known requirements for a rotor blade in terms of torsional rigidity and exceptional bending flexibility, in this case there is also the requirement for a completely free and bare inner profile and for resistance with respect to internal overpressure. Experiments were made with extruded and drawn profiles of various types. Today's blades consist of a profiled drawn Dural tube with a narrow hardwood trailing edge glued on using the Heine method.

To date, it has not yet been possible to reproduce the polars⁹⁹ of the NACA 23018 profile, which were measured several times – also by the DVL – although both the shape and the surface of the blade in use are definitely comparable to a wind tunnel model. Since the flame in the combustion chamber vibrates violently at 300 Hertz, the entire column of air inside the blade also vibrates at the same frequency and with a fairly high amplitude. It will therefore first have to be examined in the wind tunnel whether this oscillation, which naturally propagates to the surface of the blade, might influence the character of the boundary layer.

Since the performance of a reaction driven rotor with almost constant nozzle thrust increases linearly proportionally to the rotational speed, the optimum angle of attack due to the associated high rotational speeds is at significantly smaller angles of attack and thus higher circumferential

⁹⁹ Aerodynamic performance

velocities than that of a mechanically driven rotor. It is not without interest that the maximum lift is achieved at a pitch angle of around 4 to 5 degrees. The optimum is, however, very flat, so that in the future it may be possible to dispense switching the pitch angle to lower values in the event of an engine failure, since the auto-rotation occurs even without switching with the settings used today¹⁰⁰.

This new type of drive makes the design of the hub somewhat easier.

Flapping and lagging hinges were initially installed. In a more recent design, however, the provision of lagging hinges has been disregarded and the resulting slight increase in the fluctuations in lift at higher advance ratios has been compensated for by elastic suspension of the rotor. This arrangement was chosen to avoid aerodynamic balancing¹⁰¹, which is particularly difficult with reaction-driven helicopters. Furthermore, with this arrangement, the precise position of the center of gravity of the rotor is ensured at all advance ratios. As the reaction torque is omitted, only aerodynamic moments occur in the blade roots, which can be easily controlled due to the special nature of the construction. By choosing this arrangement, it is also possible to design the entire rotor without wear points, except for the single large ball bearing around which it rotates. The flapping movement of the blade and the movement around its longitudinal axis take place in spring supports.

The choice of the stiff in-plane arrangement is by no means a necessity, but an improvement made possible by the elimination of the drive torque.

The structure of the experimental machine being tested is as follows (see Fig. 2).

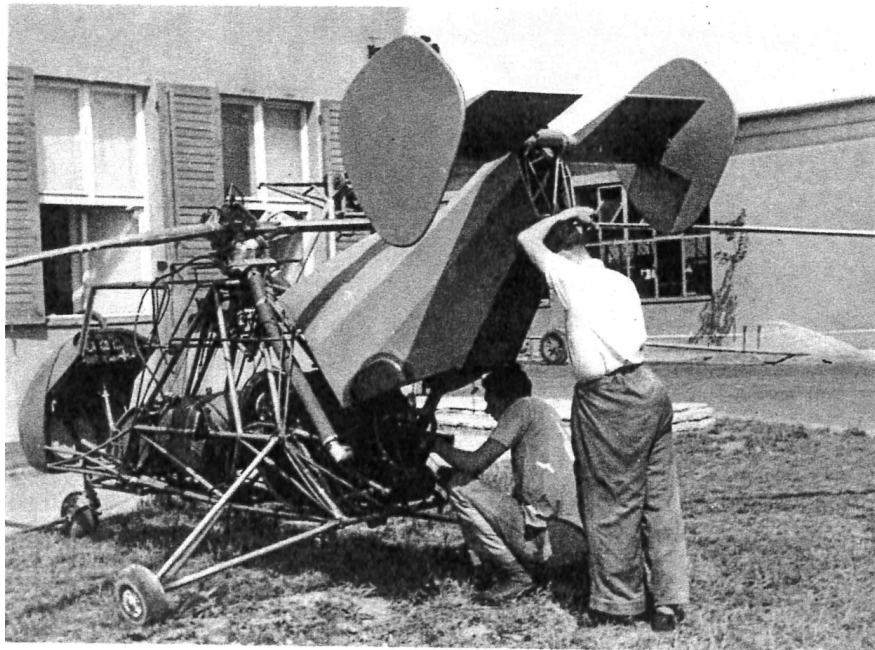

Fig. 2: Assembly of the test vehicle

The fuselage is built on a nose wheel undercarriage, in the front end of which the pilot's seat is placed for reasons of visibility. Behind it is a fuel tank with a capacity of 50 liters, which is sufficient for around 0.5 hours of flight time. Immediately behind the fuel tank there is a ball joint, which is exactly at the center of gravity and from which the fuselage is open downwards to enable

¹⁰⁰ Not considered was the exceptional drag of the jet engines out of operation at the blade tip

¹⁰¹ Rotor blade tracking

a slung load to be attached, or a center of gravity tether. Behind the center of gravity is a Walter Mikron motor with a maximum output of 60 HP, which drives an Argus 411 centrifugal compressor. The rear end of the machine is formed by a light tail that carries a horizontal stabilizer and two rudders. This tail is designed to be foldable upwards for reasons of accessibility to the compressor motor. The machine currently being in flight tests differs from the version shown in Fig. 2 only in that it has no fairing (Fig. 3).



Fig. 3: Machine without fairing during a test flight

The rotor (Fig. 4) has three blades with a chord of 15 cm and a diameter of 9 m. It is controlled by an upright stick via a spider changing the blade pitch angle. There is a setting for the collective pitch angle in order to be able to generate the highest rate of climb for a short time and also to be able to suddenly reduce lift during take-off and landing in gusty weather, which is done by setting the blade pitch angle slightly negative.

The following advantages can now be expected from the gearless helicopter:

1. The low production costs: Such a machine can be produced individually with an effort of 1500 working hours. Within series production, this workload will of course be significantly reduced.
2. The long service life: The service life of the fuselage is practically unlimited. As already mentioned, the only point of wear and tear is the rotor ball bearing with some 10,000 operating hours.
3. The low weight: The empty weight of the test machine V 1 is 255 kg with 90 HP rotor power and a 60 HP motor.

These advantages are currently countered by the high fuel consumption as a disadvantage. With the first machine, it is around 80 kg/hr and is therefore comparable to the consumption of a 360 HP engine.

In order to compare the fuel consumption of the gearless helicopter with that of other machines in operation, a coefficient was introduced with which the fuel consumption per kilogram of transported load and hour is expressed. This specific fuel consumption is by no means bad in a tip-

jet driven helicopter, as the low weight of the machine is very evident. In the first test machine, however, there was still a lot to be desired in this regard. This phenomenon is due to the fact that, for reasons of rapid development, an existing compressor had to be used and it was not possible to reach the pressure that corresponds to the lowest fuel consumption. Furthermore, due to the difficulties with the airfoil as mentioned before, the lift achieved is also significantly less than it could be with the same fuel consumption. As a theoretical best value one can roughly assume that a payload of 200 kg can be transported for one hour with 60 kg of fuel.



Fig. 4: Machine with fairing

A particularly desirable project to reduce fuel consumption would be the use of a pusher propeller that can be engaged when cruising and that can be driven by the engine instead of the compressor. Such a machine would actually represent an autogyro in which the starting gear is replaced by the centrifugal compressor and the combustion chambers. This machine would be able to meet all the requirements placed on the ideal rotating wing aircraft with the simplest construction.

Antz¹⁰², Berlin (as a guest): In addition to Mr. Focke's lecture, I would like to make a few more statements from the point of view of the development department of the Ministry and then show some movies that demonstrate the most important uses of rotating wing aircraft.

Before that, a word about the systems that are currently running. At the outside appearance of the system you can see the torque compensation, which can be solved in different ways in motor-driven helicopters. The number of possibilities is quite limited. Nevertheless, precisely this area and the question of the blade pitch control is a real treasure trove for inventor suggestions.

¹⁰² Dipl.-Ing. Hans Antz was technical officer in the Reichs Ministry of Aeronautics (RLM), Berlin. In October 1938 Hans Antz produced a report on the contemporary prospects for high-speed flight, concluding that speeds of 800-850 km/hr (500-530 mph) would only be achievable with jet propulsion. He recommended the construction of high-speed wind tunnels at aerodynamic research institutes.

Why were the systems by Focke and Flettner progressively advanced from all the possible solutions for torque compensation, and what other solutions are also being sought?

At Focke, the direction of development was initially given by the Focke 61 study, which demonstrated the practical application possibilities through its testing and led to the consequent development of the Fa 223 and the planned and partly already started development of Fa 284 with 2 BMW 801 motors. In addition to the possibility of using it as an artillery observer, liaison or ambulance aircraft, this system is primarily responsible for lifting and transporting loads (flying crane). The disadvantages of bulkiness and excessively large dimensions and the resulting poor maneuverability as cited by tactical departments are, however, not of decisive importance with regard to the tasks as a flying crane. The best explanation for this is given by the movie about the use of the Fa 223 as a crashed aircraft recovery vehicle. The planned development of the Fa 284 with a payload of 6.5 tons in overload should be the suitable crane “tool”.

In addition, Prof. Focke dealt early on with the possibilities of single-rotor, fast and agile helicopters. The implementation of this proposal, which is now experimentally made by the motorization of the “wagtail” autogyro kite¹⁰³, repeatedly failed due to the lack of development personnel, a situation that also did not allow for so many other tasks to be carried out.

When, at the beginning of 1938, after previous cautious attempts in other directions, the Flettner company proposed the implementation of the system you now know. The possibility of developing a small but maneuverable helicopter on the basis of the dual rotor was given. It was particularly desired by the navy for use on the smallest take-off and landing areas on the ships of the navy. Recently, the army showed interest for the small helicopter as a command and liaison aircraft. For the task of transporting larger loads (i.e. as a crane aircraft), this system is not suitable, especially since the outstanding characteristics of great maneuverability could not be exploited at all.

Of the other options for torque compensation for motor-driven helicopters, the oldest system of coaxial pairs of rotor blades (Bréguet system) should be mentioned. At the moment, a French development that has been underway for a long time is being completed in order to gain experience and knowledge about this proposed solution.¹⁰⁴

From an aircraft manufacturing point of view, of course, a helicopter gearbox (this includes everything that is used to transmit power and control between the motor and the rotating wing blade) is quite expensive in terms of tooling and machining, which eventually can develop into a real bottleneck. I would like to refer to the experience gained during the preparation of the Fa 223 series production. For this reason, the Ministry sought from early on to develop helicopters with the least possible gearbox expenditure. While a necessary amount of gear parts cannot be completely avoided for the control, other solutions can be implemented for the power transmission, which at the same time bring the advantage of eliminating the torque compensation. One of the tasks currently being supported provides for the arrangement of the motor or several motors with

¹⁰³ Fa 330 follow-on project as a single rotor helicopter Fa 336.

¹⁰⁴ It is not clear which development is meant here. The following is taken from an Allied intelligence report restricted at the time: L.V. Honsinger, German Rotary Wing Development During World War II, U.S. Naval Technical Mission in Europe, Technical Report No. 395-45, 1945: “Little is known about a Helicopter designed and built by Zauder. The development and construction were carried on in secrecy. Only one model was built and tested. It was a smooth streamlined machine with a single rotor at the center of gravity built up on an off-set rotor tower looking like an inverted boot with the toe pointing forward. It had a small anti-torque propeller in the rear similar to the configurations of American Bell and Sikorsky Helicopters. Due to incorrect flexure mount of rotors, this one ship literally exploded in trial flight. Analysis of the wreckage revealed principal failure in rotor support mast at a point just below the off-set structure (above the ankle of the boot, so to speak). No further development was attempted.”

puller propellers mounted at the rotor blades. The suggestion is suitable for elastic blade attachment, but only for small vehicles (Nagler and Rolz, Vienna).¹⁰⁵

The aim of developing a gearless helicopter as far as possible is given by the use of the tip-jet drive, which with respect to the low circumferential speed¹⁰⁶ the use of the pure reaction drive with special fuel due to the poor efficiency (too great a difference between the circumferential speed that is limited by the influence of the Mach number and the gas velocity from the jet nozzle) is practically unacceptable. It is therefore only acceptable to use normal fuels with the addition of air. Mr. von Doblhoff has already given you a report on this very positive development at Wiener-Neustädter Flugzeugwerke. Here is of particular interest the solution suggested by him as a helicopter for take-off and landing, while in horizontal flight the motor required to generate the compressed air works on a propeller (i.e. during autogyro operation) – this is of course particularly with a view to economic efficiency.

The tasks described above largely comprise the officially controlled development program in the helicopter field.

At this point I would like to support a request that Mr. Focke has already made earlier and that relates to the cooperation of the research centers¹⁰⁷. Apart from the generally valid knowledge and advances in the aerodynamic field, the development plants actually had to find their own way in this new territory of helicopter development pretty much alone and without much support. In addition to the lack of staff for development, this may be one of the reasons why development only takes place very slowly and sometimes you come across indefinable phenomena, especially during flight tests. Our efforts, like the Americans in New York (headed by Alexander Klemin¹⁰⁸), to have a special institute for rotating wing issues, to set up a special position in our research, have unfortunately remained unsuccessful¹⁰⁹. Collaboration would be particularly desirable in the aerodynamics of the rotating wing blade and in the question of flying qualities.

Regarding the latter, based on my own flight experiences with the Fa 223 and the Fl 282, I would like to say that Focke and Flettner went in separate ways. While in Focke's solution, especially in the Fa 223, an almost perfect adaptation to the properties of the fixed wing aircraft was achieved — apart from the deviation in longitudinal stability that inevitably adheres to all rotating wing aircraft — something very specific is present in the Fl 282, which is particularly different to the stability of the fixed wing aircraft. At first — to put it somewhat incorrectly — one has the impression of a more unstable state, which is not unpleasant, however, and did not lead to any complaints when it was first deployed by the troops. Certain improvements are required in both solutions — but it is too early to make determinations about this today, since the testing beyond the company tests has not progressed far enough to speak of specific helicopter flight characteristics or to require that these be in level flight to match the characteristics of the fixed wing. It is important that although helicopter flying has to be learned, it does not place any severe demands on the pilot. The experiences made so far in training and in action confirm this.

Subsequently will follow the movies about (1) the experiments with the Fa 330 (wagtail) on the submarine, (2) the ship deck landings of the Fl 282 on the salvage ship »Greif« (3) — the movie

¹⁰⁵ One-man backpack helicopter

¹⁰⁶ “low” with respect to Mach 1, but high compared to those of Focke and Flettner helicopters. The rotor of the von Doblhoff Helicopter rotated at 450 rpm and had a radius of 4.5 m (see: Göttinger Monograph N), resulting in a tip Mach number of 0.62 — 1.7 times the one of the Focke helicopter, confirming footnote 90.

¹⁰⁷ DVL Berlin, DFL Braunschweig, AVA Göttingen

¹⁰⁸ Alexander A. Klemin, Guggenheim school of Aeronautics, New York University, College of Engineering

¹⁰⁹ Not true. In 1943 Gerhard J. Sissingh from the Flettner company took position as rotating wing branch head within Küssner's Institute at the AVA Göttingen for the desired purpose.

about the use of the Fa 223 as a recovery of a crashed fixed wing aircraft has to be canceled due to lack of time — and (4) one short movie about the Sikorsky helicopter, which König-Warthausen¹¹⁰ has acquired from abroad.

¹¹⁰ Friedrich Karl Freiherr Koenig von und zu Warthausen, German pilot and lord of the manor

List of Symbols

| Symbol (Focke) | Symbol (today) | Explanation |
|----------------------------------|-----------------------------------|--|
| c_a | | Rotor lift coefficient, based on speed of flight. Becomes infinite in hover. German: Auftrieb (a) |
| c'_a | $C_{l\alpha}$ | Airfoil lift curve slope, $c'_a = C_{l\alpha}$ |
| F | A | Rotor disc area, $F = A = \pi R^2$. German: Fläche (F) |
| $FM = \frac{\sqrt{k_n^3}}{2k_d}$ | $FM = \frac{\sqrt{C_T^3/2}}{C_P}$ | Hover figure of merit = ideal power / real power |
| H | H | Longitudinal force of the rotor. German: Horizontalkraft (H) |
| I_1 | I_b | Blade mass moment of inertia, $I_1 = I_b$ |
| k_a | | Rotor lift coefficient |
| $k_d = \frac{N}{(\rho/2)Fu^3}$ | $C_P = \frac{P}{\rho AU^3}$ | Power (or torque) coefficient, $k_d = 2C_P$. German: Koeffizient (k), Drehmoment (d) |
| $k_n = \frac{S}{(\rho/2)Fu^2}$ | $C_T = \frac{T}{\rho AU^2}$ | Thrust coefficient, $k_n = 2C_T$. German: Koeffizient (k), Normalkraft (n) |
| K_{sv} | C_L | Rotor lift coefficient (in vertical direction), based on blade tip speed, $K_{sv} = 2C_L$ |
| K_{sh} | C_H | Rotor longitudinal force coefficient, $K_{sh} = 2C_H$ |
| M | Q | Rotor torque, $M = Q$. German: Moment (M) |
| N | P | Power, $N = P$ |
| n | n | Load factor |
| R | R | Rotor radius |
| r | r | Rotor blade radial coordinate |
| S | T | Thrust, $S = T$. German: Schub (S) |
| $\frac{dS_1}{dr}$ | $\frac{dT}{dr}$ | Radial thrust distribution, $\frac{dS_1}{dr} = \frac{dT}{dr}$ |
| t | c | Rotor blade chord length, $t = c$. German: Profiltiefe (t) |
| t_0 | c_0 | Chord length at blade root |
| $t_0 - t_1$ | c_{tip} | Chord length at blade tip, $t_0 - t_1 = c_{tip}$ |
| $u = \omega R$ | $U = \Omega R$ | Blade tip speed, $u = U$. German: Umfangsgeschwindigkeit (u) |
| v | V | Speed of flight, $v = V$ |
| v_B | V_g | Gust velocity, $v_B = V_g$. German: Böe (B) |
| v_d | w | Total inflow velocity normal to the rotor disc, $v_d = -w$. Focke: pos. upwards, today: pos. downwards |
| $x = \frac{v_d}{R\omega}$ | $\lambda = \frac{w}{\Omega R}$ | Axial inflow ratio normal to the rotor disc, $x = -\lambda$ |

| | | |
|---|--|--|
| z | N_b | Number of rotor blades, $z = N_b$. German: the rotor with all its blades appears like a toothed gear, the German word for tooth is: Zahn (z) |
| Greek Symbols | | |
| Symbol (Focke) | Symbol (today) | Explanation |
| α_π | α_S | Rotor shaft angle of attack, pos. nose up, $\alpha_\pi = \alpha_S$ |
| β | β | Rotor blade flapping angle, pos. up |
| β_0 | β_0 | Coning angle |
| β_1 | β_1 | 1/rev blade flapping angle = rotor disc tilt angle |
| ϑ | Θ | Blade pitch angle, pos. nose up, $\vartheta = \Theta$ |
| $\mu = \frac{v \cdot \cos \alpha_\pi}{R\omega}$ | $\mu = \frac{V \cdot \cos \alpha_S}{\Omega R}$ | (Tangential) advance ratio |
| ρ | ρ | Air density |
| ψ | ψ | Rotor blade azimuth, zero at rear blade position |
| ω | Ω | Rotor rotational frequency, $\omega = \Omega$ |