

**IMPORTANT: Due to Raw Material Fluctuation, Catalog Prices Below May Not Be Accurate.
GO TO WWW.OUTWATER.COM FOR THE MOST UP-TO-DATE PRICES**

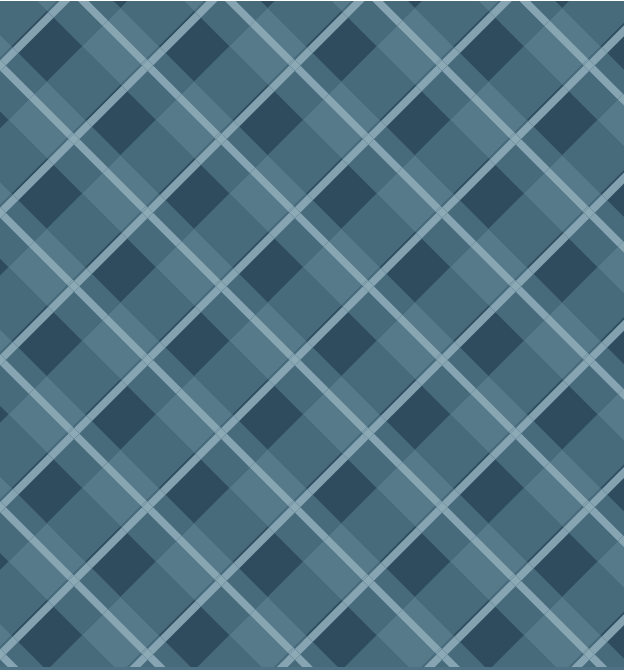

Catalog: 030

Sign Essentials & Lighting

1-800-631-8375
www.outwater.com
New Jersey & Arizona

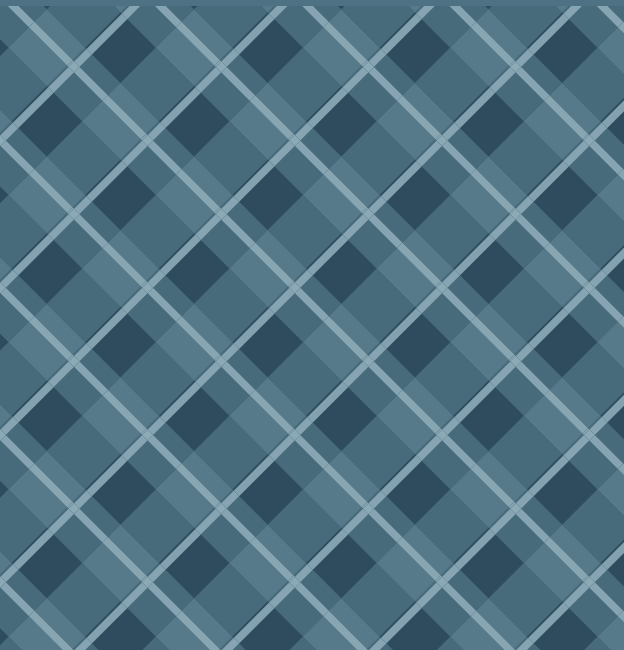

Sign Essentials

Cable Display System	
<i>3 in 1 Cable Hardware Kits</i>	S-8
<i>15 Series Cable Signage Kit</i>	S-9
<i>30 Series Cable Signage Kit</i>	S-10
<i>30 Series Cable Shelving</i>	S-11~12
<i>Adjustable Cable Hook Hardware</i>	S-18
<i>Double Loop Cables</i>	S-18
<i>LED MR16 Rod</i>	S-13
<i>Heavy Duty 3mm Ceiling to Floor</i>	S-5
<i>Heavy Duty 3mm Ceiling to Sign</i>	S-7
<i>Standard 1.5mm Ceiling to Floor</i>	S-4
<i>Standard 1.5mm Ceiling to Sign</i>	S-6
<i>Trackless 2mm Hanging System</i>	S-16~17
<i>Wall Track 2mm For Art</i>	S-15
Exhibit Systems	
<i>Aluminum Framing Systems</i>	S-95~102
<i>Klem® Connecting Systems</i>	S-104~105
Extrusions	
<i>Angle Moulding</i>	S-68~71
<i>Cap & Divider Moulding</i>	S-76~80
<i>Corner Moulding</i>	S-74~75
<i>Price Tag Moulding</i>	S-72~73
<i>U-Channel Moulding</i>	S-62~67
<i>Z Panel Moulding</i>	S-26
Fastmount Panel Mounting Systems	S-106~110
Frames & Profiles	
<i>Aluminum Frame Profiles</i>	S-52~54
<i>Fully Assembled, Front Loading Aluminum Frames</i>	S-55~58
<i>LED Crystal Light Box</i>	S-59
<i>LED Fully Assembled, Front Loading Aluminum Frames</i>	S-60
<i>PVC Frame Profiles</i>	S-48
<i>Slide In Frames</i>	S-61
Great Wall PVC & Aluminum Slatwall	S-103
Hangman® Hanging Products	S-19~25
SEG Modular Frames/Components	
<i>Banner Ups® SEG Design™ Modular SEG Frames</i>	S-82~85
<i>Foga® Fabric Flex Framing System (for SEG)</i>	S-86~94
Sign Components	
<i>Free Standing & Wall Mount Sign Holders</i>	S-81
<i>Magnaclamps® Sign/Banner Holders</i>	S-48
<i>Sign/Banner Holders</i>	S-47, 49-51
Standoffs	
<i>Cap It Off Series</i>	S-45~46
<i>Easy Fasten</i>	S-27~30, 34
<i>Edge It - No Drill</i>	S-37~38
<i>Grip It - No Drill</i>	S-39~42
<i>Invisi Series</i>	S-44
<i>LED</i>	S-43
<i>Secure Fasten</i>	S-30~33
<i>Tamper Proof</i>	S-28, 34~36
Striplox	S-111~114

Table of Contents

Lighting

Angled Power Strips	L-170~171
Backlighting Panel Series	L-1~16, 119~121
Bulbs	L-151~152
Cables, Connectors & Switches	L-145~149
Canister Lighting 120V	L-115
Ceiling Panel Lighting	L-153
Channel Letter Modules	L-131~133
Closet Rod Kit 12V	L-100
Controllers	L-150
Dimmers	L-134~136, 142~144
Display Arms	L-127~130
Edge Lighting	L-54
Fiber Optic 110V	L-116
Fixtures	
24V	L-84~85
120V	L-79~83
Indirect Lighting Profiles	L-172~176
LED Channels	L-55~62
LED Standoffs	L-117~118
Light Frames/Boxes	L-122~124
Light Ceiling Panels	L-141
Linear Flexible	
12V	L-45~54
24V	L-23~44
120V	L-17~22
Linear Rigid	
12V	L-66~67, 86~89, 92~93
24V	L-63~65, 90~91, 94~96
Power Track System 12V/24V	L-97~99
Omni Wand System	L-68~78
Power Hubs	L-158~167
Power Supplies	L-137~141
Puck Lighting	
12V	L-104~112
24V	L-102~103, 113
120V	L-101
Qi Chargers	L-168~169
Spot Lighting 12V	L-114, 125
WAC 120V LED Track Heads	L-154~157
Wall Washers	L-126

STANDARD Duty Cable System

1.5mm Cable & Fittings
Supports up to 110 lbs. per cable



This low cost system includes **1.5mm** cables with **aluminum** fittings. This system is designed for small display areas up to **6'6"** high.



Contents

- 3 in 1 Cable Hardware Kits For Both Standard 1.5mm & Heavy Duty 3mm S-8
- Standard 1.5mm Ceiling to Floor Cable Signage S-4
- Heavy Duty 3mm Ceiling to Floor Cable Signage S-5
- Standard 1.5mm Ceiling to Sign Cable Signage S-6
- Heavy Duty 3mm Ceiling to Sign Cable Signage S-7
- 15 Series Cable Signage Kit S-9
- 30 Series Cable Signage Kit Illuminating S-10
- 30 Series Cable Shelving S-11~12
- Adjustable Cable Hook Sign Hanging Hardware & Double Loop Cables ... S-18
- LED MR16 Rod S-13



HEAVY Duty Cable System

3mm Cable & Fittings
Supports up to 220 lbs per cable



This premium system includes **3mm** cables with **solid brass** fittings. This system is designed for large display areas up to **13'** high.

A wide range of shelving options are possible with this system as well as illuminated and non-illuminated signage options.



Illuminating

IMPORTANT: Due to Raw Material Fluctuation, Catalog Prices Below May Not Be Accurate. GO TO WWW.OUTWATER.COM FOR THE MOST UP-TO-DATE PRICES

Standard 1.5mm Ceiling to Floor Cable Signage

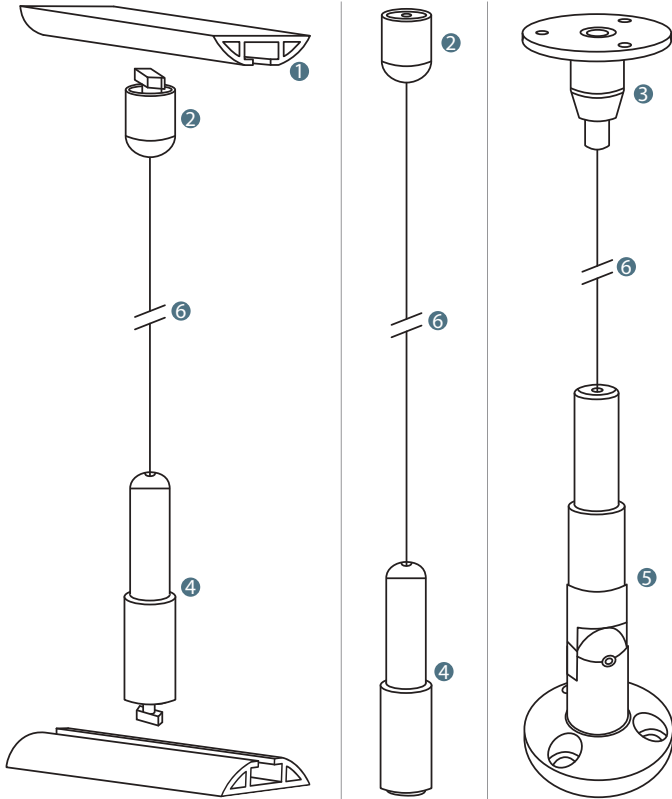

English measurements converted from metric. Metric is the most accurate.

1. Mounting Channel

CSK-ALU
Material: Aluminum
Finish: Clear Anodized
Cable Diameter: 1.5mm
Length: 6'6"
Price: \$19.95 ea.
Carton Price: \$18.95 ea.
 (10 Pieces Per Ctn.)

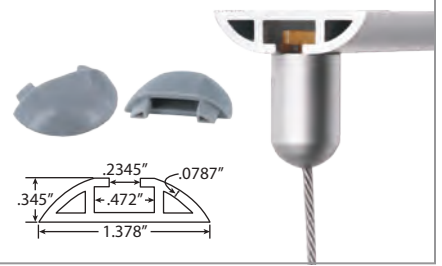

2. Channel/Ceiling Top Fitting

CSKE-CHTF-ALU
Material: Aluminum
Finish: Clear Anodized
Cable Diameter: 1.5mm
Price: \$3.95 ea.
Carton Price: \$3.70 ea.
 (50 Pieces Per Ctn.)
Comes with both toggle & screw mount

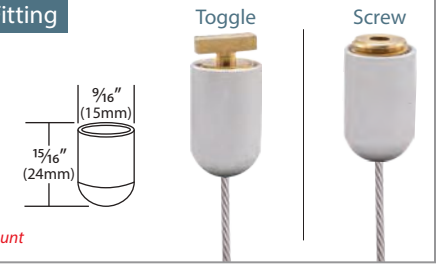

3. Ceiling Top Fitting

CSKE-CSTF-ALU
Material: Aluminum
Finish: Clear Anodized
Cable Diameter: 1.5mm
Price: \$5.65 ea.
Carton Price: \$5.25 ea.
 (50 Pieces Per Ctn.)



4. Channel/Floor Bottom Fitting

CSKE-CHBF-ALU
Material: Aluminum
Finish: Clear Anodized
Cable Diameter: 1.5mm
Price: \$5.25 ea.
Carton Price: \$4.95 ea.
 (25 Pieces Per Ctn.)
Comes with both toggle & screw mount

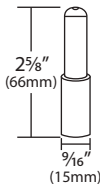

5. Bottom Fitting

CSKE-BF-ALU
Material: Aluminum
Finish: Clear Anodized
Cable Diameter: 1.5mm
Price: \$15.75 ea.
Carton Price: \$14.60 ea.
 (25 Pieces Per Ctn.)

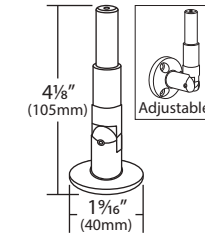

6. 1.5mm Bulk 304 Grade Stainless Steel Cables

Part #	Description	Cable Length	Price	Carton Qty.	Carton Price
304 Stainless Steel Cables					
CSKE-CABLE	Standard 7x7 Construction	13'	\$3.25 ea.	50	\$2.95 ea.
Coated Stainless Steel Cables					
CSKE-CABLE-C	Nylon Coating Over 7x7 Cable	13'	\$4.90 ea.	50	\$4.55 ea.

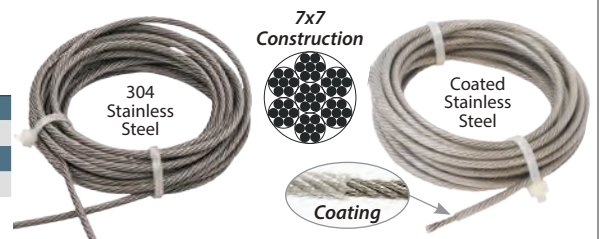

Horizontal Sign Clamps

CSKE-SSGC-ALU
Material: Aluminum
Finish: Clear Anodized
Cable Diameter: 1.5mm
Price: \$3.25 ea.
Carton Price: \$2.95 ea.
 (50 Pieces Per Ctn.)
Use 3mm Hex Key

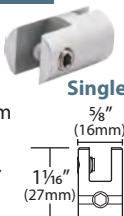

CSKE-DSGC-ALU
Material: Aluminum
Finish: Clear Anodized
Cable Diameter: 1.5mm
Price: \$3.95 ea.
Carton Price: \$3.75 ea.
 (50 Pieces Per Ctn.)
Use 3mm Hex Key

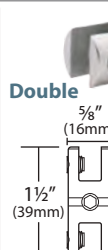

Clear Acrylic Sign Holder with Polished Edges

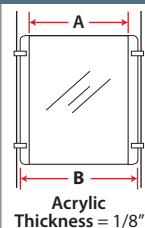

Part #	A (Graphic Size)	B (Overall Size)	Price
CSK-ASH-7P	7"W x 11"H	8.25"W x 11"H	\$15.75 ea.
CSK-ASH-7L	11"W x 7"H	12.25"W x 7"H	\$15.40 ea.
CSK-ASH-8P	8.5"W x 11"H	9.75"W x 11"H	\$16.25 ea.
CSK-ASH-8L	11"W x 8.5"H	12.25"W x 8.5"H	\$15.85 ea.
CSK-ASH-11P	11"W x 17"H	12.25"W x 17"H	\$25.00 ea.
CSK-ASH-11L	17"W x 11"H	18.25"W x 11"H	\$25.00 ea.
CSK-ASH-22P	22"W x 28"H	23.25"W x 28"H	\$55.00 ea.
CSK-ASH-22L	28"W x 22"H	29.25"W x 22"H	\$61.00 ea.

IMPORTANT: Due to Raw Material Fluctuation, Catalog Prices Below May Not Be Accurate. GO TO WWW.OUTWATER.COM FOR THE MOST UP-TO-DATE PRICES

Heavy Duty 3mm Ceiling to Floor Cable Signage

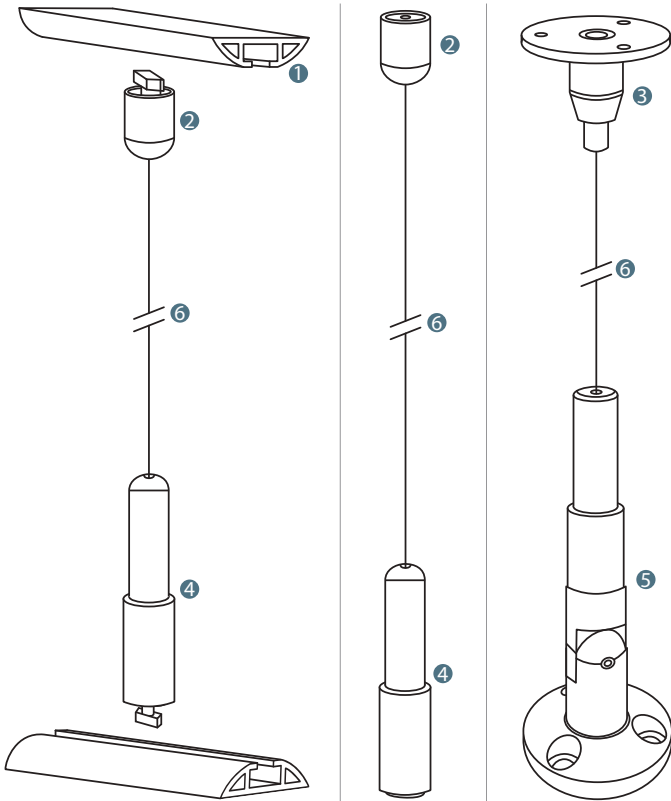

English measurements converted from metric. Metric is the most accurate.

1. Mounting Channel

CSK-ALU

Material: Aluminum
Finish: Clear Anodized
Cable Diameter: 3mm
Length: 6'6"
Price: \$19.95 ea.
Carton Price: \$18.95 ea.
 (10 Pieces Per Ctn.)



2. Channel/Ceiling Top Fitting

CSK-CHTF-*

Material: Solid Brass
Finish: Satin Chrome (*SC)
 & Polished Chrome (*PC)
Cable Diameter: 3mm
Price: \$5.95 ea.
Carton Price: \$5.45 ea.
 (25 Pieces Per Ctn.)

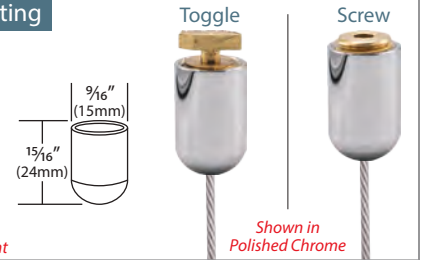

3. Ceiling Top Fitting

CSK-CSTF-*

Material: Solid Brass
Finish: Satin Chrome (*SC)
 & Polished Chrome (*PC)
Cable Diameter: 3mm
Price: \$11.95 ea.
Carton Price: \$11.10 ea.
 (25 Pieces Per Ctn.)



4. Channel/Floor Bottom Fitting

CSK-CHBF-*

Material: Solid Brass
Finish: Satin Chrome (*SC)
 & Polished Chrome (*PC)
Cable Diameter: 3mm
Price: \$6.90 ea.
Carton Price: \$6.45 ea.
 (25 Pieces Per Ctn.)

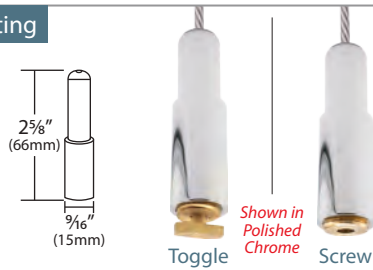

5. Bottom Fitting

CSK-BF-*

Material: Solid Brass
Finish: Satin Chrome (*SC)
 & Polished Chrome (*PC)
Cable Diameter: 3mm
Price: \$17.35 ea.
Carton Price: \$15.15 ea.
 (10 Pieces Per Ctn.)

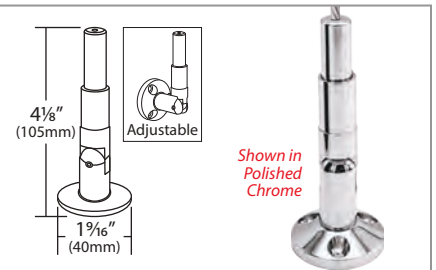

6. 3mm Bulk 304 Grade Stainless Steel Cables

Part #	Description	Cable Length	Price	Carton Qty.	Carton Price
Stainless Steel Cables					
CSK-CABLE		13'	\$9.85 ea.	25	\$7.45 ea.
CSK-CABLE-26	Standard 7x7 Construction	26'	\$15.00 ea.	10	\$13.95 ea.
CSK-CABLE-100		100'	\$49.80 ea.	10	\$47.95 ea.
Coated Steel Cables					
CSK-CABLE-C	Nylon Coating Over 7x7 Cable	13'	\$10.95 ea.	25	\$9.95 ea.



Horizontal Sign Clamps

CSK-SSGC-*

Material: Solid Brass
Finish: Satin Chrome (*SC)
 & Polished Chrome (*PC)
Cable Diameter: 3mm
Price: \$5.35 ea.
Carton Price: \$5.15 ea.
 (25 Pieces Per Ctn.)

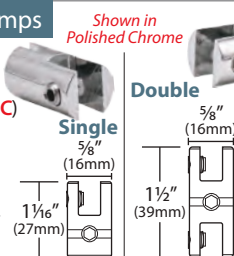

CSK-DSGC-*

Material: Solid Brass
Finish: Satin Chrome (*SC)
 & Polished Chrome (*PC)
Cable Diameter: 3mm
Price: \$6.95 ea.
Carton Price: \$6.55 ea.
 (25 Pieces Per Ctn.)



Clear Acrylic Sign Holder with Polished Edges

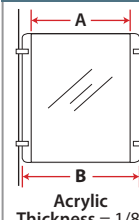

Part #	A (Graphic Size)	B (Overall Size)	Price
CSK-ASH-7P	7"W x 11"H	8.25"W x 11"H	\$15.75 ea.
CSK-ASH-7L	11"W x 7"H	12.25"W x 7"H	\$15.40 ea.
CSK-ASH-8P	8.5"W x 11"H	9.75"W x 11"H	\$16.25 ea.
CSK-ASH-8L	11"W x 8.5"H	12.25"W x 8.5"H	\$15.85 ea.
CSK-ASH-11P	11"W x 17"H	12.25"W x 17"H	\$25.00 ea.
CSK-ASH-11L	17"W x 11"H	18.25"W x 11"H	\$25.00 ea.
CSK-ASH-22P	22"W x 28"H	23.25"W x 28"H	\$55.00 ea.
CSK-ASH-22L	28"W x 22"H	29.25"W x 22"H	\$61.00 ea.

IMPORTANT: Due to Raw Material Fluctuation, Catalog Prices Below May Not Be Accurate. GO TO WWW.OUTWATER.COM FOR THE MOST UP-TO-DATE PRICES

Standard 1.5mm Ceiling to Sign Cable Signage

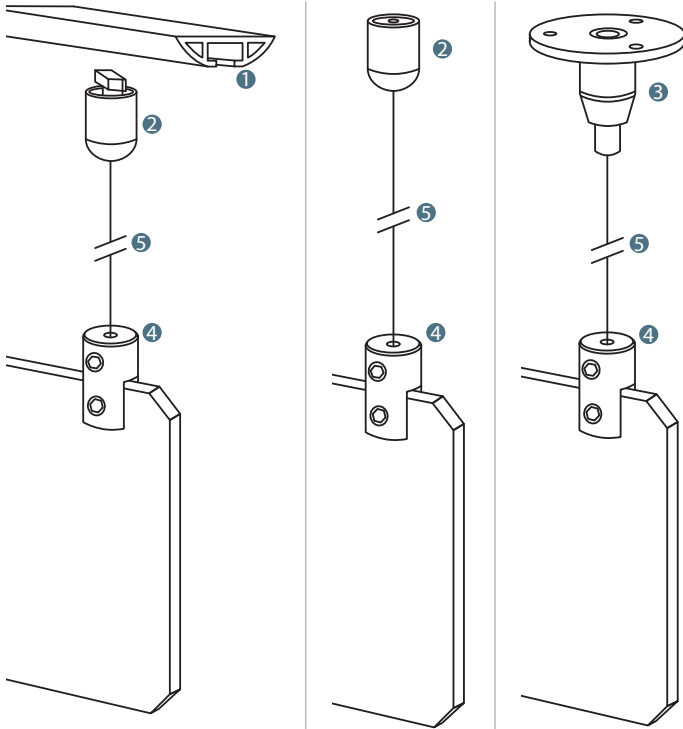

English measurements converted from metric. Metric is the most accurate.



1. Mounting Channel

CSK-ALU

Material: Aluminum
Finish: Clear Anodized
Cable Diameter: 3mm
Length: 6'6"
Price: \$19.95 ea.
Carton Price: \$18.95 ea.
 (10 Pieces Per Ctn.)



2. Channel/Ceiling Top Fitting

CSKE-CHTF-ALU

Material: Aluminum
Finish: Clear Anodized
Cable Diameter: 1.5mm
Price: \$3.95 ea.
Carton Price: \$3.70 ea.
 (50 Pieces Per Ctn.)

Comes with both toggle & screw mount

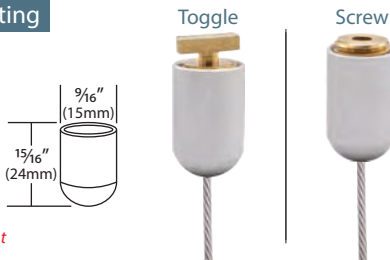

3. Ceiling Top Fitting

CSKE-CSTF-ALU

Material: Aluminum
Finish: Clear Anodized
Cable Diameter: 1.5mm
Price: \$5.65 ea.
Carton Price: \$5.25 ea.
 (50 Pieces Per Ctn.)



4. Sign Fitting (Holds 3/16" Thick Signage)

CSKE-CSSC-ALU

Material: Aluminum
Finish: Clear Anodized
Cable Diameter: 1.5mm
Price: \$3.25 ea.
Carton Price: \$2.95 ea.
 (50 Pieces Per Ctn.)
 Use 3mm Hex Key

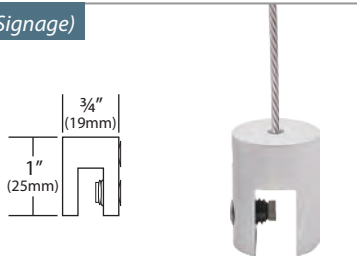

Vertical Double Sign Clamp

CSK-DSSC-*

Material: Solid Brass
Finish: Satin Chrome (*SC) & Polished Chrome (*PC)
Cable Diameter: 1.5mm
Price: \$7.60 ea.
Carton Price: \$6.95 ea.
 (25 Pieces Per Ctn.)
 Use 3mm Hex Key

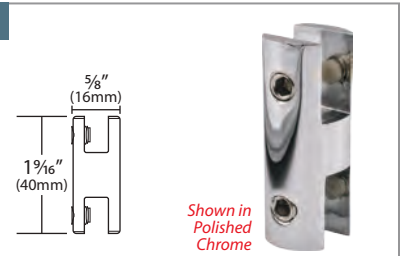

6. 1.5mm Bulk 304 Grade Stainless Steel Cables

Part #	Description	Cable Length	Price	Carton Qty.	Carton Price
304 Stainless Steel Cables					
CSKE-CABLE	Standard 7x7 Construction	13'	\$3.25 ea.	50	\$2.95 ea.
Coated Stainless Steel Cables					
CSKE-CABLE-C	Nylon Coating Over 7x7 Cable	13'	\$4.90 ea.	50	\$4.55 ea.

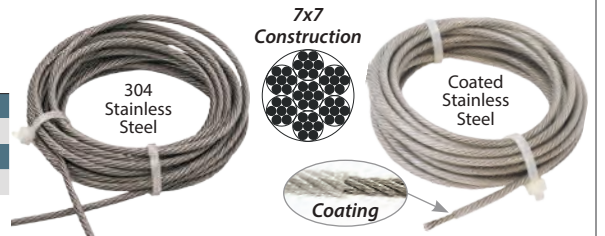

IMPORTANT: Due to Raw Material Fluctuation, Catalog Prices Below May Not Be Accurate. GO TO WWW.OUTWATER.COM FOR THE MOST UP-TO-DATE PRICES

Heavy Duty 3mm Sign to Floor Cable Signage

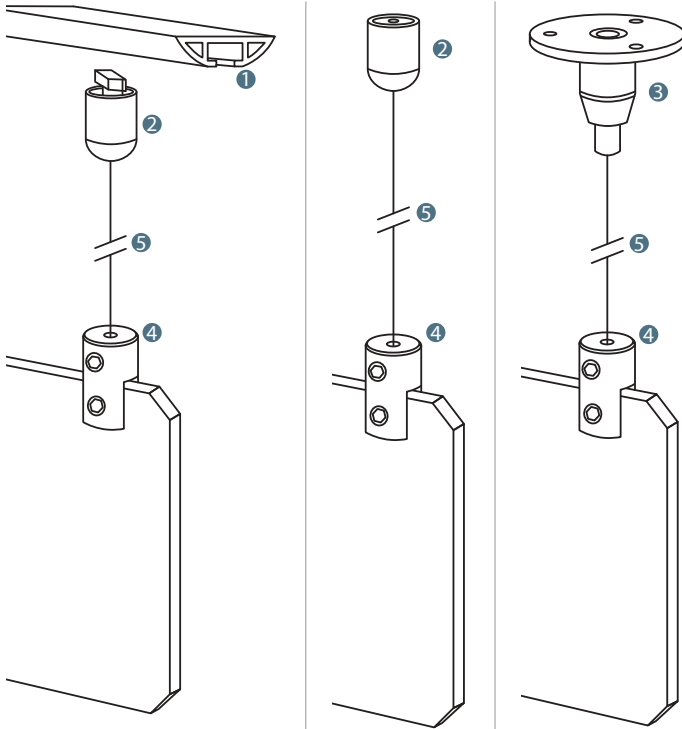

English measurements converted from metric. Metric is the most accurate.



1. Mounting Channel

CSK-ALU

Material: Aluminum
Finish: Clear Anodized
Cable Diameter: 3mm
Length: 6'6"
Price: \$19.95 ea.
Carton Price: \$18.95 ea.
 (10 Pieces Per Ctn.)



2. Channel/Ceiling Top Fitting

CSK-CHTF-*

Material: Solid Brass
Finish: Satin Chrome (*SC)
 & Polished Chrome (*PC)
Cable Diameter: 3mm
Price: \$5.95 ea.
Carton Price: \$5.45 ea.
 (25 Pieces Per Ctn.)

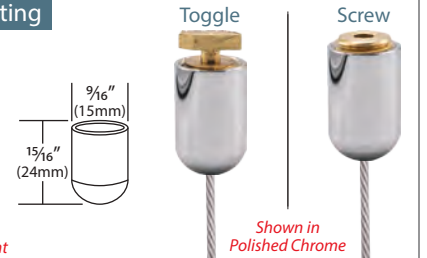

Comes with both toggle & screw mount

Shown in Polished Chrome

3. Ceiling Top Fitting

CSK-CSTF-*

Material: Solid Brass
Finish: Satin Chrome (*SC)
 & Polished Chrome (*PC)
Cable Diameter: 3mm
Price: \$11.95 ea.
Carton Price: \$11.10 ea.
 (25 Pieces Per Ctn.)

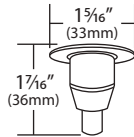

Shown in Polished Chrome

4. Sign Fitting (Holds 3/16" Thick Signage)

CSK-CSSC-*

Material: Solid Brass
Finish: Satin Chrome (*SC)
 & Polished Chrome (*PC)
Cable Diameter: 3mm
Price: \$4.50 ea.
Carton Price: \$4.20 ea.
 (25 Pieces Per Ctn.)

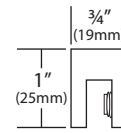

Shown in Polished Chrome

Use 3mm Hex Key

4. Sign Fitting (Holds 1/2" Thick Signage)

CSK-CSSC12-*

Material: Solid Brass
Finish: Satin Chrome (*SC)
 & Polished Chrome (*PC)
Cable Diameter: 3mm
Price: \$5.95 ea.
Carton Price: \$5.55 ea.
 (50 Pieces Per Ctn.)

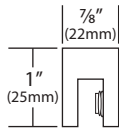

Shown in Polished Chrome

Use 3mm Hex Key

Vertical Double Sign Clamp

CSK-DSSC-*

Material: Solid Brass
Finish: Satin Chrome (*SC)
 & Polished Chrome (*PC)
Cable Diameter: 1.5mm
Price: \$7.60 ea.
Carton Price: \$6.95 ea.
 (25 Pieces Per Ctn.)

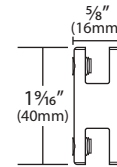

Shown in Polished Chrome

Use 3mm Hex Key

6. 3mm Bulk 304 Grade Stainless Steel Cables

Part #	Description	Cable Length	Price	Carton Qty.	Carton Price
Stainless Steel Cables					
CSK-CABLE		13'	\$9.85 ea.	25	\$7.45 ea.
CSK-CABLE-26	Standard 7x7 Construction	26'	\$15.00 ea.	10	\$13.95 ea.
CSK-CABLE-100		100'	\$49.80 ea.	10	\$47.95 ea.
Coated Steel Cables					
CSK-CABLE-C	Nylon Coating Over 7x7 Cable	13'	\$10.95 ea.	25	\$9.95 ea.

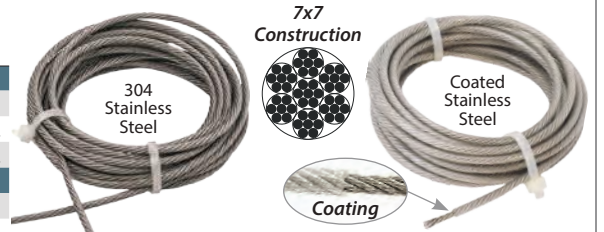

IMPORTANT: Due to Raw Material Fluctuation, Catalog Prices Below May Not Be Accurate. GO TO WWW.OUTWATER.COM FOR THE MOST UP-TO-DATE PRICES

3 in 1 Cable Hardware Kits For Both Standard 1.5mm & Heavy Duty 3mm

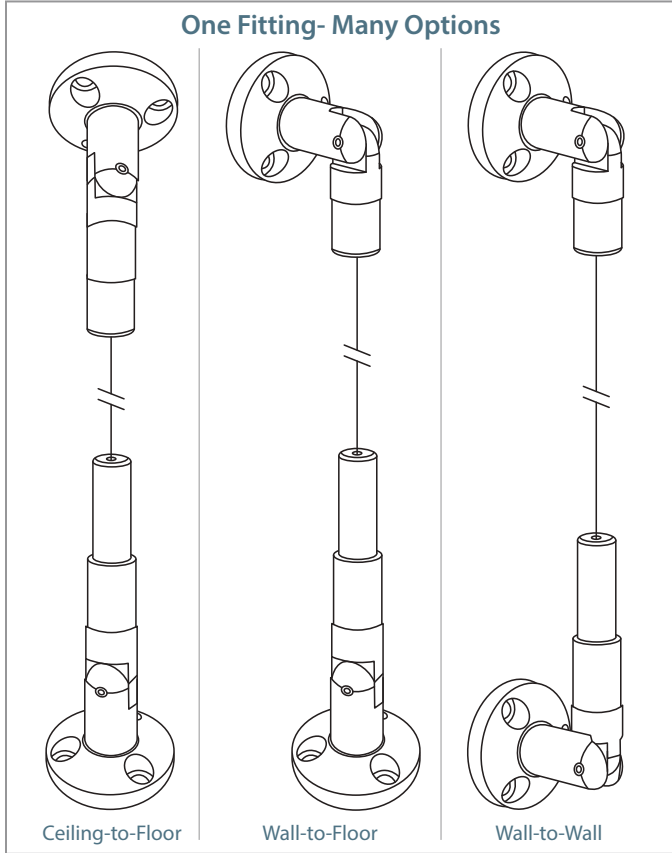

English measurements converted from metric. Metric is the most accurate.

Standard 1.5mm 3 in 1 Kit

MATERIAL = Aluminum (*Fittings*)
304 Grade Stainless Steel (*Cable*)

FINISH = Clear Anodized

- **Aluminum** universal fittings are hinged to allow for use in *Wall-to-Wall* and *Wall-to-Floor* applications
- For 8-1/2" x 11" and 11" x 17" graphics
- Can be used for single or double sided displays

Each Hardware Kit Contains:

- 1 universal top fitting
- 1 universal bottom fitting
- 1 cables - 13' length - 1.5mm thick (trimmable)

Part #	Price	
	Each Set	10+ Sets
CSKE-GN-ALU	\$25.95	\$24.45 ea

For 1.5mm: Horizontal Sign Clamps & Clear Acrylic Sign Holders, See Page S-4

Heavy Duty 3mm 3 in 1 Kit

MATERIAL = Solid Brass (*Fittings*)
304 Grade Stainless Steel (*Cable*)

FINISHES = Polished Chrome (***PC**) & Satin Chrome (***SC**)

- **Solid Brass** universal fittings are hinged to allow for use in *Wall-to-Wall*, *Wall-to-Floor* and *Floor-to-Ceiling* applications
- For 8-1/2" x 11" and 11" x 17" graphics
- Can be used for single or double sided displays

Each Hardware Kit Contains:

- 1 universal top fitting
- 1 universal bottom fitting
- 1 cables - 13' length - 3mm thick (trimmable)

Part #	Price	
	Each Set	10+ Sets
CSK-FC*	\$39.95	\$38.25 ea

For 3mm: Horizontal Sign Clamps & Clear Acrylic Sign Holders, See Page S-5

15 Series Cable Signage Kit
Non-Illuminating



Complete Graphic Kit

MATERIAL = Aluminum (*Fittings*)
304 Grade Stainless Steel (*Cable*)
FINISH = Clear Anodized

- *Aluminum* universal fittings are hinged to allow or use in *Wall-to-Wall* and *Wall-to-Floor* applications
- For 8-1/2" x 11" and 11" x 17" graphics
- Can be used for single or double sided displays

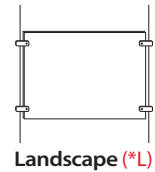
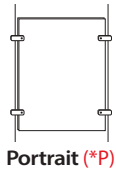
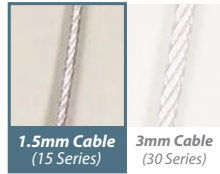

- Each kit contains:**
- 2 universal top fittings
 - 2 universal bottom fittings
 - 2 cables - 6' 6" length - 1.5mm thick (trimmable)
 - 12 mounting screws & anchors
 - 1 hex key
 - 4 sign clamps per graphic holder
 - 1/8" thick clear acrylic graphic holders w/polished edges

Hinged Fittings are adjustable:

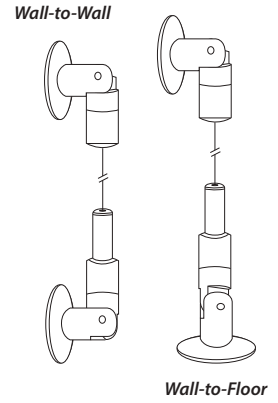

	Part #	Size	Type	Price
2 Graphic Kit	CSKE-LITKIT2-8-*	8½" x 11"	Portrait (*P) Landscape (*L)	\$67.93 kit
	CSKE-LITKIT2-11-*	11" x 17"		\$91.58 kit
3 Graphic Kit	CSKE-LITKIT3-8-*	8½" x 11"	Portrait (*P) Landscape (*L)	\$87.45 kit
	CSKE-LITKIT3-11-*	11" x 17"		\$122.93 kit
4 Graphic Kit	CSKE-LITKIT4-8-*	8½" x 11"	Portrait (*P) Landscape (*L)	\$106.98 kit
	CSKE-LITKIT4-11-*	11" x 17"		\$154.28 kit

2 Graphic Kits

CSKE-LITKIT2-8-P
CSKE-LITKIT2-11-P

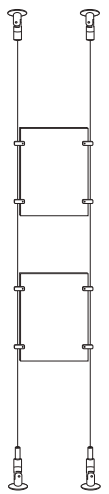

CSKE-LITKIT2-8-L
CSKE-LITKIT2-11-L

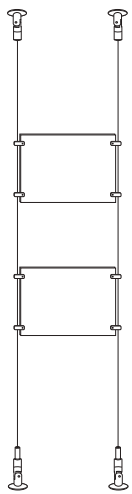

3 Graphic Kits

CSKE-LITKIT3-8-P
CSKE-LITKIT3-11-P

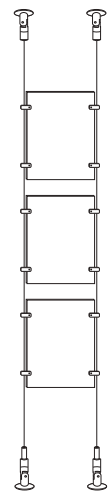

CSKE-LITKIT3-8-L
CSKE-LITKIT3-11-L

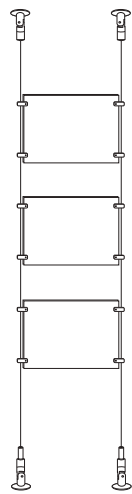

4 Graphic Kits

CSKE-LITKIT4-8-P
CSKE-LITKIT4-11-P

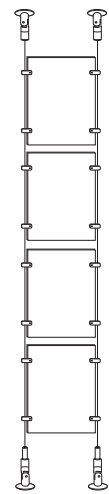

CSKE-LITKIT4-8-L
CSKE-LITKIT4-11-L

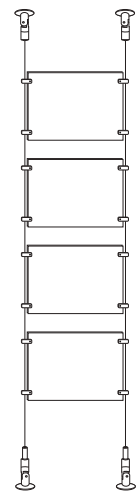

IMPORTANT: Due to Raw Material Fluctuation, Catalog Prices Below May Not Be Accurate. GO TO WWW.OUTWATER.COM FOR THE MOST UP-TO-DATE PRICES

30 Series Cable Signage Kit
Illuminating

*Illuminate your signs
all night, without
breaking your budget!*

Complete Illuminating Graphic Kit

12V

MATERIAL = Solid Brass (Fittings)
304 Grade Stainless Steel (Cable)

FINISH = Polished Chrome

- Solid Brass universal fittings are hinged to allow for use in *Wall-to-Wall*, *Wall-to-Floor* and *Floor-to-Ceiling* applications
- For 8-1/2" x 11" and 11" x 17" graphics
- **Illuminated**



Hinged Fittings are adjustable:

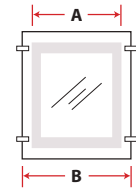
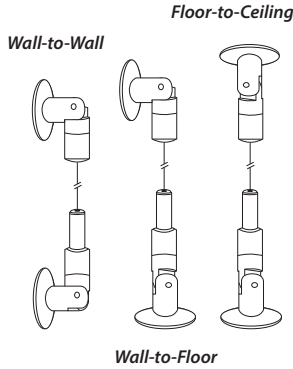

Portrait (*P)

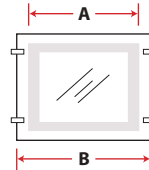

Landscape (*L)

Each kit contains:

- 2 universal top and bottom fittings
- 2 cables - 13' length - 3mm thick (trimmable)
- 12 mounting screws & anchors
- 1 hex key
- 1 UL 12V power supply w/plug
- 1/8" thick clear acrylic graphic holders w/polished edges

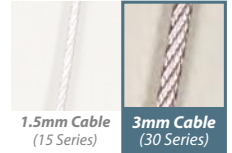

1.5mm Cable
(15 Series)

3mm Cable
(30 Series)

Lighting Specifications

Color Temperature	Cool White CW: 6100K
Lumens	CSK-CLB-8*: 186 CSK-CLB-11*: 93
Color Rendering Index	CW: 70
Rated Average Life	CW: 50,000 hrs.
Constant	Voltage
Chip Size	SMD 2835



Part #	Graphic Size	Reveal Dimensions (nominal)	Overall Dimensions (nominal)	Total Wattage	Type	Price	
2 Graphic Kit	CSK-ILITKIT2-8-*	8-1/2" x 11"	8-1/4" x 10-1/4"	12-1/8" x 13-3/8"	1.8W	Portrait (*P) Landscape (*L)	\$271.00
	CSK-ILITKIT2-11-*	11" x 17"	10-3/8" x 16-3/8"	13-1/2" x 19-1/2"	3.6W		\$324.00
3 Graphic Kit	CSK-ILITKIT3-8-*	8-1/2" x 11"	8-1/4" x 10-1/4"	12-1/8" x 13-3/8"	1.8W	Portrait (*P) Landscape (*L)	\$348.00
	CSK-ILITKIT3-11-*	11" x 17"	10-3/8" x 16-3/8"	13-1/2" x 19-1/2"	3.6W		\$428.00
4 Graphic Kit	CSK-ILITKIT4-8-*	8-1/2" x 11"	8-1/4" x 10-1/4"	12-1/8" x 13-3/8"	1.8W		\$434.00
	CSK-ILITKIT4-11-*	11" x 17"	10-3/8" x 16-3/8"	13-1/2" x 19-1/2"	3.6W		\$542.00

2 Graphic Kits

CSK-ILITKIT2-8-P CSK-ILITKIT2-8-L
CSK-ILITKIT2-11-P CSK-ILITKIT2-11-L

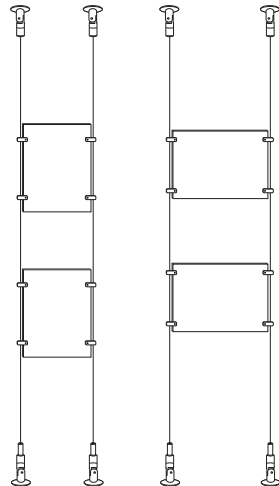

3 Graphic Kits

CSK-ILITKIT3-8-P CSK-ILITKIT3-8-L
CSK-ILITKIT3-11-P CSK-ILITKIT3-11-L

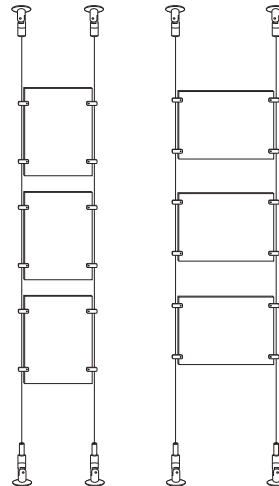

4 Graphic Kits

CSK-ILITKIT4-8-P CSK-ILITKIT4-8-L
CSK-ILITKIT4-11-P CSK-ILITKIT4-11-L

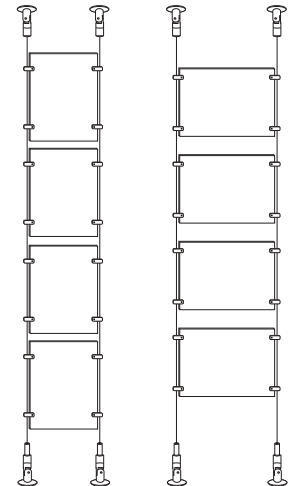

Insert and remove graphic from top



U-Shaped Cut Out

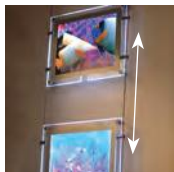

Can be set to varying heights



Beveled edge creates outer glow illumination!

Shelf Hardware Sets

MATERIAL = Solid Brass (*Fittings*), 304 Grade Stainless Steel (*Cable*)
FINISHES = Polished Chrome (***PC**), Satin Chrome (***SC**)

• Load Rating: 220 lbs. per cable

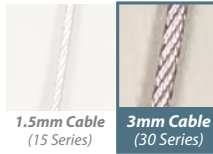

Wall-to-Wall



Includes:



Part #	Description	Price
CSK-WWSH-6-*	w/ 6" Shelf Stabilizer	\$61.95 set
CSK-WWSH-8-*	w/ 8" Shelf Stabilizer	\$61.95 set

Note: 2 Sets needed for single unit display

Wall-to-Floor



Includes:



Part #	Description	Price
CSK-WFSH-6-*	w/ 6" Shelf Stabilizer	\$61.95 set
CSK-WFSH-8-*	w/ 8" Shelf Stabilizer	\$61.95 set

Note: 2 Sets needed for single unit display

Floor-to-Ceiling



Includes:



Part #	Price
CSK-FC-*	\$47.25 set

Note: 4 Sets needed for single unit display

A Few Examples of the Many Possible Shelving Configurations:

Wall-to-Wall

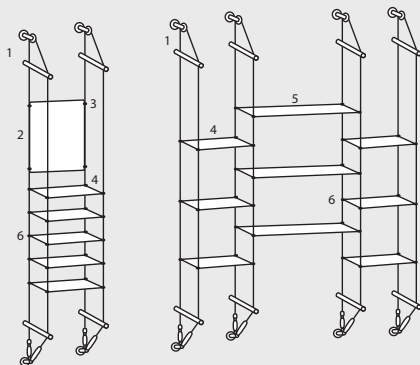

- 1 CSK-WWSH-*/Shelf Hardware Set pg. S-11
- 2 CSK-ASH-11P/Acrylic Sign Holder pg. S-5
- 3 CSK-SSGC/Horizontal Sign Clamp pg. S-5
- 4 CSK-SHF-1212/Clear Acrylic Flat Shelf pg. S-12
- 5 CSK-SHF-1224/Clear Acrylic Flat Shelf pg. S-12
- 6 CSK-SSC-*/Horizontal Shelf Clamp pg. S-12

Wall-to-Floor

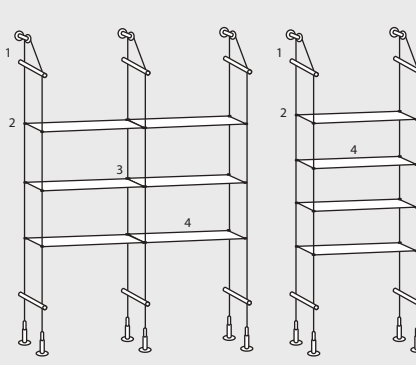

- 1 CSK-WFSH-*/Shelf Hardware Set pg. S-11
- 2 CSK-SSC-*/Horizontal Shelf Clamp pg. S-12
- 3 CSK-DSC-*/Double Horizontal Shelf Clamp pg. S-12
- 4 CSK-SHF-1224/Clear Acrylic Flat Shelf pg. S-12

Floor-to-Ceiling

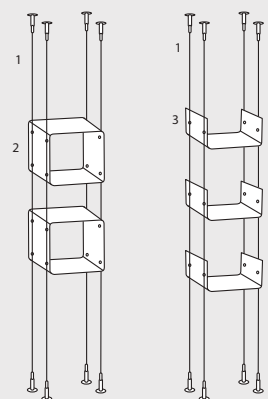

- 1 CSK-FC-*/Shelf Hardware Set pg. S-11
- 2 CSK-CUBE/Clear Acrylic Display Cube pg. S-12
- 3 CSK-FSHF-12/Clear Folded Acrylic Display Shelf pg. S-12

30 Series Cable Shelving

Acrylic Shelves

Clear Folded Acrylic Display Shelves with Polished Edges



ACRYLIC THICKNESS = 1/4" nominal

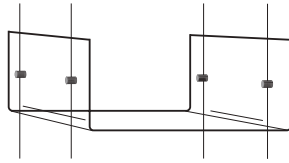

Polished Chrome Mounting Clamps Included

Part #	Overall Size	Price
CSK-FSHF-12	12"D x 12"L x 6"H	\$35.00 ea.
CSK-FSHF-24	12"D x 24"L x 6"H	\$48.00 ea.

**Nominal Size*

Clear Acrylic Display Cubes with Polished Edges



ACRYLIC THICKNESS = 1/4" nominal

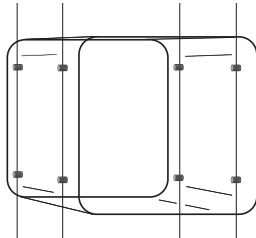

Polished Chrome Mounting Clamps Included

Part #	Overall Size	Price
CSK-CUBE	12"W x 12"L x 12"D	\$80.00 ea.

**Nominal Size*

Clear Acrylic Flat Shelves with Polished Edges



ACRYLIC THICKNESS = 1/4" nominal

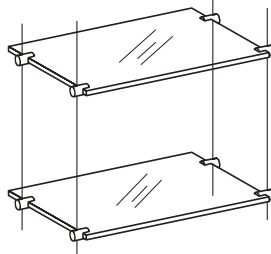

Shelf Clamps Sold Separately

Part #	Overall Size	Price
CSK-SHF-1212	12"W x 12"D	\$17.60 ea.
CSK-SHF-1224	24"W x 12"D	\$35.00 ea.

**Nominal Size*

Clear Acrylic Angled Shelves with Polished Edges

ACRYLIC THICKNESS = 1/4" nominal

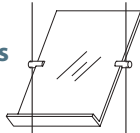

Part #	Overall Size	Price
CSK-ASHF-9	9"W x 11-1/2"L x 1" Lip	\$17.00 ea.

Works with CSK-ADJ- Adjustable Sign/Shelf Clamp*

30 Series Shelf Clamps

Horizontal Shelf Clamps

- MATERIAL** = Solid Brass
FINISHES = Polished Chrome (*PC), Satin Chrome (*SC)
- Works with material up to 5/16" thick
 - Use 3mm Hex Key

Part #	Type	Price
CSK-SSC-*	Single	\$5.35 ea.
CSK-DSC-*	Double	\$7.60 ea.

Single

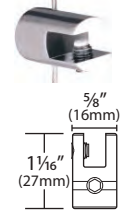

Double

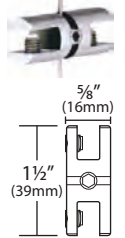

Adjustable Sign/Shelf Clamps

- MATERIAL** = Solid Brass
FINISHES = Polished Chrome (*PC), Satin Chrome (*SC)
- Rotates for sign or shelf applications
 - Works with material up to 5/16" thick
 - Use 3mm Hex Key



Part #	Price
CSK-ADJ-*	\$8.25 ea.

Undermount Shelf Support

- MATERIAL** = Solid Brass
FINISHES = Polished Chrome (*PC), Satin Chrome (*SC)
- Shelf support for use under drilled or slotted shelves
 - Works with material up to 5/16" thick
 - Hole Size: 5/16" - 3/8" (8-10mm)
 - Slot Size: 1/8" (3.5mm)
 - Use 3mm Hex Key

Part #	Price
CSK-UM-*	\$4.50 ea.

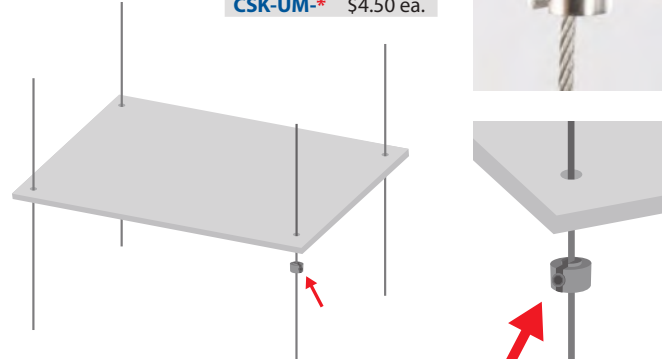

Optional Cable Display Accessories

Hex Keys

- Set of 3 hex keys M4, M5 & M6



Part #	Price
CSK-HEX	\$0.95 set

Cable Cutter



Part #	Price
CSK-CUTTER	\$27.95 ea.

IMPORTANT: Due to Raw Material Fluctuation, Catalog Prices Below May Not Be Accurate. GO TO WWW.OUTWATER.COM FOR THE MOST UP-TO-DATE PRICES

LED MR16 Rod



12V
MATERIAL = Polished Chrome Steel

- Works With Any 30 Series Cable System
- 180° Rotation of lamp holder
- Built in heat sink
- Energy efficient
- Adjustable
- MR16, 5W bulb included

**As Bright As A
 50W
 Halogen Bulb**

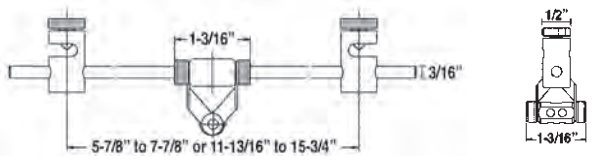

Part #	Color Temp	Width Adjusts From:	# Of LED Chips	Total Wattage	Price	
					Each	10+ Pcs.
CSK-MR16-100-WW	Warm White	5-7/8" to 7-7/8"	4	5W	\$12.00	\$9.95 ea.
CSK-MR16-100-CW	Cool White				\$12.00	\$9.95 ea.
CSK-MR16-200-WW	Warm White	11-13/16" to 15-3/4"			\$12.00	\$9.95 ea.
CSK-MR16-200-CW	Cool White				\$12.00	\$9.95 ea.

Lighting Specifications

Color Temperature	CW: 5500K-6500K WW: 2700K-3500K
Beam Spread	30°
Lumens	CW: 340 WW: 290
Color Rendering Index	WW: 75 CW: 80
Rated Average Life	CW/WW: 30,000-50,000 hrs.
Constant Voltage	Voltage
Chip Size	SMD2835

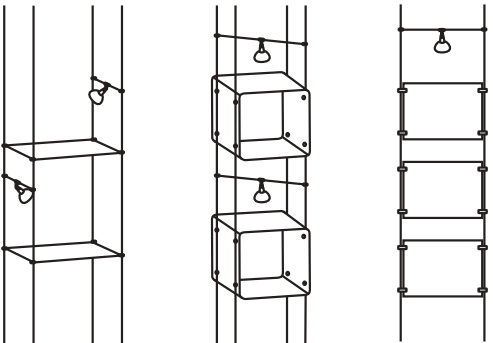

Works with our Cable Display System, see pgs. S-11~12



Power Supply (3A / 12V / 36W)

- 3.41" L x 2.31" W x 1.26" H
- 18AWG Output Cord: 6'
- Polarized 2 Prong Plug

LED-12V-3A
Each: \$16.15
6+ Pcs.: \$14.70 ea.

**IMPORTANT: Due to Raw Material Fluctuation, Catalog Prices Below May Not Be Accurate.
GO TO WWW.OUTWATER.COM FOR THE MOST UP-TO-DATE PRICES**

Picture & Art Hanging Systems

Outwater's hanging systems allows you to easily add, reposition/remove art or wall objects without wall damage.

- Hanging & display solutions for residential & commercial use
- Easy to adjust and change artwork
- Eliminates wall repairs and repainting
- No tools needed
- Aluminum track load capacity: 110 lbs per length
- Nylon cable load capacity: 33 pounds per length
- Stainless cable load capacity: 44 pounds per length



1 Select Your Channel



2 Select Your Vertical Cables



3 Select Your Picture Hooks

New! Click Track

Versatile • Discreet • Easy to Install

The Click Track is secured to the wall using click buttons that conceal all fittings and wall anchors

Secure Click Buttons to Wall



Track Attaches to Click Buttons

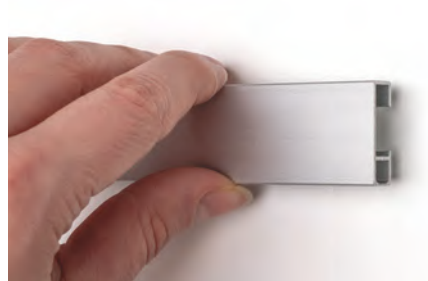

Slide Fitting in to Track & Install End Cap

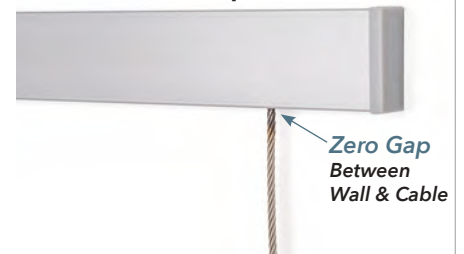

Wall Track in 2mm Cable For Art

Channels For Cables With Top Hooks

1. Click Track

GPX-TK100-*

Finish: Black (*BK), White (*WH) & Satin (*S)

Cable Diameter: 2mm

Length: 6'

Price: \$15.95 ea.

Carton Price: \$14.95 ea. (10 Pieces Per Ctn.)



*Included:
2 End Caps,
3 Click Buttons
& 1 Splicer*

2. Wall Track

GPX-TK101-*

Finish: Black (*BK), White (*WH) & Satin (*S)

Cable Diameter: 2mm

Length: 6'

Price: \$12.95 ea.

Carton Price: \$11.95 ea. (10 Pieces Per Ctn.)



3. Ceiling Track

GPX-TK102-*

Finish: Black (*BK), White (*WH) & Satin (*S)

Cable Diameter: 2mm

Length: 6'

Price: \$19.95 ea.

Carton Price: \$16.95 ea. (10 Pieces Per Ctn.)



4. J Track

ALU851-*

Finish: Black (*BK), White (*WH), Satin (*S), Mill (*M) & Polished (*P)

Cable Diameter: 2mm

Length: 12'



*Holes
Approx.
4" Spacing*

Part #	Mill (*M)	Polished (*P)	Satin (*S)	Black (*BK)	White (*WH)
ALU851-*	\$1.05'	\$1.72'	\$1.58'	\$2.24'	\$2.24'

Vertical Cables



Part #	Description	Cable Material	Length	Price	Carton Qty.	Carton Price
1 GPX-T48-N	T-End Cable	Nylon	48"	\$2.45 ea.	50	\$2.35 ea.
1 GPX-T120-N	T-End Cable	Nylon	120"	\$4.25 ea.	50	\$4.05 ea.
1 GPX-T48-SS	T-End Cable	Stainless Steel	48"	\$2.55 ea.	50	\$2.45 ea.
1 GPX-T120-SS	T-End Cable	Stainless Steel	120"	\$4.35 ea.	50	\$4.15 ea.
2 GPX-B48-SS	Ball End Cable	Stainless Steel	48"	\$2.30 ea.	50	\$2.15 ea.
2 GPX-B120-SS	Ball End Cable	Stainless Steel	120"	\$4.45 ea.	50	\$4.15 ea.
3 GPX-V48-SS	V-End Cable	Stainless Steel	48"	\$7.25 ea.	50	\$6.95 ea.
3 GPX-V120-SS	V-End Cable	Stainless Steel	120"	\$9.95 ea.	50	\$9.55 ea.
4 GPX-P48-N	P-End Cable	Nylon	48"	\$1.80 ea.	50	\$1.65 ea.
4 GPX-P120-N	P-End Cable	Nylon	120"	\$2.95 ea.	50	\$2.80 ea.
4 GPX-P48-SS	P-End Cable	Stainless Steel	48"	\$1.90 ea.	50	\$1.75 ea.
4 GPX-P120-SS	P-End Cable	Stainless Steel	120"	\$3.10 ea.	50	\$2.95 ea.
5 GPX-H48-N	Hex End Cable	Nylon	48"	\$1.95 ea.	50	\$1.85 ea.
5 GPX-H120-N	Hex End Cable	Nylon	120"	\$2.85 ea.	50	\$2.65 ea.
5 GPX-H48-SS	Hex End Cable	Stainless Steel	48"	\$2.10 ea.	50	\$1.95 ea.
5 GPX-H120-SS	Hex End Cable	Stainless Steel	120"	\$2.95 ea.	50	\$2.75 ea.

Picture Hooks



Part #	Description	Finish	Price	Carton Qty.	Carton Price
1 GPX-HK5-NP	Self Gripping Hook	Bright Nickel	\$4.75 ea.	50	\$4.40 ea.
2 GPX-HK6-NP	L-End Hook		\$4.75 ea.	50	\$4.40 ea.
3 GPX-HK8-NP	Smart Spring		\$1.45 ea.	50	\$1.30 ea.
4 GPX-HK9-NP	Spring Hook		\$1.45 ea.	50	\$1.30 ea.
5 GPX-HK58-NP	Self Locking Hook		\$4.20 ea.	50	\$3.95 ea.
6 GPX-HK7-NP	Self Gripping Hook		\$5.35 ea.	50	\$4.95 ea.
7 GPX-HK3-NP	L Hook		\$3.85 ea.	50	\$3.65 ea.
8 GPX-HK1-NP	J-End Hook		\$3.95 ea.	50	\$3.75 ea.

Accessories

Hex Keys

CSK-HEX

Price: \$0.95 ea.

Ctn. Price: \$0.79 ea. (100 Pieces Per Ctn.)



Cable Cutter

CSK-CUTTER

Price: \$27.95 ea.

Ctn. Price: \$25.95 ea. (10 Pieces Per Ctn.)

Large Picture Stabilizer

Recommended for pictures 16" x 16" and up



GPX-HK13-NP

Price: \$6.95 ea.

Ctn. Price: \$6.65 ea. (25 Pieces Per Ctn.)

IMPORTANT: Due to Raw Material Fluctuation, Catalog Prices Below May Not Be Accurate. GO TO WWW.OUTWATER.COM FOR THE MOST UP-TO-DATE PRICES

Trackless 2mm Cable Hanging System For Wall & Ceiling

Option 1: Stand Alone 2mm Cables

1. Adjustable Hinged Fitting Cable

Mounts on Walls & Ceilings



2. Standoff End Cable

Mounts on Walls



	Part #	Cable Material	Length	Price	Ctn. Qty.	Carton Price
1	GPX-ADJ48-N	Nylon	48"	\$4.20 ea.	50	\$3.95 ea.
1	GPX-ADJ120-N		120"	\$4.95 ea.	50	\$4.60 ea.
1	GPX-ADJ48-SS	Stainless Steel	48"	\$4.45 ea.	50	\$4.15 ea.
1	GPX-ADJ120-SS		120"	\$5.50 ea.	50	\$4.80 ea.
2	GPX-STD48-N	Nylon	48"	\$3.15 ea.	50	\$3.00 ea.
2	GPX-STD120-N		120"	\$3.95 ea.	50	\$3.80 ea.
2	GPX-STD48-SS	Stainless Steel	48"	\$3.25 ea.	50	\$3.10 ea.
2	GPX-STD120-SS		120"	\$4.05 ea.	50	\$3.90 ea.

Option 2: Bulk 2mm Cable- Make Your Own

2MM Nylon Cable

GPX-CABLE-100

Material: Nylon

Cable Diameter: 2mm

Length: 100'

Price: \$23.00 ea.

Carton Price: \$21.50 ea.
(10 Pieces Per Ctn.)



Economy Cable Looper

GPXE-HK41-M

Material: Aircraft Grade Aluminum

Finish: Mill

Cable Diameter: 2mm

Price: \$1.85 ea.

Carton Price: \$1.77 ea.
(50 Pieces Per Ctn.)



Cable Looper

GPX-HK41-NP

Material: Solid Brass

Finish: Bright Nickel

Cable Diameter: 2mm

Price: \$5.55 ea.

Carton Price: \$5.20 ea.
(50 Pieces Per Ctn.)



Economy Cable Looper



Cable Looper

Option 3: Premade Single Loop 2mm Cable with Ferrule



Nylon



Stainless Steel

	Part #	Material	Length	Price	Ctn. Qty.	Carton Price
	GPX-L48-N	Nylon	48"	\$1.80 ea.	50	\$1.65 ea.
	GPX-L120-N		120"	\$3.00 ea.	50	\$2.85 ea.
	GPX-L48-SS	Stainless Steel	48"	\$2.10 ea.	50	\$1.95 ea.
	GPX-L120-SS		120"	\$3.30 ea.	50	\$3.15 ea.

IMPORTANT: Due to Raw Material Fluctuation, Catalog Prices Below May Not Be Accurate. GO TO WWW.OUTWATER.COM FOR THE MOST UP-TO-DATE PRICES

Trackless 2mm Cable Hanging System For Wall & Ceiling

Mounting Options For 2mm Cable

1 S-Hook



▲ Works With ALU851-*

2 Picture Frame Hook



3



Fits Standard Ceiling Grids

4



Part #	Description	Finish	Price	Ctn. Qty.	Carton Price
1 GPX-HK10-NP	S-Hook	Bright Nickel	\$1.85 ea.	50	\$1.75 ea.
2 GPX-HK11-WW	L-End Hook	White	\$2.40 ea.	50	\$2.16 ea.
3 1215	Standard Twist Clip	White & Zinc	\$0.75 ea.	100	\$0.59 ea.
4 1216	Threaded Twist Clip	Plated Steel	\$0.99 ea.	100	\$0.89 ea.

Picture Hooks For 2mm Cable

1



2



3



4



5



6



7



8



Part #	Description	Finish	Price	Ctn. Qty.	Carton Price
1 GPX-HK5-NP	Self Gripping Hook	Bright Nickel	\$4.75 ea.	50	\$4.40 ea.
2 GPX-HK6-NP	L-End Hook	Bright Nickel	\$4.75 ea.	50	\$4.40 ea.
3 GPX-HK8-NP	Smart Spring	Bright Nickel	\$1.45 ea.	50	\$1.30 ea.
4 GPX-HK9-NP	Spring Hook	Bright Nickel	\$1.45 ea.	50	\$1.30 ea.
5 GPX-HK58-NP	Self Locking Hook	Bright Nickel	\$4.20 ea.	50	\$3.95 ea.
6 GPX-HK7-NP	Self Gripping Hook	Bright Nickel	\$5.35 ea.	50	\$4.95 ea.
7 GPX-HK3-NP	L Hook	Bright Nickel	\$3.85 ea.	50	\$3.65 ea.
8 GPX-HK1-NP	J-End Hook	Bright Nickel	\$3.95 ea.	50	\$3.75 ea.

Accessories For All Cables

Hex Keys



CSK-HEX

Price: \$0.95 ea.

Ctn. Price: \$0.79 ea.
(100 Pieces Per Ctn.)

Cable Cutter



CSK-CUTTER

Price: \$27.95 ea.

Ctn. Price: \$25.95 ea.
(5 Pieces Per Ctn.)

Large Picture Stabilizer

Recommended for pictures 16" x 16" and up

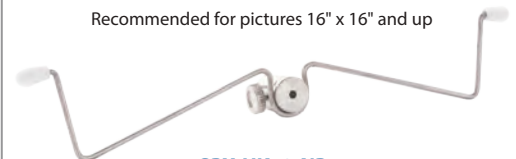

GPX-HK13-NP

Price: \$6.95 ea.

Ctn. Price: \$6.65 ea.
(25 Pieces Per Ctn.)

IMPORTANT: Due to Raw Material Fluctuation, Catalog Prices Below May Not Be Accurate. GO TO WWW.OUTWATER.COM FOR THE MOST UP-TO-DATE PRICES

Adjustable Cable Hook Sign Hanging Hardware

Locking Adjustable Cable Hook Kit w/Top Fitting

- **Material:**
304 Grade Stainless Steel Cable with Polished Chrome Steel Hook & Top Fitting
- **Wire Gauge:**
1.5mm

44 HOLDS LBS. per cable assembly

Field Cuttable to Any Length

Mounting Screw Not Included
Toggle Option Available, Please Inquire

Kit Includes:

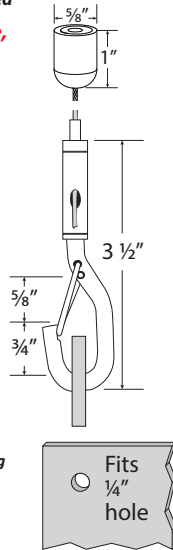
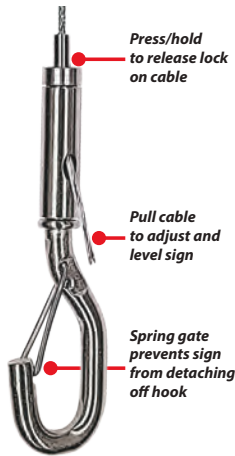

Part #	Description	Each	25 Pcs.
FWH-8-PC	8 ft. Cable	\$7.15	\$6.70 ea.
FWH-15-PC	15 ft. Cable	\$7.95	7.50 ea.

Locking Adjustable Cable Hook Kit w/2" Loop End

- **Material:**
304 Grade Stainless Steel Cable with Polished Chrome Steel Hook & Top Fitting
- **Wire Gauge:**
1.5mm

44 HOLDS LBS. per cable assembly

Field Cuttable to Any Length

Kit Includes:

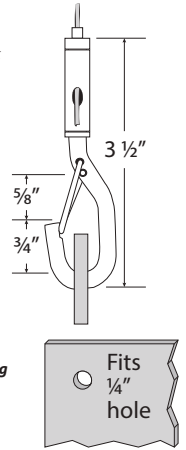
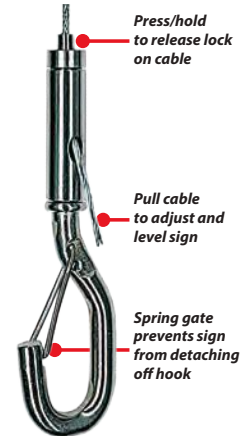
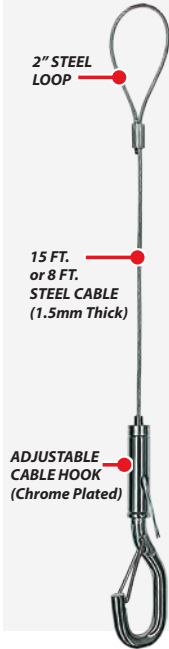

Part #	Description	Each	50 Pcs.
GSH-8	8 ft. Cable	\$3.55	\$3.40 ea.
GSH-15	15 ft. Cable	\$4.25	\$3.95 ea.

Double Loop Cables

3MM 304 Grade Stainless Steel Cable w/ 2 Loops



Part #	Length	Price	Carton Qty.	Carton Price
LRP-CLP6-1	1'	\$1.92 ea.	25	\$1.82 ea.
LRP-CLP6-18	18"	\$2.67 ea.	25	\$2.54 ea.
LRP-CLP6-2	2'	\$3.42 ea.	25	\$3.25 ea.
LRP-CLP6-3	3'	\$4.94 ea.	25	\$4.69 ea.
LRP-CLP6-4	4'	\$6.45 ea.	25	\$6.13 ea.
LRP-CLP6-6	6'	\$9.48 ea.	25	\$9.00 ea.



Apartment Hanger

HGHB-APT-*

- **Material:** Aluminum
- No drill, easy to install
- Foam liner, so no damage to walls
- Wall bracket holes drilled every inch
- Patented/Made in USA

The Hangman Apartment Hanger consists of two aluminum interlocking brackets modeled after the French Cleat featuring a built in level which ensures an accurate installation. The aircraft grade aluminum brackets will not corrode and can be used indoors or outdoors. The system uses small nails which leave pin size holes and a foam back to protect walls from scuffs and marks. Once installed it can be adjusted left or right.



Part #	Size	Load Rating	Hardware Includes: (1) Wall Bracket, (1) Mounting Bracket, (1) Bubble Level,		Each	30 Sets	50 Sets
			#8 x 5/8" Screws	Nails			
HGHB-APT-6	6" Long	50 lbs.	2	5	\$3.97/st	\$3.61/st	\$3.29/st
HGHB-APT-12	12" Long	100 lbs.	3	14	\$6.22/st	\$5.66/st	\$5.16/st
HGHB-APT-18	18" Long	150 lbs.	5	20	\$8.69/st	\$7.91/st	\$7.22/st

Heavy Duty Mirror & Picture Hanger

HGHB-HM-*

- **Material:** Aluminum
- Wall bracket holes drilled every inch
- Brackets are angled to ensure a flush mount
- Patented/Made in USA

The Hangman Heavy Duty Mirror & Picture Hanger is our classic and best selling product. It consists of two aluminum interlocking brackets modeled after the French Cleat featuring a built in level which ensures an accurate installation. The aircraft grade aluminum brackets will not corrode and can be used indoors or outdoors on all surfaces. The system includes walldog anchorless fasteners.



Part #	Size	Load Rating	Hardware Includes: (1) Wall Bracket, (1) Mounting Bracket, (1) Bubble Level,		Each	30 Sets	50 Sets
			#8 x 5/8" Screws	Walldog Screws			
HGHB-HM-6	6" Long	75 lbs.	2	2	\$4.66/st	\$4.24/st	\$3.87/st
HGHB-HM-10	10" Long	100 lbs.	3	3	\$6.28/st	\$5.71/st	\$5.21/st
HGHB-HM-12	12" Long	100 lbs.	3	3	\$6.78/st	\$6.17/st	\$5.63/st
HGHB-HM-18	18" Long	200 lbs.	5	5	\$9.49/st	\$8.64/st	\$7.88/st
HGHB-HM-30	30" Long	300 lbs.	8	8	\$12.56/st	\$11.43/st	\$10.42/st
HGHB-HM-42	42" Long	300 lbs.	10	10	\$16.55/st	\$15.06/st	\$13.73/st

Professional French Cleat Hanger

HGHB-CBH-*

- **Material:** Aluminum
- Two piece system includes inset mounting bracket for a flush fit
- Aircraft grade aluminum
- Patented/Made in USA

The Hangman Professional French Cleat Hanger is a variation of the Heavy Duty Hangman and has several unique features. The overlapping design of the mounting bracket provides high torque leverage for use in hanging cantilevered shelves. The wall track is punched every inch making it easy to hit at least one stud. In addition to hanging shelves, it works great on cabinets, mirrors, and other heavy wall déco.



Part #	Size	Load Rating	Hardware Includes: (1) Wall Bracket, (1) Mounting Bracket, (1) Bubble Level, #8 x 5/8" Screws		Each	30 Sets	50 Sets
			Walldog Screws				
HGHB-CBH-18	18" Long	200 lbs.	5	5	\$9.24/st	\$8.41/st	\$7.67/st
HGHB-CBH-30	30" Long	300 lbs.	8	8	\$13.46/st	\$12.25/st	\$11.17/st
HGHB-CBH-42	42" Long	300 lbs.	10	10	\$17.47/st	\$15.90/st	\$14.50/st

Self Leveling Flushmount Hanger

HGHB-SCH-2

- **Material:** Aluminum
- Inset for a flush fit
- Aircraft grade aluminum
- Patented
- Works well with open back canvas

The Hangman Self Leveling Flushmount Hanger is a single piece hanger that attaches to the back of your canvas and hangs on the provided Bear Claw Hanger. The inset created allows the canvas to hang flush against the wall. Ideal for unframed canvas art. Also works on wooden frames.



Hardware Includes:

- (2) #4 x 5/8" Screws
- (2) Double Headed Bear Claw Screws
- (2) Sawtooths

Part #	Size	Load Rating	Each	30 Sets	50 Sets
HGHB-SCH-2	38 x 22 mm	20 lbs.	\$1.03/st	\$0.94/st	\$0.85/st

Canvas Hanger

HGHB-CH-5

- **Material:** Aluminum
- Brackets are angled to ensure a flush mount
- Patented/Made in USA

The Hangman Canvas Hanger is a two piece bracket system that hangs giclees, gallery wraps, canvas or open back frames flush to the wall.

The wall track includes a bubble level for an accurate installation.



Hardware Includes:

- (2) #4 x 5/8" Screws
- (2) #8 x 1" Screws
- (1) Bubble Level
- (1) Mounting Bracket
- (1) Wall Bracket

Part #	Size	Load Rating	Each	30 Sets	50 Sets
HGHB-CH-5	5" Long	20 lbs.	\$2.73/st	\$2.48/st	\$2.27/st



Aluminum Frame Hanger

HGHB-ALH-5

- **Material:** Aluminum
- Offset almost flush
- Single piece wall hanger

The Hangman Aluminum Frame Hanger is a one bracket system that is designed to hook into standard aluminum frames or specially designed wooden frames with an undercut. The track includes a bubble level and anchorless Walldog fasteners for a fast and accurate installation.



Hardware Includes:

- (2) Walldog Screws
- (1) Bubble Level
- (1) Frame Hanger

Part #	Size	Load Rating	Each	30 Sets	50 Sets
HGHB-ALH-5	5" Long	60 lbs.	\$2.73/st	\$2.48/st	\$2.27/st

Z-Hanger

HGZ-6948-* Z-Hanger

HGZL-6986-* Z-Lite Hanger

- **Material:** Aluminum
- **Load Rating:** 100 lbs. per ft. (HGZ-6948-*)
60 lbs. per ft. (HGZL-6986-*)
- Offset .22" (5.6 mm)
- Alternating holes every 1" (3/16" dia. & 1/4" dia.)
- Sold as pairs, including:
1" walldog screws & 5/8" bear claw screws
- **HGZL-6986-***: Slight flexibility allows for easier engagement on non-plumb walls
- *Sold in full cases only, where indicated (■)*

The Hangman Z-Hanger consists of two aluminum interlocking brackets modeled after the French Cleat. The aircraft grade aluminum brackets will not corrode and can be used indoors or outdoors on all surfaces. The system is compatible with various fasteners, and can be adjusted left or right. Hangman's unique Z-Hanger comes with alternating holes punched every inch.



Part #	Size	Load Rating	Hardware Includes: (1) Wall Bracket, (1) Mounting Bracket,		Case Quantity	Each	30 Sets	50 Sets
			#8 x 5/8" Screws	Walldog Screws				
HGZ-6948-18	18" Long	120 lbs./ft.	5	5	-	\$5.82/st	\$5.29/st	\$4.83/st
HGZ-6948-30	30" Long	120 lbs./ft.	8	8	-	\$8.65/st	\$7.87/st	\$7.18/st
						1-5 Cases	6-10 Cases	10+ Cases
■ HGZ-6948-18-12	18" Long	120 lbs./ft.	Hardware Not Included		6 sets	\$69.59/bx	\$63.33/bx	\$57.76/bx
■ HGZ-6948-30-12	30" Long	120 lbs./ft.	Hardware Not Included		6 sets	\$105.42/bx	\$95.93/bx	\$87.50/bx
■ HGZL-6986-18-12	18" Long	60 lbs./ft.	Hardware Not Included		6 sets	\$40.11/bx	\$36.50/bx	\$33.29/bx
■ HGZL-6986-30-12	30" Long	60 lbs./ft.	Hardware Not Included		6 sets	\$56.45/bx	\$51.37/bx	\$46.85/bx

Z-Man Mounting Bracket

HGZM-6318-*

- **Material:** Aluminum
- Slight flexibility allows for easier engagement on non-plumb walls
- Aircraft grade aluminum
- Alternating holes every 1" (3/16" dia. & 1/4" dia.)
- Easily cuttable with a carbide tip saw
- **Load Rating:** 60 lbs. per ft.
- *Sold in full cases only, 6 sets/case*



Hardware Not Included

Part #	Size	Load Rating	Case Quantity	1-5 Cases	6-10 Cases	10+ Cases
HGZM-6318-18-12	18" Long	60 lbs./ft.	6 sets	\$46.03/bx	\$41.89/bx	\$38.21/bx
HGZM-6318-30-12	30" Long	60 lbs./ft.	6 sets	\$64.68/bx	\$58.86/bx	\$53.38/bx

Hangman® Hanger Products



Machine Thread Double-Headed Screw

HGSCR-MT-*

- **Material:** Steel
- #10-24 x 2-1/4" Long
- Machine screw threading
- Double-headed hanging surface
- **Load Rating:** 100 lbs.
- Works w/Toggler TA-1013 snap-toggle
- Sold in full cases only



Part #	Case Quantity	1-5 Cases	6-10 Cases	10+ Cases
HGSCR-MT-10P	10 pcs.	\$4.83/box	\$4.40/box	\$4.01/box
HGSCR-MT-100	100 pcs.	\$44.10/box	\$40.13/box	\$36.60/box
HGSCR-MT-1000	1000 pcs.	\$357.00/box	\$324.87/box	\$296.31/box

Walldog Screws

HGSCR-WDS-*

- **Material:** Steel
- 1-1/4" Screws
- #8 Pan head
- Hi-Lo thread, 1/4" bore hole
- **Load Rating:** 60 lbs. sheer, 40 lbs. tension in drywall
- Sold in full cases only



The Hangman Walldog Screws are an all steel, one piece, threaded fastener, which is used to fasten various fixtures directly to drywall. Walldog fasteners are fast. Unlike conventional screw anchors, which require the secondary step of threading a sheet metal screw into an anchor, the Walldog is installed directly through the fixture into the drywall.

Part #	Case Quantity	1-5 Cases	6-10 Cases	10+ Cases
HGSCR-WDS-100	100 pcs.	\$23.10/box	\$21.02/box	\$19.17/box
HGSCR-WDS-1000	1000 pcs.	\$189.00/box	\$171.99/box	\$156.87/box

Walldog Safety Hanger

HGSH-WDH-*

- **Material:** Aluminum
- Aircraft grade aluminum
- Security lip prevents wire from slipping out
- 8 wide pivot point prevents frames from slipping
- Patented/Made in USA

The Hangman Walldog Safety Hanger is an extruded aluminum track that has a security lip to prevent picture hanging wire from slipping out. The wire is easy to insert and won't come out if bumped. The brackets are installed using anchorless Walldog fasteners that require no drilling and no stud. Friction bumpers included to keep walls clean and keep art from shifting.

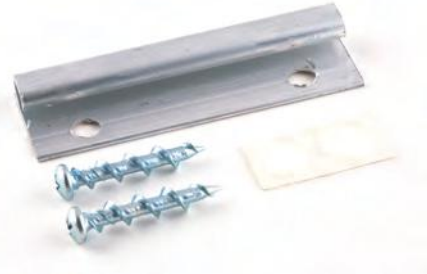

Part #	Length	Load Rating	Hardware Includes:	Each	30 Sets	50 Sets
HGSH-WDH-40	1-1/2"	40 lbs.	(1) Walldog, (1) Pair Bumper, (1) Hanger	\$1.66/st	\$1.51/st	\$1.38/st
HGSH-WDH-80	3"	80 lbs.	(2) Walldogs, (1) Pair Bumper, (1) Hanger	\$2.18/st	\$1.99/st	\$1.81/st

Bear Claw Hanger

HGSCR-*

- **Material:** Steel
- Self-drilling tip, no pilot hole required
- Works with D-rings, wire, keyhole & sawtooths
- **Load Rating:** 30 lbs. drywall, 100 lbs. stud
- Sold in full cases only

The Hangman Black Bear Claw Hangers work with D-rings, wire, sawtooths and keyholes for simple mirror and picture hanging solutions. Installs with a hand-held Phillips screwdriver. Self-drilling tip for easy installation.

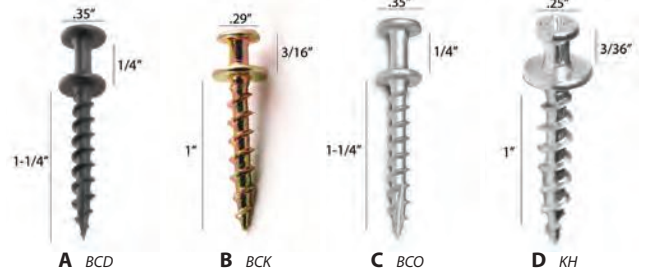

Part #	Length	Description	Case Quantity	1-5 Cases	6-10 Cases	10+ Cases
HGSCR-BCD-10P	#8 x 1-1/4"	Black Oxide	10 pcs.	\$1.97/box	\$1.80/box	\$1.64/box
HGSCR-BCD-100			100 pcs.	\$17.64/box	\$16.05/box	\$14.64/box
HGSCR-BCD-1000			1000 pcs.	\$136.92/box	\$124.60/box	\$113.64/box
HGSCR-BCK-10P	#8 x 1"	Zinc Plated	10 pcs.	\$1.64/box	\$1.49/box	\$1.36/box
HGSCR-BCK-100			100 pcs.	\$14.28/box	\$12.99/box	\$11.85/box
HGSCR-BCK-1000			1000 pcs.	\$115.92/box	\$105.49/box	\$96.21/box
HGSCR-BCO-10P	#8 x 1-5/8"	Special Outdoor Coating	10 pcs.	\$6.20/box	\$5.64/box	\$5.14/box
HGSCR-BCO-100			100 pcs.	\$58.80/box	\$53.51/box	\$48.80/box
HGSCR-BCO-1000			1000 pcs.	\$455.70/box	\$414.69/box	\$378.23/box
HGSCR-KH-10P	#8 x 1"	.25" Head Size	10 pcs.	\$1.64/box	\$1.49/box	\$1.36/box
HGSCR-KH-100			100 pcs.	\$14.28/box	\$12.99/box	\$11.85/box
HGSCR-KH-1000			1000 pcs.	\$115.92/box	\$105.49/box	\$96.21/box

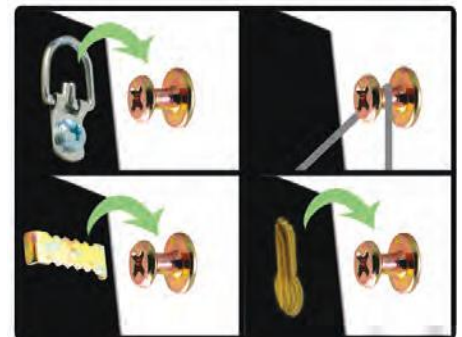



Christmas Light Hangers

HGSH-QH-*

- **Material:** Stainless Steel
- Screws have an open loop (5/32" opening)
- **Load Rating:** 100 lbs. in wood beam or stud
- *Sold in full cases only*

The Hangman Christmas Light Hangers are an all year outdoor stainless steel wire holder. A simple way to hang holiday lights, bird feeders, bird houses, wind chimes, etc. Installs easily and is wind and weather resistant with a lifetime warranty. These are made to last.



Part #	Size	Case Quantity	1-5 Cases	6-10 Cases	10+ Cases
HGSH-QH-12	38 x 22 mm	12 pcs.	\$6.26/bx	\$5.69/bx	\$5.19/bx
HGSH-QH-20		20 pcs.	\$10.23/bx	\$9.31/bx	\$8.49/bx



Elephant Hook Ceiling Hook

- **Material:** Steel
- Weather resistant coating
- Swivels & locks
- **Load Rating:** Holds 20 lbs. in drywall, 100 lbs. in wood

Elegant and easy, the Elephant Hook ceiling hook installs in under a minute. No drilling or pilot hole necessary. Simply screw in the self-drilling double-headed Bear Claw Hanger. Snap the Elephant Hook in place over the exposed collar. Swivel to desired angle and allow the weight of your item to lock into place. Comes in three finishes to match decor. For use indoor or outdoors, holds 100 lbs. in wood, 20 lbs. in drywall.

Hardware Includes:

- (1) Elephant hook
- (1) #8 x 1-1/4" Double-headed screw
- (1) Snap skru

Part #	Finish	Each	30 Sets	50 Sets
HGH-EHO-B	Bronze	\$4.77/st	\$4.37/st	\$3.96/st
HGH-EHO-N	Nickel	\$4.77/st	\$4.37/st	\$3.96/st
HGH-EHO-W	White	\$4.77/st	\$4.37/st	\$3.96/st



Push and Hang

HGSH-PSH-*

- **Material:** Steel Plating
- Pushed directly into drywall
- Creates an easy hanging surface
- *Sold in full cases only*

Push and hang. Absolutely the simplest and easiest to use picture hanger on the planet! Simply push into drywall, no tools needed.

Part #	Size	Load Rating	Case Quantity	1-5 Cases	6-10 Cases	10+ Cases
HGSH-PSH-S-100	9 x 26 mm	10 lbs.	100 pcs.	\$39.48/bx	\$35.93/bx	\$32.77/bx
HGSH-PSH-S-1000			1000 pcs.	\$294.00/bx	\$267.54/bx	\$244.02/bx
HGSH-PSH-L-100	16 x 35.5 mm	20 lbs.	100 pcs.	\$45.78/bx	\$41.66/bx	\$38.00/bx
HGSH-PSH-L-1000			1000 pcs.	\$336.00/bx	\$305.76/bx	\$278.88/bx



IMPORTANT: Due to Raw Material Fluctuation, Catalog Prices Below May Not Be Accurate. GO TO WWW.OUTWATER.COM FOR THE MOST UP-TO-DATE PRICES

Hangman® Hanger Products



Furniture Anti-Tip Kit

HGA-TK-400

- **Material:** Steel
- Aircraft grade steel cables
- Secures dressers, curio cabinet, chests and entertainment centers
- **Load Rating:** 400 lbs.
- Also available for leaner mirrors

The Hangman Furniture Anti-Tip Kit consists of an aircraft grade steel cable that connects on one end to your furniture with a bracket installed into a stud on the wall. The cable prevents the furniture from tipping over. This kit is a leader in furniture safety.



Hardware Includes:

- (2) #8 x 5/8" Screws
- (2) #8 x 1-1/2" Screws
- (2) Steel Brackets
- (2) Clevis Pins
- (2) Hair Pins
- (1) 6" Stainless Steel Cable

Part #	Each	30 Sets	50 Sets
HGA-TK-400	\$3.70/st	\$3.36/st	\$3.07/st

No Stud TV Hanger

HGA-S2040-A

- **Material:** Aluminum
- Built-in level
- Hangs 26" - 55" flat screen TV's
- 1" Clearance from the wall
- No stud, no anchors required
- Won't damage walls, installs with tiny picture hanging nails
- Installs in 10 minutes
- Security cable included
- Black anodized finish
- UL rated to hold 80 lbs.
- Easy tilt for access to cables
- Only tools required are a hammer and a screwdriver
- Bracket length is 18"

The Hangman No Stud TV Hanger will hang any LED thin screen TV in less time than it takes to unpack it. Consists of two 18" interlocking aircraft-grade aluminum brackets. One bracket attaches to the back of the TV and the other bracket installs on the wall. Once installed a 1" clearance from the wall provides easy access and space for cords and cables. The wall track has a foam backing to minimize wall damage. Once removed all that is left behind are tiny pinholes that can be easily covered up. Comes in Black Anodize Finish. Patented & UL Rated.



Here's How It Works

Our Light but Strong Materials Are Of The Highest Quality

NO DRILLING OR ANCHORS
WON'T DAMAGE WALLS
ACTUAL NAIL & WALL HOLE SIZE



AIRCRAFT-GRADE
BRACKETS INTERLOCK



Hardware Includes:

- (1) 18" TV mount bracket
- (1) 18" wall bracket
- Hardware

Part #	Each	30 Sets	50 Sets
HGA-S2040-A	\$22.79/st	\$20.73/st	\$18.91/st



Gallery Track

HGGS-GT-*

- Material: Aluminum
- Paintable

The Hangman Gallery Track is a part of Hangman's new gallery track system. They are a professional system that can be used at home or the office. Enjoy the ease of changing frames whenever you desire without damaging your walls. Available in 2', 3', 4', 6' and 8' lengths.



Part #	Length	Hardware Includes:			Each	30 Sets	50 Sets
		(1) Connector, (1) Pair of End Caps, +					
HGGS-GT-24	24"	(2) #8 x 1-1/2" Screws, (2) Anchors, (2) Sliders			\$14.24/st	\$12.96/st	\$11.82/st
HGGS-GT-36	36"	(2) #8 x 1-1/2" Screws, (2) Anchors, (3) Sliders			\$19.82/st	\$18.04/st	\$16.45/st
HGGS-GT-48	48"	(3) #8 x 1-1/2" Screws, (3) Anchors, (4) Sliders			\$25.75/st	\$23.43/st	\$21.37/st
HGGS-GT-72	72"	(3) #8 x 1-1/2" Screws, (3) Anchors, (6) Sliders			\$35.99/st	\$32.75/st	\$29.88/st
HGGS-GT-96	96"	(3) #8 x 1-1/2" Screws, (3) Anchors, (8) Sliders			\$47.88/st	\$43.57/st	\$39.74/st

Accessories for Gallery Track

GALLERY HOOKS

- Material: Chrome Plated Zinc
- Tension hooks grip when pulled down
- Push button to move upwards



HGGS-GT-H

Each | \$4.58 ea.
60 Pcs. | \$4.17 ea.
100 Pcs. | \$3.80 ea.

GALLERY WIRE

- Material: Chrome Plated Zinc
- High Grade Wire
- Works only with our gallery track
- Can be coiled to control length
- Available in 6' and 8' lengths



HGGS-GT-6W

6 ft. Length
Each | \$1.87 ea.
60 Pcs. | \$1.70 ea.
100 Pcs. | \$1.55 ea.

HGGS-GT-8W

8 ft. Length
Each | \$2.50 ea.
60 Pcs. | \$2.27 ea.
100 Pcs. | \$2.07 ea.

GALLERY HANGING BRACKET

- Material: Chrome Plated Zinc
- Works only with our gallery track
- Slides left or right for positioning
- Holds our gallery track cables



HGGS-GT-SL

Each | \$1.03 ea.
60 Pcs. | \$0.94 ea.
100 Pcs. | \$0.85 ea.

GALLERY TRACK CONNECTOR

- Material: Chrome Plated Zinc
- Makes aligning tracks easy



HGGS-GT-C

Each | \$0.63 ea.
60 Pcs. | \$0.57 ea.
100 Pcs. | \$0.52 ea.

GALLERY TRACK END CAPS

- Material: Plastic
- Gives a finished look



HGGS-GT-EC

Each | \$0.88 ea.
60 Pcs. | \$0.80 ea.
100 Pcs. | \$0.73 ea.

Z-Panel Hangers & Clips

"A FAST, EASY & COST EFFECTIVE METHOD OF HANGING CABINETS, WALL PANELS, PARTITIONS & SIGNAGE!"

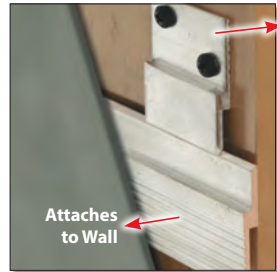
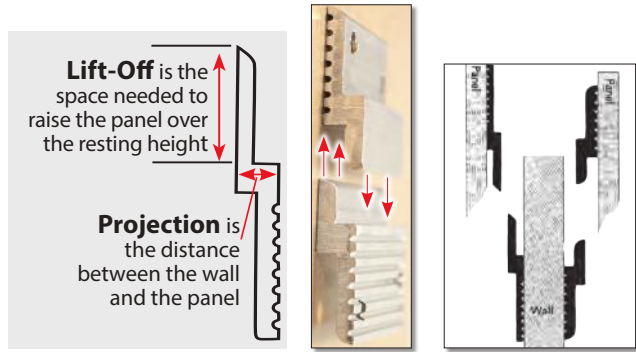

Holes & Spacing:

- Pre-cut pieces: 1-1/2" distance (except where noted)
- 4 ft., 8 ft. & 12 ft. Lengths: 8" on center

Note: All holes are 3/16" diameter and accommodate #10 screws.

For our Acrylic Z & W Bar, Please Inquire

Pre-Cut with 2 Punched Holes

Part #	Length	100 Pcs.	500 + Pcs.
ALU111-2-M	1.5 in.	\$0.42 ea.	\$0.39 ea.

4 ft. & 8 ft. Lengths without Holes

Part #	Length	120 Ft.	600+ Ft.
ALU111-4	4 ft.	\$1.15'	\$1.02'
ALU111-8	8 ft.	\$1.16'	\$1.02'

with Punched Holes

Part #	Length	120 Ft.	600+ Ft.
ALU111-4H	4 ft.	\$1.40'	\$1.23'
ALU111-8H	8 ft.	\$1.40'	\$1.23'

Projection: 0.180"
Lift-Off: 0.750"

4 ft. & 8 ft. Lengths without Holes

Part #	Length	120 Ft.	600+ Ft.
ALU333-4-M	4 ft.	\$0.86'	\$0.77'
ALU333-8-M	8 ft.	\$0.86'	\$0.77'

with Punched Holes

Part #	Length	120 Ft.	600+ Ft.
ALU333-4-MH	4 ft.	\$1.09'	\$0.99'
ALU333-8-MH	8 ft.	\$1.09'	\$0.99'

Projection: 0.198"
Lift-Off: .673"

Pre-Cut with 2 Punched Holes

Part #	Length	100 Pcs.	500 + Pcs.
ALU112-2-M	2 in.	\$0.49 ea.	\$0.45 ea.

4 ft. & 8 ft. Lengths without Holes

Part #	Length	120 Ft.	600+ Ft.
ALU112-4	4 ft.	\$1.35'	\$1.14'
ALU112-8	8 ft.	\$1.35'	\$1.14'

with Punched Holes

Part #	Length	120 Ft.	600+ Ft.
ALU112-4H	4 ft.	\$1.57'	\$1.32'
ALU112-8H	8 ft.	\$1.57'	\$1.32'

Projection: 0.240"
Lift-Off: 0.375"

Pre-Cut with 2 Punched Holes

Part #	Length	100 Pcs.	500 + Pcs.
ALU211-2-M	2 in.	\$0.70 ea.	\$0.61 ea.

4 ft. & 8 ft. Lengths without Holes

Part #	Length	120 Ft.	600+ Ft.
ALU211-4	4 ft.	\$1.56'	\$1.30'
ALU211-8	8 ft.	\$1.56'	\$1.30'

with Punched Holes

Part #	Length	120 Ft.	600+ Ft.
ALU211-4H	4 ft.	\$1.77'	\$1.48'
ALU211-8H	8 ft.	\$1.77'	\$1.48'

Projection: 0.250"
Lift-Off: .360"

Pre-Cut with 2 Punched Holes

Part #	Length	100 Pcs.	500 + Pcs.
ALUHAC22-2-M	2 in.	\$1.13 ea.	\$1.00 ea.

12 ft. Lengths without Holes

Part #	Length	120 Ft.	600+ Ft.
ALUHAC22-M	12 ft.	\$2.23'	\$1.96'

with Punched Holes

Part #	Length	120 Ft.	600+ Ft.
ALUHAC22-MH	12 ft.	\$2.47'	\$2.15'

Projection: 0.250"
Lift-Off: 0.750"

Pre-Cut with 2 Punched Holes (1-3/4" Distance)

Part #	Length	100 Pcs.	500 + Pcs.
ALUHA4049-25-M	2.5 in.	\$1.00 ea.	\$0.90 ea.

4 ft. & 8 ft. Lengths without Holes

Part #	Length	120 Ft.	600+ Ft.
ALUHA4049-4-M	4 ft.	\$2.24'	\$1.88'
ALUHA4049-8-M	8 ft.	\$2.24'	\$1.88'

with Punched Holes

Part #	Length	120 Ft.	600+ Ft.
ALUHA4049-4-MH	4 ft.	\$2.45'	\$2.06'
ALUHA4049-8-MH	8 ft.	\$2.45'	\$2.06'

Projection: 0.240"
Lift-Off: .440"

Pre-Cut with 2 Punched Holes

Part #	Length	100 Pcs.	500 + Pcs.
ALUHAC23-2-M	2 in.	\$1.08 ea.	\$0.98 ea.

12 ft. Lengths without Holes

Part #	Length	120 Ft.	600+ Ft.
ALUHAC23-M	12 ft.	\$1.89'	\$1.66'

with Punched Holes

Part #	Length	120 Ft.	600+ Ft.
ALUHAC23-MH	12 ft.	\$2.06'	\$1.85'

Projection: 0.210"
Lift-Off: 1.000"

Pre-Cut with 2 Punched Holes (1-3/4" Distance)

Part #	Length	100 Pcs.	500 + Pcs.
ALUS4049-25-M	2.5 in.	\$0.70 ea.	\$0.63 ea.

4 ft. & 8 ft. Lengths without Holes

Part #	Length	120 Ft.	600+ Ft.
ALUS4049-4-M	4 ft.	\$1.74'	\$1.46'
ALUS4049-8-M	8 ft.	\$1.74'	\$1.46'

with Punched Holes

Part #	Length	120 Ft.	600+ Ft.
ALUS4049-4-MH	4 ft.	\$1.96'	\$1.64'
ALUS4049-8-MH	8 ft.	\$1.96'	\$1.64'

Projection: 0.250"
Lift-Off: .440"

Bubble Level

Acrylic bubble level used for leveling our panel clips, or any other horizontal surface.

BL-1
\$0.49 ea.

For any quantities less than 120 ft. add 15% to the 120 ft. price

For any quantities less than 100 pieces add 15% to the 100 piece price

IMPORTANT: Due to Raw Material Fluctuation, Catalog Prices Below May Not Be Accurate. GO TO WWW.OUTWATER.COM FOR THE MOST UP-TO-DATE PRICES

Easy Fasten Standoffs



Eco Lite Series

MATERIAL = 202 Stainless Steel
FINISH = Brushed Stainless (BSS)

- 2 Part Assembly
- Lightweight construction
- #6 flat head screws and drywall anchors included

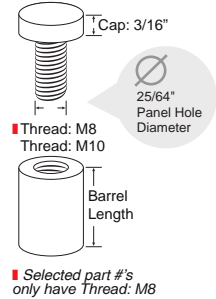

Finish:
(BSS)
Brushed
Stainless

Selected part #'s only have Thread: M8



Easy mounting design

Part #	Panel Thickness	Barrel Length	Thread Length	Diameter	Price
STDE-1313-BSS	Up to 3/8"	1/2"	1/2"	1/2"	\$0.69 ea.
STDE-1324-BSS	Up to 1/2"	3/4"	3/4"	1/2"	\$0.77 ea.
STDE-1332-BSS	Up to 1/2"	1"	3/4"	1/2"	\$0.85 ea.
STDE-1348-BSS	Up to 1/2"	1-1/2"	3/4"	1/2"	\$0.93 ea.
STDE-1364-BSS	Up to 1/2"	2"	3/4"	1/2"	\$1.01 ea.
STDE-1396-BSS	Up to 1/2"	3"	3/4"	1/2"	\$1.15 ea.
STDE-13128-BSS	Up to 1/2"	4"	3/4"	1/2"	\$1.36 ea.
STDE-2024-BSS	Up to 1/2"	3/4"	3/4"	5/8"	\$0.90 ea.
STDE-2032-BSS	Up to 1/2"	1"	3/4"	5/8"	\$0.98 ea.
STDE-2048-BSS	Up to 1/2"	1-1/2"	3/4"	5/8"	\$1.19 ea.
STDE-2064-BSS	Up to 1/2"	2"	3/4"	5/8"	\$1.28 ea.
STDE-2096-BSS	Up to 1/2"	3"	3/4"	5/8"	\$1.58 ea.
STDE-20128-BSS	Up to 1/2"	4"	3/4"	5/8"	\$1.77 ea.
STDE-2424-BSS	Up to 1/2"	3/4"	3/4"	3/4"	\$1.21 ea.
STDE-2432-BSS	Up to 1/2"	1"	3/4"	3/4"	\$1.56 ea.
STDE-2448-BSS	Up to 1/2"	1-1/2"	3/4"	3/4"	\$1.76 ea.
STDE-2464-BSS	Up to 1/2"	2"	3/4"	3/4"	\$1.94 ea.
STDE-2496-BSS	Up to 1/2"	3"	3/4"	3/4"	\$2.43 ea.
STDE-24128-BSS	Up to 1/2"	4"	3/4"	3/4"	\$2.81 ea.

Part #	Panel Thickness	Barrel Length	Thread Length	Diameter	Price
STDE-3224-BSS	Up to 1/2"	3/4"	3/4"	1"	\$1.77 ea.
STDE-3232-BSS	Up to 1/2"	1"	3/4"	1"	\$2.21 ea.
STDE-3248-BSS	Up to 1/2"	1-1/2"	3/4"	1"	\$2.43 ea.
STDE-3264-BSS	Up to 1/2"	2"	3/4"	1"	\$2.65 ea.
STDE-3296-BSS	Up to 1/2"	3"	3/4"	1"	\$3.20 ea.
STDE-32128-BSS	Up to 1/2"	4"	3/4"	1"	\$3.65 ea.
STDE-32192-BSS	Up to 1/2"	6"	3/4"	1"	\$4.41 ea.
STDE-4024-BSS	Up to 5/8"	3/4"	3/4"	1-1/4"	\$2.56 ea.
STDE-4032-BSS	Up to 5/8"	1"	3/4"	1-1/4"	\$2.68 ea.
STDE-4048-BSS	Up to 5/8"	1-1/2"	3/4"	1-1/4"	\$3.22 ea.
STDE-4064-BSS	Up to 5/8"	2"	3/4"	1-1/4"	\$3.55 ea.
STDE-4096-BSS	Up to 5/8"	3"	3/4"	1-1/4"	\$4.64 ea.
STDE-40128-BSS	Up to 5/8"	4"	3/4"	1-1/4"	\$5.54 ea.
STDE-40192-BSS	Up to 5/8"	6"	3/4"	1-1/4"	\$6.84 ea.
STDE-4824-BSS	Up to 5/8"	3/4"	3/4"	1-1/2"	\$3.01 ea.
STDE-4832-BSS	Up to 5/8"	1"	3/4"	1-1/2"	\$3.34 ea.
STDE-4848-BSS	Up to 5/8"	1-1/2"	3/4"	1-1/2"	\$4.02 ea.
STDE-4864-BSS	Up to 5/8"	2"	3/4"	1-1/2"	\$4.58 ea.
STDE-4896-BSS	Up to 5/8"	3"	3/4"	1-1/2"	\$5.90 ea.
STDE-48128-BSS	Up to 5/8"	4"	3/4"	1-1/2"	\$6.91 ea.
STDE-48192-BSS	Up to 5/8"	6"	3/4"	1-1/2"	\$9.22 ea.

Clear Acrylic Transparent Standoffs



MATERIAL = Acrylic
FINISH = Clear (CL)

- 2 Part Assembly
- Lightweight, durable construction
- Transparent acrylic
- #6 flat head screws and drywall anchors included

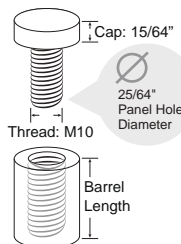

Please Inquire for our wall anchor selections



Part #	Panel Thickness	Barrel Length	Thread Length	Diameter	Price
STDY-2424-CL	Up to 5/16"	3/4"	5/8"	3/4"	\$1.94 ea.
STDY-2432-CL	Up to 1/2"	1"	7/8"	3/4"	\$2.05 ea.
STDY-3232-CL	Up to 1/2"	1"	7/8"	1"	\$2.83 ea.

IMPORTANT: Due to Raw Material Fluctuation, Catalog Prices Below May Not Be Accurate. GO TO WWW.OUTWATER.COM FOR THE MOST UP-TO-DATE PRICES

Tamper Proof Standoffs



Eco Lock Series

MATERIAL = 201 Stainless Steel

FINISHES = Polished Stainless (*PSS),
Brushed Stainless (*BSS)

- 2 Part Assembly
- Medium weight construction
- 2mm Hex Key included (**One per order**)
- #6 flat head screws and drywall anchors included

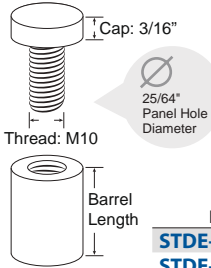

Finishes:



Part #	Panel Thickness	Barrel Length	Thread Length	Diameter	Price
STDE-TM1313*	Up to 1/2"	1/2"	1/2"	1/2"	\$1.81 ea.
STDE-TM1324*	Up to 1/2"	3/4"	3/4"	1/2"	\$1.93 ea.
STDE-TM1332*	Up to 3/4"	1"	1"	1/2"	\$2.08 ea.
STDE-TM2024*	Up to 1/2"	3/4"	1"	5/8"	\$2.31 ea.
STDE-TM2032*	Up to 3/4"	1"	1"	5/8"	\$2.49 ea.
STDE-TM2424*	Up to 1/2"	3/4"	1"	3/4"	\$2.38 ea.
STDE-TM2432*	Up to 3/4"	1"	1"	3/4"	\$2.66 ea.
STDE-TM2448*	Up to 3/4"	1-1/2"	1"	3/4"	\$3.17 ea.
STDE-TM2464*	Up to 3/4"	2"	1"	3/4"	\$2.48 ea.

Part #	Panel Thickness	Barrel Length	Thread Length	Diameter	Price
STDE-TM3224*	Up to 1/2"	3/4"	1"	1"	\$3.30 ea.
STDE-TM3232*	Up to 3/4"	1"	1"	1"	\$3.58 ea.
STDE-TM3248*	Up to 3/4"	1-1/2"	1"	1"	\$4.40 ea.
STDE-TM3264*	Up to 3/4"	2"	1"	1"	\$5.59 ea.
STDE-TM4024*	Up to 1/2"	3/4"	1"	1-1/4"	\$4.79 ea.
STDE-TM4032*	Up to 3/4"	1"	1"	1-1/4"	\$5.20 ea.
STDE-TM4048*	Up to 3/4"	1-1/2"	1"	1-1/4"	\$6.21 ea.
STDE-TM4064*	Up to 3/4"	2"	1"	1-1/4"	\$6.80 ea.

Need Extra Hex Keys?
2 mm Hex Key

STD-ALANKEY-2 \$0.37 ea.

Easy Fasten Standoffs



Eco Solid Barrels

MATERIAL = 201 Stainless Steel

FINISH = Brushed Stainless

- Must be used with 1" diameter "Eco Lock Series" standoffs **STDE-TM32***
- 2 Part Assembly
- Medium weight construction
- Ideal for layering signage designs

Finish:



Part #	Panel Thickness	Barrel Length	Barrel Length	Diameter	Price
STDE-32BAR-1	Up to 3/4"	1"	1"	1"	\$1.67 ea.
STDE-64BAR-1	Up to 3/4"	2"	1"	1"	\$2.33 ea.
STDE-96BAR-1	Up to 3/4"	3"	1"	1"	\$2.95 ea.
STDE-32BAR-2	Up to 1"	1"	1-1/2"	1"	\$1.82 ea.
STDE-64BAR-2	Up to 1"	2"	1-1/2"	1"	\$2.48 ea.
STDE-96BAR-2	Up to 1"	3"	1-1/2"	1"	\$3.10 ea.

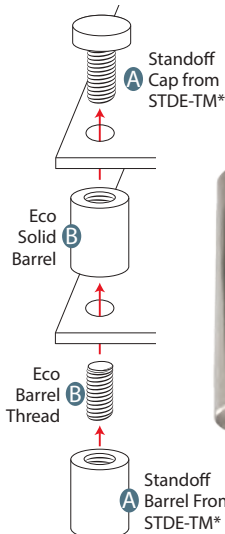

Easy Fasten Standoffs



Eco Aluminum Standoffs



New 1-1/2" & 2" Barrel Length

MATERIAL = Aluminum

FINISHES = Cherry Red (*RD), Purple (*PL), Rosy Pink (*RP), Steel Grey (*SG), Champagne Brown (*BR), Copper (*CP), Blue (*BL), Black (*BK), Gold (*GD), Green (*GN), Silver (*SL)

- 2 Part Assembly
- Lightweight, durable aluminum construction
- #6 flat head screws and drywall anchors included

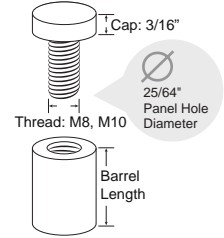

Finishes:

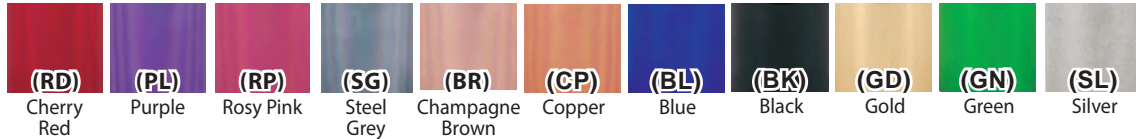

Part #	Panel Thickness	Barrel Length	Thread Length	Thread Size	Thread Diameter	Price
STDE-A1313*	Up to 1/4"	1/2"	1/2"	M8	1/2"	\$1.97 ea.
STDE-A1324*	Up to 1/2"	3/4"	3/4"	M8	1/2"	\$2.08 ea.
STDE-A2424*	Up to 1/2"	3/4"	3/4"	M10	3/4"	\$2.77 ea.
STDE-A2432*	Up to 5/8"	1"	1"	M10	3/4"	\$2.98 ea.

Part #	Panel Thickness	Barrel Length	Thread Length	Thread Size	Thread Diameter	Price
STDE-A3224*	Up to 1/2"	3/4"	3/4"	M10	1"	\$3.91 ea.
STDE-A3232*	Up to 5/8"	1"	1"	M10	1"	\$4.12 ea.
STDE-A3248*	Up to 3/4"	1-1/2"	1"	M10	1"	\$4.82 ea.
STDE-A3264*	Up to 3/4"	2"	1"	M10	1"	\$5.40 ea.



Easy mounting design



Euro Square Standoffs



MATERIAL = Solid Carbon Steel or Aluminum

FINISHES = Polished Chrome (PC), Matte Chrome (MC), Aluminum (ALU)

- 2 Part Assembly
- Heavyweight, durable steel construction
- Modern look complements any design
- #6 flat head screws and drywall anchors included

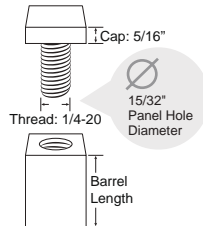

Part #	Panel Thickness	Barrel Length	Thread Length	Cap Size	Price
STD-SQ2424-PC	Up to 1/2"	3/4"	3/4"	3/4" sq.	\$10.54 ea.
STD-SQ2424-MC	Up to 1/2"	3/4"	3/4"	3/4" sq.	\$10.57 ea.
STD-SQ2424-ALU	Up to 1/2"	3/4"	3/4"	3/4" sq.	\$8.42 ea.
STD-SQ2432-PC	Up to 1/2"	1"	3/4"	3/4" sq.	\$11.59 ea.
STD-SQ2432-MC	Up to 1/2"	1"	3/4"	3/4" sq.	\$11.62 ea.
STD-SQ2432-ALU	Up to 1/2"	1"	3/4"	3/4" sq.	\$9.08 ea.
STD-SQ2464-PC	Up to 1"	2"	1-1/2"	3/4" sq.	\$14.08 ea.
STD-SQ2464-MC	Up to 1"	2"	1-1/2"	3/4" sq.	\$14.13 ea.
STD-SQ2464-ALU	Up to 1"	2"	1-1/2"	3/4" sq.	\$10.78 ea.
STD-SQ4024-PC	Up to 1/2"	3/4"	3/4"	1-1/4" sq.	\$14.69 ea.
STD-SQ4024-MC	Up to 1/2"	3/4"	3/4"	1-1/4" sq.	\$14.72 ea.
STD-SQ4024-ALU	Up to 1/2"	3/4"	3/4"	1-1/4" sq.	\$11.16 ea.
STD-SQ4032-PC	Up to 1/2"	1"	3/4"	1-1/4" sq.	\$16.33 ea.
STD-SQ4032-MC	Up to 1/2"	1"	3/4"	1-1/4" sq.	\$16.38 ea.
STD-SQ4032-ALU	Up to 1/2"	1"	3/4"	1-1/4" sq.	\$12.43 ea.
STD-SQ4064-PC	Up to 1"	2"	1-1/2"	1-1/4" sq.	\$21.10 ea.
STD-SQ4064-MC	Up to 1"	2"	1-1/2"	1-1/4" sq.	\$21.16 ea.
STD-SQ4064-ALU	Up to 1"	2"	1-1/2"	1-1/4" sq.	\$15.36 ea.

Finishes:



Please Inquire for our wall anchor selections

Easy Fasten Standoffs

Euro Mini Series

MATERIAL = Solid Carbon Steel
FINISHES = Polished Chrome (PC),
 Matte Chrome (MC)

- 2 Part Assembly
- Lightweight, durable steel construction
- Euro Style
- #6 flat head screws and drywall anchors included

Finishes:

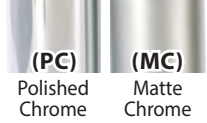

Part #	Panel Thickness	Barrel Length	Thread Length	Diameter	Price
STD-1313-PC	Up to 3/16"	1/2"	5/16"	1/2"	\$2.64 ea.
STD-1313-MC	Up to 3/16"	1/2"	5/16"	1/2"	\$2.69 ea.
STD-1319-PC	Up to 5/16"	3/4"	1/2"	1/2"	\$3.32 ea.
STD-1319-MC	Up to 5/16"	3/4"	1/2"	1/2"	\$3.35 ea.

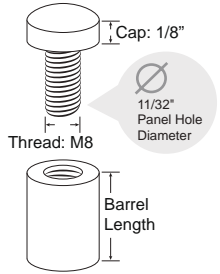

Euro Aluminum Standoffs

MATERIAL = Aluminum
FINISH = Silver Anodized (SIL)

- 2 Part Assembly
- #6 flat head screws and drywall anchors included

Finish:

 (SIL)
 Silver Anodized



Part #	Panel Thickness	Barrel Length	Diameter	Price
STD-MH3264-SIL	Up to 1"	2"	1"	\$6.27 ea.

Secure Fasten Standoffs

Cone Topped Standoffs

MATERIAL = Carbon Steel
FINISH = Polished Chrome (PC)

- 2 Part Assembly
- Medium weight, durable steel construction
- Modern look complements any design
- 2.5mm Hex Key included
(One per order)
- #6 flat head screws and drywall anchors included



Part #	Panel Thickness	Barrel Length	Thread Length	Diameter	Price
STD-C2424-PC	Up to 3/8"	3/4"	3/4"	3/4"	\$4.60 ea.
STD-C2432-PC	Up to 1/2"	1"	3/4"	3/4"	\$5.21 ea.
STD-C2448-PC	Up to 3/4"	1-1/2"	1"	3/4"	\$6.21 ea.
STD-C2464-PC	Up to 3/4"	2"	1"	3/4"	\$7.33 ea.
STD-C24128-PC	Up to 1"	4"	1-1/4"	3/4"	\$10.57 ea.

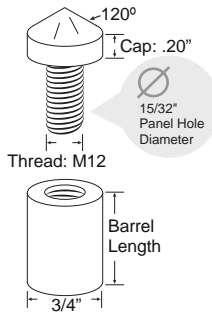

Finish:

 (PC)
 Polished Chrome



Please Inquire for our wall anchor selections

Need Extra Hex Keys?
 2.5mm Hex Key
STD-ALANKEY \$0.53 ea.

IMPORTANT: Due to Raw Material Fluctuation, Catalog Prices Below May Not Be Accurate. GO TO WWW.OUTWATER.COM FOR THE MOST UP-TO-DATE PRICES

Secure Fasten Standoffs

Premium Steel Series



MATERIAL = Solid Carbon Steel
FINISHES = Polished Chrome (*PC), Matte Chrome (*MC), Black Nickel (*BN), Bright Brass (*BB), Brushed Stainless (*BSS), Satin Copper (*SC), Oil Rubbed Bronze (*ORB)

- 3 Part Assembly
- Medium weight construction
- 2.5mm Hex Key included **(One per order)**
- #6 flat head screws and drywall anchors included



Finishes:

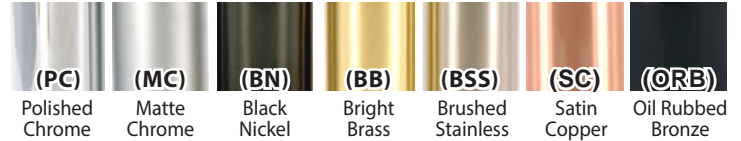

See page S-46 for Caps

Part #	Panel Thickness	Barrel Length	Thread Length	Diameter	Finish	Price
STD-2424-*	Up to 1/2"	3/4"	3/4" and 1"	3/4"	*PC *MC *BN *BB *BSS *SC *ORB	\$6.27 ea.
STD-2432-*	Up to 1/2"	1"	1"	3/4"	*PC *MC *BN *BB *BSS *SC *ORB	\$6.77 ea.
STD-2448-*	Up to 1/2"	1-1/2"	1"	3/4"	*PC *MC *BN *BB *BSS *ORB	\$749 ea.
STD-24128-*	Up to 1/2"	4"	1"	3/4"	*PC *MC *BN *BB *BSS *ORB	\$11.07 ea.

Part #	Panel Thickness	Barrel Length	Thread Length	Diameter	Finish	Price
STD-4024-*	Up to 1/2"	3/4"	3/4" and 1"	1-1/4"	*PC *MC *BN *BB *BSS *ORB	\$9.22 ea.
STD-4032-*	Up to 1/2"	1"	1"	1-1/4"	*PC *MC *BN *BB *BSS *ORB	\$10.66 ea.
STD-4048-*	Up to 1/2"	1-1/2"	1"	1-1/4"	*PC *MC *BN *BB *BSS *ORB	\$12.94 ea.
STD-40128-*	Up to 1/2"	4"	1"	1-1/4"	*PC *MC *BN *BB *BSS *ORB	\$13.91 ea.
STD-40192-*	Up to 1/2"	6"	1"	1-1/4"	*PC *MC *BN *BB *BSS *ORB	\$15.19 ea.



Please Inquire for our wall anchor selections

Need Extra Hex Keys?

2.5mm Hex Key

STD-ALANKEY \$0.53 ea.

IMPORTANT: Due to Raw Material Fluctuation, Catalog Prices Below May Not Be Accurate. GO TO WWW.OUTWATER.COM FOR THE MOST UP-TO-DATE PRICES

Secure Fasten Standoffs

Premium Steel X Series



MATERIAL = Carbon Steel
FINISH = Polished Chrome (*PC), Matte Chrome (*MC), Black Nickel (*BN), Bright Brass (*BB), Brushed Stainless (*BSS), Oil Rubbed Bronze (*ORB)

- 3 Part Assembly
- Medium weight construction
- Holds thicker panels (longer cap thread)
- Includes both 1" & 1-1/2" cap threads
- 2.5mm Hex Key included **(One per order)**
- #6 flat head screws and drywall anchors included

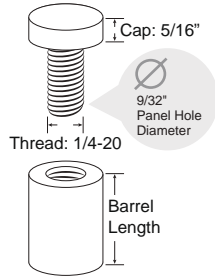

Finishes:

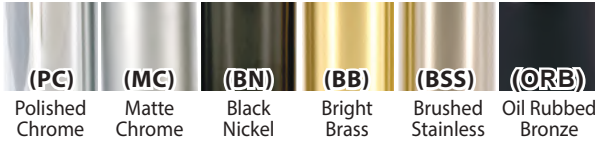

Part #	Panel Thickness	Barrel Length	Thread Length	Diameter	Price
STD-LG2448-*	Up to 3/4"	1-1/2"	1" & 1-1/2"	3/4"	\$6.85 ea.
STD-LG24128-*	Up to 3/4"	4"	1" & 1-1/2"	3/4"	\$9.95 ea.
STD-LG4048-*	Up to 3/4"	1-1/2"	1" & 1-1/2"	1-1/4"	\$11.75 ea.
STD-LG40128-*	Up to 3/4"	4"	1" & 1-1/2"	1-1/4"	\$12.25 ea.
STD-LG40192-*	Up to 3/4"	6"	1" & 1-1/2"	1-1/4"	\$13.25 ea.

■ 6" Available in MC or BSS only



Need Extra Hex Keys?
2.5mm Hex Key

STD-ALANKEY \$0.53 ea.

Premium Stainless Series

MATERIAL = 316 Stainless Steel
FINISH = Satin Stainless (SS)

- 3 Part Assembly
- Medium weight construction
- Marine grade - Will not rust!
- 2.5mm Hex Key included **(One per order)**
- #6 flat head screws and drywall anchors included

Marine grade - Will not rust!

Finish:

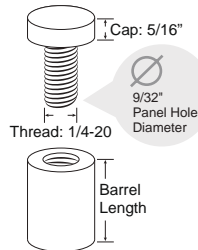

Part #	Panel Thickness	Barrel Length	Thread Length	Diameter	Price
STD-2424-SS	Up to 1/2"	3/4"	1"	3/4"	\$12.56 ea.
STD-2432-SS	Up to 1/2"	1"	1"	3/4"	\$13.08 ea.
STD-2448-SS	Up to 1/2"	1-1/2"	1"	3/4"	\$13.67 ea.
STD-24128-SS	Up to 1/2"	4"	1"	3/4"	\$17.50 ea.
STD-4024-SS	Up to 1/2"	3/4"	1"	1-1/4"	\$18.03 ea.
STD-4032-SS	Up to 1/2"	1"	1"	1-1/4"	\$18.99 ea.
STD-4048-SS	Up to 1/2"	1-1/2"	1"	1-1/4"	\$20.13 ea.
STD-40128-SS	Up to 1/2"	4"	1"	1-1/4"	\$26.81 ea.



Need Extra Hex Keys?
2.5mm Hex Key

STD-ALANKEY \$0.53 ea.



Please Inquire for our wall anchor selections

IMPORTANT: Due to Raw Material Fluctuation, Catalog Prices Below May Not Be Accurate. GO TO WWW.OUTWATER.COM FOR THE MOST UP-TO-DATE PRICES

Secure Fasten Standoffs



Premium Aluminum Series

MATERIAL = Aluminum
FINISHES = Polished Chrome (*PC),
 Satin Stainless (*SS)

- 3 Part Assembly
- Lightweight, durable aluminum construction
- Will not rust!
- Flat Cap - 1/4-20 thread
- 2.5mm Hex Key included **(One per order)**
- #6 flat head screws and drywall anchors included

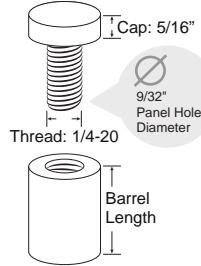

Finishes:

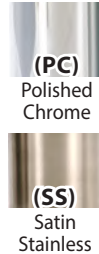

Part #	Panel Thickness	Barrel Length	Thread	Diameter	Price
STDA-2020-SS	Up to 3/8"	5/8"	3/4"	5/8"	\$2.39 ea.
STDA-2032-SS	Up to 1/2"	1"	1"	5/8"	\$2.75 ea.
STDA-2048-SS	Up to 1/2"	1-1/2"	1"	5/8"	\$3.28 ea.
STDA-2064-SS	Up to 1/2"	2"	1"	5/8"	\$3.93 ea.
STDA-2096-SS	Up to 1/2"	3"	1"	5/8"	\$4.78 ea.
STDA-20128-SS	Up to 1/2"	4"	1"	5/8"	\$5.04 ea.
STDA-2424-*	Up to 1/2"	3/4"	3/4"-1"	3/4"	\$4.85 ea.
STDA-2432-*	Up to 1/2"	1"	1"	3/4"	\$5.04 ea.
STDA-2448-*	Up to 1/2"	1-1/2"	1"	3/4"	\$5.23 ea.
STDA-24128-*	Up to 1/2"	4"	1"	3/4"	\$6.12 ea.
STDA-4024-*	Up to 1/2"	3/4"	1"	1-1/4"	\$6.36 ea.
STDA-4032-*	Up to 1/2"	1"	1"	1-1/4"	\$6.68 ea.
STDA-4048-*	Up to 1/2"	1-1/2"	1"	1-1/4"	\$7.68 ea.
STDA-40128-*	Up to 1/2"	4"	1"	1-1/4"	\$8.71 ea.



Need Extra Hex Keys?
 2.5mm Hex Key

STD-ALANKEY \$0.53 ea.



Counter Series

MATERIAL = Die Cast Zamac
FINISHES = Gold (*GD),
 Titanium (*TN)

- 3 Part Assembly
- Medium weight construction
- Screws in a counter-clockwise direction to deter tampering
- Fingerprint proof finish
- 1.5mm Hex Key included **(One per order)**
- #6 flat head screws and drywall anchors included

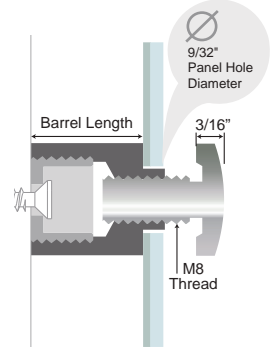

Please Inquire for our wall anchor selections

Part #	Panel Thickness	Barrel Length	Diameter	Price
STD-MX3238-*	Up to 3/4"	1-3/16"	1"	\$6.15 ea.

Need Extra Hex Keys?
 1.5mm Hex Key

STD-ALANKEY-1 \$0.26 ea.



IMPORTANT: Due to Raw Material Fluctuation, Catalog Prices Below May Not Be Accurate. GO TO WWW.OUTWATER.COM FOR THE MOST UP-TO-DATE PRICES

Easy Fasten Standoffs



Eco Solid Series

MATERIAL = 201 Stainless Steel
FINISHES = Polished Stainless (***PSS**)
 Brushed Stainless (***BSS**)

- 2 Part Assembly
- Medium weight construction
- #6 flat head screws and drywall anchors included

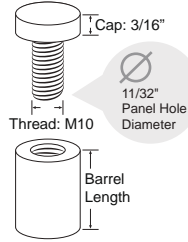

Part #	Panel Thickness	Barrel Length	Diameter	Price
STDE-S3264-PSS	Up to 1/2"	2"	1"	\$3.72 ea.
STDE-S4048-*	Up to 5/8"	1-1/2"	1-1/4"	\$3.68 ea.
STDE-S4064-PSS	Up to 5/8"	2"	1-1/4"	\$4.28 ea.

Finishes:



Please Inquire for our wall anchor selections



Tamper Proof Standoffs

Latte X Standoffs



MATERIAL = Die Cast Zamac
FINISHES = Polished Chrome (***PC**), Matte Chrome (***MC**),
 Bright Brass (***BB**), Satin Copper (***SC**),
 Brushed Stainless (***BSS**), Antique Brass (***AB**)

- 2 Part Assembly
- Medium weight, durable construction
- Euro style round cap pops into place inside barrel
- 2mm Hex Key included (**One per order**)
- #6 flat head screws and drywall anchors included

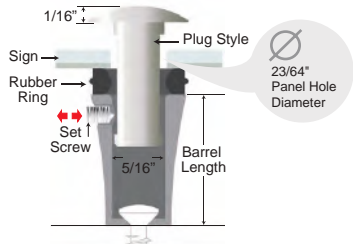

Part #	Panel Thickness	Barrel Length	Diameter	Price
STD-D1828-*	Up to 1/2"	13/16"	9/16"	\$3.20 ea.



Please Inquire for our wall anchor selections



Need Extra Hex Keys?
2 mm Hex Key

STD-ALANKEY-2 \$0.37 ea.

IMPORTANT: Due to Raw Material Fluctuation, Catalog Prices Below May Not Be Accurate. GO TO WWW.OUTWATER.COM FOR THE MOST UP-TO-DATE PRICES

Tamper Proof Standoffs



Shape Series

MATERIAL = Die Cast Zinc

FINISHES = Polished Chrome (*PC), Matte Chrome (*MC),
Bright Brass (*BB), Satin Copper (*SC),
Brushed Stainless (*BSS), Antique Brass (*AB)

- 2 Part Assembly
- Medium weight construction
- Unique and special shape designs
- Plug system with tamper proof set screw
- 2mm Hex Key included **(One Per Order)**
- #6 flat head screws and drywall anchors included

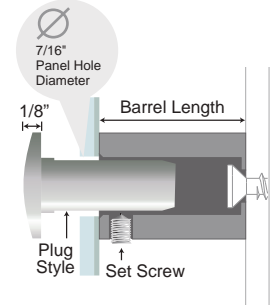

Part #	Panel Thickness	Barrel Length	Diameter	Price
STD-3C2126-*	Up to 7/16"	13/16"	5/8"	\$3.00 ea.
STD-4C1826-*	Up to 7/16"	13/16"	9/16"	\$3.00 ea.
STD-6C1826-*	Up to 7/16"	13/16"	9/16"	\$3.00 ea.

Need Extra Hex Keys?
2 mm Hex Key

STD-ALANKEY-2 \$0.37 ea.

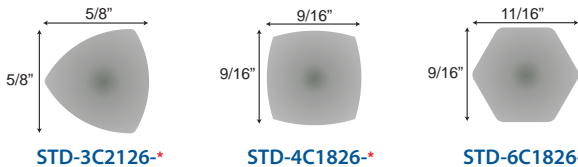

Euro Mini Stainless Standoffs

MATERIAL = 304 Stainless

FINISH = Brushed Stainless (BSS)

- 2 Part Assembly
- Lightweight construction
- 1.5mm Hex Key included **(One Per Order)**
- #6 flat head screws and drywall anchors included

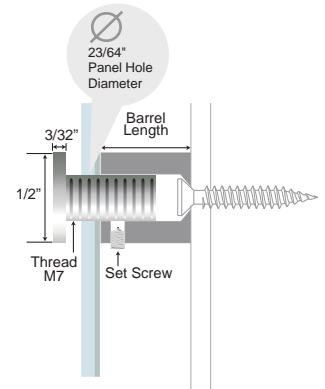

Finish:



Part #	Panel Thickness	Barrel Length	Diameter	Price
STD-TMS1313-BSS	Up to 3/8"	1/2"	1/2"	\$3.35 ea.
STD-TMS1324-BSS	Up to 3/8"	3/4"	1/2"	\$5.45 ea.

Need Extra Hex Keys?
1.5mm Hex Key

STD-ALANKEY-1 \$0.26 ea.



Please Inquire for our wall anchor selections

IMPORTANT: Due to Raw Material Fluctuation, Catalog Prices Below May Not Be Accurate. GO TO WWW.OUTWATER.COM FOR THE MOST UP-TO-DATE PRICES

Tamper Proof Standoffs



Cubby Series

MATERIAL = Die Cast Zinc
FINISH = Brushed Nickel (BHN)

- 2 Part Assembly
- Medium weight construction
- Smooth even head blends with panels
- Tamper proof plug thread stops head from moving
- 2mm Hex Key included (**One per order**)
- #6 flat head screws and drywall anchors included

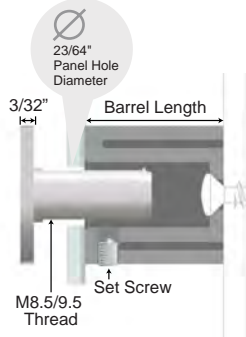

Part #	Panel Thickness	Barrel Length	Diameter	Price
STD-CBX24-BHN	Up to 3/8"	3/4"	3/4"	\$5.05 ea.
STD-CBX40-BHN	Up to 3/4"	1-1/4"	1-1/4"	\$8.30 ea.

Finish:

(BHN)
Brushed Nickel

Need Extra Hex Keys?

2 mm Hex Key

STD-ALANKEY-2 \$0.37 ea.



Low Profile Tamperproof

MATERIAL = Solid Brass
FINISH = Polished Stainless (PSS)
Brushed Stainless (BSS)

- 2 Part Assembly
- Medium weight construction
- 2mm Hex Key included (**One per order**)
- #6 flat head screws and drywall anchors included

Part #	Panel Thickness	Barrel Length	Diameter	Price
STDL-2032-PSS	Up to 1/2"	1"	5/8"	\$2.78 ea.
STDL-2032-BSS	Up to 1/2"	1"	5/8"	\$2.90 ea.
STDL-3232-PSS	Up to 1/2"	1"	1"	\$3.98 ea.
STDL-3232-BSS	Up to 1/2"	1"	1"	\$4.11 ea.

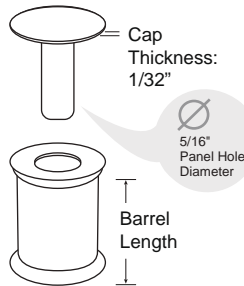

Need Extra Hex Keys?

2 mm Hex Key

STD-ALANKEY-2 \$0.37 ea.



Please Inquire for our wall anchor selections

IMPORTANT: Due to Raw Material Fluctuation, Catalog Prices Below May Not Be Accurate. GO TO WWW.OUTWATER.COM FOR THE MOST UP-TO-DATE PRICES

Edge It- No Drill Standoffs

Edge Grip: Eco Easy Edge Standoffs



for indoor & outdoor use

MATERIAL = 201 Stainless Steel
FINISH = Brushed Stainless (BSS)

- Lightweight construction
- Ideal for one panel
- 2mm Hex Key included (One per order)
- #6 flat head screws and drywall anchors included for 5/8" & 3/4" diameter

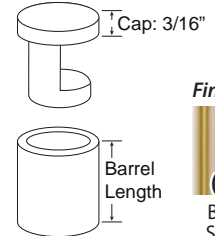

Finish:



Part #	Panel Thickness	Barrel Length	Diameter	Price
STDE-ED1313-BSS	Up to 1/2"	1/2"	1/2"	\$2.59 ea.
STDE-ED1324-BSS	Up to 1/2"	3/4"	1/2"	\$2.71 ea.
STDE-ED1332-BSS	Up to 1/2"	1"	1/2"	\$2.84 ea.
STDE-ED1348-BSS	Up to 1/2"	1-1/2"	1/2"	\$3.20 ea.
STDE-ED2024-BSS	Up to 1/2"	3/4"	5/8"	\$3.39 ea.
STDE-ED2032-BSS	Up to 1/2"	1"	5/8"	\$3.58 ea.
STDE-ED2048-BSS	Up to 1/2"	1-1/2"	5/8"	\$3.95 ea.
STDE-ED2432-BSS	Up to 1/2"	1"	3/4"	\$3.76 ea.
STDE-ED2448-BSS	Up to 1/2"	1-1/2"	3/4"	\$4.25 ea.

■ Screws & anchors not included

Need Extra Hex Keys?

2 mm Hex Key

STD-ALANKEY-2 \$0.37 ea.



Please Inquire for our wall anchor selections



for indoor & outdoor use

Edge Grip: Eco 4 Way Series

MATERIAL = 201 Stainless Steel & Aluminum
FINISHES = Polished Stainless (PSS), Brushed Stainless (BSS)

- Lightweight construction
- Ideal for up to 4 panels
- No drilling required
- Will hold multiple signs
- 2.5mm Hex Key included (One per order)
- #6 flat head screws and drywall anchors included
- Tamper proof

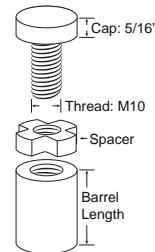

Part #	Panel Thickness	Barrel Length	Diameter	Price
STDE-SP-3224-PSS	Up to 5/16"	3/4"	1"	\$4.10 ea.
STDE-SP-3224-BSS	Up to 5/16"	3/4"	1"	\$3.57 ea.
STDE-SP-3232-PSS	Up to 5/16"	1"	1"	\$4.58 ea.
STDE-SP-3232-BSS	Up to 5/16"	1"	1"	\$3.99 ea.
STDE-SP-3248-PSS	Up to 5/16"	1-1/2"	1"	\$5.36 ea.
STDE-SP-3248-BSS	Up to 5/16"	1-1/2"	1"	\$4.70 ea.
STDE-SP-3264-PSS	Up to 5/16"	2"	1"	\$5.84 ea.
STDE-SP-3264-BSS	Up to 5/16"	2"	1"	\$5.10 ea.

Finishes:



Please Inquire for our wall anchor selections

Need Extra Hex Keys?

2.5mm Hex Key

STD-ALANKEY \$0.53 ea.

IMPORTANT: Due to Raw Material Fluctuation, Catalog Prices Below May Not Be Accurate. GO TO WWW.OUTWATER.COM FOR THE MOST UP-TO-DATE PRICES

Edge It- No Drill Standoffs



Edge Grip: Easy Edge Premium Series

MATERIAL = Solid Carbon Steel
FINISHES = Polished Chrome (PC), Matte Chrome (MC)

- Medium weight, durable steel construction
- Ideal for one panel
- 2mm Hex Key included (**One per order**)
- #6 flat head screws and drywall anchors included



Part #	Panel Thickness	Barrel Length	Diameter	Price
STD-EDGE-PC	Up to 1/2"	1"	1"	\$7.76 ea.
STD-EDGE-MC	Up to 1/2"	1"	1"	\$7.76 ea.

Finishes:

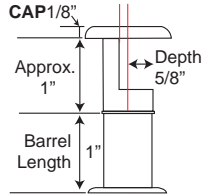
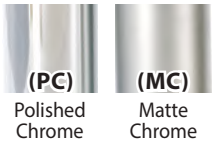

Need Extra Hex Keys?
 2 mm Hex Key

STD-ALANKEY-2 \$0.37 ea.

Edge Grip: 4 Way Premium Series



MATERIAL = Solid Carbon Steel
FINISHES = Polished Chrome (PC), Matte Chrome (MC)

- Medium weight, durable steel construction
- Ideal for up to 4 panels
- 2.5mm Hex Key included (**One per order**)
- #6 flat head screws and drywall anchors included

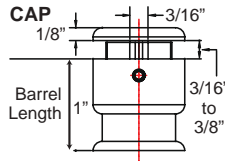
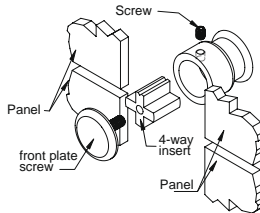

Part #	Panel Thickness	Barrel Length	Diameter	Price
STD-4WAY-PC	Up to 5/16"	1"	1"	\$11.86 ea.
STD-4WAY-MC	Up to 5/16"	1"	1"	\$11.86 ea.

Finishes:

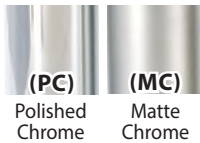

Need Extra Hex Keys?
 2.5mm Hex Key

STD-ALANKEY \$0.53 ea.



Please Inquire for our wall anchor selections

IMPORTANT: Due to Raw Material Fluctuation, Catalog Prices Below May Not Be Accurate. GO TO WWW.OUTWATER.COM FOR THE MOST UP-TO-DATE PRICES

Grip It- No Drill Standoffs



Slotted Standoffs

MATERIAL = Solid Brass
FINISHES = Polished Chrome (PC), Matte Chrome (MC)

- Can be mounted either vertically or horizontally
- Perfect for holding partition panels, signage or shelving
- No drilling required
- Hex key to tighten
- 2.5mm Hex Key included (**One per order**)
- 1-1/2" L x 5/16" Hanger Bolt included
- Maximum Load Rating: 17 lbs.

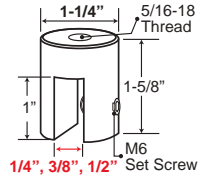

Finishes:



(PC)
Polished Chrome



(MC)
Matte Chrome

Part #	Panel Thickness	Barrel Length	Diameter	Price
STD-SL14-PC	Up to 1/4"	1-5/8"	1-1/4"	\$8.25 ea.
STD-SL14-MC	Up to 1/4"	1-5/8"	1-1/4"	\$8.25 ea.
STD-SL38-PC	Up to 3/8"	1-5/8"	1-1/4"	\$8.25 ea.
STD-SL38-MC	Up to 3/8"	1-5/8"	1-1/4"	\$8.25 ea.
STD-SL12-PC	Up to 1/2"	1-5/8"	1-1/4"	\$8.25 ea.
STD-SL12-MC	Up to 1/2"	1-5/8"	1-1/4"	\$8.25 ea.



Signage Grips

A

- Rubber pads included to adjust for different panel thickness
- #6 screw and anchor included

B

- 4 Screws included

C

- Rubber pads included to adjust for different panel thickness
- #6 screw and anchor included

D

- 4 Screws included

Part #	Panel Thickness	Finish	Material	Price
A SSFZ-618F-SC	3/16" - 3/8"	Brushed Stainless Steel	Zamac	\$6.85 ea.
B S83-108F-BR	1/4"	Polished Brass	Brass	\$12.75 ea.
C SSF-618FADJ-SC	1/4" - 5/16"	Brushed Stainless Steel	304 Grade Satin Stainless Steel	\$12.00 ea.
D S83-108F-CH	1/4"	Polished Stainless Steel	Stainless Steel	\$17.50 ea.

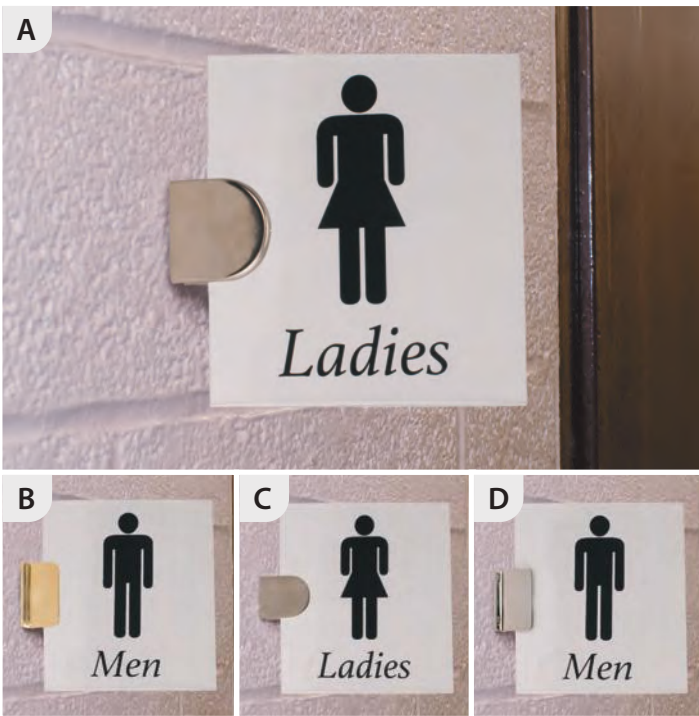

Please Inquire for our wall anchor selections

Need Extra Hex Keys?
 2.5mm Hex Key
STD-ALANKEY \$0.53 ea.

IMPORTANT: Due to Raw Material Fluctuation, Catalog Prices Below May Not Be Accurate. GO TO WWW.OUTWATER.COM FOR THE MOST UP-TO-DATE PRICES

Grip It- No Drill Standoffs



for indoor use only

Uno Clamp

Ideal for *Lightweight 1mm Materials*

MATERIAL = Polyethylene and Nylon
FINISH = White Silver Matte

- Can be mounted vertically or horizontally
- Great for panels without holes so you don't have to drill through your material
- Max weight 11 lbs.
- All screws and anchors included

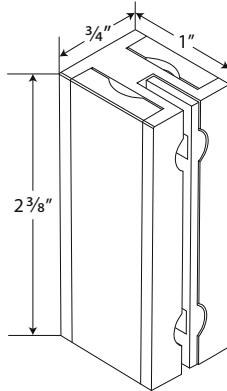
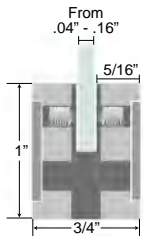

Part #	Panel Thickness	Price
GRP-2464-HLDR	Up to .16"	\$5.45 ea.

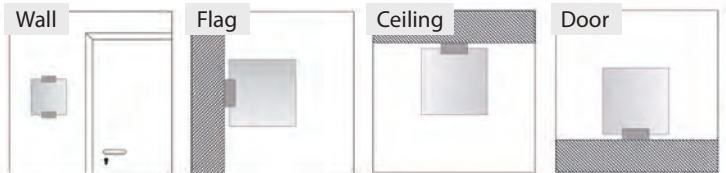
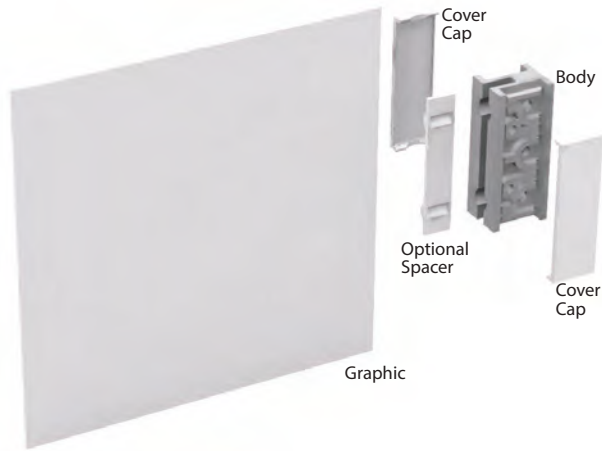

Table Sign Clamp



for indoor use only

MATERIAL = 304 Grade Stainless Steel
FINISHES = Stainless Steel (SS)

- Perfect for nameplates and small desktop signs
- Sleek modern look
- Quality stainless steel construction

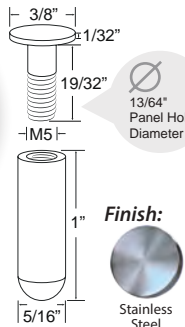

Part #	Panel Thickness	Barrel Length	Price
STD-D32-SS	Up to 5/16"	1"	\$2.00 ea.



IMPORTANT: Due to Raw Material Fluctuation, Catalog Prices Below May Not Be Accurate. GO TO WWW.OUTWATER.COM FOR THE MOST UP-TO-DATE PRICES

Grip It- No Drill Standoffs

Grip It Clamp
Non-Illuminated



for indoor use only

MATERIAL = Clear Anodized Aluminum

FINISHES = Polished Chrome (*PC)
Matte Chrome (*MC)

- 2mm Hex Key included (**one per order**)
- #6 flat head screws and drywall anchors included
- No drilling required

Kit Includes:

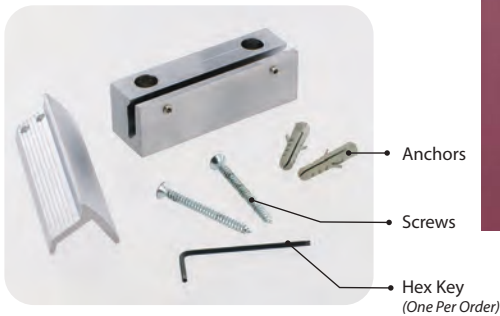

Part #	Panel Thickness	Length	▲ Maximum Sign Size	Price	
				Each	20+ PCS
SC-80-*	1/8" - 1/2"	3-1/8"	6-5/16" x 9-1/2"	\$9.45	\$8.65 ea.
SC-120-*	1/8" - 1/2"	4-3/4"	9-1/2" x 14-3/16"	\$12.32	\$11.17 ea.
SC-180-*	1/8" - 1/2"	7-1/16"	14-3/16" x 21-1/4"	\$15.00	\$13.69 ea.

▲ Maximum sign size per piece

Finishes:



(PC)

Polished Chrome

(MC)

Matte Chrome



Please Inquire for our wall anchor selections

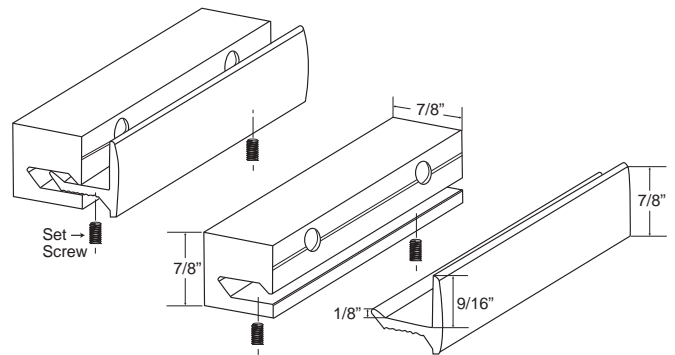

IMPORTANT: Due to Raw Material Fluctuation, Catalog Prices Below May Not Be Accurate. GO TO WWW.OUTWATER.COM FOR THE MOST UP-TO-DATE PRICES

Grip It- No Drill Standoffs



Grip It Clamp
Illuminated

12V
MATERIAL = Clear Anodized Aluminum
FINISH = Matte Chrome (MC)

- 2mm Hex Key included (**one per order**)
- #6 flat head screws and drywall anchors included
- No drilling required
- The clamp wire is 38" long

Lighting Specifications

Color Temperature	CW: 6000K-6500K
Beam Spread	120°
Lumens	CW: 40-80
Color Rendering Index	CW: 70
Rated Average Life	CW: 50,000 hrs.
Chip Size	SMD3528

Please Inquire for our wall anchor selections

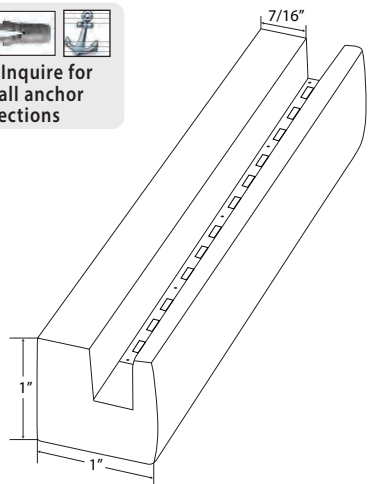

Finish:
(MC)
Matte Chrome

Part #	Color Temp	Panel Thickness	▲ Maximum Sign Size	Length	# Of LED Chips	Total Wattage	Price	
							Each	20+ PCS
LED-SC80-MC	Cool White	3/16" - 5/16"	6-5/16" x 6-5/16"	3-1/8"	6	.4W	\$14.06	\$12.85 ea.
LED-SC120-MC		3/16" - 5/16"	9-1/2" x 9-1/2"	4-3/4"	9	.6W	\$19.42	\$18.26 ea.
LED-SC180-MC		3/16" - 5/16"	14-3/16" x 14-3/16"	7-1/16"	12	.8W	\$20.63	\$18.85 ea.

▲ Maximum sign size per piece

Power Supplies (Required)
LED-SC-TR-1A
Each: \$8.95
6+ Pcs.: \$8.20 ea.

2.91"L x 1.61"W x 1.14"H
1A / 12V / 12W
Input Cord: 5'
Color: Black

Junction Box (Required)
Function: Is to join multiple fixtures to one power supply.

LED-STD-JB10
\$3.00 ea.
2"L x 1-1/4"W x 1/2"D
Number of Outputs: 10
Input Cord: 19-11/16"
Color: White

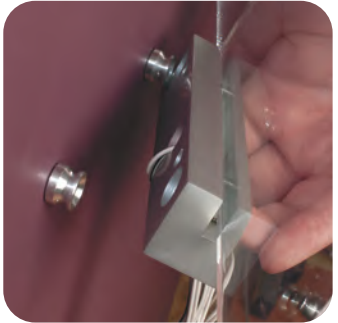

LED

Perfect for lobbies & reception areas



12V MATERIAL = Aluminum

- The standoff wire is 38" long
- Up to 10 pieces can be connected to one power supply
- #6 screws & drywall anchors included

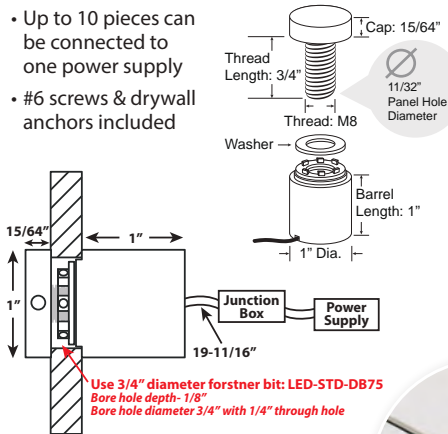

Maximum Recommended Spacing: 20" x 20" for 4 Standoffs

Finishes:

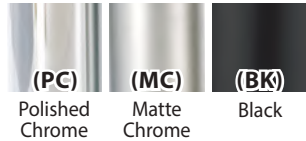

Part #	Color Temp	Finish	Panel Thickness (when graphic is routed)	Barrel Length	Thread Length	Diameter	# of LED	Total Wattage	Price Each	Price 60+
STD-LED-2525-PC	Cool White	Polished Chrome	Up to 1/2"	1"	3/4"	1"	6	.4W	\$7.83	\$6.83 ea.
STD-LED-2525-MC	Cool White	Matte Chrome	Up to 1/2"	1"	3/4"	1"	6	.4W	\$7.83	\$6.83 ea.
STD-LED-2525-BK	Cool White	Black	Up to 1/2"	1"	3/4"	1"	6	.4W	\$9.00	\$8.16 ea.
STD-LED-2525-M-*	Red (*RD) Blue (*BL) Green (*GR)	Matte Chrome	Up to 1/2"	1"	3/4"	1"	6	.4W	\$9.00	\$8.16 ea.
STD-LED-2525-B-*	Red (*RD) Blue (*BL) Green (*GR)	Black	Up to 1/2"	1"	3/4"	1"	6	.4W	\$9.00	\$8.16 ea.

Lighting Specifications

Color Temperature	CW: 6000K-6500K
Beam Spread	120°
Lumens	CW: 30-40
Color Rendering Index	CW: 70
Rated Average Life	CW: 10,000 hrs.
Chip Size	SMD2908



Power Supplies (Required)

LED-STD-TR-1A
\$8.95 ea.
6+...\$8.20 ea.



2.91"L x 1.61"W x 1.14"H
1A / 12V / 12W
Input Cord: 5'
Color: Black

Junction Box (Required)

Function: Is to join multiple fixtures to one power supply.



LED-STD-JB10
\$3.00 ea.
2"L x 1-1/4"W x 1/2"D
Number of Outputs: 10
Input Cord: 19-11/16"
Color: White



Forstner Drill Bit (Optional)

LED-STD-DB75
\$10.50 ea.



- Extra sharp cutting edges for smooth, flat bottomed holes
- Hole Size: 3/4"
- Shank: 3/8"

Optional Rechargeable Battery Available See page L-140



How Long Will My Battery Last?
Battery Longevity:
(AMPS x VOLTS) = HRS
WATTS

IMPORTANT: Due to Raw Material Fluctuation, Catalog Prices Below May Not Be Accurate. GO TO WWW.OUTWATER.COM FOR THE MOST UP-TO-DATE PRICES

Invisi Series Standoffs



Eco Invisible Standoffs



MATERIAL = Polycarbonate
FINISH = Clear

- No screws visible on the letter or sign front
- For letters & signs weighing up to .75 lbs.
- Available with or without adhesive
- #8 flat head screw & drywall anchor included

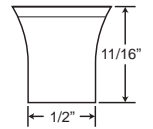
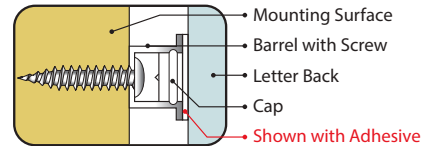
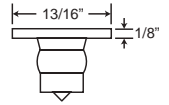

Part #	Description	Barrel Length	Diameter	Price
STDI-6875	Invisible Standoff	11/16"	9/16"	\$0.28 ea.
STDI-6875-A	Invisible Standoff with Adhesive	11/16"	9/16"	\$0.35 ea.



Casper Invisible Standoffs



MATERIAL = Polycarbonate & Brass
FINISH = Chrome

- Must be purchased in increments of 4
- No screws visible on the sign front
- Removable
- Tamper proof

Kit Includes:

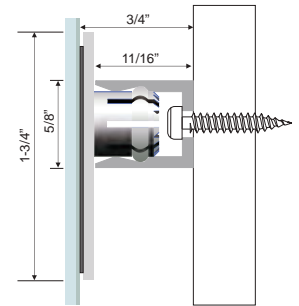
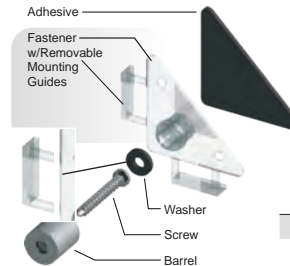

Part #	Barrel Length	Diameter	Price
STDI-CASPER	11/16"	9/16"	\$5.40 ea.



Crystal Round Standoffs



MATERIAL = Clear Polycarbonate
FINISH = Clear

- Lightweight construction
- Tamper proof
- Cap snaps into body of standoff
- Metal spring clamp locks standoff in place

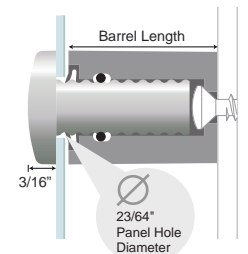

Part #	Panel Thickness	Barrel Length	Diameter	Price
STD-P2026-CL	Up to 1/2"	13/16"	5/8"	\$2.00 ea.

Please Inquire for our wall anchor selections



Colorful Wall

MATERIAL = Polypropylene

- Sold in sets of 4. Each Kit includes 4 caps, 4 bases, 4 #6 x 1" screws & 4 anchors
- All caps are made from polypropylene
- All metallic finishes are vacuum plated
- Polypropylene caps are UV stabilized for outdoor use (does not apply to metallics)

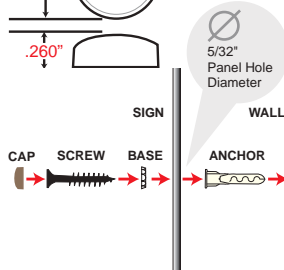

W While Supplies Last

Part #	Diameter	Finish	Part #	Diameter	Finish	Part #	Diameter	Finish	Part #	Diameter	Finish
STDC-24-BK	11/16"	Black	STDC-24-GR	11/16"	Green	STDC-24-LP	11/16"	Light Pink	STDC-24-SC	11/16"	Satin Chrome
STDC-24-WH	11/16"	White	STDC-24-BL	11/16"	Blue	STDC-24-RD	11/16"	Red	STDC-24-CH	11/16"	Bright Chrome
STDC-24-BR	11/16"	Brown	STDC-24-OR	11/16"	Orange	STDC-24-TQ	11/16"	Turquoise	STDC-24-BRS	11/16"	Bright Brass
STDC-24-BE	11/16"	Beige	STDC-24-PL	11/16"	Purple	STDC-24-YW	11/16"	Yellow	STDC-24-SCOP	11/16"	Satin Copper
STDC-24-LG	11/16"	Light Gray	STDC-24-DB	11/16"	Dark Blue	STDC-24-FG	11/16"	Forest Green	STDC-24-COP	11/16"	Bright Copper

Color Pricing

Per Finish \$3.16/Set...**25 Sets** \$2.53/Set

Metallic Pricing

Per Finish \$4.21/Set...**25 Sets** \$3.37/Set

Eco Lite Wall Mount



MATERIAL = 202 Stainless Steel
FINISH = Brushed Stainless (BSS)



Part #	Diameter	Price
STD-32AMC-BSS	1"	\$2.41/set of 4
STD-40AMC-BSS	1-1/4"	\$2.87/set of 4
STD-48AMC-BSS	1-1/2"	\$3.42/set of 4

Finish:



Please Inquire for our wall anchor selections

Eco Wall Mount Signage Caps



MATERIAL = 201 Stainless Steel
FINISHES = Brushed Stainless (BSS)
Polished Stainless (PSS)

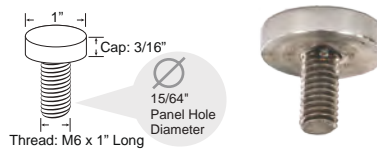

Part #	Diameter	Price
STDE-32CAP-BSS	1"	\$0.92 ea.
STDE-32CAP-PSS	1"	\$0.92 ea.

Finishes:



Eco Solid Stainless Wall Mount



MATERIAL = 202 Stainless Steel
FINISH = Brushed Stainless (BSS)



Finish:



Part #	Diameter	Price
STD-C2P20-BSS	5/8"	\$4.47/set of 4
STD-C2P24-BSS	3/4"	\$5.06/set of 4
STD-C2P32-BSS	1"	\$5.65/set of 4

IMPORTANT: Due to Raw Material Fluctuation, Catalog Prices Below May Not Be Accurate. GO TO WWW.OUTWATER.COM FOR THE MOST UP-TO-DATE PRICES

Cap It Off Series

Premium Steel Wall Mount Signage Caps



for indoor use only

MATERIAL = Solid Carbon Steel

FINISHES = Polished Chrome (*PC), Matte Chrome (*MC), Black Nickel (*BN), Bright Brass (*BB), Brushed Stainless (*BSS), Oil Rubbed Bronze (*ORB)

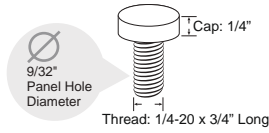

Part #	Diameter	Price
STD-24CAP-*	3/4"	\$2.65 ea.
STD-40CAP-*	1-1/4"	\$3.85 ea.

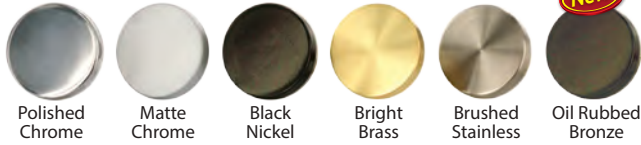

Premium Aluminum Wall Mount Signage Caps



for indoor use only

MATERIAL = Aluminum

FINISHES = Polished Chrome (PC), Polished Stainless (PS)

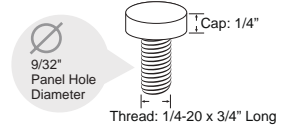

Part #	Diameter	Price
STDA-24CAP-PC	3/4"	\$2.19 ea.
STDA-24CAP-PS	3/4"	\$2.19 ea.
STDA-40CAP-PC	1-1/4"	\$2.37 ea.
STDA-40CAP-PS	1-1/4"	\$2.37 ea.



Insert Nuts

Thread: 1/4-20



No Flange
I-NUT250

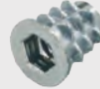

With Flange
I-NUT250F

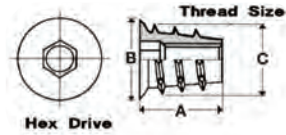

Part#	Dimensions		
	A	B	C
I-NUT250	.512"	-	.453"
I-NUT250F	.512"	.492"	.461"

Part#	Price			
	Each	100 Pcs.	1000 Pcs.	5000 Pcs.
I-NUT250	\$0.16	\$0.10 ea.	\$0.08 ea.	\$0.06 ea.
I-NUT250F	\$0.16	\$0.10 ea.	\$0.08 ea.	\$0.06 ea.



for indoor use only

Button It

MATERIAL = Chrome Plated Solid Brass

FINISHES = Polished Chrome (PC), Matte Chrome (MC)

- Used to make "Sandwich" style signs
- Tightens with 2mm Hex Key included (One per order)

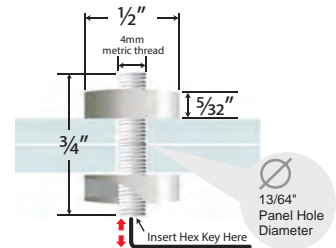

Part #	Panel Thickness	Diameter	Price
STD-13CAPSET-PC	Up to 1/2"	9/16"	\$1.58 ea.
STD-13CAPSET-MC	Up to 1/2"	9/16"	



Need Extra Hex Keys?

2 mm Hex Key

STD-ALANKEY-2 \$0.37 ea.



Please Inquire for our wall anchor selections

IMPORTANT: Due to Raw Material Fluctuation, Catalog Prices Below May Not Be Accurate. GO TO WWW.OUTWATER.COM FOR THE MOST UP-TO-DATE PRICES

Sign / Banner Holders

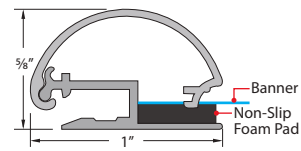
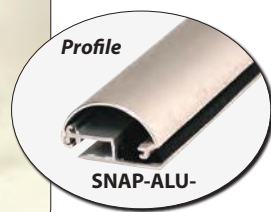
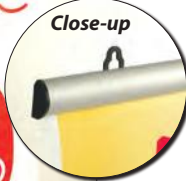

THE "SNAP-EASE" ALUMINUM BANNER HANGING SYSTEM

CLEAR ANODIZED ALUMINUM
24", 36", 48" & 96" LENGTHS

NOTE: ALL LENGTHS ARE NOMINAL



- Clear anodized aluminum finish with 4 black plastic end caps for a "finished" look.
- The spring clips inside the rail will "snap" close to securely hold your banner in place.
- Ideal for paper, fabric and vinyl banners up to .08" thick.
- Recommend to be used at the bottom of your banner for added stability.
- Includes removable hanging clips. The banner hanging system can be attached to the wall or hung from the ceiling using our ceiling hooks, **Please Inquire**.

Part #	Length	Price	
		Per Set	10+ Sets
SNAP-24	24"	\$9.14 ea.	\$8.55 ea.
SNAP-36	36"	\$11.29 ea.	\$10.59 ea.
SNAP-48	48"	\$13.44 ea.	\$12.61 ea.
SNAP-96	96"	\$26.34 ea.	\$24.70 ea.

Components To Complete Your Customization

Hanging Clips



SNAP-HC \$0.27 ea.

End Caps



SNAP-EC \$0.54 pr.

Spring Clips

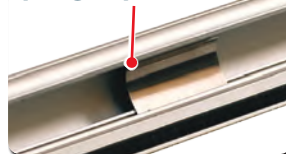

SNAP-SC \$0.23 ea.

4" Joiner Bar



HGR-JOIN
Each: \$0.79
100 pcs. \$0.65 ea.

Material: Aluminum
Finish: Mill

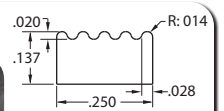

Snap Ease Sign Kits

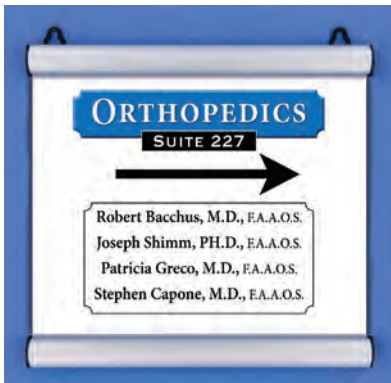

- Vertical or Horizontal mounting
- All inclusive kits:
 - 2 length banner holders
 - 2 hanging clips
 - 4 end caps
 - 2 spring clips

Part #	Length	Price
SNAP-KIT-8	8-1/2"	\$9.14 ea.
SNAP-KIT-11	11"	\$10.48 ea.



IMPORTANT: Due to Raw Material Fluctuation, Catalog Prices Below May Not Be Accurate. GO TO WWW.OUTWATER.COM FOR THE MOST UP-TO-DATE PRICES

Front Loading Plastic Frame Profiles

These plastic profiles can be easily cut & mitered to a variety of frame sizes. The flip open & snap close design will allow you to change graphics without disassembling the whole unit!

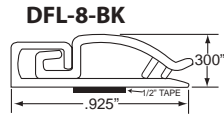

8 Ft. Lengths W/Adhesive High Gloss Black (BK)

• Material: PVC

Part #	Description	Price		
		120 Ft.	600 Ft.	1000 Ft.
DFL-8-BK	High gloss black-2 piece frame	\$1.40 ft.	\$1.30 ft.	\$1.19 ft.

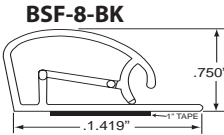

Part #	Description	Price		
		120 Ft.	600 Ft.	1000 Ft.
BSF-8-BK	Black bullnose snap frame	\$2.90 ft.	\$2.75 ft.	\$2.55 ft.



12 Ft. Lengths

White (*WH), Black (*BK), Silver (*SI)

• Material: Dual Durometer PVC

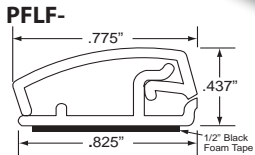

Part #	Description	120 Ft.	600 Ft.
PFLF-1040*	w/o Adhesive	\$1.24 ft.	\$1.16 ft.
PFLF-1040A*	w/ Adhesive	\$1.37 ft.	\$1.27 ft.

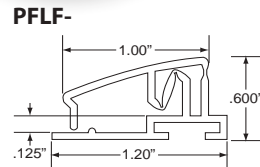
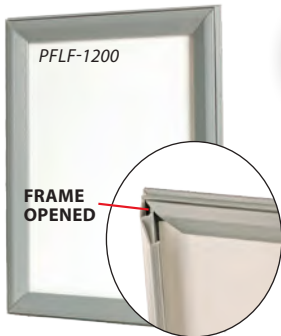
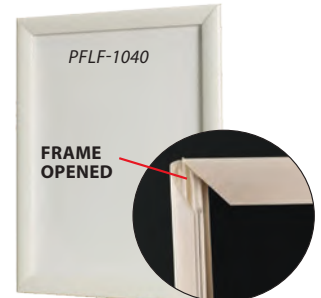

12 Ft. Lengths

White (*WH), Black (*BK), Silver (*SI)

• Material: Dual Durometer PVC
• Metal corner to hold miter cut

Part #	Description	120 Ft.	600 Ft.
PFLF-1200*	w/o Adhesive	\$1.55 ft.	\$1.49 ft.
PFLF-1200A*	w/ Adhesive	\$1.64 ft.	\$1.59 ft.



METAL CORNER		
Part #	Each	1000
PFLF-1200-CORN	\$0.45	\$0.25 ea.

Magnaclamp®

THE EFFICIENT WAY OF HANGING SIGNS, BANNERS AND DISPLAY MATERIAL

- Unaffected by frost
- Wash over, squeegee over
- Neat appearance - no unsightly residue
- Leaves no residue if removed
- **LASTS FOR YEARS!**

Standard surface is WHITE.
Black & custom colors available.
Custom Sizes Available

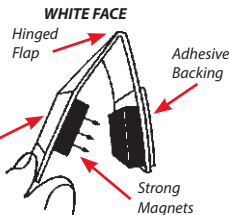

ADHESIVE BACK

Part #	Length	Price
MC-03-WH	3"	\$0.61 ea.
MC-06-WH	6"	\$1.30 ea.
MC-24-WH	24"	\$4.60 ea.
MC-36-WH	36"	\$6.65 ea.

Magnaclamp II®

THE HARD-SHELL MAGNACLAMP® FOR THE UPSCALE LOOK

- Attaches to a flat surface with permanent adhesive
- Integrated hinge opens to accept signage and clamp shut for a secure hold.
- Black or White, 24" long with adhesive



Part #	Length	Price
MCHS-24-BK	24"	\$5.50 ea.
MCHS-24-WH	24"	\$5.50 ea.



“KLEMMFIX” SIGN HOLDERS

*A quick & easy way to install and replace signs.
Simply snap open, insert material & close.
No notching or stapling required.*

Available In Black, White & Clear PVC • 8 Ft. Lengths

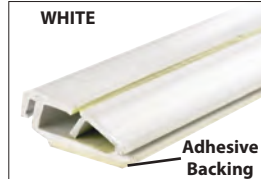

KLEMMFIX 18

SPECIFICATIONS:

- Suitable for paper thickness up to .04 inch.
- Stocked with & without adhesive backing.
- Hooks are available for hanging applications.



Part #	Color	Price	
		Per Ft.	100+ Ft.
Without Adhesive Backing			
3000-18BK	Black	\$0.76'	\$0.70'
3000-18WH	White	\$0.76'	\$0.70'
3000-18CL	Clear	\$0.76'	\$0.70'

Part #	Color	Price	
		Per Ft.	100+ Ft.
With Adhesive Backing			
3000-18BK-T	Black	\$0.82'	\$0.75'
3000-18WH-T	White	\$0.82'	\$0.75'
3000-18CL-T	Clear	\$0.82'	\$0.75'

KLEMMFIX 28

SPECIFICATIONS:

- Suitable for paper thickness up to .08 inch.
- Hooks are available for hanging applications.

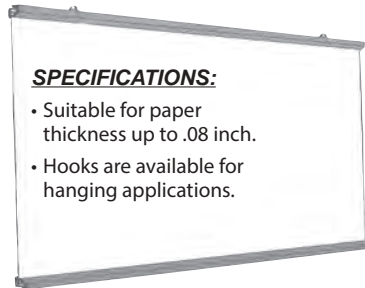

Part #	Color	Price	
		Per Ft.	100+ Ft.
3000-28BK	Black	\$1.60'	\$1.44'
3000-28WH	White	\$1.60'	\$1.44'
3000-28CL	Clear	\$1.60'	\$1.44'

KLEMMFIX 36

SPECIFICATIONS:

- Suitable for paper thickness up to .04 inch.
- Hooks are available for hanging applications.
- End caps are also available in black or white to give the finishing touch.

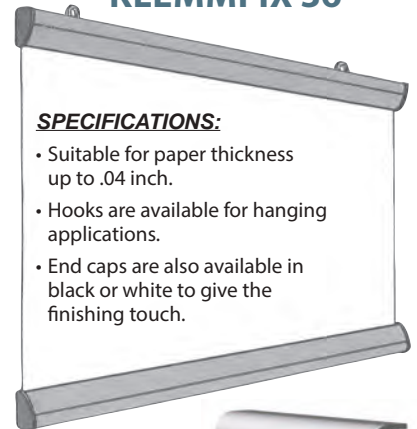

Part #	Color	Price	
		Per Ft.	100+ Ft.
3002-36BK	Black	\$1.66'	\$1.50'
3002-36WH	White	\$1.66'	\$1.50'

END CAPS For Klemmfix 36
MATERIAL: Polypropylene



Part #	Color	Price	
		Per Pr.	50+ Prs.
3003-END-BK	Black	\$1.60 pr.	\$1.45 pr.
3003-END-WH	White	\$1.60 pr.	\$1.45 pr.

HANGING CLIPS

For Klemmfix 18, 28 & 36

MATERIAL: Polypropylene



Part #	Color	Price	
		Each	100+ Pcs.
3001-PH-BK	Black	\$0.13	\$0.12 ea.
3001-PH-WH	White	\$0.13	\$0.12 ea.
3001-PH-CL	Clear	\$0.13	\$0.12 ea.

Sign / Banner Holders

- An easy & affordable way to emphasize brands & your marketing message.
- Channels can easily be cut-to-size to accommodate a variety of banner widths.
- All channels can be used as a top & bottom rail.



142F-

- Material: Styrolux
- Flared legs for easy graphic insertion

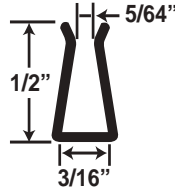

Holds 3/16" thick material

Part #	Color	Length	Price	
			120 Ft.	600 Ft.
142F-CL	Clear	12'	\$0.74'	\$0.69'
142F-BK	Black	12'	\$0.73'	\$0.68'
142F-WH	White	12'	\$0.73'	\$0.68'



670-A-

- Material: Styrolux
- Classic universal clip design

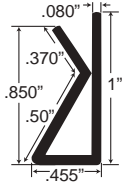

Holds up to 1/4" thick material

Part #	Color	Length	Price	
			120 Ft.	600 Ft.
670-A-BK	Black	8'	\$1.10'	\$1.04'
670-A-WH	White	8'	\$1.10'	\$1.04'



HS-447- "Super Clamp"

- Material: PVC
- Each 4' length piece comes with 6 hanging hardware (BH-788-H) to hang banner onto the wall or from the ceiling

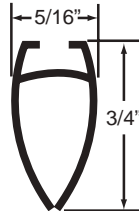

Holds 1/8"- 1/4" thick material

Part #	Color	Length	Price	
			120 Ft.	600 Ft.
HS-447-CL	Clear	4'	\$0.51'	\$0.48'
HS-447-BK	Black	4'	\$0.49'	\$0.48'
HS-447-WH	White	4'	\$0.51'	\$0.48'



130- "Banner Clamp"

- Material: Clear PVC or Black & White Styrene

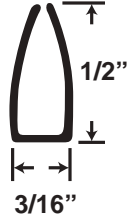

Holds up to 1/8" thick material

Part #	Color	*Length	Price	
			120 Ft.	600 Ft.
130-CL-*	Clear	(*8) = 8 ft.	\$0.28'	\$0.26'
130-BK-*	Black	(*10) = 10 ft.	\$0.24'	\$0.22'
130-WH-*	White	(*10) = 10 ft.	\$0.24'	\$0.22'



131- "Clamp It"

- Material: Clear PVC or Black & White Styrene

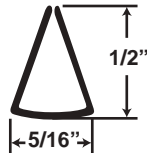

Holds up to 1/4" thick material

Part #	Color	*Length	Price	
			120 Ft.	600 Ft.
131-CL-*	Clear	(*8) = 8 ft.	\$0.28'	\$0.26'
131-BK-*	Black	(*10) = 10 ft.	\$0.24'	\$0.22'
131-WH-*	White	(*10) = 10 ft.	\$0.24'	\$0.22'



2326- "Banner Channel"

- Material: Black ABS with high gloss film on the front of the profile

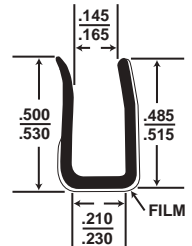

Holds 1/8"- 3/16" thick material

Part #	Color	Length	Price	
			120 Ft.	600 Ft.
2326-BK	Black	12'	\$0.29'	\$0.28'



1059- "Banner Channel"

- Material: Rigid PVC

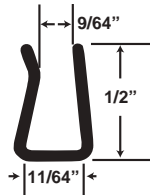

Holds 3/16" thick material

Part #	Color	Length	Price	
			120 Ft.	600 Ft.
1059-CL	Clear	12'	\$0.38'	\$0.35'



HS-2010- "The Great Gripper"

- Material: PVC
- Each 8' length piece comes with 4 hanging hardware (BH-788-H) to hang banner onto the wall or from the ceiling

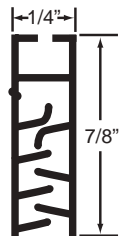

Holds up to .080" thick material

Part #	Color	Length	Price	
			120 Ft.	600 Ft.
HS-2010-CL	Clear	8'	\$1.32'	\$1.22'

For any quantities less than 120 ft. add 10% to the 120 ft. price

- An easy & affordable way to emphasize brands & your marketing message.
- Channels can easily be cut-to-size to accommodate a variety of banner widths.
- All channels can be used as a top & bottom rail.

PFLF-1200-



- Material: Dual Durometer PVC
- With or without adhesive

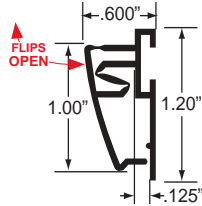

Part #	*Color	Length	Price	
			120 Ft.	600 Ft.
PFLF-1200-*	(*WH) = White	12'	\$1.55'	\$1.49'
PFLF-1200A-*	(*BK) = Black (*SL) = Silver	12'	\$1.64'	\$1.59'

PFLF-1040-



- Material: Dual Durometer PVC
- With or without adhesive

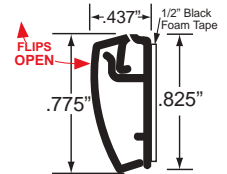

Part #	*Color	Length	Price	
			120 Ft.	600 Ft.
PFLF-1040-*	(*WH) = White	12'	\$1.24'	\$1.16'
PFLF-1040A-*	(*BK) = Black (*SL) = Silver	12'	\$1.37'	\$1.27'

BH-788- "Banner Holder" w/Snap Action



- Material: Styrene
- Contoured shape allows for 2 sided graphics
- Easy mount channel for hanging hardware (BH-788-H), hang banner onto the wall or from the ceiling.

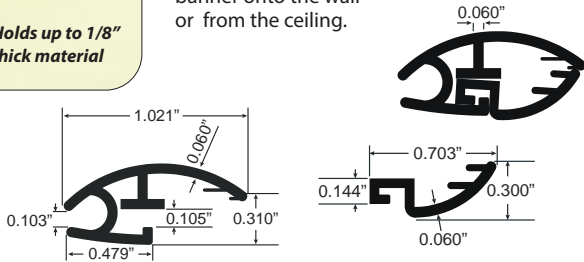

Part #	Color	Length	Price		
			120 Ft.	600 Ft.	1000 Ft.
BH-788-BK	Black	8'	\$1.51'	\$1.38'	\$1.28'
BH-788-WH	White	8'	\$1.51'	\$1.38'	\$1.28'

2799- "Mini Snap"



- Material: Rigid PVC
- Clear rubber based film tape for wall mounting

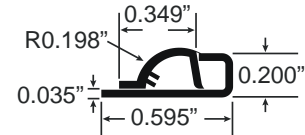

Part #	Color	Length	Price			
			8 Ft.	120 Ft.	600 Ft.	1000 Ft.
2799-BK	Black	8'	\$0.85'	\$0.79'	\$0.72'	\$0.63'
2799-WH	White	8'	\$0.85'	\$0.79'	\$0.72'	\$0.63'

For any quantities less than 120 ft. add 10% to the 120 ft. price

BH-788-H- "Universal Hanger"



Fits into channels up to 1/4" wide

- Material: Clear Polyethylene
- Easily slides into the BH-788- * "Banner Holder", HS-2010-CL "The Great Gripper" and HS-447- * "Mini Snap".

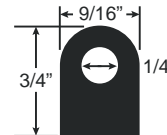

Part #	Color	Price	
		100 Pcs.	1000 Pcs.
BH-788-H	Clear	\$0.18 ea.	\$0.17 ea.

IMPORTANT: Due to Raw Material Fluctuation, Catalog Prices Below May Not Be Accurate. GO TO WWW.OUTWATER.COM FOR THE MOST UP-TO-DATE PRICES

Aluminum Frame Profiles

"SNAP-EASE" FRONT LOADING FRAME PROFILES
MAKE YOUR OWN FRAMES WITH OUR COMPONENTS!



- Stocked in 8 ft. lengths for shipping
- Each profile includes base and cap



SHOWN ASSEMBLED

***CORNER:** Joins mitered profiles. 4 required to assemble frame.

***SPRING:** Allows frame to open and snap-close. Requires minimum 2 per 10" and 1 every additional 4-6". Example: 22" x 28" frame = [4] [5] springs

*** Corners and Springs sold separately**

FLF-29S-

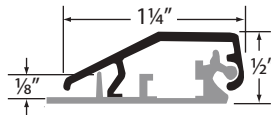
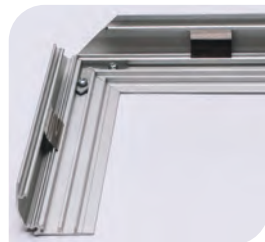

REQUIRED ACCESSORIES



FLF-29S-CORNER
 joins mitered profiles
 (Requires 4 per frame)
 \$0.85 ea.
 \$0.45 ea./100+ pcs.

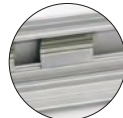

FLF-29S-SPRING
 to open/close frame
 (min. 2 per 10")
 \$0.59 ea.
 \$0.19 ea./100+ pcs.

FOR 1/8" INSERT
With Matching Base & Cap Finish

Part #	Base & Cap Finish	Price	
		120 Ft.	600+ Ft.
FLF-29S-AL	Clear Anodized	\$3.17 ft.	\$2.62 ft.



For any quantities less than 120 ft. add 15% to the 120 ft. price.

IMPORTANT: Due to Raw Material Fluctuation, Catalog Prices Below May Not Be Accurate. GO TO WWW.OUTWATER.COM FOR THE MOST UP-TO-DATE PRICES

Aluminum Frame Profiles

"SNAP-EASE" FRONT LOADING FRAME PROFILES
MAKE YOUR OWN FRAMES WITH OUR COMPONENTS!

Stocked in 8 ft. lengths

FLF-19P1-

2 CORNER ASSEMBLY METHODS TO CHOOSE FROM!
MITERED • ROUNDED



MITERED
saves money!
No need to spend extra money on corners!

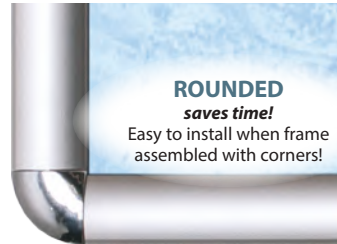
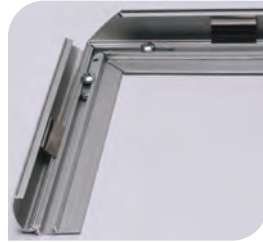

FLF-19P-RND
joins straight profiles
(Requires 4 per frame)
\$1.02 ea.
\$0.59 ea./100+ pcs.

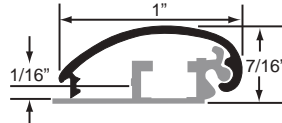
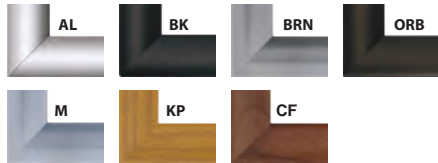

FOR 1/16" INSERT

With Matching Base & Cap Finish

Part #	Base & Cap Finish	Price	
		120 Ft.	600+ Ft.
FLF-19P1-AL	Clear Anodized	\$2.54 ft.	\$2.13 ft.
FLF-19P1-BK	Black Matte	\$3.23 ft.	\$2.71 ft.
FLF-19P1-BRN	Brushed Nickel	\$3.93 ft.	\$3.35 ft.
FLF-19P1-ORB	Oil Rubbed Bronze	\$3.42 ft.	\$2.87 ft.
FLF-19P1-KP	Knotty Pine Wood Grain	n/a	n/a
FLF-19P1-CF	Cherry Flame Wood	n/a	n/a
FLF-19P1-M	Mill	\$1.55 ft.	\$1.26 ft.

With Mill Base & Finished Cap

Part #	Cap Finish	Price	
		120 Ft.	600+ Ft.
FLF-19P1M-AL	Clear Anodized	\$2.06 ft.	\$1.86 ft.
FLF-19P1M-BK	Black Matte	\$2.41 ft.	\$2.16 ft.
FLF-19P1M-BRN	Brushed Nickel	\$3.54 ft.	\$3.18 ft.
FLF-19P1M-ORB	Oil Rubbed Bronze	\$2.48 ft.	\$2.24 ft.
FLF-19P1M-KP	Knotty Pine Wood Grain	\$6.26 ft.	\$5.57 ft.
FLF-19P1M-CF	Cherry Flame Wood	\$6.26 ft.	\$5.57 ft.

REQUIRED ACCESSORIES



FLF-19P-CORNER
joins mitered profiles
(Requires 4 per frame)
\$0.85 ea.
\$0.45 ea./100+ pcs.

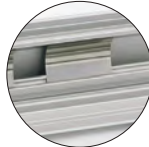

FLF-19P-SPRING
to open/close frame
(min. 2 per 10")
\$0.59 ea.
\$0.19 ea./100+ pcs.

FLF-8-

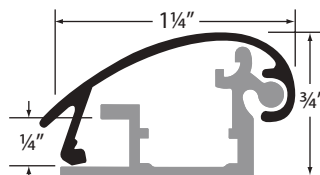
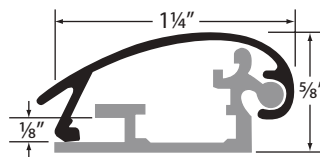
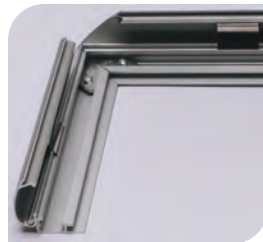

FOR 1/8" INSERT

With Matching Base & Cap Finish

Part #	Base & Cap Finish	Price	
		120 Ft.	600+ Ft.
FLF-8-AL	Clear Anodized	\$3.31 ft.	\$2.78 ft.
FLF-8-BK	Black Matte	\$3.11 ft.	\$2.56 ft.
FLF-8-BRN	Brushed Nickel	\$4.73 ft.	\$3.98 ft.
FLF-8-ORB	Oil Rubbed Bronze	\$4.00 ft.	\$3.35 ft.
FLF-8-KP	Knotty Pine Wood Grain	n/a	n/a
FLF-8-CF	Cherry Flame Wood	n/a	n/a
FLF-8-M	Mill	\$2.15 ft.	\$1.81 ft.

With Mill Base & Finished Cap

Part #	Cap Finish	Price	
		120 Ft.	600+ Ft.
FLF-8M-AL	Clear Anodized	\$2.73 ft.	\$2.29 ft.
FLF-8M-BK	Black Matte	\$2.73 ft.	\$2.32 ft.
FLF-8M-BRN	Brushed Nickel	\$4.13 ft.	\$3.79 ft.
FLF-8M-ORB	Oil Rubbed Bronze	\$3.07 ft.	\$2.58 ft.
FLF-8M-KP	Knotty Pine Wood Grain	\$6.73 ft.	\$5.99 ft.
FLF-8M-CF	Cherry Flame Wood	\$6.73 ft.	\$5.99 ft.

FOR 1/4" INSERT

With Mill Base & Finished Cap

Part #	Cap Finish	Price	
		120 Ft.	600+ Ft.
FLF-8QM-AL	Clear Anodized	\$3.02 ft.	\$2.72 ft.
FLF-8QM-BK	Black Matte	\$3.28 ft.	\$2.95 ft.
FLF-8QM-BRN	Brushed Nickel	\$4.91 ft.	\$4.43 ft.
FLF-8QM-ORB	Oil Rubbed Bronze	\$3.45 ft.	\$3.11 ft.
FLF-8QM-KP	Knotty Pine Wood Grain	\$7.37 ft.	\$6.57 ft.
FLF-8QM-CF	Cherry Flame Wood	\$7.37 ft.	\$6.57 ft.
FLF-8Q-M	Mill	\$2.80 ft.	\$2.43 ft.

REQUIRED ACCESSORIES



FLF-CORNER
joins mitered profiles
(Requires 4 per frame)
\$0.85 ea.
\$0.45 ea./100+ pcs.

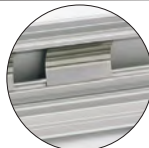

FLF-SPRING
to open/close frame
(min. 2 per 10")
\$0.59 ea.
\$0.19 ea./100+ pcs.

For any quantities less than 120 ft. add 15% to the 120 ft. price.

IMPORTANT: Due to Raw Material Fluctuation, Catalog Prices Below May Not Be Accurate. GO TO WWW.OUTWATER.COM FOR THE MOST UP-TO-DATE PRICES

Aluminum Frame Profiles

"SNAP-EASE" FRONT LOADING FRAME PROFILES

MAKE YOUR OWN FRAMES WITH OUR COMPONENTS!

Stocked in 8 ft. lengths

FLF-19N-

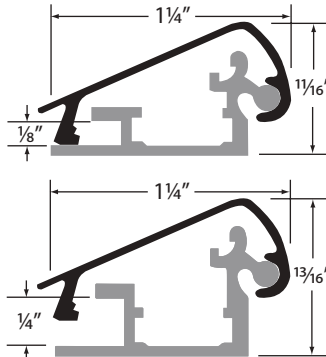
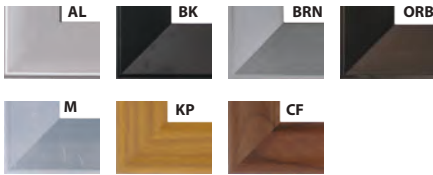
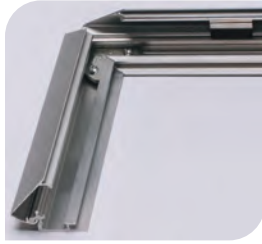

FOR 1/8" INSERT

With Matching Base & Cap Finish

Part #	Base & Cap Finish	Price	
		120 Ft.	600+ Ft.
FLF-19N-AL	Clear Anodized	\$3.18 ft.	\$2.68 ft.
FLF-19N-BK	Black Matte	\$3.59 ft.	\$3.02 ft.
FLF-19N-BRN	Brushed Nickel	\$4.88 ft.	\$4.10 ft.
FLF-19N-ORB	Oil Rubbed Bronze	\$3.96 ft.	\$3.32 ft.
FLF-19N-KP	Knotty Pine Wood Grain	n/a	n/a
FLF-19N-CF	Cherry Flame Wood	n/a	n/a
FLF-19N-M	Mill	\$2.60 ft.	\$2.18 ft.

With Mill Base & Finished Cap

Part #	Cap Finish	Price	
		120 Ft.	600+ Ft.
FLF-19NM-AL	Clear Anodized	\$2.60 ft.	\$2.40 ft.
FLF-19NM-BK	Black Matte	\$3.01 ft.	\$2.77 ft.
FLF-19NM-BRN	Brushed Nickel	\$4.30 ft.	\$3.76 ft.
FLF-19NM-ORB	Oil Rubbed Bronze	\$3.03 ft.	\$2.69 ft.
FLF-19NM-KP	Knotty Pine Wood Grain	\$6.70 ft.	\$5.97 ft.
FLF-19NM-CF	Cherry Flame Wood	\$6.60 ft.	\$5.97 ft.

FOR 1/4" INSERT

With Mill Base & Finished Cap

Part #	Cap Finish	Price	
		120 Ft.	600+ Ft.
FLF-19NQM-AL	Clear Anodized	\$3.36 ft.	\$2.88 ft.
FLF-19NQM-BK	Black Matte	\$3.71 ft.	\$3.29 ft.
FLF-19NQM-BRN	Brushed Nickel	\$5.05 ft.	\$4.58 ft.
FLF-19NQM-ORB	Oil Rubbed Bronze	\$3.81 ft.	\$3.31 ft.
FLF-19NQM-KP	Knotty Pine Wood Grain	\$7.34 ft.	\$6.55 ft.
FLF-19NQM-CF	Cherry Flame Wood	\$3.34 ft.	\$6.55 ft.
FLF-19NQM-M	Mill	\$2.88 ft.	\$2.49 ft.

REQUIRED ACCESSORIES



FLF-19N-CORNER
joins mitered profiles
(Requires 4 per frame)
\$0.85 ea.
\$0.45 ea./100+ pcs.

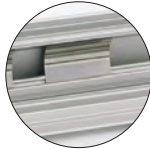

FLF-19N-SPRING
to open/close frame
(min. 2 per 10")
\$0.59 ea.
\$0.19 ea./100+ pcs.

FLF-37S-

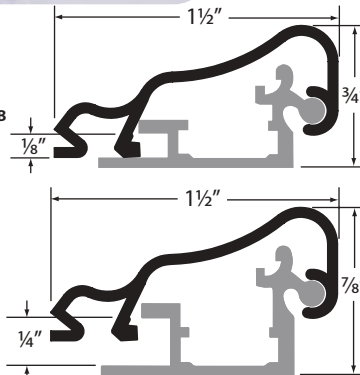
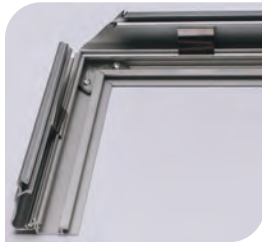

FOR 1/8" INSERT

With Matching Base & Cap Finish

Part #	Base & Cap Finish	Price	
		120 Ft.	600+ Ft.
FLF-37S-AL	Clear Anodized	\$3.63 ft.	\$3.05 ft.
FLF-37S-BK	Black Matte	\$3.86 ft.	\$3.27 ft.
FLF-37S-BRN	Brushed Nickel	\$5.85 ft.	\$4.91 ft.
FLF-37S-ORB	Oil Rubbed Bronze	\$4.32 ft.	\$3.63 ft.
FLF-37S-KP	Knotty Pine Wood Grain	n/a	n/a
FLF-37S-CF	Cherry Flame Wood	n/a	n/a
FLF-37S-M	Mill	\$2.42 ft.	\$2.00 ft.

With Mill Base & Finished Cap

Part #	Cap Finish	Price	
		120 Ft.	600+ Ft.
FLF-37SM-AL	Clear Anodized	\$3.06 ft.	\$2.57 ft.
FLF-37SM-BK	Black Matte	\$3.41 ft.	\$3.06 ft.
FLF-37SM-BRN	Brushed Nickel	\$5.46 ft.	\$4.92 ft.
FLF-37SM-ORB	Oil Rubbed Bronze	\$3.50 ft.	\$3.16 ft.
FLF-37SM-KP	Knotty Pine Wood Grain	\$7.08 ft.	\$6.31 ft.
FLF-37SM-CF	Cherry Flame Wood	\$7.08 ft.	\$6.31 ft.

FOR 1/4" INSERT

With Mill Base & Finished Cap

Part #	Cap Finish	Price	
		120 Ft.	600+ Ft.
FLF-37SQM-AL	Clear Anodized	\$3.76 ft.	\$3.33 ft.
FLF-37SQM-BK	Black Matte	\$4.11 ft.	\$3.59 ft.
FLF-37SQM-BRN	Brushed Nickel	\$6.17 ft.	\$5.55 ft.
FLF-37SQM-ORB	Oil Rubbed Bronze	\$4.21 ft.	\$3.68 ft.
FLF-37SQM-KP	Knotty Pine Wood Grain	\$7.73 ft.	\$6.89 ft.
FLF-37SQM-CF	Cherry Flame Wood	\$7.73 ft.	\$6.89 ft.

REQUIRED ACCESSORIES



FLF-37S-CORNER
joins mitered profiles
(Requires 4 per frame)
\$0.85 ea.
\$0.45 ea./100+ pcs.

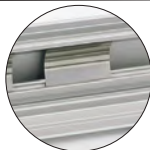

FLF-37S-SPRING
to open/close frame
(min. 2 per 10")
\$0.59 ea.
\$0.19 ea./100+ pcs.

For any quantities less than 120 ft. add 15% to the 120 ft. price.

IMPORTANT: Due to Raw Material Fluctuation, Catalog Prices Below May Not Be Accurate. GO TO WWW.OUTWATER.COM FOR THE MOST UP-TO-DATE PRICES

Fully Assembled, Front Loading Aluminum Frames

ATTRACTIVE AND EASY-TO-USE!

Built-in spring loaded hinge enables you to change graphics in a snap without disassembling the frame.

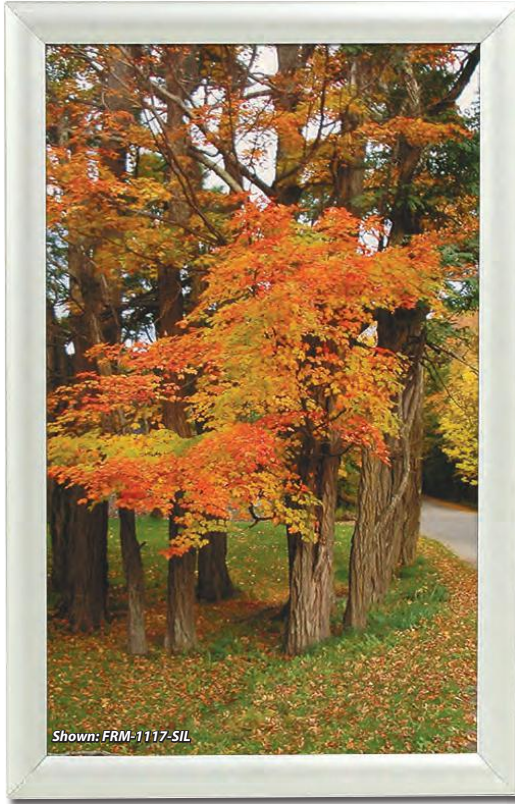

- Fully assembled frame comes with clear non-glare lens and back panel
- Strong aluminum construction
- Snap/Spring loaded
- Screw holes on the back for easy mounting - portrait or landscape
- Screws and drywall anchors are included
- Custom sizes and finishes available at a minimum. Please inquire for more details.



7 SIZES TO CHOOSE FROM...

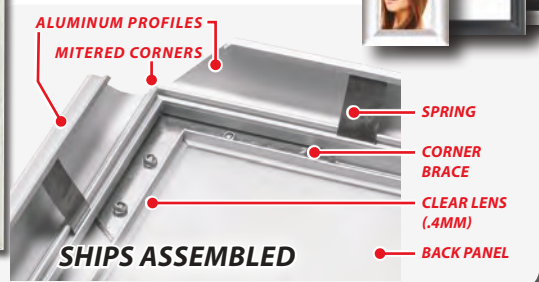

...AN ARRAY OF STYLES!

1" Easy-Frame With Clear Anodized, Black Powder Coat Or Woodgrain Finish

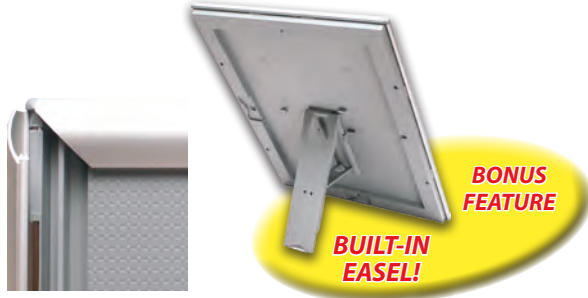
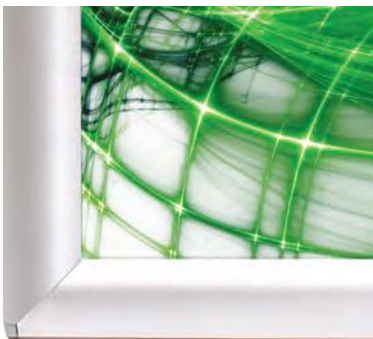

- Mounts Portrait or Landscape
- 2 Holes on 2 sides
- Screws & Anchors included

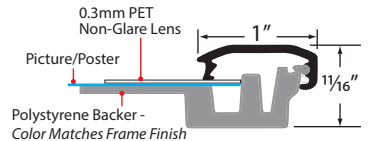

Part #	Graphic Size	Reveal Dimensions	Overall Dimensions	Finish	Price	
					Each	10+ Pcs.
FRM-O57-SIL	5" x 7"	4-1/4" x 6-1/4"	6-1/4" x 8-1/4"	Clear Anodized	\$5.10	\$4.60 ea.
FRM-O57-BK	5" x 7"	4-1/4" x 6-1/4"	6-1/4" x 8-1/4"	Black Powder Coat	\$5.15	\$4.65 ea.
FRM-O57-WG	5" x 7"	4-1/4" x 6-1/4"	6-1/4" x 8-1/4"	Woodgrain	\$10.80	\$9.80 ea.
FRM-O8511-SIL	8-1/2" x 11"	7-3/4" x 10-1/4"	9-3/4" x 12-1/4"	Clear Anodized	\$9.45	\$8.50 ea.
FRM-O8511-BK	8-1/2" x 11"	7-3/4" x 10-1/4"	9-3/4" x 12-1/4"	Black Powder Coat	\$10.90	\$9.80 ea.
FRM-O8511-WG	8-1/2" x 11"	7-3/4" x 10-1/4"	9-3/4" x 12-1/4"	Woodgrain	\$15.30	\$13.75 ea.

Custom sizes & finishes can be produced. Please Inquire.

Packed 5 per carton. \$5.00 broken box fee (BB5) for less than full carton.

IMPORTANT: Due to Raw Material Fluctuation, Catalog Prices Below May Not Be Accurate. GO TO WWW.OUTWATER.COM FOR THE MOST UP-TO-DATE PRICES

Fully Assembled, Front Loading
Aluminum Frames

Built-in spring loaded hinge enables you to change graphics in a snap without disassembling the frame.

1" Frame With Clear Anodized Or Black Powder Coat Finish

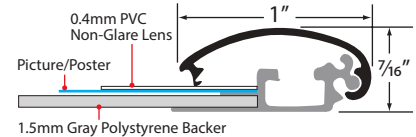
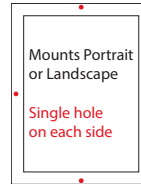

Part #	Graphic Size	Reveal Dimensions	Overall Dimensions	Finish	Price	
					Each	10+ Pcs.
FRM-8511-SIL	8-1/2" x 11"	7-5/8" x 10-1/8"	9-11/16" x 12-3/16"	Clear Anodized	\$11.06	\$10.44 ea.
FRM-8511-BK	8-1/2" x 11"	7-5/8" x 10-1/8"	9-11/16" x 12-3/16"	Black Powder Coat	\$15.07	\$14.17 ea.
FRM-1117-SIL	11" x 17"	10-1/4" x 16-3/16"	12-1/4" x 18-3/16"	Clear Anodized	\$16.10	\$15.05 ea.
FRM-1117-BK	11" x 17"	10-1/4" x 16-3/16"	12-1/4" x 18-3/16"	Black Powder Coat	\$21.05	\$19.59 ea.
FRM-1620-SIL	16" x 20"	15-1/8" x 19-1/8"	17-3/16" x 21-3/16"	Clear Anodized	\$20.15	\$19.31 ea.
New FRM-1620-BK	16" x 20"	15-1/8" x 19-1/8"	17-3/16" x 21-3/16"	Black Powder Coat	\$24.45	\$23.51 ea.

1-1/4" Frame With Clear Anodized Or Black Powder Coat Finish

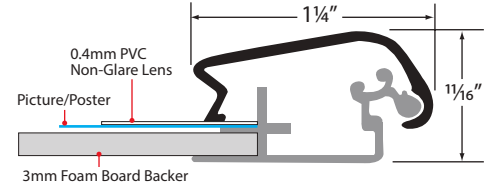
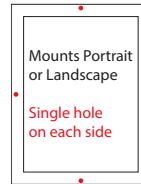

Part #	Graphic Size	Reveal Dimensions	Overall Dimensions	Finish	Price	
					Each	10+ Pcs.
FRM-2228-SIL	22" x 28"	21-5/8" x 27-11/16"	24-1/8" x 30-1/8"	Clear Anodized	\$32.45	\$29.35 ea.
FRM-2228-BK	22" x 28"	21-5/8" x 27-11/16"	24-1/8" x 30-1/8"	Black Powder Coat	\$42.72	\$39.79 ea.
FRM-2436-SIL	24" x 36"	23-1/2" x 35-5/8"	26-1/8" x 38-1/8"	Clear Anodized	\$46.87	\$44.18 ea.
FRM-2436-BK	24" x 36"	23-1/2" x 35-5/8"	26-1/8" x 38-1/8"	Black Powder Coat	\$53.28	\$49.56 ea.

1-1/4" Frame With Clear Anodized Finish

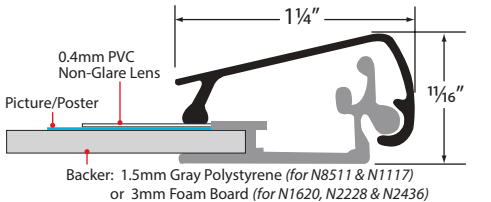
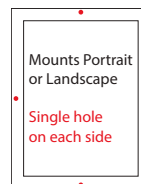

Part #	Graphic Size	Reveal Dimensions	Overall Dimensions	Price	
				Each	10+ Pcs.
FRM-N8511-SIL	8-1/2" x 11"	8-1/16" x 10-5/8"	10-3/16" x 13-3/16"	\$17.95	\$17.05 ea.
FRM-N1117-SIL	11" x 17"	10-1/4" x 16-3/16"	12-3/16" x 18-1/8"	\$24.07	\$21.17 ea.
FRM-N1620-SIL	16" x 20"	15-1/2" x 19-1/2"	18" x 22-1/8"	\$28.44	\$25.68 ea.
FRM-N2228-SIL	22" x 28"	21-5/8" x 27-5/8"	24-1/8" x 30-1/8"	\$42.56	\$40.08 ea.
FRM-N2436-SIL	24" x 36"	22-5/8" x 35-1/2"	26-1/4" x 38-1/16"	\$52.49	\$50.17 ea.

Custom sizes & finishes can be produced. Please Inquire.

Packed 5 per carton. \$5.00 broken box fee (BB5) for less than full carton.

IMPORTANT: Due to Raw Material Fluctuation, Catalog Prices Below May Not Be Accurate. GO TO WWW.OUTWATER.COM FOR THE MOST UP-TO-DATE PRICES

Fully Assembled, Front Loading Aluminum Frames

Built-in spring loaded hinge enables you to change graphics in a snap without disassembling the frame.

1-1/4" Frame With High Quality Anodized Satin Silver Finish



- Mounts Portrait or Landscape
- 2 Holes on 2 sides
- Screws & Anchors included

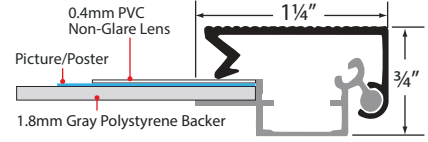

Part #	Graphic Size	Reveal Dimensions	Overall Dimensions	WAS		NOW	
				Each	10+ Pcs.	Each	10+ Pcs.
FRMD-A8511-SS	8-1/2" x 11"	7.91" x 10.41"	10.27" x 12.77"	\$19.80	\$18.00 ea.	\$14.54	\$13.51 ea.
FRMD-A1117-SS	11" x 17"	10.41" x 16.41"	12.77" x 18.77"	\$23.75	\$21.60 ea.	\$16.48	\$15.31 ea.
FRMD-A2228-SS	22" x 28"	21.41" x 27.41"	23.77" x 29.77"	\$39.60	\$36.00 ea.	\$28.10	\$26.11 ea.
FRMD-A2436-SS	24" x 36"	23.41" x 35.41"	25.77" x 37.77"	\$54.10	\$49.20 ea.	\$38.75	\$36.00 ea.

1-1/4" Frame With High Quality Anodized Satin Silver Finish

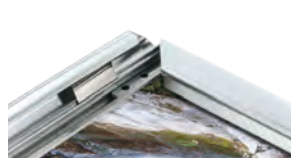

- Mounts Portrait or Landscape
- 2 Holes on 2 sides
- Screws & Anchors included

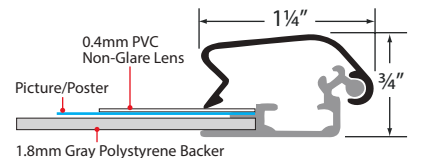

Part #	Graphic Size	Reveal Dimensions	Overall Dimensions	WAS		NOW	
				Each	10+ Pcs.	Each	10+ Pcs.
FRMD-B8511-SS	8-1/2" x 11"	7.79" x 10.29"	10.23" x 12.73"	\$16.35	\$14.90 ea.	\$12.01	\$11.16 ea.
FRMD-B1117-SS	11" x 17"	10.29" x 16.29"	12.73" x 18.73"	\$19.25	\$17.50 ea.	\$14.15	\$13.15 ea.
FRMD-B2436-SS	24" x 36"	23.29" x 35.29"	25.73" x 37.73"	\$36.15	\$32.90 ea.	\$26.55	\$24.67 ea.

1-7/16" Frame With High Quality Anodized Satin Silver Finish

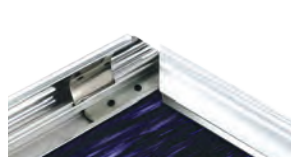

- Mounts Portrait or Landscape
- 2 Holes on 2 sides
- Screws & Anchors included

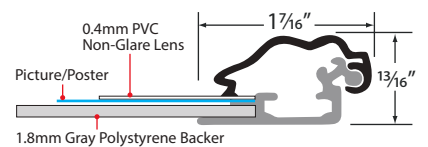

Part #	Graphic Size	Reveal Dimensions	Overall Dimensions	WAS		NOW	
				Each	10+ Pcs.	Each	10+ Pcs.
FRMD-C8511-SS	8-1/2" x 11"	7.94" x 10.44"	10.70" x 13.20"	\$22.45	\$20.40 ea.	\$16.48	\$15.31 ea.
FRMD-C1117-SS	11" x 17"	10.44" x 16.44"	13.20" x 19.20"	\$25.10	\$22.80 ea.	\$18.41	\$17.11 ea.
FRMD-C2228-SS	22" x 28"	21.44" x 27.44"	24.20" x 30.20"	\$42.25	\$38.40 ea.	\$31.00	\$28.80 ea.
FRMD-C2436-SS	24" x 36"	23.44" x 35.44"	26.20" x 38.20"	\$54.00	\$49.00 ea.	\$43.60	\$40.51 ea.

1-5/8" Frame With High Quality Anodized Satin Silver Finish

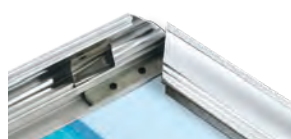

- Mounts Portrait or Landscape
- 2 Holes on 2 sides
- Screws & Anchors included

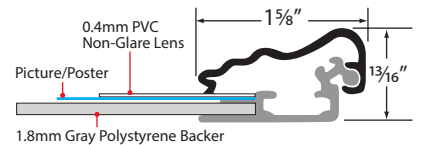

Part #	Graphic Size	Reveal Dimensions	Overall Dimensions	WAS		NOW	
				Each	10+ Pcs.	Each	10+ Pcs.
FRMD-D8511-SS	8-1/2" x 11"	7.55" x 10.05"	10.70" x 13.20"	\$25.10	\$22.80 ea.	\$18.41	\$17.11 ea.
FRMD-D1117-SS	11" x 17"	10.05" x 16.05"	13.20" x 19.20"	\$27.75	\$25.20 ea.	\$20.35	\$18.91 ea.
FRMD-D2228-SS	22" x 28"	21.05" x 27.05"	24.20" x 30.20"	\$44.90	\$41.00 ea.	\$32.94	\$30.60 ea.
FRMD-D2436-SS	24" x 36"	23.05" x 35.05"	26.20" x 38.20"	\$64.70	\$58.90 ea.	\$47.48	\$44.11 ea.

Custom sizes & finishes can be produced. Please Inquire.

Packed 5 per carton. \$5.00 broken box fee (BB5) for less than full carton.

IMPORTANT: Due to Raw Material Fluctuation, Catalog Prices Below May Not Be Accurate. GO TO WWW.OUTWATER.COM FOR THE MOST UP-TO-DATE PRICES

Fully Assembled, Front Loading Aluminum Frames

Built-in spring loaded hinge enables you to change graphics in a snap without disassembling the frame.

1-3/4" Frame With High Quality Anodized Satin Silver Finish

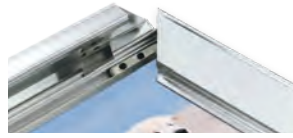

- Mounts Portrait or Landscape
- 2 Holes on 2 sides
- Screws & Anchors included

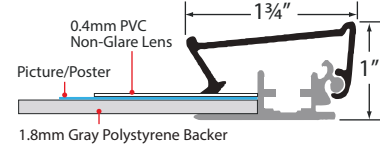

while supplies last!

Part #	Graphic Size	Reveal Dimensions	Overall Dimensions	WAS		NOW	
				Each	10+ Pcs.	Each	10+ Pcs.
FRMD-E8511-SS	8-1/2" x 11"	6.96" x 9.46"	10.35" x 12.85"	\$19.80	\$18.00 ea.	\$14.54	\$13.51 ea.
FRMD-E1117-SS	11" x 17"	9.46" x 15.46"	12.85" x 18.85"	\$23.75	\$21.60 ea.	\$17.44	\$16.20 ea.
FRMD-E2228-SS	22" x 28"	20.46" x 26.46"	23.85" x 29.85"	\$39.60	\$36.00 ea.	\$29.06	\$27.00 ea.
FRMD-E2436-SS	24" x 36"	22.46" x 34.46"	25.85" x 37.85"	\$54.10	\$49.20 ea.	\$39.73	\$36.91 ea.

1-1/4" Jumbo Frame With Clear Anodized Finish

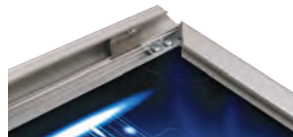

- Mounts Portrait or Landscape
- 2 Holes on 2 sides
- Screws & Anchors included

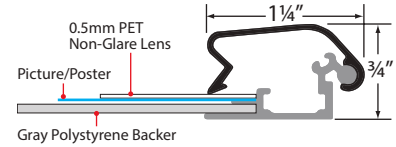

Part #	Graphic Size	Reveal Dimensions	Overall Dimensions	Price	
				Each	10+ Pcs.
FRM-L3648-SIL	36" x 48"	35-1/4" x 47-1/4"	37-11/16" x 49-11/16"	\$85.10	\$76.60 ea.

1-3/4" Jumbo Frame With Clear Anodized Finish



- Mounts Portrait or Landscape
- 2 Holes on 2 sides
- Screws & Anchors included

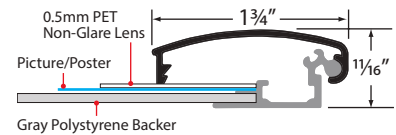

Part #	Graphic Size	Reveal Dimensions	Overall Dimensions	Price	
				Each	10+ Pcs.
FRM-J3648-SIL	36" x 48"	34-1/4" x 46-1/4"	37-11/16" x 49-11/16"	\$99.00	\$89.00 ea.

1-1/4" Lockable Waterproof Frame With Clear Anodized Or Black Powder Coat Finish



- Mounts Portrait or Landscape
- 2 Holes on 2 sides
- Screws & Anchors included

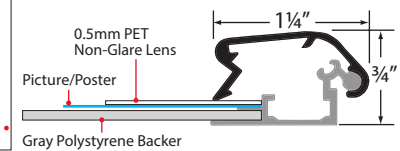

Part #	Graphic Size	Reveal Dimensions	Overall Dimensions	Finish	Price	
					Each	10+ Pcs.
FRM-L2228-SIL	22" x 28"	21-11/16" x 27-11/16"	24-7/16" x 30-7/16"	Clear Anodized	\$47.20	\$42.50 ea.
FRM-L2228-BK	22" x 28"	21-11/16" x 27-11/16"	24-7/16" x 30-7/16"	Black Powder Coat	\$52.45	\$47.20 ea.
FRM-L2436-SIL	24" x 36"	23-11/16" x 35-11/16"	26-7/16" x 38-7/16"	Clear Anodized	\$61.65	\$55.50 ea.
FRM-L2436-BK	24" x 36"	23-11/16" x 35-11/16"	26-7/16" x 38-7/16"	Black Powder Coat	\$61.60	\$55.44 ea.

Custom sizes & finishes can be produced. Please Inquire.

Packed 5 per carton. \$5.00 broken box fee (BB5) for less than full carton.

IMPORTANT: Due to Raw Material Fluctuation, Catalog Prices Below May Not Be Accurate. GO TO WWW.OUTWATER.COM FOR THE MOST UP-TO-DATE PRICES

LED Lighting

Crystal Light Box

12V

Super Bright Light Output

UL Power Supply

For Counter & Wall Mount Displays

Material: Acrylic with Aluminum Post

- Super thin 3/8"
- Available in wall mount & counter top
- Power supply included
- Includes On / Off Switch

SLEEK THIN DESIGN

COUNTER TOP



WALL MOUNT

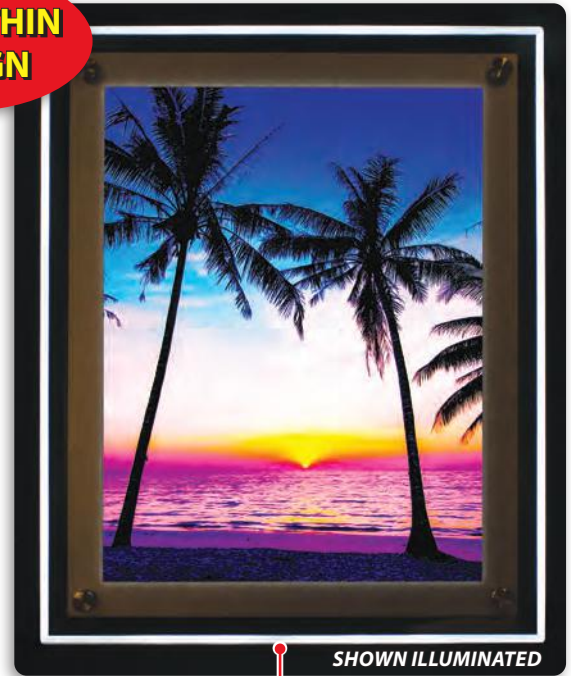

SHOWN ILLUMINATED

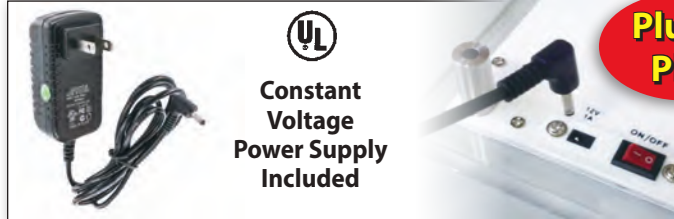

BEVELED EDGE CREATES OUTER GLOW ILLUMINATION!

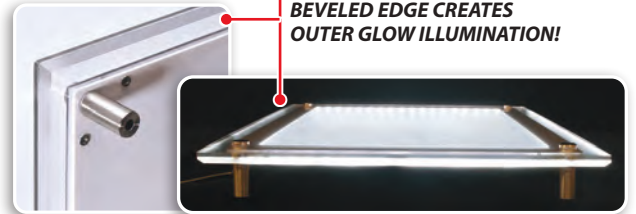

FRAME COMPONENTS

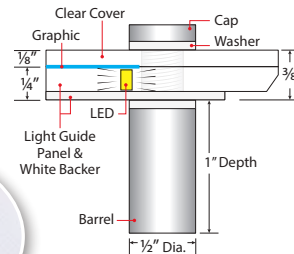
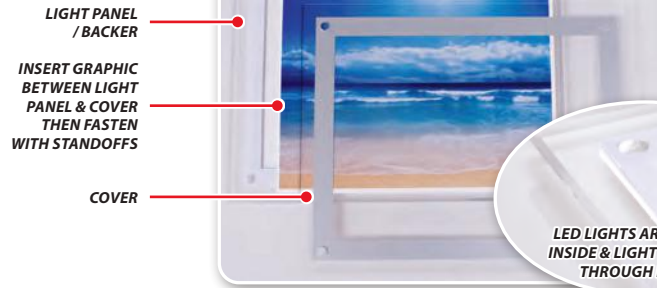

Lighting Specifications

Color Temperature	CW: 6100K
Lumens	CLB-LED-0811-W: 186
	CLB-LED-1117-W: 93
	CLB-LED-1620-W: 102
	CLB-LED-2228-W: 121
	CLB-LED-2436-W: 167
	CLB-LED-0811-C: 186
CLB-LED-1117-C: 93	
Color Rendering Index	CW: 70
Rated Average Life	50,000 hrs.
Constant	Voltage
Chip Size	SMD2835

Part #	Color Temp	Graphic Size	Reveal Dimensions (Nominal)	Overall Dimensions (Nominal)	Total Wattage	Price	
						Each	5+
CLB-LED-0811-W	Cool White	8.5" x 11"	8" x 10-5/8"	10-13/16" x 13-5/16"	1.8	\$60.48	\$50.40 ea.
CLB-LED-1117-W	Cool White	11" x 17"	10-5/8" x 16-5/8"	13-3/4" x 19-3/4"	3.6	\$92.99	\$77.49 ea.
CLB-LED-1620-W	Cool White	16" x 20"	15-1/2" x 19-3/4"	18-1/4" x 23-11/16"	6	\$130.41	\$108.68 ea.
CLB-LED-2228-W	Cool White	22" x 28"	21-9/16" x 27-9/16"	24-3/4" x 30-3/4"	9	\$232.85	\$194.04 ea.
CLB-LED-2436-W	Cool White	24" x 36"	23-1/2" x 35-5/8"	27-1/8" x 39-1/8"	11	\$340.20	\$282.50 ea.
CLB-LED-0811-C	Cool White	8.5" x 11"	8" x 10-5/8"	10-13/16" x 13-5/16"	1.8	\$62.78	\$52.32 ea.
CLB-LED-1117-C	Cool White	11" x 17"	10-5/8" x 16-5/8"	13-3/4" x 19-3/4"	3.6	\$95.29	\$79.41 ea.

Available for either wall mount (-w) or counter top (-c) applications.

Phone: 1-800-631-8375 - Fax: 1-800-888-3315
Due to raw material cost fluctuations, prices are subject to change.

IMPORTANT: Due to Raw Material Fluctuation, Catalog Prices Below May Not Be Accurate. GO TO WWW.OUTWATER.COM FOR THE MOST UP-TO-DATE PRICES

LED Lighting

Fully Assembled Front Loading Aluminum Frames



Material: Aluminum Frame with Acyclic Light Guide Panel

- Comes ready to use: Clear PVC cover, mounting hardware & power supply included
- Easy front load feature
- Can be used either landscape or portrait
- Low profile, should meet ADA requirements
- Plug & Play



SHOWN ILLUMINATED

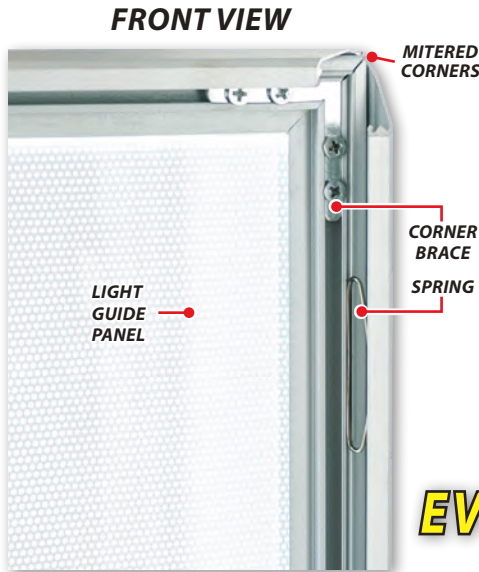

**SUPER BRIGHT!
EVEN ILLUMINATION!**

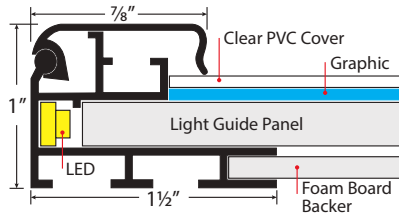
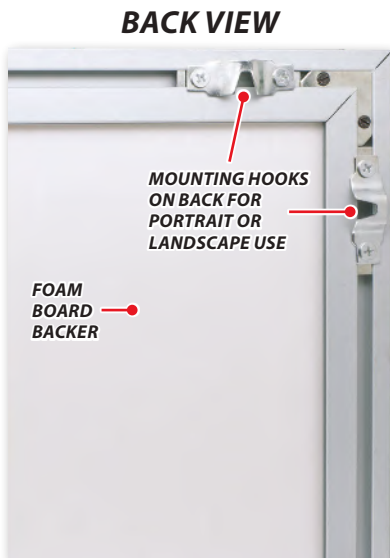
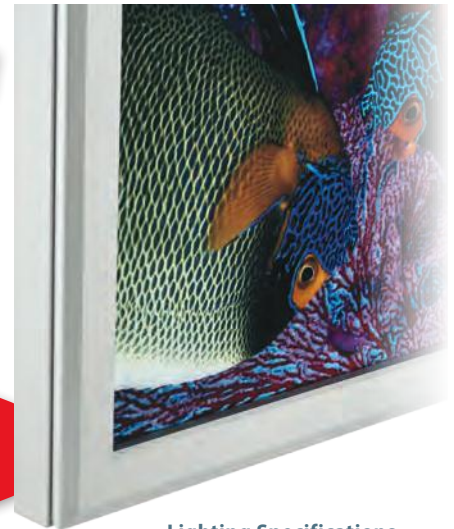

**BEVELED EDGE
PROFILE**



Lighting Specifications

Color Temperature	WW: 7500K-8500K
Lumens	FLF-LED-0811: 275
	FLF-LED-1117: 475
	FLF-LED-1620: 625
	FLF-LED-2228: 1000
	FLF-LED-2436: 1250
Color Rendering Index	CW: 75-80
Rated Average Life	50,000 hrs.
Chip Size	SMD2835

Part #	Color Temp	Finish	Graphic Size	Reveal Dimensions (Nominal)	Overall Dimensions (Nominal)	Total Wattage	Price	
							Each	5+
FLF-LED-0811	Cool White	Anodized Aluminum	8.5" x 11"	8-1/8" x 10-11/16"	10-1/8" x 12-3/4"	3	\$88.20	\$70.56 ea.
FLF-LED-1117	Cool White	Anodized Aluminum	11" x 17"	10-5/8" x 14-3/8"	12-1/2" x 18-5/16"	4	\$116.55	\$92.40 ea.
FLF-LED-1620	Cool White	Anodized Aluminum	16" x 20"	15-19/32" x 19-5/8"	17-3/8" x 21-3/8"	6	\$141.75	\$113.40 ea.
FLF-LED-2228	Cool White	Anodized Aluminum	22" x 28"	21-1/2" x 27-1/2"	23-3/8" x 29-3/8"	10	\$199.50	\$162.23 ea.
FLF-LED-2436	Cool White	Anodized Aluminum	24" x 36"	23-5/8" x 35-1/2"	25-1/2" x 37-3/8"	13	\$333.90	\$267.12 ea.

Single Sided Slide In Frame



- Comes with mounting hardware (2 Screws & 2 Anchors)
- Anti-Glare 3mm PVC Lens
- White Backer Board
- Silver (Clear Anodized) Finish
- Can be used for either portrait or landscape orientation
- 4 Mounting Holes at 5/32" Diameter
- Frame Profile is 1" Wide
- Frame Thickness is 9/16" Thick

Part #	Graphic Size	Reveal Dimensions	Overall Dimensions	Each
HGR-SL-845	8-1/2" x 11"	7-9/16" x 10-1/16"	9-13/16" x 12-5/16"	\$15.95
HGR-SL-1117	11" x 17"	10-1/16" x 16-1/16"	12-5/16" x 18-5/16"	\$18.54
HGR-SL-1824	18" x 24"	17-1/16" x 23-1/16"	19-5/16" x 25-5/16"	\$23.19
HGR-SL-2228	22" x 28"	21-1/16" x 27-1/16"	23-5/16" x 29-5/16"	\$27.81
HGR-SL-2436	24" x 36"	23-1/16" x 25-1/16"	25-5/16" x 27-5/16"	\$34.10



Front



Back

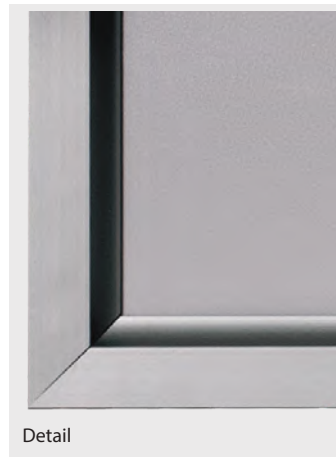

Detail



Side loading!
Change graphics quickly and easily

Z-Panel Hangers & Clips

For more details and other Z-Panel Hangers, see page S-26



"A FAST, EASY & COST EFFECTIVE METHOD OF HANGING CABINETS, WALL PANELS, PARTITIONS & SIGNAGE!"

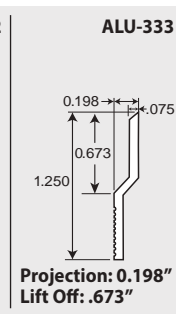
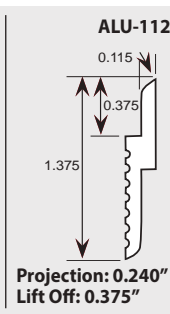
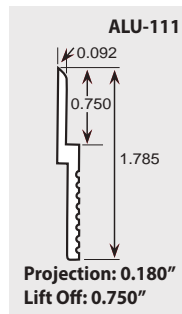
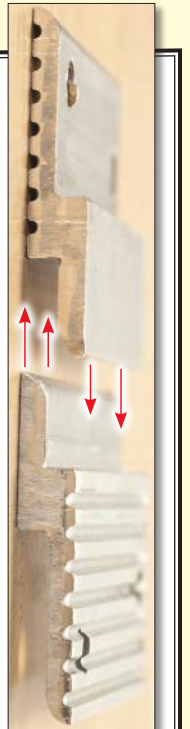
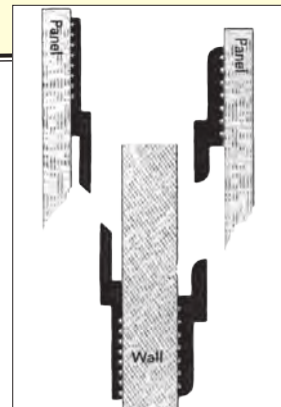
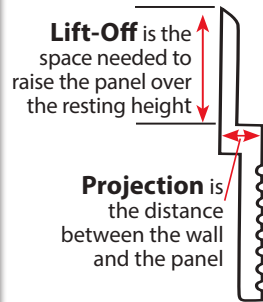

IMPORTANT: Due to Raw Material Fluctuation, Catalog Prices Below May Not Be Accurate. GO TO WWW.OUTWATER.COM FOR THE MOST UP-TO-DATE PRICES

Color U-Channel Moulding

Lengths: 12 Ft.
Material: Styrene
Colors Available

*WH - White *BK - Black *BE - Beige *SIL - Silver
unless otherwise noted

Fits Up To 1/8"

8 & 10 Ft. Lengths

Part #	120 Ft.	600 Ft.	1000 Ft.
132-*	\$0.28'	\$0.26'	\$0.25'

Fits Up To 1/8"

8 & 10 Ft. Lengths

Part #	120 Ft.	600 Ft.	1000 Ft.
130-*	\$0.24'	\$0.22'	\$0.21'

Fits 1/8"

Part #	120 Ft.	600 Ft.	1000 Ft.
R104-581-*	\$0.33'	\$0.29'	\$0.26'

Fits 3/16"

Part #	120 Ft.	600 Ft.	1000 Ft.
R104-582-*	\$0.34'	\$0.30'	\$0.27'

Fits 1/8"

8 Ft. Lengths
Material: PVC
w/Adhesive

Part #	120 Ft.	600 Ft.	1000 Ft.
106-4808-*	\$1.12'	\$1.08'	\$1.02'

Fits 5/32"

Material: High Gloss ABS/Film

Part #	120 Ft.	600 Ft.	1000 Ft.
2326-*	\$0.29'	\$0.28'	\$0.25'

Fits 7/32"

Part #	120 Ft.	600 Ft.	1000 Ft.
R104-744-*	\$0.40'	\$0.37'	\$0.29'

Fits 3/16"

Material: Styrolux

Part #	120 Ft.	600 Ft.	1000 Ft.
142F-*	\$0.73'	\$0.68'	\$0.64'

Fits 1/4"

Silver Material: PVC

Part #	120 Ft.	600 Ft.	1000 Ft.
141-*	\$0.22'	\$0.20'	\$0.18'
141-SIL	\$0.33'	\$0.32'	\$0.25'

Fits 1/4"

Part #	120 Ft.	600 Ft.	1000 Ft.
R104-588-*	\$0.42'	\$0.40'	\$0.33'

Fits Up To 1/4"

8 & 10 Ft. Lengths

Part #	120 Ft.	600 Ft.	1000 Ft.
131-*	\$0.24'	\$0.22'	\$0.21'

Fits 5/16"

Part #	120 Ft.	600 Ft.	1000 Ft.
R104-4016-*	\$0.50'	\$0.48'	\$0.40'

Fits 3/8"

Part #	120 Ft.	600 Ft.	1000 Ft.
383-*	\$0.24'	\$0.22'	\$0.20'

Fits 3/8"

Part #	120 Ft.	600 Ft.	1000 Ft.
R104-589-*	\$0.55'	\$0.51'	\$0.47'

Fits Heavy 3/8"

8 Ft. Lengths
Material: Rigid PVC

Part #	120 Ft.	600 Ft.	1000 Ft.
133-BK	\$0.68'	\$0.60'	\$0.55'
133-SIL	\$0.71'	\$0.63'	\$0.58'

Fits 1/2"

Silver Material: PVC

Part #	120 Ft.	600 Ft.	1000 Ft.
121-*	\$0.25'	\$0.23'	\$0.21'
121-SIL	\$0.45'	\$0.38'	\$0.32'

PROTOTYPE SAMPLES
We are happy to provide samples for prototypes & design builds.
- Please Inquire

For any quantities less than 120 ft. add 10% to the 120 ft. price.

IMPORTANT: Due to Raw Material Fluctuation, Catalog Prices Below May Not Be Accurate. GO TO WWW.OUTWATER.COM FOR THE MOST UP-TO-DATE PRICES

Color U-Channel Moulding

Lengths: 12 Ft.
Material: Styrene
Colors Available

*WH - White *BK - Black *BE - Beige *SIL - Silver
unless otherwise noted

<p>Fits 1/2"</p> <table border="1"> <thead> <tr> <th>Part #</th> <th>120 Ft.</th> <th>600 Ft.</th> <th>1000 Ft.</th> </tr> </thead> <tbody> <tr> <td>212*</td> <td>\$0.34'</td> <td>\$0.32'</td> <td>\$0.28'</td> </tr> </tbody> </table>	Part #	120 Ft.	600 Ft.	1000 Ft.	212*	\$0.34'	\$0.32'	\$0.28'	<p>Fits 1/2"</p> <table border="1"> <thead> <tr> <th>Part #</th> <th>120 Ft.</th> <th>600 Ft.</th> <th>1000 Ft.</th> </tr> </thead> <tbody> <tr> <td>R104-683*</td> <td>\$0.50'</td> <td>\$0.43'</td> <td>\$0.38'</td> </tr> </tbody> </table>	Part #	120 Ft.	600 Ft.	1000 Ft.	R104-683*	\$0.50'	\$0.43'	\$0.38'	<p>Fits 9/16"</p> <p>8 Ft. Lengths Material: PVC</p> <table border="1"> <thead> <tr> <th>Part #</th> <th>120 Ft.</th> <th>600 Ft.</th> <th>1000 Ft.</th> </tr> </thead> <tbody> <tr> <td>PLEC*</td> <td>\$0.40'</td> <td>\$0.37'</td> <td>\$0.35'</td> </tr> </tbody> </table>	Part #	120 Ft.	600 Ft.	1000 Ft.	PLEC*	\$0.40'	\$0.37'	\$0.35'	<p>Fits 5/8"</p> <table border="1"> <thead> <tr> <th>Part #</th> <th>120 Ft.</th> <th>600 Ft.</th> <th>1000 Ft.</th> </tr> </thead> <tbody> <tr> <td>585*</td> <td>\$0.31'</td> <td>\$0.29'</td> <td>\$0.24'</td> </tr> </tbody> </table>	Part #	120 Ft.	600 Ft.	1000 Ft.	585*	\$0.31'	\$0.29'	\$0.24'				
Part #	120 Ft.	600 Ft.	1000 Ft.																																				
212*	\$0.34'	\$0.32'	\$0.28'																																				
Part #	120 Ft.	600 Ft.	1000 Ft.																																				
R104-683*	\$0.50'	\$0.43'	\$0.38'																																				
Part #	120 Ft.	600 Ft.	1000 Ft.																																				
PLEC*	\$0.40'	\$0.37'	\$0.35'																																				
Part #	120 Ft.	600 Ft.	1000 Ft.																																				
585*	\$0.31'	\$0.29'	\$0.24'																																				
<p>Fits 5/8"</p> <table border="1"> <thead> <tr> <th>Part #</th> <th>120 Ft.</th> <th>600 Ft.</th> <th>1000 Ft.</th> </tr> </thead> <tbody> <tr> <td>158*</td> <td>\$0.42'</td> <td>\$0.40'</td> <td>\$0.36'</td> </tr> </tbody> </table>	Part #	120 Ft.	600 Ft.	1000 Ft.	158*	\$0.42'	\$0.40'	\$0.36'	<p>Fits 5/8"</p> <table border="1"> <thead> <tr> <th>Part #</th> <th>120 Ft.</th> <th>600 Ft.</th> <th>1000 Ft.</th> </tr> </thead> <tbody> <tr> <td>R104-554*</td> <td>\$0.53'</td> <td>\$0.47'</td> <td>\$0.44'</td> </tr> </tbody> </table>	Part #	120 Ft.	600 Ft.	1000 Ft.	R104-554*	\$0.53'	\$0.47'	\$0.44'	<p>Fits 3/4"</p> <table border="1"> <thead> <tr> <th>Part #</th> <th>120 Ft.</th> <th>600 Ft.</th> <th>1000 Ft.</th> </tr> </thead> <tbody> <tr> <td>R104-569*</td> <td>\$0.72'</td> <td>\$0.68'</td> <td>\$0.61'</td> </tr> </tbody> </table>	Part #	120 Ft.	600 Ft.	1000 Ft.	R104-569*	\$0.72'	\$0.68'	\$0.61'	<p>Fits 3/4"</p> <p>Silver Material: PVC</p> <table border="1"> <thead> <tr> <th>Part #</th> <th>120 Ft.</th> <th>600 Ft.</th> <th>1000 Ft.</th> </tr> </thead> <tbody> <tr> <td>341*</td> <td>\$0.36'</td> <td>\$0.34'</td> <td>\$0.31'</td> </tr> <tr> <td>341-SIL</td> <td>\$0.57'</td> <td>\$0.54'</td> <td>\$0.48'</td> </tr> </tbody> </table>	Part #	120 Ft.	600 Ft.	1000 Ft.	341*	\$0.36'	\$0.34'	\$0.31'	341-SIL	\$0.57'	\$0.54'	\$0.48'
Part #	120 Ft.	600 Ft.	1000 Ft.																																				
158*	\$0.42'	\$0.40'	\$0.36'																																				
Part #	120 Ft.	600 Ft.	1000 Ft.																																				
R104-554*	\$0.53'	\$0.47'	\$0.44'																																				
Part #	120 Ft.	600 Ft.	1000 Ft.																																				
R104-569*	\$0.72'	\$0.68'	\$0.61'																																				
Part #	120 Ft.	600 Ft.	1000 Ft.																																				
341*	\$0.36'	\$0.34'	\$0.31'																																				
341-SIL	\$0.57'	\$0.54'	\$0.48'																																				
<p>Fits 1"</p> <table border="1"> <thead> <tr> <th>Part #</th> <th>120 Ft.</th> <th>600 Ft.</th> <th>1000 Ft.</th> </tr> </thead> <tbody> <tr> <td>100*</td> <td>\$0.50'</td> <td>\$0.48'</td> <td>\$0.45'</td> </tr> </tbody> </table>	Part #	120 Ft.	600 Ft.	1000 Ft.	100*	\$0.50'	\$0.48'	\$0.45'	<p>Fits 1-1/16"</p> <table border="1"> <thead> <tr> <th>Part #</th> <th>120 Ft.</th> <th>600 Ft.</th> <th>1000 Ft.</th> </tr> </thead> <tbody> <tr> <td>R104-5145*</td> <td>\$0.73'</td> <td>\$0.70'</td> <td>\$0.64'</td> </tr> </tbody> </table>	Part #	120 Ft.	600 Ft.	1000 Ft.	R104-5145*	\$0.73'	\$0.70'	\$0.64'	<p>Fits 1-1/4"</p> <table border="1"> <thead> <tr> <th>Part #</th> <th>120 Ft.</th> <th>600 Ft.</th> <th>1000 Ft.</th> </tr> </thead> <tbody> <tr> <td>114*</td> <td>\$0.57'</td> <td>\$0.54'</td> <td>\$0.49'</td> </tr> </tbody> </table>	Part #	120 Ft.	600 Ft.	1000 Ft.	114*	\$0.57'	\$0.54'	\$0.49'	<p>Fits 1-1/2"</p> <table border="1"> <thead> <tr> <th>Part #</th> <th>120 Ft.</th> <th>600 Ft.</th> <th>1000 Ft.</th> </tr> </thead> <tbody> <tr> <td>112*</td> <td>\$0.62'</td> <td>\$0.59'</td> <td>\$0.56'</td> </tr> </tbody> </table>	Part #	120 Ft.	600 Ft.	1000 Ft.	112*	\$0.62'	\$0.59'	\$0.56'				
Part #	120 Ft.	600 Ft.	1000 Ft.																																				
100*	\$0.50'	\$0.48'	\$0.45'																																				
Part #	120 Ft.	600 Ft.	1000 Ft.																																				
R104-5145*	\$0.73'	\$0.70'	\$0.64'																																				
Part #	120 Ft.	600 Ft.	1000 Ft.																																				
114*	\$0.57'	\$0.54'	\$0.49'																																				
Part #	120 Ft.	600 Ft.	1000 Ft.																																				
112*	\$0.62'	\$0.59'	\$0.56'																																				

Fits 2"

Part #	120 Ft.	600 Ft.	1000 Ft.
110*	\$0.69'	\$0.66'	\$0.62'

PROTOTYPE SAMPLES
We are happy to provide samples for prototypes & design builds - Please inquire.

ALUMINUM PROFILES & SHAPES

Wide Variety of Finishes
Available in 12 Ft. Lengths

- Angle (Even/Uneven) Mouldings...pgs. S-70~71
- Cap & Divider Mouldings...pgs. S-77, 79
- Channel Mouldings...pgs. S-66~67
- Corner Mouldings...pg. S-74
- Cove Mouldings...pg. S-68
- Filler Tee Mouldings...Please Inquire
- No Notch & Real Tee Mouldings...Please Inquire
- Price Tag Mouldings...pg. S-73
- Rounded Trim Mouldings...Please Inquire
- Tubes, Rods, Bars & Squares Shapes...Please Inquire
- Showcase Mouldings...Please Inquire
- Sliding Door Track Mouldings...Please Inquire
- Z Bar Mouldings...Please Inquire



Largest Stocking Distributor in the USA

For any quantities less than 120 ft. add 10% to the 120 ft. price.

**IMPORTANT: Due to Raw Material Fluctuation, Catalog Prices Below May Not Be Accurate.
GO TO WWW.OUTWATER.COM FOR THE MOST UP-TO-DATE PRICES**

Clear U-Channel Moulding

Cut Program Available
Please Inquire

Lengths: 12 Ft.
Material: PVC
unless otherwise noted

Fits 1/16"

Material: Butyrate

Part #	120 Ft.	600 Ft.	1000 Ft.
2128-CL	\$0.57'	\$0.54'	\$0.51'

Fits 1/16"

Gap adjustable

Material: Butyrate

Part #	120 Ft.	600 Ft.	1000 Ft.
708-CL	\$0.53'	\$0.51'	\$0.47'

Fits 1/8"

8 & 10 Ft. Lengths

Part #	120 Ft.	600 Ft.	1000 Ft.
130-CL	\$0.28'	\$0.26'	\$0.24'

Fits 3/16"

Material: Styrolux

Part #	120 Ft.	600 Ft.	1000 Ft.
142F-CL	\$0.69'	\$0.65'	\$0.61'

Fits 1/4"

Part #	120 Ft.	600 Ft.	1000 Ft.
141-CL	\$0.33'	\$0.31'	\$0.24'

Fits 11/64"

Part #	120 Ft.	600 Ft.	1000 Ft.
1059-CL	\$0.38'	\$0.35'	\$0.29'

Fits 1/4"

Material: Butyrate

Part #	120 Ft.	600 Ft.	1000 Ft.
1830-CL	\$0.44'	\$0.42'	\$0.37'

Fits 1/4"

.060 wall thickness

Material: Butyrate
8 Ft. Lengths

Part #	120 Ft.	600 Ft.	1000 Ft.
P2743	\$0.78'	\$0.72'	\$0.68'

Fits 1/4"

8 & 10 Ft. Lengths

Part #	120 Ft.	600 Ft.	1000 Ft.
131-CL	\$0.28'	\$0.26'	\$0.24'

Fits 1/4"

Material: Butyrate

Part #	120 Ft.	600 Ft.	1000 Ft.
2014-CL	\$0.71'	\$0.67'	\$0.63'

Fits 3/8"

Part #	120 Ft.	600 Ft.	1000 Ft.
383-CL	\$0.40'	\$0.37'	\$0.29'

Fits 3/8"

3/64" Wall

Part #	120 Ft.	600 Ft.	1000 Ft.
385-CL	\$0.48'	\$0.46'	\$0.43'

Fits 1/2"

Part #	120 Ft.	600 Ft.	1000 Ft.
121-CL	\$0.44'	\$0.42'	\$0.33'

Fits 5/8"

Part #	120 Ft.	600 Ft.	1000 Ft.
585-CL	\$0.51'	\$0.49'	\$0.43'

Fits 3/4"

Part #	120 Ft.	600 Ft.	1000 Ft.
341-CL	\$0.56'	\$0.53'	\$0.49'

Fits 1"

Part #	120 Ft.	600 Ft.	1000 Ft.
100-CL	\$0.75'	\$0.72'	\$0.68'

PROTOTYPE SAMPLES





We are happy to provide samples for prototypes & design builds.
- Please Inquire

For any quantities less than 120 ft. add 10% to the 120 ft. price.

IMPORTANT: Due to Raw Material Fluctuation, Catalog Prices Below May Not Be Accurate. GO TO WWW.OUTWATER.COM FOR THE MOST UP-TO-DATE PRICES

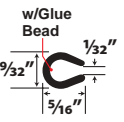
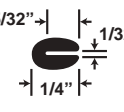

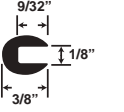

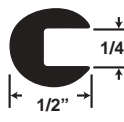
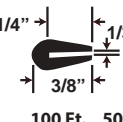
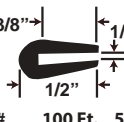
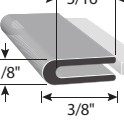
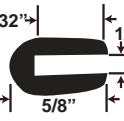
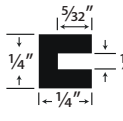
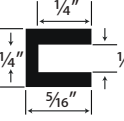
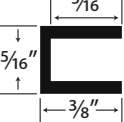
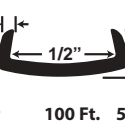
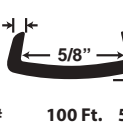
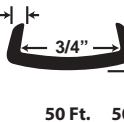

Flexible U-Channel Moulding

Lengths: 250 Ft. Coils • Material: Dense Neoprene • Rubber Black

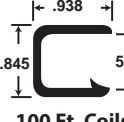
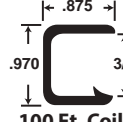
<p>Fits Up To 1/16"</p>  <p>Material: PVC 200 Ft. Coils Available in Black (*BK) & White (*WH)</p> <table border="1"> <tr><th>Part #</th><th>200 Ft.</th><th>600 Ft.</th><th>1000 Ft.</th></tr> <tr><td>1964*</td><td>\$0.49'</td><td>\$0.46'</td><td>\$0.43'</td></tr> </table>	Part #	200 Ft.	600 Ft.	1000 Ft.	1964*	\$0.49'	\$0.46'	\$0.43'	<p>Fits 1/32"</p>  <p>500 Ft. Coils</p> <table border="1"> <tr><th>Part #</th><th>100 Ft.</th><th>500 Ft.</th><th>1000 Ft.</th></tr> <tr><td>113-1001</td><td>\$0.54'</td><td>\$0.51'</td><td>\$0.47'</td></tr> </table>	Part #	100 Ft.	500 Ft.	1000 Ft.	113-1001	\$0.54'	\$0.51'	\$0.47'	<p>Fits 1/16"</p>  <p>500 Ft. Coils</p> <table border="1"> <tr><th>Part #</th><th>100 Ft.</th><th>500 Ft.</th><th>1000 Ft.</th></tr> <tr><td>113-1002</td><td>\$0.57'</td><td>\$0.54'</td><td>\$0.48'</td></tr> </table>	Part #	100 Ft.	500 Ft.	1000 Ft.	113-1002	\$0.57'	\$0.54'	\$0.48'	<p>Fits 1/8"</p>  <p>500 Ft. Coils</p> <table border="1"> <tr><th>Part #</th><th>100 Ft.</th><th>500 Ft.</th><th>1000 Ft.</th></tr> <tr><td>113-1003</td><td>\$0.76'</td><td>\$0.73'</td><td>\$0.64'</td></tr> </table>	Part #	100 Ft.	500 Ft.	1000 Ft.	113-1003	\$0.76'	\$0.73'	\$0.64'
Part #	200 Ft.	600 Ft.	1000 Ft.																																
1964*	\$0.49'	\$0.46'	\$0.43'																																
Part #	100 Ft.	500 Ft.	1000 Ft.																																
113-1001	\$0.54'	\$0.51'	\$0.47'																																
Part #	100 Ft.	500 Ft.	1000 Ft.																																
113-1002	\$0.57'	\$0.54'	\$0.48'																																
Part #	100 Ft.	500 Ft.	1000 Ft.																																
113-1003	\$0.76'	\$0.73'	\$0.64'																																
<p>Fits 3/16"</p>  <p>500 Ft. Coils</p> <table border="1"> <tr><th>Part #</th><th>100 Ft.</th><th>500 Ft.</th><th>1000 Ft.</th></tr> <tr><td>113-1004</td><td>\$1.39'</td><td>\$1.36'</td><td>\$1.24'</td></tr> </table>	Part #	100 Ft.	500 Ft.	1000 Ft.	113-1004	\$1.39'	\$1.36'	\$1.24'	<p>Fits 1/4"</p>  <p>250 Ft. Coils</p> <table border="1"> <tr><th>Part #</th><th>100 Ft.</th><th>500 Ft.</th><th>1000 Ft.</th></tr> <tr><td>113-1005</td><td>\$1.51'</td><td>\$1.45'</td><td>\$1.34'</td></tr> </table>	Part #	100 Ft.	500 Ft.	1000 Ft.	113-1005	\$1.51'	\$1.45'	\$1.34'	<p>Fits 1/32"</p>  <p>500 Ft. Coils</p> <table border="1"> <tr><th>Part #</th><th>100 Ft.</th><th>500 Ft.</th><th>1000 Ft.</th></tr> <tr><td>113-2000</td><td>\$0.98'</td><td>\$0.95'</td><td>\$0.91'</td></tr> </table>	Part #	100 Ft.	500 Ft.	1000 Ft.	113-2000	\$0.98'	\$0.95'	\$0.91'	<p>Fits 1/16"</p>  <p>500 Ft. Coils</p> <table border="1"> <tr><th>Part #</th><th>100 Ft.</th><th>500 Ft.</th><th>1000 Ft.</th></tr> <tr><td>113-2010</td><td>\$1.06'</td><td>\$1.02'</td><td>\$0.95'</td></tr> </table>	Part #	100 Ft.	500 Ft.	1000 Ft.	113-2010	\$1.06'	\$1.02'	\$0.95'
Part #	100 Ft.	500 Ft.	1000 Ft.																																
113-1004	\$1.39'	\$1.36'	\$1.24'																																
Part #	100 Ft.	500 Ft.	1000 Ft.																																
113-1005	\$1.51'	\$1.45'	\$1.34'																																
Part #	100 Ft.	500 Ft.	1000 Ft.																																
113-2000	\$0.98'	\$0.95'	\$0.91'																																
Part #	100 Ft.	500 Ft.	1000 Ft.																																
113-2010	\$1.06'	\$1.02'	\$0.95'																																
<p>New</p> <p>Fits 1/16"</p>  <p>500 Ft. Coils</p> <table border="1"> <tr><th>Part #</th><th>100 Ft.</th><th>500 Ft.</th><th>1000 Ft.</th></tr> <tr><td>113-2013</td><td>\$0.76'</td><td>\$0.72'</td><td>\$0.65'</td></tr> </table>	Part #	100 Ft.	500 Ft.	1000 Ft.	113-2013	\$0.76'	\$0.72'	\$0.65'	<p>Fits 1/8"</p>  <p>250 Ft. Coils</p> <table border="1"> <tr><th>Part #</th><th>50 Ft.</th><th>500 Ft.</th><th>1000 Ft.</th></tr> <tr><td>113-2020</td><td>\$1.47'</td><td>\$1.41'</td><td>\$1.33'</td></tr> </table>	Part #	50 Ft.	500 Ft.	1000 Ft.	113-2020	\$1.47'	\$1.41'	\$1.33'	<p>Fits 1/16"</p>  <p>500 Ft. Coils</p> <table border="1"> <tr><th>Part #</th><th>100 Ft.</th><th>500 Ft.</th><th>1000 Ft.</th></tr> <tr><td>113-3010</td><td>\$0.97'</td><td>\$0.94'</td><td>\$0.90'</td></tr> </table>	Part #	100 Ft.	500 Ft.	1000 Ft.	113-3010	\$0.97'	\$0.94'	\$0.90'	<p>Fits 1/8"</p>  <p>500 Ft. Coils</p> <table border="1"> <tr><th>Part #</th><th>100 Ft.</th><th>500 Ft.</th><th>1000 Ft.</th></tr> <tr><td>113-3015</td><td>\$1.02'</td><td>\$0.96'</td><td>\$0.91'</td></tr> </table>	Part #	100 Ft.	500 Ft.	1000 Ft.	113-3015	\$1.02'	\$0.96'	\$0.91'
Part #	100 Ft.	500 Ft.	1000 Ft.																																
113-2013	\$0.76'	\$0.72'	\$0.65'																																
Part #	50 Ft.	500 Ft.	1000 Ft.																																
113-2020	\$1.47'	\$1.41'	\$1.33'																																
Part #	100 Ft.	500 Ft.	1000 Ft.																																
113-3010	\$0.97'	\$0.94'	\$0.90'																																
Part #	100 Ft.	500 Ft.	1000 Ft.																																
113-3015	\$1.02'	\$0.96'	\$0.91'																																
<p>Fits 3/16"</p>  <p>500 Ft. Coils</p> <table border="1"> <tr><th>Part #</th><th>100 Ft.</th><th>500 Ft.</th><th>1000 Ft.</th></tr> <tr><td>113-3030</td><td>\$1.28'</td><td>\$1.23'</td><td>\$1.16'</td></tr> </table>	Part #	100 Ft.	500 Ft.	1000 Ft.	113-3030	\$1.28'	\$1.23'	\$1.16'	<p>Fits 1/2"</p> <p>Material: PVC</p>  <p>100 Ft. Coils</p> <table border="1"> <tr><th>Part #</th><th>100 Ft.</th><th>500 Ft.</th><th>1000 Ft.</th></tr> <tr><td>808-500-BK</td><td>\$0.49'</td><td>\$0.47'</td><td>\$0.45'</td></tr> </table>	Part #	100 Ft.	500 Ft.	1000 Ft.	808-500-BK	\$0.49'	\$0.47'	\$0.45'	<p>Fits 5/8"</p> <p>Material: PVC</p>  <p>100 Ft. Coils</p> <table border="1"> <tr><th>Part #</th><th>100 Ft.</th><th>500 Ft.</th><th>1000 Ft.</th></tr> <tr><td>808-625-BK</td><td>\$0.54'</td><td>\$0.48'</td><td>\$0.46'</td></tr> </table>	Part #	100 Ft.	500 Ft.	1000 Ft.	808-625-BK	\$0.54'	\$0.48'	\$0.46'	<p>Fits 3/4"</p> <p>Material: PVC</p>  <p>50 Ft. Coils</p> <table border="1"> <tr><th>Part #</th><th>50 Ft.</th><th>500 Ft.</th><th>1000 Ft.</th></tr> <tr><td>808-750-BK</td><td>\$0.59'</td><td>\$0.56'</td><td>\$0.54'</td></tr> </table>	Part #	50 Ft.	500 Ft.	1000 Ft.	808-750-BK	\$0.59'	\$0.56'	\$0.54'
Part #	100 Ft.	500 Ft.	1000 Ft.																																
113-3030	\$1.28'	\$1.23'	\$1.16'																																
Part #	100 Ft.	500 Ft.	1000 Ft.																																
808-500-BK	\$0.49'	\$0.47'	\$0.45'																																
Part #	100 Ft.	500 Ft.	1000 Ft.																																
808-625-BK	\$0.54'	\$0.48'	\$0.46'																																
Part #	50 Ft.	500 Ft.	1000 Ft.																																
808-750-BK	\$0.59'	\$0.56'	\$0.54'																																

Material: PVC w/Segmented Metal Core / Aluminum Core • Embossed Vinyl • Black or White

- Used for classic car, bus, snowmobile, air and other industries
- Made with a tough PVC cover with a metal segmented core / aluminum core, our channel provides and aesthetic and protective edge trim
- Easy to install with a strong clip-on grip
- Does not need tacking, gluing or riveting
- Used with metal, plastic, fiberglass, glass and wood to cover sharp edges and flanges.
- Labor saving product that can eliminate the need to deburr or remove sharp edge and painting.

<p>Fits 1/2"</p>  <p>150 Ft. Coils</p> <table border="1"> <tr><th>Part #</th><th>150 Ft.</th><th>500 Ft.</th><th>1000 Ft.</th></tr> <tr><td>809-349-BK</td><td>\$1.18'</td><td>\$1.12'</td><td>\$1.09'</td></tr> <tr><td>809-349-WH</td><td>\$1.25'</td><td>\$1.20'</td><td>\$1.17'</td></tr> </table>	Part #	150 Ft.	500 Ft.	1000 Ft.	809-349-BK	\$1.18'	\$1.12'	\$1.09'	809-349-WH	\$1.25'	\$1.20'	\$1.17'	<p>Fits 5/8"</p>  <p>100 Ft. Coils</p> <table border="1"> <tr><th>Part #</th><th>100 Ft.</th><th>500 Ft.</th><th>1000 Ft.</th></tr> <tr><td>809-837-BK</td><td>\$1.58'</td><td>\$1.50'</td><td>\$1.47'</td></tr> </table>	Part #	100 Ft.	500 Ft.	1000 Ft.	809-837-BK	\$1.58'	\$1.50'	\$1.47'	<p>Fits 3/4"</p>  <p>100 Ft. Coils</p> <table border="1"> <tr><th>Part #</th><th>100 Ft.</th><th>500 Ft.</th><th>1000 Ft.</th></tr> <tr><td>809-838-BK</td><td>\$1.60'</td><td>\$1.53'</td><td>\$1.49'</td></tr> </table>	Part #	100 Ft.	500 Ft.	1000 Ft.	809-838-BK	\$1.60'	\$1.53'	\$1.49'	<p>New</p> <p>Fits 1/8"</p>  <p>125 Ft. Coils</p> <p>Aluminum Core</p> <table border="1"> <tr><th>Part #</th><th>125 Ft.</th><th>500 Ft.</th><th>1000 Ft.</th></tr> <tr><td>809-343-BK</td><td>\$1.02'</td><td>\$0.97'</td><td>\$0.93'</td></tr> <tr><td>809-343-WH</td><td>\$1.08'</td><td>\$1.05'</td><td>\$1.01'</td></tr> </table>	Part #	125 Ft.	500 Ft.	1000 Ft.	809-343-BK	\$1.02'	\$0.97'	\$0.93'	809-343-WH	\$1.08'	\$1.05'	\$1.01'
Part #	150 Ft.	500 Ft.	1000 Ft.																																								
809-349-BK	\$1.18'	\$1.12'	\$1.09'																																								
809-349-WH	\$1.25'	\$1.20'	\$1.17'																																								
Part #	100 Ft.	500 Ft.	1000 Ft.																																								
809-837-BK	\$1.58'	\$1.50'	\$1.47'																																								
Part #	100 Ft.	500 Ft.	1000 Ft.																																								
809-838-BK	\$1.60'	\$1.53'	\$1.49'																																								
Part #	125 Ft.	500 Ft.	1000 Ft.																																								
809-343-BK	\$1.02'	\$0.97'	\$0.93'																																								
809-343-WH	\$1.08'	\$1.05'	\$1.01'																																								
<p>Fits 1/32" - 1/8"</p>  <p>Aluminum Core</p> <p>400 Ft. Coils</p> <table border="1"> <tr><th>Part #</th><th>400 Ft.</th><th>800 Ft.</th><th>1200 Ft.</th></tr> <tr><td>810-318-BK</td><td>\$1.02'</td><td>\$0.95'</td><td>\$0.89'</td></tr> </table>	Part #	400 Ft.	800 Ft.	1200 Ft.	810-318-BK	\$1.02'	\$0.95'	\$0.89'	<p>Fits 3/16" - 1/4"</p>  <p>Aluminum Core</p> <p>125 Ft. Coils</p> <table border="1"> <tr><th>Part #</th><th>125 Ft.</th><th>500 Ft.</th><th>1000 Ft.</th></tr> <tr><td>810-443-BK</td><td>\$1.17'</td><td>\$1.08'</td><td>\$1.00'</td></tr> </table>	Part #	125 Ft.	500 Ft.	1000 Ft.	810-443-BK	\$1.17'	\$1.08'	\$1.00'	<p>Fits 1/2"</p>  <p>Aluminum Core</p> <p>150 Ft. Coils</p> <table border="1"> <tr><th>Part #</th><th>150 Ft.</th><th>600 Ft.</th><th>1200 Ft.</th></tr> <tr><td>810-449-BK</td><td>\$1.38'</td><td>\$1.26'</td><td>\$1.19'</td></tr> </table>	Part #	150 Ft.	600 Ft.	1200 Ft.	810-449-BK	\$1.38'	\$1.26'	\$1.19'	<p>New</p> <p>Fits 1/16"</p>  <p>Aluminum Core</p> <p>250 Ft. Coils</p> <table border="1"> <tr><th>Part #</th><th>250 Ft.</th><th>500 Ft.</th><th>1000 Ft.</th></tr> <tr><td>815-062-375T</td><td>\$1.23'</td><td>\$1.19'</td><td>\$1.06'</td></tr> </table>	Part #	250 Ft.	500 Ft.	1000 Ft.	815-062-375T	\$1.23'	\$1.19'	\$1.06'								
Part #	400 Ft.	800 Ft.	1200 Ft.																																								
810-318-BK	\$1.02'	\$0.95'	\$0.89'																																								
Part #	125 Ft.	500 Ft.	1000 Ft.																																								
810-443-BK	\$1.17'	\$1.08'	\$1.00'																																								
Part #	150 Ft.	600 Ft.	1200 Ft.																																								
810-449-BK	\$1.38'	\$1.26'	\$1.19'																																								
Part #	250 Ft.	500 Ft.	1000 Ft.																																								
815-062-375T	\$1.23'	\$1.19'	\$1.06'																																								

IMPORTANT: Due to Raw Material Fluctuation, Catalog Prices Below May Not Be Accurate. GO TO WWW.OUTWATER.COM FOR THE MOST UP-TO-DATE PRICES

Aluminum Channel Moulding



Finishes Available

Lengths: 12 Ft. • Material: Aluminum

- *M - Mill - Dull Finish: As Extruded - May or May Not Have "Scratches"/Die Lines
 - *S - Satin/Clear Anodized - Dull, Matte Finish
 - *BK - Black Powder Coated Finish
 - *ORB - Oil Rubbed Bronze
 - *P - Polished - Shiny/Mirror Finish
 - *BS - Brushed Satin - Lightly Brushed (Shows Grain) Satin Finish
 - *WH - Glossy White Powder Coated Finish
- Other Colors Available, Please Inquire. Samples Are Available

Fits 1/8"

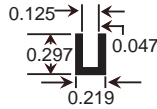

Part #	Length	Mill	Polished	Satin
ALU757-*	120 Per Ft.	\$0.47'	\$1.43'	\$1.03'
	600 Ft. +	\$0.43'	\$1.27'	\$0.95'

Fits 1/4"

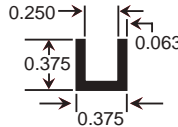

Part #	Length	Mill	Polished	Satin
ALU257-*	120 Per Ft.	\$0.66'	\$1.67'	\$0.80'
	600 Ft. +	\$0.60'	\$1.48'	\$0.72'



Fits 1/4"

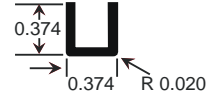

Part #	Length	Mill	Satin
ALU782-*	120 Per Ft.	\$0.68'	\$1.20'
	600 Ft. +	\$0.62'	\$1.10'

Fits 9/32"

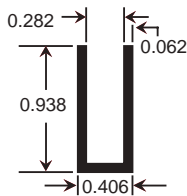

Part #	Length	Mill	Polished	Satin
ALU1257-*	120 Per Ft.	\$1.12'	\$2.24'	\$1.67'
	600 Ft. +	\$1.01'	\$1.82'	\$1.51'

Fits 5/16"

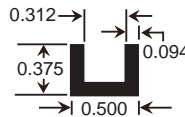

Part #	Length	Mill	Polished	Satin
ALU148-*	120 Per Ft.	\$0.89'	\$1.83'	\$1.45'
	600 Ft. +	\$0.82'	\$1.62'	\$1.32'

Fits 3/8"

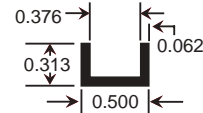

Part #	Length	Mill	Polished	Satin	Black	Glossy White	White
ALU57-*	120 Per Ft.	\$0.65'	\$1.66'	\$1.21'	\$1.56'	\$1.56'	
	600 Ft. +	\$0.59'	\$1.47'	\$1.10'	\$1.42'	\$1.42'	

Fits 7/16"

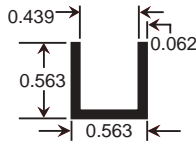

Part #	Length	Mill	Polished	Satin
ALU547-*	120 Per Ft.	\$0.87'	Please Inquire	\$1.43'
	600 Ft. +	\$0.80'		\$1.30'

Fits 1/2"

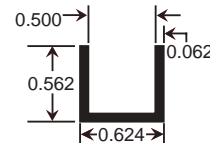

Part #	Length	Mill	Polished	Satin	Black	Glossy White	Oil Rubbed Bronze
ALU847-*	120 Per Ft.	\$0.90'	\$1.97'	\$1.46'	\$1.81'	\$1.81'	\$1.83'
	600 Ft. +	\$0.82'	\$1.75'	\$1.32'	\$1.64'	\$1.64'	\$1.64'

Fits 5/8"

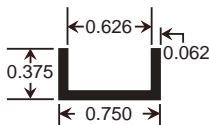

Part #	Length	Mill	Polished	Satin
ALU347-*	120 Per Ft.	\$0.81'	Please Inquire	\$1.35'
	600 Ft. +	\$0.73'		\$1.24'

Fits 5/8"

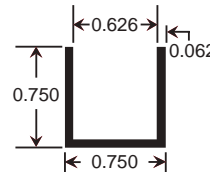

Part #	Length	Mill	Polished	Satin
ALU570-*	120 Per Ft.	\$1.11'	Please Inquire	\$1.66'
	600 Ft. +	\$1.00'		\$1.49'

Fits 3/4"

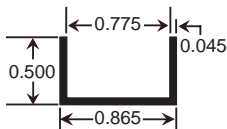

Part #	Length	Mill	Polished	Satin	Black	Glossy White
ALU447-*	120 Per Ft.	\$0.76'	\$1.81'	\$1.32'	\$1.67'	\$1.67'
	600 Ft. +	\$0.70'	\$1.60'	\$1.20'	\$1.52'	\$1.52'

Fits 3/4"

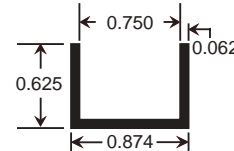

Part #	Length	Mill	Polished	Satin
ALU560-*	120 Per Ft.	\$1.26'	Please Inquire	\$1.59'
	600 Ft. +	\$1.15'		\$1.43'

For any quantities less than 120 ft. add 15% to the 120 ft. price.

IMPORTANT: Due to Raw Material Fluctuation, Catalog Prices Below May Not Be Accurate. GO TO WWW.OUTWATER.COM FOR THE MOST UP-TO-DATE PRICES

Aluminum Channel Moulding

Lengths: 12 Ft. • Material: Aluminum

*M - Mill - Dull Finish: As Extruded - May or May Not Have "Scratches"/Die Lines
 *S - Satin/Clear Anodized - Dull, Matte Finish
 *BK - Black Powder Coated Finish
 *P - Polished - Shiny/Mirror Finish
 *BS - Brushed Satin - Lightly Brushed (Shows Grain) Satin Finish
 *WH - Glossy White Powder Coated Finish
 Other Colors Available, Please Inquire. *Samples Are Available*

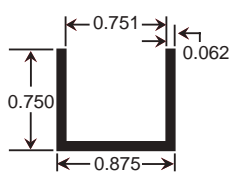

Fits 3/4"

Part #	Length	Mill	Polished	Satin
ALU947*	120 Per Ft.	\$1.15'	Please	\$1.71'
	600 Ft. +	\$1.04'	Inquire	\$1.54'

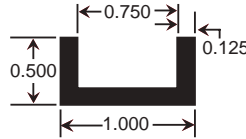

Fits 3/4"

Part #	Length	Mill	Polished	Satin
ALU247*	120 Per Ft.	\$1.66'	Please	\$2.03'
	600 Ft. +	\$1.51'	Inquire	\$1.62'

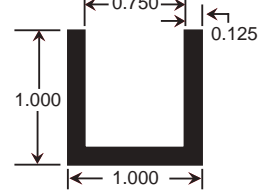

Fits 3/4"

Part #	Length	Satin
ALU1041-S	120 Per Ft.	\$3.00
	600 Ft. +	\$2.73'

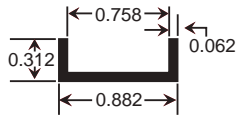

Fits 3/4"

Part #	Length	Satin
ALU2161-S	120 Per Ft.	\$1.35'
	600 Ft. +	\$1.24'

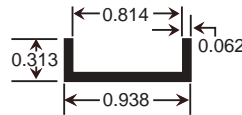

Fits 13/16"

Part #	Length	Mill	Polished	Satin
ALU157C*	120 Per Ft.	\$0.90'	Please	\$1.35'
	600 Ft. +	\$0.85'	Inquire	\$1.23'

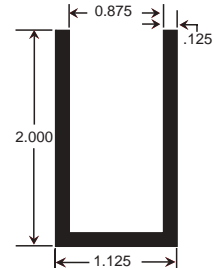

Fits 7/8"

Part #	Length	Mill	Polished	Satin
ALU565*	120 Per Ft.	\$5.51'	Please	\$6.08'
	600 Ft. +	\$4.53'	Inquire	\$4.45'

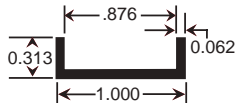

Fits 7/8"

Part #	Length	Mill	Polished	Satin
ALU357*	120 Per Ft.	\$0.85'	Please	\$1.41'
	600 Ft. +	\$0.77'	Inquire	\$1.28'

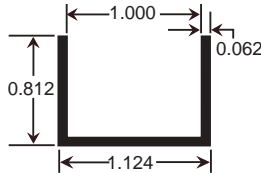

Fits 1"

Part #	Length	Mill	Polished	Satin	B. Satin
ALU448*	120 Per Ft.	\$1.67'	Please	\$1.85'	\$3.15'
	600 Ft. +	\$1.41'	Inquire	\$1.56'	\$2.53'

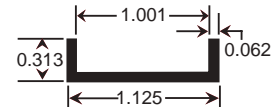

Fits 1"

Part #	Length	Mill	Polished	Satin
ALU557*	120 Per Ft.	\$0.90'	Please	\$1.46'
	600 Ft. +	\$0.82'	Inquire	\$1.32'

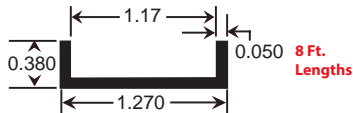

Fits 1-11/64"

Part #	Length	Satin
ALU450-S	120 Per Ft.	\$1.43'
	600 Ft. +	\$1.30'

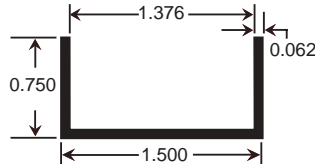

Fits 1-3/8"

Part #	Length	Mill	Polished	Satin
ALU578*	120 Per Ft.	\$1.40'	Please	\$1.94'
	600 Ft. +	\$1.27'	Inquire	\$1.76'

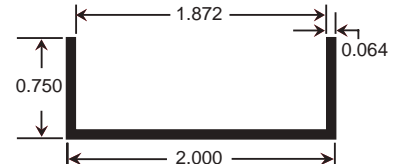

Fits 1-7/8"

Part #	Length	Mill	Polished	Satin
ALU575*	120 Per Ft.	\$1.64'	Please	\$2.30'
	600 Ft. +	\$1.49'	Inquire	\$2.10'

Aluminum "No Bow" Shelf Channel

Lengths: 8 Ft. - For 1/2", 5/8" & 3/4" Shelves

*S - Clear Anodized - Dull, Matte Finish • *BK - Black Powder Coated Gloss Finish • *WH - White Powder Coated Gloss Finish

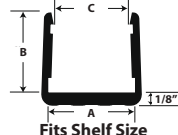
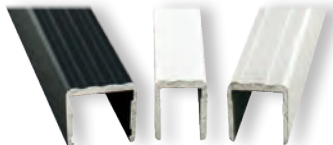

Part #	A	B	C	Satin		Black Or White	
				120 Ft.	600 + Ft.	120 Ft.	600 + Ft.
SHF-A500*	43/64"	3/4"	1/2"	\$1.90'	\$1.73'	\$2.31'	\$1.94'
SHF-A625*	51/64"	3/4"	5/8"	\$1.83'	\$1.60'	Please Inquire	
SHF-A750*	15/16"	3/4"	3/4"	\$1.92'	\$1.75'	\$2.35'	\$1.98'

For any quantities less than 120 ft. add 15% to the 120 ft. price.

IMPORTANT: Due to Raw Material Fluctuation, Catalog Prices Below May Not Be Accurate. GO TO WWW.OUTWATER.COM FOR THE MOST UP-TO-DATE PRICES

Plastic Clear Right Angle Moulding

Lengths: 12 Ft.
Material: Butyrate

Cut Program Available
Please Inquire



Part #	120 Ft.	600 Ft.	1000 Ft.
519-CL	\$0.51'	\$0.48'	\$0.43'



approx. .040 thickness

Part #	120 Ft.	600 Ft.	1000 Ft.
520-CL	\$0.55'	\$0.51'	\$0.45'

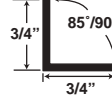

approx. .070 thickness

Part #	120 Ft.	600 Ft.	1000 Ft.
1748-CL	\$0.69'	\$0.65'	\$0.61'

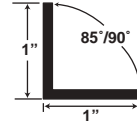

approx. .095 thickness

Part #	120 Ft.	600 Ft.	1000 Ft.
1749-CL	\$0.96'	\$0.90'	\$0.86'

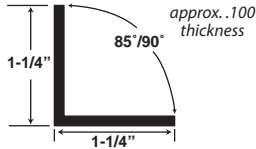

Part #	120 Ft.	600 Ft.	1000 Ft.
1750-CL	\$1.16'	\$1.11'	\$1.03'

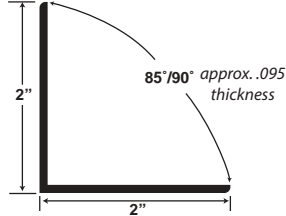

Part #	120 Ft.	600 Ft.	1000 Ft.
1755-CL	\$2.00'	\$1.91'	\$1.75'

Plastic Color Angle Moulding w/Adhesive

Lengths: 12 Ft. • Material: Styrene

Colors Available

*WH - White *BK - Black

Fits 5/16" x 7/16"

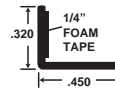

Part #	100 Ft.	1000 Ft.	5000 Ft.
2206A*	\$0.44'	\$0.42'	\$0.36'

Plastic Metallic Angle Moulding w/Adhesive

Lengths: 12 Ft.
Material: ABS/Mylar

Finishes Available

*POL/B - Polished Brass

*POL/C - Polished Chrome

*BRU/B - Brushed Brass

*BRU/C - Brushed Chrome

Please inquire as finishes vary from style to style

Fits 3/8"

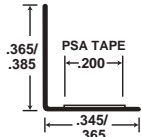

Part #	120 Ft.	600 Ft.	1000 Ft.
2406*	\$0.58'	\$0.55'	\$0.50'

Fits 1/2"

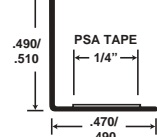

Part #	120 Ft.	600 Ft.	1000 Ft.
2407*	\$0.60'	\$0.57'	\$0.53'

Fits 3/4"

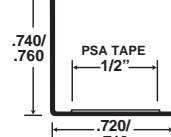

Part #	120 Ft.	600 Ft.	1000 Ft.
2409*	\$0.83'	\$0.78'	\$0.72'

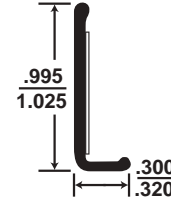

Part #	120 Ft.	600 Ft.	1000 Ft.
2001*	\$0.93'	\$0.88'	\$0.80'

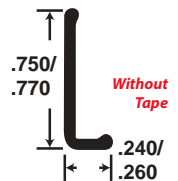

Part #	120 Ft.	600 Ft.	1000 Ft.
2163*	\$0.65'	\$0.60'	\$0.58'

For any quantities less than 120 ft. add 10% to the 120 ft. price.

Aluminum & Stainless Steel Cove Moulding

Lengths: 12 Ft.

Finishes Available

*P, *PH (w/holes) - Mechanical Polish - Shiny/Mirror Finish

*S - Satin/Clear Anodized - Dull, Matte Finish

*BS, BSH (w/holes) - Brushed Satin - Lightly Brushed (Shows Grain) Satin Finish

We can also supply custom orders without holes - minimums apply - please inquire.

Reverse cove moulding is used to cover up seams or joints wherever two perpendicular planes meet. The sink top to its backsplash or the ceiling to a wall surface represent typical applications for which our reverse cove moulding was designed. The leg of the profile seals tightly against both surfaces to lend a cleanly trimmed appearance to the finished product.



Punched holes spacing every 4-5"

Part #	Length	Polished w/Holes
ALU141-PH	120 Ft.	\$1.48'
	600 Ft. +	\$1.14'



Counter sunk holes spacing every 7"

Part #	Length	Polished w/Holes
ALU121-PH	120 Ft.	\$1.62'
	600 Ft. +	\$1.18'

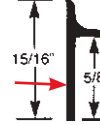

Counter sunk holes spacing every 6-7"

Part #	Length	Polished w/Holes
ALU1016-PH	120 Ft.	\$1.46'
	600 Ft. +	\$1.24'

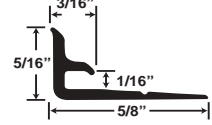

Not Available With Holes

Part #	Length	Satin
ALU426-S	120 Ft.	\$0.71'
	600 Ft. +	\$0.62'

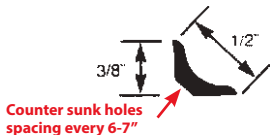

Counter sunk holes spacing every 6-7"

Part #	Length	Polished w/Holes
ALU441-PH	120 Ft.	\$1.44'
	600 Ft. +	\$1.05'



Counter sunk holes spacing every 6-7"

Part #	Length	Polished w/Holes	B. Satin w/Holes
ALU669*	120 Ft.	\$2.63'	\$2.78'
	600 Ft. +	\$1.91'	\$2.02'

STAINLESS STEEL COUNTER EDGE SNAP-ON MOULDINGS

Grade 430 (Magnetic)

Part #	Length	Polished
SS801A-P	120 Ft.	\$2.57'
	600 Ft. +	\$2.31'
SS806-P	120 Ft.	\$4.35'
	600 Ft. +	\$3.95'

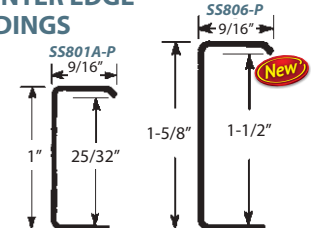

For any quantities less than 120 ft. add 15% to the 120 ft. price.

IMPORTANT: Due to Raw Material Fluctuation, Catalog Prices Below May Not Be Accurate. GO TO WWW.OUTWATER.COM FOR THE MOST UP-TO-DATE PRICES

Plastic Color Right Angle Moulding

Cut Program Available
Please Inquire

Lengths: 12 Ft.
Material: Styrene
Colors Available

*WH - White *BK - Black *BR - Brown
unless otherwise noted

<p>(approx. .050 thickness)</p> <p>Part # 120 Ft. 600 Ft. 1000 Ft. 1919-* \$0.23' \$0.20' \$0.18'</p>	<p>(approx. .055 thickness)</p> <p>Part # 120 Ft. 600 Ft. 1000 Ft. 1933-* \$0.46' \$0.44' \$0.38'</p>	<p>(approx. .060 thickness)</p> <p>Part # 120 Ft. 600 Ft. 1000 Ft. 1934-* \$0.49' \$0.46' \$0.42'</p>	<p>(approx. .075 thickness)</p> <p>Part # 120 Ft. 600 Ft. 1000 Ft. 1935-* \$0.61' \$0.57' \$0.53'</p>	<p>(approx. .100 thickness)</p> <p>Part # 120 Ft. 600 Ft. 1000 Ft. 1936-* \$0.74' \$0.70' \$0.66'</p>
<p>(approx. .100 thickness)</p> <p>Part # 120 Ft. 600 Ft. 1000 Ft. 1937-* \$0.87' \$0.84' \$0.77'</p>	<p>(approx. .125 thickness) Material: Rigid PVC</p> <p>Part # 120 Ft. 600 Ft. 1000 Ft. 1938-* \$1.74' \$1.68' \$1.56'</p>	<p>(approx. .045 thickness)</p> <p>Part # 120 Ft. 600 Ft. 1000 Ft. 1940-* \$0.72' \$0.68' \$0.63'</p>	<p>(approx. .100 thickness)</p> <p>Part # 120 Ft. 600 Ft. 1000 Ft. 1951-* \$0.74' \$0.70' \$0.66'</p>	<p>(approx. .100 thickness)</p> <p>Part # 120 Ft. 600 Ft. 1000 Ft. 1952-* \$0.74' \$0.70' \$0.66'</p>

Plastic Color Uneven Angle Moulding

Lengths: 12 Ft.
Material: Styrene
Colors Available

*WH - White *BK - Black

<p>Fits 5/16" x 7/16"</p> <p>(approx. .050 thickness)</p> <p>Part # 120 Ft. 600 Ft. 1000 Ft. 2206-* \$0.35' \$0.33' \$0.26'</p>	<p>Fits 1/2" x 1"</p> <p>(approx. .040 thickness)</p> <p>Part # 120 Ft. 600 Ft. 1000 Ft. 1920-* \$0.40' \$0.38' \$0.33'</p>	<p>Fits 1-1/4" x 3/8"</p> <p>(approx. .040 thickness)</p> <p>Part # 120 Ft. 600 Ft. 1000 Ft. 1441-* \$0.40' \$0.38' \$0.32'</p>	<p>Fits 1" x 2"</p> <p>(approx. .040 thickness)</p> <p>Part # 120 Ft. 600 Ft. 1000 Ft. 1921-* \$0.44' \$0.42' \$0.37'</p>	<p>Fits 1" x 3"</p> <p>(approx. .062 thickness)</p> <p>Part # 120 Ft. 600 Ft. 1000 Ft. 1922-* \$1.13' \$1.03' \$0.93'</p>
---	---	---	---	---

For any quantities less than 120 ft. add 10% to the 120 ft. price.

Plastic Flexible Uneven Angle Moulding

Material: PVC • Black

<p>Fits 1/2"</p> <p>150 Ft. Coils</p> <p>Part # 150 Ft. 600 Ft. 1050 Ft. 807-631-BK \$0.89' \$0.83' \$0.79'</p>	<p>Fits 3/4"</p> <p>100 Ft. Coils</p> <p>Part # 100 Ft. 600 Ft. 1000 Ft. 807-555-BK \$0.91' \$0.85' \$0.80'</p>	<p>Fits 7/8"</p> <p>50 Ft. Coils</p> <p>Part # 50 Ft. 600 Ft. 1000 Ft. 807-591-BK \$0.92' \$0.87' \$0.81'</p>
---	---	---

IMPORTANT: Due to Raw Material Fluctuation, Catalog Prices Below May Not Be Accurate. GO TO WWW.OUTWATER.COM FOR THE MOST UP-TO-DATE PRICES

Aluminum Even Angle Moulding

Lengths: 12 Ft.
Material: Aluminum
Finishes Available

*M - Mill - Dull Finish: As Extruded - May or May Not Have "Scratches"/Die Lines
 *S - Satin/Clear Anodized - Dull, Matte Finish

*P - Polished/Mechanical-Shiny/Mirror Finish
 (NEW) *BK - Black Anodized Finish

Special Order: Other Colors Available, Please Inquire

1/2" x 1/2"

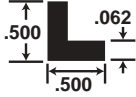

Part #	Length	Mill	Polished	Satin
ALU269-*	120 Per Ft.	\$0.62'	\$1.35'	\$1.03'
	600 Ft. +	\$0.57'	\$1.20'	\$0.91'

1/2" x 1/2"

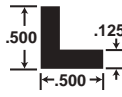

Part #	Length	Mill	Polished	Satin
ALU269-18-*	120 Per Ft.	\$0.96'	\$1.77'	\$1.51'
	600 Ft. +	\$0.87'	\$1.57'	\$1.38'

3/4" x 3/4"

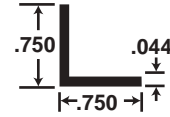

Part #	Length	Mill	Satin
ALU222-*	120 Per Ft.	\$0.76'	\$1.12'
	600 Ft. +	\$0.73'	\$1.03'

3/4" x 3/4"

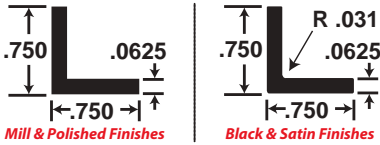

Part #	Length	Mill	Polished	Satin	Black	
ALU369-*	120 Per Ft.	\$0.82'	\$1.61'	\$1.17'	\$1.20'	
	600 Ft. +	\$0.74'	\$1.43'	\$1.06'	\$1.09'	

3/4" x 3/4"

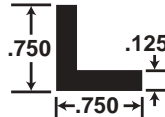

Part #	Length	Mill	Polished	Satin
ALU449-*	120 Per Ft.	\$1.35'	\$2.11'	\$1.89'
	600 Ft. +	\$1.24'	\$1.88'	\$1.72'

13/16" x 13/16"

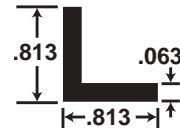

Part #	Length	Mill	Polished	Satin
ALU136-*	120 Per Ft.	\$0.88'	\$1.68'	\$1.21'
	600 Ft. +	\$0.81'	\$1.49'	\$1.11'

1" x 1"

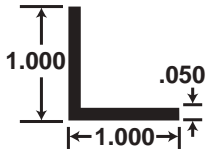

Part #	Length	Mill	Satin
ALU444-*	120 Per Ft.	\$1.09'	\$1.43'
	600 Ft. +	\$1.00'	\$1.29'

1" x 1"

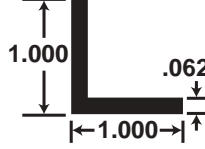

Part #	Length	Mill	Polished	Satin
ALU469-*	120 Per Ft.	\$1.02'	\$1.86'	\$1.56'
	600 Ft. +	\$0.92'	\$1.64'	\$1.42'

1" x 1" (135°)

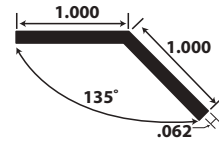

Part #	Length	Mill	Satin
ALU469-135-*	120 Per Ft.	\$1.17'	\$1.70'
	600 Ft. +	\$1.04'	\$1.55'

1" x 1"

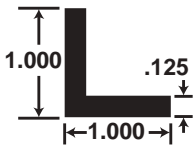

Part #	Length	Mill	Polished	Satin
ALU749-*	120 Per Ft.	\$1.76'	\$2.77'	\$2.29'
	600 Ft. +	\$1.60'	\$2.21'	\$2.09'

1" x 1"

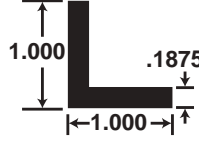

Part #	Length	Mill	Satin
ALU749-316-*	120 Per Ft.	\$2.45'	\$2.98'
	600 Ft. +	\$2.23'	\$2.71'

1-1/4" x 1-1/4"

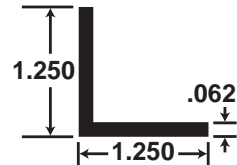

Part #	Length	Mill	Polished	Satin
ALU569-*	120 Per Ft.	\$1.23'	\$2.11'	\$1.77'
	600 Ft. +	\$1.11'	\$1.69'	\$1.60'

1-1/4" x 1-1/4"

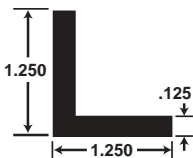

Part #	Length	Mill	Polished	Satin
ALU5569-*	120 Per Ft.	\$2.16'	\$3.42'	\$2.70'
	600 Ft. +	\$1.97'	\$2.73'	\$2.45'

1-1/2" x 1-1/2"

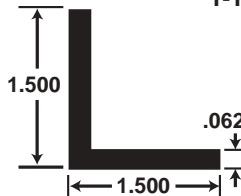

Part #	Length	Mill	Polished	Satin
ALU1569-*	120 Per Ft.	\$1.43'	\$2.63'	\$1.96'
	600 Ft. +	\$1.30'	\$2.13'	\$1.78'

1-1/2" x 1-1/2"

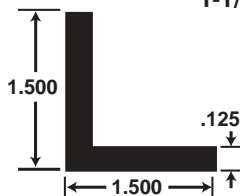

Part #	Length	Mill	Polished	Satin
ALU1569-18-*	120 Per Ft.	\$2.57'	\$4.05'	\$3.10'
	600 Ft. +	\$2.33'	\$3.24'	\$2.82'

For any quantities less than 120 ft. add 15% to the 120 ft. price.

IMPORTANT: Due to Raw Material Fluctuation, Catalog Prices Below May Not Be Accurate. GO TO WWW.OUTWATER.COM FOR THE MOST UP-TO-DATE PRICES

Aluminum Even Angle Moulding

Lengths: 12 Ft.
Material: Aluminum
Finishes Available

*M - Mill - Dull Finish: As Extruded - May or May Not Have "Scratches"/Die Lines
 *S - Satin/Clear Anodized - Dull, Matte Finish

*P - Polished/Mechanical - Shiny/Mirror Finish

Special Order: Other Colors Available, Please Inquire

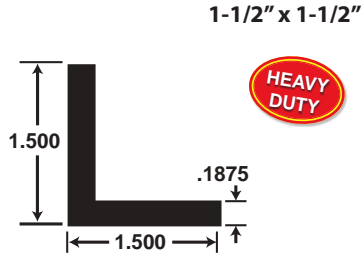

Part #	Length	Mill	Satin
ALU1569-316-*	120 Per Ft.	\$3.67'	\$4.19'
	600 Ft. +	\$3.27'	\$3.82'

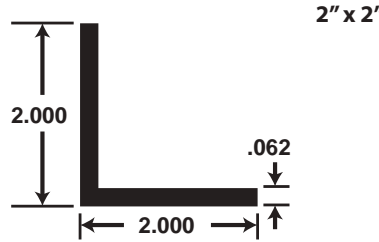

Part #	Length	Mill	Satin
ALU4469-*	120 Per Ft.	\$1.83'	\$2.60'
	600 Ft. +	\$1.66'	\$2.37'

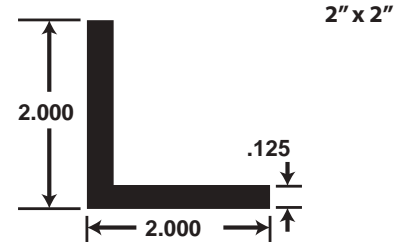

Part #	Length	Mill	Polished	Satin
ALU8469-*	120 Per Ft.	\$3.38'	\$5.33'	\$4.15'
	600 Ft. +	\$3.01'	\$3.88'	\$3.77'

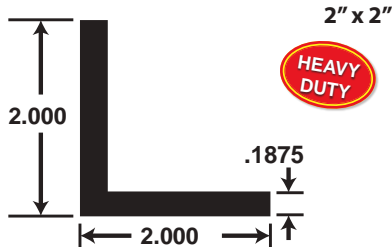

Part #	Length	Mill	Satin
ALU4469-316-*	120 Per Ft.	\$4.87'	\$5.64'
	600 Ft. +	\$4.34'	\$5.14'

Aluminum Uneven Angle Moulding

Lengths: 12 Ft.
Material: Aluminum
Finishes Available

*M - Mill - Dull Finish: As Extruded - May or May Not Have "Scratches"/Die Lines
 *BSH (w/holes) - Brushed Satin - Lightly Brushed (Shows Grain) Satin Finish

*P, PH (w/holes) - Polished/Mechanical - Shiny/Mirror Finish
 *S - Satin/Clear Anodized - Dull, Matte Finish

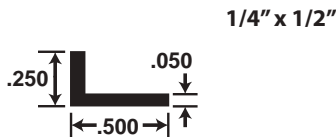

Part #	Length	Mill	Polished	Satin
ALU149-*	120 Per Ft.	\$0.47'	\$1.17'	\$1.04'
	600 Ft. +	\$0.43'	\$1.04'	\$0.95'

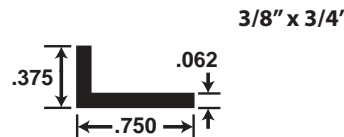

Part #	Length	Mill	Polished	Satin
ALU249-*	120 Per Ft.	\$0.68'	\$1.32'	\$1.24'
	600 Ft. +	\$0.61'	\$1.17'	\$1.13'

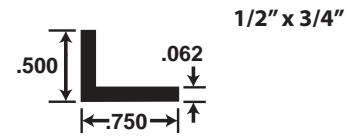

Part #	Length	Mill	Satin
ALU888-*	120 Per Ft.	\$0.88'	\$1.21'
	600 Ft. +	\$0.81'	\$1.11'

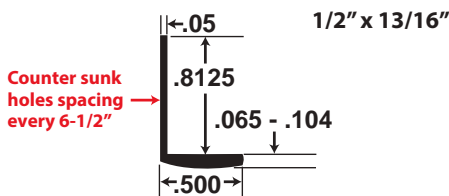

Part #	Length	Polished w/Holes	B. Satin w/Holes
ALU669-*	120 Ft.	\$2.63'	\$2.78'
	600 Ft. +	\$1.91'	\$2.02'

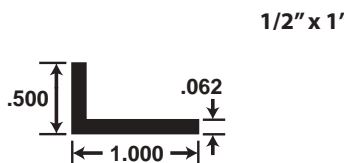

Part #	Length	Mill	Polished	Satin
ALU904-*	120 Per Ft.	\$0.83'	\$1.61'	\$1.39'
	600 Ft. +	\$0.75'	\$1.43'	\$1.26'

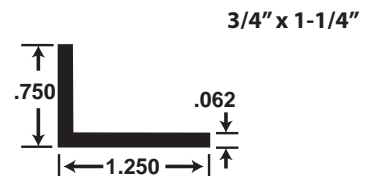

Part #	Length	Mill	Satin
ALU555-*	120 Per Ft.	\$1.21'	\$1.71'
	600 Ft. +	\$1.11'	\$1.52'

For any quantities less than 120 ft. add 15% to the 120 ft. price.

IMPORTANT: Due to Raw Material Fluctuation, Catalog Prices Below May Not Be Accurate. GO TO WWW.OUTWATER.COM FOR THE MOST UP-TO-DATE PRICES

Plastic Flat Back Price Tag Color Moulding

Without Adhesive Backing
 Lengths: 12 Ft. • Material: Styrene
 Colors Available

Cut Program Available
 Please Inquire

*WH - White *BK - Black

<p>Holds 1/2" Ticket</p> <p>Part # 120 Ft. 600 Ft. 1000 Ft. 35-500* \$0.34' \$0.30' \$0.26'</p>	<p>Holds 3/4" Ticket</p> <p>Part # 120 Ft. 600 Ft. 1000 Ft. 35-750* \$0.40' \$0.37' \$0.32'</p>	<p>Holds 7/8" Ticket</p> <p>Part # 120 Ft. 600 Ft. 1000 Ft. 35-875* \$0.41' \$0.38' \$0.33'</p>	<p>Holds 1 1/4" Ticket</p> <p>Part # 120 Ft. 600 Ft. 1000 Ft. 35-1-250* \$0.43' \$0.41' \$0.35'</p>
<p>Holds 1 1/2" Ticket</p> <p>Part # 120 Ft. 600 Ft. 1000 Ft. 35-1-500* \$0.48' \$0.45' \$0.38'</p>	<p>Holds 2" Ticket</p> <p>Part # 120 Ft. 600 Ft. 1000 Ft. 35-2* \$0.69' \$0.66' \$0.51'</p>	<p>Holds 2 1/2" Ticket</p> <p>Part # 120 Ft. 600 Ft. 1000 Ft. 35-2-500* \$0.74' \$0.71' \$0.57'</p>	<p>Holds 3" Ticket</p> <p>Part # 120 Ft. 600 Ft. 1000 Ft. 35-3* \$0.80' \$0.76' \$0.59'</p>
<p>Holds 3 1/2" Ticket</p> <p>Part # 120 Ft. 600 Ft. 1000 Ft. 35-3-500* \$0.85' \$0.80' \$0.68'</p>	<p>Holds 4" Ticket</p> <p>Part # 120 Ft. 600 Ft. 1000 Ft. 35-4* \$1.29' \$1.23' \$1.07'</p>	<p>Holds 5" Ticket</p> <p>Part # 120 Ft. 600 Ft. 1000 Ft. 35-5* \$1.39' \$1.34' \$1.19'</p>	

With Adhesive Backing
 Lengths: 12 Ft. • Material: Styrene
 Colors Available

*WH - White *BK - Black

<p>Holds 1/2" Ticket</p> <p>Part # 120 Ft. 600 Ft. 1000 Ft. 25-500* \$0.50' \$0.43' \$0.39'</p>	<p>Holds 3/4" Ticket</p> <p>Part # 120 Ft. 600 Ft. 1000 Ft. 25-750* \$0.56' \$0.53' \$0.47'</p>	<p>Holds 7/8" Ticket</p> <p>Part # 120 Ft. 600 Ft. 1000 Ft. 25-875* \$0.61' \$0.58' \$0.51'</p>	<p>Holds 1 1/4" Ticket</p> <p>Part # 120 Ft. 600 Ft. 1000 Ft. 25-1-250* \$0.69' \$0.66' \$0.61'</p>
<p>Holds 1 1/2" Ticket</p> <p>Part # 120 Ft. 600 Ft. 1000 Ft. 25-1-500* \$0.73' \$0.70' \$0.69'</p>	<p>Holds 2" Ticket</p> <p>Part # 120 Ft. 600 Ft. 1000 Ft. 25-200* \$0.81' \$0.77' \$0.73'</p>	<p>Holds 2 1/2" Ticket</p> <p>Part # 120 Ft. 600 Ft. 1000 Ft. 25-2-500* \$0.95' \$0.90' \$0.84'</p>	

PROTOTYPE SAMPLES
 We are happy to provide samples for prototypes & design builds.
 - Please Inquire

For any quantities less than 120 ft. add 10% to the 120 ft. price.

IMPORTANT: Due to Raw Material Fluctuation, Catalog Prices Below May Not Be Accurate. GO TO WWW.OUTWATER.COM FOR THE MOST UP-TO-DATE PRICES

Plastic Flat Back Price Tag Clear Moulding

Cut Program Available
Please Inquire

Without Adhesive Backing
Lengths: 12 Ft. • Material: Butyrate • Clear

<p>Holds 1/2" Ticket</p> <table border="1"> <tr> <th>Part #</th> <th>120 Ft.</th> <th>600 Ft.</th> <th>1000 Ft.</th> </tr> <tr> <td>43-500</td> <td>\$0.52'</td> <td>\$0.49'</td> <td>\$0.44'</td> </tr> </table>	Part #	120 Ft.	600 Ft.	1000 Ft.	43-500	\$0.52'	\$0.49'	\$0.44'	<p>Holds 3/4" Ticket</p> <table border="1"> <tr> <th>Part #</th> <th>120 Ft.</th> <th>600 Ft.</th> <th>1000 Ft.</th> </tr> <tr> <td>43-750</td> <td>\$0.55'</td> <td>\$0.53'</td> <td>\$0.47'</td> </tr> </table>	Part #	120 Ft.	600 Ft.	1000 Ft.	43-750	\$0.55'	\$0.53'	\$0.47'	<p>Holds 7/8" Ticket</p> <table border="1"> <tr> <th>Part #</th> <th>120 Ft.</th> <th>600 Ft.</th> <th>1000 Ft.</th> </tr> <tr> <td>43-875</td> <td>\$0.69'</td> <td>\$0.66'</td> <td>\$0.59'</td> </tr> </table>	Part #	120 Ft.	600 Ft.	1000 Ft.	43-875	\$0.69'	\$0.66'	\$0.59'	<p>Holds 1 1/4" Ticket</p> <table border="1"> <tr> <th>Part #</th> <th>120 Ft.</th> <th>600 Ft.</th> <th>1000 Ft.</th> </tr> <tr> <td>43-1-250</td> <td>\$0.78'</td> <td>\$0.75'</td> <td>\$0.65'</td> </tr> </table>	Part #	120 Ft.	600 Ft.	1000 Ft.	43-1-250	\$0.78'	\$0.75'	\$0.65'
Part #	120 Ft.	600 Ft.	1000 Ft.																																
43-500	\$0.52'	\$0.49'	\$0.44'																																
Part #	120 Ft.	600 Ft.	1000 Ft.																																
43-750	\$0.55'	\$0.53'	\$0.47'																																
Part #	120 Ft.	600 Ft.	1000 Ft.																																
43-875	\$0.69'	\$0.66'	\$0.59'																																
Part #	120 Ft.	600 Ft.	1000 Ft.																																
43-1-250	\$0.78'	\$0.75'	\$0.65'																																
<p>Holds 1-1/2" Ticket</p> <table border="1"> <tr> <th>Part #</th> <th>120 Ft.</th> <th>600 Ft.</th> <th>1000 Ft.</th> </tr> <tr> <td>43-1-500</td> <td>\$0.90'</td> <td>\$0.86'</td> <td>\$0.74'</td> </tr> </table>	Part #	120 Ft.	600 Ft.	1000 Ft.	43-1-500	\$0.90'	\$0.86'	\$0.74'	<p>Holds 2" Ticket</p> <table border="1"> <tr> <th>Part #</th> <th>120 Ft.</th> <th>600 Ft.</th> <th>1000 Ft.</th> </tr> <tr> <td>43-2</td> <td>\$1.08'</td> <td>\$1.04'</td> <td>\$0.91'</td> </tr> </table>	Part #	120 Ft.	600 Ft.	1000 Ft.	43-2	\$1.08'	\$1.04'	\$0.91'	<p>Holds 3" Ticket</p> <table border="1"> <tr> <th>Part #</th> <th>120 Ft.</th> <th>600 Ft.</th> <th>1000 Ft.</th> </tr> <tr> <td>43-3</td> <td>\$1.67'</td> <td>\$1.62'</td> <td>\$1.49'</td> </tr> </table>	Part #	120 Ft.	600 Ft.	1000 Ft.	43-3	\$1.67'	\$1.62'	\$1.49'									
Part #	120 Ft.	600 Ft.	1000 Ft.																																
43-1-500	\$0.90'	\$0.86'	\$0.74'																																
Part #	120 Ft.	600 Ft.	1000 Ft.																																
43-2	\$1.08'	\$1.04'	\$0.91'																																
Part #	120 Ft.	600 Ft.	1000 Ft.																																
43-3	\$1.67'	\$1.62'	\$1.49'																																

With Adhesive Backing
Lengths: 12 Ft. • Material: Butyrate • Clear

<p>Holds 1/2" Ticket</p> <table border="1"> <tr> <th>Part #</th> <th>120 Ft.</th> <th>600 Ft.</th> <th>1000 Ft.</th> </tr> <tr> <td>43A-500</td> <td>\$0.63'</td> <td>\$0.60'</td> <td>\$0.54'</td> </tr> </table>	Part #	120 Ft.	600 Ft.	1000 Ft.	43A-500	\$0.63'	\$0.60'	\$0.54'	<p>Holds 3/4" Ticket</p> <table border="1"> <tr> <th>Part #</th> <th>120 Ft.</th> <th>600 Ft.</th> <th>1000 Ft.</th> </tr> <tr> <td>43A-750</td> <td>\$0.73'</td> <td>\$0.70'</td> <td>\$0.61'</td> </tr> </table>	Part #	120 Ft.	600 Ft.	1000 Ft.	43A-750	\$0.73'	\$0.70'	\$0.61'	<p>Holds 7/8" Ticket</p> <table border="1"> <tr> <th>Part #</th> <th>120 Ft.</th> <th>600 Ft.</th> <th>1000 Ft.</th> </tr> <tr> <td>43A-875</td> <td>\$0.89'</td> <td>\$0.86'</td> <td>\$0.78'</td> </tr> </table>	Part #	120 Ft.	600 Ft.	1000 Ft.	43A-875	\$0.89'	\$0.86'	\$0.78'	<p>Holds 1" Ticket</p> <table border="1"> <tr> <th>Part #</th> <th>120 Ft.</th> <th>600 Ft.</th> <th>1000 Ft.</th> </tr> <tr> <td>43A-100</td> <td>\$0.96'</td> <td>\$0.86'</td> <td>\$0.82'</td> </tr> </table>	Part #	120 Ft.	600 Ft.	1000 Ft.	43A-100	\$0.96'	\$0.86'	\$0.82'
Part #	120 Ft.	600 Ft.	1000 Ft.																																
43A-500	\$0.63'	\$0.60'	\$0.54'																																
Part #	120 Ft.	600 Ft.	1000 Ft.																																
43A-750	\$0.73'	\$0.70'	\$0.61'																																
Part #	120 Ft.	600 Ft.	1000 Ft.																																
43A-875	\$0.89'	\$0.86'	\$0.78'																																
Part #	120 Ft.	600 Ft.	1000 Ft.																																
43A-100	\$0.96'	\$0.86'	\$0.82'																																
<p>Holds 1 1/4" Ticket</p> <table border="1"> <tr> <th>Part #</th> <th>120 Ft.</th> <th>600 Ft.</th> <th>1000 Ft.</th> </tr> <tr> <td>43A-1-250</td> <td>\$1.06'</td> <td>\$1.00'</td> <td>\$0.96'</td> </tr> </table>	Part #	120 Ft.	600 Ft.	1000 Ft.	43A-1-250	\$1.06'	\$1.00'	\$0.96'	<p>Holds 1 1/2" Ticket</p> <table border="1"> <tr> <th>Part #</th> <th>120 Ft.</th> <th>600 Ft.</th> <th>1000 Ft.</th> </tr> <tr> <td>43A-1-500</td> <td>\$1.18'</td> <td>\$1.13'</td> <td>\$1.03'</td> </tr> </table>	Part #	120 Ft.	600 Ft.	1000 Ft.	43A-1-500	\$1.18'	\$1.13'	\$1.03'	<p>Holds 2" Ticket</p> <table border="1"> <tr> <th>Part #</th> <th>120 Ft.</th> <th>600 Ft.</th> <th>1000 Ft.</th> </tr> <tr> <td>43A-2</td> <td>\$1.38'</td> <td>\$1.34'</td> <td>\$1.19'</td> </tr> </table>	Part #	120 Ft.	600 Ft.	1000 Ft.	43A-2	\$1.38'	\$1.34'	\$1.19'	<p>Holds 3" Ticket</p> <table border="1"> <tr> <th>Part #</th> <th>120 Ft.</th> <th>600 Ft.</th> <th>1000 Ft.</th> </tr> <tr> <td>43A-3</td> <td>\$1.78'</td> <td>\$1.77'</td> <td>\$1.57'</td> </tr> </table>	Part #	120 Ft.	600 Ft.	1000 Ft.	43A-3	\$1.78'	\$1.77'	\$1.57'
Part #	120 Ft.	600 Ft.	1000 Ft.																																
43A-1-250	\$1.06'	\$1.00'	\$0.96'																																
Part #	120 Ft.	600 Ft.	1000 Ft.																																
43A-1-500	\$1.18'	\$1.13'	\$1.03'																																
Part #	120 Ft.	600 Ft.	1000 Ft.																																
43A-2	\$1.38'	\$1.34'	\$1.19'																																
Part #	120 Ft.	600 Ft.	1000 Ft.																																
43A-3	\$1.78'	\$1.77'	\$1.57'																																

For any quantities less than 120 ft. add 10% to the 120 ft. price.

Aluminum Price Tag Mouldings w/Holes

<p>For 1 1/4" Price Tag</p> <table border="1"> <tr> <th>Part #</th> <th>Length</th> <th>Polished w/Holes</th> <th>Satin w/Holes</th> <th>B. Satin w/Holes</th> </tr> <tr> <td>ALU154-*</td> <td>120 Ft.</td> <td>\$2.12'</td> <td>\$2.05'</td> <td>\$2.54'</td> </tr> <tr> <td></td> <td>600 Ft.+</td> <td>\$1.88'</td> <td>\$1.87'</td> <td>\$2.04'</td> </tr> </table>	Part #	Length	Polished w/Holes	Satin w/Holes	B. Satin w/Holes	ALU154-*	120 Ft.	\$2.12'	\$2.05'	\$2.54'		600 Ft.+	\$1.88'	\$1.87'	\$2.04'	<p>Lengths: 12 Ft. Finishes Available</p> <ul style="list-style-type: none"> *P, PH (w/holes) - Polished/Mechanical - Shiny/Mirror Finish *BSH (w/holes) - Brushed Satin - Lightly Brushed (Shows Grain) Satin Finish *S, SH (w/holes) - Satin/Clear Anodized - Dull Matte Finish 	<p>For 1" Price Tag</p> <table border="1"> <tr> <th>Part #</th> <th>Length</th> <th>Polished</th> <th>Satin</th> </tr> <tr> <td>ALU157-*</td> <td>120 Ft.</td> <td>\$1.76'</td> <td>\$1.55'</td> </tr> <tr> <td></td> <td>600 Ft.+</td> <td>\$1.56'</td> <td>\$1.41'</td> </tr> </table>	Part #	Length	Polished	Satin	ALU157-*	120 Ft.	\$1.76'	\$1.55'		600 Ft.+	\$1.56'	\$1.41'	<p>For 5/8" Price Tag</p> <table border="1"> <tr> <th>Part #</th> <th>Length</th> <th>Polished</th> <th>Satin</th> </tr> <tr> <td>ALU151-*</td> <td>120 Ft.</td> <td>Please Inquire</td> <td>Please Inquire</td> </tr> <tr> <td></td> <td>600 Ft.+</td> <td>Inquire</td> <td>Inquire</td> </tr> </table>	Part #	Length	Polished	Satin	ALU151-*	120 Ft.	Please Inquire	Please Inquire		600 Ft.+	Inquire	Inquire	<p>For Universal Price Tag (No Holes)</p> <table border="1"> <tr> <th>Part #</th> <th>Length</th> <th>Polished</th> <th>Satin</th> </tr> <tr> <td>ALU1316-*</td> <td>120 Ft.</td> <td>Please Inquire</td> <td>Please Inquire</td> </tr> <tr> <td></td> <td>600 Ft.+</td> <td>Inquire</td> <td>Inquire</td> </tr> </table>	Part #	Length	Polished	Satin	ALU1316-*	120 Ft.	Please Inquire	Please Inquire		600 Ft.+	Inquire	Inquire
Part #	Length	Polished w/Holes	Satin w/Holes	B. Satin w/Holes																																																			
ALU154-*	120 Ft.	\$2.12'	\$2.05'	\$2.54'																																																			
	600 Ft.+	\$1.88'	\$1.87'	\$2.04'																																																			
Part #	Length	Polished	Satin																																																				
ALU157-*	120 Ft.	\$1.76'	\$1.55'																																																				
	600 Ft.+	\$1.56'	\$1.41'																																																				
Part #	Length	Polished	Satin																																																				
ALU151-*	120 Ft.	Please Inquire	Please Inquire																																																				
	600 Ft.+	Inquire	Inquire																																																				
Part #	Length	Polished	Satin																																																				
ALU1316-*	120 Ft.	Please Inquire	Please Inquire																																																				
	600 Ft.+	Inquire	Inquire																																																				
<p>For 1 1/4" Price Tag</p> <table border="1"> <tr> <th>Part #</th> <th>Length</th> <th>Polished w/Holes</th> <th>Satin w/Holes</th> </tr> <tr> <td>ALU618-*</td> <td>120 Ft.</td> <td>Please Inquire</td> <td>\$1.89'</td> </tr> <tr> <td></td> <td>600 Ft.+</td> <td>Inquire</td> <td>\$1.72'</td> </tr> </table>	Part #	Length	Polished w/Holes	Satin w/Holes	ALU618-*	120 Ft.	Please Inquire	\$1.89'		600 Ft.+	Inquire	\$1.72'	<p>For 1" Price Tag</p> <table border="1"> <tr> <th>Part #</th> <th>Length</th> <th>Polished</th> <th>Satin</th> </tr> <tr> <td>ALU157-*</td> <td>120 Ft.</td> <td>\$1.76'</td> <td>\$1.55'</td> </tr> <tr> <td></td> <td>600 Ft.+</td> <td>\$1.56'</td> <td>\$1.41'</td> </tr> </table>	Part #	Length	Polished	Satin	ALU157-*	120 Ft.	\$1.76'	\$1.55'		600 Ft.+	\$1.56'	\$1.41'	<p>For 5/8" Price Tag</p> <table border="1"> <tr> <th>Part #</th> <th>Length</th> <th>Polished</th> <th>Satin</th> </tr> <tr> <td>ALU151-*</td> <td>120 Ft.</td> <td>Please Inquire</td> <td>Please Inquire</td> </tr> <tr> <td></td> <td>600 Ft.+</td> <td>Inquire</td> <td>Inquire</td> </tr> </table>	Part #	Length	Polished	Satin	ALU151-*	120 Ft.	Please Inquire	Please Inquire		600 Ft.+	Inquire	Inquire	<p>For Universal Price Tag (No Holes)</p> <table border="1"> <tr> <th>Part #</th> <th>Length</th> <th>Polished</th> <th>Satin</th> </tr> <tr> <td>ALU1316-*</td> <td>120 Ft.</td> <td>Please Inquire</td> <td>Please Inquire</td> </tr> <tr> <td></td> <td>600 Ft.+</td> <td>Inquire</td> <td>Inquire</td> </tr> </table>	Part #	Length	Polished	Satin	ALU1316-*	120 Ft.	Please Inquire	Please Inquire		600 Ft.+	Inquire	Inquire				
Part #	Length	Polished w/Holes	Satin w/Holes																																																				
ALU618-*	120 Ft.	Please Inquire	\$1.89'																																																				
	600 Ft.+	Inquire	\$1.72'																																																				
Part #	Length	Polished	Satin																																																				
ALU157-*	120 Ft.	\$1.76'	\$1.55'																																																				
	600 Ft.+	\$1.56'	\$1.41'																																																				
Part #	Length	Polished	Satin																																																				
ALU151-*	120 Ft.	Please Inquire	Please Inquire																																																				
	600 Ft.+	Inquire	Inquire																																																				
Part #	Length	Polished	Satin																																																				
ALU1316-*	120 Ft.	Please Inquire	Please Inquire																																																				
	600 Ft.+	Inquire	Inquire																																																				

For any quantities less than 120 ft. add 15% to the 120 ft. price.

IMPORTANT: Due to Raw Material Fluctuation, Catalog Prices Below May Not Be Accurate. GO TO WWW.OUTWATER.COM FOR THE MOST UP-TO-DATE PRICES

Aluminum Outside Corners

Lengths: 12 Ft. • Fits 3/4" Panel Boards • Patent #4840440

Finishes Available

*S - Satin/Clear Anodized - Dull, Matte Finish

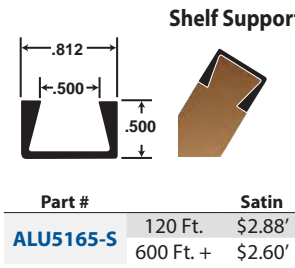
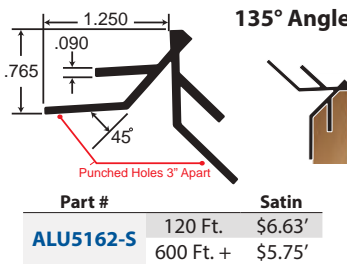
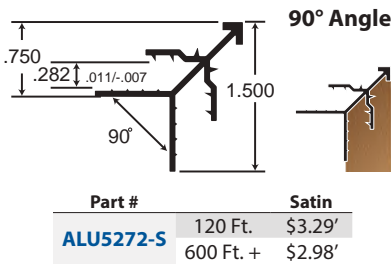
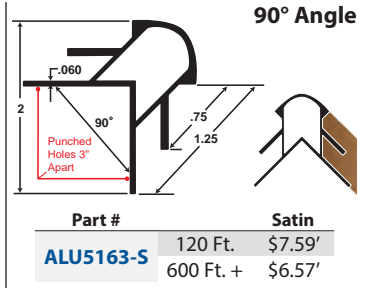
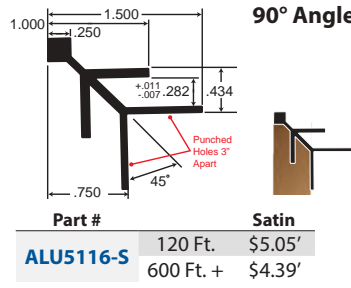
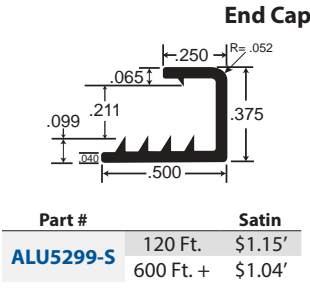
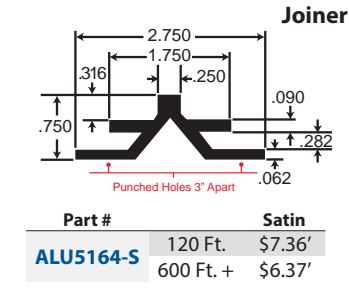

Instructions: 2 Cutting Methods
 1. Using Table saw
 2. Using 5 piece cutter head w/shaper

Part #: CW-TOOLS
\$1,250.00
(sold separately, please inquire)

Aluminum Corners

Lengths: 12 Ft.

Finishes Available

*M - Mill - Dull Finish: As Extruded - May or May Not Have "Scratches"/Die Lines

*P - Polished - Shiny/Mirror Finish

*S - Satin/Clear Anodized - Dull, Matte Finish

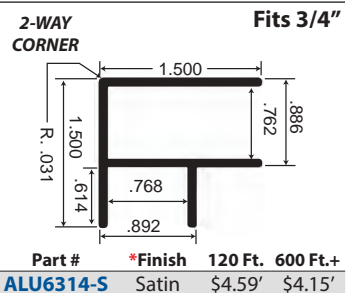
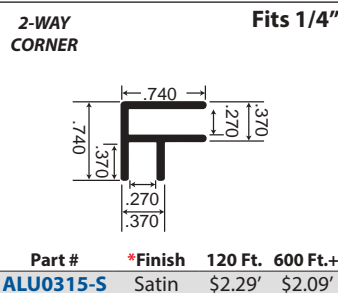
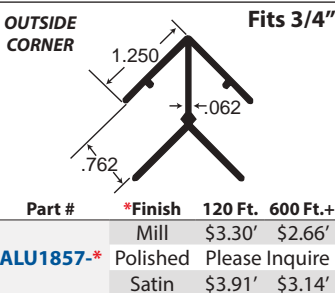
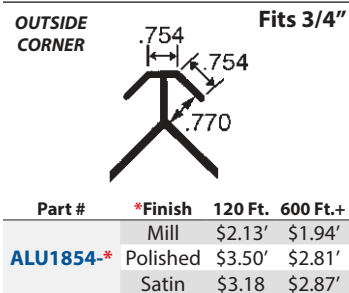
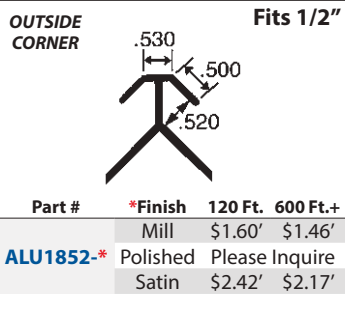
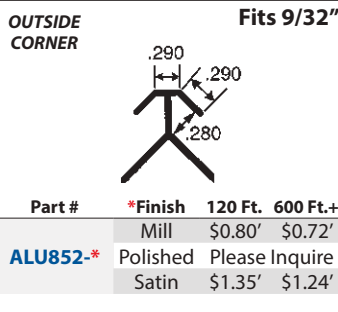
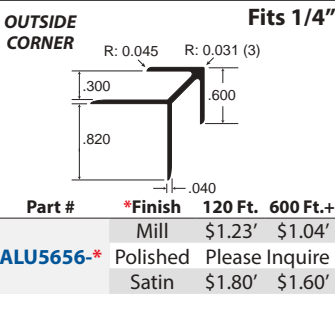
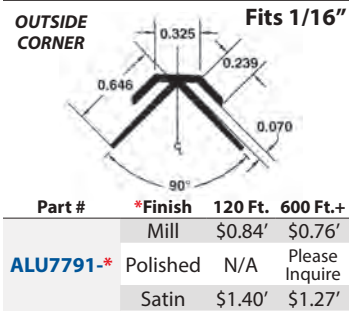
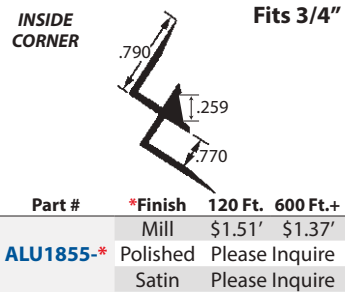
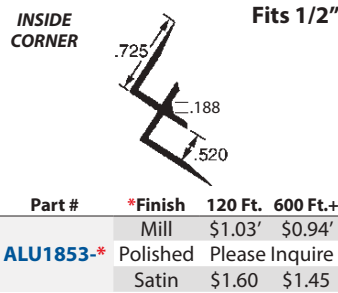
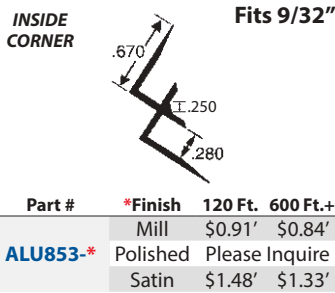
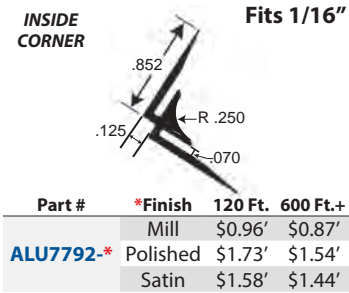

For any quantities less than 120 ft. add 15% to the 120 ft. price.

IMPORTANT: Due to Raw Material Fluctuation, Catalog Prices Below May Not Be Accurate. GO TO WWW.OUTWATER.COM FOR THE MOST UP-TO-DATE PRICES

Plastic Corner Channel Moulding

90° Corner Channel

Cut Program Available
Please Inquire

Lengths: 12 Ft.
Material: Styrene
Colors Available

*WH - White *BK - Black *BR - Brown ▲ *DG - Dove Gray ▲ ▲ 5000 ft. minimum apply
unless otherwise noted



Fits 1/16"

Part Tapers For Friction Fit

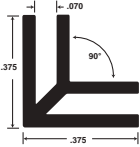

Part #	120 Ft.	600 Ft.	1000 Ft.
107-680-*	\$0.31'	\$0.27'	\$0.24'

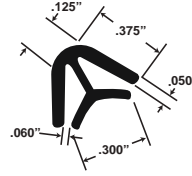

Fits 1/16"

Gloss finish closely matches
Acrylic and PETG sheets

Color Clear Others Available Min. Apply
Styrolux - 8 Ft. Lengths

Part #	120 Ft.	600 Ft.	1000 Ft.
107-681-*	\$0.60'	\$0.52'	\$0.48'

Fits 1/8"

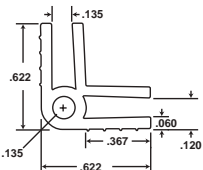

Part #	120 Ft.	600 Ft.	1000 Ft.
184-*	\$0.56'	\$0.47'	\$0.43'

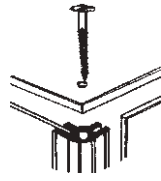

Fits 1/4"

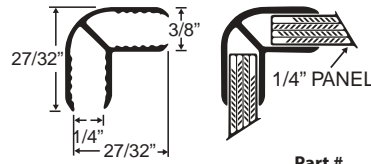

Part #	120 Ft.	600 Ft.	1000 Ft.
107-685-BR	\$0.61'	\$0.50'	\$0.46'

Polypropylene

Fits 1/4"

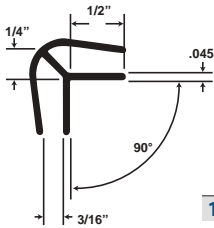

Part #	120 Ft.	600 Ft.	1000 Ft.
107-664-*	\$0.61'	\$0.52'	\$0.49'

8 Ft. Lengths

Fits 1/2"

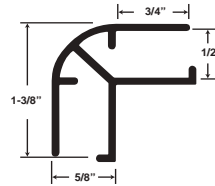

Part #	120 Ft.	600 Ft.	1000 Ft.
107-687-*	\$1.25'	\$1.14'	\$1.02'

Also Stocked in Dove Gray -
No Minimum Required

8 Ft. Lengths

Fits 5/8"

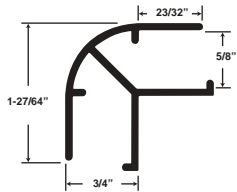

Part #	120 Ft.	600 Ft.	1000 Ft.
107-688-*	\$1.34'	\$1.23'	\$1.11'

8 Ft. Lengths

Fits 3/4"

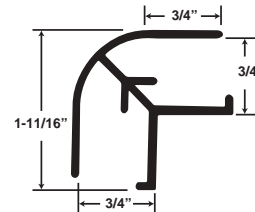

Part #	120 Ft.	600 Ft.	1000 Ft.
107-689-*	\$1.54'	\$1.49'	\$1.44'

8 Ft. Lengths

60° Corner Channel

Lengths: 8 Ft.
Material: Styrene
Colors Available

*WH - White *BK - Black *BR - Brown ▲ *DG - Dove Gray ▲ ▲ 5000 ft. minimum apply

Fits 1/4"

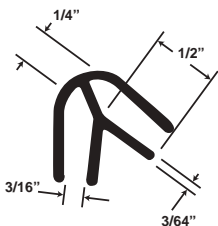

Part #	120 Ft.	600 Ft.	1000 Ft.
107-665-*	\$0.61'	\$0.52'	\$0.49'

Fits 1/2"

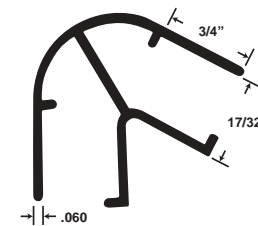

Part #	120 Ft.	600 Ft.	1000 Ft.
107-667-*	\$1.25'	\$1.14'	\$1.02'

For any quantities less than 120 ft. add 10% to the 120 ft. price.

Color Plastic Divider



For matching Cap Moulding, see page S-78

Lengths: 8 Ft.
Material: Styrene

Colors Available

*WH - White *BK - Black *BR - Brown *SIL - Silver

A = Available with Adhesive (1/2" Foam Tape)

unless otherwise noted

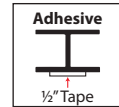

Cut Program Available
Please Inquire

Fits 1/16"

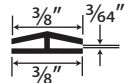

Material:
Rigid PVC

Part #	120 Ft.	600 Ft.	1000 Ft.
2383*	\$0.28'	\$0.23'	\$0.20'
2383*-A	\$0.38'	\$0.31'	\$0.29'

Fits 1/16"

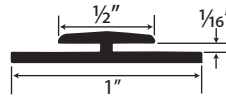

Part #	120 Ft.	600 Ft.	1000 Ft.
P610*	\$0.37'	\$0.28'	\$0.26'
P610*-A	\$0.55'	\$0.52'	\$0.49'

Fits 1/8"

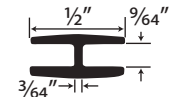

Part #	120 Ft.	600 Ft.	1000 Ft.
P611*	\$0.36'	\$0.24'	\$0.20'



Fits 1/4" Even Leg

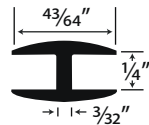

Part #	120 Ft.	600 Ft.	1000 Ft.
P612*	\$0.51'	\$0.42'	\$0.40'

Fits 1/8" Even Leg

Dividers with 11/16" Legs

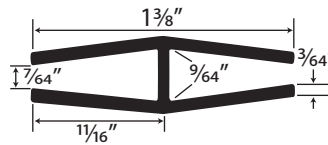

Part #	120 Ft.	600 Ft.	1000 Ft.
883*	\$0.86'	\$0.80'	\$0.70'

Fits 1/8"

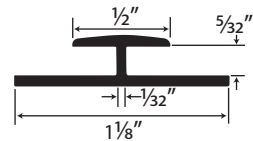

Silver
Material:
PVC

Part #	120 Ft.	600 Ft.	1000 Ft.
P601*	\$0.38'	\$0.28'	\$0.26'
P601*-A	\$0.55'	\$0.52'	\$0.49'
P601-SIL	\$0.57'	\$0.50'	\$0.47'
P601-SIL-A	\$0.73'	\$0.68'	\$0.60'



Fits 3/16"

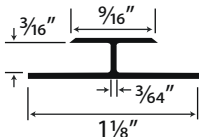

Part #	120 Ft.	600 Ft.	1000 Ft.
P604*	\$0.41'	\$0.30'	\$0.28'
P604*-A	\$0.53'	\$0.49'	\$0.46'

Fits 1/8"

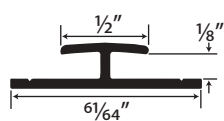

Material:
ABS

Part #	120 Ft.	600 Ft.	1000 Ft.
1134*	\$0.54'	\$0.48'	\$0.44'

Fits 1/4"

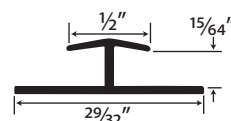

Material:
ABS

Part #	120 Ft.	600 Ft.	1000 Ft.
1031*	\$0.54'	\$0.49'	\$0.45'

Fits 1/4"

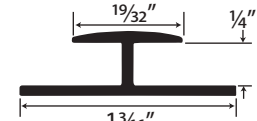

Silver
Material:
PVC

Part #	120 Ft.	600 Ft.	1000 Ft.
P651*	\$0.38'	\$0.31'	\$0.29'
P651*-A	\$0.58'	\$0.54'	\$0.50'
P651-SIL	\$0.61'	\$0.58'	\$0.53'
P651-SIL-A	\$0.81'	\$0.77'	\$0.73'

Fits 5/16"

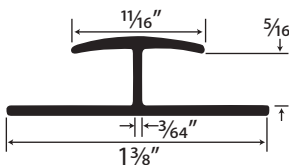

Part #	120 Ft.	600 Ft.	1000 Ft.
P660*	\$0.42'	\$0.38'	\$0.35'

Fits 3/8"



Part #	120 Ft.	600 Ft.	1000 Ft.
4158*	\$0.44'	\$0.41'	\$0.36'

Fits 1/2"

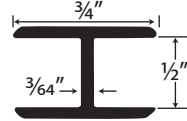

Part #	120 Ft.	600 Ft.	1000 Ft.
4050*	\$0.41'	\$0.35'	\$0.31'

Fits 3/4"

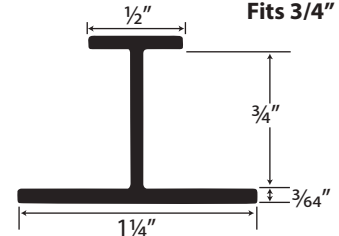

Part #	120 Ft.	600 Ft.	1000 Ft.
P750*	\$0.55'	\$0.52'	\$0.48'

Fits 3/4" Even Leg

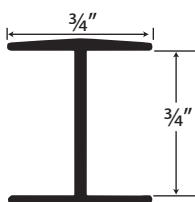

Part #	120 Ft.	600 Ft.	1000 Ft.
P751H*	\$0.56'	\$0.53'	\$0.49'

Plastic Cap & Divider Sets

COLOR

Cap	Divider	Size	Cap	Divider	Size
2384*	Works with 2383*	1/16"	650*	Works with P651*	1/4"
616*	Works with P610*	1/16"	1032*	Works with 1031*	1/4"
600*	Works with P601*	1/8"	652*	Works with 4050*	1/2"
1135*	Works with 1134*	1/8"	4069*	Works with P750*	3/4"

CLEAR

Cap	Divider	Size
846*	Works with 2028*	1/8"
2030*	Works with 2029*	1/4"

For any quantities less than 120 ft. add 10% to the 120 ft. price.

IMPORTANT: Due to Raw Material Fluctuation, Catalog Prices Below May Not Be Accurate. GO TO WWW.OUTWATER.COM FOR THE MOST UP-TO-DATE PRICES

Aluminum Divider

Lengths: 12 Ft. • Material: Aluminum

- *M - Mill - Dull Finish: As Extruded - May or May Not Have "Scratches"/Die Lines
 - *S - Satin/Clear Anodized - Dull Matte Finish
 - *P - Polished/Mechanical - Shiny/Mirror Finish
 - *ORB - Oil Rubbed Bronze Anodize Finish
 - *BK - Black Powder Coated Finish
 - *WH - Glossy White Powder Coated Finish
- Samples Are Available



Finishes Available

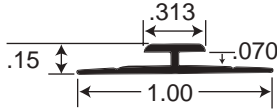

Fits 1/16"

Part #	Length	Mill	Satin	Black	Glossy White	Bronze
ALU0023*	120 Per Ft.	\$0.58'	\$1.12'	Please	\$1.46'	\$1.54'
	600 Ft. +	\$0.53'	\$1.02'	Inquire	\$1.33'	\$1.40'



Fits 3/32"

Part #	Length	Satin
ALU5044-S	120 Per Ft.	\$1.39'
	600 Ft. +	\$1.26'

New!

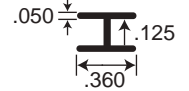

Fits 1/8"

Part #	Length	Satin
ALU0829-S	120 Per Ft.	\$0.66'
	600 Ft. +	\$0.58'

Fits 1/8" to 5/32"

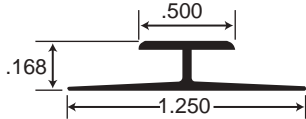

Part #	Length	Mill	Polished	Satin
ALU849*	120 Per Ft.	\$0.71'	\$1.32'	\$1.27'
	600 Ft. +	\$0.65'	\$1.17'	\$1.15'

Fits 5/32"

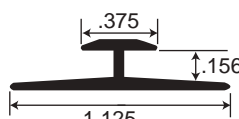

Part #	Length	Mill	Satin
ALU5639*	120 Per Ft.	\$0.96'	\$1.02'
	600 Ft. +	\$0.89'	\$0.95'

Fits 1/4"

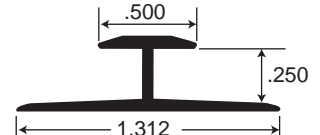

Part #	Length	Mill	Satin
ALU1798*	120 Per Ft.	\$0.96'	\$1.19'
	600 Ft. +	\$0.89'	\$1.09'

Fits 1/4"

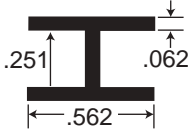

Part #	Length	Mill	Satin
ALU4299*	120 Per Ft.	\$0.94'	\$1.31'
	600 Ft. +	\$0.87'	\$1.19'

Fits 1/4" to 9/32"

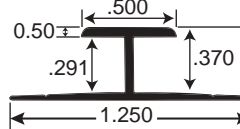

Part #	Length	Mill	Polished	Satin	Black	Glossy White
ALU850*	120 Per Ft.	\$0.75'	\$1.39'	\$1.31'	\$1.66'	\$1.66'
	600 Ft. +	\$0.69'	\$1.23'	\$1.19'	\$1.52'	\$1.52'

Fits 1/4" to 9/32"

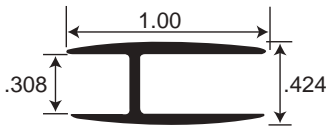

Part #	Length	Satin
ALUT155-S	120 Per Ft.	\$1.53'
	600 Ft. +	\$1.39'

Fits 1/2"

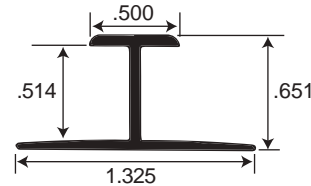

Part #	Length	Mill	Polished	Satin	Black	Glossy White
ALU1850*	120 Per Ft.	\$1.01'	Please	\$1.56'	\$1.90'	\$1.90'
	600 Ft. +	\$0.91'	Inquire	\$1.42'	\$1.74'	\$1.74'

Stainless Steel Cap & Corner Divider

Lengths: 12 Ft.

Material: All Stainless Steel 430 Grade (Magnet) • Polished-Brite Dipped Polish

DIVIDER

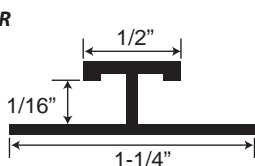

Fits 1/16"

Part #	Length	Polished
SS1450-P	120 Per Ft.	\$2.12'
	600 Ft. +	\$1.80'

CAP

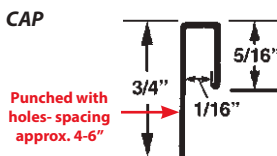

Fits 1/16"

Part #	Length	Polished
SS1451-P	120 Per Ft.	\$1.62'
	600 Ft. +	\$1.45'

CAP

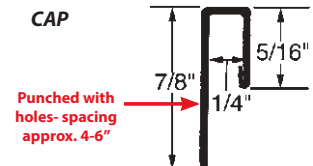

Fits 1/4"

Part #	Length	Polished
SS851-P	120 Per Ft.	\$1.63'
	600 Ft. +	\$1.48'

For any quantities less than 120 ft. add 10% to the 120 ft. price.

IMPORTANT: Due to Raw Material Fluctuation, Catalog Prices Below May Not Be Accurate. GO TO WWW.OUTWATER.COM FOR THE MOST UP-TO-DATE PRICES

Color Plastic Capping

Cut Program Available
Please Inquire

Lengths: 8 Ft.
Material: Styrene
Colors Available

*WH - White *BK - Black *BR - Brown *SIL - Silver
A = Available with Adhesive (1/2" Foam Tape)
unless otherwise noted

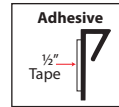

Fits 1/64"

12 Ft. Lengths
Material: PVC
Available only with
3/8" Film Tape

Part #	120 Ft.	600 Ft.	1000 Ft.
210A-*	\$0.34'	\$0.31'	\$0.25'

Fits 1/16"

Material:
Rigid PVC
3/8" Foam Tape

Part #	120 Ft.	600 Ft.	1000 Ft.
2384-*	\$0.28'	\$0.23'	\$0.19'
2384-*-A	\$0.38'	\$0.31'	\$0.28'

Fits 1/16"

Part #	120 Ft.	600 Ft.	1000 Ft.
616-*	\$0.37'	\$0.34'	\$0.22'
616-*-A	\$0.47'	\$0.41'	\$0.38'

Fits 1/8"

Material:
PVC
Silver

Part #	120 Ft.	600 Ft.	1000 Ft.
600-*	\$0.38'	\$0.24'	\$0.23'
600-*-A	\$0.47'	\$0.41'	\$0.38'
600-SIL	\$0.54'	\$0.47'	\$0.43'
600-SIL-A	\$0.71'	\$0.66'	\$0.60'

Fits 1/8"

Part #	120 Ft.	600 Ft.	1000 Ft.
P640-*	\$0.37'	\$0.34'	\$0.32'

Fits 1/8"

Part #	120 Ft.	600 Ft.	1000 Ft.
P630-*	\$0.37'	\$0.34'	\$0.32'

Fits 1/8"

Material:
ABS

Part #	120 Ft.	600 Ft.	1000 Ft.
1135-*	\$0.54'	\$0.48'	\$0.44'
1135-*-A	\$0.71'	\$0.61'	\$0.57'

Fits 3/16"

NEW

Part #	120 Ft.	600 Ft.	1000 Ft.
605-*	\$0.40'	\$0.27'	\$0.25'
605-*-A	\$0.51'	\$0.46'	\$0.41'

Fits 1/4"

Material:
PVC
Silver

Part #	120 Ft.	600 Ft.	1000 Ft.
650-*	\$0.40'	\$0.29'	\$0.27'
650-*-A	\$0.51'	\$0.48'	\$0.43'
650-SIL	\$0.59'	\$0.50'	\$0.47'
650-SIL-A	\$0.74'	\$0.70'	\$0.66'

Fits 1/4"

Material:
ABS

Part #	120 Ft.	600 Ft.	1000 Ft.
1032-*	\$0.55'	\$0.49'	\$0.46'

Fits 1/4"

Part #	120 Ft.	600 Ft.	1000 Ft.
P641-*	\$0.37'	\$0.34'	\$0.32'

Fits 1/4"

Part #	120 Ft.	600 Ft.	1000 Ft.
P631-*	\$0.37'	\$0.34'	\$0.32'

Fits 3/8"

NEW

Part #	120 Ft.	600 Ft.	1000 Ft.
654-*	\$0.45'	\$0.41'	\$0.36'

Fits 1/2"

Part #	120 Ft.	600 Ft.	1000 Ft.
2395-*	\$0.36'	\$0.29'	\$0.27'

Fits 1/2"

3/4" Foam Tape

Part #	120 Ft.	600 Ft.	1000 Ft.
652-*	\$0.47'	\$0.42'	\$0.38'
652-*-A	\$0.60'	\$0.55'	\$0.53'

Fits 5/8"

Part #	120 Ft.	600 Ft.	1000 Ft.
4068-*	\$0.51'	\$0.47'	\$0.43'

Fits 3/4"

Part #	120 Ft.	600 Ft.	1000 Ft.
4069-*	\$0.52'	\$0.48'	\$0.44'

For matching
Divider Moulding,
see page S-76

For any quantities less than 120 ft. add 10% to the 120 ft. price.

IMPORTANT: Due to Raw Material Fluctuation, Catalog Prices Below May Not Be Accurate. GO TO WWW.OUTWATER.COM FOR THE MOST UP-TO-DATE PRICES

Aluminum Capping



Finishes Available

Lengths: 12 Ft. • Material: Aluminum

- *M, MH (w/holes) - Mill - Dull Finish: As Extruded - May or May Not Have "Scratches"/Die Lines
- *S, SH (w/holes) - Satin/Clear Anodized - Dull Matte Finish
- *P, PH (w/holes) - Polished/Mechanical - Shiny/Mirror Finish
- *ORB, ORBH (w/holes) - Oil Rubbed Bronze Anodized Finish
- *BK, BKH (w/holes) - Black Powder Coated Finish
- *WH, WHH (w/holes) - Glossy White Powder Coated Finish
- Samples Are Available

Fits 1/16"

Part #	Length	Mill	Satin
ALU2013-*	120 Per Ft.	\$0.53'	\$0.74'
	600 Ft. +	\$0.49'	\$0.71'

Fits 5/32"

Part #	Length	Mill	Satin
ALU2000-*	120 Per Ft.	\$0.65'	\$0.88'
	600 Ft. +	\$0.63'	\$0.83'

Fits 1/8" to 5/32"

w/Punched Holes
Hole/slot pattern approx. every 4"

Part #	Length	Satin
ALU7441-S	120 Per Ft.	\$0.50'
	600 Ft. +	\$0.46'

Fits 1/8"

New!

Part #	Length	Mill	Satin
ALU4637-*	120 Per Ft.	\$1.00'	\$1.44'
	600 Ft. +	N/A	N/A

Fits 3/64"

Part #	Length	Satin
ALU0204-S	120 Per Ft.	\$0.63'
	600 Ft. +	\$0.58'

Fits 3/32"

Part #	Length	Satin
ALU0214-S	120 Per Ft.	\$1.04'
	600 Ft. +	\$0.95'

Fits 3/16"

New!

Part #	Length	Satin
ALU0316-S	120 Per Ft.	\$1.75'
	600 Ft. +	\$1.57'

Fits 1/4" to 9/32"

w/Punched Holes
Hole/slot pattern approx. every 4"

Part #	Length	Mill	Polished	Satin
ALU961-*	120 Per Ft.	\$1.05'	\$1.81'	\$1.21'
	600 Ft. +	\$0.96'	\$1.60'	\$1.11'

Fits 1/4" to 9/32"

w/Punched Holes
Hole/slot pattern approx. every 4"

Part #	Length	Mill	Polished	Satin	Black	Glossy White	Bronze
ALU851-*	120 Per Ft.	\$1.05'	\$1.72'	\$1.58'	\$2.24'	\$2.24'	\$1.52'
	600 Ft. +	\$0.96'	\$1.53'	\$1.434'	\$2.03'	\$2.03'	\$1.35'

Fits 1/16"

Part #	Length	Mill	Satin	Black	White
ALU2334-*	120 Per Ft.	\$0.54'	\$1.03'	\$1.38'	\$1.38'
	600 Ft. +	\$0.45'	\$0.95'	\$1.26'	\$1.26'

Fits 1/2"

Part #	Length	Mill	Polished	Satin	Black	Glossy White
ALU1851-*	120 Per Ft.	\$0.98'	Please	\$1.53'	\$1.88'	\$1.88'
	600 Ft. +	\$0.88'	Inquire	\$1.40'	\$1.71'	\$1.71'

Metallic Plastic Capping

Lengths: 12 Ft. • Material: ABS/Film

Finishes Available

- *POL/C - Polished Chrome
 - *POL/B - Polished Brass
 - *BRU/B - Brushed Brass
 - *B/C - Brite Chrome
- unless otherwise noted

Fits 5/32"

Part #	120 Ft.	600 Ft.	1000 Ft.
1976-POL/C	\$0.49'	\$0.42'	\$0.38'

Fits 5/32"

Part #	120 Ft.	600 Ft.	1000 Ft.
2469-*	\$0.48'	\$0.40'	\$0.36'

Fits 1/8"

8 Ft. Lengths
Material:
ABS/Foil

Part #	120 Ft.	600 Ft.	1000 Ft.
11340B/C	\$0.52'	\$0.43'	\$0.40'

For any quantities less than 120 ft. add 10% to the 120 ft. price.

Clear Plastic Capping

Lengths: 12 Ft.
A = Available with Adhesive (1/2" Clear Tape)
 unless otherwise noted

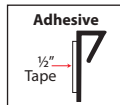

Fits 1/64"

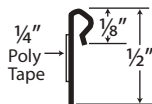

Material: PVC

Part #	120 Ft.	600 Ft.	1000 Ft.
12A-CL	\$0.42'	\$0.38'	\$0.36'

Fits 1/64"

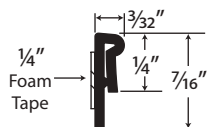

8 Ft. Lengths - Material: Styrolox

Part #	120 Ft.	600 Ft.	1000 Ft.
220-CL-A	\$0.57'	\$0.51'	\$0.47'

Fits 1/64"

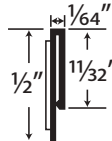

Material: PVC

Available only with 3/8" Film Tape

Part #	120 Ft.	600 Ft.	1000 Ft.
210-CL	\$0.26'	\$0.22'	\$0.21'
210A-CL	\$0.33'	\$0.26'	\$0.25'

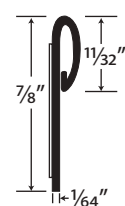

Material: Polyester

Part #	120 Ft.	600 Ft.	1000 Ft.
23-CL	\$0.53'	\$0.50'	\$0.44'
23A-CL	\$0.59'	\$0.54'	\$0.49'

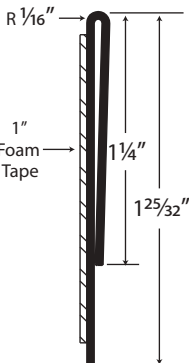

Fits 1/32"

8 Ft. Lengths - Material: Styrolox

Part #	120 Ft.	600 Ft.	1000 Ft.
55-5949	\$0.86'	\$0.840'	\$0.730'
55-5949A	\$0.97'	\$0.91'	\$0.82'

Fits 3/32"

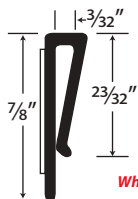

Material: Butyrate

White Foam Tape

Part #	120 Ft.	600 Ft.	1000 Ft.
847-CL	\$0.73'	\$0.71'	\$0.67'
847A-CL	\$0.91'	\$0.88'	\$0.85'

Fits 1/8"

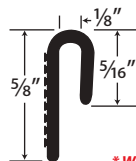

Material: Polyester

* White Foam Tape
 ** Clear Tape

Part #	120 Ft.	600 Ft.	1000 Ft.
846-CL	\$0.55'	\$0.48'	\$0.42'
*846A-CL	\$0.66'	\$0.56'	\$0.53'
**846-CL-CLA	\$0.62'	\$0.54'	\$0.50'

Fits 1/4"

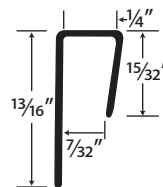

Material: Butyrate

Part #	120 Ft.	600 Ft.	1000 Ft.
2030-CL	\$0.87'	\$0.83'	\$0.76'
2030-CL-CLA	\$0.99'	\$0.90'	\$0.89'

Earring Card Holder

Fits 5/32"

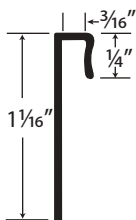

Material: Butyrate

Part #	120 Ft.	600 Ft.	1000 Ft.
2033-CL	Please Inquire		

Clear Plastic Divider

Lengths: 12 Ft. • Material: Butyrate

A = Available with Clear Adhesive

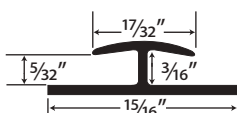

Part #	120 Ft.	600 Ft.	1000 Ft.
2028-CL	\$0.61'	\$0.57'	\$0.53'
2028-CL-CLA	\$0.70'	\$0.62'	\$0.59'

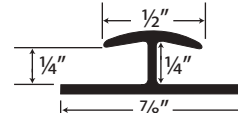
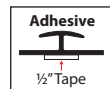

Part #	120 Ft.	600 Ft.	1000 Ft.
2029-CL	\$0.62'	\$0.58'	\$0.54'
2029-CL-CLA	\$0.71'	\$0.66'	\$0.65'

Clear Plastic Joiner Moulding

Lengths: 8 Ft. • Material: Butyrate • Fits 1/4" Material

Divider

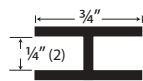

.050 Wall Thickness

Part #	120 Ft.	600 Ft.	1000 Ft.
P2658	\$0.99'	\$0.93'	\$0.83'

2-Way Corner

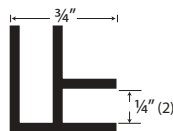

.050 Wall Thickness

Part #	120 Ft.	600 Ft.	1000 Ft.
P2718	\$1.06'	\$0.99'	\$0.90'

3-Way Corner

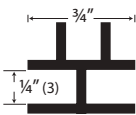

.050 Wall Thickness

Part #	120 Ft.	600 Ft.	1000 Ft.
P2719	\$1.12'	\$1.02'	\$0.95'

4-Way Channel

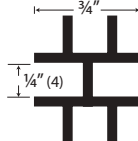

.060 Wall Thickness

Part #	120 Ft.	600 Ft.	1000 Ft.
P2720	\$1.31'	\$1.21'	\$1.11'

U-Channel

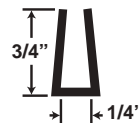

.060 Wall Thickness

Part #	120 Ft.	600 Ft.	1000 Ft.
P2743	\$0.78'	\$0.72'	\$0.68'

For any quantities less than 120 ft. add 10% to the 120 ft. price.

Free Standing & Wall Mount Sign Holders

MOST CAN BE USED IN HORIZONTAL AND VERTICAL APPLICATIONS

COUNTER TOP SIGN HOLDER



- Material: PVC
- Lengths: 12 in.
- Color: Available in Black ***(BK)**, White ***(WH)** & Silver ***(SI)**
- Holds material 1/16" - 1/8" thick
- 3.25"W x 12" L with dual durometer grip

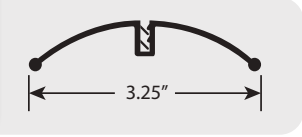

Part #	100 Pcs.	500 Pcs.	1000 Pcs.
SNH-325-12*	\$2.70 ea.	\$2.60 ea.	\$2.25 ea.

COUNTER TOP SIGN CHANNEL



- Material: PVC
- Lengths: 8 ft.
- Color: Available in Black ***(BK)**, White ***(WH)** & Silver ***(SI)**
- Holds material 1/16" - 1/8" thick
- 3.25"W x 8" L with dual durometer grip



Part #	120 Ft.	600 Ft.	1000 Ft.
SNH-325-*	\$2.63'	\$2.33'	\$2.24'

For quantities less than 120 ft. please add 10% to the 120 ft. price.

SPECIALTY SIGN HOLDER



- Material: Clear Butyrate
- Holds material up to 0.100" thick
- 1/2" H tension grip sign holder w/ 1-1/4" L x 1" deep curved mounting base to work w/shelving and showcases

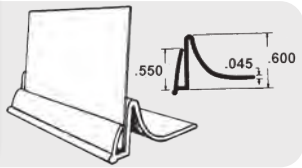

Part #	Length	100 Pcs.	500 Pcs.	1000 Pcs.
6201-01	1-1/4"	\$0.17 ea.	\$0.16 ea.	\$0.13 ea.

For quantities less than 100 pieces please inquire.

SIGN CHANNEL PVC/DUAL DUROMETER

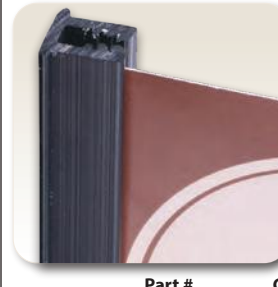

- Material: PVC
- Lengths: 8 ft.
- Holds material 1/8" thick
- Peel and stick foam back
- 1/2"W base x 7/16" H with dual durometer grip

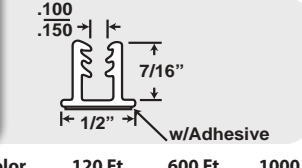

Part #	Color	120 Ft.	600 Ft.	1000 Ft.
106-4808-BK	Black	\$1.12'	\$1.08'	\$1.02'
106-4808-WH	White	\$1.12'	\$1.08'	\$1.02'

For quantities less than 120 ft. please add 10% to the 120 ft. price.

FREE STANDING CARD HOLDER WITHOUT ADHESIVE



- Material: Clear Butyrate
- Lengths: 12 ft.
- Fits material 1/16" & 1/8" thick
- 1-5/16"W base x 1/4"H

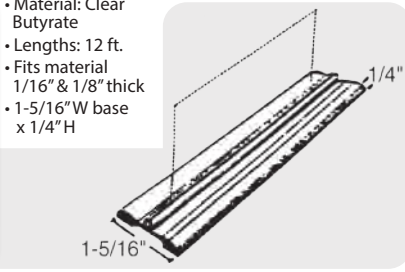

Part #	Fits Card	120 Ft.	600 Ft.	1000 Ft.
32-CL	1/16"	\$3.57'	\$3.21'	\$2.94'
33-CL	1/8"	\$3.57'	\$3.21'	\$2.94'

FREE STANDING CARD HOLDER



- Material: White Styrene
- Lengths: 12 ft.
- Fits material 1/8" and 1/16"-1/4" thick
- 1" or 2"W flat base x 1/2" or 1"H

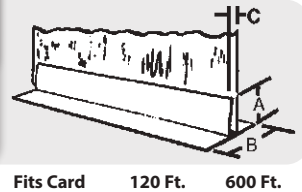

Part #	A	B	Fits Card	120 Ft.	600 Ft.	1000 Ft.
245M125-WH	1/2"	1"	1/8"	\$0.49'	\$0.47'	\$0.41'
24-WH	1"	2"	1/16"-1/4"	\$1.37'	\$1.20'	\$1.17'

For quantities less than 120 ft. please add 10% to the 120 ft. price.

CLEAR/PVC



- Material: Clear PVC
- Lengths: 12 ft.
- Holds material up to .060" thick
- 1-1/2"W base x 3/4" H

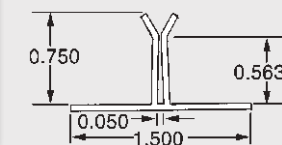

Part #	120 Ft.	600 Ft.	1000 Ft.
1255-CL	\$0.81'	\$0.74'	\$0.66'

IMPORTANT: Due to Raw Material Fluctuation, Catalog Prices Below May Not Be Accurate. GO TO WWW.OUTWATER.COM FOR THE MOST UP-TO-DATE PRICES

SEGDesigns™: Modular SEG Frames

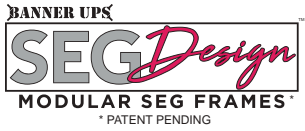

SEG Made Simple...and Beautiful!

Stock Color: Silver Aluminum

Material: ABS

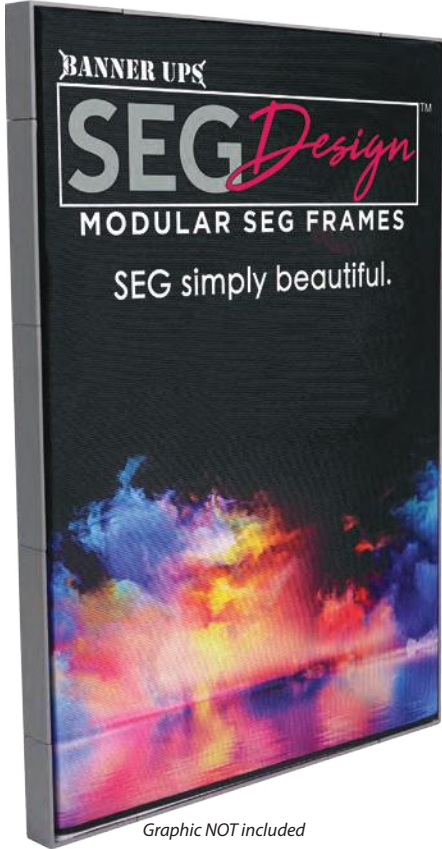

Modular system - fast and easy to assemble

- No assembly tools needed. Snaps together instantly.
- Can be pressure fit, screw-secured, or glued.
- Corner pieces and T-Connectors make unlimited size and shapes easy.
- No mitered corners / all straight cut sides.
- Cut with any hand or power saw. Custom sizes a breeze!



Slide rails into corner brackets



Simply snap together corners

Superior to Aluminum

- Lower total cost than aluminum.
100% MADE IN THE USA (PAT. pending)
- Lighter weight than aluminum - easier to ship and hang.
- Breaks down to shippable sizes - NO UPS/FedEx surcharge.
- No hidden hardware or cutting charges.



Unlimited length with T-Connectors

Environmentally-friendly polymer

- ABS, Non-PVC recyclable polymer

Enhances the value of complementary products:

- Ask us for a list of approved recommend textile media.
- Works with all Latex, Dye Sub, and Eco-Solvent printers.



Cleat for hanging frame on wall

Add DESIGN to your SEG frames - wrapable, paintable, designable!

- Add color easily with common spray paint (Krylon Fusion 28 colors*)
- Match customers logo or image color!
- Let your creativity flow! "Upsell" through beautiful design.

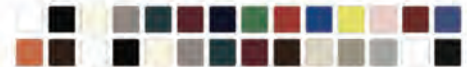

Krylon is a registered trademark of Sherwin-Williams*



Works great with KederTape™ - a complete simple solution

- Enter the SEG market NOW, with no equipment cost.

NO SEWING NEEDED!

IMPORTANT: Due to Raw Material Fluctuation, Catalog Prices Below May Not Be Accurate. GO TO WWW.OUTWATER.COM FOR THE MOST UP-TO-DATE PRICES

SEGDesigns™: Modular SEG Frames

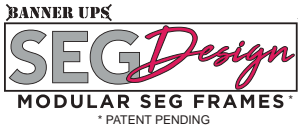

SEG Made Simple...and Beautiful!



Stock Color: Silver Aluminum
Material: ABS

- Fast & easy to assemble, no mitering!
- Paintable, wrappable...designable!
- Lightweight, easy to ship!
- No aluminum, no tools, no hassle!



Buy SEG Modular Frames In Bulk!

Part #	Description	# Of Pieces Per Case	Price Per Case	
			1-3 Cases	4+ Cases
BU-SEGD15-1824	15mm frame, 18" x 24" O.A.	5	\$150.00 (\$30.00 ea.)	\$130.00 (\$26.00 ea.)
BU-SEGD15-2436	15mm frame, 24" x 36" O.A.	5	\$190.00 (\$38.00 ea.)	\$165.00 (\$33.00 ea.)
BU-SEGD15-3648	15mm frame, 36" x 48" O.A.	5	\$240.00 (\$48.00 ea.)	\$210.00 (\$42.00 ea.)

Create Any Size Frame You Want!

Buy SEG Components Separately in Bulk and Cut Size as Needed!

Part #	Description	# Of Pieces Per Case	Price Per Case	
			1-3 Cases	4+ Cases
BU-SEGD15-R15	15mm side rail, 15"	48	\$158.40 (\$3.30 ea.)	\$136.80 (\$2.85 ea.)
BU-SEGD15-R21	15mm side rail, 21"	48	\$220.80 (\$4.60 ea.)	\$189.60 (\$3.95 ea.)
BU-SEGD15-R33	15mm side rail, 33"	48	\$348.00 (\$7.25 ea.)	\$297.60 (\$6.20 ea.)
BU-SEGD15-R45	15mm side rail, 45"	48	\$472.80 (\$9.85 ea.)	\$405.60 (\$8.45 ea.)
BU-SEGD15-R93	15mm side rail, 93"	48	\$960.00 (\$20.00 ea.)	\$816.00 (\$17.00 ea.)
BU-SEGD15-CORNER	15mm 90° corner	48	\$64.80 (\$1.35 ea.)	\$57.60 (\$1.20 ea.)
BU-SEGD15-TCON	15mm t-connector	48	\$72.00 (\$1.50 ea.)	\$62.40 (\$1.35 ea.)
BU-SEGD15-CLEAT	15mm wall cleat	48	\$24.00 (\$0.50 ea.)	\$19.20 (\$0.40 ea.)

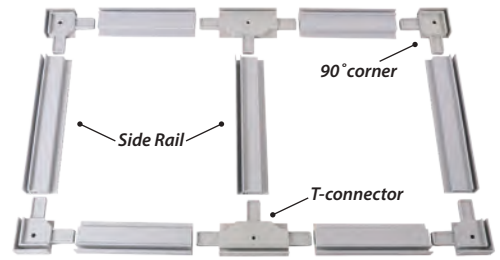

• Use T-Connector to connect rails for unlimited lengths & provide cross support

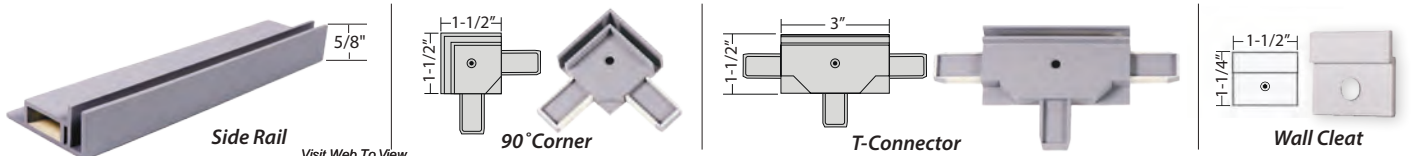

When ordering, take overall frame size and subtract 3" from each rail. (ie) 18" - 3" = 15" rail, 24" - 3" = 21" rail. The 90° corners add 3" to meet overall frame dimension of 18" x 24".



Make Silicone Edge Graphic (SEG) Signs without sewing by using KederTape™!



KederTape™ is a high-quality keder that is laminated with a premium pressure sensitive adhesive which allows the product to be "peel and stick" applied to textiles for SEG (Silicone Edge Graphic) applications. KederTape™ adhesive has been engineered to aggressively adhesive to textiles.



- 3mm thick x 14mm wide, 80 ft. spool
- Peel and Stick

NO SEWING NEEDED!

Part #	1-3 Spools	4+ Spools
BU-KTAPE143-80AS	\$64.00 ea.	\$56.00 ea.



TRY A SEGDESIGN STARTER KIT

INTRO SPECIAL \$109.95 KIT

BU-STARTKTSEG-1AS

Starter Kit includes:

- (1) 18" x 24" 15mm Frame
- (1) 24" x 36" 15mm Frame
- (1) 8" x 10" Sample Display Frame
- (1) 80 ft. Spool Keder™ Tape
- (6) Wall Cleats

IMPORTANT: Due to Raw Material Fluctuation, Catalog Prices Below May Not Be Accurate. GO TO WWW.OUTWATER.COM FOR THE MOST UP-TO-DATE PRICES

Banner Ups®: Banner Tabs & Tape



- 1.875" x 3.875" clear tab, folds to 1.875" square shape
- Works great both at corners and along banner edges
- BravoTabs® are a great grommets/eyelet replacement
- Faster to install translates to lower cost
- No neck loop for improved appearance
- Crystal clear banner tab, allowing your color graphics to shine through



Crystal Clear BravoTabs® A Stronger Grommet / Eyelet!

New!



One Size Fits All - Corner and Edges



BravoTab® Corner Mount

BravoTab® Edge Mount



4 clear tabs per sheet

Part #	# Of Pieces		Price	
	Per Case	1-3 Cases	4+ Cases	
BU-BAN017	500	\$195.00 (\$0.39 ea.)	\$165.00 (\$0.33 ea.)	



- 1.5" x 3.125" clear tab, folds to 1.5" square shape
- Perfect for hanging posters & indoor banners
- Apply to corners of plastic film and then secure using a rope or stake through the center hole
- 2000 Tabs per dispenser roll; roll liner is perforated every four tabs
- Our most economical tab

Clear Polytabs for high volume jobs

New!



Part #	# Of Pieces		Price	
	Per Case	1-3 Cases	4+ Cases	
BU-BAN062	2000	\$330.00 (\$0.165 ea.)	\$270.00 (\$0.135 ea.)	

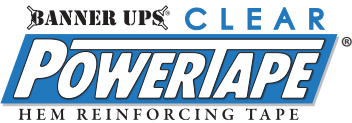

- 1.5" wide, 36 yard clear roll
- Use PowerTape® to create a super strong banner of any length
- Single-sided super strong film. No need to fold hem
- Duplicates the strength of folded hem and double sided banner tape, but eliminates the hassle!
- Eliminate the risk of damage to image by post-print sewing
- Create a perfectly sharp digital banner. No rippled hem
- Fabricate a mighty banner in only 3 minutes

Clear PowerTape® Reinforce banner edges without folding or sewing a hem

New!



Part #	# Of Rolls		Price	
	Per Case	1-3 Cases	4+ Cases	
BU-PTAPECLEAR	5	\$120.00 (\$24.00 ea.)	\$95.00 (\$19.00 ea.)	

TRY A BANNER UPS® STARTER KIT

Enough for about 20 banners, The Starter Kit will let you give Banner Ups® a good trial and find out why so many banner makers LOVE Banner Ups® when it comes to custom banner finishing products!

100 Banner Ups® Crystal Clear BravoTabs®

Square shape works great on banner edge or corners. Durable for outdoor use. Use with PowerTape for banners over 6 ft.

1 roll of Banner Ups® Clear PowerTape®

Super-strong single sided hem tape. No folding of hem required! Perfect for double-sided banners.

1 Banner Ups® PowerPunch®

Perfectly sized heavy duty hole punch. Tough enough to cleanly punch tab, tape, and media. Great for punching 4mm corrugated plastic or foam board too!

INTRO SPECIAL
\$89.95
kit

BU-STARTKT4AS



Ultra High Strength Double Sided Clear MegaTape®
Banner hem tape that withstood
winds up to 108 MPH!



- 1.5" wide, 30 yard double sided clear roll
- Double sided banner hem reinforcing tape that is made of a super strong film
- Wind tunnel tested - improved MegaTape® banner hem tape withstood winds up to 108 MPH!
- Clear film is less visible / more attractive when used in mesh banners
- Produces a fold-finished banner edge
- Easy to apply banner hem tape. Wears like steel!
- Much cleaner appearance and twice as strong as ordinary double sided banner hem tape.



Part #	# Of Rolls Per Case	Price	
		1-3 Cases	4+ Cases
BU-MEGATAPE-CL	5	\$195.00 (\$29.50 ea.)	\$130.00 (\$26.00 ea.)



Premium Double Sided Clear TigerTape™
High-performance banner hem tape



- 1" wide, 36 yard length double sided roll
- Double coated polyester (PET) carrier film (.005") on both sides with high deposition of a high tack acrylic pressure sensitive adhesive (PSA)
- A high performance banner hem tape specifically designed for the most demanding bonding applications
- Provides a permanent bond of foams, plastics, metal and composite materials subjected to a broad range of environmental conditions
- Highly UV, temperature and plasticizer resistant making it ideal for banner hemming applications

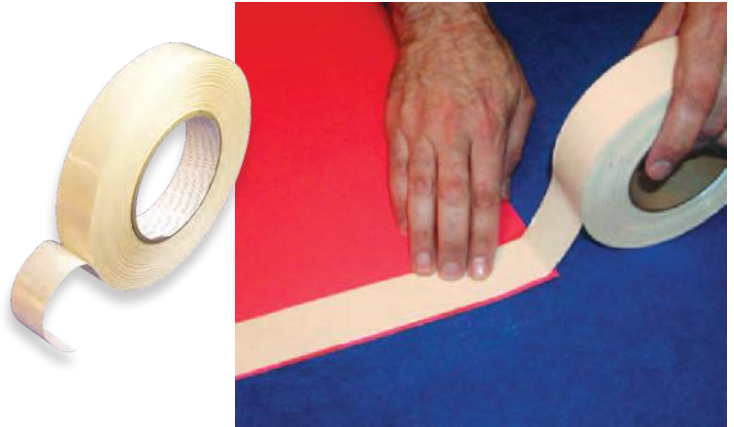

Part #	# Of Rolls Per Case	Price	
		1-3 Cases	4+ Cases
BU-TIGTAPE1036	12	\$141.00 (\$11.75 ea.)	\$120.00 (\$10.00 ea.)



PowerPunch® -
The perfect punch for Powertabs®



- Powerful and durable, lightweight to handle
- Portable and much less expensive
- Cut cleanly through tabs, PowerTape® and banner media
- Cuts a 5/16" banner hole
- Easily punch holes in 4mm corrugated plastic and foamboard without deforming the board

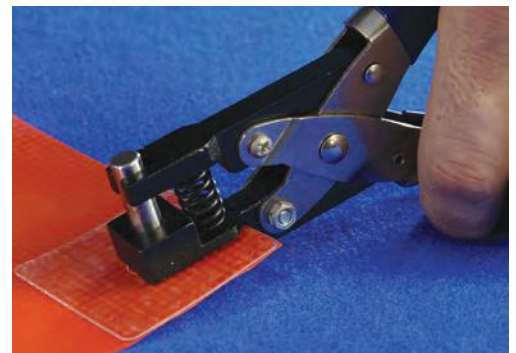

Part #	Price	
	1-3 Pcs.	4+ Pcs.
BU-PPUNCH	\$44.00 ea.	\$38.00 ea.

**IMPORTANT: Due to Raw Material Fluctuation, Catalog Prices Below May Not Be Accurate.
GO TO WWW.OUTWATER.COM FOR THE MOST UP-TO-DATE PRICES**



The System
with profile
since 1965

Introducing...
**Fabric Flex
Framing
System**

For Silicone Edge
Graphics (SEG)

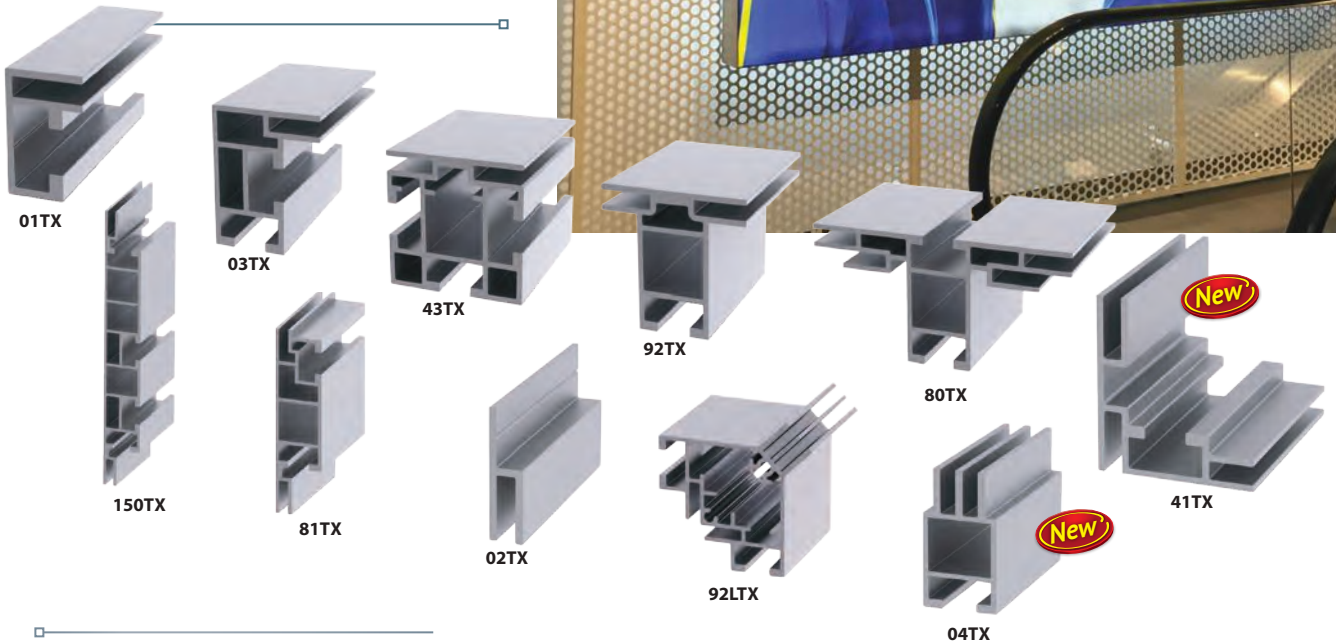

Your Fabric...
Our Framing System!

11 Aluminum Profile Options for
Single, Double Sided Signage with or without LED Illuminations & Cube Application

2 OPTIONS TO CHOOSE FROM!

Buy Components In Bulk or Mitered Frames Shipped Knock Down
Please Inquire

IMPORTANT: Due to Raw Material Fluctuation, Catalog Prices Below May Not Be Accurate. GO TO WWW.OUTWATER.COM FOR THE MOST UP-TO-DATE PRICES

Foga® Systems



The System with profile since 1965



FRAME OPTIONS	Profile Width	MOUNTING OPTIONS						LIGHTING OPTIONS	
		Single	Double	FOGA® Exhibition	Free Standing Bases	Wall	Hanging	Illuminated	Non-Illuminated
 FSB01TX-CL	15.5mm (.61")	✓	×	×	×	✓	×	×	✓
 FSB03TX-CL	30mm (1.18")	✓	×	×	×	✓	×	×	✓
 FSB41TX-CL New!	40mm (1.58")	✓	×	×	×	✓	✓	✓	✓
 FSB43TX-CL	40mm (1.58")	✓	✓	✓ <i>For use with 194 Series</i>	✓	×	✓	×	✓
 FSB92TX-CL	40mm (1.58")	✓	✓	✓ <i>For use with 194 Series</i>	✓	✓	✓	×	✓
 FSB80TX-CL	80mm (3.15")	×	✓	✓ <i>For use with 80S</i>	✓	×	✓	×	✓
 FSB81TX-CL	80mm (3.15")	✓	×	✓ <i>For use with 80S</i>	✓	✓	✓	✓	✓
 FSB150TX-CL	150mm (5.91")	✓	✓	×	✓	✓	✓	✓	✓
 FSB02TX-CL	n/a	✓	✓	×	×	×	×	✓	✓
<i>For use with wood frames</i>									
 FSB04TX-CL New!	n/a	Cube		✓	×	×	✓	✓	✓
 FSB92LTX-CL	n/a	Cube		✓	×	×	✓	✓	✓
<i>For 4-sided cubes & exhibition. Design assistance required</i>									

IMPORTANT: Due to Raw Material Fluctuation, Catalog Prices Below May Not Be Accurate. GO TO WWW.OUTWATER.COM FOR THE MOST UP-TO-DATE PRICES

Foga® Systems



The System with profile since 1965

SEG Profiles

All Dimension Are In Millimeters

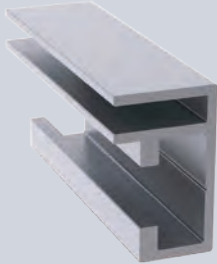

FSB01TX-CL

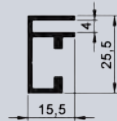

Part #	Finish	Length	Graphic Sides	Corner	Mounting Options	Price
FSB01TX-CL	Clear Anodized Aluminum	16 Ft.	Non-Illuminated Single	FS613	Wall only Screw to the wall	\$1.79 Ft.

CONVERSION CHART

MM	4	15.5	25.5
FRACTION	5/32"	39/64"	1"
DECIMAL	.16"	.61"	1"

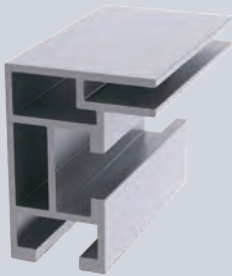

FSB03TX-CL

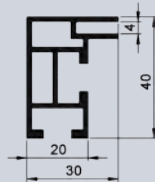

Part #	Finish	Length	Graphic Sides	Corner	Mounting Options	Price
FSB03TX-CL	Clear Anodized Aluminum	16 Ft.	Non-Illuminated Single	FS613	FS520 Wall Mount Bracket	\$3.39 Ft.

CONVERSION CHART

MM	4	20	30	40
FRACTION	5/32"	25/32"	1-3/16"	1-37/64"
DECIMAL	.16"	.79"	1.18"	1.58"



FSB41TX-CL

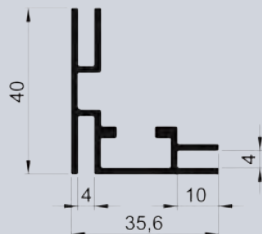

Part #	Finish	Length	Graphic Sides	Corner	Mounting Options	Price
FSB41TX-CL	Clear Anodized Aluminum	16 Ft.	Single Illuminated, Double Non-Illuminated	FS613	Freestanding, Wall or Hanging	\$3.62 Ft.

CONVERSION CHART

MM	10	35.6	40
FRACTION	25/64"	1-13/32"	1-37/64"
DECIMAL	.394"	1.402"	1.58"

IMPORTANT: Due to Raw Material Fluctuation, Catalog Prices Below May Not Be Accurate. GO TO WWW.OUTWATER.COM FOR THE MOST UP-TO-DATE PRICES

Foga® Systems



The System with profile since 1965

SEG Profiles

All Dimension Are In Millimeters



FSB43TX-CL

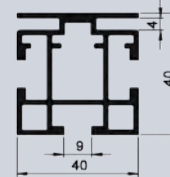

CONVERSION CHART

MM	4	9	40
FRACTION	5/32"	23/64"	1-37/64"
DECIMAL	.16"	.35"	1.58"

Part #	Finish	Length	Graphic Sides	Corner	Mounting Options	Price
FSB43TX-CL	Clear Anodized Aluminum	16 Ft.	Non-Illuminated Single or Double	FS613	Floor, Hanging & Foga 194 Series	\$8.28 Ft.



FSB92TX-CL

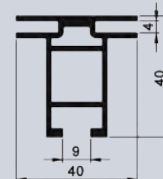

CONVERSION CHART

MM	4	9	40
FRACTION	5/32"	23/64"	1-37/64"
DECIMAL	.16"	.35"	1.58"

Part #	Finish	Length	Graphic Sides	Corner	Mounting Options	Price
FSB92TX-CL	Clear Anodized Aluminum	16 Ft.	Non-Illuminated Double	FS614	Freestanding, Wall or Hanging	\$3.57 Ft.



FSB80TX-CL

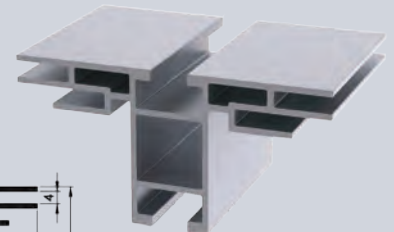
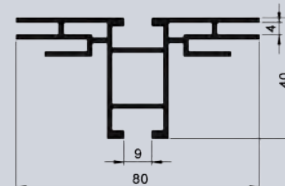

CONVERSION CHART

MM	4	9	40	80
FRACTION	5/32"	23/64"	1-37/64"	3-5/32"
DECIMAL	.16"	.35"	1.58"	3.15"

Part #	Finish	Length	Graphic Sides	Corner	Mounting Options	Price
FSB80TX-CL	Clear Anodized Aluminum	16 Ft.	Non-Illuminated Double	FS614	Freestanding or Hanging	\$7.99 Ft.

IMPORTANT: Due to Raw Material Fluctuation, Catalog Prices Below May Not Be Accurate. GO TO WWW.OUTWATER.COM FOR THE MOST UP-TO-DATE PRICES

Foga® Systems



The System with profile since 1965

SEG Profiles

FSB81TX-CL

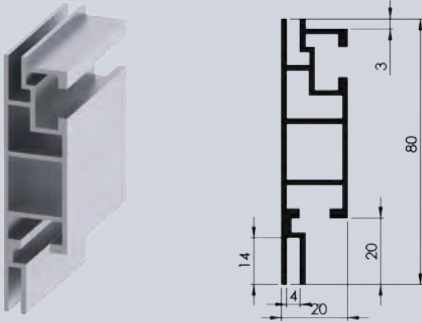

All Dimension Are In Millimeters

Part #	Finish	Length	Graphic Sides	Corner	Mounting Options	Price
FSB81TX-CL	Clear Anodized Aluminum	16 Ft.	Single Illuminated, Double Non-Illuminated	FS613	Freestanding, Wall or Hanging	\$4.89 Ft.

CONVERSION CHART

MM	3	4	14	20	80
FRACTION	15/128"	5/32"	35/64"	25/32"	3-5/32"
DECIMAL	0.1181"	.16"	.55"	.79"	3.15"

FSB150TX-CL

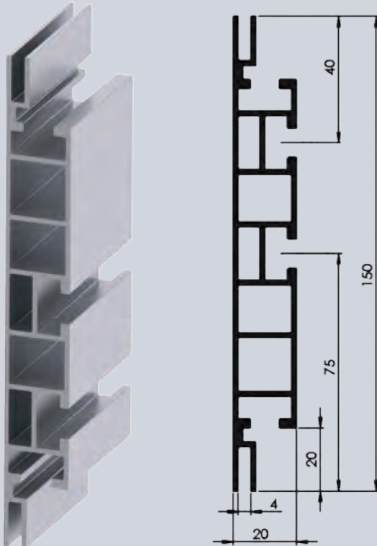

Part #	Finish	Length	Graphic Sides	Corner	Mounting Options	Price
FSB150TX-CL	Clear Anodized Aluminum	16 Ft.	Single Illuminated, Double Non-Illuminated	FS613	Freestanding, Wall or Hanging	\$7.99 Ft.

CONVERSION CHART

MM	4	20	40	75	80	150
FRACTION	5/32"	25/32"	1-37/64"	2-61/64"	3-5/32"	5-29/32"
DECIMAL	.16"	.79"	1.58"	2.95"	3.15"	5.91"

IMPORTANT: Due to Raw Material Fluctuation, Catalog Prices Below May Not Be Accurate. GO TO WWW.OUTWATER.COM FOR THE MOST UP-TO-DATE PRICES

Foga® Systems



The System with profile since 1965

SEG Profiles

All Dimension Are In Millimeters



Profile attaches to inner walls on all 4 sides



FSB02TX-CL For Wood Frame Applications

CONVERSION CHART					
MM	3	4	12	14	28
FRACTION	15/128"	5/32"	15/32"	35/64"	1-7/64"
DECIMAL	.1181	.16"	.472"	.55"	1.10"

Part #	Finish	Length	Graphic Sides	Corner	Mounting Options	Price
FSB02TX-CL	Clear Anodized Aluminum	16 Ft.	Single or Double	Miter To Mount Inside Frame	Mounts Inside Your Own Frame	\$1.27 Ft.

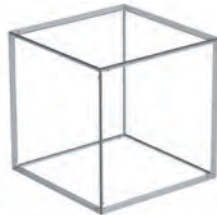

FSB04TX-CL

New!

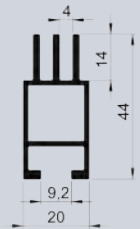
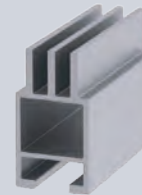

CONVERSION CHART					
MM	4	9.2	14	20	44
FRACTION	5/32"	23/64"	35/64"	25/32"	1-47/64"
DECIMAL	.16"	.362"	.55"	.79"	1.732"

Part #	Finish	Length	Graphic Sides	Mounting Options	Price
FSB04TX-CL	Clear Anodized Aluminum	16 Ft.	For Cubes	Hanging Options - Please Call To Discuss	\$5.69 Ft.

Required Accessories

Part #	Description	Price
FSB04TX-JOINT	3-Way Corner Joint, 1 Per Corner Required	\$6.50 Ft.



FSB80TX-CL

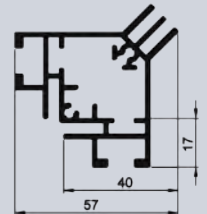
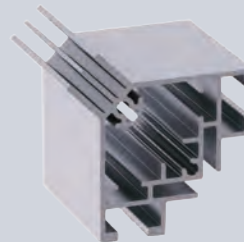

Part #	Finish	Length	Graphic Sides	Mounting Options	Price
FSB80TX-CL	Clear Anodized Aluminum	16 Ft.	For Cubes	Hanging Options - Please Call To Discuss	\$9.95 Ft.

Required Accessories

Part #	Description	Price
FS614	Corner Coupling, 3 Per Corner Required	\$4.29 Ea.
FST92LTX	Steel End Cap	\$15.50 Ea.

CONVERSION CHART				
MM	17	40	57	
FRACTION	11/16"	1-37/64"	2-1/4"	
DECIMAL	.67"	1.58"	2.25"	

**IMPORTANT: Due to Raw Material Fluctuation, Catalog Prices Below May Not Be Accurate.
GO TO WWW.OUTWATER.COM FOR THE MOST UP-TO-DATE PRICES**

Foga® Systems



The System
with profile
since 1965

Accessories

CORNERS

FS613



Works With:
FSB01TX, FSB03TX,
FSB41TX, FSB81TX,
FSB150TX (2 per corner required),
FSB43TX
\$3.63 ea.

FS614



Works With:
FSB92TX, FSB80TX, FSB92TX
\$4.29 ea.

WALL BRACKET

FS520



Works With:
FSB03TX, FSB41TX, FSB81TX,
FSB92TX, FSB80TX, FSB150TX
\$3.08 ea.

SUPPORT BEAM KITS

FS01CL-KIT-*



Consists of:
(1) FS01CL & (2) FS600QF

8 Ft. or 16 Ft. Lengths
Consists of:
(1) FS01CL & (2) FS600QF
Works With:
FSB01TX
Please Inquire for Pricing

FS90CL-KIT-



Consists of:
(1) FS90CL, (1) FS600QFL & (1) FS600QFR

8 Ft. or 16 Ft. Lengths
Works With:
FSB92TX, FSB81TX, FSB150TX,
FSB03TX, FSB80TX, FSB43TX
Please Inquire for Pricing

SPLICE CONNECTOR

FS609QF

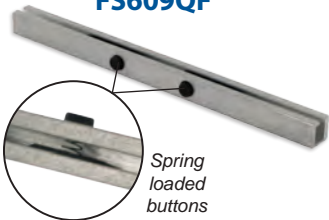

Works With:
FSB81TX,
FSB150TX

BASES

FSB-2200B



Nominal
17-3/4" x 3-3/4" x 3/16"
Thick Rectangle
\$26.82 ea.
*Ideal for Signage Under
8' High, Use Every 3'*

FSB-740B

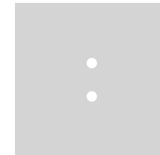

Nominal
16" x 16" x 3/16"
Thick Square
\$55.00 ea.
*Ideal for Signage Over
8' High, Use Every 3'*

LOCKING HOOKS WITH CABLE

FWH-8-PC (8 Ft. Length) FWH-15-PC (15 Ft. Length)

8 Ft. or 15 Ft. Lengths
Works With:
FSB73TX, FSB92TX, FSB80TX, FSB81TX,
FSB150TX, FSB04TX, FSB41TX
\$7.15 ea. (8 Ft. Length)
\$7.95 ea. (15 Ft. Length)

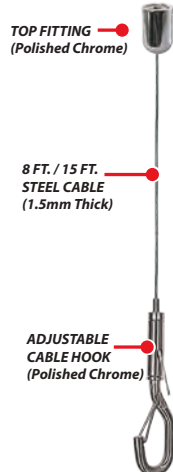

TOP FITTING
(Polished Chrome)

8 FT. / 15 FT.
STEEL CABLE
(1.5mm Thick)

ADJUSTABLE
CABLE HOOK
(Polished Chrome)

GSH-8 (8 Ft. Length) GSH-15 (15 Ft. Length)

8 Ft. or 15 Ft. Lengths
Works With:
FSB73TX, FSB92TX, FSB80TX, FSB81TX,
FSB150TX, FSB04TX, FSB41TX
\$3.10 ea. (8 Ft. Length)
\$3.85 ea. (15 Ft. Length)

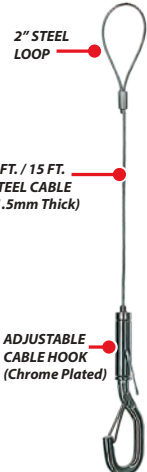

2" STEEL
LOOP

8 FT. / 15 FT.
STEEL CABLE
(1.5mm Thick)

ADJUSTABLE
CABLE HOOK
(Chrome Plated)

IMPORTANT: Due to Raw Material Fluctuation, Catalog Prices Below May Not Be Accurate. GO TO WWW.OUTWATER.COM FOR THE MOST UP-TO-DATE PRICES

Foga® Systems



The System with profile since 1965



24V Super Bright Light Output **UL** US **FAB LED STRIP**

2 Powerful LED Options
Illuminates SEG Graphics Evenly Without Hot Spots

- Designed to fit inside the frame of FSB81TX and FSB150TX-CL.
- Comes complete with finger lift hi-tack acrylic permanent tape.

To ensure even illumination, the Fab LED Strip should be spaced no more than 2" apart.
Strip Distance: 2"

• The overall width of your frame should not exceed 96", but the brightness level is greatest at 50" or less.
• Do not exceed running more lights than suggested because of voltage drop. However, if you "split" the load using a 2-way connector then you can have more lights on each side. The 2-way connector requires 2 power linking cables (LED-FBF-PWL*) that work with these lights.

Specially designed lens spreads light evenly, creating no hot spots or shadows

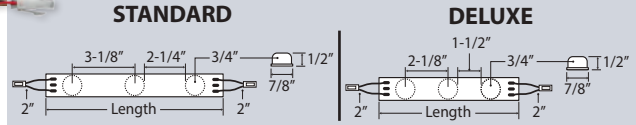

Lighting Specifications

Color Temperature	CW: 6000K-7000K
Beam Spread	40°
Initial Lumens	LED-FBF83-CW: 550-650 per ft. LED-FBF14-CW: 1000-1100 per ft. LED-FBF7-DLX-CW: 550-650 per ft. LED-FBF84-DLX-CW: 700-800 per ft. LED-FBF18-DLX-CW: 2000-2100 per ft.
Color Rendering Index	75+
Rated Average Life	30,000 hrs.
Constant	Voltage
Chip Size	SMD3535
Warranty	3 Years Limited

Part #	Length	Color Temp	# Of LED Modules	Total Wattage	Max # Can Connect	Price	20+ Pcs.
STANDARD BRIGHTNESS							
LED-FBF83-CW	8"	Cool White	3	7	10	\$12.50 ea.	\$11.25 ea.
LED-FBF14-CW	14"	Cool White	5	10	7	\$19.14 ea.	\$17.23 ea.
DELUXE BRIGHTNESS							
LED-FBF7-DLX-CW	6-1/8"	Cool White	3	7	8	\$12.88 ea.	\$11.59 ea.
LED-FBF84-DLX-CW	8"	Cool White	4	8	10	\$14.50 ea.	\$13.05 ea.
LED-FBF18-DLX-CW	18-1/2"	Cool White	9	20	4	\$35.00 ea.	\$31.50 ea.

Accessories

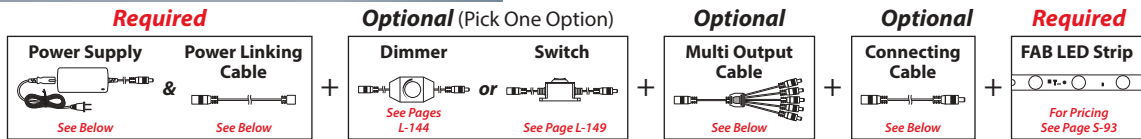

Required

Power Supplies

NEW LED-24V-2.5A-HWSL Is So Slim It Can Now Be Concealed Inside The SEG Frame

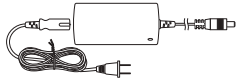

Part #	Type	Amps	Volts	Watts	Dimensions	Price	
						Each	6+ Pcs.
LED-24V-2.5A-HWSL	Hardwire	2.5A	24V	60W	11.8" L x 1.25" W x 0.78" H	\$45.36	\$40.50 ea.
LED-24V-3A	Desktop	3A	24V	72W	4.68" L x 2.34" W x 1.48" H	\$28.75	\$26.05 ea.
LED-24V-4A	Desktop	4A	24V	96W	6.77" L x 2.83" W x 1.57" H	\$44.05	\$39.90 ea.
LED-24V-6A	Desktop	6A	24V	144W	6.77" L x 2.83" W x 1.57" H	\$52.15	\$47.40 ea.

For Product Details & More Power Options, See Pages L-137~140
Other Options: Plug In | Hardwire | Hardwire Dimmable | Rechargeable Battery

Power Linking Cable

Required for power supplies, dimmers & multi output cables.



Part #	Works With	Description	Overall Length	Finish	Price	
					Each	6+ Pcs.
LED-FBF-PWL18	FAB LED Strip	Power Link Cable	18"	Black	\$3.10	\$2.90 ea.
LED-FBF-PWL40	FAB LED Strip		40"	Black	\$4.55	\$4.30 ea.

Optional

Multi Output Cables

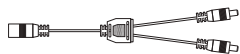

Part #	Description	Finish	Arms Size	# of Arms	Overall Length	Max # of Power Linking Cables	Price	
							Each	6+ Pcs.
LED-2WAY-BK	2-Way Sweep	Black	3"	2	6-3/4"	2	\$2.95	\$2.50 ea.

Power Linking Cable Required For Each Outlet

Connecting Cables

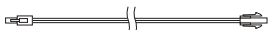

Part #	Works With	Description	Finish	Length	Price	
					Each	6+ Pcs.
LED-FBF-CC-12	FAB LED Strip	Allows the designer to get around unlit areas without multiple power supplies	Black & Red	12"	\$1.65	\$1.49 ea.
LED-FBF-CC-18	FAB LED Strip		Black & Red	18"	\$2.75	\$2.48 ea.
LED-FBF-CC-40	FAB LED Strip		Black & Red	40"	\$4.50	\$3.95 ea.

Wire Bushing

NEW



Part #	Color	Dimensions			Price	
		Height	Width	Max. Panel Thickness	100 Pcs.	1000 Pcs.
FSB-WB	Black	.500"	.465"	.156"	\$5.80/C	\$52.00/M

IMPORTANT: Due to Raw Material Fluctuation, Catalog Prices Below May Not Be Accurate. GO TO WWW.OUTWATER.COM FOR THE MOST UP-TO-DATE PRICES

Foga® Systems



LED Ladder Backlight System

Available Lengths: Nominal 20" & 40"

Material: Aluminum with White Coating

- Ultra Bright: Latest 2835 chip technology produces up to 1440 lumens per length.
- Works with FSB41TX-CL, FSB81TX-CL & FSB150TX-CL. *See Pages S-88 & S-90*
- Backlight as little as 1-1/2" depth without hotspots
- Easily connect ladders together for versatile sizing
- No heat sink required

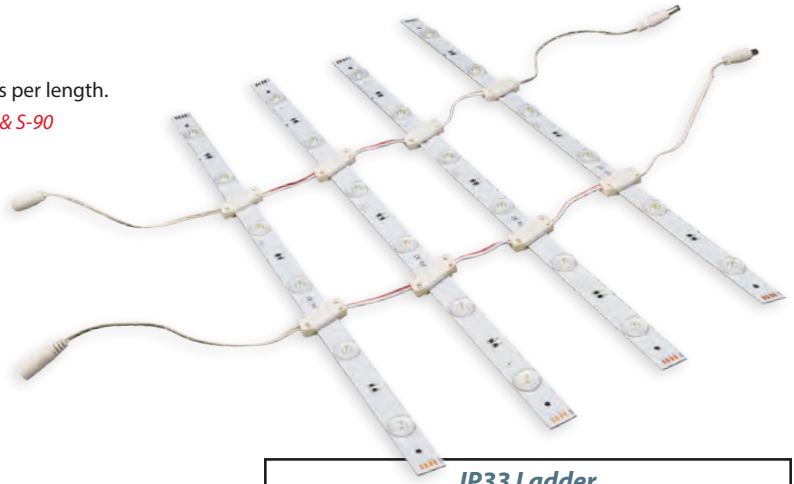

IP33 Ladder
Limited Protection From Touch, Tools & Splashing Water



Ask About Our Sample SEG Framing Kit



Part #: **FOGA-DES-KIT**

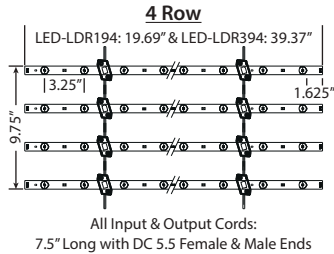
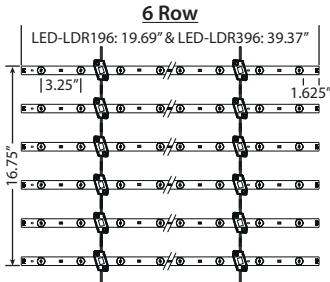

Part #	Color Temp	Description	# Of LED Chips	Total Wattage	Max # Can Connect	Each	Price 10+ Pcs.
LED-LDR194-CW	Cool White	4- Row 19.69" Length	24	29	5	\$15.90	\$12.75 ea.
LED-LDR196-CW	Cool White	6- Row 19.69" Length	36	43	3	\$23.75	\$18.90 ea.
LED-LDR394-CW	Cool White	4- Row 39.37" Length	48	58	2.5	\$26.00	\$20.75 ea.
LED-LDR396-CW	Cool White	6- Row 39.37" Length	72	86	1.5	\$39.00	\$31.25 ea.

Lighting Specifications

Color Temperature	CW: 6500K
Beam Spread	168°
Lumens	436 per ft.
Color Rendering Index	85+
Rated Average Life	50,000 hrs.
Constant	Voltage
Chip Size	2835

Required

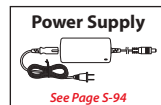

Optional (Pick One Option)

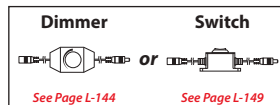

Required



Required

Power Supplies (IP20)

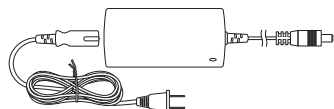

Part #	Type	Amps	Volts	Watts	Dimensions	Each	Price 6+ Pcs.
LED-12V-6A	Desktop	6A	12V	72W	4.68"L x 2.34"W x 1.48"H	\$27.85	\$25.35 ea.
LED-12V-9A	Desktop	9A	12V	108W	6.77"L x 2.83"W x 1.57"H	\$44.05	\$40.35 ea.

For Product Details & More Power Options, See Pages L-137~140
Other Options: Plug In | Hardwire | Hardwire Dimmable | Rechargeable Battery

IMPORTANT: Due to Raw Material Fluctuation, Catalog Prices Below May Not Be Accurate. GO TO WWW.OUTWATER.COM FOR THE MOST UP-TO-DATE PRICES

Aluminum Framing System



Let Our Simple Concept Form Your Great Idea!

Our Aluminum Framing System is Available in 3/4", 1" & 1-1/2" Square Tubing and corresponding Tubing Connectors & Accessories



Great For:

- ★ **Tradeshows**
- ★ **Greenhouses**
- ★ **Menus**
- ★ **Signs**

IDEAL FOR INDOOR & OUTDOOR USE!



To enhance our Aluminum Framing System, Outwater offers full services from design to production. We can help with your design, choosing the most cost effective profiles and connectors, figuring the overall sizes for the highest yield from stock lengths, to packing your order for shipment.

Our experienced design staff can work with the simplest drawings to the newest CAD drawings to produce an aesthetically pleasing, totally functional final product. Our Fabrication Department can cut all tubing to size, notch flanges, and drill or punch holes to exacting standards so the fit and finish is unmatched. Finally, we can help with packing your order so it arrives in excellent condition.



Great Ideas Need Accessories!

Shown 1" Tubing with Cladding Fittings & Wide Variety of LED Lighting Options



For more information go to www.outwater.com (see lighting)



IMPORTANT: Due to Raw Material Fluctuation, Catalog Prices Below May Not Be Accurate. GO TO WWW.OUTWATER.COM FOR THE MOST UP-TO-DATE PRICES

Aluminum Framing System

3/4" Square Aluminum Tubing

Lengths: 8 Ft.

Square Tube Wall Thickness: .050

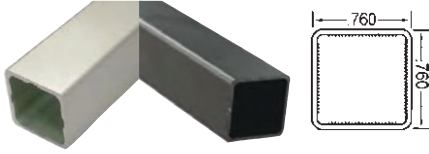

Part #	Finish	120 Ft.	600 Ft.	1000 Ft.
AT24-2BK-8	Black Anodized	\$2.16 ft.	\$2.06 ft.	\$1.72 ft.
AT24-2CL-8	Clear Anodized	\$1.62 ft.	\$1.54 ft.	\$1.28 ft.

3/8" Flange Wall Thickness: .050

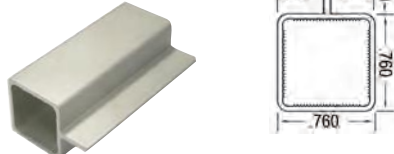

Part #	Finish	120 Ft.	600 Ft.	1000 Ft.
AT24-3BK-8	Black Anodized	\$2.32 ft.	\$2.21 ft.	\$1.94 ft.
AT24-3CL-8	Clear Anodized	\$1.75 ft.	\$1.67 ft.	\$1.48 ft.



3/8" 90° Flange Wall Thickness: .050

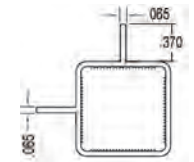

Part #	Finish	120 Ft.	600 Ft.	1000 Ft.
AT24-4BK-8	Black Anodized	\$2.71 ft.	\$2.58 ft.	\$2.15 ft.
AT24-4CL-8	Clear Anodized	\$2.16 ft.	\$2.06 ft.	\$1.72 ft.

Clear anodized finish is suitable for indoor and outdoor use. Black for indoor only. For any quantities less than 120 ft. add 15% to the 120 ft. price

3/4" Tubing Connectors & Accessories

Material: Dupont™ Super Toughened Nylon
Available in Black or Grey



2Way Right Angle Connector

Part #	Finish	Each	10 Pcs.
F24521BK	Black	\$1.74	\$1.66 ea.
F24521GY	Grey	\$1.74	\$1.66 ea.



3Way Tee Connector

Part #	Finish	Each	10 Pcs.
F24532BK	Black	\$1.98	\$1.89 ea.
F24532GY	Grey	\$1.98	\$1.89 ea.

3Way Corner Connector



Part #	Finish	Each	10 Pcs.
F24533BK	Black	\$1.98	\$1.89 ea.
F24533GY	Grey	\$1.98	\$1.89 ea.

Straight Base Connector



Part #	Finish	Each	10 Pcs.
F245323BK	Black	\$1.98	\$1.89 ea.
F245323GY	Grey	\$1.98	\$1.89 ea.

4Way Connector



Part #	Finish	Each	10 Pcs.
F24545BK	Black	\$2.09	\$2.00 ea.
F24545GY	Grey	\$2.09	\$2.00 ea.

Straight Connector



Part #	Finish	Each	10 Pcs.
F24500BK	Black	\$1.63	\$1.55 ea.
F24500GY	Grey	\$1.63	\$1.55 ea.

Perpendicular Joiner/Splicer For 3/4" At Tubing W/3/4" Long Self Tapping Screw

ALLOWS TO ATTACH ANY TUBING AT A PERPENDICULAR ANGLE

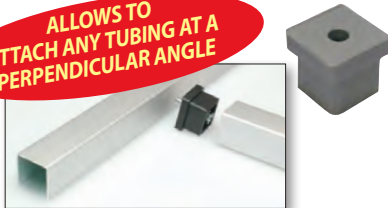

Part #	Finish	Each	10 Pcs.
F245112MCBK	Black	\$1.37	\$1.30 ea.
F245112MCGY	Grey	\$1.37	\$1.30 ea.

End Cap

Material:
Low-Density Polyethylene

Part #	Color	100 Pcs.	1000 Pcs.
DNW-S24-BK	Black	\$24.50/C	\$69.50/M

Cavity Insert For 3/4" Connector Legs

This accessory fits any 3/4" connector increasing surface area for a tighter fit



Part #	Finish	Each	10 Pcs.
F24007BK	Black	\$0.42	\$0.40 ea.
F24007GY	Grey	\$0.42	\$0.40 ea.

4Way Cross Connector



Part #	Finish	Each	10 Pcs.
F24544BK	Black	\$2.09	\$2.00 ea.
F24544GY	Grey	\$2.09	\$2.00 ea.



5Way Connector

Part #	Finish	Each	10 Pcs.
F24558BK	Black	\$2.36	\$2.25 ea.
F24558GY	Grey	\$2.36	\$2.25 ea.

6Way Connector



Part #	Finish	Each	10 Pcs.
F24568BK	Black	\$2.51	\$2.39 ea.
F24568GY	Grey	\$2.51	\$2.39 ea.

1" Square Aluminum Tubing *Wall Thickness: .044"*

Lengths: 8 Ft.

Double Channel 90°

Fits 1/8" Panel

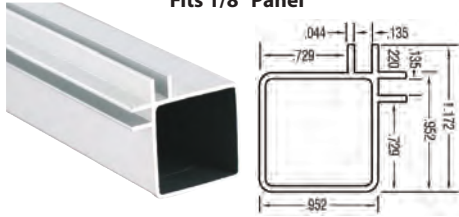

Part #	Finish	120 Ft.	600 Ft.	1000 Ft.
AT-14CL-8	Clear Anodized	\$2.15 ft.	\$2.05 ft.	\$1.73 ft.

Single Channel With 1/4" Flange

Fits 1/8" Panel

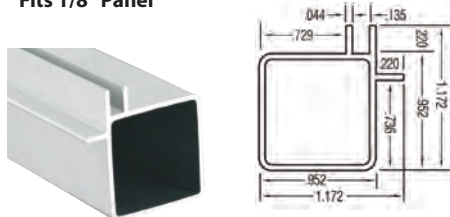

Part #	Finish	120 Ft.	600 Ft.	1000 Ft.
AT-15CL-8	Clear Anodized	\$2.09 ft.	\$1.99 ft.	\$1.69 ft.

Single Channel

Fits 1/8" Panel

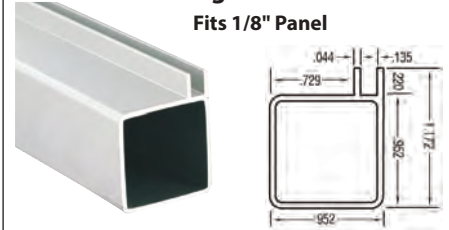

Part #	Finish	120 Ft.	600 Ft.	1000 Ft.
AT-17CL-8	Clear Anodized	\$1.96 ft.	\$1.87 ft.	\$1.58 ft.

Single Channel With 1/4" Flange

Fits 1/4" Panel

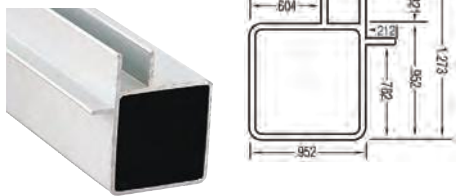

Part #	Finish	120 Ft.	600 Ft.	1000 Ft.
AT-16CL-8	Clear Anodized	\$2.22 ft.	\$2.11 ft.	\$1.79 ft.

Single Channel

Fits 1/4" Panel

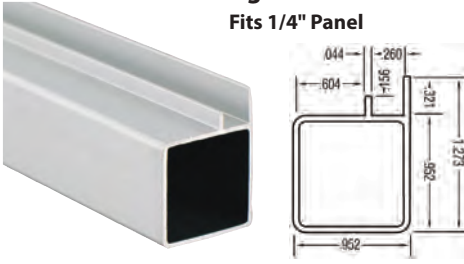

Part #	Finish	120 Ft.	600 Ft.	1000 Ft.
AT-18CL-8	Clear Anodized	\$2.09 ft.	\$1.99 ft.	\$1.69 ft.

1/4" Flange

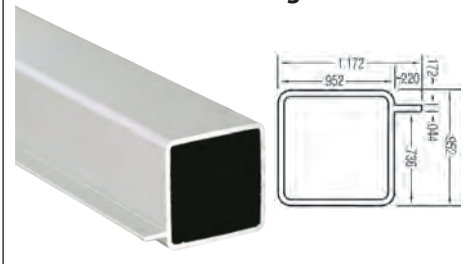

Part #	Finish	120 Ft.	600 Ft.	1000 Ft.
AT-19CL-8	Clear Anodized	\$1.90 ft.	\$1.81 ft.	\$1.53 ft.

For any quantities less than 120 ft. add 15% to the 120 ft. price

Sliding Door Track

Peel & Stick Adhesive

NOTE:
Rough Opening
Less 7/8" = Door Size

1 Roller
Per Running
Foot Included

**Styrene Track
W/Rollers &
Peel-N-Stick
Adhesive**

Colors Available
*BK - Black *SG - Silver Gray

Peel & Stick
Adhesive Mount
to AT Tubing on
Please Inquire

With Adhesive - Available In 4 & 8 Ft. Lengths

Part #	Length	120 Ft.	600 Ft.	1000 Ft.
MT38-A4-*	4 ft.	\$2.57 ft.	\$2.48 ft.	\$2.37 ft.
MT38-A8-*	8 ft.	\$2.57 ft.	\$2.48 ft.	\$2.37 ft.

For any quantities less than 120 ft. add 15% to the 120 ft. price

Plastic Finger Pulls

With high quality pressure sensitive adhesive backing. No holes to drill. Peel off protective backing paper and apply directly to surface of glass.

Part #	Finish	Each	100 Pcs.
170-BK	Black	\$0.50	\$0.45 ea.
170-CL	Clear	\$0.55	\$0.50 ea.

**Packed 100 pieces per carton.
\$2.00 broken box fee (BB2) for less than full carton.**



IMPORTANT: Due to Raw Material Fluctuation, Catalog Prices Below May Not Be Accurate. GO TO WWW.OUTWATER.COM FOR THE MOST UP-TO-DATE PRICES

Aluminum Framing System

1" Square Aluminum Tubing *Wall Thickness: .065"*

We Can Cut To Size - Please Inquire

Lengths: 8 Ft.

Square Tube

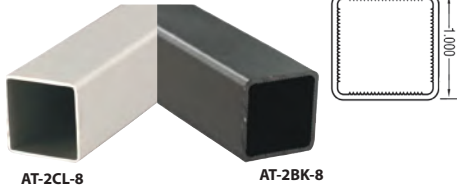

AT-2CL-8 AT-2BK-8

Part #	Finish	120 Ft.	600 Ft.
AT-2CL-8	Clear Anodized	\$2.97 ft.	\$2.58 ft.
AT-2BK-8	Black Anodized	\$3.20 ft.	\$3.05 ft.

5/8" Flange

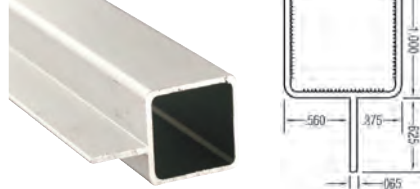

Part #	Finish	120 Ft.	600 Ft.	1000 Ft.
AT-3CL-8	Clear Anodized	\$2.79 ft.	\$2.66 ft.	\$2.24 ft.
AT-3BK-8	Black Anodized	\$3.42 ft.	\$3.26 ft.	\$2.76 ft.

Single Channel Fits 7/32" Panel

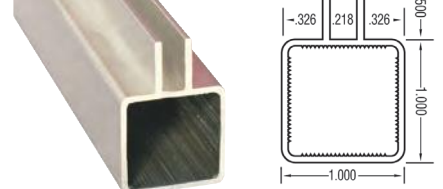

Part #	Finish	120 Ft.	600 Ft.	1000 Ft.
AT-6CL-8	Clear Anodized	\$3.17 ft.	\$3.02 ft.	\$2.56 ft.
AT-6BK-8	Black Anodized	\$3.72 ft.	\$3.54 ft.	\$3.01 ft.

5/8" 90° Flanges

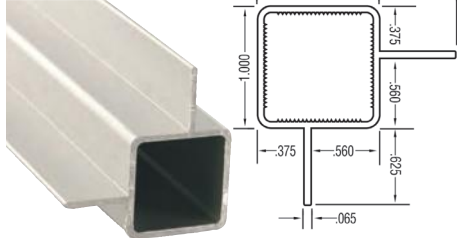

Part #	Finish	120 Ft.	600 Ft.	1000 Ft.
AT-4CL-8	Clear Anodized	\$3.42 ft.	\$3.26 ft.	\$2.76 ft.
AT-4BK-8	Black Anodized	\$3.93 ft.	\$3.74 ft.	\$3.16 ft.

5/8" 180° Flanges

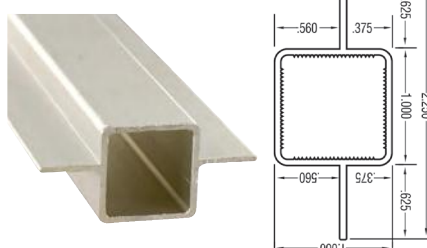

Part #	Finish	120 Ft.	600 Ft.	1000 Ft.
AT-5CL-8	Clear Anodized	\$3.30 ft.	\$3.14 ft.	\$2.66 ft.
AT-5BK-8	Black Anodized	\$3.93 ft.	\$3.74 ft.	\$3.16 ft.

Double Channel 180° Fits 1/4" Panel

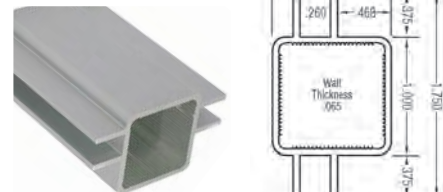

Part #	Finish	120 Ft.	600 Ft.	1000 Ft.
AT-7CL-8	Clear Anodized	\$3.05 ft.	\$2.89 ft.	\$2.85 ft.
AT-7BK-8	Black Anodized	\$3.55 ft.	\$3.35 ft.	\$3.29 ft.

Triple Channel Fits 1/4" Panel

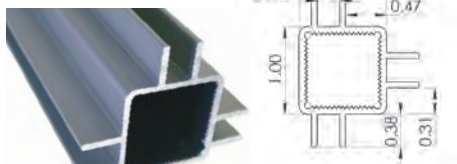

Part #	Finish	120 Ft.	600 Ft.	1000 Ft.
AT-8CL-8	Clear Anodized	\$3.53 ft.	\$3.33 ft.	\$3.28 ft.
AT-8BK-8	Black Anodized	\$4.00 ft.	\$3.79 ft.	\$3.72 ft.

Slotted 1" Tubing

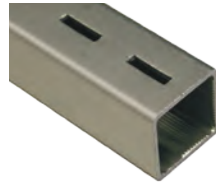

Part #	Finish	120 Ft.	600 Ft.	1000 Ft.
AT-9CL-8	Clear Anodized	\$5.70 ft.	\$5.40 ft.	\$5.05 ft.
AT-9BK-8	Black Anodized	\$6.19 ft.	\$5.85 ft.	\$5.47 ft.

Slots are 1/8" x 1/2"-1" on center for hardware support



MAY BE USED WITH:

Steel Shelf Brackets



Part #	Description	Finish/Color	Each	Qty. Break
Tap-In - .080 Thick Material				
6KB-BC	6" Long Bracket	Bright Chrome	\$1.37	\$1.16 ea.@48 pcs.
6KB-AL	6" Long Bracket	Almond	\$1.18	\$0.99 ea.@48 pcs.
6KB-BK	6" Long Bracket	Black	\$1.18	\$0.99 ea.@48 pcs.
8KB-BC	8" Long Bracket	Bright Chrome	\$1.45	\$1.26 ea.@25 pcs.
8KB-AL	8" Long Bracket	Almond	\$1.25	-
10KB-BC	10" Long Bracket	Bright Chrome	\$1.59	\$1.49 ea.@48 pcs.
12KB-BC	12" Long Bracket	Bright Chrome	\$1.78	\$1.66 ea.@48 pcs.
12KB-BK	12" Long Bracket	Black	\$1.56	\$1.36 ea.@25 pcs.
12KB-SC	12" Long Bracket	Satin Chrome	\$2.66	\$2.31 ea.@25 pcs.
14KB-BC	14" Long Bracket	Bright Chrome	\$2.09	\$1.96 ea.@48 pcs.
14KB-AL	14" Long Bracket	Almond	\$1.80	-
14KB-WH	14" Long Bracket	White	\$1.80	-
16KB-BK	16" Long Bracket	Black	\$2.03	-
16KB-WH	16" Long Bracket	White	\$2.03	-
16KB-BC	16" Long Bracket	Bright Chrome	\$2.36	\$2.05 ea.@25 pcs.

Note: For All Tubing

Clear anodized finish is suitable for indoor and outdoor use. Black for indoor only.

For any quantities less than 120 ft. add 15% to the 120 ft. price

1" Tubing Connectors & Accessories

Material: Dupont™ Super Toughened Nylon
Available in Black or Grey

2Way Right Angle Connector



Part #	Color	Each	10 Pcs.
F521BK	Black	\$2.68	\$2.55 ea.
F521GY	Grey	\$2.68	\$2.55 ea.

3Way Tee Connector



Part #	Color	Each	10 Pcs.
F532BK	Black	\$2.93	\$2.79 ea.
F532GY	Grey	\$2.93	\$2.79 ea.

**** 3Way Connector w/Heavy Duty Caster Socket**



****NOTE:** #F533C will accept a 3/8" diameter x 1" long friction fit caster stem (not included)
See Below for Caster

Part #	Color	Each	10 Pcs.
F533C/BK	Black	\$3.05	\$2.91 ea.
F533C/GY	Grey	\$3.05	\$2.91 ea.

3Way Corner Connector

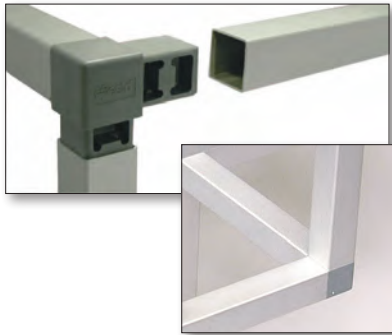

Part #	Color	Each	10 Pcs.
F533BK	Black	\$2.78	\$2.65 ea.
F533GY	Grey	\$2.78	\$2.65 ea.

4Way Cross Connector



Part #	Color	Each	10 Pcs.
F544BK	Black	\$3.25	\$3.10 ea.
F544GY	Grey	\$3.25	\$3.10 ea.

4Way Connector



Part #	Color	Each	10 Pcs.
F545BK	Black	\$3.25	\$3.10 ea.
F545GY	Grey	\$3.25	\$3.10 ea.

3Way Connector w/2-3/8" Dia Caster w/Friction Ring Stem



Without Brake			
Part #	Color	Each	10 Pcs.
F533C/BK-CST	Black	\$4.08	\$3.83 ea.
F533C/GY-CST	Grey	\$4.08	\$3.83 ea.
With Brake			
Part #	Color	Each	10 Pcs.
F533C/BK-CSTB	Black	\$4.29	\$4.04 ea.
F533C/GY-CSTB	Grey	\$4.29	\$4.04 ea.

5Way Connector



Part #	Color	Each	10 Pcs.
F558BK	Black	\$3.44	\$3.28 ea.
F558GY	Grey	\$3.44	\$3.28 ea.

6Way Connector

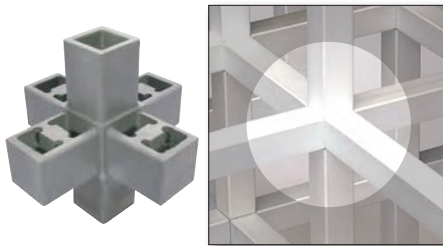

Part #	Color	Each	10 Pcs.
F568BK	Black	\$3.64	\$3.47 ea.
F568GY	Grey	\$3.64	\$3.47 ea.

3Way Connector w/Leveler 1/4-20 x 1" Long



1-3/8" Base Dia.
w/Thread Stem & Insert

Part #	Color	Each	10 Pcs.
F533C/BK-LEV	Black	\$3.77	\$3.52 ea.
F533C/GY-LEV	Grey	\$3.77	\$3.52 ea.

IMPORTANT: Due to Raw Material Fluctuation, Catalog Prices Below May Not Be Accurate. GO TO WWW.OUTWATER.COM FOR THE MOST UP-TO-DATE PRICES

Aluminum Framing System

1" Tubing Connectors & Accessories

Material: Dupont™ Super Toughened Nylon
Available in Black or Grey

90° Base Connector



Part #	Color	Each	10 Pcs.
F5323SPBK	Black	\$2.11	\$2.01 ea.
F5323SPGY	Grey	\$2.11	\$2.01 ea.

The Invisible Coupling

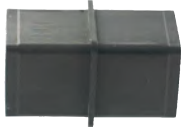

Part #	Color	Each	10 Pcs.
F5101BK	Black	\$2.08	\$1.98 ea.
F5101GY	Grey	\$2.08	\$1.98 ea.

End Cap



Material:
Low-Density
Polyethylene

Part #	Color	100 Pcs.	1000 Pcs.
SHK-32S-BK	Black	\$30.00/C	\$85.70/M

Straight Base Connector



Part #	Color	Each	10 Pcs.
F5323BK	Black	\$1.98	\$1.89 ea.
F5323GY	Grey	\$1.98	\$1.89 ea.

Straight Connector



Part #	Color	Each	10 Pcs.
F500BK	Black	\$2.75	\$2.61 ea.
F500GY	Grey	\$2.75	\$2.61 ea.

Stack Plug For Use With F533C Connector



**GREAT FOR
STACKING CASES!**



Part #	Color	Each	10 Pcs.
F4PSPGY	Grey	\$1.65	\$1.58 ea.

Perpendicular Joiner/Splicer For 1" AT Tubing with 1 x #8 3/4" Long Self Tapping Screw

**ALLOWS TO ATTACH
ANY TUBING AT A
PERPENDICULAR
ANGLE!**

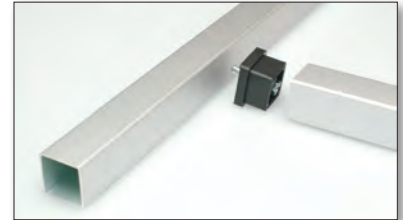

Part #	Color	Each	10 Pcs.
F5112MCBK	Black	\$1.79	\$1.70 ea.
F5112MCGY	Grey	\$1.79	\$1.70 ea.

All Metal Heavy Duty Shelf Rest For Glass Or Wood Shelving



Part #	Finish	Each	100 Pcs.
F514BK	Black Anodized	\$1.65	\$1.50 ea.
F514CL	Clear Anodized	\$1.65	\$1.50 ea.

U-Clip

4" Lengths

Aluminum Material - Satin Finish

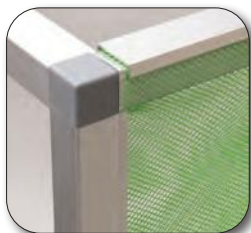

FMJ557-4-S...\$1.45 ea.

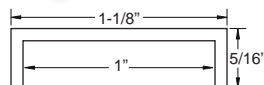

Cavity Insert For 1" Connector Legs

This accessory fits any 1" connector increasing surface area for a tighter fit



Part #	Color	Each Pair	10 Pcs.
F007BK	Black	\$0.42	\$0.40 pr.
F007GY	Grey	\$0.42	\$0.40 pr.

1" Tubing Connectors & Accessories

Fits 1" Tube & Holds 1/4" Panel Cladding Rigid Vinyl
Available in Clear
Material: PVC 12' lengths

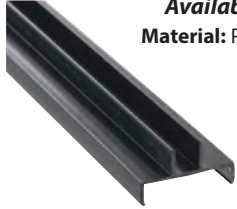

Shown in Black (no longer available)

Part #	Finish	120 Ft.	600 Ft.	1000 Ft.
109-CL	Clear	\$0.56 ft.	\$0.52 ft.	\$0.47 ft.

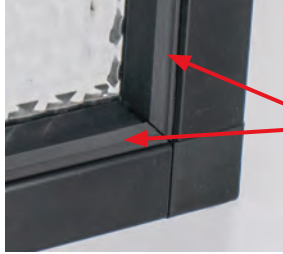

Casing Trim



All cast trim sides can come apart for easy access to insert or remove signage



Cast trim with adhesive tape is shown attached to our 1" tubing

Casing Trim For 1/4" Panels 1" Base
Available in Black or Nickel
With Adhesive Tape
Material: PVC 6' lengths

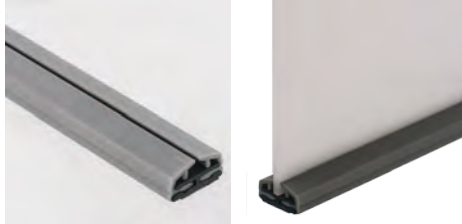

Part #	Finish	Price
CT8NC	Nickel	\$5.95 ft.
CT8BK	Black	\$5.95 ft.

Casing Trim for 1/2" Panels 1" Base
Available in Black or Nickel
With Adhesive Tape
Material: PVC 6' lengths

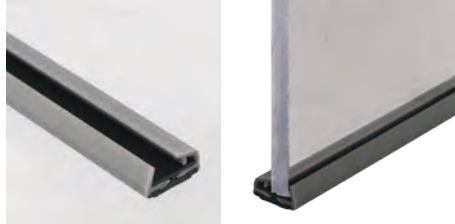

Part #	Finish	120 Ft.	600 Ft.	1000 Ft.
CT16NC	Nickel		Please Inquire	
CT16BK	Black		Please Inquire	

Casing Trim for 3/4" Panels 1" Base
Available in Black or Nickel
With Adhesive Tape
Material: PVC 6' lengths



Part #	Finish	120 Ft.	600 Ft.	1000 Ft.
CT24NC	Nickel		Please Inquire	
CT24BK	Black		Please Inquire	

For any quantities less than 120 ft. add 15% to the 120 ft. price

Material: Dupont™ Super Toughened Nylon
Available in Black or Grey

Adjustable 2Way Connector
Material: PVC

15° Incremental locking from 90° to 180° for 1" Tubing



Part #	Finish	Each	10 Pcs.
FJ22BK	Black	\$8.47	\$8.06 ea.
FJ22GY	Grey	\$8.47	\$8.06 ea.

Adjustable Tee Style Connector With Rotating Base
Vertical/Horizontal For 1" Tubing
Material: PVC

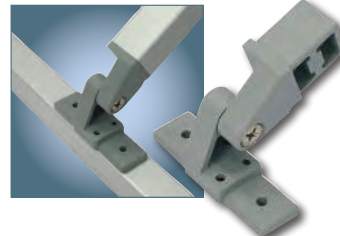

Part #	Finish	Each	10 Pcs.
FJ32BK	Black	\$12.94	\$12.33 ea.
FJ32GY	Grey	\$12.94	\$12.33 ea.

Adjustable 2Way In-Line Base Connector
For 1" tubing to connect with another tube at multiple angles
Material: PVC



Part #	Finish	Each	10 Pcs.
FJ31BK	Black	\$12.94	\$12.33 ea.
FJ31GY	Grey	\$12.94	\$12.33 ea.

Adjustable 2Way Connector W/Locking Nut
For 1" Tube



CAPABLE OF 280° RADIUS



Part #	Color	Each	10 Pcs.
F52AJNBK	Black	\$4.84	\$4.61 ea.
F52AJNGY	Grey	\$4.84	\$4.61 ea.

IMPORTANT: Due to Raw Material Fluctuation, Catalog Prices Below May Not Be Accurate. GO TO WWW.OUTWATER.COM FOR THE MOST UP-TO-DATE PRICES

Aluminum Framing System

1-1/2" Heavy Duty Aluminum Tubing

Wall Thickness: 1/8" • Lengths: 8 Ft.

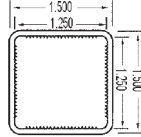
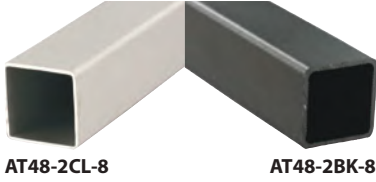

Part #	Finish	120 Ft.	600 Ft.	1000 Ft.
AT48-2CL-8	Clear Anodized	\$5.72 ft.	\$5.45 ft.	\$4.54 ft.
AT48-2BK-8	Black Anodized	\$6.29 ft.	\$5.99 ft.	\$4.99 ft.

Clear anodized finish is suitable for indoor and outdoor use. Black for indoor only. For any quantities less than 120 ft. add 15% to the 120 ft. price

1-1/2" Tubing Connectors & Accessories

Material: Dupont™ Super Toughened Nylon
Available in Black or Grey

Connectors fit any 1-1/2" O.D. Aluminum or Steel Tubing with 1/8" wall thickness



2 Way Right Angle Connector

Part #	Color	Each	10 Pcs.
F48521BK	Black	\$6.62	\$6.30 ea.
F48521GY	Grey	\$6.62	\$6.30 ea.

3 Way Corner Connector



Part #	Color	Each	10 Pcs.
F48533BK	Black	\$9.00	\$8.57 ea.
F48533GY	Grey	\$9.00	\$8.57 ea.



Straight Connector

Part #	Color	Each	10 Pcs.
F48500GY	Grey	\$8.42	\$8.02 ea.
F48500BK	Black	\$8.42	\$8.02 ea.



3 Way Tee Connector



Part #	Color	Each	10 Pcs.
F48532BK	Black	\$11.36	\$10.82 ea.
F48532GY	Grey	\$11.36	\$10.82 ea.



End Cap

Material:
Low-Density Polyethylene

Part #	Color	100 Pcs.	1000 Pcs.
SHK-48S-BK	Black	\$58.00/C	\$200.00/M



4 Way Connector

Part #	Color	Each	10 Pcs.
F48545BK	Black	\$13.78	\$13.13 ea.
F48545GY	Grey	\$13.78	\$13.13 ea.

Perpendicular Joiner/Splicer with 4 x #10 1-1/4" Long Self Tapping Screws



Part #	Color	Each	10 Pcs.
F485112MCBK	Black	\$3.68	\$3.51 ea.
F485112MCGY	Grey	\$3.68	\$3.51 ea.



PROTOTYPE SAMPLES
We are happy to provide samples for prototypes & design builds. - Please Inquire

IMPORTANT: Due to Raw Material Fluctuation, Catalog Prices Below May Not Be Accurate. GO TO WWW.OUTWATER.COM FOR THE MOST UP-TO-DATE PRICES

Great Wall PVC & Aluminum Slatwall System

UNIQUE INTERLOCKING DESIGN SECURELY FITS TOGETHER

HERCULES HEAVY DUTY PANELS

Material: Aluminum

Length: 6' x 8' • 3" on center

- Panel 11/32" thick
- 300 lbs. per sq. ft. load capacity
- Aluminum slatwall designed to interlock with standard duty PVC slatwall (above) when extra strength is needed.

Part #	Finish	Per Ft	120 Ft	600 Ft
ALU6969-S	Satin	\$9.91'	\$9.76'	\$8.88'
ALU6969-M	Mill	\$8.50'	\$8.35'	\$7.46'



FOR USE WITH ALL ACCESSORIES IN THE SLATWALL HARDWARE SECTION



Mix & MATCH

Please Inquire For Garage Hardware

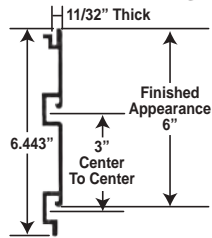

STANDARD DUTY GREAT WALL PANELS

- Panel 11/16" thick
- 25 lbs. per sq. ft. load capacity

Part #	Size	Price
GRW-1X4-WH		\$11.20 ea.
GRW-1X4-BK	1' x 4'	\$11.20 ea.
GRW-1X4-AL		\$11.70 ea.
GRW-1X8-WH		\$22.00 ea.
GRW-1X8-BK	1' x 8'	\$22.00 ea.
GRW-1X8-AL		\$23.00 ea.

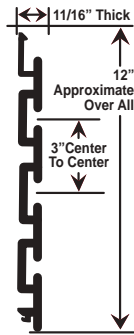

Must be ordered in full boxes of 8 pcs. x 4 ft. or 4 pcs. x 8 ft.

HIGH DENSITY HEAVY DUTY GREAT WALL PANELS

- Panel 11/16" thick
- 100 lbs. per sq. ft. load capacity

Part #	Size	Price
GRW-HD1X4BX-WH		\$130.52 box
GRW-HD1X4BX-BK	1' x 4'	\$134.94 box
GRW-HD1X4BX-GY	8 pcs. per box	\$130.52 box
GRW-HD1X4BX-AL		\$130.52 box
GRW-HD1X4BX-MP		\$149.65 box
GRW-HD1X8BX-WH		\$130.52 box
GRW-HD1X8BX-BK	1' x 8'	\$134.94 box
GRW-HD1X8BX-GY	4 pcs. per box	\$130.52 box
GRW-HD1X8BX-AL		\$130.52 box
GRW-HD1X8BX-MP		\$149.65 box

Screws & Mouldings For Great Wall Panels

COLOR MATCH MOULDINGS

Material: PVC • Length: 8'

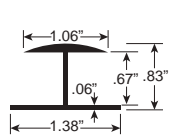

Part #	Price
GRW-JNR8-WH	\$2.75 ea.
GRW-JNR8-BK	\$2.75 ea.
GRW-JNR8-AL	\$2.95 ea.
GRW-JNR8-MP	\$3.10 ea.

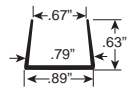

End Cap

Part #	Price
GRW-END8-WH	\$1.50 ea.
GRW-END8-BK	\$1.50 ea.
GRW-END8-AL	\$1.65 ea.
GRW-END8-MP	\$1.75 ea.

Colors Available

WH - White BK - Black AL - Almond MP - Maple

COLOR MATCH SCREWS

Material: Steel • Length: 2-1/2"

Part #	100 Pcs.	1000 Pcs.
GRW-2500SCR*	\$16.00 box	\$13.00 box

Screws packed 100 pcs. per box - No Broken Boxes

Ticket Holder



Clear Butyrate 12 ft. Lengths Fits 1-1/4" Ticket

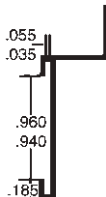

Part #	120 Ft.	600 Ft.	1000 Ft.
62-CL	\$1.15'	\$1.00'	\$0.94'

Aluminum Slatwall 3/4" Thick Shelf Support Bracket

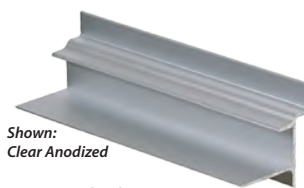

Shown: Clear Anodized

- **Material:** Aluminum
- Works with 3/4" shelf
- Holds up to 12" deep shelf
- **Load Rating:** 20 lbs. per linear ft.

The Hangman Slatwall 3/4" Shelf Bracket is an aluminum extrusion that is designed to accept any 3/4" wood or melamine panel. Insert the panel and set with a screw from the underside. Available in clear anodized, or powder coated black. Custom sizes available for extra cutting charge. A great way to improve your garage or slatwall systems.

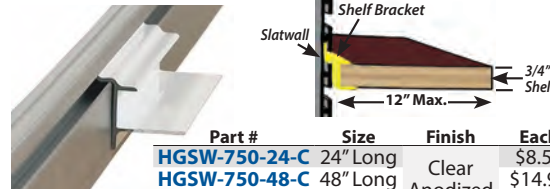

Part #	Size	Finish	Each	30 Pcs.	50 Pcs.
HGSW-750-24-C	24" Long	Clear Anodized	\$8.55	\$8.10 ea.	\$7.65 ea.
HGSW-750-48-C	48" Long		\$14.95	\$14.25 ea.	\$13.75 ea.
HGSW-750-96-C	96" Long	Black Powder Coated	\$30.95	\$28.50 ea.	\$27.00 ea.
HGSW-750-24-B	24" Long		\$8.55	\$8.10 ea.	\$7.65 ea.
HGSW-750-48-B	48" Long		\$14.95	\$14.25 ea.	\$13.75 ea.
HGSW-750-96-B	96" Long		\$30.95	\$28.50 ea.	\$27.00 ea.

EASY AS:

- 1 - PICK SHELF LENGTH
- 2 - INSERT SHELF INTO EXTRUSION
- 3 - HANG ON SLATWALL



Shown: Black Powder Coated

IMPORTANT: Due to Raw Material Fluctuation, Catalog Prices Below May Not Be Accurate. GO TO WWW.OUTWATER.COM FOR THE MOST UP-TO-DATE PRICES

Any Angle, Any Panel, Any Display



- Join panels in thicknesses ranging from 1/8" to 3/4"!
- The Klem® connector makes it easy to create angles from 90° to 270°!
- Ideal for straight or curved walls, prisms, squares, cubes, pyramids, domes or any type of display!
- Made of nickel plated zinc alloy and synthetic rubber inserts. The Klem® connector provides great strength and long term durability.
- Standard gap between panels
Mini: 1/2"
Super: 3/4"
- To Close gap between panels, Notch the panels
Mini: 1/4" x 15/16"
Super: 5/16" x 1-3/8"



MULTIPLE PANELS

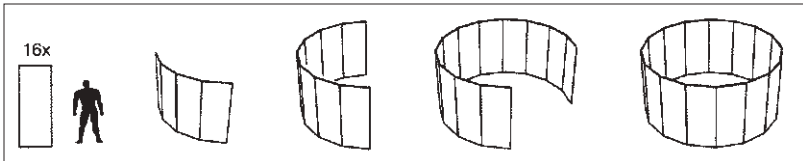

SHOWCASE



PARTITION



BMW SHOWROOM IN AUSTRIA



MUSEUMS & GALLERIES



TRADE SHOWS



IMPORTANT: Due to Raw Material Fluctuation, Catalog Prices Below May Not Be Accurate. GO TO WWW.OUTWATER.COM FOR THE MOST UP-TO-DATE PRICES



ANY PANEL! ANY ANGLE! ANY DISPLAY!

MINI klem®
For panel thicknesses from 1/8" to 5/16"

Part #	1-19 Sets	20+ Sets
7123M*	\$14.18 set	\$11.91 set

* Please specify panel size

2 = 1/8", 4 = 3/16", 6 = 1/4", 8 = 5/16"

Example: for 1/4" panels, Part# is 7123M-6

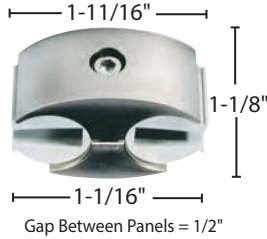

SUPER klem®
For panel thicknesses from 1/4" to 3/4"

Part #	1-19 Sets	20+ Sets
7123S*	\$22.00 set	\$17.98 set

* Please specify panel size

6 = 1/4", 10 = 3/8", 12 = 1/2", 16 = 5/8", 19 = 3/4"

Example: for 1/2" panels, Part# is 7123S-12

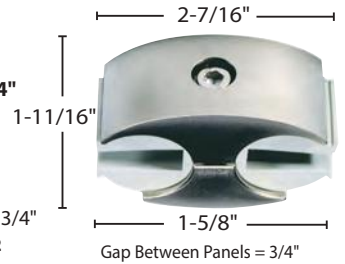

BODIES ONLY without inserts

MINI KLEM 7123M		SUPER KLEM 7123S	
1-19 Sets	20+ Sets	1-19 Sets	20+ Sets
\$10.19 ea.	\$9.04 ea.	\$16.03 ea.	\$13.01 ea.

Fits 3/4" Tubing

Fits 1-1/8" Tubing

BODY WITH LEVELING FOOT

MINI KLEM 7123M-LF		SUPER KLEM 7123S-LF	
1-19 Sets	20+ Sets	1-19 Sets	20+ Sets
\$15.17 set	\$14.11 set	\$21.19 set	\$20.18 set

To be used with a single insert or tubing

INSERT PAIRS ONLY

MINI KLEM		SUPER KLEM	
0802PR = 1/8"	0206PR = 1/4"	0210PR = 3/8"	0216PR = 5/8"
0804PR = 3/16"	0212PR = 1/2"	0219PR = 3/4"	
0806PR = 1/4"			
0808PR = 5/16"			
1-19 Sets	20+ Sets	1-19 Sets	20+ Sets
\$4.17 pr.	\$2.98 pr.	\$6.34 pr.	\$4.68 pr.

BODY WITH TWIN WHEEL CASTER w/BRAKE

MINI KLEM 7123M-CSTR		SUPER KLEM 7123S-CSTR	
1-19 Sets	20+ Sets	1-19 Sets	20+ Sets
\$20.55 ea.	\$18.52 ea.	\$24.43 ea.	\$23.15 ea.

Caster Diameter is 2" - Load Rating = 75 lbs per caster
To be used with a single insert or tubing

SINGLE INSERTS ONLY

MINI KLEM		SUPER KLEM	
0802 = 1/8"	0206 = 1/4"	0210 = 3/8"	0216 = 5/8"
0804 = 3/16"	0212 = 1/2"	0219 = 3/4"	
0806 = 1/4"			
0808 = 5/16"			
1-19 Sets	20+ Sets	1-19 Sets	20+ Sets
\$2.08 ea.	\$1.54 ea.	\$3.36 ea.	\$2.54 ea.

To be used when connecting panels

BODY WITH WALL MOUNT

MINI KLEM 7123M-WM		SUPER KLEM 7123S-WM	
1-19 Sets	20+ Sets	1-19 Sets	20+ Sets
\$20.84 ea.	\$19.96 ea.	\$23.33 ea.	\$22.39 ea.

To be used with a single insert or tubing

TUBING INSERTS ONLY

MINI KLEM 0713		SUPER KLEM 0320	
1-19 Sets	20+ Sets	1-19 Sets	20+ Sets
\$1.93 ea.	\$1.47 ea.	\$3.09 ea.	\$2.31 ea.

To be used when connecting tubes.

HEX KEY

MINI KLEM 0160		SUPER KLEM 0170	
1-19 Sets	20+ Sets	1-19 Sets	20+ Sets
\$1.28 ea.	\$1.22 ea.	\$1.28 ea.	\$1.22 ea.

NUTS AND BOLTS

MINI KLEM 7123M-NB		SUPER KLEM 7123S-NB	
1-19 Sets	20+ Sets	1-19 Sets	20+ Sets
\$0.36 ea.	\$0.30 ea.	\$0.66 ea.	\$0.60 ea.

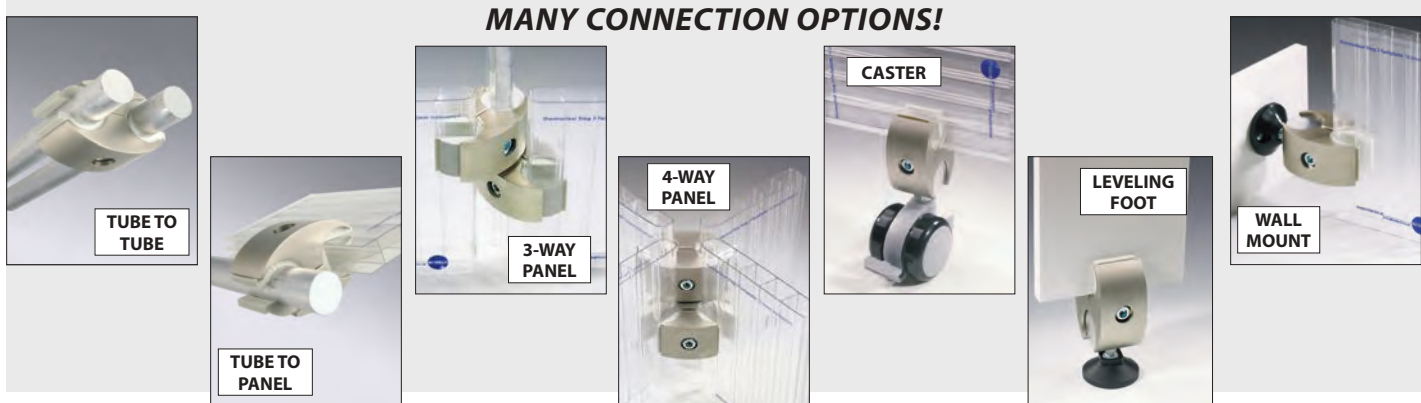

IMPORTANT: Due to Raw Material Fluctuation, Catalog Prices Below May Not Be Accurate. GO TO WWW.OUTWATER.COM FOR THE MOST UP-TO-DATE PRICES

Fastmount Panel Mounting Systems

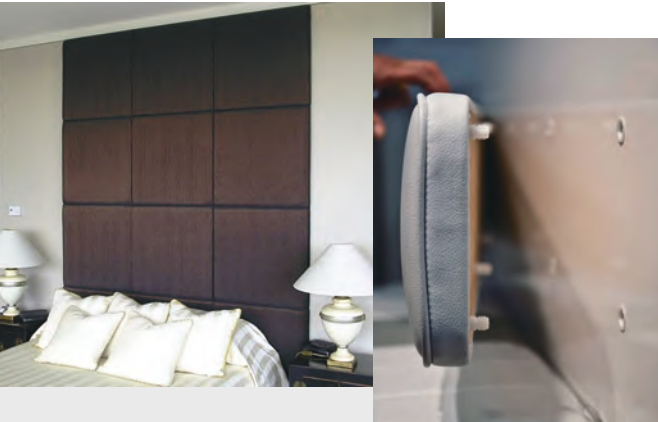

This revolutionary panel mounting system will work with a wide range of panel sizes and materials. Unlike traditional Z bar and panel clips, this system can be utilized for ceiling and wall panels.

Panels are installed head-on and can be affixed in any sequence, ultimately saving the installer time and money.

There are 3 systems to choose from:

Standard Profile

- Maximum panel weight: Up to 88 lbs. for wall panels. Up to 66 lbs. for ceiling panels.
- Support substrate should be 9/16" or thicker
- Easily installed with the CT-08 tool kit
- Can be used in ceiling applications in conjunction with the panel control system, see page S-110.
- For use with steel, wood, plywood and MDF frames

Low Profile

- Maximum panel weight: Up to 88 lbs. for wall panels.
- Support substrate should be 3/8" or thicker
- Easily installed with the LP-08Y tool kit
- Ideally suited for drywall applications when LP-DF8 is used, see page S-109.

Very Low Profile

- For lightweight panels/light duty applications
- No minimum support substrate thickness because female clips can be surface mounted
- Easily installed with 2-part epoxy and the center point alignment tool
- Perfect for mounting removable panels and facing such as wall panels, headboards and inspection panels
- Ideally suited for mounting panels where no drilling is preferred

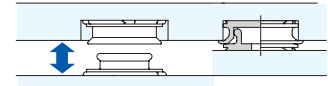
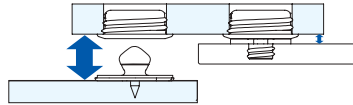
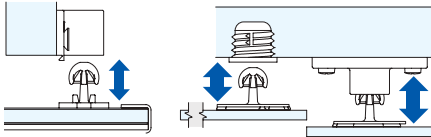



Standard Profile

- Maximum panel weight: Up to 88 lbs. for wall panels. Up to 66 lbs. for ceiling panels.
- Support substrate should be 9/16" or thicker
- Easily installed with the CT-08 tool kit
- Can be used in ceiling applications in conjunction with the panel control system, [see page S-110](#).
- For use with steel, wood, plywood and MDF frames



Female clips for Standard Profile are mounted to the support substrate. Choose from these 4 options:

Standard Self-Tapping



PC-F1
\$0.85 ea.

- Best option for most applications. Must be used for 9/16" or thicker substrates.
- CP Stainless Steel tip accessory works with female clips and used to mark hole center in panel for correct clip alignment, [see page S-110](#).
- 16.8mm (.66") hole drill required. Install with CT-08 tool kit, [see page S-110](#).

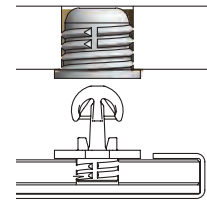
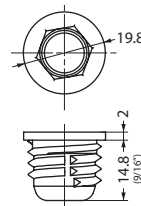

Surface Mount



PC-SF1
\$0.85 ea.

- Can be used with thinner support materials such as steel frames.
- CP Stainless Steel tip accessory works with female clips and used to mark hole center in panel for correct clip alignment, [see page S-110](#).
- Affix with #6 screws

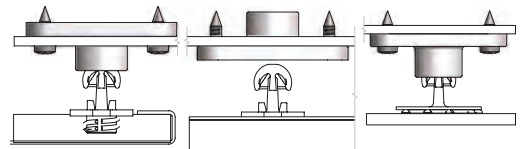
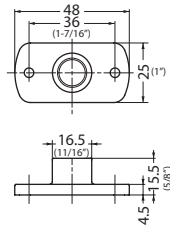

Side Surface Mount



PC-RF1-B
\$0.85 ea.

- Ideally suited for corner detail at cabinet, shelf or cabinet floor, *(Not for use on actual flooring)*.
- CP Stainless Steel tip accessory works with female clips and used to mark hole center in panel for correct clip alignment, [see page S-110](#).
- Affix with #6 countersunk screws

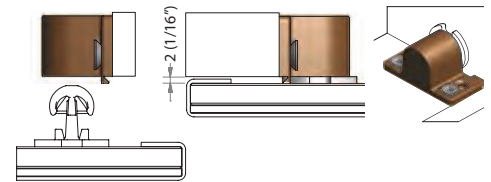
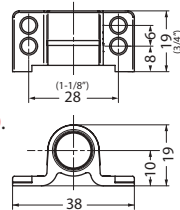

Auto Fit



PC-AF1
\$1.87 ea.

- Ideally suited for curved panels. Lateral adjustment provides perfect panel alignment and secure mounting.
- CP Stainless Steel tip accessory works with female clips and used to mark hole center in panel for correct clip alignment, [see page S-110](#).
- Affix with #6 countersunk screws

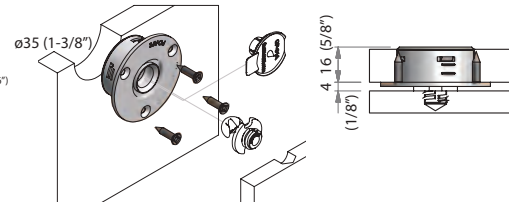
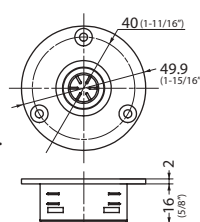

Fastmount Panel Mounting Systems

Standard Profile



Male clips for Standard Profile are mounted to the panel. Choose from these 6 options:

Standard Self-Tapping



PC-M1B
\$0.85 ea.

- Mounts into 3/8" hole
- 11 lb. Pull out force
- Install with CT-08 tool kit, [see page S-110](#).

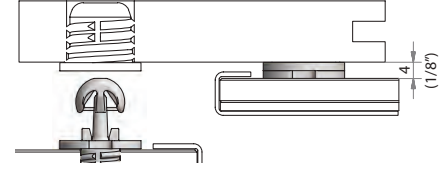
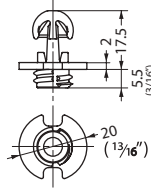

Heavy Duty Self-Tapping



PC-M2H
\$1.02 ea.

- Mounts into 3/8" hole
- 22 lb. Pull out force
- Install with CT-08 tool kit, [see page S-110](#).

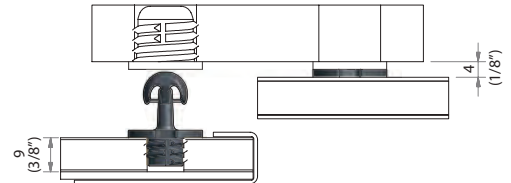
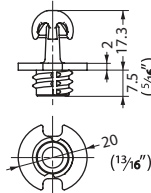

Vario Standard Self-Tapping



PC-VM1
\$1.02 ea.

- Mounts into 3/8" hole
- Variable gap 1/8"~1/4"
- 11 lb. Pull out force
- Install with CT-08 tool kit, [see page S-110](#).

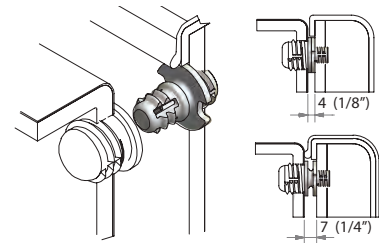
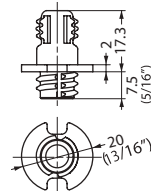

Vario Heavy Duty Self-Tapping



PC-VMX
\$1.35 ea.

- Mounts into 3/8" hole
- Variable gap 1/8"~1/4"
- 22 lb. Pull out force
- Install with CT-08 tool kit, [see page S-110](#).

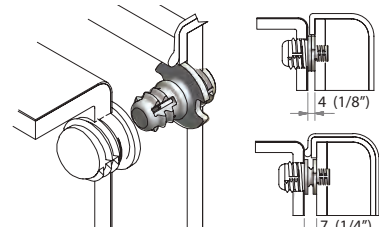
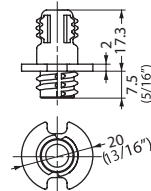

Surface Mount



PC-SM2
\$0.85 ea.

- Mounts with 2-part epoxy
- 11 lb. Pull out force
- Affix using a 2-part epoxy adhesive

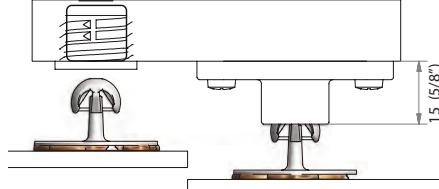
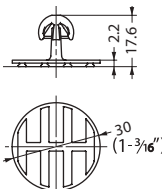

Heavy Duty Surface Mount



PC-SM2H
\$1.02 ea.

- Mounts with 2-part epoxy
- 22 lb. Pull out force
- Affix using a 2-part epoxy adhesive

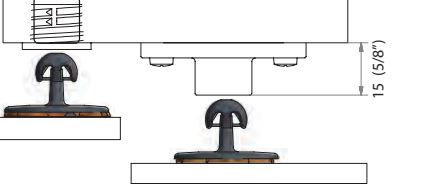
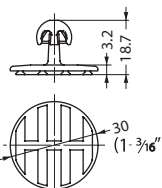

Fastmount Panel Mounting Systems

Low Profile

- Maximum panel weight: Up to 88 lbs. for wall panels.
- Support substrate should be 3/8" or thicker
- Easily installed with the LP-08Y tool kit
- Ideally suited for drywall applications when LP-DF8 is used, see page S-109.



Female clips for Low Profile are mounted to the support substrate. Choose from these 3 options:

Self-Tapping



LP-F8
\$0.77 ea.

- Ideally suited for plywood and MDF boards 3/8" or thicker
- CP Stainless Steel tip accessory works with female clips and used to mark hole center in panel for correct clip alignment, see page S-110.
- Mounts into 1" hole
- Install with LP-08Y tool kit, see page S-110.

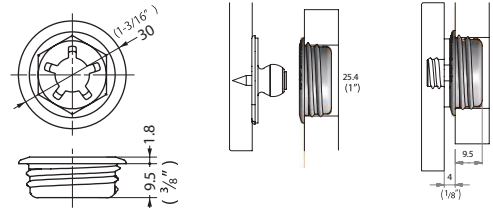

Self-Tapping Coarse Thread



LP-DF8
\$0.77 ea.

- Ideally suited for drywall/sheet rock and soft core materials 1/2" or thicker
- CP Stainless Steel tip accessory works with female clips and used to mark hole center in panel for correct clip alignment, see page S-110.
- Mounts into 1" hole
- Install with LP-08Y tool kit, see page S-110.

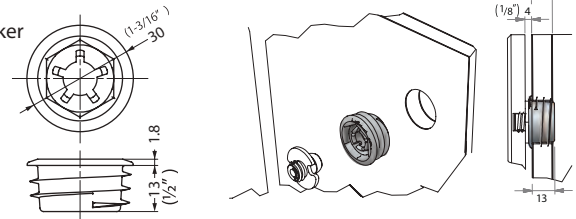

Auto Fit



LP-AF8
\$1.96 ea.

- Ideally suited for curved panels 7/16" or thicker
- CP Stainless Steel tip accessory works with female clips and used to mark hole center in panel for correct clip alignment, see page S-110.
- Lateral adjustment provides perfect panel alignment and secure mounting.
- Affix with #4 countersunk screws

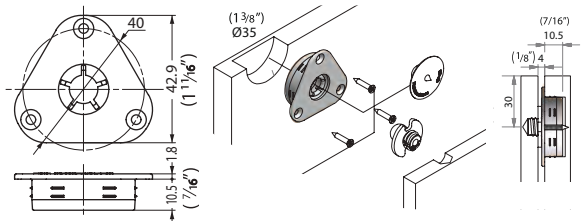

Male clips for Low Profile are mounted to the panel. Choose from these 2 options:

Self-Tapping



LP-M8A
\$0.77 ea.

- Mounts into 3/8" hole
- 11 lb. Pull out force
- Install with LP-08Y tool kit, see page S-110.

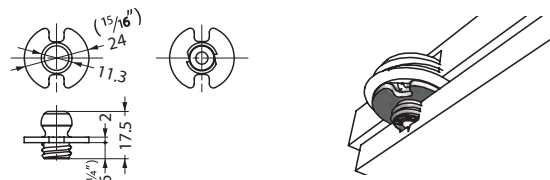

Surface Mount



LP-SM8AS
\$0.77 ea.

- Affix with #4 screw or a 2-part epoxy adhesive
- 11 lb. Pull out force
- Install with LP-08Y tool kit, see page S-110.

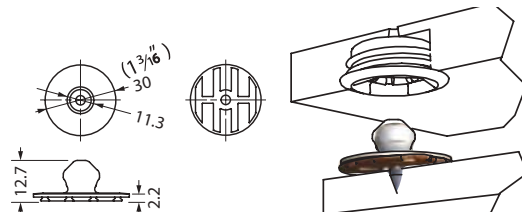

Fastmount Panel Mounting Systems



Very Low Profile

- For lightweight panels/light duty applications
- No minimum support substrate thickness because female clips can be surface mounted
- Easily installed with 2-part epoxy and the center point alignment tool
- Perfect for mounting removable panels and facing such as wall panels, headboards and inspection panels
- Ideally suited for mounting panels where no drilling is preferred

Female clips for Very Low Profile are mounted to the support substrate. Male clips are mounted to the panel. Choose from these 2 clip sets:

Standard Male/Female Clip Set



VL-03
Pull out Force: 11 lbs.
\$1.11/set

- Surface or recess mount into 1" hole
- Can be installed with included stainless steel screw or affixed with 2-part epoxy glue
- CP Stainless Steel tip accessory works with female clips and used to mark hole center in panel for correct clip alignment, *see below*.

Surface Mount

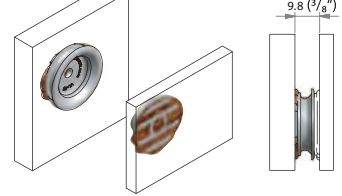

Heavy Duty Male/Female Clip Set



VL-03H
Pull out Force: 22 lbs.
\$1.42/set

Female Clip

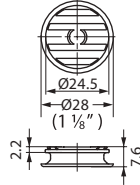

Male Clip

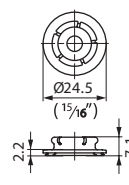

Recess Mount

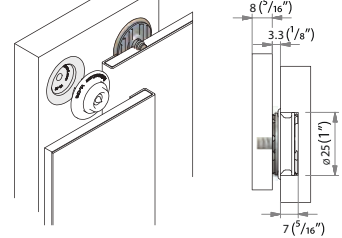

Accessories

Installation Tool Sets include carbide tipped drill bits, installation tools, panel removal tool. **(Required for 1st purchase)**



CT-08
Use with: Standard Profile
\$280.50/set



LP-08Y
Use with: Low Profile
\$144.50/set

Stainless Steel Center Point Tip works with female clips and used to mark hole center in panel for correct clip alignment. **(Optional)**



CP-01ST
Use with: Standard Profile
\$6.80 ea.



CP-08ST
Use with: Low Profile
\$6.80 ea.



VL-CP3
Use with: Very Low Profile
\$8.25 ea.

Panel Control System used in conjunction with standard profile clips to provide additional security and control. This allows for convenient service behind the panel or controlled removal of the panel by releasing the wire. The drop length for this stainless steel cable is 5-7/8".



PS-150E
Use with: Self-Tapping Standard Profile
\$28.90/set

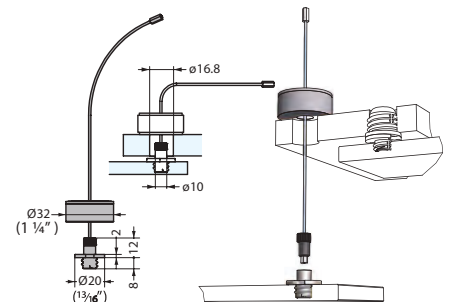

PS-S150E
Use with: Surface Mount Standard Profile
\$28.90/set

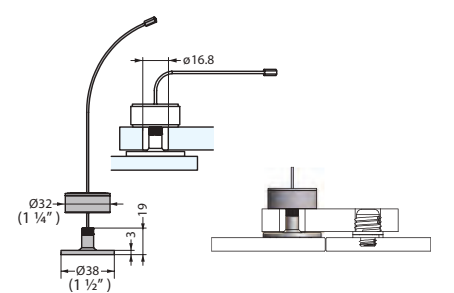

Fully Concealed Hidden Joining System

- Material: Glass Reinforced Nylon
- UV and Fire Rated
- Guaranteed to save on production time and labor costs because it's easy to install and you do not need to wait for glue to dry.
- Units can ship knock down. Less money will be spent on transportation.
- Reduce inventory levels on other fastening components when you switch to this system. Very cost effective and requires less fasteners.
- There is no need to buy expensive new tooling because this system allows you to use standard router, screw drivers or CNC machine.



Striplox Pro 23



This connector has over 100 uses and can be used in a variety of applications ranging from large scale Architectural projects to hanging artwork or building floating shelves

Striplox Pro 55



Striplox Clip 50



Designed for small and precise applications, while providing a secure connection in the tightest of places.

Striplox Mini 60



Allows the user to create fully concealed joints.

Striplox Mini 120



Striplox 90D 98



Designed to quickly and easily connect any right angle, miter box and flush joints.

Striplox 180D



Allows you to easily join tables together at conference venues and restaurants in less than a minute.

Striplox Griplox



Is a great alternative to traditional wood biscuits. No more glue, no more waiting time and no more bulge.

Striplox Megalox



Megalox is ideal for bench, table top installations with mitre joints, T joints or box joints.

For Striplox Starter Kits, Please Inquire

Striplox



Striplox Pro 23 & 55

- **Type of Application:** Ceiling panels, acoustic panels, timber battens, floating shelves, furniture, bookcases, mirrors, RV and marine, exhibition/tradeshows events, shop fitting displays and signage.
- **Connection:** Male and female, ideally male is mounted to the wall, ceiling or other surfaces.
- Designed for panels, frames or components. This hidden mounting system delivers a flawless finish with a perfect alignment every time.
- Very strong and durable and will support the load capacity evenly over the entire product.
- Cabinetry or panels can be fitted permanently or removed and re-used with ease.
- 2 sizes to choose from with slim design for easy concealment.
- **Mounting Options:** Horizontal, Vertical and Ceiling Mount
- **Board or Panel Materials To Use:** Solid Wood, MDF, Composite Materials, Aluminum, Acrylic and More
- **Lock Tab:** Lock tab for permanent mounting or remove when repeated access is needed.

Striplox Pro 23

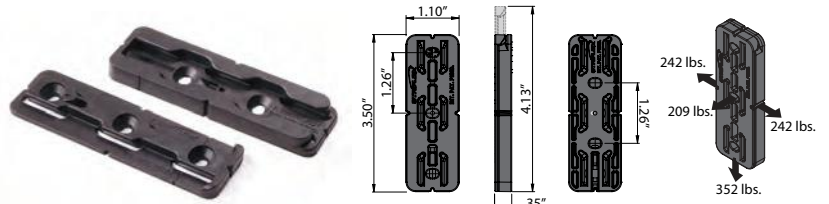

- **Lift Clearance (Direction of Travel):** 1/2" (12.7mm)
- **Projection- Surface Mounted:** .38" (9.5mm)
- **Projection- Recessed Mounted:** Sits flush against the wall
- **Projection- Set Back Mounted:** .08" to .30"
- **Size of Screws:** #8 x 5/8"
- **# of Screws:** 5 pieces
- **Screw Adjustment:** Yes
- **32MM Compatible**

Striplox Pro 55

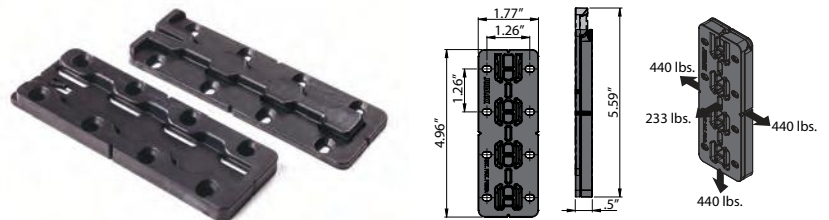

- **Lift Clearance (Direction of Travel):** 3/4" (19mm)
- **Projection- Surface Mounted:** .50" (12.8mm)
- **Projection- Recessed Mounted:** Sits flush against the wall
- **Projection- Set Back Mounted:** .15" or .35"
- **Size of Screws:** #8 x 5/8"
- **# of Screws:** 16 pieces
- **Screw Adjustment:** Yes
- **32MM Compatible**

Part #	Description	Color	Price
SPX-P23	Striplox Pro 23	Black	\$2.20 ea.
SPX-P55	Striplox Pro 55	Black	\$3.45 ea.

See Mounting Accessories On Page S-114

Striplox Clip 50

- **Type of Application:** Wall, cabinetry, commercial panels, acoustic panels, signage, exhibition & shop fitting.
- **Connection:** Male and female, ideally male is mounted to the wall, ceiling or other surfaces.
- Its unique design allows you to mount your products to uneven walls.
- Can be screw or glue mounted.
- Stronger than many panel mounting options on the market today.
- **Mounting Options:** Horizontal, Vertical and Ceiling Mount
- **Board or Panel Materials To Use:** Solid Wood, MDF, Composite Materials, Aluminum, Acrylic and More
- **Lock Tab:** Lock tab for permanent mounting or remove when repeated access is needed.



- **Lift Clearance (Direction of Travel):** 1/4" (6.4mm)
- **Projection- Surface Mounted:** .38" (9.5mm)
- **Projection- Recessed Mounted:** Sits flush against the wall
- **Projection- Set Back Mounted:** .125" to .25"
- **Size of Screws:** #8 x 5/8"
- **# of Screws:** 4 pieces
- **32MM Compatible**

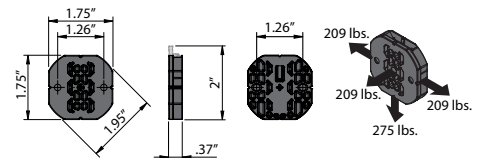

Part #	Color	Price
SPX-C50	Black	\$2.41 ea.

See Mounting Accessories On Page S-114



Striplox Mini 60 & 120

- **Type of Application:** Commercial, domestic and architectural furniture, wardrobe closets, cabinetry, framing of artwork and mirrors, RV and marine fit outs and locker room.
- **Connection:** Male and female mortised into position.
- Replaces the need to use biscuit joints, fasteners or cam dowels. This saves time on labor with a quick and easy install. Completely hidden joint.
- The connectors produce a tight and strong joint either in permanent or reversible applications.
- Will not interfere with substrate finishes, such as veneers and paint.
- **Mounting Options:** Horizontal, Vertical and Lock Up Mount
- **Board or Panel Materials To Use:** Solid Wood, MDF and Other Composite Materials

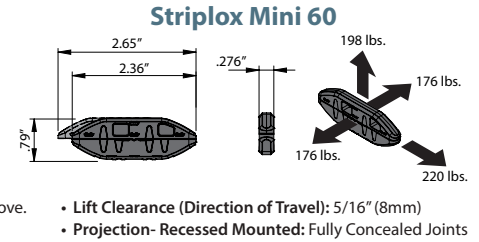

Part #	Description	Color	Price
SPX-M60	Striplox Mini 60	Black	\$1.15 ea.
SPX-M120	Striplox Mini 120	Black	\$1.85 ea.

See Mounting Accessories On Page S-114

Striplox 90D 98

- **Type of Application:** Bulk head and kickboard, furniture, shop fitting displays and signage, exhibition and tradeshow events.
- **Connection:** Male and female, ideal male is mounted to the wall ceiling or other surface. Surface mounted ideal for any right angle.
- This patented design pulls the substrate firmly together to form a strong and tight joint in one simple action by distributing the loads evenly over the entire connector and joint.
- The joint is not visible once the cover is snapped into place.
- Can create a perfect 90 degree angle.
- **Mounting Options:** Horizontal, Vertical and Side Mount
- **Board or Panel Materials To Use:** Solid Wood, MDF and Other Composite Materials
- **Lock Tab:** Cannot be removed, but can be overridden when you start the connection from the beginning of the clip.

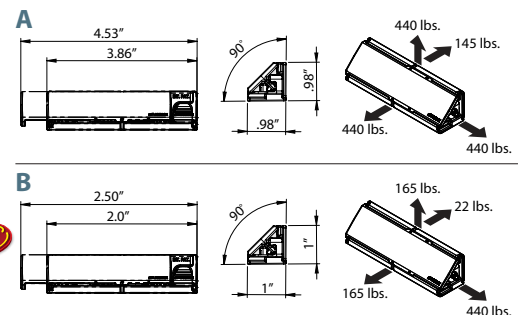
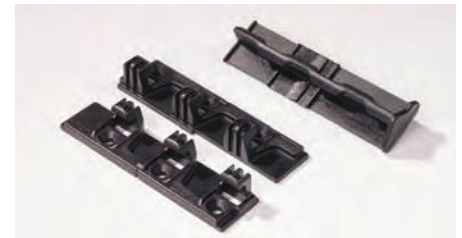

Part #	Color	Price
A SPX-90DBK	Black	\$3.45 ea.
SPX-90DWH	White	\$3.45 ea.
B SPX-90DBK-51	Black	\$.95 ea.

See Mounting Accessories On Page S-114

Striplox Griplox

- **Type of Application:** Anywhere traditional wood biscuits are used.
- **Connection:** Knock in (no glue required) std NO.20 biscuit slot.
- Easy to install, use standard biscuit cutter and simply knock in with a hammer.
- Unique gripping spikes on the front and back secure your project in place without glue.
- **Mounting Options:** Horizontal & Vertical
- **Board or Panel Materials To Use:** Solid Wood, MDF and Other Composite Materials

Part #	Color	Price
SPX-GP20	Black	\$.30 ea.

See Mounting Accessories On Page S-114

- **Board Depth:** .394"
- **Projection- Recessed Mounted:** Fully concealed joints

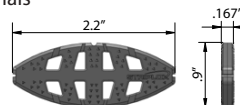

IMPORTANT: Due to Raw Material Fluctuation, Catalog Prices Below May Not Be Accurate. GO TO WWW.OUTWATER.COM FOR THE MOST UP-TO-DATE PRICES

Striplox



Striplox 180D

- **Type of Application:** Conference room tables, kitchen and benchtop tables, workstations, retail displays, signage and large exhibition displays.
- **Connection:** Male and female, ideally male is mounted to the wall, ceiling or other surfaces.
- Primarily used when you need to join items at 180 degrees.
- Can be used even when board is already laminated.
- Very secure connection. The round disc locks closed by hand. Some force is required to unlock.
- **Mounting Options:** Horizontal, Vertical and Under Mount
- **Board or Panel Materials To Use:** Solid Wood, MDF and Other Composite Materials
- **Lock Tab:** Must add a screw in designated hole to make permanent.

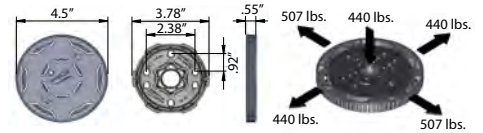

Part #	Color	Price
SPX-180D	Black	\$7.83 ea.

- **Board Depth:** 3/4"
- **Projection- Surface Mounted:** 1/2"
- **Size of Screws:** #8 x 5/8"
- **# of Screws:** 6 pieces
- 32MM Compatible

See Mounting Accessories Below

Striplox Megalox

- **Type of Application:** Bathroom, office, toilet or locker room partitions and bench top waterfalls.
- **Connection:** Male and female mortised into position.
- When creating a waterfall, saves time and because there is no glue to dry.
- Will allow you to create a perfect alignment.
- Can support heavy panels, 650 lbs. when used vertically.
- **Mounting Options:** Horizontal, Vertical and Lock Up Mount
- **Board or Panel Materials To Use:** Solid Wood, MDF and Other Composite Materials
- **Lock Tab:** Lock tab for permanent mounting or must be sanded off or sliced off with a utility knife.

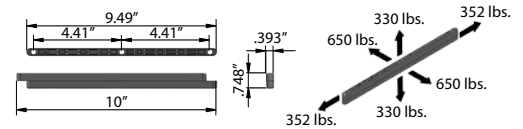

- **Board Depth:** 3/4"
- **Projection- Recessed Mounted:** Fully concealed joints
- **Size of Screws:** #8 x 5/8"
- **# of Screws:** 6 pieces
- **Screw Adjustment:** Yes
- 32MM Compatible

Part #	Color	Price
SPX-MEG	Black	\$4.75 ea.

See Mounting Accessories Below

Accessories

Liquidlox Adhesive 20G

General purpose, middle viscosity, fast cure adhesive

Part #	Price
SPX-ADH	\$12.39 ea.

Grivoly Jig Set

Adds speed to install & helps determine install of hardware

Part #	Size	Price
SPX-P23-JIG	Pro 23	\$7.23 ea.
SPX-C50-JIG	Clip 50	\$7.08 ea.
SPX-P55-JIG	Pro 55	\$7.67 ea.

Router Bits

Part #	Size	Price
SPX-7RB	7mm	\$12.39 ea.
SPX-10RB	10mm	\$12.39 ea.

Striplox Template

Adds speed to install & helps determine install of hardware

Part #	Price
SPX-TEMP	\$18.65 ea.

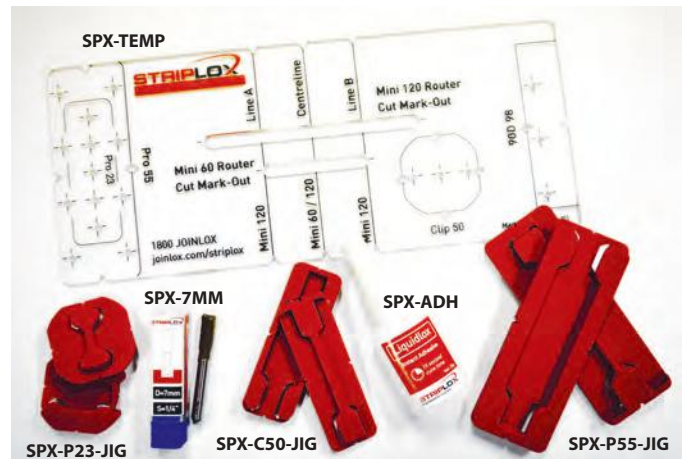

**IMPORTANT: Due to Raw Material Fluctuation, Catalog Prices Below May Not Be Accurate.
GO TO WWW.OUTWATER.COM FOR THE MOST UP-TO-DATE PRICES**

THE ART OF BACKLIGHTING

AuragamiTM



\$74.00-\$79.00
Per Square Foot
Part #: BLS-AU-NW

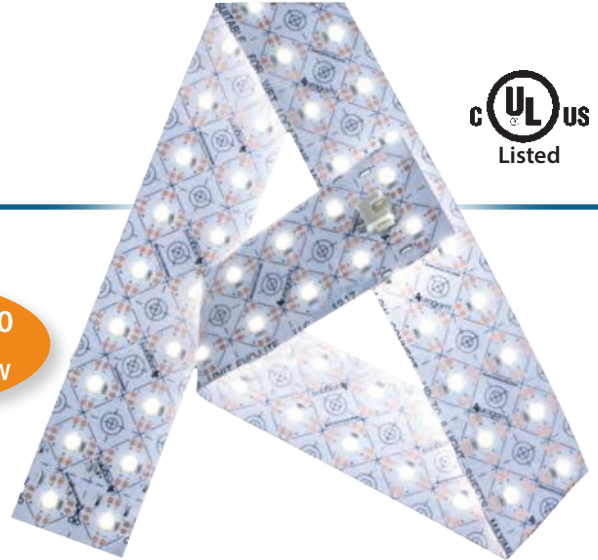

The high LED density (330 LEDs per square foot) combined with a decreased individual LED brightness, eliminates hot spots and "dotting," allowing for as little as 3/8" of clearance between the Light Sheet and the translucent material. Auragami's unique power distribution grid allows you to cut groups, or even single LEDs, from the flexible sheet while maintaining a resilient circuit to the remaining diodes. Cut lines on multiple axis (horizontal, vertical, and diagonal) to maximize customization.

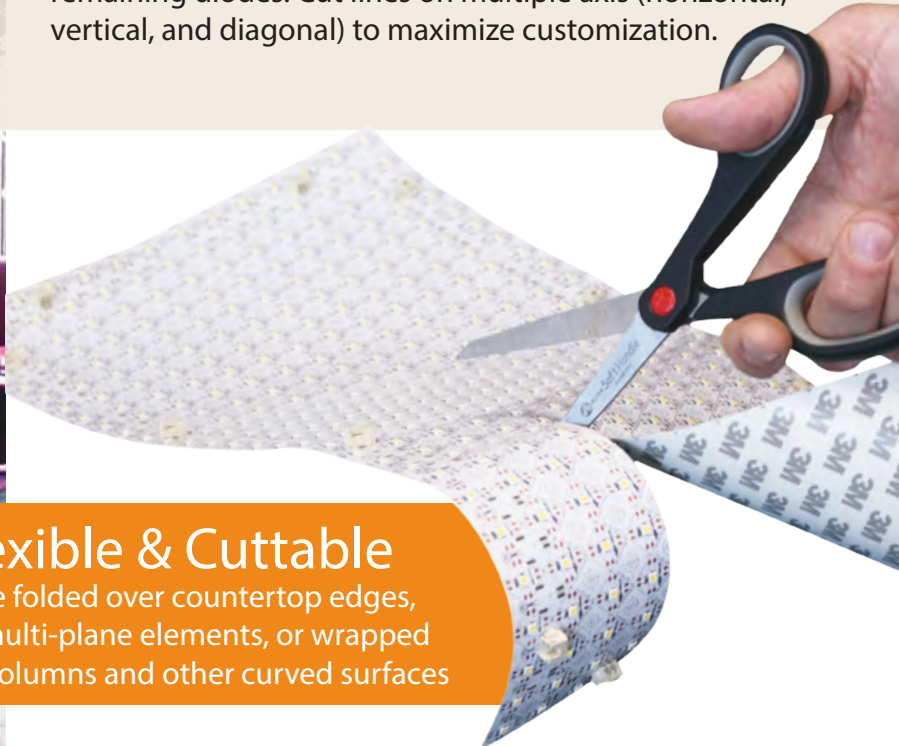

Flexible & Cuttable

Can be folded over countertop edges, other multi-plane elements, or wrapped around columns and other curved surfaces



IMPORTANT: Due to Raw Material Fluctuation, Catalog Prices Below May Not Be Accurate. GO TO WWW.OUTWATER.COM FOR THE MOST UP-TO-DATE PRICES



ILLUMINATED SURFACES

Auragami is ideally suited for onyx, quartz and many manufactured materials into lit counter and bar tops, curved surfaces and low clearance applications. This light sheet provides extremely uniform illumination with as little as 3/8" installation depth for countertops.

Specs

- 24V
- IP65
- UL Listed
- Fully Dimmable
- Natural White (5300K)
- 9.25" x 19.8" Sheet Which Is Cuttable As Small As 5/8" x 5/8" Square



CUTTABLE

A low voltage UL Listing allows for on-site customization which can eliminate custom order lead times. Cut LEDs from any part of the sheet to avoid obstacles without interrupting power to the rest of the sheet, while maintaining UL Listing. When discrepancies occur between drawing specs and field measurements or when changes need to be made, on-site customization avoids delays!



Connect

Auragami sheets interconnect quickly and easily with included sheet-to-sheet connection wires. Connect up to eight sheets in any arrangement while operating within Class 2 guidelines. Integrated 2-pin connection blocks eliminate the need to solder and speed installation.



IMPORTANT: Due to Raw Material Fluctuation, Catalog Prices Below May Not Be Accurate. GO TO WWW.OUTWATER.COM FOR THE MOST UP-TO-DATE PRICES



LED Lighting

Auragami Flexible LED Sheet

Panel Size: 9.25" x 19.8"

Material: Polyimide with a Conformable Coating Layer (Silicon Based)

\$74.00 - \$79.00
Per Sq. Ft.

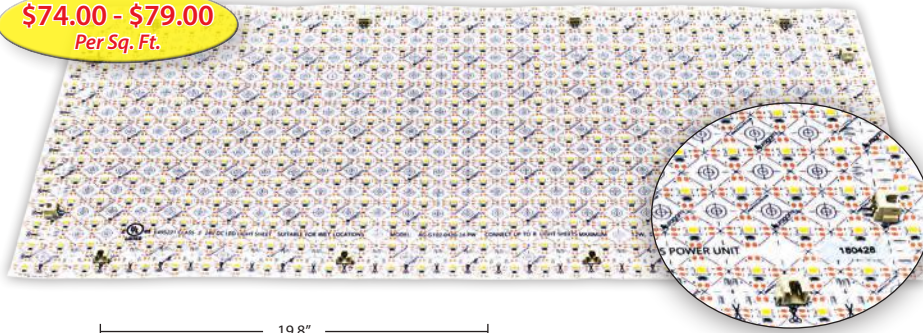

Included with Each Sheet:

- A: 4- .71" Sheet-To-Sheet Connection Wires
- B: 4- 3.74" Sheet-To-Sheet Connection Wires
- C: 1- 24" Power Connection Lead Wire
- D: 2- Wago Connectors For Wires With Same Polarity
- E: 4- Cable Management Clips with Silicone Adhesive Backing
- F: 8- Domed Spacing Bumpers with Silicone Adhesive Backing

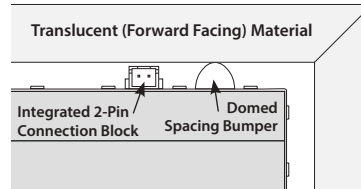
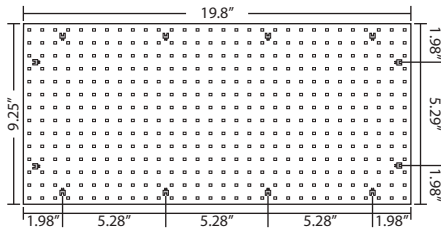

IP65 Auragami
Provides Protection From Dust & Splashing Water, Not Submersible

Lighting Specifications

Color Temperature	5300K
Beam Spread	120°
Lumens	860 sq. ft.
Color Rendering Index	95+
Rated Average Life	50,000 hrs.
Power Input	Constant Voltage
Chip Size	2835

Part #	Dimension	# Of LED Chips	Total Wattage	Max # Can Connect	Each	Price
BLS-AU-NW	9.25" x 19.8" (1.27 sq. ft.)	420	12	12 Sq. Ft.	\$100.37 (\$79.00 sq. ft.)	\$93.98 ea. (\$74.00 sq. ft.)

AURAGAMI SAMPLE KIT AVAILABLE, PLEASE INQUIRE (BLS-AU-KIT)

Required Power Supply + **Optional** (Pick One Option) Dimmer or Switch + **Required** Power Linking Cable + **Required** Auragami

See Page L-3 | See Page L-3 | See Page L-149 | See Page L-3 | For Pricing, See Page L-3

Required

Power Supplies (IP20)

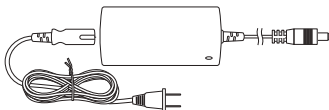

Part #	Type	Finish	Amps	Volts	Watts	Dimensions	Price	
							Each	6+ Pcs.
LED-24V-3A	Desktop	Black	3A	24V	72W	4.68"L x 2.34"W x 1.48"H	\$28.75	\$26.05 ea.
LED-24V-4A	Desktop	Black	4A	24V	96W	6.77"L x 2.83"W x 1.48"H	\$44.05	\$39.90 ea.

For Product Details & More Power Options, See Pages L-137~140

Other Options: Plug In | Hardwire | Hardwire Dimmable | Rechargeable Battery

Power Linking Cable

Required for power supplies, dimmers & multi output cables.



Part #	Description	Overall Length	Finish	Price	
				Each	10+ Pcs.
BLS-PWL	Connects from power supplies, dimmers & multi output cables to light panel	12"	White	\$1.50	\$1.25 ea.

Optional

Dimmers

A power linking cable required.



Part #	Description	Finish	Range of Dimming	Size	Price	
					Each	6+ Pcs.
LED-INLINE-DIM-WH	Inline Rotary	White	0-100%	2-5/8"L x 1-3/8"W x 1"H	\$5.95	\$5.25 ea.

For Product Details & More Dimmer Options, See Pages L-134~136 & L-142~144

Other Options: Rotary | Touch Dimmer | Radio Frequency

**IMPORTANT: Due to Raw Material Fluctuation, Catalog Prices Below May Not Be Accurate.
GO TO WWW.OUTWATER.COM FOR THE MOST UP-TO-DATE PRICES**



\$48.00-\$52.00
Per Square Foot
Part #: QM-1212-CW

Introducing "The Original" Quadmod LED Panel Light



Customized lighting solutions are just a "SNAP" away with the Quadmod Panels. Sold in 12" x 12" squares, the razor-thin (1.65mm thick) panels can be snapped down to 3" x 3" squares.

Backlighting your signs or surfaces requires just 1"-2" separation between panel and surface being illuminated (depending on the substrate density) for even illumination.

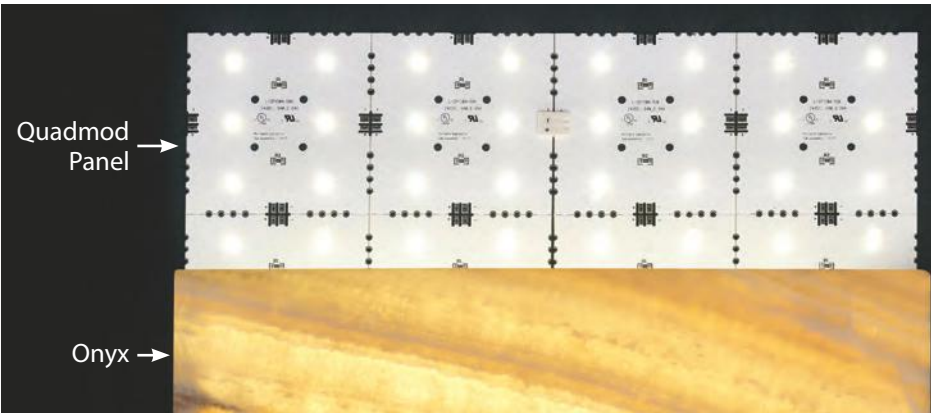

- 24V & Fully Dimmable
- Offered In 6500K
- Easy to use connectors & accessories make installation fast & simple
- Limited 3 Year Warranty

IMPORTANT: Due to Raw Material Fluctuation, Catalog Prices Below May Not Be Accurate. GO TO WWW.OUTWATER.COM FOR THE MOST UP-TO-DATE PRICES

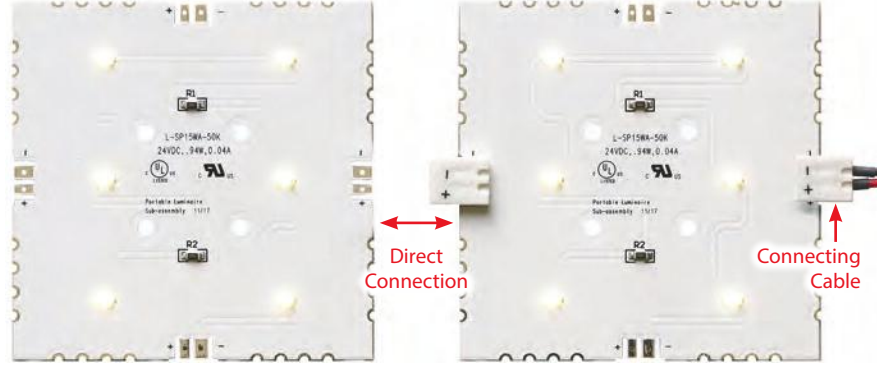

End-to-end connection using our simple DIY connectors and connecting cables. (no soldering necessary)
Can connect up to 12 panels on one power supply.

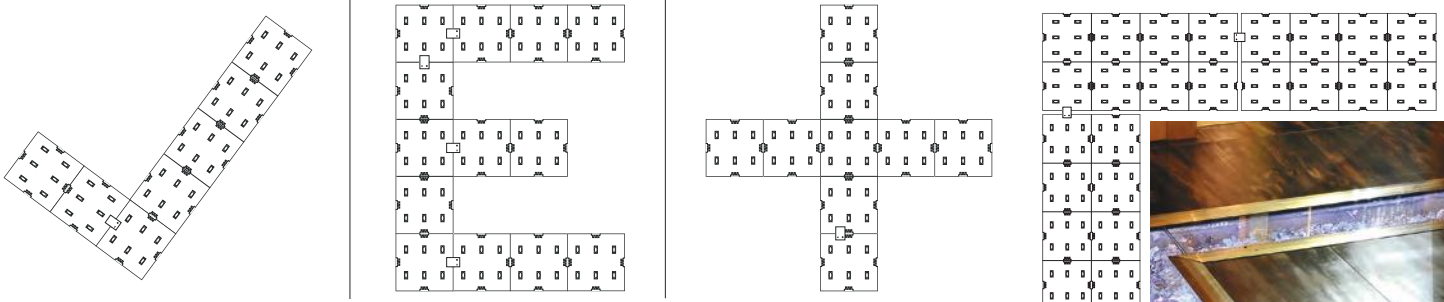

Achieve versatile sizes & shapes

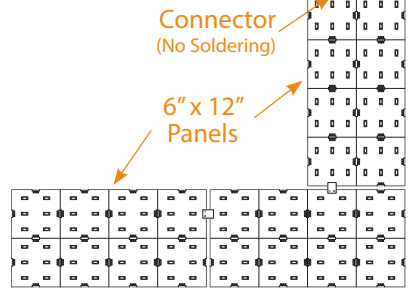
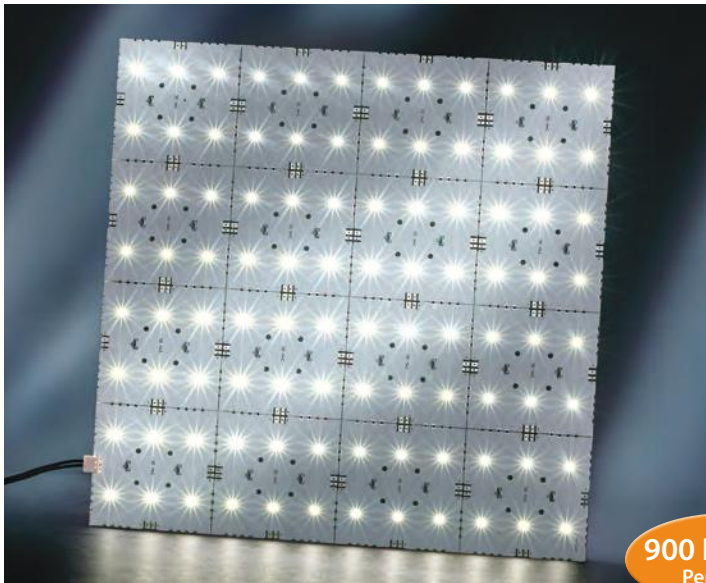

900 Lumens
Per Sq. Ft.

Material: Aluminum With White Powder Coating

IP 20

Black Rubber Feet On Back Aid In Mounting Stability & Heat Dissipation

IMPORTANT: Due to Raw Material Fluctuation, Catalog Prices Below May Not Be Accurate. GO TO WWW.OUTWATER.COM FOR THE MOST UP-TO-DATE PRICES

LED Lighting



Quadmod LED Lighting Panel

Panel Size: 12" x 12" - Can "Snap" To 3" x 3"
Material: Aluminum with White Powder Coating

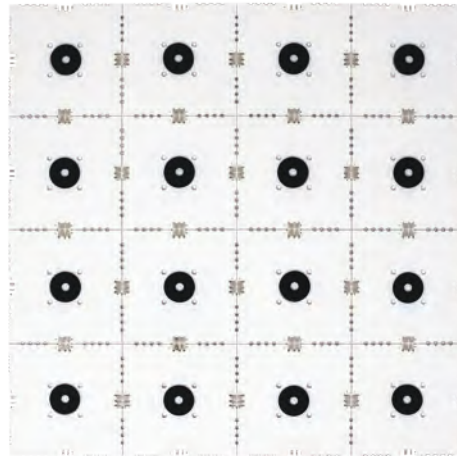

900 Lumens
Per Sq. Ft.

Front

Back

Black rubber feet aid in mounting stability & heat dissipation



IP20 Quadmod

Provides Low Protection of Dust & Water

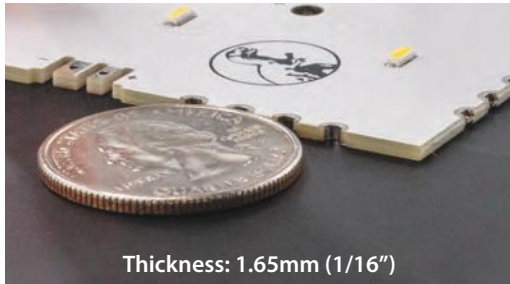

Thickness: 1.65mm (1/16")



Kit Includes:
Mounting Clips & Screws

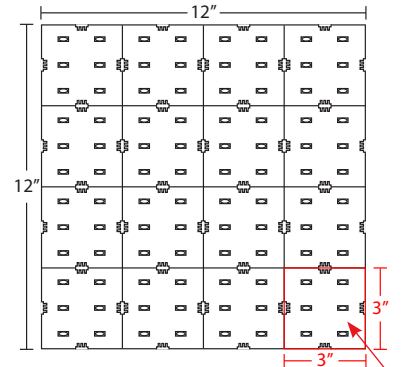

"Snap" In 3" Increments

2 Mounting Options

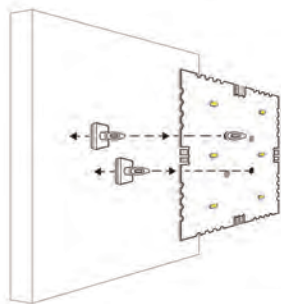

Mounting Clips

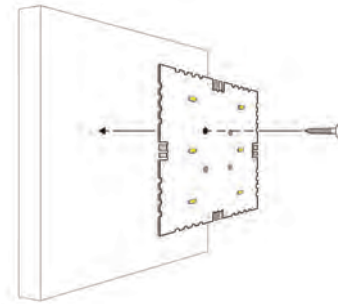

Screws



Lighting Specifications

Color Temperature	6500K
Beam Spread	120°
Lumens	900 sq. ft.
Color Rendering Index	80
Rated Average Life	50,000 hrs.
Constant Voltage	
Chip Size	4014

Part #	Dimension	# Of LED Chips	Total Wattage	Max # Can Connect	Price	
					Each	10+ Pcs.
QM-1212-CW	12" x 12"	96	8	12 Sq. Ft.	\$52.00	\$48.00 ea.

QUADMOD SAMPLE KIT AVAILABLE, PLEASE INQUIRE (QM-KIT)
OTHER COLOR TEMPERATURES AVAILABLE, PLEASE INQUIRE MINIMUMS APPLY

IMPORTANT: Due to Raw Material Fluctuation, Catalog Prices Below May Not Be Accurate. GO TO WWW.OUTWATER.COM FOR THE MOST UP-TO-DATE PRICES



LED Lighting

Accessories for Quadmod LED Lighting Panel

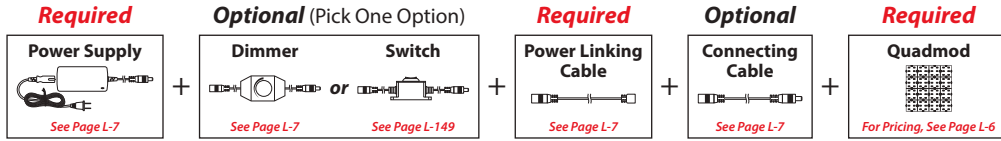

Required

Power Supplies (IP20)

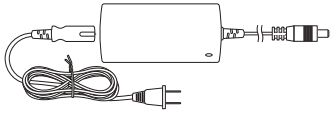

Part #	Type	Finish	Amps	Volts	Watts	Dimensions	Price	
							Each	6+ Pcs.
LED-24V-3A	Desktop	Black	3A	24V	72W	4.68"L x 2.34"W x 1.48"H	\$28.75	\$26.05 ea.
LED-24V-4A	Desktop	Black	4A	24V	96W	6.77"L x 2.83"W x 1.48"H	\$44.05	\$39.90 ea.

For Product Details & More Power Options, See Pages L-137~140
Other Options: Plug In | Hardwire | Hardwire Dimmable | Rechargeable Battery

Power Linking Cable

Required for power supplies, dimmers & multi output cables.



Part #	Description	Overall Length	Finish	Price	
				Each	10+ Pcs.
QM-PWL12	Connects from power supplies, dimmers & multi output cables to light panel	12"	White	\$5.00	\$4.50 ea.
QM-PWL39		39"	White	\$6.00	\$5.50 ea.

Optional

Dimmers

A power linking cable required.

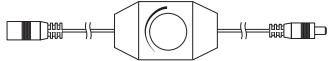

Part #	Description	Finish	Range of Dimming	Size	Price	
					Each	6+ Pcs.
LED-INLINE-DIM-WH	Inline Rotary	White	0-100%	2-5/8"L x 1-3/8"W x 1"H	\$5.95	\$5.25 ea.

For Product Details & More Dimmer Options, See Pages L-134~136 & L-142~144
Other Options: Rotary | Touch Dimmer | Radio Frequency

Multi Output Cables

5-Way Sweep: DC 5.5

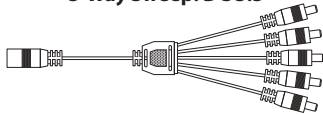

Part #	Description	Finish	Arms Size	# of Arms	Overall Length	Max # of Power Linking Cables	Price	
							Each	6+ Pcs.
LED-5OUT-CBL-WH	5-Way Sweep	White	8-3/4"	5	19"	5	\$5.50	\$4.85 ea.

For More Extension Cable Options, See Page L-147

Power Extension Cables



Part #	Description	Finish	Length	Price	
				Each	10+ Pcs.
QM-EXT39	Allows the designer to get around unlit areas without multiple power supplies	White	39"	\$6.00	\$5.50 ea.
QM-EXT79		White	79"	\$8.00	\$7.50 ea.
QM-EXT118		White	118"	\$11.00	\$10.25 ea.

Connecting Cables



Part #	Description	Finish	Length	Price	
				Each	10+ Pcs.
QM-CC03	Allows the designer to get around unlit areas without multiple power supplies	White	3"	\$2.00	\$1.50 ea.
QM-CC10		White	10"	\$4.00	\$3.25 ea.
QM-CC24		White	24"	\$6.00	\$5.25 ea.
QM-CC48		White	48"	\$8.00	\$7.25 ea.

Direct Connector

Sold 10 pieces per bag



Part #	Description	Dimensions	Price For Bag of 10	
			Each Bag	10+ Bags
QM-DCC	Female to Female connect end-to-end	1/2" L x 3/8"W x 1/4"H	\$4.75	\$4.00 ea.

**IMPORTANT: Due to Raw Material Fluctuation, Catalog Prices Below May Not Be Accurate.
GO TO WWW.OUTWATER.COM FOR THE MOST UP-TO-DATE PRICES**

Nova Backlighting System

The Original Edge Lite Panel

The Nova Backlight System can be customized per order for a wide variety of applications



- *Material: Optical Grade PMMA Acrylic*
- *Super bright and long lasting up to 70,000 hours*
- *Integrated thermal management will ensure maximum life span and even illumination throughout*
- *Limited 3 Year Warranty*



Customizable

The Nova sheet can be custom manufactured in most sizes, shapes & light color options



Signage

Ultra Thin...
No Required Installation Depth



Ceiling

Durable... Strong



Countertops

Illuminate Any Translucent Material



Flooring

Damp Location Option Available



Wallscapes

Less Build Up... Save Time & Money
No Frame or Housing



Store Interior

Even Illumination... No Dark Spots
Substrate can lay directly on the Nova sheet panel

IMPORTANT: Due to Raw Material Fluctuation, Catalog Prices Below May Not Be Accurate. GO TO WWW.OUTWATER.COM FOR THE MOST UP-TO-DATE PRICES



LED Lighting

Nova Backlighting System

Material: Optical Grade PMMA Acrylic

THE TECHNOLOGY

Nova sheet utilizes a patented 3-D v-groove etched grid pattern to create a bright and uniform illumination across the entire surface of the panel.

The Nova sheet utilizes superior quality 12V constant voltage LED's. The LED's are integrated into the perimeter of the panel without the use of framing materials.

The built in heat sink will ensure that the panel will last the life span, 70,000 hours!

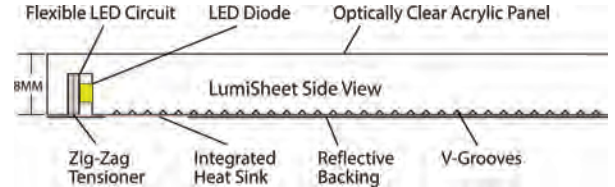

LED LIGHT COLOR OPTIONS

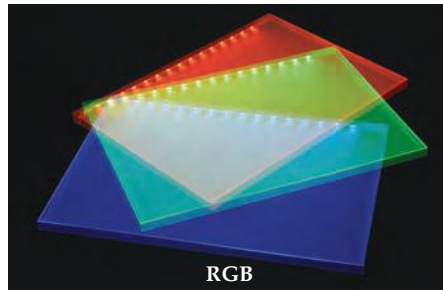

Color Temperature:

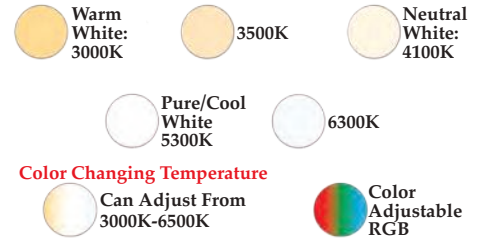

CUSTOMIZABLE

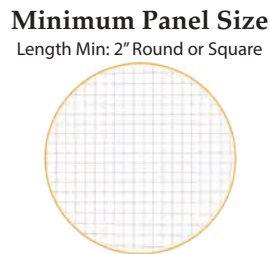
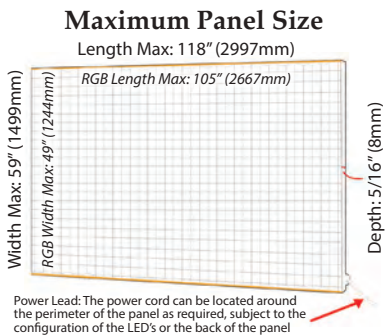

ILLUMINATING OPTIONS

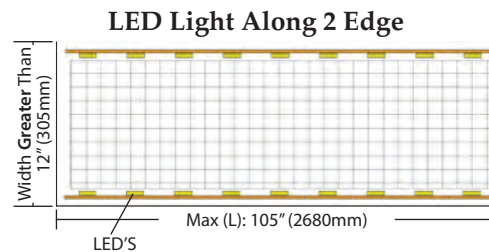
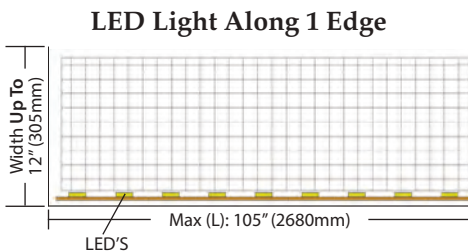

LED Light Along All 4 Edges

For Square Panels

For Example 36" x 36" or 48" x 48"

LED'S

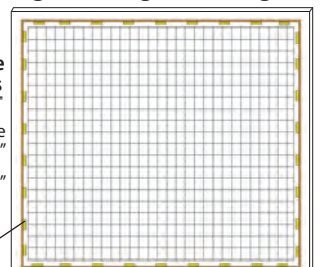

** This is only recommended for when panels are "nearly" square. It is not recommended for long narrow panels

IMPORTANT: Due to Raw Material Fluctuation, Catalog Prices Below May Not Be Accurate. GO TO WWW.OUTWATER.COM FOR THE MOST UP-TO-DATE PRICES

LED Lighting



Nova Backlighting System

Material: Optical Grade PMMA Acrylic

FACE OPTIONS

Single Face Illumination (Standard)

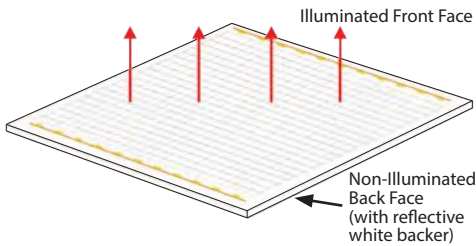

Double Face Illumination (Option)

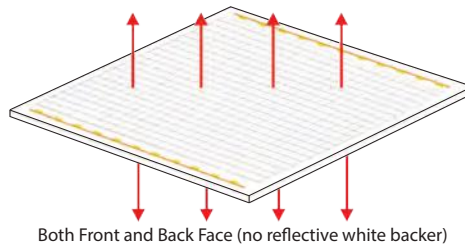

Application Options

- A wide variety of accessory options are available, See Page L-11.
- Environment: Dry environments are standard but if needed for a wet location, then please inquire further
- Quoting Requirements: DXF (CAD) and/or PDF drawings with dimensions and wire locations labeled must be provided

BRIGHTNESS

2,000 to 10,000 Lux- Readings will vary with panel size & design

24" x 48" Sheet with 5300K LED's Lit Along 2 Edges (30W)

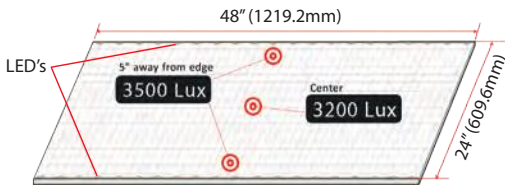

12" x 12" Sheet with 5300K LED's Lit Along 2 Edges (8W)

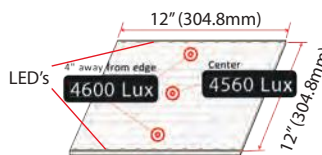

48" x 96" Sheet with 5300K LED's Lit Along 2 Edges (60W)

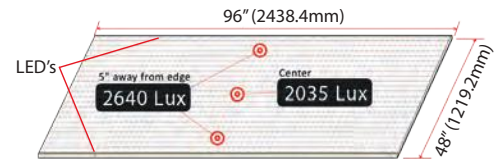

MOUNTING OPTIONS

Screw Mounting with Pre-Drilled Holes

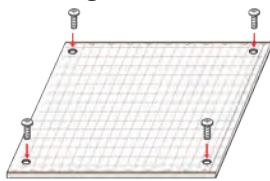

Detailed Dimensions From Customer Required

Mounting with Mirror Clips

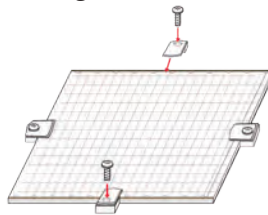

Mounting with Z-Clips

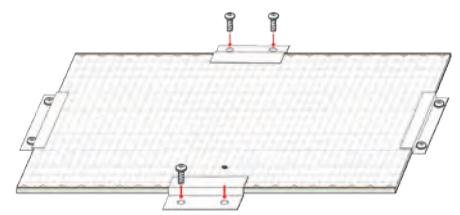

Fabric Frame Option Available: Please Inquire

POWER CORD EXIT

Power Cord Exits From Short Side Edge Corner

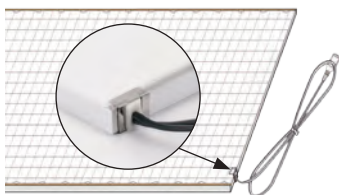

Power Cord Exits From Middle of Each Long Side

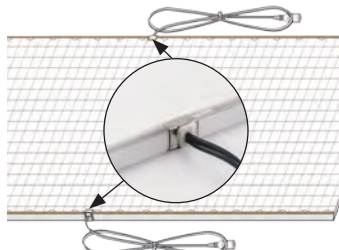

Power Cord Exits From The Back Side

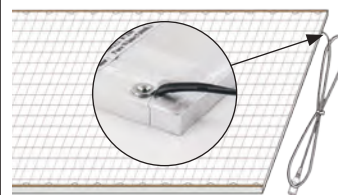

Recessed Notched Power Cord Exit

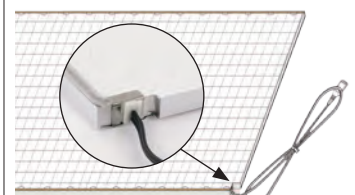

IMPORTANT: Due to Raw Material Fluctuation, Catalog Prices Below May Not Be Accurate. GO TO WWW.OUTWATER.COM FOR THE MOST UP-TO-DATE PRICES



LED Lighting

Accessories for Nova Backlighting System

Material: Optical Grade PMMA Acrylic

POWER SUPPLIES



Plug In (12W)



Plug In (60W)



Hardwire (60W)



Hardwire (150W)

DIMMERS

RF Dimmer with Remote (Plug In: Up To 60W)



Dimming Module Hardwire: 60W



+ Leviton Sliding Dimmer



Magnetic Dimming Power Supply Hardwire: 60W & 150W



+ Lutron Diva Sliding Dimmer



CONTROLLERS

RGB Mini



Color Changing Temperature



For Turnable (CCT) White Only

RGB DMX Key



SPIDER CABLES

2-Way Long

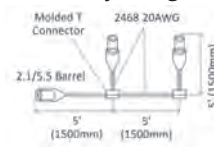

4-Way Long

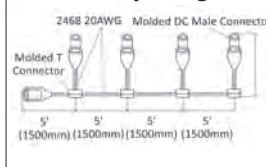

6-Way Long

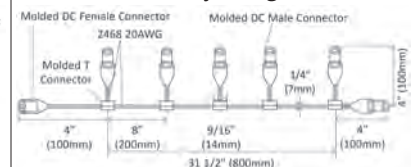

10' Extension Cable

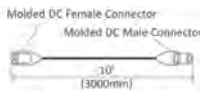

2-Way Short

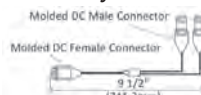

4-Way Short

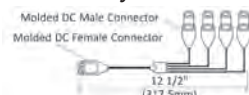

SAMPLE KITS



1 pc. of Cool, Warm White & Pure White 10" x 8" Sample with 1A Power Supply
Part#: **NOVA-SAMP-KIT**
Price: \$169.00 ea.



10" x 8" Sample with 1A Power Supply
Part#: **NOVA-SAMP108-* -P**
Price: \$59.00 ea.



10" x 8" Sample with 1A Power Supply & Dimmer
Part#: **NOVA-SAMP108-* -D**
Price: \$69.00 ea.



10" x 8" RGB Sample with 1A Power Supply & RGB Controller
Part#: **NOVA-SAMP108-RGB-K**
Price: \$89.00 ea.



10" x 8" CCT Sample with 1A Power Supply & CCT Controller
Part#: **NOVA-SAMP108-CCT-K**
Price: \$245.00 ea.

Cool White (*CW), Pure White (*PW) & Warm White (*WW)

IMPORTANT: Due to Raw Material Fluctuation, Catalog Prices Below May Not Be Accurate. GO TO WWW.OUTWATER.COM FOR THE MOST UP-TO-DATE PRICES

LED Lighting



This light guide sheet was designed for edge lit illumination formulated with evenly dispersed illuminating (Pixie Dust) particles.



Framing Options (Required)

Thickness of Acrylic	U Channel Recommended	Angled Recommended	LED Ribbon Recommended	Aluminum Tape Recommended
.157"	---	ALU149-*	SPT12-*-30*-*-CW	LED-ALUTAPNC-375
.157"	---	ALU149-*	SPT12-*-30*-*-CW or SPT12-*-3560-*-RGB	LED-ALUTAPNC-375
.236"	ALU257-*	ALU149-*		
.236"	1991-*			

magic
BACKLIGHT SHEET



Available Lengths: 2' x 2' & 2' x 4' Sheets
Material: Clear Acrylic

- **SINGLE OR DOUBLE SIDED**
- Crystal clear when illumination is off
- Can run any temperature of white or RGB
- **Made with embedded diffuser particles to deflect and evenly emitted the light across the surface**
- Can be machined, drilled, threaded and routed with standard equipment such as circular saws, drills and band saws
- Can easily be cut using a 3/32" carbide tipped blade with 5-6 teeth per inch, no polish req'd
- Edges can be flame polished or sanded with wet/dry 600 grit sandpaper for desired edge
- 4mm: Ideal for small applications, signage & shelving
- 6mm: Ideal for larger applications, signage, wall art & countertops
- **Other sheet sizes available, please inquire**

Part #	Thickness	Illumination Distance	Size	Price
MLS-2424-157	4mm	up to 12"	2' x 2'	\$44.00 ea.
MLS-2448-157	(.157")	single side	2' x 4'	\$88.00 ea.
MLS-2424-236	6mm	up to 18"	2' x 2'	\$63.67 ea.
MLS-2448-236	(.236")	single side	2' x 4'	\$127.33 ea.

IMPORTANT: Due to Raw Material Fluctuation, Catalog Prices Below May Not Be Accurate. GO TO WWW.OUTWATER.COM FOR THE MOST UP-TO-DATE PRICES

LED Lighting

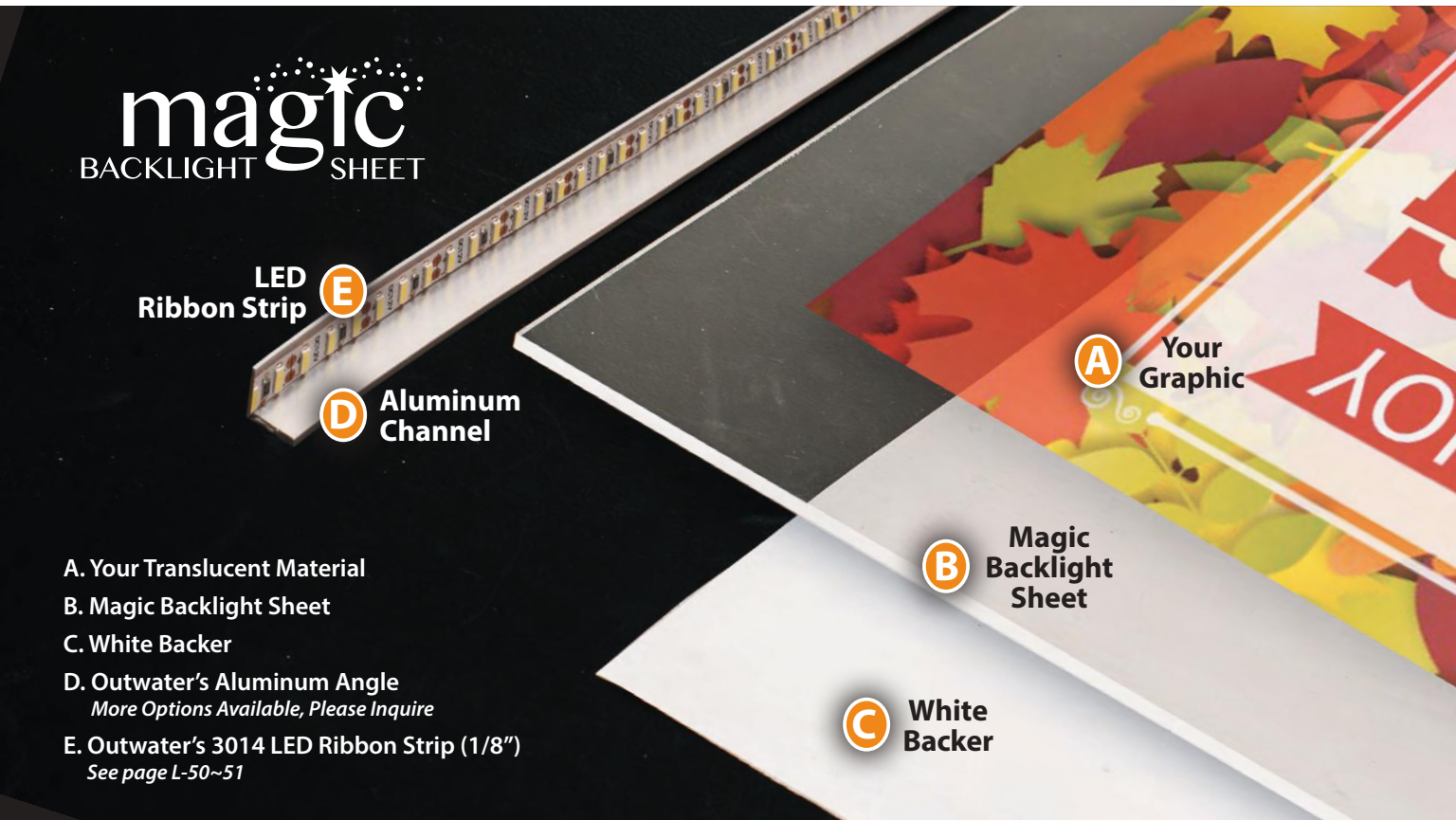

- A. Your Translucent Material
- B. Magic Backlight Sheet
- C. White Backer
- D. Outwater's Aluminum Angle
More Options Available, Please Inquire
- E. Outwater's 3014 LED Ribbon Strip (1/8")
See page L-50~51

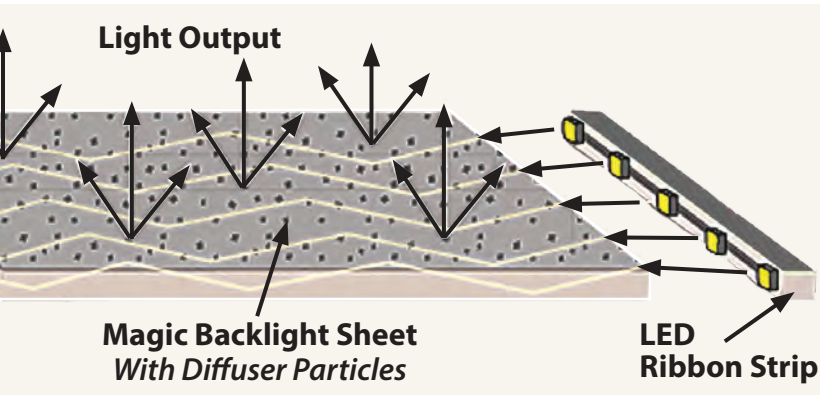

FREE Sample Kit

MLS-FSK (4mm)
MLS-FSK-236 (6mm)

Includes the following:

- Small piece of Magic Backlight Sheet
- Small piece of 3014 LED Ribbon
- Small piece of L-TASK-149 Aluminum Channel



Self Adhesive White Backer (Optional)



- 5' wide rolls
- 5' square ft. minimum

MLS-BACKER
Per Sq. Ft.: \$1.25

3M™ Wetordry™ Sandpaper (Optional)



- Used to polish edges
- 600 Grit
- 9" x 11" Sheet
- Can be used wet or dry

MLS-SAND-600
5 Pack: \$8.23

Foil Tape (Optional)

- Function: To Prevent light from escaping, thus providing maximum brightness
- Non conductive tape
- 3/8" x 10' per roll

LED-ALUTAPNC-375
Per Roll: \$22.00

IMPORTANT: Due to Raw Material Fluctuation, Catalog Prices Below May Not Be Accurate. GO TO WWW.OUTWATER.COM FOR THE MOST UP-TO-DATE PRICES

LED Lighting



DIY: Brite Light Sheet

An inexpensive way to create Light Guide Panels

Brite Light Sheet is an optical PVC film with dot matrix designed to disperse light evenly across your acrylic panel

- **The most affordable way to create DIY backlighting**
- Sold in nominal 4 ft. x 25 ft. rolls... Can be shipped via UPS
- **Easy to install...** The Brite Light Sheet adheres to any acrylic or glass surface
- **Zero gap clearance** allows for heavy loads
- Low tack resistance enables the Brite Light Sheet to be easily removed and repositioned as desired without damage to the Light Guide Sheet
- Ideal for one sided small signs and shelving. When lit with 2 edges of LED's will illuminate evenly up to 14" in width

Part#: **BLPS-1248**

For Just
\$2.95
per sq. ft.

Framing Options (Required)

Thickness of Acrylic	U Channel Recommended	Angled Recommended	LED Ribbon Recommended	Aluminum Tape Recommended
1/8"	ALU757-* 132-*	ALU149-*	SPT12-*30*-* CW	LED-ALUTAPNC-375
3/16"	R104-582* 2325-*	ALU149-*	SPT12-*30*-* CW	LED-ALUTAPNC-375
1/4"	ALU257-* 1991-*	ALU149-*	SPT12-*30*-*CW or SPT12-*3560-*RGB	LED-ALUTAPNC-375
3/8"	ALU57-* 383-*	ALU269-* or ALU249-*	SPT12-*30*-*CW, SPT12-*3560-*RGB or ECO12-*35-*	LED-ALUTAPNC-375
3/8"	2317-*			



DIY: Brite Light Sheet

An inexpensive way to create light guide panels

E LED Ribbon Strip

D Aluminum Channel

A Your Graphic

B Your Acrylic

C DIY Sheet

- A. Your Translucent Material
- B. Your Acrylic or Glass
- C. Outwater's Brite Light Sheet
- D. Outwater's Aluminum Angle
More Options Available, Please Inquire
- E. Outwater's 3014 LED Ribbon Strip (1/8")
See page L-50~51

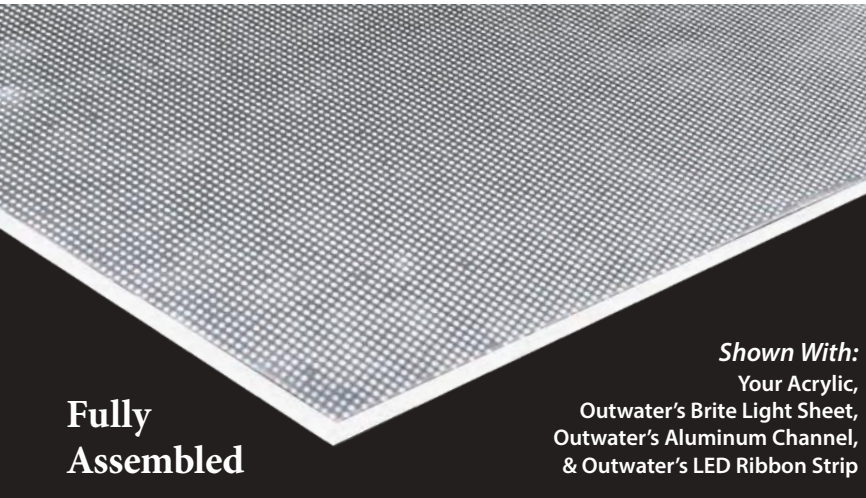

Fully Assembled

Shown With:
Your Acrylic,
Outwater's Brite Light Sheet,
Outwater's Aluminum Channel,
& Outwater's LED Ribbon Strip

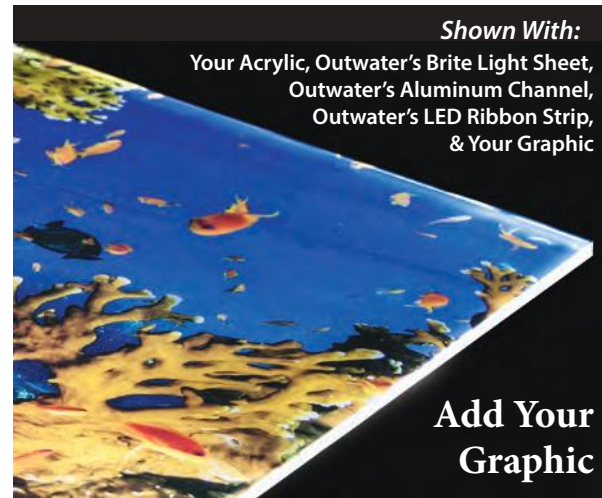

Shown With:
Your Acrylic, Outwater's Brite Light Sheet,
Outwater's Aluminum Channel,
Outwater's LED Ribbon Strip,
& Your Graphic

Add Your Graphic

FREE Sample Kit

BLPS-FSK

Includes the following:

- Small piece of acrylic
- 6" square of Brite Light Sheet
- 5" piece of 3014 LED Ribbon
(works with any 12 volt transformer)



Foil Tape (Optional)

- Function: To Prevent light from escaping, thus providing maximum brightness
- Non conductive tape
- 3/8" x 10' per roll

LED-ALUTAPNC-375
Per Roll: \$22.00

Deluxe Kits

BLPS-KIT

\$29.00 ea.

Includes the following:

- 2 ft. of 12V **Ultra** Brite LED Ribbon
(Cool White, 3014 Chip)
- 2 ft. of 12V **Standard** Brite LED Ribbon
(Cool White, 3014 Chip)
- 1 ft. x 2 ft. of Brite Light Sheet
- 1 piece of 2 ft. Aluminum Channel
(L-Task-149)
- 1 Power Supply

BLPS-KIT-DIM

\$35.00 ea.

Includes the following:

- 2 ft. of 12V **Ultra** Brite LED Ribbon
(Cool White, 3014 Chip)
- 2 ft. of 12V **Standard** Brite LED Ribbon
(Cool White, 3014 Chip)
- 1 ft. x 2 ft. of Brite Light Sheet
- 1 piece of 2 ft. Aluminum Channel
(L-Task-149)
- 1 Power Supply
- 1 Inline Dimmer

IMPORTANT: Due to Raw Material Fluctuation, Catalog Prices Below May Not Be Accurate. GO TO WWW.OUTWATER.COM FOR THE MOST UP-TO-DATE PRICES

LED Lighting



Triflex Flexible LED Sheet

Panel Size: 12" x 24"

Material: Flexible PCB with Copper Base

- Economical way to light up signs or translucent material
- Trimmable down to 2" x 4" pieces
- Connect up to 4 panels together
- Requires 1-1/2" depth for NO HOT SPOTS
- Limited 3 Year Warranty

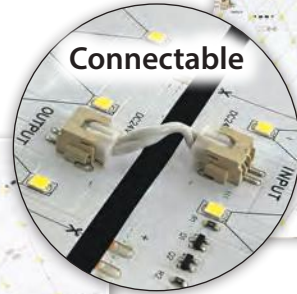

\$55.00 - \$59.00
Per Sq. Ft.

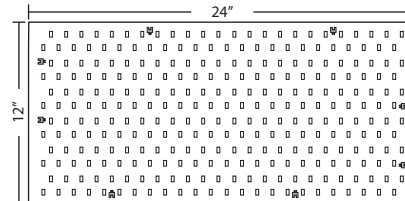

IP54 Triflex
Protection Against Dust
& a Fair Amount of Protection
Against Splashing Water

Lighting Specifications

Color Temperature	6500K
Beam Spread	120°
Lumens	1710 sq. ft.
Color Rendering Index	85+
Rated Average Life	50,000 hrs.
Constant	Voltage
Chip Size	2835

Part #	Dimension	# Of LED Chips	Total Wattage	Max # Can Connect	Price
BLS-TFX-CW	12" x 24" (2 sq. ft.)	108	26	8 Sq. Ft.	Each: \$118.00 (\$59.00 sq. ft.) 10+ Pcs.: \$110.00 ea. (\$55.00 sq. ft.)

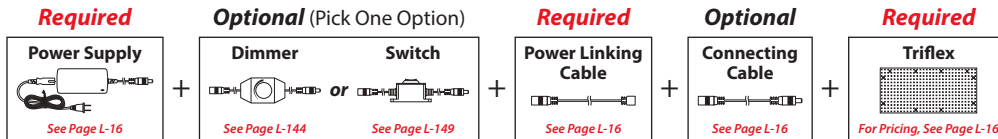

Required

Power Supplies (IP20)

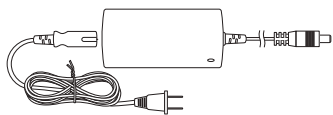

Part #	Type	Finish	Amps	Volts	Watts	Dimensions	Price	
							Each	6+ Pcs.
LED-24V-3A	Desktop	Black	3A	24V	72W	4.68"L x 2.34"W x 1.48"H	\$28.75	\$26.05 ea.
LED-24V-4A	Desktop	Black	4A	24V	96W	6.77"L x 2.83"W x 1.48"H	\$44.05	\$39.90 ea.

For Product Details & More Power Options, See Pages L-137~140

Other Options: Plug In | Hardwire | Hardwire Dimmable | Rechargeable Battery

Power Linking Cable

Required for power supplies, dimmers & multi output cables.



Part #	Description	Overall Length	Finish	Price	
				Each	10+ Pcs.
BLS-PWL	Connects from power supplies, dimmers & multi output cables to light panel	12"	White	\$1.50	\$1.25 ea.

Optional

Connecting Cables



Part #	Function	Finish	Length	Price	
				Each	10+ Pcs.
BLS-CC01	Is to allow the designer to get around unlit areas without multiple power supplies	White	1"	\$0.75	\$0.50 ea.
BLS-CC24		White	24"	\$1.50	\$1.00 ea.

IMPORTANT: Due to Raw Material Fluctuation, Catalog Prices Below May Not Be Accurate. GO TO WWW.OUTWATER.COM FOR THE MOST UP-TO-DATE PRICES



120V MAXX Light Flex

The Modern Day Ropelight



Plug & Play * Waterproof * Dimmable

*No Amplifiers or Power Supply Needed * Up To 165' Can Be Run From One Power Cord*



3 Styles Available

Ideal For... Deck • Path Lighting • Building Outlines

STANDARD (Solid Color)



Dimmable

See Page L-18

ULTRA BRIGHT (Solid Color)



Dimmable

See Page L-18

STANDARD (RGB)



Color Changing

See Page L-19

Standard
120V



**EASY
TO
USE**



Hardwire
To Wall
Switch

Phone: 1-800-631-8375 - Fax: 1-800-888-3315
Due to raw material cost fluctuations, prices are subject to change.

IMPORTANT: Due to Raw Material Fluctuation, Catalog Prices Below May Not Be Accurate. GO TO WWW.OUTWATER.COM FOR THE MOST UP-TO-DATE PRICES

LED Lighting

120V

High Light Output



MAXX LED Light (Indoor/Outdoor): No Power Supply Needed!

Can Run Up To 164 Ft. On One Power Cord
Available Lengths: 33', 82' & 164'

Material: Flexible PVC

- Ideal for applications in which longer lengths are desired
- Includes a factory sealed 2' power cord & end cap
- Consistent binning/color
- Field cuttable every 20" nominal and connectable
- Dimmable
- Limited 2 Year Warranty



IP67 MAXX LED Light
Suitable For Wet Locations

Standard (Up To 152 Lumens Per Foot / 2835 Chip 60 Pcs/Meter)



7/16" |
• • 1/4"
Chip Spacing:
5/8"

Part #	Length	# Of LED Chips	Total Wattage	Max # Can Connect	Price	10+ Pcs.
<i>Cool White *CW & Warm White *WW</i>						
MXL60-28-*3	33'	600	60	164'	\$47.00 ea. (\$1.42)	\$44.70 ea. (\$1.35')
MXL60-28-*5	82'	1500	148	164'	\$104.00 ea. (\$1.27)	\$95.00 ea. (\$1.16')
MXL60-28-*6	164'	3000	295	164'	\$190.00 ea. (\$1.16')	\$173.00 ea. (\$1.05')

Lighting Specifications

Color Temperature	CW: 6500K WW: 3000K
Beam Spread	120°
Lumens	MXL60-28-*: 152 per ft. MXL140-28-*: 320 per ft.
Color Rendering Index	80
Rated Average Life	30,000 hrs.
Constant	Voltage
Chip Size	2835

Ultra Bright (Up To 320 Lumens Per Foot / 2835 Chip 140 Pcs/Meter)



7/16" |
• • 1/4"
Chip Spacing:
1/8"

Part #	Length	# Of LED Chips	Total Wattage	Max # Can Connect	Price	10+ Pcs.
<i>Cool White *CW & Warm White *WW</i>						
MXL140-28-*3	33'	1400	103	164'	\$61.00 ea. (\$1.85')	\$55.00 ea. (\$1.67')
MXL140-28-*5	82'	3500	256	164'	\$139.00 ea. (\$1.69')	\$126.00 ea. (\$1.54')
MXL140-28-*6	164'	7000	512	164'	\$259.00 ea. (\$1.58')	\$235.00 ea. (\$1.43')

Our MAXX LED Light products are ETL certified and warranted as non-cuttable. If a customer does cut the product, they do so at their own risk.

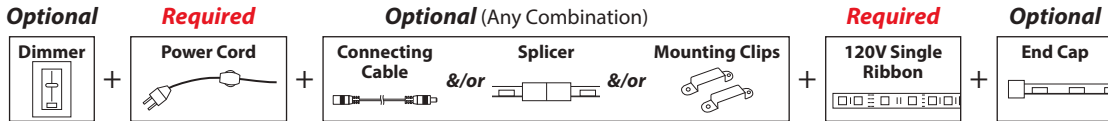

Power Cord (Additional Quantities Optional)



legrand Dimmer Switches (Optional)

Input & Output Cords: 5.875" • Range of Dimming: 0-100% • Mounting: Wall
softTap
Touch Switch With Touch Slide Dimmer

LGD120-DIMST-MG Each: \$63.28 (Magnesium) | **LGD120-DIMST-WH** Each: \$54.98 (White)

For More Options, Product Details & Wall Plates, See Page L-143



Connecting Cables (Optional)

Function: Allows the designer to get around unlit areas without multiple power supplies



Part #	Finish	Length	Price
MXL28-CC05M	White	19"	\$4.00 ea.
MXL28-CC-1M	White	39"	\$4.50 ea.

End Cap (Optional)



Splicer (Optional)



Mounting Clips (Optional)



2-Way L Connector (Optional)

MXL28-2L
Each: \$1.75 / 10+ Pcs.: \$1.40 ea.



3-Way T Connector (Optional)

MXL28-3T
Each: \$2.25 / 10+ Pcs.: \$1.95 ea.



Universal LED Ribbon Mounting Channels

Aluminum channels that work with our ribbons

For Pricing & To See A Full Line Of Our Mounting Channels, See Pages L-55-62

IMPORTANT: Due to Raw Material Fluctuation, Catalog Prices Below May Not Be Accurate. GO TO WWW.OUTWATER.COM FOR THE MOST UP-TO-DATE PRICES



LED Lighting

Brite Light Flex Color Changing (RGB: Indoor/Outdoor): No Power Supply / Amplifiers Needed!

Can Run Up To 164 Ft. On One Power Cord

Available Lengths: 33', 82' & 164'

Material: Flexible PVC

Recognized as the most versatile and brightest RGB LED Ribbon Lighting on the market today, Outwater has expanded its offering with the introduction of the new super bright 120V RGB LED variant.

With no fixtures to hide, Outwater's 120V RGB LED Ribbon Flex Lighting can be easily mounted in all of those "hard to light" areas or virtually anyplace that could not be previously lit, and is perfectly suited for illuminating any type of indoor or outdoor application.

- Ideal for applications in which longer lengths are desired
- Consistent binning/color
- Includes factory installed end cap
- Power and controller included



IP65 Brite Lite Flex: Color Changing RGB
Provides Protection From Dust & Splashing Water, Not Submersible

7 Colors From One Lighting Source



Standard Color Changing RGB (Up To 190 Lumens Per Foot / 5050 Chip 60 Pcs/Meter)



5/8" |
• 3/8"

Lighting Specifications

Beam Spread	120°
Lumens	Red: 190 per ft. Green: 144 per ft. Blue: 160 per ft.
Rated Average Life	35,000 hrs.
Constant	Voltage
Chip Size	SMD5050

Part #	Color Temp	Length	# Of LED Chips	Total Wattage	Max # Can Connect	Price	
						Each	5+ Pcs.
DRL33-5060-RGB	RGB	33'	600	80	33'	\$89.00 (\$2.70')	\$75.00 ea. (\$2.27')
DRL82-5060-RGB	RGB	82'	1500	200	82'	\$180.00 (\$2.20')	\$162.00 ea. (\$1.98')
DRL164-5060-RGB	RGB	164'	3000	400	164'	\$287.00 (\$1.75')	\$262.40 ea. (\$1.60')

Our Brite Light Flex Color Changing products are ETL certified and warranted as non-cuttable. If a customer does cut the product, they do so at their own risk.

Power & Controller Included



Works with
DRL33-5060-RGB & DRL82-5060-RGB



Works with DRL164-5060-RGB

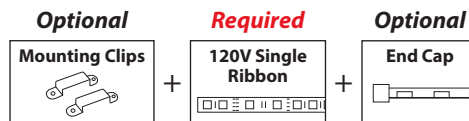
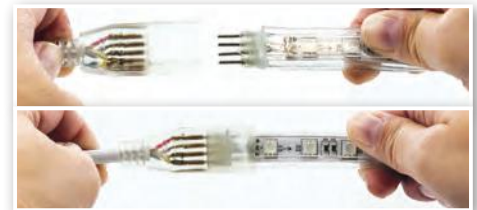

Mounting Clips (Optional)

DRL-50MNT
Each: \$0.21
100+ Pcs.: \$0.12 ea.



End Cap (Optional)

DRL-50END
Each: \$0.21
100+ Pcs.: \$0.12 ea.



Universal LED Ribbon Mounting Channels
Aluminum Channels That Work With Our Ribbons

For Pricing & To See A Full Line Of Our Mounting Channels, See Pages L-55~62



**IMPORTANT: Due to Raw Material Fluctuation, Catalog Prices Below May Not Be Accurate.
GO TO WWW.OUTWATER.COM FOR THE MOST UP-TO-DATE PRICES**

LED Lighting



Non-Neon Lighting

Replaces Glass Neon Tubes

Material: PVC



IP65 Non-Neon Lighting

Provides Protection From Dust & Splashing Water, Not Submersible



PRODUCT FEATURES:

For Interior & Exterior!

- More economical option for signage and interior design.

Energy Efficient!

- This unique LED product will save you up to 70% or more on your energy costs!
- Very low consumption
- Low heat - cool to the touch!

Long Life Rating and Durability!

- The LED's are rated to last up to 50,000 hours.
- Virtually unbreakable
- Unique, flexible, and soft PVC jacket, is durable and impervious to the elements.
- 100% waterproof, when properly sealed.

Commercial Quality & Superior Brightness!

- NO HOT SPOTS!

This product provides a neon and fiber optic light brightness.

Flexible and Easy to Use!

- Standard 120V - no drivers or transformers are necessary, just plug into the wall!
- Field cuttable- 120V every 39" & 24V every 4"
- Field bendable. This product can be bent to a minimum radius of 2" - 3-1/8".
- Various connector options are available for diverse applications.

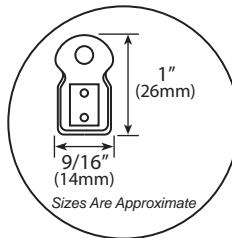

When Off This Light Has A Milky White Cover

Field Cuttable
See charts on next page for cut lengths.



IMPORTANT: Due to Raw Material Fluctuation, Catalog Prices Below May Not Be Accurate. GO TO WWW.OUTWATER.COM FOR THE MOST UP-TO-DATE PRICES

120V

LED Lighting

Non-Neon Lighting

Replaces Glass Neon Tubes

Material: PVC



MADE TO ORDER: SOLD BY THE INCH - MUST PURCHASE POWER CORD & END CAPS

Part #	Cut Increments	Watts Per Foot	LED Color	Price
NZL120-CUT-RD	20"	3	Red	\$0.36 in.
NZL120-CUT-YE	20"	3	Yellow	\$0.36 in.
NZL120-CUT-BL	20"	3	Blue	\$0.36 in.
NZL120-CUT-GR	20"	3	Green	\$0.36 in.
NZL120-CUT-CW	20"	3	Cool White	\$0.36 in.
NZL120-CUT-WW	20"	3	Warm White	\$0.36 in.

33 FT. ROLL: INCLUDES FACTORY SEALED POWER CORD & END CAP

Part #	Cut Increments	Watts Per Foot	LED Color	Price	2+ Pcs.
NZL120-33B-RD	20"	3	Red	\$124.83 ea. (\$3.78')	\$112.41 ea. (\$3.41')
NZL120-33B-YE	20"	3	Yellow	\$124.83 ea. (\$3.78')	\$112.41 ea. (\$3.41')
NZL120-33B-BL	20"	3	Blue	\$124.83 ea. (\$3.78')	\$112.41 ea. (\$3.41')
NZL120-33B-GR	20"	3	Green	\$124.83 ea. (\$3.78')	\$112.41 ea. (\$3.41')
NZL120-33B-CW	20"	3	Cool White	\$124.83 ea. (\$3.78')	\$112.41 ea. (\$3.41')
NZL120-33B-WW	20"	3	Warm White	\$124.83 ea. (\$3.78')	\$112.41 ea. (\$3.41')



164 FT. ROLL: INCLUDES FACTORY SEALED POWER CORD & END CAP

Part #	Cut Increments	Watts Per Foot	LED Color	Price	2+ Pcs.
NZL120-164B-RD	20"	3	Red	\$582.90 ea. (\$3.55')	\$524.89 ea. (\$3.20')
NZL120-164B-YE	20"	3	Yellow	\$582.90 ea. (\$3.55')	\$524.89 ea. (\$3.20')
NZL120-164B-BL	20"	3	Blue	\$582.90 ea. (\$3.55')	\$524.89 ea. (\$3.20')
NZL120-164B-GR	20"	3	Green	\$582.90 ea. (\$3.55')	\$524.89 ea. (\$3.20')
NZL120-164B-CW	20"	3	Cool White	\$582.90 ea. (\$3.55')	\$524.89 ea. (\$3.20')
NZL120-164B-WW	20"	3	Warm White	\$582.90 ea. (\$3.55')	\$524.89 ea. (\$3.20')



Our Non-Neon Lighting products are ETL certified and warranted as non-cuttable. If a customer does cut the product, they do so at their own risk.

Phone: 1-800-631-8375 - Fax: 1-800-888-3315
Due to raw material cost fluctuations, prices are subject to change.

IMPORTANT: Due to Raw Material Fluctuation, Catalog Prices Below May Not Be Accurate. GO TO WWW.OUTWATER.COM FOR THE MOST UP-TO-DATE PRICES

LED Lighting



Accessories for Non-Neon Lighting

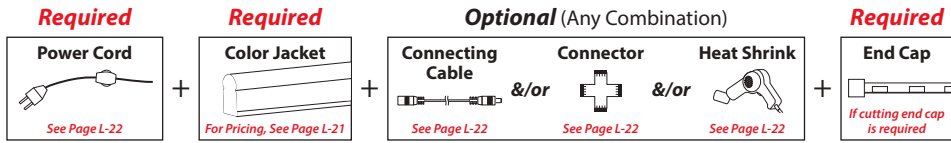

ACCESSORIES FOR NON-NEON FLEXIBLE LED LIGHTING

Part #	Description	Price
A NZL-1426-PWR	1.65 Ft. Long Powercord (Required)	\$4.35 ea.
B NZL-1426-2JN	2 Ft. Long Connecting Cable (Optional)	\$2.15 ea.
C NZL-1426-6JN	6 Ft. Long Connecting Cable (Optional)	\$4.55 ea.
D NZL-1426-2L	L Connector: 2 Way - Pins Included (Optional)	\$1.50 ea.
E NZL-1426-3T	T Connector: 3 Way - Pins Included (Optional)	\$1.60 ea.
F NZL-1426-SPL	2 in. Long Heat Shrink With Splicing Pin To Fit PVC Tubing (Optional)	\$1.00 ea.
G NZL-1426-END	End Cap (Required If Cutting)	\$0.35 ea.
H NZL-1426-MNT	2" Long Plastic Mounting Clip (Optional)	\$0.20 ea.
I NZL-1426-CH2	2" Long Aluminum Mounting Clip (Optional)	\$0.50 ea.
J CT-2000	Multi Purpose Cutter w/5 Interchangeable Anvils & Storage Case (Optional)	\$29.95 kit

*** Seal w/GE Silicone or Equivalent**

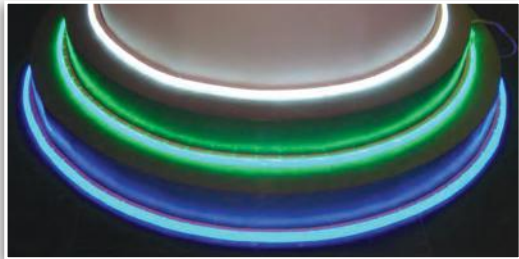
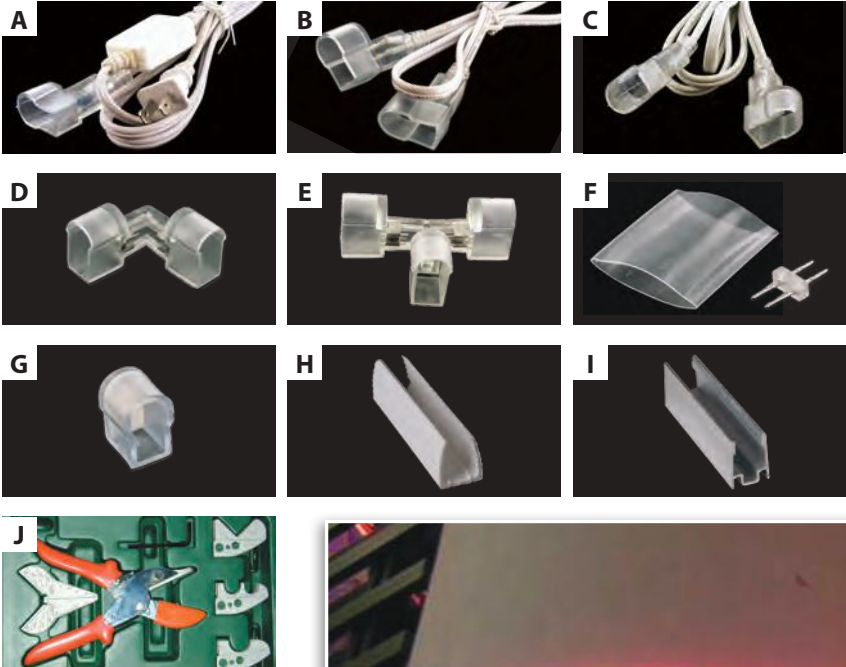

24V

LED Lighting

Mini Non-Neon Lighting

Replaces Glass Neon Tubes: Sold By The Foot or 33' Coils

Material: PVC

- Field Cuttable Every 4"
- Rated 50,000 Hours
- For interior signage & interior design
- Extremely Flexible- Bend into letters and shapes. Can be bent to a minimum radius of 1.9" - 3.15"
- Energy Saving
- Virtually Unbreakable- Extremely durable. Crush resistant up to 450 psi.

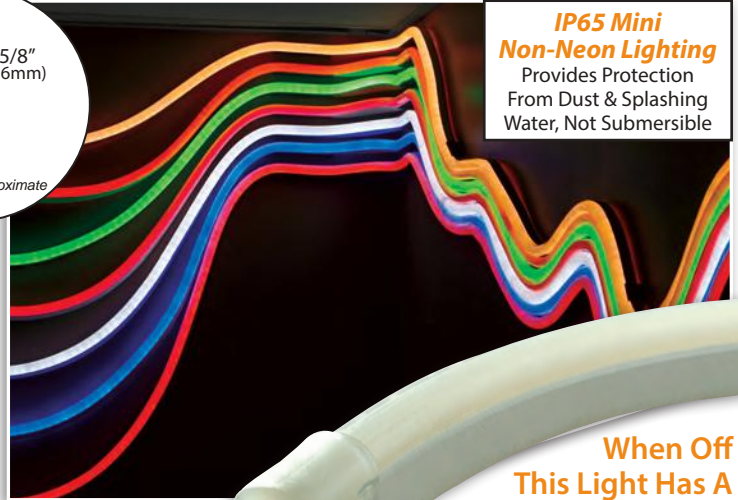
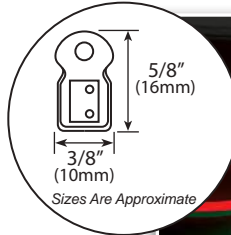

IP65 Mini Non-Neon Lighting
Provides Protection From Dust & Splashing Water, Not Submersible



When Off This Light Has A Milky White Cover

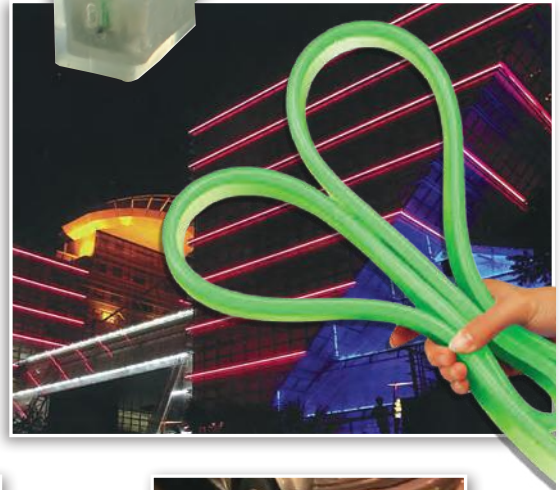

6 Vivid Colors

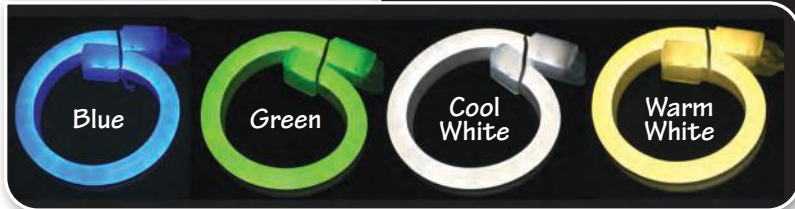
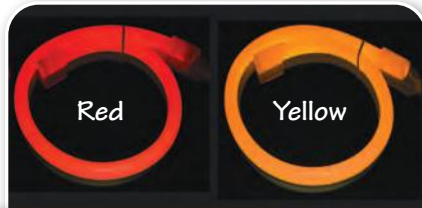

Extremely Flexible

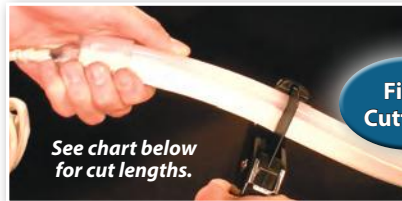

Field Cuttable

See chart below for cut lengths.



Virtually Unbreakable

33' ROLL: INCLUDES FACTORY SEALED POWER CORD & END CAP (MUST BE HARDWIRED)

Part #	Cut Increments	Watts Per Foot	LED Color	Price	10+ Pcs.
NZL24-1016-33RD	4"	3	Red	\$101.22 ea. (\$3.07)	\$91.14 ea. (\$3.20)
NZL24-1016-33YE	4"	3	Yellow	\$101.22 ea. (\$3.07)	\$91.14 ea. (\$3.20)
NZL24-1016-33BL	4"	3	Blue	\$101.22 ea. (\$3.07)	\$91.14 ea. (\$3.20)
NZL24-1016-33GR	4"	3	Green	\$101.22 ea. (\$3.07)	\$91.14 ea. (\$3.20)
NZL24-1016-33CW	4"	3	Cool White	\$101.22 ea. (\$3.07)	\$91.14 ea. (\$3.20)
NZL24-1016-33WW	4"	3	Warm White	\$101.22 ea. (\$3.07)	\$91.14 ea. (\$3.20)

Our Mini Non-Neon Lighting products warranted as non-cuttable. If a customer does cut the product, they do so at their own risk.

IMPORTANT: Due to Raw Material Fluctuation, Catalog Prices Below May Not Be Accurate. GO TO WWW.OUTWATER.COM FOR THE MOST UP-TO-DATE PRICES

LED Lighting

24V

Accessories for Mini Non-Neon Lighting

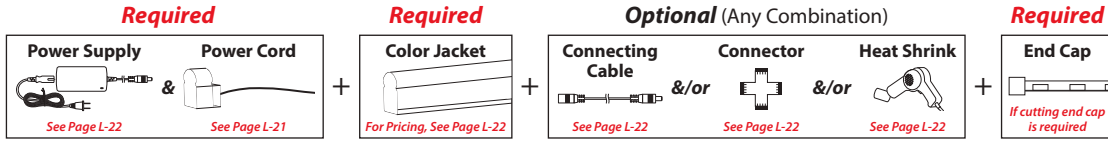

HARDWARE POWER SUPPLIES (Required)

Part #	Dimensions	Voltage	Watts	Amps	Input Cord	Output	Constant	Price
A LED-24V-2.5A-HW	7.5" x 1.88" x 1.33"	24	60	2.5	10.5"	10.5"	Voltage	\$25.00 ea.
B LED-24V-4.17A-HW	8.74" x 2.71" x 1.69"	24	100	4.17	10.5"	10.5"	Voltage	\$42.00 ea.
C LED-24V-8.3A-HW	9.84" x 3.11" x 2"	24	199	8.3	10.5"	10.5"	Voltage	\$74.70 ea.



ACCESSORIES FOR NON-NEON FLEXIBLE LED LIGHTING

Part #	Description	Price
C NZL-1016-PWR	1.65 Ft. Long Powercord (Required)	\$4.35 ea.
D NZL-1016-2JN	2 Ft. Long Connecting Cable (Optional)	\$2.15 ea.
E NZL-1016-6JN	6 Ft. Long Connecting Cable (Optional)	\$4.55 ea.
F NZL-1016-2L	L Connector: 2 Way - Pins Included (Optional)	\$1.50 ea.
G NZL-1016-3T	T Connector: 3 Way - Pins Included (Optional)	\$1.60 ea.
H NZL-1016-SPL	2 in. Long Heat Shrink With Splicing Pin To Fit PVC Tubing (Optional)	\$1.00 ea.
I NZL-1016-END	End Cap (Required If Cutting)	\$0.35 ea.
J NZL-1016-MNT	2" Long Plastic Mounting Clip (Optional)	\$0.20 ea.
K NZL-1016-CH2	2" Long Aluminum Mounting Clip (Optional)	\$0.50 ea.
L CT-2000	Multi Purpose Cutter w/5 Interchangeable Anvils & Storage Case (Optional)	\$29.95 kit

* Seal w/GE Silicone or Equivalent

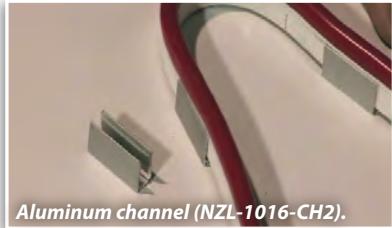
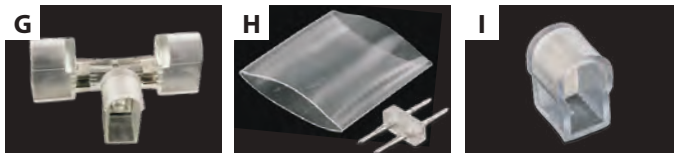

Create A Sign In No Time!

Our Mini Non-Neon Lighting products warranted as non-cuttable. If a customer does cut the product, they do so at their own risk.

IMPORTANT: Due to Raw Material Fluctuation, Catalog Prices Below May Not Be Accurate. GO TO WWW.OUTWATER.COM FOR THE MOST UP-TO-DATE PRICES

DP24 SERIES

THIS NEW LED 2835 CHIP, PROVIDES GREATER ENERGY EFFICIENCY, HIGH LUMENS & BUDGET FRIENDLY PRICING.



DP246 28140 (Up To 406 Lumens Per Foot)



DP248 2860 (Up To 209 Lumens Per Foot)



DP2410 2860 (Up To 339 Lumens Per Foot)



DP2410 28120 (Up To 408 Lumens Per Foot)

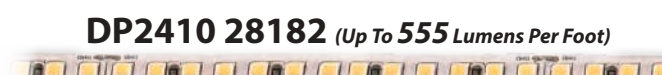

DP2410 28182 (Up To 555 Lumens Per Foot)



DP2415 28196 (Up To 740 Lumens Per Foot)

- This comprehensive array of LED 2835 ribbons includes width ranging from 1/4" to 1-3/16"
- Special Feature: Ribbon has 2 female ends (DC 5.5) so it can be cut to size and then the remaining piece can be used for another project
- Available Lengths: 8.25' & 16.5" (Nominal)
- Available In: IP65 & IP20
- Most design options can be accommodated with use of our FPC* connector series.
- Limited 2 Year Warranty



DP2420 28252 (Up To 947 Lumens Per Foot)



DP2430 28384 (Up To 1253 Lumens Per Foot)

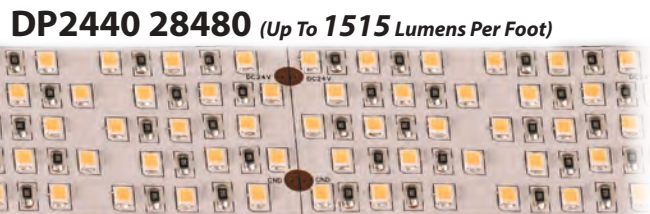

DP2440 28480 (Up To 1515 Lumens Per Foot)



IMPORTANT: Due to Raw Material Fluctuation, Catalog Prices Below May Not Be Accurate. GO TO WWW.OUTWATER.COM FOR THE MOST UP-TO-DATE PRICES

LED Lighting



DP24 Ribbon Flex Series

Available Lengths: 8.25' & 16.5' (Nominal)
Material: Flexible White PCB with Adhesive

2 Options Available

IP65 24V DP24 Ribbon

Provides Protection From Dust & Splashing Water, Not Submersible

IP20 24V DP24 Ribbon

Provides Low Protection of Dust & Water



Ultra Thin DP246 28140 (Up To 406 Lumens Per Foot)

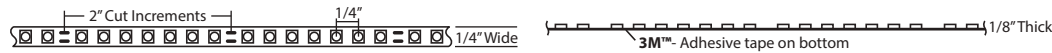

Shown IP20

Part #	Length	# Of LED Chips	Total Wattage	Max # Can Connect	Price	
					Each	5+ Pcs.
IP20 (Cool White *CW, Warm White *WW & Pure White *PW)						
DP246-I28140-8*	8.25'	350	26	8.25'	\$31.92 (\$3.87')	\$27.36 ea. (\$3.32')

Lighting Specifications

Color Temperature	CW: 6000K-6500K WW: 2800K-3000K PW: 4000K-4500K
Beam Spread	120°
Lumens	CW: 406 per ft. WW: 400 per ft. PW: 403 per ft.
Color Rendering Index	80
Rated Average Life	30,000 hrs.
Constant	Voltage
Chip Size	SMD2835

DP248 2860 (Up To 209 Lumens Per Foot)

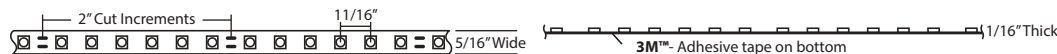

Shown IP20

Part #	Length	# Of LED Chips	Total Wattage	Max # Can Connect	Price	
					Each	5+ Pcs.
IP65 (Cool White *CW, Warm White *WW & Pure White *PW)						
DP248-N2860-8*	8.25'	150	14	16.5'	\$20.52 (\$2.49')	\$17.10 ea. (\$2.07')
DP248-N2860-16*	16.5'	300	29	16.5'	\$37.44 (\$2.27')	\$31.20 ea. (\$1.89')
IP20 (Cool White *CW, Warm White *WW & Pure White *PW)						
DP248-I2860-8*	8.25'	150	14	16.5'	\$15.12 (\$1.83')	\$12.60 ea. (\$1.53')
DP248-I2860-16*	16.5'	300	29	16.5'	\$26.64 (\$1.61')	\$22.20 ea. (\$1.89')
DP248-I2860-33WW	33'	600	58	16.5'	\$37.50 (\$1.14')	\$31.25 ea. (\$0.95')

Lighting Specifications

Color Temperature	CW: 6000K-6500K WW: 2800K-3000K PW: 4000K-4500K
Beam Spread	120°
Lumens	CW: 209 per ft. WW: 200 per ft. PW: 206 per ft.
Color Rendering Index	80
Rated Average Life	30,000 hrs.
Constant	Voltage
Chip Size	SMD2835

DP2410 2860 (Up To 339 Lumens Per Foot)

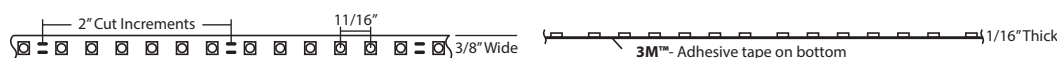

Shown IP20

Part #	Length	# Of LED Chips	Total Wattage	Max # Can Connect	Price	
					Each	5+ Pcs.
IP65 (Cool White *CW, Warm White *WW, Pure White *PW & Natural White *NW)						
DP2410-N2860-8*	8.25'	150	29	16.5'	\$22.85 (\$2.77')	\$19.99 ea. (\$2.42')
DP2410-N2860-16*	16.5'	300	58	16.5'	\$41.86 (\$2.54')	\$36.62 ea. (\$2.22')
IP20 (Cool White *CW, Warm White *WW, Pure White *PW & Natural White *NW)						
DP2410-I2860-8*	8.25'	150	29	16.5'	\$17.09 (\$2.07')	\$14.95 ea. (\$1.81')
DP2410-I2860-16*	16.5'	300	58	16.5'	\$30.34 (\$1.84')	\$26.54 ea. (\$1.61')

Lighting Specifications

Color Temperature	CW: 6000K-6500K WW: 2800K-3000K PW: 4000K-4500K NW: 5000K-5500K
Beam Spread	120°
Lumens	CW: 339 per ft. WW: 330 per ft. PW: 333 per ft. NW: 335 per ft.
Color Rendering Index	80
Rated Average Life	30,000 hrs.
Constant	Voltage
Chip Size	SMD2835

IMPORTANT: Due to Raw Material Fluctuation, Catalog Prices Below May Not Be Accurate. GO TO WWW.OUTWATER.COM FOR THE MOST UP-TO-DATE PRICES



24V

LED Lighting

DP24 Ribbon Flex Series

Available Lengths: 8.25' & 16.5' (Nominal)

Material: Flexible White PCB with Adhesive

Special Feature

Ribbon has 2 female ends (DC 5.5) so it can be cut to size and then the remaining piece can be used for another project



7" Cable With DC5.5

7" Cable With DC5.5

2 Options Available

IP65 24V DP24 Ribbon

Provides Protection From Dust & Splashing Water, Not Submersible

IP20 24V DP24 Ribbon

Provides Low Protection of Dust & Water

DP2410 28120 (Up To 408 Lumens Per Foot)



UL
Shown IP20

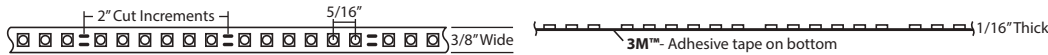

Part #	Length	# Of LED Chips	Total Wattage	Max # Can Connect	Price	
					Each	5+ Pcs.
IP65 (Cool White *CW, Warm White *WW, Pure White *PW & Natural White *NW)						
DP2410-N28120-8*	8.25'	300	32	16.5'	\$29.57 (\$3.58)	\$25.87 ea. (\$3.14)
DP2410-N28120-16*	16.5'	600	64	16.5'	\$55.30 (\$3.35)	\$48.38 ea. (\$2.93)
IP20 (Cool White *CW, Warm White *WW, Pure White *PW & Natural White *NW)						
DP2410-I28120-8*	8.25'	300	32	16.5'	\$23.81 (\$2.89)	\$20.83 ea. (\$2.53)
DP2410-I28120-16*	16.5'	600	64	16.5'	\$43.78 (\$2.65)	\$38.30 ea. (\$2.32)

Lighting Specifications

Color Temperature	CW: 6000K-6500K WW: 2800K-3000K PW: 4000K-4500K NW: 5000K-5500K
Beam Spread	120°
Lumens	CW: 408 per ft. WW: 400 per ft. PW: 403 per ft. NW: 335 per ft.
Color Rendering Index	80
Rated Average Life	30,000 hrs.
Constant	Voltage
Chip Size	SMD2835

DP2410 28182 (Up To 555 Lumens Per Foot)



UL
Shown IP20

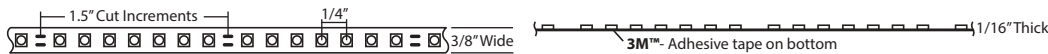

Part #	Length	# Of LED Chips	Total Wattage	Max # Can Connect	Price	
					Each	5+ Pcs.
IP65 (Cool White *CW, Warm White *WW & Pure White *PW)						
DP2410-N28182-8*	8.25'	455	39	16.5'	\$42.62 (\$5.17)	\$37.30 ea. (\$4.52)
DP2410-N28182-16*	16.5'	910	75	16.5'	\$81.41 (\$4.93)	\$71.23 ea. (\$4.32)
IP20 (Cool White *CW, Warm White *WW & Pure White *PW)						
DP2410-I28182-8*	8.25'	455	39	16.5'	\$36.86 (\$4.47)	\$32.26 ea. (\$3.91)
DP2410-I28182-16*	16.5'	910	75	16.5'	\$69.89 (\$4.24)	\$61.15 ea. (\$3.71)

Lighting Specifications

Color Temperature	CW: 6000K-6500K WW: 2800K-3000K PW: 4000K-4500K
Beam Spread	120°
Lumens	CW: 555 per ft. WW: 552 per ft. PW: 554 per ft.
Color Rendering Index	80
Rated Average Life	30,000 hrs.
Constant	Voltage
Chip Size	SMD2835

DP2415 28196 (Up To 740 Lumens Per Foot)



UL
Shown IP20

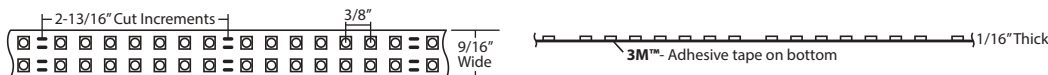

Part #	Length	# Of LED Chips	Total Wattage	Max # Can Connect	Price	
					Each	5+ Pcs.
IP65 (Cool White *CW, Warm White *WW, Pure White *PW & Natural White *NW)						
DP2415-N28196-8*	8.25'	490	53	16.5'	\$47.81 (\$5.79)	\$41.83 ea. (\$5.07)
DP2415-N28196-16*	16.5'	980	105	16.5'	\$91.78 (\$5.56)	\$80.30 ea. (\$4.87)
IP20 (Cool White *CW, Warm White *WW, Pure White *PW & Natural White *NW)						
DP2415-I28196-8*	8.25'	490	53	16.5'	\$42.05 (\$5.10)	\$36.79 ea. (\$4.46)
DP2415-I28196-16*	16.5'	980	105	16.5'	\$80.26 (\$4.86)	\$70.22 ea. (\$4.26)

Lighting Specifications

Color Temperature	CW: 6000K-6500K WW: 2800K-3000K PW: 4000K-4500K NW: 5000K-5500K
Beam Spread	120°
Lumens	CW: 740 per ft. WW: 738 per ft. PW: 739 per ft. NW: 335 per ft.
Color Rendering Index	80
Rated Average Life	30,000 hrs.
Constant	Voltage
Chip Size	SMD2835

IMPORTANT: Due to Raw Material Fluctuation, Catalog Prices Below May Not Be Accurate. GO TO WWW.OUTWATER.COM FOR THE MOST UP-TO-DATE PRICES

LED Lighting



DP24 Ribbon Flex Series

Available Lengths: 8.25' & 16.5' (Nominal)
Material: Flexible White PCB with Adhesive

DP2420 28252 (Up To 947 Lumens Per Foot)



Special Feature
Ribbon has 2 female ends (DC 5.5) so it can be cut to size and then the remaining piece can be used for another project



Shown IP20

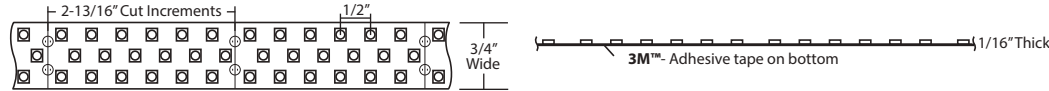

Part #	Length	# Of LED Chips	Total Wattage	Max # Can Connect	Price Each	Price 5+ Pcs.
<i>IP20 (Cool White *CW, Warm White *WW & Pure White *PW)</i>						
DP2420-I28252-8*	8.25'	630	75	8.25'	\$48.58 (\$5.89)	\$41.95 ea. (\$5.09)

Lighting Specifications

Color Temperature	CW: 6000K-6500K WW: 2800K-3000K PW: 4000K-4500K
Beam Spread	120°
Lumens	CW: 947 per ft. WW: 941 per ft. PW: 944 per ft.
Color Rendering Index	80
Rated Average Life	30,000 hrs.
Constant	Voltage
Chip Size	SMD2835

DP2430 28384 (Up To 1253 Lumens Per Foot)



Shown IP20

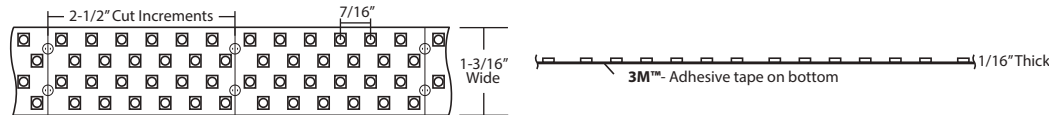

Part #	Length	# Of LED Chips	Total Wattage	Max # Can Connect	Price Each	Price 5+ Pcs.
<i>IP20 (Cool White *CW, Warm White *WW & Pure White *PW)</i>						
DP2430-I28384-8*	8.25'	960 Per Ft.	104	8.25'	\$72.34 (\$8.77)	\$62.47 ea. (\$7.57)

Lighting Specifications

Color Temperature	CW: 6000K-6500K WW: 2800K-3000K PW: 4000K-4500K
Beam Spread	120°
Lumens	CW: 1253 per ft. WW: 1245 per ft. PW: 1249 per ft.
Color Rendering Index	80
Rated Average Life	30,000 hrs.
Constant	Voltage
Chip Size	SMD2835

DP2440 28480 (Up To 1515 Lumens Per Foot)



Shown IP20

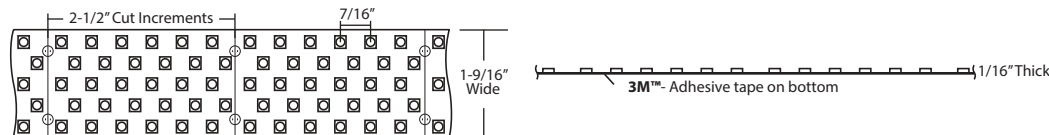

Part #	Length	# Of LED Chips	Total Wattage	Max # Can Connect	Price Each	Price 5+ Pcs.
<i>IP20 (Cool White *CW, Warm White *WW & Pure White *PW)</i>						
DP2440-I28480-8*	8.25'	1200	130	8.25'	\$89.50 (\$10.85)	\$77.29 ea. (\$9.37)

Lighting Specifications

Color Temperature	CW: 6000K-6500K WW: 2800K-3000K PW: 4000K-4500K
Beam Spread	120°
Lumens	CW: 1514 per ft. WW: 1512 per ft. PW: 1509 per ft.
Color Rendering Index	80
Rated Average Life	30,000 hrs.
Constant	Voltage
Chip Size	SMD2835



Accessories for DP24 Ribbon Flex Series

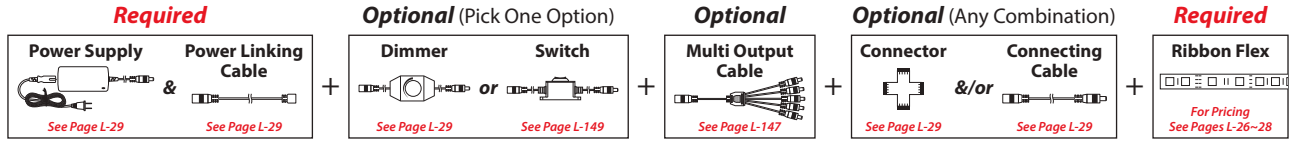

Required

Power Supplies

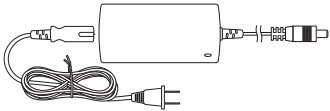

Part #	Type	Amps	Volts	Watts	Dimensions	Price	
						Each	6+ Pcs.
LED-24V-3A	Desktop	3A	24V	72W	4.68"L x 2.34"W x 1.48"H	\$28.75	\$26.05 ea.
LED-24V-4A	Desktop	4A	24V	96W	6.77"L x 2.83"W x 1.57"H	\$44.05	\$39.90 ea.
LED-24V-6A	Desktop	6A	24V	144W	6.77"L x 2.83"W x 1.57"H	\$52.15	\$47.40 ea.

For Product Details & More Power Options, See Pages R-119~120b
Other Options: Plug In | Hardwire | Hardwire Dimmable | Rechargeable Battery

Power Linking Cable

Required for power supplies, dimmers & multi output cables.

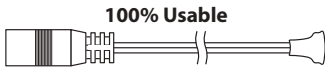

Part #	Works With	Description	Overall Length	Finish	Price	
					Each	6+ Pcs.
LED-FPC-8-PWL	24V D248*	Power Link Cable with 100% Usable Connection	24"	Black	\$2.40	\$2.20 ea.
LED-FPC-10-PWL	24V D2410*		24"	Black	\$2.50	\$2.30 ea.
LED-FPC-15-PWL	24V D2415*		24"	Black	\$2.60	\$2.40 ea.
LED-FPC-20-PWL	24V D2420*		24"	Black	\$2.95	\$2.75 ea.

For Hardwire Power Linking Cables, See Page L-141

Optional

Dimmers

A power linking cable required.

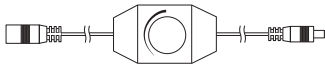

Part #	Description	Finish	Range of Dimming	Size	Price	
					Each	6+ Pcs.
LED-INLINE-DIM	Inline Rotary	Black	0-100%	2-5/8"L x 1-3/8"W x 1"H	\$5.95	\$5.25 ea.

For Product Details & More Dimmer Options, See Pages L-134~136 & L-142~144
Other Options: Rotary | Touch Dimmer | Radio Frequency

Connecting Cables

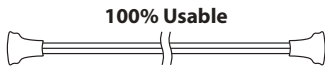

Part #	Works With	Description	Finish	Length	Price	
					Each	6+ Pcs.
LED-FPC-8-CON24	24V DP248*	Directly connect 2 cut pieces of ribbon while providing ability to get around unlit areas	White	24"	\$2.15	\$2.00 ea.
LED-FPC-8-CON36	24V DP248*		White	36"	\$2.50	\$2.30 ea.
LED-FPC-10-CON24	24V DP2410*		White	24"	\$2.40	\$2.20 ea.
LED-FPC-10-CON36	24V DP2410*		White	36"	\$2.70	\$2.50 ea.
LED-FPC-15-CON24	24V DP2415*		White	24"	\$2.60	\$2.40 ea.
LED-FPC-15-CON36	24V DP2415*		White	36"	\$2.95	\$2.75 ea.
LED-FPC-20-CON24	24V DP2420*		White	24"	\$2.80	\$2.60 ea.
LED-FPC-20-CON36	24V DP2420*		White	36"	\$3.15	\$2.95 ea.

For More Extension Cable Options, See Page L-145

End-To-End For

100% Usable Connections



Part #	Works With	Description	Price	
			Each	6+ Pcs.
LED-FPC-8-EE-C	24V DP248*	Usable connection directly connects 2 cut pieces	\$1.10	\$1.00 ea.
LED-FPC-10-EE-C	24V DP2410*		\$1.30	\$1.20 ea.
LED-FPC-15-EE-C	24V DP2415*		\$1.60	\$1.45 ea.
LED-FPC-20-EE-C	24V DP2420*		\$1.85	\$1.70 ea.

Universal LED Ribbon Mounting Channels

Aluminum channels that work with our ribbons

For Pricing & To See A Full Line Of Our Mounting Channels, See Pages L-55~62

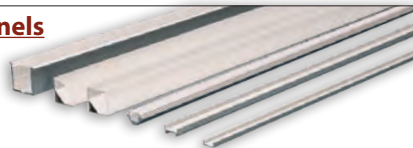

IMPORTANT: Due to Raw Material Fluctuation, Catalog Prices Below May Not Be Accurate. GO TO WWW.OUTWATER.COM FOR THE MOST UP-TO-DATE PRICES

LED Lighting

24V



Cut Per LED Ribbon

Now you can create any desired length! Cut increment is LESS THEN 1"!

Nominal Lengths: 8.25' & 16.5'

Material: Flexible White PCB with Adhesive

- This NEW LED 2835, provides greater energy efficiency, high lumens & budget friendly pricing.
- This comprehensive array of LED 2835 ribbons has a width of 3/8", 36 chips per ft. & 8.7 watts per ft.
- Special Feature: Ribbon Has 2 female ends (DC 5.5) so it can be cut to size and then the remaining piece can be used for another project.
- 3M Adhesive Back
- Limited 3 Year Warranty



IP20 Cut Per LED Ribbon
Provides Low Protection of Dust & Water



FPC Connectors Will Work With Cut Pieces

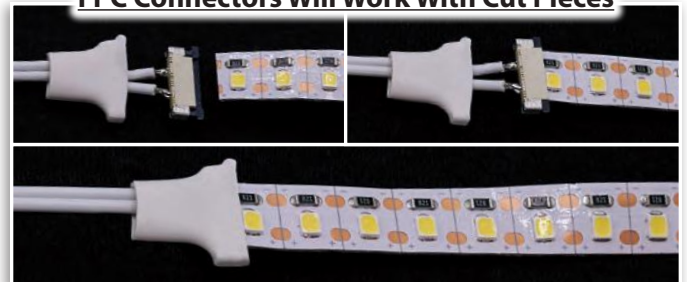

CTL2410-I28120 (Up To 667 Lumens Per Foot)



Cut Increment is LESS THEN 1"!

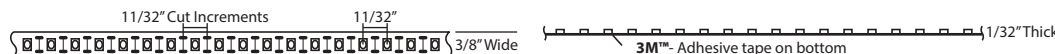

Part #	Length	# Of LED Chips	Total Wattage	Max # Can Connect	Price Each	Price 5+ Pcs.
Cool White *CW, Warm White *WW & Pure White *PW						
CTL2410-I28120-8*	8.25'	300	72	16.5'	\$38.22 (\$4.63')	\$34.12 ea. (\$4.14')
Cool White *C, Warm White *W & Pure White *P						
CTL2410-I28120-16*	16.5'	600	144	16.5'	\$72.80 (\$4.41')	\$65.00 ea. (\$3.94')

Lighting Specifications

Color Temperature	CW/C: 6500K WW/W: 3000K PW/P: 4500K
Beam Spread	120°
Lumens	667 per ft.
Color Rendering Index	80
Rated Average Life	35,000 hrs.
Constant	Voltage
Chip Size	2835

IMPORTANT: Due to Raw Material Fluctuation, Catalog Prices Below May Not Be Accurate. GO TO WWW.OUTWATER.COM FOR THE MOST UP-TO-DATE PRICES



LED Lighting

Accessories for Cut Per LED

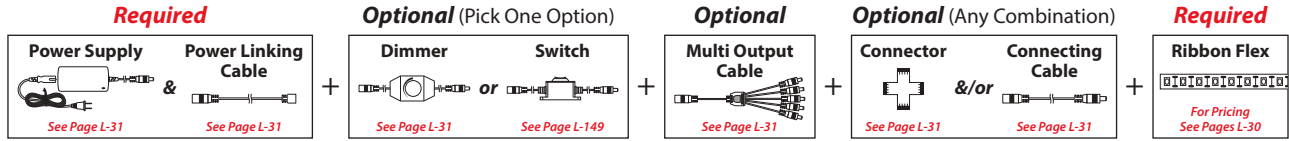

Required

Power Supplies

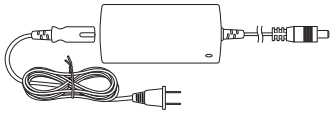

Part #	Type	Amps	Volts	Watts	Dimensions	Price	
						Each	6+ Pcs.
LED-24V-3A	Desktop	3A	24V	72W	4.68"L x 2.34"W x 1.48"H	\$28.75	\$26.05 ea.
LED-24V-6A	Desktop	6A	24V	144W	6.77"L x 2.83"W x 1.57"H	\$52.15	\$47.40 ea.

For Product Details & More Power Options, See Pages R-119~120b
 Other Options: *Plug In | Hardwire | Hardwire Dimmable | Rechargeable Battery*

Power Linking Cable

Required for power supplies, dimmers & multi output cables.



Part #	Description	Overall Length	Finish	Price	
				Each	6+ Pcs.
LED-FPC-10-PWL	Power Link Cable with 100% Usable Connection	24"	Black	\$2.50	\$2.30 ea.

For Hardwire Power Linking Cables, See Page L-141

Optional

Dimmers

A power linking cable required.

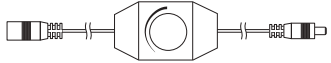

Part #	Description	Finish	Range of Dimming	Size	Price	
					Each	6+ Pcs.
LED-INLINE-DIM	Inline Rotary	Black	0-100%	2-5/8"L x 1-3/8"W x 1"H	\$5.95	\$5.25 ea.

For Product Details & More Dimmer Options, See Pages L-134~136 & L-142~144
 Other Options: *Rotary | Touch Dimmer | Radio Frequency*

Multi Output Cables

2-Way Sweep: DC 5.5

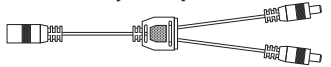

5-Way Sweep: DC 5.5

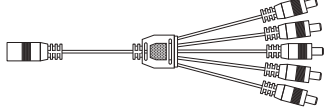

3-Way Spider: DC 5.5

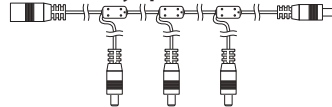

Part #	Description	Finish	Arms Size	# of Arms	Overall Length	Max # of Power Linking Cables	Price	
							Each	6+ Pcs.
LED-2WAY-BK	2-Way Sweep	Black	3"	2	7"	2	\$2.95	\$2.50 ea.
LED-5OUT-CBL-BK	5-Way Sweep	Black	8-3/4"	5	19"	5	\$5.50	\$4.85 ea.
LED-SPIDER-CBL	3-Way Spider	Black	4-1/2"	3	96"	4	\$6.25	\$5.55 ea.

For Cut Pieces of Ribbon & Pin Connection (Power Linking Cable Required For Each Outlet)

For More Extension Cable Options, See Page L-147

Connecting Cables

100% Usable

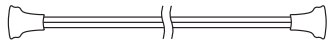

Part #	Description	Finish	Length	Price	
				Each	6+ Pcs.
LED-FPC-10-CON24	Directly connect 2 cut pieces of ribbon while	White	24"	\$2.40	\$2.20 ea.
LED-FPC-10-CON36	providing ability to get around unlit areas	White	36"	\$2.70	\$2.50 ea.

For More Extension Cable Options, See Page L-145

End-To-End For 100% Usable Connections



Part #	Description	Price	
		Each	6+ Pcs.
LED-FPC-10-EE-C	Usable connection directly connects 2 cut pieces	\$1.30	\$1.20 ea.

Universal LED Ribbon Mounting Channels

Aluminum channels that work with our ribbons

For Pricing & To See A Full Line Of Our Mounting Channels, See Pages L-55~62

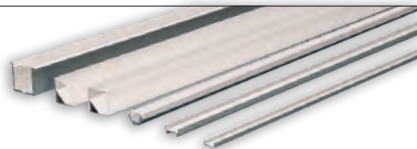

IMPORTANT: Due to Raw Material Fluctuation, Catalog Prices Below May Not Be Accurate. GO TO WWW.OUTWATER.COM FOR THE MOST UP-TO-DATE PRICES

LED Lighting



High Density Ribbon

LED's are so close together that when installed inside our Vision Task Extrusions there is virtually NO HOT SPOTS! (See Pages L-55~62)

Nominal Lengths: 8.25' & 16.5'
Material: Flexible White PCB with Adhesive

- This high density 2216, provides greater energy efficiency, high lumens & budget friendly pricing.
- This comprehensive array of LED 2216 ribbons has a width of 3/8", 127 chips per ft. & 7.3 watts per ft.
- Special Feature: Ribbon Has 2 female ends (DC 5.5) so it can be cut-to-size and then the remaining piece can be used for another project.
- 3M Adhesive Back
- Limited 3 Year Warranty



HDL2410-I22420 (Up To 545 Lumens Per Foot)

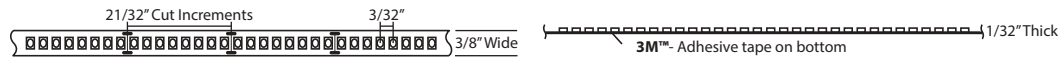

Lighting Specifications

Color Temperature	CW/C: 6500K WW/W: 2800K-3000K PW/P: 4000K-4500K
Beam Spread	120°
Lumens	545 per ft.
Color Rendering Index	80
Rated Average Life	35,000 hrs.
Constant	Voltage
Chip Size	2216

Part #	Length	# Of LED Chips	Total Wattage	Max # Can Connect	Price Each	Price 5+ Pcs.
Cool White *CW, Warm White *WW & Pure White *PW						
HDL2410-I22420-8*	8.25'	1050	60	16.5'	\$65.52 (\$7.94')	\$58.50 ea. (\$7.09')
Cool White *C, Warm White *W & Pure White *P						
HDL2410-I22420-16*	16.5'	2100	120	16.5'	\$127.40 (\$7.72')	\$113.75 ea. (\$6.89')

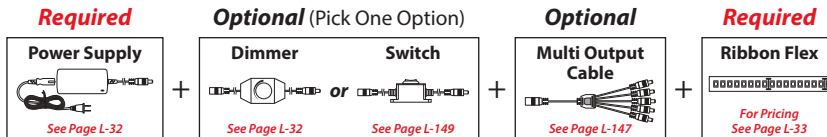

Required

Power Supplies

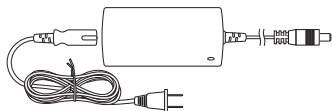

Part #	Type	Amps	Volts	Watts	Dimensions	Price Each	Price 6+ Pcs.
LED-24V-3A	Desktop	3A	24V	72W	4.68"L x 2.34"W x 1.48"H	\$28.75	\$26.05 ea.
LED-24V-6A	Desktop	6A	24V	144W	6.77"L x 2.83"W x 1.57"H	\$52.15	\$47.40 ea.

For Product Details & More Power Options, See Pages L-137~140
Other Options: Plug In | Hardwire | Hardwire Dimmable | Rechargeable Battery

Optional

Dimmers

A power linking cable required.

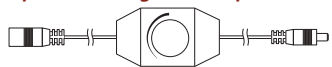

Part #	Description	Finish	Range of Dimming	Size	Price Each	Price 6+ Pcs.
LED-INLINE-DIM	Inline Rotary	Black	0-100%	2-5/8"L x 1-3/8"W x 1"H	\$5.95	\$5.25 ea.

For Product Details & More Dimmer Options, See Pages L-134~136 & L-142~144
Other Options: Rotary | Touch Dimmer | Radio Frequency

Universal LED Ribbon Mounting Channels

Aluminum channels that work with our ribbons
For Pricing & To See A Full Line Of Our Mounting Channels, See Pages L-55~62

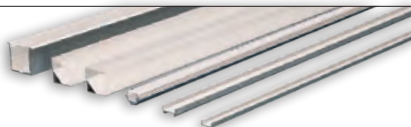

IMPORTANT: Due to Raw Material Fluctuation, Catalog Prices Below May Not Be Accurate. GO TO WWW.OUTWATER.COM FOR THE MOST UP-TO-DATE PRICES



LED Lighting

Color Changing Temperature (CCT) Cut Per LED Ribbon

Versatile & field trimmable LED ribbon can be adapted to meet many design needs. Can program color temperature ranges between 3000K-6000K. Cut increment is less than 1"!

Nominal Lengths: 16.5'

Material: Flexible White PCB with Adhesive

- Now you can create any desired length! Cut increments is less than 1"!
- This NEW color changing temperature (CCT) LED 2835, provides greater energy efficiency, high lumens & budget friendly pricing.
- This comprehensive array of LED 2835 ribbons has a width of 3/8", 36 chips per ft. & 8.7 watts per ft.
- 3M Adhesive Back
- Limited 3 Year Warranty

IP20 CCT Cut Per LED Ribbon
Provides Low Protection of Dust & Water



7" BARE WIRE ENDS CONNECT DIRECTLY TO CONTROLLER

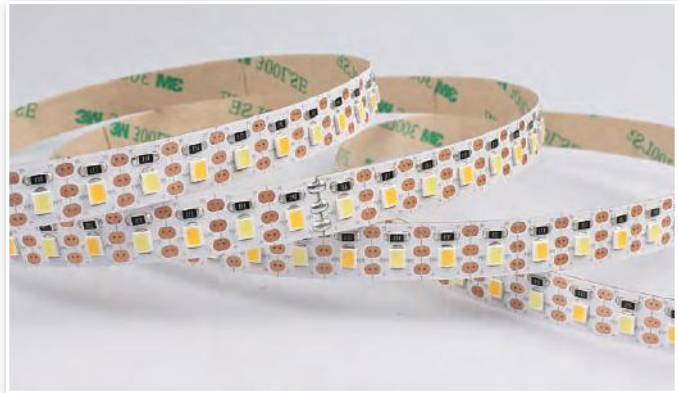

CTL2410-I28120-CCT (Up To 667 Lumens Per Foot)



Cut Increments LESS THAN 1"!

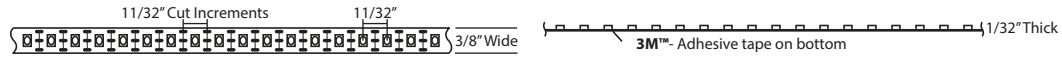

Lighting Specifications

Color Temperature	3000K-6500K
Beam Spread	120°
Lumens	667 per ft.
Color Rendering Index	80
Rated Average Life	35,000 hrs.
Constant	Voltage
Chip Size	2835

Part #	Length	# Of LED Chips	Total Wattage	Max # Can Connect	Each	Price	5+ Pcs.
CTL2410-I28120-CCT	16.5'	600	72	16.5'	\$70.98 (\$4.30')	\$63.38 ea. (\$3.84')	

IMPORTANT: Due to Raw Material Fluctuation, Catalog Prices Below May Not Be Accurate. GO TO WWW.OUTWATER.COM FOR THE MOST UP-TO-DATE PRICES

LED Lighting



Accessories for Color Changing Temperature (CCT) Cut Per LED Ribbon

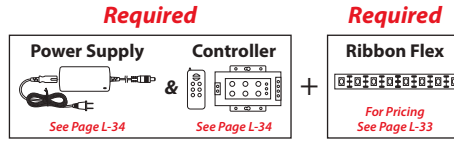

Required

Power Supplies

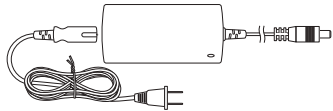

Part #	Type	Amps	Volts	Watts	Dimensions	Price	
						Each	6+ Pcs.
LED-24V-3A	Desktop	3A	24V	72W	4.68"L x 2.34"W x 1.48"H	\$28.75	\$26.05 ea.
LED-24V-6A	Desktop	6A	24V	144W	6.77"L x 2.83"W x 1.57"H	\$52.15	\$47.40 ea.

For Product Details & More Power Options, See Pages L-137~140
 Other Options: **Plug In | Hardwire | Hardwire Dimmable | Rechargeable Battery**

Option 1: RF Controller With Remote For CCT



LED-ADJTEM-CR2
 Each: \$24.50
 6+ Pcs.: \$21.75 ea.

Features:

- 3A / 24V / 72W
- Input Wire: Female DC 5.5 / Hardwire
- Output Wire: Hardwire
- Controller Size: 4-1/2"L x 2-3/16"W x 3/4"H
- Receiver Size: 3-5/8"L x 1-3/4"W x 7/8"H
- Color: White

Controller Functions:

- Mounting: Surface
- Remote Control Function: RF
- Gradient Change: 11 Grades
- Brightness Adjusting: 20 Grades
- Sound: No

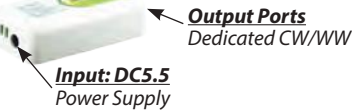

Option 2: RF CCT Controller With Desktop or Wall Option



Receiver

Included With Every Dimmer
 7" L x 1.75"W x .75"H
 Female DC 5.5 Input Cord: 18"

- Each dimmer is paired to the included receiver. However, multiple dimmers can be paired to one receiver. (Instructions included in package)
- Range of Dimming: 10%-100%
- Push Button On/Off Function
- All dimmers work up to 50' away from receiver
- All dimmer controllers run on battery
- Limited 3 Year Warranty
- Radio frequency goes through walls

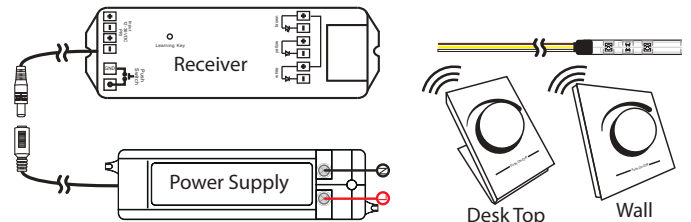

Wall Dimmer

Fits Over A Standard Receptacle Box
 3.5" L x 1.37"W x .75" H
RF-CCT-CTRL-WT
 Each: \$114.75
 6+ Pcs.: \$100.98 ea.



Desk Top Dimmer

4" L x 1.5"W x 1.8" H
RF-CCT-CTRL-DT
 Each: \$120.40
 6+ Pcs.: \$105.95 ea.

For More On Radio Frequency Dimmers, See Pages L-134~136

Universal LED Ribbon Mounting Channels

Aluminum channels that work with our ribbons
For Pricing & To See A Full Line Of Our Mounting Channels, See Pages L-55~62

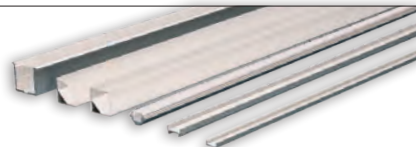

IMPORTANT: Due to Raw Material Fluctuation, Catalog Prices Below May Not Be Accurate. GO TO WWW.OUTWATER.COM FOR THE MOST UP-TO-DATE PRICES



LED Lighting

Premium Ribbon Flex

Available Lengths: 23.5", 8.25' & 16.5'
Material: Flexible Silicone Cover with Adhesive

- Commercial Grade
- Field Trimmable
- Consumes Only a Few Watts Per Field Cuttable Strip
- 30,000 Hour Average Bulb Life
- Dimmable
- IP20 & IP65 Options
- No UV Radiation- Safe For Artwork
- Limited 2 Year Warranty

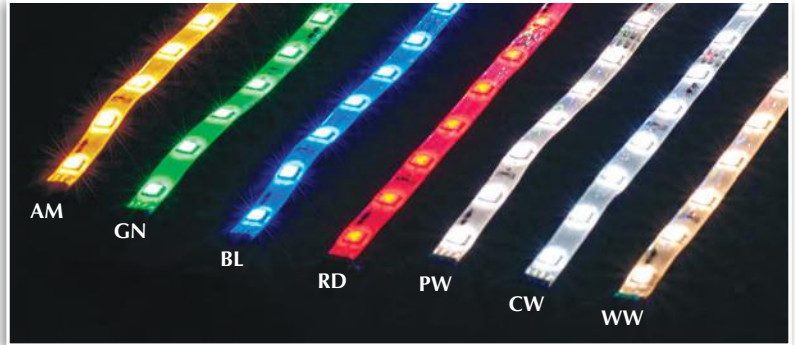

2 Options Available

IP65 Premium Ribbon

Provides Protection From Dust & Splashing Water, Not Submersible

IP20 Premium Ribbon

Provides Low Protection of Dust & Water



Single Ribbon Flex (Up To 280 Lumens Per Foot)

2 Pins Included

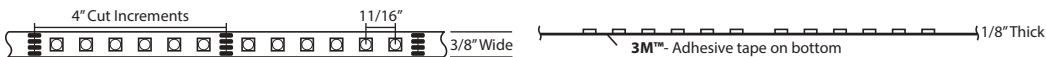
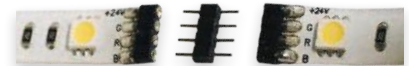

Part #	Color Temp	Length	# Of LED Chips	Total Wattage	Max # Can Connect	Price	
						Each	10+ Pcs.
IP65							
RIB24-N5060-23-*	*CW/*PW/*WW	23.5"	36	7	16.5'	\$6.74 (3.37')	\$6.06 ea. (\$3.03')
RIB24-N5060-8-*	*CW/*PW/*WW	8.25'	150	29	16.5'	\$20.02 (\$2.42')	\$16.45 ea. (\$1.99')
RIB24-N5060-16-*	*CW/*PW/*WW	16.5'	300	58	16.5'	\$39.90 (\$2.41')	\$32.78 ea. (\$3.18')
RIB24-N5060-16-AM	Amber	16.5'	300	58	16.5'	\$63.98 (\$3.87')	\$52.56 ea. (\$3.18')
RIB24-N5060-16-RD	Red	16.5'	300	58	16.5'	\$46.62 (\$2.82')	\$38.30 ea. (\$2.32')
RIB24-N5060-16-BL	Blue	16.5'	300	58	16.5'	\$46.62 (\$2.82')	\$38.30 ea. (\$2.32')
RIB24-N5060-16-GN	Green	16.5'	300	58	16.5'	\$46.62 (\$2.82')	\$38.30 ea. (\$2.32')
IP20							
RIB24-I5060-8-*	*CW/*PW/*WW	8.25'	150	29	16.5'	\$15.82 (\$1.91')	\$13.00 ea. (\$1.57')
RIB24-I5060-16-*	*CW/*PW/*WW	16.5'	300	58	16.5'	\$31.50 (\$1.90')	\$25.88 ea. (\$1.56')

Lighting Specifications

Color Temperature	CW:6000K-6500K PW: 4000K-4500K WW: 2800K-3200K AM: 1800K-2000K
Beam Spread	120°
Lumens	280 per ft.
Color Rendering Index	>80
Rated Average Life	30,000 hrs.
Constant	Voltage
Chip Size	5050

IMPORTANT: Due to Raw Material Fluctuation, Catalog Prices Below May Not Be Accurate. GO TO WWW.OUTWATER.COM FOR THE MOST UP-TO-DATE PRICES

LED Lighting



Accessories for Premium Ribbon Flex

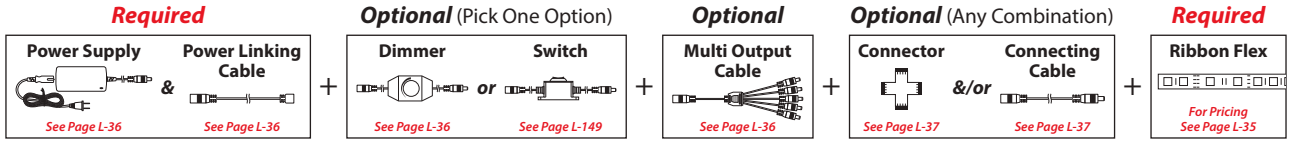

Required

Power Supplies

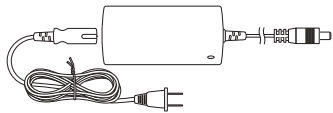

Part #	Type	Amps	Volts	Watts	Dimensions	Price	
						Each	6+ Pcs.
LED-24V-3A	Desktop	3A	24V	72W	4.68"L x 2.34"W x 1.48"H	\$28.75	\$26.05 ea.
LED-24V-4A	Desktop	4A	24V	96W	6.77"L x 2.83"W x 1.57"H	\$44.05	\$39.90 ea.
LED-24V-6A	Desktop	6A	24V	144W	6.77"L x 2.83"W x 1.57"H	\$52.15	\$47.40 ea.

For Product Details & More Power Options, See Pages L-137~140
 Other Options: *Plug In | Hardwire | Hardwire Dimmable | Rechargeable Battery*

Power Linking Cable

Required for power supplies, dimmers & multi output cables.

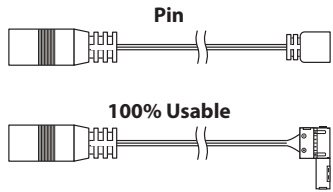

Part #	Description	Overall Length	Finish	Price	
				Each	6+ Pcs.
Pin Connection (Pins Included)					
LED-RIBBON-PWL	Power Link Cable with Pin Connection	18"	Black	\$3.00	\$2.60 ea.
For Cut Pieces of Ribbon					
LED-RIBBON-100U-PL	Power Link Cable with 100% Usable Connection	18"	Black	\$4.00	\$3.50 ea.

For Hardwire Power Linking Cables, See Page L-141

Optional

Dimmers

A power linking cable required.

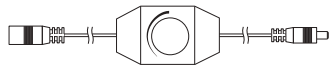

Part #	Description	Finish	Range of Dimming	Size	Price	
					Each	6+ Pcs.
LED-INLINE-DIM	Inline Rotary	Black	0-100%	2-5/8"L x 1-3/8"W x 1"H	\$5.95	\$5.25 ea.

For Product Details & More Dimmer Options, See Pages L-134~136 & L-142~144
 Other Options: *Rotary | Touch Dimmer | Radio Frequency*

Multi Output Cables

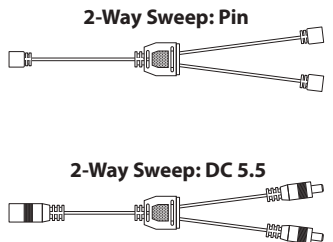

Part #	Description	Finish	Arms Size	# of Arms	Overall Length	Max # of Power Linking Cables	Price	
							Each	6+ Pcs.
Pin Connection (Pins Included)								
LED-2WAY-4P-WH	2-Way Sweep	White	5"	2	12"	2	\$2.95	\$2.50 ea.
For Cut Pieces of Ribbon & Pin Connection (Power Linking Cable Required For Each Outlet)								
LED-2WAY-BK	2-Way Sweep	Black	3"	2	7"	2	\$2.95	\$2.50 ea.
LED-5OUT-CBL-BK	5-Way Sweep	Black	8-3/4"	5	19"	5	\$5.50	\$4.85 ea.
LED-SPIDER-CBL	3-Way Spider	Black	4-1/2"	3	96"	4	\$6.25	\$5.55 ea.

For More Extension Cable Options, See Page L-147

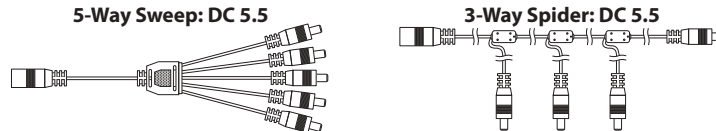

End-To-End For

100% Usable Connections

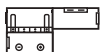

Part #	Description	# of Pins	Price	
			Each	6+ Pcs.
LED-RIBBON-100U-EE	Usable connection directly connects 2 cut pieces	4	\$0.85	\$0.75 ea.

IMPORTANT: Due to Raw Material Fluctuation, Catalog Prices Below May Not Be Accurate. GO TO WWW.OUTWATER.COM FOR THE MOST UP-TO-DATE PRICES



LED Lighting

Accessories for Premium Ribbon Flex

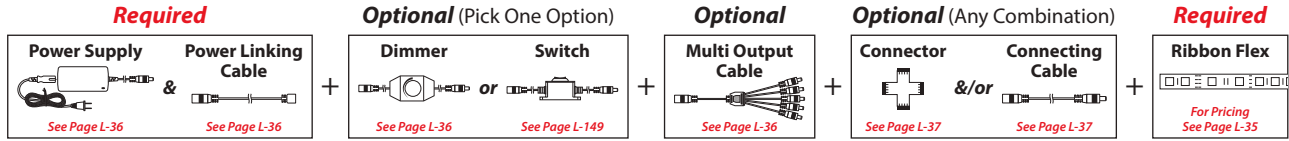

Optional

Connecting Cables

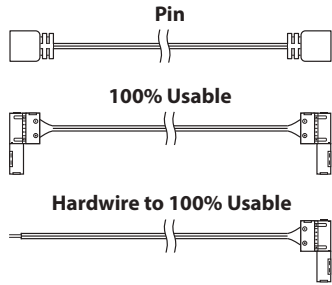

Part #	Description	Finish	Length	Price	
				Each	6+ Pcs.
Pin Connection (Pins Included)					
LED-RIB-CON-BK	Allows the designer to get around unlit areas without multiple power supplies	Black	18"	\$2.75	\$2.40 ea.
LED-RIB-CON24-WH		White	24"	\$3.25	\$2.85 ea.
LED-RIB-CON36-BK		Black	36"	\$3.50	\$3.05 ea.
LED-RIB-CON36-WH		White	36"	\$3.50	\$3.05 ea.
For Cut Pieces of Ribbon					
LED-RIBBON-100U-C1	Directly connect 2 cut pieces of ribbon while providing ability to get around unlit areas	White	24"	\$3.25	\$2.85 ea.
LED-RIBBON-100U-C2		White	36"	\$3.50	\$3.05 ea.
Hardwire					
LED-RIBBON-100U-ST	Hardwire power supply or dimmer to cut pieces	White	79"	\$4.50	\$3.95 ea.

For More Extension Cable Options, See Page L-146

Connectors

Connects ribbon at a 90° angle.

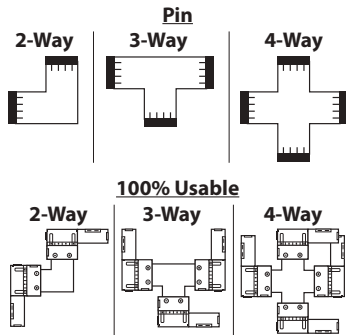

Part #	Description	# of Pins	Price	
			Each	6+ Pcs.
Pin Connection (Pins Included)				
LED-RIBBON-2W-C	2-Way L	4	\$1.75	\$1.50 ea.
LED-RIBBON-3W-C	3-Way T	4	\$1.75	\$1.50 ea.
LED-RIBBON-4W-C	4-Way Cross	4	\$1.75	\$1.50 ea.
For Cut Pieces of Ribbon				
LED-RIBBON-2W-EE-C	2-Way L	4	\$1.75	\$1.50 ea.
LED-RIBBON-3W-EE-C	3-Way T	4	\$1.75	\$1.50 ea.
LED-RIBBON-4W-EE-C	4-Way Cross	4	\$1.75	\$1.50 ea.

Mounting Clips

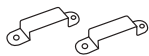

Part #	Description	Length	Price	
LED-5050-MC	1 mounting clips & 2 screws	10mm	Each	100+ Pcs.
			\$0.10	\$0.085 ea.

For More Mounting Clip Options, See Page L-149

End-To-End For Pin Connections

Replacement parts- included with each ribbon & accessory



Part #	Description	# of Pins	Price	
LED-4P-CON	Male to male connect end-to-end	4	Each	100+ Pcs.
			\$0.15	\$0.10 ea.

Universal LED Ribbon Mounting Channels

Aluminum channels that work with our ribbons

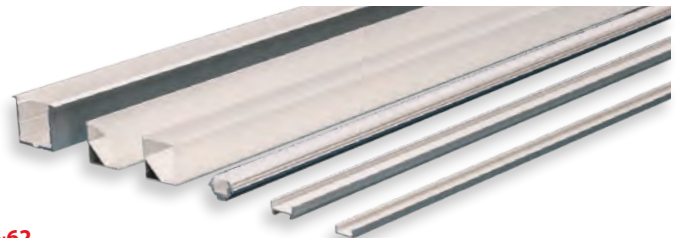
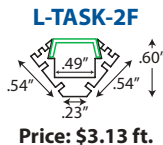
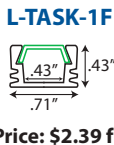
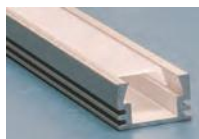

For Pricing & To See A Full Line Of Our Mounting Channels, See Pages L-55~62

IMPORTANT: Due to Raw Material Fluctuation, Catalog Prices Below May Not Be Accurate. GO TO WWW.OUTWATER.COM FOR THE MOST UP-TO-DATE PRICES

LED Lighting



Premium RGB Ribbon Flex

Nominal Lengths: 40", 6.5' & 16.5'

Material: Flexible Silicon Cover with Adhesive

- Commercial Grade
- Field Trimmable
- Nominal 40", 8.5' & 16.5' rolls
- Consumes Only a Few Watts Per Field Cuttable Strip
- 30,000 Hour Average Bulb Life
- 3M Adhesive Back
- No UV Radiation- Safe For Artwork
- Limited 2 Year Warranty

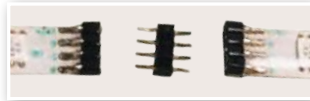

IP65 Premium 24V RGB Ribbon
Provides Protection From Dust & Splashing Water, Not Submersible



Single Ribbon Flex Strips (Up To 48 Lumens Per Foot)

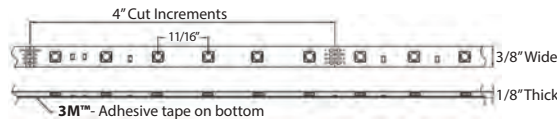
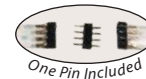

Part #	Length	# Of LED Chips	Total Wattage	Max # Can Connect	Price	
					Each	10+ Pcs.
RIB24-N5060-40RGB	40"	60	12	16.5'	\$8.37 (\$2.53')	\$6.88 ea. (\$2.08')
RIB24-N5060-8RGB	8.5'	120	29	16.5'	\$20.72 (\$2.44')	\$17.02 ea. (\$2.00')

Lighting Specifications

Beam Spread	140°
Lumens	Red: 22 per ft. Green: 48 per ft. Blue: 7 per ft.
Rated Average Life	30,000 hrs.
Constant	Current
Chip Size	SMD5050

Single Ribbon Flex Coils (Up To 48 Lumens Per Foot)

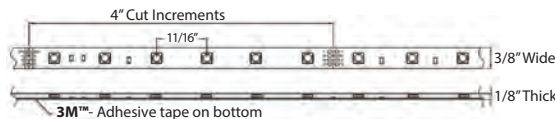

Part #	Length	# Of LED Chips	Total Wattage	Max # Can Connect	Price	
					Each	10+ Pcs.
RIB24-N5060-16RGB	16.5'	300	58	16.5'	\$41.30 (\$2.50')	\$33.93 ea. (\$2.06')

Lighting Specifications

Beam Spread	140°
Lumens	Red: 22 per ft. Green: 48 per ft. Blue: 7 per ft.
Rated Average Life	30,000 hrs.
Constant	Current
Chip Size	SMD5050





Accessories for Premium RGB Ribbon Flex

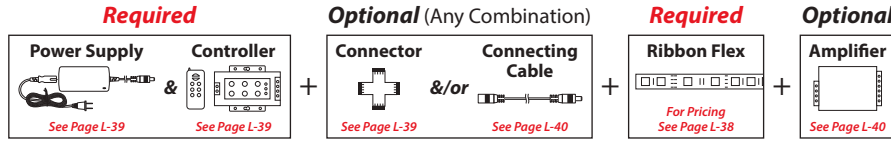

Required

Power Supplies

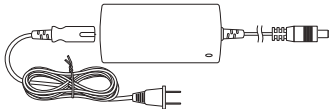

Part #	Type	Amps	Volts	Watts	Dimensions	Price	
						Each	6+ Pcs.
LED-24V-3A	Desktop	3A	24V	72W	4.68"L x 2.34"W x 1.48"H	\$28.75	\$26.05 ea.
LED-24V-4A	Desktop	4A	24V	96W	6.77"L x 2.83"W x 1.57"H	\$44.05	\$39.90 ea.
LED-24V-6A	Desktop	6A	24V	144W	6.77"L x 2.83"W x 1.57"H	\$52.15	\$47.40 ea.

For Product Details & More Power Options, See Pages L-137~140
 Other Options: [Plug In](#) | [Hardwire](#) | [Hardwire Dimmable](#) | [Rechargeable Battery](#)

Controllers

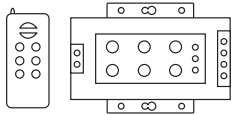

Part #	Description	Input Wire	Output Wire	Dimensions	Price	
					Each	6+ Pcs.
LED-RGB36-CRP	Deluxe RGB controller with up to 25 color changing functions	Female DC 5.5: 18"	4 Pin Connection: 18"	4-3/8"L x 2-1/8"W x 1"H	\$35.95	\$31.00 ea.
LED-RGB36-INLINE	Super small RGB controller with up to 20 color changing functions	Female DC 5.5: 3-1/2"	4 Pin Connection	1-1/2"L x 1/2"W x 1/8"H	\$9.95	\$9.00 ea.

For Product Details & More Controller Options, See Pages L-134~136 & L-150
 Other Options: [Radio Frequency](#) | [Sound Activated](#)

Optional

Connectors

Connects ribbon at a 90° angle.

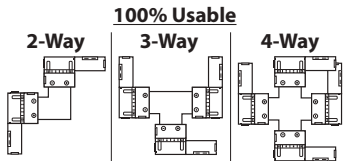
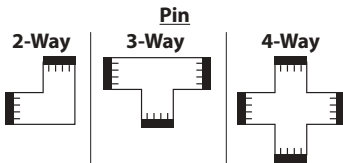

Part #	Works With	Description	# of Pins	Price	
				Each	6+ Pcs.
Pin Connection (Pins Included)					
LED-RIBBON-2W-C	RGB Ribbon	2-Way L	4	\$1.75	\$1.50 ea.
LED-RIBBON-3W-C	RGB Ribbon	3-Way T	4	\$1.75	\$1.50 ea.
LED-RIBBON-4W-C	RGB Ribbon	4-Way Cross	4	\$1.75	\$1.50 ea.
For Cut Pieces of Ribbon					
LED-RIBBON-2W-EE-C	RGB Ribbon	2-Way L	4	\$1.75	\$1.50 ea.
LED-RIBBON-3W-EE-C	RGB Ribbon	3-Way T	4	\$1.75	\$1.50 ea.
LED-RIBBON-4W-EE-C	RGB Ribbon	4-Way Cross	4	\$1.75	\$1.50 ea.

End-To-End For

100% Usable Connections

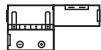

Part #	Works With	Description	# of Pins	Price	
				Each	6+ Pcs.
LED-RIBBON-100U-EE	RGB Ribbon	Usable connection directly connects 2 cut pieces	4	\$0.85	\$0.75 ea.

IMPORTANT: Due to Raw Material Fluctuation, Catalog Prices Below May Not Be Accurate. GO TO WWW.OUTWATER.COM FOR THE MOST UP-TO-DATE PRICES

LED Lighting



Accessories for Premium RGB Ribbon Flex

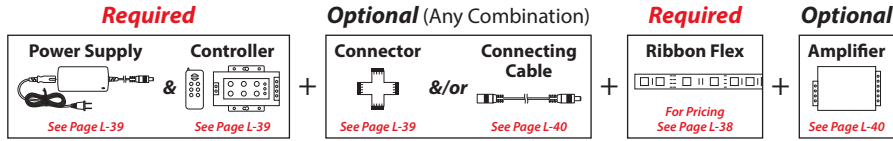

Optional

Connecting Cables

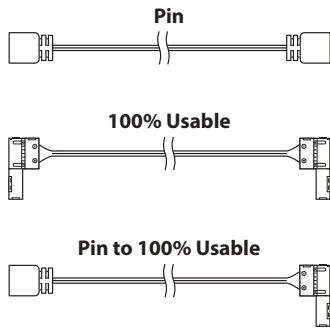

Part #	Works With	Description	Finish	Length	Price	
					Each	6+ Pcs.
Pin Connection (Pins Included)						
LED-RIBBON-RGB-CON	RGB Ribbon	Allows the designer to get around unlit areas without	Black	18"	\$2.75	\$2.40 ea.
LED-RIBBON-RGB-C24	RGB Ribbon	multiple power supplies	Black	24"	\$3.25	\$2.85 ea.
LED-RIBBON-RGB-C36	RGB Ribbon		Black	36"	\$3.50	\$3.05 ea.
For Cut Pieces of Ribbon						
LED-RIBBON-100U-R1	RGB Ribbon	Directly connect 2 cut pieces of ribbon while providing ability to get around unlit areas	Multi	24"	\$4.25	\$3.70 ea.
LED-RIBBON-100U-R2	RGB Ribbon		Multi	36"	\$4.50	\$3.95 ea.
Pin Connection (Pin Included) To Cut Pieces of Ribbon						
LED-RIBBON-100U-4P	RGB Ribbon	Directly connect pin to cut piece of ribbon to get around unlit areas	Multi	18"	\$1.85	\$1.70 ea.

For More Extension Cable Options, See Page L-146

Amplifiers

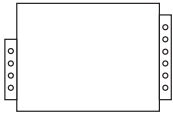

Part #	Description	Input Wire	Output Wire	Dimensions	Price	
					Each	6+ Pcs.
LED-RIBBON-RGB-AMP	Is to extend the signal of an RGB controller when the power supply is exceeded.	4 Pin Connection: 18"	4 Pin Connection: 18"	3-1/2"L x 2-1/2"W x 7/8"H	\$17.50	\$15.65 ea.
LED-RGBMIN-AMP	(Must purchase another power supply when using this product)	4 Pin Connection	4 Pin Connection	1-5/8"L x 1/2"W x 1/8"H	\$8.00	\$7.20 ea.

Mounting Clips

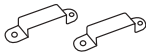

Part #	Works With	Description	Length	Price	
				Each	100+ Pcs.
LED-5050-MC	RGB Ribbon	1 mounting clips & 2 screws	10mm	\$0.10	\$0.085 ea.

For More Mounting Clip Options, See Page L-149

End-To-End For Pin Connections

Replacement parts-included with each ribbon & accessory



Part #	Works With	Description	# of Pins	Price	
				Each	100+ Pcs.
LED-4P-CON	RGB Ribbon	Male to male connect end-to-end	4	\$0.15	\$0.10 ea.

Universal LED Ribbon Mounting Channels

Aluminum channels that work with our ribbons

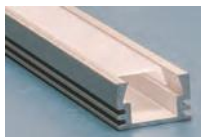

L-TASK-1F

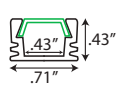

Price: \$2.39 ft.



L-TASK-2F

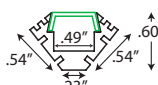

Price: \$3.13 ft.

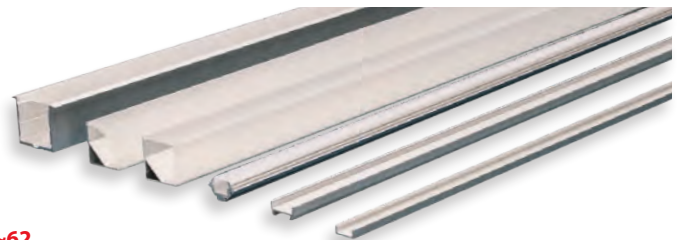

For Pricing & To See A Full Line Of Our Mounting Channels, See Pages L-55~62

IMPORTANT: Due to Raw Material Fluctuation, Catalog Prices Below May Not Be Accurate. GO TO WWW.OUTWATER.COM FOR THE MOST UP-TO-DATE PRICES



LED Lighting

10MM 4 In 1 Chip Technology: Including Dedicated Warm or Cool White Option

Available Lengths: 16.5'

Material: Rolled Copper PCB with White Coating

- Field Cuttable
- Flexible
- Limited 2 Year Warranty



2 Options Available

IP65 10MM 4 in 1 Ribbon
Provides Protection From Dust & Splashing Water, Not Submersible

IP20 10MM 4 in 1 Ribbon
Provides Low Protection of Dust & Water



7" BARE WIRE ENDS CONNECT DIRECTLY TO CONTROLLER

4 In 1 Ribbon Flex: Including Dedicated Warm or Cool White Options

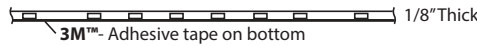
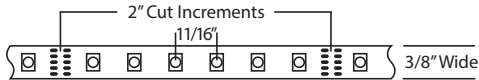

Lighting Specifications

Color Temp	CW: 5500K-6500K WW: 2800K-3000K
Beam Spread	120°
Lumens	CW: 90 per ft. WW: 83 per ft. Red: 21 per ft. Green: 34 per ft. Blue: 9 per ft.
Color Rendering Index	80
Rated Average Life	30,000 hrs.
Constant	Voltage
Chip Size	SMD5050

Part #	IP Rating	Length	# Of LED Chips	Total Wattage	Max # Can Connect	Price	
						Each	5+ Pcs.
RGB/Cool White *C5060-16 & RGB/Warm White *W5060-16							
FNR24-NRGB*	IP65	16.5'	300	57.5	16.5'	\$87.68 (\$5.31)	\$76.24 ea. (\$4.62)
FNR24-IRGB*	IP20	16.5'	300	57.5	16.5'	\$79.07 (\$4.79)	\$68.76 ea. (\$4.17)

To See A Full Line Of Our Mounting Channels, See Pages L-55~62

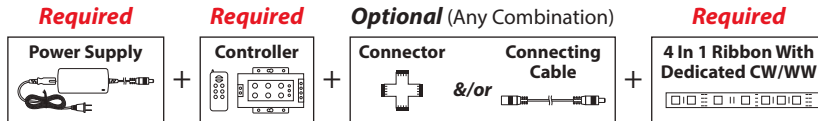

For Mounting Clips (LED-5050-MC), See Page L-149

Required

Power Supply

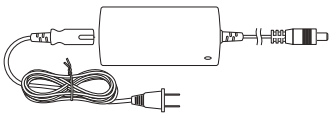

Part #	Type	Amps	Volts	Watts	Dimensions	Price	
						Each	6+ Pcs.
LED-24V-4A	Desktop	4A	24V	96W	6.77"L x 2.83"W x 1.57"H	\$44.05	\$39.90 ea.

RF Controller

Features:

- 3A / 24V / 72W
- Controller Size: 4-1/4"L x 2"W x 3/4"H
- Receiver Size: 3-5/8"L x 1-3/4"W x 7/8"H
- Mounting: Surface
- Remote Control Function: RF

Controller Functions:

- Static: 3 Options
- Flashing Strobe: 4 Options
- Gradient Change: 2 Options
- Brightness Adjusting: 8 Grades
- Color Jumping: 5 Options
- Sound: No



Optional

End-To-End For 100% Usable Connections

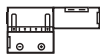

Part #	Description	# of Pins	Price	
			Each	6+ Pcs.
LED-RGBW-100U-EE	Usable connection directly connects 2 cut pieces	5	\$0.85	\$0.75 ea.

Connecting Cables

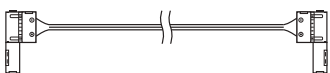

Part #	Description	Finish	Length	Price	
				Each	6+ Pcs.
For Cut Pieces of Ribbon					
LED-RGBW-C1	Directly connect 2 cut pieces of ribbon while providing ability to get around unlit areas	White	24"	\$3.25	\$2.85 ea.
LED-RGBW-C2		White	36"	\$3.50	\$3.05 ea.

IMPORTANT: Due to Raw Material Fluctuation, Catalog Prices Below May Not Be Accurate. GO TO WWW.OUTWATER.COM FOR THE MOST UP-TO-DATE PRICES

LED Lighting



12MM 4 In 1 Chip Technology: Including Dedicated Warm or Cool White Option

Available Lengths: 16.5'

Material: Rolled Copper PCB with White Coating

- Field Cuttable
- Flexible
- Limited 2 Year Warranty

2 Options Available

IP65 12MM 4 in 1 Ribbon
Provides Protection From Dust & Splashing Water, Not Submersible

IP20 12MM 4 in 1 Ribbon
Provides Low Protection of Dust & Water

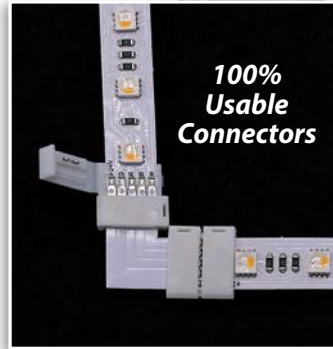
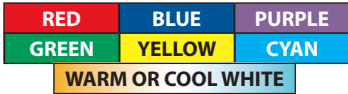

100% Usable Connectors



7" BARE WIRE ENDS CONNECT DIRECTLY TO CONTROLLER

12MM 4 In 1 Ribbon Flex: Including Dedicated Warm or Cool White Options

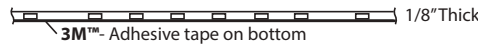
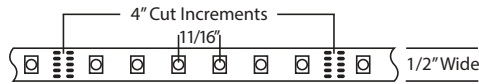

Lighting Specifications

Color Temp	RGB/CW RGB/WW
Beam Spread	120°
Color Rendering Index	80
Rated Average Life	30,000 hrs.
Constant	Current
Chip Size	5050

Part #	IP Rating	Length	# Of LED Chips	Total Wattage	Max # Can Connect	Price	
						Each	5+ Pcs.
RGB/Cool White *C5060-16 & RGB/Warm White *W5016-16							
FNC24-NRGB*	IP65	16.5'	300	88	16.5'	\$97.52 (\$5.91)	\$85.82 ea. (\$5.20')
FNC24-IRGB*	IP20	16.5'	300	88	16.5'	\$84.30 (\$5.11)	\$74.20 ea. (\$4.50')

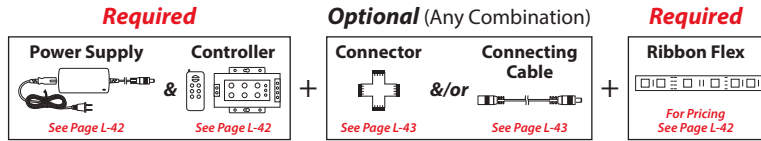

Required

Power Supply

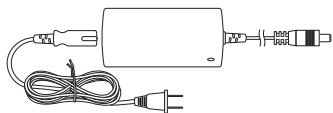

Part #	Type	Amps	Volts	Watts	Dimensions	Price	
						Each	6+ Pcs.
LED-24V-3A	Desktop	3A	24V	72W	4.68"L x 2.34"W x 1.48"H	\$28.75	\$26.05 ea.
LED-24V-6A	Desktop	6A	24V	144W	6.77"L x 2.83"W x 1.57"H	\$52.15	\$47.40 ea.

For Product Details & More Power Options, See Pages L-137~140
Other Options: **Plug In | Hardwire | Hardwire Dimmable | Rechargeable Battery**

RF Controller

Features:

- 3A / 24V / 72W
- Controller Size: 4-1/4"L x 2"W x 3/4"H
- Receiver Size: 3-5/8"L x 1-3/4"W x 7/8"H
- Mounting: Surface
- Remote Control Function: RF

Controller Functions:

- Static: 3 Options
- Flashing Strobe: 4 Options
- Gradient Change: 2 Options
- Brightness Adjusting: 8 Grades
- Color Jumping: 5 Options
- Sound: No

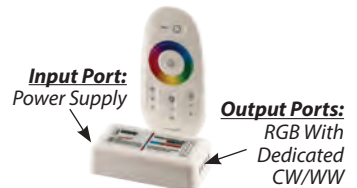

IMPORTANT: Due to Raw Material Fluctuation, Catalog Prices Below May Not Be Accurate. GO TO WWW.OUTWATER.COM FOR THE MOST UP-TO-DATE PRICES



LED Lighting

Accessories for 12MM 4 In 1 Chip Technology

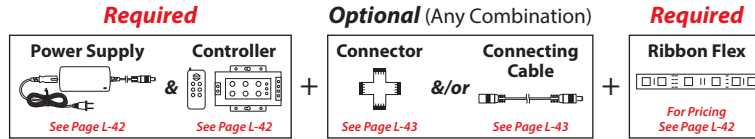

Optional

Connectors

Connects ribbon at a 90° angle.

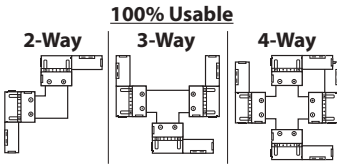

Part #	Description	# of Pins	Price	
			Each	6+ Pcs.
For Cut Pieces of Ribbon				
LED-RGBW12-2W-EE-C	2-Way L	5	\$2.05	\$1.75 ea.
LED-RGBW12-3W-EE-C	3-Way T	5	\$2.05	\$1.75 ea.
LED-RGBW12-4W-EE-C	4-Way Cross	5	\$2.05	\$1.75 ea.

End To End For

100% Usable Connections

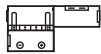

Part #	Description	# of Pins	Price	
			Each	6+ Pcs.
LED-RGBW12-100U-EE	Usable connection directly connects 2 cut pieces	5	\$0.85	\$0.75 ea.

Connecting Cables

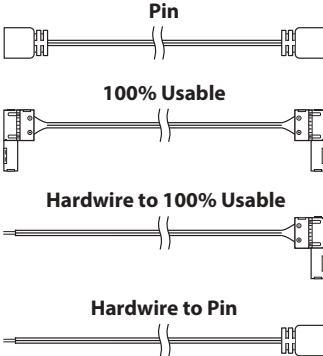

Part #	Description	Finish	Length	Price	
				Each	6+ Pcs.
Pin Connection (Pins Included)					
LED-RGBW12-CON18	Allows the designer to get around unlit areas without multiple power supplies	Black	18"	\$2.75	\$2.40 ea.
LED-RGBW12-CON24		Black	24"	\$3.25	\$2.85 ea.
LED-RGBW12-CON36		Black	36"	\$3.50	\$3.05 ea.
For Cut Pieces of Ribbon					
LED-RGBW12-100U-C1	Directly connect 2 cut pieces of ribbon while providing ability to get around unlit areas	Multi	24"	\$4.25	\$3.70 ea.
LED-RGBW12-100U-C2		Multi	36"	\$4.50	\$3.95 ea.
Hardwire To 100% Usable					
LED-RGBW12-100U-ST	Hardwire power supply or dimmer to cut pieces	Multi	79"	\$4.50	\$3.95 ea.
Hardwire To Pin					
LED-RGBW12-MCC	Hardwire power supply or dimmer to cut pieces	Black	6"	\$1.95	\$1.50 ea.

Mounting Clips



Part #	Description	Length	Price	
			Each	100+ Pcs.
LED-12MM-MC-IP20	1 mounting clips & 2 screws	12mm	\$0.10	\$0.085 ea.

End-To-End For Pin Connections

Replacement parts- included with each ribbon & accessory



Part #	Description	# of Pins	Price	
			Each	100+ Pcs.
LED-5P-CON	Male to male connect end-to-end	5	\$0.20	\$0.15 ea.

Universal LED Ribbon Mounting Channels

Aluminum channels that work with our ribbons
For Pricing & To See A Full Line Of Our Mounting Channels, See Pages L-55~62

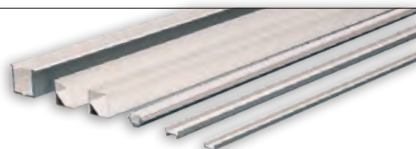

IMPORTANT: Due to Raw Material Fluctuation, Catalog Prices Below May Not Be Accurate. GO TO WWW.OUTWATER.COM FOR THE MOST UP-TO-DATE PRICES

LED Lighting



5 In 1 Warm White, Cool White & RGB Ribbon

Now you can mix colors and/or create white ranging from warm to cool

Nominal Lengths: 16.5'

Material: Flexible White PCB with Adhesive

- 5 colors on the same chip
- Over 1 trillion color combinations
- Seamless blending of RGB with Tunable White (2400K to 6500K)
- Field Trimmable
- Flexible
- 3M Adhesive Back
- Limited 3 Year Warranty

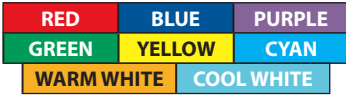

IP20 5 in 1 WRGBW Ribbon
Provides Low Protection of Dust & Water



7" BARE WIRE ENDS CONNECT DIRECTLY TO CONTROLLER

5 In 1 Warm White, Cool White & RGB Ribbon

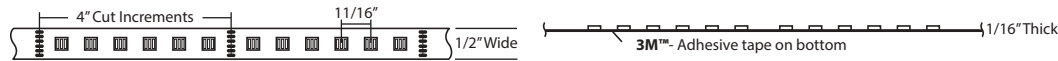

Lighting Specifications

Color Temperature	2400K + RGB + 6500K
Beam Spread	120°
Color Rendering Index	80
Rated Average Life	35,000 hrs.
Constant	Voltage
Chip Size	5050

Part #	Length	# Of LED Chips	Total Wattage	Max # Can Connect	Each	5+ Pcs.
FVR24-IRGWH5060-16	16.5'	300	120	16.5'	\$109.20 (\$6.62')	\$97.50 ea. (\$5.91')

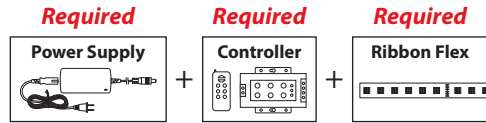

Required

Power Supplies

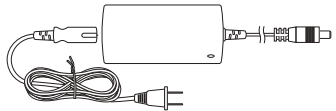

Part #	Type	Amps	Volts	Watts	Dimensions	Price	
						Each	6+ Pcs.
LED-24V-6A	Desktop	6A	24V	144W	6.77"L x 2.83"W x 1.57"H	\$52.15	\$47.40 ea.

For Product Details & More Power Options, See Pages L-137~140
Other Options: Plug In | Hardwire | Hardwire Dimmable | Rechargeable Battery

RF Controller

Features:

- 6A / 24V / 144W
- 4 Zones
- Input Wire: Female DC 5.5 / Hardwire
- Output Wire: Hardwire
- Controller Size: 5-7/16"L x 2-1/4"W x 3/4"H
- Receiver Size: 3-11/32"L x 1-3/4"W x 7/8"H
- Color: White

Controller Functions:

- Mounting: Surface
- Remote Control Function: RF
- Gradient Change: 11 Grades
- Brightness Adjusting: 20 Grades
- Fire Simulator
- Sound: No

LED-WRGBW-CR
Each: \$41.60 / 6+ Pcs.: \$39.00 ea.



Universal LED Ribbon Mounting Channels

Aluminum channels that work with our ribbons
For Pricing & To See A Full Line Of Our Mounting Channels, See Pages L-55~62

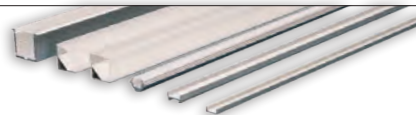

IMPORTANT: Due to Raw Material Fluctuation, Catalog Prices Below May Not Be Accurate. GO TO WWW.OUTWATER.COM FOR THE MOST UP-TO-DATE PRICES



12V

LED Lighting

Standard 12V Ribbon Flex: Most Economical LED Ribbon

Available Lengths: 8.25' & 16.5'
Material: Flexible Silicon Cover with Adhesive



Special Feature
Ribbon has 2- 7" female ends (DC 5.5) so it can be cut to size and then the remaining piece can be used for another project



2 Options Available

IP65 Standard 12V Ribbon Provides Protection From Dust & Splashing Water, Not Submersible | **IP20 Standard 12V Ribbon** Provides Low Protection of Dust & Water

ECO12-*3560-* (Up To 136 Lumens Per Foot)



Shown IP65



Lighting Specifications

Color Temperature	CW: 5500K WW: 2800K-3200K PW: 4200K AM: 2300K
Beam Spread	120°
Lumens	110-136 per ft.
Color Rendering Index	CW: 75 WW: 80 PW: 75 AM: 75
Rated Average Life	50,000 hrs.
Constant	Voltage
Chip Size	SMD3528

Part #	Length	# Of LED Chips	Total Wattage	Max # Can Connect	Price	
					Each	10+ Pcs.
IP65 (Cool White *CW, Warm White *WW, Pure White *PW & Amber *AM)						
ECO12-N3560-8-*	8.25'	150	12	33'	\$14.76 (\$1.79)	\$12.30 ea. (\$1.49)
ECO12-N3560-16-*	16.5'	300	24	33'	\$25.20 (\$1.53)	\$21.00 ea. (\$1.27)
IP20 (Cool White *CW, Warm White *WW, Pure White *PW & Amber *AM)						
ECO12-I3560-8-*	8.25'	150	12	33'	\$9.36 (\$1.13)	\$7.80 ea. (\$0.95)
ECO12-I3560-16-*	16.5'	300	24	33'	\$16.20 (\$0.98)	\$13.50 ea. (\$0.82)

ECO12-*35120-* (Up To 273 Lumens Per Foot)



Shown IP65



Lighting Specifications

Color Temperature	CW: 5500K WW: 2800K-3200K PW: 4200K AM: 2300K
Beam Spread	120°
Lumens	252-273 per ft.
Color Rendering Index	CW: 75 WW: 80 PW: 75 AM: 75
Rated Average Life	50,000 hrs.
Constant	Voltage
Chip Size	SMD3528

Part #	Length	# Of LED Chips	Total Wattage	Max # Can Connect	Price	
					Each	10+ Pcs.
IP65 (Cool White *CW, Warm White *WW, Pure White *PW & Amber *AM)						
ECO12-N35120-8-*	8.25'	300	24	33'	\$23.52 (\$2.85)	\$19.32 ea. (\$2.34)
ECO12-N35120-16-*	16.5'	600	48	33'	\$42.00 (\$2.55)	\$34.50 ea. (\$2.09)
IP20 (Cool White *CW, Warm White *WW, Pure White *PW & Amber *AM)						
ECO12-I35120-8-*	8.25'	300	24	33'	\$18.48 (\$2.24)	\$15.18 ea. (\$1.84)
ECO12-I35120-16-*	16.5'	600	48	33'	\$33.60 (\$2.04)	\$27.60 ea. (\$1.67)

Phone: 1-800-631-8375 - Fax: 1-800-888-3315
Due to raw material cost fluctuations, prices are subject to change.

IMPORTANT: Due to Raw Material Fluctuation, Catalog Prices Below May Not Be Accurate. GO TO WWW.OUTWATER.COM FOR THE MOST UP-TO-DATE PRICES

LED Lighting



Standard 12V Ribbon Flex: Most Economical LED Ribbon

ECO12-*5060-* (Up To 382 Lumens Per Foot)



Shown IP20

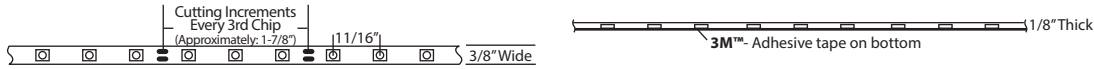

Lighting Specifications

Color Temperature	CW: 5500K WW: 2800-3200K PW: 4200K AM: 2300K
Beam Spread	120°
Lumens	341-382 per ft.
Color Rendering Index	CW: 75 WW: 80 PW: 75 AM: 75
Rated Average Life	50,000 hrs.
Constant	Voltage
Chip Size	SMD5050

Part #	Length	# Of LED Chips	Total Wattage	Max # Can Connect	Price Each	Price 10+ Pcs.
IP65 (Cool White *CW, Warm White *WW, Pure White *PW & Amber *AM)						
ECO12-N5060-8-*	8.25'	150	36	23'	\$23.52 (\$2.85)	\$19.32 ea. (\$2.34)
ECO12-N5060-16-*	16.5'	300	72	23'	\$43.68 (\$2.65)	\$35.88 ea. (\$2.17)
IP20 (Cool White *CW, Warm White *WW, Pure White *PW & Amber *AM)						
ECO12-I5060-8-*	8.25'	150	36	23'	\$18.48 (\$2.24)	\$15.18 ea. (\$1.84)
ECO12-I5060-16-*	16.5'	300	72	23'	\$35.28 (\$2.14)	\$28.98 ea. (\$1.76)

Accessories For Standard 12V Ribbon Flex

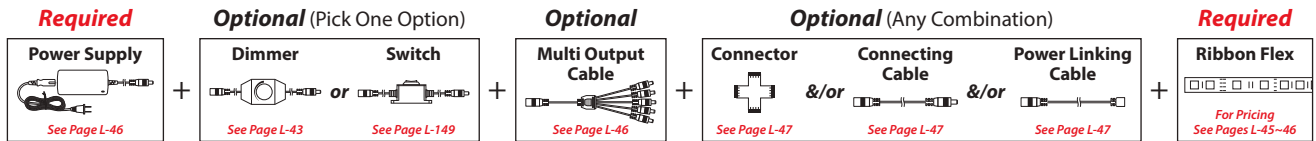

Required

Power Supplies

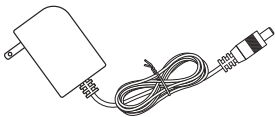

Part #	Type	Amps	Volts	Watts	Dimensions	Price Each	Price 6+ Pcs.
LED-12V-1A	Wall Mount	1A	12V	12W	2.91"L x 1.61"W x 1.14"H	\$8.95	\$8.20 ea.
LED-12V-3A	Wall Mount	3A	12V	36W	3.41"L x 2.31"W x 1.26"H	\$16.15	\$14.70 ea.

For Product Details & More Power Options, See Pages L-137~140
 Other Options: Plug In | Hardwire | Hardwire Dimmable | Rechargeable Battery

Optional

Dimmers

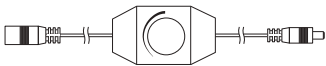

Part #	Description	Finish	Range of Dimming	Size	Price Each	Price 6+ Pcs.
LED-INLINE-DIM	Inline Rotary	Black	0-100%	2-5/8"L x 1-3/8"W x 1"H	\$5.95	\$5.25 ea.

For Product Details & More Dimmer Options, See Pages L-134~136 & L-142~144
 Other Options: Rotary | Touch Dimmer | Radio Frequency

Multi Output Cables



Part #	Description	Finish	Arms Size	# of Arms	Overall Length	Max # of Power Linking Cables	Price Each	Price 6+ Pcs.
LED-2WAY-BK	2-Way Sweep	Black	3"	2	7"	2	\$2.95	\$2.50 ea.
LED-5OUT-CBL-BK	5-Way Sweep	Black	8-3/4"	5	19"	5	\$5.50	\$4.85 ea.
LED-SPIDER-CBL	3-Way Spider	Black	4-1/2"	3	96"	4	\$6.25	\$5.55 ea.

For More Extension Cable Options, See Page L-147

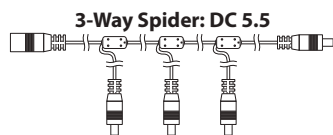

IMPORTANT: Due to Raw Material Fluctuation, Catalog Prices Below May Not Be Accurate. GO TO WWW.OUTWATER.COM FOR THE MOST UP-TO-DATE PRICES



LED Lighting

Accessories For Standard 12V Ribbon Flex

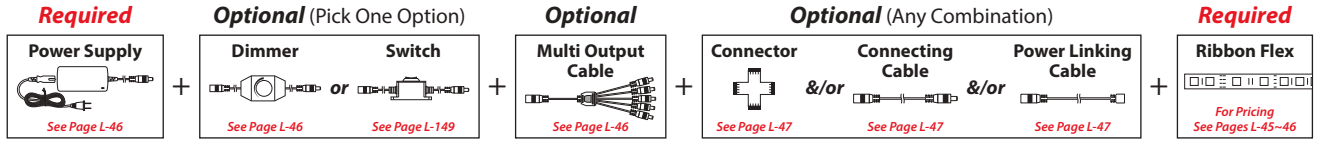

Optional

End-To-End For 100% Usable Connections

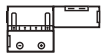

Part #	Works With	Description	# of Pins	Price	
				Each	6+ Pcs.
ECO12V-35-100U-EE	3528	Usable connection directly	2	\$0.85	\$0.75 ea.
LED-RIBBON-100U-EE	5050	connects 2 cut pieces	4	\$0.85	\$0.75 ea.

Power Linking Cable

Required for multi output cables or cut pieces of ribbon.

100% Usable

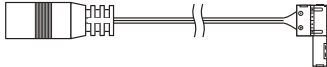

Part #	Works With	Description	Overall Length	Finish	Price	
					Each	6+ Pcs.
For Cut Pieces of Ribbon						
ECO12V-35-100U-PL	3528	Power Link Cable with 100% Usable	18"	Black	\$4.00	\$3.50 ea.
LED-RIBBON-100U-PL	5050	Connection	18"	Black	\$4.00	\$3.50 ea.

For Hardwire Power Linking Cables, See Page L-141

Connecting Cables

100% Usable

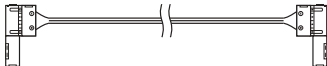

Hardwire to 100% Usable

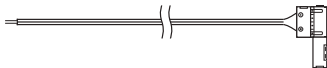

Part #	Works With	Description	Finish	Length	Price	
					Each	6+ Pcs.
For Cut Pieces of Ribbon						
ECO12V-35-100U-C1	3528	Directly connect 2	Red/Black	24"	\$3.25	\$2.85 ea.
LED-RIBBON-100U-C1	5050	cut pieces of ribbon while	White	24"	\$3.25	\$2.85 ea.
ECO12V-35-100U-C2	3528	providing ability to get	Red/Black	36"	\$3.50	\$3.05 ea.
LED-RIBBON-100U-C2	5050	around unlit areas	White	36"	\$3.50	\$3.05 ea.
Hardwire						
ECO12V-35-100U-ST	3528	Hardwire power supply or	Red/Black	79"	\$4.50	\$3.95 ea.
LED-RIBBON-100U-ST	5050	dimmer to cut pieces	White	79"	\$4.50	\$3.95 ea.

For More Extension Cable Options, See Pages L-145~146

Connectors

Connects ribbon at a 90° angle.

100% Usable

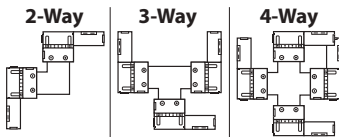

Part #	Works With	Description	# of Pins	Price	
				Each	6+ Pcs.
For Cut Pieces of Ribbon					
ECO12V-35-2W-EE-C	3528	2-Way L	2	\$1.75	\$1.50 ea.
LED-RIBBON-2W-EE-C	5050		4	\$1.75	\$1.50 ea.
ECO12V-35-3W-EE-C	3528	3-Way T	2	\$1.75	\$1.50 ea.
LED-RIBBON-3W-EE-C	5050		4	\$1.75	\$1.50 ea.
ECO12V-35-4W-EE-C	3528	4-Way Cross	2	\$1.75	\$1.50 ea.
LED-RIBBON-4W-EE-C	5050		4	\$1.75	\$1.50 ea.

Mounting Clips



Part #	Works With	Description	Length	Price	
				Each	100+ Pcs.
LED-3528-MC	3528	1 mounting clips & 2 screws	10mm	\$0.10	\$0.085 ea.
LED-5050-MC	5050	1 mounting clips & 2 screws	10mm	\$0.10	\$0.085 ea.

For More Mounting Clip Options, See Page L-149

Universal LED Ribbon Mounting Channels

Aluminum channels that work with our ribbons

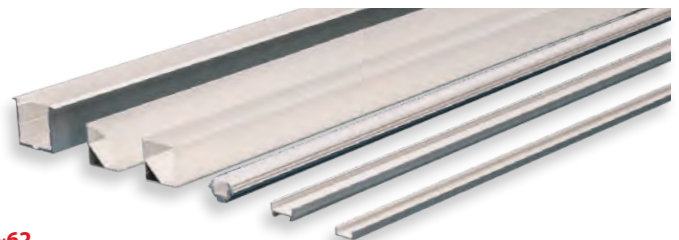

For Pricing & To See A Full Line Of Our Mounting Channels, See Pages L-55~62

IMPORTANT: Due to Raw Material Fluctuation, Catalog Prices Below May Not Be Accurate. GO TO WWW.OUTWATER.COM FOR THE MOST UP-TO-DATE PRICES

LED Lighting



Standard 12V LED RGB Ribbon Flex: Most Economical LED Ribbon

Available Lengths: 8.25' & 16.5'
Material: Flexible White PCB with Adhesive

- Ideal for budget conscience applications
- Field trimmable

2 Options Available

IP65 Standard 12V RGB Ribbon

Provides Protection From Dust & Splashing Water, Not Submersible

IP20 Standard 12V RGB Ribbon

Provides Low Protection of Dust & Water



Connect Ribbon Using Our 4 Pin Connecting System

Standard 12V LED RGB Ribbon Flex

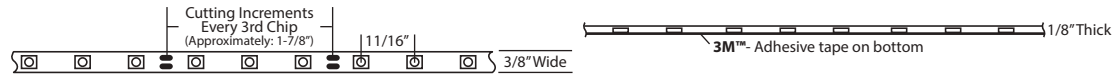

4" Cable With 4 Pin

Part #	Color Temp	Length	# Of LED Chips	Total Wattage	Max # Can Connect	Price	
						Each	10+ Pcs.
IP65							
ECO12-N5060-8-RGB	RGB	8.25'	150	36	16.5'	\$23.48 (\$2.85')	\$19.27 ea. (\$2.34')
ECO12-N5060-16-RGB	RGB	16.5'	300	72	16.5'	\$43.89 (\$2.66')	\$35.85 ea. (\$2.17')
IP20							
ECO12-I5060-8-RGB	RGB	8.25'	150	36	16.5'	\$20.16 (\$2.44')	\$16.56 ea. (\$2.01')
ECO12-I5060-16-RGB	RGB	16.5'	300	72	16.5'	\$36.96 (\$2.24')	\$30.36 ea. (\$1.84')

Lighting Specifications

Beam Spread	120°
Rated Average Life	50,000 hrs.
Constant	Voltage
Chip Size	SMD5050

Accessories for Standard 12V LED RGB Ribbon Flex

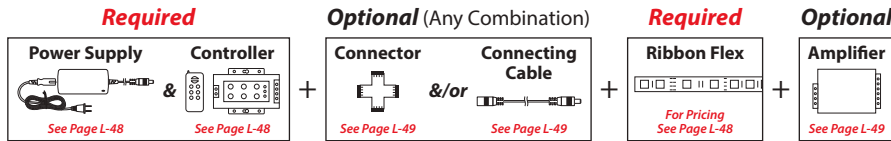

Required

Power Supplies

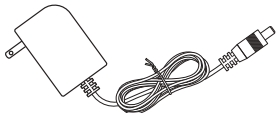

Part #	Type	Amps	Volts	Watts	Dimensions	Price	
						Each	6+ Pcs.
LED-12V-1A	Wall Mount	1A	12V	12W	2.91"L x 1.61"W x 1.14"H	\$8.95	\$8.20 ea.
LED-12V-3A	Wall Mount	3A	12V	36W	3.41"L x 2.31"W x 1.26"H	\$16.15	\$14.70 ea.

For Product Details & More Power Options, See Pages L-137~140
Other Options: Plug In | Hardwire | Hardwire Dimmable | Rechargeable Battery

Controllers

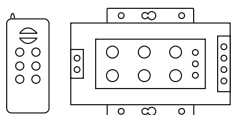

Part #	Description	Input Wire	Output Wire	Dimensions	Price	
					Each	6+ Pcs.
LED-RGB36-CRP	Deluxe RGB controller with up to 25 color changing functions	Female DC 5.5: 18"	4 Pin Connection: 18"	4-3/8"L x 2-1/8"W x 1"H	\$35.95	\$31.00 ea.
LED-RGB36-INLINE	Super small RGB controller with up to 20 color changing functions	Female DC 5.5: 3-1/2"	4 Pin Connection	1-1/2"L x 1/2"W x 1/8"H	\$9.95	\$9.00 ea.

For Product Details & More Controller Options, See Pages L-134~136 & L-150
Other Options: Radio Frequency | Sound Activated



Optional

Connectors

Connects ribbon at a 90° angle.

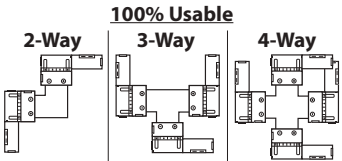
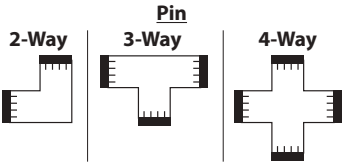

Part #	Works With	Description	# of Pins	Price	
				Each	6+ Pcs.
Pin Connection (Pins Included)					
LED-RIBBON-2W-C	RGB Ribbon	2-Way L	4	\$1.75	\$1.50 ea.
LED-RIBBON-3W-C	RGB Ribbon	3-Way T	4	\$1.75	\$1.50 ea.
LED-RIBBON-4W-C	RGB Ribbon	4-Way Cross	4	\$1.75	\$1.50 ea.
For Cut Pieces of Ribbon					
LED-RIBBON-2W-EE-C	RGB Ribbon	2-Way L	4	\$1.75	\$1.50 ea.
LED-RIBBON-3W-EE-C	RGB Ribbon	3-Way T	4	\$1.75	\$1.50 ea.
LED-RIBBON-4W-EE-C	RGB Ribbon	4-Way Cross	4	\$1.75	\$1.50 ea.

End-To-End For 100% Usable Connections

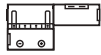

Part #	Works With	Description	# of Pins	Price	
				Each	6+ Pcs.
LED-RIBBON-100U-EE	RGB Ribbon	Usable connection directly connects 2 cut pieces	4	\$0.85	\$0.75 ea.

Connecting Cables

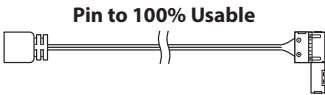
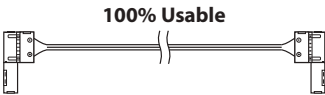
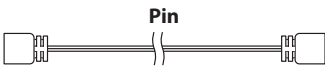

Part #	Works With	Description	Finish	Length	Price	
					Each	6+ Pcs.
Pin Connection (Pins Included)						
LED-RIBBON-RGB-CON	RGB Ribbon	Allows the designer to get around unlit areas without multiple power supplies	Black	18"	\$2.75	\$2.40 ea.
LED-RIBBON-RGB-C24	RGB Ribbon		Black	24"	\$3.25	\$2.85 ea.
LED-RIBBON-RGB-C36	RGB Ribbon		Black	36"	\$3.50	\$3.05 ea.
For Cut Pieces of Ribbon						
LED-RIBBON-100U-R1	RGB Ribbon	Directly connect 2 cut pieces of ribbon while providing ability to get around unlit areas	Multi	24"	\$4.25	\$3.70 ea.
LED-RIBBON-100U-R2	RGB Ribbon		Multi	36"	\$4.50	\$3.95 ea.
Pin Connection (Pin Included) To Cut Pieces of Ribbon						
LED-RIBBON-100U-4P	RGB Ribbon	Directly connect pin to cut piece of ribbon to get around unlit areas	Multi	18"	\$1.85	\$1.70 ea.

For More Extension Cable Options, See Pages L-146

Amplifiers



Part #	Description	Input Wire	Output Wire	Dimensions	Price	
					Each	6+ Pcs.
LED-RIBBON-RGB-AMP	Is to extend the signal of an RGB controller when the power supply is exceeded. (Must purchase another power supply when using this product)	4 Pin Connection: 18"	4 Pin Connection: 18"	3-1/2"L x 2-1/2"W x 7/8"H	\$17.50	\$15.65 ea.
LED-RGBMIN-AMP		4 Pin Connection	4 Pin Connection	1-5/8"L x 1/2"W x 1/8"H	\$8.00	\$7.20 ea.

Mounting Clips



Part #	Works With	Description	Length	Price	
				Each	100+ Pcs.
LED-5050-MC	RGB Ribbon	1 mounting clips & 2 screws	10mm	\$0.10	\$0.085 ea.

For More Mounting Clip Options, See Page L-149

End-To-End For Pin Connections

Replacement parts- included with each ribbon & accessory



Part #	Works With	Description	# of Pins	Price	
				Each	100+ Pcs.
LED-4P-CON	RGB Ribbon	Male to male connect end-to-end	4	\$0.15	\$0.10 ea.

Universal LED Ribbon Mounting Channels
Aluminum channels that work with our ribbons

For Pricing & To See A Full Line Of Our Mounting Channels, See Pages L-55~62

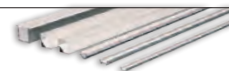

LED Lighting



Thin 12V Ribbon Flex

Available Lengths: 4', 8.25' & 16.5'
Material: Flexible White PCB with Adhesive



- Super Bright: Up To 482 Lumens Per Ft.
- 60% Smaller Than Anything On The Market
- Works With Our Magic Backlighting Sheet & DIY: Brite Light Sheet (See Pages L-12~15)
- Easy To Hide



**Thinnest Ribbon On The Market...
 Only 4mm (.157")**

**Easy To Hide
 In Fixtures**

2 Options Available

IP65 Thin 12V Ribbon

Provides Protection From Dust & Splashing Water, Not Submersible

IP20 Thin 12V Ribbon

Provides Low Protection of Dust & Water

7" Cable
 With DC5.5

7" Cable
 With DC5.5

Special Feature
 Ribbon has 2 female ends (DC 5.5) so it can be cut to size and then the remaining piece can be used for another project

Basic Brightness (Up To 146 Lumens Per Foot)



Part #	Length	# Of LED Chips	Total Wattage	Max # Can Connect	Price	
					Each	10+ Pcs.
IP65 (Cool White *CW, Warm White *WW & Pure White *PW)						
SPT12-N3060-4*	4'	75	6	23'	\$9.58 (\$2.39)	\$7.87 ea. (\$1.97)
SPT12-N3060-8*	8.25'	150	12	23'	\$18.82 (\$2.28)	\$15.46 ea. (\$1.87)
SPT12-N3060-16*	16.5'	300	24	23'	\$36.96 (\$2.24)	\$30.36 ea. (\$1.84)
IP20 (Cool White *CW, Warm White *WW & Pure White *PW)						
SPT12-I3060-4*	4'	75	6	23'	\$8.40 (\$2.10)	\$6.90 ea. (\$1.73)
SPT12-I3060-8*	8.25'	150	12	23'	\$16.30 (\$1.98)	\$13.39 ea. (\$1.62)
SPT12-I3060-16*	16.5'	300	24	23'	\$31.92 (\$1.93)	\$26.22 ea. (\$1.59)

Lighting Specifications

Color Temperature	CW: 6300K PW: 4400K WW: 3200K
Beam Spread	120°
Lumens	120-146 per ft.
Color Rendering Index	80
Rated Average Life	20,000 hrs.
Constant	Voltage
Chip Size	SMD3014

Standard Brightness (Up To 292 Lumens Per Foot)

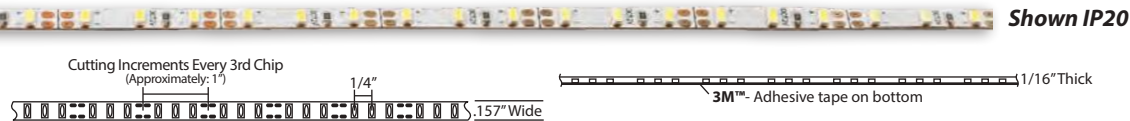

Part #	Length	# Of LED Chips	Total Wattage	Max # Can Connect	Price	
					Each	10+ Pcs.
IP65 (Cool White *CW, Warm White *WW & Pure White *PW)						
SPT12-N30120-4*	4'	150	12	13'	\$15.12 (\$3.78)	\$12.42 ea. (\$3.11)
SPT12-N30120-8*	8.25'	300	24	13'	\$30.24 (\$3.67)	\$24.84 ea. (\$3.01)
SPT12-N30120-16*	16.5'	600	48	13'	\$49.68 (\$3.01)	\$43.20 ea. (\$2.62)
IP20 (Cool White *CW, Warm White *WW & Pure White *PW)						
SPT12-I30120-4*	4'	150	12	13'	\$13.83 (\$3.46)	\$11.36 ea. (\$2.84)
SPT12-I30120-8*	8.25'	300	24	13'	\$27.72 (\$3.36)	\$22.77 ea. (\$2.76)
SPT12-I30120-16*	16.5'	600	48	13'	\$45.54 (\$2.76)	\$39.60 ea. (\$2.40)

Lighting Specifications

Color Temperature	CW: 6300K PW: 4400K WW: 3200K
Beam Spread	120°
Lumens	272-292 per ft.
Color Rendering Index	80
Rated Average Life	20,000 hrs.
Constant	Voltage
Chip Size	SMD3014

IMPORTANT: Due to Raw Material Fluctuation, Catalog Prices Below May Not Be Accurate. GO TO WWW.OUTWATER.COM FOR THE MOST UP-TO-DATE PRICES



12V

LED Lighting

Thin 12V Ribbon Flex

Ultra Brightness (Up To 482 Lumens Per Foot)

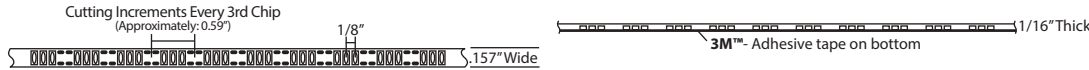

Lighting Specifications

Color Temperature	CW: 6300K PW: 4400K WW: 3200K
Beam Spread	120°
Lumens	450-482 per ft.
Color Rendering Index	80
Rated Average Life	20,000 hrs.
Constant	Voltage
Chip Size	SMD3014

Part #	Length	# Of LED Chips	Total Wattage	Max # Can Connect	Price	
					Each	10+ Pcs.
IP65 (Cool White *CW, Warm White *WW & Pure White *PW)						
SPT12-N30198-4-*	4'	248	20	11.5'	\$24.02 (\$6.01)	\$19.73 ea. (\$4.93)
SPT12-N30198-8-*	8.25'	495	40	11.5'	\$47.04 (\$5.70)	\$38.64 ea. (\$4.68)
SPT12-N30198-16-*	16.5'	990	79	11.5'	\$77.28 (\$4.68)	\$70.98 ea. (\$4.30)
IP20 (Cool White *CW, Warm White *WW & Pure White *PW)						
SPT12-I30198-4-*	4'	248	20	11.5'	\$22.74 (\$5.68)	\$18.68 ea. (\$4.67)
SPT12-I30198-8-*	8.25'	495	40	11.5'	\$44.52 (\$5.40)	\$36.57 ea. (\$4.43)
SPT12-I30198-16-*	16.5'	990	79	11.5'	\$73.14 (\$4.43)	\$66.78 ea. (\$4.04)

Accessories For Thin 12V Ribbon Flex

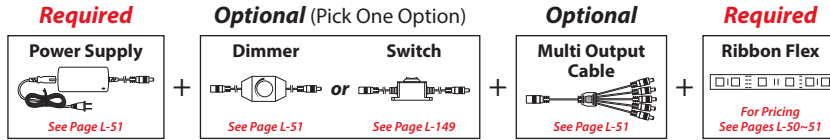

Required

Power Supplies

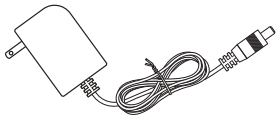

Part #	Type	Amps	Volts	Watts	Dimensions	Price	
						Each	6+ Pcs.
LED-12V-1A	Wall Mount	1A	12V	12W	2.91"L x 1.61"W x 1.14"H	\$8.95	\$8.20 ea.
LED-12V-3A	Wall Mount	3A	12V	36W	3.41"L x 2.31"W x 1.26"H	\$16.15	\$14.70 ea.

For Product Details & More Power Options, See Pages L-137~140
Other Options: Plug In | Hardwire | Hardwire Dimmable | Rechargeable Battery

Optional

Dimmers

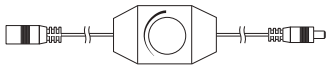

Part #	Description	Finish	Range of Dimming	Size	Price	
					Each	6+ Pcs.
LED-INLINE-DIM	Inline Rotary	Black	0-100%	2-5/8"L x 1-3/8"W x 1"H	\$5.95	\$5.25 ea.

For Product Details & More Dimmer Options, See Pages L-134~136 & L-142~144
Other Options: Rotary | Touch Dimmer | Radio Frequency

Multi Output Cables

2-Way Sweep: DC 5.5

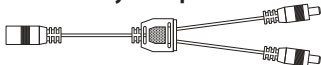

5-Way Sweep: DC 5.5

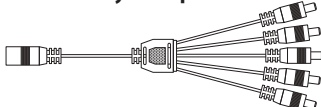

3-Way Spider: DC 5.5

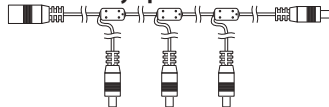

Part #	Description	Finish	Arms Size	# of Arms	Overall Length	Max # of Power Linking Cables	Price	
							Each	6+ Pcs.
LED-2WAY-BK	2-Way Sweep	Black	3"	2	7"	2	\$2.95	\$2.50 ea.
LED-SOUT-CBL-BK	5-Way Sweep	Black	8-3/4"	5	19"	5	\$5.50	\$4.85 ea.
LED-SPIDER-CBL	3-Way Spider	Black	4-1/2"	3	96"	4	\$6.25	\$5.55 ea.

For More Extension Cable Options, See Page L-147

Universal LED Ribbon Mounting Channels

Aluminum channels that work with our ribbons

For Pricing & To See A Full Line Of Our Mounting Channels, See Pages L-55~62



IMPORTANT: Due to Raw Material Fluctuation, Catalog Prices Below May Not Be Accurate. GO TO WWW.OUTWATER.COM FOR THE MOST UP-TO-DATE PRICES

LED Lighting



Thin 12V RGB Ribbon Flex

Available Lengths: 8.25' & 16.5'

Material: Flexible White PCB with Adhesive

- 60% Smaller Than Anything
- Works With Our Magic Backlighting Sheet & DIY: Brite Light Sheet (See Pages L-12~15)
- Easy To Hide

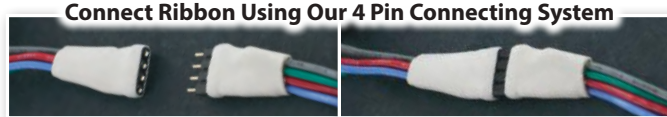

2 Options Available

IP65 Thin 12V RGB Ribbon Provides Protection From Dust & Splashing Water, Not Submersible	IP20 Thin 12V RGB Ribbon Provides Low Protection of Dust & Water
---	--

Thin 12V LED RGB Ribbon Flex

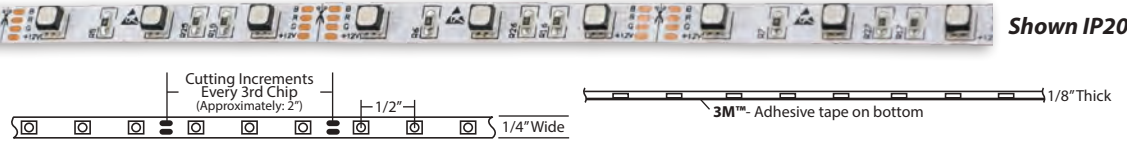

Part #	Color Temp	Length	# Of LED Chips	Total Wattage	Max # Can Connect	Price	
						Each	10+ Pcs.
IP65							
SPT12-N3560-8-RGB	RGB	8.25'	150	36	23'	\$50.40 (\$6.11')	\$41.40 ea. (\$5.02)
SPT12-N3560-16-RGB	RGB	16.5'	300	72	23'	\$100.80 (\$6.11')	\$82.80 ea. (\$5.02)
IP20							
SPT12-3560-8-RGB	RGB	8.25'	150	36	23'	\$47.88 (\$5.80')	\$39.33 ea. (\$4.77')
SPT12-3560-16-RGB	RGB	16.5'	300	72	23'	\$95.76 (\$5.80')	\$78.66 ea. (\$4.77')

Lighting Specifications

Beam Spread	120°
Rated Average Life	20,000 hrs.
Constant	Voltage
Chip Size	SMD3535

Accessories for Standard 12V LED RGB Ribbon Flex

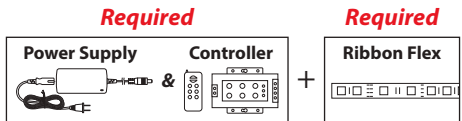

Required

Power Supplies

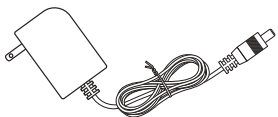

Part #	Type	Amps	Volts	Watts	Dimensions	Price	
						Each	6+ Pcs.
LED-12V-1A	Wall Mount	1A	12V	12W	2.91"L x 1.61"W x 1.14"H	\$8.95	\$8.20 ea.
LED-12V-3A	Wall Mount	3A	12V	36W	3.41"L x 2.31"W x 1.26"H	\$16.15	\$14.70 ea.

For Product Details & More Power Options, See Pages L-137~140
Other Options: Plug In | Hardwire | Hardwire Dimmable | Rechargeable Battery

Controllers

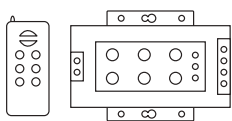

Part #	Description	Input Wire	Output Wire	Dimensions	Price	
					Each	6+ Pcs.
LED-RGB36-CRP	Deluxe RGB controller with up to 25 color changing functions	Female DC 5.5: 18"	4 Pin Connection: 18"	4-3/8"L x 2-1/8"W x 1"H	\$35.95	\$31.00 ea.
LED-RGB36-INLINE	Super small RGB controller with up to 20 color changing functions	Female DC 5.5: 3-1/2"	4 Pin Connection	1-1/2"L x 1/2"W x 1/8"H	\$9.95	\$9.00 ea.

For Product Details & More Controller Options, See Pages L-134~136 & L-150
Other Options: Radio Frequency | Sound Activated

IMPORTANT: Due to Raw Material Fluctuation, Catalog Prices Below May Not Be Accurate. GO TO WWW.OUTWATER.COM FOR THE MOST UP-TO-DATE PRICES



LED Lighting

Flex-S Ribbon

Flexible design allows you to create visible bends & 90° turns

Nominal Lengths: 16.5'

Material: Flexible White PCB with Adhesive

- Flex-S LED Strip Lights Are Ideal For: Halo Effect Signage, Back-lit 3D Letters, Sign Letter Lighting, Archways, Retail Display Lighting, Architectural Lighting & Accent Lighting.
- Field Trimmable
- Flexible
- Twist & Turn On Sharp Corners
- Bend Sideways
- 3M Adhesive Back
- Limited 3 Year Warranty



IP20 Flex-S Ribbon
Provides Low Protection of Dust & Water

FLX126-I2860-16 (Up To 363 Lumens Per Foot)

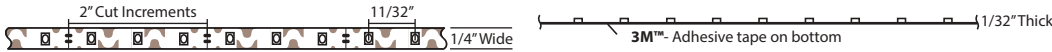

Lighting Specifications

Color Temperature	CW: 6000K WW: 3000K PW: 4000K
Beam Spread	120°
Lumens	363 per ft.
Color Rendering Index	80
Rated Average Life	35,000 hrs.
Constant	Voltage
Chip Size	2835

Part #	Length	# Of LED Chips	Total Wattage	Max # Can Connect	Each	Price
FLX126-I2860-16*	16.5'	300	36	16.5'	\$40.04 (\$2.43)	\$35.75 ea. (\$2.17)

*Cool White *CW, Warm White *WW & Pure White *PW*

Required

Optional (Pick One Option)

Required

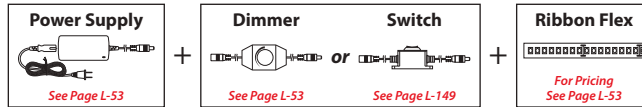

Required

Power Supplies

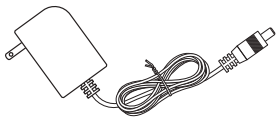

Part #	Type	Amps	Volts	Watts	Dimensions	Price	
						Each	6+ Pcs.
LED-12V-3A	Wall Mount	3A	12V	36W	3.41"L x 2.31"W x 1.26"H	\$16.15	\$14.70 ea.
LED-12V-6A	Desktop	6A	12V	72W	4.68"L x 2.34"W x 1.48"H	\$27.85	\$25.35 ea.

For Product Details & More Power Options, See Pages L-137~140
Other Options: Plug In | Hardwire | Hardwire Dimmable | Rechargeable Battery

Optional

Dimmers

A power linking cable required.

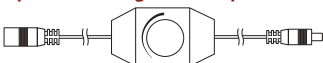

Part #	Description	Finish	Range of Dimming	Size	Price	
					Each	6+ Pcs.
LED-INLINE-DIM	Inline Rotary	Black	0-100%	2-5/8"L x 1-3/8"W x 1"H	\$5.95	\$5.25 ea.

For Product Details & More Dimmer Options, See Pages L-134~136 & L-142~144
Other Options: Rotary | Touch Dimmer | Radio Frequency

Universal LED Ribbon Mounting Channels

Aluminum channels that work with our ribbons

For Pricing & To See A Full Line Of Our Mounting Channels, See Pages L-55~62

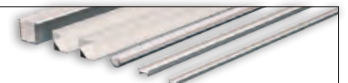

IMPORTANT: Due to Raw Material Fluctuation, Catalog Prices Below May Not Be Accurate. GO TO WWW.OUTWATER.COM FOR THE MOST UP-TO-DATE PRICES

LED Lighting



Edge of Light: Light Is Directed To The Front or Back of Desired Lit Surface

Available Lengths: 22.5" , 6' & 16.5'

Material: Flexible PVC Cover with Adhesive

- Commercial Grade
- Field Trimmable
- Connectable male / female connector included
- Dimmable
- IP67 suitable in damp locations, not submersible



IP65 Edge of Light
Provides Protection From Dust & Splashing Water, Not Submersible

Edge of Light (Up To 125 Lumens Per Foot)

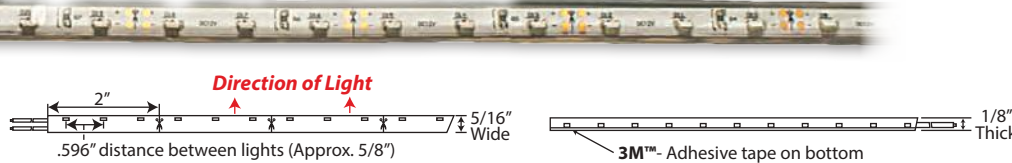

Lighting Specifications

Color Temperature	CW: 5500K WW: 3300K
Beam Spread	120°
Lumens	CW: 125 per ft. WW: 113 per ft.
Color Rendering Index	CW: 75 WW: 80
Rated Average Life	40,000 hrs.
Constant	Voltage
Chip Size	SMD3020

Part #	Length	# Of LED Chips	Total Wattage	Max # Can Connect	Price	
					Each	10+ Pcs.
Cool White *CW & Warm White *WW						
LED-EOL-12V-*	22.5"	40	3.12	32'	\$7.65 (\$4.08')	\$6.12 ea. (\$3.26')
LED-EOL-12V-*6	6'	120	9.36	32'	\$22.95 (\$3.83')	\$18.36 ea. (\$3.06')
LED-EOL-12V-*9	16.5'	330	26.4	32'	\$64.80 (\$3.93')	\$51.84 ea. (\$3.14')

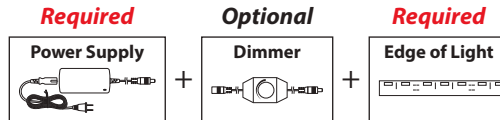

Required

Power Supplies

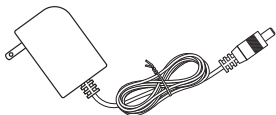

Part #	Type	Amps	Volts	Watts	Dimensions	Price	
						Each	6+ Pcs.
LED-12V-3A	Wall Mount	3A	12V	36W	3.41"L x 2.31"W x 1.26"H	\$16.45	\$14.70 ea.
LED-12V-6A	Desktop	6A	12V	72W	4.68"L x 2.34"W x 1.48"H	\$27.85	\$25.35 ea.

For Product Details & More Power Options, See Pages L-137~140
Other Options: Plug In | Hardwire | Hardwire Dimmable | Rechargeable Battery

Optional

Dimmers



Part #	Description	Finish	Range of Dimming	Dimensions	Price	
					Each	6+ Pcs.
LED-INLINE-DIM	Inline Rotary	Black	0-100%	2-5/8"L x 1-3/8"W x 1"H	\$5.95	\$5.25 ea.
LED-INLINE-TCHDIM	Inline Touch	Black	0-100%	1-1/4"L x 3/4"W x 7/16"H	\$7.95	\$7.25 ea.

For Product Details & More Dimmer Options, See Pages L-134~136 & L-142~144
Other Options: Rotary | Touch Dimmer | Radio Frequency



Outwater's Plastic Lens For LED Lighting: Lens Only

LENS CHARACTERISTICS				
Color	Transmission	Dispersion	Surface Texture	LED Diodes
Frosted	High	Low	Pebbled	Visible
Milk White	Medium	Medium	Smooth	Slightly Visible
Opaque White	Low	High	Smooth	Not Visible

Frosted Lens: Allows the most light transmission. This is recommended for task lighting.

Milk White Lens: Allows moderate light transmission. The effect softens the light and reduces glare. A good choice for the largest variety of lighting situations

Opaque White Lens: Allows the least light transmission. The effect softens the light, reduces glare and eliminates the "scalloping" caused by the LED's in most cases

These characteristics are general descriptions. Customers must decide which color most suits their needs.



L-TASK-10LENS

- Material: Acrylic
- Color: Frosted Or Opaque White
- Length: 8 Ft.

Part #	Under		
	120 Ft.	120 Ft. +	600 Ft. +
L-TASK-10LENS*	\$1.03 ft.	\$0.96 ft.	\$0.90 ft.

**For Opaque White Add -WH to the Part Number*

L-TASK-12LENS

- Material: Styrene
- Color: Frosted Or Opaque White
- Length: 8 Ft.

Part #	Under		
	120 Ft.	120 Ft. +	600 Ft. +
L-TASK-12LENS*	\$0.76 ft.	\$0.68 ft.	\$0.62 ft.

**For Opaque White Add -WH to the Part Number*

L-TASK-14LENS

- Material: Styrene
- Color: Frosted Or Opaque White
- Length: 4 Ft.

Part #	Under		
	120 Ft.	120 Ft. +	600 Ft. +
L-TASK-14LENS*	\$1.21 ft.	\$1.07 ft.	\$0.98 ft.

**For Opaque White Add -WH to the Part Number*

L-TASK-6LENS

- Material: Acrylic
- Color: Frosted
- Length: 8 Ft.

Part #	Under		
	120 Ft.	120 Ft. +	600 Ft. +
L-TASK-6LENS	\$1.253 ft.	\$1.12 ft.	\$1.00 ft.

L-TASK-7DLENS

- Material: Acrylic
- Color: Frosted Or Opaque White
- Length: 8 Ft.

Part #	Under		
	120 Ft.	120 Ft. +	600 Ft. +
L-TASK-7DLENS*	\$1.21 ft.	\$1.09 ft.	\$0.99 ft.

**For Opaque White Add -WH to the Part Number*

L-TASK-8LENS

- Material: Acrylic
- Color: Frosted Or Opaque White
- Length: 8 Ft.

Part #	Under		
	120 Ft.	120 Ft. +	600 Ft. +
L-TASK-8LENS*	\$1.35 ft.	\$1.22 ft.	\$1.12 ft.

**For Opaque White Add -WH to the Part Number*

LED-OS-216-*

- Material: Styrene
- Color: Frosted
- Length: 4 Ft. & 8 Ft.

Part #	Length	Under		
		120 Ft.	120 Ft. +	600 Ft. +
LED-OS-216-4	4 Ft.	\$0.745 ft.	\$0.69 ft.	\$0.64 ft.
LED-OS-216-8	8 Ft.	\$0.745 ft.	\$0.69 ft.	\$0.64 ft.

L-TASK-15LENS

- Material: Acrylic
- Color: Frosted Or Opaque White
- Length: 8 Ft.

Part #	Under		
	120 Ft.	120 Ft. +	600 Ft. +
L-TASK-15LENS*	\$1.22 ft.	\$1.07 ft.	\$0.99 ft.

**For Opaque White Add -WH to the Part Number*

L-VISION-D-WH

- Material: Acrylic
- Color: Opaque White
- Length: 8 Ft.

Part #	Under		
	120 Ft.	120 Ft. +	600 Ft. +
L-VISION-D-WH	\$0.94 ft.	\$0.84 ft.	\$0.80 ft.

L-VISION-F-WH

- Material: Acrylic
- Color: Opaque White
- Length: 8 Ft.

Part #	Under		
	120 Ft.	120 Ft. +	600 Ft. +
L-VISION-F-WH	\$0.98 ft.	\$0.92 ft.	\$0.82 ft.

LED-MTLENS

- Material: Acrylic
- Color: Milk White
- Length: 4 Ft.

Part #	Under		
	120 Ft.	120 Ft. +	600 Ft. +
LED-MTLENS	\$0.745 ft.	\$0.69 ft.	\$0.65 ft.

L-TASK-1LENS

- Material: Acrylic
- Color: Frosted Or Opaque White
- Length: 8 Ft.

Part #	Under		
	120 Ft.	120 Ft. +	600 Ft. +
L-TASK-1LENS*	\$1.03 ft.	\$0.96 ft.	\$0.895 ft.

**For Opaque White Add -WH to the Part Number*

IMPORTANT: Due to Raw Material Fluctuation, Catalog Prices Below May Not Be Accurate. GO TO WWW.OUTWATER.COM FOR THE MOST UP-TO-DATE PRICES

LED Lighting



LED CHANNELS

Create Your Own Light Fixture

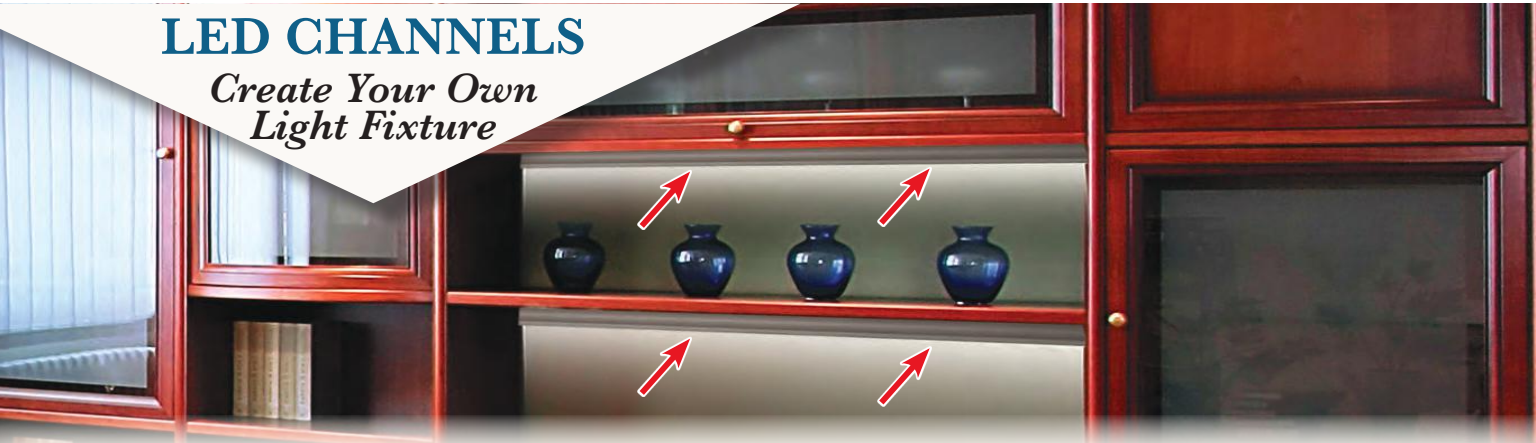

Enhances Lighting Effect While Providing Even Illumination

LED task system allows for the look of a fixture • Tremendous design opportunities for custom sizes • Options available to work with all of our ribbons

LED Channels

PART #	4MM	6MM	8MM W/O CONN	8MM W/ CONN	10MM W/O CONN	10MM W/ CONN	11MM x 6MM	12MM W/O CONN	12MM W/ CONN	15MM W/O CONN	15MM W/ CONN	15.9MM x 9.5MM	20MM W/O CONN	20MM W/ CONN	30MM	40MM
	.157" W	1/4" W	5/16" W	1/2" W	3/8" W	9/16" W	7/16" x 1/4"	1/2" W	5/8" W	9/16" W	13/16" W	5/8" x 3/8"	9/16" W	1" W	1-3/16" W	1-9/16" W
	SPT 12V	SPT 12V RGB DP 24V	ECO 12V DP 24V FLX 12V	ECO 12V DP 24V FLX 12V	CTL 24V RIB 24V ECO 12V FNR 24V	CTL 24V RIB 24V ECO 12V FNR 24V	MXL 120V	FNC 24V FVR 24V	FNC 24V FVR 24V	DP 24V	DP 24V	DBL RGB	DP 24V	DP 24V	DP 24V	DP 24V
Clear Anodized Aluminum Channels																
L-TASK-1F	X	X	X		X											
L-TASK-2F	X	X	X		X											
L-TASK-3F	X	X	X		X											
L-TASK-3LF	X	X	X	X	X	X		X		X			X			
L-TASK-4D & 4S	X	X	X	X	X	X	X	X	X	X		X	X			
L-TASK-4SD & 4SS	X	X	X	X	X	X	X	X	X	X			X			
L-TASK-6F	X	X	X	X	X	X		X	X	X			X			
L-TASK-7D	X	X	X	X	X	X	X	X	X	X	X	X	X			
L-TASK-8F	X	X	X	X	X	X	X	X	X	X	X	X	X	X	X	
L-TASK-9	X	X	X	X	X	X	X	X	X	X	X	X	X			
L-TASK-10F	X	X	X	X	X	X	X	X	X	X		X	X			
L-TASK-11	X	X	X		X											
L-TASK-12 & 12F	X	X	X		X		12									
L-TASK-13	X	X	X	X	X	X	X	X	X	X	X	X	X	X	X	
L-TASK-14F	X	X	X	X	X	X	X	X		X			X			
L-TASK-15D	X	X	X	X	X	X	X	X		X			X			
L-TASK-16	X	X	X	X	X	X	X	X		X			X			
L-TASK-17 & 17D	X	X	X	X	X	X	X	X	X	X	X	17D	X			
L-TASK-18 & 18F	X	X	X		X		X									
L-TASK-19D & 19S	X	X	X		X		X									
L-TASK-20PD-6	X	X	X	X	X	X	X	X	X	X	X	X	X	X		
L-TASK-21PD-6	X	X	X	X	X	X	X	X	X	X		X	X			
L-TASK-22WP-6	X	X	X	X	X		X	X								
L-TASK23W-6	X	X	X		X											
L-TASK-25-6	X	X	X	X	X	X		X	X	X	X		X	X		
L-TASK26-6	X	X	X	X	X	X	X	X	X	X			X	X		
L-TASK-57	X															
L-TASK-82	X															
L-TASK-149	X															
L-TASK-CLO	X	X	X		X											
Plastic PVC Channels																
L-TASK-133-BK & SIL	X	X	X		X											
L-TASK-35P-4 & 8	X	X	X		X											
L-TASK-50P-4 & 8	X	X	X	X	X			X								
L-TASK-50PS-4 & 8	X	X	X	X	X			X								

English measurements converted from metric. Metric is the most accurate.



LED Lens

LENS CHARACTERISTICS				
Color	Transmission	Dispersion	Surface Texture	LED Diodes
Frosted	High	Low	Pebbled	Visible
Milk White	Medium	Medium	Smooth	Slightly Visible
Opaque White	Low	High	Smooth	Not Visible

These characteristics are general descriptions. Customers must decide which color most suits their needs.

Frosted Lens: Allows the most light transmission. This is recommended for task lighting.

Milk White Lens: Allows moderate light transmission. The effect softens the light and reduces glare. A good choice for the largest variety of lighting situations

Opaque White Lens: Allows the least light transmission. The effect softens the light, reduces glare and eliminates the "scalping" caused by the LED's in most cases

LED Aluminum Channels With Lens: *Create Your Own Light Fixture*

L-TASK-1F

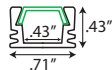
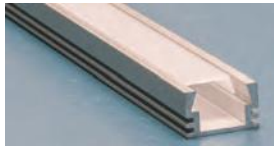

Length: 4 Ft.
Soft White Acrylic Lens

Part #	Price	120+
L-TASK-1F	\$2.57 ft.	\$2.24 ft.

Accessory Pack

Part #	Price	100+
L-TASK-13-ACC	\$1.45 set	\$1.25 set

Includes 2 End Caps, 2 Mounting Clips & Screws

L-TASK-2F

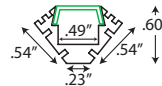

Length: 4 Ft.
Soft White Acrylic Lens

Part #	Price	120+
L-TASK-2F	\$3.36 ft.	\$2.92 ft.

Accessory Pack

Part #	Price	100+
L-TASK-2-ACC	\$1.45 set	\$1.25 set

Includes 2 End Caps, 2 Mounting Clips & Screws

L-TASK-3F

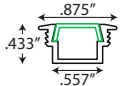

Length: 4 Ft.
Soft White Acrylic Lens

Part #	Price	120+
L-TASK-3F	\$2.47 ft.	\$2.15 ft.

L-TASK-3LF

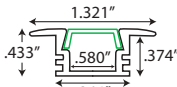
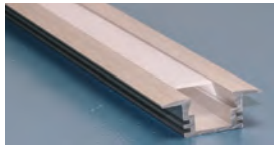

Length: 4 Ft.
Frosted Styrene Lens

Part #	Price	120+
L-TASK-3LF	\$3.03 ft.	\$2.63 ft.

L-TASK-4

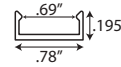
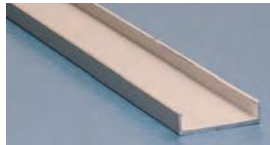

Length: 8 Ft.
No Lens

Part #	Price	120+
L-TASK-4	\$1.42 ft.	\$1.27 ft.

L-TASK-4D

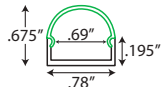
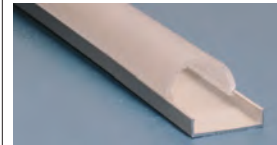

Length: 8 Ft.
Frosted Acrylic Lens

Part #	Price	120+
L-TASK-4D	\$2.24 ft.	\$1.95 ft.

L-TASK-4S

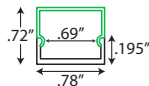
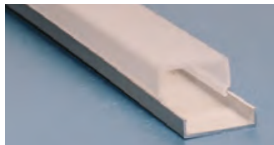

Length: 8 Ft.
Frosted Acrylic Lens

Part #	Price	120+
L-TASK-4S	\$2.45 ft.	\$2.13 ft.

L-TASK-45D

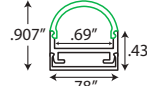
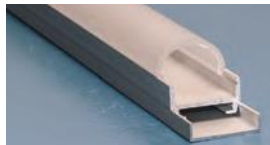

Length: 8 Ft.
Frosted Acrylic Lens

Part #	Price	120+
L-TASK-45D	\$3.87 ft.	\$3.36 ft.

L-TASK-45S

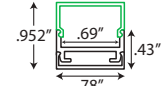
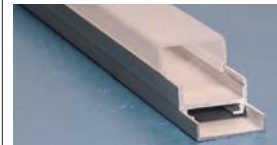

Length: 8 Ft.
Frosted Acrylic Lens

Part #	Price	120+
L-TASK-45S	\$3.98 ft.	\$3.46 ft.

L-TASK-6F

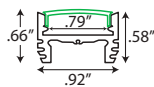
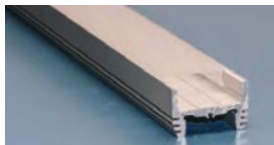

Length: 8 Ft.
Frosted Acrylic Lens

Part #	Price	120+
L-TASK-6F	\$3.30 ft.	\$2.87 ft.

End Caps - Set of 2

Part #	Price	100+
L-TASK-6-END	\$1.25 set	\$1.05 set

Mounting Clips - Set of 2

Part #	Price	100+
L-TASK-6-CLIP	\$1.50 set	\$1.40 set

L-TASK-7D

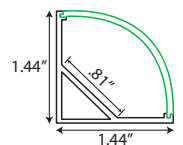

Length: 8 Ft.
Frosted Styrene Lens

Part #	Price	120+
L-TASK-7D	\$2.96 ft.	\$2.57 ft.

IMPORTANT: Due to Raw Material Fluctuation, Catalog Prices Below May Not Be Accurate. GO TO WWW.OUTWATER.COM FOR THE MOST UP-TO-DATE PRICES

LED Lighting



LED Aluminum Channels With Lens: Create Your Own Light Fixture

L-TASK-8F

Length: 8 Ft.
Frosted Acrylic Lens

Part #	Price	120+
L-TASK-8F	\$3.80 ft.	\$3.30 ft.

L-TASK-9

Length: 12 Ft.
No Lens

Part #	Price	120+
L-TASK-9	\$1.45 ft.	\$1.26 ft.

L-TASK-10F

Length: 8 Ft.
Frosted Acrylic Lens

Part #	Price	120+
L-TASK-10F	\$3.13 ft.	\$2.72 ft.

L-TASK-11

Length: 8 Ft.
No Lens

Part #	Price	120+
L-TASK-11	\$1.32 ft.	\$1.17 ft.

L-TASK-12

Length: 8 Ft.
No Lens

Part #	Price	120+
L-TASK-12	\$1.43 ft.	\$1.25 ft.

L-TASK-12F

Length: 8 Ft.
Frosted Styrene Lens

Part #	Price	120+
L-TASK-12F	\$2.29 ft.	\$1.99 ft.

End Caps- Set of 2

Part #	Price	100+
L-TASK-12-END	\$0.75 set	\$0.60 set

Mounting Clips- Set of 2

Part #	Price	100+
L-TASK-12-CLIP	\$1.00 set	\$0.80 set

End Caps- Set of 2

Part #	Price	100+
L-TASK-12-END	\$0.75 set	\$0.60 set

Mounting Clips- Set of 2

Part #	Price	100+
L-TASK-12-CLIP	\$1.00 set	\$0.80 set

L-TASK-13

Length: 8 Ft.
No Lens

Part #	Price	120+
L-TASK-13	\$1.66 ft.	\$1.44 ft.

L-TASK-14F

Length: 4 Ft.
Frosted Styrene Lens

Part #	Price	120+
L-TASK-14F	\$3.54 ft.	\$3.07 ft.

L-TASK-15D

Length: 8 Ft.
White Opaque Styrene Lens

Part #	Price	120+
L-TASK-15D	\$2.66 ft.	\$2.31 ft.

L-TASK-16

Length: 12 Ft.
No Lens

Part #	Price	120+
L-TASK-16	\$1.63 ft.	\$1.42 ft.

L-TASK-17

Length: 8 Ft.
No Lens

Part #	Price	120+
L-TASK-17	\$1.66 ft.	\$1.51 ft.

L-TASK-17D

Length: 8 Ft.
White Opaque Styrene Lens

Part #	Price	120+
L-TASK-17D	\$2.87 ft.	\$2.49 ft.



LED Aluminum Channels With Lens: Create Your Own Light Fixture

L-TASK-18-6

Length: 6.6 Ft. • Milky White Lens
Accessories (2- End Caps & 2- Mounting Clips)

Part #	Price	120+
L-TASK-18-6	\$1.21 ft.	\$1.05 ft.

End Caps- Set of 2

Part #	Price	100+
L-TASK-18-CAP	\$0.35 set	\$0.29 set

Mounting Clips- Set of 2

Part #	Price	100+
L-TASK-18-CLIP	\$0.35 set	\$0.29 set

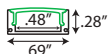

L-TASK-18F-6

Length: 6.6 Ft. • Milky White Lens
Accessories (2- End Caps & 2- Mounting Clips)

Part #	Price	120+
L-TASK-18F-6	\$1.27 ft.	\$1.10 ft.

End Caps- Set of 2

Part #	Price	100+
L-TASK-18F-CAP	\$0.35 set	\$0.29 set

Mounting Clips- Set of 2

Part #	Price	100+
L-TASK-18F-CLIP	\$0.35 set	\$0.29 set

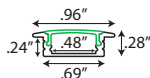

L-TASK-19D-*

Length: 3.3 Ft. & 6.6 Ft. • Milky White Lens
Accessories (2- End Caps & 2- Mounting Clips)

Part #	Price	120+
L-TASK-19D-3	\$1.46 ft.	\$1.27 ft.
L-TASK-19D-6	\$1.30 ft.	\$1.13 ft.

End Caps- Set of 2

Part #	Price	100+
L-TASK-19D-CAP	\$0.45 set	\$0.35 set

Mounting Clips- Set of 2

Part #	Price	100+
L-TASK-19D-CLIP	\$0.45 set	\$0.35 set



L-TASK-19S-*

Length: 6.6 Ft. • Milky White Lens
Accessories (2- End Caps & 2- Mounting Clips)

Part #	Price	120+
L-TASK-19S-3	\$1.56 ft.	\$1.36 ft.
L-TASK-19S-6	\$1.40 ft.	\$1.22 ft.

End Caps- Set of 2

Part #	Price	100+
L-TASK-19S-CAP	\$0.45 set	\$0.35 set

Mounting Clips- Set of 2

Part #	Price	100+
L-TASK-19S-CLIP	\$0.45 set	\$0.35 set



L-TASK-20PD-6

Length: 6.6 Ft. • Milky White Lens
Accessories (2- End Caps & 2- Mounting Clips)

Part #	Price	120+
L-TASK-20PD-6	\$2.38 ft.	\$2.07 ft.

End Caps- Set of 2

Part #	Price	100+
L-TASK-20PD-CAP	\$0.45 set	\$0.35 set

Mounting Clips- Set of 2

Part #	Price	100+
L-TASK-20PD-CLIP	\$0.45 set	\$0.35 set

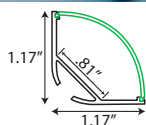

L-TASK-21PD-6

Length: 6.6 Ft. • Milky White Lens
Accessories (2- End Caps & 2- Mounting Clips)

Part #	Price	120+
L-TASK-21PD-6	\$2.51 ft.	\$2.18 ft.

End Caps- Set of 2

Part #	Price	100+
L-TASK-21PD-CAP	\$0.60 set	\$0.55 set

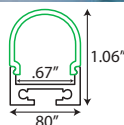

L-TASK-22WP-6

Length: 6.6 Ft. • Milky White Lens
Accessories (2- End Caps & 2- Mounting Clips)

Part #	Price	120+
L-TASK-22WP-6	\$2.11 ft.	\$1.83 ft.

End Caps- Set of 2

Part #	Price	100+
L-TASK-22WP-CAP	\$0.45 set	\$0.35 set

Mounting Clips- Set of 2

Part #	Price	100+
L-TASK-22WP-CLIP	\$0.45 set	\$0.35 set

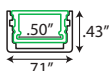

L-TASK-23W-6

Length: 6.6 Ft. • Milky White Lens
Accessories (2- End Caps & 2- Mounting Clips)

Part #	Price	120+
L-TASK-23W-6	\$1.41 ft.	\$1.23 ft.

End Caps- Set of 2

Part #	Price	100+
L-TASK-23W-CAP	\$0.45 set	\$0.35 set

Mounting Clips- Set of 2

Part #	Price	100+
L-TASK-23W-CLIP	\$0.45 set	\$0.35 set

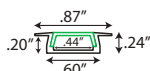

L-TASK-25-6

Length: 6.6 Ft. • Milky White Lens
Accessories (2- End Caps & 2- Mounting Clips)

Part #	Price	120+
L-TASK-25-6	\$2.51 ft.	\$2.18 ft.

End Caps- Set of 2

Part #	Price	100+
L-TASK-25-CAP	\$0.45 set	\$0.35 set

Mounting Clips- Set of 2

Part #	Price	100+
L-TASK-25-CLIP	\$0.45 set	\$0.35 set

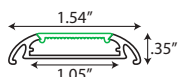

L-TASK-26-6

Length: 6.6 Ft. • Milky White Lens
Accessories (2- End Caps & 2- Mounting Clips)

Part #	Price	120+
L-TASK-26-6	\$1.99 ft.	\$1.66 ft.

End Caps- Set of 2

Part #	Price	100+
L-TASK-26-CAP	\$0.45 set	\$0.35 set

Mounting Clips- Set of 2

Part #	Price	100+
L-TASK-26-CLIP	\$0.45 set	\$0.35 set

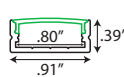
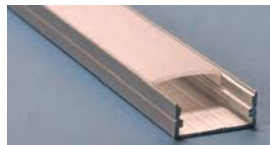

IMPORTANT: Due to Raw Material Fluctuation, Catalog Prices Below May Not Be Accurate. GO TO WWW.OUTWATER.COM FOR THE MOST UP-TO-DATE PRICES

LED Lighting



LED Aluminum Channels With Lens: Create Your Own Light Fixture

L-TASK-57 New!



Length: 12 Ft.
No Lens

Part #	Price	120+	600+
L-TASK-57	\$0.85 ft.	\$0.74 ft.	\$0.67 ft.

L-TASK-82 New!



Length: 12 Ft.
No Lens

Part #	Price	120+	600+
L-TASK-82	\$1.38 ft.	\$1.20 ft.	\$1.10 ft.

L-TASK-149 New!



Finish: Mill With Tape
Length: 4 Ft.
No Lens

Part #	Price	120+	600+
L-TASK-149	\$0.51 ft.	\$0.44 ft.	\$0.40 ft.

L-TASK-CLO



Length: 8 Ft.
Frosted Styrene Lens

Part #	Price	15+
L-TASK-CLO	\$23.00 ea.	\$20.50 ea.

Mounting Brackets

Part #	Price	40+
S84-30155-SC	\$0.61 ea.	\$0.53 ea.

For LED Closet Rod Kit, See page L-100



Plastic PVC Channels: Create Your Own Light Fixture

- Designed for glass or acrylic edge lighting
- Holds our 3/8" LED Ribbon
- Perfect for etched or engraved substrate light guide panels
- No adhesive needed - friction fit

L-TASK-133



Shown In Silver

Length: 8 Ft.
No Lens

Part #	Finish	Price	120+
L-TASK-133-SIL	Silver	\$0.70 ft.	\$0.64 ft.
L-TASK-133-BK	Black	\$0.67 ft.	\$0.61 ft.

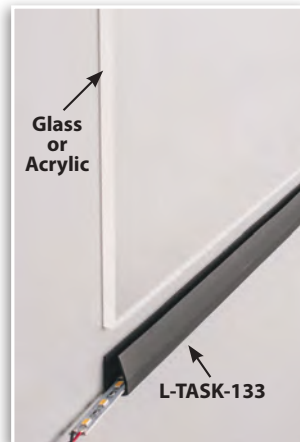

L-TASK-35P-*



Length: 4 Ft. or 8 Ft.
No Lens

Part #	Finish	Length	Price	120+
L-TASK-35P-*	Clear	4 ft. (*4) or 8 ft. (*8)	\$0.40 ft.	\$0.36 ft.

L-TASK-50



Shown In Silver

Length: 4 Ft. or 8 Ft.
No Lens

Part #	Finish	Length	Price	120+
L-TASK-50P-*	Clear	4 ft. (*4) or 8 ft. (*8)	\$0.44 ft.	\$0.40 ft.
L-TASK-50PS-*	Silver		\$0.45 ft.	\$0.41 ft.

IMPORTANT: Due to Raw Material Fluctuation, Catalog Prices Below May Not Be Accurate. GO TO WWW.OUTWATER.COM FOR THE MOST UP-TO-DATE PRICES



LED Lighting

Introducing Outwater's Vision Series

"See The Glow"

Our Special Opaque White Lens will soften & virtually eliminate hot spots

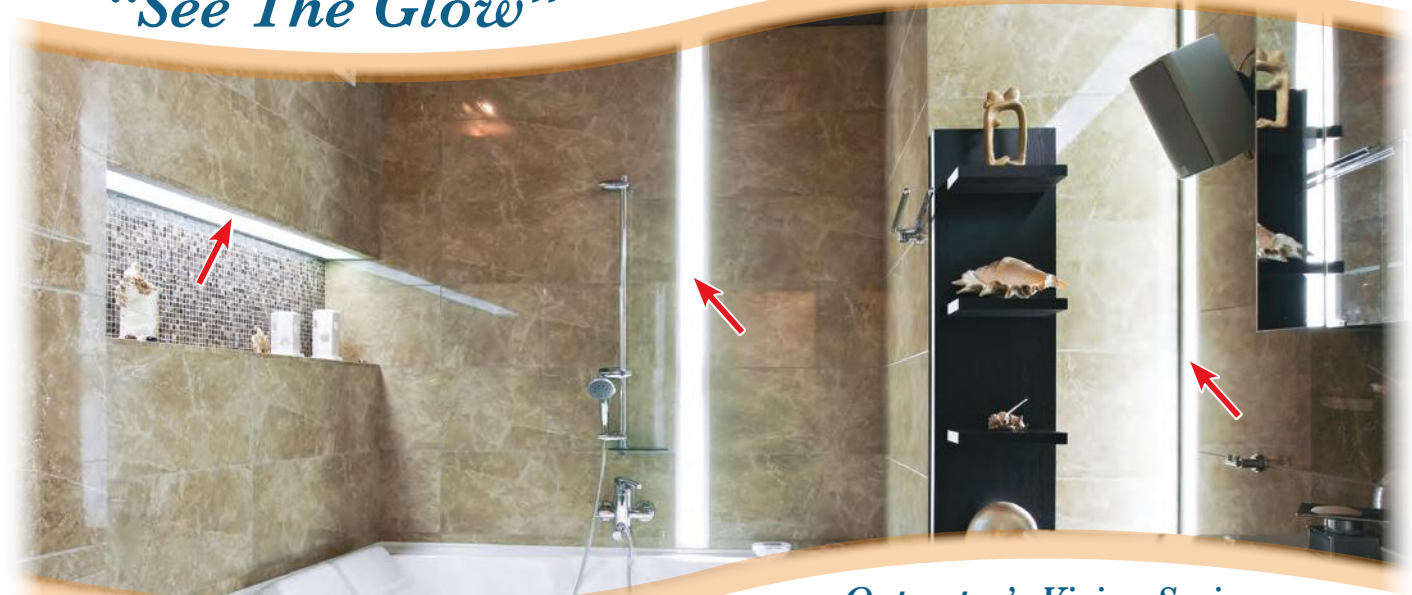

Outwater's Vision Series enables designers to readily create colorful RGB wallsapes or high luminescence task lights.

LED Lens

LENS CHARACTERISTICS				
Color	Transmission	Dispersion	Surface Texture	LED Diodes
Opaque White	Low	High	Smooth	Not Visible

Opaque White Lens: Allows the least light transmission. The effect softens the light, reduces glare and eliminates the "scalloping" caused by the LED's in most cases

These characteristics are general descriptions. Customers must decide which color most suits their needs.

- LED vision system allows for the look of a fixture
- Tremendous design opportunities for custom sizes
- Options available to work with all of our ribbons



LED Channels

PART #	4MM	6MM	8MM W/O CONN	8MM W/ CONN	10MM W/O CONN	10MM W/ CONN	11MM x 6MM	12MM W/O CONN	12MM W/ CONN	15MM W/O CONN	15MM W/ CONN	15.9MM x 9.5MM	20MM W/O CONN	20MM W/ CONN	30MM	40MM
	.157" W	1/4" W	5/16" W	1/2" W	3/8" W	9/16" W	7/16" x 1/4"	1/2" W	5/8" W	9/16" W	13/16" W	5/8" x 3/8"	9/16" W	1" W	1-3/16" W	1-9/16" W
	SPT 12V	SPT 12V RGB DP 24V	ECO 12V DP 24V FLX 12V	ECO 12V DP 24V FLX 12V	CTL 24V RIB 24V ECO 12V FNR 24V	CTL 24V RIB 24V ECO 12V FNR 24V	MXL 120V	FNC 24V FVR 24V	FNC 24V FVR 24V	DP 24V	DP 24V	DBL RGB	DP 24V	DP 24V	DP 24V	DP 24V
Clear Anodized Aluminum Channels																
L-VISION-12BF	X	X	X		X	X		X		X			X			
L-VISION-3F	X	X	X		X		X									
L-VISION-3LF	X	X	X	X	X	X	X	X	X	X			X	X		
L-VISION-4D	X	X	X	X	X	X	X	X	X	X		X	X			
L-VISION-45	X	X	X	X	X	X	X	X	X	X		X	X			
L-VISION-7D	X	X	X	X	X	X	X	X	X	X	X	X	X			
L-VISION-8F	X	X	X	X	X	X	X	X	X	X	X	X	X	X	X	
L-VISION-10F	X	X	X	X	X	X	X	X	X	X		X	X			
L-VISION-15D	X	X	X	X	X	X	X	X	X	X			X			
L-VISION-17D	X	X	X	X	X	X	X	X	X	X		X	X			

English measurements converted from metric. Metric is the most accurate.

Phone: 1-800-631-8375 - Fax: 1-800-888-3315
Due to raw material cost fluctuations, prices are subject to change.

IMPORTANT: Due to Raw Material Fluctuation, Catalog Prices Below May Not Be Accurate. GO TO WWW.OUTWATER.COM FOR THE MOST UP-TO-DATE PRICES

LED Lighting



Outwater's Vision Series: Aluminum Channel with Opaque White Lens

L-VISION-12BF

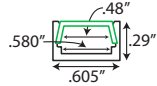

Length: 8 Ft. • Lens Material: Acrylic

Part #	Price	120+
L-VISION-12BF	\$2.29 ft.	\$1.99 ft.

End Caps- Set of 2

Part #	Price	100+
L-VISION-12BF-END	\$0.75 set	\$0.60 set

Mounting Clips- Set of 2

Part #	Price	100+
L-VISION-12BF-CLIP	\$1.00 set	\$0.80 set

L-VISION-3F

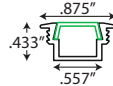

Length: 4 Ft. • Lens Material: Styrene

Part #	Price	120+
L-VISION-3F	\$2.52 ft.	\$2.19 ft.

L-VISION-3LF

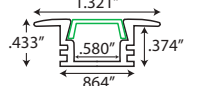

Length: 4 Ft.
Frosted Styrene Lens

Part #	Price	120+
L-VISION-3LF	\$2.97 ft.	\$2.58 ft.

L-VISION-4D

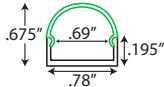

Length: 8 Ft. • Lens Material: Acrylic

Part #	Price	120+
L-VISION-4D	\$2.15 ft.	\$1.87 ft.

L-VISION-4S

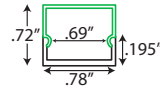

Length: 8 Ft. • Lens Material: Acrylic

Part #	Price	120+
L-VISION-4S	\$2.26 ft.	\$1.97 ft.

L-VISION-7D

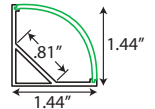

Length: 8 Ft. • Lens Material: Styrene

Part #	Price	120+
L-VISION-7D	\$3.18 ft.	\$2.76 ft.

L-VISION-8F

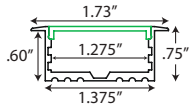
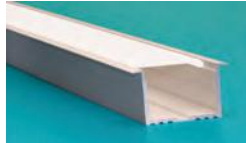

Length: 8 Ft. • Lens Material: Acrylic

Part #	Price	120+
L-VISION-8F	\$4.08 ft.	\$3.55 ft.

L-VISION-10F

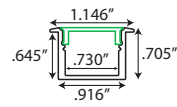

Length: 8 Ft. • Lens Material: Acrylic

Part #	Price	120+
L-VISION-10F	\$3.36 ft.	\$2.92 ft.

L-VISION-15D

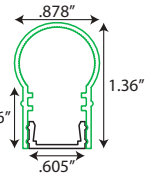

Length: 8 Ft. • Lens Material: Styrene

Part #	Price	120+
L-VISION-15D	\$2.66 ft.	\$2.31 ft.

L-VISION-17D

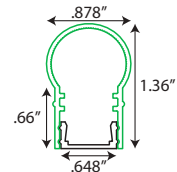

Length: 8 Ft. • Lens Material: Styrene

Part #	Price	120+
L-VISION-17D	\$2.87 ft.	\$2.49 ft.



**IMPORTANT: Due to Raw Material Fluctuation, Catalog Prices Below May Not Be Accurate.
GO TO WWW.OUTWATER.COM FOR THE MOST UP-TO-DATE PRICES**

Modular Vision Rail

Perfect For Task Lighting

- NO GLARE!.. NO HOT SPOTS!
- Clean Continuous Lighting
- Modular Connections Allows User To Create Seamless Design
- Low Profile, Under 1"
- Super Bright!
Approximately 330 Lumens Per Foot!
- Dimmable! When Dimmed Provides Soft & Ambient Light
- Limited 2 Year Warranty



With Our New
Modular Vision Rail,
You Can Put A
Light Anywhere
You Need



Continuous Runs



3-Way



4-Way

LED Lighting



Modular Vision Rail

Available Lengths: 8", 1', & 2' Nominal

Material: Aluminum with Opaque White Polycarbonate Lens

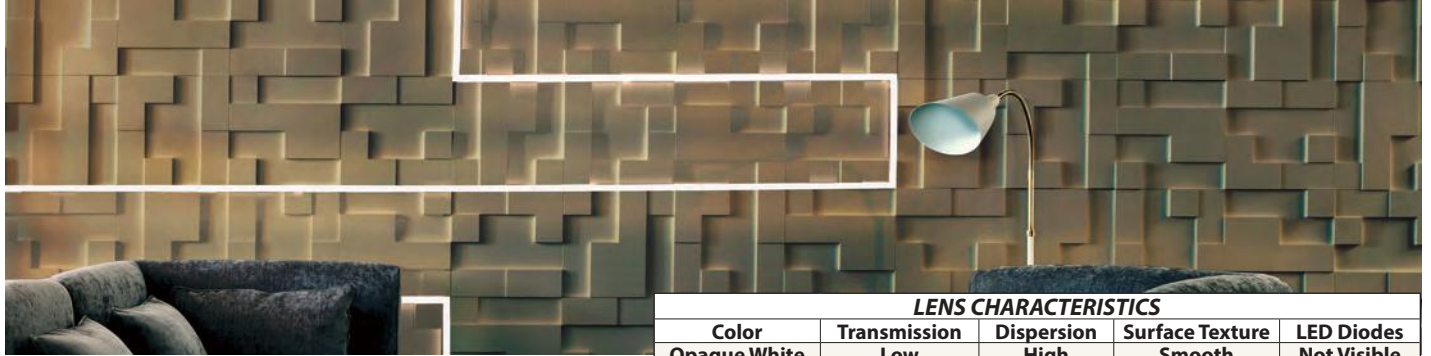

LENS CHARACTERISTICS

Color	Transmission	Dispersion	Surface Texture	LED Diodes
Opaque White	Low	High	Smooth	Not Visible

Opaque White Lens: Allows lower light transmission, without seeing the LED diodes. The effect softens the light, reduces glare and eliminates the "scalloping" caused by the LED's in most cases.

Guide Rail Power Track

Material: ABS Plastic with Metal Rods

- Trimmable in the field
- Simply add lamp fixtures & connectors in any position onto the track

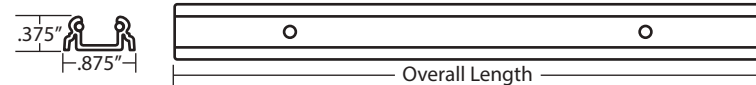

Part #	Overall Length	Price	
		Each	6+ Pcs.
MVR-RAIL9	8.6"	\$2.25	\$1.95 ea.
MVR-RAIL13	12.9"	\$2.45	\$2.15 ea.
MVR-RAIL25	24.8"	\$2.75	\$2.45 ea.
MVR-RAIL49	48.8"	\$4.25	\$3.95 ea.
MVR-RAIL73	72.4"	\$5.35	\$4.95 ea.

Modular Vision Light (Up To 680 Lumens Per Fixture)

Material: Aluminum with Opaque White Polycarbonate Lens

- Unique magnetic connection will "CLICK" onto the track for easy assembly

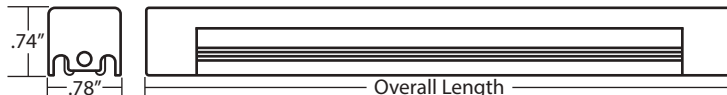

Lighting Specifications

Color Temperature	PW: 4000K WW: 3000K
Lumens	MVR-8-": 220 MVR-12-": 380 MVR-24-": 680
Color Rendering Index	80+
Rated Average Life	50,000 hrs.
Constant	Current
Chip Size	SMD2835

Part #	Overall Length	# Of LED Chips	Total Wattage	Max # Can Connect	Price	
					Each	6+ Pcs.
<i>Pure White *PW & Warm White *WW</i>						
MVR-8-*	7.8"	24	3	16'	\$7.45	\$6.93 ea.
MVR-12-*	11.8"	36	5	16'	\$8.95	\$8.40 ea.
MVR-24-*	23.6"	60	9	16'	\$14.10	\$13.25 ea.

Power Linking Cable



- Length: 6"
- Finish: White

Illuminated Connectors

(Material: Aluminum with Opaque White Polycarbonate Lens)



1.18" L x 1.18" W x .74" H

MVR-ANGLE-*

Each: \$1.95

6+ Pcs.: \$1.83 ea.



1.57" L x 1.57" W x .74" H

MVR-CROSS-*

Each: \$2.95

6+ Pcs.: \$2.77 ea.

Lighting Specifications

Color Temperature	PW: 4000K WW: 3000K
Lumens	MVR-ANGLE: 40 MVR-CROSS: 90
Color Rendering Index	80+
Rated Average Life	50,000 hrs.
Constant	Current
Chip Size	SMD2835

*Pure White *PW & Warm White *WW*

IMPORTANT: Due to Raw Material Fluctuation, Catalog Prices Below May Not Be Accurate. GO TO WWW.OUTWATER.COM FOR THE MOST UP-TO-DATE PRICES



24V

LED Lighting

Accessories for Modular Vision Rail

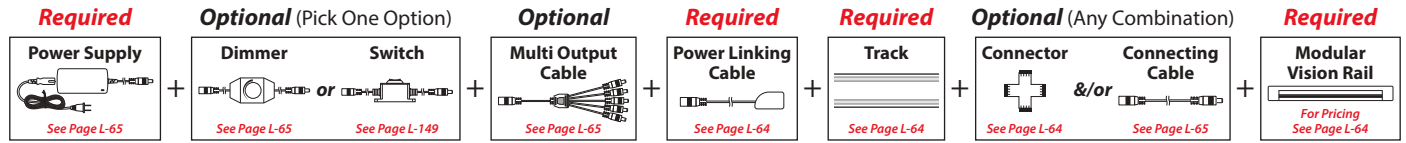

Required

Power Supplies

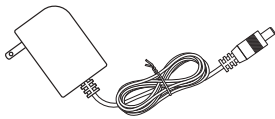

Part #	Type	Amps	Volts	Watts	Dimensions	Price	
						Each	6+ Pcs.
LED-24V-1A	Wall Mount	1A	24V	24W	3.13"L x 2.07"W x 1.52"H	\$11.65	\$10.60 ea.
LED-24V-3A	Desktop	3A	24V	72W	4.68"L x 2.34"W x 1.48"H	\$28.75	\$26.05 ea.

For Product Details & More Power Options, See Pages L-137~140
 Other Options: **Plug In | Hardwire | Hardwire Dimmable | Rechargeable Battery**

Optional

Dimmers

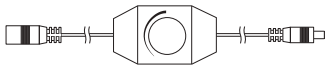

Part #	Description	Finish	Range of Dimming	Dimensions	Price	
					Each	6+ Pcs.
LED-INLINE-DIM	Inline Rotary	Black	0-100%	2-5/8"L x 1-3/8"W x 1"H	\$5.95	\$5.25 ea.
LED-INLINE-TCHDIM	Inline Touch	Black	0-100%	1-1/4"L x 3/4"W x 7/16"H	\$7.95	\$7.25 ea.

For Product Details & More Dimmer Options, See Pages L-134~136 & L-142~144
 Other Options: **Rotary | Touch Dimmer | Radio Frequency**

Multi Output Cables



2-Way Sweep: DC 5.5

Part #	Description	Finish	Arms Size	# of Arms	Overall Length	Max # of Power Linking Cables	Price	
							Each	6+ Pcs.
LED-2WAY-BK	2-Way Sweep	Black	3"	2	6-3/4"	2	\$2.95	\$2.50 ea.
LED-SPIDER-CBL	3-Way Spider	Black	4-1/2"	3	96"	4	\$6.25	\$5.55 ea.

For More Extension Cable Options, See Page L-147

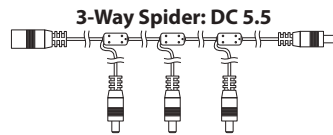

3-Way Spider: DC 5.5

Connecting Cables



Part #	Description	Finish	Length	Price	
				Each	6+ Pcs.
MVR-CC24	Is to allow the designer to get around unlit areas without multiple power supplies	White	23.6"	\$3.25	\$3.06 ea.
MVR-CC40		White	39.3"	\$3.65	\$3.43 ea.

IMPORTANT: Due to Raw Material Fluctuation, Catalog Prices Below May Not Be Accurate. GO TO WWW.OUTWATER.COM FOR THE MOST UP-TO-DATE PRICES

LED Lighting



Thin Strip- Fastest & Easiest Connection In The Industry Today

Available Length: 12"

Material: White Aluminum PCB Board

- 100% Usable Lighting System
- 100% Connectable- No Soldering Necessary
- Dimmable
- Field Trimmable
- Limited 2 Year Warranty



IP20 Thin Strip
Provides Low Protection of Dust & Water



Connect Up To 4' of Thin Strip Using Our PATENTED POWER CONNECTOR

Thin Strip (Up To 485 Lumens Per Foot)

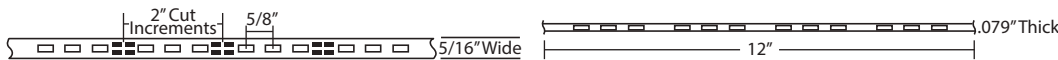

Lighting Specifications

Color Temperature	CW: 6200K-6800K WW: 2800K-3200K
Beam Spread	120°
Lumens	CW: 485 per ft. WW: 380 per ft.
Color Rendering Index	CW/WW: 80
Rated Average Life	30,000 hrs.
Constant	Voltage
Chip Size	SMD2835

Part #	Length	# Of LED Chips	Total Wattage	Max # Can Connect	Price Each	10+ Pcs.
<i>Cool White *CW & Warm White *WW</i>						
LED-PCB2-12-*	12"	18	5.4	6	\$9.95	\$8.50 ea.

Aluminum LED Mounting Channels (Optional)

Create Your Own CUSTOMIZED FIXTURE IN MINUTES

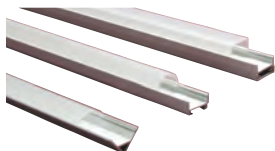

Choose Your Channel & Measure Length
See Pages L-55~62



Lay In Tape



Measure & Cut Thin Strip Where Marked



Lay Light In Channel



Apply Lens & Enjoy

IMPORTANT: Due to Raw Material Fluctuation, Catalog Prices Below May Not Be Accurate. GO TO WWW.OUTWATER.COM FOR THE MOST UP-TO-DATE PRICES



LED Lighting

Accessories for Thin Strip

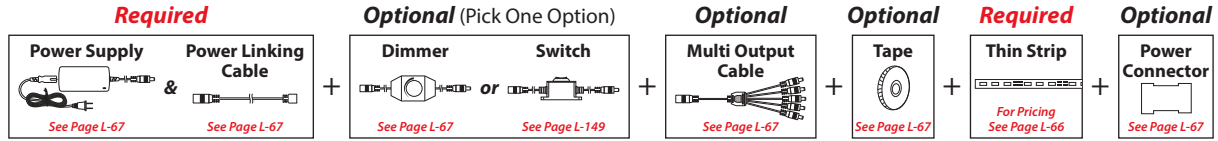

Required

Power Supplies

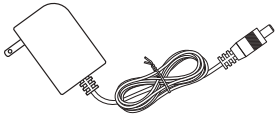

Part #	Type	Amps	Volts	Watts	Dimensions	Price	
						Each	6+ Pcs.
LED-12V-1A	Wall Mount	1A	12V	12W	2.91"L x 1.61"W x 1.14"H	\$8.95	\$8.20 ea.
LED-12V-3A	Wall Mount	3A	12V	36W	3.41"L x 2.31"W x 1.26"H	\$16.15	\$14.70 ea.

For Product Details & More Power Options, See Pages L-137~140
Other Options: Plug In | Hardwire | Hardwire Dimmable | Rechargeable Battery

Power Linking Cable

Designed to provide power to rigid ribbon strips. Comes with female DC 5.5 and one solderless clip.



Part #	Description	Overall Length	Finish	Price	
				Each	10+ Pcs.
LED-OS-662P	Power Link Cable with Thin Strip Connection	60"	Black	\$2.30	\$1.99 ea.

Power Connector

Required to join thin strip fixtures.



Part #	Description	Price	
		Each	10+ Pcs.
LED-PCB-CLIP	Allows seamless connection of 2 thin strips without soldering	\$1.50	\$1.25 ea.

Optional

Dimmers

A starter fixture required.

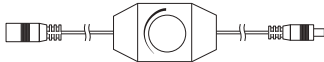

Part #	Description	Finish	Range of Dimming	Dimensions	Price	
					Each	6+ Pcs.
LED-INLINE-DIM	Inline Rotary	Black	0-100%	2-5/8"L x 1-3/8"W x 1"H	\$5.95	\$5.25 ea.

For Product Details & More Dimmer Options, See Pages L-134~136 & L-142~144
Other Options: Rotary | Touch Dimmer | Radio Frequency

Multi Output Cables

A starter fixture required for each outlet.

5-Way Sweep: DC 5.5

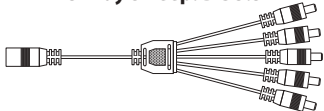

2-Way Sweep: DC 5.5



Part #	Description	Finish	Arms Size	# of Arms	Overall Length	Max # of Power Linking Cables	Price	
							Each	6+ Pcs.
LED-5OUT-CBL-BK	5-Way Sweep	Black	8-3/4"	5	19"	5	\$5.50	\$4.85 ea.
LED-2WAY-BK	2-Way Sweep	Black	3"	2	6-3/4"	2	\$2.95	\$2.50 ea.

For More Extension Cable Options, See Page L-147

Adhesive Tape



Part #	Thickness	Width	Roll Size	Price	
				Each	6+ Pcs.
OUT-3/8X216	1/32"	3/8"	216'	\$15.00	\$13.50 ea.

IMPORTANT: Due to Raw Material Fluctuation, Catalog Prices Below May Not Be Accurate. GO TO WWW.OUTWATER.COM FOR THE MOST UP-TO-DATE PRICES

LED Lighting

Omni Wand: One System With Multiple Solutions



The Problem:

This Display required 16 different custom sized light fixtures, which would have been very costly and time consuming to order with an extensive lead time.



The Solution:

Omni Wand made this project simple and cost effective utilizing just one system. Up to 8 ft. long, the Omni Wand fixture can be easily trimmed to any size required. With Omni Wand, now you are finally in control to create lights as per your specs... not the other way around.



Many Mounting & Connecting Options

LENS CHARACTERISTICS				
Color	Transmission	Dispersion	Surface Texture	LED Diodes
Frosted	High	Low	Pebbled	Visible

Frosted Lens: Allows the most light transmission. This is recommended for task lighting.



Omni Wand: *One System With Multiple Solutions*



Pre-Assembled Fixtures
See Page L-70



Customize Lengths Up To 8 Ft.
See Page L-71



Perimeter & Showcase Lighting
See Page L-74



Omni Vertical
See Page L-72

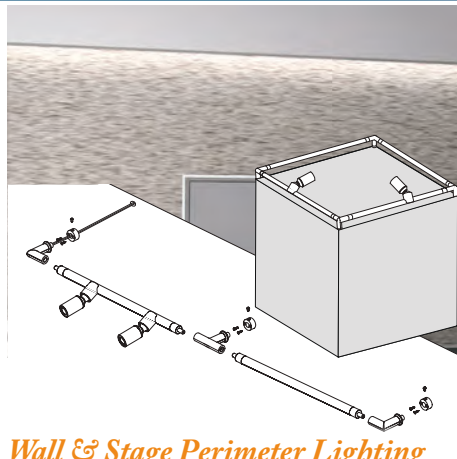

Wall & Stage Perimeter Lighting
See Omni Wand Brochure



Glass Shelf Lighting
See Omni Wand Brochure



Top Mounted Lighting
See Page L-76



Omni Wand Sample Kit & Accessories
See Page L-77

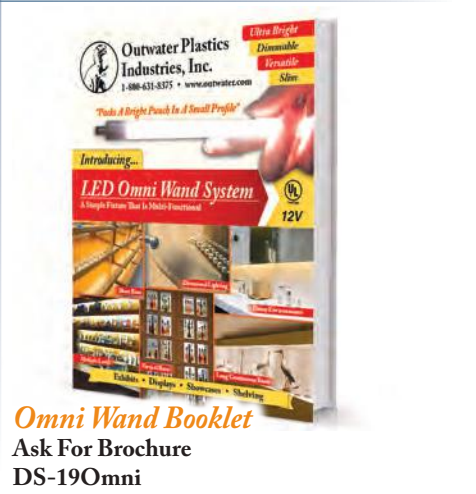

Omni Wand Booklet
Ask For Brochure
DS-19Omni

IMPORTANT: Due to Raw Material Fluctuation, Catalog Prices Below May Not Be Accurate. GO TO WWW.OUTWATER.COM FOR THE MOST UP-TO-DATE PRICES

LED Lighting



Omni Wand T2: Pre-Assembled 12" Fixture With Lens

Omni Wand: One System With Multiple Solutions

Available Lengths: 12"

Material: Clear Anodized Aluminum Channel with Frosted Polycarbonate Lens

- Clear Anodized
- Fixture can be rotated even when installed
- 12" (nominal) length

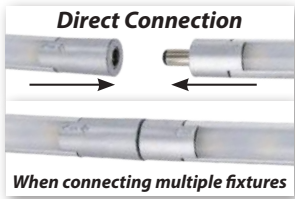
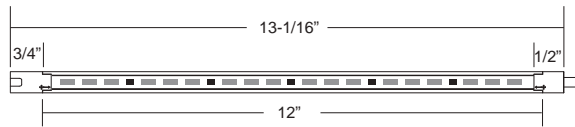

Part #	Length	# Of LED Chips	Total Wattage	Max # Can Connect	Price Each	Price 10+ Pcs.
<i>Cool White *CW & Warm White *WW</i>						
LED-OS-116-*	12"	18	9	8	\$15.50	\$13.20 ea.

Lighting Specifications

Color Temperature	CW: 6500K WW: 3100K
Beam Spread	120°
Lumens	CW: 540 WW: 450
Color Rendering Index	CW/WW: 80
Rated Average Life	50,000 hrs.
Constant	Voltage

Accessories For Omni Wand T2

Required **Optional** (Pick One Option) **Optional** (Any Combination) **Required** **Optional**

Power Supply (See Page L-70) +
 Dimmer (See Page L-70) **or** **Switch** (See Page L-70) +
 Connecting Cable (See Page L-71) **&/or** **U-Connector** (See Booklet) **&/or** **Mounting Clips** (See Page L-71) +
 Omni Wand Fixture (For Pricing See Page L-70) +
 End Cap (See Page L-71)

Required

Power Supplies

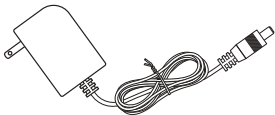

Part #	Type	Amps	Volts	Watts	Dimensions	Price Each	Price 6+ Pcs.
LED-12V-1A	Wall Mount	1A	12V	12W	2.91"L x 1.61"W x 1.14"H	\$8.95	\$8.20 ea.
LED-12V-3A	Wall Mount	3A	12V	36W	3.41"L x 2.31"W x 1.26"H	\$16.15	\$14.70 ea.
LED-12V-6A	Desktop	6A	12V	72W	4.68"L x 2.34"W x 1.48"H	\$27.85	\$25.35 ea.

For Product Details & More Power Options, See Pages L-137~140
Other Options: Plug In | Hardwire | Hardwire Dimmable | Rechargeable Battery

Optional

Dimmers

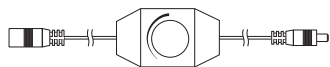

Part #	Description	Finish	Range of Dimming	Size	Price Each	Price 6+ Pcs.
LED-INLINE-DIM	Inline Rotary	Black	0-100%	2-5/8"L x 1-3/8"W x 1"H	\$5.95	\$5.25 ea.

For Product Details & More Dimmer Options, See Pages L-134~136 & L-142~144
Other Options: Rotary | Touch Dimmer | Radio Frequency

Switches

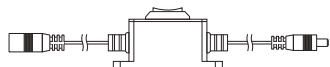

Part #	Description	Finish	Mounting	Dimensions	Price Each	Price 6+ Pcs.
LED-SWITCH-3A/6A	On/Off	Black	Surface	2-1/4"L x 1"W x 3/4"H	\$4.50	\$4.05 ea.

For Product Details & More Switch Options, See Page L-149

For Additional Accessories, See Page L-77

IMPORTANT: Due to Raw Material Fluctuation, Catalog Prices Below May Not Be Accurate. GO TO WWW.OUTWATER.COM FOR THE MOST UP-TO-DATE PRICES



12V

LED Lighting

Create Your Own Custom LED Omni Wand Lighting Up To 8 Ft.

Omni Wand: One System With Multiple Solutions

Available Lengths: Up To 8'

Material: Clear Anodized Aluminum Channel with Frosted Polycarbonate Lens

it's as **Easy** as

1  Cut omni housing to size

2  Measure and fill housing with ribbon strip and solderless clip

3  Add proper end to fixture and snap lens into place



Rigid Ribbon: In Cool White Or Warm White

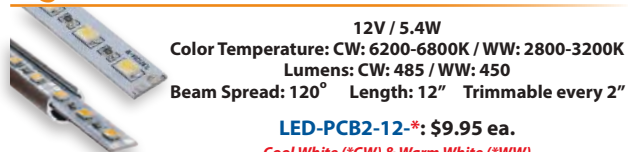

LED-PCB2-12-*: \$9.95 ea.
Cool White (*CW) & Warm White (*WW)

Housing Extrusion
4 ft. (*4) & 8 ft. (*8)
Diameter: 1/2"
Material: Aluminum
Finish: Clear Anodized
Designed to receive our 5630 SMD Rigid Ribbon & Power Track
LED-OS-400-*: \$2.07 per ft.

Female/Male Connecting Cable

Length- 24": **LED-OS-24:** \$3.25 ea.
Length- 30": **LED-OS-30:** \$3.50 ea.
Length- 48": **LED-OS-48:** \$3.75 ea.

Solderless Clips
Effortlessly joins multiple Ribbons and Track

LED-PCB-CLIP: \$1.50 ea.

Circuit Bridging Kit
Kit includes 2" Trimmable Power Track & 1 Solderless Clip
Kit allows adjustments to 1/16"
For More Info, Please Inquire
LED-OS-EXT: \$1.99 ea.

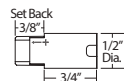
Frosted Polycarbonate Lens
4 ft. (*4) & 8 ft. (*8)
LED-OS-216-*: \$0.69 per ft.

Female End
Used for power input
Left (*L) & Right (*R)

LED-OS-665-*: \$1.55 ea.

Female End Cap

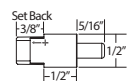
LED-OS-664: \$0.30 ea.

Male End
Used for power input
Left (*L) & Right (*R)

LED-OS-657-*: \$1.55 ea.

Male End Cap

LED-OS-663: \$0.30 ea.

Finishing End Cap
Designed to connect directly to housing

LED-OS-667: \$0.50 ea.

Mounting Clips
Material: Polycarbonate
Size: 1/2"

Screw Included
Light Can Pivot With Mounting Clip
LED-OS-676: \$0.35 ea.

Standoff Mount
Material: Aluminum

Screws Included
LED-OS-660: \$3.45 ea.

For Power Supplies & Accessories, See Page L-77

Phone: 1-800-631-8375 - Fax: 1-800-888-3315
Due to raw material cost fluctuations, prices are subject to change.

Omni Wand: Vertical

Omni Wand: One System With Multiple Solutions

Available Lengths: In Pre-Fabricated 10" & 16" Lengths or Create Your Own Length

Material: Clear Anodized Aluminum Channel with Frosted Polycarbonate Lens

As previously noted, the LED Omni Wand System's Spot Vertical LED Lighting System enables one to utilize corresponding snap on Modern Swivel or Bell Swivel Spot Lights for a targeted 15° beam spread, which can be added, removed or even repositioned to accommodate one's ever changing lighting needs along the length of the System's kitted 10-in. and 16-in. long, 1/2-in. diameter silver anodized aluminum fixtures.

Omni Wand Fixture



Modern Style Fixture

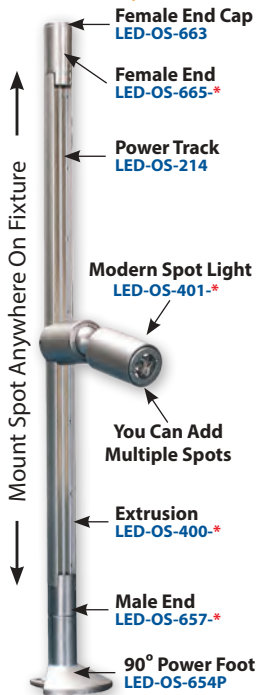

Bell Style Fixture

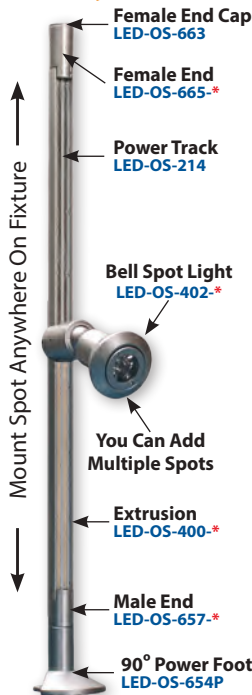

Base / Foot Styles

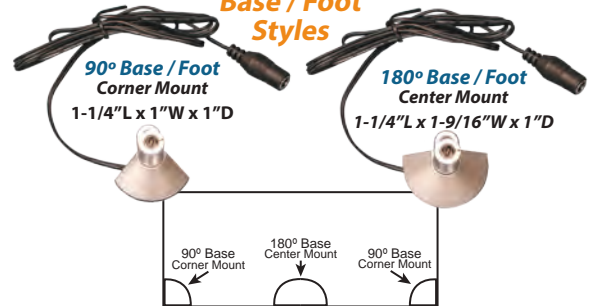

Pricing For 10" & 16" Pre-Fabricated Fixtures

Part #	Color Temp	Kit Includes	Size	# Of LED Chips	Total Wattage	Price
OMNI WAND FIXTURE						
LED-OS-V10-3*180		(1) Wand Light & (1) 180° Base / Foot	10" Height	15	7.5W	\$14.20 ea.
LED-OS-V16-3*180	Cool White (*CW)	(1) Wand Light & (1) 180° Base / Foot	16" Height	24	12W	\$19.25 ea.
LED-OS-V10-3*90	Warm White (*WW)	(1) Wand Light & (1) 90° Base / Foot	10" Height	15	7.5W	\$14.20 ea.
LED-OS-V16-3*90		(1) Wand Light & (1) 90° Base / Foot	16" Height	24	12W	\$19.25 ea.
MODERN STYLE FIXTURE						
LED-OS-V10-1*180		(1) Modern Spot Light & (1) 180° Base / Foot	10" Height	1	1W	\$25.60 ea.
LED-OS-V16-1*180	Cool White (*CW)	(1) Modern Spot Light & (1) 180° Base / Foot	16" Height	1	1W	\$26.55 ea.
LED-OS-V10-1*90	Warm White (*WW)	(1) Modern Spot Light & (1) 90° Base / Foot	10" Height	1	1W	\$25.60 ea.
LED-OS-V16-1*90		(1) Modern Spot Light & (1) 90° Base / Foot	16" Height	1	1W	\$26.55 ea.
BELL STYLE FIXTURE						
LED-OS-V10-2*180		(1) Bell Spot Light & (1) 180° Base / Foot	10" Height	1	1W	\$26.95 ea.
LED-OS-V16-2*180	Cool White (*CW)	(1) Bell Spot Light & (1) 180° Base / Foot	16" Height	1	1W	\$27.90 ea.
LED-OS-V10-2*90	Warm White (*WW)	(1) Bell Spot Light & (1) 90° Base / Foot	10" Height	1	1W	\$26.95 ea.
LED-OS-V16-2*90		(1) Bell Spot Light & (1) 90° Base / Foot	16" Height	1	1W	\$27.90 ea.
ADD A SPOT						
LED-OS-401-*	Cool White (*CW)	(1) Modern Spot Light	2-3/8"L x 1 1/16" Dia.	1	1W	\$17.30 ea.
LED-OS-402-*	Warm White (*WW)	(1) Bell Spot Light	2-1/2"L x 1-1/4" Dia.	1	1W	\$18.70 ea.

For Customizable Parts, See Page L-73

IMPORTANT: Due to Raw Material Fluctuation, Catalog Prices Below May Not Be Accurate. GO TO WWW.OUTWATER.COM FOR THE MOST UP-TO-DATE PRICES



12V

LED Lighting

Create Your Own Custom LED Omni Wand Lighting Up To 8 Ft.

Omni Wand: One System With Multiple Solutions

Available Lengths: Up To 8'

Material: Clear Anodized Aluminum Channel with Frosted Polycarbonate Lens

Housing Extrusion



LED-OS-400-*: \$2.07 per ft.

4 ft. (*4) & 8 ft. (*8)

Diameter: 1/2"

Material: Aluminum

Finish: Clear Anodized

Designed to receive our 5630 SMD

Rigid Ribbon & Power Track

Rigid Ribbon

In Cool White or Warm White

12V / 5.4W

Color Temperature:

CW: 6200- 6500K

WW: 2800-3200K

Lumens:

CW: 485 / WW: 450

Beam Spread: 120°

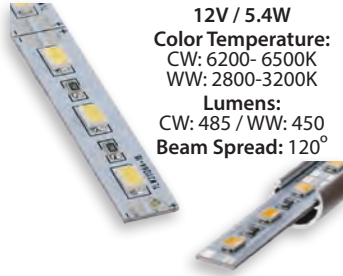

LED-PCB2-12-*: \$9.95 ea.

Cool White (*CW) & Warm White (*WW)

Length: 12"

Trimnable every 2"

Modern Swivel Spot Light

In Cool White or Warm White

12V / 1W

Lumens:

CW: 80

WW: 60

Beam Spread: 15°

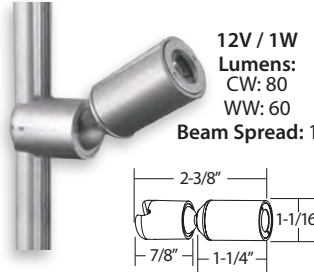

LED-OS-401-*: \$17.30 ea.

Cool White (*CW) & Warm White (*WW)

Bell Swivel Spot Light

In Cool White or Warm White

12V / 1W

Lumens:

CW: 80

WW: 60

Beam Spread: 15°

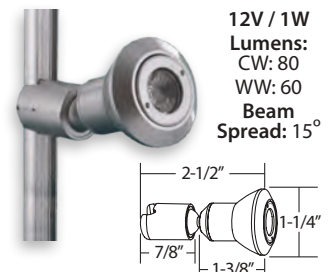

LED-OS-402-*: \$18.70 ea.

Cool White (*CW) & Warm White (*WW)

Power Track



LED-OS-214-*: \$4.15 ea.

Length: 39"

Works With Any Spot

Frosted Polycarbonate Lens



LED-OS-216-*: \$0.69 per ft.

4 ft. (*4) & 8 ft. (*8)

Solderless Clip



LED-PCB-CLIP-*: \$1.50 ea.

Effortlessly joins multiple Ribbons and Track

Male End

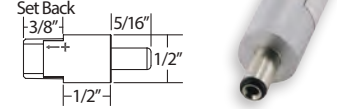

LED-OS-657-*: \$1.55 ea.

Used for power output

Female End



LED-OS-665-*: \$1.55 ea.

Used for power output
Left (*L) & Right (*R)

Female End Cap



LED-OS-664-*: \$0.30 ea.

Finishing End



LED-OS-667-*: \$0.50 ea.

Designed to connect directly to housing

90° Power Foot (Plastic)



LED-OS-654P-*: \$3.30 ea.

180° Power Foot (Plastic)



LED-OS-655P-*: \$3.30 ea.

With 60" power cord

For heights over 2 ft. with multiple spots we recommend metal O-Flange

Cover & Screw Included

Offers robust screw mounted support and is ideal for use in highly trafficked vertical or horizontal applications. Can be used on top & bottom.

Economy O-Flange (Metal)



Hex Key Included

LED-OS-678-*: \$2.65 ea.

2 Screws Included

Deluxe O-Flange (Metal)

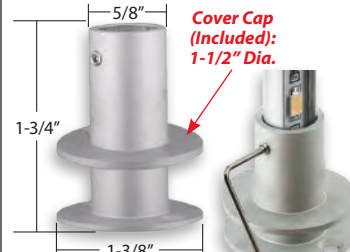

Cover Cap (Included): 1-1/2" Dia.

LED-OS-681-*: \$7.95 ea.

2 Screws Included

Hex Key Included

Power Cord With Solderless Clip

Designed to provide power to Rigid Ribbon Strips housed in the O-Flange. Comes with Female DC 5.5 and one Solderless Clip. O-Flange sold separately.



Works With O-Flange

LED-OS-662P-*: \$2.30 ea.

Length: 60"

For Power Supplies & Accessories, See Page L-77

IMPORTANT: Due to Raw Material Fluctuation, Catalog Prices Below May Not Be Accurate. GO TO WWW.OUTWATER.COM FOR THE MOST UP-TO-DATE PRICES

LED Lighting



Omni Wand: 2-Way, 3-Way & 4-Way Perimeter Lighting

Omni Wand: One System With Multiple Solutions

Material: Clear Anodized Aluminum Channel with Frosted Polycarbonate Lens

The LED Omni Wand System's Housing can be easily rotated even after installation to direct a generous 120° linear beam spread wherever it may be desired. In addition, the System can accommodate snap on Modern Swivel or Bell Swivel Spot Lights for a targeted 15° beam spread, which can be added, removed or even repositioned to accommodate one's ever changing lighting needs.

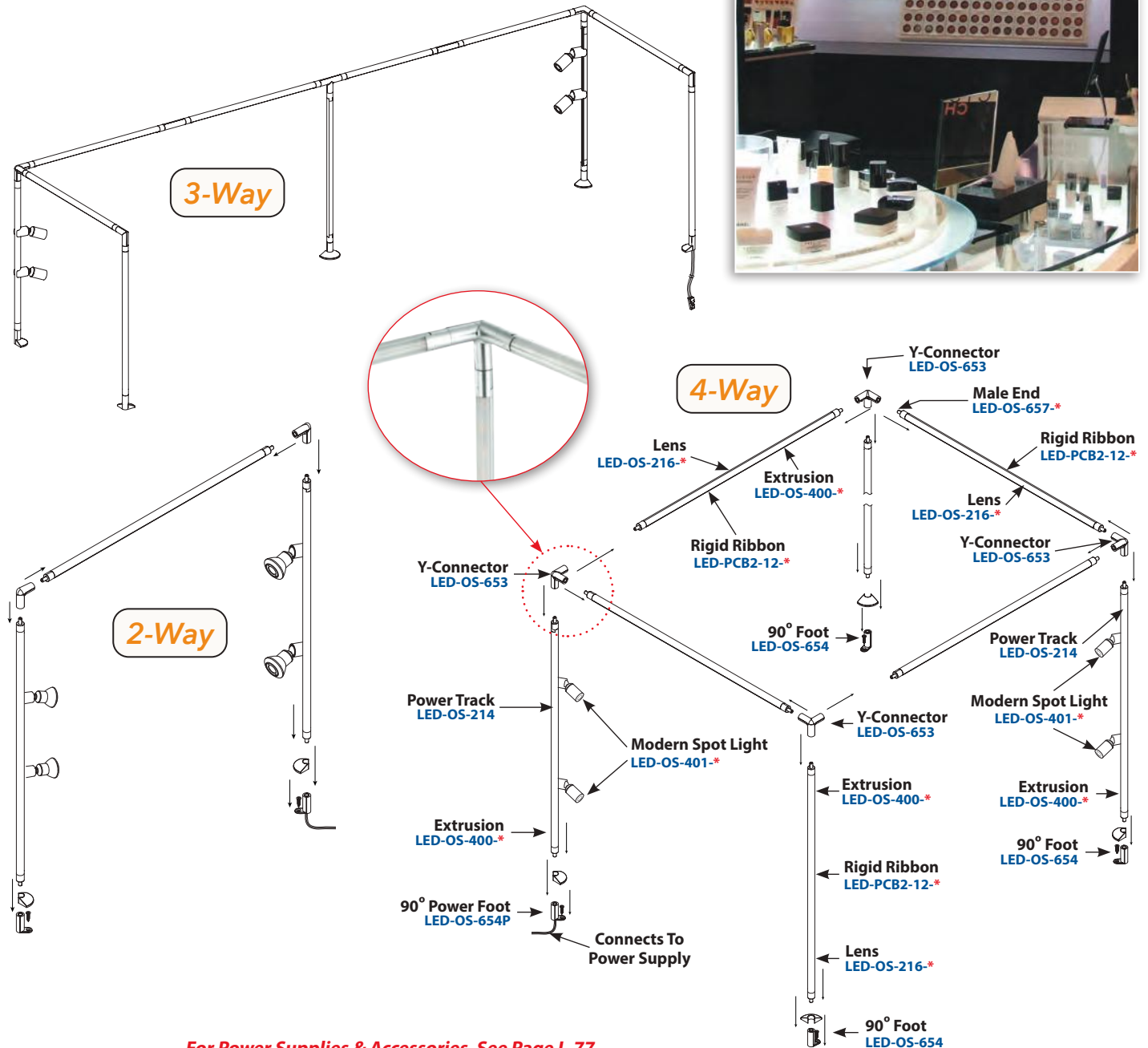

For Power Supplies & Accessories, See Page L-77



12V

LED Lighting

Omni Wand: 2-Way, 3-Way & 4-Way Perimeter Lighting

Omni Wand: One System With Multiple Solutions

Material: Clear Anodized Aluminum Channel with Frosted Polycarbonate Lens

Housing Extrusion



4 ft. (*4) & 8 ft. (*8)
Diameter: 1/2"

Material: Aluminum
Finish: Clear Anodized
Designed to receive our

5630 SMD Rigid Ribbon & Power Track
LED-OS-400-*: \$2.07 per ft.

Rigid Ribbon

In Cool White or Warm White
12V / 5.4W
Color Temperature:
CW: 6200- 6500K
WW: 2800-3200K
Lumens:
CW: 485 / WW: 450
Beam Spread: 120°



Length: 12"
Trimable every 2"

LED-PCB2-12-*: \$9.95 ea.
Cool White (*CW) & Warm White (*WW)

Modern Swivel Spot Light

In Cool White or Warm White



12V / 1W
Lumens:
CW: 80
WW: 60
Beam Spread: 15°

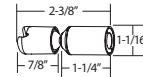

LED-OS-401-*: \$17.30 ea.
Cool White (*CW) & Warm White (*WW)

Bell Swivel Spot Light

In Cool White or Warm White



12V / 1W
Lumens:
CW: 80
WW: 60
Beam Spread: 15°

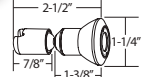

LED-OS-402-*: \$18.70 ea.
Cool White (*CW) & Warm White (*WW)

Power Track

Length: 39"
Works With Any Spot



LED-OS-214: \$4.15 ea.

Frosted Polycarbonate Lens

4 ft. (*4) & 8 ft. (*8)

LED-OS-216-*
\$0.69 per ft.

Solderless Clip

Effortlessly joins multiple
Ribbons and Track

LED-PCB-CLIP: \$1.50 ea.

Circuit Bridging Kit

Kit includes 2" Trimable Power Track
& 1 Solderless Clip
Kit allows adjustments to 1/16"



LED-OS-EXT: \$1.99 ea.
For More Info, Please Inquire

90° Foot (Plastic)



Cover & Screw Included

LED-OS-654: \$2.35 ea.

For heights over 2 ft. with multiple spots
we recommend metal O-Flange

90° Power Foot (Plastic)

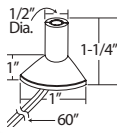

Cover & Screw Included

LED-OS-654P: \$3.30 ea.

With 60" power cord
For heights over 2 ft. with multiple spots
we recommend metal O-Flange

Offers robust screw mounted support and is ideal for use in highly trafficked vertical or horizontal applications. Can be used on top & bottom.

Economy O-Flange (Metal)



Hex Key Included

LED-OS-678: \$2.65 ea.
2 Screws Included

Deluxe O-Flange (Metal)



Cover Cap (Included):
1-1/2" Dia.

Hex Key Included

LED-OS-681: \$5.45 ea.
2 Screws Included

Power Cord With Solderless Clip

Designed to provide power to Rigid Ribbon Strips housed in the O-Flange. Comes with Female DC 5.5 and one Solderless Clip. O-Flange sold separately.



Works With O-Flange

LED-OS-662P: \$2.30 ea.
Length: 60"

Male End

Used for power output

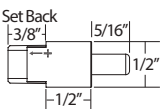

LED-OS-657-*: \$1.55 ea.
Left (*L) & Right (*R)

L-Connector



LED-OS-652: \$2.50 ea.

Y-Connector



LED-OS-653: \$3.30 ea.

T-Connector

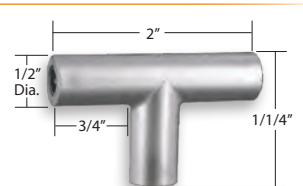

LED-OS-651: \$3.45 ea.

For Power Supplies & Accessories, See Page L-77

Omni Wand: Top Mount

Omni Wand: One System With Multiple Solutions

Material: Clear Anodized Aluminum Channel with Frosted Polycarbonate Lens

The LED Omni Wand System can also be used as Top Mounted LED Lighting. Utilizing high intensity 5630 SMD chips, the System radiates beautiful unimpeded illumination without shadows or scalloping, lending itself for use as a perfect wall washing light. The System's brackets are extremely durable and comprise all aluminum museum quality construction. The lighting can be mounted either horizontally or vertically and can be pivoted within its housing to direct the lighting where it is required.

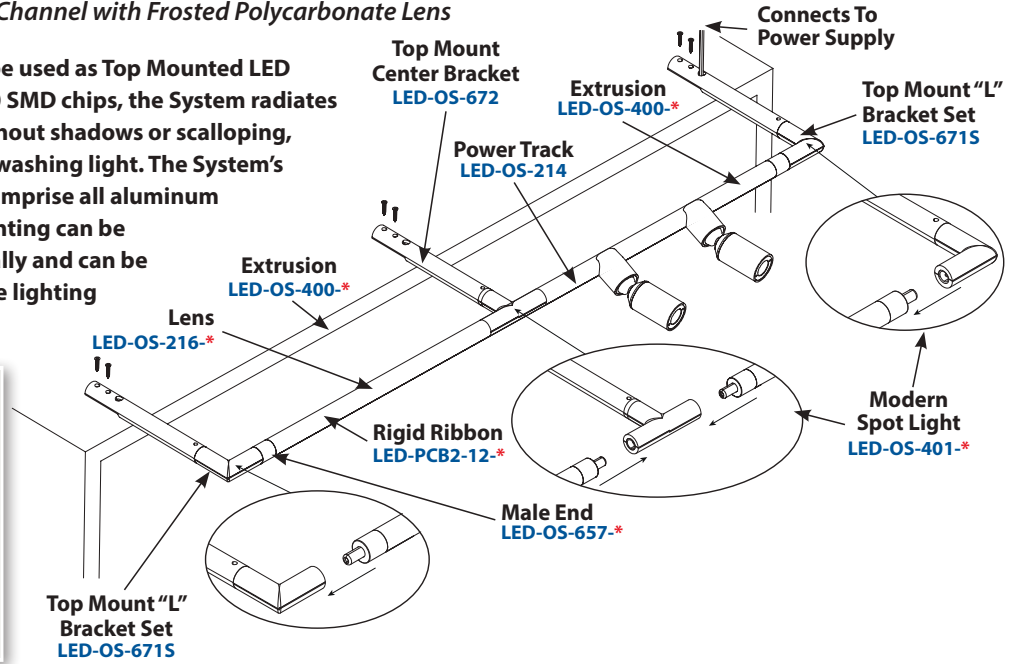

Rigid Ribbon

In Cool White or Warm White
12V / 5.4W
Color Temperature:
CW: 6200-6500K / WW: 2800-3200K
Lumens: CW: 485 / WW: 450
Beam Spread: 120°
Length: 12"
Trimable: Every 2"
LED-PCB2-12-*: \$9.95 ea.
*Cool White (*CW) & Warm White (*WW)*

Housing Extrusion

Diameter: 1/2"
Material: Aluminum
Finish: Clear Anodized
Designed to receive our
5630 SMD Rigid Ribbon & Power Track
LED-OS-400-*: \$2.07 per ft.
*4 ft. (*4) & 8 ft. (*8)*

Solderless Clips

Effortlessly joins multiple
Ribbons and Track
LED-PCB-CLIP: \$1.50 ea.

Power Track

Length: 39"
Works With Any Spot
LED-OS-214: \$4.15 ea.

Modern Swivel Spot Light

In Cool White or Warm White
12V / 1W
Lumens: CW: 80 / WW: 60
Beam Spread: 15°
LED-OS-401-*
*Cool White (*CW) & Warm White (*WW)*

Bell Swivel Spot Light

In Cool White or Warm White
12V / 1W
Lumens: CW: 80 / WW: 60
Beam Spread: 15°
LED-OS-402-*: \$18.70 ea.
*Cool White (*CW) & Warm White (*WW)*

Top Mount "L" Bracket Set

With 60" power cord
1-1/4"
4" Extension From Shelf
5-1/4"
1-1/4"
60"
LED-OS-671S: \$10.35 set

Circuit Bridging Kit

Kit includes 2" Trimmable
Power Track &
1 Solderless Clip
Kit allows
adjustments to 1/16"
LED-OS-EXT: \$1.99 ea.
For More Info, Please Inquire

Frosted Polycarbonate Lens

LED-OS-216-*: \$0.69 per ft.
*4 ft. (*4) & 8 ft. (*8)*

Male End

Used for power input
Set Back 3/8"
5/16"
1/2"
1-1/2"
LED-OS-657-*: \$1.55 ea.
*Left (*L) & Right (*R)*

Top Mount "L" Bracket Set

2"
1-3/4"
4" Extension From Shelf
5-1/4"
1-1/4"
LED-OS-672: \$4.40 ea.

For Power Supplies & Accessories, See Page L-77

IMPORTANT: Due to Raw Material Fluctuation, Catalog Prices Below May Not Be Accurate. GO TO WWW.OUTWATER.COM FOR THE MOST UP-TO-DATE PRICES



12V

LED Lighting

Accessories For Omni Wand System

Omni Wand: One System With Multiple Solutions

Material: Clear Anodized Aluminum Channel with Frosted Polycarbonate Lens

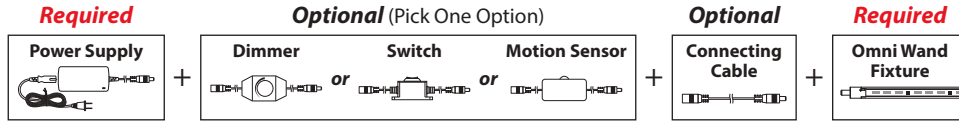

Required

Power Supplies

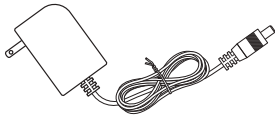

Part #	Type	Amps	Volts	Watts	Dimensions	Price	
						Each	6+ Pcs.
LED-12V-1A	Wall Mount	1A	12V	12W	2.91"L x 1.61"W x 1.14"H	\$8.95	\$8.20 ea.
LED-12V-3A	Wall Mount	3A	12V	36W	3.41"L x 2.31"W x 1.26"H	\$16.15	\$14.70 ea.

For Product Details & More Power Options, See Pages L-137~140
 Other Options: Plug In | Hardwire | Hardwire Dimmable | Rechargeable Battery

Optional

Dimmers

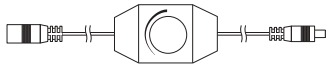

Part #	Description	Finish	Range of Dimming	Dimensions	Price	
					Each	6+ Pcs.
LED-INLINE-DIM	Inline Rotary	Black	0-100%	2-5/8"L x 1-3/8"W x 1"H	\$5.95	\$5.25 ea.
LED-DIM-648D	Standard Touch	Silver/Black	0-100%	22mm: Dia. x 16mm: W	\$9.00	\$8.25 ea.

For Product Details & More Dimmer Options, See Pages L-134~136 & L-142-144
 Other Options: Rotary | Touch Dimmer | Radio Frequency

Switches

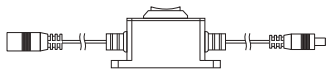

Part #	Description	Finish	Mounting	Dimensions	Price	
					Each	6+ Pcs.
LED-SWITCH-3A/6A	On/Off	Black	Surface	2-1/4"L x 1"W x 3/4"H	\$4.50	\$4.05 ea.
LED-OS-648A	Touch On/Off	Silver/Black	Recessed	22mm: Dia. x 16mm: W	\$9.00	\$8.50 ea.

For Product Details & More Switch Options, See Page L-149

Motion Sensors



Part #	Description	Finish	Mounting	Dimensions	Price	
					Each	6+ Pcs.
LED-DSEN	Door Sensor	Silver	Surface/Recessed	Surface: 2-1/2"L x 1-1/8"W x 11/16"H Recessed: 2-1/2"L x 5/8": Dia.	\$11.75	\$10.90 ea.

For Product Details & More Motion Sensor Options, See Page L-142

Connecting Cable



Part #	Description	Finish	Length	Price
LED-OS-24	Allows the designer to get around unlit areas without multiple power supplies	Silver/Black	24"	\$3.25 ea.
LED-OS-30		Silver/Black	30"	\$3.50 ea.
LED-OS-48		Silver/Black	48"	\$3.75 ea.

IMPORTANT: Due to Raw Material Fluctuation, Catalog Prices Below May Not Be Accurate. GO TO WWW.OUTWATER.COM FOR THE MOST UP-TO-DATE PRICES

LED Lighting



Omni Wand: Sample Kit

Omni Wand: One System With Multiple Solutions

Material: Aluminum with Polycarbonate Accessories

Experience the LED Omni Wand System for yourself! This fully functional "plug & play" sample kit comes complete with a power supply and everything you will need to come to appreciate this unprecedented, extremely versatile lighting system!



KIT INCLUDES



IMPORTANT: Due to Raw Material Fluctuation, Catalog Prices Below May Not Be Accurate. GO TO WWW.OUTWATER.COM FOR THE MOST UP-TO-DATE PRICES



Fluorescent Lighting

"D" Light T5 Compact Light

Available Lengths: 22-1/2", 23-13/16", 25-1/8", 35-1/2" & 47"

Material: White PVC with Clear Polycarbonate Lens

- Each fixture comes with a cool or white bulb, protective lens cover, 6-foot power cord, screws, plastic mounting clips and one direct connector.
- Sturdy all white PVC construction
- Standard On/Off switch
- Built in electronic end of life ballast with rapid start
- Approximate bulb life is 10,000 hours
- Ultra Low Profile- Only 7/8"
- Easy to find replacement bulbs: T5 lamps readily available!

GREAT FOR UNDER CABINETS, FURNITURE DISPLAYS OR GONDOLAS!



"D" Light T5 Compact Light (Up To 1820 Lumens Per Fixture)

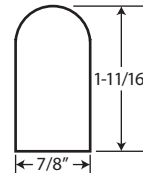

"D"-LIGHT FIXTURES WITH BULBS								REPLACEMENT BULBS	
Part #	Watts	Lumens	Max # Can Join	Dimensions			Price	Replacement Lamps	Price
				Length	Width	Depth			
<i>Cool White *CW & Warm White *WW</i>									
DLS-13W.*	13	715	10	22-1/2"	1-11/16"	7/8"	\$10.45 ea.	DLSB-13W.*	\$2.05 ea.
DLS-14W.*	14	750	10	23-13/16"	1-11/16"	7/8"	\$10.55 ea.	DLSB-14W.*	\$2.05 ea.
DLS-18W.*	18	900	10	25-1/8"	1-11/16"	7/8"	\$11.35 ea.	DLSB-18W.*	\$2.45 ea.
DLS-21W.*	21	1260	10	35-1/2"	1-11/16"	7/8"	\$12.55 ea.	DLSB-21W.*	\$2.85 ea.
DLS-28W-CW	28	1820	10	47"	1-11/16"	7/8"	\$14.35 ea.	DLSB-28W-CW	\$3.95 ea.

Optional (Any Combination)

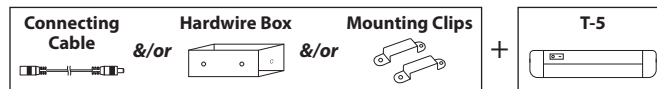

Connecting Cables (Optional)

Function: Allows the designer to get around unlit areas without multiple power supplies.



Part #	Length	Price
DLS-6CC	6"	\$1.00 ea.
DLS-12CC	12"	\$1.00 ea.

Hardwire Box (Optional)



Shown: DLS-HB-S

Part #	Description	Price
DLS-HB	Without Switch	\$8.00 ea.
DLS-HB-S	With Switch	\$8.50 ea.

PVC Mounting Clips (Optional)

Set of (2) Plastic White Mounting Clips & Screws



DLS-CLP-K
Each: \$0.75 set

IMPORTANT: Due to Raw Material Fluctuation, Catalog Prices Below May Not Be Accurate. GO TO WWW.OUTWATER.COM FOR THE MOST UP-TO-DATE PRICES

Look Of Fluorescent With Functionality & Energy Savings Of LED

★ STARLINK

Even Illumination

No Hotspots

No Power Supply

Simply Plug & Play

Can Link Up To 75 pcs. Off One Power Cord

Limited 3 Year Warranty

Sizes Available: 1', 2', 3' & 4'



Several Mounting Options

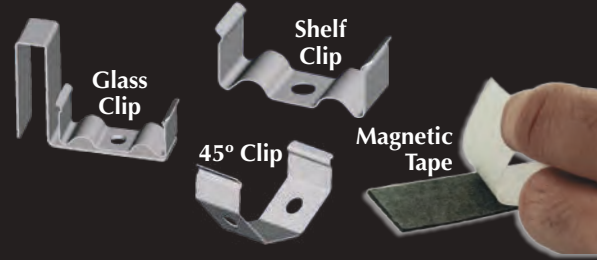

★ **Virtually Seamless Connection**
With Very Little Loss Of Light When Connected
 Only .40" gap, while others can be up to 2"



★ **90° Angled Power Cord**
Power Cord With Rocker Switch & Right Angle Space Saving Connection



LED Lens

LENS CHARACTERISTICS				
Color	Transmission	Dispersion	Surface Texture	LED Diodes
Opaque White	Low	High	Smooth	Not Visible

Opaque White Lens: Allows the least light transmission. The effect softens the light, reduces glare and eliminates the "scalloping" caused by the LED's in most cases

Outwater Plastics Industries, Inc. - www.outwater.com
 Due to raw material cost fluctuations, prices are subject to change.

• Catalog Is Priced
 • In U.S. Dollars

IMPORTANT: Due to Raw Material Fluctuation, Catalog Prices Below May Not Be Accurate. GO TO WWW.OUTWATER.COM FOR THE MOST UP-TO-DATE PRICES



120V

LED Lighting

Starlink T5 Light Fixture

Available Nominal Lengths: 1', 2', 3' & 4'

Material: Polycarbonate with Opaque White Polycarbonate Lens



Starlink T5 Lighting Fixture (Up To 1550 Lumens Per Fixture)

Includes: Fixture & Plastic Mounting Clips

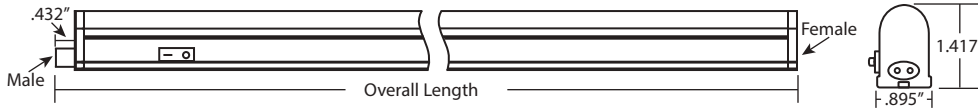

Lighting Specifications

Color Temperature	CW: 6500K
Beam Spread	180°
Lumens	LED-120T5-12-CW: 300 LED-120T5-24-CW: 550 LED-120T5-36-CW: 1050 LED-120T5-48-CW: 1550
Color Rendering Index	CW: 80
Rated Average Life	25,000 hrs.
Constant	Current
Chip Size	SMD2835

Part #	Color Temp	Finish	Overall Length	Length With Straight Power Cord	Length With Angled Power Cord	Total Wattage	Max # Can Connect	Price	
								Each	6+ Pcs.
LED-120T5-12-CW	Cool White	White	10-7/8"	13"	12-3/16"	4	75	\$17.50	\$16.50 ea.
LED-120T5-24-CW	Cool White	White	19-13/16"	22"	21-1/8"	7	42	\$22.00	\$20.75 ea.
LED-120T5-36-CW	Cool White	White	32-7/8"	35"	34-1/4"	13	23	\$27.00	\$25.50 ea.
LED-120T5-48-CW	Cool White	White	44-3/4"	46-7/8"	46-1/16"	18	16	\$31.00	\$29.00 ea.

Required

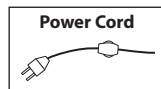

Optional (Any Combination)

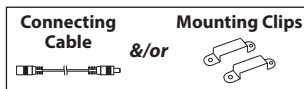

Required

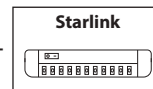

Straight Power Cords (Required)



- Length: 6' 6"
- Finish: White

LED-120T5-PC-2M

Each: \$3.25 / 6+ Pcs.: \$2.80 ea.

90° Angled Power Cords (Required)



6' 6" Power Cord

LED-120T5-PC-2MR

Each: \$5.25 / 6+ Pcs.: \$4.50 ea.



Power cord includes a rocker switch that will control all connected lights at one time

10' Power Cord

LED-120T5-PC-3MR

Each: \$6.25 / 6+ Pcs.: \$5.50 ea.

Connecting Cable (Optional)

Function: Allows the designer to get around unlit areas without multiple power supplies



Finish: White

Part #	Length	Price	6+ Pcs.
LED-120T5-CC-6	6"	\$2.15 ea.	\$1.85 ea.
LED-120T5-CC-12	12"	\$2.50 ea.	\$2.17 ea.
LED-120T5-CC-48	48"	\$4.00 ea.	\$3.50 ea.

Mounting Options (Optional)

Metal 45° Mounting Clip



LED-120T5-45C
Each: \$2.00 set
6+ Pcs.: \$1.80 set

Material: Stamped Steel

Metal Mounting Clip For Shelf



LED-120T5-MC
Each: \$2.00 set
6+ Pcs.: \$1.80 set

Material: Stamped Steel

4" x 3/4" 3M Magnetic Tape



LED-120T5-MT
Each: \$0.68 set
6+ Pcs.: \$0.58 set

IMPORTANT: Due to Raw Material Fluctuation, Catalog Prices Below May Not Be Accurate. GO TO WWW.OUTWATER.COM FOR THE MOST UP-TO-DATE PRICES

LED Lighting

120V



Professional LED Undercabinet Light

Available Lengths: 14" & 22"

Material: Aluminum Housing with Opaque White Polycarbonate Lens

- Replace older design with never version
- Dimmable
- Built in On/Off switch, along with a high/low light output option
- Join together with connector or linking cable
- Other Colors Available: Stainless Steel & Oil Rubbed Bronze Please Inquire



LENS CHARACTERISTICS				
Color	Transmission	Dispersion	Surface Texture	LED Diodes
Opaque White	Low	High	Smooth	Not Visible

Professional LED Undercabinet Light (Up To 520 Lumens Per Fixture)

Includes: Connector & Twin-Screw Clamp Connector



Included In Every Fixture

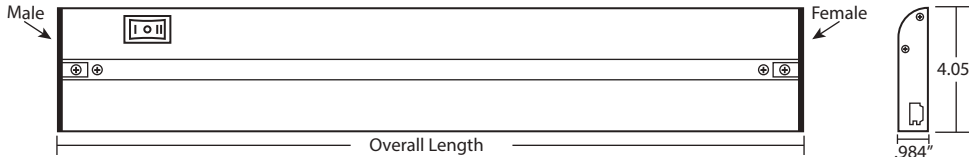

Part #	Color Temp	Finish	Overall Length	Total Wattage	Max # Can Connect	Price	
						Each	6+ Pcs.
UC-14WH	Warm White	White	14"	7	115	\$30.00	\$26.25 ea.
UC-22WH	Warm White	White	22"	11	50	\$41.00	\$37.00 ea.

Lighting Specifications

Color Temperature	UC-14WH: 3000K UC-15WH: 3000K
Beam Spread	120°
Lumens	UC-14WH: 330 UC-15WH: 520
Color Rendering Index	90
Rated Average Life	50,000 hrs.
Constant	Voltage

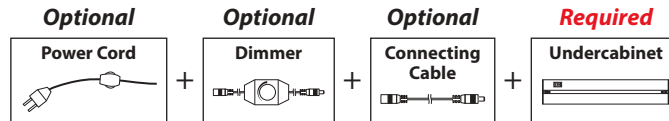

Power Cord (Optional)



- Length: 6' 6"
- Finish: White

UC-PWR-CBL
Each: \$5.95
6+: \$5.25 ea.

legrand Dimmer Switches (Optional)

Input & Output Cords: 5.875"
Range of Dimming: 0-100% • Mounting: Wall



softTap
Touch Switch With Touch Slide Dimmer

LGD120-DIMST-MG
Each: \$63.28 (Magnesium)

LGD120-DIMST-WH
Each: \$54.98 (White)



For More Options, Product Details & Wall Plates, See Page L-143

Connecting Cable (Optional)

Function: Allows the designer to get around unlit areas without multiple power supplies



- Length: 12"
- Finish: White

UC-LINK-CBL
Each: \$2.55
6+: \$2.25 ea.

IMPORTANT: Due to Raw Material Fluctuation, Catalog Prices Below May Not Be Accurate. GO TO WWW.OUTWATER.COM FOR THE MOST UP-TO-DATE PRICES



120V

WAC LIGHTING
Responsible Lighting®

LED Lighting

Duo LED Under Cabinet Light Bar

Available Lengths: 8", 12", 18", 24" & 30"

Material: Aluminum Body with Frosted Polycarbonate Lens

- Bringing out the best in bold, eye-catching residential, retail and commercial displays, Duo LED Under cabinet light bars are ideal for counters and cabinets. Thermally efficient, these fixtures are crated for illuminating heat sensitive perishables and color sensitive apparel, artwork and collectibles.
- Does not require any driver or transformers
- Backlighting with parabolic reflector allows a high uniformity of light
- Free of projected heat, UV and IR radiation
- On/Off Switch- Switch to either 2700K or 300K color temperature
- Easily mounts to surface with included matching screws
- 5 Year WAC Lighting product warranty

Each Light Bar Includes One Direct Connector For Virtually Seamless Connection



LENS CHARACTERISTICS				
Color	Transmission	Dispersion	Surface Texture	LED Diodes
Frosted	High	Low	Pebbled	Visible

Duo LED Under Cabinet Light Bar (Up To 1095 Lumens Per Fixture)

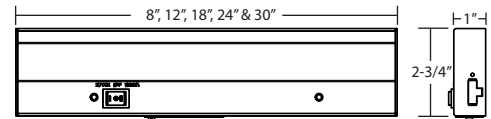
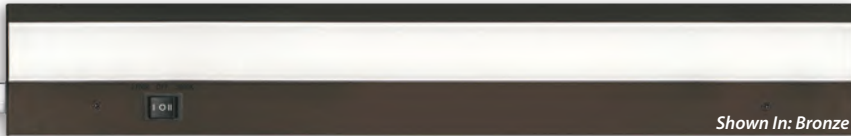

Lighting Specifications

Color Temperature	2700K or 3000K
Beam Spread	30°
Lumens	BA-ACLEDD827/30*: 330
	BA-ACLEDD1227/30*: 475
	BA-ACLEDD1827/30*: 545
	BA-ACLEDD2427/30*: 930
BA-ACLEDD3027/30*: 1095	
Color Rendering Index	90+
Rated Average Life	54,000 hrs.
Constant	Voltage

Part #	Length	# Of LED Chips	Total Wattage	Max # Can Connect	Price
<i>Brushed Aluminum *ALU, Bronze *BRZ & White *WH</i>					
BA-ACLEDD827/30*	8"	12	6	6	\$85.50 ea.
BA-ACLEDD1227/30*	12"	18	8	6	\$104.31 ea.
BA-ACLEDD1827/30*	18"	24	10	6	\$123.30 ea.
BA-ACLEDD2427/30*	24"	36	15	6	\$142.11 ea.
BA-ACLEDD3027/30*	30"	42	17.5	6	\$161.10 ea.

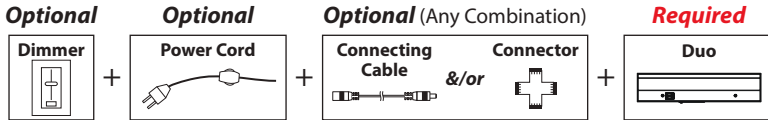

Power Cord (Optional)



- Length: 6'
 - Finish: White
- BA-PC6-WH**
Each: \$10.71

Lutron Dimmer Switches (Optional)

Input & Output Cords: 5.875" • Range of Dimming: 5-100% • Mounting: Wall



Skylark
On/Off Switch
With Slide Dimmer
S-600P-WH
Each: \$18.00



Diva
Rocker Switch
With Slide Dimmer
DVLV-600P-WH
Each: \$43.50

For Product Details & Wall Plates, See Page L-142

Connecting Cables (Optional)

Function: Allows the designer to get around unlit areas without multiple power supplies



Part #	Length	Finish	Price
BA-IC12-WH	12"	White	\$9.90 ea.
BA-IC24-WH	24"	White	\$10.71 ea.
BA-IC36-WH	36"	White	\$11.70 ea.

Direct Connector (Optional)

Function: Connects two light bars



BA-I-WH
Each: \$3.51

IMPORTANT: Due to Raw Material Fluctuation, Catalog Prices Below May Not Be Accurate. GO TO WWW.OUTWATER.COM FOR THE MOST UP-TO-DATE PRICES

LED Lighting

WAC LIGHTING
Responsible Lighting®

24V



LED Cabinet and Niche Light

Available Lengths: 6-15/16", 12-3/4", 18-5/8", 24-3/8" & 30-1/4"

Material: Extruded Aluminum Body with a Polycarbonate Lens

- The low profile LED Cabinet and Niche Light luminaire is the ultimate high output, low power consumption task light. Seamless connections provide the perfect glare free solution for all surfaces while offering luxurious color rendering for full color spectrum illumination. Perfect for highly reflective surfaces such as stainless steel and polished stone, LED Cabinet and Niche Light produces an evenly diffused light with asymmetrical lighting distribution. Unique installation detail provides versatility and security.
- Energy Star® rated
- 30° asymmetrical forward throw illumination for full coverage of the task plane
- Free of projected heat, UV and IR radiation
- Connections made at the center of each fixture
- Includes screws for easy mount or simply mounts with magnetic plates
- 5 Year WAC Lighting product warranty

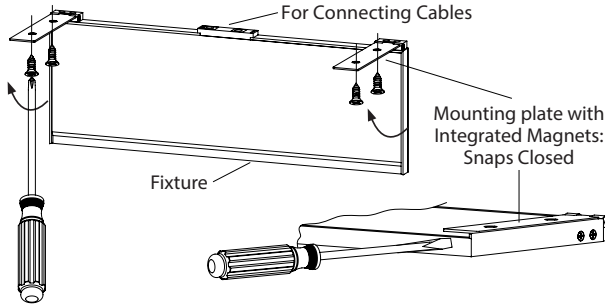

LED Cabinet and Niche Light (Up To 1210 Lumens Per Fixture)

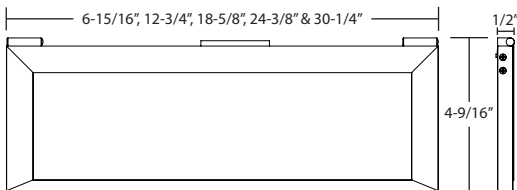

Lighting Specifications

Color Temperature	2700K
Beam Spread	30°
Lumens	LN-LED06P-27*: 250
	LN-LED12P-27*: 470
	LN-LED18P-27*: 825
	LN-LED24P-27*: 985
	LN-LED30P-27*: 1210
Color Rendering Index	90
Rated Average Life	100,000 hrs.
Constant	Voltage

Part #	Length	# Of LED Chips	Total Wattage	Max # Can Connect	Price
Abrasion Resistant Brushed Aluminum *AL & Anti-Microbial White Paint *WH					
LN-LED06P-27-*	6-15/16"	18	6.5	11	\$123.30 ea.
LN-LED12P-27-*	12-3/4"	35	10.5	6	\$161.10 ea.
LN-LED18P-27-*	18-5/8"	56	16	4	\$207.90 ea.
LN-LED24P-27-*	24-3/8"	70	20	3	\$245.70 ea.
LN-LED30P-27-*	30-1/4"	84	23.5	2	\$282.51 ea.

IMPORTANT: Due to Raw Material Fluctuation, Catalog Prices Below May Not Be Accurate. GO TO WWW.OUTWATER.COM FOR THE MOST UP-TO-DATE PRICES



WAC LIGHTING
Responsible Lighting®

LED Lighting

Accessories for LED Cabinet and Niche Light

Optional



Required



Optional

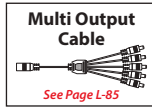

Optional (Any Combination)



Required



Power Supplies (Required)

Wall Mount & Desktop

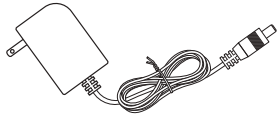

Part #	Type	Amps	Volts	Watts	Dimensions	Price	
						Each	6+ Pcs.
LED-24V-1A	Wall Mount	1A	24V	24W	3.13"L x 2.07"W x 1.52"H	\$11.65	\$10.60 ea.
LED-24V-3A	Desktop	3A	24V	72W	4.68"L x 2.34"W x 1.48"H	\$28.75	\$26.05 ea.
LED-24V-6A	Desktop	6A	24V	144W	6.77"L x 2.83"W x 1.57"H	\$52.15	\$47.40 ea.

For Product Details & More Power Options, See Pages L-137~140

Dimmable Hardwire

(2.5A / 24V / 60W)

- 6-1/2" L x 1-5/8" W x 1-1/4" H
- 10AWG Output Cord: 72"
- Class 2

EN-2460-RB2-S
Each: \$71.91



(4A / 24V / 96W)

- 6-1/2" L x 1-5/8" W x 1-1/4" H
- 10AWG Output Cord: 72"
- Class 2

EN-24100-RB2-S
Each: \$75.51



(4A / 24V / 96W)

- 12-5/8" L x 3-1/4" W x 2" H
- 10AWG Output Cord: 72"
- Class 2

EN-24100-277-RB2-T
Each: \$170.10

Lutron Dimmer Switches (Optional)

Input & Output Cords: 5.875" • Range of Dimming: 5-100% • Mounting: Wall



Skylark
On/Off Switch
With Slide Dimmer
S-600P-WH
Each: \$18.00



Diva
Rocker Switch
With Slide Dimmer
DVLV-600P-WH
Each: \$43.50

For Product Details & Wall Plates, See Page L-142

Connecting Cables (Optional)

FUNCTION: ALLOWS THE DESIGNER TO GET AROUND UNLIT AREAS WITHOUT MULTIPLE POWER SUPPLIES



Part #	Length	Price
SL-IC-06	6"	\$7.11 ea.
SL-IC-12	12"	\$7.11 ea.
SL-IC-24	24"	\$8.10 ea.
SL-IC-36	36"	\$8.91 ea.

Multi Output Cables (Optional)

Function: Is to join multiple fixtures to one power supply

Cable Extender



- Length: 3-5/8"
 - Finish: White
- SL-IF**
Each: \$7.11

3-Way "Y" Connector

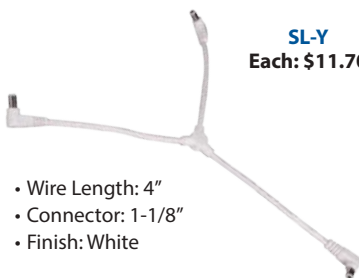

- Wire Length: 4"
- Connector: 1-1/8"
- Finish: White

4-Way "X" Connector



- Wire Length: 4"
- Connector: 1-1/8"
- Finish: White

Multiple Terminal Block



- Outputs: 8
 - 4-7/8" L x 1-5/8" W x 3/4" H
 - Finish: White
- MTB-08**
Each: \$31.50

Power Supply Accessories (Optional)

Wiring Box With Switch

Function: Conceal wire connections

- 6-1/4" L x 1-5/8" W x 1-1/4" H
- Finish: White

TB-S
Each: \$18.90



12" Extension Cable

Function: Used to extend distance between power supply and light

- Wire: 144"
- Connector: 1-1/8"
- Finish: White

SL-EXT-144
Each: \$15.30



Mounting Clips (Optional)

Function: Holds cables neatly



- Sold 10 pieces per bag
 - 1/2"
 - Finish: White
- SL-WC-1**
Each Bag: \$8.91

IMPORTANT: Due to Raw Material Fluctuation, Catalog Prices Below May Not Be Accurate. GO TO WWW.OUTWATER.COM FOR THE MOST UP-TO-DATE PRICES

LED Lighting



DP Conx

Available Lengths: 12", 24", 36", 48" & 60"
Material: Aluminum Housing with Clear Polycarbonate Lens

- Used For: Cove Lighting, Cabinet Lighting & Shelf Lighting
- Uses smaller DC 3.5 connector
- Light Source: SMD2835 strip
- Low profile can be easily hidden
- Excellent heat sink
- Mounting clips & screw included
- Joinable by middle and right angle connector
- Easy Installation
- Limited 2 Year Warranty

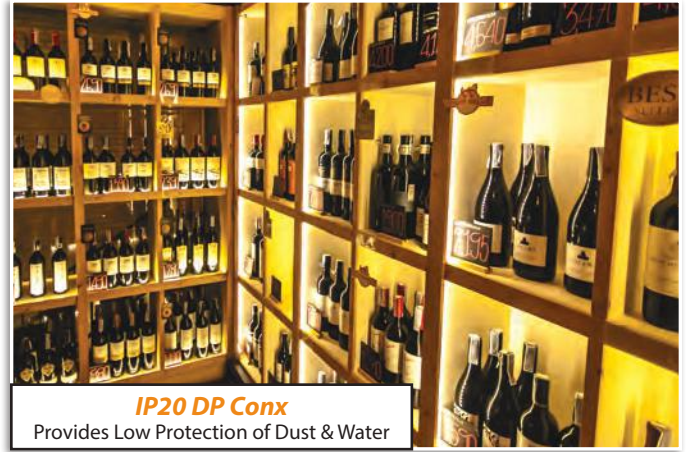

LENS CHARACTERISTICS				
Color	Transmission	Dispersion	Surface Texture	LED Diodes
Clear	High	High	Smooth	Visible

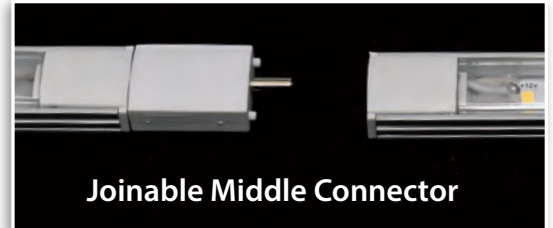

DP Conx (Up To 243 Lumens Per Foot)

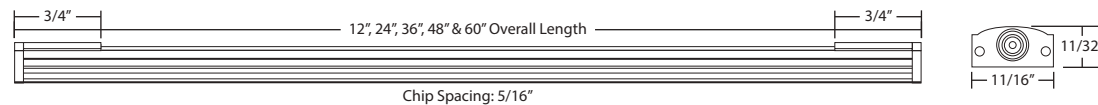

Lighting Specifications

Color Temperature	CW:6000K-6500K NW: 5000-5500K PW: 4000K-4500K WW: 2800K-3200K
Beam Spread	120°
Lumens	CW: 225 per ft. NW: 243 per ft. PW: 243 per ft. WW: 243 per ft.
Color Rendering Index	80+
Rated Average Life	30,000 hrs.
Constant	Voltage
Chip Size	2835

Part #	Length	# Of LED Chips	Total Wattage	Max # Can Connect	Price	
					Each	6+ Pcs.
<i>Cool White *CW, Natural White *NW, Pure White *PW & Warm White *WW</i>						
DPCONX12-12-*	12"	30	4	16'	\$14.41	\$12.62 ea.
DPCONX12-24-*	24"	66	8	16'	\$18.56	\$16.57 ea.
DPCONX12-36-*	36"	102	12	16'	\$22.20	\$19.82 ea.
DPCONX12-48-*	48"	138	16	16'	\$26.63	\$23.77 ea.
DPCONX12-60-*	60"	174	20	16'	\$32.06	\$28.62 ea.

IMPORTANT: Due to Raw Material Fluctuation, Catalog Prices Below May Not Be Accurate. GO TO WWW.OUTWATER.COM FOR THE MOST UP-TO-DATE PRICES



LED Lighting

Accessories for DP Conn

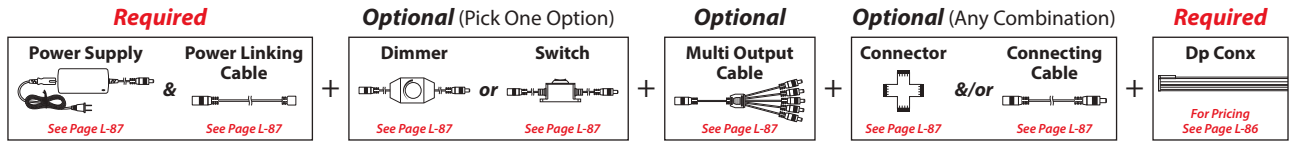

Required

Power Supplies (IP20)

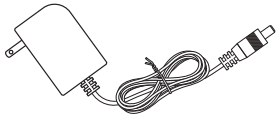

Part #	Type	Amps	Volts	Watts	Dimensions	Price	
						Each	6+ Pcs.
LED-12V-3A	Wall Mount	3A	12V	36W	3.41"L x 2.31"W x 1.26"H	\$16.15	\$14.70 ea.
LED-12V-6A	Desktop	6A	12V	72W	4.68"L x 2.34"W x 1.48"H	\$27.85	\$25.35 ea.

For Product Details & More Power Options, See Pages L-137~140
 Other Options: **Plug In | Hardwire | Hardwire Dimmable | Rechargeable Battery**

Power Linking Cable

Required for power supplies, dimmers & multi output cables.



Part #	Description	Overall Length	Finish	Price	
				Each	6+ Pcs.
DC 3.5 Connection					
DPCONX12-PWL	Power Link Cable DC 5.5 female to DC 3.5 male	6"	Black	\$1.75	\$1.45 ea.
Hardwire					
DPCONX12-PWL-MCC	Power Link Cable with DC 3.5	39"	Black	\$2.25	\$1.95 ea.

Optional

Dimmers

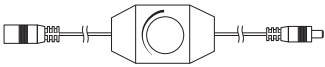

Part #	Description	Finish	Range of Dimming	Dimensions	Price	
					Each	6+ Pcs.
LED-INLINE-DIM	Inline Rotary	Black	0-100%	2-5/8"L x 1-3/8"W x 1"H	\$5.95	\$5.25 ea.

For Product Details & More Dimmer Options, See Pages L-134~136 & L-142-144
 Other Options: **Rotary | Touch Dimmer | Radio Frequency**

Switches



Part #	Description	Finish	Mounting	Dimensions	Price	
					Each	6+ Pcs.
LED-SWITCH-3A/6A	On/Off	Black	Surface	2-1/4"L x 1"W x 3/4"H	\$4.50	\$4.05 ea.

For Product Details & More Switch Options, See Page L-149

Multi Output Cables

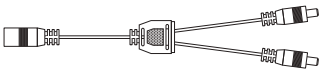

Part #	Description	Finish	Arms Size	# of Arms	Overall Length	Max # of Power Linking Cables	Price	
							Each	6+ Pcs.
LED-2WAY-BK	2-Way Sweep	Black	3"	2	7"	2	\$2.95	\$2.50 ea.

For More Extension Cable Options, See Page L-147

Connecting Cables



Part #	Function	Finish	Length	Price	
				Each	6+ Pcs.
LED-35MM-39CC-BK	Is to allow the designer to get around unlit areas without multiple power supplies	Black	39"	\$2.50	\$2.05 ea.

Connectors



Part #	Function	Dimensions	Price	
			Each	6+ Pcs.
DPCONX12-SCONN	Straight	1"L	\$1.45	\$1.30 ea.
DPCONX12-LCONN	Angle	7/8" L x 7/8" W	\$1.45	\$1.30 ea.

IMPORTANT: Due to Raw Material Fluctuation, Catalog Prices Below May Not Be Accurate. GO TO WWW.OUTWATER.COM FOR THE MOST UP-TO-DATE PRICES

ADJUST TO ANY HEIGHT NEEDED WITHOUT RE-WIRING

STEP 1

STEP 2

STEP 3

Introducing Billy Color Changing Temperature (CCT) Adjustable Shelf System

Go From 2700K-6500K

CCT TECHNOLOGY

Warm White ← → Cool White

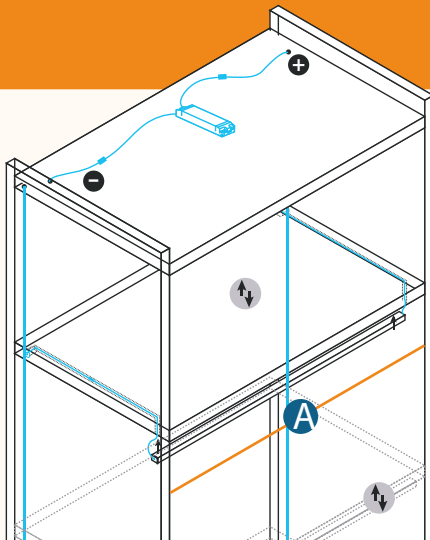

Peel & Stick Adhesive & Wood Screws Included

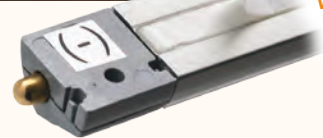

- No Visible Wires
- Now you can reposition your shelves multiple times without the need to re-wire the unit.
- Standard lengths can ship from stock but customized options are available. Please Inquire.
- 2 choices of power supplies, both utilize "CCT" technology and allow for variable temperatures between warm white and cool white.

- Dimmable
- Low Profile, High Efficiency Fixtures with Angled Beam
- White, opaque lens offers no visible LED diodes
- Will work with wood or glass shelves

Customizable Length Available, Please Inquire! (All we need is dimension A)



IMPORTANT: Due to Raw Material Fluctuation, Catalog Prices Below May Not Be Accurate. GO TO WWW.OUTWATER.COM FOR THE MOST UP-TO-DATE PRICES



LED Lighting

Billy Color Changing Temperature (CCT) Adjustable Shelf System

Nominal Lengths: 24", 36" & 48"

Material: Anodized Aluminum with Opaque White Lens

IP20 Billy CCT Adjustable Shelf System
Provides Low Protection of Dust & Water



LENS CHARACTERISTICS				
Color	Transmission	Dispersion	Surface Texture	LED Diodes
Opaque White	Low	High	Smooth	Not Visible



Low Profile, High Efficiency Fixtures with Angled Beam

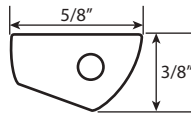

Fixtures Available In: 24", 36" or 48"
Screws & Adhesive Included with Every Fixture
Customizable Lengths Available, Please Inquire

Part #	Description	Total Wattage	Price
BLYK-136-CCT	36"- 1 Shelf Kit with 13' Copper Power Track	13.8	\$99.00 ea.
BLYK-148-CCT	48"- 1 Shelf Kit with 13' Copper Power Track	18.5	\$109.00 ea.
BLYK-224-CCT	24"- 2 Shelf Kit with 13' Copper Power Track	18.5	\$109.00 ea.
BLYK-236-CCT	36"- 2 Shelf Kit with 13' Copper Power Track	27.6	\$149.00 ea.
BLYK-248-CCT	48"- 2 Shelf Kit with 13' Copper Power Track	37	\$139.00 ea.
BLYK-324-CCT	24"- 3 Shelf Kit with 13' Copper Power Track	27.6	\$149.00 ea.
BLYK-336-CCT	36"- 3 Shelf Kit with 13' Copper Power Track	41.4	\$169.00 ea.
BLYK-348-CCT	48"- 3 Shelf Kit with 13' Copper Power Track	55	\$199.00 ea.
BLYK-424-CCT	24"- 4 Shelf Kit with 13' Copper Power Track	37	\$179.00 ea.
BLYK-436-CCT	36"- 4 Shelf Kit with 13' Copper Power Track	55	\$199.00 ea.
BLYK-524-CCT	24"- 5 Shelf Kit with 13' Copper Power Track	46	\$209.00 ea.

Lighting Specifications

Color Temperature	3000K-6000K
Beam Spread	120°
Lumens	BLYK-136-CCT: 214 per kit BLYK-148-CCT: 287 per kit BLYK-224-CCT: 287 per kit BLYK-236-CCT: 428 per kit BLYK-248-CCT: 574 per kit BLYK-324-CCT: 428 per kit BLYK-336-CCT: 642 per kit BLYK-348-CCT: 860 per kit BLYK-424-CCT: 574 per kit BLYK-436-CCT: 856 per kit BLYK-524-CCT: 717 per kit
Color Rendering Index	90
Rated Average Life	50,000 hrs.
Constant	Voltage
Chip Size	2835

Required (Choose One)

Bluetooth/IR Power Supply with IR Remote (5A / 12V / 60W)

Includes: Driver, EZ Plug with Connector, Module & Remote Control

Allow user to dim & change temperature from 2700K to 600K.

BLYK-PWR-IR
Each: \$139.00



Bluetooth Power Supply (5A / 12V / 60W)

Includes: Driver, EZ Plug with Connector & Module

Bluetooth module allows control of light through your phone or tablet

BLYK-PWR-BT
Each: \$119.00



IMPORTANT: Due to Raw Material Fluctuation, Catalog Prices Below May Not Be Accurate. GO TO WWW.OUTWATER.COM FOR THE MOST UP-TO-DATE PRICES

LED Lighting



Zip Strip

Available Lengths: 12" & 24"

Material: White Aluminum with Frosted Polycarbonate Lens

Mounting Options (Included)

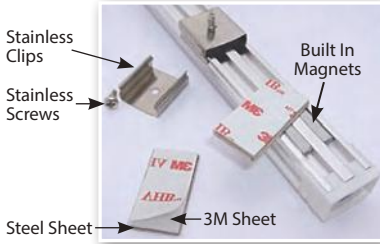

Interconnection

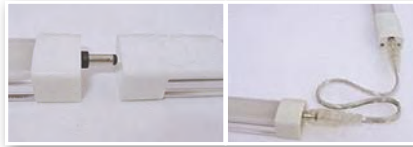

LENS CHARACTERISTICS

Color	Transmission	Dispersion	Surface Texture	LED Diodes
Frosted	High	Low	Pebbled	Visible

Starter with Touch Dimmer Function (Up To 650 Lumens Per Fixture)

The touch function lights come equipped with built in On/Off switch that doubles as a low, medium and high 3-stage touch dimmer. When leading with the dimmer fixture all following connection lamps will be controlled by the dimmer function.



Single without Touch Dimmer (Up To 650 Lumens Per Fixture)

The single lights can be connected to the touch function strip or used individually.



Lighting Specifications

Color Temperature	PW: 4500K WW: 3000K
Beam Spread	120°
Lumens	PW (12"): 330 WW (12"): 315 PW (24"): 650 WW (24"): 620
Color Rendering Index	PW/WW: 85
Rated Average Life	PW/WW: 30,000 hrs.
Constant	Voltage
Chip Size	SMD3528

Low Profile

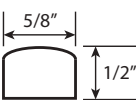

Part #	Finish	Length	# Of LED Chips	Total Wattage	Max # Can Connect	Price
Pure White *PW & Warm White *WW						
LED-SZIP-12-*	White (Starter)	12"	60	4.5	8	\$17.25 Each / \$14.50 ea. 10+ Pcs.
LED-ZIP-12-*	White (Single)	12"	60	4.5	8	\$13.50 Each / \$11.50 ea. 10+ Pcs.
LED-ZIP-24-PW	White (Single)	24"	120	9	4	\$20.75 Each / \$17.00 ea. 10+ Pcs.

Required Optional Required

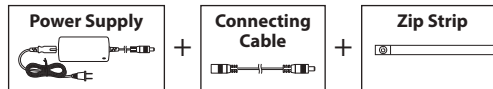

Power Supplies With Connection (Required)

PLUG & PLAY

Short Circuit Protection • Overload Circuit Protection • IP20 • Constant Voltage • Comes With DC 3.5 Male Power Linking Cable • Limited 2 Year Warranty

Deck Top (.75A / 24V / 18W)

- 3" L x 1-1/2" W x 2" H
- Input Cord: 62"
- Polarized 2 Prong Plug

LED-ZIP-TR-18W
Each: \$10.35 / 6+ Pcs.: \$9.32 ea.

Desk Top (1.5A / 24V / 36W)

- 5-3/16" L x 2-3/16" W x 1-1/4" H
- Input Cord: 36"
- Output Cord: 36"
- Green On/Off LED Indicator Light
- Polarized 2 Prong Plug

LED-ZIP-TR-36W
Each: 16.50
6+ Pcs.: \$14.85 ea.

Connecting Cable (Optional)

Function: Is to allow the designer to get around unlit areas without multiple power supplies



Part #	Length	Price	6+ Pcs.
LED-ZIP-CC-06	6"	\$1.50 ea.	\$1.35 ea.
LED-ZIP-CC-24	24"	\$3.50 ea.	\$3.15 ea.
LED-ZIP-CC-36	36"	\$3.75 ea.	\$3.38 ea.

IMPORTANT: Due to Raw Material Fluctuation, Catalog Prices Below May Not Be Accurate. GO TO WWW.OUTWATER.COM FOR THE MOST UP-TO-DATE PRICES



LED Lighting

Tri-Glow Strip

Available Lengths: 12" , 20" & 40"

Material: Aluminum with Clear Polycarbonate Lens

- Finish: High quality satin nickel finish
- Can be used vertical & horizontal
- Ideal for application where corner mounting is required
- Easy to connect
- Excellent for freezer application

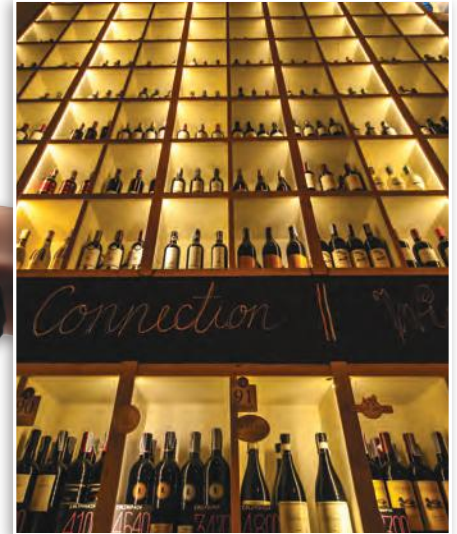
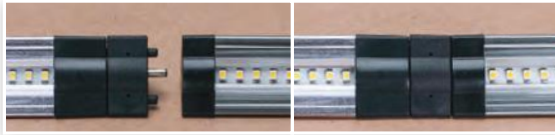

Tri-Glow Strip (Up To 980 Lumens Per Fixture)

Each Fixture Includes: 39" Connecting Cable, 2 Mounting Clips & 1 End to End Connector



Part #	Length	# Of LED Chips	Total Wattage	Max # Can Connect	Price	
					Each	10+ Pcs.
<i>Pure White *PW & Warm White *WW</i>						
LED-AGL-12-*	12"	42	3	12	\$16.00	\$12.95 ea.
LED-AGL-20-*	20"	72	5	8	\$24.00	\$18.95 ea.
LED-AGL-40-*	40"	144	11	3	\$44.00	\$36.95 ea.

Lighting Specifications

Color Temperature	PW: 4100K
	WW: 3200K
Beam Spread	90°
Lumens	LED-AGL-12-PW: 290
	LED-AGL-20-PW: 490
	LED-AGL-40-PW: 980
	LED-AGL-12-WW: 275
	LED-AGL-20-WW: 465
	LED-AGL-40-WW: 931
Color Rendering Index	PW/WW: 75
Rated Average Life	PW/WW: 50,000 hrs.
Constant	Voltage
Chip Size	SMD3528

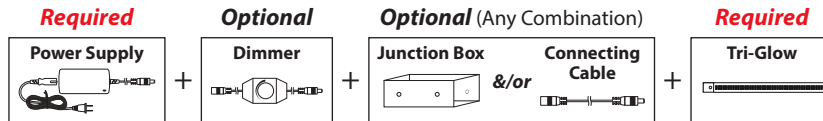

Power Supplies With Connection (Required)

PLUG & PLAY

Short Circuit Protection • Overload Circuit Protection • IP20 • Constant Voltage
Comes With DC 3.5 Male Power Linking Cable • Limited 2 Year Warranty

Desk Top (1.5A / 24V / 36W)

- 4.56" L x 1.92" W x 1.3" H
- 18AWG Input Cord: 60"
- 20AWG Output Cord: 60"
- Green On/Off LED Indicator Light
- Polarized 2 Prong Plug



LED-24V-1.5A

Each: \$23.50 / 6+ Pcs.: \$21.15 ea.

Desk Top (2A / 24V / 45W)

- 4.375" L x 1.75" W x 1.25" H
- 18AWG Input Cord: 60"
- 20AWG Output Cord: 60"
- Green On/Off LED Indicator Light
- Polarized 2 Prong Plug

LED-24V-2A

Each: \$24.50 / 6+ Pcs.: \$22.25 ea.

Dimmer (Optional)



LED-CLE-DIM
Each: \$5.95
6+ Pcs.: \$5.25 ea.

- On/Off Switch
- 3-3/4" L x 1-1/8" W x 3/8" H
- Male DC 3.5 Output Cord: 36"
- Range of Dimming: 0-100%
- Mounting: Screw

Junction Box (Optional)

Function: Is to join multiple fixtures to one power supply

- 1-5/8" L x 1-1/4" W x 5/8" H
- Power In: 1 Port
- Power Out: 4 Ports



LED-CLE-JB

Each: \$2.95 / 6+ Pcs.: \$2.45 ea.

Connecting Cable (Optional)

Function: To connect junction box or other lights

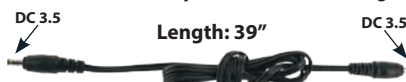

LED-35MM-39CC-BK

Each: \$2.50

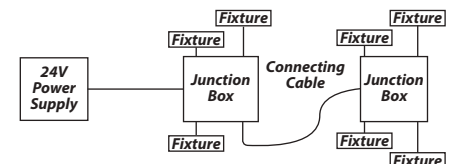

IMPORTANT: Due to Raw Material Fluctuation, Catalog Prices Below May Not Be Accurate. GO TO WWW.OUTWATER.COM FOR THE MOST UP-TO-DATE PRICES

LED Lighting



Gen Next Thin Light Fixture

Available Lengths: 8", 12" & 16"

Material: Clear Polycarbonate

- Improved design & connection
- Easy to hide ultra compact
- High lumen output packed into a very small fixture

LENS CHARACTERISTICS

Color	Transmission	Dispersion	Surface Texture	LED Diodes
Clear	Full	None	Smooth	Visible



Dimmable!



Gen Next Thin Light Fixture (Up To 260 Lumens Per Fixture)

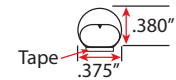
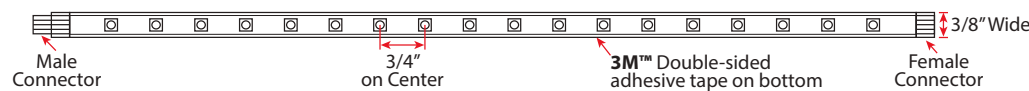

Part #	Length	# Of LED Chips	Total Wattage	Max # Can Connect	Price	
Pure White *PW & Warm White **WW						
LED-SLSHX-8-*	8"	9	1.6	23'	\$8.95	\$7.75 ea.
LED-SLSHX-12-*	12"	12	2.3	23'	\$9.95	\$8.65 ea.
LED-SLSHX-16-*	16"	18	3.0	23'	\$11.25	\$9.75 ea.

Lighting Specifications

Color Temperature	PW: 4200K WW: 2800K-3200K
Beam Spread	120°
Lumens	LED-SLSHX-8-*: 155 LED-SLSHX-12-*: 190 LED-SLSHX-16-*: 260
Color Rendering Index	PW/WW: 80
Rated Average Life	PW/WW: 30,000 hrs.
Constant	Voltage
Chip Size	SMD2835



Accessories for Gen Next Thin Light Fixture

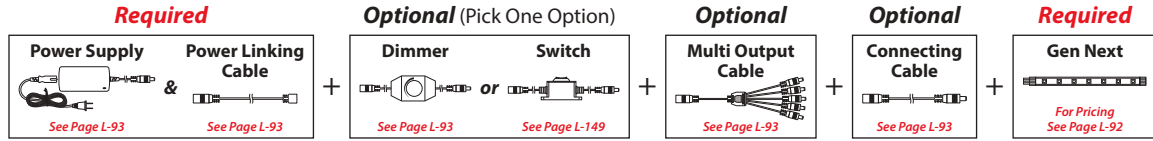

Required

Power Supplies

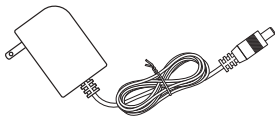

Part #	Type	Amps	Volts	Watts	Dimensions	Price	
						Each	6+ Pcs.
LED-12V-1A	Wall Mount	1A	12V	12W	2.91"L x 1.61"W x 1.14"H	\$8.95	\$8.20 ea.
LED-12V-3A	Wall Mount	3A	12V	36W	3.41"L x 2.31"W x 1.26"H	\$16.15	\$14.70 ea.

For Product Details & More Power Options, See Pages L-137~140
 Other Options: **Plug In | Hardwire | Hardwire Dimmable | Rechargeable Battery**

Power Linking Cable

Required for power supplies, dimmers & multi output cables.



Part #	Description	Overall Length	Finish	Price	
				Each	6+ Pcs.
LED-SLSHX-PWL	Power Link Cable with Gen Next Connection	18"	White	\$3.50	\$2.95 ea.

For Product Details & More Power Linking Cables, See Page L-141

Optional

Dimmers

A power linking cable required.

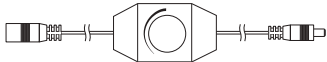

Part #	Description	Finish	Range of Dimming	Dimensions	Price	
					Each	6+ Pcs.
LED-INLINE-DIM	Inline Rotary	Black	0-100%	2-5/8"L x 1-3/8"W x 1"H	\$5.95	\$5.25 ea.
LED-INLINE-TCHDIM	Inline Touch	Black	0-100%	1-1/4"L x 3/4"W x 7/16"H	\$7.95	\$7.25 ea.

For Product Details & More Dimmer Options, See Pages L-134-136 & L-142~144
 Other Options: **Rotary | Touch Dimmer | Radio Frequency**

Multi Output Cables

A power linking cable required for each outlet.

5-Way Sweep: DC 5.5

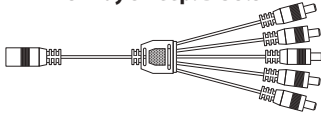

3-Way Spider: DC 5.5

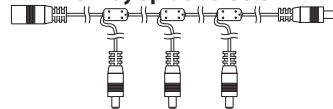

Part #	Description	Finish	Arms Size	# of Arms	Overall Length	Max # of Power Linking Cables	Price	
							Each	6+ Pcs.
LED-5OUT-CBL-BK	5-Way Sweep	Black	8-3/4"	5	19"	5	\$5.50	\$4.85 ea.
LED-SPIDER-CBL	3-Way Spider	Black	4-1/2"	3	96"	4	\$6.25	\$5.55 ea.

For More Extension Cable Options, See Page L-147

Connecting Cables



Part #	Function	Finish	Length	Price	
				Each	6+ Pcs.
LED-SLSHX-12C-WH	Is to allow the designer to get around unlit areas without multiple power supplies	White	12"	\$1.75	\$1.58 ea.
LED-SLSHX-24C-WH		White	24"	\$3.25	\$2.93 ea.
LED-SLSHX-36C-WH		White	36"	\$4.25	\$3.83 ea.

**IMPORTANT: Due to Raw Material Fluctuation, Catalog Prices Below May Not Be Accurate.
GO TO WWW.OUTWATER.COM FOR THE MOST UP-TO-DATE PRICES**

SunRay LED T5 Fixture

Low Profile &
Easily Hidden
5/8" Dia.

No Hot Spots or Shadowing-
Even Illumination!



- Our SunRay T5 fixture is made to work with all major brands of shelving such as Madix, Lozier & Streater.
- NOW: Lighting Facts & UL
- Easy Attachment
- Finish: Aluminum Housing
- Lens: Opaque White Diffuser
- Direct Connection: Male & Female Connector
- Limited 3 Year Warranty

Available in 5 Lengths
1', 2', 3', 4' & 5' Nominal



IMPORTANT: Due to Raw Material Fluctuation, Catalog Prices Below May Not Be Accurate. GO TO WWW.OUTWATER.COM FOR THE MOST UP-TO-DATE PRICES



LED Lighting

SunRay T5 Fixture

Available Lengths: 1', 2', 3', 4' & 5' Nominal
Material: Aluminum with Opaque White Polycarbonate Lens



Direct Connection
Male & Female Connector



NEW & IMPROVED
Higher Lumens!
Lower Cost!



LENS CHARACTERISTICS				
Color	Transmission	Dispersion	Surface Texture	LED Diodes
Opaque White	Low	High	Smooth	Not Visible

Opaque White Lens: Allows the least light transmission. The effect softens the light, reduces glare and eliminates the "scalloping" caused by the LED's in most cases

SunRay (Up To 1140 Lumens Per Fixture)

Resembles a High Powered T5 Fluorescent bulb with the benefits of LED

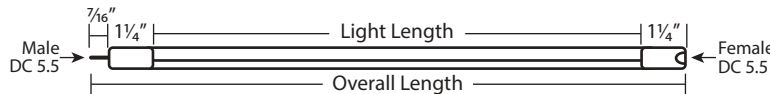

Lighting Specifications

Color Temperature	CW: 3700K-4300K WW: 2800K-3200K
Lumens	LED-T512-CW: 289 LED-T512-WW: 273 LED-T524-CW: 597 LED-T524-WW: 553 LED-T536-CW: 932 LED-T536-WW: 926 LED-T548-CW-S: 1287 LED-T548-WW-S: 1227 LED-T560-CW: 1603 LED-T560-WW: 1525
Color Rendering Index	80+
Rated Average Life	50,000 hrs.
Constant	Voltage
Chip Size	SMD3014



Part #	Length		# Of LED Chips	Total Wattage	Max # Can Connect	Price	
	Overall Length	w/Power Adaptor				Each	12+ Pcs.
<i>Cool White *CW & Warm White *WW</i>							
LED-T512-*	13-3/16"	14-1/2"	60	4.5	15'	\$22.95	\$19.20 ea.
LED-T524-*	23-3/8"	24-5/8"	120	8.5	15'	\$30.25	\$26.15 ea.
LED-T536-*	35-1/8"	36-3/8"	192	13	15'	\$40.75	\$35.15 ea.
LED-T548-*S	45"	46-1/4"	240	16	15'	\$48.60	\$41.95 ea.
LED-T560-*	58-3/4"	60"	336	20	15'	\$60.25	\$52.05 ea.

Mounting Hardware

INCLUDED WITH EACH FIXTURE!

A VARIETY OF MOUNTING HARDWARE OPTIONS W/SCREWS



OPTION A
Wood Shelf Clip

1 Pair/Non-Handed Horizontal



OPTION B
Wood Shelf Clip

SUPER STRONG

1 Pair/Non-Handed Vertical/Horizontal



OPTION C
1/4" Glass Shelf Clip

Magnetic Clip Connects To Metal (Optional)



Ideal for Gondola Shelving

- Material: Stamped Steel
- 1/2" Diameter Base
- 22 lbs. Pull Magnet

LED-T5-MAGCON
\$3.00 (pair)

Note: SunRay can pivot in clips

IMPORTANT: Due to Raw Material Fluctuation, Catalog Prices Below May Not Be Accurate. GO TO WWW.OUTWATER.COM FOR THE MOST UP-TO-DATE PRICES

LED Lighting



Accessories for SunRay T5 Fixture

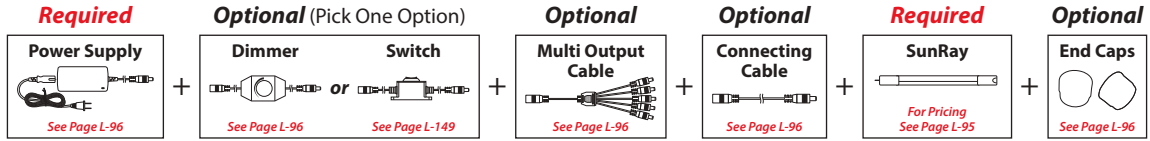

Required

Power Supplies

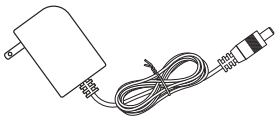

Part #	Type	Amps	Volts	Watts	Dimensions	Price	
						Each	6+ Pcs.
LED-24V-1A	Wall Mount	1A	24V	24W	3.13"L x 2.07"W x 1.52"H	\$11.65	\$10.60 ea.
LED-24V-3A	Desktop	3A	24V	72W	3.41"L x 2.31"W x 1.26"H	\$28.75	\$26.05 ea.

For Product Details & More Power Options, See Pages L-137~140
 Other Options: Plug In | Hardwire | Hardwire Dimmable | Rechargeable Battery

Optional

Dimmers

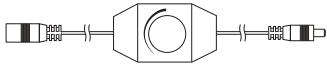

Part #	Description	Finish	Range of Dimming	Dimensions	Price	
					Each	6+ Pcs.
LED-INLINE-DIM	Inline Rotary	Black	0-100%	2-5/8"L x 1-3/8"W x 1"H	\$5.95	\$5.25 ea.
LED-INLINE-TCHDIM	Inline Touch	Black	0-100%	1-1/4"L x 3/4"W x 7/16"H	\$7.95	\$7.25 ea.

For Product Details & More Dimmer Options, See Pages L-134~136 & L-142~144
 Other Options: Rotary | Touch Dimmer | Radio Frequency

Multi Output Cables

5-Way Sweep: DC 5.5

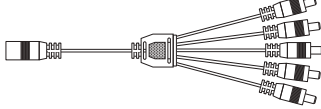

Part #	Description	Finish	Arms Size	# of Arms	Overall Length	Max # of Power Linking Cables	Price	
							Each	6+ Pcs.
LED-5OUT-CBL-BK	5-Way Sweep	Black	8-3/4"	5	19"	5	\$5.50	\$4.85 ea.
LED-SPIDER-CBL	3-Way Spider	Black	4-1/2"	3	96"	4	\$6.25	\$5.55 ea.

For More Extension Cable Options, See Page L-147

3-Way Spider: DC 5.5

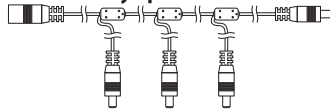

Connecting Cables

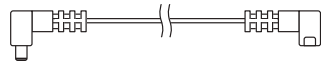

Part #	Description	Function	Finish	Length	Price	
					Each	6+ Pcs.
LED-A55MF-12CC-BK	Angled	Is to allow the designer to get around unlit areas without multiple power supplies	Black	12"	\$1.80	\$1.55 ea.
LED-A55MF-24CC-BK	Angled		Black	24"	\$2.00	\$1.70 ea.

For More Extension Cable Options, See Page L-148

End Caps



• 1-1/2" L x 11/16" Dia.

LED-T5-END
Each: \$1.95



**IMPORTANT: Due to Raw Material Fluctuation, Catalog Prices Below May Not Be Accurate.
GO TO WWW.OUTWATER.COM FOR THE MOST UP-TO-DATE PRICES**

Power Track System

The Best In Store Adjustable Shelf Lighting Solution On The Market



- Clean appearance with magnetic power cords- hide away cords from merchandise
- Posi-Lock Connection assures merchandise will not pull wiring like other brands
- Money Saving: Easy to adjust shelves without an electrician
- Low profile, easily hidden for clean neat appearance
- Lit shelves increase sales
- Limited 2 Year Warranty On Lighting



Phone: 1-800-631-8375 - Fax: 1-800-888-3315
Due to raw material cost fluctuations, prices are subject to change.

L- 97
Lighting

IMPORTANT: Due to Raw Material Fluctuation, Catalog Prices Below May Not Be Accurate. GO TO WWW.OUTWATER.COM FOR THE MOST UP-TO-DATE PRICES

LED Lighting

12V / 24V



Power Track System

Power Track



- Length: 71-1/8"
- Material: PVC
- Finish: Black (*BK) & White (*WH)
- Magnetic Track: Requires no hardware to install
- Trimmable
- Once installed, no professional needed when reconfiguring for seasonal products & new store plans
- Accommodates 12V or 24V lighting up to 10 amps
- Low profile & easily hidden

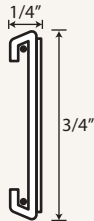

LED-PWT-6-*
Each: \$15.00
12+ Pcs.: \$14.20 ea.

Posi-Lock Connection

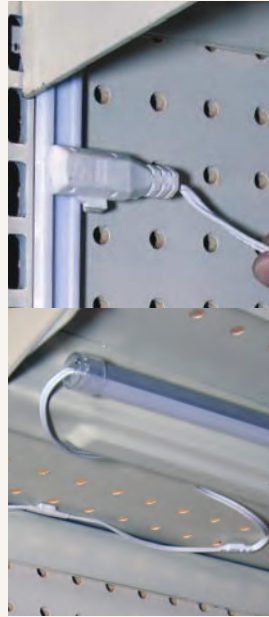

- Overall Length: 26-1/4"
- Cable Length: 22-3/4"
- Finish: Black (*BK) & White (*WH)
- Locking link cable can be repositioned for easy shelf adjustment
- All cables have a posi-lock connection when connected to the track. It will not easily dislodge by merchandise
- Built in rare earth magnet on cables will allow you to easily hide wires

Power Linking Cable

Connects from power supply to power track
LED-PWT-PL-*
Each: \$4.00
12+ Pcs.: \$3.75 ea.

Locking Linking Cable

Connects from power track to the light
LED-PWT-LL2-*
Each: \$4.00
12+ Pcs.: \$3.75 ea.

Power Track Lighting (Up To 905 Lumens Per Fixture)

Material: Aluminum with Opaque White Polycarbonate Lens (Pre-Installed Locking Linking Cable)

12V

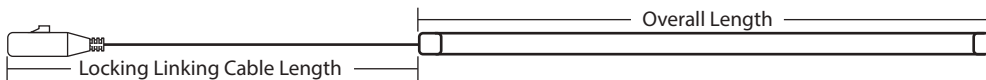

Lighting Specifications

Color Temperature	CW: 6000K
Beam Spread	120°
Lumens	LED-PWT-12V-CW3: 785 LED-PWT-12V-CW4: 905
Color Rendering Index	CW: 80
Rated Average Life	20,000 hrs.
Constant	Voltage
Chip Size	3014

Part #	Overall Length	Locking Linking Cable Length	# Of LED Chips	Total Wattage	Max # Can Connect	Price	
						Each	12+ Pcs.
LED-PWT-12V-CW3	35-1/8"	25"	63	9.8	-	\$36.40	\$31.15 ea.
LED-PWT-12V-CW4	46-7/16"	25"	84	13.7	-	\$42.58	\$36.20 ea.

SunRay (Up To 1018 Lumens Per Fixture)

Material: Aluminum with Opaque White Polycarbonate Lens (Locking Linking Cable Sold Separately)

24V

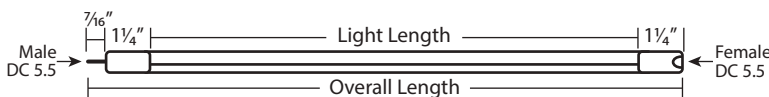

Lighting Specifications

Color Temperature	CW: 3700K-4300K WW: 2800K-3200K
Lumens	LED-T536-CW: 932 LED-T536-WW: 926 LED-T548-CW-S: 1287 LED-T548-WW-S: 1227
Color Rendering Index	80+
Rated Average Life	50,000 hrs.
Constant	Voltage
Chip Size	SMD3014

Part #	Overall Length	Length w Power Adaptor	# Of LED Chips	Total Wattage	Max # Can Connect	Price	
						Each	12+ Pcs.
Cool White *CW & Warm White *WW							
LED-T536-*	35-1/8"	36-3/8"	192	13	15'	\$40.75	\$35.15 ea.
LED-T548-*-S	45"	46-1/4"	240	16	15'	\$48.60	\$41.95 ea.

IMPORTANT: Due to Raw Material Fluctuation, Catalog Prices Below May Not Be Accurate. GO TO WWW.OUTWATER.COM FOR THE MOST UP-TO-DATE PRICES



12V / 24V

LED Lighting

Power Track System

Shelf Edge Ticket With Integrated LED Lighting (Up To 1700 Lumens Per Fixture)

Material: Aluminum with Opaque White Polycarbonate Lens (Locking Linking Cable Sold Separately)

24V



- Direct attention to your merchandise
- Will hold 1", 1-1/4" & 1-1/2" price or scan tickets
- Will work with gondola shelving and wire shelvings
- Mounting clips included



Lighting Specifications

Color Temperature	PW: 4200K
Beam Spread	120°
Lumens	LSL24-45-PW: 1870
Color Rendering Index	CW: 80
Rated Average Life	50,000 hrs.
Constant	Voltage
Chip Size	2835

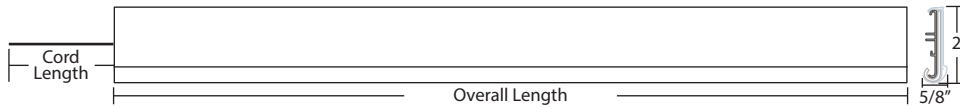

Part #	Overall Length	Cord Length	# Of LED Chips	Total Wattage	Max # Can Connect	Price	
						Each	12+ Pcs.
LSL24-45-PW	45"	5"	161	22	-	\$60.48	\$51.66 ea.

Required Power Supply + **Optional** (Pick One Option) Dimmer or Switch + **Required** Power Linking Cable + **Required** Track + **Optional** Locking Linking Cable + **Required** Power Track Lighting

Required

Power Supplies

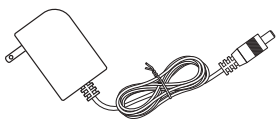

Part #	Type	Amps	Volts	Watts	Dimensions	Price	
						Each	6+ Pcs.
LED-12V-3A	Wall Mount	3A	12V	36W	3.41"L x 2.31"W x 1.26"H	\$16.15	\$14.70 ea.
LED-24V-3A	Desktop	3A	24V	72W	4.68"L x 2.34"W x 1.48"H	\$28.75	\$26.05 ea.

For Product Details & More Power Options, See Pages L-137~140
Other Options: Plug In | Hardwire | Hardwire Dimmable | Rechargeable Battery

Optional

Dimmers

A power linking cable required.

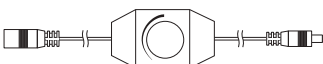

Part #	Description	Finish	Range of Dimming	Dimensions	Price	
					Each	6+ Pcs.
LED-INLINE-DIM	Inline Rotary	Black	0-100%	2-5/8"L x 1-3/8"W x 1"H	\$5.95	\$5.25 ea.

For Product Details & More Dimmer Options, See Pages L-134~136 & L-142~144
Other Options: Rotary | Touch Dimmer | Radio Frequency

Switches

A power linking cable required.

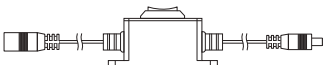

Part #	Description	Finish	Mounting	Dimensions	Price	
					Each	6+ Pcs.
LED-SWITCH-3A/6A	On/Off	Black	Surface	2-1/4"L x 1"W x 3/4"H	\$4.50	\$4.05 ea.

For Product Details & More Switch Options, See Page L-149

IMPORTANT: Due to Raw Material Fluctuation, Catalog Prices Below May Not Be Accurate. GO TO WWW.OUTWATER.COM FOR THE MOST UP-TO-DATE PRICES

LED Lighting



LED Closet Rod Kit: Customized To Any Length

Kit Includes (Available In 3 Sizes): Closest Rod, Ribbon Flex Light & 2 Mounting Brackets

Material: Aluminum

- Trimmable in 2" increments
- Beautifully illuminates your closet space to find what you need with ease



Will Fit Any Closet Opening

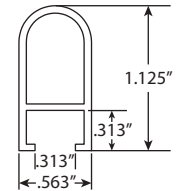
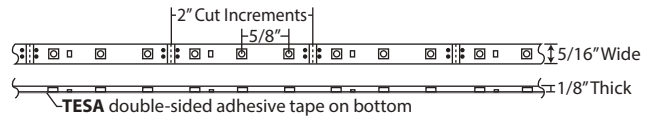

Lighting Specifications

Color Temperature	CW: 6500K
Beam Spread	120°
Lumens	3 Ft.: 480 4 Ft.: 800 5 Ft.: 1120
Color Rendering Index	CW: 75
Rated Average Life	40,000 hrs.
Constant	Voltage
Chip Size	SMD3528

Part #	Color Temp	Finish	Length	# Of LED Chips	Total Wattage	Price Per Kit	
						Each	10+
LED-CLOSET-3	Cool White	Clear	3'	54	7.4	\$39.00	\$36.00 ea.
LED-CLOSET-4	Cool White	Anodized	4'	72	9.9	\$52.00	\$47.50 ea.
LED-CLOSET-5	Cool White	Aluminum	5'	90	12.4	\$65.00	\$57.00 ea.

For 8 ft. Lens (L-TASK-CLO), See page L-60

Required + **Optional** (Pick One Option) or + **Required**

Optional Rechargeable Battery Available See page L-140

Required

Power Supplies

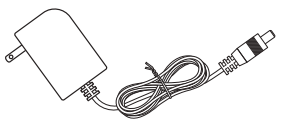

Part #	Type	Amps	Volts	Watts	Dimensions	Price	
						Each	6+ Pcs.
LED-12V-1A	Wall Mount	1A	12V	12W	2.91"L x 1.61"W x 1.14"H	\$8.95	\$8.20 ea.
LED-12V-3A	Wall Mount	3A	12V	36W	3.41"L x 2.31"W x 1.26"H	\$16.15	\$14.70 ea.

For Product Details & More Power Options, See Pages L-137~140
Other Options: Plug In | Hardwire | Hardwire Dimmable | Rechargeable Battery

Optional

Switches

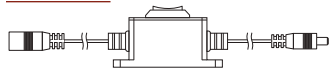

Part #	Description	Finish	Mounting	Dimensions	Price	
					Each	6+ Pcs.
LED-SWITCH-3A/6A	On/Off	Black	Surface	2-1/4"L x 1"W x 3/4"H	\$4.50	\$4.05 ea.

For Product Details & More Switch Options, See Page L-149

Motion Sensors



Part #	Description	Finish	Mounting	Dimensions	Price	
					Each	6+ Pcs.
LED-DSEN	Door Sensor	Silver	Surface/Recessed	Surface: 2-1/2"L x 1-1/8"W x 11/16"H Recessed: 2-1/2"L x 5/8"; Dia.	\$11.75	\$10.90 ea.

For Product Details & More Motion Sensor Options, See Page L-142

IMPORTANT: Due to Raw Material Fluctuation, Catalog Prices Below May Not Be Accurate. GO TO WWW.OUTWATER.COM FOR THE MOST UP-TO-DATE PRICES



120V

LED Lighting

Infinity Light

Material: Aluminum Construction with Polycarbonate Lens

- Connectable
- Supplied with 18" connecting cable
- Connect up to 20 fixtures
- Limited 3 Year Warranty



LENS CHARACTERISTICS				
Color	Transmission	Dispersion	Surface Texture	LED Diodes
Opaque White	Low	High	Smooth	Not Visible
Clear	Full	None	Smooth	Visible

Infinity Lights (Up To 180 Lumens Per Fixture)

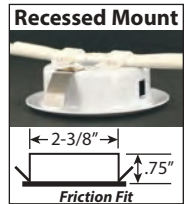
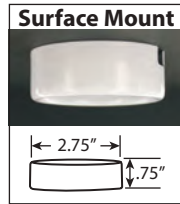
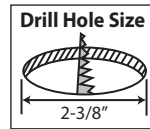

Lighting Specifications

Color Temperature	CW: 5700K PW: 4000K WW: 2800K-3200K
Beam Spread	120°
Lumens	CW: 166 PW: 180 WW: 166
Color Rendering Index	CW/PW: 85 WW: 80
Rated Average Life	50,000 hrs.
Constant	Voltage
Chip Size	SMD2835

Part #	Color Temp	Lens Type	# Of LED Chips	Total Wattage	Max # Can Connect	Price			
						Each		10+ Pcs.	
						OB, WH or BK	MC	OB, WH or BK	MC
<i>Matte Chrome *MC, Oil Rubbed Bronze *OB, White *WH & Black *BK</i>									
LED-L1TW*-CW	Cool White	Clear	12	3.8	20	\$18.00	\$24.00	\$16.00 ea.	\$21.00 ea.
LED-L1TW*-PW	Pure White		12	3.8	20	\$18.00	\$24.00	\$16.00 ea.	\$21.00 ea.
LED-L1TW*-WW	Warm White	Opaque White	12	3.8	20	\$18.00	\$24.00	\$16.00 ea.	\$21.00 ea.
LED-L1TW*-CW-FR	Cool White		12	3.8	20	\$18.00	\$24.00	\$16.00 ea.	\$21.00 ea.
LED-L1TW*-PW-FR	Pure White		12	3.8	20	\$18.00	\$24.00	\$16.00 ea.	\$21.00 ea.
LED-L1TW*-WW-FR	Warm White		12	3.8	20	\$18.00	\$24.00	\$16.00 ea.	\$21.00 ea.

Optional



Required

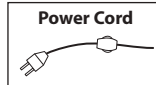

Optional

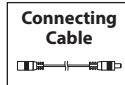

Required

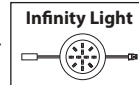

Power Cord (Required)



- Function: On/Off
- Cord Length: 10'

Part #	Finishes	Each	6+ Pcs.
LED-L1TW-PC-BK	Black	\$3.95	\$3.56 ea.
LED-L1TW-PC-WH	White	\$3.95	\$3.56 ea.

legrand® Dimmer Switches (Optional)



Input & Output Cords: 5.875" • Range of Dimming: 0-100% • Mounting: Wall

sofTap

Touch Switch With Touch Slide Dimmer

LED120-DIMST-MG Each: \$63.28 (Magnesium) | LED120-DIMST-WH Each: \$54.98 (White)

For More Options, Product Details & Wall Plates, See Page L-143



Connecting Cable (Optional)

Function: Is to allow the designer to get around unlit areas without multiple power supplies



Part #	Length	Color	Price	6+ Pcs.
LED-L1TW-CC24-WH	24"	White	\$2.50 ea.	\$2.25 ea.
LED-L1TW-CC36-BK	36"	Black	\$3.00 ea.	\$2.70 ea.
LED-L1TW-CC36-WH	36"	White	\$3.00 ea.	\$2.70 ea.

IMPORTANT: Due to Raw Material Fluctuation, Catalog Prices Below May Not Be Accurate. GO TO WWW.OUTWATER.COM FOR THE MOST UP-TO-DATE PRICES

LED Lighting

24V

LED lighting facts
A Figure of the LED 90!

Super Bright Light Output



Utopia Ultra Bright Puck Light- Only Pivot Option On The Market!

Does It All! Even Light Distribution Without Any Hot Spots!

Material: Aluminum with Opaque White Polycarbonate Lens

- Pivoting head allows light to be directed to desired locations
- Connectable
- Supplied with 18" connecting cable
- Connect up to 20 fixtures off one power supply

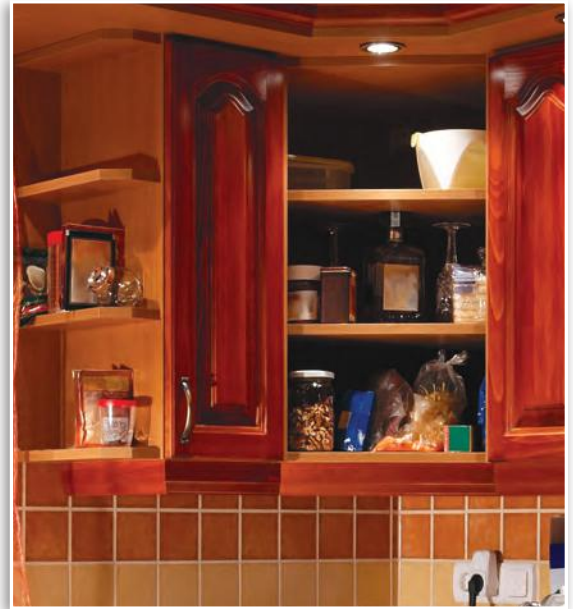

LENS CHARACTERISTICS				
Color	Transmission	Dispersion	Surface Texture	LED Diodes
Opaque White	Low	High	Smooth	Not Visible

Opaque White Lens: Allows the least light transmission. The effect softens the light, reduces glare and eliminates the "scalloping" caused by the LED's in most cases

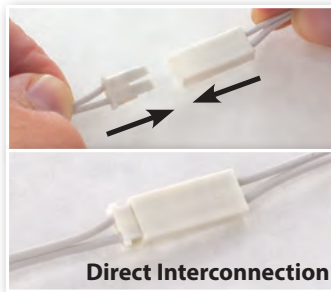

Utopia Ultra Bright Puck Light (Up To 180 Lumens Per Fixture)

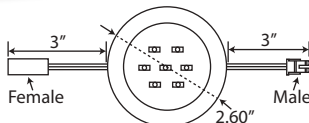
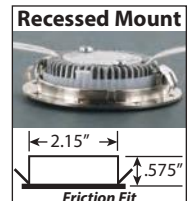
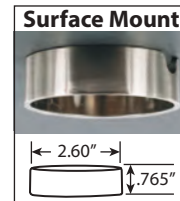
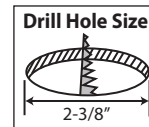

Lighting Specifications

Color Temperature	PW: 5700K WW: 2800K-3200K
Beam Spread	120°
Lumens	PW: 240 WW: 148
Color Rendering Index	PW/WW: 85
Rated Average Life	30,000 hrs.
Constant	Voltage
Chip Size	SMD5730

Part #	Finish	# Of LED Chips	Total Wattage	Max # Can Connect	Price	
					Each	10+ Pcs.
Pure White *PW & Warm White *WW						
LED-UTO-CHR-*	Stainless	7	2.5	20	\$11.50	\$10.25 ea.
LED-UTO-BK-*	Black	7	2.5	20	\$11.50	\$10.25 ea.
LED-UTO-WH-*	White	7	2.5	20	\$11.50	\$10.25 ea.
LED-UTO-SC-*	Satin Chrome	7	2.5	20	\$11.50	\$10.25 ea.



Accessories for Utopia Ultra Bright Puck Light

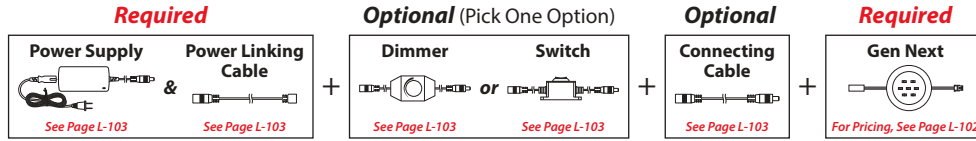

Required

Power Supplies

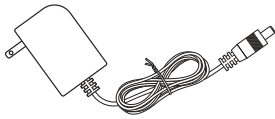

Part #	Type	Amps	Volts	Watts	Dimensions	Price	
						Each	6+ Pcs.
LED-24V-1A	Wall Mount	1A	24V	24W	3.13"L x 2.07"W x 1.52"H	\$11.65	\$10.60 ea.
LED-24V-3A	Desktop	3A	24V	72W	4.68"L x 2.34"W x 1.48"H	\$28.75	\$26.05 ea.

For Product Details & More Power Options, See Pages L-137~140
 Other Options: [Plug In](#) | [Hardwire](#) | [Hardwire Dimmable](#) | [Rechargeable Battery](#)

Power Linking Cable

Required for power supplies, dimmers & switches.



Part #	Description	Overall Length	Finish	Price	
				Each	6+ Pcs.
LED-WF-PWL	Power Link Cable with Utopia Connection	18"	White	\$3.00	\$2.60 ea.

For Product Details & More Power Linking Cables, See Page L-141

Optional

Dimmers

A power linking cable required.

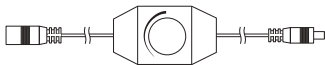

Part #	Description	Finish	Range of Dimming	Dimensions	Price	
					Each	6+ Pcs.
LED-INLINE-DIM	Inline Rotary	Black	0-100%	2-5/8"L x 1-3/8"W x 1"H	\$5.95	\$5.25 ea.
LED-INLINE-TCHDIM	Inline Touch	Black	0-100%	1-1/4"L x 3/4"W x 7/16"H	\$7.95	\$7.25 ea.

For Product Details & More Dimmer Options, See Pages L-134~136 & L-142~144
 Other Options: [Rotary](#) | [Touch Dimmer](#) | [Radio Frequency](#)

Switches

A power linking cable required.

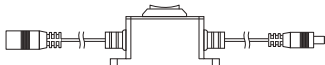

Part #	Description	Finish	Mounting	Dimensions	Price	
					Each	6+ Pcs.
LED-SWITCH-3A/6A	On/Off	Black	Surface	2-1/4"L x 1"W x 3/4"H	\$4.50	\$4.05 ea.

For Product Details & More Switch Options, See Page L-149

Connecting Cables



Part #	Function	Finish	Length	Price	
				Each	6+ Pcs.
LED-WF-CC24	Is to allow the designer to get around unlit areas without multiple power supplies	White	24"	\$2.00	\$1.60 ea.
LED-WF-CC36		White	36"	\$2.50	\$2.25 ea.

IMPORTANT: Due to Raw Material Fluctuation, Catalog Prices Below May Not Be Accurate. GO TO WWW.OUTWATER.COM FOR THE MOST UP-TO-DATE PRICES

LED Lighting



Marquee Puck Light Series

Material: Aluminum with Milk White Polycarbonate Lens

- Super bright with high output LED chip
- Offers even illumination without hotspots
- Very low profile & not obtrusive
- Easy install with included screws or spring clip

**NEW
COLOR TEMPS
Cool White,
Warm White &
Pure White**



LED Lens

LENS CHARACTERISTICS				
Color	Transmission	Dispersion	Surface Texture	LED Diodes
Milk White	Medium	Medium	Smooth	Slightly Visible

Milk White Lens: Allows moderate light transmission. The effect softens the light and reduces glare. A good choice for the largest variety of lighting situations.



12V

LED Lighting

Marquee Puck Light Series

Surface Square Marquee Puck (Up To 300 Lumens Per Fixture)

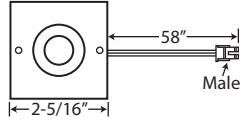

Surface Mount

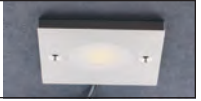
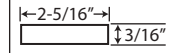

Lighting Specifications

Color Temperature	CW: 6000K-6500K WW: 2900K-3100K PW: 4000K
Beam Spread	120°
Lumens	CW/WW: 260-300
Color Rendering Index	CW/WW: 80
Rated Average Life	20,000 hrs.
Constant	Voltage
Chip Size	COB

Part #	Finish	# Of LED Chips	Total Wattage	Max # Can Connect	Price	
					Each	6+ Pcs.
Cool White *CW, Warm White *WW & Pure White *PW						
LED-MQSS-S*	Satin Aluminum	1	3.5	10	\$15.75	\$13.75 ea.

Recessed Square Marquee Puck (Up To 300 Lumens Per Fixture)

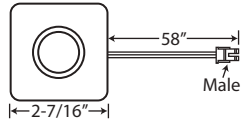

Drill Hole Size

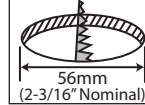

Recessed Mount

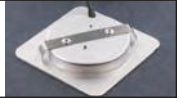

Lighting Specifications

Color Temperature	CW: 6000K-6500K WW: 2900K-3100K PW: 4000K
Beam Spread	120°
Lumens	CW/WW: 260-300
Color Rendering Index	CW/WW: 80
Rated Average Life	20,000 hrs.
Constant	Voltage
Chip Size	COB

Part #	Finish	# Of LED Chips	Total Wattage	Max # Can Connect	Price	
					Each	6+ Pcs.
Cool White *CW, Warm White *WW & Pure White *PW						
LED-MQSR-S*	Satin Aluminum	1	3.5	10	\$13.00	\$11.25 ea.

Surface Round Marquee Puck (Up To 300 Lumens Per Fixture)

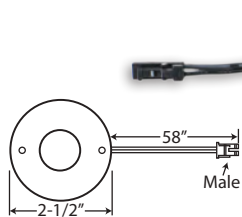

Surface Mount

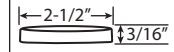

Lighting Specifications

Color Temperature	CW: 6000K-6500K WW: 2900K-3100K PW: 4000K
Beam Spread	120°
Lumens	CW/WW: 260-300
Color Rendering Index	CW/WW: 80
Rated Average Life	20,000 hrs.
Constant	Voltage
Chip Size	COB

Part #	Finish	# Of LED Chips	Total Wattage	Max # Can Connect	Price	
					Each	6+ Pcs.
Cool White *CW, Warm White *WW & Pure White *PW						
LED-MRQRD-S*	Satin Aluminum	1	3.5	10	\$14.25	\$12.25 ea.

Surface Square Marquee Plus (Up To 450 Lumens Per Fixture)

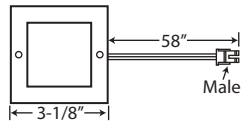

Surface Mount

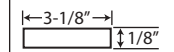

Lighting Specifications

Color Temperature	CW: 6000K-6500K WW: 2900K-3100K PW: 4000K
Beam Spread	120°
Lumens	CW/WW: 400-450
Color Rendering Index	CW/WW: 80
Rated Average Life	20,000 hrs.
Constant	Voltage
Chip Size	SMD5630

Part #	Finish	# Of LED Chips	Total Wattage	Max # Can Connect	Price	
					Each	10+ Pcs.
Cool White *CW, Warm White *WW & Pure White *PW						
LED-MQKS-B*	Brushed Satin	12	5	7	\$23.25	\$19.50 ea.



Accessories for Marquee Puck Light Series

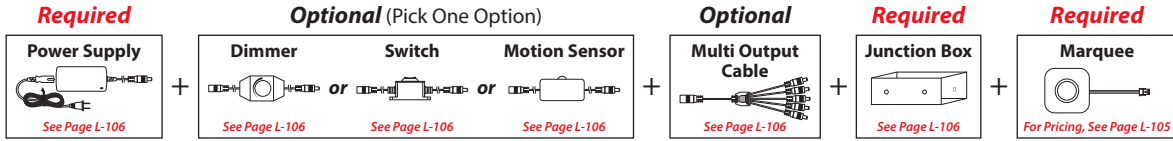

Required

Power Supplies

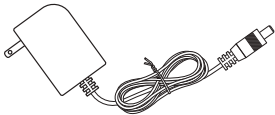

Part #	Type	Amps	Volts	Watts	Dimensions	Price	
						Each	6+ Pcs.
LED-12V-1A	Wall Mount	1A	12V	12W	2.91"L x 1.61"W x 1.14"H	\$8.95	\$8.20 ea.
LED-12V-3A	Wall Mount	3A	12V	36W	3.41"L x 2.31"W x 1.26"H	\$16.15	\$14.70 ea.

For Product Details & More Power Options, See Pages L-137~140
Other Options: Plug In | Hardwire | Hardwire Dimmable | Rechargeable Battery

Junction Box

Required for power supplies, dimmers, switches, motion sensors & multi output cables.



Part #	Function	Input Cord	# of Outputs	Dimensions	Price	
					Each	6+ Pcs.
LED-MQ-J3	Joins multiple	39" Female DC 5.5	3	1-1/2"L x 1-1/4"W x 3/8"H	\$2.75	\$2.30 ea.
LED-MQ-J4	fixtures to one	39" Female DC 5.5	4	1-1/2"L x 1-5/8"W x 3/8"H	\$3.25	\$2.70 ea.
LED-MQ-J5	powers supply	39" Female DC 5.5	5	1-1/2"L x 2-1/4"W x 3/8"H	\$3.45	\$2.85 ea.

Optional

Dimmers



Part #	Description	Finish	Range of Dimming	Dimensions	Price	
					Each	6+ Pcs.
LED-INLINE-DIM	Inline Rotary	Black	0-100%	2-5/8"L x 1-3/8"W x 1"H	\$5.95	\$5.25 ea.
LED-INLINE-TCHDIM	Inline Touch	Black	0-100%	1-1/4"L x 3/4"W x 7/16"H	\$7.95	\$7.25 ea.
LED-DIM-648D	Standard Touch	Silver/Black	0-100%	22mm: Dia. x 16mm: W	\$9.00	\$8.25 ea.

For Product Details & More Dimmer Options, See Pages L-134~136 & L-142~144
Other Options: Rotary | Touch Dimmer | Radio Frequency

Switches

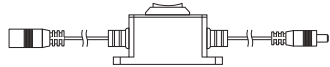

Part #	Description	Finish	Mounting	Dimensions	Price	
					Each	6+ Pcs.
LED-SWITCH-3A/6A	On/Off	Black	Surface	2-1/4"L x 1"W x 3/4"H	\$4.50	\$4.05 ea.
LED-OS-648A	Touch On/Off	Silver/Black	Recessed	22mm: Dia. x 16mm: W	\$9.00	\$8.50 ea.

For Product Details & More Switch Options, See Page L-149

Motion Sensors



Part #	Description	Finish	Mounting	Dimensions	Price	
					Each	6+ Pcs.
LED-DSEN	Door Sensor	Silver	Surface/ Recessed	Surface: 2-1/2"L x 1-1/8"W x 11/16"H Recessed: 2-1/2"L x 5/8": Dia.	\$11.75	\$10.90 ea.
LED-MSEN	Door Sensor	Black	Surface	2-1/4"L x 1"W x 3/4"H	\$14.50	\$13.05 ea.

For Product Details & More Motion Sensor Options, See Page L-142

Multi Output Cables

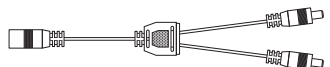

Part #	Description	Finish	Arms Size	# of Arms	Overall Length	Max # of Power Linking Cables	Price	
							Each	6+ Pcs.
LED-2WAY-BK	2-Way Sweep	Black	3"	2	6-3/4"	2	\$2.95	\$2.50 ea.

For More Extension Cable Options, See Page L-147

**IMPORTANT: Due to Raw Material Fluctuation, Catalog Prices Below May Not Be Accurate.
GO TO WWW.OUTWATER.COM FOR THE MOST UP-TO-DATE PRICES**

For Multiple Design Options...
**Outwater Introduces:
The “Way Far” Better Light**



LED Wafer Puck Light Series

Wafer Puck Light

- No Holes To Bore
- Surface Mount
- Connectable
- Lightweight
- Super Thin
- Easy To Install:
Available In Magnetic, Adhesive or Surface Mount



See Page L-108

Moveable Wafer Track System

- Add A Light
Anywhere Needed
- Adjustable
- Lightweight
- Super Thin 1/4”
- Easy To Install

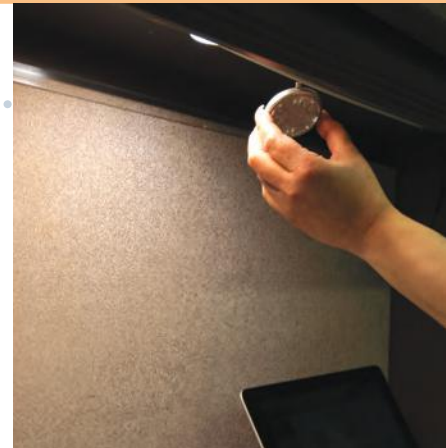

See Page L-109

Wafer Puck Light Battery Kit

- No Power Supply
- Install Anywhere
- All Inclusive Kit
- Lightweight
- Super Thin 1/4”
- Easy To Install



See Page L-112

Phone: 1-800-631-8375 - Fax: 1-800-888-3315
Due to raw material cost fluctuations, prices are subject to change.

L- 107
Lighting

IMPORTANT: Due to Raw Material Fluctuation, Catalog Prices Below May Not Be Accurate. GO TO WWW.OUTWATER.COM FOR THE MOST UP-TO-DATE PRICES

LED Lighting



Wafer Puck Light

The "Way Far" Better Light
Thinnest Surface Mounted Puck- Recessed Look Without The Work!

Material: PVC Body with Prismatic Clear Polycarbonate Lens

- Super thin & super bright
- Greater light output than a 20W halogen bulb
- Dimmable
- Supplied with 18" connecting cable



Screw Mount for Wood Surfaces
 *Screws Included



"Rare Earth" Magnet for Metal Surfaces

Designed For Multiple Surfaces



Self Adhesive 3M™ for Glass

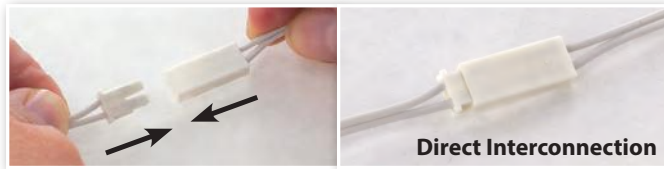

Direct Interconnection

Connect Up To 25 Pucks Per Power Supply

Wafer Puck Light (Up To 250 Lumens Per Fixture)



IP20 Wafer Puck Light
 Provides Low Protection of Dust & Water



Each Fixture Includes Additional 18" Extension Cable

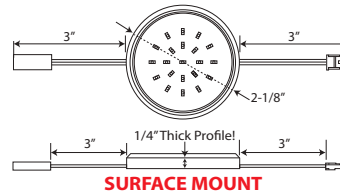

Lighting Specifications

Color Temperature	CW: 6500K WW: 2800K-3200K
Beam Spread	120°
Lumens	CW: 250 WW: 230
Color Rendering Index	CW: 80 WW: 85
Rated Average Life	30,000 hrs.
Constant	Voltage
Chip Size	SMD3014

Part #	Color Temp	Finish	Mount Options	# Of LED Chips	Total Wattage	Max # Can Connect	Price	
							Each Kit	10+ Kits
LED-WF-MC-CW-A	Cool White	Matte Chrome	Adhesive or Screw Mount	21 Per Fixture	2.2	5 fixtures for 1 amp power supply 15 fixtures for 3 amp power supply	\$9.00	\$7.80 ea.
LED-WF-MC-WW-A	Warm White	Matte Chrome	Adhesive or Screw Mount	21 Per Fixture	2.2	25 fixtures for 5 amp power supply	\$9.00	\$7.80 ea.

IMPORTANT: Due to Raw Material Fluctuation, Catalog Prices Below May Not Be Accurate. GO TO WWW.OUTWATER.COM FOR THE MOST UP-TO-DATE PRICES



12V

LED Lighting

Moveable Wafer Track System

Material: PVC Body with Prismatic Clear Polycarbonate Lens

- Easily move the puck light anywhere along the track
- Freedom to add puck lights anywhere you need them
- Offered with 3', 4', 6' & 12' track
- Connect up to 25 puck lights off 1 power supply
- Available jumper cable allow for shelf to shelf lighting connection



Connect Up To 25 Pucks Per Power Supply

IP20 Moveable Wafer Track System
Provides Low Protection of Dust & Water

Moveable Wafer Track System (Up To 250 Lumens Per Fixture)

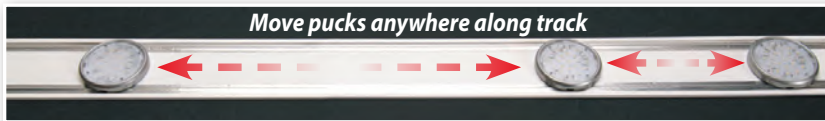

Add a light anywhere needed!

1 Choose a Track (comes with adhesive):



Part #	Length	Price
<i>Black *BK & White *WH</i>		
LED-WF-TRK-2*	2'	\$4.00 ea.
LED-WF-TRK-3*	3'	\$6.00 ea.
LED-WF-TRK-4*	4'	\$8.00 ea.
LED-WF-TRK-6*	6'	\$12.00 ea.
LED-WF-TRK-12*	12'	\$24.00 ea.

Lighting Specifications

Color Temperature	CW: 6500K WW: 2800K-3200K
Beam Spread	120°
Lumens	CW: 250 WW: 230
Color Rendering Index	CW: 80 WW: 85
Rated Average Life	30,000 hrs.
Constant	Voltage
Chip Size	SMD3014

2 Choose Number of Wafer Lights:

Part #	Color Temp	Finish	# Of LED Chips	Total Wattage	Max # Can Connect	Price	
						Each	10+
LED-WF-MC-CW-MT	Cool White	Matte Chrome	21 Per Fixture	2.2	5 fixtures for 1 amp power supply 15 fixtures for 3 amp power supply	\$9.00	\$7.80 ea.
LED-WF-MC-WW-MT	Warm White	Matte Chrome	21 Per Fixture	2.2	25 fixtures for 5 amp power supply	\$9.00	\$7.80 ea.

Accessories for Wafer Puck Light & Moveable Wafer Track System

Accessories That Work With Wafer Puck Light

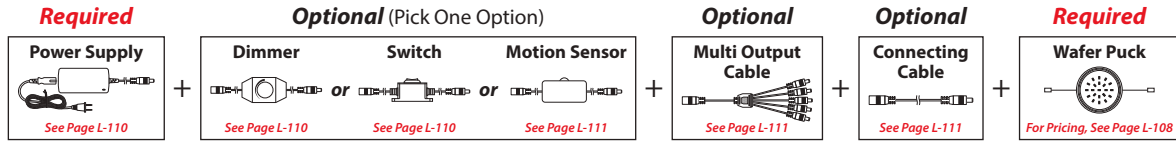

Accessories That Work With Moveable Wafer Track System

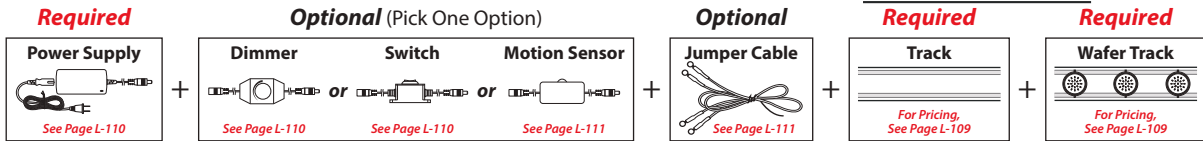

Required

Power Supplies

PLUG & PLAY

Short Circuit Protection • Overload Circuit Protection • IP20 • Constant Voltage • Comes With Appropriate Power Linking Cable • Limited 2 Year Warranty

Plug Type (1A / 12V / 12W)

- 2.91" L x 1.61" W x 1.14" H
- 22AWG Output Cord: 72"
- Polarized 2 Prong Plug

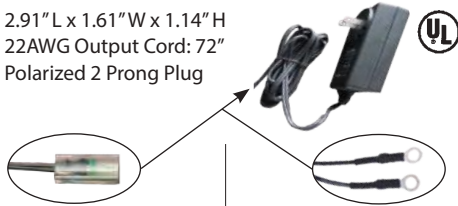

Wafer Puck
LED-WF-TR-1A

Each: \$8.95 / 6+ Pcs.: \$8.20 ea.

Wafer Track
LED-WFT-TR-1A

Each: \$8.95 / 6+ Pcs.: \$8.20 ea.

Plug Type (3A / 12V / 36W)

- 3.41" L x 2.31" W x 1.26" H
- 18AWG Output Cord: 72"
- Polarized 2 Prong Plug

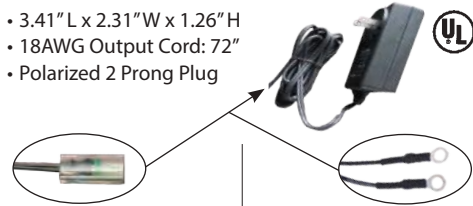

Wafer Puck
LED-WF-TR-3A

Each: \$16.15 / 6+ Pcs.: \$14.70 ea.

Wafer Track
LED-WFT-TR-3A

Each: \$16.15 / 6+ Pcs.: \$14.70 ea.

Power Linking Cable

Required for dimmers, switches & multi output cables.



Part #	Description	Overall Length	Finish	Price	
				Each	6+ Pcs.
LED-WF-PWL	Power Link Cable with Wafer Connection	18"	White	\$3.00	\$2.60 ea.

For Product Details & More Power Linking Cables, See Page L-141

Optional

Dimmers

A power linking cable required.

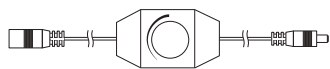

Part #	Description	Finish	Range of Dimming	Dimensions	Price	
					Each	6+ Pcs.
LED-INLINE-DIM	Inline Rotary	Black	0-100%	2-5/8"L x 1-3/8"W x 1"H	\$5.95	\$5.25 ea.
LED-INLINE-TCHDIM	Inline Touch	Black	0-100%	1-1/4"L x 3/4"W x 7/16"H	\$7.95	\$7.25 ea.

For Product Details & More Dimmer Options, See Pages L-134~136 & L-142~144

Other Options: Rotary | Touch Dimmer | Radio Frequency

Switches

A power linking cable required.

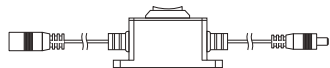

Part #	Description	Finish	Mounting	Dimensions	Price	
					Each	6+ Pcs.
LED-SWITCH-3A/6A	On/Off	Black	Surface	2-1/4"L x 1"W x 3/4"H	\$4.50	\$4.05 ea.
LED-PLUNT-36-WH	On Door Opens/ Off Door Closed	Black	Surface	2-3/4"L x 2"W x 1"H	\$13.50	\$12.15 ea.

For Product Details & More Switch Options, See Page L-149



Accessories for Wafer Puck Light & Moveable Wafer Track System

Accessories That Work With Wafer Puck Light

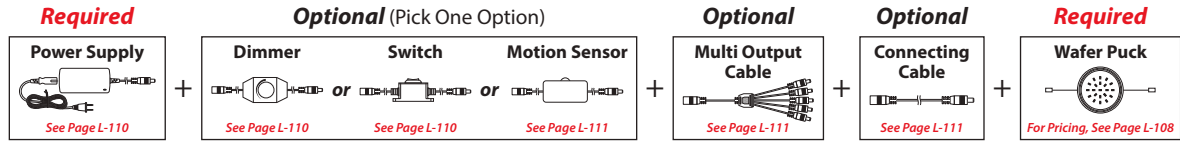

Accessories That Work With Moveable Wafer Track System

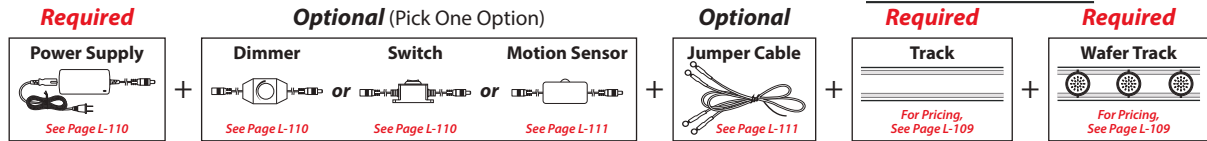

Optional

Motion Sensors

A power linking cable required.



Part #	Description	Finish	Mounting	Dimensions	Price	
					Each	6+ Pcs.
LED-MSN	Door Sensor	Black	Surface	2-1/4"L x 1"W x 3/4"H	\$14.50	\$13.05 ea.

For Product Details & More Motion Sensor Options, See Page L-142

Multi Output Cables

Works with wafer puck light only
A power linking cable required for each outlet.



Part #	Description	Finish	Arms Size	# of Arms	Overall Length	Max # of Power Linking Cables	Price	
							Each	6+ Pcs.
LED-5OUT-CBL-BK	5-Way Sweep	Black	8-3/4"	5	19"	5	\$5.50	\$4.85 ea.
LED-SPIDER-CBL	3-Way Spider	Black	4-1/2"	3	96"	4	\$6.25	\$5.55 ea.

For More Extension Cable Options, See Page L-147

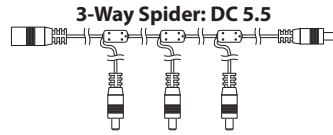

Connecting Cables

Works with wafer puck light only



Part #	Function	Finish	Length	Price	
				Each	6+ Pcs.
LED-WF-CC24	Is to allow the designer to get around unlit areas without multiple power supplies	White	24"	\$2.00	\$1.60 ea.
LED-WF-CC36		White	36"	\$2.50	\$2.25 ea.

Jumper Cable

Works with wafer puck light only



Part #	Function	Finish	Length	Price	
				Each	6+ Pcs.
JC24	Designed to connect one track to another / Useful when going level to level or make a 90° turn	Black	24"	\$2.50	\$2.25 ea.

IMPORTANT: Due to Raw Material Fluctuation, Catalog Prices Below May Not Be Accurate. GO TO WWW.OUTWATER.COM FOR THE MOST UP-TO-DATE PRICES

LED Lighting



Wafer Puck Light- Battery Operated Kit

Outwater is proud to introduce the first of its kind, low cost LED Closet & Cabinetry battery operated Wafer Puck Light!

Material: PVC Body with Prismatic Clear Polycarbonate Lens

- Super thin, low profile... great for tight applications
- The included door plunger allows the light to turn on when the door is open & off when closed without depleting battery life
- When activated, the built-in timer on the door plunger allows light to turn off automatically in 90 seconds, thus saving battery power
- Cheaper than installing an electrical outlet
- Suited for existing closets, cabinets or drawers
- Surface mounts with supplied peel & stick tape or screws
- Low voltage - no risk of shock



IP20 Thin Strip
Provides Low Protection of Dust & Water

Wafer Puck Light- Battery Operated Kit (Up To 250 Lumens Per Fixture)



ALL INCLUSIVE KIT WITH RECHARGEABLE BATTERY



- (A) 3 lights w/peel & stick adhesive, screws & (3) 18" extension leads.
- (B) Rechargeable 4800MAH Battery pack: 4-1/4"L x 2-1/4"W x 3/4"H comes supplied with power supply
Battery Life Expectancy: 8.7 Hours Continuous
See Page L-140 For More Info.
- (C) Door plunger: 2-3/4"L x 2"W x 1"H w/3' input/output wires

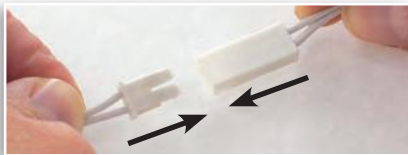

Direct Interconnection

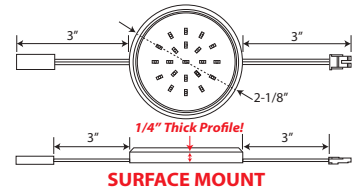

Lighting Specifications

Color Temperature	CW: 6500K WW: 2800K-3200K
Beam Spread	120°
Lumens	CW: 250 WW: 230
Color Rendering Index	CW: 80 WW: 85
Rated Average Life	30,000 hrs.
Constant	Voltage
Chip Size	SMD3014

Part #	Color Temp	Description	Finish	Mount Options	# Of LED Chips	Total Wattage	Price	
							Each Kit	10+ Kits
LED-WF-RB-MC-CW	Cool White	Rechargeable	Matte	Adhesive or	21 Per	2.2	\$59.95	\$54.95 ea.
LED-WF-RB-MC-WW	Warm White	Battery Kit	Chrome	Screw Mount	Fixture	2.2	\$59.95	\$54.95 ea.

See Page L-108 for our LED Wafer "Way Far" Better Light & Page L-109 for our LED Wafer Track System

For other Closet Lighting, See Page L-100

IMPORTANT: Due to Raw Material Fluctuation, Catalog Prices Below May Not Be Accurate. GO TO WWW.OUTWATER.COM FOR THE MOST UP-TO-DATE PRICES



LED Lighting

Venus Ultra Bright Puck Light

Material: Aluminum with Clear Polycarbonate Lens

- Extremely bright 3-1/2" produces a "Shower of Light"
- Supplied with 39" connecting cable
- Connect up to 12 fixtures off one power supply



**NEW & IMPROVED
Higher Lumens!
Lower Cost!**



IP65 Venus Ultra Bright Puck Light
Provides Protection From Dust & Splashing Water, Not Submersible

Venus Ultra Bright Puck Light (Up To 325 Lumens Per Fixture)

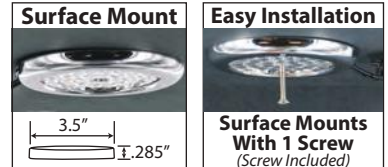

Lighting Specifications

Color Temperature	PW: 3800K-4200K WW: 2800K-3200K
Beam Spread	90°
Lumens	PW: 325 WW: 300
Color Rendering Index	PW/WW: 75
Rated Average Life	50,000 hrs.
Constant	Voltage
Chip Size	SMD3528

Part #	Finish	# Of LED Chips	Total Wattage	Max # Can Connect	Price	
					Each	10+ Pcs.
Pure White *PW & Warm White *WW						
LED-VEN-CHR*	Polished Chrome	42	3	12	\$17.25	\$14.95 ea.
LED-VEN-BCH*	Brushed Chrome	42	3	12	\$17.25	\$14.95 ea.

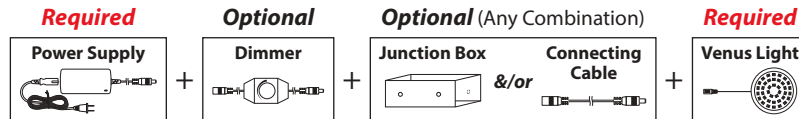

Power Supplies With Connection (Required)

PLUG & PLAY

Short Circuit Protection • Overload Circuit Protection • IP20 • Constant Voltage
Comes With DC 3.5 Male Power Linking Cable • Limited 2 Year Warranty

Desk Top (1.5A / 24V / 36W)

- 4.56" L x 1.92" W x 1.3" H
- 18AWG Input Cord: 60"
- 20AWG Output Cord: 60"
- Green On/Off LED Indicator Light
- Polarized 2 Prong Plug



LED-24V-1.5A

Each: \$23.50 / 6+ Pcs.: \$21.15 ea.

Desk Top (2A / 24V / 45W)

- 4.375" L x 1.75" W x 1.25" H
- 18AWG Input Cord: 60"
- 20AWG Output Cord: 60"
- Green On/Off LED Indicator Light
- Polarized 2 Prong Plug

LED-24V-2A

Each: \$24.50 / 6+ Pcs.: \$22.25 ea.

Junction Box (Optional)

Function: Is to join multiple fixtures to one power supply

- 1-5/8" L x 1-1/4" W x 5/8" H
- Power In: 1 Port
- Power Out: 4 Ports



LED-CLE-JB

Each: \$2.95 / 6+ Pcs.: \$2.45 ea.

Connecting Cable (Optional)

Function: To connect junction box or other lights

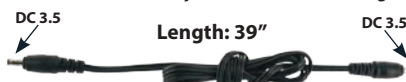

LED-35MM-39CC-BK

Each: \$2.50

Dimmer (Optional)



LED-CLE-DIM

Each: \$5.95
6+ Pcs.: \$5.25 ea.

- On/Off Switch
- 3-3/4" L x 1-1/8" W x 3/8" H
- Male DC 3.5 Output Cord: 36"
- Range of Dimming: 0-100%
- Mounting: Screw

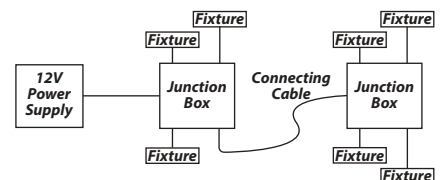

IMPORTANT: Due to Raw Material Fluctuation, Catalog Prices Below May Not Be Accurate. GO TO WWW.OUTWATER.COM FOR THE MOST UP-TO-DATE PRICES

LED Lighting



LED Top Hat Spotlight

Material: Satin Aluminum with Clear Polycarbonate Lens

- Sleek & Attractive Design
- Connectable
- Surface Mount

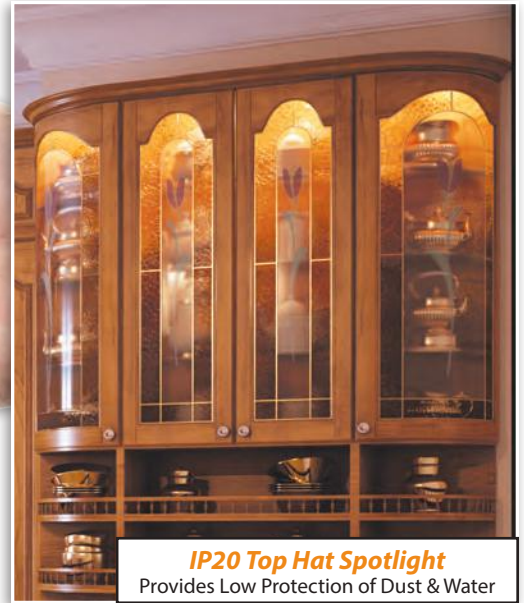

IP20 Top Hat Spotlight
Provides Low Protection of Dust & Water

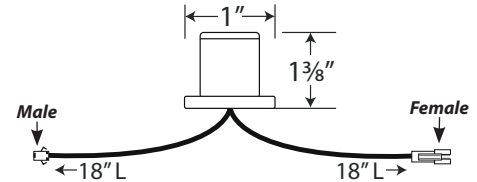

Top Hat Spotlight (Up To 85 Lumens Per Fixture)



Lighting Specifications

Color Temperature	CW: 6500K
Beam Spread	60°
Lumens	CW: 85
Color Rendering Index	CW: 80
Rated Average Life	30,000 hrs.
Constant Voltage	
Chip Size	5MM DIA

Part #	Color Temp	Nominal Size	# Of LED Chips	Total Wattage	Max # Can Connect	Each	Price
LED-TOPHAT-CW	Cool White	1" Dia. x 1-3/8" H	1	1	10	\$15.00	10+ Pcs. \$13.95 ea.

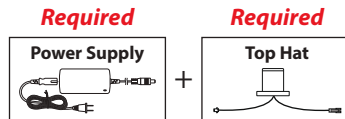

Power Supplies (Required)

PLUG & PLAY

Short Circuit Protection • Overload Circuit Protection • IP20 • Constant Voltage Comes With Appropriate Power Linking Cable • Limited 2 Year Warranty



Plug Type (1A / 12V / 12W)

- 2.91" L x 1.61" W x 1.14" H
 - 22AWG Output Cord: 60"
 - Polarized 2 Prong Plug
- LED-12V-1A**
Each: \$8.95
6+: \$8.20 ea.

Optional Rechargeable Battery Available
See page L-140



How Long Will My Battery Last?

Battery Longevity: $\frac{\text{AMPS} \times \text{VOLTS}}{\text{WATTS}} = \text{HRS}$



Connectable Canister Light- LED & Halogen

Material: Steel

- All metal construction
- Spring clip mounting
- 3-3/4" drill hole size
- FB-*: Includes 50W PAR-20 Halogen Bulb
- LED-FB-*: Includes 8W LED PAR-20 Bulb

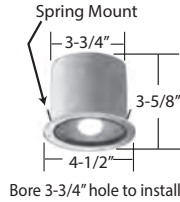

FB-1 (Single)
LED-FB-1 (Single)
Roll switch 5' from plug
Cord Length: 10'



FB-2 (Starter)
LED-FB-2 (Starter)
Roll switch 5' from plug
Cord Length: 10' 30" Extension



FB-3 (Joiner)
LED-FB-3 (Joiner)
30" Extension



FB-4 (End)
LED-FB-4 (End)
30" Power Cord



Part #	Bulb Type	Price	
		Each	5+ Pcs.
Black (*BK), Polished Brass (*BR) & Polished Chrome (*PC)			
FB-1*	Halogen	\$31.22	\$27.36 ea.
FB-2*	Halogen	\$32.51	\$28.47 ea.
FB-3*	Halogen	\$32.51	\$28.47 ea.
FB-4*	Halogen	\$32.51	\$28.47 ea.
LED-FB-1*-CW	LED Cool White	\$41.17	\$36.40 ea.
LED-FB-2*-CW	LED Cool White	\$42.46	\$37.50 ea.
LED-FB-3*-CW	LED Cool White	\$42.46	\$37.50 ea.
LED-FB-4*-CW	LED Cool White	\$42.46	\$37.50 ea.
LED-FB-1*-WW	LED Warm White	\$41.17	\$36.40 ea.
LED-FB-2*-WW	LED Warm White	\$42.46	\$37.50 ea.
LED-FB-3*-WW	LED Warm White	\$42.46	\$37.50 ea.
LED-FB-4*-WW	LED Warm White	\$42.46	\$37.50 ea.

Lighting Specifications

Color Temperature	CW: 6000K-6800K WW: 2700K-3200K Halogen: 3000K
-------------------	--

Plug-In Swivel Recessed- LED & Halogen

Material: Steel

- All metal construction
- Spring clip mounting
- 2-7/8" drill hole size
- 24" cord with polarized plug

Available Finishes for RLF & HSP Series:



Lighting Specifications

Color Temperature	NW: 5000K WW: 2700K-3200K Halogen: 2700K
-------------------	--

HSP Series

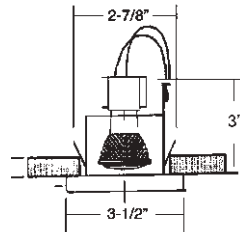

Part #	Bulb Type	Price	
		Each	20+ Pcs.
Black (*BK), White (*WH), Brushed Chrome (*BC), & Chrome (*CHR)			
HSP-35-*	Halogen	\$20.27	\$17.06 ea.
LED-35-*-4W-NW	LED Natural Wh.	\$28.00	\$24.40 ea.
LED-35-*-5W-WW	LED Warm White	\$28.00	\$24.40 ea.
REPLACEMENT HALOGEN BULB			
HSP-35-BULB	Halogen	\$6.83	-
REPLACEMENT LED BULB			
LG10-40-NW	Natural White	\$7.75	-
LG10-30-WW	Warm White	\$7.75	-

See Page L-151 For LED Bulb Specs

- HSP-35-* includes halogen 35W/120V GU-10 base lamp
- LED-35-*-5W-* includes LED 5W/120V GU-10 base lamp
- Dimmable

PLEASE NOTE: BULBS ARE COMPLIMENTARY. WE ARE NOT RESPONSIBLE FOR BREAKAGE DURING SHIPPING OR DEFECTS.

IMPORTANT: Due to Raw Material Fluctuation, Catalog Prices Below May Not Be Accurate. GO TO WWW.OUTWATER.COM FOR THE MOST UP-TO-DATE PRICES

LED Lighting

110V

Ambient Mood Light Output

RGB

Twinkle Fiber Optics

Recommended Panel Material: Gloss Finish Acrylic

Material: PMMA

- Endless End of Light for ceiling & Curtain Effect possibilities for creating one of a kind effects
- Covers area approximately 6.5' x 6.5' (42.25 sq. ft.)
- Light engine can be set for single color, gradual change, jumping change or twinkle effects
- Fiber optic kits with black polyethylene coating are suitable for moist environments
- Star point refers to the points where the fibers come through the panel
- In End of Light applications, alternating the use of included end pieces and optional starburst end caps create a realistic night sky effect
- In Light Curtain applications, fibers can be trimmed at any point to create your desired effect

Lighting Specifications

Beam Spread	120°
Lumens	Red/Green/Blue: 180
Rated Average Life	50,000 hrs.



End of Light Kit With Black Polyethylene Coating

ALL INCLUSIVE KIT

- (A) Light engine w/remote
Installation instructions included
- (B) 40 strands of fiber, 2.2mm thick
- (C) 40 end pieces

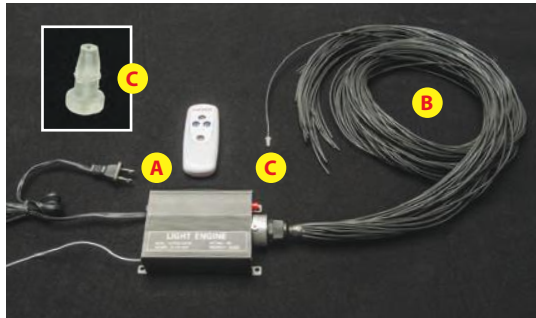
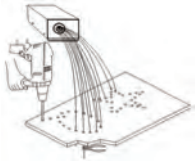

Part #	Length	# of Fibers	Star Points Per Sq. Ft.	Total Wattage	Price
LED-FO-40	6'6"	40	2	16	\$184.00 ea.

Curtain Effect Kit Without Black Polyethylene Coating

ALL INCLUSIVE KIT

- (A) Light engine w/remote
Installation instructions included
- (B) 120 strands of fiber,
(60) .75mm thick, (60) 1.0mm thick
- (C) 120 end pieces

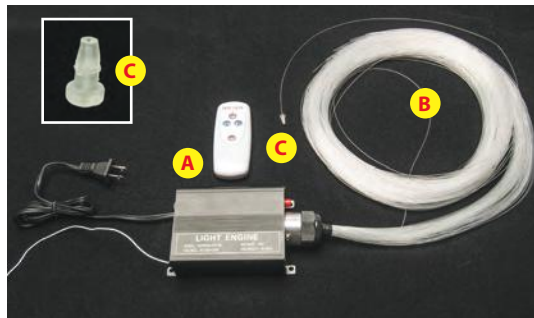

Part #	Length	# of Fibers	Star Points Per Sq. Ft.	Total Wattage	Price
LED-FO-60	6'6"	120	6	16	\$189.00 ea.

Starburst End Cap (Optional)



LED-FO-STAR
Each: \$0.50

Optic Comb For Use With Curtain Effect Kit (Optional)



LED-FO-COMB
Each: \$2.00

- 30" L x 3/16" W x 5/8" H
- Material: Linear PE Plastic
- Color: Ivory

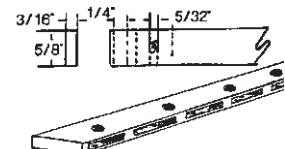

IMPORTANT: Due to Raw Material Fluctuation, Catalog Prices Below May Not Be Accurate. GO TO WWW.OUTWATER.COM FOR THE MOST UP-TO-DATE PRICES



LED Lighting

Grip It - No Drill Clamp: Illuminated

Material: Clear Anodized Aluminum

- No drilling required
- All mounting hardware installed
- The clamp wire 38" long

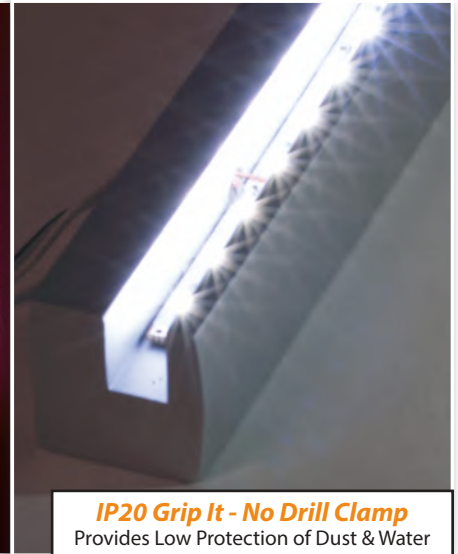

IP20 Grip It - No Drill Clamp
Provides Low Protection of Dust & Water

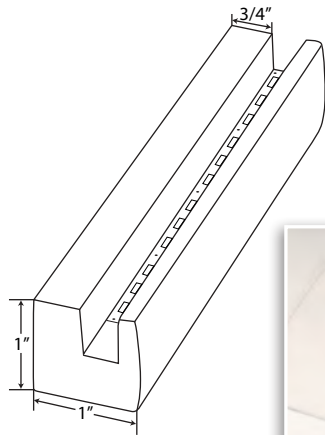

Finish:

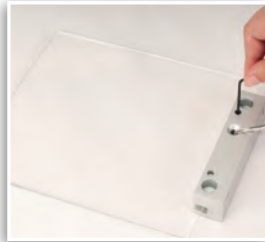

Part #	Color Temp	Finish	Panel Thickness	▲ Maximum Sign Size	Length	# Of LED Chips	Total Wattage	Price	
								Each	20+
LED-SC80-MC	Cool	Matte	3/16"	6-5/16" x	3-1/8"	6	.4	\$12.16	\$11.01 ea.
	White	Chrome	5/16"	6-5/16"					
LED-SC120-MC	Cool	Matte	3/16"	9-1/2" x	4-3/4"	9	.6	\$15.07	\$13.67 ea.
	White	Chrome	5/16"	9-1/2"					
LED-SC180-MC	Cool	Matte	3/16"	14-3/16" x	7-1/16"	12	.8	\$17.82	\$16.12 ea.
	White	Chrome	5/16"	14-3/16"					

▲ Maximum sign size per piece

Lighting Specifications

Color Temperature	CW: 6000K-6500K
Beam Spread	120°
Lumens	CW: 40-80
Color Rendering Index	CW: 70
Rated Average Life	50,000 hrs.
Chip Size	SMD3528

Required

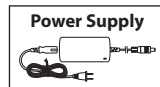

Required

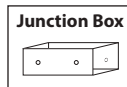

Required



Power Supplies (Required)

PLUG & PLAY

Short Circuit Protection • Overload Circuit Protection • IP20
Constant Voltage • Limited 2 Year Warranty
Comes With Appropriate Power Linking Cable

Plug Type (1A / 12V / 12W)

- 2.91" L x 1.61" W x 1.14" H
- Output Cord: 60"
- Polarized 2 Prong Plug

LED-SC-TR-1A

Each: \$8.95 / 6+ Pcs.: 8.20 ea.



Junction Box (Required)

Function: Is to join multiple fixtures to one power supply

LED-STD-JB10

Each: \$3.00

- 2" L x 1-1/4" W x 1/2" H
- # of Outputs: 10
- Input Cord: 19-11/16"



IMPORTANT: Due to Raw Material Fluctuation, Catalog Prices Below May Not Be Accurate. GO TO WWW.OUTWATER.COM FOR THE MOST UP-TO-DATE PRICES

LED Lighting



LED Standoffs: Perfect for Lobbies & Reception Areas

Material: Aluminum

- The standoff wire is 38" long
- Up to 10 pieces can be connected to one power supply
- #6 screws & drywall anchors included



IP20 LED Standoffs
Provides Low Protection of Dust & Water

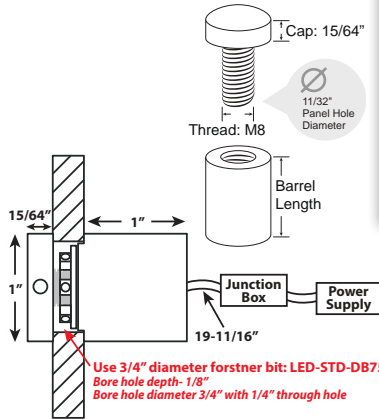

Use 3/4" diameter forstner bit: LED-STD-DB75
Bore hole depth: 1/8"
Bore hole diameter 3/4" with 1/4" through hole

Maximum Recommended Spacing:
20" x 20" for 4 Standoffs

Finishes:

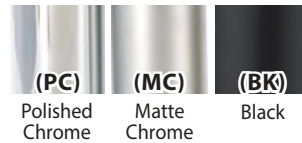

Lighting Specifications

Color Temperature	CW: 6000K-6500K
Beam Spread	120°
Lumens	CW: 30-40
Color Rendering Index	CW: 70
Rated Average Life	10,000 hrs.
Chip Size	SMD2908

Part #	Color Temp	Finish	Panel Thickness (When Graphic is Routed)	Barrel Length	Thread Length	Diameter	# Of LED Chips	Total Wattage	Price	
									Each	60+
STD-LED-2525-PC	Cool White	Polished Chrome	Up to 1/2"	1"	3/4"	1"	6	.4	\$7.83	\$6.83 ea.
STD-LED-2525-MC	Cool White	Matte Chrome	Up to 1/2"	1"	3/4"	1"	6	.4	\$7.83	\$6.83 ea.
STD-LED-2525-BK	Cool White	Black	Up to 1/2"	1"	3/4"	1"	6	.4	\$7.83	\$6.83 ea.
STD-LED-2525-M-*	Red (*RD), Blue (*BL) & Green (*GR)	Matte Chrome	Up to 1/2"	1"	3/4"	1"	6	.4	\$7.83	\$6.83 ea.
STD-LED-2525-B-*	Red (*RD), Blue (*BL) & Green (*GR)	Black	Up to 1/2"	1"	3/4"	1"	6	.4	\$7.83	\$6.83 ea.

Please Inquire for our wall anchor selections
For More Standoffs, Please Inquire

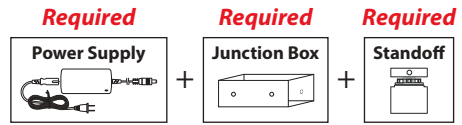

Power Supplies (Required)

PLUG & PLAY

- Short Circuit Protection • Overload Circuit Protection • IP20
- Constant Voltage • Limited 2 Year Warranty
- Comes With Appropriate Power Linking Cable

Plug Type (1A / 12V / 12W)

- 2.91" L x 1.61" W x 1.14" H
- Output Cord: 60"
- Polarized 2 Prong Plug

LED-STD-TR-1A
Each: \$8.95
6+ Pcs.: \$8.20 ea.



Junction Box (Required)

Function: Is to join multiple fixtures to one power supply

LED-STD-JB10
Each: \$3.00

- 2" L x 1-1/4" W x 1/2" H
- # of Outputs: 10
- Input Cord: 19-11/16"



Forstner Drill Bit (Optional)

- Extra sharp cutting edges for smooth, flat bottomed holes
- Hole Size: 3/4"
- Shank: 3/8"

LED-STD-DB75
Each: \$10.50



Optional Rechargeable Battery Available
See page L-140



How Long Will My Battery Last?

Battery Longevity:
(AMPS x VOLTS) = HRS WATTS

IMPORTANT: Due to Raw Material Fluctuation, Catalog Prices Below May Not Be Accurate. GO TO WWW.OUTWATER.COM FOR THE MOST UP-TO-DATE PRICES



LED Lighting

LED Ladder Backlight System

Available Lengths: Nominal 20" & 40"

Material: Aluminum with White Coating

- Ultra Bright: Latest 2835 chip technology produces up to 1440 lumens per length.
- Works with FSB41TX-CL, FSB81TX-CL & FSB150TX-CL. *Please Inquire*
- Backlight as little as 1-1/2" depth without hotspots
- Easily connect ladders together for versatile sizing
- No heat sink required

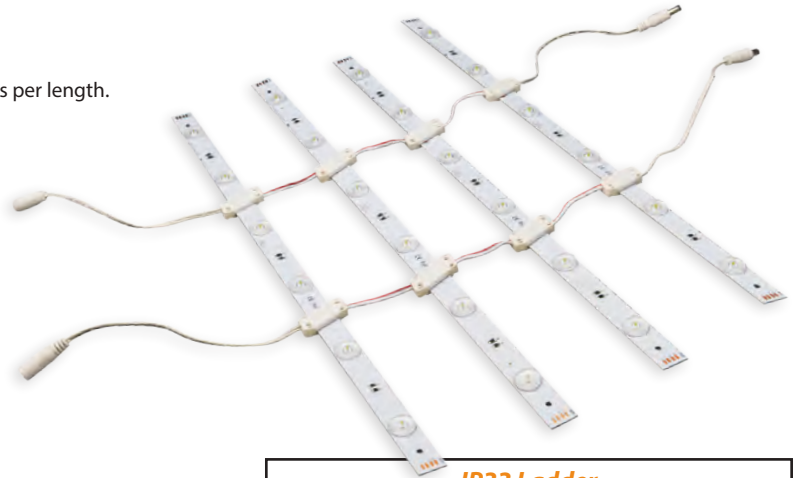

IP33 Ladder
Limited Protection From Touch, Tools & Splashing Water

Ask About Our Sample SEG Framing Kit



Part #: FOGA-DES-KIT

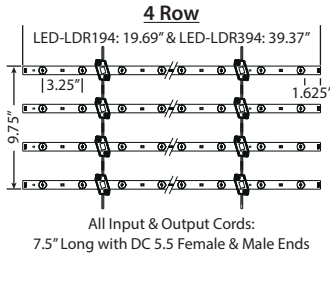
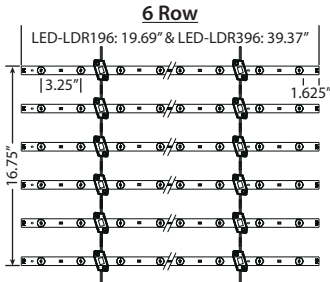

All Input & Output Cords:
7.5" Long with DC 5.5 Female & Male Ends

Lighting Specifications

Color Temperature	CW: 6500K
Beam Spread	168°
Lumens	436 per ft.
Color Rendering Index	85+
Rated Average Life	50,000 hrs.
Constant	Voltage
Chip Size	2835

Part #	Color Temp	Description	# Of LED Chips	Total Wattage	Max # Can Connect	Each	10+ Pcs.
LED-LDR194-CW	Cool White	4- Row 19.69" Length	24	29	5	\$15.90	\$12.75 ea.
LED-LDR196-CW	Cool White	6- Row 19.69" Length	36	43	3	\$23.75	\$18.90 ea.
LED-LDR394-CW	Cool White	4- Row 39.37" Length	48	58	2.5	\$26.00	\$20.75 ea.
LED-LDR396-CW	Cool White	6- Row 39.37" Length	72	86	1.5	\$39.00	\$31.25 ea.

Required

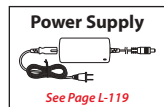

Optional (Pick One Option)

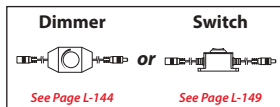

Required

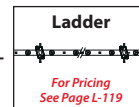

Required

Power Supplies (IP20)

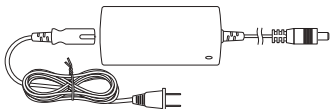

Part #	Type	Amps	Volts	Watts	Dimensions	Price	
						Each	6+ Pcs.
LED-12V-6A	Desktop	6A	12V	72W	4.68"L x 2.34"W x 1.48"H	\$27.85	\$25.35 ea.
LED-12V-9A	Desktop	9A	12V	108W	6.77"L x 2.83"W x 1.57"H	\$44.05	\$40.35 ea.

For Product Details & More Power Options, See Pages L-137~140
Other Options: Plug In | Hardwire | Hardwire Dimmable | Rechargeable Battery

IMPORTANT: Due to Raw Material Fluctuation, Catalog Prices Below May Not Be Accurate. GO TO WWW.OUTWATER.COM FOR THE MOST UP-TO-DATE PRICES

LED Lighting



The System with profile since 1965

FAB LED STRIP

24V



2 Powerful LED Options Illuminates SEG Graphics Evenly Without Hot Spots

- Designed to fit inside the frame of FSB81TX and FSB150TX-CL.
- Comes complete with finger lift hi-tack acrylic permanent tape.



Specially designed lens spreads light evenly, creating no hot spots or shadows

STANDARD

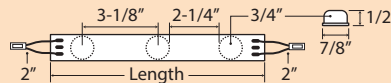

DELUXE

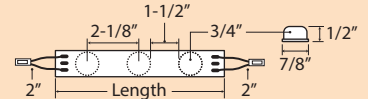

Lighting Specifications

Color Temperature	CW: 6000K-7000K
Beam Spread	40°
Initial Lumens	LED-FBF83-CW: 550-650 per ft. LED-FBF14-CW: 1000-1100 per ft. LED-FBF7-DLX-CW: 550-650 per ft. LED-FBF84-DLX-CW: 700-800 per ft. LED-FBF18-DLX-CW: 2000-2100 per ft.
Color Rendering Index	75+
Rated Average Life	30,000 hrs.
Constant	Voltage
Chip Size	SMD3535
Warranty	3 Years Limited

To ensure even illumination, the Fab LED Strip should be spaced no more than 2" apart.

Strip Distance: 2"

- The overall width of your frame should not exceed 96", but the brightness level is greatest at 50" or less.
- Do not exceed running more lights than suggested because of voltage drop. However, if you "split" the load using a 2-way connector then you can have more lights on each side. The 2-way connector requires 2 power linking cables (LED-FBF-PWL*) that work with these lights. **For Accessories, See Page L-121.**

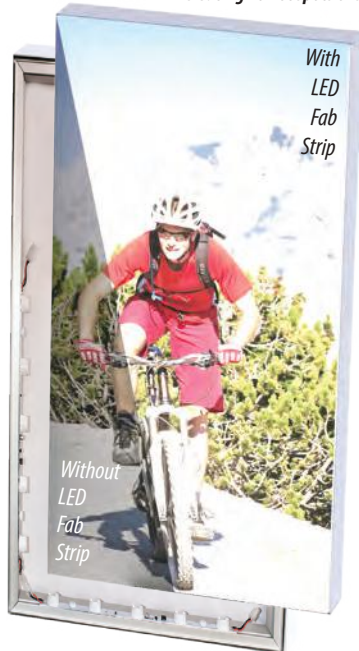

Part #	Length	Color Temp	# Of LED Modules	Total Wattage	Max # Can Connect	Price	20+ Pcs.
STANDARD BRIGHTNESS							
LED-FBF83-CW	8"	Cool White	3	7	10	\$13.50 ea.	\$12.50 ea.
LED-FBF14-CW	14"	Cool White	5	10	7	\$23.00 ea.	\$21.50 ea.
DELUXE BRIGHTNESS							
LED-FBF7-DLX-CW	6-1/8"	Cool White	3	7	8	\$16.00 ea.	\$15.00 ea.
LED-FBF84-DLX-CW	8"	Cool White	4	8	10	\$21.00 ea.	\$20.00 ea.
LED-FBF18-DLX-CW	18-1/2"	Cool White	9	20	4	\$47.00 ea.	\$45.10 ea.



IMPORTANT: Due to Raw Material Fluctuation, Catalog Prices Below May Not Be Accurate. GO TO WWW.OUTWATER.COM FOR THE MOST UP-TO-DATE PRICES

LED Lighting

The System with profile

since 1965



Accessories for FAB LED Strips

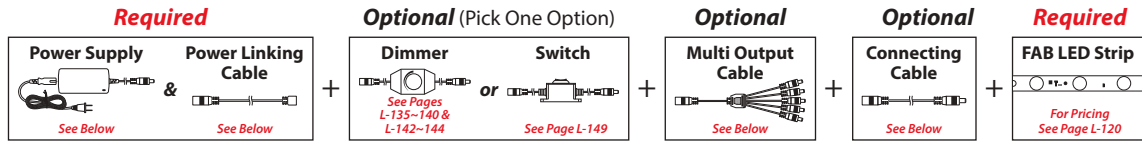

Required

Power Supplies

New! LED-24V-2.5A-HWSL Is So Slim It Can Now Be Concealed Inside The SEG Frame

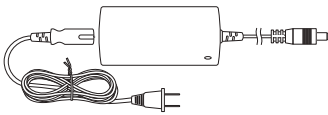

Part #	Type	Amps	Volts	Watts	Dimensions	Price	
						Each	6+ Pcs.
LED-24V-2.5A-HWSL	Hardwire	2.5A	24V	60W	11.8" L x 1.25"W x 0.78"H	\$45.36	\$40.50 ea.
LED-24V-3A	Desktop	3A	24V	72W	4.68"L x 2.34"W x 1.48"H	\$28.75	\$26.05 ea.
LED-24V-4A	Desktop	4A	24V	96W	6.77"L x 2.83"W x 1.57"H	\$44.05	\$39.90 ea.
LED-24V-6A	Desktop	6A	24V	144W	6.77"L x 2.83"W x 1.57"H	\$52.15	\$47.40 ea.

For Product Details & More Power Options, See Pages L-137-140
Other Options: Plug In | Hardwire | Hardwire Dimmable | Rechargeable Battery

Power Linking Cable

Required for power supplies, dimmers & multi output cables.



Part #	Works With	Description	Overall Length	Finish	Price	
					Each	6+ Pcs.
LED-FBF-PWL18	FAB LED Strip	Power Link Cable	18"	Black	\$3.10	\$2.90 ea.
LED-FBF-PWL40	FAB LED Strip		40"	Black	\$4.55	\$4.30 ea.

Optional

Multi Output Cables

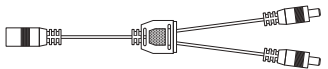

Part #	Description	Finish	Arms Size	# of Arms	Overall Length	Max # of Power Linking Cables	Price	
							Each	6+ Pcs.
LED-2WAY-BK	2-Way Sweep	Black	3"	2	6-3/4"	2	\$2.95	\$2.50 ea.

Power Linking Cable Required For Each Outlet

Connecting Cables

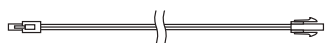

Part #	Works With	Description	Finish	Length	Price	
					Each	6+ Pcs.
LED-FBF-CC-12	FAB LED Strip	Allows the designer to get	Black & Red	12"	\$1.65	\$1.49 ea.
LED-FBF-CC-18	FAB LED Strip	around unlit areas without	Black & Red	18"	\$2.75	\$2.48 ea.
LED-FBF-CC-40	FAB LED Strip	multiple power supplies	Black & Red	40"	\$4.50	\$3.95 ea.

Hanging Cable

Works With: FSB43TC-CL, FSB92TX-CL, FSB80TX-CL, FSB81TX-CL & FSB150TX-CL

Hold 44 lbs. per cable assembly



FWH-8-PC

8 Ft. Cable

Each: \$7.15 / 200 Pcs. \$5.20 ea.

FWH-15-PC

15 Ft. Cable

Each: \$7.95 / 200 Pcs. \$6.10 ea.



Ask About Our Sample SEG Framing Kit

Part #: **FOGA-DES-KIT**



IMPORTANT: Due to Raw Material Fluctuation, Catalog Prices Below May Not Be Accurate. GO TO WWW.OUTWATER.COM FOR THE MOST UP-TO-DATE PRICES

LED Lighting



Nova SEG Frame: Bring Your SEG Game To The Next Level

Available Lengths: 16" x 20", 24" x 36", 30" x 40" & 36" x 48"

Material: PMMA with Aluminum Frame

- Only 10.6MM Overall Thick-Ultra Thin & Light
- Supplied with a 12V Power Supply at No Extra Cost
- Fast Activation- No Flickering
- Aluminum heat sink preserves the life span of your frame
- Uses High Quality PMMA Material- 90% Output
- Limited 5 Year Warranty



7/16" Thick



IP20 Nova SEG Frame

Provides Low Protection of Dust & Water



Power Supply Included with Every Frame

Lighting Specifications

Color Temperature	CW: 6500K-7300K
Beam Spread	120°
Lumens	NOVA-1620-CW: 1400 NOVA-2436-CW: 2520 NOVA-1620-CW: 2802 NOVA-1620-CW: 3360
Color Rendering Index	85+
Rated Average Life	50,000 hrs.
Constant	Current
Chip Size	2835

Part #	Description	# Of LED Chips	Total Wattage	Price	
				Each	10+ Pcs.
NOVA-1620-CW	16" x 20" X 7/16" Frame With Power Supply	105	15	\$104.63	\$99.40 ea.
NOVA-2436-CW	24" x 36" X 7/16" Frame With Power Supply	189	28	\$252.00	\$239.40 ea.
NOVA-3040-CW	30" x 40" X 7/16" Frame With Power Supply	210	31	\$325.00	\$308.75 ea.
NOVA-3648-CW	36" x 48" X 7/16" Frame With Power Supply	252	37	\$444.00	\$421.80 ea.

Required

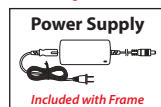

Optional (Pick One Option)

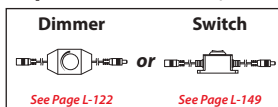

Required



Optional

Dimmers

A power linking cable required.

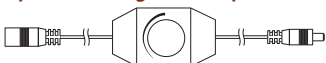

Part #	Description	Finish	Range of Dimming	Size	Price	
					Each	6+ Pcs.
LED-INLINE-DIM-WH	Inline Rotary	White	0-100%	2-5/8"L x 1-3/8"W x 1"H	\$5.95	\$5.25 ea.

For Product Details & More Dimmer Options, See Pages L-134~136 & L-142~144

Other Options: Rotary | Touch Dimmer | Radio Frequency

IMPORTANT: Due to Raw Material Fluctuation, Catalog Prices Below May Not Be Accurate. GO TO WWW.OUTWATER.COM FOR THE MOST UP-TO-DATE PRICES



12V

LED Lighting

Fully Assembled Front Loading Aluminum Frames

Material: Aluminum Frame with Acrylic Light Guide Panel

- Comes ready to use: Clear PVC cover, mounting hardware & power supply included
- Easy front load feature
- Can be used either landscape or portrait
- Low profile, should meet ADA requirements
- Plug & Play

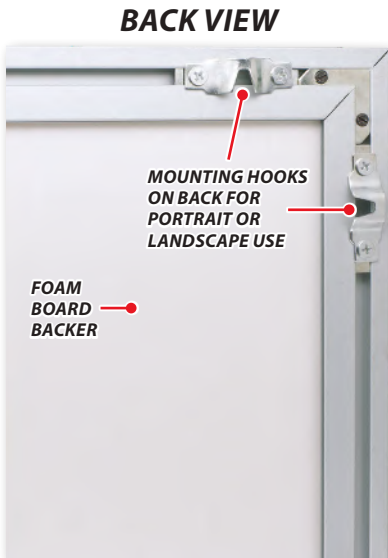
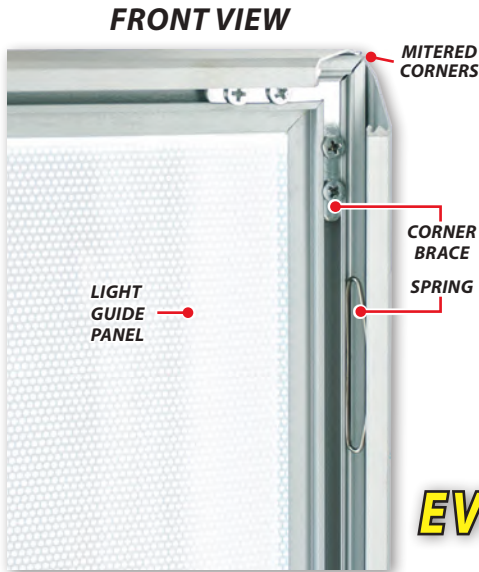

SHOWN ILLUMINATED

**SUPER BRIGHT!
EVEN ILLUMINATION!**

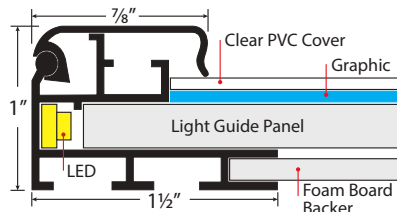

**BEVELED EDGE
PROFILE**

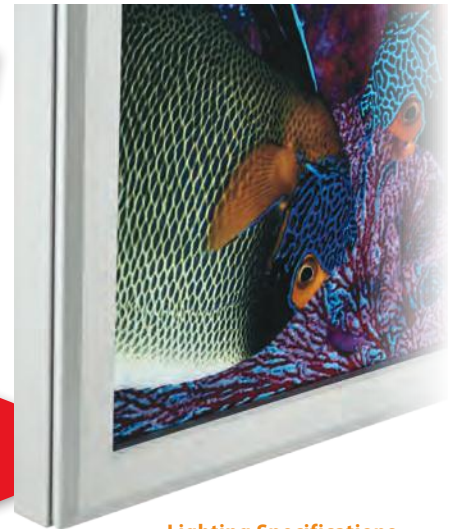

Lighting Specifications

Color Temperature	WW: 7500K-8500K
Lumens	FLF-LED-0811: 275
	FLF-LED-1117: 475
	FLF-LED-1620: 625
	FLF-LED-2228: 1000
	FLF-LED-2436: 1250
Color Rendering Index	CW: 75-80
Rated Average Life	50,000 hrs.
Chip Size	SMD2835

Part #	Color Temp	Finish	Graphic Size	Reveal Dimensions (Nominal)	Overall Dimensions (Nominal)	Total Wattage	Price	
							Each	5+
FLF-LED-0811	Cool White	Anodized Aluminum	8.5" x 11"	8-1/8" x 10-11/16"	10-1/8" x 12-3/4"	3	\$88.20	\$70.56 ea.
FLF-LED-1117	Cool White	Anodized Aluminum	11" x 17"	10-5/8" x 14-3/8"	12-1/2" x 18-5/16"	4	\$116.55	\$92.40 ea.
FLF-LED-1620	Cool White	Anodized Aluminum	16" x 20"	15-19/32" x 19-5/8"	17-3/8" x 21-3/8"	6	\$141.75	\$113.40 ea.
FLF-LED-2228	Cool White	Anodized Aluminum	22" x 28"	21-1/2" x 27-1/2"	23-3/8" x 29-3/8"	10	\$199.50	\$162.23 ea.
FLF-LED-2436	Cool White	Anodized Aluminum	24" x 36"	23-5/8" x 35-1/2"	25-1/2" x 37-3/8"	13	\$333.90	\$267.12 ea.

Phone: 1-800-631-8375 - Fax: 1-800-888-3315
Due to raw material cost fluctuations, prices are subject to change.

IMPORTANT: Due to Raw Material Fluctuation, Catalog Prices Below May Not Be Accurate. GO TO WWW.OUTWATER.COM FOR THE MOST UP-TO-DATE PRICES

LED Lighting



Crystal Light Box

For Counter & Wall Mount Displays

Material: Acrylic with Aluminum Post

- Super thin 3/8"
- Available in wall mount & counter top
- Power supply included
- Includes On / Off Switch

SLEEK THIN DESIGN

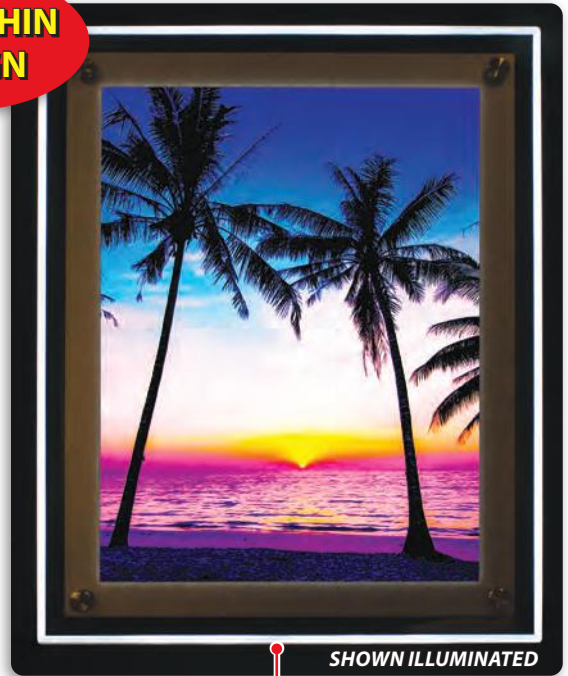

SHOWN ILLUMINATED

BEVELED EDGE CREATES OUTER GLOW ILLUMINATION!

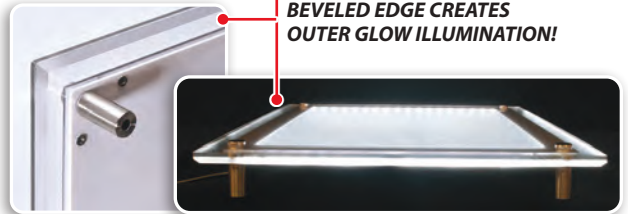

COUNTER TOP



WALL MOUNT

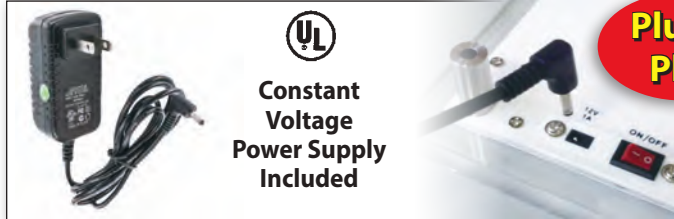

Constant Voltage Power Supply Included

Plug & Play

FRAME COMPONENTS

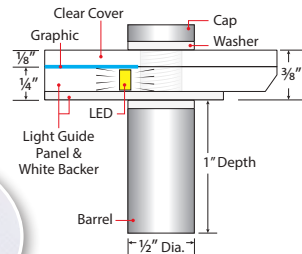

Lighting Specifications

Color Temperature	CW: 6100K
Lumens	CLB-LED-0811-W: 186
	CLB-LED-1117-W: 93
	CLB-LED-1620-W: 102
	CLB-LED-2228-W: 121
	CLB-LED-2436-W: 167
	CLB-LED-0811-C: 186
Color Rendering Index	CW: 70
Rated Average Life	50,000 hrs.
Constant	Voltage
Chip Size	SMD2835

Part #	Color Temp	Graphic Size	Reveal Dimensions (Nominal)	Overall Dimensions (Nominal)	Total Wattage	Price	
						Each	5+
CLB-LED-0811-W	Cool White	8.5" x 11"	8" x 10-5/8"	10-13/16" x 13-5/16"	1.8	\$60.48	\$50.40 ea.
CLB-LED-1117-W	Cool White	11" x 17"	10-5/8" x 16-5/8"	13-3/4" x 19-3/4"	3.6	\$92.99	\$77.49 ea.
CLB-LED-1620-W	Cool White	16" x 20"	15-1/2" x 19-3/4"	18-1/4" x 23-11/16"	6	\$130.41	\$108.68 ea.
CLB-LED-2228-W	Cool White	22" x 28"	21-9/16" x 27-9/16"	24-3/4" x 30-3/4"	9	\$232.85	\$194.04 ea.
CLB-LED-2436-W	Cool White	24" x 36"	23-1/2" x 35-5/8"	27-1/8" x 39-1/8"	11	\$340.20	\$282.50 ea.
CLB-LED-0811-C	Cool White	8.5" x 11"	8" x 10-5/8"	10-13/16" x 13-5/16"	1.8	\$62.78	\$52.32 ea.
CLB-LED-1117-C	Cool White	11" x 17"	10-5/8" x 16-5/8"	13-3/4" x 19-3/4"	3.6	\$95.29	\$79.41 ea.

Available for either wall mount (-w) or counter top (-c) applications.

IMPORTANT: Due to Raw Material Fluctuation, Catalog Prices Below May Not Be Accurate. GO TO WWW.OUTWATER.COM FOR THE MOST UP-TO-DATE PRICES



12V

LED Lighting

"Tiny" Spot LED Lights

Material: Aluminum with Clear Polycarbonate Lens

- Ultra compact & extremely bright
- Fully Connectable
- Emits virtually no heat
- Heads swivels 360° and pivots 180° for easy direction of light
- On/Off Switch (Only Tiny Spot 15)
- 39" connecting cable (Only Tiny Spot 15)
- 39" connecting cable with 3.5 Male/Male Connector (Only Tiny Spot 11)
- Screws Included



Tiny Spot 15 (Up To 110 Lumens Per Fixture)

LED-TS05S-CW

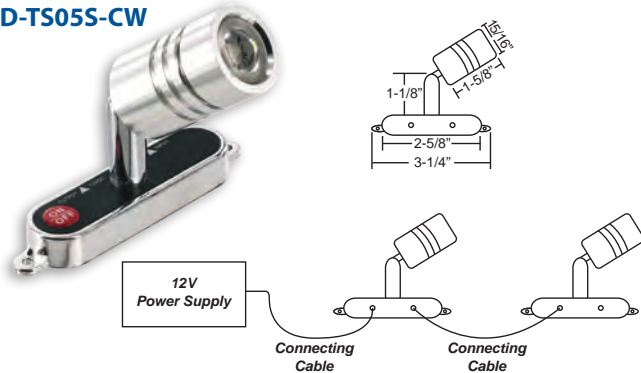

Tiny Spot 11 (Up To 110 Lumens Per Fixture)

LED-TS05-CW

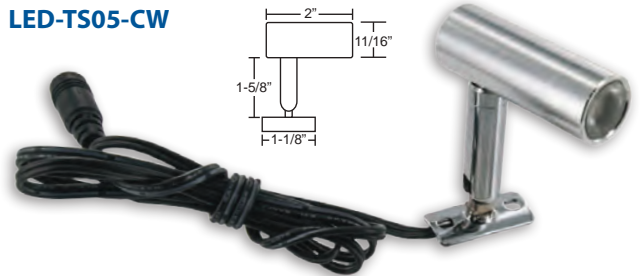

Lighting Specifications For Tiny Spot 15 & Tiny Spot 11

Color Temperature	CW: 6500K
Beam Spread	60°
Lumens	CW: 110
Color Rendering Index	CW: 75
Rated Average Life	50,000 hrs.
Constant	Voltage
Chip Size	CREE3535

Part #	Color Temp	Finish	# Of LED Chips	Total Wattage	Max # Can Connect	Each	Price 10+ Pcs.
LED-TS05S-CW	Cool White	Polished Chrome	1	2	15	\$13.00	\$11.85 ea.
LED-TS05-CW	Cool White	Polished Chrome	1	2	15	\$12.25	\$11.00 ea.

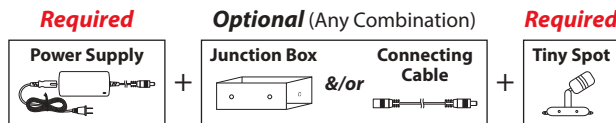

Power Supplies (Required)

PLUG & PLAY

Short Circuit Protection • Overload Circuit Protection • IP20 • Constant Voltage Comes With DC 3.5 Reducer Power Linking Cable • Limited 2 Year Warranty

Plug Type (1A / 12V / 12W)

- 2.91" L x 1.61" W x 1.14" H
- 22AWG Output Cord: 5'
- Polarized 2 Prong Plug

LED-12V-1A
Each: \$8.95

10+ Pcs.: \$8.20 ea.



Plug Type (3A / 12V / 36W)

- 3.41" L x 2.31" W x 1.26" H
- 18AWG Output Cord: 6'
- Polarized 2 Prong Plug

LED-12V-3A
Each: \$16.15

6+ Pcs.: \$14.70 ea.

Optional Rechargeable Battery Available See page L-140



How Long Will My Battery Last?

Battery Longevity: $\frac{\text{AMPS} \times \text{VOLTS}}{\text{WATTS}} = \text{HRS}$

Junction Box (Optional)

Function: Is to join multiple fixtures to one power supply
Only Works With LED-TS05-CW

- 1-5/8" L x 1-1/4" W x 5/8" H
- Power In: 1 Port
- Power Out: 4 Ports

LED-CLE-JB

Each: \$2.95 / 6+ Pcs.: \$2.45 ea.



Connecting Cable (Optional)

Function: To connect junction box or other lights

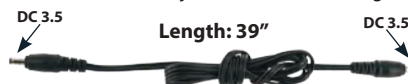

LED-35MM-39CC-BK

Each: \$2.50 / 6+ Pcs.: \$2.25 ea.

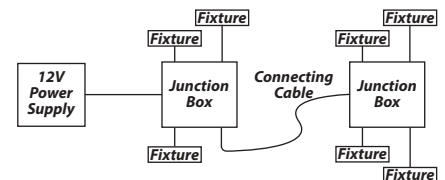

IMPORTANT: Due to Raw Material Fluctuation, Catalog Prices Below May Not Be Accurate. GO TO WWW.OUTWATER.COM FOR THE MOST UP-TO-DATE PRICES

LED Lighting



Slim Series: Wall Washer

Available Lengths: 19.7" & 39.4"

Material: Silver Aluminum Housing

- Perfect for landscape lighting, buildings facades and both indoor and outdoor displays.
- No UV & RF Interference
- Maintenance Free
- Low Voltage
- Easily connectable with waterproof connectors
- Two Sizes for numerous applications
- Limited 5 Year Warranty

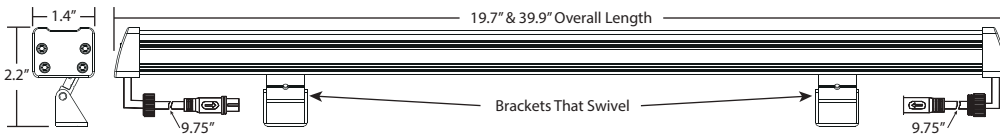

Lighting Specifications

Color Temperature	CW: 5000K
Beam Spread	30°
Lumens	LED-WALL24-CW: 1000 LED-WALL48-CW: 2000
Color Rendering Index	80
Rated Average Life	50,000 hrs.
Constant	Voltage
Chip Size	SMD2835

Part #	Color Temp	Size	# Of LED Chips	Total Wattage	Max # Can Connect	Max. Lig. Dis.	Price	
							Each	10+ Pcs.
LED-WALL24-CW	Cool White	1.4" D x 2.2" H x 19.7" L	24	10	10	10'	\$85.00	\$74.80 ea.
LED-WALL48-CW	Cool White	1.4" D x 2.2" H x 39.4" L	48	20	5	13'	\$138.07	\$121.51 ea.

Required **Required** **Required**

Power Supply
See Page L-126

+

Power Linking Cable
See Page L-126

+

Wall Washer
For Pricing, See Page L-126

Required

Power Supplies (IP67)



Part #	Type	Amps	Volts	Watts	Dimensions	Price	
						Each	6+ Pcs.
LED-24V-2.5A-HW	Hardwire	2.5A	24V	60W	7.5"L x 1.8"W x 1.3"H	\$25.00	\$22.50 ea.
LED-24V-4.17A-HW	Hardwire	4.17A	24V	100W	8.7"L x 2.7"W x 1.7"H	\$42.00	\$38.20 ea.

For Product Details & More Power Options, See Pages L-137~140
Other Options: Plug In | Hardwire | Hardwire Dimmable | Rechargeable Battery

Power Linking Cable

Required for power supplies



Part #	Description	Overall Length	Finish	Price	
				Each	6+ Pcs.
LED-WALL-PWL	Connects from power supplies to wall washer	12"	Black	\$7.95	\$7.25 ea.

IMPORTANT: Due to Raw Material Fluctuation, Catalog Prices Below May Not Be Accurate. GO TO WWW.OUTWATER.COM FOR THE MOST UP-TO-DATE PRICES



12V

LED Lighting

Omni Display Arms For Wall & Cabinets

Material: Anodized Aluminum with Frosted Polycarbonate Lens

- 270° rotation on fixture
- No assembly required
- Mounting screws included



Wall Mount (Up To 540 Lumens Per Fixture)



Female DC 5.5

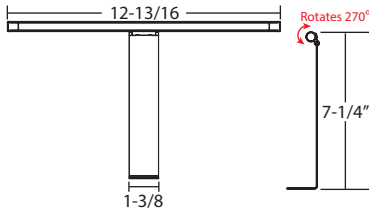

Lighting Specifications

Color Temperature	CW: 6000K-6500K WW: 2900K-3200K
Beam Spread	120°
Lumens	CW: 540 WW: 450
Color Rendering Index	CW/WW: 80
Rated Average Life	50,000 hrs.
Constant	Voltage
Chip Size	SMD5630

Part #	# Of LED Chips	Total Wattage	Price	
			Each	10+ Pcs.
Cool White *W & Warm White *WW				
LED-OS-226A-*	18	9	\$16.95	\$14.95 ea.

Cabinet Mount (Up To 550 Lumens Per Fixture)



Female DC 5.5

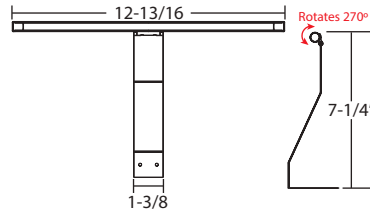

Lighting Specifications

Color Temperature	CW: 6000K-6500K WW: 2900K-3200K
Beam Spread	120°
Lumens	CW: 550 WW: 460
Color Rendering Index	CW/WW: 80
Rated Average Life	50,000 hrs.
Constant	Voltage
Chip Size	SMD5630

Part #	# Of LED Chips	Total Wattage	Price	
			Each	10+ Pcs.
Cool White *W & Warm White *WW				
LED-OS-220A-*	18	5.4	\$21.90	\$18.90 ea.

Required

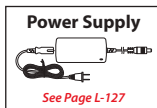

Optional (Pick One Option)

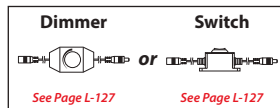

Optional

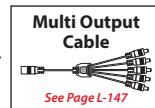

Required



Required

Power Supplies



Part #	Type	Amps	Volts	Watts	Dimensions	Price	
						Each	6+ Pcs.
LED-12V-3A	Wall Mount	3A	12V	36W	3.41"L x 2.31"W x 1.26"H	\$16.15	\$14.70 ea.

For Product Details & More Power Options, See Pages L-137~140
Other Options: Plug In | Hardwire | Hardwire Dimmable | Rechargeable Battery

Optional

Dimmers

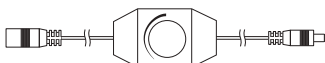

Part #	Description	Finish	Range of Dimming	Dimensions	Price	
					Each	6+ Pcs.
LED-INLINE-DIM	Inline Rotary	Black	0-100%	2-5/8"L x 1-3/8"W x 1"H	\$5.95	\$5.25 ea.

For Product Details & More Dimmer Options, See Pages L-134~136 & L-142~144
Other Options: Rotary | Touch Dimmer | Radio Frequency

Halogen / LED Lighting



Klem Light Fixture

Material: Metal

- **Lightweight But Extremely Durable!** All stainless steel construction with nickel plated components and highly polished shades of the light head.
- **Safe For Museum Pieces!** Halogen bulbs with dichroic reflector. 80% of potentially harmful heat is reflected to the rear of the light head while 100% of the light shines on the subject matter.
- **Easy To Use!** Each fixture is uniquely designed for ease of fixation
- **No Transformer Required!** 120V simply plug into any outlet. Black power cord is 10 feet long with 3 prong plug.
- **Versatile and Portable!** The light head clamp can be adjusted to various angles for the greatest potential of any exhibit.

Lighting Specifications

LED

Color Temperature	CW: 6000K WW: 2700K-3000K
Beam Spread	35°
Lumens	CW: 340 WW: 290
Color Rendering Index	CW/WW: 80
Rated Average Life	CW/WW: 30,000 hrs.
Constant	Voltage
Chip Size	SMD2835

Lighting Specifications

HALOGEN

Beam Spread	50°
Lumens	CW: 1260
Rated Average Life	CW: 2,000 hrs

Cielo® XL: Sturdy Clamp Mechanism Fits Up To 3" Thick Material (No Screw Mounting)



Part #	Description	Price
	Cool White (*CW) & Warm White (*WW)	
200X-CL	Cielo® Exhibit Light Fixture	\$99.75 ea.
200X-CL-HAL	Cielo® Exhibit Light Fixture With 75W Halogen Bulb	\$110.25 ea.
200X-CL-LED-*	Cielo® Exhibit Light Fixture With 5W LED Bulb	\$99.75 ea.



Paneo®: Top Panel Mounted (Two-Piece Bracket Assembly & Mounting)

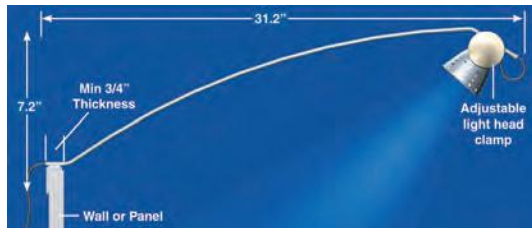

Part #	Description	Price
	Cool White (*CW) & Warm White (*WW)	
205-P	Paneo® Exhibit Light Fixture	\$89.25 ea.
205-P-HAL	Paneo® Exhibit Light Fixture With 75W Halogen Bulb	\$99.75 ea.
205-P-LED-*	Paneo® Exhibit Light Fixture With 5W LED Bulb	\$89.25 ea.

Mount to panel by hooking the light fixture into a base unit affixed invisibly to the rear edge of the panel.

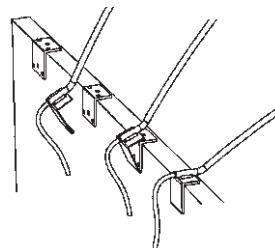

Imago®: Surface Mounted



Part #	Description	Price
	Cool White (*CW) & Warm White (*WW)	
210-I	Imago® Exhibit Light Fixture	\$93.45 ea.
210-I-HAL	Imago® Exhibit Light Fixture With 75W Halogen Bulb	\$103.95 ea.
210-I-LED-*	Imago® Exhibit Light Fixture With 5W LED Bulb	\$93.45 ea.

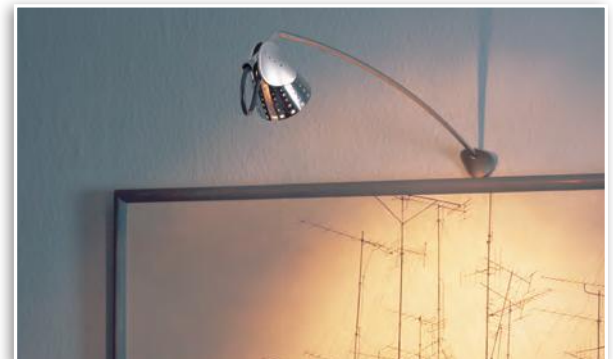



"Arc It" Lights

Material: Metal

- Fully adjustable light head allows for great flexibility in a variety of applications
- Display arm can also be adjusted at a variety of angles by using the gear adjuster to lock into place
- Adjustable C-clamps will accommodate 7/8" to 3-3/8" thick panels
- 12V 60 watt power supply included with 6' power cord
- Steel construction in Satin Chrome finish
- Available in cool white or warm white

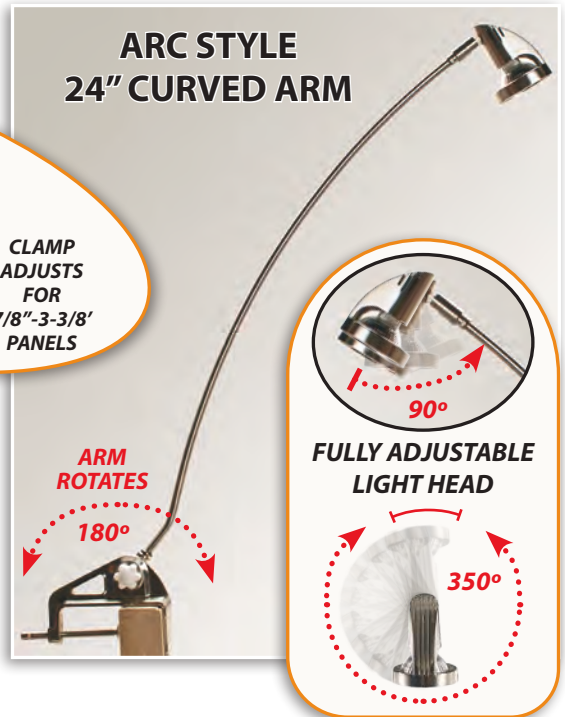

Part #	Description	Price	
		Each	10+ Pcs.
<i>Cool White (*CW) & Warm White (*WW)</i>			
LED-ARC-SC*	24" Curved Arm, 5W High Powered LED Bulb	\$62.65	\$56.77 ea.
LED-GNECK-SC*	19" Flexible Arm, 5W High Powered LED Bulb	\$62.65	\$56.77 ea.
HAL-ARC-SC	24" Curved Arm, 50W Halogen Bulb	\$54.90	\$49.02 ea.
HAL-GNECK-SC	19" Flexible Arm, 50W Halogen Bulb	\$54.90	\$49.02 ea.
REPLACEMENT LED BULB			
LMR16-30-CW	Cool White	\$7.75	-
LMR16-30-WW	Warm White	\$7.75	-

See Page L-151 For LED Bulb Specs

Lighting Specifications

LED	
Color Temperature	CW: 6000K WW: 3000K
Beam Spread	30°
Lumens	CW: 340 WW: 290
Color Rendering Index	CW/WW: 80
Rated Average Life	CW/WW: 50,000 hrs.
Constant	Voltage
Chip Size	SMD2835

Lighting Specifications HALOGEN

Beam Spread	36°
Lumens	CW: 1700
Rated Average Life	CW: 2,000 hrs

IMPORTANT: Due to Raw Material Fluctuation, Catalog Prices Below May Not Be Accurate. GO TO WWW.OUTWATER.COM FOR THE MOST UP-TO-DATE PRICES

LED Lighting

120V



"Center Stage" Exhibit & Display Lights

Super bright, energy efficient & cost effective LED option for showcasing your exhibit, display & products

Material: Aluminum

- Super bright- comparable to an 150W halogen bulb
- Energy efficient only 21W
- Includes On/Off switch at the base of the fixture
- Includes a 10' long power cords with a 3 prong plug
- Nominal 18" overall length
- The light head will swivel approximately 360° and will rotate down or up 45°
- Sturdy, but light weight aluminum construction with a protective acrylic lens
- Light head measures 5-3/4" x 2-1/2"

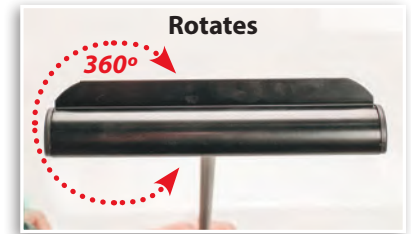

Lighting Specifications

Color Temperature	CW: 6000K-7000K
Beam Spread	120°
Lumens	CW/WW: 1600
Color Rendering Index	70
Rated Average Life	36,000 hrs.
Constant	Voltage
Chip Size	5630

Part #	Color Temp	Finish	Length	# Of LED Chips	Total Wattage	Price	
						Each	10+
LED-EXL21-BK	Cool White	Black	18" (Nominal)	50	21	\$58.00	\$54.00 ea.
LED-EXL21-SL	Cool White	Silver	18" (Nominal)	50	21	\$58.00	\$54.00 ea.

Mounting Clips (Optional)

Small Clamp

- Clamps up to 1-3/16"
- Material: Aluminum

LED-EXL-SC-*
Each: \$6.75 ea.
Black (*BK) & Silver (*SIL)



Large Clamp

- Clamps up to 1-3/4"
- Material: Aluminum

LED-EXL-LC-*
Each: \$6.75
Black (*BK) & Silver (*SIL)



Cabinet Mounting Plate

- Screw mount to the top of a cabinet
- Material: Aluminum
- 1/4" Screw Hole, Screws Included

LED-EXL-CP-*
Each: \$2.95
Black (*BK) & Silver (*SIL)



Note: Other Mounting Options Available- Please Inquire

IMPORTANT: Due to Raw Material Fluctuation, Catalog Prices Below May Not Be Accurate. GO TO WWW.OUTWATER.COM FOR THE MOST UP-TO-DATE PRICES



LED Lighting

Channel Letter Lighting System: The New Generation Of Channel Letters

Available Lengths: 30', 37' & 49'

Material: Polycarbonate Housing

- NEW LED modules innovatively designed for indoor & outdoor lighting
- Widest, most even spread of light, to work in shallow and deep cans
- Offers the most even lighting technology available
- UV/IR protected and IP67 rating to handle extreme weather conditions
- Mounts with supplied 3M adhesive on the back or can be fastened with screws (Not Supplied)
- Limited 3 Year Warranty



IP67 Channel Letter Lighting
Suitable For Wet Locations

LED-YOCL-UCW (Up To 125 Lumens Per Foot)

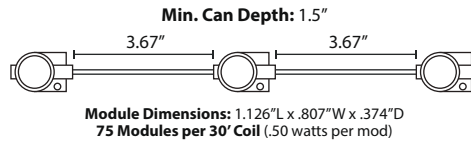

Lighting Specifications

Color Temperature	UCW: 7500K
Beam Spread	180°
Lumens	125 per ft
Color Rendering Index	70+
Rated Average Life	50,000 hrs.
Constant Voltage	
Chip Size	2835

Part #	Color Temp	Description	Length	# Of LED Chips	Total Wattage	Each	10+
LED-YOCL-UCW	Ultra Cool White	75 pc. module string	30'	3	38W (.50W per mod)	\$56.00 (\$0.75 per mod)	\$49.80 ea. (\$0.66 per mod)

LED-LGCL-CW (Up To 140 Lumens Per Foot)

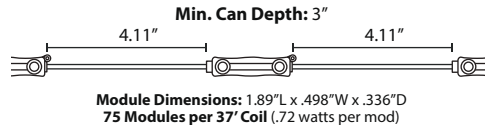

Lighting Specifications

Color Temperature	CW: 6500K
Beam Spread	180°
Lumens	140 per ft
Color Rendering Index	70+
Rated Average Life	50,000 hrs.
Constant Voltage	
Chip Size	2835

Part #	Color Temp	Description	Length	# Of LED Chips	Total Wattage	Each	10+
LED-LGCL-CW	Cool White	75 pc. module string	37'	3	54W (.72W per mod)	\$39.70 (\$0.52 per mod)	\$36.50 ea. (\$0.49 per mod)

LED-ANPCL-UCW (Up To 205 Lumens Per Foot)

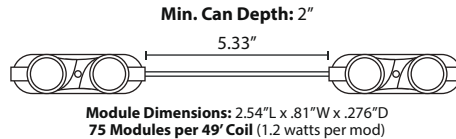

Lighting Specifications

Color Temperature	UCW: 7500K
Beam Spread	180°
Lumens	205 per ft
Color Rendering Index	70+
Rated Average Life	50,000 hrs.
Constant Voltage	
Chip Size	3030

Part #	Color Temp	Description	Length	# Of LED Chips	Total Wattage	Each	10+
LED-ANPCL-UCW	Ultra Cool White	75 pc. module string	49'	2	90W (1.2W per mod)	\$105.33 (\$1.40 per mod)	\$96.55 ea. (\$1.28 per mod)

Recommended Depth/ Spacing Coverage Chart To Avoid Hot Spots	Part #	Min. Depth	Frame Depth	Rcmd. Spacing Between Rows	Frame Depth	Rcmd. Spacing Between Rows	Frame Depth	Rcmd. Spacing Between Rows	Frame Depth	Rcmd. Spacing Between Rows	Frame Depth	Rcmd. Spacing Between Rows
	LED-YOCL-UCW	1.5"	2"	3"	3"	7"	4"	10"	5"	15"	6"-8"	15"
	LED-ANPCL-UCW	2"	2"	3"	3"	7"	4"	10"	5"	15"	6"-8"	15"
	LED-LGCL-CW	3"	N/A	N/A	3"	5"	4"	7.5"	5"	9"	6"-8"	12"

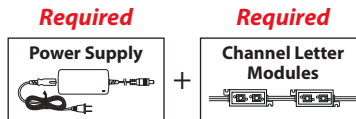

Required

Power Supplies (IP67)



Part #	Type	Amps	Volts	Watts	Dimensions	Each	6+ Pcs.
LED-12V-5A-HW	Hardwire	5A	12V	60W	7.5"L x 1.88"W x 1.33"H	\$25.00	\$22.50 ea.
LED-12V-8.3A-HW	Hardwire	8.3A	12V	100W	8.74"L x 2.71"W x 1.69"H	\$44.00	\$39.50 ea.

For Product Details & More Power Options, See Pages L-137~140
Other Options: Plug In | Hardwire | Hardwire Dimmable | Rechargeable Battery

IMPORTANT: Due to Raw Material Fluctuation, Catalog Prices Below May Not Be Accurate. GO TO WWW.OUTWATER.COM FOR THE MOST UP-TO-DATE PRICES

LED Lighting



RGB Channel Letter Lighting: The New Generation Of Channel Letters

Available Lengths: 30'

Material: Polycarbonate Housing

- NEW LED modules innovatively designed for indoor & outdoor lighting
- Latest LED chip technology = maximum brightness output
- Smart RGB controller offers a multitude of programmable patterns
- High IP67 rating to handle damp weather conditions
- Mounts with supplied 3M adhesive on the back or can be fastened with screws (Not Supplied)
- Limited 3 Year Warranty



Endless Possibilities of Colors

7 Solid Colors

RED	BLUE
PURPLE	WHITE
GREEN	YELLOW
CYAN	

LED-TRICL-RGB

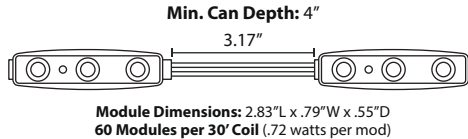

Lighting Specifications

Color Temperature	RGB
Beam Spread	160°
Color Rendering Index	70+
Rated Average Life	50,000 hrs.
Constant	Voltage
Chip Size	5050

Part #	Color Temp	Description	Length	# Of LED Chips	Total Wattage	Price	
						Each	10+
LED-TRICL-RGB	RGB	60 pc. module string	30'	3	43W .72W per mod	\$197.80 (\$3.29 per mod)	\$179.40 ea. (\$2.99 per mod)



Required

Power Supplies (IP67)



Part #	Type	Amps	Volts	Watts	Dimensions	Price	
						Each	6+ Pcs.
LED-12V-5A-HW	Hardwire	5A	12V	60W	7.5"L x 1.88"W x 1.33"H	\$25.00	\$22.50 ea.
LED-12V-8.3A-HW	Hardwire	8.3A	12V	100W	8.74"L x 2.71"W x 1.69"H	\$44.00	\$39.50 ea.

For Product Details & More Power Options, See Pages L-137~140
Other Options: Plug In | Hardwire | Hardwire Dimmable | Rechargeable Battery

Smart Controller (SPI)

RGB Channel Letter WIFI- 28 Preset Programs & 80+ SPI Programmable Functions

LED-TRICL-CTRL
Each: \$75.00



Features:

- 8A / 12V / 100W
- Receiver Size: 5"L x 3.34"W x 1.23"H
- Max Length: 50'
- Output Signal: SPI
- Input: Female DC 5.5
- Output: Ethernet CAT5E
- Mounting: Screw
- Remote Control Function: WIFI
- Limited 3 Year Warranty

Controller Functions:

- Create a strobing, chasing, flashing, meteor & curtain effect!
- Racing Patterns
- Wave Patterns
- Jumping Patterns
- Strobing Color Combination Patterns
- Static/Color: 7 Options (Red, Green, Blue, Purple, Cyan (Aqua) & White)

IMPORTANT: Due to Raw Material Fluctuation, Catalog Prices Below May Not Be Accurate. GO TO WWW.OUTWATER.COM FOR THE MOST UP-TO-DATE PRICES



12V

LED Lighting

Diamond Brite LED Channel Letter Modules

Material: Polycarbonate Housing

- New Technology: Each LED is lensed separately, no silicone! This prevents yellowing from U.V. or salt water air.
- IP 68 rated modules and power supply
- Supplied with 3M adhesive
- Can be mounted with screw (not included)



Lighting Specifications

Color Temperature	CW: 6500K
Beam Spread	120°, 140° or 160°
Lumens	LED-EC2: 43 per mod. LED-ECS2: 50 per mod. LED-EC3: 64 per mod. LED-ECE3: 65 per mod. LED-ECS3: 75 per mod. LED-EC4: 85 per mod.
Color Rendering Index	80
Rated Average Life	50,000 hrs.
Constant	LED-EC*: Voltage LED-ECE*: Voltage LED-ECS*: Current
Chip Size	2835

A. 2 LED Module

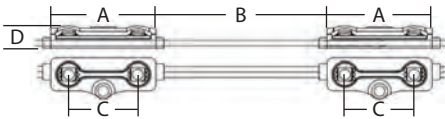

B. 3 LED Module

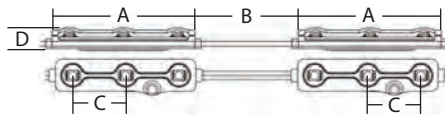

C. 4 LED Module

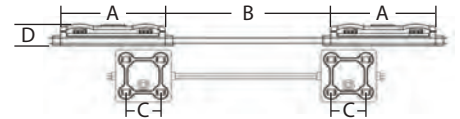

Part #	Beam Spread	Dimensions				# Of LED Chips	Total Wattage	Min. Can Depth	Max # Can Connect	Price		
		A	B	C	D					50 Pcs.	100+ Pcs.	
Cool White (Must be purchased in 50 pc. increments)												
A	LED-EC2-CW	120°	1.50"	2.50"	1"	.29"	2	.72	3-1/8"	50	\$0.95 ea. (\$47.50/50 pcs.)	\$0.81 ea. (\$81.00/100 pcs.)
A	LED-ECS2-12-CW	160°	1.50"	2.25"	1"	.375"	2	.90	2"	50	\$1.00 ea. (\$50.00/50 pcs.)	\$0.88 ea. (\$44.00/100 pcs.)
B	LED-EC3-CW	120°	2.60"	3.75"	1"	.29"	3	.72	3-1/8"	50	\$1.10 ea. (\$55.00/50 pcs.)	\$0.97 ea. (\$97.00/100 pcs.)
B	LED-ECE3-12-CW	140°	2.50"	3.75"	1"	.375"	3	.72	2"	50	\$0.80 ea. (\$40.00/50 pcs.)	\$0.70 ea. (\$70.00/100 pcs.)
B	LED-ECS3-12-CW	160°	2.50"	3.50"	1"	.375"	3	.72	2"	50	\$1.15 ea. (\$57.50/50 pcs.)	\$1.03 ea. (\$51.50/100 pcs.)
C	LED-EC4-CW	120°	1.57"	4.25"	1"	.29"	4	1.44	3-1/8"	50	\$1.72 ea. (\$86.00/50 pcs.)	\$1.58 ea. (\$158.00/100 pcs.)

Required

Power Supplies



Part #	Type	Amps	Volts	Watts	Dimensions	Price	
						Each	6+ Pcs.
LED-12V-5A-HW	Hardwire	5A	12V	60W	7-1/2"L x 1-5/8"W x 1-1/4"H	\$25.00	\$22.50 ea.

For Product Details & More Power Options, See Pages L-137~140

Other Options: Plug In | Hardwire | Hardwire Dimmable | Rechargeable Battery

Optional

Channels For Diamond Brite: Will Hold 2 LED Module & 3 LED Module

Clear PVC Channel



L-TASK-58P-4
Per Ft.: \$0.46'
120 Ft.: \$0.44'

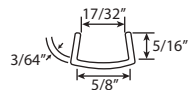

Sold In 4 Ft. Lengths
Other Lengths Available, Please Inquire

White Channel Letter Track & Cover With Adhesive



LED-ECTKC-WH
Per Ft.: \$0.75'
120 Ft.: \$0.69'

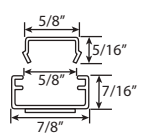

• Cover to be snipped to size to hide wires inside the track

Sold In Nominal 3.25 Ft. Lengths

**IMPORTANT: Due to Raw Material Fluctuation, Catalog Prices Below May Not Be Accurate.
GO TO WWW.OUTWATER.COM FOR THE MOST UP-TO-DATE PRICES**

Works With All 12V & 24V Standard & RGB Lighting

Outwater's Wireless Radio Frequency Dimmers

Now You Are In Control

Now You Have Greater Control Of Your Lighting Design With Our 10 Zone Dimmer
By Pairing Multiple Controllers To One Receiver Or Several Receivers To One Controller

- No Wiring Needed
- Each dimmer is paired to the included receiver.
- Unlike infrared receivers which operate on line of site, Outwater's radio frequency sends signals thru any obstacles, such as: walls, cabinet doors, furniture, up to 50 ft. away from receiver.
- Dimmer controller runs on a battery (3V CR302 included) for all styles
- Battery Life: 3 Years
- Freedom to position controller anywhere
- Dimmer Range: 10-100%
- Dimmer Type: PWM
- Push button On/Off function for all styles
- Limited 3 year warranty
- IP Rating: IP20

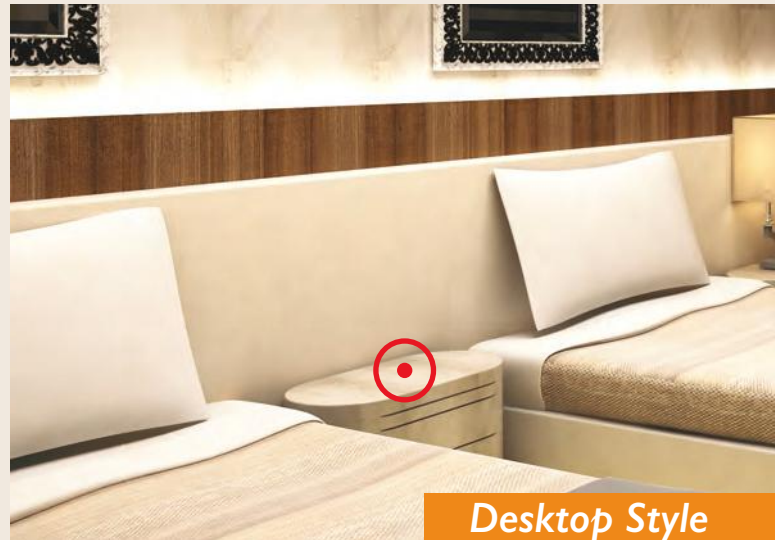
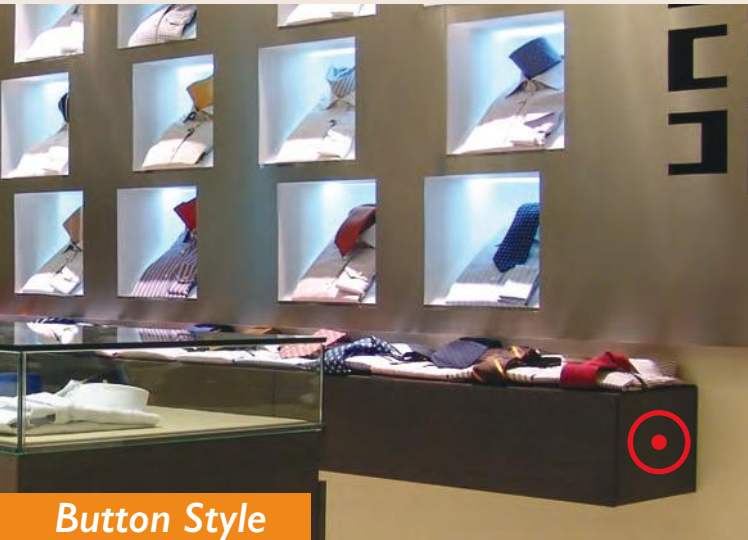

Available In
3 Styles

Button Style



Standard

Desktop Style



Standard

RGB

CCT

Wall Style



Standard

RGB

CCT

Outwater Plastics Industries, Inc. - www.outwater.com
Due to raw material cost fluctuations, prices are subject to change.

• Catalog is Priced
• In U.S. Dollars



LED Dimmers

Wireless Radio Frequency For Standard Dimming Control

Button Style



Dia: 1.25" x H: .45"
Mounting: Screw
Battery Operated
Finish: Stainless Steel

Standard Dimmer: 10 - 100%

Desktop Style



L: 4" x W: 1.5" x H 1.8"
Battery Operated
Finish: Black Case With
Black Button
Non Skid Bumpers

Wall Style



No Wiring Needed
L: 3.5" x W: 1.37" x H .75"
Mounting: Wall
Battery Operated
Finish: White Case With
Silver Button



Easily installs into standard receptacle box. Attaches with 2 screws.

Standard Receiver



L: 3.5" x W: 1.375" x H: .75"
12V/8A/96W or 24V/8A/192W
Input Cord: 18" DC 5.5 Female
Output Cord: 18" DC 5.5 Male

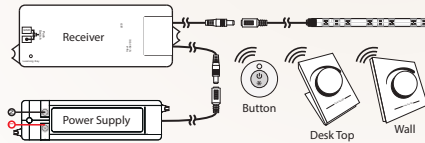

Part #	Description	Price	
		Each	6+ Pcs.
Standard RF Dimmer Kits			
RF-CTRL-BT	Button Style With Receiver	\$48.00	\$43.20 ea.
RF-CTRL-DT	Desktop Style With Receiver	\$67.50	\$60.75 ea.
RF-CTRL-WT	Wall Style With Receiver	\$65.00	\$58.50 ea.
Individual Price To Create Your Own Kit: For Standard			
RF-RECVR	Receiver	\$33.00	\$29.70 ea.
RF-BUTTON	Button Style	\$18.25	\$16.45 ea.
RF-DESK	Desktop Style	\$38.50	\$34.65 ea.
RF-WALL	Wall Style	\$36.55	\$32.90 ea.

Wireless Radio Frequency For RGB Control

RGB Dimmer: Allows to stop on one color and dim from 10 - 100% range

Desktop Style



L: 4" x W: 1.5" x H 1.8"
Battery Operated
Finish: Black Case With
Black Button
Non Skid Bumpers

Wall Style



No Wiring Needed
L: 3.5" x W: 1.37" x H .75"
Mounting: Wall
Battery Operated
Finish: White Case With
Silver Button



Easily installs into standard receptacle box. Attaches with 2 screws.

RGB Receiver



L: 7" x W: 1.75" x H: .75"
12V/8A/96W or 24V/8A/192W
Input Cord: 18" DC 5.5 Female
Output Cord: 18" Pin Connection
Screw Mount

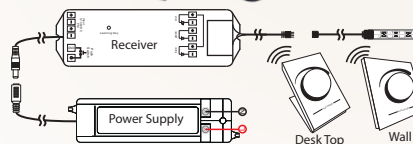

Part #	Description	Price	
		Each	6+ Pcs.
RGB RF Dimmer Kits			
RF-RGB-CTRL-DT	Desktop Style With Receiver	\$95.50	\$86.00 ea.
RF-RGB-CTRL-WT	Wall Style With Receiver	\$91.15	\$82.05 ea.
Individual Price To Create Your Own Kit: For RGB			
RF-RGB-RECVR	Receiver	\$58.00	\$52.20 ea.
RF-RGB-DESK	Desktop Style	\$44.00	\$39.60 ea.
RF-RGB-WALL	Wall Style	\$39.35	\$35.45 ea.

IMPORTANT: Due to Raw Material Fluctuation, Catalog Prices Below May Not Be Accurate. GO TO WWW.OUTWATER.COM FOR THE MOST UP-TO-DATE PRICES

LED Lighting



LED Dimmers

Wireless Radio Frequency For CCT Control

CCT Dimmer: Allows to stop on one color and dim from 10 - 100% range

Desktop Style



L: 4" x W: 1.5" x H 1.8"
Battery Operated
Finish: Black Case With Black Button
Non Skid Bumpers

Wall Style



No Wiring Needed
L: 3.5" x W: 1.37" x H .75"
Mounting: Wall
Battery Operated
Finish: White Case With Silver Button



Easily installs into standard receptacle box. Attaches with 2 screws.

CCT Receiver



L: 7" x W: 1.75" x H: .75"
12V/8A/96W or 24V/8A/192W
Input Cord: 18" DC 5.5 Female
Screw Mount

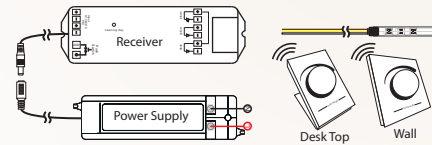

Part #	Description	Price	
		Each	6+ Pcs.
CCT RF Dimmer Kits			
RF-CCT-CTRL-DT	Desktop Style With Receiver	\$120.40	\$105.95 ea.
RF-CCT-CTRL-WT	Wall Style With Receiver	\$114.75	\$100.98 ea.
Individual Price To Create Your Own Kit: For CCT			
RF-CCT-RECVR	Receiver	\$60.75	\$58.05 ea.
RF-CCT-DESK	Desktop Style	\$47.61	\$45.49 ea.
RF-CCT-WALL	Wall Style	\$42.52	\$40.64 ea.

Allows Flexibility To Control Your LED Lights

Up To 10 Zones



For Power Supply, See Pages L-137~140 (Required) • The switch must be within 50' of each receivers.

Scenario 1:
Pairing One Controller (C)
To One Receiver (R)

Works With Standard RF, RGB RF & CCT RF

Scenario 2:
Pairing Several Receivers (R)
To One Controller (C)

Works With Standard RF, RGB RF & CCT RF

Scenario 3:
Pairing Multiple Controllers (C)
To One Receiver (R)

Works With Standard RF

LED Power Supplies

Our high quality power supplies have many safety features. Reference individual series, the safety features are defined below.

CLASS 2: Refers to the NEC- National Electric Code. To avoid potential cable overheating due to excessive currents and electric shock, the output of the power supply is limited to 60VDC or 100VA. (100W when used with an AC-DC power supply)

CLASS II: Referring to a power supply with either a double or reinforced insulation barrier between the input and the output. Class II power supplies will have a double square symbol.

LEVEL VI: Increase efficiency and reduced "no-load" power consumption.

SHORT CIRCUIT PROTECTION: A protection circuit that limits current and acts as an electronic circuit breaker, unit returns to full functionality when the short is removed.

OVERLOAD CIRCUIT PROTECTION: A protection circuit that prevents the output current from exceeding maximum ratings.

Wall Mount

- Certification: UL, ROHS, FCC
- Input Voltage: 100V - 220V
- Operating Temperature: 32° - 104°
- Frequency: 50HZ - 60HZ
- Constant Voltage
- IP Rating: IP20
- Indoor Use
- Plug Type: Polarized 2 Prong
- Output Cord: DC 5.5
- Warranty: Limited 2 Year
- Housing Material: ABS Plastic

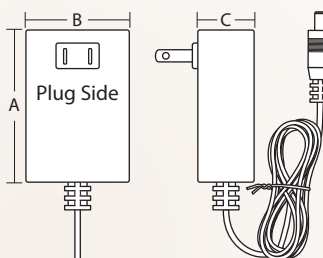

Part #	Output Volts	Max Watts	Max Amps	Input Cord	Output Cord	Wire Gauge	Class	Dimensions	Price	
									Each	6+ Pcs.
12V										
LED-12V-1A	12V	12W	1A	-	72"	22AWG	Class 2	A: 2.91" x B: 1.61" x C: 1.14"	\$8.95	\$8.20 ea.
LED-12V-3A	12V	36W	3A	-	72"	18AWG	Class 2	A: 3.41" x B: 2.31" x C: 1.26"	\$16.15	\$14.70 ea.
24V										
LED-24V-1A	24V	24W	1A	-	72"	22AWG	Class 2	A: 3.13" x B: 2.07" x C: 1.52"	\$11.65	\$10.60 ea.
LED-24V-1.5A-DC5.5	24V	36W	1.5A	-	72"	22AWG	Class 2	A: 3.13" x B: 2.07" x C: 1.52"	\$12.22	\$11.59 ea.

Desktop

- Certification: UL, ROHS, FCC
- Input Voltage: 100V - 220V
- Operating Temperature: 32° - 104°
- Frequency: 50HZ - 60HZ
- Constant Voltage
- IP Rating: IP20
- Indoor Use
- Plug Type: Polarized 2 Prong
- Output Cord: DC 5.5
- Warranty: Limited 2 Year
- Housing Material: ABS Plastic

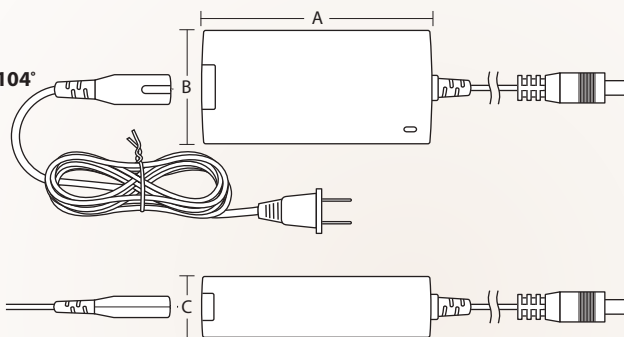

Part #	Output Volts	Max Watts	Max Amps	Input Cord	Output Cord	Wire Gauge	Class	Dimensions	Price	
									Each	6+ Pcs.
12V										
LED-12V-6A	12V	72W	6A	48"	72"	18AWG	Class 2 / Class II	A: 4.68" x B: 2.34" x C: 1.48"	\$27.85	\$25.35 ea.
LED-12V-9A	12V	108W	9A	48"	72"	18AWG	Class II	A: 6.77" x B: 2.83" x C: 1.57"	\$44.05	\$40.35 ea.
24V										
LED-24V-3A	24V	72W	3A	48"	72"	18AWG	Class 2 / Class II	A: 4.68" x B: 2.34" x C: 1.48"	\$28.75	\$26.05 ea.
LED-24V-4A	24V	96W	4A	48"	72"	18AWG	Class II	A: 6.77" x B: 2.83" x C: 1.57"	\$44.05	\$39.90 ea.
LED-24V-6A	24V	144W	6A	48"	72"	18AWG	Class II	A: 6.77" x B: 2.83" x C: 1.57"	\$52.15	\$47.40 ea.

Some LED fixtures may require a power link cable to connect to the power supply. Please refer to product listing.

IMPORTANT: Due to Raw Material Fluctuation, Catalog Prices Below May Not Be Accurate. GO TO WWW.OUTWATER.COM FOR THE MOST UP-TO-DATE PRICES

LED Lighting

LED Power Supplies

Our high quality power supplies have many safety features. Reference individual series, the safety features are defined below.

CLASS 2: Refers to the NEC- National Electric Code. To avoid potential cable overheating due to excessive currents and electric shock, the output of the power supply is limited to 60VDC or 100VA. (100W when used with an AC-DC power supply)

CLASS II: Referring to a power supply with either a double or reinforced insulation barrier between the input and the output. Class II power supplies will have a double square symbol.

SHORT CIRCUIT PROTECTION: A protection circuit that limits current and acts as an electronic circuit breaker, unit returns to full functionality when the short is removed.

OVERLOAD CIRCUIT PROTECTION: A protection circuit that prevents the output current from exceeding maximum ratings.

Non-Dimmable Hardwire

- **Certification:** UL, ROHS
- **Input Voltage:** 100V - 265V
- **Operating Temperature:** -22° - 122°
- **Frequency:** 50HZ - 60HZ
- **Constant:** Voltage
- **IP Rating:** IP67
- **Indoor & Outdoor Use**
- **Warranty:** Limited 2 Year
- **Housing Material:** Aluminum
(Aluminum housing provided superior heat sink for maximum performance)

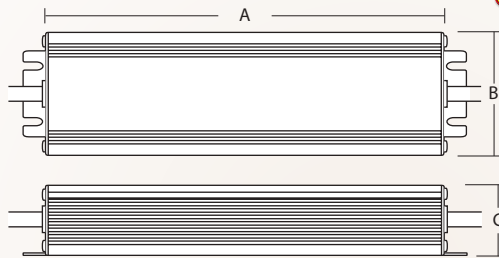

New! LED-24V-2.5A-HWSL Is So Slim It Can Now Be Concealed Inside The SEG Frame

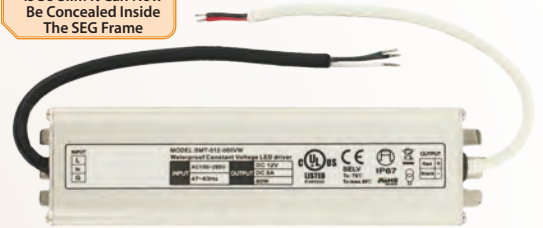

Part #	Output Volts	Max Watts	Max Amps	Input Cord	Output Cord	Wire Gauge	Class	Dimensions	Price	
									Each	6+ Pcs.
12V										
LED-12V-5A-HW	12V	60W	5A	7.5"	7.5"	18AWG	Class 2	A: 7.5" x B: 1.88" x C: 1.33"	\$25.00	\$22.50 ea.
LED-12V-8.3A-HW	12V	99.6W	8.3A	10.5"	10.5"	18AWG	-	A: 8.74" x B: 2.71" x C: 1.69"	\$44.00	\$39.50 ea.
LED-12V-16.6A-HW	12V	199W	16.6A	10.5"	10.5"	18AWG	Class 2	A: 9.84" x B: 3.11" x C: 2"	\$74.70	\$67.10 ea.
24V										
LED-24V-1.25A-HW	24V	30W	1.25A	10.5"	10.5"	18AWG	Class 2	A: 7.16" x B: 1.14" x C: .78"	\$15.50	\$13.95 ea.
New! LED-24V-2.5A-HWSL	24V	60W	2.5A	39" with US plug	39" with DC5.5	18AWG	Class 2	A: 11.8" x B: 1.25" x C: .78"	\$45.36	\$40.50 ea.
LED-24V-2.5A-HW	24V	60W	2.5A	10.5"	10.5"	18AWG	Class 2	A: 7.5" x B: 1.88" x C: 1.33"	\$25.00	\$22.50 ea.
LED-24V-4.17A-HW	24V	100W	4.17A	10.5"	10.5"	18AWG	Class 2	A: 8.74" x B: 2.71" x C: 1.69"	\$42.00	\$38.20 ea.
LED-24V-8.3A-HW	24V	199W	8.3A	10.5"	10.5"	18AWG	-	A: 9.84" x B: 3.11" x C: 2"	\$74.70	\$67.10 ea.

MOX Lighting Universal Dimmable Hardwire

- **Certification:** ETL
- **Input Voltage:** 100 - 130VAC
- **Operating Temperature:** 4° - 104°
- **Frequency:** 50HZ - 60HZ
- **Constant:** Voltage
- **Indoor & Outdoor Use**
- **Warranty:** Limited 3 Year
- **Housing Material:** ABS Plastic or Aluminum (Fully insulated case)

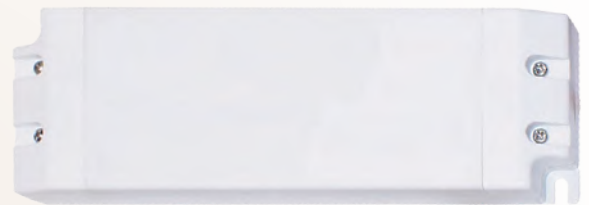
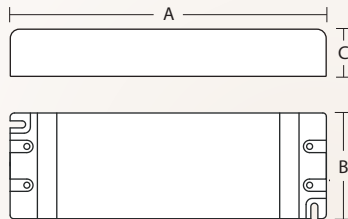

Part #	Output Volts	Max Watts	Max Amps	Input Cord	Output Cord	Wire Gauge		Class	Dimensions	Price	
						Primary	Secondary			Each	6+ Pcs.
12V											
LED-12V-5A-HWUD	12V	60W	5A	-	-	-	-	Class 2	A: 7.09" x B: 2.36" x C: 1.38"	\$71.20	\$64.30 ea.
LED-12V-10A-HWUD	12V	120W	10A	-	-	-	-	Class 2	A: 10.12" x B: 3.07" x C: 1.89"	\$117.55	\$106.15 ea.
24V											
LED-24V-2.5A-HWUD	24V	60W	2.5A	-	-	-	-	Class 2	A: 7.09" x B: 2.36" x C: 1.38"	\$71.20	\$64.30 ea.
LED-24V-5A-HWUD	24V	120W	5A	-	-	-	-	Class 2	A: 10.12" x B: 3.07" x C: 1.89"	\$117.55	\$106.15 ea.

Some LED fixtures may require a power link cable to connect to the power supply. Please refer to product listing.

LED Power Supplies

Our high quality power supplies have many safety features. Reference individual series, the safety features are defined below.

CLASS 2: Refers to the NEC- National Electric Code. To avoid potential cable overheating due to excessive currents and electric shock, the output of the power supply is limited to 60VDC or 100VA. (100W when used with an AC-DC power supply)

CLASS II: Referring to a power supply with either a double or reinforced insulation barrier between the input and the output. Class II power supplies will have a double square symbol.

SHORT CIRCUIT PROTECTION: A protection circuit that limits current and acts as an electronic circuit breaker, unit returns to full functionality when the short is removed.

OVERLOAD CIRCUIT PROTECTION: A protection circuit that prevents the output current from exceeding maximum ratings.

Magnitude Magnetic Dimmable Hardwire

- Certification: ETL
- Input Voltage: 120V
- Operating Temperature: -22° - 122°
- Frequency: 50HZ - 60HZ
- Constant: Voltage
- IP Rating: NEMA 3R
- Indoor & Outdoor Use
- Warranty: Limited 5 Year
- Housing Material: Aluminum
(Aluminum housing provided superior heat sink for maximum performance)

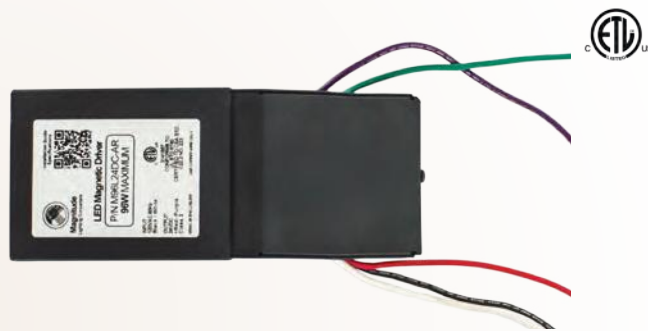
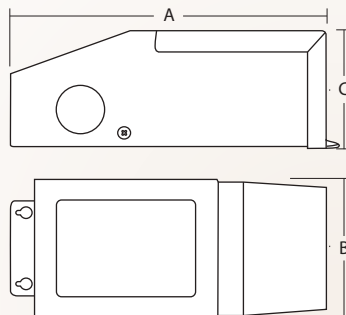

Part #	Output Volts	Max Watts	Max Amps	Input Cord	Output Cord	Wire Gauge		Class	Dimensions	Price	
						Primary	Secondary			Each	6+ Pcs.
12V											
LED-12V-5A-HDM	12V	60W	5A	6"	6"	20AWG	14AWG	Class 2	A: 6.55" x B: 2.25" x C: 2.55"	\$80.85	\$78.16 ea.
LED-12V-13A-HDM	12V	156W	13A	6"	6"	18AWG	12AWG	Class 2	A: 9.80" x B: 3.00" x C: 3.00"	\$97.35	\$94.11 ea.
LED-12V-16.6A-HDM	12V	200W	16.6A	6"	6"	18AWG	12AWG	Class 2	A: 9.80" x B: 3.00" x C: 3.00"	\$103.95	\$100.49 ea.
24V											
LED-24V-4A-HDM	24V	96W	4A	6"	6"	20AWG	14AWG	Class 2	A: 9.80" x B: 3.00" x C: 3.00"	\$89.93	\$86.93 ea.
LED-24V-6A-HDM	24V	144W	6A	6"	6"	18AWG	12AWG	Class 2	A: 9.80" x B: 3.00" x C: 3.00"	\$97.35	\$94.11 ea.
LED-24V-8.3A-HDM	24V	200W	8.3A	6"	6"	18AWG	12AWG	Class 2	A: 9.80" x B: 3.00" x C: 3.00"	\$103.95	\$100.49 ea.

Magnitude MLV/TROAC Dimmable Hardwire

- Certification: UL, UL 8750, FCC
- Input Voltage: 120VAC
- Operating Temperature: -22° - 122°
- Frequency: 50HZ - 60HZ
- Constant: Voltage
- IP Rating: NEMA 3R
- Indoor & Outdoor Use
- Warranty: Limited 5 Year
- Housing Material: Aluminum
(Compact aluminum housing provided superior heat sink for maximum performance)

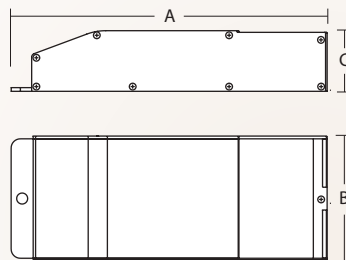

Part #	Output Volts	Max Watts	Max Amps	Input Cord	Output Cord	Wire Gauge		Class	Dimensions	Price	
						Primary	Secondary			Each	6+ Pcs.
12V											
LED-12V-3.3A-HDMB	12V	40W	3.3A	6"	6"	18AWG	14AWG	Class 2	A: 6.77" x B: 2.67" x C: 1.26"	\$63.15	\$61.05 ea.
LED-12V-5A-HDMB	12V	60W	5A	6"	6"	18AWG	14 AWG	Class 2	A: 6.77" x B: 2.67" x C: 1.26"	\$76.40	\$73.86 ea.
24V											
LED-24V-2.5A-HDMB	24V	60W	2.5A	6"	6"	18AWG	14AWG	Class 2	A: 6.77" x B: 2.67" x C: 1.26"	\$76.40	\$73.86 ea.
LED-24V-4A-HDMB	24V	96W	4A	6"	6"	18AWG	14AWG	Class 2	A: 6.77" x B: 2.67" x C: 1.26"	\$84.98	\$82.15 ea.

Some LED fixtures may require a power link cable to connect to the power supply. Please refer to product listing.

LED Lighting

LED Power Supplies

Our high quality power supplies have many safety features. Reference individual series, the safety features are defined below.

CLASS 2: Refers to the NEC- National Electric Code. To avoid potential cable overheating due to excessive currents and electric shock, the output of the power supply is limited to 60VDC or 100VA. (100W when used with an AC-DC power supply)

CLASS II: Referring to a power supply with either a double or reinforced insulation barrier between the input and the output. Class II power supplies will have a double square symbol.

SHORT CIRCUIT PROTECTION: A protection circuit that limits current and acts as an electronic circuit breaker, unit returns to full functionality when the short is removed.

OVERLOAD CIRCUIT PROTECTION: A protection circuit that prevents the output current from exceeding maximum ratings.

Magnitude MLV/TROAC Dimmable Hardwire

- **Certification:** UL Recognized, UI 8750 & FCC
- **Input Voltage:** 120V
- **Operating Temperature:** -22° - 122°
- **Frequency:** 50HZ - 60HZ
- **Constant:** Voltage
- **IP Rating:** IP67
- **Indoor & Outdoor Use**
- **Warranty:** Limited 5 Year
- **Housing Material:** Aluminum
(Super compact aluminum housing provided superior heat sink for maximum performance and easy to hide)

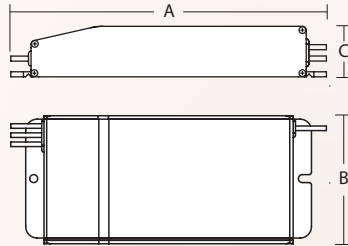

Part #	Output Volts	Max Watts	Max Amps	Input Cord	Output Cord	Wire Gauge		Class	Dimensions	Price	
						Primary	Secondary			Each	6+ Pcs.
12V											
LED-12V-3.3A-HDMC	12V	40W	3.3A	6"	6"	18AWG	14AWG	Class 2	A: 4.92" x B: 1.97" x C: .77"	\$56.91	\$55.02 ea.
LED-12V-5A-HDMC	12V	60W	5A	6"	6"	18AWG	14AWG	Class 2	A: 4.92" x B: 1.97" x C: .77"	\$70.16	\$67.82 ea.
24V											
LED-24V-2.5A-HDMC	24V	60W	2.5A	6"	6"	18AWG	14AWG	Class 2	A: 4.92" x B: 1.97" x C: .77"	\$70.58	\$68.23 ea.
LED-24V-4A-HDMC	24V	96W	4A	6"	6"	18AWG	14AWG	Class 2	A: 4.92" x B: 1.97" x C: .77"	\$76.40	\$73.86 ea.

Rechargeable Battery With Overcharge Protection

- **Constant:** Voltage
- **Warranty:** Limited 2 Year
- **IP Rating:** IP20
- **LED Indicator:** Red when not fully charged & green when charged
- **Can use switch or sensor without depleting battery life**
- **On/Off switch on battery**
- **Power Supply:** Included for charging
- **Plug Type:** Input- DC 5.5 Male & Output- DC 5.5 Female

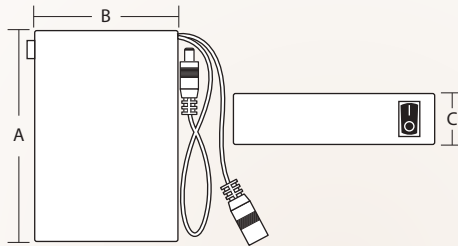

Power Supply Included

Part #	Volts	Amps	Input Cord	Output Cord	Dimensions	Class	Longevity	Price	
								Each	6+ Pcs.
12V									
LED-RB12V-4.8A	12V	4.8	9-1/2" DC 5.5	5-1/2" DC 5.5	A: 4.25" x B: 2.25" x C: .75"	Class II	2.5 hrs. (ECO12-*3560-16-*)	\$30.60	\$27.05 ea.
LED-RB12V-8A	12V	8	Male	Female	A: 4.313" x B: 2.688" x C: .875"	Class II	4 hrs. (ECO12-*3560-16-*)	\$44.30	\$39.05 ea.
24V									
LED-RB24V-3A	24V	3	3" DC 5.5	6" DC 5.5	A: 4.375" x B: 2.25" x C: .688"	Class II	12 hrs. (RIB24-15060-*)	\$72.55	\$63.90 ea.
LED-RB24V-5A	24V	5	Female	Male	A: 5" x B: 2.563" x C: 1.75"	Class II	20 hrs. (RIB24-15060-*)	\$108.63	\$95.70 ea.

How Long Will My Battery Last? Battery Longevity: $\frac{(\text{AMPS} \times \text{VOLTS})}{\text{WATTS}} = \text{HRS}$

Some LED fixtures may require a power link cable to connect to the power supply. Please refer to product listing.

LED Power Supplies

Power Linking Cables

Some LED fixtures may require a power link cable to connect to the power supply. Please refer to product listing.

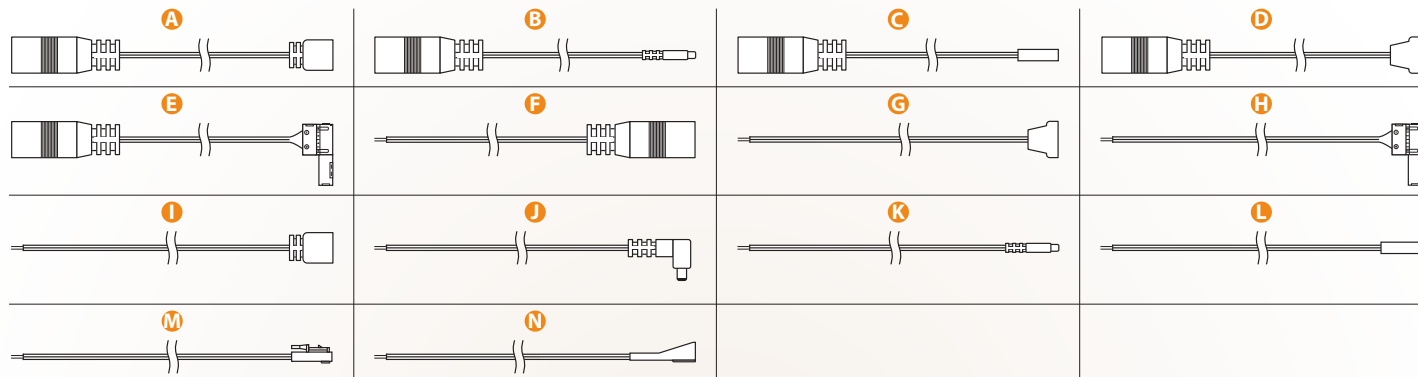

Part #	Compatible	Function	Length	Wire Gauge	Color	Price		
						Each	6+ Pcs.	
Dedicated System Connection								
A	LED-RIBBON-PWL	Single Ribbon	With Pin Connection (Pins Included)	18"	22AWG	Black	\$3.00	\$2.60 ea.
B	LED-SLSHX-PWL	Gen Next Thin Light	With Gen Next Connection	18"	18AWG	White	\$3.50	\$2.95 ea.
C	LED-WF-PWL	Utopia & Wafer	With Utopia & Wafer Connection	18"	24AWG	White	\$3.00	\$2.60 ea.
For Cut Pieces of Ribbon								
D	LED-FPC-8-PWL	24V DP248* Ribbon	100% Usable Connection	24"	22AWG	White	\$2.40	\$2.20 ea.
D	LED-FPC-10-PWL	24V DP2410* Ribbon	100% Usable Connection	24"	22AWG	White	\$2.50	\$2.30 ea.
D	LED-FPC-15-PWL	24V DP2415* Ribbon	100% Usable Connection	24"	22AWG	White	\$2.60	\$2.40 ea.
D	LED-FPC-20-PWL	24V DP2420* Ribbon	100% Usable Connection	24"	22AWG	White	\$2.95	\$2.75 ea.
E	ECO12V-35-100U-PL	ECO12V 3528 (8MM)	100% Usable Connection	18"	22AWG	Black	\$4.00	\$3.50 ea.
E	LED-RIBBON-100U-PL	Single Ribbon	100% Usable Connection	18"	22AWG	White	\$4.00	\$3.50 ea.
Hardwire								
F	LED-WIR9-BK	-	With Female DC 5.5	108"	22AWG	Black	\$2.55	\$2.25 ea.
F	LED-DCF-MCC	-	With Female DC 5.5	18"	22AWG	Black	\$1.95	\$1.65 ea.
G	LED-FPC-8-ST	24V DP248* Ribbon	With 100% Usable Connection	36"	22AWG	White	\$1.75	\$1.60 ea.
G	LED-FPC-10-ST	24V DP2410* Ribbon	With 100% Usable Connection	36"	22AWG	White	\$1.85	\$1.70 ea.
G	LED-FPC-15-ST	24V DP2415* Ribbon	With 100% Usable Connection	36"	22AWG	White	\$1.95	\$1.80 ea.
G	LED-FPC-20-ST	24V DP2420* Ribbon	With 100% Usable Connection	36"	22AWG	White	\$2.05	\$1.90 ea.
H	LED-RIBBON-100U-RT	24V Single RGB Ribbon	With 100% Usable Connection	79"	22AWG	Multi	\$4.50	\$3.95 ea.
H	LED-RIBBON-100U-ST	24V Single Ribbon	With 100% Usable Connection	79"	22AWG	White	\$4.50	\$3.95 ea.
I	LED-RIBBON-MCC	24V Single Ribbon	With Pin Connection (Pins Included)	18"	22AWG	White	\$1.95	\$1.65 ea.
I	LED-RIB-RGB-MCC	24V Single RGB Ribbon	With Pin Connection (Pins Included)	18"	22AWG	Multi	\$1.95	\$1.65 ea.
J	LED-T5-MCC	T-5 Sunray	With Right Angle Male DC 5.5	18"	22AWG	White	\$1.95	\$1.65 ea.
K	LED-SLSHX-MCC	Gen Next Thin Light	With Gen Next Connection	18"	18AWG	White	\$2.50	\$2.25 ea.
L	LED-WF-MCC	Utopia & Wafer	With Utopia & Wafer Connection	18"	24AWG	White	\$1.95	\$1.65 ea.
M	LED-813MINI-M	Marque Puck Light	With Marque Connection (Male)	6"	22AWG	Black	\$1.95	\$1.65 ea.
N	LED-813MINI-F	Marque Puck Light	With Marque Connection (Female)	6"	22AWG	Black	\$1.95	\$1.65 ea.

Luminous Ceiling Panels: LED & Fluorescent Applications

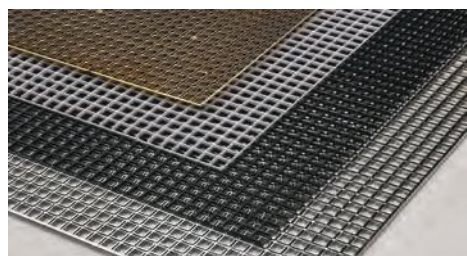

EGG CRATE LOUVER

White, Black, Brass or Chrome

Material: Styrene • Available by sheet or case • Sheet size: 2' x 4'
Durable & Economical • Variety of patterns to choose from

Egg Crate Louver

Part #	Pattern	Color	Panel Thickness	Sheets Per Case	Price Per Sheet	Case Per Sheet
L2-BK	Egg Crate Louver 5/8" x 5/8" x 3/8"	Black	3/8"	15*	\$13.40	\$12.15
L2-WH	Egg Crate Louver 5/8" x 5/8" x 3/8"	White	3/8"	15*	\$12.35	\$10.75
L2-CH	Parabolic Louver 1/2" x 1/2" x 5/16"	Chrome	7/16"	10*	\$32.00	\$30.00

* CRATING CHARGES ARE EXTRA

Additional \$5.00 carting charge under 15 sheets. Additional \$5.00 charge under 10 sheets.

LED Lighting



LED Dimmers

LUTRON

- Lutron dimmers work with our magnetic low voltage & TRIAC hardwire dimmable power supplies
- Range of dimming depends on the led light (most LED's will not dim to 0)

- Wall plates sold separately
- Fits most standard wall plates
- Works with Nova Sheet

- IP Rating: IP20
- Limited 2 Year Warranty

120V Dimmer Feature List

Features	Skylark (S-600P-WH)	Diva (DVLV-600P-WH)
Single Pole	X	X
Night Time Locator	X	X
Works With Our Hardwire Dimmable Driver	X	X
RF Wireless	X	X
Color: White	X	X
Power Failure Memory	X	X
UL	X	X
ROHS		
cULus		
FCC		
Wall Mounting	X	X

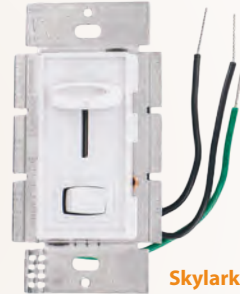
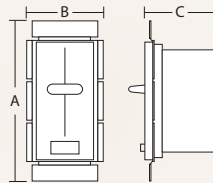

Skylark



Diva

Part #	Description	Volts	Max. Watts	Input Cord	Output Cord	Dimensions	Price
S-600P-WH	SKYLARK- On/Off switch with slide dimmer	120V	450W	5.875"	5.875"	A: 4.125" x B: 2.125" x C: 1.687"	\$18.00 ea.
DVLV-600P-WH	DIVA- Rocker switch with slider dimmer	120V	450W	5.875"	5.875"	A: 4.125" x B: 2.125" x C: 1.625"	\$43.50 ea.
CW-1-WH	White Wall Plate (screwless)	-	-	-	-	A: 4.69" x B: 2.94" x C: 0.30"	\$4.25 ea.

OPI Series

120V Dimmer Feature List

Features	OPI Series (OPDM-16-3)
3-Way	X
Single Pole	X
Night Time Locator	X
Works With Our Hardwire Dimmable Driver	X
RF Wireless	
Color: White	X
Magnesium Color	
UL	X
FCC	
Wall Mounting	X
LED Light Indicator	X

- OPI Series dimmer works with our magnetic low voltage & TRIAC hardwire dimmable power supplies
- Range of dimming depends on the led light (most LED's will not dim to 0)
- Wall plates sold separately
- Fits most standard wall plates
- Works with 120V Brite Light Flex & Infinity

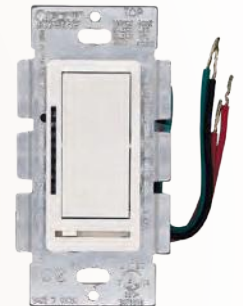
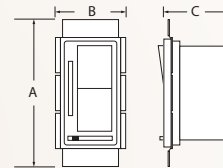

Part #	Description	Volts	Max. Watts	Input Cord	Output Cord	Dimensions	Price
OPDM-16-3	Rocker switch with slider dimmer	120V	600W	5.875"	5.875"	A: 4.125" x B: 2.25" x C: 1.50"	\$15.00 ea.
CW-1-WH	White Wall Plate (screwless)	-	-	-	-	A: 4.69" x B: 2.94" x C: 0.30"	\$4.25 ea.
RWP26W	White Wall Plate (screwless)	-	-	-	-	A: 4.94" x B: 3.15" x C: 0.25"	\$2.52 ea.

Sensor

Works With All Wall Mount & Desktop Power Supplies

- IP Rating: IP20
- Warranty: Limited 1 Year
- Mounting: Surface or Recessed

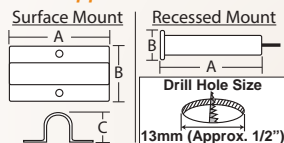

Surface Mount



Recessed Mount

Part #	Description	Volts	Max. Amps	Max. Watts	Input Cord	Output Cord	Dimensions	Price	
								Each	6+
LED-DSEN	Door Sensor	12V 24V	2A 2A	24W 48W	18" DC 5.5 Female	18" DC 5.5 Male	Surface: A: 2.5" x B: 1.125" x C: .687" Recessed: A: 2.5" x B: .625"	\$11.75	\$10.90 ea.



LED Dimmers



120V Dimmer Feature List

Features	Radiant (RH703PTUTC)	Radiant Wireless Main (LC2101-WH)	Radiant Wireless Remote (LC2103-WH)	Softouch (LGD120-DIMST*)
Tru-Universal	X	X		X
3-Way	X			X
Bottom End Cut-Off	X	X		X
Single Pole	X	X		X
Night Time Locator	X			X
Works With Our Hardwire Dimmable Driver	X	X	X	X
RF Wireless		X	X	X
Color: White		X	X	X
Magnesium Color				X
3 Face Colors: White, Light Almond & Ivory	X			X
UL	X	X	X	X
ROHS	X	X	X	X
cULus	X			X
FCC	X	X		X
Wall Mounting	X	X	X	X

- Legrand dimmers work with our magnetic low voltage & TRIAC hardwire dimmable power supplies
- Ranging of dimming depends on the led light (most LED's will not dimm to 0)
- Wall plates sold separately
- Fits most standard wall plates
- True-Universal technology automatically adapts to light eliminating flickering
- Radiant wireless features voice activated control with Google Assistant or Amazon Alexa (Only LC2101-WH & LC2103-WH)
- Work with 120V Brite Light Flex & Infinity
- IP Rating: IP20

Radiant
Shown With Wall Plate

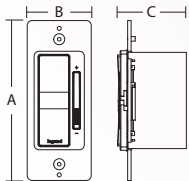

Radiant Wireless Main
Shown With Wall Plate

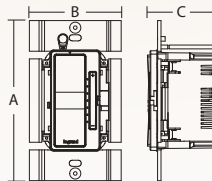

Radiant Wireless Remote
Shown With Wall Plate

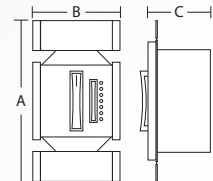

sofTap
Shown With Wall Plate

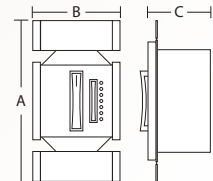

Part #	Description	Finish	Volts	Max. Watts	Dimensions	Price
RH703PTUTC	Radiant- Rocker switch with slide dimmer	White	120V	450W	A: 4.25" x B: 1.75" x C: 1.25"	\$62.30 ea.
LC2101-WH	Radiant Wireless Main- Touch with touch slide dimmer	White	120V	450W	A: 4.19" x B: 1.75" x C: 1.73"	\$90.72 ea.
LC2103-WH	Radiant Wireless Remote- Touch with touch slide dimmer	White	120V	450W	A: 4.19" x B: 1.75" x C: 1.73"	\$71.06 ea.
LGD120-DIMST-MG	sofTap- Touch switch with touch slide dimmer	Magnesium	120V	450W	A: 4.187" x B: 1.75" x C: 1.75"	\$63.28 ea.
LGD120-DIMST-WH		White	120V	450W	A: 4.187" x B: 1.75" x C: 1.75"	\$54.98 ea.
LGD120-WP-MG	Wall Plates For sofTap (Sold Separately)	Magnesium	-	-	A: 5" x B: 3.375" x C: .375"	\$7.98 ea.
LGD120-WP-WH		White	-	-	A: 5" x B: 3.375" x C: .375"	\$5.50 ea.
RWP26W	Wall Plates For Radiant & Radiant Wireless (Sold Separately)	White	-	-	A: 4.94" x B: 3.15" x C: .375"	\$2.52 ea.

LED Lighting

LED Dimmers

Standard Dimmers

Works With All Wall Mount & Desktop Power Supplies

- Warranty: Limited 1 Year
- IP Rating: IP20

A. Inline Rotary (Short Cables)
Available In : Black or White



D. Inline Touch



C. Touch To Bare Wire

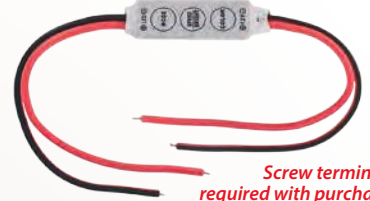

Screw terminals required with purchase, See Page L-148

D. Rotary



E. Touch



I. DC 3.5



G. Radio Frequency

New!



- 10 level brightness adjustment
- 10 level of speed adjustment
- Dimmer adjust shortcut-Switch to 100%, 50%, 25% brightness
- 8 dynamic effects
- Auto save function
- Ultra slim design

Part #	Volts	Max. Amps	Max. Watts	Input Cord	Output Cord	Dimensions	Dimmer Type	Range of Dimming	Mounting	Price	
										Each	6+ Pcs.
A LED-INLINE-DIM (Finish: Black)	12V	6A	72W	6" DC 5.5	6" DC 5.5	L: 2.6" x W: 1.4" x H: 1"	Rotary	0-100%	-	\$5.95	\$5.25 ea.
A LED-INLINE-DIM-WH (Finish: White)	12V	6A	72W	6" DC 5.5	6" DC 5.5	L: 2.6" x W: 1.4" x H: 1"	Rotary	0-100%	-	\$5.95	\$5.25 ea.
B LED-INLINE-TCHDIM	12V	2A	24W	6" DC 5.5	6" DC 5.5	L: 1.25" x W: .75" x H: .44"	Touch	0-100%	-	\$7.95	\$7.25 ea.
C LED-DIM-BR	12V	6A	72W	3.75"	3.75"	L: 2.25" x W: .5" x H: .18"	Push	0-100%	-	\$2.50	\$2.35 ea.
D LED-ROTY-DIM	12V	8A	96W	24" DC 5.5	24" DC 5.5	L: 2.25" x W: 3.5" x H: 1.5"	Rotary	0-100%	Screw	\$9.95	\$9.00 ea.
E LED-DIM-648D	12V	2A	24W	18" DC 5.5	18" DC 5.5	Dia: 22mm x L: 16mm	Touch	0-100%	Recessed	\$9.00	\$8.25 ea.
F LED-CLE-DIM	12V	2A	24W	-	36" DC 3.5	L: 3.75" x W: 1.13" x H: .37"	Push	0-100%	Screw	\$5.95	\$5.25 ea.
G LED-INLINE-RF	12V	6A	72W	3.5" DC 5.5	3.5" DC 5.5	L: 1.5" x W: .5" x H: .125"	RF	0-100%	-	\$9.95	\$9.00 ea.
	24V	6A	144W	Female	Male						

LED Cables & Connectors

Connecting Cables For 24V DP24, ECO12V 3528 & ECO 12V RGB

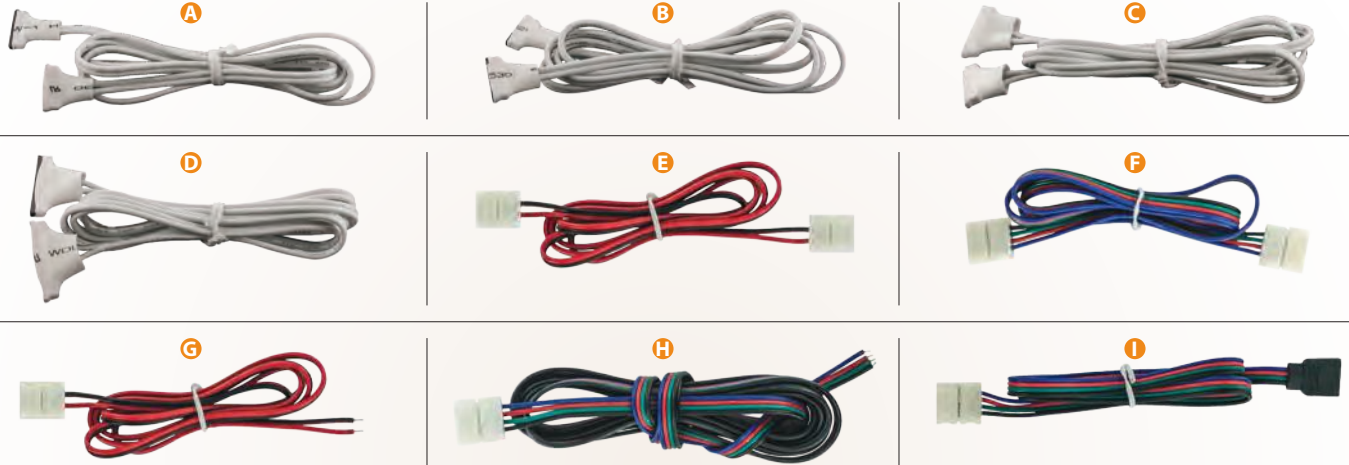

Part #	Descriptions	Works With	Function	Length	Wire Gauge	Color	Price	
							Each	6+ Pcs.
A	LED-FPC-8-CON24	Connecting Cable	24V DP248*	24"	22AWG	White	\$2.15	\$2.00 ea.
A	LED-FPC-8-CON36	Connecting Cable	24V DP248*	36"	22AWG	White	\$2.50	\$2.30 ea.
B	LED-FPC-10-CON24	Connecting Cable	24V DP2410*	24"	22AWG	White	\$2.40	\$2.20 ea.
B	LED-FPC-10-CON36	Connecting Cable	24V DP2410*	36"	22AWG	White	\$2.70	\$2.50 ea.
C	LED-FPC-15-CON24	Connecting Cable	24V DP2415*	24"	22AWG	White	\$2.60	\$2.40 ea.
C	LED-FPC-15-CON36	Connecting Cable	24V DP2415*	36"	22AWG	White	\$2.95	\$2.75 ea.
D	LED-FPC-20-CON24	Connecting Cable	24V DP2420*	24"	22AWG	White	\$2.80	\$2.60 ea.
D	LED-FPC-20-CON36	Connecting Cable	24V DP2420*	36"	22AWG	White	\$3.15	\$2.95 ea.
E	ECO12V-35-100U-C1	Connecting Cable	ECO12V 3528	24"	22AWG	Red/Black	\$3.25	\$2.85 ea.
E	ECO12V-35-100U-C2	Connecting Cable	ECO12V 3528	36"	22AWG	Red/Black	\$3.50	\$3.05 ea.
F	LED-RIBBON-100U-R1	Connecting Cable	ECO12V RGB	24"	22AWG	Multi	\$4.25	\$3.70 ea.
F	LED-RIBBON-100U-R2	Connecting Cable	ECO12V RGB	36"	22AWG	Multi	\$4.50	\$3.95 ea.
G	ECO12V-35-100U-ST	Connecting Cable	ECO12V 3528	79"	22AWG	Red/Black	\$4.50	\$3.95 ea.
H	LED-RIBBON-100U-RT	Connecting Cable	ECO12V RGB	79"	22AWG	Multi	\$4.50	\$3.95 ea.
I	LED-RIBBON-100U-4P	Connecting Cable	ECO12V RGB	18"	22AWG	Multi	\$1.85	\$1.70 ea.

Connectors For 24V DP24, ECO12V 3528 & ECO 12V RGB



Part #	Descriptions	Works With	Function	Price	
				Each	6+ Pcs.
A	LED-FPC-8-EE-C	Connector	24V DP248*	\$1.10	\$1.00 ea.
B	LED-FPC-10-EE-C	Connector	24V DP2410*	\$1.30	\$1.20 ea.
C	LED-FPC-15-EE-C	Connector	24V DP2415*	\$1.60	\$1.45 ea.
D	LED-FPC-20-EE-C	Connector	24V DP2420*	\$1.85	\$1.70 ea.
E	ECO12V-35-100U-EE	Connector	ECO12V 3528	\$0.85	\$0.75 ea.
F	LED-RIBBON-100U-EE	Connector	ECO12V RGB	\$1.15	\$.95 ea.
G	ECO12V-35-2W-EE-C	2-Way L-Shape Connector	ECO12V 3528	\$1.75	\$1.50 ea.
H	ECO12V-35-3W-EE-C	3-Way T-Shape Connector	ECO12V 3528	\$1.75	\$1.50 ea.
I	ECO12V-35-4W-EE-C	4-Way +-Shape Connector	ECO12V 3528	\$1.75	\$1.50 ea.

IMPORTANT: Due to Raw Material Fluctuation, Catalog Prices Below May Not Be Accurate. GO TO WWW.OUTWATER.COM FOR THE MOST UP-TO-DATE PRICES

LED Lighting

LED Cables & Connectors

Connecting Cables & Connectors For Premium 24V Ribbon & RGB

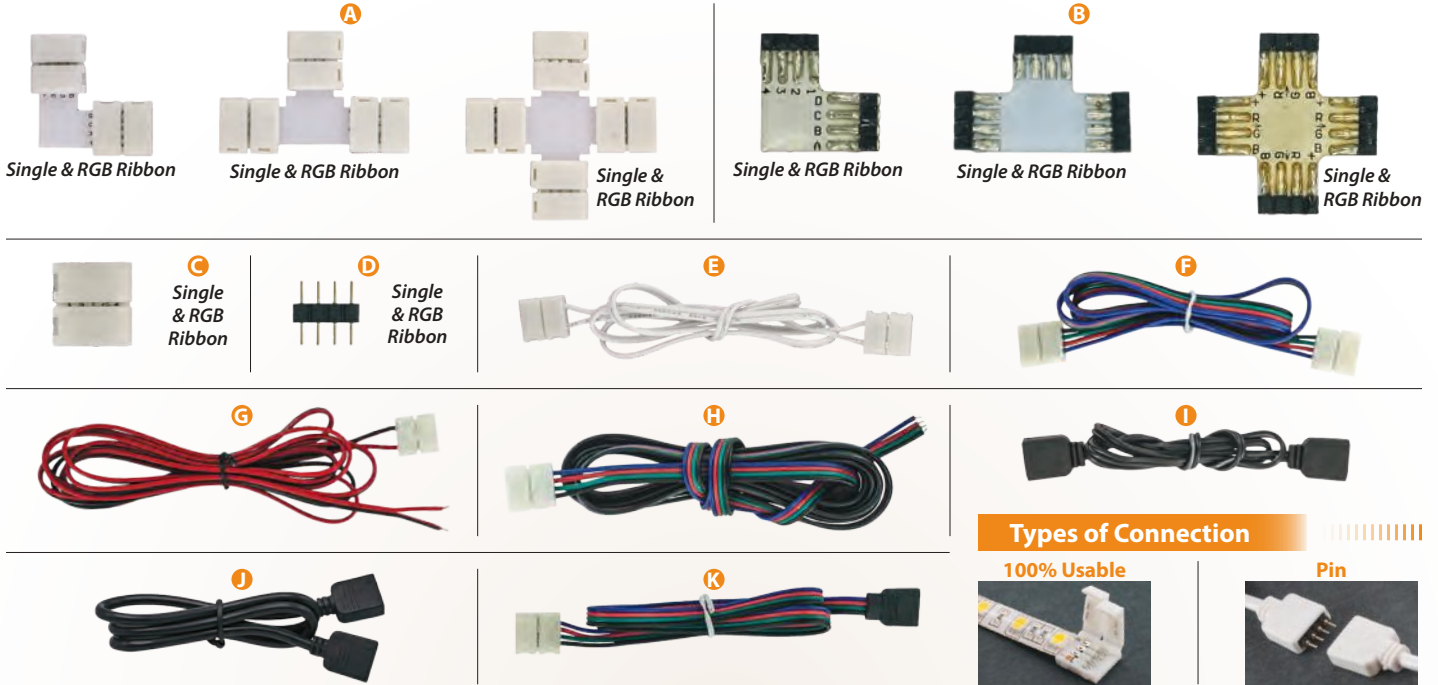

Part #	Descriptions	Works With	Function	Price	
				Each	6+ Pcs.
A LED-RIBBON-2W-EE-C	2-Way L-Shape Connector	Single & RGB Ribbon	Usable connection to connect ribbon at 90° angle	\$1.75	\$1.50 ea.
A LED-RIBBON-3W-EE-C	3-Way T-Shape Connector	Single & RGB Ribbon		\$1.75	\$1.50 ea.
A LED-RIBBON-4W-EE-C	4-Way +-Shape Connector	Single & RGB Ribbon		\$1.75	\$1.50 ea.
B LED-RIBBON-2W-C	2-Way L-Shape Connector	Single & RGB Ribbon	Pin connection to connect ribbon at 90° angle	\$1.75	\$1.50 ea.
B LED-RIBBON-3W-C	3-Way T-Shape Connector	Single & RGB Ribbon		\$1.75	\$1.50 ea.
B LED-RIBBON-4W-C	4-Way +-Shape Connector	Single & RGB Ribbon		\$1.75	\$1.50 ea.
C LED-RIBBON-100U-EE	Connector	Single & RGB Ribbon	Usable connection directly connect 2 cut pieces	\$0.85	\$0.75 ea.

Part #	Descriptions	Works With	Function	Price	
				Each	100+ Pcs.
D LED-4P-CON	Pin Connector	Single & RGB Ribbon	Pin connection to connect ribbon strips	\$0.15	\$0.10 ea.

Part #	Descriptions	Works With	Function	Length	Wire Gauge	Color	Price	
							Each	6+ Pcs.
E LED-RIBBON-100U-C1	Connecting Cable	Single Ribbon	Directly connect 2 cut pieces of ribbon while providing ability to get around unlit areas	24"	22AWG	White	\$3.25	\$2.85 ea.
E LED-RIBBON-100U-C2	Connecting Cable	Single Ribbon		36"	22AWG	White	\$3.50	\$3.05 ea.
F LED-RIBBON-100U-R1	Connecting Cable	RGB Ribbon	Directly connect 2 cut pieces of ribbon while providing ability to get around unlit areas	24"	22AWG	Multi	\$4.25	\$3.70 ea.
F LED-RIBBON-100U-R2	Connecting Cable	RGB Ribbon		36"	22AWG	Multi	\$4.50	\$3.95 ea.
G LED-RIBBON-100U-ST	Connecting Cable	Single Ribbon	Hardwire power supply or dimmer to cut pieces of ribbon	79"	22AWG	Red/Black	\$4.50	\$3.95 ea.
H LED-RIBBON-100U-RT	Connecting Cable	RGB Ribbon		79"	22AWG	Multi	\$4.50	\$3.95 ea.
I LED-RIB-CON-BK	Connecting Cable	Single Ribbon	Allows the designer to get around unlit areas without multiple power supplies	18"	22AWG	Black	\$2.75	\$2.40 ea.
I LED-RIB-CON-WH	Connecting Cable	Single Ribbon		18"	22AWG	White	\$2.75	\$2.40 ea.
I LED-RIB-CON24-WH	Connecting Cable	Single Ribbon		24"	22AWG	White	\$3.25	\$2.85 ea.
I LED-RIB-CON36-BK	Connecting Cable	Single Ribbon		36"	22AWG	Black	\$3.50	\$3.05 ea.
I LED-RIB-CON36-WH	Connecting Cable	Single Ribbon		36"	22AWG	White	\$3.50	\$3.05 ea.
J LED-RIBBON-RGB-CON	Connecting Cable	RGB Ribbon		18"	22AWG	Black	\$2.75	\$2.40 ea.
J LED-RIBBON-RGB-C24	Connecting Cable	RGB Ribbon	24"	22AWG	Black	\$3.25	\$2.85 ea.	
J LED-RIBBON-RGB-C36	Connecting Cable	RGB Ribbon	36"	22AWG	Black	\$3.50	\$3.05 ea.	
K LED-RIBBON-100U-4P	Connecting Cable	RGB Ribbon	Directly connect pin to cut piece of ribbon to get around unlit areas	18"	22AWG	Multi	\$1.85	\$1.70 ea.

LED Cables & Connectors

Multi Output Cables/Ports

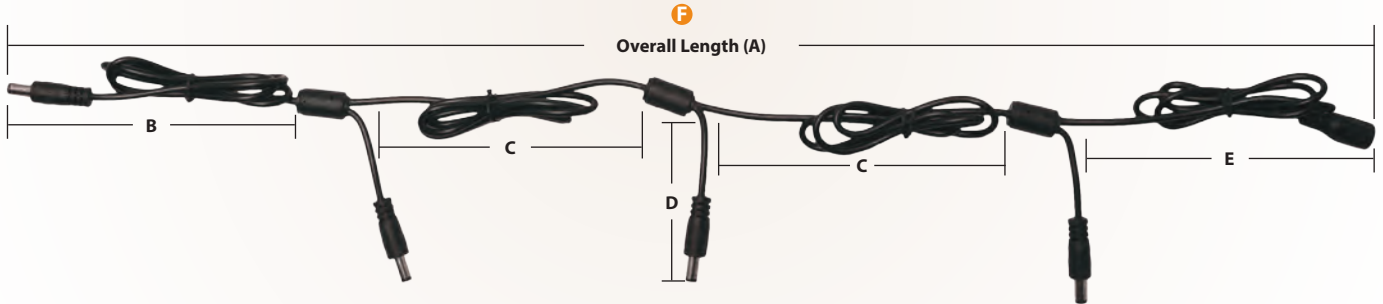
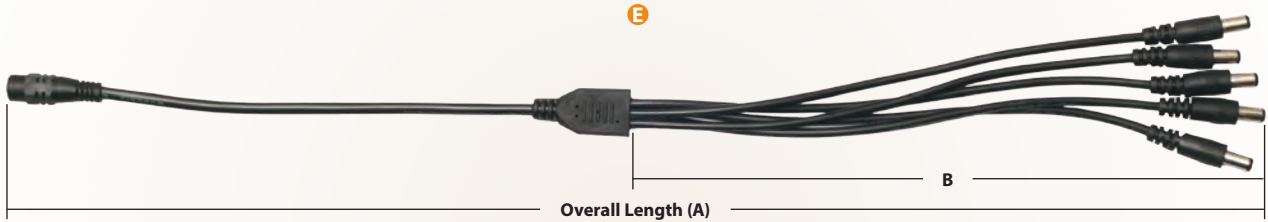
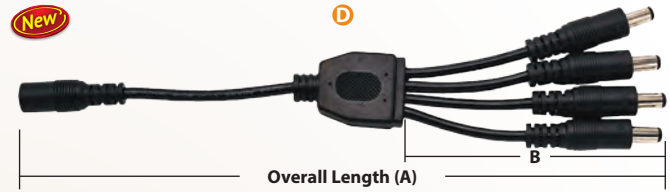
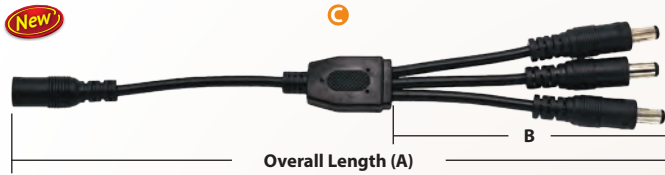
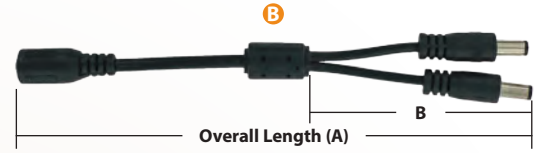

Part #	Descriptions	Length					# of Outputs	Wire Gauge	Color	Price	
		A	B	C	D	E				Each	6+ Pcs.
A LED-2WAY-4P-WH	2 Way Splitter with 4 Pin	12"	5.5"	-	-	-	2 Arms	22AWG	White	\$2.95	\$2.50 ea.
B LED-2WAY-BK	2 Way Splitter with DC 5.5	7"	3"	-	-	-	2 Arms	22AWG	Black	\$2.65	\$2.25 ea.
C LED-3WAY-S-BK	3 Short Arm Sweep Cable w/ DC 5.5	9"	3.75"	-	-	-	3 Arms	22AWG	Black	\$2.75	\$2.45 ea.
D LED-4WAY-BK	4 Short Arm Sweep Cable w/ DC 5.5	9"	3.75"	-	-	-	4 Arms	22AWG	Black	\$3.05	\$2.75 ea.
E LED-3WAY-BK	3 Arm Sweep Cable with DC 5.5	30"	17"	-	-	-	3 Arms	22AWG	Black	\$4.25	\$3.85 ea.
E LED-5OUT-CBL-BK	5 Arm Sweep Cable with DC 5.5	19"	8.75"	-	-	-	5 Arms	22AWG	Black	\$5.50	\$4.85 ea.
E LED-5OUT-CBL-WH	5 Arm Sweep Cable with DC 5.5	19"	8.75"	-	-	-	5 Arms	22AWG	White	\$5.50	\$4.85 ea.
F LED-SPID2-CBL	2 Arm Spider Cable with DC 5.5	98"	54"	38"	6"	4"	2 Arms & 1 End	18AWG	Black	\$7.20	\$6.48 ea.
F LED-SPID3-CBL	3 Arm Spider Cable with DC 5.5	96"	40"	26"	6"	4"	3 Arms & 1 End	18AWG	Black	\$8.40	\$7.56 ea.
F LED-SPIDER-CBL	3 Arm Spider Cable with DC 5.5	96"	25"	23.5"	4.5"	25"	3 Arms & 1 End	22AWG	Black	\$6.25	\$5.55 ea.
F LED-SPIDER-CBL-WH	3 Arm Spider Cable with DC 5.5	96"	25"	23.5"	4.5"	25"	3 Arms & 1 End	22AWG	White	\$6.25	\$5.55 ea.

Bulk Wire

Part #	Description	Works With	Length	# of Wires	Wire Gauge	Price	100+ Ft.
LED-2WR18-PVC-BK	Bulk Roll	Single Ribbon	656.17' (200M)	2 Wire PVC Coated	18AWG	\$0.70	\$0.63 per ft.
LED-4WR18-PVC-BK	Bulk Roll	RGB Ribbon	656.17' (200M)	4 Wire PVC Coated	18AWG	\$0.85	\$0.77 per ft.
LED-5WR18-PVC-BK	Bulk Roll	Special Effects: Dedicated Cool or Warm White Options	656.17' (200M)	5 Wire PVC Coated	18AWG	\$0.95	\$0.85 per ft.

IMPORTANT: Due to Raw Material Fluctuation, Catalog Prices Below May Not Be Accurate. GO TO WWW.OUTWATER.COM FOR THE MOST UP-TO-DATE PRICES

LED Lighting

LED Cables & Connectors

Connectors

For Use With DC 5.5 & DC 3.5 Connections



For Use With Bare Wire Connections



For Use With Bare Wire Connections

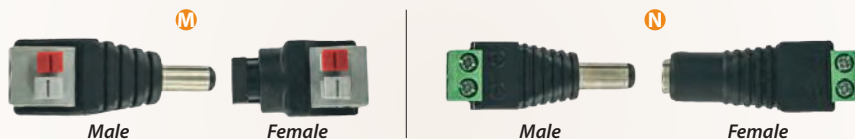

Part #	Descriptions	Function	Length	Price	
				Each	6+ Pcs.
A LED-5555-MM	Barrel Connector	DC 5.5 male to DC 5.5 male	1.625"	\$0.85	\$0.68 ea.
B LED-3535-MM	Barrel Connector	DC 3.5 male to DC 3.5 male	1.5"	\$0.85	\$0.68 ea.
C LED-RCONV-35	Barrel Connector	DC 5.5 male to DC 3.5 female	1.5"	\$1.29	\$1.15 ea.
D LED-RCONV-35M	Barrel Connector	DC 3.5 male to DC 5.5 female	1.5"	\$1.29	\$1.15 ea.
E LED-5555-FF	Barrel Connector	DC 5.5 female to DC 5.5 female	1.5"	\$0.85	\$0.68 ea.
F LED-SNAP-D1	Single Straight Snap Connector	For 18-24 AWG wire	1"	\$1.02	\$0.95 ea.
G LED-SNAP-T1	Single T Snap Connector	For 18-24 AWG wire	1"	\$1.25	\$1.18 ea.
H LED-SNAP-H2	Double H Snap Connector	For 18-24 AWG wire	1"	\$1.62	\$1.55 ea.
I LED-SNAP-T2	Double T Snap Connector	For 18-24 AWG wire	1.125"	\$1.72	\$1.64 ea.
J LED-SPLICE-2	Two Pole Splice Connector	For 12-24 AWG wire	.75"	\$0.46	\$0.42 ea.
K LED-SPLICE-3	Three Pole Splice Connector	For 12-24 AWG wire	.75"	\$0.53	\$0.49 ea.
L LED-SPLICE-4	Four Pole Splice Connector	For 12-24 AWG wire	.75"	\$0.69	\$0.64 ea.
M LED-5555-PM	Push Terminal Connector	DC 5.5 male to push terminal connector	1.5"	\$0.85	\$0.68 ea.
M LED-5555-PF	Push Terminal Connector	DC 5.5 female to push terminal connector	1"	\$0.85	\$0.68 ea.
N LED-5555-SM	Screw Terminal Connector	DC 5.5 male to screw terminal connector	1.5"	\$0.85	\$0.68 ea.
N LED-5555-SF	Screw Terminal Connector	DC 5.5 female to screw terminal connector	1.5"	\$0.85	\$0.68 ea.

Connecting Cables

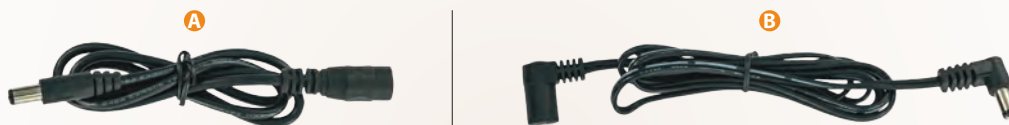

Part #	Descriptions	Function	Length	Wire Gauge	Color	Price	
						Each	6+ Pcs.
A LED-55MF-12*	Connecting Cable	DC 5.5 male to DC 5.5 female	12"	22AWG	Black (*BK) & White (*WH)	\$1.80	\$1.55 ea.
A LED-55MF-24*	Connecting Cable		24"	22AWG	Black (*BK) & White (*WH)	\$2.00	\$1.70 ea.
A LED-55MF-48*	Connecting Cable		48"	22AWG	Black (*BK) & White (*WH)	\$3.50	\$3.05 ea.
B LED-A55MF-12CC*	Angled Connecting Cable	Right angle DC 5.5 male to right angle DC 5.5 female	12"	22AWG	Black (*BK) & White (*WH)	\$1.80	\$1.55 ea.
B LED-A55MF-24CC*	Angled Connecting Cable		24"	22AWG	Black (*BK) & White (*WH)	\$2.00	\$1.70 ea.
B LED-A55MF-48CC*	Angled Connecting Cable		48"	22AWG	Black (*BK) & White (*WH)	\$3.50	\$3.05 ea.

LED Connectors, Mounting Clips & Switches

Switches



Part #	Function	Volts	Max. Amps	Max. Watts	Input Cord	Output Cord	Dimensions	Warranty	IP Rating	Mounting	Price	
											Each	6+ Pcs.
<i>Black *BK & White *WH</i>												
A LED-SWITCH-3A/6A	On/Off	12V 24V	6A 6A	72W 144W	12" DC 5.5 Female	12" DC 5.5 Male	L: 2.25" x W: 1" x H: .75"	1 Year	IP20	Surface	\$4.50	\$4.05 ea.
B LED-PLUNT-36-W	Light turns on when door is opened and off when closed	12V 24V	6A 6A	72W 144W	36" DC 5.5 Female	36" DC 5.5 Male	L: 1.063" x W: .375" x H: .875"	-	-	Surface	\$5.02	\$4.75 ea.
C LED-RSW-18-*	On/Off	12V 24V	6A 6A	72W 144W	18" DC 5.5 Female	18" DC 5.5 Male	1/2" Nominal Diameter	-	-	Recessed	\$2.64	\$2.45 ea.
C LED-RSW-24-*	On/Off	12V 24V	6A 6A	72W 144W	24" DC 5.5 Female	24" DC 5.5 Male	1/2" Nominal Diameter	-	-	Recessed	\$2.90	\$2.61 ea.
C LED-RSW-36-*	On/Off	12V 24V	6A 6A	72W 144W	36" DC 5.5 Female	36" DC 5.5 Male	1/2" Nominal Diameter	-	-	Recessed	\$3.37	\$3.03 ea.
C LED-LRSW-18-*	On/Off	12V 24V	6A 6A	72W 144W	18" DC 5.5 Female	18" DC 5.5 Male	3/4" Nominal Diameter	-	-	Recessed	\$2.97	\$2.67 ea.
C LED-LRSW-24-*	On/Off	12V 24V	6A 6A	72W 144W	24" DC 5.5 Female	24" DC 5.5 Male	3/4" Nominal Diameter	-	-	Recessed	\$3.20	\$2.88 ea.
C LED-LRSW-36-*	On/Off	12V 24V	6A 6A	72W 144W	36" DC 5.5 Female	36" DC 5.5 Male	3/4" Nominal Diameter	-	-	Recessed	\$3.66	\$3.29 ea.

Heat Shrink Tubing



- Material: Black Polyethylene (PE)
- Halogen-free retardant and environmentally friendly material- UL224
- 2:1 Shrink Ratio
- Operating Temperature Range: -65 F To +225 F (-55C to +125C)
- Other Colors Available, Please Inquire

Part #	Nominal Inside Diameter	Approximate Wire Gauge	Price Per Foot	Full Coil Length	Price Per Full Coil
HST-332-BK	3/32"	22-24AWG	\$0.06	1312'	\$62.00 ea.
HST-18-BK	1/8"	20-22AWG	\$0.08	1312'	\$84.00 ea.
HST-316-BK	3/16"	18-20AWG	\$0.11	1312'	\$114.00 ea.
HST-14-BK	1/4"	16-18AWG	\$0.16	656'	\$85.00 ea.
HST-932-BK	9/32"	14-16AWG	\$0.17	656'	\$88.00 ea.
HST-38-BK	3/8"	12-14AWG	\$0.21	656'	\$111.00 ea.
HST-12-BK	1/2"	10-12AWG	\$0.53	656'	\$139.00 ea.
HST-34-BK	3/4"	8-10AWG	\$0.60	656'	\$312.00 ea.

Mounting Clips with Screws



Part #	Description	Material	Price	
			Each	100+ Pcs.
A LED-3528-MC	5/16" IP20/IP65 Ribbon	Silicone	\$0.10	\$0.085 ea.
A LED-5050-MC	3/8" IP20/IP65 Ribbon	Silicone	\$0.10	\$0.085 ea.
B LED-8MM-MC-IP20	5/16" IP20 Ribbon	Plastic	\$0.10	\$0.085 ea.
B LED-10MM-MC-IP20	3/8" IP20 Ribbon	Plastic	\$0.10	\$0.085 ea.
B LED-12MM-MC-IP20	1/2" IP20 Ribbon	Plastic	\$0.10	\$0.085 ea.
C LED-8MM-MC-IP65	5/16" IP20 Ribbon	Plastic	\$0.10	\$0.085 ea.
C LED-10MM-MC-IP65	3/8" IP20 Ribbon	Plastic	\$0.10	\$0.085 ea.

IMPORTANT: Due to Raw Material Fluctuation, Catalog Prices Below May Not Be Accurate. GO TO WWW.OUTWATER.COM FOR THE MOST UP-TO-DATE PRICES

LED Lighting

LED Controllers & Amplifiers

Standard RGB Controllers

Works With All Wall Mount & Desktop Power Supplies

A. 12V Small RGB Controller With Up To 20 Color Changing Functions

Controller Functions:

- Static: 16 Options
- Gradual Color Change: 2 Options
- Color Jumping: 2 Options



B. Super Small RGB Controller With Up To 20 Color Changing Functions

Controller Functions:

- Static: 20 Options
- Brightness Adjusting: 19 Options



C. Small RGB Controller With Up To 5 Color Changing Functions

Controller Functions:

- Flashing: 1 Options
- Gradual Color Change: 2 Options
- Color Jumping: 2 Options



D. Deluxe RGB Controller With Up To 25 Color Changing Functions

Controller Functions:

- Static: 7 Options
- Flashing: 10 Options
- Gradual Color Change: 2 Options
- Color Jumping: 2 Options



E. RGBW Controller For 4 in 1 Ribbon

Controller Functions:

- Static: 3 Options
- Flashing Strobe: 4 Options
- Gradient Change: 2 Options
- Brightness Adjusting: 8 Grades
- Color Jumping: 5 Options



F. RGB & CCT Controller For 5 in 1 Ribbon

Controller Functions:

- Gradient Change: 11 Grades
- Brightness Adjusting: 20 Grades
- Fire Simulator
- 4 Zones



Part #	Volts	Max. Amps	Max. Watts	Input Cord	Output Cord	Dimensions	Color	Remote Control			Price	
								Function	Mounting	Each	6+ Pcs.	
A LED-RGB12-CON	12V	6A	72W	DC 5.5 Female Port	5" Pin Connection	L: 1.87" x W: 1.37" x H: .87"	White	IR	Screw	\$7.95	\$7.00 ea.	
B LED-RGB36-INLINE	12V 24V	6A 6A	72W 144W	3.5" DC 5.5 Female	5" Pin Connection	L: 1.5" x W: .5" x H: .12"	White	RF	Inline	\$9.95	\$9.00 ea.	
C LED-RGB36-MIN	12V 24V	6A 6A	72W 144W	DC 5.5 Female Port	9.5" Pin Connection	L: 1.87" x W: 1.37" x H: .87"	White	RF	Screw	\$12.95	\$12.00 ea.	
D LED-RGB36-CRP	12V 24V	12A 12A	144W 288W	18" DC 5.5 Female	18" Pin Connection	L: 4.75" x W: 2" x H: 1"	Black	RF	Screw	\$29.95	\$25.00 ea.	
E LED-RGBW-CR	12V 24V	6A 6A	72W 144W	DC 5.5 Female Port	DC 5.5 Terminal	L: 3.62" x W: 1.75" x H: .87"	White	RF	Adhesive	\$29.95	\$25.00 ea.	
F LED-WRGBW-CR	12V 24V	6A 6A	72W 144W	DC 5.5 Female Port	DC 5.5 Terminal	L: 3.62" x W: 1.75" x H: .87"	White	RF	Adhesive	\$41.60	\$39.00 ea.	

Amplifiers

Used to extend the signal of an RGB controller- power supply required



Part #	Volts	Max. Amps	Max. Watts	Input Cord	Output Cord	Dimensions	Color	Mounting	Price	
									Each	6+ Pcs.
A LED-RIBBON-RGB-AMP	12V 24V	12A 12A	144W 288W	18" Pin Connection	18" Pin Connection	L: 3.5" x W: 2.5" x H: .87"	Silver	Screw	\$14.60	\$12.78 ea.
B LED-RGBMIN-AMP	12V 24V	12A 12A	144W 288W	Pin Connection	Pin Connection	L: 1.62" x W: .5" x H: .12"	White	Inline	\$8.00	\$7.20 ea.

Center Stage LED Bulbs

Narrow Spot & Flood Options • Low Wattage & High Lumens

Available In Satin Aluminum & White

LMR16-30 LMR16-120WH



MR16 Bulbs (12V)



Part #	Color Temp	Finish	# Of LED Chips	Total Wattage	Price		Lighting Specifications						
					Each	25+ Pcs.	Color Temp	Beam Spread	Lumens	CRI	Average Life (Hrs)	Constant	Chip Size
LMR16-30-CW	Cool White	Satin	4 x 1.25W	5	\$7.75	\$7.35 ea.	6000K	30°	340	80	30,000	Voltage	SMD2835
LMR16-30-WW	Warm White		4 x 1.25W	5	\$7.75	\$7.35 ea.	2700K-3000K	30°	290	80	30,000	Voltage	SMD2835
LMR16-120-CW	Cool White	Aluminum	4 x 1.25W	5	\$7.75	\$7.35 ea.	6000K	120°	340	80	30,000	Voltage	SMD2835
LMR16-120-WW	Warm White		4 x 1.25W	5	\$7.75	\$7.35 ea.	2700K-3000K	120°	290	80	30,000	Voltage	SMD2835
LMR16-30WH-CW	Cool White	White	4 x 1.25W	5	\$7.75	\$7.35 ea.	6000K	120°	315	80	30,000	Voltage	SMD2835
LMR16-30WH-WW	Warm White		4 x 1.25W	5	\$7.75	\$7.35 ea.	2700K-3000K	120°	290	80	30,000	Voltage	SMD2835
LMR16-120WH-CW	Cool White		4 x 1.25W	5	\$7.75	\$7.35 ea.	6000K	120°	315	80	30,000	Voltage	SMD2835
LMR16-120WH-WW	Warm White		4 x 1.25W	5	\$7.75	\$7.35 ea.	2700K-3000K	120°	290	80	30,000	Voltage	SMD2835



MR16 COB Bulbs (12V)

Part #	Color Temp	Finish	# Of LED Chips	Total Wattage	Price		Lighting Specifications						
					Each	25+ Pcs.	Color Temp	Beam Spread	Lumens	CRI	Average Life (Hrs)	Constant	Chip Size
LMR16-80CB-CW	Cool White	Satin	1	5	\$9.95	\$9.00 ea.	5700K-6300K	80°	500	80	30,000	Voltage	18 x 33mm
LMR16-80CB-WW	Warm White	Aluminum	1	5	\$9.95	\$9.00 ea.	2700K-3500K	80°	450	80	30,000	Voltage	18 x 33mm



LG10-40

LG10-120

Dimmable GU10 Bulbs (120V)



Part #	Color Temp	Finish	# Of LED Chips	Total Wattage	Price		Lighting Specifications						
					Each	25+ Pcs.	Color Temp	Beam Spread	Lumens	CRI	Average Life (Hrs)	Constant	Chip Size
LG10-40-NW	Natural White	White	5 x .9W	4.5	\$7.95	\$7.35 ea.	5000K	40°	370	80	25,000	Voltage	SMD2835
LG10-40-WW	Warm White	White	5 x .9W	4.5	\$7.95	\$7.35 ea.	2700K-3000K	40°	290	80	25,000	Voltage	SMD2835
LG10-120-CW	Cool White	Aluminum	4 x 1.25W	5	\$7.75	\$7.35 ea.	6000K	120°	340	80	30,000	Voltage	SMD2835
LG10-120-WW	Warm White		4 x 1.25W	5	\$7.75	\$7.35 ea.	2700K-3000K	120°	290	80	30,000	Voltage	SMD2835



Dimmable GU10 COB Bulbs (120V)

Part #	Color Temp	Finish	# Of LED Chips	Total Wattage	Price		Lighting Specifications						
					Each	25+ Pcs.	Color Temp	Beam Spread	Lumens	CRI	Average Life (Hrs)	Constant	Chip Size
LG10-35CB-CW	Cool White	Satin	1	5	\$9.95	\$9.00 ea.	5700K-6300K	35°	500	80	30,000	Voltage	18 x 33mm
LG10-35CB-WW	Warm White		1	5	\$9.95	\$9.00 ea.	2700K-3500K	35°	450	80	30,000	Voltage	18 x 33mm
LG10-80CB-CW	Cool White	Aluminum	1	5	\$9.95	\$9.00 ea.	5700K-6300K	80°	500	80	30,000	Voltage	18 x 33mm
LG10-80CB-WW	Warm White		1	5	\$9.95	\$9.00 ea.	2700K-3500K	80°	450	80	30,000	Voltage	18 x 33mm

IMPORTANT: Due to Raw Material Fluctuation, Catalog Prices Below May Not Be Accurate. GO TO WWW.OUTWATER.COM FOR THE MOST UP-TO-DATE PRICES

LED Bulbs

Center Stage LED Bulbs

Narrow Spot & Flood Options • Low Wattage & High Lumens

PAR 38



Dimmable LED Par Bulb (120V): E26 Base



Part #	Color Temp	Finish	Type	# Of LED Chips	Total Wattage	Price		Lighting Specifications						
						Each	12+ Pcs.	Color Temp	Beam Spread	Lumens	CRI	Average Life (Hrs)	Constant	Chip Size
LP20-30-CW	Cool White	Satin Aluminum	PAR 20	7	8	\$9.95	\$9.40 ea.	6000K-6800K	30°	550	80	30,000	Voltage	SMD2835
LP20-30-WW	Warm White			7	8	\$9.95	\$9.40 ea.	2700K-3200K	30°	475	80	30,000	Voltage	SMD2835
LP20-120-CW	Cool White			7	8	\$9.95	\$9.40 ea.	6000K-6800K	120°	520	80	30,000	Voltage	SMD2835
LP20-120-WW	Warm White			7	8	\$9.95	\$9.40 ea.	2700K-3200K	120°	430	80	30,000	Voltage	SMD2835
LP30-30-CW	Cool White		PAR 30	9	11	\$15.95	\$15.10 ea.	6000K-6800K	30°	807	80	30,000	Voltage	SMD2835
LP30-30-WW	Warm White			9	11	\$15.95	\$15.10 ea.	2700K-3200K	30°	786	80	30,000	Voltage	SMD2835
LP30-120-CW	Cool White			9	11	\$15.95	\$15.10 ea.	6000K-6800K	120°	700	80	30,000	Voltage	SMD2835
LP30-120-WW	Warm White			9	11	\$15.95	\$15.10 ea.	2700K-3200K	120°	690	80	30,000	Voltage	SMD2835
LP38-30-CW	Cool White		PAR 38	15	20	\$23.95	\$22.70 ea.	6000K-6800K	30°	1330	80	30,000	Voltage	SMD2835
LP38-30-WW	Warm White			15	20	\$23.95	\$22.70 ea.	2700K-3200K	30°	1120	80	30,000	Voltage	SMD2835
LP38-120-CW	Cool White			15	20	\$23.95	\$22.70 ea.	6000K-6800K	120°	1300	80	30,000	Voltage	SMD2835
LP38-120-WW	Warm White			15	20	\$23.95	\$22.70 ea.	2700K-3200K	120°	1200	80	30,000	Voltage	SMD2835

Dimmable LED Par COB Bulbs (120V): E26 Base



PAR 38
LP38-38CB



PAR 30
LP30-38CB



PAR 20
LP20-38CB

Part #	Color Temp	Finish	Neck Type	# Of LED Chips	Total Wattage	Price		Lighting Specifications						
						Each	12+ Pcs.	Color Temp	Beam Spread	Lumens	CRI	Average Life (Hrs)	Constant	Chip Size
LP20-38CB-CW	Cool White	Satin Aluminum	PAR 20	1	6	\$16.95	\$16.00 ea.	5700K-6300K	38°	550	80	30,000	Voltage	18 x 33mm
LP20-38CB-WW	Warm White			1	6	\$16.95	\$16.00 ea.	2700K-3200K	38°	450	80	30,000	Voltage	18 x 33mm
LP30-38CB-CW	Cool White		PAR 30	1	10	\$31.35	\$29.75 ea.	5700K-6300K	38°	950	80	30,000	Voltage	18 x 33mm
LP30-38CB-WW	Warm White			1	10	\$31.35	\$29.75 ea.	2700K-3200K	38°	850	80	30,000	Voltage	18 x 33mm
LP38-80CB-CW	Cool White		PAR 38	1	16	\$39.95	\$37.95 ea.	5700K-6300K	80°	1600	80	30,000	Voltage	18 x 33mm
LP38-80CB-WW	Warm White			1	16	\$39.95	\$37.95 ea.	2700K-3200K	80°	1500	80	30,000	Voltage	18 x 33mm

IMPORTANT: Due to Raw Material Fluctuation, Catalog Prices Below May Not Be Accurate. GO TO WWW.OUTWATER.COM FOR THE MOST UP-TO-DATE PRICES



120V

LED Lighting

Horizon LED Ceiling Panels: Edge To Edge Uniform Lighting

Material: White Powder Coated Aluminum Frame with PMMA LGP & PS Diffuser

- The PMMA provides a 5-8 year life span without turning yellow. The PS diffuser offers a 90% light transmission.
- Save money on energy costs, due to low wattage consumption
- Save money on maintenance costs, as average rated life is 50,000 hours
- Easy to install- drop in, suspended install options or surface mount with included clips
- Instant on, no delay, no flickering of light or buzzing noise, as with fluorescent lamps, 90% power factor
- Ideal for commercial applications because no RF interference, no UV or IR radiation & mercury free!
- Includes dimmable power supply, 0-10V dimming
- 5 Year Manufacturer Warranty



DLC Standard 2' x 2' Ceiling Panel

(Up To **4600 Lumens Per Fixture: 115 Lumens Per Watt**)

Fits 2' x 2' Drop In Ceiling Grid
Actual Size: 23-3/4" x 23-3/4"
 (Nominal: 603mm x 603mm)
Dimmable

AS LOW AS **\$34**

Back View
UL Power Supply Included

- Color Temp: PW- 4000K
- Total Wattage: 40W
- Weight: Under 9 lbs.

LED-PAN-2X2
Each: \$40.00
6+ Pcs.: \$38.00 ea.
12+ Pcs.: \$34.00 ea.

Lighting Specifications	
Color Temperature	PW: 4000K
Beam Spread	120°
Lumens	4600 115 Lumens Per Watt
Color Rendering Index	PW: >80
Rated Average Life	50,000 hrs.
Power Factor	≥ .90
THD	< 15%
Input Voltage	AC 100-277V

DLC Standard 2' x 4' Ceiling Panel

(Up To **5750 Lumens Per Fixture: 115 Lumens Per Watt**)

Fits 2' x 4' Drop In Ceiling Grid
Actual Size: 23-3/4" x 47-3/4"
 (Nominal: 603mm x 1213mm)
Dimmable

UL Power Supply Included

- Color Temp: PW- 4000K
- Total Wattage: 50W
- Weight: Under 18 lbs.

LED-PAN-2X4
Each: \$64.00
6+ Pcs.: \$61.00 ea.
12+ Pcs.: \$56.00 ea.

Lighting Specifications	
Color Temperature	PW: 4000K
Beam Spread	120°
Lumens	5750 115 Lumens Per Watt
Color Rendering Index	PW: >80
Rated Average Life	50,000 hrs.
Power Factor	≥ .90
THD	< 15%
Input Voltage	AC 100-277V

PACKED 2 PER CARTON - \$10.00 BROKEN BOX FEE (#BB10)

LED Lighting

WAC LIGHTING
Responsible Lighting®

120V



WAC 120V LED Track Heads



OCULUX

The Oculux 7001 combines high output COB LED with easy-to-install films for three separate beam-spread, along with an adjustable base to accommodate a variety of user preferences. Ideal for residential spaces and lower-mounted commercial applications.

Material: Die-cast aluminum with baffled front cover for glare control



Lighting Specifications

Color Temperature	3000K
3 Beam Spread Options	50°, 30° & 17°
Lumens	890
Color Rendering Index	90+
Rated Average Life	50,000 hrs.
Chip Size	COB LED
Limited Warranty	5 Years

Part #	Finish	Total Wattage	Price
H-7011-930-BK	Black (BK)	11	\$56.70 ea.
H-7011-930-BN	Brushed Nickel (BN)	11	\$66.51 ea.
H-7011-930-WH	White (WH)	11	\$56.70 ea.
H-7011-930-DB	Dark Bronze (DB)	11	\$56.70 ea.

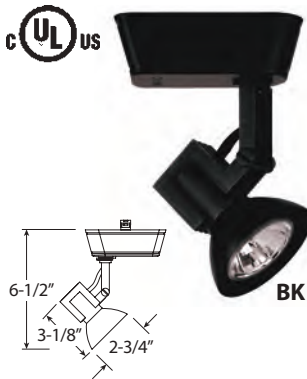

RADIANT

The Radiant low voltage track luminaire is designed in four finishes including an elegant Antique Bronze. The Radiant features a transitional look with a rich elegance that complements many architectural styles, ideal for various spot lighting applications.

Material: Die-cast aluminum fixture with polycarbonate track adapter. Ceramic bi-pin socket.



Lighting Specifications

Color Temperature	3000K
Beam Spread Options	N/A
Lumens	490
Color Rendering Index	90
Rated Average Life	50,000 hrs.
Chip Size	MR16 LED
Limited Warranty	5 Years

Part #	Finish	Total Wattage	Price
HHT-856LED-BK	Black (BK)	9	\$113.31 ea.
HHT-856LED-BN	Brushed Nickel (BN)	9	\$123.30 ea.
HHT-856LED-WH	White (WH)	9	\$113.31 ea.
HHT-856LED-AB	Antique Bronze (AB)	9	\$123.30 ea.



SILO X10

Silo offers superior light output in a small, sleek design. Engineered synthesis of driver, single point source LED, optical and thermal management in a slender die-cast housing. Ideal for residential, retail and lower mounting height commercial applications.

Material: Die-cast aluminum fixture with removable front cap for lenses or accessories.



Lighting Specifications

Color Temperature	3000K
2 Beam Spread Options	35° & 25°
Lumens	790
Color Rendering Index	90
Rated Average Life	50,000 hrs.
Chip Size	COB LED
Limited Warranty	5 Years

Part #	Finish	Total Wattage	Price
H-2010-930-BK	Black (BK)	10	\$92.70 ea.
H-2010-930-BN	Brushed Nickel (BN)	10	\$102.51 ea.
H-2010-930-WH	White (WH)	10	\$92.70 ea.
H-2010-930-DB	Dark Bronze (DB)	10	\$92.70 ea.
H-2010-930-BR	Brushed Brass (BR)	10	\$102.51 ea.



SILO X20

Silo offers superior light output in a small, sleek design. Engineered synthesis of driver, single point source LED, optical and thermal management in a slender die-cast housing. Ideal for residential, retail and lower mounting height commercial applications.

Material: Die-cast aluminum fixture with removable front cap for lenses or accessories.



Lighting Specifications

Color Temperature	3000K
2 Beam Spread Options	50° & 15°
Lumens	785
Color Rendering Index	90
Rated Average Life	50,000 hrs.
Chip Size	COB LED
Limited Warranty	5 Years

Part #	Finish	Total Wattage	Price
H-2020-930-BK	Black (BK)	20	\$149.31 ea.
H-2020-930-BN	Brushed Nickel (BN)	20	\$159.30 ea.
H-2020-930-WH	White (WH)	20	\$159.30 ea.
H-2020-930-DB	Dark Bronze (DB)	20	\$149.31 ea.
H-2020-930-BR	Brushed Brass (BR)	20	\$97.20 ea.



120V

WAC LIGHTING
Responsible Lighting®

LED Lighting

WAC 120V LED Track Heads



BK

SUMMIT 201

Summit track luminaires offer driverless AC LED technology and easy change of beam angles in field. Superior light output in a small, unobtrusive design. The high output LED's outperform halogen 50W MR16. Developed for upscale residential and commercial environments.

Material: Die-cast aluminum fixture with removable front cap for lenses or accessories.

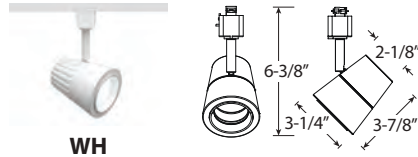

WH

Lighting Specifications

Color Temperature	3000K
2 Beam Spread Options	40° & 15°
Lumens	750
Color Rendering Index	90
Rated Average Life	50,000 hrs.
Chip Size	COB LED
Limited Warranty	5 Years

Part #	Finish	Total Wattage	Price
H-LED201-30-BK	Black (BK)	15	\$94.50 ea.
H-LED201-30-WH	White (WH)	15	\$94.50 ea.



BK

SUMMIT 202

Summit track luminaires offer driverless AC LED technology and easy change of beam angles in field. Superior light output in a small, unobtrusive design. The high output LED's outperform halogen 50W MR16. Developed for upscale residential and commercial environments.

Material: Die-cast aluminum fixture with removable front cap for lenses or accessories.

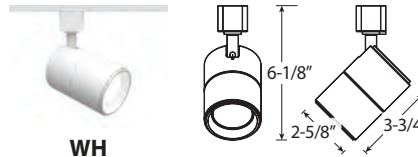

WH

Lighting Specifications

Color Temperature	3000K
2 Beam Spread Options	40° & 15°
Lumens	750
Color Rendering Index	90
Rated Average Life	50,000 hrs.
Chip Size	COB LED
Limited Warranty	5 Years

Part #	Finish	Total Wattage	Price
H-LED202-30-BK	Black (BK)	15	\$94.50 ea.
H-LED202-30-WH	White (WH)	15	\$94.50 ea.



BK

SUMMIT 207

Summit track luminaires offer driverless AC LED technology and easy change of beam angles in field. Superior light output in a small, unobtrusive design. The high output LED's outperform halogen 50W MR16. Developed for upscale residential and commercial environments.

Material: Die-cast aluminum fixture with removable front cap for lenses or accessories.

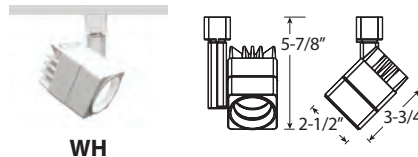

WH

Lighting Specifications

Color Temperature	3000K
2 Beam Spread Options	40° & 15°
Lumens	750
Color Rendering Index	90
Rated Average Life	50,000 hrs.
Chip Size	COB LED
Limited Warranty	5 Years

Part #	Finish	Total Wattage	Price
H-LED207-30-BK	Black (BK)	15	\$94.50 ea.
H-LED207-30-WH	White (WH)	15	\$94.50 ea.



AB

SUMMIT 208

Summit track luminaires offer driverless AC LED technology and easy change of beam angles in field. Superior light output in a small, unobtrusive design. The high output LED's outperform halogen 50W MR16. Developed for upscale residential and commercial environments.

Material: Die-cast aluminum fixture with removable front cap for lenses or accessories.

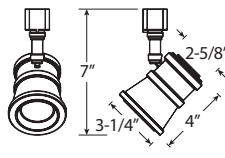

Lighting Specifications

Color Temperature	3000K
2 Beam Spread Options	40° & 15°
Lumens	750
Color Rendering Index	90
Rated Average Life	50,000 hrs.
Chip Size	COB LED
Limited Warranty	5 Years

Part #	Finish	Total Wattage	Price
H-LED208-30-AB	Antique Bronze (AB)	15	\$113.31 ea.

WAC 120V LED Track Heads

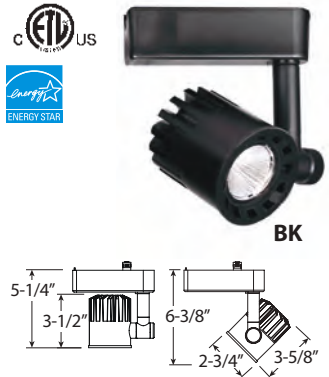

EXTERMINATOR

Exterminator offers superior light output in a small, unobtrusive design. The high output LED's out perform a 20W metal halide fixture at the size of a typical MR16 luminaire. Developed for upscale residential and commercial environments.

Material: Die-cast aluminum fixture with removable front cap for lenses or accessories.

Lighting Specifications

Color Temperature	3000K
Beam Spread	40°
Lumens	920
Color Rendering Index	90
Rated Average Life	60,000 hrs.
Chip Size	COB LED
Limited Warranty	5 Years



Part #	Finish	Total Wattage	Price
H-LED20F-930-BK	Black (BK)	23	\$197.91 ea.
H-LED20F-930-BN	Brushed Nickel (BN)	23	\$206.91 ea.
H-LED20F-930-WH	White (WH)	23	\$197.91 ea.

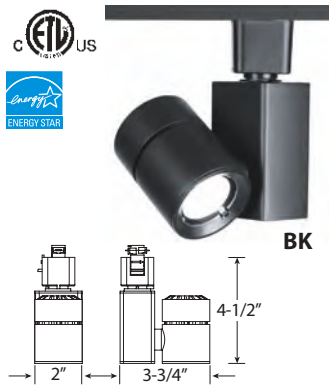

EXTERMINATOR II (14W)

Exterminator offers superior light output in a small, unobtrusive design. The high output LED's out perform a 20W metal halide fixture at the size of a typical MR16 luminaire. Developed for upscale residential and commercial environments.

Material: Die-cast aluminum fixture with removable front cap for lenses or accessories.

Lighting Specifications

Color Temperature	3000K
Beam Spread	40°
Lumens	663
Color Rendering Index	90
Rated Average Life	100,000 hrs.
Chip Size	COB LED
Limited Warranty	5 Years



Part #	Finish	Total Wattage	Price
H-1014F-930-BK	Black (BK)	14	\$160.11 ea.
H-1014F-930-BN	Brushed Nickel (BN)	14	\$169.11 ea.
H-1014F-930-WH	White (WH)	14	\$160.11 ea.

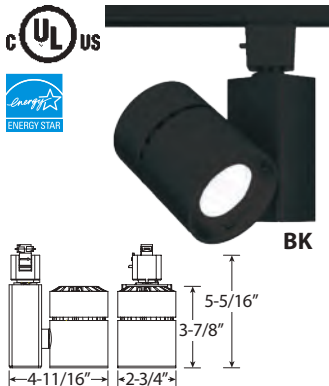

EXTERMINATOR II (22W)

Exterminator offers superior light output in a small, unobtrusive design. The high output LED's out perform a 20W metal halide fixture at the size of a typical MR16 luminaire. Developed for upscale residential and commercial environments.

Material: Die-cast aluminum fixture with removable front cap for lenses or accessories.

Lighting Specifications

Color Temperature	3000K
Beam Spread	40°
Lumens	1535
Color Rendering Index	90
Rated Average Life	50,000 hrs.
Chip Size	COB LED
Limited Warranty	5 Years



Part #	Finish	Total Wattage	Price
H-1023F-930-BK	Black (BK)	22	\$218.70 ea.
H-1023F-930-BN	Brushed Nickel (BN)	22	\$227.70 ea.
H-1023F-930-WH	White (WH)	22	\$218.70 ea.

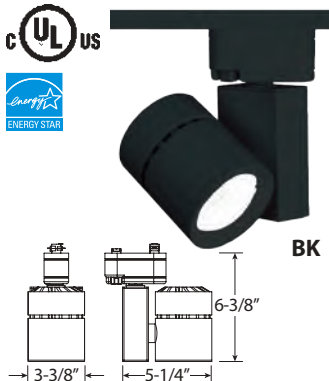

EXTERMINATOR II (35W)

Exterminator offers superior light output in a small, unobtrusive design. The high output LED's out perform a 20W metal halide fixture at the size of a typical MR16 luminaire. Developed for upscale residential and commercial environments.

Material: Die-cast aluminum fixture with removable front cap for lenses or accessories.

Lighting Specifications

Color Temperature	3000K
Beam Spread	55°
Lumens	2185
Color Rendering Index	90
Rated Average Life	60,000 hrs.
Chip Size	COB LED
Limited Warranty	5 Years



Part #	Finish	Total Wattage	Price
H-1035F-930-BK	Black (BK)	35	\$292.50 ea.
H-1035F-930-BN	Brushed Nickel (BN)	35	\$301.50 ea.
H-1035F-930-WH	White (WH)	35	\$292.50 ea.



120V

WAC LIGHTING
Responsible Lighting®

LED Lighting

Accessories for WAC 120V LED Track Heads

This hardware is applicable to the line-volt track heads
A power connector must be purchased separately from the track

Colors Available: Black (*BK), White (*WH), Dark Bronze (*DB) & Brushed Nickel (*BN)

1. Track & Power Connectors

Track

- 2 end caps supplied with each length.
- Can be installed on sheetrock, plaster, wood or suspended ceilings.
- Field cuttable



Part #	Finish	Length	Price
WL-HT6-*	*BK & *WH	6'	\$46.71 ea.
WL-HT6-*	*DB & *BN	6'	\$62.91 ea.
WL-HT8-*	*BK & *WH	8'	\$56.70 ea.
WL-HT8-*	*DB & *BN	8'	\$79.11 ea.

Floating Canopy

- Connects to outlet box allowing track to be powered anywhere along the length of the track.



Part #	Finish	Price
WL-HFC-*	*BK & *WH	\$17.91 ea.
WL-HFC-*	*DB & *BN	\$21.50 ea.

Live End Connector

- Used for direct wiring from conduit through the ceiling.



Part #	Finish	Price
WL-HLE-*	*BK & *WH	\$11.70 ea.
WL-HLE-*	*DB & *BN	\$13.50 ea.

2. Track Joiners with Power Connectors

Straight Line Power Connector

- Used to supply power from the source at the junction of two tracks.



Part #	Finish	Price
WL-HI-PWR-*	*BK & *WH	\$17.10 ea.
WL-HI-PWR-*	*DB & *BN	\$18.90 ea.

Flexible Track Connector

- Connects two track sections at variable angles from 60° to 180°.



Part #	Finish	Price
WL-HFLX-*	*BK & *WH	\$25.11 ea.
WL-HFLX-*	*DB & *BN	\$28.71 ea.

"T" 3-Way Connector

- Used to join three track sections to make a "T" configuration.



Part #	Finish	Price
WL-HT-*	*BK & *WH	\$20.70 ea.
WL-HT-*	*DB & *BN	\$25.11 ea.

"L" Left/Right Angle Connector

- Used to join two track sections to make a 90° angle.



Part #	Finish	Price
WL-HL-*	*BK & *WH	\$17.10 ea.
WL-HL-*	*DB & *BN	\$20.70 ea.

"X" 4-Way Connector

- Used to join four track sections to make a "X" configuration.



Part #	Finish	Price
WL-HX-*	*BK & *WH	\$25.11 ea.
WL-HX-*	*DB & *BN	\$29.70 ea.

15' Plug-In Power Cord

- Used with any power connector to wire a section of track as a portable unit.



Part #	Finish	Price
WL-HCORD-BK	Black	\$15.30 ea.
WL-HCORD-WH	White	\$15.30 ea.

3. Track Joiners w/o Power Connectors

Straight Line Connector

- Used to join two sections of track.



Part #	Finish	Price
WL-HI-*	*BK & *WH	\$11.70 ea.
WL-HI-*	*DB & *BN	\$13.50 ea.

Dead End Straight Line Connector

- Used as connector where power is not to go through.



Part #	Finish	Price
WL-HI-DEC-*	*BK & *WH	\$9.90 ea.
WL-HI-DEC-*	*DB & *BN	\$11.70 ea.

4. Extended Track Heads & Suspension Kit

Extended Track Heads

- Extend drop of track heads.



Part #	Finish	Price
WL-H18-*	*BK & *WH	\$30.51 ea.
WL-H18-*	*DB & *BN	\$34.11 ea.
WL-H36-*	*BK & *WH	\$35.91 ea.
WL-H36-*	*DB & *BN	\$39.51 ea.

Suspension Kit

- Supports the weight of the track. Parts & instructions included.



Part #	Finish	Length	Price
WL-SK18-*	*BK & *WH	18"	\$28.71 ea.
WL-SK18-*	*DB & *BN	18"	\$32.31 ea.
WL-SK24-*	*BK & *WH	24"	\$30.51 ea.
WL-SK24-*	*DB & *BN	24"	\$34.11 ea.
WL-SK36-*	*BK & *WH	36"	\$34.11 ea.
WL-SK36-*	*DB & *BN	36"	\$37.71 ea.
WL-SK48-*	*BK & *WH	48"	\$37.71 ea.
WL-SK48-*	*DB & *BN	48"	\$41.31 ea.

IMPORTANT: Due to Raw Material Fluctuation, Catalog Prices Below May Not Be Accurate. GO TO WWW.OUTWATER.COM FOR THE MOST UP-TO-DATE PRICES

Power Hubs

Power Station

we've got the POWER!!!



PDS-NL-300



PDS-LE-220

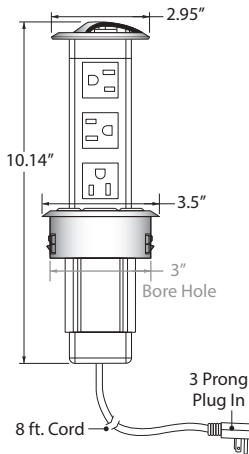

Housing & Receptacles:

- **Material:** ABS
- **Color/Finish:** Black
- Recommended material thickness: 3/4" to 3"
- Each outlet faces a different direction minimizing issues caused by oversized plugs
- Unit locks in its upper most position
- 12" clearance under mounting surface required
- 3 year warranty



Waterproof Ring

Part #	Receptacles	Plug		USB		Price	
		Rating	Ports	Rating	Each	10 +	
PDS-LE-220-BK	2	AC 125V/12A Max	2	2.1A Shared	\$39.00	\$36.00 ea.	
PDS-NL-300-BK	3	AC 125V/12A Max	0	n/a	\$38.00	\$35.00 ea.	

Vertical Mount Power Dock • 120V

PDS-MO-300-BK

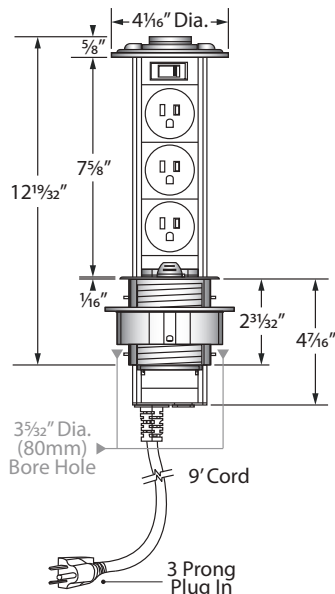
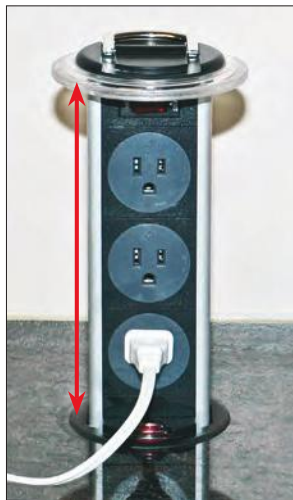

Housing:

- **Material:** Aluminum
- **Color/Finish:** Anodized

Receptacles:

- **Material:** ABS & Polycarbonate
- **Color/Finish:** Black

- Recommended material thickness: 5/16" to 1-3/4"
- Reset Switch, Rated A 15A
- LED Power Switch
- For use in kitchen, plug into a GFCI outlet
- Surge protection & Reset button
- Locking ring holds unit firmly in place from underneath
- Unit locks in its upper most position
- Standard splash proof, water resistant seal when in recessed position
- 12" Clearance under mounting surface required
- 100% guarantee on normal wear and tear

Part #	Receptacles	Plug		Price	
		Rating	Each	10 +	
PDS-MO-300-BK	3	15A/125V/AC	\$102.22	\$92.93 ea.	

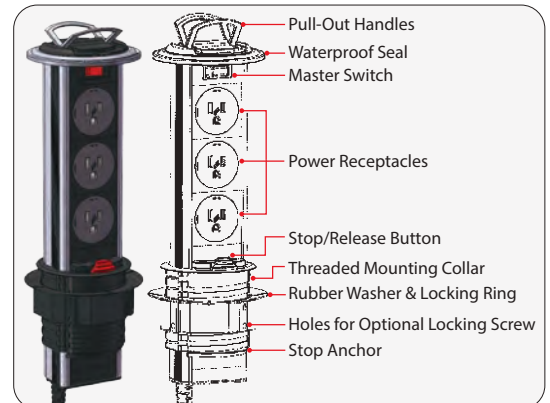

we've got the POWER!!!



PDS-CA-420-BK

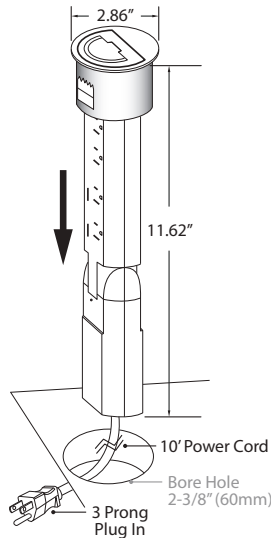

Housing & Receptacles:

- **Material:** Flame Retardant ABS
- **Color/Finish:** Black
- Recommended material thickness: up to 1-1/2"
- Surge protection
- 1 year warranty



Part #	Plug		USB		Price	
	Receptacles	Rating	Ports	Rating	Each	12 +
PDS-CA-420-BK	4	12A, 125V, 50/60HZ	2	5V/2.1A Max Total	\$82.35	\$71.60 ea.

PDD-HC-240-BK

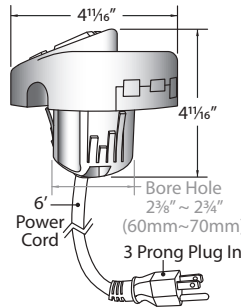

Housing & Receptacles:

- **Material:** ABS
- **Color/Finish:** Black
- Recommended material thickness: 5/8" to 1"
- Two high speed ethernet jacks & two RJ11 phone jacks
- Supports Windows 98, 2000, ME, XP & Mac OS X
- Can support up to 4 high speed downstream devices up to 480 bps
- Circuit breaker & surge protection
- Two 2.0A USB smart phone charging ports - 1 primary, 1 secondary
- 1 year warranty



Part #	Plug		USB		Price	
	Receptacles	Rating	Ports	Rating	Each	12 +
PDD-HC-240-BK	2	10A, 1250V Max	4	2.0A Each	\$59.95	\$56.95 ea.

Power Dome

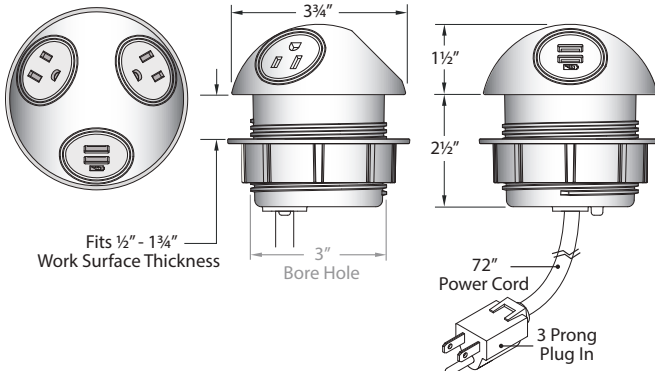

Housing & Receptacles:

- **Material:** Polycarbonate
- **Color/Finish:** Black
- Recommended material thickness: 1/2" to 1-3/4"
- Available in White, Green & Orange, please inquire.
- 1 year warranty



Part #	Plug		USB		Price	
	Receptacles	Rating	Ports	Rating	Each	10 +
PDG-BEH-220-BK	2	15A	2	2A Shared	\$136.20	\$129.64 ea.

IMPORTANT: Due to Raw Material Fluctuation, Catalog Prices Below May Not Be Accurate. GO TO WWW.OUTWATER.COM FOR THE MOST UP-TO-DATE PRICES

Power Hubs

Power Pyramid

we've got the POWER!!!



Includes 3 Decorative Insert Options

Additional options and customization available, please inquire.

Housing:

- **Material:** Polycarbonate
- **Color/Finish:** Gloss Black

Receptacles:

- **Material:** Polycarbonate
- **Color/Finish:** Black

- Recommended material thickness: 1/4" to 1-1/4"
- Available in Gloss White, please inquire.
- Optional surge protection available, please inquire.
- 1 year warranty

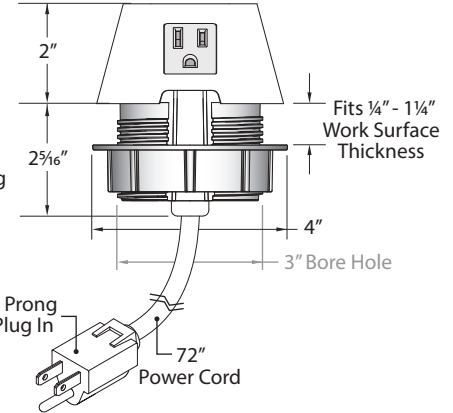
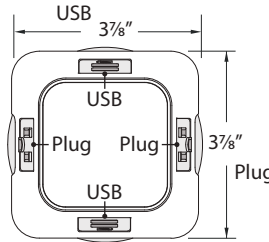

Part #	Plug		Ports	USB		Price	
	Receptacles	Rating		Rating	Each	10 +	
PDD-BEM-240-BK	2	15A	4	2A Shared per Module	\$207.92	\$197.90 ea.	

Power Bar



Includes 3 Decorative Insert Options

Additional options and customization available, please inquire.

Housing:

- **Material:** Polycarbonate
- **Color/Finish:** Gloss Black

Receptacles:

- **Material:** Polycarbonate
- **Color/Finish:** Black

- Recommended material thickness: 1/4" to 1-1/2"
- Available in Gloss White, please inquire.
- Optional surge protection available, please inquire.
- 1 year warranty

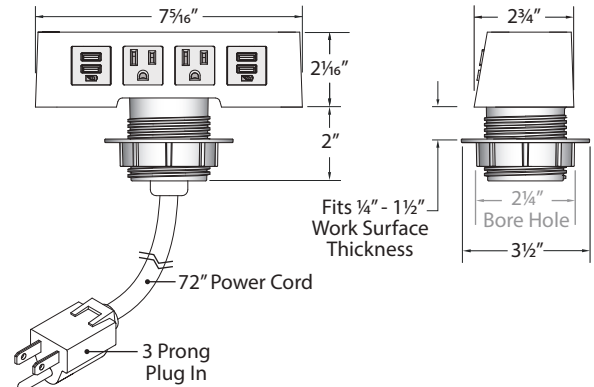

Part #	Plug		Ports	USB		Price	
	Receptacles	Rating		Rating	Each	10 +	
PDD-BEB-240-BK	2	15A	4	2A Shared per Module	\$231.65	\$228.75 ea.	

IMPORTANT: Due to Raw Material Fluctuation, Catalog Prices Below May Not Be Accurate. GO TO WWW.OUTWATER.COM FOR THE MOST UP-TO-DATE PRICES

Power Hubs



Power Center Grommets • 120V

we've got the POWER!!!



Housing & Receptacles:

- **Material:** ABS
- **Color/Finish:** Black
- Recess Mounts in an 80mm (3-1/8") Dia. Hole
- Recommended material thickness: 3/4" to 3"
- 1 year warranty

PDG-FE-200

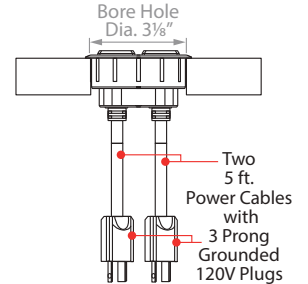
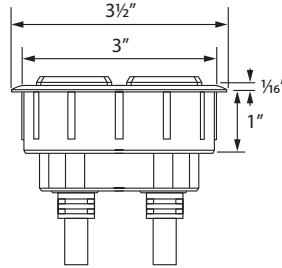
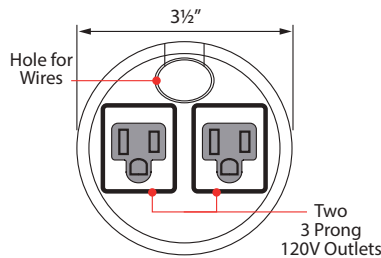

Part #	Plug		USB		Price	
	Receptacles	Rating	Ports	Rating	Each	10 +
PDG-FE-200-BK	2	AC120V/10A	0	-	\$12.26	\$11.23 ea.

PDG-FE-120

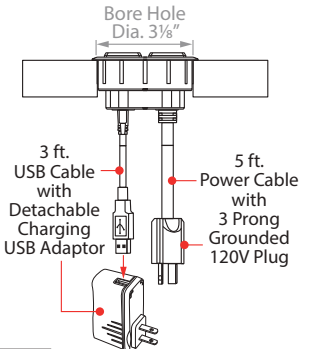
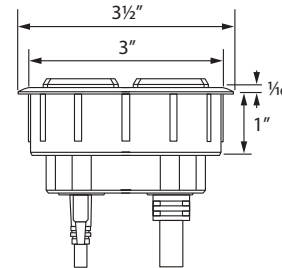
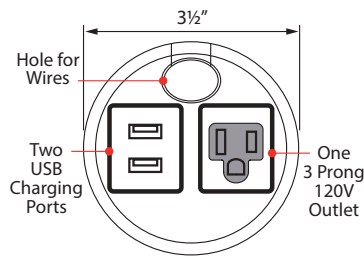

Part #	Plug		USB		Price	
	Receptacles	Rating	Ports	Rating	Each	10 +
PDG-FE-120-BK	1	AC120V/10A	2	2A	\$23.65	\$21.45 ea.

PDG-FE-040

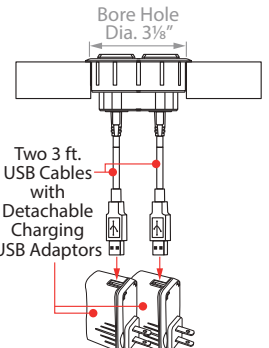
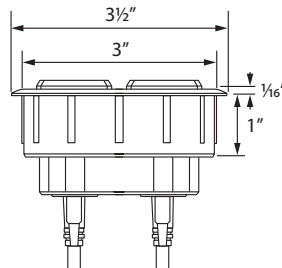
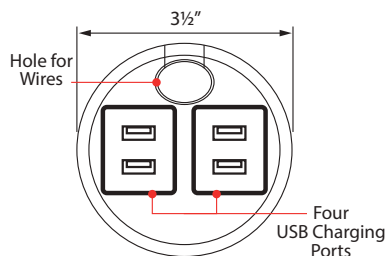

Part #	Plug		USB		Price	
	Receptacles	Rating	Ports	Rating	Each	10 +
PDG-FE-040-BK	0	-	4	0.5A each	\$27.41	\$25.16 ea.

IMPORTANT: Due to Raw Material Fluctuation, Catalog Prices Below May Not Be Accurate. GO TO WWW.OUTWATER.COM FOR THE MOST UP-TO-DATE PRICES

Power Hubs

PDG-NL-120-BK



PDG-NL-200-BK



we've got the POWER!!!



Housing & Receptacles:

- **Material:** ABS
- **Color/Finish:** Black
- Recommended material thickness: 3/4" to 2"
- Flip top lid/ABS plastic
- Surge protection
- 3 year warranty

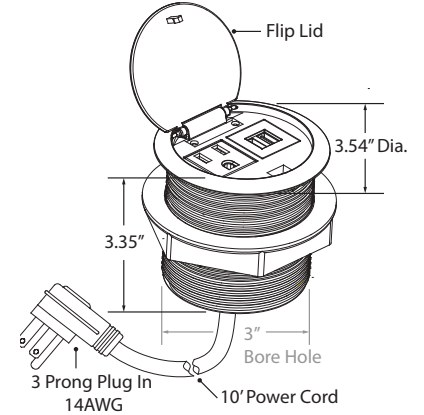

Part #	Plug		USB		Price	
	Receptacles	Rating	Ports	Rating	Each	10 +
PDG-NL-200-BK	2	125V, 15A	-	-	\$67.64	\$60.88 ea.
PDG-NL-120-BK	1	125V, 15A	2	4.2A Shared	\$102.84	\$92.56 ea.

Power Rotate

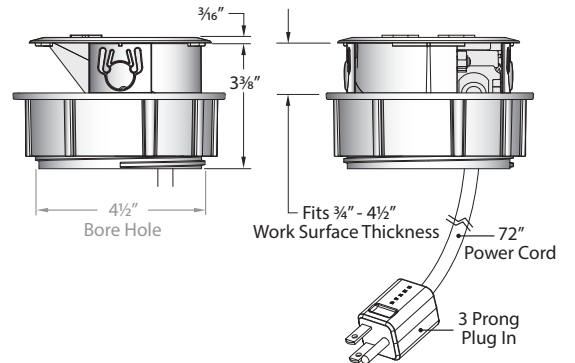
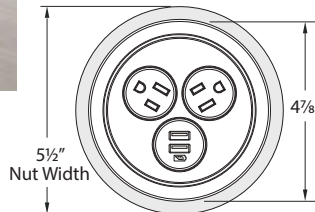

Housing & Receptacles:

- **Material:** Polycarbonate
- **Color/Finish:** Black
- Recommended material thickness: 3/4" to 1-1/2"
- Rotates to hide away
- Available in White, Green & Orange, please inquire.
- 1 year warranty



Part #	Plug		USB		Price	
	Receptacles	Rating	Ports	Rating	Each	10 +
PDG-BEE-300-BK	3	15A	-	-	\$150.38	\$148.50 ea.
PDG-BEE-220-BK	2	15A	2	2A Shared	\$178.11	\$175.89 ea.

we've got the POWER!!!

Power Distribution Center



PDC-BY-320-BK

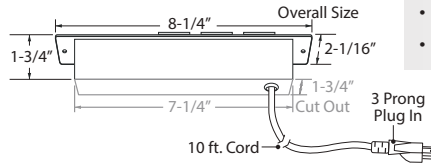

Housing & Receptacles:

- **Material:** ABS
- **Color/Finish:** Black
- Recommended material thickness: 1-1/2"
- 1 year warranty



Part #	Plug		USB		Price	
	Receptacles	Rating	Ports	Rating	Each	10 +
PDC-BY-320-BK	3	125V/60HZ/12A	2	2.1A Shared	\$26.04	\$23.44 ea.

Horizontal Power Docks



Housing:

Receptacles:

- **Material:** Aluminum
- **Color/Finish:** Matte Black
- Recommended material thickness: 5/8" to 2-3/8"
- Can be locked into position at 45° or 60° to allow easy access
- Cover can be closed with cords in place, concealed by a flexible strip
- 2 Category 5E data modules (Note: Data modules are un-wired)
- 100% guarantee on normal wear and tear
- Clear Anodized housing available, please inquire

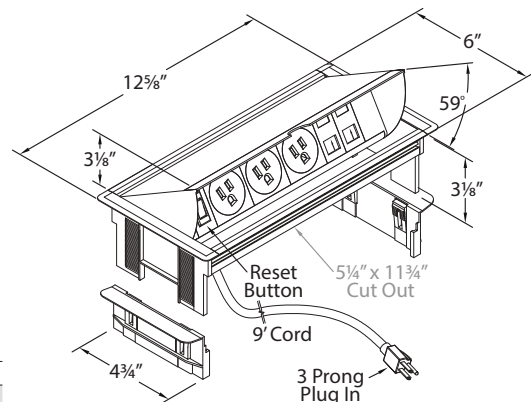
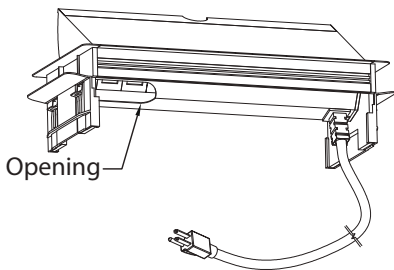

Part #	Plug		Price	
	Receptacles	Rating	Each	10 +
PDC-MO-300-BK	3	15A/125VAC	\$126.88	\$117.39 ea.

IMPORTANT: Due to Raw Material Fluctuation, Catalog Prices Below May Not Be Accurate. GO TO WWW.OUTWATER.COM FOR THE MOST UP-TO-DATE PRICES

Power Hubs

we've got the POWER!!!



PDC-NL-120



Housing:

- **Material:** Aluminum
- **Color/Finish:** Black, Satin Aluminum
- Recommended material thickness: 3/4" to 3"
- Pop-up spring loaded
- Optional surge protection available, please inquire.
- 3 year warranty

Receptacles:

- **Material:** ABS Plastic
- **Color/Finish:** Black

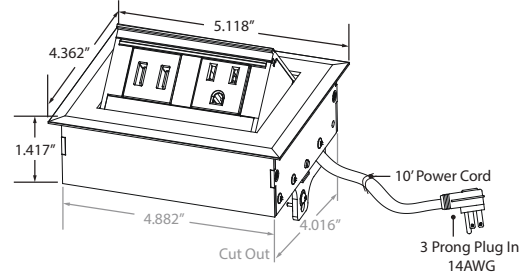

Part #	Housing Color	Plug		Ports	USB	Price	
		Receptacles	Rating			Rating	Each
PDC-NL-120-BK	Black	1	125V, 12A	2	4.2A Shared	\$140.72	\$126.64 ea.
PDC-NL-120-SA	Satin Aluminum	1	125V, 12A	2	4.2A Shared	\$140.72	\$126.64 ea.

PDC-NL-200

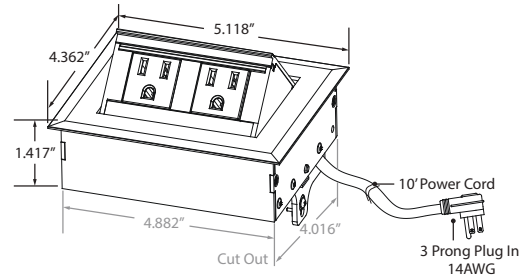

Part #	Housing Color	Plug		Ports	USB	Price	
		Receptacles	Rating			Rating	Each
PDC-NL-200-BK	Black	2	125V, 12A	-	-	\$100.12	\$90.11 ea.
PDC-NL-200-SA	Satin Aluminum	2	125V, 12A	-	-	\$100.12	\$90.11 ea.

PDC-NL-220

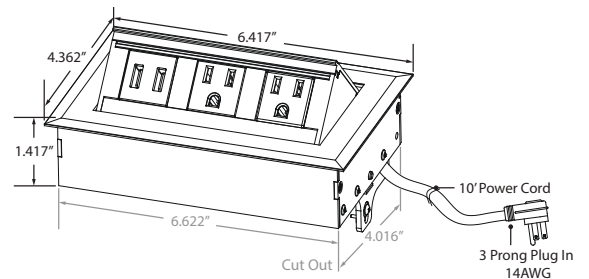

Part #	Housing Color	Plug		Ports	USB	Price	
		Receptacles	Rating			Rating	Each
PDC-NL-220-BK	Black	2	125V, 12A	2	4.2A Shared	\$156.96	\$141.26 ea.
PDC-NL-220-SA	Satin Aluminum	2	125V, 12A	2	4.2A Shared	\$156.96	\$141.26 ea.

IMPORTANT: Due to Raw Material Fluctuation, Catalog Prices Below May Not Be Accurate. GO TO WWW.OUTWATER.COM FOR THE MOST UP-TO-DATE PRICES

Power Hubs

we've got the POWER!!!



PDC-BT-320-SA-M



Housing:

- **Material:** Anodized Aluminum
- **Color/Finish:** Silver/Aluminum

Receptacles:

- **Material:** ABS Plastic
- **Color/Finish:** Black

- Recommended material thickness: 3/4" to 2-1/4"
- 1 year warranty



Buttons to Show/Hide Outlet



- Motorized rotation, Dual IC protection, Photoelectric detection

MOTORIZED ROTATION

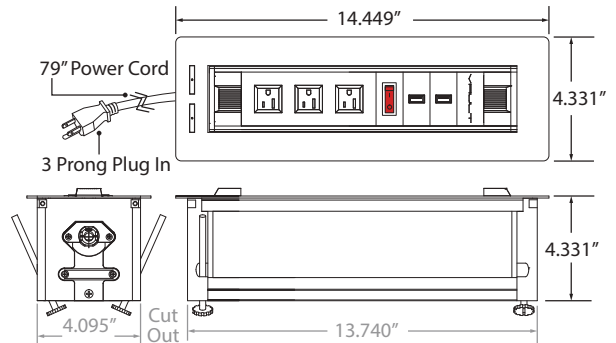

Part #	Plug		Ports	USB		Price	
	Receptacles	Rating		Rating	Each	5 +	
PDC-BT-320-SA-M	3	110V	2	5V 2.5A Each	\$213.92	\$203.17 ea.	

PDC-BT-320-SA

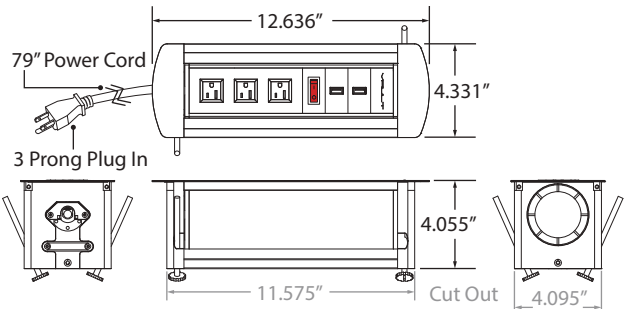

- Manual rotate to hide away



Part #	Plug		Ports	USB		Price	
	Receptacles	Rating		Rating	Each	5 +	
PDC-BT-320-SA	3	110V	2	5V 2.5A Each	\$138.68	\$131.68 ea.	

IMPORTANT: Due to Raw Material Fluctuation, Catalog Prices Below May Not Be Accurate. GO TO WWW.OUTWATER.COM FOR THE MOST UP-TO-DATE PRICES

Power Hubs

PDG-BY-020-BK



we've got the POWER!!!



Housing:

- **Material:** Flame Retardant ABS
- **Color/Finish:** Black
- Recommended material thickness: Up to 3"
- 1 year warranty

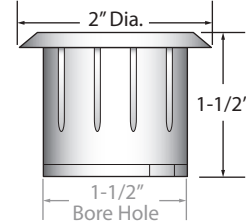

Part #	Plug		USB		Price	
	Receptacles	Rating	Ports	Rating	Each	10 +
PDG-BY-020-BK	0	-	2	2@2.1A Each	\$16.22	\$14.59 ea.

PDC-BY-120-*

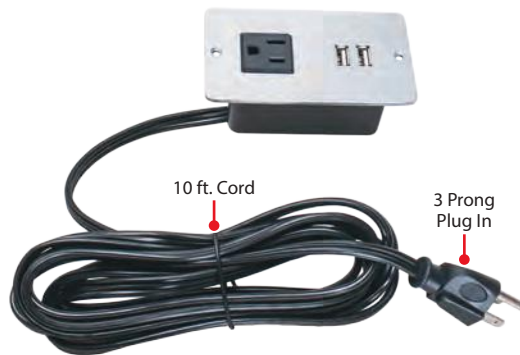

Receptacles:

- **Material:** Aluminum / ABS
- **Color/Finish:** Brushed Chrome & Black
- Recommended material thickness: Up to 1-1/2"
- 1 year warranty

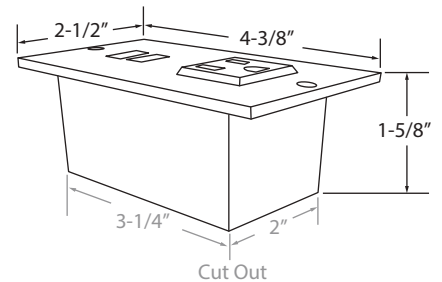

Part #	Plug		USB		Price	
	Receptacles	Rating	Ports	Rating	Each	10 +
PDC-BY-120-BCHR	1	120V, 12A	2	2.1A Shared	\$19.53	\$17.58 ea.
PDC-BY-120-BK	1	120V, 12A	2	2.1A Shared	\$16.25	\$14.30 ea.

IMPORTANT: Due to Raw Material Fluctuation, Catalog Prices Below May Not Be Accurate. GO TO WWW.OUTWATER.COM FOR THE MOST UP-TO-DATE PRICES

Power Hubs

we've got the POWER!!!

PDC-BY-220-BK

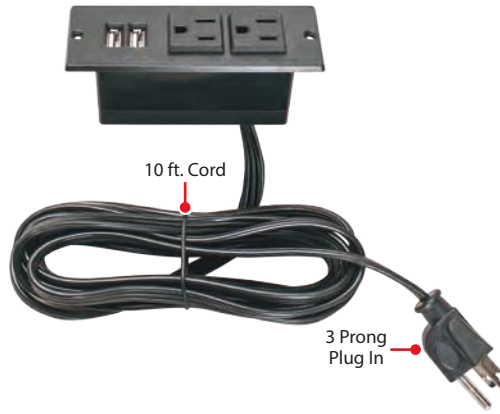

Housing & Receptacles:

- **Material:** Flame Retardant ABS
- **Color/Finish:** Black
- Recommended material thickness: Up to 1-1/2"
- 1 year warranty

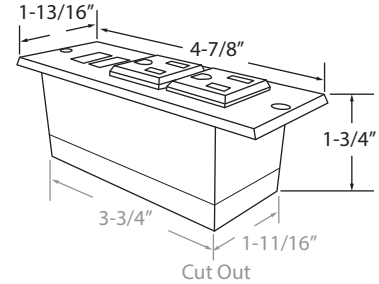

Part #	Plug		USB		Price	
	Receptacles	Rating	Ports	Rating	Each	10 +
PDC-BY-220-BK	2	120V, 12A	2	2.1A Shared	\$20.62	\$18.55 ea.

PDC-BY-320-BKS



Housing & Receptacles:

- **Material:** Flame Retardant ABS
- **Color/Finish:** Black
- Recommended material thickness: Up to 1-1/2"
- Reset On/Off Switch
- 1 year warranty

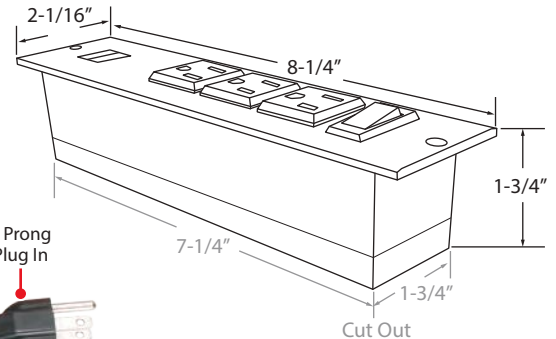

Part #	Plug		USB		Price	
	Receptacles	Rating	Ports	Rating	Each	10 +
PDC-BY-320-BKS	3	120V, 12A	2	2.1A Shared	\$27.12	\$24.41 ea.

IMPORTANT: Due to Raw Material Fluctuation, Catalog Prices Below May Not Be Accurate. GO TO WWW.OUTWATER.COM FOR THE MOST UP-TO-DATE PRICES

Qi Chargers

we've got the POWER!!!

Works With All Glass Back Cell Phones • Overcharge Protection: Phone will not continue to charge once at 100%

WCD-NL-150-BK (Wireless Charging  & USB)



Housing:

- **Material:** Polycarbonate
- **Color/Finish:** Black
- Pop up with USB ports for charging
- Recommended material thickness: 2-1/8"
- 1 year warranty

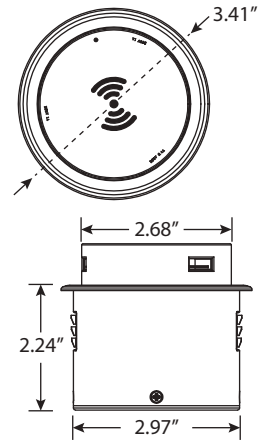

Part #	Plug		USB		Price	
	Output	Rating	Ports	Rating	Each	6 +
WCD-NL-150-BK	5W	5V/5A	3	1@2.4A Each 2@1A Each	\$63.64	\$58.33 ea.

WCD-NL-950-BK & WCD-NL-951-BK (Wireless Charging )



Housing:

- **Material:** Polycarbonate
- **Color/Finish:** Black
- Recommended material thickness: 1-1/16"
- 1 year warranty

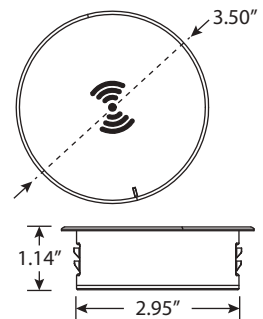

Part #	Plug		USB		Price	
	Output	Rating	Ports	Rating	Each	6+
WCD-NL-950-BK	5W	5V/2A	-	-	\$42.54	\$38.99 ea.
WCD-NL-951-BK	10W	9V/1.67A	-	-	\$48.33	\$44.30 ea.

IMPORTANT: Due to Raw Material Fluctuation, Catalog Prices Below May Not Be Accurate. GO TO WWW.OUTWATER.COM FOR THE MOST UP-TO-DATE PRICES

Qi Chargers

we've got the POWER!!!

Works With All Glass Back Cell Phones • Overcharge Protection: Phone will not continue to charge once at 100%

WCD-NL-900-BK (Wireless Charging) 



Decal Not Included



2 Prong Plug In

96" Cord

Housing:

- Material: Polycarbonate
- Color/Finish: Black
- Can be installed on top or under desk
- Recommended material thickness: 1/8"
- 1 year warranty

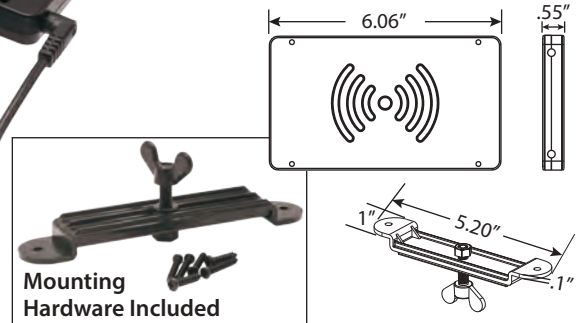

Mounting Hardware Included

Part #	Plug		USB		Price	
	Output	Rating	Ports	Rating	Each	6+
WCD-NL-900-BK	5W	12V/1A	-	-	\$54.57	\$50.02 ea.

PDG-HP-010-BK & PDG-SH-000-BK (Wireless Charging  & USB)

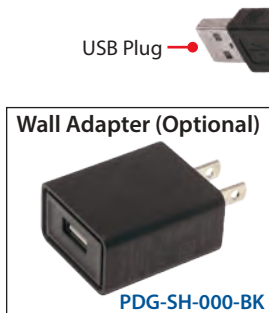

Wall Adapter (Optional)

PDG-SH-000-BK



USB Plug

3.3 Ft. Cord

Housing:

- Material: ABS
- Color/Finish: Black
- Compatible with iPhone XS/MAX/XR/X/8/8+ & Samsung Galaxy Note 9/S9/S9+/Note8/S8.
- Recommended material thickness: .866"
- 1 year warranty

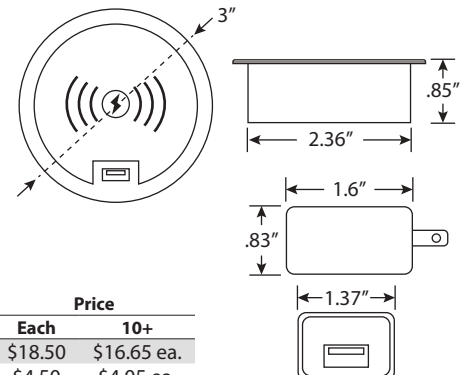

Part #	Plug		USB		Price	
	Output	Rating	Ports	Rating	Each	10+
PDG-HP-010-BK	10W	5V/2A	1	2.0A	\$18.50	\$16.65 ea.
PDG-SH-000-BK	10W	5V/2A	1	2.0A	\$4.50	\$4.05 ea.

IMPORTANT: Due to Raw Material Fluctuation, Catalog Prices Below May Not Be Accurate. GO TO WWW.OUTWATER.COM FOR THE MOST UP-TO-DATE PRICES

Angled Power Strips (120V)



By eliminating wall cutouts, show off your backsplash or showcase without the interruption of obtrusive outlets and extension cords!



APT Series

Angle Power Strip with Tamper-Resistant Receptacles Slim Profile

36" Fixture: APT-36

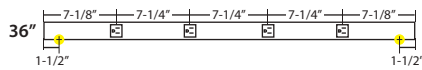

30" Fixture: APT-30

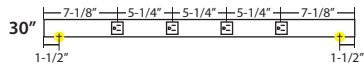

24" Fixture: APT-24

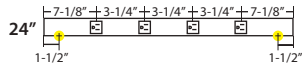

18" Fixture: APT-18

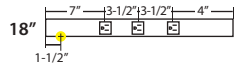

12" Fixture: APT-12

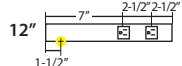

● = Knock-out (all knock-outs are 1-1/2" from end)
 □ = 15 amp receptacle available

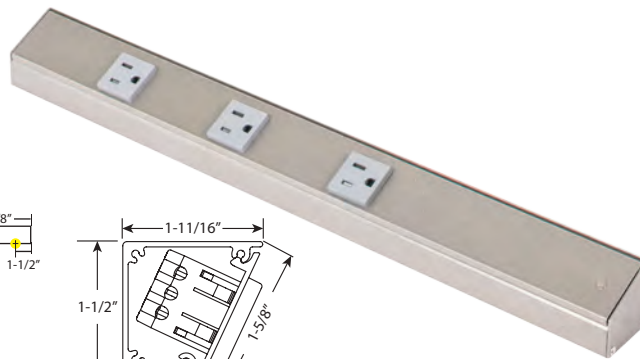
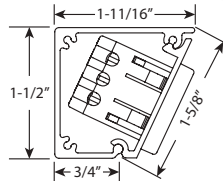

Standard Receptacle Color with Finish Option

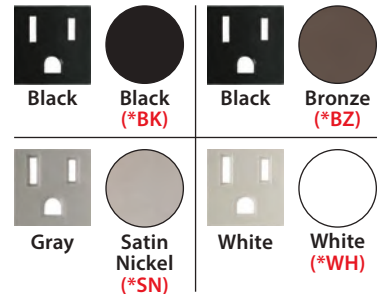

Part #	Length	# of Single Receptacles	Price	
			Each	5+ Pcs.
<i>Black *BK (Receptacle Color: Black), Bronze *BZ (Receptacle Color: Black), Satin Nickel *SN (Receptacle Color: Gray) & White *WH (Receptacle Color: White)</i>				
APT-12-* (L or R)	12"	2	\$137.76	\$130.87 ea.
APT-18-* (L or R)	18"	3	\$150.06	\$142.56 ea.
APT-24-*	24"	4	\$175.48	\$166.71 ea.
APT-30-*	30"	4	\$182.86	\$173.72 ea.
APT-36-*	36"	4	\$203.36	\$193.19 ea.

WIRE ENTRY

When purchasing 12" or 18" APS series you must specify left or right wire entry.

L = Left Wire Entry

R = Right Wire Entry

All other sizes have a knockout on either side, so that wiring can be done in the field.

It is recommended that all electrical products be installed by a licensed electrician.

IMPORTANT: Due to Raw Material Fluctuation, Catalog Prices Below May Not Be Accurate. GO TO WWW.OUTWATER.COM FOR THE MOST UP-TO-DATE PRICES



Angled Power Strips (120V)

By eliminating wall cutouts, show off your backsplash or showcase without the interruption of obtrusive outlets and extension cords!

TR Series

Angle Power Strip with Tamper-Resistant Duplex Receptacles

36" Fixture: TR-36

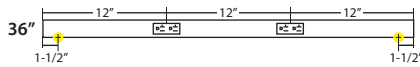

30" Fixture: TR-30

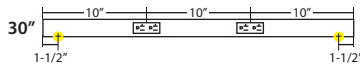

24" Fixture: TR-24

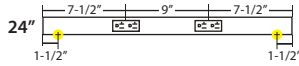

18" Fixture: TR-18

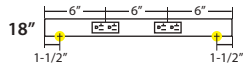

12" Fixture: TR-12

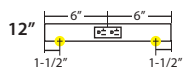

● = Knock-out (all knock-outs are 1-1/2" from end)

Ⓜ = 20 amp receptacle available

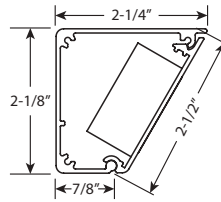

Standard Receptacle Color with Finish Option

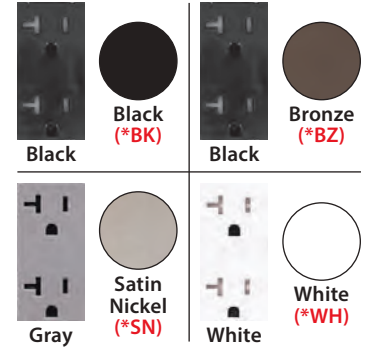

Part #	Length	# of Duplex Receptacles	Price	
			Each	5+ Pcs.
<i>Black *BK (Receptacle Color: Black), Bronze *BZ (Receptacle Color: Black), Satin Nickel *SN (Receptacle Color: Gray) & White *WH (Receptacle Color: White)</i>				
TR-12.*	12"	2	\$111.52	\$105.94 ea.
TR-18.*	18"	4	\$132.84	\$126.20 ea.
TR-24.*	24"	4	\$145.14	\$137.88 ea.
TR-30.*	30"	4	\$157.44	\$149.57 ea.
TR-36.*	36"	4	\$168.92	\$160.47 ea.

WIRE ENTRY

Knockouts are located on either side, so that wiring can be done in the field.

TR-USB Series

Angle Power Strip with Tamper-Resistant Duplex Receptacles & USB Included

36" Fixture: TRU-36

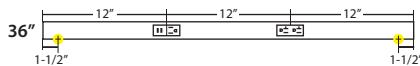

30" Fixture: TRU-30

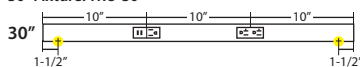

24" Fixture: TRU-24

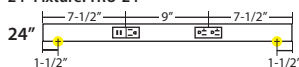

18" Fixture: TRU-18

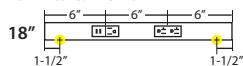

12" Fixture: TRU-12



● = Knock-out (all knock-outs are 1-1/2" from end)

Ⓜ = 20 amp receptacle available

Ⓜ = USB/Receptacle combo 15 amp standard receptacle

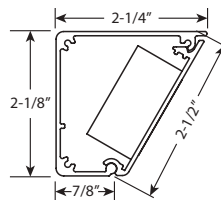

Standard Receptacle Color with Finish Option

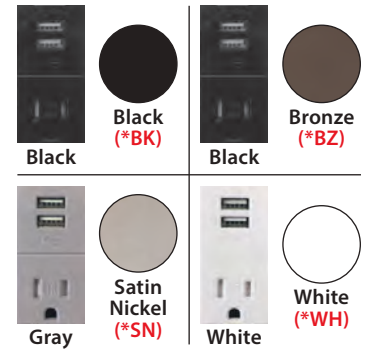

Part #	Length	Receptacle Information	Price	
			Each	5+ Pcs.
<i>Black *BK (Receptacle Color: Black), Bronze *BZ (Receptacle Color: Black), Satin Nickel *SN (Receptacle Color: Gray) & White *WH (Receptacle Color: White)</i>				
TRU-12.*	12"	1 Combination Receptacle with 1 Plug Outlet & 2 USB Ports	\$173.84	\$165.15 ea.
TRU-18.*	18"	2 Receptacles with 1 Duplex Plug Outlet & 1 Combination	\$195.16	\$185.40 ea.
TRU-24.*	24"	Receptacle & 1 Combination	\$207.46	\$197.09 ea.
TRU-30.*	30"	Receptacle with 1 Plug Outlet & 2 USB Ports	\$218.94	\$207.99 ea.
TRU-36.*	36"		\$230.42	\$218.90 ea.

WIRE ENTRY

Knockouts are located on either side, so that wiring can be done in the field.

It is recommended that all electrical products be installed by a licensed electrician.

**IMPORTANT: Due to Raw Material Fluctuation, Catalog Prices Below May Not Be Accurate.
GO TO WWW.OUTWATER.COM FOR THE MOST UP-TO-DATE PRICES**

ORAC[®]
DECOR

Indirect Lighting

Indirect lighting creates a warm atmosphere and adds depth to a room by producing subtle lighting effects. Our innovative profiles for indirect lighting are specially designed to incorporate compact LEDs and disperse light evenly. They can direct light upward or downward and are offered in a variety of shapes and sizes to fit seamlessly into any interior.



IMPORTANT: Due to Raw Material Fluctuation, Catalog Prices Below May Not Be Accurate. GO TO WWW.OUTWATER.COM FOR THE MOST UP-TO-DATE PRICES

ORAC[®]
DECOR
by Outwater

Indirect Lighting

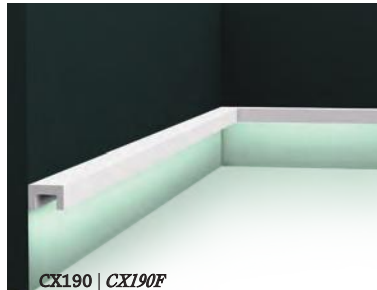
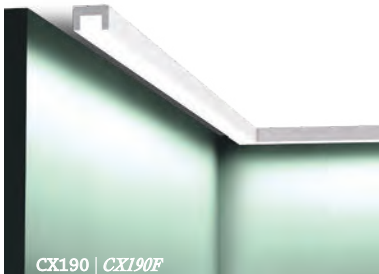

CX189 | CX189F (flexible)



Duropolym[®]
H: 1" | 2,7cm
P: 1" | 2,7cm
F: 1-3/8" | 3,5cm
L: 6'6" | 200cm
*Designed By
Orio Tonini*

CX188 | CX188F (flexible)



Duropolym[®]
H: 1-3/8" | 3,4cm
P: 1-1/8" | 3cm
F: 1-1/2" | 3,9cm
L: 6'6" | 200cm
*Designed By
Orio Tonini*

CX190 | CX190F (flexible)



Duropolym[®]
H: 3/4" | 2cm
P: 1-1/8" | 3cm
L: 6'6" | 200cm
*Designed By
Orio Tonini*

CX190 | CX190F (flexible)



Duropolym[®]
H: 3/4" | 2cm
P: 1-1/8" | 3cm
L: 6'6" | 200cm
*Designed By
Orio Tonini*

CX190 | CX190F (flexible)



Duropolym[®]
H: 3/4" | 2cm
P: 1-1/8" | 3cm
L: 6'6" | 200cm
*Designed By
Orio Tonini*

C380



Purotouch[®]
H: 2" | 5cm
P: 2" | 5cm
F: 2-1/2" | 6,4cm
L: 6'6" | 200cm
*Designed By
Orio Tonini*

C361



Purotouch[®]
H: 2" | 5cm
P: 2" | 5cm
F: 2-3/4" | 7cm
L: 6'6" | 200cm
*Designed By
Pierre Daems*

C362



Purotouch[®]
H: 2" | 5cm
P: 2" | 5cm
F: 2-3/4" | 7cm
L: 6'6" | 200cm
*Designed By
Pierre Daems*

Purotouch[®] a proprietary polymer blend formulated to create deep reliefs and crisp details.

≡ Collections ≡

Duropolym[®] high impact resin blend. Ideally suited for baseboards and chair rails.

**IMPORTANT: Due to Raw Material Fluctuation, Catalog Prices Below May Not Be Accurate.
GO TO WWW.OUTWATER.COM FOR THE MOST UP-TO-DATE PRICES**

ORAC[®]
DECOR
by Outwater

Indirect Lighting



C394



C381



C373 | FC373



SX179 | SX179F



SX179 | SX179F



2x SX179 | SX179F

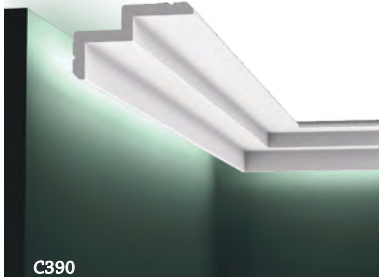

C390



C357

C394



Purotouch[®]

H: 3-3/4" | 9,5cm
P: 1-1/4" | 3,1cm
F: 3-3/4" | 9,6cm
L: 6'6" | 200cm

Designed By
Oriò Tonini

C381



Purotouch[®]

H: 3-3/4" | 9,5cm
P: 2" | 5cm
F: 3-3/4" | 9,5cm
L: 6'6" | 200cm

Designed By
Oriò Tonini

C373 | FC373 (flexible)



Purotouch[®]

H: 3-1/8" | 8cm
P: 2" | 5cm
F: 3-3/4" | 9,5cm
L: 6'6" | 200cm

Designed By
Ulf Moritz

SX179 | SX179F (flexible)



Duopolymer[®]

H: 3-7/8" | 9,7cm
P: 1-1/8" | 2,9cm
F: 3-7/8" | 9,8cm
L: 6'6" | 200cm

Designed By
Oriò Tonini

SX179 | SX179F (flexible)



Duopolymer[®]

H: 3-7/8" | 9,7cm
P: 1-1/8" | 2,9cm
F: 3-7/8" | 9,8cm
L: 6'6" | 200cm

Designed By
Oriò Tonini

2x SX179 | SX179F (flexible)



Duopolymer[®]

H: 3-7/8" | 9,7cm
P: 1-1/8" | 2,9cm
F: 3-7/8" | 9,8cm
L: 6'6" | 200cm

Designed By
Oriò Tonini

C390

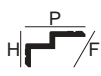

Purotouch[®]

H: 2-3/8" | 6cm
P: 3-7/8" | 10cm
F: 4-1/8" | 10,5cm
L: 6'6" | 200cm

Designed By
Oriò Tonini

C357

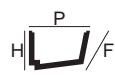

Purotouch[®]

H: 2-3/4" | 7,1cm
P: 4-3/8" | 11cm
F: 5" | 12,6cm
L: 6'6" | 200cm

Designed By
Jacques Vergracht

Purotouch[®] a proprietary polymer blend formulated to create deep reliefs and crisp details.

≡ Collections ≡

Duopolymer[®] high impact resin blend. Ideally suited for baseboards and chair rails.

**IMPORTANT: Due to Raw Material Fluctuation, Catalog Prices Below May Not Be Accurate.
GO TO WWW.OUTWATER.COM FOR THE MOST UP-TO-DATE PRICES**

ORAC[®]
DECOR
by Outwater

Indirect Lighting



C382



C383

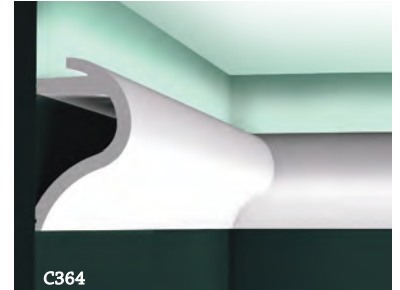

C364

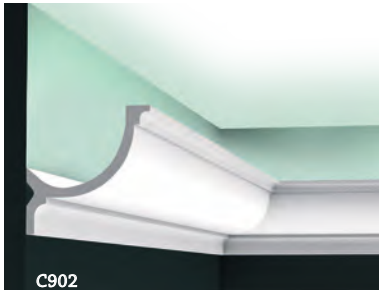

C902

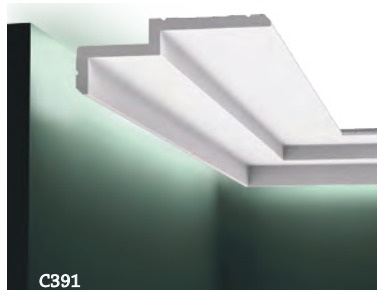

C391

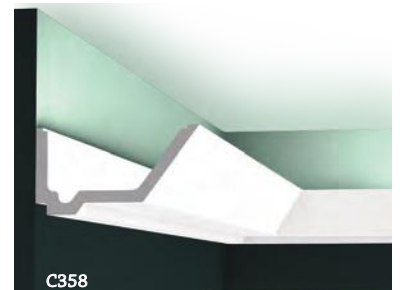

C358

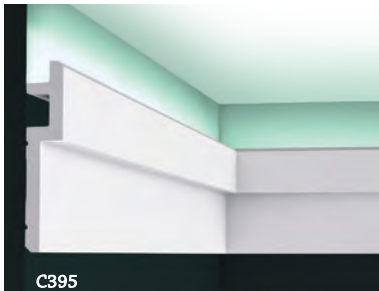

C395



C991

C382



Purotouch[®]

H: 5-1/2" | 14cm
P: 2" | 5cm
F: 5" | 12,7cm
L: 6'6" | 200cm

Designed By
Orio Tonini

C383



Purotouch[®]

H: 5-1/2" | 14cm
P: 2" | 5cm
F: 5" | 12,8cm
L: 6'6" | 200cm

Designed By
Orio Tonini

C364



Purotouch[®]

H: 5-1/2" | 14cm
P: 3-1/8" | 8cm
F: 5-5/8" | 14,2cm
L: 6'6" | 200cm

Designed By Pierre Daems
Red Dot Design Award 2014

C902



Purotouch[®]

H: 4" | 10,3cm
P: 4" | 10,3cm
F: 5-5/8" | 14,2cm
L: 6'6" | 200cm

C391

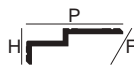

Purotouch[®]

H: 2-3/8" | 6cm
P: 6-1/4" | 16cm
F: 5-7/8" | 14,8cm
L: 6'6" | 200cm

Designed By
Orio Tonini

C358



Purotouch[®]

H: 2-7/8" | 7,3cm
P: 5-1/2" | 14cm
F: 6" | 15,3cm
L: 6'6" | 200cm

Designed By
Jacques Vergracht

C395



Purotouch[®]

H: 6-1/8" | 15,5cm
P: 1-1/4" | 3,1cm
F: 6-1/8" | 15,6cm
L: 6'6" | 200cm

Designed By
Orio Tonini

C991



Purotouch[®]

H: 4-3/8" | 11cm
P: 5-1/2" | 14cm
F: 7" | 17,8cm
L: 6'6" | 200cm

Designed By
Ulrich Moritz

Purotouch[®] a proprietary polymer blend formulated to create deep reliefs and crisp details.

≡ Collections ≡

Duopolymer[®] high impact resin blend. Ideally suited for baseboards and chair rails.

IMPORTANT: Due to Raw Material Fluctuation, Catalog Prices Below May Not Be Accurate. GO TO WWW.OUTWATER.COM FOR THE MOST UP-TO-DATE PRICES

ORAC[®]
DECOR
by Outwater

Indirect Lighting



C352

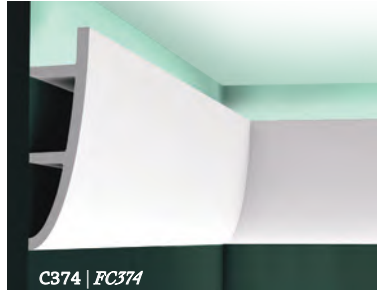

C374 | FC374



C396

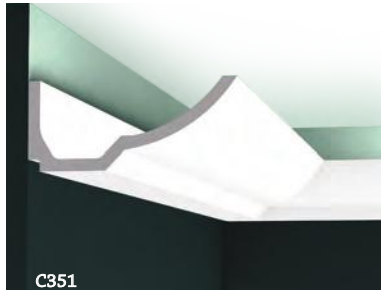

C351

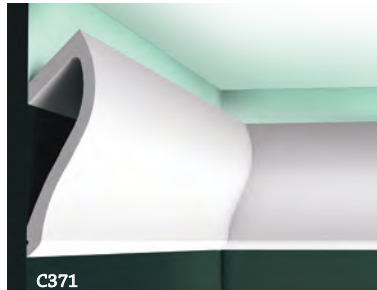

C371

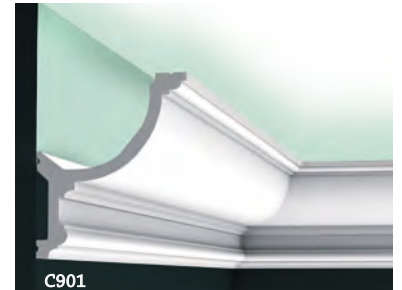

C901

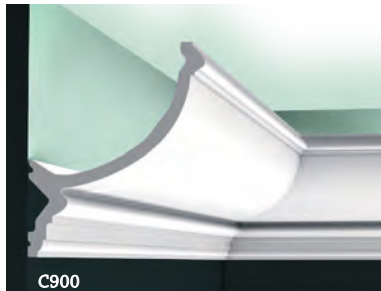

C900

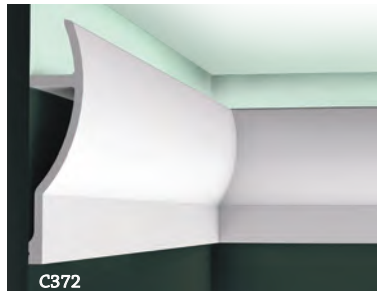

C372

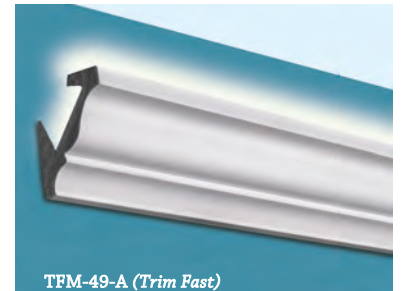

TFM-49-A (Trim Fast)

C352

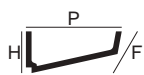

Purotouch[®]

H: 3" | 7,6cm
P: 6-3/4" | 17,1cm
F: 7-1/8" | 18,1cm
L: 6'6" | 200cm

Designed By
Jacques Vergracht

C374 | FC374 (flexible)

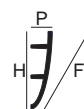

Purotouch[®]

H: 7-1/8" | 18cm
P: 2" | 5cm
F: 7-3/8" | 18,6cm
L: 6'6" | 200cm

Designed By
Ulf Moritz

C396



Purotouch[®]

H: 7-1/4" | 18,5cm
P: 2-3/8" | 6,1cm
F: 7-1/2" | 19,1cm
L: 6'6" | 200cm

Designed By
Orio Tonini

C351

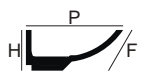

Purotouch[®]

H: 2-7/8" | 7,4cm
P: 6-3/4" | 17,3cm
F: 7-1/2" | 19cm
L: 6'6" | 200cm

Designed By
Jacques Vergracht

C371



Purotouch[®]

H: 7-1/4" | 18,5cm
P: 2-1/4" | 5,8cm
F: 7-1/2" | 19cm
L: 6'6" | 200cm

Designed By
Ulf Moritz

C901



Purotouch[®]

H: 5-7/8" | 14,8cm
P: 4-7/8" | 12,4cm
F: 7-1/2" | 19,2cm
L: 6'6" | 200cm

C900

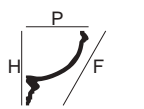

Purotouch[®]

H: 6-3/4" | 17,1cm
P: 5-3/4" | 14,6cm
F: 8-5/8" | 21,8cm
L: 6'6" | 200cm

C372

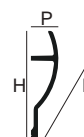

Purotouch[®]

H: 11" | 28cm
P: 2-3/4" | 7cm
F: 11-1/8" | 28,4cm
L: 6'6" | 200cm

Designed By
Ulf Moritz

TFM-49-A (Trim-Fast)



(2) 1/2" permanent adhesive strips on the bottom back of the moulding.

Purotouch[®] a proprietary polymer blend formulated to create deep reliefs and crisp details.

≡ Collections ≡

Duopolymer[®] high impact resin blend. Ideally suited for baseboards and chair rails.

**IMPORTANT: Due to Raw Material Fluctuation, Catalog Prices Below May Not Be Accurate.
GO TO WWW.OUTWATER.COM FOR THE MOST UP-TO-DATE PRICES**

TERMS AND CONDITIONS

"Vendor":

Outwater Plastics Industries, Inc. & Architectural Products by Outwater, LLC

PRICES:

All prices are subject to change without notice. No deduction will be allowed at settlement. Minimum order is \$25.00 (Merchandise only). Orders less than this minimum will be billed as \$25.00 plus shipping charges and tax, if applicable.

NOTE:

Orders are accepted with the understanding that they will be billed at the price in effect on the day of shipment.

PAYMENT TERMS:

N30

To establish N30 terms, we must be supplied with your company's Dun & Bradstreet number (DUNS Number). Concerns not rated favorably with Dun & Bradstreet, not rated at all with Dun & Bradstreet or inactive accounts, are required to furnish, on company letterhead, four (4) trade references, the name of their bank and account number, their Federal I.D. number or CRA-issued business number, and the date and state/province their business was incorporated.

Please note: If supplying trade references, please allow 2-3 weeks for processing.

Credit Card

We accept major credit cards (Visa, MasterCard, American Express and Discover.) Please note: When authorizing us to charge your card in an amount over \$500.00, we require a signed credit card authorization form, which we will fax or email to you for your signature. Order processing will not begin until this authorization is returned to us.

C.O.D.

C.O.D. orders are no longer accepted.

Prepayment

Customers not wishing to use a credit card or set up N30 terms, may prepay orders. Please speak with your sales representative when placing your order. We accept company checks and certified / bank checks. Order processing will not begin until we receive payment. Non-certified checks (company or personal) may take an additional five business days after receipt before order processing will begin.

Other Terms

Large orders, Custom or Special Order items may require certified funds and/or a deposit, regardless of existing credit terms. If applicable, this will be discussed at time of order. If a deposit is required, order processing will not begin until deposit is received by us. Should deposit be sent in the form of a non-certified check, it may take an additional five business days after receipt before order processing will begin.

WARRANTY:

All merchandise is produced to standard and commercial tolerances. Vendor warrants product to be free from defects in workmanship and material. When Vendor has determined that a product is defective, it will be replaced. At Vendor's discretion, a credit may be offered instead of replacement. Vendor liability is limited to the cost of the defective product. No other warranty is expressed or implied.

LIABILITY:

The customer shall test and verify the suitability of the product for intended use. No warranty for intended use is made. The customer assumes all risk and liability. Vendor's only obligation is replacement or credit for product proven defective. Vendor shall not be liable for any loss or damage from the use or inability to use the product.

TECHNICAL ADVICE:

Any technical advice furnished or recommended by Vendor or any representative of Vendor concerning any use or application of any product is believed to be reliable but the company makes no warranty of results obtained. The customer shall test for and verify suitability for intended use.

FREE SAMPLE POLICY:

Reasonable sample quantities are available at no charge for many of the products within this catalog; to test their suitability for your intended use or application. Most samples are shipped free of charge via standard U.S. mail or UPS ground. Other shipping options are available, at customer's expense. Please discuss with our sales representatives.

MERCHANDISE RETURN POLICY:

Merchandise may not be returned for credit without prior authorization from our Customer Service department. Please have your order number available when contacting us.

- You may return most items purchased for a partial refund within 30 days of purchase. A restocking fee will apply and shipping charges will not be refunded. Restocking fees as follows:
 - 20% restocking fee applies to most stock items. Some dropship items will be subject to a higher restocking fee. Where applicable, fees are stated within our catalog.
 - 40% restocking fee applies on items that have been cut for shipping purposes. Custom or Special order items may not be returned.
- Refund will only be issued in the original form of payment.
- Customer is responsible for the shipping cost of items returned. Be mindful of packaging as any damage during return shipment is the responsibility of the customer.
- Returned material must be received in original condition.
- Any products cut, altered, modified or installed by the customer may not be returned.
- We reserve the right to refuse unauthorized returns. Unauthorized returns will be returned to the customer at their expense.

DAMAGE/LOSS:

- Upon receiving your shipment, please inspect the packages carefully for signs of damage. Check contents for damaged or missing items.
- Damage and/or loss claims must be reported within 48 hours from time of receipt!
- We utilize small parcel carriers [UPS and Federal Express] and many LTL freight carriers [such as YRC, New Penn and UPS Freight] when shipping our products. Specific instructions will vary depending on the carrier.
- If Damage/Loss is suspected, please do the following:
 - Inspect your shipment as soon as it arrives.
 - If your merchandise has arrived via LTL freight carrier, all damages/loss must be noted on the delivery receipt at time of delivery. Please take digital photographs and email to: customerservice@outwaterplastics.com.
 - Please keep all merchandise and packing material for possible inspection by the carrier.
 - Contact our Customer Service Department immediately! It is best to get in touch with us right away. Be advised that claims made after 48 hours of receipt will not be honored.

DEFECTIVE MERCHANDISE POLICY:

Every item that we sell meets our highest standards for quality and performance. If a defect in merchandise is suspected, please proceed as follows:

- Inspect merchandise for quality before altered or installed.
- Upon the finding of parts which may be defective, contact our Customer Service Department immediately! We will request digital images, a sample of the material, or a combination of both material and images to be sent to our Customer Service Department for evaluation.
- Upon review of the samples/images we will determine if replacement or refund is appropriate. Return of the defective merchandise will also be determined at this time and if deemed necessary an RMA (Return Merchandise Authorization) will be issued.
- The responsibility of Outwater Plastics and Architectural Products ends here. Any loss incurred for labor, transportation or any other expenses are not covered.

PICK UP ORDERS:

Orders placed for pick up must be picked up within 2 weeks from the date placed, or the date material becomes available. Orders not picked up within 2 weeks will be cancelled. To secure material for a longer time period; arrangements may be made for non-refundable prepayment and pick up by a specified date.

SHIPPING TERMS:

Shipments are F.O.B. shipping point.



SHIPPING TERMS IN CANADA:

- All transport (shipping) fees are F.O.B. shipping point.
- Brokerage Fees (Entry, Duties and GST):
 - Will be paid by shipper for shipments that meet all of the following conditions:
 - (1) shipment departs from our Bogota, NJ warehouse,
 - (2) shipment is transported via UPS Ground Service and
 - (3) shipping fees are pre-paid and added to the order total.
 - Are the responsibility of the purchaser for all shipments that have any one of the following conditions:
 - (1) shipment departs from a warehouse location other than Bogota, NJ,
 - (2) shipment is being transported by a carrier other than UPS,
 - (3) shipment is being transported through a UPS service level other than Ground or
 - (4) shipping fees are not being pre-paid and added to the order total.



***** WE RESERVE THE RIGHT TO SUBSTITUTE OR "EQUAL" *****

EAST COAST

24 River Road • Bogota, NJ 07603

2 LOCATIONS

(800) 631-8375

WEST COAST

4720 West Van Buren • Phoenix, AZ 85043

**IMPORTANT: Due to Raw Material Fluctuation, Catalog Prices Below May Not Be Accurate.
GO TO WWW.OUTWATER.COM FOR THE MOST UP-TO-DATE PRICES**

Outwater Plastics Industries, Inc.
24 River Road
P.O. Box 500
Bogota, NJ 07603-0500

Catalog Code
030

We encourage you to explore our new website, which makes shopping at Outwater easier than ever before. Online you can access videos, product details and installation guides, download specialty catalogs, and create an account.

When you become a registered user take advantage of these benefits:

- Track orders
- View purchase history
- Manage payment methods
- Save items and create wish lists
- Get quotes
- Set up multiple users under one company account



Join our mailing list to receive exclusive offers, free passes to trade shows, and information about exciting new products!



Outwater stocks all products in our east and west coast warehouse facilities to provide customers with fast, cost-effective shipping. Please call our sales department to request free samples.

1-800-631-8375