

# Manual on Fundamentals of **ENTOMOLOGY**



Edited by  
**Uma Shankar**  
**V. Kaul**  
**Devender Sharma**  
**Amit K. Singh**  
**R. K. Gupta**  
**D. P. Abrol**



**Division of Entomology**  
**Faculty of Agriculture**

**Sher-e-Kashmir University of Agricultural Sciences & Technology of Jammu**  
**Main Campus Chatha, Jammu-180009, J&K, India**

Manual on  
**Fundamentals of  
ENTOMOLOGY**



Edited by  
**Uma Shankar  
V. Kaul  
Devender Sharma  
Amit K. Singh  
R. K. Gupta  
D. P. Abrol**



**Division of Entomology  
Faculty of Agriculture**

**Sher-e-Kashmir University of Agricultural Sciences & Technology of Jammu  
Main Campus Chatha, Jammu-180009, J&K, India**

# Fundamentals of Entomology

Ento-121, Credit hrs 4(3+1)

## Syllabus for theory

### Part – I-

History of Entomology in India, Major points related to dominance of Insecta in Animal kingdom. Classification of phylum Arthropoda up to classes. Relationship of class Insecta with other classes of Arthropoda. Morphology: Structure and functions of insect cuticle and molting. Body segmentation. Structure of Head, thorax and abdomen. Structure and modifications of insect antennae, mouth parts, legs, Wing venation, modifications and wing coupling apparatus. Structure of male and female genital organ. Metamorphosis and diapause in insects. Types of larvae and pupae. Structure and functions of digestive, circulatory, excretory, respiratory, nervous, secretory (Endocrine) and reproductive system, in insects. Types of reproduction in insects. Major sensory organs like simple and compound eyes, chemoreceptor.

### Part-II

Insect Ecology: Introduction, Environment and its components. Effect of abiotic factors—temperature, moisture, humidity, rainfall, light, atmospheric pressure and air currents. Effect of biotic factors – food competition, natural and environmental resistance.

### Part III

Categories of pests. Concept of IPM, Practices, scope and limitations of IPM. Classification of insecticides, toxicity of insecticides and formulations of insecticides. Chemical control-importance, hazards and limitations. Recent methods of pest control, repellents, antifeedants, hormones, attractants, gamma radiation. Insecticides Act 1968-Important provisions. Application techniques of spray fluids. Symptoms of poisoning, first aid and antidotes.

### Part – IV

Systematics: Taxonomy –importance, history and development and binomial nomenclature. Definitions of Biotype, Sub-species, Species, Genus, Family and Order. Classification of class Insecta up to Orders, basic groups of present day insects with special emphasis to orders and families of Agricultural importance like Orthoptera: Acrididae, Tettigoniidae, Gryllidae, Gryllotalpidae; Dictyoptera: Mantidae, Blattidae; Odonata; Isoptera: Termitidae; Thysanoptera: Thripidae; Hemiptera: Pentatomidae, Coreidae, Cimicidae, Pyrrhocoridae, Lygaeidae, Cicadellidae, Delphacidae, Aphididae, Coccidae, Lophophoridae, Aleurodidae, Pseudococcidae; Neuroptera: Chrysopidae; Lepidoptera: Pieridae, Papilionidae, Noctuidae, Sphingidae, Pyralidae, Gelechiidae, Arctiidae, Saturniidae, Bombycidae; Coleoptera: Coccinellidae, Chrysomelidae, Cerambycidae, Curculionidae, Bruchidae, Scarabaeidae; Hymenoptera: Tenthredinidae, Apidae. Trichogrammatidae, Ichneumonidae, Braconidae, Chalcididae; Diptera: Cecidomyiidae, Tachinidae, Agromyziidae, Culicidae, Muscidae, Tephritidae.

## Syllabus for Practicals

Methods of collection and preservation of insects including immature stages; External features of Grasshopper/Blister beetle; Types of insect antennae, mouthparts and legs; Wing venation, types of wings and wing coupling apparatus. Types of insect larvae and pupae;

Dissection of digestive system in insects (Grasshopper); Dissection of male and female reproductive systems in insects (Grasshopper); Study of characters of orders Orthoptera, Dictyoptera, Odonata, Isoptera, Thysanoptera, Hemiptera, Lepidoptera, Neuroptera, Coleoptera, Hymenoptera, Diptera and their families of agricultural importance. Insecticides and their formulations. Pesticide appliances and their maintenance. Sampling techniques for estimation of insect population and damage.

**Reference books:**

1. Borror, D. J., Triple Horn, C. A. and Johnson, N.F. 1987. **An introduction to the study of insects (VI Edition)**. Harcourt Brace College Publishers, New York, 875p.
2. Chapman, R. F. 1981. **The Insects: Structure and function**. Edward Arnold (Publishers) Ltd, London, 919p.
3. Gullan, P. J. and Cranston, P. S. 2001. **The insects- An outline of Entomology**, II edition, Chapman & Hall, Madras, 491p.
4. Richards, O. W. and Davies, R. G. 1977. **Imm's general text book of Entomology, Vol.1&2**, Chapman and Hall Publication, London, 1345p.
5. Romoser, W.S. 1988. **The Science of Entomology**, McMillan, New York, 449p.
6. Pedigo, L. P. 1999. **Entomology and Pest Management**. III Edition. Prentice Hall, New Jersey, USA, 691p.
7. Snodgrass, R. E. 2001. **Principles of Insect Morphology**. CBS Publishers and Distributors, New Delhi
8. Nayar, K. K., Ananthakrishnan, T. N. and David, B. V. 1976. **General and applied Entomology**, Tata McGraw Hill Publishing Company Limited, New Delhi, 589p.
9. Pant, N. C. and Ghai, S. 1981. **Insect physiology and Anatomy**, ICAR, New Delhi.
10. Tembhare, D. B. 1997. **Modern Entomology**. Himalaya Publishing House, Mumbai, 623p.
11. Srivastava, P. D. and Singh, R. P. 1997. **An introduction to Entomology**, Concept Publishing Company, New Delhi, 269 p.

## Contents

Practical No.	Titles	Page No.
1.	To study the methods of collection and preservation of insects including immature stages	04-11
2.	To study the External features of Grasshopper	12-13
3.	To study about the Types of insect antennae and their modifications	14-15
4.	To study the different types mouthparts and their modifications	16-19
5.	To study the legs and their modifications	20-23
6.	To study the Wing venation, types of wings and wing coupling apparatus	24-27
7.	To study the Types of insect larvae and pupae	28-30
8.	To study the dissection of alimentary canal and nervous system in insects (cockroach)	31-33
9.	To study the of male and female reproductive systems in insects (Grasshopper)	34-37
10.	To study the characters of orders Orthoptera, Dictyoptera, Odonata, Neuroptera, Isoptera, Thysanoptera and their families	38-43
11.	To study the characters of order Hemiptera and its families	44-47
12.	To study the characters of order Lepidoptera and its families	48-49
13.	To study the characters of order Coleoptera and its families	50-51
14.	To study the characters of order Hymenoptera, Diptera and their families	52-54
15.	To study the Insecticides and their formulations.	55-60
16.	To study the Pesticide appliances and their maintenance.	61-67
17.	To study the Sampling techniques for estimation of insect population and damage.	68-70

## Practical-1

### *To study the methods of collection and preservation of insects including immature stages*

Insect collection is a source of recreation for many people and may be a hobby for those who are interested in studying insects. Methods of collection and preservation of insects are the pre-requisite to study the insects and their various internal and external organs. After collection, it becomes imperative to keep and preserve the insect specimens intact and safe for longer time to further study the characters or to develop the insect collection museum.

Let's have a look and do the different types methods of collection, devices used for collection and preservation of insects including immature stages in this practical session.

#### **Nature of insect collection**

A good Zoological collection should consist of at least four (4) individual representative of each of the order of insects. So that the collection comprises the great diversity and it should reflect the different forms occurs in insect fauna in a certain ecosystem.

#### **Places of insect collection**

Insects are omnipresent and abound anywhere and everywhere. A good place to start collecting insects is a flowering hedgerow or garden where insects can be found on the different parts of plants like flowers, leaves and stems. Besides these, we can also probe the small insects in the soil or near the roots of plants, aquatic insects can be collected in water, ponds, streams, rivers, lakes etc. and even do the indoors collection year round.

They can be collected from- **Air** (flying insects), **Water** (dragonflies, mayflies and stoneflies that hover over water, aquatic insects and sea shore insects), **Home** (from furniture, boxes, bookshelves (fleas, bugs, flies, and mosquitoes), flower, fruits and vegetables brought in), **Debris and animal dung** (which acts as food source for many insects), and from **domestic animals and birds** (ecto and endo- parasites).

**Catching insects:** Aerial insects can be caught during flight or after they have alighted by sweeping a net through the air or foliage or by beating the foliage and holding the net below.

- The aerial/ sweep nets can catch aerial insects.
- Net forceps, dippers and dredge, can catch aquatic insects.
- Separator and Berlese funnel can catch soil dwelling insects.

#### **Methods of insect collection**

##### **1. Hand picking**

This method is suitable for catching the large insects like beetles and grasshoppers. It is very tedious (hard working) method and not suitable for catching the biting and stinging natured insects.

## 2. Aerial net or Butterfly net

It is light in weight, useful for catching active fliers like butterflies, moths, dragonflies, wasp, flies etc. The net consists of three parts viz., loop or frame; handle and porous muslin cloth bags. The diameter of hoop and the depth of the bag should be in the proportion of 1:2.

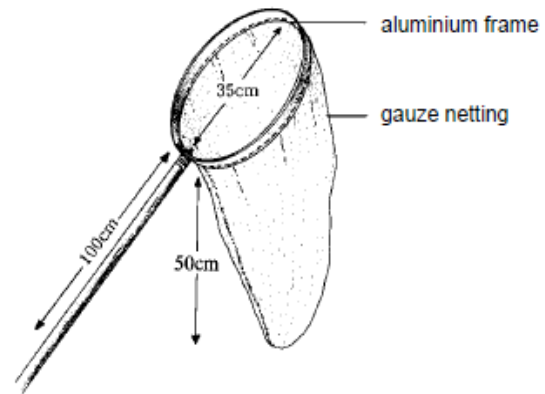

## 3. Sweep net

It is heavier than the aerial net. It consists of short handle, a large loop and dense cloth bag. This is suitable for collecting leafhoppers, grasshoppers and other small insects. The net is swept over vegetation.

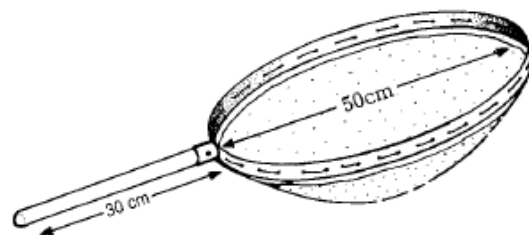

## 4. Beating tray

This method is suitable for collecting crawling insects and those, which rest on branches. A beating tray is held under a branch, which is then hit sharply with a stick.

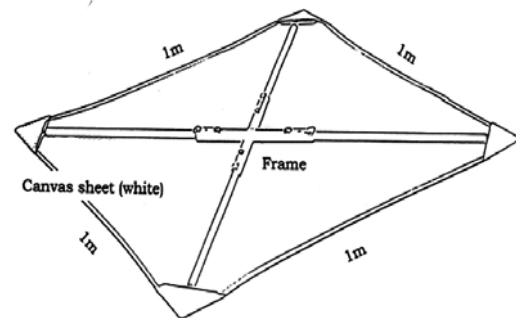

## 5. Aspirator/Potters/Suction tube

It is the device to collect small insects into glass vials with no damage to the specimens. It is employed to suck in through a rubber tube small and minute insect that is already collected in the net or sitting on wall or foliage and on the bark of the tree. Usually it is meant for catching more active insects. To prevent entry of insect in to mouth, a small cloth piece is kept in between the glass and rubber tube.

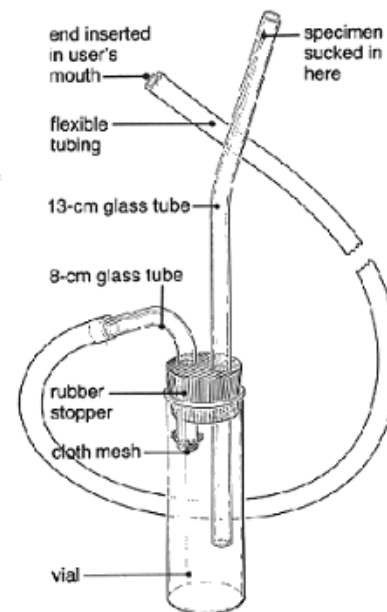

## 6. Berlese (Tullgren) funnel

Soil arthropods can be sorted out by this methods. Debris including soil arthropods can be collected by using the light as the source of heat in berlese funnel method.

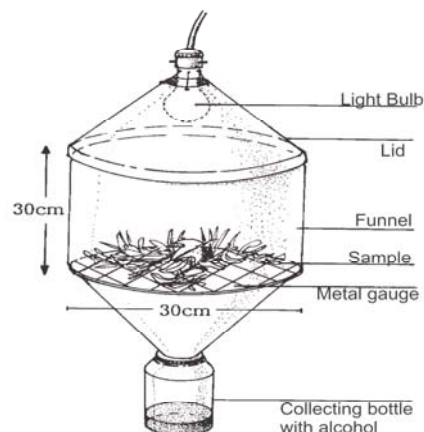

7. **Traps-** Trapping is a method of collecting insects in the absence of collector. This is the most common methods or techniques used by growers in Integrated pest management programme to catch the insects. There are many different types of traps used for collection of insects. They are pheromone traps or sleeve traps, fruit fly trap, sticky traps, delta traps, water or Wota traps, pit fall trap, wind pan trap, malaise trap and light traps.

### Pheromone traps

Synthetic sex pheromones are placed in the traps to attract male moths. The rubberized septa containing the pheromone lure are kept in the traps designed especially for this purpose and used in monitoring, mass trapping and mating disruption programmes. sticky tarps, Water pan traps and funnel type models are available for use in pheromone based insect-pest control programmes.

**Yellow sticky traps:** Aphids, whiteflies, thrips prefer yellow colour. Yellow colour is painted on tin boxes and sticky material like castor oil/vaseline is smeared on the sticky material.

**Probe trap:** It is used by keeping them under grain surface to trap stored product pests.

**Pitfall traps:** Containers such as small plastic buckets, plant pots, glass jars or jam tins are sunk into the ground to trap flightless, ground-living insects and arachnids, especially beetles (ground beetles), cockroaches, crickets, spiders, harvestmen and mites. The container should be placed in a hole with the upper rim flush with the ground surface. A killing agent and preservative, such as ethylene glycol, should be placed in traps that are not emptied daily. Radiating vanes, such as wooden planks, placed in the substrate will increase the effective area of the trap. A bait can be added to the trap to increase its effectiveness. The type of bait will depend on the specimens one wishes to catch.

**Light traps:** Light traps are mainly used for attracting moths & other night flying insects which are attracted towards the light. The insects are actively caught or encouraged to enter a trap. The simplest light trap consists of a light on a cable hanging out in the field for attracting the pests during nights. However, besides a number of species of moths, beetles, flies, and other insects, most of which are not pests, are also attracted to artificial light. So identification of pests and beneficial insects is of prime importance before any control operation is executed.

**Mercury vapour lamp light trap:** This trap is the basic model designed by Robinson (1952). This trap produces ultraviolet, blue and green radiation with little red. This is currently used



towards a wide range of noctuids and other nocturnal flying insects. a mercury lamp (125W) is fixed at the top of a funnel shaped (or) trapezoid galvanized iron cone terminating in a jar containing dichlorvos soaked in cotton as insecticide to kill the insect.

### **Killing insects**

Killing should be immediately after capture. Potassium cyanide (KCN), ethyl acetate, carbon tetrachloride and chloroform are commonly used for killing insects. KCN kills the insects quickly but deadly poisonous and must be handled with extreme care. Ethyl acetate kills the insects slowly and does not last long. But the dead insects remain in relaxed condition for a longer time without becoming brittle and stiff.

**Pinching-** In this method, thorax is pressed between thumb and index finger swiftly and with jerk. It needs constant practice. e.g. butterfly, grasshopper.

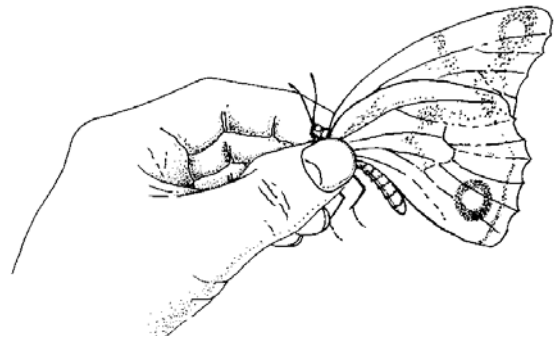

**Injecting-** Hypodermic injection of fluids.

**Drowning-** Larvae and insects without scales, hairs or powdery covering can be killed by submerging them in water. They die of Auto toxicity when excessive CO<sub>2</sub> unable to escapes from spiracles and collects in trachea and tissues.

### **How to prepare Killing Bottle/ Cyanide Bottle?**

Steps involved in preparing the killing bottles are given below -

- Take a wide mouthed strong bottle or vial with a tight fitting lid.
- Place a layer of potassium cyanide granules/pellets (1/4-inch thickness) at the bottom of bottle.
- Cover it with a layer of dry plaster of Paris (1/4 -inch thickness)
- Mix plaster of Paris with enough water so that it will pour off from the end of spoon. Pour 1/2-inch layer of wet plaster of Paris over the dry layer.
- Tap the bottle lightly on the table to eliminate any bubble in the bottle.
- Leave the lid off for a day to let the plaster dry in a well-ventilated room, completely away from direct sunlight.
- Keep a circular piece of filter or blotting paper on the top of plaster of

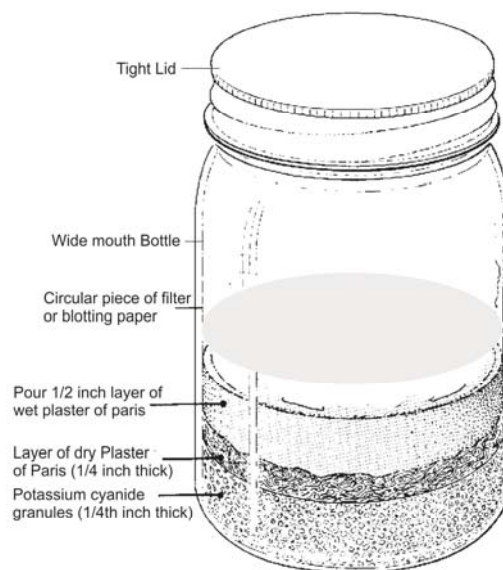

**Killing Bottle**

Paris and avoid condensation of water droplets on the side of bottom (to check the sweating process).

- Lastly, the bottle should be tightly corked and labeled with the word "Poison".
- In place of KCN, now a day's Ethyl acetate is being used as the replacement in killing bottle.

### **Insect Collection Box**

Storage of insects is done in the insect boxes, which is made up of wood (top and bottom could be of plywood) and lined on one (bottom) or both (roof also) sides with cork sheets covered with white paper. It is light in weight, moisture proof and airtight. General (common) size of insect collection box is 45×30×15 cm.

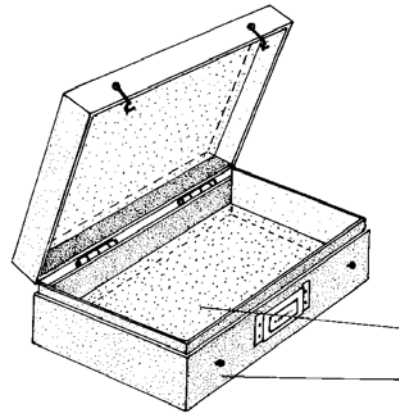

### **Labeling**

Specimen collected should be uniform in size and labeled properly on stiff paper or reference card. Labeling consists of following notes *i.e.*, **Host, Date, collector and Location.**

### **Setting or stretching boards**

Setting is the method that wings antennae and Occasionally (Hymenopterans) spread legs in full display of their features. This method needs a setting or stretching board which have two side's boards separated by groove. Both board and grooves are lined with thin sheet of cork. The width of groove varies according to the width of insect body.

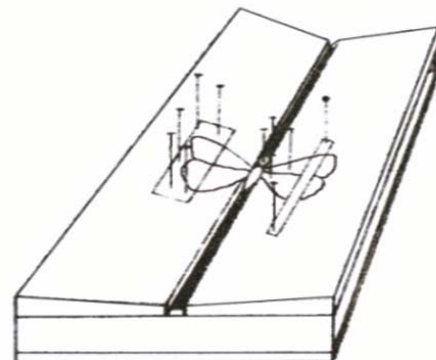

### **Methods of preservation**

#### **Protection of Insect specimens**

Collected Insects can be protected for longer time in insect collection box by putting the naphthalene balls on the corner side of box.

#### **Preservation of insects**

- a) Temporary preservation
- b) Permanent preservation: Insects can be permanently preserved either dry, in fluid, or on microscope slides. Arachnids are always preserved in liquid or on microscope slides. The method of preservation depends on the type of arthropods. It can be done by the following methods-
  - **Dry preservation-** Insects that are to be preserved dry are best mounted in ways that facilitate study and permanent storage. Specimens should be mounted soon after killing, if possible while still soft.

- **Liquid preservation-** It is done in 70 % ethyl alcohol + 4 % formaline solution. **Soft scale insects and mealybugs** can be preserved in mixture of 4 parts 90 % ethanol and 1 part glacial acetic acid whereas, **thrips** can be preserved in a mixture of 9 parts 60 % ethanol and 1 part glacial acetic acid. It is very important to periodically check and top up containers of a liquid collection.
- **Mounting on a microscopic slide-** Small specimens have to be mounted on microscope slides so that they can be studied under a compound microscope. These include groups such as thrips, aphids, parasitic wasps, scale insects, booklice, lice and mites. Insect and spider body parts (e.g. mouthparts and genitalia), and larvae often have to be slide-mounted. Microscope slide mounts may be temporary or permanent, but specimens maintained in collections require permanent mounts.

### Bringing the specimen home or the laboratory

#### Materials required

Butterflies and other large-winged insects can be stored in folded protective paper envelopes. Most arthropod specimens can be conveniently stored between layers of absorbent paper. Paper envelopes (Newspaper, waxpaper) can be used to keep the specimen and brought it to home or laboratory (having good absorbent quality) Cellophane and transparent plastics can also be used for this purpose.

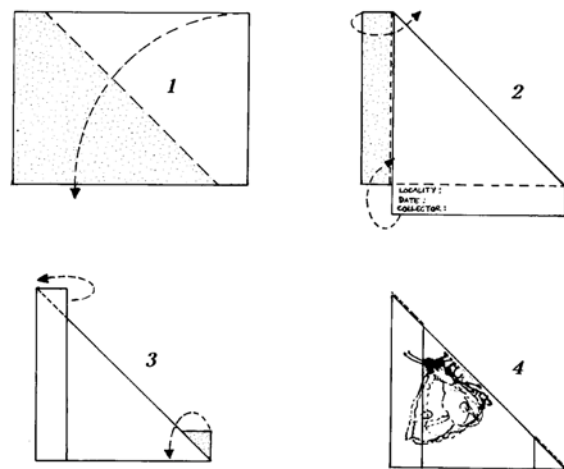

#### Relaxing container/Jar

Relaxing is the method / process of re-softening the insects. Relaxing container/Jar – contains a layer of sand (5 cm thick) or any other absorbent materials (basal wood, pith, synthetic sponge) and few drops of formaline or carbolic acid is added to prevent mould/fungal growth and then covered with filter paper. Cleaning- Dust, pollens and dirt can be removed with a camel hairbrush dipped in water mixed with detergent.

#### Preparing insects for the insect collection box

Insects longer than about 8 mm are usually mounted on pins pushed through the thorax. Insect pins are longer than ordinary pins, and are made of stainless steel that does not rust. A No. 2 or No. 3 entomological pin is suitable for most insects, although those with delicate bodies may require a size No. 0 or No. 1.

**Entomological pins-**There is three general series of pins *viz.*,





**English pins:** Sold by weight, range of 18-30 mm in length and stout, used to pin lepidopteran insects, which lies or kept low in the box.

**Continental pins:** Sold by 100s, Range 35 mm in length,( 000,00,0 & 1-7 Nos.), No. 2 & 3 are useful for general purpose, 38 mm( No. 8-10), 50 mm( No. 11-12), 000 is the thinnest pin and No. 12 is the thickest pin.

**Minute pin:** Minutest and finest pins, used for pinning the insects meant to stage, for minute, softest and fragile insects.

## Pinning

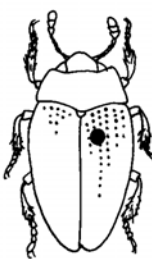
It is the best and common method to preserve hard bodied insects. They will dry and remain in perfect condition on the pins for long time without any further treatment. They are pinned vertically through the body. Depending upon the size of insect's pins has to be selected accordingly. Exact place of insertion of the pin varies among different groups of insects.

Insect groups	Sketch diagram	Pinning region
Grasshopper, crickets, Preying mantids and cockroaches		Pronotum
Bugs (most of the Hemipterans)		Scutellum
Beetles and weevils (Colepterans)		Right elytra
Dragonfly, damselfly, antlion, green lace wing fly, Moths, butterfly bees, wasp, ants and true flies etc.		Thorax

## Double mounting

Pinning is troublesome in smaller insects. Very small insects cannot be pinned because most of the body parts of the insects are lost during pinning. For such insects double mounting can be followed.

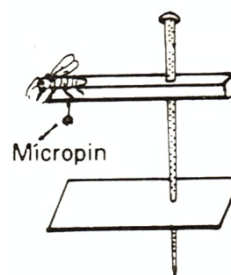

### Staging

The stage is narrow rectangular piece of cork or pith. The small insect is pinned correctly with a micro pin to the stage. Later the stage is pinned in the insect store box with a bigger pin.

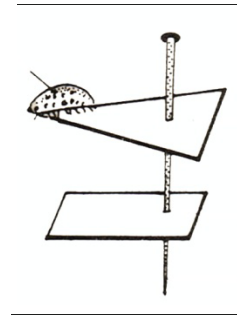

### Carding

A rectangular white card (5×8 or 5× 12 mm) may be used as stage. On stage instead of pinning, the insect specimen is stuck on it by **using glue or adhesive**. After mounting the insect, card is pinned in the box with a large pin.

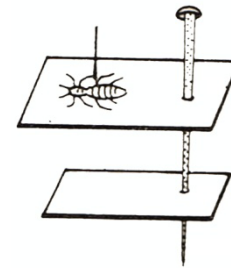

### Pointing / gumming

The insect specimen is glued to a card cut into a triangle of 10 mm height and 5 mm base. Bend down the tip of card to form a small surface to which the insect is stuck. Apply a drop of glue or adhesive by touching the point to the glue and to the thorax of the insects to be mounted.

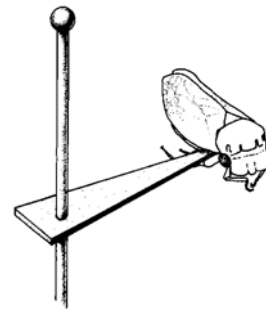

## Practical - 2

### *To study the External features of Grasshopper*

The grasshoppers are widely distributed throughout the country and may be seen in abundance during monsoon season. For the generalized morphological description, this insect has been considered as the most suitable representative of class insects because its structural details are not much variable. Apart from this, being larger in size, it can be studied easily.

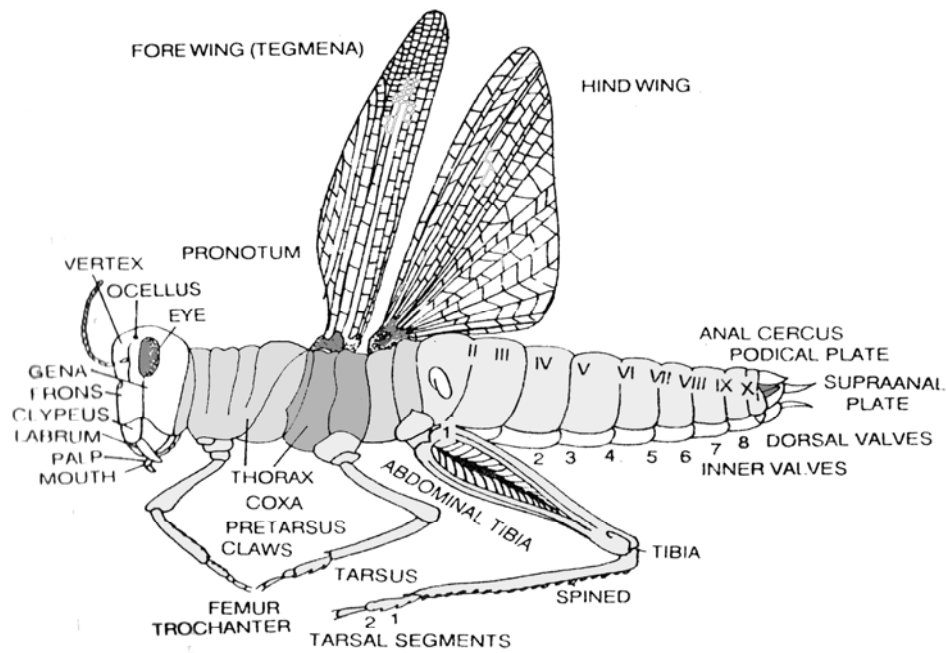

**External features of Grass hopper**

The generalized insect body is divided into 3 distinct body regions: a head, a thorax and an abdomen. Grouping of body segments into distinct regions is known as **tagmosis** and the body regions are called as **tagmata**.

### **The Head**

This is an anterior part of the body formed by the fusion of six segments viz., ocellary, antennal, intercalary, mandibular, maxillary and labial. All these segments are closely amalgamated to form a hard case or head capsule, the cranium that bears the antennae, eyes and mouthparts. The head is attached to the thorax by means of a flexible membranous neck (cervix) that allows its movement. Head capsule is sclerotized and the head capsule excluding appendages formed by the fusion of several sclerites is known as **cranium**.

### **Sclerites of Head**

- i. **Vertex:** Summit of the head between compound eyes.
- ii. **Frons:** Facial area below the vertex and above clypeus.
- iii. **Clypeus:** Cranial area below the frons to which labrum is attached.
- iv. **Gena:** Lateral cranial area behind the compound eyes.
- v. **Occiput :** Cranial area between occipital and post occipital suture.

**Sutures of Head:** The linear invaginations of the exoskeleton between two sclerites are called as suture (sometimes referred as sulcus).

- i. **Epicranial suture/ ecdysial line:** Inverted 'Y' shaped suture found medially on the top of head, with a median suture (coronal suture) and lateral sutures (frontal suture).
- ii. **Epistomal suture/ Fronto clypeal suture:** Found between frons and clypeus. (epi – above; stoma- mouth parts)
- iii. **Clypeo-labral suture:** Found between clypeus and labrum (upper lip).
- iv. **Postoccipital suture:** Groove bordering occipital foramen. Line indicating the fusion of maxillary and labial segment.

### **The Thorax**

It is a body region situated between head and abdomen. The insect thorax is composed of three segments: an anterior prothorax, a middle mesothorax, and a posterior metathorax. Each segment bears a pair of legs. The last two segments often called as pterothorax may bear wings. Meso and metathorax which bear wings are called as **Pterothorax**. Thoracic segments are made up of three sclerites namely, dorsal body plate **tergum or nota**, ventral body plate **sternum** and lateral plate **pleuron**

**Functions of thorax:** Site of locomotion.

### **Abdomen**

Abdominal segments are telescopic in nature, highly flexible and are interconnected by a membrane called **conjunctiva**. Each abdominal segment is made up of only two sclerites namely dorsal body plate (tergum) and ventral body plate (sternum). In grass hopper eight pairs of spiracles are present in the first eight segments, in addition to a pair of tympanum in the first segment. Eight and ninth abdominal segments bears the female genital structure and ninth segment bears male genital structure. Abdominal appendages in adult insects are genital organs and cerci.

**Function:** Site of metabolism and reproduction.

## Practical -3

### *To study the types of insect antennae*

The collected insect samples can be inspected in laboratory after detaching the antenna and put them under the microscope. They can also be studied through the permanent slides of different types of antennae by the help of microscope.

*Antennae are mobile sensory segmented appendages of the head.* They articulate with head in front or between the eyes and arise from antennal socket. The size and shape of antennae varies in different insects. They used for sensory perception which includes motion and orientation, odor, sound, humidity, and a variety of chemical cues. Sensilla on antenna acts as tactile, olfaction, carbon dioxide, temperature, wind, humidity, and sound receptors.

**Structure of Antenna:** Antennae consist of **three parts**:

- a) **Scape-** It is first basal segment of antenna by which the antennae is attached to the head. It is often distinctly larger than the other succeeding joints. It articulates with the antennal ridge.
- b) **Pedicel-** The joint immediately followed the scape is pedicel. It is usually small and contains a special sensory structure known as **Johnston's organ**, which is absent in Diplura, Collembola.
- c) **Flagellum-** It is also known as **clavola**, and is the remaining part of the antenna. Flagellum segments (flagellomeres) increase in number in certain insects. It is modified according to the surroundings and habits of the insects.

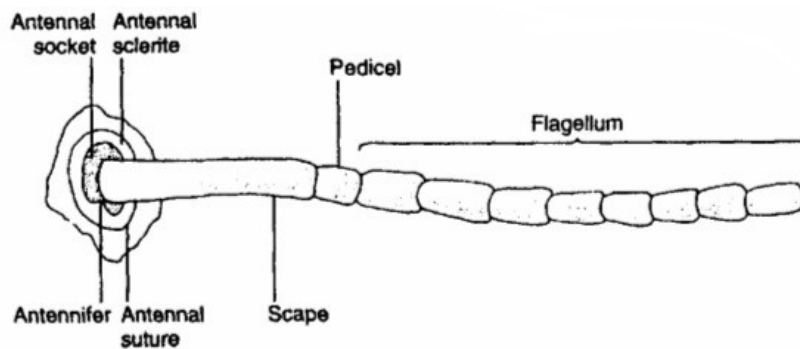

### **Types of antennae:**

1. **Setaceous:** (Bristle like) Size of the segments decreases from base to apex. e.g. Leafhopper, Dragonfly, Damselfly.
2. **Filiform:** (Thread like) Segments are usually cylindrical. Thickness of segments remains same throughout. e.g. Grasshopper.
3. **Moniliform:** (Beaded) Segments are either globular or spherical with prominent constriction in between e.g. Termite.
4. **Serrate:** (Saw like) Segments have short triangular projections on one side. e.g. Longicorn beetle
5. **Pectinate:** (Comb like) Segments with long slender processes on one side e.g. Sawfly
6. **Bipectinate:** (Double comb like) Segments with long slender lateral processes on both



the sides e.g. Silkworm moth

7. **Clavate:** (Clubbed) Antenna enlarges gradually towards the tip. e.g. Blister beetle
8. **Capitate:** (Knobbed) Terminal segments become enlarged suddenly e.g. butterfly
9. **Lamellate:** (Plate like) Antennal tip is expanded laterally on one side to form flat plates e.g. lamellicorn beetle
10. **Aristate:** The terminal segment is enlarged. It bears a conspicuous dorsal bristle called arista e.g. House fly
11. **Stylate:** Terminal segment bear a style like process eg. Horse fly, Robber fly.
12. **Plumose:** (Feathery) Segments with long whorls of hairs e.g. male mosquito
13. **Pilose:** (Hairy) Antenna is less feathery with few hairs at the junction of flagellomeres. e.g. Female mosquito.
14. **Geniculate:** (Elbowed) Scape is long remaining segments are small and are arranged at an angle to the first resembling an elbow joint. e.g. Ant, weevil and honey bee.

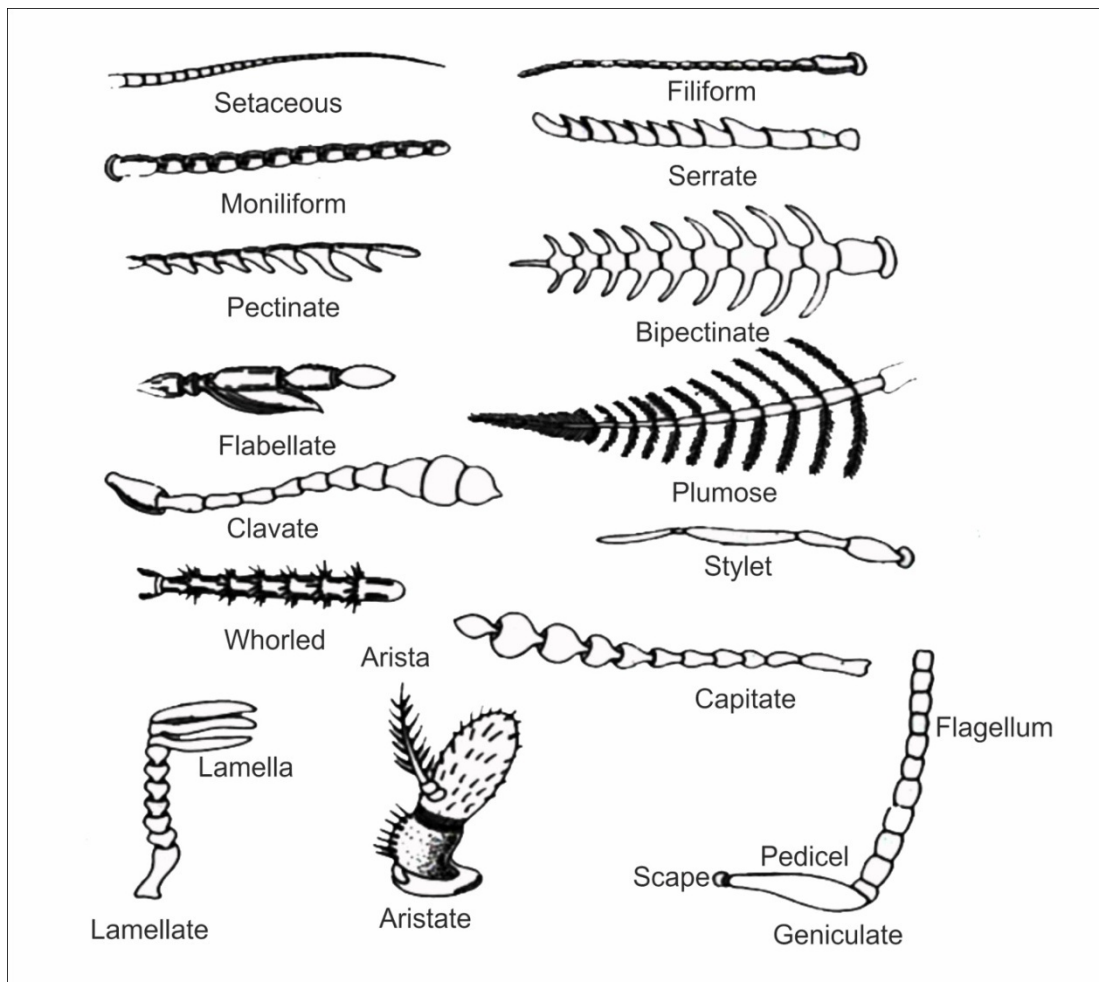

*To study the different types of mouthparts and their modifications*

Mouthparts of insects vary among insects of different groups depending upon their feeding habits. They are mainly of two types *viz.*, Mandibulate (feeding mainly on solid food) and haustellate (feeding mainly on liquid food). Insect mouthparts have become modified in various groups to perform the ingestion of different types of food and by different methods. Indeed the modifications in the mouthparts to ingest almost all kinds of the food material, are one of the factors for the success of the group.

**1. Biting and chewing type:** e.g. Cockroach & grasshopper.

It is the primitive type of mouth part and consists of the following parts.

- i. Labrum : (Upper lip)** It is flap like, bilobed and attached to the clypeus by an articular membrane. It is movable. It covers the mouth cavity from above. It helps to pull the food into the mouth. It holds the food in position so that mandibles can act on it. It forms the roof of the pre oral food cavity.
- ii. Labrum-epipharynx:** Inner surface of the labrum is referred to as epipharynx. It is frequently membranous and continuous with the dorsal wall of pharynx. It is an organ of taste.
- iii. Mandibles:** There is a pair of mandibles. They are the first pair of jaws. They are also called as primary jaws or true jaws. Mandibles articulate with the cranium at two points. They are heavily sclerotised. They are toothed on their inner border. There are two types of teeth. Distal are sharply pointed and are called incisor or cutting teeth and proximal teeth are called molar or grinding teeth. They act transversely to bite and grind the food into small fragments.
- iv. Maxillae:** They are paired and more complicated than mandibles. They are called secondary jaws or accessory jaws. At proximal end the first sclerite cardo joins the maxilla to head. The second sclerite is called stipes which articulates with cardo. Stipes carries a lateral sclerite called palpifer which bears a five segmented antenna like maxillary palp. On the distal end of the stipes, there are two lobes. The outer lobe is called galea and inner lobe is lacinia which is toothed. Maxille direct the food into the mouth. They hold the food in place when the mandibles are in action. They act as auxiliary jaws and assist in mastication of food. Sense organs connected with the perception of touch, smell and taste are abundantly found in palpi.
- v. Hypopharynx :** It is a tongue like organ. It is located centrally in the preoral cavity. Salivary gland duct opens through it.
- vi. Labium /lower lip:** It is a composite structure formed by the fusion of two primitive segmented appendages. It bounds the mouth cavity from below or behind. It forms the base of the preoral cavity. It consists of three median sclerites *viz.*, submentum (large basal sclerite), mentum (middle sclerite) and prementum (apical sclerite). On the lateral side of the prementum there are two small lateral sclerites called palpiger bearing three segmented labial palpi. Distally prementum bears two pairs of lobes. The other pair of lobes is called paraglossae and inner pair of lobes, glossae. Both pairs when fused are called ligula.

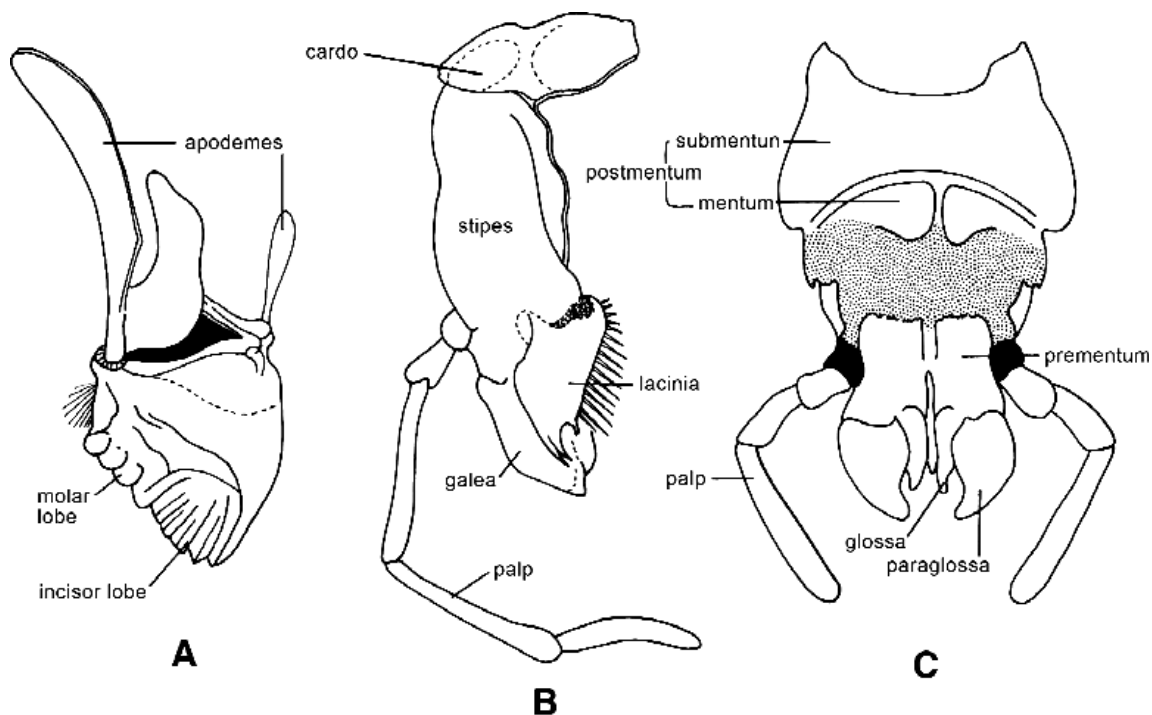

Structure of (A) mandible, (B) maxilla, and (C) labium of a typical chewing insect.

**2. Piercing and sucking / hemipterous / bug type e.g. Plant bugs.**

Labium projects downwards from the anterior part of the head like a beak. Beak is four segmented and grooved throughout its entire length. At the base of the labium there is a triangular flap like structure called labrum. Labium is neither involved in piercing nor sucking. It functions as a protective covering for the four stylets (fascicle) found within the groove.

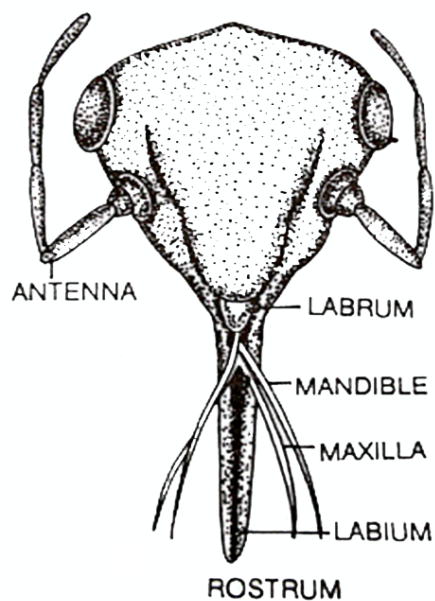

Both mandibles and maxillae are modified into long slender sclerotized hair like structure called stylets. They are lying close together and suited for piercing and sucking. The tips of the stylets may have minute teeth for piercing the plant tissue. The inner maxillary stylets are doubly grooved on their inner faces. When these are closely opposed they form two canals viz., food canal and salivary canal through sap and saliva are conducted respectively. Saliva contains enzymes or toxins that can distort plant cell wall to permit the stylets to penetrate down and reach phloem for sucking the sap. Both palps are absent.

**3. Piercing and sucking / dipterous / mosquito type : e.g. Female mosquito**

Mouthparts of female mosquito consists of an elongate labium which is grooved forming a gutter which encloses six stylets. The stylets are composed of labrum - epipharynx (enclosing the food canal), the hypopharynx (containing the salivary canal), two maxillae and two mandibles. Both the ends of maxillary stylets and mandibular stylets are saw like and suited piercing flesh.

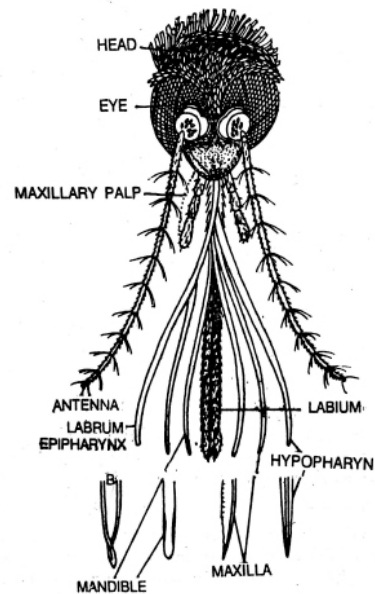

The stylets are inserted into host's skin by a strong downward and forward thrust of body. Both mandibles and maxillae are reduced in male and they feed on plant nectar and juices of decaying fruits. Female pierces the skin of human beings into which it injects saliva containing an anticoagulant (to keep the blood flowing without clotting) and an anesthetic (to keep the victim unaware of the bite) and sucks up the blood. Labium does not pierce but folds up or back as stylets pierce. Maxillary palpi are present.

**4. Chewing and lapping type : e.g. honey bee**

Labrum and mandibles are as in biting and chewing type of mouth parts. But mandibles are blunt and not toothed. They are useful to crush and shape wax for comb building; ingest pollen grains and other manipulative functions. Maxillolabial structures are modified to form the lapping tongue.

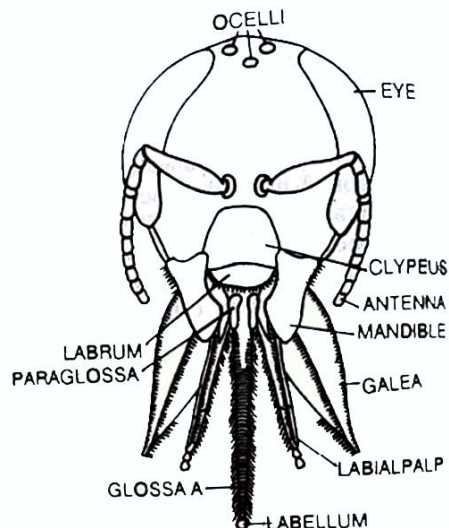

The tongue unit consists of two galea of maxillae, two labial palpi and elongated flexible hairy glossa of labium. The glossa terminates into a small circular spoon shaped lobe called spoon or bouton or flabellum which is useful to lick the nectar.

**5. Rasping and sucking : e.g. Thrip**

Mouth cone consists of labrum, labium and maxillae. There are three stylets derived from two maxillae and left mandible. Right mandible is absent. Stylets are useful to lacerate the plant tissue and the oozing sap is sucked up by the mouth cone. Both maxillary palpi and labial palpi are present.

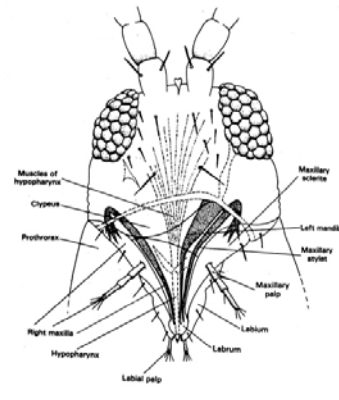

**6. Sponging type : e.g. House fly**

The proboscis is fleshy, elbowed, retractile and projects downwards from head. The proboscis can be differentiated into basal rostrum and distal haustellum. The proboscis consists of labium which is grooved on its anterior surface. Within this groove lie the labrum-epipharynx (enclosing the food canal) and slender hypopharynx (containing the salivary canal).

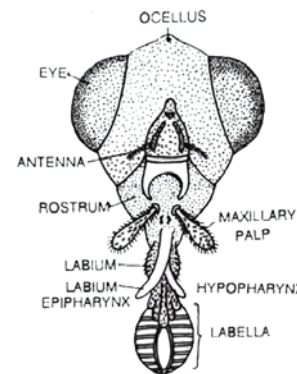

Mandibles are absent. Maxillae are represented by single segmented maxillary palpi. The end of the proboscis is enlarged, sponge like and two lobed which acts as suction pads.

They are called oral discs or labella. The surfaces of labella are transversed by capillary canals called pseudotracheae which collect the liquid food and convey it to the canal. Labella function as sponging organs and are capable of taking exposed fluids. These insects often spit enzyme containing saliva onto solid foods to liquify them.

**7. Siphoning type : e.g. Moths and butterflies**

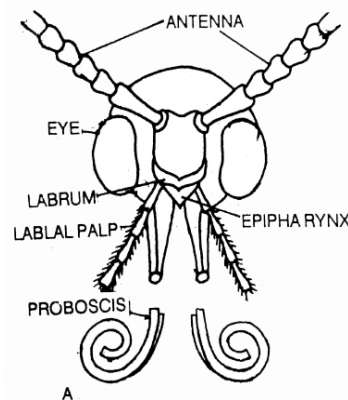

Mouth parts consists of elongate sucking tube or proboscis. It is formed by two greatly elongated galeae of maxillae which are zippered together by interlocking spines and hooks. Galeae are grooved on their inner surface and when they are fitting together closely they form a suctorial food canal through which the nectar is sucked up. The proboscis is coiled up like watch spring and kept beneath the head when it is not in use. By pumping of blood into galeae, the proboscis is extended. The other mouth parts are reduced or absent except the labial palpi and smaller maxillary palpi.

## Practical -5

### *To study the legs and their modifications*

The typical thoracic leg consists of six parts, basal coxa that articulates with the thorax in the pleural region, small trochanter, femur, tibia, segmented tarsus, and pretarsus. The coxa is often divided into two parts, the posterior and the anterior (usually the larger part) being called the meron. The trochanter articulates with the coxa, but usually forms an immovable attachment with the femur. The femur and tibia are typically the longest leg segments. The tarsus, which is derived from a single segment, - is usually sub-divided into individual tarsomeres. The pretarsus may consist of a single claw, but it is usually composed of a pair of moveable claws and one or more pads or bristles.

Legs are usually looked upon as the principal organs of terrestrial locomotion. They have undergone many modifications and have been adapted to a wide variety of functions including swimming, prey capture, pollen collection and digging.

**Ambulatorial** (Ambulate - to walk; Walking leg) e.g. Fore leg and middle leg of grasshopper. Femur and tibia are long. Legs are suited for walking.

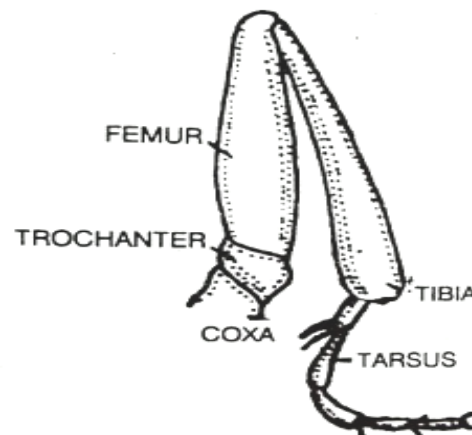
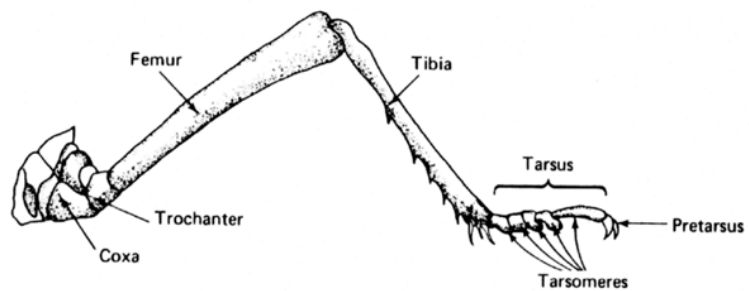

**Cursorial:** (Cursorial = adapted for running : Running leg) e. g. All the three pairs of legs of cockroach. Legs are suited for running. Femur is not swollen.

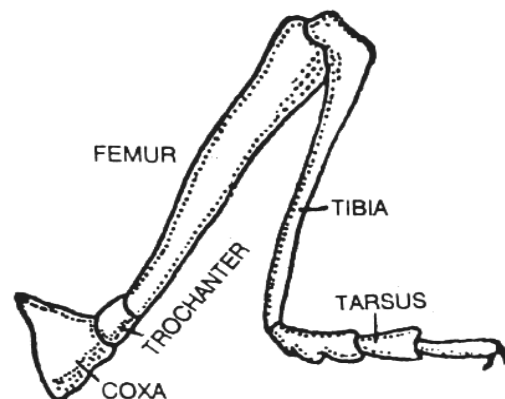

**Saltatorial:** (Saltatorial = Leaping; Jumping Leg) e.g. hind leg of grasshopper.

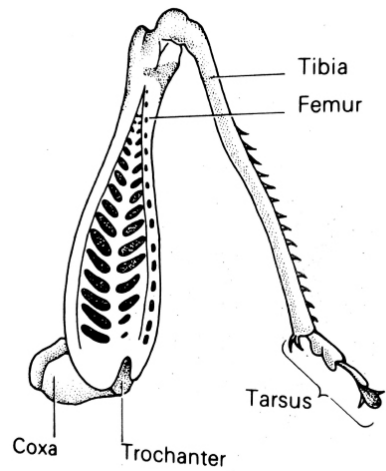

**Fossorial:** (Fossorial = Digging; Burrowing leg) e.g. Fore legs of mole cricket.

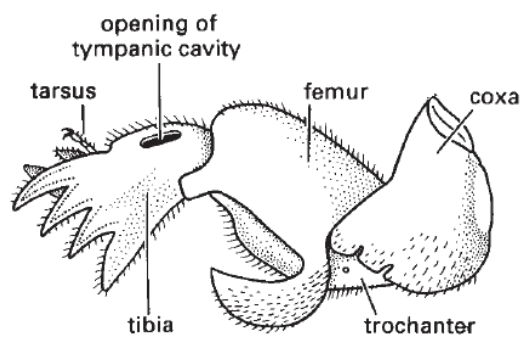

**Natatorial:** (Natatorial = pertaining to swimming; Swimming leg) e.g. hind legs of water bug and water beetle.

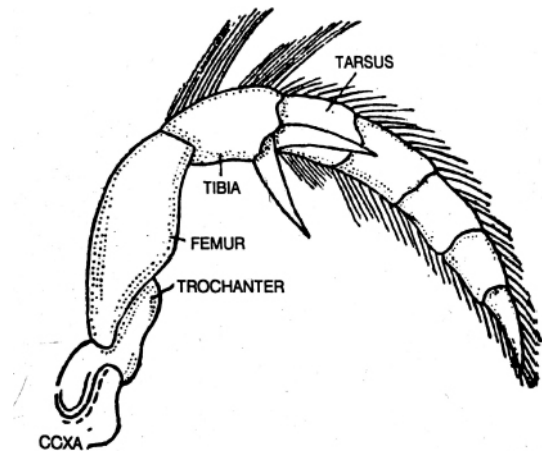

**Raptorial:** (Raptorial = predatory; Grasping leg) e.g. Forelegs of preying mantids.

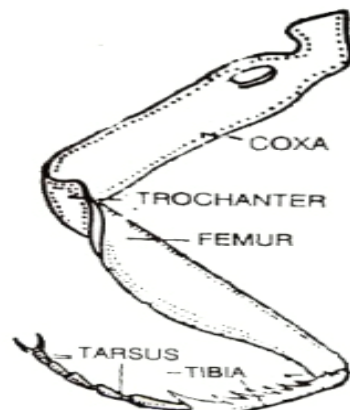

**Scansorial:** (Scansorial = Climbing; climbing or clinging leg) e.g. all the three pairs of legs of head louse.

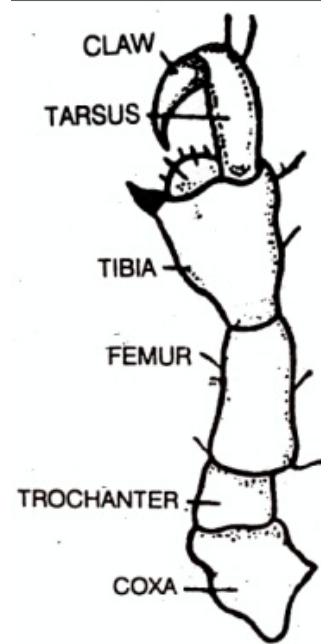

**Foragial leg:** (Forage = to collect food material) e.g. Legs of honey bee.

i. **Forelegs** : The foreleg has three important structures (Eye brush, Antenna cleaner or strigillis and Pollen brush)

ii. **Middle legs:** It has two important structures. (a.) **Pollen brush:** Stiff hairs on basitarsus form pollen brush which is useful to collect pollen from middle part of their body. (b.) **Tibial spur:** At the distal end of the tibia, a movable spur is present which is useful to loosen the pellets of pollen from the pollen basket of hind legs and to clean wings and spiracles.

iii. **Hind legs:** It has three important structures viz., pollen basket, pollen packer and pollen comb. (a.) **Pollen basket:** It is also called corbicula. The outer surface of the hind tibia contains a shallow cavity. The edges of the cavity are fringed with long hairs. The pollen basket enables the bee to carry a larger load of pollen and propolis from the field to the hive. (b.) **Pollen packer:** It is also called pollen press. It consists of pecten and auricle. Pecten is a row of stout bristles at the distal end of tibia. Auricle is a small plate

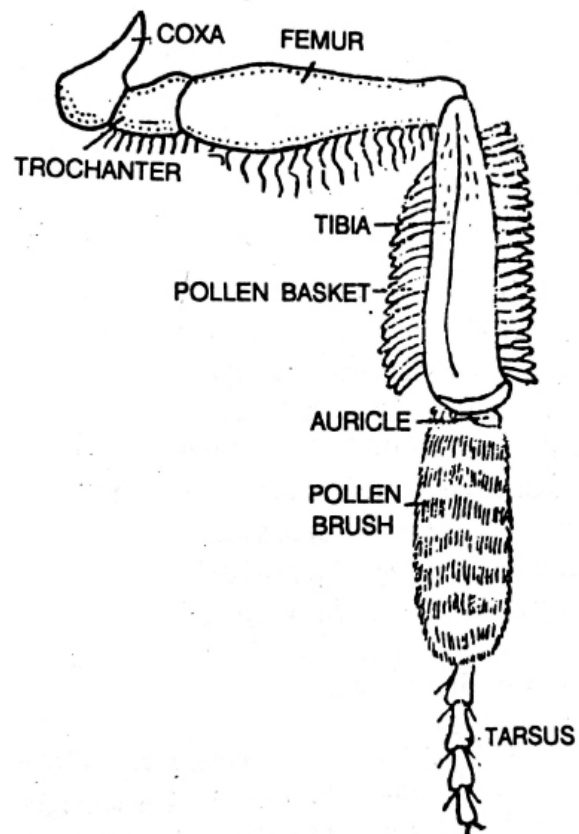



**Climbing or Sticking leg:** e.g. all the three pairs of legs of house fly.

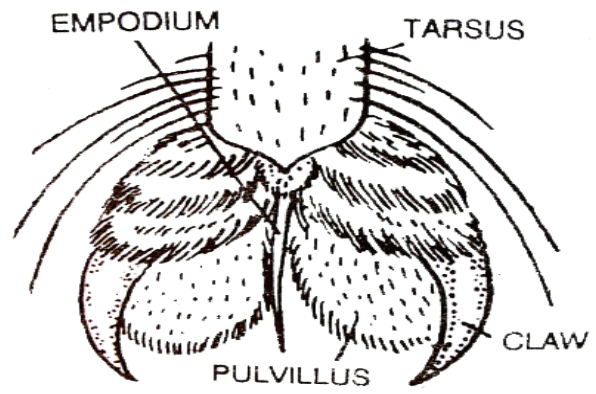

**Clasping leg:** e.g. Forelegs of male water beetle.

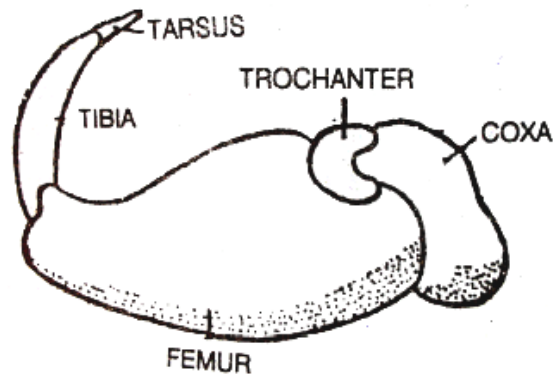

## Practical- 6

*To study about the Wing venation, types of wings and wing coupling apparatus.*

The complete system of veins of a wing is termed as venation or neurulation. Generally in all the insects there is some similarity in wing venation and therefore, it is presumed that all types of wing venation have developed from the common base or the same ancestor. By means of an extensive study of wing venation in different groups of insects, **Comstock and Needham** constructed a hypothetical type of wing venation from which all other types have presumably been derived. According to them the primitive wing venation has developed from two tracheae which are situated on the anterior and the posterior basal margins of wings and their branches are spread all over the wing. Each main trachea gives rise to three principal veins, thereby forming 6 principal veins namely costa, radius, medius, cubitus, penultimate and ultimate. Each principal vein gives rise to a sub-vein near its base.

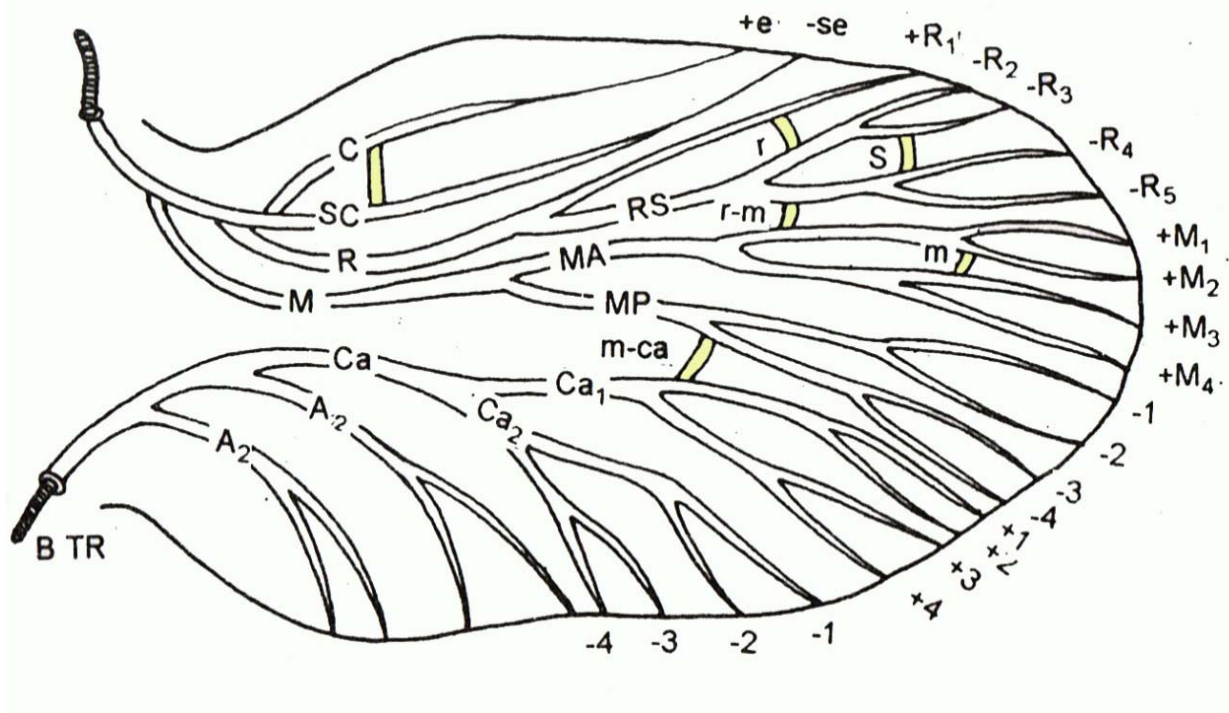

**Wing venation of a hypothetical wing**

The **principal veins** are represented by **+** sign whereas the **sub veins** by **-** sign. Thus the whole wing venation system is represented by **+** and the **-** signs in alternate as shown in the figure. The branching of principal veins is represented in the following manner:

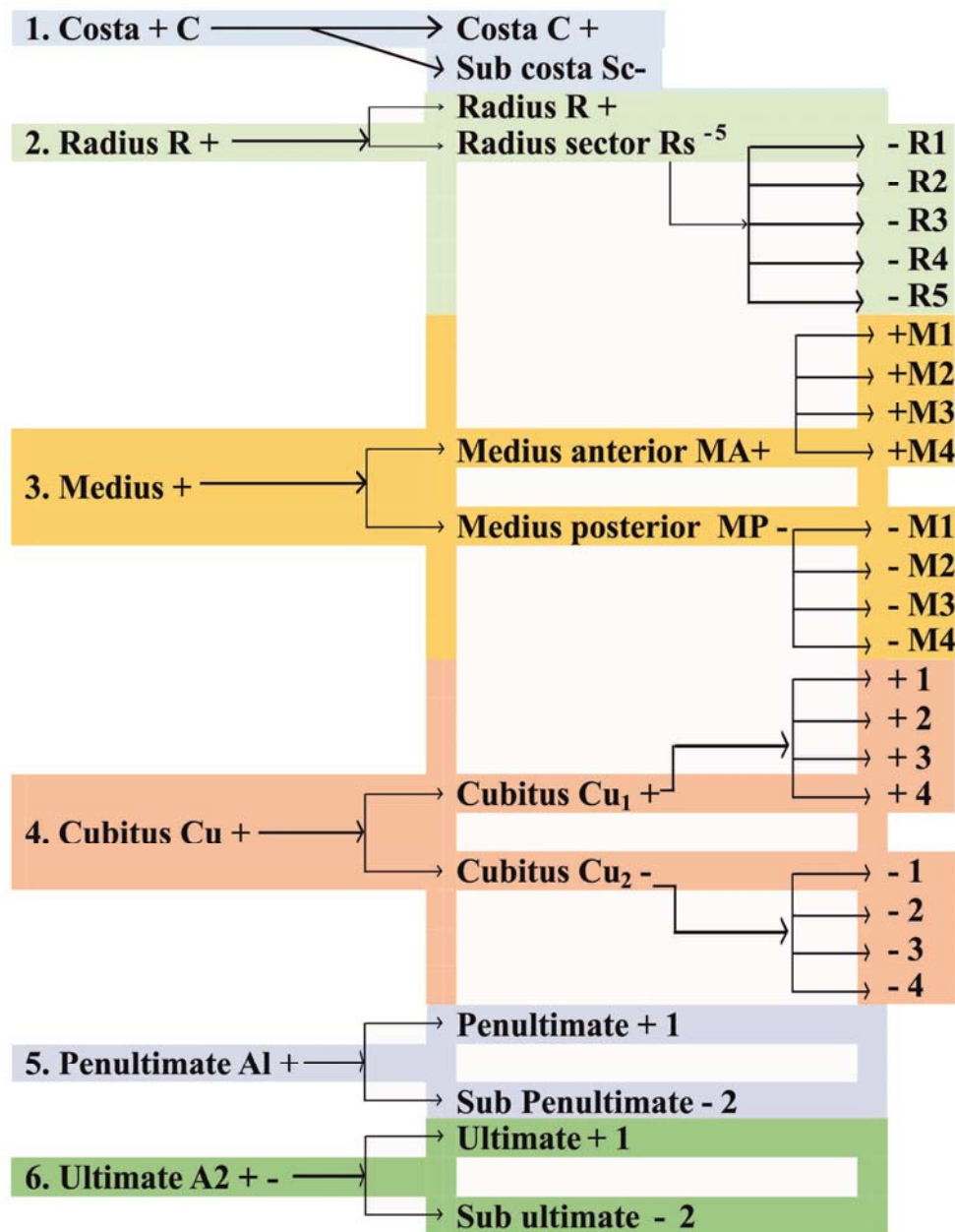

Such type of hypothetical wing venation is never met in any insect as one or the other vein is invariably found lacking for example the medius vein is absent in order Hemiptera and Ephemera and submedius is missing in Odonata. Some of the scientists consider precosta, costa, subcosta, radius, medius, cubitus and anal as the principal veins of the insect wing.

### Cross veins

The veins joining the two longitudinal veins are known as cross veins. The important cross veins along with their symbols are given below :

- (i) **Humeral cross vein (h)**- It extends from costa to sub-costa near the humeral angle and vein.
- (ii) **Radio-medial cross vein (rm)**- It joins the sub radius and the medius veins.

- (iii) **Medial cross vein (m)** -The vein joining the  $m^2$  and  $m^3$  branches of medius is termed as medial cross vein.
- (iv) **Medio-cubital cross vein (m-cu)** - It joins the medius and the cubitus longitudinal veins.
- (v) **Radial cross vein (r)** -It extends from  $R_1$  to  $R_2$

### Wing coupling apparatus

In certain insects special structures have been developed to fasten together the two wings of each side so that it may bring more synchronus action of the fore and hind wings, thereby enabling the insects to fly more swiftly. This action in many insects is ensured simply by fore wing overlapping the hind wing. The important coupling device developed in insects' wing for adding more efficiency in flying are described below-

- (i) **Jugal and humeral lobe-** This coupling device is commonly found in Lepidoptera, Thchoptera and Mecoptera wherein the wing bases are highly modified. The posterior end of the fore wing is modified into slender finger like organ which is stiffened by a branch of  $III^{rd}$  anal vein is known as the jugal lobe; whereas the anterior margin of the hind wings is modified in to a small humeral lobe. The lobes of fore and the hind wings are coupled with each other during flight.

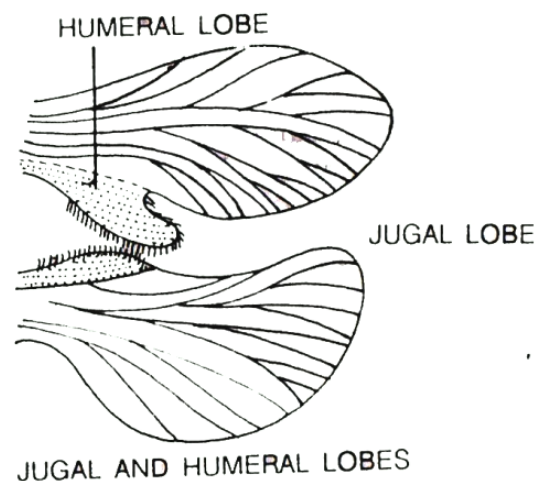

- (ii) **Frenulum and Retinaculum** -This type of coupling apparatus is well illustrated in higher Lepidoptera wherein the jugum is lost and the frenulum assumes more importance. In female butterflies a number of stout bristle arise beneath the extended fore wing known as frenulum which engages in a retinaculum from a patch of hair near the cubitus of a hind wing. However, in males the frenulum bristles are fused into a single stout structure and is held by a curved process from the sub-costal vein of the fore-wing.

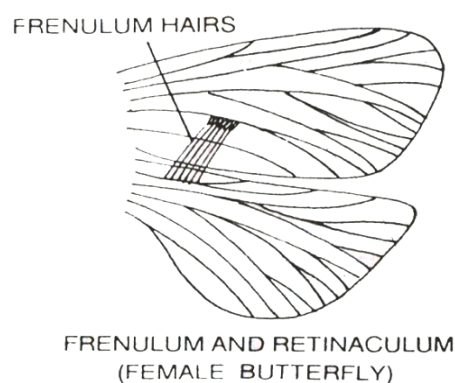
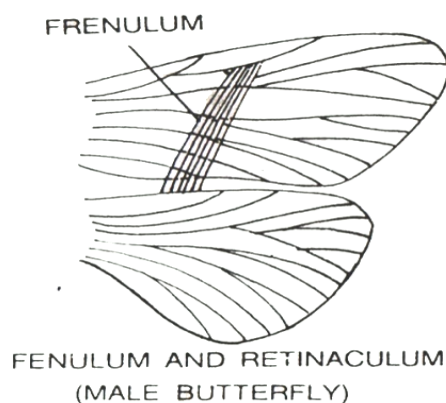

- (iii) **Hamuli** -In this modification the costal margin of the hind wings bears a row of small hooks known as hamuli. These hooks get attached into a fold on the inner margin of the fore-wings. Such coupling apparatus is generally met in Hymenoptera.

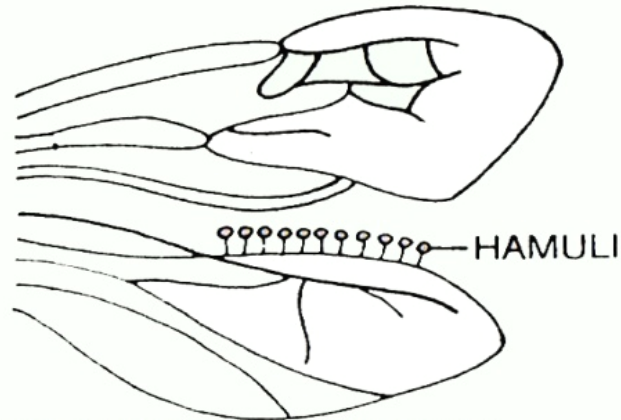

HAMULATE (DORSAL VIEW)

(iv) **Amplexiform** - This example is commonly met in the insects belonging to family papilionidac and bombycidae of order Lepidoptera. In this case the wings are coupled simply by overlapping basally to each other.

ANTERIOR WING

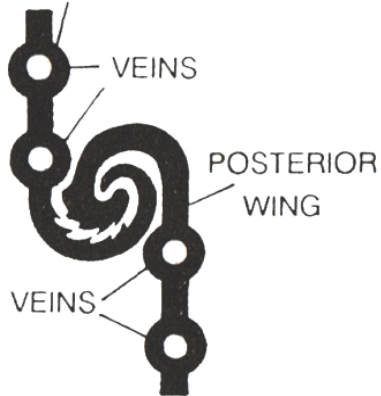

AMPLEXIFORM (VERTICAL SECTION)

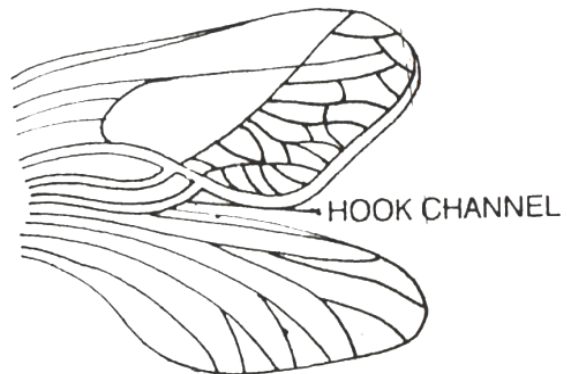

HOOK AND CHANNEL

## Practical- 7

### *To study the types of insect larvae and pupae*

#### **Metamorphosis and immature stages**

The change in growth and development (form) of an insect during its life cycle from birth to maturity is called metamorphosis. There are four basic types of metamorphosis in insects.

**Ametabola:** (No metamorphosis) e.g. Silver fish.

These insects have only 3 stages in their life cycle namely egg, young ones and adults. It is most primitive type metamorphosis. The hatching insects resemble the adult in all respects except for the size and called as juveniles. Moulting continues throughout the life.

**Hemi-metabole:** (Incomplete metamorphosis) e.g. Dragonfly, damselfly and may fly.

These insects also have 3 stages in their life namely egg, young ones and adults. The young ones are aquatic and are called **naiads**. They are different from adults in habits and habitat. They breathe by means of tracheal gills. In dragonfly naiad, the lower lip (labium) is called **mask** which is hinged and provided with hooks for capturing prey. After final moult, the insects have fully developed wings suited for aerial life.

**Pauro-metabola:** (Gradual metamorphosis) e.g. Cockroach, grasshopper, bugs.

The young ones are called nymphs. They are terrestrial and resembles the adults in general body form except the wing and external genitalia. Their compound eyes and mouth parts are similar to that of adults. Both nymphs and adults share the same habitat. Wing buds externally appear in later instars. The genitalia development is gradual. Later instars nymphs closely resemble the adult with successive moults.

**Holo-metabola:** (Complete metamorphosis) e.g. Butterflies, moths, fly and bees.

These insects have 4 stages namely egg, larva, pupa and adult. Majority of the insects undergo complete metamorphosis. Larvae of butterfly is called caterpillar. Larva differs greatly in form from adult. Compound eyes are absent in larva. Lateral ocelli or stemmata are the visual organs. Their mouth parts and food habits differ from adults. Wing development is internal. When the larval growth completed it transforms into pupa. It is the resting and non feeding stage in which the larval tissues disintegrate and adult organs are built up.

#### **Immature stages in insects**

**Larva:** Larval stage is the active growing and immature stage between the egg and pupal stage of an insect having complete metamorphosis. This stage differs radically from the adults.

**Types of larvae:** There are mainly 3 main types of insect larvae (Oligopod, Polypod and Apod) on the basis of the number of legs they possess.

**Oligopod:** Thoracic legs are well developed. Abdominal legs are absent. There are 2 sub types-

(a) **Campodeiform:** They are similar with diplurans genus Campodea. Body is elongate, depressed dorsoventrally and well sclerotized. Head is prognathous. Thoracic legs are

long. A pair of abdominal or caudal processes is usually present. Larvae are generally predators and are very active. E.g. grub of ant lion or grub of lady bird beetle.

- (b) **Scarabaeiform:** Body is “C” shaped, stout and sub-cylindrical. Head is well developed. Thoracic legs are short. Caudal processes are absent. Larva is sluggish, burrowing into wood or soil. e.g. grub of rhinoceros beetle.

**Polypod or Eruciform:** The body consists of an elongate trunk with large sclerotized head capsule. Head bears powerful mandibles which tear up vegetation. Two groups of single lensed eyes Stemmata found on either side of the head constitute the visual organs. The antenna is short. 3 pairs of thoracic legs and up to 5 pairs of unsegmented abdominal legs or prolegs or pseudolegs are present. e.g. Caterpillar (larva of moth and butterfly).

- (a) **Hairy caterpillar:** The body hairs may be dense, sparse or arranged in tufts. Hairs may cause irritation, when touched. e.g. red hairy caterpillar.
- (b) **Slug caterpillar:** Larva is thick, short, stout and fleshy. Larval head is small and retractile.
- (c) **Semilooper:** either 3 or 4 pairs of prolegs are present. e.g. castor semilooper.
- (d) **Looper:** They are also called measuring worm or inch worm. In this type, only 2 pairs of prolegs are present in 6<sup>th</sup> and 10<sup>th</sup> abdominal segments. e.g. Daincha looper.

**Apod:** They are larvae without appendages for locomotion. Based on the degree of development and sclerotization of head capsule there are 3 subtypes-

- (a) **Eucephalous:** Larva with well developed head capsule with functional mandibles, maxillae, stemmata and antennae. Mandibles act transversely. e.g. Wiggler (larva of mosquito) and grub of red palm weevil.
- (b) **Hemicephalous:** Head capsule is reduced and can be withdrawn into thorax. Mandibles act vertically. e.g. larva of house fly and robber fly.
- (c) **Acephalous:** Head capsule is absent. Mouth parts consists of a pair of protrusible curved mouth hooks and associated internal sclerites. They are also called vermiform larvae. e.g. Maggot (larva of house fly)

**Pupa:** It is the resting and inactive stage in all holometabolous insects. During this stage, the insect is incapable of feeding and is quiescent. During the transitional stage, the larval characters are destroyed and new adult characters are created. There are 3 main types of pupae i.e., Obtect, Exarate and coarctate.

**Obtect:** Various appendages of pupa viz. Antennae, legs and wing pads are glued to the body by a secretion produced during the last larval moult. Exposed surfaces of the appendages are more heavily sclerotized than the inner surface. e.g. moth pupa.

- (a) **Chrysalis:** It is naked obtect type of butterfly. It is angular and attractive coloured. The pupa is attached to the substratum by **hooks** present at the terminal end of the abdomen called **Cremaster**. The body of chrysalis is attached to the substratum by 2 strong silken threads called **gridle**.
- (b) **Tumbler:** Pupa of mosquito is called tumbler. It is an obtect type pupa. It is comma shaped with rudimentary appendages. Breathing trumpets are present in the cephalic end and anal paddles are present at the end of the abdomen. Abdomen is capable of jerky movements which are produced by the anal paddles. The pupa is **very active**.

**Exarate:** Various appendages viz. antennae, legs and wing pads are not glued to the body. They are free. All oligopod larvae will turn into exarate pupae. The pupa is soft and pale. e.g. pupa of rhinoceros beetle.

**Coarctate:** the last larval skin is changed into a pupal case and the pupa is actually an exarate pupa. The pupal case is dark brown, barrel shaped, smooth with no apparent appendages and called as **puparium**. e.g. fly pupa



## Practical -8

*To study the dissection of alimentary canal/nervous system in insects (Grasshopper/ Cockroach)*

The best learning situation requires one specimen and set of tools per two students for studies. Students working in pairs have ample opportunity to fully participate in the dissection and to carefully examine the specimen. They are also able to share and discuss their observations during and after the dissection.

### **Materials required for dissecting Cockroach**

**Dissection Kit includes-** Surgical scissors, Iris scissors, Tissue forceps, Scalpel, handle, Scalpel blades, Probe with angled tip, Dissection needles, Dropping pipette, Blow pipes, Dissection tray, Dissecting pins, Rigid metal ruler, And case Camel hair brush etc

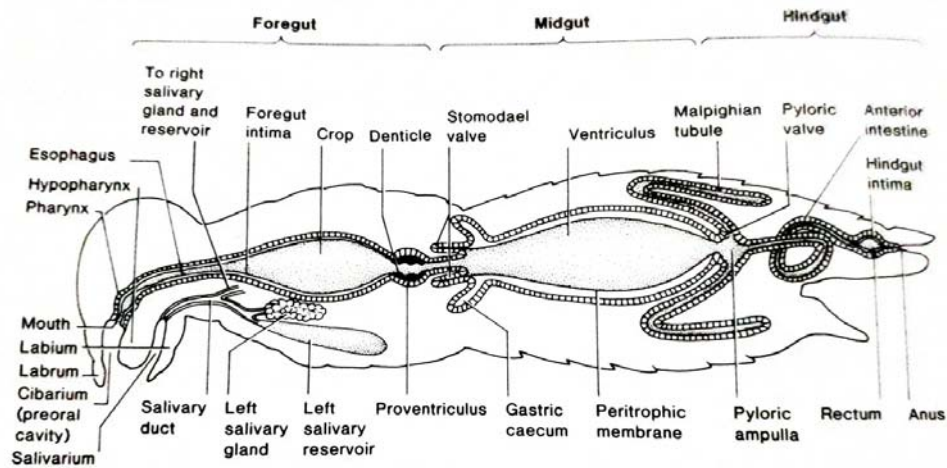

*Diagram of Alimentary canal showing the major subdivisions in a generalized Grasshopper insect*

### **Digestive system**

It includes the organs of ingestion (alimentary canal and its associated glands) and the physiology of digestion. The organs of ingestion are located in the head and are meant for the intake of food. The preoral cavity is enclosed by the mouth parts and is divided into two parts by the hypopharynx, the anterior region in which the alimentary canal opens is termed as cibarium and in which the salivary duct opens is known as salivarium. In the sucking Insects the cibarium is modified into a sucking pump while salivarium serves as the salivary syringe.

### **Alimentary canal**

The alimentary canal of grasshopper/cockroach is a simple, hollow and tubular in structure which runs from the buccal cavity to anus. It is distinctly divided into the following three primary regions

1. Foregut or stomodaeum.
2. Mid gut or mesenteron or ventriculus.
3. Hind gut or proctodaeum.

## 1. Foregut or Stomodaeum

It constitutes the anterior region of the alimentary canal which is primarily an organ of ingestion and shows as a site for storing food. It consists of the following parts

- (i) **Pre-oral food cavity**-It has been described previously and indeed it is not a part of alimentary canal.
- (ii) **Pharynx**-It is situated in between the pre-oral cavity and the oesophagus and is provided by the dilator muscles. These muscles are highly developed in those insects which pharynx helps in forming the sucking pump.
- (iii) **Oesophagus**-It is simple straight tube which runs from the posterior region of the head to thorax and joins with the crop.
- (iv) **Crop**- It is simple bag like structure and serves as a storage reservoir for the food. Apparently it is a dilated portion of the oesophagus but differs histologically by the presence of sclerotized ridges which are arranged transversely in the crop. Since it serves as a reservoir for food hence its walls are thin and the muscles are poorly developed.
- (e) **Gizzard**-It is situated in the posterior region of the crop which cannot be apparently distinguished from crop but differs internally by having the longitudinal folds into the lumen in which cuticular teeth are attached. Its posterior part is concentric in the internal layer of six 'V' shaped processes are attached which form the cardiac valve with the folds of gizzard. Its major function is to regulate the passage of food into the mid gut.

Histologically, the following layers may be distinguished in the walls of the stomodaeum

- (1) Intima - The inner most layer of chitin found in continuation of body cuticle.
- (2) Epithelial layer-It is a thin layer secreting the intima.
- (3) Basement membrane- Bounding the outer most surface of the epithelium.
- (4) Longitudinal muscles—These muscles are less developed than circulatory muscles.
- (5) Circulatory muscles - These are well developed.
- (6) Peritoneal membrane - It is often difficult to detect and consists of apparently structureless connective tissue.

## 2. Mid Gut or Mesenteron

It is relatively a short tube or elongated sac with uniform diameter extends from hepatic caecae or cardiac valve to Malpighian tubes or pyloric valve. Histologically, the inner wall of mesenteron or stomach is not made up of chitin, but consists of following layers

- (i) Peritrophic membrane
- (ii) Enteric epithelium
- (iii) Basement membrane
- (iv) circular muscles
- (v) Longitudinal muscles
- (vi) Peritoneal membrane

The enteric epithelium is made up of three types of cells: (i) The columnar cells which secrete the enzymes and absorb the digested food, (ii) the regenerative cells which renew the destroyed and dead epithelial cells through secretion or in the process of degeneration and (iii) the goblet cells which are of uncertain functions.

Thus, there are following five major functions of enteric epithelium: (i) to make digestive enzymes (ii) to absorb the digested food (iii) to produce new cells (iv) to absorb the water (v) to excrete the waste material outside the body.

The inner surface of midgut is sometime lined by a thin membrane known as peritrophic membrane which protects the epithelial cells from the direct contact of food particles. This membrane is absent in Lepidopterans and hemipterans.

### 3. Hind Gut or Proctodaeum

It extends from the posterior end of midgut to the anus and is also an invagination of the body wall. The hind gut consists of the some layers as the fore gut except that the circular muscles of its are developed both inside and outside the layer of longitudinal muscles. The hind gut is externally marked by the insertion of the Malpighian tubes and internally by the pyloric valve. It may be divided into three distinct regions

(i) Ileum or small intestine (ii) Colon or large intestine (iii) Rectum.

**Ileum-** It is a small tube which has many folds in its inner wall.

**Colon-** It is situated on the 5th and 6th segments of the abdomen and is a slender tube which, cannot be easily distinguished from the ileum. In some insects it is just like 'S' in structure.

**Rectum-** Both the ends of the rectum are comparatively slender while the middle portion is thick and large which consists of six rectal papillae internally and six ridges of longitudinal muscles externally. The rectum opens to exterior through the anus which is situated at the caudal end of the abdomen.

**Salivary Glands -** The labial glands which are associated with the gnathal appendages are the salivary glands. A pair of salivary glands is found in the grasshopper which generally lie in the thorax and are convoluted tubes often branched and racemose. Both the ducts of salivary glands unite together beneath the oesophagus to form a common salivary duct which opens into the salivarium.

### Physiology of digestion

The grasshopper is phytophagous and eats the leaves and soft parts of the plants which are hold by the maxillae and, they bring the food near to mandibles where it is broken into small particles. These small food particles are sent to the buccal cavity with the help of labrum and labium. On entering the buccal cavity, it is subjected to the action of saliva which contains the amylase enzyme. It acts on the carbohydrates present in the food and change them into simple sugar i.e., glucose which is absorbed in the crop. Saliva is also helpful in moistening the food. This food passes onward to the crop where the secretions of the midgut and the hepatic 'caecae mix with it. These secretions are weakly acidic or alkaline and contain maltase, invertase, lactase, protease, lipase, peptidase, erypsin and trypsin enzymes which act on the food. Due to the action of these ezymes the starch is converted into sugars, protein into amino acids and fat into fatty acids. After this the food comes to gizzard where it is again masticated then it passes through the cardiac valve into mesenteron where further digestion of the food takes place. The digested food is absorbed by the spongy and thick walls of mesenteron. The undigested food passes to the hind gut (proctodaeum) through pyloric valve where the absorption of water takes place and then waste and undigested food expelled out through anus in the form of excreta. The absorbed food is utilized for the following purposes

(i) In the form of energy required for different life activites (ii) Some part is consumed in the formation of muscles etc. (iii) The rest is stored in the fat bodies which is used in emergency.

## Practical- 9

*To study the male and female reproductive systems in insects (Grasshopper)*

### **MALE REPRODUCTIVE ORGANS**

The male reproductive organs consist of the followings- (i) A pair of testes (ii) A pair of vasa deferentia (iii) Seminal vesicles (iv) Ejaculatory duct (v) Penis or Aedeagus (vi) Accessory glands (vii) Male genital atrium

**The Testes**-They are located above the midgut and held in position by the surrounding fat bodies and tracheae. Each testis is a more or less ovoid body partly or completely divided into a variable number of follicles or lobes which are cylindrical in shape. Each follicle is connected with vas deferens by a relatively well developed slender tube known as vas deferens. The peritoneal investment of the follicle is developed to the extent of enveloping the testis as a whole in a common coat known as scrotum. The presence of the sex cells in different stages of development. These zones are as follows

- (i) **The germarium** - It is the region having primordial germ cells or spermatogonia which undergo multiplication.
- (ii) **The zone of growth** – In this zone the spermatogonia increase in size and undergo repeated mitotic division and develop into spermatocytes.
- (iii) **The zone of division and reduction**-Here the spermatocytes undergo meiosis and produce spermatids.
- (iv) **The zone of transformation** - The spermatids are transformed into spermatozoa.

The masses of spermatozoa are generally enclosed in the testicular cyst cells from which they are released in the vas deferens. In addition, the testes contain large elements known as Leydig's cells or apical cells.

**Vas deferens**- These are the paired canals leading from the testes which are partly or wholly mesodermal in origin.

**Seminal Vesicles**- The Vas deferens vary greatly in length in the majority of insects. Each Vas deferens becomes enlarged along its course to form a sac known as seminal vesicle in which spermatic fluid is collected.

**Ejaculatory duct** -Posteriorly, the vasa deferentia unite to form a short common canal which is continuous with a median ectodermal tube known as ejaculatory duct. The terminal end of ejaculatory duct opens in the male genital atrium.

**Aedeagus**- The terminal end of the ejaculatory duct is enclosed in a finger-like evagination of the ventral body wall which forms the male intromittent organ known as aedeagus. It is situated on 9<sup>th</sup> abdominal sternum of the grasshopper on the conjunctival membrane of the posterior margin.

**Accessory glands**- These are one to three pairs in number and usually present in relation with the genital ducts opening into seminal vesicle. These are tubular or sac-like in structure. In most of the cases their secretions mix with spermatozoa and in some insects glands are directly concerned with the formation of the spermatophores.

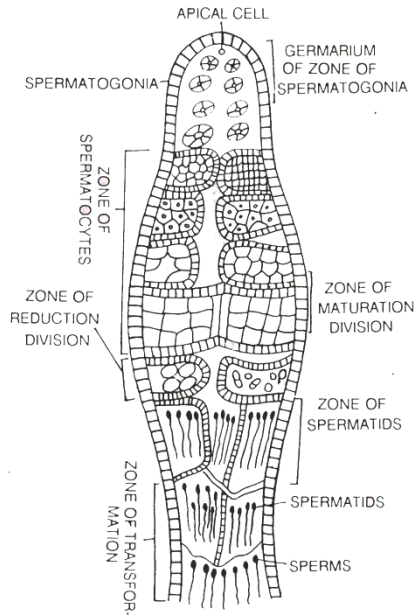

**Longitudinal section of Testicular follicle**

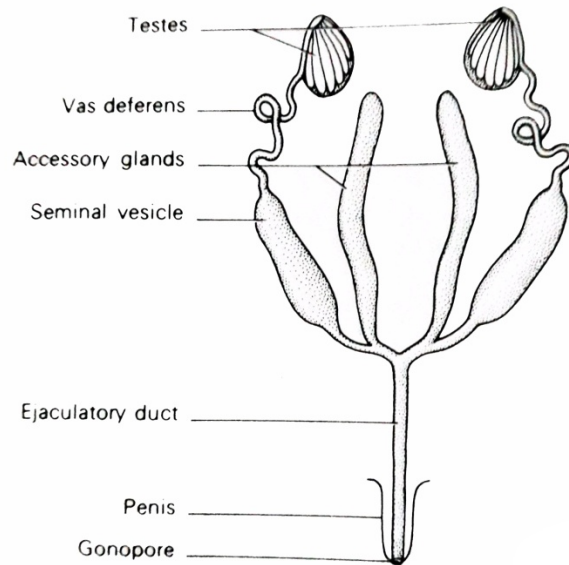

**Male reproductive organ**

### THE FEMALE REPRODUCTIVE ORGANS

The female reproductive system consists of the following organs- (i) A pair of ovaries (ii) A pair of lateral oviducts (iii) Spermatheca (iv) Vagina and genital chamber (v) Accessory glands (Collateral glands)

**The ovaries**-These are typically more or less compact bodies lying in the body cavity of the abdomen on either side of the alimentary canal. Each ovary is about 2 cm long and composed of a variable number of ovarioles and open into the oviduct. A typical ovariole is an elongated tube in which the developing eggs are disposed one after the other in a single chain. The oldest oocyte is situated nearer the union with the oviduct. The wall of an ovariole is made of follicular epithelium whose cells rest upon a basement membrane known as tunica propria.

Each ovariole may be differentiated into three zones:

- (i) **Terminal filament**- It is the slender thread like apical prolongation of the peritoneal layer. The filaments of the ovary combine to form a common thread termed as terminal filament. The terminal filament of one ovary unites with the filament of the other ovary to form a median ligament. It aids in maintaining the ovaries in the position and is attached to the dorsal diaphragm.
- (ii) **The germarium**- It is situated below the terminal filament and forms the apex of an ovariole. It consists of a mass of cells which are differentiated from the primordial germ cells.
- (iii) **The region of growth**- It is also called as vitellarium which constitutes the major portion of an ovariole. The vitellarium contains the developing eggs (oocytes). The epithelial layer of the wall of vitellarium grows inwards to enclose each oocyte in a definite sac known as follicle. The cells of the follicle secrete the chorion of the egg and in some cases serve to nourish the oocytes.

Three types of ovarioles may be recognized on the basis of presence or absence of nutritive cells.

**(a) Panoistic type**– Nutritive cells are absent e.g., grasshopper and other insects of Orthoptera and Isoptera. **(b) Polytrophic type**–Nutritive cells are present and arranged in alternate with the oocytes e.g., Hymenoptera. **(c) Acrotrophic type**–Nutritive cells are present and situated at the apices of the ovarioles e.g., Hemiptera.

**The oviducts**– The lateral oviducts are paired canals leading from the ovaries and are formed from the mesoderm. These lateral oviducts form the common oviduct which opens into the vagina. Each oviduct is an enlarged pouch which stores eggs. The vagina is greatly enlarged to form a chamber, known as uterus, for the reception of developing eggs.

**The Spermatheca**– This is a pouch or sac for the reception and storage of the spermatozoa (seminal fluid) and is also known as receptaculum seminis. It generally opens by a duct into the dorsal wall of the vagina which is known as sperm duct. In many insects pairing takes place only once and since the maturation of eggs may extend after the union of the sexes, the provision of spermatheca allows for their fertilization from time to time. A special spermathecal gland opens into the duct of spermatheca and secretes a fluid which lengthens the life of sperms.

**Genital chamber**– The vagina opens into the genital chamber on 9<sup>th</sup> sternum and this chamber is called bursa copulatrix which helps in copulation.

**Accessory glands**– These are paired structures opening into the distal portion of the vagina. These glands provide material for the formation of egg pod or ootheca.

**Fertilization**– After copulation; the spermatic fluid is received in the spermatheca. The egg comes down from the oviduct to the vagina which has an opening (micropyle) into its shell for the entrance of male germ cell (spermatzoan). One or two spermatozoa enter the egg through micropyle and only one succeeds in fertilizing the egg. After fertilization the accessory glands secrete a fluid around the egg which hardens it.

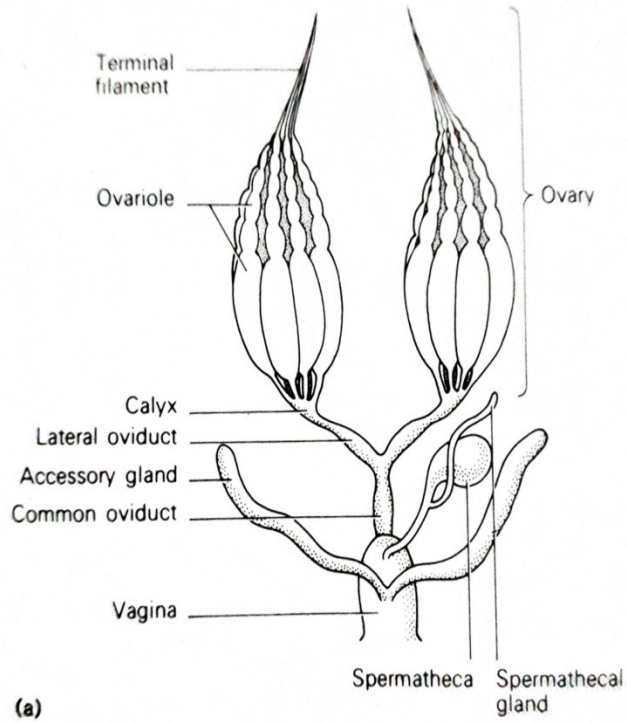

**Female reproductive organ**

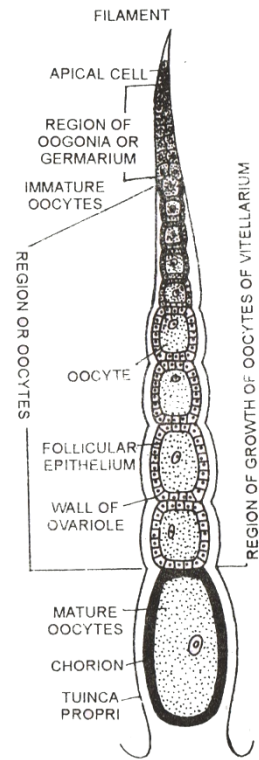

**L.S. of an Ovariole**

## Practical -10

To study the characters of orders Orthoptera, Dictyoptera, Odonata, Neuroptera, Isoptera, Thysanoptera and their families

### Order- Orthoptera

(Ortho- straight; ptera - wing)

- Synonyms : Saltatoria, Saltatoptera, Orthopteroid  
Common names : Grasshoppers, Locust, Katydid, Cricket, Mole cricket

#### Characters

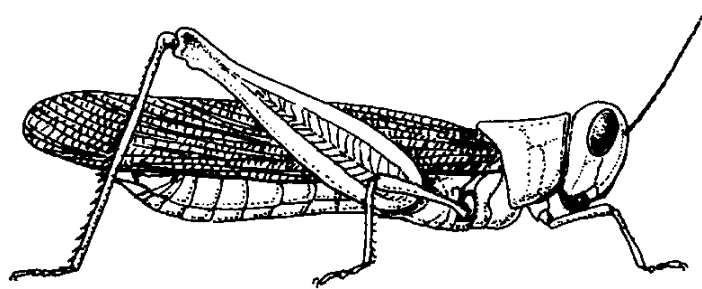

- Distribution : Worldwide but mainly in tropics  
Body : Medium to large sized  
Mouthparts : Chewing and biting type  
Eyes : Well developed compound eyes; ocelli 2 or 3  
Antenna : variable, filiform in most of the insects  
Thorax : Large prothorax with shield in many of the insects  
Wings : Forewings are called **tegmina** (hard and lathery in texture),  
Hind wings are **membranous**  
Legs : Hind legs is usually adopted for jumping (saltatorial)  
Cerci : Short and unsegmented  
Ovipositor : Long and well developed  
Specialized organs : Stridulatory (sound producing) organ and auditory (hearing) organ present  
Metamorphosis : Gradual / Paurometabola type  
Sub-orders : Caelifera and Ensifera

#### Family: Acrididae (Caelifera)

##### Characters

- Antenna : shorter than the body length  
Legs : Hind legs are long and meant for jumping with the help of **levator muscles**  
Tarsus : three segmented  
Ovipositor : Short and horny



Sound production : Tympanum is located on either side of the 1<sup>st</sup> abdominal segment. Sound is produced by **femoro-alary mechanism** (a row of peg like projections found on the innerside of each hind femur which are rubbed against hard radial vein of the tegmen)

Examples : Dhan ka tidda – *Hieroglyphus banian*  
(Short horned Grasshopper and Locusts) Kharif ka tidda – *H. nigrorepletus*  
Ghas ki tiddi – *Chrotogonus* sp.  
Locust – *Schistocerca gregaria*

### Family: Tettigonidae (Ensifera)

#### Characters

Antenna : Long as long as body or larger

Tarsus : Four segmented

Ovipositor : Sword like

Sound production : Alary type (a thick region on the hind margin of forewing (scraper) is rubbed against a row of teeth on the stridulatory vein (file) present on the ventral side of another forewing which throws the redonant areas on the wing (mirror) into vibrations to produce sound)

Examples : (Long horned grasshoppers, Katydids and bush crickets)

### Order-Dictyoptera

(Dictyon = network; ptera=wings)

Synonyms : Oothecaria, Blattiformia

Common names : Cockroaches and preying mantids

#### Characters

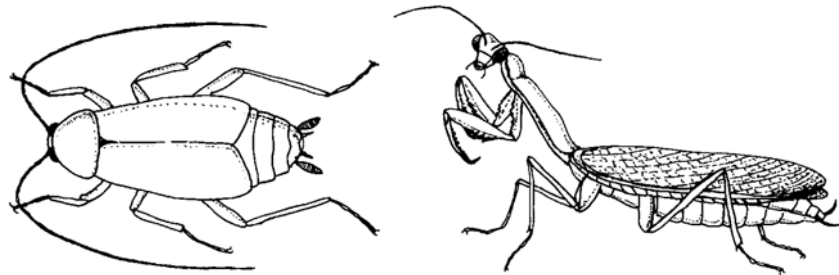

Body : Medium to large sized

Head : Hypognathous

Antenna : Filiform or setaceous

Mouthparts : Chewing type

Thorax : Prothorax usually larger than meso and meta thorax

Wings : Forewings thickened, leathery with a marginal costal vein called tegmina, Hindwings membranous and folded fanlike

Tarsi : 5 segmented

- Cerci : Short and many segmented  
 Eggs : Contained in Ootheca  
 Metamorphosis : Gradual/paurometabola  
 Sub-orders : Blattaria (Cockroach) and Mantodea (Preying mantids)

**Important Families of Dictyoptera**

Characters	Blattidae	Mantidae
Head	Not mobile in all directions	Mobile in all directions
Pronotum	Shield like and cover the head	Elongated, do not cover head
Ocelli	Degenerated- 2 called as fenestra	Three
Body	Flattened, dark colored	Elongated sometimes cylindrical
Legs	Cursorial running type	Forelegs are raptorial, middle and hind legs are ambulatorial
Gizzard	Powerfully armed with chitinous teeth	Chitinous teeth absent
Mating behaviour	Do not devour male during mating	Often (but not always)
Ootheca	Chitinous	Not chitinous
Nymphal character	Not cannibalistic	Cannibalistic
Mimicry	Absent	Mimic leaves and flowers
Habitat	Omnivorous	Mostly outdoors
Economic importance	Household pest	Predators on crop pest
Examples	American Cockroach	Preying mantids

**Order- Odonata**

**(Odon = tooth; strong mandibles)**

- Common names : Dragonflies and damselflies

**Characters**

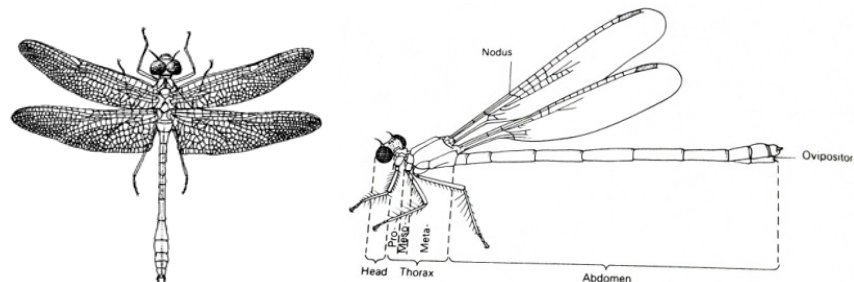

- Body : Long, cylindrical, medium to large sized, attractively coloured  
 Head : Globular and constricted behind into a petiolate neck  
 Antenna : Very short, bristle like, setaceous  
 Eyes : Compound eyes are large. Ocelli- Three  
 Mouthparts : Adapted for biting, Mandibles are strongly toothed Lacinia and galea are fused to form mala which is also toothed

Wings	: Membraneous, venation is net work with many cross veins. Wings have a dark pterostigma towards the costal apex. Sub costa ends in nodus. Wing flexing mechanism is absent.
Legs	: Basket type arrangement, 3 segmented tarsi, They are suited for grasping, holding and conveying the prey to the mouth.
Abdomen	: Abdomen is long and slender, In male gonopore is present on 9 <sup>th</sup> abdominal segment. But the functional copulatory organ is present on the 2 <sup>nd</sup> abdominal sternite. Before mating sperms are transferred to the functional penis. Female have gonopore on 8 <sup>th</sup> segment.
Metamorphosis	: Incomplete with three life stages. The Nymphs (called naiad) is aquatic. Labium is greatly elongated, jointed and bears two hooks at apex. It is called mask. It is useful to capture the prey.
Sub-orders	: Anisoptera (Dragonfly) and Zygoptera (damselfly)
Importance	: Adults are aerial predators. They are able to catch, hold and devour the prey in flight. Naiads are aquatic predators. Dragonflies and damselflies can be collected with an aerial net near streams and ponds especially on a sunny day. Naiads can be collected from shallow fresh water ponds and rice fields.

### Order- Neuroptera

(Neuro=nerve; ptera=wing)

Common names : Lace wings, Ant lions, Mantispidflies, Owlflies

#### Characters

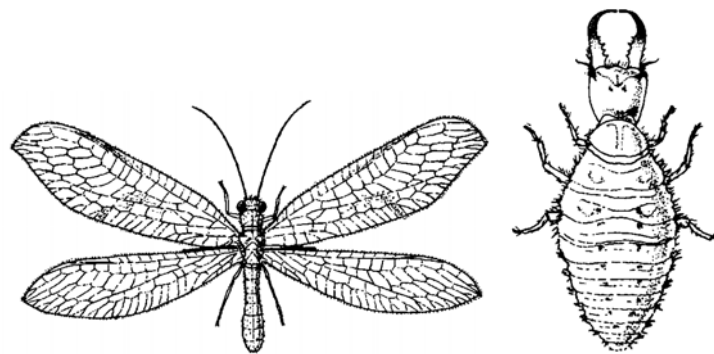

Body	: Soft bodied insects
Antenna	: Filiform, with or without a terminal club
Mouthparts	: Chewing type in adults
Wings	: Wings are equal, membranous with many cross veins, held in a roof-like manner over the abdomen, weak fliers
Larva	: Campodeiform with mandibulo-suctorial mouthparts
Pupa	: Exarate, Pupation takes place in a silken cocoon, Six out of eight Malpighian tubules are modified as silk glands. They spin the cocoons through anal spinnerets.
Sub-orders	: Megaloptera and Planipennia

**Planipennia : Families**

1. **Chrysopidae:** Body pale green in colour, eyes are golden yellow in colour, pedicellate/stalked eggs to avoid cannibalism and predation, larvae prey on soft bodied insects especially on aphids, exhibits camouflage with debris, biocontrol agents, mass multiplied easily for pest control in field. (e.g. Green lacewings, Goldeneyes, Stinkflies, Aphid lions)
2. **Mantispidae:** Resemble preying mantids, larvae predaceous (e.g. Mantispidflies).
3. **Myrmeleontidae:** Resemble damselfly (Ant lions)
4. **Ascalaphidae:** resemble dragonfly (Owlflies)

**Order- Isoptera**

**(Iso=equal; ptera=wing)**

Synonyms : Termitina / termitida / Socialia

Common names : Termites, White ants

**Characters**

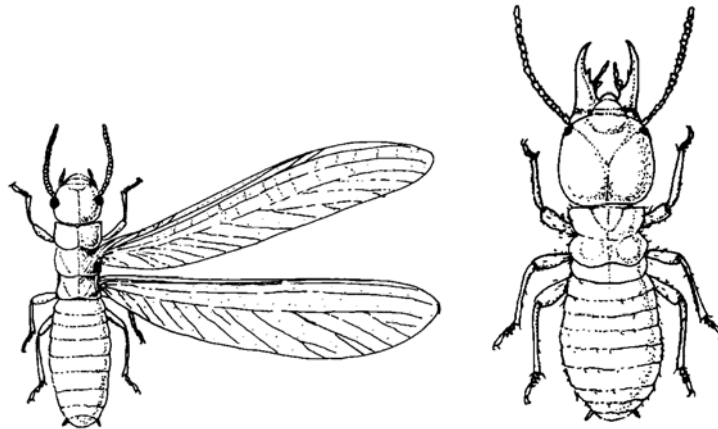

Body : Minute to large sized and soft

Head : Prognathus, characteristic depression "**Fontanella**" is present on the dorsum of head

Mouthparts : Biting and chewing type

Eyes : Compound eyes present in the winged form; in apterous form it may or may not be present; Ocelli 0 – 2

Antenna : Short and moniliform

Wings : Identical in size, form and venation, two pairs, membranous and semi transparent. Wings are extended beyond abdomen and flexed over abdomen when at rest.

Abdomen : Broadly joined to the thorax without constriction

Cerci : Short

Genital organs : Externally lacking in both sexes

**Specialities** : They are ancient polymorphic, **social insects** living in colonies

Examples : Termites- *Odontotermus obesus*, *Eutermus heimi*, *Microtermes anandi*

Caste system is existing in isopteran.

#### Termite castes

##### 1. Reproductives

**King**

**Queen**

##### 2. Non-reproductives (sterile)

**Workers** (dominate the colony, usually blind and apterous)

**Soldiers**- (a) mandibulate (b) Nasute (defend the colony)

#### Order: Thysanoptera

(Thysano-fringe; ptera- wing)

Synonyms : Physopoda

Common names : Thrips

#### Characters



Body : Minute, slender, soft bodied insects

Mouthparts : Rasping and sucking type, Mouth cone is formed by the labrum and labium together with basal segments of maxilla. There are three stylets derived from 2 maxillae and left mandibles. **Right mandible is absent.** Hence mouth parts are asymmetrical.

Antenna : Moniliform

Eyes : Compound eyes well developed, ocelli present in alate form

Wings : Either present or absent, when present very narrow and **fringed with hairs** which increase the surface area, weak fliers and passive flight in wind is common

Legs : Ambulatorial, Tarsus is with one or two segments, At the apex of each tarsus a protrusible vesicle is present.

Abdomen : 11 segmented, pointed. An appendicular ovipositor may be present or absent

Cerci : absent

Metamorphosis : Paurometabola/gradual, Nymphal stage is followed by prepupal and pupal stages which are analogous to the pupae of endopterygote insects.

Sub-orders : Terebrantia (Important family is **Thripidae**) and tubulifera (ovipositor absent, tubular abdomen, Wing venation is absent)

Economic importance : Most of the thrips species belong to the family Thripidae and are phytophagous. They suck the plant sap. Some are vectors of plant diseases. Few are predators.

Examples : Rice thrips, *Stenchaetothrips biformis* and Onion thrips, *Thrips tabaci*

## Practical -11

*To study of characters of order Hemiptera and its families*

### Order –Hemiptera (Hemi - half; ptera – wings)

Synonyms : Rhynchota

Common names : True bugs

#### Characters

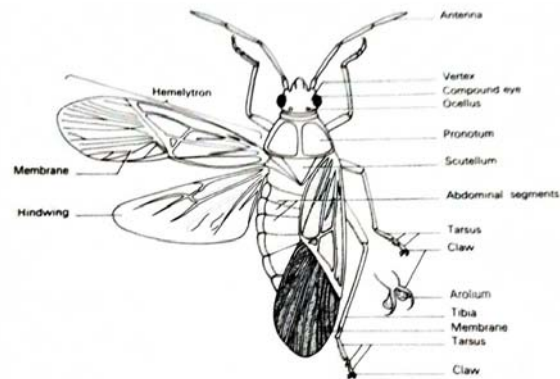

Body : Minute to large sized

Head : Opisthognathous

Mouthparts : Piercing and sucking type, 2 pairs of bristle like stylets which are the modified mandibles and maxilla are present. Stylets rest in the grooved labium or rostrum

Antenna : Mostly with 4 or 5 segments

Thorax : Mesothorax is represented dorsally by scutellum.

Wings : Forewings are mostly hemelytra basally coriaceous and distally membranous

Cerci : Always absent

Metamorphosis : Usually gradual, rarely complete

Alimentary canal : Modified into **filter chamber** to regulate liquid food

Sub-orders : Heteroptera (Hetero -different; ptera - wing) and Homoptera (Homo - uniform; ptera - wing)

#### Characters

Forewings

#### Heteroptera

heavily sclerotized at the base called hemelytra

#### Homoptera

Uniformly textured

Wings at rest

Held flat over the abdomen

held roof like over the back

Head

porrect or horizontal

deflexed

Bases of forelegs

do not touch the head

touch the head

Habitat

Both terrestrial and aquatic (Herbivorous, predaceous or blood sucking)

Only terrestrial (Herbivorous)

Glands	Odoriferous or scent glands present	Wax glands usually present
Honey dew secretion	uncommon	Common
Scutellum	(Triangular plate found between the wing bases) well developed	Not well developed
Antenna	Relatively long	Short
Ocelli	Dorsal ocelli 0 or 2	2 or 3

### **Families of Heteroptera sub-order**

#### **Family: Coreidae (Squash bugs / Leaf footed bugs)**

Members with many branching veins arising from a transverse basal vein. Stink glands are found inside the metathorax and glands opening are found on the sides of the thorax between middle and hind coxae. They emit disagreeable / foul pungent odour. Hind tibia and tarsi are expanded and leaf like. Nymphs and adult suck the sap from the panicles or pods of pulses.

e.g. Rice gundhi bug- *Leptocorisa acuta*, Pod bug- *Riptortus pedestris*

#### **Family: Pyrrhocoridae (Red bug or Stainer)**

They are elongate oval bugs. They show warning colouration. They are brightly marked with red and black. Feeding injury caused by these bugs leads to the contamination by the fungus *Nematospora* resulting in yellowish brown discolouration of the lint.

e.g. Red cotton bug- *Dysdercus cingulatus*

#### **Family: Reduviidae (Assassin bugs or Kissing bugs)**

Predaceous insects, Head is narrow elongated and beak like. The portion behind the compound eyes is narrow and resembles a beak. The rostrum is short and three segmented antenna is filiform. Abdomen is broad in the middle. The lateral margins of the abdomen are exposed beyond the margin of the wings. e.g. *Rhynocoris marginatus*- predators on bees and other pests.

### **Families of Homoptera sub-order**

#### **Family: Jassidae or Cicadellidae (Leaf hoppers and Jassids)**

Insects have wedge shaped body with attractive colour. Hind tibiae have a double row of spines. Ovipositor is modified for lacerating plant tissue. Nymphs and adults have the habits of running sidewise. They suck the plant sap and also transmit the viral disease.

e.g. Green leaf hopper- *Nephotettix virescens* transmits the Rice tungro virus disease.

#### **Family: Delphacidae (Plant hoppers)**

Large mobile flattened spur is present at the apex of hind tibia. It causes hopper burn, transmits viral disease in rice. e.g. Brown plant hopper- *Nilaparvata lugens*

#### **Family: Lophopidae (Aeroplane bugs)**

Head is produced into snout. Hind trochanter is directed backward. Hind basitarsus is moderately long. Both nymph and adult suck the sap and reduce the quality and quantity of cane juice. e.g. Sugarcane leaf hopper- *Pyrilla purpusilla*

**Family: Aleyrodidae (Whiteflies)**

Minute insects, which superficially resemble like tiny moths. Wings are opaque and dusted with mealy white powder wax. Wing venation is much reduced. Vasiform orifice is present in the last abdominal tergite. It is conspicuous opening provided with an operculum. Beneath the operculum there is a tongue- like organ termed ligula. The anus opens at the base of the ligula through which the honey dew is excreted in large amount. Immature instars are sessile, scale like, with wax covering. Metamorphosis approaches the holometabolous type due to the presence of a quiescent stage prior to the emergence of adults. It transmits vein clearing/mosaic disease in Bhendi (Okra). e.g. Cotton whitefly- *Bemisia tabaci*

**Family: Aphididae (Aphids or Plant Lice)**

Body is pear shaped. Both apterous and alate forms are found. A pair of cornicles or siphunculi or wax tube or honey tube is present in the dorsum of 5<sup>th</sup> or 6<sup>th</sup> abdominal segments which secretes wax like substance. The chief constituents are being Myristic acid, sugars and water. They excrete copious amount of honey dew on which ants feed and sooty mould fungus grows. Aphids are known for their extraordinary fecundity, short life cycle and parthenogenetic reproduction. Life cycle is highly complex and it involves alteration of generation. They feed on plant sap and disseminate plant diseases. e.g. Cotton aphid - *Aphis gossypii*

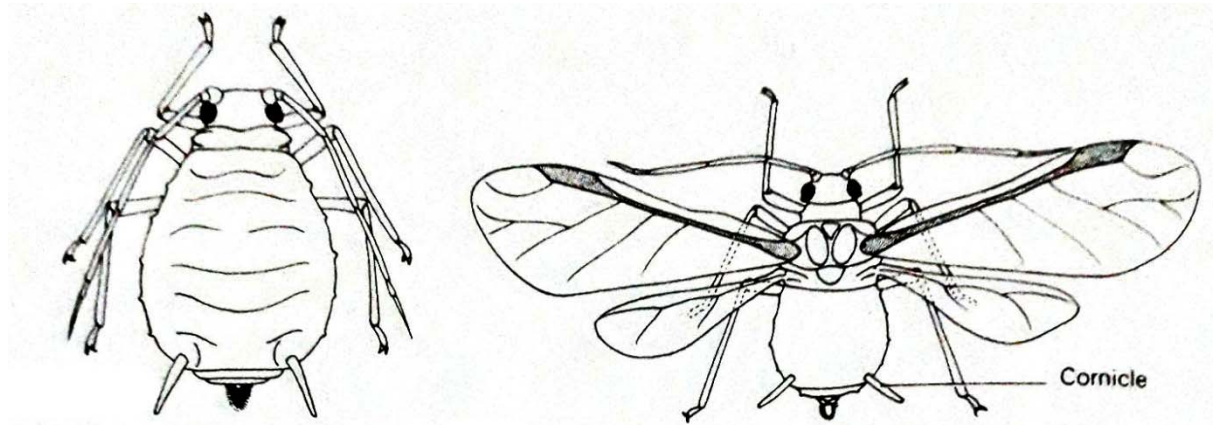

**Family: Kerridae or Lacciferidae (Lac Insect)**

Females are highly degenerate without legs, wings and antennae. The body is irregular globular. Body is enclosed in a thick resinous cell. Dermal glands secretion of this insect provides the stick lac. e.g. Lac insect – *Laccifer lacca*

**Family: Pseudococcidae (Mealy bug)**

Body is elongate, oval in shape. Body segmentation is distinct. Body is covered by long radiating thread of mealy secretion. Functional legs are present in all instars. Wings are absent. Nymph and adults suck the sap and affect the growth of spindle leaf. e.g. Coconut mealy bug- *Pseudococcus longispinus*.

**Family: Cicadidae (Cicadas)**

Males have sound producing organs at the base of the abdomen. Sound producing organs consists of a pair of large plates, the opercula covering the cavity containing structures producing sound. In the anterior part of the cavity beneath each operculum is a yellowish membrane. A shining mirror is located in the posterior part of the cavity. In the



lateral wall of the cavity is an oval shaped ribbed structure, the tymbal. These are vibrated by strong muscles to produce sound. Each species has a characteristics song. Tympanum is present in both the sexes. Wings are transparent. Eggs are inserted into the tree twigs by the female. Nymphs drop to the ground, enter the soil and feed on root sap. Anterior femurs of the nymph are thickened with spines beneath and are suited for digging the soil. Life cycle of periodical cicada lasts for 13- 17 years.

## Practical- 12

To study of characters of order Lepidoptera and its families

### Order: Lepidoptera

(Lepido- scale; ptera- wings)

Synonyms : Glossata  
Common names : Butterflies, moths and skippers

#### Characters

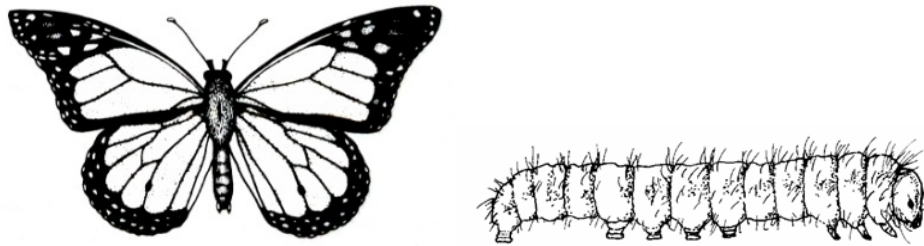

- Body : Body, wings and appendages are densely clothed with overlapping scales, which give colour, rigidity and strength. They insulate the body and smoothen air flow over the body.
- Mouthparts : Mouthparts in adults are of **siphoning type**. Mandibles are absent. The **galeae of maxillae are greatly elongated** and are held together by interlocking hooks and spines. The suctorial proboscis is coiled up like a watch spring and kept beneath the head when not in use.
- Wings : Wings are membranous and are covered with overlapping **pigmented scales**. Forewings are larger than hind wings. Wings are coupled by either frenate or amplexiform type of wing coupling.
- Larvae : Larvae are **polypod-eruciform** type. Mouthparts are adapted for chewing with strong mandibles.  
There are three pairs of five segmented thoracic legs ending in claws. Two to five pairs of fleshy unsegmented **prolegs** are found in the abdomen. At the bottom of the proleg, **crochets** are present.
- Pupae : Pupa is generally **obtect**. It is either naked or enclosed in a cocoon made out of soil, frass, silk or larval hairs.
- Sub-orders : **Ditrysia and Monotrysia**

Most of the lepidoptern insects (97 %) are grouped under the **suborder Ditrysia** in which the female insects have **two pores i.e., the copulatory pore** is located in the 8<sup>th</sup> abdominal sternite and the egg pore in the 9<sup>th</sup> abdominal sternite. Remaining insects are grouped under the **suborder Monotrysia** in which the female insects have **one pore**.

## **Butterfly Family**

### **1. Papilionidae (Swallowtail Butterfly)**

They are often large and brightly coloured (Fig. on cover page). Prothoracic legs have tibial epiphysis. In many species hind wings has tail like prolongation. Amplexiform type of wing coupling is present. Larval body is either smooth or with tubercles. Retractable Osmeteria are present on the prothoracic tergum of the caterpillar. e.g. Citrus butterfly, *Papilio demoleus*

### **2. Pieridae (Whites and sulphurs)**

They are white or yellow or orange coloured with black markings. Larva is green, elongate and covered with fine hairs. Larval body segments have annulets. e.g. Cabbage white butterfly, *Pieris brassicae*

## **Moth Family**

### **1. Arctidae (Tiger moth)**

Wings are conspicuously spotted or banded. They are nocturnal and attracted to light. Larva is either sparsely hairy or densely hairy (wooly bear). e.g. Spotted boll worm, *Earias vitella*, Sunhemp caterpillar, *Utetheisa pulchella*

### **2. Bombycidae (Silk worm moths)**

Antenna is bipectinate. Larva is either with tuft of hairs or glabrous with medio dorsal horn on 8<sup>th</sup> abdominal segment. Pupation occurs in dense silken cocoon. e.g. Mulberry silk worm, *Bombyx mori*

### **3. Gelichidae (Paddy moths)**

Forewings trapezoidal and narrower than hind wing. Caterpillars bore into the seeds tubers and leaves. e.g. Cotton pink boll worm, *Pectinophora gossypiella*, Angamous grain moth, *Sitotroga cerealella*, Potato tuber moth, *Pthoremea operculella*

### **4. Noctuidae (Noctua moths)**

They are medium sized, stoutly built moths. They are nocturnal and attracted to lights. Labial palpi is well developed. All crochets on the larval prolegs are of same size and arranged in semi circle. Some larvae are semiloopers. They have either 3 or 4 pairs of prolegs. Larvae attack the plants during night. Larvae of some species remain concealed beneath the surface of the ground or litter during day and feed on plants during night. They often cut small seedlings close to the ground and hence they are called cut worms. e.g. Tobacco cut worm, *Spodoptera litura*

### **5. Pyraustidae/ Pyralidae**

Proboscis is vestigial in many species. Labial palp is snout like. Larval habit varies. It may live among aquatic plants and bore into the stem or remain in silken web among spun up plants parts. Some larvae are aquatic and gill breathing. e.g. Rice stem borer, *Scirpophaga incertullus*

### **6. Saturniidae (Moon moth, giant silk worm moth)**

They are large sized moths. Antenna is bipectinate. Transparent eye spots are present near the centre of each wing. The spots are either circular or crescent shaped. Larva is stout and smooth with scoli. Cocoon is dense and firm. e.g. Tusor silk worm, *Antherea paphia*, which yields silk.

To study the characters of order Coleoptera and its families

**Order: Coleoptera**  
**(Coleo-Sheath; petra- wing)**

Synonyms : Elytroptera  
Common names : Beetles, Weevils

**Characters**

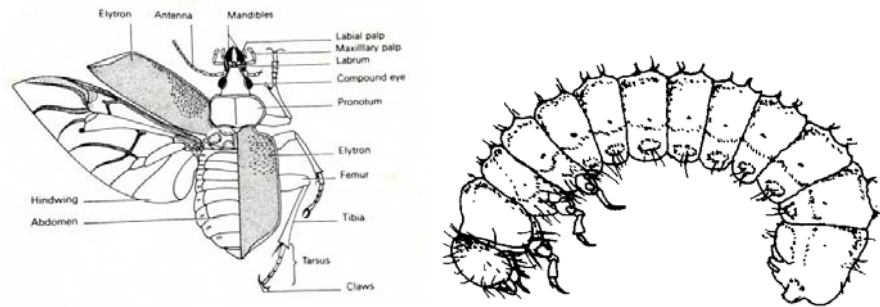

Body : Minute to large sized insects  
Antenna : 11 segmented  
Mouthparts : **Chewing and biting** type, Mandibles are short with blunt teeth at the mesal face in phytophagous group, In predators the mandibles are long, sharply pointed with blade like inner ridge. In pollen feeders teeth are absent and the mandibles are covered with stiff hairs.  
Thorax : Prothorax is large, distinct and mobile. Mesothorax and metathorax are **fused** with the first abdominal segment. Forewings are heavily sclerotized, veinless, hardened and called **elytra**.  
Wings : Forewings are heavily sclerotised, veinless and hardened. They are called elytra. Forewings do not overlap and meet mid-dorsally to form a mid-dorsal line. It is not used for flight. They serve as a pair of convex shields to cover the hind wings and delicate tergites of abdomen. Hind wings are membranous with few veins and are useful in flight. At rest they are folded transversely and kept beneath the elytra. In some weevils and ground beetles the forewings are fused and hind wings are atrophied.  
Abdomen : Cerci and a distinct ovipositor are absent.  
Development : Metamorphosis is complete. Larvae are often called grubs. Pupae are usually exarate and rarely found in cocoons.  
Importance : It is the largest order. It includes predators, scavengers and many crop pests. They also damage stored products.  
Sub-orders : **Adephaga (predators/ devourers) and Polyphaga (eaters of many things).**

**Families of predators:** Cicindelidae (Tiger beetle), Carabidae (Ground beetle), Dytiscidae (True water beetle), Gyrinidae (whirligig beetle), Coccinellidae (Lady bird beetle), Lampyridae (Firefly, glow worm)

**Families of scavengers:** Scarabaeidae (Scarabs, dung beetle), Hydrophilidae (water scavenger beetle)

**Families of stored product pests:**

Anobiidae (Wood worm/ wood borer) e.g. Cigarette beetle- *Lasioderma serricorne*

Bostrychidae (Grain borer) e.g. Lesser grain borer -*Rhizopertha dominica*

**Families of crop pests:**

1. **Apionidae** e.g. Sweet potato weevil, *Cylas formicarius*, a pest both in the field and in storage. Head is produced into snout. Antennae are not elbowed. Grubs are apodous.

2. **Cerambycidae (Longicorn beetles/ Longhorn beetles)**

e.g. Mango stem borer, *Batocera rufomaculata*

3. **Curculionidae (Weevils/ snout beetles)**

Minute to large sized insects. Frons and vertex of the head produced into snout, which is cylindrical and in some species larger than the beetle itself. Mouthparts (mandible and maxilla) are present at the tip of the snout, It is useful to feed on internal tissues of the plant and provide a place for egg laying. Antenna is geniculate and usually found in the middle of the snout. Grubs are apodous and acephalous. Weevils are important crop pests during both in field and in storage. e.g. Coconut red palm weevil, *Rhynchophorus ferrugineus*

4. **Galerucidae / Chrysomelidae (Pumpkin beetle)**

Antenna are closely approximated. Third tarsomere is deeply bilobed. Larvae are root feeders. Adults bite holes on plants.

Red pumpkin beetles, *Raphidopalpa foenicollis*

5. **Melolonthidae (Chaffer beetle, June beetle, White grub)**

They are stout beetles with glossy surface. Head is small. Labrum is well sclerotized. Adults are attracted to lights. They feed on tree foliage during night and hide in soil during day time. Larvae are scarabaeiform and root feeders. e.g. Groundnut white grub, *Holotrichia consanguinea*, a serious pest under rainfed conditions.

**Families of Predators:**

1. **Coccinellidae (Lady bird beetle)**

They are hemispherical insects. The body is convex above and flat below. The body appearance resembles like a split pea, head is small, turned down ward and received into a prominent notch of prothorax. Elytra is strongly convex, brightly coloured and variously spotted. Grubs are campodeiform and spiny. The last larval skin either covers the pupa and gets attached to its anal end. Except the genus *Epilachna* others are predators on aphids, scales, mites and whiteflies. e.g. *Coccinella septempunctata*, *Coccinella vigintioctopunctata*

## Practical- 14

To study the characters of order Hymenoptera and Diptera and their families

### Order: Hymenoptera

(Hymen- membrane; ptera- wings), (Marriage on wings)

Common names : Sawflies, ants, bees, and wasps

#### Characters

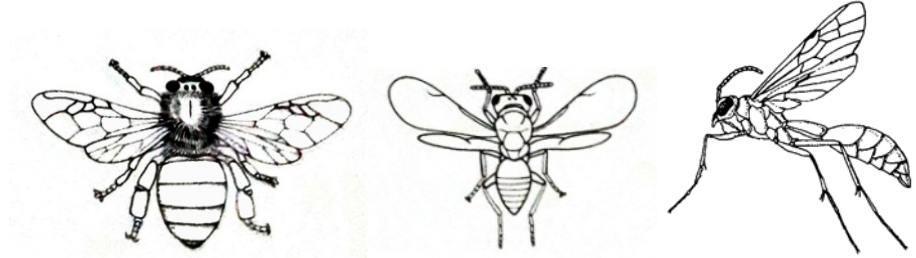

- Mouthparts : Primarily adapted for chewing, Mandibles are very well developed. In bees both labium and maxillae are integrated to form the **lapping tongue**.
- Thorax : Modified for efficient flight. Pronotum is collar like. Mesothorax is enlarged. Metathorax is small. Both prothorax and metathorax are fused with mesothorax.
- Wings : Stiff and membranous. Forewings are larger than hindwings. Wing venation is reduced. Both forewings and hindwings are coupled by a row of hooklets (**hamuli**) present on the leading edge of the hindwing.
- Abdomen : Basally constricted, The first abdominal segment is called **propodeum**. It is fused with metathorax. The first pair of abdominal spiracles is located in the propodeum. The second segment is known as **pedicel** which connects the thorax and abdomen. Abdomen beyond the pedicel is called **gaster** or **metasoma**.
- Ovipositor : Always present in females. It is variously modified for oviposition or stinging or sawing or piercing plant tissue.
- Metamorphosis : Complete
- Larva : Often the grub is apodous and eucephalous. Larva is rarely eruciform.
- Pupa : Exarate and frequently enclosed in a silken cocoon secreted from labial glands
- Sex determination : Fertilized eggs develop into females and males are produced from unfertilized eggs.
- Importance : Productive and beneficial insects
- Sub-orders : **Symphyla and Apocrita**

**Suborder Symphyta-** Abdomen is broadly joined with thorax, stemmata present, ovipositor is saw like and suited for piercing plant tissues, habits are phytophagous ,e.g. sawflies and horntails

**Family: Tenthridinidae (Saw flies)**

They are wasp like insects. Abdomen is broadly joined to the thorax. Ovipositor is saw toothed and suited for slicing the plant tissue. Larva is eruciform. It resembles a lepidoptern caterpillar. It has 1 pair od ocelli, papillae (reduced antenna), 3 pairs of thoracic legs and 6-8 pairs of abdominal legs. Prolegs lack chrochets. They are external feeder on the foliage. Larvae while feeding usually have posterior part of the body coiled over the edge of the leaf. (Mustard Sawfly, *Athlia lugens proxima* is a defoliator of mustard and cruciferous vegetables.

**Suborder Apocrita**– Abdomen is petiolated, Stemmata are absent, Legs are absent, ovipositor is not saw like and Suited for piercing or stinging, they are generally parasitic.

**Family: Apidae (Honey bee)**

Body is covered with branching or plumose hairs. Mouth parts are chewing and lapping type. Mandibles are suited for crushing and shaping wax for building combs. Legs are specialized for pollen collection. Scopa (pollen basket) is present on hind tibia. They are social insects with 3 castes viz. Queen, drone and workers. Division of labour is noticed among honey bees. Indian honey bee, *Apis indica*

**Formicidae (Ants)**

They are common widespread insects. Antennae are geniculate. Mandibles are well developed. Wings are present only in sexually mature forms. Petiole may have 1 or 2 spines. They are social insects with 3 castes viz. Queen, males and workers. Workers are the sterile females and they form the bulk of the colony. Exchange of food materials between adults and immature insects is common. After a mating flight queen alone finds a suitable nesting site. Many species have associated symbiotic relationship with homopteran insects.

**Braconidae (Braconid wasp)**

They are small, stout bodied insects. Fore wing has one recurrent vein. Petiole is neither curved nor expanded at the apex. Gaster is sessile or subsessile. Abdomen is as long as head and thorax together. They parasitize lepidoptern larvae commonly. They are gregarious parasites. In many species, Polyembryony is observed. *Bracon brevicornis* is mass multiplied and released for the control of black headed coconut caterpillar.

**Order- Diptera**

**(Di-two;ptera-wings)**

Common names : True flies, Mosquitoes, midges, gnats

**Characters**

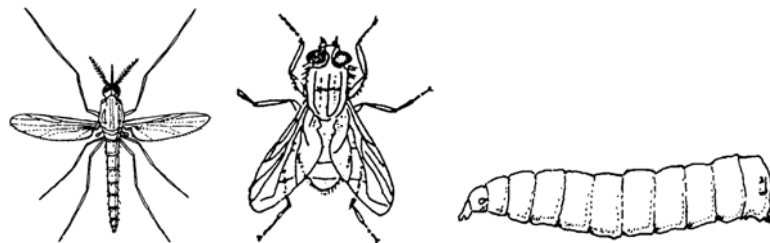

- Body : Small to medium sized, soft bodied insects
- Antenna : Often hemispherical and attached to the thorax by a slender neck
- Mouthparts : Sucking type
- Thorax : Fused together. The thoracic mass is largely made up of mesothorax.

Wings	:	Single pair of wings. Forewings are larger, membranous and used for flight. Hind wings are highly reduced, knobbed at the end and are called <b>halteres</b>
Metamorphosis	:	Complete
Larvae	:	Larvae of more common forms are known as maggots. They are <b>apodous</b> and <b>acephalous</b> .
Pupa	:	Pupa is generally with free appendages, often enclosed in the hardened last larval skin called <b>puparium</b> . Pupa belongs to the coarctate type.
Sub-orders	:	<b>Nematocera (Thread-horn), Brachycera (Short-horn) and Cyclorrhapha (Circular-crack)</b>

### **Families of agricultural Importance:**

#### **Syrphidae (Horse flies, Flower flies)**

They are brightly coloured and brilliantly striped. A vein like thickening is present in between the radius and median in the forewing. Abdomen has distinct black and yellow markings. Maggots prey on soft bodied insects especially aphids. Adults are excellent fliers. They hover over flowers. They feed on pollen and nectar. They aid in pollination.

#### **Tephritidae (Fruit flies)**

Sub costa bends apically and fades out. Wings are spotted or banded. Female has a sharp and projecting ovipositor. Maggots can hop. They are highly destructive to fruits and vegetables. Cucurbit fruit fly, *Dacus cucurbitae*.

#### **Tachinidae (Tachinid flies)**

Arista is completely bare. Abdomen is stout with several noticeable bristles. They are non specific endoparasite on the larvae and pupae of Orthoptera, Hemiptera, Lepidoptera and Coleoptera.



*To study the Insecticides and their formulations.*

## **INSECTICIDE FORMULATIONS**

After an insecticide is manufactured in a relatively pure form (technical grade), it must be formulated before it can be applied. Formulation is the processing of the technical grade by various methods which is done to make the product safer, more effective and more convenient to use. Formulation is the final physical condition in which the insecticide is sold commercially. In a formulation, there are one or more chemicals (formulants) which are the active ingredients (a.i.) and other ingredients which have no pesticide action (inert ingredients). There are mainly three types of pesticide formulations (liquid, solid and gas). A single pesticide may be sold in more than one formulation. Formulation type depends on several factors:

- toxicology of the active ingredient,
- chemistry of the active ingredient,
- how effective the product is against the pest,
- the effect of the product on the environment (plant, animal or surface etc.),
- how the product will be applied and the equipment needed the application rate.

### *Characteristics of an Appropriate Insecticides Formulation*

- Highly toxic to target insects.
- Not repellent or irritant to target insects
- Long-lasting
- Safe to humans and domestic animals
- Stable during storage and transportation
- Cost-effective

## **TYPE OF FORMULATIONS**

### **Emulsifiable Concentrates (EC)**

- It consists of a technical grade material, organic solvent and a emulsifier.
- Emulsifier makes the water insoluble toxicant to water soluble
- When an emulsifiable concentrate is added to water and agitated (i.e., stirred vigorously), the emulsifier causes the oil to disperse uniformly throughout the carrier (i.e., water) producing an opaque liquid (oil in Water suspension).
- A few formulations are Water in oil suspension. These are opaque and thick, employed as herbicide formulations, because they result in little drift.
- These are easy to transport and store, and require little agitation in the tank. However, care must be exercised in handling the toxic concentrates.
- Shelf life approximately 3 years
- More than 75% of all insecticides formulations are applied as sprays.
- Examples : Quinalphos 25EC, Dimethoate 30EC, Chlorpyrifos 20EC.

### **Dusts (D)**

- Simplest of all formulations and the easiest to apply.
- The technical material (active ingredient) is mixed with an inert diluents carrier such as clay, organic flour, pulverised minerals.
- In a formulated dust, the following two types of mixtures are usually found :

**Undiluted toxic agent**, e.g., sulfur dust used for control of mites and powdery mildew and **Toxic** a.i. plus an inert diluent. This is the most common dust formulation sold as 2%, 5%, or 10% a.i dust.

- Concentration of dust formulation ranged between 0.1% to 25%
- Particle size of dust particles 1-40  $\mu$  pass through 325 mesh sieve.
- Least effective and cause wind drift leading to poor deposit on surface. It has been calculated that not more than 10-15% of the applied material is retained on the surface.
- Highly toxic to beneficial insects.
- Example : Carbryl 5 D, Malathion 5D.

### **Granules (G)**

- The chemical is in the form of small granules of inert material, either as a coating on the surface of the inert granules, or as an impregnated toxicant in the granules.
- Consist of small pellets of the active ingredients sprayed on to clay and allowing solvents to evaporate
- Size: 0.25 – 0.38 mm (20-80 mesh or 30-60 mesh i.e (i.e., the number of grits (granules) per inch of the sieve through which they have to pass).)
- The amount of active ingredient varies from 2-10 per cent.
- Used mainly as systemic insecticides and can be applied on to the soil, or may be placed in the whorl of leaves depending on the nature of pest control required.
- Granular insecticides may be more economic since precise applications are possible with them.
- Much safer to apply than dusts and are generally less harmful to beneficial insects such as bees.
- Example : Carbofuran 3G, Phorate 10G, Cratap 4G.

### **Wettable Powders (WP)**

- Concentrated dusts containing an inert diluents (50-75% talc or clay) and a wetting agent to facilitate mixing the powder with water before spraying.
- Much more concentrated than dusts, containing 15 to 95 per cent active ingredient.
- Do not dissolve washers and rubber hoses;do not damage materials sensitive to organic solvents
- Leave effective residues in cracks and crevices and are not phytotoxic.
- Require frequent agitation and cause corrosion of valves, nozzles and pumps and sprayers
- Should never be used without dilution.

- These are easy to carry, store, measure, and mix. However, care must be taken to protect against inhalation during handling.
- Example: Carbaryl 50WP, Sulfur 80WP, *Bacillus thuringiensis* var. *kurstaki* 5WP.

### **Soluble Powders (SP or WSP)**

- Contain a finely ground water soluble solid which dissolves readily upon the addition of water forming true solution.
- Do not require constant agitation and forms no precipitate.
- The amount of active ingredient in soluble powder ranges from 15-95% by weight; it is usually not more than 50%.
- Soluble powder have all the advantages of wettable powders except the inhalation hazard during mixing.
- Example: Cartap hydrochloride 50SP, Acephate 75SP.

### **Water Dispersible Granules (WDG)**

- Water dispersible granules, or dry flowables is a relatively new type of formulation and being developed as safer and more commercially attractive alternatives to wettable powders and suspension concentrates formulations.
- They are becoming more popular because of convenience in packaging and use, non-dusty, free-flowing granules which should disperse quickly when added to water in the spray tank.
- They therefore represent a technological improvement over wettable powders. The dispersion time in water is a very important property and to ensure that no problems should occur during mixing in the spray tank.
- It is necessary for all the granules to disperse completely within two minutes in varying degrees of water temperature and hardness.
- Example: Endosulfan 50 WG, Cypermethrin 40 WG, Thiamethaxam 25 WG, Deltamethrin 25 WG.

### **Suspension Concentrates (SC)**

- Pesticide particles maybe suspended in an oil phase, but it is much more usual for suspension concentrates to be dispersed in water.
- A stable suspension of solid pesticide(s) in a fluid usually intended for dilution with water before use. Ideally, the suspension should be stable (i.e. not settle out).
- The active ingredient range between 0.1-60%.
- A.I. must be water insoluble with friable crystals, Easy to tankmix (very compatible) - A.I. tends to settle out over time.
- Farmers generally prefer suspension concentrates to wettable powders because they are non-dusty and easy to measure and pour into the spray tank.
- Example: Fipronil 5 SC, Sulphur 52 SC.

### **Microencapsulation/Capsule Suspensions (CS)**

- The polymer membrane, or microencapsulation technique, has become popular in recent years.

- These are particles of pesticide, either solid or liquid encapsulated by polymeric coatings. Microcapsule solids are suspended in water as a concentrate and diluted product (1:100 to 1:1000) is applied in spray solution to soil or foliar canopy.
- The rate of release of the active ingredient can be controlled by adjusting the microcapsule/droplet size, the thickness of the polymer membrane and the degree of cross-linking or porosity of the polymer.
- Example: Lambda Cyhalothrin 10 CS, Lambda Cyhalothrin 25 CS etc

#### **O/W Emulsions (EW)**

- Oil-in-water emulsions are now receiving considerable attention reduced or eliminated volatile organic compounds (VOCs) for safer handling.
- They are water based, oil-in-water emulsions can have significant advantages over emulsifiable concentrates in terms of cost and safety in manufacture, transportation and use.
- The active ingredient must have very low water solubility to avoid crystallization issues.
- Example: Butachlor 50 EW, Cyfluthrin 5 EW, Tricentanol 0.1 EW etc

#### **Flowable Suspension (FS)**

- Flowable suspensions are concentrated 40% to 70% w/w suspensions of micronized insoluble active pesticide in water.
- FSs must be formulated for low viscosity and good fluidity, so that transfer to the spray tank is easy and complete. This requires an effective wetting agent and an efficient dispersing agent to ensure adequate dispersion of the pesticide in the water. Since the active ingredients in FSs are insoluble, good suspension stability is essential.
- If the suspension settles and leaves sediment at the bottom of the container, the application of the pesticide may be too weak to be effective.
- A combination of smectite clay (bentonite) and xanthan gum works synergistically to provide excellent long term suspension stability at low viscosity and at low cost.
- Example: Thiram 40 FS, Thiamethoxam 30 FS, Tebuconazole 5.36 FS

#### **Microemulsions (ME)**

- Microemulsions are thermodynamically stable transparent dispersions of two immiscible liquids and are stable over a wide temperature range.
- Involves the incorporation of the insecticide in a permeable covering, microcapsules or small spheres with diameter ranging from 1-50  $\mu$ .
- The total concentration of surfactants for a microemulsion can be as high as 10–30% or more, compared with about 5% for a typical o/w emulsion.
- The insecticides escape through the small sphere wall at a slow rate over an extended period of time.
- Microemulsions have relatively low active ingredient concentrations, but the high surfactant content and solubilisation of the active ingredient may give rise to enhanced biological activity.
- Example: Neemazal 30 MEC, Pyrethrin Na 5.4 + Quinalofop-P-Ethyl 10.6 ME.

### **Oil Dispersion Formulations**

- One of the latest formulation types is oil dispersions (ODs). This technology allows very efficient and environmentally friendly agrochemical formulations.
- In ODs the solid active ingredient is dispersed in the oil phase, making it especially suitable for water-sensitive or non-soluble active ingredients.
- The oil-phase can comprise different oils such as mineral oils, vegetable oils or esters of vegetable oils.
- Special attention is needed with the auxiliaries in ODs: suitable oil-compatible dispersing agents and emulsifiers adjusted to the type of oil which forms a stable emulsion after dilution with water.

### **ZW Formulation of CS & EW**

- A mixed formulation of CS and EW is a stable suspension of microcapsules of the active ingredient and fine droplets of active ingredient(s) in fluid, normally intended for dilution with water before use.
- In the case of microcapsules, the active ingredient is present inside discrete, inert, polymeric microcapsules.
- The formulation is intended for dilution into water prior to spray application. Mixtures of active ingredients one of which is encapsulated are used to provide a broader spectrum of pest control.
- Formulating the active ingredients together eliminates the need for tank mixing (which can lead to incompatibilities).
- Example: Lambda Cyhalothrin-25.0 CS + Chloropyrifos-10.0 EW

### **Flowable Powder (FP)**

- The technical material is wet milled with a clay diluent and water with a suspending agent, a thickener and anti freeze compound forming a thick creamy pudding like mixture which mixes well with water.
- Needs constant agitation to prevent the insecticide from coming out of suspension and settling.

### **Oil solutions**

- Formulated by dissolving the insecticides in an organic solvents for direct use in insect control
- Rarely used on crops as they cause severe burning of foliage.
- Effective on livestock, as weeds sprays along roadsides, in standing pools for mosquito's larvae control, and in fogging machines for adult mosquito control.

### **Aerosols**

- Most common of all formulations for home use
- Consists of toxicant (2%), solvent (10%), knockdown agent (2%) and propellant (86%).
- The active ingredients soluble in volatile petroleum oil is kept under pressure provided by propellant gas
- When solvent is atomized, it evaporates quickly leaving behind small droplets of the insecticides suspended in air

- The toxicant is suspended as minute particle (0.1 - 50 w/w) in air as a fog or mist.
- Used for the knockdown and control of flying insects and cockroaches, but they provide no residual effect.
- Caution must be taken when used as they produce droplets well below 10  $\mu$ , readily absorbed by alveolar tissues in the lungs.

#### **Ultra low volume concentrates (ULV)**

- Technical ingredient is dissolved in minimum amount of solvent 0.6 litre to 5.0 litre/ha in very small droplets of 1-15 $\mu$ .
- Small droplets can better penetrate thick vegetation and other barriers
- Used for insect control in large areas where high volume of water constitutes a technical difficulty.

#### **Fumigants**

- Gases or low volatile liquids of low molecular weight which readily penetrate the material to be protected
- Used for the control of insects in stored products, for soil sterilization.
- Most of the fumigants are liquid and are mixtures of two or more gases.

#### **Fogging concentrates**

- Used in control of adult flies and mosquitoes for public health.
- Fogging machines generate droplets of 1-10 $\mu$ .

#### **Smoke generators**

- They are used in the form of coil like strips containing pyrethrum, oxidant and wood dust for the control of mosquitoes. When ignited, these coils release vapours.

#### **Impregnating materials**

- Used in the treatment of woollens for moth proofing and timbers against wood destroying organisms.

#### **Poison bait**

- Contains low level of toxicant incorporated in to material such as food stuffs, sugars, molasses etc. that are attractive to target pest.

#### **LABEL INFORMATION**

Every pesticide container has a label affixed on it with a leaflet. The label gives information of the pesticide in the container. The leaflet contains information on directions to use warnings, disposal and storage. Both the lable and leaflet are statutorily required under the Insecticide Act, 1968. The following information must be furnished on the label.

- Name of the pesticide (Brand name, Trade name, Common name), Name of the manufacturer and address, Registration number, Kind and name of active ingredient and their percentage, Types of formulation, Net content by weight, Batch number (assigned by manufacturer), Date of manufacture, Expiry date, Antidote statement
- Warning symbols and signal (warning symbol is of diamond shaped consisting of two triangles with a colour in the lower triangle and a signal in the upper triangle).

**To study the Pesticide appliances and their maintenance**

**Plant Protection Equipments**

**SPRAYERS**

Sprayer is a machine used to apply liquid chemicals on plants to control pest and diseases. It can also be used to apply herbicides to control weeds and to spray micro-nutrients to enhance plant growth. The main functions of a sprayer are

- Breaking the chemical solution in to fine droplets of effective size.
- Distributing the droplets uniformly over the plants.
- Applying the chemicals with sufficient pressure for positive reaching the plants
- Regulating the amount of liquid applied on plants to avoid excessive application.

A variety of high volume sprayers are available in the market. Almost all types of high volume sprayers have some kind of pump to supply pressurised spray liquid to the hydraulic nozzle which breaks the liquid into spray droplets and throws the spray away from it. The high volume sprayers are both manually operated or power operated type.

**Principle:** The function of sprayer is to atomize the spray fluid in to small droplets and eject it with some force.

**Parts of sprayers:** The important parts are tank, agitator, pressure gauge, valves, filters, pressure chamber, hose, spray lance, cut off device, boom and nozzle.



**Fig.1. Sprayer components**

**Nozzle body:** It is the main component on which other component of a nozzle fit (Fig. 1a).

**Swirl plate:** It is the part of a cone nozzle which imparts rotation to the liquid passing through it (Fig. 1b).

**Spray gun:** It is a lance from which spray is readily adjustable during the operation.

**Spray boom:** It is a spray lance with spray nozzles fitted to a head, mounted at right angles to the lance (Fig. 1d).

**Filter:** It is a component to remove suspended matter larger than a predetermined size from fluid.

**Over-flow pipe:** It is a conduit through which excess fluid from a pump is by-passed by the action of a relief valve or pressure regulator.

**Relief valve:** It is an automatic device to control the pressure of fluid or gas within range a predetermined value.

**Pressure regulator:** It is an automatic device to control the pressure of fluid or gas within a range of settings.

**Cut-off valve:** It is a mechanism between the pump and the nozzle to control the flow of liquid from the sprayer. This is operated by hand.

**Nozzle disc:** It is component containing the final orifice of a nozzle usually a cone nozzle.

**Nozzle boss:** It is a lug on spray boom or spray lance to which a nozzle body or cap is screwed.

**Nozzle tip:** It is component containing the final orifice of a nozzle usually a fan nozzle.

**Spray lance:** A hand-held pipe through which the liquid reaches the nozzle mounted at the free end.

**TYPES OF NOZZLE:** The three common types of nozzle

a. **Hollow cone nozzle:** This liquid is fed into a whirl chamber through a tangential entry or through a fixed spiral passage to give a rotating motion. The liquid comes out in the form of a narrow conical sheet which then breaks up into small drops. This is used for insecticide and fungicide spraying.

b. **Solid cone nozzle:** This nozzle covers the entire area at small range. The construction is similar to hollow cone nozzle with the addition of an internal jet which strikes the rotating liquid just within the orifice of discharge. The breaking of drop is mainly due to impact. This is used for herbicide spraying.

c. **Fan nozzle:** It is a nozzle which forms narrow elliptical spray pattern. In this type the liquid is forced to come out as a flat fan shaped sheet which is then broken into droplets. This nozzle is mostly used for low pressure spraying.

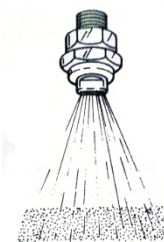
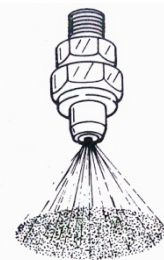

**TYPES OF SPRAYERS:**

**A. Manually Operated Hydraulic Sprayers-** In this type, the hydraulic pump directly acts on the spray fluids and discharge it.

a. **Hand syringe**

It is a single acting pump working on the principle of cycle pump. It consists of cylinder in to which the spray fluid is drawn during the suction stroke and delivered during the pressure stroke and discharge through nozzle. It is useful to operate only a small area.

b. **Hand Sprayers**

This is a simple sprayer. It creates hydraulic pressure by forcing spray solution to a nozzle by the direct action of hand pumping. The spray solution is filled in a plastic can (5-10 L) which is usually shoulder slung. A dip-tube draws liquid from the tank due to hand actuation of the plunger. Held by both the hands the piston pump is worked by sliding action. The capacity of this sprayer is about 0.5 acre per day. It is useful for small scale spraying in nursery or kitchen gardens and pot plants.

c. **Bucket or Stirrup Pump Sprayer:**

It consist either of a double acting pump with two cylinders or a single acting pump with one cylinder. The other parts of the sprayer are the plunger assembly, foot valve



assembly, hose, lance and nozzle, a stirrup and an adjustable foot rest. The suction part of the pump is immersed in the spray solution kept on floor in a bucket. The pump is operated by hand by one person while the other person holding the delivery line, trigger cut-off device and lance nozzle sprays pesticide. This sprayer is used both for public health spraying and agricultural spraying purposes. This type of sprayer is useful for spraying small trees. Area covered per day is 0.5 to 0.8 ha.

**d. Knapsack Sprayer**

The sprayer is mounded on the back of operator with help of a pair of mounting straps. The pump of the sprayer is actuated by working a hand lever up and down by one hand of the operator and the other hand holds the cut off device for spraying purpose. This sprayer consists of liquid tank, hydraulic pump, operating lever, pressure chamber, agitator, delivery hose, spray lance and nozzle. A bean shaped plastic tank of 14-16 liters capacity is commonly used. It is necessary to operate the hand lever continuously at the rate of 15-20 strokes per minute. The normal working pressure is 40 psi. It is user for spraying field crops vegetables and nurseries. The area covered per day is 0.8 to 1 ha.

**e. Rocker Sprayer**

It is very much similar to the foot sprayer. The main difference is the operation of pump. The pump actuation is done by hand of the operator. The sprayer pump mounted on wooden platform is kept on ground and the spray solution is kept in a separate tank or container. It can develop high pressure 10 kg/cm<sup>2</sup>. For spraying tall trees, an extension bamboo lance can be fitted. The adjustable type hydraulic nozzle (Triple Action Nozzle) is normally used. It can be used for spraying trees and tall field crops. It covers about 1.5 to 2 hectares of area in a day.

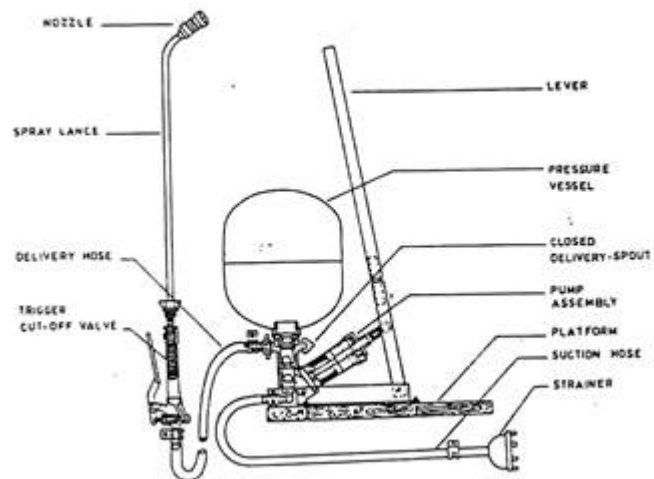

**f. Foot Sprayer or Pedal Pump:**

The pump of the sprayer is worked by operating a pedal lever by the foot of the operator. The spray liquid is kept in bucket or container and it is sucked by a suction hose through a filter (strainer) due to piston movement. A suitable ball valve is provided in the piston assembly to serve as suction valve. The liquid from the pump cylinder is then delivered into a pressure chamber where from the pressurized liquid reaches

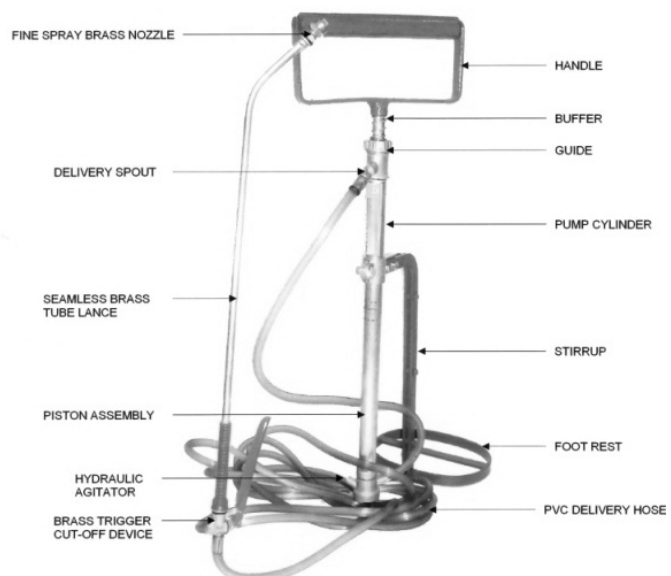

hydraulic nozzle. Minimum two person team is required to work on this machine. Hydraulic pressure of 10 kg/cm<sup>2</sup> can be achieved which is necessary to project the jet of spray to tall trees simultaneously from two spray nozzles. The foot operated sprayer is basically for orchard and tree spraying. The design is strong and sturdy. An adjustable type hydraulic nozzle (Tripple Action Nozzle) is generally used which can generate different types of spray patterns viz., fine spray (hollow cone), medium spray and coarse spray (jet). The fine and medium spray are suited for low height orchards, jet spray are necessary for tree spraying. The spray jet can reach height of 15 - 20 feet. For spraying taller trees an extra extension like bamboo lance may be used to gain additional height by 8 - 10 feet. It is difficult to treat field crops by foot sprayers because the sprayer is kept on ground and pesticide solution tank is also kept on ground separately and so movement of the long delivery hose becomes very difficult. About 1 to 1.5 ha area can be sprayed in a day.

## B. Manually Operated air compression Sprayers

These are also known as pneumatic sprayers because air pressure is employed for forcing the liquid through the nozzle for atomization. The containers of these sprayers should not be filled completely with the spray fluid. A part of the container is kept empty so that adequate air pressure can be developed over the spray fluid in the tank. They do not have agitators and hence are not useful spraying materials which settle down quickly.

### a. Pneumatic Hand Sprayer

The container for the spray fluid also acts as the pressure chamber. An air pump attached to the chamber inside. The inner end of the discharge pipe runs down to the bottom of the container and its outlet terminates in a nozzle. The container is filled about 3/4th of it and the pump is worked force air into the space to build sufficient pressure upon the spray fluid. These sprayers are used extensively in kitchen gardens, in glasshouses and in doors against household insects. The capacity of tank is up to one liter, if used in field it can cover an area of 0.1 ha in a day.

### b. Pneumatic Knapsack Sprayer

This is similar to compression hand sprayer but are used for spraying large quantities of liquids (9-10 Litres). It comprises a tank for holding the spray as well as compressed air, a vertical air pump with a handle, filling hole with a strainer, spray lance with nozzle and release and shut-off devices. The tank is provided a convenient rest with the back of the operator and has shoulder straps that allow it to be carried by him. These sprayers are used against agricultural pests and mosquito control operations. This pump covers an area of about 0.8 to 1.2 ha in a day.

## C. Power Sprayer (Mist blowers cum Duster)

Here the spray fluid is blown out by an air produced in the machine. It consists of chemical tank, fuel tank, carburator, spark plug, engine, blower assembly, delivery system, nozzle system and starter pulley. The power operated spraying system can be converted in to a dusting unit by changing certain components. The tank in these is made of a thick

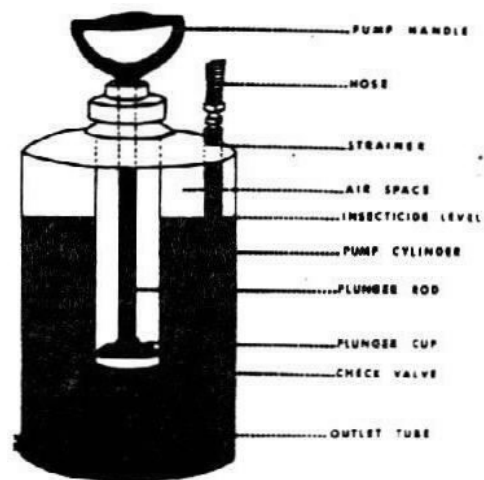
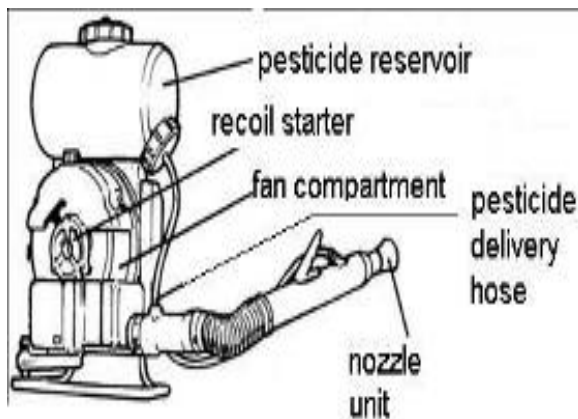
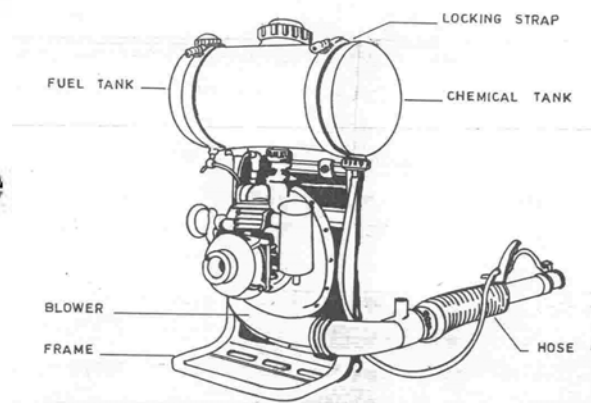

Figure 8. Compressed Air Sprayer

polyethylene and has a capacity of 10 liters. The fuel tank capacity is 1.0 to 1.5 liters. It is provided with 1.2 to 3.0 hp petrol engine. This can also be used for dusting provided suitable accessories. The area covered by these sprayers is about 2 ha in a day.



**Mist blower**



**Motorized Knapsack sprayer**

#### **D. Hand carried, battery operated spinning disc sprayer (Ultra Low Volume Sprayer)**

The pesticides are applied as such or with less than 5 litres spray fluid produces fine droplets (80µm). These are light weight sprayers (<3kg) have a rotary atomizer (spinning disc) powered by an enclosed DC motor with a plastic spray head, a liquid reservoir, a handle and a power supply unit. Liquid is gravity fed from polyethene container screwed in to the spray head moulding and the liquid is flung off by centrifugal force.

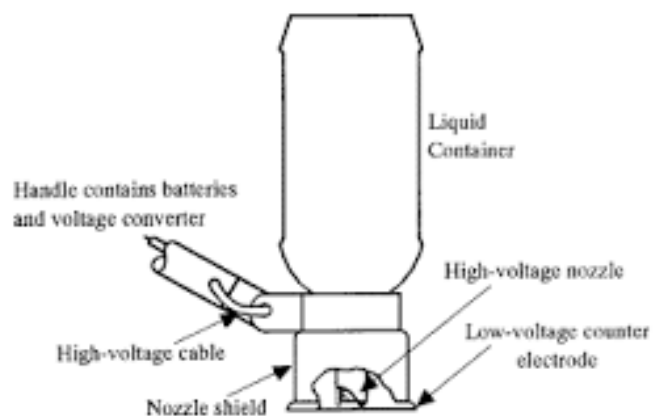

#### **E. Electro-dyn Sprayers (EDS)**

It is new system of spraying for the controlled droplet application of chemicals (CDA). EDS puts more of active chemical on the target than any other spraying system since the charged particles are attracted to target crop which ensure coverage on the underside of leaves where many pests feed and also there is minimal drift to non target areas. The EDS consists of a spray stick and an unique combination of bottle plus nozzle the bozzle. The spray stick consists of the batteries and a solid state high voltage generator. The bozzle contains ready formulated chemical for immediate application to crops. The pesticide in ULV formulation is used undiluted at a quantity less than 6 liters/ha and usually at 0.5 to 2.0 liters/ha for field crops. The droplet size varies from 20-150 micron with ground spraying equipment for ULV spray an area of 5 ha can be covered in a day.

#### **DUSTERS**

The dusting powders are low concentration ready to use type, dry formulations containing 2 to 10% pesticide. The inert material or dry diluents is talc, soapstone, attapulgit, etc., and it is non toxic. The sulphur dust is not diluted with inert material. The dusts are applied at 20 - 50 kg/ha. It should be noted that the application is done in highly

concentrated form, as compared to high volume or low volume spraying technique. Therefore, adequate precautions must be taken in handling the dust and during the application in field. The dusters are available both manually operated and power operated models. All dusters consist essentially of a hopper which usually contains an agitator, an adjustable orifice and delivery tubes. A rotary fan or a bellows provides the conveying air.

#### **A. Manually operated dusters**

##### **a. Plunger duster**

They are very simple, low cost machines and useful in a limited way. It consists of a dust chamber, a cylinder with a piston or plunger, a rod and a handle. The field application capacity is low. They hold 200 to 400 g of dust in a chamber into which air is pushed by an adjoining piston type air pump operated by hand. The dust cloud is issued from the discharge outlet. It is useful for small scale use in kitchen garden and in household.

##### **b. Bellows duster**

This is also a simple design low cost dusting machine. A collapsible bellows pushes air into a dust hopper of 1-2 kg capacity and dust is discharged from the nozzle outlet.

##### **c. Rotary duster:**

This type of duster makes use of a fan or blower to flow large volume of air at high speed. The dust powder is fed into the stream of air and blown from the outlet tube. The fan or blower rotates at high speed by hand cranking handle, which is geared to it. The higher gear-ratio and better blower design provide easy cranking and good volume of air is emitted. The dust hoppers are generally cylindrical and are provided with agitator, feeders and dust metering mechanism.

Such rotary dusters are either shoulder slung type or belley mounted type. The shoulder-slung models are better balanced when the dust hoppers are filled. But it becomes inconvenient to operate in crops like sugarcane and cotton. The belley mounted type can be used in such situations. A hand rotary duster can discharge dust powder from 0 – 150 g/min and displace air about one m<sup>3</sup>/min at 35 RPM. Such machine can treat 1 to 1.5 ha /day.

##### **d. Power Duster**

These are bigger machines run with the help of engine or electrical motor. Some power dusters are tractor mounted type and are driven by tractor P.T.O. The equipment is mounted on iron frame (stretcher) and can be carried by 2-3 men. The engine/motor drives a centrifugal fan usually via V-belt drive. The engine is petrol/ diesel run and 3 - 5 H.P. The fan displaces 20 m<sup>3</sup> air/min or more at 100-250 km/hr air velocity. These dusters are good for large area treatment and suitable for application on tall trees. In this type of duster design, usually the dust powder is not rotated in the fan-case but dust powder is aspirated in the delivery channel by air blast. The dust hopper capacity is 10- 20 kg and dust can be discharged at a rate of 1 to 8 kg/min. A power duster can cover about 10 ha/day.

##### **e. KNAPSACK DUSTER**

The motorised knapsack sprayer can be converted to a duster by replacing some plastic fittings inside the hopper. Almost all mist blowers have provision of converting them from spraying unit to dusting unit. The two stroke petrol engine runs a blower fan and delivers the air through a hose pipe system. The dust is agitated and lifted by the blast of air in the hopper (2-5kg capacity) and it is fed into the main air hose or a long dusting hose (40-50 ft

long polythene perforated hose) can also be attached to knapsack duster. Such an attachment is very good for large area treatment in less time. The dust output can be adjusted from 0 to 1.5 kg/min. The motorised knapsack sprayer-cum-duster unit is therefore useful for both low volume spraying and dusting operation.

### **Soil Injector**

It is also known as soil gun, which consists of a cylindrical tank for the liquid fumigant, a pump barrel and plunger assembly, injector nozzle, thrust handle and injection handle. The hand operated soil injectors have a capacity of 1 to 3 liters and they can cover about 0.5 ha in a day. They are used to apply liquid nematicides to kill soil nematodes.

### **Granule Applicators:**

They are used to apply granular formulations of pesticides uniformly. These are two types of granular applicators.

- i. There is a plastic hopper 1 liter capacity from which the granules flow by gravity to a nozzle.
- ii. It is a knapsack type with hopper of 10 liters capacity.

### **Bird Scarer**

It produce loud noise at regular interval and used to scare away the birds. It has three essential chambers, a chamber to hold calcium carbide, a smaller chamber placed inside the former to hold water and combustion chamber attached to the main chamber. Water acts with calcium carbide and generates acetylene which explodes producing the noise. The frequency of flow of water into calcium carbide chamber. One kg of calcium carbide is sufficient for working a machine for 24 hours. One bird scarer is sufficient to cover 1 to 2 ha.

### **Rat Traps:**

Several types of mechanical devices for trapping rats and mice are used in India. In these traps baits like dry fish are used for attracting these rats. The cage type wooden box with a door closing device and spring board types are the more common ones used in the houses.

## Practical- 17

### *To study about the Sampling techniques for estimation of insect population and damage*

Sampling population estimates of insect pests are the fundamental activity in ecological entomology. Regular monitoring can answer several important questions such as- What kinds of pests are present? Are the pest numbers great enough to do damage and to warrant control? Are bio-agents or natural control present and working? When is the right time to begin control? and have management efforts successfully reduced the number of pests?

Pest monitoring is the pre-requisite for any successful pest management program wherein, no control measure should be undertaken for a pest unless it is known that- the pest is actively present and it is present in sufficient numbers to cause an economic loss.

#### **How to count or measure a species/damage caused in plant, soil or other habitat ?**

**The sampling method should be:** suitable for all key pests, rapid and simple to use, easy integration into current sampling program, sampling equipment readily available and easy to carry and sampling procedure be simple to understand and conduct.

**Sample unit:** Single plant, clusters, plants/hill, plant/m<sup>2</sup> etc.

**Sampling Size:** In preliminary studies: sample size will be small and 10% of the mean error shall be acceptable. Number of samples depends on degree of precision required and chosen to minimize the variance and cost..

#### **Types of Sampling**

**Random sampling:** The sample is taken at random with good field coverage to determine insect numbers or damage per samples unit. For this purpose, use of random numbers is made.

**Stratified random sampling:** It involves the division of population in to different strata based on distribution of population.

**Sequential sampling:** It requires continuous sampling until a pre established upper or lower infestation level is found.

**Trap sampling:** This refers to using light, suction, sticky or sex pheromone traps to detect the presence of insects in an area.

**Systematic sampling:** It involves sampling of population at fixed intervals.

#### **Selection of Sampling Site**

1. Random
2. Along one diagonal
3. Along two diagonals
4. Zig-zag diagonally
5. Along alphabet 'W'
6. In micro-plots of 1m<sup>2</sup>
7. Meter row length

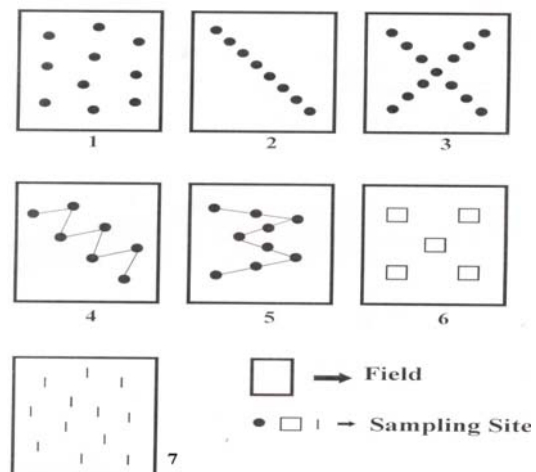

## Important Sampling Methods

**Absolute methods:** This method is used to estimate density of insects per unit area. Different

types of absolute sampling are denoted by **n**.

### Unit of habitat method

- *In situ or direct counts:* e.g. Leafhoppers
- *Knock down:* removing insects from the habitats-drop sheet method e.g. *Helicoverpa spp.* brushing, washing etc.
- *Netting:* for highly mobile insects
- *Trapping:* Use of different types of traps. Phermone traps, Light traps, suction traps etc.
- *Extraction from soil:* From a fixed volume of soil insects can be counted. e.g. white grubs, cutworms, pupae of several lepidopterous larvae.
- *Indirect techniques:* By taking crop samples for example, **dead hearts** in case of sugarcane shoot borer, **number of plants cut** e.g. cutworms, **per cent defoliation** e.g. foliage feeders, **root damage** e.g. termites, root weevils; **shoot damage** e.g. spotted bollworms, **per cent fruiting bodies damaged** e.g. bollworms of cotton, pod borers, **stubble infestation** e.g. in sugarcane.

**Absolute sampling** methods are desirable because they are accurate, however, these methods are time consuming, often difficult to conduct and are usually expensive compared to relative methods. Relative methods are more economical in terms of time, labour and equipments.

**Relative methods:** This method provides an identification of insect pests abundance or damage relative to other times or location. Different types of relative methods are as follows- visual searches, use of various traps, plant damage etc.

**Remote sensing:** Acquiring information through the satellite about pest damage without coming into physical contact. It can be useful in monitoring of certain pests. A radar can monitor height, speed and direction of insects like locusts, aphids etc.

## Components of Remote Sensing

### 1. Platform

- The vehicle/device on which sensors are mounted
- Carriers or vehicles for the sensors

### 2. Sensor System

- The device which senses the energy reflected/emitted by the target object

### 3. Data Products

- Information received from the sensor Packaged as per user requirement

## OTHER METHODS

**Beat bucket:** Requires 20-25 litre capacity plastic bucket (white or light coloured); similar to shake cloth/drop sheet method; top 25 cm of a single plant is bent into the bucket and shaken vigorously (12-15 times during 4-5 seconds); plant is quickly removed and insects/predators and spiders are counted. It is more effective than shake cloth method; reduces variability due to field scouts.

**Vacuum sampling:** Sucks into bags most everything from on and around a single plant or plant part; impractical for regular use in sampling and the samples are too messy to process.

Further improvements could be made by better initial planning and involvement of the statistician with the biologists.

### Sampling techniques for major insect pests on Paddy crops

Crop	Pest	Economic threshold level	Method of sampling
<b>Paddy</b>	<b>Green leafhopper</b>		
	<i>a) At earing stage</i>	5-15 insects/hill	Select 5 micro-plots of 1m <sup>2</sup> each in a field and shake vigorously plants in 5 hills/plot or shake vigorously 25 random plants and count leafhopper fallen on water.
	<i>b) At flowering stage</i>	10-15 insects/hill	Same as above
	<b>Stem borer</b>	5-10% plants with dead-hearts or 2% white ears or one egg mass or moth/m <sup>2</sup> .	Count infested and healthy tillers in 25 random plants.
	<b>Leaf-folder</b>	2 damaged leaves/plant or one larva/hill	Count infested and healthy plants among 25 random plants or count number of larvae in 25 plants.
	<b>Rice gundhi bug</b>	1-2 insects/hill	Count the insect on 25 random plants.
<b>Gram</b>	<b>Gram pod borer</b>	One larva/meter row length	Count larvae in one meter row length from 10-20 random sites in a field.
<b>Okra</b>	<b>Leafhopper</b>	2-5 nymphs/leaf	Count leafhopper nymphs from underside of three fully developed leaves in the upper canopy of each of 20 random plants or count leaves showing yellowing and curling from margins and healthy leaves of 20 random plants in a field.
	<b>Whitefly</b>	6-8 adults/leaf	Count whitefly adults as above.
	<b>Spotted bollworm</b>	10% drooping shoots or 5-10% infested fruiting bodies	Count drooping shoots and healthy shoots of 25 random plants or examine all green fruiting bodies of the above plants for spotted bollworm induced holes or damage.
<b>Tomato</b>	<b>Fruit borer</b>	One larva/m <sup>2</sup>	Count larvae in 1 m <sup>2</sup> micro plot from 10 random sites in a field.



# Manual on Fundamentals of ENTOMOLOGY

