

NOAA Technical Report NMFS Circular 446



Marine Flora and Fauna of  
the Northeastern United States.  
Lichens (Ascomycetes) of  
the Intertidal Region

Ronald M. Taylor

August 1982

U.S. DEPARTMENT OF COMMERCE

Malcolm Baldrige, Secretary

National Oceanic and Atmospheric Administration

John V. Byrne, Administrator

National Marine Fisheries Service

William G. Gordon, Assistant Administrator for Fisheries

## FOREWORD

This NMFS Circular is part of the subseries "Marine Flora and Fauna of the Northeastern United States," which consists of original, illustrated, modern manuals on the identification, classification, and general biology of the estuarine and coastal marine plants and animals of the northeastern United States. The manuals are published at irregular intervals on as many taxa of the region as there are specialists available to collaborate in their preparation.

Geographic coverage of the "Marine Flora and Fauna of the Northeastern United States" is planned to include organisms from the headwaters of estuaries seaward to approximately the 200 m depth on the continental shelf from Maine to Virginia, but may vary somewhat with each major taxon and the interests of collaborators. Whenever possible representative specimens dealt with in the manuals are deposited in the reference collections of major museums of the region.

The "Marine Flora and Fauna of the Northeastern United States" is being prepared in collaboration with systematic specialists in the United States and abroad. Each manual is based primarily on recent and ongoing revisionary systematic research and a fresh examination of the plants and animals. Each major taxon, treated in a separate manual, includes an introduction, illustrated glossary, uniform originally illustrated keys, annotated checklist with information when available on distribution, habitat, life history, and related biology, references to the major literature of the group, and a systematic index.

These manuals are intended for use by biology students, biologists, biological oceanographers, informed laymen, and others wishing to identify coastal organisms for this region. Often they can serve as guides to additional information about species or groups.

The manuals are an outgrowth of the widely used "Keys to Marine Invertebrates of the Woods Hole Region," edited by R. I. Smith in 1964, and produced under the auspices of the Systematics Ecology Program, Marine Biological Laboratory, Woods Hole, Mass. After a sufficient number of manuals of related taxonomic groups have been published, the manuals will be revised, grouped, and issued as special volumes, which will consist of compilations for phyla or groups of phyla.

## CONTENTS

Introduction . . . . .	1
Methods of collection and studying . . . . .	1
Ecology . . . . .	2
Glossary . . . . .	4
Illustrated key to species . . . . .	6
Annotated list of species . . . . .	15
Selected bibliography . . . . .	22
Systematic index . . . . .	24
Acknowledgments . . . . .	25
Coordinating Editor's comments . . . . .	26

The National Marine Fisheries Service (NMFS) does not approve, recommend or endorse any proprietary product or proprietary material mentioned in this publication. No reference shall be made to NMFS, or to this publication furnished by NMFS, in any advertising or sales promotion which would indicate or imply that NMFS approves, recommends or endorses any proprietary product or proprietary material mentioned herein, or which has as its purpose an intent to cause directly or indirectly the advertised product to be used or purchased because of this NMFS publication.

# Marine Flora and Fauna of the Northeastern United States. Lichens (Ascomycetes) of the Intertidal Region

RONALD M. TAYLOR<sup>1</sup>

## ABSTRACT

This manual treats the lichens found in the intertidal region from New Jersey to Newfoundland. Methods of collection, preparation, and study are briefly treated. Twenty-two species are covered, both in an illustrated key and an alphabetical listing, with brief descriptions and notes on ecology and distribution. A glossary of terms is included.

## INTRODUCTION

The content and style of this paper are intended to encourage and serve all who might wish to study the lichens of the fascinating and complex marine littoral environment. It is evident from the literature and from inquiries directed to the author that the marine lichen flora presents an interesting enigma to biologists of diverse disciplines. It is hoped that this paper will help them in studying, recognizing, and accurately reporting the lichens of the littoral zone.

A lichen is not "a plant" but rather a life or growth form comprised of two kinds of plants, a fungus and an alga, growing together in a symbiotic relationship. Although botanists differ as to the exact nature of the symbiotic relationship, each member of the relationship seems to benefit from the other. In reality, there are probably different kinds of relationships in different lichens. Most lichens are fungus dominated, i.e., the shape and most of the mass of the lichen is derived from the fungus. All the marine lichens treated in this manual, except for the genus *Lichina*, are fungus dominated and the fungus is an Ascomycete.

Marine lichens occur in three growth forms: fruticose, foliose, and crustose. Fruticose forms are usually upright or pendant in relationship to the substrate; they stand out away from the substrate. *Lichina*, the only genus of fruticose lichens in the littoral region grows in a shrublike form. Foliose forms, as the name implies, have a leafy appearance, often in rosette form, and may be removed from the substrate. The only genus of foliose lichens in the littoral region is *Xanthoria*. Crustose forms often appear as discolored areas on rocks and are usually destroyed if one attempts to remove them from the substrate. They may be shiny or dull, black, green, or brown. Most marine lichens are crustose and grow on rocks; one species, *Arthopyrenia halodytes*, grows on barnacles.

Lichens may be found in a continuous range of habitats, from low tide to mountain tops. The species included in this manual are those found in the intertidal zone plus the normal spray zone but not what is often called the "storm spray zone."

Some of the lichens in this manual are obligate marine lichens, i.e., they grow only where they are struck directly by saltwater. Others are facultative, being found also in areas remote from the sea. My criterion for including a facultative lichen is its occurrence with, or at the same height on the shore as, an obligate marine species.

## METHODS OF COLLECTION AND STUDYING

Marine lichens inhabit rocks or the barnacles attached to them. Most littoral lichens are crustose and cannot be removed from the rocks without being destroyed. They must be collected along with a piece of the rock substrate, using rock chisels and a 3-lb hammer. Ideally one should strive to collect specimens on pieces of rock small enough to fit well into 4" × 6" herbarium packets. This will not always be possible because the lichen may grow on an irregular piece of rock that does not break easily. Further preparation can be done in the laboratory, but it is usually easier to reduce the size of a rock in the field.

Once the specimen is removed it must be placed in a suitable container. Paper bags are quite satisfactory if the bag is strong. Unfortunately, the specimens are often wet, and the wet bag may need to be placed in another bag. Plastic or other waterproof bags are not desirable since they retard drying and promote molding. If a waterproof bag is used in the field, the specimen should be transferred to a paper bag and air dried within a day of collection.

A rock saw would seem to provide a fairly ideal solution to the problem of shaping rocks for herbarium packets in the laboratory. However, the use of a rock saw requires a liquid coolant to protect the blade. In preparing lichen specimens, water should be used rather than the oil employed in lapidary work. This works well with nonlittoral specimens, but with littoral lichens the soaking that results from the water coolant and the additional water required to rinse the specimen causes excessive reticulation that is detrimental to future study.

Hydraulic devices are available which break rocks by applying pressure to chisel-like jaws. These produce fractures in the rocks that are not as neat or predictable as the cut of a saw but they do avoid reticulation and are quite satisfactory.

After sizing, the rocks should be glued to cards of suitable size. This prevents abrasion of the specimens and degradation of the rock. Also, it provides a way to permanently identify the rock fragments examined for the lichen in question.

Many of the diagnostic characteristics of littoral lichens are readily observed with a dissecting microscope at a magnification of 20 power. Bright illumination is important because of the dark color of many thalli, especially in the genus *Verrucaria*. Thalli should be observed in both wet and dry conditions. Water added to the thallus sparingly to avoid unnatural reticulation often increases its transparency, thus revealing subsurface patterns.

<sup>1</sup>Science Department, Lansing Community College, Lansing, MI 48914.

Sections of fruiting structures may be made by hand with a razor blade. The small size of the perithecia of many species of *Verrucaria* are difficult but not impossible to section. A double edged razor blade, broken lengthwise, is most suitable.

Microtome sections are complicated by the thin crustose nature of the thalli and their adherence to the rock substrate. Furthermore the involucrella of pyrenocarpous lichens are hard and brittle and do not respond well to the usual paraffin imbedding techniques.

Two techniques employing a freezing microtome are satisfactory. One technique involves pouring a shallow layer of agar in a small container. The perithecium is moistened several times with water containing a small amount of wetting agent, such as alcohol. The perithecium and the subtending and surrounding thallus are then scooped from the rock with a razor blade, taking care to lift the entire perithecium from the rock. Faulty diagnosis will result if the base of the perithecium is left on the rock. The thallus and perithecium are then transferred to the surface of the agar. A drop of melted agar placed over the lichen material embeds it between the two layers of agar. A cube cut from the agar is then placed on the freezing microtome so that the thallus is perpendicular to the blade and the vertical axis of the perithecium is parallel to the blade. The material is then frozen and sectioned.

The other technique involves commercially available synthetic plastic materials intended for embedding frozen sections. A mound is built up on the microtome's object disc and frozen. A vertical face is cut facing and perpendicular to the blade. The lichen material to be cut is prepared as before and then pressed firmly against the embedding material. The pressure melts the plastic and when the pressure is released the plastic and embedding lichen fuse and freeze solid.

Both techniques have the disadvantage of leaving visible residues on the slide surrounding the sections. This is a problem only if the slide is to be photographed.

Some species of lichens give a color reaction to potassium hydroxide. A drop of 10% solution is applied with a dropping pipette or capillary tube, directly to the cortex, or to medulla exposed by fragmentation or an incision.

Santesson (1939) described a number of environmentally induced morphological variations in littoral lichens in general and described in detail the variations of certain selected species. Both Weber (1962) and Santesson (1939) have emphasized the importance of understanding the range of variation induced by the environment.

The author has traced variations of single thalli from continuous to areolate and from smooth to ridged. The author has also observed variations of perithecia from sunken to prominently raised on a single thallus. Even the darkness of the lower side of the excipulum (inner lining of perithecium) is quite variable within a single species. Shade modification is well known and predictable among littoral lichens. Shade causes lighter pigmentation and reduction in size and number of juga (black pegs, lumps, or ridges protruding from the surface). Some species that are distinct in appearance when growing in good illumination appear much less distinct when growing in the shade. The distinguishing features of a species are frequently reduced by the shade modification. As a result there is considerable taxonomic confusion among the shade modifications of *Verrucaria striatula*, *V. ditmarsica*, and, to a lesser degree, *V. erichsenii*. Too much stress can be placed on perithecium size. Variations of perithecium size on a single thallus beyond the range accepted in some taxonomic keys have been observed. Thus the taxonomic character "perithecia slightly smaller (or larger) than . . ." should be regarded with suspicion.

If one's study is restricted to a few specimens, it is easy to see dichotomy among the species examined. As the number of specimens increases, the kinds and degrees of variations also increase and extreme forms are bridged by lesser variations. Since the littoral environment is one of great physical contrasts and many microhabitats, it is not surprising that considerable taxonomically confusing variations in the lichens have resulted.

## ECOLOGY

Between low and high tide marks the rocks of the shore are largely covered by macroalgae such as *Fucus* sp. Among the holdfasts of such algae, the marine lichens compete for space with barnacles, Bryozoa, and such algae as *Hildenbrandia* and *Lithothamnium*. The lichen *Arthopyrenia halodytes* often occupies the shells of the barnacles with which the other lichens compete. Perithecia, the cone-like fruiting structures of marine lichens, are often seen protruding through the thalli of *Hildenbrandia* or *Lithothamnium* which have overgrown them. Such competition with the lichen *Verrucaria mucosa* has mixed results; either the lichen or the alga may establish itself on top. Only the lichen genera *Arthopyrenia*, *Stigidium*, and *Verrucaria* are found throughout this zone of the shore. The *Verrucaria* species *maura* and *ceuthocarpa* do not extend very far down into this zone.

From the high tide mark upward for about 0.5 m is the barnacle belt. The barnacles are so successful in the competition for space that only their shells are available as a substrate for lichens. The lichen *Arthopyrenia halodytes* is found here in pits dissolved into the barnacle shells.

Extending upward from the barnacle belt is the black belt populated by various species of *Verrucaria* in competition with blue-green algae, especially of the genus *Calothrix*.

Investigators in northern Europe find a well defined orange belt above the black belt and a white "Ramalina belt" above that. In northeastern North America the orange belt is intermittent or absent and the "Ramalina belt" is entirely absent. The orange belt, where present, is comprised of members of the genera *Caloplaca* and *Xanthoria*. *Lichina confinis*, a black fruticose lichen, may be found in this belt or extending down to the black belt. Various other lichens may extend into the orange belt but in the few and incomplete orange belts encountered in northeastern North America by the author, only *Lecanora grantii*, a gray crustose lichen with cup-like fruiting bodies, was found. Nothing above the orange belt was considered in this study because it is the highest zone to contain obligate marine lichens.

The lichen flora collected at the northern end of the study range was comprised of 22 species. At the southern end of the range the lichen flora was reduced to two species. In an attempt to explain the distribution in terms of environmental cause, a multiple regression analysis was used to assess the impact of environmental factors on the success of individual species and on the general diversity of species. The environmental factors whose individual and interactive effects were computed are: salinity, air and water temperatures, solar insolation, and tidal range. No simple answers emerged either for the success of any species or for general diversity. However, by tallying the number of times that each environmental factor was involved as one of the most important influences, the following frequencies resulted: salinity, 21; insolation, 15; air temperature, 12; tidal range, 7; and water temperature, 2.

Where sufficient collections were made to provide adequate data, vertical distributions of the various marine lichens were graphed (Figs. 1-8). In these graphs the extent above mean high

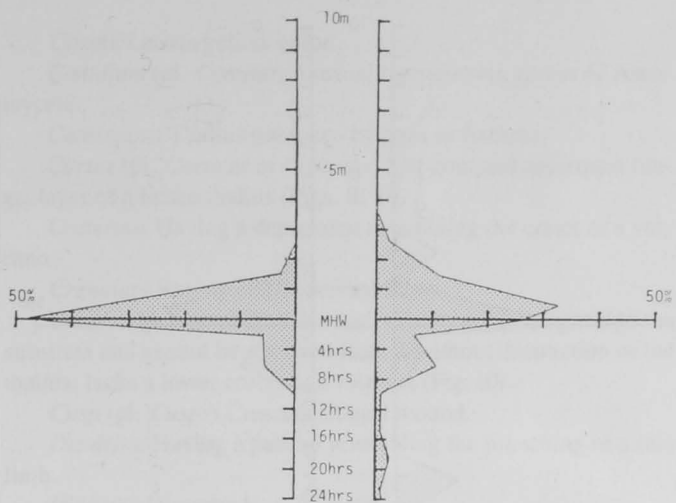

Figure 1.—Vertical distribution of *Arthopyrenia halodytes*.

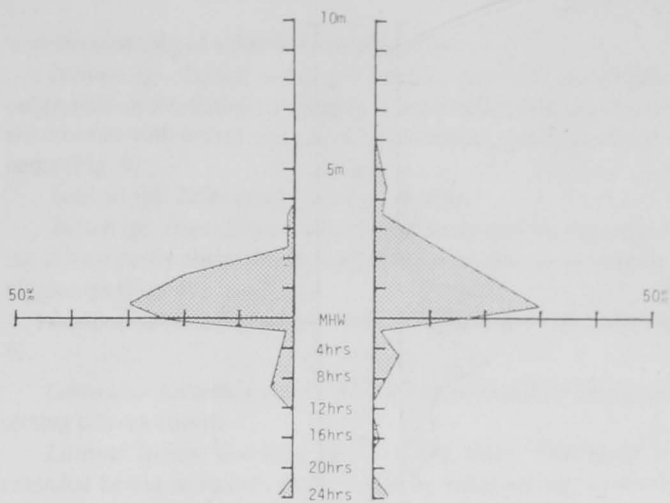

Figure 4.—Vertical distribution of *Verrucaria erichsenii*.

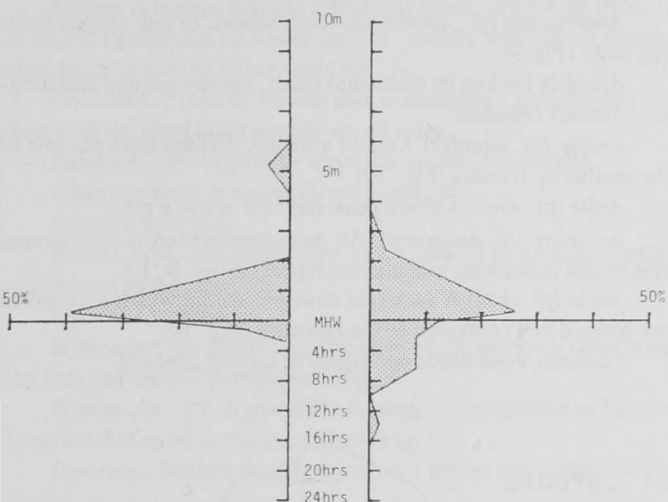

Figure 2.—Vertical distribution of *Verrucaria degelii*.

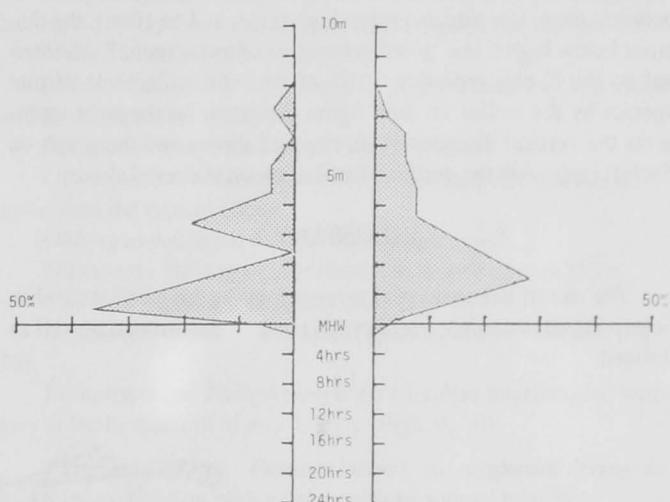

Figure 5.—Vertical distribution of *Verrucaria maura*.

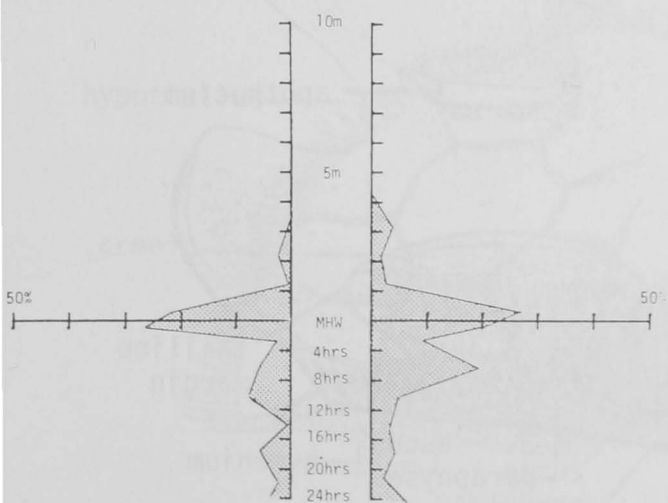

Figure 3.—Vertical distribution of *Verrucaria ditmarsica*.

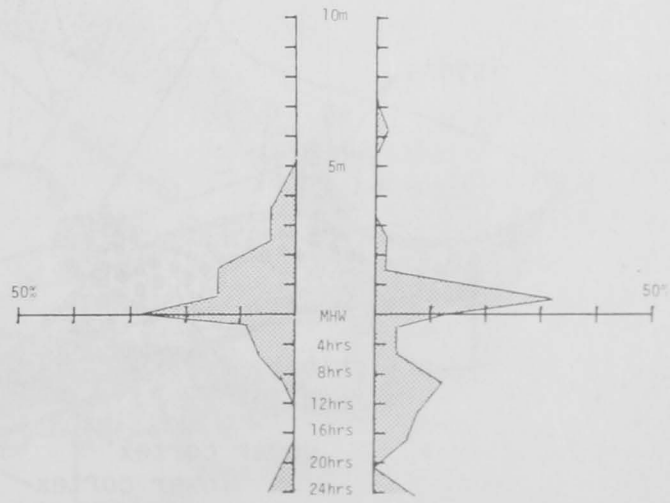

Figure 6.—Vertical distribution of *Verrucaria microspora*.

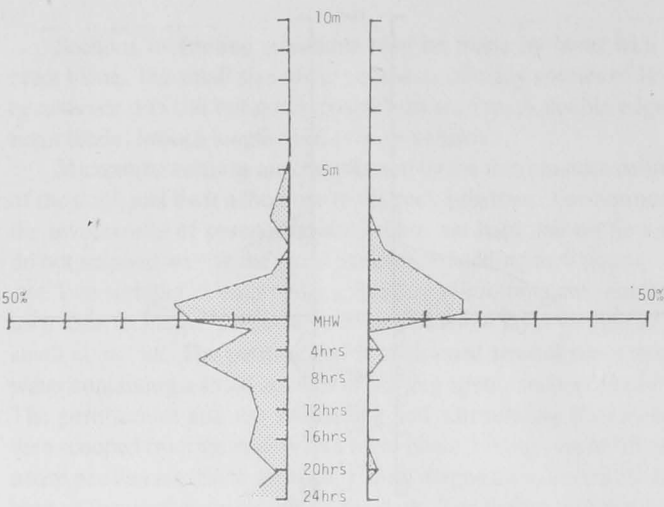

Figure 7.—Vertical distribution of *Verrucaria mucosa*.

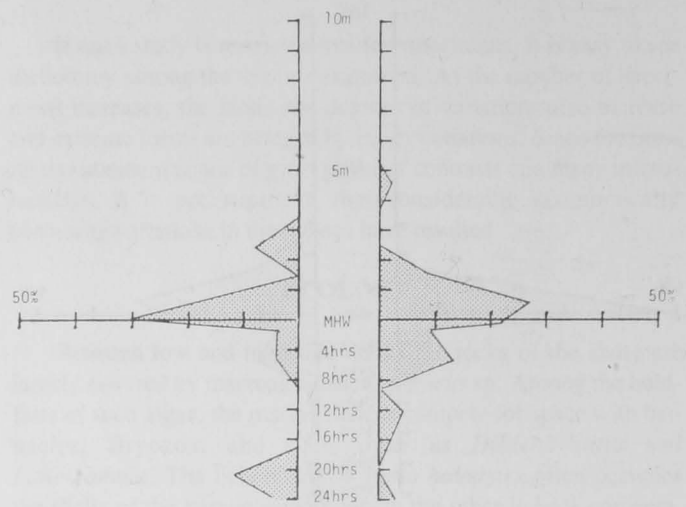

Figure 8.—Vertical distribution of *Verrucaria striatula*.

tide is given in meters. Due to the great variation in the distance between mean low tide and mean high tide (ca. 1 to 10 m), the distance below high tide is given in hours of submergence. Each interval on the X-axis represents 10% of the total collections of that species by the author. In each figure the graph on the right represents the vertical distribution on exposed shores and the graph on the left represents the vertical distribution on sheltered shores.

### GLOSSARY

The use of lichenological terminology in this publication has been reduced to a minimum. Several terms are illustrated as well as defined.

*Apical* At the tip or apex (Fig. 9).

*Apothecium* (pl. *Apothecia*) Disc, saucer, or cup shaped fruiting body (Fig. 9).

*Areolate* Broken by clefts into small, usually angular and irregular patches (areoles).

*Areole* (pl. *Areoles*) Area of a thallus divided from the rest of the thallus by fissures (Fig. 10).

*Arête* (pl. *Arêtes*) Sharp peak elevated above a ridge.

*Ascocarp* (pl. *Ascocarps*) An Ascomycete fruiting body giving rise to and containing asci and ascospores (Figs. 9, 10).

*Ascus* (pl. *Asci*) A sack-like structure within which ascospores are formed and contained in the ascocarp (Fig. 10).

*Carbonaceous* Made up largely of carbon deposits.

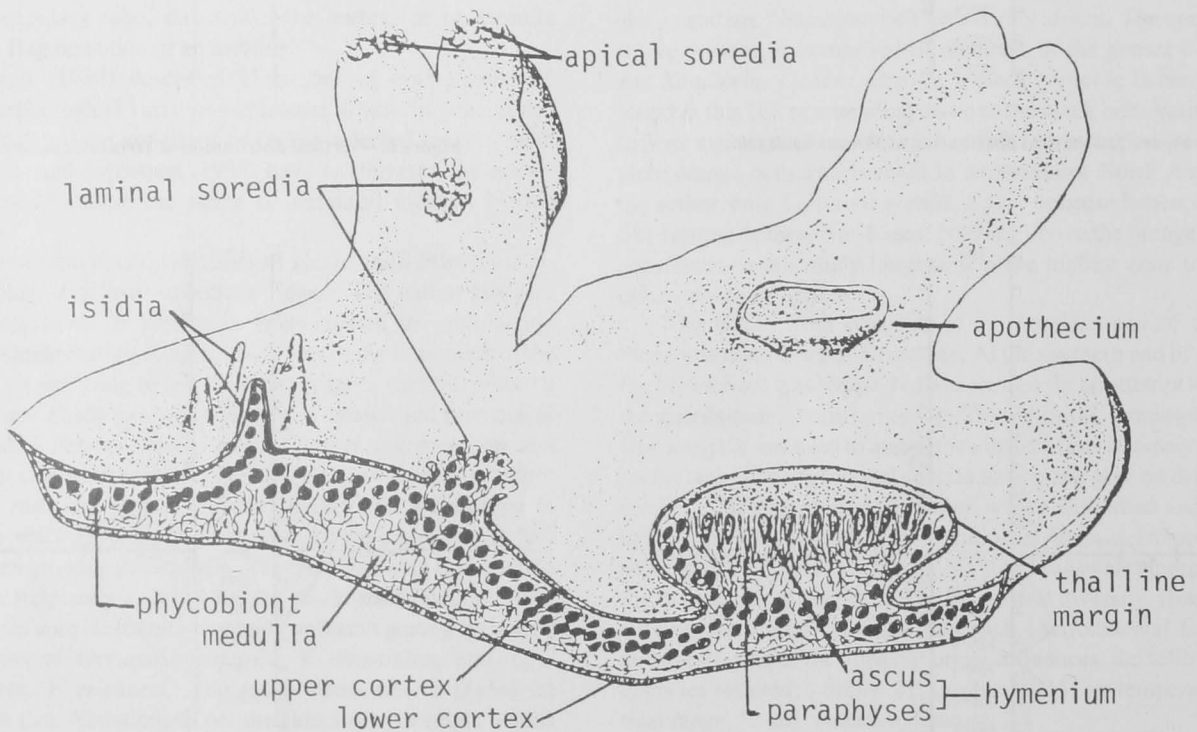

Figure 9.—Composite foliose lichen with apothecia.

*Citrine* Lemon yellow color.

*Conidium* (pl. *Conidia*) Asexual reproductive spores of Ascomycete.

*Continuous* Thallus unbroken by gaps or fissures.

*Cortex* (pl. *Cortices* or *Cortexes*) The compact outermost fungal layer of a lichen thallus (Figs. 9, 10).

*Craterous* Having a depression resembling the crater of a volcano.

*Crenulate* Having small rounded lobes.

*Crustose* A type of thallus which usually adheres tightly to the substrate and cannot be removed from it without destruction of the thallus; lacks a lower cortex and rhizines (Fig. 10).

*Cusp* (pl. *Cusps*) Crescent shaped mound.

*Dendritic* Having a pattern resembling the branching of a tree limb.

*Dispersed* Scattered.

*Endolithic* Growing within the rock substrate.

*Epithecium* (pl. *Epithecia*) Covering of the hymenium.

*Evaginate* To protrude as if a pocket turned inside-out.

*Excipulum* (pl. *Excipula*) As used here, the inner wall of a perithecium.

*Foliose* A type of thallus, leaflike or lobed, often with rhizines or hairlike processes on lower surface, usually with lower cortex, algal layer limited to upper side (Fig. 9).

*Fruticose* A type of thallus that is shrublike, stalked, or pendant with the algal layer usually on all sides.

*Fusiform* Narrowed both ways from a swollen middle.

*Glabrous* Having a smooth even surface.

*Globose* Spherical.

*Holdfast* (pl. *Holdfasts*) The basal portion of an algal thallus attaching it to the substrate.

*Hyaline* Colorless.

*Hymenium* (pl. *Hymenia*) The layer of the ascocarp containing the asci and usually paraphyses (Fig. 9).

*Hypothallus* (pl. *Hypothalli*) A marginal outgrowth of hyphae from the thallus of a crustose lichen (Fig. 10).

*Immersed* Sunken mostly or entirely below the surface of the thallus.

*Impressed* Indented.

*Involucrellum* (pl. *Involucrella*) The usually black and carbonaceous covering of a perithecium (Fig. 10).

*Isidium* (pl. *Isidia*) Small cylindrical, coralloid, or globose outgrowths of the thallus serving as vegetative disseminules. They are covered with cortex and contain both fungal and algal components (Fig. 9).

*Isthmus* (pl. *Isthmuses*) A narrow passage.

*Jugum* (pl. *Juga*) Protrusions of carbonaceous material extending at least partly above the thallus surface as ridges, pegs, or irregular lumps (Fig. 10).

*Laminal* On the flat surface of the thallus (usually upper) (Fig. 9).

*Lenticular* An area, pointed at each end, inclosed by two intersecting convex curves.

*Littoral lichen* Growing between the tides. The term is extended herein to include those struck by saltwater due to wave action and is used interchangeably with the term "marine."

*Locule* (pl. *Locules*) Chamber or cavity.

*Medulla* (pl. *Medullae*) An area of loosely packed hyphae internal to the thallus and its projections such as podetia, isidia, etc. (Figs. 9, 10).

*Morphotype* (pl. *Morphotypes*) A thallus of a given species having a different appearance than other members of the species.

*Necral* Occurring after death.

*Necral reticulation* A network of cracks caused by treatment and/or storage after collection.

*Nodular convex* Like a small rounded lump.

*Oblong ellipsoid* In the form of an elongated circle; more elongated than the typical ellipse.

*Oblong ovoid* In the form of an elongated oval.

*Olivaceous* Having a color similar to that of a green olive.

*Orbicular* Spherical or nearly so.

*Ostiole* (pl. *Ostioles*) The apical opening of a perithecium (Fig. 10).

*Paraphysis* (pl. *Paraphyses*) Sterile hyphae intermingled with asci in the hymenium of an ascocarp (Figs. 9, 10).

*Parasymbiont* (pl. *Parasymbionts*) An organism living in harmless association with another without mutual benefit.

*Pendant* Dangling.

*Perithecioid* In the shape of a perithecium.

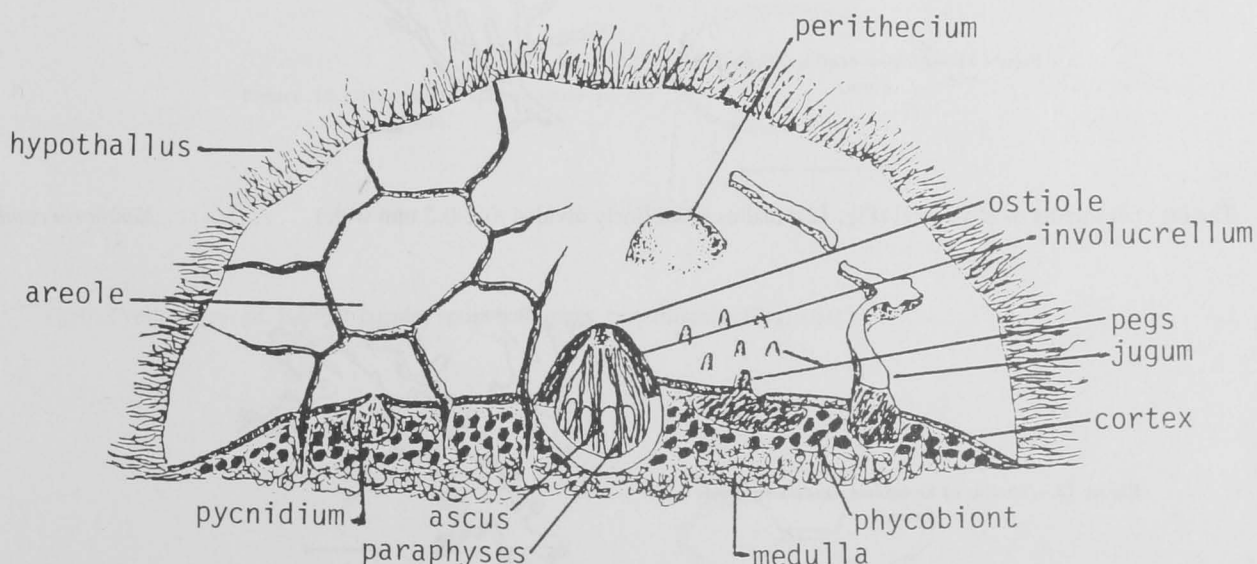

Figure 10.—Composite crustose lichen with perithecia.



*Perithecium* (pl. *Perithecia*) A flask-shaped ascocarp enclosed except for the apical pore (ostiole). It is usually more or less sunken into the thallus (Fig. 10).

*Phycobiont* (pl. *Phycobionts*) The algal member of the lichen symbiosis (Figs. 9, 10).

*Pseudoseptum* (pl. *Pseudosepta*) Appearing to be an internal wall but not composed of the same material forming the cell wall.

*Pycnidium* (pl. *Pycnidia*) Small flask-shaped to globular structures resembling perithecia but containing conidia instead of asci and ascospores.

*Pyrenocarpous* Having perithecia.

*Pyrenolichen* (pl. *Pyrenolichens*) Lichen having perithecia (Fig. 10).

*Reniform* Kidney shaped.

*Reticulation* A netlike appearance.

*Rimose* Having minute cracks, usually referring to a form of areolation.

*Saxicolous* Growing on a rock or rock-like substrate.

*Sessile* Not supported by a stalk.

*Simple* Describing a spore having a single, undivided cavity.

*Sorediate* Having soredia on the thallus.

*Soredium* (pl. *Soredia*) A means of vegetative reproduction of the lichen consisting of masses of hyphae and their associated algae rupturing through and not covered by or containing cortex (Fig. 9).

*Spray zone* (pl. *zones*) That area above high tide that is struck by drops of seawater resulting from the impact of waves on the rocky shore under nonstorm conditions.

*Storm spray zone* (pl. *zones*) That area, above the usual spray zone, that is sprayed with seawater only during a storm.

*Subconvex* Barely curved outward.

*Subeffuse* Having boundaries that are poorly distinguished.

*Submerged* Sunken entirely or mostly below the upper surface of the thallus.

*Submoniliform* Having constrictions at intervals giving an appearance nearly like a string of beads but not so pronounced.

*Thalline margin* (pl. *margins*) Apothecial rim having the same composition as the thallus (Fig. 9).

*Thallus* (pl. *Thalli*) The lichen body containing both algal and fungal components.

*Tuberculate* Having a warty appearance.

### ILLUSTRATED KEY TO SPECIES

The key is based primarily on characteristics that can be observed with a dissecting microscope at 20× magnification; in some cases observation of spores with a compound microscope may be required.

The vertical sections of perithecia of *Verrucaria* species illustrated in the key are typical sections.

Because of the extreme degree of variation of species of marine lichens (especially of *Verrucaria*), identification of species from the key alone should be regarded as tentative until the more detailed description in the Annotated List of Species is read.

Five species from the Canadian Maritime Provinces are included even though at present they are not known from the eastern United States. At least one species, *Verrucaria maura*, has not been collected in the eastern United States recently but the author has seen specimens collected from the area over 50 yr ago.

- 1      Thallus foliose (Fig. 9); always orange and KOH + purple .....2
- 1      Thallus crustose (Fig. 10) only in a few species orange and KOH + purple .....4
- 1      Thallus erect, fruticose, composed primarily of algal (*Calothrix*) filaments; ascocarp perithecioid (Fig. 11) .... *Lichina confinis*

Figure 11.—*Lichina confinis*. Scale is 0.1 mm.



- 2 (J)    Thallus with soredia mostly apical (Fig. 12); thallus lobes finely divided (0.2-0.5 mm wide) ..... *Xanthoria candelaria*

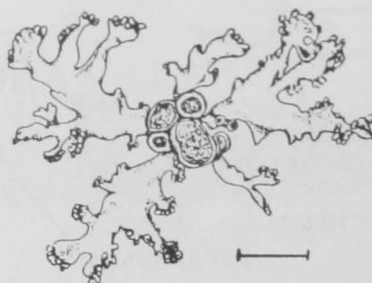
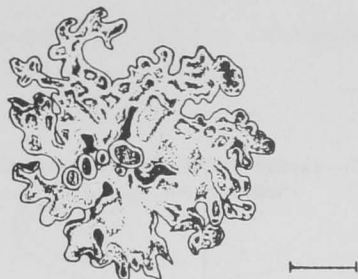

Figure 12.—Thallus of *Xanthoria candelaria*. Scale is 1 mm.

- 2 (J)    Thallus not sorediate, lobes wider than 0.5 mm .....3

3 (2) Lobes flattened and 1 mm or more broad (Fig. 13) ..... *Xanthoria parietina*

Figure 13.—Thallus of *Xanthoria parietina*. Scale is 1 mm.



3 (2) Lobes nodular-convex, lobes less than 1 mm wide (Fig. 14) ..... *Xanthoria elegans*

Figure 14.—Thallus of *Xanthoria elegans*. Scale is 1 mm.

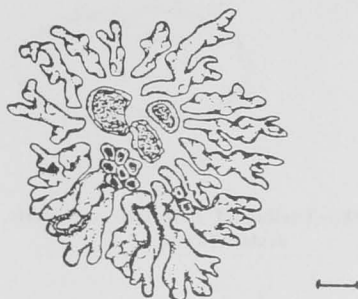

4 (1) Ascocarp an apothecium (Fig. 9); thallus light (shades of white, gray, or yellow orange) ..... 5

4 (1) Ascocarp a perithecium (Fig. 10); occasionally more or less immersed with only ostiole showing; thallus dark (shades of green, brown, or black) or apparently absent ..... 9

5 (4) Thallus whitish to gray, KOH + yellow; spores colorless, one-celled (Fig. 15),  $11-18 \times 6-8.5 \mu\text{m}$  ..... *Lecanora grantii*

Figure 15.—One-celled spore. Scale is  $10 \mu\text{m}$ .

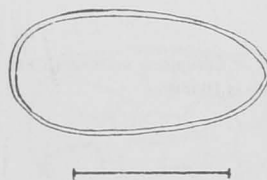

5 (4) Thallus yellow orange, KOH + purple; spores colorless, polarilocular (Fig. 16) ..... 6

Figure 16.—Polarilocular spore. Scale is  $10 \mu\text{m}$ .

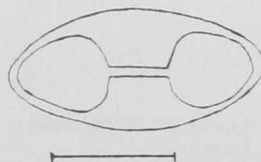

6 (5) Thallus covered with globose isidia (Fig. 17); spores  $9-14 \times 4-6\mu\text{m}$  ..... *Caloplaca verruculifera*

Figure 17.—Thallus of *Caloplaca verruculifera*.  
Scale is 10 mm.

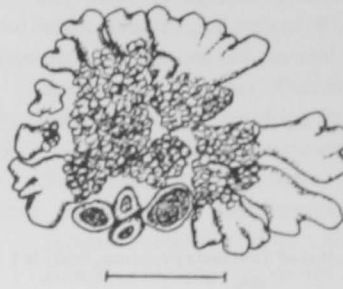

6 (5) Thallus without isidia ..... 7

7 (6) Thallus forming circular patches with radiating lobes (Fig. 18); spores  $10-15 \times 5-7\mu\text{m}$  ..... *Caloplaca scopularis*

Figure 18.—Thallus of *Caloplaca scopularis*.  
Scale is 10 mm.

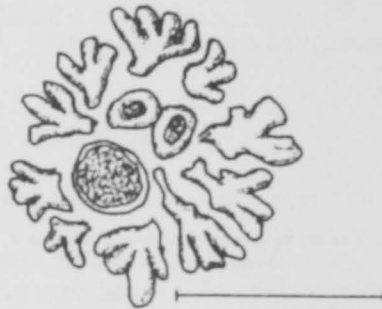

7 (6) Thallus irregular, composed of scattered lobes or numerous granules ..... 8

8 (7) Thallus citrine of granules 1-3 mm diameter (Fig. 19), spores  $10-18 \times 5-8\mu\text{m}$  ..... *Caloplaca microthallina*

Figure 19.—Thallus of *Caloplaca microthallina*.  
Scale is 10 mm.



8 (7) Thallus orange yellow, marginal lobules subconvex oriented in radiating manner; spores  $10-14 \times 5-7\mu\text{m}$  (Fig. 20)  
..... *Caloplaca marina*

Figure 20.—Thallus of *Caloplaca marina*. Scale is  
1 mm.



9 (4)	Spores one-celled .....	11
9 (4)	Spores more than one-celled .....	10
10 (9)	Growing on thallus of <i>Verrucariae</i> ; paraphyses gelatinizing, spores 10-15 × 3.5-5μm with 4 locules and distinct central septum (Fig. 21) .....	<i>Stigmatidium marinum</i>

Figure 21.—Spore of *Stigmatidium marinum*. Scale is 10μm.

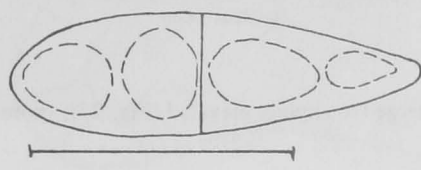

10 (9)	On barnacles or rock; thallus scant to evidently lacking; paraphyses persistent, spores 9-20 × 4-7μm with two locules (Fig. 22) .....	<i>Arthopyrenia halodytes</i>
--------	---	-------------------------------

Figure 22.—Spore of *Arthopyrenia halodytes*. Scale is 10μm.

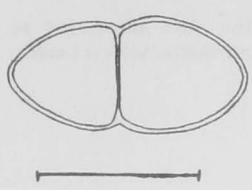

11 (9)	Thallus with pegs and/or ridges present (Fig. 23) .....	16
--------	---	----

Figure 23.—a. Thallus with pegs. b. Thallus with ridges. Scale is 1 mm.

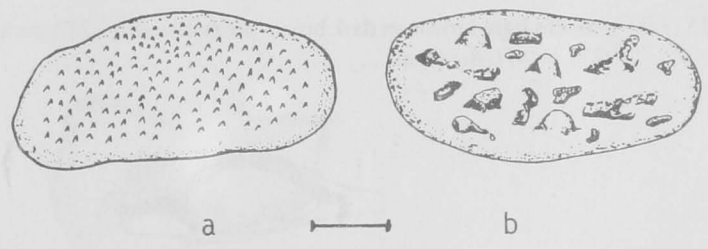

11 (9)	Thallus smooth; pegs and ridges lacking .....	12
--------	---	----

12 (11)	Thallus areolate (divided into fields by fissures, Fig. 24) .....	15
---------	---	----

Figure 24.—Areolate thallus. Scale is 1 mm.

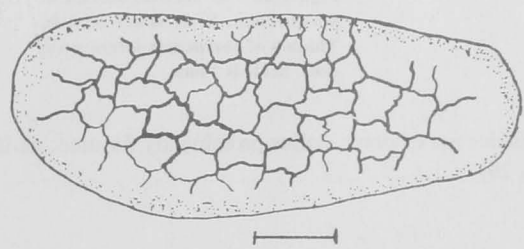

12 (11)	Thallus continuous or discontinuous but not areolate (Fig. 25) .....	13
---------	--	----

Figure 25.—a. Continuous thallus. b. Discontinuous thallus. Scale is 1 mm.

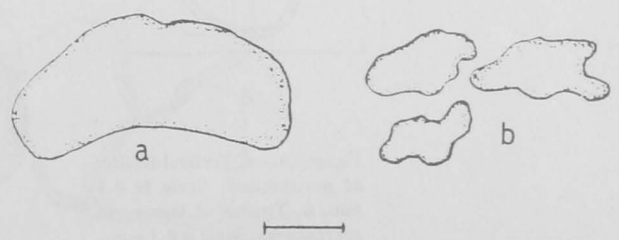

13 (12) Perithecia elevated, often shiny, dome-shaped to hemispherical or sometimes pointed (Fig. 26) .....14

Figure 26.—Thallus with elevated perithecia.  
Scale is 1 mm.

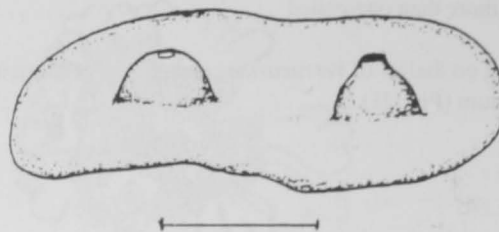

13 (12) Perithecia submerged to slightly elevated (Fig. 27); spores  $8-11 \times 4-5 \mu\text{m}$ ; thallus thick, green to greenish-black .....*Verrucaria mucosa*

Figure 27.—Thallus with submerged to slightly elevated perithecia. Scale is 1 mm.



14 (13) Spores  $6-11 \times 3-5 \mu\text{m}$  .....*Verrucaria microspora*

14 (13) Spores  $18-22 \times 8-9 \mu\text{m}$  .....*Verrucaria silicicola*

15 (12) Areoles light brown on dark brown prothallus (Fig. 28); perithecia brown; spores thick walled (11.5) 15-23 (27)  $\times$  (4) 6-8(14) $\mu\text{m}$  .....*Verrucaria internigrescens*



a

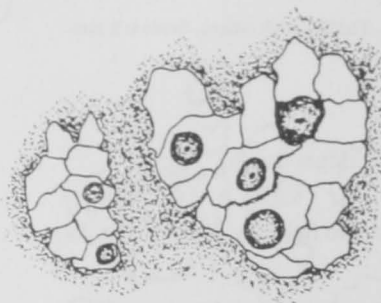

b

Figure 28.—a. Vertical section of perithecium. Scale is 0.1 mm. b. Thallus of *Verrucaria internigrescens*. Scale is 1 mm.

15 (12) Prothallus not evident; thallus prominently fissured; perithecia brown or black; spores thin-walled,  $9-12 \times 5-6 \mu\text{m}$  (Fig. 29) .....*Verrucaria ceuthocarpa*

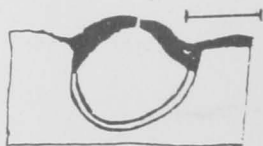

a

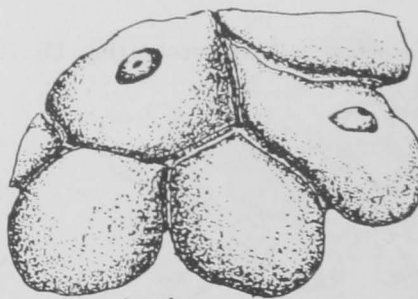

Figure 29.—a. Vertical section of perithecium. Scale is 0.1 mm. b. Thallus of *Verrucaria ceuthocarpa*. Scale is 0.1 mm.

Figure 30.—Areolate thallus. Scale is 1 mm.

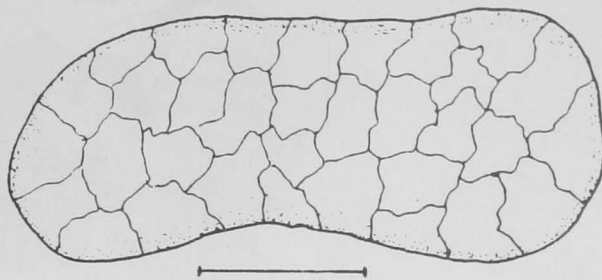

Figure 31.—Areoles bordered by juga. Scale is 0.1 mm.

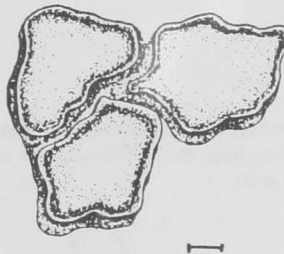
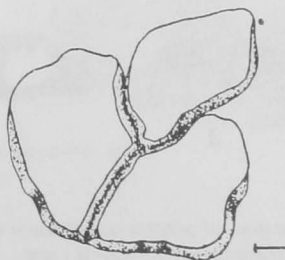

Figure 32.—Areoles without juga. Scale is 0.1 mm.



18 (17) Perithecia usually immersed, ostiole border frequently raised, spores  $9-12 \times 5-6\mu\text{m}$ ; juga rarely limited to borders of areoles, usually scattered within areoles (Fig. 33); thallus more translucent wet than dry . . . . . *Verrucaria degelii*

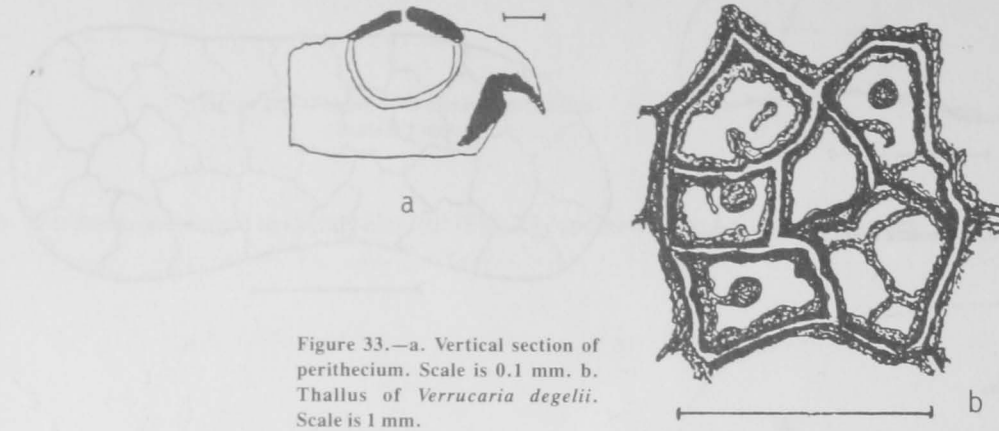

Figure 33.—a. Vertical section of perithecium. Scale is 0.1 mm. b. Thallus of *Verrucaria degelii*. Scale is 1 mm.

18 (17) Perithecia elevated, often craterous, juga forming a reticulate pattern (Fig. 34); thallus opaque dry, translucent wet . . . . . *Verrucaria amphibia*

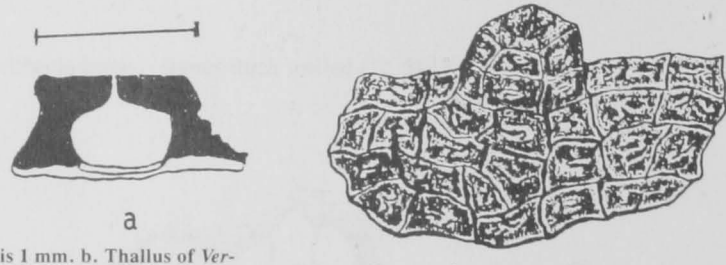

Figure 34.—a. Vertical section of perithecium. Scale is 1 mm. b. Thallus of *Verrucaria amphibia*. (Specimen illustrated is thicker and stored longer than that in Fig. 39b.) Scale is 1 mm.

19 (17) Juga appearing as pegs protruding from thallus and also to some extent on perithecia; thallus rimose-areolate, usually blackish-brown and opaque (wet or dry); perithecia often large, 0.3-0.7 mm diameter, immersed or elevated, gently sloped to rising abruptly, sometimes depressed on top (Fig. 35); spores  $10-20 \times 7-10\mu\text{m}$  . . . . . *Verrucaria maura*

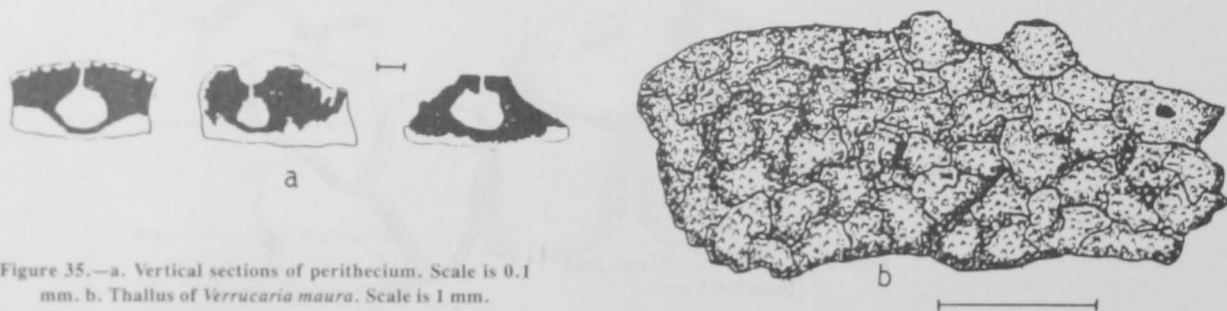

Figure 35.—a. Vertical sections of perithecium. Scale is 0.1 mm. b. Thallus of *Verrucaria maura*. Scale is 1 mm.

- 9 (17) Juga raised or immersed, appearing as usually irregular and often branched ridges often merging with or continuing over perithecia, if immersed appearing as black spots when wet; thallus blackish-brown, becoming brown to amber and translucent when wet; perithecia spreading and irregular at base, up to 0.3 mm diameter (Fig. 36); spores  $8-9 \times 4.5-7\mu\text{m}$  ..... *Verrucaria erichsenii*

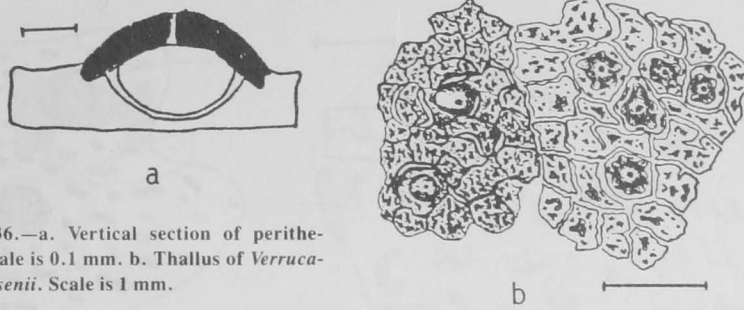

Figure 36.—a. Vertical section of perithecium. Scale is 0.1 mm. b. Thallus of *Verrucaria erichsenii*. Scale is 1 mm.

- 20 (16) Perithecia immersed, spores  $9-12 \times 5-6\mu\text{m}$ ; juga appearing as long sharp black ridges on borders of thallus, sometimes extending across thallus, fissures occasionally develop along juga and simulate areolation; thallus usually green to cream colored (Fig. 37) ..... *Verrucaria degelii*

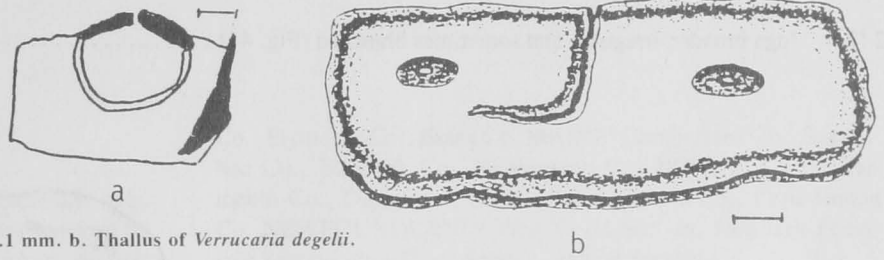

Figure 37.—a. Vertical section of perithecium. Scale is 0.1 mm. b. Thallus of *Verrucaria degelii*. Scale is 1 mm.

- 20 (16) Perithecia raised and prominent (Fig. 38) ..... 21

Figure 38.—Thallus with prominent raised perithecia.



- 21 (20) Juga inclosing lenticular areas giving appearance of ripples on water, continuing on perithecium to form reticular pattern. Perithecium elevated, often craterous (Fig. 39); spores  $9-20 \times 4-7.5\mu\text{m}$  ..... *Verrucaria amphibia*

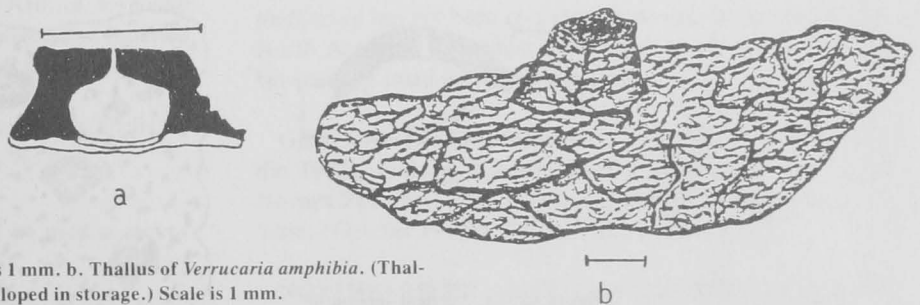

Figure 39.—a. Vertical section of perithecium. Scale is 1 mm. b. Thallus of *Verrucaria amphibia*. (Thallus thinner than Fig. 34b. Cracks developed in storage.) Scale is 1 mm.

- 21 (20) Juga scattered, not inclosing lenticular areas ..... 22



22 (21) Juga appearing as pegs, usually short ridges, usually straight but sometimes crescent shaped, sometimes coalescing with perithecium at base; thallus usually dark olive green but lighter and with fewer juga in shade; perithecia hemispherical, often shiny (Fig. 40); spores  $6-11 \times 3-5\mu\text{m}$  ..... *Verrucaria ditmarsica*

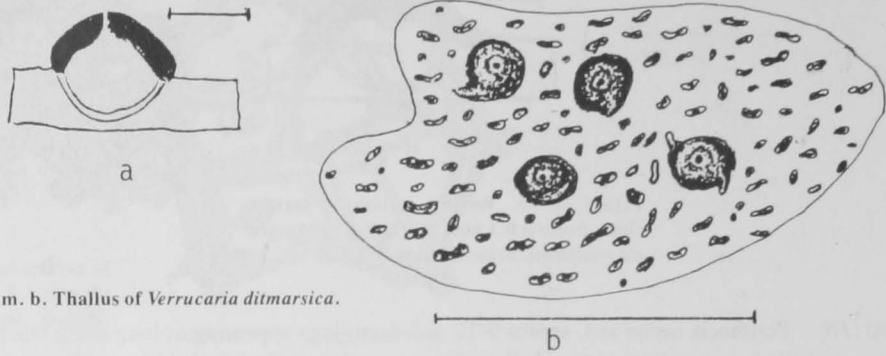

Figure 40.—a. Vertical section of perithecium. Scale is 0.1 mm. b. Thallus of *Verrucaria ditmarsica*. Scale is 1 mm.

22 (21) Juga broader, irregular, and sometimes branched (Fig. 41) ..... 23



Figure 41.—Thallus with broad, sometimes branched juga. Scale is 1 mm.

23 (22) Juga conspicuous, highly irregular, frequently branched, raised or immersed and appearing as conspicuous black spots in wet thallus, often merged with perithecia; wet thallus usually brown to amber and translucent (Fig. 42); perithecia up to 0.3 mm diameter, spores  $8-9 \times 4.5-7\mu\text{m}$  ..... *Verrucaria erichsenii*

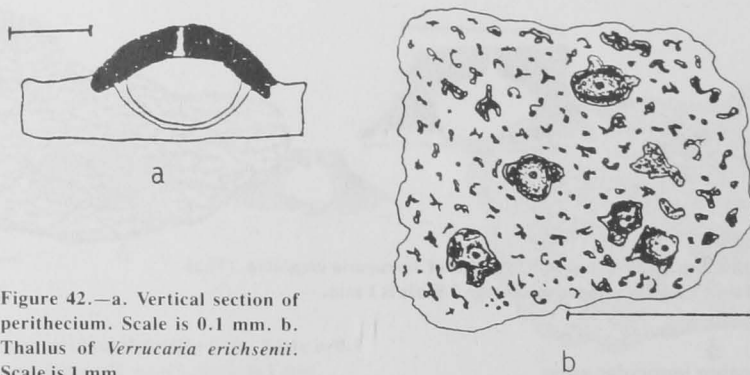

Figure 42.—a. Vertical section of perithecium. Scale is 0.1 mm. b. Thallus of *Verrucaria erichsenii*. Scale is 1 mm.

- 3 (22) Juga prominent, black, and shiny, much thicker than in *V. erichsenii*, frequently broadened into thick irregular plates, especially at thallus margin; thallus usually grass green but darker in the sun and depigments rapidly in shade or in storage; perithecia typically hemispherical to globular with flattened tops but may become quite irregular, angular, or dissected (Fig. 43); spores  $8-10 \times 4-6\mu\text{m}$  ..... *Verrucaria striatula*

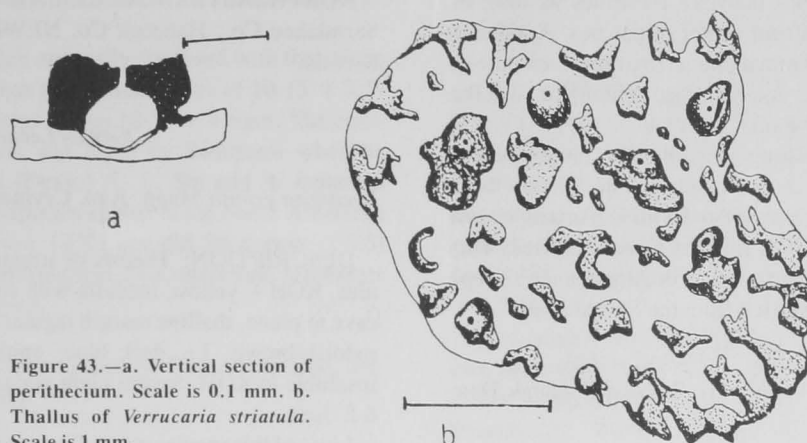

Figure 43.—a. Vertical section of perithecium. Scale is 0.1 mm. b. Thallus of *Verrucaria striatula*. Scale is 1 mm.

#### ANNOTATED LIST OF SPECIES

Where distributions were derived from the literature only, author and date are given. All other specimens were examined by the author. Where such specimens were collected by others, the collector's name is given followed by the identification of the herbarium retaining the specimen. The remaining distributions are from the author's collections.

#### Genus *Arthopyrenia*

*Arthopyrenia halodytes* (Nyl.) Arn. Ber. Bayer. Bot. Ges. 1:122. 1891. *Verrucaria halodytes* Nyl. Mem. Soc. Sci. Nat. Cherbourg 5:212. 1857.

**DESCRIPTION:** Thallus epilithic (siliceous rock), endolithic (calcareous rock and shells), yellowish if epilithic, greyish or blackish-brown if endolithic. Perithecium almost wholly immersed in substrate or sessile with black hemispherical to broadly conical involucrellum, 0.15 to 0.5 mm diameter, excipulum colorless to pale brown. Spores eight per ascus, ovoid, two-celled, one cell usually broader than the other,  $9-20 \times 4-7.5\mu\text{m}$ .

Swinscow (1965) considered this to be the only littoral species of the genus and treated *A. sublitoralis* (Leight.) Arn., *A. foveolata* A. L. Sm. and *A. gyalectoidea* Knowles as synonyms and reported a range of  $10-20 \times 5-10\mu\text{m}$  in spore size. Richard C. Harris (1975) treats this species as co. a *Pyrenocollema*.

*Arthopyrenia halodytes* is often associated with shells or calcareous rocks but may also be found on siliceous rock.

**GENERAL DISTRIBUTION:** Worldwide on marine shores (Santesson 1939:52-63).

**NORTHEASTERN AMERICAN DISTRIBUTION:** NEW JERSEY: Cape May Co. CONNECTICUT: New London Co. RHODE ISLAND: Newport Co. MASSACHUSETTS: Barnstable

Co., Plymouth Co., Essex Co. MAINE: Cumberland Co., Sagadahoc Co., Hancock Co., Washington Co. NOVA SCOTIA: Yarmouth Co., Digby Co., Halifax Co., Victoria Co., Cape Breton Co. NEWFOUNDLAND: West Coast Section, Northern Peninsula Section, East Coast Section, Avalon Section.

#### Genus *Caloplaca*

All of the littoral species of *Caloplaca* collected belong to the section Gasparrinia.

*Caloplaca marina* (Wedd.) DuRietz, Method. Grund. Modern. Pflanzensoziol. 170. 1921. *Lecanora marina* Wedd. Mem. Soc. Sci. Nat. Sherbourg 19:275. 1875.

**DESCRIPTION:** Thallus orange yellow to red orange, citrine in shade, orbicular, irregular, or subeffuse, small convex lobes contiguous or, in center of thallus, minutely granular or tuberculate, whitish prothallus sometimes visible. Apothecia reddish-orange, 0.5-1.0 mm diameter, plane to convex, margins entire or crenulate. Spores ellipsoid, polarilocular, isthmus about 0.3 length of spore,  $10-14 \times 5-7\mu\text{m}$ .

Wade (1965) found this species often associated with *Caloplaca thallincola* and *Verrucaria maura* in the British Isles. *Caloplaca thallincola* has not been collected, however, in the littoral zone of North America. The white hypothallus is seen in young growth between the small subconvex lobules.

**GENERAL DISTRIBUTION:** Norway, Sweden, Poland (Nordén 1972), Finland (Räsänen 1927), Germany (Erichsen 1957), Novaya Zemlya (Lynge 1928), England (Ferry and Sheard 1969), Wales (Fletcher 1973b), France (Werner MSC).

**NORTHEASTERN AMERICAN DISTRIBUTION:** MAINE: Cumberland Co., Hancock Co. NOVA SCOTIA: Yarmouth Co., Digby Co., Shelburne Co., Halifax Co. NEWFOUNDLAND: Northern Peninsula Section.

*Caloplaca microthallina* (Wedd.) Zahlbr. Cat. Lich. Univ. 7:247. 1931. *Lecanora microthallina* Wedd. Mem. Soc. Sci. Nat. Cherbourg 19:276. 1875.

**DESCRIPTION:** Thallus citrine, 1-3 mm diameter, comprised of scattered lobes on the periphery, scattered granules toward center, forming patches on rocks, lobes convex, 1-2 times as long as broad, tending toward granules near center of patches. Apothecia yellow to pale orange, 0.15-0.8 mm diameter, margins crenulate or entire. Spores oblong-ellipsoid, polarilocular, isthmus ca. 0.3 the length of the spores, 10-18 × 5-8 μm.

*Caloplaca microthallina* is distinguished by its minute granular thallus forming patches up to 3 mm diameter and by its citrine color. Wade (1965) found it often associated with *Verrucaria maura* in the British Isles. This also holds true for North America. This species is not previously reported from North America. In Europe this species is not commonly reported from the littoral zone.

**GENERAL DISTRIBUTION:** Norway, Sweden, Finland, Denmark (Nordin 1972).

**NORTHEASTERN AMERICAN DISTRIBUTION:** NOVA SCOTIA: Digby Co., Halifax Co., Cape Breton Co. NEWFOUNDLAND: West Coast Section, Northern Peninsula Section.

*Caloplaca scopularis* (Nyl.) Lett. Hedwegia 52:242. 1912. *Lecanora scopularis* Nyl. Flora 66:105. 1883.

**DESCRIPTION:** Thallus yellow orange to deep orange, radiate, up to 1.5 cm diameter, lobes narrow, 0.25-0.3 × 0.5-2.0 mm, convex, apices crenulate or branched, center of thallus usually thickly covered with apothecia. Apothecia orange, 0.5-0.75 mm diameter, margins entire. Spores ellipsoid, polarilocular, 10-15 × 5-7 μm, isthmus ca. 0.3 the length of the spore.

*Caloplaca scopularis* is unique among the littoral Caloplacae due to its radiating thallus. Wade (1965) indicated that this species resembles a small form of *C. heppiana* or *C. thallicola* but is distinguished by ellipsoid spores and the submoniliform nature of the upper parts of the paraphyses.

**GENERAL DISTRIBUTION:** Novaya Zemlya (Lyngby 1928), Norway, Sweden, Denmark (Nordin 1972), Finland (Räsänen 1927), Germany (Erichsen 1957), Japan (Nylander 1890).

**NORTHEASTERN AMERICAN DISTRIBUTION:** MAINE: Cumberland Co., Hancock Co. NOVA SCOTIA: Halifax Co., Victoria Co. NEWFOUNDLAND: West Coast Section, Avalon Section.

*Caloplaca verruculifera* (Vain.) Zahlbr. Cat. Lich. Univ. 7:272, 1931. *Placodium verruculifera* Vainio in Med. om Grön. 30:313. 1905.

**DESCRIPTION:** Thallus orange or yellow, up to 3 cm diameter, or dispersed, lobes 3-5 mm long, convex, center of thallus areolate, granular, isidia globose, spores oblong-ellipsoid, polarilocular, isthmus ca. 0.3 length of spore, 9-14 × 4-6 μm.

Specimens of this species, previously unreported from North America, were identified for the author by J. Poelt. It is easily confused with *Caloplaca granulosa* which also has globose isidia but

has smaller rosettes of 1-1.5 cm and shorter lobes of about 2 mm (Poelt 1969).

**GENERAL DISTRIBUTION:** Norway, Sweden, Finland, and Siberia (Nordin 1972).

**NORTHEASTERN AMERICAN DISTRIBUTION:** MAINE: Sagadahoc Co., Hancock Co. NEWFOUNDLAND: West Coast Section.

### Genus *Lecanora*

*Lecanora grantii* Magn. Ann. Cryptog. Exot. 5(1):21. 1932.

**DESCRIPTION:** Thallus of irregular whitish-grey large granules, KOH+ yellow, medulla with small crystals. Apothecia concave to plane, thalline margin regular to crenulate; hymenium dark reddish-brown, I+ dark blue; epithecium with small crystals, insoluble in KOH. Spores eight per ascus, oblong-ovoid, 11-18 × 6-8.5 μm.

Little of this species was collected since it extends down only into the upper limits of the littoral zone. The scant material collected conforms to the original material described from a log on a sea beach by Magnusson (1932).

**GENERAL DISTRIBUTION:** Washington (Magnuson 1932), British Columbia (Brodo MSC).

**NORTHEASTERN AMERICAN DISTRIBUTION:** MAINE: Sagadahoc Co. NEW YORK: Suffolk Co. (Latham MSC). NOVA SCOTIA: Shelburne Co. NEWFOUNDLAND: West Coast Section.

### Genus *Lichina*

*Lichina confinis* (O. Müll.) Ag. Sp. Algar. 1:105. 1821. *Lichen Confinis* O. Müll. Icon. Pl. Daniaw 5:5. 1872.

**DESCRIPTION:** Thallus fruticose, branches rounded in cross section, blackish-brown, phycobiont *Calothrix*. Ascocarps terminal, globose, perithecioid, small ostioles. Spores colorless, simple ovoid, 15-24 × 12-15 μm.

*Lichina confinis*, appearing as black tufts in the upper limits of the littoral zone, is the only fruticose lichen found in the area included in this treatment.

**GENERAL DISTRIBUTION:** England (Ferry and Sheard 1969), Wales (Fletcher 1973b), Finland (Räsänen 1927), Germany (Degelius 1939), Italy (Jatta 1909-1911), Norway (Havaas MSC), Sweden (Degelius MSC).

**NORTHEASTERN AMERICAN DISTRIBUTION:** MASSACHUSETTS: Essex Co. (Tuckerman 1882). NOVA SCOTIA: Cape Breton Co. (Lamb 1954). NEWFOUNDLAND: East Coast Section, Northern Peninsula Section, West Coast Section.

### Genus *Stigmidium*

*Stigmidium marinum* (Deak.) Swins. Lichenologist 3:55. 1965. *Sagedoa marina* Deak. Ann. Mag. Nat. Hist. I. 12:40, pl. 4, f. 13. 1954.

**DESCRIPTION:** Parasymbiont on littoral Verrucariae, especially *V. mucosa* and *V. microspora*, lacking a visible thallus of its own. Perithecia usually resembling that of host lichen, totally immersed on *V. mucosa* and hemispherical on *V. microspora*. Involucrellum black with pigment extending into hyaline excipulum. Spores eight per ascus, two-celled with each cell often divided by pseudosepta, upper cell usually slightly wider than the lower,  $10-15 \times 3.5-5\mu\text{m}$ .

The perithecia of *Stigidium* are easily confused with that of the host. *Stigidium*, however, has two-celled spores of  $10-15 \times 3.5-5\mu\text{m}$ . Swinscow (1965) reported spores  $10-15 \times 4-6\mu\text{m}$ . The combination *Stigidium marinum* was made by Swinscow when he united *Arthopyrenia marina* (Deak.) A. L. Sm and *A. leptotera* (Nyl.) Arn. Neither of these species appear in the North American checklist (Hale and Culberson 1970) nor did Swinscow (1965) report a specimen from North America. This, therefore, represents a new record for North America.

**GENERAL DISTRIBUTION:** Germany, Finland, Ireland, Jersey, England (Swinscow 1965).

**NORTHEASTERN AMERICAN DISTRIBUTION:** MAINE: Cumberland Co., Hancock Co. NEW JERSEY: Ocean Co. NEWFOUNDLAND: Avalon Section.

### Genus *Verrucaria*

The species of this genus form crusts which may be continuous or form scattered patches, rimose areolate or divided into discrete areoles or lobes. The thalli vary in thickness from 20 to  $500\mu\text{m}$ , and may be almost completely transparent to entirely opaque. In some species, the transparency of the thallus may be enhanced by wetting, while others remain opaque when wet. The thalli may be smooth or roughened by dark points or ridges. The ridges, called juga (Santesson 1939), vary in length, width, and thickness. The exact origin and ontogeny of the juga is not known but it appears that they originate at or just below the surface of the thallus. In the author's experience, they do not extend to the substrate except at the edges of the areoles. Often a distinction is made in keys between point and ridge forms of the juga, but it is common that the points are merely peaks on inconspicuous or hidden ridges.

The perithecia of all of the littoral Verrucariae, with which the author has worked, have a dark involucrellum which may spread widely or be closely appressed to the excipulum. This darkening may extend into the lower excipulum, terminating a short distance below the involucrellum proper or it may not extend into the lower excipulum. The darkening may occur intermittently or continuously throughout the lower excipulum. This darkening is given considerable taxonomic importance by Servit (1954) and by Erichsen (1957) but Swinscow (1965) discounted this importance on the grounds that it is highly variable within a species. The author concurs with Swinscow in this view. Perithecial size is not, in itself, very useful in distinguishing species. Perithecium diameters vary generally between 0.05 and 0.7 mm and these dimensions overlap considerably between *Verrucaria* species. Although vertical sections are illustrated in the key, none is claimed to be typical for there is much variation in many, if not all species.

Santesson (1939) has noted the high variability of spore size in littoral pyrenolichens and suggested that they should not be given great taxonomic importance. All spores in *Verrucaria* are simple and hyaline. For the most part, the spores are thin walled and of similar size, occurring eight per ascus. *Verrucaria internigrescens*

and *V. silicicola* are the notable exceptions to the above in north-eastern North America. The spores of *V. internigrescens* are thick walled and those of *V. silicicola* are unusually large. The remainder are ovoid to reniform and exhibit overlapping size ranges between species.

*Verrucaria amphibia* R. Clem. Ess. Var. Veg. Andalusia 299. 1807.

**DESCRIPTION:** Thallus continuous to rimose areolate, black when dry, translucent green to amber when wet, with irregular black ridges often enclosing lenticular areas  $50-100\mu\text{m}$  thick. Perithecia large (13-16 mm), prominently elevated, often flattened or concave on top, vertical and horizontal ridges forming reticular pattern, lenticular areas often enclosed by ridges at base; excipulum hyaline to partly darkened below. Spores hyaline, ovoid,  $7-19 \times 4-7.5\mu\text{m}$ .

This species might readily be confused with *V. maura*. Both species have dark thalli with juga forming pegs or ridges and with robust perithecia. However, they are easily distinguished on closer examination. Whereas *V. maura* tends to have points raised above the thallus, *V. amphibia* tends toward ridges. The ridges tend to enclose lenticular areas on a dry thallus giving the impression of ripples on water. When wet, *V. amphibia* becomes more translucent and light colored against which the black ridges become contrasted. The thallus of *V. maura* remains dark when wet except on very thin juvenile specimens. The thallus of *V. amphibia* tends to be continuous whereas that of *V. maura* tends to be rimose areolate but in neither case are the characters absolute. Areolation appears to develop and increase with age in *V. amphibia*. *Verrucaria amphibia* produces large, steep sided perithecia often strongly depressed on top, a form also produced in some instances by *V. maura*. Such perithecia of *V. amphibia* have two characteristics not demonstrated by *V. maura*; whereas *V. maura* may have many fine points or pegs covering the perithecium, the design on *V. amphibia* is a reticulum of vertical and horizontal ridges. Also, where the *V. amphibia* perithecium meets the thallus, the ridges tend to enclose areas of ovoid shape and appear light and translucent when wet (see the Key).

*Verrucaria amphibia* is little discussed in literature. Santesson<sup>2</sup> says that it is not known from Scandinavia, although it occurs in England. Ferry and Sheard (1969) included *V. amphibia* in their key but did not deal with it in detail. The author first became acquainted with it by examining herbarium specimens and his measurements should not be regarded as limits due to the small amount of material examined. There is no prior report of this species from North America.

**GENERAL DISTRIBUTION:** England (Ferry and Sheard 1969), Wales (Fletcher 1973a), Germany (Ullrich MSC).

**NORTHEASTERN AMERICAN DISTRIBUTION:** NEWFOUNDLAND: East Coast Section, Avalon Section.

*Verrucaria ceuthocarpa* Wahlenb. in Ach. Suppl. Meth. Lich. 22. 1803.

**DESCRIPTION:** Thallus brown, rimose areolate, glabrous, forming discrete areoles or lobes, ridges absent, perithecia sub-

<sup>2</sup>R. Santesson, Director, Systematic Institute of Oslo, Oslo, Norway; pers. commun. November 1966.

merged, 0.1-0.15 mm wide, involucrellum usually brown, excipulum hyaline to dark below, spores hyaline, ovoid 8-10 × 5-8 μm.

*Verrucaria ceuthocarpa* is easily confused with *Verrucaria degelii* when either is modified by environment or when its structure is obscured by epiphytic algae. The clefts of *V. ceuthocarpa* may become darkened and, on cursory examination, may resemble the dark ridged border of areoles of *V. degelii*. Careful examination is needed to observe the absence of ridges. Conversely sometimes the ridges are scant on a thallus of *V. degelii* and it may be mistaken for that of *V. ceuthocarpa*.

Perhaps the greatest obstacle to correct identification is obscuring of surface detail by epiphytic algae. Portions of questionable thalli should be flooded with water to soften and expand the algae. If details are still obscured, the flooded portion can be scrubbed with a small water color brush. True ridges are fairly resistant to such gentle abrasion and will persist until the thallus becomes too softened by the water to maintain its integrity.

According to Santesson's key (1939), the prime diagnostic feature of *V. degelii* vs. *V. ceuthocarpa* is the presence of ridges on *V. degelii*.

The author finds that two other features are quite useful. The best of the two is tendency for flatness to concavity between ridges of an areole of *V. degelii* compared with the convexness of areoles and branches thereof in *V. ceuthocarpa*. *Verrucaria ceuthocarpa* is truly glabrous. Further, from the limited material in the author's three North American collections it also appears that the involucrellum of *V. ceuthocarpa* tends to be brown whereas that of *V. degelii* is distinctly black.

GENERAL DISTRIBUTION: Northern Europe, Spitsbergen, Bear Island, Novaya Zemlya, Siberia, Bering Straits, Greenland, Kerguelen, Antarctica (Lamb 1953); Washington U.S.A. (collected by Fink and determined as *Verrucaria maura* by Zahlbruckner MSC).

NORTHEASTERN AMERICAN DISTRIBUTION: NEW-FOUNDLAND: East Coast Section.

*Verrucaria degelii* R. Sant. Ark. Bot. 29A (10):31. 1939.

DESCRIPTION: Thallus rimose, forming lobes or discrete areoles, amber, brown or black when dry, amber to brown when wet, prominent black ridges bordering areoles and often perithecia, thin to thick (100-320 μm). Perithecia sunken to prominently raised, 0.1-0.25 mm diameter, excipulum hyaline. Spores hyaline, ovoid 9-13 × 5-6 μm.

Though published in 1939, this species was known only from Norway until the author's collections, thus there are few specimens and little study of ecology upon which to base conclusions about environmental influences on variations. It is reasonable to assume, however, that the nature of variations is consistent with that seen in other *Verrucariae*. If so, color would be lighter in shade forms than sun forms and ridges would be fewer and thinner in shade forms than on sun forms. This kind of variation is probably the cause of confusion of some specimens of *V. degelii* with *V. ceuthocarpa*. The identity of a robust specimen of *V. degelii* is beautifully clear. However, the ridges may become scant and the specimen strongly resembles the morphotype of *V. ceuthocarpa* with darkened clefts between areoles. A second source of confusion is the epiphytic growth of algae on thalli of either *V. degelii* or *V. ceuthocarpa*. A growth of algae on *V. degelii* can obscure ridges and produce the glabrous appearance of *V. ceuthocarpa*. Such a growth can also produce a shade condition for the

underlying thallus and reduce the growth of ridges. On the other hand, a growth of dark algae on *V. ceuthocarpa*, especially when dry, may obscure the color and glabrous nature of the thallus and give the illusion of ridges on the edge of areoles. One cannot over-emphasize the importance of detecting and removing such epiphytic algae!

The thallus of *V. degelii* varies greatly in thickness and transparency depending on age or extent of development. It is almost always areolate, with only one known exception. In that case, a rather large area of smooth, continuous thallus was surrounded by a raised black ridge and a crack, also bordered by a black raised ridge, extended inward toward the center. At the edges of this patch of thallus was more thallus divided into typical discrete areoles with similar black borders. More commonly a young thallus is thin, nearly transparent, smooth and brown to tan. It is areolate and is often divided into lobes by a dendritic pattern of grooves. In such a thallus, the grooves are usually hyaline.

The ontogeny of these lichens has not been studied and must be inferred from observations of what could as easily be the results of conditions of growth as of aging. It appears, however, that older thalli thicken and develop discrete areoles, usually with black borders and frequently with black lines connecting them with the perithecium. These areas of blackness then seem to proliferate under some conditions to produce unelevated patterns or raised juga. Sometimes the black area extends beneath the perithecium and sometimes it does not.

The perithecium is commonly immersed, with or without raised ridges around the ostiole. At times there is a convex area raised around the ostiole. The author has seen prominently raised convex perithecia on the same thallus as sunken perithecia. The degree of perithecial elevation appears to be a variable character of the species.

Spores are ovoid but sometimes pointed when young. A clear spot commonly, although not always, appears in the center of the younger spores. Santesson (1939) reported the range of spore sizes for *Verrucaria degelii* as 10-13 × 5-6 μm, which is consistent with that observed by the author.

GENERAL DISTRIBUTION: NORWAY (Santesson 1939).

NORTHEASTERN AMERICAN DISTRIBUTION: MAINE: Hancock Co., Washington Co. MASSACHUSETTS: Essex Co. NOVA SCOTIA: Yarmouth Co., Digby Co., Halifax Co. NEW-FOUNDLAND: West Coast Section, Northern Peninsula Section, East Coast Section, Avalon Section.

*Verrucaria ditmarsica* Erichs. Schriften Naturwiss. Vereins Schleswig-Holstein 22:90. 1937.

DESCRIPTION: Thallus entire, olivaceous, with pegs to short ridges, thin (20-50 μm), opaque to translucent when dry, more translucent when wet. Perithecia slightly dome-shaped to globose (usually hemispherical), 0.1-0.25 mm diameter, usually shiny; excipulum hyaline to dark below. Spores ovoid to reniform, colorless, 6-11 × 3.5-6 μm.

The thallus of *Verrucaria ditmarsica* is usually olivaceous, but the darkness varies with light exposure. In bright light the thallus is dark olive and if grown in the shade it is a very light olive green. It usually is rather transparent to translucent. The transparency is increased by wetting upon examination. Short, mostly straight ridges are characteristic on the thallus. These become reduced in size and frequency in the shade modification. In this reduced condition it is easily confused with the shade modification of *V. erich-*

*senii* and especially with *V. striatula* whose color is also similar. Ridges often merge with the perithecia at the base.

The perithecia are convex to hemispherical and usually shiny. Darkness of the lower excipulum is a highly variable factor. Generally some carbonaceous granules tend to extend below the involucrellum and may continue somewhat throughout the lower involucrellum (see the key). However, the species should not be characterized as having an involucrellum that is dark below, a view adopted by Erichsen (1957).

GENERAL DISTRIBUTION: Germany (Erichsen 1957), Norway (Santesson MSC).

NORTHEASTERN AMERICAN DISTRIBUTION: MAINE: Cumberland Co., Sagadahoc Co., Hancock Co. RHODE ISLAND: Newport Co. MASSACHUSETTS: Plymouth Co., Essex Co. NEW HAMPSHIRE: Rockingham Co. NOVA SCOTIA: Yarmouth Co., Digby Co., Shelburne Co., Halifax Co., Victoria Co. NEWFOUNDLAND: West Coast Section, Northern Peninsula Section, East Coast Section. Not previously reported from North America.

*Verrucaria erichsenii* Zsch. in Erichs. Verh. Bot. Vereins Prov. Brandenburg 70:192. 1928.

DESCRIPTION: Thallus entire or areolate, black to blackish-brown dry, amber and more translucent when wet, roughened by rows of pegs or ridges; ridges often branched, sometimes submerged in thallus and visible only when wet; thallus 30-70 $\mu$ m thick. Perithecia elevated, conical to hemispherical, spreading in irregular pattern at base, often with pegs or ridges as on thallus, 0.1-0.3 mm diameter, excipulum hyaline below. Spores ovoid, colorless, 8-9  $\times$  4.5-7 $\mu$ m.

*Verrucaria erichsenii* demonstrates considerable thallus variation. It is usually considered to be clearly rimose or areolate. Typically this is so but it is not uncommon to find a thallus of *V. erichsenii* continuous in an especially wet environment, where the thallus becomes thick and gelatinous. When dry the thallus is usually blackish-brown to black. A grey morphotype with a texture like that of graphite was collected in the Narragansett Bay area. When moistened during examination the thallus increased in transparency, one of the best tests of questionable thalli. When wetted they reveal a pattern of black markings typical of the pattern of ridges usually seen above the surface. The thallus of *V. erichsenii* typically has short, often branched irregular ridges or rows of points, frequently confluent with or continuing up over the perithecia. Ridges are longer than wide and rarely very high. In extreme circumstances ridges become higher and sharper forming cusps and arêtes. In other extremes they may be immersed within the thallus to be revealed only by wetting.

The most consistent character of the perithecium appears to be the irregular spreading base which seems most pronounced when viewed from above a wet thallus or when the thallus has been peeled from the rock and placed on a slide and illuminated from below. The diameters of perithecia tend to fall between 0.1 and 0.3 mm.

Zschacke (1934) and Erichsen (1957) both list a spore range of 8-12  $\times$  5-7 $\mu$ m which agrees with the author's observations.

GENERAL DISTRIBUTION: Germany (Erichsen 1957), British Columbia (Ohlsson MSC), Sweden (Santesson MSC), Norway

(Santesson MSC), Wales (Brodo MSC), Scotland (Brodo MSC).

NORTHEASTERN AMERICAN DISTRIBUTION: MAINE: Cumberland Co., Sagadahoc Co., Hancock Co., Lincoln Co. (Merrill MSC), Washington Co. MASSACHUSETTS: Essex Co., Bristol Co. (Willey MSC), Plymouth Co., Barnstable Co. RHODE ISLAND: Newport Co., Washington Co. CONNECTICUT: New London Co. NEW HAMPSHIRE: Rockingham Co. NOVA SCOTIA: Yarmouth Co., Digby Co., Shelburne Co., Halifax Co., Victoria Co., Cape Breton Co. NEWFOUNDLAND: West Coast Section, Northern Peninsula Section, Avalon Section.

*Verrucaria internigrescens* (Nyl.) Erichs. Vern. Bot. Vereins Prov. Brandenburg 70:193. 1929. *Verrucaria aethiobola* var. *Internigrescens* Nyl. in Brenner, Meddeland. Soc. Fauna Fl. Fenn 13:125. 1886.

DESCRIPTION: Thallus of brown areoles connected by darker brown prothallus. Perithecia brown, convex, 0.2-0.34 mm diameter, excipulum hyaline or intermittently darkened below. Spores hyaline, thick walled, fusiform, (11.5) 15-23 (27)  $\times$  (4) 6-8 (14) $\mu$ m.

The brown prothallus, thallus, and perithecia are distinctive. The thallus is thin by comparison with other areolate forms such as *V. maura* and *V. ceuthocarpa*. The spores are distinctive, being fusiform and thick walled. Erichsen (1957) reported a spore range of 15-27  $\times$  7-12 $\mu$ m. As indicated above, spores were found in the North American collections as large as reported by Erichsen but they were bloated and of atypical shape. Most spores seen were in the range of 15-23  $\times$  6-8 $\mu$ m. Erichsen (1957) listed this species as both littoral and nonlittoral, therefore, it may be assumed to be facultative in its habits. This species was collected at only one locality in North America and this is the first record from North America.

GENERAL DISTRIBUTION: Germany (Erichsen 1957).

NORTHEASTERN AMERICAN DISTRIBUTION: NEWFOUNDLAND: Avalon Section.

*Verrucaria maura* Wahlenb. in Ach. Suppl. Meth. Lich. 19. 1803.

DESCRIPTION: Thallus dark, usually black to brownish-black, sometimes green, opaque (wet or dry), rimose areolate, usually with small black pegs or points (sometimes obscured by epithallic algae), thin to thick (75-300  $\mu$ m). Perithecia small to large (usually large) 0.3-0.7 mm diameter, sunken to prominently raised tops rounded to concave, may be covered visibly by pegs, excipulum entirely black below. Spores ovoid, hyaline 10-20  $\times$  7-10 $\mu$ m.

*Verrucaria maura* is probably one of the most widely used names among the littoral lichens. This often leads to the report of the species based on the most cursory examination. The species is highly variable and its variation has probably been best understood and described by Santesson (1939, footnote 2). The author can add little to the description of variation provided by Santesson (footnote 2) and would like here to merely record his concurrence and quote Santesson's description (the material quoted was provided for the author in Swedish by Santesson) of typical *V. maura* as: "1. Indistinct or dark prothallus, 2. Definite black thallus, 3. areolate thallus, 4. thallus surface with distinct but little conspicuous points, 5.

rounded conical conspicuous perithecia, 6. rounded, not impressed perithecia tops, and 7. spores with a width of 7-10 mic. (length 10-19 or at most 20 mic.)”

Santesson continues by describing seven deviations with which he associates names of varieties or what he considers to be synonyms:

- “1. With white or light brown clear prothallus. ‘*V. zschackeana* Erichs.’
2. With green-gray or greenish black thallus. ‘var. *fumosocinerea* Vain.’
3. With connected or triflingly fissured thallus. ‘*V. scotina* Wedd.’
4. Thallus surface with many strongly conspicuous pegs. ‘*V. aractina* Wg.’
5. a. With perithecia almost entirely sunken into the thallus. ‘*V. malmei* Serv.’
- b. With hemispherical to nearly spherical perithecia. ‘var. *prominula* Vain.’
6. With clearly impressed, frequently somewhat irregular perithecium tops. ‘*V. trachinodes* Norm.’ ‘*V. häyrenii* Erichs.’, ‘var. *aractinoides* Vain.’, ‘f. *evoluta* Th. Fr.’
- (?7. Spores with a width of 11-15 mic. ‘*V. finmarkica* Zsch.’).”

The author has seen all of these forms in North America except “*V. finmarkica*.” A common variation results from frequent washing with water from rain or waves which causes the thallus color and texture to become obscured by epithallic algae which produce a smooth greenish surface.

GENERAL DISTRIBUTION: Novaya Zemlya (Lyngé 1928), Finland (Räsänen 1927), Germany (Erichsen 1957), Spain to Finland (Degelius 1935), Italy (Jatta 1909-1911), India (Awasthi 1965), Japan (Nylander 1890), Greenland, Iceland, Bear Island, Spitsbergen, Siberia, Bering Strait, Fuegia, Patagonia, Chile, Falkland Islands, and New Zealand (Lamb 1953), Norway (Santesson MSC), Sweden (Santesson MSC), Wales (Fletcher 1973a), England (Ferry and Sheard 1969), British Columbia (Brodo MSC).

NORTHEASTERN AMERICAN DISTRIBUTION: MAINE: (Plitt USA). NOVA SCOTIA: Yarmouth Co., Digby Co., Shelburne Co., Halifax Co., Victoria Co., Cape Breton Co. NEWFOUNDLAND: West Coast Section, Northern Peninsula Section, East Coast Section, Avalon Section. NEW BRUNSWICK: Campobello.

*Verrucaria microspora* Nyl. Ann. Sci. Nat. Bot. IV. 3:175. 1855.

DESCRIPTION: Thallus usually brown to amber, sometimes green or grey, smooth thin, 20-30  $\mu\text{m}$  continuous or in patches but never areolate, translucent when dry, more transparent when wet. Perithecia dome-shaped (slightly arched) to hemispherical, sometimes pointed, 0.05-0.3 mm diameter, excipulum entirely hyaline below. Spores hyaline, reniform to ovoid, 6-11  $\times$  3-5  $\mu\text{m}$ .

*Verrucaria microspora* is characterized by a thin, normally brown to amber thallus which is either continuous or in scattered patches but never areolate. The thallus is devoid of pegs or ridges but may contain artifacts that might superficially resemble pegs or ridges. In some instances tests have proven these to be perithecial remains. The thallus becomes translucent to quite transparent when

wet. Erichsen (1957) recognized a var. *laetevirens* as characterized by a leek green thallus which is less transparent. The author has also observed this in material from the southern part of its range in North America as well as a dark grey thallus in the same area. The dark grey thallus has a color and texture resembling graphite used in pencils. Upon wetting, the dark color disappears.

The perithecia are brown to black and may be shiny or dull. Their shape may range from that of a slightly arched dome to more nearly hemispherical and pointed. The diameter of the perithecia is reported as 0.15-0.25 mm (Lamb 1953), 0.1-0.3 mm (Santesson footnote 2), 0.2-0.3 mm (Zschacke 1925), and 0.2-0.3 mm (Erichsen 1957). Erichsen (1957) also recognized var. *friesiaca* as having a smaller perithecia of only 0.1-1.15 mm diameter. The author measured 230 perithecia (10 each from 23 specimens) and found a range of 0.08-0.28 mm except for a single collection in which the range was 0.16-0.48 mm with 4 out of 10 exceeding 0.3 mm. In no other collection did the diameter exceed 0.3 mm. Clusters of small or larger perithecia may be found and due to the normal patchy appearance of the thalli, one may be tempted to consider such patches as distinct species. Perithecium size should not be considered of taxonomic significance in this species.

Spores of *V. microspora* are thin walled and will change shape somewhat with osmotic changes. Generally they are ovoid to slightly reniform. The species name infers smallness of spores, but this is not noticeably different from *V. ditmarsica* and *V. striatula*. Spore sizes have been reported as 7-12  $\times$  4-5  $\mu\text{m}$  (Lamb 1953), 7-11  $\times$  5-7  $\mu\text{m}$  (Zschacke 1925), and 7-11  $\times$  4-5  $\mu\text{m}$  (Erichsen 1957). Erichsen (1957) also recognized var. *mucosula* Sands. with spores 5-9  $\times$  4-9  $\mu\text{m}$ . The author's spore measurements give a range of 6-11  $\times$  3-5  $\mu\text{m}$ .

GENERAL DISTRIBUTION: Germany (Erichsen 1957), England (Ferry and Sheard 1969), Greenland, Japan, Chile, Antarctica (Lamb 1953), Wales (Fletcher 1973a), Norway (Santesson MSC), Scotland (Brodo MSC), Australia (Willis MICH).

NORTHEASTERN AMERICAN DISTRIBUTION: MAINE: Cumberland Co., Sagadahoc Co., Hancock Co. MASSACHUSETTS: Essex Co., Plymouth Co., Barnstable Co. RHODE ISLAND: Newport Co. CONNECTICUT: New London Co. NEW JERSEY: Ocean Co., Cape May Co. NOVA SCOTIA: Colchester Co., Cumberland Co., Yarmouth Co., Digby Co., Shelburne Co., Victoria Co. NEWFOUNDLAND: West Coast Section, Northern Peninsula Section, East Coast Section.

*Verrucaria mucosa* Wahlenb. in Ach. Suppl. Meth. Lich. 23. 1803.

DESCRIPTION: Thallus grass green to blackish-green, smooth and tough, continuous, often with necral cracks in herbarium specimens, 130-150  $\mu\text{m}$  thick, usually opaque (wet or dry); juga absent; prothallus, is present, whitish. Perithecia submerged to slightly raised, sometimes with prominent ostioles surrounded by chimney, excipulum clear below, involucrellum 0.05-0.2 mm diameter. Spores simple, colorless, usually ovoid, 8-11  $\times$  4-5  $\mu\text{m}$ .

Thallus of this species is easily recognized in the field or in the herbarium. In old herbarium specimens it is brown. Upon drying it develops cracks that are strictly necral artifacts not to be confused with the rimose areolation typical of *V. maura*. A whitish prothallus is often seen around a thallus on smooth rock.

Perithecia are normally flush to slightly raised or sunken. When ripe, the involucrellum tends to evaginate somewhat presenting a

prominent ostiole with a short chimney around it. One often sees whitish pits in the thallus which are the remains of old perithecia divested of their involucrella.

The thallus of *V. mucosa* is quite aggressive and often grows over crustose algae, such as *Hildenbrandia* and *Lithothamnium*. It also is commonly found growing over other Verrucariae where the perithecia of the overgrown material project through the thallus of *V. mucosa* causing a potential source of misidentification.

Spores of *V. mucosa* are not distinctive in either shape or size. Santesson (1939) reported the size of spores to be highly variable, 7-15  $\times$  4-8  $\mu$ m.

Pycnidia are quite common on *V. mucosa* thalli. They appear as pits ringed with brown and occur widely scattered or in clusters. It is not uncommon to find mounds made up of aggregated pycnidia.

GENERAL DISTRIBUTION: Sweden, Norway, Finland, Iceland, Faroe Islands, Germany, Ireland, France (Santesson 1939), England (Ferry and Sheard 1969), Wales (Fletcher 1973a), Greenland, Siberia, Fuegia, Aukland Islands, Campbell Island, New Zealand (Lamb 1953), British Columbia (Brodo MSC).

NORTHEASTERN AMERICAN DISTRIBUTION: MASSACHUSETTS: Essex Co., Plymouth Co. NEW HAMPSHIRE: Rockingham Co. MAINE: Cumberland Co., Sagadahoc Co., Hancock Co., Lincoln Co. (Merrill MSC), Washington Co. NOVA SCOTIA: Colchester Co., Cumberland Co., Yarmouth Co., Digby Co., Shelburne Co., Halifax Co., Victoria Co., Cape Breton Co. NEWFOUNDLAND: Northern Peninsula Section, East Coast Section, Avalon Section.

*Verrucaria silicicola* Fink in Hedrick, Mycologia 25(4):305, 1933.

DESCRIPTION: Thallus brownish, continuous to patchy, not areolate. Perithecia shallow domes to hemispherical, 0.15-0.4 mm broad; excipulum hyaline to dark below. Spores hyaline, 18-22  $\times$  8-9  $\mu$ m.

The author's knowledge of this species is limited to the examination of available herbarium specimens collected and known only from Long Island, N.Y. The material seen resembled *V. microspora* to a considerable degree. The thallus was brownish and patchy. The perithecia, for the most part, were shallow domes. Hedrick (1933) gave 0.15-0.4 mm as the diameter of perithecia and those seen by the author fell within this range. The salient characteristic of this species is the spore size, listed by Hedrick (1933) as 19-22  $\times$  8-9  $\mu$ m. The author was unable to find spores but Brodo (1968) reported the range as 16-25  $\times$  6-10  $\mu$ m.

NORTHEASTERN AMERICAN DISTRIBUTION: NEW YORK: Suffolk Co. (Latham MSC), (Brodo MSC).

*Verrucaria striatula* Wahlenb. in Ach. Suppl. Meth. Lich. 23, 1803.

DESCRIPTION: Thallus entire, light to dark green usually opaque when dry, more translucent when wet, containing numerous black, rather broad ridges often branched, ridges especially common at thallus margins. Perithecia hemispherical to globular, often irregular, flattened and/or dissected, shiny, 0.07-0.3 mm diameter, excipulum hyaline to entirely dark below. Spores ovoid, may be pointed at one end, 8-10  $\times$  4-6  $\mu$ m.

*Verrucaria striatula* is most noted for the strikingly large carbonaceous structures termed juga by Santesson (1939). The juga rise above the thallus and tend to be broad and often branched. They commonly encompass a perithecium. Near the edge of the thallus they often radiate out from the center, marking the leading edge of thallus lobes. They are different from the ridges of *V. erichsenii* and *V. ditmarsica*, being more like flattened plateaus and buttes than narrow ridges.

The thallus is normally a bright green when fresh but darkens in more intense sunlight. It fades quickly in the shade. In the herbarium the thallus soon becomes colorless and scarcely visible, a condition causing early workers to think that the juga were the entire thallus (Santesson 1939). The thallus is continuous but often shows necral cracks upon drying.

The perithecia are often amorphous, coalescing with juga or appearing as spheres frequently with flattened tops. The perithecia often are cracked or dissected and usually a shiny black.

In the shade modification the perithecia become more nearly spherical or may be elongated vertically. Juga become reduced, causing the shade modification of *V. striatula* to resemble *V. ditmarsica*. However, even in the shade modification, juga usually retain their flatness and are reduced in size, but still are broad by comparison with other ridged species. Perithecium diameters are in the general range of 0.05-0.3 mm. Zschacke (1934) listed the spore range as 8-12  $\times$  4-5  $\mu$ m and Erichsen (1957) as 8-11  $\times$  4-5  $\mu$ m.

GENERAL DISTRIBUTION: Sweden, Norway, Denmark, Iceland, Ireland, France, Spain, Portugal (Santesson 1939), Wales (Fletcher 1973a), Scotland (Brodo MSC), England (James MSC).

NORTHEASTERN AMERICAN DISTRIBUTION: MASSACHUSETTS: Essex Co., Plymouth Co. RHODE ISLAND: Newport Co. NEW HAMPSHIRE: Rockingham Co. MAINE: Cumberland Co., Hancock Co. NOVA SCOTIA: Yarmouth Co., Digby Co., Shelburne Co., Halifax Co., Victoria Co. NEWFOUNDLAND: West Coast Section, Northern Peninsula Section, East Coast Section, Avalon Section. NEW BRUNSWICK: Grand Manan (W. R. Taylor MICH).

### Genus *Xanthoria*

*Xanthoria candelaria* (L.) Th. Fr. Gen. Heterolich. Europ. 61, 1861. *Lichen candelarius* L. Sp. Pl. 1141, 1753.

DESCRIPTION: Thallus foliose, light gold, diffuse or forming rosettes, KOH + purple. Lobes small (0.2-0.5 mm broad) plane to convex, lacerated, sorediate, soredia mostly apical, lobes tend to rise off substrate. Apothecia ca. 2 mm broad with thalline margin. Spores eight per ascus, polarilocular, 9-13  $\times$  4-6  $\mu$ m.

This species superficially resembles members of the genus *Candelaria* for which it is named but differs in reaction to KOH and spore type. The *Candelariae* are KOH- and the spores are not polarilocular. There is also a resemblance between *Xanthoria candelaria* and *X. fallax* when the latter displays lobe widths at the narrow end of the range for that species. However, in such a case the location of soredia will distinguish them. In *X. candelaria* the soredia are apical or laminar as opposed to the labrose mode in *X. fallax*.

GENERAL DISTRIBUTION: Alaska (Krog 1968), South Dakota (Wetmore 1967), Nevada (Imshaug 1957), Washington (Howard 1950), Utah (Wetmore MSC), California (Newcomb



MSC), British Columbia (Ohlsson MSC), west central Canada (Bird 1970), Cuba (Montagne 1838-42), Greenland (Lyngé 1932), Novaya Zemlya (Lyngé 1932), France (Harmand 1905), Germany (Erichsen 1957), Nepal (Awasthi 1965), England (Ferry and Sheard 1969).

NORTHEASTERN AMERICAN DISTRIBUTION: NOVA SCOTIA: Cape Breton Co. NEWFOUNDLAND: Avalon Section.

*Xanthoria elegans* (Link) Th. Fr. Lich. Arct. 69. 1860. *Lichen elegans* Link. Ann. Naturges. 1:37. 1791.

DESCRIPTION: Thallus foliose, red orange to citrine, rising off of substrate at least at tips, KOH+ purple, forming rosettes about 2-5 cm diameter, lobes nodular-convex, including tips. Apothecia orange yellow to red orange, about 1-2 mm broad. Spore colorless, polarilocular, 10-13 × 5-8 μm.

Upon cursory inspection this species may appear to be crustose but it does have a developed lower cortex and lifts off the substrate at least at the tips. The lobes have a tubular appearance but of quite irregular width and thickness, giving it a rather nodular appearance. Like *X. parietina* it is devoid of soredia.

GENERAL DISTRIBUTION: Washington (Howard 1950), Alaska (Krog 1968), South Dakota (Wetmore 1967), New Mexico (Rudolph 1953), Arizona (Nash MSC), Colorado (Wetmore MSC), Wyoming (Shushan MSC), Montana (Imshaug MSC), Iowa (Imshaug MSC), Michigan (Imshaug MSC), Minnesota (Fink MSC), Wisconsin (Malachowski MSC), New York (Brodo MSC), Mexico (Beaman MSC), Manitoba (Gillis MSC), Northwest Territory (Prest MSC), Nova Scotia (Lamb 1953), Greenland (Lyngé 1932), Finland (Räsänen 1927), India (Awasthi 1965), China (Magnusson 1940), New Zealand (Nylander 1888), Ontario (Wang MSC), Iceland (Copeland MSC).

NORTHEASTERN AMERICAN DISTRIBUTION: MAINE: Sagadahoc Co., Hancock Co. NOVA SCOTIA: Digby Co., Shelburne Co., Halifax Co., Victoria Co., Cape Breton Co. NEWFOUNDLAND: West Coast Section, Northern Peninsula Section.

*Xanthoria parietina* (L.) Th. Fr. Lich. Arct. 67. 1860. *Lichen parietinus* L. Sp. Pl. 1143. 1753.

DESCRIPTION: Thallus foliose, orange to citrine, radiate, often rosettelike, KOH+ purple, lobes flat, wrinkled, ca. 1 mm broad, usually forked at the tips, soredia absent. Apothecia numerous, ca. 5 mm broad, plane to concave with thin thalline margin disappearing with age. Spores eight per ascus, polarilocular, colorless, 10-13 × 6-9 μm.

This widespread oceanic species is easily distinguished from all other littoral *Xanthoriae* by its relatively broad, thin, distinctly wrinkled thallus divided dichotomously at the tips. The apothecia often contrast with the thallus by being more red colored.

GENERAL DISTRIBUTION: Greenland (Lyngé 1937), Novaya Zemlya (Lyngé 1928), Sweden (Degelius 1935), Finland (Räsänen 1927), Italy (Jatta 1909-1911), India (Awasthi 1965), Cuba (Montagne 1838-42), Tenerife (Imshaug MSC), England (Ferry and Sheard 1969), Wales (Fletcher 1937b), Spain (W. & C. Culberson MSC).

NORTHEASTERN AMERICAN DISTRIBUTION: MAINE: Cumberland Co., Sagadahoc Co., Hancock Co. MASSACHUSETTS: (Fisher MSC). NEW YORK: (Brodo 1968). NOVA SCOTIA: Halifax Co., Yarmouth Co., Digby Co., Shelburne Co.

## SELECTED BIBLIOGRAPHY

- AWASTHI, D. D.  
1965. Catalogue of the lichens from India, Nepal, Pakistan, and Ceylon. Nova Hedwigia, Beihefte, Suppl. 17:137 p.
- BIRD, C. D.  
1970. Keys to the lichens of west central Canada. The Herbarium, Dep. Biol., Univ. Calgary, mimeogr., p. 132.
- BRODO, I. M.  
1968. The lichens of Long Island, New York: A vegetational and floristic analysis. N.Y. State Mus. Sci. Serv. Bull. 410, 330 p.
- DEGELIUS, G.  
1935. Das ozonische element der strauch-und-laub-flechten flora von Skandinavien. Acta Phytogeogr. Suec. 7:1-411.  
1939. Die flechten von norra skåföten. Uppsala Univ. Arsskr. 11:1-205.
- ERICHSEN, C. F. E.  
1957. Flechten flora von Nordwestdeutschland. Gustav Fischer Verlag, Stuttgart, p. 1-411.
- FERRY, B. W., and J. W. SHEARD.  
1969. Zonation of supralittoral lichens on shores around the Dale Peninsula, Pembrokeshire. Field Stud. 3:41-67.
- FLETCHER, A.  
1973a. The ecology of marine (littoral) lichens on some rocky shores of Anglesey. Lichenologist 5:368-400.  
1973b. The ecology of maritime (supralittoral) lichens on some rocky shores of Anglesey. Lichenologist 5:401-422.
- HALE, M. E., Jr., and W. L. CULBERSON.  
1970. A fourth checklist of the lichens of the continental United States and Canada. Bryologist 73:499-543.
- HARMAND, L. J.  
1905. Lichens de France. Epinal, Paris. 4:609.
- HARRIS, R.  
1975. A taxonomic revision of the genus *Arthopyrania* Massal. S. Lat. (Ascomycetes) in North America. Mich. State Univ., East Lansing, 301 p.
- HEDRICK, J.  
1933. New genera and species of lichens from the herbarium of Bruce Fink I. Mycologia 25: 303-316.
- HOWARD, G. E.  
1950. Lichens of the state of Washington. Univ. Wash. Press, Seattle, 191 p.
- IMSHAUG, H. A.  
1957. Alpine lichens of western United States and adjacent Canada. I. The macrolichens. Bryologist 60:177-272.
- JATTA, A.  
1909-1911. Flora italica cryptogama. Pars III. Lichens. Rocca S. Casciano. Stabilimento Tipografico L. Cappelli, 460 p.
- KROG, H.  
1968. The macrolichens of Alaska. Nor. Polarinst. Skr. 144, 180 p.
- LAMB, I. M.  
1953. Antarctic pyrenocarp lichens. Discovery Rep. 25:1-30.  
1954. Lichens of Cape Breton Island, Nova Scotia. Annu. Rep. Natl. Mus. Can. 132:239-313.
- LYNGÉ, B.  
1928. Lichens from Novaya Zemlya (excl. of *Acarospora* and *Lecanora*). Rep. Sci. Results Norw. Exped. Novaya Zemlya 1921, 43, 299 p.  
1932. Lichens from north east Greenland, II. Microlichens. Skr. Svalbard Ishavet. 81:1-143.  
1937. Lichens from west Greenland, collected chiefly by Th. M. Fries. Medd. Grönl. 118(8), 225 p.
- MAGNUSSON, A. H.  
1932. Lichens from western Northamerica, mainly Washington and Alaska. Ann. Cryptog. Exot. 5(1):16-38.  
1940. Lichens from central Asia. Rep. Sci. Exped. North-w. Prov. China 13, 168 p.
- MONTAGNE, J. F. C.  
1838-1842. Botanique-Plantes Cellulaires. In R. de la Sagra. Histoire physique, politique et naturelle de l'île de Cuba 8:105-237.

- NORDIN, I.  
1972. *Caloplaca* sect. *Gasparrinia* i Nordeuropa. Uppsala, p. 1-184.
- NYLANDER, W.  
1888. *Lichenes Novae Zelandiae*. Paris, p. 1-156.  
1890. *Lichenes Japoniae*. Paris, p. 1-122.
- POELT, J.  
1969. Bestimmungsschlüssel Europäischer Flechten. J. Cramer, Lehre, p. 1-259.
- RASANEN, V.  
1927. Über Flechtenstandorte und Flechtenvegetation im westlichen Nordfinland. Ann. Soc. Zool. Bot. Fenn. Vanamo 7:1-202.
- RUDOLPH, E. D.  
1953. A contribution to the lichen flora of Arizona and New Mexico. Ann. Mo. Bot. Gard. 40:63-72.
- SANTESSON, R.  
1939. Amphibious pyrenolichens I. Ark. Bot. 29A(10):1-67.
- SERVÍT, M.  
1954. Československé lisenjníky celed: Verrucariaceae. Nakladatelství Československé Akademie Ved. Prana.
- SWINSCOW, T. D. V.  
1965. The marine species of *Arthopyrenia* in the British Isles. Lichenologist 3:55-64.
- TUCKERMAN, E.  
1882. A synopsis of the North American lichens: Part I., comprising the *Parmeliacei*, *Cladoni*, and *Coenogonie*. S.E. Cassino, Boston, 261 p.
- WADE, A. E.  
1965. The genus *Caloplaca* Th. Fr. in the British Isles. Lichenologist 3:1-28.
- WEBER, W. A.  
1962. Environmental modification and the taxonomy of the crustose lichens. Sven. Bot. Tidskr. 56:293-333.
- WETMORE, C. M.  
1967. Lichens of the Black Hills of South Dakota and Wyoming. Publ. Mus. Mich. State Univ., Biol. Ser. 3:209-464.
- ZSCHACKE, H.  
1925. Die mitteleuropäischen Verrucariaceen. IV. Hedwigia 65:46-64.  
1934. Epigloeaceae, Verrucariaceae und Dermatocarpaceae. Rabenhorst's kryptogamen-flora 1, part 9, 695 p.

## SYSTEMATIC INDEX

<i>Arthopyrenia halodytes</i> .....	1, 2, 3, 9, 15
<i>Caloplaca marina</i> .....	8, 15
<i>Caloplaca verruculifera</i> .....	8, 16
<i>Caloplaca microthallina</i> .....	8, 15, 16
<i>Caloplaca scopularis</i> .....	8, 16
<i>Lecanora grantii</i> .....	2, 7, 16
<i>Lichina confinis</i> .....	2, 6
<i>Stigmidium marinum</i> .....	9, 16
<i>Verrucaria amphibia</i> .....	12, 13, 17
<i>Verrucaria ceuthocarpa</i> .....	10, 17, 18, 19
<i>Verrucaria degelii</i> .....	3, 12, 13, 18
<i>Verrucaria ditmarsica</i> .....	2, 3, 14, 18, 20, 21
<i>Verrucaria erichsenii</i> .....	2, 3, 13, 14, 18, 19, 21
<i>Verrucaria internigrescens</i> .....	10, 17, 19
<i>Verrucaria maura</i> .....	3, 10, 12, 15, 16, 17, 19, 20
<i>Verrucaria microspora</i> .....	3, 10, 17, 20, 21
<i>Verrucaria mucosa</i> .....	2, 4, 10, 17, 20, 21
<i>Verrucaria silicicola</i> .....	10, 17, 21
<i>Verrucaria striatula</i> .....	2, 4, 15, 19, 20, 21
<i>Xanthoria candelaria</i> .....	6, 21
<i>Xanthoria elegans</i> .....	7, 22
<i>Xanthoria parietina</i> .....	7, 22

## ACKNOWLEDGMENTS

Preparation of the "Marine Flora and Fauna of the Northeastern United States" is being coordinated by the following Board:

- Coordinating Editor: Melbourne R. Carriker, College of Marine Studies, University of Delaware, Lewes, DE 19958.
- Editorial Advisers: Marie B. Abbott, 259 High Street, Coventry, Conn. (Formerly with Gray Museum, Marine Biological Laboratory, Woods Hole, Mass.)
- Arthur G. Humes, Boston University Marine Program, Marine Biological Laboratory, Woods Hole, Mass.
- Wesley N. Tiffney, Retired, Boston University, 226 Edge Hill Road, Sharon, Mass.
- Ruth D. Turner, Museum of Comparative Zoology, Harvard University, Cambridge, Mass.

Roland L. Wigley, Retired, National Marine Fisheries Service, Northeast Fisheries Center, NOAA, Woods Hole, Mass.

Robert T. Wilce, Department of Botany, University of Massachusetts, Amherst, Mass.

The Board established the format for the "Marine Flora and Fauna of the Northeastern United States," invites systematists to collaborate in the preparation of manuals, reviews manuscripts, and advises the Scientific Editor of the National Marine Fisheries Service.

Thanks are expressed to Henry A. Imshaug for his assistance in research and advice in preparing the manuscript. Thanks are also expressed to Melbourne R. Carriker for continued assistance in later research stages and manuscript preparation. Richard D. Wood was very helpful in the field work in the Narragansett Bay area. Helen S. Taylor, Brian M. Taylor, and Sheryl M. Taylor contributed both in the research for and preparation of the manuscript. Adele Denison and Ralph Gorton aided in the preparation of the final manuscript.

## COORDINATING EDITOR'S COMMENTS

Publication of the "Marine Flora and Fauna of the Northeastern United States" is most timely in view of the growing universal emphasis on environmental work and the urgent need for more precise and complete identification of coastal organisms than has been available. It is mandatory, wherever possible, that organisms be identified accurately to species. Accurate scientific names unlock the great quantities of biological information stored in libraries, obviate duplication of research already done, and often make possible prediction of attributes of organisms that have been inadequately studied.

Ronald Taylor started his research on lichens in 1964 at Michigan State University where he later received his doctoral degree. He was then, and is now, on the faculty of Lansing Community College at Lansing, Mich.

Preparation of this manual was supported in part by a grant from the Environmental Protection Agency to the Editorial Board of the "Marine Flora and Fauna of the Northeastern United States." Work on the "Marine Flora and Fauna of the Northeastern United States" by the Coordinating

Editor is supported by the College of Marine Studies, University of Delaware.

Manuals are available from the following:

Superintendent of Documents, U.S. Government Printing Office, Washington, DC 20402, for a charge.

User Service Branch, Library and Information Services, Division D822, Washington Science Center, Building 4, Rockville, MD 20852, at no charge as long as the supply lasts.

National Technical Information Services, U.S. Department of Commerce, 5285 Port Royal Road, Springfield, VA 22161, either as paper copy or microfiche, for a charge.

Manuals are not copyrighted, and so may be photocopied from the NOAA Technical Report NMFS Circulars available in most major libraries.

The manuals so far published in the NOAA Technical Report NMFS Circular series are listed below by author, title, circular number, and NTIS accession number.

Marine Flora and Fauna of the Northeastern United States:	Circular No.	NTIS NO.
COOK, DAVID G., and RALPH O. BRINKHURST. Annelida: Oligochaeta	374	COM 73 50670
BORROR, ARTHUR C. Protozoa: Ciliophora.	378	COM 73 50888
MOUL, EDWIN T. Higher Plants of the Marine Fringe.	384	COM 74 50019
McCLOSKEY, LAWRENCE R. Pycnogonida.	386	COM 74 50014
MANNING, RAYMOND B. Crustacea: Stomatopoda.	387	COM 74 50487
WILLIAMS, AUSTON B. Crustacea: Decapoda.	389	COM 74 51194
POLLOCK, LELAND W. Tardigrada.	394	PB 257 987
LARSON, RONALD J. Cnidaria: Scyphozoa.	397	PB 261 839
CAVALIERE, A. R. Higher Fungi: Ascomycetes, Deuteromycetes, and Basidiomycetes.	398	PB 268 036
COULL, BRUCE C. Copepoda: Harpacticoida.	399	PB 268 714
CUTLER, EDWARD B. Sipuncula.	403	PB 273 062
PAWSON, DAVID L. Echinodermata: Holothuroidea.	405	PB 274 999
HO, JU-SHEY. Copepoda: Lernaepodidae and Sphyrriidae.	406	PB 280 040
HO, JU-SHEY. Copepoda: Cyclopoids Parasitic on Fishes.	409	PB 281 969
CRESSEY, ROGER F. Crustacea: Branchiura.	413	PB 222 923
BOVEE, EUGENE C., and THOMAS K. SAWYER. Protozoa: Sarcodina: Amoebae.	419	PB 285 538
WATLING, LES. Crustacea: Cumacea.	423	PB 296 460
ZULLO, VICTOR A. Arthropoda: Cirripedia.	425	PB 297 676
CAIRNS, STEPHEN D. Cnidaria: Scleractinia.	438	PB 124 520
TODD, RUTH, and DORIS LOW. Protozoa: Sarcodina: Benthic Foraminifera.	439	PB 225 053
BUSH, LOUISE F. Turbellaria: Acoela and Nemertodermatida.	440	PB 219 387
TAYLOR, RONALD M. Lichens (Ascomycetes) of the Intertidal Region.		