

**BY ORDER OF THE COMMANDER  
EGLIN AIR FORCE BASE**

**EGLIN AIR FORCE BASE  
INSTRUCTION 13-204**



**22 DECEMBER 2020**

***Nuclear, Space, Missile, Command and  
Control***

**AIR OPERATIONS**

**COMPLIANCE WITH THIS PUBLICATION IS MANDATORY**

---

**ACCESSIBILITY:** Publications and forms are available on the e-Publishing website at [www.e-Publishing.af.mil](http://www.e-Publishing.af.mil) for downloading or ordering

**RELEASABILITY:** There are no releasability restrictions on this publication

---

OPR: 96 OSS/OSA

Certified by: 96 OG/CC  
(Col Douglas O. Creviston)

Supersedes: EGLINAFBI 11-201;  
13 June 2016

Pages: 189

---

This instruction implements and extends the guidance of Air Force Instruction (AFI) 13-204, Volume 3, *Airfield Operations Procedures and Programs*, 1 September 2010 and AFPD 13-2, *Air Traffic Control, Airspace, Airfield, and Range Management*. This Directive sets forth policies regarding Eglin AFB and the Eglin Range Complex activities of Air Force civilian and military personnel, including the Air Force Reserve, Air National Guard, and Civil Air Patrol. It establishes procedures for safe and efficient airfield operations. It applies to all flying activities within Eglin Air Force Base delegated airspace to include its auxiliary airfields and all test areas in the Eglin Reservation. It also promotes the safe expenditure of ordnance and use of lasers during all test missions, weapons employment training missions, aerial demonstrations, and aircraft exercises in the 96th Test Wing (96 TW) test area complex. It supplements AFI 32-1043, *Managing, Operating, and Maintaining Aircraft Arresting Systems*, and all applicable Federal Aviation Administration Handbooks/Joint Orders, and Department of Defense Flight Information Publications. Refer recommended changes and questions about this publication to the Office of Primary Responsibility (OPR) using the AF Form 847, *Recommendation for Change of Publication*; route AF Forms 847 from the field through the appropriate functional chain of command. Ensure that all records created as a result of processes prescribed in this publication are maintained IAW Air Force Manual (AFMAN) 33-363, *Management of Records*, and disposed of IAW Air Force Records Information Management System (AFRIMS) Records Disposition Schedule (RDS).

***SUMMARY OF CHANGES***

This document has been substantially revised and must be completely reviewed. An accompanying change document is available upon request to the OPR.

<b>Chapter 1—GENERAL INFORMATION</b>	<b>12</b>
1.1. Scope.....	12
1.2. Administration. ....	12
1.3. Flight Information Publications (FLIP) Accounts. ....	13
1.4. Airfield Operations Board. ....	13
Table 1.1. AOB Membership.....	13
Table 1.2. Annual Review Items.....	14
1.5. Bird Wildlife Aircraft Strike Hazard (BASH) Alerting Procedures. ....	14
1.6. Local Frequency Channelization. Table 1.3. ....	16
Table 1.3. Common Frequencies/Local Channels. ....	16
Table 1.4. Additional Local Area Frequencies. ....	17
1.7. Local Aircraft Operational Priorities. ....	17
1.8. Airfield Quiet Period Request.....	18
1.9. Procedures for Eglin AFB Assigned Off-Station Aircraft.....	18
1.10. Supervisor of Flying (SOF). ....	19
<b>Chapter 2—LOCAL AIRSPACE/FLYING AREAS/TEST AREAS</b>	<b>20</b>
2.1. EAFB Reservation. ....	20
2.2. Local Flying Area. ....	20
2.3. Restricted Areas.....	20
2.4. Military Operations Areas (MOA).....	20
2.5. 14 CFR PART 93 Airspace.....	21
2.6. Warning Areas. ....	22
2.7. Military Training Routes (MTR). ....	22
2.8. Controlled Firing Areas (CFA).....	22
2.9. Class D/E Surface Areas.....	23

2.10.	Eglin/Duke Tower Transition Area (TTA). .....	24
2.11.	Water Hoist Helicopter Training Area.....	24
2.12.	Aero Club/General Aviation Training Areas:.....	24
2.13.	Hurlburt “H” Alignment Area. ....	25
2.14.	Duke Field Alignment Area.....	25
2.15.	Eglin Water Test Area (EWTA). ....	25
2.16.	Eglin “E” Area. ....	25
2.17.	Air Traffic Control Assigned Airspace (ATCAA). ....	25
2.18.	Other Airports and Facilities.....	26

**Chapter 3—RADAR AND MISSION PROCEDURES 27**

3.1.	Eglin Radar Control Facility (ERCF). ....	27
3.2.	Enroute Procedures.....	27
3.3.	Special Use Airspace (SUA) Procedures.....	27
3.4.	Recovery Procedures. ....	31

**Chapter 4—EAFB OPERATIONS AND PROCEDURES 35**

4.1.	EGLINAFB (VPS) Operating Hours. ....	35
4.2.	Prior Permission Required (PPR). ....	35
4.3.	Civil Aircraft Landing Permit (CALP). ....	35
4.4.	Transient Alert (TA). ....	35
4.5.	Runways and Taxiways. ....	35
4.6.	Restricted/Classified Areas.....	37
4.7.	Aircraft Parking Plan. ....	37
4.8.	Aircraft Special Operation Areas/Ramps: .....	37
4.9.	Ground Navigational Aid (NAVAID) Checkpoints. ....	38
4.10.	Navigational Aids (NAVAIDS) and Air Traffic Control and Landing Systems (ATCALs). ....	38
4.11.	Permanently Closed/Unusable Portions of the Airfield.....	39
4.12.	Airfield Lighting.....	39
4.13.	ATIS, Weather Dissemination and Coordination Procedures.....	39

	4.14.	Active Runway Selection and Change Procedures.....	39
	4.15.	Runway Surface Condition (RSC) and/or Runway Condition Reading (RCR) Values.....	41
	4.16.	Aircraft Arresting Systems.....	41
Table	4.1.	Eglin Aircraft Arresting System Locations.....	41
	4.17.	NOTAM Procedures.....	42
	4.18.	Airfield Maintenance.....	42
	4.19.	Airfield Tobacco Use Policy.....	42
	4.20.	Photograph/Video on the Airfield and Ranges.....	42
Table	4.2.	Photograph/Video Responsible Agencies.....	43
	4.21.	Wear of Hats.....	44
	4.22.	Scheduling and Flight Plan Procedures.....	44
	4.23.	Controlled Movement Area (CMA).....	45
	4.24.	Precision Approach Critical Area.....	46
	4.25.	Engine Test/Run-Up Areas and Procedures.....	46
	4.26.	Procedures for Suspending, Opening, and/or Closing the Runway.....	47
	4.27.	Airfield Inspections/Checks.....	47
	4.28.	Aircraft Towing Procedures.....	47
	4.29.	Aeromedical Aircraft Arrival Procedures.....	47
	4.30.	Local Control Points.....	47
Table	4.3.	Local Control Points.....	48
Table	4.4.	Eglin VFR Reporting/Holding Points.....	49
	4.31.	Taxi Procedures.....	49
	4.32.	Reduced Same Runway Separation (RSRS).....	50
Table	4.5.	RSRS Standards.....	50
	4.33.	General Departure Procedures.....	51
Table	4.6.	EAFB Intersection Departure Distance Remaining.....	52
	4.34.	General Recovery Procedures.....	53
Table	4.7.	VFR Pattern Matrix.....	57

	4.35. Simulated Flameout (SFO) and Precautionary Flameout (PFO) Approaches. ....	62
	4.36. Rectangular Pattern.....	66
	4.37. Noise Abatement Procedures.....	67
Table	4.8. Minimum Noise Abatement Altitudes.....	67
	4.38. Areas of Potential Conflict.....	68
	4.39. Hurlburt Field Patterns.....	68
	4.40. IFR Procedures. ....	68
	4.41. Restricted Low Approach. ....	69
	4.42. Aero Club Procedures.....	70
	4.43. Helicopter/Tiltrotor Operations. ....	71
<b>Chapter 5—DUKE FIELD OPERATIONS AND PROCEDURES</b>		<b>74</b>
	5.1. EAFB/Auxiliary Field Three (Duke Field, KEGI) Operating Hours.....	74
	5.2. Transient Alert. ....	74
	5.3. Runway and Taxiways.....	75
	5.4. Restricted/Classified Areas on the Airfield. ....	75
	5.5. Aircraft Parking Plan. ....	76
	5.6. Aircraft Special Operation Areas/Aprons.....	76
	5.7. Airfield Hazards.....	80
	5.8. NAVAIDs and ATCALs.....	80
	5.9. Permanently Closed/Unusable Portions of the Airfield.....	80
	5.10. Airfield Lighting.....	80
	5.11. ATIS, Weather Dissemination and Coordination Procedures.....	81
	5.12. Active Runway Selection and Change Procedures.....	81
	5.13. Runway Surface Condition (RSC) and/or Runway Condition Reading (RCR) Values. ....	81
	5.14. Aircraft Arresting Systems. ....	81
Table	5.1. Duke Field Aircraft Arresting System Locations. ....	82
	5.15. NOTAM Procedures.....	82
	5.16. Airfield Maintenance. ....	83

	5.17. Airfield Tobacco Use Policy.....	83
	5.18. Wear of Hats. ....	83
	5.19. Airfield Photography. ....	83
	5.20. Scheduling and Flight Plan Procedures. ....	83
	5.21. Controlled Movement Area (CMA).....	83
	5.22. Precision Approach Critical Area. ....	84
	5.23. Engine Test/Run-Up Areas and Procedures. ....	84
	5.24. Procedures for Suspending, Opening and/or Closing the Runway. ....	84
	5.25. Airfield Inspections/Checks.....	84
	5.26. Aircraft Towing Procedures.....	84
	5.27. Aeromedical Aircraft Arrival Procedures.....	84
	5.28. Local Control Points. ....	84
	5.29. Tower Visual Blind Spots.....	84
	5.30. Reduced Same Runway Separation (RSRS).....	85
	5.31. General Departure Procedures. ....	85
Table	5.2. Duke Field Intersection Departure Distance Remaining. ....	85
	5.32. General Recovery Procedures.....	85
	5.33. SFO and PFO Approaches.....	88
	5.34. Duke Field Random Steep Approach. ....	91
	5.35. Duke Field Random Shallow Approach. ....	92
	5.36. VFR NVD Operations: .....	93
	<b>Chapter 6—EMERGENCY PROCEDURES</b>	<b>94</b>
	6.1. Daily Primary Crash Alarm System (PCAS) Phone Check.....	94
	6.2. Emergency Notification.....	94
	6.3. Arrival/Departures. ....	94
	6.4. Eglin/Duke Field Discrete Emergency Frequency.....	94
	6.5. In-Flight/Ground Emergency Responsibilities/Procedures. ....	94
	6.6. Emergency Information. ....	95
	6.7. Emergency Locator Transmitters (ELT) and Crash Position Indicators (CPI).....	96

6.8.	Beacon Code 7700 Response on the Ground.....	97
6.9.	Runway Checks Following an Emergency. ....	97
6.10.	Aircraft Arresting System Procedures. ....	97
6.11.	Fuel Dumping. ....	98
6.12.	External Stores/In-Flight Aircraft Cargo Jettison Procedures. ....	98
6.13.	MC-130 Refueling Hose Jettison Procedures. ....	98
6.14.	Aircraft Abandonment/Controlled Bailout Procedures.....	98
6.15.	Emergency Landing Gear Checks. ....	99
6.16.	Hot Brakes Parking Areas.....	99
6.17.	Hydrazine Leak Parking Areas. ....	99
6.18.	Alternate ATC Facility Procedures.....	100
6.19.	Unauthorized Movement/Preventing/Resisting Aircraft Piracy/Hijacking. ....	103
<b>Chapter 7—RANGE EMERGENCY PROCEDURES</b>		<b>104</b>
7.1.	Inadvertent Release Procedures. ....	104
7.2.	Unintentional Release Procedures. ....	104
7.3.	Unexpended Ordnance Procedures. ....	104
7.4.	Hung/Jammed/Unsafe Gun Procedures. ....	104
7.5.	Jettison Procedures. ....	107
7.6.	Hung Ordnance General Procedures.....	107
Table 7.1.	Munitions (Ordnance)/External Stores Categories for Developmental Weapons. ..	108
7.7.	Hung Ordnance Notification Procedures. ....	109
Table 7.2.	In-Flight Emergency (IFE) Crash Rescue Response. ....	110
7.8.	Hung Ordnance Recovery Procedures. ....	110
7.9.	IFR Hung Ordnance Recovery Routes. ....	112
7.10.	De-Arming Procedures. ....	112
7.11.	Radio Failure Procedures with Ordnance. ....	113
7.12.	Helicopter and AC-130 Gunship Weapon System Malfunctions. ....	113
7.13.	Crash Procedures. ....	113
7.14.	RCO Procedures during Emergencies. ....	114

<b>Chapter 8—TEST MISSION PROCEDURES</b>	<b>115</b>
8.1. Test Area Scheduling.....	115
8.2. Test Area Control.....	115
Table 8.1. Test Area Control Authority.....	116
8.3. Test Area Operations Responsibilities.....	116
8.4. Departure Procedures.....	117
8.5. Test Area Procedures for Ordnance Delivery Missions.....	117
<b>Chapter 9—RANGE OPERATIONS</b>	<b>119</b>
9.1. Purpose.....	119
9.2. Policies.....	119
9.3. Test Area Safety.....	119
9.4. General Test Area Procedures.....	119
9.5. Test Area Entry.....	119
9.6. Test Area C-62 Procedures.....	120
Table 9.1. Test Area C-62 Delivery Headings and Pattern Directions.....	120
9.7. Test Area C-52N Procedures.....	121
9.8. Test Area B-6 (Eglin Field 6, Army Ranger Camp, Camp Rudder).....	123
9.9. Rejoins/Departures.....	123
9.10. RCO Procedures.....	123
Table 9.2. AFI 13-212 Items.....	123
<b>Chapter 10—OPERATIONAL PROCEDURES FOR THE EMPLOYMENT OF ELECTRONIC PROTECTIVE MEASURES (EPM), CHAFF, FLARES, AND LASERS</b>	<b>127</b>
10.1. Purpose.....	127
10.2. Responsibilities.....	127
10.3. Authorized Systems.....	128
10.4. Scheduling.....	128
10.5. Departure Procedures.....	128
10.6. Flare Employment Procedures.....	128



10.7.	Chaff Employment Procedures:.....	128
10.8.	EPM Employment Procedures:.....	129
10.9.	Recoveries.....	129
10.10.	Airborne Laser Operations.....	129
Table 10.1.	Laser Targets.....	130
<b>Chapter 11—SUPERSONIC OPERATIONS</b>		<b>132</b>
11.1.	Supersonic Operations. ....	132
<b>Chapter 12—REMOTELY PILOTED AIRCRAFT (RPA)</b>		<b>133</b>
12.1.	General.....	133
12.2.	Airfields for RPA.....	133
12.3.	Airspace for SUAS. ....	134
12.4.	Emergency Procedures. ....	135
12.5.	Weapon Employment. ....	136
<b>Attachment 1—GLOSSARY OF REFERENCES AND SUPPORTING INFORMATION</b>		<b>137</b>
<b>Attachment 2—EGLIN AFB AIRFIELD DIAGRAM</b>		<b>144</b>
<b>Attachment 3—EGLIN AFB CONTROLLED MOVEMENT AREA DIAGRAM</b>		<b>145</b>
<b>Attachment 4—EGLIN AFB HOT PIT/LOLA PROCEDURES</b>		<b>146</b>
<b>Attachment 5—EGLIN AFB VFR OVERHEAD PATTERNS</b>		<b>147</b>
<b>Attachment 6—EGLIN AFB VFR RECTANGULAR PATTERNS</b>		<b>148</b>
<b>Attachment 7—EGLIN VFR TRAFFIC PATTERNS RUNWAYS 12/19 ACTIVE</b>		<b>149</b>
<b>Attachment 8—EGLIN VFR TRAFFIC PATTERNS RUNWAYS 1/30 ACTIVE</b>		<b>150</b>
<b>Attachment 9—RUNWAY 12/30 SIMULATED FLAMEOUT (SFO) PATTERN</b>		<b>151</b>
<b>Attachment 10—OVERHEAD SFO AND STRAIGHT-IN SFO PATTERNS</b>		<b>152</b>
<b>Attachment 11—RWY 12/30 RANDOM ENTRY SIMULATED FLAMEOUT PATTERN (RESFO) PROCEDURES</b>		<b>153</b>
<b>Attachment 12—VFR TOWER TO TOWER PROCEDURES – SOUTH FLOW</b>		<b>154</b>
<b>Attachment 13—VFR TOWER TO TOWER PROCEDURES – NORTH FLOW</b>		<b>155</b>
<b>Attachment 14—VFR TOWER TO TOWER PROCEDURES – MIXED FLOW VPS RWY 1/30 &amp; EGI RWY 18</b>		<b>156</b>

<b>Attachment 15—VFR TOWER TO TOWER PROCEDURES – MIXED FLOW VPS RWY 12/19 &amp; EGI RWY 36</b>	<b>157</b>
<b>Attachment 16—EGLIN AFB RADAR RECTANGULAR PATTERNS</b>	<b>158</b>
<b>Attachment 17—DDUNE RECOVERY</b>	<b>159</b>
<b>Attachment 18—WHISKEY HOTEL RECOVERY</b>	<b>161</b>
<b>Attachment 19—NORTH FLOW RECOVERY</b>	<b>162</b>
<b>Attachment 20—DUKE FIELD AIRFIELD DIAGRAM</b>	<b>164</b>
<b>Attachment 21—DUKE FIELD CONTROLLED MOVEMENT AREA DIAGRAM</b>	<b>165</b>
<b>Attachment 22—DUKE FIELD SOUTH OPERATIONS</b>	<b>166</b>
<b>Attachment 23—DUKE FIELD NORTH OPERATIONS</b>	<b>167</b>
<b>Attachment 24—DUKE FIELD STOVL PADS SOUTH OPERATIONS</b>	<b>168</b>
<b>Attachment 25—DUKE FIELD STOVL PADS NORTH OPERATIONS</b>	<b>169</b>
<b>Attachment 26—DUKE FIELD VFR RECTANGULAR PATTERNS</b>	<b>170</b>
<b>Attachment 27—DUKE FIELD VFR OVERHEAD PATTERNS</b>	<b>171</b>
<b>Attachment 28—DUKE FIELD RANDOM SHALLOW APPROACH</b>	<b>172</b>
<b>Attachment 29—DUKE FIELD RANDOM STEEP APPROACH</b>	<b>173</b>
<b>Attachment 30—DUKE FIELD EQUIPMENT DROP ZONE PROCEDURES</b>	<b>174</b>
<b>Attachment 31—DUKE FIELD HELICOPTER VFR EAST TRAINING AREA (VETA)</b>	<b>175</b>
<b>Attachment 32—DUKE FIELD, HURLBURT FIELD, DESTIN, AND CRESTVIEW RADAR RECTANGULAR PATTERNS</b>	<b>176</b>
<b>Attachment 33—HURLBURT FIELD VFR RECTANGULAR PATTERNS</b>	<b>177</b>
<b>Attachment 34—HURLBURT FIELD VFR OVERHEAD PATTERNS</b>	<b>178</b>
<b>Attachment 35—EGLIN LOCAL FLYING AREA</b>	<b>179</b>
<b>Attachment 36—CLASS DELTA AND ECHO SURFACE AREAS, MOAS, AND RESTRICTED AREAS</b>	<b>180</b>
<b>Attachment 37—FAR PART 93 AIRSPACE (NORTH/SOUTH – EAST/WEST CORRIDORS)</b>	<b>181</b>
<b>Attachment 38—LOCAL CONTROL POINTS</b>	<b>182</b>
<b>Attachment 39—EGLIN WATER TEST AREAS</b>	<b>183</b>
<b>Attachment 40—W-151 AND W-470 SUBDIVISIONS</b>	<b>184</b>

<b>EGLINAFBI13-204 22 DECEMBER 2020</b>	<b>11</b>
<b>Attachment 41—W-470</b>	<b>185</b>
<b>Attachment 42—WARNING AIRSPACE BREEDING/THUNDER/LIGHTNING AREA DIAGRAM</b>	<b>186</b>
<b>Attachment 43—AERO CLUB TRAINING AREAS AND SANTA ROSA ISLAND CFA</b>	<b>187</b>
<b>Attachment 44—EMERGENCY JETTISON/BAILOUT AREAS</b>	<b>188</b>
<b>Attachment 45—NOISE ABATEMENT AND SAFETY MINIMUM ALTITUDES</b>	<b>189</b>

## Chapter 1

### GENERAL INFORMATION

**1.1. Scope.** The rules and instructions herein are issued to promote the safe, orderly, and expeditious movement of air traffic within Eglin's Air Traffic Control (ATC) airspace and the safe expenditure of ordnance and use of lasers during all test missions, weapons employment training missions, aerial demonstrations, and aircraft exercises in the Eglin Range Complex. Pilots, air traffic controllers, and airfield operations professionals are expected to exercise their best judgment for real-time decision making and contact the OPR for guidance not covered in this instruction. Commanders of assigned, associate, and deployed units will ensure their personnel understand and comply with applicable chapters of this instruction, the Safety Appendix to the test directive (TD), memorandums of agreement, letters of agreement (LOA), appropriate command directives, and aircraft technical orders, for planning and executing of their individual test program or weapons employment training program.

**1.2. Administration.** The Commander, 96th Test Wing (96 TW/CC) is responsible for this instruction. The 96 TW/CC will ensure all units visiting EAFB to conduct missions on the Eglin Range complex review and abide by this instruction. The 96 TW/CC has delegated waiver approval authority to this instruction for special mission requirements to the 96 OG/CC, except when higher waiver approval authority is dictated by AFI. All procedural changes affecting air traffic control must be approved by AFMC/A3OO before implementation. All airfield/airspace criteria waiver requests will be accomplished IAW AFI 13-204V3, *Airfield Operations Procedures and Programs*, using AF IMT 4058, *Airfield Operations Policy Waiver*. Suggested changes to this instruction and all waiver requests shall be sent to 96 OSS/OSA, 505 N. Barrancas Ave, Bldg 104, Ste 209D, Eglin AFB FL 32542-6818, or by email to [96baseops@us.af.mil](mailto:96baseops@us.af.mil) for review and coordination.

1.2.1. The 96 OG/OGV is responsible for establishing a Flight Crew Information File (FCIF) process to ensure all affected units receive timely updates to this instruction. Any 96 OG/OGV FCIF issued that affects topics within EAFBI 13-204, operations at EAFB, or the EAFB Reservation will be distributed to 96 OSS, 33 OG/OGV, 325 OG/OGV, 492 SOG/OGV, 85 TES/DOV, 919 SOG/OGV, 1 SOG/OGV, Eglin Aero Club Manager, and Destin-Fort Walton Beach Airport Manager.

1.2.2. A list of references, terms, abbreviations, and acronyms to this instruction is included in [Attachment 1](#).

1.2.3. Within this instruction, visibility distances are measured in statute miles (SM) and all other distances are measured in nautical miles (NM) unless otherwise identified.

1.2.4. All references to AFI 13-204 within this instruction shall read AFMAN 13-204 once AFMAN 13-204 is published.

**1.3. Flight Information Publications (FLIP) Accounts.** Eglin Airfield Management Operations (AMOPS) manages the 96 TW FLIP accounts for all assigned units on Eglin and Duke Field. Send all suggested nonprocedural FLIP changes to 96 OSS/OSAM, 601 N. Choctawhatchee Ave, Ste 80, Eglin AFB FL 32542-5718 or call COMM: (850) 882-2614/ DSN: 872-2614. Send all procedural FLIP changes to 96 OSS/OSA (TERPS), 505 N. Barrancas Ave, Ste 209J, Eglin AFB FL 32542.

**1.4. Airfield Operations Board.** IAW AFI 13-204V3, the 96 TW/CV has delegated chair responsibility to the 96 OG/CC for the Eglin AFB Airfield Operations Board (AOB). The AOB will meet on a quarterly basis, IAW AFI 13-204V3, para 4.2. New agenda items shall be provided to the Airfield Operations Flight (96 OSS/OSA) no later than 15 working days prior to the board meeting to ensure they will be included for discussion. The Eglin Airfield Operations Flight Commander (AOF/CC) will distribute a proposed agenda at least 10 working days prior to each board meeting. Each subject matter Office of Primary Responsibility (OPR) shall be prepared to brief the status of each open agenda item.

1.4.1. AOB Membership. The AOB shall consist of the members (or their representative) listed in [Table 1.1](#)

**Table 1.1. AOB Membership.**

96 OG/CC	85 TES/CC
96 OG/OGV	85 TES/SE
96 OSS/CC	40 FLTS/CC
96 OSS/DO	58 FS/CC
96 OSS/OSA	86 FWS/CC
96 OSS/OSB	86 FWS/SE
96 OSS/OSM	413 FLTS/CC
96 WS/CC	417 FLTS/CC
96 TW/SEF	492 SOW/SE
96 TW/CP	492 SOG/OGV
96 CEG/CC	492 SOSS/OSO
96 CEG/CEIEA	919 SOW/SE
96 CEG/CENPL	919 SOG/OGV
96 CEG/ CENMP	919 SOSS/DOO
96 MXG/CC	1 SOW/SE
796 CES/CL	1 SOSS/OSA
33 FW/SEF	Destin Fixed Base Operator
33 OSS/CC	Crestview Fixed Base Operator
33 OG/OGV	Destin-Fort Walton Beach Airport Manager

53 WG/SE	Eglin Aero Club
43 FS/CC	FAA ATREP
2 FS/CC	USDA Wildlife Services
325 OG/OGV	AFRL SE

1.4.2. AOB Annual Review Items. The following items shall be reviewed annually in the quarter indicated and briefed at the AOB:

**Table 1.2. Annual Review Items.**

1st Quarter	2d Quarter	3d Quarter	4th Quarter
Aircraft Parking Plan	Annual Airfield Certification/Safety Inspection	Results of Self-Inspection	Letters of Procedure (LOP) Review
Special Interest Items (SII)	Air Installation Compatible Use Zone (AICUZ) (optional)	Terminal Procedures (TERPS)	Airfield Waivers

**1.5. Bird Wildlife Aircraft Strike Hazard (BASH) Alerting Procedures.** BASH program guidance and procedures are established in the EAFB Bird Aircraft Strike Hazard Plan (EAFB Plan 91-212, *Bird Wildlife Aircraft Strike Hazard Plan*). All personnel utilizing EAFB, the Range Complex or Duke Field will comply with this instruction and EAFB Plan 91-212. Refer to EAFB Plan 91-212 for Bird Watch Conditions (BWC) terminology (e.g. definition of BWCs of SEVERE, MODERATE, or LOW).

1.5.1. When in the Tower, the SOF is the primary party responsible for declaring, raising, or lowering the Bird Watch Condition (BWC). In the absence of a SOF in the Tower, AMOPS has the authority to declare, raise, or lower the BWC. In addition, the Tower Watch Supervisor (WS), USDA, and SEF may elevate, but not reduce, the BWC.

1.5.1.1. After elevating the airfield BWC, a localized BWC may be declared once potentially unaffected areas have been deemed safe from wildlife activity. Thereafter, the localized BWC applies only to a specific geographic location on the airfield.

1.5.2. Aircrew can obtain the current BWC from the Automatic Terminal Information Service (ATIS), Improved Weather Dissemination System (IWDS), Avian Hazard Advisory System (AHAS), and/or by contacting AMOPS or the command post. See EAFB Plan 91-212 for more procedures.

1.5.3. Aircrews must report any bird or wildlife sightings which pose a probable threat to safe flight operations to one or all of the following: Eglin SOF, Eglin Tower, Eglin Radar Control Facility (ERCF), mission controller or the Range Control Officer (RCO). ATC must relay the information to AMOPS and to aircraft under their control. Information should include the following:

1.5.3.1. Aircraft callsign.

1.5.3.2. Altitude of birds.

- 1.5.3.3. Approximate number of birds.
- 1.5.3.4. Type of birds, if known.
- 1.5.3.5. Location/direction of flight or roost.
- 1.5.3.6. Local time of sighting.

1.5.4. The following will be used to implement unit operational procedures.

1.5.4.1. BWC/Range Complex SEVERE. Operations in BWC SEVERE will only be conducted with the flying unit's OG/CC approval.

1.5.4.1.1. Landings. Only one approach to a full-stop landing is permitted.

1.5.4.1.2. Takeoffs. Takeoffs are prohibited without the flying unit's OG/CC or higher approval. If approved, no formation takeoffs are permitted.

1.5.4.1.3. Pattern. Aircraft will hold (fuel permitting) until the hazards no longer exist. The SOF will consider closing the overhead pattern if that will minimize the risk due to observed bird activity.

1.5.4.1.4. Units should consider delaying departures, arrivals and/or diverting aircraft. The SOF and Tower Watch Supervisor may consider closing the VFR pattern, as well as changing or suspending a runway with inputs from the Airfield Manager. If the Eglin SOF in the Tower (or AM in the SOF's absence) determines the hazard is confined to a specific location that would allow safe operations to the adjacent runway, the SOF may continue operations to the hazard free runway. Supervisors and aircrews must thoroughly evaluate mission needs before conducting operations in areas under BWC SEVERE. OG/CCs should consider prohibiting takeoffs and limiting approaches to a full stop landing when under BWC SEVERE.

1.5.4.1.5. If the BWC is declared SEVERE in the range complex, the RCO will identify a specific area and altitude to ensure the area is avoided by all aircrew utilizing the range.

1.5.4.2. BWC/Range Complex MODERATE.

1.5.4.2.1. Traffic patterns shall be limited to the minimum required to accomplish training requirements. OG/CCs should consider limiting takeoffs and landing to the minimum necessary to fulfill mission requirements. OG/CCs should also consider restricting close formation in the traffic pattern. Supervisors and aircrews shall thoroughly evaluate mission requirements utilizing all available risk mitigation methods and tools before conducting flight operations in areas under Bird Watch Condition MODERATE. Pilots will be particularly cognizant of bird activity when on final and will avoid low, flat approaches.

1.5.4.2.2. If BWC MODERATE is declared in the Eglin Range Complex, flight leads will change event order or amend altitudes to minimize the hazard.

1.5.4.3. BWC/Range Complex LOW.

1.5.5. All personnel discovering a bird strike will initiate AF Form 853, *Air Force Wildlife Strike Report*, or equivalent and notify the appropriate Maintenance Operations Control Center (MOCC) or AMOPS for transient aircraft. The MOCC will notify AMOPS, 96th Test Wing Flight Safety (96 TW/SEF), and Quality Assurance. More guidance is found in EAFB Plan 91-212.

**1.6. Local Frequency Channelization.** Table 1.3. lists the frequencies that will normally be issued by the controlling agency as a local channel number.

**Table 1.3. Common Frequencies/Local Channels.**

<b>LOCAL CHANNEL</b>	<b>FREQUENCY (UHF/VHF)</b>	<b>AGENCY</b>
<b>1</b>	At Unit Discretion	Squadron Ops Frequency
<b>2</b>	377.2/127.7	Clearance Delivery
<b>3</b>	335.8/121.8	Eglin Ground
<b>4</b>	353.65/118.2	Eglin Tower
<b>5</b>	360.6/132.1	Departure/Approach (South)
<b>6</b>	281.45/125.1	Departure/Approach (North)
<b>7</b>	290.5/124.25	ERCF Arrival (Primary)
<b>8</b>	276.0	Wolf Call
<b>9</b>	269.15	Emergency/Single Frequency Approach
<b>10</b>	264.6	SOF location in Eglin Tower
<b>11</b>	316.9/135.25	Land Mission Common/Return to Base (RTB)
<b>12</b>	290.9/135.25	Water Mission Common/RTB
<b>13</b>	351.675/126.5	Hurlburt Tower
<b>14</b>	290.425/133.2	Duke Tower
<b>15</b>	363.4	Air Refueling Common
<b>16</b>	255.4	Flight Service
<b>20</b>	273.5/134.625	Eglin ATIS
<b>NOTE: 33 FW uses Channel 19 for Eglin ATIS.</b>		



**Table 1.4. Additional Local Area Frequencies.**

<b>FREQUENCY</b>	<b>AGENCY</b>
305.6/143.875	40th/85th Ops
354.2	58 FS Ops
258.1	Air Traffic Control Assigned Airspace (ATCAA) East
274.15	ATCAA West
275.8/123.975	Hurlburt Ground
251.125/123.25	Duke Ground
268.075	Duke VFR East Training Area (VETA)
389.1	Crestview Navy Helicopter Advisory
360.675/134.475	Hurlburt ATIS
372.2/142.3	Duke/Eglin Pilot to Dispatch
225.75	919th Command Post (Sand Castle)
342.2	Eglin Pilot to Metro
133.925	Destin Automated Service Observing System (ASOS)
123.075	Destin Common Traffic Advisory Frequency (CTAF) (2200L-0600L)
121.6	Destin Clearance Delivery
118.45	Destin Tower
121.6	Destin Ground
122.95	Crestview/Bob Sikes CTAF
119.275	Crestview/Bob Sikes ASOS
122.95	Aero Club UNICOM
342.1/118.275	W-470
284.65/124.05	Bob Sikes Approach

**1.7. Local Aircraft Operational Priorities.** Local aircraft operational priorities were established to facilitate mission accomplishment. When feasible, Eglin/Duke ATC shall provide priority service in the order listed below. These priorities shall not take precedence over the priorities listed in **Chapter 2** of Federal Aviation Administration Job Order (JO) 7110.65 per [www.faa.gov](http://www.faa.gov).

1.7.1. Contingency Mission Priority Departures. Contingency mission priority expedites operations supporting real-world contingencies. On initial contact, aircraft shall inform Ground Control, "REQUEST CONTINGENCY PRIORITY."

1.7.2. Test Mission Priority Departures. Test mission priority departures may be requested to prevent loss of a test mission due to a departure delay. Prior to taxi, a test pilot requesting priority should inform Ground Control, "REQUEST TEST PRIORITY DEPARTURE."

1.7.3. Exercise Priority Departures. Any flight participating in an exercise involving precise air refueling control times or air drop times over a target may request priority by informing Ground Control on initial contact, "REQUEST EXERCISE CONTROLLED TAKEOFF TIME AT (time)." This priority shall only be used when timing is critical. When possible, operational units requiring exercise priority shall coordinate controlled takeoff times and/or unusual requests with the Tower Chief Controller.

1.7.4. Star Priority. Identifies aircraft operated by general officers. The filing agency shall notify AMOPS that star-priority procedures are desired for a specific flight. AMOPS shall notify the ERCF and Tower that star-priority procedures are in effect for (callsign). Star-priority aircraft will be given expeditious handling whenever possible.

1.7.5. Distinguished Visitor (DV) Support Flights. The pilot must inform the controlling agency that the flight is a DV support flight. The pilot of an Air Combat Command (ACC) DV support flight may only declare priority when the DV is aboard the aircraft.

1.7.6. Government Aircraft Departures and Arrivals.

1.7.7. Air carrier/Aero Club Departures and Landings.

1.7.8. Practice Approaches.

**1.8. Airfield Quiet Period Request.** Quiet periods at Eglin and Duke Field shall be requested IAW EAFBI 13-200, *Eglin Range Mission Scheduling and Control*.

**1.9. Procedures for Eglin AFB Assigned Off-Station Aircraft.** The Eglin Command Post is responsible for maintaining accountability of all aircraft assigned to EAFB. To accomplish this requirement, the following procedures will be followed.

1.9.1. Flying Squadron Responsibilities. All Eglin flying squadrons will provide a daily flying schedule to the Eglin Command Post that will include weekends and holidays detailing off-station itineraries (not to include individual sorties flown at the deployed location).

1.9.2. Aircrew Responsibilities. All Eglin aircrew will:

1.9.2.1. Notify the Eglin Command Post at COMM: (850) 883-4020/DSN: 875-4020 of any deviations to their planned itinerary prior to takeoff.

1.9.2.2. Provide Command Post with the following information after each flight:

1.9.2.2.1. Actual departure and arrival times.

1.9.2.2.2. Total flying time.

1.9.2.2.3. Aircraft and aircrew status.

1.9.2.2.4. Phone number where they can be reached.

1.9.3. Command Post Responsibilities. Eglin Command Post will:

1.9.3.1. Confirm all landings and departures of assigned aircraft at all locations.

1.9.3.2. During normal duty hours, the command post will call the individual squadron operations to pass along the information.

1.9.3.3. Implement appropriate checklist actions for all unconfirmed aircraft and submit applicable reports in accordance with AFI 10-206, *Operational Reporting*.

**1.10. Supervisor of Flying (SOF).**

1.10.1. The SOF program and support provided by the Airfield Operations Flights will be IAW AFMCI 11-201, *Supervision of Flight Operations*.

## Chapter 2

### LOCAL AIRSPACE/FLYING AREAS/TEST AREAS

**2.1. EAFB Reservation.** The EAFB reservation comprises all real property under jurisdiction of the 96th Test Wing Commander (96 TW/CC). The boundaries, in general, may be described as Choctawhatchee Bay and Santa Rosa Sound to the south; East Bay on the west; US Highway 331 on the east; and Yellow River and US Highway 90 to the north. The reservation includes multiple tactical training areas, test areas, instrumented sites, EAFB, Hurlburt Field, Eglin Auxiliary Field 3 (Duke Field), FL34 (Field 6), Auxiliary Field 1, Auxiliary Field 10 (Dillon Field or NOLF Choctaw), Federal Aviation Administration (FAA) identifier NFJ. Specific procedures for Choctaw Field are not prescribed in this regulation. Restricted airspace and 14 CFR Part 93, *Special Air Traffic Rules*, airspace overlays most of the reservation and there are parts of the airspace over publicly owned property (See [Attachment 36](#)).

**2.2. Local Flying Area.** The local flying area consists of the National Airspace System (NAS), Special Use Airspace (SUA), Airspace for Special Use (ASU), restricted areas, military operations areas (MOA), 14 CFR Part 93 airspace, warning areas, controlled firing areas (CFA), Class C, D, and E airspace, military training routes, and the uncharted Eglin Water Test Areas (EWTA). This document will only address that airspace under the control of the 96th Test Wing. Other SUA or ASU in the local area are available for mission execution and the attributes and scheduling of each can be found in the DoD FLIPs, JO 7400.10, *Special Use Airspace*, and Hurlburt Field Instruction (HFI) 11-201, *Fixed and Rotary Wing Operations* (See [Attachments 35, 36, and 37](#)).

**2.3. Restricted Areas.** Eglin's SUA includes restricted areas R-2914A/B, R-2915A/B/C, R-2917, R-2918, and R-2919A/B (See [Attachment 36](#)). The attributes of these areas are described in the DoD FLIP and JO 7400.10. R-2917, utilized by United States Space Command (USSPACECOM), is the hazard zone around Site C-6, Space Detection and Tracking System (SPADATS). Site C-6 is the FPS-85 radar located within a 1 NM radius circle centered at 30°34'21"N/086°12'53"W which goes from surface to 5,000 ft Mean Sea Level (MSL). Due to the nature and operation of SPADATS, R-2917 (surface to 5,000 ft MSL) is a no-fly zone for all aircraft.

**2.4. Military Operations Areas (MOA).** EAFB SUA includes Eglin A East, A West, B, C, D, E, F MOAs and Rose Hill MOA. Eglin A East, A West, B, C, D, and F MOAs are designated for controlled egress and ingress for aircraft that wish to utilize the airspace over the EAFB Reservation (See [Attachment 36](#)). This only applies to aircraft under the control of ERCF that cannot be contained in the airspace over the EAFB Reservation due to a mission profile. These MOAs shall be called up automatically by the ERCF for the requested altitudes if the profile for the mission reflects utilization of that airspace. The attributes of these MOAs are described in the DoD FLIP and JO 7400.10. **NOTE:** Due to high density airway traffic and flow constraints north of the EAFB Reservation, normally only a block altitude of 2,000 ft may be scheduled within the Eglin A, B, C and D MOAs at any given time. Excluding Eglin F MOA, any altitude requested above 10,000 ft MSL will require Jacksonville Center approval. **NOTE:** The Eglin A MOA is divided into an east and west section. The west section lies within Pensacola Approach's airspace and requires 15 minutes prior coordination by Eglin Approach for use. The Navy Whiting Class C airspace is not part of Eglin A MOA.

2.4.1. Eglin D MOA. The Eglin D MOA is designated to provide airspace for the control of aircraft transitioning from the Clear Springs Initial Point (IP) to Eglin Test Area C-62, within R- 2914A, and from R-2914A to the IP. This MOA is designed to be used in conjunction with Eglin C MOA. Use of the area is coordinated through the ERCF with a minimum of 15 minutes prior notification.

2.4.2. Eglin E MOA. Eglin E MOA overlies all of the Eglin restricted areas and the 14 CFR Part 93 airspace. Use of Eglin E MOA is for those missions that are not classified as hazardous. Upon request, ERCF may approve up to, but not including FL180. **NOTE:** This is not to be confused with the Eglin E ATCAA as they are different airspaces.

2.4.3. Eglin F MOA. This MOA is designated for controlled penetration of the small triangular area on the western boundary of R-2915B by mission aircraft under control of the ERCF that cannot be contained in R-2915A/B/C because of the mission profile.

**2.5. 14 CFR PART 93 Airspace.** See [Attachment 37](#). 14 CFR Part 93 Airspace is necessary to simplify operating procedures, airspace assignment, and airspace use within the Valparaiso, Florida, Terminal Area. 14 CFR Part 93 Airspace denotes special airport traffic patterns and airport traffic areas. It also prescribes special air traffic rules for operating aircraft in those traffic patterns, traffic areas, and in the vicinity of airports so designated as needing special consideration. Unless otherwise authorized by ATC, each person operating an aircraft shall do so in accordance with the special air traffic rules in 14 CFR Part 93 in addition to other applicable rules in 14 CFR Part 91.

2.5.1. Eglin North-South Corridor. For dimensions of airspace within the boundaries of the Eglin North-South Corridor, see 14 CFR Part 93 rules and the New Orleans Sectional. To operate in the North-South Corridor, an aircraft must receive permission from the ERCF and maintain two-way radio communications with the ERCF or an appropriate ATC facility.

2.5.1.1. This area is designed to facilitate aircraft movement to and from Eglin, Duke Field, Hurlburt Field, Destin Airport, and other airports along the Florida Panhandle. This area is also used in conjunction with the Eglin eastern range complex, Eglin western range complex, or both range complexes to support special mission requirements.

2.5.1.2. The 96th TW has agreed to only close this corridor for the purpose of testing long-range air-delivered weapons and missiles and to ensure that test missions requiring the closing of this corridor do not delay air carrier arrival/departure flights more than 15 minutes. The Eglin North- South corridor **IS NOT** Special Use Airspace below FL180. Therefore, the use of the corridor below FL 180 requires a NOTAM to be sent at least 12 hours prior to the planned mission. This Airspace does lie within the confines of the Eglin E MOA but cannot be scheduled separately from the rest of the E MOA, as the E MOA has no subdivisions. Both the FAA and the ERCF recognize the need to occasionally schedule this airspace for missions below FL 180 and will make every attempt to accommodate such requests.

2.5.1.2.1. The 7th SFG (A) Cantonment Area is in the Eglin North-South Corridor. Olson Helicopter Landing Zone (HLZ) on the 7th SFG (A) Cantonment Area will not be used for routine training and will be limited to Distinguished Visitor support.

2.5.1.2.2. Routine paradrop training will not be conducted in the Eglin North-South Corridor. Directing paradrop aircraft for orbit and run-ins to a Drop Zone (DZ) in the Eglin North-South Corridor significantly disrupts Eglin and Duke Class D airspace. ATC must vector aircraft out of the Eglin North-South Corridor into restricted airspace which has a corresponding impact to Eglin test and training missions. To support the 7th SFG (A), paradrop operations will be limited to the 7th SFG (A) Cantonment Area for high priority/special events only such as 7th SFG (A)/CC Changes of Command, opening ceremonies, or memorial services. Limited event rehearsal Eglin North- South Corridor paradrop missions will be scheduled. Eglin North-South Corridor paradrop operations will be approved by the 96 OSS/CC.

2.5.2. Eglin East-West Corridor. For dimensions of airspace within these boundaries of the Eglin East-West Corridor, see 14 CFR Part 93 rules and the New Orleans Sectional. The corridor is divided into three sections to accommodate the different altitudes of R-2915C, R-2919B, and R-2914B. The East-West Corridor facilitates access to airports in the Eglin-Fort Walton Beach area and transition of aircraft from Pensacola to Panama City. The Eglin East-West Corridor is not Special Use Airspace. It does lie within the confines of the Eglin E MOA but cannot be scheduled separately from the rest of the E MOA, as the E MOA has no subdivisions. The Santa Rosa Controlled Firing Area is also contained in this airspace and rules for use are defined in [Paragraph 2.8](#)

**2.6. Warning Areas.** EAFB SUA includes warning areas W-151, W-168, and W-470 (See [Attachments 39, 40, and 41](#)). The attributes of these areas are described in the DoD FLIP and JO 7400.10. In DoD FLIP and the JO, W-151 and W-470 are subdivided into A through F areas. The 96th Test Wing further subdivides these areas and the descriptions can be found in [Attachments 40, 41, and 42](#). The W-151 Shoreline Areas are a subdivision of W-151A and W-151B and designated as W-151 S3, S4, S5, S6, and S7. The Shoreline airspace below 16,000' shall only be scheduled as a last resort after coordination with 96 OSS/OSO.

**2.7. Military Training Routes (MTR).** There are two Visual Routes (VR) scheduled by the 96th Test Wing: VR1082 and VR1085. The description and attributes of MTRs can be found in DoD FLIP AP/1B. Both routes terminate on the EAFB Reservation. Other MTRs (instrument, visual, and slow routes) not owned or scheduled by the 96th Test Wing may also terminate on the reservation.

## **2.8. Controlled Firing Areas (CFA).**

2.8.1. Santa Rosa Island CFA is used for developmental and operational testing of missiles, rockets, and artillery (See [Attachment 43](#)). Activity within the CFA is transparent to nonparticipating traffic and must be suspended immediately if traffic intrudes. The CFA will not be used for UAS operations. UAS operations in the EWC require a Certificate of Authorization (CoA) from the FAA.

## 2.9. Class D/E Surface Areas.

2.9.1. Egin Class D Airspace. Egin Class D is that airspace extending upward from the surface to and including 2,600 feet MSL within a 5.5-mile radius of Egin AFB, and within a 4.4-mile radius of Destin Executive Airport (DTS), excluding the portion north of a line connecting the 2 points of intersection within a 5.2-mile radius centered on Duke Field; excluding the portion southwest of a line connecting the 2 points of intersection within a 5.3-mile radius of Hurlburt Field; excluding a portion east of a line beginning at lat. 30°30'43" N., long. 86°26'21" W. extending east to the 5.5 mile radius of Egin AFB. When the tower at DTS is operational, it excludes the DTS Class D airspace defined as that airspace south of the triangle beginning at lat. 30°23'39" N., long. 86°23'13" W. to lat. 30°27'00" N., long. 86°30'19" W. to lat. 30°20'54" N., long. 86°31'56" W. from the surface to and including 1,600 feet MSL. Egin Tower may use that airspace within a 4 NM radius of the geographic center of Egin airport, extending from the surface, up to and including 2,100 ft MSL for Visual Flight Rules (VFR) pattern work.

2.9.1.1. When mission profiles on Test Area B-71 extend beyond the borders of R-2915A and intrude into the Egin Tower traffic patterns, Egin Tower shall not approve takeoffs on RWY 30 or landings on RWY 12 unless winds, runway condition, or emergencies preclude using RWY 1 and 19. **NOTE:** When Test Area B-71 activity is due to ground mounts, it shall be the pilot's responsibility to avoid Test Area B-71 when it has been reported active.

2.9.2. Hurlburt Class D Airspace is that airspace extending upward from the surface up to and including 2,500 ft MSL within a 5.3 NM radius of the geographical center of the airport, excluding that airspace which lies east of the eastern boundaries of R-2915A and R-2915B (See [Attachment 36](#)) and the East-West Corridor West section. To the maximum extent possible, Egin Chief of Airspace Management and Mission Planning (CAMMP) will provide a minimum of 48 hours prior notification to 1 SOG/OGO for all known mission activities within R-2915A/B that will affect Hurlburt operations. ERCF will notify Hurlburt Tower 15 minutes prior to the airspace actually being activated and real time when deactivated.

2.9.3. Duke Field Class D Airspace. The Duke Field Class D is that airspace extending from the surface up to and including 2,700 ft MSL within a 5.2 NM radius of the geographical center of Duke Field airport. Duke Tower may use that airspace starting at the northeast corner of R2915A, bordered to the north by the northern boundary of the North/South corridor, to a parallel line 1NM east of RWY 18/36 centerline, to a parallel line 1 NM east and 4 NM south, to the eastern border of R2915A, surface up to and including 2,200 MSL. Beginning 1 NM east of and parallel to the extended RWY 18/36 centerline to 4NM east, surface up to and including 1,200 MSL. All other Class D airspace is released to ERCF. The lowest usable altitude over the TSA for ERCF is 2,700 MSL and 1,700 MSL beginning 1 NM east of and parallel to the extended RWY 18/36 centerline.

2.9.4. Crestview/Bob Sikes Airport (CEW) Surface Area Class E Airspace. The Crestview/Bob Sikes Airport Surface Area is within a 4.2 NM radius of CEW (DWG 360/18). This surface area is effective during published times or as established by NOTAM. At other times, the surface area will revert to Class G airspace.

2.9.4.1. Bob Sikes Airport is located approximately 8 NM north of Duke Field. Many civil and military aircraft (Navy and AFSOC helicopters, C-130, T-34, and T-6) operate within 5 NM of CEW at or below 1,000 ft MSL. Bob Sikes Airport patterns are not tower controlled. Aircraft operating in the vicinity of CEW should self-announce on CEW CTAF frequency 122.95.

2.9.5. Destin Executive Airport (DTS) Class D Airspace. Destin Airport is located approximately 6 NM south-southeast of Eglin (DWG 155/06). The DTS Class D is that airspace extending upward from the surface to and including 1,600 feet MSL within a 4.4 mile radius of DTS, excluding that portion north of the triangle beginning at lat. 30°23'39" N., long. 86°23'13" W., to lat. 30°27'00" N., long. 86°30'19" W., to lat. 30°20'54" N., long. 86°31'56" W. This Class D airspace is effective during the operating hours of the Destin tower published in the Airport/Facility Directory. The airspace is incorporated into the Eglin Class D airspace when the tower is closed.

**2.10. Eglin/Duke Tower Transition Area (TTA).** A TTA is established between Eglin and Duke Field from the surface up to and including 2,200 ft MSL for VFR aircraft transiting between the two airports. The transition area is that airspace contained within a north/south line running from the western edges of Eglin and Duke Class D airspace and a line extending from the eastern edge of the Eglin Class D due north to a point bearing 060 degree and 4.7 NM from the Eglin Digital Airport Surveillance Radar (DASR) antenna, then a line extending northwest to a point bearing 007 degree from the Eglin DASR antenna to the southern edge of the Duke Field Class D. The transition area is delegated to Eglin Tower when Duke Tower is open. At other times, the ERCF may release this area to Eglin Tower when requested, traffic permitting.

**2.11. Water Hoist Helicopter Training Area.** The water hoist helicopter training area is located at the intersection of Boggy Bayou and Choctawhatchee Bay from the surface to 500 ft MSL. Pilots shall:

2.11.1. Conduct training in Visual Meteorological Conditions (VMC) (1,000-foot ceiling and 3 SM visibility for helicopters).

2.11.2. Establish two-way radio communications with Eglin Tower; advise the tower of their intentions (length of time area will be used, direction/altitude of pattern, and hover altitude); obtain clearance from the tower to proceed with intended operation; monitor tower frequency; and advise the tower when flight activity in the area is completed.

2.11.3. Fly a rectangular traffic pattern maneuvering to the water hoist pickup point. Maximum altitude shall be 500 ft MSL.

2.11.4. Maintain separation from other traffic. **NOTE:** Although this area is located in the Eglin Class D Surface Area, Eglin Tower personnel cannot observe the water hoist pickup point or the overlying airspace that is beneath the controller's line of sight.

**2.12. Aero Club/General Aviation Training Areas:**

2.12.1. North Training Area: The North Training Area is bounded on the north by Floral Airport, on the east by the eastern boundary of Eglin D MOA, on the south by US Highway 90, and on the west by a straight line extending southward from the northwest corner of Eglin D MOA, through a point 6 NM east of Bob Sikes Airport, to Highway 90 (See [Attachment 43](#)). Altitudes are from the surface to 6,000 ft MSL.



2.12.2. East Training Area: The East Training Area is located over the eastern portion of the Choctawhatchee Bay (See [Attachment 43](#)). The East Training Area extends from Four Mile Point northward to the north shore of Choctawhatchee Bay, eastward to the north end of the Highway 331 Bridge, southward to Grayton Beach, westward along the beach to a point directly south of Four Mile Point, northward to Four Mile Point. Altitudes, when active, are from surface to 4,000 ft MSL.

**2.13. Hurlburt “H” Alignment Area.** Hurlburt “H” area is used for airborne alignment of sensor/fire control systems. This area is within a 5.3 NM radius around the geographical center of Hurlburt Field, excluding that portion of airspace east of the eastern boundary of R-2915A/B. It coincides with the Hurlburt Field Class D surface area. Assigned altitudes will be as coordinated with ERCF. Restrictions may be imposed due to other mission activity. The 1 SOG/CC authorizes Military Authority Assumes Responsibility for Separation of Aircraft (MARSA) of 1 SOW assigned aircraft operating simultaneously in A-77, A-78, B-6, B-7, and the Hurlburt H Area. 1 SOW will also self-deconflict all other missions exclusively involving 1 SOW aircraft.

**2.14. Duke Field Alignment Area.** The Duke Field Gun Alignment area is used for airborne alignment of munitions systems. It encompasses the same lateral limits of the Duke Field Class D Surface Area. The altitudes flown while in the area are as coordinated with the ERCF. Restrictions may be imposed due to other mission airspace activity. Alignment sensor is located on the south end of the airfield near the perimeter road and consists of a radar reflector, obstruction light, light sensor relay, laser sensor/relay, and microponder with mounting stand.

**2.15. Eglin Water Test Area (EWTA).** The EWTA is uncharted and procedures for use of this airspace are established by LOA with Houston, Jacksonville, and Miami Centers. The areas do not encompass any warning or restricted airspace but are used in conjunction with warning areas. The purpose of the EWTA is to simplify the process of issuing NOTAMs when hazardous tests require this airspace. The areas are known as Eglin Water Test Areas 1 through 6 and are shown in [Attachment 39](#).

**2.16. Eglin “E” Area.** The Eglin “E” Area is used for airborne alignment of sensor/fire control systems. This area is within a 5.3 NM radius around the geographical center of Eglin Airfield. Assigned altitudes will be as coordinated with the ERCF. Restrictions may be imposed due to active mission airspace.

**2.17. Air Traffic Control Assigned Airspace (ATCAA).**

2.17.1. The Gulf Regional Airspace Strategic Initiative (GRASI) ATCAA description, coordination and procedural requirements are published in the GRASI ATCAA LOA.

2.17.2. The Eglin E ATCAA overlays only the North-South Corridor and that part of the East- West Corridor not under restricted airspace and extends from FL180 to FL600. This is not to be confused with the Eglin E MOA.

**2.18. Other Airports and Facilities.**

2.18.1. Crestview VORTAC (CEW). The CEW VORTAC is located approximately 9 NM west/northwest of Bob Sikes Airport. Many civil aircraft, Air Force and Navy helicopters, fixed-wing aircraft, and AF C-130 aircraft operate VFR within 10 NM of CEW. VFR aircraft transiting this area should obtain traffic advisories from Eglin Approach Control, 124.05.

2.18.2. DeFuniak Springs Airport (54J) (DWG 054/24). DeFuniak Springs Airport lies outside the northeast corner of R-2914A and 2 NM west of DeFuniak Springs. The airport is a small public airport used by general aviation aircraft. Airport patterns are uncontrolled and the 54J CTAF frequency is 123.05.

2.18.3. Fort Walton Beach Airport (1J9) (DWG 258/16). The Fort Walton Beach Airport is located 7 NM west of Hurlburt Field and underlies Eglin F MOA when active. Boomer Aviation operates a banner tow service from the airport. When military air operations occur on Santa Rosa Island and in the East-West Corridor, coordinate with Boomer Aviation by calling COMM: (850) 244-1313. Airport patterns are uncontrolled and the 1J9 CTAF frequency is 122.7.

## Chapter 3

### RADAR AND MISSION PROCEDURES

**3.1. Eglin Radar Control Facility (ERCF).** Normal operating hours for the ERCF are 24 hours a day, 7 days a week. The ERCF is divided into two co-located functions:

3.1.1. Eglin Radar Approach Control (RAPCON). RAPCON is responsible for providing terminal ATC services.

3.1.2. Eglin Mission Control (EMC). During ingress/egress to/from mission assigned airspace, EMC may provide ATC services to aircraft. While aircraft are within mission assigned airspace, EMC serves as a monitor agency only to ensure airspace integrity and is not responsible for separation of aircraft operating within that airspace.

**3.2. Enroute Procedures.** Off-Station Flight Procedures are covered in [Paragraph 1.10](#)

**3.3. Special Use Airspace (SUA) Procedures.**

3.3.1. All ATCAAs will be scheduled and assigned to missions IAW EAFBI 13-200.

3.3.1.1. MISTY and COVEY will be activated (i.e. called up for use by JTTOCC from JAX Center) 30 minutes prior to mission start times by the JTTOCC based on scheduled mission activity.

3.3.1.2. Eastern ATCAAs (NAIL, RUSTIC, RAVEN North/South), will only be activated (i.e. called up for use by JTTOCC from JAX Center) for individual flight callsigns, and only by request from the flight lead or flying unit supervision to the JTTOCC (882-5800 or callsign “WOLF CALL”, UHF 276.0/Local channel 8) the day of and NLT 45 minutes prior to entry time. Participating aircraft will be allowed to enter the ATCAAs while activated in accordance with participating aircraft procedures in [Paragraph 3.3.9](#)

3.3.1.3. Eastern ATCAAs should not be activated only for the purpose of high altitude transit to and from W-470. The ERCF can work individual flight coordination with Tyndall Approach or JAX Center to permit transit.

3.3.1.4. ATCAAs will be deactivated and given back to JAX Center upon the flight exiting without another flight currently using or requesting their use within the next 60 minutes. ERCF will advise JTTOCC when the last aircraft exits the ATCAAs.

3.3.2. Aircraft may proceed to/return from SUA either IFR or VFR and conduct operations either VMC or Instrument Meteorological Conditions (IMC). However, once the aircraft enters the assigned airspace, they are responsible for maintaining separation from all other participating aircraft. All aircraft will squawk their assigned Mode 3 beacon code while in the airspace. If flight elements have not been assigned a specific beacon code, they will squawk in sequence with their flight lead. EXAMPLE: MOJO 1 is squawking 5341 and MOJO 2 will squawk 5342, in sequence.

3.3.3. Pilots are required to establish operational deconfliction through pre-coordinated “shared airspace” agreements or real-time coordination between participating aircraft.

3.3.4. Once mission aircraft enter their assigned airspace/profile, the TAC C2 agency will provide radar monitoring/traffic advisories to the maximum extent possible, based on workload and equipment limitations. Mission aircraft working with the Central Control Facility (CCF), (callsign CHAMBER) will not have radar service terminated. Individual pilots are responsible for remaining within their assigned airspace. EMC will monitor the airspace for boundary integrity and advise pilots whenever their track appears as though it will take them outside their assigned airspace/profile. Example: “(Call sign) WORK NORTH.”

3.3.5. Aircraft shall provide EMC a ‘Return to Base (RTB) in 5 minutes’ call with recovery intentions 5 minutes prior to exiting the Restricted/Warning airspace. This notification is necessary to allow sufficient time for coordination and sequencing into the airfield. If aircrew cannot provide 5 minutes RTB notification or immediate entry into the traffic pattern is not feasible, aircraft may be requested to hold within their respective mission airspace until an ATC clearance can be issued. When aircraft will RTB as a flight, rejoins will be conducted while within the SUA and only the flight lead will squawk Mode 3C. All other flight elements will squawk standby unless in non-standard formation.

3.3.6. Due to the volume of aircraft that operate in the vicinity of the Crestview VORTAC, mission aircraft operating in this area may broadcast applicable traffic advisories on 298.025/121.95, which are discrete frequencies established for this purpose. **NOTE:** These frequencies are separate from Bob Sikes Airport (Crestview) CTAF (122.95).

#### 3.3.7. Separation Standards for SUA.

3.3.7.1. Nonparticipating IFR aircraft. ERCF will separate all IFR aircraft not participating in Warning/Restricted Area activity by at least 500 ft vertically or 3 NM laterally from the SUA peripheral boundary.

3.3.7.2. Nonparticipating VFR aircraft. ERCF will separate all VFR aircraft not participating in Restricted Area activity from active Restricted Areas by at least 500 ft vertically or up to the boundary.

3.3.7.3. Nonparticipating IFR/VFR aircraft ground mission airspace separation. ERCF will separate nonparticipating IFR/VFR aircraft from ground mission activity protected airspace by at least 100 ft vertically or up to the boundary.

#### 3.3.8. W-151/W-470 Operations.

3.3.8.1. EMC will provide advisories to pilots inbound to W-470/W-151 about aircraft operating within W-470/W-151. Once aircraft enter the warning area they shall be considered participating aircraft and are responsible for deconfliction from all other participating aircraft. Pilots shall advise EMC when deconfliction coordination has been accomplished.

3.3.8.2. Pilots will follow published entry/exit procedures and establish contact with flights working inside W-470 or W-151. Flights exiting W-470/W-151 will follow published recovery procedures IAW **Paragraph 4.34** W-151 airspace is normally entered and exited via the 86°0'W, and 86°48'W longitude lines. Pilots entering and exiting the airspace are expected to remain within 1 NM of the longitude line. Pilots established with the airspace will not fly within 1 NM of the 86°0'W or the 86°48'W longitude lines. Pilots on the 86°0'W or the 86°48'W longitude lines will fly altitude as assigned, or if not assigned, will use the 0-4 block (i.e., 100-140 or FL200-FL240) when traveling southbound and the 5-9 block (i.e., 050-090 or 150-FL190) when traveling northbound.

3.3.9. Airspace Utilization Changes and Participating Aircraft Procedures. The procedures outlined below for participating aircraft are for shared use of the Special Use Airspace owned by Eglin and Tyndall. These procedures are for “short timeline” (defined as 1500L Central Time the day prior to execution to the day of execution) requests for participating aircraft to enter and use special use airspace not previously assigned when the unit’s assigned airspace is either unworkable, or additional time is needed. These procedures supplement Federal Aviation Administration (FAA) orders 7110.65, 7610.4, and the Eglin AFB/Tyndall Special Use Airspace LOA. Participating aircraft may conduct operations in non-owned subsection(s) of the locally owned special use airspace using pre-mission or execution coordination rules below. Day prior requests will utilize scheduling procedures currently in place to add airspace to a unit’s mission number.

3.3.9.1. Prior to departure/pre-mission, requesting aircraft will advise the Joint Test and Training Operations Control Center (JTTOCC) of a requested schedule change through their respective squadron Operations Supervisor (Ops Sup) or control room, to include: maintenance/weather delays; range schedule deviations/modifications and/or intention to work airspace with other missions.

3.3.9.1.1. Requesting unit Ops Sups should coordinate with the owning unit’s Ops Sup or scheduled flight lead for approval into the requested airspace and pass the owning unit’s approval/denial to the aircrew. If approved, provide the callsign, mission number, and expected working frequency of the owning aircraft to the requesting aircraft.

3.3.9.1.2. The requesting Ops Sup will then contact JTTOCC or RIPTIDE and inform them of the coordination. JTTOCC will inform EMC of participating aircraft requests as the Ops Sups pass them.

3.3.9.1.3. If coordination through the Ops Sup is not feasible, the pilot will submit their request through the JTTOCC via landline at COMM: (850) 882-5800 or 2760/DSN: 872-5800 or 2760 or on frequency 276.0 (Call sign WOLF CALL).

3.3.9.1.4. When possible, flight leads should inform Eglin Mission Control (EMC) or Tyndall MOA Monitor prior to takeoff that pre-coordination has been completed in order to ensure that the information has been provided and to reduce delays. If unable to contact EMC or Tyndall MOA Monitor prior to takeoff, the requesting aircraft will remain outside the requested airspace and communicate to EMC/MRU that pre-coordination with the owning aircraft has been completed. Requesting aircraft will refer to the callsign and/or mission number of the owning aircraft.

3.3.9.2. If the JTTOCC is unable to accommodate an airspace scheduling change and the pilot still desires to utilize airspace scheduled/in use by another mission, EMC will inform the pilot of the aircraft currently in the airspace or scheduled (i.e., callsign, number and type aircraft, and working frequency). The pilot is then responsible for coordination with the scheduled aircraft and should advise EMC when deconfliction measures have been established via the procedures below.

3.3.9.2.1. Requesting pilot will remain outside the requested airspace until making positive radio contact with the owning aircraft or MRU controlling them. Remain on EMC frequency while coordinating with the owning aircraft.

3.3.9.2.2. If approved by the owning aircraft, requesting pilots will inform EMC they are proceeding into the airspace. EMC will provide requesting aircraft with routing into the new airspace as required.

3.3.9.2.3. If unable to contact the owning aircraft for approval, requesting pilots will remain outside the requested airspace.

3.3.9.2.4. Pilots will remain on a common frequency with the owning aircraft once established within the participating airspace. If the owning aircraft approves, requesting pilots can change to a different frequency.

3.3.9.3. Airborne aircraft with valid mission numbers may coordinate directly with EMC for substitute airspace or extensions.

3.3.9.4. If, while operating the shared airspace as a ‘participating aircraft,’ the original owner determines they require the full use of their assigned airspace, requesting aircraft will vacate the airspace as soon as possible.

3.3.9.5. Workload permitting, participating aircraft may be allowed by EMC to operate within airspace not currently in use. However, if a scheduled aircraft requires the use of that airspace, the scheduled aircraft has priority and any other aircraft will be required to exit the airspace upon notification by EMC.

3.3.9.6. Late Entry: If an airspace owner will be significantly late for assigned airspace, they are encouraged to release the unused airspace to EMC through the JTTOCC. If a participating aircraft previously coordinated to share airspace with an owner and they arrive at the airspace prior to the owner, they will notify EMC of the agreement and proceed into the airspace IAW the agreed deconfliction plan. When the airspace owner arrives, EMC will notify the owning pilot that the participating aircraft is established in the airspace, and note their callsign and mission number. Mission aircraft utilizing airspace that have not coordinated with the owning aircraft will exit the airspace upon the EMC controller request.

3.3.9.7. Early Return to Base: Owning or requesting aircraft vacating airspace with no intent to return, and no expected further use by the owning aircraft's unit, will inform EMC/MRU that the airspace is released back to EMC. After the airspace is released back to EMC, EMC may assign the airspace on a "first-come, first-served" basis until that scheduled airspace expires. If unsure of anticipated further use of the airspace, or if the vacating aircraft fail to release the airspace, the airspace will remain assigned to the owning aircraft's unit. Once aircrew vacate shared airspace, they are no longer considered under the 'participating aircraft' agreement (i.e. no returning to the airspace without coordinating as stated above).

3.3.9.8. Non-participation. If the owning aircraft mission requires no interruption by requesting aircraft, owning aircraft will communicate to EMC/MRU on check-in that they are non-participating. This will primarily be reserved for Large Force Exercise (LFEs), or complex test missions that require the entire scheduled airspace.

3.3.10. Early departure procedures to meet scheduled airspace times.

3.3.10.1. Departures from Eglin before the scheduled mission start times in CSE are permissible, but require coordination from the flying unit to ensure proper staffing of required positions and deconfliction from other traffic.

3.3.10.2. In general, early departures for missions with only ATCAA and/or overland restricted airspace will not be approved.

3.3.10.3. For overwater airspace (W-151/W-470), flight leads wishing to takeoff before their scheduled airspace start time should contact Eglin Mission while on the ground via local Channel 12 with their projected departure time and desired entry point into the scheduled airspace. Flights going to W-151 should file to BEICH or KOAST and expect to "ride-the-line" IAW procedures in [para 3.3.8.2](#) (i.e. remain within 1 NM of the line and altitude as assigned or 0-4 block southbound, 5-9 block northbound). Flights will not be cleared into their working area until Eglin Mission can ensure deconfliction with flights exiting the airspace or the entering/established mission flight declares "participating" with the existing mission numbers IAW [Paragraph 3.3.9](#). If this coordination is completed on the ground by the missions involved, it will afford better service by ATC and less delays. If unable to contact Eglin Mission, contact the JTTOCC (WOLF CALL) to relay the request.

3.3.11. MARSAs Operations. Individual pilots and controllers cannot invoke or deny MARSAs. All military missions which occur within the SUA controlled and managed by the 96 TW operate under MARSAs through the several deconfliction methods established via scheduling, inter-agency agreements, shared use agreements, etc. Individual MARSAs requests will not be approved.

#### **3.4. Recovery Procedures.**

3.4.1. General Recovery Procedures. In general, recovering aircraft shall provide ATC with the following information upon initial contact or as soon as possible thereafter:

3.4.1.1. Appropriate ATIS code.

3.4.1.2. Type approach/landing requested (e.g., pilots must specifically request Tactical Initial.)

3.4.1.3. Desired Landing Runway.

3.4.1.4. Special Requirements/Information.

3.4.2. Nonstandard Formation. If a nonstandard or flight split-up recovery is desired, advise ATC as soon as possible. When requesting a nonstandard formation, the pilot shall specify the amount and type of spacing required to the maximum extent possible. If approved for nonstandard formation, the first aircraft will squawk normal and the last aircraft in the flight will change the last two digits of the lead's squawk to 00 and Mode-C; others will squawk standby.

3.4.2.1. Aircraft shall request in-trail spacing with EMC prior to leaving Warning/Restricted Airspace. Aircraft returning from other than Eglin SUA shall make request with Eglin Approach Control as soon as possible.

3.4.2.2. In-trail flights shall be limited to a maximum of four aircraft and must be approved by ATC prior to establishing radar-in-trail spacing. ATC may limit the number of aircraft per flight depending on traffic density and SUA activity or complexity.

3.4.2.3. In-trail spacing for arrivals shall be defined as no more than 2.5 NM between each element of the flight.

3.4.2.4. If individual control is requested, the flight elements shall be responsible for separation within the flight until standard separation as defined in FAA JO 7110.65 has been achieved. Each element shall be given a discrete squawk in the event individual control is requested.

3.4.2.5. A request for an in-trail recovery automatically implies that the entire flight will make full-stop landings (unless otherwise requested).

3.4.2.6. Practice approaches while utilizing in-trail spacing shall only be conducted in VMC.

3.4.3. Flight Split-up. Requests for flight split-ups outside of active SUA may result in delays due to congestion or active restricted airspace. Pilots should make every attempt to complete flight split-ups prior to exiting their assigned airspace. When requesting a flight split-up the flight lead shall state the order of recovery, type approach and landing and when ready for the flight split-up.

3.4.4. Vectors to Initial. Request for vectors to initial will be approved on a case-by-case basis. When "vectors to initial" is requested or assigned, ATC will vector the flight to/toward the VFR entry point for the runway in use. Once the pilot reports the field in sight at any point during the vectors, the IFR clearance is automatically canceled (see [Paragraph 3.4.7](#)), follow ATC vectors until cleared to entry point. The pilot is expected to proceed to the entry point then to a 3- to 5- mile initial.

3.4.5. Local Climbout and Radar Traffic Patterns. Aircraft making multiple approaches at Eglin or Hurlburt shall use the following climbout instructions unless otherwise directed by ATC. Aircraft making multiple radar approaches can expect vectors for a pattern as depicted in [Attachments 16 and 32](#), or as controller workload dictates. **NOTE:** Once climbout has been issued for the first approach, that same climbout applies to all subsequent approaches unless changed by ATC.



3.4.5.1. Eglin Local Climbout. ATC phraseology for base assigned aircraft shall be “EXECUTE LOCAL CLIMBOUT.” If multiple approaches will be made with tower, phraseology shall be “AFTER COMPLETING (type approach), MAINTAIN VFR, CONTACT TOWER.” Local climbout will be flown IAW Paragraph 4.34.4.2.

3.4.5.2. Hurlburt Field Local Climbout. ATC phraseology for base assigned aircraft shall be “EXECUTE LOCAL CLIMBOUT.” If multiple approaches will be made with tower, phraseology shall be “AFTER COMPLETING (type approach), MAINTAIN VFR, CONTACT TOWER.”

3.4.5.2.1. RWY 18: “CROSS DEPARTURE END OF RUNWAY AT OR BELOW ONE THOUSAND TWO HUNDRED, THEN CLIMB AND MAINTAIN ONE THOUSAND SIX HUNDRED AND FLY RUNWAY HEADING.” **NOTE:** Departure end altitude restriction may be deleted if overhead pattern is closed.

3.4.5.2.2. RWY 36: “CROSS DEPARTURE END OF RUNWAY AT OR BELOW ONE THOUSAND TWO HUNDRED, THEN CLIMB AND MAINTAIN ONE THOUSAND SIX HUNDRED, AND TURN LEFT HEADING TWO ZERO ZERO.” **NOTE:** Departure end altitude restriction may be deleted if overhead pattern is closed.

3.4.5.2.3. Hurlburt Field Mission Climb-Out. Use when mission activity dictates. ATC phraseology for base assigned aircraft shall be “EXECUTE MISSION CLIMBOUT”.

3.4.5.2.3.1. RWY 36: “CROSS DEPARTURE END OF RUNWAY AT OR BELOW ONE THOUSAND TWO HUNDRED THEN CLIMB AND MAINTAIN ONE THOUSAND SIX HUNDRED AND TURN RIGHT HEADING ONE FIVE ZERO.” **NOTE:** Departure end altitude restriction may be deleted if overhead pattern is closed.

3.4.5.3. Duke Field Local Climbout. Duke Field local climbout will be flown IAW **Paragraph 5.32.1**

3.4.6. Missed Approach Procedures. Unless otherwise instructed, aircraft flying a published IFR approach procedure can expect to execute a missed approach as published. Controllers may issue alternate instructions as conditions (weather, traffic, airspace configuration, etc.) dictate.

3.4.7. Automatic Cancellation of IFR. For base assigned or hosted aircraft recovering to the VFR pattern (straight-in or overhead), IFR clearance is canceled automatically when pilot reports field in sight or communications are transferred to tower. If unable to maintain VMC, the pilot shall advise ATC and request alternate instructions. Unless otherwise directed, aircraft remaining within the tower VFR pattern for multiple approaches shall maintain their assigned squawk or squawk VFR with altitude. All aircraft will be sequenced to the VFR entry point for the requested runway’s tower patterns, and aircraft shall remain on ERCF’s frequency until instructed to contact tower.

3.4.8. Opposite Direction/Crossing Runway Separation Standards. If the tower display workstation (TDW) is inoperative, the radar controller shall assume responsibility for maintaining appropriate separation from opposite direction traffic. Aircraft requesting opposite direction operations can expect delays until the following restrictions are met:

3.4.8.1. When both aircraft are IFR:

3.4.8.1.1. Arrival vs. Departure. Arrival aircraft shall not proceed inbound past a point 10 NM from the landing threshold (6 NM for crossing runway) before a departing aircraft is airborne and turning onto a course to ensure required separation will be maintained.

3.4.8.1.2. Arrival vs. Arrival. Arrival aircraft shall not proceed inbound past a point 10 NM from the landing threshold (6 NM for crossing runway) before a preceding arriving aircraft has crossed the landing threshold for a full stop or crossed the landing threshold and turned onto a course to ensure required separation for a low approach or touch and go.

3.4.8.2. When one or both of the aircraft involved is VFR the above separation standards may be reduced to 6 NM for opposite direction and 3 NM for crossing runway—except when at least one heavy aircraft is involved.

3.4.8.3. VFR Pattern. Aircraft in the VFR pattern will be held at downwind or restricted from turning base until the opposite direction departure is airborne and turned to ensure conflict resolution or a preceding opposite direction arrival aircraft has landed.

## Chapter 4

### EAFB OPERATIONS AND PROCEDURES

**4.1. EGLINAFB (VPS) Operating Hours.** The EAFB aerodrome, AMOPS, ERCF and Eglin Tower are open 24 hours a day, 7 days a week. Approval for airfield and/or facility closures of 96 hours or less is delegated to 96 OG/CC.

**4.2. Prior Permission Required (PPR).** All aircraft not assigned to EAFB must have a PPR number prior to landing. Project officers, POCs and TDY liaisons shall coordinate with the 96 OSS/OSAM (Eglin AMOPS) at COMM: (850) 882-5313/DSN: 872-5313.

**4.3. Civil Aircraft Landing Permit (CALP).** The Airfield Manager is designated as the approver for CALPs.

**4.4. Transient Alert (TA).** For current TA operating hours refer to the most current DoD Flight Information Publication IFR Supplement or NOTAMs. TA is only able to support up to four aircraft per hour due to limited resources. No transient alert support is available for local, round robin, or out and back flights by transient aircraft and limited weekend and holiday maintenance capability exists. Arrival/departure overtime support is extremely limited and requires 24 hours advance approval through AMOPS prior to issuing a PPR. No transient aircraft are allowed when TA services are unavailable. All transient aircraft must use "FOLLOW-ME" to parking. See the DoD Flight Information Publication, IFR Supplement, for further guidance.

#### **4.5. Runways and Taxiways.**

4.5.1. Runways. EAFB has two runways with intersecting flight paths at the southern end (See [Attachment 2](#)).

4.5.1.1. RWY 12/30 is 11,987 ft by 300 ft, asphaltic concrete. The first 1,000 ft on both ends is concrete. Overruns at each end are 1,013 ft long by 300 ft wide, asphalt. RWY 12/30 is the primary runway for F-35 operations.

4.5.1.2. RWY 1/19 is 10,001 ft by 300 ft, asphalt. Overruns are nonstandard: RWY 19 overrun is 720 ft long by 300 ft wide and RWY 1 overrun is 550 ft long by 300 ft wide, asphalt.

4.5.1.2.1. F-35 operations to RWY 19 are limited to takeoffs, unless necessary for emergencies, unplanned contingencies, and weather affecting aircraft performance limitations and requirements.

4.5.1.2.2. F-35 operations to RWY 1 are limited to approaches and landings, unless necessary for emergencies, unplanned contingencies, and weather affecting aircraft performance limitations and requirements.

4.5.2. Field Elevation. EAFB has a field elevation of 84 ft and the gradient for each runway is listed below:

4.5.2.1. RWY 1: +0.13% and RWY 19: -0.13%

4.5.2.2. RWY 12: +0.30% and RWY 30: -0.30%

4.5.3. Taxiway Restrictions.

- 4.5.3.1. TWY U East, from TWY R to TWY M, (Hot Gun 1), is prohibited for aircraft with a wingspan larger than an A-10 (57.6 ft) unless coordinated and approved by the Airfield Manager. If approved, larger aircraft may only enter/exit at TWY R.
- 4.5.3.2. TWY B between TWY D and TWY E is prohibited to taxi aircraft with a wingspan larger than a C-130 (132.7 ft) without prior coordination with AMOPS.
- 4.5.3.3. Prior coordination with the Eglin Airfield Manager is required to allow aircraft with a wingspan larger than a C-130 (132.6 ft) to use TWY G and TWY H east of RWY 1/19.
- 4.5.3.4. Prior coordination with the Eglin Airfield Manager is required to allow aircraft with a wingspan larger than a C-17 (169.8 ft) to use TWY R from TWY G through TWY M-East (east of RWY 19).
- 4.5.3.5. Tow-way A does not have edge lights. Tow-way L (north of TWY M-West and west of RWY 19) does not have taxiway edge lights. Neither surface shall be used at night.
- 4.5.3.6. TWY/Tow-way L, north of TWY M-West is prohibited for aircraft with a wingspan larger than an A-10 (57.6 ft).
- 4.5.3.7. Tow-way A and Tow-way L from Hardstand (HS)-10 north to TWY M-West are limited to towed aircraft only.
- 4.5.3.8. TWY H between RWY 1/19 and TWY R will not be used as an EOR. Aircraft preflight/maintenance runs are not allowed in this area. Additionally, aircraft will not hold with exhaust pointing south in this area.
- 4.5.3.9. C-5 (223 ft) aircraft will normally be parked on TWYs B-West and M-West. Restrictions for C-5 include: prior coordination required, wing walkers required, no use of TWY R between TWY G and TWY M-East.
- 4.5.3.10. B-52 (185 ft) aircraft will normally be parked on TWY M-West only. Restrictions for B-52 include: prior coordination required, wing walkers required, and no use of TWY G. If landing on RWY 1/19, B-52 aircraft must back taxi to TWY M-West. If landing on RWY 12/30, B-52 aircraft must turn off at TWY F only. All B-52 aircraft will be escorted to parking by a "Follow Me" truck.
- 4.5.3.11. C-17 (170 ft) aircraft and KC-10 (165 ft) aircraft will normally be parked on Live Ordnance Loading Area (LOLA) parking apron, B-West, M-West, or Hot Gun 3 (**Paragraph 4.7.5.3**). Restrictions for C-17 and KC-10 aircraft include: prior coordination required, wing walkers required, and no use of TWY H at R east of RWY 1/19.
- 4.5.3.12. Hazardous Cargo areas are located at TWY M-West Spot 3, LOLA ramp and HS-1 located on TWY K west of TWY L. Hot Cargo parking must be coordinated with AMOPS.

**4.6. Restricted/Classified Areas.** EAFB has two primary restricted areas marked on the airfield; the Test Ramp encompassing parking rows B thru J and the 33 FW Ramp encompassing parking rows T thru W and several other locations to include: LOLA parking apron, TWY Mike west parking, Transient Aircraft parking ramp, General Aviation ramp, Hot Gun 1, 2 and 3, HS 1 and 10.

**4.7. Aircraft Parking Plan.**

4.7.1. 33d Ramp. All parking areas south of RWY 12/30 (including the "Christmas Tree" area).

4.7.2. Test Ramp. All parking areas south of Fire Station 2 and east of TWY R.

4.7.3. SOF Ramp. Parking area east of B row on the Test Ramp. SOF Ramp parking is restricted to 417th aircraft and project aircraft using the climatic lab.

4.7.4. Transient Ramp. All parking areas north of TWY J and west of RWY 1/19. Additionally, all parking areas north of Fire Station 2 and east of TWY R (excluding Hot Gun 1, General Aviation Ramp, and the Aero Club Ramp).

4.7.5. Hot Gun Spots. See EAFBMAN 91-202, *Designation of Explosives Laden Vehicle Routes, Combat Aircraft Parking Areas, Explosives Loading/Unloading Areas and Arm/De-arm Areas* for all aircraft explosive weight limits.

4.7.5.1. Hot Gun 1. Parking area on TWY U between TWY R and TWY M-East.

4.7.5.2. Hot Gun 2. Hot Gun Line 2 is not operational.

4.7.5.3. Hot Gun 3. Parking area on TWY M-East between TWY U and TWY S.

4.7.5.4. LOLA. Parking area south of TWY E and between TWY E and TWY F.

4.7.5.5. TWY M-West Spots 1-6

4.7.6. Aero Club Ramp. Parking areas east of TWY S. Only 96 FSS/FSWA (Eglin Aero Club) aircraft are allowed to park on the Aero Club Ramp.

4.7.6.1. All aircraft taxiing from the Aero Club Ramp must first be towed to the interior taxi lane marking to ensure proper wingtip clearance IAW Unified Facilities Criteria (UFC) 3-260-1.

4.7.7. General Aviation Ramp: Parking areas south of TWY T.

4.7.8. Destin-Fort Walton Beach Airport Ramp: All parking areas north of RWY 12/30 at TWY D1 and D2. Military and general aviation aircraft are not authorized to taxi into the Destin-Fort Walton Beach Airport area without prior permission from the Destin-Fort Walton Beach Airport Manager. Permission requests are coordinated through the Eglin Airfield Manager.

**4.8. Aircraft Special Operation Areas/Ramps:**

4.8.1. Hot Pit Refueling Areas. EAFB has four authorized hot pit refueling areas. See [Attachment 4](#).

4.8.1.1. The 33 FW Hot Pit Refueling Area is located on the west side of TWY B near TWY E. The 33 FW has four hot pit refueling locations and are listed in order of preference: Pit ALPHA, LOLA, Pit BRAVO, and Pit CHARLIE. Each location can support four pits and all locations are certified for F-35A, F-35B, F-15, F-16, F/A-18, and A-10 operations. F-35Cs can utilize all locations except for CHARLIE since CHARLIE sunshades lack heat shields to compensate for upward IPP exhaust. Squadrons will share the pits equitably. One squadron can utilize all four pits as long as it does not cause another squadron's aircraft to wait. As a rule, no squadron will utilize more than two pits if it causes another squadron to lack access to a pit. Aircraft will monitor their respective Ops/Base frequencies. Ops Sups/ODOs will determine which pit location is being utilized and coordinate pit sharing/operations.

4.8.1.2. Hot Gun 3 is sited and certified for hot pit refueling operations on four F-15s simultaneously using R-11 fuel trucks. Each pit will have one 50-gallon halon fire extinguisher. A minimum of 100 ft distance will be maintained between fuel trucks to allow adequate wingtip clearance for aircraft taxiing off the pits IAW UFC 3-260-01.4.7.1.2.1. Hot pit operations on Hot Gun 3 will require prior coordination with AMOPS, Transient Alert, 96 TW Ground Safety, 96 TW Weapons Safety, and 96 MOCC to ensure there are no conflicting operations, tests, or additional aircraft parking issues.

4.8.1.3. The LOLA is sited and certified for hot pit refueling operations on four aircraft simultaneously using R-11 fuel trucks. Each pit will have one 50-gallon halon fire extinguisher and a minimum of 100 ft distance will be maintained between fuel trucks to allow adequate wingtip clearance for aircraft taxiing off the pits IAW UFC 3-260-01. ACC WSEP aircraft will have priority to utilize the LOLA during weapons evaluations.

4.8.2. Arm/De-arm Areas. EAFB's arm/de-arm areas are depicted in [Attachment 2](#) and on the 96 CEG D-8 Tab map.

4.8.3. Engine Run-up Areas. See [Paragraph 4.25](#)

4.8.4. Drag Chute Jettison areas. ATC will coordinate with AMOPS as soon as possible after the request to coordinate a designated area for drag chute jettison.

4.8.5. Unless otherwise instructed by ATC, all transient aircraft must use "FOLLOW-ME" to parking.

#### **4.9. Ground Navigational Aid (NAVAID) Checkpoints.**

4.9.1. Eglin's ground NAVAID checkpoints are located on TWY D-North, TWY G-East, and TWY Q.

#### **4.10. Navigational Aids (NAVAIDs) and Air Traffic Control and Landing Systems (ATCALs).**

4.10.1. Preventive Maintenance Inspection (PMI). Refer to DoD FLIP for available navigational aids and their current PMI schedules for EAFB, Duke Field and all associated satellite airports served by ERCF. Where no PMI times are published, PMI schedules are not on a reoccurring basis or required. All PMI request and response times are IAW 96 OSS OI 13-1 on "Air Traffic Control Approach Landing Systems (ATCALs) NAVAID Coordination."

4.10.2. Civil Use of USAF ATCALs. Civil aircraft may use USAF NAVAID facilities at EAFB on a noninterference basis. Practice approaches to low approach/go-around are authorized. Requests for services will be considered on an individual basis and dependent on controller workload and equipment availability. Approval is at the discretion of the ATC WS. For further guidance on civil use of USAF ATCALs, see AFI 10-1001, *Civil Aircraft Landing Permits*.

4.10.3. Auxiliary Power for ATCALs Facilities. The following procedures will be adhered to any time CE Power Production requires auxiliary generator checks or maintenance on any ATCALs/NAVAID or ATC facility generator:

4.10.3.1. Before transferring to generator power at the ERCF or either Eglin Tower, Power Production must request approval from the WS/SC at the respective facility.

4.10.3.2. Before transferring to generator power at any ATCALs/NAVAID facility, Power Production must request approval from 96 OSS/OSM, which in turn will coordinate with the appropriate ATC facility IAW 96 OSS OI 13-1. During other than normal duty hours, Power Production will request approval from the Eglin Tower WS/SC who will coordinate in turn with all affected ATC facilities prior to approval.

**4.11. Permanently Closed/Unusable Portions of the Airfield.** TWY U between RWY 1/19 and TWY R is permanently closed and marked with standard closed markings.

**4.12. Airfield Lighting.**

4.12.1. See DoD FLIP for available instrument approach lighting systems. All airfield lighting will be operated from the Eglin Tower, Eglin alternate control tower or by Civil Engineering (CE) exterior electric via the airfield lighting control vault.

4.12.2. Tow-way A and the portion of TWY L that is north of TWY M are unlit.

**4.13. ATIS, Weather Dissemination and Coordination Procedures.**

4.13.1. Automatic Terminal Information Service (ATIS). Eglin Tower operates the ATIS 24/7.

4.13.2. Hazardous/Severe Weather Notification Procedures. The 96th Weather Squadron (96 WS) is responsible for monitoring and evaluating weather information and conditions and, as necessary, issuing hazardous/severe weather statements in the form of weather watches, warnings and advisories IAW EAFB Plan 15-1, *Weather Support Plan*. The 96 WS is also the official source for lightning information for Eglin AFB and its land and water ranges. AMOPS will activate secondary crash network (SCN) to relay weather warnings.

4.13.3. Personnel on the airfield shall act IAW EAFB Plan 15-1 in response to hazardous/severe weather and lightning notifications.

**4.14. Active Runway Selection and Change Procedures.**

4.14.1. Runway Use Program. The Eglin Tower WS or Senior Controller (SC) shall designate the primary/alternate runway IAW JO 7110.65 and criteria in this paragraph.

4.14.2. Designated primary runways:

4.14.2.1. RWY 19 is the primary instrument/calm wind runway.

- 4.14.2.2. RWY 12/30 is the primary VFR/overhead runway.
- 4.14.2.3. RWY 12/30 is the primary approach end arrestment runway.
- 4.14.2.4. RWY 12/30 is the primary runway for simulated flameout (SFO) approaches.
- 4.14.3. RWY 12/19 shall be the primary runways when the tailwind component for either runway does not exceed 10 knots and runways are dry.
- 4.14.4. When RWY 1/30 are in use, the following preferred departure/arrival procedures shall be used to the maximum extent possible. All noise abatement procedures are applicable.
  - 4.14.4.1. RWY 1 for all departures.
  - 4.14.4.2. RWY 30 for all arrivals.
- 4.14.5. Exceptions:
  - 4.14.5.1. Aircraft carrying Cat I, II, III, or test stores shall depart RWY 12, 19, or 30. Under extenuating circumstances, the 96 OG/CC may authorize RWY 1 departures for Cat I, II or III ordnance. Prior approval is required. Reference **Table 7.1** for Munitions (Ordnance)/External Stores Categories for Developmental Weapons.
  - 4.14.5.2. DV and Aero Club aircraft shall land on RWY 1/19 to the maximum extent possible contingent upon other traffic and winds.
- 4.14.6. Runway Change Procedures. Eglin Tower WS/SC shall direct runway changes based on sound judgment, traffic, and the criteria above. The following notifications are required:
  - 4.14.6.1. Eglin Tower shall notify:
    - 4.14.6.1.1. ERCF and Duke Tower.
    - 4.14.6.1.2. Duty Weather Forecaster.
    - 4.14.6.1.3. Eglin AMOPS.
    - 4.14.6.1.4. Eglin SOF (if applicable).
  - 4.14.6.2. Eglin AMOPS will update IWDS and notify the following agencies:
    - 4.14.6.2.1. CE Power Production.
    - 4.14.6.2.2. Fire Department Communications Center.
    - 4.14.6.2.3. Eglin Command Post.
    - 4.14.6.2.4. 96 TW, 33 FW and 53 WG Operations Supervisor.
    - 4.14.6.2.5. Transient Alert.
    - 4.14.6.2.6. Maintenance Operations Control Center.
    - 4.14.6.2.7. Aero Club.
    - 4.14.6.2.8. Destin-Fort Walton Beach Airport.



**4.15. Runway Surface Condition (RSC) and/or Runway Condition Reading (RCR) Values.** The RSC can be reported as either wet or dry. EAFB will not report RCR. For more information see AFI 13-204V3, Chapter 18.

**4.16. Aircraft Arresting Systems.** See DoD FLIP, IFR Supplement, [Attachment 2](#), and [Table 4.1](#) for a description, type and location of the cables currently available at Eglin AFB.

**Table 4.1. Eglin Aircraft Arresting System Locations.**

<b>AIRCRAFT ARRESTING SYSTEM LOCATIONS</b>				
	<b>FEET FROM THRESHOLD</b>		<b>FEET INTO THE OVERRUN</b>	
<b>Runway</b>	<b>Approach</b>	<b>Departure</b>		
	<b>BAK-12</b>	<b>BAK-12</b>	<b>MB-100</b>	<b>E-5</b>
RWY 19	1778	1625	N/A	- 33 **
RWY 1	1625	1778	N/A	- 27 **
RWY 12	1522	1663	48	N/A
RWY 30	1663	1522	48	N/A
<b>** NOTE:</b> E-5 Barriers are on the runway. MB-100 Barriers are in the overrun				

4.16.1. EAFB's Arresting System Standard Configuration.

4.16.1.1. During normal operations and with both runways operational, the approach end BAK- 12 and departure end BAK-12 shall be in place and available for RWY 12/30. The BAK-12 system will use 8 point tie downs. The MB-100 cable shall be up at all times.

4.16.1.2. During normal operations, RWY 1/19 approach end E-5 cable and BAK-12 cable shall be disconnected and pulled to the side of the runway. RWY 1/19 departure end BAK-12 and E-5 arresting cables shall be in place and available IAW AFI 32-1043.

4.16.1.3. When RWY 12/30 is closed or its approach end BAK-12 is unusable for a significant period of time, RWY 1/19 approach end BAK-12 shall be connected until RWY 12/30 becomes available again. Based on the Wing flying schedule, the Tower WS will determine the barrier configuration on RWY 1/19.

4.16.2. CE will report the status of cables to ATC/AMOPS using the following terminology, "in service" or "out of service" after all inspections and/or maintenance.

4.16.3. Aircraft Arresting Systems Maintenance.

4.16.3.1. The Power Production section of CE maintains arresting systems for EAFB. Arresting systems will be thoroughly inspected by Power Production personnel by 0900. Additional inspections will be conducted throughout the day when deemed necessary by the Tower WS, AMOPS, and/or any SOF. Eglin Tower advises AMOPS if arresting system problems are reported or require any action. During duty hours, AMOPS will coordinate with Power Production for action. After duty hours, AMOPS will coordinate with the Fire Department for action.

4.16.3.2. All arresting systems maintenance must be pre-coordinated with and approved by the Airfield Manager or a designated representative and will be conducted at a time which ensures minimum impact to wing flying. Certifications will be scheduled Monday through Friday, normally after the last sortie of the day. All certifications will take place during daylight hours. Power Production is responsible for ensuring annual barrier certifications are scheduled prior to the barrier expiring from service. AMOPS will notify all affected agencies and assist Power Production in coordinating and scheduling the engagement. Power Production will provide Airfield Manager a current copy of the aircraft arresting system annual certification.

**4.17. NOTAM Procedures.** The NOTAM monitoring facility/dispatching facility for EAFB is Eglin Tower/AMOPS respectively. AMOPS will receive, transmit, post and document required NOTAM action IAW AFI 11-208\_IP, *Department of Defense NOTAM System*.

4.17.1. All flying squadrons will obtain their required NOTAMs through the Defense Internet NOTAM Service (DINS) manager site (<https://www.notams.faa.gov>). In the event the NOTAM web sites are not operational, contact the destination airport via telephone to obtain the most current NOTAMs. Contact Eglin AMOPS at COMM: (850) 882-5313/DSN: 872-5313 or via direct line to obtain local NOTAMs. Hurlburt Field AMOPS will disseminate or dispatch NOTAMs as required for EAFB if the communication link to the Air Force Central NOTAM facility is locally inoperative.

**4.18. Airfield Maintenance.** All airfield maintenance (e.g., all sweeper operations, grass mowing, and general maintenance operations in the airfield environment) will be coordinated and directed through AMOPS.

**4.19. Airfield Tobacco Use Policy.** There is no smoking on the airfield outside designated tobacco use areas. For further guidance see AFI 40-102, *Tobacco Free Living*.

**4.20. Photograph/Video on the Airfield and Ranges.** Photography is normally not authorized in restricted areas; however, if a valid need exists, permission can be obtained. A memorandum will be generated by the requester and signed by the requesting commander; see EAFB Plan 31-101, *Integrated Defense Plan (FOUO)*, Tab D to Appendix 2 to Annex C. 96 TW/PA is the approval authority for 96 TW restricted areas and 33 FW/PA is the approval authority for 33 FW restricted areas. All other requests will be made through the appropriate control center, listed in **Table 4.2**. If the requester does not possess unescorted entry privileges into the area, the unit responsible for the area must provide an escort. Once approved, a copy of the memorandum must be hand carried to 96 SFS/S3O, Bldg. 272, Room 101. A copy will be maintained on the requester's person while taking photographs. Prior to entering an area for photography, one of the appropriate control centers will preannounce their intent by calling the Base Defense Operations Center (BDOC) at COMM: (850) 882-2502/DSN: 872-2502 and Eglin/Duke AMOPS at COMM: (850) 882-5313/DSN: 872-5313 or COMM: (850) 883-6538/DSN: 875-6538 respectively. Copies of all approved memorandums will be distributed to 96 TW/PA and 96 TW/MOCC or 33 FW/PA and 33 FW/MOCC prior to the photography session.

**Table 4.2. Photograph/Video Responsible Agencies.**

<b>Area</b>	<b>Approval Authority</b>	<b>Contact Number</b>
<b>96 TW aircraft/range</b>	96 TW/PA	882-3931
<b>53 WG aircraft</b>	53 WG/PA	882-3435
<b>33 FW aircraft</b>	33 FW/CPO	883-4020
<b>919/492 SOW aircraft</b>	919 SOW/CP	883-6701
<b>Duke Field</b>	96 TW/PA	882-3931

#### 4.20.1. Exceptions.

4.20.1.1. For transient aircraft, the aircraft commander must approve photography/video of their respective aircraft along with the commander who owns the restricted area.

4.20.1.2. Photographs will not be taken in an area where classified/sensitive operations are underway. This is not to restrict requests where a valid need exists, but is designed to afford the appropriate level of protection for specified areas and resources assigned to 96 TW.

4.20.1.3. Anyone observing individuals taking photographs from off base, referencing operations identified in EAFB Plan 31-101, *Integrated Defense Plan (FOUO)*, will notify the BDOC at COMM: (850) 882-2502/DSN: 872-2502 immediately and provide all possible information on the location, vehicle description, personnel description/identification data, etc.

4.20.1.4. When aircraft are on static display during open house, tours and similar events, a project officer will specify photography requirements.

#### 4.20.2. Blanket Approvals.

4.20.2.1. Personnel assigned to 96 TW Safety (96 TW/SE) may take or direct photography in support of official safety mishap investigations or in support of safety briefings without prior approval. 96 TW/SE is responsible for pre-announcing flight line photography to BDOC through the appropriate MOCC.

4.20.2.2. Personnel assigned to PA may take or direct photography in support of base or civilian news media requests. If the PA representative does not have unescorted entry privileges, the agency responsible for the area must provide an escort. PA will provide BDOC with a list of authorized photographers. PA is responsible for ensuring this list is current and all personnel are preannounced to BDOC.

4.20.2.3. Personnel assigned to 96 CEG may take or direct photography in support of official environmental and facility infrastructure management without prior approval. If the 96 CEG personnel do not have unescorted entry privileges, the agency responsible for the area must provide an escort. 96 CEG will provide BDOC with names of authorized photographers. A copy of authorization will be carried while taking photographs. The 96 CEG is responsible for ensuring names of authorized photographers are current and all personnel are pre-announced to BDOC.

4.20.2.4. Official photographs are authorized for higher headquarters inspections as indicated on the authenticated Entry Authorization List (EAL), which is signed by the installation commander or designated representative(s).

4.20.2.5. Official photographs of crime scenes are authorized at the direction of Det 104, AFOSI/CC and 96 SFS/CC.

4.20.2.6. All personnel assigned to the 96 OSS Airfield Operations Flight are authorized to take photographs for official business on the airfield after coordinating with AMOPS.

4.20.2.7. Personnel assigned to perform maintenance and quality assurance functions are authorized to take photos of their respective aircraft in the performance of their duties.

4.20.2.8. Aerial photographers assigned to 40 FLTS may take photographs in accordance with mission requirements.

**4.21. Wear of Hats.** The Eglin Airfield is designated as a no-hat area IAW the 96 TW supplement to AFI 21-101, *Aircraft and Equipment Maintenance Management*.

**4.22. Scheduling and Flight Plan Procedures.** IAW AFI 13-204V3, all aircraft departing Air Force installations must have a flight plan on file (Stereo, VFR local, DD Form 175, *Military Flight Plan*, or DD Form 1801, *DoD International Flight Plan*) with AMOPS prior to departure. Flight plans must be filed in person unless there is an approved LOA on file between Airfield Management and the user(s) or the organization is listed in [Paragraph 4.22.1](#) of this instruction. All flight plans will be maintained on file in accordance with Air Force RDS, Table 13-07, Rule 3.00.

4.22.1. The following flying units are authorized to file flight plans electronically and/or via phone:

4.22.1.1. Units assigned to and/or TDY to the 96 TW, 33 FW, or 53 WG. TDY units must have a mission number.

4.22.1.2. Civil Air Patrol/Eglin Composite Squadron.

4.22.1.3. Eglin Aero Club. Flight plans may be filed by telephone with AMOPS via the Aero Club hotline only for those VFR local flights with no enroute stops. Touch-and-go's and taxi backs conducted for training purposes only are authorized at Eglin AFB, Duke Field, Destin Airport and Bob Sikes Airport only. These flights will use an "Aero Club" call sign and remain within a 50 NM radius of Eglin AFB.

4.22.2. Flight Join Up for Departure. When two or more aircraft with different call signs wish to depart as a single flight, the aircraft in the lead will inform ATC as soon as possible, i.e. "Racer 1 flight join up with Mozam 1, now a flight of four, request to taxi to RWY 12 with (ATIS Code)." This is not to be confused with the term MARSAs which is discussed in [Paragraph 3.3.9](#). Instead, this will be handled as a flight join up. ATC must be notified as soon as possible so appropriate flight plan amendments can be made in the NAS computer system. If the joining flight wishes to keep their flight plan open, they will notify Clearance Delivery so his/her flight plan can be retained and activated in the NAS system. If there is no longer a need for the joining aircraft's flight plan, the flight plan can be removed from the NAS system. ATC instructions will only be issued to the lead aircraft.

4.22.2.1. Clearance Delivery will place a remark on the flight plans identifying the call signs of the other formations involved in the flight join up if the intent is to keep the joining aircraft's flight plan available. For example, add a remark of "Plus Mozam flight" on Racer's flight plan and "With Racer" on Mozam's flight plan. Clearance Delivery will send a Departure Message upon departure for the flight who has joined the lead flight so the flight plan will be active in the system. This will allow the flight to return from the airspace separately from the lead aircraft/flight.

4.22.2.2. If the joining aircraft/flight will remain with the lead aircraft throughout the flight and does not wish to have the option to return separately, they shall inform ATC of this intent and their flight plan will be removed from the NAS system and the number in flight for the lead aircraft will be amended to show the total number in the flight. All aircraft will use the lead aircraft's call sign (in sequence) from that point on. For example, Mozam 1 and 2 would now be Racer 3 and 4 and Mozam 1's flight plan would be removed.

4.22.2.3. Flights will be standard formation unless otherwise coordinated with ATC.

**4.23. Controlled Movement Area (CMA).** Eglin Tower is the controlling agency for all ground traffic in the controlled movement areas. The CMA consists of runways, overruns, the portion of all taxiways between the runway hold lines, and all grass between the distance remaining markers and runway edges. Vehicles are required to be in radio contact with Eglin Tower when operating on any part of the CMA.

4.23.1. Eglin Tower FM Nets (Ramp to Tower and Crash to Tower) are used solely for communications on the airfield. Tower shall continuously monitor these nets during vehicle/personnel operations on the CMA. Vehicles/personnel operating in the CMA shall continuously monitor these nets and may transmit as necessary to ensure the safety/care of personnel and/or equipment within the CMA.

4.23.2. No vehicle is authorized in, nor shall be approved to enter a CMA unless the vehicle is radio equipped (or escorted by a radio-equipped vehicle) and in direct two-way contact with Eglin Tower. Light gun signals for vehicle crossing of runways are not authorized at Eglin AFB.

4.23.3. Vehicle Recall Procedures when Radio Communications Fail. In the event radio contact is lost, exit the runway and controlled movement area immediately. Eglin Tower may indicate that radio contact has been lost by raising and lowering the intensity level of the runway lights or by flashing a red light in your direction.

4.23.4. CMA Vehicle/Pedestrian Operations: All personnel are required to abide by the responsibilities and procedures for operating on or near the EAFB airfield outlined in EAFBI 13- 213V1, *Eglin AFB Airfield Driving Instruction*.

**4.24. Precision Approach Critical Area.** When the ceiling is reported less than 800 ft or visibility less than 2 SM, no aircraft or vehicles will be allowed to operate within the ILS critical areas or precision obstacle free zones depicted in **Attachment 2** unless approved and in radio contact with tower. In addition, aircraft and vehicles shall not transit the precision approach critical areas or proceed beyond the INST hold lines when an aircraft executing an ILS approach is inside the final approach fix. EAFB has ILS critical area stop lights in place along the departure end of RWY 30 to signal when the critical zones must be protected. All vehicle traffic along the airfield perimeter road shall strictly adhere to the ILS critical area stop lights when activated by tower personnel.

**4.25. Engine Test/Run-Up Areas and Procedures.** Aircraft engine ground run-ups up to 100 percent power for maintenance purposes are authorized between 0600L-2300L. IAW AFI 11-218, *Aircraft Operations and Movement on the Ground*, aircraft are required to contact Eglin Tower prior to engine start. Exception: Engine run-ups coinciding with actual flight operations are exempt from these restrictions and may be done on the runway and/or taxiways leading up to the runway provided the aircraft is pointed in a safe direction with respect to personnel, equipment and Foreign Object Debris (FOD).

4.25.1. Test Ramp: Engine run-ups at any power setting may be conducted in the sound suppresser test cell or Hush House. Run-ups up to 85 percent power on the Test Ramp are not restricted. Run-ups above 85 percent power outside the approved window in **Paragraph 4.25** require approval from the 96 OG/CC or the 96 MXG/CC. Request approval through the Eglin Command Post.

4.25.2. 33d RAMP: Engine run-ups are not restricted in the sound suppresser test cell. Outside the sound suppresser test cell, engine run ups above 80 percent during the night quiet hours (2301L- 0559L) require approval from the 33d Maintenance Group Commander (33 MXG/CC). Request approval through the Eglin Command Post.

4.25.3. C-130 Engine Maximum Power Run Areas: Idle speed engine runs are permitted anywhere C-130 aircraft are authorized to park or taxi. There will be one vacant spot ahead and two vacant spots behind the aircraft being run. The engine run supervisor is responsible for posting an additional monitor aft of the aircraft being run to regulate vehicle and pedestrian traffic behind the aircraft when engines are run at maximum power. The following parking spot locations are designated as primary C-130 maximum power engine run spots:

4.25.3.1. ALPHA 3 (aircraft nose facing south).

4.25.3.2. BRAVO 4 (aircraft nose facing north).

4.25.3.3. BRAVO 5 (aircraft nose facing north).

4.25.4. The aft monitor will be positioned in a vehicle on the taxiway between ALPHA and BRAVO rows at least one spot east of the aircraft being run with vehicle lights and flashers activated. The monitor vehicle is not required to have direct radio communication with the aircraft but must be positioned to maintain line of sight with the engine run supervisor.

4.25.5. The following locations are designated as transient aircraft and alternate C-130 maximum power engine run spots as appropriate. An aft monitor should be posted behind the aircraft as necessary to ensure safe operations. Approval from AMOPS is required before using these locations except where noted.

4.25.5.1. TWY M-West.

4.25.5.2. TWY M between RWY 1/19 and TWY R (aircraft facing south).

4.25.5.3. HS-10 (west trim pad). Use shall be coordinated with 96 TW MOCC.

4.25.5.4. ALPHA Trim Pad from 1700L to 0700L (24 hours on weekends and holidays). Use shall be coordinated with the 96 TW/MOCC.

#### **4.26. Procedures for Suspending, Opening, and/or Closing the Runway.**

4.26.1. Eglin Tower and AMOPS have authority to suspend runway operations anytime there is an observed or reported hazardous condition or situation. Only AMOPS has the authority to close or open the runway. Appropriate NOTAMs will be sent for suspensions/closures of the runway that exceed 30 minutes.

4.26.2. Runway operations will be suspended to the affected runway during aircraft arresting system changes. Aircraft may be allowed to taxi over a BAK-12 cable that has not been secured with tie-down ropes as long as it has been connected and properly tensioned and the pilot is informed that the cable is not tied down.

#### **4.27. Airfield Inspections/Checks.**

4.27.1. Airfield inspections and checks will be completed IAW requirements and procedures outlined in AFI 13-204V3.

4.27.2. The requirement for the AFM to review and sign the daily AF Form 3616 is delegated to the Deputy Airfield Manager (DAFM).

#### **4.28. Aircraft Towing Procedures.**

4.28.1. All Aero Club/Transient Aircraft. Prior coordination is required with AMOPS for all aircraft tow operations at EAFB. AMOPS will relay this information to ATC. Direct two-way radio contact and approval from Eglin Ground Control is required prior to any aircraft being towed across any controlled movement area.

4.28.2. 96 TW/33 FW. Prior coordination with AMOPS or ATC is not required. Direct two-way radio contact and approval from Eglin Tower is required prior to any aircraft being towed across any controlled movement area.

#### **4.29. Aeromedical Aircraft Arrival Procedures.**

4.29.1. AMOPS shall coordinate crash/rescue stand-by protection for aeromedical aircraft if required.

4.29.2. Eglin Tower shall notify AMOPS when arriving aeromedical airlift aircraft reach 15 NM from the airport and relay any information requested by the pilot.

**4.30. Local Control Points.** In addition to those published in the DoD FLIPs, local control points listed in [Table 4.3;](#) [4.4;](#) and depicted in [Attachment 38](#) may be used for navigation and control instructions.

Table 4.3. Local Control Points.

<b>Name</b>	<b>Radial/DME (DWG)</b>	<b>Latitude/Longitude</b>
<b>BAY</b>	149/03	30 26.12N/86 29.46W
<b>BIECH</b>	234/17	30 19.15N/86 47.53W
<b>BIG T</b>	340/8.6	30 36.64N/86 34.86W
<b>BROOKS BRIDGE</b>	221/06	30 24.15N/86 35.80W
<b>CHEAF</b>	207/30	30 01.86N/86 46.90W
<b>DDUNE</b>	180/08	30 20.67N/86 31.25W
<b>EBETH</b>	012/14	30 42.41N/86 27.82W
<b>HISEA</b>	180/20	30 08.65N/86 31.25W
<b>GATE</b>	347/04	30 32.60N/86 32.30W
<b>GULFF</b>	145/47	29 50.04N/86 00.26W
<b>JAIL</b>	330/07	30 34.77N/86 35.30W
<b>JAMMM</b>	120/18	30 19.65N/86 13.23W
<b>KOAST</b>	120/30	30 13.58N/86 01.26W
<b>MYMMS</b>	193/65	29 25.18N/86 48.00W
<b>PHIPS</b>	307/16.5	30 16.28N/ 85 56.56W
<b>SHOAL</b>	350/13.4	30 41.92N/86 33.95W
<b>TUFER</b>	180/12	30 16.67N/86 31.25W
<b>W. POINT</b>	243/14	30 22.32N/86 45.67W
<b>E. POINT</b>	118/20	30 19.25N/86 10.85W



**Table 4.4. Eglin VFR Reporting/Holding Points.**

<b>Name</b>	<b>Radial/DME (DWG)</b>	<b>Latitude/Longitude</b>
<b>GATE</b>	347/04	30 32.60N/86 32.30W
<b>JAIL</b>	330/07	30 34.77N/86 35.30W
<b>FIELD 2</b>	030/07	30 34.78N/86 26.82W
<b>WHITE POINT</b>	107/05	30 27.08N/86 25.26W
<b>FIELD 5</b>	320/09	30 35.27N/86 37.42W
<b>FREEPART BRIDGE</b>	103/19	30 24.40N/86 09.94W
<b>DESTIN BRIDGE</b>	179/05	30 23.64N/86 31.01W
<b>BROOKS BRIDGE</b>	221/06	30 24.15N/86 35.80W
<b>BAY</b>	149/03	30 26.12N/86 29.46W
<b>SHALIMAR BRIDGE</b>	238/04.2	30 26.43N/86 35.39W
<b>SHIRK'S POINT</b>	081/03	30 29.12N/86 27.95W

**4.31. Taxi Procedures.** Eglin Tower is not responsible for ground traffic operating in those areas not visible from the tower. See [Attachment 2](#) for those locations.

4.31.1. Aircraft will call Eglin Ground Control for taxi to appropriate runway with “(Call sign), number in flight, request taxi, RWY ---- with information (Current ATIS letter).”

4.31.2. Aircraft will change to Eglin Ground Control frequency after exiting the runway surface. Locally assigned aircraft (except Aero Club aircraft) shall:

4.31.2.1. Monitor Eglin Ground Control frequency and give way to other aircraft taxiing on the main taxiway, emergency response vehicles, and taxi toward their parking locations.

4.31.2.2. Notify Ground Control before changing to another radio frequency while taxiing unless switching to Eglin Tower frequency for departure.

4.31.3. RWY 1/30 Departure Taxi Procedures. Fighter aircraft departing RWY 1 or RWY 30 shall taxi down the runway at least 500 ft (700 ft if using afterburner) before starting takeoff roll to limit the effects of jet blast at the apex. When two or more aircraft depart simultaneously ensure the last element in the flight is at least 500 ft (700 ft if using afterburner) down the runway before starting takeoff roll. C-130 and larger aircraft shall taxi at least 700 ft down the runway before beginning engine run-up. **NOTE:** If operational necessity requires the use of the entire runway, pilots shall make the request with Eglin Tower prior to takeoff.

4.31.4. 33 FW aircraft will utilize EOR De-arm to hold prior to takeoff, and post flight to check for hot brakes and tire conditions IAW [Attachment 2](#). Aircraft will not utilize TWY B for hot brake checks.

**4.32. Reduced Same Runway Separation (RSRS).** Reduced same runway separation is authorized by the AFI 13-204V3 AFMC SUP 1 and may be applied to all Air Force, Air Force Reserve and Air National Guard aircraft. Host units will ensure TDY aircraft are provided detailed briefings on local RSRS procedures prior to local flying. For non-USAF aircraft, RSRS may be authorized under a LOA between the unit commander and the 96 OG/CC.

4.32.1. Controllers treat aircraft within the same formation (whether similar or dissimilar) as a single aircraft, and do not apply reduced runway separation standards. Separation between aircraft within a formation is the responsibility of the flight leader and pilots of the other aircraft in the flight (JO 7110.65, Pilot/Controller Glossary). However, pilots will adhere to the same runway separation standards as required in **Table 4.5** In order to apply RSRS, Air Traffic Controllers must always be able to see the aircraft involved and determine distances by reference to suitable landmarks (distance markers, taxiways, etc.).

**Table 4.5. RSRS Standards.**

PAIRINGS	FS behind TG	FS behind LA	LA behind LA	FS behind FS	LA behind FS	TG behind TG	TG behind LA
Same Fighter-Type/ Same Trainer Type	Day: 3,000 ft Night: 6,000 ft	Day: 3,000 ft Night: 6,000 ft	Day: 3,000 ft Night: 6,000 ft	Day: 3,000 ft Night: 6,000 ft	Day: 3,000 ft Night: 6,000 ft	Day: 3,000 ft Night: 6,000 ft	Day: 3,000 ft Night: 6,000 ft
Dissimilar Fighter/ Trainer Type	Day: 6,000 ft Night: 6,000 ft	Day: 6,000 ft Night: 6,000 ft	Day: 6,000 ft Night: 6,000 ft	Day: 6,000 ft Night: 6,000 ft	Day: 6,000 ft Night: 6,000 ft	Day: 6,000 ft Night: 6,000 ft	Day: 6,000 ft Night: 6,000 ft
Same Non-Heavy, Tactical Airlift Type (i.e., C-130s)	Day: 3,000 ft Night: 6,000 ft	Day: 3,000 ft Night: 6,000 ft	Day: 3,000 ft Night: 6,000 ft	Day: 3,000 ft Night: 6,000 ft	Day: 3,000 ft Night: 6,000 ft	Day: 3,000 ft Night: 6,000 ft	Day: 3,000 ft Night: 6,000 ft
Same Non-Heavy, Same-Type Aircraft Formations	Day: 6,000 ft Night: 6,000 ft	Day: 6,000 ft Night: 6,000 ft	Day: 6,000 ft Night: 6,000 ft	Day: 6,000 ft Night: 6,000 ft	Day: 6,000 ft Night: 6,000 ft	Day: 6,000 ft Night: 6,000 ft	Day: 6,000 ft Night: 6,000 ft
Same Type Heavy, FS Only	*	*	*	Day: 8,000 ft Night: 8,000 ft	*	*	*

\* = JO 7110.65 standard runway separation applies.

FS – Full Stop; LA – Low Approach; TG – Touch and Go

**NOTE:** Daytime standards may be used through the end of civil twilight.

4.32.2. When maintaining visual separation or operating under VFR, pilots are responsible for wake turbulence separation, and controllers must provide appropriate cautionary wake turbulence advisories. When aircraft are operating IFR or under ATC instructions, air traffic controllers must ensure standard wake turbulence separation.

4.32.3. Reduced same runway separation is not authorized under the following conditions:

4.32.3.1. Any situation involving an emergency aircraft.

4.32.3.2. Non-AF aircraft, unless authorized under an LOA.

4.32.3.3. Any aircraft “Cleared for the option”, “Cleared stop-and-go”, low approach behind a touch-and-go, or a touch-and-go behind a full stop.

4.32.3.4. When braking action reports of “medium”, “poor”, or “nil” are reported.

4.32.3.5. “Heavy” aircraft (capable of takeoff weight more than 255,000 pounds) other than full stop following full stop.

#### 4.33. General Departure Procedures.

4.33.1. Eglin Standard Departure. IFR aircraft initially departing EAFB shall be issued the following departure instructions by Clearance Delivery: “FLY RUNWAY HEADING, MAINTAIN THREE THOUSAND, EXPECT (altitude) ONE ZERO MINUTES AFTER DEPARTURE....”

4.33.1.1. IFR aircraft issued a heading to fly on departure shall initiate their turn within 1 NM from the departure end of the runway, or advise ATC if unable.

4.33.2. VFR Overhead Pattern Protection. All departures from EAFB shall maintain at or below 1,000 ft MSL, and Hurlburt Field shall maintain at or below 1,200 ft MSL, until the departure end of the runway to protect the VFR overhead pattern, unless otherwise directed.

4.33.3. Quick Climbs/Max Climbs/Unrestricted Climbs/Functional Check Flights (FCF). If a nonstandard rate of climb is desired, pilots will advise during initial contact with ground control their intent for a max performance climb and requested altitude block. Eglin Tower, in turn, will coordinate with the ERCF and inform the pilot if approved or disapproved. Approval for max climbs will be contingent upon other traffic and/or airspace limitations.

4.33.4. Two minute call. All locally based or hosted aircraft departing IFR will call to Eglin Ground Control: “(Call sign), 2 minutes” prior to departure. When ready for departure inform Eglin Tower “(Call sign), number of aircraft in flight, ready for takeoff, RWY \_\_\_”

4.33.5. EAFB Intersection Departures (VFR and IFR). Intersection departures are authorized from all taxiway intersections except from TWY M, due to obstructed visibility from Eglin Tower. Eglin Tower will not issue runway distance remaining to locally based C-130 and Aero Club aircraft making an intersection departure. **NOTE:** Aero Club aircraft are expected to depart from TWY N for RWY 19 departures and TWY J for RWY 1 departures. Aero Club multiengine aircraft will depart from TWY P for RWY 19 departures and TWY W for RWY 1 departures.

4.33.5.1. The runway distances remaining from each of the taxiways at Eglin are as depicted in [Table 4.6](#)

**Table 4.6. EAFB Intersection Departure Distance Remaining.**

<b>INTERSECTION DEPARTURE FEET</b>		
<b>AVAILABLE</b>		
<b>RWY 19</b>	<b>TWY</b>	<b>RWY 1</b>
8900	P	1100
7100	N	2500
5600	M-East	4400
5200	M-West	4800
4200	J	5800
1900	W	8100
1100	H	8900
<b>RWY 12</b>	<b>TWY</b>	<b>RWY 30</b>
4000	F	8000
8000	E	4000

4.33.6. Immediate Takeoff Clearance. When issued an immediate takeoff clearance, pilots are expected to begin takeoff roll within 20 seconds of clearance receipt. Eglin Tower shall advise the pilot in advance to "EXPECT IMMEDIATE DEPARTURE." If the pilot is unable to comply, they shall notify the tower prior to taxiing onto the runway.

4.33.7. Abbreviated Departure Clearance. Eglin Clearance Delivery shall issue an abbreviated IFR clearance to all local aircraft with Eglin stereo route flight plans. Example: "(Call sign), EGLIN CLEARANCE DELIVERY, CLEARED TO EAFB VIA THE VPS (Stereo Route Number) DEPARTURE AS FILED, (departure procedure), (altitude data in order flown), (frequency and beacon code information)."

4.33.8. Airborne pickup procedures.

4.33.8.1. Upon initial contact with Eglin Ground Control, the pilot will advise ATC of intention to use an airborne pickup.

4.33.8.2. When ready for takeoff, contact Tower and include the airborne pickup request.

4.33.8.3. Airborne pickups including heavy aircraft, such as tankers, will be coordinated in advance with ATC. When cleared for takeoff, clearance for the airborne pickup and closed pattern direction will be issued by the tower.

4.33.8.4. Both aircraft involved in this maneuver will remain on tower frequency until instructed to change to departure.

4.33.8.5. The first aircraft to depart will execute a left/right turn (as directed by ATC) to inside downwind. The aircraft will configure as required/desired, execute a base turn (radio call to tower not required), and roll out offset from the runway left or right as necessary.

4.33.8.6. The second aircraft will release brakes and the airborne aircraft will execute the join up. When both aircraft are at a safe altitude, tower will direct them to change to departure.

4.33.8.7. ATC may have first airborne aircraft “report initial for airborne pickup/carry through” if conditions warrant. Additionally, the pilot may request “re-entry to initial for airborne pickup” if desired (subject to ATC approval).

4.33.8.8. Restrictions.

4.33.8.8.1. Simultaneous operations to crossing runway are prohibited during airborne pickup operations.

4.33.8.8.2. Weather minimums for executing the airborne pickup procedure shall be a 2,100 ft MSL ceiling and 3 statute miles (SM) visibility.

4.33.8.8.3. Aircraft will slow to no lower than final approach speed during the airborne pickup.

4.33.8.8.4. Minimum altitude during the airborne pickup is 200 ft AGL unless approved by test and safety review boards for specific test mission requirements.

4.33.9. Avoiding Restricted Airspace. Reduced separation may be applied to the periphery of restricted airspace for participating aircraft departing Eglin AFB **ONLY**. All aircraft will be considered participating with the exception of Air Carriers, civil aircraft (unless participating in scheduled missions), heavy aircraft, or transient aircraft. Operations will be conducted IAW the following:

4.33.9.1. Host unit will be responsible for briefing all aircraft they sponsor of the reduced minima being applied by ERCF for aircraft departing Eglin AFB. Tower will notify departure of airspace affecting the departure and ERCF will flight follow participating aircraft, providing safety alerts/traffic advisories as necessary to help prevent an encroachment into active restricted airspace. Responsibility rests with the aircraft commander to laterally/vertically avoid the area.

4.33.9.2. ERCF will suspend restricted area operations affecting a participating departure if the aircrew determines they cannot remain outside restricted airspace. Expect a five-/ten-minute delay in such situations.

#### **4.34. General Recovery Procedures.**

4.34.1. On initial contact with Eglin Tower, specify position and landing intentions [i.e., “EGLIN TOWER, (call sign), DDUNE INITIAL RWY 12 OPTION”].

4.34.2. South Flow Recovery Procedures. The South Flow Recovery procedure is designed to provide IFR or VFR recoveries during RWY 12/19 operations. Aircraft shall remain on ERCF frequency until instructed to contact Eglin Tower. Aircraft will be cleared and fly the recovery as depicted (See [Attachment 17](#)). IFR clearance is automatically canceled when the aircraft reports the field in sight. Aircraft reporting the field in sight are expected to fly to initial unless otherwise coordinated. The VFR portion of the Eglin South Recovery shall not be flown when the ceiling is less than 2,100 ft MSL.

4.34.2.1. DDUNE Recovery. This procedure is utilized during south flow (RWY 12/19) operations to return aircraft to the VFR pattern. Aircraft shall remain on ERCF frequency until instructed to contact Eglin Tower. Aircraft will be cleared and fly the recovery as depicted (See [Attachment 17](#)). IFR clearance is automatically canceled when the aircraft reports the field in sight. Aircraft reporting the field in sight are expected to fly GATE to initial unless otherwise coordinated. If unable to proceed VFR by GATE, continue outbound on the DWG R-347 for an instrument approach.

4.34.2.1.1. From DDUNE, proceed to DWG via DWG R-180; cross DWG at 4,000 ft MSL (See [Attachment 17](#)). At DWG, track outbound on DWG R-347 to GATE (DWG 347/04). Cross GATE between 2,100 and 3,000 ft MSL. Descend to pattern altitude and proceed to initial, straight-in, or as instructed by Eglin Tower.

4.34.2.1.2. North Transition: Proceed to EBETH (DWG012/14) at or above 3,000 ft MSL then proceed direct to JAIL (DWG 330/07) to cross JAIL between 2,200 and 3,000 ft MSL, then proceed to GATE (DWG 347/04) to cross GATE between 2,100 and 3,000 ft MSL (See [Attachment 17](#)). Descend to pattern altitude and proceed to initial, straight-in, or as instructed by Eglin Tower. If recovering in IMC, proceed to EBETH to pick up the ILS to RWY 19. Cross EBETH at or above 3,000 ft MSL.

4.34.2.1.3. East Transition: Intercept the 86°0'W longitude line and track 360° to KOAST (DWG 120/30) (See [Attachment 17](#)). Cross GULFF (DWG 145/047) between 15,000 and 19,000 ft MSL; cross KOAST between 6,000 and 9,000 ft MSL, then turn left and proceed to DDUNE (DWG 180/08) via course 286°; cross DDUNE at or above 6,000 ft MSL, then proceed with the DDUNE recovery.

4.34.2.1.4. West Transition: Intercept the 86°48'W longitude line and track 360° to BIECH (DWG 236/17) (See [Attachment 17](#)). Cross CHEAF (DWG 207/30) between 15,000 and 19,000 ft MSL; cross BIECH between 6,000 and 9,000 ft MSL, then turn right and proceed to DDUNE (DWG 180/08) via course 083°; cross DDUNE at or above 6,000 ft MSL, then proceed with the DDUNE recovery.

4.34.2.2. Whiskey Hotel Recovery: This procedure is designed to provide a VFR recovery to EAFB during RWY 12/19 operations. The minimum weather for this recovery is a 3,500 ft MSL ceiling and 3 SM visibility (See [Attachment 18](#)).

4.34.2.2.1. R-2915B activities may preclude Whiskey Hotel recoveries.

4.34.2.2.2. Once approved, IFR clearances and radar arrival sequencing are automatically canceled. Radar flight following service shall continue until communications transfer to Eglin Tower.

4.34.2.2.3. Aircraft shall cross the Hurlburt TACAN (Channel 45X) at or above 3,000 ft MSL, cross abeam B-71 at 2,500 ft MSL, and then descend to 1,600 ft MSL for initial or proceed straight-in.

4.34.2.2.4. Aircraft shall remain clear of R-2915A throughout the recovery.

4.34.2.3. Brooks Bridge Recovery: This procedure is designed to provide a VFR recovery option to EAFB during RWY 12/19 operations. The minimum weather for this recovery is a 2,600 ft MSL ceiling and 3 SM visibility. Once approved “Brooks Bridge recovery,” IFR clearances and radar arrival sequencing are automatically cancelled. Radar flight following services shall continue until communications transfer to Eglin tower.

4.34.2.3.1. Pilots will report BROOKS BRIDGE (DWG 221/6) between 2,100 and 3,500 ft MSL with intentions. When weather allows (aircraft must maintain 500 feet below lowest weather), aircrew will strive to enter at the top of the block for noise abatement and reduce throttle settings over populated areas in the descent. Normal intentions aircraft may request with Tower include: 1) direct to initial; or 2) direct to a VFR straight-in for RWY 12. Pilots will maintain a minimum of 2,100 ft MSL until cleared to descend to initial or VFR straight-in altitudes.

4.34.2.3.2. If Tower is unable to sequence traffic entering the pattern via BROOKS BRIDGE to initial or to a straight-in for RWY 12, pilots will proceed direct to the DWG TACAN and then direct GATE at a minimum of 2,100 ft MSL to re-enter the pattern flow and deconflict with normal pattern traffic at 1,600 ft MSL.

4.34.3. North Flow Recovery Procedures. The North Flow Recovery procedure is designed to provide IFR or VFR recoveries during RWY 1/30 operations. Aircraft shall remain on ERCF frequency until instructed to contact Eglin Tower. Aircraft will be cleared and fly the recovery as depicted (See [Attachment 19](#)). IFR clearance is automatically canceled when the aircraft reports the field in sight. Aircraft reporting the field in sight are expected to fly to initial unless otherwise coordinated. The VFR portion of the Eglin North Recovery shall not be flown when the ceiling is less than 2,100 ft MSL.

4.34.3.1. North Transition. Intercept the DWG R-012 and track inbound to DWG. Cross DWG R-012/14 DME (EBETH) at 6,000 ft MSL; cross DWG between 4,000 and 6,000 ft MSL (See [Attachment 19](#)). At DWG, track outbound to DDUNE (DWG 180/08) via R-180; cross DWG 180/04 (DUTBE) between 2,100 and 5,000 ft MSL; cross DDUNE between 1,600 and 5,000 ft MSL. Then recover via procedures stated below:

4.34.3.1.1. VFR Recovery. Descend to pattern altitude and proceed to initial, VFR straight-in, or as instructed by ATC. If unable to proceed VMC, aircraft shall advise ATC and proceed with the IFR portion of the recovery.

4.34.3.1.2. IFR Recovery. In the absence of further ATC instructions, depart DDUNE heading 133° to join the DWG 12 DME arc. Upon joining the arc, proceed with the published ILS or TACAN approach to RWY 30. Maintain 3,000 ft MSL throughout the 12 DME arc until passing the lead radial for the intended approach.

4.34.3.2. East Transition. If a heading or restriction is not assigned by EMC, intercept the 86°0'W longitude line and track 360 degrees to KOAST (DWG 120/30) (See [Attachment 19](#)). Cross GULFF (DWG 145/57) between 15,000 and 19,000 ft MSL; cross KOAST between 6,000 and 9,000 ft MSL, then turn left and proceed inbound via DWG R-120. Cross JAMMM (DWG 120/18) at or above 3,000 ft MSL. Then depart JAMMM and join ILS or TACAN procedures as stated below:

4.34.3.2.1. ILS Approach. Depart JAMMM to join the procedure at DWG 120/17 and proceed with the approach.

4.34.3.2.2. TACAN RWY 30 Approach. Depart JAMMM heading 280°, intercept the DWG R- 133 and proceed with the approach.

4.34.3.3. West Transition. Intercept the 86°48'W longitude line and track 360° to BIECH (DWG 236/17) (See [Attachment 19](#)). Cross CHEAF (DWG 207/30) between 15,000 and 19,000 ft MSL; cross BIECH between 6,000 and 9,000 ft MSL, then turn right and proceed to DEJAH (DWG 218/11) via course 083°; cross DEJAH at 3,000 ft MSL, then proceed to DDUNE (DWG 180/08). Cross DDUNE between 2,000 and 1,600 ft MSL. Then recover via procedures stated below:

4.34.3.3.1. VFR Recovery. Descend to pattern altitude and proceed to initial, VFR straight-in, or as instructed by ATC. If unable to proceed VMC, aircraft shall advise ATC and proceed with the IFR portion of the recovery.

4.34.3.3.2. IFR Recovery. In the absence of further ATC instructions, depart DDUNE heading 133° to join the DWG 12 DME arc. Upon joining the arc, proceed with the published ILS or TACAN approach to RWY 30. Climb and maintain 3,000 ft MSL throughout the 12 DME arc until passing the lead radial for the intended approach.

4.34.4. Local Climbout and Radar Traffic Patterns. Aircraft making multiple approaches at Eglin shall use the following climbout instructions unless otherwise directed by ATC. Aircraft making multiple radar approaches can expect vectors for a pattern as depicted in [Attachment 16](#) or as controller workload dictates.

4.34.4.1. ATC phraseology for base assigned aircraft shall be “EXECUTE LOCAL CLIMBOUT.” If multiple approaches will be made with tower, phraseology shall be “AFTER COMPLETING (type approach), MAINTAIN VFR, CONTACT TOWER.”

4.34.4.2. Eglin Local Climbout:

4.34.4.2.1. RWY 1: “AFTER COMPLETING (type approach), CROSS DEPARTURE END OF THE RUNWAY AT OR BELOW ONE THOUSAND, CLIMB AND MAINTAIN THREE THOUSAND, THEN TURN RIGHT HEADING ONE ONE ZERO, CONTACT ARRIVAL 124.25/290.5/LOCAL CHANNEL 7.”

4.34.4.2.2. RWY 12: “AFTER COMPLETING (type approach), CROSS DEPARTURE END OF THE RUNWAY AT OR BELOW ONE THOUSAND, FLY RUNWAY HEADING, CLIMB AND MAINTAIN FOUR THOUSAND, AT THREE DME TURN LEFT HEADING ZERO THREE ZERO, CONTACT ARRIVAL 124.25/290.5/LOCAL CHANNEL 7.”

4.34.4.2.3. RWY 19: “AFTER COMPLETING (type approach), CROSS DEPARTURE END OF THE RUNWAY AT OR BELOW ONE THOUSAND, TURN RIGHT HEADING TWO SEVEN ZERO, CLIMB AND MAINTAIN THREE THOUSAND, CONTACT ARRIVAL 124.25/290.5/LOCAL CHANNEL 7.”



4.34.4.2.4. RWY 30: “AFTER COMPLETING (type approach), CROSS DEPARTURE END OF THE RUNWAY AT OR BELOW ONE THOUSAND, TURN LEFT HEADING ONE EIGHT ZERO, CLIMB AND MAINTAIN THREE THOUSAND, CONTACT ARRIVAL 124.25/290.5/LOCAL CHANNEL 7.”

4.34.5. VFR Traffic Patterns. Basic weather minimums for all VFR traffic patterns are ceiling of 500' above the pattern altitude and 3 SM visibility. Weather should allow use of visual entry/reentry points for the respective runway in use (GATE or BAY) however, the Tower WS, after coordination with the SOF, may approve vectors to initial/straight-in when visual entry/reentry points are not usable. These patterns will usually be limited to one approach to a full stop landing. Multiple approach/pattern work requires the availability of the breakout/reentry points to avoid pattern saturation. Eglin Tower WS or Eglin SOF may close any VFR pattern when deemed necessary even if the weather is above VFR minimums due to obscured visibility or operational necessity, such as traffic saturation, poor tower visibility, and/or equipment limitations. The traffic patterns described below are standard patterns. However, Eglin Tower may direct use of traffic patterns other than as described herein when deemed necessary. See [Table 4.7](#)

**Table 4.7. VFR Pattern Matrix.**

<sup>1</sup> Ceiling At Least (MSL)	VFR Patterns Available	What to expect on ATIS	What to expect on recovery	<sup>4</sup> What to expect in the pattern
12000'	All	N/A	Published Recovery (DDUNE/Eglin North)	No restrictions
6500'	All except High Key SFO/PFO			
2600'	Overhead (Fighter) Pattern w/ <sup>2</sup> Breakout, Conventional Rectangular/Helicopter			
2100'	Overhead (Fighter) - No Breakout Conventional Rectangular/Helicopter	"Pattern Open, Restricted Fighter Ops"	Expect vectors to initial (MVA 1600') or DDUNE/Eglin North Recovery transition to instrument approach	<b>Breakout Unavailable.</b> The published breakout/reentry altitude (2100') is not available due to the ceiling. <sup>3</sup> <b>Reentry restricted to 1600' throughout the pattern.</b> Fighter VFR traffic pattern ops should usually be limited to one pattern/FULL STOP to avoid saturation. Fighter reentry

				<p>pattern is limited to 1600' throughout the pattern.</p> <p><b>Tower to Tower Transitions to/from Duke are not authorized.</b></p> <p>Tower/aircrew shall be vigilant of potential conflicts when utilizing "re-enter" when 2100' MSL is not available due to low ceilings. Tower watch supervisor may direct full stop landings or direct aircraft to depart the pattern to prevent pattern saturation.</p> <p>Aircrew will immediately report ceilings less than 2600' discovered during pattern ops. Pattern checks are authorized at the discretion of the tower watch supervisor.</p>
1600'	Conventional Rectangular/ Helicopter	"Overhead Pattern Closed"	<b>Fighters limited to recovery via instrument approach.</b>	Non-fighter aircraft will enter the conventional rectangular pattern (1100') via the VFR entry point (when able to maintain VMC) or an instrument approach (option) to the VFR pattern.
1100'	Helicopter		Normal helicopter VFR operations. <b>All others limited to recovery via instrument approach.</b>	VFR, East Transition and Water Hoist area patterns (600') available without restrictions.

**Notes:**

Items in bold are directive. Other items are subject to ATC/pilot judgement in execution IAW directives.

<sup>1</sup>Cloud layers are reported in AGL on the official observation: MSL=AGL+100

<sup>2</sup> Breakout procedures will be used only for traffic conflicts, emergencies, or landing gear problems and are not to be confused with reentry procedures.

<sup>3</sup> Reentry is used for re-sequencing and spacing requirements.

<sup>4</sup> Tower WS or SOF may close the pattern when deemed necessary regardless of official observation due to obscured visibility or operational necessity, such as traffic saturation, poor tower visibility, and/or equipment limitations.

4.34.5.1. Overhead Pattern. Overhead pattern altitude is 1,600 ft MSL with 45 degree entries and a 3 to 5 NM initial (See [Attachment 5](#)). Aircraft will break approach end (if no conflicts are on inside downwind). Pilots can request midfield or departure end breaks. Airspeed in the overhead pattern is 300 knots indicated airspeed (KIAS) (Exception: 350 KIAS for tactical initial). The overhead pattern shall be open to only one runway at a time. On RWY 12/30 Tower may direct traffic on initial to offset north or south to deconflict with PFO/SFO traffic. If told to offset the north, line up to overfly the south end of TWY M. If told to offset south, line up on Nomad Way. These visual references produce a 0.5nm offset. When RWY 12/19 are in use, overhead patterns shall normally be flown to RWY 12 (See [Attachment 7](#)). When RWY 1/30 are in use, overhead patterns shall normally be made to RWY 30 (See [Attachment 8](#)). **NOTE:** Traffic conditions permitting, Eglin Tower may approve other overhead patterns at pilot request. The standard overhead patterns are as follows:

4.34.5.1.1. RWY 1. Left turns.

4.34.5.1.2. RWY 19. Right turns.

4.34.5.1.3. RWY 12. Left turns.

4.34.5.1.4. RWY 30. Left turns.

4.34.5.2. Tactical Initial. Tactical initial request shall be made on initial contact with Eglin Tower. Eglin Tower has the authority to approve or deny this request. If denied, aircraft must be no further than 500 ft separation prior to reaching the 3 to 5 NM initial point. The following procedures shall be adhered to for aircraft approved to recover tactical initial:

4.34.5.2.1. RWY 12: Aircraft will remain no further than 4,000 ft line abreast with the flight lead lined up on RWY 12 with the wingman lined up on Nomad Way, south of the runway centerline.

4.34.5.2.2. RWY 30: Aircraft will remain no further than 4,000 ft line abreast with the flight lead lined up on RWY 30 with the wingman lined up north of the runway centerline.

4.34.5.2.3. RWY 1/19: Aircraft will remain no further than 4,000 ft line abreast with the flight lead lined up on RWY 1/19 with the wingman east of the runway centerline.

4.34.5.3. VFR Straight-in. Altitude for a VFR straight-in approach is 1,100 ft MSL on a 3 to 5 NM final. When entering from a downwind or GATE (DWG 347/04), aircraft will begin their descent when turning base and be established at 1,100 ft MSL prior to turning final. RWY 30 south straight-in entries shall maintain 2,100 ft MSL until BAY (DWG 149/03) to avoid Destin Airport traffic, then descend to 1,100 ft MSL. Maneuvering to the southeast may be required to execute RWY 30 straight-in approaches.

4.34.5.4. Reentries. Reentry is used for re-sequencing and spacing requirements. The radio call for reentry is ["(Call sign), REENTER"]. When directed to, or when requesting to reenter, aircraft flying straight through initial will climb and maintain 2,100 ft MSL until the departure end of the runway. Aircraft on climbout after a low-approach/touch-and-go will maintain at or below 1,000 ft MSL until the departure end of the runway and clear of inside downwind traffic. All aircraft reentering will turn crosswind or maneuvering for re-entry at departure end and climb/maintain 2,100 ft MSL unless instructed by tower. Aircraft will remain within 4 NM of the airport when reentering the pattern. The following are the standard reentry procedures for RWY 12/30 and RWY 1/19:

4.34.5.4.1. The standard reentry point for RWY 12 is GATE. Aircraft will proceed direct GATE once over Choctawhatchee Bay (feet wet) and at 2,100 ft MSL. Pilots will strive to be rolled out towards GATE as they are leveling at 2,100 ft MSL (similar to completing a closed pull-up). If reentering for a VFR straight-in, apply VFR straight-in altitude procedures described in [Paragraph 4.34.5.3](#)

4.34.5.4.2. The standard reentry point for RWY 30 is BAY. On crosswind, aircraft will maintain 2,100 ft MSL and turn left direct to BAY (east of DTS RWY 32 centerline). At BAY, the aircraft will turn to make a 45-degree entry to 3 NM initial while descending to 1,600 ft MSL. If reentering for a VFR straight-in, apply VFR straight-in altitude procedures described in [Paragraph 4.34.5.3](#)

4.34.5.4.3. The standard reentry point for RWY 19 is GATE. On crosswind, aircraft will maintain 2,100 ft MSL and turn right to outside downwind approximately twice the distance from the runway as inside downwind and then fly direct to GATE. Aircraft will remain east of the approach end of RWY 12 until north of RWY 12. At GATE, the aircraft will turn to make a 45-degree entry to 3 NM initial while descending to 1,600 ft MSL. If reentering for a VFR straight-in, apply VFR straight-in altitude procedures described in [Paragraph 4.34.5.3](#)

4.34.5.4.4. The standard reentry point for RWY 1 is SHALIMAR BRIDGE (DWG 238/4.2). On crosswind, aircraft will maintain 2,100 ft MSL and turn left to fly direct to SHALIMAR BRIDGE. At SHALIMAR BRIDGE, the aircraft will turn to make a 45-degree entry to 3 NM initial while descending to 1,600 ft MSL. If reentering for a VFR straight-in, apply VFR straight-in altitude procedures described in [Paragraph 4.34.5.3](#)

4.34.5.5. Go Around. Aircraft instructed “(Call sign), GO AROUND, (Reason, time permitting)” will execute the following procedures:

4.34.5.5.1. Aircraft will fly straight ahead or as directed by the Eglin Tower. [e.g., “(Call sign), GO AROUND, SOUTH SIDE OF RUNWAY, AIRCRAFT ON RUNWAY”] and maintain at or below 1,000 ft MSL until departure end.

4.34.5.6. Breakouts. Breakout procedures will be used only for traffic conflicts, emergencies, or landing gear problems and are not to be confused with reentry procedures. The radio call for breakouts are “(Call sign) BREAKOUT” or when initiated by the pilot, “(Call sign) BREAKING OUT.” Aircraft will execute the following breakout procedures when directed by Eglin Tower or as required. (See [Attachments 7 and 8](#))

4.34.5.6.1. Aircraft conducting overhead approaches: Aircraft established on initial have priority over aircraft 45-degree to initial. If a conflict exists, aircraft on 45-degree to initial will immediately climb to 2,100 ft MSL, notify tower of the climb to 2,100 ft MSL [“(Call sign), BREAKING-OUT”] and turn to parallel/overfly the runway. Continue runway heading until departure end, then follow Eglin Tower’s instructions. If no instructions are received, extend upwind 1.5 NM past the departure end of the runway and turn crosswind. Clear traffic reentering and turn to outside downwind. Once established on outside downwind, follow the normal reentry procedures for the runway in use and expect further tower instructions at reentry points.

4.34.5.6.2. Aircraft Established on Downwind. When directed by Eglin Tower to breakout, or when a pilot initiates a breakout from inside downwind, the aircraft will climb and maintain 2,100 ft MSL, immediately turn and proceed to the reentry point for the runway in use. The pilot must check for aircraft established on outside downwind. RWY 12/19, if a conflict exists with an aircraft on outside downwind the aircraft breaking out will maneuver to follow the outside downwind traffic to GATE. RWY 30, after clearing outside downwind, climb and maintain 2,100 ft MSL to avoid Destin Airport traffic and follow any outside downwind traffic to BAY. RWY 1, after clearing outside downwind, climb and maintain 2,100 ft MSL and follow any outside downwind traffic to SHALIMAR BRIDGE. At GATE/BAY/SHALIMAR BRIDGE, the aircraft will follow the normal reentry procedures or proceed as directed by Eglin Tower personnel.

4.34.5.6.3. Aircraft Established on Base Turn: Aircraft on a straight-in have priority over aircraft in the overhead pattern. Aircraft that have commenced a base turn and perceive a traffic conflict (or have an aircraft malfunction) will not break out but instead will continue the turn to the runway in use while maneuvering to avoid straight-in traffic and immediately inform Eglin Tower [“(Call sign), GOING AROUND”]. If possible, once aircraft separation is assured, offset to the inside of the runway in use (left side for RWY 1/12/30 and right side for RWY 19). Aircraft will maintain at or below 1,000 ft MSL until departure end of runway, and request closed, reenter, or proceed as directed by Eglin Tower.

4.34.5.6.4. Aircraft Established on Straight-in Approach: Aircraft established on a straight-in approach have priority over aircraft in the overhead traffic pattern and will continue with the approach while monitoring base turn traffic that is maneuvering to resolve the conflict. If straight-in traffic must also maneuver to ensure flight path separation, aircraft shall clear prior to maneuvering to avoid potential conflicts with other aircraft in the pattern. After maneuvering, parallel the runway, remain below 1,000 ft MSL until the departure end of the runway and proceed as directed by Eglin Tower.

4.34.5.7. Eglin Apex Separation. When an aircraft is on base leg or on a straight-in final and the potential exists for a conflict at the Eglin “Apex”, aircraft will be issued the conflicting traffic information and instructed to “EXPECT MIDFIELD CLOSED” as a last means of providing “Apex” separation. Pilots who inform the Eglin Tower they are unable to accept a midfield closed can expect to be broken out and instructed to reenter the traffic pattern. If, after the aircraft turns final, it is determined that a midfield closed is not required, tower shall advise the aircraft to make a normal closed (departure end) and issue applicable traffic.

4.34.5.8. ATC shall approve closed traffic requests by stating, “LEFT/RIGHT CLOSED TRAFFIC APPROVED.” **Pilots shall not begin a crosswind turn until the departure end of the runway unless specifically directed or approved by the Eglin Tower to execute an earlier turn.** Pilots may execute an earlier turn ONLY if ATC states “PRESENT POSITION LEFT/RIGHT CLOSED TRAFFIC APPROVED” or “MIDFIELD LEFT/RIGHT CLOSED TRAFFIC APPROVED.” All aircraft entering a closed pattern shall maintain at or below 1,000 ft MSL until departure end of the runway or established in the turn if cleared closed prior to the departure end to protect the VFR overhead pattern.

**4.35. Simulated Flameout (SFO) and Precautionary Flameout (PFO) Approaches.** Both the SFO and PFO will utilize the same approach patterns. The overhead simulated flameout (OH SFO), and the straight-in simulated flameout (SI SFO) approaches will be conducted between the hours of sunrise to sunset and only during periods of low density traffic (at the discretion of the Eglin/Duke Tower WS). To the maximum extent possible, SFOs shall be requested prior to RTB due to the increased coordination required. In addition, tower personnel may disapprove or cancel the procedure whenever they deem it necessary for safety of flight. Approval of an SFO by the tower does not absolve the pilot from the responsibility to comply with VFR see and avoid requirements. Participating aircraft are considered to have canceled IFR upon communications transfer to tower. SFO airspace is defined as a 5 NM radius from center of the airport from surface up to and including 12,000 ft MSL unless otherwise coordinated.

4.35.1. Weather and Runway Requirements. Official reported weather at the airport to which the approach is conducted will be ceiling at least 1,000 ft above the requested high or low key altitude and visibility of at least 5 SM.

4.35.2. Duke Field is the primary choice for SFO training based on traffic pattern congestion at Eglin. Every attempt should be made to conduct SFO practice approaches to Duke Field RWY 18/36. When accomplishing SFOs at Eglin, RWY 12/30 is the primary runway but will be dependent on existing traffic and/or controller workload.

4.35.3. SI SFO primary location is Duke Field RWY 18. EAFB RWY 30 can be approved depending on traffic and/or controller workload.

4.35.4. OH SFO Pattern Procedures. (See [Attachments 9 and 10](#))

4.35.4.1. RWY 12 OH PFO/SFO Procedures: Aircraft on climbout or initial straight through will fly runway heading and maintain 2,100 ft MSL. At 1.5 NM past the departure end of runway, make a right hand climbing turnout to "HIGH KEY". Eglin Tower may direct or approve pilot request to execute an earlier turn when traffic conditions warrant. Pilot will report high key with: "(Call sign), HIGH KEY" or "(Call sign), HIGH KEY, ORBIT." If required to orbit at high key, the aircraft will initiate a right hand turn at high key altitude and report high key when over the desired touchdown point. When executing a PFO/SFO from high key, a right 360-degree PFO/SFO will be performed. Tower may approve opposite direction (left turn) PFO/SFOs if requested and traffic allows. Aircraft will remain within 4 NM of the airport when flying the PFO/SFO pattern.

4.35.4.2. RWY 30 OH PFO/SFO Procedures: Aircraft on climbout or initial straight through will make a right hand climbing turnout to a 360-degree right turning PFO/SFO. The pilot will report high key over the desired touchdown point. If required to orbit at high key, the aircraft will maintain a right hand turn at high key altitude and report high key when over the desired touchdown point. Tower may approve opposite direction (left turn) PFO/SFOs if requested and traffic allows.

4.35.4.3. RWY 1/19 OH SFO Procedures: SFOs to RWY 1/19 will normally only be flown during single runway operations when Duke Field is not available. The ATC WS has the final authority to authorize SFOs to RWY 1/19 based on traffic density and controller training. Aircraft on climbout or initial straight through will make a climbing turnout to the west and report high key when over the desired touchdown point in order to execute a 360-degree turning SFO. If required to orbit at high key, the aircraft will maintain a western orbit at high key altitude and report high key when over the desired touchdown point. When executing an SFO from high key, a 360-degree SFO to the west will be performed.

4.35.4.4. Additional Information:

4.35.4.4.1. High Key will normally be flown at 7,000 – 11,500 ft MSL.

4.35.4.4.2. Low Key will normally be flown at 3,000 – 6,000 ft MSL.

4.35.4.4.3. Airspeed will normally be 200 to 250 KIAS, but may vary due to weight and aircraft configuration. Pilots requiring a speed in excess of 250 KIAS will notify ATC prior to commencing the approach.

4.35.4.4.4. Mandatory Reporting Points: High Key and Low Key (with gear and intentions).

4.35.4.4.5. RWY 12/30 OH SFO pattern will be flown in the opposite direction as the normal overhead pattern unless otherwise specified by tower.

4.35.4.4.6. RWY 1/19 OH SFO pattern will be flown to the west of the runway for noise abatement unless otherwise specified by tower.

4.35.4.4.7. OH SFO Breakout Procedures. Prior to base key, tower shall state “(Call sign), REENTER, (Reason, time permitting, and follow-on instructions).” Aircraft shall climb to or maintain 2,100 ft MSL and comply with tower instructions. If no instructions are received, transmit intentions and request to tower.

4.35.4.4.8. OH SFO Go-Around Procedures. Tower shall state “(Call sign), GO AROUND, (Reason, time permitting, and follow-on instructions).” If at or above 2,100 ft MSL, maintain 2,100 ft MSL (500 ft above overhead pattern). If below 2,100 ft MSL the aircraft will continue to descend to maintain at or below 1,000 ft MSL until departure end, and comply with tower instructions. If none are received, transmit intentions and requests to tower.

4.35.4.4.8.1. For a pilot-initiated go-around or when a landing clearance is not received, the pilot shall report “(Call sign) BASE KEY, ON THE GO.” Execute the go-around procedure described above and follow tower instructions. If no instructions are received, the pilot shall transmit intentions and request to tower in the blind.

4.35.4.4.9. If weather does not allow the execution of an SFO initiated from High Key, tower can authorize SFOs initiated from Low Key based on current weather conditions and traffic density within the traffic pattern. The same ground track will be flown as described above, while remaining clear of clouds. Weather requirements are ceiling of at least 1,000 ft above the requested low key altitude and visibility of at least 5 SM.

#### 4.35.5. SI SFO Pattern Descriptions and Procedures. (See Attachment 10)

4.35.5.1. An SI SFO approach begins 8 NM from the runway and ends at the landing threshold.

4.35.5.2. The 8 NM SI SFO point is straight out from the approach end of the runway at 7,000 – 11,000 ft MSL.

4.35.5.3. The 5 NM SI SFO point is straight out from the approach end of the runway at 3,000 – 6,000 ft MSL.

4.35.5.4. SI SFO airspeed will normally be 200 to 250 KIAS, but may vary due to weight and aircraft configuration. Pilots requiring a speed in excess of 250 KIAS will notify ATC prior to commencing the approach.

4.35.5.5. If ERCF traffic permits, SI SFOs can expect descent to the requested altitude and vectors to the 8 NM reporting point. ERCF will coordinate with tower for SI SFO approval. Tower will deny the approach if more than three aircraft are projected to be in the VFR pattern when the SI SFO will arrive, or if a safety issue is involved.



4.35.5.6. If tower approval is not received by 20 NM from the runway, expect descent to pattern altitude and sequencing with normal arriving traffic. If tower approval is received by the 20 NM point, expect a vector to a point 12-14 NM on final/dogleg, instructions to proceed visually, and to contact tower. At this point, the IFR flight plan is canceled. Communications transfer to tower must occur prior to commencing the SI SFO maneuver. After contact with tower, and prior to 8 NM on final, expect verbal approval for the SI SFO from tower. If conditions develop which preclude the approach, expect to be sequenced by tower into the overhead pattern. If unable to communicate with tower, maintain assigned altitude and VFR, fly towards the runway and contact ERCF on last assigned ERCF frequency.

4.35.5.7. Mandatory reporting points: Report: “(Call sign), 8-MILE SFO” and “(Call sign), 5- MILE SFO FINAL, GEAR, and intentions (e.g., touch and go, low approach)” to tower. Expect clearance at 5 NM. If clearance is not received by 3 NM on final, proceed straight ahead, maintain 2,100 ft MSL, and expect an overhead approach. Once the SI SFO aircraft is 8 NM final or closer, no arrival or departure aircraft will be permitted in front of the SI SFO aircraft.

4.35.5.8. If tower does not have a visual or radar-indicated position of the aircraft by 5 NM final, tower will discontinue the SI SFO approach and give directions to sequence the aircraft into the overhead pattern.

4.35.5.9. SI SFO Breakout/Go-Around Procedures.

4.35.5.10. Prior to 5 NM final, the tower shall state “(Call sign), TERMINATE Straight In SFO, (Reason, time permitting, and follow-on instructions.)” If no instructions are received, climb to or maintain 2,100 ft MSL and expect an overhead approach.

4.35.5.10.1. Pilot initiated/tower directed go-around at or after 5 NM final. If at or above 2,100 ft MSL, maintain 2,100 ft MSL (500 ft above overhead pattern.) If below 2,100 ft MSL the aircraft will continue to descend to maintain at or below 1,000 ft MSL until departure end, and comply with tower instructions. If none are received, transmit intentions and requests to tower.

4.35.6. F-35 aircraft may perform PFOs using the SFO patterns at Eglin and Duke Field. For the purposes of this instruction, PFO and SFO are synonymous. However, expect slightly higher altitudes and airspeeds at High Key and Low Key, and a slightly extended pattern at Low Key. SI PFOs will be flown slightly faster (215-245 KCAS). Pilots will request high key with an altitude (e.g., “LIGHTNING-01, REQUEST HIGH KEY AT 11,500). Controllers and pilots will use the term PFO when referring to an F-35 in the SFO pattern (e.g., "LIGHTNING-01, 8-MILE PFO").

4.35.7. 12/30 Random Entry Simulated Flameout Pattern (RESFO) Procedures.

4.35.7.1. A RESFO is intended to intercept a straight-in SFO or overhead SFO pattern at some point from a random position and altitude on initial recovery to VPS (aircrew should not expect multiple RESFO approaches.) A RESFO approach begins at a point outside and above the defined SFO airspace, and ends at a landing threshold. A VFR descent from outside the SFO airspace direct to a Low Key position or 5 nm SI SFO point is maintained until within the defined SFO airspace.

4.35.7.2. If Eglin ERCF traffic and airspace permit, RESFOs can expect a VFR descent from the present aircraft position enroute to DDUNE or JAIL as the initial reporting point with the Tower. ERCF will coordinate with Tower for RESFO approval. Tower will deny the approach if more than three aircraft are projected to be in the VFR pattern when the RESFO will arrive.

4.35.7.2.1. If Tower approval is not received by DDUNE/JAIL, aircraft will proceed direct to High Key. If SFO airspace is unavailable due to pattern congestion and a lengthy delay is expected, aircraft will be instructed to execute a DDUNE recovery from the south or descent to pattern altitude from JAIL and will be sequenced in with normal arriving traffic.

4.35.7.3. The Low Key RESFO is normally flown at 3,000 to 6,000 ft MSL. Aircrew will take the most direct route from the initial reporting point to Low Key (see [Attachment 11](#)). The 5 nm RESFO point is identical to the SI SFO 5 NM point at 3,000 – 6,000 ft MSL. If Tower does not have a visual or radar-indicated position of the aircraft by Low Key or 5 NM final, Tower will discontinue the RESFO approach and give directions to sequence the aircraft into the overhead pattern. Expect clearance for a low approach at Low Key or 5 NM final.

4.35.7.4. Once inside low key or 5 NM final, breakout/go-around procedures are identical to the respective OH SFO or SI SFO procedure. Once the RESFO aircraft is low key, 5 NM on final or closer, no arrival or departure aircraft will be permitted in front of the RESFO aircraft. If clearance is not received by base key or 3 NM final, climb and maintain 2,100 ft MSL and expect an overhead approach.

4.35.7.5. RESFO airspeed will normally be 200 to 250 KIAS with an approximate 1,000 ft/NM descent rate, but may vary due to weight, position, and aircraft configuration. Pilots requiring a speed in excess of 250 KIAS will notify ATC prior to commencing the approach.

4.35.7.6. Mandatory reporting points: DDUNE/JAIL, and Low Key/5 miles. Report: “(Call sign), DDUNE/JAIL and intentions e.g. direct LOW KEY or direct 5-MILE SFO FINAL” and “(Call sign), LOW KEY or 5-MILE SFO FINAL, GEAR, and intentions (e.g. low approach)” to Tower.

#### **4.36. Rectangular Pattern.**

4.36.1. Fighter/Trainer Rectangular Pattern.

4.36.1.1. RWY 1: Left Turns, 1,600 ft MSL.

4.36.1.2. RWY 12: Left Turns, 1,600 ft MSL.

4.36.1.3. RWY 19: Right Turns, 1,600 ft MSL.

4.36.1.4. RWY 30: Left Turns, 1,600 ft MSL.

4.36.2. Conventional Rectangular Pattern (See [Attachment 6](#)):

4.36.2.1. RWY 1: Right Turns, 1,100 ft (600 ft Helicopters) MSL.

4.36.2.2. RWY 12: Right Turns, 1,100 ft (600 ft Helicopters) MSL.

4.36.2.3. RWY 19: Left Turns, 1,100 ft (600 ft Helicopters) MSL.

4.36.2.4. RWY 30: Left Turns, 1,100 ft (600 ft Helicopters) MSL.

**4.37. Noise Abatement Procedures.** All military aircraft operating in airspace delegated to the Eglin Radar Control Facility (ERCF) shall adhere to the following procedures to the maximum extent possible unless established on a published approach/departure procedure or deviations are dictated by Air Traffic Control (ATC), safety, or mission constraints/requirements. See **Table 4.8** and **Attachment 45** for a depiction of these restrictions.

4.37.1. Turbojet, Propeller, and Tiltrotor Aircraft. All turbojet, propeller, and tiltrotor aircraft shall maintain at or above 1,500 ft AGL over populated areas and will use minimum thrust levels consistent with safe operations. Aircraft within 5 NM of an airfield may descend once they are established on final approach or are in an established traffic pattern. See **Table 4.8**

4.37.1.1. Helicopters. All helicopters shall maintain at or above 500 ft AGL over congested areas. Helicopters within 5 NM of an airfield may descend once they are established on final approach or are in an established traffic pattern. See **Table 4.8**

4.37.1.2. Water Overflight. All aircraft shall remain at or above 500 ft AGL over water in the noise abatement areas. See **Table 4.8** and **Attachment 45**.

**Table 4.8. Minimum Noise Abatement Altitudes.**

Type Aircraft	Minimum Noise Abatement Altitude outside of 5 NM from Airfield
<b>Turbojet, Propeller, and Tiltrotor</b>	1,500 ft AGL
<b>Helicopters</b>	500 ft AGL
<b>All Aircraft Over Water in Noise Abatement Area</b>	500 ft AGL

4.37.2. Specific Runway Selection and Flight Operating Procedures. To minimize aircraft noise in the surrounding communities, all aircraft operating from EAFB or on Eglin ranges shall use the following procedures consistent with aircraft configuration, MAJCOM directives, aircraft technical orders, flight safety, and mission requirements:

4.37.2.1. Designation of primary runways.

4.37.2.1.1. RWY 12/19 shall be the primary runways when the tailwind component for either runway does not exceed 10 knots and the runways are dry in order to minimize overflight of the Valparaiso/Niceville areas. When RWY 1/30 are in use, RWY 1 shall be used for departures and RWY 30 shall be used for arrivals to the maximum extent possible.

4.37.2.1.2. RWY 12/30 is the primary VFR/overhead/Simulated Flameout (SFO) runway.

4.37.2.2. On all afterburner takeoffs, aircraft shall retard throttle out of afterburner as soon as safety permits, but not later than reaching 300 KIAS. Climb to 3,000 ft MSL at or below 350 KIAS using military thrust or less. Afterburner takeoffs between 2300L and 0600L shall be limited to RWY 12, 19, or 30.

4.37.2.3. When departing RWY 1, aircraft shall climb runway heading until 3,000 ft MSL. Departure control should not allow turns over the towns of Valparaiso/Niceville until aircraft are at or above 3,000 ft MSL and north of the towns. Wingmen DO NOT use cutoff procedures to rejoin on the flight leader until above 3,000 ft MSL. Exception: If R-2918 is active, a left turn of no more than 20 degrees will be issued.

4.37.2.4. Unless safety or mission requirements dictate otherwise, aircraft recovering from the east will fly a DDUNE recovery to avoid overflight of the towns of Valparaiso/Niceville.

4.37.2.5. Recoveries from the West will utilize the Whiskey Hotel Recovery, whenever possible.

4.37.2.6. Avoid populated areas on all low-level routes and plan departure/landing turns to minimize overflight of populated areas. Commensurate with safe flight operations and mission necessities, aircrew should use the minimum required power setting over populated areas.

4.37.2.7. Avoid uncontrolled airports by 1500 ft AGL or 2 NM laterally.

4.37.2.8. Populated areas will be avoided as much as possible when carrying external ordnance.

4.37.2.9. Aircrew are encouraged to fly at the highest practical altitude consistent with mission accomplishment in order to minimize the noise impact on the local community. Avoid overflying private homes and buildings to the maximum extent possible.

**4.38. Areas of Potential Conflict.** Contact 96 TW/SEF for the most current MACA program updates.

**4.39. Hurlburt Field Patterns.** Procedures for Hurlburt Field Patterns are outlined in HFI 11-201, *Fixed and Rotary Wing Operations*.

**4.40. IFR Procedures.** Aircraft at EAFB shall use the following go-around procedures unless otherwise directed by ATC:

4.40.1. Eglin Go-Around Procedures Inside the Final Approach Fix. ATC phraseology shall be as follows:

4.40.1.1. RWY 1: "TOWER CLEARANCE CANCELED/NOT RECEIVED, FLY RUNWAY HEADING, CROSS DEPARTURE END OF THE RUNWAY AT OR BELOW ONE THOUSAND FEET, CLIMB AND MAINTAIN THREE THOUSAND, THEN TURN RIGHT HEADING ONE ONE ZERO."

4.40.1.2. RWY 12: "TOWER CLEARANCE CANCELED/NOT RECEIVED, FLY RUNWAY HEADING, CROSS DEPARTURE END OF THE RUNWAY AT OR BELOW ONE THOUSAND FEET, CLIMB AND MAINTAIN FOUR THOUSAND FEET, AT THREE DME TURN LEFT HEADING ZERO THREE ZERO."

4.40.1.3. RWY 19: "TOWER CLEARANCE CANCELED/NOT RECEIVED, FLY RUNWAY HEADING, CROSS DEPARTURE END OF THE RUNWAY AT OR BELOW ONE THOUSAND FEET, TURN RIGHT HEADING TWO SEVEN ZERO, CLIMB AND MAINTAIN THREE THOUSAND."

4.40.1.4. RWY 30: "TOWER CLEARANCE CANCELED/NOT RECEIVED, FLY RUNWAY HEADING, CROSS DEPARTURE END OF THE RUNWAY AT OR BELOW ONE THOUSAND FEET, TURN LEFT HEADING ONE EIGHT ZERO, CLIMB AND MAINTAIN THREE THOUSAND."

4.40.2. Eglin Breakout Procedures Outside the Final Approach Fix. ATC phraseology shall be as follows:

4.40.2.1. RWY 1: "(Call sign) BREAKOUT, TURN LEFT HEADING TWO SEVEN ZERO, CLIMB AND MAINTAIN (altitude)."

4.40.2.2. RWY 12: "(Call sign) BREAKOUT, TURN LEFT HEADING THREE FOUR ZERO, CLIMB AND MAINTAIN (altitude)."

4.40.2.3. RWY 19: "(Call sign) BREAKOUT, TURN RIGHT HEADING TWO SEVEN ZERO, CLIMB AND MAINTAIN (altitude)."

4.40.2.4. RWY 30: "(Call sign) BREAKOUT, TURN RIGHT HEADING ONE ZERO ZERO, CLIMB AND MAINTAIN (altitude)."

4.40.3. Hurlburt Go-Around procedures:

4.40.3.1. Inside of four miles:

4.40.3.1.1. RWY 18: "CROSS DEPARTURE END OF RUNWAY AT OR BELOW ONE THOUSAND TWO HUNDRED, THEN CLIMB AND MAINTAIN ONE THOUSAND SIX HUNDRED, AND FLY RUNWAY HEADING." **NOTE:** Departure end altitude restriction may be deleted if overhead pattern is closed.

4.40.3.1.2. RWY 36: "CROSS DEPARTURE END OF RUNWAY AT OR BELOW ONE THOUSAND TWO HUNDRED, THEN CLIMB AND MAINTAIN ONE THOUSAND SIX HUNDRED, AND TURN LEFT HEADING TWO ZERO ZERO." **NOTE:** Departure end altitude restriction may be deleted if overhead pattern is closed.

4.40.3.2. Four or more miles from the runway:

4.40.3.2.1. RWY 18: "CLIMB AND MAINTAIN ONE THOUSAND SIX HUNDRED, FLY RUNWAY HEADING."

4.40.3.2.2. RWY 36: "CLIMB AND MAINTAIN ONE THOUSAND SIX HUNDRED, TURN LEFT HEADING TWO ZERO ZERO."

**4.41. Restricted Low Approach.** IAW JO 7110.65 a low approach with an altitude restriction of not less than 500 ft above the airport may be authorized except over an aircraft in takeoff position or a departure aircraft. Tower personnel will determine the most appropriate altitude for the traffic situation.

#### 4.42. Aero Club Procedures.

4.42.1. Normally, the Aero Club shall not use EAFB for practice approaches between 0700L- 1700L, Monday through Friday, except holidays unless military flying has terminated and practice approaches are approved by tower personnel.

4.42.2. IFR and VFR cross-country flight plans shall be filed with AMOPS.

4.42.3. Aero Club aircraft shall contact Eglin Clearance Delivery and state intentions to use either the North or East Training Areas prior to taxiing. Clearance Delivery will disapprove East Training Area requests if mission traffic is scheduled in R-2914A or R-2919A.

4.42.4. Aero Club aircraft shall receive approval from Eglin Approach for flight in the North/South Corridor ("NORTH CORRIDOR FLIGHT APPROVED"). Eglin Approach shall advise aircraft if R-2918 is active for North Training Area flights. Aero Club aircraft operating within training areas are on a VFR flight plan and shall remain VMC at all times, remain on the appropriate ERCF frequency, and advise prior to departing a training area.

4.42.5. VFR Departures/Arrivals.

4.42.5.1. Aircraft shall use RWY 1/19 to the maximum extent possible or as directed by ATC.

4.42.5.1.1. RWY 1. Northbound departures shall turn eastward to clear the departure course, then proceed direct to Field 2 while eastbound aircraft shall proceed direct to White Point. Aircraft will climb to and maintain 1,100 ft MSL until arriving at Field 2 or White Point unless approved otherwise by ATC. RWY 1 arrivals making other than a straight-in landing shall turn base leg south of King Hangar and north of the RWY 30 arrival course unless otherwise approved by tower. If the pilot cannot meet this restriction, he/she shall notify the tower no later than midfield downwind. Simultaneous approaches (aero club base to RWY 1 north of RWY 30) and RWY 30 arrivals are not authorized.

4.42.5.1.2. RWY 19 departures shall turn left, south of King Hangar and north of RWY 12. If the pilot cannot meet this restriction, he/she shall notify the tower prior to departure or immediately once airborne. Northbound aircraft shall proceed to Shirk's Point (3 NM ENE of KVPS) direct to Field 2 while eastbound/westbound traffic shall proceed to Shirk's Point direct to White Point. Aircraft will climb to and maintain 1,100 ft MSL until arriving at Field 2 or White Point unless approved otherwise by ATC.

4.42.5.1.3. If the pilot desires a runway heading departure, he/she must request permission from Eglin Tower prior to takeoff.

4.42.6. VFR departures and arrivals direct to and from the Destin Airport are authorized with the following guidelines:

4.42.6.1. Departures to Destin. The pilot shall request Destin departure through Eglin Tower prior to departure ["(Call sign) REQUEST DESTIN DEPARTURE"].

4.42.6.1.1. RWY 1: Turn right at the departure end of the runway direct White Point. The tower personnel shall issue traffic information and send the aircraft to Destin Tower no later than White Point.

- 4.42.6.1.2. RWY 19: Turn left direct White Point remaining north of RWY 12 departure course. Eglin Tower shall issue traffic information and send the aircraft to Destin Tower no later than White Point. **NOTE:** Eglin Tower will send the aircraft to Destin CTAF when Destin Tower is closed.
- 4.42.6.2. Arrivals from Destin. Aircraft operating at Destin will contact Eglin Tower to report intentions prior to entering Eglin traffic pattern. Specific instructions will be issued to enter the pattern at 1,100 ft MSL or as assigned by tower. (Example: “REPORT 2-MILE FINAL FOR RWY 1”, or “REPORT LEFT DOWNWIND VIA WHITE POINT FOR RWY 19.”) If entering Eglin traffic pattern at a VFR reporting point, Eglin Tower may transfer control to ERCF.
- 4.42.7. Normally, pattern altitude for Aero Club aircraft is 1,100 ft MSL. Aircraft will maintain 1,100 ft MSL within the Class D surface area when VFR unless ATC approves otherwise. They shall squawk the assigned Aero Club beacon code and altitude. A 600 ft MSL VFR traffic pattern for local Aero Club and other civil aircraft may be authorized in order to maintain 500 ft below clouds and depart under special VFR.
- 4.42.8. Aero Club aircraft shall contact Eglin Ground Control on 121.8 after landing when clear of the runway, and when operating on the taxiways.
- 4.42.9. VFR Holding Points and Procedures: Aircraft will circle over a VFR holding point when directed by Eglin Tower or when communication with the Eglin Tower is not established.

**4.43. Helicopter/Tiltrotor Operations.** Unless otherwise stated, all helicopter procedures in this regulation also apply to tiltrotor aircraft.

4.43.1. Eglin helicopter operating areas:

- 4.43.1.1. Hover point. The hover point, located on TWY M, between RWY 1/19 and TWY R is unmarked, but it may be used by base assigned and transient helicopters. When in use by helicopters, it shall be closed to all other traffic.
- 4.43.1.2. Hospital Pad is located northwest of the 96th Medical Group Hospital.

4.43.2. General Helicopter Procedures:

- 4.43.2.1. All departures and arrivals shall be in accordance with the clearance issued by the appropriate ATC agency.
- 4.43.2.2. Avoid overflight of the munitions storage area.
- 4.43.2.3. Departures and arrivals to and from the north should be flown at or above 500' AGL along unpopulated terrain such as Tom's Bayou and Boggy Bayou in order to avoid overflight of schools, hospitals, and residential areas.
- 4.43.2.4. When approach or departure route will require crossing a runway or its extended centerline, obtain clearance from Eglin Tower before crossing. Traffic patterns may be adjusted to take advantage of existing winds when approved by Eglin Tower.

4.43.2.5. Departures and arrivals to and from the southeast should follow a route between RWY 1/19 and TWY M to King Hangar, then east, parallel to RWY 12/30 to the bay coast, remaining clear of Test Site A-22. Departures and arrivals from the south or southwest should follow a route along the bay coast from the apex to Brooks Bridge. Aircraft will remain at or below 600 ft MSL. See [Attachment 2](#).

4.43.2.6. All VFR helicopter traffic departing Eglin to the north shall depart as cleared by Eglin Tower and remain at or below 600 ft MSL.

4.43.2.7. When mission requirements dictate, helicopters are authorized to depart/land at any point in the Eglin complex where such departure/landing will not endanger life or property, unless such point is specifically excluded by regulation.

4.43.2.8. If the pilot elects to land short of the airport of intended landing, every effort shall be made to advise the ERCF, Eglin/Duke Tower, or Eglin AMOPS by telephone as soon as practical after landing.

4.43.2.9. Helicopters shall remain at least 50 ft from flightline road at all times.

#### 4.43.3. Traffic Patterns.

4.43.3.1. EAFB. Pattern altitude is 600 ft MSL with 45 degree entry legs to downwind.

4.43.3.1.1. RWY 1: Right Traffic.

4.43.3.1.2. RWY 12: Right Traffic.

4.43.3.1.3. RWY 19: Left Traffic.

4.43.3.1.4. RWY 30: Left Traffic.

#### 4.43.4. Communications.

4.43.4.1. Radio Contact. Helicopters shall maintain radio communications with the appropriate ATC agency (ERCF, Eglin Tower or Duke Tower), if possible, when performing landing or approaches at other than controlled airports. Position and status shall be reported every 30 minutes to make sure assistance can be requested if necessary.

4.43.4.2. Radio Failure. In the event of radio failure in VFR conditions, helicopters shall approach the field with landing lights on and remain clear of traffic in the conventional and overhead traffic patterns. In addition, helicopters shall watch for light gun signals from the tower. In IFR conditions, reattempt contact on last assigned frequency or **CH 9/269.15**. If unsuccessful, intercept the 12 or 14 DME arc and proceed with the ILS or TACAN approach to the runway in use. Maintain 3000' or last assigned altitude, whichever is higher, until established on a segment of the approach.

4.43.5. Special VFR. Special VFR for helicopters operating within Class D surface areas is authorized in accordance with applicable regulations. Such flights shall remain clear of clouds at all times and under the control of ATC.



4.43.6. Training at EAFB. Helicopter VFR training and FCF sorties are authorized at EAFB in the Helicopter Transition Area (TWY M-West). Two-way radio contact must be maintained with Eglin Tower at all times. Traffic patterns may be varied, as necessary, to take advantage of existing winds. In addition, helicopters shall remain at least 600 ft west of RWY 1/19 and 600 ft North of RWY 12/30 and avoid overflying the munitions storage areas. Aircraft will remain at or below 600 ft MSL. **NOTE:** This area is not marked as a landing surface and therefore not considered part of the movement area under control by ATC. **CAUTION:** Expect uncontrolled vehicle operations within the immediate vicinity.

4.43.7. Autorotation.

4.43.7.1. Helicopter test and practice autorotations shall only be conducted in the following areas:

4.43.7.1.1. Eglin active runways, with tower approval.

4.43.7.1.2. The west end of TWY M-West.

4.43.7.2. Designated autorotation landing areas shall be accessible to Crash Disable or Damaged Aircraft Recovery (CDDAR) crews on normal duty or special standby.

4.43.7.3. Tower clearance shall be obtained prior to climbing above normal traffic pattern altitude of 600 ft MSL.

4.43.7.4. Helicopter slide landings shall not be conducted on pavement areas unless approved by the Airfield Manager.

4.43.8. Helicopter Functional Check Flight Areas. The primary helicopter FCF area is within the Tower Transition Area (TTA), as coordinated with Duke ATCT, primarily between Duke Field and Big T Landing Zone (LZ) (DWG 340/8.6) up to 2,200 ft MSL. The secondary helicopter FCF area is defined as the sector of airspace from the VPS TACAN 310° Radial to the 350° Radial and from 2 DME to 5 DME, surface to 600 ft MSL. Helicopter aircrew from the 413 FLTS will conduct maintenance check flights within these areas. When FCF profiles require an altitude higher than 600 ft MSL at Eglin or 2,200 ft MSL in the TTA, aircrew will work north into the Eglin C/D MOAs and request specific altitude blocks from Eglin Approach.

## Chapter 5

### DUKE FIELD OPERATIONS AND PROCEDURES

**5.1. EAFB/Auxiliary Field Three (Duke Field, KEGI) Operating Hours.** Duke Field's published hours of operation are M-F, 0800L-0100L, closed weekends and federal holidays. 919/492 SOW Current Ops and 413 FLTS Current Ops should schedule first aircraft departure times 30 minutes after airfield open time to facilitate communication between the aircraft and tower for engine start and taxi. Use of Duke Field outside published hours must be coordinated with the Airfield Manager and approved by the 96 OG/CC at least 48 hours in advance. For request outside normal hours, the airfield will open 30 minutes prior to the requested aircraft departure time provided by 919/492 SOW Current Ops or 413 FLTS Current Ops to facilitate communication between the aircraft and tower for engine start and taxi. Duke Field Airfield Manager shall notify 96 WS for weather support as required.

5.1.1. Airfield closures less than 96 hours for Family Days in conjunction with holidays and weekends may be approved by the 96 OG/CC.

5.1.2. Uncontrolled Operations. Uncontrolled operations are permitted for 492 SOW/919 SOW/413 FLTS assigned/attached aircrew and aircraft to conduct takeoff, landing, ground operations and related support functions when the Duke ATCT and AMOPS are closed and are unable to provide support outside published hours. 96 OG/CC approval must be obtained through 96 OSS/OSB within 48 hours (preferred) but no less than 24 hours prior to conducting each instance of Uncontrolled Airfield Operations. See LOA titled Uncontrolled Airfield Operations at Duke Field.

5.1.3. Aircraft Rescue and Fire Fighting. Fire/rescue services are available 24 hours a day, 7 days a week. CDDAR services for base-assigned aircraft are available. CDDAR services for transient aircraft are not immediately available. CDDAR response is dispatched to Duke from Eglin. See IFR Supplement for aircraft rescue and firefighting capabilities.

5.1.4. Prior Permission Required (PPR). All aircraft not assigned to Duke Field must have a PPR number prior to full stop landing and shutdown. Transient parking is extremely limited. PPR requests must be coordinated 7 calendar days in advance to ensure use of Duke Field. Project officers, POCs and TDY liaisons shall coordinate with the 96 OSS/OSBM (Duke Field AMOPS) at COMM: (850) 883-6516 or 6093/DSN: 875-6516.

**5.2. Transient Alert.** Transient Alert services are based out of Eglin and are only available for approved Army 7th Special Forces Group (SFG) missions and approved aircraft supporting local (base-assigned 492/919 SOW) aircraft deployments or support missions. Other aircraft requiring transient services should use EAFB (KVPS) and coordinate with 96 OSS/OSAM (Eglin AMOPS) at COMM: (850) 882-5313/DSN: 872-5313 for parking and services at Eglin.

5.2.1. Aircraft assigned to Eglin and Hurlburt Field are considered within the local area and do not require transient alert services to land and park at Duke Field. Aircrews are still required to obtain a PPR 48 hours in advance to ensure parking availability. Aircrew operating under this provision will be issued progressive taxi instructions by Duke Tower and instructed to park at their own risk. Approved transient aircrews are responsible for the parking, and coordinating services, maintenance, security, and any additional support their aircraft may require.

### 5.3. Runway and Taxiways.

5.3.1. Duke Field's airfield diagram, field elevation and runway gradients can be found in [Attachment 20](#).

5.3.2. RWY 18/36 is 8,025 ft long by 150 ft wide, asphalt, with 25 ft non-load bearing asphalt shoulders. Overruns are non-load bearing and non-standard in length: RWY 18 overrun is 555 ft long by 150 ft wide and RWY 36 overrun is 554 ft long by 150 ft wide.

5.3.3. Taxiway/Taxilane Restrictions. All Taxiways/Taxilanes are 75 feet wide except TWY E Center which is 60 feet wide.

5.3.3.1. Taxilane A. Restricted to C-17 and smaller aircraft due to wingtip setback criteria of parked aircraft on the main apron. The shoulders are unpaved.

5.3.3.2. TWY A. Restricted to C-17 and smaller aircraft due to uprising terrain obstruction on the west side of taxiway. The shoulders are unpaved.

5.3.3.3. TWY B. Restricted to C-17 and smaller aircraft due to obstruction criteria (mandatory sign placement on north side of TWY B). The shoulders are unpaved. Two tower blind spots exist on TWY B: one at the intersection of TWY A/TWY B and another on the western end of TWY B.

5.3.3.4. TWY C. Restricted to C-17 and smaller aircraft due to obstruction criteria (mandatory sign placement on north side of TWY C). The shoulders are unpaved.

5.3.3.5. TWY D. Restricted to C-17 and smaller aircraft. TWY D east of the LZ has weight restrictions for C-17 aircraft; see Airfield Suitability Restrictions Report (ASRR) and contact Airfield Management for use. Weight waivers required for C-17s weighing over 464,000 lbs. Expect short notice closures when TWY D has aircraft parked with hazardous cargo. TWY D east of the apex is closed to all aircraft except aircraft authorized to utilize the Landing Helicopter Assault (LHA) Deck.

5.3.3.6. TWY E. Restricted to C-17 and smaller aircraft. TWY E Center (between the runway and the LZ) is 60 feet wide with 10-foot shoulders. Operations are restricted to aircrews qualified to operate on a 60-foot wide taxiway. TWY E East restricted to C-130 and smaller aircraft.

5.3.3.7. TWY F. Restricted to C-17 and smaller aircraft. TWY F east of the LZ has weight restrictions for C-17 aircraft; see ASRR and contact Airfield Management for use. Weight waivers are required for C-17s weighing over 327,000 lbs. Expect short notice closures for TWY F east of the LZ when aircraft with hazardous cargo are parked on TWY D.

**5.4. Restricted/Classified Areas on the Airfield.** Duke Airfield has one restricted area (restricted area 18). Restricted area 18 encompasses apron parking rows 1-8. All assigned aircraft are designated as PL-4 or higher. Transient aircraft designated as PL1 - PL3 will require Security Forces to guard them while they are on station.

## 5.5. Aircraft Parking Plan.

5.5.1. Apron parking rows 1-8 are designated for 492 SOW/919 SOW base-assigned or attached aircraft. Each row has 3 parking spots (ALPHA, BRAVO, and CHARLIE spots). 492/919 SOW shall use Row 8 for passenger drop off or pick-up. Personnel will stage on the wash rack or grassy area north of the wash rack and enter the apron via the ECP. Aircraft should not expect to use rows 9-15 for passenger pick-up/drop-off. All special use or parking requests outside of rows 1-8 must be pre-coordinated with Airfield Management in advance to ensure availability.

5.5.2. Apron parking rows 9, 10, and row 15 designated for transient aircraft. Transient parking extremely limited. Row 10 has 2 parking spots (ALPHA and BRAVO spots), rows 9 and 15 have 1 parking spot identified as BRAVO row based on the placement of lead-in lines as they relate to other apron markings. Rows 9 and 15 are primary spots for C-130 and C-17. Fighters and small transient aircraft will use row 10. Any other contingency use of these parking spots requires coordination and approval from Airfield Management.

5.5.3. Apron parking rows 11-14 are designated for 413 FLTS-assigned or attached rotary wing aircraft. Each row has 2 parking spots (ALPHA and BRAVO spots). Additionally, BRAVO 12 is designed to support 1x CV-22 or 1x MH-47 provided ALPHA row is open with no aircraft. Any other contingency use of these parking spots requires coordination and approval from Airfield Management.

5.5.4. North Hangar Apron designated for support of 96 TW mission aircraft only. Any other contingency use of these parking spots requires coordination and approval from the Facility Manager of Hangar 3150 and Airfield Management.

## 5.6. Aircraft Special Operation Areas/Aprons.

5.6.1. Duke Field LZ. The LZ is parallel and 1,000 ft east of RWY 18/36. The LZ is restricted to VFR Ops only for C-130s and smaller aircraft. The 919 SOW, 492 SOW, 96 TW, and AFSOC assigned or attached aircraft are authorized to use the LZ. The LZ is 3,500 ft long and 60 ft wide with 10 ft paved shoulders. Visual LZ marker panels are not available. No intersection departures are authorized. See [Paragraph 5.10.2](#) for AMP lighting. Painted markings consist of threshold markings on each end, a centerline stripe, and two touchdown box configurations: one 500 ft from the threshold line and one 200 ft from the threshold line. Load bearing overruns 300 ft long (with no chevrons) are provided to facilitate rollout and taxi operations. The first 700 ft of the north end is constructed with grooved concrete and the first 900 ft of the south end is constructed with grooved concrete. Caution: the north Perimeter fence presents an Approach Departure Clearance Surface violation to the LZ. Reference LOA 2-2.1 for additional information.

5.6.1.1. The 919 SOSS/OSO is the OPR for the use and scheduling of the LZ. 919 SOW and 492 SOW assigned units will coordinate the use of the LZ through established scheduling procedures IAW 711 SOS OI 90-02. A PPR number from AMOPS is not required. Units not assigned to 919/492 SOW will coordinate their request for use of the LZ through the 919 SOSS/OSO, COMM: (850) 882-6550/DSN: 872-6550 and receive an LZ procedures briefing prior to operations on the LZ.

5.6.2. Landing Helicopter Assault (LHA) Deck. The LHA Deck is a mock-up of a Tarawa class aircraft carrier. It is approximately 800 feet long and 120 feet wide, with 9 parking spots to which aircraft land and depart from. Use of LHA Deck is restricted to rotary wing and tiltrotor aircraft assigned or attached to the 413 FLTS and 1 SOW. 413 FLTS aircraft will retain priority for use, but otherwise operations are first come, first serve. Expect mixed rotary operations.

5.6.2.1. All operators on the LHA Deck must use caution, since vehicles on or near the LHA Deck are uncontrolled. All vehicles operating east of RWY 18/36 must maintain radio communication with Duke Tower at all times. No grounding points are available. LHA Deck lighting is not available. Aircrews may utilize temporary lighting (chem/glow sticks) on the LHA Deck at their own risk. Aircrews are responsible for initial placement and removal of all temporary lighting. All temporary lighting will be removed prior to final departure from the LHA Deck.

5.6.2.2. Spots 1-6 (spots forward/south of the LHA Tower) have restrictions. Due to airfield clearance criteria, aircraft that cannot depart under their own power must shut down and be towed to the main apron or remain at these locations for repairs. The fuel lanes west of the LHA tower are not available to any aircraft and are marked closed. Maintenance repair teams must check in with Airfield Management (Bldg 3052) and must be licensed to drive on Duke's CMA or have an escort to access the LHA Deck by vehicle.

5.6.2.3. Aircraft that experience maintenance issues on spot 7-9 that need to access the main apron may do so via TWY D (east of the apex), and TWY F as required to gain access to the main apron.

5.6.2.4. Taxi operations on TWY D east of the apex are restricted to rotary wing and tiltrotor aircraft assigned or attached to the 413 FLTS and Hurlburt Field.

5.6.2.5. Special use or other operations on the LHA Deck or LHA Deck FOD Cover must be coordinated with the Airfield Manager. Tiltrotor aircraft are prohibited from using the LHA FOD Cover.

### 5.6.3. Vertical Landing Pads (VL Pads).

5.6.3.1. VL North. VL North is located off TWY F east of the LZ near the apex of TWY D and F. It is approximately 225' x 225' with vertical landing markings and edge lighting. Use of VL North is restricted to rotary wing and tiltrotor aircraft assigned or attached to the 413 FLTS and Hurlburt Field. Use caution, vehicles on VL North are uncontrolled. All vehicles operating east of the main RWY must maintain radio communication with Duke Tower at all times. No grounding points are available on VL North. Overlapping safety profiles for hazardous cargo operations on TWY D prohibit use of VL North during these operations (hazardous cargo operations take priority).

5.6.3.2. VL South. VL South is located at the far east end of TWY E. It is approximately 250' x 250' with vertical landing markings and edge lighting. Rotary wing and tiltrotor aircraft assigned or attached to the 413 FLTS and Hurlburt Field are authorized to use VL South. VL South may also be utilized as an alternate hot cargo pad (HCP). A centerline is provided to facilitate taxiing aircraft during hazardous cargo operations. Use of VL South for hazardous cargo operations is restricted to C-130 and smaller aircraft carrying up to hazard division (HD) 1.1 hazardous cargo. Aircrew must use caution, since vehicles on VL South are uncontrolled. Overlapping safety profiles prohibit use of VL South during hazardous cargo operations or Drop Zone (DZ) operations. Hazardous cargo operations take priority.

5.6.3.3. Fighter Short Take-off and Vertical Landing Operations. Fighter short take off and vertical landing operations are prohibited on Duke Field.

#### 5.6.4. Helicopter/Tiltrotor Procedures.

5.6.4.1. Helicopter/Tiltrotor VFR Traffic Patterns. Helicopter/Tiltrotor VFR Pattern altitude is 700 ft MSL with 45-degree entry legs to downwind. Traffic patterns shall be flown at or below 700 ft MSL unless otherwise approved by Duke Tower. Based on wind direction, right or left rectangular patterns may be conducted. See [Attachment 26](#).

5.6.4.2. VFR East Training Area (VETA)/FOD Cover Area. See [Attachment 31](#). Helicopter/Tiltrotor VFR training missions (including external cargo, LHA landings & LHA FOD Cover landings) are authorized on the eastside of Duke Field. The VETA is defined by the western edge of the LHA Deck extending 1 NM east of the LHA Deck, to 1 NM north and south of the LHA Deck, altitude is at or below 700' MSL. The FOD Cover Area is defined as the 1800' X 350' asphalt area north of the LHA deck. Tiltrotor aircraft are prohibited from using the LHA FOD Cover. Tower will clear aircraft into and out of the VETA. Once established in the VETA, pilots are responsible for maintaining their own separation from other helicopter/tiltrotor aircraft operating in the VETA. The LHA FOD Cover is not fully visible from Duke Tower. Clearances from Duke Tower for successive approaches inside the VETA are not required. No more than 6 aircraft are authorized in the VETA at any one time. 413 FLTS aircraft have priority over Hurlburt aircraft. Personnel and vehicle operators requiring access to the VETA shall be briefed by Duke Airfield Management to remain clear of landing areas. Pilots shall monitor Duke Tower Frequency (290.425/133.2) and utilize the Duke VETA frequency 268.075 UHF during all operations.

5.6.4.3. Helicopter/Tiltrotor pilots shall contact Duke Tower for clearance into and out of the VETA. Tiltrotor Airplane Mode (APLN) patterns will be controlled by Duke Tower until clearance to enter the VETA is granted. APLN aircraft will report initial at 1,000 MSL with a 1,000 MSL downwind until all other VETA aircraft are visually acquired. The initial flight path for APLN approach is offset west of the LHA deck and east of TWY D/F apex with an eastbound break. If planned successive APLN approaches are required at 1,200 MSL, pilots will advise Duke Tower on initial contact. Duke Tower will control successive APLN or conventional patterns. Minimum weather for APLN operations is 1,500' ceiling/3 SM visibility.

5.6.4.4. The 413 FLTS helicopter slide on landing area is the eastern 75 feet of the FOD cover, which is 1,200 feet long defined by white painted borders.

5.6.4.5. Autorotation. The primary location for helicopter test and practice autorotation is the LHA Deck FOD cover. Additional locations include the active runway, LZ and VL pads. All areas offered are accessible to CDDAR crews on normal duty or special standby. **NOTE:** Autorotation of skidded helicopters that touch down are not authorized on VL pads nor the LHA deck.

5.6.4.6. Night Vision Device (NVD) flight training inside the VETA may be conducted to unlit surfaces of the LHA Deck and LHA FOD Cover while other aircraft operations are being conducted to all other lit or unlit airfield landing surfaces (runway, taxiways, LZ, VL pads). Aircrews may conduct NVD operations to unlit VL pads while aircraft are operating on the main runway under normal airport lighting. Approaches to unlit VL pads are not authorized when the LZ is lit with AMP 2 (overt) lighting.

5.6.5. Equipment DZ Use on Duke Field. Duke Field shall not be considered a primary DZ training location, but will serve as an alternate location if other range assets are not available. The center of the Duke Field Equipment DZ is located approximately 600 ft northeast of the south VL Pad. The DZ is rectangular with a width of 700 yards and length of 900 yards. The DZ run-in will be north/south in accordance with the DZ survey. Drops will not be conducted if the release point is computed over or west of the LZ. Simultaneous aircraft operation of the DZ and LZ, VL pads, LHA Deck, VETA, nor neither HCP is not permitted. Hazardous cargo operations have priority over DZ operations. Duke DZ will not be used for personnel drops. Personnel/vehicles will remain outside of the established DZ boundaries per [Attachment 30](#). See LOA between the 96 OG, 919 OG, and Air Force Special Operations Air Warfare Center.

5.6.6. Hazardous Cargo Areas/HCPs. Use of the HCPs requires prior coordination and approval from Duke AMOPS.

5.6.6.1. TWY D east of the LZ is authorized for aircraft carrying up to HD 1.1. See EAFBMAN 91-202 for specific classification restrictions. The ASRR Limits TWY D east to C-17s weighing 464,000 lbs or less. Currently, aircraft that use TWY D HCP must transit TWY F east of the LZ. The ASRR limits TWY F east of the LZ to C-17s weighing 327,000 lbs. or less. See ASRR and/or contact the Airfield Manager.

5.6.6.2. VL South is restricted to C-130 and smaller aircraft. VL South is authorized for aircraft carrying up to HD 1.1 hazardous cargo. See EAFBMAN 91-202 for specific classification restrictions. There are no aircraft weight restrictions.

5.6.6.3. Apron Spot 15B is restricted to 1 C-130 or 1 C-17. Apron Spot 15B is authorized for aircraft carrying up to 1.2.2 hazardous cargo. See EAFBMAN 91-202 for specific classification restrictions. There are no aircraft weight restrictions.

5.6.6.4. Apron Spots 6C/7C/8C are restricted to base-assigned aircraft only. Apron Spots 6C/7C/8C are authorized for aircraft carrying 1.4S hazardous cargo. See EAFBMAN 91-202 for specific classification restrictions. There are no aircraft weight restrictions.

5.6.7. Arm/De-arm Areas. There is no arm/de-arm support at Duke Field. Aircraft requiring arm/de-arm services must ensure to pre-coordinate support prior to landing. Supporting organizations will ensure the appropriate arm/de-arm areas are manned for these operations. In the event an aircraft requiring de-arming lands at Duke Field, contact Duke Tower for de-arming locations. Default arm/de-arm areas are as follows: TWY B (west of the runway, hold short of TWY A) and TWY E (west of the runway, hold short of TWY A).

5.6.8. Hot Pit Refueling Areas. No Hot Pit Refueling areas are sited on Duke. Fuel lanes identified as FUEL 1 and FUEL 2 located off TWY D adjacent to the LHA deck are closed and not available for use.

5.6.9. Forward Area Refueling Point (FARP). Duke Field has six FARP areas. These areas require certification and established procedures prior to approval for use. Contact the Airfield Manager for more information.

5.6.10. Taxi Training Areas. Taxi training for base-assigned aircraft must be accomplished on taxiways east of RWY 18/36, on VL North or VL South, or on parking rows 7-8 on the main apron.

**5.7. Airfield Hazards.** See IFR Supplement and current NOTAMs.

**5.8. NAVAIDs and ATCALs.** See [Paragraph 4.9](#) for PMI information.

5.8.1. Civil Use of USAF ATCALs. Civil aircraft may use USAF NAVAID facilities at Duke Field on a noninterference basis. Practice approaches to low approach/go-around are authorized. Touch and go, stop and go, and full stop landings are not authorized without a valid Civil Aircraft Landing Permit. Requests for services will be considered on an individual basis and dependent on controller work load and equipment availability. Approval is at the discretion of the Duke Tower WS or SC; PPR is not required. For further guidance on civil use of USAF ATCALs, see AFI 10-1001, *Civil Aircraft Landing Permits*.

5.8.2. Auxiliary Power for ATCALs Facilities. The following procedures will be adhered to any time Power Production requires auxiliary generator checks or maintenance on any ATCALs/NAVAID or ATC facility generator.

5.8.2.1. Before transferring commercial power to generator power in the Duke Control Tower, CE Power Production must request approval from the Tower WS/CS. Before transferring to generator power at any ATCALs/NAVAID facility, Power Production must request approval from 96 OSS/OSM, which in turn will coordinate with the appropriate ATC facility IAW 96 OSS OI 13-1. There is no auxiliary power generator for the localizer facility. A battery backup system provides short-term power for approximately 30 minutes.

**5.9. Permanently Closed/Unusable Portions of the Airfield.** The portion of TWY F southeast of TWY D is permanently closed.

**5.10. Airfield Lighting.** See DoD FLIP for available instrument approach lighting systems. All airfield lighting except the LHA deck lights will be operated/controlled from Duke Tower. Airfield lighting shall be operated according to JO 7110.65 and AFI 13-204V3. IAW 13-204v3, simultaneous normal airfield light operations and NVD operations will not be mixed. Duke Tower does not have the capability to operate LHA deck lights.



5.10.1. The LZ has a non-standard airfield marking pattern (AMP) light configuration. AMP lighting configurations consist of overt (white lights), covert lights, and no lights. AMP 2, 3, and 4 are available. Flashing Strobe Lights (FSLs) which normally depict the end and center of the landing surface are not provided. End lights (non-flashing) are offset 30 feet to the left on each end. **Do not use end lights as a centerline aiming point.**

5.10.2. Prior to the start of covert NVD flight operations on the LZ, AMOPS must conduct a covert lighting check.

#### **5.11. ATIS, Weather Dissemination and Coordination Procedures.**

5.11.1. Duke Field does not have an ATIS. Current/forecasted weather will be issued by Duke Tower.

5.11.2. Hazardous/Severe Weather Notification Procedures. The 96 WS is responsible for monitoring and evaluating weather information and conditions and, as necessary, issuing hazardous/severe weather statements in the form of weather watches, warnings and advisories IAW EAFB Plan 15-1, *Weather Support Plan*. The 96 WS is also the official source for lightning information for Eglin AFB and its land and water ranges. Duke AMOPS will activate the SCN to relay Duke Field weather warnings.

5.11.3. Personnel on the airfield shall act IAW EAFB Plan 15-1 in response to hazardous/severe weather and lightning notifications.

**5.12. Active Runway Selection and Change Procedures.** The Duke Tower WS/SC shall be responsible for designating the runway in use IAW JO 7110.65 and criteria in this paragraph. Deviations from this instruction will be based on WS/SC judgment.

5.12.1. Designated Primary Runway. RWY 18 is designated the primary instrument/calm wind runway.

5.12.2. Runway Change Procedures. The Duke Tower WS/SC shall direct runway changes based on sound judgment, prevailing winds, and current/forecasted traffic.

5.12.2.1. Duke Tower will notify the following agencies when a runway change is made: ERCF, Eglin Tower, Eglin Crash Station, Duke Command Post, and Duke AMOPS.

5.12.2.2. Eglin Crash Station will notify Duke Crash Station.

5.12.2.3. Duke AMOPS will notify the Duke Weather Forecaster.

**5.13. Runway Surface Condition (RSC) and/or Runway Condition Reading (RCR) Values.** The RSC can be reported as either wet or dry. Duke AMOPS will not report RCR. For more information see AFI 13-204V3, Chapter 18.

**5.14. Aircraft Arresting Systems.** See DoD FLIP, IFR Supplement, [Attachment 20](#), and [Table 5.1](#) for description, type and location of the cables currently available at Duke Field.

**Table 5.1. Duke Field Aircraft Arresting System Locations.**

<b>AIRCRAFT ARRESTING SYSTEM LOCATIONS</b>		
	<b>FEET FROM THRESHOLD</b>	
<b>Runway</b>	<b>Approach</b>	<b>Departure</b>
	<b>BAK-12(H)</b>	<b>BAK-12(H)</b>
RWY 36	1260	1260
RWY 18	1260	1260

#### 5.14.1. Duke Field Arresting System Standard Configuration.

5.14.1.1. During normal operations, the BAK-12/H systems for RWY 18/36 will be in the lowered position.

5.14.1.2. The departure end cable will be in the raised position and available when tailhook- equipped aircraft are on approach or departing. Both cables will be available upon request. Aircrew should expect up to a 30 second delay to raise the cables.

5.14.2. CE will report the status of cables to ATC/AMOPS using the following terminology, “in service” or “out of service” after all inspections and/or maintenance.

5.14.2.1. AMOPS will publish a Safety NOTAM when notified by ATC or CE Power Production that the arresting system is not available.

5.14.3. Aircraft Arresting Systems Maintenance. The Power Production section of CE maintains arresting systems for Duke Field. Arresting systems will be inspected by Power Production personnel daily, normally before 0900. Additional inspections will be conducted throughout the day when deemed necessary by the Tower WS, AMOPS, and/or any SOF. Tower advises AMOPS if arresting system problems are reported or require any action. During duty hours, AMOPS will coordinate with Power Production for action. After duty hours, AMOPS will coordinate with the Fire Department for action.

5.14.3.1. All arresting systems maintenance must be pre-coordinated with and approved by the Airfield Manager or a designated representative and will be conducted at a time which ensures minimum impact to wing flying. Certifications will be scheduled Monday through Friday, commensurate with scheduling availability of Eglin support aircraft. All certifications will take place during daylight hours. Power Production is responsible for ensuring annual barrier certifications are scheduled prior to the barrier expiring from service. AMOPS will notify all affected agencies and assist Power Production in coordinating and scheduling the engagement.

**5.15. NOTAM Procedures.** The NOTAM monitoring facility/dispatching facility for Duke Field is Duke Field Tower/AMOPS respectively. AMOPS will receive, transmit, post and document required NOTAM action IAW AFI 11-208\_IP, *Department of Defense Notice to Airmen (NOTAM) System*.

5.15.1. All flying squadrons will obtain their required NOTAMs through the FAA NOTAM manager site (<https://www.notams.aim.faa.gov>). In the event the NOTAM web sites are not operational, contact the destination airport via telephone to obtain the most current NOTAMs. Contact Duke Field AMOPS at COMM: (850) 883-6516 or 6093/DSN: 875-6516 or via direct line to obtain local NOTAMs. Hurlburt Field AMOPS will disseminate or dispatch NOTAMs as required for Duke Field if the communication link to the Air Force Central NOTAM facility is locally inoperative.

**5.16. Airfield Maintenance.** All airfield maintenance (e.g., all sweeper operations, grass mowing, and general maintenance operations in the airfield environment) will be coordinated and directed through the Airfield Manager.

**5.17. Airfield Tobacco Use Policy.** There is no smoking on the airfield outside designated tobacco use areas. For further guidance see AFI 40-102.

**5.18. Wear of Hats.** The Duke Field Airfield is designated as a no-hat area IAW the 96 TW supplement to AFI 21-101, *Aircraft and Equipment Maintenance Management*.

**5.19. Airfield Photography.** Refer to **Paragraph 4.19** for photography restrictions.

**5.20. Scheduling and Flight Plan Procedures.** IAW AFI 13-204V3, all aircraft departing Air Force installations must have a flight plan on file (Stereo, VFR local, DD Form 175 or DD Form 1801) with AMOPS prior to departure. Flight plans must be filed in person unless there is an approved LOA on file between Airfield Management and the user(s). All flight plans will be maintained on file in accordance with Air Force RDS, Table 13-07, Rule 3.00.5.20.1. Aircrews should refer to the latest approved LOA between the 96 OSS and their squadron.

**5.21. Controlled Movement Area (CMA).** Duke Tower is the controlling agency for all ground traffic in the controlled movement areas. Duke Field's CMA consists of RWY 18/36, the LZ, overruns, portions of all taxiways inside the VFR hold lines for both landing surfaces to the edge of the pavement, all grassy areas between the distance remaining markers and the runway edge, and grassy areas approximately 225' out from the edge of the LZ in line with the VFR hold lines.

5.21.1. Duke Field Tower FM Nets (Ramp to Tower and Crash to Tower) are used solely for communications in the CMA. Tower shall continuously monitor these nets during vehicle/personnel operations in the CMA. Vehicles/personnel operating in the CMA shall continuously monitor these Nets and may transmit as necessary to ensure the safety/care of personnel and/or equipment within the CMA. Tower may terminate unnecessary radio transmissions from vehicles/personnel that are no longer operating in the CMA to reduce frequency congestion, IAW AFI 13-204V3.

5.21.2. No vehicle is authorized in, nor shall be approved to enter a CMA unless the vehicle is radio-equipped (or escorted by a radio-equipped vehicle) and in direct two-way radio contact with Duke Tower. All vehicles operating east of the main RWY will maintain radio communication with Duke Tower at all times.

5.21.3. Vehicle Recall Procedures when Radio Communications Fail. In the event radio contact is lost, vehicles/personnel will exit the runway and CMA immediately. Duke Tower will use light gun signals to attempt vehicle contact in the event of radio failure. Duke Tower may also attempt to indicate that radio contact has been lost by raising and lowering the intensity level of the runway lights.

5.21.4. CMA Vehicle/Pedestrian Operations. All personnel are required to abide by the responsibilities and procedures for operating on or near Duke Field airfield outlined in EAFBI 13-213V2, *Duke Field Airfield Driving Instruction*.

**5.22. Precision Approach Critical Area.** When the ceiling is reported less than 800 ft or visibility less than 2 SM, aircraft and vehicles shall not be allowed to operate within the ILS critical area depicted in [Attachment 20](#) unless approved and in radio contact with Duke Tower. Aircraft and vehicles shall not transit the precision approach critical areas or proceed beyond the INST hold lines when an aircraft executing an ILS approach is inside the final approach fix. All vehicles will request permission from Duke Tower by radio to cross both the north and south areas of perimeter road that intersect precision approach critical areas regardless of weather conditions.

**5.23. Engine Test/Run-Up Areas and Procedures.** IAW AFI 11-218, *Aircraft Operations and Movement on the Ground*, aircraft are required to contact Duke Tower prior to engine start. The MOC will advise AMOPS of all engine runs with tail number and location. AMOPS will in-turn notify Tower of the engine run with tail number and location. Engine runs outside airfield hours will be conducted by LOA between the 96 OG and applicable user.

**5.24. Procedures for Suspending, Opening and/or Closing the Runway.** Duke Tower and AMOPS have authority to suspend runway operations anytime there is an observed or reported hazardous condition or situation. Only AMOPS has the authority to close or open the runway. Appropriate NOTAMs will be sent for suspensions/closures of the runway that exceed 30 minutes.

**5.25. Airfield Inspections/Checks.** Airfield inspections and checks will be completed IAW requirements and procedures outlined in AFI 13-204V3. AMOPS shall accomplish an airfield check after the arrival or departure of any wide-body aircraft to mitigate FOD risk due to the narrow width of RWY 18/36 and lack of shoulders on several taxiways. AMOPS conducting night time lighting checks have priority over NVD operations.

**5.26. Aircraft Towing Procedures.** All aircraft tows will be coordinated through 919 MOC. The 919 MOC will notify AMOPS of aircraft tows (from where/to where). AMOPS will in-turn notify the Tower of aircraft tows (from where/to where). Tows outside airfield hours will be conducted by Letter of Agreement between the 96 OG and applicable user.

**5.27. Aeromedical Aircraft Arrival Procedures.** Duke Tower shall notify AMOPS when arriving aeromedical airlift aircraft reach 15 NM from the airport and relay any information requested by the pilot.

**5.28. Local Control Points.** See EAFB procedures, [Paragraph 4.30](#)

**5.29. Tower Visual Blind Spots.** Duke Tower is not responsible for ground traffic operating in those areas not visible from the tower.

5.29.1. Visual blind spots for Duke Tower include the westernmost portion of TWY B, intersection of TWY A/TWY B and the northern end of the FOD cover of the LHA Deck.

**5.30. Reduced Same Runway Separation (RSRS).** See EAFB procedures, [Paragraph 4.32](#)

**5.31. General Departure Procedures.**

5.31.1. Duke Field Standard Departure. IFR aircraft initially departing Duke Field shall maintain 2,000 ft MSL and be issued a departure heading by Duke Tower except as specified in 5.32.2.

5.31.2. VFR Overhead Pattern Protection. When the overhead pattern is active, all departures from Duke Field shall maintain at or below 1,200 ft MSL until the departure end of the runway to protect the VFR overhead pattern, unless otherwise directed.

5.31.3. Intersection Departures (VFR and IFR). Intersection departures are authorized from all RWY 18/36 taxiway intersections. No intersection departures are authorized for the LZ. Duke Tower is not required to issue runway distance remaining to locally assigned aircraft making an intersection departure. The runway distances remaining from each of the taxiways at Duke Field are as depicted in [Table 5.2](#)

**Table 5.2. Duke Field Intersection Departure Distance Remaining.**

<b>INTERSECTION DEPARTURE FEET AVAILABLE</b>		
<b>RWY 36</b>	<b>TWY</b>	<b>RWY 18</b>
3200	C	4800
6400	D	1600
3200	F	4800
LZ: No intersection departures available		

5.31.4. Immediate Takeoff Clearance. When issued an immediate takeoff clearance, pilots are expected to begin takeoff roll within 20 seconds of clearance receipt. Tower shall advise the pilot in advance to "EXPECT IMMEDIATE DEPARTURE."

5.31.5. Abbreviated Departure Clearance. Duke Tower shall issue an abbreviated IFR clearance to all locally assigned aircraft with Duke stereo route flight plans. Example: "GOOSE71, DUKE GROUND, CLEARED TO DUKE FIELD AS FILED, <departure procedure>, <altitude data in order flown>, <frequency and beacon code information>."

**5.32. General Recovery Procedures.**

5.32.1. Duke Field Local Climbout.

5.32.1.1. RWY 18: "AFTER COMPLETING (type approach), CROSS DEPARTURE END OF THE RUNWAY AT OR BELOW ONE THOUSAND TWO HUNDRED, TURN RIGHT HEADING THREE THREE ZERO, CLIMB AND MAINTAIN TWO THOUSAND, CONTACT DEPARTURE (frequency assigned by ATC)."

5.32.1.2. RWY 36: “AFTER COMPLETING (type approach), CROSS DEPARTURE END OF THE RUNWAY AT OR BELOW ONE THOUSAND TWO HUNDRED, TURN LEFT HEADING THREE THREE ZERO, CLIMB AND MAINTAIN TWO THOUSAND, CONTACT DEPARTURE (frequency assigned by ATC).”

5.32.2. Light Aircraft Rectangular Pattern. Light aircraft pattern is 700 ft MSL with a 45-degree entry to downwind. See [Attachment 26](#).

5.32.2.1. RWY 18 will use right/left traffic.

5.32.2.2. RWY 36 will use right/left traffic.

5.32.3. Overhead Pattern. The overhead pattern altitude is 1,700 ft MSL. See [Attachment 27](#).

5.32.3.1. RWY 18. Left or right entry; right turns.

5.32.3.2. RWY 36. Left or right entry; left turns.

5.32.4. Tactical Initial/Chase Aircraft. Tactical initial request shall be made on initial contact with Duke Tower. Duke Tower has the authority to approve or deny this request. If denied, aircraft must be no further than 500 ft separation prior to reaching the 3 NM initial point. If tactical initial is approved, aircraft will remain no further than 4,000 ft line abreast with the flight lead lined up on runway in use with the wingman lined up on the east side or west side based on LZ traffic. When approved, Duke Tower will deconflict tactical initials with LZ operations. When required due to traffic, flights with a chase aircraft may be requested by Duke Tower to position chase aircraft offset to the west of the runway in use to deconflict with LZ traffic.

5.32.5. VFR Straight-in. Duke Tower will approve VFR Straight-in approaches based on traffic. Duke Tower will direct entry to final. **A request by an IFR aircraft to land on the LZ 18/36 is considered a request to automatically cancel IFR and conduct a VFR LZ 18/36 approach.** Duke Tower will notify ERCF of aircraft's IFR cancellation. Aircraft established in Duke Tower's VFR patterns requesting VFR straight-in approaches to RWY 18 will not extend beyond 3.5 NM north of RWY 18 to remain south Interstate 10 (I-10). If aircraft requires to extend north of I-10, aircraft will transfer to ERCF for VFR flight following. Aircraft requesting VFR straight-in approach to RWY 36 will not extend beyond 3.5 NM south of RWY 36. If aircraft requires to extend south of 3.5 NM, Duke Tower will request and receive approval from ERCF and/or Eglin Tower based on pattern (east side/west side) flown. VFR straight-ins beyond 3.5 NM may be disapproved based on ERCF and/or Eglin Tower traffic.

5.32.6. Reentries. Reentry is used for re-sequencing and spacing requirements. The radio call for reentries is “(Call sign), REENTER”.

5.32.6.1. The standard reentry point for RWY 18 is SHOAL (DWG 350/13.4). Reentry pattern altitude is 2,200 ft MSL. Aircraft will maintain 2,200 ft MSL until established at 3 NM initial, unless otherwise directed by Duke Tower. Aircraft performing straight-in approaches can expect descent to 1,200 ft MSL once established at SHOAL. Straight-in approaches may be disapproved based on existing traffic.

5.32.6.2. The standard reentry point for RWY 36 is BIG T (DWG 340/8.6). Reentry pattern altitude is 2,200 ft MSL. Aircraft will maintain 2,200 ft MSL until established at 3 NM initial, unless otherwise directed by Duke Tower. Aircraft performing straight-in approaches can expect descent to 1,200 ft MSL once established at BIG T. Straight-in approaches may be disapproved based on existing traffic.

#### 5.32.7. Breakouts/Go Around Procedures.

5.32.7.1. VFR Procedures. VFR aircraft instructed by Duke Tower to breakout will be given specific instructions [e.g., “(Call sign), BREAKOUT TO THE WEST, MAINTAIN ONE THOUSAND SEVEN HUNDRED, REENTER INITIAL RUNWAY ONE EIGHT”].

5.32.7.2. IFR Procedures. Aircraft at Duke shall use the following go-around procedures unless otherwise directed by ATC:

5.32.7.3. Duke Go-Around Procedures inside 3 NM. ATC phraseology shall be as follows: “Tower clearance canceled/not received, fly runway heading, CROSS DEPARTURE END OF THE RUNWAY AT OR BELOW ONE THOUSAND TWO HUNDRED, TURN (left/right) HEADING THREE THREE ZERO, CLIMB AND MAINTAIN TWO THOUSAND.”

5.32.7.3.1. RWY 18: TURN RIGHT.

5.32.7.3.2. RWY 36: TURN LEFT.

5.32.7.4. Duke Go-Around Procedures outside 3 NM. ATC phraseology shall be as follows: “(Call sign), BREAKOUT, TURN (left/right) HEADING THREE THREE ZERO, CLIMB AND MAINTAIN TWO THOUSAND.”

5.32.8. VFR Fixed-Wing Tower to Tower Transitions between Eglin and Duke Towers. Duke Tower Runway in Use will direct the inbound and outbound VFR transition routes. Reference [Attachments 12, 13, 14, and 15](#).

5.32.8.1. South Flow Operations (EGI RWY 18 and VPS RWY 12/19). See [Attachment 12](#).

5.32.8.1.1. VPS RWY 12/19 VFR departures tower to tower to EGI proceed northbound to JAIL at 2,200 ft MSL then proceed to SHOAL at 2,200 ft MSL. Eglin Tower will specify a left or right turn northbound. Once established at SHOAL, turn 90 eastward to initial and expect overhead pattern altitude of 1,700 ft MSL at 3 NM initial or descent for VFR straight-in with Duke Tower approval.

5.32.8.1.2. EGI RWY 18 VFR departures tower to tower to VPS proceed southbound to JAIL at 1,600 ft MSL for Eglin Tower pattern entry.

5.32.8.2. North Flow Operations (EGI RWY 36 and VPS RWY 1/30). See [Attachment 13](#).

5.32.8.2.1. VPS RWY 1/30 VFR departures tower to tower to EGI proceed northbound to GATE at 1,700 ft MSL then direct to initial or straight-in RWY 36. Expect overhead pattern altitude of 1,700 MSL at 3 NM initial or descent for VFR straight-in with Duke Tower approval.

5.32.8.2.2. EGI RWY 36 VFR departures tower to tower to VPS proceed southwest-bound to JAIL at 2,200 ft MSL for Eglin Tower pattern entry. Expect to cross the field at 2,100 ft MSL for a left turn to initial.

5.32.8.3. Mixed Flow Operations (EGI RWY 18 and VPS RWY 1/30). See [Attachment 14](#).

5.32.8.3.1. VPS RWY 1/30 VFR departures tower to tower to EGI proceed northbound to JAIL at 2,200 ft MSL then proceed to SHOAL at 2,200 ft MSL. Once established at SHOAL, turn 90 eastward to initial and expect overhead pattern altitude of 1,700 ft MSL at 3 NM initial or descent for VFR straight-in with Duke Tower approval.

5.32.8.3.2. EGI RWY 18 VFR departures tower to tower to VPS proceed southwest-bound to JAIL at 1,600 ft MSL for Eglin Tower pattern entry.

5.32.8.4. Mixed Flow Operations (EGI RWY 36 and VPS RWY 12/19). See [Attachment 15](#).

5.32.8.4.1. VPS RWY 12/19 VFR departures tower to tower to EGI proceed northbound to GATE at 1,700 ft MSL then proceed to EGI RWY 36. Eglin Tower will specify a left or right turn northbound.

5.32.8.4.2. EGI RWY 36 VFR departures tower to tower to VPS will proceed southwest-bound to JAIL at 2,200 ft MSL for Eglin Tower pattern entry.

5.32.9. Aircraft Taxi Procedures. Aircraft will change to Duke Ground Control frequency after exiting the runway or landing zone surface. All aircraft shall:

5.32.9.1. Monitor Duke Ground Control frequency and give way to aircraft taxiing on Taxiway alpha and emergency response vehicles, and taxi toward their parking locations.

5.32.9.2. Notify Ground Control before changing to another radio frequency while taxiing unless switching to Duke Tower frequency for departure.

**5.33. SFO and PFO Approaches.** The terms PFO and SFO are synonymous and will utilize the same approach patterns. SFO approaches will be conducted between the hours of sunrise to sunset. To the maximum extent possible, SFOs shall be requested prior to RTB due to the increased coordination required. In addition, Duke Tower may disapprove or cancel the procedure whenever they deem it necessary for safety of flight. Approval of an SFO by Duke Tower does not absolve the pilot from the responsibility to comply with VFR see and avoid requirements. Participating aircraft are considered to have canceled IFR upon communications transfer to Duke Tower. SFO airspace is defined as a 4 NM radius from center of the airport from surface up to and including 10,000 ft MSL unless otherwise coordinated.

5.33.1. Weather and Runway Requirements. Official reported weather at the airport to which the approach is conducted will be ceiling at least 1,000 ft above the requested high or low key altitude and visibility of at least 5 SM.

5.33.2. Duke Field is the primary choice for SFO training based on traffic pattern congestion at Eglin. Every attempt should be made to conduct SFO practice approaches to Duke Field.

5.33.3. SI SFO primary location is Duke Field RWY 18.



5.33.4. OH SFO Pattern Procedures. See [Attachment 10](#).

5.33.4.1. RWY 18/36 OH SFO Procedures: From low approach or initial straight through an aircraft will make a climbing turnout to the west or as directed by Duke Tower and report high key when over the desired touchdown point in order to execute a 360-degree turning SFO to the west. If required to orbit at high key, Duke Tower will state, “(callsign) ORBIT HIGH KEY”; the aircraft will maintain a western orbit at high key altitude and report high key when over the desired touchdown point.

5.33.4.1.1. Additional information:

5.33.4.1.2. High Key will normally be flown at 7,000-10,000 ft MSL; other altitudes may be coordinated.

5.33.4.1.3. Low Key will normally be flown at 3,000-6,000 ft MSL.

5.33.4.1.4. Airspeed will normally be 200 to 250 KIAS, but may vary due to weight and aircraft configuration. Pilots requiring a speed in excess of 250 KIAS will notify ATC prior to commencing the approach.

5.33.4.1.5. Mandatory reporting points: High Key and Low Key (with gear and intentions).

5.33.4.1.6. The OH SFO pattern will be flown in the same direction as the normal overhead pattern unless specified by tower.

5.33.4.1.7. OH SFO breakout procedures. Prior to base key, tower shall state “(Call sign), REENTER, (Reason, time permitting, and follow-on instructions).” Aircraft shall climb to or maintain 500 ft above the overhead pattern altitude and comply with tower instructions. If none are received, transmit intentions to Duke Tower.

5.33.4.1.8. OH SFO Go-Around procedures. Tower shall state “(Call sign), GO AROUND, (Reason, time permitting, and follow-on instructions).” If at or above 2,200 ft MSL, maintain 2,200 ft MSL (500 ft above overhead pattern). If below 2,200 ft MSL the aircraft will continue to descend to maintain at or below 1,200 ft MSL until departure end, and comply with tower instructions. If none are received, transmit intentions and requests to tower.

5.33.4.1.9. For a pilot-initiated go-around or when a landing clearance is not received, the pilot shall report “(Call sign), BASE KEY, ON THE GO.” Execute the go-around procedure described above and follow tower instructions. If no instructions are received, the pilot shall transmit intentions to Duke Tower in the blind.

5.33.4.1.10. If weather does not allow the execution of an SFO initiated from High Key, Tower can authorize SFOs initiated from Low Key based on current weather conditions and aircraft workload within the traffic pattern. The same ground track will be flown as described above, while remaining clear of clouds.

5.33.5. SI SFO Pattern Descriptions and Procedures. See [Attachment 10](#).

5.33.5.1. An SI SFO approach begins 8 NM from the runway and ends at the landing threshold.

5.33.5.2. The 8 NM SI SFO point is straight out from the runway extended centerline at 8,000 ft MSL.

5.33.5.3. The 5 NM SI SFO point is straight out from the runway extended centerline at 4,000 to 6,000 ft MSL.

5.33.5.4. SI SFO airspeed will normally be 200 to 250 KIAS, but may vary due to weight and aircraft configuration. Pilots requiring a speed in excess of 250 KIAS will notify ATC prior to commencing the approach.

5.33.5.5. If ERCF traffic permits, SI SFOs can expect descent to 8,000 ft MSL and vectors to the 8 NM reporting point. ERCF will coordinate with tower for SI SFO approval. Tower will deny the approach if more than three aircraft are projected to be in the VFR pattern when the SI SFO will arrive, or if a safety issue is involved.

5.33.5.6. If tower approval is not received by 20 NM from the runway, expect descent to pattern altitude and sequencing with normal arriving traffic. If tower approval is received by the 20 NM point, expect a vector to a point 12-14 NM on final/dogleg, instructions to proceed visually, and to contact Duke Tower. At this point, IFR flight plan cancellation is deemed to have occurred. Communications transfer to Duke Tower must occur prior to commencing the SI SFO maneuver. After contact with tower, and prior to 8 NM on final, expect verbal approval for the SI SFO from tower. If conditions develop which preclude the approach, expect to be sequenced by Duke Tower into the overhead pattern. If unable to communicate with Duke Tower, maintain 8,000 ft MSL and VFR, fly toward the runway and contact ERCF on last assigned ERCF frequency.

5.33.5.7. Mandatory reporting points: Report: “(Call sign), 8-MILE SFO FINAL” and “(Call sign), 5-MILE SFO FINAL, GEAR, and intentions (e.g., touch and go, low approach)” to tower. Expect low approach clearance at 5 NM. If clearance is not received by 3 NM on final, proceed straight ahead, maintain 2,200 ft MSL (500 ft above the overhead pattern), and expect an overhead approach.

5.33.5.8. If tower does not have a visual or radar-indicated position of the aircraft by 5 NM final, tower will discontinue the SI SFO approach and give directions to sequence the aircraft into the overhead pattern.

5.33.5.9. Once the SI SFO aircraft is 8 NM final or closer, no arrival or departure aircraft will be permitted in front of the SI SFO aircraft.

5.33.5.10. SI SFO Breakout/Go-Around Procedures.

5.33.5.10.1. Prior to 5 NM final the tower shall state “(Call sign), TERMINATE THE SI-SFO, (Reason, time permitting, and follow-on instructions).” If no instructions are received, climb to or maintain 2,200 ft MSL (500 ft above the overhead pattern), and expect an overhead approach.

5.33.5.10.2. Pilot initiated/tower directed go-around at or after 5 NM final. If at or above 2,200 ft MSL, maintain 2,200 ft MSL (500 ft above overhead pattern). If below 2,200 ft MSL the aircraft will continue to descend to maintain at or below 1,200 ft MSL until departure end, and comply with tower instructions. If none are received, transmit intentions to Duke Tower.

5.33.6. F-35 aircraft may perform PFOs using the SFO patterns at Eglin and Duke Field. For the purposes of this instruction, PFO and SFO are synonymous. However, expect slightly higher altitudes and airspeeds at high key and low key, and a slightly extended pattern at low key. Controllers and pilots will use the term PFO when referring to an F-35 in the SFO pattern (e.g., "LIGHTNING-01, 8-MILE PFO FINAL").

**5.34. Duke Field Random Steep Approach.** The Random Steep Approach is a VFR maneuver that consists of a steep spiral descent, similar to an overhead approach, from higher than normal traffic pattern altitudes directly over the airport. Aircraft will remain within a 4 NM radius of Duke Field during descent. Approval for Random Steep Approach is at the discretion of the Duke Tower WS after coordination with ERCF. Random Steep Approaches may be disapproved or canceled because of traffic or for other reasons, either before or after the start of the maneuver. Approval of a Random Steep Approach does not relieve the pilot from the responsibility to comply with VFR see and avoid requirements. Participating aircraft are considered to have canceled IFR upon communications transfer to Duke Tower.

5.34.1. Weather and Landing Surface Requirements. Random Steep Approaches may be conducted to RWY 18/36 or LZ 18/36. Official reported weather at Duke Field to conduct a Random Steep Approach will be:

5.34.1.1. Ceiling: At least 500 ft above the requested inbound altitude.

5.34.1.2. Visibility: At least 3 SM visibility. Aircraft must maintain VFR cloud clearance throughout the maneuver.

5.34.2. Random Steep Approach Pattern Descriptions and Procedures. See [Attachment 29](#).

5.34.2.1. ERCF will coordinate with Duke Tower for Random Steep Approach approval prior to the aircraft reaching 10 NM. Coordination will include callsign, type aircraft, aircraft location, requested altitude and inbound heading (180, 360, 270, or 090). ERCF will release Duke Field Random Steep Approach maneuvering airspace to Duke Tower. Communications transfer to Duke Tower must occur prior to 5 NM from the descent point. Inbound altitude will vary based on pilot's request (normally 4,500-10,000 ft MSL). Aircraft airspeed is normally 120-150 KIAS. Inbound heading is normally in line with runway in use. Other inbound headings may be requested. Approval will be based on traffic. Descent point is normally at the midfield point. At descent point, aircraft will report landing gear down and request landing clearance from Duke Tower. Based on aircraft altitude, aircraft may spiral in descent east and west of runway to land on runway in use. If conditions develop which preclude the completion of the approach, aircraft can expect to be sequenced by tower into either the overhead pattern or rectangular traffic pattern. Aircraft requesting Random Steep Approaches from the Duke rectangular VFR pattern or initial departure will normally be transferred to ERCF for climb to Random Steep Approach altitude unless ERCF releases Random Steep Approach maneuvering airspace to Duke Tower. Once Random Steep Approach maneuvering airspace is released to Duke Tower, ERCF will not allow other aircraft to transit the maneuvering airspace.

**5.35. Duke Field Random Shallow Approach.** Random Shallow Approach is a VFR maneuver that consists of low-altitude/high-speed entry towards the runway from various inbound headings.

5.35.1. The Random Shallow Approach will be approved at the discretion of the Duke Tower WS. Random Shallow Approaches may be disapproved or canceled because of traffic or for other reasons, either before or after the start of the maneuver. Approval of a Random Shallow Approach does not relieve the pilot from the responsibility to comply with VFR see and avoid requirements and AFI 11-202V3, *General Flight Rules*, avoidance criteria. Participating aircraft are considered to have canceled IFR upon communications transfer to Duke Tower.

5.35.2. The three types of Random Shallow Approaches are as follows:

5.35.2.1. 90-degree to the runway abeam. The aircraft flies to the runway's midfield point, then performs a 90-degree turn for a downwind entry to the runway in use.

5.35.2.2. Straight-in to the active runway with a teardrop maneuver to land the opposite runway. Similar to a circling approach.

5.35.2.3. Straight-in to the active runway. Aircraft performs a straight-in approach to the runway in use.

5.35.3. Weather and Landing Surface Requirements. Random Shallow Approaches may be conducted to RWY 18/36 or LZ 18/36. Official reported weather at Duke Field to conduct a Random Shallow Approach will be:

5.35.3.1. Ceiling: At least 500 ft above the rectangular pattern altitude.

5.35.3.2. Visibility: At least 3 SM visibility. Aircraft must maintain VFR cloud clearance throughout the maneuver.

5.35.4. Random Shallow Approach Pattern Descriptions and Procedures. See [Attachment 29](#).

5.35.4.1. ERCF will coordinate with Duke Tower for aircraft RTB to Duke Field for Random Shallow Approach prior to 10 NM. Coordination will include callsign, type aircraft, aircraft location, and type of Random Shallow Pattern requested (abeam, teardrop, or straight-in). All approaches will be made to the runway in use unless previously coordinated. Aircraft in the Duke VFR pattern who request Random Shallow Approach from Duke Tower will remain within a 4 NM radius of Duke Field and in radio contact with Duke Tower at all times. East entries will be approved by ERCF on a case-by-case basis due to the proximity of Eglin's RWY 19 final approach course. Communications transfer to Duke Tower must occur prior to entering Duke Field's Class D airspace (5.2 NM radius of the geographical center of Duke Field). Inbound altitude will be 1,200 ft MSL or higher. Once inside Duke Tower's Class D airspace, aircraft may descend to 500 ft AGL (IAW AFI 11-202V3) to perform the maneuver. Aircraft will avoid over flying populated areas. Aircraft initial airspeed is normally 250 KIAS. If conditions develop which preclude the completion of the approach, aircraft can expect to climb to 1,200 ft MSL and be sequenced by Duke Tower into the rectangular traffic pattern.

**5.36. VFR NVD Operations:** Duke Field VFR NVD operations apply only to 919/492 SOW, 96 TW, and 1 SOW, and any units temporarily assigned under OPCON to these units. The following procedures are IAW AFI 13-204V3. No IFR approach NVD procedures exist for Duke Field. Base assigned NVD qualified aircrews may depart/arrive VFR under NVDs if the airfield runway lights/taxiway lights are out of service. Note; a NOTAM will be published for the affected lighting system out of service.

5.36.1. NVD Taxi Routes. All taxiways, aprons, both VL Pads, the LHA Deck, and LHA FOD cover are approved NVD routes for qualified aircrews attached to the units listed above. NVD taxi routes are standard for the runway in use.

5.36.2. NVD Vehicle Operations. Duke Airfield Management is authorized to drive within the Duke Airfield CMA wearing NVDs. Airfield Management may only use NVDs while conducting a lighting check of the IR lights on the LZ. All units that have the operational requirement to drive on the airfield while using NVDs are required to establish a training plan outlined in AFMAN 24-306 Chapter 18 and AFI 13-213 [Paragraph 3.2.7.22](#) Units will coordinate with the Duke Airfield Wing Airfield Driving Program manager to establish a LOA that outlines all the procedures.

5.36.3. NVD VFR Traffic Patterns. NVD traffic patterns are coincidental with the standard VFR traffic patterns for the runway in use and standard VFR pattern position reports are required. Request for NVD airfield light settings (AMP 3 or AMP 4) and appropriate step settings will be made on initial contact with Duke Tower and prior to turning base. **A request by an IFR aircraft to conduct NVG operations is considered a request to automatically cancel IFR.** Duke Tower will notify ERCF of aircraft's IFR cancellation. The maximum number of aircraft simultaneously performing NVD operations is five, not to include aircraft operating in the VETA (See [Paragraph 5.6.4.6](#)). Duke Tower may reduce this number based on safety of flight. VFR straight-in approaches to RWY 36 will be approved based on traffic. Aircraft requesting 10 NM straight-in VFR finals for RWY 18 will ensure the final approach course is at least 2 NM east of CEW airport to avoid CEW RWY 17/35 departures/arrivals. Altitude for VFR straight-in approaches is at or above 1,000 ft AGL. Aircraft will be switched to ERCF for flight following based on CEW traffic. Aircraft will monitor CEW CTAF on 122.95 when in the vicinity of CEW airport and maintain maximum vigilance for CEW traffic. All aircraft require Duke Tower approval to cross RWY 18/36 final approach course.

5.36.4. Transition to Normal Lighting Configuration for Nonparticipating Aircraft. Nonparticipating aircraft will not mix with participating NVD aircraft in any traffic pattern, on any controlled movement area, or when taxiing. When transitioning to normal airfield lighting configuration for non-participating arriving aircraft, the airfield lights will be configured prior to the nonparticipating aircraft entering the Class D airspace. For nonparticipating departures, normal airfield lighting will be utilized prior to the nonparticipating aircraft taxi.

5.36.5. Emergency Termination/Knock it Off Procedures. Duke Tower or aircrew may terminate NVD operations whenever safety of flight becomes an issue.

## Chapter 6

### EMERGENCY PROCEDURES

**6.1. Daily Primary Crash Alarm System (PCAS) Phone Check.** A quality assurance check of the Eglin crash phone shall be performed daily, normally between 0700L and 0730L. The quality assurance check of the Duke Field crash phone shall be performed daily prior to opening Duke Tower.

**6.2. Emergency Notification.** In order to expedite the activation and movement of emergency response agencies/vehicles, pilots shall declare an emergency with ATC as soon as possible when a situation in the aircraft commander's judgment warrants response from emergency response agencies or when the aircraft has hung Category I (Cat I) or hung developmental ordnance.

**6.3. Arrival/Departures.** No aircraft should be allowed to land on or takeoff from the same runway after an inbound emergency aircraft is within 10 NM (fighter aircraft) or within 5 NM (all other aircraft).

**6.4. Eglin/Duke Field Discrete Emergency Frequency.** The Eglin/Duke Field discrete emergency frequency is local channel 9/269.15. The purpose of this discrete frequency is to provide ATC, Eglin SOF, and Eglin/Duke Field Fire Department Crash or on-scene commander with a single frequency to handle aircraft emergencies. Eglin/Duke Field Towers shall announce over the PCAS if the emergency aircraft is on a frequency other than local channel 9/269.15. Simulcasting on local channel 9/269.15 or any discrete frequency assigned to an emergency aircraft is prohibited. All transmissions to the emergency aircraft shall be pertinent to the emergency.

**6.5. In-Flight/Ground Emergency Responsibilities/Procedures.**

6.5.1. Eglin and Duke Field Towers shall:

6.5.1.1. Activate the PCAS when any of the following occur:

6.5.1.1.1. Any known or suspected crash involving an aircraft operating within ERCF, Eglin Tower, or Duke Tower assigned airspace.

6.5.1.1.2. All emergency landings.

6.5.1.1.3. All unescorted lost communications aircraft.

6.5.1.1.4. All observed or reported ground emergencies.

6.5.1.1.5. Aircraft reporting hot brakes.

6.5.1.1.6. Aircraft landing with hung Cat I or hung developmental ordnance.

6.5.1.1.7. Pilot request.

6.5.1.1.8. When deemed necessary by the WS/SC or Eglin SOF. **NOTE:** The PCAS should be reactivated any time there are significant changes to an existing situation that may warrant it.

6.5.1.2. Advise AMOPS at least 15 minutes prior, or as soon as possible, any time the pilot of an emergency aircraft requests Eglin Boulevard and Memorial Trail traffic be stopped for an emergency landing. See **Chapter 7** of this instruction for Hung Ordnance procedures.

6.5.1.3. Broadcast the following on ground control frequencies, Ramp Net, and Crash Net: “THIS IS EGLIN/DUKE GROUND WITH AN EMERGENCY RECOVERY IN PROGRESS, GIVE WAY TO ALL RESPONDING EMERGENCY VEHICLES AND EVACUATE ALL ATCALS FACILITIES.”

6.5.1.4. Advise responding emergency teams of the appropriate frequency during a ground emergency or when multiple emergencies occur.

6.5.1.5. Instruct the pilot to contact Chief-2 or the Incident Commander after the emergency aircraft has landed and no further ATC communications are necessary. Example: “(Call sign), WHEN ABLE, CONTACT CHIEF TWO/INCIDENT COMMANDER THIS FREQUENCY.”

6.5.1.6. Monitor communications through termination of the emergency.

#### 6.5.2. AMOPS Responsibilities:

6.5.2.1. Activate the Secondary Crash Net (SCN) in response to information received via the primary crash net.

6.5.2.2. When required, Eglin AMOPS shall advise the 96th Security Forces Squadron (96 SFS) to stop traffic on Eglin Boulevard and Memorial Trail for an emergency landing. The 96 SFS shall then take action as necessary. At Duke Field, Duke AMOPS will request Security Forces close SR213 between the east and west security fences when aircraft with hung ordnance are heading south.

#### 6.5.3. Designation and responsibilities of the Incident Commander (On/Off Base).

6.5.3.1. EAFB will respond to disaster situations occurring on base or on AF-owned property and assist the local civilian community in coping with disaster situations off base, when requested.

6.5.3.2. The Incident Commander is designated IAW EAFB Plan 10-2, *Installation Emergency Management Plan*, and EAFB Plan 91-204, *Mishap Response Plan (FOUO)*. The Incident Commander will designate the Entry Control Point (ECP) and serve until the emergency/mishap site is declared safe.

6.5.3.3. The Incident Commander shall not initiate transmissions on local emergency frequencies until contacted by ATC.

6.5.3.4. The Incident Commander shall notify the tower via the crash net when the emergency is terminated. Any assigned discrete emergency frequency shall be returned to ATC immediately after termination of the emergency.

### 6.6. Emergency Information.

6.6.1. Aircraft shall provide ATC with the following initial information when an emergency is declared (time permitting):

6.6.1.1. Call sign (identification).

6.6.1.2. Type aircraft.

6.6.1.3. Nature of emergency.

6.6.1.4. Pilot's intentions.

6.6.2. After an emergency notification, ATC will relay the following items or any other pertinent information over the PCAS.

6.6.2.1. Call sign (identification).

6.6.2.2. Type aircraft.

6.6.2.3. Nature of emergency.

6.6.2.4. Pilot's intentions.

6.6.2.5. Number of personnel on board.

6.6.2.6. Fuel remaining.

6.6.2.7. Landing runway, wind, and Estimated Time of Arrival (ETA).

6.6.2.8. Emergency response requirements (example: approach end engagement, stop boulevard traffic).

6.6.2.9. Ordnance type and number.

## **6.7. Emergency Locator Transmitters (ELT) and Crash Position Indicators (CPI).**

6.7.1. An inadvertent activation of an ELT/CPI does not require an immediate response or processing as an emergency. Unless a requirement for assistance is verified, the PCAS should not be activated. **NOTE:** Operational ground testing of ELT/CPI has been authorized during the first 5 minutes of each hour. To avoid confusing the tests with an actual alarm, the testing is restricted to no more than three audio sweeps.

6.7.2. When Eglin Tower is notified or receives an ELT/CPI, other than during the first 5 minutes of the hour, they will notify the ERCF, Command Post, and AMOPS. The ERCF will notify Jacksonville Center.

6.7.3. If ERCF is notified or receives an ELT/CPI other than during the first 5 minutes of the hour, they will notify Eglin, Duke, and Hurlburt towers, Command Post, AMOPS, and Jacksonville Center.

6.7.4. AMOPS will notify Tower, ERCF, and MOCC, if they receive ELT/CPI information from another source.

6.7.5. If the ELT/CPI signal strength indicates the signal may be emanating from somewhere on the airport, the MOCC will notify appropriate base personnel to attempt to determine if the signal is emitting from the base survival equipment shop or a parked aircraft. If located, inform AMOPS and they will inform tower and ERCF that the signal was located and/or terminated.

6.7.6. ERCF will notify Jacksonville Center if signal source is located and/or terminated.



**6.8. Beacon Code 7700 Response on the Ground.** When a 7700 squawk is detected at Eglin/Duke, the following actions shall apply:

- 6.8.1. ERCF shall notify tower with the suspected location/source, if known.
- 6.8.2. Tower personnel shall activate the PCAS and state the following: “WE ARE RECEIVING SQUAWK 7700 ON THE GROUND AT EGLIN/DUKE.”
- 6.8.3. AMOPS shall relay the same message over the SCN.
- 6.8.4. The Eglin Command Post shall notify required agencies to locate the source.
- 6.8.5. The fire department shall respond to the area identified, but shall not block operations to and from the area. They shall stand by in this advanced response state waiting for more information on the nature of the emergency or until the squawk is declared inadvertent.
- 6.8.6. If it cannot be immediately determined that the 7700 squawk is inadvertent, tower shall suspend all airfield operations.
- 6.8.7. The Incident Commander shall determine/terminate the response/emergency.

**6.9. Runway Checks Following an Emergency.**

- 6.9.1. The following personnel are authorized to perform runway checks after an emergency:
  - 6.9.1.1. AMOPS.
  - 6.9.1.2. 96 OG/CC or designated representative.
  - 6.9.1.3. Eglin SOF.
  - 6.9.1.4. Incident Commander/Senior Fire Officer.
  - 6.9.1.5. 96 TW, 33 FW or 53 WG Safety.
- 6.9.2. Runway operations shall be suspended to the affected runway after an IFE or ground emergency in order to allow AMOPS to check the runway. The Eglin SOF has the authority to waive a runway check for those IFEs that are of a non-FOD producing nature (e.g., smoke in the cockpit, sick crew member or passenger). The Tower WS may suspend taxiway operations when a potential FOD hazard exists due to IFE recovery or when the on-scene commander establishes a cordon around an emergency aircraft.
- 6.9.3. If the Eglin SOF determines to waive the runway check, then the SOF will call AMOPS to advise “NO RUNWAY CHECK REQUIRED.” AMOPS will, in turn, document in AF Form 3616, *Daily Record of Facility Operation*.

**6.10. Aircraft Arresting System Procedures.**

- 6.10.1. Should a cable engagement be made at any time during a landing when the pilot has not declared intention to do so, it will be treated as an emergency.
- 6.10.2. Lost Communication Procedures. Plan the approach as dictated by the emergency. Squawk 7600. While on final, monitor tower for light gun signals. Flashing your landing light while on final will signify intent to engage a barrier.
- 6.10.3. Approximate successive cable engagement intervals are as follows:
  - 6.10.3.1. BAK 12: 10 to 20 minutes.

6.10.3.2. MB-100: 4-hour minimum time to replace the one-time use textile brake system.

6.10.3.3. E5: 60 minutes.

**6.11. Fuel Dumping.** Fuel dumping shall be coordinated with ATC and shall be conducted, to the extent possible, over water or unpopulated land areas at an altitude at least 5,000 ft above the highest obstacle.

**6.12. External Stores/In-Flight Aircraft Cargo Jettison Procedures.** When requested, the ERCF may provide navigation assistance to an external stores/cargo jettison area. When feasible, release of external stores or cargo shall be made over water or uninhabited land areas (See [Attachment 44](#)) within the Eglin Range complex (preferably B-71) IAW [Paragraph 7.5](#). Prior to release, if conditions permit, the aircraft commander will ensure the ground or water is clear of personnel, vessels, or equipment and notify the controlling agencies of desired release location.

**6.13. MC-130 Refueling Hose Jettison Procedures.**

6.13.1. MC-130 aircraft with a hung refueling hose shall jettison over the following ranges: SONTAY DZ (R-2915A CEW 218/12), PINO DZ (R-2914A CEW 120/17), inactive ranges, or Eglin water range.

6.13.2. If a hose fails to cut, avoid populated areas and make an approach to RWY 1, RWY 12, or RWY 30 at Eglin; RWY 18 or 36 at Duke Field; or RWY 18 at Hurlburt Field. Advise ATC if a road should be closed for the approach.

**6.14. Aircraft Abandonment/Controlled Bailout Procedures.**

6.14.1. Controlled Conditions. To preclude the possibility of aircraft crashing into a populated area in the Eglin complex after abandonment, the following procedures shall be used when an aircraft can be flown and abandoned under controlled conditions:

6.14.1.1. Maintain VFR if practical. If unable to maintain VFR, request appropriate control instruction from ERCF.

6.14.1.2. Notify applicable control agencies of intention to abandon aircraft. Eject/bail out over land areas, if practical. Utilize the Eglin range complex (preferably B-71). Eglin Approach Control/Mission Control will provide radar monitoring and furnish Eglin and Duke Towers (for PCAS activation) the probable impact point of the aircraft or eject point of the aircrew. ATC personnel will record the anticipated/suspected point of impact on appropriate crash grid maps and pass location information to emergency responders.

6.14.1.3. Recommended Pilot Procedures:

6.14.1.3.1. Coordinate with the Eglin SOF.

6.14.1.3.2. Altitude: 5,000 ft MSL for Eglin.

6.14.1.3.3. Radial/DME 293/7 ([CH 2](#)) or 360/06 ([CH 45](#)).

6.14.1.3.4. Once established within B-71:

6.14.1.3.4.1. Heading: 320° for ejection.

6.14.1.3.4.2. Airspeed: As slow as practical.

6.14.1.3.4.3. Flight Controls: Trimmed for wings-level flight. No Sink rate.

6.14.1.3.4.4. Throttles: Idle prior to ejection.

6.14.2. Aircraft commanders may bail out crew members at any suitable predestinated area prior to initiating the procedures outlined in this paragraph.

6.14.3. The areas shown in [Attachment 44](#) should be used if possible when bailing out from an aircraft in the traffic pattern in order to avoid populated areas.

### **6.15. Emergency Landing Gear Checks.**

6.15.1. A pilot experiencing landing gear trouble shall be cleared to make a low pass by the control tower for visual check of the landing gear. When passing the control tower, altitude shall be at the pilot's discretion, but no lower than 200 ft AGL.

6.15.2. Time permitting, the pilot may have the landing gear checked over the runway by the Eglin SOF, a pilot proficient in that type of aircraft, a maintenance officer/chief, or AMOPS. Comments of ground observers and information/assistance rendered by other qualified aircraft in-flight are advisory in nature only. The pilot shall determine the final course of action.

**6.16. Hot Brakes Parking Areas.** Pilots shall notify the Tower of hot brakes and parking intentions. Tower personnel shall notify AMOPS via the PCAS, which shall then notify the appropriate maintenance organization. Aircraft having hot brakes after landing or aborting takeoff shall be parked on the following taxiways to the maximum extent possible:

6.16.1. EAFB (See [Attachment 2](#)):

6.16.1.1. RWY 1: TWY P.

6.16.1.2. RWY 19: TWY G-East.

6.16.1.3. RWY 12: TWY G-East, TWY V, or the revetted De-arm area at the intersection of TWY B and TWY F.

6.16.1.4. RWY 30: TWY D-North, TWY C, or the revetted De-arm area at the intersection of TWY B and TWY F.

6.16.2. Duke Field (See [Attachment 20](#)):

6.16.2.1. RWY 18: TWY E-West.

6.16.2.2. RWY 36: TWY B.

**6.17. Hydrazine Leak Parking Areas.** Pilots with a suspected hydrazine leak shall notify the appropriate ATC agency as soon as possible. Tower shall notify AMOPS via the crash phone, which shall then notify the appropriate maintenance organization. After landing, aircrew will use judgment to determine whether to remain stationary or taxi to a designated hydrazine area following EPU activation or suspected hydrazine leak. Designated hydrazine areas are as follows:

6.17.1. EAFB (See [Attachment 2](#)):

6.17.1.1. RWY 1: TWY L, adjacent to HS-12 for daytime use only. (Aircraft shall use TWY J- West after dark.)

6.17.1.2. RWY 19: TWY J-West, adjacent to HS-2.

6.17.1.3. RWY 12: TWY F-North.

6.17.1.4. RWY 30: TWY E-North.

6.17.2. Duke Field (See [Attachment 20](#)):

6.17.2.1. RWY 18/36: Apex of TWY D and F or VL South Pad, as dictated by Duke AMOPS.

## **6.18. Alternate ATC Facility Procedures.**

6.18.1. Tower Evacuation Procedures.

6.18.1.1. Eglin Tower: In the event of an Eglin Tower evacuation, tower operations will be conducted from King Hangar, Bldg. 130. Due to the limited personnel and equipment in the alternate facility, practice approaches will not be approved. In the event of an evacuation of the primary control tower, Eglin Tower WS will:

6.18.1.1.1. Relay the information over landline to AMOPS for SCN activation.

6.18.1.1.2. Direct all ground vehicles to exit the runway/controlled movement area and expect further directions when the alternate tower is operational.

6.18.1.1.3. Notify ERCF of the evacuation and request they monitor frequencies 353.65 and 118.2 and provide airport advisories until the alternate facility is operational.

6.18.1.1.4. Activate the PCAS and state "EGLIN TOWER IS BEING EVACUATED TO THE ALTERNATE CONTROL TOWER DUE TO (reason)." In addition, if time permits, they will broadcast on all assigned frequencies "ALL AIRBORNE AIRCRAFT CONTACT EGLIN APPROACH CONTROL ON (frequency). ALL GROUND TRAFFIC HOLD YOUR POSITION AND STANDBY, EXPECT A THREE ZERO MINUTE DELAY."

6.18.1.1.5. When Tower is ready to resume operations from the alternate tower, Tower will notify ERCF, assume control of any aircraft within their area of jurisdiction, and activate the PCAS and broadcast on all assigned frequencies "EGLIN TOWER HAS RESUMED OPERATION FROM THE ALTERNATE CONTROL TOWER."

6.18.1.2. Duke Tower: In the event of Duke Tower evacuation, the ERCF shall provide airport advisory service, monitor Duke Tower frequencies, and maintain communications with aircraft until landing. No alternate fixed or mobile tower facility exists at Duke; all airborne aircraft will be diverted.

6.18.1.2.1. Tower personnel will activate the PCAS and state "DUKE TOWER IS BEING EVACUATED DUE TO (reason)." If time permits, they will broadcast on all assigned frequencies "ALL AIRBORNE AIRCRAFT CONTACT EGLIN APPROACH CONTROL ON (frequency). ALL GROUND TRAFFIC HOLD YOUR POSITION AND STANDBY. CONTACT PILOT TO DISPATCH ON (frequency) FOR INFORMATION."

6.18.1.2.2. Notify ERCF of the evacuation and request they monitor Duke frequencies and provide airport advisories until Duke Tower is ready to resume operations.

6.18.1.2.3. When Duke Tower is ready to resume operations, and the opening checklists are complete, the WS will notify ERCF/Eglin Tower, assume control of any aircraft within their area of jurisdiction, and activate the PCAS and broadcast on all assigned frequencies "DUKE TOWER HAS RESUMED OPERATIONS."

6.18.1.2.4. Wind Limitations on Eglin and Duke Towers. Personnel shall evacuate Eglin Tower (primary) Eglin Alternate Tower, and Duke Tower Cab when sustained winds are  $\geq 60$  knots and/or gusts  $\geq 75$  knots. When the reason for evacuation is for winds or when Alternate Tower requires evacuation, Eglin Tower personnel will evacuate to the ERCF. Duke Tower personnel will evacuate to the first floor of the tower for weather phenomena.

#### 6.18.2. ERCF Evacuation Procedures.

6.18.2.1. In the event of the ERCF evacuation, the ERCF shall accomplish the following in addition to any checklist items established by the facility chief controller. Time permitting, the ERCF shall attempt to coordinate and/or handoff all aircraft to the appropriate facility prior to evacuation.

6.18.2.1.1. Immediately notify Jacksonville Center and Eglin Tower. Ensure tower activates PCAS.

6.18.2.1.2. Instruct aircraft in the terminal area to contact the appropriate tower. Instruct other aircraft to contact Jacksonville Center (ZJX).

6.18.2.1.3. Dispatch one supervisor and two qualified controllers to Eglin Tower with the fly-away kit to provide conventional ATC.

6.18.2.1.4. Time permitting, notify Hurlburt Tower, Duke Tower, Pensacola Approach, Tyndall Approach, Cairns Approach, Seabreeze, and Gainesville Flight Service Station (FSS).

6.18.2.1.5. Broadcast on all available frequencies, including 121.5 and 243.0, "ATTENTION ALL AIRCRAFT. EGLIN APPROACH CONTROL IS BEING EVACUATED DUE TO (Reason). CONTACT JACKSONVILLE CENTER ON (Frequency) FOR FURTHER INSTRUCTIONS."

6.18.2.1.6. Broadcast on all assigned mission frequencies, "ATTENTION ALL AIRCRAFT. EGLIN APPROACH CONTROL IS BEING EVACUATED DUE TO (Reason). CEASE OPERATIONS AND REMAIN IN ASSIGNED MISSION AIRSPACE, CONTACT JACKSONVILLE CENTER ON (Frequency) FOR FURTHER INSTRUCTIONS."

6.18.2.1.7. Evacuate remaining personnel to the AMOPS parking lot, take a head count and wait for further instructions.

6.18.2.1.8. Notify AOF/CC and Chief Controller.

6.18.2.2. Limitations: There will be no practice instrument approaches or airborne mission activity support while the ERCF is out of service. The airspace will be controlled by ZJX IAW the LOA titled "Jacksonville ARTC Center and Eglin Radar Control Facility." A copy of the LOA can be obtained through the Airfield Operations Flight upon request.

6.18.3. AMOPS (Bldg. 60) Evacuation Procedures. In the event Bldg. 60 has to be evacuated, AMOPS shall accomplish the following (time and safety permitting):

6.18.3.1. Notify all occupants of Bldg. 60 to evacuate.

6.18.3.2. Activate the SCN and notify all parties of evacuation and alternate location: Bldg. 104, COMM: (850) 882-7800/DSN: 872-7800.

6.18.3.3. Notify the Eglin Tower and ERCF via HOTLINE of the evacuation and alternate location.

6.18.3.4. Notify Hurlburt AM to commence emergency NOTAM and flight planning backup services.

6.18.3.5. Secure all classified materials and lock safe.

6.18.3.6. Collect the NOTAM and Read File binders, handheld radios/batteries, EVAC KIT and vehicle keys.

6.18.3.7. Time permitting, post signs on facility doors informing of the evacuation/relocation.

6.18.3.8. Proceed to Bldg. 104, ERCF, and log onto the computer.

6.18.3.9. Eglin Tower will activate the PCAS and broadcast on all frequencies that Eglin AMOPS has evacuated.

6.18.3.10. Notify Eglin AOF/CC and Airfield Manager.

6.18.4. Duke AMOPS (Bldg. 3052) Evacuation Procedures. In the event Bldg. 3052 has to be evacuated, AMOPS shall accomplish the following (time and safety permitting):

6.18.4.1. Notify all occupants of Bldg. 3052 to evacuate.

6.18.4.2. Activate the SCN and notify all of evacuation and alternate location: Bldg. 3139, Duke Tower, COMM: (850) 883-6179/DSN: 875-6179. If necessary, accomplish at the alternate location ASAP after relocation.

6.18.4.3. Notify the Duke AOF/CC of the evacuation.

6.18.4.4. Notify Gainesville Flight Service Station (FSS) and Eglin AMOPS via the Aeronautical Information System Replacement (AISR). Eglin AMOPS will Guard for Duke AMOPS Until Further Notice.

6.18.4.5. Gather EVAC KIT and any open flight plan paperwork, and then relocate to Bldg. 3139. **NOTE:** Duke Field AMOPS has no classified storage.

6.18.4.6. Notify Duke Tower of the evacuation and alternate location; Duke Tower will activate the PCAS.

**6.19. Unauthorized Movement/Preventing/Resisting Aircraft Piracy/Hijacking.** Procedures are outlined in the Integrated Defense Plan, EAFB Plan 31-101 (FOUO). Additional guidance can be found in AFI 13-207, *Preventing and Resisting Aircraft Piracy (Hijacking)* (FOUO).

## Chapter 7

### RANGE EMERGENCY PROCEDURES

#### 7.1. Inadvertent Release Procedures. (Uncommanded release of any store)

7.1.1. If an inadvertent release occurs, switches shall be safed, and the pilot shall discontinue test area operations. Pilots will avoid populated areas during RTB.

7.1.2. Switch positions, exact location, time of release, and circumstances of malfunction will be recorded by the pilot and provided to armament/safety personnel.

7.1.3. Pilots will notify the RCO, Test Area Controller, and EMC of the location, type of munitions, and whether or not the munitions exploded, for any release that caused munitions to impact off the test area.

7.1.4. A multiple release of a practice bomb or rocket from an SUU-20 Bomb Dispenser when a single release was intended is not considered an inadvertent release.

#### 7.2. Unintentional Release Procedures. (Accidental release induced by aircrew)

7.2.1. If an unintentional release occurs, note munitions impact point. For on-test-area impacts, pilots may elect to continue weapons delivery passes.

7.2.2. For any release that causes munitions to impact off the test area, switches will be safed, no additional weapons delivery passes will be made, and record the information IAW [Paragraph 7.1.3](#)

#### 7.3. Unexpended Ordnance Procedures.

7.3.1. Any unexpended ordnance may be returned to EAFB without a safety chase. Pilots will avoid populated areas.

7.3.2. Unexpended Cat I/II ordnance require a straight in to a full stop landing. If recovering from the North (ranges), attempt to land on RWY 12. If recovering from the south (water) attempt to land on RWY 30. RWY 1 should only be used if winds or other conditions do not allow landing on RWY 12/30. RWY 19 will only be used with 96 OG/CC approval.

7.3.2.1. Aircraft with Cat III, IV, V, and VI ordnance, chaff, and self-protection flares may make an overhead pattern to any runway including RWY 19 if permitted by MDS guidance.

#### 7.4. Hung/Jammed/Unsafe Gun Procedures.

7.4.1. In the event of hung/jammed/unsafe gun, pilots may return to EAFB without a safety chase. Aircraft with internal percussion-activated ammunition and aircraft carrying pod-mounted percussion-activated ammunition will orbit for 15 minutes to allow the gun to cool down prior to leaving the test area safety profile. Pilots will avoid populated areas. For Hung Ordnance/Gun Clearing areas see [Attachment 2](#).



7.4.2. Eglin Tower personnel will pass road closure requests at EAFB from aircrew to AMOPS via the PCAS on the initial emergency notification. The only mandatory road closure is when aircraft with CAT I munitions recover to RWY 12. AMOPS will alert the 96th Security Forces Squadron. The 96 SFS will dispatch security forces to standby positions, as appropriate. The ERCF will notify tower personnel when the emergency aircraft is 30 NM from the runway. Tower personnel will reactivate the PCAS and request AMOPS to have security forces personnel close the roads. If the aircraft is within 30 NM from the runway during the initial emergency notification, the request will be made to close the roads on the initial PCAS activation. The roads must be closed prior to aircraft landing and remain closed until directed to be opened by the incident commander responding to the emergency.

7.4.2.1. Recovering from the south. Aircraft will attempt to land on RWY 30 in order to minimize overflight of civilian population and proceed to the revetted De-arm area at the intersection of TWY B and TWY F and park in spot 2 or spot 4 as close to the revetment as possible. Aircraft landing RWY 1 will preferably roll out to the end of the runway, turn right onto TWY P, proceed to Hot Gun 1 and point toward the earthen berm.

7.4.2.2. Recovering from the North. Aircraft will attempt to land on RWY 12 in order to minimize overflight of civilian population. Aircraft landing RWY 12 will proceed to the revetted De-arm area at the intersection of TWY B and TWY F and park in spot 2 or spot 4. Aircraft will taxi straight to and as close to the revetment as possible. If approved by the SOF, aircraft landing on RWY 19 will make a 180° right turn on the runway and back-taxi preferably turn right onto TWY P, then proceed to Hot Gun 1 and point toward the earthen berm.

7.4.2.3. Once in the Hung Ordnance/Gun Clearing area, the aircraft will be chocked and all other munitions safed (if applicable) before proceeding with gun safe operations. All personnel and equipment must be kept from passing in front of the muzzle-end of the gun until it is properly safed. If the gun can be properly safed and clear of live rounds, the aircraft may taxi back to the appropriate parking spot. If the gun cannot be properly secured safe, rounds cannot be cleared from the gun, or a hazardous condition exists, then the aircraft will be shut down and grounded before proceeding with gun clearing procedures. Also see EAFBI 21-102, *Flightline Explosives Operations*.

7.4.2.4. The fire department and emergency responders are authorized to establish a 300 ft cordon around the hung/jammed/unsafe gun area IAW AFMAN 91-201, para 10.12., Withdrawal Distances for Airfield Emergencies Not Involved in Fire.

7.4.3. Hung/Jammed/Unsafe Gun Procedures to Duke Field. The preferred recovery for a hung/jammed/unsafe gun recovery to Duke Field is an approach to RWY 18. Default arm/de-arm areas are as follows:

7.4.3.1. Landing RWY 18: Turn left (east) on TWY E, proceed to VL South, point weapon east. Helicopters with dual guns may park so that guns are pointed east and downward.

7.4.3.2. Landing RWY 36: Complete a right 180-degree turn, back taxi to TWY E, turn left (east) on TWY E, proceed to VL South, point weapon east. Helicopters with dual guns may park so that guns are pointed east and downward.

#### 7.4.4. Hung/Jammed/Unsafe Gun Recovery Procedures (Side-Door Firing).

7.4.4.1. For aircraft with side-door firing guns unable to recover at Hurlburt Field, Duke Field is the primary option for hung gun recoveries. The following procedures will be applied to any side-door gun aircraft landing at Duke Field with hung/unsafe guns. **NOTE:** The following directions assume guns are pointing out of the left side of the aircraft (orientation of AC-130). If guns are oriented another direction, care should be taken by the aircraft operator and response agencies to ensure that the hung gun faces north, east, or south to the greatest extent possible during landing and taxi, and that the aircraft is parked with the gun facing east.

7.4.4.1.1. Aircraft landing RWY 36 will perform a 180° right turn after landing in order to keep the gun pointing north and east. Then back-taxi down the runway and turn left onto TWY E-East. After crossing the LZ, continue onto VL South Pad, turning the nose of aircraft south (90° right turn), ensuring gun is facing east.

7.4.4.1.2. Aircraft landing RWY 18 will roll out to the end of runway, turn left onto TWY E-East. After crossing the LZ, continue onto VL South Pad, turning the nose of the aircraft south (90° right turn), ensuring gun is facing east.

7.4.4.1.3. In event of simultaneous jammed/unsafe gun recoveries, the first aircraft landing will follow the procedures described in [Paragraphs 7.4.3.1 and Paragraphs 7.4.3.2](#). If landing RWY 18, the second aircraft will remain on the runway and stop south of the south BAK-12. If landing RWY 36, the second aircraft will execute a 180° turn on the runway, back taxi and stop south of the BAK-12.

7.4.4.1.4. The VL South, Duke Field DZ, and the LZ will be temporarily closed or suspended until the Airfield Manager or designated representative reopens them.

7.4.4.2. For aircraft with side-door firing guns unable to recover at Hurlburt Field, Eglin AFB is the tertiary option for hung gun recoveries. The following procedures will be applied to any side-door gun aircraft landing at Eglin AFB with hung/unsafe guns. **NOTE:** The following directions assume guns are pointing out of the left side of the aircraft (orientation of AC-130). If guns are oriented another direction, care should be taken by the aircraft operator and response agencies to ensure that the hung gun faces north, east, or south to the greatest extent possible during landing and taxi, and that the aircraft is parked with the gun facing east.

7.4.4.2.1. All approaches to the airfield will be from the South avoiding populated areas. RWY 30 will be the primary runway for VFR and IFR recoveries. For VFR, enter a left base for RWY 30 once North of Destin. Aircraft unable to proceed visually will recover via TACAN approach to RWY 1 and circle to land on RWY 30. If winds are out of limits for RWY 30, RWY 12 will be used.

7.4.4.2.2. The primary parking location will be the LOLA.

7.4.4.2.2.1. For RWY 30 landings (primary) turn left on TWY E if able, then left on B and into the LOLA. If unable to exit on TWY E, make a left 180 degree turn on the runway and right on TWY E, then left on TWY B and into the LOLA.

7.4.4.2.2.2. For RWY 12 landings (secondary) turn right at TWY F if able, then left on TWY B and into the LOLA. If unable to turn right on TWY F, make a left 180 degree turn on the runway and left on TWY F, then left on TWY B and into the LOLA.

7.4.4.2.3. The secondary parking location will be Hot Gun 3.

7.4.4.2.3.1. For RWY 30 landings (primary) turn left 180 degrees on the runway, then left on TWY G, left on RWY 1 and right on TWY M to Hot Gun 3.

7.4.4.2.3.2. For RWY 12 landings (secondary) turn left at TWY G, then right on TWY M and into Hot Gun 3.

## 7.5. Jettison Procedures.

7.5.1. Normally, jettison should be accomplished below 5,000 ft MSL over land areas (preferably B-71) or below 10,000 ft MSL over water areas. AC-130s should use the guidance from HFI 11-201. For emergencies immediately after takeoff that necessitate jettisoning, the emergency jettison areas shown in [Attachment 44](#) will be used if possible.

7.5.2. The pilot is responsible for both surface and air clearance on any TW test area. When the water test areas are used, the designated Salvo Area is a 10 NM wide corridor along the western edge of W-151 beginning at a point 30 NM south of Santa Rosa Island (DWG 190/054) to 63 NM due south of Santa Rosa Island along the 86° 48'W longitude line.

7.5.3. During land test missions, ordnance will be jettisoned according to instructions from the Test Area Controller. If any doubt exists about the safety of jettisoning armed ordnance on a land test area, the pilot may elect to jettison safe. During over water test missions, ordnance will be jettisoned armed after visually clearing the impact area.

7.5.4. In the event an emergency precludes the use of the Salvo Area, the flight may drop ordnance on any test area. Pilots are required to clear areas visually prior to release of ordnance and will notify EMC, if possible, prior to drop. Ordnance will be dropped in the minimum safe release interval. Caution must be exercised when dropping ordnance in an armed configuration. The area cleared must exceed the prescribed ground safe distance of the ordnance, and the release altitude must exceed the minimum safe altitude prescribed for the particular munitions.

7.5.5. If the primary aircraft experiences radio failure, the chase aircraft must coordinate the jettison with EMC or other appropriate agency. The primary aircraft will release on visual signals initiated by the chase. These visual signals and procedures for radio failure must be thoroughly covered in the mission briefing.

## 7.6. Hung Ordnance General Procedures. Hung ordnance procedures apply to Cat I through VI ordnance. See [Table 7.1](#)

7.6.1. The briefing for all ordnance delivery missions will include specific hung ordnance procedures, to include recovery routes. The applicable hung ordnance recovery procedure will be followed unless a modified procedure has been approved in writing for the specific ordnance by the 96 TW Test Approval Brief, 53 WG Test Plan, or 33 OG/CC for their respective projects. Any modification will be approved by the 96 OG/CC before use.

7.6.2. After reselecting the affected station and checking weapons release procedures, additional attempts to release the hung ordnance are authorized within the bounds of the applicable TD. The aircraft should remain within the approved profile not to exceed the reservation boundaries.

7.6.3. Further normal release attempts of ordnance aboard other aircraft stations are not authorized. Exception: When an aircraft is configured with training ordnance on more than one station, the pilot may continue release attempts as long as the aircraft can remain within the range boundary.

7.6.4. Pilots will attempt to jettison all hung unsecured ordnance IAW **Paragraph 7.5** before landing unless a written waiver has been approved by appropriate agency in **Paragraph 7.6.1**

7.6.5. Aircraft with hung Cat I munitions and hung, unsecured Cat II through VI munitions, will declare an emergency. Hung secure rockets do not require declaration of emergency. Further requirements for declaration of emergency will be at the pilot's discretion.

**Table 7.1. Munitions (Ordnance)/External Stores Categories for Developmental Weapons.**

I	All live ordnance containing primary explosive such as: Rockets and missiles with live motors, Live bombs regardless of type of fuse, live cluster bomb unit (CBU) munitions, and LUU-series flare/ground markers. NOTE: A recovery to RWY 12 with CAT I munitions mandates an Eglin Blvd road closure.
II	Ordnance with initiating explosive only, or with an incomplete explosive, such as: Inert bombs with live fuses or boosters, Inert CBU munitions with live detonators, and MJU-2/7/10 flares, RR-170/180 chaff.
III	Jettisonable nonexplosives such as Inert munitions, training shapes, instrumentation or pods (fuel tanks are excluded) and all confirmed empty dispensers.
IV	BDU-33, MK-106, or similar training ordnance.
V	Any gun loaded with live rounds of any type.
VI	Nonjettisonable, nonexplosive stores, that have the appearance of ordnance. These are stores that are completely inert and secured to aircraft with no method of release, such as pods, training shapes, training missiles, and baggage pods.
*NOTE: During development of the Safety Appendix to the test directive, the 96 TW Test and Range Safety Office will assign an appropriate category number (Cat I through VI) to munitions (ordnance)/external stores as outlined above. The assigned category will be reviewed by the Safety Review Board (SRB) and any disagreements will be resolved by coordination between the SRB and 96 TW Weapons Safety. The munitions category is used to determine the correct takeoff runway and the decision tree/crash response to be used for landing with hung ordnance. The type ordnance and number loaded on the aircraft must be reported during aircraft emergencies.	

## 7.7. Hung Ordnance Notification Procedures.

7.7.1. Pilots with hung munitions shall notify EMC IAW [Table 7.2](#)

7.7.2. The pilot will notify the Eglin SOF and EMC as soon as possible to coordinate recovery for Hung Ordnance. As a minimum, the Eglin SOF and EMC must know the weapon category, type and number, status (secure/unsecure), time of attempted release, and intentions (i.e., landing runway and type approach, and special requests to stop traffic on Eglin Boulevard/Perimeter Road, runway inspection after landing if required). For hung Cat I/II/III ordnance, pilots will contact EMC 5 minutes prior to departing the test area.

7.7.2.1. Eglin Tower personnel will pass road closure requests from aircrew to AMOPS via the PCAS on the initial emergency notification. AMOPS will alert the 96th Security Forces Squadron. The 96th Security Forces Squadron will dispatch security forces to standby positions, as appropriate. The ERCF will notify tower personnel when the emergency aircraft is 30 NM from the runway. Tower personnel will reactivate the PCAS and request AMOPS to have security forces personnel close the roads. If the aircraft is within 30 NM from the runway during the initial emergency notification, the request will be made to close the roads on the initial PCAS activation. The roads must be closed prior to aircraft landing and remain closed until directed to be opened by the incident commander responding to the emergency.

7.7.3. EMC shall:

7.7.3.1. Make sure aircraft and Eglin Approach are provided a route clear of active test areas from the point of hand-off to the point where the aircraft will exit the restricted/warning areas.

7.7.3.2. Advise Eglin Approach Control of the following:

7.7.3.2.1. Identification and type of aircraft.

7.7.3.2.2. Hung ordnance.

7.7.3.2.3. Landing runway and type approach requested.

7.7.3.3. Advise Tower of the following:

7.7.3.3.1. Identification and type of aircraft.

7.7.3.3.2. Hung ordnance status (including category and number).

7.7.3.3.3. Landing runway (per pilot's request).

7.7.3.3.4. Additional pilot requests.

7.7.3.4. Notify JTTOCC and request personnel for de-arming. The JTTOCC will notify the appropriate MOCC.

7.7.4. Eglin Approach Control shall:

7.7.4.1. Provide EMC with an altitude for exit from the test areas.

7.7.4.2. Provide aircraft with vectors and directions that avoid overflight of populated areas to the max extent possible.

7.7.5. MOCC shall:

7.7.5.1. Inform Crash Rescue, via the hot line, of the specific type and location of ordnance that was loaded on the aircraft.

7.7.5.2. Request armament personnel for de-arming.

7.7.6. Crash Rescue will respond according to **Table 7.2**

**Table 7.2. In-Flight Emergency (IFE) Crash Rescue Response.**

Category	Hung/ Unsecure	Hung/Secure
<b>I</b>	Emergency	Emergency
<b>II, III</b>	Emergency	Advisory
<b>IV, V, VI</b>	Emergency	No Response
<b>Hung secure rockets do not required declaration of emergency</b>		

### 7.8. Hung Ordnance Recovery Procedures.

7.8.1. The primary airfield for aircraft landing with secure or unsecure hung ordnance is EAFB.

7.8.2. For hung Target Practice (TP) and White Phosphorus (WP) rockets, if the rockets can be confirmed secure, then the aircraft will return to EAFB, declaration of emergency is not required and is at the discretion of the pilot. Fly a straight-in to RWY 12 or RWY 30. Taxi to the revetted De-arm area at the intersection of TWY B and TWY F and park in spot 2 or spot 4. If the rocket/pod can be safed, the aircraft will then be allowed to taxi to the LOLA or Hot Gun line for download as directed by de-arm crews. If it cannot be safed, the aircraft will be shut down and turned over to Explosive Ordnance Disposal (EOD) personnel for safing and disposition. Individual hung rocket procedures for high-explosive (HE) munitions will be developed IAW **Paragraph 7.6.1** For hung unsecured rockets, the pilot shall attempt to jettison the rocket pod prior to landing. If unsuccessful, the pilot may land at EAFB with a hung unsecured rocket, following hung Cat I procedures.

7.8.3. Hung LUU-Series Flare Procedures. For both secure and unsecure, hung LUUs, land at EAFB IAW hung CAT I procedures. For hung LUU-flares with a fire, jettison the SUU dispenser, if possible, then land at EAFB. For hung, unsecure LUUs without a fire, retain the pod and land at EAFB.

7.8.4. For hung CAT I (except fuselage and rail-launched missiles) and all unsecure ordnance, pilots will attempt to get a safety chase to help determine ordnance/aircraft status and provide assistance during recovery.

7.8.5. A straight-in approach will be flown avoiding populated areas.

7.8.5.1. For all hung unsecure munitions, stop straight ahead on the runway. Follow the incident commander's directions for download or chocks.

7.8.6. Recovering from the North. Fly an approach to RWY 12 minimizing overflight of populated areas. Recovery of CAT II through IV munitions does not require the closure of Eglin Boulevard.

7.8.6.1. RWY 12 CAT I/II munitions. Attempt to exit the runway at TWY F-South. Proceed to the revetted De-arm area at the intersection of TWY B and TWY F and park in spot 2 or spot 4. If unable to land on RWY 12 due to winds or other conditions, minimize overflight of populated areas and land on RWY 30 and follow the procedures in [Paragraph 7.8.7](#)

7.8.6.2. RWY 12 with CAT I munitions. Eglin Boulevard, between the control tower and Memorial Trail, must be closed. TWY H between TWY F and RWY 1/19 will also be closed. Memorial Trail must also be closed to traffic crossing the departure end between Eglin Boulevard and the horse stables.

7.8.7. RWY 30 CAT I/II munitions. Attempt to exit the runway at TWY E. Proceed to the revetted De-arm pad area at the intersection of TWY B and TWY F and park in spot 2 or spot 4. If unable to land on RWY 30 due to winds or other conditions, minimize overflight of populated areas and land on RWY 12 and follow the procedures in [Paragraph 7.8.6](#)

7.8.7.1. An initial 300' safety zone will be established. The safety zone may be adjusted by the incident commander as required. The incident command may consider closing taxiways, runways and traffic roads to ensure safety.

7.8.8. For aircraft recovering with hung secure CAT III/IV munitions, taxi to normal de-arm areas at TWY G or TWY D. Recovery of aircraft with CAT II through IV munitions does not require closure of any roads.

7.8.9. Weapons personnel will inspect aircraft with hung ordnance and determine if the aircraft can proceed to the parking area, or if it must be shut down. Aircrew taxiing back to Hot Gun 1 will request to taxi on RWY 1, exiting at TWY P. If the aircraft must be shut down, Weapons personnel will safe the hung ordnance and have the arm/de-arm crew pin all remaining munitions. EOD personnel will take other necessary emergency actions as required.

7.8.9.1. De-arm crew (composed of weapons personnel) will notify the pilot of action taken to safe hung ordnance. A headset for aircraft interphone is required.

7.8.10. In the event RWY 1 is used for landing, Hot Gun 1 will be used in place of the revetted De-arm area at the intersection of TWY B and TWY F when previously required (i.e., CAT I/II hung ordnance). Attempt to exit RWY 1 at TWY P and park facing the berm.

7.8.11. For unique munitions requiring special handling (i.e., thermal batteries), follow ground procedures approved during the 96 TW TAB, 53 WG Test Plan, or by the 33 OG/CC. All procedures must be approved by the 96 OG/CC.

7.8.12. Duke Field: The preferred recovery for a hung ordnance/jammed/unsafe gun recovery to Duke Field is an approach to RWY 18.

7.8.12.1. Aircraft landing RWY 36 will perform a 180° right turn after landing, back-taxi down the runway, and turn left onto TWY E-East. After crossing the LZ, continue onto VL South Pad. If applicable, point forward firing ordnance east.

7.8.12.2. Aircraft landing RWY 18 will roll out to the end of runway, turn left onto TWY E-East. After crossing the LZ, continue onto VL South Pad. If applicable, point hung weapon east.

7.8.12.3. In event of simultaneous hung ordnance/jammed/unsafe gun recoveries, the first aircraft landing will follow the procedures described in **Paragraphs 7.8.11; Paragraphs 7.8.12**. If landing RWY 18, the second aircraft will remain on the runway and stop south of the south BAK-12. If landing RWY 36, the second aircraft will execute a 180-degree turn at the end of the runway and proceed south, and stop south of the south BAK-12.

7.8.12.4. The VL South Pad, Duke Field DZ, and the LZ will be temporarily closed or suspended until the Airfield Manager or designated representative reopens them.

7.8.12.5. The Fire Department will have Weapons Maintenance attempt to immediately safe the weapon. If the weapon is breached or unsecure, EOD teams will determine the weapon status. After munitions are safed, the aircraft may depart for original destination or be relocated for parking.

### **7.9. IFR Hung Ordnance Recovery Routes.**

7.9.1. EAFB. Expect radar vectors to avoid populated areas to the maximum extent possible. Expect clearance for standard recoveries: RWY 1/30, Eglin North Recovery, and RWY 12/19, DDUNE Recovery. If weather is IFR, expect applicable instrument approach. The pilot will request to land on the runway most appropriate for the situation, i.e., ordnance carried, weather.

7.9.2. Duke Field: Expect radar vectors to avoid populated areas to the maximum extent possible. In IFR conditions, expect to land via ILS to RWY 18 to avoid overflight of EAFB and populated areas.

7.9.3. Hurlburt Field: Approaches shall be under radar control except during lost communications conditions. Make every effort to avoid populated areas as soon as visual contact with the runway environment is made.

### **7.10. De-Arming Procedures.**

7.10.1. All aircraft will proceed through de-arm immediately after landing, regardless of munitions carried in order to have safety pins/devices installed prior to taxiing back to parking. Aircrew will verify all armament switches are OFF/SAFE and hold hands in view of armament personnel during de-arming operations.

7.10.2. Aircraft with forward firing ordnance should taxi so as to eliminate or minimize the time the aircraft is pointed toward an inhabited area. Minimize pointing forward firing ordnance toward inhabited areas by continuing to the end of the runway before turning toward the de-arm area.

7.10.3. Host and associate organizations will ensure the appropriate arm/de-arm areas are manned by arm/de-arm crews during launch and recovery of unit aircraft regardless of munitions carried.

7.10.4. Arm/de-arm crews will check all unexpended ordnance as soon as the aircraft is parked at the arm/de-arm area and make sure munitions are still loaded/installed properly.



7.10.5. When any aircraft not requiring use of the de-arm area (e.g., C-130) exits the runway, aircrew should verify status of weapons system. If any hung munitions condition exists, aircraft will follow Tower instructions for a safe parking area to avoid conflict with other aircraft movement on the ground until the system can be made safe to continue taxi to park or the aircraft will be shutdown in position.

7.10.6. After receiving permission from the Tower to enter the runway, AMOPS and/or EOD personnel shall make a runway inspection following the landing of an aircraft carrying loaded CBU type munitions dispensers (downward or rearward dispensing) with submunitions aboard. When this need exists, as identified during a TAB, EOD will advise the tower of this requirement.

### **7.11. Radio Failure Procedures with Ordnance.**

7.11.1. If one member of a flight has radio failure, that member will make a dry pass in normal sequence by the tower, rock the wings to indicate a radio failure, pull off in the direction of traffic, and establish an orbit 2,000 ft above the highest pattern remaining to be flown, and await join up. If single ship, the pilot will accomplish the same procedure with the exception of departing the test area after pulling off in the direction of traffic. The pilot will squawk Code 7600. The Test Area Controller/RCO will notify EMC who will notify Eglin Approach Control who will notify Eglin Tower.

7.11.2. If a pilot has radio failure with an emergency or with hung ordnance, the pilot will make a dry pass (circumstances permitting), rock the wings, and break opposite the pattern direction. Squawk Code 7700. The Test Area Controller/RCO will notify EMC who will notify Eglin Approach Control who will notify Eglin Tower.

7.11.3. If the Test Area Controller/RCO loses radios, the aircraft will remain at pattern altitude and attempt contact on alternate frequencies. Notify the JTTOCC if no contact. No ordnance will be dropped without radio contact with the appropriate test area control/RCO authority. The JTTOCC will monitor Test Area Control Common (Wolf Call) frequency 276.0 to approve test area operation/ordnance delivery on unmanned test areas, and to act as a backup point of contact for manned test areas.

7.11.4. Other unit/command procedures for radio failure will be followed if they are more restrictive.

### **7.12. Helicopter and AC-130 Gunship Weapon System Malfunctions.**

7.12.1. The aircraft commander will be notified of any weapon system malfunction.

7.12.2. The aircraft will remain over assigned test area until the weapons can be placed in a safe condition.

7.12.3. If system cannot be safed, or a hung flare condition exists, an emergency should be declared. On recovery, minimize overflight of populated areas. Gun systems should not be directed at populated areas. AC-130s use guidance IAW HFI 11-201 for specific jettison procedures in the Eglin ranges.

**7.13. Crash Procedures.** If a known or suspected crash occurs on or near the test area, the following actions will be taken by the RCO:

7.13.1. Close the test area.

7.13.2. Request a specific flight member to notify Eglin Tower.

7.13.3. Call Eglin AMOPS at COMM: (850) 882-5313/DSN: 872-5313 and provide all known information, including crash site location, caller's name, and phone number.

7.13.4. Notify the Eglin Command Post at COMM: (850) 883-4020/DSN: 875-4020 with the same information.

7.13.5. Remain in the control tower to coordinate rescue action and provide information.

#### **7.14. RCO Procedures during Emergencies.**

7.14.1. In-Flight Emergency/Hung Ordnance. The RCO will notify the EMC as soon as possible when an aircraft has a problem necessitating special recovery procedures.

7.14.2. Communication Failure. In the event of radio failure, the RCO will:

7.14.2.1. Attempt contact on the field radio, secondary test area frequency, or EMC frequency.

7.14.2.2. If it is necessary to abort a pass by a delivery aircraft, fire one flare from the control tower.

7.14.2.3. If it is necessary to close the test area, fire two flares from the control tower.

7.14.2.4. Notify EMC by landline of test area radio problems or failure.

7.14.3. Notify EMC immediately when an aircraft departs the test area with apparent radio failure or an emergency.

## Chapter 8

### TEST MISSION PROCEDURES

#### 8.1. Test Area Scheduling.

8.1.1. Test area airspace will be scheduled according to EAFBI 13-204, *Mission Scheduling and Control*. This instruction also contains procedures for scheduling “shared airspace,” which enables a lower priority mission to be scheduled with a higher priority mission by deconfliction of mission profiles, enabling maximum use of test area airspace.

**8.2. Test Area Control.** All test area operations must have clearance and two-way radio communication with the appropriate test area RCO before and during ordnance release or launching operations. Callsigns for appropriate test area control authorities are listed in **Table 8.1**

8.2.1. Warning Area/Water Missions. The aircrew is responsible for ensuring that they meet all safety criteria and procedures to include those stipulated in the Safety Appendix issued for the particular test/mission being conducted before going hot over water within all scheduled warning airspace. The aircraft commander is designated as the safety observer for all hot missions while in scheduled warning airspace. For those missions using the CCF (Call sign CHAMBER), as mission control, approval from Chamber is required before going hot.

8.2.2. For manned test areas, the Test Area Controller is the appropriate authority for approval of test area operations and the RCO is the appropriate authority for expenditure of ordnance on the test area.

8.2.2.1. Test Area Controllers performing RCO duties must meet the criteria and qualifications IAW AFI 13-212.

8.2.3. For unmanned test areas, the JTTOCC (Call sign WOLF CALL) is the appropriate test area control authority. The JTTOCC monitors frequency 276.0 to approve test area operation/ordnance delivery on unmanned test areas, and as a backup point of contact for manned test areas. **NOTE:** Aircrew will check in, obtain clearance, and check out with the JTTOCC, but will monitor their assigned mission frequency when working the unmanned test area.

8.2.4. The RCO is responsible for the conduct and safety of ordnance delivery missions after obtaining assurance from the Test Area Controller that the gates are closed and the test area is clear of all personnel.

**Table 8.1. Test Area Control Authority.**

<b>Test Area</b>	<b>Call sign</b>	<b>Test Area</b>	<b>Call sign</b>
<b>B-7</b>	Wolf Call	<b>C-72</b>	C-72 Control
<b>C-7</b>	C-72 Control	<b>C-74</b>	C-74 Control
<b>B-12</b>	B-75 Control	<b>B-75</b>	B-75 Control
<b>C-52</b>	C-52 Control/Darken	<b>A-77</b>	Wolf Call
<b>C-53</b>	C-52 Control	<b>A-78</b>	Wolf Call
<b>C-62</b>	C-62 Control	<b>A-79</b>	Wolf Call
<b>C-64</b>	C-64 Control	<b>C-80</b>	C-80 Control
<b>B-70</b>	B-75 Control	<b>B-82</b>	B-75 Control
<b>B-71</b>	B-75 Control		
<b>NOTE:</b> General test area status information for other test areas not listed can be received by contacting the JTTOCC at COMM: (850) 882-5800 or 2760/DSN: 872-5800 or 2760.			

**8.3. Test Area Operations Responsibilities.**

## 8.3.1. The JTTOCC will:

8.3.1.1. Coordinate daily test area air and ground operations and deconflict mission profiles by terminating/canceling the mission with the lower priority when prevailing conditions preclude the completion of all scheduled activity.

8.3.1.2. Advise EMC of those missions that have been terminated or canceled.

8.3.1.3. Provide test area control for unmanned test areas and act as a back-up point of contact for manned test areas.

## 8.3.2. Aircrew will:

8.3.2.1. Remain within their assigned airspace/profile.

8.3.2.2. Advise EMC 5 minutes prior to RTB.

## 8.3.3. EMC will:

8.3.3.1. Monitor all restricted and warning area activity and issue traffic advisories for present and/or pending traffic within adjacent test areas.

8.3.3.2. Advise when changes to the status of adjacent test areas occur. **NOTE:** EMC is not an appropriate test area control agency for approval of the application/delivery of ordnance or laser firing.

8.3.3.3. Place aircraft in a "safety hold" (immediate discontinuance of mission, aircraft/ground crew activities and follow ATC instructions until mission can be resumed or is canceled) when the aircraft is unable to remain within its approved profile, the safety of other aircraft is in jeopardy, until the problem is resolved, or the aircraft returns to base.

8.3.3.4. Advise the JTTOCC when aircraft are placed in or removed from a "safety hold," or when prevailing conditions, such as overlapping profiles, etc., preclude the completion of mission activity.

8.3.3.5. Route profile deviations reported by Eglin Mission through the ERCF Chief Controller to Chief, Airspace Management and Mission Planning (CAMMP). The CAMMP will initiate the 96 TW Form 115, *Profile Deviation Report*, and submit it to the Airspace Manager. Reports shall be completed within 30 days of initial notification of the deviation and submitted to 96 OGV for final disposition. Copies of the completed 96 TW Form 115 shall also be forwarded to 96 OSS/CC and 96 TW/SEF. Final reports shall be retained by 96 OSS/OSA.

8.3.4. Test Engineers/Project Officers. Test engineers or project officers will brief aircrew on conflicting or shared airspace missions.

#### **8.4. Departure Procedures.**

8.4.1. Arm/De-arm Areas. EAFB's arm/de-arm areas are depicted in [Attachment 2](#). The de-arm area for Duke Field is an 800 ft circle centered on TWY E.

8.4.2. Takeoff.

8.4.2.1. Takeoff directions should be selected, as far as safety permits, to allow the most expeditious route to the desired test area; however, takeoffs with externally loaded ordnance will normally not be made on RWY 1 for Cat I, II, and III ordnance. Under extenuating circumstances, the 96 OG/CC may authorize RWY 1 departures for Cat I, II or III ordnance. Prior approval is required.

#### **8.5. Test Area Procedures for Ordnance Delivery Missions.**

8.5.1. Clearance into a restricted/warning area must be obtained from EMC. Clearance from EMC into a restricted/warning area and profile is not clearance to release. Clearance to release on the test area must be obtained from the appropriate test area control authority listed in [Table 8.1](#) or IAW [Paragraph 8.2](#)

8.5.2. The flight lead shall check in with callsign, mission number, type ordnance (unless prohibited for security reasons) and number of aircraft in the flight.

8.5.3. Armament switches will remain OFF/SAFE until the aircraft enters the specified safety profile for the test area as defined in the Safety Appendix of the TD. At that time, the munitions may be prepared for release (warm-up, station selection, etc.) up to, but not including, final release arming. Final release arming selection will be made on base leg. For level and climbing deliveries, final release arming will not be made until wings level on final within the safety profile. Release arming will be returned to the OFF/SAFE position after each delivery if the aircraft will depart the safety profile.

8.5.4. During test missions, aircraft carrying ordnance will call "HOT" or "DRY" on both the base leg and final run-in position of each pass. The base call is required whether range instrumentation is being used or not. Aircraft position at the time of this call will be dependent on the mission profile shape and size, but will be no less than 30 seconds from the point at which the ordnance leaves the aircraft. The test area control authority will acknowledge each call and clear the pass "HOT" or "DRY." If no acknowledgment is received, the pass will be completed "DRY" and reaffirmed "DRY" by the aircraft commander. "HOT/DRY" base calls are not required for training missions.

8.5.5. Patterns and applicable test area procedures for a test mission will conform to the TD.

8.5.6. Prior to departing the test area on any ordnance delivery mission, each aircraft will be visually checked for hung ordnance. If a visual check cannot be accomplished, the pilot will assume hung ordnance and will follow the hung ordnance procedures. A visual check may be made by:

8.5.6.1. The delivery aircraft, if the crew has the station in sight,

8.5.6.2. The delivery aircraft or RCO, if the number of impacts can be counted,

8.5.6.3. The RCO--aircraft will not descend below 200 ft AGL nor fly within 500 ft slant range of the tower during the fly-by check (Cat I and II ordnance only) or,

8.5.6.4. A chase aircraft.

8.5.7. Pilots will safe all armament switches prior to departing the test area.

## Chapter 9

### RANGE OPERATIONS

**9.1. Purpose.** This chapter provides guidance for operations within the Eglin range complex and the expenditure of ordnance from fighter/attack/Forward Air Control (FAC)/AC-130 aircraft, and helicopters on test missions or weapons employment training missions. Modification of these procedures, if necessary, and complete procedures for any other test area will be contained in the Safety Appendix to the TD documenting the individual training programs. All coordinates listed are based on the World Geodetic Survey, 1984 (WGS 84), rounded to the nearest 100th and derived from *AAC Technical Facilities Manual, Volume II*, July 1996. For further information on available facilities and operating procedures within the Eglin Range Complex, refer to EAFBI 13-212, *Range Planning and Operations*.

#### **9.2. Policies.**

9.2.1. When operating outside the boundaries of the Eglin reservation, and not on an approved low-level route, comply with the procedures outlined in [Attachment 45](#) and [Paragraph 4.37](#)

**9.3. Test Area Safety.** In the event an aircraft crashes on the test area, the flight or deputy leader will assist the appropriate test area control authority in determining the exact crash location for relay to rescue crews. The flight/deputy leader will assist the Test Area Controller/RCO until released or fuel state requires departure.

#### **9.4. General Test Area Procedures.**

9.4.1. Aircraft will be cleared into and out of Eglin restricted airspace by EMC. Munitions release will be IAW [Chapter 8](#).

9.4.2. Patterns that require maneuvering outside restricted airspace will require prior coordination with EMC, who will attempt to obtain the necessary airspace from the appropriate agency.

9.4.3. A maximum of four aircraft may be scheduled in a test area at any one time, unless exceptions allowed by other guidance and approved by the RCO.

9.4.4. Up to three dissimilar types aircraft of compatible airspeed will be allowed in the weapons delivery pattern at any one time. Exceptions to these rules are authorized only with the specific approval of the 96 OG/CC, 85 TEG/CC, 1 SOW/CC, or 919 SOW/CC for aircraft under their operational control. A copy of that approval will be provided to 96 TW/SE.

#### **9.5. Test Area Entry.**

9.5.1. Flights proceeding directly to the test area after takeoff will be handed off to EMC as soon as possible after departure. If the flight is scheduled to fly a low-level route prior to test area entry, the flight leader should request a VFR clearance to the appropriate initial point (North IP or East IP) and contact EMC prior to entry into the restricted area.

9.5.2. Restricted Area Clearance. The flight leader will contact EMC for clearance into the restricted area. This call will include callsign, mission number, and number of aircraft in the flight. Permission to enter the restricted area must be received prior to entry. **NOTE:** Clearance into a restricted area from EMC is not permission to expend ordnance on the test area.

## 9.6. Test Area C-62 Procedures.

9.6.1. Flight lead will give flight callsign, number and type of aircraft, number and type ordnance, sequence of events, targets, release conditions, type of patterns to be flown, and verify any laser operations. Ordnance will not be expended without clearance from the Test Area Controller/RCO. Flight leaders will inform the Test Area Controller/RCO of any changes to events.

9.6.2. Holding Points and Altitudes: If immediate clearance into the restricted area or the test area is not possible, flights entering from other than low-level routes will hold at an assigned altitude and holding point until cleared by the controlling agency (ATC or EMC). Flights entering from the northern low-level route may hold at the north initial point (North IP).

9.6.2.1. Entry from Low-Level Routes. Entry onto the test area directly from a low-level route will be flown at the following altitudes:

9.6.2.2. North IP (30°58.5'N/86°21.0'W; 200 ft AGL)--Maintain a minimum of 1,500 ft AGL until reaching the boundary of the Eglin Reservation (Interstate 10). **NOTE:** Exercise extreme vigilance north of Test Area C-62 for helicopter and light aircraft traffic.

9.6.3. Specific allowable test area procedures are defined by the program's TD and associated Safety Appendix. EAFBI 13-212 lists current training targets, release conditions and, as appropriate, may be referenced in the Safety Appendix.

9.6.4. Simulated Nuclear Delivery and Radar Pattern Procedures.

9.6.4.1. Procedures will be according to **Table 9.1**

9.6.4.2. Switch positions: The master arm switch will not be turned ON until passing Interstate 10 or Highway 331 inbound to Test Area C-62. When performing multiple deliveries, the master arm switch will be turned OFF or SIM every time prior to departing the reservation. **NOTE:** The nuclear tone transmit switch will remain OFF at all times.

**Table 9.1. Test Area C-62 Delivery Headings and Pattern Directions.**

EVENT	HEADING	PATTERN DIRECTION
Nuclear (North IP)	159° ±5°	Right or Left
Nuclear (East IP)	282° ±5°	Right or Left
Nuclear (American Farms IP)	300°	Right Figure Eight



#### 9.6.4.3. Radio calls:

9.6.4.3.1. Turning base: "(Call sign), BASE."

9.6.4.3.2. Highway 331 or Interstate 10: "(Call sign), HIGHWAY, (event)."

9.6.4.3.3. Off target: "(Call sign), OFF, (wet or dry)."

#### 9.6.5. Night Procedures.

9.6.5.1. Flight will normally be two-ship maximum (three-ship allowed in nuclear pattern).

9.6.5.2. The position of SPADATS relative to C-62 will be briefed for all night attack missions.

9.6.5.3. Four clusters of lights are located around the main bombing pylon (TT-1). The lights are positioned on the cardinal headings around the edge of the cleared area, 200 ft from the pylon.

9.6.5.4. Entry and orbit are the same as daytime.

9.6.5.5. Minimum altitude for holding at night is 4,000 ft MSL.

9.6.5.6. All night missions require an RCO.

### 9.7. Test Area C-52N Procedures.

9.7.1. Test Area C-52N is a manned, scored test area that can be used for weapons employment training. Also, it can be used as an unmanned, unscored test area for random attacks.

#### 9.7.2. Entry/Holding.

9.7.2.1. Range Clearance. Normal entry will be from the Freeport Bridge orbit point; however, EMC can provide entry from other locations. When the flight is cleared to the assigned test area frequency, the flight leader will establish contact with the Test Area Controller/RCO (callsign "C- 52 Control/Darken"). Flight lead will give flight callsign, number and type of aircraft, number and type ordnance, sequence of events, target, release conditions, type of patterns to be flown, verify bomb fuse type, and verify any laser operations. The flight will be cleared on the test area or directed to hold. The flight will be advised of any restrictions to delivery patterns and given the current altimeter setting. Most recent wind information will also be provided. All flight members will acknowledge this information. Ordnance will not be expended without clearance from the Test Area Controller/RCO. Flight leaders will inform the Test Area Controller/RCO of any changes to events.

9.7.2.1.1. AC-130 Clearance Procedures. Comply with HFI 11-201, *Fixed and Rotary Wing Operations*, range clearing procedures for C-52.

9.7.2.1.2. Holding Points and Altitudes: If holding is required, the flight will hold northeast of the Freeport Bridge at a minimum altitude of 2,000 ft MSL (day) and 4,000 ft MSL (night).

9.7.3. Test Area Procedures: Specific allowable test area procedures are defined by the program's Test Directive and associated Safety Appendix. EAFBI 13-212 lists current training targets, release conditions and, as appropriate, may be referenced in the Safety Appendix.

9.7.4. Night Procedures.

9.7.4.1. All night procedures require an RCO.

9.7.4.2. During the Freeport Bridge entry, the flight will attain proper spacing on the turn to downwind or as briefed by the flight lead.

9.7.4.3. When a cargo-type flare ship is to be used on Test Area C-52N, flights will enter the test area at or above 4,000 ft MSL.

9.7.4.4. A maximum of four aircraft will be in the night test area pattern at any time. Four aircraft are authorized only if one is being used for flare delivery, otherwise no more than three aircraft are authorized.

9.7.4.5. The flare launch aircraft will fly a circular or elliptical right-hand pattern.

9.7.4.6. When operating with a flare delivery aircraft, all ordnance delivery patterns will be left hand. Attack heading is restricted to 090 degree  $\pm$  20 degree.

9.7.4.7. Flares will not be dropped when surface winds exceed 15 knots or when the fire index, as determined by Natural Resources Branch (96 CEG/CEVSN), presents an unacceptable hazard.

9.7.4.8. When flares are employed and the restrictions previously outlined in this chapter are complied with, aircraft are authorized to expend ordnance against any target within C-52N. When flare illumination is not used, deliveries are limited to targets illuminated by ground lights. At least two ground lights will be illuminated for weapons delivery using ground illumination only.

9.7.4.9. Descent from base leg altitude will not be made until after the turn to final is initiated, visual orientation with the target area is accomplished, and the flare ship is in sight.

9.7.4.10. It is the responsibility of the ordnance delivery aircrew to maintain safe separation from the flare ship.

9.7.4.11. Flare aircraft procedures (SUU-25):

9.7.4.11.1. If a flare should ignite while still in the dispenser, the SUU-25 will be jettisoned.

9.7.4.11.2. Aircraft carrying SUU-25 flare dispensers will select only one station at a time, and will dispense all flares from one station prior to dispensing flares from the other station.

9.7.4.11.3. Alternate release of flares and weapons by the same aircraft is prohibited.

9.7.4.11.4. Minimum altitude for flare deliveries is 3,000 ft AGL. **NOTE:** All LUU-2 deliveries will be planned to ensure flare is burned out by 500 ft AGL.

**9.8. Test Area B-6 (Eglin Field 6, Army Ranger Camp, Camp Rudder).** No aircraft will overfly Eglin Field 6 below 1,500 ft AGL (1,700 ft MSL) unless intending to land there or with specific approval of 96 OG/CC. This no-overflight area has a 1 NM radius centered on the Field 6 Runway intersection. In cases where overflight approval is granted, the responsible project officer will provide Camp Rudder operations personnel with information on date, time, altitude, speed, type of aircraft, and reason for the operation 48 hours in advance of the scheduled overflight.

**9.9. Rejoins/Departures.**

9.9.1. The Test Area Controller/RCO will broadcast a "5 MINUTES UNTIL END OF TEST AREA PERIOD " information call. Flight leaders will make sure their flights are clear of the test area at the conclusion of their test area period, or coordinate an extension through EMC.

9.9.2. After join-up and prior to departing the test area, the flight leader will advise the RCO and Test Area Controller of any hung/unexpended ordnance by type and aircraft. Hung/unexpended ordnance procedures are in [Chapter 7](#).

9.9.3. The flight leader will pass recovery requirements to EMC prior to departing the test area.

9.9.4. Emergency Departures. In an emergency, a pilot may clear the test area from any position and proceed as necessary to the field of intended landing. Extreme caution should be used in departing R-2914. As soon as possible notify EMC with intentions.

**9.10. RCO Procedures.** If an RCO is used to control a test area, the RCO will:

9.10.1. Prior to departing for the test area:

9.10.1.1. Determine test area status and accessibility.

9.10.1.2. Check on any deviations to scheduled test area missions.

9.10.1.3. Receive any additional instructions from the duty controller or SOF.

9.10.1.4. Be familiar with the Safety Appendix to the TD.

9.10.2. Be in position on the designated test area before the flight is cleared onto the test area.

9.10.3. Determine the operational status of the test area items listed in [Table 9.2](#) according to AFI 13-212.

**Table 9.2. AFI 13-212 Items.**

Skip Panels	Strafe Targets	Strafe Impact Area
Flares and Flare Gun	Control Tower	Bomb Targets
Acoustical Scorer	Wind Device	Facilities
Secondary Radios	Primary Radios	Personnel

- 9.10.4. Ensure test area facilities, personnel, and weather are suitable for test area operations.
- 9.10.5. Brief test area personnel on the scheduled missions and control procedures.
- 9.10.6. Confirm with the Test Area Controller that all range gates are closed and the test area has been visually cleared of all personnel prior to flight clearance on the test area.
- 9.10.7. Obtain current altimeter setting and information on any activity that may restrict test area operations from EMC.
- 9.10.8. Obtain flight lineup, crew numbers, events, and targets to be used from all flights prior to entering the test area.
- 9.10.9. Provide flight with clearance into the test area, the current altimeter setting, winds and weather observations, profile/pattern restrictions (if any), and assigned targets (when applicable).
- 9.10.10. Assume procedural control of all flights entering the test area and make sure aircraft are operated according to sound safety practices and appropriate directives.
- 9.10.11. Observe all aircraft in the pattern insofar as possible, noting specifically pattern and delivery techniques and spacing.
- 9.10.12. Issue clearance for each delivery upon determining that aircraft position and spacing will allow release of the appropriate ordnance and subsequent safe recovery of the aircraft.
- 9.10.13. Observe each aircraft flight path during the final phase of delivery.
- 9.10.14. Notify the aircrew when they are unsafe or have committed a foul (as established in AFI 11-214, *Air Operations Rules and Procedures*).
- 9.10.15. Assess fouls and take corrective action according to command directives.
- 9.10.16. Require all flight members to acknowledge directive radio transmissions.
- 9.10.17. Monitor bird activity in the target area, especially during hours around dawn and dusk, and advise aircrew members.
- 9.10.18. When flights are attempting to meet a firm time over target (TOT), verify weapons impact with a "SPLASH" call.
- 9.10.19. Monitor bomb plotting and event/score documentation in the control tower.
- 9.10.20. Ensure an orderly flow of missions on and off the test area by advising flights when they are approaching the final 5 minutes of their test area period.
- 9.10.21. As soon as departing flights have joined up, obtain from them a summary of hung/unexpended ordnance by type and aircraft.
- 9.10.22. For those flights exercising forward air controller (FAC) profiles on a manned test area, surrender tactical control to the FAC during the employment phases of the mission. All FAC controlling aircraft on any Eglin range/test area must be certified by the Chief RCO for each range upon which the individual will perform FAC duties (e.g., Range 52 Chief RCO to work Range 52, Range 62 Chief RCO to work Range 62). Monitor the conduct of the flight for compliance with stipulated safety criteria.

9.10.23. For those flights exercising random attack profiles, surrender RCO responsibilities to the FAC or flight lead. Make sure the test area is clear and all personnel have evacuated the complex before the flight enters the test area.

9.10.24. In addition to those duties outlined above, the night RCO will:

9.10.24.1. Make sure Jackson Guard has been consulted to determine if the burning index will allow flare delivery and surface winds do not exceed 15 knots.

9.10.24.2. If requested, establish flare drop sequence, altitude, delay, and burnout altitude with the flare ship.

9.10.24.3. Monitor burned out or dud flares and immediately notify flight members of potential hazards. Hold fighters high and dry if burned out or dud flares present a hazard, resuming operation only when the hazard has passed.

9.10.24.4. Make sure all delivery aircrew call "FLARE SHIP IN SIGHT" when turning final if a cargo ship is used for flaring or when a fighter flare ship delivery pattern opposes the fighter pattern.

9.10.24.5. Monitor aircraft spacing throughout the pattern with special emphasis on the final approach, recovery, and turn to downwind leg.

9.10.25. Crash Procedures. See [Paragraph 7.13](#)

9.10.26. Emergency Procedures: In accordance with [Chapter 7](#).

9.10.27. Weather:

9.10.27.1. Delivery patterns will not be allowed when the weather is below the specified minimum for that event. When a weather observer is not present on the test area, a pilot report (PIREP) can be used as an aid in determining test area weather.

9.10.27.2. The RCO can request additional test area weather observations when conditions so dictate. Additional weather requirements should be coordinated with 96 WS as early as possible.

9.10.28. Strafe Target Scoring:

9.10.28.1. Low-angle strafe scoring will normally be accomplished on the acoustically scored targets. Acoustical scores will be recorded and the number of hits transmitted to the delivery aircraft after each pass.

9.10.28.2. When strafe target manual scoring or maintenance is accomplished while aircraft are in the delivery pattern, the RCO will direct the flight to avoid overflight of the strafe target area by 1,500 ft MSL, permit no strafing, and allow weapons deliveries only on the nuclear target. The target team chief will illuminate the red warning lights inside the control tower and contact the RCO prior to departing for the strafe target area. Upon return, the team chief will again notify the RCO confirming that all personnel are off the test area.

9.10.28.3. Test area personnel will not normally hoist the strafe panels when surface winds exceed 20 knots.

9.10.29. Weapons Delivery Scoring Record. The RCO is responsible for proper completion of the weapons delivery scoring record. Although test area personnel actually complete the scoring record while the mission is in progress, it is essential that the RCO verify its accuracy by comparing it with the delivery data that was recorded in the control tower.

## Chapter 10

### OPERATIONAL PROCEDURES FOR THE EMPLOYMENT OF ELECTRONIC PROTECTIVE MEASURES (EPM), CHAFF, FLARES, AND LASERS

**10.1. Purpose.** This chapter provides guidance for procedures for the employment of EPM, chaff, flares, and lasers within the Eglin range complex. Frequency requirements will be coordinated with the DoD Gulf Area Frequency Coordinator [DoD GAFC (96 CS/SCXF)]. 96 OSS Frequency Control and Analysis (96 OSS/OSOQ) is the initial point of contact for notification of all Radio Frequency Interference (RFI), and will exercise authority to terminate radiation of the detected source of interference. The DoD GAFC will be the final authority for resolution of frequency conflicts/interference.

#### 10.2. Responsibilities.

10.2.1. Flight leaders, individual pilots, or Electronic Warfare Officers (EWO) will include applicable portions of this instruction during flight briefings.

10.2.2. Commanders of associate and transient organizations using self-protection systems are responsible for compliance with this chapter.

10.2.3. The host unit is responsible for providing instructions and procedures to units visiting the Eglin complex for missions involving EPM, chaff, or flare, regardless of whether or not the unit launches or recovers at EAFB.

10.2.4. Units desiring to deploy chaff and EPM must submit mission requests in advance to 96 OSS/OSOQ to coordinate the activity with FAA Jacksonville Center. If normal submittal times are not met, then blackboards will have to be submitted by 1300L one day prior to mission date. 96 OSS/OSOQ will be responsible for notifying the organization scheduling representative when missions are denied the use of chaff, flares, or EPM.

10.2.5. Frequency Control and Analysis (FCA) (96 OSS/OSOQ) is responsible for the scheduling of EPM and chaff within Eglin Restricted Areas and W-151/W-470. The area of responsibility is bounded on the north by 31°00'N, on the east by 83°30'W, on the south by 28° 15'N, and on the west by 86°48'W.

10.2.6. Operations officers will ensure all aircrew conducting EPM, carrying chaff, or flares on Eglin Complex fields or test areas understand the provisions of this instruction before operations are attempted. Additionally, they will establish procedures to ensure aircrew know the areas and times during which they are scheduled to employ EPM, chaff, or flares. EPM, chaff, and flares will not be employed in the Eglin test area complex unless scheduled in compliance with this instruction (as appropriate) and authorized by an appropriate TD and applicable Radio Frequency Authorization (RFA).

10.2.7. All aircraft conducting EPM or employing chaff are required to monitor 243.0 MHz (UHF Guard channel) and stop employment operations upon hearing a "STOP (or CEASE) BUZZER/STREAMBURST" call from the appropriate controlling agency [e.g., EMC, Military Radar Unit (MRU), or CCF (callsign CHAMBER)].

10.2.7.1. After “STOP (or CEASE) BUZZER/STREAMBURST” has been given and the aircraft has ceased EPM, then FCA will try to determine when and what part of the EPM can be resumed. If the EPM band causing the problem cannot be separated or the frequency bands cannot be determined, then the EPM is to remain off until the safety issue or emergency has been cleared and FCA has given the approval to resume.

10.2.8. Each unit will provide 96 OSS/OSOQ the name and phone numbers of its operations officer to contact for interference resolution.

**10.3. Authorized Systems.** All systems operating with a valid RFA from 96 CS/SCXF and properly scheduled through 96 RANSS/DOSF are authorized on the range.

#### **10.4. Scheduling.**

10.4.1. EPM, chaff, and flares should be requested as deletable items, if appropriate, to preclude missions being nonscheduled for conflicts in this area.

10.4.2. Missions desiring to use EPM will require inclusion of the appropriate RFA line numbers on the mission request form. EPM will be scheduled on a mission-to-mission basis, regardless of the working area.

10.4.3. Individual aircrew or units will contact their organization’s scheduling agency if changes to the schedule are desired. These changes must be coordinated through 96 RANSS scheduling prior to 1300L on the day preceding the mission.

**10.5. Departure Procedures.** Arming and de-arming of chaff and flare systems will be conducted in the normal arm/de-arm areas. Start, taxi, arming, and takeoff will be according to the procedures in [Chapter 8](#).

**10.6. Flare Employment Procedures.** All missions employing flares will be scheduled as hot missions. Any airspace changes must be coordinated through the JTTOCC, and informed that the mission intends to drop flares. JTTOCC shall notify the Coast Guard of changes in flare activity.

10.6.1. W-151/W-470: Flares may be employed within W-151 and W-470 provided the aircraft is above 1,500 ft AGL or the aircraft is below 1,500 ft AGL and at least 3 NM from any surface vessel, platform, or land mass. Flare operations within warning areas will be under flight lead control.

10.6.2. Overland: Flares may be employed over the Eglin Reservation only. Avoid expending flares over populated areas, personnel, or structures. Minimum release altitude over authorized test areas is 200 ft AGL, and 500 ft AGL when not over authorized test areas. Further restrictions may be imposed by 96 TW Test and Range Safety and central scheduling authority (96 OSS/OSO) when required.

**10.7. Chaff Employment Procedures:** All missions employing chaff shall be scheduled. Wind conditions and complexity of air traffic may make it necessary for EMC to terminate chaff dispersal. Chaff dispersal outside the parameters identified in this chapter must be coordinated according to FAA Handbook 7610.4, *Special Military Operations*, and approved by the GAFC.

10.7.1. W-151/W-470: Chaff will normally (depending upon test/training mission requirements) be authorized within W-151/W-470, provided it is included under an applicable RFA and meets the criteria for use outlined in the RFA.



10.7.1.1. Flight leads will ensure that operational chaff is not employed under any conditions that would cause it to drift outside of the scheduled working area. Areas of particular emphasis include to the south where it could interfere with the Gulf Crossing Air Routes, drift into the North-South or East-West Corridors, or affect air traffic facilities.

10.7.1.2. Chaff employment operations within the warning areas will be under flight lead control.

10.7.2. Overland: Chaff drops in R-2915A, north of Auxiliary Field 6 and west of A-77, are limited to 2,000 ft AGL and below. All other areas in R-2915A are limited to 4,000 ft AGL and below. Chaff over C-52 in R-2914A is limited to 4,000 ft AGL and below. No chaff is permitted in the North-South or East-West VFR Corridors. In all other areas of Egin restricted airspace, chaff is limited to 2,000 ft AGL and below. Strictly adhere to chaff type requirements defined in the RFA (i.e., cannot use wide-band chaff when RFA permits use of only narrow-band chaff).

10.7.2.1. Wind conditions and traffic complexity may make it necessary for ATC to terminate chaff expenditure authorization. The final authority rests with EMC.

**10.8. EPM Employment Procedures:** All missions employing EPM shall be scheduled. Normally, operations for F-15 Internal Countermeasures Set (ICS) I-band and below will be approved, without exception, within W-151C, D, E, and F, provided operating under an approved RFA. Flight leads, individual pilots, and EWOs are responsible for ensuring that EPM is not conducted outside of the areas and times scheduled. Frequency interference problems will be reported real-time to the JTTOCC. 96 OSS/OSOQ FCA will coordinate with the appropriate organization operations officer(s) for immediate resolution.

### **10.9. Recoveries.**

10.9.1. Pilots will ensure all EPM, chaff, and flare switches are OFF/SAFE prior to departing the test and training area.

10.9.2. Aircraft returning to EAFB with unexpended chaff or flares may recover to the overhead pattern.

10.9.3. De-arming will be according to [Chapter 8](#).

10.9.4. Following de-arming, aircraft may return to parking on the Test Ramp according to EAFBMAN 91-202.

10.9.5. Any malfunction of chaff or flare systems will be handled IAW [Chapter 7](#) procedures.

### **10.10. Airborne Laser Operations.**

10.10.1. In order to minimize the safety risk and maximize the opportunity for effective testing/training, the procedures outlined in the following paragraphs will be used when employing a targeting pod (e.g., LANTIRN/LITENING/SNIPER), or any other airborne laser designation system.

10.10.1.1. The training or eye-safe laser (1.54 microns) may be used during any mission on or off the Eglin complex, including low-level routes. Aircrew will confirm the laser is set to 1.54 microns during the preflight inspection. In-flight, aircrew will confirm that a "T" is present on the cockpit targeting pod display prior to lasing. If the pod power is cycled after a laser failure indication, the laser may power up in the combat "L" setting (1.06 microns). Confirmation of the "T" indication is mandatory to prevent potentially serious eye damage to ground personnel.

10.10.1.2. Combat airborne lasers (1.06 microns) may be used for test or training missions on the Eglin test area complex targets listed in [Table 10.1](#) or as approved under the Test/Training Directive's respective Safety Appendix.

**Table 10.1. Laser Targets.**

<b>TARGET</b>	<b>RUN-IN</b>
<b>C-62 TT-1,4,6</b>	270 degree or 159 degree
<b>C-52N TT-2,8,25</b>	270 degree
<b>B-70 TT-1,3,7</b>	237 degree
<b>B-75 TT-7</b>	237 degree
<b>NOTE:</b> AC-130s using laser target designators for altitude updates only; see HFI 11-201, for required procedures.	

#### 10.10.2. Airborne Laser Operations Restrictions and Procedures.

10.10.2.1. When scheduling missions or requesting airspace, test engineers or squadron schedulers will indicate on the Center Scheduling Enterprise (CSE) mission request that combat lasing operations will be performed during the mission. If the mission request forms do not reflect this desire, airborne lasing with combat (1.06 microns) lasers cannot be performed. Real-time requests for combat (1.06 microns) lasing will not be authorized.

10.10.2.2. Once airborne and on range, aircrew are required to get clearance from the appropriate test area control authority for airborne combat (1.06 microns) laser operations, and range control must verify that eye protection is being used and the hazardous area is clear. Aircrew should make a positive "laser on" and "laser off" call during weapon delivery passes.

#### 10.10.3. Weapon Delivery Procedures.

10.10.3.1. For any delivery where the target will be directly lased, the aircrew will not activate the laser until the target has been positively identified, an unrestricted line of sight exists, and a steady track on the target is assured. The aircrew should cease lasing after weapon release for unguided munitions, after weapon impact for guided weapons, or if the laser drifts towards the edge of the clear area.

10.10.3.2. For deliveries where the target is not directly lased [i.e., Continuously Designated Impact Point (CDIP)/Continuously Computed Impact Point (CCIP)], the aircrew will not activate the laser until rolled-out wings level on final, and the laser (or piper) is aimed within the clear area. A good rule of thumb is to activate the laser at 5 sec prior to release. Cease lasing after weapon release.

10.10.3.3. Safety will determine the limits for test programs and reference applicable parent regulations to determine limits per MDS for training events.

## Chapter 11

### SUPERSONIC OPERATIONS

**11.1. Supersonic Operations.** Supersonic flight operations over the Eglin Land Range and the Eglin Gulf Test and Training Range shall be conducted IAW AFI 13-201, *Airspace Management*, and the Eglin Supersonic Waiver 75-1.

11.1.1. Supersonic training may be accomplished over water above 10,000 ft MSL and at least 15 NM from the coast. Supersonic training profiles below 10,000 ft MSL will be flown a minimum of 25 NM from the coast if on a southerly heading, and a minimum of 50 NM from the coast if on a northerly heading.

11.1.2. Supersonic flight test profiles must be approved through the TAB process and adhere to the following restrictions:

11.1.2.1. All overland profiles below FL300 shall be performed on Test Area B-70 and shall be restricted to a maximum over-pressure of 3.5 pounds per square foot (PSF) at a distance of 5 NM from the aircraft ground track. In no case will an over-pressure exceeding 3.5 PSF be allowed outside of the Eglin Land Range from the surface to FL300.

11.1.2.2. All overland supersonic profiles shall terminate in a level flight attitude so as not to expand the over-pressure envelope towards the ground.

11.1.2.3. Vehicular traffic on state roads and all personnel within the reservation shall be adequately protected from over-pressure exposure during scheduled runs.

11.1.2.4. No supersonic missions over land shall be flown unless the test engineer has notified the Public Affairs Office (96 TW/PA) the day prior to the mission. The test engineer should again notify 96 TW/PA 1 hour prior to aircraft takeoff to confirm the mission status and update any changes. Aircrew shall confirm that this has been done before going to the aircraft.

11.1.2.5. Test teams shall make every effort to minimize dry supersonic passes overland.

11.1.2.6. Supersonic flight test profiles may be accomplished over water above 10,000 ft MSL at least 25 NM from the coast. Supersonic flight test profiles below 10,000 ft MSL will be flown a minimum of 25 NM from the coast if on a southerly heading, and a minimum of 50 NM from the coast if on a northerly heading.

11.1.2.7. For supersonic flight test runs below 10,000 ft MSL, a boat check will be accomplished prior to commencing the test run to ensure there are no boats within 5 NM of the ground track.

## Chapter 12

### REMOTELY PILOTED AIRCRAFT (RPA)

**12.1. General.** RPA use airspace and airfields to conduct both test and training missions. Training missions include initial qualification training, mission qualification training and proficiency training of small RPA operators and sensor operators. This chapter will provide information on airfields, airspace, airspace request processes, safety requirements, emergency procedures, and weapons employment.

**12.2. Airfields for RPA.** Depending on the type and size of RPA, a prepared runway/landing zone may or may not be required. Small Unmanned Aircraft Systems (SUAS) and Micro Air Vehicles (MAV) may be hand launched (e.g., WASP, Raven), pneumatically launched (e.g., Shadow, Scan Eagle), or takeoff from a runway (e.g., Hunter, Dakota, Pioneer). There currently is no universally accepted definition of RPA, SUAS, or MAV between DoD and commercial vendors. From a safety perspective, anything above 20 knots or 1 pound can be lethal. SUAS may be recovered by net, skyhook, belly in with no landing gear, or land on a runway. Hand-launched and pneumatic-launched SUAS, to include Vertical Takeoff or Landing (VTOL) SUAS, may operate from open fields or roads anywhere approved on the Eglin Land Range. In addition, RPA may operate from a boat on the bays surrounding Eglin's south side or some of the waterways contained within Eglin's restricted or warning areas as approved within the scope of the TD and Safety Appendix. The following airfields/landing zones are located on the Eglin Land Range (Choctaw NOLF, Duke Field, Field 1, Field 7, and Field 6 support manned test and training operations of both fixed wing aircraft and helicopters.):

12.2.1. Choctaw Navy Outlying Field (NOLF). Choctaw NOLF is located at the western end of the Eglin Land Range (outside restricted airspace) and is operated by the Navy for Navy pilot training. There is one asphalt runway, 18/36, 8,000 ft by 150 ft. When the ATC tower is in operation, the airspace is non-joint use military Class D. All other times the airspace is Class E. RPA operations in the past have been from the diagonal taxiway with flight operations to the east side of the field. The Class D adjoins R-2915A.

12.2.2. Eglin Auxiliary (Aux) Field 6. Eglin Aux Field 6 (Test Area B-6) is located in the north center of R-2915A. There is an asphalt landing zone, 18/36, 4,000 ft by 60 ft with concrete pads on each end for helicopter and CV-22 operations. There is no ATC tower at the field. There is a UHF radio repeater that provides communications to the ERCF from aircraft and operators on the ground. SUAS launch and recovery from the landing zone or taxiways requires coordination with other missions and the Army Rangers. AFSOC SUAS training and various one-of-a-kind/ unique experimental RPA have used this facility.

12.2.3. Eglin Aux Field 7. Eglin Aux Field 7 (Test Area B-12) is located in the central part of R-2915A. There are various closed runways in various states of disrepair which may be adequate for SUAS operations depending on the size of wheels and strength of landing gear. Hand- and pneumatic-launched SUAS would be able to operate provided the surface is adequate for recovery or a soft recovery system is used. Field 7 offers a more remote location for explosives and laser testing; however, it is often difficult to schedule due to high-priority large footprint missions on Test Area B-70 nearby. There is no ATC tower at the field.

12.2.4. Eglin Aux Field 1. Eglin Aux Field 1 (Test Area C-5) is located in the northwest section of R-2914A. There is a 4,000 ft landing zone running 18/36. SUAS launches and recoveries may be made from other hard surfaces of the old airfield. There is no ATC tower at the field. There are some available office buildings, storage and Test Area C-72 control nearby.

12.2.5. Santa Rosa Island (SRI) RPA Operations. Potentially suitable launch and recovery areas are located at Test Site A-15 on Santa Rosa Island in R-2915B. There are two launch and recovery areas made of concrete. There is no ATC tower at the two sites. Because of the close proximity to Hurlburt Field's Class D airspace and the East-West Corridor, special safety precautions typically apply to these Test Directive Safety Appendixes.

12.2.6. Eglin Aux Field 3. Eglin Aux Field 3 (Duke Field) is located to the north of EAFB in the 14 CFR Part 93 North-South Corridor. See [Chapter 2](#) and [Chapter 5](#) for information regarding this field. When the ATC tower is in operation, the airspace is non-joint use military Class D. This airspace adjoins R-2918. An FAA facility COA must be established for RPA operations from this field, through the Class D airspace, and into restricted areas.

12.2.7. Other Airfields/Landing Zones. As new customers and requirements develop in the future, new airfields/landing zones may be constructed on the range through existing Range Configuration Control Committee (RCCC) and Range Development Executive Steering Committee (RDESC) or various existing areas used for RPA operations where approved through Test Directive, Environmental, and Safety review processes. 96th Test Wing personnel responsible for test and training execution will be able to provide specific information. When appropriate, new airfields/landing zones will be added to this document.

**12.3. Airspace for SUAS.** The USAF and the FAA require RPA operations be conducted in restricted and warning airspace where possible, IAW the Memorandum of Agreement for Operations of RPA in the NAS (24 Sep 07) or waived/authorized per specific RPA type and operations area by the FAA. The Eglin Range has eight restricted areas and two warning areas which may be used for RPA operations. See [Chapter 3](#) for descriptions of restricted and warning areas under the management of the Eglin Airspace Management Office and available via the Center Scheduling Enterprise (CSE) system. RPA operations will be allowed in all restricted areas and all warning areas provided all required TD, Environmental, and Safety Reviews and approvals have been obtained and safety requirements are followed IAW AFTCI 91-202, *AFTC Test Safety Review Process*, and the 96 TW supplement. Restricted airspace over land outside the Eglin Reservation or land not owned by the government must be specifically approved on a case-by-case basis through 96 TW/SE. RPA operations over populated areas or private land, yet within Eglin's restricted airspace are designated as an elevated risk and require appropriate approval levels in accordance with AFTCI 91-202 and the 96 TW supplement unless the particular RPA, operator, training, and maintenance have established and demonstrated operational airworthiness essentially equivalent to that of manned aircraft rates. The Santa Rosa Island Controlled Firing Area may not be used for RPA operations. Operations outside of restricted and warning areas may be accomplished provided the sponsor of the mission has obtained approval from the FAA through an RPA COA (FAA Form 7711-2) or by the FAA approving a nonjoint use military Class D facility COA.

12.3.1. Nonjoint Use Military Class D Airspace. Choctaw NOLF, Duke Field and Hurlburt Field all have tower-controlled nonjoint use military Class D airspace. The FAA and DoD will allow RPA operations within nonjoint use military Class D airspace provided procedures are established and an ATC or facility COA is approved by the FAA and USAF/USN. RPA operations at the above locations must have an airworthiness certificate/statement for each system and the operator/observer must be qualified, meet currency proficiency requirements, and have a current FAA Class II medical certificate or military equivalent. In addition, a NOTAM describing the RPA operations must be issued at least 24 hours prior to flight. See FAA Aviation Safety Unmanned Aircraft Program Office (AIR-160) guidance.

12.3.2. Class G Airspace. The FAA and DoD have agreed to allow military RPA operations within Class G airspace in the NAS for SUAS weighing less than 20 pounds and within visual range of the operator. The Class G airspace must be above land owned or leased by the government and not closer than 5 NM from any civil airport, below 1,200 ft AGL, and a NOTAM will be issued during the time of use. RPA operations must have an airworthiness certificate/statement for each system and the operator(s) and observer(s) must be qualified, meet current proficiency requirements, and have current FAA Class II medical certificates or military equivalent. In addition, a NOTAM must be issued at least 24 hours prior to operations. AFSOC/A3OUI will provide requesters with a Class G request checklist and coordinate the request with the Eglin Airspace Manager. There is a small area of land outside the northern boundary of R-2914A or Choctaw NOLF during times of use when the ATC tower is not manned which are considered Class G airspace for the purpose of operating military RPA. Call the Eglin Airspace Management Office for details to operate in this area. See FAA Order 1110.150, *Small Unmanned Aircraft System Aviation Rulemaking Committee*.

12.3.3. Operations in the NAS. If there is a requirement to operate RPA outside of restricted or warning areas and not in non-joint use military Class D airspace, or in Class G airspace, then an approved COA must be received from the FAA. RPA operations in the Eglin Part 93 airspace, North-South and East-West Corridors will require a COA. The Eglin Airspace Management Office can provide the details to apply for the COA.

**12.4. Emergency Procedures.** If an emergency should occur, all operators will adhere to the following basic sequence: aviate, navigate, and communicate. Operators will refer to the published emergency procedures checklists for the system they are operating. As soon as practical, after completing the appropriate emergency procedures checklist, notify the controlling agency and appropriate command and control (C2) agency of the description and extent of the difficulty, intentions, assistance required, and other pertinent information. Operators will report deviations from directives that occur as a result of an emergency IAW applicable unit governing guidance.

**12.5. Weapon Employment.** Small RPA typically do not directly employ weapons; however, they are enablers for air-to-surface weapons delivery and may contain hazardous lasers or designators. Depending upon the specific capabilities of the SUAS and the training and certification of the operators, they may be employed for tasks ranging from target detection and identification, to target area orientation for visual talk-on, to coordinate generation, to target marking or laser target designation. In the event an RPA does employ a weapon, the Non-Nuclear Munitions Safety Board stipulations, delivery, and hung ordnance procedures will be addressed in the TD and associated appendices.

SCOTT A. CAIN,  
Brigadier General, USAF  
Commander



**Attachment 1****GLOSSARY OF REFERENCES AND SUPPORTING INFORMATION*****References***

14CFR Part 93, *Special Air Traffic Rules*, 11 Dec 20

96TWI 21-102, *Parking, Launch, and Recovery of Explosive Loaded Aircraft*, 26 Feb 15

AFI 10-1001, *Civil Aircraft Landing Permits*, 22 Aug 18

AFI 11-208, *Department of Defense Notice to Airmen (NOTAM) System*, 12 Feb 18

AFI 11-214, *Air Operations Rules and Procedures*, 7 Jul 20

AFI 11-218, *Aircraft Operations and Movement on the Ground*, 1 Aug 19

AFI 11-235, *Specialized Refueling Operations*, 30 May 19

AFI 13-201, *Airspace Management*, 6 Oct 13

AFI 13-207-O, *Preventing and Resisting Aircraft Piracy (Hijacking) (FOUO)*, 4 Feb 19

AFI 13-213, *Airfield Driving*, 3 Feb 20

AFI 32-1043, *Managing, Operating, and Maintaining Aircraft Arresting Systems*, 4 Mar 15

AFI 33-322, *Records Management and Information Governance Program*, 22 Mar 20

AFI 36-2903, *Dress and Personal Appearance of Air Force Personnel*, 6 Feb 20

AFI 48-104, *Tobacco Free Living*, 10 Jul 19

AFMAN 11-202V3\_AFMCSUP, *General Flight Rules*, 23 Nov 15

AFMAN 13-204\_AFMCSUP\_I, *Airfield Operations, Procedures, and Programs*, 30 Apr 13

AFMAN 13-204V3, *Airfield Operations Procedures and Programs*, 21 Jul 20

AFMAN 13-212V1, *Range Planning and Operations*, 21 Jun 18

AFMAN 91-110, *Nuclear Safety Review and Launch Approval for Space or Missile Use of Radioactive Material and Nuclear Systems*, 21 May 19

AFMAN 91-201\_EGLINAFBSUP\_I, *Explosives Safety Standards*, 11 Aug 11

AFMCI 11-201, *Supervision of Flight Operations*, 31 Jul 07

AFPD 11-2, *Aircrew Operations*, 30 Jan 19

AFTCI 91-202, *AFTC Test Safety Review Process*, 12 Nov 18

EAFB Plan 31-101, *Integrated Defense Plan*, 17 Apr 15

EAFB Plan 10-2, *Installation Emergency Management Plan*, 29 Oct 19

EAFB Plan 10-245, *Installation Antiterrorism Plan (FOUO)*, 25 Sep 14

EAFB Plan 91-204, *Mishap Response Plan (FOUO)*, 3 Jun 15

EAFB Plan 91-212, *Bird Wildlife Aircraft Strike Hazard Plan*, 1 Jan 15

EAFBI 13-200, *Eglin Mission Scheduling and Control*, 23 Jul 19

EAFBI 13-212, *Range Planning and Operations*, 17 Mar 11

EAFBI 13-213V1, *Eglin AFB Airfield Driving Instruction*, 8 Jan 19

EAFBI 13-213V2, *Duke Field Airfield Driving Instruction*, 8 Jan 19

EAFBMAN 91-202, *Designation of Explosive Loaded Aircraft Parking Areas, Load/Unload Areas, and Arm/de-arm Areas*, 4 Feb 19

FAA Order 1110.150, *Small Unmanned Aircraft System Aviation Rulemaking Committee*, 4 Oct 08

HFI 11-201, *Aircraft Operations*, 8 Dec 15

JO 7110.65, *Air Traffic Control*, 20 Jun 19

JO 7210.766, *Unmanned Aircraft Operations in the National Airspace System (NAS)*, 25 Nov 15

JO 7400.10, *Special Use Airspace*, 14 Feb 20

JO 7610.4, *Special Operations*, 5 May 19

UFC 3-260-01, *Air Field and Heliport Planning and Design*, 4 Feb 19

*Uniform Code of Military Justice (UCMJ) Article 92*, 2016

### ***Prescribed Forms***

96TW Form 115, *Profile Deviation Report*

### ***Adopted Forms***

AF Form 847, *Recommendation for Change of Publication*

AF Form 853, *Air Force Wildlife Strike Report*

AF Form 3616, *Daily Record of Facility Operation*

AF Form 4058, *Airfield Operations Policy Waiver*

DD Form 175, *Military Flight Plan*

### ***Abbreviations and Acronyms***

**96TW**—96th Test Wing

**AAC**—Air Armament Center (Deactivated 18 July 2012)

**ACC**—Air Combat Command

**AFMC**—Air Force Materiel Command

**AFSOC**—Air Force Special Operations Command

**AGL**—Above Ground Level

**AHAS**—Avian Hazard Advisory System

**AMOPS**—Airfield Management Operations

**AMP**—Airfield Marking Pattern  
**AOB**—Air Operations Board  
**AOF**—Airfield Operations Flight  
**APLN**—Tiltrotor Airplane Mode  
**ASOS**—Automated Service Observing System  
**ASR/DASR**—Digital Airport Surveillance Radar  
**ASRR**—Airfield Suitability and Restrictions Report  
**ASU**—Airspace for Special Use  
**ATC**—Air Traffic Control  
**ATCAA**—Air Traffic Control Assigned Airspace  
**ATCAL**S—Air Traffic Control and Landing Systems  
**ATIS**—Automatic Terminal Information Service  
**BASH**—Bird Aircraft Strike Hazard  
**BDOC**—Base Defense Operations Center  
**BFD**—Battery Firing Device  
**BWC**—Bird Watch Condition  
**CBU**—Cluster Bomb Unit  
**CCF**—Central Control Facility  
**CDDAR**—Crash Damage or Disabled Aircraft Recovery  
**CE**—Civil Engineering  
**CFA**—Controlled Firing Area  
**CFR**—Code of Federal Regulations  
**CMA**—Controlled Movement Area  
**COA**—Certificate of Authorization  
**CPI**—Crash Position Indicator(s)  
**CSE**—Center Scheduling Enterprise  
**CST**—Customer Support Team  
**CTAF**—Common Traffic Advisory Frequency  
**DoD**—Department of Defense  
**DV**—Distinguished Visitor  
**DZ**—Drop Zone  
**EAFB**—Eglin AFB

**EAFBI**—Eglin Air Force Base Instruction  
**ECM**—Electronic Countermeasures  
**ECP**—Entry Control Point  
**ELT**—Emergency Locator Transmitter(s)  
**EMC**—Eglin Mission Control  
**EOD**—Explosive Ordnance Disposal  
**EPM**—Electronic Protective Measures  
**ERCF**—Eglin Radar Control Facility  
**ETA**—Estimated Time of Arrival  
**EWO**—Electronic Warfare Officer  
**EWTA**—Eglin Water Test Areas  
**FAA**—Federal Aviation Administration  
**FAC**—Forward Air Control/Controller  
**FAR**—Federal Aviation Regulation  
**FARP**—Forward Area Refueling Point  
**FCA**—Frequency Control and Analysis  
**FCF**—Functional Check Flight  
**FLIP**—Flight Information Publication  
**FM**—Frequency Modulation  
**FOD**—Foreign Object Damage  
**FSL**—Flashing Strobe Light  
**FW**—Fighter Wing  
**GAFC**—Gulf Area Frequency Coordinator  
**HCP**—Hot Cargo Pad  
**HD**—Hazard Division  
**HE**—High-Explosive  
**HFI**—Hurlburt Field Instruction  
**HS**—Hardstand  
**ICS**—Internal Countermeasures Set  
**IFE**—In-Flight Emergency  
**IFR**—Instrument Flight Rules  
**ILS**—Instrument Landing System

**IMT**—Information Management Tool  
**IP**—Initial Point  
**IR**—Infrared  
**IWDS**—Improved Weather Dissemination System  
**JO**—Job Order  
**JTTOCC**—Joint Test and Training Operational Control Center  
**KIAS**—Knots Indicated Airspeed  
**LHA**—Landing Helicopter Assault  
**LOA**—Letter of Agreement  
**LOLA**—Live Ordnance Loading Area  
**LOP**—Letters of Procedure  
**LSO**—Landing Systems Officer  
**LUU**—Luminating Unit  
**LZ**—Landing Zone (also Assault Landing Zone)  
**MACA**—Mid-Air Collision Avoidance  
**MARSA**—Military Authority Assumes Responsibility for Separation of Aircraft  
**MAV**—Micro Air Vehicle  
**MOA**—Memorandum of Agreement  
**MOA**—Military Operations Area  
**MOCC**—Maintenance Operations Control Center  
**MSL**—Mean Sea Level  
**NAS**—National Airspace System  
**NAVAID**—Navigational Aid  
**NM**—Nautical Mile(s)  
**NOLF**—Navy Outlying Field  
**NOTAM**—Notice to Airmen  
**NVD**—Night Vision Device  
**NVIS**—Night Vision Imaging Systems  
**OG/CC**—Operations Group Commander  
**OH SFO**—Overhead Simulated Flameout  
**OPR**—Office of Primary Responsibility  
**PAOL**—Pilot/AOF Liaison Program

**PCAS**—Primary Crash Alarm System  
**PFO**—Precautionary Flameout  
**PMI**—Preventive Maintenance Inspection  
**PPR**—Prior Permission Required  
**PSF**—Pounds per Square Foot  
**QA**—Quality Assurance  
**RAPCON**—Radar Approach Control  
**RCO**—Range Control Officer  
**RCR**—Runway Condition Reading  
**RDS**—Records Disposition Schedule  
**RFA**—Radio Frequency Authorization  
**RPA**—Remotely Piloted Aircraft  
**RSC**—Runway Surface Condition  
**RSRS**—Reduced Same Runway Separation  
**RTB**—Return to Base  
**RWY**—Runway  
**SC**—Senior Controller  
**SCN**—Secondary Crash Net  
**SFC**—Surface  
**SFO**—Simulated Flameout  
**SI**—Straight-in  
**SM**—Statute Miles  
**SOF**—Supervisor of Flying  
**SPADATS**—Space Detection and Tracking System  
**SRB**—Safety Review Board  
**SUA**—Special Use Airspace  
**SUAS**—Small Unmanned Aircraft System(s)  
**TA**—Transient Alert  
**TD**—Test Directive  
**TERPS**—Terminal Instrument Procedures  
**TP**—Target Practice  
**TTA**—Tower Transition Area

**TW/CC**—Test Wing Commander

**TWY**—Taxiway

**UFC**—Unified Facilities Criteria

**UNL**—Unlimited

**USDA**—United States Department of Agriculture Wildlife Services

**UTAI**—Up To And Including

**UTBNI**—Up To But Not Including

**VETA**—VFR East Training Area

**VFR**—Visual Flight Rules

**VL**—Vertical Landing

**VMC**—Visual Meteorological Conditions

**VORTAC**—VHF Omnidirectional Range/Tactical Air Navigation

**VSTOL**—Vertical/Short Takeoff or Landing

**VTOL**—Vertical Takeoff or Landing

**WS**—Watch Supervisor

**ZJX**—Jacksonville Air Route Traffic Control Center

Attachment 2

EGLIN AFB AIRFIELD DIAGRAM

Figure A2.1. Eglin AFB Airfield Diagram.

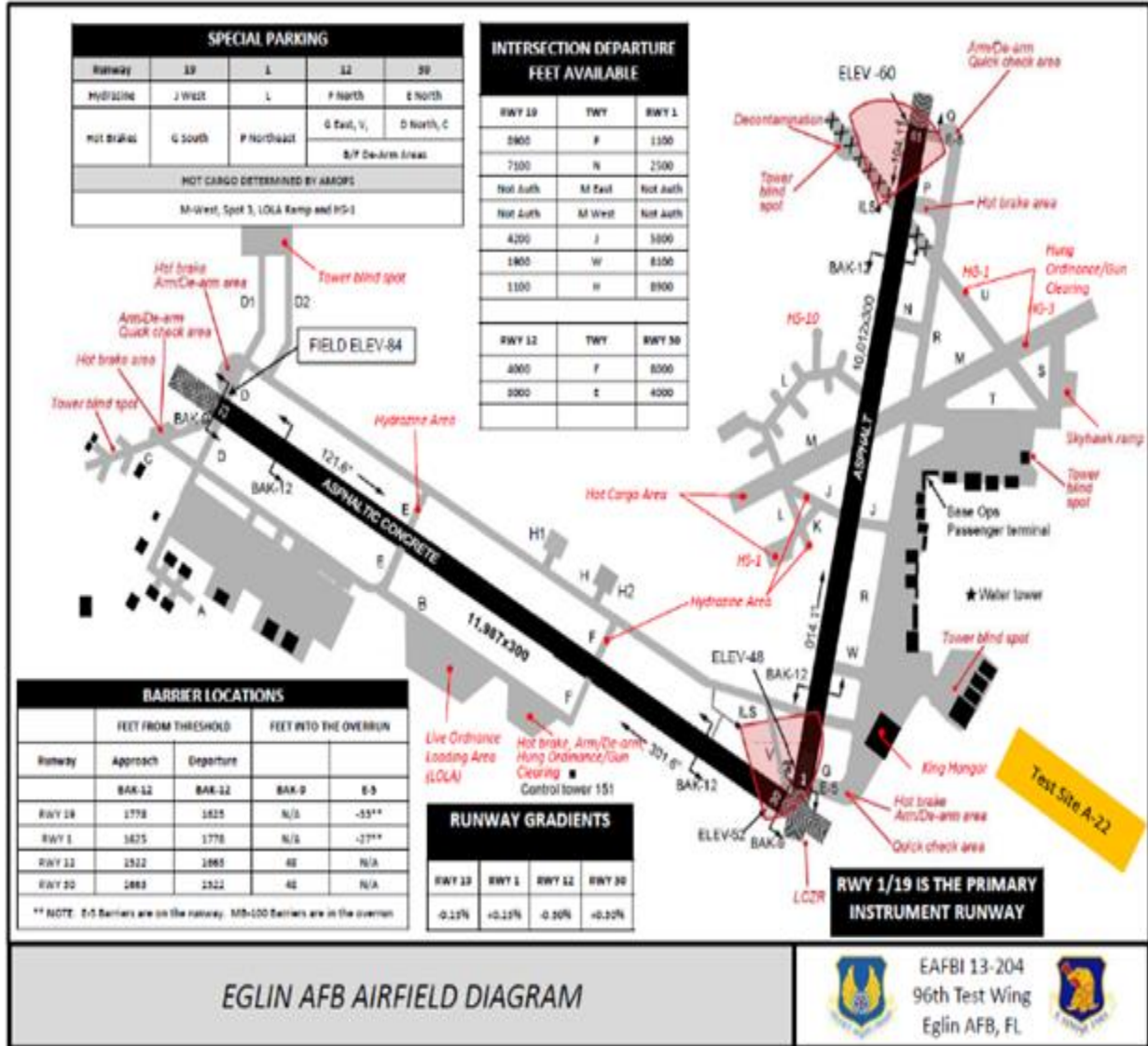



Attachment 3

EGLIN AFB CONTROLLED MOVEMENT AREA DIAGRAM

Figure A3.1. Eglin AFB Controlled Movement Area Diagram.

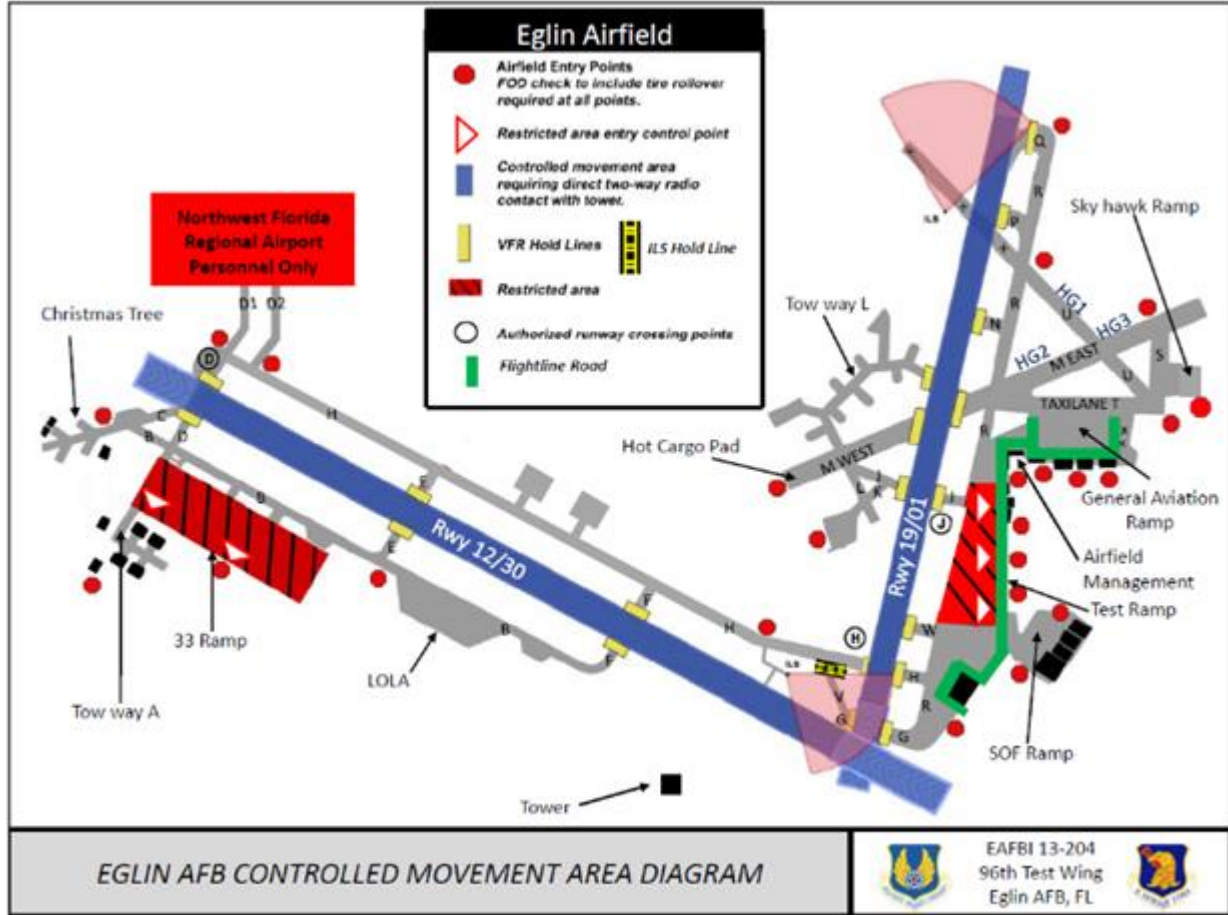

Attachment 4

EGLIN AFB HOT PIT/LOLA PROCEDURES

Figure A4.1. Eglin AFB Hot Pit/Lola Procedures.



<p>EGLIN AFB HOT PIT/LOLA PROCEDURES</p>	 <p>EAFBI 13-204 96<sup>th</sup> Test Wing Eglin AFB, FL</p> 
--	---

Attachment 5

EGLIN AFB VFR OVERHEAD PATTERNS

Figure A5.1. Eglin AFB VFR Overhead Patterns.

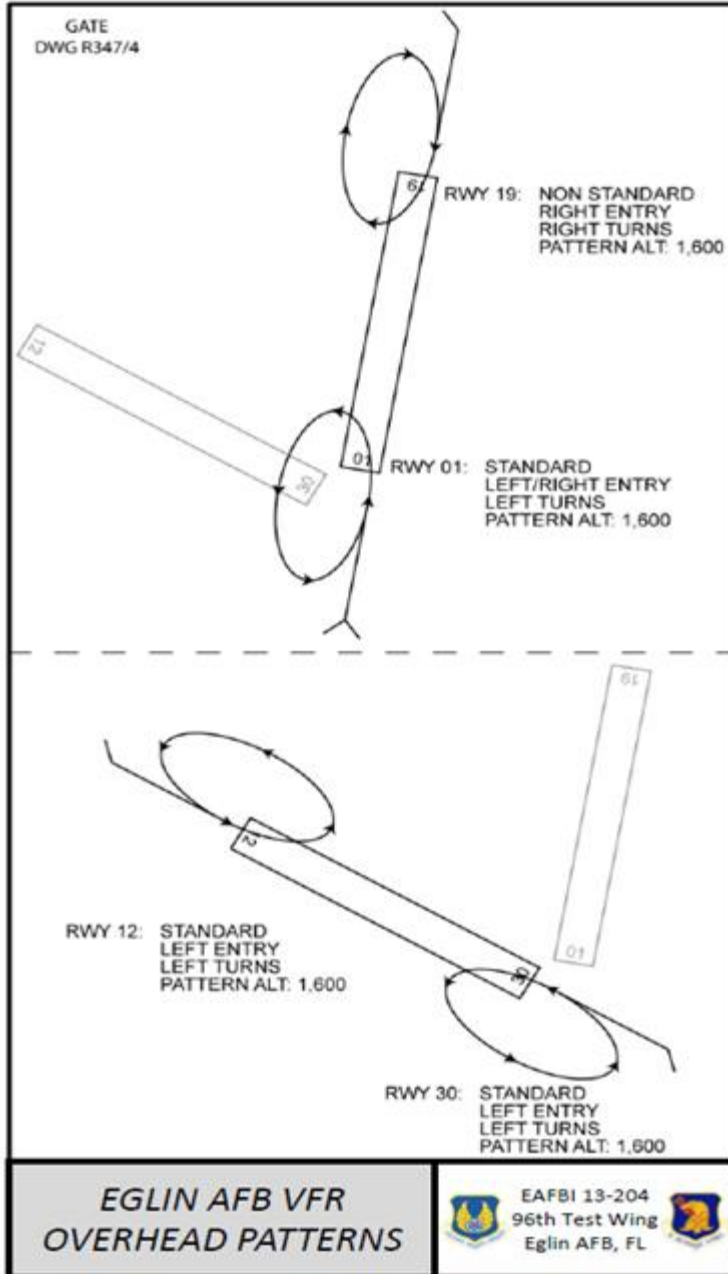

Attachment 6

EGLIN AFB VFR RECTANGULAR PATTERNS

Figure A6.1. Eglin AFB VFR Rectangular Patterns.

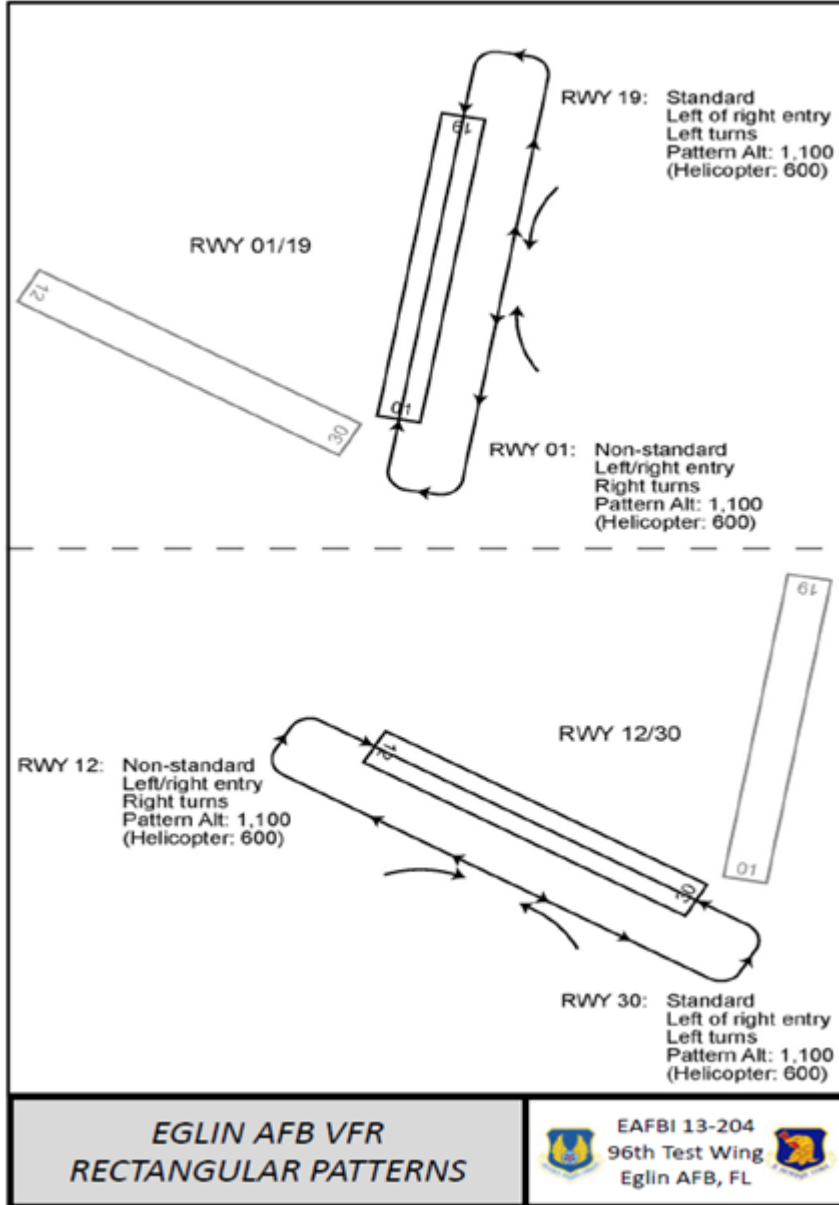

Attachment 7

EGLIN VFR TRAFFIC PATTERNS RUNWAYS 12/19 ACTIVE

Figure A7.1. Eglin VFR Traffic Patterns Runways 12/19 Active.

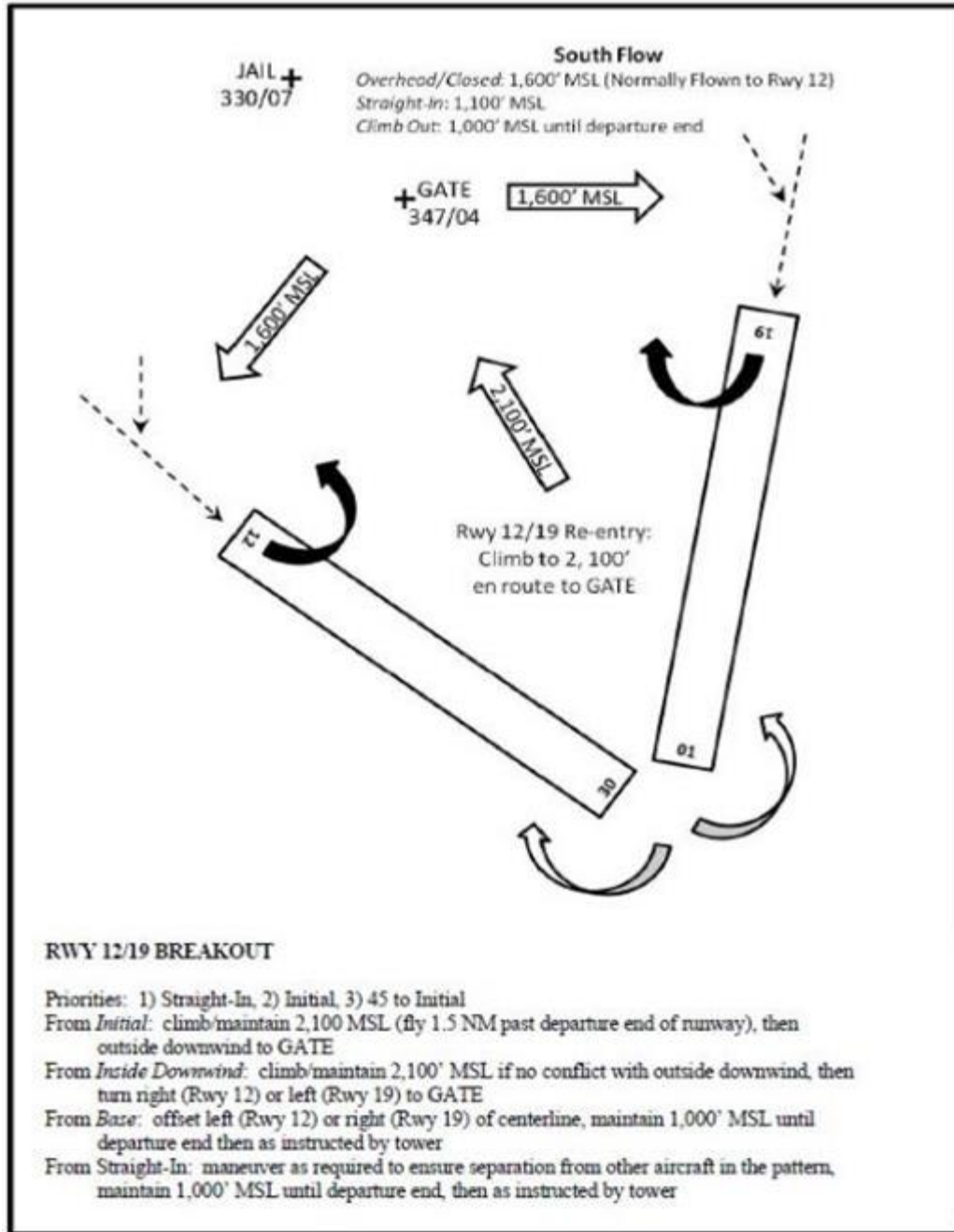

## Attachment 8

## EGLIN VFR TRAFFIC PATTERNS RUNWAYS 1/30 ACTIVE

Figure A8.1. Eglin Traffic Patterns Runways 1/30 Active.

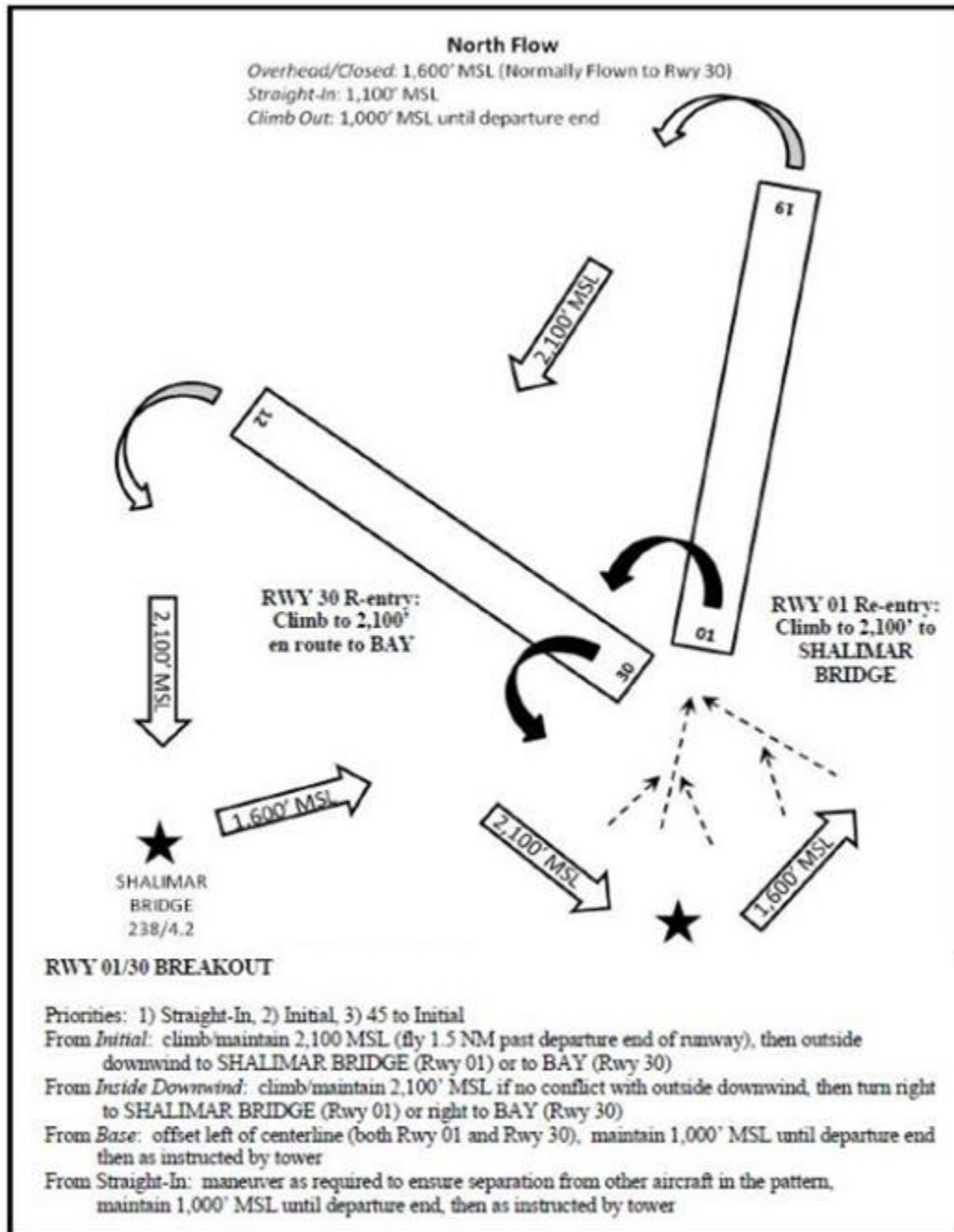

Attachment 9

RUNWAY 12/30 SIMULATED FLAMEOUT (SFO) PATTERN

Figure A9.1. Runway 12/30 Simulated Flameout (SFO) Pattern.

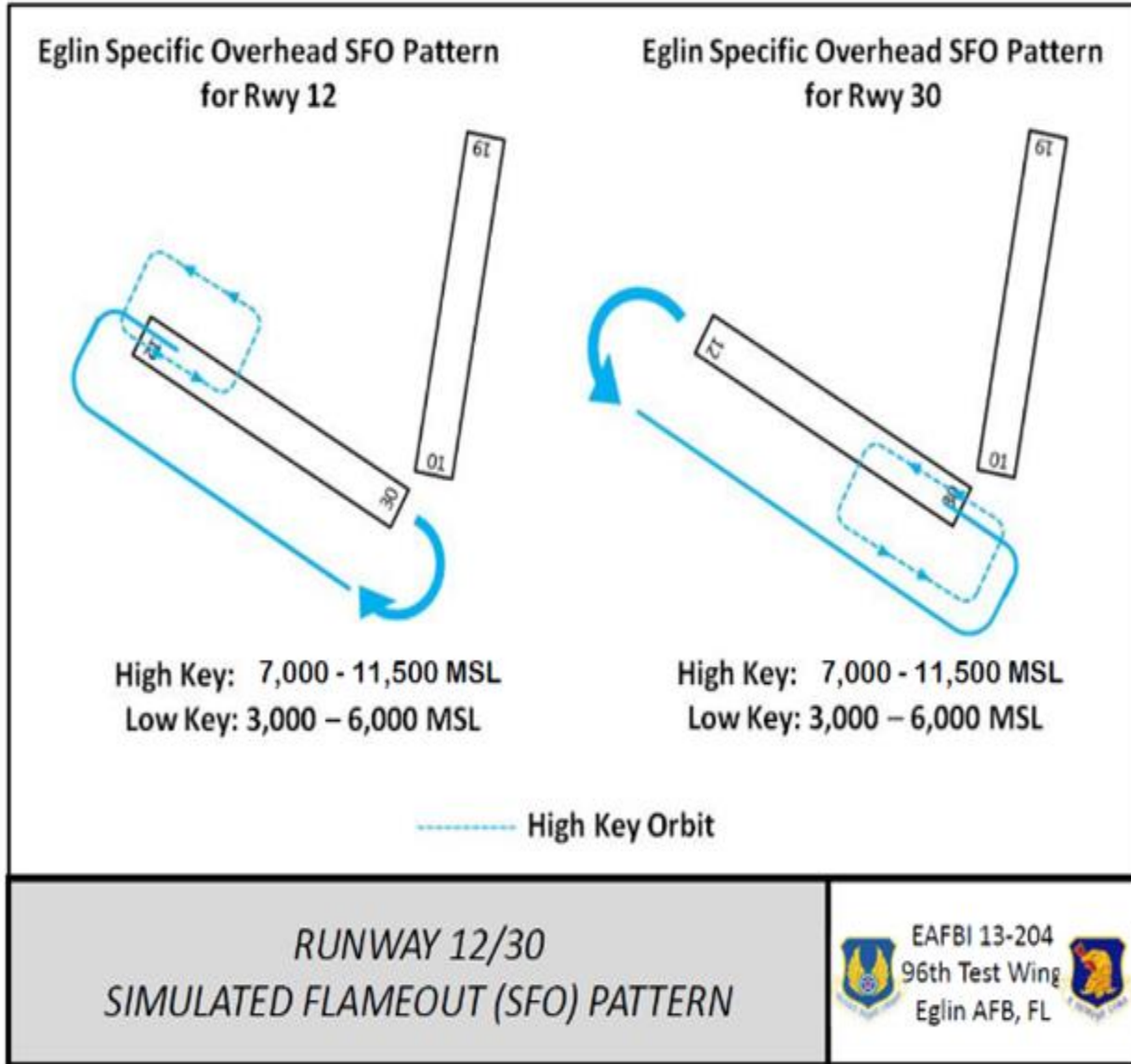

Attachment 10

OVERHEAD SFO AND STRAIGHT-IN SFO PATTERNS

Figure A10.1. Overhead SFO/PFO and Straight-In SFO Patterns.

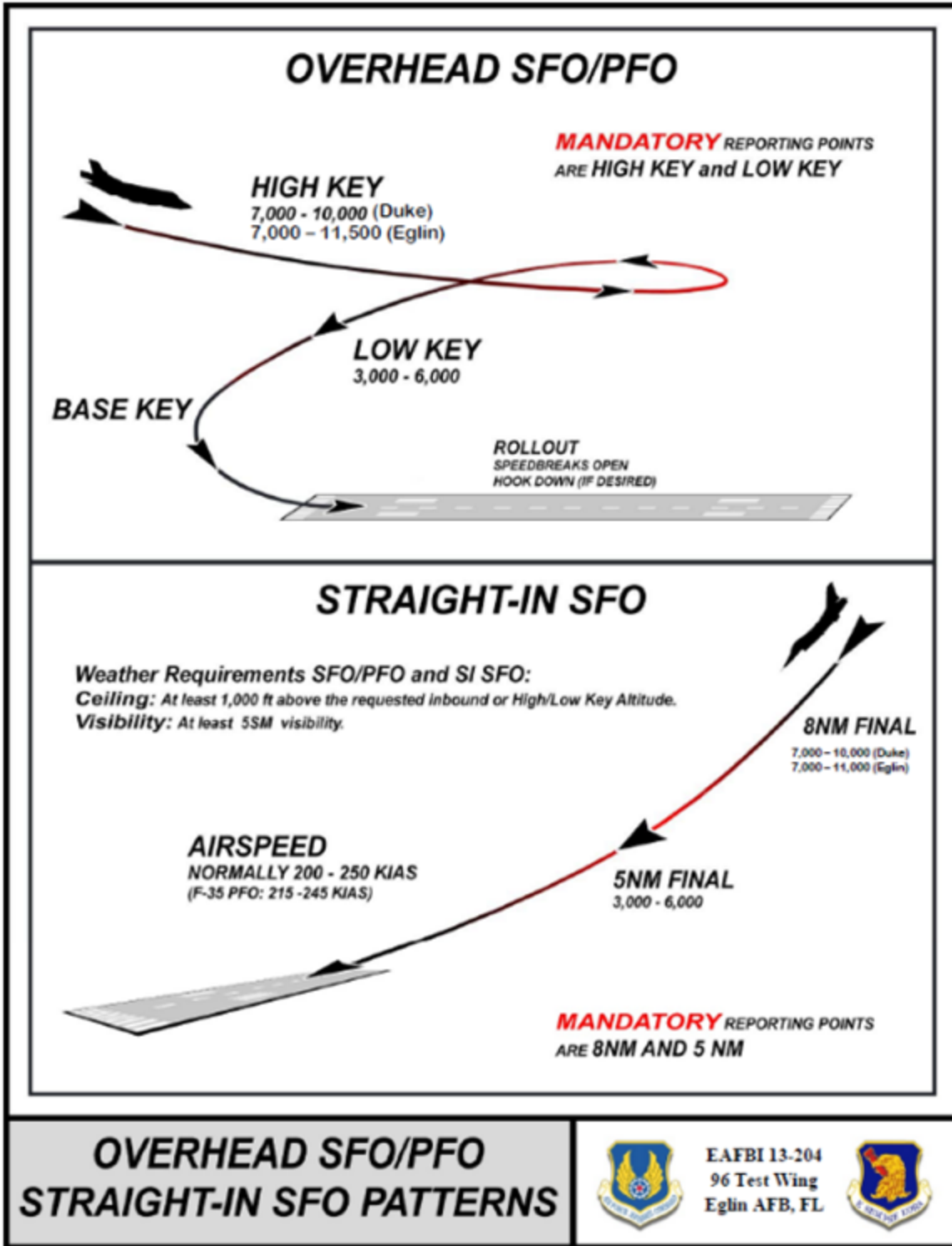



Attachment 11

RWY 12/30 RANDOM ENTRY SIMULATED FLAMEOUT PATTERN (RESFO) PROCEDURES

Figure A11.1. Rwy 12/30 Random Entry Simulated Flameout Pattern (RESFO) Procedures.

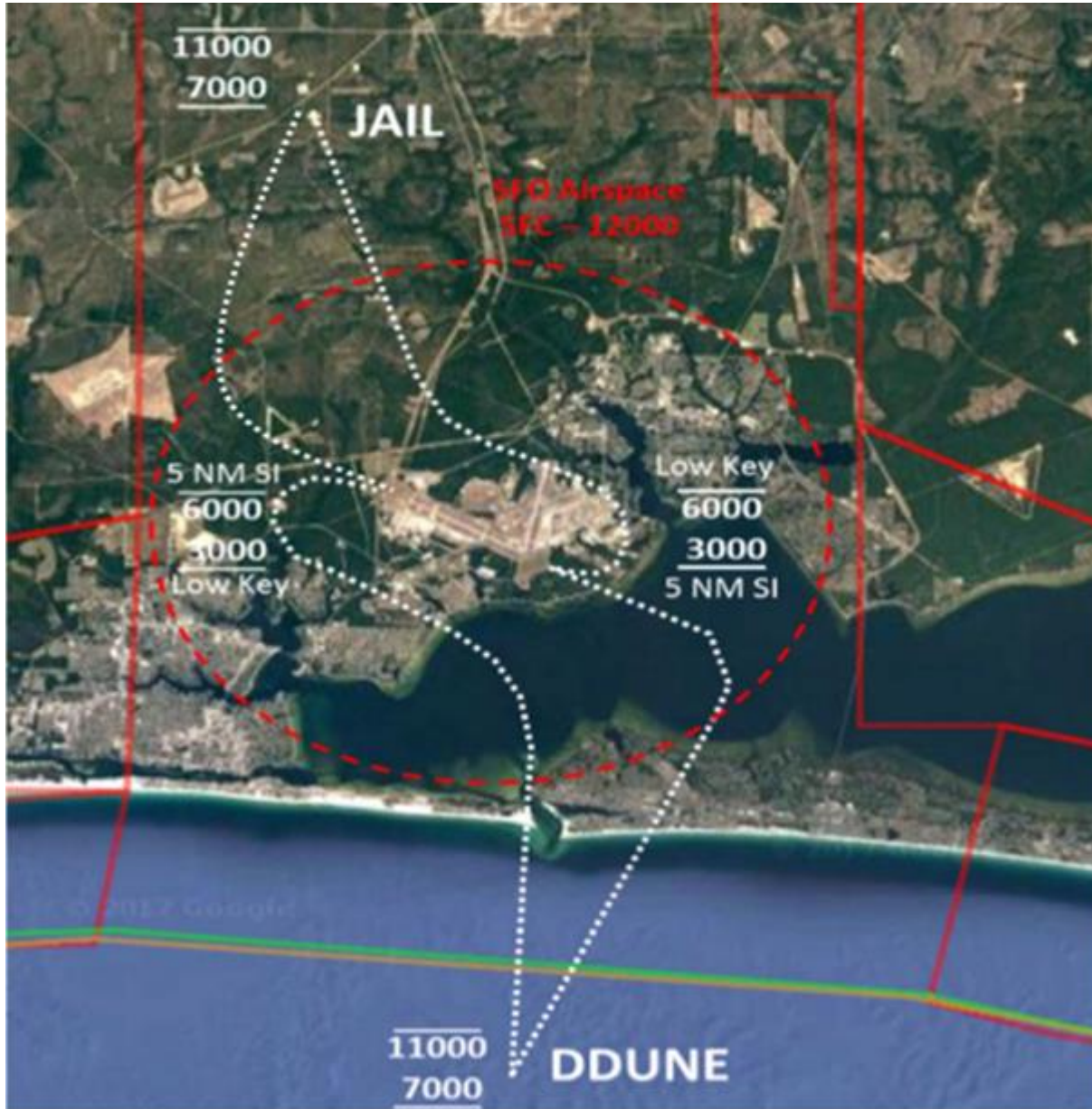

Attachment 12

VFR TOWER TO TOWER PROCEDURES – SOUTH FLOW

Figure A12.1. VFR Tower to Tower Procedures – South Flow.

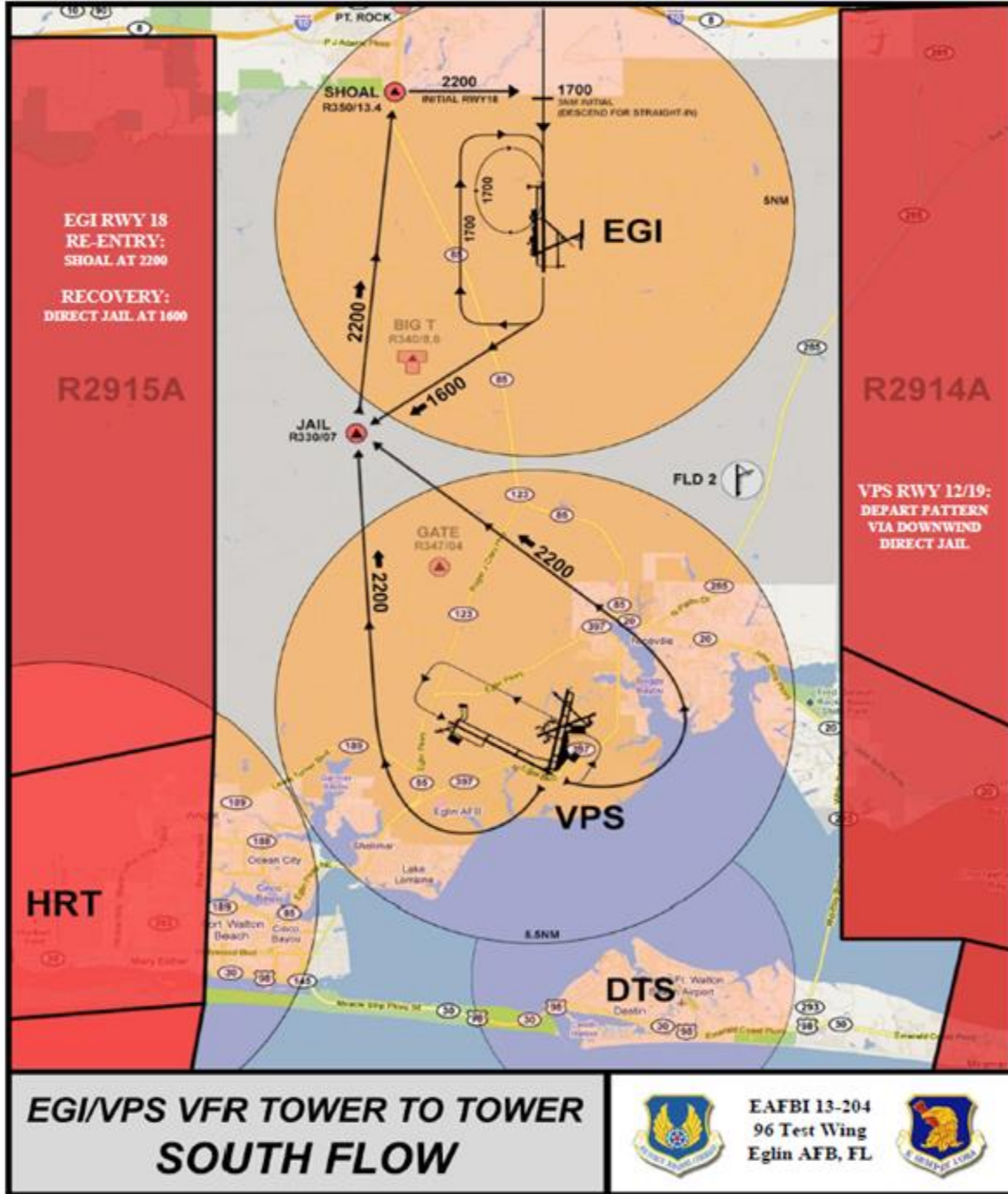

**EGI/VPS VFR TOWER TO TOWER  
SOUTH FLOW**



EAFBI 13-204  
96 Test Wing  
Eglin AFB, FL



Attachment 13

VFR TOWER TO TOWER PROCEDURES – NORTH FLOW

Figure A13.1. VFR Tower to Tower Procedures – North Flow.

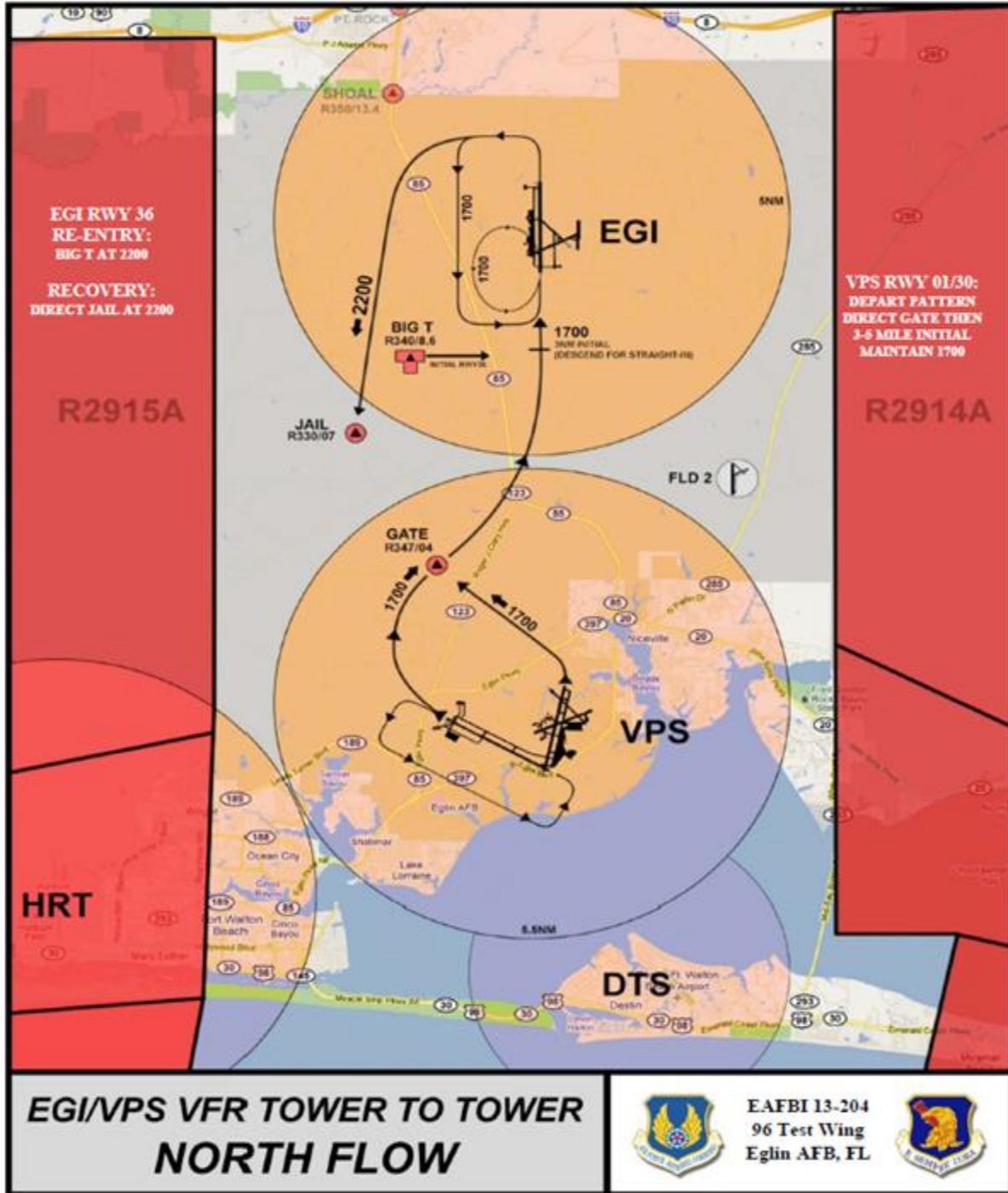

Attachment 14

VFR TOWER TO TOWER PROCEDURES – MIXED FLOW VPS RWY 1/30 & EGI RWY 18

Figure A14.1. VFR Tower to Tower Procedures – Mixed Flow VPS RWY 1/30 & EGI RWY 18.

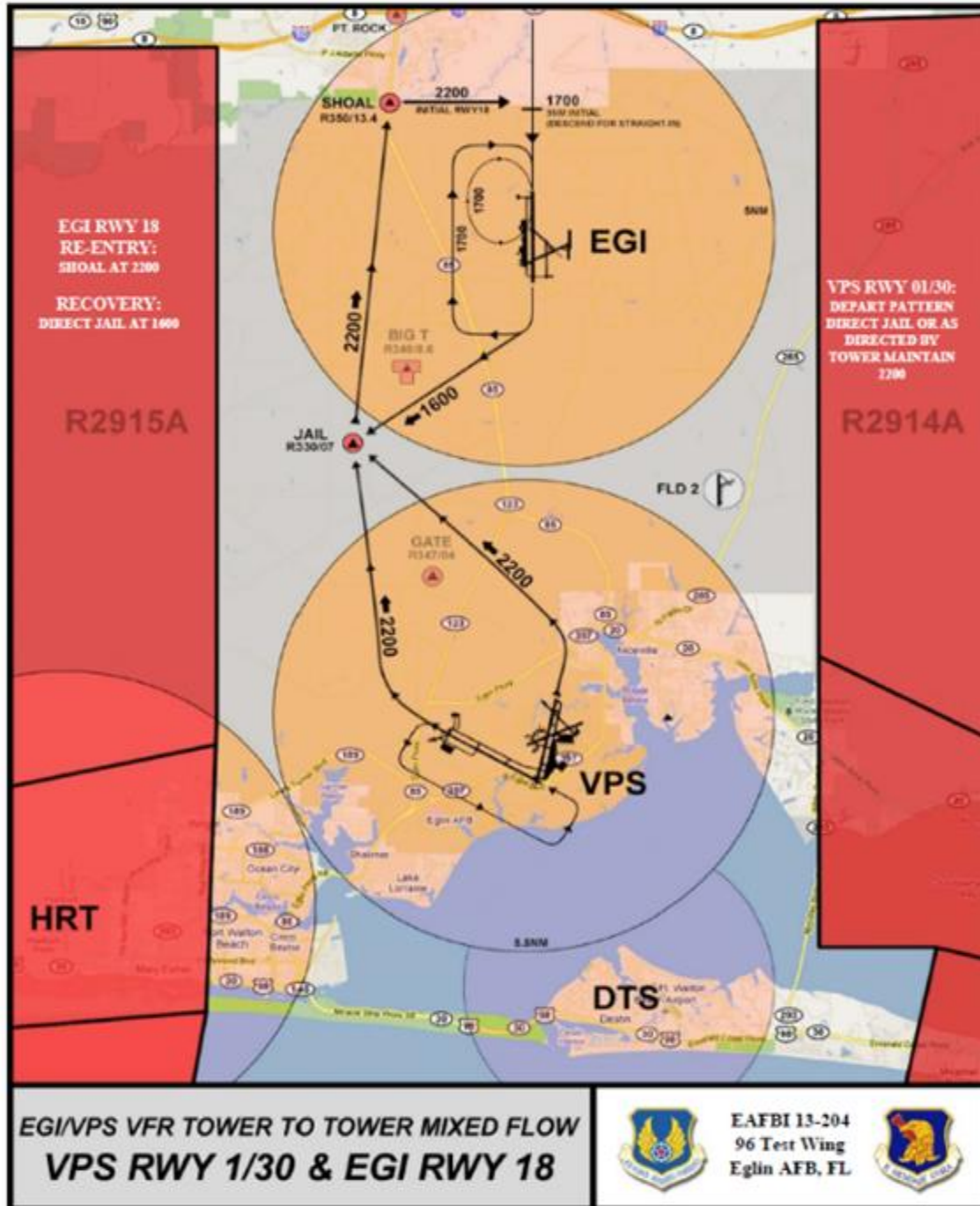

Attachment 15

VFR TOWER TO TOWER PROCEDURES – MIXED FLOW VPS RWY 12/19 & EGI RWY 36

Figure A15.1. VFR Tower to Tower Procedures – Mixed Flow VPS RWY 12/19 & EGI RWY 36.

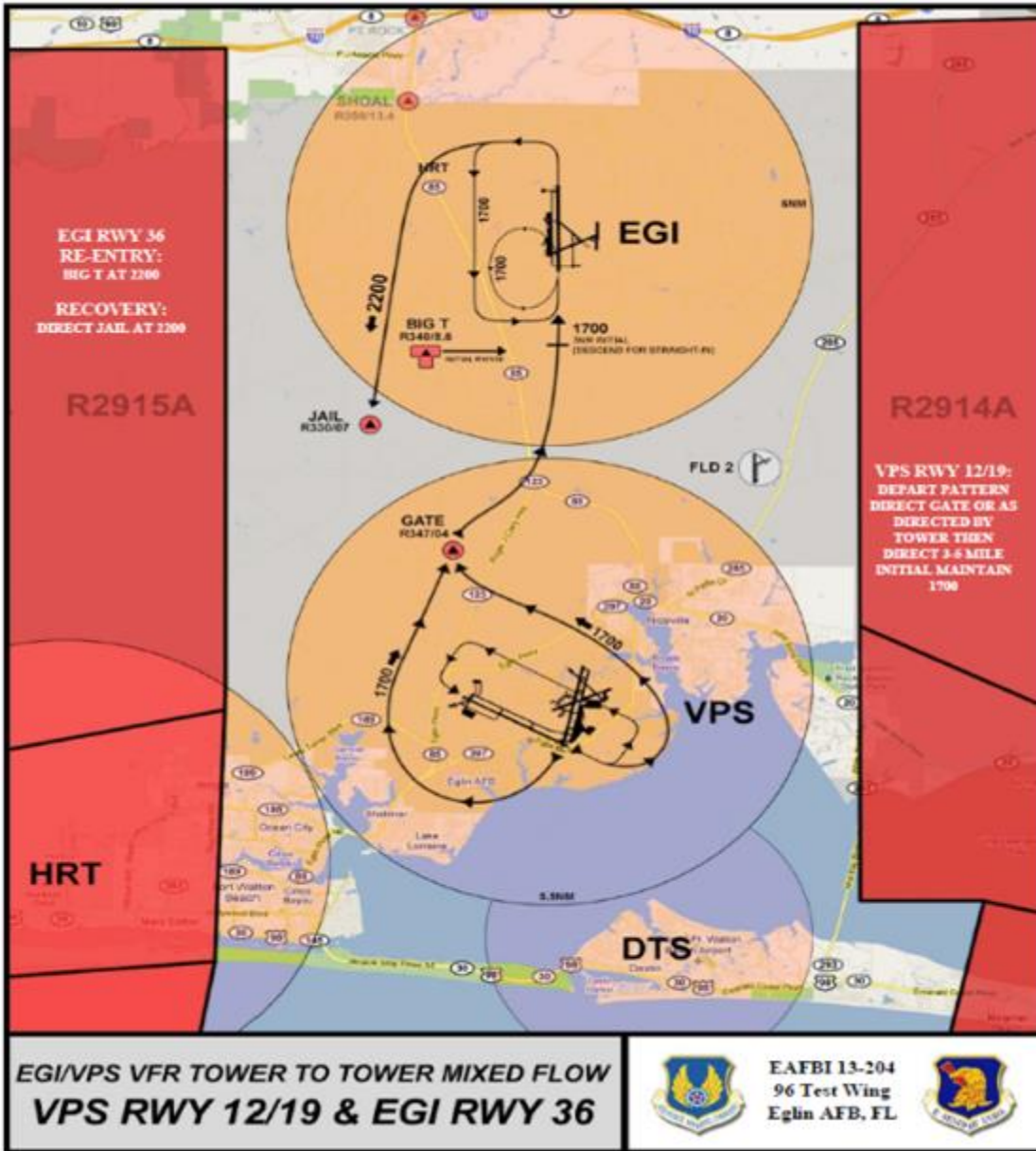

Attachment 16

EGLIN AFB RADAR RECTANGULAR PATTERNS

Figure A16.1. Eglin AFB Radar Rectangular Patterns.

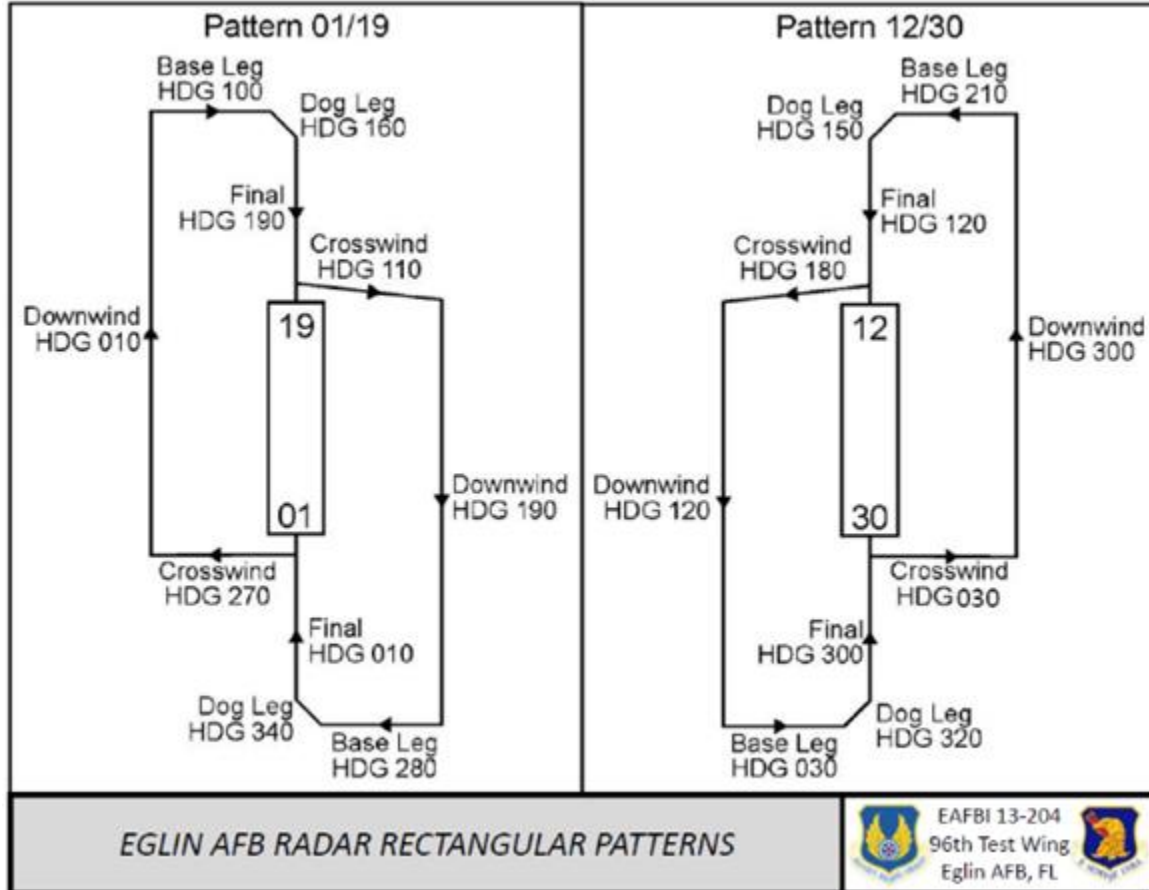

Attachment 17  
DDUNE RECOVERY

Figure A17.1. DDUNE Recovery.

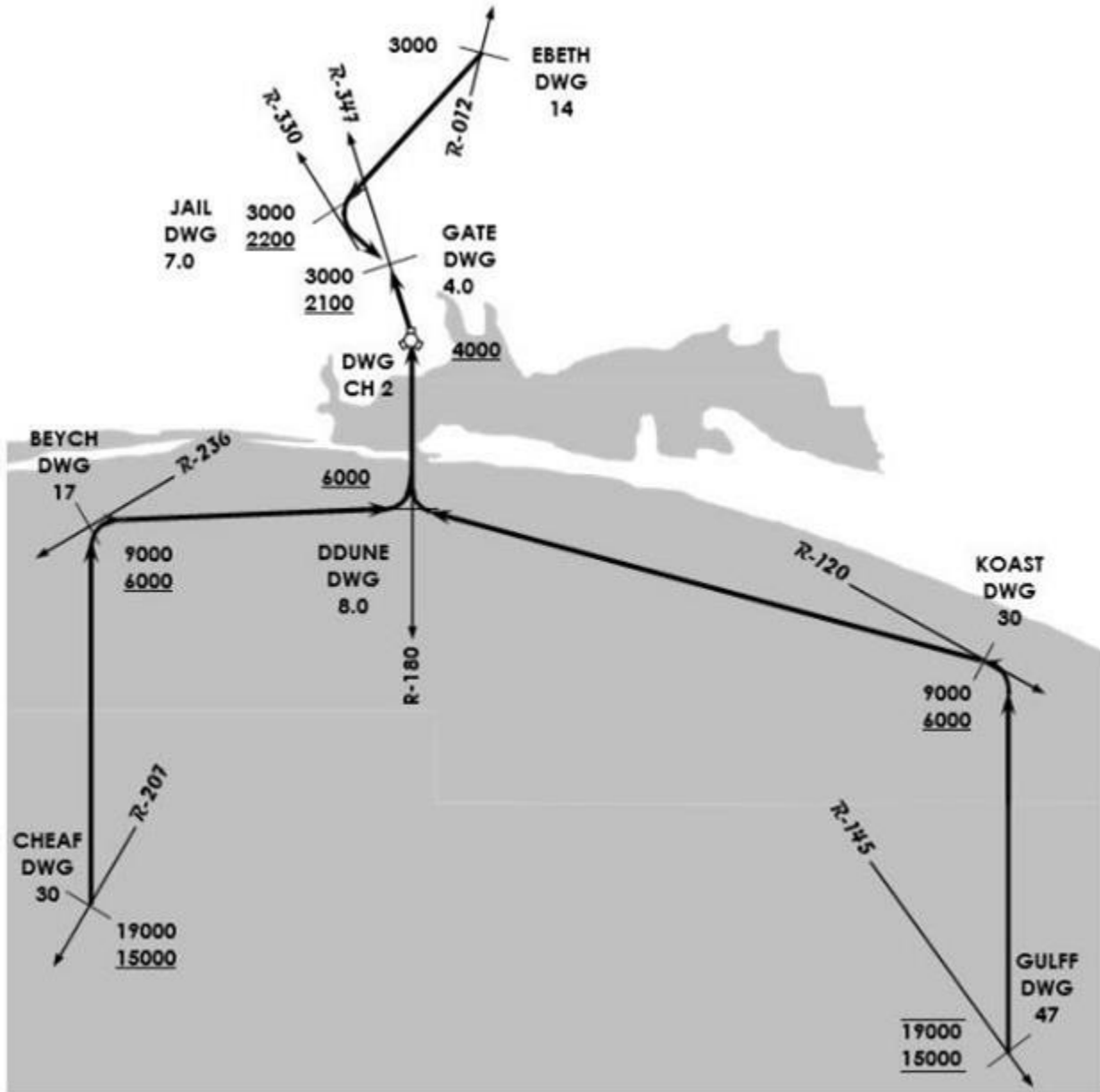

**Figure A17.2. DDUNE Recovery.**

**FROM EAST:** Intercept the 86-degree west longitude line and track 360 degrees to KOAST. Cross GULFF between 15,000 and 19,000 feet MSL; cross KOAST between 6000 and 9000 feet MSL, then turn left and proceed to DDUNE via course 286 degrees; cross DDUNE at or above 6000 feet MSL.

**FROM WEST:** Intercept the 86-degree, 48-minute west longitude line and track 360 degrees to BEICH. Cross CHEAF between 15,000 and 19,000 feet MSL; cross BEICH between 6000 and 9000 feet MSL, then turn right and proceed to DDUNE via course 083 degrees; cross DDUNE at or above 6000 feet MSL.

**FROM DDUNE:** Proceed to DWG via DWG R-180; cross DWG at 4000 feet MSL. At DWG, track outbound on DWG R-347 to GATE. Cross GATE between 2100 feet MSL and 3000 feet MSL. Descend to pattern altitude and proceed to initial, straight in, or as instructed by tower.

**FROM NORTH:** Proceed to EBETH then direct to JAIL then to GATE. Cross EBETH at or above 3000' MSL then cross JAIL between 2200' MSL and 3000' MSL. Cross GATE between 2,100 feet MSL and 3000 feet MSL. Descend to pattern altitude and proceed to initial, straight in, or as instructed by tower.

**NOTE:** If unable to proceed VFR at GATE, advise ATC and continue outbound on the DWG R-347 and climb to 3,000 MSL



Attachment 18  
WHISKEY HOTEL RECOVERY

Figure A18.1. Whiskey Hotel Recovery.

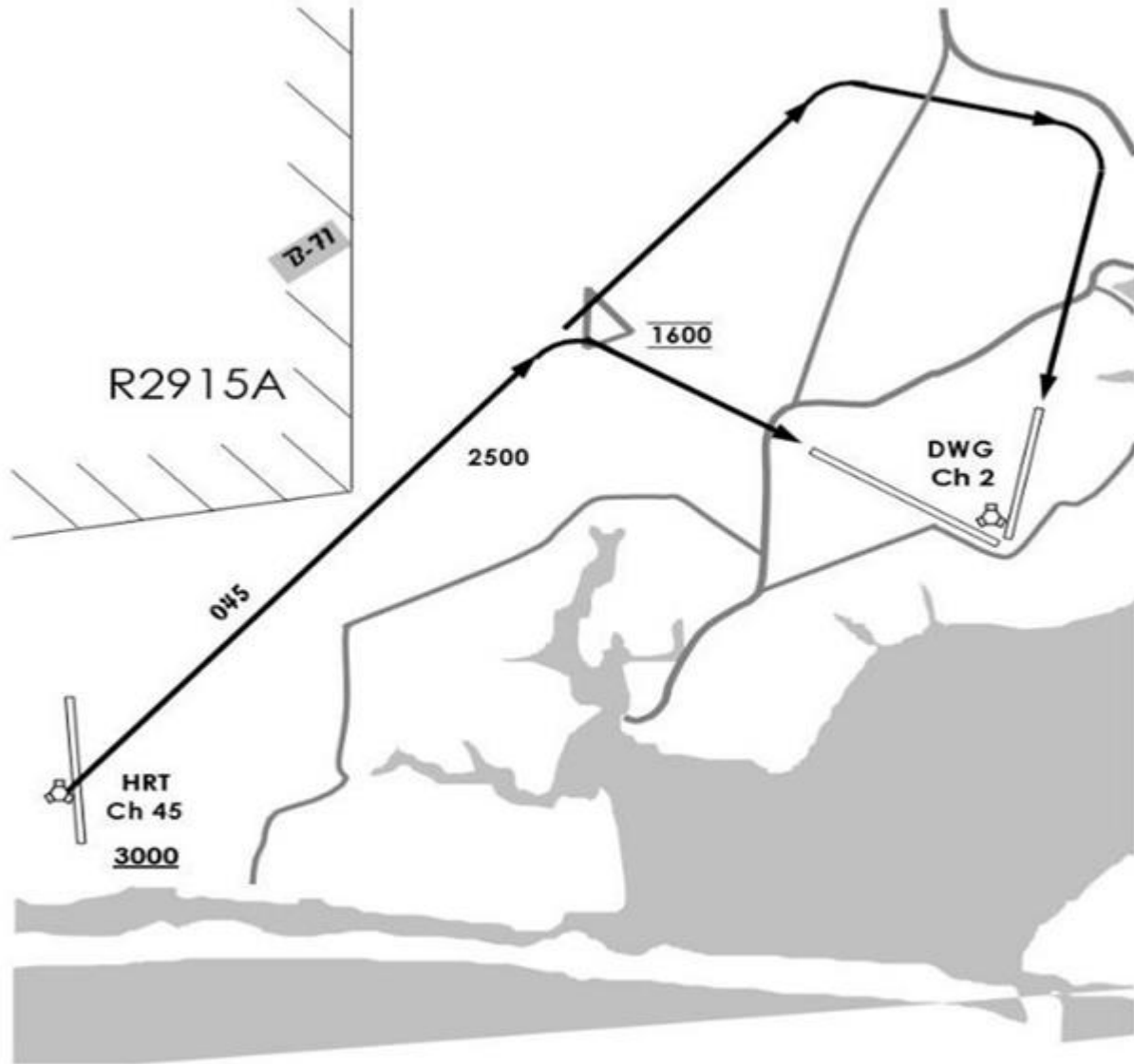

**WHISKEY HOTEL:** Weather required is 3,500/3. Cross Hurlburt at or above 3,000'. Maintain 2,500' MSL until abeam B-71, then descend to 1,600' for initial.

Attachment 19

NORTH FLOW RECOVERY

Figure A19.1. North Flow Recovery.

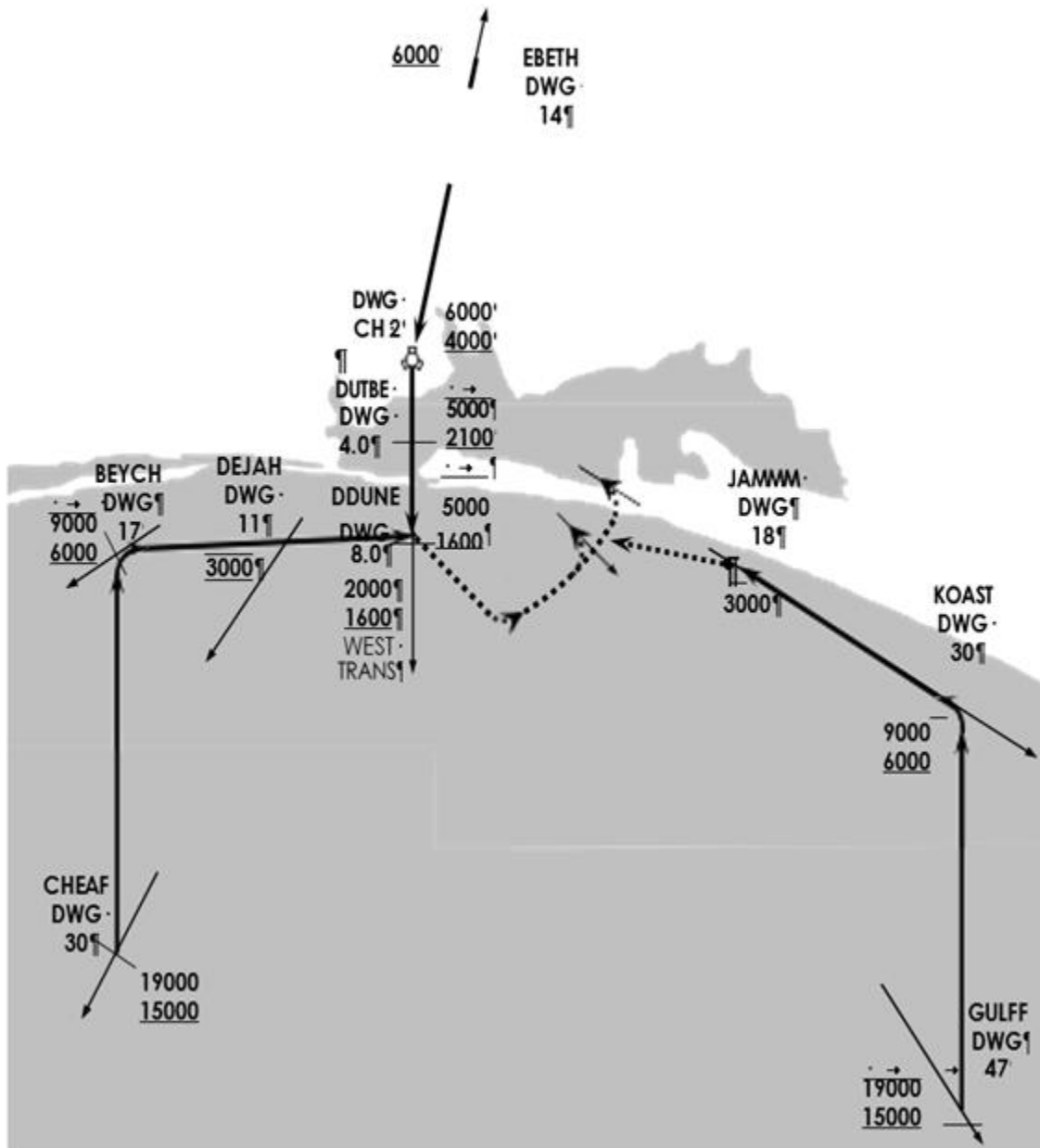

**Figure A19.2. North Flow Recovery.**

**FROM EAST:** Intercept the 86-degree west longitude line and track

360 degrees to KOAST. Cross GULFF between 15,000 and 19,000 feet MSL; cross KOAST between 6000 and 9000 feet MSL, then turn left and proceed inbound via DWG R-120. Cross JAMMM at or above 3000 feet MSL. Descend to pattern altitude and proceed to initial, straight-in, or as instructed by tower

**FROM WEST:** Intercept the 86-deg, 48-min west longitude line and track 360 degrees to BEICH. Cross CHEAF between 15,000 and 19,000 feet MSL; cross BEICH 6000 and 9000 feet MSL, then turn right and proceed to DEJAH via course 083 degrees; cross DEJAH at 3000 MSL, then proceed to DDUNE. Cross DDUNE between 2000 and 1600 MSL. Descend to pattern alt and proceed to initial, straight-in, or as instructed by tower.

**FROM NORTH:** Intercept the DWG R-012 and track inbound to DWG. Cross EBETH at 6000 MSL; cross DWG between 4000 MSL and 6,000 MSL; At DWG, track outbound to DDUNE via R-180; cross DWG 180/04 between 2100 MSL and 5000 MSL; cross DDUNE between 1600 MSL and 5000 MSL. Descend to pattern altitude and proceed to initial, straight-in, or as instructed by tower.

Attachment 20

DUKE FIELD AIRFIELD DIAGRAM

Figure A20.1. Duke Field Airfield Diagram.

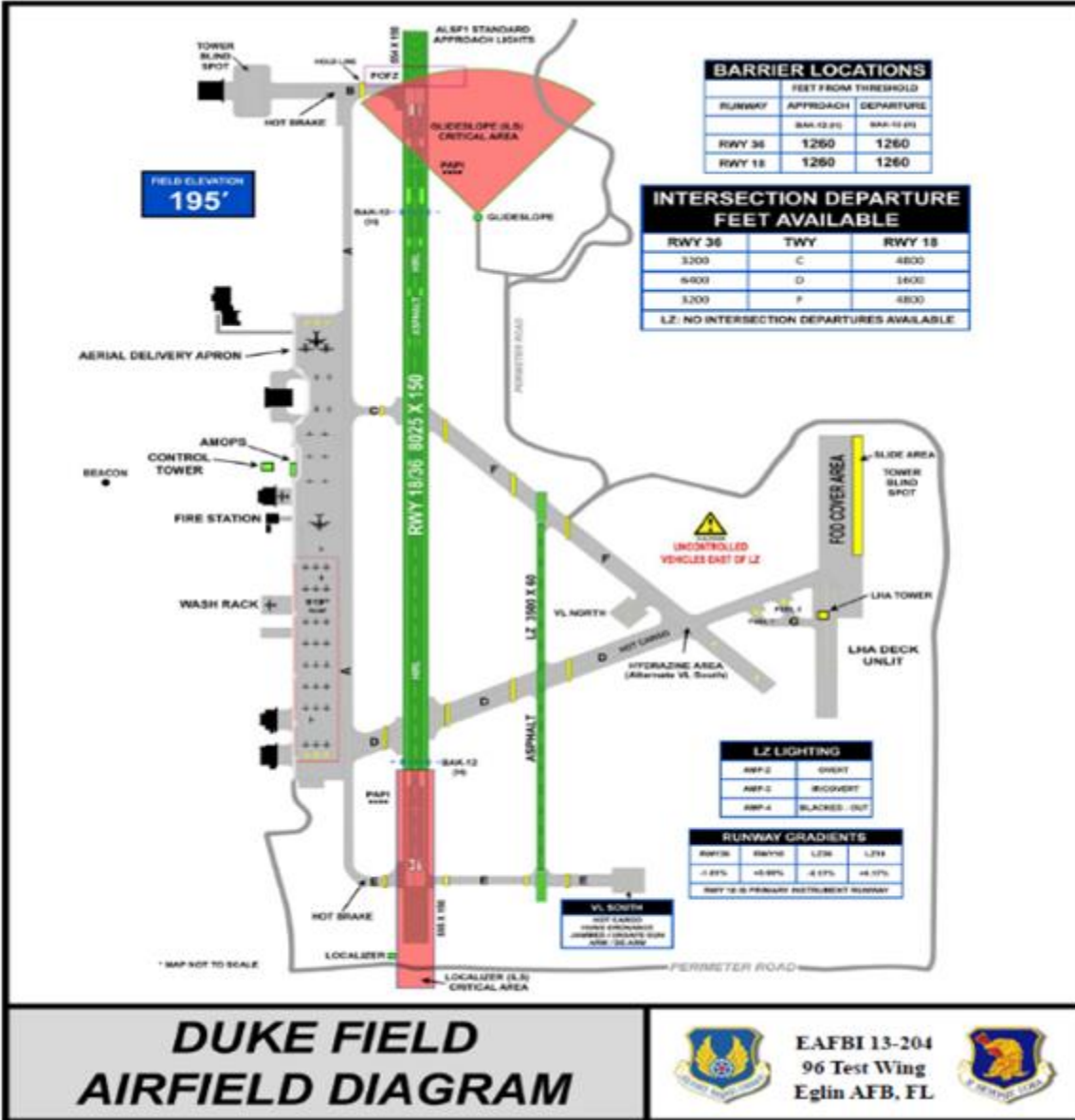

Attachment 21

DUKE FIELD CONTROLLED MOVEMENT AREA DIAGRAM

Figure A21.1. Duke Field Controlled Movement Area Diagram.

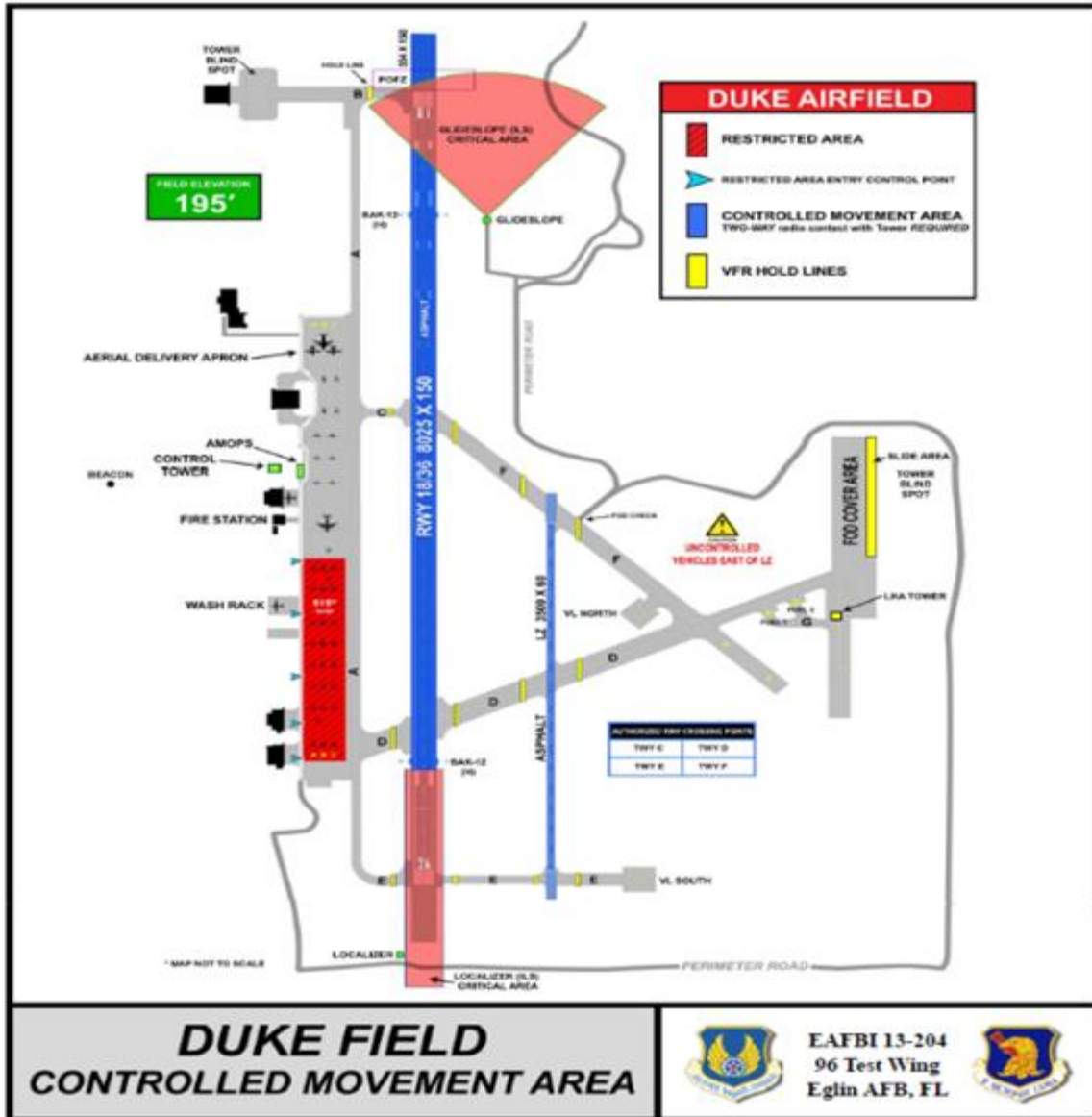

Attachment 22

DUKE FIELD SOUTH OPERATIONS

Figure A22.1. Duke Field South Operations.

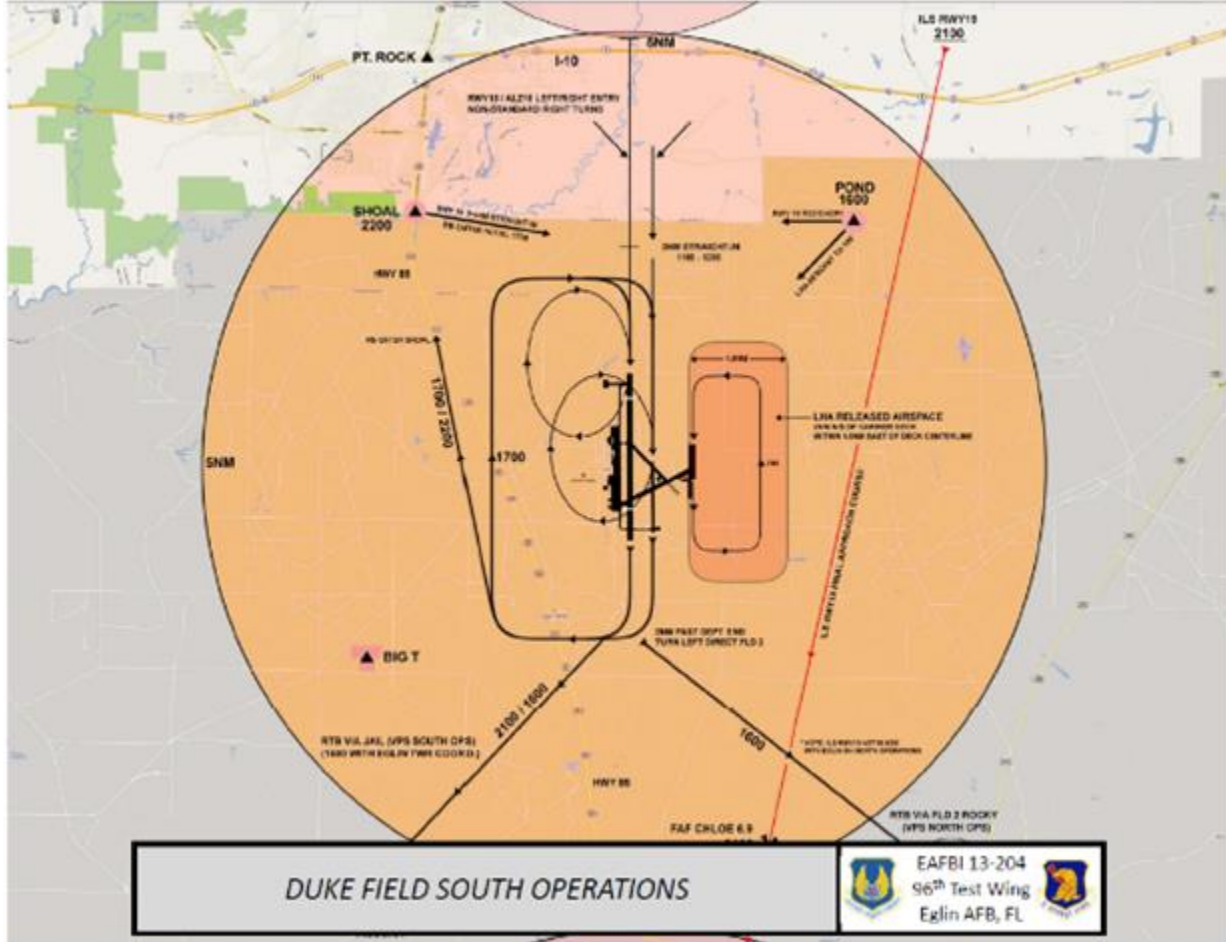

Attachment 23

DUKE FIELD NORTH OPERATIONS

Figure A23.1. Duke Field North Operations.

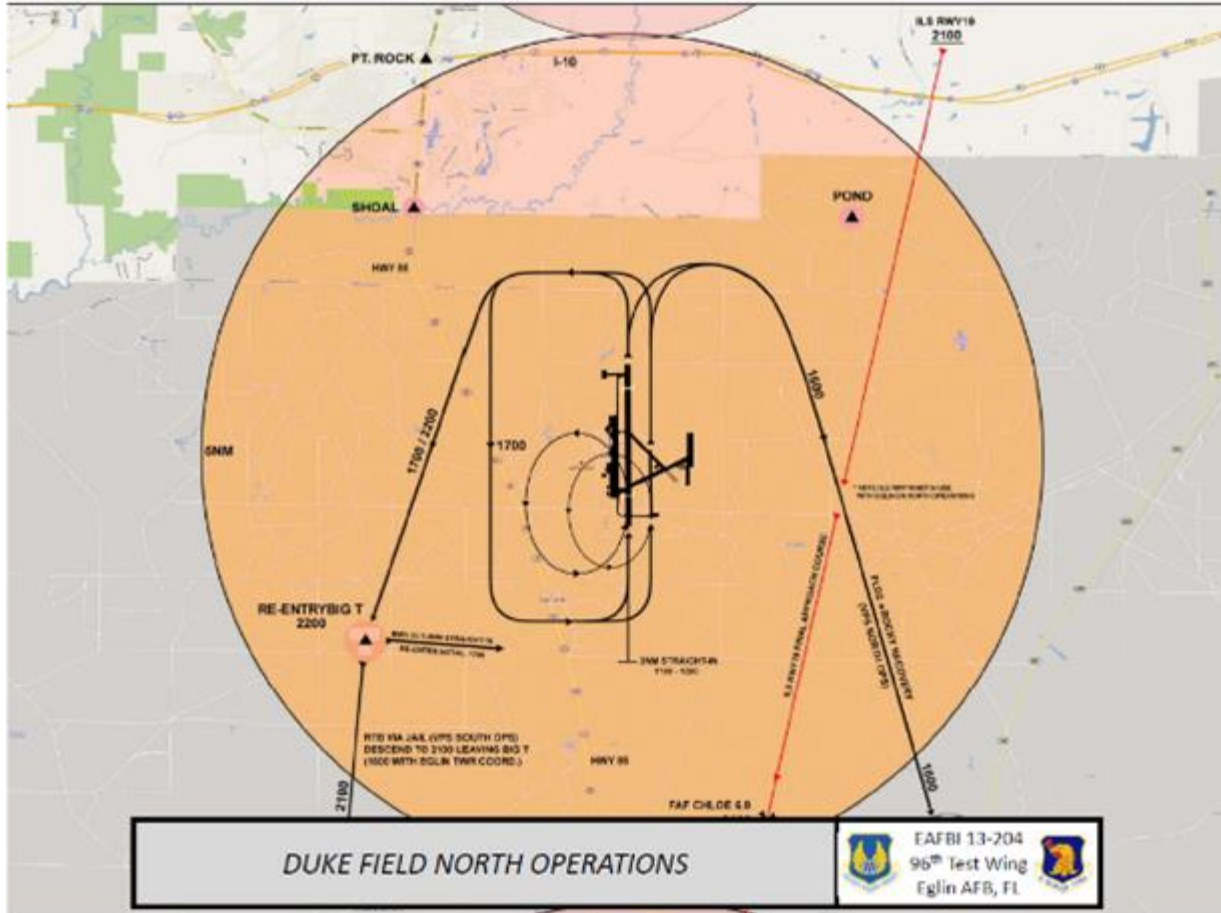

Attachment 24

DUKE FIELD STOVL PADS SOUTH OPERATIONS

Figure A24.1. Duke Field STOVL Pads South Operations.

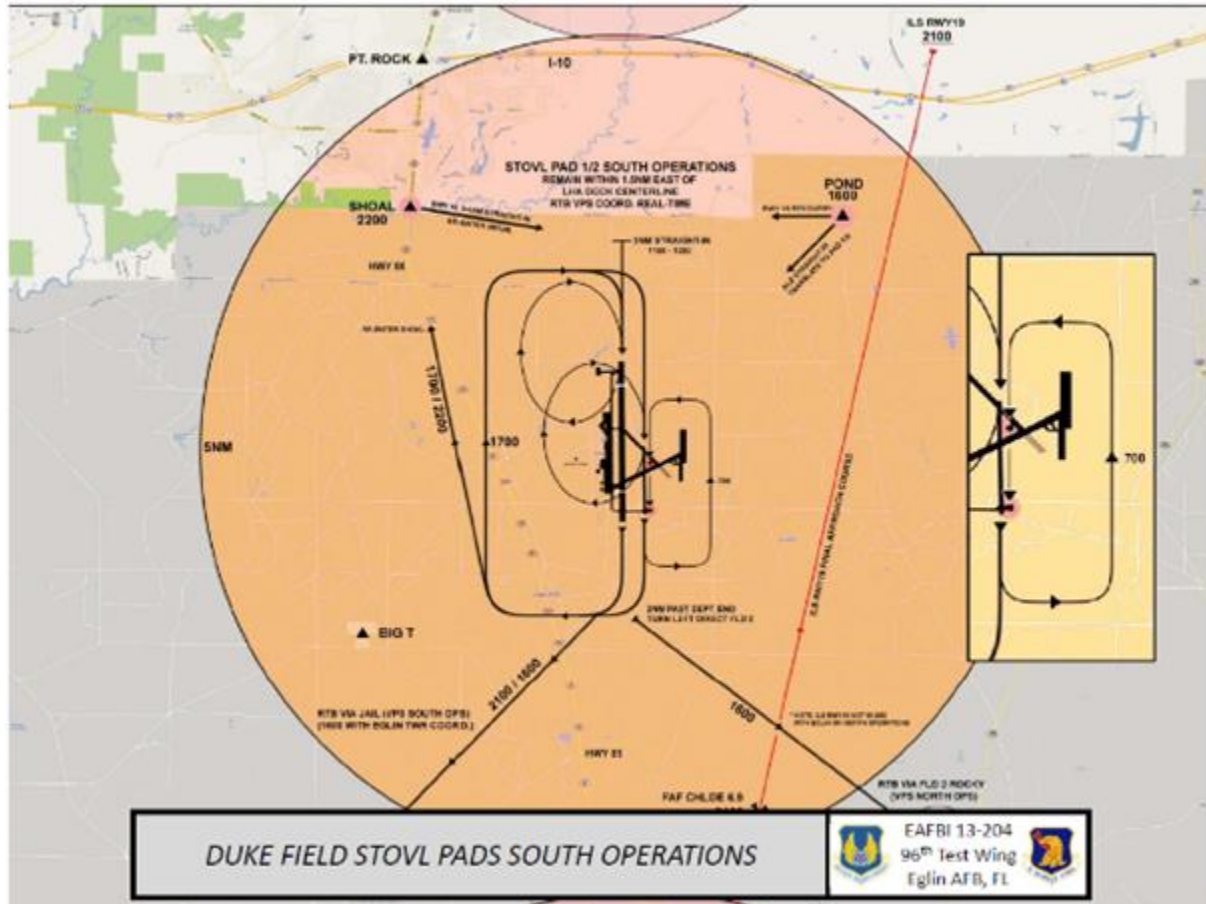



Attachment 25

DUKE FIELD STOVL PADS NORTH OPERATIONS

Figure A25.1. Duke Field STOVL Pads North Operations.

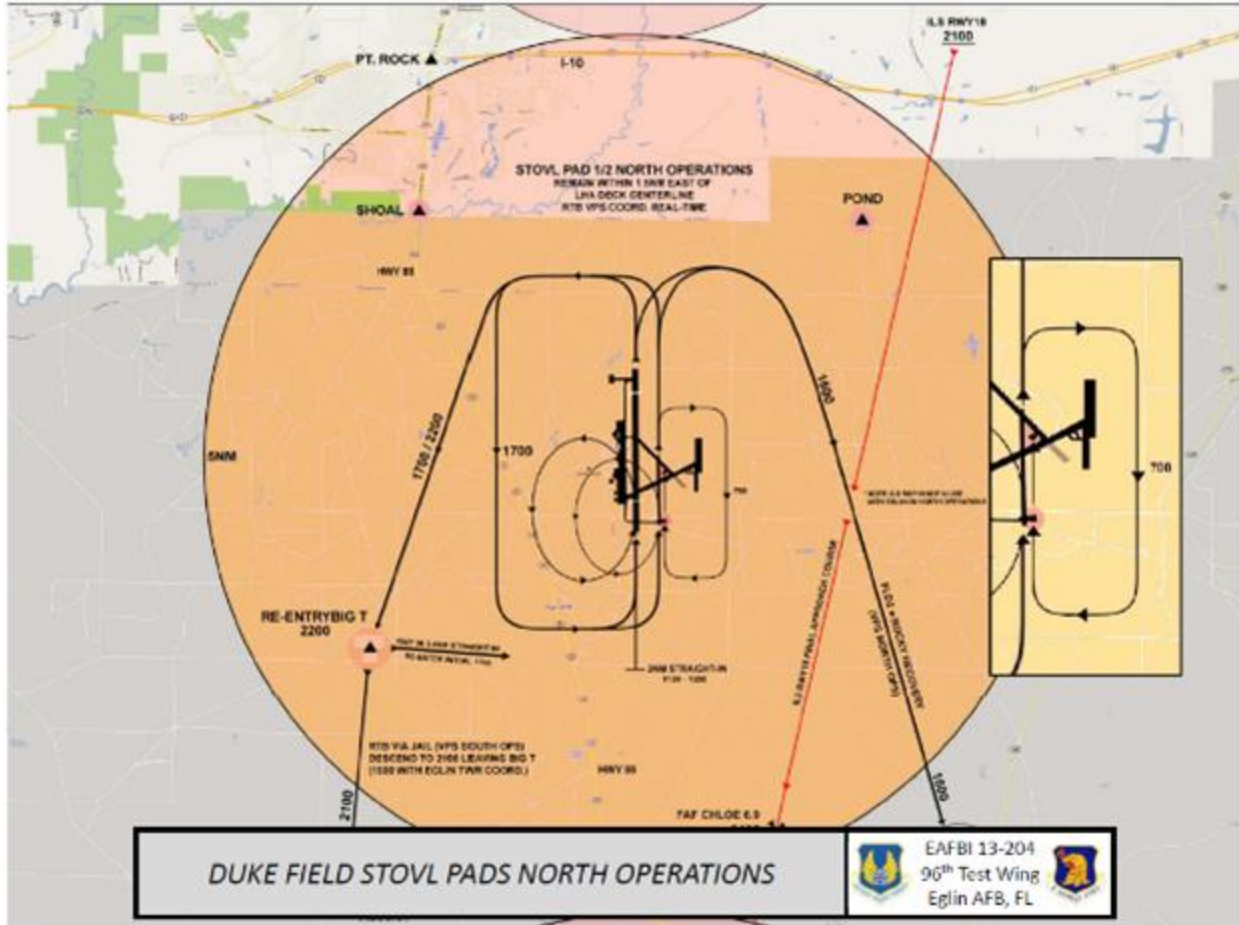

Attachment 26

DUKE FIELD VFR RECTANGULAR PATTERNS

Figure A26.1. Duke Field VFR Rectangular Patterns.

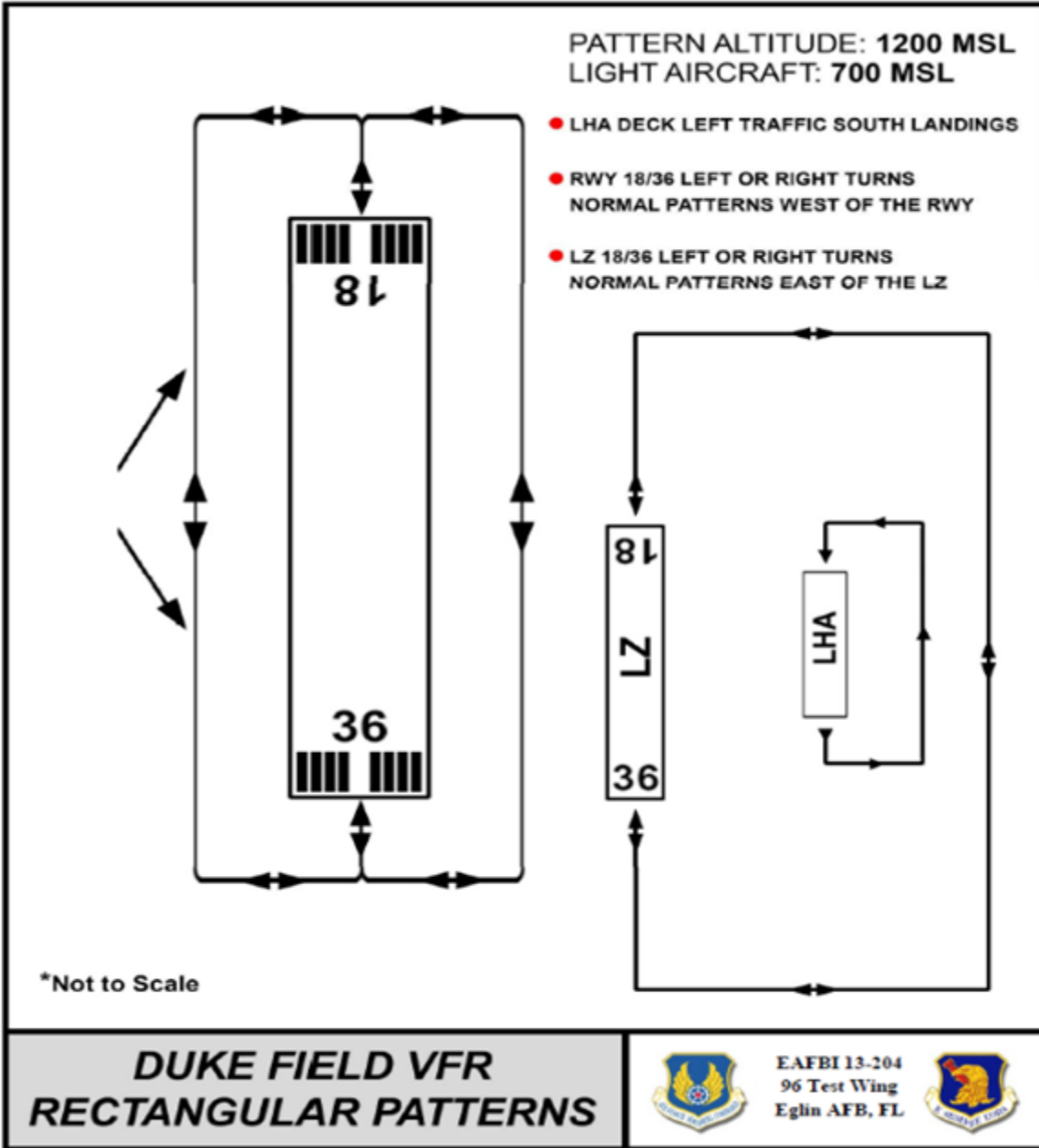

Attachment 27

DUKE FIELD VFR OVERHEAD PATTERNS

Figure A27.1. Duke Field VFR Overhead Patterns.

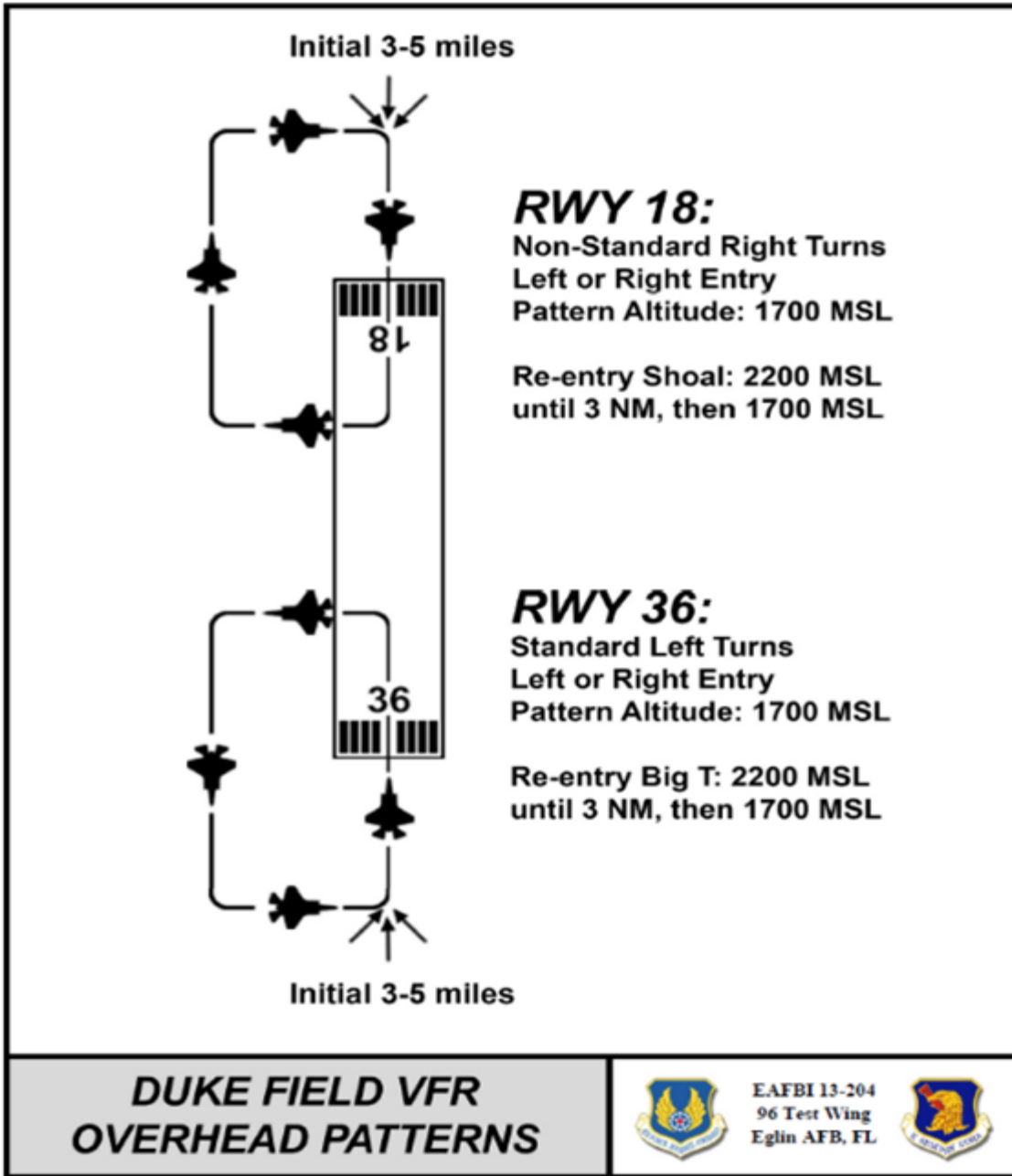

Attachment 28

DUKE FIELD RANDOM SHALLOW APPROACH

Figure A28.1. Duke Field Random Shallow Approach.

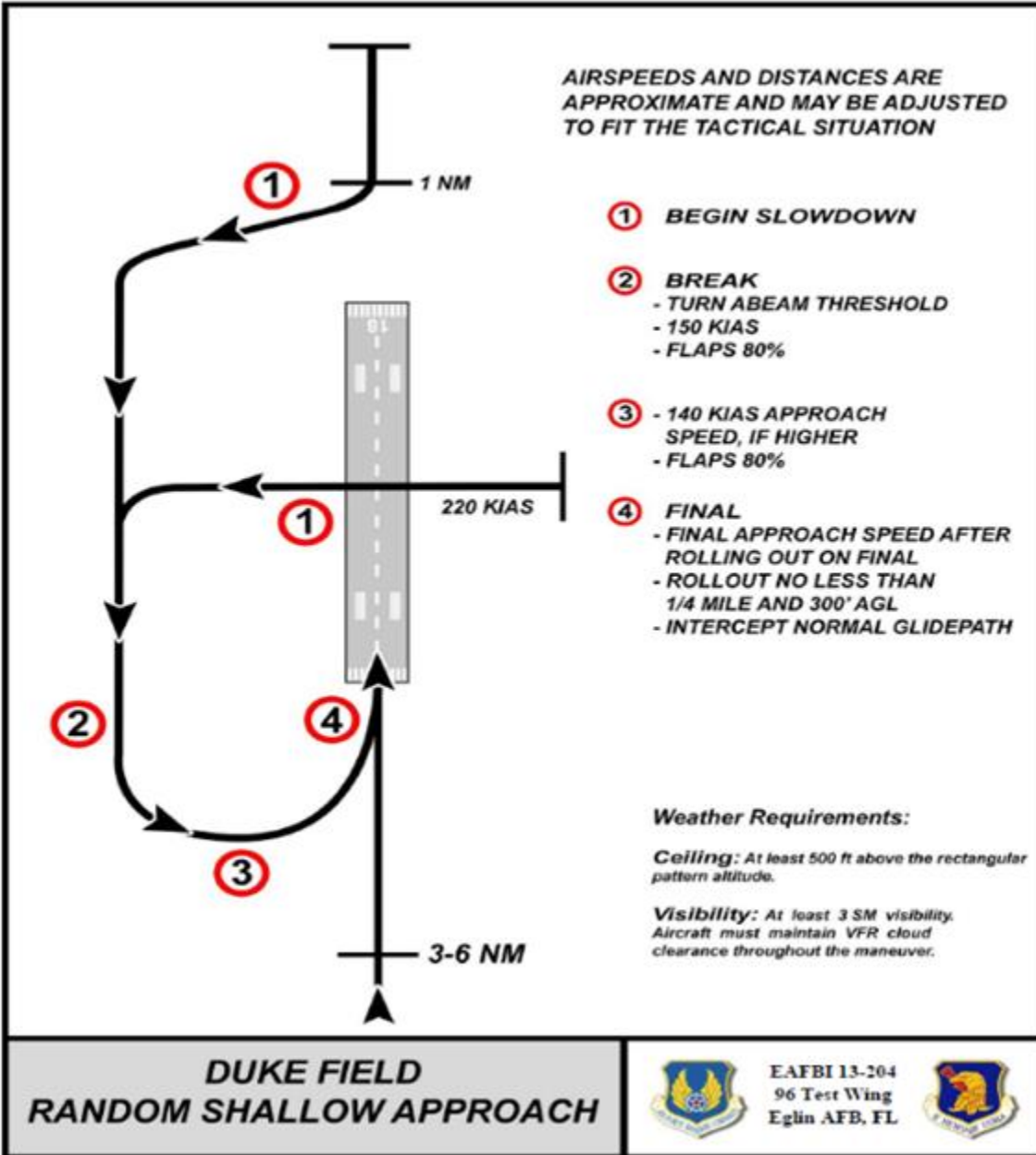

Attachment 29

DUKE FIELD RANDOM STEEP APPROACH

Figure A29.1. Duke Field Random Steep Approach.

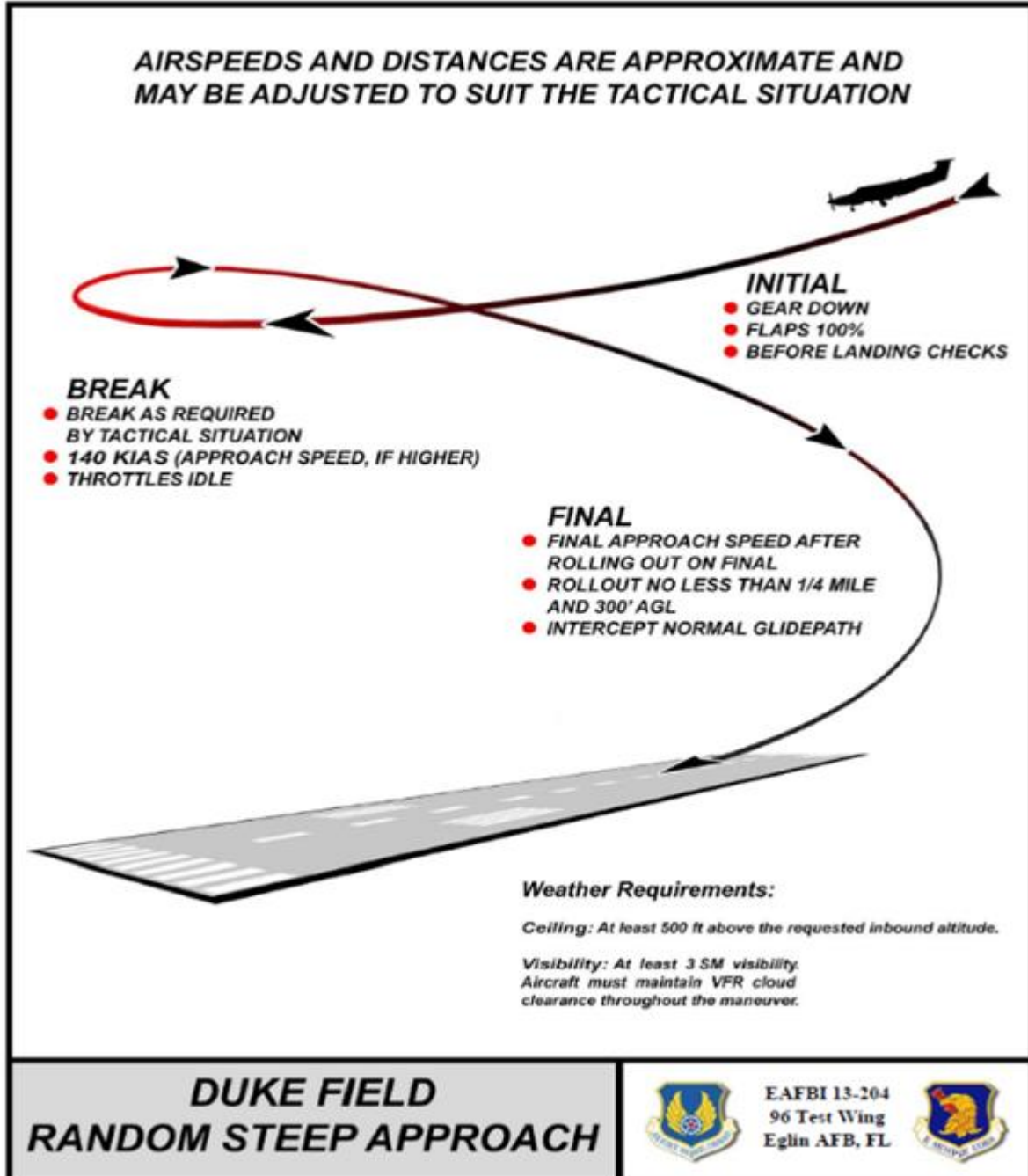

Attachment 30

DUKE FIELD EQUIPMENT DROP ZONE PROCEDURES

Figure A30.1. Duke Field Equipment Drop Zone Procedures.

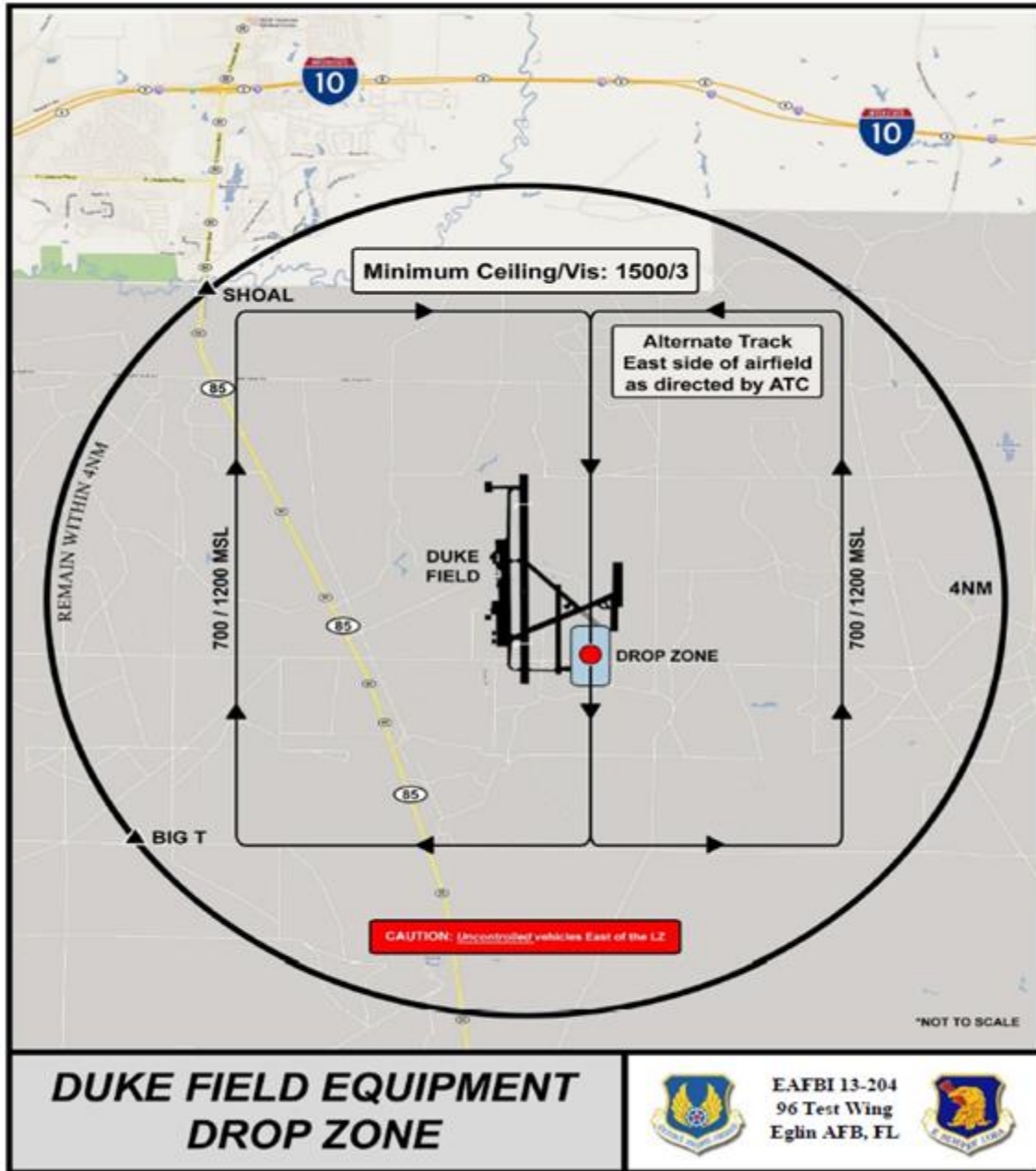

Attachment 31

DUKE FIELD HELICOPTER VFR EAST TRAINING AREA (VETA)

Figure A31.1. Duke Field Helicopter VFR East Training Area.

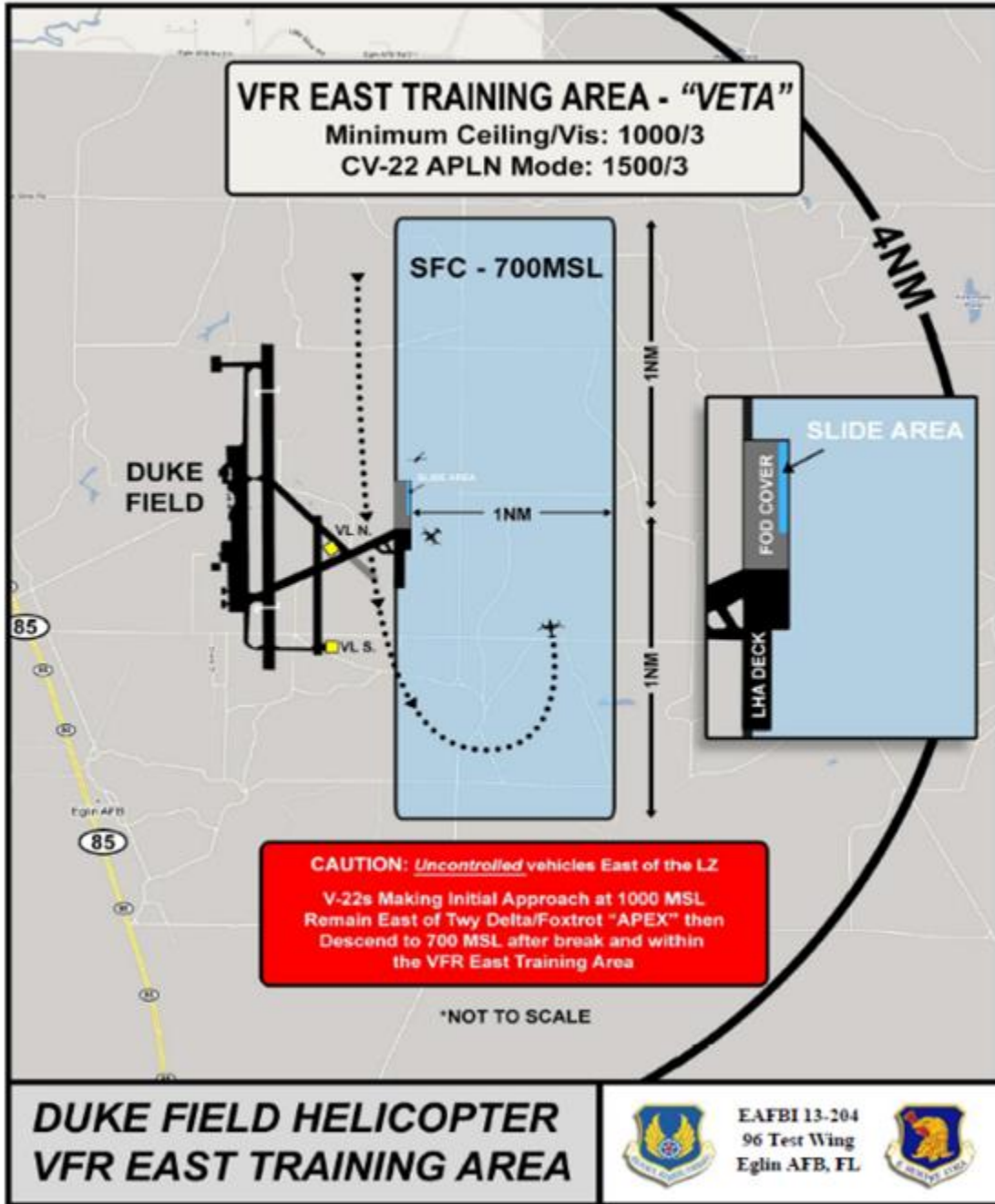

Attachment 32

DUKE FIELD, HURLBURT FIELD, DESTIN, AND CRESTVIEW RADAR RECTANGULAR PATTERNS

Figure A32.1. Duke Field, Hurlburt Field, Destin, and Crestview Radar Rectangular Patterns.

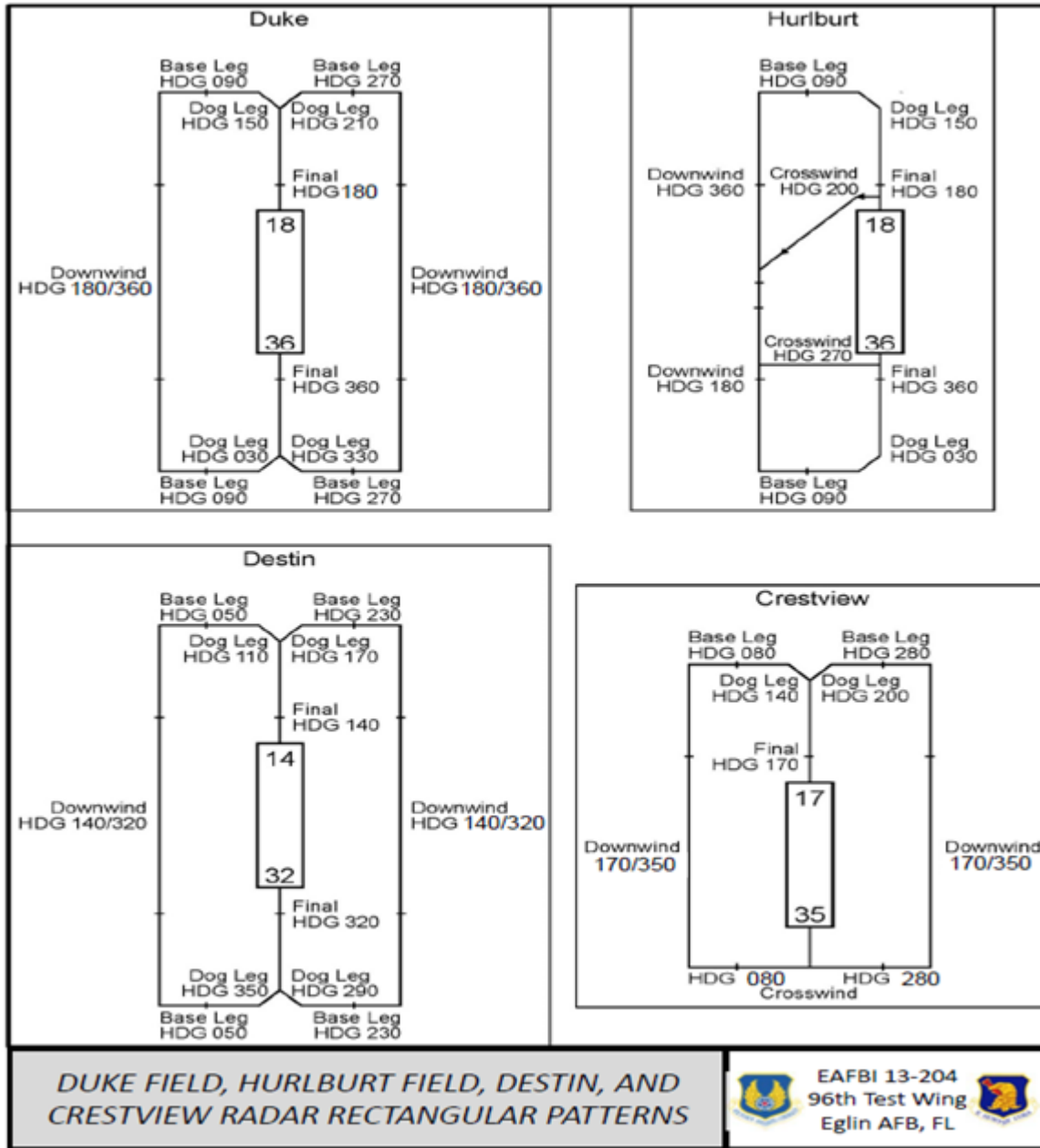



Attachment 33

HURLBURT FIELD VFR RECTANGULAR PATTERNS

Figure A33.1. Hurlburt Field VFR Rectangular Patterns.

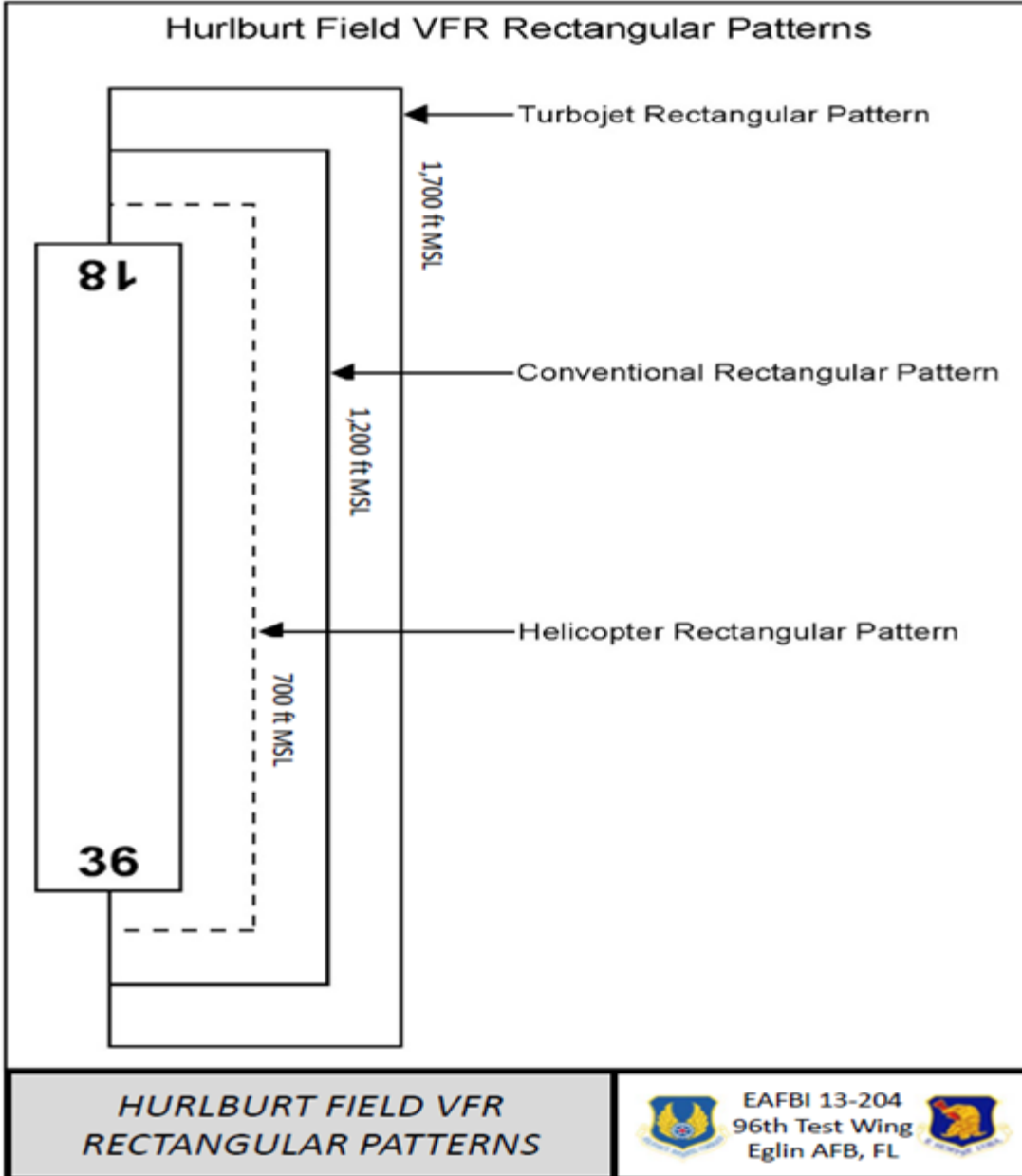

Attachment 34

HURLBURT FIELD VFR OVERHEAD PATTERNS

Figure A34.1. Hurlburt Field VFR Overhead Pattern.

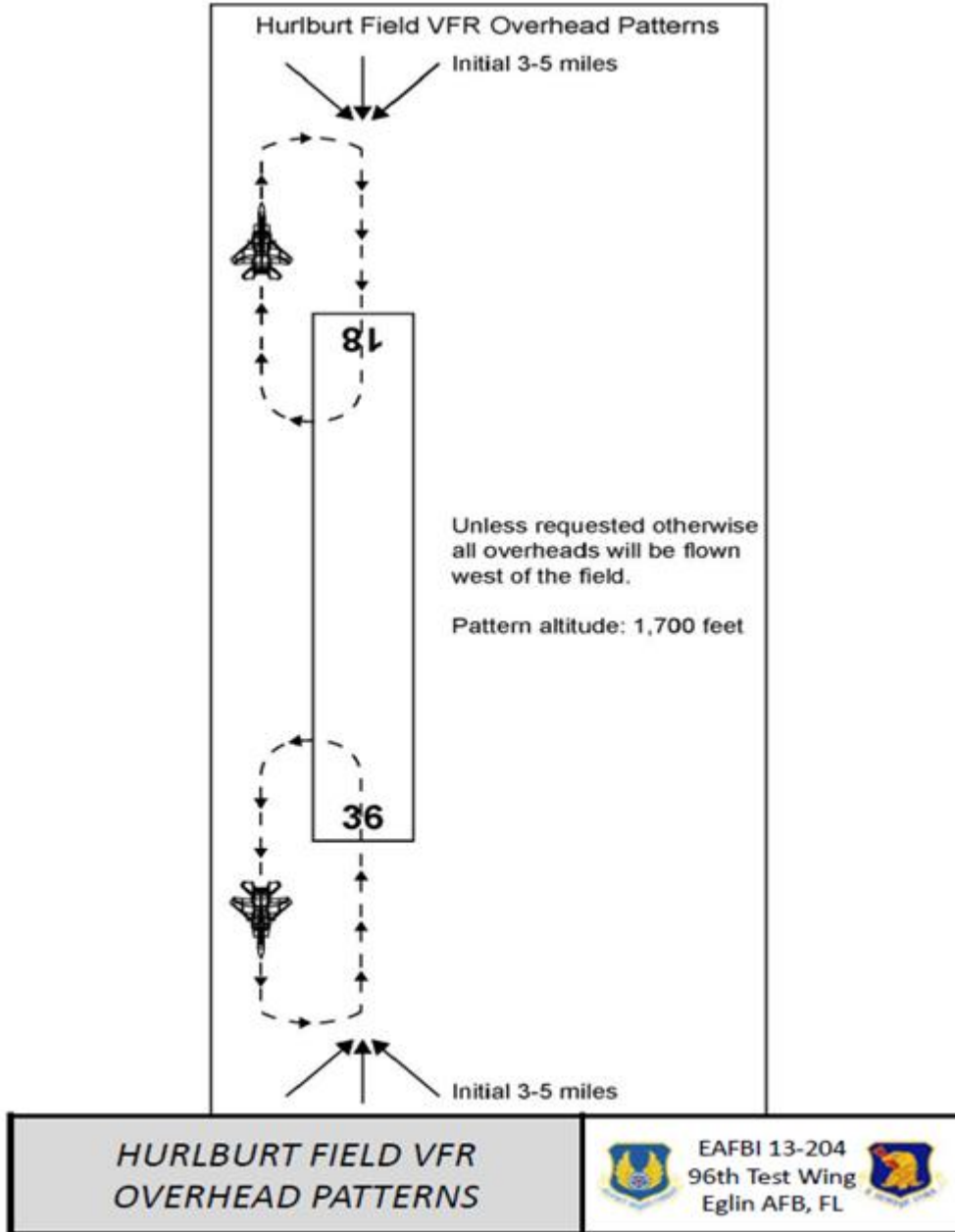

Attachment 35

EGLIN LOCAL FLYING AREA

Figure A35.1. Eglin Local Flying Area.

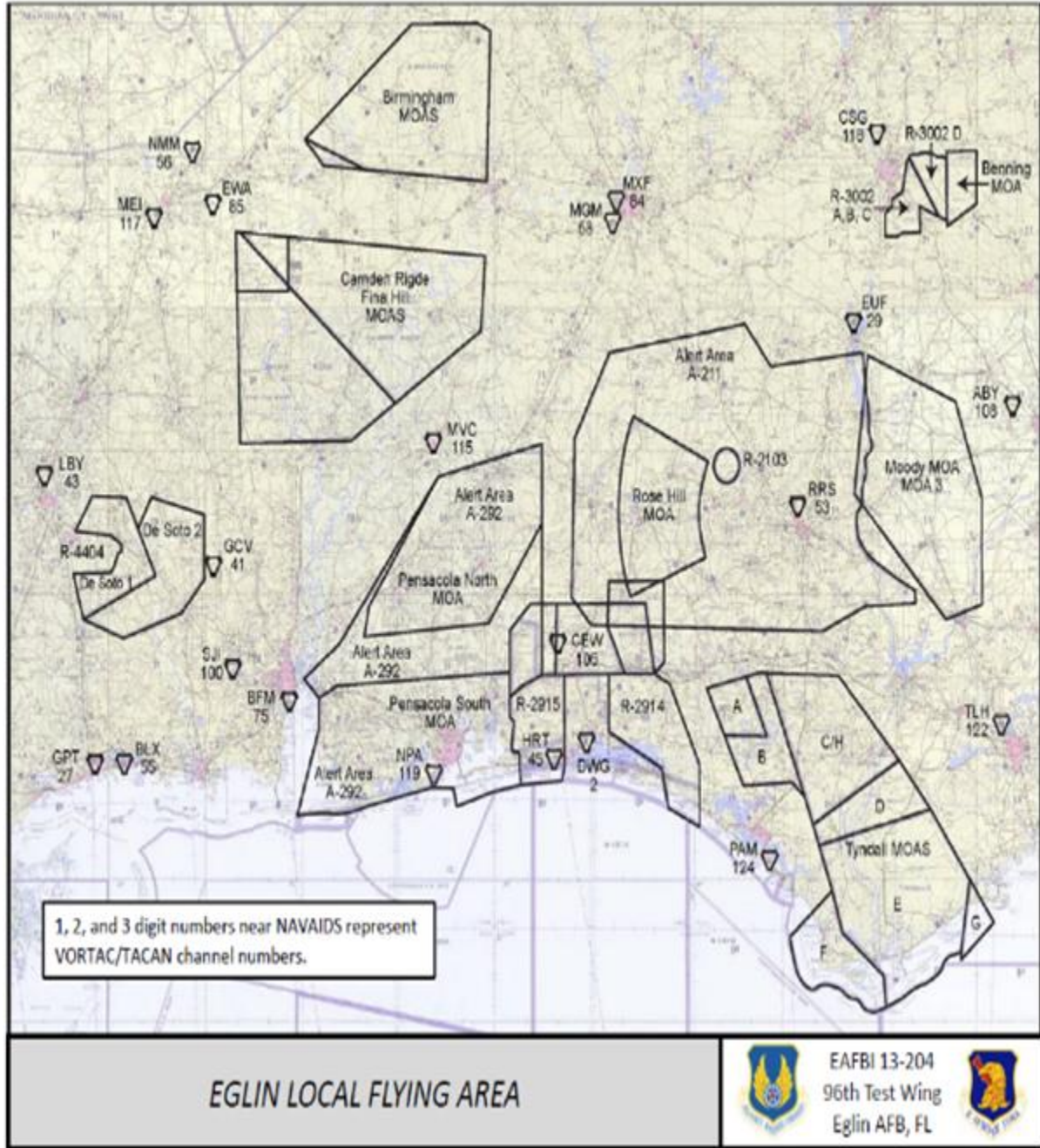

Attachment 36

CLASS DELTA AND ECHO SURFACE AREAS, MOAS, AND RESTRICTED AREAS

Figure A36.1. Class Delta and Echo Surface areas, MOAs, and Restricted Areas.

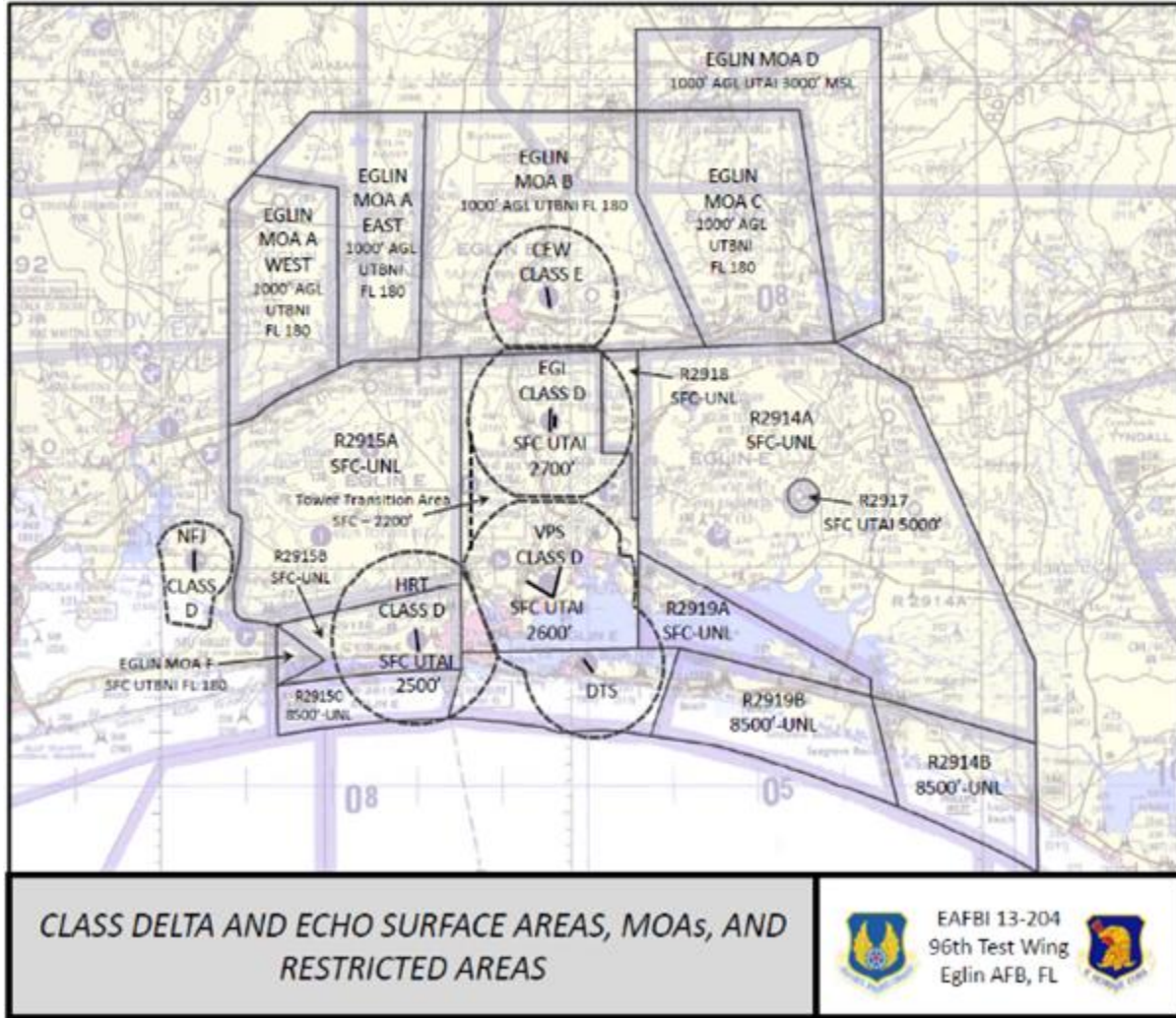

Attachment 37

FAR PART 93 AIRSPACE (NORTH/SOUTH – EAST/WEST CORRIDORS)

Figure A37.1. Far Part 93 Airspace (North/South – East/West Corridors).

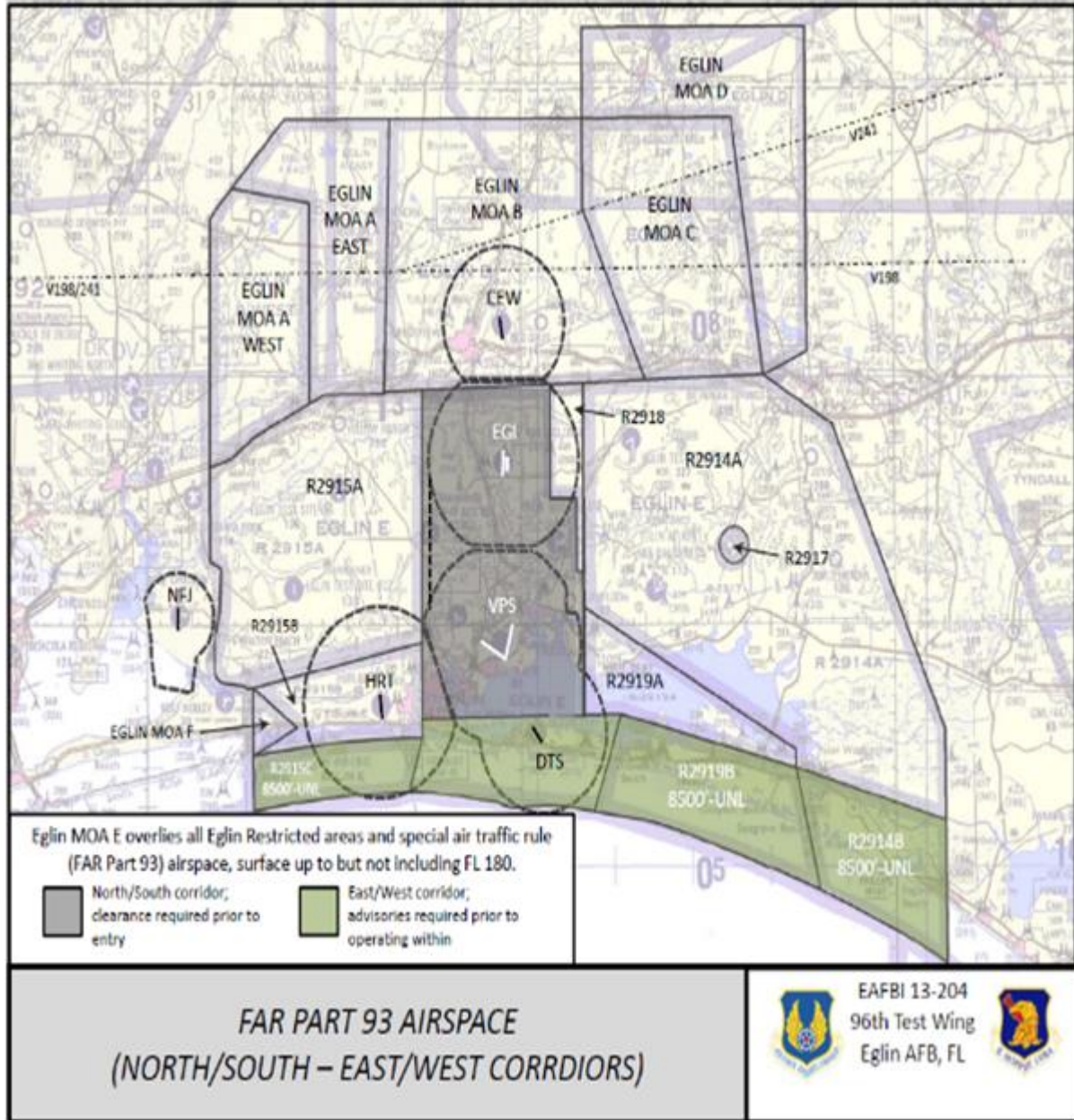

Attachment 38

LOCAL CONTROL POINTS

Figure A38.1. Local Control Points.

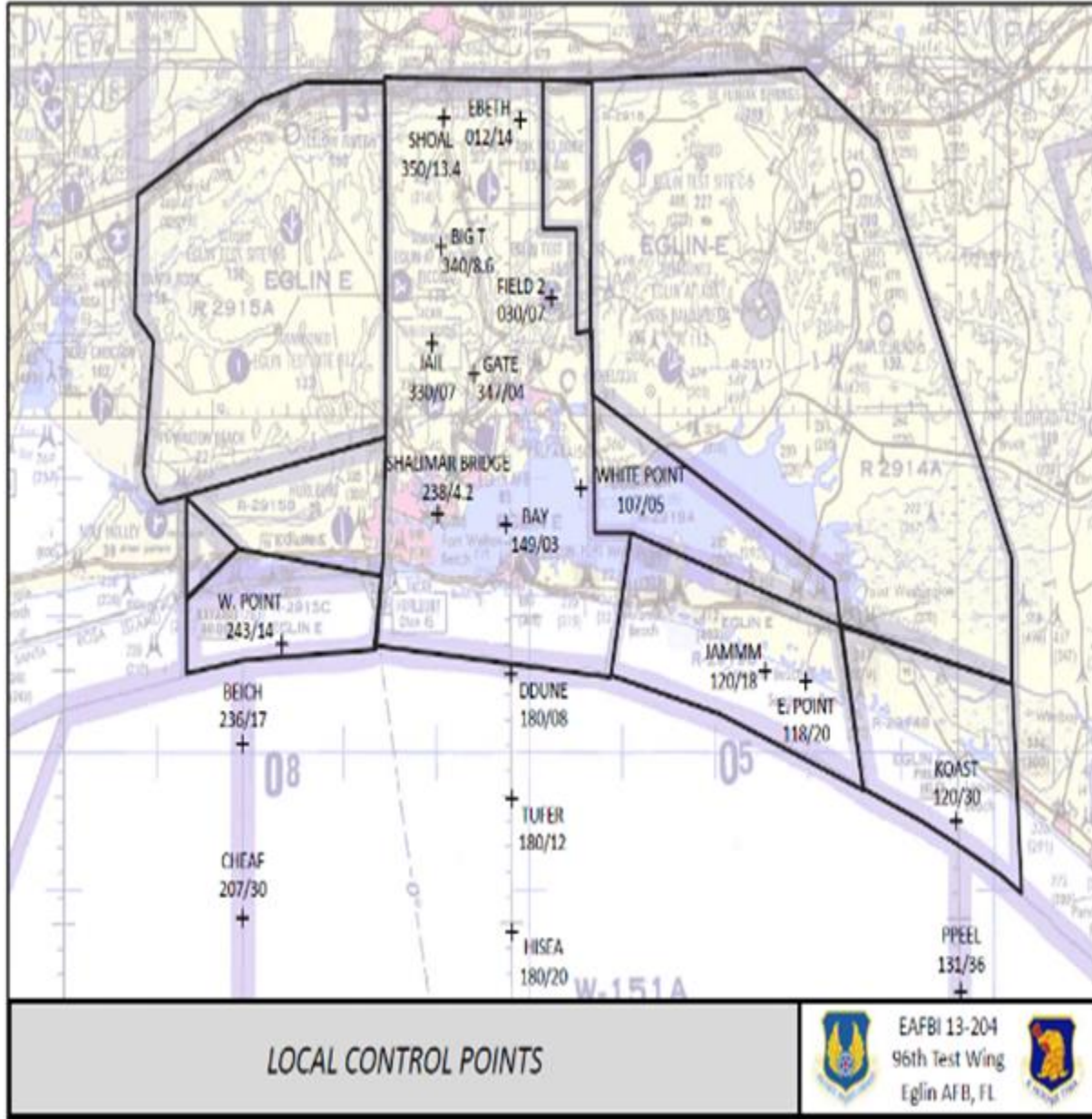

Attachment 39

EGLIN WATER TEST AREAS

Figure A39.1. Eglin Water Test Areas.

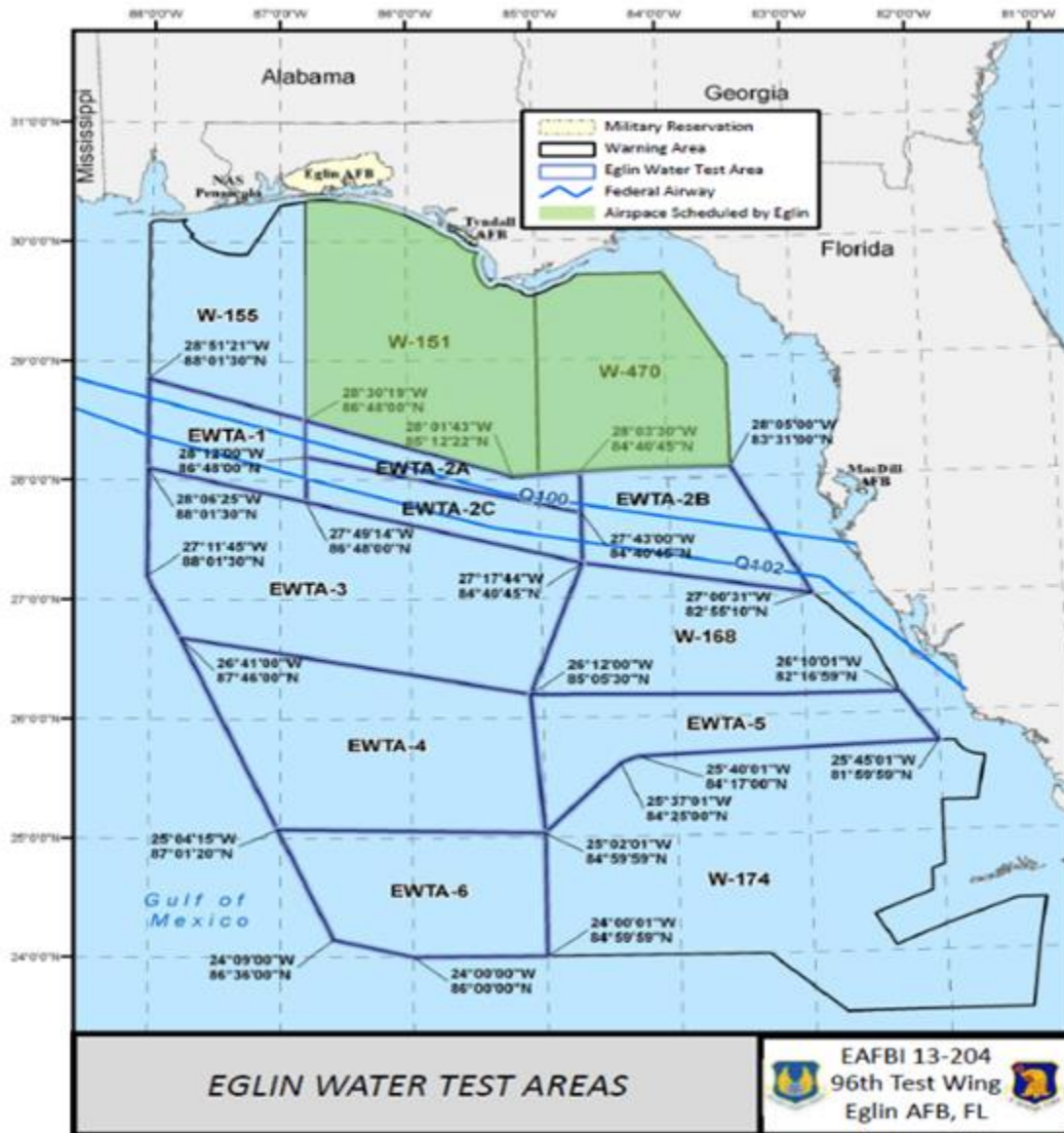

Attachment 40

W-151 AND W-470 SUBDIVISIONS

Figure A40.1. W-151 and W-470 Subdivisions.

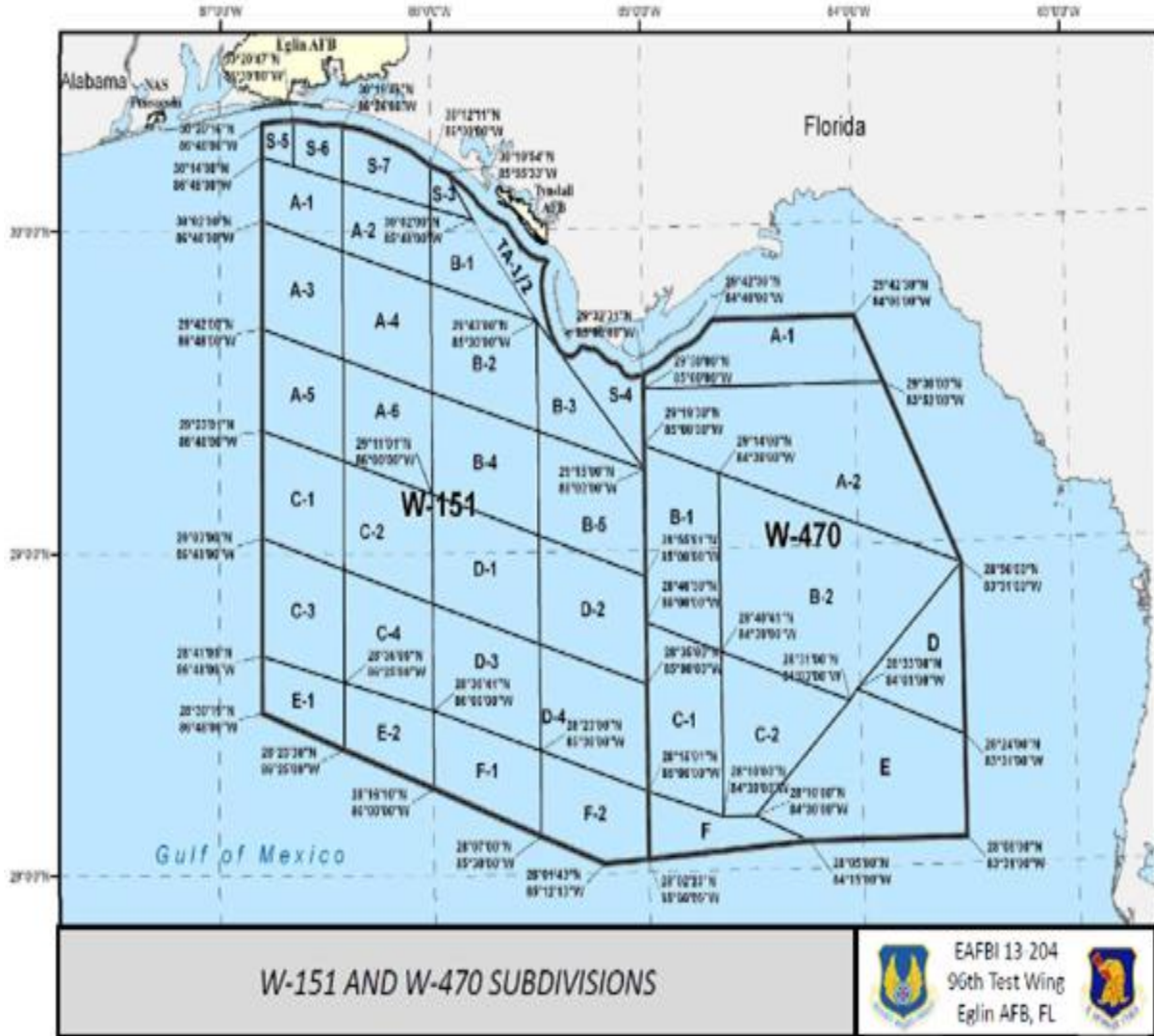



Attachment 41

W-470

Figure A41.1. W-470.

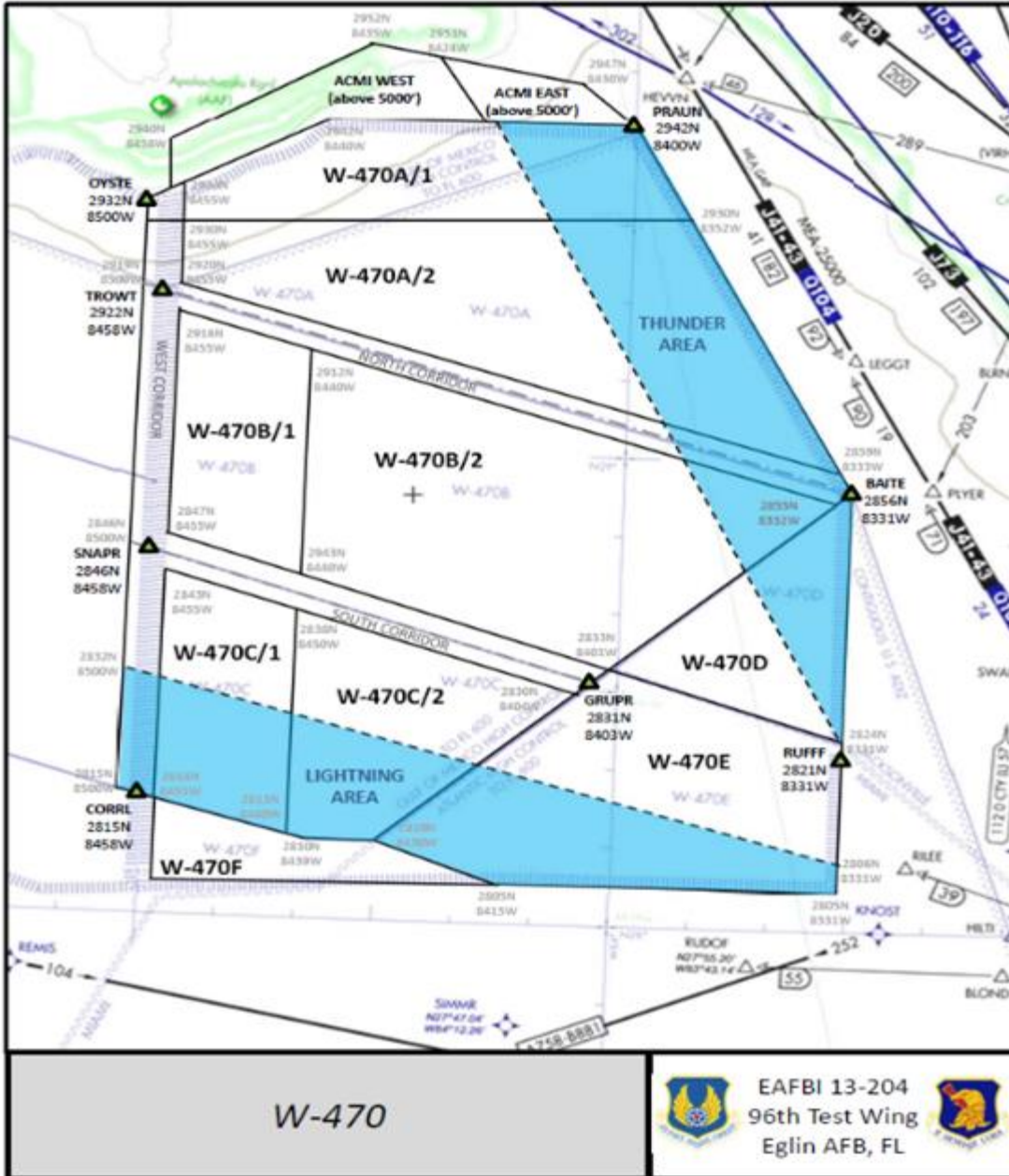

Attachment 42

WARNING AIRSPACE BREEDING/THUNDER/LIGHTNING AREA DIAGRAM

Figure A42.1. Warning Airspace Breeding/Thunder/Lightning Area Diagram.

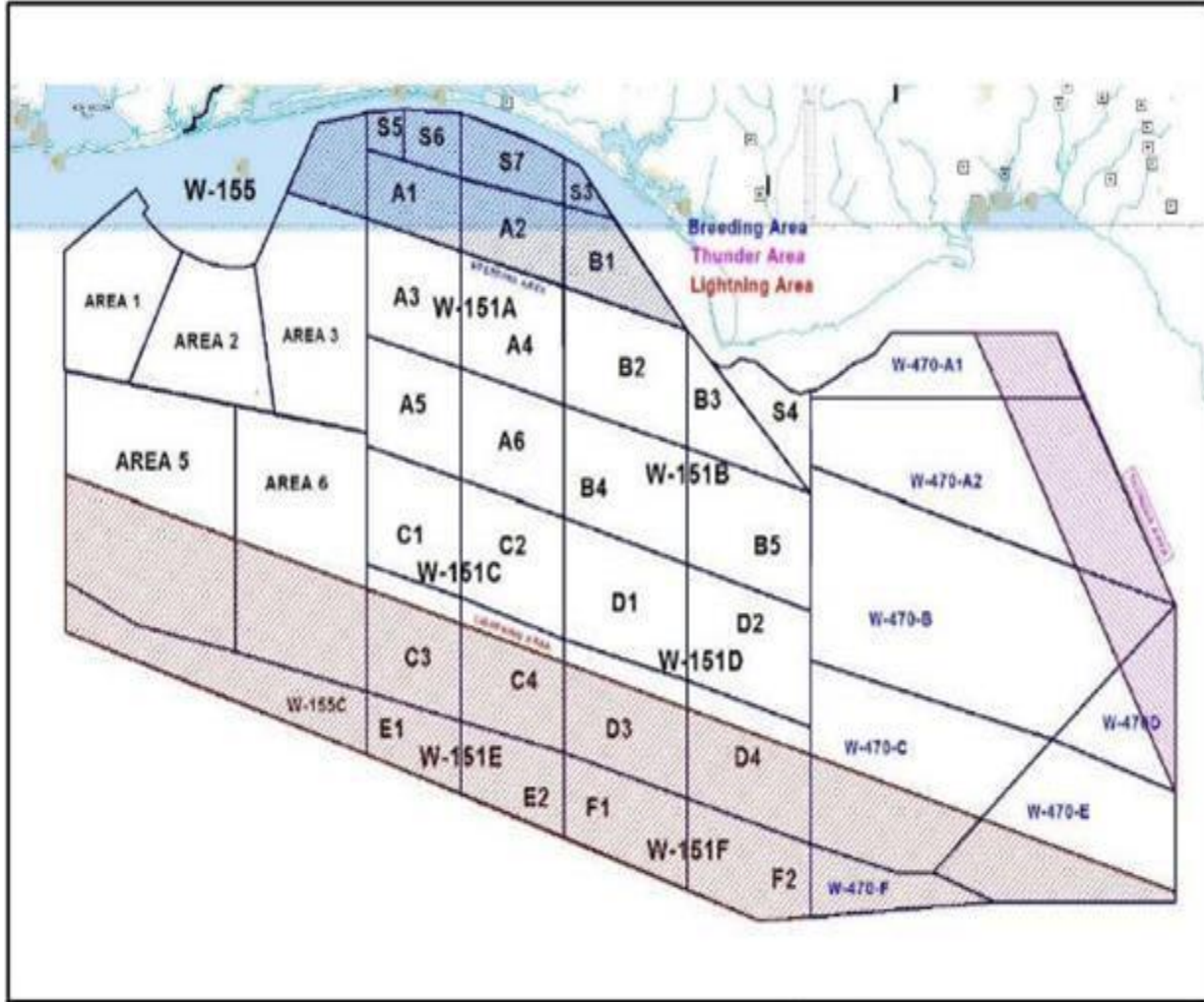

Attachment 43

AERO CLUB TRAINING AREAS AND SANTA ROSA ISLAND CFA

Figure A43.1. Aero Club Training Areas and Santa Rosa Island CFA.



Attachment 44

EMERGENCY JETTISON/BAILOUT AREAS

Figure A44.1. Emergency Jettison/Bailout Areas.

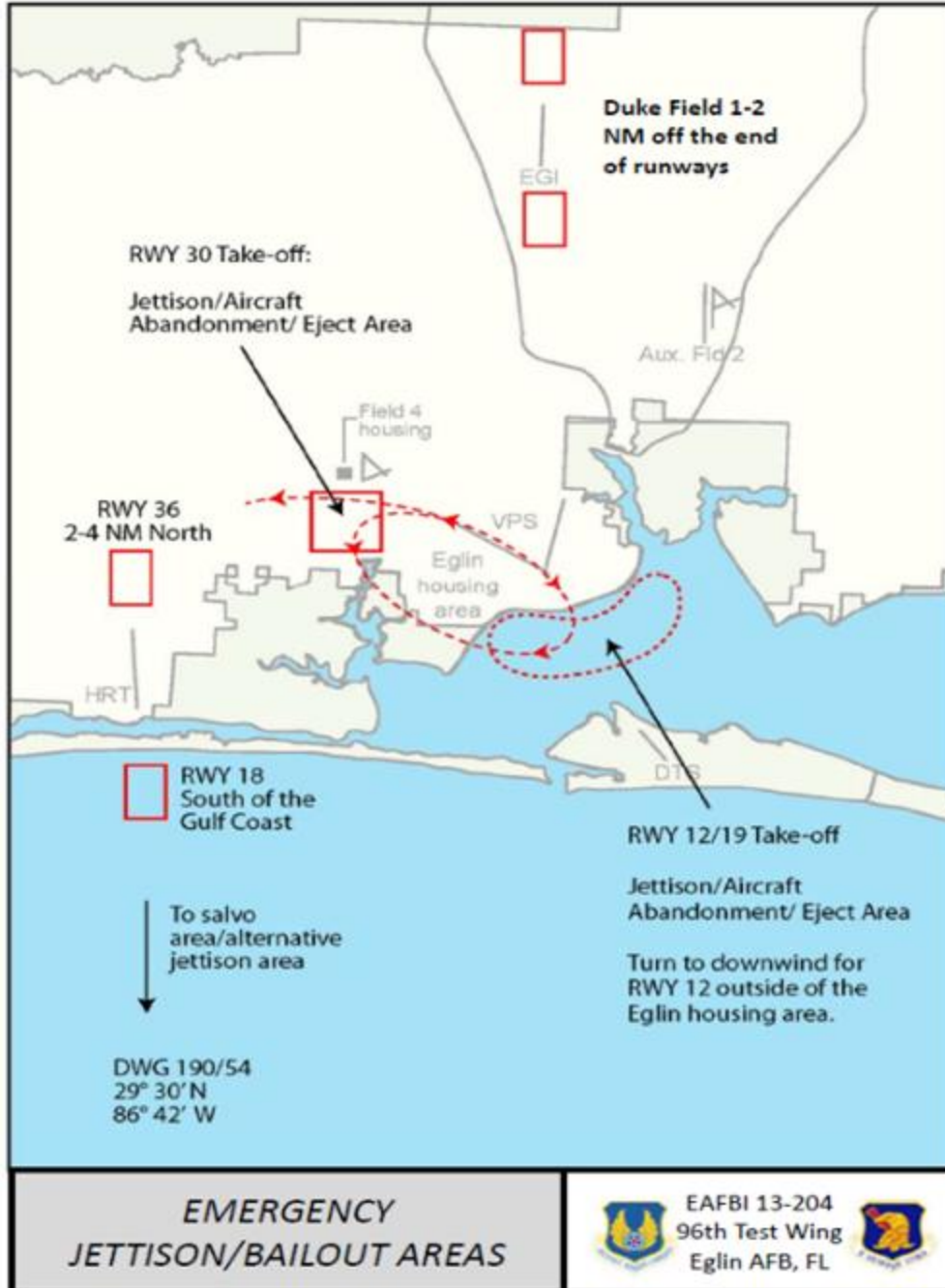

Attachment 45

NOISE ABATEMENT AND SAFETY MINIMUM ALTITUDES

Figure A45.1. Noise Abatement and Safety Minimum Altitudes.

