

# INTERNATIONAL RESEARCH CONFERENCE ON HUANGLONGBING

## Proceedings of the Meeting



### Editors:

Tim R. Gottwald  
James H. Graham

### Section Editors:

Armando Bergamin-Filho  
John DaGraça  
William Dawson  
Wayne Dixon  
Tim Gottwald  
James Graham  
Susan Halbert  
David Hall  
John Hartung  
Michael Irely  
Michael Rogers  
Edward Stover

### General Editors:

Mary Peck  
Karen Gottwald

IRCHLB Proceedings Compilation Copyright © 2009 Plant Management Network

Orlando, Florida



December 2008

# INTERNATIONAL RESEARCH CONFERENCE ON HUANGLONGBING



## *The Mission*

of this conference is to assemble the greatest number possible from the international research community, plus regulatory agency representatives, and commercial industry leaders with specific expertise on HLB for the express purpose to exchange the latest information, knowledge, ideas and concepts relative to HLB. We also want to provide a venue for increased international collaboration as well to deal with a disease that does not respect the political or physical boundaries of states or countries. Invited scientists and participants will be asked to reach beyond current information, thinking, scientific disciplines, and dogma in an attempt to broaden our global knowledge, provide new researchable goals and horizons and foster progress toward new and innovative solutions to HLB.

## *The Theme*

of this International Research Conference on Huanglongbing is

### *Reaching Beyond Boundaries,*

indicating our determination and need to reach beyond political, scientific and national boundaries in an attempt to find commercially feasible solutions to this devastating disease.

Orlando, Florida



December 2008

# INTERNATIONAL RESEARCH CONFERENCE ON HUANGLONGBING



## The Organizing Committee:

Tim Gottwald (Co-Chair) – USDA, ARS - [Tim.Gottwald@ars.usda.gov](mailto:Tim.Gottwald@ars.usda.gov)  
 Wayne Dixon (Co-Chair) – FDACS, DPI - [dixonw@doacs.state.fl.us](mailto:dixonw@doacs.state.fl.us)  
 Jim Graham (Co-Chair) – University of Florida - [jhg@crec.ifas.ufl.edu](mailto:jhg@crec.ifas.ufl.edu)  
 Phil Berger (Co-Chair) – USDA, APHIS - [Philip.H.Berger@aphis.usda.gov](mailto:Philip.H.Berger@aphis.usda.gov)

## Research Program Committee

Michael Rogers – University of Florida  
 Bill Dawson - University of Florida  
 Mike Irey – Southern Garden Citrus, US Sugar Corp.  
 David Hall – USDA, ARS  
 Ed Stover – USDA, ARS  
 John daGraca – TAMU  
 Marylou Polek – CCTEA, CDA  
 Susan Halbert – FDACS, DPI  
 Pat Gomes – USDA, APHIS  
 Armando Bergamin-Filho – Univ. São Paulo

## Industry Organizing Committee

Mike Sparks – Florida Citrus Mutual (Chair)  
 Ted Batkin – California Research Board  
 Jerry Newlin – Florida HLB Task Force  
 Ray Prewett – Texas Citrus Mutual  
 Peter McClure - FCPRAC  
 Juliano Ayres – Fundecitrus, Brazil

### Organizers



### Sponsors



Orlando, Florida



December 2008

# INTERNATIONAL RESEARCH CONFERENCE ON HUANGLONGBING



## *Conference Overview*

Over the past decade, Huanglongbing (HLB) has spread to, and is increasing in, the western hemisphere and continues to increase to near pandemic proportions throughout the citrus-producing areas of the world. Major citrus production areas presently without HLB are experiencing the introduction and spread of the disease's psyllid vector(s). The globalization of the disease and its vector places all citrus production worldwide at increased risk. Key elements which exacerbate the probability of pathogen and pest introduction are the continued increases in international trade and travel. Clearly, HLB has become a global issue that threatens the continued successful production of citrus.

Multiple local, regional and international workshops and meetings, including the 2005 International Citrus Canker and HLB Workshop in Orlando, have taken place over the last few years to address the HLB problem and are demonstrative of the continued and increasing need to find solutions to this devastating disease. Each meeting has added valuable increments to our better understanding the HLB puzzle.

The mission of this conference is to assemble the greatest number possible from the international research community, plus regulatory agency representatives, and commercial industry leaders with specific expertise on HLB for the express purpose to exchange the latest information, knowledge, ideas and concepts relative to HLB. We also want to provide a venue for increased international collaboration as well to deal with a disease that does not respect the political or physical boundaries of states or countries. Invited scientists and participants will be asked to reach beyond current information, thinking, scientific disciplines, and dogma in an attempt to broaden our global knowledge, provide new researchable goals and horizons and foster progress toward new and innovative solutions to HLB.

The theme of this International Research Conference on Huanglongbing is *Reaching Beyond Boundaries*, indicating our determination and need to reach beyond political, scientific and national boundaries in an attempt to find commercially feasible solutions to this devastating disease.

Orlando, Florida



December 2008

<b><i>Internacional Research Conference on Huanglongbing (IRCHLB)</i></b>		
<b><i>'Reaching Beyond Boundaries'</i></b>		
<b>Index of Presentations:</b>		
<b>No.</b>	<b>Presentation and Authors</b>	<b>Page</b>
<b>Keynote Lectures</b>		
<b>K1</b>	<b>Historical perspectives of HLB in Asia - Bernard Aubert</b>	<b>14</b>
<b>K2</b>	<b>Evolution of Citrus, <i>Diaphorina citri</i>, and <i>Liberibacter asiaticus</i> - Andrew Beattie</b>	<b>23</b>
<b>K3</b>	<b>Research and Health Management of Citrus Huanglongbing in Taiwan - Hong-Ji Su</b>	<b>57</b>
<b>Session 1: Current HLB Situation and Concerns Regarding Asian Citrus Greening and the Asian Citrus Psyllid - Peter McClure, Moderator</b>		
<b>1.1</b>	<b>Current HLB situation and industry perspective in Asia – <u>Beattie, G.A.C.</u> and Holford, P.</b>	<b>94</b>
<b>1.2</b>	<b>Current HLB situation and citrus producer's perspective in South America - <u>Clóvis Penalva Monteiro</u></b>	<b>95</b>
<b>1.3</b>	<b>Current HLB situation and citrus producer's perspective in US - <u>Jim Snively</u></b>	
<b>Session 2: HLB Survey - M. Irey, Moderator</b>		
<b>2.1</b>	<b>Current situation of citrus huanglongbing in Cuba – <u>Llauger, R.</u>, Luis, M. Collazo, C., Peña, I., González, C., Batista, L., Teixeira, D., Martins, E., Perdomo, A., Casin, J.C., Pérez, J.L., and Cueto, J.R. and Bové, J.M.</b>	<b>99</b>
<b>2.2</b>	<b>Data trends and results from an HLB laboratory that has processed over 55,000 commercial and research samples over a two year period in Florida. <u>Irey, M.</u>, Mai, P., Graham, J., and Johnson, J.</b>	<b>103</b>
<b>2.3</b>	<b>Texas steps up surveys for huanglongbing and the Asian citrus psyllid – daGraca, J. V., Skaria, M., Setamou, M., Kunta, M., Arredondo, M., Salas, B., Parker, P.E.</b>	<b>104</b>
<b>2.4</b>	<b>National plan for detection of HLB in Mexico – Robles, G.P., Sanchez, A.H., Mendez, L.O.</b>	<b>106</b>
<b>2.5</b>	<b>Survey for “<i>Candidatus Liberibacter</i> species in South Africa – <u>Pietersen, G.</u>, Kotzé, A., Phahladira, M.N.B., Schwerdtfeger, M.</b>	<b>110</b>
<b>2.6</b>	<b>Large-scale distribution of <i>Diaphorina citri</i> Kuwayama and citrus huanglongbing in Florida – <u>Halbert, S.E.</u>, Manjunath, K., and Brodie, M.W.</b>	<b>112</b>
<b>2.7</b>	<b>Is it possible to replant young groves in an area with endemic HLB – a hierarchical sampling approach to determine infection? – <u>Irey, M.</u>, Gottwald, T., Stewart, M., and Chamberlain, H.</b>	<b>116</b>
<b>Session 3: HLB Detection and Diagnostics – J. Hartung, Moderator</b>		
<b>3.1</b>	<b>Lessons learned from a comparison and evaluation of multiple HLB testing laboratories employing common and different testing methodologies on a common set of samples – <u>Irey, M.</u>, Sieburth, P., Brlansky, R., DaGraca, J., Graham, J., Gottwald, T., Hartung, J., Hilf, M., Kunta, M., Manjunath, K., Lin, H., Ramdugu, C., Roberts, P., Rogers, M., Shatters, R., Sun, X., and Wang, N.</b>	<b>119</b>
<b>3.2</b>	<b>Improved detection of low-titer, non-lethal, seed transmitted <i>Candidatus Liberibacter asiaticus</i> in citrus, periwinkle, and dodder using nested PCR – Zhou, L.-J., Benyon, L. S., Powell, C. A., Gottwald, T., and Duan, Y.-P.</b>	<b>120</b>
<b>3.3</b>	<b>Detection of “<i>Candidatus Liberibacter asiaticus</i>” by cycleave isothermal and chimeric primer-initiated amplification of nucleic acids (Cycleave ICAN) – Urasaki, N., <u>Kawano, S.</u>, Mukai, H., Uemori, T., Takeda, O., and Sano, T.</b>	<b>124</b>
<b>3.4</b>	<b>A novel molecular diagnostic tool for improved sensitivity and reliability detection of “<i>Candidatus Liberibacter asiaticus</i>” bacterium associated with huanglongbing (HLB) – Lin, H., Doddapaneni, H., and Civerolo, E. L.</b>	<b>127</b>
<b>3.5</b>	<b>Citrus greening (Huanglongbing) disease in India: present status and diagnostic efforts – <u>Das, A.K.</u></b>	<b>129</b>
<b>3.6</b>	<b>Improvement of <i>Candidatus Liberibacter asiaticus</i> diagnosis by nested PCR – Coletta-Filho, H.D., Alves, K.C.S., Carlos, E.F., Pereira, M.A.R., <u>Machado, M.A.</u></b>	<b>134</b>

<b>3.7</b>	<b>Optimizing qPCR for detection of <i>Candidatus Liberibacter species</i> in plants and psyllid samples</b> – Shatters, R. G., Hunter, W., Hall, D., Niedz, R., Evens, T. J.	<b>135</b>
<b>3.8</b>	<b>Comparison of detection sensitivity of different primer pairs for citrus huanglongbing bacterium</b> – Ding, F., Wang, G., Yi, G., Hong, N., Zhong, Y.	<b>136</b>
<b>3.9</b>	<b>Quantification of viable <i>Candidatus Liberibacter asiaticus</i> in hosts using quantitative PCR with the aid of ethidium monoazide (EMA)</b> – Sagaram, U.S., Trivedi, P., Kim, J-S, Brlansky, R.H., Rogers, M.E., Stelinski, L.L., Oswalt, C., and Wang, N.	<b>138</b>
<b>3.10</b>	<b>PCR for detection of Asian and American strains of <i>Candidatus Liberibacter</i> In citrus, <i>Murraya</i> and <i>Diaphorina</i> from Northwest Argentina</b> – Ramallo, J., Acosta, E., Rojas, A., Stein, B.	<b>139</b>
<b>3.11</b>	<b>Current situation of citrus Huanglongbing associated with “<i>Candidatus Liberibacter asiaticus</i>” in Guangdong, China.</b> Deng, X., Chen, J., Xu, J., Guo, H., Pu, X., Cai, L., and Li, H.	<b>141</b>
<b>3.12</b>	<b>Molecular approach for early detection of <i>Candidatus Liberibacter species</i> in Texas citrus</b> – Bextine, B., Gunawan, S., Hunter, W., and Shatters, R.	<b>142</b>
<b>3.13</b>	<b>Comparison of a starch-based field test for Huanglongbing to results from real-time PCR testing of field samples from symptomatic trees in Florida</b> - Chamberlain, H. L. and M. S. Irey	<b>144</b>
<b>Session 4: Pathogen Genome Sequencing, Phylogenetics, and Culturing</b> – W. Dawson, Moderator		
<b>4.1</b>	<b>Evaluation of potential pathogenicity genes identified by genomic sequencing of <i>Ca. Liberibacter asiaticus</i></b> – Zhang, S., Reddy, S., and Gabriel, D. W.	<b>146</b>
<b>4.2</b>	<b>Zebra complex and HLB: Seeking a common enemy?</b> Bextine, B. Swatsell, C. and Hunter, W.	<b>149</b>
<b>4.3</b>	<b>Microbiome analysis of HLB pathogen infected citrus using phylochips and 16S rDNA clone library sequencing</b> – Sagaram, S., DeAngelis, K. M., Trivedi, P., Kim, J-S, Anderson, G.L., and Wang, N.	<b>151</b>
<b>4.4</b>	<b>Several <i>Liberibacter</i> and phytoplasma species are individually associated with HLB</b> – Bové, J.M., Teixeira, D.C., Wulff, N.A., Eveillard, S., Saillard, C., Bassanezi, R. B., Lopes, S., Yamamoto, P.T., Ayres, A.J.	<b>152</b>
<b>4.5</b>	<b>Phylogenetic analysis of citrus huanglongbing bacterium based on the sequences of 16S rDNA and 16S / 23S rDNA intergenic regions among isolates in China</b> – Ding, F., Deng, X., Hong, N., Zhong, Y., Wang, G., Yi, G.	<b>156</b>
<b>4.6</b>	<b>Ribosomal RNA operons and genome size of <i>Candidatus Liberibacter americanus</i>, a bacterium associated with citrus huanglongbing in Brazil</b> – Wulff, N.A., Eveillard, S., Foissac, X., Ayres, A.J., and Bové, J.M.	<b>159</b>
<b>4.7</b>	<b>Genome analysis of <i>Candidatus Liberibacter asiaticus</i> reveals unique features for designing HLB control strategies</b> – Duan, Y.-P., Zhou, L.J, Hall, D., Li, W.B., Lin, H., Doddapaneni, H., Liu, L., Vahling, C.M., and Gottwald, T.	<b>165</b>
<b>4.8</b>	<b>Cocultivation of <i>Candidatus Liberibacter asiaticus</i> with actinobacteria from citrus with huanglongbing</b> – Davis, M.J., Mondal, S.N., Chen, H.-Q., Rogers, M.E., Brlansky, R.H.	<b>166</b>
<b>4.9</b>	<b>Development of an Asian citrus psyllid (<i>Diaphorina citri</i>) insect cell line</b> – M.W. Lewis and Keyhani, N.O.	<b>167</b>
<b>4.10</b>	<b>Enrichment of <i>Candidatus Liberibacter americanus</i> using an artificial psyllid feeding system</b> – Locali-Fabris, E.C., Coletta-Filho, D., Miranda, M.P., Francisco, C.S., Lopes, J.R.S., Machado, M.A.	<b>168</b>
<b>4.11</b>	<b>Asian citrus psyllid (<i>Diaphorina citri</i>) cell culture methods</b> – Marutani-Hert, M., Hunter, W., Hall, D.G.	<b>169</b>
<b>4.12</b>	<b>Genetic diversity of <i>Candidatus Liberibacter asiaticus</i> and <i>Ca. L. americanus</i> based on sequence variations of their rRNA operon</b> – Zhou, L.J., Powell, C.A., Gottwald, T., Duan, Y.P.	<b>172</b>
<b>4.13</b>	<b>Efficient enrichment of the pathogen DNA from HLB infected host</b> – Chen, C., Yu, Q., Gmitter, F.	<b>176</b>
<b>4.14</b>	<b>Characterization of “<i>Candidatus Phytoplasma asteri</i>” citrus huanglongbing strain in</b>	<b>177</b>

	<b>Guangdong, China</b> – Chen, J., Deng, X., Pu, X., Cai, L., and Guo, H.7	
<b>4.15</b>	<b>Visible/near-infrared spectroscopy for discrimination of HLB-infected citrus leaves from healthy leaves</b> - Poole, G., Windham, W., Heitschmidt, G., Park, B., and Gottwald, T.	<b>178</b>
<b>Session 5: Host Pathogen Interaction – J. daGraca, Moderator</b>		
<b>5.1</b>	<b><i>Liberibacter</i> populations in citrus and orange jasmine trees in São Paulo, Brazil</b> – Lopes, S. A., Frare, G. F., Bertolini, E., Wulff, N. A.	<b>182</b>
<b>5.2</b>	<b>The effects of HLB-infection on respiration and development of roots of <i>Feroniella</i> rootstock (<i>Feroniella oblata</i>) which showed resistance to HLB bacterium</b> – Ogata, T., Kobori, Y., Kawabe, K., Yonemoto, H., Ohto, Y., Nguyen, T.B., and Nguyen, M.C.	<b>184</b>
<b>5.3</b>	<b>Anatomical evolution of symptoms from infection with the HLB bacterium</b> – Achor, D. S., Chung, K-R., Exteberria, E., Wang, N., and Albrigo, L. G.	<b>185</b>
<b>5.4</b>	<b>Influence of temperature on huanglongbing infection under controlled environment</b> – Gasparoto, M. C. G., Bassanezi, R. B., Lopes, S. A., Frare, G., Martins, E. C., Della Colletta Filho, H., Amorim, L.	<b>186</b>
<b>5.5</b>	<b>Can <i>Ca. Liberibacter asiaticus</i> be transmitted through citrus seed?</b> Hartung, J. S., Halbert, S., Shatters, R.	<b>188</b>
<b>5.6</b>	<b>Biochemical changes after infection with <i>Candidatus Liberibacter asiaticus</i> in citrus</b> – JiangBo, Zhong, Y., Wanghui, Yi, G.	<b>189</b>
<b>5.7</b>	<b>“<i>Candidatus Liberibacter solanacearum</i>” associated with zebra chip of potato is not associated with citrus huanglongbing and is absent in Asian citrus psyllid</b> – Li, W., Abad, J. A., and Levy, L.	<b>190</b>
<b>5.8</b>	<b>Discovery of <i>Candidatus Liberibacter psyllauros</i> and its insect vector the tomato psyllid (<i>Bactericera cockerelli</i>)</b> – Hansen, A.K., Paine, T.P., Stouthamer, R.	<b>194</b>
<b>5.9</b>	<b>Response of sweet orange (<i>Citrus sinensis</i>) to <i>Candidatus Liberibacter asiaticus</i> infection: microscopy and microarray analyses</b> – Kim, J-S., Sagaram, U.S., Burns, J. K., Li, J-L., and Wang, N.	<b>196</b>
<b>5.10</b>	<b>Asian strains of citrus greening bacterium with genetic and pathogenic variation on pummelo</b> – Miyata, S., Tomimura, K., Furuya, N., Okuda, M., Subandiyah, S., Tsai, C.H., Hung, T.H., Su, H.J., and Iwanami, T.	<b>197</b>
<b>5.11</b>	<b>Detection of <i>Candidatus Liberibacter asiaticus</i> in citrus seedlings germinated from Florida seed</b> – Shatters, R. G.	<b>198</b>
<b>5.12</b>	<b>Assessment of transmission of <i>Liberibacter asiaticus</i> from seed to seedlings of ‘Pineapple’ sweet orange and ‘Carrizo’ citrange</b> – Graham, J. H., Ireby, M. S., Dawson, W. O., Hall, D., Duan, Y.	<b>199</b>
<b>5.13</b>	<b>Metabolite changes in HLB orange leaves by GC-MS and other techniques</b> – Cevallos-Cevallos, J.M., Reyes-De-Corcuera, J.I.	<b>201</b>
<b>5.14</b>	<b>Regeneration and chemotherapy of huanglongbing-affected periwinkle</b> – Zhang, M-Q., Duan, Y-P., Powell, C.A.	<b>203</b>
<b>5.15</b>	<b>Differences in secondary metabolites in leaves from trees affected with the greening (HLB) disease</b> – Manthey, J.	<b>207</b>
<b>5.16</b>	<b>Role of <i>Murraya</i> species in the spread of huanglongbing</b> – Ramadugu, C., Lopes, S., Manjunath, K., Halbert, S., Roose, M., and Lee, R.	<b>210</b>
<b>5.17</b>	<b>Identification of a new <i>Liberibacter</i> species associated with diseases of solanaceous plants</b> – Liefting, L., Sutherland, P.W., Ward, L.I., Weir, B.S., Kumarasinghe, L., Quinn, B.D., and Clover, G.R.G	<b>211</b>
<b>Session 6: Asian Citrus Psyllid (Biology and Genomics) – D. Hall, Moderator</b>		
<b>6.1</b>	<b>Gene expression in midgut tissues of <i>Diaphorina citri</i>: application to biology and vector control</b> – Hunter, W., Marutani-Hert, M., Shelby, K., Coudron, T.	<b>214</b>
<b>6.2</b>	<b>Pheromones of the Asian citrus psyllid, <i>Diaphorina citri</i> Kuwayama (Hemiptera: Psyllidae) elicit behavioral responses from its parasitoid, <i>Tamarixia radiata</i> (Waterston) (Hymenoptera: Eulophidae)</b> – Onagbola, E. O., Rouseff, R. L., Stelinski, L. L.	<b>218</b>
<b>6.3</b>	<b>Effects of freezes on survival of <i>Diaphorina citri</i></b> – Hall, D. G.	<b>219</b>
<b>6.4</b>	<b>Characterization of electrical penetration graphs of <i>Diaphorina citri</i> Kuwayama</b>	<b>222</b>

	<b>(Hemiptera: Psyllidae) in citrus</b> – Bonani, J.P., Fereres, A., Appezzato-da-Gloria, B., Garzo, E.I., Miranda, M.P., Lopes, J.R.S.	
<b>6.5</b>	<b>Symbionts associated with <i>Diaphorina citri</i> Kuwayama (Hemiptera: Psyllidae) in Brazil and a look into their role</b> – Salvador, I., Cônsoli, F. L.	<b>223</b>
<b>6.6</b>	<b>Endosymbiotic microbiota of Asian citrus psyllid (<i>Diaphorina citri</i>)</b> – Marutani-Hert, M., Hunter, W., Dowd, S., and Hall, D.	<b>224</b>
<b>6.7</b>	<b>FK506-Binding protein from <i>Diaphorina citri</i> (Hemiptera: Psyllidae)</b> – Hunter, W., Shatters, R.	<b>228</b>
<b>6.8</b>	<b>Gene expression in Asian citrus psyllid adults feeding from Florida citrus: Application to biology and vector control</b> – Hunter, W., Shelby, K., Dowd, S., McKenzie, C., Shatters, R.	<b>233</b>
<b>6.9</b>	<b>Asian citrus psyllid, genetic basis of immunity</b> – Marutani-Hert, M., Hunter, W.B., Shelby, K.S.	<b>238</b>
<b>6.10</b>	<b>Effects of host plant on fitness of the Asian citrus psyllid, <i>Diaphorina citri</i></b> – Tsagkarakis, A. E., and Rogers, M. E.	<b>242</b>
<b>6.11</b>	<b>Development of a potato psyllid (<i>Bactericera cockerelli</i>) cell culture</b> - Bextine, B., Tufts, D., Timmons, C., Hunter, W., Marutani-Hert, M.4	<b>244</b>
<b>Session 7: Asian Citrus Psyllid (Ecology and Transmission) – S. Halbert, Moderator</b>		
<b>7.1</b>	<b>Acquisition of <i>Candidatus Liberibacter asiaticus</i> by the Asian citrus psyllid, <i>Diaphorina citri</i>, and the potential use of insecticides to prevent pathogen transmission</b> – Rogers, M. E., Brlansky, R. H., Ebert, T. A., Serikawa, R. H., Schumann, R. A., and Stelinski, K. P.	<b>247</b>
<b>7.2</b>	<b>Leaf age influencing acquisition of <i>Candidatus Liberibacter asiaticus</i> by the psyllid vector <i>Diaphorina citri</i></b> – Bonani, J.P., Appezzato-da-Gloria, B., Fereres, A., Engels, F.E., Lopes, J.R.S.	<b>249</b>
<b>7.3</b>	<b>Ecological studies on initial invasion of <i>Diaphorina citri</i> into the newly planting citrus fields</b> – Kobori, Y., Nakata, T., Ohto, Y., and Takasu, F.	<b>250</b>
<b>7.4</b>	<b>Spatial distribution of adults of <i>Diaphorina citri</i> Kuwayama (Hemiptera: Psyllidae) in ‘Valencia’ sweet orange trees</b> – Costa, M.G., Felipe, M. R., Garbim, L.F., Carmo-Uehara, A., Yamamoto, P.T., Barbosa, J.C.	<b>251</b>
<b>7.5</b>	<b>Population dynamics of <i>Diaphorina citri</i> in citrus orchards in São Paulo State, Brazil</b> – Yamamoto, P.T., Felipe, M.R., Rugno, G.R., Beloti, V. H., Coelho, J.H.C., Ximenes, N.L., Garbim, L.F., Carmo-Uehara, A.	<b>252</b>
<b>7.6</b>	<b>The seasonal influence of <i>Candidatus Liberibacter asiaticus</i> in the Asian citrus psyllid, <i>Diaphorina citri</i> Kuwayama (Homoptera: Psyllidae) in Okinawa, Japan</b> – Sadoyama, Y., and Takushi, T.	<b>253</b>
<b>7.7</b>	<b>Diurnal patterns in flight activity and effect of light on host finding behavior of the Asian citrus psyllid</b> – Sétamou, M., Sanchez, A., Patt, J., Louzada, E.	<b>255</b>
<b>7.8</b>	<b>Psyllids of citrus orchards in South Texas</b> – Thomas, D.B.	<b>258</b>
<b>7.9</b>	<b>Seasonal occurrence of <i>Candidatus Liberibacter asiaticus</i> in Asian citrus psyllids in Florida</b> – Ebert, T.A., Rogers, M.E., and Brlansky, R. H.	<b>259</b>
<b>7.10</b>	<b>Incidence and population of “<i>Candidatus Liberibacter asiaticus</i>” in Asian citrus psyllids (<i>Diaphorina citri</i>) on citrus plants affected by huanglongbing in Florida</b> – Li, W., Duan, Y.P., Brlansky, R. H., Twieg, E. and Levy, L.	<b>261</b>
<b>7.11</b>	<b>Response of Asian citrus psyllid to aromas emitted by the flushing shoots of their rutaceous host plants in a Y-tube olfactometer.</b> Sétamou, M. and Patt, J. M.	<b>266</b>
<b>Session 8: Economics, Fruit Quality, Crop Loss – L. Baldwin, Moderator</b>		
<b>8.1</b>	<b>An update on the effect of HLB on orange juice flavor – 2) Sensory evaluation</b> – Plotto, A., McCollum, G., Baldwin, E., Manthey, J., and Irely, M.	<b>267</b>
<b>8.2</b>	<b>Effect of greening plant disease (huanglongbing) on orange juice flavor and consumer acceptability.</b> Goodrich-Schneider, R., Sims, C., Valim, M., Spann, T., Danyluk M. and Rouseff, R.	<b>269</b>
<b>8.3</b>	<b>Yield reduction caused by huanglongbing in different sweet orange cultivars in São Paulo, Brazil</b> – Bassanezi, R. B., Montesino, L. H., Amorim, L., Gasparoto, M.C.G., Bergamin Filho, A.	<b>270</b>



<b>8.4</b>	<b>The production and price effects of citrus greening in São Paulo and Florida on the world orange juice market</b> – Spreen, T. H., Brown, M.G., Jauregui, C.	<b>274</b>
<b>8.5</b>	<b>The economics of management strategies to mitigate the impact of citrus greening in Florida citrus</b> – Muraro, R.P., Morris, R. A.	<b>275</b>
<b>8.6</b>	<b>An update on the effect of citrus HLB on orange juice flavor 1) Chemical components</b> – Baldwin, E., Manthey, J., Plotto, A., McCollum, G., and Irey, M.	<b>276</b>
<b>8.7</b>	<b>The citrus greening bibliographical database, a new tool for researchers, students and growers</b> – Arevalo, H.A., Snyder, G., and Stansly, P. A.	<b>277</b>
<b>Session 9: International Regulatory Agencies – Regulating HLB - Phil Berger and Wayne Dixon, Moderators</b>		
<b>9.0</b>	Select representatives for various countries will present how their National Plant Protection Organizations have addressed or are addressing the challenges of HLB. The emphasis will be on what has worked, what has not, and common international unifying themes.	<b>279</b>
<b>Session 10: Epidemiology – A. Bergamin, Moderator</b>		
<b>10.1</b>	<b>Relationship between insecticide sprays and huanglongbing progress in a citrus orchard in São Paulo, Brazil</b> – Bergamin-Filho, A., Gasparoto, M.C.G., Bassanezi, R.B., Amorim, L.	<b>282</b>
<b>10.2</b>	<b>A stochastic spatiotemporal analysis of the contribution of primary versus secondary spread of HLB</b> – Gottwald, T., Irey, M., Bergamin-Filho, A., Bassanezi, R., and Gilligan, C.A.	<b>285</b>
<b>10.3</b>	<b>HLB survival analysis – a spatiotemporal assessment of the threat of an HLB - positive tree to its neighbors</b> – Gottwald, T., Irey, M., and Taylor, E.	<b>291</b>
<b>10.4</b>	<b>Use of mathematical models to inform control of an emerging epidemic</b> – Gilligan, C.A. Cunniffe, N.J., Cook, A.R., DeSimone, R.E. and Gottwald, T.R.	<b>296</b>
<b>10.5</b>	<b>An approach to model the impact of huanglongbing on citrus yield</b> – Bassanezi, R.B., Bassanezi, R.C.	<b>301</b>
<b>10.6</b>	<b>The plantation edge effect of HLB – a geostatistical analysis</b> – Gottwald, T. and Irey, M.	<b>305</b>
<b>10.7</b>	<b>Estimating the spatial distribution of huanglongbing from a sample</b> – Parnell, S., Gottwald, T.R., Irey, M. S., and van den Bosch, F.	<b>309</b>
<b>10.8</b>	<b>Within-tree spatial distribution of <i>Candidatus Liberibacter asiaticus</i></b> – Gottwald, T., Parnell, S., Taylor, E., Poole, K., Hodge, J., Ford, A., Therrien, L., Mayo, S. and M. Irey	<b>310</b>
<b>Session 11: Psyllid Management Strategies – M. Rogers, Moderator</b>		
<b>11.1</b>	<b>Bioecology of <i>Diaphorina citri</i> and <i>Tamarixia radiata</i>: zoning for citrus groves of the State of São Paulo</b> – Torres, M.G. and Parra, J. R. P., (presented by Lopes, J. S.)	<b>315</b>
<b>11.2</b>	<b>Repellent effect of guava odor against adults of citrus psyllid, <i>Diaphorina citri</i></b> – Zaka, S. M., Zeng, X. N.	<b>316</b>
<b>11.3</b>	<b>Wounding of guava (<i>Psidium guajava</i> L.) leaves produces defensive sulfur volatiles</b> – Rouseff, R. L., Onagbola, E. O., Smoot, J. M., and Stelinski, L.L.	<b>318</b>
<b>11.4</b>	<b>Chemical ecology of Asian citrus psyllid (<i>Diaphorina citri</i>) and potential applications of behavior-modifying chemicals for its management</b> – Stelinski, L.L., Onagbola, O.E., and Rouseff, R.L.	<b>319</b>
<b>11.5</b>	<b>Novel reovirus in <i>Diaphorina citri</i> (Hemiptera: Psyllidae)</b> – Marutani-Hert, M., Hunter, W., Hall, D.	<b>320</b>
<b>11.6</b>	<b>Efficiency of insecticides to control <i>Diaphorina citri</i>, vector of huanglongbing bacteria</b> – Yamamoto, P.T., Felipe, M.R., Beloti, V. H., Rugno, G.R.	<b>324</b>
<b>11.7</b>	<b>Integrated pest management of the Asian citrus psyllid (ACP) in Florida</b> – Stansly, P.A., Qureshi, J.A., and Arevalo, H. A.	<b>326</b>
<b>11.8</b>	<b>Perspectives for biological control of <i>Diaphorina citri</i> (Hemiptera: Psyllidae) in Mexico.</b> López-Arroyo, J.I., Jasso, J., Reyes, M., Loera-Gallardo, J., Cortez-Mondoaca, E. and Miranda, M.	<b>329</b>
<b>11.9</b>	<b>Investigations of the feasibility for managing the Asian citrus psyllid using <i>Isaria fumosorosea</i></b> – Avery, P.B., Hunter, W. B., Hall, D. G., Jackson, M. A. Powell, C. A., Rogers, M. E.	<b>331</b>
<b>11.10</b>	<b>Natural enemies of <i>Diaphorina citri</i> Kuwayama in Northwest Mexico</b> – Cortez-	

	Mondaca, E., Lugo-Angulo, N. E., Pérez-Márquez,	332
<b>11.11</b>	<b>Managing Asian citrus psyllid <i>Diaphorina citri</i> with soil and foliar applications of insecticides – Qureshi, J. A., and Stansly, P. A.</b>	333
<b>Session 12: HLB Management Strategies – J. Graham, Moderator</b>		
<b>12.1</b>	<b>Factors associated with control of huanglongbing in São Paulo, Brazil: A case study -</b> Belasque, J., Bassanezi, R.B., Yamamoto, P.T., Lopes, S.A., Ayres, A.J., Barbosa, J.C., Tachibana, A., Violante, A.R., Tank, A., Giorgetti, C.L., Di Giorgi, F., Tersi, F. Menezes, G., Dragone, J., Catapani, L.F., Jank, R.H. and Bové, J. M.	337
<b>12.2</b>	<b>Monitoring psyllids for early detection and management of huanglongbing –</b> Manjunath, K.L., Halbert, S.E., Ramadugu, C., and Lee, R.	342
<b>12.3</b>	<b>Occurrence and management strategies for HLB in the State of Paraná, Brazil –</b> Leite, R.P.	343
<b>12.4</b>	<b>Observations gleaned from the geospatially referenced and documented spread of HLB in three commercial groves in Florida and the implications of these observations on scouting and management decisions –</b> Irey, M., Gast, T., Terra, R., and Snively, J.	345
<b>12.5</b>	<b>Effect of strategies of inoculum reduction and vector control on huanglongbing progress –</b> Bassanezi, R. B., Yamamoto, P.T., Gimenes-Fernandes, N., Montesino, L. H., Tersi, F.E.A., Sperandio, P. H., Gottwald, T. R., Bergamin-Filho, A., Amorim, L	347
<b>12.6</b>	<b>Better management for citrus greening: chemical-uses or guava-interplanting?</b> Ichinose, K., Bang, D. V., Dien, L. Q.	350
<b>12.7</b>	<b>Imidacloprid-induced systemic acquired resistance (SAR) in Cleopatra mandarin and development of HLB –</b> Graham, J. H., Dawson, W. O., Robertson, C.	352
<b>12.8</b>	<b>Detection of greening in sprouts from citrus tree stumps –</b> Futch, S., Brlansky, R., Irey, M., and Weingarten, S.	353
<b>12.9</b>	<b>Beating huanglongbing – an integrative solution –</b> Hunter, W. B., Peretz, Y., Sela, I., Huet, H., Lapidot, M., Yarden, G.	357
<b>12.10</b>	<b>Flying dragon trifoliolate orange rootstock for high density plantings in São Paulo, Brazil –</b> Stuchi, E.S., Silva, S.R., Sempionato, O.R., Reiff, E.T.	358
<b>12.11</b>	<b>Research on the technique of eliminating huanglongbing disease from Tankan -</b> Yun Zhong, Ganjun Yi, Bo Jiang, Nonghui Jiang, Yan Liu	359
<b>12.12</b>	<b>National and international networking to develop solutions for HLB in South America –</b> Franca, F. H., Machado, M. A., Vieira, L.F., Morais, A. M., Astúa, J. F., Lopes, D. B., Druck, S.	360
<b>12.13</b>	<b>Delivery of antibacterial peptides into citrus cultivars for the control of citrus Huanglongbing (HLB; citrus greening) -</b> Gowda, S., Folimonova, S., Robertson, C., Shilts, T., Garnsey, S. M., and Dawson, W. O.	364
<b>12.14</b>	<b>Micro-budded, High Density Citrus Planting: Is There an Opportunity for HLB Control and Financial Returns? –</b> Skaria, M. and Hanagriff, R.	365
<b>12.15</b>	<b>The State of California implements its action plan for Asian Citrus Psyllid -</b> Polek, M. and Luque-Williams, M.J.	369
<b>Session 13: Host Resistance – F. Gmitter, Moderator</b>		
<b>13.1</b>	<b>Genetic modification of citrus for resistance against citrus greening: preventing expression of anti-bacterial peptides in the fruit –</b> Gurley, B.	371
<b>13.2</b>	<b>Susceptibility of some local mandarins to a Japanese isolate of <i>Candidatus Liberibacter asiaticus</i> –</b> Iwanami, T., and Miyata, S.	372
<b>13.3</b>	<b>Developing transgenic solutions for HLB resistant citrus at the US Horticulture Research Laboratory –</b> Stover, E., Bowman, K., McCollum, G., Niedz, R.	374
<b>13.4</b>	<b>A newly developed agilent microarray designed for the characterization of citrus responses to pathogens –</b> Moore, G. A., Khalaf, A. A., Febres, V. J., Li, L., and Gmitter, F.	375
<b>13.5</b>	<b>Transgenic approaches to control bacterial diseases of citrus –</b> Astúa-Monge, G., Francischini, F.J.B., Kemper, E., Capella, A., Kitajima, J.P., Ferro, J. A., da Silva, A.C.R.	376
<b>13.6</b>	<b>Towards the ultimate solution: genetic resistance to HLB in commercial citrus –</b> Grosser, J.W., Dutt, M., Omar, A., Orbovic, V., and Barthe, G. A.	377

<b>13.7</b>	<b>Examination of host responses of different citrus varieties to HLB infection – Folimonova, S. Y., Garnsey, S. M., and Dawson, W. O.</b>	<b>378</b>
<b>13.8</b>	<b>Evaluation of <i>Candidatus Liberibacter</i> spp. in genetically transformed sweet orange ‘Hamlin’ with atacin A gene – Simões, T. S., Boscariol-Camargo, R.L., Mendes, B.M.J., Mourão Filho, F.A.A., Carlos, E.F., Machado, M.A.</b>	<b>379</b>
<b>13.9</b>	<b>Colonization of citrus relatives by <i>Candidatus Liberibacter asiaticus</i> – Boscariol-Camargo, R. L., Simões, T. S., Malosso, A., Carlos, E.F., Coletta Filho, H.D., Machado, M.A.</b>	<b>380</b>
<b>13.10</b>	<b>Occurrences of huanglongbing disease of pomelo (<i>Citrus grandis</i>) in Northern Thailand – Akarapisan, A., Piwkhao, K., Chanbang, Y., Naphrom, D., Santasup, C.</b>	<b>381</b>
<b>13.11</b>	<b>A preliminary survey of HLB survivors found in abandoned citrus groves – Chen, C., Zeng, J., Yi, G., Xiao, Y., Ou, S., Gmitter, F.</b>	<b>386</b>
<b>13.12</b>	<b>Using transgenic NPR1 to enhance systemic acquired resistance (SAR) in citrus – Febres, V. J., Moore, G. A.</b>	<b>387</b>
<b>13.13</b>	<b>Navelina ISA 315 sweet orange: a CVC tolerant cultivar – Stuchi, E.S., Silva, S.R., Coletta-Filho, H.D., Franco, D., Carvalho, S.A., Sempionato, O.R. Donadio, L.C., Alves, K.C.S.</b>	<b>388</b>
<b>13.14</b>	<b>Phloem specific transgene expression of anti-bacterial genes driven by AtSUC2 gene promoter in transgenic citrus plants to develop citrus greening resistance <u>Omar, A.</u>, Dutt, M., Barthe, G., Orbovic, V. and Grosser, J.</b>	<b>390</b>
<b>13.15</b>	<b>Citrus variegated chlorosis damage assessment in six sweet orange cultivars in São Paulo, Brazil. Franco, D., Stuchi, E., Silva, S., Martins, A., Laranjeira, F.</b>	<b>391</b>
<b>13.16</b>	<b>Colonization of Asiatic Citrus Psyllid and Huanglongbing Development on <i>Citrus</i> and <i>Citrus</i> Relatives in Indonesia – <u>Subandiyah, S.</u>, Himawan, A., Joko, T., Astuti I.P., Holford, P., Beattie, G.A.C., Krugger, R.</b>	<b>393</b>
<b>13.17</b>	<b>A transgenic approach to the control of citrus greening - <u>Reddy, J.D.</u>, and Gabriel, D.W.</b>	<b>394</b>
<b>Session 14: International Citrus Industries: Coping with HLB - Jerry Newlin, Moderator</b>		
<b>14.1</b>	<b>Presentation of Ranked International Research Priorities – T. Gottwald and W. Dixon</b>	<b>401</b>
<b>14.2</b>	<b>Florida Citrus Producers Research Advisory Council (FCPRAC)/National Academy of Science (NAS) –Research and Development - Tom Turpen (<i>Verbal – No Text</i>)</b>	<b>-</b>
<b>Key Take-Home Messages and a View to the Future: Summaries of Research Sessions</b>		
<b>14.3</b>	<b>HLB status and crop losses - Tim Schubert</b>	<b>409</b>
<b>14.4</b>	<b>Survey, detection, diagnosis - Mike Irely</b>	<b>411</b>
<b>14.5</b>	<b>Pathogen sequencing and culturing - William Dawson</b>	<b>413</b>
<b>14.6</b>	<b>Host pathogen interaction - John daGraça</b>	<b>414</b>
<b>14.7</b>	<b>Psyllid biology and genomics - David Hall</b>	<b>415</b>
<b>14.8</b>	<b>Psyllid management - Michael Rogers</b>	<b>417</b>
<b>14.9</b>	<b>HLB management - Andrew Beattie</b>	<b>419</b>
<b>14.10</b>	<b>Host resistance - Ed Stover</b>	<b>421</b>
<b>Key Take-Home Messages and a View to the Future: Industry Summaries/Perspectives</b>		
<b>14.11</b>	<b>Juliano Ayres (<i>Verbal – No Text</i>)</b>	<b>-</b>
<b>14.12</b>	<b>Ray Prewett (<i>Verbal – No Text</i>)</b>	<b>-</b>
<b>14.13</b>	<b>Ted Batkin</b>	<b>-</b>
<b>14.14</b>	<b>Peter McClure (<i>Verbal – No Text</i>)</b>	<b>-</b>
<b>Key Take-Home Messages and a View to the Future: Regulatory Summaries/Perspectives</b>		
<b>14.15</b>	<b>W. Dixon and P. Berger</b>	<b>425</b>
<b>Key Take-Home Messages and a View to the Future: Final Wrap up</b>		
<b>14.16</b>	<b>Jerry Newlin (<i>Verbal – No Text</i>)</b>	<b>-</b>
<b>Addenda</b>		
<b>A1</b>	<b>Author Index</b>	<b>428</b>
<b>A2</b>	<b>List of Participants</b>	<b>436</b>
<b>A3</b>	<b>Meeting Agenda</b>	<b>449</b>

<b>A4</b>	<b>Huanglongbing (HLB) a graft transmissible psyllid-borne citrus disease: Diagnosis and strategies for control in Reunion Island - A case study</b> (Translation from French of excerpts from the original 1988 Ph.D. Thesis of Bernard Aubert, entitled: <i>Le greening une maladie infectieuse des agrumes d'origine bactérienne transmise par des homoptères psyllidés Stratégies de lutte développées à l'île de la Réunion, Circonstances épidémiologiques en Afrique Asie et modalités d'intervention</i> )	<b>460</b>
<b>A5</b>	<b>THE CITRUS HUANG LUNG BIN (GREENING) DISEASE IN CHINA</b> - Kung Hsiang LIN and Kung Hsun LIN. South China Agricultural College, Plant Protection Department, South China Agricultural Research Institute, Guangzhou, Guangdong, P. R. C. Document translated from the original Chinese by Kung Hsun LIN and adapted by B, AUBERT. Original document published in 1956 in <i>Acta Phytopathologica Sinica</i> , Vol. II, Part I, No. I, pp. I-II and Part 2, pp. 14-48.	<b>461</b>
<b>A6</b>	<b>Ranked International Research Priorities: A ranking resulting from a survey of IRCHLB participants</b> – Prepared by T. Gottwald, W. Dixon and E. Taylor	<b>462</b>

# INTERNATIONAL RESEARCH CONFERENCE ON HUANGLONGBING



## Keynote Addresses

Orlando, Florida



December 2008

## K1. KEYNOTE ADDRESS 1: Historical perspectives of HLB in Asia

Aubert B.

### Citrus Huanglongbing experiences of integrated vector management (IVM) in Reunion and Guadeloupe, two ultra-peripheral regions of the European Union

By the early 1960s Citrus Huanglongbing (HLB) [syn Citrus Greening] increased to the status of a major economic disease both in sub-Saharan Africa and Asia. With the advent of transmission electron microscopy (TEM), Laflèche and Bové (1970) claimed the first identification of the causal agent in the sieve tubes of presumably infected orange leaves originating from South Africa, India and Reunion Island. The HLB organism was the first phloem sieve tube restricted bacterium seen in plants (Bové 2006) with the capacity to proliferate not only in all types of citrus, but also in the hemolymph and salivary glands of two psyllid vectors endemic to either Africa or Asia. Intertropical islands used often as natural quarantine facilities over the previous centuries, were and still are critical steps for the spread of vector borne citrus diseases such as HLB. Biocontrol approaches combined with targeted preventive actions were found relevant for sustainable sanitation in two territories.

### HLB and the socioeconomic situation of Reunion Island

**Distinctive conditions for HLB epidemics** The densely populated territory of La Reunion (currently ~800.000 inhabitants, with a large proportion of migrants from the rim of the Indian Ocean and China), and adjacent Mauritius alike, were facing uncontrolled conditions for HLB epidemics (Moreira 1967 Bové & Cassin 1968, Catling 1973). The reasons were: 1) Presence of the African vector *Trioza erytreae* thriving without any of its natural parasitoids, and of the Asian vector *Diaphorina citri* poorly controlled by a single endoparasitic wasp *Diaphorencyrtus aligarhensis*; 2) High diversity of climates over a small volcanic island of only 2500 km<sup>2</sup> with steep topography combined with tropical trade winds and occasional hurricanes, thus offering multiple opportunities for vectors to build up and HLB disease to appear; 3) Substantial colonies of ornamental and wild rutaceous plants harbouring the two vectors; 4) Fragmented land ownership of commercial citrus orchards interspersed with countless small citrus plantings and backyard trees; 5) Lack of expedient diagnostic tools for discriminating HLB infection from physiological disorders; and 6) Limited research funding from the Agricultural Research institution IRFA-IRAT-CIRAD in charge

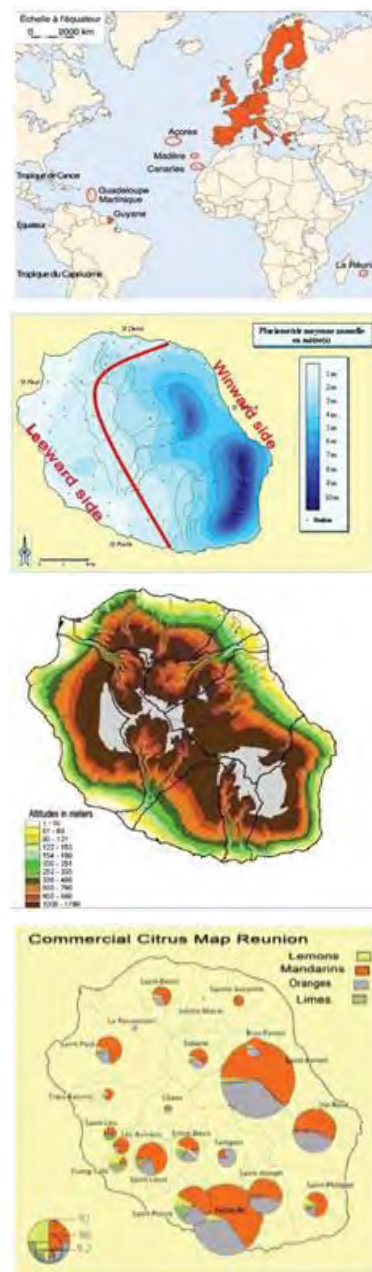


Fig. 1: Map of average yearly rainfall in Reunion.

Fig. 2: Map of rainfall.

Fig. 3: Map of altitude gradients.

Fig. 4: Map of commercial citrus orchards 2002(courtesy D. Vincenot, Chambre d'Agriculture de la Reunion).

locally.

### A patrimonial citrus production likely to exacerbate HLB problem

In Reunion, rainfall, relative humidity and temperature greatly influenced citrus psylla population upsurges, with *T. erythrae* more adapted to high-lying windward cool and wet areas, and *D. citri* favoring dry hot leeward low-lying areas. Depending on the season, overlap of psyllid territories was possible. Furthermore, the intermixing of both types of HLB organisms (i.e. African HLB showing symptoms only in cool climates as opposed to Asian HLB that is less temperature dependant) was enhanced by the capacity of each citrus psyllid to transmit either pathogen. Not surprisingly, individual trees were found to host both strains of agents *Ca. Liberibacter asiaticus* and *Ca. Liberibacter africanus* simultaneously (Garnier et al 1996). Taking advantage of the ecological situations, local growers had eagerly cultivated a multitude of citrus types, from deeply coloured mandarins in the mountains, to limes and grapefruits in the coastal areas. This diverse range of commercial plantings was closely intertwined and formed a continuum with small citrus gardens, backyard trees, and urban hedges of *Murraya exotica* orange jasmine. The citrus map, Fig. 4, of present commercial orchards in Reunion, [400ha producing 10.000t of fruit, (Insa et al 2002)] traces back the old struggling situation of the early 1970s when a mere output of 800t was obtained. At that time tree declines due to HLB epidemics were typically compensated by accelerated cycles of orchard replanting with unsafe nursery material. Under such conditions, any attempt of compulsory eradication for citrus and citrus-relatives in Reunion appeared socially and technically unbearable.

### Strategies of sustainable sanitation based on integrated vector management (IVC)

In line with the recommendations of the International Organization of Citrus Virologists (IOCV) especially during a post-conference tour taking place after the 6<sup>th</sup> congress held in Mbabane, Swaziland 1972, and initiated by J. M. Bové, the following strategy was decided:

**Incentives for replanting certified disease-free material:** Registered budwood, free of graft transmissible diseases, was received from SRA San Giuliano Corsica in 1969. New cultivars, especially easy peelers exhibiting attractive qualities, were propagated within strict registered nursery requirements (up to 35,000 trees/year). To enhance the removal of affected commercial orchards, local authorities (Chambre d'Agriculture de la Réunion) refunded the cost of replanting and trained extension service personnel to survey/assist a new generation of growers aware of the benefits of preventive sprays. Although uncertain in terms of prognosis, this strategy was nevertheless considered more appropriate than a costly and hazardous eradication scheme. Such a propagation system of certified planting material, first initiated in 1969, is currently operating with modern insect-proof and full covered greenhouses delivering virus-free and citrus-canker-free planting material. This compulsory CAC- EU label: *conformité agricole communautaire*, is now required since Reunion is an ultra-peripheral region of the European Union.



Fig. 5: Tullus Ltd. container-grown citrus nursery in Reunion (courtesy M. Roux Cuvelier CIRAD Réunion Sept. 2008).

**Biological control of the vectors:** Concurrently, a specific biological control program was launched in 1974. Its aim was the introduction, rearing, and mass release of primary parasites of psyllid nymphs (Order Hymenoptera superfamily Chalcidoidea,). Primary ectoparasitic wasps *Tamarixia* spp were found much more efficient than primary endoparasitic *Psyllaephagus* sp. or *Diaphorencyrtus* sp. Emphasis was therefore put on the African *Tamarixia dryi* which originated from Nelspruit South Africa and on the Asian *Tamarixia radiata* which originated from Badal, West Punjab, India. For the former wasp, 33,000 adults were released on the island thus corresponding to 50 adults per km<sup>2</sup> of citrus area, and this was followed by a release of 3,500 adults in the restricted citrus area of the dry lowlands where *D.citri* was predominant.

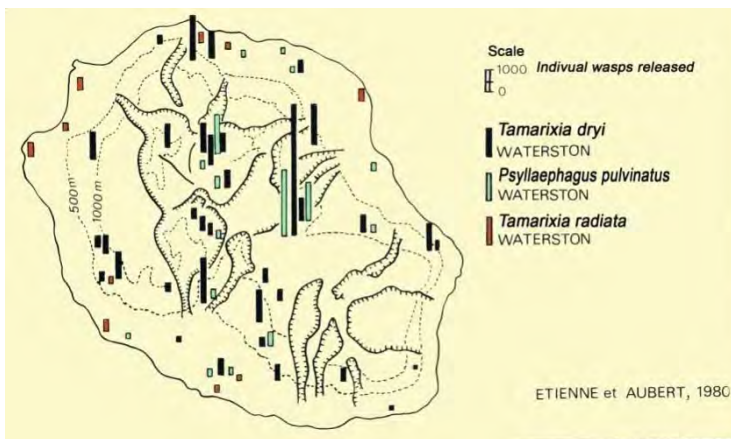


Fig. 6: Map of wasp releases for the biological control of both psyllids. Releases took place preferably within non-sprayed backyard trees.

A careful elimination of secondary or tertiary parasitoids enabled these wasps to establish properly and resulted in a drastic reduction of vector populations within 3 years (Etienne and Aubert 1980).

The two primary ectoparasitic wasps have similar biologies and show remarkable host-searching ability. The females lay eggs on psyllid nymphs of the 3<sup>rd</sup>, 4<sup>th</sup> and 5<sup>th</sup> instars. Their life cycle is

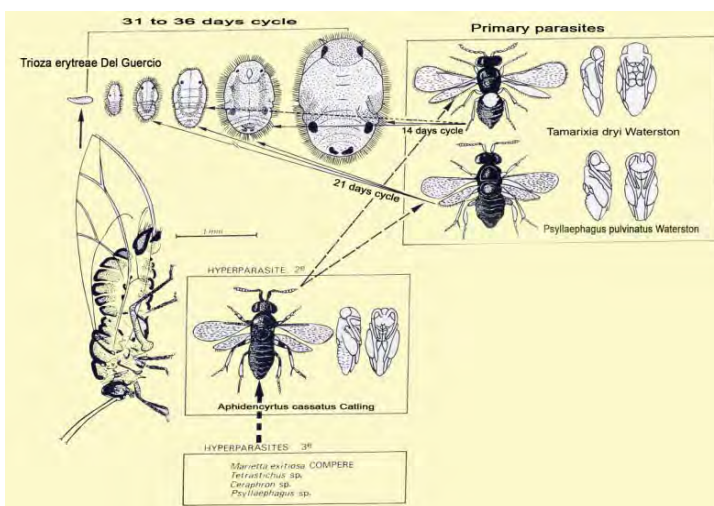


Fig. 7: Parasitoid complex of *T. erytreae* nymphs after Catling 1969, McDaniel and Moran 1973. *Tamarixia* sp. shows a characteristic white patch on the abdomen.

only 12 to 14 days as opposed to 21 days for endoparasitic wasps. Being ectoparasitic, the larva feed on and suck out the hemolymph of the psyllid nymphs. Adults pupate in the mummies of the nymphs and emerge by chewing a hole through the thorax of the psyllid host. The size and shape of the hole, and the meconium left by the parasitoid in the nymph mummy give a signature of the absence of secondary or tertiary parasitoids. Taxonomic studies related to this biocontrol

were carried out with the assistance of the Museums of Natural History of Pretoria and London (Annecke

*et al* 1971, Prinsloo 1981 and Hollis 1984) and with information on hyperparasites available from Husein and Nath (1924).

The primary endoparasitic *Psyllaephagus pulvinatus*, imported into Reunion from South Africa, was largely outcompeted by *T. dryi* and disappeared. *Trioza erytreae*, easily spotted by its remarkable formation of galls left by feeding nymphs on citrus leaves, survived for six years on



semi-wild lemon plants at 900m elevation in an extremely wet area, but was eventually completely eliminated. The only explanation for this unexpected result is the build-up of *T. dryi* on an alternative polyphagous psyllid *Trioza litseae* (Hollis 1984), occasionally feeding on avocados, citrus, vanilla and papaws, but predominantly on a common aromatic shrub *Litsea glutinosa*. This plant originated from Asia and Australia, was imported into Reunion many years ago, and was largely disseminated by local birds. *T. dryi* ex *T. litseae* was found to be conspecific with *T. dryi* ex *T. erytraeae* (Prinsloo unpublished). In Eastern and Southern

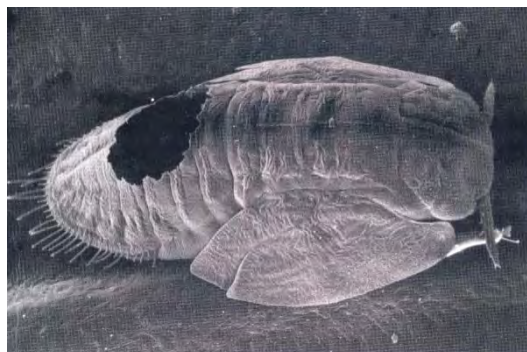


Fig. 8: Mummy of *D. citri* nymph with exit hole of hatched *T. radiata*.

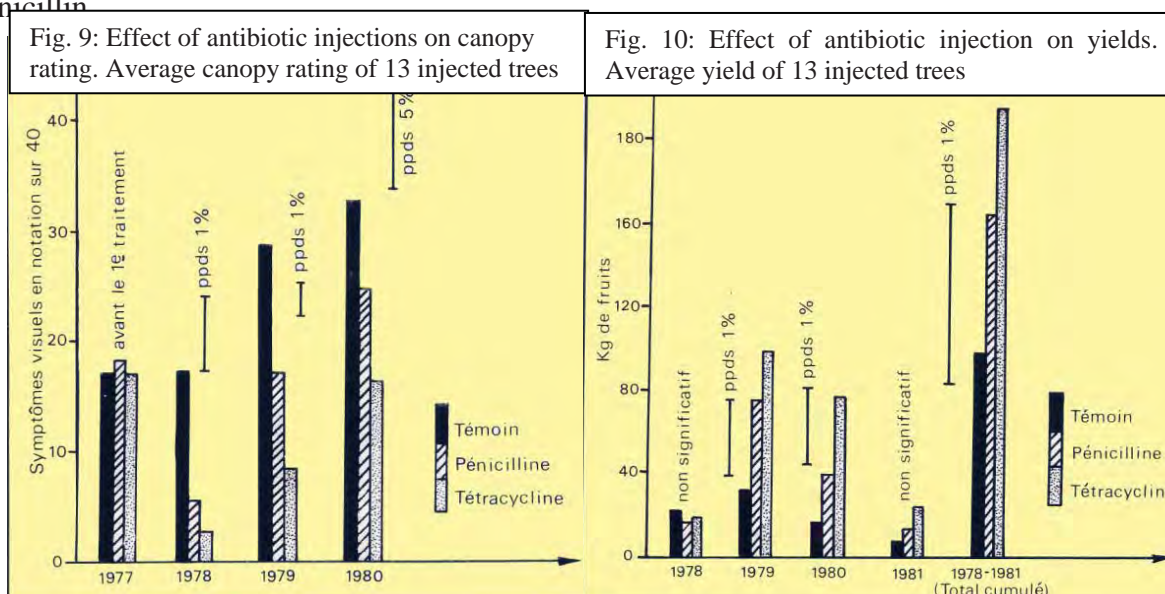
Africa, *T. dryi* is apparently unable to parasitize any psyllid other than *T. erytraeae*. Neither *T. litseae* nor *Litsea chinensis* occur in Africa, both having an Asian origin. Relative to the Asian citrus psyllid, *D. citri*, it survived on pruned hedges of *Murraya exotica* but was rarely seen on citrus, even on neglected trees. *T. radiata* was unable to parasitize any psyllid other than *D. citri* (Aubert and Quilici 1984), and further laboratory studies were conducted for disclosing its basic life-history traits (Fauvergue and Quilici 1991, Quilici 1992).

**Symptomatology.** Experimental transmissions of HLB by grafting were performed under screen house conditions to track mineral-like deficiencies induced by the disease, as well as phloem disorders. These investigations consisted of both healthy and HLB-affected trees and were useful to accurately assess visual symptoms, especially the sectoring of blotchy mottle plus Mn and Zn deficiencies that preceded twig dieback. A canopy rating method was subsequently developed for field evaluation of HLB. For this rating, individual trees were divided into eight quadrants, and each quadrant was assigned a value of 0 to 5 for increasing symptoms of HLB severity. Thus an individual tree could have a combined HLB severity rating of 0 to 40. Any tree beyond quotation rating 25 was considered as commercially nonviable. Extension service personnel were trained to evaluate the severity of HLB symptoms using this canopy rating system.

**Disease aetiology and antibiotic injections.** Considering the tedious and costly diagnostic procedure of sampling trees and assaying via TEM (leaf midribs or fruit columella dispatched to INRA Bordeaux in 2% buffered glutaraldehyde), a field experiment was initiated to confirm the bacterial infection of HLB epidemics. Antibiotic injections were tested in a 6-year-old orange grove (one hectare) leased from a private sugar estate (Sucreries Bénard du Gol). Although planted in 1971 with SRA disease-free material, and established in the middle of sugar cane blocks with preventive insecticide sprays, these orange trees were inoculated via psyllid at early stage of planting. The trial comprised eleven triplets of trees with the same HLB canopy rating. The triplets comprising a total of 33 trees were injected once a year during the main flush season for three years (October 1977, 1978, and 1979) with penicillin, tetracycline, or plain water, respectively. Canopy rating was assessed once a year after the main flush, and fruit harvested for yields and weights just before full maturity to avoid yield losses due to theft. The individual tree dosage of penicillin was 100mg per kg of fresh weight, *i.e.*, for 6-year-old trees an injection of 18g diluted into 6 liters of water. For tetracycline 35mg per kg of fresh weight was chosen, *i.e.*, 6g diluted into 2 liters of water. The pressure for injections was 5kg/cm<sup>2</sup>. No phytotoxic effect

was noticed with penicillin, while tetracycline induced brief willow-leaf symptoms prior to stimulating vigorous healthy-looking regrowth. Concerning penicillin, antibiograms performed on crushed leaf-midribs after the onset of tree injection showed that bacteriostatic effects in orange leaves lasted for 120 hours.

The results of this field experiment were the following: 1) significant canopy recovery was followed by yield increase with penicillin injections, and 2) similar but longer beneficial effect of tetracycline injections. The recovery with penicillin treatments implied that the origin of the disease was the infection by a gram negative bacterium, since this antibiotic is hindering the formation of peptidoglycane layers of the bacterial cell wall, as demonstrated conclusively by Garnier et al., (1984) on graft-inoculated young orange seedlings treated by root drenching with penicillin



But neither penicillin nor tetracycline resulted in long-term suppression of HLB, probably due to the bacteriostatic rather than bactericidal effect of antibiotics and possible developments of resistance. This experiment also demonstrated how rapidly treated trees relapsed following the second and third injections, a clear indication of the virulent character of the HLB organism.

**Epidemiological survey.** Temporal increase of HLB disease was evaluated by visual canopy

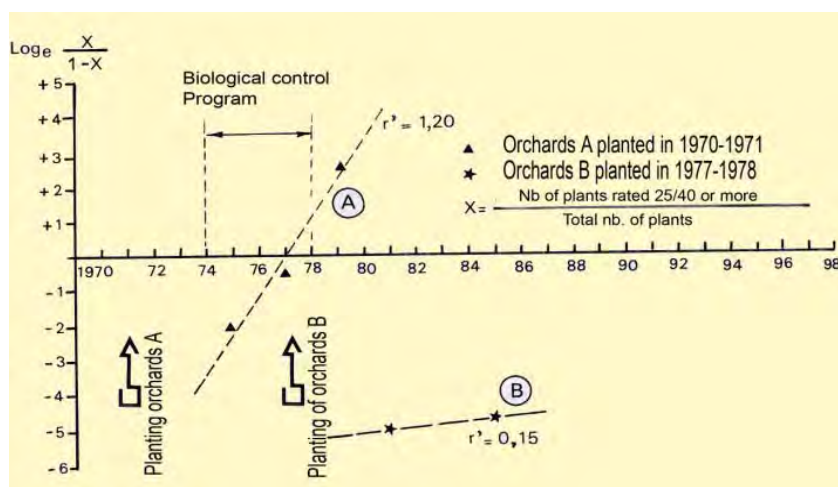


Fig. 11: Temporal increase of HLB epidemics within two groups of orchards planted before or after the biological control of both vectors

respectively in 1981, 1984. Comparative rates of spread of the disease were evaluated following Van der Plank's analysis. In group A, 50% of the trees were commercially lost seven years after planting, while in group B disease rate was so low that 50% loss would theoretically occur around 2015. Gottwald et al, (2007) recently reviewed the epidemiology of HLB by comparing Reunion, Chinese, Brazilian and Florida situations.

### Conclusion on the Integrated Vector Management story of Reunion

In spite of an original hopelessly massive psylla build-up and spread of the pathogen, substantial results for controlling the HLB disease were obtained in a rather short time for a problem affecting perennial plants. The training of extension service consultants for monitoring the disease, and training/educating the farmers were important aspects of the program. As stressed by Ohmart (2008) integrated management cannot succeed without the awareness of the growers. The new generation of orchards sprayed with horticultural oil for controlling other insects and mites, resulted in an extremely low rate of disease progression.



Fig 12 Twenty-five-year-old citrus orchard in Reunion (Courtesy Vincenot Chambre d'Agriculture de la Réunion 2008).

the biocontrol program of psyllid vectors was similarly evaluated by the farmers in commercial orchards and by many residential owners of small gardens and backyard trees, was then to voluntarily remove affected trees and replant. Today HLB is a forgotten nightmare in Reunion, to the point that any research on this dangerous disease is being discontinued. However, accurately detecting the last HLB foci for their eradication would be wise.

Neither hurricanes nor the strange episode of rural hyper epidemics of human 'chikungunya' virus disease transmitted by *A. albopictus* in 2006, had any marked effect on the new citrus psyllid ecosystem,

notwithstanding massive emergency applications of fenitrothion and deltamethrin to eliminate the adult mosquito vectors of this human disease. The major challenge for the citrus growers now is the replacement of old healthy trees established over the past 30 years, with novel cultivar selections that have better prices on the local fresh fruit market.

With as much as 130 Corine biotopes and a rich flora including 600 endemic species and some 2400 imported/introduced ones, Reunion is considered a hot spot of world biodiversity. This may explain the success of the psyllid vector biocontrol. Similar results were obtained in the neighbouring Mauritius island, where the Reunion approach was duplicated concomitantly.

### **Integrated Vector Management in Guadeloupe**

The first detection of *D.citri* in the Caribbean island-chain, occurred in Guadeloupe on backyard orange trees in January 1998 (Étienne et al, 1998). After one year of investigation, no parasitism was found on these intrusive *D.citri* colonies, and the introduction of *Tamarixia radiata* from Réunion was decided in January 1999 (Étienne et al., 2001). The rearing and release of a few hundred wasps succeeded in establishing the ectoparasitoid and noticeably reduced *D.citri* populations not only on citrus backyard trees and *Murraya exotica* hedges, but also over the 360 ha of local commercial orchards of limes, oranges and mandarins. This program of biocontrol was developed together with three other biocontrol programs, targeting newly arrived citrus pests appearing suddenly in the late 1990s and for which specific wasps were also imported, i.e. *Anagyrus kamali* against the hibiscus pink mealybug, *Ageniaspis citricola* against the citrus the leaf miner, and *Lysiphlebus* sp. against the brown citrus aphid. In April 1998, Guadeloupe sent a warning to the entomology department of UF-IFAS Homestead, and three months later *D.citri* was detected in South Florida (Knapp et al., 1998).

Today, ten years after the preventive biocontrol launched against *D.citri* in Guadeloupe, the HLB organism has not yet been detected there, and the neighbouring Martinique and La Dominique islands are still free of *D. citri*. In the Greater Antilles, the Asian vector of HLB was found in Cuba in 1999, then in Haiti in 2000, in the Dominican Republic in 2001, in Puerto Rico in 2002 and in Jamaica in 2003 (Halbert and Nunez, 2004). Besides Guadeloupe, *T.radiata* is now present in Florida, Cuba and Puerto Rico. It has to be seen what will result in terms of vector control and HLB spread for the latter territories, depending on local ecosystems, specific ectoparasitoid introductions, and strategies of integrated management.

### **Other recent island situations**

The accidental introduction of *Trioza erytrae* in Madeira in 1994 (Fernandes & Franquinho 2001) and its extension some years later into Tenerife, Gomera & Palma Canary Islands (Perez Padron & Hernandez 2002), is a new threat for the citrus production of the western part of the Mediterranean Basin. Similarly the presence of *D. citri* on the islands of Hawaii and Maui (Conant et al 2007) and the interception in 2008 of the Asian HLB vector on ornamental rutaceous plants (curry plant) dispatched from there to California is an additional example of the need for relevant surveys and controls in island situations.

The sudden spread of HLB in citrus-producing areas previously regarded as HLB-free, highlights the potential threat of one of the most serious diseases of citrus. Considering the extreme fertility

of both psyllid vectors with each female laying as many as 1000 to 2000 eggs in a matter of 3 weeks, chemical protection alone may end in a vicious cycle with rising levels of resistance and damage to the environment. Boosting carefully screened natural enemies and helping farmers to learn the dynamics of their ecosystems may offer interesting alternatives.

## Literature cited

- Annecke DP, Insley P and Patricia H. 1971. Catalogue of Ethiopian Encyrtidae and Aphelinidae (Hymenoptera, Chalcidoidea) Entomol. Mem. Dep. Agric. Techn. Serv. Rep S Afr 23: 1-53.
- Aubert B and Quilici S. 1984. Biological control of the African and Asian citrus psyllids (Hemiptera, Psylloidea) through eulophid and encyrtid parasites (Hymenoptera, Chalcidoidea) in Reunion Island. Proc. 9th IOCV conference pp 100-108.
- Bové JM and Cassin PJ. 1968. Problèmes de l'agrumiculture réunionnaise Compte-rendu de mission IFAC.
- Bové JM. 2006. Huanglongbing: a destructive newly-emerging century-old disease of citrus. J. Plant Pathol 88 (1) 7-37.
- Catling HD. 1969. The bionomics of the South Africa citrus psylla, *Trioza erytrae* (Del Guercio) J. ent. Soc. Sth Afr. Vol 32 p 191- 223, Vol n 2 p 273-290.
- Catling HD. 1970. The bionomics of the South Africa citrus psylla, *Trioza erytrae* (Del Guercio) J. ent. Soc. Sth Afr. Vol 33 p 341-348, Vol 35 p 235-251.
- Catling HD. 1972. Result of a survey for psyllid vectors of citrus greening disease in Reunion. FAO Plant Protection Bull n 4 , 78-82.
- Conant PC, Hyrayama BR, Kumashiro and Heu RA. 2006. Asian Citrus Psyllid *Diaphorina citri* Kuwayama ( Hemiptera Psylloidea) State Department of Agriculture New Pest Advisory 1p.
- Etienne J and Aubert B. 1980. Biological control of psyllid vectors of greening disease in Reunion Island, Proc. 8th IOCV Conf. p 118-121.
- Étienne J, Burckhardt D, Grapin C. 1998. *Diaphorina citri* (Kuwayama) en Guadeloupe, premier signalement pour les Caraïbes (Hem., Psyllidae), Bull. Soc. Entomol. Fr 103 (1):32.
- Etienne J, Quilici S, Marival D, Franck A. 2001. Biological control of *Diaphorina citri* (Hemiptera: Psyllidae) in Guadeloupe by imported *Tamarixia radiata* (Hymenoptera: Eulophidae) Fruits vol 54 n 5 pp 307-315.
- Fauvergue X et Quilici S. 1991. Etude de certains paramètres de la biologie de *Tamarixia radiata* (Waterston, 1922) (Hymenoptera : Eulophidae), ectoparasitoïde primaire de *Diaphorina citri* Kuwayama (Hemiptera : Psyllidae), vecteur asiatique du greening des agrumes. Fruits, 46 (2) : 179- 185.
- Fernandes A and Franquinho Aguiar AM. 2001. Development of quarantine pests *Toxoptera citricida* and *Trioza erytrae* in the archipelago of Madeira Boletim Sanidad Vegetal Plagas 27 57-58.
- Garnier SM, Danel MN, and Bové JM. 1984. The greening organism is a gram negative bacterium, Proc. of 9th conf. IOCV pp 115-124.
- Garnier SM, Jagoueix S, Taorawa P, Grisoni M, Malessard R, Dookun A, Saurntally S, Autrey JC, Bové JM. 1996. Both huanglungbing (greening) *Liberibacter* species are present in Mauritius and Reunion, Proceed. of 13th Conf IOCV Riverside, 392-394.
- Gottwald TR, da Graça JV, and Bassani RB. 2007. Citrus Huanglongbing: the pathogene and its impact Online Plant Health Progress doi: 10 1094/PHP.

- Halbert SE and Nunez CA. 2004. Distribution of the Asian Citrus psyllid, *Diaphorina citri* Kuwayama (Rhynchota: Psyllidae) in the Caribbean Basin. *Florida Entomologist* 87 (3): 401-402.
- Hollis D. 1987. A new citrus-feeding psyllid from the Comores Islands with a review of the *Diaphorina amoena* species group (Homoptera:Psyllidae) *Systematic Entomology* 1 5p.
- Hollis D. 1984. Afrotropical jumping plant lice of the family Triozidea ( Homoptera: Psylloidea) *Bull. of the British Museum (Nat. Hist.) Ent. Ser.* vol 49 N 1 1-102.
- Insa G Rossolin G, Vincenot D, Bordenave S, Cazin F, Ethève G, Lucas E, Hoareau E, Martin Y, Payet N, Picard L. 2002. Les Agrumes Dossier technico-économique Chambre d'Agriculture de la Réunion-SUAD 40 p.
- Husain MA and Nath LD. 1924. The life history of *Tetrastichus radiatus* parasitic on *Euphalerus citri* Kuw and its hyperparasite *Rep. Proc. 5th Entomol. Mest. Pusa* , p. 122-128.
- Garnier SM, Danel MN and Bove JM. 1984. The greening organism is a gram negative bacterium *Proc. of 6th conf. IOCV* pp 115-124.
- Knapp JL, Halbert S, Lee R, Hoy M, Clark R, Kesinger M. 1998. The Asian citrus psyllid and citrus greening disease. *Citrus Ind.*28-29.
- Lafleche D and Bove JM. 1970. Structures de type mycoplasme dans les feuilles d'orangers atteints de la maladie du greening. *C.A. Acad. Sci. Ser. D.* 270: 1915-1917.
- Mc Daniel JR and Moran VC. 1972. The parasitoid complex of the citrus psylla *Trioza erytreae* (Del Guercio) (Homoptera: Psyllidae ) *Entomophaga* 17: 297-317.
- Moreira, S. 1967. Enquête sur les maladies des agrumes: îles Maurice et de la Réunion *Bull. Phyt. FAO*, 15 54-60.
- Ohmart C. 2006. Integrated pest management implementation at field level: What are the impediments to grower adoption of IPM ? Why do they exist and what can be done to get around them? *Endure 2008 International Conference Diversifying Crop Protection* 13-15 October 2008 La Grande Motte.
- Perez Padron F and Carnero Hernandez A. 2001. Presence of *Trioza erytreae* the African citrus psyllid on the island of Tenerife *Revista Granja* 9 54-57.
- Prinsloo GL. 1981. On the encyrtid parasites (Hymenoptera: Chalcidoidea) associated with psyllids (Hemiptera: Psylloidea) in Southern Africa *J. ent. Soc.South Afr.* 44 (2) 9-244.
- Quilici S, Joulain H et Manikom R. 1992. Etude de la fécondité de *Tamarixia radiata* (Waterston, 1922) (Hymenoptera: Eulophidae), ectoparasitoïde primaire du psylle asiatique *Diaphorina citri* Kuwayama (Homoptera: Psyllidae), vecteur du greening des agrumes. *Fruits, N Spécial Agrumes* 1992, 184-194.

## **K2. KEYNOTE ADDRESS 2: On the Origins of *Citrus*, Huanglongbing, *Diaphorina citri* and *Trioza erytreae***

**Beattie G.A.C.**<sup>1</sup>, Holford P.<sup>1</sup>, Mabblerley D.J.<sup>1,2</sup>, Haigh A.M.<sup>1</sup> and Broadbent P.<sup>4</sup>

<sup>1</sup> Centre for Plant and Food Science, University of Western Sydney, Locked Bag 1797, Penrith South DC, New South Wales 1797, Australia; <sup>2</sup> Royal Botanic Gardens, Kew, Richmond, Surrey, TW9 3AB, United Kingdom; <sup>3</sup> PO Box 46 Mulgoa, NSW 2745, Australia. Email: a.beattie@uws.edu.au

We question widely held assumptions about the origins of huanglongbing (HLB) and the genus *Citrus* [Rutaceae: Aurantioideae: Aurantieae] and propose alternative hypotheses. In doing so, we comment on recent changes in the systematics of the family Rutaceae, particularly the subfamily Aurantioideae.

The widely accepted assumptions are that the genus *Citrus* originated in China and that HLB originated, in *Citrus*, in the same region. We present evidence that suggests: that *Citrus* evolved in Australasia (where HLB and its vectors do not occur naturally); and that ‘*Candidatus Liberibacter*’ forms known to infect *Citrus* and other Rutaceae originated in Africa in association with the African citrus psyllid, *Trioza erytreae* (del Guercio) [Hemiptera: Sternorrhyncha: Triozidae] and one or more species of *Vepris* [Rutaceae: Rutoideae].

Other evidence suggests that the ‘*Ca. Liberibacter*’ forms that cause HLB spread from Africa to India in infected citrus budwood or plants, then from India to Guangdong in China (directly or indirectly) about 1930, then from Guangdong to Taiwan, the Philippines, Indonesia, Malaysia after 1945, and subsequently more widely to other countries.

Ours view that HLB did not originate in China is supported by published literature and other documents that have not been cited in major reviews of HLB and its vectors, particularly the Asiatic citrus psyllid, *Diaphorina citri* Kuwayama [Hemiptera: Sternorrhyncha: Psyllidae].

Recent hypothesis about the origins of ‘*Ca. Liberibacter*’ in Gondwana 100-300 million years ago, and the possible role of parasitic plants in natural spread of the bacteria, are considered. Our views are continually being revised as new information, including historical records, becomes available.

### **The genus *Citrus***

The most widely used taxonomic systems for classifying citrus are those of Walter Swingle (Swingle 1943, Swingle & Reece 1967) and Tyozaburo Tanaka (Tanaka 1977). They recognised 16 and 162 species respectively. Their views have led to widespread confusion in the use of names of cultivar groups, inappropriate species status of hybrids, and the names of true species (Scora 1975, Mabblerley 1997), and a profound misunderstanding of generic limits (Mabblerley 1998). Confusion and turmoil has been exacerbated by the use of a plethora of species names for apomictic hybrid clones. There has been no consensus on the names of these entities and many dubious synonyms and invalid names are widely used in books, journals and, most recently, in poorly referenced and inconsistent popular and technical internet websites that could perpetuate errors *ad infinitum*. Some papers, including molecular studies, deal with plants for which claimed

taxonomic relationships are invalid or poorly understood and for which verifiable voucher specimens have not been preserved. Many such publications are therefore of limited value and may mislead the unwary. Recent work suggests that the genus *Citrus* comprises about 25 species (Mabberley 2004). This view is based on (i) recent reunification of *Eremocitrus*, *Fortunella*, *Microcitrus* and *Poncirus* with *Citrus* (see Mabberley 1998), (ii) molecular studies by Guerra et al. (2000) and Samuel et al. (2001) that support these reunifications, and (iii) other molecular studies that suggest that the six species of *Oxanthera* from New Caledonia and the monotypic *Clymenia polyandra* (Tanaka) Swingle from New Ireland in eastern Papua New Guinea should be reunited with *Citrus* (see Mabberley 2004, Bayer 2004, Bayer et al. 2009). Australasia is therefore a ‘hot-spot’ for *Citrus* biodiversity with up to 13 endemic species (about 50% of all extant species) in the region. Most cultivated citrus is derived from the handful of Southeast Asian species (Table 1). The citron, *C. medica*, the first described species of *Citrus*, and long considered to be native to India, may have originated in Australasia, possibly in New Guinea. Its closest relative is *C. polyandra*, a species native to New Ireland, a small island to the north-east of mainland Papua New Guinea (Bayer et al. 2009).

Common hybrids are listed in Table 2. Mabberley (1997) suggested that where the history of a particular cultivar is not certain it may be preferable to not use a Linnaean classification, and, for example in the case of the ‘Meyer’ lemon, refer to it as *Citrus* ‘Meyer’. Where there is certainty, he considered it more informative to use a Linnaean system, where species and hybrid names for citrus crops indicate their presumed relationship with wild plants. The oldest name for the hybrid group involving oranges (pomelo-mandarin crosses) is *C. × aurantium* L. and that for the wild tangerine (i.e., mandarin) is *C. reticulata* Blanco, so that a Valencia orange is classified as *C. × aurantium* L. ‘Valencia’ and ‘Dancy’ tangerine is classified as *C. reticulata* Blanco ‘Dancy’.

**Table 1.** Specific and common names of 23 species considered to be true species of the genus *Citrus* (Rutaceae: Aurantioideae: Aurantieae) and their endemic region(s). Widely cultivated species are in bold. Good photographs of some Australasian species, excluding those from New Caledonia, can be viewed on Mike Saalfeld’s website (<http://www.saalfelds.freeserve.co.uk/HobbyCitrusGrowers.htm>).

Species	Common names	Endemic region
<i>C. amblycarpa</i> (Hassk.) Ochse (a possible hybrid)	sambal, djerook leemo, nasnaran mandarin, ‘Celebes’ papeda	Malaysia & Indonesia
<i>C. australis</i> (Mudie) Planch.	Australian round lime, dooja	Australia
<i>C. australasica</i> F. Muell.	Australian finger-lime	Australia
<i>C. cavaleriei</i> H. Léveillé ex Cavalerie ( <i>C. ichangensis</i> Swingle)	Ichang papeda/lime/lemon	China
<i>C. garrawayi</i> F. M. Bailey	Mount White lime, Garraway’s Australian wild lime	Australia
<i>C. glauca</i> (Lindl.) Burkill	Australian desert lime	Australia
<i>C. gracilis</i> Mabb.	Humpty Doo lime	Australia
<i>C. halimii</i> BC Stone	sultan lemon, limau kadangsa, limau kedut kera	West Malaysia & Sumatera in Indonesia
<i>C. hystrix</i> DC. ( <i>C. macroptera</i> Montrouz.)	kaffir lime, limau purut, limau hantu	Southeast Asia
<i>C. inodora</i> F. M. Bailey	Russell River lime, large-leaf Australian wild lime	Australia
<i>C. japonica</i> Thunb. syn. <i>Fortunella</i>	Kumquat	China
<i>C. medica</i> L.	citron	Possibly north-east Australia
<i>C. maxima</i> (Burm.) Merr.	pomelo	Indo-China
<i>C. neocaledonica</i> Guill.	false orange, large-leaf oxanthera	New Caledonia
<i>C. oxanthera</i> Beauvisage	orange flower oxanthera	New Caledonia
<i>C. polyandra</i> Tanaka syn. <i>Clymenia</i>		New Ireland in Papua New Guinea



<i>C. reticulata</i> <sup>1</sup> Blanco	mandarin, tangerine, satsuma: includes <i>C. × suhuiensis</i> <sup>2</sup> Hort. ex Tanaka, known as Canton mandarin, shatangju, sz-wei-kom, som keo wan, siem, xiem, limau langkat	China
<i>C. sp. (Oxanthera fragrans</i> Montr.)	fragrant oxanthera	New Caledonia
<i>C. trifoliata</i> L. syn. <i>Poncirus</i>	trifoliolate orange	China
<i>C. undulata</i> Guill.		New Caledonia
<i>C. warburgiana</i> F. M. Bailey	Milne Bay lime, New Guinea wild lime	New Guinea
<i>C. wintersii</i> Mabb. syn. <i>Microcitrus papuana</i> H. F. Winters	Brown River finger lime	New Guinea

**Table 2.** Common hybrids within the genus *Citrus* (Rutaceae: Aurantioideae: Aurantieae) arranged in cultivated groups (see Zhang et al. 2008). Widely cultivated hybrids are in bold.

Hybrid	Common names
<i>C. × aurantiifolia</i> (Christm.) Swingle	Lime
<i>C. × aurantium</i> L. (= <i>C. aurantium</i> L. and <i>C. sinensis</i> (L.) Osbeck)	sour, sweet, Valencia and navel oranges; grapefruit, and king orange/tangor/mandarin, the latter sometimes given as <i>C. nobilis</i> Lour.
<i>C. × indica</i> Tanaka	Indian wild orange
<i>C. × insitorum</i> Mabb. (× <i>Citroncirus webberi</i> J. Ingram & H. E. Moore)	Citrangle
<i>C. × limon</i> (L.) Osbeck	Lemon
<i>C. × macrophylla</i> Wester	Alemow
<i>C. × microcarpa</i> Bunge	Calamondin
<i>C. × taitensis</i> Risso (= × <i>jambhiri</i> Lush.)	rough lemon
<i>C. × latifolia</i> (Yu. Tanaka) Tanaka	Tahitian lime

### The possible origins and dispersal of *Citrus*

It is widely considered that *Citrus* originated in Southeast Asia between India and China and southwards through Malesia (Webber et al. 1967, Dugo & Di Giacomo 2002), but scant attention has been given by citrus horticulturists, pathologists and entomologists to the biogeography of *Citrus* and its close relatives since the impact of plate tectonics on the geography of the Earth were accepted in the 1960s and 1970s. The current perception of a Southeast Asian origin for *Citrus* is based on Swingle's<sup>3</sup> circumscription of the genus (Swingle 1943, Swingle & Reece 1947), and widespread lack of awareness of the origins of both Southeast Asia and Australasia and how the landmasses are related. The eastern-most limit to the distribution of true species of *Citrus* is New Caledonia, which has been in the same relative position, some 1200 km east of Australia, for 55 mya: about the time that India collided with Asia (Hartley 2001a). The flora of New Caledonia contains many groups of plants that appear to be remnants of the late Cretaceous–early Tertiary (97 to 23 mya).

In commenting on the origins of *Microcitrus*, which they considered a primitive genus related to *Citrus*, Swingle & Reece (1967) opined that 'these remarkable citrus fruits are extremely interesting, in that they show how evolution has proceeded in regions isolated as Australia and New Guinea have been during the last 20 or 30 my since they were cut off from all other landmasses'. Swingle & Reece 1967 also stated 'perhaps some of its species are very like the ancestral species from which *Citrus* developed' and 'the evolution of other citrus fruits is not so easily followed, since *Citrus*, *Fortunella*, and *Poncirus* did not originate in regions that were geographically isolated in definitely dated geologic eras.' They quoted Brough (1933), who in turn quoted Benson (1923), to support his view that 'Australia is considered to have been joined to the Asiatic mainland at least during the Cretaceous period, but probably a complete separation has existed since the

<sup>1</sup> Before 1930 most mandarins were referred to as *C. nobilis*.

<sup>2</sup> This mandarin type, known in Guangdong as shatangju, is named after the town of Sihui, 63 km to the northwest, of Guangzhou in Guangdong China.

<sup>3</sup> Walter Tennyson Swingle 1871-1952.

beginning of the Eocene.’ Swingle & Reece (1967) concluded that ‘The migrations of higher plants into Australia are held to have occurred during later Cretaceous times.’ The notion of the distribution of the Aurantioideae from Southeast Asia through Malesia to Australasia during the Neogene or Quaternary (up to 1.6 mya) periods, more recently than the Cretaceous era (146 to 65 mya), was considered likely as recently as the 1990s (Stace et al. 1993) in relation to movement of plants across ‘land-bridges’ (Armstrong 1975, Barlow 1981). However, Australia has never been joined to the Asiatic mainland (Hall 1997, 2001, 2002, van Welzen et al. 2005) and there is no record of species of *Citrus* being native to Wallacea, the islands between Wallace’s Line in the west and Lydekker’s Line, which runs along the Australasian continental shelf in the east.

Swingle’s view was that the genus *Citrus* may have originated in the New Guinea-Melanesia region, and that it evolved into fragrant, delicious-flavoured species from a few species with sour and bitter-flavoured, almost inedible fruit, such as *C. hystrix* and *C. cavaleriei* (syn. *C. ichangensis*), that had developed in the East Indian Archipelago, in the Philippines, New Guinea and Melanesia. He regarded this evolutionary path as the culmination of a very long period of progressive evolution that certainly began before Australia was cut off from land connection with New Guinea and Asia, probably more than 20 mya. Swingle (Swingle & Reece 1967) regarded the genera *Eremocitrus*, *Fortunella*, *Microcitrus* and *Poncirus* as ‘ancestral’ to his circumscription of *Citrus*. He regarded *C. polyandra* (syn. *Cly. polyandra*) as monospecific and probably the most primitive of all the genera within the ‘True Citrus Fruit Trees’, and with an extraordinarily close resemblance of its leaves and petioles of those of *Monanthocitrus*, represented by the then monospecific *Monanthocitrus cornuta* (Lauterb.) Tanaka (there are now four described species of *Monanthocitrus*: see Stone & Jones (1988)). This convinced Swingle that *Cly. polyandra* was an entirely new type of citrus fruit tree, possibly having descended from a remote ancestral species common also to *Monanthocitrus*. He considered *Oxanthera*, which has large, white fragrant flowers very much like those of *Citrus*, to be a highly specialized, xerophytic genus that possibly developed from the common ancestor of the genera *Wenzelia* and *Monanthocitrus*, and that the latter arose from an ancestral form much like that of some species of *Wenzelia*. He placed *Oxanthera*, *Wenzelia* and *Monanthocitrus* with several other ‘minor citroid’ genera in the subtribe Triphasiinae.

It is now clear that the species of *Oxanthera*, as species of *Citrus* (see Bayer et al. 2004, Bayer et al. 2009), belong to the true citrus group of fruit trees within Swingle’s subtribe Citrinae (the Aurantieae). Moreover, Bayer et al. (in press) have shown that citron, *C. medica*, the first described species of *Citrus*, and long considered to be native to India, probably originated in Australasia, possibly in New Guinea. It and other Australasian species belong to a distinct Australasian clade that shares a common progenitor with Asiatic species that belong to a distinct Asiatic clade (Bayer et al. 2009). The closest relative of the citron is *C. polyandra*, a species native to New Ireland, a small island to the north-east of mainland Papua New Guinea (Bayer et al. 2009). Its next closest relatives are the *Citrus* species of New Caledonia, then the remaining Australasian species in Australia and New Guinea.

Most of Southeast Asia is derived from a complex agglomeration of terranes now far removed from their Gondwanan origins. North and South China (excluding Hainan and Taiwan), Indochina, Myanmar (Burma), Thailand, Malaysia and western Indonesia rifted from northeast Gondwana in three significant tectonic events starting in the Early Devonian (about 400 mya)

and ending before the origin of Angiosperms (flowering plants) about 145 mya in the Early Cretaceous in the African component of Gondwana (Raven & Axelrod 1974, Burrett et al. 1991, Metcalf 1991, 1998, Scotese 1991, Crane et al. 1995, Morley 1998, Baillie et al. 2004, Burgoyne et al. 2005). The Rutaceae appeared in Africa-South America in the Mid Cretaceous, about 90 mya (Raven & Axelrod 1974). Muellner et al. (2007) estimated the age of the Rutaceae as 91 my, the Aurantioideae as 71 my, *Citrus glauca* as 22 my, and *C. japonica* and *C. trifoliata* at 18 my.

Australasia comprises Australia (including Tasmania), New Guinea, the Bismarck Archipelago Solomon Islands, New Hebrides, Fiji, Lau, Tonga, Kermadec Islands, New Caledonia and New Zealand. Progressive separation of the now western margins of this region from India from 96 mya in the Late Cretaceous to 35.5 mya in the Late Eocene marked the second major phase in the breakup of eastern Gondwana. Separation of Madagascar from India, Australia from Antarctica, and New Zealand and New Caledonia from Australia also began about 96 mya in the Late Cretaceous. Separation of Australia and Antarctica ended when sea formed between Tasmania (then still linked to the Australian landmass) and Antarctica about 35.5 mya (Hartley 2001a, b). India rifted northwards to collide with Asia in the Middle Eocene about 50 to 55 mya. At this point, both the northern margin of the Indian plate and Sundaland (Java, Sumatra, Borneo, western Celebes, Malaya, Shan and peninsular Myanmar, Thailand and Indochina) experienced an ever-wet, equatorial climate (Morley 1998).

Southern New Guinea is part of the Australasian craton whereas the northern sector comprises accretions of terranes of Pacific and Gondwanan origins, the latter including terranes that rifted into the Pacific and then back (e.g., New Britain and New Ireland). The terranes that form Wallacea originated from parts of Australasia, Gondwanic and Pacific accretions, and volcanoes following the collision of Australasia with Sundaland about 20 mya in the Middle Miocene (16 to 11.6 mya). These events over the past 55 million years have been most recently summarised by several authors (Veevers et al. 1991, Metcalfe 1998, Hall 1997, 2001, 2002, Hartley 2001a, b). Animations of events over the past 55 my can be viewed on the internet (SE Asia Research Group 2006: [http://searg.rhul.ac.uk/current\\_research/plate\\_tectonics/globe\\_2001\\_svg.mov](http://searg.rhul.ac.uk/current_research/plate_tectonics/globe_2001_svg.mov)).

Other animations can be viewed at:

- <http://www.pbs.org/wgbh/nova/eden/media/sttnq.html>,and
- <http://kartoweb.itc.nl/gondwana/gondwana.html>.

These animations and detailed documentation of reconstructions (Hall 2001a, 2002) suggest that favourable opportunities existed for migration of *Citrus* from eastern Australasia to Asia via island arcs in the Pacific Ocean from the Bartonian (40.4 to 37.2 mya) stage of the Middle Eocene epoch (48.6 to 37.2 mya) until the present age, and likewise, but less likely given the movement of terranes and directions of flow of equatorial currents, for migration from Asia to Australasia.

Based on recent molecular evidence, Bayer et al. (2009) Beattie et al. (2006) hypothesised that the genus evolved in Gondwana. They (Beattie et al. 2008a, b) subsequently, hypothesised that the genus evolved in Australasia, as Australasia rafted northwards and fragmented (Hall 1997, 2001, 2002) after separation from Antarctica.

Fruit of early species, which may have been thick-rinded, buoyant (such as the citron and the pomelo) and salt tolerant species growing in coastal river deltas (such as the pomelo: see Groff 1927), may have dispersed westward in equatorial currents, to Southeast Asia, when such currents existed to the north of what is now New Guinea (Beattie et al. 2008). Dispersal may have also been linked to island terranes that moved 1,000s of kilometres eastward across the same region (Hall 1997, 2001, 2002).

Some dispersal could have been endozoochorous, through migrations of birds and bats. Evidence to support such dispersal is scant, as there have been no detailed studies. Mature fruits of extant native Australasian *Citrus* are relatively small compared to most extant cultivated Asiatic forms. Mature fruit of native Australian rainforest species are green. This suggests that their seeds may be dispersed by palaeotropical, non-echolocating, frugivorous, pteropodid bats; birds are more closely linked to dispersal of brightly coloured red and orange fruit (Hodgkison et al. 2003, Ingle 2003). However, mature fruits of extant citrus relatives native to New Guinea range from green to orange and red: *Mo. cornuta* fruit are small and red, and those of *Wenzelia dolichophylla* (Lauterb. & K. Schum.) Tanaka are red (Swingle & Reece 1967). Such endozoochorous dispersal if it occurred would have been aided by formation, movement and accretion of terranes to the east, north and west of New Guinea over the past 37 my (see Burrett et al. 1991, Hall, 2001a, 2002), particularly terranes that now form the Halmahera Islands and most of the Philippines (see Hall 2001a, b; Morley 2003). Evidence to support possible endozoochorous dispersal of primitive *Citrus* germplasm with relatively small fruit is provided by Hartley (2001a) in his treatise on the taxonomy, origins and biogeography of the Australasian genera *Euodia* and *Melicope*. Evidence of dispersal of sour and sweet oranges by water and animals is provided by Gade (1976) who noted that the distribution of these fruit in Paraguay was related to 'dissemination of the abundant propagules to uncultivated sites is achieved via the gaudy and bouyant fruit by birds, mammals, water and man' and that 'orange tree populations in remote forest areas may be attributed more to zoochory than anthropochory'. Parrots, attracted to brightly-coloured ripe fruit, carry orange pulp in their beaks, dropping pips along the way, and certain macaws, are fruit eating species. Mammalian dispersers of seeds include monkeys, rodents, cattle and pigs (Gade 1976). Gade (1976) also mentioned that 'birds and mammals may disgorge or excrete viable seeds as their germinability is enhanced by gastric juices acting on the tough and woody seed coat'.

### On the origins of huanglongbing

The accepted view, as expressed by Zhao (1981), da Graça (1991), Bové (2006), and in many other publications, is that HLB<sup>4</sup> originated in China. It is based on three assumptions: (a) that the disease was present in China in the 1800s (Lin 1956), (b) that Reinking (1919), Lee (1921), Tu (1932), and some other authors, described symptoms of the disease, and (c) that HLB evolved with *Citrus*. However, presence of the disease in China in the 1800s was based on interviews with farmers and technicians between 1947 and 1955 (Lin 1956), and the symptoms of maladies described by Reinking (1919) and Lee (1921) do not describe HLB. Furthermore, there is no evidence that HLB evolved with *Citrus*. Wallace (1978), in reviewing leaf-mottle yellows disease in the Philippines, concluded that the ‘mottle leaf’ studied by Lee (1921), was caused by Zn deficiency and the severity of leaf mottle on trees on pomelo was due to the susceptibility of the stock to citrus tristeza virus. Reinking (1921), in his report on ‘Citrus diseases of the Philippines, Southern China, Indo-China and Siam’, did not mention symptoms akin to those of HLB.

Early Indian records of symptoms resembling those of the disease seem to have been ignored. These records suggest that symptoms resembling those of HLB in *Citrus* were reported in the mid 1700s in the central provinces of India by Roghoji, the Bhonsla Raja of Nagpur (Capoor 1963). Other reports suggest that the disease was present in north-western and north-eastern India in the 1800s and early 1900s (Bonavia 1888-1890, Husain & Nath 1927, Pruthi & Mani 1945, Asana 1958, Capoor 1963, Fraser et al. 1966, Chadra et al. 1970, Raychaudhuri et al. 1972).

Husain & Nath (1927), when describing severe damage by *D. citri* populations at Sargodha in the western Punjab between 1915 and 1920, were the first, in a widely overlooked paper, to describe damage resembling that caused by HLB. In part they said: ‘... *D. citri* neither produces galls nor causes any malformation of the plant tissues. The only sign of injury is defoliation and death of the shoots attacked and the drying up of the branches. On badly infested trees the continual feeding of myriads of insects is, in itself, a very great drain on the food-supply of the plant, but most probably some poison is also injected into tissues of the host and this produces the more serious results. This is evident from the fact that the fruit of the infested tree is dry and insipid to taste, and branches other than those actually attacked also dry up. Besides, young shoots are killed, old leaves fall off and in course of time an attacked tree is denuded of leaves altogether ....’ ‘During the second year of attack, if the pest has been allowed to develop unchecked, all the new shoots are destroyed, and most of the branches are left without leaves and the tree begins to dry up. Very little fruit is borne and that too is of small size, insipid and dry.’ They noted that ‘The symptoms of attack by the nymphs of the citrus psylla consists in the malformation of leaves which are badly curled, look sickly and fall off prematurely’.

---

<sup>4</sup> Huanglongbing is the official name of a disease of *Citrus* and other Rutaceae caused by ‘*Ca. L. americanus*’, ‘*Ca. africanus*’ and ‘*Ca. L. asiaticus*’ (Moreno et al. 1996, van Vuuren 1996). It should not be called citrus huanglongbing. Recent use of huanglongbing in relation to ‘*Ca. L. psyllaurous*’ (Hansen et al. 2008) in tomato and potato is invalid and misleading.



Adult *D. citri* and eggs on lemon flush growth at the orchard at Palai, Malakand, 17 July 2006, at 47°C (GAC Beattie).

With the benefit of current knowledge, it is clear that the severe symptoms described by Husain & Nath (1927), and later by Pruthi & Mani (1945), were symptoms now known to be caused by 'Ca. L. asiaticus'. Damage caused by *D. citri* is much more benign and does not lead to death of trees.

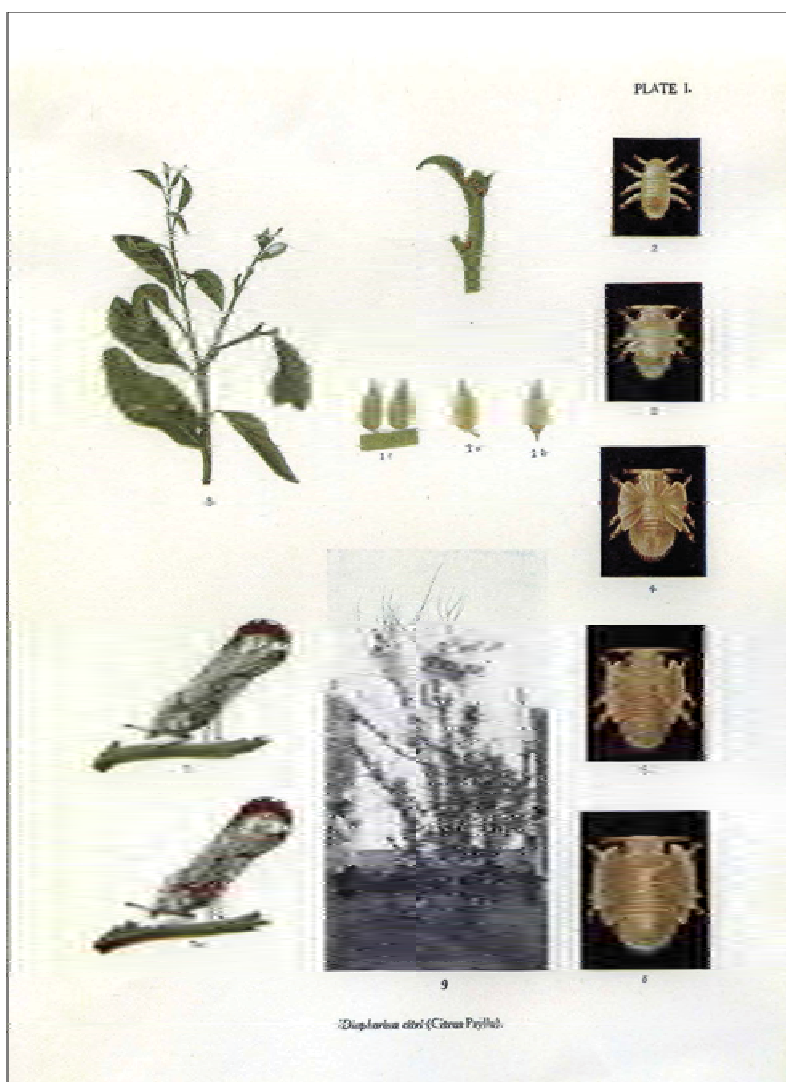


Plate I from Husain & Nath (1927), with illustrations of *D. citri* and its impact on citrus in the Punjab.

Fraser (1966) commented on the citrus industry in India before and after partition in 1947 from Pakistan. Most of the industry was confined to a band extending southwest from Assam and West Bengal in the east through central India around Nagpur in Mararashtra State to the states of Madras (now Chennai) in the southeast and Mysore and Kerala in the southwest (Fraser 1966). Fraser (1966) noted that;

- HLB was not present in Assam and West Bengal in the 1940s;
- in Mararashtra, a 48 year-old mandarin planting that she observed must have predated the introduction of HLB into the area;
- sudden wilting that she thought was due to HLB may have occurred in Mararashtra at Poona in 1946;
- the first commercial citrus trees planted at Kalimpong in West Bengal in 1864 lived for 50-60 years; and

- that a major extension of plantings in Assam commenced in 1927-1929, but there were no reports of dieback (HLB) before 1947-48, although there was a reference to some chlorosis in 1940-1941 in one area.

The citrus industries of Pakistan and India underwent considerable expansion in the 1930s and 1940s (Fraser et al. 1966). A further expansion in the (eastern) Punjab followed partition, when citrus growers from Pakistan were encouraged to plant large acreages, particularly of sweet oranges, in newly opened irrigation settlements<sup>5</sup>. The spread of dieback (HLB) coincided with this expansion and the use of infected planting material (Fraser 1966).

Aubert (1990b) considered movement of citrus material as the most efficient way of disseminating HLB and *D. citri*. His view (Aubert 1990b) was that they had been introduced unwittingly into many countries in Southeast Asia after 1940, particularly by nurserymen, orchardists and home gardeners replacing traditional local varieties.

With the possible exception of China, HLB symptoms were not recorded in Southeast Asia until after 1940. It was first recorded in:

Indonesia in 1948 (Aubert et al. 1985);

Taiwan in 1951, when it was recorded as serious (Su & Huang 1990);

the Philippines in 1957 (Martinez & Wallace 1967);

Thailand in the 1960s (Schwarz et al. 1973a, b, Aubert 1990c); and

Malaysia in the 1970s (Ko 1988, 1991), where its presence was confirmed in 1989 (Lim et al. 1990a).

Human-assisted spread of the disease through the Indonesia archipelago (Tirtawidjaja 1980) to Papua New Guinea (northern Australasia) (Davis et al. 2000, Weinert et al. 2004) took more than 50 years.

Recently observed records from Indonesia indicate that citrus was introduced from China on 2-3 occasions to the Bogor Botanic Gardens in 1945 (Inggit Puji Astuti, Bogor Botanic Gardens, pers. comm., 25 January 2008). This was around the time that the disease became widespread and severe in Guangdong (Lin 1956) and 11 years after Zhou Yuwen<sup>6</sup> recorded *D. citri* in Guangdong (Hoffmann 1936). The origin of HLB in the Philippines is not known<sup>7</sup>. However, there were many introductions of budwood and small budded trees from mainland China, India, Japan and Taiwan before 1957 (Martinez & Wallace 1969). Information provided by Ko (1991) and Saamin et al. (1991) suggests that the first record of the disease in Peninsular Malaysia may have been related to the introduction of *C. reticulata* seedlings (in this instance Tanaka's *C. suhuiensis*, a mandarin variety from Sihui near Guangzhou in Guangdong) to Terengganu in peninsular Malaysia from China in the 1950s and 1960s.

<sup>5</sup> Extensive irrigation systems were constructed in the western Punjab, of Pakistan, between 1885 and 1947 (Ali 1988)

<sup>6</sup> Zhou (Djou) Yuwen became a professor of entomology at Zhongshan University on the original site of Lingnan University. In the 1940s he worked with John Lindsley Gressitt (Bishop Museum, Hawaii) and Stanley Ellsworth Flanders (University of California, Riverside) on parasitoids of red scale, *Aonidiella aurantii* (Maskell).

<sup>7</sup> The symptoms of 'mottle leaf' reported in the Philippines by Morada (1930) resemble nutrient deficiencies, and it is clear from his notes on the severity of the malady that it was not HLB. Wallace (1978), in reviewing leaf-mottle yellows disease in the Philippines, concluded that the 'mottle leaf' studied by Lee (1921), was caused by zinc deficiency and the severity of leaf mottle on trees on pomelo was due to the susceptibility of the stock to citrus tristeza virus.



It is highly unlikely that the disease was widespread in China before the 1940s or occurred there before 1930:

- the first authentic record of the disease in China appears to have been made by Chen Qibao in 1938 (Chen 1943, Lin 1956), four years after Zhou Yuwen collected *D. citri* on citrus and other hosts at Lingnan University in Guangzhou (see Hoffmann 1936);
- parasitoids were not associated with these psyllid populations (Hoffmann 1936);
- Condit et al. (1937) clearly, and unequivocally, linked major losses of trees in Guangdong to poorly drained lowland areas;
- Benemerito (1938) in his paper on oranges of Guangdong, in which he notes the dates of introductions of varieties from China to the Philippines, does not mention maladies consistent with HLB-like symptoms;
- reports on citrus cultivation by the Botanical and Forestry Department of Hong Kong from 1853 to 1941<sup>8</sup> do not mention records of *D. citri*, or any citrus maladies resembling HLB, from 1924 to 1939; and
- Aubert (1990a), in discussing Jiaogan (Tankan) tangor production in the Chaoyan district of Guangdong from 1946 and 1990, noted that the first dramatic HLB epidemic in the region occurred from the late 1950s following use of contaminated trees, and that subsequent epidemics were related to natural spread of the disease by *D. citri*.

Condit et al. (1937) noted: 'As stated by Tu (1932) the short life of the trees is undoubtedly largely due to the high water table, poor drainage, shallow roots and the subsequent failure of the root system to renew itself and to function properly. The fact that well drained and deeper soils adjacent to nearly all lowland orchards, citrus trees up to fifty years old are to be found still vigorous and productive in spite of insect borers and bark diseases, leads one to regard the soil moisture content as the principal factor contributing to the early decline of the lowland trees.' They attributed chlorosis, that considerably alarmed Ch'ao-an growers, to the inability of the leaf to get sufficient iron on sandy soils. They reported that 'mottle leaf' of rare occurrence, in contrast to Tu (1932) who considered 'mottle leaf' being worst in the Guangzhou delta region. 'The leaves may be sickly, pale green, or yellow, but seldom distinctly mottled. In fact the deep green color of the foliage in most orchards is remarkable, considering the soil conditions in which the roots are growing.'

Contrary to other reports, Condit et al. (1937) said that they wished 'to emphasize the fact again that trees of the sweet orange and of loose-skin oranges up to twenty-five or thirty years and of pummelo up to fifty years old are common in well drained soils. For this reason we doubt that bark diseases are so much 'the limiting factor' as poor drainage and the consequently restricted root system.' Condit et al. (1937).

These records suggest eastward movement, directly or indirectly, of the disease and the psyllid from the Indian subcontinent to Guangdong, and then to Taiwan, the Philippines, Thailand, Malaysia and Indonesia. The introduction to China appears to have occurred in the late 1920s or early 1930s and may have involved lemon and pomelo cultivars. In addition to movement of plants by nurserymen, orchardists and home gardeners, such introductions may have been linked to exploration for new species of plants.

Exploration for *Citrus* species and varieties, and *Citrus* relatives, in China, Việt Nam, Thailand and the Philippines was initiated by the eminent citrus taxonomist Walter Tennyson Swingle, who visited Lingnan University<sup>9</sup> in 1916 and collaborated with staff there, and in the Philippines,

<sup>8</sup> Hong Kong Government Reports Online (1853-1941): <http://sunzi1.lib.hku.hk/hkgro/index.jsp>.

<sup>9</sup> Now the location of Zhongshan Daxue (Zhongshan University): also called Sun Yat-Sen University.

over many years (Groff 1927, McClure 1931, Cooper 1989)<sup>10</sup>. These plants appear to have been both grafted and ungrafted<sup>11</sup>. Some plants were introduced to the United States of America, most via the Philippines, so as to reduce the risk of new pests and diseases entering America (Groff 1927). Records are still being obtained, and in the case of those written in Chinese, translated. One record (Wang 1934) mentions ‘*Citrus magner* ex Hort.’ (sic), a lemon type (*C. limonia* Osbeck var. nov. *wagner*), being introduced to Guangdong by George Groff from the garden of Mr Wagner, a French resident of Saigon (now Ho Chi Minh City). There is no evidence that this plant, or other plant material taken from Việt Nam by Groff, McClure and their colleagues, harboured HLB or *D. citri*, but there is possibility that such plants, if initially imported from a region where both the disease and vector occurred (e.g., India) may have led to the introduction of both to China. Nevertheless, such plants may have occurred in Việt Nam, or elsewhere in Indo-China and the Malay Peninsula, but their presence may not have been noticed given that populations of major cities were relatively small. Moreover, citrus cultivation appears to have been low (below 500 ha?) in Việt Nam, and largely restricted to home gardens in rural areas<sup>12</sup>. Feldwick (1917) does not mention citrus cultivation in the Saigon region. Between 1860 and 1923, the population of Saigon from 6,000 to 100,000. Growth there after was less dramatic: between 1921 and 1947 it increased 1.7 times (Guillaume 1985). Together with the nearby town of Cholon, the total population of Saigon-Cholon in 1917 was about 250,000 (Feldwick 1917).

The above records suggest that ‘*Ca. L. asiaticus*’ may have originated in India, as also suggested by Halbert & Manjunath (2004). It is possible that this may have occurred in association with asymptomatic forms of *M. paniculata*, *B. koenigii* or species of *Clausena*, but not species of *Citrus*, as recent studies by Bayer et al. (in press) suggest that no true species of *Citrus* are native to India. However, the authors of this IMP consider sub-Saharan Africa to be the most likely origin of the ‘*Ca. Liberibacter*’ forms that cause HLB.

The African form of HLB was first reported (as Transvaal citrus greening) in Rustenberg in Western Transvaal (now Northern Province) in South Africa in about 1928-29 (predating our views on when it first occurred in China) and was spread to other areas with infected planting material (van der Merwe & Andersen 1937, Oberholzer et al. 1965, Moll 1977)<sup>13</sup>. The disease is characterised by chlorotic leaf symptoms, as well as poor crops of undersized and poorly coloured fruit of inferior quality. It caused severe crop losses in the Eastern Transvaal (now Mpumalanga) during the periods 1932-36 and 1939-46, but was of little importance elsewhere. From 1958, severe crop losses occurred in the Eastern and Western Transvaal and greening spread elsewhere in South Africa, presumably due to the upsurge of *T. erythrae* as a serious pest in citrus orchards, particularly in cooler areas > 700 m asl, where humidity rarely falls below 25% and mean monthly maximum temperatures vary between 18°C and 30°C (Oberholzer et al. 1965, Buitendag & von Broembsen 1993). Previously, *T. erythrae* had been troublesome only in nurseries (Buitendag & von Broembsen 1993). When a few HLB-affected trees (with their origins in the north) were found in the Eastern and Western Cape in the 1960s, they were destroyed and restrictions were placed on the movement of planting material from greening

<sup>10</sup> Other foreign scientists involved in exploration and introductions during this period included George Weidman Groff, Franklin Post Metcalf, Floyd Alonzo McClure and Elmer Drew Merrill.

<sup>11</sup> McClure’s field notes, Zhongshan University herbarium, Guangzhou, photographed by GAC Beattie, 2007.

<sup>12</sup> In 1991 the total area in Việt Nam was about 5,000 ha (Whittle 1992).

<sup>13</sup> These reports coincide with the first records of *T. erythrae* being recorded as a pest of citrus in South Africa: albeit with damage caused directly by the pest, not HLB: see, van der Merwe (1923).

infected provinces. In 1995, the disease was detected in an isolated spot in the Eastern Cape and trees were eradicated. At this point it was also recorded at Stellenbosch in the Western Cape, where the disease continues to spread slowly (le Roux 2006).

Africa is the only region in which a common association between a HLB pathogen and a seemingly asymptomatic and preferred host of a vector appears to occur: in an association involving *T. erythrae* and *V. lanceolata*. Moran (1968) suggested that *V. lanceolata*, *Cl. anisata* and *Z. capense* could be the original native hosts of *T. erythrae* in Africa, but *Cl. anisata* is not native to Africa (Molino 1994) and *Z. capense* is a relatively poor host. da Graça (1991) mentioned that efforts (JV da Graça & SP van Vuuren unpublished data) to transmit the African form of the disease to *V. lanceolata*, *Cl. anisata* and *Z. capense* by *T. erythrae* were unsuccessful, but he did not mention how the tests were done, or whether there was an expectation that the plants would exhibit symptoms of the disease normally observed on *Citrus*. However, subsequent studies indicate that *Cl. anisata* and *V. lanceolata* can harbour the bacterium. van den Berg et al. (1991-1992, 1992) reported detection of the pathogen from psyllid infested *Cl. anisata* growing in close proximity to a HLB-infected citrus orchard. Detection was based on tests involving grafting of sweet orange indicator plants to the *Cl. anisata* trees. Simultaneous tests with the native *V. lanceolata* and *Z. capense* were negative (van den Berg et al. 1991-1992), but Korsten et al. (1996), using dot blot hybridisation, detected the bacterium in a leaf sample taken from a *V. lanceolata* tree on which many *T. erythrae*-induced leaf deformations were observed. van den Berg et al. (1991-1992) recommended removal of *Cl. anisata* plants growing near citrus orchards and Korsten et al. (1996) concluded that *V. lanceolata* is a reservoir plant for the pathogen<sup>14</sup>. van den Berg et al. (1991-1992, 1992) and Korsten et al. (1996) did not mention the presence of HLB symptoms in any of these non-*Citrus* hosts of *T. erythrae*, and there are no reports of dieback or death of trees.

It is highly unlikely that HLB originated in Asia or Australasia in association with *Citrus* or any *Citrus* relative. There would be a high probability that any such association would lead to rapid extinction of the host plant(s) and the bacterium. Moreover, HLB does not occur naturally in Australasia and no indigenous psyllid species have been recorded feeding on indigenous species of *Citrus*.

In 2006, we considered it possible that the three currently recognised ‘*Candidatus Liberibacter*’ ‘species’<sup>15</sup> (‘*Ca. L. asiaticus*’, ‘*Ca. L. africanus*’ and ‘*Ca. L. americanus*’) and the one ‘sub-species’ (‘*Ca. L. africanus* subsp. *capensis*’) that cause HLB (da Graça & Korsten 2004; Teixeira et al. 2005a, b), may represent forms of a single ‘species’ that had adapted to new hosts and environments in the recent past (perhaps < 500 years) (Beattie et al. 2006). Our opinions differed about the validity of the three ‘species’ of ‘*Ca. Liberibacter*’, and we were concerned that the bacteria may have the capacity to adapt rapidly to new hosts and environments (Beattie et al. 2006). We reasoned that the probability of three forms evolving on more than one continent after

<sup>14</sup> Observations reported by Evers & Grisoni (1991), and reports by Temu & Andrew (2008) and Burgess et al (2002), suggest that two other species of *Vepris*, *V. mildbraediana* G.M. Schulze (of uncertain taxonomic status: Mziray 1992) and *V. morogorensis* var *subalata* (Kokwaro) W. Mziray, may be also be hosts of *T. erythrae*, and possible ‘*Ca. L. africanus*’ in Morogoro, Tanzania.

<sup>15</sup> ‘It is important to note that the category *Candidatus* is not covered by the Rules of the Bacteriological Code. Consequently, a name included in the category *Candidatus* cannot be validly published, and it also cannot be designated sp. nov., gen. nov., etc.’: Euzéby JP. 2008. List of Prokaryotic names with standing in nomenclature. <http://www.bacterio.cict.fr/candidatus.html> .

the separation of Gondwana, and in an initial association with a single, most probably asymptomatic, host plant species and with a single psyllid vector, would be negligible.

Based on this evidence and movement of plants by humans, we consider it possible that the HLB pathogen was transmitted from *V. lanceolata* to orange or mandarin trees by *T. erythrae* in one of the European colonies on the southeast coast of Africa and then taken to the Indian subcontinent in infected plants or budwood some 300-500 years ago. It could then have been acquired and spread by *D. citri*. Spread could also have occurred through marcotting (air-layering) and grafting, and enhanced by changes in horticultural practices, that through increased use of irrigation and fertilisers within monocultures, would have led to more abundant and frequent growth flushes. The latter would have led to far higher populations of *D. citri* than would have occurred in its original environment. Aubert (1988) commented that although widely distributed throughout the Orient, *D. citri* has a relatively narrow habitat restricted to *Citrus*, *M. paniculata* and two rare *Clausena* spp., and that *D. citri*, unlike *T. erythrae*, is not able to build up massively on a wide range of alternative rutaceous forest trees or shrubs. He suggested this as a reason why ‘*Ca. L. asiaticus*’ in Asia is generally far more associated to man’s activity in densely populated areas than ‘*Ca. L. africanus*’ in Africa. He (Aubert 1988) considered *D. citri* to be an ecologically opportunistic insect that dispersed ‘along the main communication tracks’ of naturally occurring and cultivated ‘*Citrus and Murraya paniculata*’.

Our views on the origins of the nominal genus ‘*Candidatus Liberibacter*’ are being reconsidered in light of recent reports (Liefting 2008a, b) of a fourth ‘species’ of ‘*Ca. Liberibacter*’ being discovered in potato (*Solanum tuberosum* L.), tomato (*S. lycopersicum* L.) [Solanales: Solanaceae]<sup>16</sup> and other solanaceous plants in New Zealand (Liefting et al. 2008a,b) in association with the recently introduced potato/tomato psyllid *Bactericera* (= *Paratrioza*) *cockerelli* (Šulc) [Psyllidae], presumably from North and/or Central America<sup>17</sup>, and reports of possibly the same pathogen being detected in tomato and potato in California (Hansen et al. 2008). These are the first reports of *Liberibacter*s occurring naturally in plants other than species of Rutaceae, and it is uncertain as to when symptoms caused by the pathogen in the Solanaceae were first noticed in the Americas, prior to the report of Hansen et al. (2008). Hansen (2008) noted that the most similar 16S rRNA sequence to the new ‘*Ca. Liberibacter*’ species is sequence DQ471901 ‘*Ca. L. asiaticus*’ from Brazil.

Eveillard et al. (2008), in an estimation of ‘speciation’ dating, considered ‘*Ca. L. asiaticus*’ and ‘*Ca. L. africanus*’ diverged some 150 million years ago, while speciation of ‘*Ca. L. americanus*’ might have started some 300 million years ago. Doddapaneni et al. (2008b) considered that speciation may have occurred 110-120 mya, before the breakup of Gondwana. Teixeira et al. (2008) estimated that ‘*Ca. L. africanus* and *Ca. L. asiaticus*’ diverged 147 mya and that the splitting between ‘*Ca. L. americanus*’ and the asiaticus/africanus branch would have occurred 309 mya. At the family level, psyllids appear to have colonised relatively few major lineages of plants during the diversification of both angiosperms and psyllids in the Cretaceous (146-65 mya), and subsequently evolved and diversified with their hosts (Hodkinson 1984). Gullan & Martin (2003) noted that the fossil record of the Psylloidea extends back to the Permian (> 270 mya). The extant families probably diversified in the Cretaceous (Gullan & Martin 2003).

<sup>16</sup> Solanales are estimated to be from the mid-Cretaceous (Bremer et al. 2004)

<sup>17</sup> See: <http://www.biosecurity.govt.nz/pests-diseases/plants/potato-tomato-psyllid.htm>.

However, there is no evidence that ‘*Ca. L. americanus*’ occurs naturally in the Americas: the only known hosts are not native to the Americas. Furthermore, there appears to be no logical reason, given the paucity of native species of Rutaceae and psylloids in South America, to support notions that the disease, in any form, evolved in Rutaceae in South America. Both ‘*Ca. L. americanus*’ and ‘*Ca. asiaticus*’ were discovered at the same location in two orchards in São Paulo State in Brazil, and are spreading from that point (Silvio Lopes, pers. comm, September 2008, Lopes et al. 2008). Since discovery of the disease in São Paulo State in 2004, ‘*Ca. L. americanus*’ has been the most prevalent species in citrus (Gottwald et al. 2007), and it appears to have had sufficient time to move freely from citrus to orange jasmine, without any of the limitations provided by removal of symptomatic trees or applications of insecticides, practices currently adopted in the management of HLB in citrus orchards (Lopes et al. 2008, these proceedings). However, in the last 4 years, a disproportional increase in the incidence ‘*Ca. L. asiaticus*’ has been observed in citrus. It appears that both forms were introduced simultaneously in the mid 1990s to Brazil, where *D. citri* has been present since about 1940 (Halbert & Núñez 2004).

If the bacteria evolved before the breakup of Gondwana, then their widespread distribution in Africa, Asia and South America can be explained by vicariance. However, the difficulty with this interpretation is the date of origin of plants in which the organisms are known to occur. To accommodate the age estimates of Eveillard et al. (2008) and Doddapaneni et al. (2008b) it will be necessary to identify hosts that may have occurred up to 300 mya, when only Gymnosperms were present, and how the bacteria moved from plant to plant. Currently, the liberibacters are only known to colonise two families of Angiosperms, the Rutaceae, within the subfamilies Rutoideae and Aurantioideae, and the Solanaceae. The putative oldest member of ‘*Ca. Liberibacter*’, ‘*Ca. L. americanus*’ has only been detected in two Aurantieae genera (*Citrus* and *Murraya*), and no genera within the Aurantieae, or in the Clauseneae, the other recognised tribe within the Aurantioideae, are indigenous to the South America. ‘*Ca. L. asiaticus*’ has only been detected in the Aurantioideae. ‘*Ca. L. africanus*’ has only been found naturally within African Rutoideae, and the Rutoideae evolved before the Aurantioideae (Bayer et al. in press) and occur naturally in all continents aside from Antarctica.

A brief summary, based on literature referred to above, and some other sources, of our interpretation of events related to the evolution of Rutaceae, Solanaceae, psylloids and liberibacters, and the spread of HLB into *Citrus* is presented in Table 1.

Table 1. Summary of historical events related to the evolution of Rutaceae, Solanaceae, psylloids and liberibacters, and the spread of HLB into *Citrus*.

Tectonics & Flora	Era	Period	Epoch	Start of each period (mya)	Fauna & bacteria
Extant Rutaceae and Solanaceae. Movement of plants by humans. Citrus monocultures from 1800s.	Current			0.002	Three ‘ <i>Ca. Liberibacter</i> ’ transmitted from their natural asymptomatic hosts to symptomatic <i>Citrus</i> and <i>Citrus</i> relatives, independently on three continents; only one form, ‘ <i>Ca. L. africanus</i> ’ with a possible natural host and a possible natural vector; ‘ <i>Ca. L. asiaticus</i> ’ with a possible natural vector but no identified natural asymptomatic host; ‘ <i>Ca. L. americanus</i> ’ with

					no identified natural host or vector. First encounters of <i>D. citri</i> and <i>T. erythrae</i> with <i>Citrus</i> . No beneficial or detrimental impacts of 'Ca. Liberibacter' on vectors demonstrated. Psylloid vectors move from natural hosts to colonise citrus monocultures.		
	Cenozoic	Quaternary	Holocene	0.1	'Ca. Liberibacter' exist in unknown hosts and with no identified insect vector(s)?		
Ongoing evolution of <i>Citrus</i> ?				Pleistocene		1.6	
Ongoing evolution of <i>Citrus</i> ?		Tertiary	Pliocene	5			
<i>Citrus japonica</i> (18 mya) <i>Citrus trifoliata</i> (18 mya) <i>Citrus glauca</i> (22 mya) Speciation of <i>Citrus</i> continues in Australasia and in Asia, in the absence of 'Ca. Liberibacter' and psylloids that feed on citrus.							Miocene
<i>Citrus medica</i> (?? mya) <i>Citrus</i> progenitor (?? mya). <i>Citrus</i> evolves in Australasia in the absence of 'Ca. Liberibacter' and psylloids that feed on citrus.				Oligocene			35
				Eocene			57
				Paleocene			65
		Mesozoic	Cretaceous	Late		97	Evolution of psylloids on Rutoideae then Aurantioideae?
Aurantioideae (71 mya): Clauseneae (to comprise now extant <i>Bergera</i> , <i>Clausena</i> , <i>Micromelum</i> & <i>Glycosmis</i> in Asia & Australasia) evolve before Aurantieae (initially <i>Murraya sensu stricto</i> , in South and Southeast Asia, finally <i>Citrus</i> in the Oligocene?). Rutoideae (91 mya) Rutaceae (91 mya)						Early	146
Breakup of East Gondwana begins (110-120 mya) <i>Cuscuta</i> progenitor Solanales			Jurassic	Late	157		
				Middle	178		
Geographic separation of 'Ca. Liberibacter' commences? Breakup of East and West Gondwana commences 167 mya Angiosperms (180-140 mya)				Early	208		

		Triassic	Late	235	
			Middle	241	
			Early	245	
	Paleozoic	Permian	Late	256	
			Early	290	Psylloid progenitor (> 270 mya)
		Carboniferous	Late	322	Sternorrhyncha ('Homopteran') progenitor (300 mya); speciation of ' <i>Ca. L. americanus</i> ' (300 mya)
			Early	363	
Gymnosperms (365 mya)		Devonian	Late	377	
			Middle	386	
Ferns (390 mya)			Early	409	Phytophagous insects (390 mya)
		Silurian	Late	424	
Vascular plants (425 mya)			Early	439	
		Ordovician	Late	476	
			Middle	510	
			Early	517	
		Cambrian	Late	536	Arthropods (525 mya)
			Early	570	
	Precambrian	Proterozoic		2500	
		Archaean			

We cannot gauge the accuracy of the age estimates of Eveillard et al. (2008) and Doddapaneni et al. (2008b). However, we still wonder whether diversification of the bacteria occurred more recently than their estimates even, as Beattie et al. (2006) hypothesised, in the past 1,000 years? Is it possible that modern agricultural practices may have led to relatively rapid adaptations to new hosts and environments? Geographical variation in '*Ca. L. asiaticus*' has been reported in regions where the pathogen does not occur naturally (e.g., Garnier et al. 1991, Gao et al. 1993, Bastianel et al. 2005, Teixeira et al. 2005c, Subandiyah et al. 2006, Doddapaneni et al. 2008a, Zhou et al. 2008a), and severe symptoms have been reported in hosts, e.g., limes and pomeloes, that until recently have been considered tolerant (Susan Halbert, Florida Department of Agriculture and Consumer Services, pers. comm, 2008, Tsai et al. 2008). Is it possible, if the phylogenetic relationships derived by Bastianel et al. (2005) and Teixeira et al. (2005c), and the age estimates of Eveillard et al. (2008) and Doddapaneni et al. (2008b), are accurate, that all three forms of '*Ca. Liberibacter*' that cause HLB originated on one continent, Africa, and that two of the forms have spread anthropogenically from there?

With the possible exception of *V. lanceolata*, no asymptomatic hosts have been identified, nor have insect vector-associations with these plants and plants in which the pathogens cause disease been identified. In the absence of psyllid vectors, the only avenues we can suggest for natural spread from plant to plant are root grafts and transmission by parasitic plants, particularly *Cuscuta* spp [Solanales: Convolvulaceae].

Halbert & Manjunath (2004) considered natural transmission of HLB by *Cuscuta* spp. unlikely. However, there is a possibility that natural and anthropogenic dispersal of species such *Cu. australis* and *Cu. campestris* may have contributed to the spread of several pathogens known to be transmitted by them, including HLB. Dodder is common parasite of a broad range of plants in Asia (Browne 1968, Rajak et al. 1985, Abu-Irmaileh 1987, Abu-Irmaileh & Fucik 1989, Banerjee et al. 1993). Seeds can persist in soil, and are often planted with contaminated seed of other plants (O'Driscoll 2003). Some species of *Cuscuta* have broad host ranges, and hosts can

be cereals, lucerne, clover, herbs, vegetables (e.g., carrot, celery, potato, capsicum and eggplant), flax, linseed, shrubs, and trees (Knorr 1949, Rajak et al. 1985, Abu-Irmaileh 1987, Abu-Irmaileh & Fucik 1989, Banerjee et al. 1993, O'Driscoll 2003, Stefanović et al. 2007).

The genus *Cuscuta* evolved before the breakup of Gondwana and diversified in South and Central America (Stefanović et al. 2007). The genus comprises some 165–175 currently described species<sup>18</sup>. It is nearly cosmopolitan in distribution with species found on every continent (except Antarctica), ranging from 60° N to 47° S (Stefanović et al. 2007). The vast majority of species of *Cuscuta* only occur in the Americas, with Mexico and adjacent regions as a centre of diversity. Despite their wide cosmopolitan distributions, *Cu. australis* and *Cu. campestris* (one of the most successful parasitic weeds) are of North American origin.<sup>19</sup>

Rutaceous hosts of dodder in laboratory and field observations include *Citrus* species and hybrids (Abu-Irmaileh 1987, Abu-Irmaileh & Fucik 1989, Byadgi & Ahlawat 1995, Ahlawat et al. 1996, Pant & Ahlawat 1998), bael (*Aegle marmelos* (L.) Corr. [Aurantieae] (Rajak 1985), and toothpick glycosmis (*Glycosmis trifoliata* (Blume) Spreng. syn. *Glycosmis pentaphylla* (Retz.) DC. [Clauseneae]) (Banerjee et al. 1993).

HLB and pathogens of citrus other than those that cause HLB can be transmitted by dodder. Species of *Cuscuta* have been used to transfer liberibacters between hosts (Tirtawidjaja 1981, Garnier & Bové 1983, Ke et al. 1988, Olfato et al. 1990, 1991, Subandiyah 1994, Duan et al. 2008, Zhou et al. 2007). ‘*Ca. L. asiaticus*’ can multiply and spread within infected *Cu. ceanothi* Behr (syn. *Cu. subinclusa* Dur. & Hilg.), *Cu. campestris*<sup>20</sup> (Ghosh et al. 1977) and *Cu. australis* (Su & Huang 1990)<sup>21</sup>. Ghosh et al. (1977) observed that the pathogen multiplied more favourably in dodder on diseased sweet orange (which they assumed to be natural host of the pathogen) and suggested this as evidence that it could be possible to use dodder as an alternative host of the pathogen. Zhou (2008b) reported that infected *Cu. pentagona* plants did not exhibit symptoms of HLB even when they contained high titres of ‘*Ca. L. asiaticus*’. Other diseases transmissible by dodder include transmission by *Cu. reflexa* Roxb. in India of citrus yellow corky vein (Reddy & Naidu 1989), a viral ringspot disease of citrus (Byadgi & Ahlawat 1995), and a badnavirus associated with citrus mosaic disease (Ahlawat et al. 1996).

<sup>18</sup> All members of the genus are vines with twining, slender, pale stems, with reduced, scalelike leaves, and no roots. They become attached to stems by haustoria and depend almost entirely on their hosts to supply water and nutrients (Stefanović et al. 2007). Most species have reduced amounts of, or no, chlorophyll (Stefanović et al. 2007). They divert sugars from the host crop, weakening plants and often causing total failure to set fruit.

<sup>19</sup> The monophyletic nature of these species, nested within a clade with narrow distributional ranges, led Stefanović et al. (2007) to conclude that their physiological capability to use hundreds of genera as hosts probably arose once, in their common ancestor. This capability thus allowed them to spread over large geographic areas, either naturally or as consequence of anthropogenic influences. Stefanović (et al. 2007) concluded that there was little doubt that the initial jump in dispersal and speciation had to occur from the Old World, most likely Africa, to the New World, with the first major split and subsequent diversification of *Cuscuta* species in the New World most likely occurring between South America and Mexico. They regarded Mexico as the centre of biodiversity for *Cuscuta* and a staging ground for subsequent diversification.

<sup>20</sup> Possibly *Cu. australis*, not *Cu. campestris*. See next footnote.

<sup>21</sup> For recent information on synonyms within the genus *Cuscuta* see: O'Driscoll CW. 2003. Preliminary review of the genus *Cuscuta* in North America. Prepared for the NAPPO PRA Panel – July/August 2003. North American Plant Protection Organization. 10 pp. <http://www.nappo.org/PRA-sheets/CuscutaTable2003.pdf>. Although she lists *Cu. pentagona* as a synonym of *Cu. campestris* evidence presented by Stefanović et al. (2007) indicates that it is not.



In addition to transmission of HLB by *Cuscuta* spp., transmission by another parasitic plant, dodder laurel (*Cassytha filiformis* L.<sup>22</sup> [Magnoliales: Lauraceae]) may prove possible. This possibility is based on reports of successful transmission of citrus mosaic (Reddy et al. 1985), CTV (Reddy & Murti (1988), citrus yellow corky vein (Reddy & Naidu 1989), and of a mycoplasma-like organism from coconut (*Cocos nucifera* [Arecales: Arecaceae]) to periwinkle (Saskikala et al. 1989).



Dodder (*Cuscuta* sp.) covered citrus seedlings in a citrus nursery at Sargodha in Punjab Province, Pakistan, in July 2006 (GAC Beattie).



Dodder laurel (*Cassytha* sp.) covered Chinese box orange (*Atalantia buxifolia* (Poir.) Oliv.) in a conservation reserve in coastal Hainan in October 2008 (GAC Beattie).

---

<sup>22</sup> *Ca. filiformis* is a leafless, climbing, twining, vine-like, autoparasitic and plant-hyperparasitic phanerogam. It is indigenous to Hawaii and infests a wide variety of plants, mainly woody hosts, including plants of agricultural and economic value, throughout the tropics worldwide. It belongs to a genus with about 20 species, and occurs in Australia. Hosts of economic importance include citrus, and it may cover and parasitise dozens of host species simultaneously (Nelson 2008a, b).

### The origins of *D. citri* and *T. erytrae*

Modern psylloids, including the Diaphoriniinae and Triozinae, probably evolved with the Sapindales in Gondwana (Hollis 1985, 1987, White & Hodkinson 1985). The Diaphoriniinae have an ecological preference for dry climates (Hollis 1987). The psyllid was first recorded as a serious pest of citrus in India by Husain & Nath (1927) who, in describing the damage it caused, were the first to describe what are now known to be symptoms of huanglongbing. In the early to mid 1930s, the psyllid did not assume such a destructive status in China, the Philippines, Malaya or Indonesia (Clausen 1933, Hoffmann 1936). Hoffmann and Clausen were both aware of the destruction wrought by the psyllid in India (Hoffmann 1936) as described by Husain & Nath (1927).

All evidence supports the views of Hollis (1987) and Halbert & Manjunath (2004) who suggested, that the psyllid evolved in India in association with a species of *Murraya*<sup>23</sup>: within the subtribe Clauseneae as circumscribed by Swingle & Reece (1967)<sup>24</sup>. Which species of *Murraya*, is an issue that needs to be resolved in light of the recent morphological, phytochemical (But et al. 1986) and molecular studies (Samuel et al. 2001, Bayer et al. in press) that are discussed below. Although orange jasmine, *Murraya paniculata* (L.) Jack, is generally regarded as the preferred host of *D. citri*, it was not reported as a host of the psyllid in India until 1975 (Cheema & Kapur 1975), 60, 41 and 13 years respectively after it was reported as a host in Taiwan by (Maki 1915, Kuwayama 1931), in China by He & Zhou (1935), and in the Ryukyu Islands of Japan by (Miyatake 1965). Oddly, *B. koenigii* (cited as *M. koenigii*) was the first *Citrus* relative to be recorded as host of the psyllid in India (Fletcher 1917, 1919, Husain & Nath 1927).

*D. citri* was described from Taiwan (Kuwayama 1908). Crawford (1919) recorded it as being present in the Philippines, Taiwan, Java, Malay Archipelago, Bengal, southern India and southern China, and noted that Frederick Muir collected specimens from Macao and Amboina (Moluccas) in 1906. Clausen (1933) recorded it as being present in China, the Philippine Islands, Taiwan, Malaya, Dutch East Indies, Burma, India, and Ceylon. We have not been able to verify the records for Macau and Ambon, and Hoffmann (1936) regarded detection of the psyllid in Guangdong in 1934 as the first record of *D. citri* in China. If it was present in China, it cannot have been widespread: Hoffmann<sup>25</sup> commenced his studies on pests of citrus and other plants in Guangdong in 1926 (Jiang<sup>26</sup> et al. 1935). Further evidence that the psyllid was not present in China before 1930 is provided by Luh (1936) who, in a paper on factors, including pests and diseases, causing fruit loss in 1935 in Zhejiang, did not mention the presence of *D. citri* or symptoms resembling huanglongbing.

<sup>23</sup> In 1987 the genus *Murraya*, as circumscribed by Swingle & Reece (1967), fell within the tribe Clauseneae. Some species, including orange jasmine (*M. paniculata* (L.) Jack), which is considered to be the favoured host of *D. citri*, have been recently transferred to the Aurantieae [Citreae] (Samuel et al. 2001, Bayer et al. submitted). Others, including the curry plant (*Berberis koenigii* L. = Swingle's *M. koenigii*) remain within the Clauseneae. In this document the common cultivated ornamental form of orange jasmine is considered to be *Murraya paniculata* (L.) Jack var. *exotica* (sensu Huang) (Huang CC. 1959. Preliminary study on Chinese Rutaceae. Acta Phytotaxonomica Sinica 7: 69-124. 15 plates), unless otherwise stated. The status of the species is complex and resolution of this uncertainty is the objective of a PhD being undertaken at the University of Western Sydney by Nguyen Huy Chung.

<sup>24</sup> The assumption of Tsai & Liu (2000) and Tsai et al. (2002) that *D. citri* evolved in the Far East appears to be based on misinterpretation of distribution records cited by Mead (1977).

<sup>25</sup> William Hoffmann also published under the pseudonym of He Fuming (Mandarin, in Cantonese Ho Fuman). He commenced his studies on pests of citrus in Guangdong in 1926 (Jiang et al. 1935). He was based at Lingnan University from 1924 to 1951 (Wang D. 2007. Managing God's Higher Learning: U.S.-China Cultural Encounter and Canton Christian College (Lingnan University) 1888-1952. Lanham, Maryland: Lexington Books.)

<sup>26</sup> Jiang Zhi was a pseudonym of Ira Judson Condit (1883-1981), who was a visiting professor of horticulture at Lingnan University, Guangzhou (Canton) in 1934-35. He travelled extensively in Hawaii, China (including Taiwan), Philippines and Japan.

Information about two primary parasitoids of *D. citri* also suggests that the psyllid evolved in India. Both parasitoids were first described from India, the ectoparasitoid *Tamarixia radiata* (Waterston) [Hymenoptera: Eulophidae] by Waterston (1922), and the endoparasitoid *Diaphorencyrtus aligarhensis* (Shafee, Alam & Agarwal) [Hymenoptera: Encyrtidae] by Shafee et al. (1975). Most records of *T. radiata*<sup>27</sup> in Southeast Asia appear to be related to intentional introductions (Chien et al. 1988, Chiu et al. 1988, Waterhouse 1998) whereas, records of *D. aligarhensis*<sup>28</sup> appear to be linked to unintentional movement of parasitised *D. citri* nymphs on live plants to Taiwan (possibly before 1900) and the Philippines, and to natural spread overland with its host. *D. aligarhensis* is not, as assumed by Chien et al. (1988, 1989, 1991), native to Taiwan or the Philippines. No parasitoids were associated with *D. citri* populations when the psyllid was first recorded in Guangzhou (Hoffmann 1936). Tang (1988) mentioned the introduction of *T. radiata* to Fujian in China, but considered it as possibly indigenous, given its wide distribution in Fujian, as recorded in surveys within four years of its introduction. He also considered it possible that the parasitoid occurred in Taiwan before it was released there (Tang 1988) and indigenous in Asia, from Saudi Arabia to China (Tang 1990). This is not supported by other records. An encyrtid with a yellow abdomen (presumably *D. aligarhensis*) was present in the Philippines in 1968, but *T. radiata* was not (Catling 1968): it was introduced in 1988 (Gavarrá & Mercado 1988, Gavarrá et al. 1990) and the encyrtid with the yellow abdomen was identified as *D. aligarhensis* (Gavarrá & Mercado 1988). Both parasitoids were present in Java in Indonesia in 1987 (Nurhadi 1987). Based on comments by Nurhadi (1988) it seems they may have been introduced to Indonesia on psyllid infested plants. In addition to *D. citri*, hosts of *D. aligarhensis* apparently include *Diaphorina cardiae* Crawford), *Diaphorina auberti* Hollis and *Psylla* sp. (Tang & Aubert 1990: *Diaphorina cardiae* is a junior synonym of *Diaphorina aegyptiaca* Puton (Burckhardt 1984).

*T. erytrae* is native to sub-Saharan Africa (Hollis 1984). It is the only species of *Trioza* that is known to feed and develop on Rutaceae (Hollis 1984, Aubert 1987) and belongs to a complex of species that are difficult to define morphologically, but which have discrete host plant preferences (Hollis 1984)<sup>29</sup>. It has two native rutaceous hosts in Africa on which it can complete its development, *V. lanceolata* and *Z. capense* (Moran 1968, Hollis 1984, Aubert 1987). It also feeds on the native monospecific *Calodendrum capense*, but cannot complete its life cycle on this species (Moran 1968). Synonyms of *V. lanceolata* include *Boscia undulata* Thunb., *Toddalia lanceolata* Lam, *Vepris querimbensis* Klotzsch and *Vepris undulata* (Thunb.) Verdoorn & CA Smith (see Mziray 1992). (*Z. capense* is often cited as *Fagara capensis* Thunb., and sometimes as *F. capense*). Non-native African hosts on which *T. erytrae* can complete its development in Africa include *Citrus* species and hybrids, *M. paniculata* and the *Cl. anisata* (syn. *Cl. inaequalis* (DC.) Benth.) (Moran 1968, Hollis 1984, Aubert 1987). *Cl. anisata* is often stated as being native to Africa (e.g., Moran 1968, Aubert 1987, OEPP/EPPO 2005b) and is a host of 'Ca. L. africanus' (Korsten et al. 1996). It is, however, native to the Western Ghats of India and the northeast part of the Indian subcontinent through to China and has a plethora of synonyms too long to list here (see Molino 1994). Although *Cl. anisata* is the second-most favourable non-citrus host of *T.*

<sup>27</sup> syns *Tetrastichus radiatus* Waterston (Waterston 1922, Graham 1969, Tang 1990, Tang & Aubert 1990, Waterhouse 1998) and *Tetrastichus indicus* Khan & Shafee (Hayat & Shahi 2004).

<sup>28</sup> syns *Aphidencyrtus aligarhensis* Shafee, Alam & Agarwal, *Aphidencyrtus diaphorinae* Myartsera & Tryapitzyn and *Psyllaephagus diaphorinae* Lin & Tao (Noyes & Hayat 1984, Prinsloo 1985, Tang 1990, Tang & Aubert 1990, Waterhouse 1998).

<sup>29</sup> A second species of *Trioza*, *T. litseae* Bordage (syn. *T. eastopi* Orian) has been recorded feeding occasionally on *Citrus* (Aubert & Quilici 1984, Aubert 1987).

*erytrae* in Africa (Moran 1968), there does not appear to be any report of *D. citri* feeding or developing on it in Asia. The fact that *V. lanceolata* is the preferred native host of *T. erytrae* in Africa (Moran 1968) suggests that it is the original host of this psyllid.

### Acknowledgements

Preparation of this document would not have been possible without funding provided by the Australian Centre for International Agricultural Research (ACIAR) and the Department of Education, Science and Training (DEST) for research on huanglongbing and the integrated control of citrus pests in China, Indonesia, Thailand, Malaysia and Việt Nam. We thank Dr Cen Yijing (South China Agricultural University) and Ms Yang Yueping (Guangdong Entomological Institute) for translation of Chinese texts.

### References

- Abu-Irmaileh BE. 1987. Eastern dodder (*Cuscuta monogyna* Vahl.) distribution, host range and its response to glyphosate applications. In: Weber HC, Forstreuter W (eds), Parasitic Flowering Plants. Proceedings of the Fourth International Symposium on Parasitic Flowering Plants, 2-7 August 1987, Philipps-Universität, Marburg, Germany: pp. 1-10.
- Abu-Irmaileh BE, Fucik JE. 1989. Using glyphosate to control eastern dodder on citrus in Jordan. HortScience 24: 311-312.
- Ahlawat YS, Pant RP, Lockhart BEL, Srivastava M, Chakraborty NK, Varma A. 1996. Association of a badnavirus with citrus mosaic disease in India. Plant Disease 80: 590-592.
- Ali I. 1988. The Punjab under Imperialism, 1885-1947. Princeton: Princeton University Press.
- Armstrong J. 1975. The current status of the sub-family Aurantioideae. Australian Plants 8: 226-231.
- Asana RD. 1958. The citrus die-back problem in relation to citrus cultivation in India. Indian Journal of Horticulture 15: 283-286.
- Aubert B. 1987. Le greening une maladie infectieuse des agrumes, d'origine bactérienne, transmise par des Homopteres psyllidés. Stratégie de lutte développée à l'île de la Réunion. Circonstances épidémiologiques en Afrique/Asie et modalités d'intervention. INFA/CIRAD – B.P. 180 – 97455 Saint Pierre Cedex. 185 pp. PhD thesis.
- Aubert B. 1988. Management of the citrus greening disease in Asian orchards. In: Aubert B, Ke C, Gonzales C (eds). Proceedings of the Second Asian/Pacific Regional Workshop on citrus greening, Lipa, Philippines, 20–26 November 1988. Rome: UNDP-FAO. pp. 51-52 + literature.
- Aubert B. 1990a. High density planting (HDP) of Jiaogan mandarine in the lowland area of Shantou (Guangdong China) and implications for greening control. In: Aubert B, Tontyaporn S, Buangsuwon D (eds), Proceedings of the Fourth International Asia Pacific Conference on Citrus Rehabilitation, Chiang Mai, Thailand, 4-10 February 1990. Rome: FAO UNDP. pp. 149-157.
- Aubert B. 1990b. Integrated activities for the control of huanglongbing-greening and its vector *Diaphorina citri* Kuwayama in Asia. In: Aubert B, Tontyaporn S, Buangsuwon D (eds), Proceedings of the Fourth International Asia Pacific Conference on Citrus Rehabilitation, Chiang Mai, Thailand, 4-10 February 1990. Rome: FAO UNDP. pp. 133-144.
- Aubert B. 1990c. Prospects for citriculture in Southeast Asia by the year 2000. FAO Plant Protection Bulletin 38: 151-173.
- Aubert B, Garnier M, Guillaumin D, Herbagyandono B, Setiobudi L, Nurhadi F. 1985. Greening, a serious threat for the citrus productions of the Indonesian Archipelago. Future prospects of integrated control. Fruits 40: 549-563.

- Aubert B, Quilici S. 1984. Biological control of the African and Asian citrus psyllids (Homoptera: Psylloidea), through eulophid and encyrtid parasitoids (Hymenoptera: Chalcidoidea) in Réunion Island. In: Garnsey SM, Timmer LW, Dodds JA (eds), Proceedings of the Ninth Conference of the International Organisation of Citrus Virologists, Puerto Iguagu, Misiones, Argentina, 9-13 May 1983. Riverside: International Organization of Citrus Virologists, University of California, Riverside. pp. 100-108.
- Baillie P, Fraser T, Hall R, Myers K. 2004. Geological development of Eastern Indonesia and the northern Australia collision zone: a review. In: Ellis GK, Baillie PW, Munson TJ (eds), Proceedings of the Timor Sea Symposium, Darwin, Northern Territory, Australia 19-20 June, 2003. Northern Territory Geological Survey, Special Publication 1. pp. 539-550.
- Banerjee K, Khatua DC, Mukherjee N. 1993. Some new hosts of *Cuscuta* sp. Indian Forester 119: 760-761.
- Barlow BA. 1981. The Australian flora: its origin and evolution. In: George A (ed.), Flora of Australia 1, Introduction. Canberra: Australian Government Publishing Service. p. 25-75.
- Bastianel C, Garnier-Semancik M, Renaudin J, Bové JM, Eveillard S. 2005. Diversity of 'Candidatus Liberibacter asiaticus', based on the *omp* gene sequence. Applied and Environmental Microbiology 71: 6473-6478.
- Bayer RS, Mabberley DJ, Morton C, Miller C, Sharma I, Pfeil B, Rich S, Hitchcock R, Sykes S. 2009. A molecular phylogeny of the orange subfamily (Rutaceae: Aurantioideae) using nine cpDNA sequences. American Journal of Botany 96(3):668—685.
- Bayer RS, Rich S, Morton C, Mabberley DJ, Sykes S. 2004. Phylogenetic relationships of Australasian *Citrus* (Rutaceae: Aurantioideae). Abstracts, Botany 2004, Snowbird, Utah, August 2004: 105.
- Beattie GAC, Holford P, Mabberley DJ, Haigh AM, Bayer R, Broadbent P. 2006. Aspects and insights of Australia-Asia collaborative research on Huanglongbing. In: Proceedings of an International Workshop for the Prevention of Citrus Greening Disease in Severely Infected Areas, Ishigaki, Japan, 6-7 December 2006. Tokyo: Multilateral Research Network for Food and Agricultural Safety. Japanese Ministry of Agriculture, Forestry and Fisheries, Tokyo, Japan. pp. 47-64.
- Beattie GAC, Holford P, Mabberley DJ, Haigh AM, Broadbent P. 2008a. Australia and Huanglongbing. In: Ku TY, Pham THH (eds), Proceedings of FFTC-PPRI-NIFTS Joint Workshop on Management of Citrus Greening and Virus Diseases for the Rehabilitation of Citrus Industry in the ASPAC, Plant Protection Research Institute, Hà Nội, Việt Nam, 8-12 September 2008. pp. 75-100.
- Beattie GAC, Holford P, Mabberley DJ, Haigh AM, Bayer R, Broadbent P. 2008b. Origins of *Citrus*, Huanglongbing and the Asiatic citrus psyllid. Proceedings of the Sixth Vietnam Conference on Entomology, 9-10 May 2008, Hà Nội, Việt Nam. pp. 820-834.
- Benemerito AN. 1938. The sour and sweet oranges of Kwangtung, China. Philippine Agriculturist 27: 302-341.
- Benson WN. 1923. Paleozoic and mesozoic seas in Australasia. Transactions of the New Zealand Institute 54: 1-62.
- Bonavia E. 1888-1890. The cultivated oranges and lemons etc. of India and Ceylon. London: WH Allen & Co.
- Bové JM. 2006. Huanglongbing: a destructive, newly-emerging, century-old disease of citrus. Journal of Plant Pathology 88: 7-37.

- Bremer K, Friis EM, Bremer B. 2004. Molecular phylogenetic dating of Asteroid flowering plants shows early Cretaceous diversification. *Systematic Biology* 53: 496-505.
- Brough P. 1933. The life-history of *Grevillea robusta* (Cunn.). *Proceedings of the Linnean Society of New South Wales* 58: 33-73.
- Browne FG. 1968. Pests and diseases of forest plantations trees: list of the principal species occurring in the British Commonwealth. Oxford: Clarendon Press.
- Buitendag CH, von Broembsen LA. 1993. Living with citrus greening in South Africa. In: Moreno P, da Graça JV, Timmer LW (eds), *Proceedings of the Twelfth Conference of the International Organization of Citrus Virologists*, New Delhi, India, 23-27 November 1992. Riverside: International Organization of Citrus Virologists, University of California: Riverside. pp. 269-273.
- Burckhardt D. 1984. The Mediterranean species of *Diaphorina* Loew (Homoptera, Psylloidea). *Phytophaga* 2: 1-30.
- Burgess N, Doggart, Lovet JC. 2002. The Uluguru Mountains of eastern Tanzania: the effect of forest loss on biodiversity. *Oryx* 36(2): 140-152.
- Burgoyne PM, van Wyk AE, Anderson JM, Schrire DB. 2005. Phanerozoic evolution of plants on the African plate. *Journal of African Earth Sciences* 24: 13-52.
- Burrett C, Duhig N, Berry R, Varne R. 1991. Asian and south-western Pacific continental terranes derived from Gondwana, and their biogeographic significance. *Australian Systematic Botany* 4: 13-24.
- But PPH, Kong YC, No KH, Chang HT, Li Q, Yu SX, Waterman PG. 1986. A chemotaxonomic study of *Murraya* (Rutaceae) in China. *Acta Phytotaxonomica Sinica* 24: 186-192.
- Byadgi AS, Ahlawat YS. 1995. A new viral ringspot disease of citrus (*Citrus* species) in India. *Indian Journal of Agricultural Sciences* 65: 763-770.
- Capoor SP. 1963. Decline of citrus in India. *Bulletin of the National Institute of Science of India* 24: 48-64, 3 plates.
- Catling HD. 1968. Report to the Government of the Philippines on the distribution and biology of *Diaphorina citri*, the insect vector of leaf mottling (greening) disease of citrus. United Nations Development Programme TA 2589. Rome: FAO. 14 pp. plus figures.
- Chadra KL, Randhawa NS, Bindra OS, Chohan JS, Knorr LC (eds). 1970. *Citrus Decline in India: Causes and Control*. Ludhiana: Punjab Agricultural University.
- Cheema SS, Kapur SP. 1975. *Murraya paniculata* Linn.—A new host for *Diaphorina citri* Kuwayama. *Current Science* 44: 249.
- Chen QB. 1943. A report on a study on yellow shoot of citrus in Chaoshan. *The New Agricultural Journal (Quarterly Bulletin of New Agriculture)* 3(3-4): 142-175. (In Chinese).
- Chien CC, Chiu SC, Ku SC. 1988. Biological control of citrus psylla, *Diaphorina citri*. I. The introduction, augmentation and release of *Tamarixia radiata*. *Journal of Agricultural Research of China* 4: 430-439.
- Chien CC, Chiu SC, Ku SC. 1989. Biological control of *Diaphorina citri* in Taiwan. *Fruits* 44: 401-407.
- Chien CC, Chu YI, Ku SC. 1991. Biological control of citrus psyllid, *Diaphorina citri* in Taiwan. II. Evaluation of *Tamarixia radiata* and *Diaphorencyrtus diaphorinae* for control of *Diaphorina citri*. *Chinese Journal of Entomology* 11: 25-38.
- Chiu SC, Aubert B, Chien CC. 1988. Attempts to establish *Tetrastichus radiatus* Waterson (Hymenoptera, Chalcidoidea), a primary parasite of *Diaphorina citri* Kuwayama in Taiwan. In: Timmer LW, Garnsey SM, Navarro L (eds), *Proceedings of the Tenth Conference of the*

- International Organization of Citrus Virologists, Valencia, Spain, 17-21 November 1986. Riverside: International Organization of Citrus Virologists, University of California: Riverside. pp. 265-268.
- Clausen CP. 1933. The citrus insects of tropical Asia. Circular 266. Washington: United States Department of Agriculture. 35 pp.
- Condit IJ, Benemerito AN, Wang HC. 1937. Citrus fruits and their culture in Kwangtung Province, South China. Typescript, Southern Regional Library Facility, University of California, Riverside. 58 pp.
- Cooper WC. 1989. Odyssey of the Orange in China. Natural history of the Citrus fruits in China. DeLeon Springs, Florida: EO Painter Printing Company. 122 pp.
- Crane PR, Friis EM, Pedersen KR. 1995. The origin and early diversification of angiosperms. *Nature* 374: 27-33.
- Crawford DL. 1919. The jumping plant lice of the Palaeotropics and the South Pacific Islands. *Philippine Journal of Science* 15: 139-207, Plates I-III.
- da Graça JV. 1991. Citrus greening disease. *Annual Review of Phytopathology* 29: 109-139.
- da Graça JV, Korsten L. 2004. Citrus huanglongbing: review, present status and future strategies. In: Naqvi SAMH (ed.), *Diseases of Fruits and Vegetables, Volume I*. Dordrecht: Kluwer Academic Press. pp. 229-245.
- Davis MJ, Mondal SN, Chen HG, Rogers ME, Brlansky RH. 2008. Co-cultivation of '*Candidatus Liberibacter asiaticus*' with Actinobacteria from Citrus with huanglongbing Plant Disease *Plant Disease* 92: 1547-1550.
- Doddapaneni H, Liao HH, Lin H, Bai XJ, Zhao XL, Civerolo EL, Irey M, Coletta-Filho H, Pietersen G. 2008a. Comparative phylogenomics and multi-gene analyses of the citrus huanglongbing (HLB)-associated bacterium *Candidatus Liberibacter*. *BMC Research Notes* 1: 72. 22 p. doi:10.1186/1756-0500-1-72.
- Doddapaneni H, Lin H, Liao HH, Bai XJ, Zhao XL, Civerolo E. 2008b. Molecular characterization of the citrus huanglongbing (HLB) associated bacterium *Candidatus Liberibacter*. In: Abstracts and Proceedings of the Eleventh International Citrus Congress, Wuhan, China, 26 to 30 October 2008. pp. 53-54.
- Duan Y, Zhou L, Gottwald TR, Gabriel D. 2008. First report of dodder transmission of *Candidatus Liberibacter asiaticus* to tomato (*Lycopersicon esculentum*). *Plant Disease* 91:227.
- Dugo G, Di Giacomo A (eds). 2002. Citrus. The Genus *Citrus*. London: Taylor & Francis.
- Euzéby JP. 2008. List of Prokaryotic names with standing in nomenclature. <http://www.bacterio.cict.fr/candidatus.html>.
- Eveillard S, Teixeira DC, Bové JM. 2008. Huanglongbing disease of citrus and the genus *Candidatus Liberibacter*. In: Porta-Puglia A, Gonthier (eds), Abstracts of the Ninth International Congress of Plant Pathology, Torino, Italy, 24-29 August 2008: *Journal of Plant Pathology* 90 (2 (Supplement): S2:43.
- Evers G, Grisoni M. 1991. Present situation of the citrus greening disease in Tanzania and proposal for control strategies. *Fruits* 46: 171-177.
- Feldwick W (ed.). 1917. Present Day Impressions of The Far East and Prominent & Progressive Chinese at Home and Abroad: The History, People, Commerce, Industries and Resources of China, Hongkong, Indo-China, Malaya, Netherlands India. London, Shanghai, Hongkong, Saigon, Singapore & Batavia: The Globe Encyclopedia Company.
- Fletcher TB. 1917. Proceedings of the Second Entomological Meeting, Pusa, India, 5-12 February 1917. Calcutta: Superintendent Government Printing. p. 276.

- Fletcher TB. 1919. Proceedings of the Third Entomological Meeting, Pusa, India, 3-15 February 1919. Calcutta: Superintendent Government Printing. pp. 215-216.
- Fraser L. 1966. Citrus dieback in India. Report to the Department of External Affairs, Canberra, Australia. 95 pp. 15 figs.
- Fraser LR, Singh D, Capoor SP, Nariani TK. 1966. Greening virus, the likely cause of citrus dieback in India. *FAO Plant Protection Bulletin* 14: 127-130.
- Gade DW. 1976. Naturalization of plant aliens: the volunteer orange in Paraguay. *Journal of Biogeography* 3: 269-279.
- Gao S, Garnier M, Bové JM. 1993. Production of monoclonal antibodies recognizing most strains of the greening BLO by in vitro immunization with an antigenic protein purified from the BLO. In: Moreno P, da Graça JV, Timmer LW (eds), Proceedings of the Twelfth Conference of the International Organization of Citrus Virologists, New Delhi, India, 23-27 November 1992. Riverside: International Organization of Citrus Virologists, University of California, Riverside. pp. 244-249.
- Garnier M, Bové JM. 1983. Transmission of the organism associated with citrus greening disease from sweet orange. *Phytopathology* 73: 1358-1363.
- Garnier M, Gao SJ, He Y, Villechanoux S, Gandar J, Bové JM. 1991. Study of the greening organism (GO) with monoclonal antibodies: serological identification, morphology serotypes and purification of the GO. In: Brlansky RH, Lee RF, Timmer LW (eds), Proceedings of the Eleventh Conference of the International Organization of Citrus Virologists, Orlando, Florida, 6-10 November 1989. Riverside: International Organization of Citrus Virologists, University of California: Riverside. pp. 428-435.
- Gavarrá MR, Mercado BG. 1988. Progress report on studies dealing with the psyllid vector (*Diaphorina citri* Kuwayama) of greening disease in the Philippines. In: The FAO-UNDP Project Coordinator in Fuzhou (ed.), Regional Workshop on Citrus Greening Huanglungbin Disease, Fuzhou, China, 6-12 December 1987. pp. 23-31.
- Gavarrá MR, Mercado BG, Gonzales CI. 1990. Progress report: *D. citri* trapping, identification of parasite and possible field establishment of the imported parasite, *Tamarixia radiata* in the Philippines. In: Aubert B, Tontyaporn S, Buangsuwon D (eds), Proceedings of the Fourth International Asia Pacific Conference on Citrus Rehabilitation, Chiang Mai, Thailand, 4-10 February 1990. Rome: FAO UNDP. pp. 246-250.
- Ghosh SK, Giannotti J, Lewis C. 1977. Multiplication intense des procaryotes associés aux maladies de type "greening" des agrumes dans les cellules criblées de Cuscutes. *Annals of Phytopathology* 9: 525-530.
- Gottwald TR, da Graça JV, Bassanezi RB. 2007. Citrus huanglongbing: The pathogen and its impact. *Plant Health Progress* doi:10.1094/PHP-2007-0906-01-RV.
- Graham MWR de V. 1969. The Pteromalidae of Northeastern Europe (Hymenoptera: Chalcidoidea). *Bulletin of the British Museum of Natural History (Entomology)* Supplement 16: 1-908.
- Groff GW. 1927. Culture and varieties of Siamese pummelos as related to introductions into other countries. *Lingnan Science Journal* 5(3): 187-254.
- Guerra M, dos Santos KGB, e Silva AEB, Ehrendorfer F. 2000. Heterochromatin banding patterns in Rutaceae-Aurantioideae - a case of parallel chromosomal evolution. *American Journal of Botany* 87: 735-747.
- Guillaume X. 1985. Saigon, or the failure of an ambition (1858-1945). In: *Essays on Urbanism in a Colonial Context*. The Hague: Martinus Nijhoff. pp. 181-190.



- Gullan PJ, Martin JH. 2003. Sternorrhyncha (jumping plant-lice, whiteflies, aphids, and scale insects). In: Resh VH, Cardé RT. (eds.), *Encyclopaedia of Insects*. Amsterdam: Academic Press. pp. 1078-1089.
- Halbert SE, Manjunath KL. 2004. Asian citrus psyllids (Sternorrhyncha: Psyllidae) and greening disease of citrus: a literature review and assessment of risk in Florida. *Florida Entomologist* 87: 330-353.
- Halbert SE, Núñez CA. 2004. Distribution of the Asian citrus psyllid, *Diaphorina citri* Kuyayama (Rhynchota: Psyllidae) in the Caribbean basin. *Florida Entomologist* 87: 401-402.
- Hall R. 1997. Cenozoic plate tectonic reconstructions of SE Asia. In: Fraser AJ, Matthews SJ, Murphy RW (eds) *Petroleum Geology of Southeast Asia*. Geological Society of London Special Publication 126. pp. 11-23.
- Hall R. 2001. Cenozoic reconstructions of SE and the SW Pacific: changing patterns of land and sea. In: Metcalfe I, Smith JMB, Morwood M, Davidson ID (eds) *Faunal and Floral Migrations and Evolution in SE Asia-Australasia*. Lisse: AA Balkema (Swets & Zeitlinger Publishers). pp. 35-56.
- Hall R. 2002. Cenozoic geological and plate tectonic evolution of SE Asia and the SW Pacific: computer-based reconstructions, model and animations. *Journal of Asian Earth Sciences* 20: 353-431.
- Hansen AK, Trumble J, Stouthamer R, Paine TD. 2008. A new huanglongbing species “*Candidatus Liberibacter psyllaurosus*”, found to infect tomato and potato, is vectored by the psyllid *Bactericera cockerelli* (Sulc). *Applied and Environmental Microbiology* 74(18): 5862-5865. doi:10.1128/AEM.01268-08.
- Hartley TG. 2001a. On the taxonomy and biogeography of *Euodia* and *Melicope* (Rutaceae). *Allertonia* 8: 1-319.
- Hartley TG. 2001b. Morphology and biogeography in Australasian-Malesian Rutaceae. *Malayan Nature Journal* 55: 197-219.
- Hayat M, Shahi MH. 2004. Taxonomic notes on Indian Eulophidae (Hymenoptera: Chalcidoidea). 1. On the types of some Tetrastichinae. *Oriental Insects* 38: 303-314.
- He FM (Hoffmann WE), Zhou (Djou) YW. 1935. Notes on citrus pests. *Lingnan Agricultural Journal* 2 (1): 165-218. (in Chinese with English summary by WE Hoffmann)
- He T. 2000. *Citrology*. Beijing: China Agriculture Press.
- Hodgkison R, Balding ST, Akbar Zubaid, Kunz TH. 2003. Fruit bats (Chiroptera: Pteropodidae) as seed dispersers and pollinators in a lowland Malaysia rain forest. *Biotropica* 35: 491-502.
- Hodkinson ID. 1984. Co-evolution between psyllids (Homoptera: Psylloidea) and rain-forest trees: the first 120 million years. In: Chadwick AC, Sutton SL (eds), *Tropical rain-forest, the Leeds Symposium*. Special Publication of the Leeds Philosophical and Literary Society, Leeds, UK. pp. 187-194.
- Hoffmann WE. 1936. *Diaphorina citri* Kuw. (Homoptera: Chermidae), a citrus pest in Kwangtung. *Lingnan Science Journal* 15: 127-132.
- Hollis D. 1984. Afrotropical jumping lice of the family Triozidae (Homoptera: Psylloidea). *Bulletin of the British Museum of Natural History (Entomology)* 49: 1-102.
- Hollis D. 1985. *Parapsylla*, a Gondwanan element in the psyllid fauna of southern Africa (Homoptera). *Zoological Journal of the Linnean Society* 83: 325-342.
- Hollis D. 1987. A new citrus-feeding psyllid from the Comoro Islands, with a review of the *Diaphorina amoena* species group (Homoptera). *Systematic Entomology* 12: 47-61.

- Huang CC. 1959. Preliminary study on Chinese Rutaceae. *Acta Phytotaxonomica Sinica* 7: 69-124. 15 plates.
- Husain MA, Nath D. 1927. The citrus psylla (*Diaphorina citri*, Kuw.) [Psyllidae: Homoptera]. *Memoirs of the Department of Agriculture India, Entomology Series* 10 (2): 5-27. 1 plate.
- Ingle NR. 2003. Seed dispersal by wind, birds, and bats between Philippine montane rainforest and successional vegetation. *Oecologia* 134: 251-261.
- Inoue H. 1989. Effect of soil drought and temperature on flower bud differentiation of Satsuma
- Jiang Z (Condit IJ), He FM (Hoffmann WE), Wang HZ. 1935. Observations on the culture of oranges near Swatow, China. *Lingnan Agricultural Journal* 1(2): 175-248.
- Ke S, Li KB, Ke C, Tsai JH. 1988. Transmission of the huanglongbing agent from citrus to periwinkle by dodder. In: Timmer LW, Garnsey SM, Navarro L (eds), *Proceedings of the Tenth Conference of the International Organization of Citrus Virologists, Valencia, Spain, 17-21 November 1986*. Riverside: International Organization of Citrus Virologists, University of California: Riverside. pp. 258-264.
- Knorr LC. 1949. Parasitism of citrus in Florida by various species of dodder, including *Cuscuta boldinghii* Urb., a species newly reported for the United States. *Phytopathology* 39: 411-412.
- Ko WW. 1988. Plant indexing to detect the greening disease in Malaysia. In: Aubert B, Ke C, Gonzales C (eds), *Proceedings of the Second Asian/Pacific Regional Workshop on citrus greening, Lipa, Philippines, 20-26 November 1988*. Rome: UNDP-FAO. pp. 84-86.
- Ko WW. 1991. Citrus diseases in Malaysia. In: Ke C, Osman SB (eds), *Proceedings of the Sixth International Asia Pacific Workshop on Integrated Citrus Health Management, Kuala Lumpur, Malaysia, 24-30 June 1991*. pp. 147-162.
- Korsten L, Jagoueix S, Bové JM, Garnier M. 1996. Huanglongbing (greening) detection in South Africa. In: da Graça JV, Moreno P, Yokomi RK (eds), *Proceedings of the Thirteenth Conference of the International Organization of Citrus Virologists, Fuzhou, Fujian, China, 16-23 November 1995*. Riverside: International Organization of Citrus Virologists, University of California, Riverside. pp. 395-398.
- Kuwayama Satoru. 1931. A revision of the Psyllidae of Taiwan. *Insecta Matsumarana* 5: 117-133.
- Kuwayama Shigeru. 1908. Die psylliden Japans. I. *Transactions of the Sopporo Natural History Society* 2: 149-189. (*D. citri*: p. 160-161, Plate III, Fig. 16).
- le Roux HF, van Vuuren SP, Pretorius MC, Buitendag CH. 2006. Management of huanglongbing in South Africa. In: *Proceedings of the Huanglongbing-Greening International Workshop, Ribeirão Preto, São Paulo, Brazil, 16-20 July 2006*. Araraquara: Fundecitrus. S19. pp. 43-44.
- Lee HA. 1921. The relation of stocks to mottled leaf of citrus trees. *The Philippine Journal of Science* 18(1): 85-95. + 3 plates.
- Liefting LW, Perez-Egusquiza ZC, Clover GRG, Anderson JAD. 2008a. A new 'Candidatus Liberibacter' species in *Solanum tuberosum* in New Zealand. *Disease Notes. Plant Disease* 92 (10): 1474.
- Liefting LW, Ward LI, Shiller JB, Clover GRG. 2008b. A new 'Candidatus Liberibacter' species in *Solanum betaceum* (Tamarillo) and *Physalis peruviana* (Cape Gooseberry) in New Zealand. *Disease Notes. Plant Disease* 92 (11): 1588.
- Lim WH, Ko WW, Shamsudin MO. 1990b. Evidence for the presence of greening disease of citrus in P. Malaysia. *Proceedings of the Third International Conference on Plant Protection in the Tropics: Volume VI*. Kuala Lumpur: Malaysian Plant Protection Society. pp. 120-125.

- Lim WH, Shamsudin OM, Ko WW. 1990a. Citrus greening disease and alternate hosts of the vector, *Diaphorina citri* Kuw., in P. Malaysia. MAPPS Newsletter (The Newsletter of the Malaysian Plant Protection Society) 13(4): 56-58.
- Lim WH, Shamsudin OM, Ko WW. 1990b. Citrus greening disease in Malaysia: status report. In: Aubert B, Tontyaporn S, Buangsuwon D (eds), Proceedings of the Fourth International Asia Pacific Conference on Citrus Rehabilitation, Chiang Mai, Thailand, 4-10 February 1990. Rome: FAO UNDP. pp. 100-105. I think the Lim et al 1990a under Malaysia p. 17 of Appendices should be 1990b.
- Lin KH. 1956. Observations on yellow shoot of citrus: aetiological studies of yellow shoot of citrus. *Acta Phytopathologica Sinica* 2: 1-42.
- Luh NT. 1936. A survey on the falling off of citrus fruits due to insect pests in Hwangyen during 1935. *Entomology and Phytopathology* 4(6): 102-107. *Lingnan Science Journal*, 15(3): 525.
- Mabberley DJ. 1997. A classification for edible citrus. *Telopea* 7: 167-72.
- Mabberley DJ. 1998. Australian Citreae with notes on other Aurantioideae (Rutaceae). *Telopea* 7: 333-44.
- Mabberley DJ. 2004. *Citrus* (Rutaceae): a review of recent advances in etymology, systematics and medical applications. *Blumea* 49: 481-498.
- Maki M. 1915. Namiki oyobi Kanshōyō-Shokubutsu no Jūyō Gaichu ni kwansura Chōsa (Investigations on the principal insect pests of avenue and ornamental plants). Ringyō Shienjō Tokubetsu Hōkoku (Special Report of the Forest Experiment Station, Government of Formosa), 1: 112 + 29 pp., 18 pls (reference to *Diaphorina citri* and/or *Murraya paniculata* on pp. 36-38, Pl. VIII).
- Martinez AL, Wallace JM. 1967. Citrus leaf mottle yellows disease in the Philippines and transmission of the causal virus by a psyllid, *Diaphorina citri*. *Plant Disease Reporter* 51: 692-695.
- Martinez AL, Wallace JM. 1969. Citrus greening disease in the Philippines. In: Chapman HD (ed.), Proceedings of the First International Citrus Symposium, University of California, Riverside, 16-26 March 1968. California: Publications Department of the University of California. 3: 1427-1431.
- McClure FA. 1931. A brief historical account of the Lingnan University Herbarium. *Lingnan Science Journal* 7: 267-296.
- Mead FW. 1977. The Asiatic citrus psyllid, *Diaphorina citri* Kuwayama (Homoptera: Psyllidae). *Entomology Circular* 180. Gainesville: Florida Department of Agriculture and Consumer Services, Division of Plant Industry. 4 pp.
- Metcalf I. 1991. Late Palaeozoic and Mesozoic palaeogeography of Southeast Asia. *Palaeogeography Palaeoclimatology Palaeoecology* 87: 211-221.
- Metcalf I. 1998. Palaeozoic and Mesozoic geological evolution of the SE Asian region: multidisciplinary constraints and implications for biogeography. In: Hall R, Holloway JD (eds), *Biogeography and Geological Evolution of SE Asia*. Leiden: Backhuys Publishers. pp. 25-41.
- Miyatake Y. 1965. Notes on Psyllidae from Ryukyu Islands (Hemiptera: Homoptera). *Kontyu* 33(1): 171-189.
- Molino J-F. 1994. Révision du genre *Clausena* Burm. f. (Rutaceae). *Bulletin du Muséum National d'Histoire Naturelle, Paris, 4e Sér.*, 16, sect. B, Adansonia 1: 105-153.
- Moll JN. 1977. Greening disease: fifty years of research. *California Citrograph* 62(4): 109-112.
- Morada EK. 1930. Observations on the important diseases of citrus at the Lamao Experiment Station. *Philippine Journal of Agriculture* 1(2): 195-229.

- Moran VC. 1968. The development of the citrus psylla, *Trioza erytrae* (Del Guercio) (Homoptera: Psyllidae), on *Citrus limon* and four indigenous host plants. *Journal of the Entomological Society of Southern Africa* 31: 391-402.
- Morley RJ. 1998. Palynological evidence for Tertiary plant dispersals in the SE Asian region in relation to plate tectonics and climate. In: Hall R, Holloway JD (eds), *Biogeography and geological evolution of SE Asia*. Leiden: Backhuys Publishers. pp. 211-234.
- Morley RJ. 2003. Interplate dispersal paths for megathermal angiosperms. *Perspectives in Plant Ecology, Evolution and Systematics* 6: 5-20.
- Moreno P, da Graça JV, Yokomi RK (eds). 1996. Preface. In: da Graça JV, Moreno P, Yokomi RK (eds), *Proceedings of the Thirteenth Conference of the International Organization of Citrus Virologists, Fuzhou, Fujian, China, 16-23 November 1995*. Riverside: International Organization of Citrus Virologists, University of California: Riverside. pp. v-vi.
- Muellner AN, Vassiliades DD, Renner SS. 2007. Placing Biebersteiniaceae, a herbaceous clade of Sapindales, in a temporal and geographic context. *Plant Systematics and Evolution* 266: 233–252.
- Mziray W. 1992. Taxonomic studies in Toddalieceae Hook. f. (Rutaceae) in Africa. *Acta Universitatis Upsaliensis, Symbolae Botanicae Upsalienses* 30(1): 1-95.
- Nelson SC. 2008a. *Cassytha filiformis*. *Plant Disease* July 2008, Cooperative Extension Service, College of Tropical Agriculture and Human Resources, University of Hawai'i at Mānoa. 10 pp.
- Nelson SC. 2008b. *Cassytha filiformis*. *Plant Disease*, July 2008, PD-42. Cooperative Extension Service, College of Tropical Agriculture and Human Resources, University of Hawai'i at Mānoa.
- Noyes JS, Hayat M. 1984. A review of the genera of Indo-Pacific Encyrtidae (Hymenoptera: Chalcidoidea). *Bulletin of the British Museum of Natural History (Entomology)* 48: 131-395.
- Nurhadi. 1988. Integrated approaches to formulate control measure against greening vector, *Diaphorina citri* Kuw. in Indonesia. In: Aubert B, Ke C, Gonzales C (eds), *Proceedings of the Second Asian/Pacific Regional Workshop on citrus greening, Lipa, Philippines, 20–26 November 1988*. Rome: UNDP-FAO. pp. 47-49.
- Nurhadi F. 1987. Records of important parasites attacking *Diaphorina citri* in East Java Indonesia. In: The FAO-UNDP Project Coordinator in Fuzhou (ed.), *Regional Workshop on Citrus Greening Huanglungbin Disease, Fuzhou, China, 6–12 December 1987*.
- Oberholzer PCJ, von Standen DFA, Basson WJ. 1965. Greening disease of sweet orange in South Africa. In: Price WC (ed.), *Proceedings of the Third Conference of the International Organization of Citrus Virologists, Campinas, São Paulo, Brazil, 16-18 September 1963*. Gainesville: University of Florida Press. pp. 213-219.
- O'Driscoll CW. 2003. Preliminary review of the genus *Cuscuta* in North America. Prepared for the NAPPO PRA Panel – July/August 2003. North American Plant Protection Organization. 10 pp. <http://www.nappo.org/PRA-sheets/CuscutaTable2003.pdf>.
- OEPP/EPPO. 2005b. EPPO Standards PM 7/57. Diagnostic protocol for *Trioza erytrae*. *OEPP/EPPO Bulletin* 35: 357–360.
- Olfato RB, Dimailig VM, Magnaye LV, Herradura LE. 1990. Progress report on the transmission of organism associated with the greening disease of citrus by dodder in the Philippines. In: Aubert B, Tontyaporn S, Buangsuwon D (eds), *Proceedings of the Fourth International Asia Pacific Conference on Citrus Rehabilitation, Chiang Mai, Thailand, 4-10 February 1990*. Rome: FAO UNDP. pp. 116-117.
- Olfato RB, Horadura LE, Magnaye LV, Gonzales CI. 1991. Transmission of the organism associated with citrus greening disease from Szinkom to periwinkle by dodder in the Philippines.

- In: Ke C, Osman SB.(eds), Rehabilitation of Citrus Industry in the Asia Pacific Region, Proceedings of the Sixth International Asia Pacific Workshop on Integrated Citrus Health Management, Kuala Lumpur, Malaysia, 24-30 June 1991. Malaysian Agricultural Research and Development Institute, Serdang, Malaysia. pp. 77-80.
- Pant RP, Ahlawat YS. 1998. Partial characterization of a filamentous virus associated with ringspot disease of citrus. *Indian Phytopathology* 51: 225-232.
- Prinsloo GL. 1985. Afrotropical Encyrtidae (Hymenoptera: Chalcidoidea): new records and notes. *Journal of Natural History* 19: 277-284.
- Pruthi HS, Mani MS. 1945. Our knowledge of the insect and mite pests of citrus in India and their control. The Imperial Council of Agricultural Research, Science Monograph 16: i-iii, 2-42, 6 plates.
- Raven PH, Axelrod DI. 1974. Angiosperm biogeography and past continental movements. *Annals of the Missouri Botanical Garden* 61: 539-673.
- Raychaudhuri SP, Nariani TK, Lele VC, Singh GR. 1972. Greening and citrus decline in India. In: Price WC (ed.), Proceedings of the Fifth Conference of the International Organization of Citrus Virologists, Tokyo, Japan, 30 October-8 November 1969. Gainesville: University of Florida Press. 35-37.
- Reddy MRS, Murti VD. 1988. Transmission of citrus tristeza virus by dodder laurel from acidlime to acidlime. *Indian Phytopathology* 41(1): 131.
- Reddy MRS, Naidu PH. 1989. Transmission of citrus yellow corky vein. *Indian Phytopathology* 42: 455-456.
- Reddy MRS, Naidu PH, Raju DG. 1985. Dodder laurel transmission of citrus mosaic from sweet orange to acid lime. *Indian Phytopathology* 38: 172.
- Reinking OA. 1919. Diseases of economic plants in southern China. *Philippine Agriculture* 8: 109-135.
- Reinking OA. 1921. Citrus diseases of the Philippines, Southern China, Indo-China and Siam. *The Philippines Agriculturist* 9(6-7): 121-180.
- Saamin S, Osman M, Ko WW, Osman MS. 1991. Malaysian citrus industry development perspectives. In: Ke C, Osman SB (eds), Proceedings of the Sixth International Asia Pacific Workshop on Integrated Citrus Health Management, Kuala Lumpur, Malaysia, 24–30 June 1991. pp. 163-173.
- Samuel R, Ehrendorfer F, Chase MW, Greger H. 2001. Phylogenetic analyses of Aurantioideae (Rutaceae) based on non-coding plastid DNA sequences and phytochemical features. *Plant Biology* 3: 77-87.
- Saskikala M, Mathen K, Govindakutty MP, Solomon JJ, Geetha L. 1989. Transmission of a mycoplasma-like organism from *Cocos nucifera* with root (wilt) disease to *Catharathus roseus* by *Cassytha filiformis*. *European Journal of Plant Pathology* 94: 191–194.
- Schaffer B, Andersen PC. 1994. Handbook of Environmental Physiology of Fruit Crops: Volume II: Sub-Tropical and Tropical Crops. Florida: CRC Press.
- Schwarz RE, Knorr LC, Prommintara M. 1973a. Greening—cause of a recent decline of citrus in Thailand. Plant Protection Service Technical Bulletin 20. Department of Agriculture, Ministry of Agriculture & Co-operatives, Bangkok, Thailand & UNDP 9/FAO THA 68/526.
- Schwarz RE, Knorr LC, Prommintara M. 1973b. Presence of citrus greening and its psylla vector in Thailand. *FAO Plant Protection Bulletin* 21: 132-138.
- Scora RW. 1975. On the history and origin of *Citrus*. *Bulletin of the Torrey Botanical Club* 102: 369-375.

- Scotese CR. 1991. Jurassic and Cretaceous plate tectonic reconstructions. *Palaeogeography Palaeoclimatology Palaeoecology* 87: 493-501.
- Shafee SA, Alam SM, Agarwal MM. 1975. Taxonomic survey of encyrtid parasites (Hymenoptera: Encyrtidae) in India. Aligarh Muslim University (Zoological Series) on Indian Insect Types 10 (i-iii):1-125.
- Stace HM, Armstrong JA, James SH. 1993. Cytoevolutionary patterns in Rutaceae. *Plant Systematics and Evolution* 187: 1-28.
- Stone BC, Jones DT. 1988. New and noteworthy Rutaceae—Aurantioideae from Northern Borneo. *Studies in Malesian Rutaceae, V. Proceedings of the Academy of Natural Sciences of Philadelphia* 140: 267-274.
- Stefanović S, Kuzmina M, Costea M. 2007. Delimitation of major lineages within *Cuscuta* subgenus *Grammica* (Convolvulaceae) using plastid and nuclear DNA sequences. *American Journal of Botany* 94: 568-589.
- Su HJ, Huang AL. 1990. The nature of likubin organism, life cycle morphology and possible strains. In: Aubert B, S. Tontyaporn S, Buangsuwon D (eds), *Proceedings of the Fourth International Asia Pacific Conference on Citrus Rehabilitation*, Chiang Mai, Thailand, 4-10 February 1990. Rome: FAO UNDP. pp. 106-110.
- Subandiyah S. 1994. Transmission of citrus vein phloem degeneration (CVPD) to periwinkle through dodder. *Agrivita* 17: 21-22.
- Subandiyah S, Iwanami T, Tsuyumu S, Ikki H. 2000. Comparison of 16S RNA and 16S23S intergenic region sequences among citrus greening organisms in Asia. *Plant Disease* 84: 15-18.
- Swingle WT. 1943. The botany of *Citrus* and its wild relatives of the orange subfamily (Family Rutaceae, Subfamily Aurantioideae). In: Webber HJ, Batchelor LD (eds), *The Citrus Industry, Volume 1*. Berkeley & Los Angeles: University of California Press. pp. 129-474.
- Swingle WT, Reece RC. 1967. The botany of *Citrus* and its wild relatives. In: Reuther W, Webber HJ, Batchelor LD (eds), *The Citrus Industry, Volume I, History, World Distribution Botany, and Varieties*. Berkeley: Division of Agricultural Sciences, University of California. pp. 190-430.
- Tanaka T. 1977. Fundamental discussion of *Citrus* classification. *Studia Citrologia* 14: 1-6.
- Takushi T, Toyosato T, Kawano S, Taba S, Taba K, Ooshiro A, Numazawa M, Takushi T. 2007. Scratch method for simple rapid diagnosis of citrus huanglongbing using high accumulation of starch in citrus leaves. *Japanese Journal of Phytopathology* 73: 3-8.
- Tang YQ. 1988. A preliminary survey on the parasite complex of *Diaphorina citri* Kuwayama (Homoptera: Psyllidae) in Fujian. In: Aubert B, Ke C, Gonzales C (eds), *Proceedings of the Second Asian/Pacific Regional Workshop on citrus greening*, Lipa, Philippines, 20–26 November 1988. Rome: UNDP-FAO. pp. 10-15.
- Tang YQ. 1990. On the parasite complex of *Diaphorina citri* Kuwayama (Homoptera: Psyllidae) in Asian-Pacific and other areas. In: Aubert B, Tontyaporn S, Buangsuwon D (eds), *Proceedings of the Fourth International Asia Pacific Conference on Citrus Rehabilitation*, Chiang Mai, Thailand, 4-10 February 1990. Rome: FAO UNDP. pp. 240-245.
- Tang YQ, Aubert B. 1990. An illustrated guide to the identification of parasitic wasps associated with *Diaphorina citri* Kuwayama in the Asian-Pacific Region. In: Aubert B, Tontyaporn S, Buangsuwon D (eds), *Proceedings of the Fourth International Asia Pacific Conference on Citrus Rehabilitation*, Chiang Mai, Thailand, 4-10 February 1990. Rome: FAO UNDP. pp. 228-239.
- Teixeira, DC, Ayers J, Danet L, Jagoueix-Eveillard S, Saillard C, Bové JM. 2005a. First report of a huanglongbing-like disease of citrus in São Paulo State, Brazil and association of a new

- Liberibacter species, '*Candidatus* Liberibacter americanus', with the disease. Plant Disease 89: 107.
- Teixeira DC, Eveillard S, Sirand-Pugnet P, Wulff A, Saillard C, Ayres AJ, Bové JM. 2008. The *tufB-secE-nusG-rplK*AJL-*rpoB* gene cluster of the liberibacters: sequence comparisons, phylogeny and speciation. International Journal of Systematics and Evolutionary Microbiology 58: 1414-1421.
- Teixeira DC, Danet JL, Eveillard S, Martins EC, de Jesus Junior WC, Yamamoto PD, Lopes SA, Bassanezi RB, Ayres AJ, Saillard C, Bové JM. 2005b. Citrus huanglongbing in São Paulo State, Brazil: PCR detection of the '*Candidatus*' Liberibacter species associated with the disease. Molecular and Cellular Probes 19: 173-179.
- Teixeira DC, Saillard C, Eveillard S, Danet JL, Costa PI, Ayres AJ, Bove J. 2005c. '*Candidatus* Liberibacter americanus', associated with citrus huanglongbing (greening disease) in Sao Paulo State, Brazil. International Journal of Systematic and Evolutionary Microbiology 55: 1857-1862.
- Temu RPC, Andrew SM. 2008. Endemism of plants in the Uluguru Mountains, Morogoro, Tanzania. Forest Ecology and Management 255(7): 2858-2869.
- Tirtawidjaja S. 1980. Citrus virus research in Indonesia. In: Calavan EC, Garnsey SM, Timmer LW (eds), Proceedings of the Eighth Conference of the International Organization of Citrus Virologists, Mildura, Victoria, Australia, 23-25 May 1979. Riverside: International Organization of Citrus Virologists, University of California: Riverside. pp. 129-132.
- Tsai CH, Hung TH, Su HJ. 2008. Strain identification and distribution of citrus huanglongbing bacteria in Taiwan. Botanical Studies 49: 49-56.
- Tsai JH, Liu YH. 2000. Biology of *Diaphorina citri* (Homoptera: Psyllidae) on four host plants. Journal of Economic Entomology 93: 1721-1725.
- Tsai JH, Wang JJ, Liu YH. 2002. Seasonal abundance of the Asian citrus psyllid, *Diaphorina citri* (Homoptera: Psyllidae) in southern Florida. Florida Entomologist 85: 446-451.
- Tu C. 1932. Notes on diseases of economic plants in south China. Lingnan Science Journal 11 (4): 489-504. plus 5 plates.
- van den Berg MA, van Vuuren SP, Deacon VE. 1991-1992. Studies on greening disease transmission by the citrus psylla, *Trioza erythrae* (Hemiptera: Triozidae). Israel Journal of Entomology 25-26:51-56.
- van den Berg MA, van Vuuren SP, Deacon VE. 1992. Vergroeningsietke in 'n inheemse plant in die sitrusfamilie (Presence of greening in an indigenous tree). Institute for Tropical and Subtropical Crops: Agricultural Research Council 241: 1-3.
- van der Merwe AJ, Andersen FG. 1937. Chromium and manganese toxicity. Is it important in Transvaal citrus greening? Farming in South Africa 12: 439-440.
- van Vuuren SP. 1996. Huanglongbing. The official name for greening disease of citrus. Inligtingsbulletin – Instituut vir Tropiese en Subtropiese Gewasse 287: 5-6.
- van Welzen PC, Slik JWF, Alahuhta J. 2005. Plant distribution patterns and plate tectonics in Malesia. Biologiske Skrifter 55: 199-217.
- Veevers JJ, Powell C McA, Roots SR. 1991. Review of seafloor spreading around Australia. I. Synthesis of patterns of spreading. Australian Journal of Earth Sciences 38: 373-389.
- Wallace JM. 1978. Virus and viruslike diseases. In: Reuther W, Calavan EC, Carman GE (eds), The Citrus Industry, Volume IV, Crop Protection. Berkeley: Division of Agricultural Sciences, University of California. pp. 67-184.
- Wang HC. 1934. The systematic study of citrus fruit in Kwangtung. Journal of the Agricultural Association of China. 123: 28-47. 1 fig.

- Waterhouse DF. 1998. Biological Control of Insect Pests: Southeast Asian Prospects. ACIAR Monograph Series No. 51. Canberra: Australian Centre for International Agricultural Research.
- Waterston J. 1922. On the chalcidoid parasites of psyllids (Hemiptera: Homoptera). Bulletin of Entomological Research 13: 41-58.
- Webber HJ, Reuther W, Lawton HW. 1967. History and development of the citrus industry. In: Reuther W, Webber HJ, Batchelor LD (eds), The Citrus Industry, Volume 1. Berkeley: University of California. pp. 1-39.
- Weinert MP, Jacobson SC, Grimshaw JF, Bellis GA, Stephens PM, Gunua TG, Kame MF, Davis RI. 2004. Detection of huanglongbing (citrus greening disease) in Timor Leste (East Timor) and in Papua New Guinea. Australasian Plant Pathology 33: 135-136.
- White IM, Hodkinson ID. 1985. Nymphal taxonomy and systematics of the Psylloidea (Homoptera). Bulletin of the British Museum of Natural History (Entomology). 50: 153-301.
- Whittle AM. 1992. Diseases and pests of citrus in Viet Nam. FAO Plant Protection Bulletin 40(3): 75-81.
- Zhao XY. 1981. Citrus yellow shoot disease (huanglongbing) in China – a review. In: Matsumoto K (ed.), Proceedings of the Fourth International Society Citriculture Congress, Tokyo, Japan, 9-12 November 1981. Riverside: International Society of Citriculture. 1: 466-469.
- Zhou BB, Yin YP, Hu H, Wang ZK. 2008a. Genetic diversity of ‘*Candidatus Liberibacter asiaticus*’ isolates from different geographical regions in China. Abstracts and Proceedings of the Eleventh International Citrus Congress, Wuhan, China, 26 to 30 October 2008. p. 55.
- Zhou L, Duan Y, Gabriel D, Gottwald TR. 2008b. Seed transmission of *Candidatus Liberibacter asiaticus* in periwinkle and dodder resulted in low bacterial titer and very mild disease in periwinkle. Phytopathology 98: S181.
- Zhou LJ, Gabriel DW, Duan YP, Halbert SE, Dixon WN. 2007. First report of dodder transmission of huanglongbing from naturally infected *Murraya paniculata* to *Citrus*. Plant Disease 91: 227.



### **K3. KEYNOTE ADDRESS 3: Research and Health Management of Citrus Huanglongbing in Taiwan**

**Su H-J.**

Department of Plant Pathology & Microbiology  
National Taiwan University  
Taipei, Taiwan

#### **INTRODUCTION**

Citrus greening was first reported in 1947 from South Africa, after a similar disease known as “Huanglongbing” (=HLB, yellow shoot) was already known in 1943 from Southern China (Matsumoto et al. 1961, Cheng, 1943). HLB disease, locally called “Likubin” was first identified in Taiwan in 1951, 6 years after the end of World War II. The HLB inoculum was assumed to be brought into Taiwan from southern China after 1945 through some infected propagation materials such as citrus scions or seedlings. The disease was formerly considered as being due to unfavorable soil conditions such as deficiency in essential nutrients or poor drainage. However, the spread of the disease could not be checked by improvement of soil conditions, but tended to increase year by year. Matsumoto and his coworkers (1961) began an etiological study on the new disease after it became a serious epidemic over the island in 1956 (Matsumoto et al. 1968).

Matsumoto *et al.* (1961) demonstrated that the newly invaded disease was of virus-like nature by graft transmission with diseased scion, and gave the name of Likubin (decline). This destructive virus-like disease was spread throughout Southeast Asia during the 1960's, and was locally called leaf mottle yellows in the Philippines, citrus vein phloem degeneration (CVPD) in Indonesia and citrus dieback in India. Eventually the disease became devastating in all citrus-growing areas with a tropical or subtropical climate. Miyakawa and Tsuno (1989) first found HLB in Iriomote, the southernmost island of Okinawa in Japan proximal to Taiwan in 1988, 37 years after the first incidence of HLB in Taiwan. By 2003, HLB had spread north to Tokunoshima Island, Kagoshima Prefecture in Japan. HLB was reported in Brazil in 2004 (Lopes et al. 2005) and in Florida in 2005 (Bové 2006). The continual spread of HLB now presents a serious constraint for citrus production worldwide. While the South African greening organism is heat-sensitive and only induces severe symptoms in cool temperature (22-24 C) climates, the Asian HLB organism produces symptoms in either warm (27-32 C) or cool climates, and has been characterized as a heat-tolerant form (Bové and Saglio 1974). The Asian form has caused greater devastation than the African form by shortening tree lifespan to less than 10 years and lowering fruit yield and quality in recent decades in tropical and subtropical Asian and Pacific regions.

In order to develop control measures, etiological and epidemiological studies on HLB have been conducted in Taiwan (Matsumoto et al. 1961, Su 1970, Su & Chang 1974, Su & Wu 1979, Huang et al. 1982, Huang 1987, Hung 1994, Hung et al. 2000, Hung 2006, Tsai 2007). HLB disease commonly occurs as a mixed infection with citrus tristeza and tatter leaf viruses, causing severe yellowing and decline, and ultimately death of citrus trees. These systemic diseases are transmitted via vegetative propagation with budwood, and spread by insect vectors in the field. These diseases are generally controlled by integrated control measures including production and cultivation of pathogen-free trees, elimination of inoculum sources, and prevention of secondary spread by vector insects (Su & Chang 1976, Su & Chu 1984, Su 1986, Chien et al. 1987, 1989, Su 2008). Establishment of a pathogen-free nursery system is of primary importance for reducing

prevalence of these diseases in the early stage of tree development. Precise and rapid indexing techniques are indispensable for management of a pathogen-free nursery system and health management of citrus trees in the field. Development and application of molecular diagnostic probes were made for formulating indexing techniques including diagnostic DNA probes, and Iodine kit for HLB; ELISA, rapid diagnostic strips and RT-PCR for CTV and CTLV (Su et al 1991, Hung 1994, Hung et al. 1999a, 1999b, Su 2008).

In order to promote the research and management of citrus HLB and viruses, the author and his coworkers have implemented an international cooperative research project on CTV strains and development of monoclonal antibodies against CTV, in collaboration with Drs. S. M. Garnsey and T.R. Gottwald, USDA, ARS during 1990's; and a project on development of rapid detection method and molecular characterization of HLB strains in collaboration with Drs. T. Iwanami and his colleagues, NIFTS, Japan since 2006. The author and his colleagues have held international workshops and a training course on production and indexing of citrus pathogen-free trees, under COA-FFTC or RDF-FFTC projects several times for the participants from Asia and Pacific regions since 1990.

### **ACKNOWLEDGEMENTS**

The author greatly appreciates his former graduate students and coworkers who have made excellent research contribution on the topic of the present presentation. I would make particular mention of the work of Dr. J. U. Cheon (Shoot-tip micrografting, 1984), Dr. A. L. Huang (Electron microscopy of HLB-FB, 1987), Dr. M. C. Tsai (Preparation of monoclonal antibodies against CTV strains, 1989), Dr. T. H. Hong (PCR detection of HLB-FB, 1994), Dr. S. C. Hong (vector ecology of the psyllid, 2006), and Dr. C. H. Tsai (HLB-FB strains and chemotherapy, 2007).

I am grateful to Food and Fertilizer Technology Center (FFTC), Rural Development Foundation and Council of Agriculture, Taiwan for their encouragement and financial supports which have made possible for my R&D works and technical assistance to a number of the Asian countries in establishing disease indexing laboratories and pathogen-free nursery system for citrus rehabilitation in recent decades.

I much thank Drs. S. M. Garnsey and T. Gottwald for their past collaboration in CTV and HLB research, and Ms. Y. C. Fong for her help in typing the manuscript and editing figures.

### **ETIOLOGICAL STUDY**

#### **Causal agent:**

The HLB locally called Likubin was formerly considered to be a non-parasitic disease due to unfavorable soil conditions. However, the spread of the disease could not be checked by improvement of these conditions. Matsumoto and the author (1961) demonstrated that the disease was transmissible through grafting with diseased citrus scions or buds, and therefore was assumed to be a virus-like disease. The causal agent was previously attributed to a virus closely related to *citrus tristeza virus* (CTV) because Mexican lime seedlings graft-inoculated with diseased scions, produced CTV-positive symptoms including vein clearing and stem-pitting (1). However, some other causal agent was thought to be involved since a CTV-positive reaction on Mexican lime seedlings was also demonstrated by graft-inoculation with scions from healthy-looking citrus trees in the same orchards. Typical HLB symptoms developed on healthy Ponkan-mandarin seedlings when graft-inoculated with diseased scions or buds of trifoliolate seedlings immune to CTV, which were previously graft-inoculated with HLB-diseased scions. It was

confirmed that CTV was eliminated through trifoliolate orange plant, and the unknown component of pathogen complex causing HLB was infecting the filter plants. In order to confirm the unknown component of HLB, Su and Leu, (1970, 1972) found a mycoplasma-like organism (MLO) in sieve-tubes of Likubin-diseased Ponkan and Tankan trees in an electronmicrograph, and assumed that MLO might be associated with the disease (Su 1970, Su & Leu 1972). Bové and Saglio (1974) reported that the morphology and cell envelope of citrus stubborn MLO was not identical with those of the greening organism. The envelope of greening organism was 25 nm thickness which was thicker than that of stubborn MLO (10 nm). Su and Chang (1974, 1976) reported that tetracycline (Achromycin) and Penicillin G showed therapeutic effect on Likubin pathogen in dip treatment of diseased scions and tree transfusion. It was known that Penicillin G, an inhibitor of cell-wall synthesis, was effective against bacteria. In view of the above-mentioned facts of envelope thickness and therapeutic effect of Penicillin G, the HLB pathogen was confirmed to be a bacteria-like organism. The author's graduate student, An-Li Huang (1982~1987) published his thesis on "Electronmicroscopical studies on the morphology and population dynamic of fastidious bacteria causing citrus Likubin". The fastidious bacteria (FB) causing Likubin was found in sieve tubes (Fig. 1). Electron microscopy, using serial sections and three-dimensional assessments, confirmed the presence of various forms of the pathogen. Generally present were mature rigid rods with dense cytoplasm, measuring  $350-500 \times 660-1500$  nm (Fig. 2), and surrounded by a two-layered envelope, 20-25 nm thick consisting of a cell wall and an inner cytoplasmic membrane (7.5 nm thick/each) (Fig. 3). However, FB bodies were pleomorphic, and produced flexible elongated rods ( $100-250 \times 500-2500$  nm) of the young growing cell form with dense cytoplasm which matured into a new form (Fig. 4). With maturity they formed spherical bodies 600-800 nm in diameter with thin cytoplasm (Fig. 5A). The large spherical bodies found in old FB colonies frequently showed degradation through plasmolysis, vacuolation and agglutination of cytoplasm (Fig. 5B). The cytoplasmic membrane in the mature form of FB had a tendency to infold into cytoplasm (Fig. 6). Based on the overall view of the life cycle of HLB-FB, we proposed five multiplication cycles; I. budding, II. binary fission, III. beading, IV. segmentation and V. fission (Fig. 7). Multiplication of FB was generally accomplished by budding (Fig. 8&9), and less frequently occurred by binary fission (Fig. 10A&C), beading (Fig. 10D&E), segmentation (Fig. 10F), or fission (Fig. 10B&C). The FB moved systemically in the sieve tubes by sap stream and passed through the sieve pores or lateral pores by squeezing into the pores, with the electron-lucent anterior containing less cytoplasm, and the posterior containing denser cytoplasm (Fig. 11).

In the sieve tubes of leaves of citrus varieties at any stage of maturity, FB causing citrus Likubin had a tendency to multiply most abundantly in summer and slightly less in autumn and winter; however, the FB bodies were detected at some level throughout the year. The seasonal curves of the organism's growth were most prominent and consistent in the mature leaves. The FB population was highest in Ponkan mandarin, intermediate in Tankan tangor, and lowest in Liucheng sweet orange. In further evaluations, FB were detected in sieve tubes of grapefruit, Tahitian lime, Eureka lemon, Satsuma orange and Kumquat trees with Likubin symptoms. No FB were found in jasmine orange (*Murraya paniculata*), host of vector psylla (*Diaphorina citri*). Few bodies were detected in heads of the psylla (Fig. 12). After the dodder (*Cuscuta australis*) was fed on infected Ponkan seedlings for two weeks of acquisition, few FB bodies were immediately detected in the sieve tube of dodder stems (Fig. 13A), but after two months FB multiplied abundantly was well distributed in stems, haustoria, and flower stalks (Fig. 13B). Periwinkle plants infected *via* dodder on diseased Ponkan, produced distinct yellows symptoms

on leaves (Fig. 14A&B). Abundant FB with no morphological changes were detected in sieve elements of periwinkle plants (Fig. 15). Likewise in 1983 Garnier and Bové (1983) transmitted the greening organism from sweet orange to periwinkle by dodder.

Garnier *et al.* (1984) identified the greening organism as a gram negative Gracillicute-like bacteria. In 1996, Jagoveix, Garnier and Bové (1996) classified the nonculturable fastidious bacteria causing greening disease as *Candidatus Liberibacter*, a subdivision of the Proteobacteria. The pathogen was categorized into two forms, Asian and African, based on the influence of temperature on symptom expression. The Asian form caused by “*Candidatus Liberibacter asiaticus*” was heat-tolerant and produced the symptoms at a warm temperature range, 27-32C. The African form caused by “*Candidatus Liberibacter africanus*” was heat-sensitive and produced the symptoms at cool temperature range, 22-24C.

Recently, Tsai, Hung and Su (2008) characterized strains of HLB-FB belonging to *Candidatus Liberibacter asiaticus* in Taiwan. After indexing and eliminating the citrus viruses, the selected HLB-FB isolates, free of the viruses, were used for identification of HLB-FB strains based on a pathogenicity and virulence testing with the following differential citrus cultivars: Ponkan mandarin, Liucheng sweet orange, Wentan pummelo, and Eureka lemon. Four strains of HLB-FB were identified. Strain I produced typical HLB symptoms on mandarin and sweet orange. Strain II multiplied well and was virulent on all the differential cultivars. Strain III caused intermediate symptoms on mandarin and sweet orange, mild symptoms on pummelo, and did not infect Eureka lemon. Strain IV infected mandarin and sweet orange without causing symptoms and was difficult to detect in those cultivars (Table 1 & Fig. 16). Strain II, was found in all citrus cultivars grown in Taiwan, and was the predominant strain in the field while Strains III and I were less prevalent.

Table 1. The pathogenicity characterization of HLB-FB isolates according to disease index and PCR detection of HLB-FB infection

Strain	Differential cultivars of citrus			
	PM	LSO	WP	EL
I	3 /+++ <sup>a</sup>	3 /+++	0 /-	0 /-
II	3 /+++	3 /+++	3 /+++	3 /+++
III	2 /++	2 /++	1 /+	0 /-
IV	0 /+	0 /+	0 /-	0 /-

<sup>a</sup> Disease index / PCR index. Disease index was graded 12 months after inoculation: 0, healthy looking without symptoms; 1, mild chlorotic symptoms; 2, intermediate symptoms including chlorosis, mottling with intermediate dwarfing; 3, typical greening symptoms including leaf yellow mottle and curling, vein-yellowing with distinct dwarfing. PCR index, pixel value (density count) of the HLB-FB-specific band on agarose gel electrophoresis: -, pixel value < 50; +, 50 ~ <110; ++, 110 ~ < 170; +++, 170 ~ < 230. Differential cultivars were Ponkan mandarin (PM), Liucheng sweet orange (LSO), Wentan pummelo (WP) and Eureka lemon (EL).

### Symptoms:

Although symptoms vary with citrus variety, strains of the pathogen, and environmental conditions, common symptoms are yellowing of the veins and adjacent tissue, followed by yellowing with pale-green mottling of entire leaf (Fig. 17 & 18). With age, diseased leaves

become hard, curl outwards (Fig. 17C), and occasionally develop vein corking (Fig. 17D). Leaf symptoms are followed by premature defoliation, dieback of branches, loss of fibrous roots, decline in vigor, and eventually tree mortality (Fig. 17F). Leaves that develop after premature defoliation are small and slender, with symptoms of mineral deficiency. HLB-affected trees on occasion may become stunted, bear multiple off-season flowers, most of which fall off, and produce small irregularly shaped fruits with thick peel of poor color-turning, and remaining green color (Fig. 17B & E). HLB-affected Chinese box orange (*Severinia buxifolia*), an alternative host of HLB, also shows yellow mottling and hardening of leaves (Fig. 19).

Internal symptoms of HLB-affected citrus leaves were studied by using light and electron microscopy. Starch grain accumulation generally found in the mesophyll chloroplasts was associated with the leaf yellowing due to disruption of chloroplasts. Starch grains also accumulated in parenchyma cells surrounding xylem and phloem elements progressively (Fig. 20). At about the same time, cambium became hyperactive and produced large amounts of xylem and phloem elements. The cambium produced more phloem cells in the early stage. Vascular cells showed distortion, crushing, plasmolysis, and necrosis. Finally, disruption of vein epidermis appeared to be caused by hyperplasia of xylem and phloem elements. The histology of the leaves of Liucheng sweet orange was similar to that of Ponkan, but the histological alterations did not develop further after the cambium was completely differentiated. The degree of damage due to the cytopathological changes was most serious in Tankan, Ponkan, and pummelo, wherein primary xylem was even extruded outside the epidermis in connection with vein corking (Fig. 21).

## DIAGNOSIS AND DETECTION

HLB is tentatively diagnosed in the field by characteristic foliage and fruit symptoms described above. Further diagnosis requires indexing on susceptible mandarin or tangor, e.g. Ponkan and Tankan seedlings by graft-inoculation. Because of the low population and uneven distribution of HLB-FB within the plant, bioassay with an indicator plant requires numerous test plants and inoculum buds, at least 2 buds, at least 2 buds/indicator plant, and is time-consuming (Matsumoto et al. 1961, Su 1986). HLB can be confirmed in the indicator plant by examining a sieve tube of phloem section by electron microscopy (Huang 1987).

An iodine test was developed for rapid diagnosis of citrus HLB (Tsai 2007). Iodine detects citrus trees infected by HLB based on the starch accumulation in the infected leaves due to decrease of amylase activity in the tissue. Iodine reacts with the starch accumulation to develop purple color. Color development in leaf tissue is an indicator of the starch accumulation. The Iodine kit was successfully applied for on-site diagnosis of HLB-infected citrus trees, and proved to be very promising as a rapid diagnosis tool with relatively high accuracy for the on-site detection of HLB. About 95% of citrus diseased samples showing positive reaction of PCR detection, were confirmed positive by the iodine test. The protocol for the test is as follows (Fig. 22):

- 1) Collect citrus mature leaves with symptoms, and keep in plastic bag.
- 2) Scratch the upper surface of infected leaf about 40 times with a piece of sand paper (120 grit; 1x2 cm).
- 3) Put the sand-paper piece harboring tissue debris into a small sealable plastic bag (5x8.5 cm) and add 1 ml of distilled water.
- 4) Rub the sand-paper piece to thoroughly wash off the tissue debris into the solution.
- 5) Add a drop of Iodine solution (KI 3% + 1.5%) into the suspension and mix the solution by shaking.

- 6) Watch the solution for color-change: black or dark brown color shows positive reaction while no color change (retaining yellow color) shows negative reaction.

The HLB-FB unevenly colonize the sieve tube of host plants at a low concentration. A highly sensitive and specific DNA probe, developed with DNA cloning methods has been used to detect HLB-FB in infected citrus hosts (Su et al., 1991). One of the clones containing a 0.24-kb HLB-FB-specific DNA fragment was labeled with biotinylated nucleotides by a PCR-labeling technique. A dot hybridization assay with the biotin-labeled DNA probe was successfully used for detecting HLB-FB in various citrus hosts including mandarins, tangors, sweet oranges and pummelos (Fig. 23A). This probe could specifically react with all HLB-FB strains from several Asian countries including Malaysia, China, Thailand, Philippines and Okinawa, Japan, but not with those from South Africa. The probe developed was specific and sensitive enough to detect low levels of HLB-FB infection (Hung et al. 1999).

Highly specific primer pairs for HLB-FB detection have been developed by HLB-FB-DNA cloning and sequencing. The sensitivity of HLB detection has recently been enhanced by the development of polymerase chain reaction (PCR) with appropriate primer pairs followed by electrophoresis analysis. The PCR detection also reacted with the foreign FB isolate of the Asian form, including Okinawa, Japan, China, Malaysia, Vietnam, Thailand and Saudi Arabia. The technique was successfully applied for detection and ecological study of HLB pathogen (Hung, 1994). PCR has been developed and used for the detection of HLB-FB in host plants and vector insects (Hung et al., 1999, 2004) (Fig.24). This technology is routinely applied to indexing citrus foundation stocks and pathogen-free seedlings. The protocols of the indexing techniques for detection of HLB-FB are described in detail in author's recent publication (Su 2008).

#### **DNA primer pair for PCR of HLB-FB:**

Forward: CAC CGA AGA TAT GGA CAA CA

Reverse: GAG GTT CTT GTG GTT TTT CTG

### **ECOLOGY AND EPIIDEMIOLOGY**

#### **Transmission:**

The systemic HLB disease is transmitted mainly *via* vegetative propagation of nursery stock, and spreads by insect transmission in the field. The Asian form of HLB-FB is transmitted and rapidly spread by Asian citrus psyllid (*Diaphorina citri*) (Fig. 25), while the African-form of HLB-FB is transmitted by African citrus psyllid (*Trioza erytreae*) in persistent manner (Huang 1982, Aubert 1987). The Taiwanese biotype of the psyllids is less efficient in pathogen transmission of HLB. Less than 5% of adults acquired HLB pathogen after acquisition feeding on diseased citrus plants over a one day period, while the nymphs acquired the pathogen at a much higher rate. Transovarial passage of the pathogen by psyllid was not demonstrated. The percentage of transmission by feeding with pathogen-infected adults was 12.9%. Transmission of HLB via graft propagation with infected budwood, and layering (rooting) branches from infected trees also plays an important role in spreading HLB (Fig. 26).

#### **Alternative hosts:**

Four suitable hosts of the Asian psyllid, considered as possible alternative hosts of HLB-FB, were investigated by graft-inoculation test and psyllid transmission (Hung et al. 2000). The multiplication of HLB-FB in plants was monitored by dot hybridization. The results

demonstrated that HLB-FB can replicate in Chinese box orange (*Severinia buxifolia*) and wood apple (*Limonia acidissima*), but not in common jasmine orange (*Murraya paniculata* var. *paniculata*) and curry leaf (*Murraya koenigii*). Common jasmine orange and curry leaf gave negative results with no hybridization detected up to one year after graft-inoculation. HLB-FB failed to replicate in common jasmine orange and curry leaf according to the lack of detection by dot hybridization. The wood apple and Chinese box orange showed contrasting positive results (Fig. 27A&B). In the case of wood apple, HLB-FB could be detected from the sixth to tenth month after graft-inoculation. Inoculation of wood apple produced yellows symptom about 6 months after graft inoculation, but plants recovered to a healthy state after one year (Fig. 28). The strength of the dot hybridization signal reached a peak at the seventh month and declined quickly non-detected after 11 or 12 months. HLB-FB was detected between 6 and 10 months after inoculation, but detection was much weaker than the positive control of HLB-FB-infected citrus samples. Accordingly, wood apple is considered a transient host of HLB-FB (Fig. 27A&C). Chinese box orange is a good host as HLB-FB replicates as well as in Valencia sweet orange (Fig. 27B&C). HLB-FB were detected in Chinese box orange 4 months after inoculation and repeatedly detected thereafter. Yellows symptoms developed in Chinese box orange (Fig. 19) as well as Valencia plants. Common jasmine orange is also not considered a host of HLB-FB because infected offspring could not be obtained from citrus psyllids fed on the host that were collected from common jasmine orange in HLB affected areas. No HLB-FB was detected by PCR from the many samples collected from common jasmine orange in HLB-diseased areas throughout Taiwan. However, HLB-FB has been detected in diseased samples of jasmine orange in Brazil (Lopes et al. 2005).

The Chinese box orange was demonstrated by graft-inoculation and psyllid-transmission tests to be an alternative host of HLB-FB (Fig. 19.). A PCR-based assay for detection of the HLB-FB was used to monitor infection. In graft-inoculation tests, the Chinese box orange grafted with HLB-FB-infected scions of Liucheng sweet orange showed positive detection of HLB-FB 2-3 months after graft-inoculation. The back-grafting test demonstrated that HLB-FB-infected Chinese box orange scions could transmit HLB-FB back to Liucheng hosts via grafting. In psyllid-transmission tests, psyllids transmitted HLB-FB from Liucheng to Chinese box orange within 3-4 months after feeding. Acquisition-access tests of psyllids revealed that HLB-FB-free psyllids could acquire HLB-FB from diseased Chinese box orange hosts and could transmit HLB-FB back to Liucheng plants. A field survey verified the presence of HLB-FB in Chinese box orange grown in the vicinity of citrus orchards. The Chinese box orange was confirmed to be an alternative host plant which serves as a source of inoculum for vector transmission in the field.

### **Epidemiology:**

Since 1951 HLB has been the most destructive disease of citrus in Taiwan. For controlling the spread of the disease, production and cultivation of pathogen-free citrus seedlings have been practiced since 1983. Once the healthy trees are established in the field, HLB-FB infection of the orchards is accomplished by controlling the psyllids. Transmission of HLB-FB by citrus psyllid is related to disease prevalence. Epidemics occur when vector population is high and a reservoir of the inoculum is present (Hung 2006). Natural spread of the disease is greatest during periods of bud-sprouting that promote the greatest psyllid feeding, reproduction and transmission (Fig. 29&30).

The transmission of HLB-FB by citrus psyllid is related to high vector population, incidence of HLB-FB infection of psyllids and dispersal of the psyllid (Fig. 30). The epidemic infection of healthy citrus trees in an orchard near HLB-affected groves showed a sigmoid progress curve of disease incidence (Fig. 31). The highest infection rate was detected in April. It took 1~2 month for the HLB-FB to increase to a detectable level in susceptible Ponkan mandarin. Accordingly, the highest infection rate occurred from February to March, when HLB-FB infection incidence of the psyllids and the dispersal of psyllids in the field reached a peak. This time period was critical for psyllid control with insecticide sprays. The disease incidence increased up to cumulative number approaching 70% within two years without spray and rouging diseased trees. Survey of infection rate revealed that disease spread was very rapid such that about 70% of Ponkan trees became infected 2 years after orchard establishment in southern Taiwan. HLB spread occurred gradually from the primarily infected trees to the surrounding healthy trees with a latency period of about one year (Fig. 32). A survey of HLB disease progress of infection rate (%) was conducted over a 5-year period from 1999 to 2004 in Chia-Yi area. The cumulative rate of HLB infection reached 17% in the psyllid control plot and 57% in the unsprayed plot 5 years after planting (Fig. 33) (Hung 2006).

## HEALTH MANAGEMENT

Currently, the systemic virus and HLB diseases documented are a major threat to economic viability of citrus production in the subtropics and tropics. Since these diseases are transmitted by not only vector insects, but also during the process of vegetative propagation, integrated disease management (IDM) is highly recommended to control them. IDM includes propagation of pathogen-free (PF) stock, elimination of inoculum sources, and prevention of secondary infection by vector insects. Establishment of a pathogen-free citrus nursery system (PFNS) is fundamental to prevention of the disease spread. In Taiwan, a shoot-tip micrografting technique (STG) and heat therapy are combined to prepare citrus PF foundation stock. Precise and rapid indexing techniques are indispensable for management of a pathogen-free nursery system. The PFNS in Taiwan consists of the following four steps; 1) STG, 2) Establishment of pathogen-free citrus foundation blocks, 3) PF nurseries and 4) Issue of health certificate *via* indexing.

The current scheme for the PFNS and bud-wood certification program in Taiwan was initiated in 1983 and is being operated under a joint program of National Taiwan University (NTU), Agricultural Research Institute (ARI), and Council of Agriculture (COA), Taiwan.

### 1. Shoot-tip Micrografting (STG) for obtaining virus-free citrus foundation stocks

STG is the most reliable method to recover pathogen-free (PF) citrus propagation material from infected parental sources. The shoot tip or meristem of auxiliary buds of infected plants are generally free of virus and HLB, and plants regenerated from the shoot tips are usually free of the systemic pathogens. The common STG method (Murashige 1972) was greatly improved by replacing the inverted T cut with newly developed triangle-hole cut method (Su & Chu 1984). The entire procedure of STG is carried out in a laminar-flow hood under sterile conditions (Fig. 34). The procedure of modified STG is described in detail in author's recent publication (Su 2008).

### Double grafting

A double grafting technique has been developed to enhance the growth of STG plants. The procedure of this technique is briefly summarized below:



- 1) Micro-grafted plants are taken out from the test tube. The upper part of the plant serves as the scion tissue (Fig. 35A and B).
- 2) The scion is side-grafted to a healthy and vigorously growing rootstock seedling and the bud wrapped with parafilm. The grafted plant is covered with a plastic bag, the opening sealed, and the plant placed in a greenhouse (Fig. 35 C and D).
- 3) The plastic bag is taken off 3 to 4 weeks after grafting. After about three months, the new shoot is ready for use as scion-wood for further grafting (Fig. 35 E).
- 4) Indexing for HLB and viruses is done before the STG plant is used for further propagation. For an increased multiplication of pathogen-free seedlings, scion wood is harvested from double-grafted STG-plants at 3 to 4 month intervals.

## 2. Pathogen-free citrus foundation block

The STG-seedlings that are indexed to be free of the citrus viruses and HLB can serve as the certified pathogen-free foundation stock. The stock is kept in the citrus foundation block repository (Fig. 36 A) which is an insect-proof screen house constructed with a double-door entrance and surrounded by a water canal to prevent entry of ants and mites (Fig. 36 A, B and C). The screen house is installed with an air curtain over the first door. Concrete benches are set on gravel floor for maintaining the PF foundation trees in containers above the floor surface (Fig. 36 D). The foundation trees are generally propagated on Trover or Carrizo citrange from the clean STG plants. Two to four plants are maintained per cultivar, and they are pruned every year to produce a few fruits for verification of horticultural characteristics and removal of off-types. The plants are indexed periodically and inspected for fruit abnormality.

In Taiwan, the protected foundation blocks are maintained by a public agency. The national repository of pathogen-free foundation blocks is located in Chia-Yi Agricultural Experimental Station of Taiwan Agricultural Research Institute (CAES/ TARI) (Fig. 36 A). The citrus foundation repository is located within a rice-paddy field of CAEA/TARI.

## 3. Production of pathogen-free citrus saplings

A healthy citrus orchard planted with pathogen-free saplings may outlive the grower. Healthy citrus trees have a great potential for sustainable high yield over many decades, provided appropriate horticultural and disease management practices are followed. Accordingly, production and cultivation of pathogen-free and high-quality nursery trees are fundamentally important. In a screen-house nursery, effective preventive measures to control diseases caused by *Phytophthora* spp., nematodes, and bacterial canker disease need to be practiced.

Budwood increase blocks are established ahead of the production of PF citrus stock. The blocks contain certified parent plants propagated by using budwood from foundation trees and maintained in screen houses (Fig. 36 E). Only a limited number of foundation trees are used for production of the budwood trees because of the stringent indexing for vector-transmitted pathogen and inspection of off-type mutation. These trees must be reindexed periodically, and used for the bud-supply up to three years to avoid reinfection and mutations in the propagated saplings. New budwood increase blocks must be periodically established with clean buds from foundation trees.

The PF citrus nursery stock are produced in screen houses using budwood from budwood increase blocks. Rootstock seedlings are grown from seeds of selected cultivars in seedling tubes (5 cm in diameter and 18 cm in height) or on a seedbed tank of soil containing sterile pot-mixture. The rootstock seedlings are transplanted to perforated plastic containers (10 cm in

diameter and 30 cm in height) for further cultivation when they grow to more than 40 cm high. A rootstock cultivar should be selected in terms of the compatibility with targeted scion-cultivar, i.e., Sunki and Cleopatra mandarin for mandarin cultivars; Troyer and Carrizo citrange for sweet orange; Swingle citrumelo and pummelo for pummelo; and Volkamer lemon for mandarin and sweet orange (Fig. 37).

#### 4. Health management of pathogen-free trees in the orchard

The PF citrus nursery trees may begin begin fruiting as early as 2 years after orchard establishment provided appropriate health management and cultural practices such as watering, fertilization, and pruning are followed (Fig. 38). Health management of pathogen-free citrus seedlings in orchards needs to be properly performed using the following strategies:

- 1) Prompt elimination of HLB-diseased citrus trees and alternative host plants as inoculum sources to prevent spread of HLB to adjacent healthy citrus trees,
- 2) Protection of pathogen-free trees from vector transmission by effectively spraying insecticides at critical sprouting periods, and with biological control of the vector using natural enemies including *Tamarixia radiate* introduced from Reunion by Dr. Bernard Aubert (Fig. 39).
- 3) Protecting the orchards with physical barriers such as wind breaks or distance barriers.
- 4) Pre-immunization of healthy foundation stock with protective mild strains of CTV against more severe strains.
- 5) Chemotherapy of HLB-infected citrus trees: Tetracycline (Achromycin) injection has been tested by some citrus growers using the method of Su and Chang (1976). Recently, the efficacy of the antibiotic therapy has been greatly improved by use of an air-pressured injector (Fig. 40C). Three applications (2 autumn, 1 spring) of 1,000 ppm Achromycin (2~4 L per tree) by air-pressured injector of 80 lbs have provided the best efficacy for reducing symptoms in diseased trees. No HLB symptoms have reappeared in the injected trees, which are producing normal fruits (Fig. 41). Pruning dead branches in the upper canopy improves the therapeutic efficacy. The antibiotic injection is frequently associated with temporary phytotoxicity such as mild vein necrosis, slender leaves and defoliation, but the trees quickly recover to normal growth. The tree injection method works best for the HLB-affected large trees in which the diseased branches do not constitute over half of the canopy, i.e. trees in the early stage of disease development.

## Figures

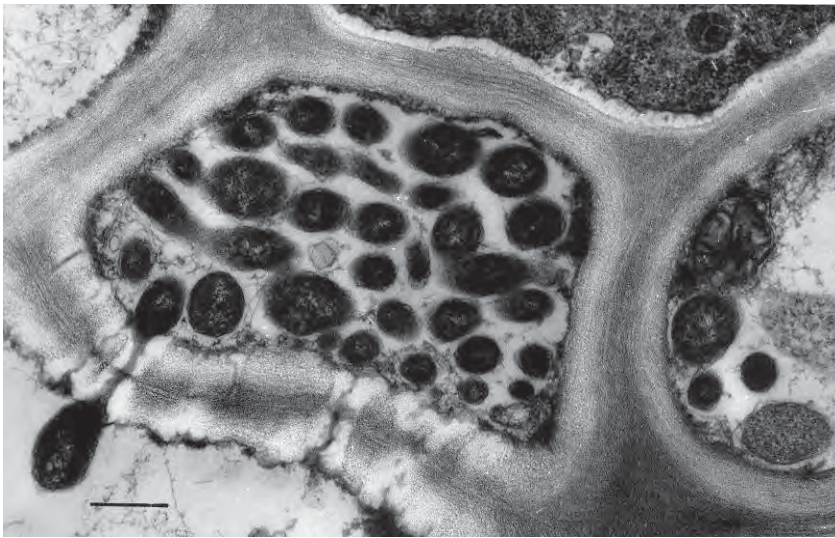


Fig. 1. Electron micrograph of Likubin (HLB) fastidious bacteria (HLB-FB) packed in sieve tube of Ponkan mandarin. Large ones are mature bodies, and smaller ones are young bodies. Bar = 500 nm

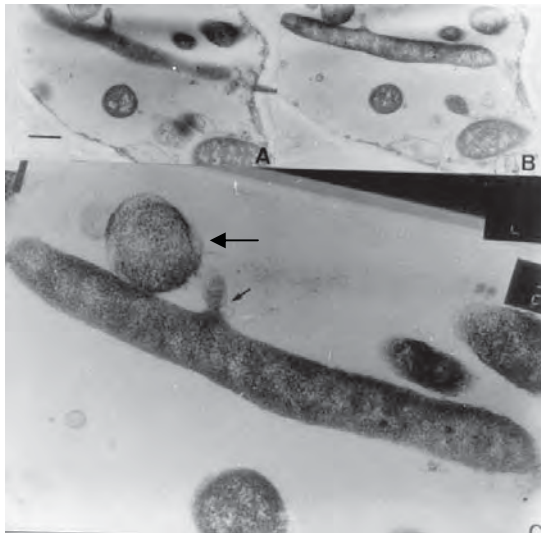


Fig. 2. Serial cross sections of lateral vein from diseased Ponkan leaf (A&B), and C) a stereomicrograph of piling up with A and B sections, showing a rigid rod of nature FB body with budding (←). Bar = 500 nm

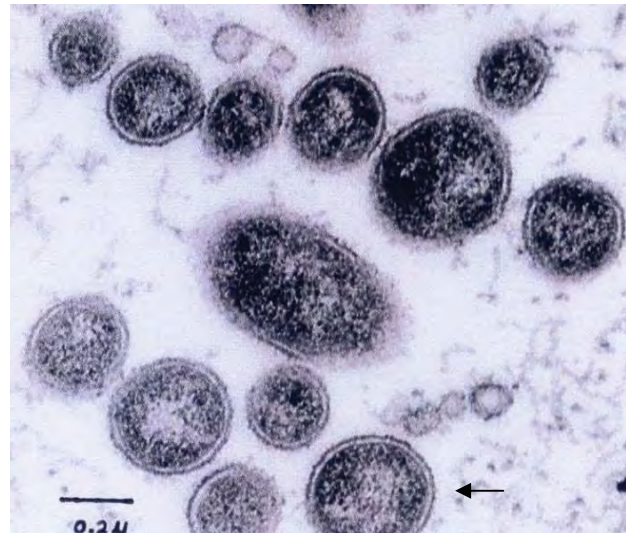


Fig. 3. Electron micrograph showing cross-section of FB bodies surrounded by two-layered envelope (←), 20-25 nm thick consisting of a cell wall and inner cytoplasmic membrane (7.5 nm thick / each).

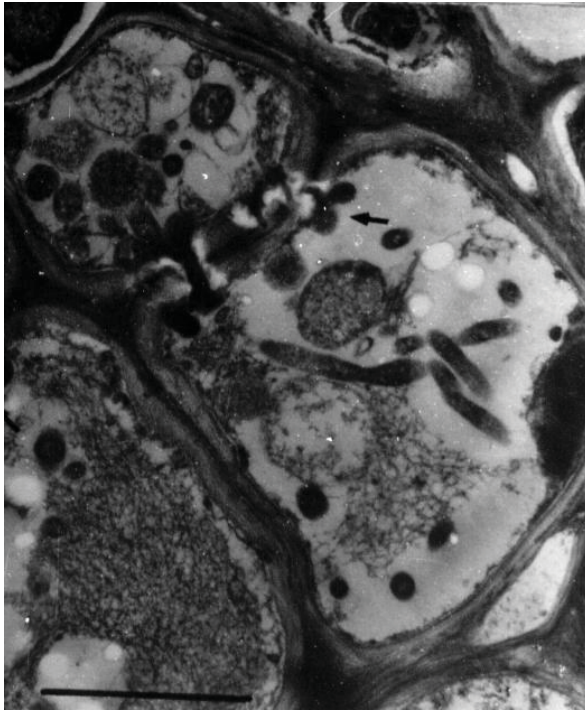


Fig. 4. Electron microscopy showing flexible elongated rods (100~250 X 500~2500 nm) of young growing form with dense cytoplasm. Bar = 2  $\mu$

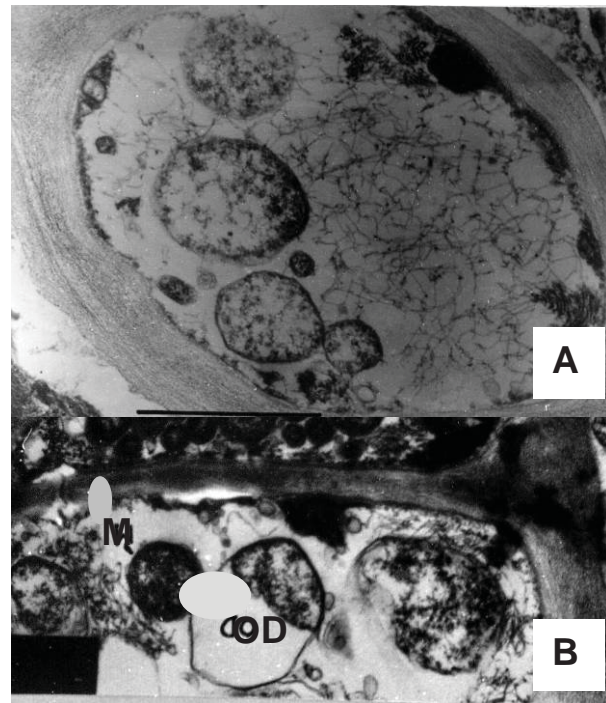


Fig. 5. (A) Large spherical bodies of old form (600-800 nm) containing thin cytoplasm in sieve tube of diseased Ponkan old leaf. (B) Disrupted old decaying spherical bodies (OD) containing granulated or clotted cytoplasm in sieve tubes of old Ponkan leaf. Bar = 1000 nm

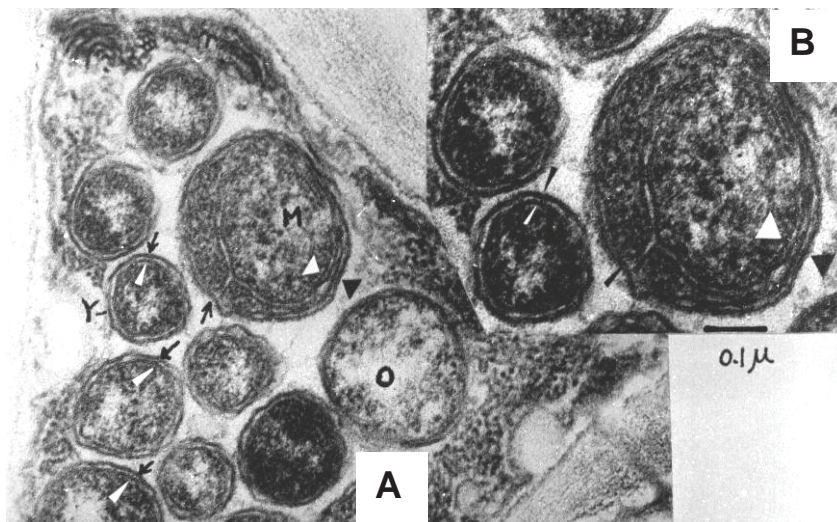


Fig. 6. (A) FB bodies of young (Y), mature (M) and old (O) forms surrounded by two-layered envelope, packed in a sieve tube, and (B) magnified micrograph showing infolding ( $\rightarrow\leftarrow$ ) of inner cytoplasm membrane from the point ( $\rightarrow$ ) of cytoplasmic membrane. Bar = 100 nm

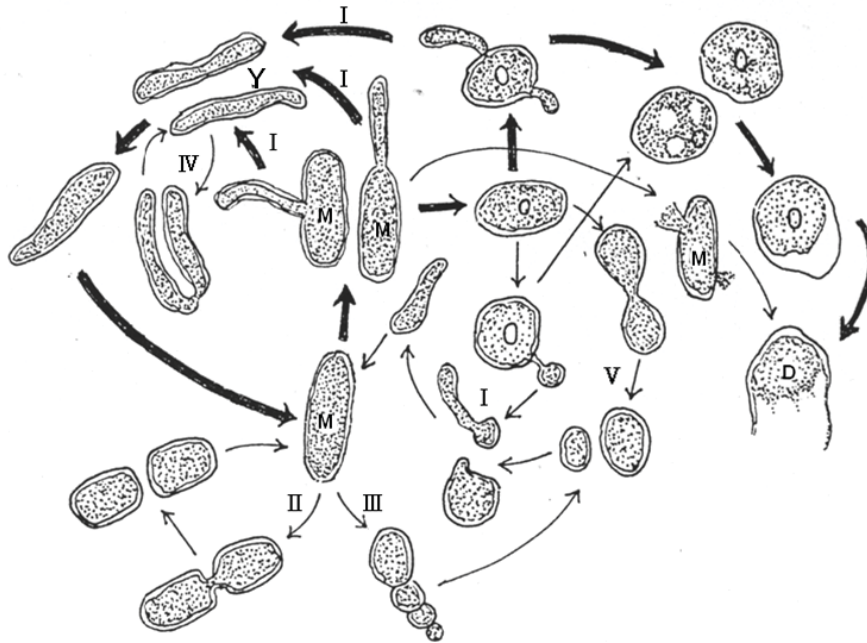


Fig. 7. Proposed mode of life cycle of fastidious bacteria causing citrus Likubin. Y, young rod of growing form; M, rigid rod of mature form; O, spherical body of old form; D, decaying body; thick arrow, common cycle (budding) of multiplication; I, budding; thin arrow, unusual cycle of multiplication; II, binary fission; III, beading; IV, segmentation; and V, fission.

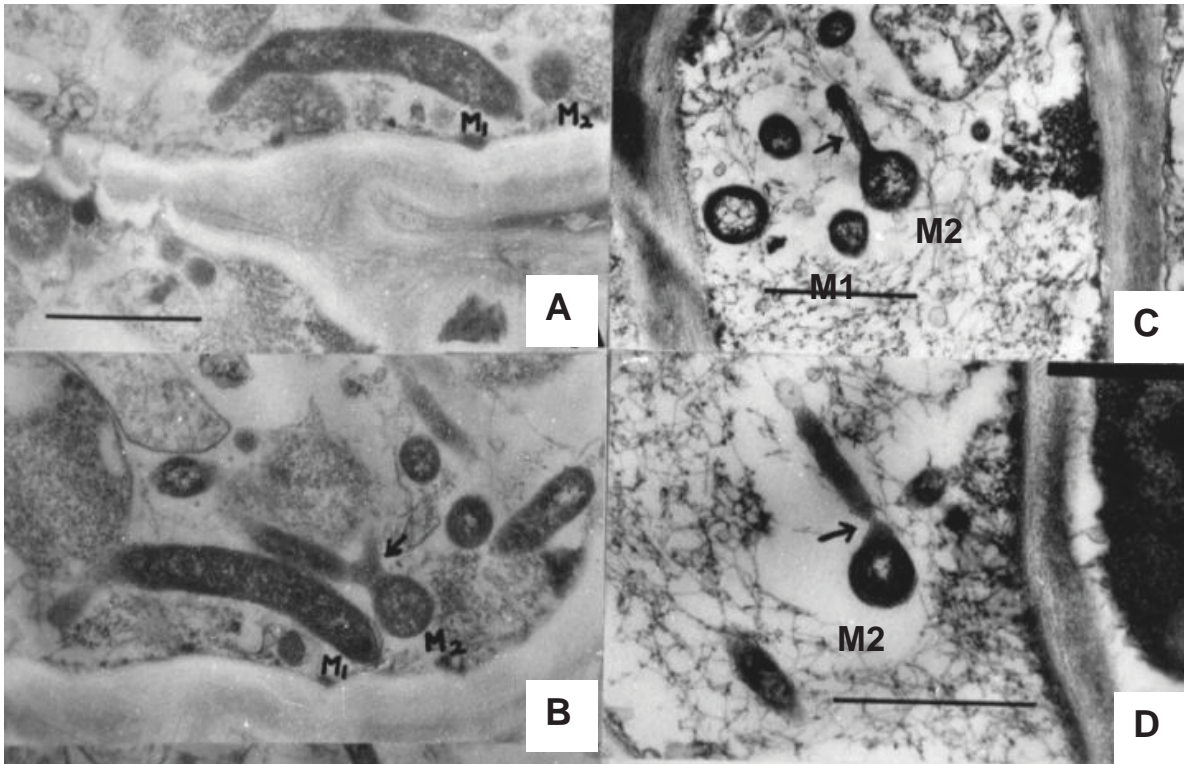
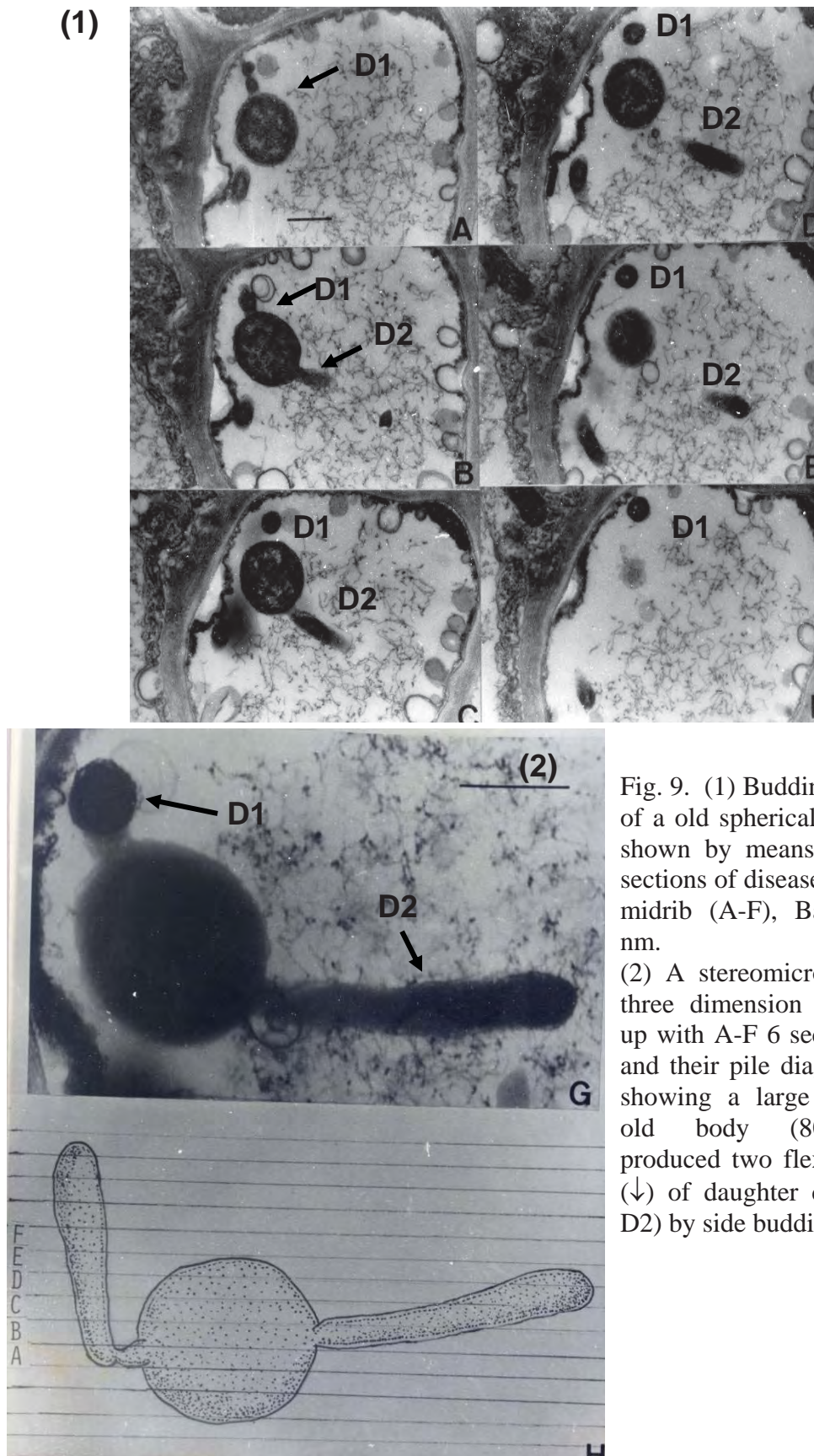


Fig. 8. Budding-type multiplication of FB mature bodies. A-D) Serial cross section of lateral vein from a diseased Ponkan young leaf, showing polar budding ( $\downarrow$ ) (M1) and side-budding ( $\downarrow$ ) (M2) of two mature bodies by producing slender rods of young daughter cell.



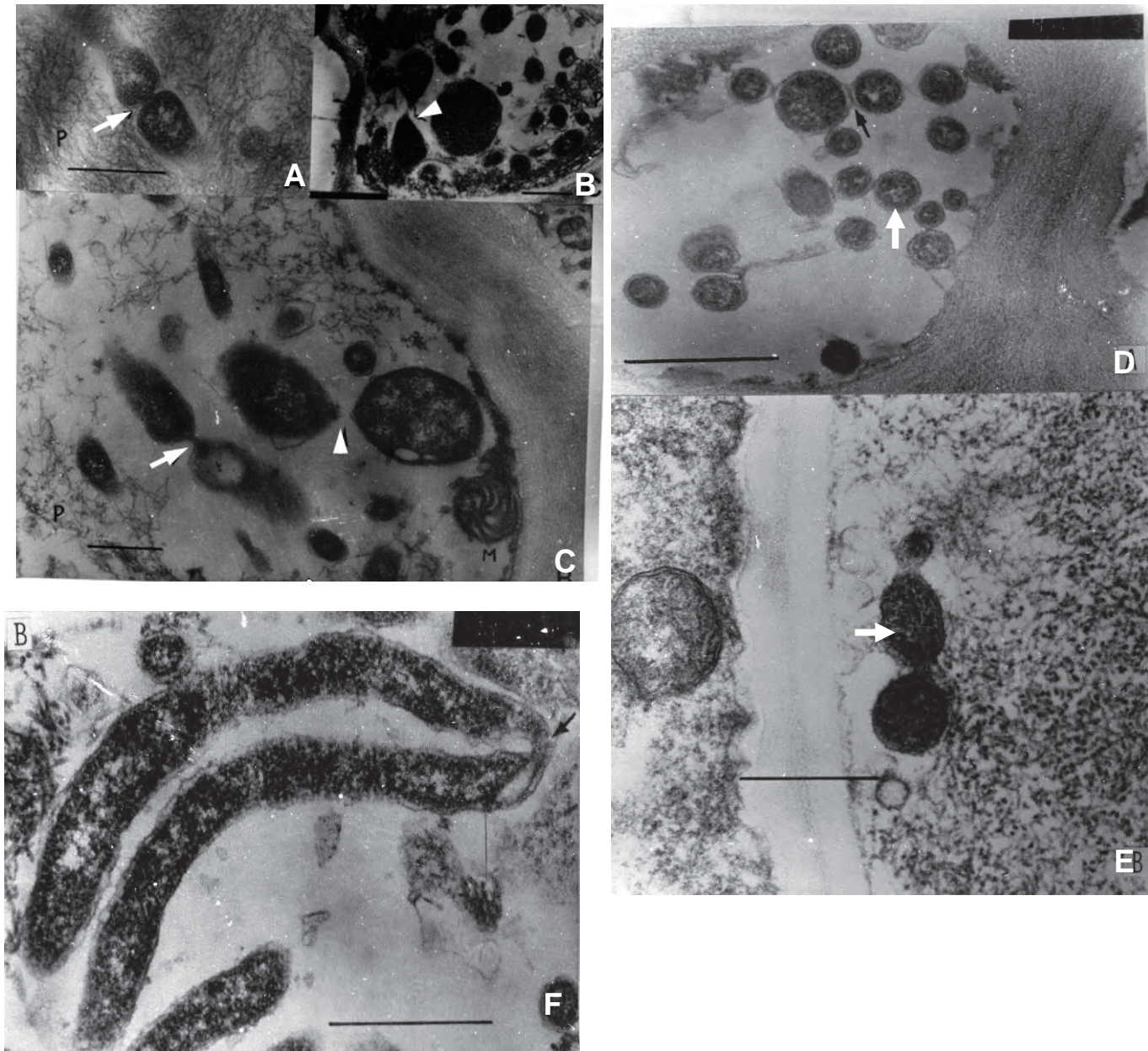


Fig. 10. Multiplication cycles of FB bodies.

(A) Elongated rod in a sieve tube in lateral vein of diseased Ponkan young leaf showing binary fission (➔), (C) Elongated body showing binary fission (➔), and spherical bodies showing fission propagation (➤), (B) old spherical FB body showing fission (➤), Bar = 500 nm. (D) and (E) Multiplication of FB bodies by beading type. Spherical bodies in a beaded chain (➔) in sieve tubes of diseased Ponkan mature leaf. Bar = 500 nm. (F) Multiplication of a FB body with segmentation type of flexible rod by constriction (➔) at bent point of elongated rod. Bar = 500 nm.

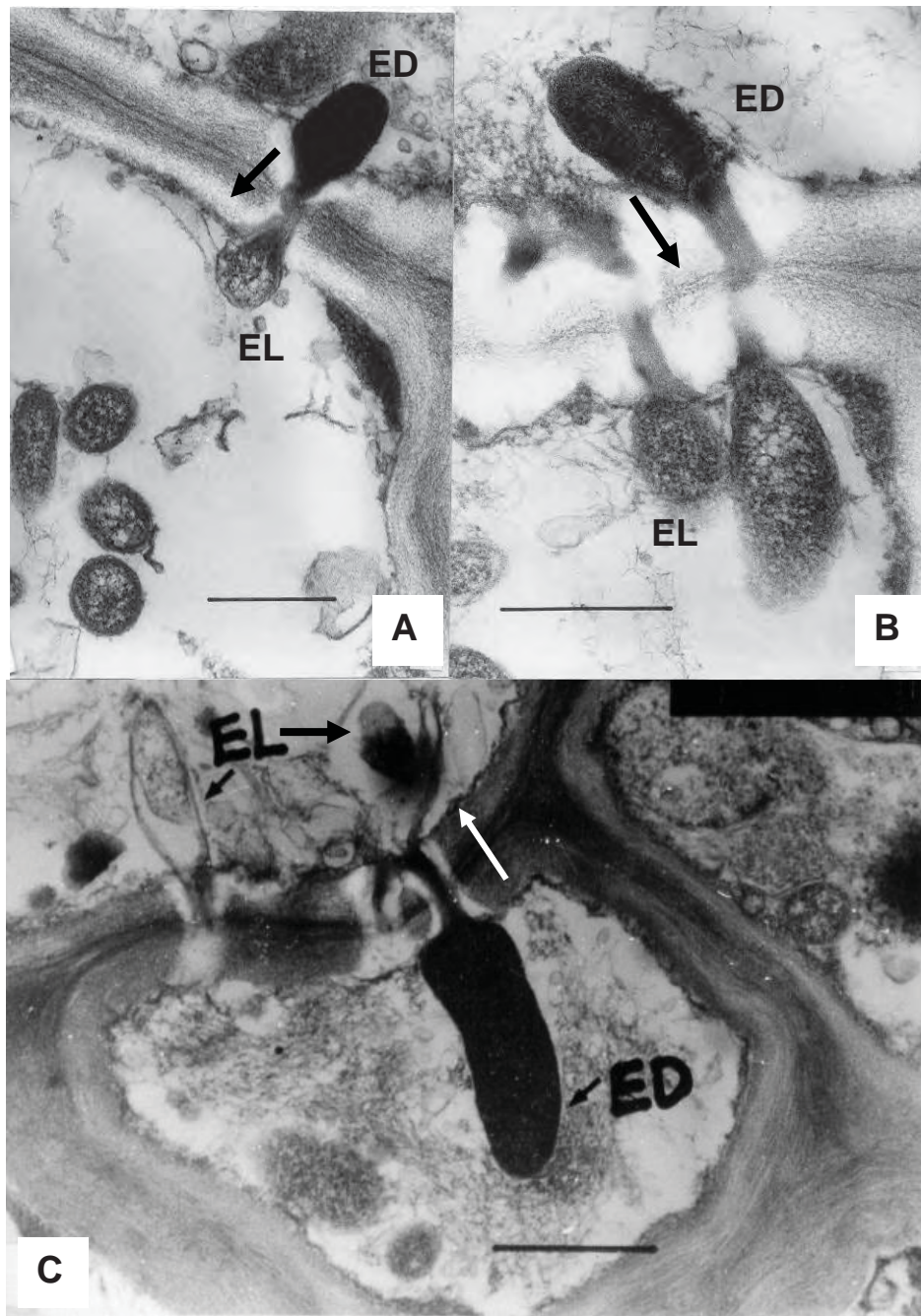


Fig. 11. Movement of FB rods by passage through sieve pore with electron-lucent anterior (EL) and electron-dense posterior (ED). (A) Sieve-passage of FA bodies in sieve tube of diseased Ponkan leaf and (B) Tankan leaf, showing electron-dense (ED) posterior at entrance side and electron-lucent (EL) anterior at the exit side of sieve pore. (C) Sieve-pore passage (→) of FA bodies in sieve tube of diseased Tankan leaf showing electron-dense posterior (ED) with dense cytoplasm at the entrance side and electron-lucent anterior (EL) at the exit side of sieve pore.



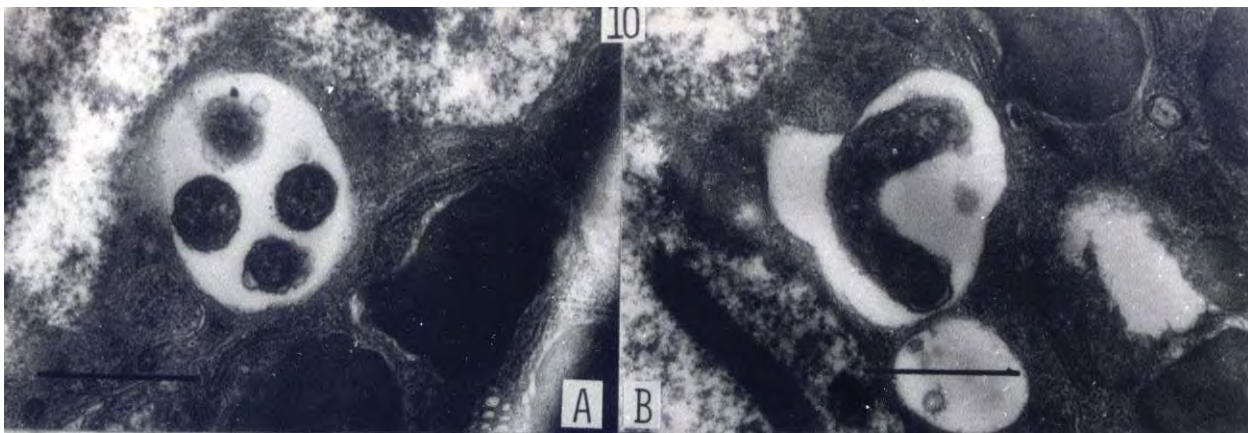


Fig. 12. Electron micrographs showing HLB-FB bodies with spherical form (A) and elongated form (B) in head of psylla (*Diaphorina citri*). Bar = 1000 nm

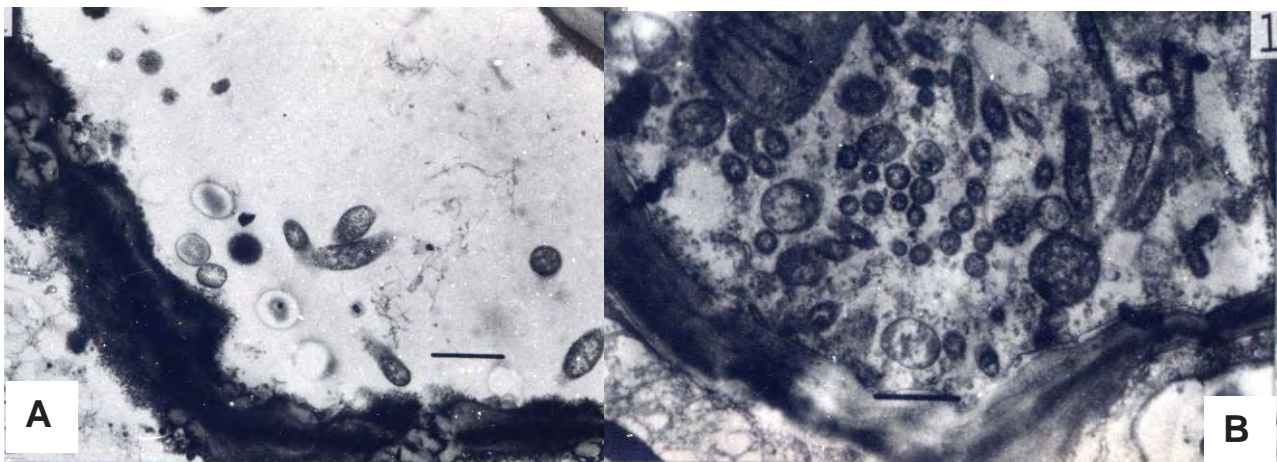


Fig. 13. Electron micrographs showing HLB-FB in sieve tubes of stem of dodder (*Cuscuta australis*) fed on diseased Ponkan 2 weeks (A), and 2 months (B) after acquisition.

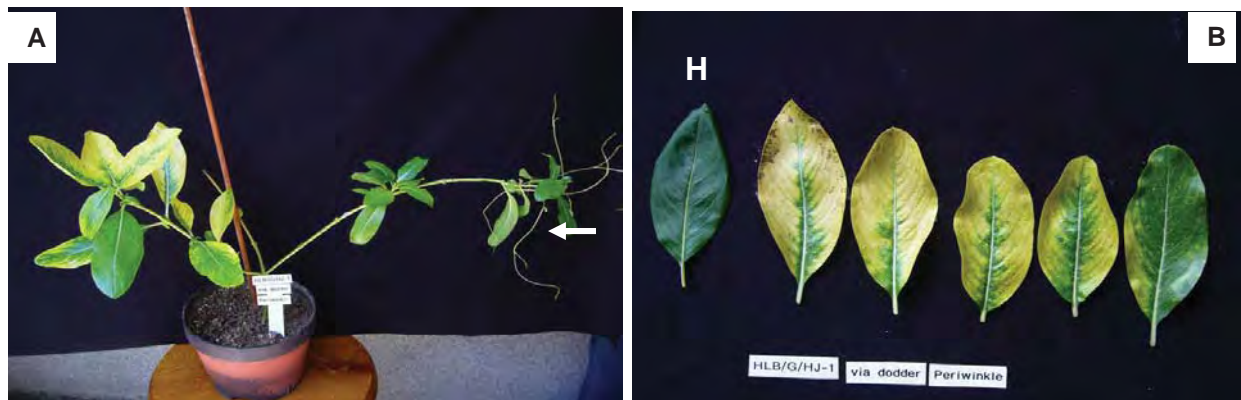


Fig. 14. (A)Yellows symptoms of periwinkle plant infected by HLB-FB *via* dodder (←) fed on diseased Ponkan plant, 3 months after inoculation. (B).Yellows symptoms on diseased leaves of different stages, mentioned above (A). H, healthy CK.

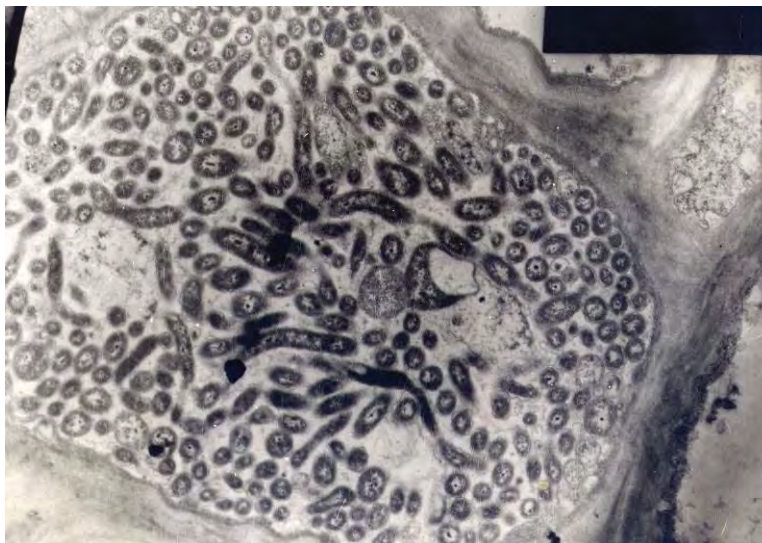


Fig. 16. Electron microscope showing abundant FA bodies multiplied in a sieve tube in vein of periwinkle leaf with yellow symptoms mentioned in Fig. 14.

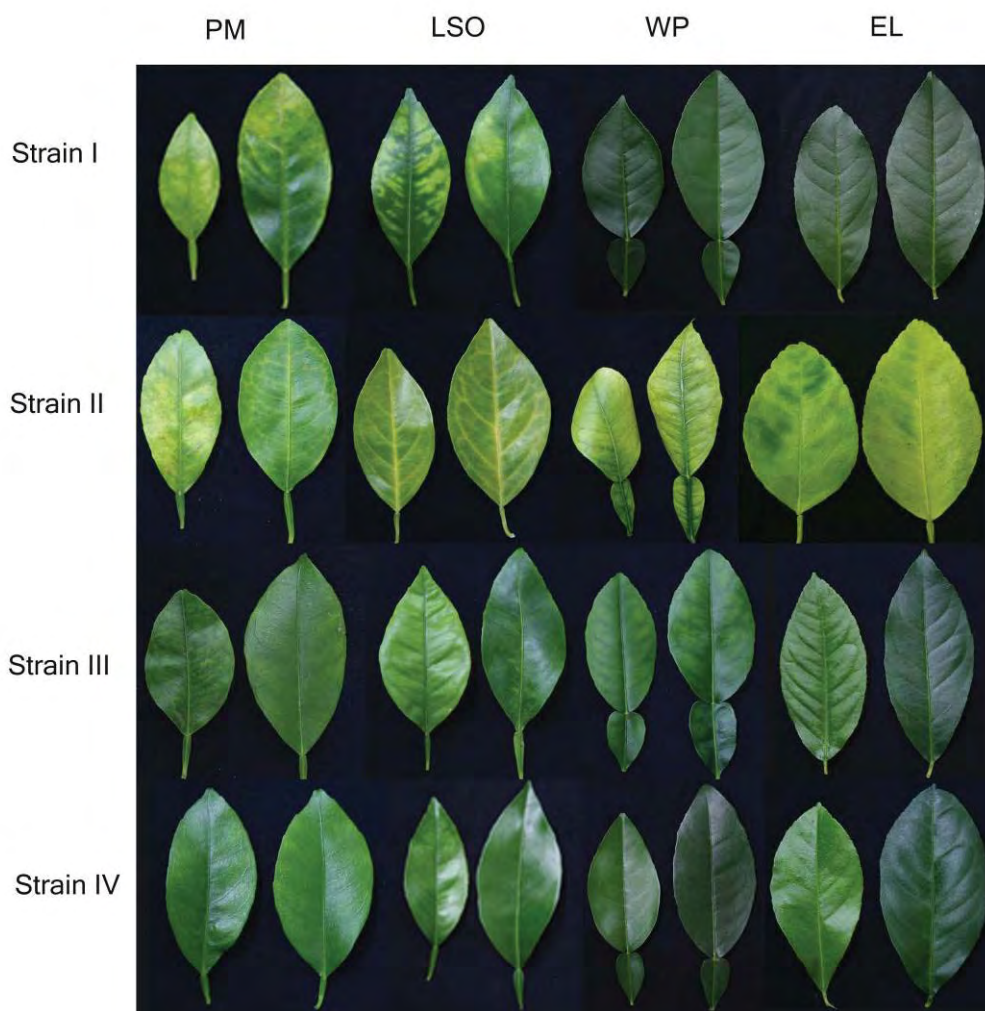


Fig. 15. Different type and severities of the symptoms induced by the 4 HLBB strains (I-IV) in four differential citrus cultivars of Ponkan mandarin (PM), Liucheng sweet orange (LSO), Wentan pummelo (WP) and Eureka lemon (EL) under greenhouse conditions during 2005~2006.

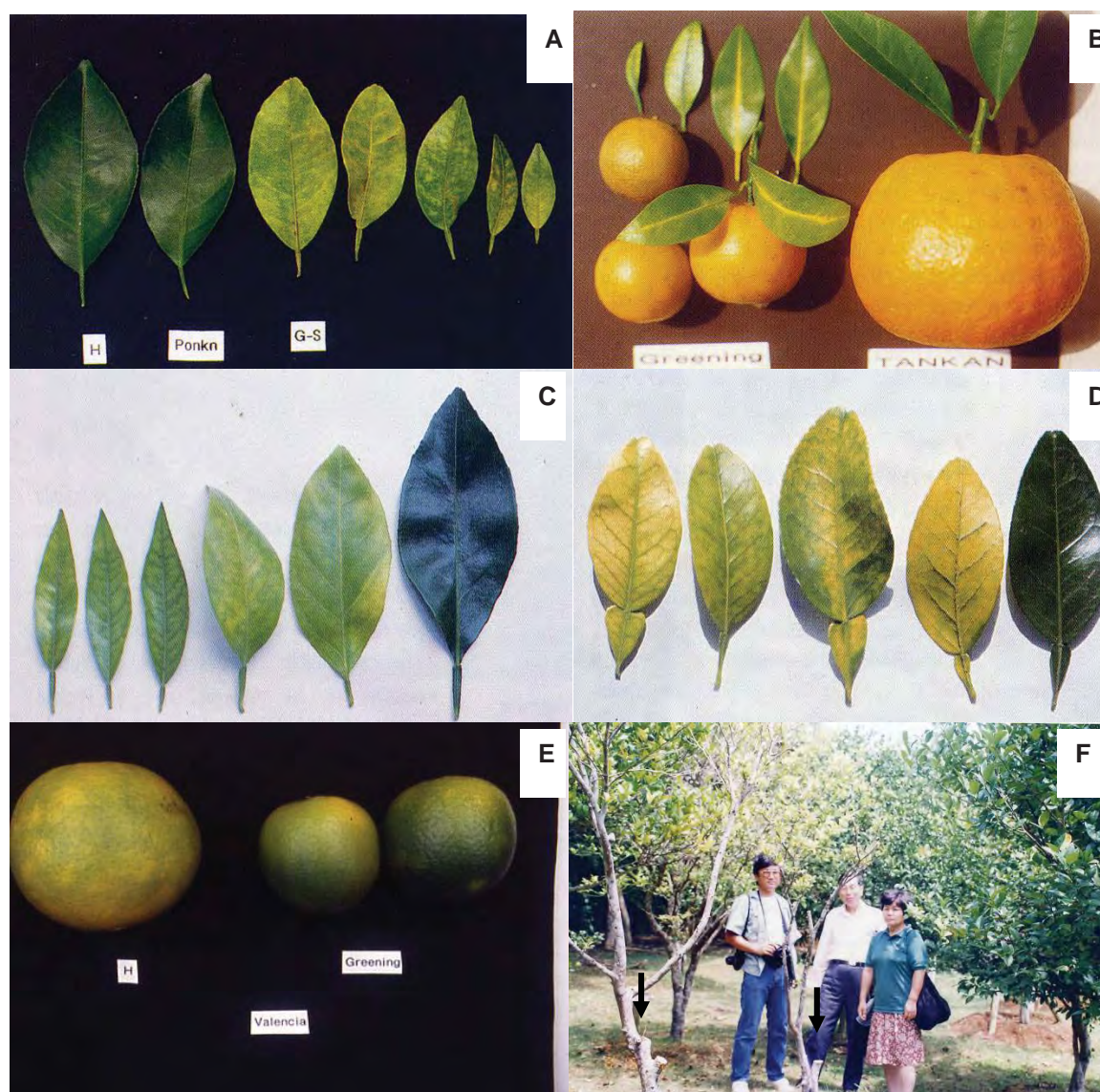


Fig. 17. Symptom expression of Likubin (HLB) in common citrus cultivars in Taiwan.

(A) Leaf symptoms of HLB-affected Ponkan mandarin, showing bright yellowing with pale green mottling of mature leaves (center two), and newly grown small and slender leaves with interveinous chlorosis resembling zinc-deficiency symptoms (right 3). (B) Leaf and fruit symptoms of diseased Tankan tangor, showing yellowing of veins and adjacent tissue, and smaller fruits with atrophy and pate green, compared to a healthy fruit with bright orange color (right). (C) Leaf symptoms of diseased Liucheng sweet orange characterized with yellow mottling on mature leaves with curling outwards (center two), and small chlorotic new leaves resembling deficiency symptom (right two). (D) Leaf symptom of diseased Wentan pummelo, showing bright-yellow mottling and vein corking on mature leaves compared with healthy leaf (right). (E) Fruit symptoms of diseased Valencia orange, showing atrophy and poor color turning of mature fruits remaining green (right 2), compared with a healthy fruit (left). (F) Severely HLB-affected Shikuashia trees, showing severe yellowing symptom with dieback (◄), and ultimately death of entire plants (↓) (August, 1994, Okinawa).

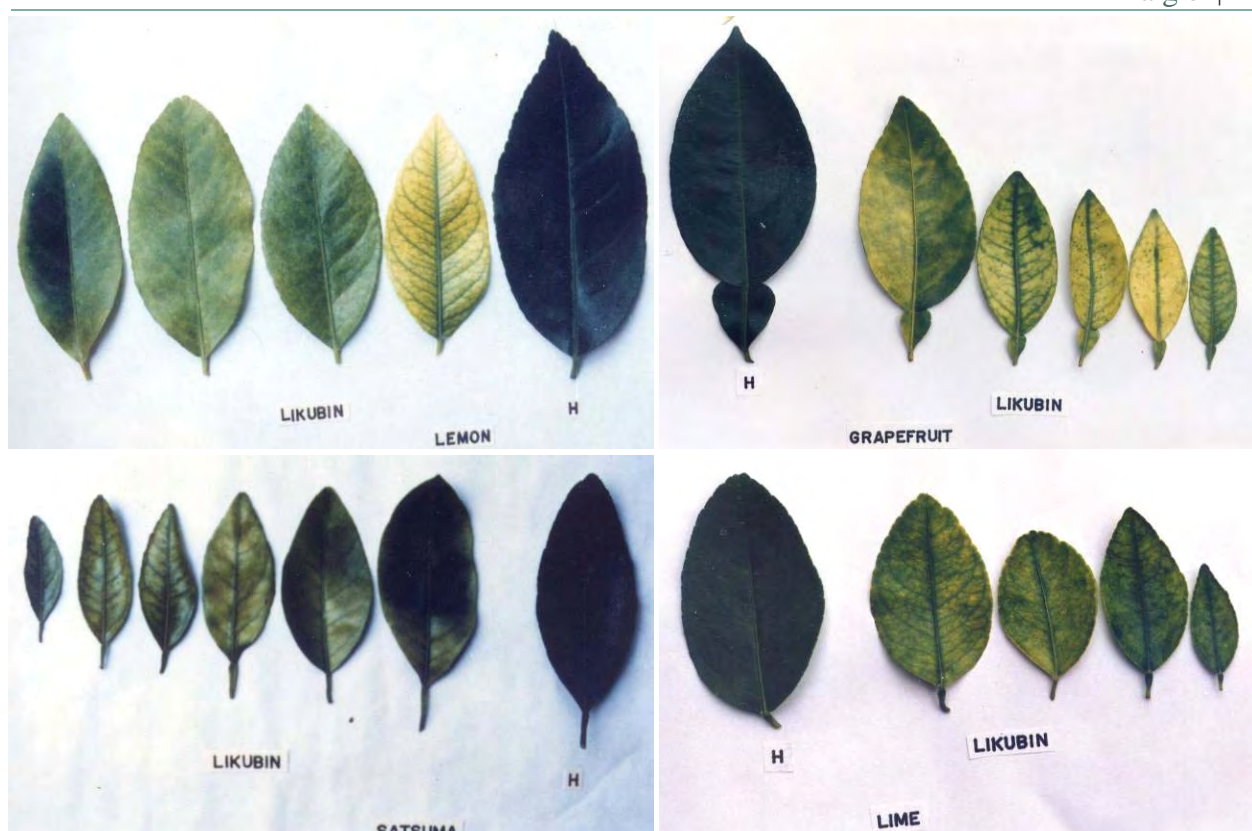


Fig. 18. Symptom expression of minor citrus cultivars in Taiwan.

(A) Leaf symptoms of diseased Eureka lemon, showing pale yellow mottling on mature leaves (left three), and interveinous yellows symptoms of young leaf compared to healthy leaf (right). (B) Leaf symptoms of diseased grapefruit, showing bright yellows with mottling compared to healthy leaf (left). (C) Leaf symptoms of Satsuma orange, showing distinct yellow mottling with hardening and curling outwards, compared to healthy leaf (right). (D) Leaf symptoms of diseased Tahitian lime, showing pale yellows with mottling compared to healthy leaf (left).



Fig. 19. Leaf symptoms of HLB-affected Chinese box orange (*Severinia buxifolia*), alternative host of HLB, showing yellow mottling and hardening of diseased leaves (GO, upper row), compared to healthy green leaves (H, under row).

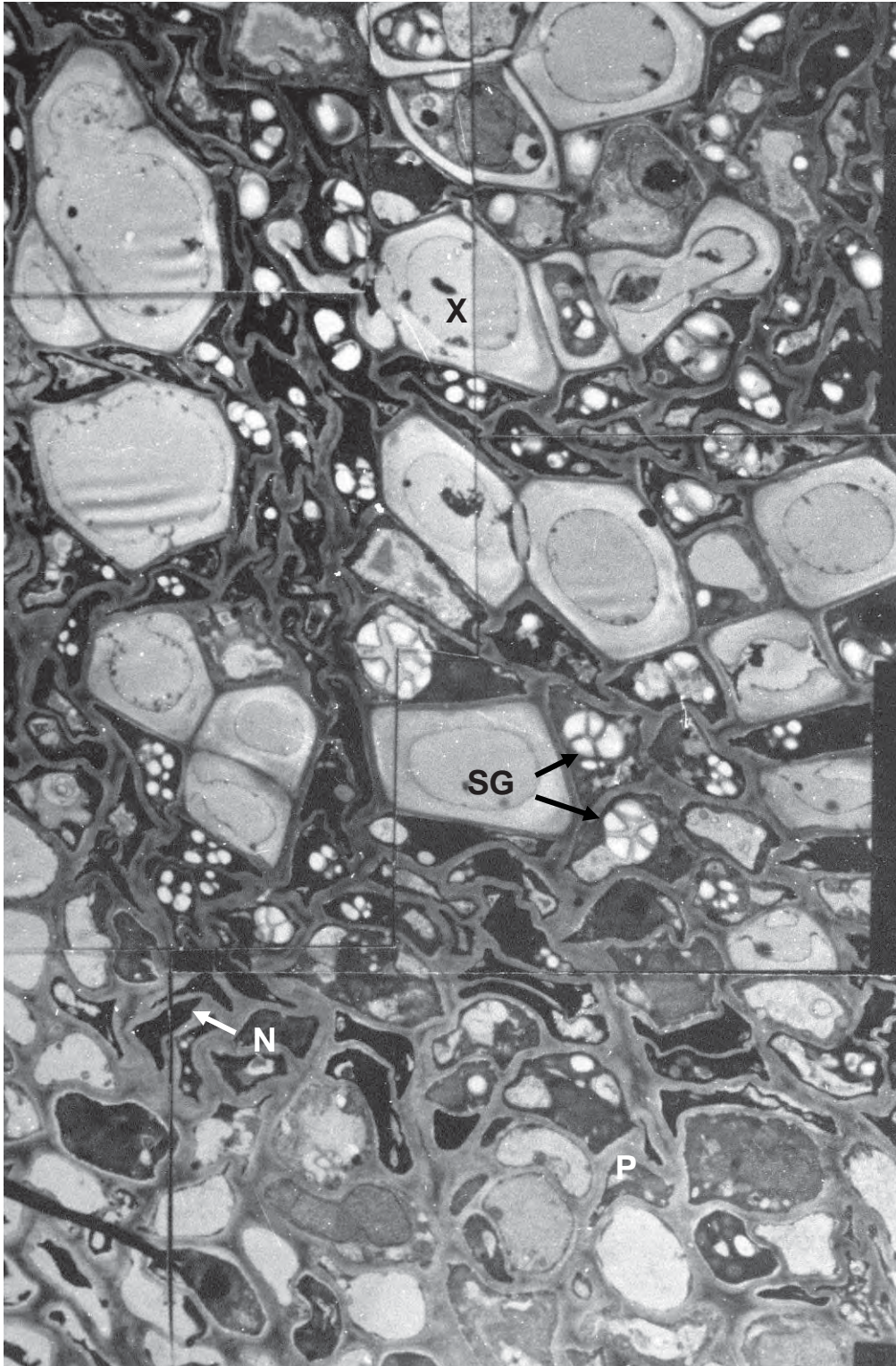


Fig. 20. Electron micrograph of a cross section of diseased Ponkan old leaf-vein, showing severe malformation, cytoplasm necrosis and starch-gain (SG) accumulation of hyperplastic xylem (X), and phloem parenchyma (P), cells degeneration in outer phloem (N). Bar = 10  $\mu$ m

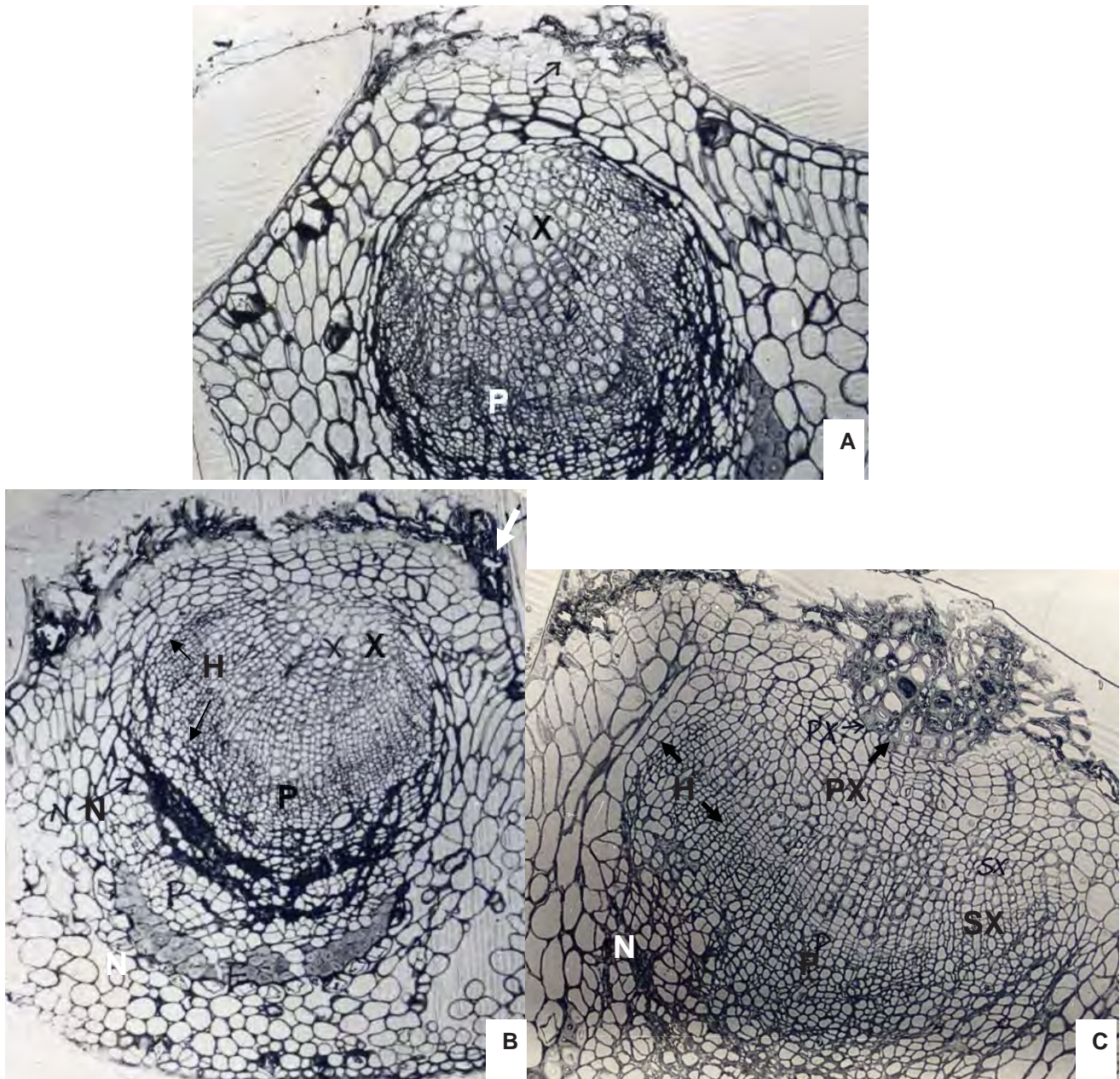


Fig. 21. Light micrographs of cross sections of later veins from diseased Ponkan old leaf (A), and Tankan old leaves (B&C), showing vein swelling and cracking-corking due to hyperplasia of inner vascular elements. Rupture ( $\downarrow$ ) of vein upper-epidermis caused by hyperplasia and necrosis (N) of bundle elements over bundle limit, including suberization ( $\downarrow$ ) of exposed epidermal cells (A&B) (652 X). (C) Vein cross section of diseased Tankan old leaf, showing advanced vein rupture, corking and extrusion of primary xylem elements (PX) due to continuous hyperplasia and necrosis of vascular elements (342 X). X = Xylem; P = Phloem; H = hyperplasia; N = necrosis; PX = primary xylem; SX = secondary xylem.

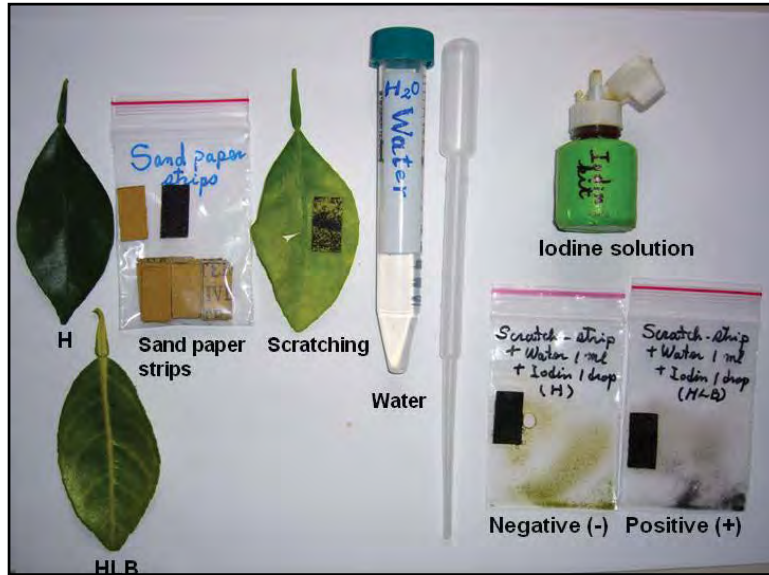


Fig. 22. Indexing of HLB infection with Iodine kit including Iodine solution, piece of sand paper, PE bag and pure water: Positive reaction (+) showing color turning to dark brown to black; Negative reaction (-) showing yellow.

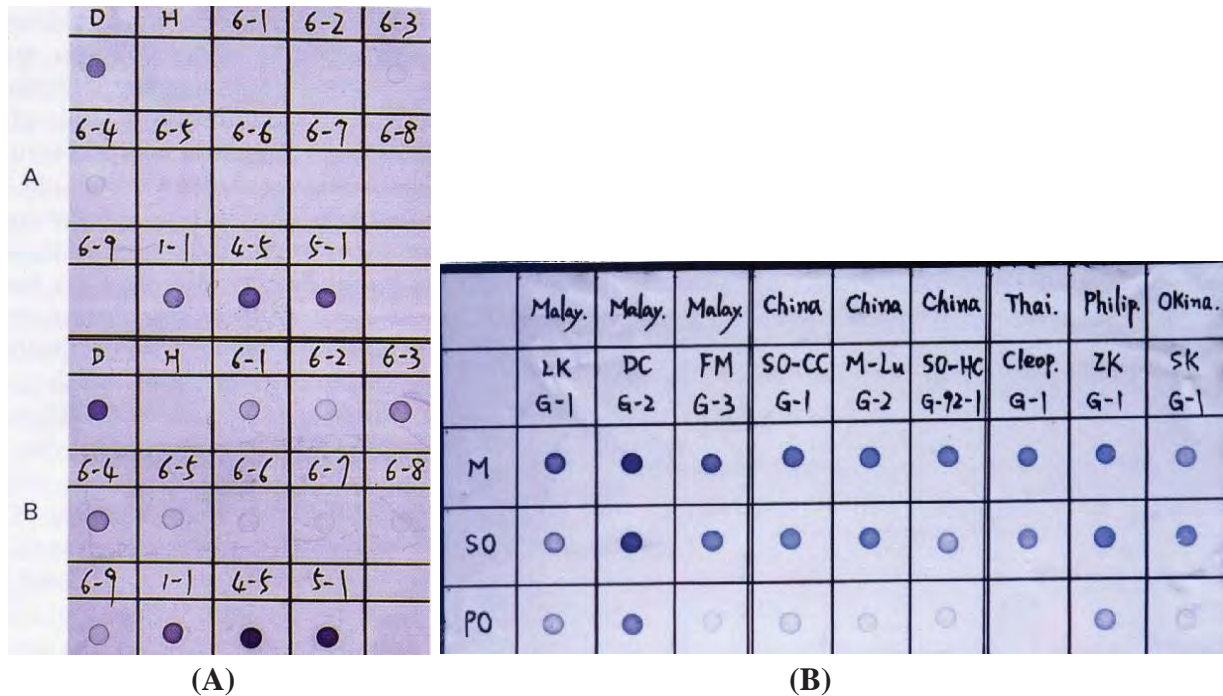


Fig. 23. Detection of HLB-FB by dot hybridization tests, with HLB-FB DNA extract (A-A), and by PCR amplification of HLB-FB DNA followed by DH with PCR products (A-B). D, diseased sample; H, healthy sample from shoot-tip grafting ponkan for negative check; 6-1~6-9, healthy-looking citrus samples collected from field; 1-1, 4-5, 5-1, citrus samples with greening symptoms.(B) Detection of HLB-FB by dot hybridization against FB isolates including Malaysia (Duncy and Fremont mandarin), China (Chanychou, Lukan mandarin, Honchian sweet orange), Thailand (Cleopatra), Philippine (zinkom mandarin), and Okinawa Japan (Shikuashia).



Fig. 24. Detection of HLB pathogen by polymerase chain reaction (PCR) followed with electrophoresis analysis: 1~4, Taiwan HLBB isolates; 5, Okinawa isolate, Japan; 6, Chain isolate; 7, Malaysia isolate; 8, Vietnam isolate; 9, Thailand isolate; 10, Saudi Arabia isolate; 11, Healthy CK.



Fig. 25. Asian citrus psylla/psyllid (*Diaphorina citri*). (A) life cycle showing adult (above) and egg, and five nymphal instars (below). (B) Adults feeding on citrus leaves.



Fig. 26. HLBB transmission via scion buds. (A) Citrus graft propagation with HLBB-infected scions showing yellow mottling and stunt symptoms. (B) Layering seedling showing HLB symptoms. (C) Citrus seedlings propagated by layering.



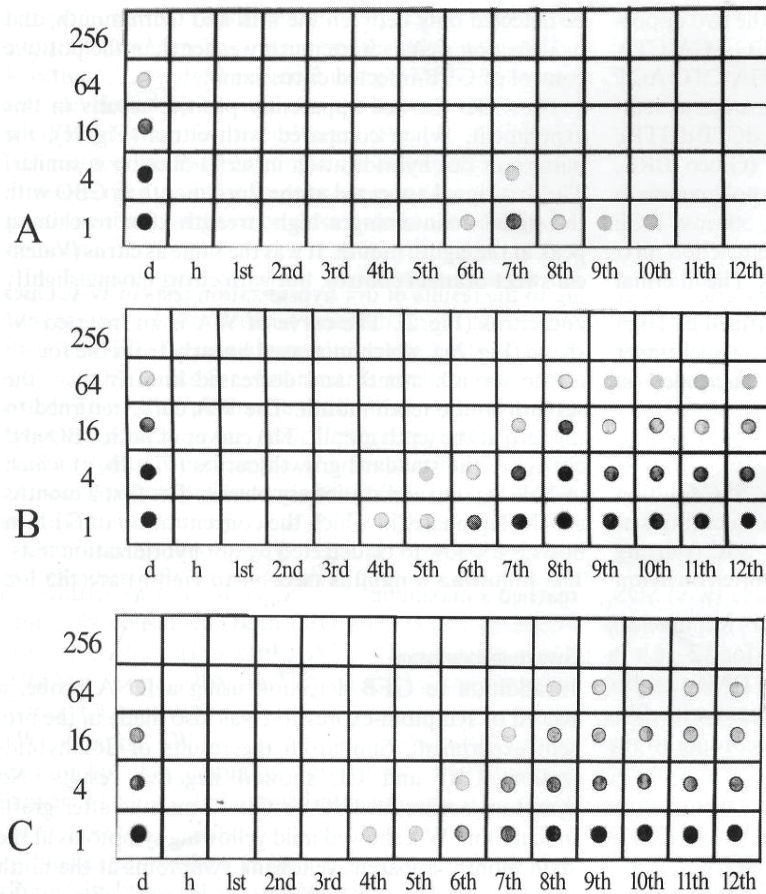


Fig. 27. Dot hybridization tests for the detection of HLB-FB in suspected alternative hosts grafted with the HLB-diseased citrus scions, were made monthly within 1 year after inoculation. The total nucleic acid extracted from the test plants of wood apple (A), Chinese box orange (B), and Valencia sweet orange (C) were diluted in four-fold dilution series, and then subjected to dot hybridization.

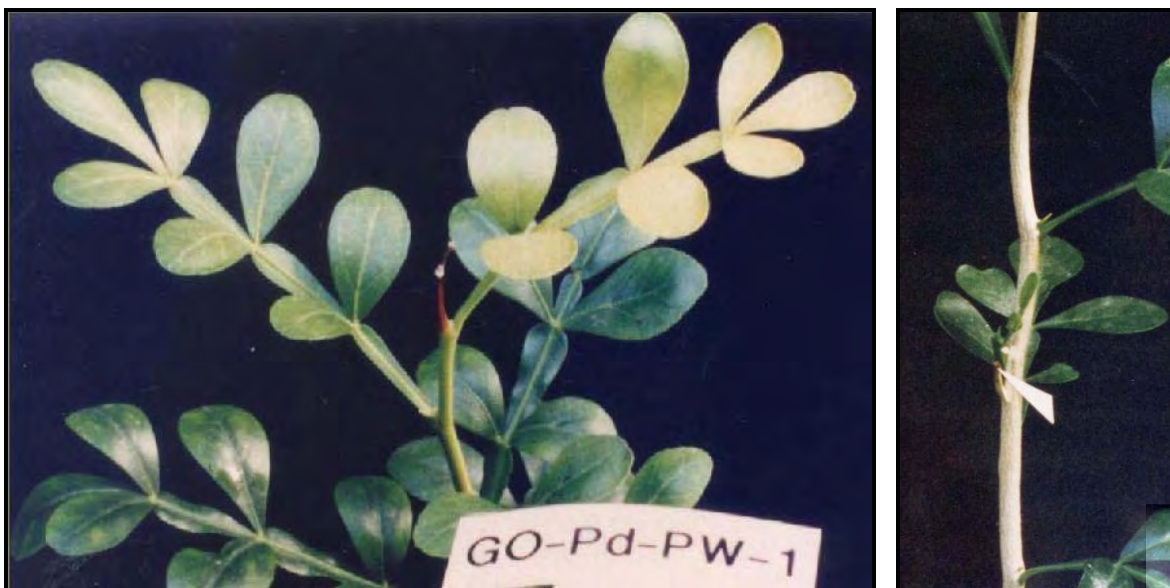


Fig. 28. The symptom expression of wood apple (*Limonia acidissima*) graft-inoculated with diseased Ponkan scion. (A) Yellows and mottling symptoms on upper leaves of inoculated WA. (B) The diseased Ponkan scion (◄) grafted on WA plant showing sprouting.

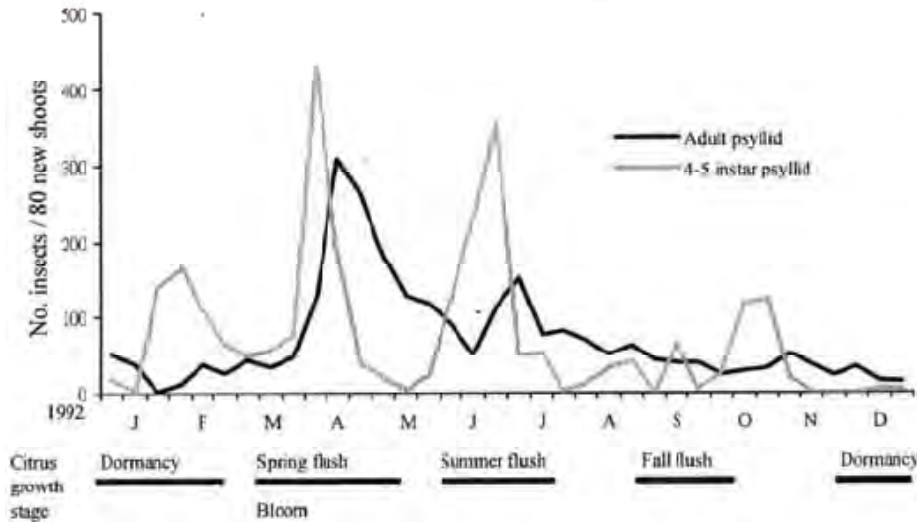


Fig. 29. Population fluctuation of citrus psyllid in a non-sprayed citrus orchard (Liucheng sweet orange) in Chai-Yi (Hung et al., 2003).

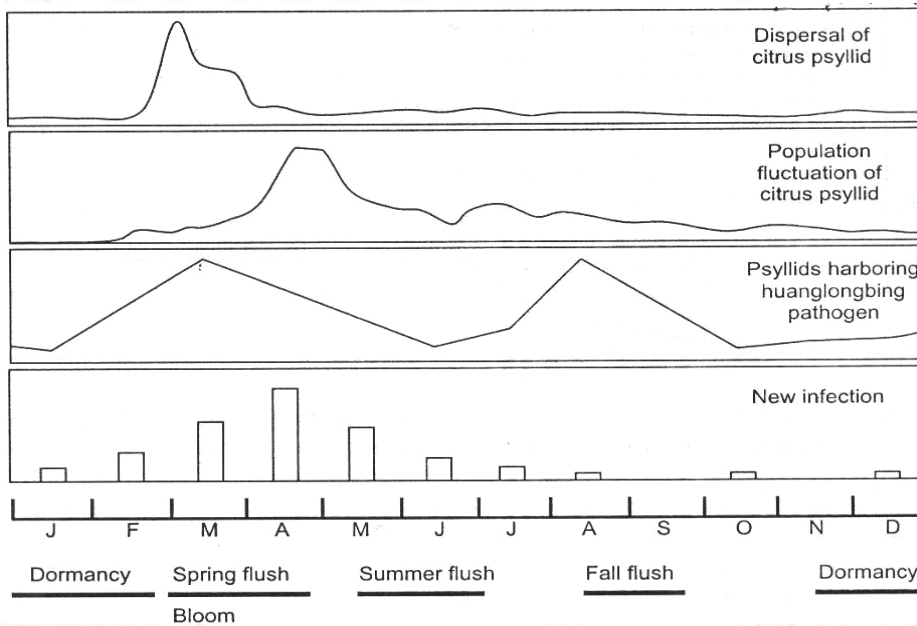


Fig. 30. Phenological patterns, population dynamic and HLBB infection of citrus psyllid in orchards.

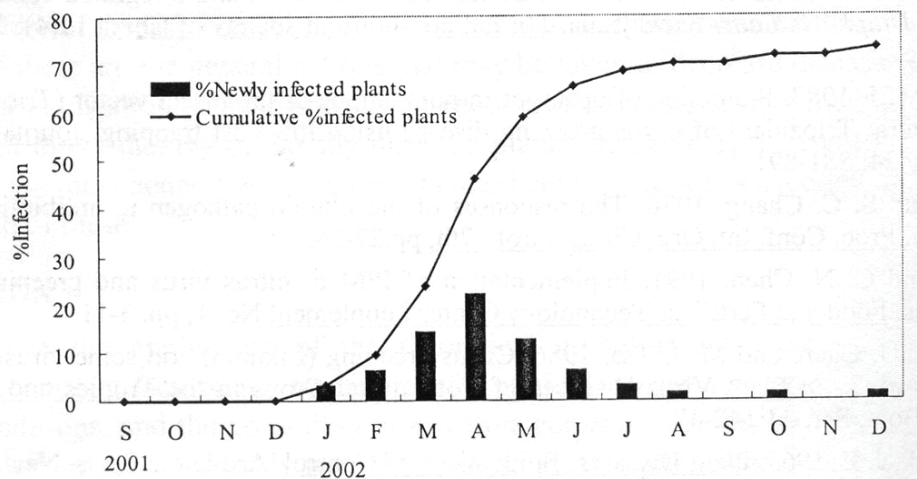


Fig. 31. Infection rate of healthy citrus trees in an orchard in diseased area.

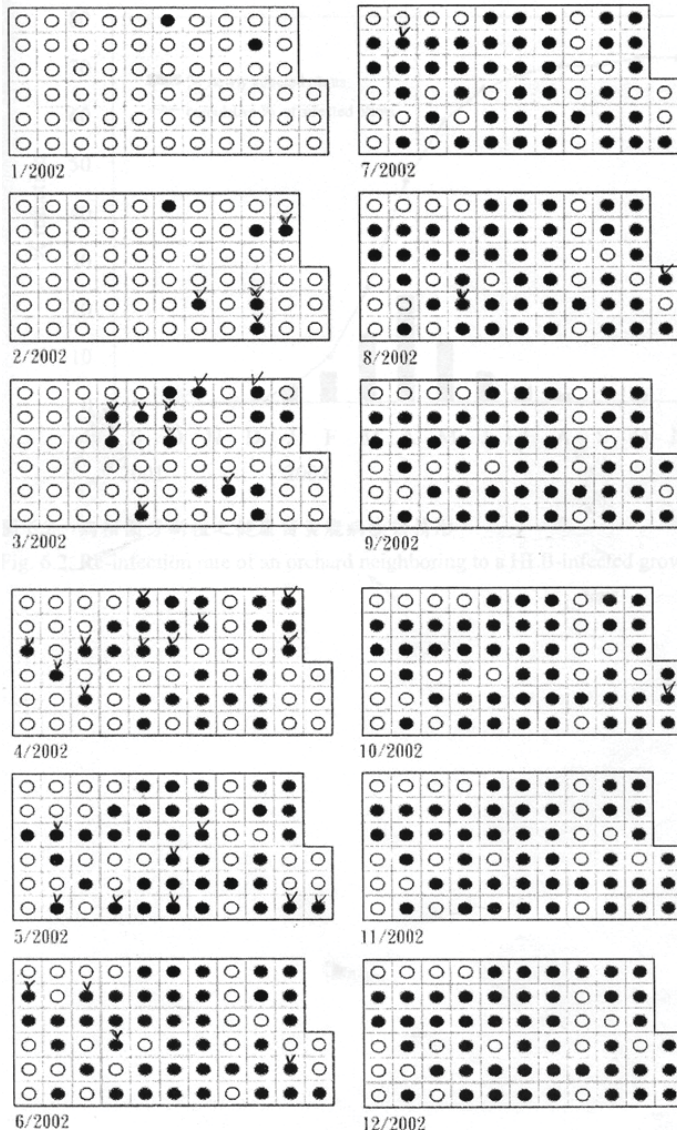


Fig. 32. Spreading pattern of HLB infection in an orchard growing pathogen-free Ponkan seedlings in disease area within one year (2002). ✓, newly infected plants each month.

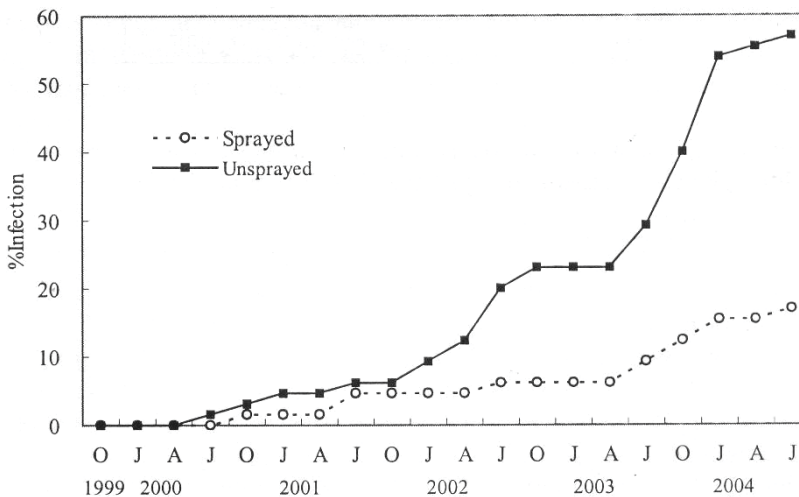


Fig. 33. HLB progresses of infection rate (%) in sprayed and unsprayed plots during 5 years. The infection cumulative rate of FB infection reached 17% in sprayed plot and 57% in unsprayed plot 5 years later.

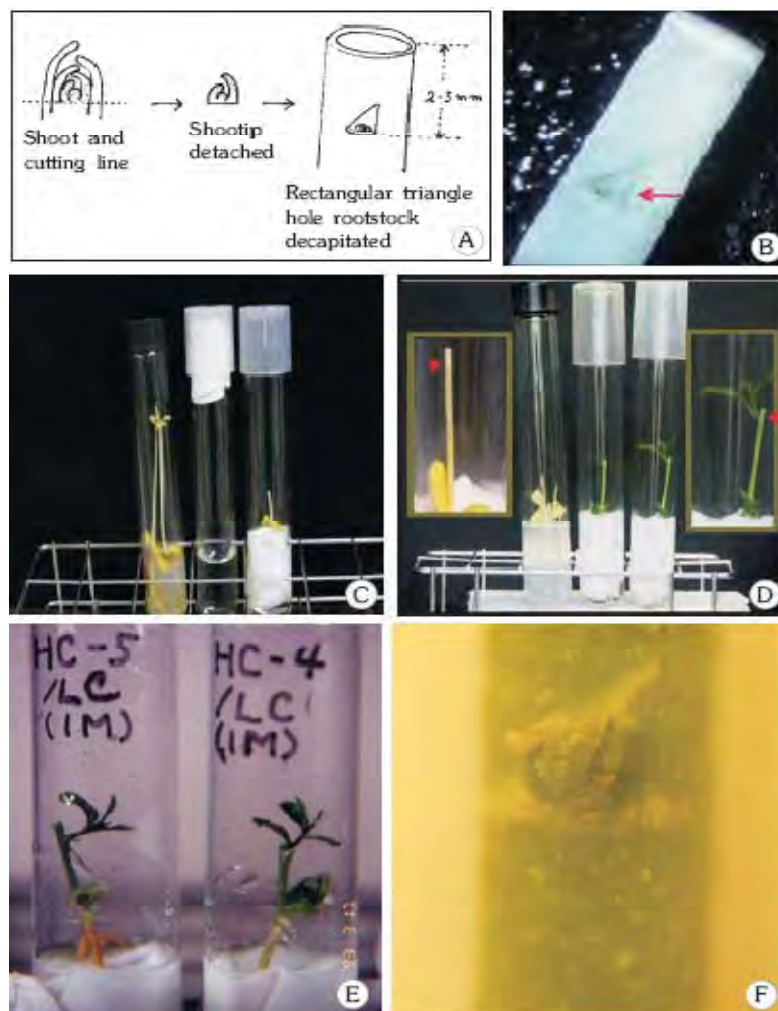


Fig. 34. Procedure for shoot tip (ST) micrografting. (A) Diagram showing excision of shoot tip with 2-leaf primordia from top of a shoot and making a rectangular triangle hole (0.3~0.5 mm) on a decapitated rootstock seedling by removing cortex layer with cutting edge of STG knife. (B) A shoot tip placed in the triangular hole on a decapitated rootstock seedling. (C) Two-week old rootstock seedlings in solid medium (left), a sterile test tube with a center-perforated filter-paper platform, containing liquid medium (center), and a test tube containing the micrografted rootstock seedling supported by filterpaper platform on liquid medium (right). (D) Different stages of STG rootstock seedlings, also showing a new sprout regenerated from the grafted shoot-tip (right). (E) Two new shoots of Hong China sweet orange regenerated from ST in triangular hole (left) and V-shaped incision (right) of rootstock seedlings one month after micrografting. (F) A new sprout from ST in triangular hole on rootstock.

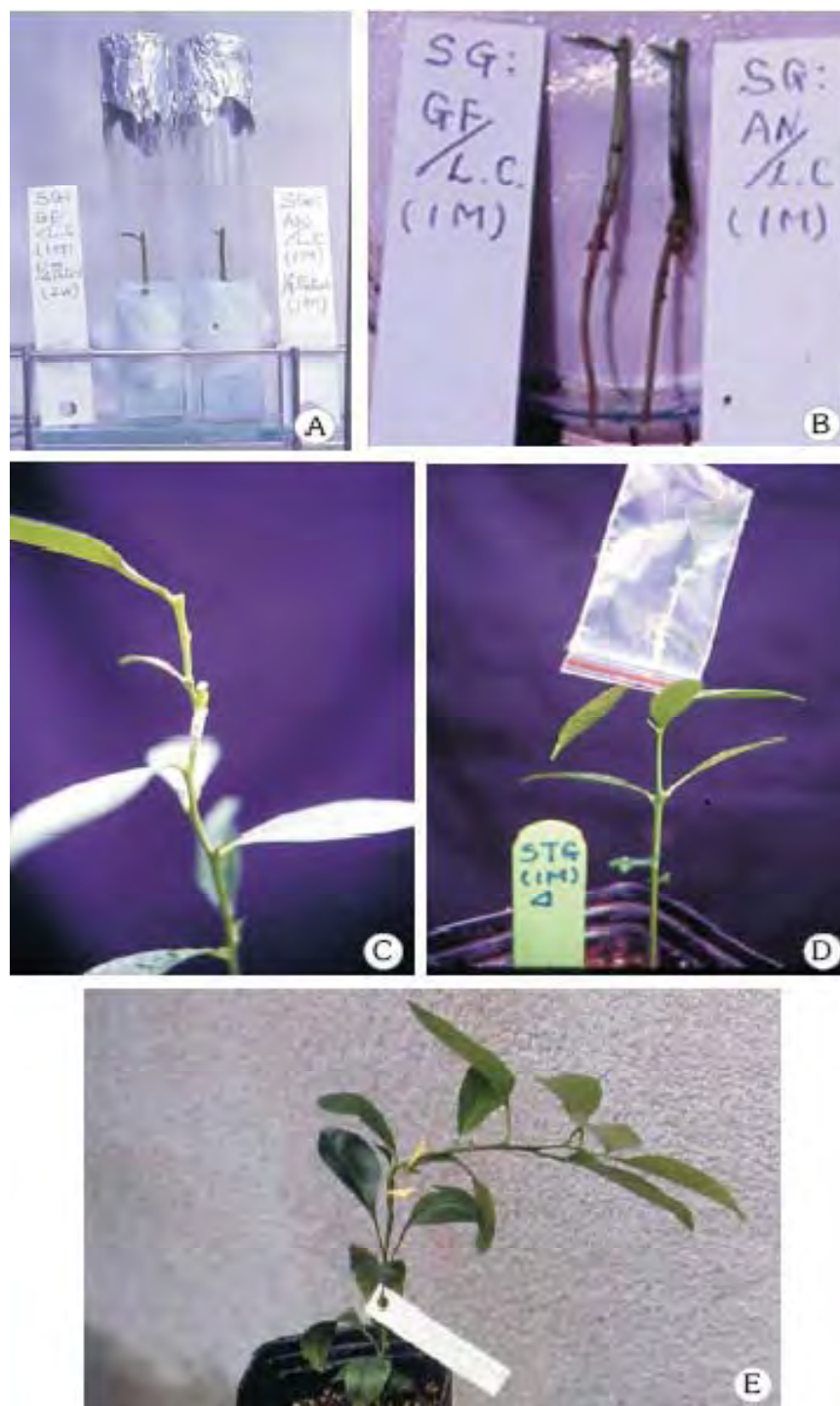


Fig. 35. The procedure of double grafting with micrografted rootstock seedlings as scion. (A) Sprouting of micrografted seedlings in test-tube culture. (B) Two STG seedlings with sprouts taken out from test tubes for secondary grafting. (C) A potted vigorous rootstock seedling side-grafted with a scion from the STG-seedling. (D) The grafted part of rootstock seedling covered with a mouth-sealed plastic bag. (E) A new mature twig grown from the double grafted rootstock three months after double grafting.

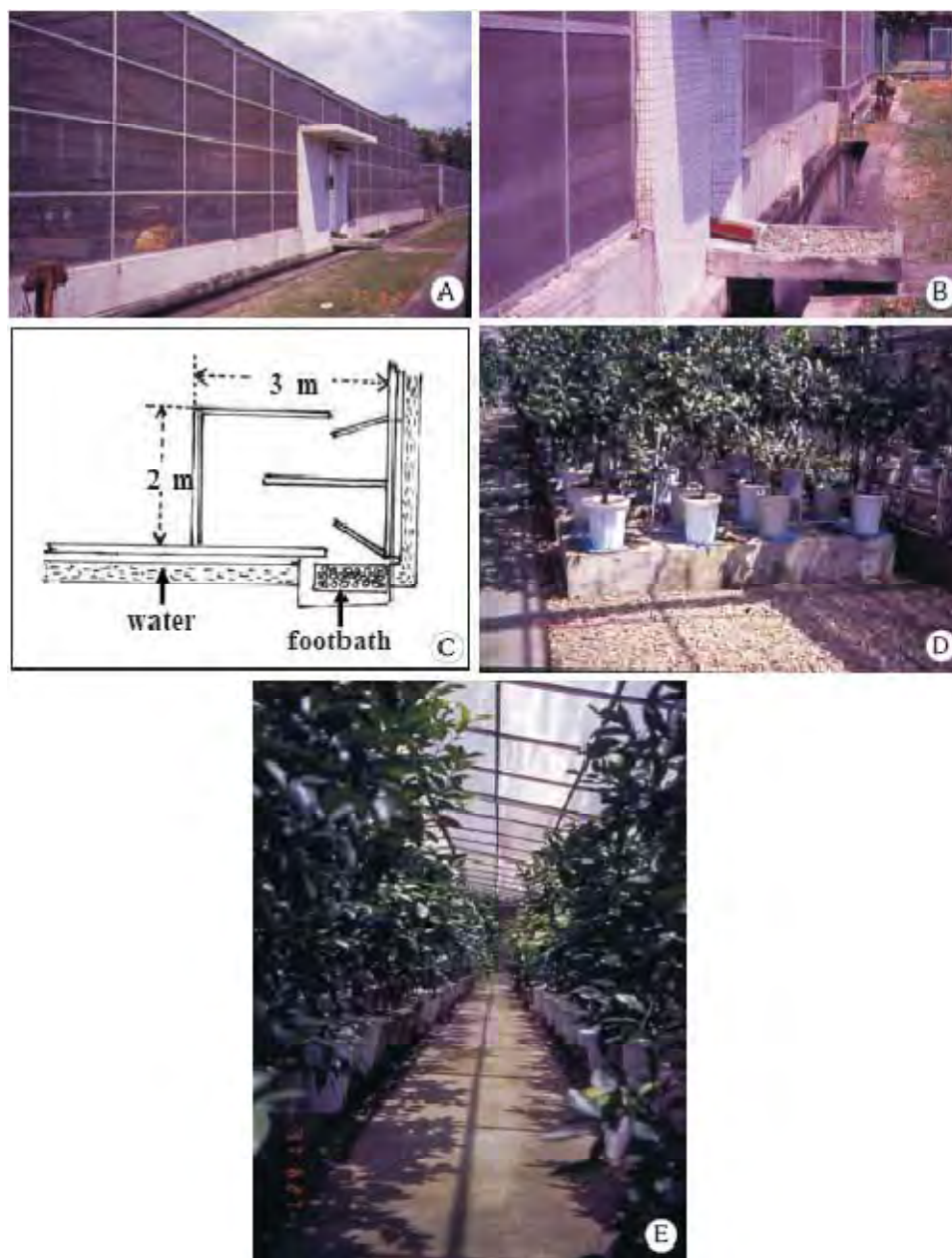


Fig. 36. National repository for maintaining the certified pathogen-free citrus foundation blocks. (A) Insect-proof stainless screen-house surrounded by water canal (arrow head) and with double doors. (B) Close-up picture of the entrance with double doors. (C) Drawing of an entrance with double door, and footbath containing gravels mixed with copper sulfate solution. (D) Inside view of the screen house showing healthy foundation trees on concrete benches on gravel floor. (E) Certified budwood increase trees grown in a screen house attached to the foundation depository.



Fig. 37. Production of PF citrus seedlings in screen houses by private nurseries. (A) Cultivation of rootstock seedlings in seedling tubes (arrow), the secondary transplanting in large plastic containers (upper left plants), and budded plants prepared by grafting clean bud or scion onto rootstock seedlings (right). (B) A well-grown budded nursery plant in container, ready for transplanting to the field.



Fig. 38. Rehabilitation of citrus orchards planted with PF seedlings. Cultivation of pathogen-free pummelo seedling (A) and Ponkan mandarin seedlings (B) in an orchard. 2 years-old PF Wentan pummelo and Ponkan tree began fruiting. Dr. Garnsey and author stand by Ponkan tree in the center (B). (C) Luxuriant growth of 3-year-old sweet orange trees in an orchard planted with PF seedlings. (D) Normal bearing of fruits of high yield on the 3-year-old PF trees in the orchard as shown in the picture (D) with the author and grower.



Fig. 39. Biocontrol of vector psylla/psyllids by natural enemy, Eulophid wasp (*Tamarixia radiata*). (A) Ectoparasitism of a wasp nymph on a psyllid. (B) A wasp adult laying egg on psyllid nymph. (C) Field releasing of cultured Eulophid wasps on jasmine orange shrub.

Fig. 40. Chemotherapy of HLB-diseased citrus tree by antibiotic injection. (A) Injection of 2~4 L of 1000 ppm Achromycin with a air-pressured injector to the basal portion of trunk (←). (B) A cordless battery-driving drill (Bosch), and a wood-type needle for drilling injecting hole. (C) Diagram of air pressure plastic injector.







Fig. 41. Recovery of HLB-affected pummelo tree injected with Acromycin. (A) HLB-affected pummelo tree with yellow mottling symptoms before injection. (B) Acromycin treated tree showing normal growth.

**REFERENCES (I)**

- Matsumoto, T Wang M, Su HJ. 1961. Studies on Likubin. In W. C. Price (ed.) Proc. 2 nd Conference of the International Organization of Citrus Virologists (IOCV). University of Florida Press. Gainesville. PP. 121-125.
- Matsumoto T, Su HJ, Lo TT. 1968. Likubin. PP 63-67. In USA Agriculture Handbook No. 333. Indexing Procedures for 15 virus Disease of Citrus Trees.
- Su, HJ. 1970 Further study on the pathogen complex causing Likubin of citrus. Plant Protection Bul. 12:190 (Abstract in Chinese).
- Su HJ, Leu SC. 1972. Study on the pathogen complex causing Likubin of citrus in Taiwan I. Nature of mycoplasma-like organism associated with the disease. Proc. National Science Council No. 5 P. 109-126.
- Su HJ, Chang SC. 1974. Electronmicroscopical study on the heat and tetracycline response and ultrastructure of the pathogen complex causing citrus Likubin disease. Proc. 8th Intern. Congress Electron Microscopy 2:628-629.
- Su HJ, Chang SC. 1976. The response of the Likubin pathogen to antibiotics and heat therapy. PP. 27-34. In E. C. Calavan, (ed). Proc. 7th Conference of IOCV, University of California, Riverside.
- Su HJ, Wu RY. 1979. Preliminary study on the etiology of Wentan pummelo decline. Nath. Sci. Counc. Sym. 1:45-57
- Huang CH. et al. 1982. Transmission trial of Likubin pathogen by citrus psyllid. Plant Protection Bull. 12:190 (Abstract in Chinese).
- Su HJ, Chu JY. 1984. Modified technique of citrus shoot-tip grafting and rapid propagation method to obtain citrus budwoods free of citrus viruses and Likubin organism. Pr.c. Int. Soc. Citriculture 2:332-334.
- Su HJ. 1986. Citrus Greening Disease. Extension Leaflet Published by the Food and Fertilizer Technology Center (FFTC) for ASPAC, Taipei, Taiwan.
- Chien CC, Chiu SC, Ku SC. 1987. Mass Rearing and Field Release of An Eulophid Wasp, *Tamarixia radiata* Waters. Extension Leaflet No. 5, published by the Food and Fertilizer Technology Center (FFTC) for ASPAC, Taipei, Taiwan.
- Huang An-Li. 1987. Electronmicroscopical Studies on the Morphology and Population Dynamic of Fastidious Bacteria Causing Citrus Likubin. In H. J. Su (Advisor), Ph. D. Thesis, NTU. 148pp.
- Chien CC, Chiu SC, Ku SC. 1989. Biological control of *Diaphorina citri* in Taiwan. Fruit 44: 401-407.
- Su HJ, Hung TH, Tsai MC. 1991. Recent developments and detection of citrus greening disease. Proc. 6th Int. Asia Pacific Workshop on Integrated Citrus Health Management, Kuala Lumpur, Malaysia, pp 24-30.
- Hung TH. 1994. Preparation and application of diagnostic DNA probes to ecological studies on the fastidious bacteria causing citrus greening. In H. J. Su (Advisor), Ph. D. Thesis, NTU. 258pp.
- Hung TH, Wu ML, Su HJ. 1999. Detection of fastidious bacteria causing citrus greening disease by nonradioactive DNA probes. Ann. Phytopathol. Soc. Jpn. 65:140-146.
- Hung TH, Wu ML, Su HJ. 1999. Development of a rapid method for the diagnosis of citrus greening disease using the polymerase chain reaction. J. Phytopathology 147, 599-604.
- Hung TH, Wu ML, Su HJ. 2000. Identification of alternative hosts of the fastidious bacterium causing citrus greening disease. J. Phytopathology 148, 321-326.

- Hung TH, Wu ML, Su HJ. 2001. Identification of the Chinese box orange (*Severinia buxifolia*) as an alternative host of the bacterium causing citrus Huanglongbing. *European Journal of Plant Pathology* 107: 183-189.
- Hung TH, Hung SC, Chen CN, Hsu MH, Su HJ. 2004. Detection by PCR of *Candidatus Liberibacter asiaticus*, the bacterium causing citrus huanglongbing in vector psyllids: application to the study of vector-pathogen relationships. *Plant Pathology* 53: 96-102
- Hung, Shi-Cheng. 2006. Ecology and vectorship of the citrus psyllid in relation to the prevalence of citrus Huanglongbing. In Ph. D. Thesis, NTU. 164pp.
- Su HJ. 2006. The current measures and perspective of controlling citrus greening disease (HLB) in Taiwan (Abstract) p30 Procd. The International Workshop for Prevention of Citrus Greening Disease in Severely Infested Areas. Dec. 2006, Ishigaki, Japan.
- Tsai Chia-Hsin. 2007. Pathogen Strains, Disease Ecology and Chemotherapy of Citrus Huanglongbing. In H. J. Su (Advisor), Ph. D. Thesis, NTU. 150pp.
- Su HJ. 2008. Production and Cultivation of Pathogen-free Citrus Saplings for Citrus Rehabilitation in Taiwan. pp 51. Published by Asia-Pacific Consortium on Agricultural Biotechnology and Asia Pacific Association of Agricultural Research Institutions (APAARI) C/O FAO Regional Office for Asia and the Pacific, Bangkok, Thailand.
- Tsai CH, Huang TH, Su HJ. 2008. Strain identification and distribution of citrus Huanglongbing bacteria in Taiwan. *Botanical Studies* 49: 49-56.

## REFERENCES (II)

- Aubert B. 1987. *Trioza erytreae* Del Guercio and *Diaphorina citri* kuwayama (Homoptera: Psylloidea), the two vectors of citrus greening disease: Biological aspects and possible control strategies. *Fruits* 42:149-162.
- Aubert B, Duilici S. 1984. Biological control of the African and Asian citrus psyllids, through eulophid and encyrtid parasites in Reunion island. PP. 100-108. In Garnsey, S. M., L. W. Timmer, Dodds JA. (eds.) Proc. 9th Conference of IOCV. Univ. Calif. Riverside.
- Bové JM, Saglio P. 1974. Stubborn and greening: a review. PP. 1-11. In Weather, L. G. and M. Cohen (eds) Proc. 6th Conference of IOCV. Univ. Calif. Riverside.
- Bové JM. 2006. Huanglongbing: a destructive, newly-emerging, century-old disease of citrus.
- Cheng, C. P. 1943. Studies on 'Huanglongbing' of Chaukan tangor. *Jour. New Agr.* 3:142-172 (In Chinese).
- Etienne J, Aubert B. 1980. Biological control of psyllid vectors of greening disease or Reunion island. PP. 118-121. In Calavan, E. C., S. M. Garnsey and L. W. Timmer. (eds.) Proc. 8th Conference of IOCV, University of California, Riverside.
- Garnier M, Bové JM. 1983. Transmission of the organism associated with citrus greening disease from sweet orange to periwinkle by dodder. *Phytopathology* 73: 1358-1363.
- Garnier M, Bové JM. 1993. Citrus greening disease and the greening bacterium. PP. 212-219. In Moreno, P., da Graca, J. V., and Timmer, W. L. (eds.) Proc. 12th Conference of IOCV. Univ. Calif. Riverside.
- Garnier M, Bové JM. 1996. Distribution of the Huanglongbing (Greening) *Liberobacter* species in fifteen African and Asian countries. PP. 388-391. In da Graca, J. V., P. Moreno and R. K. Yokomi. (eds). Poc. 13th Conference of IOCV. Univ. Calif. Riverside.
- Garnier M, Danel N, Bové JM. 1984. The greening organism is a Gram negative bacterium. PP 115-124. In Garnsey, S. M., L. W. Timmer and J. A. Dodds (eds). Poc. 9th Conference of IOCV. Univ. Calif. Riverside.

- Garnier M, Latrille J, Bové JM. 1976. *Spiroplasma citri* and the organism associated with Likubin: Comparison of their envelope systems. PP. 13-17. In Calavan, E. C. (ed.) Proc. 7th Conference of IOCV. Univ. Calif. Riverside.
- Jagoveix S, Bove JM, Garnier M. 1994. The phloem-limited bacterium of greening disease of citrus is a member of a subdivision of the Proteobacteria. *Int. J. Sys. Bacteriol.* 44:379-386.
- Lopes SA, Martins EC, Frare GF. 2005. Detecção de *Candidatus Liberibacter americanus* em *Murraya paniculata*. *Summa Phytopathologica* 31:48-49.
- Miyakawa T, Tsuno. 1989. Occurrence of citrus greening disease in the Southern islands of Japan *Annals Phytopathological Society of Japan.* 55:667-670.
- Moll JN, Van Vuuren SP, Milne DL. 1980. Greening disease, the South Africa situation. PP 109-119. In Calavan, E. C., S. M. Garnsey and L. W. Timmer. (eds.) Proc. 8th Conference of IOCV. Univ. Calif. Riverside.
- Murashige T, Bitters WP, Rangan TS, Roistacher CN, Holliday BP. 1972. A technique of shoot apex grafting and its utilization towards recovering virus-free citrus clones. *HortScience* 7:118-119.

INTERNATIONAL RESEARCH CONFERENCE  
ON HUANGLONGBING



**Session 1:**  
**Current HLB**  
**Situation and**  
**Concerns Regarding**  
**Asian Citrus Greening**  
**and the Asian Citrus**  
**Psyllid**

Orlando, Florida



December 2008

## 1.1 Current HLB Situation and Industry Perspective in Asia

Beattie G.A.C. and Holford P.

Centre for Plant and Food Science, University of Western Sydney, Locked Bag 1797, Penrith South DC, New South Wales 1797, Australia. Email: [a.beattie@uws.edu.au](mailto:a.beattie@uws.edu.au), [p.holford@uws.edu.au](mailto:p.holford@uws.edu.au).

Historical records suggest that citrus production in Asia was first affected by huanglongbing in India, possibly as early as the mid 1700s, but certainly by the early 1900s. The disease then spread to Southeast Asia, initially to mainland China (probably in the early 1930s), then to Taiwan, Indonesia, the Phillipines (in the late 1940s and early 1950s), and then to Malaysia, Thailand and Việt Nam (after 1970). Since the 1980s, the disease has had a devastating impact on citrus production in these and other countries in the region, despite heavy use of insecticides, in some instances 'cocktails' applied as frequently as 52 times a year. The impact of the disease is most severe in tropical regions with no distinct winters, and is generally less severe in regions with very hot summers, and also with increasing latitude and altitude, particularly in regions with cold winters. These differences are related to the impact of climate on disease development in trees, and the incidence of the Asiatic citrus psyllid (*Diaphorina citri* Kuwayama). HLB pathogen-free trees are used in some regions, but such plants cost more than trees produced in open nurseries, or by marcotting (air-layering). Diseased trees are rarely removed when symptoms of the disease are first noticed, or thereafter. In some regions, trees may not bear fruit, and in many instances the productive life of an infected tree is less than 6 years. The benefits of heavy pesticide use are questionable. Most sprays are not applied effectively, and the efficacy of soil and trunk applications of systemic insecticides is over-rated. Effective management is often limited by low market prices for fruit (i.e., when production costs exceed income). The future of many industries requires better market returns, cost-effective production of pathogen-free trees in numbers that meet demand, development of strategies to slow the ingress of the vector into orchards (e.g., use of plants that produce repellent volatiles), efficient scouting for, and removal of, infected trees, and effective extension (which is sadly lacking). It may be feasible, with effective quarantine, to destroy existing industries in some areas (e.g., the island of Hainan) and then re-establish them.

## 1.2 Current HLB situation and Citrus producer's perspective in South America

<sup>1</sup>Monteiro C.P.

<sup>1</sup>Citrus Producer, Catanduva, Brazil.

### HLB current situation

Brazil is the only country in South America, where HLB has been detected. The disease is present in the states of São Paulo, Minas Gerais and Paraná (fig. 1).

Fig.1. South America – Brazil – States of Paraná, São Paulo, Minas Gerais



The presence of HLB in Brazil was first confirmed in July 2004, in the region of Araraquara, State of São Paulo. At that time, 46 municipalities were found to have symptomatic trees.

The disease is caused by the bacteria *Candidatus Liberibacter asiaticus* and *Candidatus Liberibacter americanus* and it has been proved that the Asiatic psyllid (*Diaphorina citri*) is the vector of both *Ca. L. asiaticus* and *Ca. L. americanus*.

The first survey was done by Fundecitrus in October 2004 which confirmed the presence of HLB in 98 municipalities in the State of São Paulo, with 3.4% of the blocks affected. At that time, HLB was restricted to the center and south of the state and also found in one municipality in the State of Minas Gerais.

A second survey for HLB in September 2007 confirmed the disease in 12.9% of the blocks, and that it was still restricted to the center (19.28%) and south (18.15%) of Sao Paulo State.

The third and latest survey in April 2008 revealed 18.57% of the blocks with HLB present in at least one symptomatic tree and the disease, at this point, had spread to all citrus production regions of the state. Because this survey was done without using platforms, it was expected that the level of infection could be twice as much. In the center of the state, where the disease was first found, nearly 100% of the blocks were affected with HLB.

### Spatial data analysis

Using *Kriging* estimation, a geostatistical analysis was done on the third survey data to estimate the exposure of the groves to HLB in the citrus production regions of the state. It was found that 79.2 million trees (41% of the total state citrus trees) are located in municipalities which have at least 30% of the blocks affected with HLB. Those trees, therefore, are highly exposed to the disease and considered to be at high risk of infection in the short term.

Fig.2. Estimated HLB exposure in citrus production regions of São Paulo

Region	Trees (million trees)	% Blocks with HLB *	
		<30%	≥30%
Center	65.895	40%	60%
South	71.576	45%	55%
North	40.438	100%	0%
Northwest	14.504	100%	0%
<b>Total</b>	<b>192.413</b>	<b>113.227</b>	<b>79.187</b>
<b>Trees</b>		<b>59%</b>	<b>41%</b>

\* Municipalities average % of block with HLB

The center of the state has the highest density of citrus groves and 26.7% of the citrus blocks infected with HLB. This situation leads to faster spread of HLB than in any other citrus production area. Therefore, the proximity of the groves and the level of infection are important factors that should influence the producer's behavior and attitude in relation to HLB control measures.

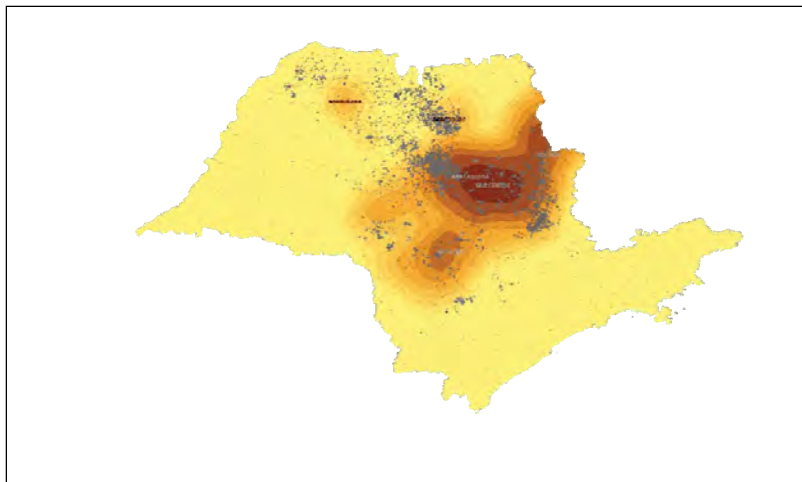


Fig.3. Kriging estimation of HLB spread in Sao Paulo State – Fundecitrus's Oct 2008 - survey data

### **Growers' Strategies**

The main factors that affect the grower's strategies for control of HLB are: the grove location, the age and size of the grove, technology level, access to information and the costs of production.

Although the majority of the growers have their own scouting crew, there are just a few growers performing exclusive and routine HLB inspections. Also, other practices such as use of platforms, inspection training programs and prompt elimination of symptomatic trees are adopted by only a few growers and large companies. The control programs for psyllids are also deficient in many instances and the average grower is still far behind in use of the best practices and precautionary measures. Contributing to this lack of implementation is the additional operation costs of HLB management which averages about US\$560/hectare, including pesticides (55%), labor (23%) and machinery (22%).

### **Legislation and Official Support**

In March 2005, the Brazilian Ministry of Agriculture published a Normative Instruction mandating the elimination of all citrus plants showing HLB symptoms as well as *Murraya paniculata*. Since May 2005, the Vegetal Defense Coordination of Agriculture Secretary of São Paulo State, in collaboration with Fundecitrus and Centro Apta Citros *Sylvio Moreira* has conducted the control program for HLB.

In October 2008, a new and more strict Normative Instruction was published by the Ministry of Agriculture, mandating the grove inspection every 3 months and a grower's report of the disease situation every 6 months. Under this new normative instruction, the blocks found to have more than 28% of trees infected with HLB, must be completely and promptly eradicated.



In addition to this legislation, since 2003, there has been an existing mandatory program to produce nursery trees under screen protected structures to prevent HLB and citrus canker infections. Finally, the research network in São Paulo, with coordination from Fundecitrus, increases the chance of success for developing a more effective program for controlling HLB in Brazil.

In support of all these efforts, Fundecitrus and the Agriculture Secretary of São Paulo State have launched a communication campaign on TV, radio, and in technical magazines to call grower attention to the need for adoption of proper control measures.

## Conclusion

From the producers' perspective, the challenges for control and suppression of HLB spread in Brazil can be summarized as the following:

Better understanding of the disease and its consequences is required

Control of the insect vector should be year round for effective disease management

IPM control of psyllids is not yet not practical

Regional control of psyllids has not yet been implemented

Disease and psyllid surveillance and tree removal are expensive

HLB has a long latent period

Disease risk is high for planting/replanting new citrus groves in highly infected areas

To face these challenges, the producers are counting on comprehensive support from the state and federal authorities, the research community, as well as fellow producers that includes: HLB-free nursery trees production, removal of abandoned groves and host species, advertising and educational programs for growers, legislation enforcement, improvement of HLB detection methods, better management practices for psyllids including new and more efficient insecticides, HLB resistant varieties, and educational programs for acceptance of GMO juice products in the international market.

## Literature cited

1. Ayres AJ. 2006. Actual situation of HLB in São Paulo State, Brazil. Proc.of the Huanglongbing – Greening – International Workshop, Ribeirão Preto, Brazil, 11.
2. Andrade AG. 2008. The use of neural network, geostatistics and geographical information system on study of citrus disease epidemics. Thesis – FCAV/UNESP, Jaboticabal, Brazil.

# INTERNATIONAL RESEARCH CONFERENCE ON HUANGLONGBING



## Session 2: HLB Survey

Orlando, Florida



December 2008

## 2.1 Current situation of citrus Huanglongbing in Cuba

**Llauger R.**<sup>1</sup>, Luis M.<sup>1</sup>, Collazo C.<sup>1</sup>, Peña I.<sup>1</sup>, González C.<sup>1</sup>, Batista L.<sup>1</sup>, Teixeira D.<sup>2</sup>, Martins E.<sup>2</sup>, Perdomo A.<sup>3</sup>, Casín J.C.<sup>4</sup>, Pérez J.L.<sup>5</sup>, Cueto J.R.<sup>1</sup> and Bové J.M.<sup>6</sup>

<sup>1</sup>Research Institute on Tropical Fruit Culture, Playa, Havana, Cuba; <sup>2</sup>Fundecitrus, Araraquara, SP, Brazil, <sup>3</sup>Jagüey Grande Citrus Enterprise, Jagüey Grande, Matanzas, Cuba; <sup>4</sup>National Center for Plant Health, Plaza, Havana, Cuba; <sup>5</sup>Fruit Enterprises Group, Boyeros, Havana, Cuba, <sup>6</sup>Centre INRA, Institut National de la Recherche Agronomique and Université de Bordeaux 2, France.

Huanglongbing, one of the most devastating diseases of citrus worldwide, has recently been detected in Cuba. The disease is caused by a Gram negative  $\alpha$  Proteobacteria of the *Candidatus* (*Ca.*) *Liberibacter* (*L.*) genus. It is phloem limited and does not grow in culture. The African type of the disease is caused by *Ca. L. africanus*, a thermosensitive species of the bacteria that is transmitted by the *Trypza erytrae* Del Guercio (Bové, 2006) psyllid. *Ca. L. asiaticus* is the most severe species; it is heat-tolerant and of the two is the most widely distributed species. Additionally *Ca. L. americanus*, another thermosensitive species, and a phytoplasma from the group IX 16S rRNA, have been detected and associated with the disease symptoms exclusively in the state of Sao Paulo, Brasil (Teixeira *et al.*, 2005; 2008; Lopes, *et al.*, 2008). Transmission occurs by grafting or is vectored by psyllid insects. *Diaphorina citri* Kuwayama, a vector of both the Asian and American *Liberibacter* species, has been present in Cuba since 1999 and has spread all over the country (González *et al.*, 2007). In 2007, *Ca. L. asiaticus* was reported in Cuba in urban areas of La Habana City. After its detection, surveys were carried out in the western, central and eastern parts of the country, as well as in residential areas of the capital to determine the extent of the disease in different geographic areas.

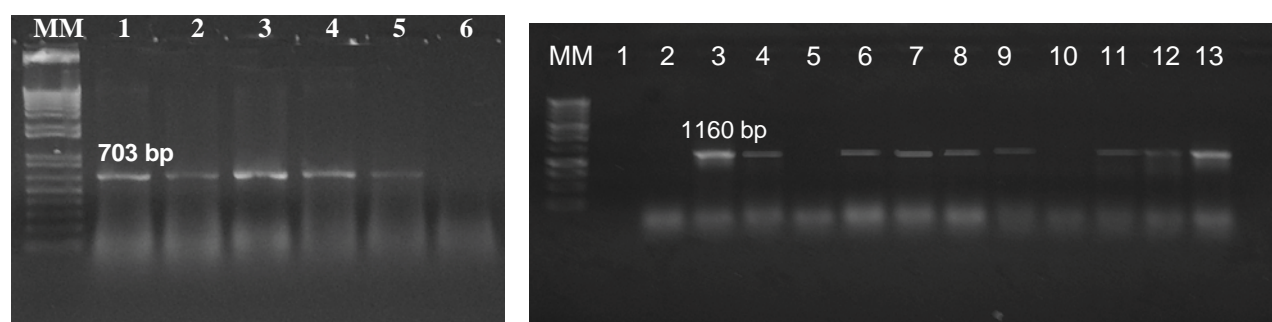
To confirm the presence of the bacteria in different citrus species, 127 symptomatic trees from the following species: grapefruit (*Citrus paradisi* Macf.), Persian lime (*C. latifolia* Tan.), tangerine (*C. reshni* Hort. and *C. tangerina* Hort.), *C. macrophylla* Webs., *C. volkameriana* Tan. & Pasq, Mexican lime (*Citrus aurantifolia* Christm. Swing.), pummelo (*C. grandis* L.) and sour orange (*C. aurantium* L.) were sampled. The trees had yellow shoots, asymmetric leaf mottling, some with chlorotic or corky veins and, in more advanced stages, nutritional deficiencies (Zn and Mn). In these plants some fruits were lopsided and showed color inversion or rounded diffuse spots, yellow vascular bundles, and aborted brownish seeds. In some trees, symptoms were present in part of the canopy, while in others the whole canopy was affected, showing dieback of the branches, suggesting that infection had occurred some time ago. Presence of *Candidatus* *Liberibacter* bacteria was confirmed by transmission electron microscopy.

Leaf DNA was extracted from 500 mg of central veins according to the CTAB protocol of Murray and Thompson (1980). Duplex PCR was performed using *rplA2/rplJ5/GB1/GB3* primers to identify *Ca. L. africanus*, *Ca. L. asiaticus* and/or *Ca. L. americanus* (Teixeira, *et al.*, unpublished data). The results showed the 703 pb band characteristic for *Candidatus* *Liberibacter* *asiaticus* in 95.3 % of the samples (Figure 1A). Amplification of the 16S rDNA was carried out using the *fOA1+fOI1/rOI2C* primers (Figure 1B) (Jagoueix *et al.*, 1996). The two-band pattern (640 and 520pb) characteristic of *Ca. L. asiaticus* obtained by enzymatic digestion

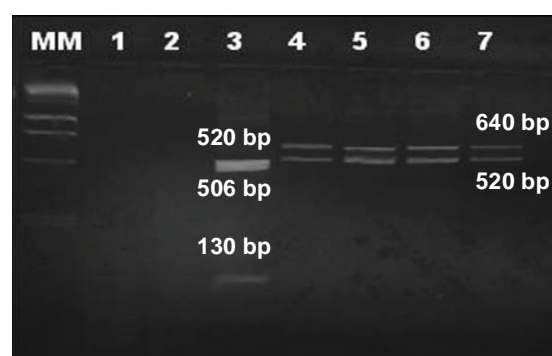
of the 1160 pb fragment using *Xba*I (Promega) was found in 121 of the analyzed samples, while for the *Ca. L. africanus* control a three-band pattern was observed (Figure 2).

Fragments of the *rplKAJL-rpoBC* operon amplified with the *rplA2/rplJ5* primers were cloned, sequenced and compared to the sequences published in international data bases. The highest percentages of identity were observed for the *Ca. L. asiaticus* isolates from Asia and Brazil, ranging from 99-100%.

For the detection of the bacteria inside the vector, 1-10 *Diaphorina citri* adult specimens were collected in symptomatic citrus plants. Presence of the bacteria was confirmed by PCR. Insect DNA was extracted according to the method described by Yamamoto *et al.*, 2006. In 21 of the 25 samples of insects studied, *Ca. L. asiaticus* was detected by two PCR reactions with the *rplA2/rplJ5* and *fOA1+fOI1/rOI2C* primer pairs, using the same protocol as for the leaf samples.

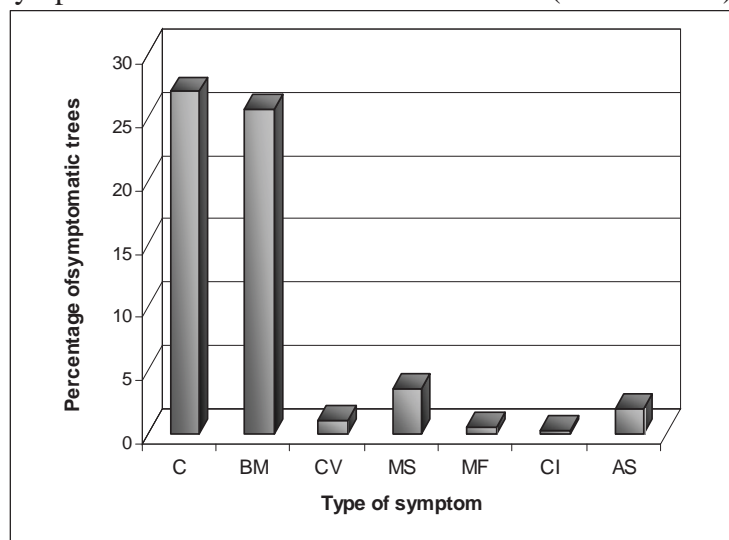


**Figure 1:** Electrophoresis on 1% Agarose gel. **A:** PCR products amplified with *rplA2/rplJ5*, GB1/GB3. MM: 1Kb DNA ladder (Promega), lane 1: Brazilian *Ca. L. asiaticus* positive control; lanes 2-5: samples of symptomatic citrus plants, lane 6: water. **B:** PCR products amplified with OI1/OA1/OI2c. MM: 1Kb DNA ladder (Promega). Lane 1: water, lane 2: negative control from a healthy plant, lane 3: *Ca. L. africanus* positive control, lane 4: *Ca. L. asiaticus* positive control from Brazil, lanes 5-13: symptomatic citrus samples.



**Figure 2:** Electrophoresis on 4% Agarose gel of the *Xba*I enzymatic digestion products of PCR using OI1/OA1/OI2c primers. MM: 1Kb DNA ladder (Promega). Lane 1: water; lane 2: healthy plant negative control; lane 3: *Ca. L. africanus* positive control; lane 4: Brazilian *Ca. L. asiaticus* positive control; lanes 5-7: symptomatic citrus samples.

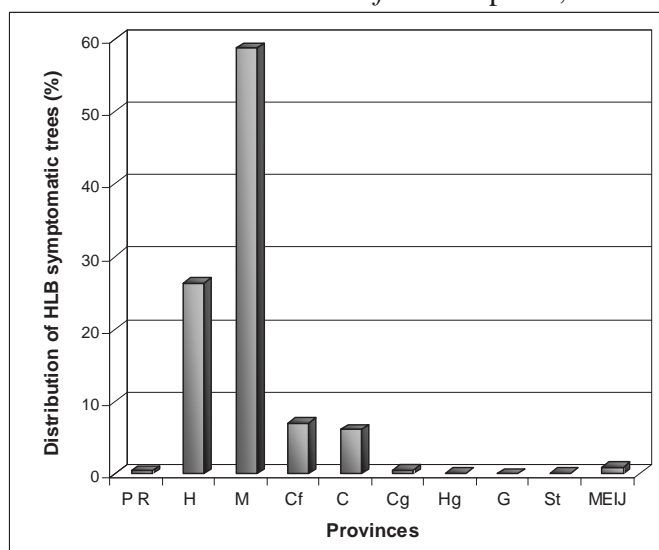
In the inspections carried out in orchards from different geographical areas of the country, 27% and 25.7% of the predominant symptoms found were intense chlorosis and asymmetric diffuse mottling of the leaves, respectively (Figure 3). In producing-trees, sometimes characteristic symptoms were also observed in the fruits (less than 5%).



**Figure 3** Percentage of plants showing different types of HLB associated symptoms with respect to the total symptomatic plants. C: leaves with intense chlorosis, BM: leaf asymmetric mottling, CV: corky veins, MS: misshapen fruits, MF: fruits with diffuse mottling, CI: fruits with color inversion, AS: fruits with aborted seeds.

Of the provinces surveyed, 58% of the total amount of plants with HLB symptoms were found in the province of Matanzas. A smaller number of symptomatic plants (less than 1%) were found in the provinces of Guantánamo, Santiago de Cuba and Holguín, located in the eastern part of the island, provinces that were farther away from the place where the insect vector was first detected.

Vector biology and behavior were studied by periodically observing young shoots of Valencia orange and Marsh grapefruit in orchards from different citrus areas. It was found that the developmental stages of *D. citri* tend to be distributed in an aggregated way. The highest population densities were observed during periods of new sprouting, with a preference for the leaf bundles, independent of the cardinal point. The highest rates of eggs and nymphs were found in La Habana during May and August; while for Cienfuegos, it was during January and May. *D. citri* had low population levels throughout the year in Isla de la Juventud, with increases in April, May and July. In Matanzas, a higher incidence was observed in January, April and May, with over 60% of nymphs. Climatic factors were found to affect the psyllid population behavior. The presence of natural enemies was studied as well for their effect on the vector. Of the list of biocontrol agents consisting of: *Cycloneda sanguinea* (L), *Chilocorus cacti* (L), *Exochomus cubensis* Dimn, *Scymnus distinctus* Casey, *Chrysopa* sp, *Ocyptamus* sp, *Tamarixia radiata* Waterston e *Hirsutella citrififormis* Speare, it was demonstrated that *T. radiata* has the leading



role in the natural control of *D. citri* in Cuba, according to its distribution, specificity and effectiveness for parasitism of the nymph stages N3, N4 y N5 (30,72% a 97,26%).

**Figure 4.** Distribution of HLB symptomatic citrus plants in the Cuban provinces. PR: Pinar del Río, H: La Habana, M: Matanzas,

Cf: Cienfuegos, C: Camagüey, Hg: Holguín, G: Granma, St: Santiago de Cuba, MEIJ: Isla de la Juventud Special Municipality.

At the present time, work is being carried out to determine HLB incidence in every citrus growing area in the country. Additionally a disease management program is being implemented that includes: periodical surveys in the commercial citrus areas, elimination of infected plants, use of certified material for planting, and control of *Diaphorina citri* by using insecticides to reduce its populations as well as the use of biological control with hymenopterous parasites, such as *Tamarixia radiata*.

## References

- Bové JM. 2006. Huanglongbing: A destructive, newly-emerging, century-old disease of citrus. *Journal of Plant Pathology* 88 (1): 7-37.
- González C, Gómez M, Fernández M, Hernández D, Tapia J-L, Batista L. 2007. *Diaphorina citri* Kuw. (Hemiptera: Psyllidae) Behaviour and natural enemies in Cuban citriculture. Program and Abstracts of the XVII IOCV, Adana, Turkey: 180.
- Jagoueix S, Bové JM, Garnier M. 1996. PCR detection of the two *Candidatus Liberobacters* species associated with greening disease of citrus. *Mol. Cel. Probes* 10: 43-50.
- Lopes SA, Frare GF, Bertolini E, Cambra M, Fernandes NG, Ayres AJ, Bové JM. 2008. Liberibacters associated with citrus Huanglongbing in Brazil: *Candidatus Liberibacter asiaticus* is heat tolerant, *Candidatus Liberibacter americanus* is heat sensitive. Submitted.
- Murray MG, Thompson WF. 1980. Rapid isolation of high molecular weight plant DNA. *Nucleic acids Res* 8: 4321-4325.
- Teixeira do Carmo, D., Saillard, C., Eveillard S., Danet, J.L., Ayres, A.J., Bové, J.M. 2005. “*Candidatus Liberibacter americanus*”, associated with citrus Huanglongbing (greening disease) in Sao Paulo state, Brazil. *International Journal of Systematic Evolution Microbiology* 55: 1857-1862.
- Teixeira do Carmo D, Wulff NA, Martins EC, Kitajima EW, Bassanezi R, Ayres J, Eveillard S, Saillard C, Bové JM. 2008. A phytoplasma closely related to the Pigeon pea witches’ broom phytoplasma (16Sr IX) is associated with citrus Huanglongbing symptoms in the State of São Paulo, Brazil. 2008. *Phytopathology*, 98: 977-984.
- Yamamoto PT, Teixeira DC, Martins EC, Santos MA, Felipe MR, Garbim LF, Carmo AU, Abrahao DP, Souza MC, Bové JM. 2006. Detection of *Candidatus Liberibacter americanus* and *asiaticus* in *Diaphorina citri* Kuwayama (Hemiptera: Psyllidae) In: Proceedings of Huanglongbing- Greening international workshop, Riberao Preto, Brasil: 87.

## **2.2 Data trends and results from an HLB testing laboratory that has processed over 64,000 commercial and research samples over a two year period in Florida.**

Irey M.<sup>1</sup>, Mai P.<sup>2</sup>; Graham J.<sup>3</sup> and Johnson J.<sup>3</sup>

<sup>1</sup>United States Sugar Corporation/Southern Gardens Citrus, Clewiston, FL;<sup>2</sup>United States Sugar Corporation, Clewiston, FL;<sup>3</sup>Univ. of Florida, CREC, Lake Alfred, FL.

Since the discovery of Huanglongbing (HLB) in Florida in 2005, the disease management procedures recommended by the University of Florida have included scouting and removal of infected trees, control of the psyllid vector, and the use of healthy material for replanting. Symptoms of HLB are easily confused with nutrient deficiencies and other non-HLB related problems. Additionally, in many cases, some grove managers and their employees are not skilled or confident enough in their ability to make a field diagnosis that would result in the roguing and destruction of trees in the grove. Thus, there is a need for laboratory testing to determine if trees are infected and also to train scouting crews to routinely and accurately make field HLB diagnoses that can be used to remove infected trees from groves. Additionally, many of the ongoing HLB projects require laboratory analysis of a large number of samples to confirm disease incidence and/or pathogen spread, latency and titer.

In October, 2006, United States Sugar Corporation/Southern Gardens Citrus Corporation opened its diagnostic laboratory to the Florida citrus industry for submission of samples for analysis by real-time polymerase chain reaction testing (RT-PCR). The samples are run free-of-charge and results are typically available to the grower in 2-4 weeks depending on the sample load at the laboratory. During the first two years of operation, 64,905 samples have been submitted and tested. These represented samples from over 1265 groves, over 200 different submitters, and 27 counties. Samples were received from commercial groves, commercial citrus nurseries, homeowners, state and federal researchers, University extension agents, and from the Florida Division of Agriculture and Consumer Services (FDACS) Bureau of Budwood Certification. As part of the sample submission process, sample information was requested from the submitter which included among other things, location, variety, age, and temporal information. These data (when provided) were entered into a database for future data mining.

Examples of the type of data that were gleaned from the database included incidence per county, % infection by month, varietal infection data, % infection by age category, bacterial titer over time, quality of commercial scouting crews, etc. For example, the highest infection levels were found in Early Gold, Hamlin, Parson Brown and Valencia sweet oranges and grapefruit while lower infection levels were found in Minneola and other tangelos and Midsweet, Navel, and Pineapple sweet oranges. The 6-9 year old age group of trees had the highest level of infection compared to other age groups. Similarly, trees 6-9 ft tall had the highest level of infection compared to other tree canopy sizes. If the number of samples submitted by month is used as a proxy for the prevalence of symptoms, then HLB symptoms were most prevalent from August through March and least prevalent from April through July. The percentage of total positive samples increased in July and declined in March, possibly indicating that the bacterial titer is highest during this time period and that the bacterial titer increases before diagnostic symptoms begin to appear.

### 2.3 Texas Steps Up Surveys for Huanglongbing and the Asian Citrus Psyllid

da Graça J.V.<sup>1</sup>, Skaria M.<sup>1</sup>, Sétamou M.<sup>1</sup>, Kunta M.<sup>1</sup>, Arredondo M.<sup>2</sup>, Salas B.<sup>2</sup>, Parker P.E.<sup>2</sup>

<sup>1</sup>Texas A & M University-Kingsville Citrus Center, Weslaco, TX USA; <sup>2</sup> USDA-APHIS-PPQ, Edinburg, TX, USA

The Asian citrus psyllid, *Diaphorina citri* Kuwayama, the vector of Huanglongbing (HLB), was first detected on orange jasmine and citrus in the Lower Rio Grande Valley (LRGV) of Texas in 2001 (French et al., 2001). When HLB was confirmed in Florida in 2005 (Halbert, 2005), surveys funded by USDA-APHIS-PPQ were initiated to determine the distribution of *D. citri* and whether HLB was present. In 2006, *D. citri* was recorded on citrus in 32 counties in southern Texas, extending from Valverde County in the southwest to Matagorda County on the Gulf coast, as well as in Harris County (including Houston) (da Graça et al., 2008). Over 300 leaf samples were analyzed for *Ca. Liberibacter asiaticus* by real-time PCR, but the bacterium was not detected in any. In addition, 50 *D. citri* samples were also analyzed, and one sample from Corpus Christi produced a borderline result for HLB, but not confirmed. A delimiting survey was nevertheless conducted in early 2007 in the Corpus Christi area, but no confirmation of *Ca. L. asiaticus* was obtained. In 2007, surveys continued, with a concentrated effort in Corpus Christi and Houston. No HLB was detected in any of the leaf and psyllid samples. Psyllids were found in one new county in 2007, Fort Bend, southwest of Houston. In 2008, two survey programs are being run. In one, surveys in the commercial orchards and counties outside the LRGV continue, led by the Citrus Center. In addition, an intensive survey of residential sites in the cities of the LRGV is being conducted by a 30-member team led by USDA-APHIS in which 72 trees/square mile are being selected as sentinel trees in 93 1-square mile blocks. The Citrus Center is now a certified HLB diagnostic laboratory, and suspect leaf and psyllid samples are being analyzed there. Thus far, psyllids have been found in nine new counties; of significance are Jefferson County in east Texas and Brazos County northwest of Houston, the most northerly psyllid find thus far. The other counties are all in southwest Texas. During the surveys up to October 2008, citrus has been recorded in 108 counties, and psyllids on trees in 56 of them (Fig. 1). Not all Texas counties have been surveyed.

#### Citations

- da Graça JV, French JV, Haslem PS, Skaria M, Sétamou M, Salas B. 2008. Subtrop. Plant Sci. 60:21-26
- French JV, Kahlke CJ, da Graça JV. 2001. Subtrop. Plant Sci. 53: 14-15.
- Halbert S. 2005. Proc. HLB-Greening Int. Workshop: 50.



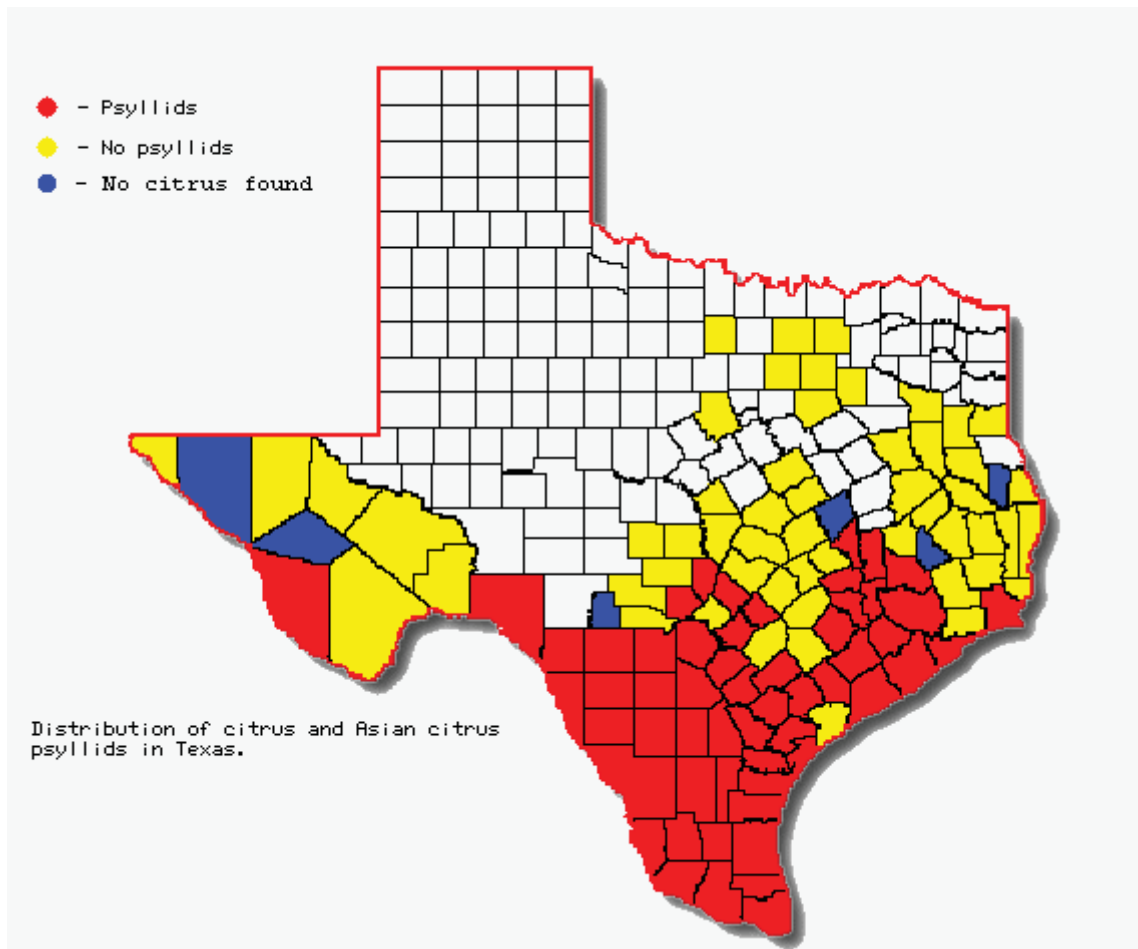


Fig 1. Map of Texas showing distribution of citrus and the Asian citrus psyllid during surveys (2006-08) by counties.

## 2.4 National Plan for the detection of HLB in Mexico

Robles G.P.<sup>1</sup>, Sánchez A.H.<sup>1</sup>, Méndez L.O.<sup>1</sup>

<sup>1</sup>Dirección General de Sanidad Vegetal-SENASICA-SAGARPA, México, D.F.

For Mexico, the detection of HLB in Sao Paulo, Brasil, Florida and Louisiana, USA and Cuba (Da Graca, 2008; Gomes, 2008), represents a serious threat for the 526 thousand hectares of citrus, that represents a production of 6.7 million tons/year, with a commercial value of US \$750 million (SIAP, 2006). The risk is increased due to the detection of the HLB vector, the Asian Citrus Psyllid (*Diaphorina citri*), in 2002 in the Yucatan Peninsula. Subsequent detections indicate that the psyllid is in every citrus growing region of the country (Trujillo et al., 2008; Trujillo, 2008). Because of this, Mexico has initiated the National Plan for the Detection of HLB.

**Objective.** Early detection of the presence of HLB in Mexico to be able to timely implement control activities.

**Action Area.** The 23 states in Mexico with citrus production (Baja California, Baja California Sur, Campeche, Colima, Chiapas, Guerrero, Hidalgo, Jalisco, Michoacán, Morelos, Nayarit, Nuevo León, Oaxaca, Puebla, Querétaro, Quintana Roo, San Luis Potosí, Sinaloa, Sonora, Tabasco, Tamaulipas, Veracruz and Yucatán).

**Activities.** The following activities will be carried out as part of the National Plan for the Detection of HLB:

- Detection surveys,
- Vector sampling and testing for *Candidatus Liberibacter* sp. Known to be associated with HLB
- Training technicians, surveyors, nursery managers and producers,
- Development of a public information program.

For a better understanding of the actions described in the plan, consult the Technical Manual for the Detection of the Citrus Huanglongbing: (<http://148.243.71.63/default.asp?id=1013>). Elements of the plan include:

**Determination of Risk for HLB Infection:** Part of the National Plan involves the assignment of a risk factor to the various citrus growing regions. Risk factors were established by taking into account the following factors:

1) distance to areas where the HLB is present, 2) presence of the vector, and 3) area of citrus under cultivation.

**Detection Surveys.** Priority will be given to orange and mandarin orchards, which are considered the most likely to be infected by the bacteria. Other aspects to take into account are:

- Young plant orchards (4 to 10 years old),
- Young orchards near to old ones, and
- Orchards near to water sources.

Once the orchards to survey have been selected, the surveyors will search for symptoms in the peripheral first five rows of the grove; the most common symptoms that will be looked for are: blotchy mottle, yellow shoots, yellow leaf vein, corky leaf veins, small and lopsided fruits, aborted seeds, irregularly colored fruit and “rabbit ears”.

**Detection surveys, collection of samples and diagnosis.**

- 1) If symptoms are detected by the surveyor: Pictures will be submitted to the DGSV (Plant Health).
- 2) DGSV will analyze them, and determine what action to take.
  - If the symptoms are not medium or highly suspicious, then DGSV will notify the surveyor that sampling is not needed.
  - If the symptoms are medium or highly suspicious, then DGSV will instruct the surveyor to collect samples.
- 3) Samples will be submitted to the Lab for diagnosis.

**Training of technicians, surveyors, nursery managers and producers.** This activity is being conducted by the technical personnel of the Auxiliary Organisms of Plant Health. These personnel were trained in Florida, in Sonora at the International Workshop of HLB and Asian Citrus Psyllid; in Tabasco at the National Workshop of the HLB, Leprosis, Canker and CVC; and in Nuevo León at the National Workshop for GPS Management.

**Vector sampling for diagnosis.** The adult psyllids will be collected and assayed to determine if they carry the HLB bacteria. Surveys will take place in the 23 states with citrus, with the survey intensity varying according to the risk level:

- In the States considered to be of high risk, a sample for psyllids will be taken every 50 ha,
- In the medium risk States, a sample will be taken every 100 ha, and
- In the low risk states, a sample will be taken every 300 ha.

Each sample is composed of 100 psyllids.

**Establishment of Sentinel sites.** In the high risk states, orchards will be selected (five per state) as sentinel sites. These orchards will have the following characteristics:

- Sweet orange,
- 4 to 10 years old, and
- Area of 50 ha or less.

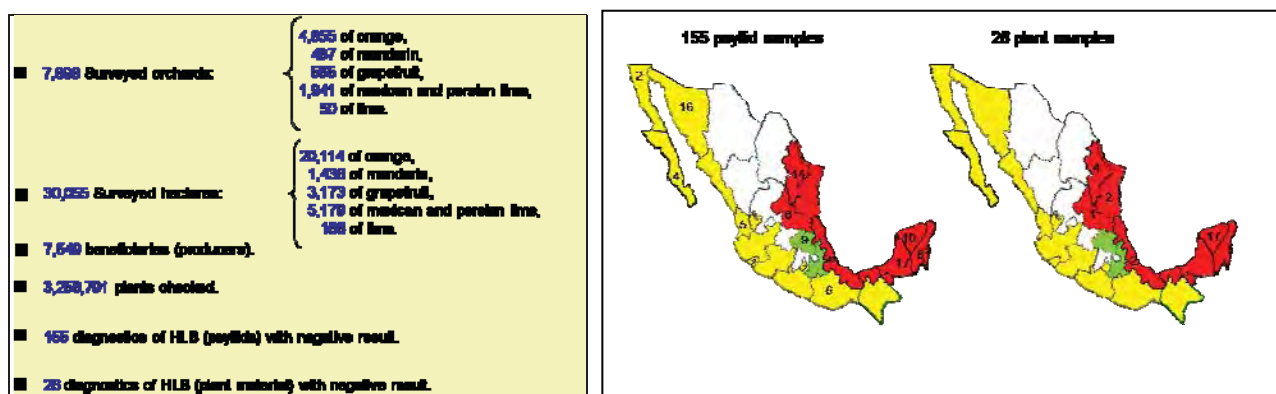
In the sentinel orchards, the following activities will be carried out: 1) survey of 100% of the trees every 2 months, and 2) psyllid sampling every 3 months.

**Diagnosis.** An official laboratory has been established that uses conventional PCR and Real Time PCR for detection. The technicians were trained by USDA/APHIS in Beltsville, Maryland, USA.

**Goals.** Goals for detection surveys, sampling and diagnosis have been established for each citrus producing state, based on the area in production and the available resources.

STATES	SURFACE CONSIDERED TO BE SURVEYED	SAMPLE COLLECTION FOR DIAGNOSIS						SURVEY PERSONNEL
		PLANT			PSYLLID			
		UNKNOWN	CS	TOTAL	UNKNOWN	CS	TOTAL	
1 BAJA CALIFORNIA	800	02	0	12	0	0	0	4
2 BAJA CALIFORNIA SUR	2,000	03	0	33	11	0	11	1
3 CAMPEC	1,000	02	0	38	02	12	14	0
4 CHIAPAS	270	00	0	50	00	0	35	2
5 COLIMA	1,000	17	0	17	03	0	23	7
6 GUERRERO	1,000	00	0	18	00	0	16	0
7 HIDALGO	700	0	0	0	4	0	4	0
8 JALISCO	300	00	0	15	00	0	15	4
9 MICHOACÁN	1,600	10	0	14	0	0	5	21
10 MORELOS	1,000	00	0	20	0	0	5	4
11 NAYARIT	300	00	0	10	00	0	10	0
12 NUYVOLA FOW	3,000	00	0	100	00	0	30	4
13 OAXACA	1,700	00	0	100	00	0	13	7
14 PUEBLA	2,000	00	0	34	00	0	24	7
15 QUERÉTARO	200	00	0	20	4	0	4	2
16 QUINTANA ROO	1,000	00	0	30	00	0	30	0
17 SAN LUIS POTOSÍ	1,000	0	0	0	0	0	10	0
18 SINALOA	2,000	00	0	50	00	0	10	4
19 SONORA	1,000	00	0	22	00	0	20	0
20 TABASCO	1,000	00	0	50	00	0	20	0
21 TAMAULIPAS	3,000	00	0	0	00	0	0	0
22 VERACRUZ	10,000	00	0	300	00	0	15	0
23 YUCATAN	2,000	00	0	55	00	0	30	0
<b>TOTAL</b>	<b>55,825</b>	<b>902</b>	<b>137</b>	<b>1,099</b>	<b>1390</b>	<b>07</b>	<b>1,465</b>	<b>150</b>

Summary of Activities to Date.



Da Craça, J.V. 2008. Biology, History and World Status of Huanglongbing. Proceedings of the Workshop on Huanglongbing (*Candidatus Liberibacter* spp.) and the Asian Citrus Psyllid (*Diaphorina citri*). May 7-9, 2008, Hermosillo, Son., Mexico.

Gomes, P. 2008. Confirmation of Huanglongbing or Citrus Greening ('*Candidatus Liberibacter asiaticus*') in Louisiana – United States (<http://www.pestalert.org>).

(SIAP) Servicio de Información Agroalimentaria y Pesquera. 2006. Anuario Estadístico (<http://www.siap.gob.mx>).

- Trujillo, A.J., Sánchez, A.H. y Robles, G.P. 2008. Current status of HLB and its vector in Mexico and perspectives. Proceedings of the Workshop on Huanglongbing (*Candidatus Liberibacter* spp.) and the Asian Citrus Psyllid (*Diaphorina citri*). May 7-9, 2008, Hermosillo, Son., Mexico.
- Trujillo, A.J. 2008. Detection of Asian Citrus Psyllid, *Diaphorina citri* Kuwayama (Hemiptera: Psyllidae), in Tijuana, Baja California, Mexico (<http://www.pestalert.org>).

## 2.5 Survey for “*Candidatus*” *Liberibacter* species in South Africa

Pieterse G.<sup>1,2</sup>, Kotzé A.<sup>1</sup>, Phahladira M.N.B.<sup>1</sup>, Schwerdtfeger M.<sup>1</sup>

<sup>1</sup>University of Pretoria, Pretoria, 0002, South Africa.

<sup>2</sup>Citrus Research International, P.O. Box 28, Nelspruit 1200 South Africa

Greening disease of citrus has been known in South Africa since the late 1920's and was shown to be caused by *Candidatus* *Liberibacter africanus* (Laf), a temperature-sensitive phloem-limited alpha-proteobacterium (Jagoueix et al., 1994; Korsten et al., 1993). In addition, a second *Liberibacter*, *Ca. L. africanus* ssp. *capensis* (LafC) was detected on an indigenous Rutaceous species, *Calondendrum capensis* (Cape Chestnut) in the Western Cape in 1995 (Garnier et al., 2000). The presence of a new *Liberibacter* species, *Ca. L. americanus* (Lam) found in Sao Paulo State, Brazil in 2004 (Texeira et al., 2005), and spread of the known *Ca. L. asiaticus* (Las) to Brazil, Cuba, and Florida, USA since 2004 (Coletta-Filho, et al., 2005; Knighten et al., 2005), prompted us to assess whether we only have Laf and LafC here. Samples displaying greening-like symptoms or related symptoms were collected from 279 citrus trees from 57 groves distributed throughout the citrus production areas of South Africa with the aid of local and international experts on the various *Liberibacter*s. Leaf material was also collected from 193 plants of various indigenous species of Rutaceae from various sites in South Africa. Total DNA extractions were performed on the samples and PCR conducted to detect the known *Liberibacter*s. None of the citrus samples yielded amplicons of 1027bp size which would have been indicative of Lam infection. Smaller amplicons were obtained from 197 citrus, and from 17 Cape Chestnut samples. The amplicons of all the Cape Chestnut samples and 112 citrus samples were sequenced to identify the *Liberibacter* species. Sequences obtained for citrus samples showed similarities ranging between 97.6% and 100% to the cognate Laf Nelspruit sequence in Genbank (U09675). No instance of Las or LafC was found on citrus. Conversely sequences of all Cape Chestnut samples had identities of 92 to 97% with that of LafC but Laf was not detected in any of the indigenous Rutaceous plants. While the incidence and geographic distribution of LafC in Cape Chestnut appears to be much wider than previously thought, it does not appear as though the epidemiology of Laf and LafC overlap significantly. Preliminary spatial distribution data also does not support significant movement of Laf from indigenous vegetation, although graft transmission of Laf to various indigenous Rutaceous hosts was demonstrated. To determine whether some variability in local Laf exists, a further PCR system, directed at the outer membrane protein (OMP) gene, known to be variable in Las (Bastianel et al., 2005) was used. No variations in sequence in this gene have thus far been obtained.

### Reference List

- Bastianel C, Garnier-Semancik M, Renaudin J, Bove JM, Eveillard S. 2005. Diversity of "Candidatus *Liberibacter asiaticus*," based on the omp gene sequence. *Applied and Environmental Microbiology* 71, 6473-6478.
- Coletta-Filho HD, Takita MA, Targon MLPN, Machado MA. 2005. Analysis of 16S rDNA Sequences from Citrus Huanglongbing Bacteria Reveal a Different "Ca. *Liberibacter*" Strain Associated with Citrus Disease in Sao Paulo. *Plant Disease* 89, 848.

- Garnier M, Jagoueix ES, Cronje PR, le Roux H, Bove JM. 2000. Genomic characterization of a *Liberibacter* present in an ornamental rutaceous tree, *Calodendrum capense*, in the Western Cape province of South Africa. Proposal of '*Candidatus Liberibacter africanus subsp. capensis*'. *International Journal of Systematic and Evolutionary Microbiology* 50, 2119-2125.
- Jagoueix S, Bove JM, Garnier M. 1994. The phloem-limited bacterium of greening disease of citrus is a member of the alpha subdivision of the Proteobacteria. *International Journal of Systematic Bacteriology* 44, 379-386.
- Knighten C, Redding J, Feiber D, Compton L. 2005. U.S. Department of Agriculture Confirms Detection of Citrus Greening. Dept. Press Release. 09-02-2005. [http://doacs.fl.us/press/2005/0902205\\_2.html](http://doacs.fl.us/press/2005/0902205_2.html)
- Korsten L, Sanders GM, Su HJ, Garnier M, Bove JM, Kotze JM. 1993. Detection of citrus greening-infected citrus in South Africa using DNA probe and monoclonal antibodies. *Proceedings of the 12th IOCV congress* 224-232.
- Texeira DC, Ayres J, de Barros AP, Kitajima EW, Tanaka FAO, Danet L, Jagoueix-Eveillard S, Saillard C, Bove JM. 2005. First report of a Huanglongbing-like disease of citrus in Sao Paulo State, Brazil and association of a new *Liberibacter* species, "*Candidatus Liberibacter americanus*", with the disease. *Plant Disease* 89, 107.

## 2.6 Large-scale distribution of *Diaphorina citri* Kuwayama and citrus Huanglongbing in Florida

Halbert S.E.<sup>1</sup>, Manjunath K.L.<sup>2</sup>, and Brodie M.W.<sup>3</sup>

<sup>1</sup>Florida Department of Agriculture and Consumer Services, Division of Plant Industry, P.O. Box 147100, Gainesville, FL 32614-7100, USA, <sup>2</sup> USDA/ARS, National Clonal Germplasm Repository for Citrus and Dates, 1060 Martin Luther King Blvd., Riverside CA 92508, USA, <sup>3</sup> Florida Department of Agriculture and Consumer Services, Division of Plant Industry, 6706 Lone Oak Blvd., Naples, FL 34109-6834.

*Diaphorina citri* Kuwayama was detected in 1998. We suspect that the insect was discovered within 6 months to one year of its establishment in Florida (Halbert et al. 2003). The original distribution was coastal, spanning three counties (Fig 1). It was distributed throughout the state primarily through migration, hitchhiking on its host plants, and retail trade in *Murraya paniculata* sold as ornamental plants (Halbert et al. 2003; Halbert 2008). Early surveys indicated that the initial psyllid population was free of huanglongbing associated bacteria.



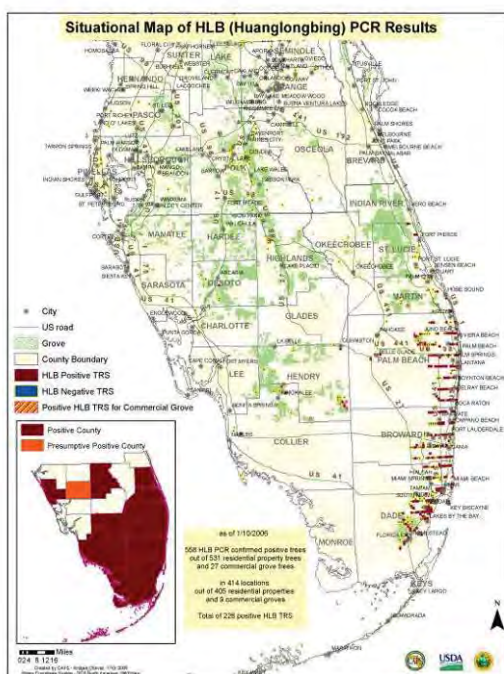
**Figure 1. Distribution of *Diaphorina citri* in Florida at the time of discovery in June 1998.**

Huanglongbing (HLB) was discovered in 2005. The initial delimiting survey found that the highest incidence of infection was in the SE urban areas of the state, suggesting that the disease spread began in South Miami-Dade County (Halbert 2008) (Fig 2.).

It took several months after the initial discovery of *D. citri* in Palm Beach County for the psyllids to be detected in Miami, and even longer for the insects to become abundant. Given our relatively firm date for the initial establishment of *D. citri*, we estimate that our HLB epidemic was at most six years old. It is possible that diseased plants already existed in Florida before the vector arrived, but the disease would be self-limiting without the vector.



Classic epidemiological data indicate that most psyllid vectors do not fly far (Gottwald et al. 1991a, b). Similarly, flight distances of approximately 1.5 km have been documented for *Trioza erytreae* (del Guercio) (van den Berg and Deacon 1998). However, we could not account for the extent of the observed distribution of HLB in Florida by short distance flights, as reported in the literature, combined with known movement of potted plants by residents.

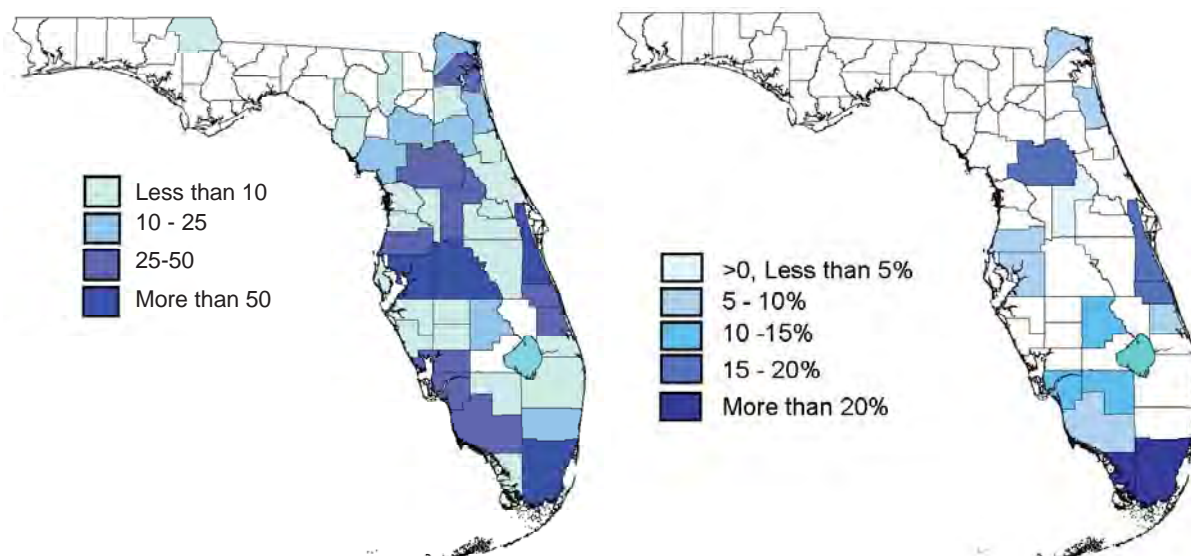


**Figure 2. HLB distribution at the time of the second (SW Florida) delimiting survey, January 2006. (Map: Andrea Chavez)**

Several other means of long distance distribution were postulated to explain the rapid range expansion of HLB in Florida. First, there is strong circumstantial evidence that *D. citri* sometimes can fly much farther than the literature would suggest. Eastern borders of large groves on the west side of the Florida Everglades had high incidence of HLB. The most likely source of inoculum is heavily infected urban areas on the east coast of Florida, approximately 70 km away, on the far side of the Everglades swamp.

At the time that HLB was becoming established, *Murraya paniculata* was one of the more popular landscape plants produced in Florida. Most of the production occurred in south Miami-Dade County, where the HLB epidemic was most intense. Unfortunately, there was no way to find out how many pots of *M. paniculata* traveled north, because they are counted together with other tropical foliage; however, it is safe to say that thousands of pots were sold. *Murraya paniculata* was found to be a host of Florida HLB bacteria (Zhou et al. 2007). We have found HLB-infected psyllid vectors, including nymphs, on *M. paniculata*. We also found infected psyllid vectors at a discount store near Florida's north-eastern border on *M. paniculata* plants that were traced to a Miami-Dade County nursery (Manjunath et al. 2008). Thus, it seems clear that HLB moved around Florida via trade in *M. paniculata* plants produced in Miami-Dade County.

HLB also moved by means of trade in retail citrus plants. We have tested nearly 800 psyllid samples from plants for sale for the presence of HLB by real time PCR (Manjunath et al. 2008). We use cycle threshold (Ct) of 30 as our cut-off point for a positive reading. Of the 782 psyllid samples tested so far, 8.6% were positive for HLB (Fig 3).



**Figure 3.** First map (left) shows numbers of *Diaphorina citri* samples collected on plants for sale by county. Second map (right) shows percent HLB-positive samples of *D. citri* collected on plants for sale by county.

By September 2008, confirmed infected plants had been found in 32 counties, and infected *D. citri* had been found in two more counties. Thus, huanglongbing spread approximately 540 km (320 mi) in 10 years after the initial discovery of psyllids in the state.

An incursion rate of 20 km (12 miles) per year is proposed in the literature for Brazil (Gottwald et al. 2007). We postulate that longer psyllid flights in the absence of host material and distribution of infected plants and infected insect vectors in retail trade may account for the rapid spread in Florida.

#### Literature Cited:

- Gottwald, T. R., Aubert, B. and Huang, M. D. 1991a. Spatial pattern analysis of citrus greening in Shantou, China. Pages 421-427 in: Proc. 11th Conference of the International Organization of Citrus Virologists. Brlansky, R. H., Lee, R. F. and Timmer, L. W., eds. University of California. Riverside.
- Gottwald, T.R., J.V. da Graça, and R.B. Bassanezi. 2007. Citrus huanglongbing: The pathogen and its impact. On line. Plant Health Progress doi: 10.1094/PHP-2007-0906-01-RV.
- Gottwald, T. R., Gonzales, C. I. and Mercado, B. G. 1991b. Analysis of the distribution of citrus greening in groves in the Philippine. Pages 414-420 in: Proc. 11th Conference of the International Organization of Citrus Virologists. Brlansky, R. H., Lee, R. F. and Timmer, L. W., eds. University of California. Riverside, CA.

- Halbert, S.E., C.L. Niblett, K.L. Manjunath, R.F. Lee, and L.G. Brown. 2003. Establishment of two new vectors of citrus pathogens in Florida. *Proceedings of the International Society of Citriculture* 9: 1016-1017.
- Manjunath, K.L., S.E. Halbert, C. Ramadugu, S. Webb, and R.F. Lee. 2008. Detection of 'Candidatus *Liberibacter asiaticus*' in *Diaphorina citri* and its importance in the management of citrus huanglongbing in Florida. *Phytopathology* 98: 387-396.
- van den Berg, M.A., and V.E. Deacon. 1988. Dispersal of the citrus psylla, *Trioza erytreae* (Hemiptera: Triozidae), in the absence of its host plants. *Phytophylactica* 20: 361-368.
- Zhou, L.-j., D.W. Gabriel, T.-p. Duan, S.E. Halbert, and W.N. Dixon. 2007. First report of dodder transmission of huanglongbing (greening) from naturally infected *Murraya paniculata* to citrus. *Plant Disease* 91: 227.

## **2.7 Is it possible to replant young groves in an area with endemic HLB – a hierarchical sampling approach to determine infection?**

Irey M.<sup>1</sup>; Gottwald T.<sup>2</sup>; Stewart M.<sup>3</sup>, and Chamberlain H.<sup>4</sup>

<sup>1</sup>United States Sugar Corporation/Southern Gardens Citrus, Clewiston, FL;<sup>2</sup>USDA-ARS, Fort Pierce, FL.;<sup>3</sup>Consolidated Citrus Limited Partnership, Fort Myers, FL; <sup>4</sup>Agri-Del, Lake Placid, FL

The acreage of Florida citrus has been declining and currently is the lowest since record keeping began in 1966. Among the reasons for the decline over the last couple of years is the lack of availability of nursery trees to reset existing groves and to plant or replant new groves. The lack of trees is due in part to the destruction of trees exposed or infected with citrus canker in 2005 and 2006 and was mandated by the citrus canker eradication program that was in effect until 2006. In addition, new regulations were put into place after the discovery of Huanglongbing (HLB) which resulted in a further reduction of available nursery trees while the nurseries built new enclosure structures that were compliant with the new pest and pathogen regulations.

After the discovery of HLB in Florida, many groves began to implement control measures that included aggressive psyllid control programs and the scouting and removal of infected trees. Despite the implementation of these management practices, many groves, especially in the southern portion of the state, are experiencing increasing infection levels. Given the current high level of inoculum pressure in these areas, it is unclear whether the increasing infection levels are a result of new infections or a result of pre-existing infections that are beginning to manifest HLB symptoms after a long latent period. In part due to the shortage of disease-free nursery trees and in part to the uncertainty of growers as to whether they can keep young trees free from HLB, some growers have chosen not to reset in existing groves and not to replant new groves until management practices can be developed that will allow newly planted trees to reach maturity with relatively low levels of HLB infection. Thus rate of infection in newly planted groves that are aggressively managed is an important factor to determine as growers decide whether they will replant and reset groves as trees are removed due to HLB. In this study, two relatively large, aggressively-managed commercial young-tree plantings are being followed to determine infection rates over time.

Two plantings, one 46 ha (115ac) in size and the other 54 ha (134ac) in size, were established in mid 2006. Together, both plantings total approximately 30,500 trees. Both plantings are located in counties with endemic HLB infection and in groves that had known previous HLB infections. One planting was located in a county that has moderate to high inoculum pressure and the other is located in a county with relatively low inoculum pressure. Both are being managed with what is considered to be an aggressive HLB management program by Florida standards. Although the programs differ slightly at each planting, the basic program consists of six inspections per year and 6-8 insecticide applications per year. In addition to the visual surveys, beginning in 2008, laboratory testing using real-time polymerase chain reaction assays (RT-PCR) was incorporated into the survey process to complement the field surveys based on visual symptoms.

RT-PCR testing is laborious, expensive, and requires specific expertise; therefore the amount of testing that can be performed is limited. However, RT-PCR is sensitive enough that samples can be bulked to some degree, thereby allowing more trees to be tested. Thus a survey method was designed that takes advantage of the sensitivity of the method and maximizes the amount of trees that can be sampled within given time and cost constraints. The survey method adopted for the RT-PCR based survey is a form of group testing that utilizes relationships between disease incidence at two levels in a spatial hierarchy, known as hierarchical sampling.

The first hierarchical sampling/RT-PCR testing of both groves was conducted beginning in August, 2008. At that time, none of the trees were showing visual symptoms. However, RT-PCR testing detected HLB in both of the young plantings. Based on the hierarchical sampling model, an estimated infection incidence of 0.44% and 0.37% was found in the plantings in the high inoculum and low inoculum pressure areas, respectively. Going forward, RT-PCR will be done on an annual basis and will be compared with infection incidence based on visual surveys.

INTERNATIONAL RESEARCH CONFERENCE  
ON HUANGLONGBING



**Session 3:**  
**HLB Detection and**  
**Diagnostics**

Orlando, Florida



December 2008

### **3.1 Lessons learned from a comparison and evaluation of multiple HLB testing laboratories employing common and different testing methodologies applied to a common set of samples.**

Irey M.<sup>1</sup>, Sieburth P.<sup>2</sup>, Brlansky R.<sup>3</sup>, DaGraça J.<sup>4</sup>, Graham J.<sup>3</sup>, Gottwald T.<sup>5</sup>, Hartung J.<sup>6</sup>, Hilf M.<sup>5</sup>, Kunta M.<sup>4</sup>, Manjunath K.<sup>7</sup>, Ling H.<sup>8</sup>, Ramdugu C.<sup>7</sup>, Roberts P.<sup>9</sup>, Rogers M.<sup>3</sup>, Shatters R.<sup>6</sup>, Sun X.<sup>10</sup> and Wang N.<sup>3</sup>

<sup>1</sup>United States Sugar Corporation/Southern Gardens Citrus, Clewiston, FL.; <sup>2</sup>FDACS, Bureau of Budwood Registration, Winter Haven, FL.; <sup>3</sup>Univ. of Florida, CREC, Lake Alfred, FL.; <sup>4</sup>Texas A & M University, Weslaco, TX.; <sup>5</sup>USDA-ARS, Fort Pierce, FL.; <sup>6</sup>USDA-ARS, Beltsville, MD.; <sup>7</sup>USDA-ARS, Riverside, CA; <sup>8</sup>USDA-ARS, Parlier, CA., <sup>9</sup>Univ. of Florida, SWFREC, Immokalee, FL.; <sup>10</sup>FDACS-DPI, Gainesville, FL.

Several laboratories in Florida and other places are now engaging in detection of Huanglongbing (HLB) disease. To ensure reproducibility of test results from various laboratories using different instruments and methodologies, a total of 276 DNA samples, including known positives, known negatives (e.g. from screened and tested budwood trees, or from states not known to have HLB), samples that tested as questionable in preliminary testing, samples from citrus-relatives, and water blanks containing no DNA were sent for comparative analysis to thirteen labs in FL, CA, TX, and MD. The participating labs were: Southern Gardens, UF/CREC, UF/SWFREC, FDACS DPI, FDACS DPI-Bureau of Budwood Registration, USDA-ARS Fort Pierce FL, USDA-ARS Parlier CA, USDA-ARS Riverside CA, USDA-ARS Beltsville MD, and Texas A&M University, Kingsville. The DNA samples were from plants from California, FDACS-DPI Bureau of Budwood Registration, UF/SWFREC, USDA-ARS Ft. Pierce, and from commercial orchards from multiple counties in Florida. Samples were run blind by all labs and the identity and HLB status of some of the samples were blind to all groups.

Several different PCR procedures were tested: conventional and real time, different types of real time PCR (Taqman®, SYBR Green® and EvaGreen®), multiplex vs. single primer sets for PCR, different master mixes, different primer sets, different machines and different systems for determining cycling threshold values. With the exception of labs that had specific reagent or equipment problems, all of the labs correctly identified the HLB status of >93% of the samples. However, most of the labs missed one or more of the positive samples and several of the labs had what were considered false positive results (i.e. positive results from the known negative samples). Between labs using real time PCR systems and the same primers, no differences were observed between machines, reagents or detection systems. Similar detection sensitivity was found for tests using primers based on different genome regions, eg. 16S rDNA,  $\beta$ -operon, or DNA polymerase nucleic acid sequences. Also no differences in results were seen between labs using multiplex vs. single primer sets for PCR. As expected, conventional PCR was slightly less sensitive than real time PCR.

Several issues were identified that will require more analysis and further testing. However, based on these data, growers and researchers, particularly in Florida, should be confident that results will be comparable for samples submitted to the different labs testing commercial samples.

### 3.2 Improved Detection of Low-titer, Non-lethal, Seed Transmitted *Candidatus Liberibacter asiaticus* in Citrus, Periwinkle and Dodder Using Nested PCR

Benyon L.S.<sup>1</sup>, Zhou L.-J.<sup>2</sup>, Duan Y.-P.<sup>1</sup>, Powell C.A.<sup>2</sup>, and Gottwald T.R.<sup>1</sup>

<sup>1</sup>USDA-ARS-USHRL, Fort Pierce, FL 34945, <sup>2</sup>University of Florida, IFAS-IRREC, Fort Pierce, FL 34945

#### Introduction:

Citrus Huanglongbing (HLB), a lethal disease of citrus, is widespread, occurring in most citrus producing areas, including Asia, Africa, and the Arabian Peninsula. It was most recently reported in Brazil and Florida. Since the initial report of the disease in Florida in August of 2005, HLB has spread throughout thirty of the citrus producing counties (2). The disease is associated with phloem-limited fastidious  $\alpha$ -Proteobacteria in the genus *Liberibacter*. *Candidatus Liberibacter asiaticus* (Las) is the most widely-distributed species and the only species that has been detected in Florida to date. Las bacterium lives in the sieve tube cells of infected plants. The low concentration and uneven distribution of the bacterium in HLB-infected host plants make it difficult to detect consistently. Many detection methods have been developed, including biological indexing, light or electron microscopy, polymerase chain reaction (PCR), real-time PCR, and loop-mediated isothermal amplification. Currently conventional PCR and quantitative real-time PCR (qPCR) are widely used for HLB detection and as a confirmation assay. Due to the low titer of the HLB pathogen in certain HLB disease phenotypes, its insect vectors, and the progenies of the HLB-infected plants, it is necessary to develop an extremely sensitive detection technique to reduce false negative results. Conventional PCR has been found to be up to 1,000 fold less sensitive than qPCR (4,5) and nested PCR (5). Both nested and qPCR have been shown to have a detection limit of 10 *Liberibacter* cells per reaction. Here we report that by using nested PCR we were able to detect Las bacterium from samples that were considered negative by qPCR. Las can be transmitted via insect vector, the Asian citrus psyllid (*Diaphorina citri*), by grafting, or through dodder transmission (1,3,6). However, there is little information on the seed transmission of HLB. Determining if the Las bacterium is seed transmissible is crucial for HLB disease control. Periwinkle (*Catharanthus roseus*) and dodder (*Cuscuta campestris*) are two experimental host plants in which HLB bacteria can multiply well. We tested for seed-transmission in these two host plants along with trifoliate (*Poncirus trifoliata*, syn. *Citrus trifoliata*) and sweet orange (*Citrus sinensis*) seedlings. The main objective of this research was to determine if the Las bacterium can translocate from seeds to seedlings and cause HLB symptoms in host plants.

#### Methods:

Fresh dodder, periwinkle and citrus samples were collected, kept on ice, and DNA isolation was begun on the same day. The Qiagen DNeasy Plant mini protocol was used with modifications.

Primer pairs listed in Table 1 were used for conventional PCR, nested PCR and quantitative PCR. Selected PCR products were cloned into the TOPO TA cloning vector pCR2.1, and subjected to sequence analysis. Real-time PCR amplifications were performed using Applied Biosystems 7500 Real-Time PCR System, and data were analyzed using Applied Biosystems 7500 system SDS software version 1.2.



Nested PCR was performed in a Peltier Thermal Cycler 200 (MJ Research) using different primer sets for the three genes, 16S rDNA, beta-operon and the outer membrane protein, with 40 cycles for first round PCR and 35 cycles for second round PCR.

Table 1. Las specific primer sequences.

Primer	Target	Sequence (5'-3')	Annealing Temp	Citation
OI1	16S rDNA	GCGCGTATGCAATACGAGCGGCA	64°C	Jagoueix, S. et al., 1996
OI2C	“ “	GCCTCGCGACTTCGCAACCCAT	64°C	Jagoueix, S. et al., 1996
LJ74f	“ “	CGGGCGATTAAGTTAGAGGT	54°C	Duan, Y.P. et al., 2008
CGO3f	16S rDNA	RGGGAAAGATTTTATTGGAG	53°C	Zhou, L.J. et al., 2007
CGO5r	“ “	GAAAATAYCATCTCTGATATCGT	53°C	Zhou, L.J. et al., 2007
MHO317	β-operon	GTGTCTCTGATGGTCCGTTTGCTTCTTTTA	64°C	Hoy, M. et al., 2001
MHO319	“ ”	GAACCTTCCACCATACGCATAGCCCCTTCA	64°C	Hoy, M. et al., 2001
Bf2	β-operon	GCGTTCATGTAGAAGTTGTG	53°C	Ding, F. et al., 2005
Br2	“ ”	CCTACAGGTGGCTGACTCAT	53°C	Ding, F. et al., 2005
OMP6f	<i>omp</i>	CACCGTAGAAGGGCATATTGAT	59°C	This Study
OMP1r	""	CATGCGATTACCTATACGAAAACC	59°C	This Study
OMP3f	“ ”	CCCTCAATTTCTATCCGCT	59°C	This Study
OMP2r	“ ”	TTATCTGACAMCAAACGGTAT	59°C	This Study
HLBas	16S rDNA	TCGAGCGCGTATGCAATACG	58°C	Li, W. et al, 2006
HLBr	“ ”	GCGTTATCCCGTAGAAAAAGGTAG	58°C	Li, W. et al, 2006
<b>Probe</b>				
HLBp		56-FAM/AGACGGGTGAGTAACGCG/3BHQ-1		Li, W. et al, 2006

## Results:

Most HLB-infected periwinkle plants died within 6 month after inoculation, but seed transmitted Las-positive periwinkle plants survived for over one year. The periwinkle progenies from HLB-infected plants did not show blotchy-mottling but did exhibited atypical HLB symptoms, denoted by vein yellowing only when they were stressed by nutrient deficiency (Figure 1). Symptoms disappeared after the stress was removed. These results suggest that although Las was seed transmitted, it was either not the form that caused severe HLB symptoms and death, or a second, undescribed component of an HLB disease complex was not transmitted.



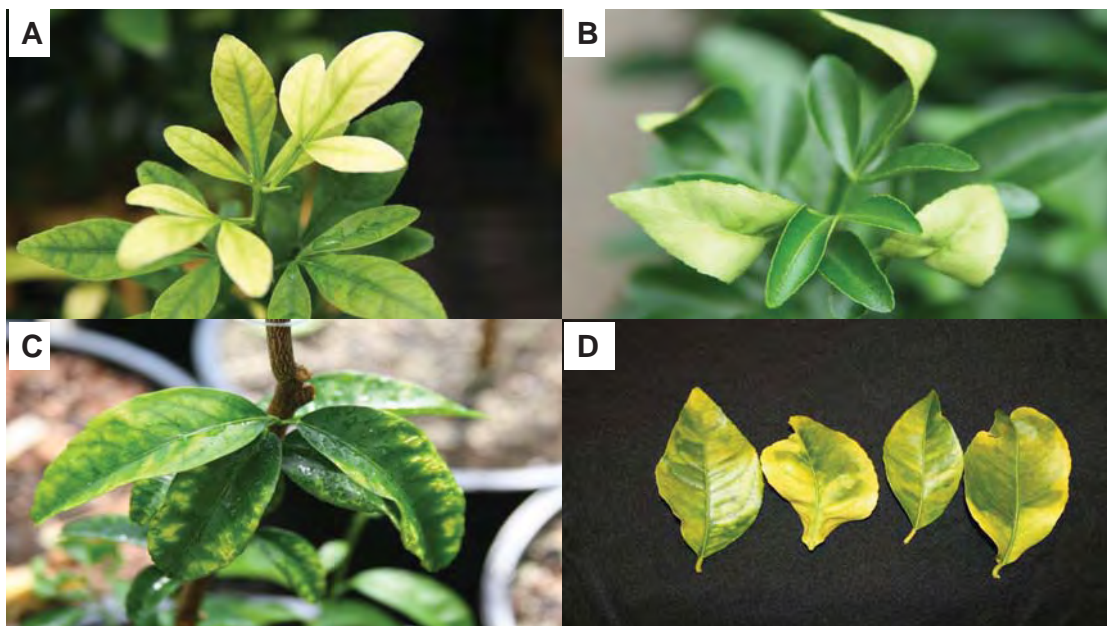
Figure 1 Phenotypic variations of Huanglongbing in periwinkle and their association with Las bacterial titer. **A.** HLB affected periwinkle leaves with typical blotchy mottle and a high titer of the Las bacterium. **B.** Vein yellowing periwinkle leaves with an extremely low titer of the Las bacterium.

The increased sensitivity of nested PCR allowed us to detect the Las bacterium in 14% more seed-transmitted periwinkle samples than conventional PCR and in 20% more samples than qPCR (Table 2).

Table 2. Detection of seed-transmitted Las in Dodder and Periwinkle samples by conventional PCR, nested PCR and qPCR

	Conv. PCR	Nested PCR	qPCR
Dodder	0/34	27/34	NT
Periwinkle (1)	22/82	58/82	NT
Periwinkle (2)	NT	77/99	57/99

Seed transmitted citrus seedlings did not display typical HLB associated blotchy mottle but did show other symptoms such as leaf yellowing, stunting, leaf curling and vein yellowing (Figure 2).



The increased sensitivity of nested PCR allowed us to detect the Las bacterium in 17% more seed-transmitted citrus samples than conventional PCR and in 10% more samples than qPCR (Table 3).

Table 3. Detection of seed-transmitted Las in citrus samples by conventional PCR, nested PCR and qPCR

	Conv. PCR	Nested PCR	qPCR
Citrus	25/170	54/170	7/32

In this work we evaluated and developed sets of primers useful for nested PCR detection of citrus Huanglongbing. Using these we were able to detect the Las bacterium in low-titer, seed transmitted host plants that were undetectable by conventional PCR or qPCR. Increasing the sensitivity of Las detection assays is of critical importance for the early discovery of the disease and for pathogen-free nursery maintenance.

Although nested PCR, with high affinity primers, is highly sensitive, false negatives will still occur if the template DNA falls near the detection threshold. Therefore sample duplication is necessary. Also due to more manipulations with nested PCR, extra caution has to be taken to avoid cross contamination.

#### References:

- Bové JM. 2006. Huanglongbing: A destructive, newly emerging, century-old disease of citrus. *J. Plant Pathol.* 88: 7-37.
- Gottwald TR, da Graca JV, Bassanezi RB. Citrus Huanglongbing: The pathogen, its epidemiology, and impact. *Plant Health Progress* doi:10.1094/PHP-2007-0906-01-RV. 2007.
- Halbert SE, Manjunath KL. 2004. Asian citrus psyllid (Sternorrhycha: Psyllidae) and greening disease of citrus: A literature review and assessment of risk in Florida. *Fla. Entomol.* 87:330-353.
- Li W, Hartung JS, Levy L. 2007. Evaluation of DNA amplification methods for improved detection of ‘*Candidatus Liberibacter species*’ associated with citrus huanglongbing. *Plant Dis.* 91:51-58.
- Teixeira DC, Saillard C, Couture C, Martins EC, Wulff NA, Eveillard-Jagoueix S, Yamamoto, PT, Ayres AJ, Bové JM. 2008. Distribution and quantification of *Candidatus Liberibacter americanus*, agent of huanglongbing disease of citrus in Sao Paulo State, Brasil, in leaves of an affected sweet orange tree as determined by PCR. *Mol. Cell. Probes* XXX :1-12 doi: 10.1016/j.mcp .2007.12.006
- Zhou LJ, Gabriel DW, Duan YP, Halbert SE, Dixon WN. 2007. First report of dodder transmission of Huanglongbing from naturally infected *Murraya paniculata* to citrus. *Plant Disease*, 91:227.

### 3.3 Detection of "*Candidatus Liberibacter asiaticus*" by cycleave isothermal and chimeric primer-initiated amplification of nucleic acids (Cycleave ICAN)

Urasaki N.<sup>1</sup>, Kawano S.<sup>1</sup>, Mukai H.<sup>2</sup>, Uemori T.<sup>2</sup>, Takeda O.<sup>2</sup>, and Sano T.<sup>3</sup>.

<sup>1</sup>Okinawa Prefectural Agr. Res. Center, Itoman, Japan; <sup>2</sup>TAKARA BIO INC., Kusatsu, Japan; <sup>3</sup>Hirosaki University, Hirosaki, Japan

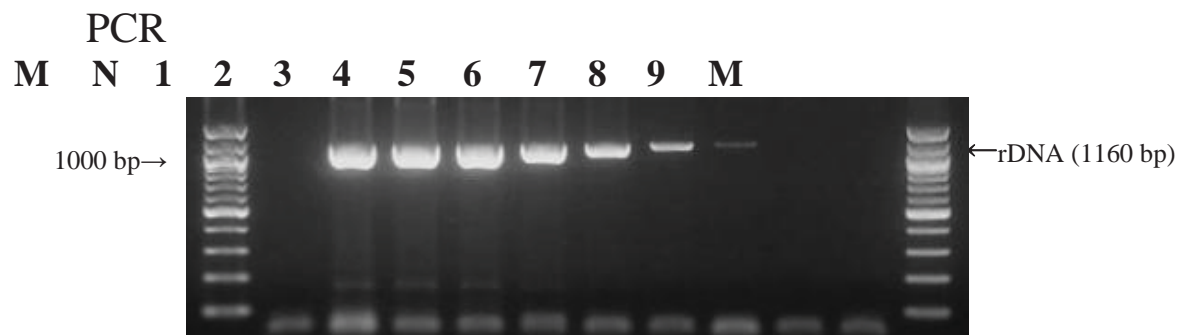
In Japan, Huanglongbing (HLB) caused by "*Ca. L. asiaticus*" was first observed in 1988 on Iriomote Island, located about 200 km east of Taiwan (Miyakawa and Tsuno 1989). Subsequently, the widespread occurrence of HLB on Okinawa prefecture was reported (Toguchi and Kawano 1997). HLB is managed by the propagation of clean nursery stock and healthy trees (Gonzales and Su 1988) and the control of the vector, citrus psyllid (*Diaphorina citri*). Furthermore, trees in commercial citrus groves and private yards need to be tested regularly by polymerase chain reaction (PCR), so that diseased trees can be removed to prevent the spread of HLB. Currently, the immediate removal of the diseased trees is of primary importance for managing HLB (Takushi et al. 2007). In the testing of citrus trees and psyllids, the PCR detection system involved the amplification of the 16S rDNA from "*Ca. L. asiaticus*" (Jagoueix et al. 1996) and agarose gel electrophoresis. But this system requires too much time to test hundreds of samples; consequently, diseased trees cannot be removed quickly. A rapid, sensitive method that does not require highly advanced equipment such as a high-throughput thermal cycler, is thus needed for the practical detection of "*Ca. L. asiaticus*". A recently developed technique, isothermal and chimeric primer-initiated amplification of nucleic acids (ICAN) (Shimada et al. 2002; Mukai et al. 2007), has shown promise for such rapid, bulk detection and uses *Bca*BEST DNA polymerase, Tli RNaseH, and two DNA–RNA chimeric primers. ICAN has also been combined with luminescence detection by probe hybridization for detecting the *Mycobacterium tuberculosis* IS6110 insertion element (Shimada et al. 2002), *Salmonella* sp. *invA* gene (Isogai et al. 2005), fluoroquinolone-resistant *Neisseria gonorrhoeae* (Horii et al. 2006), and for simultaneously detecting *Chlamydia trachomatis* Cryptic plasmid and *Neisseria gonorrhoeae* *CppB* gene (Shimada et al. 2003). ICAN, done in a water bath in the case of the *invA* gene of *Salmonella* species, is suitable for a large-scale detection system without additional equipment. Therefore, we have developed a "*Ca. L. asiaticus*" detection system that comprises the amplification of 16S rDNA by ICAN and the detection of the amplified products with cycling probe technology (Bekkaoui et al. 1996; Esaki et al. 2004) (Cycleave ICAN; Urasaki et al. 2007). Although information on the DNA of "*Ca. L. asiaticus*", a nonculturable fastidious bacterium, is limited, the ICAN, which only requires two DNA–RNA chimeric primers, can be carried out using the limited information, i.e. the 16S rDNA sequence. The cycling probe is a chimeric DNA–RNA probe that hybridizes to an amplified target sequence, not to a nonspecific product, primer dimers. Once the probe hybridizes, the RNA part of the probe is cleaved by Tli RNaseH. Thus the fluorescent molecule ROX and quencher molecule Eclipse on each side of the probe are separated, and red fluorescence is emitted. With this cycling probe technology, we can rapidly obtain red fluorescence from "*Ca. L. asiaticus*"-positive samples, and prevent the occurrence of the false-positives.

The performance of Cycleave ICAN and the conventional PCR system (Urasaki et al. 2007) were compared (Fig. 1) using the PCR primers for "*Ca. L. asiaticus*" 16S rDNA designed by Jagoueix *et al.* (1996). For the performance test, the DNAs from the healthy and HLB-diseased

*Citrus depressa* “Shiikuwasha”, maintained in the glasshouse, were used as negative and positive templates, respectively. The PCR system clearly detected a 1,160-bp rDNA fragment in the positive templates from 40 ng to 12.8 pg, but not in the positive templates from 2.56 to 0.102 pg. In the Cycleave ICAN, red fluorescence was detected from 40 ng to 0.512 pg. Weak fluorescence was obtained from 0.102 pg. There was no fluorescence from the healthy sample. From this result, the sensitivity of the Cycleave ICAN is considered to be at least 25 times higher than that of the PCR–agarose gel system. The cycling probe enables the reaction to be done in one tube and to provide rapid results without electrophoresis. Compared with the PCR system, the Cycleave ICAN could shorten the time for the detection of “*Ca. L. asiaticus*”. In our laboratory tests on 44 samples, Cycleave ICAN saved us 2.25 h (1.25 h for the thermal cycling, 1 h for the electrophoresis). The Cycleave ICAN, with detection of “*Ca. L. asiaticus*” and reliability equivalent to results from the PCR, is a rapid and sensitive detection method. Furthermore, with the Cycleave ICAN the number of samples can be greatly scaled up without the need to purchase additional equipment. The Cycleave ICAN detection system for “*Ca. L. asiaticus*” will thus greatly facilitate the timely removal of HLB-diseased trees to prevent the spread of the pathogen.

#### Citations

- Bekkaoui F, Poisson I, Crosby W, Cloney L, Duck P. 1996 *Biotechniques* 20: 240–248.
- Esaki H, Noda K, Otsuki N, Kojima A, Asai T, Tamura Y, Takahashi T. 2004 *J. Microbiol. Methods* 58:131–134.
- Gonzales CI, Su HJ. 1988 In: *Proceedings of FAO-UNDP greening workshop, Lipa, Philippines, 2nd*, pp 69–72
- Horii T, Monji A, Uemura K, Nagura O. 2006 *J. Microbiol. Methods* 65:557–561.
- Isogai E, Makungu C, Yabe J, Sinkala P, Nambota A, Isogai H, Fukushi H, Silungwe M, Mubita, C, Syakalima M, Hang’ombe BM, Kozaki S, Yasuda J. (2005) *Comp. Immun. Microbiol. Infect. Dis.* 28:363–370.
- Jagoueix S, Bove´ JM, Garnier M. (1996) *Mol. Cell Probes* 10:43–50.
- Miyakawa T, Tsuno K. 1989 Occurrence of citrus greening in the southern islands of Japan. *Ann Phytopath Soc Jpn* 55:667–670.
- Mukai H, Uemori T, Takeda O, Kobayashi E, Yamamoto J, Nishiwaki K, Enoki T, Sagawa H, Asada K, Kato I. 2007 *J. Biochem* 142:273–281.
- Shimada M, Hino F, Sagawa H, Mukai H, Asada K, Kato I. 2002 *Rinsho Byori* 50:528–532 (in Japanese).
- Shimada M, Hino F, Yamamoto J, Mukai H, Hosobe T, Onodera S, Hoshina S, Shimada M, Hino F, Yamamoto J, Mukai H, Hosobe T, Onodera S, Hoshina S, Machida K. (2003) *Rinsho Byori* 51:1061–1067 (in Japanese).
- Takushi T, Toyozato T, Kawano S, Taba S, Taba K, Ooshiro A, Numazawa M, Tokeshi M. 2007 *Jpn J. Phytopathol* 73:3–8 (in Japanese).
- Toguchi A, Kawano S. 1997 *Plant Prot* 51:565–570 (in Japanese).
- Urasaki N, Uehara T, Kawano S. 2007 *Jpn J. Phytopathol* 73:25–28 (in Japanese).
- Urasaki N, Kawano S, Mukai H, Uemori T, Takeda O, Sano T. 2008 *J. Gen Plant Pathol* 74:151–155.



Cycleave ICAN

N 1 2 3 4 5 6 7 8 9

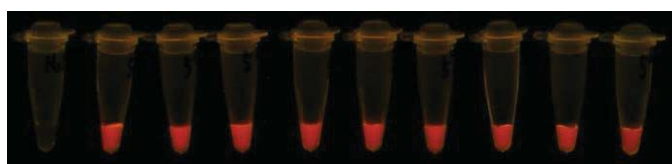


Fig1 Performance test of the PCR and the Cycleave ICAN detection system for “*Candidatus Liberibacter asiaticus*”. **M**: 100bp DNA ladder; **N**: 50 ng of DNA from leaf midrib of healthy *Citrus depressa* (Shiikuwasha); DNA from DNA from leaf midrib of HLB-diseased Shiikuwasha: **1**:40 ng, **2**:8 ng, **3**:1.6 ng, **4**:0.32 ng, **5**:64 pg, **7**:2.56 pg, **8**:0.512 pg, **9**:0.102 pg

### 3.4 A novel molecular diagnostic tool for improved sensitivity and reliability detection of “*Candidatus Liberibacter asiaticus*”, bacterium associated with huanglongbing (HLB)

Lin H.<sup>1</sup>, Doddapaneni H.<sup>1&2</sup>, and Civerolo E. L.<sup>1</sup>

<sup>1</sup>USDA-ARS, Parlier, California, USA<sup>2</sup>University of California, Davis, USA

Sensitive and accurate detection is a prerequisite for efficient management and regulatory responses to prevent the spread and introduction of HLB-associated “*Candidatus Liberibacter* species to unaffected areas. Various molecular diagnostic protocols have been developed for “*Ca. Liberibacter*” spp detection and identification. These include conventional PCR, LAMP-based method, nested PCR and a real-time PCR. While the first two methods are inherently slow and less sensitive, nested PCR and the gel-free real-time PCR method improve the sensitivity of “*Ca. Liberibacter*” detection and HLB diagnosis. While these methods work well with symptomatic samples, it has often been observed that these methods are not reliable for consistently detecting “*Ca. Liberibacter*” in infected, but asymptomatic field or nursery trees or in psyllids. This is usually attributed, at least in part, to the bacterium being present in very low titers and/or unevenly distributed infected hosts. In such cases, nested PCR appears to be diagnostically more reliable than real-time PCR protocols. To improve the current detection limit of HLB-associated “*Ca. Liberibacter*” spp, we developed a novel ultra-sensitive dual-primer TaqMan PCR for HLB molecular diagnosis. This new detection method significantly improves the sensitivity of detection of HLB-associated “*Ca. Liberibacter asiaticus*”. This system uses two sets of primers, analogous to the standard nested PCR and two sequential amplification steps. However, unlike two-tube nested PCR, this dual-primer Taq-Man PCR is carried out in a single closed tube. Computational algorithms were used to carefully design set of primers and probes that minimized interactions and avoided any possible self and cross dimer formations. PCR conditions were optimized such that each pair of primers worked sequentially during the amplification process. Specificity of the designed primers was validated by *in silico* BLAST and PCR tests with other citrus disease pathogens, and citrus and insect vector DNAs. The specificity of this detection system is high because the target amplicon was amplified sequentially by specific dual primers and the fluorescent signal is detected only from the probe which specifically hybridizes with the target amplicon. The sensitivity of this dual primer detection system is significantly higher than that of a standard Taq-Man PCR and has comparable sensitivity to a two-tube nested PCR. However, the standard two-tube nested PCR procedure requires a second amplification from the first amplified product in a separate tube. This processing of the previously amplified products could cause the cross contamination and false positives, making this approach risky for practical application unless extreme caution is taken. Use of a single closed tube PCR procedure, as described here, eliminates the possibility of contamination. Also, the cost of consumable reagents is reduced by nearly half with this new single-tube dual primer Taq-Man PCR protocol compared to the conventional two-tube nested PCR. Like other real-time PCR assays, this new system is gel-free and results are available immediately after the PCR is completed. Therefore, it is particularly suitable for high throughput processing of large numbers of clinical samples. In a recent survey from HLB infected citrus groves, the comparative detection rate was ~12% higher using the single-tube dual primer Taq-Man PCR protocol than that using the single primer pair real-time PCR method. Cloning and re-sequencing of the amplicons confirmed the detections were true positives. Availability of a simple, ultra-sensitive detection system will be an extremely useful tool for detecting and

monitoring the spread of HLB-associated “*Ca. Liberibacter*”, and for early diagnosis of HLB. It is also a powerful tool for clinical testing of imported materials, monitoring vectors, and performing surveys in areas that are still free of the disease.



### 3.5 Citrus Greening (Huanglongbing) Disease in India : Present Status and Diagnostic Efforts

Das A. K.

National Research Centre for Citrus, Amravati Road, Nagpur – 440010, India.

Among all diseases of citrus described to date, citrus greening disease (CGD) (syn. Huanglongbing, HLB) is considered probably the most destructive and lethal. The disease infects citrus trees of almost all cultivars and causes substantial economic losses to the citrus industry. CGD is now known to occur in 40 different Asian, African, Oceanian, South and North American countries and is slowly invading new citrus growing areas (1). The causal pathogen of CGD is a fastidious, phloem-limited bacterium, belongs to the genus *Candidatus Liberibacter*, three species of which are currently known, *Candidatus Liberibacter asiaticus*, occurring in Asian countries, in Brazil and the USA (Florida), *Ca. L. africanus* in African countries, and *Ca. L. americanus* present in Brazil. The disease is graft- and vector (psyllid) -transmissible. The psyllids, *Diaphorina citri* and *Trioza erythrae* are natural vectors: the heat-sensitive African form transmitted by *T. erythrae*, and the heat-tolerant Asian and American form, transmitted by *D. citri*.

CGD is attributed to one of the major causes of citrus decline in India (2). The presence of greening disease in India was first suspected in 1960s (3). Thereafter it was reported from different citrus growing regions of India and was considered to be principal cause of citrus dieback disease. A major survey and disease diagnosis project was initiated at the beginning of this decade at National Research Centre for Citrus, Nagpur. Extensive surveys were conducted during 2002- 2007 in some of the major citrus belts of the country (Vidarbha and Marathwada regions of Maharashtra, Abohar and Hosiarpur regions of Punjab, Chettalli, Gudur and Periyakulam regions of Southern India and different parts of North-East India) to record the incidence and distribution of this disease. Commercially important citrus cultivars like sweet orange (Mosambi, Sathgudi, Jaffa, Malta), mandarin (Nagpur, Kinnow, Coorg, Darjeeling), acid lime (Kaghzi, Vikram, Pramalini, Jayadevi) and lemon (Assam) were surveyed. Different kinds of CGD-associated symptoms were observed *viz.*, mottling or blotchy mottle (Fig.1, B, Fig. 2, B, C), severe chlorosis with green veins (Fig. 2, A), pale green colour in young leaves, Zinc-deficiency-like symptoms, vein yellowing and general yellowing in different cultivars of citrus. Sometimes leaves become almost chlorotic with scattered green spots (Fig. 2, D). However, 'leaf mottling' symptom was found to be highly diagnostic for the disease especially for sweet orange group. Typical HLB (yellow shoot)-like symptoms were often seen emerged from a part of the canopy (Fig. 1, A). Severely infected trees were found sparsely foliated affected by extensive twig dieback. Biological indexing of budwoods collected from greening- suspected plants was done on 1- year old sweet orange (Mosambi) indicator plants. Typical symptoms of disease on the indicator plants developed 4-6 months after inoculation. The disease was preliminary diagnosed through analysis of the fluorescent marker substances by thin layer chromatography (TLC). Results of survey indicated that incidence of greening was more on sweet orange and mandarin groups. Incidence of the disease ranged from 8-43% in Mosambi sweet orange, 30-40% in Malta sweet orange, 9 – 46 % in Sathgudi sweet orange, 15-47% in Coorg mandarin, 1-6% in Nagpur mandarin, 16-30% in Sikkim mandarin, 10-20% in Darjeeling mandarin, 10-53% in Jampui Hills mandarin, 3-15% in Kinnow mandarin, 8-38% in Assam lemon and 2-13% in acid lime.

To confirm the presence of this bacterium through polymerase chain reaction (PCR), DNA was extracted from leaf midrib and bark tissues by CTAB procedure / Qiagen DNeasy™ Plant mini kit. PCR was performed with different sets of greening-specific primers for amplification of 16S rDNA (OI1/ OI2c), ribosomal protein genes (A2/ J5) and 16S/23S intergenic regions (OI2 / 23S1). All the infected samples yielded specific amplification products indicating the presence of the causal bacterium and the size of PCR products obtained were found similar to that amplified from *Candidatus Liberibacter asiaticus* (Fig. 4, A). Further, digestion of the 16S rDNA PCR product (amplified fragment using primers OI 1/ OI 2c) yielded two fragments of 640 and 520 bp as reported only for *Ca. L. asiaticus* (4) (Fig. 4, B). To ascertain the nature of the amplicon, the amplified DNA fragments were purified from the agarose gel using QIAquick gel extraction kit (Qiagen, Gmbh, Germany). The purified PCR products were cloned into the pGEM-T™ easy vector (Promega Biosciences, Calif.) and sequenced at the commercially available automated DNA sequencing facility (Genei, Bangalore, India). Search for homologies in GenBank databases (<http://www.ncbi.nlm.nih.gov/blast>) were carried out using the BLAST programme. The sequencing and subsequent phylogenetic analyses (using the Neighbour-Joining method, conducted in MEGA software version 4.0) (5) confirmed amplification of ‘*Ca. L. asiaticus*’ DNA from the GenBank database (Fig. 5). The DNA nucleotide sequences of *Ca. Liberibacter asiaticus* Nagpur mandarin isolate and sweet orange isolate have been deposited in the GenBank database under accession numbers EU 939452 and FJ 177536 respectively. The psyllid vector of greening, *Diaphorina citri* was found present in most of the areas surveyed. *Ca. L. asiaticus* could also be detected by PCR from psyllids (Fig. 3,A, B) collected in HLB-affected orchards using OI1/ OI2c primer pairs. Efforts are however continuing to improve every steps of the diagnostic protocol for developing more robust and highly sensitive diagnostic tools.



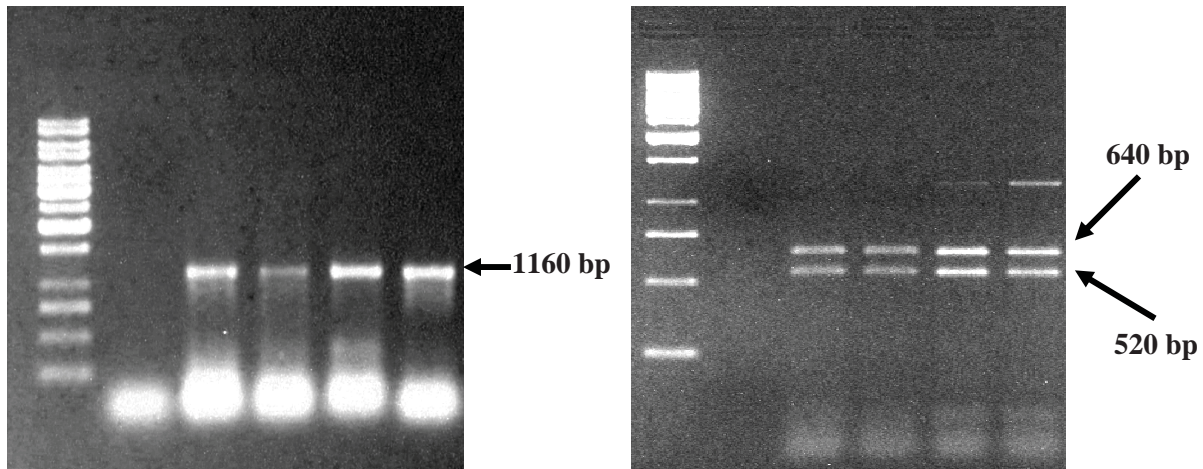
Fig 1. A, Emergence of CSD symptoms from the upper canopy of a Mosambi sweet orange (*C. sinensis*) tree. B, Classic blotchy mottle symptoms in Mosambi sweet orange leaves.



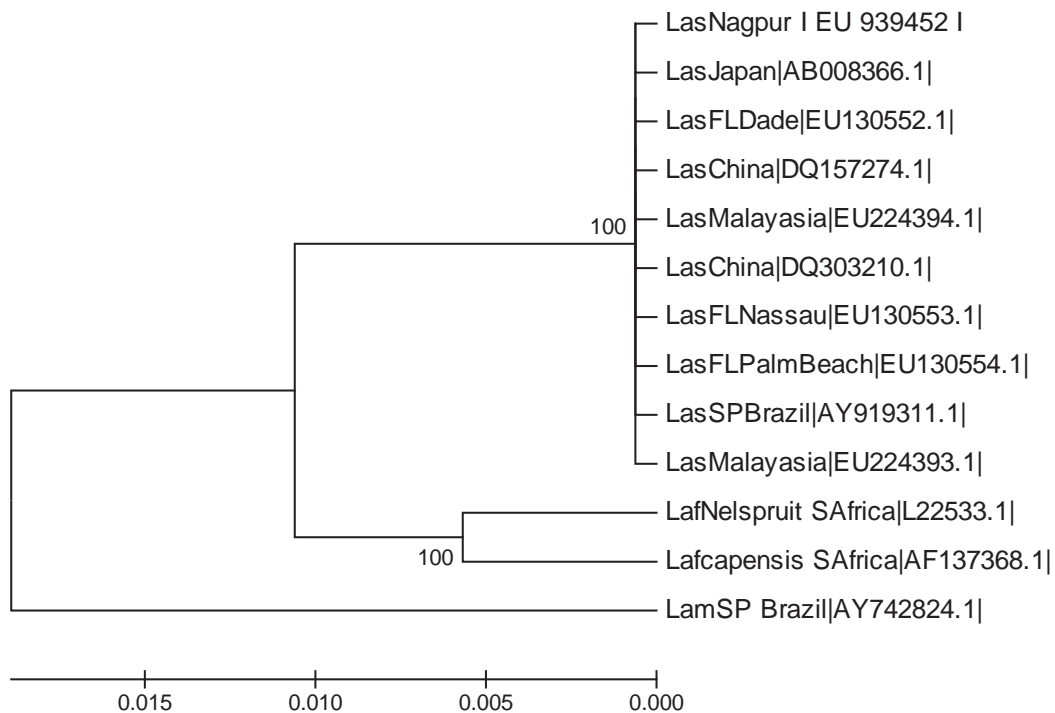
**Fig 2.** CGD symptoms in different varieties of citrus in India. **A**, Nagpur mandarin (*C. reticulata*) **B**, Kaghzi lime (*C. aurantifolia*) **C**, Assam lemon (*C. limon*) and **D**, Pummelo (*C. grandis*).



**Fig 3.** **A**, Psyllid (*Diaphorina citri*) nymphs on the new flushes of Nagpur mandarin tree. **B**, Adult psyllids feeding on a CGD-infected Nagpur mandarin leaf.



**Fig. 4.** PCR detection of CGD bacterium, *Ca. L. asiaticus* in India. **A**, Agarose gel electrophoresis of DNA extracted from citrus leaf midribs and bark tissues amplified with the OI1/OI2c primers and **B**, Digestion of the amplified product with the restriction enzyme *Xba* I. M : 1 Kb ladder (MBI Fermentas, Hanover, MD, USA), lane1, extracts from healthy citrus, lane 2-5, extracts from CGD-infected citrus plants.



**Fig. 5.** Phylogenetic tree constructed from alignment of 16S rRNA gene sequences from “*Ca. Liberibacter*”. Genbank accession nos. are given in parentheses. Bootstrap values (based on 1000 replications) are indicated at the nodes. The phylogenetic tree was linearized assuming equal evolutionary rates in all lineages. Las= *Ca. Liberibacter asiaticus*, Laf = *Ca. L. africanus*, Lam = *Ca. L. americanus*,

**Literature cited**

- Bové JM. 2006. Huanglongbing : a destructive, newly emerging, century-old disease of citrus. *J. Plant Pathol.* 88: 7-37.
- Ahlawat YS. 1997. Viruses, greening bacterium and viroids associated with citrus (*Citrus* spp.) decline in India. *Indian J. Agril. Sci.* 67: 51-57.
- Fraser LR, Singh D. 1966. Greening virus, a threat to citrus industry. *Indian Hort.* 10 : 21-22.
- Jagoueix S, Bové JM, Garnier M. 1996. PCR detection of the two liberobacter species associated with greening disease of citrus. *Mol. Cell. Probes* 10: 43 - 50.
- Tamura K, Dudley J, Nei M, Kumar S. 2007. MEGA 4: Molecular Evolutionary Genetics Analysis (MEGA) software version 4.0. *Mol. Bio. Evol.* 24: 1596-1599.

### 3.6 Improvement of *Candidatus Liberibacter asiaticus* diagnosis by nested-PCR

Coletta-Filho H.D., Alves K.C.S., Carlos E.F., Pereira M.A.R., Machado M.A.

Centro APTA Citros Sylvio Moreira – IAC, CP 04, CEP 13490-970, Cordeirópolis/SP, Brazil. 2. Departamento de Entomologia/ESALQ-USP, Piracicaba/SP, Brazil.

*Huanglongbing* (HLB) is a citrus disease caused by *Candidatus Liberibacter* spp, a phloem inhabits and psyllid vectored bacterium. The Asiatic species of *Liberibacter* known as *Ca. Liberibacter asiaticus* (CLAs) is widely distributed through the world, but like the other species of *Liberibacter*, its diagnosis from asymptomatic tissues or from the psylla is difficult, due its erratic distribution and low titer within the hosts. Amplification of CLAs by one-step of PCR from these samples fails, requiring more sensitive methods such as real-time quantitative PCR, which is an expensive but highly sensitive method. We describe here a sensitive and specific method for diagnosis of CLAs from asymptomatic citrus trees using a nested-PCR assay. The set of primers for the first and second round of PCR were based on the consensus of eight *omp* gene (outer membrane protein) sequences present at GenBank. The first round of PCR by the OMP1F/R primers amplified a fragment of 884 bp and the second round by the OMP2F/R a 411 bp fragment internal to the first product. In the assays using DNA from asymptomatic citrus trees or experimentally infected psyllids as templates it was possible to amplify CLAs only after the second round of PCR. As expected, the sequenced fragments showed homology against the CLAs *omp* sequences deposited on GenBank.

Financial support: FAPESP (2005/00718-2)

### 3.7 Optimizing qPCR for Detection of *Candidatus Liberibacter* Species in Plant and Psyllid Samples

Shatters, Jr. R. G.<sup>1</sup>, Hunter W.<sup>1</sup>, Hall D.<sup>1</sup>, Niedz R.<sup>2</sup>, Evens T. J.<sup>2</sup>

<sup>1</sup>USDA, ARS, U. S. Horticultural Research Laboratory, Subtropical Insects Research Unit, Fort Pierce, FL 34945

<sup>2</sup>USDA, ARS, U. S. Horticultural Research Laboratory, Horticulture and Breeding Research Unit, Fort Pierce, FL 34945

Although there are approved PCR-based methods for *Candidatus Liberibacter* (CL) detection, we have shown that they grossly under-estimate the presence of this pathogen due to detection sensitivity limitations associated with the assay procedure. The lack of sensitivity means that current survey methods are not accurately predicting the total number of infected trees and that research on acquisition and transmission of CL cannot be accurately conducted. We have used a set of multivariate statistical strategies called minimum run and response surface methodology to identify the components of the PCR-based detection methods that influence sensitivity. Significant influences of the buffer/salt composition and temperature profiles, have been identified and interactions among these were apparent. The information is being used to develop the most cost-effective assay that does not compromise assay sensitivity. Optimized methods for CL detection in both citrus and psyllids, including DNA preparation methods for each organism, were developed that take into account minimal sample handling as a means of reducing the risk of sample cross-contamination.

### 3.8 Comparison of Detection Sensitivity of Different Primer Pairs for Citrus Huanglongbing Bacterium

Ding F.<sup>1,2</sup>, Wang G.<sup>1,2</sup>, Yi G.<sup>3</sup>, Hong N.<sup>1,2</sup>, Zhong Y.<sup>3,1</sup>.

<sup>1</sup>Plant Science and Technology Academy Huazhong Agricultural University, Wuhan, Hubei Province, China <sup>2</sup>. The Key Lab of Plant Pathology of Hubei Province, Huazhong Agricultural University, Wuhan, Hubei Province, China <sup>3</sup>. Institute of Fruit Tree Research, Guangdong Academy of Agricultural Science, Guangzhou, Guangdong Province, China

**Abstract:** A comparison of the detection sensitivity of five primer pairs for citrus huanglongbing pathogen was carried out using simple PCR, semi-nested PCR and nested PCR (Table 1).

Table 1 Primer sets used for the detection of HLB pathogen

Primer	Sequence of primer pair	Amplicon	Genomic region
fOI1/rOI2c	5'-GCGCGTATGCAATACGAGCGGCA-3' 5'-GCGTCGCGACTTCGCAACCCAT-3'	1160 bp	16SrDNA
fOI2/r23S1	5'-ATGGGTTGCGAAGTCGCGAGGC-3' 5'-CGCCCTTCTCTCGCGCTTGA-3'	912 bp	16S/23SrDNA
fA2/rJ5	5'-TATAAAGGTTGACCTTTCGAGTTT-3' 5'-ACAAAAGCAGAAATAGCACGAACAA-3'	703 bp	$\beta$ -operon
fP535/rP535	5'-TGAATTCTTCGAGGTTGGTGAGC-3'* 5'-AGAATTCGACTTAATCCCCACCT-3'*	535 bp	16SrDNA
fp400/rP400	5'-GAGTTCATGTAGAAGTTGTG-3'***1 5'-CCTACAGGTGGCTGACTCAT-3'***	400 bp	16SrDNA

Note: \*: outer primer for Nested-PCR and Semi- Nested-PCR; \*\*: inner primer for Nested-PCR; \*\*\*1 inner primer for Semi- Nested-PCR.

The results showed that different primer pairs had distinct detection sensitivities. The most sensitive primer pair fp400/rP400 was nearly a thousand times more sensitive than primer pair fOI2 / r23S1. From the highest sensitivity to the lowest were primer pairs fp400/rP400 > fp535/rP535 > fA2/rJ5 > fOI1 / rOI2c > fOI2 / r23S1 (Fig1).

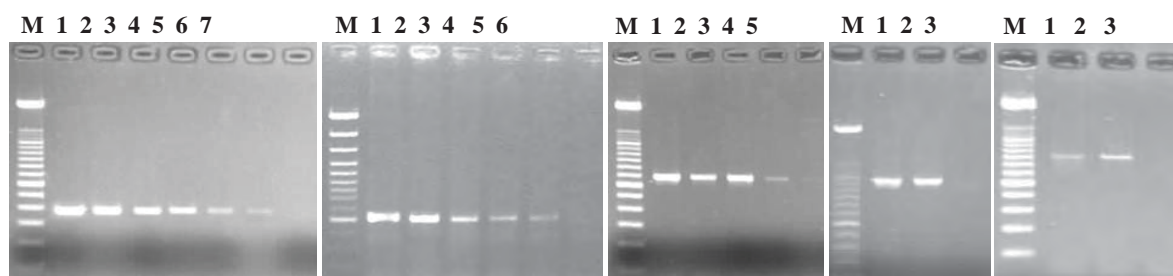


Fig.1 Sensitivity comparison of 5 different primer sets fp<sub>400</sub>/r P<sub>400</sub> (A) fp<sub>535</sub>/r P<sub>535</sub> (B) fA2/rJ5 (C) fOI1/rOI2c (D) fOI2/r23S1 (E)

Note: M. 100 bp DNA ladder marker (Fig. A, C, D, E, D015-2 Dingguo Fig. B, 100 bp DNA Ladder IV, Shenggong) 1.10ng/  $\mu$ L; 2. 1.0ng/  $\mu$ L; 3.  $10^{-1}$  ng/ $\mu$ L; 4. $10^{-2}$  ng/ $\mu$ L; 5. $10^{-3}$  ng/ $\mu$ L; 6. $10^{-4}$  ng/ $\mu$ L; 7.  $10^{-5}$  ng/ $\mu$ L



The sensitivities of semi-nested PCR and nested PCR were much higher than that of simple PCR. These assays can detect target DNA at the lowest concentration tested of  $10^{-7}$  ng/ $\mu$ L, and there is no obvious difference between the two assays. (Fig 2).

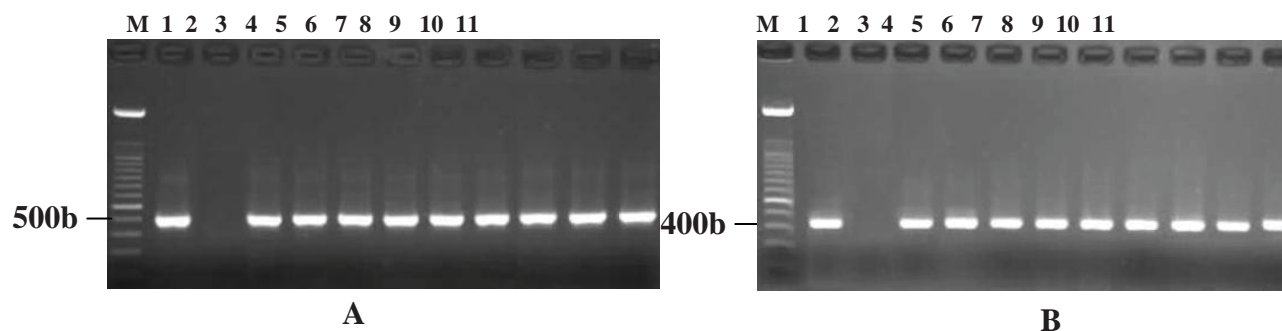


Fig.2 Sensitivity of Semi-Nested PCR (A) and Nested PCR (B)

Note: M. 100 bp DNA ladder marker (D015-2, Dingguo); 1. Positive control; 2. Negative control; 3-11: Template DNA diluted from 10ng/ $\mu$ L to  $10^{-7}$  ng/ $\mu$ L.

Therefore, it is important to choose sensitive primer pairs which amplify smaller target fragments for the detection of citrus huanglongbing pathogen. Especially when citrus huanglongbing pathogen concentration is extremely low in the samples, it is essential to choose much more sensitive primers in order to avoid false negative results.

### 3.9 Quantification of viable *Candidatus Liberibacter asiaticus* in hosts using Quantitative PCR with the aid of ethidium monoazide (EMA)

Sagaram U.S.<sup>1\*</sup>, Trivedi P.<sup>1\*</sup>, Kim J-S.<sup>1</sup>, Brlansky R.H.<sup>1</sup>, Rogers M.E.<sup>1</sup>, Stelinski L.L.<sup>1</sup>, Oswald C.<sup>2</sup>, and Wang N.<sup>1</sup>

<sup>1</sup> Citrus Research and Education Center, University of Florida, 700 Experiment Station Road, Lake Alfred, FL 33850, USA.

<sup>2</sup> Polk County Cooperative Extension Service, University of Florida, Bartow, FL 33831, USA.

\* Those two authors contribute equally to this work.

**Correspondence to:** Nian Wang, Citrus Research and Education Center, Department of Microbiology and Cell Science, University of Florida, 700 Experiment Station Road, Lake Alfred, FL, 33850, USA; Tel. 863-956-1151; Fax. 863-956-4631; Email: nianwang@crec.ifas.ufl.edu

Citrus Huanglongbing (HLB) is a devastating disease of citrus known to be associated with a fastidious, phloem-limited Gram-negative, yet to be cultured bacterium in the genus *Candidatus Liberibacter*. In the present study we have developed a method to quantify viable *Candidatus Liberibacter asiaticus* (Las) with the aid of ethidium monoazide (EMA) which can differentiate the live from dead cells. Firstly, calibration curves were developed with the aid of quantitative real-time PCR (QPCR) by using plasmid template consisting of a 703 bp DNA fragment of *rplKAJL-rpoBC* ( $\beta$ -operon) region. Standard equations were then developed to quantify Las genome equivalents in citrus, periwinkle, and psyllid, respectively. To overcome the limitation of real time PCR in discriminating live and dead bacterial cells, EMA was used to inhibit the amplification of DNA from the dead cells of Las in plant samples. By using the standard equations and EMA-PCR methods developed in the study we found that the viable cells range from 17-31% in the citrus and 16-28% in the periwinkle. It was indicated that a minimum bacterial concentration was required for HLB symptom development in studying the population of Las in symptomatic and asymptomatic leaves. This is the first report of the use of EMA-QPCR in distinction between the viable and dead cells of any unculturable bacteria. The EMA-QPCR methodology developed in the present study would provide an accurate assessment of viable HLB pathogen, thus providing a tool to study the epidemiology of disease and act as a crucial component for disease assessment and management.

### 3.10 PCR for detection of Asian and American strains of *Candidatus Liberibacter* in *Citrus*, *Murraya* and *Diaphorina* from Northwest Argentina

Ramallo J., Acosta E., Rojas A., Stein B.

Estación Experimental Agroindustrial Obispo Colombres (EEAOC), Tucumán, Argentina.  
jramallo@eeaoc.org.ar

Huanglongbing (HLB) (syn= citrus greening) was detected in São Paulo, Brazil, in September, 2004, and in Florida, USA, one year later in September 2005. In Brazil the disease is associated with the phloem-limited bacteria *Candidatus Liberibacter asiaticus* (Las) and *Ca. L. americanus* (Lam) and can be transmitted by graft and by the Asian citrus psyllid, *Diaphorina citri*. HLB is considered the most destructive citrus disease in the world. There are no commercial varieties known to be tolerant to the disease and no effective control method. The symptoms of HLB on leaves are blotchy mottle, corky veins and asymmetric yellowing, and on fruits, colour inversion, size reduction and fruit drop. All of these symptoms are characteristic but not specific for HLB. The disease has not been detected in Argentina but is present near the eastern border with Brazil in Parana State (Altonia). The insect vector *Diaphorina citri*, has been present in the northeastern citrus region of Argentina since 1984 and in the extreme northwestern region since 2006. *Murraya paniculata*, a weakly symptomatic host for HLB, is widely planted as an ornamental plant in both regions. Highly sensitive and specific detection tools are needed for early and accurate detection of the pathogen. The objective of this program is to adopt an accurate PCR methodology for identification of Las and Lam in plants and in psyllids. In 2005 we implemented a Duplex PCR technique employing GB1 and GB3, primers that amplify a 1027 bp region from the 16sRNA for Las, (Teixeira et al 2005) and a 703 bp region from the nusG-*rp/Kajl-rpoBC* operon for Lam (Hocquellet et al, 1999). Modifications in protocols were made to accommodate the PCR cyclers and to adjust for the small size of tissue DNA samples. Later, the primers of Hung *et al.* (1999) were employed for Las which are more sensitive than the those of Teixeira et al. (2005) and Li et al (2007).

Different extraction methods were tested for *Citrus*, *Murraya* and insect tissues to optimize the amount of plant or insect tissues (CTAB- *Murraya*); (Hung, et al., 1999 ; M. Irey, personal communication). Universal extraction bags yielded better results than hand maceration. Nested PCR was also trialed to improve the detection sensitivity to 0.01 ng of infected DNA (Teixeira et al, 2008). The positive control was *Candidatus* species DNA from Brazil and USA. For *Diaphorina* samples, DNA from infected psyllids provided by Brazil was employed. Samples with suspicious symptoms of HLB were from orchards located in Salta and Jujuy provinces where *Diaphorina citri* is present. Thus far, all samples have been negative. At present the EEAOC utilizes conventional PCR and nested PCR to detect the bacteria and a key group of researchers, technicians and field workers have been trained to recognize HLB symptoms and the vector.

#### References

Hocquellet A, Toorawa P, Bové JM, Garnier M. 1999. Detection and identification of the two *Candidatus Liberobcter* species associated with citrus Huanglongbing by PCR amplification of ribosomal protein genes of the  $\beta$  operon. *Molecular and Cellular Probes* 13(5): 373-379.

- Li W, Hartung JS, Levy L. 2007. Evaluation of DNA Amplification Methods for Improved Detection of *Candidatus Liberibacter* Species Associated with Citrus Huanglongbing. *Plant Dis.* 91:51-58.
- Murray MG, Thomson WF. 1980. Rapid isolation of high molecular weight plant DNA. *Nucleic Acids Res.* 8:4321-4325.
- Teixeira DC, Danet JL, Eveillard S, Martins EC, de Jesus Junior WC, Yamamoto PT, Lopes SA, Bassanezi RB, Ayres AJ, Saillard C, Bové JM. 2005. Citrus huanglongbing in Sao Paulo State, Brazil: PCR detection of the *Candidatus Liberibacter* species associated with the disease. *Molecular and Cellular Probes* 19(3): 173-179.
- Teixeira DC, Saillard C, Couture C, Martins CE, Wulff NA, Eveillard-Jagoueix S, Yamamoto PT, Ayres AJ, Bové JM. 2008. Distribution and quantification of *Candidatus Liberibacter americanus* agent of huanglongbing disease of citrus in São Paulo State, Brazil, in leaves of and affected sweet orange tree as determined by PCR. *Molecular and Cellular Probes* 22, 139-150.
- Hung TH, Wu ML, Su HJ. 1999. Development of a rapid method for the diagnosis of citrus greening disease using the polymerase chain reaction. *J. of Phytopathology.* 147: 599-604.

### 3.11 Current situation of citrus Huanglongbing associated with “*Candidatus Liberibacter asiaticus*” in Guangdong, China

Deng X.<sup>1</sup>, Chen J.<sup>2</sup>, Xu J.<sup>1</sup>, Guo H.<sup>1</sup>, Pu X.<sup>1</sup>, Cai L.<sup>1</sup>, and Li H.<sup>1</sup>

<sup>1</sup> Laboratory of Citrus Huanglongbing Research, South China Agricultural University, Guangzhou, P. R. China; <sup>2</sup>USDA-ARS, Parlier, California, USA

Email: [xldeng@scau.edu.cn](mailto:xldeng@scau.edu.cn)

Guangdong province is one of the major citrus production regions in China with over 220,000 ha. The province is located between 20°13'~25°31'N and 109°39'~117°19'E with a subtropical climate. During the past 20 years, citrus production in Guangdong has gradually shifted from the coastal Chaoshan and Pearl River delta areas to the mountainous West of Guangdong. Citrus Huanglongbing (HLB) was observed in Guangdong in the early 1900's. Over the years, it is believed that HLB spread to other parts of the province along with the cultivation of new varieties. To investigate the current situation of HLB in Guangdong, we collected samples from 12 citrus production cities, including: Meizhou, Chaozhou, Jieyang, Heyuan, Huizhou, Shaoguan, Qingyuan, Zhaoqing, Yunfu, Yangjiang, Maoming, Zhanjiang. Samples were from 16 cultivars included: Shatianyou (*Citrus grandis* var. Shatian Yu) Navel (*C. sinensis*) Tankan (*C. reticulata* cv. Tankan) Ponkan (*C. reticulata* cv. Ponkan) Chazhigan (*C. reticulata* cv. Chachiensis) Chuntianju (*C. reticulata* cv. Chuntian Ju) Nianju (*C. reticulata* cv. Nian Ju) Anliucheng (*Citrus sinensis* cv. Liu Cheng) Wendanyou (*C. grandis* cv. Wentan Yu) Wenzhoumigan (*C. reticulata* cv. Unshiu) Shatangju (*C. reticulata* cv. Shiyue Ju) Foshou (*C. medica* var. *sarcodactylis*) Gonggan (*C. reticulata* var. *szehuikan*) Mashuiju (*C. reticulata* cv. Mashui Ju) Juhong (*C. maxima* cv. *Tomentosa*) and Hongjiangcheng (*C. sinensis* cv. Hongjiang Cheng). Symptoms were grouped into four symptom types: mottling, yellowing, and Zn-deficiency-like and one asymptomatic type. Primer set OI1/OI2c specific to “*Candidatus Liberibacter asiaticus*” was used for PCR. Among the total of 359 samples collected, 241 samples were positive with the detection rate of 67.1%. Among the 12 cities, Heyuan, Shaoguan, Yangjiang and Maoming were the first to report the presence of HLB. With the exception of cultivar Wendanyou from Shaoguan City where “*Ca. L. asiaticus*” was not detected, all of the other 15 cultivars showed positive results. Among them, Chuntianju, Nianju, Mashuiju, Foshou and Juhong were the first to detect the presence of “*Ca. L. asiaticus*”. The bacterium was detected in both samples of symptomatic and asymptomatic samples. However, mottling symptoms and PCR positive results were correlated at 92.94%. Therefore, mottling symptoms can be used as a unique criterion for rapid diagnosis of HLB associated “*Ca. L. asiaticus*” under field condition.

### 3.12 Molecular approach for early detection of *Candidatus Liberibacter* species in Texas Citrus

Bextine B.R.<sup>1</sup>, Gunawan S.<sup>1</sup>, Hunter W.B.<sup>2</sup>, and Shatters R.G.<sup>2,1</sup>

Department of Biology, University of Texas, Tyler, TX 75799;<sup>2</sup> USDA ARS, Ft. Pierce, FL

North America was first invaded by the Asian citrus psyllid (AsCP), *Diaphorina citri* (Hemiptera: Psyllidae) in 1998 (3) and has spread from Florida to Texas (2). However, *Candidatus Liberibacter asiaticus*, *Can.La*, the pathogen associated with the development of Huanglongbing (HLB) in citrus has not been reported in Texas citrus. On June 12, 2008, the Animal and Plant Health Inspection Service Plant (APHIS), Plant Protection and Quarantine (PPQ) Molecular Diagnostics Laboratory and the PPQ Center for Plant Health Science and Technology (CPHST) National Plant Germplasm and Biotechnology Laboratory in Beltsville, Maryland, confirmed the identification of *Can.La* in citrus in a lime tree leaf sample from a residential property in Algiers, Orleans Parish, Louisiana (APHIS report DA-2008-24). The initial symptoms of HLB are leaf yellowing and development of small, misshapen, unpalatable fruit. Currently, the vector of *Can.La*, AsCP, occurs in the southeastern USA, from Florida to Texas. With a recent report from California. The development of HLB has been reported to take from 2-6 years to show symptoms (1). Early detection of this pathogen is a crucial part of a HLB management plan to maintain a viable citrus industry. Automated detection systems such as PCR and real-time PCR have improved the detection of plant pathogens, but, several problems still exist with these methods, mainly stemming from low titers of bacteria in samples. *Liberibacter* collection methods also hamper detection techniques used for pathogen management and study. The most common method of collection, extraction of the bacterium directly from leaf tissue has several limitations, such as low cell numbers collected and high amounts of plant DNA and organic matter that can interfere with molecular diagnostics, hindering early detection and often resulting in false negatives. Improving the consistency of plant pathogen detection has been the cornerstone of the Bextine lab and will enhance the study of the interaction between vectors, host plants, and the pathogen.

The point of our diagnostic program is to determine if *Can.La* has crossed the Texas border and is currently infecting plants prior to symptom expression. As a preliminary assessment of our capabilities, citrus leaves were collected from trees in 4 citrus regions in southern TX, [Beaumont (on the LA border), northern Houston, Pearland (southern Houston), and McAllen] and analyzed for presence of the bacterium. DNA was extracted from leaves using the DNeasy tissue extraction kit (Qiagen Inc., Valencia, CA). Detection of *Can.La* by quantitative real time PCR was done using two 16S rDNA primer sets (RS-HLBr 5'-GCGTTATCCCGTAGAAAAAGGTAG-3'/RS-HLBas 5'-TCGAGCGCGTATGCAATACG-3' and USHRL-CL1-R 5'-CTTACCAGCCCTTGACATGTATAGGA-3'/USHRL-CL1-L 5'-TCCCTATAAAGTACCCAACATCTAGGTA-3'). For both primer sets an initial 3 minute melt at 94°C, followed by 35 cycles of 95°C for 15 sec, 58°C or 54°C for 30 sec, and 72°C for 30 sec (4). Only positive values with a crossing threshold of less than 30 were considered possible positive samples using both primer sets. If a sample tested positive, the amplicon was sequenced and compared to known *Candidatus Liberibacter* species sequences. Extra care must be taken when analyzing samples due to the highly sensitive real time PCR methodology, as it is possible that some samples may produce 'false' positives resulting in a closely related bacterium being

detected that does not cause disease. In this case, sequencing the PCR product is the best way to confirm the identity of the amplicon. All samples collected from three of the areas of Texas (Northern Houston, Pearland, and McAllen) tested negative for the presence of *Can.La*. One non-symptomatic, dooryard lemon tree in Beaumont, TX initially tested positive for the presence of *Can.La* using both of our primer sets; however this sample tested negative in subsequent assays by the USDA-APHIS and thus has not been confirmed. From this tree, 48 leaf samples were collected and only one sample resulted in a positive reaction (cycle time value of 28) and the 180 bp amplicon from the RS-Las long primer set was sequenced and matched 100% *Can.La*. A second sample from this tree was considered “questionable” because it had a cycle time of around 31. We were unable to sequence this sample and thus it is now considered to be negative. All 46 of the other samples collected from this tree tested negative for the presence of *Can.La*.

**References:**

- Bové JM. 2006. Huanglongbing: A destructive, newly-emerging, century-old disease of citrus. *J. Plant Pathol.* 88:7-37.
- French JV, Kahlke C, da Graça J. 2001. Asian psyllid found on Texas citrus. *Citrus Center* 19:1.
- Halbert SE. 1998. Entomology section, *Tri-ology* (May–June 1998) 37:6–7.
- Shatters Jr., RG, Hunter W, Hall D, McKenzie CL, Duan YP. 2008. Optimizing a 16S rRNA-Based Double Stranded DNA Dye Binding Q-PCR Method for Detection of *Candidatus Liberibacter* Species Associated with Plants and Psyllids. Submitted to *Molecular and Cellular Probes*, September, 2008.

### **3.13 Comparison of a starch-based field test for Huanglongbing to results from real-time PCR testing of field samples from symptomatic trees in Florida.**

Chamberlain H.L.<sup>1</sup> and Irey M.S.<sup>2</sup>

<sup>1</sup>PDM Scouting, Lake Placid, FL; <sup>2</sup> U. S. Sugar Corporation, Clewiston, FL

One of the difficulties of diagnosing Huanglongbing (HLB) in the field is the variety of symptoms that infected trees may present. In addition to the variation in symptom type, field observations in Florida indicate that not all symptoms are present on all trees, that there may be some periodicity to the types of symptoms that are present throughout the year, and that there is tree to tree and grove to grove variation at any given time. In addition, many of the symptoms of HLB are similar to symptoms of other problems commonly found in Florida citrus orchards. HLB symptoms can resemble nutrient deficiencies, Phytophthora-induced symptoms, herbicide injury, mechanical damage, etc., and thus laboratory testing is often needed to verify the presence of HLB in the grove. Currently, laboratory testing is based on one of many different polymerase chain reaction-based testing methods (PCR) that have been reported in the literature. Although sensitive, specific, and accurate, PCR-based testing is tedious and expensive thus limiting the number of samples that can be tested. A starch-based field test has been reported to be useful as a field test for HLB but little data regarding temporal, varietal, and spatial variability are available thus far as to the correlation of the starch-based test results to PCR-based testing.

During 2007 and early 2008, leaf samples were collected from 1759 HLB suspect trees. For each tree, the predominant symptom type on the tree was noted and leaf samples were tested using the starch test and real time PCR (RT-PCR). Over all samples collected from the symptomatic trees, 85% of the samples were positive by RT-PCR versus 78% positive for the starch test. The starch and the RT-PCR test results agreed for 76% of the samples. There did not appear to be substantial differences in the correlation between the tests during the months of July and February, but there was a difference in the correlation between the two tests in June. No difference between early-midseason and Valencia varieties with respect to the correlation between the two types of tests was found, but there was a difference between the various symptom types. The best correlation between the tests was obtained for leaves exhibiting the classic blotchy mottle leaf symptom and the worst correlation was obtained with leaves showing the green island symptom type. Overall, the RT-PCR testing was more consistent in detecting HLB infected trees than the starch test. Therefore, the starch test should be considered a useful tool for HLB diagnosis in the field, but not as a substitute for PCR-based testing.



INTERNATIONAL RESEARCH CONFERENCE  
ON HUANGLONGBING



**Session 4:**  
**Pathogen Genome  
and Sequencing**

Orlando, Florida



December 2008

#### 4.1 Evaluation of potential pathogenicity genes identified by genomic sequencing of *Ca. Liberibacter asiaticus*.

Zhang S., Reddy S. and **Gabriel D.W.**

Plant Pathology Dept, U. Florida, Gainesville, FL USA.

Huanglongbing (HLB), also known as citrus “greening” is a lethal disease of citrus that is now found in every county where citrus is grown in Florida. Based primarily on 16S rDNA sequence analysis, HLB is associated with at least three different species of *Candidatus Liberibacter*. None of the candidate species have been cultured; consequently Koch’s postulates have not been completed. The titer of these phloem-limited bacteria is so low that the genome size has not been estimated and < 25 kb of nonredundant genomic DNA has been publically available. Nearly all PCR tests to confirm HLB are based on two genomic regions, and phylogenetic information relevant to strain identity has not been assessed.

**Curation.** Using dodder transmission, we have continuously transmitted HLB from a single infected Florida citrus tree to citrus and periwinkle for two years; by PCR, this HLB “strain”, UF506, is associated with *Ca. L. asiaticus* (Las). We developed a DNA extraction protocol that enriched for Las and greatly reduced chloroplast and mitochondrial DNA contamination (as determined by PCR) and used multiple displacement amplification (MDA) to obtain sufficient DNA for shotgun library sequencing. To date, 14,000 sequencing reactions from this library have resulted in the identification of > 68 kb of new Las DNA sequence in the 15 largest contigs. These contigs have been validated by PCR primers against at least two plant sources (citrus and periwinkle). One of the contigs, currently 7.2 kb in size, completely encompasses and extends the existing 988 bp singlet for DNA polymerase from Las (GenBank M94320). Twenty new primer sets have been developed and validated against Florida Las samples; some primers revealed potential phylogenetic differences between the Florida and one Brazilian Las samples tested.

**New Las genomic sequence.** A total of 1,127 contigs of size > 1 kb was obtained from the 14,000 shotgun library reads. The largest 100 contigs, ranging in size from 1.2 to 17 kb, totaling 224 kb of DNA, were analyzed by comparisons against the GenBank nonredundant database. These contigs fell into the following categories:

"Las"	Other bacterial	Plant nuclear	Chloro	Mito	Other	Mis-assembly	Total (kb)
82 kb	23 kb	71 kb	26 kb	11 kb	3 kb	7 kb	217 kb
38%	11%	33%	12%	5%	1%	3%	100%

Those contigs that appeared to be plant nuclear DNA, chloroplast, mitochondrial or bacterial with >50% GC content were eliminated from further consideration. Of the 82 kb of presumptive “Las” DNA, 68 kb was confirmed to be authentic UF506 DNA by PCR. Additional primers were subsequently designed in different regions of several larger contigs, and large PCR products were confirmed to be authentic Las assemblies by hybridization against both Las-infected and uninfected citrus and periwinkle. The % GC content of these contigs varied from 35 - 44%.

Preliminary examination of presumptive ORFs from the largest assembled contigs were identified by BLASTX. The majority of ORFs from these larger contigs appeared to be either phage related or hypothetical unknowns, indicating a bias in our metagenomic library, and possibly the existence of a prophage or plasmid associated with Las. However, one of these

showed similarity to an RTX (repeats in toxin) family effector. As a result of our work with *Xylella fastidiosa* (Xf), we knew that RTX proteins can be involved in host-specific symptom elicitation as a result of Type I secretion (Gabriel, 2008). Type I secretion systems are used for defense against plant antimicrobial compounds (eg., in *Erwinia chrysanthemi* (Barabote et al. 2003), *E. amylovora* (Burse et al. 2004), *Agrobacterium tumefaciens* (Palumbo et al. 1998; Peng and Nester 2001), *Rhizobium etli* (Gonzales-Pasayo and Martinez-Romero, 2000), *Bradyrhizobium japonicum* (Krummenacher and Narberhaus 2000) and *X. fastidiosa* (Reddy et al., 2007). More importantly, Type I secretion systems are also used for pathogen offensive purposes, being capable of directly secreting toxins and enzymes directly from the bacterial cytoplasm to the external medium. Since Las is an intracellular pathogen, this type of system could provide the basis for HLB symptom elicitation, and possibly, for Las growth in citrus. RTX proteins can be host range determining or contributing factors in plant pathogenic bacteria. Primers were designed to amplify this RTX protein coding region for use as a probe against a UF506 fosmid library. These fragments were sequenced and confirmed the SeqWright shotgun assembly in these regions.

**Identification of Las fosmids carrying a putative Las Type I gene.** Because of the sheer number of sequencing reactions (ca. 200,000) that would have to be made to begin to assemble even a small (1.5 Mb) genome, combined with the apparent overrepresentation of prophage or plasmid DNA in our largest contigs, we reasoned that the shorter contigs, once validated, could be used as probes to identify rare, but long contiguous UF506 DNA regions in a fosmid library. A fosmid library was therefore constructed consisting of 1,400 colonies. A random sampling of 18 of these were examined by restriction digestion and the average insert size was 41 kb. A 1.4 kb amplified region was labeled with  $^{32}\text{P}$  and used to probe the entire fosmid library on nylon membranes. Identified fosmids are currently being used for primer walking, adding an additional 11 kb of new Las sequence to our assembly. While this process was being carried out, the Las strain psy62 genome, obtained from psyllids, was made available to us (Duan, Y.P. et al., 2008).

**Use of the Duan et al (2008) psy62 database.** The Duan et al (2008) partial genomic DNA database, containing > 1.2 Mb of Las genomic sequence, was much more complete than our own Las genomic sequence data, and this database confirmed the presence of a Type I system, including CLIBASIA\_04987 (*tolC*), an essential outer membrane component of Type I secretion, and CHRN\_01308, an ATP-binding cassette (ABC) transporter. The Duan et al (2008) genomic sequence allowed identification of at least two likely Type I effectors: a partial serralyisin (CLIBASIA\_05478), which is an RTX protease, and a full length hemolysin (CLIBASIA\_02850), which is an RTX toxin.

PCR fragments of both the partial psy62 serralyisin (CLIBASIA\_05478) and the hemolysin (CLIBASIA\_02850) were found in UF506, and these and other potential RTX effectors in UF506 are currently being investigated. If confirmed, the protein coding regions of any full length RTX encoding genes will be re-cloned into the transient expression vector pYD40.1 (Duan et al., 1999). We plan to determine if transient expression of any full length RTX genes in plants using an *Agrobacterium tumefaciens* delivery system will indicate a potential effector function of these genes in citrus.

## Citations

- Barabote RD, et al. 2003. *Erwinia chrysanthemi* tolC is involved in resistance to antimicrobial plant chemicals and is essential to pathogenesis. *J. Bacteriol.* 185:5772-5778.
- Burse A, Weignart H, Ullrich MS. 2004. The Phytoalexin-inducible multidrug efflux pump AcrAB contributes to virulence in the fire blight pathogen, *Erwinia amylovora*. *Mol. Plant-Microbe Interact.* 17:43-54.
- Duan YP, Castaneda A, Zhao G, Erdos GW, Gabriel DW. 1999. Expression of a single, host-specific gene in citrus cells elicits division, enlargement and cell death. *Molec. Plant-Microbe Interact.* 12:556-560.
- Duan YP, Zhou LJ, Hall D, Li WB, Liu L, Gottwald TR. 2008. GenBank direct submission.
- Gabriel DW 2008. Role of Type I secretion in Pierce's Disease. 2008 Pierce's Disease Research Symposium Proceedings, in press.
- Gonzales-Pasayo R, Martinez-Romera E. 2000. Multiresistance genes of *Rhizobium etli* CFN42. *Mol. Plant-Microbe Interact.* 13:572-577.
- Krummenacher P, Narberhaus F. 2000. Two genes encoding a putative multidrug efflux pump RND/MFP family are cotranscribed with an *rpoH* gene in *Bradyrhizobium japonicum*. *Gene* 241:247-254.
- Palumbo JD, Kado CI, Phillips DA. 1998. An isoflavonoid-inducible efflux pump in *Agrobacterium tumefaciens* is involved in competitive colonization of roots. *J. Bacteriol.* 180:3107-3113.
- Peng WT., Nester EW. 2001. Characterization of a putative RND-type efflux system in *Agrobacterium tumefaciens*. *Gene* 270:245-252.
- Reddy JD, Reddy SL, Hopkins DL, Gabriel DW. 2007. TolC is required for pathogenicity of *Xylella fastidiosa* in *Vitis vinifera* grapevines. *Molec.Plant-Microbe Interact.* 20:403-410.

## FUNDING AGENCIES

This project was funded by USDA-APHIS

## 4.2 Zebra Complex and HLB: Seeking a Common Enemy?

Bextine B.R.<sup>1</sup>, Swatsell C.<sup>1</sup>, and Hunter W.B.<sup>2</sup>

<sup>1</sup>Department of Biology, University of Texas, Tyler, TX 75799; <sup>2</sup>USDA ARS, Ft. Pierce, FL.

Zebra Complex (ZC), was first documented in potato fields in Mexico in 1994, and was first identified in the USA in 2000 in commercial potato fields in Texas. This disease has recently been associated with a new, fourth, pathogenic *Candidatus* Liberibacter species (called “psyllaourous”) (Hansen 2008, Liefting 2008). *Candidatus* Liberibacter psyllaourous has also been associated with a similar disease in tomatoes and peppers. In all three cropping systems, the association of this pathogen with disease was originally missed because the traditional diagnostic method, PCR and QRT-PCR, did not amplify DNA from this fourth species. The bacterium is transmitted by the potato psyllid (*Bactericera cockerelli*), an insect that is prevalent in most growing areas of the US. While, the putative causal agent of ZC was unknown until just a few months ago, the potato psyllid’s involvement on the disease was determined in 2006 (Goolsby 2007, Munyaneza 2007). When considering the epidemiology of ZC and the association with a potential HLB causal agent, it is important to consider the timeline of ZC history. First, the potato psyllid has been a minor problem in potato and tomato production for years. However, ZC first appeared in Mexico in 1994 then in the USA in 2000. Similarly, tomato and pepper disease pressure accelerated during this same time period. The foliar symptoms that define ZC, including stunting, chlorosis, swollen internodes of the upper growth, proliferation of axillary buds and aerial tubers, browning of the vascular system in belowground portions of stems, leaf scorching, and early plant decline (Munyaneza 2007), are all similar to the symptoms in Huanglongbing, HLB, affected citrus.

The interactions and associations between the cause of HLB and potato ZC is currently unknown. Reports have identified a Liberibacter related bacterium in the potato psyllid in two countries and in several states within the USA (Hansen 2008, Liefting 2008). There is a need to either confirm or eliminate this patho-system (Liberibacter-Potato-Psyllid) as to its real or perceived threat to US citrus industry. To resolve this issue we are applying molecular approaches using Liberibacter specific primers made to 5 locations in the genome. Samples of citrus, potato, and other potential Liberibacter host plants, plus both Asian citrus psyllid and potato psyllid, are being analyzed to confirm or deny the association between these two patho-systems. Preliminary trials have been conducted to determine if the potato psyllid can survive and transmit Liberibacter to other host plants. Additionally, we have determined that the potato psyllid can survive on citrus, thus demonstrating it could potentially transmit Liberibacter between cropping systems.

### Materials and Methods

*Asian citrus psyllids on tomato.* Three groups of 20 adult Asian citrus psyllids, AsCP, *Diaphorina citri*, were caged on tomato seedlings, ~18cm tall.

*Potato psyllids on Citrus.* Three groups of 10 adult potato psyllids, *Bactericera cockerelli*, were caged on a three year old grapefruit tree for 10 days. As a control 10 adult potato psyllids were caged on pepper plant (a known acceptable host plant).

*Detection of Can. Liberibacter sp. in potato psyllid populations.* Potato psyllids were collected from potato fields in multiple locations across the US. DNA was extracted from groups of 5 psyllids using the DNeasy tissue extraction kit (Qiagen Inc., Valencia, CA). Detection of *Can.*

*Liberibacter* sp. by quantitative real time PCR was done using two 16S rDNA primer sets (Shatters 2008) and primers that have been found effected in use with the newly described *Can. Liberibacter* sp. (Liefting 2008). For all three primer sets an initial 3 minute melt at 94°C, followed by 35 cycles of 95°C for 15 sec, 58°C or 54°C for 30 sec, and 72°C for 30 sec. Only positive values with a cycle time of less than 30 were considered possible positive samples using both primer sets. If a sample tested positive, the amplicon was sequenced and compared to known *Candidatus Liberibacter* species sequences.

## Results

*Asian citrus psyllids on tomato.* The no choice test resulted in complete mortality within 48 hours, with many of the psyllids dead along the sides of the cages. AsCP did not respond to tomato as either a host, or transitory host plant. Preference of AsCP towards only citrus and its near relatives suggest that it would not be efficient at moving *Can. Liberibacter asiaticus* from citrus to tomato crops.

*Potato psyllids on citrus.* The no choice test where potato psyllids were exposed to citrus only resulted in 90% survival after 48 hours, 50% survival after 5 days, and <10% survival after 10 days. In comparison, 50% of the potato psyllids survived the 10 day period on the pepper plant. Potato psyllids did respond to citrus as a potential transitory host plant which suggests that it could be efficient at moving *Can. Liberibacter* sp. from tomato/potato crops to citrus. In this experiment, potato psyllids did not test positive for the presence of *Can. Liberibacter* sp. Therefore, vector capacity could not be evaluated.

*Detection of Can. Liberibacter sp. in potato psyllid populations.* Potato psyllids have tested positive for the presence of a *Can. Liberibacter* sp., however, we have not identified it to the species level yet.

## Discussion

Potato psyllids are a potential bridge between the citrus and potato/tomato cropping systems and may be capable of moving *Can. Liberibacter* sp. in the process. In our screening of potato psyllid populations for the presence of *Can. Liberibacter* sp., we have routinely found the “psyllaorous” species. At this point we believe this presents a threat to the citrus industry, but further investigation is needed to determine the level of the threat.

## References

- Hansen, K., Trumble, J.T., Stouthamer, R., and Paine, T.D. 2008. New Huanglongbing (HLB) *Candidatus* species, “*C. Liberibacter psyllaorous*”, found to infect tomato and potato is vectored by the psyllid *Bactericerca cockerelli* (Sulc). *Appl. Environ. Microbiol.* 74:5862-5865.
- Liefting, L. W., Ward, L.I., Shiller, J.B., and Clover, G. 2008. A New ‘*Candidatus Liberibacter*’ Species in *Solanum betaceum* (Tamarillo) and *Physalis peruviana* (Cape Gooseberry) in New Zealand. *Plant Dis.* 92: 1588.
- Shatters, Jr., RG, W Hunter, D Hall, CL McKenzie, YP Duan. 2008. Optimizing a 16S rRNA-Based Double Stranded DNA Dye Binding Q-PCR Method for Detection of *Candidatus Liberibacter* Species Associated with Plants and Psyllids. Submitted to *Molecular and Cellular Probes*, September, 2008.
- Goolsby, J.A., Bextine, B., Munyaneza, J.E., Sétamou, M., Adamczyk, J., and Bester, G. 2007. Seasonal abundance of sharpshooters, leafhoppers, and psyllids associated with potatoe saffected by zebra chip disorder. *Subtrop. Plant Scie.* 59: 15-23.
- Munyaneza, J.E., Crosslin, J.M., and Upton, J.E. 2007. Association of *Bactericerca cockerelli* (Homoptera: Psyllidae) with “Zebra Chip,” a New potato disease in Southwestern United States and Mexico. *J. Econ. Entomol.* 100:656-663.

### 4.3 Microbiome analysis of HLB pathogen infected citrus using Phylochips and 16S rDNA clone library sequencing

Sagaram U.S.<sup>1\*</sup>, DeAngelis K.M.\*, Trivedi P.<sup>1</sup>, Kim J-S.<sup>1</sup>, Andersen G.L., and Wang N.<sup>2</sup>

Citrus Research and Education Center, University of Florida, 700 Experiment Station Road, Lake Alfred, FL 33850, USA.

<sup>2</sup> Lawrence Berkeley National Lab Earth Sciences Division, One Cyclotron Road, MS-90R1116, Berkeley, CA 94720 510-486-5246

\* Those two authors contribute equally to this work.

*Candidatus Liberibacter asiaticus* is an endophytic bacterium of citrus that is phloem limited and is believed to cause citrus Huanglongbing (HLB) or citrus greening. Disease control has been a big challenge since little is known about the ecology of the pathogen and all the attempts to culture the pathogen remain unsuccessful. In this study we describe the bacterial diversity associated with citrus leaf midribs infected with *Candidatus Liberibacter asiaticus*. We employed a combination of high density phylogenetic 16S rDNA microarray and 16S rDNA clone library to determine if differences exist in microbial community composition between symptomatic and asymptomatic citrus midribs. Analysis of 16S rRNA gene amplicons using phylochip arrays indicated that nine taxa were more abundant in symptomatic midribs compared to asymptomatic midribs. The taxa otu\_7603, representing *Liberibacter* species, was detected at a very low level in asymptomatic plants, but over 200 times more abundant in symptomatic plants. Comparison of microarray with clone libraries disclosed successful detection and classification of most of the clone groups. The correspondence between phylochip analysis and 16S rDNA library suggests that the bacterial community data presented here is representative of predominant bacterial groups which account for a major portion of bacterial population of citrus. In addition, this study has shown that a comprehensive assessment of bacterial population of plants can be obtained using a combinatorial approach of phylochip and 16S rDNA clones analysis.

#### 4.4 Several *Liberibacter* and *Phytoplasma* Species are Individually Associated with HLB.

**Bové J.M.**<sup>1</sup>, Teixeira D.C.<sup>2</sup>, Wulff N.A.<sup>2</sup>, Eveillard S.<sup>1</sup>, Saillard C.<sup>1</sup>, Bassanezi R.B.<sup>2</sup>, Lopes S.<sup>2</sup>, Yamamoto P.T.<sup>2</sup>, Ayres A.J.<sup>2</sup>

<sup>1</sup> INRA and University of Bordeaux 2, UMR 1090, 33883 Villenave d'Ornon, France.

<sup>2</sup> Fundecitrus, 201, Av. Dr. Adhemar Pereira de Barros, Araraquara, SP, Brazil.

Several sieve tube-restricted bacteria are associated with HLB, worldwide. In Africa, only *Candidatus Liberibacter africanus* (Laf) has been found to be associated with HLB, and the insect vector is the African citrus psyllid, *Trioza erythrae* (see 2 for references on discovery, characterization, and detection of rutaceous liberibacters). Both the African liberibacter and the psyllid-vector are heat sensitive, as temperatures of 32°C and above are detrimental. In addition to being heat sensitive, the vector is also affected by dry conditions. These reasons explain why the disease in Africa is encountered most severely in cool areas, namely at altitudes at or above 600 m and where relative humidity rarely falls below 25%, while at lower altitudes the disease is less severe, and practically absent below 200m. Only in the Cape Town region, at the most southern tip of Africa, the disease occurs at sea level temperatures because there, the southern latitude compensates for lack of altitude. In the Cape Town province, an arborescent *Rutaceae*, *Calodendron capensis*, or Cape chestnut tree, showed leaves with blotchy mottle and was found to be infected with *Candidatus Liberibacter africanus* subsp. *capensis*. The subspecies has not (yet) been found in citrus. It has also been detected in apparently symptomless chestnut trees (14).

Until recently, *Candidatus Liberibacter asiaticus* (Las) was the only liberibacter found to be associated with HLB in Asia. In 2008, *Candidatus Liberibacter americanus* (Lam) has been reported in one of 97 citrus leaf samples from eight provinces of southern China, Las being present in the 96 other samples (13). If this report is confirmed, it would be the first time that Lam is detected out of Brazil. The insect vector in Asia is *Diaphorina citri*, the Asian citrus psyllid, an insect more heat tolerant than *T.erythrae*. Asian HLB is heat tolerant, and involves Las, not yet affected at 35°C, while Lam, like Laf, is heat sensitive (11). The disease occurs in hot, dry oases of south-western Saudi Arabia.

In Florida and Cuba, HLB was recognized in 2005 and 2006, respectively, and is of the classic Asian type, with Las as the liberibacter and *D. citri* as the psyllid vector.

A third liberibacter species has been identified in 2004 in São Paulo State (SPS), Brazil: *Candidatus Liberibacter americanus* (Lam). However, Las is also present. In 2004, Lam was widely predominant, Las being detected only in very few sweet orange trees. By 2008, the situation has reversed, as newly affected trees are now found to be more frequently infected with Las than with Lam. Both Lam and Las are transmitted by the Asian psyllid, present in SPS since the 1940s. Lam in SPS, like Laf in South Africa, is heat sensitive, while Las is heat tolerant. Also, the titres of Lam in sweet orange trees are lower than those of Las, and might result in lower insect-transmission efficiency (12). The differences between Lam and Las may explain the decrease of Lam in favour of Las in SPS.

Surprisingly, in 2007, a phytoplasma of group 16SrIX (*Candidatus Phytoplasma phoenicium* group), closely related to the pigeon pea witches' broom phytoplasma (99% 16SrDNA sequence identity) has been found associated with HLB in SPS (16). Phytoplasmas are



wall-less, sieve tube-restricted bacteria (class Mollicutes). The HLB associated phytoplasma is probably transmitted to citrus by an insect vector becoming infected on an external, non-citrus source. Several *Crotalaria juncea* plants, grown in between citrus rows for soil improvement, and showing typical witches' broom symptoms, have been found to be infected with the HLB phytoplasma (17). Thus, the presence of the HLB phytoplasma in citrus from central, northern and southern SPS, is probably the result of cultural practices, which have become widely used throughout SPS. Transmission of the phytoplasma from citrus to citrus has not yet been observed. Interestingly, in southern China, a phytoplasma of group 16Sr1 (*Candidatus* Phytoplasma asteris group) associated with HLB has been reported recently (3). The SPS phytoplasma of group 16SrIX and the China phytoplasma of group 16Sr1 are associated with characteristic HLB leaf and fruit symptoms. Even *Spiroplasma citri*, the helical mollicute responsible for citrus stubborn disease, causes HLB-like symptoms on sweet orange fruits (small size, color inversion, lopsidedness, and seed abortion); on *S. citri*-infected leaves, some blotchy mottle can be seen, but it is less conspicuous than HLB blotchy mottle. However, *Candidatus* Phytoplasma aurantifolia, the phytoplasma associated with witches' broom disease of lime (WBDL), is not associated with HLB-like fruit and leaf symptoms, and the WBDL symptoms on lime are very different from those of HLB. Thus, only some phytoplasmas are associated with HLB symptoms.

Finally, a new liberibacter species (*Candidatus* Liberibacter solanacearum) has been shown to be associated with affected solanaceous plants (9, 10), and is transmitted by the potato psyllid, *Bactericera cockerelli*. The liberibacter from the psyllid vector has also been characterized and named *Candidatus* Liberibacter psyllauros (8). *Ca. L. solanacearum*, isolated from solanaceous plants and *Ca. L. psyllauros*, isolated from the psyllid vector, are probably one and the same organism.

At this moment, no relationship has been established between huanglongbing and the liberibacter from solanaceous plants. In 1992, a Philippines' strain of Las was transmitted by dodder from citrus to tobacco (*Nicotiana tabacum*, "xanthi") plants, which became severely affected, but had liberibacter titers much lower than those in periwinkle (*Catharanthus roseus*) plants (Fig. 1) (6). Las has also been dodder-transmitted to tomato (*Lycopersicon esculentum*) plants, which became symptomatic (4). Hence, the Asian citrus liberibacter is associated with symptoms in solanaceous plants. Inversely, the solanaceous liberibacter might very well be associated with symptoms in citrus.

Why would three different liberibacter species, two different phytoplasma species, and even one spiroplasma species be associated with similar, if not identical, HLB symptoms on leaves and/or fruits? These different bacteria have one feature in common: they are strictly restricted to the phloem sieve tubes. They might also have similar mechanisms of pathogenicity! As *S. citri* is available in axenic culture since 1970 (15), transpositional mutants could be produced. A non-pathogenic mutant, GMT553, was obtained from wild type *S. citri* strain GII-3 and used to elucidate the pathogenicity mechanism of the citrus spiroplasma (5). In the presence of both fructose and glucose, GII-3 uses preferentially fructose. In GMT553, the transposon was found to be inserted into the fructose operon, rendering the mutant unable to use fructose, the utilisation of glucose, however, being unaffected (7). In healthy plants (Fig. 2A), the vacuola invertase in the companion cell produces normal amounts of fructose and glucose from sucrose. In the *S. citri*-infected plants (Fig. 2B), fructose is used by the sieve tube-restricted spiroplasmas and, as a consequence, fructose concentration decreases with a concomitant increase in invertase activity, resulting in the production of more fructose and glucose. The concentration of fructose

remains low, invertase activity remains high, but glucose concentration increases. It could be shown that the concentration of glucose in leaves infected with the wild type *S. citri* strain reached levels 20 times higher than those in healthy leaves or leaves infected with non-pathogenic mutant GMT553 (1). Also, fructose utilization by the spiroplasmas could impair sucrose loading into the sieve tubes by the companion cells and result in accumulation of carbohydrates in source leaves and depletion of carbon sources in sink leaves (7). Such mechanisms of pathogenicity are not based on specific genes, such as genes for toxins, but on deviations of sugar metabolism. Experiments are underway to examine whether such mechanism could apply to liberibacters and phytoplasmas involved in HLB.

### Literature cited

1. André A, Maucourt M, Moing A, Rolin D, Renaudin, J. 2005. Sugar import and phytopathogenicity of *Spiroplasma citri*: glucose and fructose play distinct roles. *Mol. Plant Microbe Interact.* 18: 33-42.
2. Bové JM. 2006. Huanglongbing: a destructive, newly-emerging, century-old disease of citrus. *J. Plant Pathol.* 88: 7-37.
3. Chen J, Deng X, Liu S, Pu X, Li H, Civerolo E. 2008. Detection of phytoplasma and *Candidatus Liberibacter asiaticus* in citrus showing huanglongbing (yellow shoot disease) symptoms in Guangdong, P. R. China. *Phytopathology* 98: S35.
4. Duan YP, Gottwald T, Zhou LJ., Gabriel DW. 2008. First report of dodder transmission of *Candidatus Liberibacter asiaticus* to tomato (*Lycopersicon esculentum*). *Plant disease* 92: 831.
5. Foissac X, Saillard C, Danet JL, Gaurivaud P, Paré C, Laigret F, Bové JM. 1997. Mutagenesis by insertion of transposon Tn4001 into the genome of *Spiroplasma citri*: characterization of mutants affected in plant pathogenicity and transmission to the plant by the leafhopper vector *Circulifer haematoceps*. *Mol. Plant-Microbe Interact.* 10: 454-461.
6. Garnier M, Bové JM. 1993. Citrus greening disease and the greening bacterium. In: Proc. 12<sup>th</sup> Conf. IOCV, 212-19, IOCV, Riverside, CA.
7. Gaurivaud P, Danet JL, Laigret F, Garnier, M, Bové JM. 2000. Fructose utilization and Phytopathogenicity of *Spiroplasma citri*. *Mol. Plant-Microbe Interact.* 13: 1145-1155.
8. Hansen AK, Trumble JT, Stouthammer R, Paine TD. 2008. A new Huanglongbing species, "*Candidatus Liberibacter Psyllaurosus*", found to infect tomato and potato, is vectored by the psyllid *Bactericera cockerelli* (Sulc). *Appl. Environ. Microbiol.* 74: 5862-5865.
9. Liefting LW, Sutherland PW, Paice, LI, Weir BS, Clover GRG. 2009. A new "*Candidatus Liberibacter*" species associated with diseases of solanaceous crops. *Plant disease*: in press.
10. Liefting LW, Weir BS., Pennycook SR, Clover GRG. 2009. '*Candidatus Liberibacter solanacearum*', a liberibacter associated with plants in the family Solanaceae. *Int. J. Syst. Evol. Microbiol.* : in press.
11. Lopes SA., Frare GF, Bertolini E, Cambra M, Fernandes NG, Ayres AJ, Marin DR, Bové JM. 2009. Liberibacters associated with citrus huanglongbing in Brazil: *Candidatus Liberibacter asiaticus* is heat tolerant, *Candidatus Liberibacter americanus* is heat sensitive. *Plant Disease*: in press.

12. Lopes SA, Bertolini E, Frare GF, Martins EC, Wulff NA, Teixeira DC, Fernandes NG, Cambra M. 2009. Graft Transmission Efficiencies and Multiplication of *Candidatus Liberibacter americanus* and *Ca. Liberibacter asiaticus* in Citrus Plants. *Phytopathology*: in press.
13. Lou BH, Zhou CY, Zhao XY., Li ZG., Xu M, Liu JX., Zhou Y, Tang K. S. 2008. Primary study on species and intraspecific differentiations of HLB pathogens in eight provinces of China. Program and Abstracts book, 11<sup>th</sup> international citrus congress, p. 232, abstract P333.
14. Phahladira MNB., 2008. Identification of alternative hosts to citrus of "Candidatus *Liberibacter africanus*" amongst indigenous Rutaceae of South Africa. MSc. study in progress., University of Pretoria, Pretoria, South Africa.
15. Saglio P, Laflèche D, Bonissol C, Bové JM. 1971. Isolement, culture et observation au microscope électronique des structures de type mycoplasme associés à la maladie du stubborn des agrumes et leur comparaison avec les structures observées dans le cas de la maladie du greening des agrumes. *Phys. Veg.* 9 : 569-82.
16. Teixeira DC, Wulff NA, Martins EC, Kitajima EW, Bassanezi R, Ayres AJ, Eveillard S, Saillard C, Bové JM. 2008. A phytoplasma closely related to the Pigeon pea witches' broom phytoplasma (16Sr IX) is associated with citrus huanglongbing symptoms in the State of São Paulo, Brazil. *Phytopathology* 93: 977-984.
17. Wulff NA, Teixeira DC, Yamamoto PT, Ayres AJ, Bové JM. 2008. unpublished observation.

#### 4.5 Phylogenetic Analysis of Citrus Huanglongbing Bacterium Based on the Sequences of 16S rDNA and 16S / 23S rDNA Intergenic Regions among isolates in China

Ding F.<sup>1</sup>, Deng X.<sup>2</sup>, Hong N.<sup>1</sup>, Zhong Y.<sup>3</sup>, Wang G.<sup>1</sup>, Yi G.<sup>3</sup>

<sup>1</sup>College of Plant Science and Technology, Huazhong Agricultural University, Wuhan, P.R. China. <sup>2</sup> National Key Laboratory of Crop Genetic Improvement, Huazhong Agricultural University, Wuhan, P. R. China; <sup>3</sup> Institute of Fruit Tree Research, Guangdong Academy of Agricultural Science, Guangzhou, P.R. China

**Abstract:** Phylogenetic analysis of citrus Huanglongbing bacterium in China based on the sequences of 16S rDNA and 16S/23S rDNA intergenic regions was analyzed. Nine citrus Huanglongbing samples with different symptoms from different hosts collected from 7 provinces of China were used for the analysis of 16S rDNA sequence (Fig1).



Fig. 1 Geographical locations in the map of People's Republic of China, where citrus Huanglongbing samples were collected for the present study. "▲" indicates the provinces where the HLB samples were collected.

Polymerase chain reaction was used to amplify and sequence the 16S rDNA of these isolates. The result revealed the level of homology among 9 isolates was 98.5-100%. And the homology between the 16S rDNA sequences of China and the India isolate "Poona" was also 98.5-100% (Gen Bank accession number: L22532); yet only shared 97.5% to 97.8% with the *Ca. L. africanus* strain "Nelspruit" (L22533). 96.3% to 97.3% identity with *Ca. L. africanus subsp.* strain "Capensis" (AF137368). 95.3% to 96.5% identity with the *Ca. L. sp.* strain "LSg2" (AY919312). And 94.9% to 96.0% identity with representative *Ca. L. americanus* strain in Sao Paulo State (AY742824) (Fig2).

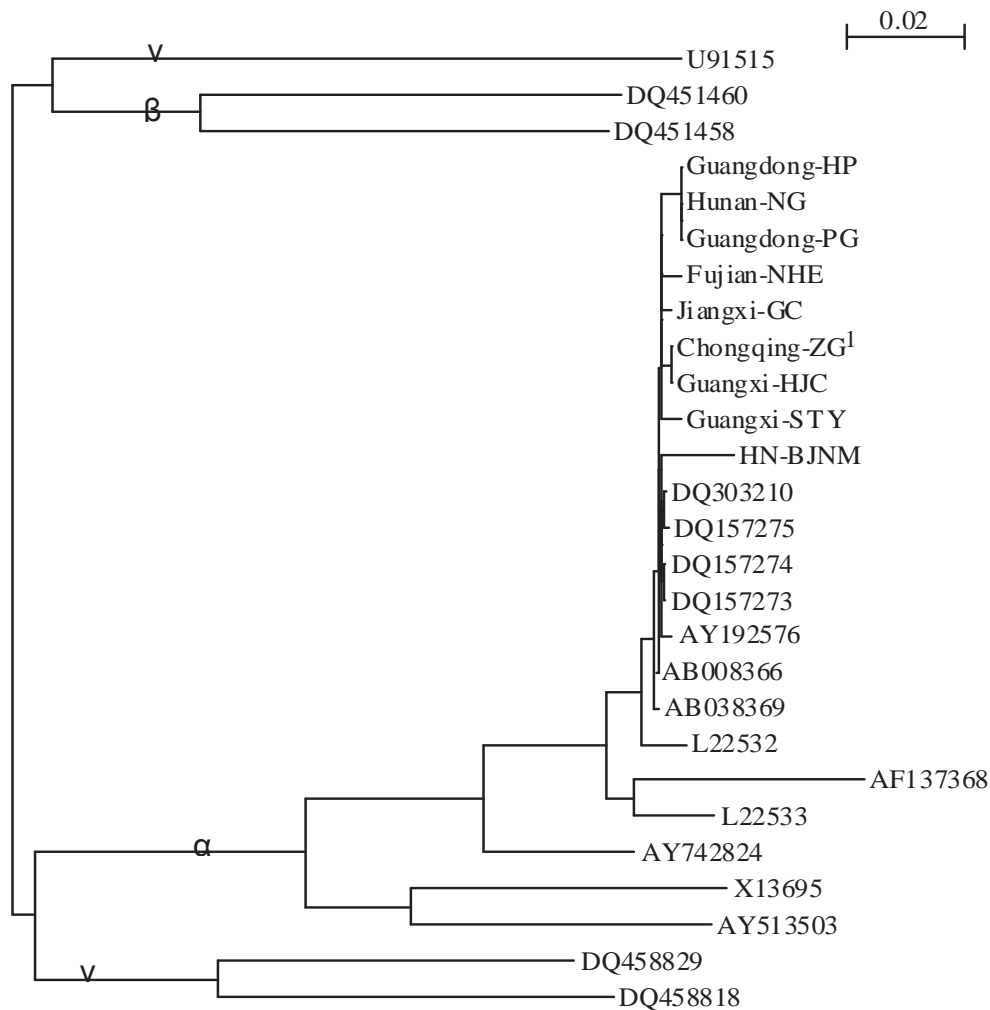


Fig. 2 Phylogenetic tree analysis based on the 16S rDNA of HLB isolates.

Phylogenetic tree constructed according to the sequences of 16S rDNA showed 9 isolates were all belong to *Ca. L. asiaticum*. For the analysis of 16S/23S rDNA intergenic regions, 18 citrus Huanglongbing samples collected from 7 provinces with different symptoms were used. The result showed the level of homology among 18 isolates was above 99.0%, no obvious variation was found. Sequencing analysis of 16S/23S rDNA intergenic region and phylogenetic tree constructed showed that 18 representative isolates were all highly homologous with *Ca. L. asiaticus*, and distinct from *Ca. L. africanum* and *Ca. L. americanus* (Fig 3). These results suggested that the HLB isolates in China should be classified to *Candidatus Liberibacter asiaticus*. This is the first report on the taxonomy grade by molecular method of HLB isolates in China.

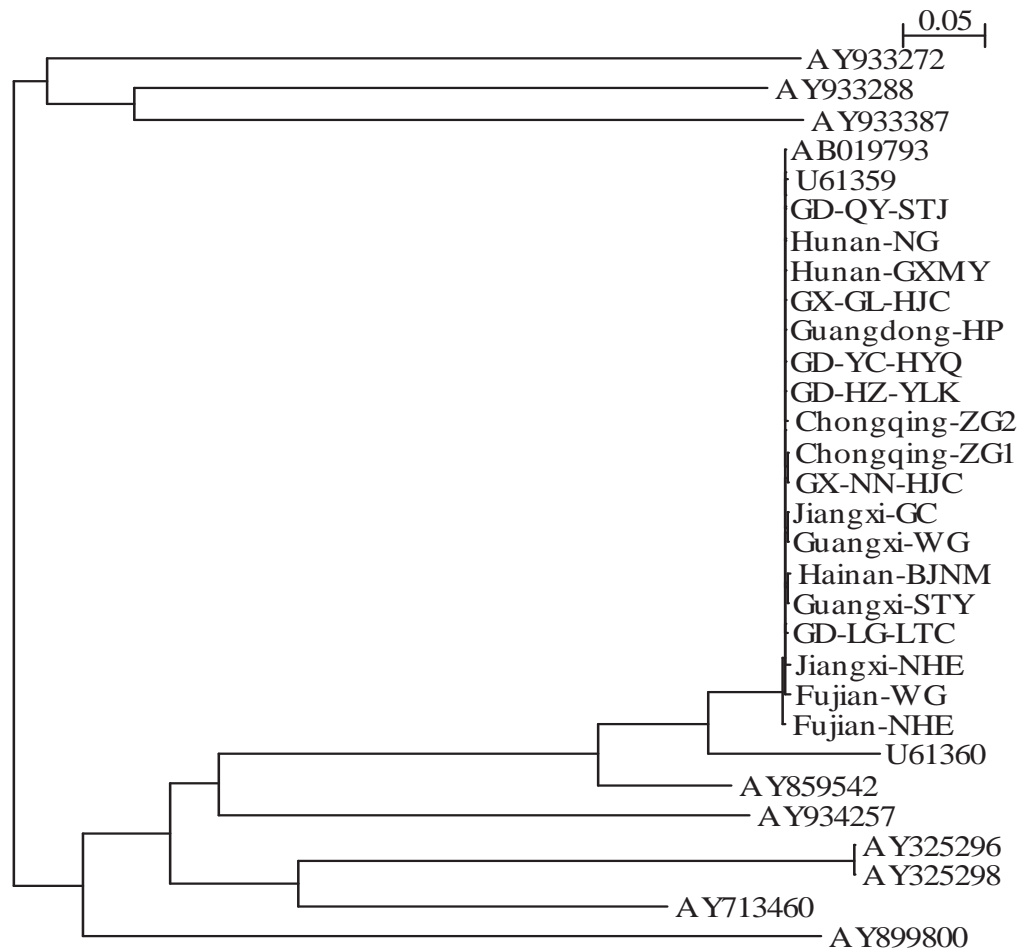


Fig. 3 Phylogenetic tree analysis for 16S/23SrDNA of 18 isolates together with other representative isolates in GenBank.

#### 4.6 Ribosomal RNA operons and Genome size of *Candidatus Liberibacter americanus*, a bacterium associated with citrus Huanglongbing in Brazil.

Wulff N.A.<sup>1</sup>, Eveillard S.<sup>2</sup>, Foissac X.<sup>2</sup>, Ayres A.J.<sup>1</sup> and Bove J.M.<sup>2</sup>

<sup>1</sup>Fundecitrus – Fundo de Defesa da Citricultura, Araraquara, SP, CEP 14807-040, Brazil;

<sup>2</sup>Université de Bordeaux 2 & INRA UMR 1090, 33883 Villenave d'Ornon, B P 81, France

nelsonwulff@fundecitrus.com.br

The GenBank/EMBL/DDBJ accession numbers for the *rrs* gene sequence and the *rrl* / *rrf* gene sequence of Lam isolate São Paulo are FJ036892 and FJ36893, respectively.

\* Paper *in press* at *International Journal of Systematic and Evolutionary Microbiology*.

#### Abstract

Huanglongbing is one of the most severe diseases of citrus worldwide and is associated with *Candidatus (Ca.) Liberibacter (L.) africanus* in Africa, *Ca. L. asiaticus* in Asia and America (Brazil, U.S.A. and Cuba), and *Ca. L. americanus* in Brazil. In the absence of axenic cultures, genetic information on liberibacters is scarce. The sequences of the entire 23S rDNA and 5S rDNA genes from *Ca. L. americanus* (Lam) have now been obtained, using a consensus primer designed on known tRNA<sub>Met</sub> sequences of rhizobiales. The size of the Lam genome was determined by pulse field gel electrophoresis, using Lam-infected periwinkle plants for bacterial enrichment, and was found to be close to 1.31Mbp. In order to determine the number of ribosomal operons on the Lam genome, probes designed to detect 16S rDNA (*rrs*) and the 3' end of 23S rDNA (*rrl*) were developed and used for Southern hybridization with ICEuI-treated genomic DNA. Our results suggest three ribosomal operons in a circular genome. Lam is the first liberibacter species for which such data is available.

#### Introduction

Huanglongbing (HLB) is one of the worst diseases of citrus and endangers the very existence of citriculture (1). Known in China since the 1870s and South Africa since 1928, HLB emerged in 2004, 2005, and 2006, respectively in São Paulo state (Brazil), Florida (USA), and Cuba (1, 3, 5, 6, 9, 14, 15, 16). Each one of the three liberibacters can be transmitted by dodder (*Cuscuta campestris*) to periwinkle plants (*Catharanthus roseus*) in which they reach higher titers than in citrus and induce severe symptoms (4, 12).

Because the liberibacters have not been available in culture, infected periwinkle plants have been one of the major experimental sources of liberibacters. Evidence for the presence of more than one *rrn*-operon in liberibacters was discovered while comparing the 16S/23S intergenic regions of Las and Laf (6). Here we show that Lam has probably three *rrn*-operons on a circular genome in the range of 1.29 to 1.34Mbp, as based on data from pulsed-field-gel-electrophoresis and hybridization assays. The sequences of the 23S rDNA and 5S rDNA (*rrf*) genes of Lam have also been obtained.

#### Materials & Methods

Healthy and infected periwinkle plants were used as source of DNA. Infected periwinkles were grafted from an original plant infected with Lam obtained by dodder (*Cuscuta campestris*) transmission from a sample from São Paulo state, Brazil.

The DNA upstream of *rrs* was obtained by PCR-amplification with degenerated forward primer *rrs\_UpDeg* (5'AGAAAGRGARACGTGGRCGGC) and reverse primer GB3 (15). The *rrl* and *rrf* genes, were obtained by PCR-amplification with forward primer GB4 (5'TTACCGACGTTAGATAACCGGACG), designed from the 16S/23S intergenic region (16), and reverse primer GB11 (5'CTACCGGGCTGCTCCACCCC), designed to anneal at the tRNA<sub>Met</sub> sequence, located at the end of the *rrn* operon. The amplicons were sequenced after cloning into pGEMT-Easy.

Probe *rplAJ* (12), probe P16S (product from GB1xGB3, 15) and probe P23S (GB12 5'GGTAGGCATTGAAGCAGAGGCG x GB13 5'GGCTGGATGTGGAAGCTGGGTA) were DIG-labelled.

High molecular weight genomic DNA was prepared as described (10, 11) with minor modifications.

Agarose blocks were treated with *ICeuI*, *SalI* and CTAB extracted DNA was treated with *BglII*. Pulsed-field-gel-electrophoresis (PFGE) was performed by the contour-clamped homogeneous-electric field (CHEF) technique using the CHEF-DR III system with 1% PFGE agarose.

For Southern hybridization, PFGE gels were stained with ethidium bromide, followed by image capture under UV light and transference to nylon membranes (2).

## Results & Discussion

Primers GB4 and GB11 were used to amplify *rrl* and *rrf* as a 3,142 bp DNA fragment that was cloned and sequenced. Primer *rrs\_UpDeg* and GB3 amplified the 5' part of *rrs* and the upstream DNA, adding 158 bp to the previous *rrs* sequence (16).

Based on the results above, the *rrl* and *rrf* genes span 2,803 bp and 119 bp, respectively, and they are separated by a 41 bp intergenic region, which contains no tRNAs. The *rrl* gene from Lam had the highest sequence identity (95%) with the *rrl* gene from Las strain Sihui (EU644449). The *rrf* gene from Lam had again the highest sequence identity (95%) with the gene *rrf* from Las (EU644449). The complete *rrs* gene from Lam has 1,495 bp and the closest match (95% sequence identity) is the complete *rrs* sequence from Las strain GuangXi-GL-1 (DQ778016.1), followed by (i) the partial *rrs* sequences from liberibacter associated with solanaceae: *Ca. Liberibacter solanacearum* NZ082226 (EU834130.1) and *Ca. Liberibacter psyllaourous* Tx15 (EU812556.1); and Laf (L22533), with 94% sequence identity. In total, the Lam *rrn* represents a stretch of 5,187 bp between primers *rrs\_UpDeg* and GB11.

In the PFGE gels (Fig. 2), a faint band (arrow) is present in lanes containing DNA from plants infected with the liberibacter, but not in lanes containing DNA from uninfected plants and this DNA band display Southern hybridization with probe *rplAJ*, specific for Lam. As expected, there was no hybridization band on the "PW" lanes or in the "PW" well. From comparisons with DNA size markers, the DNA band in Fig. 1 had an estimated size of 1.29Mbp.

Digestion of agarose blocks with restriction enzymes *ICeuI* and *SalI* produced different profiles between healthy and Lam infected samples, displaying Lam specific bands. The *ICeuI* endonuclease seemed particularly interesting to use, since the unique location of its restriction site is within the *rrl* gene of most bacteria (8), and the enzyme is frequently used to determine the number of *rrn* operons during PFGE mapping. Digestion with *ICeuI* resulted in three bands of high molecular weight DNA (C1, C2, C3) when blocks with DNA from liberibacter-infected leaf midribs were used, but no bands were seen with blocks from uninfected control leaves (Fig 2). Probe P16S hybridized with C1 and C3 while probe P23S hybridized with C2 and C3. Based on the DNA markers, the average sizes of fragments C1, C2, and C3, estimated from three



independent experiments, were found to be respectively 494kbp (SD  $\pm$  4), 447 7kbp (SD  $\pm$  3), and 399 7kbp (SD  $\pm$  3). The sum of the sizes of the three fragments, C1, C2, and C3 amounted to 1.341Mbp, a value close to that of 1.29Mbp found for the DNA band of Fig. 1. The size of the Lam genome would thus be in the range of 1.29 to 1.34Mbp.

As *ICeuI* cuts only within the *rri* gene (8), and the fact that *ICeuI* digestion of the liberibacter genome yields three liberibacter genomic DNA fragments (C1, C2, C3) means either the genome is circular with three ribosomal *rrn* operons, or linear with two ribosomal *rrn* operons. The following results suggest that the genome is circular with 3 *rrn* operons: probe P16S, binding to an extended portion of the *rrs* gene, hybridized with fragments C1 and C3, and the hybridization signal with C1 was stronger than with C3 (Fig. 2), suggesting that C1 carries two *rrs* genes, and C3 only one. Probe P23S, binding to the 3' portion of the *rri* gene, hybridized with C2 and C3, the hybridization signal with C2 being stronger than with C3, suggesting that C2 carries two *rri* genes. Bands C1, C2, and C3 were obtained reproducibly, with the hybridization signals to C1 and C2 being stronger than that of C3 in independent experiments.

After genomic DNA digestion with *SalI*, hybridization with probe P23S revealed three bands with sizes of 199, 181 and 110 kbp. The same hybridization pattern was obtained with probe P16S, even though the two upper bands were less distinct. *SalI* fragments result from restriction sites located in between the *rrn* operons. The fact that the same three fragments hybridized with P16S and P23S is further evidence for the occurrence of three *rrn* operons in Lam.

Digestion of DNA with *BglII* and hybridization with probe P16S resulted in three hybridizing bands, only with DNA from liberibacter-infected periwinkle (Fig. 2). Hybridization with probe P23S was hindered by plant DNA and could not be evaluated (Fig. 2). *BglII* sites must be downstream and upstream to each *rrn* operon, accounting for three hybridization signals with probe P16S and supporting the occurrence of three *rrn* operons in Lam.

A genome with three *rrn* operons and three DNA fragments upon digestion with *ICeuI* should have a circular configuration. Besides, Southern hybridization results indicate that two *rrn* operons are in the same orientation, and the third one is in the opposite orientation.

Among bacterial species, the number of *rrn* operons per bacterial genome varies considerably, from 1 to 15 (2, 7). In  $\alpha$ -proteobacteria, the *rrn* copy number is from 1 to 5 (7), Lam having 3 *rrn* operons. Previously our group had indicated that liberibacter harbor at least two 16S rDNA genes (6) and recently Duan et al. have submitted the draft genome from *Ca. Liberibacter asiaticus* (NZ\_ABQW000000000), where three *rrn* operons were also found, supporting the idea of three *rrn* operons for liberibacters.

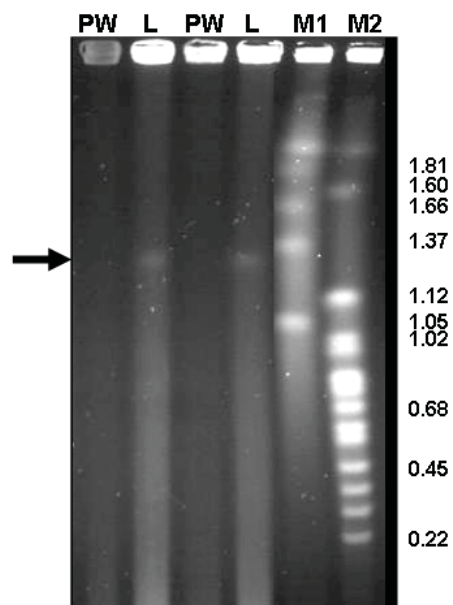
### Acknowledgements

The authors would like to thank Patrick Bonnet for periwinkle grafting and greenhouse maintenance; Anelise G. Mariano for technical assistance in cloning; Patricia Carle, Géraldine Gourgues and Sylvie Malembic-Maher for helpful suggestion for PFGE assays and Diva do C. Teixeira for reading the manuscript.

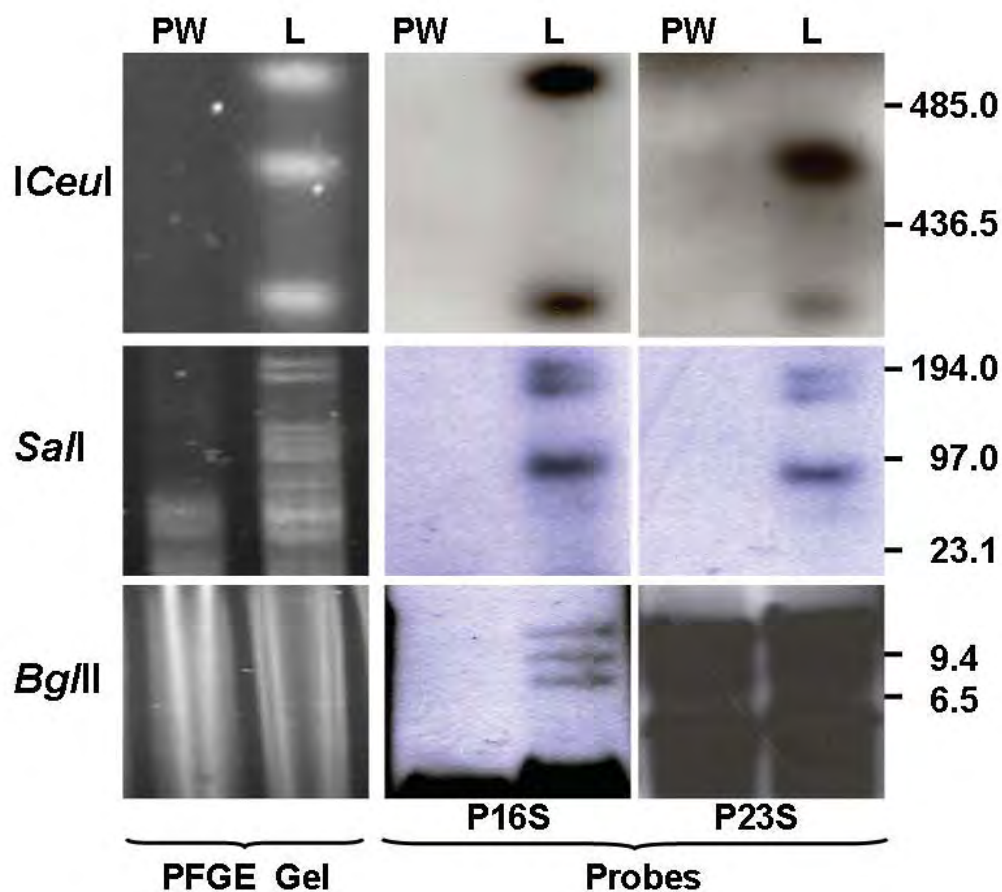
### References:

- Bové JM. (2006). Huanglongbing: a destructive, newly-emerging, century-old disease of citrus. *J Plant Pathol* 88, 7-37.
- Charles H, Ishikawa H. (1999). Physical and genetic map of the genome of *Buchnera*, the primary endosymbiont of the pea aphid *Acyrtosiphon pisum*. *J Mol Evol* 48, 142-150.

- Coletta-Filho HD, Targon MLPN, Takita MA, De Negri JD, Pompeu Jr, J, Machado MA, Amaral AM, Muller GW. (2004). First report of the causal agent of Huanglongbing (“*Candidatus Liberibacter asiaticus*”) in Brazil. *Plant Dis* 88, 1382.
- Garnier M, Bove JM. (1983). Transmission of the organism associated with citrus greening disease from sweet orange *Citrus sinensis* cultivar Madame-vinous to periwinkle vinca rosa by dodder (*Cuscuta campestris*). *Phytopathology* 73, 1358-1363.
- Jagoueix S, Bové JP, Garnier M. (1994). The phloem-limited bacterium of greening disease of citrus is a member of the  $\alpha$  subdivision of the proteobacteria. *Int. J. Systematic Bacteriol* 44, 379-386.
- Jagoueix S, Bové JP, Garnier M. (1997). Comparison of the 16S/23S ribosomal intergenic regions of “*Candidatus liberibacter asiaticum*” and “*Candidatus liberibacter africanum*”, the two species associated with citrus huanglongbing (Greening) disease. *Int J Systematic Bacteriol* 47, 224-227.
- Klappenbach JA, Dunbar JM, Schmidt TS. (2000). rRNA operon copy number reflects ecological strategies of bacteria. *Appl Environ Microbiol* 66, 1328-1333.
- Liu S-L, Hessel A, Sanderson KE. (1993). Genomic mapping with I-CeuI, an intron-encoded endonuclease specific for genes for ribosomal RNA, in *Salmonella* spp., *Escherichia coli*, and other bacteria. *Proc Natl Acad Sci U S A* 90, 6874-6878.
- Llauger R, Luis M, Collazo C, Teixeira DC, Martins EC, Pena I, López D, Batista L, Prieto D, Riano R, Borroto A, Cueto J, Ayres J, Bové JM. (2008). PCR detection of *Candidatus Liberibacter asiaticus* associated with Citrus Huanglongbing in Cuba. *Tropical Plant Pathology* 33, S93.
- Neimark H, Kirkpatrick BC. (1993). Isolation and characterization of full length chromosomes from non-culturable plant-pathogenic Mycoplasma-like organisms. *Mol Microbiol* 7, 21-28.
- Padovan AC, Firrao G, Schneider B, Gibb KS. (2000). Chromosome mapping of the sweet potato little leaf phytoplasma reveals genome heterogeneity within the phytoplasmas. *Microbiology* 146, 893-902.
- Teixeira DC, Eveillard S, Sirand-Pugnet P, Wulff NA, Saillard, C, Ayres AJ, Bové JM. (2008a). The *tufB-secE-nusG-rplKAJL-rpoB* gene cluster of the liberibacters: sequence comparisons, phylogeny and speciation. *Int J. Syst Evol Microbiol* 58, 1414-1421.
- Teixeira DC, Saillard C, Couture C, Martins E, Wulff NA, Yamamoto PT, Eveillard-Jagoueix S, Ayres AJ, Bové JM. (2008b). *Candidatus Liberibacter americanus*, agent of huanglongbing disease of citrus in Sao Paulo State, Brasil: Distribution and quantification of the liberibacter in leaves of an affected sweet orange tree as determined by PCR methods. *Mol Cell Probes* 22, 139-150.
- Teixeira DC, Ayres AJ, Kitajima EW, Tanaka FAO, Danet JL, Jagoueix-Eveillard S, Saillard C, Bové JM. (2005a). First report of a huanglongbing-like disease of citrus in Sao Paulo State, Brazil, and association of a new liberibacter species, *Candidatus Liberibacter americanus*, with the disease. *Plant Dis* 89, 107.
- Teixeira DC, Danet JL, Eveillard S, Martins EC, Jesus Junior WC, Yamamoto PT, Lopes SA, Bassanezi RB, Ayres AJ, Saillard C, Bové JM. (2005b). Citrus huanglongbing in São Paulo state, Brazil: PCR detection of the ‘*Candidatus*’ *Liberibacter* species associated with the disease. *Mol Cell Probes* 19, 173-179.
- Teixeira DC, Saillard C, Eveillard S, Danet JL, da Costa PI, Ayres AJ, Bove J. (2005c). ‘*Candidatus Liberibacter americanus*’, associated with citrus huanglongbing (greening disease) in Sao Paulo State, Brazil. *Int J. Syst Evol Microbiol* 55, 1857-62.



**Fig. 1.** PFGE of chromosomal DNA of the *Candidatus Liberibacter americanus*. Ethidium bromide-stained gel of undigested PFGE of chromosomal DNA from healthy periwinkle plants (PW) and plants infected with Lam (L). PFGE parameter was 1 to 12 s for 6 h and 60 to 120 s for 16 h (A) at 6 V/cm. DNA size markers (kbp), M1: DNA from *Hansenula wingei*, M2: DNA from *Saccharomyces cerevisiae*.



**Fig. 2.** PFGE of *Candidatus Liberibacter americanus* DNA and hybridization with probes P16S and P23S after Southern blot. Plugs containing chromosomal DNA of healthy periwinkle (PW) or Lam infected periwinkle (L) were digested with *ICEuI* and *SalI* and electrophoresed (*ICEuI* = 2-40 s for 40 h, 6 V/cm at 120° included angle; *SalI* = 1 to 12 s for 4 h and 60 to 120 s for 16 h, 6 V/cm. DNA of healthy periwinkle (PW) or Lam infected periwinkle (L) were digested with *BglII* and electrophoresed 0.5 to 12 s for 12 h, 6 V/cm. DNA size markers (kbp): DNA from *Saccharomyces cerevisiae* and  $\lambda$  DNA ladder.

#### 4.7 Genome Analysis of *Candidatus Liberibacter asiaticus* Reveals Unique Features for Designing HLB Control Strategies

Duan Y-P.<sup>1</sup>, Zhou L-J.<sup>2</sup>, Hall D.<sup>1</sup>, Li W.B.<sup>3</sup>, Lin H.<sup>4</sup>, Doddapaneni H.<sup>4</sup>, Liu L.<sup>5</sup>, Vahling C.M.<sup>1</sup> and Gottwald T.R.<sup>1</sup>

<sup>1</sup>USDA-ARS, Fort Pierce, FL, <sup>2</sup>University of Florida, IFAS-IRREC, Fort Pierce, FL, <sup>3</sup>USDA-APHIS\_PPQ\_CPHST, Beltsville, MD, <sup>4</sup>USDA-ARS, Parlier, CA, <sup>5</sup>ICBR, UF, Gainesville, FL, USA

Citrus Huanglongbing (HLB) is the most destructive and devastating disease of citrus in the world. Since the initial report of the disease in Florida in August of 2005, HLB has spread throughout 32 of the citrus-producing counties. The causal agent of this disease is believed to be three species of alpha-Proteobacteria, *Candidatus Liberibacter asiaticus* (Las), *Ca. L. africanus* and *Ca. L. americanus*. Las is the most widely-distributed species and the only species that has been detected in Florida to date. Due to its fastidious nature, the bacterium has not been cultured *in vitro*. We obtained and annotated a draft genome of *Ca. L. asiaticus* by using multiple displacement amplification and 454 pyrosequencing from Las-infected Asian citrus psyllids (*Diaphorina citri*). The draft genome contained at least 1,216,073 base pairs with ca. 17X redundancy and an average GC content of 37.4% in 36 contigs, ranging from 1.0 kb to 186 kb. The annotated draft genome contained two rRNA operons and 41 tRNA genes. Approximately 60.4 % of the 1123 predicted coding sequences (CDS) have homologues with known or putative function and 61(5.4%) are pseudogenes, whereas the remaining 34.5 % represent hypothetical-conserved open reading frames (ORFs). It is worthwhile to note that the draft genome shared similar numbers of flagella-related ORFs as *Sinorhizobium meliloti* 1021 and *Agrobacterium tumefaciens* str. C58 even though the Las genome is much smaller than the other two. Putative “toxin” proteins and their type I secretion system were also identified from the draft genome. The metabolite pathways and genome evolution of this unique  $\alpha$ -Proteobacterium, which is both an intercellular plant pathogen and insect parasite/symbiont, were also examined.

#### 4.8 Cocultivation of *Candidatus Liberibacter Asiaticus* with Actinobacteria from Citrus with Huanglongbing

Davis M. J., Mondal S. N., Chen H.-Q., Rogers M. E., Brlansky R.H.

University of Florida/IFAS, Citrus Research and Education Center, Lake Alfred, Florida

Huanglongbing (HLB), also known as citrus greening disease, is a devastating disease of citrus caused by phloem-limited bacteria that have not been grown in culture. Three species, *Candidatus Liberibacter asiaticus*, *L. africanus*, and *L. americanus*, are known. *Candidatus L. asiaticus* and its insect vector, the psyllid *Diaphorina citri*, have been recently introduced into Florida. We attempted to isolate *Candidatus L. asiaticus* using media formulations developed in response to the growth of another bacterium that appears to be related to the Liberibacters based on 16S rRNA gene identities. Cultures were obtained that were PCR positive for *Candidatus L. asiaticus*. However, transmission electron microscope examination of the culture, PCR using generic primers, and sequencing of the PCR products revealed the presence of other bacteria in the cultures. These were actinobacteria related to *Propionibacterium acnes* based on 16S rRNA identities. The cocultures remained after attempts to purify the cultures by single colony isolation suggesting that the bacteria might be mutually beneficial to each other in culture. The cocultures survived more than 10 weekly passages to fresh medium. PCR using *P. acnes* specific primers indicated that actinobacteria are common inhabitants of citrus and psyllids, whether or not *Candidatus L. asiaticus* is present.

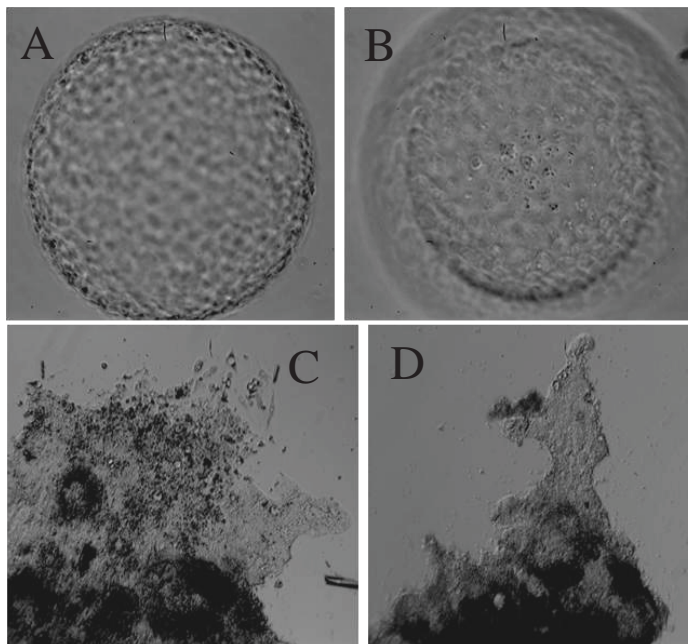
#### 4.9 Development of Asian citrus psyllid, *Diaphorina citri*, insect cell lines

Lewis M.W. and Keyhani N.O.

University of Florida, Dept. of Microbiology and Cell Science, Gainesville, FL 32608

The Asian citrus psyllid, *Diaphorina citri*, is the insect vector responsible for the transmission of the citrus greening agent, *Candidatus Liberibacter asiaticus*. A citrus psyllid cell line would represent a new tool with which to examine psyllid pathology, genetics, and potentially essential microbial endosymbionts. The project goals are to develop citrus psyllid cell lines for use in the study of the *Liberibacter* pathogens. Ideally, there are a number of desirable properties the cell lines should possess as follows: (i) the cells should adhere to tissue culture substrata, growing in a monolayer, (ii) the propagation of the cells should be rapid, (iii) the damage of cells by subculture should be low, and (iv) long-term storage of the cells should be possible. To date five groups (each comprised of multiple independent dissections) with a total of over several dozen cell lines from dissected embryos have been initiated. Experiments were performed to optimize media composition and embryo handling. Primary cells lines, presenting outgrowth cells from the dissected embryos that have begun to attach and grow in the media can now be almost routinely established. Images of the various cells lines show diverse morphologies including elongated epithelial-like cells that attach to the tissue flask surface and grow in a monolayer, large clumps of globular floating cells, and undifferentiated tissue-like growth (Fig. 1). First passage of several primary cell lines have been initiated and appear to be growing.

**Fig. 1.** DIC images of primary cell lines. Cell line Dce 15 (A & B), 16 weeks after initiation. Panel B is the same cells as in A, except focused on the bottom of the “cell ball” illustrating attachment of cell representing the “ball” to the underlying flask surface, approximately 4 weeks after initiation. Cell line Dce 19 (C & D), 14 weeks after initiation, this line has undergone its 1<sup>st</sup> passage and with cells appearing to be growing after the passage.



#### 4.10 Enrichment of *Candidatus Liberibacter americanus* using an artificial psyllid feeding system.

Locali-Fabris E.C.<sup>1</sup>, Della Coletta-Filho H.<sup>1</sup>, Miranda M.P.,<sup>2</sup>; Francisco C.S.<sup>1</sup>, Lopes J. R.S.<sup>2</sup>; **Machado M.A.**<sup>1</sup>

1. Centro APTA Citros Sylvio Moreira – IAC, CP 04, CEP 13490-970, Cordeirópolis/SP, Brazil.
2. Entomologia/ESALQ-USP, Piracicaba/SP, Brazil.

*Candidatus Liberibacter* spp., the causal agent of Huanglongbing (greening), is restricted to the phloem tissues and has an uneven and irregular distribution within plants. Two species of *Ca. Liberibacter*, *Ca. L. americanus* (Lam) and *Ca. L. asiaticus* (Las), are associated to HLB in Brazil. Due to the low concentration of the bacteria in tissues of citrus plants, isolation of the bacterial DNA and molecular dissection of the pathogen had not been successful. Therefore it has been necessary to develop new strategies for the isolation of these bacteria. We attempted to capture cells of Lam from psyllids feeding in a system based on small cages covered with membranes. The membranes contained PBS 0.005 mM + 25% of sucrose solution as a medium for feeding of infected psyllids. Psyllids and membranes solutions were collected and submitted for evaluation of the presence of the bacteria through PCR using specific primers. The results showed the presence of the bacteria in psyllids as well as in the solutions. Around 60 % of the tested samples were PCR positive. These results indicate that this strategy can be an alternative for enriching Lam without the necessity of using alternate hosts such as periwinkle for the isolation of the pathogen DNA, reducing the molecular contaminants frequently observed in plant tissues.



#### 4.11 Production of Asian Citrus Psyllid (*Diaphorina citri*) cell cultures

Marutani-Hert M., Hunter W.B., Hall D.G.

USDA, ARS, U.S. Horticultural Research Lab, 2001 South Rock Rd, Ft. Pierce, FL, USA 34945.

We successfully developed Asian citrus psyllid cell cultures as a tool to subculture *Canidatus Liberibacter asiaticus* (Las), which is a fastidious bacterium that reportedly replicates within the psyllid host. This novel approach uses psyllid cell cultures as the medium to isolate and culture this bacterium to permit further research. The Asian Citrus Psyllid (AsCP), *Diaphorina citri*, (Hemiptera: Psyllidae) is a highly competent vector of the phloem-inhabiting bacterium (Las), associated with the disease Huanglongbing (HLB). World-wide HLB has become a major limiting factor to the production of citrus. A specific psyllid cell culture medium was developed during the screening of 12 commercially available insect cell culture media. Attempts were made using starter cells from embryos and midgut tissues. Cells and tissues could be maintained for up to 4 months. The developed psyllid culture medium, Hert-Hunter-70, provided the best growth rates with doubling times at ~ten days. Previous attempts to use a lepidopteran cell culture, *Spodoptera frugiperda* (Sf9), to culture *Liberibacter* were unsuccessful, suggesting further that a psyllid cell culture would be more permissive. Psyllid cell cultures are also being used to propagate and study psyllid viral pathogens.

##### Introduction

Citrus greening disease, also known as Huanglongbing disease, HLB, is a devastating disease on citrus causing reduced fruit yields, fruit quality, and ultimately tree death. The causal agent of HLB is thought to be Las, which has thus far remained elusive in the development of pure cultures. This study attempts a new approach to isolate and culture this bacterium in a medium of psyllid cell cultures. The Asian Citrus Psyllid, AsCP, *Diaphorina citri*, (Hemiptera: Psyllidae) is a highly competent vector of this phloem-inhabiting bacterium. World-wide citrus greening has become a major limiting factor to the production of citrus. First attempts to isolate the bacteria were made using a commercially available insect cell culture, Sf9 cell culture to isolate Las from infected citrus sap. However, the PCR product derived from Las dramatically decreased one day after inoculation (dai) compared to 0 dai. This result showed Las could not survive in Sf9 cells. There may be interaction requirements needed between Las and the AsCP, or its endosymbionts. To examine these potential interactions we created psyllid cell cultures. Several commercially available insect cell culture media were screened for viability to culture cells/tissues from AsCP embryos and midgut tissues (Figure. 1 and 2). We defined an insect culture medium, labeled Hert-Hunter-70, which permitted psyllid cell lines to be established. These primary AsCP cell cultures appear healthy, and growth rates average a doubling ~10 days.

##### Materials and Methods

*Inoculation leaf sap in Sf9 cells:* Sf9 cells were maintained with Grace's insect medium containing 10% fetal bovine serum (FBS). Cells were incubated at 27°C feeding cultures every 3 days. Citrus leaves which were *Liberibacter* positively detected by PCR analysis were collected from Picos Farm in Ft. Pierce, Florida. Leaves were processed in sterile-laminar hood, surface sterilized in 70% ethanol and washed with syringe filtered water three times (0.22µm).

Leaf midribs were cut and ground with water and filtrated by cotton mesh cloth. This filtrated leaf sap was transferred into Sf9 cells (0 d) and sampled daily over next three days.

*PCR Analyses:* PCR was conducted with Las primers(Shatters, USDA, ARS) to monitor presence of Las over time.

*Cells from psyllid egg:* Psyllid eggs were isolated from the tips of growing shoots and the crevices of unfolded 'feather-flush' leaves from citrus, collected at the USDA in Ft. Pierce, FL.

- (1) Eggs were disinfected by submersion in 70% ethanol, 10 min, then rinsed 3 to 5 times by submersions in 0.05% sodium hypochlorite (= 1% chlorine bleach).
- (2) Rinse 6 times with sterile distilled water.
- (3) Transfer to tube and crush with glass rod.
- (4) Add culture medium (Hert-Hunter-70) containing antibiotics (Pen-Strep).
- (5) Culture at 25 °C.

#### *The adult Psyllid alimentary tract*

- (1) Surface sterilized adult psyllids were immersing in 70% ethanol for 30 min.
  - (2) Rinse 5 times with sterile distilled water.
  - (3) Sterilized insects were fixed on a glass slide and circle with a PAP pen and the circle filled with PBS buffer (pH6.5).
- Dissection was performed in the buffer under a dissecting microscope.
- (4) Forceps and needles were used to remove the gut.
  - (5) The excised gut was placed into a tube and crushed with a glass rod.
  - (6) Add culture medium containing antibiotics (as above #4).
  - (7) Culture at 25 °C.

#### Media and supplements used in development and evaluations:

Medium 199 (Sigma)	Grace's (GIBCO)
Ex-cell 405 (Sigma)	Sf900 III SFM (GIBCO)
Schneider's Insect Medium (Sigma)	TNM-FH Insect Medium (Sigma)
TC100 Insect Medium (Sigma)	Shields & Sang M3 Insect Medium (Sigma)
IPL-41 Insect Medium (Sigma)	Gentamicin solution (Sigma)
0.05% sodium hypochlorite	100X Penicillin-Streptomycin (sigma)
Fetal Bovine Serum, not heat inactivated, FBS	L-Glutamine 200mM (GIBCO)

## **Results and Discussion**

We have successfully produced several AsCP cell lines. Evaluation of different commercially available media for suitability to culture psyllid cells resulted in production of a medium suitable for psyllid cell growth. However, different combinations of supplements continue to be evaluated. The new medium labeled Hert-Hunter-70, supports psyllid cells in this media over three months. When psyllid eggs were used in which the eyespot could be seen, the resulting cells showed migration and adherence to the glass Petri dish. Successful cultures are being inoculated with citrus sap filtrates in an attempt to culture Las.

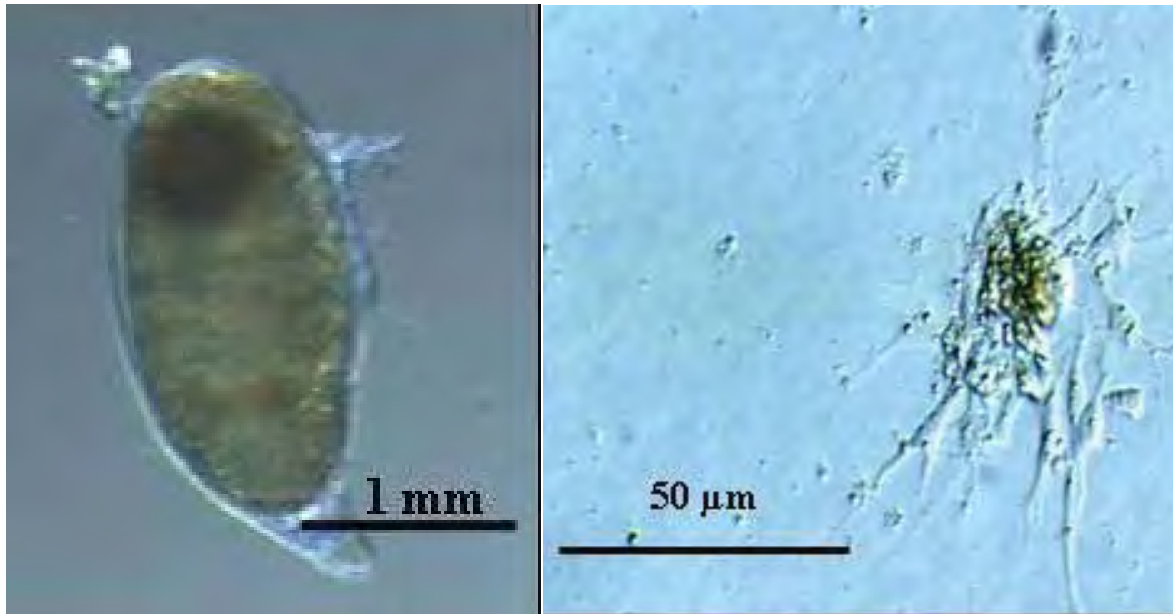
## **References**

- Marutani-Hert M, Hunter WB, Hall DG. 2008. Establishment of Asian citrus psyllid cell cultures (*Diaphorina citri*: Hemiptera). In Vitro Cell. Dev. Biol.-Animals (Accepted).
- Lynn DE. 2002. Methods for maintaining insect cell cultures. J Insect Sci. 1-6

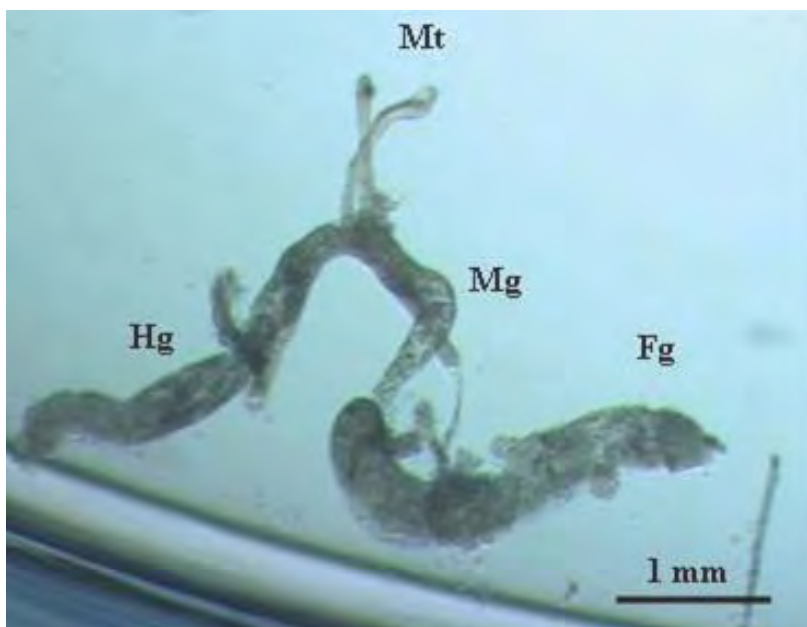
Lynn DE. 2001. Novel techniques to establish new insect cell lines. *In Vitro Cell. Dev. Biol.-Animal* 37:319-321.

Mitsuhashi J. 2002. *Invertebrate Tissue Culture Methods*, Springer lab manual, Tokyo-Shoseki

**Figure 1.** *Diaphorina citri* egg and cells from crushed eggs, 3 days post treatment showing growth.



**Figure 2.** Asian citrus psyllid alimentary tract dissected from adult. Fg- foregut, Mg- midgut, Hg- hind gut, Mt- Malpighian tubules.



#### 4.12 Genetic Diversity of *Candidatus Liberibacter asiaticus* and *Ca. L. americanus* Based on Sequence Variations of Their rRNA Operon

Zhou L.J.<sup>1</sup>, Powell C.A.<sup>1</sup>, Gottwald T.<sup>2</sup> and Duan Y-P.<sup>2\*</sup>

<sup>1</sup>University of Florida, IFAS-IRREC, Fort Pierce, FL 34945, <sup>2</sup>USDA-ARS-USHRL, Fort Pierce, FL 34945, \* Corresponding author.

##### Introduction

Citrus Huanglongbing (HLB), also known as citrus greening, is the most destructive and devastating disease of citrus in the world (Gottwald *et al.*, 2007). Since the initial report of the disease in Florida in August of 2005, HLB has spread throughout 32 of the citrus producing counties. The causal agent of this disease is believed to be three species of alpha-Proteobacteria, *Candidatus Liberibacter asiaticus* (Las), *Ca. L. africanus* (Laf) and *Ca. L. americanus* (Lam) (Jagoueix, et al., 1994; Teixeira, et al., 2005). Las is the most widely-distributed species and the only species that has been detected in Florida to date. However, different types of symptoms were observed on citrus in the fields, and on HLB-affected periwinkles when the disease was transmitted from Las-infected citrus to periwinkle via dodder. More importantly, these different types of symptoms can be maintained by graft transmission, indicating they are not caused by genetic variation of host plants, but likely by genetic variation of the pathogens. To reveal the variations of the HLB pathogens, we cloned and sequenced the 3.3-3.6 kb rDNA fragments, including 16S rRNA gene, 16S/23S intergenic region and partial 23S rRNA gene from Las and Lam-infected plant DNAs.

##### Material and methods

Six rDNA libraries of Las were constructed from the different HLB-affected citrus and periwinkle plants with distinct symptoms using PCR-based cloning (Table 1). In addition, a 3.6 kb rDNA library of Lam was also obtained from HLB-affected citrus DNA from Brazil. Two sets of primers were used to amplify the targeted DNA fragments: OI1 5'-GCGCGTATGCAATACGAGCGGCA-3' (Jagoueix, et al., 1996) and LJ11f 5'-TCTCACAAAGTCCTCCTTCATC-3' for Las rRNA operon; CGO3f 5'-RGGGAAAGATTTTATTGGAG-3' (Zhou, et al., 2007) and LJ18f 5'-TCTCACCCCTCCTATTAACC-3' for Lam rRNA operon. High Fidelity Platinum® Taq DNA Polymerase (Invitrogen Carlsbad, CA) were used for PCR amplification, and the PCR product with expected sized were cloned into the TOPO TA cloning vector pCR2.1 (Invitrogen, Carlsbad, CA). 60-80 white colonies from each library were randomly selected for PCR-RFLP analysis using restriction enzyme *MspI* and *HincII*, and the clones with different RFLP profiles revealed by the two enzymes were sent for sequencing. Sequence analyses were performed by blasting in NCBI, and multiplex alignment with software Vector NTI Advance 10.3.0, (Invitrogen Carlsbad, CA). Phylogenetic analysis was conducted using *MEGA* version 4 (Tamura, Dudley, Nei, and Kumar 2007), all the sequences used for phylogenetic analysis from this study has been submitted to NCBI.

##### Result and discussion

Instead of comparing the short sequence of the 16S rDNA or 16S/23S rDNA intergenic region (Jagoueix, et. al, 1994 and 1997), a long DNA fragment of 3.3kb (Las) or 3.6kb (Lam)

across 16S rRNA gene, 16S/23S intergenic region and partial 23S rRNA gene were amplified and cloned to generate rDNA libraries. PCR-RFLP results using *MspI* and *HincII* from the six Las rDNA libraries and one Lam rDNA library revealed different RFLP profiles existed in each population at different ratio from 0 to 12% (Fig.1 and Table 2), indicating the mixed population of the individual species of Las/Lam bacteria within a single HLB-affected plant. It is worth to noting that the library from PG9 had more RFLP profiles and single nucleotide polymorphisms (SNPs) than those of the other 5 Las rDNA libraries, and the HLB-affected periwinkle plant PG9 displayed systemic yellow symptoms in two weeks after grafting, which was two to four weeks earlier than that of the other HLB-infected periwinkle plants. Phylogenetic analysis of the 6 sequences with maximum SNPs from each of Las library based on the 1179bp sequences of their 16S rDNA revealed the sequence R8T1-462 branched out from the rest of Las sequences (Fig. 2). As indicated in the Table 1, R8T1 was the HLB-affected Pummelo citrus that only displayed yellow shoots with vein yellowing and without blotchy mottles on leaves, and contained low titer of Las bacterium.

Currently, there is little information on strain variation of the HLB pathogens. Due to the small genome size (Duan et al., unpublished data) and fastidious nature, the *Liberibacter* might have limited genetic variations in terms of insertion or deletion of their sequences within single species. However, variation of the mixed population with SNPs revealed in this study may play an important role in the disease development and epidemiology. Further study using other genetic marker(s) may reveal more information regarding the genetic diversity of the HLB pathogens.

#### References:

- Gottwald TR, da Graca JV, Bassanezi RB. 2007. Citrus Huanglongbing: The pathogen, its epidemiology, and impact. *Plant Health Progress* doi:10.1094/PHP-2007-0906-01-RV.
- Jagoueix S, Bové JM, Garnier M. 1994. The phloem-limited bacterium of greening disease of citrus is a member of the  $\alpha$ -subdivision of the *Proteobacteria*. *International Journal of Systematic Bacteriology*. 44:397-386
- Jagoueix S, Bové JM, Garnier M. 1996. PCR detection of the two ‘*Candidatus*’ *Liberobacter* species associated with greening disease of citrus. *Mol. and Cell. Probes* 10: 43-50.
- Jagoueix S, Bové JM, Garnier M. 1997. Comparison of the 16S/23S ribosomal intergenic regions of “*Candidatus* *Liberobacter asiaticum*” and “*Candidatus* *Liberobacter africanum*” the two species associated with citrus Huanglongbing (greening) disease. *Int. J. Syst. Bacteriol.* 47:224-227.
- Pillai SK, Sakoulas G, Wennersten C, Eliopoulos GM, Moellering RC Jr, Ferraro MJ, Gold HS. 2002. Linezolid resistance in *Staphylococcus aureus*: characterization and stability of resistant phenotype. *J Infect Dis* 186:1603–1607
- Tamura K, Dudley J, Nei M, Kumar S. 2007 MEGA4: Molecular Evolutionary Genetics Analysis (MEGA) software version 4.0. *Molecular Biology and Evolution* 24:1596-1599. (Publication PDF at <http://www.kumarlab.net/publications>)
- Teixeira DDC, Danet J.L., Eveillard S., Martins E.C., De Jesus Jr. W.C., Yamamoto P.T., Lopes SA, Bassnezi RB, Ayres AJ, Saillard C, Bove JM. 2005. Citrus huanglongbing in São Paulo State, Brazil: PCR detection of the 'Candidatus' *Liberibacter* species associated with the disease. *Molecular and Cellular Probes*, 19 (3), pp. 173-179.

Zhou LJ, Gabriel DW, Duan YP, Halbert SE, Dixon WN. 2007. First report of dodder transmission of Huanglongbing from naturally infected *Murraya paniculata* to citrus. Plant Disease, 91:227.

Table 1. rDNA libraries and the HLB-affected source plants and symptoms.

Cloning ID	DNA ID	Source plant	Symptom on source plant
pLJ45	3-3SL	Graft transmitted lemon in green house	No visible symptom
pLJ46	R8T1	Natural infected Pummelo in Fort Pierce, Florida	Yellow shoots with vein yellowing
pLJ47	C3	Natural infected sweet orange removed from field and maintained in green house	Blotchy mottle in the field and turned to nutrition deficiency symptom in greenhouse
pLJ56	PG6	Graft transmitted periwinkle in green house	Small, mottling leaves with vein yellowing
pLJ57	PC11	Dodder transmitted periwinkle in green house	Vein yellowing with wilt tip
pLJ58	PG9	Graft transmitted periwinkle in green house	Rapid development of systemic symptoms of yellow leaves
pLJ50	Lam	Lam-infected citrus DNA from Brazil	No record of symptoms

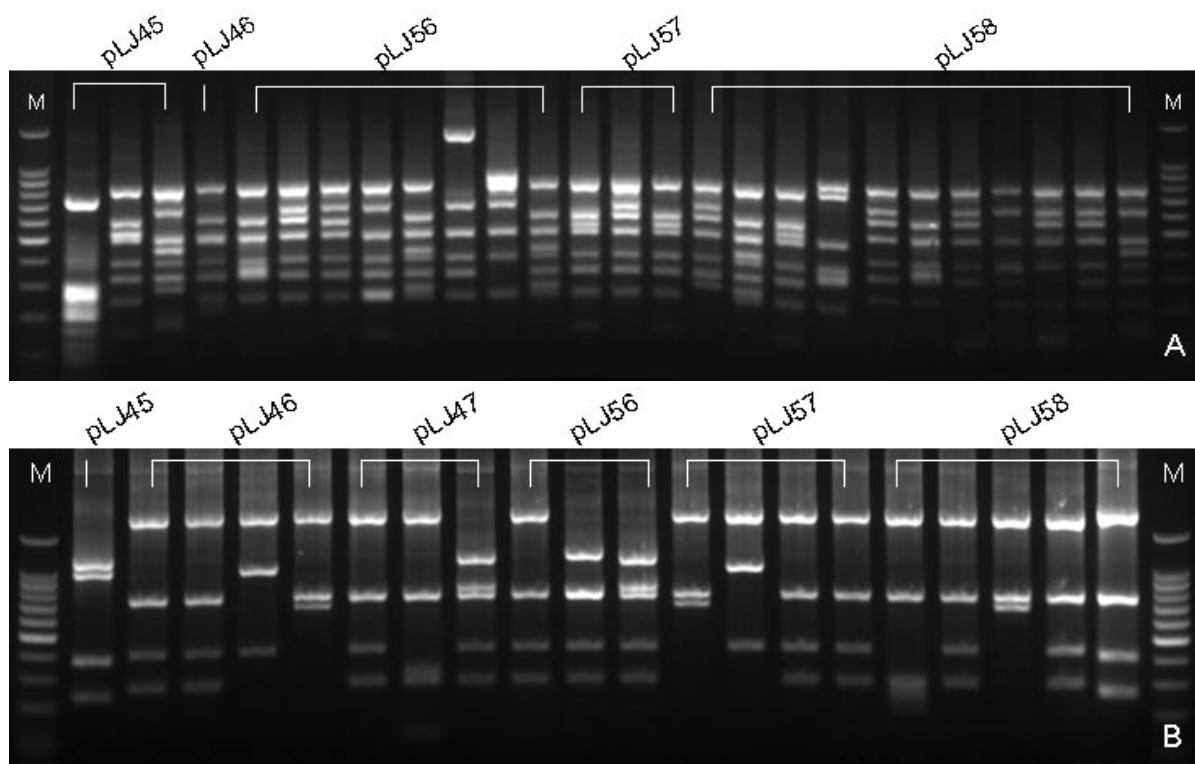


Fig. 1. *MspI* (A) and *HincII* (B) RFLP profile of PCR-amplified rDNA fragment of Las rRNA operon from HLB-infected citrus and periwinkle using primers OI1 and LJ11f.

Table 2. RF LP profiles, mutant ratio in the rDNA libraries and maximum number of single-nucleotide polymorphisms (SNPs) of each Las or Lam rDNA sequence

DNA ID		3-3SL	R8T1	C3	PG6	PC11	PG9	Lam
<i>MspI</i>	Profile number	4	2	1	7	2	8	7
	Percentage of mutants	8.1%	2.9%	0	7.5%	1.7%	8.8%	12%
<i>HincII</i>	Profile number	2	3	3	3	3	4	2
	Percentage of mutants	2.7%	5.9%	6.7%	2.5%	3.3%	3.8%	2%
Maximum no.of SNPs		7	8	5	4	4	10	7

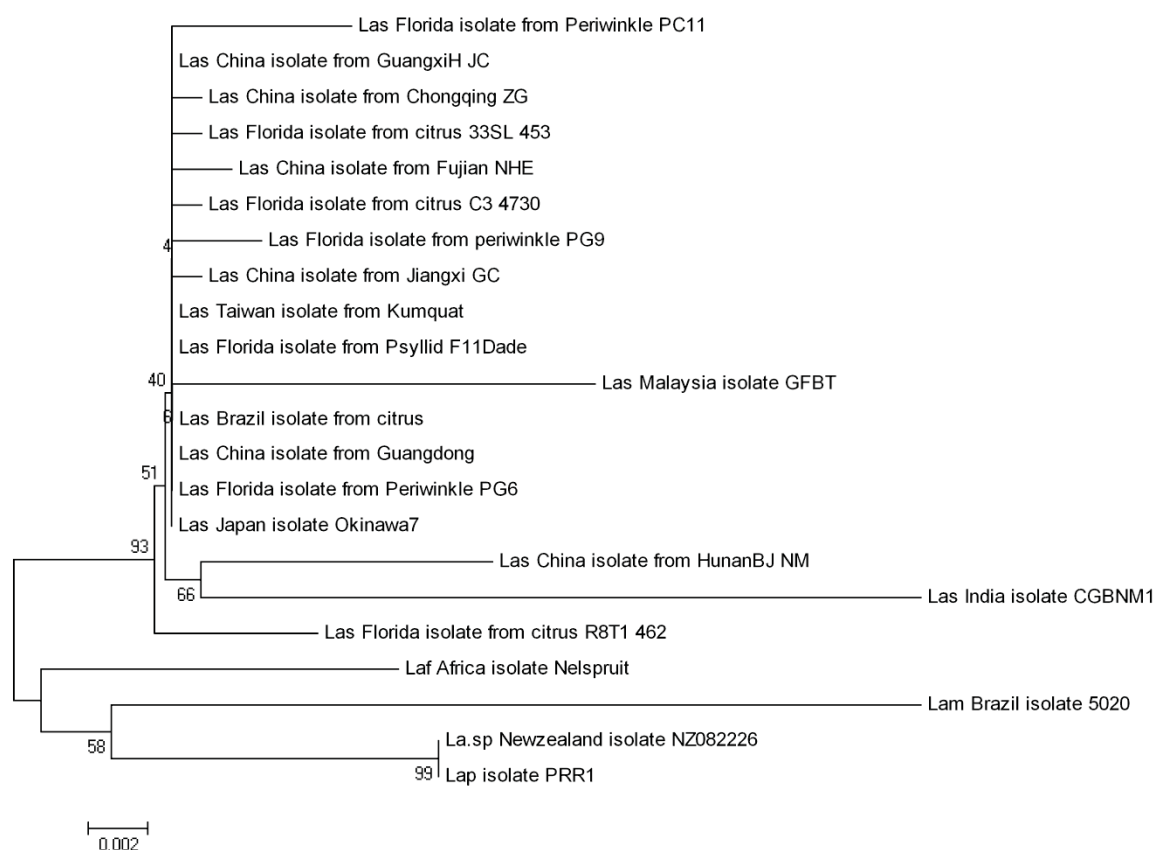


Fig. 2. Neighbor-Joining phylogenetic tree generated from alignment of 1.2kb of 16S rRNA gene sequence of *Ca. Liberibacter* by MEGA4.1 with 1000 bootstrap replication. Bootstrap values are shown at the nodes. Six of Las Florida plant isolates and one of Lam Brazil isolates 16S rRNA gene sequence were obtained in this study; all the other sequences were from GenBank.

### 4.13 Efficient Enrichment of the Pathogen DNA from HLB Infected Host

Chen C., Yu Q., Gmitter Jr F..

University of Florida, IFAS, Citrus Research and Education Center, Lake Alfred, FL 33850, USA

The presumed causal agent of citrus HLB, *Candidatus Liberibacter* spp., is a phloem-restricted alpha-proteobacterium and has not yet been cultured. Consequently, little progress has been made to determine its genome sequence and size, or to characterize the pathogen and disease, all routine tasks for most other bacteria. Very few HLB sequences have been cloned by conserved probes, degenerate primers, or genomic walking methods; these slow, inefficient methods have only claimed shorter than 30 kb of the pathogen genome cloned over the years. These sequences have been widely used to design primers for PCR detection. On the other hand, the inability to culture HLB *in vitro* continues to preclude simple isolation of the pure bacterial DNA. Direct separation of the intact bacterial genome in pulsed field gel or indirect enrichment of the bacterial genome by removal of overabundant host genome is essential for subsequent cloning and sequencing. The basics of the indirect enrichment has been characterized as genomic difference cloning – to isolate sequences present in one genomic DNA population that are absent in another. The low-titer *Liberibacter* genome present in infected host tissues, but absent in the healthy host genome, is such a case.

In addition to direct separation and size determination of the intact bacterial genome in pulsed field gels, three genomic subtractive approaches were compared to remove the overabundant host genome and enrich the low-titer *Liberibacter* genome. We monitored the DNA quantity during the processes using spectrophotometry and PCR with host and *Liberibacter* primers. Among them, the newly developed neoschizomer- and adaptor-mediated approach could remove a majority of host DNA, and resulted in a small amount of enriched DNA that was believed likely to contain a substantial portion of *Liberibacter* DNA. The neoschizomer cleavage could completely prevent re-associated healthy host genomic DNA from ligating in the subsequent cloning process. Over ten thousand clones were picked, more are under way and subject to further identification and sequencing. The details on the approaches and their efficiency, and library screening and available sequence data, as well as PFGE separation and size determination of the genome, will be presented. These genomic sequences may benefit many aspects of understanding the pathogen and managing the disease, such as diagnosis, transmission, infection, pathogenicity, culture, vector control, and resistance breeding.



#### 4.14 Characterization of “*Candidatus Phytoplasma asteri*” citrus Huanglongbing strain in Guangdong, China.

Chen J.<sup>1</sup>, Deng X.<sup>2</sup>, Pu X.<sup>2</sup>, Cai L.<sup>2</sup>, and Guo H.<sup>2</sup>

<sup>1</sup>USDA-ARS, Parlier, California, USA; <sup>2</sup>Center for Citrus Huanglongbing Research, South China Agricultural University, Guangzhou, P. R. China

Huanglongbing (HLB) or yellow shoot disease is a highly destructive disease of citrus. In addition to the citrus growing regions in Asia and Africa, HLB has recently been found in both South and North America. Understanding the etiology of HLB is critical for disease research and management. Despite efforts of over half a century, identification of the HLB causal agent remains highly challenging. Most available data show that HLB is associated with infection by “*Candidatus Liberibacter* spp.” which are vectored through psyllids. However, Koch’s postulates have not been fulfilled. There have been speculations that other microorganisms may also be involved in HLB. The latter is substantiated by two recent research findings: A phytoplasma closely related to the pigeon pea witches’-broom phytoplasma (16Sr IX) was reported to be associated with citrus HLB in the state of São Paulo, Brazil; And in a survey performed in Guangdong Province, P. R. China in 2006 and 2007, 110 out of 141 citrus samples showing typical symptoms of HLB from 11 different cities were detected positive with the presence of a strain of “*Candidatus Phytoplasma asteri*”. Many of the samples were mix-infected with “*Ca. Liberibacter asiaticus*”. To further characterize the HLB phytoplasma from Guangdong, three DNA sequences upstream and downstream of the *rrn* operon (*rrn-up1*, *rrn-down1* and *rrn-down2*) were obtained and used as queries to perform BLAST analyses against the GenBank database. Like the 16S rRNA gene locus, all three sequences identified “*Ca. Phytoplasma asteri*” strain OY-M, causing onion yellow disease in Japan, as the most similar. However, nucleotide identities varied with *rrn-up1* at 99%, *rrn-down1* at 96% and *rrn-down2* at 98%, contrasting the 99-100% nucleotide identity at the 16S rRNA gene locus. Nucleotide deletions, rather than nucleotide polymorphisms (transversions/transitions) as in the case of 16S rRNA gene sequence analysis, were the main contributors to the sequence variations. More genome-wide sequence characterizations are currently underway.

#### 4.15 Visible/near-infrared spectroscopy for discrimination of HLB-infected citrus leaves from healthy leaves

Poole G.<sup>1</sup>, Windham W.<sup>2</sup>, Heitschmidt G.<sup>2</sup>, Park B.<sup>2</sup>, and Gottwald T.<sup>1</sup>

<sup>2</sup> USDA ARS, STPP, Fort Pierce, FL, 34945, <sup>1</sup> USDA ARS, QSARU, Athens, GA 30605

##### Introduction:

Researchers have used various hyperspectral systems, covering several areas of the electromagnetic spectrum to investigate all types of disease/plant interactions. Delalieux et al. (1) used a spectrophotometer to investigate apple scab disease. They found that they could differentiate between infected and non-infected leaves at 10 days using several different statistical models, using data from 1350-2500 nm. After 26 days of inoculation, the visible portion of the electromagnetic spectrum (400-700 nm) was also useful for discrimination purposes, which they speculated to be due to chlorosis in the leaves. Liu et al. (2), using a spectrophotometer measuring between 350-2500 nm, investigated brown spot disease in rice. By using large portions of the spectrum for their analyses, they were able to determine disease severity with a RMSE of 2%.

The purpose of this research was to investigate using visible and near-infrared (400 – 1100 nm) spectroscopy to differentiate HLB infected citrus leaves from uninfected leaves.

##### Materials and methods:

Fifty-five leaves were collected from various citrus plants on the United States Horticultural Research Laboratory's research farm that showed the various symptoms of HLB infection (green islands, blotchiness, heavy chlorosis, etc). Leaves (N=22) were also collected from citrus trees in a controlled greenhouse and were used as a “negative” control. All leaves were collected on the same day. A 38mm diameter section was cut from the center of the leaf and placed into a



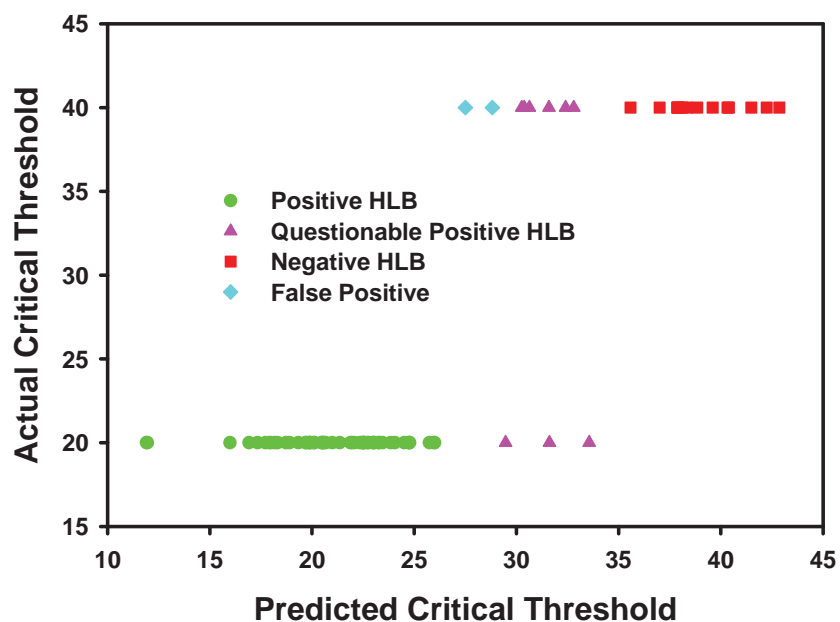
**Figure 1:** Sample cups for the FOSS, with leaf samples already placed.

cylindrical sample cell (38-mm I.D.) with an optical quartz surface and foam core backing (Figure 1). The leaf samples were analyzed using an NIRSystems 6500 monochromator (NIRSystems, Silver Spring, MD). Spectra were recorded from 400 nm to 2500 nm in 2-nm intervals and analyzed from 400 nm to 950 nm. A commercial spectral analysis program (NIRS3, Infrasoft International, Inc., Port Matilda, PA) was used to analyze the spectra and for partial least squares (PLS) regression. PLS regression was used to relate the spectra to an arbitrary HLB critical threshold (CT) variable of 20 for HLB-infected (positive) leaves and 40 for HLB-uninfected leaves (negative). The spectral data set was transformed with multiplicative scatter correction and smoothed by a 9-point running average.

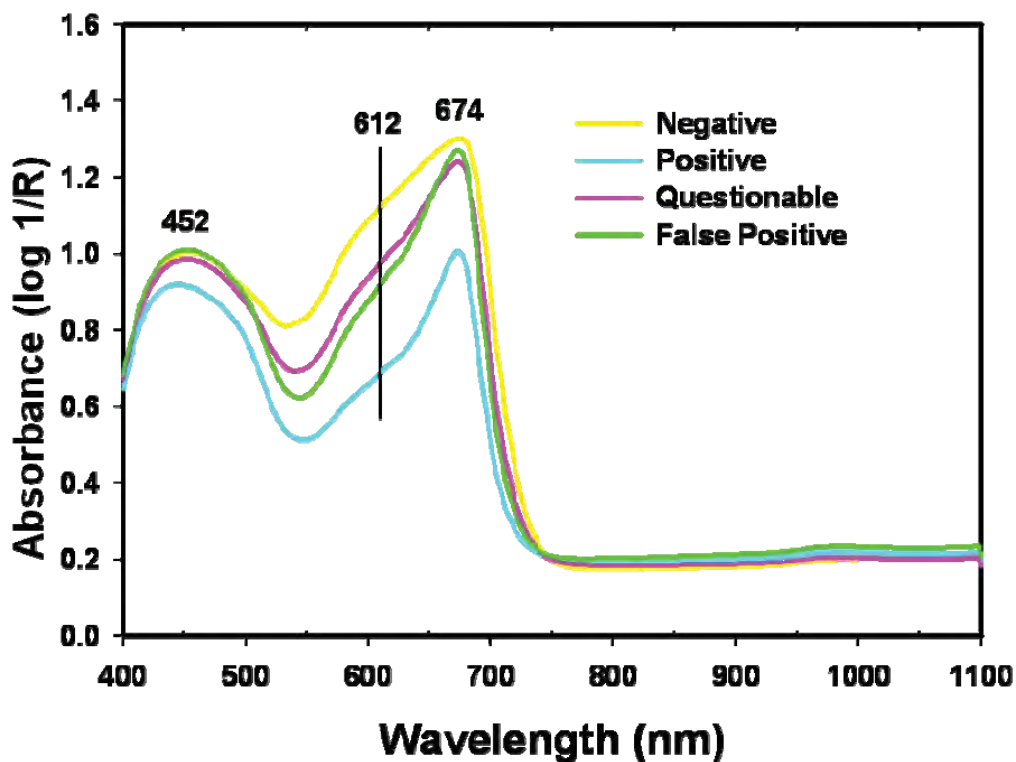
##### Results and Discussion:

A PLS calibration was obtained for prediction of HLB CT values. The model contained 6 PLS components with a standard error of prediction of 5.4 and a multiple coefficient of determination of 0.66, from full one out cross-validation. The first four PLS components accounted for 68% of the total spectral variation with components 1, 2 and 4 expressing 41, 15, and 6% of the

variation, respectively. The PLS loadings contain peaks in the red (600-700 nm) regions of the spectrum for photosynthesis.



**Figure 2.** Predicted CT values of HLB positive and negative citrus leaves.



**Figure 3:** Spectral curves for negative, positive, questionable, and false positive leaves, infected with Huanglongbing.

The scatter plot of predicted CT values from full one out cross-validation is shown in Fig 2. Ninety-five percent of the positive HLB leaves were accurately predicted with an average CT of 21, and 64% of the negative HLB leaves were accurately predicted with an average CT of 39.2. However, three positive HLB leaves and 6 negative HLB leaves had an average value 31.4 which placed them in the “questionable category” of infection. Two negative HLB leaves were incorrectly predicted as HLB false positives having an average CT of 28.2.

Spectra within each of the four groups of predicted samples shown in Figure 2 were averaged (Figure 3). Average spectra for the negative HLB leaves showed the expected spectral curve that all healthy plants show (3). There was a peak in the blue (400-500 nm) and red (600-700 nm) regions of the spectrum resulting from photosynthesis (3).

The primary difference between the HLB negative and the HLB positive leaves was that these peaks associated with chlorophyll absorption decreased for the infected leaves. PLS loading factor 1 had a large absorption band at 612 nm which appears to be a measure of the degree of “greenness” in the leaves.

A reduction in chlorophyll absorption is commonly seen when a plant is stressed by a biostressor. Chlorophyll absorption in a healthy plant is weak around 690-700 nm (4). As the plant becomes stressed (in this case, by the HLB infection) there is an expected decrease in chlorophyll production, which would lead to a corresponding increase in reflectance at this part of the spectrum (5).

Being that most plant stressors will induce this change in chlorophyll absorption due to a decrease in chlorophyll production, it is unlikely that this visible near-infrared (400 to 1000 nm) portion of the electromagnetic spectrum alone will be able to differentiate HLB infected plants from plants that are compromised by some other biostressor.

#### **Conclusion:**

A PLS model correctly predicted 95% and 64% of the leaves that were positive and negative for HLB, respectively. The PLS loadings indicated absorption bands related to chlorophyll, and bands associated with chlorophyll absorption decreased in infected leaves. However, some HLB negative leaves also showed decreased chlorophyll absorption which resulted in an inaccurate prediction. Based on the results from this study, it is unlikely that the visible near-infrared (400 to 1000 nm) portion of the electromagnetic spectrum alone will be able to differentiate HLB infected plants from plants that are compromised by some other biostressor.

#### **References:**

- Delalieux S, van Aardt J, Keulemans W, Schrevens E, Coppin P. 2007. Detection of biotic stress (*Venturia inaequalis*) in apple trees using hyperspectral data: non-parametric statistical approaches and physiological implications. *Europ. J. Agronomy*. **27**:130-143.
- Liu Z, Huang J, Shi J, Tao R, Zhao W, Zhang L. 2007. Characterizing and estimating rice brown spot disease severity using stepwise regression, principle component regression, and partial least-squares regression. *J. Zhejiang Univ. Sci. B*. **8(10)**:738-744.
- Campbell JB. 2007. *Introduction to Remote Sensing*. 4<sup>th</sup> ed., the Guilford Press, New York, NY.
- Chappelle, E.W., Kim, M. S., and J. E. McMurtrey, 1992. Ratio analysis of reflectance spectra (RARS): an algorithm for the remote estimation of the concentrations of chlorophyll a, chlorophyll b, and carotenoids in soybean leaves. *Remote Sens. Environ.* **39**:239-247.
- Carter GA, Miller RL. 1994. Early detection of plant stress by digital imaging within narrow stress-sensitive wavebands. *Remote Sens. Environ.* **50**:295-302.

INTERNATIONAL RESEARCH CONFERENCE  
ON HUANGLONGBING



**Session 5:**  
**Host-Pathogen**  
**Interaction**

Orlando, Florida



December 2008

## 5.1 Liberibacter Populations in Citrus and Orange Jasmine Trees in the State of São Paulo, Brazil

Lopes S. A.<sup>1</sup>, Frare G. F.<sup>1</sup>, Bertolini E.<sup>2</sup>, Wulff N. A.<sup>1</sup>

<sup>1</sup>Fundecitrus, Araraquara SP, Brazil, <sup>2</sup>IVIA, Moncada VA, Spain.

Two pathogens are associated with huanglongbing in Brazil: ‘*Candidatus* L. americanus’ (Lam) and ‘*Ca.* L. asiaticus’ (Las). Both are transmitted by the Asian citrus psyllid *Diaphorina citri* Kuwayama, first reported in Brazil in 1942 (2), and differ in their sensitivity to temperatures of 32°C and above, in graft transmission efficiency, and in their ability to multiply in citrus (Lopes et al., submitted). This helps to explain their uneven spatial progress and the shift in bacterial prevalence in the State of São Paulo State (SPS) over time. Hosts of Liberibacter in SPS include all commercial citrus and the ornamental orange jasmine (*Murraya paniculata*) (3,4), which is very common in most Brazilian cities. Surveys to determine the extent of Liberibacter occurrence in orange jasmine have been carried out since 2004 in the streets of 21 localities in the center of SPS. Randomly chosen old trees with symptomatic yellow shoots whether or not associated with shoot dieback were sampled. These symptoms were similar to those observed when the pathogen was first detected in orange jasmine (3). Lam and Las have been detected in 11.4% and 0.5%, respectively, of 550 sampled trees. Lam was detected in eight localities (Água Vermelha, Américo Brasiliense, Araraquara, Bueno de Andrada, Matão, Motuca, Santa Lúcia, Silvânia), and Las at two localities (Santa Eudóxia and Araraquara). The higher incidence and spatial distribution of Lam in orange jasmine might be related to the period of time Lam has predominated in those areas. On the basis of grower information and disease incidence levels observed in 2004 in the first affected citrus farms, it was estimated that HLB was already present in the center of SPS, 9 to 10 years before the first report (1,5). Field surveys and data from the Fundecitrus diagnostic laboratory indicate that Lam was the most prevalent, or may be the only Liberibacter species present, in that area at that time. Therefore, Lam might have had sufficient time to move from citrus to orange jasmine, and vice-versa, without any of the limitations provided by removal of symptomatic trees or applications of insecticides, practices currently adopted in the management of HLB in citrus orchards. In the last 4 years, a disproportional increase in Las incidence was, however, observed in citrus trees in SPS.

Whether this phenomenon also applies to Las in orange jasmine is not known at this point. Recently, DNAs extracted from leaf midribs of most infected orange jasmine sampled from 2004 to 2008, and from leaf midribs of a set of 116 infected citrus trees sampled by growers in the same time period and sent to Fundecitrus for diagnostic purposes through the use of conventional PCR, were further analyzed by quantitative real-time PCR (qPCR). Average cycle threshold values for Lam and Las were, respectively, 32.69 (n 53, SE 0.27) and 32.46 (n 5, SE 0.99) in orange jasmine, and 26.82 (n 58, SE 0.17) and 25.12 (n 58, SE 0.28) in citrus trees. The equivalent number of Liberibacter cells in 50 ng total DNA used per qPCR was, on average, for Lam and Las, respectively, 23 and 218 in orange jasmine, and 995 and 27,959 in citrus. The number of orange jasmine trees so far found to be affected by Las and included in this study was, however, too low for data comparison. Also, Liberibacter cell titers were assessed in naturally infected field-grown trees. The time intervals between inoculation and sampling dates were, therefore, not known. Insect transmission experiments, currently in progress in potted grown-

trees, should bring more information on this matter and on the importance of orange jasmine for the HLB epidemics.

### Literature Cited

- Gottwald TR, da Graça JV, Bassanezi RB. 2007. Citrus huanglongbing: the pathogen and its impact. Plant Health Progress. doi:10.1094/PHP-2007-0906-01-RS .
- Costa Lima, A. M. 1942. Insetos do Brasil. Homópteros. Rio de Janeiro. Imprensa Nacional, Tomo 3, 327p.
- Lopes SA, Martins EC, Frare GF. 2005. Detecção de *Candidatus Liberibacter americanus* em *Murraya paniculata*. Summa Phytopathol. 31:48-49.
- Lopes SA, Martins EC, Frare GF. 2006. Detecção de *Candidatus Liberibacter asiaticus* em *Murraya paniculata*. Fitopatol. Bras. 31:303.
- Teixeira DC, Danet JL, Eveillard S, Martins EC, Jesus Jr. WC, Yamamoto PT, Lopes SA, Bassanezi RB, Ayres AJ, Saillard C, Bové JM. 2005. Citrus huanglongbing in São Paulo State, Brazil: PCR detection of 'Candidatus' Liberibacter species associated with the disease. Mol. Cell. Probes, 19:173-179.

## 5.2 The effects of HLB-infection on respiration and development of roots of feroniella rootstock (*Feroniella oblata*) which showed resistance to HLB bacterium

Ogata T.<sup>1</sup>, Kobori Y.<sup>1</sup>, Kawabe K.<sup>1</sup>, Yonemoto H.<sup>1</sup>, **Ohto Y.**<sup>1</sup>, Nguyen T.B.<sup>2</sup> and Nguyen M.C.<sup>2</sup>

<sup>1</sup>Tropical Agriculture Research Front, Japan International Research Center for Agricultural Sciences, Ishigaki, Okinawa, Japan; <sup>2</sup>Southern Fruit Research Institute, Mytho, Tiengiang, Vietnam

Citrus greening (or Huanglongbing: HLB) is the most destructive disaster in citrus industries in tropical and sub tropical areas. In severely infested areas by HLB in Asian countries, *Ca. L. asiaticus* vectored by *D. citri* is common. Because the HLB is also transmittable by grafting scions from diseased trees, the disease-free seedlings are developed and applied (Su 2004) in severely infested areas. However, in Indochina countries including Thai and Vietnam, in many cases, disease-free seedlings transplanted to a grove become infected in 1-2 years. To elucidate the effects of HLB infection on citrus trees, we investigate the growth rate, photosynthesis, root growth and root vigor of tangor 'Shiranui' grafted on to rough lemon rootstocks (RL, susceptible) and *Feroniella* rootstocks (FO, resistant). The plant growth was suppressed in infected trees after the symptom expression. Relative growth of plant height reduced to 67 and 59% of healthy plant after the inoculation in RL and FO, respectively. Dry matter weights of fibrous roots were significantly reduced to 28 and 23% of healthy plants in RL and FO, respectively. Top-root ratio of dry matter weight reduced in both types of rootstocks in HLB-infected trees. These results suggest that the effect of HLB infection is more serious in the roots than in the stems and leaves. The HLB bacterium was not detected from roots of *Feroniella* rootstock. Therefore, the suppression of root growth occurs without direct association of HLB bacterium in root systems. Root respiratory rates of HLB infected plants were lower than those of healthy plants. Since the accumulation of photosynthate in HLB-infected leaves was reported (Takushi et al. 2007), the HLB-infection on the leaves probably interfere the transfer of photosynthate from leaves, and induces the insufficient supply of photosynthate to root system, resulting in the vigor-less poor root systems that causes nutrient deficiency in the leaves.

As a conclusion, the use of plants that show resistance to HLB as rootstock is seems to be meaningless in the case of seedling infection.

### Reference

Su (2004) Practical strategies for research and technology dissemination for citrus HLB control Pages 1-5 In: Proceedings of the JIRCAS-SOFRI international workshop 'Step toward mutual collaboration for controlling citrus huanglongbing in Southeast Asia'. Japan International Research Center for Agricultural Sciences. Tsukuba, Japan.

Takushi T, Toyozato T, Kawano S, Taba S, Ooshiro A, Numazawa M, Tokeshi M. (2007) Scratch method for simple, rapid diagnosis of citrus huanglongbing using iodine to detect high accumulation of starch in the citrus leaves. *Jpn. J. Plantpathology*. **73**:3-8.



### 5.3 Anatomical evolution of symptoms from infection with the HLB bacterium

Achor D.S., Chung K-R., Exteberria E., Wang N. and **Albrigo L.G.**

University of Florida, CREC, Lake Alfred, FL, USA

The most visible symptom of HLB is the non-symmetrical mottle chlorosis of leaf blades. Starch accumulation and phloem collapse have been associated with this disease caused by *Liberibacter asiaticum*. Several hypotheses were developed at our Center regarding symptom development. These were then tested by light and transmission electron microscopy (TEM). 1) Starch accumulation in leaves could be the result of inability to transport sucrose or other sugars across cell membranes or it could be the result of disruption of phloem transport (2). Starch accumulation could lead to chloroplast disintegration and thus produce chlorosis (3). Phloem necrosis could result from bacterial toxins or signals, or from sieve element plugging and carbohydrate deficiency (4). Sieve element plugging could come from bacteria accumulation, callose production or from accumulation of gels from up-regulated phloem proteins. Samples collected and fixed for TEM from various stages of HLB leaf symptom development revealed the following: Starch accumulation occurred after phloem plugging and cell collapse and, therefore, localized phloem carbohydrate deficiency may be a factor. Starch packing of chloroplasts did not rupture the outer membranes, but the inner grana structure was disrupted thus leading to chlorosis, but only in parts of the leaf where phloem plugging occurred. Sieve elements were obstructed by both amorphous and filamentous materials and both occurred in significant amounts, while bacteria were insufficient to directly cause plugging. The amorphous material has been positively identified as callose by immunoassay with gold labeling. The identification of the filamentous material is in progress and is presumed to be a phloem protein lectin. The data support the development of HLB symptoms in the following sequence: phloem plugging and some collapse, sugar backup in localized leaf blade areas, starch accumulation until chloroplast structure is disrupted, chlorosis.

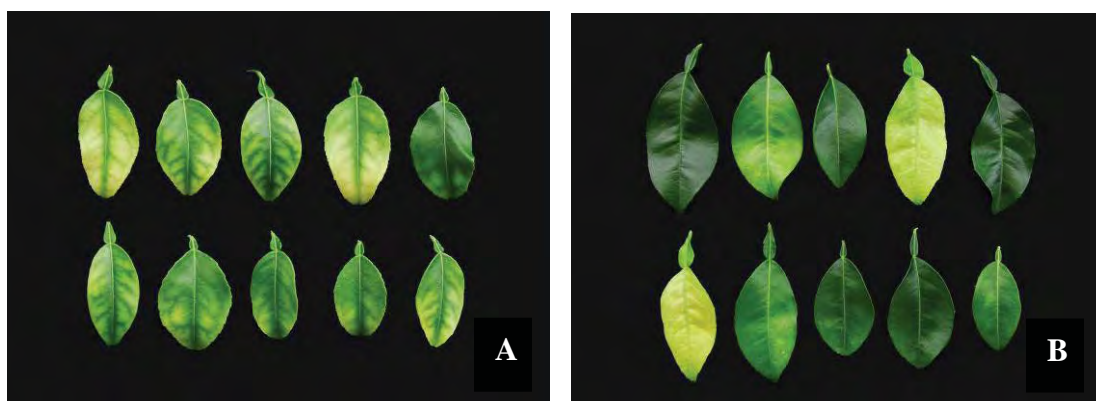
#### 5.4 Influence of temperature on Huanglongbing infection under controlled environment

Gasparoto M. C. G.<sup>(1)</sup>; Bassanezi R. B.<sup>(2)</sup>; Lopes S. A.<sup>(2)</sup>; Frare G.<sup>(2)</sup>; Martins E. C.<sup>(2)</sup>; Della Coletta Filho H.<sup>(3)</sup>; Amorim L.<sup>(1)</sup>.

<sup>(1)</sup> ESALQ/USP, Piracicaba, Brazil; <sup>(2)</sup> Fundecitrus, Araraquara, Brazil; <sup>(3)</sup> Centro APTA Citros, Cordeirópolis, Brazil

Huanglongbing (HLB) is one of the most destructive diseases in citriculture in the world. In Brazil the disease was first reported in 2004 in sweet orange orchards in the State of São Paulo. Two species were detected in affected trees in Brazil: *Candidatus Liberibacter asiaticus* and *Ca. L. americanus*. Both species are transmitted by *Diaphorina citri*. The hosts of bacteria and psyllid are *Citrus* spp. and the jasmine+ orange (*Murraya paniculata*). Due to the recent discovery of the disease in Brazil, studies on the behavior of the disease (incubation period, disease severity, bacteria infection rate, etc.) in the conditions found in Brazilian orchards are necessary in order to better understand HLB epidemiology. The objective of this work was to compare the rates of infection of *Ca. L. asiaticus* and *Ca. L. americanus* under different temperatures. This experiment was carried out in the University of São Paulo, in Piracicaba, Brazil in plant growth chambers with controlled light and temperature (Convicon®). Seedlings of 'Valencia' oranges were grafted with budsticks (approximately 4 cm long) from shoots showing HLB symptoms from orchards with only one species of bacteria: *Ca. L. asiaticus* or *Ca. L. americanus*. Budsticks were held onto the stock with plastic tape for 40 days for healing of the grafted region. Immediately after grafting, the seedlings were transferred to the growth chambers under the following conditions of day/night temperatures: 22/17°C, 27/22°C and 32/27°C, and a light/dark photoperiod of 16/8h. These conditions are similar to those found in the Southern, Central and Northern citrus regions of São Paulo State. Fourteen seedlings were used per treatment in addition to four control seedlings (grafted with budsticks from shoots of healthy plants), in each growth chamber. Samples for PCR were made up of 10 leaves per plant, collected every 141 days after the beginning of the experiment to confirm the bacteria infection. The rate of infection with each bacterium in different temperatures was estimated until 282 days after inoculation. During the leaf collections for PCR, the symptoms found in each plant were noted. The same leaf samples collected for conventional PCR were to be submitted to real-time PCR. The most characteristic symptom of HLB in leaves of sweet oranges (mottled leaf) was not observed in any of the plants in the chambers. Mineral deficiency was observed in some plants with positive PCR. The symptoms generally observed in plants with positive PCR for *Ca. L. asiaticus* were small number of leaves, small leaves (poorly developed) and strong nutritional deficiency (Figure 1A). Mineral deficiency was also observed in plants with positive PCR for *Ca. L. americanus* (Figure 1B). On the first evaluation the bacteria were detected in 11 of the plants grafted with the species *Ca. L. asiaticus* in all growth chambers, while only one sample kept in the coolest chamber was positive for the species *Ca. L. americanus* (Table 1). On the second evaluation, 282 days after grafting, the infection rates of *Ca. L. asiaticus* ranged from 71% (22/27 °C and 27/32 °C ) to 79% (17/22 °C), while the infection rates of *Ca. L. americanus* ranged from 0% (27/32°C ) to 14% (22/27 °C) (Table 2). This suggests that milder temperatures are favorable to the development of symptoms and to the population growth of *Ca. L. americanus* while higher temperatures do not affect the infection of *Ca. L. asiaticus* which can be

found across the temperature range studied (from 17 to 32°C). Also, according to the results, *Ca. L. americanus* has lower rates of transmission than *Ca. L. asiaticus*. It could explain why *Ca. L. asiaticus* is the predominant species associated to HLB in São Paulo State nowadays.



**Figure 1.** Mineral deficiency in one sample unit (10 leaves of the same plant) with positive PCR for *Ca. L. asiaticus* (A) and *Ca. L. americanus* (B)

**Table 1.** Infection rates of *Candidatus L. americanus* and *Ca. L. asiaticus* in ‘Valencia’ plants, 141 days after inoculation, kept under different temperatures

Treatment	<i>Ca. L. americanus</i> <sup>(1)</sup>	<i>Ca. L. asiaticus</i> <sup>(2)</sup>	Control <sup>(3)</sup>
17 / 22 °C	1 / 14 (7%)	4 / 14 (29%)	0 / 4
22 / 27 °C	0 / 14 (0%)	5 / 14 (36%)	0 / 4
27 / 32 °C	0 / 14 (0%)	2 / 14 (14%)	0 / 4

<sup>(1)</sup> Number of plants with positive PCR for *Ca. L. americanus* from a total of 14 plants per treatment

<sup>(2)</sup> Number of plants with positive PCR for *Ca. L. asiaticus* from a total of 14 plants per treatment

<sup>(3)</sup> Number of control plants (grafted with budsticks from shoots of healthy plants) from a total of four plants per treatment

**Table 2.** Infection rates of *Candidatus L. americanus* and *Ca. L. asiaticus* in ‘Valencia’ plants, 282 days after inoculation, kept under different temperatures

Treatment	<i>Ca. L. americanus</i> <sup>(1)</sup>	<i>Ca. L. asiaticus</i> <sup>(2)</sup>	Control <sup>(3)</sup>
17 / 22 °C	1 / 14 (7%)	11 / 14 (79%)	0 / 4
22 / 27 °C	2 / 14 (14%)	10 / 14 (71%)	0 / 4
27 / 32 °C	0 / 14 (0%)	10 / 14 (71%)	0 / 4

<sup>(1)</sup> Number of plants with positive PCR for *Ca. L. americanus* from a total of 14 plants per treatment

<sup>(2)</sup> Number of plants with positive PCR for *Ca. L. asiaticus* from a total of 14 plants per treatment

<sup>(3)</sup> Number of control plants (grafted with budsticks from shoots of healthy plants) from a total of four plants per treatment

## 5.5 Can *Ca. Liberibacter asiaticus* be transmitted through citrus seed?

**Hartung J.S.**<sup>1</sup>, Halbert S.E.<sup>2</sup>, Shatters R.<sup>3</sup>

<sup>1</sup>USDA ARS Beltsville, MD, <sup>2</sup> Florida Department of Food and Consumer Services, Gainesville, FL, <sup>3</sup> USDA ARS Ft Pierce, FL

Seed was extracted from citrus fruit condemned by DPI due to HLB. The varieties tested include *Murraya paniculata*, rough and ‘Meyer’ lemon, sour orange, grapefruit and ‘Valencia’ sweet orange. Seed from symptomatic fruit was germinated and seedlings were maintained in a greenhouse for nearly 3 years. Seedlings have been observed regularly for symptoms of HLB and tested for *Candidatus Liberibacter asiaticus* (Las) by Q-PCR three times using a 16SRNA based procedure. In all 319 seedlings have been observed and tested. The large majority of seedlings have not shown any symptoms of disease, and none of the seedlings has tested positive for Las by a real-time PCR test targeting the 16S RNA genes of Las. However 9 of 89 sour orange seedlings show abnormal growth patterns which include stunting, defoliation and chlorosis. One of these sour orange seedlings in particular is severely stunted and shows symptoms similar to citrus yellow shoot. This seedling was positive for the presence of Ca Las when tested with a different set of primers that targeted the 16S region Las. The amplicon was sequenced from duplicate reactions and was found to have a 100% match to the 16S gene sequence from several strains of Las deposited in Genbank. Further testing of these seedlings is in progress.

## 5.6 Biochemical changes after infection with *Candidatus Liberibacter asiaticus* in citrus

Jiang, B.<sup>1</sup>, Zhong Y.<sup>1</sup>, Wang H.<sup>2</sup>, Yi G.<sup>1</sup>.

<sup>1</sup> Fruit Research Institute of Guangdong Academy of Agricultural Science, Guangzhou, China

<sup>2</sup> Huazhong Agricultural University, Wuhan, China

Citrus greening disease (Huanglongbing) caused by a phloem-limited bacterium, *Candidatus Liberibacter asiaticus* (Las), is transmitted by citrus psyllid and is the most serious citrus disease in China. Several members of the family Rutaceae including all citrus species and plants in other families such as periwinkle (*Catharanthus roseus*) can be infected by Las. Four plant species were used in this study and were tested for Ca. Las by PCR: *Citrus sinensis*, *Clausena lansium*, *Murraya paniculata*, *Catharanthus roseus*. Positive and negative samples of the four species selected were ground in liquid-nitrogen. The proteins were extracted by TPG buffer: 1M Tris-Cl (pH 8.0), 6% PVP, 75% glycerin and precipitated by frozen acetone. A <14.3KD protein was detected in LAS-positive sweet orange but absent in healthy, by 15% SDS-PAGE. The positive plants were graft-inoculated in October, 2007 and maintained in a greenhouse. It was noted that when the temperature was above 40°C, greening leaf symptoms were not observed. This is in contradiction with previous reports.

## 5.7 ‘*Candidatus Liberibacter solanacearum*’ Associated with Zebra Chip of Potato is not Associated with Citrus Huanglongbing and is Absent in Asian Citrus Psyllid

Li W.<sup>1</sup>, Abad J.A.<sup>2</sup>, and Levy L.<sup>1</sup>

<sup>1</sup>National Plant Germplasm and Biotechnology Laboratory, USDA-APHIS-PPQ-CPHST, Beltsville, MD 20705; <sup>2</sup>Plant Germplasm Quarantine Program, USDA-APHIS-PPQ-PHP-PSPI, Beltsville, MD 20705

A new *Liberibacter* species, ‘*Candidatus Liberibacter solanacearum*’ (Lso) recently associated with the potato/tomato psyllid-transmitted diseases in tomato and capsicum in New Zealand (Liefing et al., 2009), was found to be associated with a newly emerging potato zebra chip (ZC) disease in Texas (Abad et al., 2008) and other southwestern states in the USA. In this study, DNA extracts were obtained, through the tissue homogenization using a PastPrep machine, from suspect psyllids by the Qiagen DNeasy Blood & Tissue Kit, or from suspect plant tissues by the Qiagen DNeasy Plant Mini Kit. A 16S rRNA gene-based primer LsoF (5’-CGA GCG CTT ATT TTT AAT AGG AGC -3’) was developed specific to Lso. The primer can be reliably used in both quantitative real-time PCR (qPCR) and conventional PCR (cPCR) to detect, identify and quantify Lso in infected samples.

The primer Lso was paired with the primer OI2c (Jagoueix et al., 1996), producing an amplicon of 1163 bp from 16S rDNA of the new *Liberibacter* species. A positive internal control (PIC) primer set (COXfc: 5’-GTA TGC CAC GTC GCA TTC CAG A-3’ and COXrc: 5’-GTT CAA CAG CCC AAG GAC TTG GAG-3’) were developed for plant samples. The PIC primer set targets at the cytochrome oxidase (COX) gene of host plant DNA, yielding reliably an amplicon of 174 bp when multiplexed with the Lso-targeted cPCR primer set LsoF/OI2c. Another PIC primer set (BCOfc: 5’-GCG AGG ACT CAG TTT CGT GTC G-3’ and BCOr: 5’-CAG CGA GTC GCG ACG TTC-3’) were designed for psyllid samples. This PIC primer set targets at 28S rRNA gene of the vector DNA of potato/tomato psyllid (PTP) (*Bactericera cockerelli*), yielding reliably an amplicon of 175 bp when multiplexed with the Lso-targeted cPCR primer set LsoF/OI2c. The third PIC primer set ACPfr was used for cPCR for Asian citrus psyllids (ACP) (*Diaphorina citri*) (Li et al. 2008). Both the single and multiplex cPCR assays were run under the optimized amplification conditions (Li et al., 2007).

In qPCR assays, the primer Lso was used together with the *Liberibacter*-universal reverse primer HLBr and TaqMan probe HLBP (Li et al., 2006). This Lso-specific qPCR primer/probe set could be multiplexed with the PIC primer/probe set COXfpr reacting with the host plant DNA (Li et al., 2006), or with the PIC primer/probe set WGrpf for ACP samples (Li et al., 2008), or with the new designed PIC primer/probe set BCOfpr for PTP samples (BCOf: 5’-GTC CGG GCT ATG TTC ATC CGG-3’; BCOp: 5’-5TET/ACC GAT TTT CCT CGC CGC AG/3BHQ\_2/-3’; BCOr: 5’-CAG CGA GTC GCG ACG TTC-3’). Both the single and multiplex qPCR assays were run under the optimized amplification conditions (Li et al., 2006). All these PIC primer and/or probe sets could be reliably used to evaluate the quality of DNA extraction, to check the PCR reaction cocktails, and to normalize qPCR data for accurate quantification of the bacterial populations in the samples.

The low detection limit of the multiplex qPCR was about 20 copies of the target DNA templates per reaction for environmental samples. Neither the qPCR nor the cPCR assays for Lso detection reacted with other *Liberibacter* species such as '*Ca. L. asiaticus*' (Las), '*Ca. L. africanus*' (Laf) and '*Ca. L. americanus*' (Lam), all of which are associated with different forms of citrus huanglongbing (HLB) (also known as citrus greening disease), and vectored by ACP or the African citrus psyllid (*Trioza erytreae*). Similarly, none of the cPCR and qPCR assays for the *Liberibacter* species associated with HLB cross-reacted with the new *Liberibacter* species associated with diseases of solanaceous crops. As the qPCR had a significant advantage in detection sensitivity over cPCR for the citrus *Liberibacter* species (Li et al., 2007), the qPCR was 10 to 100 fold more sensitive than cPCR for Lso detection potato plant samples (Figure 1) and in potato/tomato psyllid samples.

Lso was detected, identified and quantified in various tissues of potato plants affected with ZC in the fields and also in samples of the potato/tomato psyllid collected in various states in the USA, but has not been yet detected in hundreds and thousands of samples of Las-suspect or infected ACP adults and nymphs or HLB-suspect or infected citrus plants samples collected from seven citrus producing countries in the world and 29 States in USA (Table 1). Conversely, none of three known *Liberibacter* species of citrus (Las, Laf and Lam) has been to date detected in the ZC-suspect samples of potato plants and *B. cockerelli* collected in the fields in various states in the USA and Mexico.

The new cPCR and qPCR methods for Lso detection will facilitate further studies on the etiological relationship of the newly-found *Liberibacter* species infecting potato/tomato crops and psyllids with the three known *Liberibacter* species of citrus, their vector psyllids and associated HLB disease.

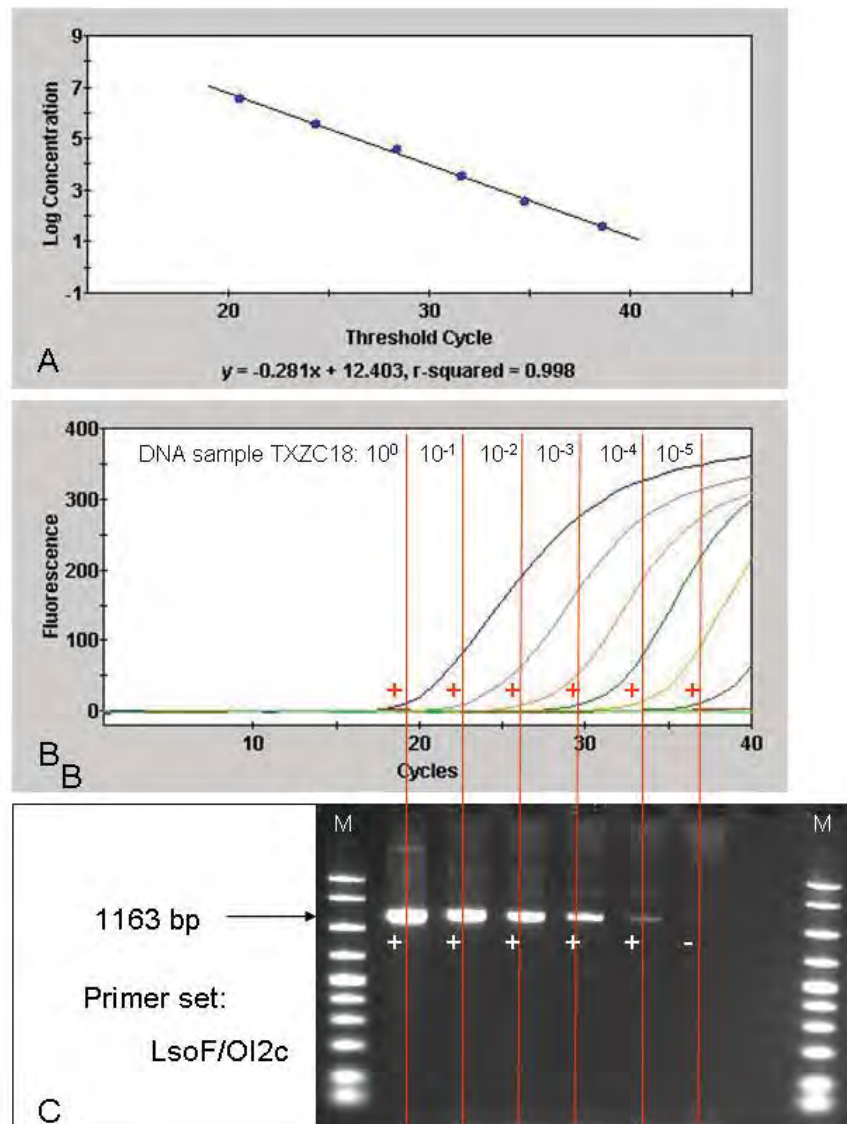
### Literature cited

- Abad JA, Bandla M, French-Monar R, Liefting LW, Clover GR. 2008. First report of the detection of '*Candidatus Liberibacter*' species in zebra chip (ZC) disease infected potato plants in the United States. *Plant Dis.* 93:108
- Jagoueix S, Bové JM, Garnier M. 1996. PCR detection of the two '*Candidatus Liberobacter* species' associated with greening disease of citrus. *Mol. Cell. Probes* 10:43-50.
- Li W, Hartung JS, Levy L. 2006. Quantitative real-time PCR for detection and identification of '*Candidatus Liberibacter* species' associated with citrus huanglongbing. *J. Microbiol. Methods* 66:104-115.
- Li W, Hartung JS, Levy L. 2007. Evaluation of DNA amplification methods for improved detection of '*Candidatus Liberibacter* species' associated with citrus huanglongbing. *Plant Dis.* 91:51-58.
- Li W, Duan Y, Brlansky RH, Twieg E, Levy, L. 2008. Incidence and population of '*Candidatus Liberibacter asiaticus*' in Asian citrus psyllids (*Diaphorina citri*) on citrus plants affected by huanglongbing in Florida. *Proc. Int. Res. Conf. on Huanglongbing*; 231.
- Liefting LW, Weir BS, Pennycook SR, Clover GRG. 2009. '*Candidatus Liberibacter solanacearum*', a liberibacter associated with plants in the family Solanaceae. *Int. J. Syst. Evol. Microbiol.* (In press)

**Table 1.** Samples of host plants and vector psyllids of ‘*Candidatus Liberibacter spp.*’ tested in this study

Sample collection location	Sample type				
	Asian psyllids	citrus	Citrus plants	Potato/tomato psyllids	Potato/ tomato plants
USA State:					
AL	6				
AZ			2		
CO			2		2
CA	1,180		115		
FL	369		158		
GA	40				
HI	28		18		
KY			1		
LA	2,606		50		
MA			5		
MD			12		4
MI			3		
MN			3		
MO			0		
MS			1		
NC			3		
NE			1		2
NH			2		
NJ			3		
OH			1		
OK			3		
PA			8		
PR	936		14		
SC	78		1		
TN			2		
TX	1,168		110	256	200
VA			1		
WA			5		
WV			3		
Brazil			118		
China			2		
Dominican Rep.	2				
Japan			4		
Mexico	24		6	19	
South Africa			24		
<i>Total: 29 US States 7 countries</i>	<i>6,397</i>		<i>670</i>	<i>275</i>	<i>208</i>





**Figure 1.** Low detection limit of primer-probe set LsoR/HLBp/HLBr specific to 'Ca. L. solana ceaurum' in multiplex real-time PCR with the positive internal control primer

-probe set COXfpr. Templates were serial dilutions of an environmental DNA sample extracted from a ZC symptomatic potato plant grown in Texas.

## 5.8 Discovery of *Candidatus Liberibacter psyllauros* and its insect vector the tomato psyllid (*Bactericera cockerelli*)

Hansen A.K.<sup>1</sup>, Paine T.P.<sup>1</sup>, Stouthamer R.<sup>1</sup>

<sup>1</sup>Department of Entomology, University of California, Riverside, U.S.A.

A new *Candidatus Liberibacter* species infecting the psyllid *Bactericera cockerelli* and its solanaceous host plants potato and tomato was genetically and ecologically characterized (1). Phylogenetic analysis using the 16s rRNA sequence, places the new bacterium within the genus *Candidatus Liberibacter*, and it is designated as “*Candidatus Liberibacter psyllauros*” (1). Based on *Ca. L. psyllauros*'s 16s rRNA, intergenic spacer region (ISR), and 23s rRNA gene regions the same strain of *Ca. L. psyllauros* was found in psyllid populations from Texas and California, and in psyllid-*Ca. L. psyllauros* infected potato and tomato plants (1). The same strain was also found in New Zealand infecting *Solanum lycopersicum*, based on the 16s rRNA and ISR (2). Using PCR detection of *Ca. L. psyllauros*, bacterial infection frequencies of psyllids are variable between psyllid life stages and the host plants potato and tomato. In addition, the bacterium is vertically as well as horizontally transmitted (1). Higher infection frequencies are found in eggs, 1<sup>st</sup>, and 2<sup>nd</sup> instar nymphs isolated from potato host plants relative to nymphs isolated from tomato host plants (1). One explanation for lower efficacy rates of transovarial transmission and lower rates of horizontal transmission on tomato plants relative to potato plants is that there is a higher titer of the bacterium in potato relative to tomato host plants. Transovarial transmission has also been found in the psyllid *Trioza erytreae* infected with an unspecified “greening disease agent”, which was associated with Huanglongbing (a.k.a. citrus greening disease), on sweet orange in South Africa (3).

In vector-transmission trials potato plants and tomato plants inoculated with infected psyllids were positive for *Ca. L. psyllauros* infection and showed signs of yellowing, whereas control plants were negative for the bacterium and showed no signs of yellowing (1). Consequently it is highly likely that the symptoms described as psyllid yellows on potato and tomato are caused by this bacterium. All three known citrus *Liberibacter* species are associated with necrosis of plant phloem tissue and subsequent yellowing of leaves (4). Necrosis of phloem has also been observed in “psyllid yellow” diseased potato relative to healthy potato plants (5).

Implications of these findings for disease management of potato and tomato plants are substantial. More information is needed from natural psyllid populations to determine how widespread *Ca. Liberibacter psyllauros* infection is in *B. cockerelli*. The host plant range of *Ca. Liberibacter psyllauros*, other than tomato and potato, is unknown at this time. Since this insect is polyphagous and has a very wide range of host plants, including many solanaceous plants as well as other plants outside the Solanaceae such as pine, spruce, and cedar (6), other economically and ecologically important plants may be exposed to this disease as well.

### Literature Cited

Hansen AK, Trumble JT, Stouthamer R, Paine TD. 2008. New Huanglongbing (HLB) *Candidatus* species, “*C. Liberibacter psyllauros*”, found to infect tomato and potato is vectored by the psyllid *Bactericera cockerelli* (Sulc). *Appl. Environ. Microbiol.* 74: 5862–5865.

Liefting LW, Sutherland PW, Ward LI, Paice KL, Weir BS, Clover GRG. A new 'Candidatus Liberibacter' species associated with Solanaceous crops. Unpublished. Genbank accession number: EU834130.

Van den Berg MA, van Vuuren SP, Deacon VE. 1992. Studies on greening disease transmission by the citrus psylla, *Trioza erytreae* (Hemiptera: Triozidae). *Israel J. Entomol.* 25-26:51-56.

Bové JM. 2006. Huanglongbing: A destructive, newly-emerging, century-old disease of citrus. *J. Plant Pathol.* 88:7-37.

Eyer JR. 1937. Physiology of psyllid yellows of potatoes. *J. Econ. Entomol.* 30:891-898.

Knowlton GF, Thomas WL. 1934. Host plants of the potato psyllid. *J. Econ. Entomol.* 27:547.

## 5.9 Response of sweet orange (*Citrus sinensis*) to *Candidatus Liberibacter asiaticus* infection: microscopy and microarray analyses

Kim J-S.<sup>1†</sup>, Sagaram U.S.<sup>1†</sup>, Burns J.K.<sup>1</sup>, Li J-L.<sup>3</sup>, and Wang N.<sup>1,2</sup>

<sup>1</sup>Citrus Research and Education Center, University of Florida, 700 Experiment Station Road, Lake Alfred, FL 33850

<sup>2</sup>Department of Microbiology and Cell Science, University of Florida, Gainesville, FL 32611

<sup>3</sup>Interdisciplinary Center for Biotechnology Research, University of Florida, Gainesville, FL32610, USA

† These two authors contributed equally to this paper.

Corresponding author: [nianwang@crec.ifas.ufl.edu](mailto:nianwang@crec.ifas.ufl.edu)

Citrus greening or Huanglongbing (HLB) is a devastating disease of citrus caused by the phloem-limited fastidious prokaryotic  $\alpha$ -proteobacterium *Candidatus Liberibacter* spp. In this report, we used sweet orange (*Citrus sinensis*) leaf tissue infected with *Ca. L. asiaticus* and compared this with healthy controls. Investigation of the host response was examined with citrus microarray hybridization based on 33,879 EST sequences from several citrus species and hybrids. The microarray analysis indicated that HLB infection significantly affected expression of 624 genes whose encoded proteins were categorized according to function. The categories included genes associated with sugar metabolism, plant defense, phytohormone, and cell wall metabolism, as well as 14 other gene categories. The anatomical analyses indicated that HLB infection caused phloem disruption, sucrose accumulation, and plugged sieve pores. The up-regulation of three key starch biosynthetic genes including ADP-glucose pyrophosphorylase (AGPase), starch synthase, granule-bound starch synthase and starch debranching enzyme apparently proceeding unaltered, together with restricted movement of sucrose from leaves due to phloem plugging, likely leads to accumulation of starch in HLB pathogen infected leaves. The disturbed sucrose transportation resulted from the plugged sieve pores rather than the HLB bacterial aggregates since *Ca. L. asiaticus* does not form aggregates in citrus. The up-regulation of *pp2* gene is related to callose deposition to plug the sieve pores in a HLB pathogen-infected plant.

## 5.10 Colonisation of Asiatic Citrus Psyllid and Huanglongbing Development on *Citrus* and *Citrus* Relatives in Indonesia

Subandiyah S.<sup>1</sup>, Himawan A.<sup>1</sup>, Joko T.<sup>1</sup>, Astuti I.P.<sup>2</sup>, Holford P.<sup>3</sup>, Beattie G.A.C.<sup>3</sup>, Krugger R.<sup>4</sup>

<sup>1</sup>Universitas Gadjah Yogyakarta, Indonesia; <sup>2</sup>Bogor Botanic Garden, Indonesia; <sup>3</sup>University of Western Sydney, Australia; <sup>4</sup>ARS National Clonal Germplasm Repository for Citrus and Dates, Riverside, USA.

The susceptibility of *Citrus* and *Citrus* relatives to *Diaphorina citri* Kuwayama and huanglongbing (HLB) is being assessed in two field plots at Purworejo (~50 m asl) in Central Java, where incidence of the disease is high. Seedlings were planted in the first of two plots in November 2005. With the exception of *Berberis koenigii* L. (curry leaf), seedlings were planted 2 m apart in 16 blocks of 20 species or varieties. Border rows of Siem mandarin (*Citrus reticulata* Blanco) were planted around each block. In 2006, the incidence of *D. citri* was highest on *Swinglea glutinosa* (Blanco) Merr., followed by *Murraya paniculata* (L.) Jack var. *exotica* (sensu Huang), *C. × junos* Siebold ex Tanaka, *B. koenigii*, *M. paniculata*, then other species and varieties. In 2007, the most favoured host was *M. paniculata* var. *exotica* followed by *S. glutinosa*, *M. paniculata*, *B. koenigii*, and the other species and varieties. In 2008, the highest populations were recorded on *M. paniculata* var. *exotica* then *M. paniculata*, *B. koenigii* and the other species and varieties that included *C. × aurantium* L. (sour orange, natsudaikai and Japanese citron); *C. hystrix* DC.; *C. maxima* (Burm.) Merr.; *C. reticulata*; *Aegle marmelos* (L.) Corr.; *Feroniella lucida* Swingle; *Limonia acidissima* L.; *Triphasia trifolia* (Burm. f.) P. Wilson from the Aurantieae, and *Cl. harmandiana* Pierre ex Guillaumin *Cl. lansium* (Lour.) Skeels and *Glycosmis pentaphylla* (Retz.) DC from the Clauseneae. PCR confirmed the presence of *Candidatus Liberibacter asiaticus* in natsudaikai in early 2007, and in Siem mandarin in late 2007. In late 2008, chlorosis was visible on the foliage of 55 plants, but HLB-positive PCR results were only obtained for natsudaikai, pummelo (*C. maxima*) and *C. reticulata* var. Grabag.

The second plot, in which seedlings were planted 1.5 m apart in March 2007 in five blocks of 12 species and varieties, included an unknown *Citrus* sp., *Citrus × virgata* Mabb., *Atalantia buxifolia* (Poir.) Oliv., two *M. paniculata* var. *exotica* selections (California and Yunnan), *Afraegle paniculata* Engl., three species of *Citropsis* (Aurantieae), and *Cl. excavata* Burm f. (Clauseneae). Within this group, most *D. citri* have been recorded on the two *M. paniculata* var. *exotica* selections, and no HLB symptoms have been observed.

### 5.11 Detection of *Candidatus Liberibacter asiaticus* in Citrus Seedlings Germinated from Florida Seed.

Shatters, Jr. R. G.

USDA, ARS, U. S. Horticultural Research Laboratory, Subtropical Insects Research Unit, Fort Pierce, FL 34945

Seed transmission of *Candidatus Liberibacter asiaticus* (Las) is a mode of pathogen transmission that has yet to be proven. We have observed HLB-like symptoms in seedlings of Duncan grapefruit (*Citrus x paradisi* Macf.) emerging in insect-free controlled-environment greenhouses. Using a newly developed qPCR-based method for the detection of Las 16S rDNA sequence, we were able to detect Las sequence in less than 10% of these seedlings; however, the detection of Las did not necessarily correlate with appearance of symptoms. In subsequent studies with Ruby Red grapefruit (*Citrus paradisi* Macf.) and Hamlin sweet orange (*Citrus sinensis* (L.) Osbeck), the 16S rDNA sequence was detected in seedlings that were surface sterilized and germinated in sterile Magenta jars. Sequence analysis of the 16S rDNA sequence indicated that the amplified DNA was 100% identical to previously reported Las sequence and only 98% of the bases were identical to *Ca. L. americanus*. Dissection of the sterile-grown seedlings showed that the highest detectable level of Las was in the seedling roots. As plants grew, HLB-symptomatic plants developed more slowly than asymptomatic plants, however, most lost HLB symptoms over time.

## 5.12 Assessment of transmission of *Liberibacter asiaticus* from seed to seedlings of ‘Pineapple’ sweet orange and Carrizo citrange

<sup>1</sup>Graham J. H., <sup>2</sup>Irey M.S., <sup>1</sup>Dawson W. O., <sup>3</sup>Hall D. and <sup>3</sup>Duan Y-P.

<sup>1</sup>Univ. FL, Citrus Research and Education Center, Lake Alfred, FL; <sup>2</sup>U.S. Sugar Corp. Clewiston, FL, <sup>3</sup>USDA-ARS, Ft. Pierce, FL, USA

Recently, *Xylella fastidiosa*, a xylem-limited bacterium causing citrus variegated chlorosis (CVC) was reported to be transmitted to citrus seedlings (3). Tirtawidjaja (4) reported transmission from seed of tangerine fruit with citrus vein phloem degeneration (considered to be a synonym to Huanglongbing) to seedlings that developed stunting and mottled leaf symptoms resembling those of psyllid vector-inoculated seedlings. Currently, seed source trees in FL nurseries are located outdoors and only protected from psyllid transmission of HLB by preventative insecticide applications. Given the reported potential for seed transmission and the risk of introduction of HLB into nurseries by seed from seed trees, studies of the potential for seed transmission were initiated in 2006.

In November 2006, seed were collected from mature Pineapple sweet orange (*Citrus sinensis*) trees in a commercial grove in Collier Co., FL. This variety was chosen because of the high level of seediness of the fruit and the severity of HLB tree decline in this location. Based on previous assays of seed, it was known that seed coats from infected fruit contain high titers of *Liberibacter asiaticus* (Las) based on real time (RT-) PCR assay. Seeds were extracted and seed coats removed and frozen for assay later. The seed minus seed coats was germinated in containers in a peat-based potting mix located within a controlled environment growth room. The seed coats were assayed by RT-PCR using primers based on Li et al. (2). All surviving seedlings from seed with RT-PCR positive seed coats as well as 45 plants with negative seed coats were sampled and tested by RT-PCR. From the 59 plants sampled, seven plants were either positive or questionable. The Ct values for one plant were 28.22 and second was 31.38. The remaining suspects were between 32.3 and 33.4. In the Southern Gardens Diagnostic Lab (SGDL) (<http://www.flcitrusmutual.com/files/d964760d-7b78-4649-8.pdf>) a Ct value between 30 and 32 is considered questionable for HLB. Upon re-assay, three of the seven plants were positive and yielded ~700 bp 16s rDNA sequences for Las after nested PCR (1). The three plants testing positive were transferred to the USDA-ARS facility in Ft. Pierce to conduct psyllid transmission studies to partially fulfill Koch’s postulates. Of these three plants, only one tested positive in subsequent RT-PCR testing. In addition to the 59 plants tested, 356 plants not tested in the original group of 56 were tested and none found positive or questionable.

In November 2007, fruit were collected from eight symptomatic trees at the same location as in 2006 and seed extracted from fruit of each tree and seed classified as healthy (28%), off colored-gummy (29%) or aborted (43%). Healthy (359) and off-colored (344) seed were planted and the resultant 723 seedlings were assayed by RT-PCR in February 2008. From this group of seedlings, 6 had Ct values less than or equal to 32 after two assays.

In 2008, HLB was confirmed for two Carrizo seed source trees in a FL citrus nursery. From each positive tree, fruit were collected for extraction and germination of at least 200 seedlings. In seedlings assayed by RT-PCR for transmission, 142 seedlings from the first source yielded two

seedlings with Ct values 32 or less and of 148 seedlings from a second source, five seedlings had Ct values 32 or less.

For the 2007-08 plants with Ct values of 32 or less, the PCR product is being confirmed for presence of Las by standard PCR and cloning and sequencing using primers for 16S rDNA.

**Literature cited:**

Benyon L, Zhou L, Weathersbee A, Duan Y. 2008. Nested PCR is essential for detection of extremely low titer of *Candidatus Liberibacter asiaticus* from citrus and its vector psyllid *Diaphorina citri*. *Phytopathology* 98: S21.

Li W, Hartung JS, Levy L. 2006. Quantitative real-time PCR for detection and identification of *Candidatus Liberibacter* species associated with citrus huanglongbing. *J. Microbiol. Methods*. 66: 104-115.

Li W, Pria WD, Jr., Lacava PM, Qin X, Hartung JS. 2003. Presence of *Xylella fastidiosa* in sweet orange fruit and seeds and its transmission to seedlings. *Phytopathology* 93: 953-958.

Tirtawidjaja S. 1981. Insect, dodder and seed transmissions of citrus vein phloem degeneration (CVPD). *Proc. Int. Soc. Citriculture* 3: 469-471.

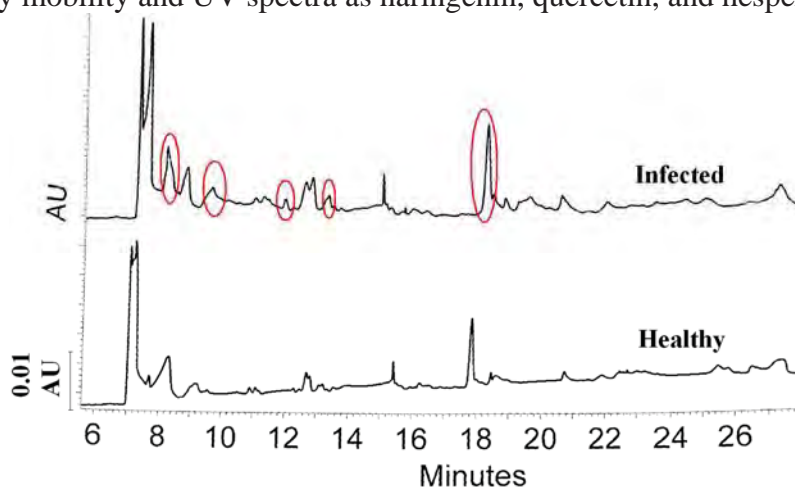


### 5.13 Metabolite Changes in HLB Orange Leaves by GC-MS and Other Techniques

Cevallos-Cevallos J.M., and Reyes-DeCorcuera J.I.

University of Florida, Citrus Research and Education Center, Lake Alfred, FL, USA

Citrus Huanglongbing (HLB) is considered the most destructive citrus disease in the world. Currently the only approved methods for HLB diagnosis are PCR-based. However, methods that do not rely on the presence of the bacteria in the sample are needed for fast in-field analysis. A metabolomic approach for biomarker discovery for early detection of HLB was undertaken. Procedures for orange leaf metabolite extraction, separation, detection and identification were developed and optimized to maximize the number and amount of metabolites detected. PCR-confirmed samples of healthy and HLB-infected ‘Valencia’ leaves were taken monthly for 6 months and analyzed under optimized conditions. Preliminary results were obtained from the application of capillary zone electrophoresis coupled to photodiode array (CZE-PDA), HPLC-MS, and GC-MS. CZE-PDA showed six potential HLB biomarkers (Figure 1) from which three were identified by mobility and UV spectra as naringenin, quercetin, and hesperidin.



**Figure 1.** Typical electropherograms of healthy and infected leaves. Significant difference was found in the circled compounds.

HPLC-MS analysis revealed about 190 potential biomarkers. Identification of these compounds is being carried out by other tools such as tandem MS and NMR.

GC-MS analysis identified inositol derivatives, sugar alcohols such as arabitol and ribitol, aminoacids such as proline and alanine, and dicarboxylic acids such as propanedioic acid as additional potential biomarkers.

Additional experiments will be conducted for selectivity analysis of the characterized biomarkers.

#### Literature Cited:

Abu-Nada Y, Kushalappa A, Marshall W, Al-Mughrabi K, Murphy A. 2007. Temporal dynamics of pathogenesis-related metabolites and their plausible pathways of induction in potato leaves following inoculation with *Phytophthora infestans*. *Eur. J. Plant Pathol.* 118:375-91.

- Bove JM. 2006. Huanglongbing: A destructive, newly-emerging, century-old disease of citrus. *J. Plant Pathol.* 88:7-37.
- Chung K, Brlansky R. 2006. Citrus Diseases Exotic to Florida: Huanglongbing (Citrus Huanglongbing). *IFAS Bull.* PP 210pp.
- Ding F, Yi G, Wang G. 2004. Research on the PCR and nested-PCR detection of citrus Huanglongbing pathogen. *Acta Hortic. Sin.* 31:803-806
- Glauser G, Guillarme D, Grata E, Boccard J, Thiocone A, Carrupt P, Veuthey Rudaz JS, Wolfender J. 2008. Optimized liquid chromatography–mass spectrometry approach for the isolation of minor stress biomarkers in plant extracts and their identification by capillary nuclear magnetic resonance. *J. Chromatogr.* 1180: 90-98.

## 5.14 Regeneration and Chemotherapy of Huanglongbing- Affected Periwinkle

Zhang M.-Q<sup>1,2</sup>, DUAN Y.-P,<sup>3</sup>, Powell C.A.<sup>1\*</sup>

<sup>1</sup> IRREC/IFAS, University of Florida, Fort Pierce, FL34945, USA <sup>2</sup> Fujian Agri. & Forestry Univ., Fuzhou, 350002, P.R. China <sup>3</sup> Horticultural Lab, ARS/USDA, Fort Pierce, FL 34945, USA \* Corresponding author

Citrus Huanglongbing (HLB) is the most destructive and devastating disease of citrus in the world. HLB is believed to be associated with three species of  $\alpha$ -Proteobacteria in the genus of *Candidatus Liberibacter*. *Ca. L. asiaticus* (Las) is the only one that has yet been found to be associated with citrus HLB in the United States. Current management of the disease by using disease-free nurseries, roguing infected trees, and chemical or biological control of the insect vectors has had limited success, and the disease is endangering the entire citrus industry in the United States. Periwinkle is an excellent experimental host of HLB pathogen. Because of its rapid growth and ease of propagation, HLB-affected periwinkles were used as the model plants for developing a rapid process for screening chemical compound against liberibacter while simultaneously assessing phytotoxicity. To overcome the decline and poor regeneration of HLB-affected periwinkle cuttings, the optimal conditions for regenerating the cuttings were determined based on partial least squares regression analysis (PLS) in uniform design. The predicted models derived from the empirical relationship between the regenerated plants from cuttings and their influence factors were used to optimize the regeneration conditions. The optimal conditions for regeneration plants from the HLB-affected periwinkle were half-strength MT medium supplemented with 5 mg.L<sup>-1</sup> NAA and 5 mg.L<sup>-1</sup> IBA. In addition, vermiculite is a better material than potting soil for rooting and regenerating of periwinkle cuttings (Table 1).

Two chemical agents, the antibiotic penicillin G and the biocide 2,2-dibromo-3-nitrilopropionamide (DBNPA), were effective in eliminating or suppressing the HLB pathogen when used to treat the HLB-affected periwinkle cuttings. The regenerated plants and the grafted plants from the HLB-affected cuttings treated with penicillin G @ 50 mg.L<sup>-1</sup> had no positive signal in nest PCR using the primer sets of OI1/OI2C and CGO3f/CGO5r. The other plants showed the nest PCR-positive from the HLB-affected cuttings. When the regenerated plants from the cutting treated with penicillin G @ 25 mg.L<sup>-1</sup> were re-grafted on the healthy periwinkle, the same leaf symptom occurred again and had positive signal in nest PCR as the regenerated plants (Figure 1). The regenerated plants from Las-infected periwinkle significantly reduced the ratio and titer of Las bacterium by 66.7% (four PCR-negative out of six regenerated plants) in nest PCR and 83.3% (five PCR-negative out of six regenerated plants) in conventional PCR when 200-ppm DBNPA was used for cutting treatment (Figure 2). In comparison with the untreated control, the cuttings treated with penicillin G or DBNPA regenerated more efficiently and grew faster. The biomass of the regenerated plants was increased by 116.5% from the Las-infected cuttings treated with penicillin G @ 50 mg.L<sup>-1</sup>, and by 49.9% treated with DBNPA @ 200  $\mu$ L.L<sup>-1</sup> (Table 2). Another chemical, Oxytetracycline-HCl was also effective at the concentration of 150~250 mg.L<sup>-1</sup> by watering the root, which resulted in symptom reduction and increased growth of the diseased periwinkle and suppressing the Las bacterium, (Figure 3). The results demonstrated that the developed system using HLB-affected periwinkle cuttings is a rapid and cause-effective system for screening chemicals for HLB control. Chemicals, such as

Oxytetracycline-HCl and DBNPA that are effective in eliminating or suppressing the Las bacterium in periwinkle, are being further evaluated in the HLB-affected citrus in the greenhouse and in the field.

**Table 1.** Integrated effects of rooting medium mixture (RM) and plant growth regulators (PGRs) on periwinkle cuttings (PC) with or without HLB-affected revealed by biomass weight (FW) and percentage of regeneration (%) at 2 months after cuttings transplanted

Treatments (RM×PGRs×PC)			Biomass weight per cutting (g)	Percentage regenerated (%)
100% Vermiculite	IBA	HP <sup>†</sup>	15.05±2.75	100
		DP <sup>‡</sup>	9.45±1.42	66.7
	NA	HP	13.76±1.59	100
		DP	8.15±2.25	100
	CK	HP	10.72±1.86	100
		DP	7.25±3.27	66.7
50% Vermiculite+50% Soil (v/v)	IBA	HP	9.43±3.28	100
		DP	4.44±4.13	100
	NA	HP	14.45±2.74	100
		DP	13.19±1.03	100
	CK	HP	6.17±3.78	50.0
		DP	6.33±1.45	100
100 % Soil	IBA	HP	5.39±3.08	100
		DP	1.67±0.83	100
	NA	HP	12.51±1.35	100
		DP	7.20±1.48	100
	CK	HP	5.13±1.81	50.0
		DP	6.15±0.28	100

<sup>†</sup> HP: cutting with nest PCR negative using primer sets of OI<sub>1</sub>/OI<sub>2c</sub> and CGO3F/CGO5R

<sup>‡</sup> DP: cutting with PCR positive using primer set of OI<sub>1</sub>/OI<sub>2c</sub>

Each value of the biomass weight per cutting represents the mean ± S.E. of n = 15. The split-split-plot analysis of variance (ANOVA) was used for evaluating the biomass data. The main plot analysis contains the sum of squares for RM divided by main plot error sum of squares. The split-plot test included PGRs and RM×PGRs mean square and subplot error sums of squares. Finally, the split-split-plot test included PC, PC×PGRs, PC×MM and PC×PGRs×RM corresponding mean square divided by split-subplot error.

**Table 2.** Biomass weight per cutting (g) and regeneration percentage (%) of the regenerated plants in 2 months after cutting treated with penicillin G and DBNPA (2,2-dibromo-3-nitrilopropionamide) at different concentrations

Chemical Compounds	Conc.	cultivars	biomass weight per cutting (g)	Regeneration Percentage (%)
Penicillin G (mg.L <sup>-1</sup> )	50	CPW	22.71±4.74	66.7
		CR	8.94±1.41	66.7
	25	CPW	13.35±6.93	100
		CR	7.25±6.05	100

	0	CPW	12.29±0.72	50.0
		CR	4.13±4.29	50.0
DBNPA ( $\mu\text{L.L}^{-1}$ )	200	CR	5.320±1.005	50.0
	100	CR	3.824±1.057	75.0
	0	CR	3.550±1.666	50.0

CR, HLB-affected cutting from periwinkle *Catharanthus roseus*; CPW, HLB-affected cutting from periwinkle *Catharanthus 'Pacific pure white'*

The biomass was weighed from more than six regenerated plants from cuttings. Each value represents mean  $\pm$  S.E. of regenerated plants.

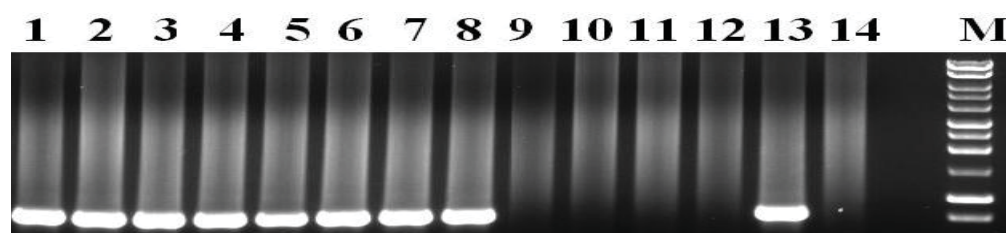


Figure 1. HLB-PCR amplification from the HLB-affected periwinkle treated with penicillin G at different concentrations using the nest PCR with the primer sets of OI1/OI2c and CGO3F/CGO5R

Lanes: M:DNA marker; 1, HLB-affected cutting from parent periwinkle (*Catharanthus roseus*, CR); 2, HLB-affected cutting from parent periwinkle (*Catharanthus 'Pacific pure white'*, CPW); 3, HLB-affected CR cutting treated with water as control (CR-CK); 4, HLB-affected CPW treated with water as control (CPW-CK); 5, HLB-affected CR cutting treated with penicillin G @ 25 mg.L<sup>-1</sup> (CR-25); 6, grafting periwinkle from CR-25 (GCR-25); 7, HLB-affected CPW cutting treated with penicillin G @ 25 mg.L<sup>-1</sup> (CPW-25); 8, grafting periwinkle from CPW-25; 9, HLB-affected CR cutting treated with penicillin G @ 50 mg.L<sup>-1</sup> (CR-50); 10, grafting periwinkle from CR-50 (GCR-50); 11, HLB-affected CPW cutting treated with penicillin G @ 50 mg.L<sup>-1</sup> (CPW-50); 12, grafting periwinkle from CPW-50; 13, positive control; 14, negative control

The HLB- affected periwinkle cuttings were treated with penicillin G at different concentrations. The plants were regenerated from the treated cuttings and used for HLB-PCR test at 2 months post-treatment. Then the regenerated plants were recorded and transplanted into the pot with soil. One month later, the cuttings were grafted into the healthy periwinkle of same variety. Forty-five days later, the grafted periwinkle was sampled for HLB-PCR test.

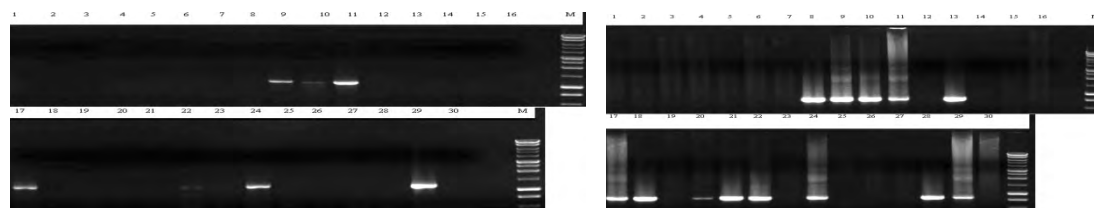


Figure 2 HLB-PCR amplification from the HLB-affected and unaffected periwinkle treated with DBNPA at different concentrations using the primer set of OI1/OI2c (LEFT), and its nest PCR with the primer sets of OI1/OI2c and CGO3F/CGO5R (RIGHT)

Lanes: 1~7, regenerated plants from the unaffected periwinkle cuttings; 8~13, regenerated plants from the HLB-affected cuttings treated with water as control; 14~22, regenerated plants from the HLB-affected cuttings treated with DBNPA @  $100\mu\text{L}^{-1}$ ; 23~28, regenerated plants from the HLB-affected cuttings treated with DBNPA @  $200\mu\text{L}^{-1}$ , 29, PCR positive control; 30, PCR negative control; M: marker (1 Kb).

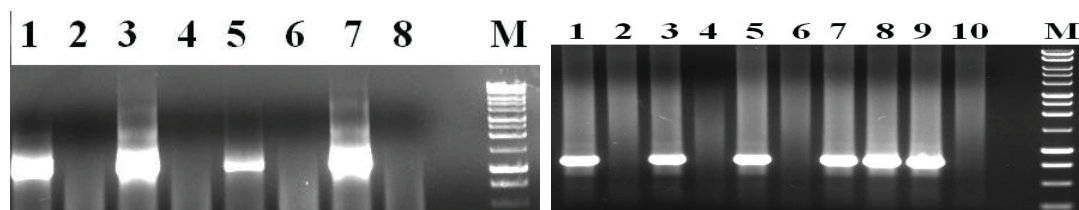


Figure 3 HLB-PCR amplification from the HLB-affected periwinkle pre- and post-treated with Oxytetracycline-HCl and 2,2-dibromo-3-nitrilopropionamide using conventional PCR with the primer set of OI1/OI2c (LEFT), and the nest PCR with the primer sets of OI1/OI2c and CGO3F/CGO5R (RIGHT)

Lanes: M:DNA marker; 1, PG8; 2, PG8 treated with oxytetracyclin HCl @ 200 mg/L PG32 ; 3, PG13; 4, PG13 treated with oxytetracyclin HCl @ 150 mg/L; 5, PG24; 6, PG24 treated with oxytetracyclin HCl @ 250 mg/L; 7, PG32; 8, PG32 treated with 2,2-dibromo-3-nitrilopropionamide (DBNPA) @ 200mg/L; 9, PCR positive control; 10, PCR negative control.

The pre-treated samples were taken before the treatments. The post-treated samples were taken at 1 months after the first treatment of chemical compounds.

## 5.15 Differences in Secondary Metabolites in Leaves from Trees Affected with the Greening (HLB) Disease

**Manthey J.A.**

USDA,ARS, Citrus and Subtropical Products Laboratory, Winter Haven, Florida, USA.

Preliminary analyses of methanolic extracts of orange leaves that were either healthy or symptomatic of citrus greening (HLB) showed consistent differences in the levels of important classes of phytochemicals. The main flavonoids and other related phenols in the symptomatic and healthy leaves were monitored by HPLC at 330 nm. The flavanone glycoside, hesperidin, and several of the main flavone *C*- and *O*-glycosides were identified by mass spectral (MS) analysis and by co-elution with authentic standards. Hydroxycinnamates were located by comparison of UV spectra of the unknowns to those of ferulic, caffeic, and *p*-coumaric acids. In some cases, where UV quantification of targeted compounds were poor due to either low concentrations or UV peak overlaps, quantifications were made by MS ion-extracted chromatograms. In these analyses significant differences were detected in a number of the hydroxycinnamates, flavone glycosides, and polymethoxylated flavones. In symptomatic Valencia and Midsweet orange leaves the concentrations of certain hydroxycinnamates were nearly twice as high as in the healthy leaves (Table 1). In contrast, the concentrations of most of the main apigenin glycosides were much lower in the HLB-symptomatic leaves. Levels of hesperidin, and the main diosmetin glycoside, diosmin, were relatively unaffected.

Table 1. HLB/CON peak area ratios of hydroxycinnamates (HCA) and flavonoid glycosides in Midsweet and Valencia sweet orange leaves

Elution time	MS fragment	Structure	Midsweet	Valencia
5.3	---	HCA	1.84	1.95
6.3	---	HCA	1.2	1.43
7.2	---	HCA	1.78	2.06
8.3	595/577/559/457	6,8-di- <i>C</i> -glucosyl apigenin	0.50	0.67
8.8	---	HCA	1.30	1.92
9.4	---	flavone glycoside	0.83	0.87
13.2	565/433	apigenin- <i>C</i> -glucosyl- <i>O</i> -xyloside	0.69	0.66
13.7	565/433	2''-xylosylvitexin	0.63	0.63
14.7	595/449/287	luteolin rutinoside	0.70	0.80
18.3	579/433/271	isorhoifolin (apigenin-7- <i>O</i> -rutinoside)	0.42	0.59
19.1	609/463/301	diosmin (diosmetin-7- <i>O</i> -rutinoside)	0.99	0.97
19.9	611/465/303	hesperidin	1.39	1.34

The fragment ions at 271, 287, 301, and 303 are due to apigenin (5,7,4'-trihydroxyflavone), luteolin (5,7,3',4'-tetrahydroxyflavone), diosmetin (5,7,3'-trihydroxy-4'-methoxyflavone), and hesperetin (5,7,3'-trihydroxy-4'-methoxyflavanone), respectively, and are indicative of flavone- and flavanone-*O*-glycosides. The HLB/CON peak area ratios are calculated from averages of peak areas measured in HLB and CON samples prepared in triplicate.

Differences were also detected in the ratios of the polymethoxylated flavones (PMFs) in HLB-symptomatic and healthy leaves (Table 2). While most of the PMFs (sinensetin, nobiletin, and tangeretin) were moderately lower in the HLB-affected leaves (HLB/CON ratios ~ 0.7), the levels of 3',4',5,6,7,8-heptamethoxyflavone were higher in the HLB-affected leaves for both

varieties. It is unusual that a specific PMF would exhibit significant fluctuations in concentrations in the diseased leaf tissues, while other PMFs do not.

Table 2. HLB/CON peak area ratios of the main polymethoxylated flavones in Midsweet and Valencia sweet orange leaves

Variety	UK(373)	SIN(373)	TAN(373)	NOB(403)	HMF(433)
Midsweet	0.74	0.79	0.90	0.74	4.82
Valencia	0.70	0.64	0.63	0.57	1.66

Peak areas of the 4 identified compounds (SIN, sinensetin; TAN, tangeretin; NOB, nobiletin; and HMF, heptamethoxyflavone) and the one unknown compound (UK) were measured as mass extracted chromatograms from the Total Ion Chromatograms (TICs) recorded during the HPLC chromatographic runs. Values in parentheses are the mass ions ( $m/z$ ) at which the TICs were recorded. Ratios are calculated from averages of triplicate values obtained for the HLB-symptomatic and healthy (control) leaves.

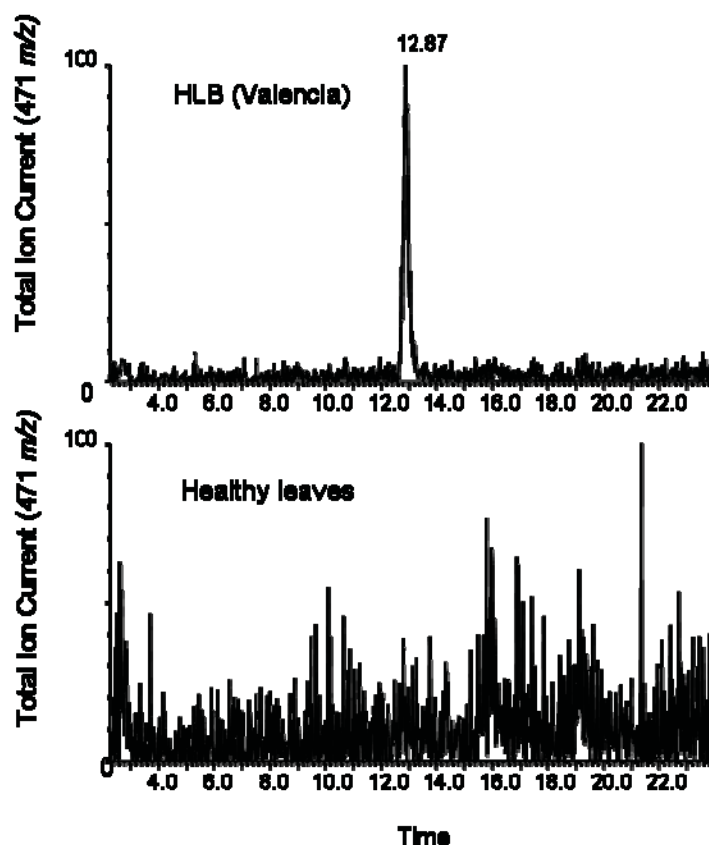


Figure 1. Mass extracted (471 amu) total ion chromatograms of Valencia HLB-symptomatic (upper) and healthy (lower) leaves. Limonin glucoside eluted at 12.87 min.

Other differences were detected in the Total-Ion-Chromatograms (TICs) of the HPLC-mass spectral analyses of the leaf extracts. With this technique,  $300 \pm 22$  ppm ( $n=3$ ) limonin glucoside was measured in the HLB-affected Valencia leaves (Figure 1), while only trace levels were detected in the healthy leaves. Similar findings (approximately 70 ppm ( $n=3$ ) limonin glucoside in the HLB-symptomatic leaves) were made with the Midsweet orange leaves.



Another main difference was the elevated concentration of a compound with an  $m/z$  of 187 amu, which was also visualized as an Ehrlich reagent positive band in normal phase TLC of symptomatic leaf extracts (Figure 2). The Ehrlich reagent is useful for the detection of limonoids, as well as secondary amines, including alkaloids. The detection by the Ehrlich reagent and the molecular weight suggest that this compound may contain an odd number of N atoms (an alkaloid).

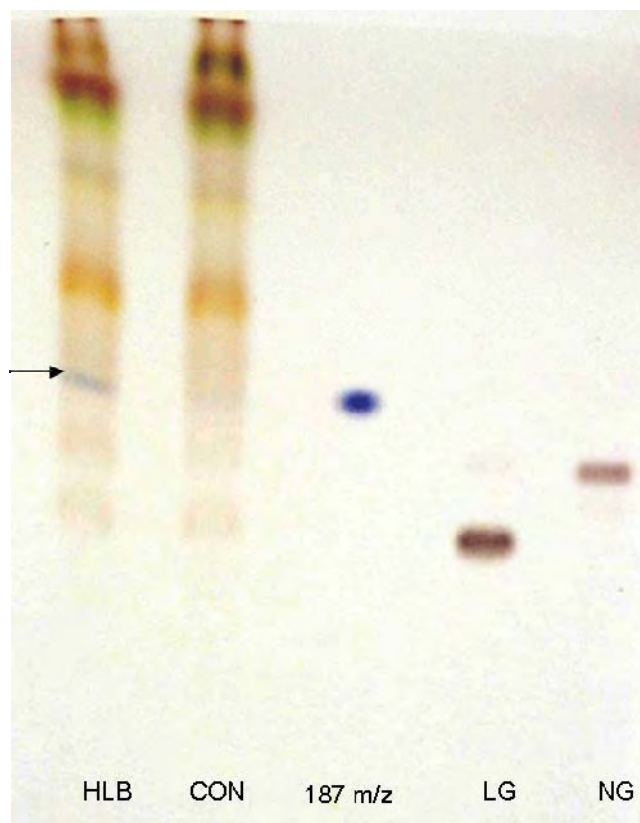


Figure 2. TLC of Valencia leaf extracts. HLB denotes HLB-symptomatic and CON denotes healthy leaf extracts. The middle spot shows the 187  $m/z$  compound recovered after separation by semi-preparative HPLC. LG denotes limonin glucoside and NG denotes nomilin glucoside standards. The arrow shows the Ehrlich reagent positive spot that co-migrates with the 187  $m/z$  compound enriched in the HLB-symptomatic Valencia orange leaves.

The changes detected in the symptomatic fruit are being compared to the changes in the profiles of compounds in healthy and symptomatic juice of Hamlin and Valencia oranges. Thus far, no significant differences have been detected in the putative 187 amu alkaloid, or in the main flavanone glycosides, but significant differences have been preliminarily detected in the limonin and nomilin aglycones between the juice of healthy and HLB-affected oranges.

### 5.16 Role of *Murraya* species in the spread of Huanglongbing

Ramadugu C.<sup>1</sup>, Lopes S.<sup>2</sup>, Manjunath K.L.<sup>3</sup>, Halbert S.<sup>4</sup>, Roose M.<sup>1</sup>, and Lee R.F.<sup>3</sup>

<sup>1</sup>Dept. of Botany and Plant Sciences, University of California, Riverside, CA 92521; <sup>2</sup>FUNDECITRUS

Caixa Postal 391 – CEP 14807-040, 201 Araraquara, S.P., Brazil; <sup>3</sup>USDA ARS, NCGRCD, 1060 Martin Luther King Blvd., Riverside, CA 92507: and ; <sup>4</sup>Division of Plant Industry, FDACS, 1911 SW 34 St, Gainesville, FL 32614

Huanglongbing (citrus greening) is a devastating disease responsible for the destruction of several citrus industries in Asia, Africa and recently in the Americas. In the USA the disease spreads naturally through psyllid vectors, *Diaphorina citri*. In an effort to understand the role of ornamental plants in the spread of HLB, psyllids from *Murraya* plants from several Florida venues were collected and analyzed. Psyllid adults and nymphs carrying HLB bacteria (*Candidatus Liberibacter asiaticus*) were found on *Murraya* plants from garden centers in several counties indicating movement of the disease through *Murraya*. About 17% of the psyllid adult samples and 12% of the nymph samples tested from *Murrayas* were positive for HLB bacteria. Presence of HLB in symptomatic *Murraya* plants in field was confirmed by qPCR assay, followed by conventional PCR and sequencing. *Murraya* plants exhibit phenotypic variability. Samples of infected *Murraya* plants collected from Florida and Brazil were compared to healthy samples collected from California by analyzing sequences of selected nuclear and chloroplast genes. Preliminary phylogenetic analysis revealed the presence of two distinct clades of *Murrayas* and that both groups are susceptible to HLB.

### 5.17 Identification of a New *Liberibacter* Species Associated with Diseases of Solanaceous Plants

Liefting L.W.<sup>1</sup>, Sutherland P.W.<sup>2</sup>, Ward L.I.<sup>1</sup>, Weir B.S.<sup>1</sup>, Kumarasinghe L.<sup>1</sup>, Quinn B.D.<sup>1</sup>, Clover G.R.G.<sup>1</sup>

<sup>1</sup>Plant Health and Environment Laboratory, MAF Biosecurity New Zealand, PO Box 2095, Auckland 1140, New Zealand; <sup>2</sup>The Horticulture and Food Research Institute of New Zealand Ltd, Private Bag 92 169, Auckland 1142, New Zealand

In early 2008, a disease of glasshouse-grown tomato (*Solanum lycopersicum*) and pepper (*Capsicum annuum*) was observed in Auckland, New Zealand. Symptoms in tomato include spiky, chlorotic apical growth, general mottling of the leaves, curling of the midveins, overall stunting of the plants and in some cultivars, fruit deformation. In pepper, symptoms include chlorotic or pale green leaves, shortened internodes and overall stunting. Leaf cupping and sharp tapering of the leaf apex resulting in a spiky appearance may also occur in pepper. Extensive testing ruled out the presence of pathogenic fungi, culturable bacteria, viruses, viroids and phytoplasmas. The first breakthrough came when a phloem-limited bacterium-like organism (BLO) was observed in thin sections of symptomatic plant tissue by transmission electron microscopy. A range of universal and specific 16S rRNA PCR primers were used in different combinations on DNA extracted from healthy and symptomatic plants. Most of the primer combinations produced the same size fragments from both healthy and symptomatic plants. One of the primer combinations produced a unique product from symptomatic plants only. Sequence analysis of this PCR product revealed that it covered about two-thirds of the 16S rRNA gene and shared high identity with ‘*Candidatus Liberibacter*’ species (1). The remainder of the 16S rRNA gene was sequenced as well as the 16S/23S rRNA spacer region, and a 1.7-kb fragment of the *rplKAJL-rpoBC* operon. Phylogenetic analysis of these three genomic regions showed that the bacterium is clearly a member of the genus ‘*Candidatus Liberibacter*’ but is distinct from the currently described species and strains (Figure 1). Subsequently, with the development of a specific PCR diagnostic method, this new liberibacter was also detected in four additional solanaceous hosts, potato (*Solanum tuberosum*), tamarillo (*Solanum betaceum*), cape gooseberry (*Physalis peruviana*) (2, 3), and chilli (*Capsicum* sp.). Symptoms in potato resemble those of the “zebra chip” disease; a new disease of potato observed in Mexico, Guatemala, and the United States. The tubers have necrotic flecking and streaking that became marked when the potatoes are fried. Affected plants generally senesce early, the mean yield was approximately 60% less than expected, and harvested tubers have less dry matter. No symptoms have yet been observed in tamarillo, cape gooseberry, and chilli plants infected with the liberibacter. It is unknown if the symptoms in these hosts are seasonal, or if they act as symptomless reservoirs of the pathogen. The tomato/potato psyllid, *Bactericera cockerelli*, has been confirmed to be the vector of this new liberibacter species (unpublished data). *B. cockerelli* was first discovered in an Auckland glasshouse tomato crop in May 2006, and is now established throughout the North Island and the top half of the South Island of New Zealand. A national survey of glasshouse-grown tomato and pepper, and packhouse-stored potato tubers determined that the liberibacter follows the same distribution in New Zealand as *B. cockerelli*. This new liberibacter species of solanaceous plants has been named ‘*Candidatus Liberibacter solanacearum*’ (4).

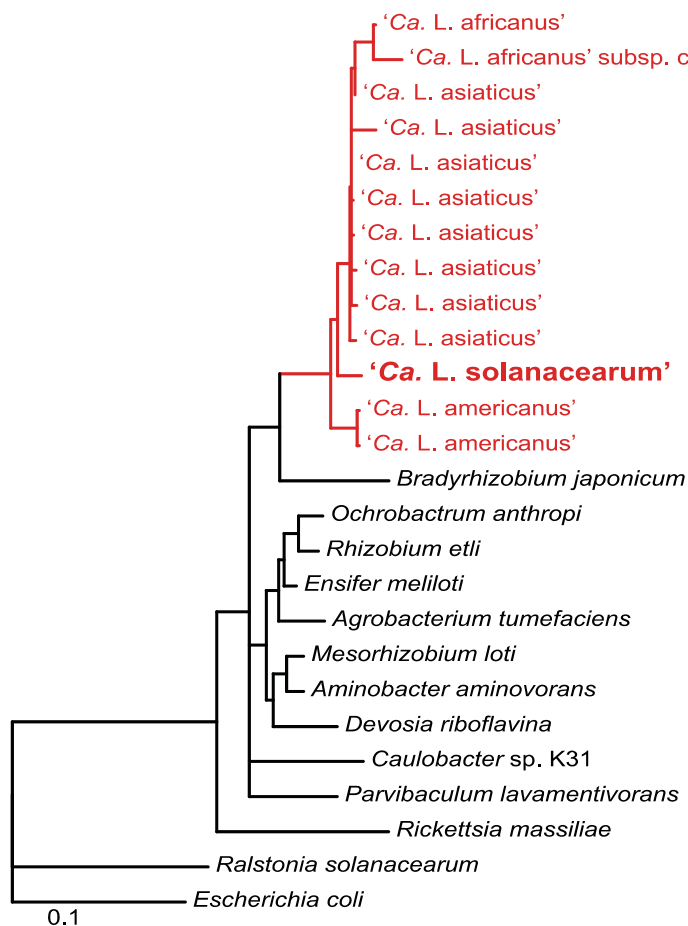


Figure 1. Phylogenetic tree based on 16S rRNA sequences showing the relationships of the four 'Candidatus Liberibacter' species (red font) and representatives of the alpha subdivision of the Proteobacteria (black font). *E. coli* was used as an outgroup.

### Literature cited:

- Liefting LW, Sutherland PW, Ward LI, Paice KL, Weir BS, Clover GRG. 2009. A new 'Candidatus Liberibacter' species associated with diseases of solanaceous crops. *Plant Dis.* 93:208-214.
- Liefting LW, Perez-Egusquiz ZC, Clover GRG, Anderson JAD. 2008. A new 'Candidatus Liberibacter' species in *Solanum tuberosum* in New Zealand. *Plant Dis.* 92: 1474.
- Liefting LW, Ward LI, Shiller JB, Clover GRG. 2008. A new 'Candidatus Liberibacter' species in *Solanum betaceum* (tamarillo) and *Physalis peruviana* (cape gooseberry) in New Zealand. *Plant Dis.* 92: 1588.
- Liefting LW., Weir BS, Pennycook SR, Clover GRG. 2009. 'Candidatus Liberibacter solanacearum', a liberibacter associated with plants in the family Solanaceae. *Int. J. Syst. Evol. Microbiol.* (in press).

INTERNATIONAL RESEARCH CONFERENCE  
ON HUANGLONGBING



**Session 6:**  
**Asian Citrus Psyllid**  
**(Biology and**  
**Genomics)**

Orlando, Florida



December 2008

## 6.1 Gene Expression in Midgut tissues of *Diaphorina citri*: Application to biology and vector control

Hunter W.B.<sup>1</sup>, Marutani-Hert M.<sup>1</sup>, Shelby K.<sup>2</sup>, and Coudron T.<sup>2</sup>

<sup>1</sup>USDA, ARS, U.S. Horticultural Research Lab, 2001 South Rock Rd, Ft. Pierce, FL, USA 34945. <sup>2</sup>USDA, ARS, Biol. Control of Insects Res., Columbia, MO 65203.

Digestive enzymes advantageous for feeding from plants include the specific digestive enzymes amylase and pectinase (Cohen 1996). Plant feeding Hemiptera, like the Asian citrus psyllid, AsCP, *Diaphorina citri*, Kuwayama (Hemiptera: Psyllidae) are specialized feeders in that they feed primarily from plant phloem. To gain an understanding of *D. citri* feeding and digestion we elected to examine the genes expressed in the midgut tissues. During feeding *D. citri* can transmit bacteria, specifically *Candidatus Liberibacter asiaticus* which is considered the primary cause of the citrus disease Huanglongbing, HLB. Psyllid expressed sequence tags, ESTs, provide useful information on the midgut genes being expressed within these specific tissues. This information enables the identification of many of the genes and proteins having key roles in psyllid digestion. Thus we undertook a 5' end sequencing project from adult *D. citri*. Through these and other efforts ~17,000 ESTs have been produced from *D. citri* (Hunter et. al. 2005-2008). The Midgut cDNA library is providing valuable information from which researchers are now developing new management strategies based on emerging RNAi methodologies to disrupt psyllid feeding.

### Materials and Methods

Asian citrus psyllids, *D. citri*, were obtained from a colony established from field caught adults, maintained at the USDA, ARS, U.S. Horticultural Research Laboratory, Ft. Pierce, FL. Insects were reared on *Murraya paniculata* (L.) 'Orange-jasmine' seedlings in screen cages contained in an insectary, and held at 25°C, 16 L: 8 D. Three hundred psyllid midguts were dissected out in RNAlater, then homogenized and total RNA extracted. cDNA was synthesized using Stratagene ZAP-cDNA Synthesis Kit (Stratagene, La Jolla, CA, USA). Mass excision of the amplified library was carried out using Ex-Assist helper phage (Stratagene, La Jolla, CA, USA) and bacterial clones containing excised pBluescript SK(+) phagemids were recovered by random colony selection. Sequencing performed at the USDA, ARS, U.S. Hort. Res. Lab, genomic lab, Ft. Pierce, FL. Reactions were performed using the ABI PRISM® BigDye™ Primer Cycle Sequencing Kit (Applied Biosystems). Reactions were prepared in 96-well format using the Biomek2000™ liquid handling robot (Beckman Coulter, Inc., USA). Sequencing reaction products were precipitated with 70% isopropanol, resuspended in 15 µL sterile water and loaded onto an ABI 3730 DNA Analyzer (Applied Biosystems, Foster City, CA, USA). Of the 7,800 ESTs, 6,200 were validated for submission after base calling, quality trimming, vector trimming and sequence fragment alignments were performed by Sequencher™ (Gene Codes Corp., USA). Low-quality bases (quality score <12) were trimmed from both ends of sequences. Assembly parameters were set using a minimum overlap of 30 bp, match spacing of 150, minimum length of 150bp and 90% identity. Putative sequence identity was determined based on BLAST similarity searches (BLASTX and BLASTn) using NCBI, Batch Blast (June 2008). Available at GenBank, dbEST, Accession numbers: FK254041- FK260232. GenBank <http://www.ncbi.nlm.nih.gov>

## Results and Discussion

Most insects produce a range of digestive proteases, which may be regulated in direct response to food or produced constitutively throughout the life of the insect (Terra & Ferreira, 1994; Lehane *et al.* 1996). Our results identified many different enzymes within *D. citri*, (Fig 1) Biological Process: Distribution of *Diaphorina citri* transcripts from Blastx analysis using a summary with a minimum of 70 sequences per category resulted in these categories in descending order: Response to stress, 227; Proton transport 167; Response to chemical stimuli 157; Glycolysis 139; Instar/pupal development 137; Larval development 129; Mesoderm development 124; Intracellular signaling cascade 118; Proteolysis 117; Oogenesis 113; Behavior 111; Amino acid metabolic process 111; Proteins amino acid phosphorylation 109; Negative regulation of cellular process 109; Cytokinesis 107; DNA metabolic process 105; and Monocarboxylic acid metabolism 104. While regulation of enzyme production and release appears to be influenced by feeding, it is likely also to involve a combination of hormonal release, paracrine activity and direct feeding mechanisms. This has been observed in the beetle, *C. zealandica*, where addition of serine protease inhibitors to the diet caused trypsin and leucine aminopeptidase activities to increase (Dymock *et al.*, 1992). Research has also shown that protease activity can be affected by disease infection of *C. zealandica* larvae by the bacteria *Serratia* spp. containing a specific plasmid results in a rapid elimination of serine protease activity in the midgut (Grkovic *et al.* 1995; Hurst *et al.*, 2000).

Disruption of insect-specific physiological processes has been identified as a useful route for the development of novel management strategies against insect pests. One such area is disruption is to affect the specific enzymes used in digestion which can be inhibited or blocked at synthesis by RNAi approaches. This tactic is promising but has proven more difficult than first envisaged as insects generally produce a range of enzymes under control of multiple genes, thus in-depth genetic studies need to be completed to identify specific enzymes and their biological pathways. The availability of these sequences now enables investigations into these important questions regarding *D. citri* digestion and biology. The *D. citri* gene expression data set advances what is currently known about psyllid digestion. The enzymes identified further provide possible genetic targets to be used to alter *D. citri* digestive enzymes and physiological processes.

In summary, a gene expression library was made from the alimentary tract of adult Asian citrus psyllids, AsCP. Analysis of the expressed sequence tags produced a gene dataset of 7,800 EST's. Enzymes important to digestion and feeding on a phloem diet were identified including several serine proteases, hydrolases, and cathepsins. These and other transcripts with significant homology (E-value  $\leq 10^{-20}$  or better) were identified through homology searches to other known insect genomes. Use of genomics approaches has enabled us to identify some of the genetic basis of psyllid digestion and pathogen interactions. Further genomic analyses of the AsCP, *Diaphorina citri*, will advance our understanding of the psyllid/phloem/bacterium interactions which may be linked to the acquisition and transmission of the pathogenic bacterium *Liberibacter asiaticus*, associated with the citrus disease Huanglongbing (HLB). However, a much greater understanding of psyllid genomics is still needed. Continued development of these genetic products will set the foundation for further functional genomic studies to isolate AsCP specific genes to be targeted to reduce the spread of HLB, citrus greening disease, and to reduce psyllid populations using environmentally friendly, highly specific management strategies.

## Acknowledgements

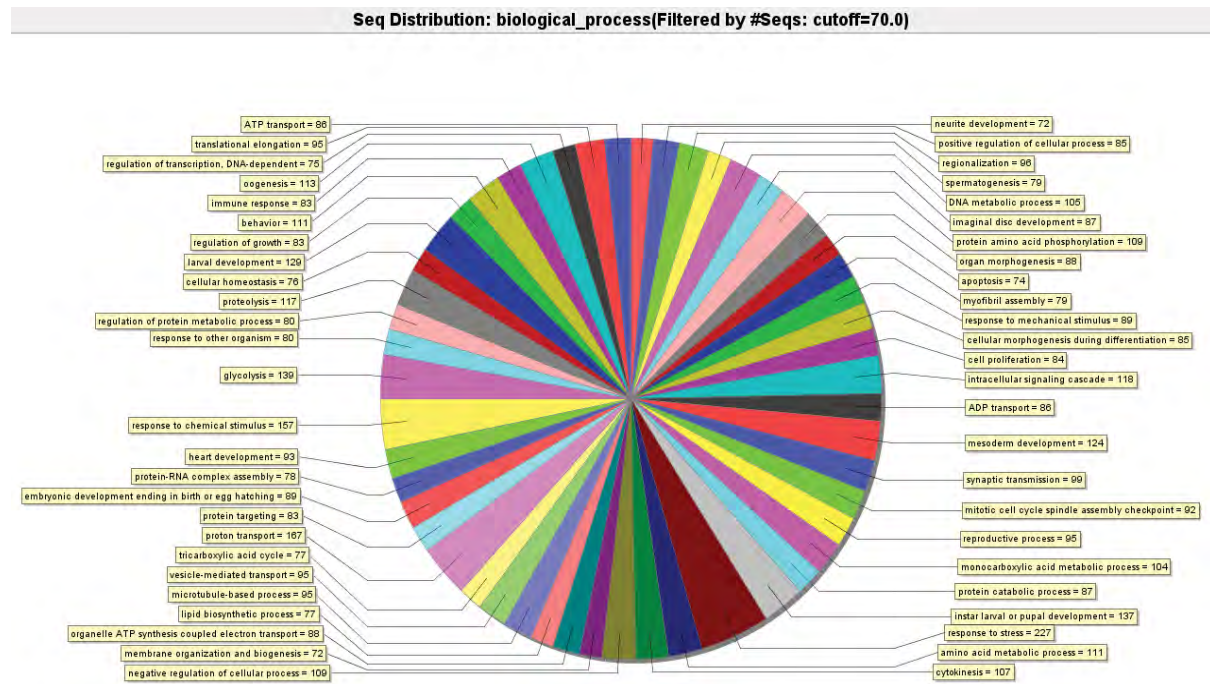
We kindly thank Christine Lynch, Biological Science Technician, for dissections, tissue collection, library construction, and data processing. USDA, ARS, USHRL, Ft. Pierce, FL.

## References

- Cohen AC. 1996. Plant feeding by predatory Heteroptera: evolutionary and adaptational aspects of trophic switching, pp. 1-17. In O. Alomar and R. N. Wiedenmann (eds.), *Zoophytophagous Heteroptera: implications for life history and integrated pest management*. Entomological Society of America, Lanham, MD.
- Dymock JJ, Laing WA, Shaw BD, Gatehouse AMR, Christeller JT. 1992. Behavioral and physiological responses of grass grub larvae (*Costelytra zealandica*) feeding on protease inhibitors. *NZ J Zool* 19:221–231.
- Grkovic S, Glare TR, Jackson TA, Corbett GE. 1995. Genes essential for amber disease in grass grubs are located on the large plasmid found in *Serratia entomophila* and *Serratia proteamaculans*. *Appl Environ Microbiol* 61:2218–2223.
- Hurst MR, Glare TR, Jackson TA, Ronson CW. (2000). Plasmid-located pathogenicity determinants of *Serratia entomophila*, the causal agent of amber disease of grass grub, show similarity to the insecticidal toxins of *Photorhabdus luminescens*. *J Bacteriol* 182:5127–38.
- Hunter WB, Hall DG. 2008. Testes gene expression in Asian citrus psyllid, *Diaphorina citri* (Hemiptera: Psyllidae). GD264847-GD269020. NCBI.
- Hunter WB, Hall DG. 2008. Midgut gene expression in Asian citrus psyllid, *Diaphorina citri* (Hemiptera: Psyllidae). USDA-FP 190004-FK254041- FK260232.
- Hunter WB, Dang PM, McKenzie, CL. 2005. Gene expression in *Diaphorina citri* Kuwayama (Hemiptera: Psyllidae) DN465721-DN470410, NCBI.
- Hunter WB, Dowd SE, Katsar CS, Shatters Jr, RG, McKenzie CL, Hall DG. 2008. Psyllid biology: expressed genes in adult Asian citrus psyllids, *Diaphorina citri* Kuwayama. *Insect Science* (submitted).
- Hunter WB, McKenzie CL, Shatters RG, Weathersbee AA, Hall DG. 2005. Gene expression in field collected Asian citrus psylla, *Diaphorina citri* Kuwayama (Hemiptera: Psyllidae). DN202325- DN201110. NCBI.
- Hunter, WB, Hunnicutt LE, Hall DG. 2006. Ribosomal proteins of the Asian citrus psyllid, *Diaphorina citri*. 88 Proteins, DQ675535-DQ673441. NCBI.
- Lehane MJ, Muller HM, Crisanti A. (1996) Mechanisms controlling the synthesis and secretion of digestive enzymes in insects. In *Biology of the Insect Midgut* (Lehane, M.J. and Billingsley, P.F., eds), pp. 195–205. Chapman & Hall, London, UK.
- Notredame C, Higgins D, Heringa J. 2000. T-Coffee: A novel method for multiple sequence alignments. *Journal of Molecular Biology* 302:205-217.
- Terra WR, Ferreira C. 1994. Insect digestive enzymes: properties, compartmentalization and function. *Comp Biochem Physiol B Biochem Mol Biol* 109:1–62.



**Fig. 1 Biological Process: Distribution of *Diaphorina citri* transcripts blastx summary for minimum of 70 sequences per category.** Highest Categories in descending order: Response to stress, 227; Proton transport 167; Response to chemical stimuli 157; Glycolysis 139; Instar/pupal development 137; Larval development 129; Mesoderm development 124; Intracellular signaling cascade 118; Proteolysis 117; Oogenesis 113; Behavior 111; Amino acid metabolic process 111; Proteins amino acid phosphorylation 109; Negative regulation of cellular process 109; Cytokinesis 107; DNA metabolic process 105; Monocarboxylic acid metabolism 104. (Blast2Go).



**6.2 Pheromones of the Asian citrus psyllid, *Diaphorina citri* Kuwayama (Hemiptera: Psyllidae) elicit behavioral responses from its parasitoid, *Tamarixia radiata* (Waterston) (Hymenoptera: Eulophidae).**

Onagbola E.O., Rouseff R.L. and Stelinski L.L.

University of Florida, Institute of Food and Agricultural Sciences, Citrus Research and Education Center, Lake Alfred, FL 33850.

**Abstract**

Volatile chemicals mediate inter-specific interactions between organisms. Biological control agents use host kairomones (volatile chemicals emanating from hosts) for location and recognition of hosts. *Tamarixia radiata* Waterston is an ectoparasitoid of several psyllid species including the Asian citrus psyllid (ACP), *Diaphorina citri* (Kuwayama), which vectors the causal bacteria responsible for citrus greening disease. Because the native biological control agents of the ACP in FL are insufficient for suppression of ACP populations, current research interests are focusing on enhancing the impact of parasitoid species against the ACP. As a result, we embarked on investigating the volatile chemicals produced by the adult male and female ACP and adult male and female *T. radiata*. Determining the chemical cues this parasitoid uses to find its host may allow us to exploit these chemicals for improved biological control of the ACP. Using standard solvent extraction and solid phase microextraction (SPME) techniques, volatiles were trapped from adult male and female *D. citri* and its parasitoid, *T. radiata* under ambient laboratory conditions. Collected volatiles were analyzed using gas chromatography coupled with mass spectrometer (GC-MS) equipped with Turbo Mass software and a DB-wax capillary columns and identified using NIST 2005 version 2.0 standard spectra. Pheromones of *D. citri* and *T. radiata* were identified. Responses of male and female *T. radiata* to the entrained air-borne volatiles from the adult male and female ACP and to the synthetic samples of the ACP pheromones were investigated in Y-tube olfactometer bioassays. Male and female *T. radiata* were behaviorally attracted to the air-borne volatiles from live adult ACP and to the synthetic *D. citri* pheromones. The results of this study provide insight into the chemical ecology of *T. radiata* and its *D. citri* host and suggest that *T. radiata* explores the kairomones of its *D. citri* host during host location processes.

### 6.3 Effects of Freezes on Survival of *Diaphorina citri*

Hall D.G.

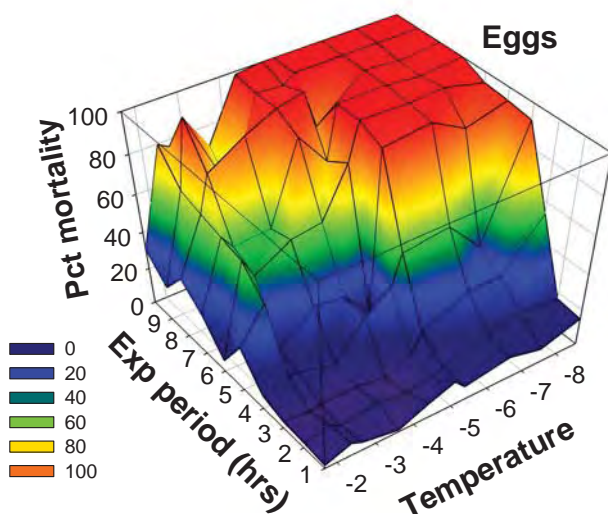
USDA-ARS, Fort Pierce, FL, USA

Citrus in Florida is occasionally subjected to freezing temperatures. Freezes that affect citrus in Florida have been described as ‘light’ (0 to  $-2.0^{\circ}\text{C}$ ), ‘moderate’ ( $-2.0$  to  $-4.0^{\circ}\text{C}$ ), ‘hard’ ( $-4.0$  to  $-6.5^{\circ}\text{C}$ ), and ‘severe’ ( $< -6.5^{\circ}\text{C}$ ) (Rogers and Rohli 1991). Some freeze events in Florida citrus have lasted for only a short period of time, often less than an hour. Other freeze events have lasted a number of hours. *Diaphorina citri*, the Asian citrus psyllid, has been known in Florida since June 1998 (Tsai et al. 2002) and is established throughout the state’s citrus-growing regions (Michaud 2004). The psyllid has also spread into northern Florida well above the northern limits of commercial citrus. The probability of a freeze at  $\leq -2.2$ ,  $\leq -4.4$  or  $\leq -6.7^{\circ}\text{C}$  occurring in north central Florida (Ocala in Marion County) was estimated to be 82.4, 47.1 or 17.6%, respectively (Miller and Glantz 1988). Freeze probabilities for Florida citrus declined southwardly. The probability of a freeze at  $\leq -2.2$ ,  $\leq -4.4$  or  $\leq -6.7^{\circ}\text{C}$  occurring in south central Florida (Moore Haven in Glades County) was estimated to be 23.1, 7.7 or 0.0%, respectively (Miller and Glantz 1988). No information was available on the effect of freezing temperatures on mortality of *Diaphorina citri* in Florida. Studies were therefore initiated to assess mortality rates of *D. citri* eggs, nymphs and adults exposed to different freeze events varying in minimum temperature ( $-1.5$  to  $-9.5^{\circ}\text{C}$ ) and duration (1 to 10 hours), all of which could realistically occur in some areas in Florida. Presented here is a research progress report.

Freezes in the range of  $-1.5$  to  $-5.0^{\circ}\text{C}$  for up to 4 hours resulted in no more than a maximum of around 40% mortality of eggs (Figure 1). The greatest percentages of egg mortality occurred at the upper range of the temperatures studied ( $-8.6^{\circ}\text{C}$ ), but only when the freeze duration exceeded around 4 hours.

A single trial has been conducted thus far with nymphs exposed to cold. Less than 30% mortality of fifth instar nymphs occurred following exposure to  $-2.6^{\circ}\text{C}$  for up to 10 hours.

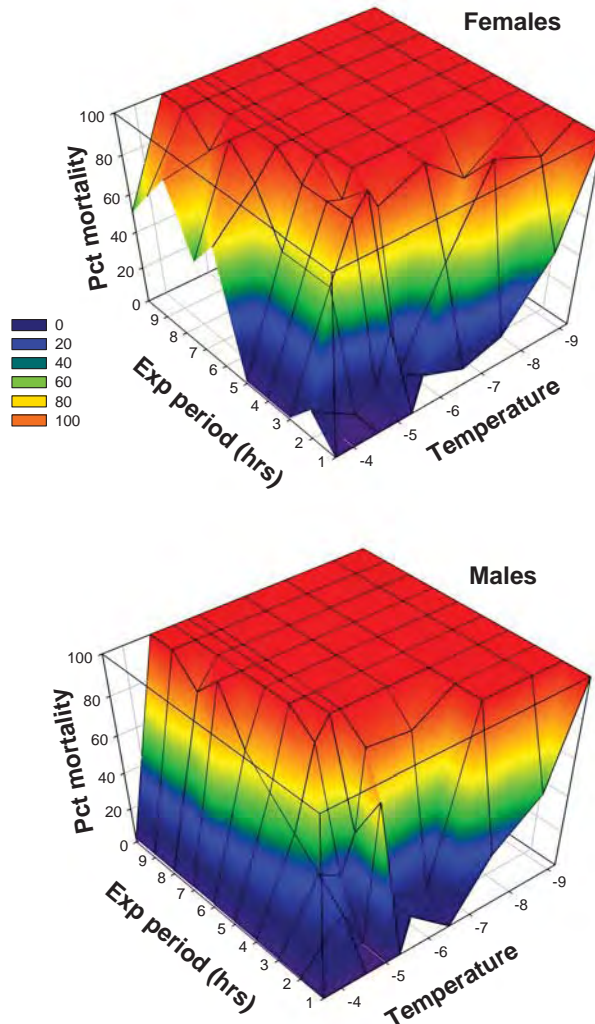
Figure 1. Percent mortality of *Diaphorina citri* eggs exposed to freezing temperatures for from one to ten hours.



Working with adults from a psyllid colony maintained in a temperature-regulated greenhouse, freezes of  $-3.6^{\circ}\text{C}$  for up to 5 hours killed relatively low percentages of females (Figure 2). Low percentages of males were killed when they were exposed to this same temperature for up to ten hours. Whether females are more susceptible to cold than males remains to be determined. Freezes at  $-5$  to  $-$

7°C for over 2 hr or longer killed 95 to 100% of adults of both sexes. For both males and females at -5 to -6°C, there appeared to be a time window of exposure below which only low percentages of adults died, above which large percentages of adults died within a day, and within which relatively large percentages of adults died but slowly over time (apparently because they stopped feeding). The lower threshold for this time-period of exposure appeared to be just below 3 hr and the upper threshold just above 4 hr for both males and females.

Figure 2. Mortality of adult *Diaphorina citri* exposed to freezing temperatures for one to ten hours.



Studies with adults from a psyllid colony maintained in cages outdoors during the winter indicated that adult *D. citri* may acclimate to cold. Based on two trials, 100% mortality of adults from this outdoor colony occurred immediately following 8 to 9 hours of exposure to -5°C. Although not side-by-side comparison to the outdoor colony, several trials with the indoor colony indicated that 100% mortality of adults occurred immediately following 5 to 7 hours of exposure to -5.5°C. More research is needed to determine if psyllids acclimate to cold.

The studies reviewed here only addressed survival of psyllids following exposure to cold. It is possible that exposure to some freezes might not kill a psyllid but alter its biology in some way. Some freeze events particularly in northern areas of Florida and up into Georgia might be severe enough to temporarily eradicate the psyllid, with subsequent repopulation by migrating psyllids. In central and north-central Florida where a 'moderate' to 'hard' freeze could occur, population levels of *D. citri*

might be greatly reduced but probably only for a relatively short period of time, as surviving individuals would likely continue to reproduce.

**References**

- Michaud JP. 2004. Natural mortality of Asian citrus psyllid (Homoptera: Psyllidae) in central Florida. *Biological Control*. 29: 260-269.
- Miller KA, Glantz MH. 1988. Climate and economic competitiveness: Florida freezes and the global citrus processing industry. *Climatic Change*. 12: 135-164.
- Rogers JC, Rohli RV. 1991. Florida citrus freezes and polar anticyclones in the Great Plains. *J. Climate*. 4: 1103-1113.
- Tsai JH, Wang, Liu YH. 2002. Seasonal abundance of the asian citrus psyllid, *Diaphorina citri* (Homoptera: Psyllidae) in southern Florida. *Florida Entomol.* 85 (3): 446-451.

#### 6.4 Characterization of electrical penetration graphs of *Diaphorina citri* Kuwayama (Hemiptera: Psyllidae) in citrus

Bonani J.P.<sup>1</sup>, Fereres A.<sup>2</sup>, Appezzato-da-Gloria B.<sup>1</sup>, Garzo E.I.<sup>2</sup>, Miranda M.P.<sup>1</sup>, and Lopes J.R.S.<sup>1</sup>

<sup>1</sup>ESALQ/Universidade de São Paulo, Piracicaba, Brazil; <sup>2</sup> ICA/Consejo Superior de Investigaciones Científicas, Madrid, Spain.

##### Abstract

For decades the Asian citrus psyllid, *Diaphorina citri* Kuwayama has been known as a vector of phloem-limited bacteria associated to citrus Huanglongbing (HLB), *Candidatus Liberibacter* spp. However, some aspects of transmission remain poorly understood, such as the feeding activities inside the plant tissue that result in bacterial acquisition and inoculation. This research was carried out to investigate stylet penetration and feeding activities of *D. citri* on seedlings of *Citrus sinensis* (L.) Osbeck cv. 'Pêra' by using the electrical penetration graph (DC-EPG system) technique. EPG waveforms were described based on amplitude, frequency, voltage level and electrical origin of the observed traces during stylet penetration on plant tissues. The main waveforms were correlated with histological observations of salivary sheath termini in plant tissues, in order to determine the putative location of stylet tips. The behavioral activity was also inferred based on waveform similarities in relation to other Sternorrhynchs, particularly aphids and whiteflies. By analyzing 8-h EPGs of 20 adult females, five waveforms were described: (C) salivary sheath secretion and extracellular stylet pathway through epidermis and parenchyma; (D) first contact with phloem tissue (distinct from other waveforms reported for Sternorrhyncha); (E1) putative salivation in the phloem; (E2) probably phloem ingestion; and (G) putative xylem ingestion. *D. citri* always initiate a probe with stylet pathway through epidermis and parenchyma (C), with mean duration of 10 min. After waveform C, stylet withdrawal from the plant and return to non-probing status (Np) is the most frequent event (86.2%), especially in the first 2 h of recording. The probability of phloem contact after C is 12.5%. Waveform D is always observed upon phloem contact, followed by E1 (salivation; mean duration of 1.55 min). After E1, there is a 45% probability of phloem ingestion (E2), but return to pathway activity (C) is a more frequent outcome (55%). This insect only reached the phloem vessels after an average of 155 min following the onset of the first probe. Despite the long time to reach the sieve elements, phloem ingestion is the main activity of *D. citri* within the plant, with average total duration of 206.1 min (42.9% of the recording time). Waveform G was observed after C with a very low frequency (1.3%) and mean duration of 23.7 min. These data on probing behavior of *D. citri* are basic to determine stylet activities and time periods required for acquisition and inoculation of *Candidatus Liberibacter* spp. in citrus, as well as to establish effective control tactics for preventing HLB spread.

## 6.5 Symbionts associated with *Diaphorina citri* Kuwayama (Hemiptera: Psyllidae) in Brazil and a look into their role.

Salvador I. and C nsoli F.L.

Departamento de Entomologia, Escola Superior de Agricultura “Luiz de Queiroz”, Universidade de S o Paulo, Piracicaba, S o Paulo, Brazil.

### Abstract

Many insects harbour primary symbionts within specialized cells or structures for their growth and maintenance, while secondary symbionts may infect other tissues. These symbionts, mainly bacteria, may affect the host physiology and its interactions with the trophic levels, besides being necessary for the production of required nutrients. Because symbionts play a major role in determining host fitness, their use in developing new technologies for pest and disease control has been investigated. However, a candidate symbiont with a known effect on host biology has to be selected for the development of such technologies. The citrus psyllid *Diaphorina citri* vectors greening disease in Brazil, and is known to harbor the symbionts *Carsonella*, *Wolbachia* and the syncytium symbiont. We proposed to develop symbiont lines of the citrus psyllid to understand the role symbionts play on *D. citri* development and reproduction as a step forward to develop strategies to control the disease it vectors. Ten-day old adults were fed antibiotic solutions (tetracycline, streptomycin, ampicillin, cefotaxime and rifampicin) for three days, and transferred to mating cages for egg collection and immature development. Although preliminary PCR analysis had indicated a possible elimination of some of the symbionts associated with the citrus psyllid, more detailed Q-PCR analysis indicated only *Wolbachia* had a reduction. In every antibiotic treatment, a negative effect on *Wolbachia* was observed, the *Carsonella* and the syncytium symbiont load increased, indicating the possible negative effects of the interactions between the psyllid primary symbionts and *Wolbachia*. Streptomycin and tetracycline were the most effective antibiotics in reducing the symbiont load associated with the citrus psyllid, resulting in lower egg and nymphal survivorship, respectively. However, the effects on egg survivorship seem to be related to an undesirable effect of the antibiotic treatment itself instead of a change in the load of a particular symbiont. The effects of each particular antibiotic on the symbiofauna of the citrus psyllid and their consequence to psyllid development and reproduction will be discussed.

Funding: FAPESP/FUNDECITRUS

## 6.6 Endosymbiotic microbiota of Asian Citrus Psyllid (*Diaphorina citri*)

Marutani-Hert M.<sup>1</sup>, Hunter W.B.<sup>1</sup>, and Dowd S.<sup>2</sup>

<sup>1</sup>USDA, ARS, U.S. Horticultural Research Lab, 2001 South Rock Rd, Ft. Pierce, FL, USA 34945. <sup>2</sup>USDA, ARS, LIRU, Lubbock, TX, 79403

Huanglongbing (HLB), known in the U.S. as citrus greening disease, is one of the most severe diseases of citrus across the U.S., South America, Asia and Africa. The disease is thought to be associated with infection by an unculturable, gram-negative, phloem-limited bacteria, *Candidatus Liberibacter* spp., which belongs to the  $\alpha$ -subdivision of the *Proteobacteria*. Huanglongbing is a threat to the world citrus industry. The disease is transmitted to healthy plants during feeding by the Asian citrus psyllid, *Diaphorina citri* (Hemiptera). Efforts to reduce *D. citri* include insecticides, biological control agents, and more recently efforts to develop RNAi based strategies against the host of bacteria associated with the psyllid and disease. Insects such as psyllids within the Hemiptera, feed from the phloem of plants ingesting a diet which includes rich carbohydrates but which is deficient in essential amino acids. Like most Hemipterans, these insects support maternally inherited bacterial mutualists, referred to as endosymbionts. The endosymbionts live within specialized host cells (bacteriocytes) and are generally thought to supplement their host's diet. It was reported *Buchnera aphidicola* synthesizes the vitamin riboflavin, which is essential to the aphid host's growth. In *D. citri*, five types of nucleotide sequences related to endosymbionts were determined, however some of secondary endosymbiont may not occur in all individuals. Knowledge of the bacteria community in *D. citri* will provide information for the production of novel strategies to manage or reduce *D. citri* by manipulation of its endosymbionts. In this study we have extended these studies by an analysis of rDNA from *D. citri*. In order to investigate the endosymbiotic microbiota of *D. citri*, we analyzed eubacterial 16S-23S rDNA amplified from *D. citri* feeding from citrus. We have used DNA sequence characterization to explore the microbial communities in psyllids. As many as eight endosymbiotic or gut fauna bacteria were identified.

### Materials and Methods

*DNA extraction, PCR and cloning rDNA.* Whole DNA of psyllids was extracted by AquaPure Genomic DNA kits (BioRad, Hercules, CA, USA). Eubacterial 16S rDNA was amplified by PCR using primers 16SF and 16SR as described by Munson et al (Munson et al, 1991). A Eubacterial 16S rDNA and a partial 23S rDNA were amplified with 10F and 480R from Hansen et al (2007). These primers were selected because they do not amplify other psyllids (*G. brimblecombei*) primary endosymbiont, *Candidatus Carsonella ruddii*, an obligate endosymbiont that is reported to occur in all psyllid individuals (Hansen et al., 2007). PCR was conducted with Platinum PCR<sup>®</sup> SuperMix (Invitrogen, Carlsbad, CA, USA). The PCR product was cloned TA-cloning vector (Invitrogen, Carlsbad, CA, USA) and *E. coli* using ampicillin and X-gal blue-white selection system. White colonies were subjected to plasmid extraction and sequenced.

### Results and Discussion

Previously, the genetic sequences were examined from adult psyllids collected from citrus trees. In these sequences, we successfully identified the psyllid primary endosymbiont, *Candidatus*



*Carsonella ruddii*. To avoid amplifying this primary endosymbiont bacteria, two pair of primers, 16S and a pair of 10F, 480R were chosen to detect novel endosymbiont bacterial sequences (Munson et al, 1991, Hansen et al., 2007). Almost the entire length of 16s rDNA was successfully amplified from the total psyllid DNA. A total of 47 cloned 1.5 kb DNA fragments were sequenced and subjected to homology searches in the DNA databases (NCBI). Sequence homology results found 40 of the 47 were 100% homologous to a *Syncytium* endosymbiont of *D. citri* (accession number EF433792) and seven were 100% homologous to *Wolbachia* endosymbiont of *D. citri* (accession number EF433793). The 2.5 kb of PCR product obtained with primer pair 10F, 480R contained six major types of sequences (A-E). These sequences were subjected to homology search in DNA databases (Table 1). The A-type and E-type sequences were members of the  $\beta$ -Proteobacteria, closely related to *Janthinobacterium* IC161 (99 %) and *Oxalobacteraceae* (97- 98 %). The B-type sequence was a member of the  $\gamma$ -Proteobacteria, closely related to *Escherichia* (96 %) and *Shigella* (95 %). The C-type sequence was a member of the  $\gamma$ -Proteobacteria, closely related to *Alkanindiges illinoisensis* (97 %). The D-type sequence was a member of the  $\gamma$ -Proteobacteria, closely related to *Acinetobacter* sp. (95 %) and *Alvinella pompejana* symbiont APG130A (97 %). *Acinetobacter* sp. are widespread in nature and can be obtained from water, soil and living organism. *Acinetobacter* are known to be involved in biodegradation of a number of different compounds (Abdel-El-Haleem, 2003). The F-type sequence was a member of the  $\beta$ -Proteobacteria, closely related to *Nitrosospira multiformis* (91 %). Biological functions of the endosymbionts of psyllids have not been investigated. Here we provide a first report of functional bacterial homologies from *D. citri* microbial data: such as Carbazole degrading bacteria, *Janthinobacterium* sp. IC161 (99%), ammonia-oxidizing bacterium, *Nitrosospira multiformis* ATCC25196 (CP000103) (91%), multidrug resistant bacteria, *Acinetobacter baumannii* ACICU(CP000863) (95%). These data suggest psyllids are supported by many endosymbiotic bacteria and various types of interactions between the *Ca. Liberibacter* species and other endosymbionts which occur in psyllids.

In summary, citrus greening is one of the most severe diseases of oranges in Asia and Africa, caused by an unculturable, gram-negative, phloem-limited bacteria, *Ca. Liberibacter* spp., belonging to the  $\alpha$ -subdivision of the *Proteobacteria*. The disease, called citrus greening disease in the U.S. and known as Huanglongbing world-wide, was recently discovered in Florida, 2005. The disease is transmitted from infected to healthy plants by insects known as the Asian citrus psyllid, *Diaphorina citri* (Hemiptera) which are found throughout citrus in Florida. One strategy to manage citrus greening is aimed at suppression of psyllid populations. Insects such as psyllids within the Hemiptera, feed from the phloem of plants ingesting a diet which includes rich carbohydrates but is deficient in essential amino acids. These insects support maternally inherited bacterial mutualists, referred to as endosymbionts. The endosymbionts live within specialized host cells (bacteriocytes) and are generally thought to supplement their host's diet. In order to investigate the endosymbiotic microbiota of psyllids, we analyzed eubacterial 16S-23S rDNA amplified from *D. citri* and identified transcripts from a cDNA psyllid library made from field-collected Asian citrus psyllids feeding from citrus. These data suggest psyllids are supported by several endosymbiotic bacteria and live with a rich bacterial fauna of various types all of which may have important interactions between each other including *Liberibacter asiaticus* when it occurs in psyllids.

## References

- Bogan BW, Sullivan WR, Kayser KJ, Derr K, Aldrich HC, Paterek JR. 2003. *Alkanindiges illinoisensis* gen. nov., sp. nov., an obligatory hydrocarbonoclastic, aerobic squalane-degrading bacterium isolated from oilfield soils. *Int. J. Syst. Evol. Microbiol.* 53: 1389-1395.
- Fukatsu T, Nikoh N. 1998. Two Intracellular Symbiotic Bacteria from the Mulberry Psyllid *Anomoneura mori* (Insecta, Homoptera). *Appl Environ Microbiol.* 64: 3599–3606.
- Halbert SE, Manjunath KL. 2004. Asian citrus psyllids (Sternorrhyncha: Psyllidae) and greening disease of citrus: A literature review and assessment of risk in Florida. *Florida Entomologist.* 87: 330–353.
- Hansen AK, Jeong G, Paine TD, Stouthamer R. 2007. Frequency of secondary symbiont infection in an invasive psyllid relates to parasitism pressure on a geographic scale in California. *Appl Environ Microbiol.* 73:7531-7535.
- Inoue K, Habe H, Yamane H, Omori T, Nojiri H. 2005. Diversity of carbazole-degrading bacteria having the car gene cluster: isolation of a novel gram-positive carbazole-degrading bacterium. *FEMS Microbiol. Lett.* 245: 145-153.
- Meyer JM, Hoy MA. (2008). Molecular survey of endosymbionts in Florida populations of *Diaphorina citri* (Homoptera: Psyllidae) and its parasitoids *Tamarixia radiata* (Hymenoptera: Eulophidae) and *Diaphorencyrtus aligarhensis* (Hymenoptera: Encyrtidae). *Florida Entomologist.* 91: 294-304.
- Munson MA, Baumann P, Clark MA, Baumann L, Moran NA, Voegtlin DJ, Campbell BC. 1991. Evidence for the establishment of aphid-eubacterium endosymbiosis in an ancestor of four aphid families. *J Bacteriol.* 173:6321-4.
- Nakabachi A, Ishikawa H. 1999. Provision of riboflavin to the host aphid, *Acyrtosiphon pisum*, by endosymbiotic bacteria, *Buchnera*. *Journal of Insect Physiology.* 45: 1-6.
- Sandstrom JP, Russell JA, White JP, Moran NA. 2001. Independent origins and horizontal transfer of bacterial symbionts of aphids. *Mol. Ecol.*: 217-228.
- Subandiyah,S., Nikoh,N., Tsuyumu,S., Somowiyarjo,S., Fukatsu,T. (2000). Complex endosymbiotic microbiota of the citrus psyllid *Diaphorina citri* (Homoptera: Psylloidea). *Zoolog. Sci.* 17: 983-989.
- Spaulding AW, von Dohlen CD. 1998. Phylogenetic Characterization and Molecular Evolution of Bacterial Endosymbionts in Psyllids (Homoptera: Sternorrhyncha). *Molecular Biology and Evolution.* 15: 1506-1513.
- Subandiyah S, Naruo N, Shinji T, Susanto S, Takema F. 2000. Complex Endosymbiotic Microbiota of the Citrus Psyllid *Diaphorina citri* (Homoptera : Psylloidea)(Phylogeny). *Zoological science* 17: 983-989.
- Thao ML, Clark MA, Baumann L, Brennan EB, Moran NA, Baumann P. 2000 Secondary endosymbionts of psyllids have been acquired multiple times. *Curr Microbiol.* 41: 300-304.
- Thao ML, Moran NA, Abbot P, Brennan EB, Burckhardt DH, Baumann P. 2000. Cospeciation of psyllids and their primary prokaryotic endosymbionts. *Appl. Environ. Microbiol.* 66: 2898-2905.
- Norton JM, Klotz MG, Stein LY, Arp DJ, Bottomley PJ, Chain PS, Hauser LJ, Land ML, Larimer FW, Shin MW, Starkenburg SR. 2008. Complete genome sequence of *Nitrosospora multififormis*, an ammonia-oxidizing bacterium from the soil environment. *Appl Environ Microbiol.* 74: 3559-3572.

Table 1. Endosymbiotic microbiota of Asian Citrus Psyllid (*Diaphorina citri*)

	Group	Function	Homology
Syncytium endosymbiont of <i>D. citri</i> (EF433792)			100%
Wolbachia endosymbiont of <i>D. citri</i> (EF433793)	Alphaproteobacteria		100%
<i>Janthinobacterium</i> sp. IC161	Betaproteobacteria	Carbazole degrading bacteria	99%
<i>Oxalobacteraceae</i>	Betaproteobacteria		97- 98 %
<i>Escherichia</i>	Gammaproteobacteria		96 %
<i>Shigella</i>	Gammaproteobacteria		95 %
<i>Alkanindiges illinoisensis</i>	Gammaproteobacteria	alkane-degrading strain	97%
<i>Acinetobacter</i> sp.	Gammaproteobacteria	multidrug resistant	95 %
<i>Nitrosospira multiformis</i>	Betaproteobacteria	ammonia-oxidizing bacterium	91%

## 6.7 FK506-Binding Protein from *Diaphorina citri* (Hemiptera: Psyllidae)

Hunter W.B. and Shatters, Jr R.

USDA, ARS, U.S. Horticultural Research Lab, 2001 South Rock Rd, Ft. Pierce, FL, USA 34945.

We report the isolation and characterization of the first 11.7-kDa FK506-binding protein from psyllids, *Diaphorina citri*. New strategies in insect and disease management depend on using genes and proteins of an organism against itself, through disruption, down-regulation, or silencing methodologies. To facilitate the rapid development of these strategies, gene expression libraries have been produced from *D. citri* (Hunter et al., 2005,2006,2008). Mining of these datasets has identified many potential genetic targets for psyllid management. One such protein described a member of the FK506-binding proteins (FKBPs). The FKBPs represent a large gene family in plants and insects that are involved in growth and development [pfam00254]. They are a highly conserved and ubiquitous group of chaperones that bind immunosuppressive proteins. The *D. citri*-FK506BP member had a *calc.* molecular weight of 11.7 kDa, with 109 amino acids in length (Table 1). These proteins are involved in regulation of Calcium ion channels within intracellular membrane systems which is associated with certain pathological states. This means that the movement of salts and water within cell fluids are regulated such that disruption of these channels causes or stimulates cell death. Disruption of genes encoding FKBPs in plants and animals has underlined the importance of this family of proteins in the regulation of cell division and differentiation.

FKBPs, like other immunophilins, are found in all classes of organisms, some of them being highly conserved and others being more specific. These proteins have multiple roles in the cell, the best known as receptors for medically important immunosuppressors. However, the functions of these enzymes are still being elucidated and recent results obtained in plants and animals indicate that these proteins are master regulators in the control of development.

Several FKBPs have been identified in invertebrates, including in the tunicate *Botryllus schlosseri*, the sponge *Suberites domuncula*, in worms *Schistosoma mansoni* and *Caenorhabditis elegans*, as well in several insects, *Drosophila melanogaster*, *Spodoptera frugiperda* (Alnemri et al., 1994), *Manduca sexta*, *Anopheles gambiae* and *Bombyx mori* (Somarelli, et al., 2007). In insects, FKBPs can be separated into several main categories. The first group includes orthologues to human FKBP12 and FKBP13. The second type of insect FKBPs are all similar in sequence and range in size from 38–46 kDa. The third class of insect FKBPs corresponds to potential orthologues of human FKBP52. Much of the empirical work on insect FKBPs has been related to FKBP46, which was first identified in *Spodoptera frugiperda* Sf9 cells (Alnemri et al., 1994). In Lepidoptera, *Manduca sexta*, the FKBP46 is a member of the ecdysone receptor (EcR) complex (Song et al., 1997).

## Methods and Materials

*cDNA library construction.* Adult *D. citri* were collected from citrus seedlings, Evans Properties, for RNA extraction and library construction as in (Hunter et al., 2008). Sequences have been deposited in the public database NCBI (Hunter et al., 2005ab, 2006, Hunter and Hall 2008).

*Bioinformatics analyses of Diaphorina citri-FKBP12.* The *D. citri*-FKBP12 cDNA [ABG82004.1|110671506] was translated into an amino acid sequence using the ExPASy translate tool. Multiple sequence alignments were generated using the ClustalW alignment tool bundled within the BioEdit program version 7.0.5 (Fig 1)(Hall, 1999). Alignments were performed using the ClustalW default parameters with no gap penalties and using the BLOSUM62 similarity matrix. Identities and similarities, as well as the rate of conservative versus non-conservative amino acid substitutions, between the FKBP12 proteins were calculated using the BLOSUM62 matrix (Henikoff and Henikoff, 1992) (Table 1). Phylogenetics analyses were performed using the Paup package version 4.0. Phylogenetic reconstructions were obtained with both mRNA and protein alignments using maximum parsimony and 1000 bootstrap replicates (Fig 2). (Somarelli and Herrera, 2007). The *D. citri* FKBP506 sequence were determined using cDNA, TBLASTX, and BLASTP, NCBI nr databases. *Diaphorina citri* FKBP12 was most closely related to *Bombyx mori* [114052971], with 84% identities and 91% positive amino acid matches.

## Results and Discussion

Here, we report the isolation and characterization of a FK506-binding protein, with a molecular weight of 11.7-kDa (*calc.*) from the Asian citrus psyllid *Diaphorina citri*. The FKBP12, have been shown to have a role as modulators of calcium channel functions (Marks 1996). The *Diaphorina citri* FKBP12 was most closely related to *Bombyx mori* [114052971], with 84% identities and 91% positive amino acid matches. Disruption of this and similar genes may provide unique genetic targets to reduce psyllid survival, thus limiting populations in the field.

Mining of the available genomic information from adult Asian citrus psyllid, *Diaphorina citri*, cDNA libraries (Hunter *et al*) identified a FK-binding protein (FKBP) which functions in many critical pathways needed for psyllid survival. The FKBP's are members of the peptidylprolyl *cis trans* isomerase family of enzymes, PPIases. They are a highly conserved and ubiquitous group of chaperones that bind immunosuppressive macrolides. The best studied proteins from the FKBP's are the 12 kDa FKBP's, which participate in a diversity of cellular functions. In addition members of this family are involved in apoptosis, cell-cycle progression, calcium release, nucleic acid binding and transport of high-molecular-mass receptor complexes. Several proteins that associate with FKBP12 have been identified in insect systems; such as calmodulin and calcineurin homologues in *Bombyx mori* (silkworm), mTOR and ryanodine receptors in *Drosophila melanogaster* and two calmodulin-like proteins in *Manduca sexta* (tobacco hornworm) suggesting that similar FKBP-mediated pathways and interactions exist in insects. Herein we describe the first *D. citri*-FK506BP of a molecular weight of 11.7 kDa, of 109 amino acids. The *D. citri* FK506BP cDNA was also isolated and sequenced using adult whole body tissues. A high degree of similarity among FKBP proteins across many different taxonomic groups has been reported which includes insects, bacteria, fungi, nematodes, tunicates, fish,

plants and mammals and found to be highly conserved. The importance of FK506BP functions may lend it to be a possible genetic target to reduce *D. citri* populations through the use of emerging RNAi technologies in insect management.

## References

- Alnemri ES., Fernandes-Alnemri T, Pomeranke K, *et al.* 1994. FKBP46, a novel Sf9 insect cell nuclear immunophilin that forms a protein-kinase complex. *J. Biol. Chem.* 269:30828–834.
- Hall TA. 1999. BioEdit: a user-friendly biological sequence alignment editor and analysis program for Windows 95/98/NT. *Nucleic Acids Symp. Ser.* 41:95–98.
- Henikoff S, Henikoff JG. 1992. Amino acid substitution matrices from protein blocks. *Proc. Natl. Acad. Sci. USA.* 89:10915–10919.
- Hunter WB, Dowd SE, Katsar CS, Shatters Jr RG, McKenzie CL, Hall DG. 2008. Psyllid biology: expressed genes, *Diaphorina citri*. *Insect Science* (submitted 07/08/08).
- Hunter WB, Dang P, McKenzie CL. 2005 *Diaphorina citri* (Hemiptera) DN465721-DN470410, NCBI.
- Hunter WB, McKenzie CL, Shatters RG, Hall DG. 2005. Gene expression in field collected Asian citrus psyllids, *Diaphorina citri* Kuwayama (Hemiptera: Psyllidae) DN202325-DN201110. NCBI.
- Hunter WB, Hunnicutt LE, Hall DG. 2006. Ribosomal proteins of the Asian citrus psyllid, *Diaphorina citri*. 88 Proteins, DQ675535-DQ673441. NCBI.
- Hunter WB., Hall DG. 2008. *Diaphorina citri* midgut gene expression, Asian citrus psyllid (Hemiptera: Psyllidae) FK254041- FK260232, NCBI.
- Kay JE. 1996. Structure–function relationships in the FK506-binding protein (FKBP) family of peptidylprolyl *cis–trans* isomerases. *Biochem. J.* 314:361–385.
- Marks AR. 1996. Immunophilin modulation of calcium channel gating. *Methods* 9:177-187.
- Somarelli JA, Herrera RJ. 2007. Evolution of the 12 kDa FK506-binding protein gene. *Biol. Cell* 99:311-321.
- Somarelli JA, Coll JL, Velandia A, Marinez L, Herrera RJ. 2007. Characterization of immunophilins in the silkworm *Bombyx mori*. *Archives of Insect Biochemistry and Physiology* 65:195-209.
- Song Q, Alnemri ES, Litwack G, Gilbert LI. 1997. An immunophilin is a component of the insect ecdysone receptor (EcR) complex. *Insect Biochem Mol Biol* 27:973–982.

**Figure 1. Sequence and structural alignment of FK506 Binding Protein, FKBP, from Asian Citrus Psyllid, *Diaphorina citri*.** A multiple sequence alignment among species from insect taxonomic groups shows high similarity among FKBP12 paralogues and orthologues at the amino acid level (blue). Critical residues necessary for PPIase activity and FK506 binding, according to Kay (1996), are highlighted in grey color.

CLUSTAL W (1.81) multiple sequence alignment

```

[Bombyx_mori]gi|116688016|gb|A   MGVTVETISPGDGSTYPKSGQTVVVHYTGTLTNGKKFDSRRDRGKPFKFRIGKSEVIRGWDEGVAQMSVGERAKL
[Manduca sexta]gi|6560679|gb|A   MGVTVDITPGEESTYPKNGQTVVVHYTGTLTSGKKFDSRRDRGKPFKFRIGKGEVIRGWDEGVAQMSVGERAKL
[Diaphorina citri]gi|110671506   MGVDVETLSPGDGQTYPKPGQVVVHYTGTLTDGKFDSSDRGVPFKFRLGKGDVIKGDWGHIAQLCVGQTAKL
[Bombyx_mori]gi|114052971|ref.    MGVDVETISPGNGSTYPKPGQTVVVHYTGTLQNGKKFDSRRDRGQPFKFTLKGKGDVIKGDWQGLAKMSVGERAKL
[Apis mellifera]gi|66558413|re    MGVDVEVLSPGDGQTYPKTGQTVVVHYTGTLNDGKKFDSRRDRGVPFKFKIGKGEVIKGDWQGVAKMCSVGERARL
[Nasonia vitripennis]gi|156555    MGVNVEVLSPGDGQTYPKTGQTVVVHYTGTLANGKKFDSRRDRGVPFKFKIGKGEVIKGDWQGVAKMCSVGERARL
[Tribolium castaneum]gi|910866    MGVDVETISPGDGQTYPKTGQTVVVHYTGTLNGTKFDSRRDRGVPFKFRIGKGEVIKGDWDEGVAQLSVGQRAKL
[Maconellicoccus hirsutus]gi|1    MGVDVETISPGDGSTYPKHGQTVVVHYTGTLVDGKKFDSRRDRGTFFKFKLKGGEVIKGDWDEGVAQLCVGQRAKL
[Drosophila melanogaster]gi|78    MGVDVETISPGDGSTYPKHGQTVVVHYTGTLVDGKKFDSRRDRGTFFKFKLKGGEVIKGDWDEGVAQLSVGQRAKL
[Aedes aegypti]gi|157117168|re    MGVDVETISPGDGSTYPKHGQTVVVHYTGTLVDGKKFDSRRDRGTFFKFKLKGGEVIKGDWDEGVAQLSVGQRAKL
[Danio rerio]gi|41152406|ref|N    MGVEVETIVPGDQTFPKKGQVRRVHYVGTLMNGQMFDSRRDRGKPFKFKIGHGEVIRGWEEGVAQMSVGERAKL
[Tetraodon nigroviridis]gi|472    MGVEVETIVPGDQTFPKKGQVRRVHYVGTLMNGQMFDSRRDRGKPFKFKIGHGEVIRGWEEGVAQMSVGERAKL
[Xenopus laevis]gi|27469642|gb    MGVDLETISPGDGRTPPKKGQTCVVHYTGMLQNGKKFDSRRDRNKPFFKFKIGRQEVIRGWEEGVAQMSVGERAKL
[Bos_taurus]gi|118151036|ref|N    MGVDLETISPGDGRTPPKKGQTCVVHYTGMLQNGKKFDSRRDRNKPFFKFKIGRQEVIRGWEEGVAQMSVGERAKL
*** : . :* : .** ** .***. * . * ***** * .** : . : * : * : * : * : * : * : * : * : * : *

```

```

[Bombyx_mori]gi|116688016|gb|A   TCSFDYAYGQQGHPGVIPPNSTLIFDVELLRLE-
[Manduca sexta]gi|6560679|gb|A   TCTPDYAYGQQGHPGVIPPNSTLIFDVELLRLE-
[Diaphorina citri]gi|110671506    TCSPDFAYGSRGHPGIIPPNATLIFDVELLRVEP
[Bombyx_mori]gi|114052971|ref.    TCSPDFAYGSRGHPGVIPPNATLIFDVELLRVE-
[Apis mellifera]gi|66558413|re    TCSPDFAYGSRGHPGVIPPNATLIFDVELLRVE-
[Nasonia vitripennis]gi|156555    TCPPEVAYGPRGHPGVIPPNATLIFDVELLKV-
[Tribolium castaneum]gi|910866    TCSFDYAYGSRGHPGIIPPNSTLIFDVELLKV-
[Maconellicoccus hirsutus]gi|1    ICSFDYAYGSRGHPGIIPPNATLIFDVELLKV-
[Drosophila melanogaster]gi|78    ICSFDYAYGSRGHPGVIPPNATLIFDVELLKV-
[Aedes aegypti]gi|157117168|re    VCSFDYAYGSRGHPGVIPPNATLIFDVELLRVE-
[Danio rerio]gi|41152406|ref|N    TCTPDFAYGSKGHPGVIPPNATLIFDVELLIGLE-
[Tetraodon nigroviridis]gi|472    ICSPDFAYGSKGHPGIIPPNATLIFDVELLIGLE-
[Xenopus laevis]gi|27469642|gb    TCSFDVAYGATGHPGVIPPNATLIFDVELIRIE-
[Bos_taurus]gi|118151036|ref|N    TVSPDYAYGSRGHPGIIPPNATLIFDVELLKLLE-
* : * * * * * : * * * * * : * * * * * : *

```

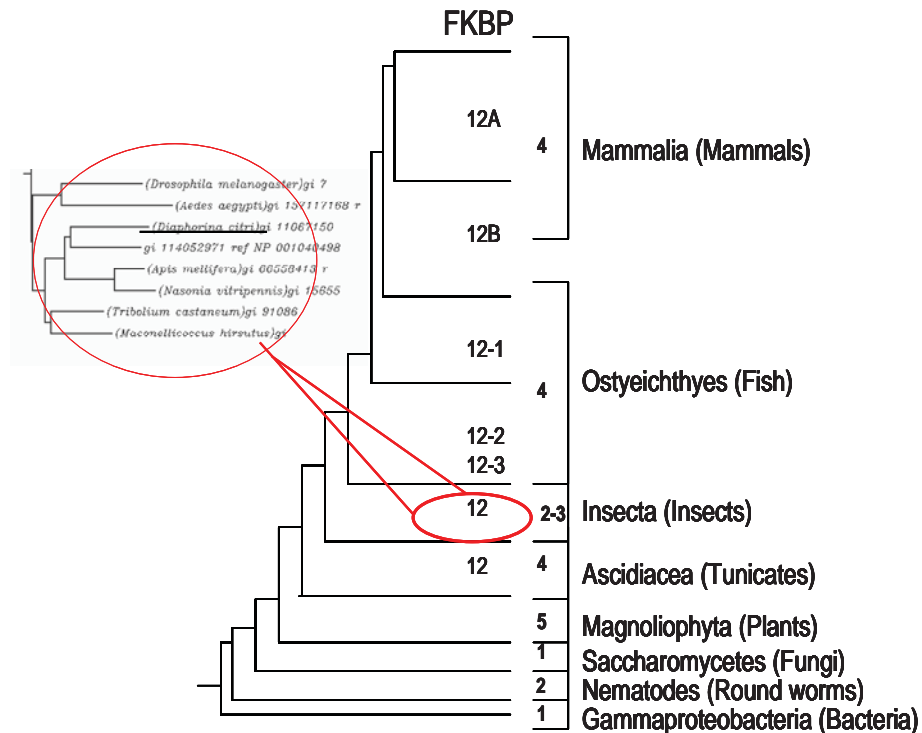
**Table 1. Average size of insect FKBP's (in shading), reduced number of members used, alignments with *D. citri* FK506 Binding Protein, ~11.7 kDa mol. wt. (CLUSTALW (1.81)).**

Sequence type explicitly set to Protein, Sequence format is Pearson

Sequence 1:	[ <i>Diaphorina citri</i> ]gi 110671506	109 aa
Sequence 2:	[ <i>Apis mellifera</i> ]gi 66558413 re	109 aa
Sequence 3:	[ <i>Tribolium castaneum</i> ]gi 910866	108 aa
Sequence 4:	[ <i>Bombyx mori</i> ]gi 114052971	108 aa
Sequence 5:	[ <i>Maconellicoccus hirsutus</i> ]gi 1	109 aa
Sequence 6:	[ <i>Nasonia vitripennis</i> ]gi 156555	108 aa
Sequence 7:	[ <i>Bombyx mori</i> ]gi 116688016 gb A	108 aa
Sequence 8:	[ <i>Manduca sexta</i> ]gi 6560679 gb A	108 aa
Sequence 9:	[ <i>Drosophila melanogaster</i> ]gi 78	108 aa
Sequence 10:	[ <i>Aedes aegypti</i> ]gi 157117168 re	108 aa
Sequence 11:	[ <i>Danio rerio</i> ]gi 41152406 ref N	108 aa
Sequence 12:	[ <i>Xenopus laevis</i> ]gi 27469642 gb	133 aa
Sequence 13:	[ <i>Bos taurus</i> ]gi 118151036 ref N	108 aa
Sequence 14:	[ <i>Tetraodon nigroviridis</i> ]gi 472	108 aa

Phylogenetic tree examined with bootstrap with the number of exons in each clade to the right between the brackets. Although the bootstrap support is lower, the phylogenetic cladogram constructed from protein sequences (inset) supported the same general morphology as the one based on mRNA sequences. The overall dendrogram topology based on mRNA sequences supports placement of the *Diaphorina citri* FKBP within the insect clade (after Somarelli and Herrera, (2007)).

**Figure 2. Phylogenetic relationships of FKBP genes using maximum parsimony.**





## 6.8 Gene Expression in Asian Citrus Psyllid Adults Feeding from Florida Citrus: Application to biology and vector control

Hunter W.B.<sup>1</sup>, Shelby K.<sup>2</sup>, Dowd S.<sup>3</sup> McKenzie C.<sup>1</sup>, and Shatters Jr R.<sup>1</sup>

1.USDA, ARS, U.S. Horticultural Research Lab, 2001 South Rock Rd, Ft. Pierce, FL, USA 34945. 2.USDA, ARS, BCIR, 1503 S. Providence, Columbia, MO 65203. 3.USDA, ARS, LIRU, 1604 E. FM. 1294, Lubbock, TX 79403. USA.

Where it occurs the Asian citrus psyllid, AsCP, *Diaphorina citri*, Kuwayama (Hemiptera: Psyllidae) is considered the primary vector of Huanglongbing (HLB), which is a serious plant pathogenic bacterium, *Candidatus Liberibacter asiaticus*, that is strongly associated with severe losses in citrus production worldwide. We elected to fill a void in psyllid genomics by producing expressed sequence tags, ESTs, to adult *D. citri*. Use of ESTs provides immediate information on the genes being expressed within insects under set conditions. This information enables the identification of many of the genes and proteins playing a role in psyllid survival. Therefore, we undertook a 5' end sequencing project from adult *D. citri*. Through our efforts, over 17,000 ESTs have been produced from *D. citri* (Hunter et. al. 2005-2008). These cDNA libraries are producing valuable information which researchers are now using to develop new management strategies based on emerging RNAi methodologies. The psyllid data was compared to genomic datasets of *C. elegans*, *D. melanogaster*, *A. mellifera*, *A. aegypti*, and *H. sapien* since these have a higher level of annotation. The *D. citri* gene expression data set will advance current research efforts in the identification of genes and physiological processes of psyllids. Knowledge of these genes and proteins are being used in the development of novel management strategies against psyllids and other sap feeding insects within the Order: Hemiptera.

### Materials and Methods

Asian citrus psyllids, *D. citri*, were obtained from a colony established from field caught adults, maintained by Cindy McKenzie at the USDA, ARS, U.S. Horticultural Research Laboratory, Ft. Pierce, FL. Insects were reared on *Murraya paniculata* (L.) 'Orange-jasmine' seedlings in screen cages contained in an insectary, and held at 25oC, 16 L: 8 D. Field caught adults were collected from citrus seedlings, ~1 m tall, using sweep nets. Over 3,000 adults of mixed gender were used for each library construction. Whole psyllids were ground in liquid nitrogen and total RNA extracted using guanidinium salt-phenol-chloroform procedure as previously described by Strommer *et al.* (1993). Poly(A) + RNA was purified using two rounds of selection on oligo dT magnetic beads according to the manufacturer's instructions (Dynal, Oslo, Norway). cDNA was synthesized using Stratagene ZAP-cDNA Synthesis Kit (Stratagene, La Jolla, CA, USA). Mass excision of the amplified library was carried out using Ex-Assist helper phage (Stratagene, La Jolla, CA, USA) and bacterial clones containing excised pBluescript SK(+) phagemids were recovered by random colony selection. Sequencing was performed at the USDA, ARS, U.S. Hort. Res. Lab, genomic lab, Ft. Pierce, FL. Reactions were performed using the ABI PRISM® BigDye™ Primer Cycle Sequencing Kit (Applied Biosystems). Reactions were prepared in 96-well format using the Biomek2000™ liquid handling robot (Beckman Coulter, Inc., USA). Sequencing reaction products were precipitated with 70% isopropanol, resuspended in 15 µL sterile water and loaded onto an ABI 3730 DNA Analyzer (Applied Biosystems, Foster City,

CA, USA). Base calling, quality trimming, vector trimming and sequence fragment alignments were performed by SeqMan Pro (DNASTar, USA). Low-quality bases (quality score <12) were trimmed from both ends of sequences. Assembly parameters were set using a minimum overlap of 30 bp, match spacing of 150, minimum sequence length of 150bp and 90% identity. Putative sequence identity was determined based on BLAST similarity searches (BLASTX and BLASTn) using WND.BLAST Dowd against Uniprot (Dec2006). A rich set of the originally described ESTs (4,595 were used for the current analyses) from adult AsCP providing a rich data set which is available at GenBank, dbEST, for further studies, Accession numbers: DN201110-DN470410. GenBank <http://www.ncbi.nlm.nih.gov>

## Results and Discussion

A total of 5,906 cDNA clones were sequenced, resulting in 4,595 high-quality ESTs. Assembly of the cDNAs resulted in a total of 636 sequences (544 contigs plus 92 singlets). The putative protein transcripts for each assembled sequence were annotated using BLASTX (Swissprot-Tremble 03-2007), which produced 202 sequences ( $E < 10^{-10}$ ). The remaining 61.3% of the cDNA's showed 'No significant match' in either the non-redundant protein or nucleic acid databases, providing new information to the scientific community. Comparison of assembled sequences to five other organism genome projects, nr datasets. Each analysis was run separately and sorted for best E-value homologies (**Table 1**).

*Digestive enzymes*-isolation of a set of 17 cathepsins from *D. citri*, forming five predicted phylogenetic groups which contain: four F-like proteases, three B-like protease and procathepsin, four B-like cysteine proteases, two B-S cysteine proteases, and a L-like cysteine protease, and D-cathepsin (**Fig. 1**). Whereas mammalian cathepsins are well studied, emerging studies for arthropods on cathepsins have only started to characterize these enzymes. Cathepsins in insects function in digestion and some are involved in embryonic vitellin degradation (egg yolk proteins and hormones), taking part in changes during metamorphosis (body formation). Function of these enzymes includes processing yolk proteins, where results showed that the lysosomal cathepsins, especially cathepsin D and sometimes cathepsin L, are responsible for the degradation of muscle protein during stresses such as maturation and starvation. So cathepsins are important to psyllid survival, development, and reproduction making them key targets for further studies which will target their expression and more importantly what happens when they are 'down-regulated' or silenced by RNAi experiments to determine their potential in psyllid management. Psyllid Serine proteases identified: Serine proteases play critical roles in a variety of invertebrate immune processes. Examples of serine protease mediated defense responses include hemolymph coagulation, activation of antimicrobial peptide synthesis, and melanin synthesis which is used to surround and isolate pathogens in insects. The majority of insect serine protease genes have been cloned primarily through genome projects, fruit flies, honey bee, and others. Understanding how Serine Proteases interact with *Liberibacter* within psyllids or how *Liberibacter* can avoid this insect defense system may provide another angle by which altered psyllids may be unable to transmit *Liberibacter*. The availability of these sequences will permit investigations into important questions regarding *D. citri* biology, development, insecticide resistance, and disease interactions which will advance the understanding of the underlying genetic basis of *D. citri* biology.

In summary, we used a genomics approach to identify the genetic basis of the biology of *D. citri*, identifying in particular genes associated with feeding, reproduction, and insecticide resistance. The Asian citrus psyllid, AsCP, *Diaphorina citri*, (Hemiptera: Psyllidae) is a highly competent vector of the phloem-inhabiting bacterium *Ca. Liberibacter asiaticus*, the agent of Huanglongbing. We created and analyzed two expressed sequence tags, EST, libraries made from adult *D. citri*, one field-collected from young citrus trees and another from psyllids on citrus in culture. While relatively few genes have been specifically isolated from psyllids, herein we describe analysis of a data set of ESTs from adult AsCP, *D. citri*. Of the 5,906 ESTs generated from single-pass 5' end sequencing, 4,595 ESTs were quality and averaged a length of 553 bases. Contig alignment resulted in 636 total sequences after assembly (544 contigs plus 92 singlets). Even though this *D. citri* gene expression data set advances current research efforts in the identification of genes and physiological processes of psyllids, a much greater knowledge of psyllid genomics is still needed. Use of a *full* genomics approach will rapidly advance the understanding of the genetic basis of *D. citri* biology and its endosymbiotic bacteria. The development of these genetic products will set the foundation to conduct further functional genomic studies to isolate species specific genes needed for the development of emerging management strategies aimed at reducing psyllids and the spread of citrus greening.

### Acknowledgments

We thank P.M. Dang, Genomics lab, ARS, U.S. Hort. Res. Lab., Ft. Pierce, FL, for sequencing, Christine Lynch, and Laura Hunnicutt, Biological Science Technicians, USHRL, Ft. Pierce, FL for cDNA library construction and data analysis, and K. Moulton, Biological Science Technician, USHRL, FL for field sample collections and preparations.

### References

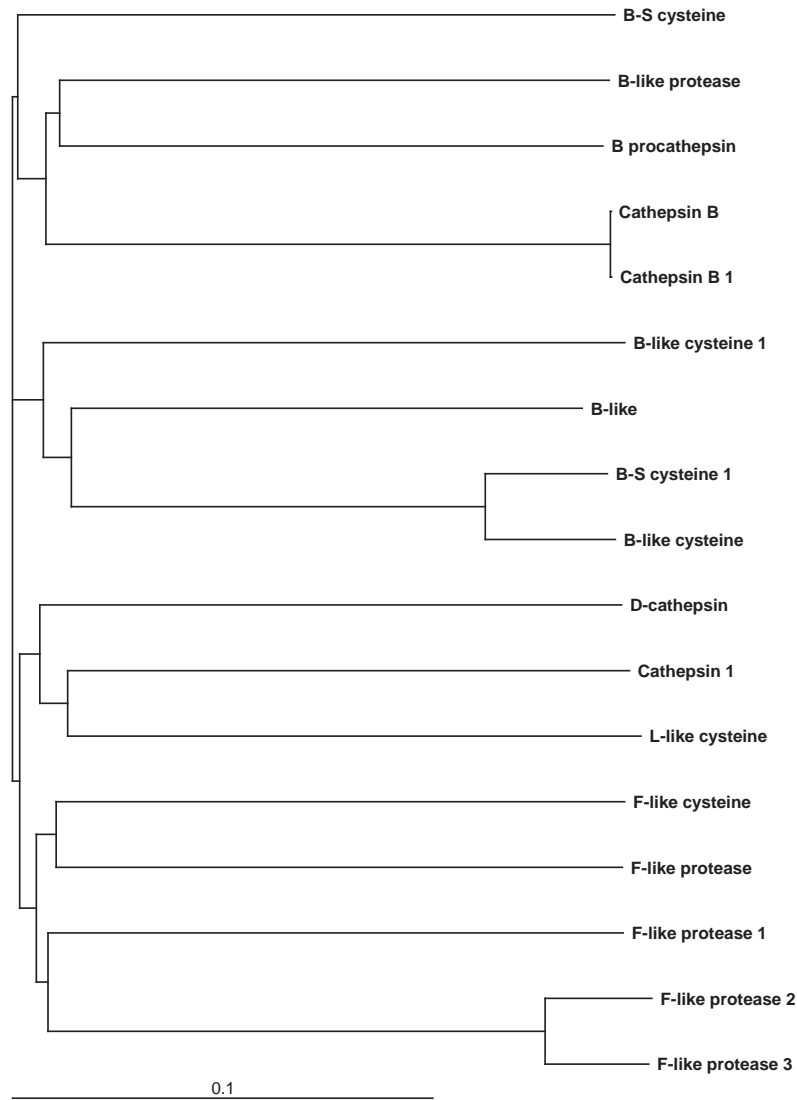
- Hunter WB, Hall DG 2008. Testes gene expression in Asian citrus psyllid, *Diaphorina citri* (Hemiptera: Psyllidae). GD264847-GD269020. NCBI.
- Hunter WB, Hall DG. 2008. Midgut gene expression in Asian citrus psyllid, *Diaphorina citri* (Hemiptera: Psyllidae). USDA-FP 190004-FK254041- FK260232.
- Hunter WB, Dang PM, McKenzie CL. 2005. Gene expression in *Diaphorina citri* Kuwayama (Hemiptera: Psyllidae) DN465721-DN470410, NCBI.
- Hunter WB, Dowd SE, Katsar CS, Shatters Jr RG, McKenzie CL, Hall DG. 2008. Psyllid biology: expressed genes in adult Asian citrus psyllids, *Diaphorina citri* Kuwayama. Insect Science (submitted).
- Hunter WB, McKenzie CL, Shatters RG, Weathersbee AA, Hall DG. 2005. Gene expression in field collected Asian citrus psylla, *Diaphorina citri* Kuwayama (Hemiptera: Psyllidae). DN202325- DN201110. NCBI.
- Hunter WB, Hunnicutt LE, Hall DG. 2006. Ribosomal proteins of the Asian citrus psyllid, *Diaphorina citri*. 88 Proteins, DQ675535-DQ673441. NCBI.
- Notredame C, Higgins D, Heringa J. 2000. T-Coffee: A novel method for multiple sequence alignments. *Journal of Molecular Biology* 302:205-217.
- Strommer JN, Gregerson R, Vayda M. 1993 Isolation and characterization of plant mRNA., *Methods in Plant Molecular Biology and Biotechnology*, (eds B.R. Glik & J.E. Thompson), pp. 49-65, Boca Raton, Florida, CRC Press, USA.

**Table 1. Comparison of psyllid EST sequences to five genomes.** Counts and percentages of significant matches over four categories of significant E-values, obtained by comparing Psyllid assembled sequences to Nematode, Fruit fly, Human, Honeybee, and Mosquito. Psyllid data was compared to each species database separately using BLASTX analysis.

<i>Species:</i>	<i>C. elegans</i>	<i>D. melanogaster</i>	<i>H. sapien</i>	<i>A. mellifera</i>	<i>A. aegypti</i>
<b>E-Values</b>					
<b>≤ e-100</b>	<b>5</b> 3.50%	<b>6</b> 4.00%	<b>6</b> 3.90%	<b>9</b> 5.50%	<b>8</b> 4.70%
<b>≤ e-50</b>	<b>41</b> 29.10%	<b>48</b> 32.00%	<b>43</b> 28.10%	<b>54</b> 33.10%	<b>52</b> 30.80%
<b>≤ e-20</b>	<b>61</b> 43.30%	<b>66</b> 44.00%	<b>69</b> 45.10%	<b>63</b> 38.60%	<b>68</b> 40.20%
<b>≤ e-10</b>	<b>34</b> 24.10%	<b>30</b> 20.00%	<b>35</b> 22.90%	<b>37</b> 22.70%	<b>41</b> 24.30%
<b>TOTALS</b>	<b>141</b>	<b>150</b>	<b>153</b>	<b>163</b>	<b>169</b>

No significant difference between species at any E-value category. Significance Probability level at 0.05, df = 4; Chi Square = 9.488.

**Fig 1.** Phylogenetic tree of *Diaphorina citri* cathepsins. Amino acid comparison using CLUSTAL FORMAT for T-COFFEE Version\_6.07 [http://www.tcoffee.org] NJ.



## 6.9 Asian Citrus Psyllid, Genetic Basis of Immunity

Marutani-Hert M.<sup>1</sup>, Hunter W.B.<sup>1</sup>, and Shelby K.S.<sup>2</sup>

<sup>1</sup>USDA, ARS, U.S. Horticultural Research Lab, 2001 South Rock Rd, Ft. Pierce, FL, USA 34945. <sup>2</sup>USDA, ARS, Biological Control Insects Res. Lab, 1503 S. Providence, Columbia, MO, USA 65203.

A gene expression library was made from the alimentary tract of adult Asian citrus psyllids, AsCP. Analysis of the expressed sequence tags produced a gene dataset of 7,800 EST's. In these ESTs, important immunity genes were identified. These transcripts with significant homology (E-value  $\leq 10^{-20}$  or better) were identified through homology searches to other known insect genomes. Use of genomics approaches has enabled the identification of some of the genetic basis of psyllid immunity and pathogen interactions. Further genomic analyses of AsCP, *Diaphorina citri*, will advance our understanding of the psyllid/phloem/bacterium interactions which may be linked to the acquisition and transmission of the pathogenic bacterium *Candidatus Liberibacter asiaticus*, associated with Huanglongbing. However, a much greater understanding of psyllid genomics is still needed. Continued development of these genetic products will set the foundation for further functional genomic studies to isolate AsCP specific genes to be targeted to reduce the spread of HLB and to reduce psyllid populations in an environmentally, highly specific management strategy. In this study, we focused on the genetic response of cytochrome P450 and heat shock protein 70, to treatment with imidacloprid and other stress factors, as temperature to advance the understanding of insecticide resistance development and heat tolerance in *D. citri*.

### Material and Methods

*Immune challenge of psyllid and isolation of RNA.* Four leaf branches were treated with water, or 1 mL/3.7L admire for 3 days. Psyllids were transferred and incubated for 1 h. In order to induce heat shock responses, psyllids were incubated 1 h at 20°C or 50°C. RNA was extracted using RNA aqueous®-Micro (Ambion, Austion, TX, USA)

*Quantitative real-time RT-PCR:* Quantitative real-time RT-PCR was performed with the Rotor-Gene™ 6000 Real-time rotary analyzer (Corbett Life Science, Sydney, Australia) using Super Script™ III Platinum® SYBR® Green One Step qRT-PCR kit (Invitrogen, USA). Each reaction was carried out in 25  $\mu$ L volume containing 5 pmol of forward and reverse primers and 200 ng of RNA template. Amplification cycling conditions were 50°C for 30 min, 95°C for 15 min, 30 times of 95°C for 30 sec, 60°C for 30 sec and 72°C for 30 sec. We examined the expression of alpha tubulin (accession number is DQ675542) as an internal control.

### Results and Discussion

*Sequence analysis of Cyp450, Hsp70:* Previously, we created and analyzed two expressed sequence tag, EST, libraries made from adult *D. citri* (Hunter et al., 2005-2008, GenBank, NCBI). Partial Cyp 450 gene transcript which was 681 bp (accession number is DQ675542) was determined. The deduced amino acid sequence of the Cyp450 displayed homology with

*Antheraea yamamai* cytochrome P450 CYP4G25 (76 %), *Drosophila melanogaster* cytochrome P450 CYP4G15 (71 %) and *Tribolium castaneum* cytochrome P450 monooxygenase Cyp4g14 (64%). The partial hsp70 gene transcript was 549 bp. The deduced amino acid sequence of hsp70 displayed homology with *Chironomus tentans* hsp70 (62%) and *Mamestra brassicae* hsp70 (56%). The partial hsc70 gene is 550 bp (accession number is DQ675540). The deduced amino acid sequence of hsc70 displayed homology with *Bemisia tabaci* hsp70 (87%) and *Mamestra brassicae* hsc70 (86%).

*Quantitative real time RT-PCR analysis of immune induced genes in psyllid.* Adult *D. citri* were exposed to imidacloprid via plant sap. Neither the gene expression level of Cyp 450 nor hsp70 was changed by this treatment. This is similar to *D. melanogaster* Cyp4G15 expression pattern which showed the same expression between resistant and susceptible strains to the insecticide DDT and pyrethroid (Maibeche-Coisne et al, 2000). *Drosophila melanogaster*, the Cytochrome P450 gene Cyp6g1 was shown to be capable of metabolizing imidacloprid. However, the expression of Cyp4 family cyp4G33 from *Chironomus tentans* was induced by Atrazine (Londono et al., 2007). Atrazine is a herbicide used to stop pre- and post-emergence broadleaf and grassy weeds in major crops by binding to the plastoquinone-binding protein in photosystem II, inhibiting electron transport. Cytochrome P450 comprise a super family of enzymes that are involved in the biosynthesis of many biologically important compounds and metabolism of a variety of chemicals. The *D. citri* Cyp 450 may play a role in endogenous compound metabolism rather than in detoxification.

Heat shock treatment (Figure) revealed that hsp70 gene was strongly induced. Heat shock genes are known to respond to a variety of stresses, such as exposure to xenobiotics, heavy metals, metabolic poisons and temperature extremes. While the *D. citri* hsp70 was not induced by imidacloprid, it was involved in heat stress. Similarly, cyp450 transcript expression in *D. citri* was not changed by heat shock. Understanding the interactions between *D. citri* immune physiology under hot Florida summers and insecticides may lead to more efficacious insecticide applications and reduced costs to growers when managing these important economical pests in citrus groves.

In summary, only a few insecticides are being used to manage the Asian citrus psyllid, AsCP, *Diaphorina citri*, (Hemiptera: Psyllidae) to reduce the spread of the phloem-inhabiting bacterium *Ca. Liberibacter asiaticus*, associated with Huanglongbing, (Citrus greening disease). Imidacloprid is the most important systemic insecticide currently being used to control plant pests including psyllid, as either soil, seed or foliar treatments. Imidacloprid acts as an agonist at the nicotinic acetylcholine receptor and interferes with the transmission of stimuli in the insect nervous system. This blockage leads to the accumulation of acetylcholine, an important neurotransmitter, resulting in the insect's paralysis, and eventually death. In *Drosophila melanogaster*, the cytochrome P450 gene Cyp6g1 was shown to be capable of metabolizing Imidacloprid. Cytochrome P450 comprise a super family of enzymes that are involved in the biosynthesis of many biologically important compounds and metabolism of a variety of chemicals. To understand the genetic basis of how the AsCP responds against imidacloprid and other environmental stresses is important to effective management of AsCP and citrus greening. In this study, we show psyllid immune gene responses against imidacloprid and other stress factors such as temperature to advance the understanding of insecticide resistance development

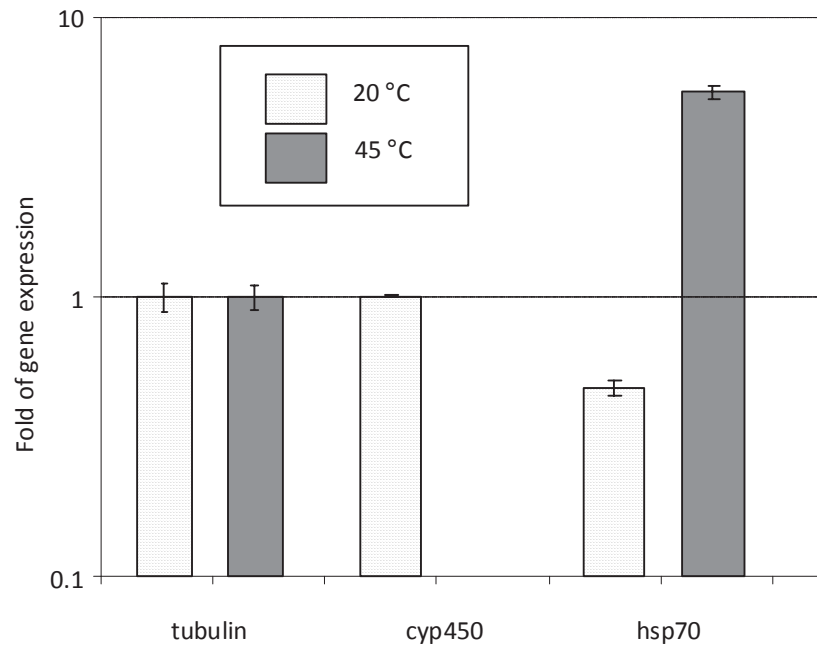
and heat tolerance. Heat shock protein 70 gene was induced by heat treatment demonstrating a response to stress within the psyllids. Further experiments are under way, to identify more genes which respond to biological and environmental stresses. These insights provide genetic targets to effectively reduce psyllids by increasing susceptibility to low dosage insecticides and to Florida hot summer temperatures.

## References

- [Altincicek B, Knorr E, Vilcinskas A.](#) (2007). Beetle immunity: Identification of immune-inducible genes from the model insect *Tribolium castaneum*. *Dev Comp Immunol.* 32(5):585-95.
- Hunter, WB, Dowd, SE, Katsar, CS, Shatters, Jr, RG, McKenzie, CL, Hall, DG. 2008. Psyllid biology: expressed genes, *Diaphorina citri*. *Insect Science* (submitted).
- Hunter WB, Dang, P, McKenzie, CL. 2005 *Diaphorina citri* (Hemiptera) DN465721-DN470410, NCBI.
- Hunter WB, McKenzie CL, Shatters RG. Hall DG. 2005. Gene expression in field collected Asian citrus psyllids, *Diaphorina citri* Kuwayama (Hemiptera: Psyllidae) DN202325-DN201110. NCBI.
- Hunter, WB, Hunnicutt, LE, Hall, DG. 2006. Ribosomal proteins of the Asian citrus psyllid, *Diaphorina citri*. 88 Proteins, DQ675535-DQ673441. NCBI.
- Hunter, WB., Hall, DG. 2008. *Diaphorina citri* midgut gene expression, Asian citrus psyllid (Hemiptera: Psyllidae) FK254041- FK260232, NCBI.
- [Joussen N, Heckel DG, Haas M, Schuphan I, Schmidt B.](#) (2008). Metabolism of imidacloprid and DDT by P450 CYP6G1 expressed in cell cultures of *Nicotiana tabacum* suggests detoxification of these insecticides in Cyp6g1-overexpressing strains of *Drosophila melanogaster*, leading to resistance. *Pest Manag Sci.* 64:65-73.
- Londoño, D., K., Siqueira, H., A.A., Wang, H., Sarath, G., Lydy M., G., and Siegfried, B., G. (2007). Cloning and expression of an atrazine inducible cytochrome P450, *CYP4G33*, from *Chironomus tentans* (Diptera: Chironomidae). *Pesticide Biochem. Physiol.* 89:104-110.
- Maïbèche-Coisne, E. Jacquin-Joly, M. C. François and P. Nagnan-Le Meillour. (2000) cDNA cloning of biotransformation enzymes belonging to the cytochrome P450 family in the antennae of the noctuid moth *Mamestra brassicae*. *Insect Molecular Biology.* 11: 273-281.
- [Sonoda S, Ashfaq M, Tsumuki H.](#) (2007). A comparison of heat shock protein genes from cultured cells of the cabbage armyworm, *Mamestra brassicae*, in response to heavy metals. *Arch Insect Biochem Physiol.* 65(4):210-22.



Figure 1. Quantitative real time RT-PCR analysis of transcriptional levels of psyllid genes, by heat shock treatment



## 6.10 Effects of host plant on fitness of the Asian citrus psyllid, *Diaphorina citri*

Tsagkarakis A.E. and Rogers M.E.

University of Florida, IFAS, Citrus Research and Education Center, Lake Alfred, FL, USA.

The reproductive biology of the Asian citrus psyllid, *Diaphorina citri* Kuwayama (Hemiptera: Psyllidae), is closely tied to the availability of new leaf flush for egg laying and subsequent development of psyllid nymphs. Increases in the psyllid population are thus most evident during periods of abundant new flush. However, what is not well understood are the varying effects of the host plant on psyllid fitness that may affect the magnitude of the increase or decrease in psyllid populations.

The host range of *D. citri* includes many citrus and close citrus relatives. While there are many observations about preferred hosts of *D. citri* (Halbert and Manjunath 2004), only a few comparative laboratory studies have been conducted to date that specifically address suitability of different host plants on psyllid fitness under controlled conditions. In one study, Tsai & Liu (2000) examined the biology of *D. citri* on four host plants, orange jasmine (*Murraya paniculata* L.) Jack), rough lemon (*Citrus jambhiri* Lushington), sour orange (*Citrus aurantium* L.), and grapefruit (*Citrus × paradisi* Macfad.). In this study, grapefruit was determined to be the best host, followed by the other plant species tested, among which there was no statistical difference. A second study, Nava et al. (2007) compared the duration and viability of psyllid egg and nymphal stages, sex ratio, fecundity and longevity on Rangpur lime (*Citrus limonia*), orange jasmine (*Murraya paniculata*) and Sunki mandarin (*Citrus sunki*) across a range of temperatures. Nymphal viability was lower on mandarin than on the other hosts evaluated while overall nymphal development was highest on *C. limonia* and *M. paniculata*. Fecundity was highest on *M. paniculata*. No other detailed comparative studies have been conducted on the effect of host plants on the fitness of *D. citri*, especially with regards to commercially grown citrus varieties in Florida.

As part of a larger project investigating the effects of host plant quality on psyllid fitness, fitness of psyllids was examined when completing development on various citrus rootstock species commonly used in Florida citrus production. Here we report our initial findings comparing psyllid fitness on two rootstock species, sour orange (*Citrus aurantium* L.) and Cleopatra mandarin (*Citrus reticulata* Blanco). Previously, we have observed marked differences in psyllid colonization of these two rootstock species when provided as host plants for laboratory maintained colonies of *D. citri*. Psyllids were observed to readily colonize *C. aurantium* whereas little or no development was believed to occur on *C. reticulata*.

The fitness of *D. citri* when reared on *C. aurantium* and *C. reticulata* was determined by evaluating the effects of these host plants on psyllid fecundity and longevity as well as mortality and developmental rate of psyllid nymphs. Host plants of both species used in this study were 30 cm in height grown in containers of potting media consisting of Canadian sphagnum peat, perlite and vermiculite mix. Plants were fertilized with 20-20-20 (N, P, K) soluble fertilizer every two weeks and watered three times per week. Plants were pruned two weeks prior to the initiation of experiments to obtain young flushes. Psyllids used in this study were from a colony reared in a

greenhouse at a temperature of  $27 \pm 2^\circ\text{C}$ , with a relative humidity (RH) of  $70 \pm 20\%$ . When young flushes were expanded, a pair of adult psyllids from the greenhouse colony was encaged on each flush, using small cylinder clear acetate transparent cages with a museline top and closed with a sponge in its lower opening to prevent psyllid escape. After psyllids were caged, plants were moved to growth chambers with a temperature of  $27 \pm 2^\circ\text{C}$ , with a relative humidity (RH) of  $70 \pm 20\%$  and a photoperiod of 12D:12L. To compare the reproductive performance on the two hosts, psyllids were left in the cages for a two week period, after which adults were removed and counts were made of the number of eggs laid. The overall rate of development from eggs to adults was determined by making daily counts of the number of adults emerged. Psyllid longevity on these host plants was determined by collecting adults reared on these host plants and making transfers to new host plants of the same species on which counts of adult longevity were made. Duration of each nymphal stage and overall duration of nymphal development was assessed by collecting pairs of adult psyllids reared on each host plant and caging them on flushing plants of the same species on which the adults developed. After 24 h, adults were removed and plants placed into a growth chamber. Nymphal development was recorded daily for each plant by using a stereomicroscope to observe ecdysis and survivorship of psyllid nymphs until adult emergence.

Our initial results of this study provide evidence that *C. reticulata* is not a suitable host plant for psyllid development. Detailed results will be presented and implications for future psyllid management programs discussed.

## References

- Halbert SE, Manjunath KL. 2004. Asian citrus psyllids (Sternorrhyncha: Psyllidae) and greening disease of citrus: a literature review and assessment of risk in Florida. *Florida Entomol.* 87: 330-353.
- Mead FW. 1977. The Asiatic citrus psyllid, *Diaphorina citri* Kuwayama (Homoptera: Psyllidae). *Entomology Circular* 180. Florida Department of Agriculture and Consumer Services, Division of Plant Industry: 4 pp.
- Nava DE, Torres MLG, Rodrigues MDL, Bento JMS, Parra JRP. 2007. Biology of *Diaphorina citri* (Hem., Psyllidae) on different hosts and at different temperatures. *J. Appl. Entomol.* 131(9–10): 709–715.
- Tsai JH, Liu YH. 2000. Biology of *Diaphorina citri* (Homoptera: Psyllidae) on four host plants. *J. Econ. Entomol.* 93: 1722–1725.

## 6.11 Development of a Potato Psyllid (*Bactericera cockerelli*) cell culture

Bextine B.<sup>1</sup>, Tufts D.<sup>1</sup>, Timmons C.<sup>1</sup>, Hunter W.B.<sup>2</sup>, and Marutani-Hert M.<sup>2</sup>

<sup>1</sup>Department of Biology, University of Texas, Tyler, TX 75799; <sup>2</sup>USDA, ARS, Ft. Pierce, FL.

Zebra Complex (ZC), was first documented in potato fields around Saltillo, Mexico in 1994, and first identified in the USA in 2000 in commercial potato fields in Pearsall, TX. Over the past eight years, ZC has spread to a number of other states, including NE, CO, KS, NM and CA. This disease was sporadically important economically until the 2004 and 2005 growing seasons, when it caused millions of dollars in losses to both potato producers and processors in numerous locations. This disease has recently been associated with a new, fourth, pathogenic *Candidatus* Liberibacter species (called “psyllaourous”) (Hansen et al., in press). *Candidatus* Liberibacter psyllaourous has also been associated with a similar disease in tomatoes and peppers. In all three cropping systems, the association of this pathogen with disease was originally missed because the traditional diagnostic method, PCR and QRT-PCR, did not amplify DNA from this fourth species. The bacterium is transmitted by the potato psyllid (*Bactericera cockerelli*), an insect that is prevalent in most growing areas of the US.

The causal agent of ZC was unknown until just a few months ago; however, the potato psyllid’s involvement with the disease was determined a few years ago by our lab and others (Goolsby 2007, Munyaneza 2007). It is now suspected that this disease is caused by the presence of *Candidatus* Liberibacter psyllaourous, a pathogen that thus far remained elusive in the development of pure cultures. Following the successful development of an Asian citrus psyllid cell culture by Dr. Hunter’s lab, we have worked toward developing a potato psyllid cell culture (figure 1). By developing an insect cell line, we can attempt to isolate and culture *Candidatus* Liberibacter psyllaourous. Several commercially available insect cell culture media were screened for viability to culture cells/tissues from potato psyllid embryos and midgut tissues without success. Following the protocols of the Hunter lab, we have determined an insect culture medium, labeled Hert-Hunter-70, which permitted psyllid cell lines to be established.

### Materials and Methods

*Cells from psyllid egg.* Psyllid eggs were isolated then disinfected by submersion in 70% ethanol, 10 min, then rinsed 3 to 5 times by submersions in 0.05% sodium hypochlorite (= 1% chlorine bleach). Eggs were rinsed six times with sterile distilled water and transferred to a tube where they were crushed with a glass rod. Culture medium (Hert-Hunter-70) containing antibiotics (Pen-Strep) was added and the culture was incubated at 25 °C.

*Cells from adult Psyllid alimentary tract.* Adult psyllids were surface sterilized by immersion in 70% ethanol for 30 min. Then, they were rinsed five times with sterile distilled water. Sterilized insects were fixed on a glass slide and circled with a PAP pen and the circle was filled with PBS buffer (pH6.5). A dissection was performed in the buffer under a dissecting microscope where a forceps and needles were used to remove the gut. Next, the excised gut was placed into a tube and crushed with a glass rod. Culture medium containing antibiotics was added and the cells were cultured at 25 °C.

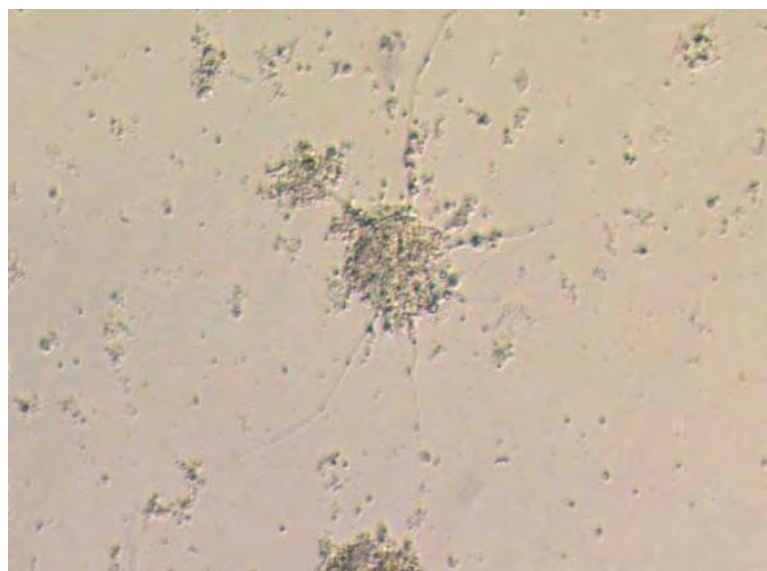
## Results and Discussion

The psyllid cell line being developed will be screened for the presence of *Liberibacter*, and other bacteria using quantitative real-time PCR.

## References

- Goolsby JA, Bextine B, Munyaneza JE, Sétamou M, Adamczyk J, Bester G. 2007. Seasonal abundance of sharpshooters, leafhoppers, and psyllids associated with potatoes affected by zebra chip disorder. *Subtrop. Plant Sci.* 59: 15-23.
- Hansen K, Trumble JT, Stouthamer R, Paine TD. 2008. New Huanglongbing (HLB) *Candidatus* species, “*C. Liberibacter psyllaurosus*”, found to infect tomato and potato is vectored by the psyllid *Bactericerca cockerelli* (Sulc). *Appl. Environ. Microbiol.* In Press.
- Lynn DE. 2002. Methods for maintaining insect cell cultures. *J Insect Sci.* 1-6
- Lynn DE. 2001. Novel techniques to establish new insect cell lines. *In Vitro Cell. Dev. Biol.-Animal* 37:319-321.
- Marutani-Hert M, Hunter WB, Hall DG. 2008. Establishment of Asian citrus psyllid cell cultures (*Diaphorina citri*: Hemiptera). *In Vitro Cell. Dev. Biol.-Animals* (Submitted).
- Mitsuhashi J. 2002 *Invertebrate Tissue Culture Methods*, Springer lab manual, Tokyo-Shoseki.
- Munyaneza JE, Crosslin JM, Upton JE. 2007. Association of *Bactericerca cockerelli* (Homoptera: Psyllidae) with “Zebra Chip,” a New potato disease in Southwestern United States and Mexico. *J. Econ. Entomol.* 100:656-663.

Figure 1. Development of a psyllid cell culture, early stage.



INTERNATIONAL RESEARCH CONFERENCE  
ON HUANGLONGBING



**Session 7:**  
**Asian Citrus Psyllid**  
**(Ecology and**  
**Transmission)**

Orlando, Florida



December 2008

## **7.1 Acquisition of *Candidatus Liberibacter asiaticus* by the Asian citrus psyllid, *Diaphorina citri*, and the potential use of insecticides to prevent pathogen transmission.**

**Rogers M.E., Brlansky R.H., Ebert T.A., Serikawa R.H., Schumann R.A., and Stelinski K.P.**

University of Florida, IFAS, Citrus Research and Education Center, Lake Alfred, FL, USA.

The spread of citrus greening disease or huanglongbing (HLB) in Florida is dependent on the transmission of the associated pathogen, *Candidatus Liberibacter asiaticus*, by the Asian citrus psyllid, *Diaphorina citri* Kuwayama. Several elements contribute to the spread of the HLB pathogen by *D. citri*, including acquisition period, latency of the pathogen in the psyllid prior to transmission, transovarial transmission, transmission efficiency, and vector competence. There are vast differences reported in the literature regarding these components of the vector-pathogen interaction. For example, in past studies with *D. citri* and the African citrus psyllid, *Trioza erythrae*, acquisition of the HLB pathogen is reported to require a minimum of 15 minutes to 24 hours and the psyllid feeding time for pathogen transmission to healthy plants from 15 minutes to 7 hours (Capoor et al 1974, Buitendag and von Broembsen 1993). In these and other past studies however, successful pathogen acquisition and transmission was determined by moving psyllids from HLB infected citrus plants to uninfected plants and subsequently monitoring the latter for symptom development. The vast differences in the results of these past studies likely are due to difficulties in separating symptoms caused by the HLB pathogen from non-pathogen related plant stresses (e.g. nutritional deficiencies). To date, a clear understanding of the vector-pathogen-plant interaction has not been established firmly using molecular techniques that now are available to researchers.

Use of insecticides has been promoted as one component of a successful HLB management program (da Graca 1991, Halbert and Manjunath 2004); however, few studies have attempted to directly measure the success of vector control with disease incidence. In a two-year study, Huang et al (1990) found that in adjacent citrus blocks, trees on a psyllid control program remained HLB free (based on visual symptoms) whereas those trees not receiving insecticide applications showed visual symptoms during the same period. While reports of apparently successful chemical control of psyllids for managing HLB are available from several countries (Chao et al 1979, Buitendag 1991), no studies have directly tested the ability of insecticides to prevent a treated plant from becoming infected when exposed to pathogen carrying psyllids. Given the reported lengthy duration of feeding time required for transmission to occur and the immediacy with which some insecticides cause mortality, detailed studies on the effects of insecticides on pathogen transmission may be useful in developing more effective psyllid control strategies to aid in the management of HLB.

As part of our larger study on this vector-pathogen interaction, here we present findings of two laboratory studies examining the rate of pathogen acquisition by adult and nymphal psyllids and the potential ability of soil-applied insecticides to prevent pathogen transmission via mortality of adult psyllids. To determine the rate of pathogen acquisition by adult *D. citri*, groups of 50-100 adult *D. citri* were confined on branches of potted citrus trees which had previously tested positive for the presence of the HLB pathogen using real-time PCR. Over a period of 1 day to 52 days, psyllid adults were removed from the plants and tested singly for the presence of the HLB pathogen using real-time PCR. Pathogen acquisition rate by psyllid nymphs was examined by caging single female psyllids on new leaf growth of HLB+ citrus

plants for oviposition. After 7 days, the adult female psyllids were removed while the young leaves containing psyllid eggs remained caged until adult psyllids emerged. Those adults then were analyzed singly for the presence of the HLB pathogen using real-time PCR. The results of these caging studies showed that the HLB pathogen was detectable in 20-30% of psyllids which fed on plants as adults only, whereas up to 100% of the psyllid adults that developed from nymphs on HLB+ plant material tested positive for the presence of the HLB pathogen. These results, together with similar results from caging studies under field conditions, demonstrate that psyllids that complete their development on HLB+ citrus trees are more likely to acquire (and potentially transmit) the HLB pathogen than psyllids that fed on HLB infected trees as adults only.

The ability of systemic insecticide applications to prevent pathogen transmission also was examined. One hundred pathogen-free citrus seedlings were treated with either a soil-drench of imidacloprid or a water only control. Fourteen days after treatments were applied, ten adult psyllids from a colony reared on HLB+ citrus plants were caged on each seedling. After a confinement period of 72 hours, psyllids from each plant were removed, psyllid mortality assessed, and the presence of the HLB pathogen determined for each psyllid using real-time PCR. Plants were then held in the greenhouse for a period of 3 months after which they were assayed monthly using real-time PCR for the presence of the HLB pathogen. To better understand how insecticide applications may prevent pathogen transmission through disruption of feeding, an electrical penetration graph (EPG) was used to directly measure psyllid feeding behaviors on insecticide treated and untreated citrus plants and correlate those feeding durations with successful pathogen transmission. Results-to-date from these experiments will be presented and implications for development of psyllid management programs discussed.

Buitendag CH. 1991. The current status and the control of greening disease of citrus in the Republic of South Africa. *Citrus Journal* 1: 35-40.

Buitendag CH, v. Broembsen LA. 1993. Living with citrus greening in South Africa. *Citrus Journal* 3: 29-32.

Capoor SP, Rao DG, Viswanath SM. 1974. Greening disease of citrus in the Deccan Trap Country and its relationship with the vector, *Diaphorina citri* Kuwayama. *Proceedings of the Sixth Conference of the International Organization of Citrus Virologists*, pp. 43-49.

Chao HY, Chiang YH, Lee SL, Chiu CS, Su WF. 1979. A preliminary study on the relation between the prevalence of the citrus yellow shoot (Huanglungbing) and the citrus psyllid, *Diaphorina citri* Kuwayama. *Acta Phytopathologica Sinica* 9: 121-126.

Da Graca JV. 1991. Citrus Greening Disease. *Annual Review of Phytopathology* 29: 109-136.

Halbert SE, Manjunath KL. 2004. "Asian citrus psyllids (*Sternorrhyncha* : *Psyllidae*) and greening disease of citrus: A literature review and assessment of risk in Florida. *Florida Entomologist* 87: 330-353.

Huang CH, Liaw CF, Chang L, Lan T. 1990. Incidence and spread of citrus likubin in relation to the population fluctuation of *Diaphorina citri*. *Plant Protection Bulletin (Taipei)* 32: 167-176.



## 7.2 Leaf age influencing acquisition of *Candidatus Liberibacter asiaticus* by the psyllid vector, *Diaphorina citri* Kuwayama

Bonani J.P.<sup>1</sup>, Appezzato-da-Gloria B.<sup>1</sup>, Fereres A.<sup>2</sup>, Engels F.E.<sup>1</sup>, **Lopes J.R.S.<sup>1</sup>**

<sup>1</sup>ESALQ/Universidade de São Paulo, Piracicaba, Brazil; <sup>2</sup>ICA/Consejo Superior de Investigaciones Científicas, Madrid, Spain.

An understanding of factors influencing acquisition efficiency of *Candidatus Liberibacter asiaticus* by the Asian citrus psylla, *Diaphorina citri* Kuwayama, is basic to determine favorable conditions for Huanglongbing (HLB) spread in citrus, as well as to select strategies to interfere with this process. This bacterium has an irregular distribution in citrus plants, with greater concentration (determined by real-time PCR) in mature leaves showing typical symptoms (blotchy mottle). Although the vector has a strong preference for young shoots, psyllid adults also are found on older leaves and branches. In this research, we investigate the effect of leaf age (young and asymptomatic x symptomatic mature leaves) in source plants infected with *Ca. L. asiaticus* on acquisition efficiency and probing behavior of *D. citri*. Under laboratory conditions, groups of healthy lab-reared *D. citri* adults were confined separately on a young and on a mature (symptomatic) leaf of four source plants of *Ca. L. asiaticus*. After an acquisition access period (PAA) of 4 days, psyllids from each treatment were kept on healthy plants for 24 days and then tested for presence of *Ca. L. asiaticus* by quantitative PCR (qPCR). None of the psyllids fed on mature leaves were infected, whereas nearly 50% of the samples (3 psyllids per sample) fed on young asymptomatic leaves were positive for the pathogen. To investigate possible reasons for the higher efficiency of bacterial acquisition on young asymptomatic leaves, we analyzed the probing behavior of adult females of *D. citri* on mature x young leaves of infected citrus plants by the Electrical Penetration Graph (EPG) technique. Phloem ingestion was observed more often on young leaves. Within 5 h, around 50% individuals on young leaves started sustained phloem ingestion (E2), whereas less than 15% individuals on mature leaves did so. On mature leaves, the insects spent most of the time with the stylets in the parenchyma (pathway phase) or non-probing. Histological analyses indicated that mature leaves show a thicker layer of fiber cells before the vascular bundles compared to young leaves. It is possible that the fiber layer affects stylet pathway towards the phloem vessels in mature leaves. The higher frequency of phloem ingestion appears to explain at least in part the higher acquisition efficiency of *Ca. L. asiaticus* when *D. citri* is confined on young asymptomatic leaves.

### 7.3 Ecological studies on initial invasion of *Diaphorina citri* into the newly planting citrus fields.

Kobori Y.<sup>1</sup>, Nakata T.<sup>1</sup>, Ohto Y.<sup>1</sup> and Takasu F.<sup>2</sup>

<sup>1</sup> Japan International Research Center for Agricultural Sciences; <sup>2</sup> Department of Information and Computer Sciences, Nara Women's University

In an IPM system to manage Huanglongbing, it is important to control the vector insect, *Diaphorina citri* Kuwayama, in proportion to invasion risk. In order to evaluate the invasion risk of *D. citri* in a disease free field, such as a new planting, properties of invasion and distribution of *D. citri*, the citrus grove need be estimated. In this paper, we report the results of two experiments. Firstly, as a basis for risk evaluation, we report variance in movement variance of *D. citri* in a citrus field after release. Secondly, we report the spatial distribution of *D. citri* that invaded citrus orchards in southern Vietnam.

A total of 1089 pots of *Citrus depressa* were set out in a grid (33 x 33 pots at 2.5m intervals) in a nearly flat experimental field in Ishigaki city, Okinawa, Japan. About 10000 pink-marked adult *D. citri* were released at the center of the pot array and the movements were recorded as time progressed. The release of pink-marked psyllids was done from cut branches infested with the insects. These branches were placed at the center of the field. The insects were expected to move when the cut branch withered. On the third day after the release, about 3300 individuals were found in the experimental field. Most of them were found near the release point. Furthermore, most of the dispersed individuals were found leeward of the release site. Until the 20th day from the release, the centroid of *D. citri* distribution in experimental field did not change from near the release point, and the diffusion gradient did not show significant change. However, the variance of the position of individuals decreased with time.

The spatial distribution of newly invaded *D. citri* in citrus fields was measured in a grove in southern Vietnam that initially was free of *D. citri*. The result was that the number of individuals was not significantly different between the center and edges of the fields. It is interesting to note that newly arrived adult psyllids were concentrated on trees with buds.

From these results, the following are suggested.

- 1) Most individual *D. citri* do not move a long distance even when they were forced to move as a result of disturbance.
- 2) The direction of movement followed the wind.
- 3) Once adult *D. citri* have found a citrus tree with buds, they hardly move again. The center of valance did not move even though constant wind was blowing almost every day.
- 4) Adult *D. citri* make a short distance movement from their initially landing site to gather on a certain tree, indicated by the fact that the variance of the position of individuals decreased with time. Adult *D. citri* favored staying on trees with buds.

#### 7.4 Spatial Distribution of Adults of *Diaphorina citri* Kuwayama (Hemiptera: Psyllidae) in Valencia Sweet Orange Trees

Costa M.G.<sup>1</sup>, Felipe M.R.<sup>2</sup>, Garbim L.F.<sup>2</sup>, Carmo-Uehara A.<sup>2</sup>, Yamamoto P.T.<sup>2</sup>, Barbosa J.C.<sup>1</sup>

<sup>1</sup>FCAV/Universidade Estadual de São Paulo, Jaboticabal, Brazil; <sup>2</sup>Fundecitrus, Araraquara, Brazil

Huanglongbing (HLB) is the most destructive citrus disease. It already has caused serious damage in several regions of Asia, Africa and more recently in the Americas. In Brazil, the disease is present in all citrus regions in the state of São Paulo, the largest producer of orange. It is caused by two species of bacteria, *Candidatus Liberibacter asiaticus* and *Candidatus Liberibacter americanus*. The last is a new species, found only in São Paulo. The psylla *Diaphorina citri* Kuwayama, vector of the disease, while feeding from the sap of plants, transmits the bacteria, which are restricted to the phloem of the plants. The sick trees initially have some yellowish branches, and with the development of the disease, may attack the whole plant causing its death. This insect vector is resistant to high temperatures and has preference for sprouts. Vector population peaks are in spring and summer. There is no variety of commercial scion or root stock immune to the disease. The strategies for management of the disease are based on: 1) planting of healthy nursery trees, 2) elimination of contaminated trees, and 3) control of vectors. In order to adopt a rational plan for its control, the spatial distribution of *D. citri* in the citrus grove was evaluated. 17 samplings were conducted from November/04 to August/05, on a 5-year-old block of Valencia sweet orange on Rangpur lime orchard [*Citrus sinensis* (L.) Osbeck], located in Motuca, in the central region of the state of São Paulo were conducted. The area was divided into 96 sampling units. On the central plant of each plot a double-sided yellow sticky trap was installed, and the numbers of psylla caught were counted. With the resulting data, we calculated the rates of dispersion  $\text{variance/average}(I)$ , Morisita Index ( $I_s$ ), Green rate ( $Cx$ ) and the  $k$  exponent of the negative binomial distribution for each sample. We tested the adjustments to the Poisson probability and negative binomial distributions. By the analysis of the indexes, it was verified that in the months where there is a high infestation of the pest (November to February), the psylla presents aggregated distribution. The adjustment of most data to the negative binomial distribution is in line with the rates of dispersal tested, which showed aggregated distribution of *D. citri* in the months of high infestation. When the infestation decreases, the distribution becomes random.

## 7.5 Population Dynamics of *Diaphorina citri* in Citrus Orchard in São Paulo State, Brazil

Yamamoto P.T.<sup>1</sup>, Felipe M.R.<sup>1</sup>, Rugno G.R.<sup>1</sup>, Beloti V.H.<sup>1</sup>, Coelho J.H.C.<sup>1</sup>, Ximenes N.L.<sup>1</sup>, Garbim L.F.<sup>1</sup>, Carmo-Uehara A.<sup>1</sup>

<sup>1</sup> Fundecitrus, Araraquara, Brazil

The purpose of the research was to study the population dynamics of *Diaphorina citri* Kuwayama in a citrus orchard located in the municipality of Gavião Peixoto, SP, Brazil. To evaluate the population dynamics and determine the points of entrance of *D. citri*, we placed, 17 yellow sticky traps (Bug Biological Agents, Piracicaba, SP) in the Oxford Farm. The traps measured 18 x 9.5 cm, and were distributed in the periphery and the interior of the property. There were 13 in periphery and 4 in the interior. Most of the counts were taken biweekly, but over a few months it was not possible to keep the established frequency of evaluation. In each evaluation, the traps were removed and replaced with fresh ones and the captured insects were counted in the laboratory. Adults of *D. citri* were captured practically every month of the year on yellow sticky traps. However, in the end of 2006 and beginning of 2007, the population was low, probably due to rainfall. In the end of 2004, the population of *D. citri* increased, and a high peak was observed in December, in which 0.229 adults per day were captured. In 2005 and 2006, this evident population peak was not observed. In 2006, the population decreased from the beginning to the end of the year, and in contrast, in 2007 the population increased from the beginning to the end of the year. In 2007, the population peak was observed in December, similar to 2004, although the population was lesser. In 2008, until June, the population was decreasing. Considering the averages of capture during the seasons, the population of *D. citri* was highest in the spring, followed by the winter, autumn and summer. The lesser capture in the summer probably was influenced by insecticide applications that are more frequent in this season, because of the high temperature and relative humidity that are favorable to the vector. In the winter, the climatic conditions are not favorable because there is little new flush on the trees. However, the control of *D. citri* in the winter is not frequent, resulting in an increase in the vector population. As the majority of the traps are installed in the periphery of the property, the adults captured are migrants from other localities. Comparing the position of traps installed in the farm, the capture of *D. citri* was higher on those located in the low part of the farm. This higher capture may have occurred due to the presence of other hosts, wind currents or more abundant vegetative flush because of the higher humidity.

## 7.6 The seasonal incidence of *Candidatus Liberibacter asiaticus* infection in the Asian citrus psyllid, *Diaphorina citri* Kuwayama (Homoptera: Psyllidae) in Okinawa, Japan.

Sadoyama Y. and Takushi T.

Okinawa Prefectural Agricultural Research Center, Okinawa, Japan.

In Japan, the citrus greening disease or Huanglongbing (HLB) was first found in 1988 on Iriomote Is., Okinawa Prefecture (Miyakawa and Tsuno, 1989). At present, HLB is prevalent in almost all Ryukyu Islands down from Kikai Island, Kagoshima Prefecture (Toguchi and Kawano, 1997; Naito et al., 2001), and has been threat to the citrus industry, especially for the native cultivar “Shiikuwasha”, *Citrus depressa* Hayata. HLB is caused by the phloem-limited bacteria, *Candidatus Liberibacter asiaticus*, which is transmitted by the Asian citrus psyllid, *Diaphorina citri* Kuwayama (Homoptera: Psyllidae) in Japan. Although suppressing HLB relies on early detection and removal of inoculums (infected citrus trees) as well as the searching for good pesticides to control the psyllid in Okinawa (Yasuda et al., 2006, 2007), an effective strategy for HLB management has not been developed. One reason for this is that the basic characteristics of transmission and epidemiology of HLB are poorly understood. Understanding the ratio and the movement of *D. citri* infected with HLB-pathogen and the seasonality of transmission in fields should facilitate control of HLB disease (Halbert and Manjunath, 2004). We regularly collected and analyzed adults of *D. citri* from the same diseased field trees in the northern part of Okinawa Is. The trees were two *Citrus depressa* and two *C. tankan* trees which are also infected with the HLB-pathogen for a period of one and a half years.

Seasonality was recognized in the occurrence of the psyllids infected with HLB-pathogen. The percentage of infected psyllids was high in Apr.-Jun. and Oct.-Dec. on *C. depressa* and in May-Aug. on *C. tankan*. The incidence of psyllids infected with HLB-pathogen on *C. depressa* was higher than that on *C. tankan*. Linear regression analyses were performed, with the percentage of HLB-infected psyllid as the dependent variable and each of the following measures (densities of new-shoots, psyllid nymphs and psyllid adults on each citrus tree studied) as independent variables. A statistically significant positive regression was detected only with the adult density on *C. depressa*. However, the mechanism underlying the seasonal pattern is still totally unknown. According to our result, it was considered that the best recommended timing of control of *D. citri* would be Apr.-Jun. and Oct.-Dec. on *C. depressa*, and May-Aug. on *C. tankan* in the northern part of Okinawa Is.

Halbert SE, Manjunath KL. 2004. Asian citrus psyllids (Sternorrhyncha: Psyllidae) and greening disease of citrus: a literature review and assessment of risk in Florida. *Florida Entomologist*. 87: 330-353.

Miyakawa T, Tsuno K. 1989. Occurrence of citrus greening disease in the southern islands of Japan. *Ann Phytopath. Soc. Jpn.* 55: 667-670.

Naito T, Taba S, Toyosato T, Kawano S, Takaesu K, Uehara K. 2001. Detection of the citrus Huanglongbing (greening disease) by polymelase chain reaction (PCR) assays and distribution in Okinawa, Japan. *Bull. Okinawa Agric. Exp. Sta.* 23: 74-81 (in Japanese with English summary).

Toguchi A. and S. Kawano (1997) Distribution and control measures of citrus greening disease in Okinawa Prefecture. *Plant Prot.* 51: 9-14 (in Japanese).

Yasuda K, Ooishi T, Kawamura F. 2006. Effect of insecticides on adults and larvae of Asian citrus psyllid, *Diaphorina citri* (Homoptera: Psyllidae). *Kyushu Pl. Prot. Res.* 52: 75-78 (in Japanese).

Yasuda K, Yoshitake H, Ooishi T, Toudou A, Uechi N. 2007. Effect of high-density scatter of the infiltration shift insecticide on invasion by adult and egg-laying individuals of the Asian citrus psyllid, *Diaphorina citri* (Homoptera: Psyllidae). *Kyushu Pl. Prot. Res.* 53: 95-98 (in Japanese).

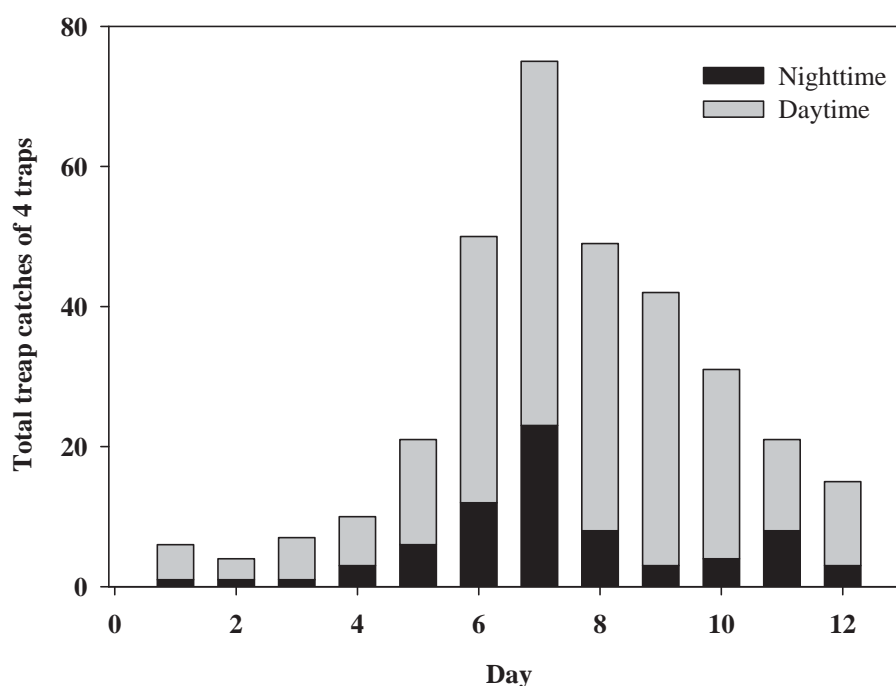
## 7.7 Diurnal patterns in flight activity and effect of light on host finding behavior of the Asian citrus psyllid

Sétamou M.<sup>1</sup>, Sanchez A.<sup>1</sup>, Patt J.<sup>2</sup>, Louzada E.<sup>1</sup>

<sup>1</sup> Texas A&M University Kingsville-Citrus Center, Weslaco, TX 78596, USA;

<sup>2</sup> USDA, ARS, Beneficial Insects Research Unit, TX 78596, USA

The Asian citrus psyllid, *Diaphorina citri* Kuwayama (Hemiptera: Psyllidae), is an invasive and abundant pest in commercial citrus production areas of Texas. *D. citri* feeds and reproduces primarily on new flush growth of citrus and other Rutaceae plants. *Diaphorina citri* potentially is a pest of economic importance in all citrus growing areas because it vectors the bacterial causal agents of the deadly citrus greening disease. We investigated the diurnal patterns of *D. citri* flight activity in the fields and the effects of light on its host selection and egg-laying behaviors. The numbers of adult psyllids caught on yellow sticky cards were 3 to 4-fold higher during daytime than nighttime (Figure 1). Illumination of the traps at night increased their attractiveness to adult psyllids by 5-fold (Figure 2). Daytime flight activity of adults *D. citri* also varied with time of the day, with peak catches occurring at midday from 12 PM to 3 PM. On potted plants, light significantly increased plant colonization ( $F = 25.34$ ;  $df = 1, 18$ ,  $P < 0.0001$ , Figure 3) and female egg deposition by adult females ( $G = 4.67$ ,  $P < 0.01$ ). In olfactometer tests, illumination significantly increased the proportion of adults responding to the host plant odor during a 30-min observation period ( $\chi^2 > 6.28$ ,  $P < 0.005$ ; Figure 4). These results suggest that the flight activity and host selection behavior of adult psyllids are regulated by light and by circadian rhythms.



**Figure 1:** Trap catches of *D. citri* adults during daytime and nighttime for a 12-day period during July-August 2007

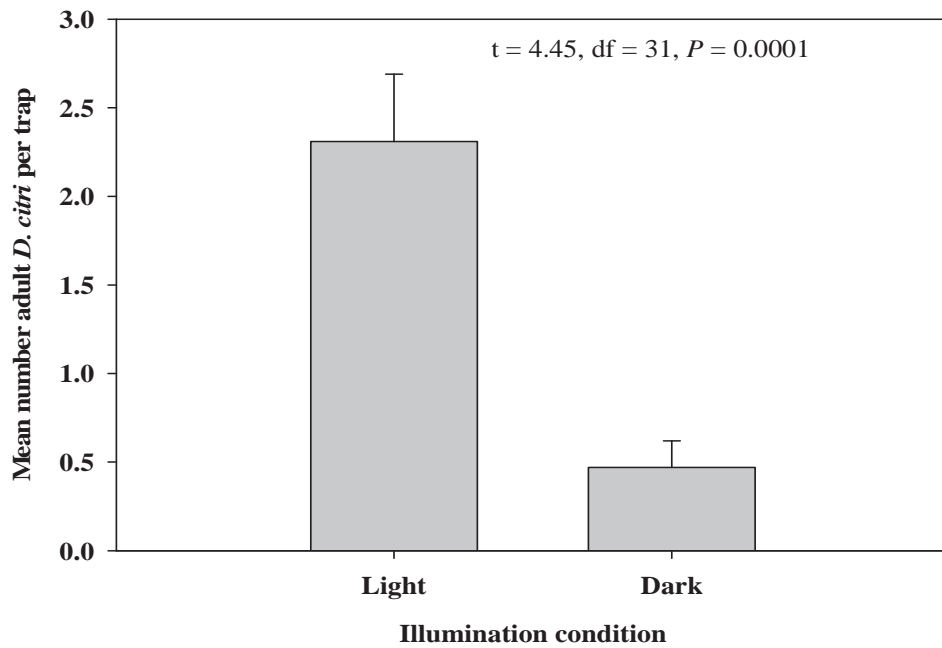


Figure 2: *D. citri* trapping efficiency of yellow sticky traps deployed at night under light or darkness

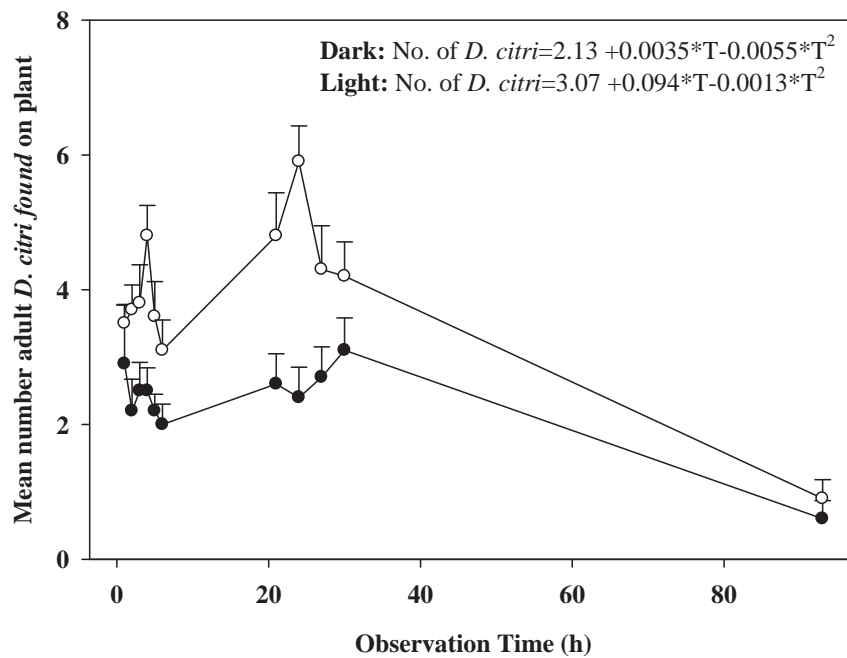
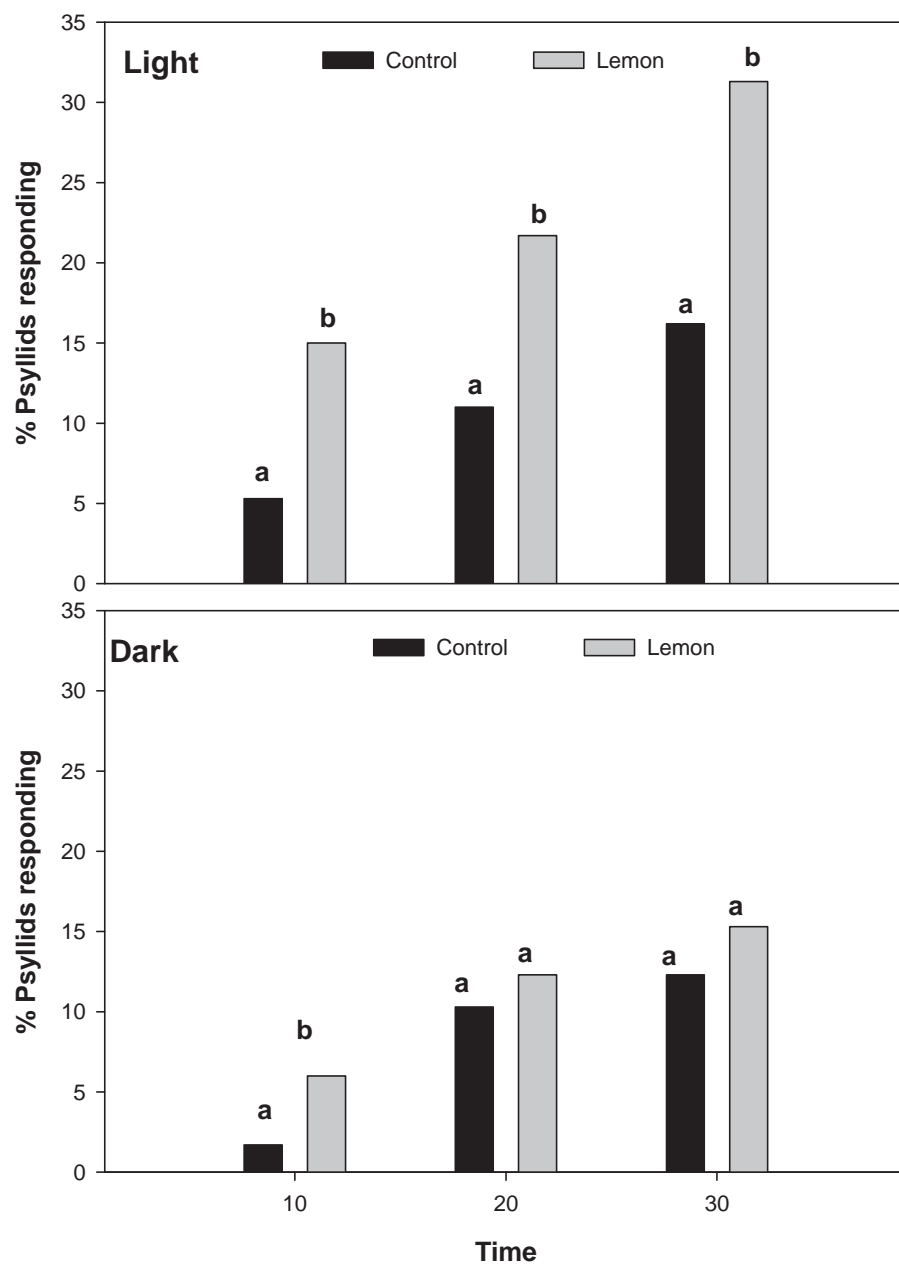


Figure 3: Number of adult *D. citri* found feeding on plants exposed to different illumination conditions





**Figure 4:** Response of *D. citri* to plant odor and control in a Y-tube olfactometer

## 7.8 Psyllids of Citrus Orchards in South Texas.

**Thomas D.B.**

USDA-ARS Subtropical Agriculture Research Center, 2413 East Bus. Hwy 83, Weslaco. TX 78596

Surveys for psyllids in Texas citrus orchards using sticky traps revealed that six species are commonly encountered. The Asian Citrus Psyllid, *Diaphorina citri*, an invasive species first reported in Texas in 2001 is essentially ubiquitous. However, an unidentified species is about equally abundant. An unidentified species in the genus *Trioza* is also commonly encountered as is a species of *Aphalaroida*. Members of the latter genus feed on thorny legumes which are common trees in the surrounding brushlands. Two other species that are not yet assignable to a genus also are occasionally encountered. Recently a species of *Pachypsylla* was detected in a shipment of Texas grapefruit bound for California. The shipment was embargoed until a determination was made that the insect was not the Asian citrus psyllid. Psyllid species tend to be host specific. Species of *Pachypsylla* for example, are commonly specialists on hackberry (*Celtis* spp.) a common tree along irrigation canals. Accurate identification of the unknown species is important so that the immature stages on the citrus flush can be reliably counted as *D. citri* in surveillance for determining management thresholds.

## 7.9 Seasonal Occurrence of *Candidatus Liberibacter asiaticus* in Asian Citrus Psyllids in Florida.

Ebert T.A., Rogers M.E. and Brlansky R.H.

University of Florida, IFAS, Citrus Research and Education Center, Lake Alfred, FL, USA

Control of Asian citrus psyllid (*Diaphorina citri*), the vector of the pathogen *Candidatus Liberibacter asiaticus* (Las), is one of several components of Huanglongbing (HLB) management programs employed worldwide. Following the discovery of HLB in Florida, citrus pest management programs have shifted from an IPM-based approach using primarily petroleum oil applications for pest management to the widespread use of multiple broad-spectrum insecticide applications primarily for psyllid control. Currently, citrus growers in Florida may apply as many as six foliar insecticide applications per season to mature groves and even more insecticide applications (including use of the soil-applied systemic insecticide imidacloprid) to solid plantings of young trees that produce greater amounts of new leaf growth, which is attractive to adult psyllids. Such increased use of insecticides is not sustainable in the long-term due to the economic and environmental constraints of the current Florida citrus production system. To date, no studies have demonstrated a clear economic benefit of increased insecticide use in reducing HLB incidence under the large scale citrus growing conditions typical of Florida and Brazil. Furthermore, the time of year and number of insecticide applications required for reducing psyllid populations, and thus disease incidence, are undetermined. Therefore, the purpose of this study is to determine if there are certain times of the year when pathogen spread by *D. citri* is most likely to occur. Such knowledge would allow for more judicious use of insecticide applications to control psyllid populations when the risk of pathogen spread is most likely to occur.

Seven citrus groves were selected in central Florida to examine the seasonal rates of *Las* presence in *D. citri* populations. On a monthly basis, two approaches were used to estimate *Las* presence in *D. citri* at each study site. Collections of natural psyllid populations were made at random throughout each grove using a sweep net and/or aspirator to collect adult psyllids resulting in the capture of 12,000 psyllids. Psyllids were analyzed using real-time PCR to determine percent *Las* infection rate in *D. citri* populations on a grove by grove basis. In many cases, overall psyllid populations were too low to collect meaningful numbers of psyllids due to intensive psyllid management programs in these commercial citrus operations. Thus, at three study sites, adult psyllids from a laboratory colony known to be *Las*(-) were caged on individual branches to determine acquisition rates by adult and nymphal *D. citri*. These tests yielded 8,000 psyllids.

Real-time PCR has shown that the overall number of field collected *D. citri* carrying *Las* in central Florida citrus groves was much lower than what we have previously observed under laboratory conditions. Less than 1% of the overall psyllid population was infected. In many groves, no *Las*(+) psyllids were collected. The highest levels of *Las*(+) *D. citri* were collected in the months of March and August. However, these findings are the result of only one year's data. This work will continue to determine if trends for higher infection rates during certain periods are indeed present from year to year.

In caging experiments where adult *D. citri* were confined on branches of *Las*(+) trees, less than 10% of those adults tested *Las*(+) after a feeding period of fourteen days. When *Las*(-) adult *D.*

*citri* were confined to new leaf growth and allowed to lay eggs, an average of 79% of the individuals in the resulting generation reared on Las(+) plants acquired the pathogen by the time they reached the adult stage. These results clearly indicate that *D. citri* completing their development on Las(+) plants are more likely to acquire the pathogen compared to those individuals that feed on Las(+) plants as adults only. Therefore, the presence of Las(+) trees on which psyllids can complete development is an important factor in the overall spread of HLB within a grove.

## 7.10 Incidence and Population of ‘*Candidatus Liberibacter asiaticus*’ in Asian Citrus Psyllids (*Diaphorina citri*) on Citrus Plants Affected by Huanglongbing in Florida

Li W.<sup>1</sup>, Duan Y.<sup>2</sup>, Brlansky R.H.<sup>3</sup>, Twieg E.<sup>1</sup> and Levy L.<sup>1</sup>

<sup>1</sup>National Plant Germplasm and Biotechnology Laboratory, USDA-APHIS-PPQ-CPHST, Beltsville, MD; <sup>2</sup>USDA-ARS, Horticultural Research Laboratory, Fort Pierce, FL; <sup>3</sup>University of Florida, Citrus Research and Education Center, Lake Alfred, FL

The Asian form citrus huanglongbing (HLB) (ex. citrus greening) is associated with ‘*Candidatus Liberibacter asiaticus*’ (Las) and vectored by the Asian citrus psyllid (ACP) (*Diaphorina citri*). Robust methods for DNA extraction, detection and quantification of the bacterium from ACP were developed and validated. The quality of DNA extraction from suspect psyllids was easily determined by the following highly efficient primer and/or probe sets of positive internal control (PIC) developed in the study:

WGfpr for real-time PCR (qPCR)

WGf: 5’-GCT CTC AAA GAT CGG TTT GAC GG -3’

WGp: 5’-TET/TTA CTG ACC ATC ACT CTG GAC GC/3BHQ-2

WGr: 5’-GCT GCC ACG AAC GTT ACC TTC-3’)

ACPfr FOR conventional PCR (cPCR)

ACPf: 5’-ACG AGG CCA GCA AGA GGT A-3’

ACPp: 5’-CAC GTC AGT CAT ATC AAC ATC ACT GTC G-3’).

The PIC set for qPCR also was reliably used to evaluate PCR reaction cocktails for a higher and stable PCR amplification efficiency, and to normalize qPCR data for accurate quantification of the Las populations in its vector insects.

The bacterium was detected readily, by multiplex cPCR using the optimized PCR conditions (Li et al., 2007) and the primer set OI1/OI2c (Jagoueix et al. 1996) or A2/J5 (Hocquellet et al., 1999) together with the PIC primer set ACPfr, and by multiplex qPCR using the primer/probe set HLBaspr (Li et al., 2006) together with the PIC set WGfpr, and quantified by the multiplex qPCR, in a single infected nymph or adult psyllid, even when experimentally mixed with up to 100 *Liberibacter*-free nymphs or adults.

The Las incidence varied from 10 to 100% among the ACP populations collected on HLB-affected citrus plants in the field in Florida (Table 1). The bacterial populations complied with a normal distribution with some skewness among the ACP populations (Figure 1). One quarter of the ACP populations carried Las populations of less than 10<sup>4</sup> Las cells/psyllid, which was on the borderline of the low detection limit of qPCR, but beyond the detection range of cPCR (Li et al., 2007).

About 3% of the infected psyllid populations retained Las populations up to 10<sup>8</sup> Las cells/psyllid. These psyllids had an elevated ratio of Las DNA to ACP DNA up to 1:1 in copy numbers. This ratio was approximately 1,500 fold higher than that of Las DNA to plant DNA obtained from symptomatic tissues of HLB-affected citrus plants collected in the field in Florida

(Li et al. 2006). Elevated ratios of Las DNA to ACP DNA were also obtained from the psyllids cage-reared on HLB-affected citrus plants. In some DNA extracts from heavily infected ACP which had a Las population above  $10^{10}$  cell/psyllid, the ratio of the Las DNA to the ACP DNA was above 1:500 (copy/copy).

The invaluable findings on DNA ratios between the Liberibacter and its vector insects have been successfully used in sequencing the whole genomes of Las from a single infected ACP (Duan et al., 2008) and of the new Liberibacter species, '*Candidatus Liberibacter solanacearum*' (Liefting et al., 2009) associated with 'zebra chip' disease of potato, from infected potato/tomato psyllids (*Bactericera cockerelli*) (Lin et al., 2008). The quantitative results of Las incidence and population in ACP will be valuable for studying the pathogen-vector interactions and understanding the swift epidemic of the destructive citrus disease. The validated methods of multiplex real-time and conventional PCR for Las detection and quantification in ACP also provide useful tools for early detection of Las in ACP for better management of the disease.

## Reference

- Duan YP et al. 2008. Genome analysis of *Candidatus Liberibacter asiaticus* reveals unique features for designing HLB control strategies. Proc. Int. Res. Conf. on Huanglongbing, page 144.
- Hocquellet et al. 1999. Detection and identification of the two *Candidatus Liberobacter* species associated with citrus huanglongbing by PCR amplification of a ribosomal protein gene of the  $\beta$  operon. Molecular and Cellular Probes 13:373-379.
- Jagoueix S et al. 1996. PCR detection of the two '*Candidatus Liberobacter* species' associated with greening disease of citrus. Mol Cell Probes 10, 43-50.
- Li W et al. 2006. Quantitative real-time PCR for detection and identification of '*Candidatus Liberibacter* species' associated with citrus huanglongbing. J. Microbiol. Methods 66, 104-115.
- Li W et al. 2007. Evaluation of DNA amplification methods for improved detection of '*Candidatus Liberibacter* species' associated with citrus huanglongbing. Plant Dis. 91, 51-58.
- Liefting L et al. 2009. '*Candidatus Liberibacter solanacearum*', a liberibacter associated with plants in the family Solanaceae. Int. J. Syst. Evol. Microbiol. (In press)
- Lin et al. 2008. A novel molecular diagnostic tool for improved sensitivity and reliability detection of '*Candidatus Liberibacter asiaticus*', bacterium associated with huanglongbing (HLB). Proc. Int. Res. Conf. on Huanglongbing, page 117.

**Table 1.** Incidence and titer of '*Candidatus* Liberibacter asiaticus' in adult psyllids collected from host plants of various citrus species in the field in Florida and reared in a greenhouse

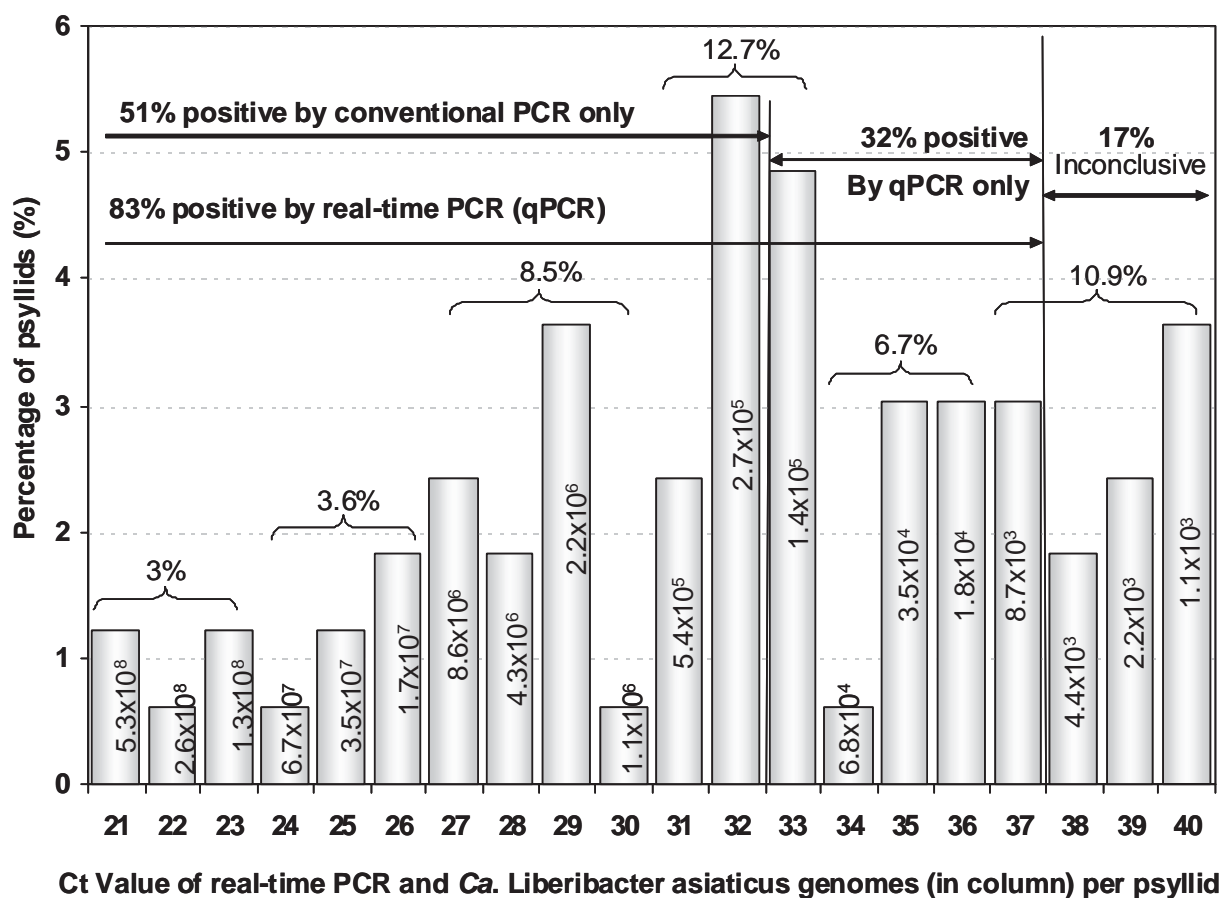
Host plant	County, State	HLB symptoms	Collection Date	Adult psyllids <sup>x</sup>	Las incidence	Lowest FAM Ct value for Las	Highest titer per psyllid <sup>y</sup>	Las
Psyllids collected in the field in Florida								
<i>Citrus aurantifolia</i>	Palm Beach (1), FL	Severe	03/21/2007	11	9%	32.11	2.25 x 10 <sup>5</sup>	
	Palm Beach (2), FL	Severe	03/21/2007	7	14%	32.07	2.57 x 10 <sup>5</sup>	
	Palm Beach (3), FL	Severe	03/22/2007	8	37%	25.32	2.68 x 10 <sup>7</sup>	
<i>Citrus limon</i>	Palm Beach, FL	Severe	03/16/2007	15	33%	38.33	3.45 x 10 <sup>3</sup>	
	Broward <sup>z</sup> , FL	Severe	03/19/2007	6	33%	21.56	3.67 x 10 <sup>8</sup>	
<i>Citrus sinensis</i> <sup>z</sup>	Broward, FL	Moderate	03/13/2007	9	67%	30.90	5.75 x 10 <sup>5</sup>	
	Collier, FL	Severe	02/22/2007	38	42%	27.15	7.61 x 10 <sup>6</sup>	
<i>Citrus aurantium</i> <sup>z</sup>	Broward, FL	Severe	03/19/2007	13	69%	20.34	8.27 x 10 <sup>8</sup>	
<i>Citrus paradissi</i> <sup>z</sup>	Broward, FL	Severe	03/19/2007	16	81%	22.43	1.96 x 10 <sup>8</sup>	
<i>Citrus reticulata</i>	Palm Beach, FL	Severe	03/22/2007	7	100%	32.88	1.47 x 10 <sup>5</sup>	
Psyllids reared in a greenhouse								
<i>Citrus sinensis</i>	*Fort Detrick, MD	7 days fed	30/12/07	30	50%	32.57	1.82 x 10 <sup>5</sup>	
<i>Citrus sinensis</i>	Lake Alfred, FL	21 days fed	02/06/08	33	42%	21.09	4.92 x 10 <sup>8</sup>	

<sup>x</sup> DNA extracts were obtained from single adult psyllid by QIAGEN DNeasy Blood & Tissue Kit and a FastPrep<sup>®</sup> 24 machine, and eluted in a final volume of 100 µl TE buffer.

<sup>y</sup> Two microliters from 100 µl DNA elution obtained per extraction was used per PCR reaction. The highest bacterial populations was obtained from the lowest FAM Ct value, based on the established equation:  $Y_{psm} = 13.3 - 0.299X_{psm}$ . The bacterial populations were estimated on basis of three rRNA operons (containing the PCR target) per cell (Duan et al., 2008).

<sup>z</sup> The trees had been confirmed positive for HLB by the US Federal confirmatory tests using real-time and conventional PCR assays, during September and October, 2005.

\* Psyllids friendly provided by Vernon D. Damsteegt.



**Figure 1.** Bacterial population distribution of '*Candidatus Liberibacter asiaticus*' in Asian citrus psyllids collected on symptomatic trees of citrus infected by citrus huanglongbing in the field in Florida.



### **7.11 Response of Asian citrus psyllid to aromas emitted by the flushing shoots of their rutaceous host plants in a Y-tube olfactometer.**

Sétamou M.<sup>1</sup> and Patt J. M.<sup>2</sup>

<sup>1</sup>Texas A & M University at Kingsville Citrus Center, Weslaco, TX; <sup>2</sup>USDA-ARS, Weslaco, TX

The Asian citrus psyllid (ACP), *Diaphorina citri* Kuwayama, relies on the young, flushing shoots of its rutaceous host plants for its reproduction and development. Given the importance of flushing shoots to its life cycle, it is likely that ACP utilizes olfactory cues emitted by different shoot stages in host plant detection, location, and acceptance. Here we provide preliminary results of Y-tube olfactometer tests that indicate that both male and female ACP were attracted to the aromas of flushing shoots. Aromas from the following host plants were tested: grapefruit (*Citrus paradisi* MacFadyen) cv Rio Red, sweet orange (*C. sinensis* L.), lemon (*Citrus limon* (L.) Burm. f.) cv Eureka, and orange jessamine (*Murraya paniculata* (L.) Jack). For these tests, a Y-tube olfactometer (ARS Inc., Gainesville, FL) was oriented vertically with the arms facing upwards. The olfactometer was illuminated with fluorescent lights positioned 30 cm above the olfactometer. Aromas for testing were generated from freshly cut sprigs of flushing shoots placed within a flask connected to the airline system of the olfactometer. To maintain turgor, the cut ends of the sprigs were placed in plastic tubes filled with hydroponic solution. As a control, charcoal-filtered air was passed through the blank arm of the Y-tube. ACP used for the tests were obtained from a colony maintained on orange jessamine at the TAMU-K Citrus Center in Weslaco, TX. ACP were sexed prior to testing and were tested individually. After their introduction into the base of the olfactometer, the insects were given 300 seconds to move into one of the arms of the Y-tube. ACP that did not select one of the arms were scored as unresponsive and discarded. For each host plant-ACP gender combination, insects were tested until at least 30 responded. Male ACP exposed to the aroma of grapefruit sprigs showed the highest response (100%) while the lowest response was observed with female ACP exposed to grapefruit aroma (71%). Of those responsive individuals, 90% of males and 46% of females selected the aroma arm of the Y-tube over the blank arm. For the other host plants tested, the percentages of individuals selecting the aroma arm of the Y-tube were as follows: lemon: 87% male and 73% female, orange jessamine: 77% male and 60% female, and sweet orange: 70% male and 57% female.

INTERNATIONAL RESEARCH CONFERENCE  
ON HUANGLONGBING



**Session 8:  
Economics,  
Fruit Quality  
and Crop Loss**

Orlando, Florida



December 2008

## 8.1 An Update on the Effect of HLB on Orange Juice Flavor – 1) Chemical Components

Baldwin E.<sup>1</sup>, Manthey J.<sup>1</sup>, Plotto A.<sup>1</sup>, McCollum G.<sup>2</sup>, Irely M.<sup>3</sup>

<sup>1</sup> USDA-ARS, Citrus & Subtropical Products Laboratory, Winter Haven, USA

<sup>2</sup> USDA-ARS, Horticultural Research Laboratory, Fort Pierce, USA

<sup>3</sup> United Sugar Corporation, Clewiston, USA

It is reported that fruit from Huanglongbing (HLB) diseased trees do not color properly (hence the name greening disease) and have a bitter taste (1), which are two quality factors that can affect fresh fruit and processed juice. Although the rind color of symptomatic fruit is not normal, not much is known about whether the color of the juice is affected by the disease. Bitter taste and other potential off-flavors are reported but not well documented or identified, and could potentially affect the flavor of processed juice and fresh fruit. The objective of this work was to begin the process to determine the potential effects of HLB disease on orange fruit and juice quality.

Results from early infected Valencia trees in 2006 (juice from non-symptomatic fruit from HLB-symptomatic trees, verified by PCR, versus healthy trees) showed that differences between hand-squeezed lightly pasteurized juice from HLB-trees were mostly due to lower acid content and higher solids-to-acid ratio, resulting in sweeter juice (2). The difference between juice with and without pulp was also evaluated. There were no differences for  $\alpha$ - or  $\beta$ -carotenoids or lycopene, although  $a^*$  values and hue angle was slightly lower for healthy juice (more red-orange color), and total ascorbic acid tended to be lower. Among volatiles,  $\alpha$ -pinene, acetaldehyde and methanol were higher in juice from diseased fruit. Removing the pulp reduced the volatile content in juice from both HLB and healthy trees.

More trees were sampled in 2007 from three cultivars from several harvests (one harvest each of Hamlin and Midsweet and 4 Valencia harvests), hand juiced and lightly pasteurized. There were no significant differences for citric or total ascorbic acids for Hamlin, Midsweet or Valencia juices in 2007. There was a significant difference in malic acid for Hamlin juice with HLB juice being lower in this acid than healthy juice. There were rind color differences (Minolta chromameter  $a^*/b^*$  ratios) for the fresh fruit of 3 of the 4 Valencia harvests. Hand squeezed fresh juice color values for Midsweet and one Valencia harvest were significantly lower for HLB samples, but still commercially acceptable. Brix was significantly lower for HLB samples for 2 of the 4 Valencia harvests, but there was no difference in titratable acidity (TA). Headspace volatiles for the 2007 fruit showed little difference for Hamlin, but some for Midsweet, with generally higher values for healthy compared to HLB juice. For Valencia there were differences in volatile levels, but no obvious pattern due to disease.

Samples from the 2008 season included both non-symptomatic and symptomatic fruit for 2 Hamlin and 2 Valencia harvests. There were significant differences in the size of Hamlin fruit in that symptomatic fruit were smaller, which is consistent with characteristics of the disease. Differences in hand squeezed, fresh juice color showed that juice from symptomatic fruit was lower in color than juice from non-symptomatic or healthy fruit. Brix and the Brix/acid ratio were lower in juice from non-symptomatic and symptomatic fruit compared to healthy for 1 of the 2 Hamlin harvests. Juice from symptomatic fruit was lower in TA compared to healthy and non-symptomatic HLB Hamlin samples. Chemical analyses of the commercially extracted (FMC) and pasteurized juice, however, showed no differences in Brix, TA, ratio, oil content, pulp, color, citric, malic or ascorbic acids for either of the Hamlin or Valencia harvests. The compounds

limonin and nomilin were higher in HLB Hamlin juice for both harvests compared to healthy, and slightly higher in one Valencia harvest. Headspace aroma volatiles for these fruit showed much more variation by harvest date and variety than by whether the juice came from healthy or diseased trees. In cases where the aroma volatiles did show significant differences due to HLB, it was mostly for Hamlin juice, and with the exception of ethanol and ethyl hexanoate, the volatiles were higher in healthy fruit.

In conclusion, there seems to be much variation in the results due to year to year seasonal, harvest date and tree differences, which makes interpretation difficult at this time and inconclusive. When differences between the levels of chemical flavor compounds for HLB versus healthy juice are found, they seem to be more prevalent in Hamlin, more detectable in fresh hand-squeezed juice vs. pasteurized juice, and very inconsistent. The next step in this research project will be to blend juice from fruit harvested from HLB versus healthy trees to simulate commercial product and determine if there are chemical differences that can be detected. More research data is needed to determine if differences exist in the levels of flavor components between HLB and healthy fruit juice, and for identification of what chemical(s) might be responsible for any possible off-flavors.

**References:**

Halbert SE, Manjunath KL. 2004. Asian citrus psyllids (Sternorrhyncha: Psyllidae) and greening disease of citrus: a literature review and assessment of risk in Florida. *Florida Entomologist* 87:330-353.

Plotto A, Baldwin EA, McCollum TG, Narciso JA, Irey M. 2008. Effect of early detection greening on juice flavor and chemistry. *Proc. Fla. StateHort. Soc.* *In press.*

## 8.2 Effect of Greening Plant Disease (Huanglongbing) on Orange Juice Flavor and Consumer Acceptability

Goodrich-Schneider R.<sup>1</sup>, Sims C.A.<sup>1</sup>, Span T.<sup>2</sup>, Danyluk M.D.<sup>2</sup> and Rouseff R.L.<sup>2</sup>

<sup>1</sup>Food Science & Human Nutrition Department, Institute of Food and Agricultural Sciences (IFAS), University of Florida, Gainesville, FL

<sup>2</sup>Citrus Research & Education Center, IFAS, University of Florida, Lake Alfred, FL

Oranges (*Citrus sinsensis*) were collected at six harvest dates during the 2007-2008 season in order to determine the effect of greening, a citrus plant disease, on juice quality and consumer acceptability. Greening (also known as Huanglongbing, HLB) is known to adversely affect citrus production and tree health, as well as fruit morphology, however the impact of this disease on the quality of juice expressed from affected fruit has not been widely reported in the scientific literature. The objective of this work was to determine the acceptability of juice expressed from fruit harvested from greening-affected trees and to collect descriptors to be subsequently used in a descriptive sensory panel in order to more fully understand the flavor of greening-affected orange juice.

Fruit were harvested on six harvest dates, with three harvests during the mid-season orange period and three during the Valencia orange harvest. The following categories of fruit were collected during each harvest period by a citrus horticulturalist with expertise in the identification of greening disease in the field: greening-affected fruit (misshapen/deformed); non-affected fruit from greening-affected trees and control fruit from non-affected trees. Juice was expressed from each category of sample, and was analyzed for routine quality parameters. The juice was then frozen in suitable containers and stored until sensory analysis.

For each of the six harvest dates, consumer panels (n=100) evaluated the juice hedonically for overall acceptability, orange flavor and sweetness. Significance comparisons were determined within each fruit variety/harvest date. For all six panels, juice expressed from greening-affected fruit was always significantly less acceptable ( $P<0.05$ ) than juice from control fruit. Juice from greening-affected fruit was rated as significantly less sweet and significantly lower in orange flavor than juice from control fruit for all six panels ( $P<0.05$ ). Juice expressed from visually normal fruit from affected trees generally fell between control juice and greening-affected fruit juice in terms of overall acceptability, sweetness and orange flavor. The differences among the three sample types were not always significant for all six harvest dates, except for Valencia juice overall acceptability. Descriptors most often used to describe juice expressed from greening-affected fruit include bitter, metallic, acidic, general off-taste and watery. This information will be used to develop a trained descriptive panel to further characterize greening-related juice quality, and to potentially identify specific chemical components leading to the observed flavor differences. As juice from greening-affected trees can enter the juice processing stream, it is important to characterize the potential flavor impact of such a scenario.

### 8.3 Yield reduction caused by Huanglongbing in different sweet orange cultivars in São Paulo, Brazil

Bassanezi R.B.<sup>1</sup>, Montesino L.H.<sup>1</sup>, Amorim L.<sup>2</sup>, Gasparoto M.C.G.<sup>2</sup>, Bergamin Filho A.<sup>2</sup>

<sup>1</sup> Fundecitrus, Araraquara, Brazil; <sup>2</sup> ESALQ-University of Sao Paulo, Piracicaba, Brazil

Citrus huanglongbing (HLB) is the most serious disease of citrus worldwide because of its crop devastation, unknown source of resistance, and difficult and expensive management. In many countries where HLB is present it represents a limiting factor for citrus production. Where HLB becomes endemic, there is no effective control by reduction of bacteria inoculum or its vector. The disease progress in the orchard is relatively fast and the evolution of symptom severity throughout the tree canopy can be very quick, greatly reducing the economic life of affected orchards (Aubert et al., 1984; Roistacher, 1996). Despite its importance, only few studies have tried to quantify the yield reduction caused by HLB (Catling & Atkinson, 1974; Aubert et al., 1984), even though such studies are fundamental in order to characterize the importance of the disease and to define economic models for HLB affected groves. Thus, the aim of this work was to characterize the damage due to HLB for different sweet orange cultivars and to determine the relationship between disease severity and yield.

Considering the difficulties to artificially establish a HLB severity gradient, the approach employed in this study was the single plant. This method is utilized in most cropping areas because large variations in disease intensity are often encountered from plant to plant (Campbell & Madden, 1990). Disease and yield were assessed on 1100 trees distributed in 11 different blocks: four of early cultivars (Hamlin and Westin), three of a mid-season cultivar (Pera) and four of a late cultivar (Valência). In each block plants showed a wide range of disease symptom severity levels and each block contained 10 plants that were asymptomatic. To estimate disease severity, each tree was divided into 8 parts, 4 in the upper canopy and 4 in the lower halves. Each part was attributed a value from 0 to 5, corresponding to 0 to 100% of the canopy affected area, respectively (Aubert et al., 1984). Each tree was individually harvested; diseased and healthy fruit were counted and weighted separately. For each tree the following variables were calculated: total yield (weight of all fruit), average weight of healthy fruit (weight of healthy fruit / number of healthy fruit), average weight of diseased fruit (weight of diseased fruit / number of diseased fruit), relative yield (yield of diseased tree / average yield of healthy trees from the same block) and relative number of fruit (number of fruit of diseased tree / average number of fruit of healthy trees from the same block). Relationships between yield variables (dependent) and disease severity (independent variable) were tested by linear and non-linear regression analysis for each group of cultivars: early, mid-season, and late. The negative exponential model [ $y = \exp(-bx)$ ] was used to describe the relationship between relative yield ( $y$ ) and disease severity ( $x$ ), and the linear model was used to describe the relationship between relative yield and relative number of fruit per tree. The parameters of the linear and non-linear equations obtained for each group of cultivars were compared by t-test. The average weight of diseased fruit and healthy fruit were compared by analysis of variance.

The relative yield was related to HLB severity by the negative exponential model (Figure 1). The rates of yield decrease were similar for all assessed cultivars ( $b = 1.66$  to  $1.95$ ). Usually the reduction on relative yield was proportionally higher than the proportion of canopy area with symptoms. The relative number of fruit per tree was linearly and positively related to the relative

yield per tree, indicating that most of the reduction in yield is due to the early fruit drop (Figure 2). The number of diseased fruit per tree was not correlated to disease severity, but the proportion of harvested fruit with HLB symptoms increased with disease severity increase. A residual yield (from 14 to 19%) was observed even in trees where disease severity was 100%. The weight of diseased fruit was significantly lower than the weight of healthy fruit, but the weights of healthy and diseased fruit were not correlated to disease severity, indicating that the effect of HLB is restricted to symptomatic branches.

Because there was no difference among rates of yield decrease for all assessed cultivars, one single model can be used to describe the relative yield-HLB severity relationship:  $y = \exp(-1.8x)$ ,  $r^2 = 0.33$ . The knowledge of the HLB severity ( $x$ ) of a grove allows prediction of the expected yield ( $y$ ).

#### References

- Aubert B, Sabine A, Geslin P, Picardi L. 1984. Epidemiology of the greening disease in Reunion Island before and after the biological control of the African and Asian citrus psyllas. In: *Proc. Int. Soc. Citricult.* 1: 440-442.
- Campbell CL, Madden LV. 1990. Introduction to Plant Disease Epidemiology. John Wiley and Sons, New York.
- Catling HD, Atkinson PR. 1974. Spread of greening by *Trioza erytreae* (Del Guercio) in Swaziland. In: *Proc. 6th Conf. IOCV*, IOCV Riverside, CA, 33-39.
- Roistacher CN. 1996. The economics of living with citrus diseases: huanglongbing (greening) in Thailand. In: *Proc. 13<sup>th</sup> Conf. IOCV*, IOCV, Riverside, CA., pp 279-285.

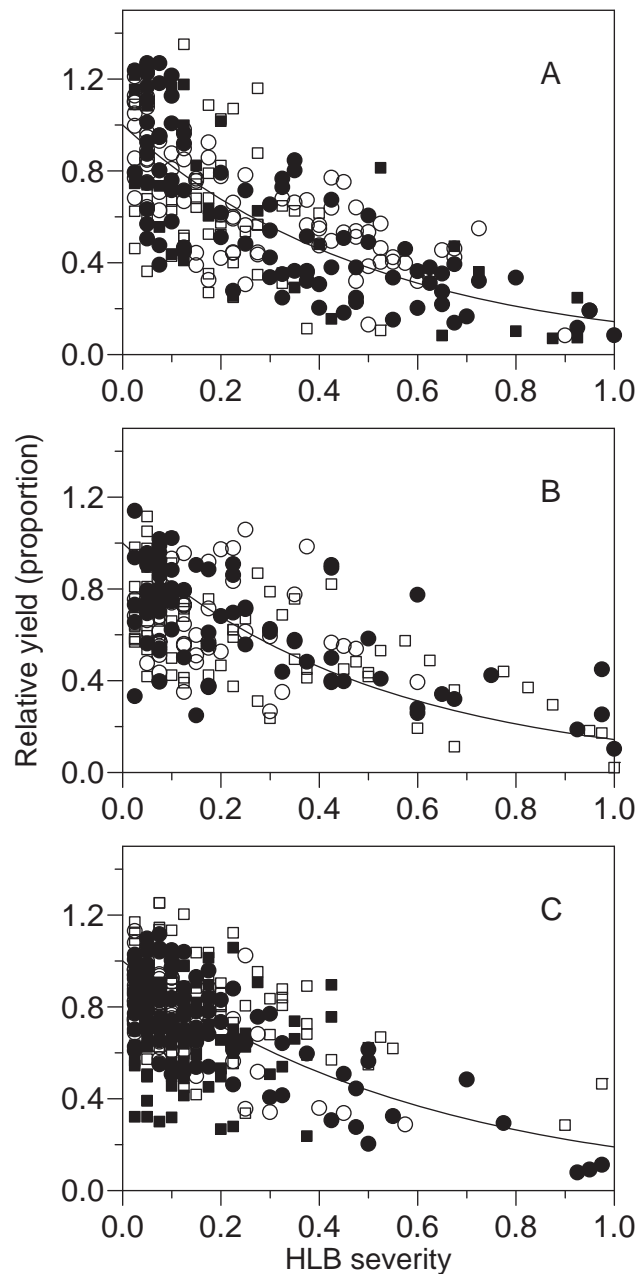


Figure 1. Relationship between HLB severity (proportion of branches with symptoms) and relative yield (yield from diseased trees / average yield from healthy trees) in early (A), mid-season (B) late (C) sweet oranges cultivars in São Paulo State. Different symbols refer to different blocks.



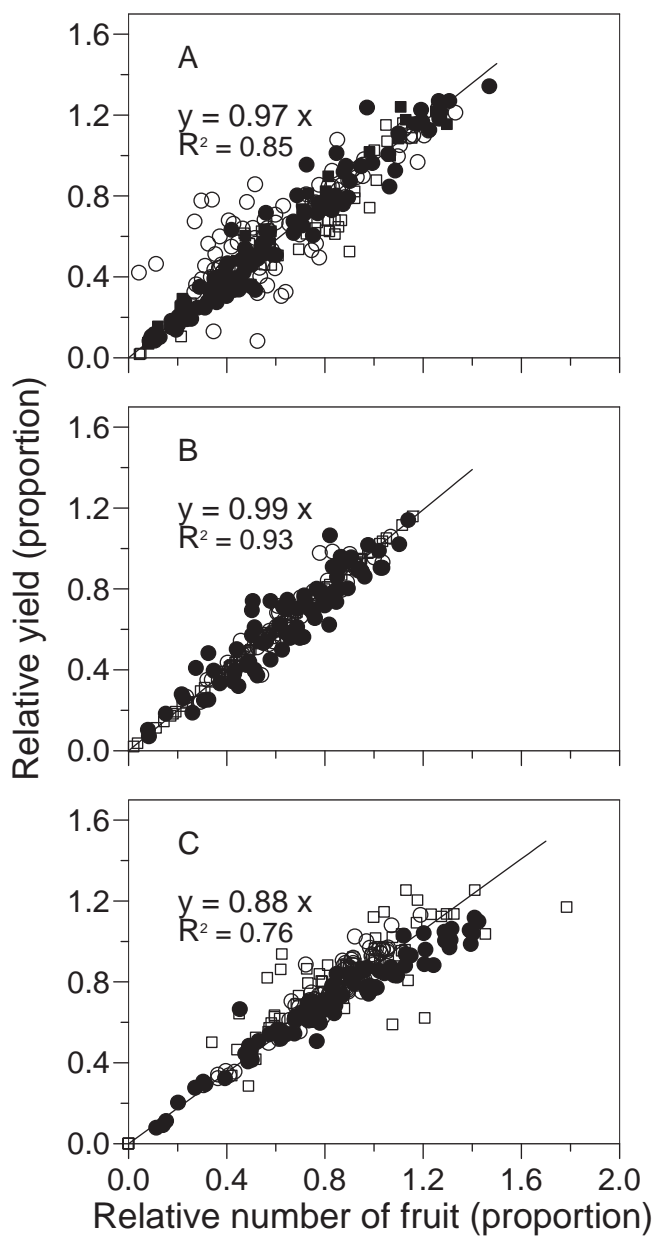


Figure 2. Relationship between the relative number of fruit (number of fruit from diseased trees / average number of fruit from healthy trees) and relative yield (yield from diseased trees / average yield from healthy trees) in early (A), mid-season (B) and late (C) sweet oranges cultivars in São Paulo State. Different symbols refer to different blocks.

## 8.4 The Production and Price Effects of Citrus Greening in Sao Paulo and Florida on the World Orange Juice Market

Spreen T.H.<sup>1</sup>, Brown M.G.<sup>2</sup>, Jauregui C.<sup>1</sup>

<sup>1</sup>Food and Resource Economics Department, University of Florida, Gainesville, FL; <sup>2</sup>Florida Department of Citrus, Gainesville, FL

Sao Paulo, Brazil and Florida, United States are dominant suppliers of orange juice to the world market. Collectively, these two regions account for over 80 percent of world orange juice production. Citrus greening (aka *Huanglongbing*) has recently been discovered into both states. Citrus greening is a particularly devastating disease which has had profound effect on commercial citrus production in parts of Asia and Africa. The purpose of this paper is to assess the possible consequences of citrus greening on future citrus production in Sao Paulo and Florida with particular interest on processed orange production. Given the importance of these two regions to world orange juice supply, supply shocks resulting from citrus greening will have implications for world orange juice prices.

The analysis will be conducted using a model of the world orange juice market that has been jointly developed by the University of Florida and the Florida Department of Citrus. The model includes endogenous production of oranges in Sao Paulo and Florida and delineates the United States, the European Union, Canada, and the rest of the world as major demand regions. Differentiated demand equations for not-from-concentrate and from concentrate orange juice in the United States and Canada have been estimated. The model is cast as a spatial equilibrium model that also encompasses tariffs and transportation costs across supply and demand regions. The impact of citrus greening is incorporated into the model through increased tree mortality. As the actual effect of the presence of greening on tree mortality in Sao Paulo and Florida is not yet known, several alternative scenarios are considered.

Given that the price impact of citrus greening may be large, discussion is also provided on the plausibility of new supply areas for orange juice.

## 8.5 The Economics of Management Strategies to Mitigate the Impact of Citrus Greening in Florida Citrus

**Muraro R.P.**, Morris R.A.

University of Florida, Citrus Research and Education Center, Lake Alfred, FL

Citrus Greening (aka *Huanglongbing*) is a particularly difficult disease to manage. Because infected trees may not exhibit symptoms for up to two years, a policy of removing symptomatic trees will likely never be successful in eradicating the disease from a particular production block or grove. Another strategy is to aggressively control the Asiatic psyllid, the vector of the disease. Through a combination of both removal of symptomatic trees and effective psyllid control, it may be possible to limit the spread of the disease to manageable levels.

Once infected trees are removed, one strategy is to immediately reset trees that were removed. However, since psyllids are attracted to new growth and young trees flush more frequently than mature trees, young trees in a block with mature trees supporting psyllids are at greater risk than solid set young trees in a newly-planted block. Another strategy is not to immediately reset trees, but continue to remove infected trees until reduced tree numbers make the block economically unproductive. Once the block is economically unproductive, the remaining trees are removed and the entire block is replanted. If resets can be cost-effectively grown to maturity, under what conditions is resetting economically preferable to replanting solid-set trees in an entire block? If the entire block is replanted, what is the optimum density of trees to reduce or delay the impact on production of future potential greening infections?

The purpose of this paper is to first identify alternative management strategies for citrus greening and estimate the costs and returns associated with each strategy. Net present value analysis is used for the economic analysis given the perennial nature of citrus production. A model that incorporates the tree age distribution of a particular block along with a yield curve that reflects the age-dependence of orange production has been developed and is modified for use in this analysis.

The results of the paper will enable better understanding of the economic implications of strategies aimed at mitigating the impact of citrus greening.

## 8.6 An Update on the Effect of HLB on Orange Juice Flavor – 2) Sensory Evaluation

Plotto A.<sup>1</sup>, McCollum G.<sup>2</sup>, Baldwin E.<sup>1</sup>, Manthey J.<sup>1</sup>, Ireby M.<sup>3</sup>

1 USDA-ARS, Citrus & Subtropical Products Laboratory, Winter Haven, USA

2 USDA-ARS, Horticultural Research Laboratory, Fort Pierce, USA

3 United Sugars Corporation, Clewiston, USA

There have been some anecdotal reports that Huanglongbing (HLB) or citrus greening disease, recently introduced in Florida, may impart off flavor to orange juice. It is of interest to the processing industry to determine what affect fruit from trees of various stages of infection would have on processed orange juice quality. The objective of our work was to determine the effects of HLB on orange juice quality. Results from early infected trees (2006) showed that differences between juice from HLB- trees were mostly due to lower acid content and higher solids-to-acid ratio, resulting in sweeter juice (1). More trees were sampled in 2007 from three cultivars and several harvests. Results showed a high tree-to-tree variation, with no difference between fruit from some HLB-affected trees and control, to some difference (less than 5 on a 10-point scale) for some other trees. When noticeable, differences between affected trees and control were mostly detected by taste (as opposed to smell), and described as less sweet/fruity and sometimes bitter. In 2006 and 2007, juice was hand-squeezed and underwent a mild flash-pasteurization to minimize flavor changes due to processing. More trees were sampled in 2008, and juice was processed under commercial conditions using an FMC-type extractor and pasteurized under simulated commercial conditions at USDA. Differences between affected and control juice were largely varietal. There was barely any flavor difference (only for some trees) between Valencia HLB and control juice, however, when juice was blended for all HLB or healthy trees, no difference was found. In Hamlin juice, there were some flavor differences perceived by trained panelists. While the total oil content and solids-to-acid ratio in Hamlin juice was similar to that of Valencia juice, total soluble solids was lower, explaining why some flavor differences could be better perceived. Flavor differences detected thus far in non-symptomatic fruit would not likely be detectable in blended juice under commercial conditions

### Reference:

Plotto A, Baldwin EA, McCollum TG, Narciso JA, Ireby M. 2008. Effect of early detection Huanglongbing on juice flavor and chemistry. Proc. Fla. StateHort. Soc. *In press*.

## 8.7 The Citrus Greening Bibliographical Database, a New Tool for Researchers Students and Growers

Arevalo H.A.<sup>1</sup>, Snyder G.<sup>2</sup>, and Stansly P.A.<sup>1</sup>

<sup>1</sup> University of Florida, SWFREC, Immokalee FL USA

<sup>2</sup> Florida Center for Library Automation, Gainesville, FL USA

The citrus industries in Brazil, the United States (Florida, Louisiana, Texas, and California), and in all major citrus producing countries are in a state of emergency due to the presence of Huanglongbing (HLB), a bacterial disease transmitted by psyllids that has no known cure or management techniques aside from prevention. For this reason, research on managing methods and better understanding the disease is being conducted all over the world. The initial step in any research project is locating and compiling information that has been published on the subject. In the case of HLB, this process can be time consuming since there is not a centralized database on the topic. If the relevant information were in one easy to access database, the time that is currently being invested in searching multiple general databases could be used more effectively in the field or laboratory.

Existing public databases related to entomology and pest management include: Formis [<http://www.ars.usda.gov/saa/cmave/ifahi/formis>] with over 38,000 references related to ants of the world: The Electronic Data Information Source EDIS with 4,000 publications related to agriculture and ecology from the University of Florida / IFAS [<http://edis.ifas.ufl.edu/index.html>] and the Plant Management Network (PMN) [<http://www.plantmanagementnetwork.org/partners/profile/default.asp#university>], a cooperative effort of 37 universities, several non-profit organizations, and country wide agricultural companies, to disseminate information related to crop management.

Presently, information related to HLB can be accessed through general non-specialized data bases. However, much of the accessed information may be irrelevant or overlapping. Sifting through the many references may be both time consuming and frustrating for researchers and students. For this reason we created and are managing a non-commercial, user-friendly database that contains bibliographical information related to all topics of citrus greening. This database can be accessed online from any computer at [<http://swfrec.ifas.ufl.edu/hlb/database>]. We have begun the process of mining information from several sources, uploading the information into our database and organizing it in the website, where it can be accessed by the public. The database presently contains 870 references and is growing daily. It includes links to the most relevant papers and extension publications. If papers cannot be linked directly, an email to [Greening.Database@ufl.edu](mailto:Greening.Database@ufl.edu) will initiate an attempt to provide the entire document. Our objective is to facilitate acquisition of scientific information and reduce hours spent looking for information on-line as well as to provide hard-to-obtain documents such as Kuwayama (1908), the original description of the Asian citrus psyllid, *Diaphorina citri*, as well as the most recently published papers on Integrated Pest Management and genetic work. We plan to have close to 1,000 references by the end of the year and to keep continually adding references. To this end we invite researchers to send us information about publications and presentations that we might have missed, so we can include them in our database. This database is managed by the Southwest Florida Research and Education Center entomology group at the University of Florida, but requires the participation of the international research community to ensure that it contains the most current and relevant information.

INTERNATIONAL RESEARCH CONFERENCE  
ON HUANGLONGBING



**Session 9:  
Regulatory  
Approaches to  
HLB/ACP**

Orlando, Florida



December 2008

## 9.0 International Regulatory Agencies - Regulating HLB

### An Evening Session on “Regulatory Approaches to HLB/ACP” Moderated by Dixon W. and Berger P.

The evening session was initiated by a brief presentations by Tim Riley (USDA APHIS PPQ) on chronology and response in Florida to detection of ACP (1998) and HLB (2005), followed by David Kaplan’s (USDA APHIS PPQ) historical review of Federal regulations with commentary on international, national and state perspectives. Thereafter, information and discussion was elicited from the session attendees. The major points raised are as follows:

**Thailand** – bringing in plant material is a concern to the regulatory authorities. The small and numerous family farms are often outside appropriate regulatory attention and are of concern. Even though plant regulatory rules exist, it almost impossible to enforce due to the large number of farms and difficulties of reaching all. This was a common theme in one form or another amongst the session attendees.

**Brazil** – the regulation and covering of nurseries began in 1997-98 in response to detection of CVC, and was completed by 2002. HLB was discovered in 2004. Government assistance was provided to farms and nurseries to encourage participation in following regulatory rules and guidelines; however, not all immediately participated.

**Florida** – it was noted that regulations must be science-based or legal problems are inevitable and costly. A key element in the distribution of Asian citrus psyllids and HLB were *Murraya* nursery plants; however, *Murraya* regulation was impossible until the host relationship with Las was proven through appropriate laboratory tests. The Hot Zone concept, centered on family farms in South Florida with ethnic connections to areas where serious pests are known to occur, was used in the successful detection of HLB. There was also acknowledgement of the value of local plant inspectors who know their territory very well.

**Costa Rica** – in 2006, a budwood registration program driven by a grower group was started and will be mandatory in 2009. However, there were difficulties in getting the government to help enforce. It was noted that the family farm or small grower was not likely to cooperate.

**Jamaica** – as soon as HLB appeared in Brazil and Florida, a task force was assembled. The Asian citrus psyllid was first detected in 2002 which then prompted budwood registration. Currently, they prohibit all citrus seed import until more is known about the issue of seed transmission of HLB.

**South Africa** – the citrus industry is highly regulated, but it was acknowledged that regulations could use more teeth for better enforcement. There is a strong movement towards compulsory compliance: which was estimated to be 95% now.

**New Zealand** – carefully regulates all plant material entering the country, which includes all travelers. There are substantial fines and prison terms for violations. Amnesty bins are placed to encourage collection of contraband. The regulatory agency has the right to destroy on first find, but must compensate for all other removals that may occur. It was emphasized that plant movement controls are designed to be strict.

- **Australia** – very strict plant movement controls are in place. All incoming nursery stock must be fumigated. There is a post entry quarantine of two years for citrus. Plant pests are assigned to either a low, medium and high risk category. There is a cost sharing program with growers and the government for pest programs. Although it was unknown at the time, the Queensland citrus canker eradication program is also the only example of successfully

eradicating Asian citrus psyllid. This was achieved by eradicating the host. It was noted that Australia has much of the same problems as US such as no compensation for plant destruction, weekend market sales and residential and hobby growers. Australian citrus dieback is expected to confound the detection of the arrival of HLB. Finally, the “Pest Specific Incursion Plan” for Australia is in review; it is a major publication that has required time for proper processing. .

- **Dominican Republic** –the Asian citrus psyllid arrived in 2000 and a HLB survey was started immediately. The Brazilian system of management was adopted. It was stated that the grower community is fragmented which has resulted in difficulty in organizing the small growers. There is an emphasis now on acquiring training for HLB diagnostics and establishing appropriate laboratories.

***Similar regulatory questions and themes the world over were raised in the session:***

What are we regulating, the pathogen or the disease? A group suggestion was made to regulate pathogen because of the latency problem inherent with the disease.

Precautionary regulations are usually not legal and difficult to establish.

In many countries, compensation is not available. In the U.S., no financial safety net for plant pest emergencies like there is for veterinary emergencies. This may be addressed in future farm bills.

Cooperation is highly variable among all stakeholders.

Legal authority (of lack thereof) to achieve biological effectiveness via regulations.- the contrast of biological reality versus legal and political aspects.

Level of anticipatory strategies – what is allowed and not due to legal constraints and perceptions of stakeholders of what needs to be done.

Discussions (or lack of discussions) among stakeholders before the arrival of an anticipated exotic plant pest.



# INTERNATIONAL RESEARCH CONFERENCE ON HUANGLONGBING



## Session 10: Epidemiology

Orlando, Florida



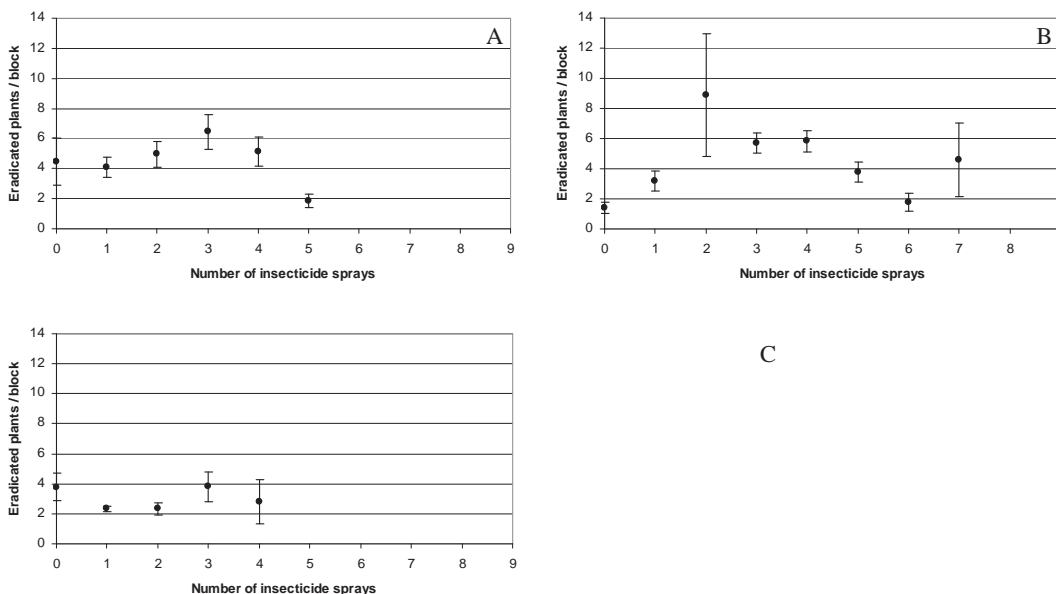
December 2008

## 10.1 Relationship between insecticide sprays and huanglongbing progress in a citrus orchard in São Paulo, Brazil

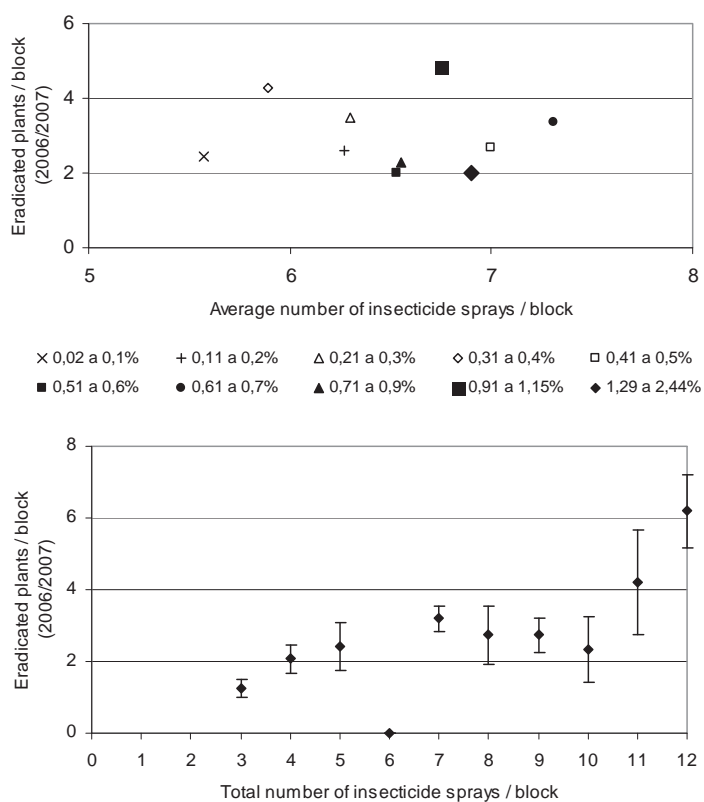
Bergamin Filho A.<sup>(1)</sup>; Gasparoto M.C.G.<sup>(1)</sup>; Bassanezi R.B.<sup>(2)</sup>; Amorim L.<sup>(1)</sup>

<sup>(1)</sup>ESALQ/USP, Piracicaba, Brazil; <sup>(2)</sup>Fundecitrus, Araraquara, Brazil

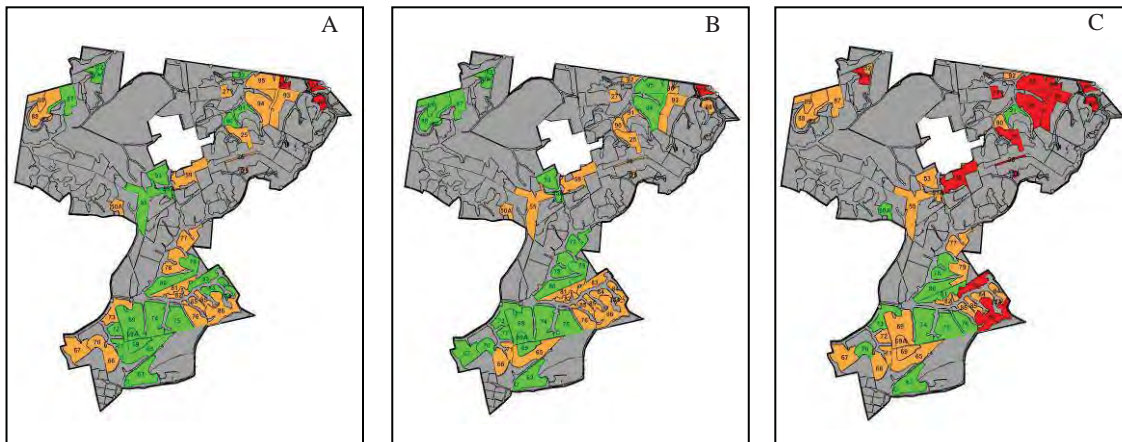
Citrus huanglongbing (HLB), also known as greening or yellow shoot disease, is one of the most serious citrus diseases in the world. The Asian citrus psyllid (*Diaphorina citri*) is considered a serious pest of citrus in the world due to its ability to transmit the HLB agent. Management of HLB is difficult and requires an integrated approach including the use of healthy nursery trees, frequent surveys and eradication of symptomatic trees, and the use of insecticides to control HLB throughout the control of its vector. The purpose of this work was to relate the number of insecticide sprays with HLB incidence, in the conditions of a commercial orchard in Brazil. A total of 716,476 citrus plants (*Citrus sinensis*), from five to ten years old, distributed in 357 blocks were subjected to a different number of insecticide sprays (3 to 12) during three growing seasons (2004/2005, 2005/2006, and 2006/2007) in a farm located in São Paulo State, Brazil. Eradication of symptomatic trees was carried out in the whole area 4 to 8 times per growing season. Incidences of HLB in all blocks ranged from 0.0 to 8.35 % of symptomatic trees. The relationship between the number of eradicated plants and the number of insecticide sprays was investigated. Temporal data analysis was done by non-linear regression between disease incidence (y) and time (x) to all blocks, which were grouped according to its management. The Gompertz model was fitted to the data and its rate parameter (*b*), final incidence and number of sprays were divided, in ascending order, in three classes. The grouped blocks, belonging to the different parameter classes, were located on the map of the farm. There was no negative relationship between the number of sprays and HLB incidence (eradicated plants) considering each one of the three growing seasons (Figure 1). No relationship was also observed between the average number (Figure 2A) or the total number (Figure 2B) of insecticide sprays per block and the eradicated plants in the last season (to minimize the influence of a long latent period). These results suggest that, in the conditions of the farm, the low incidence of HLB was due more to eradication of symptomatic trees than to insecticide sprays. On the maps, the grouped blocks with the highest rates of disease progress were close to another farm, which had no management of the disease. The grouped blocks with the lowest final incidences were located in the center of the farm (Figure 3). Probably, the trees of that farm without disease management served as source of inoculum. Internal insecticide sprays were not efficient to avoid HLB-bacteria transmission by infectious psyllids from such external source.



**Figure 1.** Average number (symbols) and standard error (bars) of eradicated plants per block related to the number of insecticide sprays, during the years 2004/2005 (A), 2005/2006 (B) and 2006/2007(C), from blocks with plants from five to ten years old.



**Figure 2.** Average number (symbols) of eradicated plants per block, during the year 2006/2007, related to the number of insecticide sprays (average per block), during the years 2004/2005, 2005/2006 and 2006/2007, classified by the initial HLB incidence (2004/2005) (A). Average number (symbols) and standard error (bars) of eradicated plants per block, during the year 2006/2007, related to the total number of insecticide sprays, during the years 2004/2005, 2005/2006 and 2006/2007 (B).



**Figure 3.** Maps of the farm. Classes of rate disease progress (A), final incidence (B) and total number of insecticide sprays (C). The different colors represent the highest (red), intermediate (orange) and lowest (green) values of each variable.

## 10.2 A Stochastic Spatiotemporal Analysis of the Contribution of Primary versus Secondary Spread of HLB.

<sup>1</sup>Gottwald T., <sup>1</sup>Taylor E., <sup>2</sup>Irey M., <sup>2</sup>Gast T., <sup>3</sup>Bergamin-Filho A., <sup>4</sup>Bassanezi R., <sup>5</sup>Gilligan C. and <sup>6</sup>Parnell S.

<sup>1</sup>USDA, ARS, US Horticultural Research Laboratory, Fort Pierce, Florida, USA; <sup>2</sup>Southern Gardens Citrus, US Sugar Corp., Clewiston, Florida, USA; <sup>3</sup>ESALQ, Universidade de São Paulo, Brazil; <sup>3</sup>Fundecitrus, Araraquara, Brazil; <sup>5</sup>University of Cambridge, Dept. of Plant Sciences, Cambridge, U.K.; <sup>6</sup>Rothamstead Research, Hampden, U.K. Corresponding author: [Tim.Gottwald@ARS.USDA.GOV](mailto:Tim.Gottwald@ARS.USDA.GOV)

The spatial and temporal dynamics of HLB in mature groves has been investigated in only very few cases, primarily from Reunion Island and People's Republic of China (PRC) (Gottwald et al 1989; 1991a; 1991b; 2007) and more recently, preliminary studies are being conducted in Brazil and Florida. In all prior cases, only the Asian HLB pathogen, *Ca. L. asiaticus*, was known to be present. With the discovery of *Ca. L. americanus* in São Paulo, Brazil, some data on disease increase and spread of that organism is beginning to be collected as well (Bassanezi et al 2005). Prior studies presented an opportunity to investigate the disease in citrus plantings in two situations, where inoculum was introduced by infected planting stock, and where clean stock was utilized and the pathogen was introduced by the immigration of bacteria-contaminated psyllid vectors. The studies were conducted to establish preliminary rates of disease increase of citrus HLB under endemic conditions in the presence of vector populations, and develop preliminary temporal models to estimate the expected longevity of infected sweet orange and mandarin groves.

These previous studies of HLB increase and spread conducted in PRC and Reunion Island indicate a rate of disease increase leading to a multi-year epidemic similar to the CTV-*Aphis gossypii* pathosystem. In contrast, more recent studies in Brazil, Vietnam, and Florida suggest a much more rapid rate of disease increase and spread (Catling and Atkinson, 1974; Bassanezi et al 2005; Gatineau, 2006 (NOT CITED); Gottwald et al 2007). In the present study, an HLB epidemic was examined in a large 4,800+ ha plantation in South Florida where no new citrus had been introduced for 10 years and thus spread was entirely dependent on psyllid transmission.

Objectives of this study were, 1) to characterize relationships of HLB-positive trees from a long-distance point of view to gain insights into psyllid transmission across a range of distances from immediately adjacent trees to regionally, and 2) to use stochastic modeling methods to parse disease spread over time into components using likelihood estimates of the 'primary infection rate' (introduction from outside the area under study) and 'secondary infection' (spread locally within the area of study).

### Materials and Methods:

Based on the commercial survey of trees with visual symptoms of HLB, the spatial pattern of HLB was determined over a large contiguous planting of citrus (4856) ha in South Florida. The area was completely surveyed via a 100% census of trees five times over a 2-year period. The commercial planting was a mixture of sweet orange cultivars but predominately Valencia and Hamlin on various rootstocks. A subsection of the plantation composed of 180 blocks (~739 ha) was used for the study. Block size was of 14 rows of 110-115 plants per row or ~1,500 trees/block. Incidence of HLB was assessed by visual inspection. The GIS location of each

symptomatic tree and date when the symptoms were assessed were recorded on GIS referenced maps of the plantation.

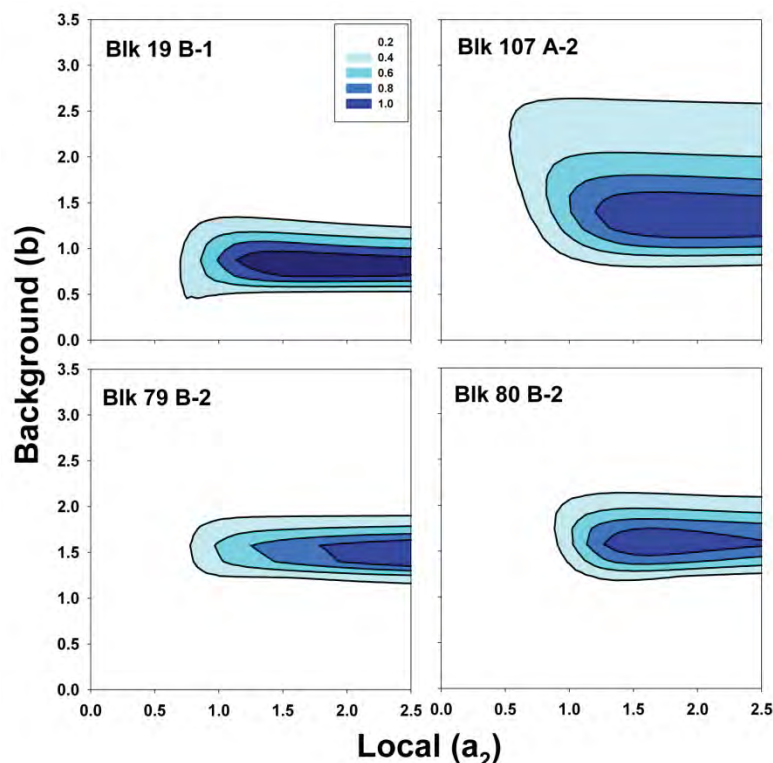
For spatio-temporal analyses, data for each of 11 HLB-infected blocks were analyzed using the spatio-temporal stochastic model for disease spread which was fitted using Markov-Chain Monte Carlo (MCMC) stochastic integration methods. For a thorough description of the MCMC model, its application, and interpretation of results, refer to Gibson (Gibson 1997a; 1997b; 1997c; Gottwald et al 1999). The results of the spatio-temporal analysis can be viewed graphically in a two-dimensional parameter space representing a series of 'posterior density' contours of parameter densities,  $L(a)$ . The two parameters represent local ( $a_2$ ) versus background ( $b$ ) interactions. The parameter  $b$  quantifies the rate at which a susceptible individual acquires the disease due to 'primary infection' independent of the infected trees in the plot and is therefore the simple interest or 'primary infection rate' in a spatio-temporal context. For many pathogens that are vector transmitted and dispersed, this usually means from sources of inoculum outside of the host population, i.e., plot. Whereas  $a_2$  represents the 'secondary infection rate' in a spatio-temporal context,  $b$  quantifies the manner in which the infective challenge presented to a susceptible individual by a diseased individual in the population decreases with the distance between them. As  $a_2$  increases, the secondary transmissions occur over shorter ranges and, so long as  $b$  is not so large that primary infections dominate, disease maps generated by the model exhibit aggregation. The MCMC analysis was accomplished by a simulation model using 500-1000 simulations. The citrus blocks studied were too large to allow this program to run due to memory restrictions. Thus we subdivided each plot into two smaller plots each with <750 trees.

### Results and Conclusions:

The main objective of the study was to attempt to parse the spatial spread of HLB into distinct and identifiable components. This was done by the use of MCMC stochastic modeling methods to give likelihood estimates of the 'primary infection rate' (introduction from outside the area under study) and 'secondary infection' (spread locally within the area of study). We have employed this stochastic modeling technique previously to examine the spatio-temporal dynamics of citrus tristeza, blight, psorosis and other pathosystems and the involvement and dynamics associated with various vector populations (Gottwald et al 1999; Castle and Gottwald 2005; Gottwald et al 2005 NOT CITED). Spatial disease spread between two assessment times was analyzed via the MCMC model when a minimum increase in disease incidence of 2.5% had occurred. Examples of posterior density contour graphs are shown in Figs. 1-3. These representative graphs are arranged into three groups which share common characteristics among their posterior density contours.

The overall interpretation was that there are two spatial processes that are ongoing during HLB epidemics, but not necessarily simultaneously. Figure 1 represents a smaller group of analyses, the largest probability category values (darkest contour color) of the posterior density  $L(a)$ , extends exclusively from the vertical  $b$  axis. The highest probability category for  $b$  (the background parameter associated with secondary spread) varied from about 0.5 to 1.2 whereas the corresponding values of  $a_2$  (the local parameter relating to secondary spread) were of about 1.75 to 3.5 along the upper end of the parameter range of the  $a_2$  axis. Here the analyses indicate '*background or primary spread of disease that originates from outside the plot areas*'. This is the most hazardous kind of spread in that it indicates a spatial process of long distance or regional vector transmission. Background primary spread from outside the plot is the most devastating because no amount of spraying will stop psyllids from feeding on distant HLB-positive sources, migrating to uninfected trees at some distance, and transmitting the bacterial pathogen before

they die from insecticide applied to the new trees they settle on. Examples of purely background spread such as those shown in Figure 1 were the least common.



**Figure 1. Posterior density estimates of Markov-Chain Monte Carlo Simulation of the Spatio-temporal increase of huanglongbing in citrus plots in south Florida. MCMC posterior density likelihood estimations are for local and background influences on disease spread between two assessment dates for selected individual plots. Contour maps represent the posterior density estimations  $L(a)$  between two assessment dates for each plot with a minimum of 2.5% increase in disease incidence between individual assessments. Plots in this figure demonstrate a predominance of background or primary spread of disease that originates from outside the plot areas.**

In all cases in the group shown in Figure 2, the largest probability category values of the posterior density  $L(a)$ , corresponded to values of  $a_2$  (the local parameter relating to secondary spread) of about 0.7 to 1.3 along the lower end of the parameter range, joined the  $a_2$  axis, and the highest probability category for  $b$  (secondary spread) varied from about 0.05 to 1.1. For this collection of analyses, posterior density estimates provides evidence of ‘*secondary spread via predominantly midrange local interactions for dispersal of inoculum within the boundaries of the plots through time*’. This spatial process is characterized by vector transmissions that are not to nearest neighboring trees, but rather to trees that are nearby within a local area of influence. The prevalence of these two spatial processes is weighted much more heavily toward the secondary spatial process with only occasional evidence of background spread from external sources, i.e., random long distance transmissions of inoculum. Note that the graph is arranged along rows and from top to bottom of the graph with increasing posterior probability contour areas. Those at the top of the graph indicate little to no evidence of background spread whereas as we look further down and to the right of the individual graphs in Figure 2, we see increasing indications of some level of background or primary spread. The final graph to the lower right indicates a lower probability contour actually descending to the  $b$  axis indicating a definite but subordinate influence of background spread.

A third category of posterior density contour graphs are shown in Figure 3. These are perhaps the most common type of model result. In this case the posterior density contours generally do not always intersect either axis and indicate mixed spatial processes of primary and secondary spread occurring simultaneously. The top row indicates posterior density contours confined near the  $a_2$  axis but still with the highest contour levels not extended to that axis indicating a prevalence of secondary spread but with significant influence of simultaneous background spread as well. For

the second row of graphs and the left portion of the third row, the contours rise above the  $a_2$  axis and begin to increase in overall parameter space area, i.e., contours. This indicates a stronger but well mixed influence of ‘both primary and secondary spread without a clear prevalence of either’, however, the highest contour level is near the center of the  $a_2$  range, indicating secondary spread that is mid range and neither nearest-neighbor nor short-range and local but somewhere in between. Lastly for the right two graphs on the third row, and all of the graphs on the fourth row, the lower probability density level contours begin to extend towards and generally intersect one or both axes, indicating a strong but mixed interaction of primary and secondary spread. The stochastic modeling analytical results characterized in Figure 3 are the

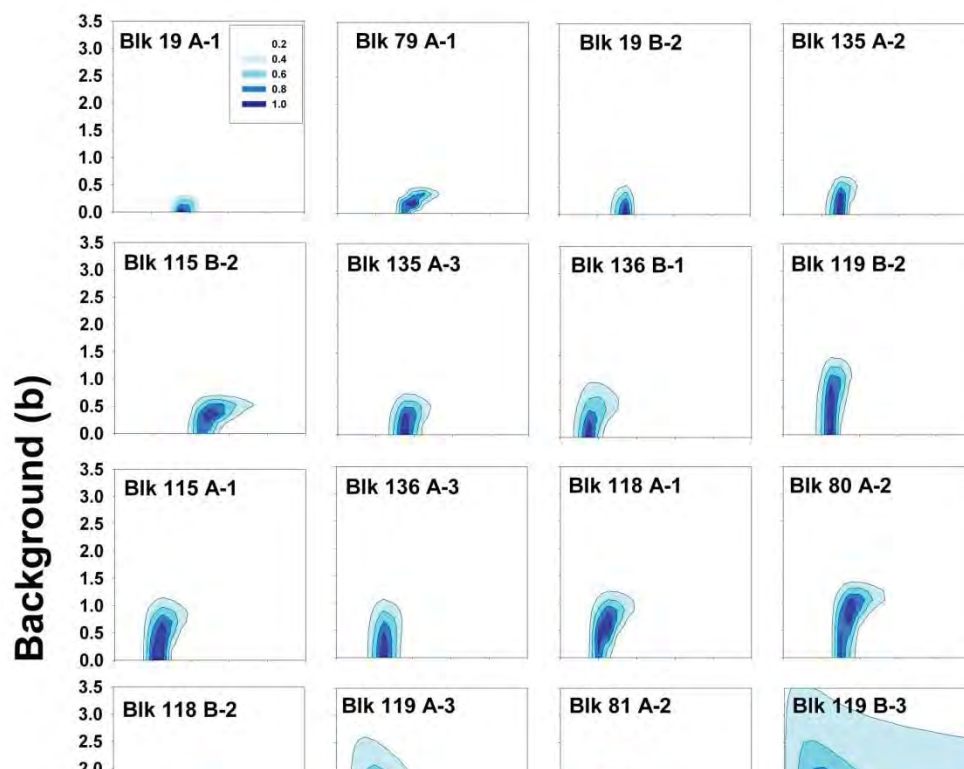


Figure 2. Posterior density estimates of Markov-Chain Monte Carlo Simulation of the Spatio-temporal increase of huanglongbing in citrus plots in south Florida. MCMC posterior density likelihood estimations are for local and background influences on disease spread between two assessment dates for selected individual plots. Contour maps represent the posterior density estimations  $L(a)$  between two assessment dates for each plot with a minimum of 2.5% increase in disease incidence between individual assessments. Plots in this figure demonstrate posterior density estimates that provide evidence of secondary spread via predominantly midrange local interactions (that are not to nearest neighboring trees, but rather to trees that are nearby within a local area of influence) for dispersal of inoculum within the boundaries of the plots through time. The graph is arranged along rows and from top to bottom of the graphic with increasing posterior probability areas. See text for interpretation and details.

most common type and indicate generally that HLB spread occurs as an incessant mixture of these two processes interpreted as a continuous introduction of inoculum from outside the plot and local spread from within the plot occurring simultaneously.



From the data presented we see that there are two spatial processes driving HLB epidemics, primary spread via psyllids carrying the HLB bacteria from sources of inoculum outside the

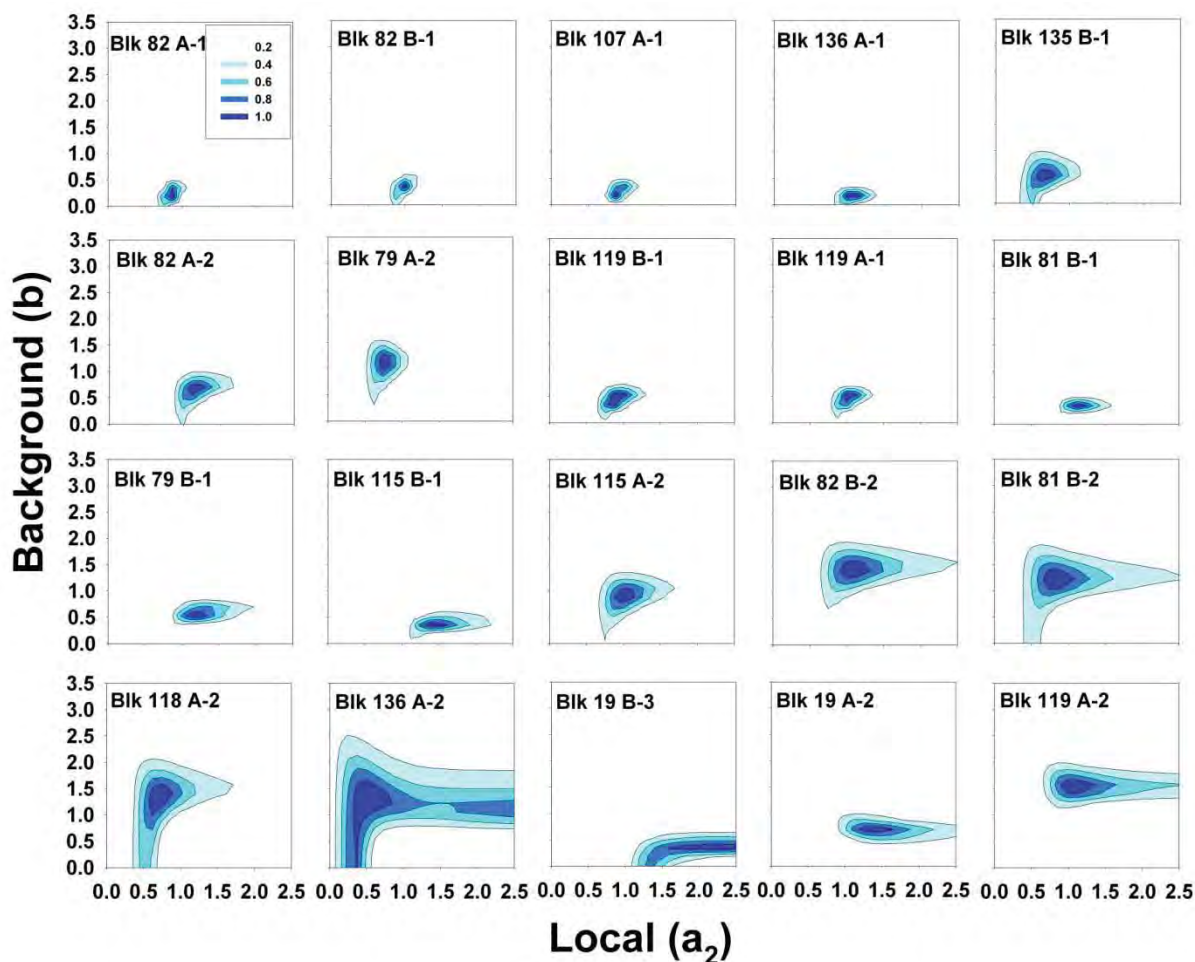


Figure. 3. Posterior density estimates of Markov-Chain Monte Carlo Simulation of the Spatio-temporal increase of huanglongbing in citrus plots in south Florida. MCMC posterior density likelihood estimations are for local and background influences on disease spread between two assessment dates for selected individual plots. Contour maps represent the posterior density estimations  $L(a)$  between two assessment dates for each plot with a minimum of 2.5% increase in disease incidence between individual assessments. Contour plots in this figure are the most common type and generally indicate that HLB spread occurs as an incessant mixture of two spatial processes i.e., a continuous introduction of inoculum from outside the plot combined with local spread from within the plot occurring simultaneously.

plantings, and secondary spread via psyllids transporting HLB bacterial inoculum within the planting. It was rare to see instances when the predominate influence was primary spread from outside the planting (Figure 1), whereas, it was relatively common to find situations when secondary spread within the planting predominated with demonstration of some primary spread (Figure 2). However, the most common situation appeared to be a simultaneous and more balanced influence of both primary and secondary spread (Figures 2 and 3).

The data from this large commercial area in south Florida is unique in several ways. It represents the earliest and most heavily HLB-infected commercial area in Florida. The data are exclusive in that they provide the first regional examination of the spatial distribution and spread of HLB.

Even though the commercial industry in the area quickly and dramatically increased vector control and instituted roguing of HLB-infected trees, the age of the trees combined with the temporal latency of the disease provided a historical record of infection and spread that no amount of insect control or tree removal could mask within the two-year period of data collection. Finally, the level of psyllid population/infestation in this planting was unprecedented compared to other recorded psyllid infestations, probably because the insect was relatively newly introduced to Florida and this area in particular and out of balance with environmental constraints. Thus this HLB epidemic is undoubtedly one of the worst ever recorded. That being said, it demonstrates the true rapid and destructive nature of the HLB-pathosystem during a time period when virtually no mitigating measures were yet influencing the epidemic and serves as a warning to commercial citrus industries who would disregard the seriousness of HLB.

### **Literature Cited:**

- Bassanezi RB, Busato LA, Bergamin-Filho A, Amorim L, Gottwald TR. 2005. Preliminary spatial analysis of huanglongbing in São Paulo, Brazil. Proc. International Org. Citrus Virol. (In press).
- Castle WS, Gottwald TR. 2005. Spatio-temporal analysis of tree decline losses among Navel orange trees on Swingle citrumelo rootstocks in two central Florida citrus groves. In: Proc. 16th Conf. IOCV, 370-380. IOCV Riverside, CA.
- Catling HD, Atkinson PR. 1974. Spread of greening by *Trioza erytreae* (Del Guercio) in Swaziland. In: Proc. 6th Conf. IOCV, 33-39. IOCV Riverside, CA.
- Gibson GJ. 1997a. Investigating mechanisms of spatiotemporal epidemic spread using stochastic models. *Phytopathology* 87:139-146.
- Gibson GJ. 1997b. Markov chain Monte Carlo methods for fitting spatiotemporal epidemic stochastic models in plant pathology. *Appl. Stat.* 46:215-233.
- Gibson GJ. 1997c. Fitting and testing spatiotemporal stochastic models with applications in plant pathology. *Plant Pathol.* 45:172-184.
- Gottwald TR, Aubert B, Long HK. 1991a. Spatial pattern analysis of citrus greening in Shantou, China. Proc. 11th Conf. IOCV 11:421-427.
- Gottwald TR, Aubert B, Zhao X-Y. 1989. Preliminary analysis of citrus greening (Huanglongbing) epidemics in the People's Republic of China and French Reunion Island. *Phytopathology* 79:687-693.
- Gottwald TR, da Graca JV, Bassanezi RB. 2007. Citrus Huanglongbing: The pathogen, its epidemiology, and impact. *Plant Health Progress* doi:10.1094/PHP-2007-0906-01-RV.
- Gottwald TR, Gibson G, Garnsey SM, Irey M. 1999. Examination of the effect of aphid vector population composition on the spatial dynamics of citrus tristeza virus spread via stochastic modeling. *Phytopathology* 89: 603-608.
- Gottwald TR, Gonzales CI, Mercado BG. 1991b. Analysis of the distribution of citrus greening in groves in the Philippines. Proc. 11th Conf. IOCV 11:414-420.
- Zhao XY 1981. Citrus yellow shoot (Huanglongbing) in China: a review. *Proc. Int. Soc. Citriculture* 466-469.

### 10.3 HLB Survival Analysis – A Spatiotemporal Assessment of the Threat of an HLB-positive Tree to its Neighbors

<sup>1</sup>Gottwald T., <sup>2</sup>Irey M. <sup>2</sup>Gast T., and <sup>1</sup>Taylor E.

<sup>1</sup>USDA, ARS, US Horticultural Research Laboratory, Fort Pierce, Florida, USA; <sup>2</sup>Southern Gardens Citrus, US Sugar Corp., Clewiston, Florida, USA Corresponding author: [Tim.Gottwald@ARS.USDA.GOV](mailto:Tim.Gottwald@ARS.USDA.GOV)

The spread of HLB is complex and can be thought of as occurring over various spatial scales, i.e., from an infected cell to surrounding cells, within an individual tree, among immediately adjacent trees within a local area, among trees within a block or plantation, among plantations within an industry, and among industries nationally and internationally. Various spatial mechanisms affect spread at each spatial hierarchy, including human movement of plant material and psyllid transmission. Bacteriferous psyllids also move and transmit the HLB bacteria within multiple spatial hierarchies. One concern voiced by citrus producers is the threat of an HLB-infected tree to surrounding trees within a planting block or the entire plantation.

Survival analysis is a class of statistical methods for studying the occurrence and timing of events and is often applied to the study of deaths. Survival analysis has been used for many years in medical studies and by the insurance industry for generation of actuarial tables. However this analytical method has served many disciplines and has been referred to by other names in other disciplines, for example event history analysis (sociology), duration analysis or transition (economics), reliability analysis or failure time analysis (engineering), etc. (5,6). Survival analysis has been used only recently in botanical epidemiology to examine plant disease epidemics and the factors affecting these epidemics through time, such as the effect of roguing of diseased plants (2,3,4,6). This paper explores the contribution of short distance transmissions of HLB by psyllids and the influence they have on the overall spatial pattern of disease that develops through time. The goal is to examine the threat of HLB-infected trees to other trees within the planting.

**Materials and Methods:** For this study we selected 11 blocks in a large commercial plantation in south Florida, each 4 ha (10 acre) in size, with 14 row of ca. 100-110 trees per row. We intensively mapped the spatial position of all trees within each of the blocks and their HLB status through 6 assessments over a 2.5 year period. HLB status was determined visually.

**Survival analysis** methods were applied first to determine the general survival characteristics of HLB in each plot using the Kaplan-Meier Survival model,

$$S(t) = \prod_{t_i \leq t} \left[ \frac{r_i - d_i}{r_i} \right]$$

where  $t$  = time in months,  $\Pi$  denotes the geometric mean,  $r$  = the hazard ratio, and  $d$  = disease status (0 or 1) for the  $i^{\text{th}}$  = individual tree. Next, the data were examined to gauge if trees with existing HLB infection from previous assessment periods could be used to explain the occurrence of new infections that occurred within different distances from the potential infection source (defining the area of influence). Radii of 7.6, 15.2, 22.9, 30.5, and 38.1 m (25, 50, 75, 100, and 125 ft) surrounding infected trees were queried. The number of HLB-positive trees found within those areas that existed during the previous assessment period, were numerated. For individual

trees occurring near the edge of the plot, the radii often extended beyond the plot boundaries. To adjust for edge effects in the data, an edge correction calculation was performed to adjust the number of HLB-positive trees within each area defined by the radii. Using these parameters, the covariate that was tested via survival analysis was the number of prior infections within areas described by these radii.

The semi-parametric Cox proportional hazards model was fitted to the data, which specifies the hazard for an individual tree  $i$  at time  $t$  as,

$$h_i(t) = h_0(t) \exp(\beta' \mathbf{X}_i)$$

where  $h_0(t)$  is an unspecified baseline hazard function,  $\mathbf{X}_i$ , a vector of time-constant covariates values and  $\beta'$  the vector of covariate coefficients that are estimated by partial likelihood (2,4,5). The potential effect of a covariate is quantified using the hazard ratio (HR), expressed in terms of an exponential of the corresponding estimated  $\beta$  coefficient for one unit change in the value of the given variable. An HR value of 1 ( $\beta = 0$ ) indicates no significant effect of the covariate tested. The explanatory covariate tested was the number of infected trees within an area of influence in a prior assessment (time period). The hazard function modified for this purpose was,

$$h_i(t) = h_0(t) \exp(\beta' \mathbf{X}_i(t))$$

with  $\mathbf{X}_i(t)$ , the vector of values at time  $t$  of the time-dependent covariates as well as the values of the time-independent covariates; and  $\beta'$  is the vector of associated coefficients (6). Analysis was performed using the Survival library of S-PLUS (Data Analysis Products Division, Mathsoft Inc.).

### Results and Conclusions:

Variability of disease increase among the 11 commercial citrus blocks studied is shown in Figure 1. Note that all of the blocks increase rapidly in HLB incidence then begin to plateau after about 400 days.

Spatial patterns maps are shown in Figure 2 for two commercial citrus blocks each 2.5ha in size.

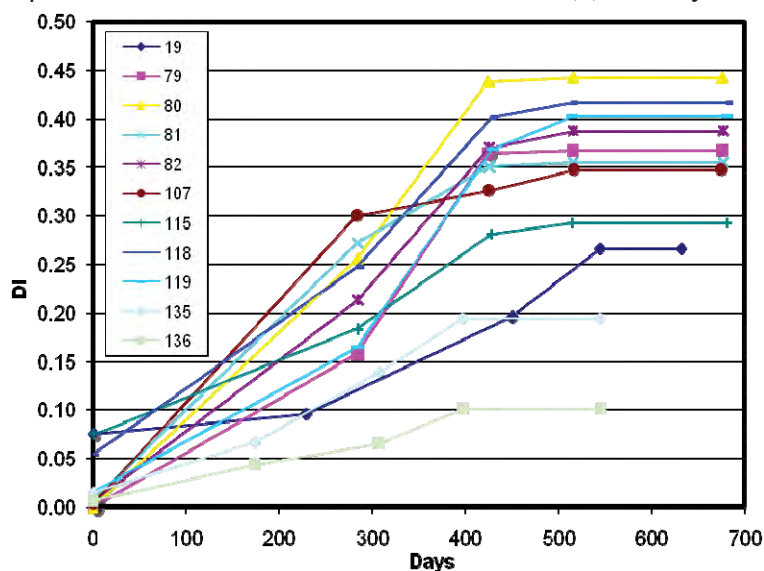


Figure 1. Disease increase of HLB in 11 commercial citrus blocks each 2.5 ha in area.

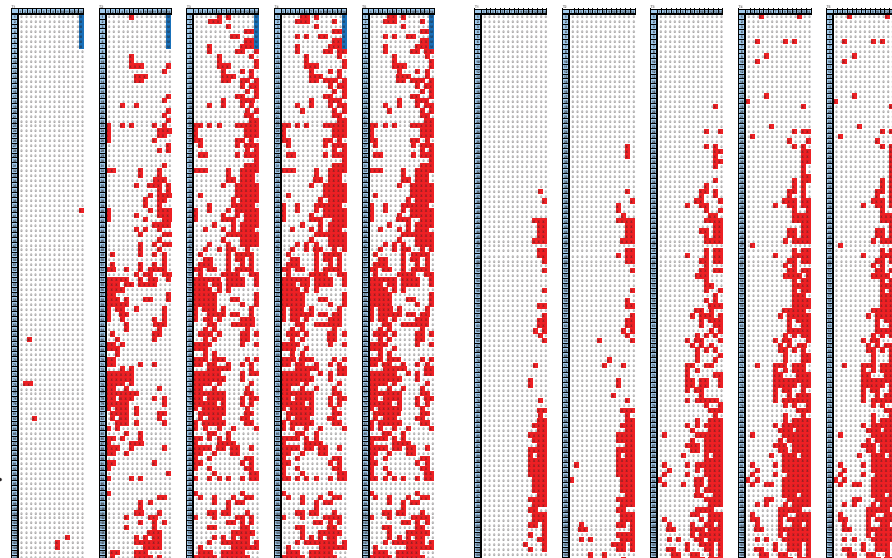


Figure 2. Spatial pattern maps for two commercial citrus blocks showing the first 5 assessments over a 2-yr period. Trees were assessed visually. Red dots indicate the spatial position of HLB + trees.

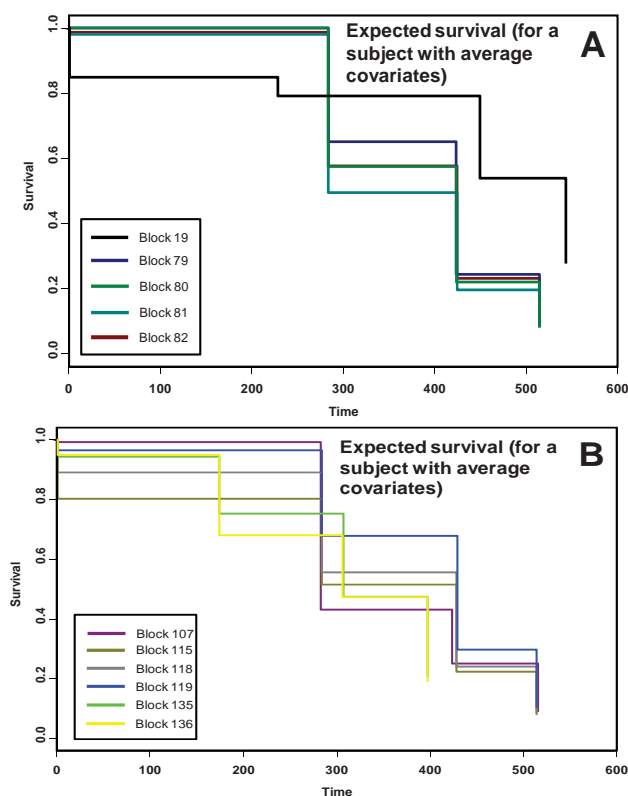


Figure 3. Survival graphs describing plants remaining in a non-symptomatic state within individual 2.5 ha blocks of commercial citrus. Time is in days.

asymptomatic tree in the block. This second approach allowed us to examine the influence or

Survival analyses of the blocks individually agree with the characteristics of disease progress presented above. Survival of trees in the HLB-free condition as estimated by the Kaplan-Meier model with average covariates, decreased with time as expected (Figure 3). This model takes into account distance as well as time on survival. The range of survival within individual blocks varied as expected and fell below 50% within 310 to 550 da ( $x=420$  da). The temporal difference in survival

corresponds well to the difference in initial onset of HLB infection within each block.

The second objective of this study was to examine the effect of a prior infection of HLB within a tree or trees within the surrounding area on subsequent infection of a HLB-symptomless tree. This was done by first looking at the effect of all HLB-symptomatic trees from previous assessment periods within a given distance on the survival (remaining in a HLB-asymptomatic state) of each remaining asymptomatic tree in the block. Secondly, survival was further examined as the effect of all HLB-symptomatic trees from previous assessment periods within a given annulus of distance on the survival of each remaining

“hazard” of prior HLB-symptomatic trees over a range of distances from each asymptomatic tree on their probability of each asymptomatic tree remaining asymptomatic. Examination of the survival characteristics of trees due to surrounding trees within various radii of asymptomatic trees, show that there is very little influence of increasing the radii, that is, all of the graphs are very similar (Figure 4, A and B). These graphs are also very similar to the individual nonparametric Kaplan-Meier curves for each block (Figure 3). Thus it appears that there is very little additional influence in survival that can be attributed to nearby trees and there is no difference among radii tested. Similarly, the same trend was seen for the influence of HLB-positive trees located within various concentric annuli from asymptomatic trees on survival (Figure 4, C and D). These annuli survival graphs are also very similar to the individual nonparametric Kaplan-Meier curves for each block (Figure 3). Therefore, no additional influence in survival could be attributed to nearby trees within concentric annuli and there was no difference among annuli tested.

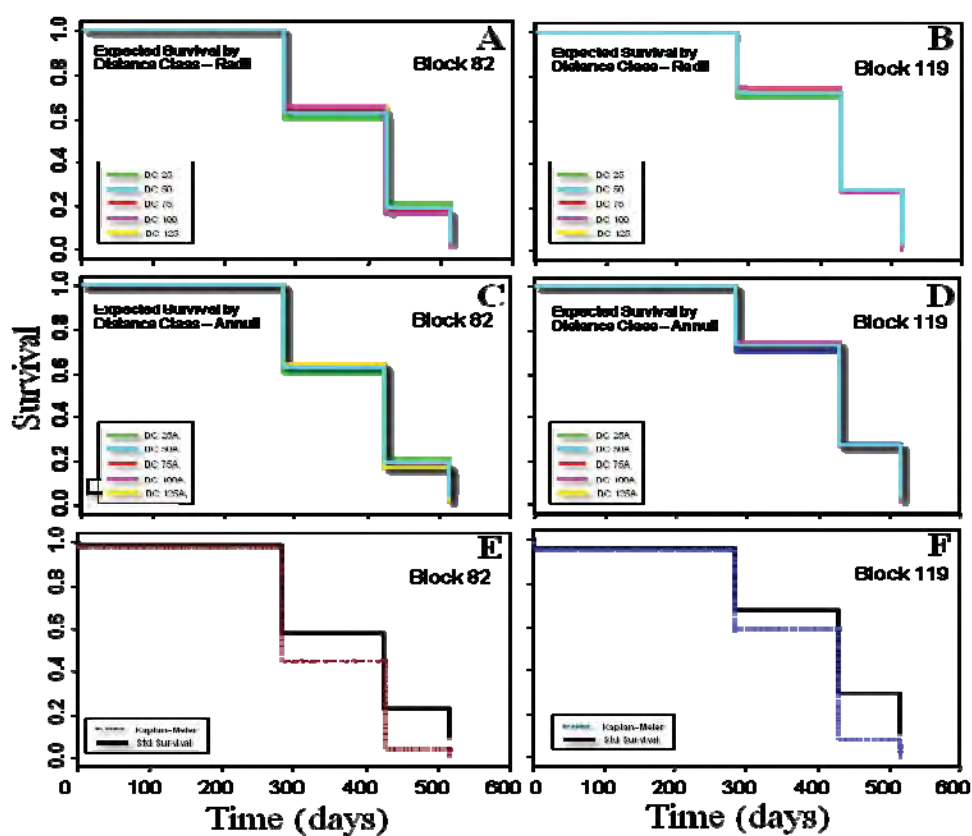


Figure 4. Survival graphs for two commercial citrus blocks of 2.4 ha, showing the probability of asymptomatic trees remaining asymptomatic (i.e., survival) based on the influence or ‘hazard’ imposed by HLB-positive trees within defined A, B) radii or C, D) annuli from each asymptomatic tree. E, F) Standard survival model with covariates of *time* and *distance* considered, and Kaplan-Meier nonparametric model with *time* only as a variable considered.

lack of such influences seen for HLB suggests quite different spatial processes at work. HLB is known to spread regionally. In another paper in this proceedings, the spatiotemporal influence of

These findings differ sharply from those found for other citrus and prunus pathosystems (2,4). For Citrus Tristeza Virus (CTV) and Plum Pox virus (PPV), both vectored by aphid species, there was a marked influence, i.e., “hazard”, of diseased trees within the immediate vicinity on the continued health “survival” of asymptomatic trees. For CTV, this influence was pronounced within 32 m of non-infected trees and incremental radii and concentric annuli could be seen to contribute significantly and differently. The

psyllid transmissions were examined by stochastic Markov-Chain Monte Carlo modeling (3). In that study, for HLB, the influence of ‘primary’ infections from outside of the blocks was the overwhelming influence on the spatiotemporal increase and spread of the disease. Only on rare occasions was it possible to distinguish the influence of ‘secondary’ spread from within the block. This demonstrates the regional aspects to HLB increase and spread and the difficulty of establishing or seeing appreciable influence of nearby Las-infected trees. This same characteristic of HLB epidemics is demonstrated in Figure 4. The survival graphs for the range of various radii and annuli tested are not appreciably different (Figure 4 A-C). The radii and annuli survival graphs are also not appreciably different from the Kaplan-Meier expected survival curves, demonstrating a lack of influence of HLB-symptomatic plants within the immediate area. The radii and annuli survival graphs also do not appreciably differ from the Kaplan-Meier nonparametric survival curves. The Kaplan-Meier nonparametric survival analysis does not consider distance as a variable. Thus the influence of ‘distance’ from prior symptomatic trees in the near vicinity or even within the block in general does not contribute greatly to ‘survival’, i.e., the probability of remaining disease free. Thus this study confirms that the overarching influence in HLB epidemics is the migration and transmission of Las via psyllids from outside the block, i.e., the influence of primary spread. It also indicates that attempting to control HLB locally is probably futile. Significant control will likely only be achieved from regional disease management strategies.

**Literature Cited:**

- Cantor AB. 2003. SAS Survival analysis techniques for medical research. 2nd Edition. SAS Institute, Cary, NC.
- Dallot S, Gottwald TR, Labonne G, Quiot JB. 2004. Factors affecting the Spread of Plum Pox Virus Strain M in Peach Orchards Submitted to Roguing in Southern France. *Phytopathology* 94:1390-1398.
- Gottwald T, Taylor E, Irely M, Gast T, Bergamin-Filho A, Bassanezi R, Gilligan CA, Parnell S. 2008. A stochastic spatiotemporal analysis of the contribution of primary versus secondary spread of HLB. Proceedings of the International Research Conference on Huanglongbing, Orlando, Florida, USA. 10.3, 6 pp.
- Gottwald TR, Taylor EL. 2005. Using survival analysis to predict the risk of infection in a citrus tristeza virus epidemic. *Proc. International Org. Citrus Virol.* p. 101-111.
- Hosmer DW, Lemeshow S. 1999. *Applied survival analysis: Regression modelling of time to event data.* 386pp. John Wiley and Sons, New York, NY.
- Scherm H, Ojiambo P. 2004. Applications of survival analysis in botanical epidemiology. *Phytopathology* 94:1022-1026.

## 10.4 Use of mathematical models to inform control of an emerging epidemic

Gilligan C.A.<sup>1</sup>, Cunniffe N.J.<sup>1</sup>, Cook A.R.<sup>1,2</sup>, DeSimone R.E.<sup>1</sup> and Gottwald T.R.<sup>3</sup>

<sup>1</sup>Epidemiology and Modelling Group Cambridge, Dept Plant Sciences, University of Cambridge, Downing Street, Cambridge, CB2 3EA, U.K.

<sup>2</sup>Current Address Department of Statistics and Applied Probability, National University of Singapore, Singapore 117546.

<sup>3</sup>U.S. Dept. of Agriculture, Agricultural Research Service, U.S. Horticultural Research Laboratory, 2001 South Rock Road, Fort Pierce, FL 34945, USA.

When confronted with a new disease and the risk of an emerging epidemic, mathematics is not perhaps the first science called upon by policy makers and pathologists. Yet, if we are to predict the future course of disease and to compare the effectiveness of different control strategies, an epidemiological model informed by biological and economic insights is an essential tool in the armoury (Gilligan 2008). Finding an appropriate model is an exercise in compromise between what we think we ought to know, what is measurable or can be reasonably estimated, and what is necessary to predict the future dynamics of epidemics, with and without control (Gilligan 2008). Here we draw upon recent work by ourselves and our collaborators in analysing the regional spread of rhizomania disease in the UK, sudden oak death in California, cassava mosaic disease in Africa and especially citrus canker disease in urban populations in Florida (Gilligan & van den Bosch 2008). Our intention is to show that a relatively simple epidemic model can allow policy makers and pathologists to examine a range of ‘what if scenarios’.

By simple epidemic model we mean a model with as few parameters and variables as possible. We begin by considering the variables: the plant, i.e. the tree, is the unit of interest. We consider initially just three classes:

- Susceptible trees (*S*): a tree starts off as healthy but susceptible to infection;
- Infectious trees (*I*): are both infected and capable of infecting other trees;
- Removed trees (*R*): comprise trees that die or are removed.

Other classes can be added, of which the most important is cryptically infected trees, in which the tree is both infected and infectious but may not be showing visible or detectable symptoms. Failure to allow for this can seriously under-estimate the spread of infection and disease, and undermine control efforts. An example is shown in Fig. 1 for Rhizomania disease of sugar beet spreading in the UK. Other refinements allow for changes in infectivity with host age.

There are three basic processes that control epidemics. These are:

- dispersal (how far can inoculum disperse?); it is characterised by a dispersal kernel with one or more dispersal parameters ( $\alpha$ );
- transmission (what is the chance of infection when inoculum contacts a susceptible host?); it is characterised by transmission rates which may distinguish primary transmission ( $\epsilon$ ) for inoculum introduced from outside a region of interest and secondary transmission ( $\beta$ ) for tree to tree spread within a region of interest;
- duration of infectiousness (when does the host stop transmitting infection?); it is characterised by an infectious period which may be natural or control-induced ( $1/\mu$ ).



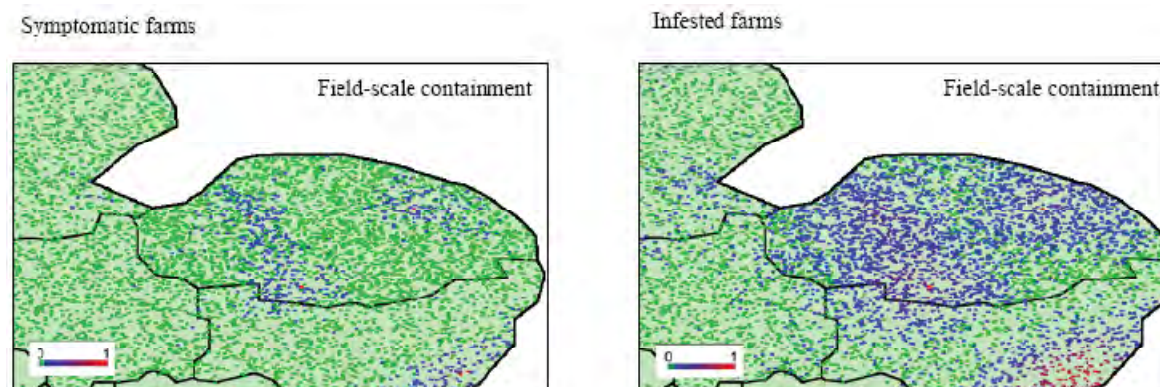


Fig. 1 Rhizomania disease of sugar-beet in the UK was believed to be localised in three sites in Eastern England. A stochastic (i.e. probabilistic) model, which allowed for cryptic infection (Gilligan et al. 2007), clearly showed that many more farms were infested (compare right with left panels) than had previously been assumed in devising field-scale control strategies. Within the model, individual fields rather than individual plants were classified as susceptible, infested/symptomatic and infested/asymptomatic (i.e. cryptically infested). The intensity of blue–red shading indicates the chance of a site being in a particular state ranging from blue (negligible) to red (highly likely).

Deriving estimates for the epidemiological parameters is one of the most challenging aspects of disease prediction. Recent work on the spread of citrus canker in urban Miami using data from Gottwald et al. (2002) has shown how Bayesian statistical methods can be used to estimate epidemiological parameters from spatio-temporal maps for the spread of disease (Cook et al. 2008; Gilligan et al. 2009). The method essentially furnishes ‘best guesses’ for the values of the epidemiological parameters. These are presented in the form of posterior probability distributions (Fig. 2) that formalise the degree of belief for parameters taking a particular value. An example is given in Fig 2 for one site in Broward county in which parameters are estimated, first with just the first three approximately monthly maps of infected and healthy trees, and then for successively more trees. We considered three parameters, the dispersal kernel ( $\alpha$ , under an assumption of exponential spread, although others were considered), the rate of secondary (tree-to-tree) transmission ( $\beta$ ) and the rate of primary transmission ( $\epsilon$ ) from external sources of inoculum. Trees were considered to remain infectious for long periods during the course of the observations.

Several important results emerge. Early predictions of the parameter values, especially of  $\alpha$  and  $\beta$ , are imprecise with very wide posterior distributions. Basing a control strategy on these estimates could lead to a lot of uncertainty. Waiting a little longer, albeit at the risk of the pathogen spreading further, provides more precise estimates for the parameters upon which to base control strategies. We note too that while  $\alpha$  and  $\epsilon$  are more or less constant after the first few observation times,  $\beta$  varies with time, becoming smaller with time. It is probable that this relates to changes in environmental conditions and the onset of a long period of dry conditions (Gottwald et al. 2002).

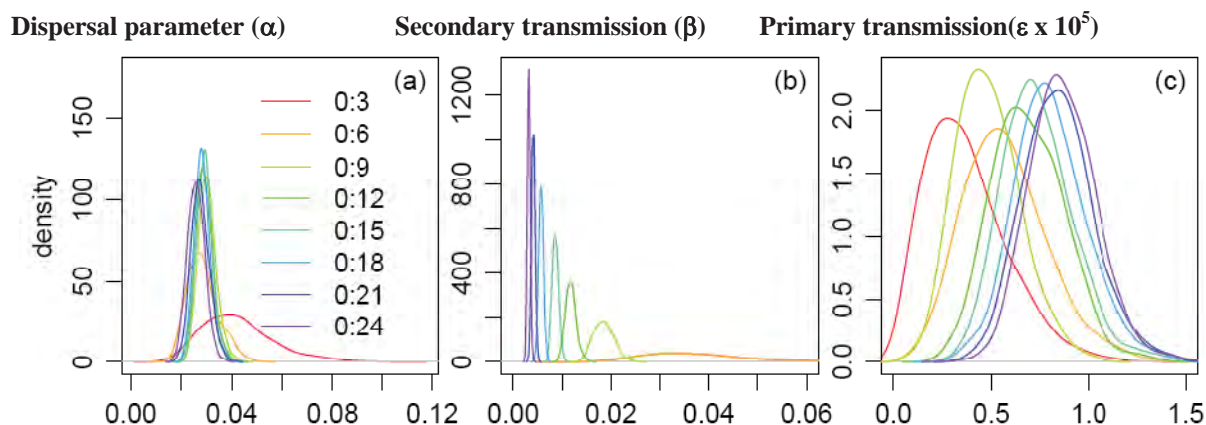
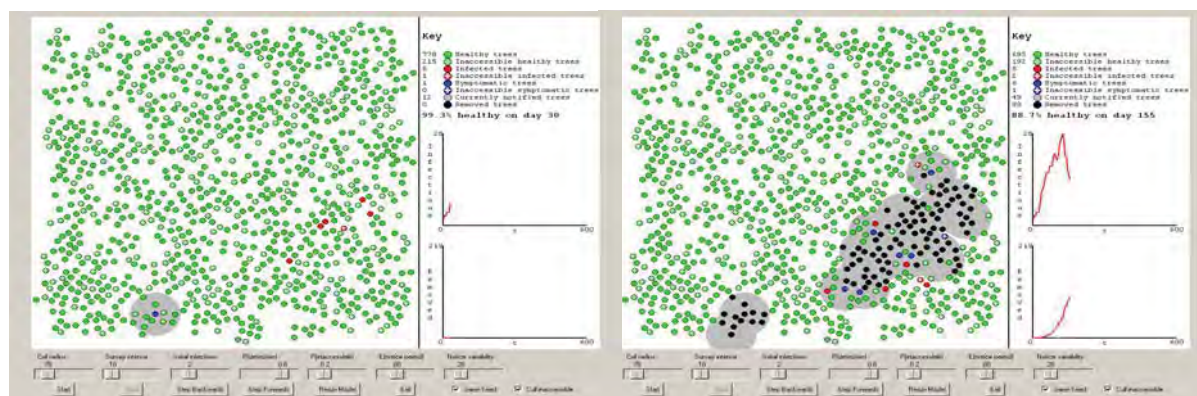


Fig. 2 Best guesses in the form of posterior probability distributions for (a) an exponential dispersal parameter ( $\alpha$ ); (b) the secondary transmission rate ( $\beta$ ) and (c) the rate of primary external transmission ( $\epsilon \times 10^5$ ) for the spread of citrus canker on trees in Broward County based upon cumulative windows taking account of successively more observations over time (Gilligan et al. 2009).

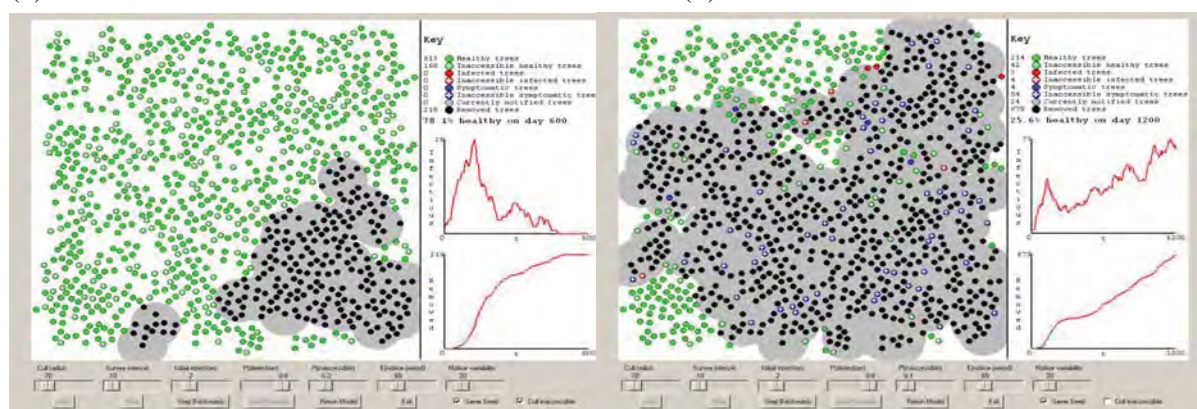
How can these parameter estimates be used to analyse control strategies? We consider an epidemic, such as for citrus canker, in which control is effected by removal of all trees around a symptomatic tree. Extending the zone of removal around an infected tree seeks to cull cryptically-infected trees that are not yet showing symptoms but which are capable of spreading infection. The challenge is to remove as few trees as possible while bringing the epidemic under control as swiftly as possible. In epidemiological terms this involves matching the scales of control with the inherent spatial and temporal scales of the epidemic (Dybiec et al. 2004). Two control variables may be changed, the radius of removal and the frequency with which sites are revisited to check for infected trees that were missed during previous visits. Individual epidemics are simulated for disease spreading on known densities of susceptible hosts and the effects of different strategies for removal radius and frequency of revisit can be compared. Two approaches are followed in the choice of parameters: either the median (most likely) parameters are chosen or the simulations are repeated many times, each time sampling parameter values from the entire posterior distributions to allow for uncertainty in what the true parameters might be. Chance variation is also incorporated into the models to reflect natural variation in the probability of transmission.

A simple example of a simulation is given in Fig 3 in which the sequence of control centred on notification of trees for removal around a symptomatic tree is illustrated with continuing spread of infection and disease from infected but undetected trees. As removal of trees proceeds, the spatial and temporal scale of control just manages to match the inherent temporal and spatial scales of the epidemic and eventually the epidemic is brought under control (Fig 3c). Strikingly, however, a small proportion of infected trees that escape removal could, in this simulated example negate the control strategy (Fig. 3d). Note too that while the underlying epidemic is captured by a relatively simple model, numerous additional practical considerations can be introduced. These include a variable detection rate, denoted by  $P(\text{detection})$ , whereby inspectors miss symptomatic trees, and allowance proportion of trees that are inaccessible, to detect,  $P(\text{inaccessible})$  or to remove.

(b)



(c)



(d)

Fig. 3 Example of output from single replications of a stochastic model for spread of infection through a population of susceptible trees in an urban environment subjected to a specified culling radius and survey (revisit). The data are used for illustration and control parameters are in arbitrary units. The model is easily adjusted for plantations. (a) Early stage epidemic. Trees are notified for removal (grey culling radius) following detection of a single symptomatic (blue) tree. Other infected trees (red) remain undetected to the north west of the detected site. (b) The epidemic continues to spread and more trees are notified for culling (grey circles). Note that there are still some infected (red) trees outside the notified zones for culling. Within the culling zones, trees are removed after a variable notice period to allow for logistical and legal delays between notification and removal. (c) Eventually by matching the scales of the control strategy with the epidemic scales, the epidemic is eradicated. (d) A small proportion infected trees escaping culling can have devastating effects upon the eradication scheme with the epidemic still spreading after 1200d.

Of course, a single simulation, although illustrative, is not sufficient to determine the selection of a single control strategy amongst competing alternatives. It is of much more importance to consider the probability distributions for the outcomes for control strategies based upon large numbers of simulated epidemics. An example for the distribution of the numbers of trees removed from an urban site is given for different culling radii and a fixed survey interval in Fig. 4. Whereas increasing the culling radius predictably shifts the distribution, it is striking to note that some treatments (cf 100m) are associated with remarkably wide distributions of outcomes. It follows that although, on average, a treatment may be successful in containing an epidemic with

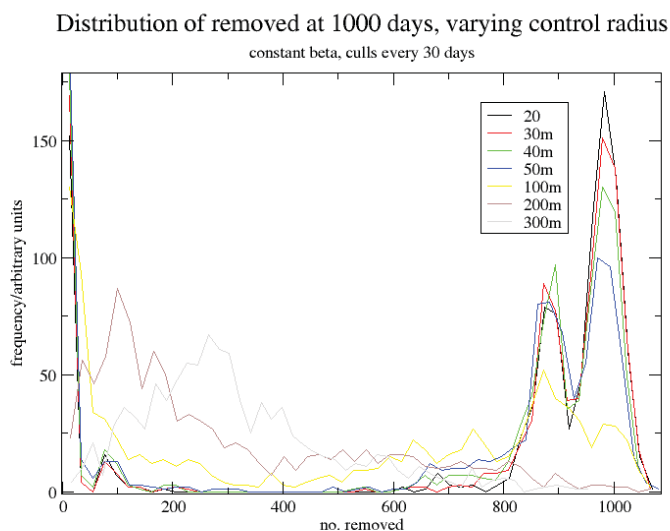


Fig. 4 An example of the distribution of the numbers of trees removed from an urban site for different culling radii and a fixed survey interval. Note that these data were simulated to analyse simple treatments for which the model assumed instant removal of notified trees.

### Acknowledgements

The authors gratefully acknowledge support from the UK Biotechnology and Biological Sciences Research Council, the UK Department of Food and Rural Affairs and the United States Department of Agriculture Cooperative agreement no 58-6618-3-169F.

### Selected references

- Cook AR, Gibson GJ, Gottwald TR, Gilligan CA. 2008 Constructing the effect of alternative intervention strategies on historic epidemics. *Journal of the Royal Statistical Society Interface* **5**, 1203-1213.
- Dybiec B, Kleczkowski A, Gilligan CA. 2004 Controlling disease spread on networks with incomplete knowledge. *Physical Reviews Series E* **70**, 066145.
- Gilligan CA. 2008 Sustainable agriculture and plant diseases: an epidemiological perspective. *Philosophical Transactions of the Royal Society Series B- Biological Sciences* **363**, 741-759.
- Gilligan CA, Cook AR, Jamieson LE, Gibson GJ, Gottwald TR. 2009 Bayesian analysis of an emerging epidemic: citrus canker in urban Miami. (in draft).
- Gilligan CA, Truscott JE, Stacey AJ. 2007 Impact of scale on the effectiveness of disease control strategies for epidemics with cryptic infection in a dynamical landscape: an example for a crop disease. *Journal of the Royal Society Interface* **16**, 925-934.
- Gilligan CA, van den Bosch F. 2008 Epidemiological models for invasion and persistence of pathogens. *Annual Review of Phytopathology* **46**, 385-418.
- Gottwald TR, Sun X, Riley T, Graham JH, Ferrandino F, Taylor EL. 2002 Geo-referenced spatiotemporal analysis of the urban citrus canker epidemic in Florida. *Phytopathology* **92**, 361-377.

relatively small numbers of trees, a stochastic model allows us also to assess the risks and likely costs of failure as well as success. Deciding how to identify an optimal strategy, often requires weighting of several variables, typically the total costs of control but also the duration of the epidemic. This is an area of current research and some approaches will be discussed in the presentation.

## 10.5 An approach to model the impact of Huanglongbing on citrus yield

Bassanezi R.B.<sup>1</sup>, Bassanezi R.C.<sup>2</sup>

<sup>1</sup>Fundecitrus, Araraquara, Brazil; <sup>2</sup>CMCC/Universidade Federal do ABC, Santo Andre, Brazil.

Citrus huanglongbing (HLB) is the most serious disease of citrus worldwide because once a tree is infected there is no cure and its yield is greatly compromised while the disease spreads all over the grove. Where HLB becomes endemic and there is no effective control, the disease progress in the orchard as well as the evolution of symptom severity throughout the tree canopy can be relatively fast, greatly reducing the economic life of affected orchards (1,11). In many countries where HLB is present, it becomes a limiting factor for citrus production. Even knowing that, it has been difficult to convince citrus farmers and regulatory agencies to take part in global HLB management programs, because HLB management is based on elimination of diseased trees and reduction of vector population demands continuous efforts and is costly. Thus, the aim of this work is to better characterize the importance of the disease and the impact of absence of any control on expected yield of affected orchards through a simple model that takes into account the disease incidence progress, disease severity progress and disease severity-fruit yield relationship according to the age of trees at first symptom onset.

The approach was to estimate the incidence of symptomatic trees ( $y$ ) and the disease severity on each symptomatic tree ( $s$ ) every year. For that, we assumed that in younger blocks, the disease incidence and severity progress is faster than in older ones. The factors that supported this were: i) more frequent and intensive new shoots in younger trees attract a higher population of HLB psyllid vector that allows higher infection rates; ii) small canopy size leads to relative higher initial severity of symptoms and faster distribution of the pathogen into the tree.

The HLB incidence progress curves have been well described by Gompertz model [ $y = \exp(-(-\ln(y_0)).\exp(-r_G.t))$ ] (9), where  $y$  is the proportion of symptomatic trees at time  $t$  (years),  $y_0$  is the proportion of symptomatic trees at the first appearance of symptomatic trees, and  $r_G$  is the annual rate of disease incidence progress. Based on literature (3,5-9) and field observations of the disease progress without control, a different value of  $r_G$  was used for each tree age class at the appearance of first symptomatic trees. The  $r_G$  values considered for 0-2, 3-5, 6-10 and >10 years old affected groves were respectively 1.300, 0.650, 0.325 and 0.244. According to this, the disease incidence reaches 50% ( $y = 0.5$ ) in less than two years after the appearance of first symptomatic trees in 0-2 years old block, and in about ten years after the appearance of first symptomatic trees in blocks older than ten years (Figure 1).

Despite there are only comments (1,2,10-12) but no multi years assessments describing the progress of HLB severity in an affected tree, we decided to use the Logistic model [ $s = 1/(1+((1/s_0)-1).\exp((-r_L.t)))$ ], where  $s$  is the proportion of HLB symptomatic area of tree canopy at time  $t$  (years),  $s_0$  is the proportion of HLB symptomatic canopy area at the onset of first symptoms in the tree, and  $r_L$  is the annual rate of disease severity progress in affected tree. Values of  $r_L$  and  $s_0$  were empiric guesses from field observation in Sao Paulo. The considered  $s_0$  values were respectively 0.2, 0.1, 0.05 and 0.025 for trees which the first symptoms appeared when they were 0-2, 3-5, 6-10 and >10 years old. The  $r_L$  values considered were 3.68 for 0-2 years old trees; 1.84 for 3-5 years old trees; 0.92 for 6-10 years old trees; and 0.69 for trees older than 10 years. According to this, for trees which the first symptoms onset occurred when they were 0-2 years old it takes about two years for the HLB severity to reach 100% ( $s = 1.0$ ), while

this time is about 12 years for trees which the first symptoms onset occurred when they were older than 10 years (Figure 2).

Then, the disease incidence and severity estimated for every year were used to estimate the total disease severity in the affected citrus block ( $S$ ) every year by a discrete model (equation 1).

$$(1) \quad S_n = \sum_{j=0}^{j=n} (y_j - y_{j-1}) s_{n-j}$$

After that, the estimated  $S$  was used in the negative exponential model (equation 2), that describes the relationship between disease severity-fruit yield, to estimate the relative yield of the affected citrus block compared to yield of healthy citrus block ( $RY$ ) (4). Equation 2 was fitted for data from 12 4-6 years old citrus blocks of 'Hamlin', 'Westin', 'Pera' and 'Valencia' sweet oranges. According to this equation, a citrus block with  $S = 0.2$  (20%) produce 65% ( $RY = 0.65$ ) that would produce the same block completely healthy (Figure 3).

$$(2) \quad RY = \exp(-1.8 \cdot S)$$

With this simple approach we could estimate  $RY$  in citrus blocks without any HLB control measures for each year depending on the age of citrus trees at the moment of HLB symptoms onset. Multiplying the estimated  $RY$  by expected yield of healthy groves for each year it was possible to estimate the impact of HLB on yield under no disease control. In Figure 4, using the average yield curve from Sao Paulo citrus belt, it was clear that, without adoption of HLB control, citrus blocks infected up to five years old would have great yield reduction about two to four years after the onset of first symptomatic trees. However, for citrus blocks infected at older age the yield reduction would be significant after five to ten years after the first symptomatic tree appearance. This results clearly show why it is so difficult to convince growers with infected older citrus trees to eliminate them immediately after detection, but also show that with no accomplishment of HLB control measures it will be very hard to grow economically sustainable new young citrus groves. With the increase of knowledge about the disease incidence and severity progress in different situations, models and parameters (rates, initial inoculums, initial severities for each age and cultivar) used in this simple approach could be changed and used to simulate the impact of HLB with more precision and accuracy.

This project has been partially supported by Fundecitrus and Fapesp (Project 2007/55013-9).

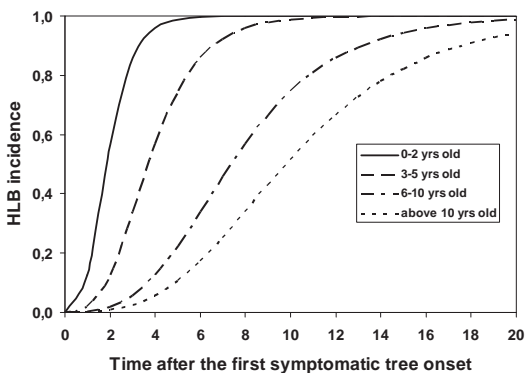


Fig.1. Estimated HLB incidence progress curves (proportion of symptomatic trees) as function of the age of trees when the first symptomatic trees appearance in citrus groves without any control measures.

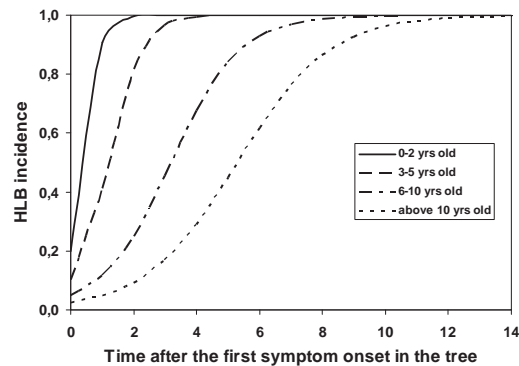


Fig.2. Estimated HLB severity curves (proportion of symptomatic canopy area) as function of the age of tree when the first symptom onset in trees without any control measures.

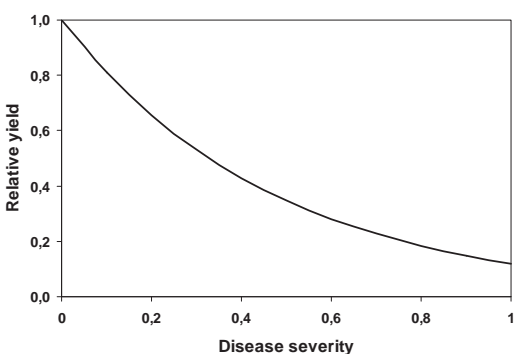


Fig.3. Relationship between disease severity (proportion of HLB symptomatic canopy area -  $S$ ) and the relative yield of the affected citrus grove compared to yield of healthy citrus grove ( $RY$ ) [4].

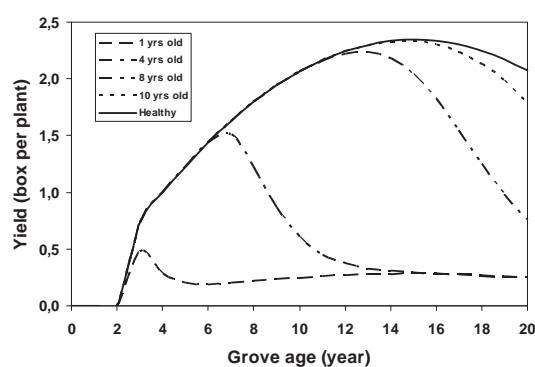


Fig.4. Expected yield curves for healthy citrus groves in Sao Paulo and for HLB infected groves without any disease control which the first HLB symptomatic trees appeared when they were 1, 4, 8 and 10 years old.

## References

- Aubert B. 1992. Citrus greening disease, a serious limiting factor for citriculture in Asia and Africa. Proc. Int. Soc. Citriculture, 817-820.
- Aubert B, Sabine A, Geslin P, Picardi L. 1984. Epidemiology of the greening disease in Reunion Island before and after the biological control of the African and Asian citrus psyllas. Proc. Int. Soc. Citricult. 1:440-442.
- Bassanezi RB, Bergamin Filho A, Amorim L, Gottwald TR. 2006. Epidemiology of Huanglongbing in São Paulo. Proc. Huanglongbing – Greening Int. Workshop, Ribeirão Preto, 37.
- Bassanezi RB, Montesino LH, Amorim L, Gasparoto MCG, Bergamin Filho A. 2008. Yield reduction caused by huanglongbing in different sweet orange cultivars in São Paulo, Brazil. Proc. International Research Conference on Huanglongbing, Orlando.
- Catling HD, Atkinson PR. 1974. Spread of greening by *Trioza erytreae* in Swaziland. Proc. 6th Conf. IOCV, Riverside, CA, 33-39.
- Gatineau F, Loc HT, Tuyen ND, Tuan TM, Hien NTD, Truc NTN. 2006. Effects of two insecticide practices on population dynamics of *Diaphorina citri* and huanglongbing incidence in south Vietnam. Proc. Huanglongbing – Greening Int. Workshop, Ribeirão Preto, 110.
- Gottwald TR, Aubert B, Huang KL. 1991. Spatial pattern analysis of citrus greening in Shantou, China. Proc. 11<sup>th</sup> I.O.C.V., 421-427.
- Gottwald TR, da Graça JV, Bassanezi RB. 2007a. Citrus Huanglongbing: The pathogen and its impact. Plant Health Progress doi: 10.1094/PHP-2007-0906-01-RV.
- Gottwald TR, Ireya M, Gast T, Parnell S, Taylor E, Hilf M. 2007b. Spatio-temporal analysis of an HLB epidemic in Florida and implications for future spread. In: Proc. 17<sup>th</sup> Conf. IOCV, Riverside, CA (*submitted*).
- Regmi C, Lama TK. 1987. Greening incidence and greening vector population dynamics in Pokhara. Proc. 10<sup>th</sup> IOCV Conference, Riverside, CA., 238-243.
- Roistacher CN. 1996. The economics of living with citrus diseases: huanglongbing (greening) in Thailand. Proc. 13<sup>th</sup> IOCV Conference, Riverside, CA., 279-285.
- Schwarz RE, Knorr LC, Prommintara. 1973. Presence of citrus greening and its psylla vector in Thailand. FAO Plant Prot. Bull. 21:132-138.



## 10.6 The Plantation Edge Effect of HLB – A Geostatistical Analysis.

<sup>1</sup>Gottwald T. <sup>2</sup>Irey M. and <sup>2</sup>Gast T.

<sup>1</sup>USDA, ARS, US Horticultural Research Laboratory, Fort Pierce, Florida, USA; <sup>2</sup>Southern Gardens Citrus, US Sugar Corp., Clewiston, Florida, USA.

When viewing maps of Huanglongbing (HLB) incidence on an areawide scale, it becomes apparent that HLB is aggregated not only within individual plots but across plots as well within regional areas. When entire plantations are examined, unique characteristics of the disease distribution become more visible. Especially during assessments of early incidence at the plantation scale, there appear to be accumulations of HLB-diseased trees in various areas within the plantation. At first examination, it appears that there is a higher incidence of HLB at the edges of the plantation. However, with continued visual scrutiny of the distribution pattern, the observer's eye is also drawn to apparent HLB-diseased tree accumulations associated with roads, canals, ponds, and other geographical features within the citrus plantation as well. Each of these features can be defined as an interface of some void of plant material immediately adjacent to areas with dense citrus planting. It is within the citrus planting immediately adjacent to these voids where a higher than expected number of HLB-diseased trees accumulate. It is this higher than expected accumulation that we describe as an "edge effect".

It is intuitively obvious that the spatial process behind edge effects is related to bacteriliferous psyllid transmission, and thus to psyllid movement and migration. As psyllid forage for new feeding sites, between and among plantations and individual blocks, they apparently preferentially accumulate at the interface or edges of plantings. This is not to say that they do not penetrate into plantings/blocks as well, but there is a higher than expected accumulation at the edge of this interface, indicating that a majority of the migrating psyllid population will alight within the first few trees that they come to at the edge of a planting or block. Therefore, the HLB-disease distribution is an indirect indicator of psyllid migration and foraging preferences and response. By understanding this edge effect, we might be able to take advantage of it for psyllid control/disease management strategies either by preferentially employing management strategies at the edges of plantings or using this information to design plantings with minimal edge-interfaces, to avoid/reduce infection. The goal of this study was to describe the edge effect in analytical terms such as disease gradients for various planting/void type interfaces, and use these descriptions to develop models and strategies for second generation plantation design.

### **Materials and Methods:**

Based on the commercial survey of trees with visual symptoms of HLB, the spatial pattern of HLB was determined over two large contiguous plantings of commercial citrus of 1,320 ha (SG) and 4,574 ha (DG) in South Florida. The area was completely surveyed via a 100% census of trees five times over a 2-year period. The commercial planting was a mixture of sweet orange cultivars but predominately Valencia and Hamlin on various rootstocks and composed of multiple blocks. Block size was 4 ha with 14 rows of 110-115 plants per row or ~1,500 trees/block. Incidence of HLB was assessed by visual inspection. The GPS location of each symptomatic tree and date when the symptoms were assessed were recorded on GIS-referenced maps of the plantation.

*Edge effects calculations* were accomplished by using ArcMAP to interrogate intensively mapped geo-referenced data sets. To examine the planting perimeter edge effect, concentric annuli were drawn within the total planting at 10 m increments (Fig. 1). The number of

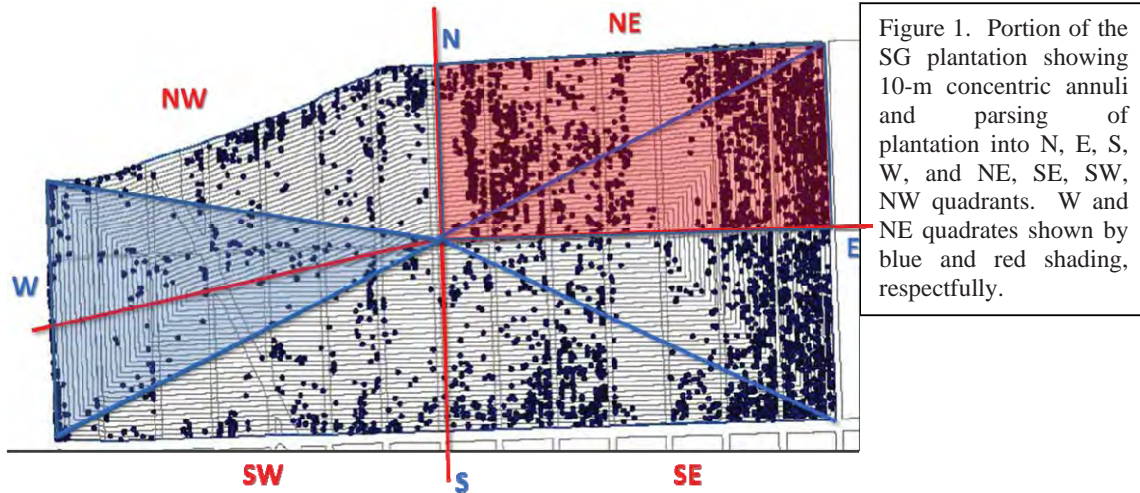


Figure 1. Portion of the SG plantation showing 10-m concentric annuli and parsing of plantation into N, E, S, W, and NE, SE, SW, NW quadrants. W and NE quadrates shown by blue and red shading, respectively.

HLB-positive trees/total trees within each annulus were quantified as a density function, i.e., No. HLB-infected trees/ha. To examine directionality, the plot was also parsed into N, E, S, W, and NE, SE, SW, NW quadrants and quantified (Fig. 1).

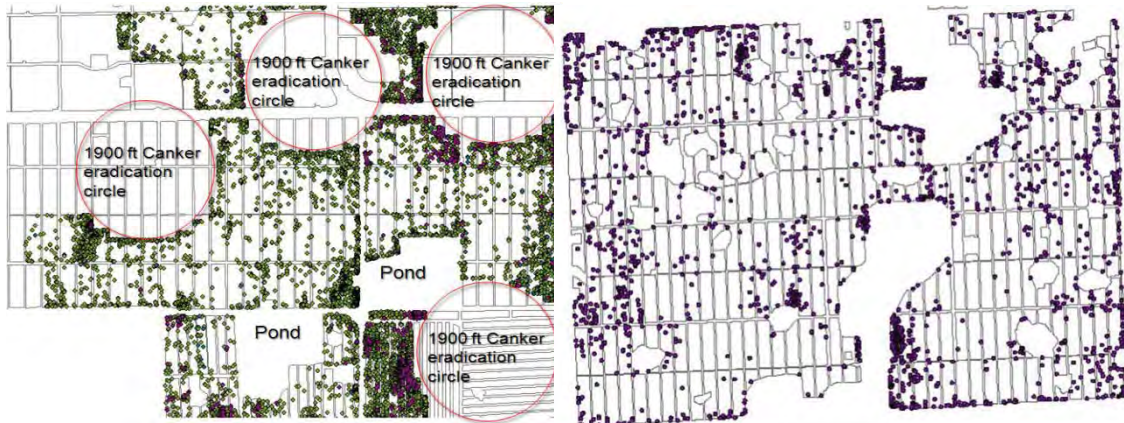


Figure 2. Demonstration of two additional plantations with perimeter edge effects. For the plantation to the right, note accumulation of HLB-positive trees in the plantation adjacent to voids caused by 1900-ft radius circles of tree removals to accomplish eradication of citrus canker.

**Results and conclusions:**

When the perimeter of the entire plantation was examined as a whole, there was a strong, decreasing curvilinear relationship with distance (Fig. 3). This was further examined as an

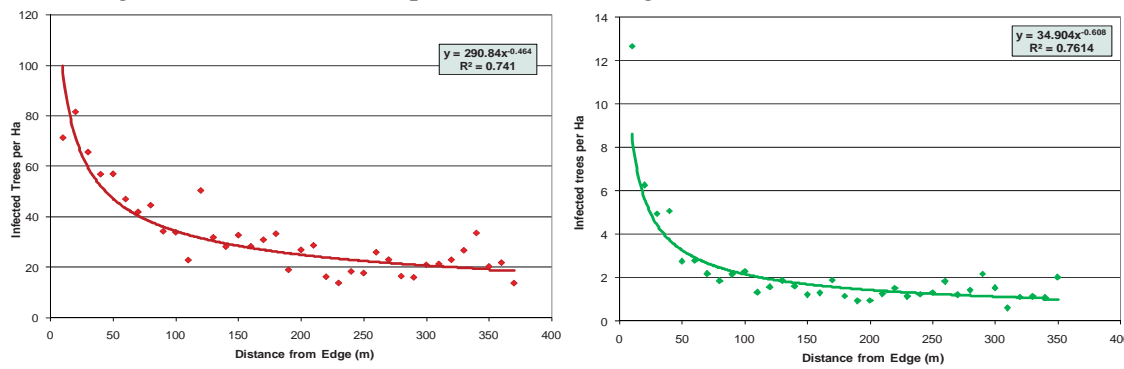


Figure 3. Perimeter edge effects of two commercial plantings in South Florida.

inverse power function (IPF), often used to describe disease gradients of other pathogens. The IPF demonstrated a rapid decrease in HLB incidence with distance indicating a significant perimeter edge effect. The plots were then broken into directional quadrants as described above. These were also fitted to either IPL or simple linear disease gradient functions where more appropriate when linear regression provided a better fit to the data than IPL (Fig. 4). These gradients were all significant but not always as strong as the the gradient of the entire perimeter. The gradients to the W and SW were better fit by an IPL and therefore show sharper drops in the edge effect in those directions, whereas, the gradients for the other directional quadrants were less consistent over distance. All demonstrated decreasing linear trends with distance (Fig. 4). The incidence of HLB across these gradients was higher in the N, E, NE and SE directions compared to the W, S, NW and SW directions, respectively. This provides evidence that the higher incidence of HLB-diseased tree accumulations were predominately expressed on the eastern perimeter, which is visually discernable in Figure 1. This is consistent with the initial accumulation of diseased trees on

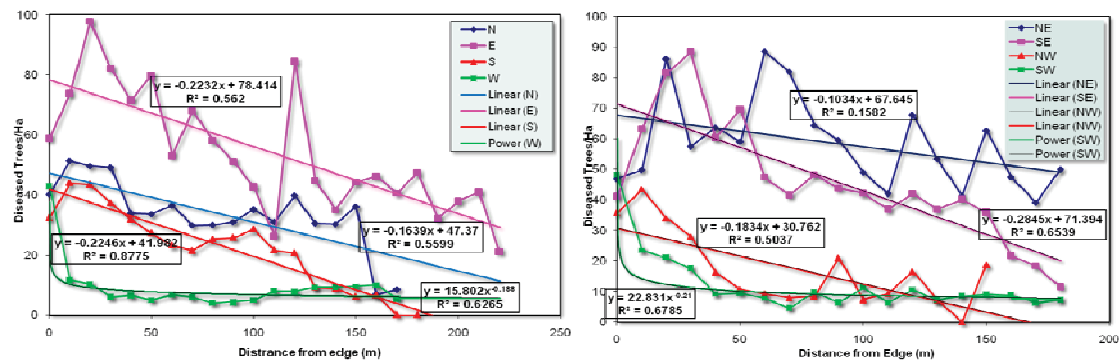


Figure 4. Directional disease gradients a large for a large commercial planting in south Florida demonstrating perimeter edge effects in all directions.

the eastern perimeter of the planting indicating migration of bacterialiferous psyllids from the east and south (Gottwald, et al. 2007).

The potential effect of internal planting roads and irrigation ditches was also examined (Fig. 5). The main road in the E-W direction gives primary access across the plantation. The first

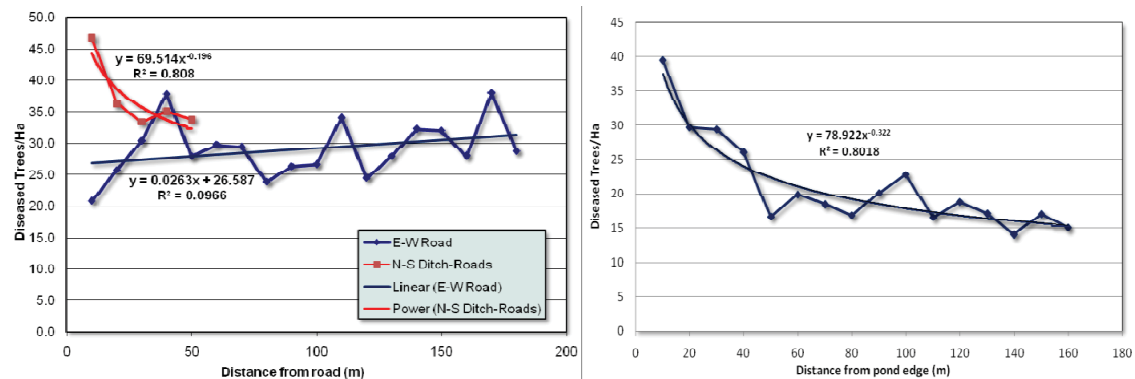


Figure 5. Edge effects of main road and ditch-roads (left panel) and ponds (right panel).

few trees on both sides of the road do not thrive as well as the majority of trees in the adjacent blocks because of the effects of the marl of the road. The block separations in the N-S direction are numerous and composed of an irrigation ditch bounded by two dirt roads, separating blocks by ca. 23 m (75 ft) and give access to individual blocks. These N-S ditch-roads had a very strong edge effect as seen by a good IPL model fit and a rapid decrease of

HLB trees from the N-S ditch-roads inward into the planting. The E-W road did not demonstrate any perceptible edge effect over distance. This may be indicative to the general migration pattern within the plantation from east to west, resulting in accumulation along the N-S voids cause by ditch-roads in that orientation. However, you can see a spike in HLB-diseased trees about 30-40 meters in from the edge. The may be due to the effects of the marl described above.

Table 1. The effects of various geographical features on the density of HLB-positive trees/ha.

Feature	Density
D DG perim	8.0
D SG perim	72.7
D N quadrant	47.3
D E quadrant	77.7
D S quadrant	39.2
D W quadrant	18.6
D N-E quadrant	59.7
D N-W quadrant	35.3
D S-E quadrant	67.8
D S-W quadrant	27.9
D N-S ditch-roads	32.1
D E-W road	NS
D Ponds	32.7

Multiple ponds within the planting were examined and the effect of decreasing density of HLB trees over distance from the voids created by ponds into the citrus plantings demonstrated a pronounced edge effect and were well fit by the IPL model as well (Fig. 5 right).

The relative density of HLB-infected trees within the first 30 meters from each of the interface/features examined for their edge effect are shown in Table 1. From this table, you can see that the density (*D*) of HLB-infected trees/ha was highest for the perimeter of the SG planting and for the eastern (E) and southern (SE) quadrants of the SG planting. Ponds and N-S roads also had a higher than expected density, but this was only about 40-42% of the density of the strongest perimeter density.

These results all provide evidence that the interface of the planting with zones of non-citrus at its perimeter as well as voids internal to the planting created by roads, canals, ponds

and other features all contribute to HLB epidemics as potential linear and/or curvilinear foci of disease, because HLB infections tend to accumulate in proportionally higher incidence at these interfaces. The shape and perimeter of citrus plantings are defined predominately by the land area available. However, there are opportunities to reduce the internal voids that accumulate HLB infections when new plantings are established by limiting internal voids created by planting infrastructure. Strategies to limit such voids in new plantings will be explored in future modeling exercises.

### Literature cited

- Gottwald TR, daGraça JV, Bassanezi RB. 2007. Citrus Huanglongbing: The pathogen, its epidemiology, and impact. *Plant Health Progress* doi:10.1094/PHP-2007-0906-01-RV.
- Irwin EG, Bockstael NE. 2007. The evolution of urban sprawl: Evidence of spatial heterogeneity and increasing land fragmentation. *Proc. Nat. Acad. Sci.* 104:20672-20677.
- Fernández, C., Acosta, F.J., Abellá, G., López, F. and Díaz, M. 2002. Complex edge effect fields as additive processes in patches of ecological systems. *Ecological Modeling* 149: 273-283.

## 10.7 Estimating the spatial distribution of Huanglongbing from a sample

**Parnell S.**<sup>1</sup>, Gottwald T.R.<sup>2</sup>, Irey M.S.<sup>3</sup>, and van den Bosch F.<sup>1</sup>

<sup>1</sup>Rothamsted Research, Harpenden, United Kingdom, AL5 2JQ; <sup>2</sup>USDA-ARS, Fort Pierce, Florida, 33495; <sup>3</sup>US Sugar Corporation, Clewiston, Florida, 33440.

The ability to accurately estimate the spatial distribution of plant disease is crucial for effective disease management. Resource constraints mean sampling cannot be done at every host location and so estimates must be made about disease incidence at unsampled locations. A key focus in plant pathology has been in the development of methods to estimate the mean incidence of disease in a given host population. Although much progress has been made in this area, these approaches provide no spatial information on disease incidence. Information on the spatial distribution of plant disease is essential in understanding disease epidemiology and facilitates the implementation of disease control policies. In plant pathology common solutions to this disease mapping problem have been taken from the field of geostatistics. Interpolation techniques (e.g. kriging) are employed to generate continuous statistical models from disease observations at point samples. However, these approaches do not incorporate the epidemiological processes and host heterogeneities which shape disease distribution. We use an iterative optimization approach which utilizes information on the underlying host distribution and on the spatial complexities in pathogen dispersal and infection to accurately map the probability of disease at unsampled host locations. The approach is pathogen generic but is especially relevant for diseases such as HLB which exhibit strong spatial dependencies. An example using observed data of HLB incidence in citrus plantations in Florida is presented.

## 10.8 Within-tree distribution of *Candidatus Liberibacter asiaticus*

<sup>1</sup>Gottwald T., <sup>2</sup>Parnell S., <sup>1</sup>Taylor E., <sup>1</sup>Poole K., <sup>1</sup>Hodge J., <sup>1</sup>Ford A., <sup>1</sup>Therrien L., <sup>1</sup>Mayo S. and <sup>3</sup>Irey M.

<sup>1</sup>USDA, ARS, US Horticultural Research Laboratory, Fort Pierce, Florida, USA; <sup>2</sup>Biomathematics and Bioinformatics, Rothamsted Research, Harpenden, UK, and <sup>3</sup>Southern Gardens Citrus, US Sugar Corp., Clewiston, Florida, USA.

### Introduction:

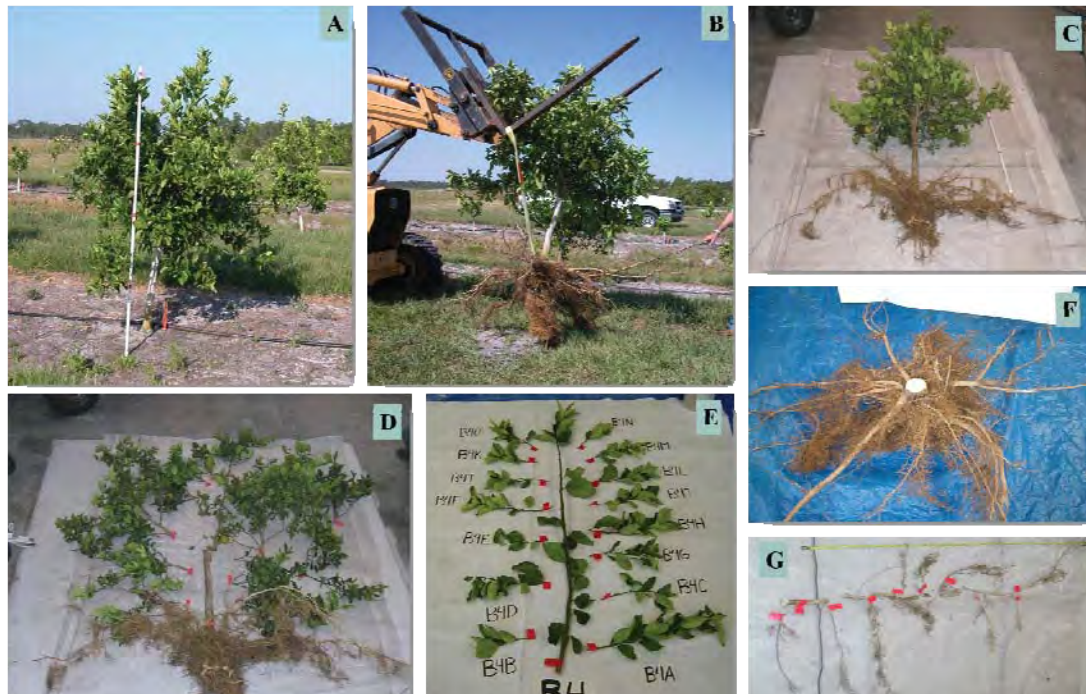
One characteristic of HLB infection that has not been intensely investigated is the within-tree distribution of *Candidatus Liberibacter asiaticus* (Las). Recently there have been some investigations of the distribution of Las in small greenhouse grown seedlings and grafted trees that have demonstrated incomplete to more systemic variability of bacterial distribution in the vascular system depending on duration of time post-infection when sampled, cultivar, and other horticultural aspects (W. Dawson, personal communication). However, the within-tree distribution of Las in field trees has been incompletely investigated due to the difficulty and complexity of doing so and the multitude of assays required. When a tree displays only minimal symptoms, it is unknown what other portions of the tree harbor the Las bacteria and if these other portions have sufficient titer to be transmissible by psyllid vectors. The goal of this study was to dissect minimally symptomatic field trees to gain an initial understanding of Las within-tree distribution and to attempt to quantitate this distribution where possible.

### Materials and methods:

Two Valencia citrus trees which were visually but minimally symptomatic for HLB were selected for PCR analysis. Both were expressing minimal initial HLB symptoms restricted to only one to two branch tips. Based on the PCR results, two trees (approximately 4 years old) were chosen for study. Analysis of leaf/petiole samples was performed via Applied Biosystems 7500 Real-time (RT) PCR using Li primers, probe and thermal cycling parameters (Li et al., 2006). Tree A (harvested November 2007 at 5 years of age) was selected because all initial leaf samples were considered positive via RT-PCR, while tree B (harvested April 2008 at 7 years of age) was selected because only 20% of its initial leaf samples tested positive. Each tree, including the root system, was removed and transported to a covered facility for dissection. Each tree was dissected over a 3-day period, during which time the individual tree sections were labeled, sketched, and photographed for reference purposes, and to allow for precise recording of branch distances and orientation with regard to one another. Beginning at the tree base, branches were removed from the trunk, consecutively numbered and stored at minus 20C. Segments within branches (named “nodes”) were dissected from the main and labeled, followed by their corresponding sub-branches (Figure 1). Representative samples from the branches and nodes consisted of 0.180g leaf vein and/or petiole tissue whenever possible. If no leaves were present on a segment, cambium was collected (0.180g). Thus all dissected pieces and the entire tree was assayed. The DNA was isolated using a modified SDS/ KOAc extraction method (De Paulo and Powell, 1995) and was analyzed as above via real-time PCR (using FAM/TAMRA chemistries with ROX dye as internal positive control). Based on the literature, cycle threshold (Ct) values of less than or equal to 30 were considered positive for the presence of HLB bacteria. (Li et al., 2006).

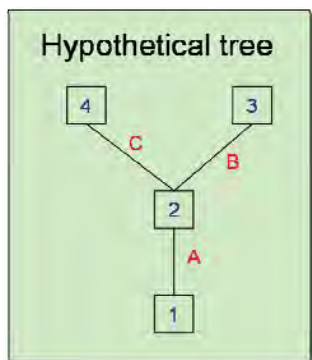
PCR data, section length, and node designations for each diseased aboveground and root piece were entered into a spreadsheet for analysis and a subsequent data file created. Analysis was performed via a C<sup>++</sup> computer program written specifically for the task by the

second author. The program was used to calculate vascular distances between PCR+ sections, by reconstructing the tree's vascular pathway utilizing unique node designations of



**Figure 1.** A) Valencia Tree B in the field, B) Tree after removing it from soil, C) Entire tree prepared for dissection, D) Initial dissection of above-ground portion, E) Individual scaffold branch dissected, F) root system, and G) individual root piece dissected.

each diseased piece (Figure 2). Frequency histograms of distances between all PCR HLB+ segments were then calculated. The algorithm assumes a priori knowledge of the physical tree structure which is acyclic. A deterministic search between a predefined 'start' and 'end' segment is performed. The search identifies the unique minimum path between the given segments which is fully determined by the connections



between all lower and upper nodes in the tree. The distance of the path travelled (i.e. the sum of the lengths of each segment in the path) is recorded and represents the vascular distance between the start and end segments. Frequency histograms of distances between all PCR HLB+ segments were then calculated.

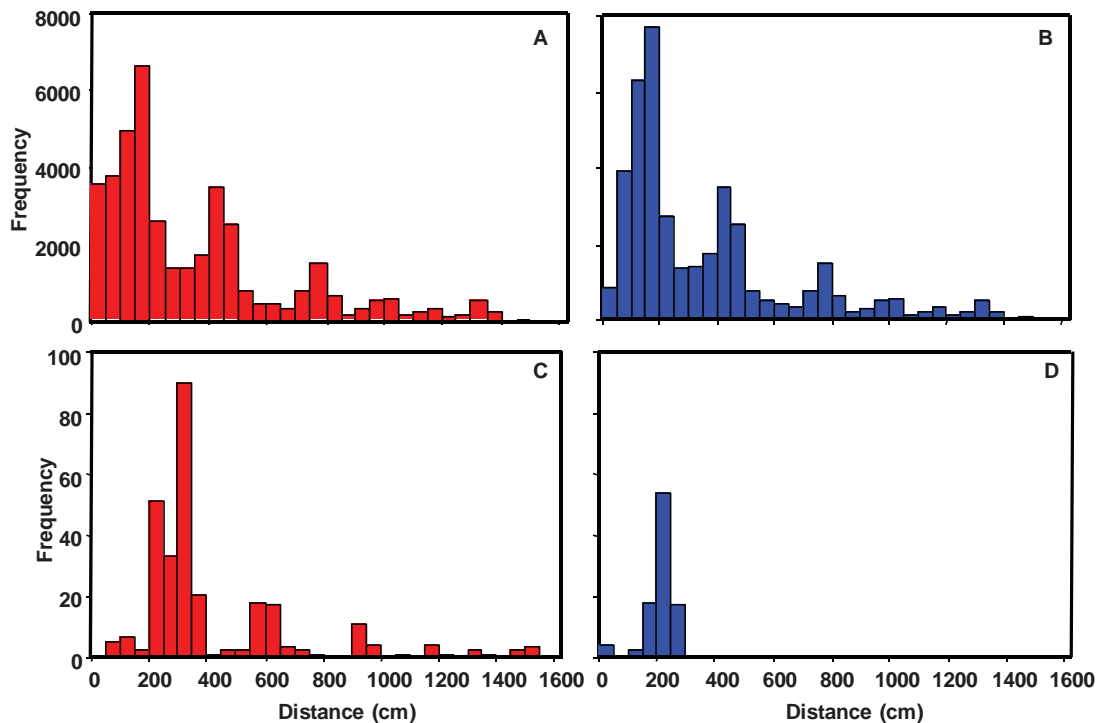
**Figure 2.** Diagrammatic representation of data matrix for identifying individual nodes and diseased tree sections used to reconstruct and analyze the tree's vascular system connections and Las distribution.

### Results and Conclusion:

For both field trees examined, only one branch displayed visual symptoms of HLB. However, for the aboveground portion of the tree, both the main scion trunk and the main rootstock trunk were both PCR-positive for Las. Of the main scaffold branches, greater than 76 percent had at least some portion that assayed as PCR-positive, i.e., at least one of the terminal branches or individual shoot pieces extending from the subtending main branch were PCR-positive. Of these main scaffold branches that were PCR-positive, Las detections via PCR were found in 5 to 100 percent of the population of distal sections. This range in the proportion of PCR-positive detections in main scaffold branches and distal branches and

shoot pieces is consistent with the often incomplete distribution of HLB symptoms seen in individual branches as disease symptoms develop. For the root systems, 26 percent of the main root scaffolds were also PCR-positive for Las. A lesser proportion of the distal root pieces extending from the main root scaffolds were PCR-positive compared to the aboveground distal pieces extending from the main scaffold scion branches, however, there was still a detectible population of 5-10 percent of the distal root pieces that tested PCR-positive for Las.

Quantitative analyses of the distribution of PCR-positive segments is shown in Figure 3. Only the analysis for the above-ground portion of the tree is shown. The results show the frequency distributions labeled that represent the frequency of occurrence of distance estimations between PCR-positive sections to the nearest 20cm. An intriguing aspect of these frequency distributions is that there are repeating peaks of approximately 200, 400, 800, 1000, 1200, and 1300 cm and these occur for both trees A and B (Figure 3 A, B). This



**Figure 3.** Tree A (A, C) and Tree B (B, D) – A and B) frequency of distances (cm) between all possible pairs of infected segments. C and D) frequency of distances (cm) between the tree base and all infected segments.

demonstrates repeating distances between PCR-positive portions of the tree and may point to slight zones of inhibition between areas of the phloem that are being colonized.

A second portion of the analysis generated frequency distributions for the distance from the base of the tree (ground level) to all above-ground PCR-positive segments (Figure 3 C, D). Although the graphs look quite different, it is because of a difference in the scale of the horizontal axis. Tree A had a peak from 200 to 400cm, whereas, Tree B had a similar peak corresponding to 200-250cm. Note also that the frequency peak related to Tree B is less extensive in magnitude and reflects a smaller number of PCR-positive segments in general near to the base of the tree. Obviously no two trees will have the exact same infection or distribution of bacteria and thus such differences in magnitude of frequency are expected.

An overall conclusion is that for trees that are displaying only very few HLB symptoms, there is still a widely detectible and systemic distribution of Las throughout the trees.



However, via PCR assay, this systemic infection is not necessarily complete. This was interpreted to indicate that it is likely that most portions of the tree have Las infection, i.e., the infection is completely or nearly completely systemic, but the bacterial titer in individual portions of the tree may be below the threshold of PCR detection. This also has implication for psyllid transmission. In trees with only few HLB symptoms, Las is still present in PCR detectable titer levels throughout much of the tree, and thus may be available to be acquired by psyllid vectors for additional transmission and spread. The transmission rate of Las from asymptomatic but PCR-positive citrus tissues continues to be a point of discussion by entomologists and vector biologists.

**Literature Cited:**

- De Paulo JJ, Powell CA. 1995. Extraction of double-stranded RNA from plant tissues without the use of organic solvents. *Plant Dis.* 79:246-248
- Gottwald TR, daGraça JV, Bassanezi RB. 2007. Citrus Huanglongbing: The pathogen, its epidemiology, and impact. *Plant Health Progress* doi:10.1094/PHP-2007-0906-01-RV.
- Li W, Hartung J, Levy L. 2006. Quantitative real-time PCR for detection and identification of *Candidatus* Liberibacter species associated with citrus Huanglongbing. *Journal of Microbiological Methods* 66:104-115

INTERNATIONAL RESEARCH CONFERENCE  
ON HUANGLONGBING



**Session 11:**  
**Psyllid Management**  
**Strategies**

Orlando, Florida



December 2008

### 11.1. Bioecology of *Diaphorina citri* and *Tamarixia radiata*: zoning for citrus groves of the State of São Paulo

Torres M.G.<sup>1</sup>, Parra J.R.P.<sup>1</sup>

<sup>1</sup>ESALQ/Universidade de São Paulo, Piracicaba, Brazil, jrpparra@esalq.usp.br

In Brazil, citrus is grown commercially in many states. The state of São Paulo is responsible for 79% of the country's yield. Consequently, Brazilian citriculture can be compromised by several phytosanitary problems, including native and introduced pests, which can be detrimental to domestic yield, affecting the industry's competitiveness at an international level. Since 2004, three new pathogens, *Candidatus Liberibacter americanus*, *Candidatus Liberibacter asiaticum*, and a phytoplasma have been detected in citrus orchards in the state of São Paulo; these bacteria are associated with the disease Huanglongbing. A combination between the presence of the psyllid vector, *Diaphorina citri*, and the pathogen in citrus-growing areas is a limiting factor for production, as recorded in other countries. The parasitoid *Tamarixia radiata* is the most important biological control agent against *D. citri*. Successful releases of *T. radiata* have been reported in many countries. The parasitoid provides high parasitism rates, and has high dispersal and establishment capacity in the field. Models to predict the occurrence of insects are prepared based on the insect's temperature requirements for development. In most zoning studies, temperature is the main factor involved. Modeling results provide a better understanding of the population dynamics of insect pests and their natural enemies in agricultural systems which can be applied in pest management programs to determine the most adequate season to conduct sampling and implement control measures. In the laboratory, *D. citri* requires 210.9 degree-days (DD) to complete its biological cycle (egg-adult). Although these values are determined under controlled temperature, humidity, and photoperiod conditions, they need to be demonstrated under field conditions where variable environmental conditions occur. By adopting identical temperature ranges (isotherms) and analyzing their effect on *D. citri* and *T. radiata* development by means of a monthly map, in which the mean monthly temperatures from 256 weather stations were analyzed by multiple linear regression, we managed to obtain the progression and development for the pest and its parasitoid in the state of São Paulo. From the results obtained, 3 to 15 *D. citri* cycles and 19 to 35 *T. radiata* cycles occurred throughout the year in the state of São Paulo. Among the factors that influence the successful establishment and abundance of a biological control agent in an area after its release, temperature is important because it affects processes such as reproduction and development. Therefore, the objective of this study was to determine the ideal conditions for *D. citri* and *T. radiata* development under laboratory conditions, allowing evaluation of its effectiveness in citrus-growing regions of the state of São Paulo, in order to provide support to groups involved in *D. citri* detection, monitoring, and control.

## 11.2 Repellent effect of guava odor against adults of citrus psyllid, *Diaphorina citri*

Zaka SM, and Zeng XN

Key Laboratory of Natural Pesticide and Chemical Biology of the Ministry of Education, South China Agricultural University, Guangzhou, Guangdong 510642, People's Republic of China

The Asian citrus psyllid, *Diaphorina citri* Kuwayama (Hemiptera: Sternorrhyncha: Psyllidae), is a major pest of citrus, and is widely distributed throughout the southern parts of Asia, from the southern islands of Japan in the east, through southern China (particularly Taiwan and the coastal provinces of Guangxi, Guangdong, Fujian and Zhejiang), southeast Asia to India and Pakistan in the west and extends as far east as the island of New Guinea (Aubert 1990; Aubert 1987; Tsai et al., 2002; Chohan et al, 2007). Much of its pest status is due to its ability to transmit the bacterium '*Candidatus Liberibacter asiaticus*' that causes huanglongbing (HLB) disease of citrus (Aubert 1990). In the orchards of Viet Nam, farmers observed that guava interplanted in citrus orchards reduce the attack of *D. citri* thus resulting in no Huanglongbing observed in the orchards (Beattie et al, 2006). So the present study was conducted in order to determine the responses of adults *D. citri* to odor emanating from guava and citrus leaves and shoots. Cage, jar and Y-tube olfactometer experiments were used to evaluate the responses of *D. citri*. In the cage experiments, more adult *D. citri* (14 and 15 adults after 12 and 24 hrs, respectively) were present on the citrus shoots in the cage where only citrus was present compared to the cage where citrus and guava shoots were present together (9 and 7 adults after 12 and 24 hrs). The young and old guava shoots showed the same response for adult *D. citri*. When the guava shoots were covered with net cloth, a similar response was also observed. For example, in the cages where guava shoots were present along with citrus shoots, fewer adult *D. citri* were present on citrus shoots compared to the cage where only citrus shoots were present. In the jar experiment, in which one jar contained guava odor while another served as a control (clean air), more adult *D. citri* (18 and 17 adults after 12 and 24 hrs, respectively) were found to be on citrus shoots in those jars where only clean air was present compared to the jar where guava odor was present (4 and 5 adults after 12 and 24 hrs, respectively). The cage and jar experiments showed that the presence of guava odor significantly reduced landings and feeding by adult *D. citri* on citrus leaves. Odor from immature and mature guava leaves had similar effects. The Y-tube olfactometer experiments showed that: 1) guava leaf odour repelled adult psyllids; 2) repellency was dose-dependent. In two experiments with 5 g of guava shoots we observed more repellence, 67% and 66.25%, respectively, of adult psyllids moved away from guava odour, while with 15 g of guava shoots we observed 83.75% and 86.25% repellence; 3) Responses of male, non-gravid female, and gravid female psyllids did not differ significantly as all sexes of *D. citri* choose to move towards the clean air control rather than the guava odour. Our results suggest that reports of guava interplant reducing the ingress of *D. citri* and huanglongbing into citrus orchards in Viet Nam (Beattie et al. 2006) are most probably due to avoidance of guava volatiles by the psyllid. The present work will be followed by the identification of the volatile compounds produced by guava and then determine which compound is responsible for the observed repellent behavior.

**Citations:**

Aubert B. 1990. Integrated activities for the control of huanglongbing greening and its vector *Diaphorina citri* Kuwayama in Asia. In: Proceedings of the Fourth FAO-UNDP International Asia Pacific Conference on Citrus Rehabilitation , Chiang Mai, Thailand, 4–10 February 1990 (eds B Aubert, S Tontyaporn & D Buangsuwon), pp. 133–144.

Aubert B. 1987. *Trioza erytreae* Del Guercio and *Diaphorina citri* Kuwayama (Homoptera: Psylloidea), the two vectors of citrus greening disease: biological aspects and possible control strategies. *Fruits* 42:149–162

Beattie GAC, Holford P, Mabblerley DJ, Haigh AM, Bayer R, Bradbent P. 2006. Aspects and Insights of Australia –Asia collaborative research on huanglongbing. In ‘Proceedings of an International Workshop for Prevention of Citrus Greening Diseases in Severely Infested Areas, 7-9 December 2006, Ishigaki, Japan’. (Multilateral Research Network for Food and Agricultural safety. Japanese Ministry of Agriculture, Forestry and Fisheries; Tokyo, Japan). 47-64

Chohan SN, Qamar R, Sadiq I, Azam M, Holford P, Beattie A. 2007. Molecular evidence for the presence of huanglongbing in Pakistan, *Australasian Plant Disease Notes*, 2007. 2:37–38.

Tsai JH, Wang JJ, Liu YH. 2002. Seasonal abundance of the Asian citrus psyllid, *Diaphorina citri* (Homoptera: Psyllidae) in southern Florida. *Fla. Entomol.* 85:446-451

### 11.3 Wounding of Guava (*Psidium guajava* L.) Leaves Produces Defensive Sulfur Volatiles

Rouseff R.L., Onagbola E.O., Smoot J.M. and Stelinski L.L.

University of Florida, Institute of Food and Agricultural Sciences, Citrus Research and Education Center, Lake Alfred, FL 33850

Volatiles from mechanically wounded and intact guava leaves (*Psidium guajava* L.) were collected using static headspace solid phase micro extraction, SPME, and determined using GC-pulsed flame photometric detection, PFPD, and GC-MS. Leaf volatiles from four common citrus cultivars were also examined similarly to determine the differences which might be responsible for guava's protective effect against the Asian citrus psyllid (*Diaphorina citri* Kuwayama) which is the insect vector of Huanglongbing (HLB) or greening disease. Seven sulfur volatiles were detected: hydrogen sulfide, sulfur dioxide, methanethiol, dimethyl sulfide, DMS, dimethyl disulfide, DMDS, methional and dimethyl trisulfide, DMTS. Identifications were achieved by matching linear retention index values on ZB-5, DB-wax and PLOT columns and MS spectra in the case of DMDS and DMS. DMDS is an insect toxic, defense volatile produced only by wounded guava and not citrus leaves. Thus, DMDS may be one of the components responsible for the protective effect of guava against the HLB vector. DMDS is formed immediately after wounding, becoming the major headspace volatile within 10 min. Forty-seven additional leaf volatiles were identified from linear retention index, LRI, and MS data in wounded guava leaf headspace.

#### **11.4 Chemical Ecology of Asian Citrus Psyllid (*Diaphorina citri*) and Potential Applications of Behavior-Modifying Chemicals for its Management**

**Stelinski L.L., Onagbola O.E., and Rouseff R.L.**

Institute of Food and Agricultural Sciences, Citrus Research and Education Center, 700 Experiment Station Rd., Lake Alfred, FL 33850, USA.

The Asian citrus psyllid, *Diaphorina citri* Kuwayama (Hemiptera: Psyllidae), is an important world-wide pest of citrus. It vectors three phloem-restricted bacteria in the genus *Candidatus Liberibacter* that cause huanglongbing (citrus greening disease). Huanglongbing is one of the world's most serious diseases of citrus. Citrus trees infected by this disease may live only 5-8 years, during which they produce misshapen, poorly-colored, bitter-tasting, and unmarketable fruit. Despite the great economic importance of *D. citri* as a vector of huanglongbing, detailed investigations into the behavior of this pest have only recently begun. Recently, we characterized the morphology of *D. citri* antennae using scanning electron microscope techniques. Five olfactory and at least three mechanosensory sensillar types were characterized supporting plausible use of olfaction and vibration for host and/or mate finding in this species. Investigations of psyllid behavior in laboratory olfactometers have provided behavioral evidence for a female-produced volatile sex attractant pheromone in *D. citri*. Furthermore, citrus volatiles have been found to attract both sexes of *D. citri*, while guava volatiles have been found to repel this insect. Analytical techniques including gas chromatography, mass spectrometry, and electroantennography have been used to isolate and identify active compounds from *D. citri*, citrus and guava. Candidate attractants and repellents are being tested that may be developed for practical pest control applications of this important pest.

## 11.5 Novel reovirus in *Diaphorina citri* (Hemiptera: Psyllidae)

Marutani-Hert M.<sup>1</sup>, Hunter W.B.<sup>1</sup>, Hall D.G.<sup>1</sup>.

<sup>1</sup>USDA, ARS, U.S. Horticultural Research Lab, 2001 South Rock Rd, Ft. Pierce, FL, USA 34945.

The Asian citrus psyllid, *Diaphorina citri*, transmits one of the most devastating diseases of citrus, the plant pathogenic bacterium, *Candidatus Liberibacter asiaticus*, which is associated with the occurrence of Huanglongbing. Previously, an insect-infecting reovirus was discovered in adult psyllids (Hunter et al., 2006). To better understand the potential of using this pathogen to reduce psyllid populations, we examined infection rates within psyllid populations, and viral pathogenicity on an insect cell culture as a rapid screening tool. Here we identified 55% of psyllids were infected with this virus in field populations. Rates of infection were similar for adult males and females. When inoculated into an SF9 insect cell line, the psyllid reovirus was shown to negatively affect cell viability. These data suggest that this new psyllid-infecting reovirus may provide tools to develop a novel strategy towards the management of psyllid populations.

### Introduction

Previously, we discovered an insect-infecting virus in adult Asian citrus psyllids in Florida (Hunter et al., 2006). The Asian citrus psyllid, *Diaphorina citri* Kuwayama (Hemiptera: Psyllidae) is a small insect that feeds on the phloem sap of citrus trees and is the primary vector of the plant pathogenic bacterium, '*Candidatus Liberibacter asiaticus*', associated with the devastating disease Huanglongbing (HLB), (Citrus Greening Disease). The bacterium, which was recently discovered in Florida (2005), causes severe economic losses to citrus by reducing fruit yields, tree death, and making the fruit unpalatable. To identify new biological control agents in psyllid populations, we examined an expression library prepared from field collected adult psyllids (Hunter et al., 2005, 2006). We identified two viral sequences, one 616 base pairs and a second, 792 base pairs. Both had significant similarity to viruses within the insect Reovirus group. Phylogenetic and homology comparisons indicated that the viral sequences were most closely related to the viruses in the Family *Reoviridae*, Genus *Fijivirus*, specifically *Nilaparvata lugens reovirus* (NLRV). Based on the genetic evidence we propose that this new reovirus be classified as *Diaphorina citri Reovirus*, Florida strain-1.

### Material and Methods

**Protein Analysis:** The deduced amino acid sequences were calculated using the 'Translate' program on the ExPASy server (<http://au.expasy.org>). The resulting sequences were then analyzed using the National Center for Biotechnology Information BLAST server (<http://www.ncbi.nlm.nih.gov>) using BLASTP. Multiple sequence alignments of predicted psyllid-*Reovirus* amino acid sequences were performed using CLUSTAL W (DNA database of Japan; <http://www.ddbj.nig.ac.jp/search/clustalw-j.html>) with the neighbor-joining (NJ) method (Saitou & Nei, 1987), using genetic distances computed with Kimura's two-parameter model (Kimura, 1980). The NJ phylogenetic tree was drawn using TreeView (Page, 1996). NJ bootstrap analyses of 1000 replicates were performed on each data set using a heuristic search to identify the most optimal tree. Analyses were unrooted. Sequences used in the phylogenetic analysis encompassed 136.6KD protein from *Nilaparvata lugens reovirus* (accession number, [NP\\_619777](#)), 'B' spike structural protein from *Fiji disease virus* (accession number, [YP\\_249761](#)), hypothetical protein from *Mal de Rio Cuarto virus* (accession number, [YP\\_956845](#)), P4 protein from *Rice black streaked*



*dwarf virus* (accession number, [NP\\_620461](#)), RNA polymerase of *Nilaparvata lugens reovirus* (accession number, [NP\\_619776](#)), *Mal de Rio Cuarto virus* (accession number, [YP\\_956848](#)), *Fiji disease virus* (accession number, [YP\\_249762](#)) and hypothetical protein (P1) from *Rice black streaked dwarf virus* (accession number, [NP\\_620452](#)), p3 of *Heliothis armigera cypovirus 5* (accession number, [YP\\_001883321](#)) and an unnamed protein product of *Diadromus pulchellus idnoreovirus* (accession number, CAA56651).

*Reovirus population evaluation:* In May of 2008, 100 Asian citrus psyllids were sampled in the ARS, U.S. Horticultural Research Lab, Picos Research Farm, Fort Pierce, FL, area to evaluate the incidence of the Reovirus in psyllid populations. For population evaluation, individual psyllids were homogenized in 20 µl of water and centrifuged at 8,000 x g for 1 min. Then 1.5 µl of dimethyl sulfoxide, DMSO (Sigma, St. Louis, MO) was added to 8.5 µl of supernatant, boiled at 100°C for 5 min to denature the dsRNA. Two µl was used as a template for RT-PCR using the One Step© RT-PCR kit (Invitrogen, Cat. 10928). RT-PCR reaction was conducted with reo2F (5'-GGGCGATTGATGCTATCGTA-3') and reo2R (5' TGAGCGTATCGAATTTGACG-3') under the condition 50°C for 30 min, 40 cycles of 94°C for 30 sec, 60°C for 30 sec and 72°C for 30 sec then 72°C for 10 min.

## Results and Discussion

We isolated two *Reovirus*-like sequences, 616 bp of Dc-Reo1 (Accession number; AB455528) and 712 bp of Dc-Reo 2 (Accession number; AB45810) from our psyllid cDNA library. The deduced Dc-Reovirus amino acid sequence had the highest homology to a *Nilaparvata lugens reovirus* (NLRV), a *Fiji disease virus* (FDV) (McQualter et al., 2003), then to a *Mal de Rio Cuarto virus* (MRCV) (Distéfano et al., 2003). Multiple sequence alignments of predicted psyllid-Reo1 amino acid sequences resulted in a 48% shared identity to RNA polymerase of NLRV, 39% identities to RNA polymerase of the MRCV, 38% identities to RNA polymerase of the FDV, 22% identities to p3 of *Heliothis armigera cypovirus 5* (Ha-CPV5). Multiple sequence alignments of predicted Dc-Reo2 amino acid sequences resulted in a 30% shared identity to segment S2 of the NLRV, 25% identities to a 'B' spike structural protein from segment 3 of the FDV, 24% identities to segment S2 the MRCV, 25% identities to P4 protein of *Rice black streaked dwarf virus* (RBSDV) segment 4 and 20% identities to an unnamed protein product of *D. pulchellus idnoreovirus 1* (DpRV). The NLRV segment S2 is proposed to be the B-spike protein located on the surface of the inner core of the virus coat protein (Nakashima et al., 1996). Reoviruses have wide host ranges and are classified into 11 genera: *Orthoreovirus*, *Orbivirus*, *Rotavirus*, *Coltivirus*, *Seadornavirus*, *Aquareovirus*, *Cypovirus*, *Idnoreovirus*, *Fijivirus*, *Phytoreovirus* and *Oryzavirus* in the family *Reoviridae* by the International Committee for the Taxonomy of Viruses (2000). The genus *Fijivirus* are further classified into five groups based on vectors, plant hosts, and serological and nucleotide sequence similarities (Mertens et al., 2000). *Fiji disease virus* (FDV) is the sole member of group 1, while group 2 contains *rice black streaked dwarf virus* (RBSDV), *maize rough dwarf virus* (MRDV), *Mal de Rio Cuarto virus* (MRCV) and *Pangola stunt virus* (PaSV). *Oat sterile disease virus* (OSDV) is the sole member of group 3, while group 4 and 5 contain *Garlic dwarf virus* (GDV) and *Nilaparvata lugens virus* (NLRV), respectively. Members of the genus have ten dsRNA components and most of them replicate in their plant hosts, in which they induce growth abnormalities. However NPLV causes no symptoms and does not replicate in plants. NPLV is also reported to be non-pathogenic to the insect (Nakashima and Noda, 1995).

To analyze *D. citri Reovirus* (DcRV) relationships with other Reovirus a phylogenetic tree was constructed using the neighbor-joining (NJ) methodology (Figure 1). The topology of the tree showed that DcRV is most closely related to NLRV. Viruses within the *Fijivirus* genera are grouped into 5 groups as mentioned before. Our tree was also able to group 5 of

the 6 sequences into their respective *Fijivirus* group: FDV in group 1, MRCV and RBSDV are group 2 and the DcRV and NPLV in group 5. The Ha-CPV5 and DpRV are a different genus of *Reovirus* member therefore they did not fit into the *Fijivirus* group.

To confirm the incidence of psyllids infected by this *reovirus*, psyllids were collected in the field and assayed for the virus by RT-PCR with reo2 primers. Psyllids which were collected from the field (May 2008) resulted in ~55% virus positives. Figure 2 shows a part of RT-PCR results to detect Dc-Reo2 fragment from ten individual psyllids. Six of ten were amplified 442bp which were positive. However, this detection decreased to 0% by July 2008 (Data not shown). This change of DcRV population was not known. No immediate pathogenic effects were observed from psyllid. Virus acquisition and transmission may be occurring due to a combination of the *D. citri* feeding behavior and wide host range which overlaps with *Reovirus* host plants. This is the first report that the *D. citri* is a vector for a *Reovirus*. Knowledge of host range, manner of transmission and genome organization of the *D. citri* *Reovirus* is important information which will help us understand the virus-vector interactions and illuminate possible roles this virus may have in development of new management strategies against *D. citri*, aimed at reducing the impact of HLB in citrus trees.

## References

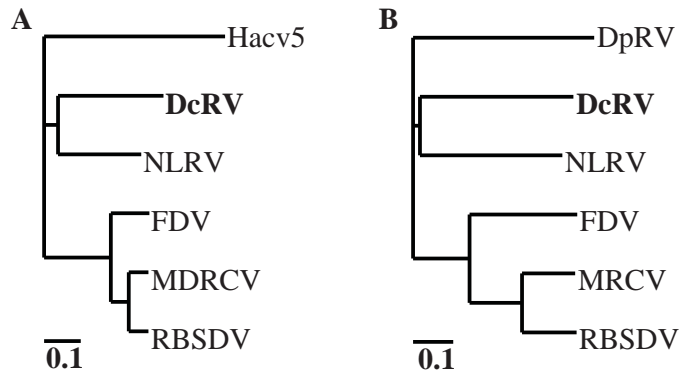
- Distéfano, AJ, Conci LR, Muñoz Hidalgo MM, Guzmán FA, Hopp HE, del Vas M. 2003. Sequence and phylogenetic analysis of genome segments S1, S2, S3 and S6 of *Mal de Río Cuarto virus*, a newly accepted *Fijivirus* species. *Virus Res.* 92:113-21.
- Halbert SE, Manjunath KL. 2004. Asian citrus psyllids (Sternorrhyncha: Psyllidae) and greening disease of citrus: A literature review and assessment of risk in Florida. *Florida Entomol.* 87:330–353.
- Kimura M. 1980. A simple method for estimating evolutionary rate of base substitutions through comparative studies of nucleotide sequences. *J Molec Evol.* 16:111-120.
- McQualter RB, Smith GR, Dale JL, Harding RM. 2003. Molecular analysis of *Fiji disease* *Fijivirus* genome segments 1 and 3. *Virus Genes.* 26:283-289.
- Marutani-Hert M, Hunter W, Hunter SX, Hall DG., Charles AP. 2008. Reovirus-like sequences isolated from adult Asian citrus psyllid, (Hemiptera: Psyllidae: *Diaphorina citri*). *Florida Entomo.* (Submitted).
- Nakashima N, Koizumi M, Watanabe H, Noda H. 1996. Complete nucleotide sequence of the *Nilaparvata lugens reovirus*: a putative member of the genus *Fijivirus*. *J Gen Virol* 77:139–146.
- Nakashima N, Noda H. 1995. Nonpathogenic *Nilaparvata lugens Reovirus* is transmitted to the Brown Planthopper through Rice Plant. *Virology* 207:303-307.
- Noda H, Nakashima N. 1995 Non-pathogenic reoviruses of leafhoppers and planthoppers. *Seminars in Virology* 6:109-116.
- Page RDM. 1996. TREEVIEW: An application to display phylogenetic trees on personal computers. *Comp Applic Biosci.* 12:357-358.
- Rabouille A, Bigot Y, Drezen JM, Sizaret PY, Hamelin MH, Periquet G. 1994. A member of the *reoviridae* (DpRV) has a ploidy-specific genomic segment in the wasp *Diadromus pulchellus* (Hymenoptera). *Virology.* 205:228-237.
- Saitou N, Nei M. 1987. The neighbor-joining method: a new method for reconstructing phylogenetic trees. *Molec Biol Evol.* 4:406-425.
- Tan L, Zhang J, Li Y, Li Y, Jiang H, Cao X, Hu Y. 2008. The complete nucleotide sequence of the type 5 *Helicoverpa armigera* cytoplasmic polyhedrosis virus genome. *Virus Genes.* 36:587-593.

Thorne CM, Otvos IS, Conder N, Levin DB. 2007. Development and evaluation of methods to detect nucleopolyhedroviruses in larvae of the Douglas-fir tussock moth, *Orgyia pseudotsugata* (McDunnough). *Applied and Environmental Microbiology*. 73:1101-1106.

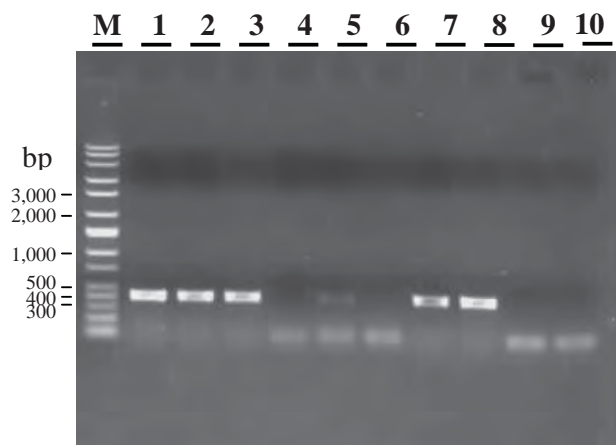
Tweeten KA, Bulla Jr LA, Consigli RA. 1981. Applied and molecular aspects of insect granulosis viruses. *Microbiol Rev*. 45:379-408.

Zhang HM, Chen JP, Adams MJ. 2001. Molecular characterization of segments 1 to 6 of *Rice black-streaked dwarf virus* from China provides the complete genome. *Arch Virol*. 146:2331-39.

**Figure 1** Phylogenetic tree conducted with Dc-Reo1 (A) and Dc-Reo2 (B) amino acid sequences and related sequences using NJ method. Bar, 0.1 substitutions per position. Virus abbreviations: *Nilaparvata lugens reovirus* (NLRV), *Fiji disease virus* (FDV), *Mal de Rio Cuarto virus* (MRCV), *Rice black streaked dwarf virus* (RBSDV), *Heliothis armigera cypovirus 5* (Hacv5) and *Diadromus pulchellus idnoreovirus* (DpRV). Numbers at nodes represent percentage bootstrap values of 1000 resamplings.



**Figure 2** PCR detection of DcRV in field collected adult *Diaphorina citri*. M; Direct Load™ Wide Range DNA Marker (Sigma, Saint Louis, Missouri, USA). Lane1-10; RT-PCR product from individual psyllid as a template.



## 11.6 Efficiency of Insecticides to Control *Diaphorina citri*, Vector of Huanglongbing Bacteria

Yamamoto P.T.<sup>1</sup>, Felipe M.R.<sup>1</sup>, Beloti V.H.<sup>1</sup>, Rugno G.R.<sup>1</sup>

<sup>1</sup>Fundecitrus, Araraquara, Brazil

Huanglongbing (HLB), or greening, is one of the most important citrus diseases in the present time. One of the management strategies is the elimination of the *Diaphorina citri* (Hemiptera: Psyllidae), vector of the bacteria *Candidatus Liberibacter* spp. Control is based on the application of insecticides to young trees both in the nursery and in the field. In Brazil, systemic insecticides are used during the rainy season on young trees during the first three years after planting. Foliar insecticides are applied during the dry period of the year. For plants greater than three years of age, foliar insecticides are applied based on monitoring of *D. citri* and the presence of new flushes. The objective of our work was to evaluate the efficiency of systemic insecticides applied in the nursery to control *D. citri* and determine the residual activity of foliar-applied insecticides. To determine the efficiency of systemic insecticides applied to nursery trees, two experiments were carried out. The first experiment was conducted under controlled conditions, within an enclosed nursery which excluded rainfall. Evaluations were made with the following products and doses (g active ingredient/plant): 1) thiamethoxam (Actara 250 WG) - 0.25; 2) imidacloprid (Confidor 700 GrDA) - 0.35, and 3) control. Insecticides were diluted in water and applied directly to the potting media of seedlings using a spray volume of 20 ml/nursery tree. Adult *D. citri* were then caged on the branches of the treated plants, 15, 30, 45 and 60 days after application. During each evaluation period, 10 replicate plants were used for each treatment. Mortality of adult psyllids was determined 1, 3, 5, 7 and 10 days after confinement by counting the number of live insects. Up to 60 days after application, thiamethoxam and imidacloprid were efficient in controlling *D. citri*, providing more than 80% efficiency from 3 to 5 days following the caging of the adult vector. The application of systemic insecticides to nursery trees prior to planting provides control of *D. citri* exceeding 60 days. The second experiment was conducted in Gavião Peixoto, SP, with the application made in the nursery and mortality assessments conducted in the field, after the trees were planted. The following products and doses were tested (g a.i./plant): 1) imidacloprid (Confidor 700 GrDA) - 0.35, 2) thiamethoxam (Actara 250 WG) - 0.25; 3) imidacloprid (Provado 200 SC) - 0.35; 4) acetamiprid (Convence 200 SL) - 0.1, 5) clothianidin (Focus 500 PM) - 0.35, and 6) control. Insecticides were diluted in water and applied directly to the potting media using a spray volume of 20 ml/nursery tree. Adult *D. citri* were then confined to branches of the treated plants, at 42, 70 and 104 days after application. Field experiments were set up in a randomized complete block design, with each treatment replicated four times. Each replicate consisted of a row of five plants. Within each replicate row of plants, 10 adult psyllids were confined to the central plant of the row. Mortality was assessed after 1 to 8 days of confinement, by counting the number of live insects. Up to 70 days after application, the insecticides, except for acetamiprid, were efficient in control of adult *D. citri*. Meanwhile, at 105 days after application, only thiamethoxam and clothianidin showed efficiency over 90%. In the formulation tested, and application in the substrate and trunk of the plant, acetamiprid was not effective in the control of *D. citri*. The residual effect of imidacloprid, in the two formulations tested, is over 70 days and below 105 days, while for thiamethoxam and clothianidin the period is over 105 days. To determine the effect of residual insecticides for control of *D. citri*, two experiments were conducted. In the first experiment, 9 treatments were used, with the following doses (g a.i./100 L of water): 1) thiamethoxam (2.5), 2)

imidacloprid (4.0), 3) thiacloprid (4.8), 4) lambda-cyhalothrin (0.5), 5) formetanate (12.5), 6) dimethoate (40.0), 7) thiamethoxam + lambda-cyhalothrin (7,05+5,3), 8) dinotefuran (2) and 9) control. In the second experiment, 10 treatments were made with the following doses (g a.i./100 L of water): 1) gamma-cyhalothrin (0.375), 2) deltamethrin (0.75), 3) methidathion (20.0), 4) clorpyrifos (24.0), 5) carbosulfan (10.0), 6) etofenprox (2.5), 7) phosmet (25.0), 8) neem (200 ml), 9) spirotetramat + imidacloprid (1.5+4.5) and 10) control. Treatments were applied to 2-year-old 'Valencia' orange trees which were then taken to a covered location. Ten adult *D. citri* were then confined to each plant using cages made of "Tunil" fabric. There were four replications/treatment and mortality of adult *D. citri* was made 1, 2, 4 and 6 days after caging by counting the number of dead insects. The results showed that the insecticides thiamethoxam, imidacloprid, formetanate, thiamethoxam + lambda-cyhalothrin and dinotefuran were effective until the 34 days after application (DAA), with efficiencies above 80%. The residual period of the insecticides dimethoate and lambda-cyhalothrin were 14 and 7 days, respectively. In the second experiment, the insecticides gamma-cyhalothrin, methidathion and phosmet showed efficiency above 80% up to 34 DAA. Spirotetramat + imidacloprid and deltamethrin showed a residual period of 20 and 7 days, respectively.

## 11.7 Integrated Pest Management of the Asian Citrus Psyllid (ACP) in Florida

Stansly P.A., Qureshi J.A. and Arevalo H.A.

University of Florida, SWFREC, Immokalee FL USA

The foundations of Integrated Pest Management (IPM) were laid 50 years ago in a seminal paper by Stern et al. 1959. The concept is based on optimal integration of biological, chemical and cultural controls. Insecticides were relegated to last resort when all else failed and pest damage was projected to exceed the cost of control, the so-called economic threshold. Therefore, monitoring the pest population became critically important. In spite of the difficulty in determining economic thresholds for one and especially a complex of pests, the general concept served well in Florida citrus where most pests were maintained well below economic threshold by a diverse complex of natural enemies, especially in processed fruit. A frequent exception in fresh fruit was the citrus rustmite *Phyllocoptruta oleivora* for which sampling plans and thresholds were developed and widely used.

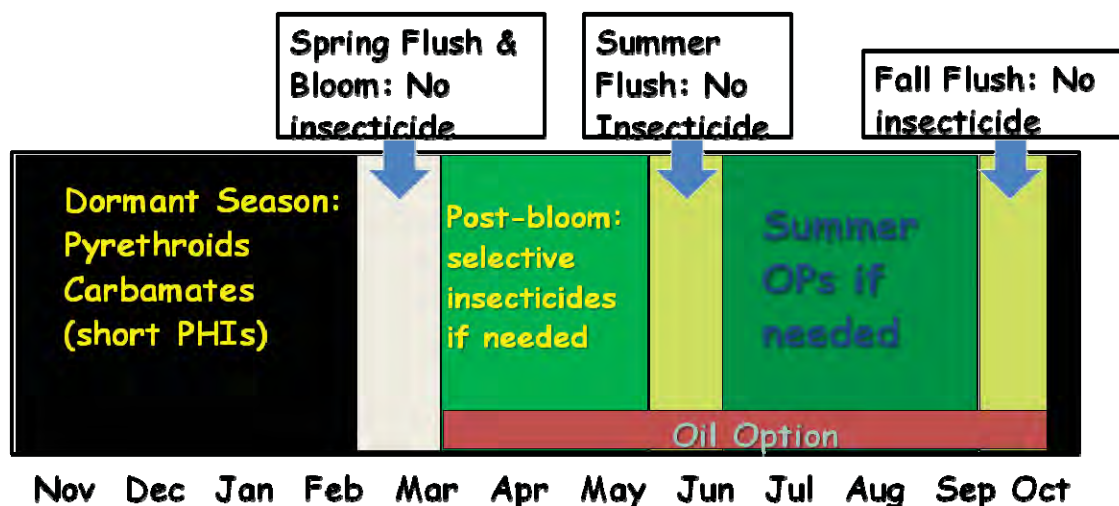
All this has changed in Florida since the advent of HLB in 2005, principally because of uncertainty regarding potential damage. How many psyllids can we tolerate and still remain viable? No one knows, so the only safe answer appears to be zero, an impossible goal that would lead to economic ruin. Therefore, we are obliged to choose a more rational approach that will optimize an affordable psyllid control program while minimizing negative impacts on key natural enemies. The goals are to maintain a viable operation by slowing down the spread of HLB, extend the productive life of citrus trees, and maintain other pests below economic thresholds.

The program includes elements of cultural, biological, and chemical control. Cultural controls include foliar micronutrients to counteract the debilitating effect of HLB, possibly combined with phosphites and inducers of systemic acquired resistance. Flush control to limit psyllid reproductive opportunities is another practice that merits investigation. Biological control includes naturally present predators such as lacewings and ladybeetles which together may account for over 90% mortality of naturally occurring cohorts of ACP. The parasitoid *Tamarixia radiata* from Viet Nam and Taiwan was released in 2000 and 2001 and has spread throughout the state. Although up to 50% parasitism has been observed, control is less than seen in other citrus growing areas. Therefore, we are investigating the possibility of mass releasing *T. radiata* to reinforce populations in the spring. We are also importing and testing additional strains of *T. radiata* and species such as *Diaphorencyrtus aligarhensis* from different parts of Asia in hopes of finding a better fit for Florida conditions.

Chemical control is used in the most efficient and least damaging manner possible. This includes soil applied systemic insecticides to the extent they are available, of which imidacloprid is the most effective. However, the maximum allowable rate for this material is 0.5 lb ai/ac/year (0.56 kg ai/ha/year) which is only sufficient for protecting young trees. Foliar applications of insecticides should be directed at adults since immature stages are hidden in fast growing flush, difficult to control but also attractive to natural enemies. A useful strategy is the dormant spray, a foliar application of broad spectrum insecticide directed at a declining population of overwintering adults. The advantages are that absence of new flush denies refuge to immature stages while not attracting psyllid predators. Consequently, adult psyllids are effectively controlled before they can enter into the spring

flush and with minimum impact on natural enemies. We have been able to observe control for up to 6 months following just a single spray in January.

No sprays are recommended during bloom to protect bees and other beneficial insects. The post-bloom period is also critical for many natural enemies and therefore, only selective insecticides should be used if infestations warrant. These include horticultural spray oils (HMO), combined or not with products such as spinetoram, spirotetramat, diflubenzuron and abamectin. Later in the season, it may be necessary to apply another broad spectrum spray directed at adults prior to fall flush. An alternative we have been experimenting with is frequent (fortnightly) ultralow volume applications of pure HMO. A diagrammatic version of the program is presented in Figure 1.



A critical activity to guide this entire program is regular psyllid monitoring. Monitoring should correspond to psyllid generation time and thus be most frequent (every two weeks) during the growing season. Young blocks also require special attention due susceptibility and frequent flushing. Three parameters are necessary to obtain a complete picture of the psyllid population: adults, percentage infested flush, and flush density. Highest priority is adult ACP which vectors HLB and is the target of most sprays. Sticky traps are labor intensive, expensive and only provide data after a week or more. In contrast, the “tap” sample is rapid, accurate, and provides recordable data immediately (Qureshi & Stansly 2007, Hall et al., 2007). A laminated sheet or clipboard is held about 30 inches below a branch to be sampled which is tapped 3 times with the hand or a stick to dislodge the psyllids which fall on the sheet to be counted. Other pests and beneficials can also be included in the count. This can be done ten times in each of 10 locations in a single block. Percentage infestation is estimated at each location by determining how many of 10 shoots contain any psyllid stage. This number can be correlated to number of psyllids according to Setamou et al., 2008. Flush density is estimated by noting the number of trees searched in order to find the 10 shoots. This parameter is used for evaluating flushing patterns and for converting flush infestation into an estimate of overall population density.

The psyllid population toward the end of winter following the dormant spray can be considered as a lower benchmark to which all future populations can be compared. Attempts to drive the population below that level will probably be counterproductive. Systemic insecticides should be used to the fullest possible extent in young trees, with imidacloprid best applied to soil and lower trunk in late spring and early fall. Significant increases in adult

numbers during the growing season compared to the dormant baseline should trigger some intervention. All but the dormant spray should be justified by scouting and the earlier in the growing season the greater the importance of choosing a selective insecticide. Hopefully, by following these recommendations we can return to a sustainable and viable integrated management program for ACP and other pests of Florida citrus.

**References cited:**

Hall DG., Hentz MG, Ciomperlik MA. 2007. A comparison of traps and stem tap sampling for monitoring adult Asian citrus psyllid (Hemiptera: Psyllidae) in citrus. Fla. Entomol. 90: 327-334.

Qureshi JA, Stansly PA. 2007. Integrated approaches for managing the Asian citrus psyllid *Diaphorina citri* (Homoptera: Psyllidae) in Florida, pp. 110-115. In Proceedings, Florida State Horticultural Society, 3-4 June 2007, Palm Beach, FL.

Sétamou M, Flores D, French JV, Hall DG. 2008. Dispersion patterns and sampling plans for *Diaphorina citri* (Homoptera: Psyllidae) in citrus. J. Econ. Entomol. 101: 1478-1487.

Stern VM, Smith RF, van den Bosch R, Hagen KS. 1959. The integrated control concept. *Hilgardia* 29:81-101.

**Contact Person:** Phil Stansly, [pstansly@ufl.edu](mailto:pstansly@ufl.edu) 239-658-3400.



## 11.8 Perspectives for biological control of *Diaphorina citri* (Hemiptera: Psyllidae) in Mexico

<sup>1</sup>López-Arroyo J.I., <sup>2</sup>Jasso J., <sup>1</sup>Reyes M.A., <sup>1</sup>Loera-Gallardo J., <sup>3</sup>Cortez-Mondaca E. and <sup>4</sup>Miranda M.A.

<sup>1</sup>INIFAP, Centro de Investigación Regional del Noreste. Río Bravo, Tamps., Méx.

<sup>2</sup>INIFAP, Centro de Investigación Regional del Sureste. Mérida, Yuc., Méx.

<sup>3</sup>INIFAP, Centro de Investigación Regional del Noroeste. Cd. Obregón, Son., Méx.

<sup>4</sup>INIFAP, Centro de Investigación Regional del Pacífico Centro. Guadalajara, Jal., Méx.

*Diaphorina citri* Kuwayama, the Asian citrus psyllid (ACP) (Hemiptera: Psyllidae) was originally found in Mexico in the states of Campeche and Quintana Roo during 2002 (4, 6). By 2004, it had invaded the most important Mexican citrus areas (5); since then, it has become widely spread in the country, and the recent detection of specimens of ACP during June 2008 in Tijuana, Baja California, in the northwest, substantiates the ultimate establishment of this pest throughout the entire Mexican citrus industry ([www.senasica.gob.mx](http://www.senasica.gob.mx)). Furthermore, during July 2008 the insect was observed thriving in scant and scattered citrus trees in rural gardens in Coahuila state, in the north of the country, far away from any commercial citrus area (Fig. 1). The importance of the ACP in Mexico, has been neglected for more than six years due to the current absence of *Candidatus Liberibacter* spp., the bacteria causing the Huanglongbing disease vectored by *D. citri* (1, 2). As a consequence, research aimed to understand its ecology and development of alternatives for pest management has been scarce and isolated. The presence of *Candidatus Liberibacter* spp in Florida, and Louisiana, U.S.A., and Cuba, represents a serious risk to the Mexican citrus industry in the short term, as adults of the ACP carrying the bacteria could migrate or accidentally be brought into the country (3). We have initiated a research project intended to develop alternatives for the management of the *D. citri*-Huanglongbing complex. Our recent findings include the detection of *D. citri* natural enemies in citrus trees and orange jessamine. The main species attacking *D. citri* in Mexico showed to be the parasitoids *Diaphorencyrtus* sp. (Hymenoptera: Encyrtidae) and *Tamarixia radiata* (Waterston) (Hymenoptera: Eulophidae), the predators *Ceraeochrysa* sp. nr. *cincta* (Schneider), *Ceraeochrysa valida* (Banks), *Chrysoperla comanche* (Banks), *Chrysoperla externa* (Hagen), *Chrysoperla rufilabris* Burmeister (Neuroptera: Chrysopidae), *Azya* sp., *Brachiacantha decora* Casey, *Cycloneda sanguinea* (L.), *Harmonia axyridis* (Pallas), *Hippodamia convergens* Guérin-Méneville, *Olla v-nigrum* (Mulsant) (Coleoptera: Coccinellidae), *Allograpta obliqua* (Say), *Pseudodoros clavatus* (F.), *Toxomerus marginatus* (Say), *Toxomerus politus* (Say) (Diptera: Syrphidae), *Vespa* sp. (Hymenoptera: Vespidae) and several species of spiders. Also, we found adults of *D. citri* infected by the fungus *Hirsutella citrififormis* Speare in 'Valencia' orange and 'Persian' lime trees in the states of Hidalgo, San Luis Potosí, Tabasco, Tamaulipas, and Veracruz, Mex. In orchards with the occurrence of *H. citrififormis*, high levels of infection were observed in the ACP populations. In the country, there are approximately 63 commercial mass-rearing laboratories that could produce different species of these beneficial organisms for release in the citrus areas invaded by the ACP. The potential for biological control of *D. citri* in Mexico is promising and it must be considered in any pest management program.

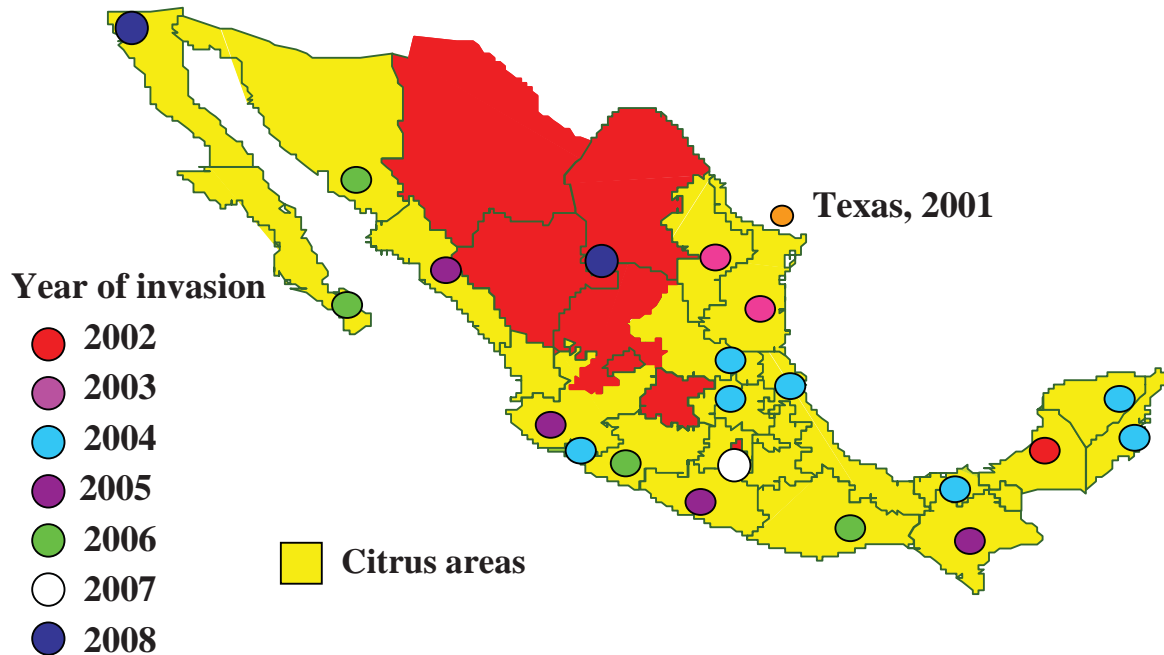


Fig. 1. Current distribution of *Diaphorina citri* in Mexico (source: [www.senasica.gob.mx](http://www.senasica.gob.mx)).

**Literature cited:**

- Bové JM. 2006. Huanglongbing: a destructive newly-emerging century-old disease of citrus. *J. Plant Pathol* 88 (1): 7-37.
- da Graça JV. 1991. Citrus greening disease. *Annu. Rev. Phytopathol.* 29: 109-136.
- da Graça JV, Sétamou M, Skaria M, French JV. 2007. Arthropod vectors of exotic citrus diseases: a risk assessment for the Texas Citrus Industry. *Subtropical Plant Science* 59: 64-74.
- Halbert SE, Núñez CA. 2004. Distribution of the Asian citrus psyllid, *Diaphorina citri* Kuwayama (Rhynchota: Psyllidae) in the Caribbean basin. *Florida Entomologist* 87(3):330-353.
- López-Arroyo JI, Peña MA, Rocha-Peña MA, Loera J. 2004. Occurrence of the Asiatic citrus psyllid, *Diaphorina citri* (Homoptera: Psyllidae) in Mexico, pp. 179. *In: Proceedings of the XVI Conference of the International Organization of Citrus Virologists.* November 7-13, 2004. Monterrey, N.L., Mex.
- Thomas DB. 2002. Trip report: Status of the brown citrus aphid in the Mexican state of Campeche: April 2002. USDA-ARS. Kika de la Garza Subtropical Agriculture Research Center. Weslaco, Texas. 9 pp (unpublished).

### 11.9 Investigations of the feasibility for managing the Asian citrus psyllid using *Isaria fumosorosea*.

Avery P.B.<sup>1</sup>, Hunter W.B.<sup>2</sup>, Hall D.G.<sup>2</sup>, Jackson M.A.<sup>3</sup>, Powell C.A.<sup>1</sup>, Rogers M.E.<sup>4</sup>

<sup>1</sup>UF-IFAS-IRREC, Fort Pierce, FL, USA; <sup>2</sup>USDA-ARS, Ft. Pierce, FL, USA; <sup>3</sup>USDA-ARS, Peoria, IL, USA; <sup>4</sup>UF-IFAS-CREC, Lake Alfred, FL, USA.

In Florida, growers are concerned about the ecological and economic ramifications of being dependent upon insecticide applications for the management of the Asian citrus psyllid, *Diaphorina citri*, the insect vector of the pathogen which causes Huanglongbing. In collaboration with Florida citrus growers, we have been evaluating approaches that would be more IPM compatible in the long term. In 2007, Meyer *et al.* isolated and identified an entomopathogenic fungus found infecting *D. citri* in citrus groves in Polk County as *Isaria fumosorosea* (= *Paecilomyces fumosoroseus* (*Pfr*)). Since this discovery, we have been evaluating the efficacy of different fungal strains of *Pfr* formulations (ARSEF *Pfr* 3581, *PFR* 97™ 20% WDG) and the effectiveness of autodissemination techniques as an alternative treatment. Results from laboratory bioassays indicated that leaves or yellow plastic tags (artificial insect attractant) sprayed with *Pfr* 3581 were equally effective in infecting and killing the adult psyllids. In a longevity study, *Pfr* 3581 blastospores sprayed on the yellow tags and hung in a greenhouse (10-30.5°C, RH 59-93%), remained infective to adult psyllids up to 10 weeks post-spray. In comparative pathogenicity studies, *Pfr* 3581 and *PFR* 97™ demonstrated the same efficacy for direct spray and residual infection. Due to the increasing use of copper applications for citrus canker management in Florida citrus groves, the effect of several commonly used copper products on the efficacy of *PFR* 97™ against *D. citri* was investigated. Leaves sprayed with different copper solutions in the field were excised and then sprayed with *PFR* 97™ prior to exposure to adult psyllids. Results indicated that efficacy of *PFR* 97™ against adult psyllids was not inhibited compared to the control. In a similar investigation, it was determined that the radial growth of *PFR* 97™ blastospores on potato dextrose and Noble agar plates was uninhibited following suspension in copper solutions or oil formulations commonly used in Florida citrus production (435 Spray Oil, Vintre™). In a preliminary field study in Midsweet orange trees in Okeechobee County, *PFR* 97™ was applied at a rate of 2 lbs/acre using a Curtec sprayer, and the efficacy against the psyllid and autodissemination of the fungal biopesticide by adults was evaluated. Results of the field study showed that 33% of psyllid eggs collected on the flush were infected with *PFR* 97™ 21 days post-spray, 17-29% of nymphs on the flush were infected 7-21 days post-spray and 100% (3/3) of the adult psyllids caught per yellow card were contaminated 28 days post-spray. Laboratory, greenhouse and field studies (although preliminary) suggested that there is potential for using *PFR* 97™ as part of an IPM strategy for managing psyllid populations in Florida. Additional larger scale field trials using various spray application methods need to be conducted and evaluated in order to verify how efficacious this product will be in the field. Presently, large scale efficacy field trials involving cold fogging *PFR* 97™ and also spraying in combination with oils are in progress. Studies are in progress assessing the pathogenicity of the newly acquired *Pfr* strain FE 9901 (NoFly™) against *D. citri*.

Citation: Meyer JM., Hoy MA, Boucias DG, Singh R, Rogers ME. 2007. 'Friendly fungi' killing psyllids in Florida citrus. *Citrus Industry* 88: 23-24.

## 11.10 NATURAL ENEMIES OF *Diaphorina citri* KUWAYAMA IN NORTHWEST MEXICO

Cortez-Mondaca E.<sup>1</sup>, Lugo-Angulo N.E.<sup>2</sup>, Pérez-Márquez J.<sup>1</sup>

<sup>1</sup>INIFAP-Campo Experimental Valle del Fuerte. Apdo. Postal 342. 81200 Los Mochis, Sinaloa, México. [cortez.edgardo@inifap.gob.mx](mailto:cortez.edgardo@inifap.gob.mx). <sup>2</sup>Universidad de Occidente, Unidad Guasave. Guasave, Sinaloa. [noraya\\_ely85@hotmail.com](mailto:noraya_ely85@hotmail.com).

Although Huanglongbing has not been detected in Mexico so far, its vector, the Asian citrus psyllid, *Diaphorina citri* Kuwayama (Hemiptera: Psyllidae) is widely spread in the different citrus areas of the country, such as Campeche, Colima, Michoacán, Oaxaca, Querétaro, Nuevo León, San Luis Potosí, Sinaloa, Sonora, Tabasco, Tamaulipas, Veracruz and Yucatán states, where the insect causes direct damage as a pest. The goal of this study was to determine occurrence of *D. citri* natural enemies in northwest Mexico, in areas recently invaded by the Asian citrus psyllid. Samplings for the search of *D. citri* natural enemies were performed every 3-7 days from June-November 2007 in the counties of Ahome, Guasave, Salvador Alvarado, and Culiacán, Sinaloa, Mex. We sampled lima *Citrus x aurantifolia* S., orange *Citrus sinensis* (L.) Osbeck, grapefruit *Citrus x paradisi* Macfad and orange jessamine *Murraya paniculata* (L.) Jack (Rutales: Rutaceae). In order to obtain parasitoids, 4<sup>th</sup>-5<sup>th</sup> instar nymphs were collected and maintained in laboratory. The guild of predators attacking *D. citri* was composed by *Cycloneda sanguinea* (L.) and *Olla v-nigrum* (Mulsant) (Coleoptera: Coccinellidae) (62% of population abundance), as well as *Chrysoperla comanche* (Banks) and *Chrysoperla rufilabris* (Burmeister) (Neuroptera: Chrysopidae) (38% of population abundance). *D. citri* nymphs were parasited by *Tamarixia radiata* (Waterston) (Hymenoptera: Eulophidae) and *Diaphorencyrtus* sp. (Hymenoptera: Encyrtidae). The mean parasitism by *T. radiata* was 59.6%; meanwhile, *Diaphorencyrtus* sp. caused 6.3% parasitism. Our results have implications for the management of the Asian citrus psyllid in Mexico.

### 11.11 Managing Asian Citrus Psyllid *Diaphorina citri* with Soil and Foliar Applications of Insecticides

Qureshi J.A. and Stansly P.A.

University of Florida/IFAS, Southwest Florida Research and Education Center, Department of Entomology and Nematology, Immokalee, Florida, USA

Email: [jawwadq@ufl.edu](mailto:jawwadq@ufl.edu)

*Diaphorina citri* Kuwayama, a worldwide pest of citrus, vectors the bacterium *Candidatus Liberibacter asiaticus*, the causal organism of the “huanglongbing” or Asian form of citrus greening disease. The introduction of *D. citri* in 1998 and advent of citrus greening disease in 2005 has elevated the psyllid vector to key pest status in Florida. Insecticides are widely used to reduce the incidence of the pest and the disease although several native and introduced biological control agents can also impart considerable mortality (1-8).

Therefore, insecticides should be used judiciously to conserve natural enemy diversity and ecological stability. Toward this end we evaluated systemic and foliar applications of several recommended and experimental insecticides against feral populations of *D. citri* and some of its natural enemies on young and mature citrus trees in experimental and commercial citrus groves. Experiments were arranged in randomized complete block designs. Treated and untreated trees were examined for *D. citri* and its natural enemies. A tap sampling method was used to evaluate treatment effects on psyllid adults and their natural enemies (2). This sample consisted of 22 × 28 cm white paper sheet (on a clipboard) held under branches selected at random that were tapped three times with hand or stick. Psyllid adults and predators falling on the paper were counted. Additional evaluations included examination of citrus shoots for infestation with *D. citri* immatures and presence of predators.

Drench applications made using EZE-DOSE (Model CCI DO 35) applicator were evaluated in 5-6 years old ‘Valencia’ orange trees on ‘Swingle’ rootstock planted on double-row raised beds at a density of 326 trees/ha. Trees were pruned to induce shoot growth and encourage psyllid infestation. Imidacloprid and another neonicotinoid systemic thiamethoxam were very effective in controlling *D. citri* for two to three months (2, 8). However, similar application of the carbamate, oxamyl was not effective. Populations of predatory coccinellids, *Curinus coeruleus*, *Olla v-nigrum*, *Harmonia axyridis*, and *Cycloneda sanguinea* were significantly reduced on treated trees compared to the untreated trees. Another carbamate, aldicarb was evaluated at 3 rates, 2 placements and 3 timings to control *D. citri* in 8-12 years old citrus trees planted at 373 trees/ha on double-row raised beds (3). Trees were ‘Valencia’ orange on ‘Swingle’ rootstock in rate and timing experiments and ‘Hamlin’ on ‘sour orange’ in a rate x placement experiment and followed natural flush cycle. A modified Gandy granular applicator provisioned with two double coulters to open a furrow, and a metering wheel to control release from a single hopper was adjusted for different application rates. A PTO-powered blower delivered granules to the furrows through a maximum of three tubes to each coulters, and a following press wheel closed the furrows set at approximately 2 and 3 ft from the tree trunk for the proximal and distal bands respectively. Application of aldicarb at 5.6, 2.8 and 1.4 kg ai/ha in March 2006 reduced *D. citri* adults 58-66% to 45-46% and 25-37% respectively compared to untreated trees in two separate experiments. No difference was observed in placement (one vs. two sides of the tree) or tree size (8 vs. 12 yr old). Application at 5.6 kg ai/ha in January 2007 reduced adults

by 86% and shoot infestation by 77% in spring, and was generally better than the November 2006 and especially February 2007 applications. More adults were negatively impacted when caged on treated trees for 25 days in March 2007. Spiders and ladybeetles were equally abundant in treated and untreated trees.

Foliar applications of several insecticides alone or with adjuvants were evaluated during growing season in 12-14 year old 'Valencia' orange trees planted on double-row raised beds at a density of 326 trees/ha. Trees were pruned on bed or swale sides to induce shoot growth and encourage psyllid infestation. Applications were made using tractor mounted hydraulic or Durand Wayland 3P-10C-32 air blast sprayer. Most of these insecticides reduced psyllid populations for 2-3 weeks and negatively impacted ladybeetles populations. In contrast, foliar applications of insecticides made during the period of tree dormancy before spring flush reduced psyllid populations for up to six months with minimal impact on natural enemies. These applications were effective because they targeted adult psyllids when little flush was present to harbor immature or psyllid predators (7).

Findings from these experiments suggest that soil applications of aldicarb at 5.6 kg/ha to mature citrus trees 2–3 months before spring growth can suppress *D. citri* through spring with minimum direct effect on principal psyllid natural enemies. Foliar applications during the dormant winter period are also effective by controlling adults when few nymphs or natural enemies are present. Few adults then survive to infest the spring flush whereas natural enemies migrate in and are available to feed on psyllid immatures. In contrast, foliar sprays during the growing season were less effective, should be based on scouting and made prior to anticipated flush to effectively target adults. Drench applications of imidacloprid controlled psyllids for 2-3 months on young trees and are best applied to the soil when trees are active and rainfall moderate to avoid leaching. In Florida, aldicarb must be applied between 15 November and 30 April in conformance with the label. Thus, frequent foliar sprays may be necessary at other times to provide needed protection for frequent flushes on young trees.

#### Literature cited:

- Michaud JP. 2004. Natural mortality of Asian citrus psyllid (Homoptera: Psyllidae) in central Florida. *Biological Control* 29: 260-269.
- Qureshi JA, Stansly PA. 2007. Integrated approaches for managing the Asian citrus psyllid *Diaphorina citri* (Homoptera: Psyllidae) in Florida. *Proc. Fla. State. Hort. Soc.* 120:110–115.
- Qureshi JA, Stansly PA. 2008. Rate, placement and timing of aldicarb applications to control Asian citrus psyllid, *Diaphorina citri* Kuwayama (Hemiptera: Psyllidae), in oranges. *Pest Management Science*. 64: 1159-1169.
- Qureshi JA, Rogers ME, Hall DG, Stansly PA. 2009. Incidence of invasive *Diaphorina citri* (Hemiptera: Psyllidae) and its introduced parasitoid *Tamarixia radiata* (Hymenoptera: Eulophidae) in Florida citrus. *Journal of Economic Entomology* (In press)
- Rogers ME. 2008. General pest management considerations. *Citrus Industry* 89: 12-17.
- Rogers ME, Stansly PA, Stelinski LL. 2008. Florida citrus pest management guide: Asian citrus psyllid and citrus leafminer. *Entomol. Nematol. Dept., Fla. Coop. Ext. Serv., Inst. Food Agri. Sci., Univer. Fla., ENY-734*. <http://edis.ifas.ufl.edu/IN686>.
- Stansly PA, Qureshi JA. 2008. Controlling Asian citrus psyllid: sparing biological control. *Citrus Industry* 89:20–24.

Stansly PA, Kostyk BC, Qureshi JA. 2008. Soil applied insecticidal control of Asian citrus psyllid and citrus leafminer. Arthropod Management Tests. D10.

**Contact Person:** Jawwad Qureshi, [jawwadq@ufl.edu](mailto:jawwadq@ufl.edu), Phone: 239-658-3400.

INTERNATIONAL RESEARCH CONFERENCE  
ON HUANGLONGBING



**Session 12:**  
**HLB Management**  
**Strategies**

Orlando, Florida



December 2008



### 12.1 Factors associated with control of huanglongbing in Sao Paulo, Brazil: a case study

**Belasque Jr. J.**<sup>1</sup>, Bassanezi R.B.<sup>1</sup>, Yamamoto P.T.<sup>1</sup>, Lopes S.A.<sup>1</sup>, Ayres A.J.<sup>1</sup>, Barbosa J.C.<sup>2</sup>, Tachibana A.<sup>3</sup>, Violante A.R.<sup>4</sup>, Tank Jr. A.<sup>5</sup>, Giorgetti C.L.<sup>6</sup>, Di Giorgi F.<sup>7</sup>, Tersi F.E.A.<sup>8</sup>, Menezes G.M.<sup>9</sup>, Dragone J.<sup>10</sup>, Catapani L.F.<sup>11</sup>, Jank Jr. R.H.<sup>12</sup>, Bové J.M.<sup>13</sup>.

<sup>1</sup>Fundecitrus, Araraquara, Brazil; <sup>2</sup>FCAV/Unesp, Jaboticabal, Brazil; <sup>3</sup>Fischer S/A Agropecuária, Matão, Brazil; <sup>4</sup>Sucocítrico Cutrale Ltda, Araraquara, Brazil; <sup>5</sup>Nova América S/A Citrus, Santa Cruz do Rio Pardo, Brazil; <sup>6</sup>Citrovita Agro Industrial Ltda, Catanduva, Brazil; <sup>7</sup>Louis Dreyfus Commodities Agroindustrial Ltda, Bebedouro, Brazil; <sup>8</sup>Cambuhy Agrícola Ltda, Matão, Brazil; <sup>9</sup>Branco Peres Agribusiness, Itápolis, Brazil; <sup>10</sup>Fazenda Rancho Rey, Araraquara, Brazil; <sup>11</sup>Catapani, Araraquara, Brazil; <sup>12</sup>Agrindus S/A, Descalvado, Brazil; <sup>13</sup>INRA and University of Bordeaux 2, Bordeaux, France.

Huanglongbing (HLB) was first identified in the central region of São Paulo State, Brazil, in March 2004. However, the first infections occurred probably 6 to 8 years before. As of November 2008, HLB is present in 201 of the 425 citrus growing municipalities of São Paulo State. In April 2008, the total number of symptomatic trees was estimated to be 1.15 million (0.58%) and at least 3 million trees have already been eradicated. The recommended practices for HLB management are based on inoculum reduction by frequent removal of symptomatic trees (at least four times per year) and control of psyllid vector populations by insecticide treatments (at least six sprays per year). After four years of HLB management, several São Paulo state farmers have shared their results on HLB control. Here, we present the data from twenty citrus farms where the recommended practices have been applied to varying degrees since 2004.

The most important factors associated with the success or failure of HLB control in a given farm, are indicated in Table 1. They are: i) HLB incidence (% of symptomatic trees) in the municipality where the farm is located, ii) distance (meters) from neighboring farms without HLB control, iii) total number of trees, iv) average age of the trees, v) time period (months) during which HLB inspection/eradication has been carried out, vi) average number of insecticide treatments per year, vii) average number of inspections/eradications per year, and viii) cumulative HLB incidence (% of all symptomatic trees removed) during the first year of control, ix) cumulative HLB incidence (% of all symptomatic trees removed) through June 2008, and x) number of eradicated trees per month. In most farms (except 2, 3, and 4), HLB eradication was initiated just after detection of the first symptomatic trees in 2004 or 2005. In almost every farm, the citrus growers applied at least six insecticide treatments per year for vector control and three inspections per year for identification and elimination of HLB-symptomatic trees. In Fig. 1, the cumulative eradicated trees per year have been presented for farms 1, 5, 8, and 11. In farm 1, this number decreased steadily from 2005 to a very low value in June 2008, demonstrating very effective HLB control. In this farm, the success of HLB control could be explained by the following favorable factors: location of the farm in a region of low HLB incidence, absence of neighboring farms without HLB control, trees older than 6 years, early start of the HLB control program. Because of these favorable factors, only four inspections and six insecticide treatments per year were enough to achieve good control. In farm 5, the number of eradicated trees decreased from 2004 to a low level in 2006, also showing effective control. The favorable factors in farm 5 were: absence of neighboring farms without HLB control, trees older than 6 years, and early start of the HLB control program. However, this farm is located in a region of high HLB incidence, and therefore a great number of inspections (15) and insecticide treatments (12) per year were necessary to

significantly reduce the number of symptomatic trees each year. In farms 8 and 11, the number of eradicated trees increased yearly, indicating a poor control because of the following unfavorable factors: location of the farms in a region of high HLB incidence, and presence of neighboring farms without HLB control. In addition, in farm 8 the trees were only one-year-old in 2004, and irrigated, which resulted in continuous production of leaf flushes, attractive to psyllids from the adjacent neighboring farms without HLB control. In this farm, in spite of as many as 26 insecticide treatments and 7 inspections per year, the number of eradicated trees continued to increase, particularly in 2007 and 2008. In farm 11, in spite of the relatively old trees (12 years of age) and 9 insecticide treatments per year, a low number of inspections per year (3) probably explains the poor HLB control. Farm 14 (Table 1), another example of poor HLB control, is located in a region of high HLB incidence, and has neighboring farms without HLB control. Even though control of HLB started as early as 2005 for relatively old trees (20 years of age), only two insecticide treatments and three inspections per year explain the very poor HLB control achieved.

A multiple regression analysis (Table 2) was performed with the 10 factors presented in Table 1. The number of eradicated trees per month (Table 1, factor 10) was considered the dependent variable. The other 9 factors were considered as independent variables, except the cumulative HLB incidence (Table 1, factor 9). The analysis was carried out using Statistica software (Statsoft, Tulsa, OK). The eight factors (Table 1, factors 1 to 8) considered as independent variables explain 95% of the variation in the regression analysis, indicating that most of the factors considered to be associated with HLB control were valid. The most important factors (Table 2) for HLB control were: cumulative HLB incidence during the first year of control (initial HLB incidence) (Table 1, factor 8), average age of the trees (Table 1, factor 4), time period (months) during which HLB inspection/eradication was carried (Table 1, factor 5), and size of the farms (total number of trees) (Table 1, factor 3). These factors are those considered most important in almost all of the 20 farms analyzed. The regression analysis indicated (i) HLB incidence in the municipality, (ii) distance from neighboring farms without HLB control, (iii) number of insecticide treatments per year, and (iv) number of inspections per year, as non-significant at the 5% level because these factors were only involved with the HLB epidemic in some of the farms. Nevertheless, these factors should be considered important for HLB control in all farms.

The data indicate that it is possible to achieve control of HLB under various conditions in areas endemic with the more aggressive *Ca. Liberibacter asiaticus*. A careful evaluation of the 10 factors involved in HLB control (Table 1) provides an explanation in every case for why in a given farm HLB control is successful or not. Strong efforts such as frequent inspections for symptomatic trees with well-trained inspectors as well as insecticide treatments must be started as quickly and as early as possible after detection of the first symptomatic trees in the farm. Moreover, it is essential for successful HLB control that these practices be adopted by all the citrus farms in the region. Isolated efforts result in only partial and often unsatisfactory control. Therefore, a global program of HLB management by inoculum reduction through removal of symptomatic trees and vector control by insecticide treatments is necessary. In the particular case of São Paulo State, since 2005 a mandatory federal regulation requires the immediate removal of all HLB-infected citrus or *Murraya paniculata* (orange jasmine) trees. The non-compliance with this federal law is one of the main reasons for the widespread occurrence of HLB-infected farms without HLB control. A new federal law was approved in October 2008. The affected citrus blocks with HLB incidences higher than 28% of symptomatic trees must be completely uprooted. For lower incidence blocks, only the symptomatic trees must be removed. The results of the present study substantiate that this new legislation is absolutely necessary for effective control of

HLB in São Paulo State and hopefully will be more efficiently applied and enforced than the previous law!

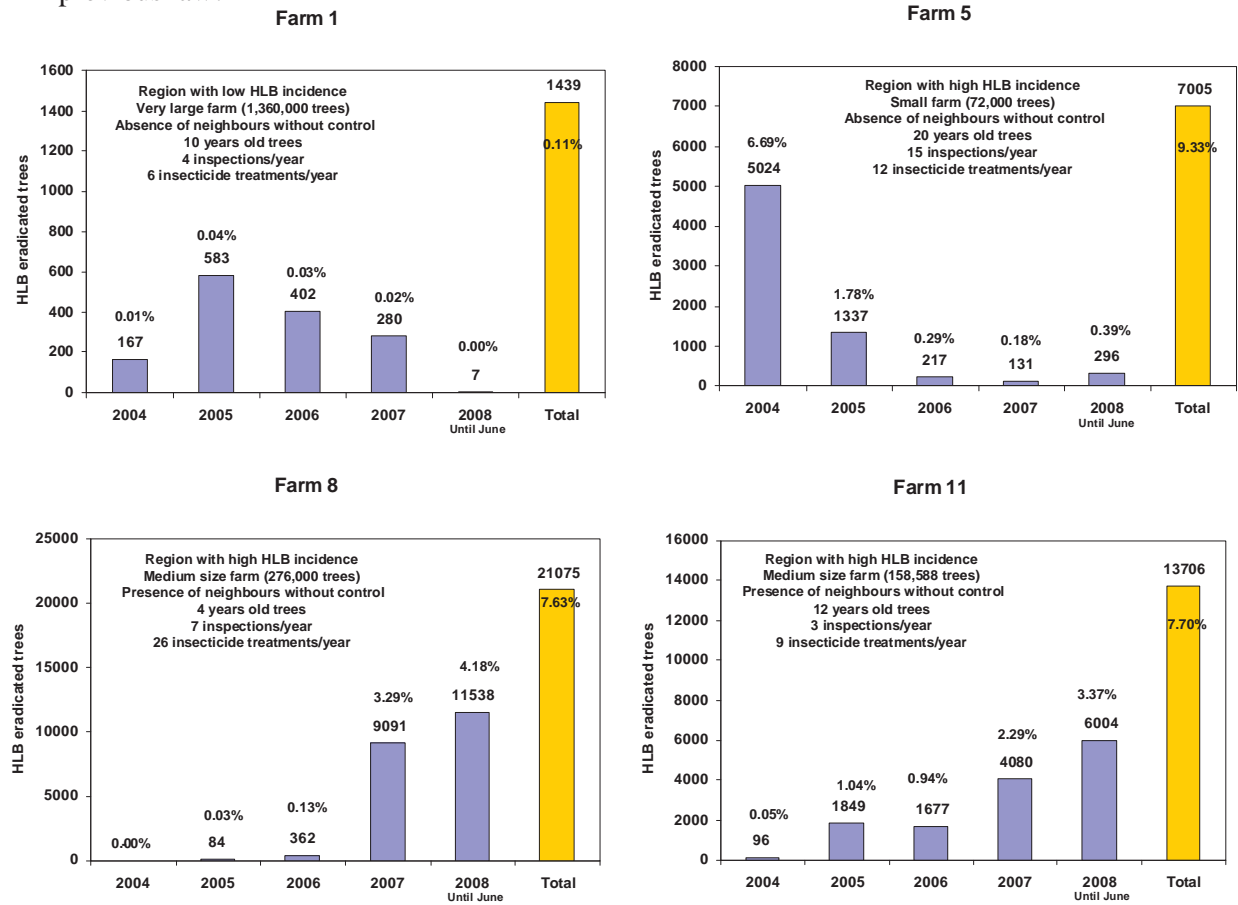


Fig. 1. Progress of HLB-eradicated trees in four of the farms studied.

Table 1. Factors associated with the HLB control in twenty citrus farms in São Paulo, Brazil.

Farm	Factors*									
	1	2	3	4	5	6	7	8	9	10
1	0.02	5,000	1,349,000	10	48	6	4	0.01	0.11	28.1
2	3.25	0	276,905	15	14	27	13	4.50	12.00	1483.4
3	3.16	0	265,391	14	14	27	12	17.60	37.30	3734.4
4	3.16	0	119,876	6	14	25	13	10.50	43.10	2791.4
5	1.29	2,000	72,000	20	50	12	15	6.69	9.33	38.0
6	0.04	2,000	231,000	15	50	8	9	0.00	0.40	18.5
7	0.02	5,000	360,000	4	50	18	6	0.00	0.03	2.2
8	3.16	0	276,000	4	50	26	7	0.00	7.63	421.2
9	4.18	4,000	260,255	6	50	13	4	0.03	2.90	149.4
10	5.11	0	233,255	12	48	9	3	0.02	2.47	119.5
11	5.11	0	158,588	12	49	9	3	0.05	7.70	247.6
12	5.11	0	241,232	12	48	9	3	0.04	5.79	289.1
13	2.03	2,000	522,612	12	47	9	2	0.04	0.35	35.1
14	5.11	0	162,532	20	41	2	3	6.69	24.59	709.6
15	5.05	0	165,069	5	48	9	25	0.10	6.81	230.8
16	4.18	2,000	284,784	7	50	7	24	0.68	4.20	200.4
17	2.84	0	3,008,000	10	50	17	3	0.15	1.60	872.3
18	4.18	2,000	670,000	14	20	32	19	2.11	3.86	586.3
19	3.47	2,000	481,000	15	50	8	26	0.13	3.53	326.6
20	0.40	1,000	74,000	8	48	5	21	0.03	2.43	37.0

\* 1) HLB incidence (% of symptomatic trees) in the municipality where the farm is located, 2) distance (meters) from neighboring farms without HLB control, 3) total number of trees, 4) average age of the trees, 5) time period (months) during which HLB inspection/eradication has been carried out, 6) average number of insecticide treatments per year, 7) average number of inspections/eradications per year, 8) cumulative HLB incidence (% of all symptomatic trees removed) during the first year of control, 9) cumulative HLB incidence (% of all symptomatic trees removed) through June 2008, and 10) the calculated number of eradicated trees per month [(cumulative number of HLB eradicated trees through June 2008 – cumulative number of eradicated trees in the first year of control)/time period during which HLB inspection/eradication has been carried out]

Table 2. Multiple regression analysis considering the calculated number of HLB trees eradicated/month as dependent variable and the other factors presented in Table 1 as independent variables.

Independent variables	Estimated parameter	<i>P</i> *
Cumulative HLB incidence in first year	0.719536	0.00002
Average tree age	-0.259314	0.00547
Time period of eradication adoption	-0.362555	0.02230
Total number of trees	0.173138	0.03180
Distance from neighboring farms without HLB control	-0.150839	0.10546
Number of insecticide treatments/year	-0.051635	0.64594
Number of inspections/year	-0.026020	0.70930
HLB incidence in the municipality	0.011162	0.89455

Calculated F value=28.8 and  $R^2=0.95$

\* probability level

## 12.2 Monitoring Psyllids for Early Detection and Management of Huanglongbing

Manjunath K.L.<sup>1</sup>, Halbert S.E.<sup>2</sup>, Ramadugu C.<sup>3</sup> and Lee R.<sup>1</sup>

<sup>1</sup>USDA/ARS, National Clonal Germplasm Repository for Citrus and Dates, 1060 Martin Luther King Blvd., Riverside CA 92508, USA, <sup>2</sup>Florida Department of Agriculture and Consumer Services, Division of Plant Industry, P.O. Box 147100, Gainesville, FL 32614-7100, USA, <sup>3</sup>Dept. Botany and Plant Sciences, University of California, Riverside, CA 92521

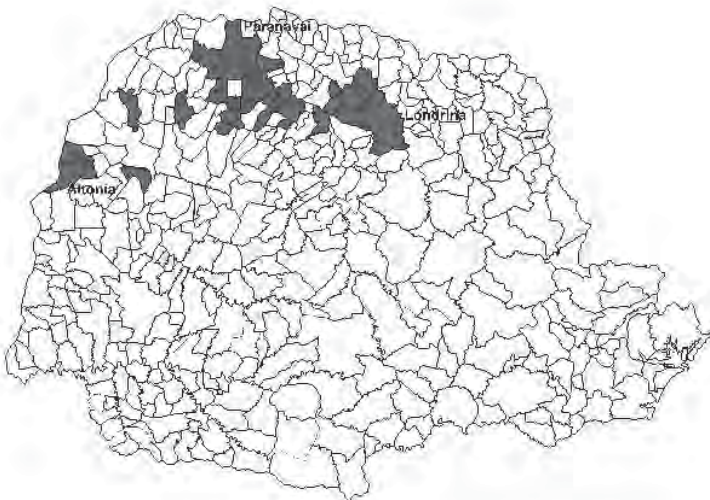
Since the detection of huanglongbing (HLB) disease in Florida in 2005, we started monitoring the movement of the HLB-associated bacterium, *Candidatus Liberibacter asiaticus* in psyllids (*Diaphorina citri*). Several studies show that infected trees can remain symptomless for a long time, and it is difficult to detect the presence of bacteria in symptomless trees. Analysis of a large number of psyllid samples collected from groves, retail nurseries, garden centers and other sources showed that psyllids can be used to detect HLB-associated Liberibacters in locations where plants are not showing symptoms. Infected psyllids were detected in many groves several months to over a year before symptomatic plants were found. Importantly, infected psyllids were found in about 15% of over 1000 samples collected from retail nurseries and garden centers in most counties sampled. However, these studies also showed a possible seasonality of the occurrence of bacteria in psyllids with the maximum incidence in fall, followed by spring, summer and least incidence in winter. These results show the value of monitoring psyllids in prevention and management of HLB and the need to develop better detection methods for monitoring of large numbers of psyllids.

### 12.3 Occurrence and management strategies for HLB in the State of Paraná, Brazil

Leite R.P.

Instituto Agronômico do Paraná - IAPAR, Londrina, PR, Brazil

Huanglongbing (HLB) caused by *Candidatus Liberibacter asiaticus* is the most severe disease of citrus around the world. The disease was first reported in Brazil in 2004 in the state of São Paulo. In Paraná, HLB was first reported in citrus orchards in the municipality of Altônia, in the Northwest region of the State, in 2006. The disease was observed on 4 to 5 years old trees of sweet orange Folha Murcha sweet orange (*Citrus sinensis* (L.) Osb.) grafted on Rangpur lime (*Citrus limonia* Osb.). Typical symptoms of HLB on leaves were blotchy mottle, reduced size and yellowish color, and on fruits were lopsidedness, poor color and aborted seeds. By now, the disease has already been reported in at least 28 municipalities in the North and Northwest regions of the State of Paraná, which comprises the main citrus producing areas of the State (Fig.



1). The disease has been found in the sweet oranges IAPAR 73, Folha Murcha, Pera and Valencia, with similar symptoms severity. The psyllid *Diaphorina citri* (Kuwayana), vector of the bacterium *Candidatus Liberibacter asiaticus*, is widespread throughout the State. The presence of *Murraya paniculata* (L.) Jack as a preferential host for the vector, occurring in backyards and landscapes has also been associated with the occurrence of HLB in Paraná.

Fig. 1. Municipalities with occurrence of HLB in the State of Paraná, Brazil.

Several measures have been enforced in Paraná to reduce the spread of HLB and to keep the disease under control. The production, commercialization and planting of *M. paniculata* have been banned in Paraná since 2006 by a state regulation. Production of citrus nursery trees are allowed only under closed insect-proof conditions. Growers are obligated to carry out orchard inspections regularly to detect symptomatic citrus trees and to eliminate the infected trees. The growers who do not eliminate diseased trees may suffer legal penalty. Sprays of insecticides are also recommended to reduce the population of *D. citri*. Campaigns have been implemented by state and municipal personal to advise growers on the seriousness of HLB for the citrus industry and for the need to quickly adopt measures to control the disease. The involvement of growers

associations and cooperatives in the actions has been key for reducing the spread and implementing a control program for HLB in Paraná State.



## **12.4 Observations gleaned from the geospatially referenced and documented spread of HLB in three commercial groves in Florida and the implications of these observations on scouting and management decisions.**

Irey M.<sup>1</sup>, Gast T.<sup>2</sup>, Terra R.<sup>2</sup> and Snively J.<sup>2</sup>

<sup>1</sup>United States Sugar Corporation, Clewiston, FL;<sup>2</sup>Southern Gardens Citrus, Clewiston, FL

Southern Gardens Citrus Corporation is one of the largest citrus producers in Florida and currently has 16,579 ac in production in three large groves. Huanglongbing (HLB) was first detected in the southernmost grove in November, 2005 in seven trees on the eastern edge of the property. Immediately after the initial discovery, a system was put into place to scout and remove HLB infected trees in all three groves. Since the initial find, a total of six scouting cycles have been conducted across all three groves.

The scouting process used at Southern Gardens consists of visual identification of HLB infected trees by trained field scouts followed by confirmation by “senior” scouts which are more experienced and more highly trained inspectors. If the senior scouts confirm the diagnosis of the initial scouting crews, the trees are marked for removal and the latitude and longitude of the tree is recorded using a rugged field computer that runs software specifically designed for HLB scouting that incorporates a global positioning system (GPS). Thus the position of every infected tree can be located within the grove for each inspection cycle. The data have been incorporated into a database and has proven useful on both a formal analytical and an anecdotal observation basis.

Cumulative over all three groves, HLB has increased from 0.1% in November, 2005 to 12.6% in March, 2008. Although HLB was found during all inspection cycles, inspection cycles conducted during suboptimal times of the year for symptom expression (April to July) were less effective than survey cycles conducted during other times of the year. Higher levels of infection were noted during all inspection cycles in trees less than 10 years of age compared to trees greater than 10 years of age. Higher incidences of HLB infected trees were observed associated with grove and block “edges”. The edge effect was apparent at various spatial scales across the groves. The edge effect was apparent at the grove, block, and sub-block level. That is to say, where ever there was a break in the trees creating an interface between continuous trees and an open space there tended to be an increase in infected trees. Examples of edges include grove and block boundaries, roads, irrigation ditches, ponds, interfaces with natural areas, and interfaces between young and mature trees.

Although based largely on anecdotal observations, some of these observations can and are being used in making scouting and management decisions. As an example, if resources are limiting and the goal is to determine if HLB is present in a new area or grove block (i.e. initial discovery), scouting efforts directed towards young trees and concentrating on edges may be warranted instead of surveys attempting 100% grove coverage. Similarly, if resources are limited, particularly when using contracted scouting services, suboptimal times of the year could be avoided for HLB surveys or could be redirected towards scouting for other diseases or pests. Also, as new groves are being planted, it may be possible to plant groves in such a way to minimize the edge effect and thus help minimize risk of HLB infection. Another possible management practice could be the application of different production practices in the areas likely to have higher infection potential (edges) compared to other portions of the groves (interior

portions). Studies are currently underway to understand and validate some of the observations gleaned from the Southern Gardens database which will hopefully result in grove management programs that are more effective for management of HLB.

## 12.5 Effect of strategies for inoculum reduction and vector control on Huanglongbing progress

**Bassanezi R.B.**<sup>1</sup>, Yamamoto P.T.<sup>1</sup>, Gimenes-Fernandes N.<sup>1</sup>, Montesino L.H.<sup>1</sup>, Tersi F.E.A.<sup>2</sup>, Sperandio P.H.<sup>2</sup>, Gottwald T.R.<sup>3</sup>, Bergamin Filho A.<sup>4</sup>, Amorim L.<sup>5</sup>

<sup>1</sup>Fundecitrus, Araraquara, Brazil; <sup>2</sup>Cambuhy Agrícola LTDA, Matão, Brazil; <sup>3</sup>USDA/ARS, Fort Pierce, USA, <sup>4</sup>ESALQ/University of São Paulo, Piracicaba, Brazil.

Since there are no known curative methods for control of huanglongbing (HLB), strategies to prevent as many trees as possible from becoming infected must be applied. Based on multiple years of experience of Asian and South Africa commercial producers and agricultural agencies, this can only be done (i) by eliminating as much as possible *Liberibacter* inoculum by removing HLB infected trees, and (ii) by keeping psyllid populations as low as possible by chemical or biological insecticides (1,2,3). Reduction of inoculum is a strategy that demands continuous and costly efforts, because every tree must be inspected by a very well trained scout team multiple times per year due to the existence of asymptomatic but potentially HLB-infected trees. This strategy is not easily accomplished by many growers, because there is an immediate loss when a symptomatic but productive tree is eliminated. Chemical control of HLB psyllid vector is perhaps the easiest HLB control strategy to accomplish by citrus growers, however the necessity for additional and frequent sprays is costly. Although there is much information for the effect of chemical control with various insecticide spray programs on the psyllid vector population, the effect of this practice on HLB epidemics remains largely undocumented. Actually, the effectiveness and the importance of both recommended strategies on HLB temporal progress in the grove remain undefined, as well as the frequency that they must be applied to achieve successful and economical management of HLB. Therefore, to establish a sustainable HLB management program based on inoculum reduction and insect vector control, it is necessary to evaluate the effectiveness of both strategies on the HLB epidemics with regard to the frequency of their application and their yearly and multiyear costs. Considering these factors, our main objectives were to study the effect of different frequencies of removal of symptomatic trees and of vector control on HLB progress.

Two field experiments were carried out in the Central region of Sao Paulo State, Brazil. This region is the area in the state most affected by HLB. Experiment 1 was established in the middle of a large citrus farm, where a rigorous HLB control has been applied since July 2004. In this farm, in October 2005, a new grove of 'Valencia Americana' sweet orange grafted on Swingle citrumelo was planted. This experimental area was divided in 27 two-acre plots with 528 trees (16 rows with 33 plants) with a spacing of 6.0 m x 2.5 m. The experiment had a 3x3 factorial design with three replications for each treatment. The factor "Inoculum reduction" had three levels: removal of symptomatic trees every 28 days, 56 days and 112 days; and the factor "Vector control" had three levels: no psyllid control, psyllid control program A, and psyllid control program B. For plots with psyllid control program, the following strategy has been applied: during the rainy season, starting in November/December, two systemic insecticide applications via soil at 56 days intervals alternating Aldicarb and Thiamethoxam; and during the rest of the year, insecticide foliar sprays every 28 days for psyllid control program A, and every 14 days for psyllid control program B, alternating Imidacloprid, Dimethoate, and Lambda-cyhalothrin. Experiment 2 was established in a small farm without citrus groves, but since the

beginning of 2007 it was surrounded by farms severely affected by HLB. The farm is still surrounded at 800 to 2,500 m distance by several non-commercial citrus groves with very low control of HLB and psyllids. In this farm, in April 2006, a new grove of ‘Valencia’ sweet orange grafted on Rangpur lime was planted. This experimental area was divided in 24 2.4-acre plots with 504 trees (18 rows with 28 plants) with a spacing of 6.7 m x 2.9 m. The experiment had a 4x2 factorial design with three replications for each treatment. The factor “Inoculum reduction” had four levels: removal of symptomatic trees every 14 days, 28 days, 84 days and 182 days; and the factor “Vector control” had two levels: no psyllid control and psyllid control program C. For plots with psyllid control program C, the same strategy of program B was applied, except by replacing Lambda-cyhalothrin by Etofenprox in foliar insecticide sprays. In both experiment 1 and 2, psyllid population was assessed fortnightly by counting adults of *Diaphorina citri* on six yellow sticky traps distributed in the central area of each plot, and HLB symptomatic trees incidence was assessed monthly by counting visually symptomatic trees in each plot (for every suspicious plant a PCR test was done to confirm the presence of *Candidatus Liberibacter species*).

The first HLB-symptomatic tree was found, in Experiment 2, 13 months after planting (May 2007), and, in experiment 1, 22 months after planting (July 2007). The average of cumulative number of adult psyllids caught by yellow sticky traps and the average of incidence of HLB symptomatic trees eradicated for each treatment and experiment are shown in the Tables 1 and 2. HLB disease progress in Experiment 2 was more rapid than in Experiment 1 (HLB incidence average in plots without vector control of 3.24% in Experiment 2 vs. 0.45% in Experiment 1), probably because of differences in external inoculum and psyllid populations present at each location. In plots with no psyllid control in Experiment 2, the average number of psyllids trapped was 5.0 psyllids/month/plot, while in plots with no psyllid control in Experiment 1 the average trapped was 2.2 psyllids/month/plot.

In Experiment 1, no significant differences in HLB incidence were observed among levels of inoculum reduction and vector control were observed (Table 1). In Experiment 2, there were also no differences in HLB incidence among the levels of inoculum reduction (Table 2). In Experiment 2, psyllid population and HLB incidence in plots with no psyllid control were significantly higher than in plots with psyllid control program C (Table 3).

Table 1. In Experiment 1, the mean cumulative number of adult psyllids caught by yellow sticky traps and incidence of HLB symptomatic trees eradicated for each treatment through November 2008 (38 months after plantation).

Inoculum reduction	Vector control	Cumulative number of caught psyllid	HLB incidence (%)
Every 28 days	No control	68.3 a	0.44 a
Every 56 days	No control	77.3 a	0.52 a
Every 112 days	No control	99.0 a	0.39 a
Every 28 days	Program A (28d)	71.0 a	0.61 a
Every 56 days	Program A (28d)	43.0 a	0.57 a
Every 112 days	Program A (28d)	65.3 a	0.32 a
Every 28 days	Program B (14d)	70.7 a	0.38 a
Every 56 days	Program B (14d)	67.7 a	0.38 a
Every 112 days	Program B (14d)	57.7 a	0.63 a

Treatments with the same letter in the column are not significantly different by Tukey’s HSD test at the 5% level.

Table 2. In Experiment 2, the mean cumulative number of adult psyllids caught by yellow sticky traps and incidence of HLB symptomatic trees eradicated for each level of inoculum reduction through November 2008 (32 months after plantation).

Inoculum reduction	Cumulative number of caught psyllid	HLB incidence (%)
Every 14 days	121.2 a	3.08 a
Every 28 days	70.0 a	2.10 a
Every 84 days	135.3 a	2.88 a
Every 182 days	86.8 a	2.07 a

Treatments with the same letter in the column are not significantly different by Tukey's HSD test at the 5% level.

Table 3. In Experiment 2, the mean cumulative number of adult psyllids caught by yellow sticky traps and incidence of HLB symptomatic trees eradicated for each level of vector control through November 2008 (32 months after plantation).

Vector control	Cumulative number of caught psyllid	HLB incidence (%)
No control	158.7 a	3.24 a
Program C (14d)	48.0 b	1.57 b

Treatments with the same letter in the column are not significantly different by Tukey's HSD test at the 5% level.

Psyllid population and HLB incidence were dependent on external sources, being higher in Experiment 2 than in Experiment 1, indicating a clear effect of regional reduction of inoculum and vector control on HLB progress (Experiment 1, lower external inoculum pressure = lower HLB incidence; Experiment 2, higher external inoculum pressure = higher HLB incidence). However, the effect of local inoculum reduction was not yet detected after almost three years (absence of differences among levels of inoculum reduction). It was probably due to low disease incidence, to the long incubation period of the disease (if there is an effect of local reduction of inoculum, this effect would be observed only after multiple years), and additionally, due to long distance dissemination of Asian psyllid (high inter-plot interference or a high external inoculum source interference, i.e., infected psyllids from neighboring HLB-affected citrus blocks could immigrate into the plots and inoculate trees before they are killed by insecticide treatments). This may be an indicative that the primary infection of HLB is from external inoculum sources rather than the secondary infection from the local inoculum source.

The vector control program tested (especially programs B and C) even though very rigorous did not completely control HLB infection and the effect of vector control was detected only under high external inoculum pressure. Moreover, the efficiency of vector control may not be sufficient to sustain the profitability of a citrus grove. In Experiment 1, with low external inoculum pressure, the HLB incidence was less than 0.5% in 3 years, while in Experiment 2 with high external inoculum pressure the HLB incidence in vector control plots were 3 times more (1.5%). More time is needed to make final conclusions from these experiments.

This project has been partially supported by Fundecitrus and Fapesp (Projects 2005/00718-2 and 2007/55013-9).

#### Literature cited

- Bové JM. 2006. Huanglongbing: A destructive, newly-emerging, century-old disease of citrus. *Journal of Plant Pathology* 88:7-37.
- Da Graça JV. 1991. Citrus greening disease. *Annual Review of Phytopathology*, 29:109-136.
- Gottwald TR, da Graça JV, Bassanezi RB. 2007. Citrus Huanglongbing: The pathogen and its impact. *Plant Health Progress* doi: 10.1094/PHP-2007-0906-01-RV.

## 12.6 Better management for citrus greening: chemical-uses or guava-interplanting?

Ichinose K.<sup>1</sup>, Bang D. V.<sup>2</sup>, Dien L. Q.<sup>2</sup>

<sup>1</sup> Japan International Research Centre for Agricultural Sciences, Ishigaki, Japan; <sup>2</sup> Southern Fruit Research Institute, Chau Thanh, Vietnam

No effective controls of citrus greening disease (CG), a lethal disease of citrus, have been established yet. The geographical type of the pathogen in Asian countries, *Candidatus Liberibacter asiaticus*, is transmitted by the vector psyllid, *Diaphorina citri*. In the Mekong Delta Region (MDR) of Vietnam, this disease has rapidly increased since the late 1980s. The percentage of infected citrus orchards in this region was generally less than 10% before 1990, but has now soared to 90%. Current management for this disease is primarily performed by chemical control of the vector insect, *Diaphorina citri* (Kuwayama). However, no chemical control program has succeeded in protection of citrus orchards, but if intensive control of the vector is not carried out, CG terminates orchards in a couple of years in the Mekong Delta. In early 2004, four farmers of Cai Be, Tien Giang Province, in southern Vietnam, communicated an exceptional observation to the scientists at the Southern Fruit Research Institute of Vietnam. The farmers had who interplanted guava, *Psidium guajava* L., in orchards of King mandarin, a sensitive variety to CG, observed a low incidence of CG in their orchards, while neighboring orchards without guava were seriously damaged. These farmers began interplanting guava not for CG control but for earlier income from the orchard. In this region, it usually takes about two years until the first crop of king mandarin but one half year for guava. We visited 17 orchards, where guava-interplanting (7), chemical control of pests (2), biological control by weaver ants (2), *Oecophylla smaragdina* (F.) (2), or no control (5) was practiced. These orchards varied in age from 2 to 4-years old. Five leaves from 10 to 20 trees were collected in each orchard and tested for CG infection by PCR to evaluate the efficacy of these managements. The mean infection percentage ( $\pm$  sem) was lowest in guava-interplanted orchards ( $12.4 \pm 2.8\%$ ), followed by chemical control ( $20.2 \pm 4.8\%$ ). Biological control appeared to be much less effective than these two managements ( $65.7 \pm 11.2\%$ ) and even no control ( $39.5 \pm 6.6\%$ ). Since the lowest infection percentage was obtained in guava-interplanted orchards, a field experiment was initiated to test 1000 m<sup>2</sup> in size. In 2004, in one plot (GI), guava trees were planted at a spacing of 2.5 m between rows and 2.5 m within rows and tree height was about 1 m by by 2005. In the non-guava-interplanted (NG) plot, no guavas were planted. The shortest distance between these two plots was about 10 m. The incidence of CG in surrounding orchards was 50 to 100%. In May 2005, disease-free king mandarin seedlings were planted so that the distance both between the rows and between the trees was 2.5 m. Thus, the distance between king mandarin and guava plants was 1.25 m in the GI plot. No chemical control for the psyllid was performed in either plot throughout the experiment. Number of adult psyllids and nymph colonies on each tree was counted in both plots once per month, and five leaves were collected from 12-15 randomly selected trees to estimate the percentage of infected trees by PCR. Incidence of other insect pests and diseases was also monitored in these plots. Adult psyllids were higher in the NG plot (0.5/shoot at maximum) than in GI plot ( $< 0.1$ /tree), as well as nymph colonies (0.15/shoot and 0.025/shoot, respectively). In the first 14 months, no CG infected trees were detected in the GI plot, but 30 % of trees were infected in the NG plot. CG infection reached 20 % after two and half years in the GI plot, and 70% after 2 years in the NG plot. Hence, guava-interplanting

reduced the incidence of CG. The effect of guava-interplanting was not only demonstrated through the reduction of psyllid vectors but also other pests. Occurrence of aphids, mealy bugs and leaf miners was significantly lower in the GI plot, compared to the NG plot. In contrast, the occurrence of mites and scab disease was significantly higher in the GI plot. Based on these results, we hypothesized that guava produces phytochemicals that repel psyllids. To test this hypothesis, extracts of guava were made with three solvents of different polarity: hexane, acetone and methanol. In May 2005, 1kg of guava leaves was collected and dried for one week under a sunshade condition. The dried leaves were immersed in 10L of hexane for one month, and the extract filtered. Then the same leaf sample was immersed again in 10L of acetone. Subsequently the same leaf sample was treated with methanol. These filtered solvents were concentrated to 100ml and used for a bioassay test. Psyllid choice tests were performed, in which five psyllids were placed in a small cage with a detached leaf of King mandarin and a leaf sprayed with one of the three extracts. Preference for leaves treated with acetone or methanol extracts was not significantly different from untreated leaves. By contrast, the number of psyllids was much lower on leaves treated with the hexane extract than on untreated leaves. Hence, guava appears to contain a substance that has low polarity and can repel psyllids. If this substance is effective as a volatiles applied to orchards for reduction of invasion by psyllids, the repellent could be used to reduce the risk of CG infection of orchards. However, guavas alone are not effective enough for control of the psyllid, since the percentage of CG-infected trees increased in the GI plot to 20% over two years. Thus, the combination of guava-interplanting and insecticides will be needed for integrated management of CG in King mandarin orchards of the MDR.

## 12.7 Imidacloprid-induced systemic acquired resistance (SAR) in Cleopatra mandarin and development of HLB

Graham J. H., Dawson W. O. and Robertson C.

University of Florida, Citrus Research and Education Center, Lake Alfred, FL, USA

Systemic acquired resistance (SAR) is a mechanism of induced defense that may confer long-lasting protection against a broad spectrum of microorganisms (1). Plants acquire an enhanced defensive capacity against subsequent pathogen attack as a result of a primary, limited pathogen infection. SAR requires the signal molecule salicylic acid (SA) and is associated with accumulation of pathogenesis-related proteins, which are thought to contribute to resistance. These pathways can be activated in the absence of pathogens by treatment of plants with chemical inducers. For example, acibenzolar-S-methyl (ASM, Actigard®, Syngenta Crop Protection), is a functional homolog of salicylic acid.

In a recently completed study (2). Potted Swingle citrumelo seedlings (*Citrus paradisi* × *Poncirus trifoliata*) were treated with imidacloprid (Admire Pro, Bayer Crop Science) and the SAR inducers, isonicotinic acid (INA) and ASM as soil drenches one week prior to inoculation of immature leaves with *Xanthomonas citri* pv. *citri* (Xcc). Seedlings were re-inoculated four times over a 24-week period. SAR induction was confirmed by expression of the PR-2 gene. Soil drenches of imidacloprid, INA, and ASM induced a high and persistent up-regulation of PR-2 gene expression and reduced canker lesions for up to 24 weeks. Soil inducers of SAR reduced canker lesions up to an average of 70% compared with the untreated control. Lesions on leaves were small, necrotic, and flat compared to pustular lesions on non-treated leaves. Populations of Xcc per leaf were reduced 1-3 log units.

The potential for SAR to reduce HLB disease development was explored in a greenhouse trial at CREC. Two rates of soil applied imidacloprid (Admire Pro) were evaluated for effects on HLB development in Cleopatra mandarin trees grafted-inoculated with HLB-infected budwood from greenhouse-infected trees one month after soil drench treatments with imidacloprid. HLB symptom development and bacterial titer were monitored over a 6-month period in comparison with non-treated plants. After 5-6 months, plants treated with no imidacloprid, low imidacloprid or high imidacloprid were 80-100% PCR positive. Thus, imidacloprid failed to reduce the HLB infection process. However, HLB-infected budwood inoculation of greenhouse plants may represent an unrealistic inoculum challenge that overcomes SAR-induction of plant defense.

A more realistic approach for evaluation of the potential of SAR will be to challenge young trees treated with imidacloprid and subjected to either infected psyllids by planting them in a HLB endemic area or graft inoculating them with infected tissue from symptomatic field trees.

### Literature cited:

- Durrant WE, Dong X. 2004. Systemic Acquired Resistance. *Ann. Rev. Phytopathology* 42, 185-209.
- Francis MI, Redondo A, Burns JK, Graham JH. 2009 Soil application of imidacloprid and related SAR-inducing compounds produces effective and persistent control of citrus canker. *Eur. J. Plant Path.* DOI 10.1007/s10658-008-9415-x



## 12.8 Detection of greening in sprouts from citrus tree stumps.

<sup>1</sup>Futch Steve, <sup>1</sup>Brlansky Ron, <sup>2</sup>Irey Mike and <sup>3</sup>Weingarten Shawron

<sup>1</sup>Citrus Research & Education Center, Lake Alfred, Florida, USA; <sup>2</sup>United States Sugar Corporation, Clewiston, Florida, USA; and <sup>3</sup>Orange-Co LP, Arcadia, Florida, USA.

A study was conducted to determine if sprouts that grow from stumps of citrus trees that were removed because they exhibited visual greening (HLB) symptoms will later produce sprouts that will be positive for greening in subsequent tests. The study was initiated in a commercial citrus grove in DeSoto County, Florida on April 14, 2008. All trees in the selected block were visually surveyed for greening symptoms by a scouting crew trained to detect greening positive trees. Suspected greening trees were flagged and then reconfirmed by the senior scout to be greening positive. Marked trees were not tested by laboratory methods to confirm the presence or absence of greening prior to removal.

After marking and visual confirmation for greening, the 15 selected trees were selected for removal using a standard tree shear that is mounted to a large front-end loader (Figure 1). This tree-shearing process, commonly referred to as clipping, is often used in the citrus and timber industries throughout Florida to remove trees of various sizes. Clipped trees were sheared off several inches above the soil surface leaving part of the stump and the entire root system intact. A common grower practice is to treat the surface of the cut stump with herbicide material to suppress sprouting from the stump or roots. However, for this study, stumps were not treated with any herbicidal products to prevent sprouting.

Stumps from greening positive trees were surveyed at approximately 30-day intervals to detect any sprout formation from the stump or lateral roots. Once a stump had any sprout formation, the entire stump and exposed lateral roots were enclosed within a screen enclosure to prohibit psyllid feeding on new vegetative growth that arose (Figure 2). The enclosure is approximately 2 feet square and 3 feet tall. The screen material selected for the enclosure was 80 mesh and of the type approved for citrus greenhouses where greening-free nursery trees are produced. This woven mesh screen prevents psyllid movement through the material.

At 160 days (Sept. 17, 2008) after the beginning of the study, leaf and stem tissue from sprouts on stumps with sufficient vegetative growth were tested by a DNA-based laboratory method (PCR) to determine if they were positive for greening. Only individual sprouts large enough to obtain an adequate tissue sample were selected, marked and tested.

During the study period, 12 of the 15 untreated stumps sprouted. Sprouts were noted over the study period with 0, 5, 3, 1 and 3 of the 15 stumps sprouting at 29, 56, 85, 113 and 141 days after tree removal, respectively (Figure 3). The number of sprouts per stump ranged from 2 to 26 and averaged 8 per stump at the end of the study. Two of the 12 stumps that sprouted did not have sufficient vegetative growth to properly analyze the plant material for the greening bacterium. Thus sprouts from 10 stumps were tested. All sprouts of sufficient size were collected from

stumps and individually analyzed using real time PCR. The number of individual sprouts per stump ranged from 2 to 8 with an average of 6 per stump.

Prior to testing the sprouts at 160 days post clipping, several stumps had sprouts exhibiting visual symptoms for greening (Figure 4). Based on PCR testing, eight of the 10 stumps (80%) had one or more sprouts that were greening positive. The percentage of greening positive sprouts recovered from a given stump ranged from 33% to 100%. The broad range in percentage of greening positive sprouts within individual stumps reflects an uneven distribution in the roots and further confirms the uneven distribution of greening within the tree.

The fact that a majority of the sprouts originating from stumps of clipped trees tested positive for greening is important because the infected sprouts can serve as a source of inoculum and further spread of greening in groves that are attempting to control the disease. While the control of sprouts from citrus stumps has always been important, it is even more essential today, given current needs to minimize the spread of greening within and between citrus groves. Sprouts from stumps of clipped trees can harbor the greening bacterium and the vigorous young flushing condition of sprouts is highly attractive for psyllid feeding. Therefore, with current production practices involving clipping and tree removal, it is imperative to keep all stumps sprout free. Timely herbicide application after clipping and periodically checking for sprouting is essential for controlling the spread of greening.



Figure 1: Front-end loader used in clipping citrus trees with tree shear attachment.



Figure 2: Screen enclosure surrounding clipped stump to prohibit psyllid feeding on sprouts.

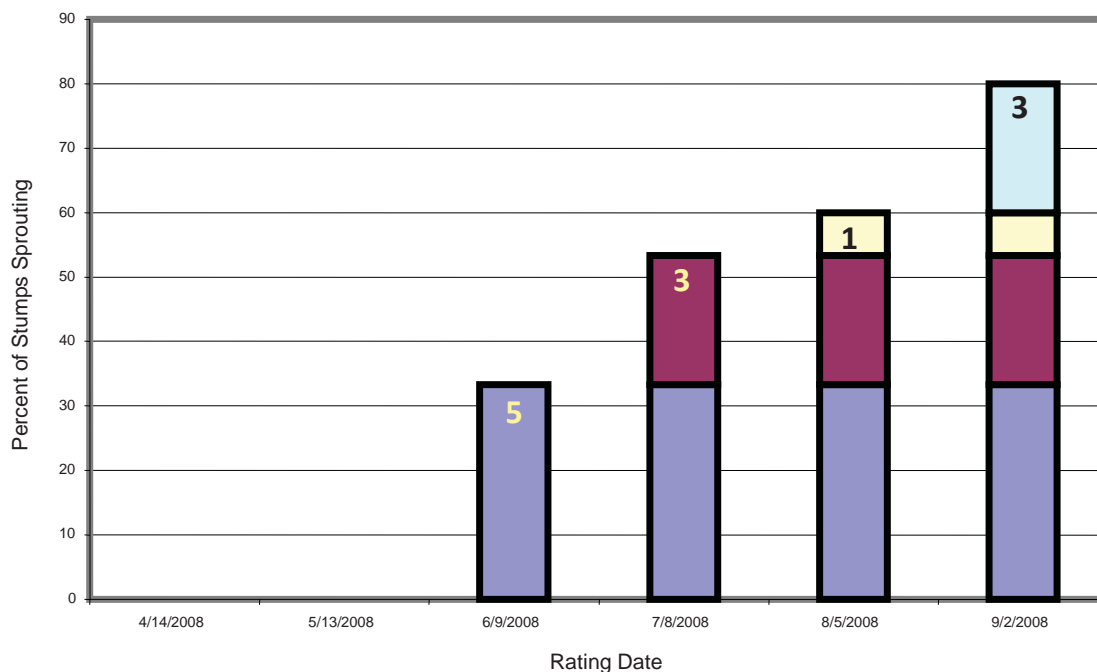


Figure 3: Bars in the graph indicate the percentage of stumps that sprouted over time after clipping on April 14, 2008. Color of bars represents the number of new stumps sprouting each time period with dark blue representing 5; red 3; yellow 1; and light blue 3. Days post clipping (DPC) for each observation date: May 13, 29 DPC; June 9, 56 DPC; July 8, 85 DPC; August 5, 113 DPC; and September 2, 141 DPC.



Figure 4: HLB symptoms on sprout from one stump in the study which was confirmed as positive for the bacterium.

## 12.9 Beating Huanglongbing – An Integrative Solution

Hunter W.B.<sup>1</sup>, Peretz Y.<sup>2</sup>, Sela I.<sup>2</sup>, Huet H.<sup>2</sup>, Lapidot M.<sup>2</sup>, Yarden G.<sup>3</sup>.

<sup>1</sup>USDA, ARS, US. Hort. Res. Lab, Ft. Pierce, FL, USA. <sup>2</sup>Hebrew University Jerusalem Israel, ISRAEL. <sup>3</sup>Morflora, LLC, Miami, FL, USA.

We are presenting a holistic approach towards the development of creative solutions to problems associated with Huanglongbing, HLB, and its psyllid vectors. The current approach being developed provides preventive and/or curative treatments to citrus seedlings and mature field trees in order to protect trees from HLB and psyllids. The treatment is based on the recently developed technology, the universal plant expressing platform, IL60, which may serve as "vaccine-like" treatment to serve as a mitigation measure against HLB. The IL-60 platform is a unique plant expression-silencing system based on viral sequences (Peretz et al. 2007). It can self-replicate and spread in all plant species tested so far, including citrus, and is totally non-pathogenic. It is not integrated into the plant genome, therefore is not transmitted to progeny nor to other plants. Another remarkable attribute is that it can express large sequences (more than 7 kb). In brief, the system has the advantages of plant transformation, but is much more flexible and safer for the environment. Here we present initial results of the systemic expression in plants of the entire operon of pyrrolnitrin (PRN) by the IL60-derived system. This provides a broad resistance against various bacteria, fungi and phytoplasma in tomato, and therefore can potentially provide resistance to HLB in citrus. Furthermore, we are presenting the use of this system, driven by specific promoters and harboring other useful elements targeting specific sequences of the insect using a gene silencing approach, which may kill or prevent transmission of bacteria associated with HLB, thus reducing disease transmission. The IL-60 platform and the PRN expression system have great potential to provide resistance to citrus seedlings and is being evaluated as a possible 'cure' for HLB infected trees.

## 12.10 Flying Dragon Trifoliolate Orange Rootstock for High Density Plantings in São Paulo, Brazil.

Stuchi E.S.<sup>1,2</sup>, Silva S.R.<sup>2</sup>, Sempionato O.R.<sup>2</sup>, Reiff E.T.<sup>2</sup>.

1 Embrapa Cassava & Tropical Fruits, Cruz das Almas, Brazil; 2 Citrus Experimental Station, Bebedouro, Brazil.

High density citrus plantings (HDP) should be considered an important horticultural mitigation strategy for HLB. HDP provide higher productivity than conventional planting mainly during the early years but, as soon as they grow older, tree size becomes a problem (2,4). Tree size control not only facilitates cultural practices and harvest, but also allows the establishment of orchards with close spacing (1). *Poncirus trifoliata* var. *monstrosa* ‘Flying Dragon’ (FD) is considered a dwarfing rootstock with similar horticultural performance as the *P. trifoliata* (3). Aiming to evaluate the performance of HDP using FD as a rootstock, two experimental plots were installed in November 1994, in the Estação Experimental de Citricultura de Bebedouro, São Paulo State, Brazil. The soil was classified as Haplustox (38% of clay). The climate is Cwa according to Koeppen. In the first experiment, the scion was ‘Tahiti’ acid lime cv. IAC-5 (*Citrus latifolia* Tanaka). Trees were planted at four densities: 1) 2,500 trees.ha<sup>-1</sup> (4.0 x 1.0 m), 2) 1,666 trees.ha<sup>-1</sup> (4.0 x 1.5 m), 3) 1,250 trees.ha<sup>-1</sup> (4.0 x 2.0m); and 4) 1,000 trees.ha<sup>-1</sup> (4.0 x 2.5 m). The experimental design was randomized blocks, with 4 treatments, 5 replicates, with 4 trees per plot. In the second experiment, trees of Hamlin, Valencia and Natal sweet oranges grafted on FD were planted at 1,250 trees.ha<sup>-1</sup> (4.0 x 2.0m) in a randomized blocks, with 5 replications, and 8 trees per plot as treatments. The experiments received the standard cultural practices recommended in Southern Brazil, with no supplementary irrigation until 2001 and 2002 for the acid lime and the sweet oranges experiments, respectively. Results on tree size, fruit yield, and fruit quality are discussed for the period from 1998 to 2007 for the first experiment and from 2004 to 2008 for the second experiment.

Forsyth JB, Barkley P, Hutton RJ, Bevington KB. 1993. Citrus high density management: dwarfing and guidelines for commercial use. Orange: NSW Agriculture & Fisheries; Division of Plant Industries, 1993. 6p. Agnote DPI/76, 6p.

Golomb A. 1989. High density plantings of intensive citrus groves: a challenge and realization. Proc. Intern. Soc. Citriculture, 6:921-930.

Rosse ML. 1986. Dwarfing rootstocks for citrus. In: Proc. 2nd Cong. Intern. Soc. of Citrus Nurserymen, Riverside, USA, pp. 1-8.

Tucker DPH, Wheaton TA, Muraro RP. 1991. Citrus tree spacing and pruning. Univ. Florida, Inst. Food and Agric. Sci., SP74, 15p.

### 12.11 Research on the technique of eliminating Huanglongbing Disease from Tankan

Zhong Y., Yi G. , Jiang B., Jiang N., Liu Y.

Institute of Fruit Tree Research, Guangdong Academy of Agricultural Science, Guangzhou, P R China

Huanglongbing (HLB) disease is caused by *Candidatus Liberobacter asiaticus*, which is a most serious problem for the Chinese citrus industry. In our studies, three methods for eliminating the HLB pathogen from budwood were compared, including shoot tip culture, shoot-tip grafting (STG) and vitrification-cryopreservation of the shoot tip. Conditions for optimizing STG were also evaluated. Presence of the HLB pathogen was determined by PCR. HLB elimination rate for shoot tip culture was 25.3% for STG, with 1 or 2 leaf promordia was 100% and for cryopreservation was 98%. Two rootstocks, pummelo and trifoliate orange, were tested for suitability for STG. Pummelo was optimal for STG from 12 to 14 days after germination while STG with trifoliate orange was optimal at 14 to 16 days. Pummelo seedlings had a larger diameter stem than trifoliate orange that was more suitable for STG. A higher survival rate of STG was obtained with pummelo (75%) than with trifoliate orange (45%). Effect of shoot tip size on elimination of the HLB pathogen by STG was evaluated. Meristems with 1, 2, 3 or 4 leaf primordia were each grafted on etiolated rootstocks. Plantlets grafted with shoot tips from 1 or 2 leaf primordia were free of the HLB pathogen, whereas rates of elimination with 3 or 4 leaf primordia were 89.5% and 66.7% respectively.

## 12.12 Networking in research and innovation to develop solutions for HLB.

<sup>1</sup>Franca F.H., <sup>2</sup>Machado M.A., <sup>3</sup>Vieira L.F., <sup>4,2</sup>do Amaral A.M., <sup>5,2</sup>Freitas-Astúa J, <sup>6</sup>Lopes D.B. and <sup>6</sup>Druck S.

<sup>1</sup>Embrapa Labex-USA, USDA-ARS/OIRP, Beltsville, MD, USA; <sup>2</sup>Centro de Citricultura Sylvio Moreira/IAC, Cordeirópolis, SP, BR; <sup>3</sup>Embrapa Labex-Europe, Agropolis, Montpellier, FR; <sup>4</sup>Embrapa Genetic Resources and Biotechnology, <sup>5</sup>Embrapa Cassava and Tropical Fruits, <sup>6</sup>Embrapa Department of Research and Development, Brasília, DF, Brazil.

Corresponding author: [felix.franca@ars.usda.gov](mailto:felix.franca@ars.usda.gov) – [felix.franca@embrapa.br](mailto:felix.franca@embrapa.br)

*Huanglongbing* (HLB) is the most important disease associated with citrus production in Brazil and in other parts of the world. Embrapa, IAC-Centro de Citricultura Sylvio Moreira and other major research institutions in Brazil, facilitated by Embrapa Labex-USA and Embrapa Labex-Europe, are convinced that the challenges posed by HLB require that efforts and resources be coordinated toward common goals through the development of joint research ventures. The Brazilian HLB Research Consortium has assembled a network of the most important federal and state universities, state and private research institutions, federal agencies for plant protection and quarantine and 15 Embrapa research centers located throughout the country and close to the main citrus production areas in Brazil. Collaboration with other research institution such as USDA-ARS, University of Florida and CIRAD will furthermore increase the probability of developing successful plant protection strategies to benefit farmers, consumers and the environment. The awareness and challenges posed by HLB provides the impetus for the connection of researchers, extension agents and farmers into networks through research programs that share common goals. Research projects have been set up, infrastructure and personnel competencies developed, sponsorship provided by an array of funding agencies [Embrapa, Science & Technology Ministry (MCT-CNPq); FAPESP, and FUNDECITRUS in Brazil; USDA-ARS, Florida Citrus Advanced Technology Program (FCATP) in the USA; CIRAD and ANR in France. Currently, the portfolio of research projects is being carried out by those institutions through diverse arrangements to cover many scientific areas. An initiative is underway to consolidate collaborations with institutions in other HLB-prone countries in South America, including INTA in Argentina and INIA in Uruguay, and, eventually institutions from China and Africa. Embrapa and Centro de Citricultura Sylvio Moreira will host a short training program with graduate students from Brazil and abroad (Argentina, Uruguay, Paraguay, Chile and Colombia), in collaboration with INTA-Argentina to be held in May 2009 to enhance capacity building in South America for which prominent researchers from US and Europe, as well as Brazil and Argentina will contribute as instructors. Considering the relatively short time, the effort put forward and the number of research projects involved, the goal is to quickly develop a network for research groups. Given the past and present evidences for the effectiveness of mobilizing science to address strategic research issues, this model of action could be adopted, adapted and further tested by research institutions in other countries.

### Introduction

*Labex concept* - The implementation of the Labex (Embrapa's Virtual Laboratory Abroad) was the result of a strategic decision made by Embrapa in 1996 (1,2). The aim was to develop new instruments of research management designed to enhance international cooperation; to foster



scientific collaboration at national and international levels considering common scenarios that would require trans-disciplinary and multi-institutional coordinated effort; to facilitate the conception of high impact research proposals; to implement and to execute strategic, top quality research; to search for national and international funding opportunities.

Other roles played by Labex researchers are: to monitor the state-of-the-art of knowledge and innovation in strategic areas; to foster networking by means of facilitating and catalyzing instruments (e.g. workshops, etc) and to promote the exchange of scientists and students among Brazil, the US, Europe and eventually other relevant regions.

*Embrapa's R&D management concept* - To improve efficiency and efficacy, from 1999 to 2001 Embrapa conceived and developed the Embrapa System of R&D Management (SEG), which was implemented in 2002 (3,4). It is based in inducing the networking required to develop solutions for a specific scientific problem [or group of scientific challenges] as represented in Figure 1.

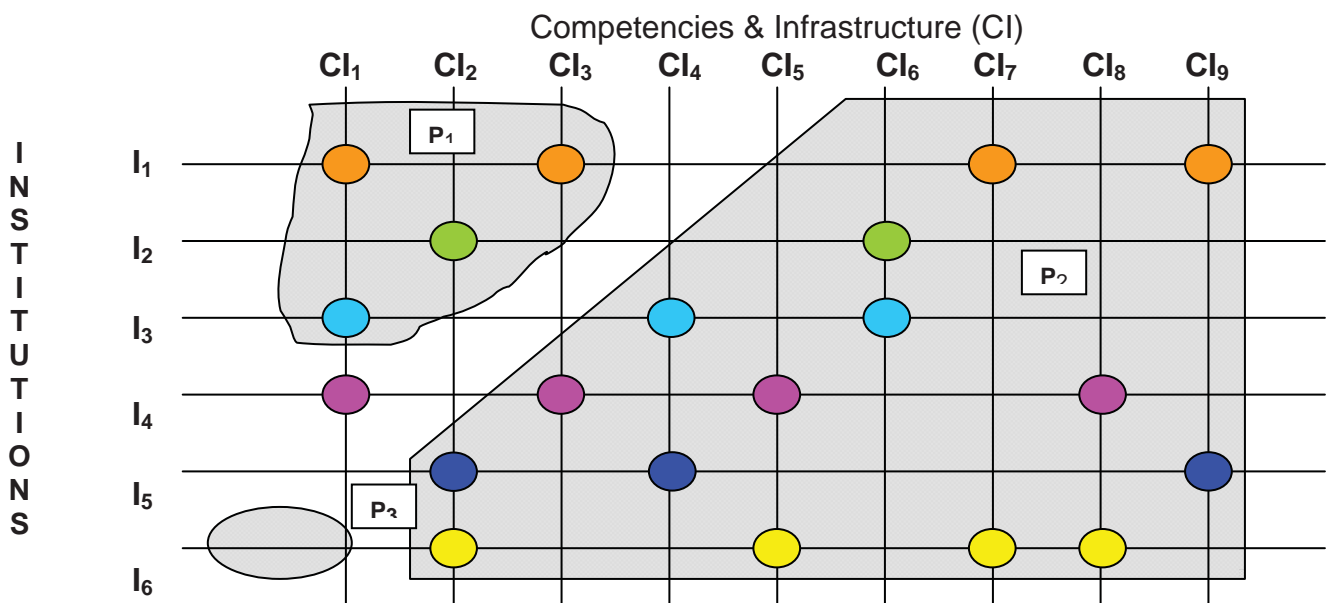


Figure 1. Research projects combining institutions and competencies at various levels. The project portfolio of the research network comprises the set of projects P<sub>1</sub>, P<sub>2</sub> and P<sub>3</sub>.

For this purpose, *Research Network* is defined as a set of institutions, research groups or research nuclei that are trans-disciplinary and multi-institutional with common scientific and/or technical objectives, with consensual coordination in order to share intellectual capital, infrastructure and financial resources, not necessarily in an equitable manner, but in a level accepted by all members, to develop a research portfolio aimed to attain common objectives and goals.

Resource sharing happens due to the urgency of complementing competencies [to align complementary infrastructures or to increase the trans-disciplinary of the intellectual capital, or

both], or by the need to increase the capacity of the infrastructure or critical mass, or both, which is needed to accomplish a set of objectives and goals. Therefore, research network is the physical-multi institutional coordinated arrangement that has the mandate to execute a research program having common goals and objectives. The *Network's Project Portfolio* is the set of projects being conducted by the research network in order to reach its objectives and goals.

## Results

*HLB Research Projects Portfolio facilitated by Labex* - A quite large number of visits, consultations, e-mail exchanges, conference-calls as well as two meetings were held between December 2007 and July 2008 and involved researchers from Brazil [Embrapa, IAC-Centro de Citricultura, ESALQ, Fundecitrus], United States [ARS, UF] and France [CIRAD]. A conclusive gathering took place at the USDA-ARS Horticulture Laboratory in Fort Pierce, FL. Each institution presented its respective research project's portfolio on HLB, competencies and infrastructures, allowing the identification of overlaps, gaps and new areas in which proposals could evolve and projects with common objectives could be developed. Decision was made to present independent and joint proposals to several funding agencies in each country represented in the meeting, in several themes, as seen in Table 1.

**Table 1. Research projects associated with Huanglongbing facilitated by Labex in 2008.**

Project Title	Research Leader	Funding Agency
Citrus <i>huanglongbing</i> (ex-greening): development of new biotechnological approaches of management.	Embrapa CNPMF, Juliana Freitas-Astúa	Embrapa Monsanto
Genomic platforms applied to citrus breeding.	IAC-Centro de Citricultura, Marcos Antonio Machado	MCT-CNPq
Biotechnological tools for studies on citrus pathogens and interaction with citrus plant.	Embrapa Cenargen, Alexandre M. do Amaral	MCT-CNPq
Biophotonics applied to early diagnosis of HLB.	Embrapa CNPDIA, Débora M. Bastos P. Milori	MCT-CNPq
Analysis of transcriptome of citrus infected with <i>Ca.L. asiaticus</i> and <i>Ca.L. americanus</i> .	IAC-Centro de Citricultura, Marcos Antonio Machado	FCPRAC
Attempts to in vitro culture <i>Candidatus Liberibacter asiaticus</i> isolates in order to fulfill Koch's postulates.	CIRAD, Michel Dollet	FCPRAC
Cultivation and identification of the causal agent of Huanglongbing disease of citrus.	ARS, Norman Schaad	FCPRAC
International Citrus Genome Consortium [ICGC]: Providing tools to address HLB and other challenges.	UF, Fred Gmitter	FCPRAC
Agrobacterium-mediated genetic transformation of mature citrus tissues.	UF, Gloria Moore	FCPRAC

Dissecting the disease complex of citrus huanglongbing in Florida.	ARS, Yong Ping Duan	FCPRAC
--	---------------------	--------

### Conclusions

Considering the relatively short time, the effort put forward and the number of research projects implemented, the process may be quite efficient for connecting and networking researchers and research groups. This process replicates results obtained by several other initiatives developed at the national level by Embrapa and, at the international level, by its Labex units in Europe and in the USA. Given the evidences of its effectiveness in mobilizing science to address strategic research issues, this model of action could be adopted, adapted and further tested by research institutions in other countries.

### Literature Cited

- Embrapa. 1995. Estratégia Gerencial da Embrapa – Gestão 95/98. Embrapa, Diretoria-Executiva. Brasília, DF.
- Pereira PAA, Vieira LF, Rodriguez-Franco C. 2007. History: Unique Instrument to Enhance International Research Cooperation. doi: [http://www.embrapa.br/a\\_embrapa/labex/noticias1/History%20Labex%20agosto%202007.pdf](http://www.embrapa.br/a_embrapa/labex/noticias1/History%20Labex%20agosto%202007.pdf)
- Embrapa. 2008. SEG - Fundamento, estruturas e funcionamentos do modelo de gestão. doi: [http://www.embrapa.br/a\\_embrapa/unidades\\_centrais/spd/seg/normas-do-seg/fundamentos.doc/view](http://www.embrapa.br/a_embrapa/unidades_centrais/spd/seg/normas-do-seg/fundamentos.doc/view)
- Embrapa. 2008. V Plano Diretor da Embrapa: 2008-2011-2023. Brasília, DF, Embrapa 2008. 44p. Embrapa-Secretaria de Gestão Estratégica. Brasília, DF. doi: [http://www.embrapa.br/publicacoes/institucionais/PDE\\_V20081230\\_CIMP.pdf/view](http://www.embrapa.br/publicacoes/institucionais/PDE_V20081230_CIMP.pdf/view)

### **12.13 Delivery of antibacterial peptides into commercial citrus cultivars for the control of citrus greening (Huanglongbing or HLB) in Florida.**

**Gowda S.**, Folimonova S., Miyata S-I., Shilts T., Robertson C., Garnsey S.M., and Dawson W.O.

Citrus Research and Education Center, IFAS, University of Florida, Lake Alfred, FL, 33850

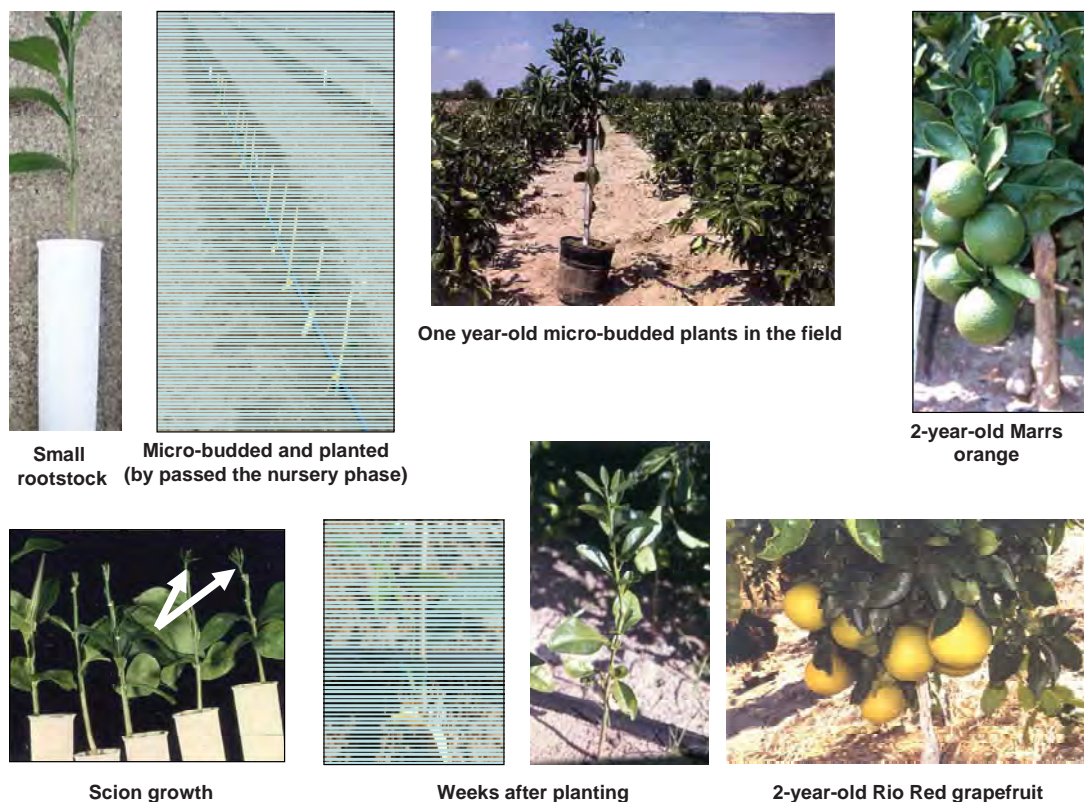
Citrus greening (Huanglongbing, HLB) is the single most economically important disease among citrus diseases worldwide. The causal agent of this disease is thought to be the non-cultured, phloem-limited,  $\alpha$ -proteobacterium, *Candidatus Liberibacter*. Three species of “*Ca Liberibacter*” have been associated with citrus greening: “*Ca Liberibacter asiaticus*” (Las), is predominant in Asia and Americas (mainly Florida and Brazil) transmitted by psyllid, *Diaphorina citri* Kuwayama; “*Ca. Liberibacter africanus*” in Africa, transmitted by *Trioza erythrae*; and in Brazil, another species, “*Ca. Liberibacter americanus*” (Lam). Since its first demonstration in August of 2005, HLB has spread rapidly into all major citrus growing regions in Florida. At this time, the control methods for HLB are reducing psyllid populations and removal of the infected trees, which may not be sustainable. In the long term, the most sustainable approach to manage citrus greening is to develop resistance in commercial cultivars. One approach is to express antibacterial peptides (AMP) in commercial citrus varieties to control the HLB bacteria. The AMP's, usually 20-40 amino acids long, are ubiquitous among eukaryotes and elicit innate defense against bacterial infections. The AMP's could be engineered to express in citrus through transgenic technology or using viral vectors. We have used a citrus tristeza virus (CTV) vector to deliver AMP's into sweet orange and grapefruit cultivars and subsequently challenge them with HLB to study the efficacy of AMP's to mitigate HLB infection. Twenty to thirty different AMP's of plant and animal origin were cloned with or without an export leader sequence into the CTV vector (Folimonov et al., 2007) between the CPm and CP genes behind the beet yellows virus CP subgenomic RNA controller element. These constructs were used to transfect *Nicotiana benthamiana* mesophyll protoplasts and the progeny virions were used to inoculate citrus plants. The result was the systemic spread of the virus and expression of the AMP throughout the trees. Details of the AMP's, replication in protoplasts, and agro-inoculations will be presented.

## 12.14 Micro-budded, High Density Citrus Planting: Is There an Opportunity for HLB Control and Financial Returns?

Skaria M. and Hanagriff R.D.

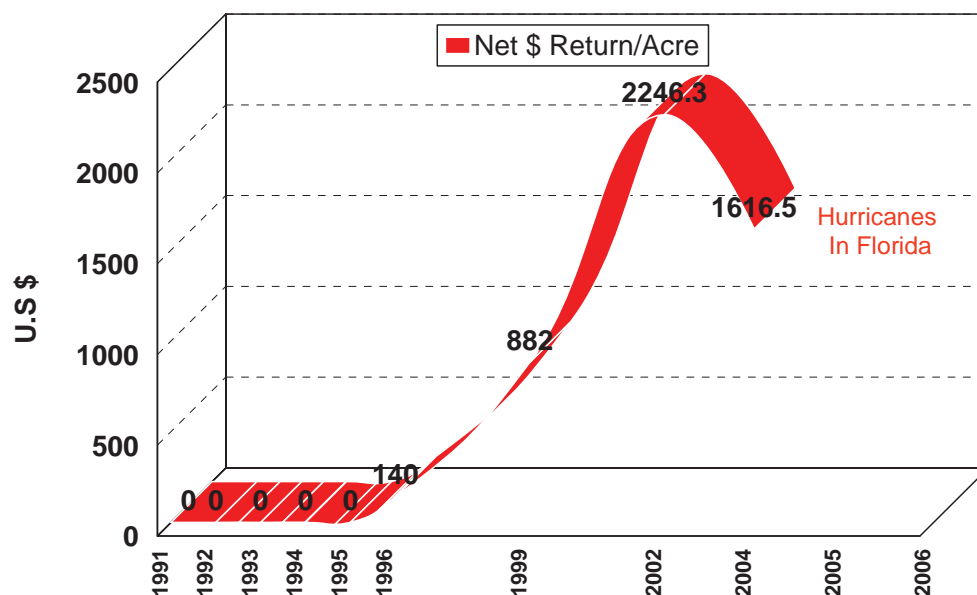
Texas A&M University-Kingsville Citrus Center, 312 N. International Blvd, Weslaco, TX

**Micro-budded citrus:** In the mid 1990s, a technique called micro-budding was developed to bud small citrus rootstocks (4,6). The rootstock used was approximately 2 month-old sour orange. Several hundred small, micro-budded citrus trees were planted in a field (3x6 ft), over a 6 month period. Some of the scions were only ½ inch long, but most had scion growth 6 inches or more when planted. The trees performed well and many had fruit in 1999 – 2 years after micro-budding. One Rio Red grapefruit tree produced 19 fruit. These trees are still alive. This process is unique in that 1) micro-budding by-passed the nursery phase, 2) produced scions smaller than conventional trees suited for ultra-high density planting and 3) trees developed early bearing. Although viewed as innovative and attempted by some nurserymen, micro-budding was not widely adopted, due to unfamiliarity of budding small plants. However, some researchers have made successful use of micro-budding (3,5) and in 2005, a private nursery in Edinburg, Texas successfully produced micro-budded trees commercially. All plants are growing well in the nursery and in orchards.



**Figure 1.** Stages of micro-budded, ultra-high density planting started on June 11, 1997.

**Example of a Florida Valencia Orange Return:** The following graph illustrates the net return from Valencia sweet orange planted in 1991, at a tree density of 250 trees per acre. After planting with conventionally budded trees, the first four years had zero income (2).



**Figure 2.** Net return from Valencia trees on Swingle citrumelo rootstock planted in 1991, Charlotte County, Florida. Data Source: Mongi Zekri, IFAS, UF, with permission. Revenue based on \$2.87 (1996) and \$2.65 per Kg solids. Pick and haul highest cost \$2 per 90 lb box.

Figure 2 above shows that net dollar return from a typical high density orchard with 250 trees per acre, using conventional trees is not high. Under HLB and psyllid pressure this level of net income will be insufficient to sustain the additional cost of HLB management. Therefore, every effort to combine all promising avenues of HLB management strategies should be explored including more efficient psyllid control and the use of high density or even ultra-high density orchard design with precocious trees of reduced tree cost. Planting a high density of micro-budded trees will offset the initial planting cost of an ultra-high density orchard. The precociousness of micro-budded trees assures more rapid economic returns.

**Ultra-high Density orchards:** Fruit yield and the net economic return to growers in the early years of an orchard are directly related to the number of trees per acre (7,8,9). In the past, all U.S citrus producing states have experimented with high density orchard planting as a means to increase fruit production and profitability. A small number of growers successfully practice high density citrus operation, some even ultra-high density but the majority of U.S citrus growers were reluctant to adapt the high density practice. Though fruit yield in high density orchard is higher in early years, most growers are not willing to change the field equipment or to pay a higher cost for more trees per acre. It has come to a reality that the US citrus growers have to adapt alternative strategies to counter the impact of HLB. An approach now under consideration is to produce citrus on a high density, short-term cycle. The idea is to push early production,

adopt efficient chemical, cultural, and biological control strategies to reduce the psyllid population and HLB infection.

**Net Present Value (NPV) comparison:** NPV is a time value of money technique that discounts future streams of projected net profits using an opportunity cost of money rate (also referred to as a discount rate) to determine a single present value of future profits. The cost of conventional high density planting and micro-budded, high density planting can then be subtracted from current value of future profits, which results in NPV. A positive NPV number communicates additional income above opportunity cost and planting cost. A negative value communicates a poor capital budgeting decision. Also, a higher NPV communicates the best capital budget decision with the differences in the values representing value differential. Capital budgeting also can utilize Pay Back Period, which is the year(s) it takes profits to repay initial planting cost as well as Internal Rate of Return (IRR) to measure the average present value of returns over the initial investment. This capital budgeting tool was applied to both micro-budded high density (565 trees) and conventional planting (150 trees) as described by Roka and Rouse (9). There is a slightly higher initial investment cost, but financial returns far exceed the expense and micro-budded HD method of production provides potential economic efficiencies of land use and higher return on investments. This method of productions needs application testing, but even partial results have high financial returns.

	<b>Conventional, 150 trees/acre</b>				<b>Micro-budded high density, 565 trees/acre</b>				
	Revenue \$	Cost \$	Net \$	Payback \$		Revenue \$	Cost \$	Net \$	Payback \$
Today	0	1,950	- <b>4,650</b>	<b>-4,650</b>	Today	0	1,978	<b>-4,978</b>	<b>-4,978</b>
Year 1	0	750	<b>-750</b>	<b>-5,400</b>	Year 1	0	1,000	<b>-1000</b>	<b>-5,978</b>
Year 2	1,387	1,000	387	<b>-5,013</b>	Year 2	5,223	1,500	3,723	<b>-2,254</b>
Year 3	1,677	1,000	677	<b>-4,336</b>	Year 3	6,318	1,650	4,668	2,414
Year 4	2,632	1,000	1,632	<b>-2,704</b>	Year 4	9,913	1,650	8,263	10,677
Year 5	3,742	1,000	2,742	38	Year 5	14,095	1,650	12,445	23,122
Year 6	3,930	1,000	2,930	2,968	Year 6	14,802	1,650	13,152	36,274
Year 7	4,922	1,000	3,922	6,890	Year 7	18,540	1,650	16,890	53,164
Year 8	4,810	1,000	3,810	10,700	Year 8	18,117	1,650	16,467	69,631
Year 9	4,776	1,000	3,776	14,475	Year 9	17,988	1,650	16,338	85,969
Year 10	4,499	1,000	3,499	17,974	Year 10	16,947	1,650	15,297	101,266

**Table1.** Conventional planting with 150 trees and micro-budded, HD cost and payback compared.

The NPV for high density planting is estimated to be \$68,037 per acre compared to the NPV from conventional planting of \$8,293. There are also an estimated 18 % higher returns and a pay back of the initial investment two years ahead of the conventional planting.

**Possibilities with micro-budded trees:** The cost of production of micro-budded trees is approximately 1/3 of the conventional system. This allows the grower to plant more trees per acre and to harvest more fruit per acre in the early years. Approximately 4X more trees may be planted for the cost of conventionally budded trees. The precocious nature of micro-budded trees enhances early fruit production.

**Negative aspects of micro-budded trees and possible mitigations:** In order to fully utilize the benefits of micro-budded trees, they should be planted young in an orchard setting. This makes them more vulnerable to psyllids and thereby to HLB infection under Florida conditions. In Texas, smaller trees are vulnerable to wind and browsing by jackrabbits. However, intensive, ultra-high density planting can be coupled with more efficient use of systemic insecticides such as imidacloprid to protect the trees. There are ways to protect small trees from wind and browsing. The newly tested open hydroponics (OHS) and the new Florida model of advanced production system (APS) combined with micro-budded ultrahigh density planting may make it a worthwhile approach to pursue under HLB and psyllid pressure in Florida. A revolutionary control strategy is required to counter the Florida HLB problem. Micro-budded, high density citrus orchards may offer some benefit to the growers in Florida and elsewhere.

### Citations

- Skaria M. 2008. 11<sup>th</sup> International Citrus Congress, Wuhan, China, October 26-30.
- Zekri M. 2008. International Citrus Congress, Wuhan, China, October 26-30.
- Ochoa FM, Dekkers MGH, Skaria M, Lee RF. 2000. Proceedings of the International Society of Citriculture 9<sup>th</sup> Congress 2000. p.583.
- Skaria M, Tao Z. 2000. Proceedings of the International Society of Citriculture. 9<sup>th</sup> Congress 2000. P 584.
- Yang ZN, Ingelbrecht IL, Louzada E, Skaria M, Mirkov TE. 2000. Plant Cell Reports 19: 1203-1211.
- Skaria M. 2000. Proc. 14<sup>th</sup> Conf. IOCV. IOCV, Riverside. p. 411-413.
- Boswell SB, McCarty CD, Hench KW, Lewis LN. 1975. J. Amer. Soc. Hort. Sci. 100: 370-373.
- Roka FM, Rouse RE, Muraro RP. 1997. Proc. Fla. State Hort. Soc. 110:82-86.
- Wheaton TA, Castle WS, Tucker DPH, Whitney JD. 1978. Proc. Fla. State Hort. Soc. 91:27-33.



## 12.15 The State of California implements its action plan for Asian Citrus Psyllid

Polek M.<sup>1</sup> and Luque-Williams M.J.<sup>2</sup>

<sup>1</sup> California Citrus Research Board, Visalia, California, 93279, <sup>2</sup>California Department of Food and Agriculture, Riverside, California 92507

The very devastating effects of huanglongbing (HLB, a.k.a. citrus greening disease) are currently being observed in the major citrus producing areas of Brazil, China and Florida, USA with the attendant loss of millions of producing citrus trees and multiple millions of dollars of crop value. The State of California is one of the most important fresh fruit producers in the world, with over 85% of production located in the Central Valley. HLB-associated bacteria are not known to occur in California but recently the vector for HLB, the Asian citrus psyllid (*Diaphorina citri* Kuwayama) (ACP) was first found in Tijuana, Mexico, then later in San Diego and Imperial Counties, California, which border Mexico. Since HLB would be devastating to the California citrus industry, the State of California Department of Food and Agriculture, in cooperation with the USDA and citrus industry, including related regulatory agencies, have developed and is implementing an action plan to detect and eradicate the ACP. The goal is to prevent the entry of HLB and confine the ACP to the most southern portion of the state thereby protecting the bulk of the state's citrus industry.

INTERNATIONAL RESEARCH CONFERENCE  
ON HUANGLONGBING



**Session 13:**  
**Host Resistance**

Orlando, Florida



December 2008

### **13.1 Develop promoters that will prevent expression of foreign genes in fruit**

Gurley W.B., Busot G. and O'Grady K.

Department of Microbiology and Cell Science, University of Florida, Gainesville, FL 32611-0700

Abstract: Efforts are in progress to develop a gene regulatory circuit that represses expression of foreign genes in citrus fruit. This objective fits into the larger plan to engineer citrus to resist or destroy pathogenic *Liberibacter*, the causal agent of citrus greening. In order to mount a robust defense against infection, plant cells will need to produce significant amounts of anti-bacterial peptides. The impact that these proteins will have on taste of the fruit and juice are unknown. In addition, consumer receptiveness to GMO orange juice is anticipated to be more likely negative than positive. The ability to prevent expression of anti-bacterial peptides in the fruit should greatly lessen the potential negative impacts on taste and consumer acceptance. In the long term, the engineering of stringently regulated gene expression in plants will contribute towards future efforts to genetically modify crop plants for improved nutrition, pathogen resistance and survival to the extremes of the environment.

### 13.2 Susceptibility of some local mandarins to a Japanese isolate of *Candidatus Liberibacter asiaticus*

Iwanami T. and Miyata S.

National Institute of Fruit Tree Science, NARO, Tsukuba, Ibaraki, Japan

Citrus greening is a serious disease which limits production in many parts of Asia and Africa. The Asian causal agent is designated *Candidatus Liberibacter asiaticus* (Las). In Japan, Asian citrus psyllid (*Diaphorina citri*), a vector of Las, is common in subtropical islands which stretch between Taiwan and Kyushu (3). The first finding of citrus greening in Japan was made in 1988 on an island which is close to Taiwan in 1988 (2), and the disease has spread northward to near Amami island (Fig. 1). There is growing concern about damage on local citrus production. Presumably due to warmer climate, the psyllid has recently invaded the Kyushu main island (Fig. 1). Fortunately, the disease is not yet found in this main island, which is a major citrus production area. However, it is very likely that the outbreak of greening follows the invasion of psyllid in a new area, as observed in Florida recently, and local citrus growers are greatly concerned.

Several local mandarins including Shikuwasha (*Citrus depressa* Hayata), Kabuchii (*C. keraji* hort. ex Tanaka var. kabuchii hort. ex Tanaka), and Unzoki (*C. keraji* hort. ex Tanaka var. unzoki hort. ex Tanaka) are grown in these sub-tropical islands. Recently, Shikuwasha has become a very profitable cash crop, and local growers try to produce more fruit. On this backdrop, the occurrence of greening on these local mandarins is greatly feared. In this study, pathogenicity of Las in 30 lines of Shikuwasha, one line of Kabuchii and another line of Unzoki were examined. Two twenty-month-old nucellar seedlings from all lines were side-grafted with a rough lemon source plant that was infected with Las. After grafting, the seedlings were cut back to force new growth, and trained to one shoot from each of the receptor plants and the grafted plants. The inoculated seedlings were grown in an air-conditioned greenhouse with temperature conditions of 32°C at day and 25°C at night. After nine months, systemic infection was confirmed by PCR detection of Las from the new shoot of the inoculated seedlings, using a common primer set of MHO353 and MHO354 (1), and symptoms on the shoots of the inoculated seedlings were observed. Severe mottling, yellowing and interveinal chlorosis appeared on leaves of all lines of Shikuwasha and Kabuchii. Most of affected seedlings showed very poor growth. In contrast, only faint yellowing appeared on shoots of both of the two Unzoki seedlings. The Unzoki seedlings grew as vigorously as healthy ones nine months after graft-inoculation. Since Las was constantly detected from leaves of Unzoki by PCR, it was considered that Unzoki is not immune to Las. The results suggested that most lines of Shikuwasha and some lines of Kabuchii are highly susceptible, whereas some lines of Unzoki are tolerant to Las. Difference in susceptibility between Kabuchii and Unzoki is interesting, because these two varieties are morphologically very similar. Further investigation on tolerance of Unzoki in fields should be made before practical implications are explored.

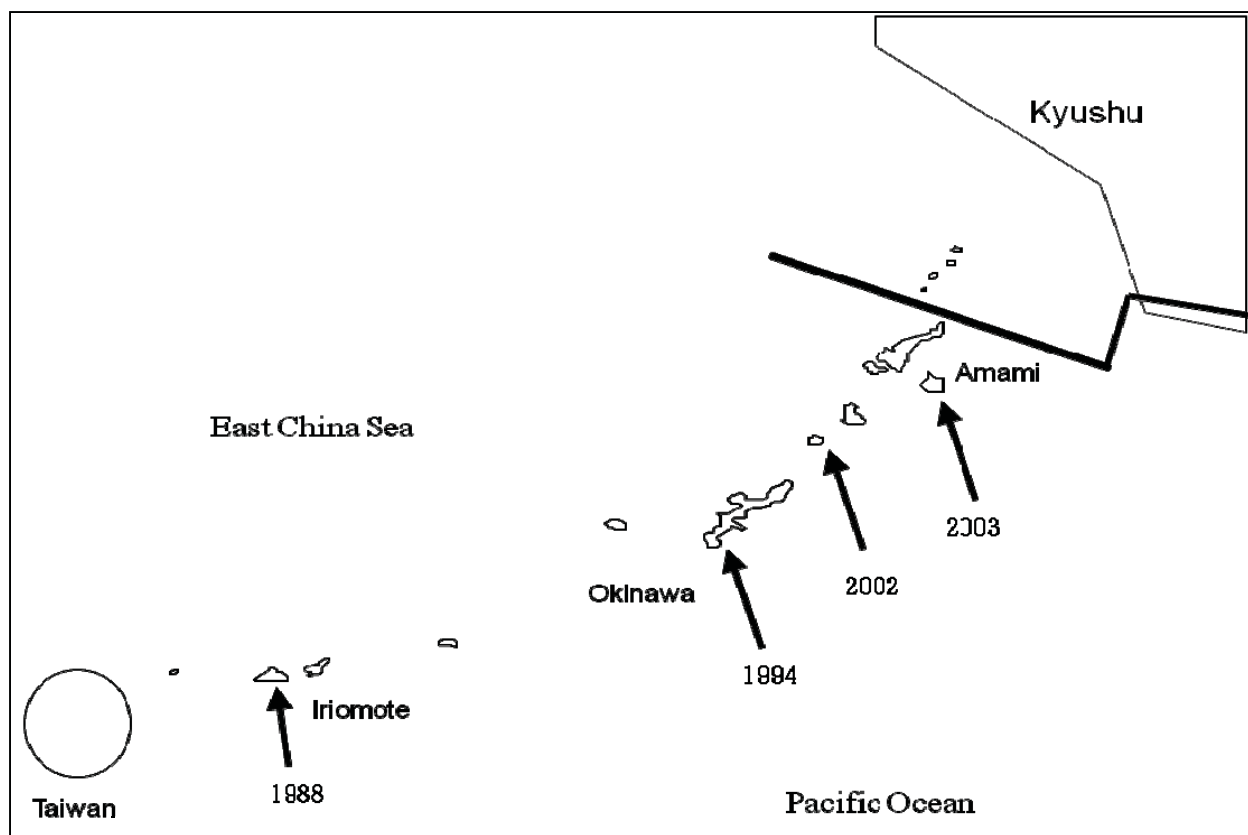


Fig. 1. Occurrence of citrus greening disease in sub-tropical islands in Japan since 1988. Arrows indicate location and year of the first recognition of the disease in each island. The thick line shows the northern limit of spread of the insect vector, *Diaphorina citri*.

### Citations

Hoy MA, Jeyaprakash A, Nguyen R. 2001. Long PCR is a sensitive method for detecting *Liberibacter asiaticum* in parasitoids undergoing risk assessment in quarantine. *Biol. Control*. 22:278-287.

Miyakawa T, Tsuno K. 1989. Occurrence of citrus greening in the southern islands of Japan. *Ann. Phytopathol. Soc. Jpn.* 66: 667-670.

Miyatake Y. 1965. Notes on the Psyllidae from the Ryukyu islands. *Konchu* 33:171-189.

### 13.3 Developing Transgenic Solutions for HLB Resistant Citrus at the US Horticulture Research Laboratory

Stover E., Bowman K., McCollum G. Niedz, R.

US Horticultural Research Laboratory, USDA-ARS, Ft. Pierce, FL

No HLB-resistance has been identified within cultivated citrus, making transgenic solutions the priority to develop plant material which will permit economic citrus production where HLB is endemic. Little is known about the HLB pathosystem and thus antimicrobial peptides (AMPs) have been the focus for current work. Related efforts are underway at Texas A&M University, the University of Florida, and the Sylvio Moreira Citrus Center in Brazil, and ongoing discussions ensure that these efforts are complementary rather than duplicative. In the USHRL program, priority AMPs are those which are from plants or synthetic rather than animal origin, are already reported to be effective against gram-negative bacteria, and have negligible potential for human health problems. There are numerous bottlenecks in efficiently mobilizing AMPs to confer HLB-resistance. Due to the urgency for identifying solutions we are moving full speed with best available information, while also attempting to improve transformation efficiency and screen AMPs for important traits. D4E1, a 17 amino acid synthetic AMP which forms a beta sheet (Lucca et al., 1998), is active against *Agrobacterium tumefaciens* in poplar (Mentag et al., 2003) and has been utilized extensively in our initial efforts. More than a 1000 putative transformants have been developed with D4E1 driven by D35S, representing a broad range of scion and rootstock genotypes. In vitro assessment of minimum inhibitory concentration (MIC) has been conducted using *Sinorhizobium* and *Agrobacterium* as surrogates for *Liberibacter* as they are closely related alpha proteobacters (Bastianel et al., 2005). The causal agent of citrus canker (*Xanthomonas smithii* pv. *citri*) is also included in these analyses, in the hope that HLB and canker resistance can be achieved with the same AMP transgene. Thus far D4E1 is the most active AMP tested, with an MIC less than 1  $\mu$ M. More than 100 transformants are verified and established in the greenhouse. Subpropagations of each independent transformant will be available in early 2009 for graft inoculation with HLB. Procedures have been developed that provide ~90% infection with symptoms and PCR positive response in around six weeks. Several other AMPs targeting *Liberibacter* and lectins targeting the psyllid are also being utilized. Phloem-specific promoters are being investigated with AMPs. Additional transgenes will be used as opportunities are identified to target *Liberibacter* gene products and virulence mechanisms.

Bastianel C, Garnier-Semancik M, Renaudin J, Bove JM, Eveillard S. 2005. Diversity of "Candidatus *Liberibacter asiaticus*," based on the omp gene sequence. *Appl. Environ. Microbiol.* 71: 6473-6478.

Lucca AJ, de Bland JM, Grimm C, Jacks TJ, Cary JW, Jaynes JM, Cleveland TE, Walsh TJ. 1998. Fungicidal properties, sterol binding, and proteolytic resistance of the synthetic peptide D4E1. *Can. J. Microbiol.* 44:514-520.

Mentag R, Luckevich M, Morency MJ, Seguin A. 2003. Bacterial disease resistance of transgenic hybrid poplar expressing the synthetic antimicrobial peptide D4E1. *Tree Physiol.* 23:405-411.

### 13.4 A Newly Developed Agilent Microarray Designed for the Characterization of Citrus Responses to Pathogens

Moore G.A.<sup>1</sup>, Khalaf A.A.<sup>1,2</sup>, Febres V.J.<sup>1</sup>, Li L.<sup>1</sup> and Gmitter Jr. F.G.<sup>2</sup>

<sup>1</sup>University of Florida, Gainesville, FL, USA

<sup>2</sup>University of Florida, Citrus Research and Education Center, Lake Alfred, FL USDA

We have constructed a new citrus microarray, with the expert aid of scientists at the Interdisciplinary Center for Biotechnology Research (ICBR), University of Florida, and Agilent Technologies Inc, Palo Alto, CA. The advantages of this array lie in improved technology in its construction, the possibility of including all of the Rutaceae ESTs currently in the NCBI Genbank (more than 474,000), and the further addition of mRNAs for genes that we have identified that may impact defense against pathogens in *Citrus*. The Rutaceae ESTs and mRNAs were first assembled using Paracel Transcript Assembler, where a series of sequence cleaning, chimera identification, clustering and assembly steps was performed. All of the resulting contigs and singlets were annotated by BLAST search against NCBI NR and NT databases where the e-value threshold was set at 1e-4. For each query sequence, the top 100 BLAST hits were obtained if available and stored in BlastQuest (Farmerie, 2005), a SQL database developed by ICBR that facilitates similarity-based sequence annotation with GeneOntology information. The NCBI Gene database was used to map Rutaceae transcripts to homologs from Arabidopsis, rice, corn, human, mouse or other organisms with descending priorities. For sequences with no BLAST hit passing the 1e-4 threshold, ESTScan (Iseli, 1999) was used to predict the CDS (coding sequence) region. ESTScan was also used to confirm the coding strand for annotated sequences. NR/NT BLAST and ESTScan results were combined to determine the sequence orientation. The final set of target sequences included: forward strands of orientation determined, annotated transcripts; both strands for orientation-undetermined, annotated transcripts; and both strands for unannotated transcripts. The “GE Probe Design” tool on eArray (Agilent) was used to design 60-mer probes. For each target sequence, one best probe was selected based on melting temperature, base composition and cross-hybridization potential. These probes were printed in a 4x44K format with random layout. Due to the limit of 44K probes on each array, only probes representing annotated transcripts and probes representing un-annotated transcripts with length >1400 bps were printed on the array. For a special group of 21 defense related genes, two probes were designed; and each of them was printed twice. Included on the array were also 1,417 Agilent negative and positive control probes. The array has been experimentally evaluated using both one-color and two-color labeling and is performing well and consistently in both types of assays. The results obtained were as expected. This array is now available to any interested member of the citrus community.

#### References:

- Iseli C, Jongeneel CV, Bucher P. (1999) ESTScan: a program for detecting, evaluating, and reconstructing potential coding regions in EST sequences. Proc Int Conf Intell Syst Mol Biol. 138-48.
- Farmerie WG, Hammer J, Liu L, Sahni A, Schneider M. (2005) Biological Workflow with BlastQuest. Data & Knowledge Engineering. 53:75-97.

### 13.5 Transgenic approaches to control bacterial diseases of citrus

Astúa-Monge G.<sup>1</sup>, Francischini F.J.B.<sup>1</sup>, Kemper E.<sup>1</sup>, Capella A.<sup>1</sup>, Kitajima J.P.<sup>1</sup>, Ferro J.A.<sup>1</sup>, da Silva A.C.R.<sup>1</sup>

<sup>1</sup> Alellyx Applied Genomics, R. James C. Maxwell 320, CEP 13069-380 Campinas, SP, Brazil

Bacterial diseases of citrus plants are currently the most damaging diseases worldwide. The rapid dissemination and severity of diseases such as Citrus Canker, Citrus Variegated Chlorosis and Huanglongbing (also known as citrus greening) are causing great economic losses in all major citrus producing areas of the world. Despite the efforts and resources committed to contain their spread, citrus producing countries are finding themselves defenseless against these threats. Since its foundation in 2002, Alellyx Applied Genomics has been committed to create solutions to important problems affecting citrus production. Alellyx has created a strong pipeline for gene discovery and proof of concept that has been used as a platform for the development of transgenic technologies focusing on citrus diseases control. The Phase I pipeline involves *in vitro* test for resistant transgenic events to the citrus canker bacterium *Xanthomonas axonopodis* pv. citri. Phase II uses the best events from phase I in the greenhouse screening against the HLB pathogen *Candidatus Liberibacter asiaticus* and *Xylella fastidiosa*. In Phase II the best events that showed significant resistance against all 3 bacteria are planted in field trials. So far, we have produced more than 1500 transgenic citrus events representing 28 candidate genes. We have already completed the first phase of testing for the 28 candidate genes and are beginning phase II with at least 12 constructs. Field trials will be initiated in 2009. The results of phase I and preliminary results from phase II showing promising candidate genes will be presented.



### 13.6 Towards the Ultimate Solution: Genetic Resistance to HLB in Commercial Citrus

Grosser J.W., Dutt M., Omar A., Orbovic V. and Barthe G.A.

University of Florida, IFAS, Citrus Research and Education Center, Lake Alfred, FL USA

Florida is the world's third largest producer of citrus, behind Brazil and China. Florida's 9 billion dollar industry is now threatened by huanglongbing (HLB), caused by a phloem limited gram negative bacterium. HLB affects all commercial citrus varieties, and no significant resistance has been identified within commercial citrus germplasm. A strategy to produce resistant citrus is genetic engineering to incorporate bacterial resistance genes not found in citrus. Antimicrobial peptides are part of the innate immune response and can be found among all classes of life, including humans. These peptides are usually small proteins and have an ability to associate with membranes. Antimicrobial peptides are also characterized by their broad spectrum antibiotic property. Incorporation of one or more genes encoding for antimicrobial peptides into the citrus genome via genetic engineering could potentially result in development of cultivars resistant to HLB, without otherwise altering varietal integrity. We have made significant progress using standard *Agrobacterium*-mediated citrus transformation and an alternative protoplast/GFP citrus transformation, developed previously in our laboratory. We have successfully incorporated several genes encoding for selected antimicrobial peptides into the citrus genomes of commercial sweet oranges, grapefruit, Key lime and Carrizo citrange, with emphasis on high-quality processing oranges. Hundreds of transgenic plants have already been regenerated. Genetically modified plants containing antimicrobial genes driven by a phloem specific *Arabidopsis* sucrose synthase promoter shown to function well in citrus have also been produced. The targeting of antimicrobial gene expression using phloem specific promoters is expected to minimize the expression of the foreign transproteins in subsequent fruit and juice products. Several transgenic plants have already been challenged with HLB, and many others are being propagated for this purpose. Our goal is to identify the most effective yet safe antimicrobial gene against HLB and then transform it into selected high-quality sweet orange cultivars with a sequential range of maturity dates.

### 13.7 Examination of host responses of different citrus varieties to HLB infection

Folimonova S.Y., Garnsey S.M., and Dawson W.O.

University of Florida, Citrus Research and Education Center, Lake Alfred, FL, USA

Citrus greening (Huanglongbing, HLB) is the most devastating disease of citrus worldwide and now is threatening the survival of the citrus industry in Florida. The causal agent of HLB in Florida is thought to be *Candidatus Liberibacter asiaticus* (Las). Las belongs to the group of the alpha-proteobacteria and resides within the phloem of citrus. The disease results in decline of infected trees and formation of small and lopsided fruit with poor coloration and taste. Understanding how *Liberibacter* multiplies, moves, and causes diseases in citrus is a necessary foundation for developing effective methods of detection, controlling its transmission by psyllids, and developing citrus varieties that can be produced economically.

To examine the response of different genotypes of citrus to HLB, we obtained thirty different citrus varieties or relatives and allowed them to grow in the greenhouse for 8-12 months. As soon as we were approved to have HLB in our greenhouse (January 31, 2007), plants were inoculated using budwood from highly symptomatic six year old field trees as HLB inoculum. Visual observations of symptoms along with real-time PCR and regular PCR detection assays of extracted DNA from inoculated plants with Las-specific oligonucleotides were performed at different time points starting at three months post inoculation when the first symptoms began to appear on some trees. Although Las was able to multiply in most of the plants, there was a wide range of responses in the different plants. Sweet orange, grapefruit, tangelo, and some mandarins were extremely sensitive, usually with reduced growth and death, while other plants tolerated the infection much better. Symptoms consisted of both leaf chlorosis and lack of growth. Based on symptoms developed upon HLB infection the varieties were grouped into four categories: sensitive, which exhibited severe chlorosis, greatly reduced growth, and eventual death; intermediate, showed milder symptoms with some reduction of growth while plants continued to survive in the greenhouse environment; tolerant, with some scattered symptoms and little or no growth reduction; and extremely tolerant, with very minimal symptoms. Although, all varieties tested positive for the presence of Las, with titers of the bacterium being similar in sensitive and tolerant plants, the latter responded to the presence of the bacterium with less vascular disruption and milder disease symptoms. Moreover, some varieties like Eureka lemon and Persian lime had relatively high titers of Las with little or no visual symptoms, which indicates that there was little relationship between Las concentration and disease production. We are continuing to study this variation in responses to Las by different citrus genotypes to develop an understanding of how the bacterium invades and causes disease in citrus.

### 13.8 Evaluation of *Candidatus Liberibacter* spp. in genetically transformed sweet orange Hamlin with Atacin A gene

Simões T.S.<sup>1</sup>, Boscariol-Camargo R.L.<sup>1</sup>, Mendes B.M.J.<sup>2</sup>, Mourão Filho F.A.A.<sup>3</sup>, Carlos E.F.<sup>1</sup>, Machado M.A.<sup>1</sup>

<sup>1</sup>Centro de Citricultura Sylvio Moreira / IAC, CSM, Cordeirópolis, SP; <sup>2</sup>CENA, Piracicaba, SP; <sup>3</sup>ESALQ, Piracicaba, SP, Brazil.

*Huanglongbing* (HLB) has become a great concern in the citrus industry around the world. It is considered a most destructive disease of citrus for which there is no source of genetic resistance. Our group's program to produce genetically modified sweet orange has generated several independent transformants using anti bacterial peptides. The HLB resistance of Hamlin sweet orange transformed with the Atacin A gene has been evaluated by monitoring symptom development and assessing the growth rate of the bacteria by RT-qPCR in plants challenged by grafting with budwood infected with *Ca. Liberibacter asiaticus* or *Ca. Liberibacter americanus*. Samples of five replicates were collected and evaluated by PCR every month for a year. The bacteria were able to multiple in all plants and the titer ranged from  $862 \times 10^4$  to  $172 \times 10^7$  cell / g of tissue among the different transformants. In the non-transformed control plants the values ranged from  $842 \times 10^6$  to  $115 \times 10^7$  cell/g indicating that some transformed plants had reduced bacteria concentrations. Although the bacteria could be detected in all transformed plants, two of them had not developed any symptoms of HLB through one year after inoculation.

Financial support: FAPESP, CNPq

### 13.9 Colonization of *Citrus* relatives by *Candidatus Liberibacter asiaticus*.

Boscariol-Camargo R.L., Simões T.S., Malosso A., Carlos E.F., Coletta Filho H.D., **Machado M.A.**

Centro APTA Citros Sylvio Moreira – IAC, CP 04, CEP 13490-970, Cordeirópolis/SP, Brazil. 2. Departamento de Entomologia/ESALQ-USP, Piracicaba/SP, Brazil.

*Huanglongbing* (HLB), caused by *Candidatus Liberibacter* spp., is a serious citrus disease with no resistance within the genus *Citrus* and its relatives. The bacteria inhabit the phloem of the host and cause symptoms like yellow shoots and leaf mottling. Considering its importance and the need to find sources of resistance, the main objective of this work has been to evaluate the response to bacteria infection in different species of Rutaceae: *Poncirus trifoliata*, *Fortunella margarita*, *Merope* sp., *Atalantia* spp., *Microcitrus* sp., *Micromellum tephrocarpa*, *Eremolemon coachella*, and *Severinia buxifolia*. Five replicates of each plant were inoculated with buds infected with *Ca. Liberibacter asiaticus*, evaluated for disease symptoms and presence of bacteria. Plants grafted with healthy budwoods were used as negative controls. Evaluation was carried out monthly by PCR, and the titer of the bacteria in the tissues was evaluated by real time PCR (qPCR) with TaqMan probes, each two months. The primers and probes used were designed previously. In the first month the bacteria was detected in all replications of *Microcitrus*, *Severinia* and *Fortunella*. In the second month, some plants of *Merope* and *Micromellum* showed positive results but interestingly, the genus *Atalantia* and *Poncirus* were negative in both analyses (PCR and qPCR) and this result was maintained after 120 days of inoculation. These plants will be evaluated after 12 months to confirm the absence of bacteria in the tissue. No plants showed HLB symptoms in spite of the presence of bacteria in their tissue.

### 13.10 Occurrence of Huanglongbing Disease of Pomelo (*Citrus grandis*) in Northern Thailand

Akarapisan A.<sup>1</sup>, Piwkhao K.<sup>1</sup>, Chanbang Y.<sup>2</sup>, Naphrom D.<sup>3</sup>, Santasup C.<sup>4</sup>

Department of Plant Pathology<sup>1</sup>, Department of Entomology<sup>2</sup>, Department of Horticulture<sup>3</sup>, Central Laboratory<sup>4</sup>, Faculty of Agriculture, Chiang Mai University, Chiang Mai 50200, Thailand; E-mail: [aangsana@chiangmai.ac.th](mailto:aangsana@chiangmai.ac.th)

Huanglongbing first appeared in Thailand in the 1960s and was so severe that the length of time between the onset of the disease and debilitation of the entire tree was about two years (1). Pomelo is a group of popular cultivars of citrus in Thailand. In recent years, pomelo plantation has been expanded in Chiang Rai Province for exportation. A survey of pomelo diseases at 10 plantation areas in Lampang, Chiang Mai and Chiang Rai Provinces conducted from 2007 to 2008 found that the “HLB type” of disease frequently affected the pomelo tree. Diseased leaves were observed with leaf mottle, chlorosis with green veins, symptoms sometimes resembling zinc deficiency, small fruit and die back. Symptoms alone should not be used to diagnose a tree as infected with HLB. This is because it resembles other diseases (such as virus diseases) and cultural conditions (such as zinc deficiency). Early symptoms of HLB include a yellowing of only one limb or sector of the tree canopy. Field trees can be identified as suspect by their foliar and fruit symptoms but verification of HLB infection requires DNA detection methods. Polymerase chain reaction (PCR) was performed by using A2/J5 primer to detect symptomatic leaves (2). Specific primers, primer A2 (5'-TATAAAGGTTGACCTTTCGAGTTT-3') and reverse primer J5 (5'ACAAAAGCAGAAATAGC AGAACAA-3') were used for amplification of the ribosomal protein genes (*rplKJL-rpoBC* operon) of *Candidatus Liberibacter* species, producing specific bands of 703 bp. Each surveyed areas showed different percentage of disease incidence ranging from 5 to 10%. Among the citrus species near assessed plantations, the highest disease incidence was observed on tangerine (*Citrus reticulata*), lime (*Citrus aurantifolia*) and kaffir lime (*Citrus hystrix*). The lessons learned from the devastation of tangerine crop by HLB should caution us to plan the development of pomelo crop hand in hand with judicious quarantine and disease management.

#### MATERIALS AND METHODS :

##### 1. Survey areas :

Between January 2007 to October 2008, the situation of diseased citrus was surveyed in 10 plantation areas in three provinces of Northern Thailand namely Chiang Mai, Chiang Rai and Lampang,.

##### 2. Sampling and Data Collection :

Symptomatic leaves were cut and placed inside transparent plastic bags, labeled properly and kept in a portable cool box and brought to the laboratory for disease assessment. Laboratory assessments were carried out by using polymerase chain reaction.

### 3. Isolation of DNA and PCR amplification for detected *Candidatus Liberibacter* sp. :

DNA was isolated from 0.5 g of leaf midribs from infected and healthy pomelo by the CTAB (cetyltrimethyl ammonium bromide) method (3). PCR reaction was performed by using A2/J5 primer to detect *Candidatus Liberibacter* sp in leaves. Specific primers, primer A2 (5'-TATAAAGGTTGACCTTTCGAGTTT-3') and reverse primer J5 (5'ACAAAAGCAGAAATAGC AGAACAA-3') were used for amplification of the ribosomal protein genes (*rplKAJL-rpoBC* operon) of *Candidatus Liberibacter* species (2). The PCR reaction was carried out in 25 µl of reaction mixture containing 1 µM of each primer, 0.2 mM of each four dNTPs, 1X PCR buffer, 2.5 mM MgCl<sub>2</sub>, 0.5 units *Taq* DNA polymerase (Invitrogen) and 1 µl DNA template. The thermal cycle conditions were: one cycle at 94°C for 3 min; 35 cycles at 94°C for 60 s, 60°C for 30 s and 72°C for 90 s; followed by 72°C extension for 5 min. Reaction was carried out in a Programable Thermal Controller PTC-100<sup>TM</sup> (MJ Research, USA).

The PCR products were analyzed by gel electrophoresis using a 1% agarose in TE buffer (Tris base, boric acid and 0.5M EDTA [pH 8.0]) and stained with ethidium bromide. Gel was visualized and analyzed by the GEL documentation (SYNGENE; GENE Genious Bio Imaging System).

### RESULTS AND DISCUSSION :

HLB symptoms were sometimes observed on the whole tree but more often were sectoral or confined to individual branches of the tree. Observation of Citrus Huanglongbing found that diseased leaves show chlorosis with green veins, sometimes with symptoms resembling zinc deficiency (Fig. 1). Other symptoms on infected branches and leaves were leaf defoliation and varieties of mottling types. At an early stage, some leaves have a small size with up right orientation. More severely infected plants show leaf chlorosis, thickening of the leaf blade and die-back.

Symptoms on fruit were lopsided shape, small fruit size and early fruit drop (Fig. 2). Among the other citrus species assessed near the pomelo plantations, the highest disease incidence was observed on tangerine (*Citrus reticulata*), lime (*Citrus aurantifolia*) and kaffir lime (*Citrus hystrix*) (Fig. 3).

The observed symptomatology and the manner of the disease spread suggested that the pomelo crop was affected by citrus Huanglongbing. PCR detection suggested that the causative agent of the citrus disease is the Liberibacter that causes citrus Huanglongbing. The PCR products obtained were the 703 bp expected for the pathogen DNA from gene-specific primers for Huanglongbing Liberibacter (Fig. 4). Based on these results, it is confirmed that the citrus samples that showed varied putative HLB leaf symptoms in the surveyed areas were infected by *Candidatus Liberibacter asiaticus*, the causal agent of HLB disease in Northern Thailand and not due to the micronutrient deficiencies or disorder.

Based on field observations, farmers' knowledge about disease spread and HLB vectors were also deficient. As a consequence, they did not protect their seedlings and trees properly and also used infected seedlings as source of planting materials for new cultivation. Problems from other insect-borne and graft-transmissible citrus diseases have already been made worse by the use of seedlings which were thought to be healthy, but were in fact infected with disease. The detection of HLB disease in young citrus plants is important to prevent a wide-spread outbreak of this disease. The sensitive PCR assay is an excellent method for detecting

fastidious bacteria in host tissue (4). An education program to inform the public of the rules and regulations restricting importation of plant materials, and enlisting public help in identifying the vectors and diseases would help prevent certain diseases.



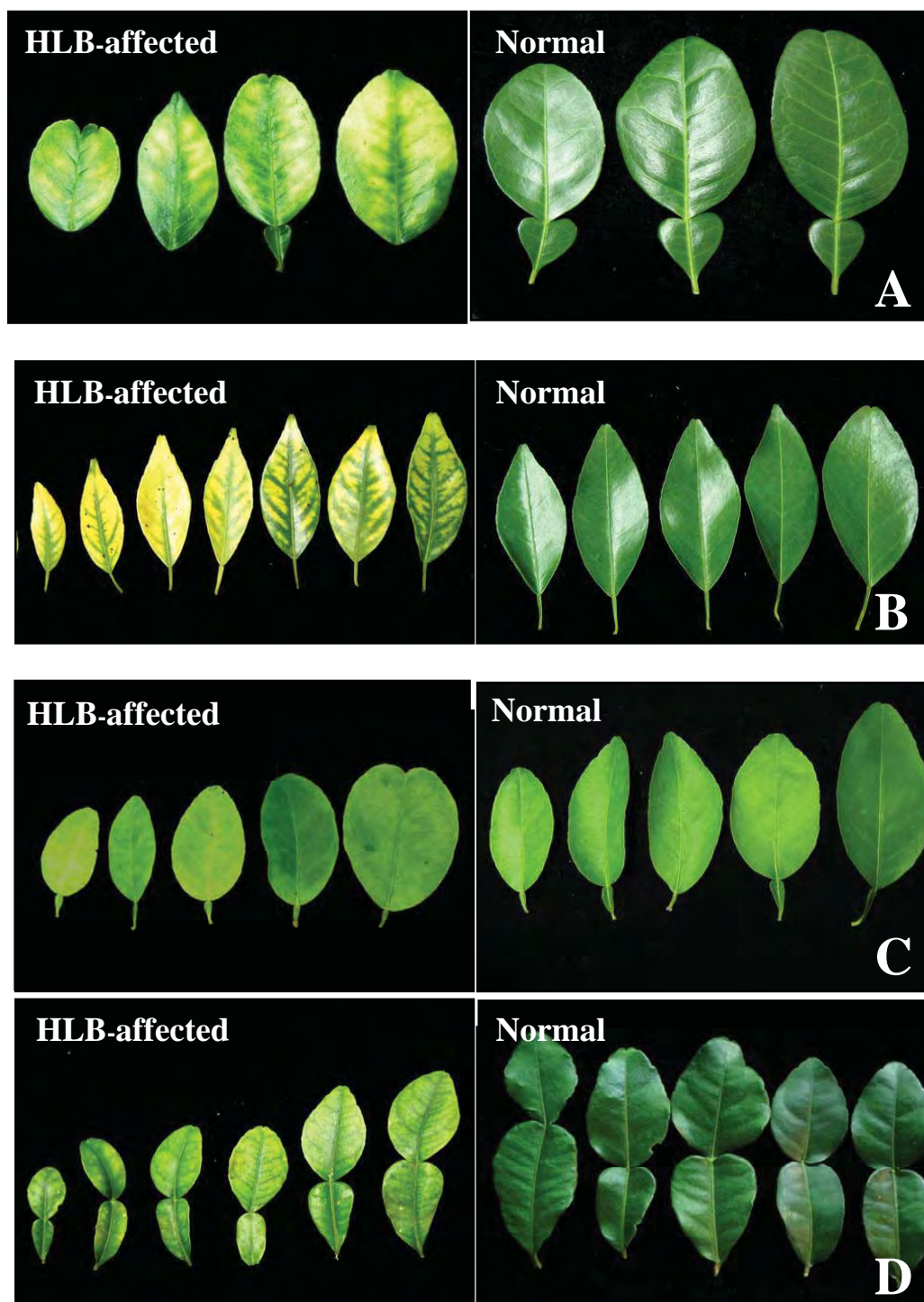
**Figure 1.** Symptoms of HLB disease observed on pomelo leaves.

**A.** Chlorosis with green vein symptom of leaves.

**B.** Mottling symptom of leaves.

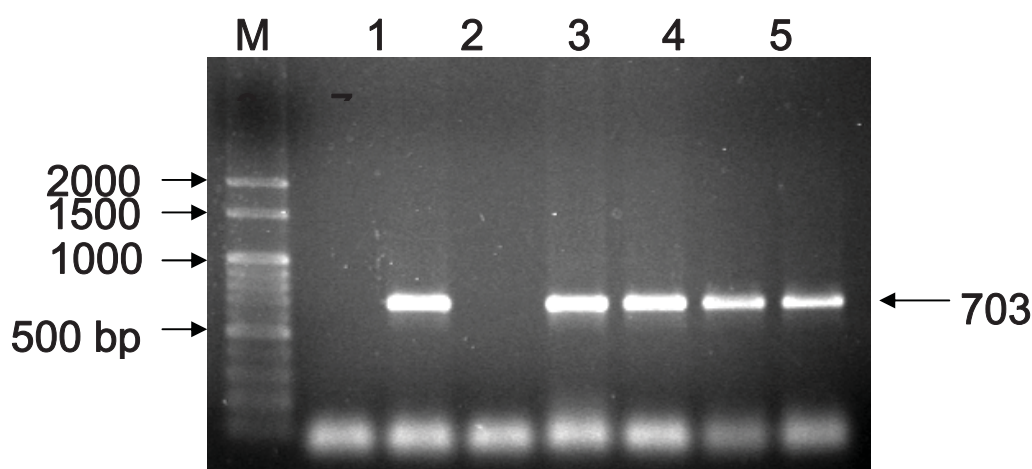


**Figure 2.** Lopsided pomelo showing vascular bundles stained orange-brown.



**Figure 3.** Symptom of HLB disease observed on *Citrus* spp. from Chiang Rai Province.  
**A.** Pomelo (*C. grandis*);      **B.** Tangerine (*C. reticulata*);  
**C.** Lime (*C. aurantifolia*);      **D.** Kaffir lime (*C. hystrix*).





**Figure 4.** The *rpLKAJL-rpoBC* operon: gene fragments with molecular weight of 703 bp were successfully amplified from infected pomelo and *Citrus* spp. leaves from Chiang Rai Province. **M:** marker 100 bp ladder;

**Lane 1:** Water (negative control); **Lane 2:** HLB-infected tangerine (positive control);  
**Lane 3:** healthy pomelo (negative control); **Lane 4:** pomelo; **Lane 5:** tangerine;  
**Lane 6:** lime; **Lane 7:** Kaffir lime.

#### ACKNOWLEDGEMENT :

This work was supported by grants from Thailand Research Fund (TRF) and the Project of Agricultural Biotechnology Transfer and Service Center (CMU).

#### REFERENCES :

- Schwarz RE, Knorr LC, Prommintara M. 1973. Presence of citrus greening and its psylla vector in Thailand. *FAO Plant Protection Bulletin* 21: 132-138.
- Hocquellet A, Toorawa P, Bove JM., Garnier M. 1999. Detection and identification of the two *Candidatus Liberobacter* (sic) species associated citrus huanglongbing by PCR amplification of ribosomal protein gene of the operon. *Molecular and Cellular Probes* 13: 373-379.
- Dellaporta SL, Wood J, Hicks JB. 1983. A plant DNA mini-preparation: version II. *Plant Mol Biol. Reporter* 1:19-21.
- Hung TH, Wu ML, Su H. 1999. Development of a rapid method for the diagnosis of citrus greening disease using the polymerase chain reaction. *J. Phytopathol.* 147 : 599-604.

### 13.11 A Preliminary Survey of HLB Survivors Found in Abandoned Citrus Groves

Chen C.<sup>1</sup>, Zeng J.<sup>2</sup>, Yi G.<sup>2</sup>, Xiao Y.<sup>3</sup>, Ou S.<sup>3</sup>, Gmitter Jr. F.G.<sup>1</sup>

1 UF, IFAS, Citrus Research and Education Center, Lake Alfred, FL 33850, USA; 2 GAAS, Institute of Fruit Tree Research, Guangzhou, Guangdong 510640, China; 3 Guangxi Citrus Research Institute, Guilin, Guangxi 541004, China

Citrus Hunaglongbing (HLB) is widespread in citrus production areas in Asia, Africa, and now in the Americas; it is considered the most serious threat to global citrus industries. In the United States, HLB has spread in Florida and also has been found in Louisiana very recently, becoming an immediate threat to the other citrus production states, such as California and Texas, because the HLB vector, the Asian citrus psyllid, has been also found in other citrus producing states and their neighbors including Texas, Mississippi, Georgia, Alabama, South Carolina, Hawaii, and most recently in San Diego, California. An ultimate solution to this incurable disease is to screen resistant citrus germplasm for breeding programs, and to develop HLB resistant/tolerant citrus by selection and mutagenesis.

To date, research on HLB has not yet identified any genetic sources of broad resistance to the pathogen, *Candidatus Liberibacter*. However, there are some reports abroad on the existence of citrus trees in China and India that have survived and continued to thrive under heavy HLB pressure. We conducted extensive field surveys in severely HLB-infected and abandoned groves in Southern China, and identified several symptom-free citrus trees over 10 years old. These individuals looked very healthy while all other neighboring trees, in contrast, were killed or severely diseased with obvious symptoms. These survivors may be potential variants or mutants with tolerance or resistance to HLB where HLB has been a serious and chronic problem. A recent diagnosis indicated the trees were PCR negative. A preliminary report on these trees will be presented. The investigation is continuing to determine if the survivor trees are truly HLB-resistant or tolerant variants, or simply escapes, to characterize these candidate trees at the gene expression level, and to seek other candidate resistant/tolerant trees in China.

### 13.12 Using transgenic NPR1 to enhance systemic acquired resistance (SAR) in citrus

Febres V.J.<sup>1</sup>, Moore G.A.<sup>1</sup>

<sup>1</sup>University of Florida, Gainesville, FL, USA

SAR is an inducible defense mechanism in which infection by a pathogen leads to an enhanced defense state that is long lasting and provides resistance or tolerance to a wide range of pathogens in subsequent challenges. Manifestation of this enhanced defense state is the increased expression of pathogenesis related (PR) genes both at the initial site of infection and systemically. Some PR proteins have demonstrated antimicrobial properties while others have unknown functions and it is thought that their combined action leads to the demise of the invading pathogen(s). The activation of PR genes is preceded by the accumulation of salicylic acid (SA) and is mediated by the NPR1 protein. NPR1 functions as a co-transcriptional activator and its expression alone does not lead to the activation of SAR but rather primes the plant for the defense response. We have transformed 'Carrizo' citrange and 'Duncan' grapefruit plants with the Arabidopsis NPR1 gene in an attempt to induce broad-spectrum disease resistance in citrus. The regenerated plants have normal phenotypes. Analysis of these plants indicates that some lines show higher expression levels of the PR1 gene (considered a marker for SAR) compared to non-transgenic plants. A few lines were also evaluated for their response to citrus canker. Although complete resistance was not observed, the transgenic plants, on average, had reduced lesion development compared to non-transgenic plants. These lines are being further evaluated for resistance to HLB. In addition, a grapefruit line is being evaluated under field conditions for performance and response to natural infection of pathogens.

### 13.13 Navelina ISA 315 sweet orange: A CVC tolerant cultivar

**Stuchi E.S.**<sup>1,2</sup>, Silva S.R.<sup>2</sup>, Coletta-Filho H.D.<sup>3</sup>, Franco D.<sup>4</sup> Carvalho S.A.<sup>3</sup>, Sempionato O.R.<sup>2</sup>, Donadio L.C.<sup>2</sup>, Alves K.C.S.<sup>3</sup>

Embrapa Cassava and Tropical Fruits, Cruz das Almas, Brazil; <sup>2</sup> Citrus Experimental Station, Bebedouro, Brazil; <sup>3</sup> Centro Apta Citros “Sylvio Moreira” - IAC, Cordeirópolis, Brazil; <sup>4</sup> Private Consultant, Bebedouro, Brazil

The citrus variegated chlorosis (CVC), caused by *Xylella fastidiosa* subsp. *pauca*, is a serious disease in Brazil. The use of resistant cultivars is highly recommended to allow a long-term coexistence with the disease. From 1990 through 2007, 503 sweet orange cultivars were challenged against *X. fastidiosa* (Yamamoto et al., 2005; Souza et al., 2005). The Navelina ISA 315 cultivar - a clone recovered by *in vitro* culture of undeveloped ovules - was introduced from Italy for CVC resistance studies, and showed to be infected by cachexia during indexing procedures. Plants were established in two field blocks in 2000 (block 1) and 2001 (block 2) with a total of three and eight trees. One and four plants were inoculated by approach grafting of CVC infected nursery trees, respectively. Inoculation was performed in the field nine to eleven months after planting. Nursery trees of the cultivar were inoculated with bacterial suspension in 2006 and 2007. Twenty sweet orange trees showing severe symptoms of CVC were topworked with Navelina ISA 315 with a total of 248 buds grafted in 2007. Isolation of the bacteria infecting the original field trees and the topworked ones was performed. From 2000 through 2007, the presence of typical symptoms of the disease in the trees was evaluated visually twice a year. PCR tests using specific primers for *X. fastidiosa* were conducted for all trees in the two blocks and for the nursery and the topworked ones. None of the trees challenged showed symptoms despite the positive PCR results and recovery of bacteria from the topworked trees (Stuchi et al., 2007). In February 2008, 69/218 topworked branches showed symptoms. However, the eleven trees in field showed no leaf and fruit symptoms. The behavior of Navelina ISA 315 could be explained by a somaclonal variation inducing tolerance to CVC or by the influence of Cachexia on CVC symptoms expression or by some endophyte such as *Curtobacterium flaccumfaciens* colonizing the cultivar and inhibiting the development of *X. fastidiosa* as reported previously (Araújo et al., 2002; Lacava et al. (2004). The same approach is being considered to find resistance against HLB and 553 sweet oranges available in two Brazilian germplasm collections will be challenged in field and greenhouse conditions.

Araujo WL, Marcon J, Macceroni Jr. W, Van Elsas JD, Van Vuurde JW, Azevedo JL. Diversity of Endophytic Bacterial Populations and Their Interaction with *Xylella fastidiosa* in Citrus Plants. *Applied and Environmental Microbiology*, October 2002, p.4906-4914, Vol.68, No.10.

Lacava PT, Araujo WL, Marcon J, Macceroni Jr W, Azevedo JL. Interaction between endophytic bacteria from citrus plants and the phytopathogenic bacteria *Xylella fastidiosa*, causal agent of citrus-variegated chlorosis *Letters in Applied Microbiology* 2004, 39, 55–59.

Souza PS, Silva SR, Stuchi ES, Donadio LC; Goes A. Reaction of citrus genotypes to citrus variegated chlorosis. In: CONFERENCE OF THE INTERNATIONAL ORGANIZATION OF CITRUS VIROLOGISTS, 16, Riverside, 2005. Proceedings. Riverside: International

Organization of Citrus Virologists, 2005. p.356-361.

Stuchi ES, Silva SR, Coletta-Filho HD, Franco D, Carvalho SA, Sempionato OR, Donadio LC, Alves KCS. Navelina ISA 315 sweet orange: a citrus variegated chlorosis (CVC) resistant cultivar. In: CONFERENCE OF THE INTERNATIONAL ORGANIZATION OF CITRUS VIROLOGISTS, 17, Riverside, 2007. Program & Abstracts. Adana, Turkey: International Organization of Citrus Virologists, 2007. p.89.

### 13.14 Phloem specific transgene expression of anti-bacterial genes driven by *AtSUC2* gene promoter in transgenic citrus plants to develop citrus greening resistance

Ahmad O., Dutt M., Barthe G., Orbovic V. and Grosser J.

University of Florida, IFAS, Citrus Research and Education Center, Lake Alfred, FL 33850 USA

Citrus greening, also known as huanglongbing (HLB) or yellow dragon disease is one of the most serious citrus diseases in the world. It is caused by different strains of *Candidatus Liberibacter*, a gram-negative bacterium that greatly reduces production, destroys the economic value of fruit, and kills trees. This pathogen is restricted to phloem tissue and transmitted from infected trees to healthy ones by the Asian citrus psyllid (*Diaphorina citri*). All citrus species are susceptible to citrus greening irrespective of rootstock. Control of citrus greening in citrus has been very difficult because of both the lack of information about the culture of the pathogen and plant tolerance or resistance to the pathogen. Classic control relies on eradication of the infected trees and use of insecticides against the vectors. One strategy to improve citrus resistance to phloem diseases involves transgenic expression of anti-microbial peptide genes in phloem. The companion cell (CC)-specific *AtSUC2* promoter was used to target phloem-specific expression. We constructed a binary vector (pC1391AO1) with an expression cassette bearing the  $\beta$ -glucuronidase (GUS) reporter gene (*uidA*) under control of the *Arabidopsis* sucrose-H<sup>+</sup> symporter gene (*AtSUC2*) promoter. Transgenic lines of Carrizo citrange, Key lime and Duncan grapefruit were generated using pC1391AO1 construct. Histological results of GUS activity indicate that the promoter of the *AtSUC2* gene is active in transgenic citrus and is capable of directing phloem-specific expression of the GUS reporter gene. We cloned selected anti-bacterial genes driven by the *AtSUC2* promoter. Transgenic lines of Hamlin and Valencia sweet oranges, Carrizo citrange, Key lime and Duncan grapefruit were generated. PCR analysis revealed the presence of the anti-bacterial and the *GFP* genes in the transgenic plantlets. The recovery of multiple transgenic plants will be expedited by *in vitro* and shoot tip grafting. The transgenic plants have shown stable GFP expression. Following successful acclimation in the greenhouse, molecular characterization including Southern blot analysis and Western blot analysis will be performed to study transgene integration and expression in these transgenic plants. Transgenic plants expressing the anti-bacterial genes will be challenged with citrus greening pathogen in a secure green house. Targeting anti-bacterial transgene expression to the phloem could minimize foreign gene product in subsequent fruit or juice products.

### 13.15 Citrus variegated chlorosis damage assessment in six sweet orange cultivars in São Paulo, Brazil

Franco D.<sup>1</sup>, Stuchi E.S.<sup>2,3</sup>, Silva S. R.<sup>3</sup>, Martins A.B.G.<sup>4</sup>, Laranjeira F.F.<sup>2</sup>

<sup>1</sup>Farm Technical Assistance, Bebedouro, Brazil; <sup>2</sup>Embrapa Cassava and Tropical Fruits, Cruz das Almas, Brazil; <sup>3</sup>Citrus Experimental Station, Bebedouro, Brazil; <sup>4</sup>São Paulo State University - UNESP, Jaboticabal, Brazil

Citrus variegated chlorosis (CVC) is a bacterial disease that is very important in the Brazilian citrus industry (Rossetti et al., 1997). It is caused by *Xylella fastidiosa* and affects the plant vegetative growth and fruit yield (Rossetti & De Negri, 1990 and Laranjeira & Pompeu Júnior, 2002). For disease control, the use of resistant or tolerant cultivars is highly recommended. Therefore, studies that evaluate these cultivars are very important (Laranjeira, 2006). From 1990 through 2007, 503 sweet orange cultivars were challenged against *X. fastidiosa* (Yamamoto et al., 2005a,b; Souza et al., 2005) and only one of them showed no symptoms (Stuchi et al., 2007). In this work we assess the CVC progression, severity and damage in six sweet orange [*Citrus sinensis* (L.) Osbeck] cultivars ('Sanguínea', 'Olivelands', 'Vaccaro Blood', 'Folha Murcha', 'São Miguel' and 'Finike'). Experimental works were carried out at the Citrus Experimental Station, Bebedouro, and São Paulo State, Brazil. The experimental design was randomized blocks, arranged in split-plots in time. One different rootstock was used for each block: 'Sunki' mandarin [*Citrus sunki* (Hayata) hort. ex Tanaka], 'Rangpur' lime (*Citrus limonia* Osbeck), and 'Cleópatra' mandarin (*Citrus reshni* hort. ex Tanaka) and 'Swingle' citrumelo [*Citrus paradisi* Macf x *Poncirus trifoliata* (L.) Raf]. The experimental unit was comprised of eighteen trees. Damage assessment was visually performed once a year using a 4-note scale, with all plants evaluated. The disease index was calculated by the number of evaluated trees and their ratings, for two years (2006 and 2007). CVC disease severity was also evaluated by effects on plant development, yield and fruit quality of the six sweet orange cultivars. Healthy plants and plants with more than 50% of the canopy with visual CVC symptoms were selected for this purpose in 2007 (eight years after planting). For this evaluation, experimental design was randomized blocks in a 6 x 2 factorial scheme (six cultivars and two infection levels), with four replicates and three trees per plot. Harvested fruits were classified into two size categories: adequate for juice extraction (diameter  $\geq$  50 mm) and inadequate ( $<$  50 mm). All fruits were analyzed for physical and chemical properties. Data was submitted to analysis of variance using the Fisher's Test, and the means were compared by the Tukey Test ( $P < 0.05$ ). 'Folha Murcha' sweet orange had the lowest disease index, while 'São Miguel' and 'Vaccaro Blood' cultivars had the highest disease index and number of leaf symptoms. The canopy height of 'Finike', 'Folha Murcha' and 'Olivelands' sweet oranges was not reduced by CVC, suggesting greater disease tolerance. Fruit yield of affected trees was decreased in 32.71% for all cultivars. Fruit weight, height and diameter were always higher for healthy trees. Sweet orange cultivars presented different fruit soluble solids (SS), titratable acidity (TA) and ratio (SS/TA). Fruit chemical properties of 'Sanguínea', 'Vaccaro Blood' and 'Olivelands' sweet oranges were less affected by the disease. Sweet oranges showed some degrees of tolerance in studies by Laranjeira & Pompeu Júnior, 2002 and in the present work we observed a similar trend. The HLB symptoms are severe on sweet oranges but little is known about different levels of resistance within different varieties and germplasm accessions. Selection of plants is an efficient approach for genetic improvement and

has been used since ancient times, especially in perennial crops such as citrus. Finding any degree of tolerance against HLB within the sweet orange group would be a significant improvement considering the actual mitigation effort to combat the disease. (Financial support: Fapesp 2004/16077-3).

Laranjeira FF. Quantificação de danos causados por doenças em citros. Laranja, Cordeirópolis, v.27, n.1, p.147-163, 2006.

Laranjeira FF., Pompeu Junior J. Comportamento de quinze cultivares de laranja-doce afetadas pela clorose variegada dos citros. Laranja, Cordeirópolis, v.23, n.2, p.401-411, 2002.

Rossetti V, De Negri JD. Clorose variegada dos citros - revisão. Laranja, Cordeirópolis, v.11, n.1, p.1-14, 1990.

Rosetti V, Gonzalez MA, Donadio LC. Histórico. In: DONADIO, L. C., MOREIRA, C. S. Clorose variegada dos citros. Bebedouro: Fundecitrus, p.1-21, 1997.

Souza PS, Silva SR, Stuchi ES, Donadio LC, Goes A. Reaction of citrus genotypes to citrus variegated chlorosis. In: CONFERENCE OF THE INTERNATIONAL ORGANIZATION OF CITRUS VIROLOGISTS, 16, Monterrey, 2005. Proceedings. Riverside: International Organization of Citrus Virologists, 2005. p.356-361.

Struchi ES, Silva SR, Colletta-Filho HD, Franco D, Carvalho SA, Sempionato OR, Donadio LC, Alves KCS. Navelina ISA 315 sweet orange: a citrus variegated chlorosis (CVC) resistant cultivar. In: CONFERENCE OF THE INTERNATIONAL ORGANIZATION OF CITRUS VIROLOGISTS, 17, Adana, 2007. Program & Abstracts. Adana: International Organization of Citrus Virologists, 2007. p.89.

Yamamoto PT et al. Field selection and evaluation of sweet orange resistance to citrus variegated chlorosis. In: CONFERENCE OF IOCV, 16, Monterrey, 2004. **Proceedings**. Riverside: International Organization of Citrus Virologists, 2005a. p.505.

Yamamoto PT et al. Assessment the resistance of sweet orange varieties from the citrus germplasm resources to the citrus variegated chlorosis. In: CONFERENCE OF IOCV, 16, 2004, Monterrey. **Proceedings**. Riverside: International Organization of Citrus Virologists, 2005b. p.505.



### 13.16 Colonization of Asiatic Citrus Psyllid and Huanglongbing Development on *Citrus* and *Citrus* Relatives in Indonesia

Subandiyah S.<sup>1</sup>, Himawan A.<sup>1</sup>, Joko T.<sup>1</sup>, Astuti I.P.<sup>2</sup>, Holford P.<sup>3</sup>, Beattie G.A.C.<sup>3</sup>, Krueger R.<sup>4</sup>

<sup>1</sup>Universitas Gadjah Yogyakarta, Indonesia; <sup>2</sup>Bogor Botanic Garden, Indonesia; <sup>3</sup>University of Western Sydney, Australia; <sup>4</sup>ARS National Clonal Germplasm Repository for Citrus and Dates, Riverside, CA, USA.

The susceptibility of *Citrus* and *Citrus* relatives to *Diaphorina citri* Kuwayama and huanglongbing (HLB) is being assessed in two field plots at Purworejo (~50 m asl) in Central Java, where incidence of the disease is high. Seedlings were planted in the first of two plots in November 2005. With the exception of *Berberis koenigii* L. (curry leaf), seedlings were planted 2 m apart in 16 blocks of 20 species or varieties. Border rows of Siem mandarin (*Citrus reticulata* Blanco) were planted around each block. In 2006, the incidence of *D. citri* was highest on *Swinglea glutinosa* (Blanco) Merr., followed by *Murraya paniculata* (L.) Jack var. *exotica* (sensu Huang), *C. × junos* Siebold ex Tanaka, *B. koenigii*, *M. paniculata*, then other species and varieties. In 2007, the most favoured host was *M. paniculata* var. *exotica* followed by *S. glutinosa*, *M. paniculata*, *B. koenigii*, and the other species and varieties. In 2008, the highest populations were recorded on *M. paniculata* var. *exotica* then *M. paniculata*, *B. koenigii* and the other species and varieties that included *C. × aurantium* L. (sour orange, natsudaikai and Japanese citron); *C. hystrix* DC.; *C. maxima* (Burm.) Merr.; *C. reticulata*; *Aegle marmelos* (L.) Corr.; *Feroniella lucida* Swingle; *Limonia acidissima* L.; *Triphasia trifolia* (Burm. f.) P. Wilson from the Aurantieae, and *Cl. harmandiana* Pierre ex Guillaumin *Cl. lansium* (Lour.) Skeels and *Glycosmis pentaphylla* (Retz.) DC from the Clauseneae. PCR confirmed the presence of *Candidatus Liberibacter asiaticus* in natsudaikai in early 2007, and in Siem mandarin in late 2007. In late 2008, chlorosis was visible on the foliage of 55 plants, but HLB-positive PCR results were only obtained for natsudaikai, pomelo (*C. maxima*) and *C. reticulata* var. Grabag.

The second plot, in which seedlings were planted 1.5 m apart in March 2007 in 5 blocks of 12 species and varieties, included an unknown *Citrus* sp., *Citrus × virgata* Mabb., *Atalantia buxifolia* (Poir.) Oliv., two *M. paniculata* var. *exotica* selections (California and Yunnan), *Afraegle paniculata* Engl., three species of *Citropsis* (Aurantieae), and *Cl. excavata* Burm f. (Clauseneae). Within this group, most *D. citri* have been recorded on the two *M. paniculata* var. *exotica* selections, and no HLB symptoms have been observed.

### 13.17 A transgenic approach to the control of citrus greening

Reddy J.D.<sup>1</sup>, and Gabriel D.W.<sup>1,2</sup>

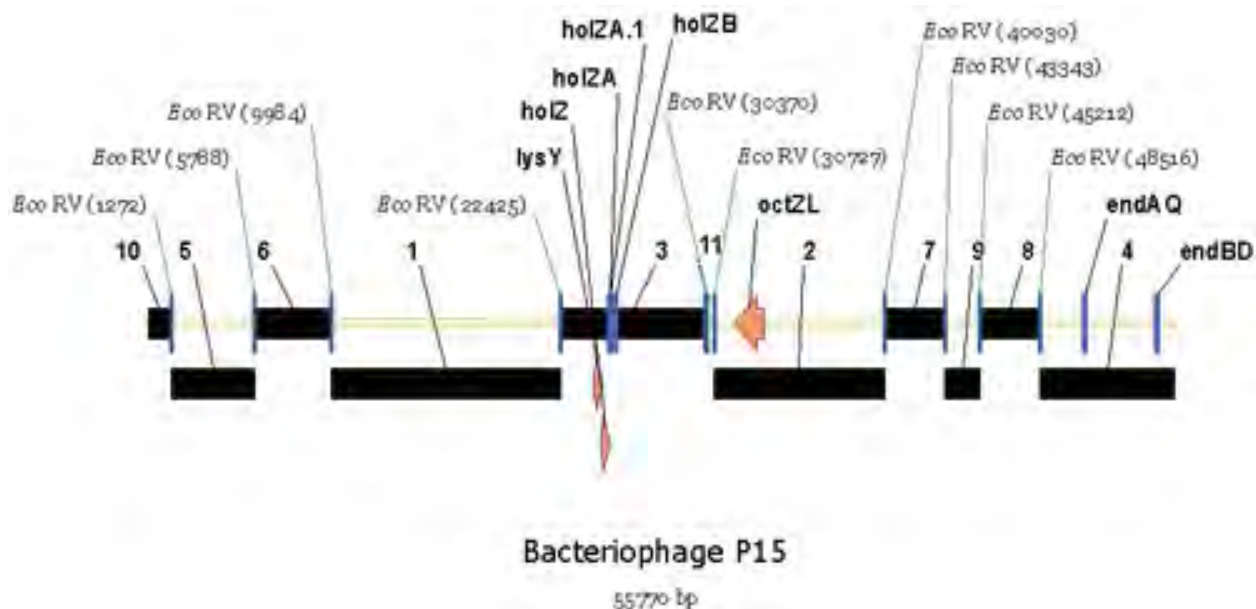
<sup>1</sup>Integrated Plant Genetics, Inc., Alachua, FL USA and <sup>2</sup>Plant Pathology Dept, U. Florida, Gainesville, FL USA.

Genetic engineering of plants provides a powerful new technology for plant disease control that goes far beyond the cloning and transfer of natural resistance genes that are used by traditional plant breeders. For example, recent success in the control of virus diseases of plants by genetic engineering does not utilize traditional plant resistance genes against the viruses. Since each gene construct to be used in a food plant must undergo a significant set of regulatory hurdles (and expense), it is commercially impractical to develop multiple, highly specific gene constructs to control multiple plant diseases. In addition, **controlling disease but not killing the pathogen is not commercially acceptable because it would then allow transgenic plants to be hidden carriers of disease that would affect nontransgenic plants of the same species.** This would create additional regulatory and shipping problems, requiring segregation of transgenic from nontransgenic plants. Therefore IPG's strategy is to develop a single technology that can serve as a platform to control multiple plant diseases in a variety of plants, in this case, citrus greening, caused by a Gram negative bacterial pathogen, *Ca. Liberibacter asiaticus* (Las).

**Background: bacteriophage are safe, effective, and lethal to bacteria.** Bacteriophage have a long history of safe and effective use against Gram negative bacterial pathogens (Flaherty et al. 2000). In all cases using intact bacteriophage, the phage must first attach to the bacterial host, and that attachment is highly host specific, limiting the utility of the phage to specific bacterial host species, and sometimes specific bacterial host strains. In addition, for attachment to occur, the bacteria must be in the right growth phase, and the phage must be able to gain access to the bacteria, which are often buried deep within tissues of either animals or plants, or shielded by bacterial biofilms. Since Las is phloem intracellular and phloem-limited, it would be impossible to deliver phage to attack this target. However, if the proteins made by phage to kill bacteria or to compromise bacterial defenses are identified, a transgenic approach could be used to deliver these proteins to the target with great efficiency and consistency.

**Isolation of phage with ability to affect non-host bacteria and genomic sequencing.** Unsterilized pond water taken from an agricultural setting was used to isolate phage using *X. pelargonii*. Plaques were observed after 24 hrs. incubation; 24 of these were collected by scraping the plaques from the plates, titered and stored. These mixtures of phage were then purified from single plaques. Cell suspensions of overnight broth cultures of *X. citri*, *X. campestris* and *R. solanacearum* were added to 0.7% water agar and individually overlaid on phage-infected *X. pelargonii* plates. Plates were incubated an additional 48 hrs at 30° C and phage were evaluated for ability to kill or affect growth of Gram negative bacteria that they could not infect. Two such phage were selected, phage isolates 13 (Xp13) and 15 (Xp15)

The Xp15 genome was completely sequenced in order to identify the gene(s) expressing the diffusible killing factor (Ramadugu, Reddy and Gabriel, unpublished). Xp15 DNA was made according to standard protocols using *X. pelargonii* as the host. The Xp15 DNA was



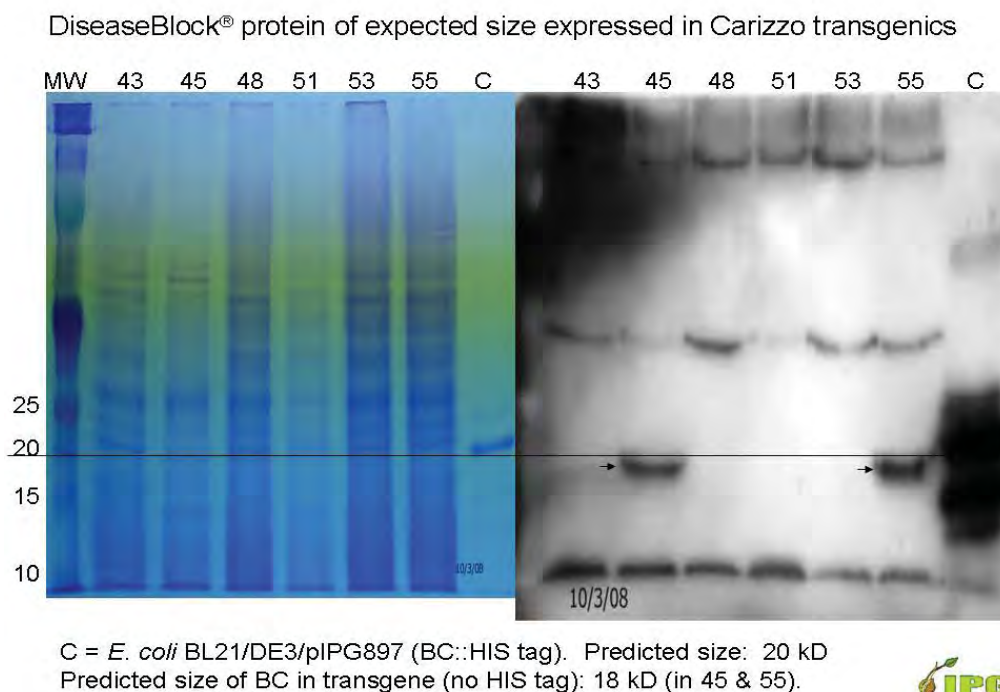
**Figure 1** digested with *EcoRV*, yielding eleven fragments, ranging in size from 12.4 kb to 357 bp. The DNA fragments were mapped (refer Fig. 1). Most of the fragments were cloned; some were not cloned, despite repeated attempts. The cloned DNA fragments were used directly for sequencing, using vector-based primers initially, and primer walking thereafter until each fragment was completed. Fragments that were not cloned were sequenced using Xp15 genomic DNA. Fragment assembly was accomplished using Xp15 genomic DNA and primers extending outside each fragment in both directions. Xp15 has a double stranded DNA genome which is 55,770 bp in length.

ORF analysis of the sequenced phage was done using a combination of several programs including PromScan, Terminator (GCG), GeSTer (Unniraman et al. 2001, 2002), Glimmer, Genie, Codon preference (GCG), ORF finder (NCBI) and Blast (NCBI) analyses. Potential Shine-Delgarno sequences were identified manually by examining the sequence. Using default Glimmer settings, only 32 ORFs were identified. After identifying the promoters and terminators in the genome, manual analysis of all ORFs using Codon preference (GCG) allowed the identification of an additional 52 ORFs. The genome encodes 84 putative ORFs, including 3 holins (needed by the phage to break through the inner bacterial membrane) and an endolysin (needed by the phage to break through the cell wall). All four of these genes were cloned into a tightly regulated expression vector and expressed in *E. coli* BL21 DE3, and functioned as expected: when each holin was expressed in *E. coli*, growth ceased almost immediately upon induction; when the endolysin and holin were expressed together, cell lysis occurred.

Identification of a novel bacteriophage gene, “B” that caused “quasi-lysis”. Several other interesting candidate genes were cloned in the same vector and analyzed in the same way; one of them, candidate “B”, caused a slow “quasi-lysis”. When combined with an endolysin, there was no lysis, indicating its primary effect was not on the inner membrane. Microscopic examination of cells expressing protein B showed near cessation of cell division, and many of the cells

appeared elongated, as if many cells failed to divide. Polyclonal antisera was raised against the Xp15 B protein overexpressed in *E. coli*.

**Transgenic tobacco and citrus expressing Xp15 “B”.** The gene encoding Xp15 B was recloned into a binary plant transformation vector and used to transform both tobacco and citrus Carrizo citrange. Forty four confirmed transgenic tobacco lines were generated and rooted from 235 leaf explants (19%). Fifty five confirmed transgenic Carrizo lines were generated and rooted from 1678 shoot explants (3%). Southern, Northern and Western blot analyses were used to confirm gene expression. Thirty of these confirmed lines were evaluated by Western blot analysis and 10 of these plant lines were confirmed to strongly express the Xp15 B protein:



**Las challenge inoculations on tobacco and citrus.** Sixteen of the confirmed transgenic tobacco lines and 5 of the confirmed transgenic Carrizo lines were moved into the UF/ICBR Plant Containment Facility for challenge inoculations. This Facility was certified for use with the Las Select Agent. Using dodder transmission from an HLB infected citrus tree provided by FDACS-DPI, HLB was transmitted to both periwinkle (*Vinca*) and to sweet orange. Transgenic tobacco carrying Xp15 B was challenge inoculated with strongly Las + dodder using HLB "strain", UF506 in four experiments beginning in July, 2007. Results using tobacco as a proxy host for Las were as follows:

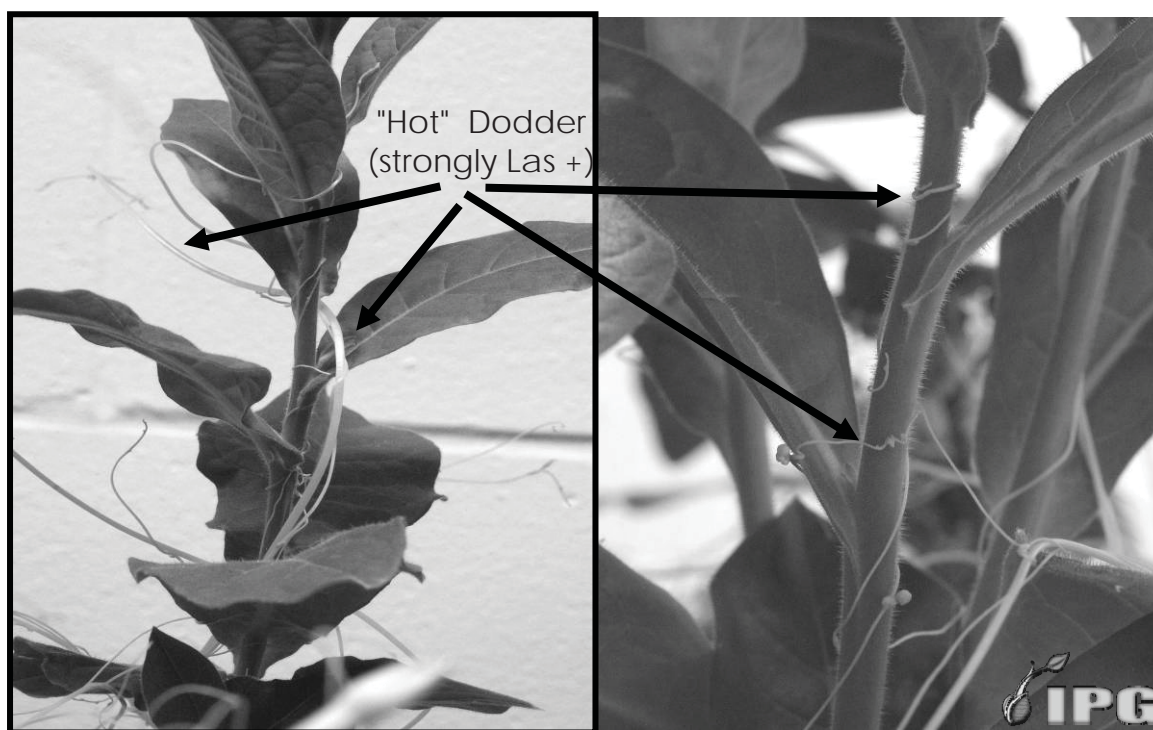
	Dodder		
	On	Attached	Off
Exp. 1.			
Tobacco	7/25/2007	10/17/2007	11/29/2007
Exp. 2			
Tobacco	1/18/2008	1/28/2008	3/31/2008
Exp.	34/18/2008	4/29/2008	6/19/2008

Tobacco			
Exp.	4		
Tobacco	6/21/2008	7/19/2008	8/15/2008
NT		8/26	(30%) Las +
Xp15 B		0/16	(0%) Las +

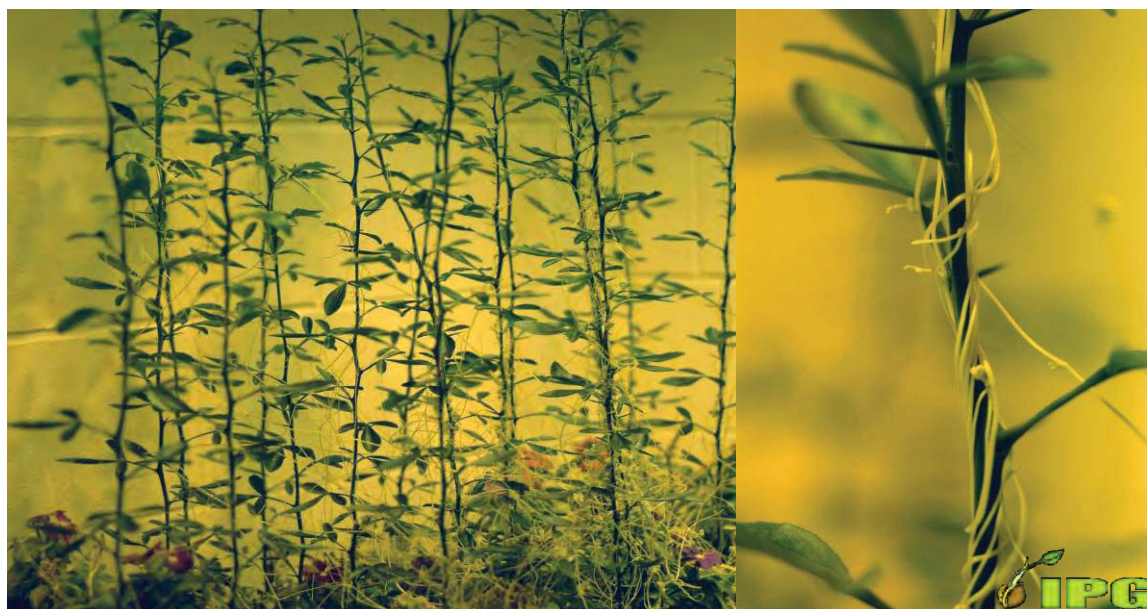
### Summary All Tobacco

Expect: 4.9/16 Xp15 B plants to be Las +, if no resistance.

Since 8/26 experimental tobacco plants (30%) were Las positive, if no resistance were found in Xp15 B plants, one would expect 4.9/16 of these plants to be Las positive, but none of the Xp15 B plants were positive. This result indicates that transgenic tobacco carrying Xp15 B are resistant to Las. The experiment was conducted by using dodder to transmit Las from confirmed, infected sweet orange as a source to periwinkle (*Vinca*). After the periwinkles became symptomatic and were confirmed by PCR to be Las +, the dodder was detached from citrus but not from periwinkle, and the infected periwinkles and infected dodder were placed in very close proximity to the tobacco. The dodder was trained to grow on tobacco. After the dodder was confirmed attached to the tobacco plants (usually after 6 weeks), the dodder was allowed to remain on the tobacco for at least 4 weeks, as indicated in the table.



Similar experiments were conducted with transgenic citrus. Transgenic Carizzo citrange carrying Xp15 B was challenge inoculated with strongly Las + dodder using HLB "strain", UF506 in four experiments beginning in April, 2008. Results using these transgenic citrus plants were as follows:



	Dodder		
	On	Attached	Off
Exp 1 Citrus			
Carrizo	4/11/2008	4/18/2008	5/19/2008
Exp.	2		
Citrus			
Carrizo	5/20/2008	5/27/2008	6/24/2008
Exp.	3		
Citrus			
Carrizo	4/18/2008	4/29/2008	6/19/2008
Exp.	4		
Citrus			
Carrizo	6/21/2008	8/1/2008	9/23/2008

#### Summary All Carrizo

NT        3/26 (11.5%) Las +  
 Xp15 B   0/14 (0%) Las +

Expect: 1.6/14 Xp15 B plants to be Las +, if no resistance.

Since 3/26 experimental Carrizo plants (11.5%) were Las positive, if no resistance were found in Xp15 B Carrizo, one would expect 1.6/16 of these plants to be Las positive, but none of the Xp15 B Carrizo plants were positive. This result indicates that transgenic citrus carrying Xp15 B is resistant to Las.

**Conclusions.** Citrus greening is a devastating plant disease that has spread throughout Florida and is now in all citrus growing counties. The lag time between the first introduction of the citrus psyllid insect vector (1999 in Florida) to the confirmation of citrus greening disease (2005 in Florida) is about six years. The psyllid is now in Texas and California. There is no practical resistance breeding in citrus, and eradication of the psyllid or greening is impossible. Chemical control of the insect vector may require up to 25 sprays per year, and this only suppresses the disease. Citrus greening is caused by Las, an intracellular, Gram negative bacterium that resides within the living phloem cell. A genetic engineering approach to introduce a gene that allows the plant to defend its own cells from within is most likely to succeed. We have evidence that a bacterial phage gene, when expressed inside both tobacco and

citrus plant cells, produces a stable protein that is not harmful to citrus and appears to give resistance to Las, and therefore the disease it causes, citrus greening.

We are in the process of obtaining regulatory agency approvals and moving these genes into mature Hamlin and Valencia tissue.

### **Citations**

Flaherty JE, Harbaugh BK, Jones JB, Somodi GC, Jackson LE. 2001. H-mutant bacteriophages as a potential biocontrol of bacterial blight of geranium. *HortScience* 36 : 98-100.

Unniraman S, Prakash R, Nagaraja V. 2001. Alternate paradigm for intrinsic transcription termination in eubacteria. *Journal of Biological Chemistry* 276:41850-41855.

### **FUNDING ACKNOWLEDGEMENTS**

This project was funded by the National Science Foundation (NSF) through its Small Business Innovative Research Program (SBIR), the USDA-APHIS, and by Southern Gardens Citrus, Clewiston, FL.

INTERNATIONAL RESEARCH CONFERENCE  
ON HUANGLONGBING



**Session 14a:**  
**International Citrus**  
**Industries: Coping**  
**with HLB**

Orlando, Florida



December 2008



14.1 Presentation of Ranked International Research Priorities – W. Dixon and T. Gottwald

INTERNATIONAL RESEARCH CONFERENCE  
ON HUANGLONGBING



Research Priorities



Orlando, Florida • December 2008

# INTERNATIONAL RESEARCH CONFERENCE ON HUANGLONGBING



## Research Priorities Survey

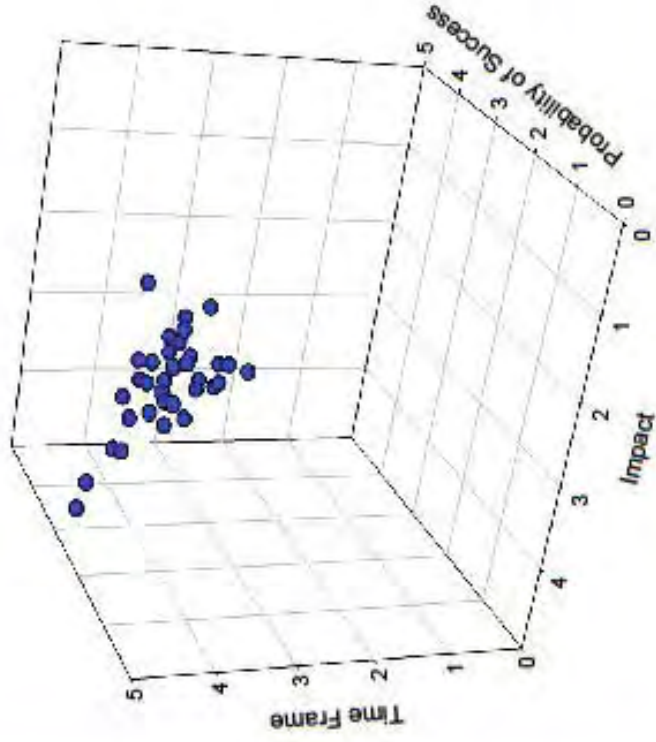
- Research/Scientist 42
- Citrus Industry 18
- Regulatory 16
- **TOTAL 76**

Orlando, Florida ● December 2008

# INTERNATIONAL RESEARCH CONFERENCE ON HUANGLONGBING



NAS Identified Research Priorities

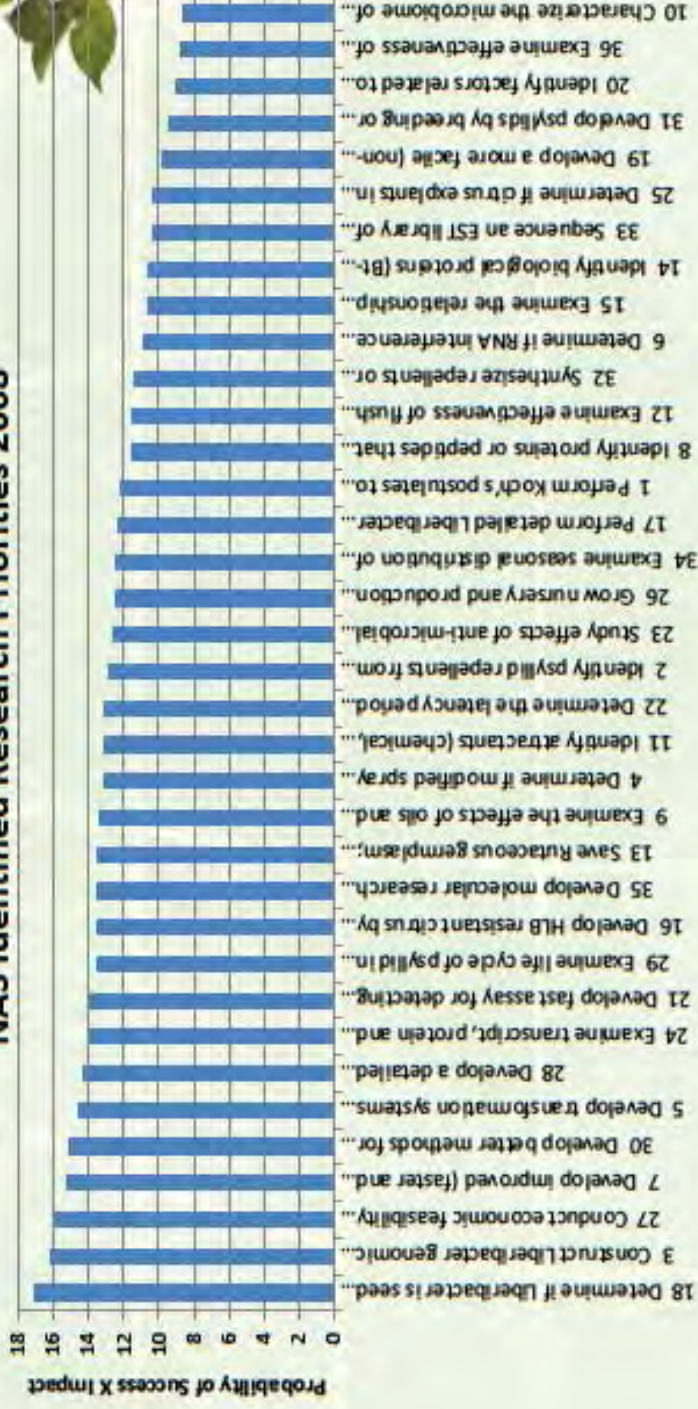


Orlando, Florida ● December 2008

# INTERNATIONAL RESEARCH CONFERENCE ON HUANGLONGBING



NAS Identified Research Priorities 2008

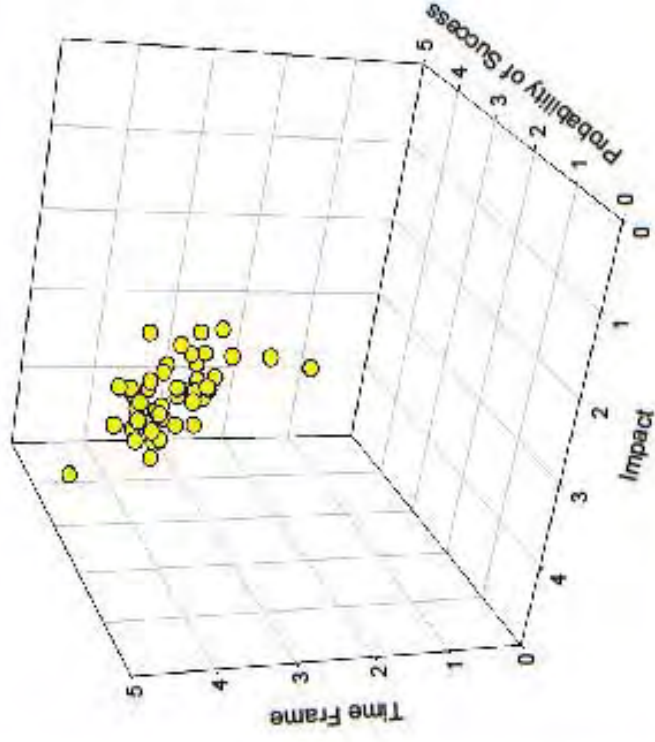


Orlando, Florida ● December 2008

# INTERNATIONAL RESEARCH CONFERENCE ON HUANGLONGBING



ARS Researchable Areas – ARS HLB Workshop



Orlando, Florida ● December 2008

# INTERNATIONAL RESEARCH CONFERENCE ON HUANGLONGBING



ARS Researchable Areas from ARS HLB Workshop 2008

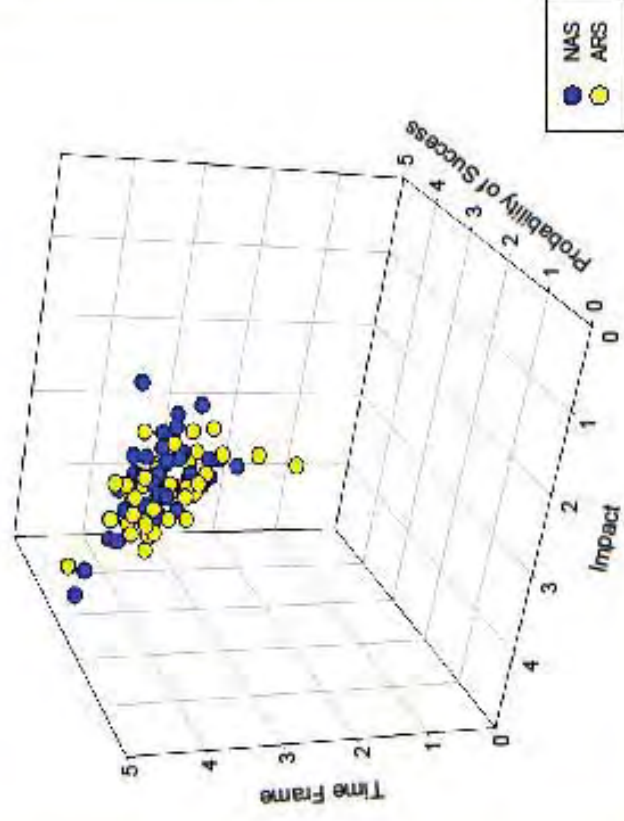


Orlando, Florida • December 2008

# INTERNATIONAL RESEARCH CONFERENCE ON HUANGLONGBING



NAS Identified Research Priorities 2008 and  
ARS Researchable Areas from ARS HLB Workshop



Orlando, Florida ● December 2008

INTERNATIONAL RESEARCH CONFERENCE  
ON HUANGLONGBING



**Session 14b:**  
**Key Take-Home**  
**Messages and a View**  
**to the Future:**  
**Summaries of**  
**Research Sessions**

Orlando, Florida



December 2008



### **14.3 HLB and ACP situation and crop losses in Asia, South America and United States – T. Schubert**

#### **1) Asia - A. Beattie**

Origin of ACP – India / Pakistan

- Origin of Liberibacter –Africa (?) then to India
- ACP spread from India / Pakistan to Taiwan and Indonesia in late 1800's, then through Asia in later decades
- HLB spread from India / Pakistan to China about 1930, from China to Taiwan, Indonesia and Philippines in 1940's, more recently into Malaysia, Thailand and southern islands of Japan
- HLB generally present throughout Asia, absent from Japan mainland but moving North
- HLB absent in Three Gorges area of China, geographic and mountain separation

Production decreasing on per ha basis

- Much ineffective pesticide use; oils perform well, help slow infection rate
- Clean nursery stock becoming available but costly, demand exceeds supply
- Little coordination or uniformity of area-wide management or education efforts
- Infection is early, rates high
- Prognosis poor for foreseeable future
- Yields and \$ returns too low to afford effective management
- Some use of guava interplanting in Vietnam

#### **2) Brazil - C. Montiero**

ACP first detected in 1942

- HLB first detected in 2004
- 3<sup>rd</sup> species – *L. americanus*, 2005
- Now *L. asiaticus* predominates

*L. americanus* only known in Brazil at present

- Other citrus in South America at great risk
- In 2008, 41% of all citrus is in a block with at least one HLB infected plant
- < 28% detection of HLB →rogue infected only
- >28% detection of HLB →block removal

HLB incidence in Brazil

In 2004, 3 states, 3.4% average incidence in 46 municipalities of São Paulo state only; In 2008, 18.6% average incidence in São Paulo state (0.7-27.5% in 5 management areas)

Brazil Crop Losses –

- Over 1,000,000 trees removed to date
- Compulsory management enforced

No data on decline in juice quality

- Yield reductions related to HLB severity by negative exponential model
- Yield reduction due to fruit drop and failure to set new fruit
- Overall production down from previous highs, but other factors in addition to HLB
- By 2020, production predicted to be down 25% due to HLB

### 3) *United States - J. Snively*

Florida - ACP arrived in 1998, HLB in 2005

- HLB incidence expanded from 2 to 32 counties in 3 years
- Worst blocks up to 80% symptomatic
- ACP has spread west, TX in 2001
- Will reach extreme southern CA by 2008 coming from Mexico
- Only HLB known to exist outside of FL is small amount in southern LA

US Crop Losses

Little to no impact on juice quality noted so far

Quality of juice from symptomatic fruit rated lower than asymptomatic fruit from symptomatic tree which tastes the same as fruit from healthy tree

Symptomatic fruit can be graded out by size

Overall FL production down from previous highs, but other factors in addition to HLB

By 2020, production predicted to be down by 15-20% due to HLB

HLB management increases costs \$474/A, up 38%

### 4) *Conclusions*

ACP precedes HLB by few to several years

- Infected plants probably precede psyllids, but disease is stationary and a dead end until vector goes to work
- Latent period variable: months to 3-5 yrs
- Profitability depends on comprehensive management which depends on crop value
- Growers not easily convinced management is worth the cost, many complex factors to consider
- Need area-wide management approach to counteract bad neighbor effect – How?

#### 14.4 HLB Survey – M. Irey

- 1) Data trends from an HLB laboratory in a commercial lab open to the industry
  - Make the “right thing easy” for the growers
  - Get growers “on a program”
  - ~65,000 samples processed over a 2-year period
  - Sample volume increasing
    - More disease
    - More awareness
  - Data Trends associated with samples
    - Best time for symptoms – Late Jul to Mar
    - Highest bacterial titer – July to Feb
    - Most susceptible – trees 6-9 yrs old and 6-9 ft tall
    - Most susceptible - grapefruit and round oranges
    - Least susceptible – tangelos and tangerines
    - More infection on edges
- 2) Texas surveys for HLB and ACP
  - ACP present in TX, HLB not detected
  - After HLB scare based on psyllid testing, survey efforts have been stepped up
    - Commercial industry in south Texas
    - Residential and specialty plantings throughout state
  - APHIS certified lab
    - 822 plant samples to date
    - 815 psyllids to date
    - All negative
  - Working to enclose budwood sources
  - Have multi-language extension efforts
  - In process of developing state action plan
  - Area-wide psyllid control pilot plan
  - Continuing APHIS supported survey
- 3) National plan for the detection of HLB in Mexico
  - Psyllids found in 2002, now present in all states with commercial citrus
  - Implementing an early detection program to detect HLB
    - Surveys
    - Vector testing
  - Amount of testing based on 3 defined risk categories which increases with risk category
  - Have authorized HLB laboratories
    - Pictures of suspect samples sent to central source
    - Based on photos, decision to sample or not is made
  - State personnel have been trained to detect HLB in Florida and by in-house training
  - Testing to date
    - 155 psyllid
    - 26 plant samples
    - All negative

- 4) Survey for Candidatus Liberibacter species in South Africa
  - Ca. Liberibacter africanus and Trioza in South Africa many years
  - No recent surveys in SA using modern PCR techniques
  - 2006 – 249 samples from 57 orchards
    - Only *Ca. L. africanus* found on citrus in SA
  - No strain variation in *Ca. L. africanus*
  - Also sampled indigenous Rutaceous plants
    - Only found *Ca. L. africanus capensis*
  - Fair amount of variability in isolates and more widespread than expected
- 5) Movement of HLB in Florida
  - ACP in Florida 1998
  - ACP largely spread throughout state by *Murraya paniculata*
    - Initial population probably free of HLB
  - Spread of HLB
    - Estimated flight of ACP 1.5 km
    - Spread of HLB too fast to be due solely to flight of ACP
    - Have found positive ACP from nursery plants (Citrus and *Murraya*)
    - Estimate that ACP can travel 54 km
  - Murraya* played a significant role in distribution of ACP and HLB in Florida
  - Testing of psyllids is a valuable tool for early monitoring of HLB
- 6) Is it possible to replant young groves in an area with endemic HLB?
  - Hierarchical approach is needed because it isn't possible to sample all trees
  - Management decision: Should we and can we replant in the presence of HLB?
  - Following 2 blocks (~30,400 trees)
    - Aggressive insect control
    - 6X scouting/yr
    - PCR testing
  - Results to date 0.4% after 2.5 yrs

### 14.5 Liberibacter sequence characterization and culture – W. Dawson

- 1) Candidatus *Liberibacter americanus*, associated with citrus HLB in Brazil has three ribosomal RNA operons and a genome size of 1.34Mbp
- 2) Features of ‘*Candidatus Liberibacter asiaticus*’ genome
  - Ca. Liberibacter asiaticus* (Las) draft genome has 1124 annotated proteins
  - Ca. Liberibacter solanacearum* (Lso) draft genome has 1128 annotated proteins
  - Common and unique proteins between citrus and potato *Liberibacter*s:  
common 815, Las 209 unique, Lso 211 unique
- 3) Evaluation of potential pathogenicity genes identified by genomic sequencing of *Ca. Liberibacter asiaticus* – D. Gabriel et al.
  - Type I secretion system
    - Secretion of proteins produced by the bacterium
    - Efflux of toxic substances from the bacterium
- 4) Several *Liberibacter* and *Phytoplasma* Species are Individually Associated with HLB: Towards a common denominator.
  - The different bacteria associated with HLB-like symptoms are all sieve tube-restricted. They might have similar pathogenicity mechanisms resulting in similar disease symptoms. However, not all sieve tube-restricted bacteria have similar pathogenicity mechanisms, and a given bacterium might have several such mechanisms. Experiments to check the hypothesis are underway.
- 5) Zebra Chip Complex and HLB Disease symptom is discoloration of potato tubers resulting in lot rejection
  - Pathogen: *Candidatus Liberibacter psyllarous*
  - Insect Vector: The Potato Psyllid (other psyllids?)
  - Are They Potato Psyllids?
    - Over 70 genera of psyllids are grouped under family Psyllidae
    - The COI sequence has been used to identify psyllids.
    - Hackberry psyllid (*Pachypsylla* sp.) and mesquite psyllid (*Heteropsylla texana*) COI sequences from South United States and Mexico were published.
- 6) Cocultivation of *Candidatus liberibacter asiaticus* with actinobacter from Citrus with HLB
- 7) Development of an Asian citrus psyllid (*Diaphorina citri*) insect cell line

## 14.6 Host-Pathogen Interaction – J. daGraca

- 1) Seed transmission findings unresolved
  - Seed from 8 spp.; >1250 tests by qPCR–no positives New assay gives positives but low titer; 20/69 sour orange with Ct from 32-39
  - Transient detection in Carrizo citrange seed
- 2) Sequence of anatomical events
  - Infection – long incubation period of build-up to a critical titer
  - Phloem plugging – 2 types, phloem necrosis follows (toxin or starvation?)
  - Sugar transport blocked > starch accumulation
  - Loss of internal structure of chloroplasts
  - Chlorosis of leaf areas distal to blocked phloem producing mottled chlorotic pattern
- 3) Host molecular responses
  - Microarrays → 600 genes up and down regulated
  - Included defense regulators, phytohormones
  - 3 genes in starch synthesis up-regulated
  - Phloem proteins up-regulated
    - Possibility to suppress the HLB symptoms by controlling the expression of genes encoding callose and phloem proteins?
    - Investigation needed for blockage of the phloem, effects on loading of nutrients, and nutrient transport.
- 4) Rootstock effects on HLB?
  - Feroniella rootstock does not confer HLB resistance to the scion
- 5) Solanaceous Liberibacter is a new *Ca. Lib. spp.* in tomato and potato + psyllid vector. May be useful as a model systems for citrus liberibacters – Liberibacter asiaticus infects tomato, but solanaceous liberibacter was not found in citrus or *D. citri*.
- 6) Titer Las > Lam; greater temp. sensitivity of Lam in Murraya; Lam disappearing in citrus in São Paulo State Brazil
- 7) Different strains of Las in Japan due to mutations or new introductions? Pummelo was resistant but now is no longer resistant. Is host range of new strains expanding?

### 14.7 Asian Citrus Psyllid (Biology and Genomics) – D. Hall

- 1) Gene expression in midgut tissues of *Diaphorina citri*: application to biology and vector control  
 RNA inhibition strategies to control the psyllid and spread of HLB involving tissue-specific gene silencing through RNA interference ( i.e. RNAi control).  
 The sequencing data includes midgut and testes tissues.
- 2) Pheromones of the ACP elicit behavioral responses from its parasitoid, *Tamarixia radiata*
  - Isolation and identification of semiochemicals associated with the parasitoid *Tamarixia* and its host *Diaphorina*.
  - Male and female *Tamarixia* apparently produce some of the same pheromone components that the psyllid produces.
  - Male *Diaphorina* and both sexes of *Tamarixia* showed attraction to synthetic  $\gamma$ -Butyrolactone
  - Female *Tamarixia* probably cue on volatile compounds produced by *Diaphorina* for host location.
  - Research in this area could be fruitful with respect to enhancing biological control of the psyllid, particularly in urban settings and abandoned groves.  
 Attractants such as  $\gamma$  –Butyrolactone might have applied applications for psyllid control.
- 3) Effects of freezes on survival of *Diaphorina citri*.
  - The research presented indicated that some freeze events particularly in northern areas of Florida might be severe enough to temporarily eradicate the psyllid.
  - The research provided some insight into where across the USA the psyllid might or might not be able to survive during the winter.
- 4) Characterization of electrical penetration graphs of *Diaphorina citri* in citrus  
 Information on feeding activities by the psyllid that may be applied with respect to understanding transmission of the HLB pathogen.
- 5) Symbionts associated with ACP in Brazil and a look into their role
  - Symbionts play a major role in determining ACP fitness.
  - ACP in Brazil harbors four different symbionts: *Carsonella*, *Wolbachia*, *Syncytium* and *Pantoea*.
  - Antibiotic treatments reduced levels of Wolbachian psyllids, with corresponding increases in levels of the other three symbionts.
  - Reductions in *Wolbachia* resulted in reductions in egg and nymph survivorship, although the effect on egg survivorship seems to be related to an undesirable effect of the antibiotic treatment itself rather than reduced levels of the symbiont.
  - Novel management tactics for the psyllid might be developed by manipulating symbionts associated with ACP.
- 6) Endosymbiotic microbiota of ACP
  - Psyllids feed from the phloem of plants ingesting a diet that is rich in carbohydrates but deficient in essential amino acids. Endosymbionts support the psyllid by supplying essential amino acids.
  - Knowledge of the bacterial community of psyllids could provide information relevant to future psyllid management strategies through manipulations of its endosymbionts.
  - Seven different endosymbionts of the psyllid were reported.
  - Many functional bacterial homologies were isolated within the psyllid.

- Interactions between psyllid endosymbionts have important ramifications not only on psyllid biology but also on the endosymbionts themselves and with other bacteria such as *Liberibacter asiaticus* when introduced to the psyllid.
- 7) FK506-Binding protein from ACP
    - Binding proteins in insects have been shown to play a role in calcium regulation.
    - A binding protein associated with ACP was isolated and characterized.
    - This binding protein may be a good genetic target for an RNA inhibition approach to managing the psyllid.
  - 8) Gene expression in ACP adults feeding from Florida citrus: Application to biology and vector control
    - Genomics approach to study the genetic basis of the biology of *D. citri* and identified a number of specific genes associated with feeding, reproduction, and insecticide resistance.
    - These genes could be targets for RNA inhibition tactics aimed at controlling the psyllid and reducing the spread of citrus greening.
  - 9) Asian citrus psyllid, genetic basis of immunity
    - ACP gene responses to imidacloprid and other stress factors such as temperature.
    - The genes could be targets for RNA inhibition tactics aimed at controlling the psyllid and reducing the spread of citrus greening.
  - 10) Effects of host plant on fitness of ACP
    - Comparisons of psyllid fitness on two rootstocks, sour orange (*Citrus aurantium*) and Cleopatra mandarin (*Citrus reticulata*)
    - Clear evidence that Cleopatra mandarin is an unsuitable host plant for ACP.
  - 11) Development of a potato psyllid (*Bactericera cockerelli*) cell culture
    - Development of a potato psyllid cell culture which is expected to allow researchers a new approach for rearing *Liberibacter* associated with potato and to screen peptides and other chemicals for toxicity to the potato psyllid.



#### 14.8 Psyllid Management Strategies – M. Rogers

- 1) Biology and ecology of *Diaphorina citri* and *Tamarixia radiata* in São Paulo State.
  - Determine optimum conditions for *D. citri* and *T. radiata* development for evaluation of the effectiveness of the parasitoid
  - Ecological zoning for *D. citri* and *T. radiata* based on temperature requirements.
  - To provide basic information for *D. citri* to facilitate detection, monitoring, and control.
- 2) Evaluation of the Efficacy of Guava against ACP
  - A few years ago Vietnamese farmers noticed that the citrus psyllid population and HLB incidence were low in citrus groves inter-planted with guava trees. The observations were confirmed by researchers at the Southern Fruit Research Institute.
  - This discovery may lead to new approaches for the environmental friendly control measures, i.e. inter-planting or use of active compounds from guava.
  - For purpose of understanding what caused the reduction of psyllid and HLB incidence in the inter-planted citrus groves, experiment were designed.
- 3) Wounding of Guava leaves produces defensive sulfur compounds.
  - Identify the active components (volatiles) in guava leaves that repel or reduce psyllid populations and avoid the negative aspects of guava trees/fruit.
  - Guava leaves produce Dimethyl disulfide (DMDS) when mechanically injured. DMDS is not produced by citrus. DMDS is highly toxic to most insect species and is one possible explanation for the repulsive effect of guava on the ACP.
- 4) Chemical ecology of ACP and potential applications of behavior-modifying chemicals for its management.
  - Investigating the ACP antenna, the sensilla and their probable functions
  - Chemical communication between male and female ACP-towards identification of a sex-attractant pheromone
  - Responses to host plant volatiles
  - Development of a Guava-based repellent
  - Analysis of ACP head-space volatiles
  - 84 compounds identified: 7 Male-specific, 14 Female-specific, 40 Shared, 12 induced compounds (physically isolated, but chemically interacting), 7 induced compounds (physically & chemically interacting)
  - Behavioral responses of male and female ACP to  $\gamma$ -Butyrolactone – male specific
  - Investigating potential role of Guava as an ACP repellent
- 5) Novel reovirus in ACP
  - Localization of reovirus in psyllid – present in all stages or tissues except eggs.
  - Population of reovirus in Ft. Pierce, FL
  - Psyllids which were collected from the field (May 2008) resulted in ~55% virus positive.
  - No immediate pathogenic effects on ACP were observed.
  - Virus acquisition and transmission may be occurring due to a combination of the ACP's feeding behavior and wide citrus host range which may act as reovirus host plants.
- 6) Efficiency of insecticides for control of ACP
  - Efficiency of systemic insecticides applied in the nursery to control ACP
  - Determine the residual period for insecticides.

- Soil applied insecticides in nurseries, before planting are most the effective method for control of ACP in the field (imidacloprid ~ 70 days; thiamethoxam and clothianidin 70-105 days; acetamiprid ineffective)
- Foliar applied insecticides that provided the longest residual period are: thiamethoxam, imidacloprid, formetanate, thiamethoxam + lambda-cyhalothrin, dinotefuran, gamma-cyhalothrin, methidathion and fosmet (effective for ~ 34 days after application)

#### 7) Integrated management of ACP in Florida

- Suppression of psyllid populations by predacious insects.
- Incidence of ACP parasitism by *Tamarixia radiata* is highest in Central FL
- *Diaphorencyrtus aligarhensis* (Encyrtidae) collected in Guangdong China Sep 2006
- Endoparasitoid attacking 2nd – 4th instars
- Host feeds on 1st – 4th instar nymphs.
- Currently being released in Florida

#### *Tamarixia radiata*

- Colonies from new collections made in Pakistan, Vietnam and Guangdong China awaiting in quarantine at FDACS-DPI for USDA-APHIS release permits.

#### Psyllid management plan for mature citrus

- Monitor populations year round
- Dormant spray(s) with short PHI adulticide
- No sprays on flushes
- Only soft chemistry post bloom
- Oil program option throughout growing season
- OPs in summer and before fall flush if necessary

### 14.9 HLB Management – A. Beattie

**Juliano Ayres**, presenting for J Belasque et al.

Noted critical practices were required for ‘control’ (effective management) of huanglongbing (HLB) in São Paulo:

- 1) eradication of diseased trees (detected by scouting, confirmed by PCR)
  - 2) ‘control’ (suppression of *Diaphorina citri*) with insecticides,
  - 3) and use of pathogen-free trees.
- 4) He added that 8 factors were associated with HLB ‘control’ in Sao Paulo,:
- a. farm location
  - b. distance from ‘bad neighbour’
  - c. farm size average
  - d. age of trees
  - e. timing of eradication,
  - f. number of sprays per year
  - g. umber of inspections per year
  - h. accumulated HLB
  - i. incidence in first year.
- 2) He gave examples illustrating the importance of these points: the key to survival being no bad neighbours, eradication, inspections, sprays.
- 3) The message was –‘if you start late you will lose the war’.

**Manjunath Keremane**, on behalf of Manjunath et al.

Noted the importance of testing sampled psyllids, particularly nymphs, as a means of early detection of the possible presence in blocks of asymptomatic orchards –possibly 3 months before infected trees develop symptoms.

He also highlighted the need to sample from various locations –including backyards and retail outlets.

**Mike Ire**y, on behalf of Irey et al., spoke on:

Scouting

Tagging

PCR

Tree eradication at Southern Gardens

Edge effects and invasions of *D. citri* and, axiomatically, HLB from ‘commencing’ in the east and southeast corners of blocks, and hot-spots associated with breaks or ‘interfaces’ in blocks (e.g., ponds). These were interesting observations.

In the reply to a question on ‘resets’, he considered (a) such practices unwise and expressed the opinion that the future of the Florida citrus industry may depend on rotational blocks.

**Roberto Bassanezi**, on behalf of Bassanezi et al.

Noted that HLB management required continuous and costly efforts.

He summarised two large scale factorial experiments, albeit with replicates comprising 504 to 528 trees.

The first, in a block planted in 2005, compared scouting and tree eradication (28, 56 and 112 days) and psyllid control (no sprays, sprays every 14 days, and sprays every 28 days).

The orchard was 1.8 km from its nearest neighbour.

The insecticides were aldicarb and thiamethoxam to soil in the rainy season at 56 day intervals and imidacloprid, dimethoate and lambda-cyhalothrin in the dry season every 14 or 28 days.

In September 2008 (36 months), cumulative numbers of psyllids caught in traps and HLB incidence.

Experiment 2 was established in a small farm without citrus groves, but until the beginning of 2007 it was surrounded by severe HLB-affected farms.

It compared scouting and tree removal every 14 days, 28 days, 84 days and 182 day) and four psyllid treatments, no psyllid control and sprays applied every 14 days with lambda-cyhalothrin replaced with etofenprox. After 29 months there were some significant differences between cumulative numbers of psyllids in the controls and insecticide treatments but none for HLB levels.

**Katsuya Ichinose**, on behalf of Ichinose et al.

Presented results of trials comparing systemic insecticides (alone) and guava (interplants alone). Levels of HLB rose relatively quickly in all treatments, and the results cast doubt on the efficacy of guava interplants.

**Jim Graham**, on behalf of Graham et al.

Presented results on the potential use of imidacloprid to induce systemic acquired resistance to reduce levels of HLB in Cleopatra mandarin.

These results did not demonstrate a reduction in symptom expression and bacterial titre in imidacloprid-treated plants.

This may have been due in part to high-inoculum potential in the experiment, which was undertaken in a glasshouse.

Field pressure may have been lower.

## 14.10 Host Resistance - E. Stover

### Objectives

- Explore resistance to HLB in existing citrus varieties or citrus relatives
  - Identify transgenes that may provide resistance to HLB and other diseases
  - Develop and test promoters and regulatory elements to control expression of resistance genes
  - Produce and test transgenic citrus with potential resistance
- 1) Explored resistance to HLB in existing citrus varieties or citrus relatives in Brazil
    - Evaluated HLB and Las progression after graft inoculation of 6 genera related to citrus.
    - Atalantia, Eremolemon and Poncirus showed slower development of Las
    - Only Atalantia had some replicates that were PCR- after 6 months
  - 2) Evaluated psyllid colonization in numerous Citrus species and genera related to citrus in Indonesia
    - Psyllids heavily colonized Bergera, Murraya, Swinglea, citron, and C. hystrix, with few on other genotypes, including mandarins and pummelos
    - After two years, few plants were PCR positive for Las
  - 3) Screened 31 Citrus varieties and relatives in Florida.
    - In tolerant plants tested, incubation under continuous light produced symptoms. Could this also happen under other stresses?
  - 4) Tested diverse citrus in Thailand for HLB resistance and found all to be susceptible.
  - 5) Explored HLB and Las in 13 selections of local mandarin in Japan.
    - 12 developed distinct symptoms of HLB, one did not
    - Seedlings of Unzoki grew as vigorously as healthy ones 11 months after graft-inoculation, but tested positive for Las in PCR.
  - 6) Resistance of somaclonal variants or varieties to CVC - possible extension to HLB?
  - 7) Conclusions:
    - So far, exploration of existing resistance in citrus and relatives appears to reveal tolerance but not resistance
    - Could be basis for future industry, but would provide “typhoid Marys” alongside existing trees
  - 8) Identifying genes for transgenic HLB resistant citrus
    - Transgenics appear to be the only medium term solution for HLB resistant citrus
    - genes which should contribute to broad resistance are needed, too little is known about host / pathogen interaction for HLB-specific target
    - antimicrobial peptides are major focus
    - some groups have focused on enhancing SAR
    - citrus genes associated with resistance for Cis-transgenics
    - Virus genes which may disrupt pathogen functions
  - 9) Antimicrobial peptides (AMPs)?
    - Antimicrobial peptides are small proteins, usually 12 and 50 amino acids.
    - They form the first line of host defense against pathogenic infections and are a key component of the innate immune system
    - Antimicrobial peptides are involved in the antimicrobial defense system among all classes of life: plants, insects, amphibians and mammals including humans
- Selection of AMPs

- Plant-derived or synthetic for greater consumer acceptance
  - Low potential for adverse health effects
  - Reports of effectiveness against related bacteria
- Several Antimicrobial gene(s) currently under evaluation at CREC breeding program
- Attacin E-Lytic peptide gene from *Hyalophora cecropia*.
  - CEAD-Codon optimized cecropin A-cecropin D lytic peptide gene.
  - CEMA-Codon optimized cecropin A-melittin lytic peptide gene.
  - CEME-Codon optimized cecropin A-melittin lytic peptide gene (differs at the *C terminus* from CEMA).
  - LIMA-Lytic peptide gene.
  - PTA-Codon optimized N terminally modified Temporin A gene.
- In –Vitro AMP Screening USHRL
- Agrobacterium and Sinorhizobium are related to Liberibacter
  - Also using Xanthomonas
  - Best AMPs, including D4E1 are effective in 1  $\mu$ M range
- 10) Genes for SAR at CREC and Gainesville
- NPR1 (Nonexpresser of PR Genes - 1 gene from Arabidopsis) – NPR1 is a key regulator in the signal transduction pathway that leads to SAR.
  - SABP2 (Salicylic Acid-Binding Protein 2 gene from tobacco) – high affinity for SA.
- 11) Identifying bacteriophage genes to kill the pathogen
- Isolated bacteriophage and sequenced to identify diffusible killing factors
  - Transformed into model plant systems and identified some promising results with model systems
- 12) Allelyx Strategies
- Defense responses
    - TF: transcription factors
    - AMP: antimicrobial peptides from citrus species
    - 28 candidate genes, more than 1000 transgenic plants
- 13) Sequencing of Liberibacter
- Availability of sequence data will open up new opportunities
  - Should permit identification of genes specific to pathogenicity
  - Allow targeting of HLB-specific solutions through transgenics
- 14) Developing and testing promoters and regulatory elements
- Use of phloem specific promoters to restrict trans-protein in phloem tissues
- HLB resides in the phloem
  - Several groups are comparing universal promoters, which may also permit control of canker etc vs. phloem specific which may be more effective against HLB and may reduce transgene in fruit
- 15) Transgenic efforts on developing HLB-and canker resistant citrus
- Transgenics appear to be the only medium term solution for HLB resistant citrus
  - Using genes to disrupt the pathogen or the vector
  - With so little known about host / pathogen interaction, genes with effects on many bacterial pathogens are needed
  - Antimicrobial peptides is a major focus
  - Also focused on enhancing SAR
  - One has identified citrus genes associated with resistance for Cis-transgenics

16) Transgenic Projects:

- Some but not all of the transgenic strategies are looking very promising
- Several groups are moving ahead fast to produce resistant plants with the best available technology
- At the same time, they and other labs are working to identify other genes/promoters etc.
- which may be more effective
- and may be more easily accepted by regulators and consumers

INTERNATIONAL RESEARCH CONFERENCE  
ON HUANGLONGBING



**Session 14d:**  
**Key Take-Home**  
**Messages and a View**  
**to the Future:**  
**Regulatory**  
**Summaries/**  
**Perspectives**

Orlando, Florida



December 2008



### **14.15 Regulatory Approaches to HLB/ACP – W. Dixon, P. Berger**

- 1) Chronology of the Florida ACP (1998) and HLB (2005) detections
- 2) Historical review of Federal regulations with commentary on international, national and state perspectives.
- 3) International situations

#### *Thailand*

- Bringing in plant material a concern.
- Family farm problem outside the regulatory attention.
- Subject to rules, but impossible to enforce - common theme.

#### *Brazil*

- Regulated/covered nurseries begun in 1997-98, complete in 2002. HLB discovered in 2004.
- Underappreciated regulatory value.
- Government assistance to growers, nurseries to encourage participation.
- Must be science-based or legal problems are inevitable and costly e.g. *Murraya* regulation impossible until host relationship with Las proven.
- Hot Zone definition –family farm concept with ethnic connections to areas where serious pests are known.
- Value of local inspectors who know their

#### *Costa Rica*

- Grower group-driven budwood registration was started in 2007 that will be mandatory in 2009.
- Problem getting the government to help enforce. Noted that the family farm or small grower was not likely to cooperate.

#### *Jamaica*

- As soon as HLB appeared in Brazil and Florida, a task force was assembled.
- Then, in 2002 ACP was discovered. Budwood registration begun.
- Currently, they will prohibit seed import until more is known.
- If HLB is discovered, there is unease about requiring tree removal and whether there is the authority?

#### Group discussion:

- What are we regulating, pathogen or disease?
- Suggestion made to regulate pathogen because of the latency problem.
- Precautionary regulations are not legal.
- No financial safety net for plant pest emergencies like there is for veterinary emergencies. This is being addressed in future farm bills.

#### *South Africa*

- Highly regulated industry, but could use more teeth.
- Moving toward compulsory compliance, at 95% now.

#### *New Zealand*

- Carefully regulate all plant material into country, all travelers. High fines and prison terms. Use amnesty bins.
- Right to destroy on first find, but must compensate for all other removals.
- Plant movement controls stiff.

#### *Australia*

- Very strict. All incoming nursery stock fumigated. Post entry quarantine is 2 years for citrus.
- Classification of risk groups for plant pests.
- There is a cost sharing program with growers and government for pest programs. e.g. Canker eradication in Queensland.
- No compensation for plant destruction, weekend market sales, residential and hobby growers.
- Australian citrus dieback will confound any arrival of HLB.
- Pest Specific Incursion Plan for HLB is in review –a major publication.

*Dominican Republic*

Psyllids arrived 2000; started HLB survey for HLB in 2000. Suspect plants found, but negative. Adopted Brazilian system of management. Grower community fragmented, small growers, will be difficult to organize. Acquiring training for HLB diagnostics, getting lab set up. Anticipating USDA help.

*Common issues among countries*

- Cooperation among all stakeholders
- Existence of compensation or not
- Legal authority to achieve biological effectiveness
- Level of anticipatory strategies— what is allowed and not
- Need for discussions among stakeholders before an event

4) Other issues - Seed transmission

- No regulatory decision yet - need more data.
- May be transmitting only one of two microbes
- No correlation of positive PCR with HLB symptoms
- Graft transmission underway
- Psyllid transmission necessary

INTERNATIONAL RESEARCH CONFERENCE  
ON HUANGLONGBING



**Addenda:**

Orlando, Florida



December 2008

**A1. Author Index**

<i>Author Name</i>	<i>Page number(s)</i>
<i>Abad, J.A.</i>	190
<i>Achor, D.S.</i>	185
<i>Acosta, E.</i>	139
<i>Akarapisan, A.</i>	381
<i>Albrigo, L.G.</i>	185
<i>Alves, K.C.S.</i>	134, 388
<i>Amorim, L.</i>	186, 270, 282, 347
<i>Andersen, G.L.</i>	151
<i>Appizzato-da-Gloria, B.</i>	222, 249
<i>Arevalo, H.A.</i>	277, 326
<i>Arredondo, M.</i>	104
<i>Astúa-Monge, G.</i>	376
<i>Astuti, I.P.</i>	197, 393
<i>Aubert, B.</i>	14
<i>Avery, P.B.</i>	331
<i>Ayres, A.J.</i>	152, 159, 337
<i>Baldwin, E.</i>	267, 276
<i>Bang, D.V.</i>	350
<i>Barbosa, J.C.</i>	251, 337
<i>Barthe, G.A.</i>	377, 390
<i>Bassanezi, R.B.</i>	152, 186, 270, 282, 285, 301, 337, 347
<i>Bassanezi, R.C.</i>	301
<i>Batista, L.</i>	99
<i>Beattie, G.A.C.</i>	23, 94, 197, 393, 419
<i>Belasque, J.</i>	337
<i>Beloti, V.H.</i>	252, 324
<i>Benyon, L.</i>	120
<i>Bergamin-Filho, A.</i>	270, 282, 285, 347
<i>Berger, P.</i>	279
<i>Bertolini, E.</i>	182
<i>Bextine, B.R.</i>	142, 149, 244
<i>Bonani, J.P.</i>	222, 249
<i>Boscariol-Camargo, R.L.</i>	379, 380
<i>Bové, J.M.</i>	99, 152, 159, 337
<i>Bowman, K.</i>	374
<i>Brlansky, R.</i>	119, 138, 166, 247, 259, 261, 353
<i>Broadbent, P.</i>	23
<i>Brodie, M.W.</i>	112
<i>Brown, M.G.</i>	274
<i>Burns, J.K.</i>	196
<i>Busot, G.</i>	371
<i>Cai, L.</i>	141, 177

<i>Capella, A.</i>	376
<i>Carlos, E.F.</i>	134, 379, 380
<i>Carmo-Uehara, A.</i>	251, 252
<i>Carvalho, S.A.</i>	388
<i>Casín, J.C.</i>	99
<i>Catapani, L.F.</i>	337
<i>Cevallos-Cevallos, J.M.</i>	201
<i>Chamberlain, H.</i>	116, 144
<i>Chanbang, Y.</i>	381
<i>Chen, C.</i>	176, 386
<i>Chen, H-Q.</i>	166
<i>Chen, J.</i>	141, 177
<i>Chung, K-R.</i>	185
<i>Civerolo, E.L.</i>	127
<i>Clover, G.R.G.</i>	211
<i>Coelho, J.H.C.</i>	252
<i>Coletta-Filho, H.D.</i>	134, 168, 186, 380, 388
<i>Collazo, C.</i>	99
<i>Cônsoli, F.L.</i>	223
<i>Cook, A.R.</i>	296
<i>Cortez-Mondaca, E.</i>	329, 332
<i>Costa, M.G.</i>	251
<i>Coudron, T.</i>	214
<i>Cueto, J.R.</i>	99
<i>Cunniffe, N.J.</i>	296
<i>Da Graça, J.V.</i>	104, 119
<i>Da Silva, A.C.R.</i>	376
<i>Danyluk, M.D.</i>	269
<i>Das, A.K.</i>	129
<i>Davis, M.J.</i>	166
<i>Dawson, W. O.</i>	199, 352, 364, 378, 413
<i>DeAngelis, K.</i>	151
<i>Deng, X.</i>	141, 156, 177
<i>DeSimone, R.E.</i>	296
<i>Di Giorgi, F.</i>	337
<i>Dien, L.Q.</i>	350
<i>Ding, F.</i>	136, 156
<i>Dixon, W.</i>	279, 401, 425, 462
<i>Do Amaral, A.M.</i>	360
<i>Doddapaneni, H.</i>	127, 165
<i>Donadio, L.C.</i>	388
<i>Dowd, S.</i>	224, 233
<i>Dragone, J.</i>	337
<i>Druck, S.</i>	360
<i>Duan, Y-P.</i>	120, 165, 172, 199, 203, 261

<i>Dutt, M.</i>	377, 390
<i>Ebert, T.A.</i>	247, 259
<i>Engels, F.E.</i>	249
<i>Eveillard, S.</i>	152, 159
<i>Evens, T.J.</i>	135
<i>Exteberria, E.</i>	185
<i>Febres, V. J.</i>	375, 387
<i>Felippe, M.R.</i>	251, 252, 324
<i>Fereres, A.</i>	222, 249
<i>Ferro, J.A.</i>	376
<i>Foissac, X.</i>	159
<i>Folimonova, S.</i>	364, 378
<i>Ford, A.</i>	310
<i>Franca, F.</i>	360
<i>Francischini, F.J.B.</i>	376
<i>Francisco, C.S.</i>	168
<i>Franco, D.</i>	3848 391
<i>Frare, G.F.</i>	182, 186
<i>Freitas-Astúa, J.</i>	360
<i>Futch, S.</i>	353
<i>Gabriel, D.W.</i>	146, 394
<i>Garbim, L.F.</i>	251, 252
<i>Garnsey, S.M.</i>	360\4, 378
<i>Garzo, E.I.</i>	222
<i>Gasparoto, M.C.G.</i>	186, 270, 282
<i>Gast, T.</i>	285, 291, 305, 345
<i>Gilligan, C.A.</i>	285, 296
<i>Gimenes-Fernandes, N.</i>	347
<i>Giorgetti, C.L.</i>	337
<i>Gmitter, F.</i>	176, 375, 386
<i>González, C.</i>	99
<i>Goodrich-Schneider, R.</i>	269
<i>Gottwald, T.</i>	116, 119, 120, 165, 172, 178, 285, 291, 296, 305, 309, 310, 347, 401, 462
<i>Gowda, S.</i>	364
<i>Graham, J.</i>	103, 119, 199, 352, 462
<i>Grosser, J.W.</i>	377, 390
<i>Gunawan, S.</i>	142
<i>Guo, H.</i>	141, 177
<i>Gurley, W.B.</i>	371
<i>Haigh, A.M.</i>	23
<i>Halbert, S.E.</i>	112, 188, 210, 342
<i>Hall, D.G.</i>	135, 165, 169, 199, 320, 415
<i>Hanagriff, R.D.</i>	365
<i>Hansen, A.K.</i>	194

<i>Hartung, J.</i>	119, 188
<i>Heitschmidt, G.</i>	178
<i>Hilf, M.</i>	119
<i>Himawan, A.</i>	197, 393
<i>Hodge, J.</i>	310
<i>Holford, P.</i>	23, 94, 197, 393
<i>Hong, N.</i>	136, 156
<i>Huet, H.</i>	357
<i>Hunter, W.</i>	135, 142, 149, 169, 214, 224, 228, 233, 238, 244, 320, 331, 357
<i>Ichinose, K.</i>	350
<i>Irey, M.</i>	103, 113, 116, 141, 195, 263, 272, 281, 288, 302, 306, 307, 341, 349
<i>Iwanami, T.</i>	197, 372
<i>Jackson, M.A.</i>	331
<i>Jank, R. H.</i>	337
<i>Jasso, J.</i>	329
<i>Jauregui, C.</i>	274
<i>Johnson, J.</i>	103
<i>Jiang, Bo</i>	189, 359
<i>Joko, T.</i>	197, 393
<i>Kawano, S.</i>	124
<i>Kemper, E.</i>	376
<i>Keyhani, N.O</i>	167
<i>Khalaf, A.A.</i>	375
<i>Kim, J-S.</i>	138, 196
<i>Kitajima, J.P.</i>	376
<i>Kobori, Y.</i>	184, 250
<i>Kotzé, A.</i>	110
<i>Kruger, R.</i>	197, 393
<i>Kumarasinghe, L.</i>	211
<i>Kunta, M.</i>	104, 119
<i>Lapidot, M.</i>	357
<i>Laranjeira, F.F.</i>	391
<i>Lee, R.F.</i>	210, 342
<i>Leite, R.P.</i>	343
<i>Levy, L.</i>	190, 261
<i>Lewis, M.W.</i>	167
<i>Li, H.</i>	141
<i>Li, J-L.</i>	196
<i>Li, W.B.</i>	165, 190, 261
<i>Liefting, L.W.</i>	211
<i>Lin, H.</i>	127, 165
<i>Ling, H.</i>	119
<i>Liu, L.</i>	165

<i>Llauger, R.</i>	99
<i>Locali-Fabris, E.C.</i>	168
<i>Loera-Gallardo, J.</i>	329
<i>Lopes, J.R.S.</i>	168, 222, 249
<i>Lopes, S.</i>	152, 210, 182, 186, 337
<i>López-Arroyo, J.I.</i>	329
<i>Louzada, E.</i>	255
<i>Lugo-Angulo, N.E.</i>	332
<i>Luis, M.</i>	99
<i>Luque-Williams, M.J.</i>	369
<i>Mabberley, D.J.</i>	23
<i>Machado, M.A.</i>	134 168, 360, 379, 380
<i>Mai, P.</i>	103
<i>Malosso, A.</i>	380
<i>Manjunath, K.L.</i>	112, 119, 210, 342
<i>Manthey, J.A.</i>	207, 267, 276
<i>Martins, A.B.G.</i>	391
<i>Martins, E.</i>	99, 186
<i>Marutani-Hert, M.</i>	169, 214, 224, 238, 244, 320
<i>Mayo, S.</i>	310
<i>McCollum, G.</i>	267, 276, 374
<i>McKenzie, Cindy</i>	233
<i>Mendes, B.M.J.</i>	379
<i>Méndez, L.O.</i>	106
<i>Menezes, G.M.</i>	337
<i>Miranda, M.P.</i>	168, 222, 329
<i>Miyata, S-I.</i>	197, 364, 372
<i>Mondal, S.N.</i>	166
<i>Monteiro, C.P.</i>	95
<i>Montesino, L.H.</i>	270, 347
<i>Moore, G.A.</i>	375, 387
<i>Morris, R.A.</i>	275
<i>Mourão-Filho, F.A.A.</i>	379
<i>Mukai, H.</i>	124
<i>Muraro, R.P.</i>	275
<i>Nakata, T.</i>	250
<i>Naphrom, D.</i>	381
<i>Niedz, R.</i>	135, 374
<i>Nonghui, J.</i>	359
<i>O'Grady, K.</i>	371
<i>Ohto, Y.</i>	184, 250
<i>Omar, A.</i>	377, 390
<i>Onagbola, E.O.</i>	2148 318, 319
<i>Orbovic, V.</i>	377, 390
<i>Oswalt, C.</i>	138



<i>Ou, S.</i>	386
<i>Paine, T.P.</i>	194
<i>Park, B.</i>	178
<i>Parker, P.E.</i>	104
<i>Parnell, S.</i>	285, 309, 310
<i>Parra, J.R.P.</i>	315
<i>Patt, J.</i>	255, 265
<i>Peña, I.</i>	99
<i>Perdomo, A.</i>	99
<i>Pereira, M.A.R.</i>	134
<i>Peretz, Y.</i>	357
<i>Peréz, J.L.</i>	99
<i>Pérez-Márquez, J.</i>	332
<i>Phahladira, M.N.B.</i>	110
<i>Pietersen, G.</i>	110
<i>Piwkhao, K.</i>	381
<i>Plotto, A.</i>	267, 276
<i>Polek, M.</i>	369
<i>Poole, G.</i>	178
<i>Poole, K.</i>	310
<i>Powell, C.A.</i>	120, 172, 203, 331
<i>Pu, X.</i>	141, 177
<i>Quinn, B. D.</i>	211
<i>Qureshi, J.A.</i>	326, 333
<i>Ramallo, J.</i>	139
<i>Ramdugu, C.</i>	119
<i>Reddy, J.D.</i>	394
<i>Reddy, S.</i>	146
<i>Reiff, E.T.</i>	358
<i>Reyes, M.A.</i>	329
<i>Reyes-DeCorcuera, J.I.</i>	201
<i>Roberts, P.</i>	119
<i>Robertson, C.</i>	352, 364
<i>Robles, G.P.</i>	106
<i>Rogers, M.E.</i>	119, 138, 166, 242, 247, 259, 331, 417
<i>Rojas, A.</i>	139
<i>Roose, M.</i>	210
<i>Rouseff, R.L.</i>	218, 269, 318, 319
<i>Rugno, G.R.</i>	252, 324
<i>Sadoyama, Y.</i>	253
<i>Sagaram, U.S.</i>	138, 151, 196
<i>Saillard, C.</i>	152
<i>Salas, B.</i>	104
<i>Salvador, I.</i>	223
<i>Sánchez, A.H.</i>	106, 255

<i>Sano, T.</i>	121
<i>Santasup, C.</i>	381
<i>Schumann, R.A.</i>	247
<i>Schwerdtfeger, M.</i>	110
<i>Sela, I.</i>	357
<i>Sempionato, O.R.</i>	358, 388
<i>Serikawa, R. H.</i>	247
<i>Sétamou, M.</i>	104, 255, 265, 266
<i>Shatters, R.</i>	119, 135, 142, 188, 198, 228, 233
<i>Shelby, K.</i>	214, 233, 238
<i>Shilts, T.</i>	364
<i>Sieburth, P.</i>	119
<i>Silva, S.R.</i>	358, 376, 388, 391
<i>Simões, T.S.</i>	379, 380
<i>Sims, C.A.</i>	269
<i>Skaria, M.</i>	104, 365
<i>Smoot, J.M.</i>	318
<i>Snively, J.</i>	345
<i>Snyder, G.</i>	277
<i>Spann, T.</i>	269
<i>Sperandio, P.H.</i>	347
<i>Spreen, T.H.</i>	274
<i>Stansly, P.A.</i>	277, 326, 333
<i>Stein, B.</i>	139
<i>Stelinski, K.P.</i>	247
<i>Stelinski, L.L.</i>	138, 218, 318, 319
<i>Stewart, M.</i>	116
<i>Stouthamer, R.</i>	194
<i>Stover, E.</i>	374, 421
<i>Stuchi, E.S.</i>	358, 388, 391
<i>Su, H-J.</i>	57
<i>Subandiyah, S.</i>	197, 393
<i>Sun, X.</i>	119
<i>Sutherland, P.W.</i>	211
<i>Swatsell, C.</i>	149
<i>Tachibana, A.</i>	337
<i>Takasu, F.</i>	250
<i>Takeda, O.</i>	124
<i>Takushi, T.</i>	253
<i>Tank, A.</i>	337
<i>Taylor, E.</i>	285, 291, 310, 462
<i>Teixeira, D.</i>	99, 152
<i>Terra, R.</i>	344
<i>Tersi, F.E.A.</i>	337, 347
<i>Therrien, L.</i>	310

<i>Thomas, D.B.</i>	258
<i>Timmons, C.</i>	244
<i>Torres, M.G.</i>	315
<i>Trivedi, P.</i>	138, 151
<i>Tsagkarakis, A.E.</i>	242
<i>Tufts, D.</i>	244
<i>Twieg, E.</i>	261
<i>Uemori, T.</i>	124
<i>Urasaki, N.</i>	124
<i>Vahling, C.M.</i>	165
<i>Van den Bosch, F.</i>	309
<i>Vieira, L.F.</i>	360
<i>Violante, A.R.</i>	337
<i>Wang, G.</i>	136, 156
<i>Wang, N.</i>	119, 138, 151, 185, 196
<i>Wanghui</i>	189
<i>Ward, L.I.</i>	211
<i>Weingarten, S.</i>	353
<i>Weir, B.S.</i>	211
<i>Windham, W.</i>	178
<i>Wulff, N.A.</i>	152, 159, 182
<i>Xiao, Y.</i>	386
<i>Ximenes, N.L.</i>	252
<i>Xu, J.</i>	141
<i>Yamamoto, P.T.</i>	152, 251, 252, 324, 337, 347
<i>Yarden, G.</i>	357
<i>Yi, G.</i>	136, 156, 189, 359
<i>Yu, Q.</i>	176
<i>Zaka, S.M.</i>	316
<i>Zeng, J.</i>	386
<i>Zeng, X.N.</i>	316
<i>Zhang, M-Q.</i>	203
<i>Zhang, S.</i>	146
<i>Zhong, Y.</i>	136, 156, 189, 359
<i>Zhou, L-J.</i>	120, 165, 172

## A2. List of Registered Participants (those registered at the time of the meeting are included)

Full Name	Affiliation	Address	City	State	ZIP	Country	Email
Ms. Diann Achor	UF/IFAS Citrus Research & Ed.	700 Experiment Station Rd	Lake Alfred	FL	33850	USA	dsar@ufl.edu
Mr. Laureano "Bruno" Ahuelican	Comite Estatal de Sanidad Vegetal	Av. Justo Mendez #330	Campeche		24040	Mexico	bruno_laureano@yahoo.com.mx
Dr. Angsana Akarapisan	Chiang Mai University - Div. of Plant Pathology		Chiang Mai		50202	Thailand	aangsana@chiangmai.ac.th
Dr. Ute Albrecht	USDA ARS USHRL	2001 S Rock Rd	Fort Pierce	FL	34945-3030	USA	ute.albrecht@ars.usda.gov
Dr. L. Gene Albrigo	UF/IFAS Citrus Research & Ed.	700 Experiment Station Rd	Lake Alfred	FL	33850	USA	albrigo@ufl.edu
Mr. Ben W. Albritton, Jr.	Albritton Companies	PO Box 1784	Wauchula	FL	33873-1784	USA	ben@albrittoncompanies.com
Dr. Lilitan Amorim	USP-ESALQ	Av. Padua Dias 11	Piracicaba, Sao Paulo		13418-900	Brazil	liamorim@esalq.usp.br
Dr. H. Alejandro Arevalo	UF/IFAS Immokalee Research & Education Center	2686 SR 29 N	Immokalee	FL	34142	USA	arevalo.ha@ufl.edu
Mr. Jose Armenteros	Citricos Tropicales	Av Maximo Gomez 182	Santo Domingo, DN			Dominican Republic	j.armenteros@mercasid.com.do
Dr. Calvin E. Arnold	US Department of Agriculture	2001 S Rock Rd	Fort Pierce	FL	34945-3030	USA	Calvin.Arnold@ars.usda.gov
Mr. Hugo Cesar Arredondo Bernal	SAGARPA SENASICA DGSV	Guillermo Valenzuela 127	Mexico, D.F.		04100	Mexico	hcesar@prodigy.net.mx
Mr. Edi Arroyo Cruz	Comite Estatal De Sanidad Vegetal	Alfa Centauro oriente #527	Pachuca de Soto, Hidalgo		42000	Mexico	mfcitricos@cesaveh.com
Dr. Francisco Assis Filho	Agdia, Inc.	30380 County Rd 6	Elkhart	IN		USA	fassis@agdia.com
Mr. Ryan Atwood	Lake County Agricultural Center	1951 Woodlea Rd	Tavares	FL	32778	USA	raatwood@ufl.edu
Dr. Bernard Aubert	ADAC-CIRAD		La Grande, Motte			France	aubert18.bernard@wanadoo.fr
Dr. Lucrecia Augier	Estacion Experimental Agroindustrial Obispo Col.	Avda William Cross 3150	Las Talitas, Tucuman		4101	Argentina	lmaugier@eeaoc.org.ar
Dr. Pasco B. Avery	UF/IFAS Indian River Research & Ed Center	2199 S Rock Rd	Fort Pierce	FL	34945-3138	USA	pbavery@ufl.edu
Mr. Juliano Ayres	Fundecitrus	Av. Dr. Adhemar Pereira de Barros 201	Arraquiara, Sao Paulo		14807-040	Brazil	ayres@fundecitrus.com.br
Dr. Elizabeth Baldwin	USDA ARS	600 Avenue S, NW	Winter Haven	FL	33881	USA	liz.baldwin@ars.usda.gov
Mr. William Barber	Lykes Citrus Management Division	7 Lykes Rd	Lake Placid	FL	33852-9582	USA	bill.barber@lykes.com
Mr. Darryl Barbour	Biosecurity Australia	GPO Box 858	Canberra, ACT		2615	Australia	darryl.barbour@biosecurity.gov.au
Mr. Juan Barcelo	Consorcio Citricola del Este	km 1 Carratera Hato Mayor-Sabana	Hato Mayor		61	Dominican Republic	citricola@citricola.com
Mr. Joe Barcinas	Foothill Agricultural Research, Inc	550 W Foothill Parkway	Corona	CA	92882	USA	farinc@att.net
Dr. Moshe Bar-Joseph	ARO, The Volcani Center Bet Dagan	Hazanchamim St. 8	Rehovot		76211	Israel	mjoseph@gmail.com

<i>Mrs. Patricia Barkley</i>	Citrus Australia Ltd	PO Box 5091	Mildura, Vic	3502	Australia	admin@citrusaustralia.com.au
<i>Mr. Al Barrenechea</i>	United Promotions, Inc.	3351 Mallard Lake	Alpharetta	GA 30022	USA	al.barrenechea@globalbac.com
<i>Mr. Alfred Barrett</i>	Jamaica Citrus Agency	PO Box 108 Bog Walk	St. Catherine	87600	Jamaica	jcpa@anbell.net
<i>Dr. Renato B. Bassanezi</i>	Fundecitrus	Av. Dr. Adhemar Pereira de Barros 201	Arraquarema, Sao Paulo	14807-040	Brazil	rbbassanezi@fundecitrus.com.br
<i>Mr. Ted Balkin</i>	California Citrus Research Board	PO Box 230	Visalia	CA 93279-0230	USA	ted@citrusresearch.org
<i>Mr. Clark Baxley</i>	Florida Citrus Mutual	PO Box 89	Lakeland	FL 33802	USA	clarkb@flcitrusmutual.com
<i>Dr. Andrew Beattie</i>	University of Western Sydney	Centre for Plant & Food Science	New South Wales, Sydney		Australia	a.beattie@uws.edu.au
<i>Mr. John Bell</i>	Bayer CropScience LP	PO Box 12014	Research Triangle Park	NC 27709-2014	USA	john.bell@bayercropscience.com
<i>Dr. Rick Bennett</i>	USDA ARS	5601 Sunnyside Ave	Beltsville	MD 20705-5000	USA	rick.bennett@ars.usda.gov
<i>Dr. Lesley Benyon</i>	USDA ARS USHRL	2001 S Rock Rd	Fort Pierce	FL 34945-3030	USA	lesley.benyon@ars.usda.gov
<i>Ms. Julia Beretta</i>	UF/IFAS Citrus Research & Ed.	700 Experiment Station Rd	Lake Alfred	FL 33850	USA	juberetta@yahoo.com
<i>Dr. Armando Bergamin-Filho</i>	University of Sao Paulo	ESALQ Fitopatologia	Piracicaba, Sao Paulo	13418900	Brazil	abergami@esalq.usp.br
<i>Dr. Philip Berger</i>	USDA APHIS PPQ Center for Plant Health	1730 Varsity Drive Ste 400	Raleigh	NC 27606	USA	philip.h.berger@aphis.usda.gov
<i>Mr. James Bettiga</i>	Paramount Citrus	PO Box 3347	Pinedale	CA 93650	USA	jbettiga@paramountcitrus.com
<i>Dr. Blake Bextine</i>	University of Texas at Tyler	3900 University Blvd	Tyler	TX 75799	USA	blake-bextine@uttyler.edu
<i>Ms. Kathie Blyskal</i>	Sunkist Growers, Inc.	10509 Business Dr Unit B	Fontana	CA 92337	USA	kblyskal@sunkistgrowers.com
<i>Dr. Clive Bock</i>	USDA ARS USHRL	2001 S Rock Rd	Fort Pierce	FL 34945-3030	USA	clive.bock@ars.usda.gov
<i>Mr. Daniel Botts</i>	Florida Fruit & Vegetable Association	PO Box 948153	Maitland	FL 32794-8153	USA	daniel.botts@ffva.com
<i>Mr. Joseph M. Bove</i>	INRA, University of Bordeaux 2	71, ave. Edouard Belraux	Villeneuve d'Ornon	33883	France	joseph.bove@wanadoo.fr
<i>Dr. Kim Bowman</i>	USDA ARS USHRL	2001 S Rock Rd	Fort Pierce	FL 34945-3030	USA	kim.bowman@ars.usda.gov
<i>Dr. Ron H. Briansky</i>	UF/IFAS Citrus Research & Ed.	700 Experiment Station Rd	Lake Alfred	FL 33850	USA	rhby@lal.ufl.edu
<i>Mrs. Cherry Brown</i>	TicoFruit, S.A.	Apartado 207-1200	San Jose		Costa Rica	
<i>Dr. Donovan Brown</i>	TicoFruit, S.A.	Apartado 207-1200	San Jose		Costa Rica	dbrown@ticofruit.com
<i>Dr. Harold W. Browning</i>	Citrus Research & Foundation, Inc.	700 Experiment Station Rd	Lake Alfred	FL 33850-2299	USA	hwbr@crec.ifas.ufl.edu
<i>Dr. Richard S. Baker, III</i>	Helena Chemical Company	2405 N 71st St	Tampa	FL 33619-2952	USA	bukert@helenachemical.com
<i>Dr. Leon "Russ" Bulluck</i>	USDA APHIS PPQ Center for Plant Health	1730 Varsity Drive Ste 400	Raleigh	NC 27606	USA	russ.bulluck@aphis.usda.gov
<i>Dr. Jacqueline K. Burns</i>	UF/IFAS Citrus Research & Ed.	700 Experiment Station Rd	Lake Alfred	FL 33850	USA	jkbu@ufl.edu
<i>Mr. Thom Cain</i>	E K C Citrus Growers, LLC	7192 SW Environmental Lab St	Arcadia	FL 34266	USA	flthom@alltel.blackberry.com

<i>Mr. Justin Cain</i>	Cain Groves	1404 N Crooked Lake Dr	Babson Park	FL	33827-9718	USA	JCain03@msn.com
<i>Dr. Paul Carcalton</i>	Florida Department of Citrus	700 Experiment Station Rd	Lake Alfred	FL	33850	USA	pcncalo@citrus.state.fl.us
<i>Dr. Luis Caniz</i>	USDA APHIS IS	4a Avenida 12-62 Zona 10	Guatemala	FL	010010	Guatemala	Luis.Caniz@aphis.usda.gov
<i>Dr. Mariano Joaquin Caprarulo</i>	C.E.C.N.E.A.	Espejo 131	Concordia, Entre Rios	FL	3200	Argentina	melceceña@arnet.com.ar
<i>Dr. Kitty Cardwell</i>	USDA CSREES PAS	800 9th St SW	Washington	DC	20024	USA	kcardwell@csrees.usda.gov
<i>Mr. Mike Carlton</i>	Florida Specialty Foundation	PO Box 948153	Maitland	FL	32794	USA	mike.carlton@ffva.com
<i>Mr. David Carson</i>	Chemical Dynamics, Inc.	4206 Business Lane	Plant City	FL	33566-1163	USA	davide@chemicaldynamics.com
<i>Mr. Dan Casper</i>	Southern Gardens Citrus	1820 County Road 833	Clewiston	FL	33440-9222	USA	dcasper@southerngardens.com
<i>Dr. Bill Castle</i>	UF/IFAS Citrus Research & Ed.	700 Experiment Station Rd	Lake Alfred	FL	33850	USA	bcastle@ufl.edu
<i>Mr. J. Peter Chaires</i>	New Varieties Development & Management Corporation	PO Box 1113	Lakeland	FL	33802	USA	pchaires@flcitruspackers.org
<i>Ms. Holly Lee Chamberlain</i>	PDM Scouting Services	1025 CR 17 North	Lake Placid	FL	33852	USA	HLCChamberlain@embarqmail.com
<i>Dr. Chunxian Chen</i>	UF/IFAS Citrus Research & Ed.	700 Experiment Station Rd	Lake Alfred	FL	33850	USA	cxchen@ufl.edu
<i>Dr. Jianchi Chen</i>	USDA ARS San Joaquin Valley Ag Sciences	9611 S Riverbend Ave	Parlier	CA	93648	USA	Jianchi.chen@ars.usda.gov
<i>Mr. Wilson Roberto Chignoli</i>	Citrus Consultants Group	Carlos Gomes 144 Centro	Cordeiropolis, Sao Paulo	FL	13490000	Brazil	wrchignoli@linkway.com.br
<i>Mr. Emmanuel K. Christopher</i>	E K C Citrus Growers, LLC	7192 SW Environmental Lab St	Arcadia	FL	34266	USA	ekccitrus@hotmail.com
<i>Dr. Edwin Civerolo</i>	USDA ARS San Joaquin Valley Ag Sciences	9611 S Riverbend Ave	Parlier	CA	93648	USA	edwin.civerolo@ars.usda.gov
<i>Dr. Darrell Cole</i>	USDA ARS	950 College Station Rd	Athens	GA	30605	USA	darrellcole@ars.usda.gov
<i>Mr. John Connell</i>	California Department of Food & Agriculture	1220 N Street	Sacramento	CA	95814	USA	jconnell@cdfa.ca.gov
<i>Mr. Jim Conrad</i>	DuPont Crop Protection	3680 Winding Lake Cir	Orlando	FL	32835	USA	jim.conrad-1@usa.dupont.com
<i>Dr. Fernando Consoli</i>	University of San Paulo - Entomology Dept.	Av. Padua Dias 11	Piracicaba, Sao Paulo	Brazil	13418-900	Brazil	fconsoli@esalq.usp.br
<i>Mr. Reinaldo Donizeti Corte</i>	Citrus Consultants Group	Carlos Gomes 144 Centro	Cordeiropolis, Sao Paulo	Brazil	13490000	Brazil	corte@gconci.com.br
<i>Dr. Edgardo Cortez-Mondaca</i>	INIFAP	Mexico-Nogales Highway, Km. 1609 Apt 342	Juan Jose Rios, Sinaloa	Mexico	81110	Mexico	come60@yahoo.com
<i>Mrs. Norma Costa</i>	INTA	CC 34	Concordia, ER	Argentina	3200	Argentina	ncosta@correo.inta.gov.ar
<i>Mr. James Cranney</i>	California Citrus Quality Council	210 Magnolia Ave Ste 3	Auburn	CA	95603	USA	jcranney@calcitrusquality.org
<i>Dr. Andre Luis Teixeira Creste</i>	Eduardo de Paula Machado e Outros	Fazenda Sao Jose, CP 31	Rio Clara, Sao Paulo	Brazil	13500970	Brazil	acreste@uol.com.br
<i>Dr. Nicholas Cunniffe</i>	University of Cambridge	Downing Street	Cambridge	England	CB33EA	England	njc1001@cam.ac.uk
<i>Dr. Darek Czokajlo</i>	Alpha Scents, Inc.	2070 Tumwater St	West Linn	OR	97068	USA	dczokajlo@comcast.net

<i>Dr. John V. daGraca</i>	Texas A&M University - Kingsville	312 N International Blvd	Weslaco	TX	78596	USA	jdgraca@ag.tamu.edu
<i>Dr. Abhaya Dandekar</i>	University of California - Davis	One Shields Ave	Davis	CA	95616	USA	amdandekar@ucdavis.edu
<i>Dr. Ashis Kumar Das</i>	National Research Centre for Citrus	Amravati Road, PO Box 464	Nagpur, Maharashtra		440010	India	dasashis.kumar@hotmail.com
<i>Dr. Kenton Dashiell</i>	USDA ARS NCARL	292.3 Medary Ave	Brookings	SD	57006	USA	kenton.dashiell@ars.usda.gov
<i>Dr. Michael J. Davis</i>	UF/IFAS Citrus Research & Ed.	700 Experiment Station Rd	Lake Alfred	FL	33850	USA	mjdavis@ufl.edu
<i>Dr. Robert E. Davis</i>	USDA ARS Molecular Plant Pathology Lab	10300 Baltimore Ave	Beltsville	MD	20705-2350	USA	robert.davis@ars.usda.gov
<i>Dr. William O. "Bill" Dawson</i>	UF/IFAS Citrus Research & Ed.	700 Experiment Station Rd	Lake Alfred	FL	33850	USA	wodtmv@crec.ifas.ufl.edu
<i>Mr. Arlindo de Salvo Filho</i>	Salvo* Arlindo	Rua Visconde Branco, 191	Limeira, SP		13480-925	Brazil	arlindopessoal@ig.com.br
<i>Mr. Juan Delgado</i>	TicoFruit S.A.	Cero Cortes de Aguas Zarcus	San Carlos, Alajuela			Costa Rica	jdelgado@ticofrut.com
<i>Dr. Megan Dewdney</i>	UF/IFAS Citrus Research & Ed.	700 Experiment Station Rd	Lake Alfred	FL	33850	USA	mmdewdney@crec.ifas.ufl.edu
<i>Mr. Fabio Di Giorgio</i>	Louis Dreyfus Citrus, Inc.	355 S 9th St	Winter Garden	FL	34787-3651	USA	fabio.di.giorgi@ldcommodities.com
<i>Mr. Don Dillon</i>	Four Winds Growers	PO Box 3538	Fremont	CA	94539	USA	dondillonjr@comcast.net
<i>Mr. Aaron Dillon</i>	Four Winds Growers	PO Box 3538	Fremont	CA	94539	USA	ad@fourwindsgrowers.com
<i>Dr. Wayne Dixon</i>	Florida Department of Agriculture	PO Box 147100	Gainesville	FL	32614-7100	USA	dixonw@doacs.state.fl.us
<i>Dr. Alan Dowdy</i>	USDA APHIS PPQ	4700 River Rd Unit 26	Riverdale	MD	20737	USA	alan.k.dowdy@aphis.usda.gov
<i>Dr. Yong ping Duan</i>	USDA ARS USHRL	2001 S Rock Rd	Fort Pierce	FL	34945-3030	USA	yongping.duan@ars.usda.gov
<i>Dr. James Dukowitz</i>	Technology Innovation Group	7006 Firewheel Hollow	Austin	TX	78750	USA	jdukowitz@aol.com
<i>Dr. Manjul Dutt</i>	UF/IFAS Citrus Research & Ed.	700 Experiment Station Rd	Lake Alfred	FL	33850	USA	manjul@ufl.edu
<i>Dr. Timothy A. Ebert</i>	UF/IFAS Citrus Research & Ed.	700 Experiment Station Rd	Lake Alfred	FL	33850	USA	tebert@ufl.edu
<i>Mr. Chocai El Mohtar</i>	UF/IFAS Citrus Research & Ed.	700 Experiment Station Rd	Lake Alfred	FL	33850	USA	mohtarc@crec.ifas.ufl.edu
<i>Mr. Robert Elliott</i>	Sunkist Growers, Inc.	10509 Business Dr Unit B	Fontana	CA	92337	USA	belliott@sunkistgrowers.com
<i>Mr. Ronnie English</i>	Ranch One Cooperative, Inc.	PO Box 3146	Immokalee	FL	34143	USA	snookfighter@yahoo.com
<i>Dr. Edgardo Etxeberria</i>	UF/IFAS Citrus Research & Ed.	700 Experiment Station Rd	Lake Alfred	FL	33850	USA	eje@crec.ifas.ufl.edu
<i>Dr. Hugh Ewart</i>	Ewart*Hugh "Wally"	716 E Promontory Rd	Shelton	WA	98584	USA	cccq.1946@pacbell.net
<i>Mr. Mauro Fagotti</i>	Citrus Consultants Group	Carlos Gomes 144 Centro	Cordeiropolis, Sao Paulo		13490000	Brazil	fagotti@gconci.com.br
<i>Miss Pamela Favero</i>	University of Entomology Dept.	San Paulo - Av. Padua Dias 11	Picraticaba, Sao Paulo		13418-900	Brazil	pamelafavero@hotmail.com
<i>Mrs. Denise Feiber</i>	Division of Plant Industry	1911 SW 34th St	Gainesville	FL	33608	USA	feiberd@doacs.state.fl.us
<i>Mr. Fernando Figueredo</i>	United Promotions, Inc.	2030 Powers Ferry Rd	Atlanta	GA	30339	USA	ferfigueredo@upitrading.com
<i>Dr. Svetlana</i>	UF/IFAS Citrus Research & Ed.	700 Experiment Station Rd	Lake Alfred	FL	33850	USA	svelana@ufl.edu

<i>Folimonova</i>		Rd												
<b>Dr. Felix Franca</b>	USDA ARS	5601 Sunnyside Ave	Beltsville	MD	20705-5000	USA								felix.franca@ars.usda.gov
<b>Dr. Marta Francis</b>	UF/IFAS Citrus Research & Ed.	700 Experiment Station Rd	Lake Alfred	FL	33850	USA								mfrancis@crec.ifas.ufl.edu
<b>Dr. Juliana Freitas-Astua</b>	Embrapa	Rod. Anhanguera km 158	Cordeiropolis, SP		13490-970	Brazil								jfastua@centrodecitricultura.br
<b>Mr. Stephen Friedt</b>	USDA APHIS PPQ Center for Plant Health	1730 Varsity Drive Ste 400	Raleigh	NC	27606	USA								stephen.friedt@aphis.usda.gov
<b>Dr. Stephen Futch</b>	UF/IFAS Citrus Research & Ed.	700 Experiment Station Rd	Lake Alfred	FL	33850	USA								shf@ufl.edu
<b>Dr. Dean Gabriel</b>	University of Florida - Pathology Dept.	PO Box 110680	Gainesville	FL	32611-0680	USA								dgabr@ufl.edu
<b>Mr. Daniel M. Galbraith</b>	Limoneira Company	26000 Avenue I16	Porterville	CA	93257	USA								dgalbraith@limoneira.com
<b>Mr. Ricky Garcia</b>	Texas Citrus Mutual	901 Business Park Dr Ste 400	Mission	TX	78572	USA								
<b>Mr. Raul Garcia</b>	Gless Ranch	19985 Van Buren Blvd	Riverside	CA	92508	USA								glessranch@aol.com
<b>Dr. Stephen Garnsey</b>	UF/IFAS Citrus Research & Ed.	700 Experiment Station Rd	Lake Alfred	FL	33850	USA								sgarnsey@worldnet.att.net
<b>Mr. David Garrett</b>	Cooperative Producers, Inc.	PO Box 3147	Immokalee	FL	34143	USA								
<b>Mr. Richard Gaskalla</b>	Division of Plant Industry	PO Box 147100	Gainesville	FL	32614-7100	USA								gaskallr@doacs.state.fl.us
<b>Miss Maria Candida Gasparoto</b>	USP-ESALQ	Av. Padua Dias 11	Piracicaba, Sao Paulo		13418-900	Brazil								megodoy@esalq.usp.br
<b>Mr. Timothy C Gast</b>	Southern Gardens Citrus	1820 County Road 833	Clewiston	FL	33440-9222	USA								tgast@southerngardens.com
<b>Mr. Tim Gaver</b>	Saint Lucie County Service	8400 Picos Rd Ste 101	Fort Pierce	FL	34945-3045	USA								tgaver.49@ufl.edu
<b>Dr. Christopher A. Gilligan</b>	University of Cambridge	Department of Plant Sciences Downing Site	Cambridge		CB2 3EA	United Kingdom								cag1@cam.ac.uk
<b>Mr. John Gless, Jr.</b>	Sunshine Citrus	1441 Ravenswood Ln	Riverside	CA	92506	USA								ccm@cacitrusmutual.com
<b>Mr. John Gless</b>	Sunshine Citrus	1441 Ravenswood Ln	Riverside	CA	92506	USA								ccm@cacitrusmutual.com
<b>Dr. Fred G. Gmitter, Jr.</b>	UF/IFAS Citrus Research & Ed.	700 Experiment Station Rd	Lake Alfred	FL	33850	USA								fgg@crec.ifas.ufl.edu
<b>Dr. Kris Godfrey</b>	California Department of Agriculture	3288 Meadowview RD	Sacramento	CA	95832-1437	USA								kgodfrey@cdfa.ca.gov
<b>Mr. Patrick J. Gomes</b>	USDA APHIS PPQ	920 Main Campus Dr Ste 200	Raleigh	NC	27606-5213	USA								patrick.j.gomes@aphis.usda.gov
<b>Mr. Pedro C. Gonzalez-Blanco</b>	UF/IFAS Citrus Research & Ed.	700 Experiment Station Rd	Lake Alfred	FL	33850	USA								pcgo@crec.ifas.ufl.edu
<b>Dr. Renee Goodrich-Schneider</b>	University of Florida - Science & Nutrition	PO Box 110370	Gainesville	FL	32611-0370	USA								goodrich@ufl.edu
<b>Dr. Tim R Gotwald</b>	USDA ARS USHRL	2001 S Rock Rd	Fort Pierce	FL	34945-3030	USA								tim.gotwald@ars.usda.gov
<b>Dr. Ananthakrishnan Govindarajulu</b>	UF/IFAS Citrus Research & Ed.	700 Experiment Station Rd	Lake Alfred	FL	33850	USA								anantha@ufl.edu
<b>Dr. Siddarama Gowda</b>	UF/IFAS Citrus Research & Ed.	700 Experiment Station Rd	Lake Alfred	FL	33850	USA								gowda@ufl.edu
<b>Dr. James H. Graham</b>	UF/IFAS Citrus Research & Ed.	700 Experiment Station Rd	Lake Alfred	FL	33850	USA								jhg@crec.ifas.ufl.edu



<i>Mr. Dustin Grant</i>	USDA APHIS	903 San Jacinto Blvd Ste 270	Austin	TX	78701	USA	dustin.r.grant@aphis.usda.gov
<i>Mr. Santin Gravena</i>	Gravena	Rodovia Deputado Cunha Bueno SP 253	Jaboticabal, SP		14870-990	Brazil	sgravena@gravena.com.br
<i>Dr. Jude W. Grosser</i>	UF/IFAS Citrus Research & Ed.	700 Experiment Station Rd	Lake Alfred	FL	33850	USA	jgrosser@ufl.edu
<i>Mr. Magona "Ric" Guevaro</i>	Comite Estatal de Vegetal	Av Justo Sioerra Mendez #330	Campeche		24040	Mexico	ricmagona73@hotmail.com
<i>Dr. William Gurley</i>	University of Florida Microbiology & Cell Scienc	PO Box 110700	Gainesville	FL	32611-0700	USA	wgurley@ufl.edu
<i>Dr. Susan Halbert</i>	Florida Department of Agriculture	PO Box 147100	Gainesville	FL	32614-7100	USA	halbers@doacs.state.fl.us
<i>Dr. David Hall</i>	USDA ARS USHRL	2001 S Rock Rd	Fort Pierce	FL	34945-3030	USA	david.hall@ars.usda.gov
<i>Ms. Allison Hansen</i>	University of California	Department of Entomology	Riverside	CA	92521	USA	allison.hansen@email.ucr.edu
<i>Mr. William G. "Gregg" Hart</i>	S Y Hartt & Son, Inc.	PO Box 1429	Avon Park	FL	33826-1429	USA	wgrghartt@htn.net
<i>Dr. John Hartung</i>	USDA ARS Molecular Pathology Lab	10300 Baltimore Ave	Beltsville	MD	20705-2350	USA	john.hartung@ars.usda.gov
<i>Mr. Jose Hernandez</i>	USDA APHIS CIAO	4700 River Rd Unit 133	Riverdale	MD	20737	USA	jose.r.hernandez@aphis.usda.gov
<i>Dr. Mizuri Hert</i>	USDA ARS USHRL	2001 S Rock Rd	Fort Pierce	FL	34945-3030	USA	marutami-hert@ars.usda.gov
<i>Dr. Mark Hilf</i>	USDA ARS USHRL	2001 S Rock Rd	Fort Pierce	FL	34945-3030	USA	mark.hilf@ars.usda.gov
<i>Mr. Nicholas Hill</i>	Greenleaf Farms, Inc.	23448 E Dinuba Ave	Dinuba	CA	93618	USA	ccm@cacitrusmutual.com
<i>Dr. Gregory Hodges</i>	Division of Plant Industry	1911 SW 34th St	Gainesville	FL	33608	USA	hodges@doacs.state.fl.us
<i>Dr. Wayne Hunter</i>	USDA ARS USHRL	2001 S Rock Rd	Fort Pierce	FL	34945-3030	USA	wayne.hunter@ars.usda.gov
<i>Mr. G. Tim Hurner</i>	Highlands County Service	4509 George Blvd	Sebring	FL	33875-5837	USA	plowboy@ufl.edu
<i>Dr. Katsuya Ichinose</i>	Japan International Centre for Ag Science	1091-1 Maezato	Ishigaki, Okinawa		907-0002	Japan	ichis@affrc-go.jp
<i>Mr. Thiago Iost</i>	IMDECIT	Ave. Constitucion 405 Pte	Monterrey, NL		64000	Mexico	thiago.iost@citrofrut.com.mx
<i>Mr. Michael Irely</i>	United States Sugar Corporation	111 Ponce de Leon Ave	Clewiston	FL	33440	USA	msirey@ussugar.com
<i>Mr. Ed Ishida</i>	Bayer Cropscience - California	1773 Powell Dr.	Ventura	CA	93004	USA	Ed.Ishida@bayercropscience.com
<i>Dr. Toru Iwanami</i>	National Institute of Science	Fruit Tree Fujimoto 2-1	Tsukuba, Ibaraki		305-8605	Japan	tiwsw37@affrc-go.jp
<i>Mr. John L. Jackson</i>	FCIRCC	36545 E Eldorado Lake Dr	Eustis	FL	32736	USA	jackson7@ufl.edu
<i>Dr. Evan Johnson</i>	UF/IFAS Citrus Research & Ed.	700 Experiment Station Rd	Lake Alfred	FL	33850	USA	egjohnson@ufl.edu
<i>Mr. Lee Jones</i>	Gardiner Florida Citrus, Inc.	6751 W Professional Pkwy Ste 107	Sarasota	FL	34240	USA	
<i>Dr. David T. Kaplan</i>	USDA APHIS PPQ	4700 River Rd	Riverdale	MD	20772	USA	David.T.Kaplan@aphis.usda.gov
<i>Dr. Shinji Kawano</i>	Okinawa Prefectural Agricultural	820 Maakabe	Ito man, Okinawa		901-0036	Japan	kawanosh@pref.okinawa.lg.jp

Research Center									
<b>Dr. James H. Keithly</b>	Keithly Citrus Consultants	8307 Columbia Dr	Tyler	TX	75703-5111	USA		jhkicrus@suddenlink.net	
<b>Mr. David Kemery</b>	TRB Groves, LLC	1802 N Alafaya Trail	Orlando	FL	32826-4716	USA		trbgrove2@aol.com	
<b>Dr. Manjunath Keremane</b>	USDA ARS National Clonal Germplasm Repository	1060 Martin Luther King Blvd	Riverside	CA	92507	USA		manjunath.keremane@ars.usda.gov	
<b>Dr. Abeer Khataf</b>	University of Horticulture Sciences	PO Box 110690	Gainesville	FL	32611	USA		abeera@ufl.edu	
<b>Mr. John S. King</b>	King*John S. Florida Department of Citrus	4503 NE Skyline Dr. 700 Experiment Station Rd	Jensen Beach Lake Alfred	FL	34957 33850	USA		jking@keyplex.com dking@citrus.state.fl.us	
<b>Mr. Tom Kirschner</b>	Cooperative Producers, Inc.	PO Box 3147	Immokalee	FL	34143	USA		tfkirschner@yahoo.com	
<b>Dr. Yutichi Kobori</b>	Japan International Centre for Ag Science	1091-1 Maezato	Ishigaki, Okinawa		907-0002	Japan		kobory@affrc.go.jp	
<b>Mr. Kevin Koppelman</b>	Louis Dreyfus Citrus, Inc.	355 S 9th St	Winter Garden	FL	34787-3651			kevin.koppelman@ldcommodities.com	
<b>Ms. Kathleen Kosta</b>	California Department of Food & Agriculture	1220 N Street	Sacramento	CA	95814	USA		kkosta@cdfa.ca.gov	
<b>Mr. Robert Krueger</b>	USDA ARS National Clonal Germplasm Repository	1060 Martin Luther King Blvd	Riverside	CA	92507	USA		robert.krueger@ars.usda.gov	
<b>Mr. Madhurababu Kunta</b>	Texas A&M University	312 N International Blvd	Weslaco	TX	78596	USA		madhurababu@tamu.edu	
<b>Mrs. Katherine Lakofsky</b>	Athena Biotechnologies	5 Innovation Way Ste 100	Newark	DE	19711	USA		klakofsky@athenabio.com	
<b>Mrs. Jewel Letchworth</b>	Florida Citrus Mutual	PO Box 89	Lakeland	FL	33802	USA		jewell@flcitrusmutual.com	
<b>Dr. Laurene Levy</b>	USDA APHIS, PPQ, CPHST, NPGBL	BARC-East, Powder Mill Rd Bldg 580	Beltsville	MD	20705	USA		laurene.levy@aphis.usda.gov	
<b>Mr. Jorge Leyva</b>	Mexico Embassy	1911 Pennsylvania Ave NW 7th Floor	Washington	DC	20006	USA		jleyva.sagarpausa@verizon.net	
<b>Dr. Wenbin Li</b>	USDA APHIS, PPQ, CPHST, NPGBL	BARC-East, Powder Mill Rd Bldg 580	Beltsville	MD	20705	USA		wenbin.li@aphis.usda.gov	
<b>Mr. Hector Antonio Li Sanchez</b>	Consorcio Citricos Dominicanos	Autopista Duarte Km 46, Basima	Villa Altigracia		91000	Dominican Republic		hli@codetel.net.do	
<b>Dr. Hui-Ling Liao</b>	UF/IFAS Citrus Research & Ed.	700 Experiment Station Rd	Lake Alfred	FL	33850	USA		bigface@ufl.edu	
<b>Dr. Lia Liefing</b>	MAF Biosecurity New Zealand	PO Box 2095	Auckland		1140	New Zealand		lia.liefing@maf.govt.nz	
<b>Dr. Hong Lin</b>	USDA ARS San Joaquin Valley Ag Sciences	9611 S Riverbend Ave	Parlier	CA	93648	USA		hong.lin@ars.usda.gov	
<b>Mr. Don Longwell</b>	Texas Citrus Mutual	901 Business Park Dr Ste-400	Mission	TX	78572	USA		don.longwell@healdsvalley.com	
<b>Dr. Joao Lopes</b>	University of Entomology Dept.	San Paulo - Av. Padua Dias 11	Picracicaba, Sao Paulo		13418-900	Brazil		jlopes@esalq.usp.br	
<b>Dr. Silvio Lopes</b>	Fundecitrus	Av. Dr. Adhemar Pereira de Barros 201	Arraraquara, Sao Paulo		14807-040	Brazil		slopes@fundecitrus.com.br	
<b>Dr. J. Isabel Lopez-Arroyo</b>	INIFAP	Campo Experimental	Gral. Teran, NL		64700	Mexico		jila64@yahoo.com	
<b>Mr. Fred Lozo</b>	Florida Phosphorus, Inc.	PO Box 1457	Loxahatchee	FL	33470-1457	USA			

<b>Mr. Eduardo Antonio Lucato</b>	Citrus Consultants Group	Carlos Gomes Centro	144	Cordoeiropolis, Sao Paulo	13490000	Brazil	ealucato@uol.com.br
<b>Ms. Magally Luque-Williams</b>	CDFA	3180 Cridge St		Riverside	CA 92507	USA	mlwilliams@jps.net
<b>Dr. Marcos Antonio Machado</b>	Centro de Citricultura Moreira - IA	Caixa Postal 04		Cordoeiropolis, SP	13493970	Brazil	marcos@centrodecitricultura.br
<b>Dr. Nasir Malik</b>	USDA ARS KSARC	2413 E Highway 83		Weslaco	TX 78596	USA	nasir.malik@ars.usda.gov
<b>Mr. Jorge Mangussi</b>	IMDECIT	Ave. Constitucion 405 Pte		Monterrey, NL	64000	Mexico	Jorge.Mangussi@citrofrut.com.mx
<b>Dr. John Manthey</b>	USDA ARS Instituto Nacional de Investigacion Agrope	600 Avenue S, NW de Colonia Gestido		Winter Haven Salto	FL 33881	USA	John.Manthey@ars.usda.gov
<b>Mr. Hector A. Mara</b>	D & K Harvesting, Inc.	PO Box 1347		LaBelle	FL 33975-1347	USA	hmara@sg.inia.org.uy
<b>Mr. Larry Marsh</b>							larrym3041@aol.com
<b>Mr. Julio Enrique Martich Sosa</b>	Consorcio Citricos Dominicanos	Autopista Duarte Km 46, Basima		Villa Altigracia	91000	Dominican Republic	juliomartich@codetel.net.do
<b>Dr. Jose Luis Martinez-Carrillo</b>	Citricola Del Yaqui, S.A. de C.V.	Allende 615 PTE Local 3 Altos		CD. Obregon, Son	85000	Mexico	jlmarca@hotmail.com
<b>Dr. Phillip Mason</b>	USDA APHIS PPQ	2150 Centre Ave Bldg B		Fort Collins	CO 80526	USA	phillip.a.mason@aphis.usda.gov
<b>Mr. Luis Matos</b>	Instituto Dominicano de Investigaciones Ag	Rafael Augusto Sanchez #89, Ensanche Evar		Santo Domingo	890-9	Dominican Republic	lmatos@idiaf.org.do
<b>Dr. Richard T. Mayer</b>	KeyPlex	200 W Welborne Ave Ste 7		Winter Park	FL 32789-4278	USA	rtmayer@Keyplex.com
<b>Mr. John P. "Peter" McClure</b>	FCPRAC	10410 Bluefield Rd		Okeechobee	FL 34972	USA	pmcclure@evansprop.com; jpetemcclure@aol.com
<b>Dr. Gregory McCollum</b>	USDA ARS USHRL	2001 S Rock Rd		Fort Pierce	FL 34945-3030	USA	greg.mccollum@ars.usda.gov
<b>Mr. Darrell W. McCullough</b>	Smoak Groves, Inc.	1025 County Rd 17 N		Lake Placid	FL 33852	USA	darrellmcl@embarqmail.com
<b>Mr. Ben McLean, III</b>	McLean Ag Chemical, Inc.	PO Box 1044		Minneola	FL 34755	USA	benmclean@aol.com
<b>Mr. John McLean</b>	McLean Ag Chemical, Inc.	PO Box 1044		Minneola	FL 34755	USA	ninett@premierofficefl.com
<b>Mr. Camilo Lazaro Medina</b>	Citrus Consultants Group	Carlos Gomes Centro	144	Cordoeiropolis, Sao Paulo	13490000	Brazil	clmedina@conplantferti.com.br
<b>Mr. Kevin Metheny</b>	Florida Citrus Mutual	PO Box 89		Lakeland	FL 33802	USA	kevinm@fleitrustmutual.com
<b>Mr. Frank Miele, Jr</b>	Magna-Bon II, LLC	2045 SW 127th Ave		Davie	FL 33325	USA	famiele1@aol.com
<b>Dr. Shin-ichi Miyata</b>	UF/IFAS Citrus Research & Ed.	700 Experiment Station Rd		Lake Alfred	FL 33850	USA	smyyata@ufl.edu
<b>Dr. Gustavo Astua Monge</b>	Alellyx Applied Genomics			Campinas, SP		Brazil	gustavo.monge@alellyx.com.br
<b>Mr. Clovis Monteiro</b>	Citrus Producer	Rua Floreal, 233		Catanduva, SP	15802145	Brazil	clovis.pm@terra.com.br
<b>Dr. Gloria A. Moore</b>	University of Horticulture Sciences	PO Box 110690		Gainesville	FL 32611	USA	gamoore@ufl.edu
<b>Mr. Robert Allen Morris</b>	UF/IFAS Citrus Research & Ed.	700 Experiment Station Rd		Lake Alfred	FL 33850	USA	ramorris@crec.ifas.ufl.edu
<b>Mr. David Munyan</b>	USDA APHIS PPQ/CHRP	8075 20th St		Vero Beach	FL 34966	USA	david.r.munyan@aphis.usda.gov
<b>Mr. Ronald P Muraro</b>	UF/IFAS Citrus Research & Ed.	700 Experiment Station Rd		Lake Alfred	FL 33850	USA	rpm@crec.ifas.ufl.edu
<b>Mr. Michael S. Murphy</b>	Cooperative Producers, Inc.	PO Box 3147		Immokalee	FL 34143	USA	msmurflf@yahoo.com
<b>Mr. Joel Nelsen</b>	California Citrus Mutual	512 N Kaweah Ave		Exeter	CA 93221-	USA	jnelson@cacitrusmutual.com

<b>Mr. Jerome M. "Jerry" Newlin</b>	Orange - Co, LP	12010 NE Hwy 70	Arcadia	FL	1200 34266-4267	USA	jnewlin@orangecofla.com
<b>Dr. Lee Newport</b>	USDA APHIS PPQ	306 S 10th St	Haines City	FL	33844	USA	lee.newport@aphis.usda.gov
<b>Ms. Kim Niblett</b>	University of Horticulture Sciences	PO Box 110690	Gainesville	FL	32611	USA	kniblett@ufl.edu
<b>Mr. Robert P. Norberg</b>	Florida Department of Citrus	PO Box 148	Lakeland	FL	33802-0148	USA	bnorberg@citrus.state.fl.us
<b>Mr. Rogaciano Nunez Pellegrin</b>	Consejo Citricola de Sinaloa	C. Tarascos No. 1716-B, Col. Salvador Alvará	Culiacan, Sinaloa		80160	Mexico	everfresh@prodigy.net.mx
<b>Ms. Juliet M. Ochasan</b>	Bureau of Plant Industry	Guisad	Baguio City		2600	Philippines	jochasan@yahoo.com
<b>Mr. Gerald O'Connor</b>	KeyPlex	200 W Welborne Ave Ste 7	Winter Park	FL	32789-4278	USA	goc@keyplex.com
<b>Mr. Jiminez Odelys</b>	Secretaria de Agricultura	Jardines del Norte	Santo Domingo		809	Dominican Republic	odelys_01@hotmail.com
<b>Dr. Yasuo Ohto</b>	Japan International Research Centre for Ag Science	1091-1 Maezato	Ishigaki, Okinawa		907-0002	Japan	october@affrc.go.jp
<b>Mr. Kevin Olsen</b>	Paramount Citrus	PO Box 3347	Pinedale	CA	93650	USA	kolsten@paramountcitrus.com
<b>Dr. Ahmad Omar</b>	UF/IFAS Citrus Research & Ed.	700 Experiment Station Rd	Lake Alfred	FL	33850	USA	omar71@ufl.edu
<b>Dr. Ebenezzer Onaghola</b>	UF/IFAS Citrus Research & Ed.	700 Experiment Station Rd	Lake Alfred	FL	33850	USA	eonaghola@ufl.edu
<b>Mr. Charles Orman</b>	CROW	466 N Orange St Ste 138	Redlands	CA	92374	USA	citrusdoc@verizon.net
<b>Mr. Paulo Eduardo Branco Paiva</b>	Citrus Consultants Group	Carlos Gomes 144 Centro	Cordeiropolis, Sao Paulo		13490000	Brazil	pebpaiva@esalq.usp.br
<b>Mr. Juan Lorenzo Palau Alanis</b>	Comite Estatal de Sanidad Vegetal	Carretera a Gral Teran Km 12.5	Montemorelos, NL		67580	Mexico	cesaveni@yahoo.com.mx
<b>Dr. Paul E. Parker</b>	USDA APHIS	22675 N Moorefield Rd	Edinburg	TX	78541	USA	paul.e.parker@aphis.usda.gov
<b>Dr. Stephen Parnell</b>	Rothamsted Research	West Common	Harpenden, Hertfordshire		AL5 2JQ	United Kingdom	stephen.parnell@bbsrc.ac.uk
<b>Mr. Gregory Parra</b>	USDA APHIS PPQ Center for Plant Health	1730 Varsity Drive Ste 400	Raleigh	NC	27606	USA	greg.r.parra@aphis.usda.gov
<b>Dr. Joseph Patt</b>	USDA ARS KSARC	2413 E Highway 83	Weslaco	TX	78596	USA	Joseph.Patt@ars.usda.gov
<b>Dr. Kirsten Pelz-Stelinski</b>	UF/IFAS Citrus Research & Ed.	700 Experiment Station Rd	Lake Alfred	FL	33850	USA	pelzstelinski@ufl.edu
<b>Mr. Rafael Perez-Duverge</b>	Instituto Dominicano de Investigaciones Ag	Rafael Augusto Sanchez #89, Ensanche Evar	Santo Domingo		890-9	Dominican Republic	pduverge@idiaf.org.do
<b>Mr. Francisco Pierri Neto</b>	Citrus Consultants Group	Carlos Gomes 144 Centro	Cordeiropolis, Sao Paulo		13490000	Brazil	fpm14@terra.com.br
<b>Dr. Gerhard Pietersen</b>	Citrus Research International - South Africa	Lunnon St, Rm 9-8	Pretoria		0002	South Africa	gerhard.pietersen@up.ac.za
<b>Mr. Ernesto Luiz Pires de Almeida</b>	Citrus Consultants Group	Carlos Gomes 144 Centro	Cordeiropolis, Sao Paulo		13490000	Brazil	elpa@btu.flash.tv.br
<b>Dr. Anne Plotto</b>	USDA ARS	600 Avenue S, NW	Winter Haven	FL	33881	USA	Anne.Plotto@ars.usda.gov
<b>Dr. MaryLou Polek</b>	CCTEA	22847 Road 140	Tulare	CA	93274-9367	USA	mpolek@cctea.org
<b>Dr. Gavin Poole</b>	USDA ARS USHRL	2001 S Rock Rd	Fort Pierce	FL	34945-3030	USA	gavin.poole@ars.usda.gov
<b>Dr. Charles A. Powell</b>	University of Florida	2199 S Rock Rd	Fort Pierce	FL	34945-	USA	C.Powell@ufl.edu

<i>Mr. Paulo Pratinha Alves</i>	Citri Agroindustrial S/A	BR158 km85	Paranaivai, PR	3138	Brazil	paulopratinha@citri.com.br
<i>Mr. Ray Prewett</i>	Texas Citrus Mutual	901 Business Park Dr Ste 400	Mission	TX 78572	USA	ray@valleyag.org
<i>Dr. Humberto Puello</i>	Consorcio Citricola del Este	km 1 Carratera Hato Mayor Mayor-Sabana	Hato Mayor	61	Dominican Republic	chpuello@yahoo.com
<i>Mr. Mario Puente Raya</i>	Plant Health Directorat in Mexico	Guillermo Perez Valenzuela #127	Mexico, D.F.	04100	Mexico	mpuente@senasica.sagarpa.gob.mx
<i>Mr. William Purvis</i>	Purvis Grove	949 Kings Post Rd	Rockledge	FL 32955	USA	sandmullet116@yahoo.com
<i>Dr. Jawwad Qureshi</i>	UF/IFAS Immokalee Research & Education Center	2686 SR 29 N	Immokalee	FL 34142	USA	jawwadq@ufl.edu
<i>Mrs. Jacqueline Ramallo</i>	Esatacion Experimental Agroindustrial Obisp	Av. William Cross 3150	Tucuman	4101	Argentina	jacqueline_ramallo@hotmail.com
<i>Mr. Alvarez Ramos</i>	Comite Estatal de Samidad Vegetal	Av Justo Sierra Mendez #330	Campeche	24040	Mexico	riaira@yahoo.com
<i>Dr. John Rascoe</i>	USDA APHIS, PPQ, CPHST, NPGBL	BARC-East, Powder Mill Rd Bldg 580	Beltsville	MD 20705	USA	john.rascoe@aphis.usda.gov
<i>Dr. Joseph Reddy</i>	Integrated Plant Genetics, Inc.	12085 Research Dr	Alachua	FL 32615	USA	reddy@ipgenetics.com
<i>Mr. Modesto Reyes</i>	Instituto Dominicano de Investigaciones Ag	Rafael Augusto Sanchez #89, Ensanche Evar	Santo Domingo	890-9	Dominican Republic	mdreyes@idiaf.org.do
<i>Dr. Jose Reyes De Corcuera</i>	UF/IFAS Citrus Research & Ed.	700 Experiment Station Rd	Lake Alfred	FL 33850	USA	jireyes@ufl.edu
<i>Mr. James Reynolds</i>	USDA APHIS	1412 Hummel Ln	Fort Collins	CO 80525	USA	jimmyreynolds@comcast.net
<i>Mr. Timothy Riley</i>	USDA APHIS PPQ CHRP	800 Thorpe Rd	Orlando	FL 32824	USA	timothy.riley@aphis.usda.gov
<i>Dr. Mark Ritenour</i>	UF/IFAS Indian River Research & Ed Center	2199 S Rock Rd	Fort Pierce	FL 34945-3138	USA	ritenour@ufl.edu
<i>Mr. Jose Renato Rivas Valdez</i>	Viveros Everfresh, SPR	C. Tarascos No. 1716-B, Col. Salvador Alvara	Culican, Sinaloa	80160	Mexico	renatorivas@prodigy.net.mx
<i>Mr. Michael A. Roberts</i>	AgraQuest, Inc.	4227 Lake Mariana Dr	Winter Haven	FL 33881	USA	mroberts@agraquest.com
<i>Mr. David Roberts</i>	California Citrus Mutual	512 N Kaweah Ave	Exeter	CA 93221-1200	USA	ccm@cacitrusmutual.com
<i>Dr. Pedro Luis Robles Garcia</i>	SENASICA	Insurgentes Sur #489 Piso 16 Col. HIPC	Mexico, D.F.	06100	Mexico	cpn@senasica.sagarpa.gob.mx
<i>Dr. Marciano Manuel Robles Gonzalez</i>	INIFAP	Progreso #5, Barrio De Sta Catarina, COY	Mexico, Distrito Federal	04010	Mexico	robles.manuel@inifap.gob.mx
<i>Mr. Hamilton Ferreira Rocha</i>	Citrus Consultants Group	Carlos Gomes 144 Centro	Cordeiropolis, Sao Paulo	13490000	Brazil	hamiltonfcr@yahoo.com
<i>Dr. Mario Rocha-Pena</i>	INIFAP	PO Box 128 F	San Nicolas de los Garza	66450	Mexico	mrocha@fcb.uanl.mx
<i>Mr. Thiago Rodas</i>	Vanderlei Rodas	Rua: Sao Pedro, 157	Monte Azul Paulista, SP	14730000	Brazil	thiago@vrodas.com.br
<i>Dr. Michael E. Rogers</i>	UF/IFAS Citrus Research & Ed.	700 Experiment Station Rd	Lake Alfred	FL 33850	USA	mrgers@ufl.edu
<i>Dr. Mikeal Roose</i>	University of California	Department of Botany & Plant Sciences	Riverside	CA 92521-0001	USA	mikeal.roose@ucr.edu
<i>Mr. Sidney Marcos Rosa</i>	Citrus Consultants Group	Carlos Gomes 144 Centro	Cordeiropolis, Sao Paulo	13490000	Brazil	s.mrosa@uol.com.br
<i>Dr. Raquel Rosales</i>	UF/IFAS Citrus Research & Ed.	700 Experiment Station	Lake Alfred	FL 33850	USA	rrosales@crec.ifas.ufl.edu

<b>Dr. Russell Rousseff</b>	UF/IFAS Citrus Research & Ed. Rd	700 Experiment Station	Lake Alfred	FL	33850	USA	rrouseff@ufl.edu
<b>Dr. Avijit Roy</b>	UF/IFAS Citrus Research & Ed. Rd	700 Experiment Station	Lake Alfred	FL	33850	USA	avijitroy@ufl.edu
<b>Mrs. Sarah Rushing Ogleby</b>	Florida Department of Agriculture	407 S Calhoun St Mayo Bldg M9	Tallahassee	FL	32399-0800	USA	rushings@doacs.state.fl.us
<b>Mr. Earl Ruiz</b>	California Citrus Research Board	PO Box 1337	Pauma Valley	CA	92061	USA	earlruiz1@mac.com
<b>Mr. Yasutune Sadoyama</b>	Okinawa Prefectural Agricultural Research Center	820 Makabe	Itoman, Okinawa		9201-0036	Japan	sadoyamy@pref.okinawa.lg.jp
<b>Dr. Bacilio Salas Sanches</b>	USDA APHIS	22675 N Moorefield Rd	Edinburg	TX	78541	USA	bacilio.salas@aphis.usda.gov
<b>Mr. Antonio Celso Sanches</b>	Citrus Consultants Group	Carlos Gomes 144 Centro	Cordeiropolis, Sao Paulo		13490000	Brazil	acsanches@terra.com.br
<b>Mr. Hector Manuel Sanchez Anguiano</b>	SENASICA	Insurgentes Sur #489 Piso 16 Col. HIPC	Mexico, D.F.		06100	Mexico	hsanchez@senasica.sagarpa.gob.mx
<b>Dr. Tim Schubert</b>	Florida Department of Agriculture	PO Box 147100	Gainesville	FL	32614-7100	USA	schubert@doacs.state.fl.us
<b>Ms. Rhonda Schumann</b>	UF/IFAS Citrus Research & Ed. Rd	700 Experiment Station	Lake Alfred	FL	33850	USA	rschuman@ufl.edu
<b>Mr. Daniel Sensenig</b>	E K C Citrus Growers, LLC	7192 SW Environmental Lab St	Arcadia	FL	34266	USA	
<b>Miss Rosana Serikawa</b>	UF/IFAS Citrus Research & Ed. Rd	700 Experiment Station	Lake Alfred	FL	33850	USA	rserikawa@ufl.edu
<b>Dr. Mamoudou Setamou</b>	Texas A&M University - Kingsville	312 N International Blvd	Weslaco	TX	78596	USA	msetamou@ag.tamu.edu
<b>Dr. Robert Shatters</b>	USDA ARS USHRL	2001 S Rock Rd	Fort Pierce	FL	34945-3030	USA	robert.shatters@ars.usda.gov
<b>Mr. Jose Luiz Silva</b>	Gravena	Rodovia Deputado Cunha Bueno SP 253	Jaboticabal, SP		14870-990	Brazil	jlsilva@gravena.com.br
<b>Mr. Oscar Augusto Simonetti</b>	Citrus Consultants Group	Carlos Gomes 144 Centro	Cordeiropolis, Sao Paulo		13490000	Brazil	oscar.simonetti@yahoo.com.br
<b>Dr. Mani Skaria</b>	Texas A&M University - Kingsville	312 N International Blvd	Weslaco	TX	78596	USA	MSkaria@ag.tamu.edu
<b>Mr. John F. Smoak, III</b>	Smoak Groves, Inc.	1025 County Rd 17 N	Lake Placid	FL	33852	USA	johnsmoak@embarqmail.com
<b>Mr. James A. Sniively</b>	Southern Gardens Corporation	1820 County Road 833	Clewiston	FL	33440-9222	USA	jmsniively@southerngardens.com
<b>Mr. Jaime Sosa</b>	MAGA	15 Ave 14-72 Zona 13	Guatemala		01013	Guatemala	jaime.sosa@pjpaa.com
<b>Mr. Mike Sparks</b>	Florida Citrus Mutual	PO Box 89	Lakeland	FL	33802	USA	mikes@flcitrusmutual.com
<b>Dr. Thomas Spreen</b>	University of Florida - Resource Economics	PO Box 110240	Gainesville	FL	32611-0240	USA	tspreen@ufl.edu
<b>Mr. Rubens Stamato, Junior</b>	Gtacc		Sao Paulo			Brazil	rubensstamatojr@terra.com.br
<b>Dr. Philip Stansly</b>	University of Florida	2686 State Rd 29 N	Immokalee	FL	34142-9514	USA	pstansly@ufl.edu
<b>Dr. Lukasz Stelinski</b>	UF/IFAS Citrus Research & Ed. Rd	700 Experiment Station	Lake Alfred	FL	33850	USA	stelinski@ufl.edu
<b>Mr. Michael J. Stewart</b>	Consolidated Citrus, LP	63 Barn Rd	Venus	FL	33960	USA	mstewart@ccjpcitrus.com
<b>Ms. Judy Stewart-Leslie</b>	USDA GWSS	729 Davis Ave	Exeter	CA	93221	USA	jsleslie@msn.com
<b>Mr. Thomas Stopyra</b>	The Packers of Indian River, Ltd.	PO Box 12969	Fort Pierce	FL	34979-	USA	tstopyra@packerscitrus.com

<i>Mrs. Vera Stopyra</i>	The Packers of Indian River, Ltd.	PO Box 12969	Fort Pierce	FL	2969	USA	34979-2969
<i>Dr. Ed Stover</i>	USDA ARS USHRL	2001 S Rock Rd	Fort Pierce	FL	34945-3030	USA	ed.stover@ars.usda.gov
<i>Dr. Eduardo Stuchi</i>	Embrapa Cassava & Tropical Fruits	PO Box 74	Bebedouro, SP		14700-970	Brazil	stuchi@estacaoexperimental.com.br
<i>Dr. Hong-Ji Su</i>	National Taiwan University	Dept. of Plant Pathology & Microbiology	Taipei			Taiwan	hjsu@ntu.edu.tw
<i>Dr. Siti Subandiyah</i>	Gadjah Mada University - Dept. of Entomology	Faculty of Agriculture UGM	Yogyakarta, DIY		55281	Indonesia	ssubandiyah@faperta.ugm.ac.id
<i>Dr. Xiaolan Sun</i>	Division of Plant Industry	1911 SW 34th St	Gainesville	FL	33608	USA	sunx@donacs.state.fl.us
<i>Dr. Walter Tabachnick</i>	University of Florida	2199 S Rock Rd	Fort Pierce	FL	34945-3138	USA	wjt@ufl.edu
<i>Dr. Earl Taylor</i>	USDA ARS USHRL	2001 S Rock Rd	Fort Pierce	FL	34945-3030	USA	earl.taylor@ars.usda.gov
<i>Mr. Enrique Cecilio Taylor</i>	C.E.C.N.E.A.	Espejo 131	Concordia, Entre Rios		3200	Argentina	meleceña@arnet.com.ar
<i>Mr. Jose Eduardo Teofilo</i>	Citrus Consultants Group	Carlos Gomes Centro	144 Cordeiropolis, Sao Paulo		13490000	Brazil	jeteofilo@vivax.com.br
<i>Mr. Fernando Eduardo Tersi</i>	Tersi*Eduardo	Rua Antonio Gonzales Sobrinho, 310	Jaboticabal, SP		14870-000	Brazil	ftersi@cambuhy.com.br
<i>Dr. Donald Thomas</i>	USDA ARS KSARC	2413 E Highway 83	Weslaco	TX	78596	USA	donald.thomas@ars.usda.gov
<i>Mr. Norman Todd</i>	Grove Crafters, Inc.	PO Box 88	LaBelle	FL	33975-0088	USA	toadcitrus@aol.com
<i>Mr. David Tomlinson</i>	Griffith Farms, Inc.	504 N Kaweah Ave	Exeter	CA	93221-1200	USA	ccm@cacitrusmutual.com
<i>Mr. Gilberto Tozatti</i>	Citrus Consultants Group	Carlos Gomes Centro	144 Cordeiropolis, Sao Paulo		13490000	Brazil	tozatti@gconci.com.br
<i>Dr. Francisco Javier Trujillo Arriaga</i>	Direccion General de Sanidad Vegetal	GMO Perez Valenzuela #127	Mexico, D.F.		04100	Mexico	trujillo@senasica.sagarpa.gob.mx
<i>Dr. Antonios E. Tsagkarakis</i>	UF/IFAS Citrus Research & Ed.	700 Experiment Station Rd	Lake Alfred	FL	33850	USA	atsagkarakis@ufl.edu
<i>Dr. Thomas Turpen</i>	FCPRAC/Technology Innovation Group	7006 Firewheel Hollow	Austin	TX	78750	USA	tom.turpen@innovationmatters.com
<i>Dr. Cheryl Vahling</i>	USDA ARS USHRL	2001 S Rock Rd	Fort Pierce	FL	34945-3030	USA	cheryl.vahling@ars.usda.gov
<i>Dr. Maria Filomena Valim</i>	Florida Department of Citrus	700 Experiment Station Rd	Lake Alfred	FL	33850	USA	fvalim@citrus.state.fl.us
<i>Mrs. Louise van Meurs</i>	Biosecurity Australia	GPO Box 858	Camberra, ACT		2615	Australia	louise.vanmeurs@biosecurity.gov.au
<i>Dr. Jose Joaquin Velazquez Moural</i>	INIFAP	Progreso #5, Barrio De Sta Catarina, COY	Mexico, Distrito Federal		04010	Mexico	velazquez.joaquin@inifap.gob.mx
<i>Mr. Ivan Veljkovic</i>	Ministry of Agriculture & Forestry Biosecurity	25 The Terrace	Wellington		6012	New Zealand	ivan.veljkovic@maf.govt.nz
<i>Dr. Georgios Vidalakis</i>	University of California	Dept of Plant Pathology	Riverside	CA	92521-0001	USA	vidalg@ucr.edu
<i>Mr. Ricardo Violante</i>	Cutrale		Sao Paulo			Brazil	violante@cutrale.com.br
<i>Dr. Nian Wang</i>	UF/IFAS Citrus Research & Ed.	700 Experiment Station Rd	Lake Alfred	FL	33850	USA	nianwang@ufl.edu

<i>Dr. Shawron Weingarten, D.P.M.</i>	Orange - Co, LP	12010 NE Hwy 70	Arcadia	FL	34266-4267	USA	sweingarten@orangecofla.com
<i>Mr. Marshall Wiseheart</i>	Florida Department of Agriculture	407 S Calhoun St Mayo Bldg M9	Tallahassee	FL	32399-0800	USA	wisehem@doacs.state.fl.us
<i>Mr. Mike Wootton</i>	Sunkist Growers, Inc.	14130 Riverside Dr	Sherman Oaks	CA	91423	USA	mwootton@sunkistgrowers.com
<i>Dr. Glenn Wright</i>	University of Arizona	6425 W 8th St	Yuma	AZ	85364	USA	gwright@ag.arizona.edu
<i>Mrs. Helene Wright</i>	USDA APHIS PPQ	650 Capitol Mall Ste 6-400	Sacramento	CA	95814	USA	helene.r.wright@aphis.usda.gov
<i>Mr. Nelson Arno Wulff</i>	Fundecitrus	Av. Dr. Adhemar Pereira de Barros 201	Arraraquara, Sao Paulo	Brazil	14807-040	Brazil	nelsonwulff@fundecitrus.com.br
<i>Dr. Pedro Yamamoto</i>	Fundecitrus	Av. Dr. Adhemar Pereira de Barros 201	Arraraquara, Sao Paulo	Brazil	14807-040	Brazil	pyamamoto@fundecitrus.com.br
<i>Dr. Gal Yarden</i>	Morflora LLC	11800 SW 77th Ave	Miami	FL	33156	USA	gal@morflora.com
<i>Miss Jamie Yates</i>	UF/IFAS Citrus Research & Ed.	700 Experiment Station Rd	Lake Alfred	FL	33850	USA	jdyates@ufl.edu
<i>Dr. Mongi Zekri</i>	Hendry County Service	Extension PO Box 68	LaBelle	FL	33975-0068	USA	maz@ufl.edu
<i>Dr. Muqing Zhang</i>	UF/IFAS Indian River Research & Ed Center	2199 S Rock Rd	Fort Pierce	FL	34945-3138	USA	mqzhang@ufl.edu
<i>Dr. Shujian Zhang</i>	University of Florida	1453 Fifield Hall, Hull Rd	Gainesville	FL	32611	USA	sjzhang@ufl.edu
<i>Dr. Jiuxu Zhang</i>	Florida Department of Citrus	700 Experiment Station Rd	Lake Alfred	FL	33850	USA	jzhang@citrus.state.fl.us
<i>Miss Lijuan Zhou</i>	UF/IFAS Indian River Research & Ed Center	2199 S Rock Rd	Fort Pierce	FL	34945-3138	USA	lijuan.zhou@ars.usda.gov



**A3. Meeting Agenda*****Reaching Beyond Boundaries***

December 1-5, 2008

***Agenda*****DAY 1: Monday, 1 December 2008**

1:00 – 7:00 PM: Registration

6:00 – 8:00 PM: Workshop Welcome Reception

**DAY 2: Tuesday, 2 December 2008**

7:00 AM – 5:00 PM: Registration

7:00 – 8:00 AM: Continental Breakfast

8:00 – 8:45 AM: Welcome

Introductions - Mike Sparks, Tim Gottwald

Mission/Goals/Objectives - Wayne Dixon

Housekeeping/Rules of the House - Tim Gottwald

**8:45 – 10:00 AM: Morning Session 1: Current HLB Situation and Concerns Regarding Asian Citrus Greening and the Asian Citrus Psyllid - Peter McClure, Moderator**

**8:45** Current HLB situation and industry perspective in Asia –Beattie, G.A.C. and Holford, P.

**9:05** Current HLB situation and citrus producer's perspective in South America - Clóvis Penalva Monteiro

**9:25** Current HLB situation and citrus producer's perspective in US - Jim Snively

10:00 – 10:15 AM: Break

10:15 AM – 12:00 PM: Morning Session 2: HLB Survey - M. Irely, Moderator

Oral Presentations:

**10:15 2.1** Current situation of citrus huanglongbing in Cuba – Llauger, R., Luis, M. Collazo, C., Peña, I., González, C., Batista, L., Teixeira, D., Martins, E., Perdomo, A., Casin, J.C., Pérez, J.L., and Cueto, J.R. and Bové, J.M.

**10:30 2.2** Data trends and results from an HLB laboratory that has processed over 55,000 commercial and research samples over a two year period in Florida. Irely, M., Mai, P., Graham, J., and Johnson, J.

**10:45 2.3** Texas steps up surveys for huanglongbing and the Asian citrus psyllid – daGraca, J. V., Skaria, M., Setamou, M., Kunta, M., Arredondo, M., Salas, B., Parker, P.E.

- 11:00 2.4** National plan for detection of HLB in Mexico – Robles, G.P., Sanchez, A.H., Mendez, L.O.
- 11:15 2.5** Survey for “*Candidatus Liberibacter* species in South Africa – Pietersen, G., Kotzé, A., Phahladira, M.N.B., Schwerdtfeger, M.
- 11:30 2.6** Large-scale distribution of *Diaphorina citri* Kuwayama and citrus huanglongbing in Florida – Halbert, S.E., Manjunath, K., and Brodie, M.W.
- 11:45 2.7** Is it possible to replant young groves in an area with endemic HLB – a hierarchical sampling approach to determine infection? – Irey, M., Gottwald, T., Stewart, M., and Chamberlain, H.

**12:00 – 1:30PM: Lunch and Keynote Lecture 1 – Bernard Aubert “Historical perspectives of HLB in Asia”**

**1:45 – 2:45 PM: Afternoon Session 3: HLB Detection and Diagnostics – J. Hartung, Moderator**

**Oral Presentations:**

- 1:45 3.1** Lessons learned from a comparison and evaluation of multiple HLB testing laboratories employing common and different testing methodologies on a common set of samples – Irey, M., Sieburth, P., Brlansky, R., DaGraça, J., Graham, J., Gottwald, T., Hartung, J., Hilf, M., Kunta, M., Manjunath, K., Lin, H., Ramdugu, C., Roberts, P., Rogers, M., Shatters, R., Sun, X., and Wang, N.
- 2:00 3.2** Improved detection of low-titer, non-lethal, seed transmitted *Candidatus Liberibacter asiaticus* in citrus, periwinkle, and dodder using nested PCR – Zhou, L.-J., Benyon, L. S., Powell, C. A., Gottwald, T., and Duan, Y.-P.
- 2:15 3.3** Detection of “*Candidatus Liberibacter asiaticus*” by cycleave isothermal and chimeric primer-initiated amplification of nucleic acids (Cycleave ICAN) – Urasaki, N., Kawano, S., Mukai, H., Uemori, T., Takeda, O., and Sano, T.
- 2:30 3.4** A novel molecular diagnostic tool for improved sensitivity and reliability detection of “*Candidatus Liberibacter asiaticus*” bacterium associated with huanglongbing (HLB) – Lin, H., Doddapaneni, H., and Civerolo, E. L.
- 2:45 3.5** Citrus greening (Huanglongbing) disease in India: present status and diagnostic efforts – Das, A.K.

**Posters:**

- 3.6** Improvement of *Candidatus Liberibacter asiaticus* diagnosis by nested PCR – Coletta-Filho, H.D., Alves, K.C.S., Carlos, E.F., Pereira, M.A.R., Machado, M.A.
- 3.7** Optimizing qPCR for detection of *Candidatus Liberibacter species* in plants and psyllid samples – Shatters, R. G., Hunter, W., Hall, D., Niedz, R., Evens, T. J.
- 3.8** Comparison of detection sensitivity of different primer pairs for citrus huanglongbing bacterium – Ding, F., Wang, G., Yi, G., Hong, N., Zhong, Y.
- 3.9** Quantification of viable *Candidatus Liberibacter asiaticus* in hosts using quantitative PCR with the aid of ethidium monoazide (EMA) – Sagaram, U.S., Trivedi, P., Kim, J-S, Brlansky, R.H., Rogers, M.E., Stelinski, L.L., Oswalt, C., and Wang, N.
- 3.10** PCR for detection of Asian and American strains of *Candidatus Liberibacter* In citrus, *Murraya* and *Diaphorina* from Northwest Argentina – Ramallo, J., Acosta, E., Rojas, A., Stein, B.
- 3.11** Current situation of citrus Huanglongbing associated with “*Candidatus Liberibacter asiaticus*” in Guangdong, China. Deng, X., Chen, J., Xu, J., Guo, H., Pu, X., Cai, L., and Li, H.
- 3.12** Molecular approach for early detection of *Candidatus Liberibacter species* in Texas citrus – Bextine, B., Gunawan, S., Hunter, W., and Shatters, R.

- 3.13** Comparison of a starch-based field test for Huanglongbing to results from real-time PCR testing of field samples from symptomatic trees in Florida - Chamberlain, H. L. and M. S. Irey

**2:45 – 3:00 PM: Break**

**3:00 – 5:15 PM: Afternoon Session 4: Pathogen Genome Sequencing, Phylogenetics, and Culturing – W. Dawson, Moderator**

**Oral Presentations:**

- 3:00** **4.1** Evaluation of potential pathogenicity genes identified by genomic sequencing of *Ca. Liberibacter asiaticus* – Zhang, S., Reddy, S., and Gabriel, D. W.
- 3:15** **4.2** Zebra complex and HLB: Seeking a common enemy? Bextine, B. Swatsell, C. and Hunter, W.
- 3:30** **4.3** Microbiome analysis of HLB pathogen infected citrus using phylochips and 16S rDNA clone library sequencing – Sagaram, S., DeAngelis, K. M., Trivedi, P., Kim, J-S, Anderson, G.L., and Wang, N.
- 3:45** **4.4** Several *Liberibacter* and phytoplasma species are individually associated with HLB – Bové, J.M., Teixeira, D.C., Wulff, N.A., Eveillard, S., Saillard, C., Bassanezi, R. B., Lopes, S., Yamamoto, P.T., Ayres, A.J.
- 4:00** **4.5** Phylogenetic analysis of citrus huanglongbing bacterium based on the sequences of 16S rDNA and 16S / 23S rDNA intergenic regions among isolates in China – Ding, F., Deng, X., Hong, N., Zhong, Y., Wang, G., Yi, G.
- 4:15** **4.6** Ribosomal RNA operons and genome size of *Candidatus Liberibacter americanus*, a bacterium associated with citrus huanglongbing in Brazil – Wulff, N.A., Eveillard, S., Foissac, X., Ayres, A.J., and Bové, J.M.
- 4:30** **4.7** Genome analysis of *Candidatus Liberibacter asiaticus* reveals unique features for designing HLB control strategies – Duan, Y.-P., Zhou, L.J, Hall, D., Li, W.B., Lin, H., Doddapaneni, H., Liu, L., Vahling, C.M., and Gottwald, T.
- 4:45** **4.8** Cocultivation of *Candidatus Liberibacter asiaticus* with actinobacteria from citrus with huanglongbing – Davis, M.J., Mondal, S.N., Chen, H.-Q., Rogers, M.E., Brlansky, R.H.
- 5:00** **4.9** Development of an Asian citrus psyllid (*Diaphorina citri*) insect cell line – M.W. Lewis and Keyhani, N.O.

**Posters:**

- 4.10** Enrichment of *Candidatus Liberibacter americanus* using an artificial psyllid feeding system – Locali-Fabris, E.C., Coletta-Filho, D., Miranda, M.P., Francisco, C.S., Lopes, J.R.S., Machado, M.A.
- 4.11** Asian citrus psyllid (*Diaphorina citri*) cell culture methods – Marutani-Hert, M., Hunter, W., Hall, D.G.
- 4.12** Genetic diversity of *Candidatus Liberibacter asiaticus* and *Ca. L. americanus* based on sequence variations of their rRNA operon – Zhou, L.J., Powell, C.A., Gottwald, T., Duan, Y.P.
- 4.13** Efficient enrichment of the pathogen DNA from HLB infected host – Chen, C., Yu, Q., Gmitter, F.
- 4.14** Characterization of “*Candidatus Phytoplasma asteri*” citrus huanglongbing strain in Guangdong, China – Chen, J., Deng, X., Pu, X., Cai, L., and Guo, H.
- 4.15** Visible/near-infrared spectroscopy for discrimination of HLB-infected citrus leaves from healthy leaves - Poole, G., Windham, W., Heitschmidt, G., Park, B., and Gottwald, T.

**5:15 – 6:15 PM: Poster Session 1**

**Dinner On Your Own**

**8:00 – 10:00 PM: Evening Sessions (Specific group/satellite meetings)**

Epidemiology discussion group – Yasuo Ohto moderator  
Other concurrent group meetings to be announced

**DAY 3: Wednesday, 3 December 2008**

**7:00 AM – 5:00 PM: Registration**

**7:00 – 8:00 AM: Continental Breakfast**

**8:00 – 10:00 AM: Morning Session 5: Host Pathogen Interaction – J. daGraca, Moderator**

**Oral Presentations:**

- 8:00 5.1** *Liberibacter* populations in citrus and orange jasmine trees in São Paulo, Brazil – Lopes, S. A., Frare, G. F., Bertolini, E., Wulff, N. A.
- 8:15 5.2** The effects of HLB-infection on respiration and development of roots of feroniella rootstock (*Feroniella oblata*) which showed resistance to HLB bacterium – Ogata, T., Kobori, Y., Kawabe, K., Yonemoto, H., Ohto, Y., Nguyen, T.B., and Nguyen, M.C.
- 8:30 5.3** Anatomical evolution of symptoms from infection with the HLB bacterium – Achor, D. S., Chung, K-R., Exteberria, E., Wang, N., and Albrigo, L. G.
- 8:45 5.4** Influence of temperature on huanglongbing infection under controlled environment – Gasparoto, M. C. G., Bassanezi, R. B., Lopes, S. A., Frare, G., Martins, E. C., Della Colletta Filho, H., Amorim, L.
- 9:00 5.5** Can *Ca. Liberibacter asiaticus* be transmitted through citrus seed? Hartung, J. S., Halbert, S., Shatters, R.
- 9:15 5.6** Biochemical changes after infection with *Candidatus Liberibacter asiaticus* in citrus – JiangBo, Zhong, Y., Wanghui, Yi, G.
- 9:30 5.7** “*Candidatus Liberibacter solanacearum*” associated with zebra chip of potato is not associated with citrus huanglongbing and is absent in Asian citrus psyllid – Li, W., Abad, J. A., and Levy, L.
- 9:45 5.8** Discovery of *Candidatus Liberibacter psyllauros* and its insect vector the tomato psyllid (*Bactericera cockerelli*) – Hansen, A.K., Paine, T.P., Stouthamer, R.

**10:00 – 10:15 AM: Break**

**10:15 – 10:45 AM: Morning Session 5: Host Pathogen Interaction (continued)– J. daGraca, Moderator**

**Oral Presentations:**

- 10:15 5.9** Response of sweet orange (*Citrus sinensis*) to *Candidatus Liberibacter asiaticus* infection: microscopy and microarray analyses – Kim, J-S., Sagaram, U.S., Burns, J. K., Li, J-L., and Wang, N.
- 10:30 5.10** Asian strains of citrus greening bacterium with genetic and pathogenic variation on pummelo – Miyata, S., Tomimura, K., Furuya, N., Okuda, M., Subandiyah, S., Tsai, C.H., Hung, T.H., Su, H.J., and Iwanami, T.

**Posters:**

- 5.11** Detection of *Candidatus Liberibacter asiaticus* in citrus seedlings germinated from Florida seed – Shatters, R. G.

- 5.12** Assessment of transmission of *Liberibacter asiaticus* from seed to seedlings of 'Pineapple' sweet orange and 'Carrizo' citrange – Graham, J. H., Irey, M. S., Dawson, W. O., Hall, D., Duan, Y.
- 5.13** Metabolite changes in HLB orange leaves by GC-MS and other techniques – Cevallos-Cevallos, J.M., Reyes-De-Corcuera, J.I.
- 5.14** Regeneration and chemotherapy of huanglongbing-affected periwinkle – Zhang, M-Q., Duan, Y-P., Powell, C.A.
- 5.15** Differences in secondary metabolites in leaves from trees affected with the greening (HLB) disease – Manthey, J.
- 5.16** Role of *Murraya* species in the spread of huanglongbing – Ramadugu, C., Lopes, S., Manjunath, K., Halbert, S., Roose, M., and Lee, R.
- 5.17** Identification of a new *Liberibacter* species associated with diseases of solanaceous plants – Liefting, L., Sutherland, P.W., Ward, L.I., Weir, B.S., Kumarasinghe, L., Quinn, B.D., and Clover, G.R.G

**10:45 AM – 12:15 PM: Morning Session 6: Asian Citrus Psyllid (Biology and Genomics) – D. Hall, Moderator**

**Oral Presentations:**

- 10:45 6.1** Gene expression in midgut tissues of *Diaphorina citri*: application to biology and vector control – Hunter, W., Marutani-Hert, M., Shelby, K., Coudron, T., Hall, D.
- 11:00 6.2** Pheromones of the Asian citrus psyllid, *Diaphorina citri* Kuwayama (Hemiptera: Psyllidae) elicit behavioral responses from its parasitoid, *Tamarixia radiata* (Waterston) (Hymenoptera: Eulophidae) – Onagbola, E. O., Rouseff, R. L., Stelinski, L. L.
- 11:15 6.3** Effects of freezes on survival of *Diaphorina citri* – Hall, D. G.
- 11:30 6.4** Characterization of electrical penetration graphs of *Diaphorina citri* Kuwayama (Hemiptera: Psyllidae) in citrus – Bonani, J.P., Fereres, A., Appezzato-da-Gloria, B., Garzo, E.I., Miranda, M.P., Lopes, J.R.S.
- 11:45 6.5** Symbionts associated with *Diaphorina citri* Kuwayama (Hemiptera: Psyllidae) in Brazil and a look into their role – Salvador, I., Cônsoli, F. L.
- 12:00 6.6** Endosymbiotic microbiota of Asian citrus psyllid (*Diaphorina citri*) – Marutani-Hert, M., Hunter, W., Dowd, S., and Hall, D.

**Posters:**

- 6.7** FK506-Binding protein from *Diaphorina citri* (Hemiptera: Psyllidae) – Hunter, W., Shatters, R., Hall, D.
- 6.8** Gene expression in Asian citrus psyllid adults feeding from Florida citrus: Application to biology and vector control – Hunter, W., Shelby, K., Dowd, S., McKenzie, C., Shatters, R., Hall, D.
- 6.9** Asian citrus psyllid, genetic basis of immunity – Marutani-Hert, M., Hunter, W.B., Shelby, K.S., Hall, D.G.
- 6.10** Effects of host plant on fitness of the Asian citrus psyllid, *Diaphorina citri* – Tsagkarakis, A. E., and Rogers, M. E.
- 6.11** Development of a potato psyllid (*Bactericera cockerelli*) cell culture - Bextine, B., Tufts, D., Timmons, C., Hunter, W., Marutani-Hert, M.4

**12:15 – 1:45PM: Lunch and Keynote Lecture 2 - Prof. Andrew Beattie**  
**“Evolution of Citrus, *Diaphorina citri*, and *Liberibacter asiaticus*”**

**2:00 – 3:45 PM: Afternoon Session 7: Asian Citrus Psyllid (Ecology and Transmission) – S. Halbert, Moderator**

**Oral Presentations:**

- 2:00 7.1** Acquisition of *Candidatus Liberibacter asiaticus* by the Asian citrus psyllid, *Diaphorina citri*, and the potential use of insecticides to prevent pathogen transmission – Rogers, M. E., Brlansky, R. H., Ebert, T. A., Serikawa, R. H., Schumann, R. A., and Stelinski, K. P.
- 2:15 7.2** Leaf age influencing acquisition of *Candidatus Liberibacter asiaticus* by the psyllid vector *Diaphorina citri* – Bonani, J.P., Appezzato-da-Gloria, B., Fereres, A., Engels, F.E., Lopes, J.R.S.
- 2:30 7.3** Ecological studies on initial invasion of *Diaphorina citri* into the newly planting citrus fields – Kobori, Y., Nakata, T., Ohto, Y., and Takasu, F.
- 2:45 7.4** Spatial distribution of adults of *Diaphorina citri* Kuwayama (Hemiptera: Psyllidae) in ‘Valencia’ sweet orange trees – Costa, M.G., Felipe, M. R., Garbim, L.F., Carmo-Uehara, A., Yamamoto, P.T., Barbosa, J.C.
- 3:00 7.5** Population dynamics of *Diaphorina citri* in citrus orchards in São Paulo State, Brazil – Yamamoto, P.T., Felipe, M.R., Rugno, G.R., Beloti, V. H., Coelho, J.H.C., Ximenes, N.L., Garbim, L.F., Carmo-Uehara, A.
- 3:15 7.6** The seasonal influence of *Candidatus Liberibacter asiaticus* in the Asian citrus psyllid, *Diaphorina citri* Kuwayama (Homoptera: Psyllidae) in Okinawa, Japan – Sadoyama, Y. and Takushi, T.
- 3:30 7.7** Diurnal patterns in flight activity and effect of light on host finding behavior of the Asian citrus psyllid – Sétamou, M., Sanchez, A., Patt, J., Louzada, E.

**Posters:**

- 7.8** Psyllids of citrus orchards in South Texas – Thomas, D.B.
- 7.9** Seasonal occurrence of *Candidatus Liberibacter asiaticus* in Asian citrus psyllids in Florida – Ebert, T.A., Rogers, M.E., and Brlansky, R. H.
- 7.10** Incidence and population of “*Candidatus Liberibacter asiaticus*” in Asian citrus psyllids (*Diaphorina citri*) on citrus plants affected by huanglongbing in Florida – Li, W., Duan, Y.P., Brlansky, R. H., Twieg, E. and Levy, L.
- 7.11** Response of Asian citrus psyllid to aromas emitted by the flushing shoots of their rutaceous host plants in a Y-tube olfactometer. Sétamou, M. and Patt, J. M.

**3:45 – 4:00 PM: Break**

**4:00 – 5:15 PM: Afternoon Session 8: Economics, Fruit Quality, Crop Loss – L. Baldwin, Moderator**

**Oral Presentations:**

- 4:00 8.1** An update on the effect of HLB on orange juice flavor – 2) Sensory evaluation – Plotto, A., McCollum, G., Baldwin, E., Manthey, J., and Irey, M.
- 4:15 8.2** Effect of greening plant disease (huanglongbing) on orange juice flavor and consumer acceptability. Goodrich-Schneider, R., Sims, C., Valim, M., Spann, T., Danyluk M. and Rouseff, R.
- 4:30 8.3** Yield reduction caused by huanglongbing in different sweet orange cultivars in São Paulo, Brazil – Bassanezi, R. B., Montesino, L. H., Amorim, L., Gasparoto, M.C.G., Bergamin Filho, A.
- 4:45 8.4** The production and price effects of citrus greening in São Paulo and Florida on the world orange juice market – Spreen, T. H., Brown, M.G., Jauregui, C.
- 5:00 8.5** The economics of management strategies to mitigate the impact of citrus greening in Florida citrus – Muraro, R.P., Morris, R. A.

**Posters:**

- 8.6** An update on the effect of citrus HLB on orange juice flavor 1) Chemical components – Baldwin, E., Manthey, J., Plotto, A., McCollum, G., and Irey, M.

- 8.7 The citrus greening bibliographical database, a new tool for researchers, students and growers** – Arevalo, H.A., Snyder, G., and Stansly, P. A.

**5:30 – 6:30 PM: Poster Session 2**

**7:00 – 8:15 PM: Conference Dinner**

**8:30 – 10:30 PM: Evening Session 9: Phil Berger and Wayne Dixon, Moderators International Regulatory Agencies – Regulating HLB**

Select representatives for various countries will present how their National Plant Protection Organizations have addressed or are addressing the challenges of HLB. The emphasis will be on what has worked, what has not, and common international unifying themes.

## DAY 4: Thursday, 4 December 2008

**7:00 AM – 5:00 PM: Registration**

**7:00 – 8:00 AM: Continental Breakfast**

**8:00 – 9:45 AM: Morning Session 10: Epidemiology – A. Bergamin, Moderator**

### Oral Presentations:

- 8:00 10.1** Relationship between insecticide sprays and huanglongbing progress in a citrus orchard in São Paulo, Brazil – Bergamin-Filho, A., Gasparoto, M.C.G., Bassanezi, R.B., Amorim, L.
- 8:15 10.2** A stochastic spatiotemporal analysis of the contribution of primary versus secondary spread of HLB – Gottwald, T., Irey, M., Bergamin-Filho, A., Bassanezi, R., and Gilligan, C.A.
- 8:30 10.3** HLB survival analysis – a spatiotemporal assessment of the threat of an HLB - positive tree to its neighbors – Gottwald, T., Irey, M., and Taylor, E.
- 8:45 10.4** Use of mathematical models to inform control of an emerging epidemic – Gilligan, C.A. Cunniffe, N.J., Cook, A.R., DeSimone, R.E. and Gottwald, T.R.
- 9:00 10.5** An approach to model the impact of huanglongbing on citrus yield – Bassanezi, R.B., Bassanezi, R.C.
- 9:15 10.6** The plantation edge effect of HLB – a geostatistical analysis – Gottwald, T. and Irey, M.
- 9:30 10.7** Estimating the spatial distribution of huanglongbing from a sample – Parnell, S., Gottwald, T.R., Irey, M. S., and van den Bosch, F.

### Posters:

- 10.8** Within-tree spatial distribution of *Candidatus Liberibacter asiaticus* – Gottwald, T., Parnell, S., Taylor, E., Poole, K., Hodge, J., Ford, A., Therrien, L., Mayo, S. and M. Irey

**9:45 – 10:00 AM: Break**

**10:00 AM – 12:00 PM: Morning Session 11: Psyllid Management Strategies – M. Rogers, Moderator**

### Oral Presentations:

- 10:00 11.1** Bioecology of *Diaphorina citri* and *Tamarixia radiata*: zoning for citrus groves of the State of São Paulo – Torres, M.G. and Parra, J. R. P., (presented by Lopes, J. S.)

- 10:15 11.2** Repellent effect of guava odor against adults of citrus psyllid, *Diaphorina citri* – Zaka, S. M., Zeng, X. N.
- 10:30 11.3** Wounding of guava (*Psidium guajava* L.) leaves produces defensive sulfur volatiles – Rouseff, R. L., Onagbola, E. O., Smoot, J. M., and Stelinski, L.L.
- 10:45 11.4** Chemical ecology of Asian citrus psyllid (*Diaphorina citri*) and potential applications of behavior-modifying chemicals for its management – Stelinski, L.L., Onagbola, O.E., and Rouseff, R.L.
- 11:00 11.5** Novel reovirus in *Diaphorina citri* (Hemiptera: Psyllidae) – Marutani-Hert, M., Hunter, W., Hall, D.
- 11:15 11.6** Efficiency of insecticides to control *Diaphorina citri*, vector of Huanglongbing bacteria – Yamamoto, P.T., Felipe, M.R., Beloti, V. H., Rugno, G.R.
- 11:30 11.7** Integrated pest management of the Asian citrus psyllid (ACP) in Florida – Stansly, P.A., Qureshi, J.A., and Arevalo, H. A.

#### Posters:

- 11.8** Perspectives for biological control of *Diaphorina citri* (Hemiptera: Psyllidae) in Mexico. López-Arroyo, J.I., Jasso, J., Reyes, M., Loera-Gallardo, J., Cortez-Mondaca, E. and Miranda, M.
- 11.9** Investigations of the feasibility for managing the Asian citrus psyllid using *Isaria fumosorosea* – Avery, P.B., Hunter, W. B., Hall, D. G., Jackson, M. A. Powell, C. A., Rogers, M. E.
- 11.10** Natural enemies of *Diaphorina citri* Kuwayama in Northwest Mexico – Cortez-Mondaca, E., Lugo-Angulo, N. E., Pérez-Márquez,
- 11.11** Managing Asian citrus psyllid *Diaphorina citri* with soil and foliar applications of insecticides – Qureshi, J. A., and Stansly, P. A.

**12:00 – 1:30 PM: Lunch and Keynote Lecture 3 – Prof. Hong-Ji Su “Research and Health Management of Citrus Huanglongbing in Taiwan”**

**1:45 – 3:45 PM: Afternoon Session 12: HLB Management Strategies – J. Graham, Moderator**

#### Oral Presentations:

- 1:45 12.1** Factors associated with control of Huanglongbing in São Paulo, Brazil: A case study - Belasque, J., Bassanezi, R.B., Yamamoto, P.T., Lopes, S.A., Ayres, A.J., Barbosa, J.C., Tachibana, A., Violante, A.R., Tank, A., Giorgetti, C.L., Di Giorgi, F., Tersi, F. Menezes, G., Dragone, J., Catapani, L.F., Jank, R.H. and Bové, J. M.
- 2:00 12.2** Monitoring psyllids for early detection and management of Huanglongbing – Manjunath, K.L., Halbert, S.E., Ramadugu, C., and Lee, R.
- 2:15 12.3** Occurrence and management strategies for HLB in the State of Paraná, Brazil – Leite, R.P.
- 2:30 12.4** Observations gleaned from the geospatially referenced and documented spread of HLB in three commercial groves in Florida and the implications of these observations on scouting and management decisions – Irey, M., Gast, T., Terra, R., and Snively, J.
- 2:45 12.5** Effect of strategies of inoculum reduction and vector control on Huanglongbing progress – Bassanezi, R. B., Yamamoto, P.T., Gimenes-Fernandes, N., Montesino, L. H., Tersi, F.E.A., Sperandio, P. H., Gottwald, T. R., Bergamin-Filho, A., Amorim, L
- 3:00 12.6** Better management for citrus greening: chemical-uses or guava-interplanting? Ichinose, K., Bang, D. V., Dien, L. Q.
- 3:15 12.7** Imidacloprid-induced systemic acquired resistance (SAR) in Cleopatra mandarin and development of HLB – Graham, J. H., Dawson, W. O., Robertson, C.

#### Posters:



- 12.8** Detection of greening in sprouts from citrus tree stumps – Futch, S., Brlansky, R., Irey, M., and Weingarten, S.
- 12.9** Beating huanglongbing – an integrative solution – Hunter, W. B., Peretz, Y., Sela, I., Huet, H., Lapidot, M., Yarden, G.
- 12.10** Flying dragon trifoliolate orange rootstock for high density plantings in São Paulo, Brazil – Stuchi, E.S., Silva, S.R., Sempionato, O.R., Reiff, E.T.
- 12.11** Research on the technique of eliminating huanglongbing disease from Tankan - Yun Zhong, Ganjun Yi, Bo Jiang, Nonghui Jiang, Yan Liu
- 12.12** National and international networking to develop solutions for HLB in South America – Franca, F. H., Machado, M. A., Vieira, L.F., Morais, A. M., Astúa, J. F., Lopes, D. B., Druck, S.
- 12.13** Delivery of antibacterial peptides into citrus cultivars for the control of citrus Huanglongbing (HLB; citrus greening) - Gowda, S., Folimonova, S., Robertson, C., Shilts, T., Garnsey, S. M., and Dawson, W. O.
- 12.14** Micro-budded, High Density Citrus Planting: Is There an Opportunity for HLB Control and Financial Returns? – Skaria, M. and Hanagriff, R.
- 12.15** The State of California implements its action plan for Asian Citrus Psyllid - Polek, M. and Luque-Williams, M.J.

### 3:30 – 3:45 PM: Break

### 3:45 – 5:45 PM: Afternoon Session 13: Host Resistance – F. Gmitter, Moderator

#### Oral Presentations:

- 3:34** **13.1** Genetic modification of citrus for resistance against citrus greening: preventing expression of anti-bacterial peptides in the fruit – Gurley, B.
- 4:00** **13.2** Susceptibility of some local mandarins to a Japanese isolate of *Candidatus Liberibacter asiaticus* – Iwanami, T., and Miyata, S.
- 4:15** **13.3** Developing transgenic solutions for HLB resistant citrus at the US Horticulture Research Laboratory – Stover, E., Bowman, K., McCollum, G., Niedz, R.
- 4:30** **13.4** A newly developed agilent microarray designed for the characterization of citrus responses to pathogens – Moore, G. A., Khalaf, A. A., Febres, V. J., Li, L., and Gmitter, F.
- 4:45** **13.5** Transgenic approaches to control bacterial diseases of citrus – Astúa-Monge, G., Francischini, F.J.B., Kemper, E., Capella, A., Kitajima, J.P., Ferro, J. A., da Silva, A.C.R.
- 5:00** **13.6** Towards the ultimate solution: genetic resistance to HLB in commercial citrus – Grosser, J.W., Dutt, M., Omar, A., Orbovic, V., and Barthe, G. A.
- 5:15** **13.7** Examination of host responses of different citrus varieties to HLB infection – Folimonova, S. Y., Garnsey, S. M., and Dawson, W. O.
- 5:30** **13.8** Evaluation of *Candidatus Liberibacter* spp. in genetically transformed sweet orange 'Hamlin' with atacin A gene – Simões, T. S., Boscariol-Camargo, R.L., Mendes, B.M.J., Mourão Filho, F.A.A., Carlos, E.F., Machado, M.A.

#### Posters:

- 13.9** Colonization of citrus relatives by *Candidatus Liberibacter asiaticus* – Boscariol-Camargo, R. L., Simões, T. S., Malosso, A., Carlos, E.F., Coletta Filho, H.D., Machado, M.A.
- 13.10** Occurrences of huanglongbing disease of pomelo (*Citrus grandis*) in Northern Thailand – Akarapisan, A., Piwkhao, K., Chanbang, Y., Naphrom, D., Santasup, C.
- 13.11** A preliminary survey of HLB survivors found in abandoned citrus groves – Chen, C., Zeng, J., Yi, G., Xiao, Y., Ou, S., Gmitter, F.

- 13.12 Using transgenic NPR1 to enhance systemic acquired resistance (SAR) in citrus** – Febres, V. J., Moore, G. A.
- 13.13 Navelina ISA 315 sweet orange: a CVC tolerant cultivar** – Stuchi, E.S., Silva, S.R., Coletta-Filho, H.D., Franco, D., Carvalho, S.A., Sempionato, O.R. Donadio, L.C., Alves, K.C.S.
- 13.14 Phloem specific transgene expression of anti-bacterial genes driven by AtSUC2 gene promoter in transgenic citrus plants to develop citrus greening resistance** Omar, A., Dutt, M., Barthe, G., Orbovic, V. and Grosser, J.
- 13.15 Citrus variegated chlorosis damage assessment in six sweet orange cultivars in São Paulo, Brazil.** Franco, D., Stuchi, E., Silva, S., Martins, A., Laranjeira, F.
- 13.16 Colonization of Asiatic Citrus Psyllid and Huanglongbing Development on Citrus and Citrus Relatives in Indonesia** – Subandiyah, S., Himawan, A., Joko, T., Astuti I.P., Holford, P., Beattie, G.A.C., Krugger, R.
- 13.17 A transgenic approach to the control of citrus greening** - Reddy, J.D., and Gabriel, D.W.

**6:00 – 7:00 PM: Poster Session 3**

**7:00 – 8:45 PM: Conference Farewell Banquet**

## **DAY 5: Friday, 5 December 2008**

**7:00 – 8:00 AM: Continental Breakfast**

**8:00 – 8:20 AM: Morning Session 14: Jerry Newlin, Moderator International Citrus Industries – Coping with HLB**

**8:00 – 8:10 AM: Presentation of Ranked International Research Priorities** – T. Gottwald and W. Dixon

**8:10 – 8:30 AM: Florida Citrus Producers Research Advisory Council (FCPRAC)/National Academy of Science (NAS) –Research and Development** - Tom Turpen

### **Key Take-Home Messages and a View to the Future:**

**8:20 – 10:00 AM: Summaries of Research Sessions**

Tim Schubert	HLB status and crop losses
Mike Irey	Survey, detection, diagnosis
William Dawson	Pathogen sequencing and culturing
John daGraça	Host pathogen interaction
David Hall	Psyllid biology and genomics
Michael Rogers	Psyllid management
Andrew Beattie	HLB management
Ed Stover	Host resistance

**9:45 – 10:15 AM: General Panel Discussion and Question and Answer**

**10:15 – 10:45 AM: Industry Summaries/Perspectives**

Juliano Ayres  
Ray Prewett  
Ted Batkin  
Peter McClure

**10:45 – 11:15 AM: General Panel Discussion and Question and Answer**

**11:15 – 11:45 AM: Regulatory Summaries/Perspectives**  
P. Berger (or P. Gomes/Russ Bullock)  
W. Dixon (or T. Schubert)

**11:45 AM – 12:15 PM: General Panel Discussion and Question and Answer**

**12:15 – 12:30 PM: Jerry Newlin – Final Wrap up**

**USDA, APHIS HLB National Science Panel Meeting (By invitation only)**

**1:30 –5:00 PM: Afternoon Special Session 15 - Phil Berger, Moderator**

**A4 Huanglongbing (HLB) a graft transmissible psyllid-borne citrus disease: Diagnosis and strategies for control in Reunion Island - A case study** (Translation from French of excerpts from the original 1988 Ph.D. Thesis of Benard Aubert, entitled: *Le greening une maladie infectieuse des agrumes d'origine bactérienne transmise par des homoptères psyllidés Stratégies de lutte développées à l'île de la Réunion, Circonstances épidémiologiques en Afrique Asie et modalités d'intervention*).

**A5. THE CITRUS HUANG LUNG BIN (GREENING) DISEASE IN CHINA** - Kung Hsiang LIN and Kung Hsun LIN. South China Agricultural College, Plant Protection Department, South China Agricultural Research Institute, Guangzhou, Guangdong, P. R. C. Document translated from the original Chinese by Kung Hsun LIN and adapted by B. AUBERT. Original document published in 1956 in *Acta Phytopathologica Sinica*, Vol. II, Part I, No. I, pp. I-II and Part 2, pp. 14-48.



Kung Hsun Lin. *Photo courtesy of B. Aubert.*

**A6.****Ranking of HLB Research Priorities****Gottwald T., Dixon W., Berger P., Graham J., and Taylor E.**

The rapid global expansion and growing economic damage caused by HLB has prompted citrus industries worldwide to explore investing in research that has potential to provide tools for mitigation/control of the epidemics before these industries succumb to the disease. Various research priorities have been identified in previous HLB meetings and workshops. Recently, both the National Academy of Sciences (NAS) and USDA ARS have compiled lists of current and future research areas that can be used by universities, federal and state government agencies, and citrus industries to prioritize and fund research. These areas mostly fall under the following broad general categories.

Economics	Alternate Hosts
Detection of Disease/Vector	Differentiation
Resistance and Breeding	Culturing HLB
Pathogen/Vector Interactions	Citrus Genetics
Chemical Control	Biological Control
Cultural Control	Pathogenesis
Epidemiology	Transgenics
Genomics	Vector Biology
Fruit Yield/Quality	

Delegates of the conference were asked to examine potential research priorities that were identified both by NAS and ARS expert panels. To accomplish this, survey forms were distributed during the IRCHLB and delegates were asked to rank the research priorities listed. Forms were created for this purpose and are shown below (Figures 1 and 2). Conference delegates were asked to indicate their affiliation in categories of: Researcher/Scientist, Citrus Industry, or Regulatory. Delegates were then asked to rank each of the research priorities on the basis of: A) Probability of Success, B.) Impact if Successful, and C.) Duration, i.e., Short versus Long Term, each of these was ranked on a 1 to 5 (low to high) scale as indicated on the survey forms.

Survey data were summarized in two ways. First as an overall ranking by adding the ranking scores of the three criteria A) Probability of Success, B.) Impact if Successful, and C.) Duration. Results of this first ranking are shown in Figures 3 to 6 for the NAS-identified priorities, and in Figures 7 to 10 for the ARS-identified priorities, in descending order. Second, the rankings were broken into the three criteria and are displayed in 3-D graphs, with each of the criteria on a separate axis, for both the NAS (Figures 11 to 13) and ARS (Figures 14 to 18) research priorities, respectively. For Figures 11 to 18, each of the individual ranked priorities is identified by its respective ID number on the 3-D graphs.

The 3-D graphs demonstrate that the dispersion of the ranked priorities was moderately clustered by Research/Scientist (Figures 11, 12, 14) and Regulatory delegates (Figures 15, 16, 18), whereas, Citrus Industry delegates tended to rank the priorities in a more dispersed fashion (Figures 13 and 17).

**Acknowledgment:** *We thank K. Poole, G. Poole, and A. Ford for data input during the conference.*

Figure 1. HLB Research Priorities Survey Form - Page 1.

Page 1.

**International Research Conference on Huanglongbing (IRCHLB)  
Orlando, FL December 1-5, 2008**

**Research Priorities**

<b>Affiliation</b>						
<input type="checkbox"/> <b>Researcher/Scientist</b>	<input type="checkbox"/> <b>Citrus Industry</b>	<input type="checkbox"/> <b>Regulatory</b>				
			For each Research Priority, rank the probability of success, impact and duration from 1 to 5, with 1 being the lowest (shortest) and 5 being the highest (longest).			
			<table border="1"> <thead> <tr> <th><b>A)</b> Probability of Success (1 - 5)</th> <th><b>B)</b> Impact Successful (1 - 5)</th> <th><b>C)</b> if Duration-- Short vs Long term (1 - 5)</th> </tr> </thead> </table>	<b>A)</b> Probability of Success (1 - 5)	<b>B)</b> Impact Successful (1 - 5)	<b>C)</b> if Duration-- Short vs Long term (1 - 5)
<b>A)</b> Probability of Success (1 - 5)	<b>B)</b> Impact Successful (1 - 5)	<b>C)</b> if Duration-- Short vs Long term (1 - 5)				
<b>NAS Identified Research Priorities 2008</b>						
1. Perform Koch's postulates to conclusively demonstrate that Liberibacter is the causative agent of HLB and investigate biological properties of any relevant co-cultures.						
2. Identify psyllid repellents from guava volatiles and other sources.						
3. Construct Liberibacter genomic DNA library. Sequence and assemble full-length genome sequence.						
4. Determine if modified spray techniques/applications etc. can improve psyllid control.						
5. Develop transformation systems for mature tissue of commercial varieties (both rootstocks and scions).						
6. Determine if RNA interference can be used to manipulate psyllid gene expression.						
7. Develop improved (faster and more sensitive) assays for Liberibacter using PCR-, antibody-based, remote sensing, or other methods of detection.						
8. Identify proteins or peptides that have anti-Liberibacter activity.						
9. Examine the effects of oils and particle films on psyllids and HLB transmission.						
10. Characterize the microbiome of citrus phloem tissue.						
11. Identify attractants (chemical, color) in psyllid hosts and from other sources.						
12. Examine effectiveness of flush management in controlling citrus psyllid interactions and HLB transmission. Ways to improve flush management include high-density planting using micrografting and tree dwarfing (with dwarfing factors, e.g. different rootstock).						
13. Save Rutaceous germplasm; Screen citrus and Vepris germplasm for Liberibacter resistance and initiate citrus breeding to develop HLB resistant citrus.						
14. Identify biological proteins (Bt-like) that affect the psyllid.						
15. Examine the relationship between environmental factors (light intensity, temperature, etc.) and HLB symptoms and timing of host and pathogen responses.						
16. Develop HLB resistant citrus by mutagenesis and selection.						
17. Perform detailed Liberibacter transmission studies using psyllid, Liberibacter and citrus genotypes found in Florida.						
18. Determine if Liberibacter is seed transmitted in citrus.						
19. Develop a more facile (non-citrus) model system for HLB.						
20. Identify factors related to variability of psyllid acquisition of pathogen; establish why less than 100% of psyllids will acquire Liberibacter.						
21. Develop fast assay for detecting pathogen in the psyllid.						
22. Determine the latency period between inoculation of citrus with Liberibacter and development of HLB symptoms, under different pathogen titers and different host conditions (phenology).						
23. Study effects of anti-microbial compounds on HLB in citrus.						
24. Examine transcript, protein and metabolite levels in Liberibacter infected citrus to better understand the plant's response to HLB.						
25. Determine if citrus explants in tissue culture support high levels of Liberibacter.						
26. Grow nursery and production stock under screen until fruit-bearing age.						
27. Conduct economic feasibility studies of alternative citrus production systems (i.e. high density planting, hydroponics, screen house propagation/culture, intercropping with guava).						
28. Develop a detailed understanding of the mechanism of HLB transmission, including Liberibacter acquisition time, mechanism of attachment to psyllid, inoculation period. Determine the mechanism and location of attachment of Liberibacter in psyllids.						
29. Examine life cycle of psyllid in detail, including mating cues (acoustics), migration/dispersal patterns, stylus formation, etc.						
30. Develop better methods for monitoring and determining the presence of psyllids in the environment.						
31. Develop psyllids by breeding or transgenic approaches that do not vector Liberibacter.						
32. Synthesize repellents or engineer microbes to synthesize repellants.						
33. Sequence an EST library of psyllid genes.						
34. Examine seasonal distribution of Liberibacter in citrus (both levels and location within a tree). Analyze the distribution of Liberibacter in symptomatic and asymptomatic citrus tissues. Develop molecular research tools for Liberibacter including monoclonal antibodies to Liberibacter, reference strains of Liberibacter and psyllids, cDNA and genomic libraries of Liberibacter.						
35. Examine effectiveness of different methods to stimulate systemic acquired resistance to HLB in citrus.						

Page 2.

**ARS Researchable Areas from ARS HLB Workshop: 4-23-08****CROP IMPROVEMENT**

A) Probability of Success (1 - 5)	B) Impact if Successful (1 - 5)	C) Duration- of - Short vs Long term (1 - 5)
---	--	---

**Plant host resistance to HLB**

1. Transgenic/cisgenic resistant varieties and rootstocks.			
2. Induced resistance w/ SAR.			
3. Virus-based host resistance (to pathogen or vector) for screening/therapy.			
4. Conventional breeding rootstocks.			
5. Host response mechanisms. Direct RNA sequencing (compare healthy vs infected plants) e.g., role of miRNAs in disease development.			

**VECTOR BIOLOGY AND MANAGEMENT****Psyllid biology**

1. Vector biology, seasonality, environmental effects, life history, dispersal.			
2. Vector capacity, survival, transmission efficiency, propensity.			
3. Vector genomics, including expression.			

**Psyllid resistance and response to the HLB pathogen**

1. Transgenic psyllid			
2. Endosymbiont targets (e.g., Wolbachia/virus transformation for Liberibacter control)			
3. Strain diversity; host-compatibility groups			
4. Histopathology of psyllid-vector relationship			

**Psyllid-based control**

1. Urban areas? Homeowner psyllid management?			
2. Area-wide program?			
3. Symbiont manipulation for vector control			
4. Novel pesticide development (RNAi targeted at specific psyllid genes for treatment of vector, BT library evaluation)			
5. Insecticide resistance management			
6. Insect repellent plant development ("virtual nets")			
7. Mating disruption by...sound/pheromones, etc.			
8. Plant Volatiles (attractants-Murraya, repellents)			
9. Natural enemies, esp. for unmanaged citrus, e.g., parasites, predators, fungal/viral pathogens of insect			
10. Kaolin clay applications			
11. Barrier-based control (plants or netting impregnated with insecticide)			
12. Wind breaks with lures and chemical treatment (trap plant)			

**PATHOGEN AND DISEASE BIOLOGY AND DETECTION****Pathogen biology and detection**

1. Pathogen detection			
2. Genome sequence			
3. Culture organism to supplement current effort (high throughput methods)			
4. Improved diagnostics in psyllid and plant tissue			
5. Pathogen variability and diversity			
6. ID factors critical to pathogenesis, virulence: Functional genomics, gene expression, proteomics, direct RNA sequencing			
7. Population biology and spatial and temporal distribution in planta			
8. Asymptomatic plant host range e.g., source of resistance, reservoir for inoculum			

**Disease biology**

1. Etiology (Koch postulates for Liberibacter., metagenomics from phloem and psyllid endophytes)			
2. Sources of variability in symptoms (interaction with other microbes, endophytes, stress interactions)			
3. Early disease detection (non-pathogen based)			
4. High throughput disease detection (e.g., imaging techniques, hyperspectral detection or laser or microwave detection, trained dogs)			
5. Seed transmission and seed treatment			
6. Rescue of infected germplasm/breeding material from field/seed			

**EPIDEMIOLOGY AND DISEASE MANAGEMENT****Epidemiology and Management of HLB**

1. Symptom remission methods (antibiotics, others? Injection methodology)			
2. Intercropping for disease management (e.g., guava)			
3. Volatile effects and identification			
4. Replacement tree protection via physical/chemical barriers (e.g., slow release "virtual net")			
5. Repellents/avoidance factors (e.g., kaolin itself and as a carrier)			
6. Cultural methods (e.g., nutrient delivery, early production systems, flush management, open hydroponic systems)			
7. Effect of climate on disease biology (e.g. effect on range of endemic Liberibacter and psyllid, grow in Northern FL?)			
8. Fruit/juice quality and abscission (productivity and quality in infected and treated trees)			



Figure 3. Ranked NAS Priorities

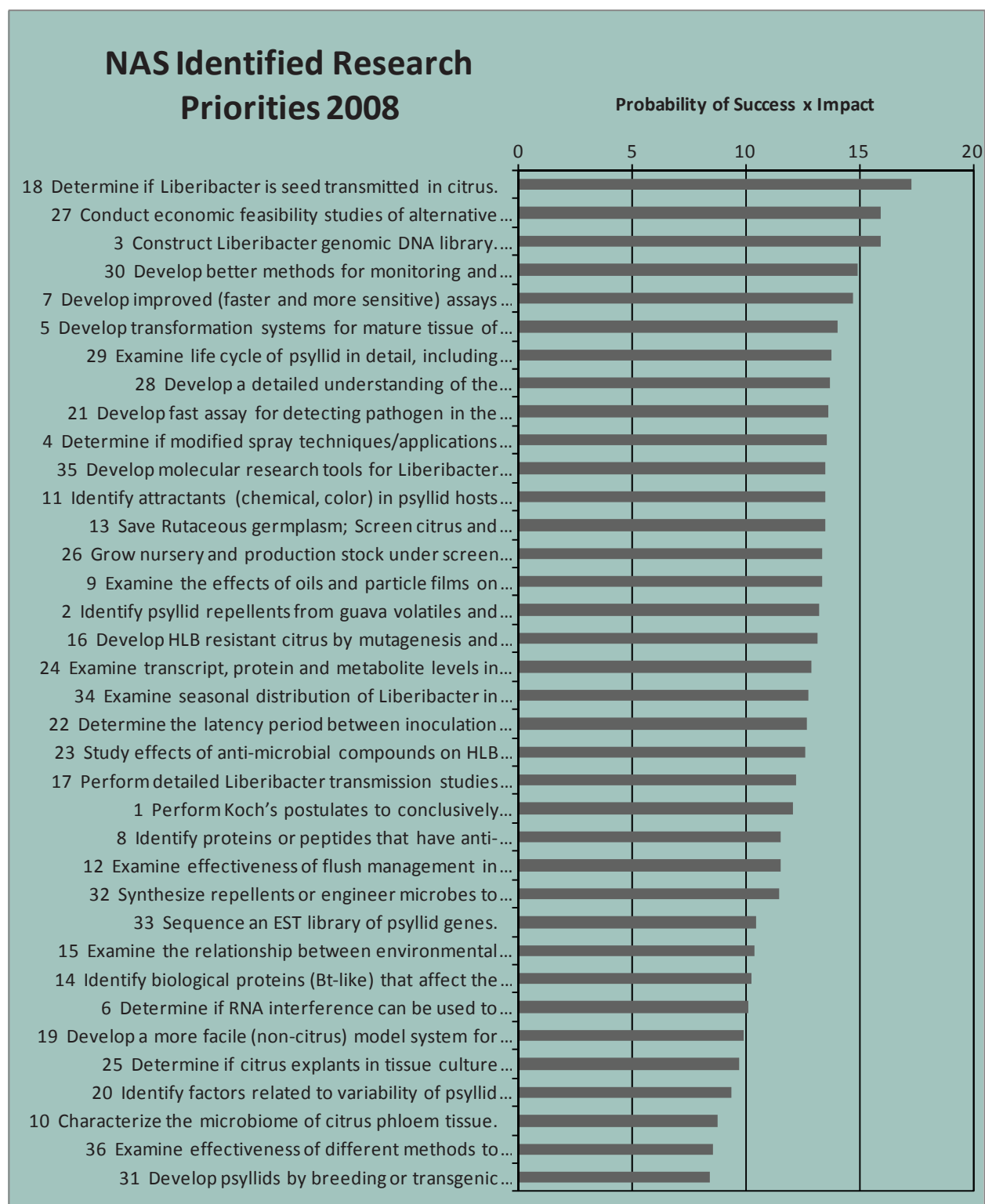


Figure 4. Ranked NAS Priorities

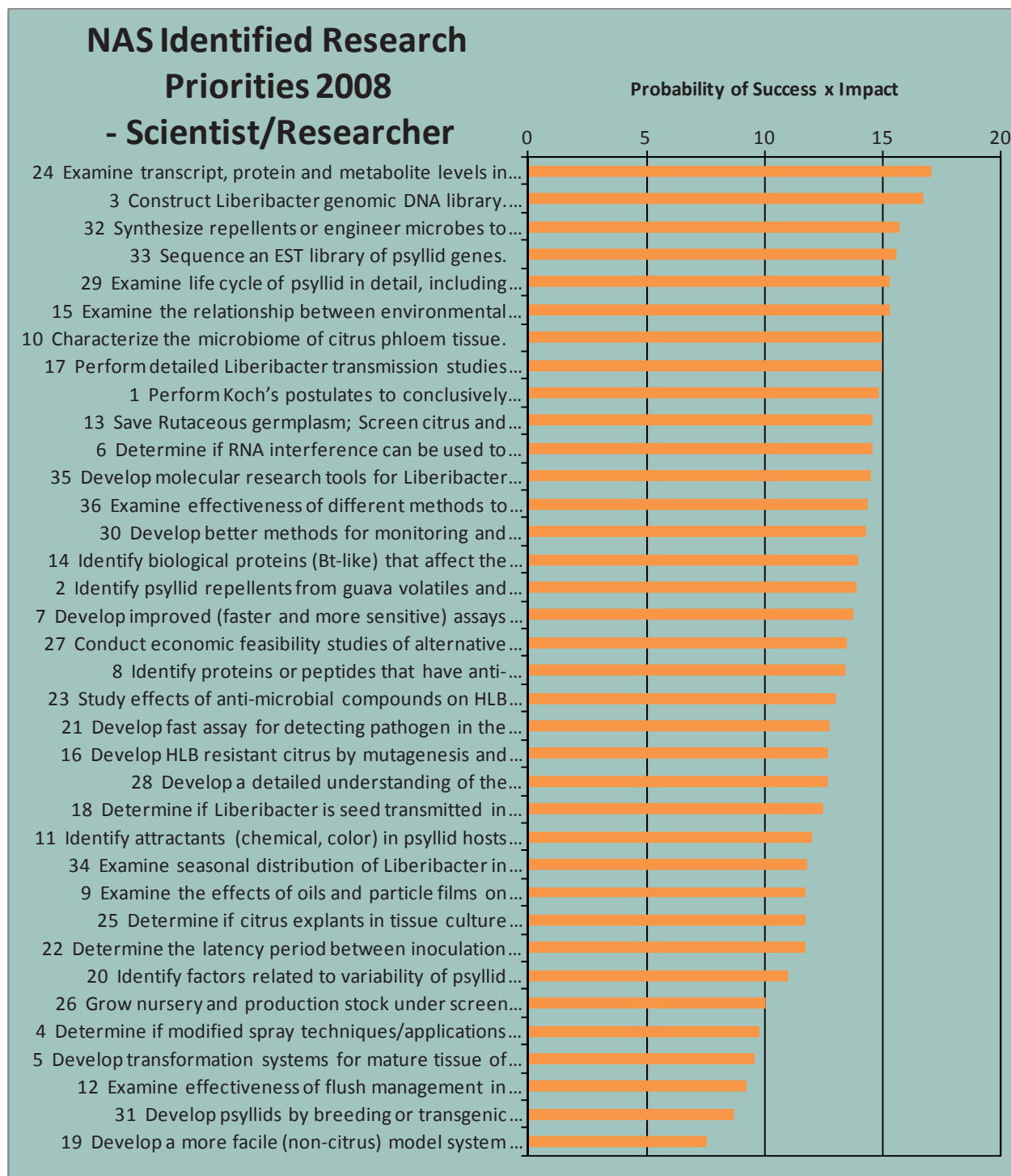


Figure 5. Ranked NAS Priorities

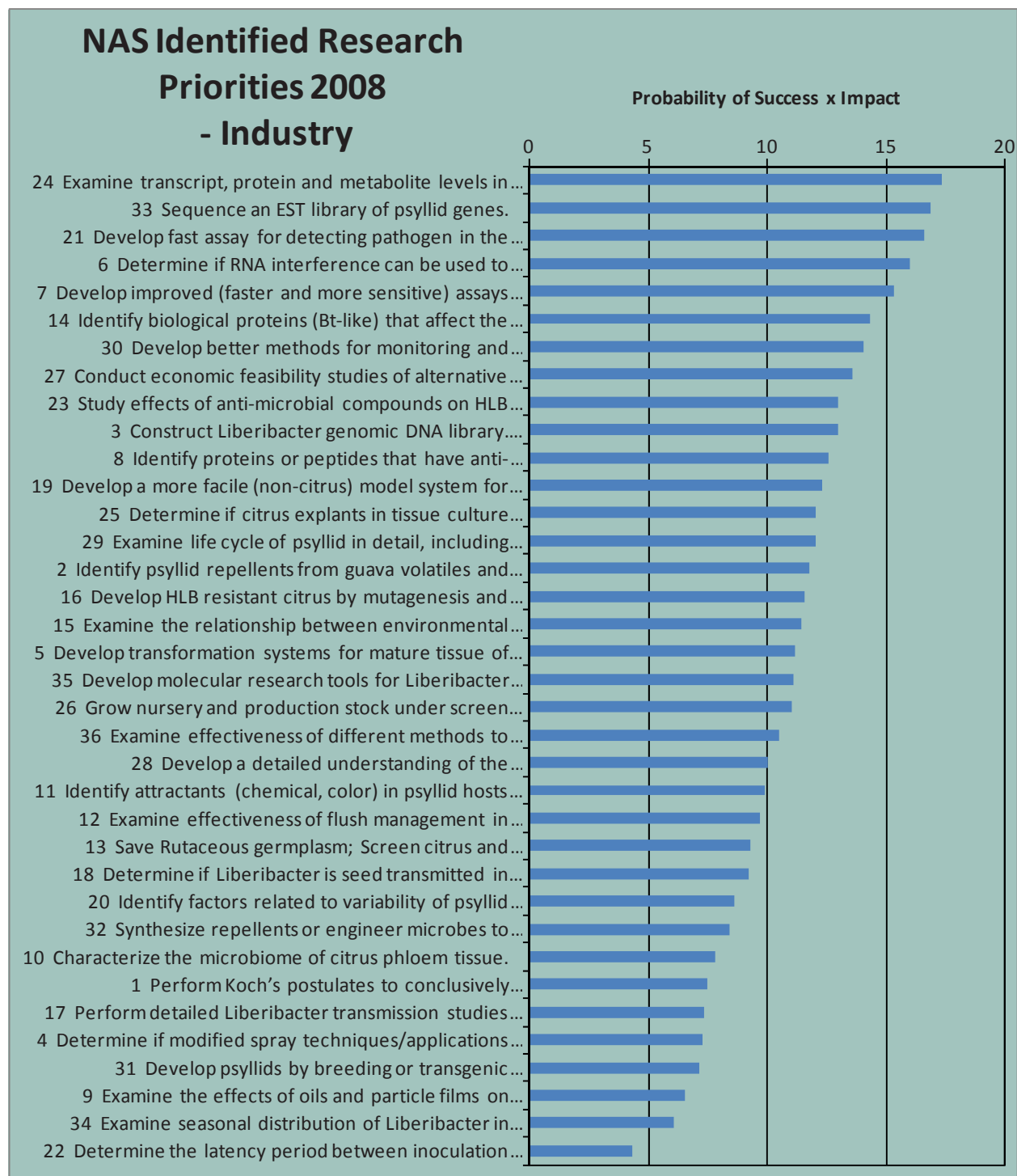


Figure 6. Ranked NAS Priorities

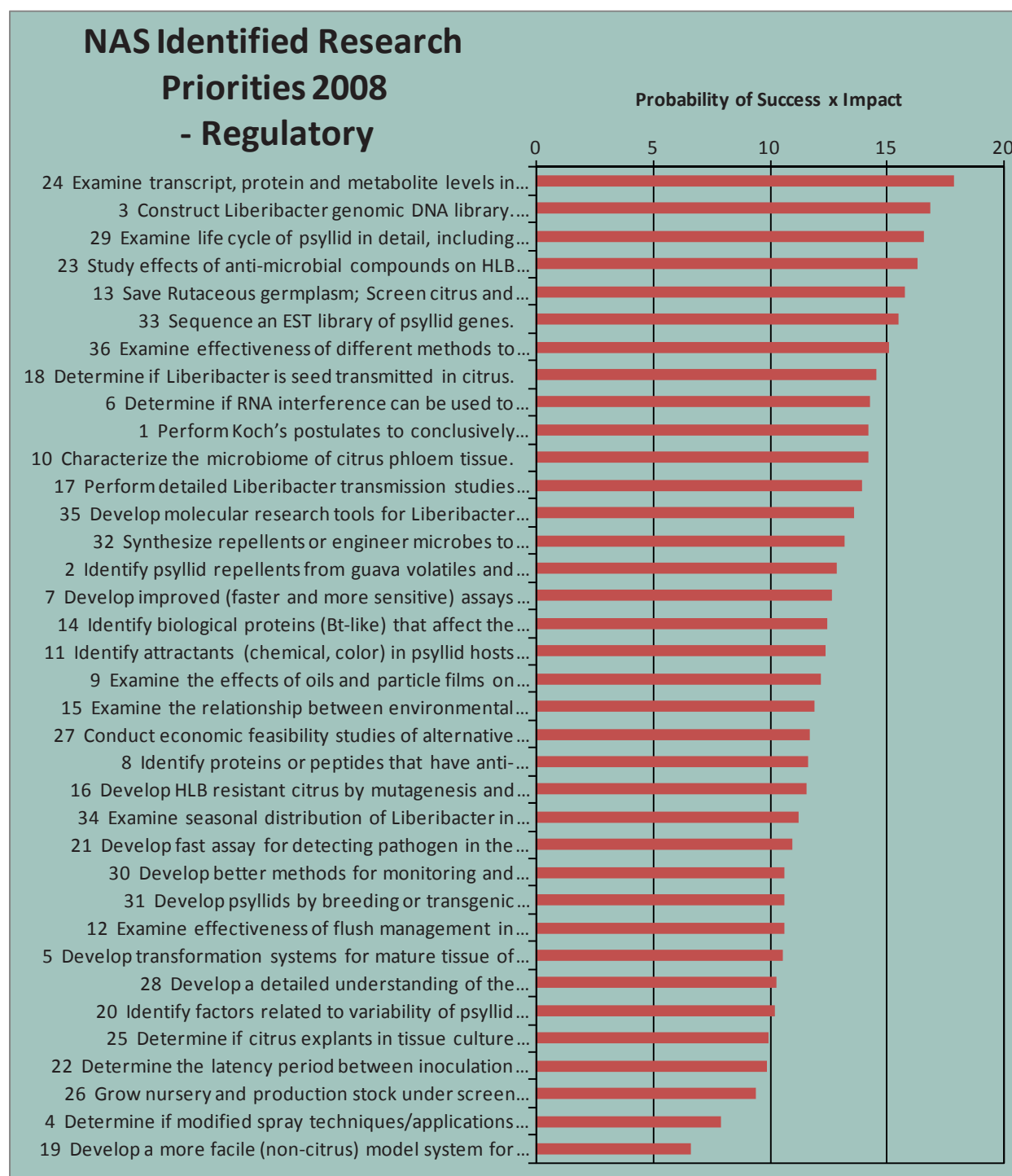


Figure 7. Ranked ARS Priorities

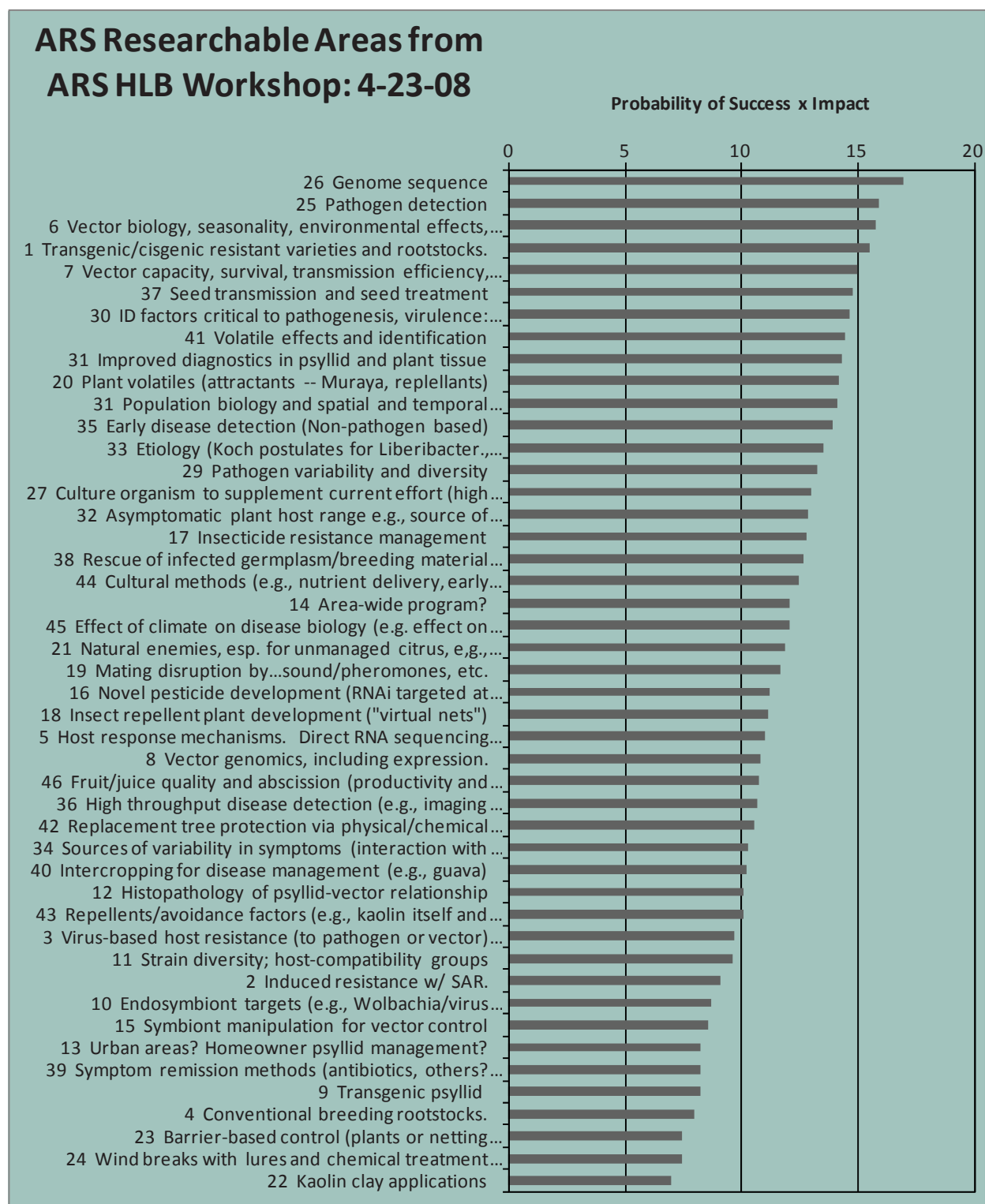


Figure 8. Ranked ARS Priorities

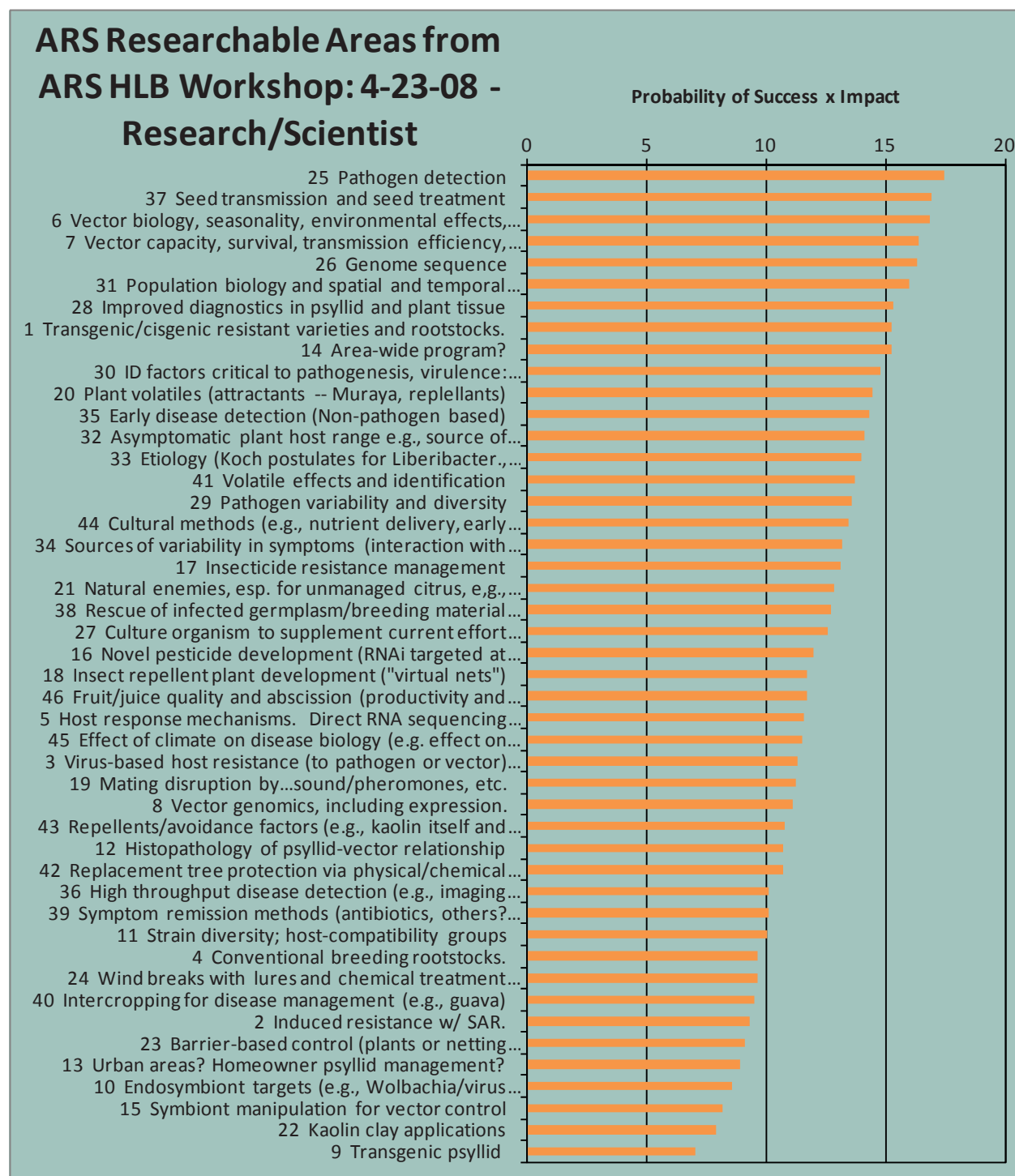


Figure 9. Ranked ARS Priorities

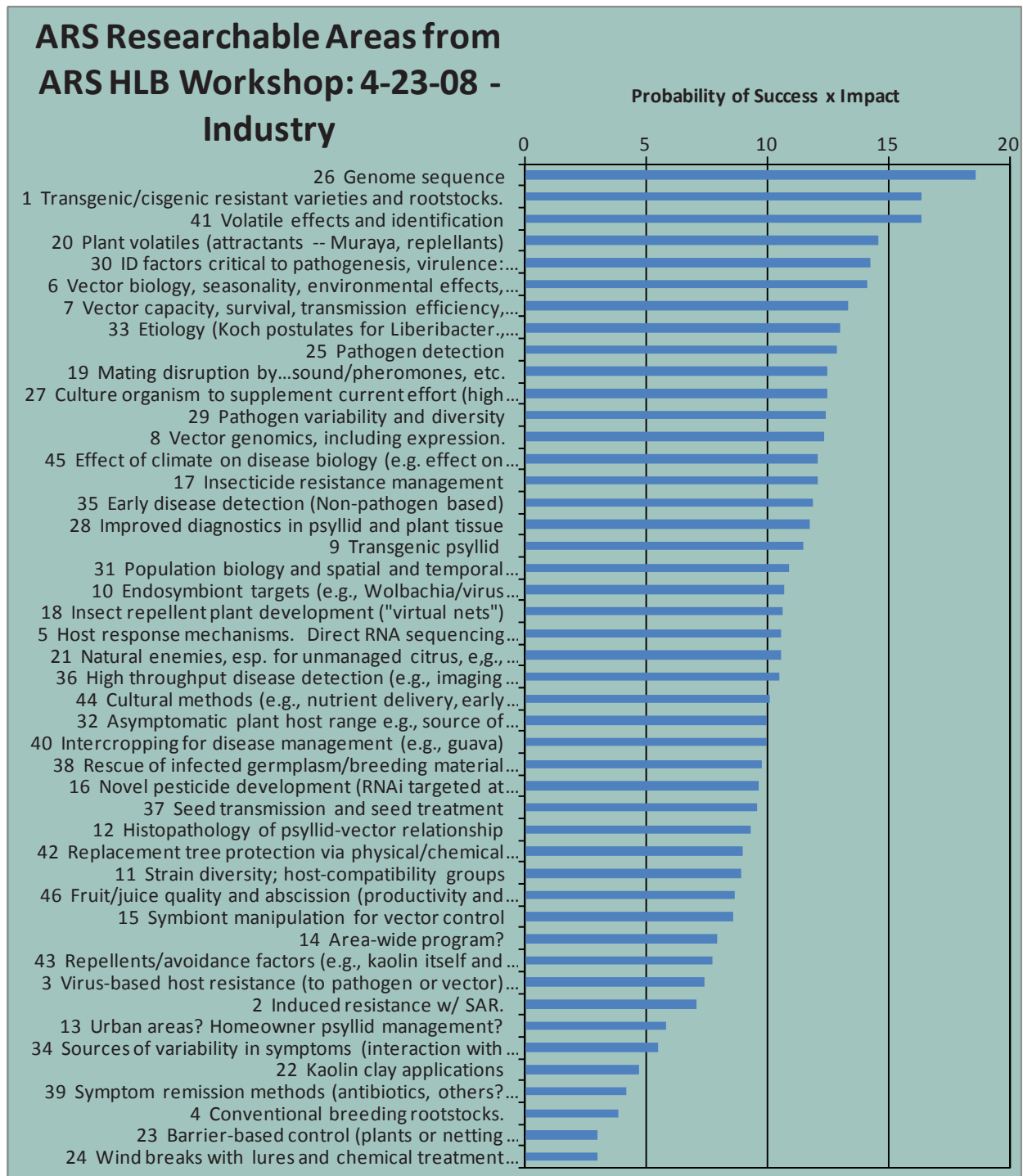


Figure 10. Ranked ARS Priorities

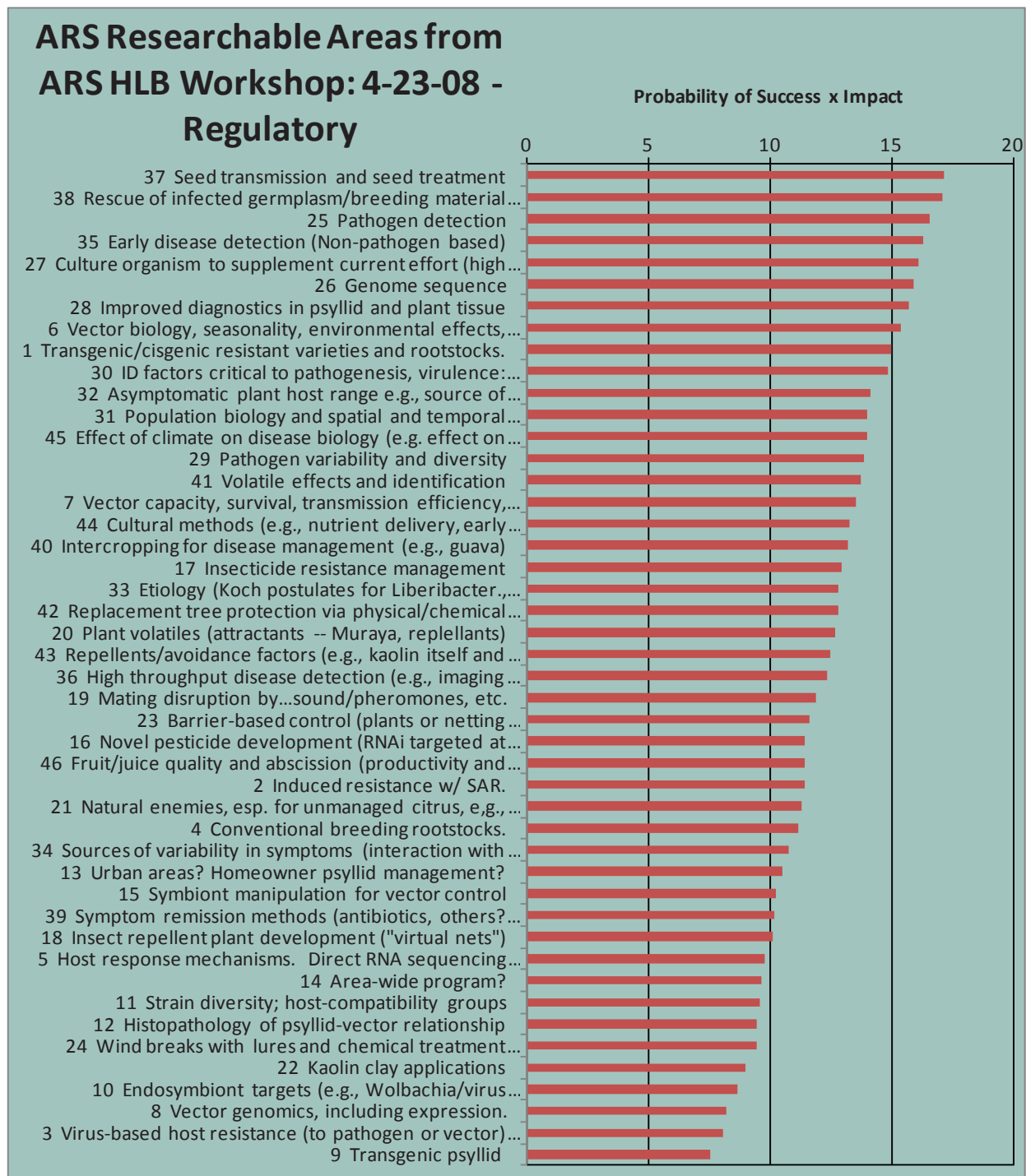




Figure 11. NAS Ranking of Impact vs. Success vs. Duration.  
 NAS Identified Research Priorities 2008

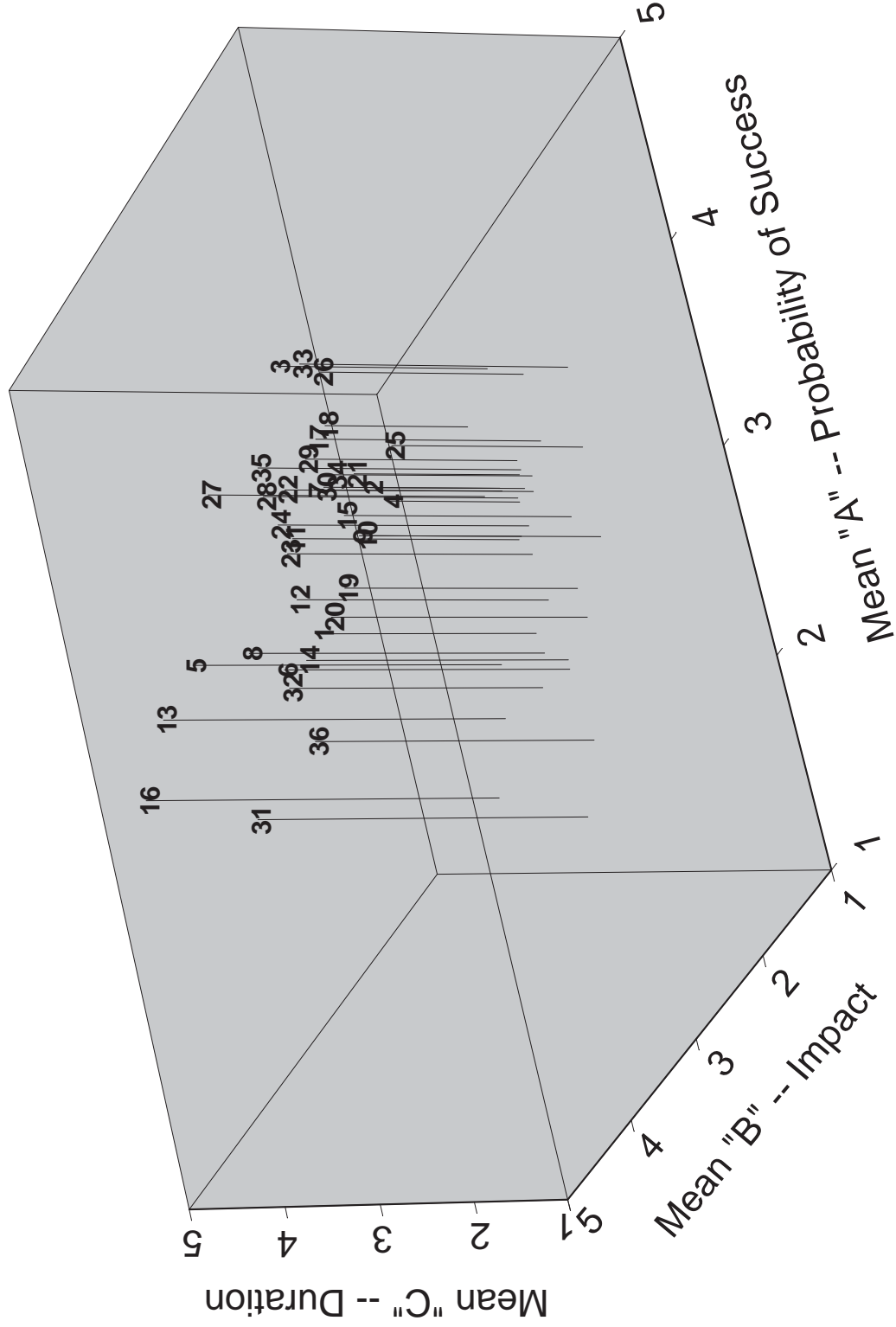


Figure 12. NAS Ranking of Impact vs. Success vs. Duration.

### NAS Identified Research Priorities 2008

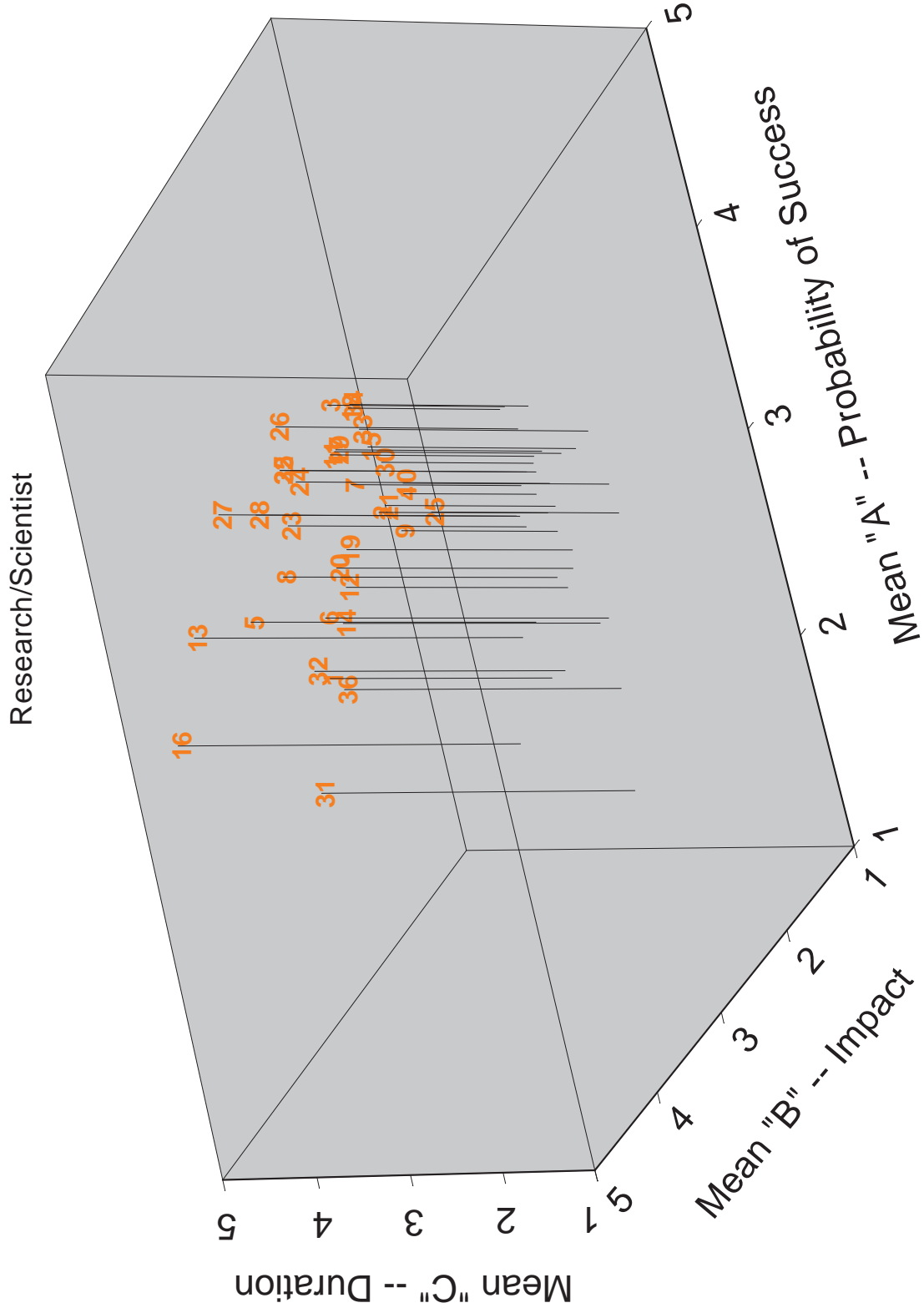


Figure 13. NAS Ranking of Impact vs. Success vs. Duration.

### NAS Identified Research Priorities 2008

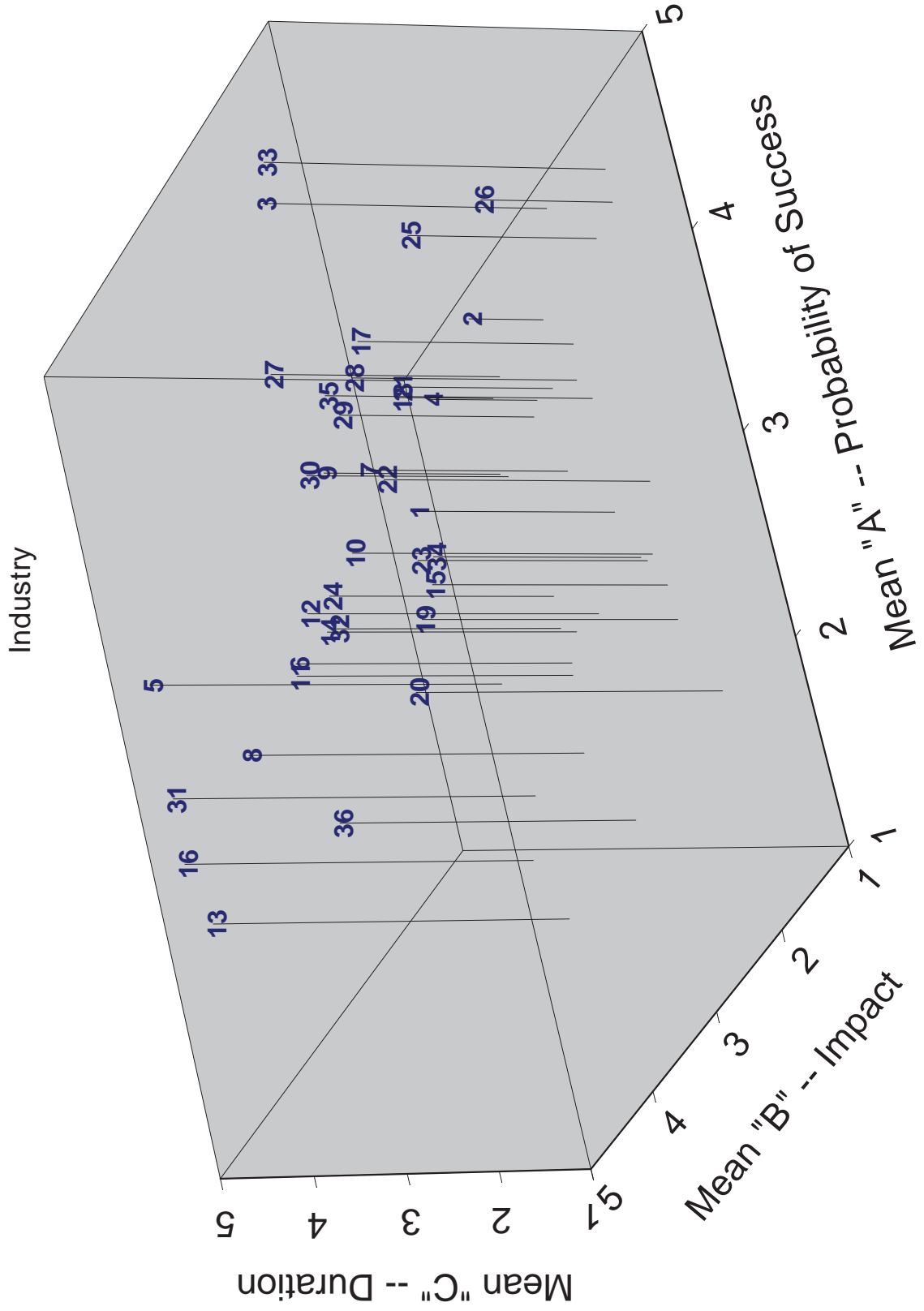


Figure 14. NAS Ranking of Impact vs. Success vs. Duration.

## NAS Identified Research Priorities 2008

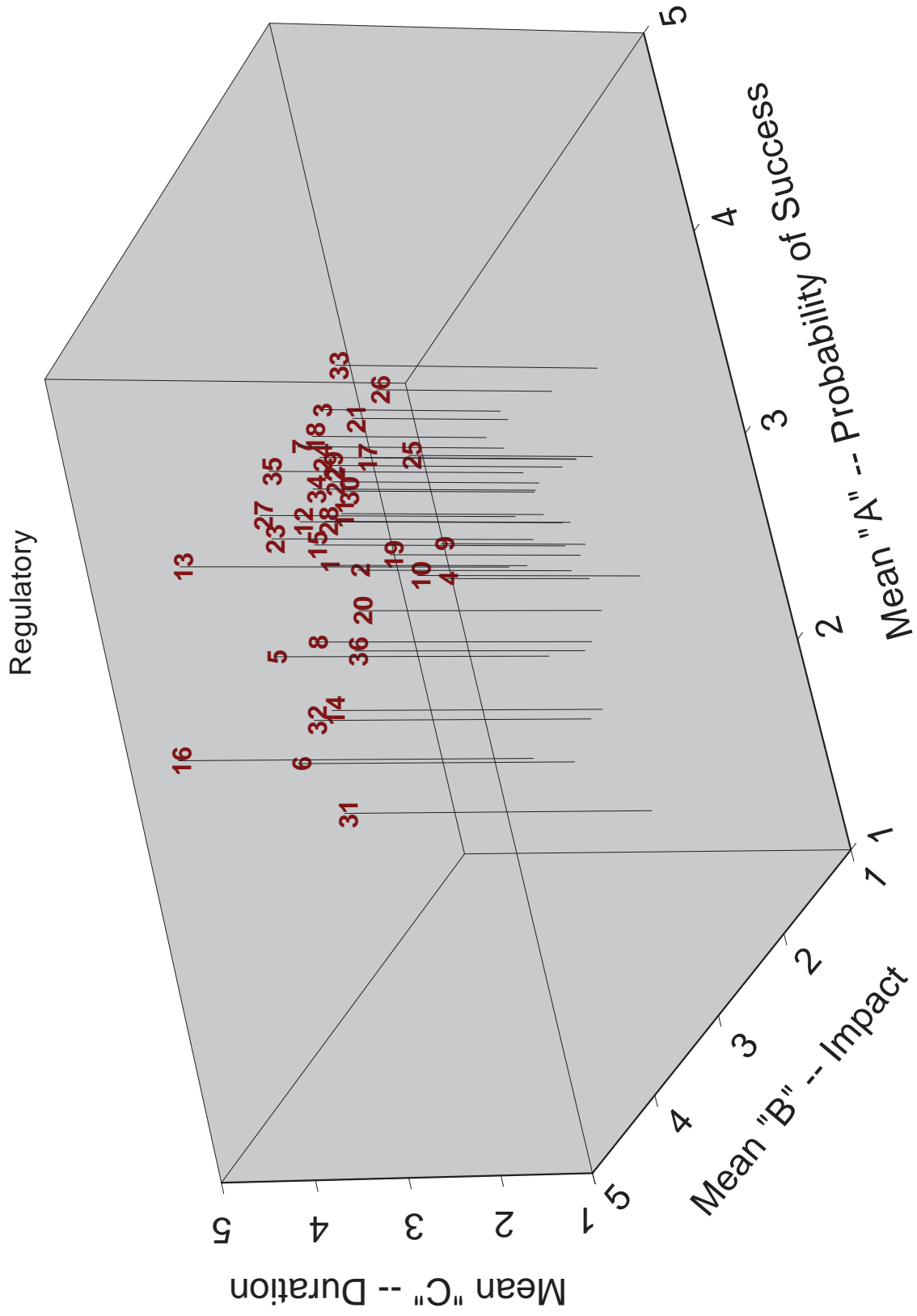


Figure 15. ARS Ranking of Impact vs. Success vs. Duration.

## ARS Researchable Areas from ARS HLB Workshop: April 23, 2008

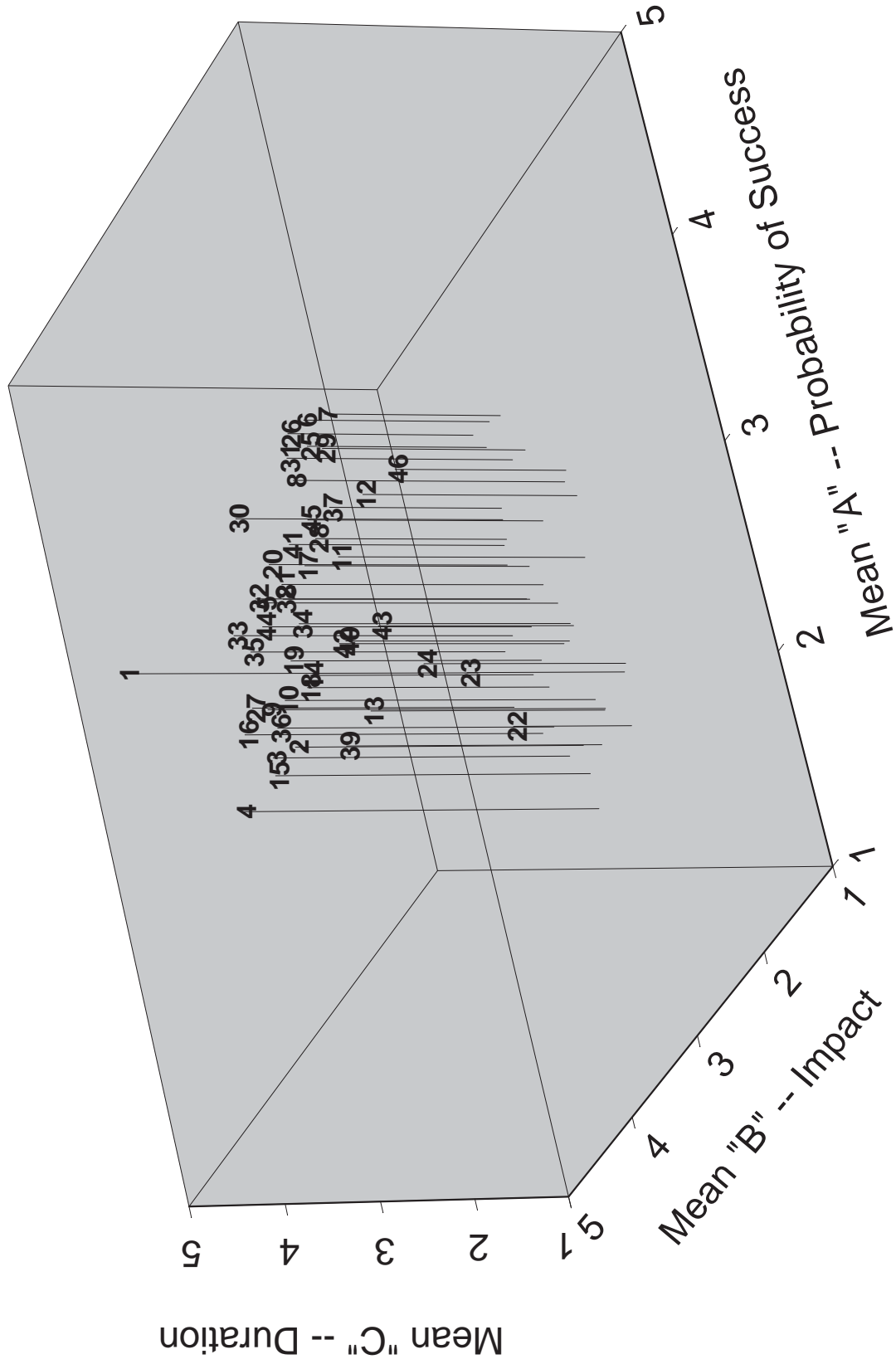


Figure 16. ARS Ranking of Impact vs. Success vs. Duration.

### ARS Researchable Areas from ARS HLB Workshop: 4-23-08

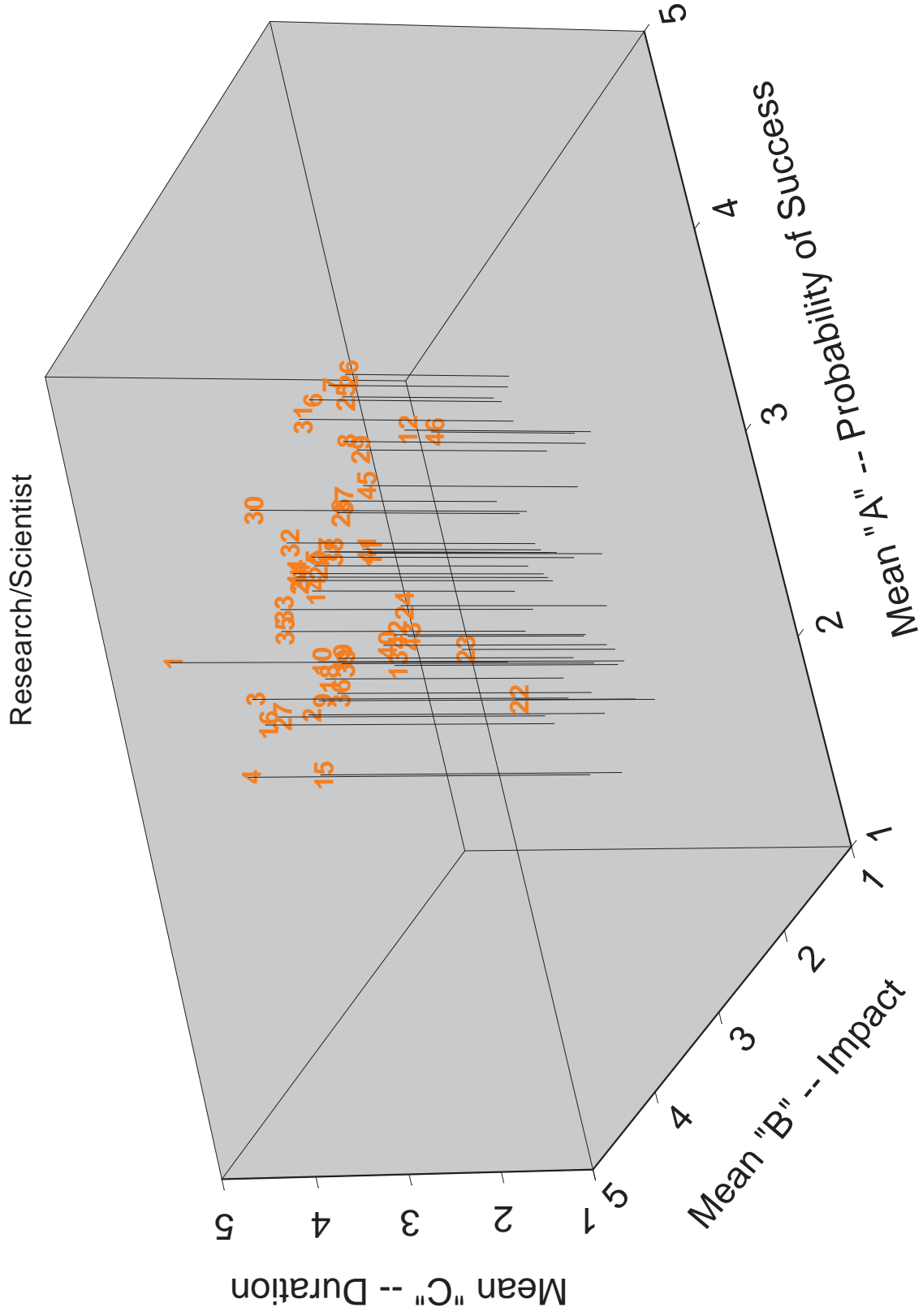


Figure 17. ARS Ranking of Impact vs. Success vs. Duration.

### ARS Researchable Areas from ARS HLB Workshop: 4-23-08

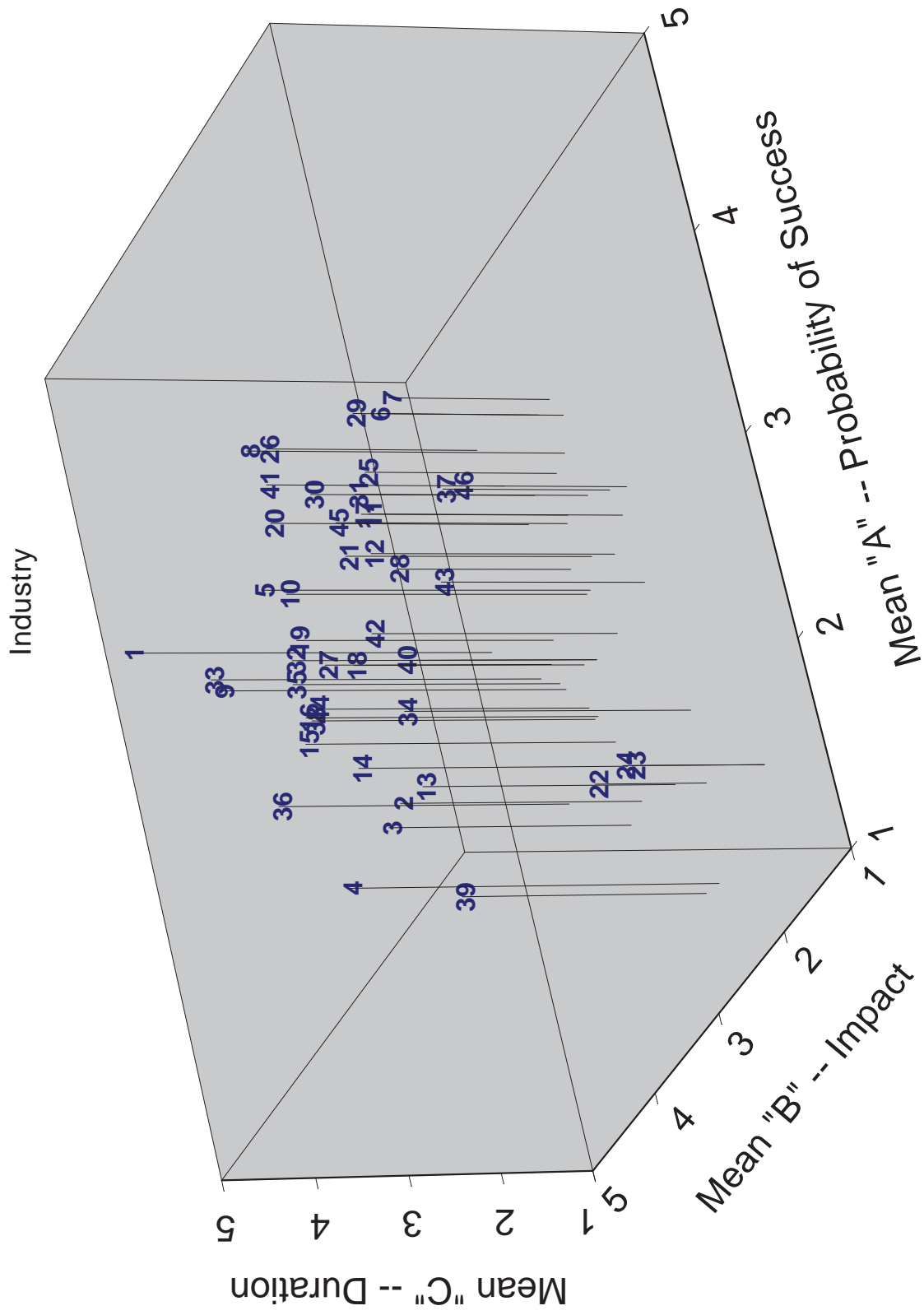


Figure 18. ARS Ranking of Impact vs. Success vs. Duration.  
 ARS Researchable Areas from ARS HLB Workshop: 4-23-08

