



**OFFICE FOR HARMONIZATION IN THE INTERNAL MARKET
(TRADE MARKS AND DESIGNS)**

The President

DECISION No EX-16-1 OF THE PRESIDENT OF THE OFFICE

of 10 March 2016

adopting the 'Guidelines for Examination in the European Union Intellectual Property Office on European Union Trade Marks and on Registered Community Designs'

THE PRESIDENT OF THE OFFICE FOR HARMONIZATION IN THE INTERNAL MARKET (TRADE MARKS AND DESIGNS),

Having regard to Council Regulation (EC) No 207/2009 of 26 February 2009 on the Community trade mark (CTMR), in particular Article 124(2)(a) thereof, and to Council Regulation (EC) No 6/2002 of 12 December 2001 on Community designs (CDR), in particular Article 100 thereof,

After consultation with the Administrative Board in accordance with Article 126(4) CTMR and Article 101(b) CDR,

HAS ADOPTED THE FOLLOWING DECISION:

Article 1

The following 'Guidelines for Examination in the European Union Intellectual Property Office on European Union Trade Marks and on Registered Community Designs', which are annexed to this Decision, are hereby adopted:

New parts of the Guidelines:

A) EUROPEAN UNION TRADE MARKS

Part A: General Rules

Section 1: Means of Communication, Time Limits

Section 2: General Principles to be Respected in the Proceedings

Section 3: Payment of Fees, Costs and Charges

Section 4: Language of Proceedings

Section 5: Professional Representation

Section 6: Revocation of Decisions, Cancellation of Entries in the Register and Correction of Errors

Section 7: Revision

Section 8: *Restitutio in integrum*

Section 9: Enlargement

Part B: Examination

Section 1: Proceedings

Section 2: Formalities

Section 3: Classification
Section 4: Absolute Grounds for Refusal and European Union Collective Marks;
Absolute Grounds for Refusal, Article 7 (1)(a) to 7(1)(e) EUTMR, Acquired
Distinctiveness;
Absolute Grounds for Refusal, Article 7(1)(f) to 7(1)(m) EUTMR, Collective
Marks

Part C: Opposition

Section 0: Introduction
Section 1: Procedural Matters
Section 2: Double Identity and Likelihood of Confusion
Chapter 1: General Principles
Chapter 2: Comparison of Goods and Services
Chapter 3: Relevant Public and Degree of Attention
Chapter 4: Comparison of Signs
Chapter 5: Distinctiveness of the Earlier Mark
Chapter 6: Other Factors
Chapter 7: Global Assessment
Section 3: Unauthorised Filing by Agents of the TM Proprietor (Article 8(3) EUTMR)
Section 4: Rights under Article 8(4) and 8(4a) EUTMR
Section 5: Trade Marks with Reputation (Article 8(5) EUTMR)
Section 6: Proof of Use

Part D: Cancellation

Section 1: Cancellation Proceedings
Section 2: Substantive Provisions

Part E: Register Operations

Section 1: Changes in a Registration
Section 2: Conversion
Section 3: EUTMs as Objects of Property
Chapter 1: Transfer
Chapter 2: Licences
Chapter 3: Rights *in rem*
Chapter 4: Levy of Execution
Chapter 5: Insolvency Proceedings or Similar Proceedings
Section 4: Renewal
Section 5: Inspection of Files
Section 6: Other Entries in the Register
Chapter 1: Counterclaims

Part M: International Marks

B) REGISTERED COMMUNITY DESIGNS

Examination of Applications for Registered Community Designs
Renewal of Registered Community Designs
Examination of Design Invalidation Applications

Article 2

The Office Practice contained in the previous Guidelines on Trade Mark Practice and on Designs is hereby repealed.

Article 3

The Guidelines referred to in Article 1 shall be published in the Official Journal of the Office.

Article 4

This Decision shall be published in the Official Journal of the Office and enters into force on 23/03/2016.



Done at Alicante, 10 March 2016

António Campinos
President

GUIDELINES FOR EXAMINATION

***EUROPEAN UNION
INTELLECTUAL PROPERTY OFFICE
(EUIPO)***

***EDITOR'S NOTE AND GENERAL
INTRODUCTION***

Table of Contents

1	Subject Matter	3
2	Structure of the Guidelines.....	3

1 Subject Matter

OHIM's practices are reflected in the [Guidelines on Trade Mark Practice](#) and the [Guidelines on Designs practice](#).

They are revised by the cross-departmental Knowledge Circles of the Office in a cyclical and open process. The yearly work is normally split into two 'work packages': Work Package 1 (WP1) runs over a twelve-month period each year from January to December, and Work Package 2 (WP2) over a twelve-month period each year from July to June.

The process to update the existing Trade Mark Regulation (Council Regulation (EC) No 2017/2009 which sets out the rules applicable to EU trade marks and to the Office) is coming to an end.

The changes brought about by the Legislative Reform affect a number of areas of OHIM's practice. In consequence, the Guidelines have to be revised accordingly, so that their content is fully aligned with the new legislative framework.

The time of entry into force of the New Regulation and the important scope of the revision required, recommend following an ad hoc process since the 'natural' revision cycle of the Guidelines does not coincide with the date on which the new regulatory framework is foreseen to take effect. Such ad hoc process is independent of the standard Work Packages, which will run in parallel to cater for the normal updates in parts of the Guidelines that are not affected by the legislative changes.

As is done at the standard revision of the Guidelines, OHIM has decided to involve its stakeholders in the submission of comments to the draft Guidelines related to the Legislative Reform. The Guidelines affected by the LR will be published for comments. Following the consultation process, the updated Guidelines will be submitted to the Members of the OHIM Administrative Board for written consultation in order for the President to subsequently adopt them. Once adopted, the Guidelines will enter into force simultaneously with the new Regulation. They will then be translated into the other official EU languages.

2 Structure of the Guidelines

The items dealt with the guidelines are set out below.

Editor's note and general introduction

EUROPEAN UNION TRADE MARKS

Part A: General rules

Section 1: Means of communication, time limits

Section 2: General principles to be respected in the proceedings

Section 3: Payment of fees, costs and charges

Section 4: Language of proceedings

Section 5: Professional representation

Section 6: Revocation of decisions, cancellation of entries in the register and correction of errors

Section 7: Revision

Section 8: Restitutio in integrum

Section 9: Enlargement

Part B: Examination

Section 1: Proceedings

Section 2: Formalities

Section 3: Classification

Section 4: Absolute grounds for refusal and European Union collective marks

Absolute grounds for refusal Article 7(1)(a) to 7(1)(e) EUTMR, Acquired distinctiveness

Absolute grounds for refusal Article 7(1)(f) to 7(1)(m) EUTMR, Collective marks

Part C: Opposition

Section 0: Introduction

Section 1: Procedural matters

Section 2: Double identity and likelihood of confusion

Chapter 1: General principles

Chapter 2: Comparison of goods and services

Chapter 3: Relevant public and degree of attention

Chapter 4: Comparison of signs

Chapter 5: Distinctiveness of the earlier mark

Chapter 6: Other factors

Chapter 7: Global assessment

Section 3: Unauthorised filing by agents of the TM proprietor (Article 8(3) EUTMR)

Section 4: Rights under Article 8(4) and 8(4a) EUTMR

Section 5: Trade marks with reputation (Article 8(5) EUTMR)

Section 6: Proof of use

Part D: Cancellation

Section 1: Cancellation proceedings

Section 2: Substantive provisions

Part E: Register Operations

Section 1: Changes in a registration

Section 2: Conversion

Section 3: EUTMs as objects of property

Chapter 1: Transfer

Chapter 2: Licences

Chapter 3: Rights in rem

Chapter 4: Levy of execution

Chapter 5: Insolvency proceedings or similar proceedings

Section 4: Renewal

Section 5: Inspection of files

Section 6: Other entries in the register

Chapter 1: Counterclaims

Part M: International marks

REGISTERED COMMUNITY DESIGNS

Examination of Applications for Registered Community Designs

Renewal of Registered Community Designs

Examination of Design Invalidation Applications

***GUIDELINES FOR EXAMINATION OF
EUROPEAN UNION TRADE MARKS***

***EUROPEAN UNION
INTELLECTUAL PROPERTY OFFICE
(EUIPO)***

PART A

GENERAL RULES

SECTION 1

MEANS OF COMMUNICATION, TIME LIMITS

Table of Contents

1	Introduction.....	3
2	Procedures for Filing and for Communication with the Office.....	3
3	Notification and Communication of Documents.....	3
3.1	Communication to the Office.....	4
3.1.1	By telecopier (fax).....	4
3.1.2	By electronic means	4
3.1.3	By post, courier service or personal delivery.....	5
3.2	Notification by the Office	5
3.2.1	Notification by telecopier	6
3.2.2	Notification by post	6
3.2.3	Notification by deposit in a post box at the Office	7
3.2.4	Notification by hand delivery.....	7
3.2.5	Notification via the Office’s official website.....	7
3.2.6	Notification by public notification	7
3.3	Addressees	8
4	Time Limits.....	8
4.1	Time limits specified by the Office	8
4.1.1	Length of the time limits specified by the Office	9
4.1.2	Expiry of time limits.....	9
4.1.3	Extension of time limits.....	10
4.1.4	Continuation of proceedings.....	11
4.1.5	<i>Restitutio in integrum</i>	12

1 Introduction

This part of the Guidelines includes those provisions that are common to all proceedings before the Office in trade mark matters, except appeals.

In the interests of efficiency and in order to prevent parties encountering different practices, the Office applies procedural rules consistently.

Proceedings before the Office can be classified into two broad types: *ex parte* proceedings, which involve only one party, or *inter partes* proceedings, in which two or more parties are in conflict.

The first category comprises, in particular, applications for registration or renewal of a European Union trade mark, transfer-related entries in the Register, licences, levy of execution or bankruptcy, and seniority and conversion proceedings.

The second category includes opposition proceedings and cancellation proceedings (revocation or declaration of invalidity of a registered European Union trade mark).

2 Procedures for Filing and for Communication with the Office

Article 25 EUTMR Rule 79 and Rule 83 EUTMIR
--

An application for a European Union trade mark (EUTM) must be filed directly with the Office.

All documents may be sent to the Office by post or courier services, handed in personally at the Office's reception desk (Avenida de Europa, 4, 03008 Alicante) during Office opening hours (Monday to Friday, 08:30 – 13:30 and 15:00 – 17:00), or sent by fax. Applications for EUTMs, oppositions and renewals may also be filed electronically via the Office's official website. As part of its e-business strategy, the Office will progressively make electronic communication available for filing other documents in all types of proceedings.

The Office has made various forms available to the public, in all the official languages of the EU. With one exception, their use is not mandatory but strongly recommended. The exception is when filing an international application or subsequent designation under the Madrid Protocol, for which either the World Intellectual Property Organization's (WIPO) MM 2 or MM 4 or the Office's EM 2 or EM 4 form must be used. All these forms can be downloaded from the Office's official website.

3 Notification and Communication of Documents

The EUTMIR distinguishes between documents originating from the parties and addressed to the Office and notifications issued by the Office.

A document's date of notification or communication is the date on which that document is **received or is deemed to be received** by the addressee (including the Office)

(judgment of 30/01/2014, C-324/13 P, 'Patricia Rocha', para. 43). Exactly when receipt is deemed to have taken place will depend on the method of notification or communication.

3.1 Communication to the Office

Article 25(2) EUTMR
Rules 79 and 79a, and Rules 80 and 82 EUTMIR
Decision No EX-13-02 of the President of the Office

3.1.1 By telecopier (fax)

Where a document is faxed to the Office, the original should be signed so that the fax received by the Office bears the facsimile of the signature. If the fax is not signed, the Office will invite the party concerned to do so within a specified deadline. If the document is not signed within that time, the application or request will be declared inadmissible, or the document will not be taken into account, as the case may be.

However, if the fax was generated electronically by computer ('electronic fax'), the indication of the name of the sender is deemed to be equivalent to the signature.

It is not necessary to follow this up with a confirmation of the fax by mail.

The Office will acknowledge receipt of a fax only in the cases expressly specified by the EUTMIR, namely when an EUTM application is filed. However, if the communication is incomplete or illegible, or the Office has reasonable doubts as to the accuracy of the transmission, it will advise the sender and invite it to retransmit the communication by fax or to submit a signed original of the document in question to the Office by post, personal delivery or any other means within a specified deadline. If the retransmission is complete, the date of receipt will be considered to be the date of the first transmission, except for the purposes of establishing a filing date for an EUTM application. Otherwise, the Office will not take the transmission into account or will consider only the received and/or legible parts (decision of 04/07/2012, R 2305/2010-4 – 'Houbigant/PARFUMS HOUBIGANT PARIS et al.').

For further information on the filing date, see the Guidelines, Part B, Examination, Section 2, Formalities.

Where a document in colour is to be transmitted, the document can be sent by fax and the coloured original filed within one additional month unless provided otherwise by the EUTMR. In this case, the date of receipt of the coloured original is deemed to be the date the Office receives the fax, including for the purposes of obtaining a filing date for an EUTM application. The time of receipt is the local time in Alicante (Spain) at which the Office received the fax.

3.1.2 By electronic means

In accordance with Rule 82 EUTMIR, if an EUTM application is filed using e-filing, or a communication is sent to the Office by any electronic means, the indication of the name of the sender is deemed to be equivalent to the signature.

The Decision of the Executive Director of the Office is decisive in determining whether, to what extent and under what technical conditions, communications may be sent to

the Office by electronic means. Particular reference is made to Decision No EX-13-2, according to which the time of receipt of requests, communications or documents submitted electronically via the official Office website is the local time in Alicante (Spain) when such receipt was validated.

Where an electronic communication is incomplete or illegible, or the Office has reasonable doubts as to the accuracy of the transmission, Rule 80(2) EUTMIR applies *mutatis mutandis*.

3.1.3 By post, courier service or personal delivery

Documents sent by post, courier service or personal delivery should be addressed to the Office at the address indicated in the explanatory notes accompanying the forms provided by the Office.

Documents sent by post, courier service or personal delivery must bear an original signature. If a document sent to the Office is not signed, the Office will invite the party concerned to do so within a specific deadline. If the document is not signed within that time, the application or request will be declared inadmissible, or the document will not be taken into account, as the case may be.

The date of receipt is the date on which the Office receives the communication. The time of receipt is the local time in Alicante (Spain).

For further information on copies of the documents submitted, see the Guidelines, Part C, Opposition, Section 1, Procedural matters, 4.2 Substantiation.

3.2 Notification by the Office

Rules 55, 61-69 EUTMIR Decision No EX-97-1 of the President of the Office Decision No EX-05-6 of the President of the Office Decision No EX-13-2 of the President of the Office
--

Written communications from the Office to the party or parties to proceedings will be 'notified'. A document is considered to be **notified** when it has been received or is deemed to have been received by the addressee, irrespective of whether the addressee has been advised of this. Consequently, the date of notification of a document is the date on which that document is **made accessible to or has reached the addressee** and not the date on which it was sent or the date on which the person to whom it was addressed actually learned of the notification. However, exactly when receipt is deemed to take place will depend on the method of notification.

The Office can freely choose the most appropriate means of notification (Rule 61(3) EUTMIR), apart from public notification, although some means of notification require the party's prior consent.

In practice, wherever feasible and provided that the number of pages to be transmitted is not excessively high, the Office will always opt for notification by electronic means, if available.

If the proper notification procedure has been followed, the document is deemed to have been notified unless the recipient can prove that it either did not receive the document at all, or received it late. If this is proved, the Office will re-notify the document(s) (judgment of 13/01/2011, T-28/09, 'Pine Tree', para. 32). Conversely, where the proper notification procedure was not followed, the document will still be considered notified if the Office can prove that the document actually reached the recipient.

Any communication or notification from the Office shall indicate the department or division of the Office and the name(s) of the official(s) responsible. These documents have to be signed by the official(s) or, if not, bear the Office's printed or stamped seal. For documents transmitted by telecopier, additional information is provided under paragraph 3.2.1 below.

3.2.1 Notification by telecopier

The Office may use notification by telecopier if the party has indicated a fax number, the exception being notifications that include colour elements.

Notification will be deemed to have taken place on the date on which the recipient's telecopier receives it. The Office keeps fax logs so that it can prove the transmission time and content. In the absence of any evidence to the contrary or information that casts doubt on the correct transmission of the notification, the date of receipt of a fax may be established by the Office transmission report (judgment of 13/01/2011, T-28/09, 'Pine Tree', para. 32).

Where documents are transmitted by telecopier, according to Decision No EX-97-1 of the President of the Office, the name of the department or division stated in the letterhead, together with the name of the official(s) indicated at the end of the document, is considered sufficient identification.

3.2.2 Notification by post

The procedure for notification by post will depend on the nature of the document notified.

If the addressee has a place of business or domicile within the European Economic Area (EEA) or has appointed a professional representative (as defined in the Guidelines, Part A, General Rules, Section 5, Professional Representation), decisions subject to a deadline for appeal, summonses and other documents as determined by the Executive Director of the Office will be notified by registered post with recorded delivery.

Where the recipient's address is not in the EEA or the addressee has not appointed a professional representative, or for any other document to be notified, the Office will send the document by post.

Notification will be deemed to have taken place 10 days after the document was posted. The recipient can only rebut this presumption by proving that it did not receive the document or that it received it later. Indications giving rise to reasonable doubt about correct receipt are considered to be sufficient proof (judgment of 25/10/2012, T-191/11, 'Miura', para. 34). In the event of a dispute, the Office must establish that the

notification reached its destination or establish the date on which it was delivered to the addressee.

Notification by registered letter will be deemed to have been effected even if the addressee refuses to accept the letter.

3.2.3 Notification by deposit in a post box at the Office

The Office may notify addressees who maintain a post box at the Office by depositing the notified document therein. The date of deposit will be recorded by the Office.

Notification will be deemed to take place five days after the document has been deposited.

3.2.4 Notification by hand delivery

The Office may also notify the addressee by delivering the document by hand if the addressee is present at the Office in person, but this method of notification is an exception. A copy of the document showing a signed and dated acknowledgement of receipt by the addressee will be kept in the file.

3.2.5 Notification via the Office's official website

Pursuant to Decision No EX-13-2 of the President of the Office of 26/11/2013, notification may also be made via the Office's official website if the holder of an electronic account with the Office has accepted this means of notification. In this case, notification consists of placing the electronic document in the holder's inbox. This date will be indicated in the holder's inbox and will be recorded by the Office (decision of 17/01/2011, R 0956/2010-4 – 'DURAMAXX/DURAMAX').

The document is deemed to have been notified five days after being placed in the holder's inbox irrespective of whether the recipient actually opened and read it (Article 4(4) of the Decision of the President EX-13-2).

3.2.6 Notification by public notification

Public notification will be used for all notifications where the addressee's address is unknown or where a notification by post has been returned to the Office after at least one failed attempt.

This relates primarily to post returned to the Office by the Post Office marked 'not known at this address' and post that has not been claimed by the addressee.

Public notifications will be published on the Office's website. The document will be deemed to have been notified one month after the day on which it was posted on the internet.

3.3 Addressees

Articles 92 and 93 EUTMR
Rules 67 and 77 EUTMIR

If a professional representative has been duly appointed, the Office will send all notifications to the representative (judgments of 12/07/2012, T-279/09, '100% Capri', and of 25/04/2012, T-326/11, 'BrainLAB'). 'Duly appointed' means that the representative is entitled to act as such and has been properly appointed, and that no general obstacle exists to preclude representation by that person, such as illicit representation of both parties in an *inter partes* proceeding. Filing an authorisation is not required in order to receive Office notifications. For further details see the Guidelines, Part A, General Rules, Section 5, Professional Representation.

Any notification addressed to the representative will have the same effect as if it had been addressed to the person represented. Similarly, any communication addressed to the Office by a representative will be considered to have originated from the person it represents.

4 Time Limits

Rules 70-72 EUTMIR

Time limits before the Office can be divided into two categories:

- those laid down by the EUTMR or EUTMIR, which are therefore mandatory;
- those specified by the Office, which are therefore not mandatory and can be extended under certain circumstances.

4.1 Time limits specified by the Office

Time limits are an essential tool for conducting orderly and reasonably swift proceedings. They are a matter of public policy and rigorous compliance with them is necessary to ensure clarity and legal certainty.

The Regulations foresee three measures that mitigate the rigorous application of the principle of strict observance of time limits (deadlines), depending on whether they are still running or have expired.

If the time limit is still running, the party may *request an extension* of the time limit pursuant to Rule 71(1) EUTMIR.

If the time limit has expired, the party who has missed it still has two possible courses of action: it can either seek *continuation of proceedings* (pursuant to Article 82 EUTMR), which only requires meeting certain formal requirements, or it can request *restitutio in integrum* (pursuant to Article 81 EUTMR), which requires meeting formal and substantive requirements (such as showing all due care).

Additional information is provided under paragraphs 4.1.4 and 4.1.5 below.

4.1.1 Length of the time limits specified by the Office

With the exception of the time limits expressly specified in the EUTMR or EUTMIR, the time limits specified by the Office, when the party concerned has its domicile or its principal place of business or an establishment within the EEA, may not be less than one month or longer than six months. When the party concerned does not have its domicile or principal place of business or an establishment within the EEA, the time limits may not be less than two months or longer than six months. The general practice is to grant two months.

For further information, see the Guidelines, Part A, General Rules, Section 5, Professional Representation.

4.1.2 Expiry of time limits

Where the Office sets a time limit in a notification, the 'relevant event' is the date on which the document is notified or deemed notified, depending on the rules governing the means of notification.

Where a time limit is expressed in months, it will expire in the relevant subsequent month on the same day as the day on which the 'relevant event' occurred.

For example, if the Office sets a two-month time limit in a communication which is notified by fax on 28 June, the time limit will expire on 28 August. It is immaterial whether the 'relevant event' occurred on a working day, a holiday or a Sunday; that is relevant only for the expiry of the time limit.

Where the relevant subsequent month has no day with the same number or where the day on which the event occurred was the last day of the month, the time limit in question will expire on the last day of that month. A two-month time limit specified in a notification on 31 July will therefore expire on 30 September. Similarly, a two-month time limit set in a notification on 30 June will expire on 31 August.

Any time limit will be deemed to expire at midnight on the final day (local time in Alicante (Spain)).

A time limit that expires on a day on which the Office is not open for receipt of documents or on which ordinary post is not delivered in the locality in which the Office is located (Saturdays, Sundays and public holidays) will be extended to the first working day thereafter. For this purpose, the Executive Director of the Office determines the days on which the Office is closed before the start of each calendar year. The extension is automatic but it applies only at the end of the time limit (decision of 12/05/2011, R 0924/2010-1 – 'whisper power-WHISPER').

In the event of a general interruption to the postal service in Spain or to the Office's connection to authorised electronic means of communication, any time limit that expires during that period will be extended to the first working day after the period of interruption. These periods will be determined by the Executive Director of the Office; the extension will apply to all parties to the proceedings.

In the event of an exceptional occurrence (strike, natural disaster, etc.) causing a disruption to the running of the Office or a serious impediment to its communication

with the outside world, time limits may be extended for a period determined by the Executive Director of the Office.

4.1.3 Extension of time limits

An extension of the time limits may be granted if the party concerned makes the request before the original time limit expires.

In **ex parte proceedings** before the Office, if a request is made for an extension before the time limit expires, then a further period should be allowed, depending on the circumstances of the case, but not exceeding six months.

For the rules applicable to the extension of time limits in **inter partes proceedings** (i.e. where there are two or more parties involved, such as in opposition, invalidity and/or revocation proceedings), see the Guidelines, Part C, Opposition, Section 1, Procedural Matters.

Unless otherwise provided for either in the Regulations or in the specific paragraphs in this Guideline, as a general rule any initial request for an extension that is received in time will always be granted, irrespective of the explanation given by the party requesting it. However, any subsequent request for an extension of the same time limit will be refused unless the party requesting it can explain and justify the 'exceptional circumstances' that (a) prevented it from carrying out the required action during the previous two periods (i.e. the original time limit plus the first extension) and (b) still prevent the requester from carrying it out, so that more time is needed.

Examples of justifications that can be accepted:

- 'Evidence is being gathered from distribution channels/all our licensees/our suppliers in several Member States. So far, we have gathered documents from some of them but, due to the commercial structure of the company (as shown in the document enclosed), we have only recently been able to contact the rest'.
- 'In order to show that the mark has acquired distinctiveness through use we started carrying out market research at the beginning of the period (on date X). However, the fieldwork has only recently been concluded (as shown in the enclosed documents); consequently, we need a second extension in order to finish the analysis and prepare our submissions to the Office.'
- 'Death' is also considered an 'exceptional circumstance'. The same applies to serious illness, provided that no reasonable substitution was available.
- Finally, 'exceptional circumstances' also include 'force majeure' situations. 'Force majeure' is defined as a natural and unavoidable catastrophe that interrupts the expected course of events. It includes natural disasters, wars and terrorism, and unavoidable events that are beyond the party's control.

Where a request is filed for an extension to an extendible time limit before this time limit expires and is not accepted, the party concerned will be granted at least one day to meet the deadline, even if the request for an extension arrives on the last day of the time limit.

4.1.4 Continuation of proceedings

Article 82 EUTMR
Communication No 06/05 of the President of the Office

The expressions ‘further processing’ and ‘continuation of proceedings’ have the same meaning.

Article 82 EUTMR provides for the continuation of proceedings where time limits have been missed but excludes various time limits laid down in certain articles of the EUTMR and EUTMIR. Communication No 06/05 of the President of the Office of 16/09/2005 on restoration into missed time limits indicates that, with a few exceptions, most of these exclusions are self-explanatory.

The excluded time limits are the following:

- Those laid down in Article 81 EUTMR, avoiding double relief for the same time limits;
- Those referred to in Article 112 EUTMR, i.e. the three-month period within which conversion must be requested and the conversion fee paid;
- The opposition period and the time limit for paying the opposition fee laid down in Article 41 EUTMR;

Those laid down in Article 42 EUTMR, i.e. the time limits set by the Office for the parties to submit observations within the opposition procedure. This covers the time limits for the opponent to substantiate its opposition under Rule 19 EUTMIR, the time limit laid down in Rule 20(2) EUTMIR for the applicant to reply, the time limit under Rule 20(4) EUTMIR for the opponent to rebut and the time limits for any further exchange of arguments, if allowed by the Office (decision of 07/12/2011, R 2463/2010-1 – ‘Pierre Robert/Pierre Robert’).

Pursuant to Rule 50(1), 2nd sentence EUTMIR, these (or the corresponding) time limits shall not be applicable in second instance proceedings before the Boards of Appeal.

None of the other time limits during the opposition procedure are referred to in Article 42 EUTMR and, therefore, they are not excluded from further processing. Consequently, the Office will grant further processing for:

- the time limit under Article 119(6) EUTMR and Rule 16(1) EUTMIR to translate the notice of opposition;
- the time limit under Rule 17(4) EUTMIR to remedy deficiencies that affect the admissibility of the opposition;
- the time limit under Rule 22(1) EUTMIR for the applicant to request that the opponent prove use of its earlier mark;
- the time limit under Rule 22(2) EUTMIR for the opponent to submit proof of use of its earlier mark;
- the time limit under Rule 22(6) EUTMIR to translate proof of use.

- Those laid down in Article 27, Articles 29(1), 33(1), 36(2) and 47(3), Articles 60 and 62, Article 65(5) and Article 82, and the time limits laid down by the EUTMR for claiming, after the application has been filed, priority within the meaning of Article 30, exhibition priority within the meaning of Article 33 or seniority within the meaning of Article 34.

Article 82 EUTMR does not exclude any of the time limits that apply in proceedings for revocation or declaration of invalidity.

The party seeking continuation of proceedings must make the request, for which a fee is charged as established in the Annex I of the EUTMR, within two months of the expiry of the original time limit and complete the omitted act by the time the request for continuation is received.

There can be no extension or continuation of the two-month deadline. There is no substantive requirement to be fulfilled such as when requesting *restitutio in integrum*.

If the Office accepts the request for continuation of proceedings, the consequences of having failed to observe the time limit will be deemed not to have occurred. If a decision has been taken between the expiry of that time limit and the request for the continuation of proceedings, the department competent to decide on the omitted act will review the decision and, where completion of the omitted act itself is sufficient, take a different decision. If, following the review, the Office concludes that the original decision does not need to be altered, it will confirm that decision in writing.

4.1.5 *Restitutio in integrum*

A party to proceedings before the Office may be reinstated in its rights (*restitutio in integrum*) if, in spite of all due care required by the circumstances having been taken, it was unable to meet a time limit vis-à-vis the Office, provided that the failure to meet the time limit had the direct consequence, by virtue of the provisions of the Regulations, of causing the loss of any right or means of redress.

For further information see the Guidelines, Part A, General Rules, Section 8, *Restitutio in Integrum*.

***GUIDELINES FOR EXAMINATION OF
EUROPEAN UNION TRADE MARKS***

***EUROPEAN UNION
INTELLECTUAL PROPERTY OFFICE
(EUIPO)***

PART A

GENERAL RULES

SECTION 2

***GENERAL PRINCIPLES TO BE RESPECTED
IN PROCEEDINGS***

Table of Contents

1	Adequate Reasoning	3
2	The Right to Be Heard	3
3	General Principles of EU Law	4
4	Means of Taking Evidence	5
4.1	Written evidence	6
4.2	Oral evidence	6
4.3	Specific means of evidence	6
4.3.1	Commissioning of experts by the Office	6
4.3.2	Affidavits	7
4.3.3	Inspections	8
4.4	Costs of taking evidence	8
5	Oral Proceedings	8
5.1	Opening of oral proceedings	8
5.2	Course of the oral proceedings	9
5.3	Minutes of evidence and of oral proceedings	10
6	Decisions	10
6.1	Contents	10
6.2	Apportionment of costs	10

Articles 75-78 and 85 EUTMR

1 Adequate Reasoning

Office decisions shall be in writing and shall state the reasons on which they are based. The reason for this is twofold: to explain to interested parties why the measure was taken so that they can protect their rights and to enable the Courts of the European Union to exercise their power to review the legality of the decision (judgments of 12/07/2012, T-389/11, 'Guddy', para. 16 and of 22/05/2012, T-585/10, 'Penteo', para. 37, as well as the case-law cited).

However, if the Office does not respond to all the arguments raised by the parties, this does not infringe the duty to state reasons.

It is sufficient that it sets out the facts and the legal considerations of fundamental importance in the context of the decision (see, among others, judgments of 18/01/2013, T-137/12, 'Vibrator', paras 41 and 42; of 20/02/2013, T-378/11, 'Medinet', para. 17; of 03/07/2013, T-236/12, 'Neo', paras 57 and 58; of 16/05/2012, T-580/10, 'Kindertraum', para. 28; or judgment of 10/10/2012, T-569/10, 'Bimbo Doughnuts', paras 42-46, confirmed by judgment of 08/05/2014, C-591/12 P).

2 The Right to Be Heard

In accordance with the general principle of the right of defence, a person whose interests are affected by a decision taken by a public authority must be given the opportunity to express their point of view. Therefore, in all proceedings before the Office, the parties will always have the opportunity to state their positions and to put forward their grounds of defence.

Decisions will only be based on reasons or evidence on which the parties have had an opportunity to present their comments. The right of defence therefore requires a communication to be received (judgment of 25/10/2012, T-191/11, 'Miura', para. 25).

The right to be heard covers all the matters of fact or law, together with the evidence that forms the basis for the decision. However, the right to be heard does not apply to the final position that is going to be adopted. Therefore, the Office is not bound to inform the parties of its legal opinion before issuing a decision and to afford them the opportunity to submit their observations on that position, or even to submit additional evidence (see, among others, judgments of 14/06/2012, T-293/10, 'Colour per se', para. 46 *in fine*; of 08/03/2012, T-298/10, 'Biodanza', para. 101; and judgment of 20/03/2013, T-277/12, 'Caffè Kimbo', paras 45 and 46).

The Office will examine the facts in proceedings before it on its own initiative, although in proceedings relating to relative grounds for refusal it will restrict this examination to the facts, evidence and arguments provided by the parties (this also applies to cancellation proceedings).

This restriction does not prevent the Office from taking into consideration, in addition to the facts expressly put forward by the parties, facts that are well known, that is, those that are likely to be known by anyone or that may be learnt from generally accessible sources or those arising from practical experience generally acquired from marketing general consumer goods that are likely to be known by anyone and are in particular

known by the consumers of those goods. Therefore, the Office can use facts that are a matter of common knowledge as a basis for its reasoning.

The Office is not required to prove the accuracy of these well-known facts and, therefore, it is not obliged to give examples of such practical experience; it is up to the party concerned to submit evidence to refute it (see, among others, judgment of 20/03/2013, T-277/12, 'Caffè Kimbo', para. 46; judgment of 11/07/2013, T-208/12, 'Rote Schnürsenkelenden', para. 24; judgment of 21/02/2013, T-427/11, 'Bioderma', paras 19-22; judgment of 08/02/2013, T-33/12, 'Medigym', paras 20 and 25; judgment of 07/12/2012, T-42/09, 'Quadratum', para. 73; and judgment of 19/09/2012, T-231/11, 'Stoffmuster', para. 51).

However, in *ex parte* proceedings when the Office, on its own initiative, assembles facts that are not well known and that are intended to serve as the basis for its decision, it is under an obligation to notify the party of those facts in order that the party may submit its views thereon.

If documents are filed or allegations are made after a deadline set by the Office has expired, these will in principle be considered to be late and the document will not be taken into account. For more details, see the Guidelines, Part C, Opposition, Section 1, Procedural matters, 4.5.1 Additional evidence for proof of use and the Guidelines, Part C, Opposition, Section 6, Proof of use, 3.3.1 Time limit for providing proof of use.

However, the Office will take legal issues into account, irrespective of whether or not they have been pleaded by the parties.

Changing circumstances arising in the course of the proceedings will also be taken into account. For example, if during opposition proceedings the earlier right on which the opposition was based lapses (e.g. it is not renewed or is declared invalid), this will always be taken into account.

3 General Principles of EU Law

The Office must respect the general principles of EU law, such as equal treatment and sound administration (see, among others, judgment of 24/01/2012, T-260/08, 'Visual Map'; judgment of 23/01/2014, T-68/13, 'Care to care', para. 51; and judgment of 10/03/2011, C-51/10 P, '1000', para. 73).

For reasons of legal certainty and of sound administration, there must be a stringent and full examination of all trade mark applications in order to prevent trade marks from being improperly registered. That examination must be undertaken in each individual case.

The lawfulness of the Office's decisions must be assessed solely on the basis of EU regulations, as interpreted by the European Union judicature. Accordingly, the European Union Intellectual Property Office (EUIPO) is not bound either by its previous decision-making practice or by a decision given in a Member State, or indeed a third country, that the sign in question is registrable as a national mark. This is the case even if such a decision was adopted in a country belonging to the linguistic area in which the word sign in question originated (judgment of 16/05/2013, T-356/11, 'Equipment', para. 7).

However, in the light of the principles of equal treatment and sound administration, the EUIPO will take into account the decisions already taken in respect of similar applications and must carefully consider whether it should decide in the same way or not (judgment of 10/03/2011, C-51/10, '1000', paras 74-75; judgment of 27/02/2014, T-225/12, 'LIDL express', para 56; judgment of 23/01/2014, T-68/13, 'Care to care', para. 51; and judgment of 12/12/2013, T-156/12, 'Oval', para. 28).

Moreover, the principle of equal treatment and sound administration must be applied in a manner that is consistent with the principle of legality, according to which a person may not rely, in support of its claim, on an unlawful act committed in another procedure (judgment of 23/01/2014, T-68/13, 'Care to care', para. 51; judgment of 12/12/2013, T-156/12, 'Oval', para. 29; judgment of 02/05/2012, T-435/11, 'UniversalPHOLED', para. 38; and judgment of 10/03/2011, C-51/10, '1000', paras 76-77).

4 Means of Taking Evidence

Articles 77 and 78 EUTMR
Rules 56-60 EUTMIR
Decision No EX-99-1 as amended by Decision No EX-03-2 of 20/1/2003

In any proceedings before the Office, evidence may be taken. The means for taking evidence are listed in Article 78 EUTMR and Rule 57 EUTMIR, although that list is not exhaustive.

The means of evidence are as follows:

- hearing the parties
- requests for information
- the production of documents and items of evidence
- hearing witnesses
- opinions by experts
- sworn or affirmed statements in writing or statements having a similar effect under the law of the State in which they are drawn up
- inspection.

Some of these means, such as requests for information, statements in writing and, in particular, the submission of documents and items of evidence, will be used more frequently than others. Hearing the parties, witnesses or experts, and inspections are used only exceptionally.

The Office will decide which of these means to use but will use them only when necessary for examining the file.

If the Office refuses a request to take evidence, an appeal can only be made together with the appeal against the final decision.

The procedure followed by the Office varies depending on the means of taking evidence proposed.

4.1 Written evidence

When taking evidence, the Office will confine itself to written evidence in most cases. This is the least costly, simplest and most flexible means of taking evidence.

The Office will therefore give preference to the submission of documents and items of evidence. However, other possible written means of taking evidence include not only a request for information or statements in writing that have been sworn or affirmed or have a similar effect thereto under the law of the State in which they are drawn up, but also opinions by experts, which may consist solely of a written report.

The Regulation makes no provision for any special procedure or formality. Therefore, the Office's general rules of procedure apply.

Any information, documents or items of evidence submitted by one party will be communicated to the other parties as soon as possible, and the Office may set the other parties a time limit of, in principle, two months to reply.

The Office will base its decision only on reasons on which both sides have had an opportunity to submit observations.

For further information on Oral Proceedings, see paragraph 5 below.

4.2 Oral evidence

This refers to evidence taken in oral proceedings, such as hearing the oral evidence of parties, witnesses or experts.

Only in exceptional cases will the Office decide to hear oral evidence, in particular because of the cumbersome nature of the procedure, which is liable to protract the proceedings, and because of the cost, which will have to be borne by the unsuccessful party in *inter partes* proceedings, or in some cases by both parties.

If the Office invites one of the parties to give evidence orally, it will advise the other parties accordingly so that they can attend.

Similarly, when the Office summons an expert or a witness to a hearing, it will advise the parties concerned. These may be present and put questions to the person giving evidence.

4.3 Specific means of evidence

4.3.1 Commissioning of experts by the Office

Opinions by experts will be used only as a last resort because they involve substantial costs and protract the proceedings.

It is up to the Office to decide whether or not to commission an expert's opinion and who to appoint as expert. However, the Office does not maintain a list of experts because it uses experts as a means of taking evidence only by way of exception.

The terms of reference of the expert include:

- a precise description of their task
- the deadline for submitting their report
- the names of the parties to the proceedings
- details of any costs to be reimbursed by the Office.

On receipt of the expert's report, the Office will forward copies to the parties.

If the Office considers the report sufficient, and if the parties accept this form of report, it will in principle be used only in its written form.

The submission of an oral report or the hearing of oral evidence given by the expert will therefore be at the Office's discretion.

The parties can object to an expert on the grounds of incompetence or a conflict of interest, or because the expert was previously involved in the dispute or is suspected of partiality. No refusal may be based on the appointed expert's nationality. If a party objects to the expert, the Office will rule on the objection. The grounds that may be cited for objecting to an expert are the same as those for objecting to an examiner or Board of Appeal member pursuant to Article 137 EUTMR.

4.3.2 Affidavits

Sworn or affirmed statements in writing or statements having a similar effect under the law of the State in which the statement is drawn up are equally admissible as evidence, if provided by a party.

In order for a statement to be considered sworn or affirmed, it must be understood by the parties that making a false statement would be considered a criminal offence under the law of the Member State in which the document was drawn up. Where that is not the case, the document will be considered simply as any other written document or statement (judgment of 28/03/2012, T-214/08, 'Outburst', para. 32 and the case-law cited therein).

The evidential value of an affidavit is relative (judgment of 28/03/2012, T-214/08, 'OUTBURST', para. 33). In assessing the evidential value of such a document, the Office will consider first and foremost the credibility of the account it contains. It will then take account, in particular, of the person who produced the document, the circumstances in which it came about, the person to whom it was addressed and whether, on the face of it, the document appears sound and reliable (judgment of 07/06/2005, T-303/03, 'Salvita' para. 42 and the case-law cited therein). Affidavits containing detailed and concrete information and/or that are supported by other evidence have a higher probative value than very general and abstractly drafted statements.

The mere fact that affidavits from third parties are made according to a predetermined draft provided by the interested party (parties) does not in itself affect their reliability and credibility, and does not call into question their probative value since the veracity of their contents is certified by the signatory (judgment of 16/09/2013, T-200/10, 'Avery Dennison', para. 73).

4.3.3 Inspections

Only in very exceptional circumstances will the Office carry out an inspection *in situ*. If it does decide to carry out an inspection, it will, as with any other Office decision, state the means by which it intends to obtain evidence (in the present case, an inspection), the facts it wishes to prove, the date, and the time and place of the inspection.

The date fixed for the inspection must allow the party concerned sufficient time to prepare for it. If the inspection cannot take place for any reason, the proceedings will continue based on the evidence on file.

4.4 Costs of taking evidence

The Office may make the taking of evidence conditional upon a deposit by the party requesting it. The amount will be fixed by the Office based on an estimate of the costs.

The witnesses and experts summoned or heard by the Office will be entitled to reimbursement of expenses for travel and subsistence, including an advance. They will also be entitled to compensation for loss of earnings and payment for their work.

The amounts reimbursed and the advances for expenses are determined by the Executive Director of the Office and are published in the Office's Official Journal. For details, see Decision No EX-99-1 as amended by Decision No EX-03-2 of 20/1/2003.

Where the Office decides to adopt means of taking evidence that require oral evidence from witnesses or experts, the Office will bear the cost of this. However, where one of the parties has requested oral evidence, then that party will bear the cost, subject to a decision on the apportionment of costs in *inter partes* proceedings.

5 Oral Proceedings

Articles 77 and 78 EUTMR Rules 56-60 EUTMIR
--

Article 77 EUTMR provides that the Office may hold oral proceedings.

Any unofficial contacts such as telephone conversations will not be considered to constitute oral proceedings within the meaning of Article 77 EUTMR.

The Office will hold oral proceedings either on its own initiative or at the request of any party to the proceedings only when it considers these to be absolutely necessary. This will be at the Office's discretion (judgment of 20/02/2013, T-378/11, 'Medinet', para. 72 and the case-law cited therein). In the vast majority of cases it will be sufficient for the parties to present their observations in writing.

5.1 Opening of oral proceedings

Where the Office has decided to hold oral proceedings and to summon the parties, the period of notice may not be less than one month unless the parties agree to a shorter period.

Since the purpose of any oral proceedings is to clarify all outstanding points before the final decision is taken, the Office, in its summons, should draw the parties' attention to the points that need to be discussed in order for the decision to be taken.

Where the Office considers it necessary to hear oral evidence from the parties, witnesses or experts, it will take a decision stating the means by which it intends to obtain evidence, the relevant facts to be proven and the date, time and place of the hearing. The period of notice will be at least one month, unless the parties concerned agree to a shorter period. The summons will provide a summary of this decision and state the names of the parties to the proceedings and details of the costs, if any, that the witnesses or experts may be entitled to have reimbursed by the Office.

If required, and in order to facilitate the hearing, the Office may invite the parties to submit written observations or to submit evidence prior to the oral hearing. The period fixed by the Office for receiving these observations must allow sufficient time for them to reach the Office and then be forwarded to the other parties.

The parties may likewise submit evidence in support of their arguments on their own initiative. However, if this evidence ought to have been produced at an earlier stage of the proceedings, the Office will decide whether these items of evidence are admissible, taking account of the principle of hearing both parties, where appropriate.

5.2 Course of the oral proceedings

Oral proceedings before the examiners, the Opposition Division and the department entrusted with maintaining the Register will not be public.

Oral proceedings, including the delivery of the decision, will be public before the Cancellation Division and the Boards of Appeal, in so far as the department before which the proceedings are taking place does not decide otherwise in cases where admission of the public could have serious and unjustified disadvantages, in particular for a party to the proceedings.

If a party who has been duly summoned to oral proceedings does not appear before the Office, the proceedings may continue without them.

If the Office invites a party to give evidence orally, it will advise the other parties accordingly so that they can attend.

Similarly, when the Office summons an expert or a witness to a hearing, it will advise the parties concerned. These may be present and put questions to the person giving evidence.

At the end of the oral proceedings the Office should allow the parties to present their final pleadings.

5.3 Minutes of evidence and of oral proceedings

Rule 60 EUTMIR

Minutes of the taking of evidence and of oral proceedings will be confined to the essential elements. In particular, they will not contain the verbatim statements made, nor will they be submitted for approval. However, any statements by experts or witnesses will be recorded so that at further instances the exact statements made can be verified. The parties will receive a copy of the minutes (but not of the recorded statements).

6 Decisions

6.1 Contents

Article 75 EUTMR
Rule 55 EUTMIR

Office decisions shall be reasoned to such an extent that their legality can be assessed at the appeal stage or before the General Court or Court of Justice.

The decision will cover the relevant points raised by the parties. In particular, if there are different outcomes for some goods and services of the EUTM application or registration concerned, the decision will make clear which of the goods and services are refused and which are not.

The name or names of the person(s) who took the decision will appear at the end of the decision (Rule 55 EUTMIR).

At the end of the decision, there will also be a notice advising of the right to appeal.

Failure to include this notice does not affect the legality of the decision and does not affect the deadline for filing an appeal.

6.2 Apportionment of costs

Article 82(5) and Article 85 EUTMR
Rules 51 and 94 EUTMIR
Annex I A(33) EUTMR

In *ex parte* proceedings, there is no decision on costs, nor any apportionment of costs. The Office will not reimburse any fees paid (the exceptions are Rule 51 EUTMIR, refund of the appeal fee in certain cases, and Article 82(5) EUTMR, refund of the fee for further processing if further processing is not granted).

Decisions on costs, or the fixing of costs, are limited to opposition and cancellation proceedings (including the ensuing appeal proceedings or proceedings before the GC and CJEU). 'Costs' comprise the costs incurred by the parties to the proceedings, chiefly (i) representation costs (although the thresholds are relatively low) and costs for

taking part in oral hearings; 'representation costs' means the costs for professional representatives within the meaning of Article 93 EUTMR, not for employees (even from another company with economic links); (ii) the opposition or cancellation fee paid by the opponent or third party.

'Apportionment of costs' means that the Office will decide whether and to what extent the parties have to reimburse each other. It does not involve the relationship with the Office (fees paid, the Office's internal costs).

Therefore, if a decision is given in *inter partes* proceedings, the Office will decide on the apportionment of costs. The losing party will bear the fees and costs incurred by the other party that are essential to the proceedings. If both parties fail on one or more heads or if reasons of equity so dictate, the Office may determine a different apportionment of costs.

The decision will fix the costs to be paid by the losing party/parties. No proof that these costs were actually incurred is needed for this purpose. This part of the decision is a title that can be executed in simplified proceedings, in all Member States of the EU.

If the contested EUTM application or EUTM is withdrawn or surrendered, or the opposition or request for cancellation is withdrawn, the Office will not decide on the substance of the case, although it will normally take a decision on costs. The party terminating the proceedings will bear the fees and costs incurred by the other party. Where the case is closed for other reasons, the Office will fix the costs at its discretion. In no case will the decision on costs be based on hypothetical assumptions about who might have won the proceedings if a decision on substance had been taken. Furthermore, within one month of the date of notification fixing the amount of the costs, the party concerned may request a review. This request must state the reasons on which it is based and must be accompanied by the corresponding fee (Annex I A(33) EUTMR).

***GUIDELINES FOR EXAMINATION OF
EUROPEAN UNION TRADE MARKS***

***EUROPEAN UNION INTELLECTUAL
PROPERTY OFFICE
(EUIPO)***

PART A

GENERAL RULES

SECTION 3

PAYMENT OF FEES, COSTS AND CHARGES

Table of Contents

1	Introduction.....	3
2	Means of Payment	4
	2.1 Payment by bank transfer.....	4
	2.1.1 Bank account.....	4
	2.1.2 Details that must accompany the payment	5
	2.2 Payment by debit or credit card	7
	2.3 Payment by the Office current account	7
3	Time of Payment.....	9
4	Date on which Payment is Deemed to be Made.....	9
	4.1 Payment by bank transfer.....	9
	4.1.1 Late payment with or without surcharge.....	9
	4.1.2 Evidence of payment and of the date of payment	10
	4.2 Payment by debit or credit card	11
	4.3 Payment by current account	11
5	Refund of Fees.....	12
	5.1 Refund of application fee.....	12
	5.2 Refund of the opposition fee	13
	5.3 Refund of fees for international marks designating the EU	13
	5.4 Refund of appeal fees	13
	5.5 Refund of renewal fees	13
	5.6 Refund of insignificant amounts	14
6	Fee Reduction for the EUTM Application Filed by Electronic Means .	14
7	Decisions on Costs	14
	7.1 Apportionment of costs	15
	7.2 Fixing of costs	15
	7.3. Enforcement of the decision on costs	15
	7.3.1 Conditions.....	15
	7.3.2 National authority.....	15
	7.3.3 Proceedings.....	16

1 Introduction

Article 144, 144 a) – c) EUTMR

Annex I EUTMR

The specific regulation on payment of fees and charges are laid down in Article 144, 144 a) – c) and in the Annex EUTMR. The full list of fees can be found on the Office website.

Similarly, for RCDs, in addition to the provisions contained in the basic CDR and in the CDIR, there is a specific regulation on the fees payable to the Office (CDFR). This regulation was amended in 2007 following the accession of the European Union to the Geneva Act of the Hague Agreement concerning the international registration of industrial designs.

Finally, the Executive Director of the Office is empowered to lay down charges that may be payable to the Office for services it may render and to authorise methods of payments in addition to those explicitly provided for in the EUTMR and the CDFR.

The differences between fees, costs and charges are as follows.

- **Fees** must be paid to the Office by users for the filing and handling of trade marks and designs proceedings; the fees regulations determine the amounts of the fees and the ways in which they must be paid. Most of the proceedings before the Office are subject to the payment of fees, such as the application fee for an EUTM or an RCD, a renewal fee, etc. Some fees have been reduced to zero (e.g. registration fees for EUTMs, transfers for EUTMs).

The amounts of the fees have to be fixed at such a level as to ensure that the revenue is in principle sufficient for the budget of the Office to be balanced (see Article 144 EUTMR), in order to guarantee the full autonomy and independence of the Office. The revenue of the Office comes principally from fees paid by the users of the system.

- **Costs** refer to the costs of the parties in *inter partes* proceedings before the Office in particular for professional representation (for trade marks see Article 85 EUTMR and Rule 94 EUTMIR, for designs see Articles 70-71 CDR and Article 79 CDIR). Decisions in *inter partes* cases must contain a decision on fees and costs of the professional representatives and must fix the amount. The decision on costs may be enforced once the decision has become final, pursuant to Article 86 EUTMR.
- **Charges** are fixed by the Executive Director of the Office for any services rendered by the Office other than those specified in Annex EUTMR (Article 144 EUTMR). The amounts of the charges laid down by the Executive Director will be published in the Official Journal of the Office and can be found on the website under decisions of the Executive Director. Examples are the charges for mediation in Brussels or for certain publications issued by the Office.

2 Means of Payment

Article 144a(1) EUTMR
 Article 5 CDFR
 Communication No 2/97 of the President of the Office of 03/07/1997

All fees and charges must be paid in euros. Payments in other currencies are not valid, do not create rights and will be reimbursed.

Fees payable to the Office may not be paid to or via national offices.

The admissible means of payment are, in most cases, bank transfers, debits from the current accounts held at the Office, and (for certain online services only) debit or credit cards. Cash payments at the Office's premises and cheques are no longer accepted (decision of 03/09/2008, R 0524/2008-1, TEAMSTAR).

The Office cannot issue invoices. However, the Office will provide a receipt when requested to do so by the user.

2.1 Payment by bank transfer

Money may be sent to the Office by means of transfer. A fee is not deemed to be paid if the order to transfer is given after the end of the time limit. If the fee is sent before the time limit but arrives after its expiry, under specific conditions the Office may consider the fee has been duly paid (see paragraph 4.1 below).

2.1.1 Bank account

Payment by bank transfer can only be made to one of the following two bank accounts of the Office:

Bank	Banco Bilbao Vizcaya Argentaria	La Caixa
Address	Explanada de España, 11 E-03002 Alicante SPAIN	Calle Capitán Segarra, 6 E-03004 Alicante SPAIN
Swift code*	BBVAESMMXXX	CAIXESBBXX
IBAN	ES8801825596900092222222	ES0321002353010700000888
Bank charges**	>OUR	>OUR

* **Swift code:** Some computer programs do not accept the last three digits XXX of the Swift/BIC code. Should this be the case, users must indicate BBVAESMM or CAIXESBB.

** **Bank charges:** It is important to make sure that the entire amount reaches the Office, without any deductions. Therefore, in the case of a transfer 'OUR' must be indicated as the method of payment for the bank charges in order to allow full reception by the Office of the amount due. However, for SEPA payments, the default SEPA specification 'SHA' is required. SEPA is a common European payments system, used by most banks in all EU Member States and five additional European countries.

2.1.2 Details that must accompany the payment

Article 144 a(2) and (3) EUTMR Article 6 CDFR
--

The payment of a fee and indication of the nature of the fee and the procedure to which it refers does not substitute the other remaining formal requirements of the procedural act concerned. For example, the payment of the appeal fee and the indication of the number of the contested decision is not sufficient for filing a valid notice of appeal (judgments of 31/05/2005, T-373/03, Parmitalia, EU:T:2005:191, § 58; 09/09/2010, T-70/08, Etrax, EU:T:2010:375, § 23-25).

When the information supplied is insufficient to properly enable the allocation of the payment, the Office will specify a time limit within which the missing information must be provided, failing which the payment will be considered not to have been made and the sum will be reimbursed. The Office receives thousands of payments a day and the incorrect or insufficient identification of the file can lead to considerable delays in processing procedural acts.

The following data must be included in the transfer form with the payment:

- number of the proceeding (e.g. EUTM, opposition number, RCD number etc.);
- payer's name and address or Office ID number;
- nature of the fee, preferably in its abbreviated form.

In order to deal with payments swiftly with regards to bank transfers, and bearing in mind that only a limited number of characters may be used in the 'sender' and 'description' fields, filling in these fields as follows is highly recommended.

Description field

- Use the codes listed in the tables below, for example: EUTM instead of: 'Application Fee for a European Union Trade Mark'.
- Remove initial zeroes in numbers and do not use spaces or dashes since they use up space unnecessarily.
- Always start with the EUTM or RCD number, e.g. EUTM 3558961.
- If the payment is for more than one trade mark or design, only specify the first and last one, e.g. EUTM 3558961-3558969, and then send a fax with the full details of the trade marks or designs concerned.

Description codes

Description	Code	Example
Payment to current account	CC + account number	CC1361
If the owner or the representative has an ID number	OWN + ID number, REP + ID number	REP10711
Number of the trade mark or the design	EUTM, RCD + number	EUTM 5104422 RCD1698
A short nickname of the CTM or RCD		'XYZABC' or 'bottle shape'
Operation code: Application fee for EUTM or RCD International application fee Renewal fee Opposition fee Cancellation fee Appeal Recordal Transfer Conversion Inspection of files Certified Copies	EUTM, RCD INT RENEWAL OPP CANC APP REC TRANSF CONV INSP COPIES	OPP, REC, RENEW, INSP, INT, TRANSF, CANC, CONV, COPIES, APP

Examples:

Payment Object	Example of Payment Description
Application fee (EUTM = European Union Trade Mark)	EUTM 5104422 XYZABC
Application fee (RCD = Registered Community Design)	RCD1234567 bottle shape
Opposition + payer	EUTM 4325047 OPP XYZABC REP10711
International application	EUTM 4325047 INT XYZABC
Renewal (EUTM)	EUTM 509936 RENEWAL
Payment to current account No 1361	CC1361
Certified Copies	EUTM 1820061 COPIES
Transfer of multiple designs (first 1420061 and last 1420065) + payer	RCD1420061-1420065 TRANSF REP10711
Recordal of a licence for a EUTM	EUTM 4325047 REC LICENCE OWN10711

Sender field

Examples for address

Address	Example
Payer's name Payer's address Payer's city and postcode	John Smith 58 Long Drive London, ED5 6V8

- Use a name that can be identified as a payer, applicant (owner or representative) or opponent.

- For the payer's name, use only the name **without abbreviations**, like DIPL.-ING. PHYS., DR., etc.
- Use the same form of identification for future payments.

2.2 Payment by debit or credit card

Decision No EX-13-2 of the President of the Office of 26/11/2013 concerning electronic communication with and by the Office: Article 7, Electronic payment of fees by credit card
Annex I A EUTMR and Article 5(2) CDFR

Payment by debit or credit card is not yet available for all of the Office's fees. Only certain online services can be paid by debit or credit card.

For applications and renewals filed electronically, payment by debit or credit card is the recommended method. Debit or credit card payments allow the Office to make the best use of its own automatic internal systems, so that work can start on the file more quickly.

Debit or credit card payments are immediate (see paragraph 4.2 below) and are therefore not allowed for delayed payments (within one month from the filing date).

For all other fees, the use of debit or credit cards is not currently available. In particular, debit or credit cards cannot be used to pay charges referred to in Article 144(1) EUTMR and Article 3 CDFR or to top up a current account.

Debit or credit card payments require some essential information. The information disclosed will not be stored by the Office in any permanent database. It will only be kept until it is sent to the bank. Any record of the form will only include the debit or credit card type plus the last four digits of the debit or credit card number. The entire debit or credit card number can safely be entered via a secure server, which encrypts all information submitted.

2.3 Payment by the Office current account

Decision No Ex-96-1 of the President of the Office of 11/01/1996 concerning the conditions for opening current accounts at the Office as amended in 1996, 2003 and 2006
Communication No 5/01 of the President of the Office of 29/06/2001 concerning the availability of current accounts statements on the Office internet site
Communication No 11/02 of the President of the Office of 11/10/2002 concerning the opening of another bank account

It is advisable to open a current account at the Office, as for any request that is subject to time limits, such as filing oppositions or appeals, the payment will be deemed to have been made on time even if the relevant documentation for which the payment was made (for instance a notice of opposition) is submitted on the last day of the deadline, provided that the current account has sufficient funds (see paragraph 4.3 below) (decision of 07/09/2012, R 2596/2011-3, 'STAIR GATES', § 13-14). The date on

which the current account is actually debited will usually be later, but payment will be deemed to have been made on the date on which the request for a procedural act is received by the Office, or as otherwise convenient for the party to the proceedings, in accordance with Article 6 of Decision No Ex-96-1 of the President of the Office as amended in 2006.

If the person (either party to the proceedings or their representative) that has filed the application or the respective procedural act is the holder of a current account with the Office, the Office will automatically debit the current account, unless instructions to the contrary are given in any individual case. In order for the account to be correctly identified, the Office recommends clearly indicating the Office ID number of the holder of the current account with the Office.

The system of current accounts is an automatic debiting system, meaning that upon identification of such an account, the Office may debit, according to the development of the procedures concerned and insofar as there are sufficient funds in the account, all fees and charges due within the limits of the aforementioned procedures, and a payment date will be accorded each time without any further instructions. The only exception to this rule is made when the holder of a current account who wishes to exclude the use of their current account for a particular fee or charge informs the Office thereof in writing. In this scenario, however, the owner of the account may change the method of payment back to payment by current account at any time before the expiry of the payment deadline.

The absence of an indication or incorrect indication of the amount of the fee does not have any negative effect, since the current account will be automatically debited with reference to the corresponding procedural act for which the payment is due.

If there are insufficient funds in a current account, the holder will be notified by the Office and given the possibility to replenish the account and to pay 20 % to cover administrative charges due to lack of funds. If the holder does so, the payment of the fee will be deemed to have been received on the date the relevant document in relation to which the payment was made (for instance a notice of opposition) is received by the Office. If payment concerns the replenishment of a current account, it is sufficient to indicate the current account number. If the account is replenished, the holder should ensure that sufficient funds are provided for all payments due or at least indicate the priorities for which the money should be used (decision of 03/09/2008, R 1350/2007-1, SCHNEIDER). Where no priorities are indicated, the Office will cover the payments in the chronological order in which they fall due.

The Office provides current account holders with access to their current account information over a secure internet connection for at least the previous year via its website. The service includes the account balance, a list of all transactions, monthly statements and a search tool to find specific transactions.

Payment of a fee by debiting a current account held by a third party requires an explicit written authorisation. Payment is considered effective on the date the Office receives the authorisation. The authorisation must be given by the holder of the current account and must state that their account can be debited for a specific fee. If the holder is neither the party nor their representative, the Office will check whether there is such an authorisation. If there is not, the Office will invite the party concerned to submit the authorisation to debit the third party's account before the time limit for payment expires, where the Office has reason to doubt the existence of such authorisation. The party

requesting the payment of a fee by debiting a third party's current account must submit the authorisation to the Office in order to allow the account to be debited.

A current account can be opened at the Office by sending a request to the general fax No +34 965 131 344, or email: fee.information@euipo.europa.eu.

The minimum amount required to open a current account is EUR 3 000.

3 Time of Payment

Article 144(2) EUTMR Article 4 CDFR
--

Fees must be paid on or before the date on which they become due.

If a time limit is specified for a payment to be made, then that payment must be made within that time limit.

Fees and charges for which the regulations do not specify a due date will be due on the date of receipt of the request for the service for which the fee or the charge is incurred, for example, a recordal application.

4 Date on which Payment is Deemed to be Made

Article 144b(1) and (3) EUTMR Article 7 CDFR Article 7 of Decision No Ex-96-1 of the President of the Office of 11/01/1996 concerning the conditions for opening current accounts at the Office as amended in 1996, 2003 and 2006 Decision No EX-13-2 of the President of the Office of 26/11/2013 concerning electronic communication with and by the Office, Article 7, Electronic payment of fees by credit card
--

The date on which a payment is deemed to be made will depend on the method of payment.

4.1 Payment by bank transfer

When the payment is made by transfer or payment to an Office bank account, the date on which payment is deemed to have been made is the date on which the amount is credited to the Office bank account.

4.1.1 Late payment with or without surcharge

A payment that is received by the Office after the expiry of the time limit will be considered to have been made in due time if evidence is submitted to the Office that the person who made the payment, (a) duly gave an order within the relevant period for payment, to a banking establishment to transfer the amount of the payment, and (b)

paid a surcharge of 10 % of the total amount due (up to a maximum amount of EUR 200). (Both conditions must be fulfilled in accordance with judgment of 12/05/2011, T-488/09, Redtube, EU:T:2011:211, § 38, and decision of 10/10/2006, R 0203/2005-1, Blue Cross).

The same is not true for the late payment of the surcharge. If the surcharge is late, the entire payment is late and cannot be remedied by the payment of a 'surcharge on the surcharge' (decision of 07/09/2012, R 1774/2011-1, LAGUIOLE, § 12-15).

The surcharge will not be due if the person submits proof that the payment was initiated more than ten days before the expiry of the relevant time limit.

The Office may set a time limit for the person who made the payment after the expiry of the time limit to submit evidence that one of the above conditions was fulfilled.

For more information on the consequences of late payment in particular proceedings, see the relevant parts of the Guidelines. For example, the Guidelines, Part B, Examination, Section 2, Formalities, deals with the consequences of late payment of the application fee while the Guidelines, Part C, Opposition, Section 1, Procedural Matters, deals with the consequences of late payment of the opposition fee.

4.1.2 Evidence of payment and of the date of payment

Article 76 EUTMR Article 144b(4) EUTMR Article 63 CDR Article 7(4) CDFR
--

Any means of evidence may be submitted, such as:

- a bank transfer order (e.g. SWIFT order) containing stamps and date of receipt by the bank involved;
- an online payment order sent via the internet or a printout of an electronic transfer provided it contains information on the date of the transfer, on the bank it was sent to, and an indication like 'transfer done'.

In addition, the following evidence may be submitted:

- acknowledgement of receipt of payment instructions by the bank;
- letters from the bank where the payment was effected, certifying the day on which the order was placed or the payment was made, indicating the proceeding for which it was made;
- statements from the party or their representative in writing, sworn or affirmed or having a similar effect under the law of the State in which the statement is drawn up.

This additional evidence is only considered sufficient if supported by the initial evidence.

This list is not exhaustive.

If the evidence is not clear, the Office will send a request for further evidence.

If no evidence is submitted, the procedure for which the payment was made is deemed not to have been entered.

In the event of insufficient proof, or if the payer fails to comply with the Office's request for the missing information, the latter will consider that the time limit for payment has not been observed.

The Office may likewise, within the same time limit, request the person to pay the surcharge. In the event of non-payment of the surcharge, the deadline for payment will be considered not to have been observed.

The fee or charges or the part thereof that have been paid will be reimbursed since the payment is invalid.

Rule 96(2) EUTMIR
Article 81(2) CDIR

Language of the evidence: the documents may be filed in any official language of the EU. Where the language of the documents is not the language of the proceedings, the Office may require that a translation be supplied in any language of the Office.

4.2 Payment by debit or credit card

Decision No EX-13-2 of the President of the Office of 26/11/2013 as amended in 2015

Payment by credit or debit card is deemed to have been made on the date on which the relevant electronic filing or request was successfully completed. If, when the Office attempts to debit the credit or debit card, the transaction fails for some reason, payment is considered not to have been made. This applies even when the payer was not responsible for the failure of the transaction.

4.3 Payment by current account

Decision No Ex-96-1 of the President of the Office of 11/01/1996 concerning the conditions for opening current accounts at the Office as amended in 1996, 2003 and 2006

If the payment is made through a current account held with the Office, Decision No EX-96-1 of the President, as amended, ensures that the date on which the payment is deemed to be made is fixed in order to be convenient for the party to the proceedings. For example, for the application fee of an EUTM, as a rule, the fees will be debited from the current account on the last day of the one-month time limit given to pay the fee. However, the applicant/representative may instruct the Office to debit their account upon receipt of the EUTM application. Likewise, upon renewal, the account holder may choose 'Debit now' or 'Debit on expiry'. If a party withdraws its action (opposition, cancellation request, appeal, renewal application) before the end of the

time limit to make the payment, fees due to be debited on expiry of the time limit to pay the fee will not be debited from the current account and the action will be deemed not to have been filed.

5 Refund of Fees

Article 144a(3) and Article 144c EUTMR
Articles 84, 154 and 156 EUTMR
Articles 6(2) and 8(1) CDR
Article 30(2) CDIR

The refund of fees is explicitly provided for in the regulations. Refunds are given by means of bank transfers or through current accounts with the Office, even when the fees were paid by debit or credit card.

5.1 Refund of application fee

Rule 9(1) and Rule (2) EUTMIR
Articles 10, 13 and 22 CDIR
Article 43(1) EUTMR

In the event of the withdrawal of an EUTM application, fees are not refunded except if a declaration of withdrawal reaches the Office:

- where payment has been made by **bank transfer**, before or at the latest on the same day as the amount actually entered the bank account of the Office;
- where payment has been made by debit or **credit card**, on the same day as the application containing the debit or credit card instructions/details;
- where payment is made by **current account**, within the one-month time limit for paying the basic application fee or, where written instruction has been given to immediately debit the current account, before or at the latest on the same day on which that instruction was received.

Where the basic application fee has to be refunded, any additional class fees paid will be refunded as well.

The Office will only refund additional class fees on their own where they have been paid in excess of the classes indicated by the applicant in the EUTM application and where such payment was not requested by the Office or where, upon examination of the classification, the Office concludes that additional classes have been included that were not required in order to cover the goods and services contained within the original application.

As regards designs, if there are deficiencies that affect the filing date, that is, the filing date is not granted due to those deficiencies, and that are not remedied by the time limit granted by the Office, the design(s) will not be dealt with as a Community design and any fees paid will be refunded. On the contrary, under no circumstances will the fees be refunded if the design applied for has been registered.

5.2 Refund of the opposition fee

Rules 17(1), 18(5) and 19(1) EUTMIR

If an opposition is deemed not entered (because it was filed after the three-month time limit) or if the opposition fee was not paid in full or was paid after the expiry of the opposition period, the Office must refund the fee, including the surcharge.

5.3 Refund of fees for international marks designating the EU

Decision No ADM-11-98 of the President of the Office related to regularisation of certain reimbursement of fees

See the Guidelines, Part M, International Marks, paragraph 3.13.

5.4 Refund of appeal fees

Provisions regarding the refund of appeal fees are dealt with under Rule 51 EUTMIR and Article 35(3) and Article 37 CDIR.

5.5 Refund of renewal fees

Article 47(8) EUTMR

Fees that are paid **before** the start of the first six-month time limit for renewal will not be taken into consideration and will be refunded.

Where the fees have been paid, but the registration is not renewed (i.e. where the fee has been paid only after the expiry of the additional time limit, or where the fee paid amounts to less than the basic fee and the fee for late payment/late submission of the request for renewal, or where certain other deficiencies have not been remedied), the fees will be refunded.

Where the owner has instructed the Office to renew the mark, and subsequently either totally or partially (in relation to some classes) withdraws their instruction to renew, the renewal fee will only be refunded:

- if, in the case of payment by **bank transfer**, the Office received the withdrawal before receiving the payment;
- if, in the case of payment by **debit** or **credit card**, the Office received the withdrawal before or on the same day as receiving the debit or credit card payment;
- if, in the case of payment by **current account**, if already debited, the Office received the withdrawal within the six-month time limit for renewal or, where written instruction was given to debit the current account immediately, before or at the latest on the same day that the Office received the instruction.

For further information, see the Guidelines, Part E, Register Operations, Section 4, Renewal.

5.6 Refund of insignificant amounts

Article 144c EUTMR
Article 9(1) CDFR
Decision No EX-03-6 of the President of the Office of 20/01/2003 determining the insignificant amount of fees and charges

A fee will not be considered settled until it has been paid in full. If this is not the case, the amount already paid will be reimbursed after the expiry of the time limit allowed for payment, since in this case the fee no longer has any purpose.

However, insofar as it is possible, the Office may invite the person to complete payment within the time limit.

Where an excess sum is paid to cover a fee or a charge, the excess will not be refunded if the amount is insignificant and the party concerned has not expressly requested a refund. Insignificant amounts are fixed at EUR 15 by Decision No EX-03-6 of the President of the Office of 20/01/2003.

6 Fee Reduction for the EUTM Application Filed by Electronic Means

Annex I A(2) EUTMR
Decision No EX-13-2 of the President of the Office of 26/11/2013 as amended in 2015

According to Annex I A(2) EUTMR, the basic fee for an application for an individual mark may benefit from a reduction if the application has been filed by electronic means. The applicable rules and procedure for such an electronic filing may be found in Decision No EX-13-2 of the President of the Office of 26/11/2013 read in conjunction with the Terms and Conditions related to this Decision.

In order to be considered an application for an EUTM filed by electronic means in the sense of Annex I A(2) EUTMR, the applicant has to insert all the goods and/or services to be covered by the application directly into the Office tool. Consequently, the applicant must not include the goods and/or services in an annexed document or submit them by any other means of communication. If the goods and/or services are annexed in a document or submitted to the Office by any other means of communication, the application will not be considered as having been filed by electronic means and may not benefit from the corresponding fee reduction.

7 Decisions on Costs

Article 85 EUTMR
Rule 94 EUTMIR

7.1 Apportionment of costs

In *inter partes* proceedings, the Opposition Division, the Cancellation Division and the Boards of Appeal must take a decision on the apportionment of costs. Those costs include in particular the costs of the professional representatives, if any, and the corresponding fees. For further information relating to the apportionment of costs in opposition proceedings, see the Guidelines, Part C, Opposition, Section 1, Procedural Matters. Where the decision contains obvious mistakes as regards the costs, the parties may ask for a corrigendum (Rule 53 EUTMR) or a revocation (Article 80 EUTMR), depending on the circumstances (see the Guidelines, Part A, General Rules, Section 6, Revocation of Decisions, Cancellation of Entries in the Register and Correction of Errors).

7.2 Fixing of costs

The decision fixing the amount of costs includes the lump sum provided in Rule 94 EUTMR for professional representation and fees (see above) incurred by the winning party, independently of whether they have actually been incurred. The fixing of the costs may be reviewed in a specific proceeding pursuant to Article 85(6) EUTMR.

7.3. Enforcement of the decision on costs

Article 86 EUTMR

The Office is not competent for enforcement procedures. These must be carried out by the competent national authorities.

7.3.1 Conditions

The winning party may enforce the decision on costs, provided that:

- the decision contains a decision fixing the costs in their favour;
- the decision has become final; the party may give evidence that the decision became final by submitting appropriate extracts from the Office's databases or individual confirmation by the Office;
- the decision bears the order of the competent national authority.

7.3.2 National authority

Each Member State will designate a national authority for the purpose of appending the order for the enforcement of Office decisions fixing the costs. The Member State will make the designation known to the Office and to the Court of Justice (Article 86(2) EUTMR).

The Office publishes such designations in its Official Journal.

References can be found for:

Austria (OJ OHIM 4/2004, p. 559 and 561)
Belgium (OJ OHIM 4/2007)
Czech Republic (pending publication)
Denmark (OJ OHIM 10/2002, p. 1883)
Estonia (OJ OHIM 10/2009)
France (OJ OHIM 5/2002, p. 886)
Germany (OJ OHIM 6/2005, p. 853 and 855)
Ireland (OJ OHIM 3/2007)
Netherlands (OJ OHIM 12/1999, p. 1517)
Slovakia (OJ OHIM 11/2004, p. 1273)
United Kingdom (OJ OHIM 12/1998, p. 1381).

Certain other Member States have assigned jurisdiction to a national authority (e.g., in the case of Spain, to the General Technical Bureau of the Ministry of Justice as per Royal Decree 1523/1997) but have not yet notified the Office or the CJEU.

7.3.3 Proceedings

- a. The interested party must request the competent national authority to append the enforcement order to the decision. For the time being, the conditions on languages of the requests, translations of the relevant parts of the decision, fees and the need of a representative depend on the practice of the Member States and are not harmonised but are considered on a case-by-case basis.

The competent authority will append the order to the decision without any other formality beyond the verification of the authenticity of the decision. As to wrong decisions on costs or fixing of costs, see paragraphs 7.1 and 7.2 above.

- b. If the formalities have been completed, the party concerned may proceed to enforcement. Enforcement is governed by the rules of civil procedure in force in the territory where it is carried out. The enforcement may be suspended only by a decision of the Court of Justice of the European Union. However, the courts of the country concerned have jurisdiction over complaints that enforcement is being carried out in an irregular manner (Article 86(4) EUTMR).

***GUIDELINES FOR EXAMINATION OF
EUROPEAN UNION TRADE MARKS***

***EUROPEAN UNION
INTELLECTUAL PROPERTY OFFICE
(EUIPO)***

PART A

GENERAL RULES

SECTION 4

LANGUAGE OF PROCEEDINGS

Table of Contents

1	Introduction	3
2	From filing to registration (excluding opposition)	3
2.1	Application	3
2.2	Other requests	4
3	After registration (excluding cancellation)	4
4	Opposition and cancellation.....	4
5	Invariable nature of the language rules	5
6	Translations and their certification	5
7	Non-compliance with the language regime	5

1 Introduction

Article 119 EUTMR
Rules 95, 96, 98 EUTMIR
Communication No 4/04 of the President of the Office

There are five Office languages: English, French, German, Italian and Spanish. However, an application for an European trade mark may be filed in any of the official EU languages. The EUTMR lays down rules for determining and using the language of the proceedings. These rules may vary from one set of proceedings to another, in particular depending on whether the proceedings are *ex parte* or *inter partes*.

This section deals only with the horizontal provisions common to all types of proceedings. The exceptions for particular types of proceedings are dealt with in the corresponding sections of the Guidelines.

2 From filing to registration (excluding opposition)

2.1 Application

An European trade mark application (EUTM application) may be filed in any of the official EU languages.

A second language must be indicated from among the five languages of the Office.

During the proceedings, the applicant may use

- the first language if it is an Office language;
- or the second language, at its discretion, if the first language is not an Office language.

The Office uses

- only the first language if it is an Office language;
- the first language if it is not an Office language, following the CJEU 'Kik' judgment (judgment of 09/09/2003, C-361/01 P), unless the applicant has declared in writing its consent for the Office to use the second language, in which case the Office proceeds accordingly. Consent to use of the second language must be given for each individual file; it may not be given for all existing or future files.

This language regime applies throughout the application and examination procedure until registration, except for oppositions and ancillary requests (see following paragraph).

2.2 Other requests

Rule 95(a) EUTMIR

During the period from filing to registration, any request, application or declaration that is not concerned with the examination of the application as such but that starts an ancillary procedure (inspection of files, registration of a transfer or licence, request for conversion, declaration of division) may be submitted in the first or second language, at the discretion of the EUTM applicant or third party. That language then becomes the language of the proceedings for those ancillary proceedings. This applies irrespective of whether or not the first language is an Office language.

3 After registration (excluding cancellation)

Rule 95(b) EUTMIR

Any request, application or declaration of division or surrender, with the exception of a cancellation request, made after the EUTM has been registered must be submitted in one of the five Office languages.

Example: After an EUTM has been registered, the EUTM proprietor may file a request for the registration of a licence in English and, a few weeks later, file a request for renewal in Italian.

4 Opposition and cancellation

Rules 16 and 38(1) EUTMIR

An opposition or request for cancellation (application for revocation or declaration of invalidity) may be filed

- at the discretion of the opponent/applicant for cancellation in the first or second language of the EUTM application if the first language is one of the five languages of the Office;
- in the second language if the first language is not an Office language.

This language becomes the language of the proceedings for the opposition or cancellation proceedings, unless the parties agree to a different one (from among the official EU languages).

An opposition or request for cancellation may also be filed in any of the other Office languages, provided that within one month of the expiry of the opposition period or within one month of the filing of the application for cancellation, the opponent/applicant for cancellation files a translation into a language that is available as a language of proceedings.

5 Invariable nature of the language rules

The Regulations allow certain choices to be made from among the available languages in the course of the proceedings (see above) and, during specified periods, a different language to be chosen as the language of the proceedings for opposition and cancellation. However, with those exceptions, the language rules are invariable. In particular, the first and second languages may not be amended in the course of the proceedings.

6 Translations and their certification

Rule 98 EUTMIR

The general rule is that where a translation of a document is required, it must reach the Office within the time limit set for filing the original document. This applies unless an exception to this rule is expressly provided in the Regulations.

The translation must identify the document to which it refers and reproduce the structure and contents of the original document. The Office may require that a certified translation be filed within a specific period, but does so only if it has reason to doubt the veracity of the translation.

7 Non-compliance with the language regime

In case the language regime is not complied with the Office will issue a deficiency letter. Should the deficiency not be remedied the application or the request will be refused.

For more information on language regimes for particular types of proceedings the corresponding sections of the Guidelines should be consulted.

***GUIDELINES FOR EXAMINATION OF
EUROPEAN UNION TRADE MARKS***

***EUROPEAN UNION
INTELLECTUAL PROPERTY OFFICE
(EUIPO)***

PART A

GENERAL RULES

SECTION 5

PROFESSIONAL REPRESENTATION

Table of Contents

1	Introduction — Principle of Representation	4
2	Who May Represent	5
2.1	Database of representatives	5
2.2	Professional representation by legal practitioners	6
2.2.1	The term ‘legal practitioner’	6
2.2.2	Qualification	6
2.2.3	Nationality and place of business	6
2.2.4	Entitlement to act in trade mark and/or design matters	7
2.3	Professional representatives admitted and entered on the lists maintained by the Office	7
2.3.1	Entitlement under national law	8
2.3.2	Nationality and place of business	9
2.3.3	Certificate	10
2.3.4	Exemptions	10
2.3.5	Procedure for entry on the list	10
2.3.6	Amendment of the list of professional representatives	11
2.3.6.1	Deletion	11
2.3.6.2	Suspension of the entry on the list	12
2.3.7	Reinstatement in the list of professional representatives	12
2.4	Representation by an employee	12
2.4.1	Employees acting for their employer	13
2.4.2	Representation by employees of a legal person with economic connections	13
2.5	Legal representation	14
3	Appointment of a Professional Representative	15
3.1	Conditions under which appointment is mandatory	15
3.1.1	Domicile and place of business	15
3.1.2	The notion of ‘in the EEA’	15
3.2	Consequences of non-compliance when appointment is mandatory	16
3.2.1	During registration	16
3.2.2	During opposition	16
3.2.3	Cancellation	17
3.3	Appointment of a representative when not mandatory	17
3.4	Appointment of a representative	17
3.4.1	Explicit appointment	17
3.4.2	Implicit appointment	18
3.4.3	Associations of representatives	18
3.4.4	ID numbers	19
4	Communication with Representatives	19
5	Authorisation	20

5.1 Individual authorisations	21
5.2 General authorisations.....	21
5.2.1 Registration of general authorisations	21
5.3 Consequences where authorisation expressly requested by the Office is missing.....	22
6 Withdrawal of a Representative’s Appointment or Authorisation.....	22
6.1 Action taken by the person represented	22
6.2 Withdrawal by the representative.....	22
7 Death or Legal Incapacity of the Party Represented or Representative.....	23
7.1 Death or legal incapacity of the party represented	23
7.2 Death or legal incapacity of the representative.....	23
Annex 1	24
Annex 2	30

1 Introduction — Principle of Representation

Articles 92 and 93 EUTMR, Rule 76 EUTMIR

A new practice will apply to EUTMs regarding the obligation to be represented before the EUIPO and the professional representatives entitled to act before the EUIPO.

Persons having their domicile or their principal place of business or a real and effective industrial or commercial establishment within the European Economic Area (EEA), which consists of the European Union and Iceland, Liechtenstein and Norway, are not required to be represented in any proceedings before the Office (see paragraph 3.1.1 below).

Natural persons not domiciled in or legal persons that do not have their principal place of business or a real and effective industrial or commercial establishment in the EEA must be represented by a representative based within the EEA. This obligation exists in all proceedings before the Office, except for the act of filing an application for an EUTM. See paragraph 3.2.1 below on the consequences of not appointing a representative, when representation is mandatory, once the EUTM application has been filed.

Representatives in the sense of Articles 92 and 93 EUTMR may be domiciled in the EEA.

For RCDs, the relevant territory for establishing the obligation to be represented and the place where the representative must be based in the sense of Article 78 CDR is the EU. This section will refer only to the 'EEA', however, references thereto should be replaced by the 'EU' for RCD proceedings.

Representation is not required for applications to renew EUTMs or RCDs or for filing an application for inspection of files.

In principle, representatives do not need to file an authorisation to act before the Office unless the Office expressly requires it, or where, in *inter partes* proceedings, the other party expressly requests it.

Where a representative has been appointed, the Office will communicate solely with that representative.

For further information on specific aspects of professional representation during proceedings before the Office in relation to international marks, please consult the Guidelines, Part M, International Marks.

The first part of this section (paragraph 2) defines the different types of representatives.

The second part of this section (paragraphs 3 to 6) deals with the appointment of representatives or failure to do so and the authorisation of representatives.

2 Who May Represent

Article 92(3) and Article 93(1)(a) and (b) EUTMR, Rule 76 EUTMIR, Article 77(3) and Article 78(1)(a) and (b) CDR

In all Member States of the EEA, representation in legal proceedings is a regulated profession and may only be exercised under particular conditions. The terminology of Article 93 EUTMR encompasses different categories of representative under the heading ‘Professional representatives’. In proceedings before the Office, the following categories of representative are distinguished:

Legal practitioners (Article 93(1)(a) EUTMR and Article 78(1)(a) CDR) are professional representatives who, depending on the national law, are always qualified to represent third parties before national offices (see paragraph 2.2).

Other professionals (Article 93(1)(b) EUTMR and Article 78(1)(b) CDR) need to comply with further conditions and need to be included on a specific list maintained by the Office for this purpose (the Office’s list of professional representatives). Amongst these, two further groups need to be distinguished: those who may represent only in Community design (CD) proceedings (‘designs list’) and those who may represent in both EUTM and CD proceedings (see paragraph 2.3 below). The Office refers to these other professionals collectively as ‘**professional representatives**’.

Several legal practitioners and professional representatives may be organised in entities called ‘**associations of representatives**’ (Rule 76(9) EUTMIR) (see paragraph 3.4.3 below).

The final category of representatives is made up of **employees** acting as representatives for the party to proceedings before the Office (Article 92(3) EUTMR, first alternative) (see paragraph 2.4.1 below) or employees of **economically linked** legal persons (Article 92(3) EUTMR, second alternative) (see paragraph 2.4.2 below).

Employees are to be distinguished from **legal representatives** under national law (see paragraph 2.5 below).

2.1 Database of representatives

All persons that identify themselves as representatives for or employees of individual parties to proceedings before the Office and that fulfil the requirements provided by the regulations are entered into the database of representatives and obtain an ID number. The database has a double function, providing all relevant contact details under the specific ID number for any type of representative as well as the public information on the Office’s list of professional representatives or designs list.

All representatives, including associations of representatives, must indicate the category of representative to which they belong, their name and their address in accordance with Rule 1 EUTMIR.

A representative may have several IDs. For example, associations of representatives may have different IDs for different official addresses (to be distinguished from different correspondence addresses, which can be identified under a single ID; see the Guidelines, Part E, Register Operations, Section 1, Changes in a Registration).

Individual representatives may have one ID as an employee representative and a different ID as a legal practitioner in their own right.

A legal practitioner cannot, in principle, appear in the database as an 'Office professional representative', since they do not need to be admitted by the Office. The Office, therefore, almost invariably refuses requests from legal practitioners to be entered on the list of Office professional representatives. The only exception is where a professional representative on the list is also a legal practitioner and such dual qualification is allowed under national law.

The database of professional representatives is available online. In the database, representatives are identified as: association, employee, lawyer (legal practitioners), and professional representative. Internally, the latter category is divided into two subcategories: type 1 consists of design attorneys exclusively entitled to represent in CD matters under Article 78 CDR and type 2 of trade mark and design attorneys under Article 93 EUTMR.

2.2 Professional representation by legal practitioners

Article 93(1)(a) EUTMR and Article 78 CDR

A legal practitioner is a professional representative who is automatically and without any further formal recognition allowed to represent third parties before the Office provided that they meet the following three conditions:

- a) they must be qualified in one of the Member States of the EEA;
- b) they must have their place of business within the EEA; and
- c) they must be entitled, within that State, to act as a representative in trade mark and/or design matters.

2.2.1 The term 'legal practitioner'

Directive 98/5/EC of the European Parliament and of the Council defines the term 'lawyer' (i.e. legal practitioner). The professional titles are identified in the column 'Terminology for legal practitioner' in Annex 1 of this section.

2.2.2 Qualification

The requirement to be qualified in one of the Member States of the EEA means that the person must be admitted to the bar or be admitted to practise under one of the professional titles identified in Annex 1 pursuant to the relevant national rules. The Office will not verify this unless there are serious doubts in this regard.

2.2.3 Nationality and place of business

There is no requirement as to nationality. Therefore, the legal practitioner may be a national of a state other than one of the Member States of the EEA.

The place of business must be in the EEA. A PO box address does not constitute a place of business. The place of business need not necessarily be the only place of business of the representative. Furthermore, the place of business may be in a Member State of the EEA other than the one in which the legal practitioner is admitted to the bar. However, legal practitioners who have their sole place of business outside the EEA are not entitled to represent before the Office even when they are admitted to practise in one of the Member States of the EEA.

Where an association of representatives, such as a law firm or a law office, has several places of business, it may perform acts of representation only under a place of business within the EEA, and the Office will communicate with the legal practitioner only at an address within the EEA.

2.2.4 Entitlement to act in trade mark and/or design matters

The entitlement to act as a representative in trade mark and/or design matters in a state must include the entitlement to represent clients before the national industrial property office of that state. This condition applies to all Member States of the EEA.

Legal practitioners referred to in Article 93(1)(a) EUTMR who fulfil the conditions laid down in this article are automatically entitled as of right to represent their clients before the Office. This basically means that if a legal practitioner is entitled to act in trade mark and/or design matters before the central industrial property office of the Member State of the EEA in which they are qualified, they will also be able to act before the Office. Legal practitioners are not entered on the list of professional representatives to which Article 93(2) EUTMR refers, because the entitlement and the special professional qualifications referred to in those provisions relate to persons belonging to categories of professional representatives specialising in industrial property or trade mark matters, whereas legal practitioners are by definition entitled to be representatives in all legal matters.

If a legal practitioner (lawyer) who has already been attributed an identification number as a lawyer requests entry on the list, the number will be maintained but the status will be changed from 'lawyer' to 'professional representative'. The only exception is where a professional representative on the list is also a legal practitioner and is allowed, under national law, to act in both contexts.

Annex 1 gives a detailed explanation of the specific rules for most of the countries.

2.3 Professional representatives admitted and entered on the lists maintained by the Office

Article 93(1)(b) and Article 93(2) EUTMR and Article 78(1)(b) CDR

The second group of persons entitled to represent third parties professionally before the Office are those persons whose names appear on one of the two lists of professional representatives maintained by the Office, the Office's list of professional representatives and the designs list.

For this category of professional representatives, the entry on the Office's list of professional representatives or designs list entitles them to represent third parties

before the Office. A representative who is entered on the Office's list of professional representatives, referred to in Article 93(1)(b) EUTMR, is automatically entitled to represent third parties in design matters according to Article 78(1)(b) CDR and will not be entered on the special list of professional representatives in design matters ('designs list').

If a person on the list maintained under Article 93 EUTMR requests entry on the designs list maintained for professional representatives authorised to act exclusively in Community design matters under Article 78(4) CDR, the request will be rejected.

The designs list is intended only for professional representatives who are entitled to represent clients before the Office in design matters but not trade mark matters.

Annex 2 gives a detailed explanation of the specific rules for most of the countries.

Entry on the lists is subject to a request being completed and signed individually by the person concerned, using the form established for this purpose by the Office at: http://oami.europa.eu/pdf/forms/prorep_form93_en.pdf.

In order to be entered on the list, three requirements must be fulfilled.

- a) The representative must be a national of one of the Member States of the EEA.
- b) They must have their place of business within the EEA.
- c) They must be entitled under national law to represent third parties in trade mark matters before the national industrial property office. To that end they must provide a certificate attesting this from the national industrial property office of a Member State of the EEA.

2.3.1 Entitlement under national law

The conditions for entry on the Office's list of professional representatives and the designs list depend on the legal situation in the Member State of the EEA concerned.

Article 93(2)(c) EUTMR and Article 78(1)(b) CDR

In a large number of Member States of the EEA, entitlement to represent third parties before the national office in trade mark matters is conditional upon possession of a special professional qualification (Article 93(2)(c) EUTMR, first alternative). Therefore, in order to be entitled to act as a representative, the person must have the required qualification. In other Member States of the EEA, there is no such requirement for a special qualification, that is to say, representation in trade mark matters is open to anybody. In this case, the person involved must have regularly represented third parties in trade mark or design matters before the national office concerned for at least five years (Article 93(2)(c) EUTMR, second alternative). A subcategory of this category of Member States of the EEA are those that have a system officially recognising a professional qualification to represent third parties before the national office concerned, although such recognition is not a prerequisite for the exercise of professional representation. In this case, persons so recognised are not subject to the requirement of having regularly acted as a representative for at least five years.

First alternative — Special professional qualifications

Where, in the Member State of the EEA concerned, entitlement is conditional upon having special professional qualifications, persons applying to be entered on the list must have acquired this special professional qualification.

This special professional qualification (often by means of an examination) is required in Austria, Bulgaria, Croatia, the Czech Republic, Estonia, France, Germany, Hungary, Ireland, Italy, Latvia, Lithuania, Poland, Portugal, Romania, Slovakia, Slovenia, Spain and the United Kingdom.

If the person confirms that they work for two different associations of representatives or from two different addresses, then they can have two different numbers attributed. It is also possible to have two different numbers, one as a lawyer and one as an Office professional representative where such a dual qualification is allowed under national law (e.g. this is not compatible in Belgium and France).

Second alternative — Five years' experience

Where, in the Member State of the EEA concerned, the entitlement is not conditional upon possession of special professional qualifications, persons applying to be entered on the list must have regularly acted as professional representatives for at least five years before a central industrial property office of a Member State of the EEA.

It is possible for the Executive Director to grant an exemption from this requirement (see paragraph 2.3.4 below).

This is the case for Benelux, Denmark, Malta, Finland and Sweden.

Third alternative — Recognition by a Member State of the EEA

Persons whose professional qualification to represent natural or legal persons in trade mark and/or design matters before the central industrial property office of one of the Member States of the EEA is officially recognised in accordance with the regulations laid down by that state shall not be subject to the condition of having exercised the profession for at least five years.

2.3.2 Nationality and place of business

Article 93(2)(a) and (b) EUTMR and Article 93(4) EUTMR
--

A professional representative requesting to be entered on the list must be a national of a Member State of the EEA and must have their place of business or employment in the EEA. Entitlement to act as a representative in other Member States of the EEA, and professional experience obtained therein, can be taken into account only within the scope of Article 93(4) EUTMR. It is possible for the Executive Director to grant an exemption from this requirement (see paragraph 2.3.4 below).

2.3.3 Certificate

Article 93(3) EUTMR

Fulfilment of the abovementioned conditions laid down in Article 93(2) EUTMR must be attested by a certificate provided by the national office concerned. Some national offices issue individual certificates while others provide the Office with block certificates. They send regularly updated lists of professional representatives entitled to represent clients before their office (Communication No 1/95 of the President of the Office of 18/09/1995; OJ OHIM 1995, 16). Otherwise, the person concerned must accompany their request with an individual certificate (see http://oami.europa.eu/pdf/forms/prorep_form93_certificate_en.pdf).

2.3.4 Exemptions

Article 93(4) EUTMR

The Executive Director of the Office may, under special circumstances, grant exemption from the requirement to be a national of a Member State of the EEA and from the requirement of having regularly represented in trade mark matters for at least five years, provided that the professional representative submits proof that they have acquired the required qualification in another way. This power is of a discretionary nature.

All the cases presented to the Executive Director of the Office so far have allowed him to grant an exemption from the nationality requirement. Exemptions from the requirement for five years' experience are limited to where a qualification to act as a representative in trade mark matters acquired in another way has already been valid for the equivalent period.

For example, this comprises cases where the professional representative, before becoming an industrial property agent, was responsible for trade mark operations within a company without having personally acted before the national office concerned. The experience must have been acquired in a Member State of the EEA.

2.3.5 Procedure for entry on the list

Article 93(3) EUTMR and Article 78 CDR
--

Entry on the list is confirmed by notification of a positive decision, which contains the indication of the ID number attributed to the professional representative. Entries on the Office's list of professional representatives or designs list are published in the Official Journal of the Office.

If any of the requirements for entry on the list are not fulfilled, and after the applicant has been given the opportunity to reply to the Office's deficiency notification to that effect, a rejection decision will be issued unless the applicant remedies the said deficiency. The party concerned may file an appeal against this decision (Article 58(1) EUTMR and Article 133 EUTMR).

Professional representatives may obtain an additional copy of the decision without the payment of a fee. The files relating to requests for entry on the Office's list of professional representatives or designs list are not open to public inspection.

2.3.6 Amendment of the list of professional representatives

2.3.6.1 Deletion

First alternative, upon own request

Article 93(5) EUTMR, Rule 78(1) and (6) EUTMIR and Article 64(1) and (6) CDIR

The entry of a professional representative on the Office's list of professional representatives or designs list will be deleted at the request of that representative.

The deletion will be entered in the files kept by the Office. The notification of deletion will be sent to the representative and the deletion will be published in the Official Journal of the Office.

Second alternative, automatic deletion from the list of professional representatives

Rule 78(2) and (5) EUTMIR and Article 64(2) and (5) CDIR

The entry of a professional representative in the Office's list of professional representatives or designs list will be deleted automatically:

- a) in the event of the death or legal incapacity of the professional representative;
- b) where the professional representative is no longer a national of a Member State of the EEA; however, the Executive Director of the Office may still grant an exemption under Article 93(4)(b) EUTMR;
- c) where the professional representative no longer has their place of business or employment in the EEA; or
- d) where the professional representative is no longer entitled to represent third parties before the central industrial property office of a Member State of the EEA.

Where the professional representative changes from a design attorney to a trade mark attorney, they will be removed from the designs list and introduced in the Office's list of professional representatives.

The Office may be informed of the above events in a number of ways. In case of doubt, the Office will, prior to deletion from the list, seek clarification from the national office concerned. It will also hear the professional representative, in particular where there is a possibility that they are entitled to remain on the list on another legal or factual basis.

The deletion will be entered in the files kept by the Office. The decision of the deletion will be notified to the representative and the deletion will be published in the Official Journal of the Office. The party concerned can lodge an appeal against this decision (Decision 2009-1 of the Presidium of the Boards of Appeal of 16 June 2009 regarding Instructions to Parties in Proceedings before the Boards of Appeal).

2.3.6.2 Suspension of the entry on the list

Rule 78(3) and (5) EUTMIR and Article 64(3) CDIR
--

The entry of the professional representative on the Office's list of professional representatives or designs list will be suspended of the Office's own motion where their entitlement to represent natural or legal persons before the national industrial property office of a Member State of the EEA has been suspended.

The national industrial property office of the Member State of the EEA concerned must, where aware of any such events, promptly inform the Office thereof. Before taking a decision to suspend the entry, which will be open to appeal, the Office will inform the representative and give them an opportunity to make comments (Decision 2009-1 of the Presidium of the Boards of Appeal of 16 June 2009 regarding Instructions to Parties in Proceedings before the Boards of Appeal).

2.3.7 Reinstatement in the list of professional representatives

Rule 78(4) EUTMIR and Article 64(4) CDIR
--

A person whose entry has been deleted or suspended will, upon request, be reinstated in the list of professional representatives if the conditions for deletion or suspension no longer exist.

A new request must be submitted in accordance with the normal procedure for obtaining an entry on the list of professional representatives (see paragraph 2.2 above).

2.4 Representation by an employee

Article 92(3) EUTMR and Article 77(3) CDR

Natural or legal persons whose domicile, principal place of business or real and effective industrial or commercial establishment is in the EEA may act before the Office through a natural person employed by them ('employee').

A natural person whose domicile is outside the EEA cannot designate an employee representative in the EEA.

Employees of the abovementioned legal persons may also act on behalf of other legal persons who have economic connections with the first legal person (decision of 25/01/2012, R 466/2011-4, FEMME LIBRE / FEMME et al., § 10) (see paragraph 2.4.2 below). This applies even if those other legal persons have neither their domicile nor their principal place of business nor a real and effective industrial or commercial establishment within the EEA (see paragraph 2.4.2 below). Where a legal person from outside the EEA is represented in this way, it is not required to appoint a professional representative within the meaning of Article 93(1) EUTMR, as an exception to the rule that parties to the proceedings domiciled outside the EEA are obliged to appoint a professional representative.

Rule 83(1)(h) EUTMIR

On the forms made available by the Office pursuant to Rule 83(1) EUTMIR, the employee signing the application or request must indicate their name and tick the checkboxes relating to employees, and fill in the field reserved for professional representatives on p. 1 of the form or the sheet with details relating to professional representatives.

Rule 12(b) EUTMIR and Rule 84(2)(e) EUTMIR

The name(s) of the employee(s) will be entered in the database and published under 'representatives' in the European Union Trade Marks Bulletin.

2.4.1 Employees acting for their employer

Article 92(3) EUTMR and Article 77(3) CDR

Where employees act for their employer, this is not a case of professional representation under Article 93(1) EUTMR. As such, Rule 94(7)(d) EUTMIR is not applicable for the apportionment and fixing of costs in *inter partes* proceedings (decision of 03/02/2011, R 898/2010-1, MYBEAUTY (fig.) / BEAUTY TV et al., § 11 and 12).

Natural or legal persons party to proceedings before the Office may act through their employees. No authorisation needs to be submitted. The Office may ask for an authorisation only where there is some doubt.. No other requirements, for example that the employees be qualified to represent third parties before national offices, need be met.

The Office will not generally verify whether there actually is an employee relationship with the party to the proceedings, but may do so where it has reason to doubt that an employment relationship exists, such as when different addresses are indicated or when one and the same person is nominated as the employee of different legal persons.

2.4.2 Representation by employees of a legal person with economic connections

Article 92(3) EUTMR and Article 77(3) CDR

Employees of legal persons may represent other legal persons provided that the two legal persons have economic connections with each other. Economic connections in this sense exist when there is economic dependence between the two legal persons, either in the sense that the party to the proceedings is dependent on the employer of the employee concerned, or vice versa. This economic dependence may exist:

- either because the two legal persons are members of the same group; or
- because of management control mechanisms.

In accordance with Article 2 of Commission Directive 80/723/EEC of 25/06/1980 (OJ L 195, 29/07/1980, p. 35) on the transparency of financial relations between Member States and public undertakings, and Article 10 of Commission Regulation No 240/96 of 31/01/1996 on the application of Article 85(3) of the Treaty to certain categories of technology transfer agreements (OJ L 31, 09/02/1996, p. 2), one enterprise has economic connections with another:

- if it holds more than half of the capital of the other; or
- if it holds more than half of the voting rights; or
- if it may appoint more than half the members of the managing body; or
- if it has the right to manage the affairs of the undertaking.

In accordance with the jurisprudence on Article 106 TFEU, there are also economic connections where both enterprises form an economic unit within which the subsidiary or branch does not have genuine autonomy in determining its marketing strategy.

On the other hand, the following are not sufficient to establish economic connections:

- a connection by virtue of a trade mark licensing agreement;
- a contractual relationship between two enterprises aimed at mutual representation or legal assistance;
- a mere supplier/client relationship, e.g. on the basis of an exclusive distribution or franchising agreement.

Where an employee representative wishes to rely on economic connections, they must tick the relevant section in the official form, and indicate their name and the name and address of their employer. It is recommended to give an indication of the nature of the economic connection, unless evident from the documents submitted. The Office will not generally make any enquiries in this regard, unless it has reason to doubt that economic connections exist. In this case, the Office may ask for further explanation and, where necessary, documentary evidence.

2.5 Legal representation

Legal representation refers to the representation of natural or legal persons through other persons in accordance with national law. For example, the president of a company is the legal representative of that company.

Furthermore, there is no representation within the meaning of the EUTMR when, in accordance with the applicable national law, a natural or legal person acts, in particular circumstances, through a legal representative, for example when minors are represented by their parents or by a custodian, or a company is represented by a liquidator. In these cases, the person actually signing must demonstrate their capacity to sign, but is not required to provide an authorisation.

It should be borne in mind, however, that a legal person addressing the Office from outside the EEA must be represented by a professional representative within the EEA. This obligation exists for all proceedings before the Office, except for the act of filing an EUTM (representation is not required for applications to renew EUTMs or RCDs or for filing an application for inspection of files). See paragraph 3.2.1 below on the consequences of not appointing a representative, when representation is mandatory, once the EUTM application has been filed.

3 Appointment of a Professional Representative

3.1 Conditions under which appointment is mandatory

Subject to the exception outlined in paragraph 2.4 above, the appointment of a professional representative is mandatory for parties to proceedings before the Office that have neither domicile nor their principal place of business or a real and effective industrial or commercial establishment in the EEA. This obligation exists for all proceedings before the Office, except for the filing of an EUTM or an RCD.

The same applies to international registrations designating the EU. For further information on this point, please consult the Guidelines, Part M, International Marks.

3.1.1 Domicile and place of business

The criterion for mandatory representation is the domicile or place of business or commercial establishment, not nationality. For example, a French national domiciled in Japan has to be represented, but an Australian national domiciled in Belgium does not have to be. The Office will determine this criterion with respect to the address indicated. Where the party to the proceedings indicates an address outside of the EEA, but relies on a place of business or establishment within the EEA, it must give the appropriate indications and explanations, and any correspondence with that party will have to be made to the address in the EEA. The criteria of the principal place of business or real and effective industrial or commercial establishment are not fulfilled where the party to the proceedings merely has a post office box or an address for service in the EEA, nor where the applicant indicates the address of an agent with a place of business in the EEA. A subsidiary is not a real and effective industrial or commercial establishment since it has its own legal personality (decision of 01/04/2014, R 1969/2013-4, DYNATRACE, § 17-19). Where the party to the proceedings indicates an address within the EEA as its own address, the Office will not investigate the matter further unless exceptional reasons give rise to some doubt.

For legal persons, the domicile is determined in accordance with Article 65 TFEU. The actual seat or main domicile must be in the EEA. It is not sufficient that the law governing the company is the law of a Member State of the EEA.

3.1.2 The notion of 'in the EEA'

Article 92(2) EUTMR

In applying Article 92(2) EUTMR, the relevant territory is the territory of the EEA, which comprises the European Union and the countries of Iceland, Liechtenstein and Norway.

3.2 Consequences of non-compliance when appointment is mandatory

Article 93(1) EUTMR

Where a party to proceedings before the Office (applicant, proprietor/holder, opponent, cancellation applicant) is in one of the situations described under paragraph 3.1, but has failed to appoint a professional representative within the meaning of Article 93(1) EUTMR in the application or request, or where compliance with the representation requirement ceases to exist at a later stage (e.g. where the representative withdraws) the legal consequences depend on the nature of the proceedings concerned.

3.2.1 During registration

Article 92(2) EUTMR and Rule 9(3) EUTMIR

Where representation is mandatory and the EUTM applicant fails to designate a professional representative in the application form, the examiner will invite the applicant to appoint a representative within a two-month time limit as part of the formality examination pursuant to Rule 9(3) EUTMIR. Where the applicant fails to comply with this communication, the EUTM application will be refused.

The same course of action will be taken where the appointment of a representative ceases to exist later during the registration process, up until any time before actual registration, that is to say even within the period between publication of the EUTMR application and registration of the EUTM.

Where a specific ('secondary') request is introduced on behalf of the EUTM applicant during the registration process, for example a request for inspection of files, a request for registration of a licence or a request for *restitutio in integrum*, the appointment of a representative need not be repeated, but the Office may in case of doubt request an authorisation. The Office will in this case communicate with the representative on file, and the representative for the recordal applicant, where different.

3.2.2 During opposition

For EUTM applicants, the preceding paragraphs apply. The procedure to remedy any deficiencies relating to representation will take place outside the opposition proceedings, which are terminated by the refusal of the EUTMR application where the applicant fails to comply with the communication.

Rule 15(2)(h)(ii) and Rule 17(4) EUTMIR

As regards the opponent, any initial deficiency relating to representation is a ground for inadmissibility of the opposition. Where the notice of opposition fails to contain the appointment of a representative, the examiner will, pursuant to Article 93(1) EUTMR, invite the opponent to appoint a representative within a two-month time limit. The opposition will be rejected as inadmissible unless this requirement is satisfied within the

time limit set (see the Guidelines, Part B, Examination, Section 1, Proceedings, paragraph 2.4.2.6).

When a representative resigns, the proceedings continue with the opponent itself if it is from the EEA. The other party is informed of the resignation of the representative. If the party whose representative has resigned is from outside the EEA, a letter is sent informing the party concerned that, under the terms of Article 92(2) EUTMR, parties not having their domicile or their place of business or a real and effective industrial or commercial establishment in the EEA must be represented before the Office in accordance with Article 93(1) EUTMR in all proceedings other than the filing of the application, and that a new representative must be appointed within a two-month time limit.

Failure to do so will result in the opposition being rejected as inadmissible.

When there is a change of representative during opposition proceedings, the Office will inform the other party of such a change by sending a copy of the letter and of the authorisation (if submitted).

3.2.3 Cancellation

Rule 37(c)(ii) and Rule 39(3) EUTMR

In cancellation proceedings, the above paragraph concerning opposition applies *mutatis mutandis* to the applicant for revocation or declaration of invalidity of an EUTM.

Where the proprietor of the EUTM is no longer represented, the examiner will invite them to appoint a representative. If they do not do so, procedural statements made by them will not be taken into account, and the request will be dealt with on the basis of the evidence that the Office has before it. However, the EUTM will not be cancelled simply because the EUTM proprietor is no longer represented after registration.

3.3 Appointment of a representative when not mandatory

Where the party to the proceedings before the Office is not obliged to be represented, they may nevertheless, at any time, appoint a representative within the meaning of Article 92 or 93 EUTMR.

Where a representative has been appointed, the Office will communicate solely with that representative (see paragraph 4 below).

3.4 Appointment of a representative

3.4.1 Explicit appointment

A representative is normally appointed in the official form of the Office initiating the procedure involved, for example, the application form or the opposition form. More than one representative (up to a maximum of two) may be appointed by ticking the appropriate box 'multiple representatives' and giving the necessary details for each of the additional representatives.

A representative may also be appointed in a subsequent communication, whether signed by the party to the proceedings or by the representative (self-appointment). The appointment must be unequivocal.

If there is no representative in the proceedings, a communication made in respect of a particular procedure (e.g. registration or opposition), accompanied by an authorisation signed by the party to the proceedings, implies the appointment of a representative. This also applies where a General Authorisation is filed in the same way. For information about General Authorisations, see paragraph 5.2 below.

If there is already a representative in the proceedings, the represented person has to clarify if the former representative will be replaced.

3.4.2 Implicit appointment

Submissions, requests, etc. filed on behalf of the parties by a representative (hereafter the 'new' representative) other than the one who appears in our register (hereafter the 'old' representative) will initially be accepted.

The Office will then send a letter to the 'new' representative inviting them to confirm their appointment within one month. The letter will include a warning that if the representative does not reply within the time limit, the Office will assume that they have not been appointed as representative.

If the 'new' representative confirms their appointment, the submission will be taken into account and the Office will send further communications to the 'new' representative.

If the 'new' representative does not reply within one month or if they confirm that they are not the 'new' representative, the proceedings will go on with the 'old' representative. The submission and the answer from the 'new' representative will not be taken into account and will be forwarded to the 'old' representative for information purposes only.

In particular, when the submission leads to closure of the proceedings (withdrawals/limitations) the 'new' representative must confirm their appointment as representative so that the closure of proceedings or the limitation can be accepted. In any case, the proceedings will not be suspended.

3.4.3 Associations of representatives

Rule 76(9) EUTMIR

An association of representatives (such as firms or partnerships of lawyers or professional representatives or both) may be appointed rather than the individual representatives working within that association.

This must be indicated accordingly, with only the name of the association of representatives to be indicated, and not the names of the individual representatives working within that association. Experience has shown that in many instances equivocal indications are made. In such cases, the Office will, wherever possible,

interpret such indications as the appointment and authorisation of an association of representatives, but if appropriate, advise the representative for future cases.

The appointment of an association of representatives automatically extends to any professional representative who, subsequent to the initial appointment, joins that association of representatives. Conversely, any representative who leaves the association of representatives automatically ceases to be authorised under that association. It is neither required nor recommended to provide information to the Office of the names of the representatives of whom the association consists. However, it is strongly recommended that any changes and information concerning representatives leaving the association be notified to the Office. The Office reserves the right to verify whether a given representative actually works within the association if this is justified under the circumstances of the case.

Article 93(1) EUTMR, Rule 76 EUTMIR

The appointment of an association of representatives does not result in departure from the general rule that only professional representatives within the meaning of Article 93(1) EUTMR may perform legal acts before the Office on behalf of third parties. Thus, any application, request or communication must be signed by a physical person possessing this qualification. The representative must indicate their name underneath the signature. They may indicate their individual ID number, if given by the Office, although it is not necessary to obtain an individual ID number, as the association ID number prevails.

3.4.4 ID numbers

On any form and in any communication sent to the Office, the representative's address and telecommunication details may, and preferably should, be replaced by the ID number attributed by the Office, together with the representative's name. Not only Office professional representatives entered on the list maintained by the Office (see paragraph 2.2 above), but also legal practitioners and associations of representatives, will have such ID numbers. Furthermore, where representatives or associations of representatives have several addresses, they will have a different ID number for each of those addresses.

The ID number can be found by consulting any of the files of the representative in question on our website: www.oami.europa.eu.

4 Communication with Representatives

Rule 77 EUTMIR

Any notification or other communication addressed by the Office to the duly authorised representative will have the same effect as if it had been addressed to the represented person, and any communication addressed to the Office by the duly authorised representative will have the same effect as if it originated from the represented person (decision of 24/11/2011, R 1729/2010-1, WENDY'S OLD FASHIONED HAMBURGERS (fig.) / WENDYS et al., § 21).

Rule 1(1)(e) and Rules 67(2) and 76(8) EUTMIR

A party to the proceedings before the Office may appoint several representatives, in which case each of the representatives may act either jointly or separately, unless the authorisation given to the Office provides otherwise. The Office, however, will as a matter of course communicate only with the first-named representative, except in the following cases:

- where the applicant indicates a different address as the address for service in accordance with Rule 1(1)(e) EUTMIR;
- where the additional representative is appointed for a specific secondary procedure (such as inspection of files or opposition), in which case the Office will proceed accordingly.

Article 92(4) EUTMR and Rule 75(1) EUTMIR

Where there is more than one EUTM applicant, opponent or any other party to proceedings before the Office, a common representative must be expressly appointed by the EUTM applicant, etc. If the common representative has not appointed a professional representative and one of the other persons is obliged to, and does, appoint a professional representative, that representative will be considered to be the common representative for all those persons.

Articles 92 and 93 EUTMR and Rule 67 EUTMIR

Where a representative within the meaning of Articles 92 or 93 EUTMR has been appointed, the Office will communicate solely with that representative.

5 Authorisation

Articles 92(3) and 93(1) EUTMR and Rule 76 EUTMIR

In principle, professional representatives do not need to file an authorisation to act before the Office. However, any professional representative (legal practitioner or Office professional representative entered on the list, including an association of representatives) acting before the Office must file an authorisation for insertion in the files if the Office expressly requires this or, where there are several parties to the proceedings in which the representative acts before the Office, if the other party expressly asks for this.

In such cases, the Office will invite the representative to file the authorisation within a specific time limit (see the Guidelines, Part A, General Rules, Section 1, Means of Communication, Time Limits). The letter will include a warning that if the representative does not reply within the time limit, the Office will assume that they have not been appointed as representative and proceedings will continue directly with the party represented. Where representation is mandatory, the party represented will be invited to appoint a new representative and paragraph 3.2 above applies. Any procedural steps, other than the filing of the application, taken by the representative will be

deemed not to have been taken if the party represented does not approve them within a period specified by the Office.

An authorisation must be signed by the party to the proceedings. In the case of legal persons, it must be signed by a person who is entitled, under the applicable national law, to act on behalf of that person. The Office will not verify this.

Simple photocopies of the signed original may be submitted, including by fax. Original documents become part of the file and, therefore, cannot be returned to the person who submitted them.

Authorisations may be submitted in the form of individual or general authorisations.

5.1 Individual authorisations

Article 93(3) EUTMR and Rule 76(1) and Rule 83(1)(h) EUTMIR

Individual authorisations may be made on the form established by the Office pursuant to Rule 83(1)(h) EUTMIR. The procedure to which the authorisation relates must be indicated (e.g. 'concerning EUTM application number 12345'). The authorisation will then extend to all acts during the lifetime of the ensuing EUTM. Several proceedings may be indicated.

Individual authorisations, whether submitted on the form made available by the Office or on the representative's own form, may contain restrictions as to its scope.

5.2 General authorisations

Article 93(1) EUTMR and Rule 76(1) and Rule 83(1)(h) EUTMIR

A 'general authorisation' authorises the representative, the association of representatives or the employee to perform all acts in all proceedings before the Office, including, but not limited to, the filing and prosecution of EUTM applications, the filing of oppositions and the filing of requests for a declaration of revocation or invalidity, as well as in all proceedings concerning registered Community designs and international marks. The authorisation should be made on the form made available by the Office, or a form with the same content. The authorisation must cover all proceedings before the Office and may not contain limitations. For example, where the text of the authorisation relates to the 'filing and prosecution of EUTM applications and defending them', this is not acceptable because it does not cover the authority to file oppositions and requests for a declaration of revocation or invalidity. Where the authorisation contains such restrictions, it will be treated as an individual authorisation.

5.2.1 Registration of general authorisations

Since April 2002, and in accordance with Communication No 2/03 of the President of the Office of 10/02/2003, representatives will no longer be issued an authorisation number and will not be notified in any way regarding the internal handling of authorisations following receipt at the Office. However, termination of issuing such

authorisation numbers does not affect the issuing of ID numbers to representatives entered in the database of representatives.

5.3 Consequences where authorisation expressly requested by the Office is missing

- a) If representation is not mandatory, the proceedings will continue with the person represented.
- b) If representation is mandatory, paragraph 3.2 above will apply.

6 Withdrawal of a Representative's Appointment or Authorisation

A withdrawal or change of representative may be brought about by an action of the person represented, the previous representative or the new representative.

6.1 Action taken by the person represented

Rule 79 EUTMIR

The person represented may at any time revoke, in a written and signed communication to the Office, the appointment of a representative or the authorisation granted to them. Revocation of an authorisation implies revocation of the representative's appointment.

Rule 76(6) EUTMIR

Where the person represented declares the revocation to their representative and not to the Office, this will have no effect on any proceedings before the Office until the revocation is communicated to the Office. Where the party to the proceedings is obliged to be represented, paragraph 3.2 above will apply.

6.2 Withdrawal by the representative

The representative may at any time declare, by a signed communication to the Office, that they withdraw as a representative. The request must indicate the number of proceedings (e.g. EUTM/RCD number, opposition, etc.). If they declare that representation will as from that moment be taken over by another representative, the Office will record the change accordingly and correspond with the new representative. If the represented person is obliged to be represented, paragraph 3.2 above will apply.

7 Death or Legal Incapacity of the Party Represented or Representative

7.1 Death or legal incapacity of the party represented

Rule 76(7) EUTMIR

In the event of the death or legal incapacity of the authorising party, the proceedings will continue with the representative, unless the authorisation contains provisions to the contrary.

Rule 73(1)(a) EUTMIR

Depending on the proceedings, the representative will have to apply for registration of a transfer to the successor in title. However, the representative may apply for an interruption to the proceedings. For more information on the interruption of opposition proceedings following death or legal incapacity, see the Guidelines, Part C, Opposition, Section 1, Procedural Matters.

For insolvency proceedings, once a liquidator has been nominated, they will assume the capacity to act on behalf of the bankrupt person and may, or in the case of mandatory representation must, appoint a new representative, or confirm the appointment of the existing representative.

For more information on insolvency proceedings, see the Guidelines, Part E, Register Operations, Section 3, EUTMs as Objects of Property, Chapter 5, Insolvency Proceedings or Similar Proceedings.

7.2 Death or legal incapacity of the representative

Rule 73(1)(c) and (3)(a) and (b) EUTMIR

In the event of the death or legal incapacity of a representative, the proceedings before the Office will be interrupted. If the Office has not been informed of the appointment of a new representative within a period of three months after the interruption, the Office will:

- where representation is not mandatory, inform the authorising party that the proceedings will now be resumed with them;
- where representation is mandatory, inform the authorising party that the legal consequences will apply, depending on the nature of the proceedings concerned (e.g. the application will be deemed to have been withdrawn, or the opposition will be rejected), if a new representative is not appointed within two months from the date of notification of that communication (decision of 28/09/2007, R 48/2004-4, PORTICO / PORTICO, § 13 and 15).

Annex 1

COUNTRY	National terminology for legal practitioner	Entitlements/specific rules for representing clients in trade mark and design matters	National terminology for person with the special qualification – patent/trade mark/design attorney (the Office PROF REP)	Entitlements/specific rules for representing clients in trade mark and design matters
Austria	Rechtsanwalt	Lawyers are fully entitled	Patentanwalt	Notaries may represent third parties before the Austrian central industrial property office because of their special professional qualification. Therefore, notaries may apply to be entered on the list of professional representatives.
Belgium	Avocat, Advocaat, Rechtsanwalt	Lawyers are fully entitled but a person cannot be a lawyer and a professional representative at the same time.	In Dutch: Merkgemachtigde In French: Conseil en Marques/Conseils en propriété industrielle In German: Patentanwalt	Falls under the Benelux Treaty for Intellectual Property (Article 4.1). Any person having an address in Benelux territory may represent clients in IP matters. The entitlement is not conditional upon the need for special professional qualifications; persons applying to be entered on the list must have regularly acted as professional representatives for at least five years before a central industrial property office of a Member State.
Bulgaria	Адвокат/Практикуващ Право Advokat/Praktikuvasho Pravo	Lawyers are not entitled	Spetsialist po targovski marki/Spetsialist po dizayni Специалист по търговски марки/Специалист по дизайни	Special professional qualification is required. The Bulgarian Patent Office is able to certify that someone has acted as representative for five years.
Croatia	Odvjetnik	Lawyers are fully entitled	Zastupnik Za Žigove	Special professional qualification is required. The 'authorised representative' is the person who passed an exam for TM representatives before the Croatian Office.
Czech Republic	Advokát	Lawyers are fully entitled	Patentový zástupce	The Czech Republic has a two-part examination. Persons who have passed part B (trade marks and appellation of origin) may act as representatives in this field and hence be entered on the list of Article 93 EUTMR. Patent attorneys, who have passed both parts of the examination, are entitled to represent applicants in all procedures before the Office.

COUNTRY	National terminology for legal practitioner	Entitlements/specific rules for representing clients in trade mark and design matters	National terminology for person with the special qualification – patent/trade mark/design attorney (the Office PROF REP)	Entitlements/specific rules for representing clients in trade mark and design matters
Cyprus	Δικηγόρος Dikigoros	Lawyers ONLY are entitled	nihil	Not relevant.
Denmark	Advokat	Lawyers are fully entitled	Varemaerkefuldmaegtig	The entitlement is not conditional upon the need for special professional qualifications; persons applying to be entered on the list must have regularly acted as professional representatives for at least five years before a central industrial property office of a Member State.
Estonia	Jurist, Advokaat	Lawyers are not entitled unless dually qualified as IP agent.	Patendivolinik	The examination consists of two independent parts: on the one hand, patents and utility models and, on the other, trade marks, designs and geographical indications. Both types of representatives are 'patendivolinik'. Persons who have only passed the patents part of the examination may not be entered on the list of Article 93 EUTMR. Entry on the list is open to persons who have passed the trade marks, industrial designs and geographical indications part.
Finland	Asianajaja, Advokat	Lawyers are fully entitled	In Finnish: Tavaramerkkiasiamies In Swedish: Varumaerkesombud	As from 1 July 2014, the Finnish Patent Office will issue certificates to those professional representatives who comply with the conditions laid down in Article 93(2) EUTMR to be entered in the list of professional representatives.

COUNTRY	National terminology for legal practitioner	Entitlements/specific rules for representing clients in trade mark and design matters	National terminology for person with the special qualification – patent/trade mark/design attorney (the Office PROF REP)	Entitlements/specific rules for representing clients in trade mark and design matters
France	Avocat	Legal practitioners are entitled but a person cannot be a lawyer and a professional representative at the same time.	Conseil en Propriété Industrielle marques et modèles ou juriste.	<p>INPI maintains two different lists:</p> <p>The Liste des Conseils en propriété industrielle and the Liste des Personnes qualifiées en Propriété industrielle.</p> <p>Only persons on the Liste des Conseils en propriété industrielle are entitled to represent third parties before the French Patent Office. Therefore, only these persons are entitled to be on the Office professional representatives list. These people appear on the block certificate.</p> <p>A 'Conseil en PI' is A person who works for an Association (Cabinet). The 'Personne qualifiée en PI' is A person who works for a private company (e.g. in the trade marks department). They are automatically switched from one list to the other in France.</p> <p>Since the 'personne qualifiée' acquired the same professional qualifications as the 'Conseils' they are entitled to apply for entry on our list, but they have to provide an individual certificate signed by the <i>Directeur des Affaires Juridiques et Internationales</i>.</p>
Germany	Rechtsanwalt	Lawyers are fully entitled	Patentanwalt	A 'Patentassessor' is not qualified to act as a professional representative. He may act as an employee representative.
Greece	Δικηγόρος - Dikigoros	ONLY Lawyers are entitled	nihil	Not relevant.

COUNTRY	National terminology for legal practitioner	Entitlements/specific rules for representing clients in trade mark and design matters	National terminology for person with the special qualification – patent/trade mark/design attorney (the Office PROF REP)	Entitlements/specific rules for representing clients in trade mark and design matters
Hungary	Ügyvéd	Legal advisers are not allowed to act as legal practitioners in procedures relating to industrial property matters. Therefore, they may not be entered on the Office's list of professional representatives.	Szabadalmi ügyvivő	A special professional qualification is required to be a patent attorney. Patent attorneys are entitled to represent clients in all procedures before the Office. Notaries are not allowed to act as legal practitioners in procedures relating to industrial property matters. Therefore, they may apply to be entered on the Office's list of professional representatives.
Ireland	Barrister, Solicitor	Lawyers are fully entitled	Trade mark agent	The person has to be entered in the Register of TM Agents.
Italy	Avvocato	Lawyers are fully entitled	Consulenti abilitati/Consulenti in Proprietà Industriale	The person has to be entered in the Register of 'Consulenti in Proprietà Industriale' ('Albo') kept by the Bar ('Consiglio dell'Ordine') and the register communicated to the Italian trade mark and patent office ('UIBM').
Latvia	Advokāts	Lawyers can only represent clients whose permanent residence is in the European Union. Clients whose permanent residence is not in the EU have to be represented by a professional representative.	Patentu pilnvarotais/Preču zīmju aģents/Profesionāls patentpilnvarotais	There is a trade mark examination. Clients whose permanent residence is not in the EU have to be represented by a professional representative. Notaries cannot act as representatives by right.
Lithuania	Advokatas	Lawyers can only represent clients whose permanent residence is in the European Union. Clients whose permanent residence is not in the EU have to be represented by a professional representative.	Patentinis patikėtinis	Clients whose permanent residence is not in the EU have to be represented by a professional representative. Notaries cannot act as representatives by right.

COUNTRY	National terminology for legal practitioner	Entitlements/specific rules for representing clients in trade mark and design matters	National terminology for person with the special qualification – patent/trade mark/design attorney (the Office PROF REP)	Entitlements/specific rules for representing clients in trade mark and design matters
Luxembourg	Avocat/Rechtsanwalt	Lawyers are fully entitled but a person cannot be a lawyer and a professional representative at the same time.	In French: Conseil en Marques/Conseils en propriété industrielle In German: Patentanwalt	Falls under the Benelux Treaty for Intellectual Property (Article 4.1). Any person having an address in the Benelux territory may represent clients in IP matters. The entitlement is not conditional upon the need for special professional qualifications; persons applying to be entered on the list must have regularly acted as professional representatives for at least five years before a central industrial property office of a Member State.
Malta	Avukat, Prokuratur Legali	Lawyers are fully entitled .		Anyone with a legal background, including notaries, can act as a trade mark agent. No documentary proof of the qualification of legal practitioners acting as trade mark agents is required.
Poland	Adwokat, radca prawny	Lawyers are not fully entitled . The lawyer can only represent in opposition and cancellation (invalidity) proceedings.	Rzecznik Patentowy	The representative has to be on the list of patent attorneys maintained by the Polish Patent Office. In Poland, a trade mark attorney must be appointed for any proceeding other than opposition and cancellation. Trade mark attorneys must have passed the appropriate examinations.
Portugal	Advogado	Lawyers are fully entitled .	Agente Oficial da Propriedade Industrial	Five years' experience or special qualifications. A notary is not a legal practitioner and, therefore, may apply to be entered on the list.
Romania	Avocat	Lawyers are not fully entitled .	Consilier în proprietate industrială	In Romania, three lists are maintained. Representatives are required to have special qualifications or five years' experience and be a member of a national chamber. A special professional qualification is required to be a professional representative.
Slovakia	Advokát, Právnik Komerčný	Lawyers are fully entitled .	Patentový zástupca	In Slovakia, legal practitioners ('advokáts') listed in the Slovak BAR Association may act as representatives before the Industrial Property Office of the Slovak Republic.

COUNTRY	National terminology for legal practitioner	Entitlements/specific rules for representing clients in trade mark and design matters	National terminology for person with the special qualification – patent/trade mark/design attorney (the Office PROF REP)	Entitlements/specific rules for representing clients in trade mark and design matters
Slovenia	Odvetnik	Lawyers are fully entitled .	Patentni zastopnik	Legal practitioners who are not entered in the Slovenian register as patent/trade mark agents are not allowed to represent parties before the Office. Notaries are not entitled by right.
Spain	Abogado	Lawyers are fully entitled .	Agente Oficial de la Propiedad Industrial	Entry on the list is conditional upon an examination.
Sweden	Advokat	Lawyers are fully entitled .	Patentombud	Entitlement is not conditional upon the need for special professional qualifications; persons applying to be entered on the list must have regularly acted as professional representatives for at least five years before a central industrial property office of a Member State.
Netherlands	Advocaat	Lawyers are fully entitled but a person cannot be a lawyer and a professional representative at the same time.	Merkengemachtigde	Falls under the Benelux Treaty for Intellectual Property (Article 4.1). Any person having an address in Benelux territory can represent clients in IP matters. The entitlement is not conditional upon the need for special professional qualifications; persons applying to be entered on the list must have regularly acted as professional representatives for at least five years before a central industrial property office of a Member State.
United Kingdom	Barrister, Solicitor, Registered Trade Mark Attorney	Lawyers are fully entitled .	Registered Trade Mark Attorney	Upon examination.

Annex 2

The list below shows the countries where a title exists for a person who is only entitled to represent in design matters. If the country is not on the list it means that the relevant entitlement also covers trade mark matters and so this person would not be on the special Design list.

COUNTRY	Design Attorney
Belgium	Modellengemachtigde, Conseil en modèles
Czech Republic	Patentový zástupce (the same denomination as trade mark agent)
Denmark	Varemaerkefuldmaegtig
Estonia	Patendivolinik
Finland	Mallioikeusasiamies/, Mönsterrättsombud
Ireland	Registered Patent Agent
Italy	Consulente in brevetti
Latvia	Patentpilnvarotais dizainparaugu lietas
Luxembourg	Conseil en Propriété Industrielle
Romania	Consilier de proprietate industrială
Netherlands	Modellengemachtigde
United Kingdom	Registered Patent Agent

***GUIDELINES FOR EXAMINATION OF
EUROPEAN UNION TRADE MARKS***

***EUROPEAN UNION
INTELLECTUAL PROPERTY OFFICE
(EUIPO)***

PART A

GENERAL RULES

SECTION 6

***REVOCAION OF DECISIONS,
CANCELLATION OF ENTRIES IN THE
REGISTER AND CORRECTION OF ERRORS***

Table of Contents

1	Revocation of Decisions and Cancellation of Entries in the Register ..	3
1.1	Obvious procedural error attributable to the Office.....	3
1.2	Who decides on requests for revocation/cancellation?	4
1.3	Procedural aspects	4
1.3.1	Assessment	5
1.3.2	Distinction between one and two parties	5
1.3.2.1	Procedures for one party.....	6
1.3.2.2	Procedure for more than one party.....	6
2	Correction of Errors in Decisions and other Notifications	7
2.1	Correction of errors in decisions	7
2.1.1	General remarks	7
2.1.2	Procedural aspects	8
2.1.2.1	Time limit	8
2.1.2.2	Assessment.....	8
2.1.2.3	Procedure.....	9
2.2	Correction of errors in notifications other than decisions	9
3	Correction of Errors in Publications and Correction of Errors in the Register or in the Publication of the Registration	9

1 Revocation of Decisions and Cancellation of Entries in the Register

Article 80 EUTMR

Under certain conditions a decision taken by the Office can be revoked or an entry in the Register cancelled. This part of the Guidelines deals with the practical aspects of revocation/cancellation under Article 80 EUTMR; it does not apply to Registered Community designs (RCDs).

The revocation procedure can be initiated either by a party to the proceedings or by the Office on its own motion.

A decision can only be revoked by another decision. The same applies to cancellations of entries in the register.

1.1 Obvious procedural error attributable to the Office

A decision may be revoked or an entry in the Register cancelled only when it contains an obvious procedural error attributable to the Office.

A decision/entry contains an obvious procedural error where there was an error in the proceedings (usually when an essential procedural step was omitted) or where the decision/entry ignores a procedural action taken by the parties. Procedural errors have to be distinguished from errors in substance, where no revocation is possible. The decision/entry is wrong from a procedural point of view (i.e. suffers from an obvious procedural error) if the procedure established by the Regulations was not followed properly.

The following is a non-exhaustive list of examples of obvious procedural errors demanding revocation.

- The EUTM is registered despite having previously been withdrawn.
- The opposition has been found admissible even though some admissibility requirements were not met (see CJEU judgment of 18/10/2012, C-402/11 P, 'REDTUBE').
- The EUTM is registered despite a deficiency in the payment of the application fees.
- The EUTM is registered despite a successful opposition.
- The EUTM's refusal on absolute grounds is notified before expiry of the time limit given to the applicant to send observations in reply to the objection, or ignoring the observations the applicant filed on time. (Where the applicant has responded within the time limit, the examiner can continue dealing with the application, for example by issuing a decision, and is not required to wait until expiry of the time limit set in the objection letter.)

- The EUTM is refused on absolute grounds, ignoring a valid request from the applicant for the opportunity to submit evidence of acquired distinctiveness (Article 7(3) EUTMR).
- The EUTM is refused on absolute grounds, ignoring the evidence of acquired distinctiveness duly submitted.
- The EUTM is refused by the Opposition Division, ignoring an unprocessed request for proof of use or without dealing with the issue of proof of use.
- The EUTM is registered despite a pending opposition.
- The opposition is rejected on the basis of lack of proof of use but
 - the opponent was not expressly given a time limit for submitting proof of use;
 - proof of use was filed on time and was overlooked.
- The opposition decision was rendered while the proceedings were suspended or interrupted or, more generally, while a time limit for one of the parties was still running.
- Any breach of the right to be heard (observations not forwarded to the other party when that party should have been given a time limit to reply pursuant to the Regulation or the Office's practice).
- When closing a file due to a limitation of the contested EUTM application or a withdrawal, the Office has issued a decision on costs, overlooking an agreement between both parties on costs that was on file at the time.
- A transfer of ownership was entered in the Register despite insufficient evidence of the transfer.

Whether or not these procedural errors were a result of human error or of the incorrect functioning of an IT tool is immaterial.

The *effect* of the revocation of a decision or of the cancellation of an entry in the Register is that the decision or entry is deemed to never have existed. The file is returned to the procedural stage it was at before the erroneous decision or entry was made.

1.2 Who decides on requests for revocation/cancellation?

Decisions on revocation/cancellation are made by the department or unit who made the entry or took the decision and can be appealed under Article 58(2) EUTMR.

1.3 Procedural aspects

Article 80 EUTMR

1.3.1 Assessment

Examiners must verify, firstly, whether the decision or entry contains an obvious procedural error, secondly, whether more than six months have passed since notification of the decision or entry in the Register and, thirdly, whether there has been an appeal against the decision/entry in the Register.

- (a) **Assessment:** It must be verified whether the decision or entry contains an obvious procedural error. For further information see above under paragraph 1.1.
- (b) **Six months:** Whenever an obvious procedural error comes to the attention of an examiner, it must be established whether more than six months have passed since notification of the decision or entry in the Register. Revocation/cancellation is not possible if more than six months have passed (Article 80(2) EUTMR).

Article 80 EUTMR mentions that cancellation or revocation 'shall be determined' within six months of the date of the entry or decision. This means that even if the time limit has lapsed, an entry will be cancelled or a decision revoked if the Office is made aware in writing of an obvious procedural error in that entry or decision within six months of notification of that entry/decision. It also means that an entry can be cancelled or a decision revoked after the six-month period if the Office sends a notification initiating the cancellation/revocation proceedings within six months of notification of that entry/decision.

- (c) **Decision/entry against which appeal pending:** Before issuing a letter notifying parties of its intention to cancel an entry or revoke a decision, and before actual cancellation/revocation, the Office must verify whether the decision or entry in the Register has been appealed against. **A decision or entry cannot be revoked/cancelled if an appeal against it is pending before the Boards** (decision of 28/04/2009, R 323/2008-G – 'BEHAVIOURAL INDEXING').

1.3.2 Distinction between one and two parties

The procedure where only **one party** is affected is described below in paragraph 1.3.2.1. Examples are when the Office duly receives third-party observations that raise doubts but the EUTM application is not blocked and continues to registration, and where an EUTM application is registered although the application fee has not been paid.

Errors that concern incorrect handling of the files after a decision has been taken, for example where an EUTM application is registered despite having been refused on absolute grounds, affect only one party – the applicant.

If revocation of a decision is likely to affect **more than one party**, the procedure described below in paragraph 1.3.2.2 must be followed. For example, more than one party is affected by the revocation of a decision in opposition proceedings where the Office overlooked a request for proof of use.

Errors that concern incorrect handling of the files after an opposition decision has been taken, such as where the entire EUTM application is rejected but is still registered, are considered to affect both the applicant and the opponent.

Errors in registering a transfer of ownership also affect more than one party. While the procedure is essentially *ex parte*, the Office may, depending on the case, consider that more than one party is affected: the new owner, the old owner and the third party that should have been entered in the Register.

1.3.2.1 Procedures for one party

Error found by the Office

If the Office itself finds out that an error has been made, it informs the applicant/owner of its intention to revoke the decision/cancel the entry and sets a time limit for observations of one month if the applicant/owner has its head office in the EU or two months if it does not. The letter must state the reasons for the revocation/cancellation.

If the applicant/owner agrees or does not submit any observations, the Office revokes the decision/cancels the entry.

If the applicant/owner does not agree to revocation or cancellation, a formal decision has to be taken, which is subject to the usual requirements as described in the Guidelines, Part A, General Rules, Section 2, General Principles to be respected in Proceedings, paragraph 7, Decisions.

Error notified by affected party

If the applicant/owner informs the Office in writing of an error that will be understood as a request for revocation/cancellation, there is no need to ask for observations. In such cases, it must be determined whether the request for revocation/cancellation is eligible. If so, the decision or entry in the Register is revoked/cancelled. If the Office finds that there are no reasons to revoke/cancel, it rejects the party's request by a decision, giving the reasons why the request is rejected.

1.3.2.2 Procedure for more than one party

Error found by the Office

If the Office itself finds out that an error has been made, it informs both parties of its intention to revoke the decision/cancel the entry and sets a time limit for observations of, in principle, two months (reduced to one month if both parties have their respective head offices in the EU).

If the parties agree or do not submit any observations in reply, the Office must revoke/cancel the decision/entry in the Register.

If one of the parties does not agree to the revocation/cancellation, a reasoned decision has to be taken, which is subject to the usual requirements as described in the Guidelines, Part A, General Rules, Section 2, General Principles to be respected in Proceedings, paragraph 7, Decisions.

Error notified by one of the parties

If the party adversely affected by the error informs the Office in writing of an error that will be understood as a request for revocation/cancellation, it must be determined whether the request for revocation/cancellation is eligible. If so, the Office notifies the party that benefited from the error (the other party) of its intention to revoke/cancel (and sends a copy of this notification to the first party for information). A time limit for observations of, in principle, two months is set (which may be reduced to one month if the adversely affected party has its head office in the EU).

If the other party agrees or does not submit any observations in reply, the Office must revoke the decision/cancel the entry.

If the other party does not agree to revocation or cancellation, a reasoned decision has to be taken, which is subject to the usual requirements as described in the Guidelines, Part A, General Rules, Section 2, General Principles to be respected in Proceedings, paragraph 7, Decisions.

For example, where an opponent that has seen its opposition upheld and the EUTM application rejected informs the Office that the EUTM application has nevertheless been registered, the applicant must be informed and given two months to submit observations. The entry will be cancelled regardless of whether the applicant agrees or does not reply.

If the party that benefited from the error informs the Office in writing, it must be determined whether the request for revocation/cancellation is eligible. If so, the party adversely affected by the error must be informed accordingly. As revocation/cancellation will be to the latter's advantage, the decision can be revoked or entry cancelled at the same time as the letter is sent (to both parties). There is no need for the party that benefited from the error to submit observations, as its letter informing the Office of the error can be taken as its agreement to revocation/cancellation.

For example, where an applicant informs the Office that its EUTM application has been registered despite being rejected by decision of the Office, the entry in the Register must be cancelled. There is no need to hear the opponent.

Finally, once a revocation or cancellation has become final, it must be published if a wrong entry in the Register has already been published. If the Office finds that there are no reasons to revoke a decision/cancel an entry, it will reject the relevant request by letter and send copies of both this letter and the original request to the other party for information.

2 Correction of Errors in Decisions and other Notifications

Rule 53 EUTMIR

2.1 Correction of errors in decisions

2.1.1 General remarks

According to Rule 53 EUTMIR, where the Office becomes aware, of its own motion or at the instance of a party to the proceedings, of a linguistic error, error of transcription

or obvious mistake in a decision, it has to ensure that the error or mistake is corrected by the department or division responsible. It is apparent from the wording that the only legitimate purpose of corrections made on the basis of this provision is to correct spelling or grammatical errors, errors of transcription – such as errors relating to the names of the parties or the written forms of the signs – or errors that are so obvious that nothing other than the wording as corrected could have been understood. However, when the error affects the dictum of a decision, only revocation is possible, and then only if all the conditions are met.

The Office defines ‘obvious error’ as in No B.16 in the Joint Statements by the Council and the Commission entered in the minutes of the Council meeting at which the EUTMR was adopted in relation to Article 44(2) EUTMR and to Rule 53 EUTMIR: ‘... the words “obvious mistake” should be understood as meaning mistakes which obviously require correction, in the sense that nothing else would have been intended than what is offered as the correction.’

The distinction between revocation under Article 80 EUTMR and correction under Rule 53 EUTMIR is that revocation annuls a decision, whereas the correction of errors does not affect the validity of the decision and does not open a new appeal period.

An example of an error of transcription would be when a trade mark is referred to incorrectly, for example, ‘HAMMER’ is referred to as ‘HUMMER’.

An example of an obvious error is when the earlier mark and the contested mark are interchanged in the comparison of the signs.

2.1.2 Procedural aspects

2.1.2.1 Time limit

The Regulations do not set a time limit for the correction of errors in decisions. This suggests that corrections can be made any time, as long as they do not clash with the principle of equity.

2.1.2.2 Assessment

Examiners must verify, firstly, whether the error to be corrected is a linguistic error, an error of transcription or an obvious error and, secondly, whether there has been an appeal against the decision.

- (a) **Assessment:** Before sending a correction letter, the examiner must verify whether the error to be corrected is a linguistic error, an error of transcription or an obvious error.
- (b) **Appeal:** The examiner must also verify whether there has been an appeal against the decision. **No correction can be made if an appeal against the decision is pending before the Boards.** However, the Boards must be informed of the situation.

2.1.2.3 Procedure

Linguistic errors, errors of transcription and obvious errors are corrected by sending a corrigendum to the affected party/parties. The accompanying letter must briefly explain the corrections.

Once the correction has been made, the examiner makes sure that the changes are reflected in the decision as it appears in the Office's database.

The date of the decision or entry **remains unchanged after correction. Therefore, the time limit for appeal is not affected.**

When the fixation of costs is part of the dictum of the decision it can be corrected only by revocation.

2.2 Correction of errors in notifications other than decisions

Errors in notifications other than decisions can be remedied by sending a corrected notification indicating that the latter replaces and annuls the one previously sent. The notification should include an apology for any inconvenience caused.

3 Correction of Errors in Publications and Correction of Errors in the Register or in the Publication of the Registration

Article 39 and 87 EUTMR Rules 14, 27, 85 EUTMIR
--

Article 39 EUTMR states that EUTM applications that have not been refused on absolute grounds should be published one month after the search report has been issued.

Rule 14 EUTMIR refers to the correction of mistakes and errors in the publication of the application pursuant to Article 39 EUTMR.

Rule 27 EUTMIR refers to mistakes and errors in the registration of a EUTM or in any entry made in the Register in accordance with Article 87 EUTMR, or a Decision of the Executive Director pursuant to Article 87(4) EUTMR, and to errors in the publication of the those entries in the Register.

The main difference between the correction of an entry in the Register pursuant to Rule 27 EUTMIR and the cancellation of an entry in the Register pursuant to Article 80 EUTMR is that the former relates to only one part of the publication, whereas the latter cancels the whole entry in the Register.

Where there is an error attributable to the Office, the latter corrects it either of its own motion (where the Office itself has become aware of the error) or at the proprietor's request.

Corrections of errors in EUTM applications that do not require republication of the application for opposition purposes are published in Section B.2 of the Bulletin. Corrections pursuant to Rule 14 EUTMIR that do require republication of the application for opposition purposes are published in Section A.2. However, republication will only be required if the initial publication published a more limited list of goods and services.

In all cases, the affected party/parties are notified of the corrections pursuant to Rule 14 or 27.

The following are examples of errors that can be corrected (Rule 27(1) EUTMIR).

- The EUTM has been published for one class fewer than applied for.
- The sign 'x' was applied for and the publication refers to the sign 'y', or the list of goods and services published is wrong.
- The EUTM has been registered without taking into consideration a limitation.

Corrections of errors in registered EUTM s that do not require republication for opposition purposes are published in subsection B.4.2 of the Bulletin. Corrections pursuant to Rule 27 EUTMIR that require republication of part of the application for opposition purposes are published in subsection A.2.1.2.

Republication for opposition purposes will always be required where a correction involves changes to the representation of the mark or a broadening of the list of goods and services already published. For other corrections, republication must be decided on a case-to-case basis.

Corrections to entries in the Register must be published pursuant to Rules 27(3) and 85(2) EUTMIR. Corrections of relative errors in an entry in the Register are published in subsection B.4.2 of the Bulletin. All the examples listed above (of corrections and of revocation/cancellations) require publication.

No correction need be published pursuant to Rule 27 EUTMIR when the initial publication was in the wrong section of the Bulletin. According to Communication No 11/98 of the President of the Office of 15/12/1998, 'the legal effect of the publication under Article 9b EUTMR remains the same regardless of whether the publication is made in Part B. 1 or Part B. 2 of the Bulletin'.

Time limit: There is no time limit for corrections pursuant to Rule 14 or Rule 27 EUTMIR. They can be made at any time once the error has been detected.

***GUIDELINES FOR EXAMINATION OF
EUROPEAN UNION TRADE MARKS***

***EUROPEAN UNION
INTELLECTUAL PROPERTY OFFICE
(EUIPO)***

PART A

GENERAL RULES

SECTION 7

REVISION

Table of Contents

1	General Principles	3
2	Procedures where Revision is Available	3
2.1	Verification whether the appeal is deemed to have been filed	3
2.2	Verification whether the appeal is admissible.....	4
2.3	Verification whether the appeal is well founded	4
2.3.1	Situations where the initial decision may be rectified	4
2.3.2	Situations where, although the appeal is well founded, revision may not be granted.....	4
2.4	Impact of a request for <i>restitutio in integrum</i>.....	5
2.5	Decision to grant revision.....	5
2.5.1	Deadline for taking the decision	5
2.5.2	Contents of the decision	5
2.6	Appeal against the decision	6
2.7	Communication of the decision	6
3	Procedure where Revision is not Granted	6

1 General Principles

Article 61 EUTMR

It is the responsibility of the Boards of Appeal to decide on an appealed decision. Pursuant to Article 61 EUTMR, in *ex parte* cases the Boards send the appealed decision back to the department that took the decision in order for it to be revised. This enables the first-instance decision-taker to rectify the decision if the appeal is admissible and well founded.

The purpose of revision is to avoid the Boards of Appeal being inundated with appeals against decisions for which a need for rectification has been recognised by the Office. However, the aim is not to remove mistakes in decisions made by the Office without changing the outcome of a case, but to grant the appellant the relief sought.

Revision can be granted where an appeal has been lodged against a decision for which the Boards of Appeal are competent pursuant to Article 58 EUTMR.

If the division or instance of the Office whose decision is appealed considers the appeal to be admissible and well founded, it must rectify its decision.

If the decision is not rectified within one month after receipt of the statement of grounds of appeal, the appeal must be remitted to the Boards of Appeal without delay and without comment as to its merits.

2 Procedures where Revision is Available

Articles 61 and 130 EUTMR

Where revision is available, the Registrar of the Boards of Appeal sends the appeal documents and any subsequent communications relating to the appeal to the Office division that took the decision.

The division concerned examines whether revision may be granted.

Revision may only be granted where the appeal is admissible and well founded.

2.1 Verification whether the appeal is deemed to have been filed

Article 60, Article 144b(3) and (4) and Annex I(21) EUTMR Rule 49(3) EUTMIR

As an appeal is deemed to have been filed only when the appeal fee has been paid, the appealed decision for which the appeal fee has not been paid may not be revised.

The competent division must, therefore, verify whether the appeal fee has been fully paid within two months of notification of the contested decision.

Otherwise, the appealed decision cannot be revised and has to be remitted without delay (not necessarily only at the end of the one-month time limit) to the Registrar at the Boards of Appeal.

For more details on fees, see the Guidelines, Part A, General Rules, Section 3, Payment of Fees, Costs and Charges.

2.2 Verification whether the appeal is admissible

Articles 58 to 60 EUTMR Rule 48 and Rule 49(1) and (2) EUTMIR
--

The competent **division** must be satisfied that the appeal is admissible, that is, that it complies with the requirements laid down in Articles 58 to 60 EUTMR and Rule 48(1)(c) EUTMIR, as well as with all other requirements to which Rule 49(2) EUTMIR refers.

The competent **division** may not under any circumstances contact the appellant to remedy formal or substantive deficiencies in the appeal. This prohibition includes oral contact. Where the requirements for admissibility of the appeal are not met, the case must be remitted without delay to the Boards of Appeal.

Where the language used is not available for lodging the appeal, revision will not be granted.

Where essential indications such as the applicant's name and address are missing or there is no signature or authorisation, revision will not be granted.

2.3 Verification whether the appeal is well founded

The competent division has to verify whether the appeal is well founded.

2.3.1 Situations where the initial decision may be rectified

The relevant date for assessing whether the appeal is well founded is that on which the competent **division** examines whether or not revision can be granted.

The appeal is well founded where the contested decision was incorrect.

2.3.2 Situations where, although the appeal is well founded, revision may not be granted

Articles 7(3) and 37(1) EUTMR Rules 9, 11 and 13 EUTMIR
--

Revision may be granted only if the objections raised by the Office are completely overcome.

For example, an appeal may not be revised where the CTM applicant only partially removes the deficiencies pointed out by the Office.

Another example is where the examiner has objected to the list of goods and services and the CTM applicant files a new list of goods and services that fails to overcome the examiner's objections completely and requires further examination.

A further example is when the Office has rejected a CTM application on absolute grounds but in its appeal the CTM applicant argues that the mark has acquired distinctiveness through use, which then requires proof.

Revision is not available when granting it would merely re-open but not resolve the issue. Revision need not necessarily result in a positive decision on the main issue (for example, in the case of a CTM application, in registration or at least publication): it may grant relief to the appellant insofar as it seeks to reverse a decision. When determining whether revision would grant the requested relief, the contested decision and the reasons on which it is based are taken as the basis.

2.4 Impact of a request for *restitutio in integrum*

Articles 60 and 81 EUTMR

Revision may not be granted where a notice of appeal, or a written statement of the grounds of appeal, was not filed in time but is accompanied by a request for *restitutio in integrum* seeking restoration of the two-month time limit for lodging an appeal or filing the statement of grounds. The appeal will be remitted to the Boards of Appeal without delay.

2.5 Decision to grant revision

Article 61(2) EUTMR Rules 51 and 52 EUTMIR

If the competent **division** concludes that revision should be granted, it must take a decision to this effect within one month of receipt of the statement of grounds of appeal.

2.5.1 Deadline for taking the decision

The decision must be dispatched at the latest on the last day of the time limit. It does not matter whether the date of notification of the decision is after that date. If, for example, the decision is notified by registered mail, the registered letter must be posted at the latest on the last day of the time limit.

2.5.2 Contents of the decision

The contents of the decision must at least provide for the annulment of the initial decision and may provide for further treatment of the case — for example, that the

CTM application be registered or the registration of transfer applied for be entered in the files of the CTM application.

The decision must also state whether or not the appeal fee is reimbursed.

Reimbursement of the appeal fee is ordered only if equitable by reason of a substantial procedural violation. The basic consideration is whether or not the Office was at fault on the date on which the contested decision was taken. If the contested decision is found to be incorrect in itself, reimbursement is granted. If the contested decision was correct on the date on which it was taken, no reimbursement is granted unless it is established that a document or observation removing the deficiency raised by the Office was actually received by the Office prior to the decision but not included in the file in time.

Where the appeal fee has been paid through a current account, the current account holder is reimbursed through that same account. Where it has not yet been debited, the decision will state that no appeal fee will be debited.

2.6 Appeal against the decision

Article 58 EUTMR

Decisions to grant revision cannot be appealed.

A decision not to reimburse the appeal fee may be appealed separately.

2.7 Communication of the decision

Once revision is granted, the competent division informs the Registrar of the Boards of Appeal accordingly.

3 Procedure where Revision is not Granted

Article 61(2) EUTMR

When the competent **division** concludes that the conditions for granting revision are not met, and at the latest upon expiry of the one-month time limit provided for in Article 61(2) EUTMR, the competent **division** must remit the case to the Boards of Appeal without any comment or statement.

When the competent division remits the case without comments, no decision has to be taken to refuse revision.

GUIDELINES FOR EXAMINATION

EUROPEAN UNION
INTELLECTUAL PROPERTY OFFICE
(EUIPO)

PART A

GENERAL RULES

SECTION 8

RESTITUTIO IN INTEGRUM

Table of Contents

1	General Principles	3
2	Criteria for Granting <i>restitutio</i>	3
2.1	The condition of ‘all due care required by the circumstances’	3
2.2	Loss of rights or means of redress caused directly by failure to meet the time limit	5
3	Procedural aspects	5
3.1	Proceedings to which <i>restitutio</i> applies	5
3.2	Parties	6
3.3	Time limit for national offices to forward an application to the Office ...	6
3.4	Time limits excluded from <i>restitutio in integrum</i>	6
3.5	Effect of <i>restitutio in integrum</i>	7
3.6	Time limit	7
3.7	Fee.....	8
3.8	Languages	8
3.9	Particulars and Evidence	8
3.10	Competence.....	9
3.11	Publications.....	9
3.12	Decision, role of other parties in <i>restitutio</i> proceedings	9
4	Third-Party Proceedings	10

1 General Principles

Article 81 EUTMR Article 67 CDR

Parties to proceedings before the Office may have their rights reinstated (*restitutio in integrum*) if they were unable to meet a time limit vis-à-vis the Office, despite taking all due care as required by the circumstances, provided that the failure to meet the time limit had the direct consequence, by virtue of the provisions of the Regulations, of causing a loss of rights or loss of means of redress (judgment of 28/06/2012, T-314/10, 'Cook', paras 16 and 17).

Observing time-limits is a matter of public policy and granting *restitutio in integrum* can undermine legal certainty. Consequently, the conditions for the application of *restitutio in integrum* have to be interpreted strictly (judgment of 19/09/2012, T-267/11, 'VR', para. 35).

Restitutio in integrum is only available upon application to the Office and there is a charge for this.

If the party is represented, the representative's failure to take all due care is attributable to the party that it represents (judgment of 19/09/2012, T-267/11, 'VR', para. 40).

2 Criteria for Granting *restitutio*

There are two requirements for *restitutio in integrum* (judgment of 25/04/2012, T-326/11, 'BrainLAB', para. 36):

- a) that the party has exercised all due care required by the circumstances,
- b) and that the non-observance (of a deadline) by the party has the direct consequence of causing the loss of any right or means of redress.

2.1 The condition of 'all due care required by the circumstances'

Rights will be re-established only under exceptional circumstances that cannot be predicted from experience (judgment of 13/05/2009, T-136/08, 'Aurelia', para. 26) and which are therefore unforeseeable and involuntary.

a) Examples of where the 'all due care' requirement has been fulfilled

In principle, failure to deliver by the postal or delivery service does not involve any lack of due care by the party concerned (decision of 25/06/2012, R 1928/2011-4, 'Sun Park Holidays'). However, it is up to the parties' representatives at least to find out in advance from their delivery company what the usual delivery times are (in the case of letters sent from Germany to Spain in decision of 04/05/2011, R 2138/2010-1 – 'Yellowline').

The degree of due care that the parties must demonstrate in order to have their rights re-established must be determined in the light of all the relevant circumstances.

Relevant circumstances may include a relevant error made by the Office and its repercussions. Thus, even though the party concerned has failed to take all due care, a relevant error by the Office may result in the granting of *restitutio* (judgment of 25/04/2012, T-326/11, 'BrainLAB', para. 57 and para. 59).

Circumstances such as natural disasters and general strikes are regarded as fulfilling the requirement for all due care.

b) Examples of where the 'all due care' requirement has NOT been fulfilled

Errors in the management of files caused by the representative's employees or by the computerised system itself are foreseeable. Consequently, due care would require a system for monitoring and detecting any such errors (judgment of 13/05/2009, T-136/08, 'Aurelia', para. 18).

'The exceptional workload and organisational strains to which the applicants claim they were subject as a result of the entry into force of Regulation No 40/94 are irrelevant in that connection' (judgment of 20/06/2001, T-146/00, 'DAKOTA', para. 62.)

An erroneous calculation of the time limit does not constitute an exceptional event that cannot be predicted from experience (decision of 05/07/2013, R 0194/2011-4 – 'PayEngine').

An error by the Renewals Department Manager, who monitors staff performance daily, does not constitute an exceptional event (decision of 24/04/2013, R 1728/2012-3, - 'Part of lifting device').

The absence of a key member of the Accounts Department cannot be regarded as an exceptional or unforeseeable event (decision of 10/04/2013, R 2071/2012-5 – 'Starforce').

A clerical error in entering a deadline cannot be regarded as an exceptional or unforeseeable event (decision of 31/01/2013, R 0265/2012-1 – 'Kansi').

A misunderstanding of the applicable law may not, as a matter of principle, be regarded as an 'obstacle' to compliance with a time limit (decision of 14/06/2012, R 2235/2011-1 – 'KA').

Delay by the owner in providing instructions is not an exceptional event (decision of 15/04/2011, R 1439/2010-4 – 'Substral Nutri + Max').

Financial problems at the proprietor's business, its closure and the loss of jobs cannot be accepted as a reason for the proprietor not to be able to observe the time-limit to renew its European Union trade mark (decision of 31/03/2013, R 1397/2010-1 – 'Captain').

Legal errors by a professional representative do not warrant *restitutio* (decision of 16/11/2010, R 1498/2010-4 – 'Regine's'). The deletion of a deadline by an assistant is not unforeseeable (decision of 28/06/2010, R 0268/2010-2 – 'Orion').

2.2 Loss of rights or means of redress caused directly by failure to meet the time limit

Article 81(1) EUTMR

Failure to meet the time limit must have had the direct consequence of causing the loss of rights or means of redress (judgment of 15/09/2011, T-271/09, 'Romuald Prinz Sobieski zu Schwarzenberg', para. 53).

Articles 42(2), 76(2) and 77(1) EUTMR
Rule 19, and Rules 20(1)-(5) and 40(1)-(3) EUTMIR

This is not the case where the Regulations offer procedural options that parties to proceedings are free to use, such as requesting an oral hearing, requesting that the opponent prove genuine use of its earlier mark, or applying for an extension of the cooling-off period, pursuant to Rule 19 EUTMIR. The cooling-off period itself is not subject to *restitutio* either because it is not a time limit by which a party must perform an action.

Article 36(1), (4), and Article 37 EUTMR
Rule 9(3), (4), Rule 10 and Rule 11(1) and (3) EUTMIR

On the other hand, *restitutio in integrum* does apply to the late response to an examiner's notification of refusal if the application is not rectified by the time limit specified because in this case there is a direct relationship between failure to meet the time limit and possible refusal.

Restitutio is also available for the late submission of facts and arguments and late filing of observations on the other party's statements in *inter partes* proceedings if and when the Office refuses to take them into account as being filed too late. The loss of rights in this case involves the exclusion of these submissions and observations from the facts and arguments on which the Office bases its decision. (In principle, the Office will disregard any statements filed in *inter partes* proceedings after the deadline has passed.)

3 Procedural aspects

Article 81(2) EUTMR
Rule 83(1)(h) EUTMIR
Article 67(2) CDR
Article 68(1)(g) CDIR

3.1 Proceedings to which *restitutio* applies

Restitutio is available in all proceedings before the Office.

This includes proceedings under the EUTMR and proceedings concerning registered Community designs under the CDR. The respective provisions do not differ materially.

Restitutio is available in *ex parte* proceedings, *inter partes* proceedings and appeal proceedings.

For *restitutio* in relation to the missed time limit for lodging an appeal and in relation to revision, see the Guidelines, Part A, General Rules, Section 7, Revision.

3.2 Parties

Article 81 EUTMR Article 67 CDR

Restitutio is available to any party to proceedings before the Office - not only to the applicant for, or holder or proprietor of, a EUTM trade mark or the applicant for, or holder of, a registered Community design, but also to the opponent, the applicant for a declaration of revocation or invalidity, or an alleged infringer who is joined as a party to invalidity proceedings pursuant to Article 54 CDR.

The time limit must have been missed by the party concerned or their representative.

3.3 Time limit for national offices to forward an application to the Office

Articles 35(1) and 38(2) CDR

The time limit of two months for transmission of a Community design application filed at a national Office has to be observed by the national Office and not by the applicant and is consequently not open to *restitutio in integrum*.

Under Article 38(2) CDR, late transmission of a Community design application has the effect of postponing the date of filing to the date the Office actually receives the relevant documents.

3.4 Time limits excluded from *restitutio in integrum*

Article 81(5) EUTMR Article 67(5) CDR
--

In the interest of legal certainty, *restitutio in integrum* is not applicable to the following time limits.

Articles 29(1) and 81(5) EUTMR
Rule 6(1) EUTMIR
Articles 41(1) and 67(5) CDR
Article 8(1) CDIR

- The priority period, which is the six-month time limit for filing an application claiming the priority of a previous trade mark or design application pursuant to Article 29(1) EUTMR or Article 41(1) CDR. However, *restitutio* does apply to the three-month time limit for providing the file number of the previous application and filing a copy of it, as specified in Rule 6(1) EUTMIR or Article 8(1) CDIR.

Articles 41(1), (3) and 81(5) EUTMR

- The time limit for filing an opposition pursuant to Article 41(1) EUTMR, including the time limit for paying the opposition fee referred to in Article 41(3) EUTMR.

Article 81(2), (5) EUTMR
Article 67(2), (5) CDR

- The time limits for *restitutio* itself, namely:
 - a time limit of two months for filing the application for *restitutio in integrum* as from the removal of the cause of non-compliance
 - a time limit of two months from the date for completing the act that was omitted
 - a time limit of one year for filing the application for *restitutio in integrum* as from expiry of the missed time limit.

3.5 Effect of *restitutio in integrum*

Granting *restitutio in integrum* has the retroactive legal effect that the time limit that was not met will be considered to have been met, and that any loss of rights in the interim will be deemed never to have occurred. If the Office takes a decision in the interim based on failure to meet the time limit, that decision will become void, with the consequence that, once *restitutio* is granted, there is no longer any need to lodge an appeal against such a decision of the Office in order to have it removed. Effectively, *restitutio* will re-establish all the applicant's rights.

3.6 Time limit

Articles 47(3) and 81(2) EUTMR
Articles 13(3) and 67(2) CDR

Applicants must apply for *restitutio in integrum* in writing and send the application to the Office.

The applicant must make the application within two months of the removal of the cause of non-compliance and no later than one year after expiry of the missed time limit. Within the same period, the act that was omitted must be completed. The date when

the cause of non-compliance is removed is the first date on which the party knew or should have known about the facts that led to the non-observance. If the ground for non-compliance was the absence or illness of the professional representative dealing with the case, the date on which the cause of non-compliance is removed is the date on which the representative returns to work. If the applicant fails to submit a request for renewal or to pay the renewal fee, the one-year time limit starts on the day on which the protection ends, and not on the date the further six-month time limit expires.

3.7 Fee

Article 81(3) EUTMR
Annex I (22) EUTMR
Article 67(3) CDR
Annex, point 15 CDFR

The applicant must also pay the fee for *restitutio in integrum* within the same time limit (see paragraph 3.6). If the applicant does not pay the fee by the expiry of the time limit, the application for *restitutio in integrum* will be deemed not to have been filed.

3.8 Languages

Article 119 EUTMR
Rule 95 EUTMIR
Article 98 CDR
Article 80 CDIR

The applicant must submit the application for *restitutio in integrum* in the language, or in one of the languages, of the proceedings in which the failure to meet the time limit occurred. For example, in the registration procedure, this is the first language indicated in the application; in the opposition procedure, it is the language of the opposition procedure; and in the renewal procedure, it is any of the Office's five languages.

3.9 Particulars and Evidence

Articles 78 and 81 EUTMR
Articles 65 and 67 CDR

In its application for *restitutio* the applicant must state the grounds on which it is based and set out the facts on which it relies. As granting *restitutio* is essentially based on facts, it is advisable for the requesting party to adduce evidence by means of sworn or affirmed statements.

Moreover, the act that was omitted must be completed, together with the application for *restitutio*, at the latest by the time limit for submitting the application for *restitutio*.

3.10 Competence

Article 81 EUTMR
Article 67 CDR

The division or department competent to decide on the act that was omitted (i.e. responsible for the procedure in which failure to meet the deadline occurred) is responsible for dealing with applications for *restitutio*.

3.11 Publications

Article 47(5), (7), (8), 81(7), 87(3)(k), (l) EUTMR
Rule 85(2) EUTMIR
Article 67 CDR
Article 22(4), (5), Article 69(3)(m), (n) and Article 70(2) CDIR

The EUTMR and CDR provide for a mention of the re-establishment of rights to be published in the Bulletin. This mention will be published only if the failure to meet the time limit that gave rise to the application for *restitutio* has actually led to publication of a change of status of the EUTM or CD application or registration, because only in such a case would third parties be able to take advantage of the absence of such rights. For example, the Office will publish a mention that *restitutio* has been granted if it published a mention that registration had expired due to failure to meet the time limit for paying the renewal fee.

In the event of such a publication, a corresponding entry will also be made in the Register.

No mention of receipt of an application for *restitutio* will be published.

3.12 Decision, role of other parties in *restitutio* proceedings

Articles 58 and 59 EUTMR

The applicant for *restitutio in integrum* is the sole party to the *restitutio* proceedings, even where failure to meet the time limit occurred in *inter partes* proceedings.

The decision on *restitutio* will be taken, if possible, in the decision terminating the proceedings. If, for specific reasons, the Office makes an interim decision on the application for *restitutio*, it will generally not allow a separate appeal. The applicant for *restitutio* can appeal the refusal of its request for *restitutio* together with an appeal against the decision terminating the proceedings.

The decision to grant *restitutio* cannot be appealed.

The other party to *inter partes* proceedings will be informed that *restitutio* has been requested and about the outcome of the proceedings. If *restitutio* is actually granted, the other party's only means of redress is to initiate third-party proceedings (see below, paragraph 4).

4 Third-Party Proceedings

Article 81 EUTMR Article 67 CDR

A third party who, in the period between the loss of right and publication of the mention of the re-establishment of rights,

- has, in good faith, put goods on the market or supplied services under a sign that is identical or similar to the EUTM, or
- in the case of a Community design, has, in good faith, put on the market products in which a design included within the scope of protection of the RCD is incorporated or to which it is applied,

may bring third-party proceedings against the decision re-establishing the rights of the applicant, proprietor or holder of the EUTM or RCD.

This request is subject to a two-month time limit which starts:

- on the date of publication, where publication has taken place,
- on the date on which the decision to grant *restitutio* took effect, where publication has not taken place.

The Regulations do not contain any provisions governing this procedure. The department or unit that took the decision to re-establish the rights is responsible for third-party proceedings. The Office will conduct adversarial *inter partes* proceedings.

***GUIDELINES FOR EXAMINATION OF
EUROPEAN UNION TRADE MARKS***

***EUROPEAN UNION
INTELLECTUAL PROPERTY OFFICE
(EUIPO)***

PART A

GENERAL RULES

SECTION 9

ENLARGEMENT

Table of Contents

1	Introduction.....	3
2	Rules Concerning Examination.....	3
2.1	Automatic Extension of EUTMs to New Member States	3
2.2	Pending EUTM Applications	3
2.3	Distinctiveness Acquired Through Use	4
2.4	Bad Faith.....	4
2.5	Conversion.....	5
2.6	Other Practical Consequences	5
2.6.1	Professional representation.....	5
2.6.2	First and second language	5
2.6.3	Translation	5
2.6.4	Seniority.....	5
2.6.5	Search	6
3	Rules Concerning Oppositions and Cancellations.....	6
Annex 1	9

1 Introduction

This chapter discusses the rules relating to the accession of new Member States to the Union and the consequences for holders of European Union trade marks. Both absolute and relative grounds are dealt with in this chapter.

Article 165 EUTMR contains the relevant provisions relating to enlargement and European Union trade marks. These provisions were introduced into the Regulation pursuant to the 2004 enlargement process (at that time Article 147a CTMR) and have remained unchanged during successive enlargement processes. The only modification in the text of the Regulation is the addition of the names of the new Member States.

A table in Annex 1 lists the new Member States along with their accession dates and official languages.

2 Rules Concerning Examination

2.1 Automatic Extension of EUTMs to New Member States

Article 165(1) EUTMR lays down the basic rule of enlargement, which is that all existing EUTM applications and registered EUTMs are automatically extended to the new Member States without any kind of additional intervention by European Union Intellectual Property Office, any other body or the holders of the rights concerned. There is no need to pay any extra fees or complete any other administrative formality. The extension of existing EUTM applications or EUTMs to the territories of new Member States ensures that these rights have equal effect throughout the EU and complies with the fundamental principle of the unitary character of the EUTM.

2.2 Pending EUTM Applications

Article 165(2) EUTMR enshrines an important transitional provision, according to which EUTM applications **pending on the accession date** may not be refused on the basis of any absolute ground for refusal if this ground becomes applicable merely because of the accession of a new Member State ('grandfathering clause'). In practice, this means that if a EUTM application is non-distinctive, descriptive, generic, deceptive or contrary to public policy or morality in the language or in the territory of a new Member State, it will not be refused if its filing date is **before** this State's accession date.

For applications filed **after the accession date** the grounds for refusal of Article 7(1) EUTMR apply also for the new Member State. This is the case even when the EUTM application has a priority date which is earlier than the relevant accession date. The priority right does not protect the EUTM applicant against any change in the law relevant to its application. Therefore, examiners have to apply the same examination criteria as for all the other official languages of the EU. This means that the examiner has to check if the EUTM application is descriptive, etc. also in the new Member State.

However, this principle should be applied with caution as it merely means that the criteria for applying Article 7(1) EUTMR should not be made stricter as a result of the accession of new Member States. The inverse conclusion that terms which are descriptive in a language or in the territory of a new Member State may, in any case, be registered for EUTM applications filed prior to the accession date will not always be

correct. For example, descriptive terms from new Member States' languages may have entered the customary languages of existing Member States or be widely known in them (for example, Vodka), and geographical indications may already have to be refused as descriptive terms (for example, Balaton or Tokaj). Consideration must also be given to geographical indications already protected in the new Member States and to protection arising from EU legislation or bilateral treaties between the new Member States and the EU or existing Member States.

More precisely, the grounds for refusal of Article 7(1)(f) and (g) EUTMR, relating to marks contrary to public policy or morality and deceptive marks respectively, are only affected by this provision insofar as the deceptiveness or breach of public morality is due to a meaning which is **only** understood in a language of a new Member State. The Office interprets Article 7(1)(f) EUTMR in accordance with Union-wide criteria, irrespective of the relative levels of morality in different countries of the EU.

Finally, the provision of Article 165(2) EUTMR does not affect the grounds for refusal of Article 7(1)(e) or (i) EUTMR: the former relates to signs consisting exclusively of the shape of the goods themselves, the shape which is necessary to obtain a technical result or the shape which gives substantial value to the goods, and the latter relates to badges and emblems not protected by Article 6ter of the Paris Convention but of particular public interest.

2.3 Distinctiveness Acquired Through Use

According to Office practice, distinctiveness acquired through use (Article 7(3) EUTMR) must exist on the EUTM filing date and subsist until its registration date. Where an applicant for an EUTM application filed **before** the accession date is able to demonstrate that acquired distinctiveness **existed** at the filing date, Article 165(2) EUTMR precludes an objection based on the ground that it is not distinctive through use in the new Member States. Therefore, the applicant does not have to prove acquired distinctiveness in the new Member States.

2.4 Bad Faith

The Office will consider the filing of an EUTM application as having been made in bad faith if it was made prior to the accession date for a term which is descriptive or otherwise not eligible for registration in the language of a new Member State for the sole purpose of obtaining exclusive rights to a non-registrable term or for otherwise objectionable purposes.

This has no practical effect during the examination stage as bad faith does not constitute an absolute ground for refusal and, consequently, the Office has no authority to object *ex officio*. The Office will exercise its duties in respect of 'bad faith filings' only when a request for a declaration of invalidity is filed (Article 52(1)(b) EUTMR). The national Offices of the new Member States are equally determined to act against bad faith in the context of enlargement. EUTM applicants should, therefore, bear in mind that, even if there are no grounds for refusal during the registration procedure, their EUTM registrations may be contested at a later date on the basis of Article 52(1)(b) EUTMR.

2.5 Conversion

Conversion of an EUTM application into national trade mark applications for new Member States may be requested as from the accession date of those States. Conversion is also possible when a converted EUTM has a filing date prior to the accession date. However, in the case of a new Member State, the converted application will have the effect of an earlier right under national law. National law in new Member States has enacted provisions equivalent to Article 165 EUTMR providing that extended EUTMs have the effect of earlier rights in the new Member States only with effect from the accession date. In practice, this means that the 'conversion date' in a new Member State cannot be earlier than that State's accession date.

Taking Croatia's accession as an example, this means that even if a converted EUTM has a filing date of 01/05/2005 in Croatia, the conversion date will not be 01/05/2005 but 01/07/2013, that is, Croatia's accession date.

The date of enlargement does not trigger a new three-month time limit for requesting conversion under Article 112(4) EUTMR.

2.6 Other Practical Consequences

2.6.1 Professional representation

As from the accession date of a new member State, applicants (as well as other parties to proceedings before the Office) having their seat or domicile in that State need no longer be represented by a professional representative. As from the accession date of a new Member State, professional representatives from that State may be entered on the list of professional representatives maintained by the Office pursuant to Article 93 EUTMR and may then represent third parties before the Office.

2.6.2 First and second language

As of the accession date of a new Member State (see Annex 1), the official language(s) of that State may be used as the first language for EUTM applications filed on or after that date.

2.6.3 Translation

EUTM applications with a filing date prior to the accession date of a new Member State and existing EUTM registrations will be neither translated into nor republished in the language of that State. EUTM applications filed after the accession date of a new Member State will be translated into and published in all official languages of the EU.

2.6.4 Seniority

Seniority may be claimed from a national trade mark which was registered before the accession of the new Member State in question or even before the creation of the

European Union. The seniority claim may, however, only be made after the accession date. The mark registered in the new Member State must be 'earlier' than the EUTM. As an extended EUTM has, in the new Member State, the effect of an earlier right as from the accession date, the seniority claim only makes sense when the earlier national mark has a filing or priority date prior to the accession date.

Example 1: The same person files an EUTM application on 01/04/1996 and a national trade mark application in Romania on 01/01/1999. After 01/01/2007 (Romania's date of accession) the seniority of the Romanian national trade mark application may be claimed.

Example 2: The same person owns an international registration designating the EU on 01/01/2005 and subsequently designating Romania on 01/01/2006. After 01/01/2007, the seniority of that Romanian designation may be claimed even though the designation itself is later than the IR designating the EU. This is because the extended EUTM takes effect from the accession date of the new Member State (in this case 01/01/2007).

2.6.5 Search

The national Offices of a new Member State may carry out searches (Article 38(2)(3) EUTMR) as from that State's accession date. Only EUTM applications with a filing date on or after the accession date are sent to national Offices for a search.

3 Rules Concerning Oppositions and Cancellations

1. According to Article 165(4)(b) EUTMR, an EUTM application cannot be opposed or declared invalid on the basis of a national earlier right acquired in a new Member State prior to that State's accession date.

However, EUTM applications filed on or after the accession date are not subject to this 'grandfathering clause' and may be rejected upon opposition, or declared invalid, on account of an earlier national right existing in a new Member State, provided that the earlier right is 'earlier' when the two filing or priority dates are compared.

2. An exception to this (transitional) rule is contained in Article 165(3) EUTMR regarding oppositions. An EUTM application, filed within the six months preceding the accession date, may be challenged by an opposition based on a national right existing in a new Member State at the date of the accession, provided that this right
 - a) has an earlier filing or priority date and
 - b) was acquired in good faith.
3. The filing date and not the priority date is the decisive element for determining when an EUTM application can be opposed on the basis of an earlier right in a new Member State. In practice, the abovementioned provisions have the consequences illustrated in the following examples with reference to the accession of Croatia (01/07/2013):

- a) An EUTM application filed before 01/01/2013 (the priority date is irrelevant in this context) cannot be opposed or declared invalid on the basis of a national earlier right in a new Member State under any circumstances.
- b) An EUTM application with a filing date between 01/01/2013 and 30/06/2013 (i.e. **during the six months prior to the date of accession**), may be opposed by a Croatian trade mark, provided that the filing or priority date of the Croatian trade mark is earlier than the filing or priority date of the opposed EUTM application and the national mark was applied for in good faith.
- c) An EUTM application with a filing date of 01/07/2013 or later may be opposed or declared invalid on the basis of a trade mark registered in Croatia if that mark has an earlier filing or priority date under the normal rules. Acquisition in good faith is not a condition. This applies to all national marks and earlier non-registered rights filed or acquired in a new Member State prior to accession.
- d) An EUTM application with a filing date of 01/07/2013 or later but with a priority date before 01/07/2013 may be opposed or declared invalid on the basis of a national trade mark registered in Croatia if that mark has an earlier filing or priority date under the normal rules.

This transitional exception is limited to the right to file an opposition and does not include the right to file an application for cancellation based on relative grounds. This means that once the abovementioned period of six months has expired without an opposition having been lodged, the EUTM application cannot be challenged any more by an opposition or by an application for a declaration of invalidity.

4. According to Article 165(5) EUTMR, the **use** of an EUTM with a filing date prior to the date of accession of a new Member State, may be prohibited pursuant to Articles 110 and 111 EUTMR on the basis of an earlier national trade mark registered in the new Member State where the latter has a filing or priority date prior to the date of accession and was registered in good faith.

The above provision also applies to:

- applications for national marks filed in new Member States, provided that they have subsequently been registered,
 - unregistered rights acquired in new Member States falling under Article 8(4) or Article 53(2) EUTMR with the proviso that the date of acquisition of the right under national law replaces the filing or priority date.
5. Where an opposition is based on a national registered mark or other right in a new Member State, whether or not that right may be validly invoked as a ground for opposition against an EUTM application depends on whether the opposition is well founded and is not an issue of admissibility.
 6. The acquisition in good faith of the earlier national mark is presumed. This means that, if good faith is questioned, the other party to the proceedings (the applicant for the opposed EUTM application in the case of Article 165(4) EUTMR or the owner of the registered EUTM in the case of Article 165(5) EUTMR) must prove

that the owner of the earlier national right obtained in a new Member State acted in bad faith when filing the national application or otherwise acquiring the right.

7. Article 165 EUTMR does not contain any transitional provisions concerning the use requirement (Articles 15 and 42 EUTMR). In opposition proceedings, the obligation to make genuine use of the mark arises when the applicant for the opposed EUTM application requests that the opponent prove use of the earlier mark pursuant to Article 42(2) and (3) EUTMR and Rule 22 EUTMIR. Issues relating to enlargement could arise regarding the time and place of use of the earlier mark.

Two cases can be distinguished:

- a) The earlier mark is a national mark registered in a new Member State

In this case the opponent must prove genuine use of the earlier mark. This situation can only arise in the context of an opposition directed either against an EUTM application with a filing date after the date of accession or against an EUTM application filed within the period of six months preceding the date of accession.

The earlier national mark must have been put to genuine use in the territory in which it is protected during the five years preceding the date of publication of the opposed EUTM application. In this regard, it is immaterial whether the use relates to a period during which the State concerned was already a Member of the European Union. In other words, the proof of use may relate also to a period prior to the date of accession (in the case of Croatia before 01/07/2013).

- b) The earlier mark is an EUTM

Where the owner of the earlier EUTM can prove use only in the territory of a new Member State or several new Member States, since the obligation of use relates to the period of five years preceding the date of publication of the opposed EUTM application, use in a new Member State (or several new Member States) can only be taken into account if the State concerned was a Member State of the European Union at the date of publication of the opposed EUTM application (Article 43(1) EUTMR requires use 'in the Union'). Before their accession dates, the new States do not constitute 'Member States of the Union'; therefore, it is not possible to prove use 'in the Union'.

Therefore, the five-year period should be counted only from the relevant date of accession.

8. There are no particular transitional problems relating to the opposition proceedings. The right pursuant to Article 119(7) EUTMR to choose a language which is not one of the five languages of the Office as the language of the proceedings applies as from the date of accession in respect of the other official languages of the European Union.

Annex 1

Member States	Accession date	Languages
Czech Republic, Cyprus, Estonia, Latvia, Lithuania, Hungary, Malta, Poland, Slovakia, and Slovenia.	01/05/2004	Czech, Estonian, Latvian, Lithuanian, Hungarian, Maltese, Polish, Slovak and Slovenian
Bulgaria and Romania	01/01/2007	Bulgarian and Romanian
Croatia	01/07/2013	Croatian

***GUIDELINES FOR EXAMINATION OF
EUROPEAN UNION TRADE MARKS***

***EUROPEAN UNION
INTELLECTUAL PROPERTY OFFICE
(EUIPO)***

PART B

EXAMINATION

SECTION 1

PROCEEDINGS

Table of Contents

1	Introduction and General Overview of Examination Proceedings	3
2	Searches.....	4
2.1	European Union search reports	4
2.2	National search reports.....	5
3	General Principles Concerning Examination Proceedings.....	5
3.1	Procedural aspects concerning third-party observations and review of absolute grounds	5
3.2	Decisions	6
3.2.1	Appeals.....	6
3.3	International registrations designating the European Union	7
4	Publication	7
5	Amendments to an EUTM Application.....	8
5.1	Withdrawal of an EUTM application	8
5.1.1	Declaration of withdrawal	8
5.1.2	Unconditional and binding character of the declaration	9
5.1.3	Action to be taken.....	9
5.2	Restriction of the list of goods and services in an EUTM application	10
5.2.1	Procedural admissibility of a restriction	10
5.3	Other amendments.....	10
5.3.1	Name, address and nationality of applicant or representative	11
5.3.2	Other elements of an application.....	12
5.3.3	Recording and publication of amendments	12
5.4	Division of an EUTM application	13
5.4.1	Requirements	13
5.4.2	Acceptance	14
5.4.3	New files and their publication.....	15

1 Introduction and General Overview of Examination Proceedings

This part of the Guidelines outlines the examination procedure from filing to publication of the European Union trade mark (EUTM) application.

Once the EUTM application has been filed, a provisional filing date is accorded, and the Office issues a receipt. At this early stage, the Office only checks whether certain filing date requirements of the European Union trade mark regulation (EUTMR) have been fulfilled. The filing date will only become definitive when the application fee has been paid.

The applicant should check the receipt carefully and notify the Office of any incorrect data. The applicant can only correct data that have an impact on the filing date, such as the applicant's name, the representation of the mark and the list of goods and services, if it notifies the Office on the same date as the incorrect data were submitted. After this date, any amendment is subject to the provisions of the EUTMR and European Union trade mark implementing regulation (EUTMIR), in particular, Articles 17 and 43 EUTMR. For further details, see paragraph 5 below and the Guidelines, Part B, Examination, Section 2, Examination of Formalities.

After the receipt has been issued, the Office carries out a language check of the verbal elements of the mark in all the official languages of the EU and prepares a European Union search report. This report will be sent to the applicant only if it was expressly requested when the application was filed.

Payment of the application fee and national search fee (if applicable) is validated at the latest one month after the EUTM application has been filed. If the applicant has applied for a national search and paid the relevant fee, the Office forwards the application to the offices of the Member States that perform national searches. For further information on searches, see paragraph 2 below. For further information on fees, see the Guidelines, Part A, General Rules, Section 3, Payment of Fees, Costs and Charges.

During examination proceedings, the Office examines the following: filing date, formalities, classification, priority and/or seniority, where applicable, the regulations governing use of the mark for collective marks and absolute grounds for refusal. All these examination steps can be carried out in parallel as there is no strict sequence in examination proceedings.

The applicant will be notified of any deficiency and given two months to remedy the deficiency and/or submit observations. Any decision partially or wholly refusing a EUTM application must give the grounds on which the EUTM application has been refused and inform the applicant of the right to appeal. For further details, see paragraph 3.2 and paragraph 3.2.1 below.

Applications that comply with the requirements of the regulation are accepted for publication and sent for translation into all the official languages of the EU.

The last step in the examination procedure is publication of the application in Part A of the European Union Trade Marks Bulletin (EUTM Bulletin). For further details on publication, see paragraph 4 below.

2 Searches

Articles 38 and 155 EUTMR
Rule 10 EUTMIR
Communication Nos 4/99, 5/00 and 4/01 of the President of the Office

The search report identifies earlier rights that could conflict with the EUTM application. However, even if the search report does not indicate any similar earlier rights, an opposition could still be filed against the EUTM application after its publication.

The results of the search report are for information purposes only and to give the applicant the option of withdrawing the EUTM application before it is published. Surveillance letters inform holders of earlier EUTMs about new, similar EUTM applications.

Figurative elements are classified under the Vienna Classification.

2.1 European Union search reports

The Office will prepare a European Union search report (EU search report) for each EUTM application or international registration (IR) designating the EU that it receives.

However, it will only send the EU search report to the EUTM applicant by standard letter or electronically when the applicant has expressly requested this at the time of filing the application.

Holders of IRs designating the EU that wish to receive an EU search report must send the request to the Office within one month of the date of notification of the IR by the World Intellectual Property Organization (WIPO).

The EU search report covers the following earlier rights:

1. EUTM applications with a filing date or priority date earlier than that of the application in question;
2. EUTM marks already registered; and
3. prior international registrations designating the EU.

The EU search report takes into account the filing date, the verbal elements of the trade mark, the figurative elements of the mark (if applicable) and the classes of goods and services according to the Nice Classification. The search is designed to identify similar earlier marks filed for the same classes or classes that are considered to contain similar goods and/or services by the Office.

Once the new application has been published, the Office will send a surveillance letter to the proprietors of any earlier EUTMs, EUTM applications or international registrations designating the EU cited in the EU search report, unless the proprietors have expressly requested not to receive these notifications.

2.2 National search reports

At the time of filing an application, an EUTM applicant may also request national search reports. These reports list any earlier national trade marks, national trade mark applications or trade marks registered under international agreements having effect in the Member State(s) concerned that have been discovered and that may be invoked under Article 8 EUTMR against the registration of the EUTM applied for, or state that the search has revealed no such rights. These reports are subject to the payment of the corresponding search fees.

Holders of IRs designating the EU that wish to apply for national searches must send the request and pay the relevant fee to the Office within one month of the date of notification of the IR by WIPO.

EUTM applications and IR designations that include a valid request for national searches are sent to the participating national offices. A request is valid if it is made at the time of filing and the relevant fee has been paid.

National search reports are prepared by offices that participate in the search system.

A request for national searches implies that all participating national offices will carry out the search. This all-or-nothing approach means that the applicant cannot select the particular participating offices that it wishes to carry out the search.

The national offices are responsible for the content of the national search report.

3 General Principles Concerning Examination Proceedings

This section describes only the **procedural** aspects of examining absolute grounds (AG) for refusal. For substantive aspects of examining absolute grounds for refusal, see the Guidelines, Part B, Examination, Section 4, Absolute Grounds for Refusal and European Union Collective Marks.

The EUTMR is intended to enable proprietors to register a right that is valid throughout the European Union provided it does not impinge on the rights of others. Although rights can only be conferred in accordance with the provisions of the EUTMR, the Office's function is to facilitate applications, not obstruct them.

During the examination of each application, the trade mark **and** the goods or services of the application must be taken into account. The Office has to bear in mind the nature of the trade concerned, the manner in which the goods or services are provided and the relevant public, for example, whether it consists of specialists or the general public.

3.1 Procedural aspects concerning third-party observations and review of absolute grounds

Article 40 EUTMR
Communication No 2/09 of the President of the Office

Observations on the existence of an absolute ground for refusal can be made by third parties. Third-party observations received before an EUTM application has been

published are dealt with during the examination of absolute grounds for refusal. The Office accepts observations received within the opposition period (three months from the date of publication) or — in cases where an opposition has been filed — observations filed before the final decision on the opposition has been taken. The observations must be filed in one of the Office's languages: English, French, German, Italian or Spanish.

The Office issues a receipt to the party that submitted the observations (the observer), confirming that the observations have been received and have been forwarded to the applicant. The observer does not become a party to the proceedings before the Office but can consult the online search tools to check the status of the relevant EUTM application. The Office does not inform the observer of any action taken, or whether or not the observations have given rise to an objection.

All observations are forwarded to the applicant, who is invited to submit comments, where appropriate. The Office considers whether the observations are well founded, that is, whether an absolute ground for refusal exists. If so, the Office issues an objection and may refuse the EUTM application if the objection is not overcome by the applicant's comments or by a restriction of the list of goods and services.

If an issue raised in observations has already been considered during the examination of an application, it is unlikely to give rise to serious doubts after publication.

The Office may also reopen the examination on absolute grounds on any other ground and at any time prior to registration, for example when third-party observations are filed before the application has been published or when the Office itself finds that a ground for refusal has been overlooked. After the application is published, this option should be exercised only in clear-cut cases.

For more information, see the Guidelines, Part B, Examination, Section 4, Absolute Grounds for Refusal and European Union Collective Marks.

3.2 Decisions

In all cases where the Office issues decisions against applicants, it must give the grounds for the decision. These must address any arguments raised by the applicant in its observations if they are pertinent. Decisions must not only refer to the appropriate parts of the EUTMR and EUTMIR but also give explicit reasons, except in the most obvious cases (for example, where a document is missing or a fee has not been paid).

Where, for example, a decision is given on the basis of internet searches, the Office must provide the applicant with proof of those searches.

3.2.1 Appeals

Articles 58 and 65 EUTMR
Decision 2009-1 of 16/06/2009 of the Presidium of the Boards of Appeal

Applicants have a right to appeal against a decision that terminates proceedings and that adversely affects them. For practical purposes, any decision issued by the Office that terminates proceedings and is not accepted by the applicant falls into this

category. Any written communication of such a decision must also inform the applicant that the decision can be appealed within two months.

Appeals have suspensive effect. Within the period in which an appeal can be lodged, the Office should not take any steps that cannot easily be reversed (e.g. publication or entry in the Register). The same goes for the period up until a final decision is taken where a case is brought before the General Court (GC) or Court of Justice of the European Union (CJEU) by an action under Article 65 EUTMR.

3.3 International registrations designating the European Union

Details about the examination of an EUTM application as a result of the transformation of an international registration designating the European Union are given in the Guidelines, Part M, International Marks.

4 Publication

Article 39 EUTMR
Rules 12, 14 and 46 EUTMIR

Publication takes place if the application fulfils all the acceptance conditions.

Applications are published in all the official languages of the EU.

The examiner must ensure that the following details are available, where applicable:

- (a) application file number
- (b) filing date
- (c) reproduction of the trade mark
- (d) indication of the collective mark
- (e) indication of the mark type other than word marks, for example figurative marks, three-dimensional marks, holograms, sound marks, colour per se marks and other marks
- (f) description of the mark
- (g) colour indication(s)
- (h) figurative elements under the Vienna Classification
- (i) acquisition of distinctive character through use
- (j) applicant's name, address and nationality
- (k) representative's name and address
- (l) first and second language
- (m) goods and services under the Nice Classification
- (n) priority data, if applicable
- (o) exhibition priority data
- (p) seniority data
- (q) transformation data.

Once the examiner has checked that all these elements are correct and the Office has received the translation in all the official languages of the EU, the application is dispatched to the publication team.

5 Amendments to an EUTM Application

This part of the Guidelines only covers issues that are relevant to EUTM application amendments.

For amendments to registered European Union trade marks, see the Guidelines, Part E, Register Operations, Section 1, Changes in a Registration.

5.1 Withdrawal of an EUTM application

Article 43, Articles 58(1), 64(3) and 65(5) and Article 119 EUTMR
 Article 101 and Article 102(2) Rules of Procedure of the General Court (RPGC)
 Article 51 Rules of Procedure of the Court of Justice (RPCJ)

5.1.1 Declaration of withdrawal

An EUTM application can be withdrawn at any time up until a final decision is taken on its subject matter.

After the Office's first-instance decision, an application can be withdrawn at appeal level within the two-month appeal period, even if no appeal was actually filed or up until the appeal is decided by the Boards of Appeal; this applies both to *ex parte* and *inter partes* proceedings (decisions of 27/09/2006, R 331/2006-G – Optima; 23/04/2014, R 451/2014-1 – 'SUPERLITE', para. 18).

At the level of the General Court (GC), an application can be withdrawn within the two-month appeal period extended by a period of ten days (on account of distance) pursuant to Article 102(2) RPGC. At the level of the Court of Justice of the European Union (CJEU), the prescribed time limit of two months to bring an action before the CJEU against a decision by the Boards of Appeal will be extended on account of distance by a single period of 10 days (order of 19/07/2003, T-15/03, Blue). The Boards of Appeal decision cannot be considered final within this period. The application can also be withdrawn up until completion of the appeal process before the GC.

At CJEU level, an application can be withdrawn within the two-month period for filing an appeal before the CJEU extended by a period of 10 days (on account of distance) pursuant to Article 51 RPCJ or before the CJEU has issued a final and binding decision (order of 18/09/2012, C-588/11 P, Omnicare).

When the case is pending before the GC or the CJEU, the applicant must ask the Office (not the GC or CJEU) to withdraw it. The Office then informs the GC or CJEU whether or not it finds the withdrawal acceptable and valid, but the withdrawal will not take place until the GC or the CJEU has delivered a final decision on the issue (by analogy, see judgment of 16/05/2013, T-104/12, 'Vortex').

Any declaration of withdrawal filed after the expiry of the appeal period is inadmissible.

There is no charge for a declaration of withdrawal but the declaration must be made in writing. No special form is provided by the Office.

The declaration of withdrawal can be made in the first or second language indicated by the applicant in its EUTM application. The same applies during opposition proceedings. However, for the procedure in cases where a restriction is made in a language other than the language of the opposition procedure, see the Guidelines, Part C, Opposition, Section 1, Procedural Matters.

For details of restrictions see paragraph 5.2 below.

Although Article 43(1) EUTMR refers only to withdrawal of a European Union trade mark application, the Court has held that oppositions can also be withdrawn in the same way as described above (decision of 07/07/2014, R 1878/2013-1 – ‘HOT CHILLYS / CHILLI BEANS (fig.)’, para. 15).

5.1.2 Unconditional and binding character of the declaration

A declaration of withdrawal becomes effective upon receipt by the Office, provided that the Office does not receive a withdrawal of the declaration on the same day.

This means that if a declaration of withdrawal and a letter withdrawing that declaration both reach the Office on the same day (regardless of the actual time of receipt), the latter annuls the former.

Once a declaration becomes effective, it cannot be withdrawn.

A declaration of withdrawal is void where it contains conditions or time limitations. For example, it must not require the Office to take a particular decision or, in opposition proceedings, require the other party to make a procedural declaration. Such a requirement is simply viewed as a suggestion for resolving the case; the Office informs the opponent accordingly and may invite the parties to come to an amicable settlement. Furthermore, a declaration does not become effective if it is made for some goods and/or services (partial withdrawal) on condition that the Office accepts the application for the remaining goods and/or services. Such a declaration is simply viewed as a suggestion to enable the Office to arrive at an acceptable list of goods and services.

Where an applicant responds to an official action by filing a restricted list of goods and services (partial withdrawal), the Office checks whether the applicant is declaring the unequivocal withdrawal of the remaining goods and services or whether the amended list of goods and services is a proposal or counterproposal by the applicant, subject to the Office's agreement.

5.1.3 Action to be taken

The Office will process a declaration of withdrawal, ensure publication of the full or partial withdrawal in the EUTM Bulletin, if the EUTM application has already been published and in the event of a full withdrawal, it will close the EUTM application file.

For the consequences of full or partial withdrawal on the opposition procedure, see the Guidelines, Part C, Opposition, Section 1, Procedural Matters.

Detailed information on the refund of application fees can be found in the Guidelines, Part A, General Rules, Section 3, Payment of Fees, Costs and Charges.

5.2 Restriction of the list of goods and services in an EUTM application

Articles 43 and 119 EUTMR

The applicant may restrict the list of goods and services of its EUTM application at any time, either of its own volition, in response to an objection regarding classification or absolute grounds, or in the course of opposition proceedings.

In principle, declarations of restrictions follow the same rules as declarations of withdrawals; see paragraph 5.1 above.

Where the case is pending before the GC or the CJEU, the restriction must be filed with the Office, not with the GC or the CJEU. The Office then informs the GC or the CJEU whether or not it finds the restriction acceptable and valid; however, the restriction is not applied until the GC or the CJEU has delivered a final decision on the issue (by analogy, see judgment of 16/05/2013, T-104/12, Vortex).

5.2.1 Procedural admissibility of a restriction

The restriction must be procedurally admissible; see paragraph 5.1.2 above.

As a matter of principle, a restriction becomes effective on the date on which the Office receives it. The restriction can only be withdrawn if the withdrawal is received on the same date as the restriction itself.

Two requirements must be met in order for a restriction to be acceptable:

1. The new wording must not constitute an extension of the list of goods and services.
2. The restriction must constitute a valid description of goods and services and apply only to acceptable goods or services that appear in the original EUTM application. For further details on restrictions of an EUTM application, see the Guidelines, Part B, Examination, Section 3, Classification.

If these requirements are not met, the Office must refuse the proposed restriction and the list of goods and services will remain unchanged (decision of 14/10/2013 R 1502/2013-4 – DARSTELLUNG EINES KREISES (fig.), paras 12-16).

5.3 Other amendments

Article 43(2) EUTMR
Rules 13 and 26 EUTMIR

This paragraph and the legal provisions cited above solely concern amendments to the EUTM application requested by the applicant on its own initiative and not amendments or restrictions made following an examination, opposition or appeal procedure as a result of a decision by an examiner, Opposition Division or Boards of Appeal.

Nor does this paragraph apply to the correction of errors in the Office's publications, which is carried out *ex officio* pursuant to Rule 14 EUTMIR.

Amendments require a written request in accordance with the language regime (for more information, see the Guidelines, Part B, Examination, Section 2, Examination of Formalities). There is no charge for this.

The following elements of an EUTM application may be amended:

- the name and address of the applicant or representative (see paragraph 5.3.1 below);
- errors of wording or of copying, or obvious mistakes, provided that the correction does not substantially change the trade mark (for further details on such amendments, see the Guidelines, Part B, Examination, Section 2, Examination of Formalities);
- the list of goods and services (see paragraph 5.2 above).

5.3.1 Name, address and nationality of applicant or representative

Article 87 EUTMR Rule 1(1)(b) and (e) and Rule 26 EUTMIR Article 1(1)(b), Article 19(7) and Article 69(2)(d) CDIR

The name and address of an applicant or its appointed representative may be amended freely, provided that

- any change in the applicant's name is not the consequence of a transfer,
- and
- as regards the name of a representative, the representative is not being substituted by another representative.

The indication of a legal person's nationality may also be amended freely, provided that it is not the consequence of a transfer.

A change in an applicant's name that does not affect the applicant's identity is an acceptable change, whereas a change in the applicant's identity is a transfer. For details and the applicable procedure in the event of doubt as to whether the change is considered to be a transfer, see the Guidelines, Part E, Register Operations, Section 3, EUTMs as Objects of Property, Chapter 1, Transfer.

Changes to a representative's name are also limited to those that do not affect the identity of the appointed representative, for example where there is a change in the name (through marriage/divorce) of a representative or the name of an association of representatives. Such changes of name must be distinguished from the substitution of one representative by another, which is subject to the rules governing the appointment of representatives. For details concerning representatives, see the Guidelines, Part A, General Rules, Section 5, Professional Representation.

Changes of name, address or nationality may be the result of changed circumstances or of an error made at the time of filing.

The applicant or its representative must request a change of name and address and this request must contain the EUTM application number and the name and address of the applicant or representative, both as recorded on the file and as amended.

No proof or evidence of the change is necessary. There is no charge for change of name or address requests.

The applicant must use a specific format in its application to indicate its name and official address in accordance with the above legal provisions, and may change it later using the same format. Both the name and address will be registered.

Legal persons can have only one official address. In case of any doubts, the Office may ask for evidence of the legal form, the state of incorporation and/or address. The official name and address are taken as the address for service by default. Ideally, an applicant should have only one address for service. Changes to the applicant's official designation or official address will be registered for all EUTM applications, registered EUTMs and registered Community designs and, unlike the address for service, cannot be recorded only for specific portfolios of rights. In principle, these rules also apply, by analogy, to representatives.

5.3.2 Other elements of an application

Other elements of an EUTM application may also be changed, such as the representation, type of mark, and the description of the mark.

For example, in priority claims, obvious mistakes in the indication of the country in which, and the date on which, the earlier mark was filed may be corrected, since the priority document will obviously show the correct version.

For further details on these changes, see the Guidelines, Part B, Examination, Section 2, Examination of Formalities.

5.3.3 Recording and publication of amendments

Article 41(2) EUTMR

If an amendment is allowed, it will be recorded in the file.

Where the EUTM application has not yet been published, it is published in the EUTM Bulletin in the amended form.

Where the EUTM application has already been published and (only) if the amendment concerns the list of goods and services or the representation of the mark, the EUTM application is published in its amended form in the EUTM Bulletin. The publication of the amended application may open a new opposition period of three months.

Any other amendments are not published separately but appear in the publication of the registration.

5.4 Division of an EUTM application

Article 44 EUTMR
Rule 13a EUTMIR

An EUTM application can be divided into different parts not only as a result of a partial transfer (see the Guidelines, Part E, Register Operations, Section 3, EUTMs as Objects of Property, Chapter 1, Transfer), but also on the EUTM applicant's own initiative. Division is particularly useful for isolating a disputed EUTM application for certain goods or services while maintaining the original application for the remainder. For information on the division of EUTMs, see the Guidelines, Part E, Register Operations, Section 1, Changes in a Registration.

Whereas a partial transfer is free of charge and involves a change of ownership, there is a charge for a request for the division of an EUTM application, and the EUTM application remains in the hands of the same applicant. If the fee is not paid, the request is deemed not to have been filed. The request can be made in the first or second language indicated by the applicant in its EUTM application.

Division is not available under the Madrid Protocol for international registrations designating the EU. The international register is kept at WIPO, and the Office does not have the authority to divide an international registration designating the EU.

5.4.1 Requirements

A request for division must contain the following information:

- the file number of the EUTM application to be divided;
- the name and address or name and ID number of the applicant;
- the list of goods and services for the divisional application or, if more than one new application will be created, the list of goods and services for each divisional application;
- the list of the goods and services that will remain in the original EUTM application.

Furthermore, the goods and services of the divisional application must not overlap with the list of goods and services of the original application.

The Office will notify the applicant of any deficiency in this regard and give it two months to remedy the deficiency. If it is not remedied within this period, the request for division will be refused.

There are certain periods during which, for procedural economy or to safeguard third-party rights, division is not admissible. These periods are outlined below.

1. While an opposition is pending, only the non-contested goods and services may be hived off. The same applies if the case is pending before the Boards of Appeal or the Courts. The Office interprets the legal provisions cited above as preventing the applicant from hiving off some or all of the contested goods to form a new

application causing the opposition proceedings to be split. If such a request for division is made, the applicant is given the opportunity to amend it by hiving off the non-contested goods and services.

2. Division is not admissible during the three-month opposition period following publication of the application. Allowing a division during this time would counteract the aim of not splitting an opposition procedure and frustrate third parties, who have to rely on the EUTM Bulletin to know what to oppose.
3. Division is not admissible during the period before a filing date has been issued either. This does not necessarily coincide with the first month following filing. For further details on the filing date, see the Guidelines, Part B, Examination, Section 2, Examination of Formalities.

For all practical purposes, in the period following publication of the application, division is only admissible if an opposition has been entered against the application and only for the non-contested part. The aim of the provisions cited is to allow the applicant to register its mark for the non-contested goods quickly, without having to wait for the outcome of a lengthy opposition procedure.

5.4.2 Acceptance

Article 44(6) EUTMR

If the Office accepts the declaration of division, a new application is created as of the date of acceptance and not retroactively as of the date of the declaration.

The new application keeps the filing date and any priority and seniority dates. The seniority effect will then become partial.

All requests and applications submitted and all fees paid prior to the date on which the Office receives the declaration of division are also deemed to have been made or paid for the divisional application. However, fees duly paid for the original application are not refunded.

The practical effects of this provision are as follows:

- where an application for the registration of a licence was made and payment of the registration fee was received by the Office prior to the declaration of division, the licence will be registered against the original registration and recorded in the file of the new registration. No further fees need be paid.
- where an EUTM application claiming six classes is to be divided into two applications of three classes each, no class fees are payable as of the date the Office receives the declaration of division. However, fees paid prior to that date cannot be refunded.

Where the division is not accepted, the old application remains unchanged. It does not matter whether:

- the declaration of division was deemed not to have been filed because no fee had been paid;

- the declaration was refused because it failed to comply with the formal requirements;
- the declaration was found inadmissible because it was filed during one of the periods in which division is not admissible.

The worst-case scenario for the applicant is that the declaration of division is not accepted, but this never affects the original application. The applicant can repeat the declaration of division later, on payment of a new fee.

5.4.3 New files and their publication

A new file has to be created for the divisional application, to contain all the documents that were on file for the original application, all the correspondence relating to the declaration of division and all future correspondence for the new application. Inspection of this file will be unrestricted under the general rules.

If the declaration of division concerns an EUTM application that has not yet been published, both the divisional and the original application are published separately and in the normal way, without any express reference to each other.

If the declaration of division concerns an EUTM application that has already been published, the fact that there has been a division is published with reference to the original application. The new application must also be published with all the usual particulars; however, no new opposition period will be opened. Division is admissible only for goods for which an opposition period has already started but not been made use of.

***GUIDELINES FOR EXAMINATION OF
EUROPEAN UNION TRADE MARKS***

***EUROPEAN UNION
INTELLECTUAL PROPERTY OFFICE
(EUIPO)***

PART B

EXAMINATION

SECTION 2

FORMALITIES

1	Introduction	5
2	Filing of Applications	5
2.1	Applicants	5
2.2	Where a European Union trade mark application can be filed	5
3	The Fees	5
3.1	Fees in general	6
3.2	Basic fee deficiency	6
3.3	Class fee deficiency	6
3.4	Fee refunds upon withdrawal	7
4	Filing Date	7
4.1	Filing date requirements	7
4.1.1	Fee	8
4.1.2	Request	8
4.1.3	Applicant	8
4.1.4	Representation of the mark	8
4.1.5	List of goods and services	8
4.2	Filing date receipt	9
4.2.1	Applications filed electronically	9
4.2.2	Applications filed by other means	9
5	Goods and Services	9
5.1	Classification	9
5.2	Specific formality deficiency for e-filing	9
6	Signature	10
7	Languages/Translations	10
7.1	First and second languages	11
7.2	The correspondence language	11
7.3	Reference language for translations	12
7.4	Translation of multilingual elements	12
7.5	Restriction of goods and services	13
8	Owner, Representative and Address for Correspondence	14
8.1	Applicant	14
8.2	Representative	14
8.3	Change of name/address	15
8.4	Transfer of ownership	15
9	Kind of Mark	15

9.1 Individual marks	15
9.2 Collective marks	16
9.2.1 Character of collective marks	16
9.2.2 Applicants for collective marks	16
9.2.3 Documents to be filed	16
9.2.4 Examination of formalities relating to collective marks	17
9.2.4.1 Regulations governing use not submitted	17
9.2.4.2 Regulations governing the use submitted but with deficiencies	17
9.2.5 Changes of the kind of mark (from collective to individual)	17
10 Mark Type	17
10.1 Word marks	18
10.2 Figurative marks	19
10.3 Three-dimensional marks	20
10.4 Sound marks	23
10.4.1 Electronic sound file	24
10.4.2 Musical notations	24
10.4.3 Sonographs	24
10.5 Colour per se	25
10.6 Holograms	27
10.7 Smell/Olfactory marks	27
10.8 Other marks	27
10.8.1 Animated marks (movement)	27
10.8.2 Position marks	28
10.8.3 Tracer marks	30
10.9 Correction of the mark type	31
10.9.1 General rules	31
10.9.2 Examples of recurring mark type deficiencies	31
10.9.2.1 Word marks	31
10.9.2.2 Figurative marks	31
11 Series Marks	33
11.1 Multiple figurative representations	33
12 Indication of Colour	34
13 Mark Descriptions	36
14 Disclaimer	40
15 (Convention) Priority	41
15.1 Principle of first filing	43
15.2 Triple identity	43
15.2.1 Identity of the marks	43
15.2.2 Identity of the goods and services	44
15.2.3 Identity of the owner	44

15.3 Priority requirements not satisfied	44
15.4 Priority documents not provided	44
15.5 Language of previous application.....	45
15.6 Priority date check after changing of the filing date.....	45
15.7 Examples of priority claims	45
15.7.1 First filing	45
15.7.2 Comparison of the marks	46
15.7.3 Comparison of the goods and services	50
15.7.4 Priority claims based on series marks.....	51
15.7.5 Claiming priority for three-dimensional or 'other' marks.....	52
15.7.6 Priority claims involving collective marks	52
16 Exhibition Priority.....	52
17 Seniority	53
17.1 Harmonised seniority information	53
17.2 Seniority examination	54
17.3 Identity of the marks	55
17.4 Goods and services	55
17.5 Treatment of seniority examination deficiencies	56
17.6 Examples of seniority claims.....	56
18 Transformation	57
19 Amendments to the EUTM Application.....	57
19.1 Amendments to the representation of the mark.....	57
20 Conversion.....	59
Annex 1: Required format for seniorities	60

1 Introduction

Every European Union trade mark (EUTM) application must abide by certain formality rules. The purpose of these Guidelines is to lay down Office practice in relation to those formality rules.

2 Filing of Applications

2.1 Applicants

Article 5 EUTMR

Any natural or legal person, including authorities established under public law, may apply for an EUTM, irrespective of their nationality or domicile.

2.2 Where a European Union trade mark application can be filed

Article 25(1) EUTMR
Rule 82 EUTMIR
Decision EX-05-3 and EX-13-2 of the President of the Office

The applicant files the application for an EUTM directly with the Office.

EUTM applications may be sent to the Office electronically (through e-filing), by fax, by regular mail or private delivery services, or handed in personally at the Office's reception desk. If the user decides to file an application electronically, the Office offers the possibility of an accelerated procedure known as Fast Track (for more details please check the Office's website).

3 The Fees

Annex I EUTMR
Article 26(2), 27, 144a, 144b EUTMR
Rule 9(5) EUTMIR
Decision EX-96-1, amended in 1996, 2003 and 2006; Decision EX-13-2 of the President of the Office

3.1 Fees in general

For the application of an EUTM the following fees are applicable:

Trade Mark	Basic Fee	Fee for a second class	Fee for each additional class
Individual mark	EUR 1 000	EUR 50	EUR 150
Individual mark filed electronically	EUR 850	EUR 50	EUR 150
Collective mark	EUR 1 800	EUR 50	EUR 150
Collective mark filed electronically	EUR 1 500	EUR 50	EUR 150

The fee must be paid in euros. Payments made in other currencies are not valid.

For more information on fees, see the Guidelines, Part A, General Rules, Section 3, Payments of Fees, Costs and Charges.

3.2 Basic fee deficiency

If the basic fee is not paid within one month from the date the Office received the application, the provisional filing date will be lost (see below under paragraph 4, Filing Date).

However, the filing date can be maintained if evidence is submitted to the Office that the person who made the payment (a) duly gave an order within the relevant period for payment to a banking establishment to transfer the amount of the payment, and (b) paid a surcharge of 10 % of the total amount due (up to a maximum amount of EUR 200).

The surcharge will not be due if the person submits proof that the payment was initiated more than 10 days before expiry of the one-month time limit.

3.3 Class fee deficiency

Where the application covers more than one class of goods and/or services, an additional class fee is payable for each additional class.

- Where the fees paid or the amount covered by the current account is less than the total sum of fees due for the classes selected in the application form, a deficiency letter will be issued setting a two-month time limit for payment. If payment is not received within the time limit specified, the application will be deemed to be withdrawn for the classes not covered by the fee paid. In the absence of other criteria to determine which classes are intended to be covered by the amount paid, the Office will take the classes in the order of the classification (starting with the lowest).
- Where additional class fees become payable following the rectification of a classification deficiency, a deficiency letter will be issued setting a two-month

time limit for payment. If payment is not received within the time limit specified, the application will be deemed to have been withdrawn for those classes resulting from the re-classification not covered by the fees actually paid. In the absence of other criteria to determine which classes are intended to be covered by the amount paid, the Office will take the classes in the order of the classification (starting with the lowest).

3.4 Fee refunds upon withdrawal

On withdrawal of the EUTM application the application fee (basic and class fees) will only be refunded in certain circumstances.

For more information on this see the Guidelines, Part A, General Rules, Section 3, Payment of Fees, Costs and Charges.

4 Filing Date

Articles 26 and 27 EUTMR Rule 9(1) EUTMIR
--

4.1 Filing date requirements

A filing date is accorded where the application fulfils the following requirements:

- the application fee has been paid;
- the application is a request for the registration of an EUTM;
- the application contains information to identify the applicant;
- the application contains a representation of the trade mark;
- the application contains a list of goods/services.

If any of the above requirements are not met, a deficiency letter will be sent out requesting the applicant to provide the missing item within two months of the notification of the deficiency letter. This time limit is not extendable. If the deficiency is not remedied, the EUTM application will be 'deemed not filed' and all fees already paid will be reimbursed. If the missing information is provided within the time limit set in the deficiency letter, the filing date will be changed to the date on which all mandatory information is complete, including the payment.

In some cases, applicants file more than one representation of the mark (in this context see below under paragraph 10.3, Three-dimensional marks and paragraph 11, Series Marks). As the application does contain a representation of the mark, this is not to be considered a filing-date deficiency. Rather, the applicant is required to indicate which of the representations filed should be used as the representation of the EUTM application; this should be done via a deficiency letter, and the Office will set a two-month time limit for the applicant to specify the correct representation.

4.1.1 Fee

Article 26(2) EUTMR
Rule 9(1)(b) EUTMIR

The basic fee and, where appropriate, class fees, must be paid within one month of the filing of the application. Where the fee is not paid within one month the Office will issue a deficiency letter (see paragraph 3.2 above).

4.1.2 Request

Article 26(1)(a) EUTMR
Rule 1(1)(a), Rule 9(1)(a)(i) and Rule 83(1)(e) EUTMIR

The application must contain a request for the registration of an EUTM.

It is strongly recommended that the EUTM application is filed using the Office's e-filing form, available in the official languages of the European Union. Forms are also made available to the public, free of charge and in all the official languages of the European Union.

4.1.3 Applicant

Article 26(1)(b) EUTMR
Rule 1(1)(a) and Rule 9(1)(a)(ii) EUTMIR

The application must contain information identifying the applicant, specifically: the name, address and nationality of the applicant and the State in which it is domiciled or has its seat or an establishment. If the applicant has previously been allocated an ID number by the Office, it is sufficient to indicate that ID number and the applicant's name.

4.1.4 Representation of the mark

Article 26(1)(d) EUTMR
Rule 1(1)(d), Rule 3 and Rule 9(1)(a)(iv) EUTMIR

The application must contain a representation of the mark in accordance with Rule 3 EUTMIR. For further information on the different types of marks, please see paragraph 10 below.

4.1.5 List of goods and services

Articles 26 and 28 and Article 43(2) EUTMR
Rule 1(1)(c) and Rule 9(1)(a)(iii) EUTMIR

The presence of a list of goods and services is a filing-date requirement. A reference in the respective field of the EUTM application form to a previous EUTM may be used to indicate the list of goods and services.

For applications filed electronically, please also see paragraph 5.2 below.

4.2 Filing date receipt

4.2.1 Applications filed electronically

For electronically filed EUTM applications, the system issues an immediate automatic electronic filing receipt, which contains the provisional filing date. The applicant should save or print this receipt.

4.2.2 Applications filed by other means

When an application is received by the Office by any other means than electronically (see paragraph 4.2.1 above), a provisional filing date is accorded and the Office issues a receipt with this filing date. The filing date will be considered the reception date if the application fulfils the filing date requirements (see paragraph 4.1 above).

5 Goods and Services

5.1 Classification

Every EUTM application must contain a list of goods and services as a condition for according a filing date (see paragraph 4.1.5 above).

The list must be classified in accordance with the Nice Agreement (Article 28(1) EUTMR).

The scope of protection defined by the original list of goods and services cannot be extended. If an applicant wants to protect additional goods or services after filing, a new application must be filed.

For further information on the classification of goods and services please refer to the Guidelines, Part B, Examination, Section 3, Classification.

5.2 Specific formality deficiency for e-filing

Rule 82(1) and Rule 9(3)(a) and Rule 9(4) EUTMIR
Decision EX-13-2 of the President of the Office of 26 November 2013 concerning electronic communication with and by the Office ('Basic Decision on Electronic Communication')

Applications filed electronically are subject to the terms and conditions concerning electronic communication with and by the Office within the User Area as established in Decision EX-13-2 (Basic Decision on Electronic Communication).

For applications filed electronically, the list of goods and services must be entered in the text fields provided for that purpose. Lists of goods and services filed as an attachment to the e-filing application, or filed separately, will not be considered to comply with the terms and conditions concerning electronic communication with and by the Office.

In such cases the Office will issue a deficiency letter requesting the payment of the difference between the reduced basic fee for applications filed by electronic means and the standard basic fee, that is to say, EUR 150 (EUR 300 for collective marks).

If the deficiency is not remedied within the period set by the Office in its notification, the application will be deemed to have been withdrawn for the goods and services that were filed as an attachment to the application form or separately. If there are no goods and services entered in the text fields provided, and the deficiency is not remedied, the application will be refused.

Where available, a reference in the respective field of the EUTM application form to a previous EUTM may be used to indicate the list of goods and services. In this case, the list of goods and services will be imported automatically.

6 Signature

Rules 80(3) and 82(3) EUTMIR

Application forms lodged by fax, post, private delivery service or personal delivery must be signed either on the form itself or on an accompanying letter. The signature may be that of the applicant or the representative. If an application communicated to the Office is not signed, the Office will invite the party concerned to correct the irregularity within a two-month time limit. If the deficiency is not remedied within the time limit, the application will be rejected.

If an application is filed electronically, the indication of the name of the sender is deemed to be equivalent to a signature.

7 Languages/Translations

Articles 119 and 120 EUTMR
Communication 4/04 of the President of the Office

An EUTM application may be filed in any of the official languages of the European Union. A second language must be indicated on the application form, which must be one of the five languages of the Office, namely, English, French, German, Italian or Spanish.

A different language version of the application form from the language chosen as the first language may be used. However, the application form must be completed in that first language, including the list of goods and services, indication of colour(s) and mark description, where appropriate.

7.1 First and second languages

All information on the application form must be in the first language; otherwise, a deficiency letter is sent. If the deficiency is not remedied within two months, the application will be rejected.

The second language serves as a potential language for opposition and cancellation proceedings. The second language must be different from the language selected as the first language. Under no circumstances can the choice of first and second language be changed once filed.

When filing the application, the applicant may choose to provide a translation into the second language of the list of goods and services and, where relevant, any mark description and colour indication. Where such a translation is submitted on its own motion, the applicant is responsible for ensuring that the translation corresponds to the first language. It is very important for the applicant to ensure the accuracy of the translation as, in particular, the translation submitted by the applicant may be used as the basis for the translation of the application into all the remaining languages of the European Union (see paragraph 7.3, Reference language for translations below). In the case of any discrepancy, the question as to which language version prevails depends on whether the first language is one of the five Office languages or not. If the first language of the application is one of the five Office languages, the first language version prevails. If the first language of the application is not one of the five Office languages, the second language prevails.

7.2 The correspondence language

The correspondence language is the language used in correspondence between the Office and the applicant in examination proceedings until registration of the mark.

If the language that the applicant has selected as the first language is one of the five languages of the Office, then this will be used as the correspondence language.

Only where the language selected as the first language is not one of the five Office languages can the applicant indicate that it wants the correspondence language to be the second language. This request can be made on the application form by ticking the respective box or can be requested later on, either by explicit request, or implied by sending a communication to the Office in the second language. However, such a request will be refused where the Office has already issued a deficiency or objection letter in the first language.

In cases where the applicant selects one of the five Office languages as the first language but then indicates that the second language is to be the correspondence language, the Office will change the correspondence language to the first language and inform the applicant.

Example		
First language selected	Second language selected	Correspondence language selected
French	English	English
The correspondence language will be changed to French.		

For more information on languages, please refer to the Guidelines, Part A, General Rules, Section 4, Language of Proceedings.

7.3 Reference language for translations

The list of goods and services are translated into the official languages of the EU. The source language for translations is defined as the reference language. If the first language of the application is one of the five Office languages, it will always be the reference language.

If the first language of the application is not one of the five Office languages and the applicant has submitted a translation of the goods and services in the second language, the reference language will be the second language. If no translation is submitted, the first language will be the reference language.

7.4 Translation of multilingual elements

Multilingual elements contain information on the application that needs, in principle, to be translated. These elements are mark descriptions and colour indications.

If a translation of goods and services is supplied in the second language, the Office will check that all relevant multilingual elements (mark description(s) and colour indication(s)) have also been translated. However, the Office will not check the accuracy of the translation. If the applicant has only submitted a partial translation, a deficiency letter will be sent to the applicant, requesting that the additional translations be submitted within two months from notification of the deficiency. If the applicant fails to submit the omitted translations, then all translations submitted by the applicant will be disregarded and the Office will proceed as if no translation had been submitted. Translations of simple colours will be added by the Office.

Before sending the application for translation, the Office will ensure that the information contained in the multilingual elements is correct and acceptable. The details can be seen below in the relevant paragraphs on colour indications and mark descriptions (paragraphs 12 and 13 respectively). Furthermore, before requesting translation of an application, 'non-translatable elements' will be identified as such by putting them into inverted commas (""), as agreed as a formatting rule with the Translation Centre for the Bodies of the European Union (CdT).

The following elements are **not** to be translated and will be put into inverted commas:

1. mark descriptions: where the acceptable mark description refers to a verbal element of the mark, this element should not be translated:

Mark description	Mark
<p>EUTM 10 003 317</p> <p>The word “Rishta” in a stylised script on a diamond-shaped background with a shadow effect and the words “Premium Quality” in a smaller font on a rectangular block positioned above the word “Rishta” and below the upper point of the diamond shape.</p>	

(For information on the examination of mark descriptions see paragraph 13 below.)

2. colour indications: where the colour indication includes a reference to an international coding system (e.g. ‘Pantone’), this must be identified with inverted commas, as it should not be translated:

Colour indication	Mark
<p>EUTM 10 171 452</p> <p>Blå (“Pantone 3115”), Grå (“Cool Grey 9”).</p>	

(For information on the examination of colour indications see paragraph 12 below.)

7.5 Restriction of goods and services

Article 43(2) EUTMR
Rule 95(a) EUTMIR

If the first language of the EUTM application is one of the five Office languages, a restriction in examination proceedings can only be accepted in the first language of the application.

In cases where the first language of the application is not one of the five Office languages, a restriction in examination proceedings can only be accepted in the second language if the second language has been indicated as the correspondence language.

Example of acceptable restriction request	
First language NL	Second language EN
A restriction sent to the Office in English would be accepted provided that English has been indicated as the correspondence language of the application.	

Example of unacceptable restriction request	
First language IT	Second language EN
A restriction sent to the Office in English would not be accepted, as in this case Italian is one of the five languages of the Office and is therefore the only language in which a restriction will be accepted.	

8 Owner, Representative and Address for Correspondence

Articles 3, 5, 92 and 93 EUTMR
Rule 1(1)(b), Rules 26 and 76 EUTMIR

8.1 Applicant

Any natural or legal person, including authorities established under public law (e.g. a university) may be the proprietor of an EUTM. Filings in the name of a legal entity in the process of foundation will be accepted.

In an EUTM application the applicant must state its name, address, nationality and the State in which it is domiciled or has its seat or establishment. The Office strongly recommends indicating the State of Incorporation for US companies, where applicable, in order to differentiate clearly between different owners in its database. Names of natural persons must be indicated by the person's family name and given name(s). The names of legal entities must be given in full and only its legal forms may be abbreviated in a customary manner, for example, PLC, S.A. If the legal form is not specified or is incorrectly indicated, a deficiency letter requesting this information will be issued. If the missing or the correct legal form is not given, the application will be rejected.

The address should contain, if possible, the street, street number, city/town or state/county, postal code and country. The applicant should indicate only one address, but if there are several the first one listed will be recorded as the address for service, unless the applicant specifically designates a different one.

If the applicant has been given an ID number by the Office in a previous case, it will be sufficient for it to indicate that number together with the name of the applicant.

For more information on communication with the Office, please refer to the Guidelines, Part A, General Rules, Section 1, Means of Communication, Time Limits.

8.2 Representative

If the applicant has its domicile, principal place of business or a real and effective industrial or commercial establishment in the European Economic Area (EEA), there is no obligation for it to be represented.

If the applicant does not have its domicile, principal place of business or a real and effective industrial or commercial establishment in the EEA, regardless of its nationality, representation must be sought to act for it in all proceedings except the filing of the EUTM application and the payment of the application fee. Every representative in the sense of Article 93 EUTMR who files an application with the Office is placed on the Representative database and given an ID number. If the representative has been allocated an identification number by the Office, it is sufficient to indicate only that ID number and the name.

For more information on representation, see the Guidelines, Part A, General Rules, Section 5, Professional Representation.

8.3 Change of name/address

The name and address of the applicant may be amended. A change in the name of the applicant is a change that does not affect the identity of the applicant, whereas a transfer is a change in the identity of the applicant. For more information on the definition of a change of name and its comparison to a transfer, see the Guidelines, Part E, Register Operations, Section 3, EUTMs as Objects of Property, Chapter 1, Transfer.

8.4 Transfer of ownership

Article 17(5), Articles 24 and 87 EUTMR Rule 31(8) EUTMIR
--

EUTM registrations and applications may be transferred from the previous proprietor/applicant to a new proprietor/applicant, primarily by way of assignment or legal succession. The transfer may be limited to some of the goods and/or services for which the mark is registered or applied for (partial transfer). Upon request, transfers of registered EUTMs are entered in the Register and transfers of EUTM applications are noted in the files.

For more information on the recording of transfers of ownership see the Guidelines, Part E, Register Operations, Section 3, EUTMs as Objects of Property, Chapter 1, Transfer.

9 Kind of Mark

The EUTM regulation distinguishes between two kinds of marks: individual and collective.

9.1 Individual marks

Article 5 EUTMR

Any natural or legal person, or person equivalent to these persons under the national law applicable to them, including authorities established under public law, may be the proprietor of a European Union individual trade mark, irrespective of their nationality.

9.2 Collective marks

Articles 66 to 68 EUTMR Rules 3 and 43 EUTMIR
--

9.2.1 Character of collective marks

A collective mark is a specific type of trade mark that indicates that the goods or services bearing that mark originate from members of an association, rather than from just one trader. Collective does not mean that the mark belongs to several persons (co-applicants/co-owners) nor that it designates/covers more than one country.

Collective marks can be used to publicise products that are characteristic of a particular region, and may be used together with the individual mark of the producer of a given good. This allows members of an association to differentiate their own products from those of competitors.

For further information as to the substantive requirements of European Union collective marks see the Guidelines, Part B, Examination, Section 4, Absolute Grounds for Refusal and European Union Collective Marks.

9.2.2 Applicants for collective marks

Associations of manufacturers, producers, suppliers of services, or traders that under the terms of the law governing them have the capacity in their own name to have rights and obligations of all kinds, to make contracts or accomplish other legal acts and to sue or be sued, as well as legal persons governed by public law, may apply for a collective mark. There are essentially two criteria to be met. Firstly, the applicant must be an association or a public body and secondly it must exist as an entity in itself.

For further information as to the substantive requirements of European Union collective marks please see the Guidelines, Part B, Examination, Section 4, Absolute Grounds for Refusal and European Union Collective Marks.

9.2.3 Documents to be filed

In addition to the information to be filed when applying for an individual trade mark, applications for a European Union collective trade mark require regulations governing use of the mark. These regulations must specify:

1. the name of the applicant and its office address;
2. the object of the association or the object for which the legal person governed by public law is constituted;
3. the bodies authorised to represent the association or the said legal person;
4. the conditions for membership;

5. the persons authorised to use the mark;
6. where appropriate, the conditions governing use of the mark, including sanctions;
7. if the mark designates the geographical origin of goods or services, authorisation for any person whose goods or services originate in the geographical area concerned to become a member of the association.

9.2.4 Examination of formalities relating to collective marks

9.2.4.1 Regulations governing use not submitted

If the regulations are not submitted with the application, a deficiency letter will be sent, setting a time limit of two months to provide them.

If the regulations are not submitted within this two-month time limit, the application will be rejected

9.2.4.2 Regulations governing the use submitted but with deficiencies

If the regulations have been submitted but fail to specify the required information as listed in paragraph 9.2.3 above, a deficiency letter will be sent, setting a time limit of two months to provide the missing information.

If the deficiency is not remedied within this two-month time limit, the application will be rejected.

9.2.5 Changes of the kind of mark (from collective to individual)

If a natural person has applied for a collective mark by mistake, that is to say, they have erroneously entered/selected the kind of mark as 'collective' on the application form, they may change the mark from collective to individual, since collective marks cannot be granted to natural persons. The fee surplus will also be refunded.

Where a legal person claims to have applied for a collective mark by mistake, the amendment will also be allowed and the fee surplus refunded. However, the filing of a collective mark would not be seen as an obvious error, and the amendment request would be rejected, where there are indications that the applicant intended to apply for this kind of mark, for example:

- the mark representation includes the words 'collective mark'; or
- the name of the applicant states that it is an association; or
- regulations of use of the collective mark are submitted.

10 Mark Type

Articles 4 and 26, Article 7(1)(a) EUTMR Rule 3 EUTMIR

The categorisation of marks serves a number of functions. Firstly, it establishes the legal requirement for the mark to be represented; secondly, it can help the Office

Guidelines for Examination in the Office, Part B, Examination Page 17

understand what the applicant is seeking to register; and finally, it facilitates research in the Office database.

A trade mark may consist of any sign capable of being represented graphically. It is a requirement of filing that there is a representation of the mark on the application form. The mark must be represented graphically and this representation cannot be replaced by a description of the mark. If the applicant fails to graphically represent its mark, a deficiency letter is sent and a filing date will not be recorded (see paragraph 4 above, Filing Date).

Where the application contains a representation of the mark without specifying the desired mark type, the Office will, based on the representation provided and any mark description, accord the appropriate mark type and inform the applicant in writing, setting a two-month time limit for observations.

Where the applicant has selected a mark type that does not correspond to the mark representation, together with any mark description provided, the mark type will be corrected following the indications set out below under paragraph 10.9, Correction of the mark type.

The examples of mark types in these Guidelines are given only in the context of formalities' issues without prejudice to the outcome of the examination proceedings.

Verbal elements consist of letters in the alphabet of any official EU language and keyboard signs. Where a mark, other than a word mark, contains any such verbal element that is visible from the representation, it must be included in the respective field. This allows for the mark to be searched for within the database and also forms the basis of the language check for marks that is carried out in all official languages of the EU.

10.1 Word marks

A word mark is a typewritten mark with elements including letters (either lower or upper case), words (either in lower or upper case letters), numerals, keyboard signs or punctuation marks written across a single line. The Office accepts the alphabet from any official EU language as a word mark. A mark consisting of text written across more than one line will not be categorised as a word mark, as these marks are considered to be figurative.



Examples of acceptable word marks (for formalities' purposes)	
EUTM 6 892 351	europadruck24
EUTM 6 892 806	TS 840
EUTM 6 907 539	4 you
EUTM 2 221 497	ESSENTIALFLOSS
EUTM 0 631 457	DON'T DREAM IT, DRIVE IT
EUTM 1 587 450	?WHAT IF!
EUTM 8 355 521	ΕΙΔ ΕΛΛΗΝΙΚΟ ΙΝΣΤΙΤΟΥΤΟ ΔΙΑΤΡΟΦΗΣ (Greek)
EUTM 8 296 832	Долината на тракийските царе (Cyrillic)

10.2 Figurative marks

A figurative mark is a mark consisting of:

- exclusively figurative elements;
- a combination of verbal and figurative or otherwise graphical elements;
- verbal elements in non-standard fonts;
- verbal elements in colour;
- verbal elements on more than one line;
- letters from non-EU alphabets;
- signs that cannot be reproduced by a keyboard;
- combinations of the above.

Marks depicting a pattern are 'figurative' marks in accordance with Office practice.

Examples of figurative marks (for formalities' purposes)	
EUTM 1 414 366 Purely graphic element with no colour	
EUTM 9 685 256 Purely graphic element in colour	
EUTM 4 705 414 Combination of graphic element and text in standard font, no colour	
EUTM 9 687 336 Combination of stylised font and figurative elements, no colour	
EUTM 4 731 725 Combination of stylised font and figurative elements in colour	
EUTM 9 696 543 Verbal element in stylised font with no colour	

<p>EUTM 2 992 105</p> <p>Verbal elements in stylised font with no colour</p>	
<p>EUTM 9 679 358</p> <p>Verbal elements in different fonts in colour</p>	
<p>EUTM 9 368 457</p> <p>Verbal elements only, over more than one line</p>	
<p>EUTM 9 355 918</p> <p>Slogan in two different fonts, letters in different sizes, on more than one line, and in colour</p>	
<p>EUTM 9 681 917</p> <p>Verbal element in non-EU alphabet (Chinese)</p>	
<p>EUTM 0 015 602</p> <p>Pattern</p>	
<p>EUTM 7 190 929</p> <p>Pattern</p>	

10.3 Three-dimensional marks

Article 43(2) EUTMR; Rule 3(4) EUTMIR
 Communication 2/98 of the President of the Office

A three-dimensional mark is a mark consisting of a three-dimensional shape (including containers, packaging and the product itself). The photographic or graphic representation may consist of up to six perspectives of the same shape that must be submitted in one single JPEG file in the case of e-filed applications or on one single A4 Guidelines for Examination in the Office, Part B, Examination

sheet in the case of paper-filed applications. While up to six perspectives may be filed, a single view of the shape is sufficient where the shape to be protected can be ascertained from that single view.



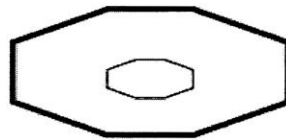

In some cases, applicants file different perspectives of a three-dimensional object on several sheets of paper (e.g. one page per picture/perspective). In such a case, a deficiency should be raised, setting a time limit for the applicant to indicate which of the representations filed should be used as the representation of the EUTM application.

Applicants applying for registration of a three-dimensional mark must make a corresponding indication in the application. If no mark type is indicated and only one view of the object has been provided and the mark description — if any — does not say that the mark filed is three-dimensional, the Office will treat it as a figurative trade mark.

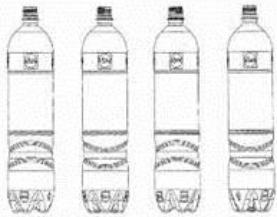

Example

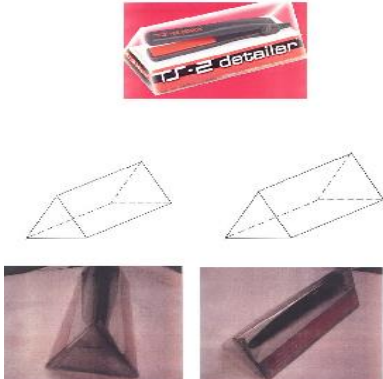

No mark type was selected for this sign and no mark description was provided. The Office will treat this as a figurative mark.

Examples of acceptable representations of three-dimensional marks (for formalities' purposes)	
<p>EUTM 4 883 096</p> <p>Four different drawings of the same object</p>	
<p>EUTM 4 787 693</p> <p>Six photographs of the same object from different perspectives, with text</p>	
<p>EUTM 30 957</p> <p>Two photographs in colour showing different perspectives of the same object</p>	
<p>EUTM 8 532 475</p> <p>Six views in colour showing six different perspectives of the same object</p>	
Examples of marks that are not acceptable as three-dimensional marks (for formalities' purposes)	
<p>EUTM 6 910 021</p> <p>Five views, but not showing the same object</p>	

Examples of marks that are not acceptable as three-dimensional marks (for formalities' purposes)

<p>EUTM 7 469 661</p> <p>No text in addition to the representation of the mark is allowed (text below the photo of the bottle)</p>	 <p>Spiš Original Slivka</p>
<p>EUTM 9 739 731</p> <p>The first and third bottles show two different perspectives of the same bottle, both with a grey lid. The second bottle has a blue lid, and is therefore a different object to those pictured in the first and third bottles. The fourth image is completely different, showing two bottle tops and a label. Of the four perspectives, only the first and third are views of the same object.</p>	

Where the views filed for the application of a three-dimensional EUTM consist of different objects depicted on a single sheet of A4 paper or in one JPEG file, the deficiency cannot be remedied since the deletion of one or more of these different objects would mean a considerable alteration of the mark representation (see below under paragraph 19, Amendments to the EUTM Application). In this case, the application must be rejected as the representation does not show a single three-dimensional shape.

10.4 Sound marks

Article 4 EUTMR; Decision EX-05-3 of the President of the Office

A sound mark must be represented graphically using the standard methods for reproducing sound graphically, in particular musical notation. A description of the sound in words is not sufficient (decision of 27/09/2007, R 0708/2006-4, TARZAN YELL). The lyrics of a song combined with musical notations and the tempo is acceptable. A sonograph alone is not an acceptable graphical representation of a sound mark if it is not accompanied by an electronic file containing the sound. Where the sound applied for cannot be depicted in conventional musical notation, for example the roar of a lion, a sonograph together with a sound file is the only means of representing the mark.

10.4.1 Electronic sound file

The attachment of an MP3 sound file is optional where musical notation has been provided and this is only possible in e-filings. The Office will not accept the filing of an electronic sound file on its own, since a graphical representation is required. Where an application does not include a graphic representation of the mark, a filing date deficiency will be raised (for more information on filing dates, see paragraph 4 above).



The sound file must be in MP3 format and its file size cannot exceed two megabytes. Office requirements do not allow the sound to stream or loop. Any other attachments or attachments that do not comply with these criteria will be deemed not to have been filed.

10.4.2 Musical notations

The applicant may file musical notation alone. This will satisfy the requirement for graphically representing the mark. In these cases an electronic sound file may be attached but it is not mandatory.

10.4.3 Sonographs

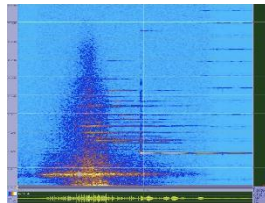
The applicant cannot file a sonograph alone (decision of 27/09/2007, R 0708/2006-4, TARZAN YELL). In these cases an electronic sound file is mandatory, since the Office and third parties cannot deduce the sound from the sonograph alone. Any colours used in a sonograph are not part of the mark, as the applicant is applying for a sound mark. Therefore, no colour indication is to be recorded and where such indication is provided, it will be deleted by the Office.

Examples of acceptable sound marks (for formalities' purposes)	
<p>EUTM 8 116 337</p> <p>Sonograph that was accompanied by a sound file</p>	
<p>EUTM 9 199 134</p> <p>Sonograph that was accompanied by a sound file</p>	
<p>EUTM 1 637 859</p> <p>Musical notation</p>	

Examples of acceptable sound marks (for formalities' purposes)	
<p>EUTM 6 596 258</p> <p>Musical notation including musical directions</p>	





10.5 Colour per se

Colour per se means that trade mark protection is sought for one or several colours, regardless of any specific shape or configuration. What is protected is the shade of colour(s) and, in the case of more than one colour, the ratio and position of the various colours, which must be systematically arranged by associating them in a predetermined and uniform way (judgments of 24/06/2004, C-49/02, Blau/Gelb, EU:C:2004:384, § 33 and 14/06/2012, T-293/10, Colour per se, EU:T:2012:302, § 50). The representation of a colour per se mark must consist of a representation of the colour or colours without contours. Where there is more than one colour, the proportion of each colour must be specified in the mark description field. If this has not been done in the application, the Office will notify the deficiency, allowing two months for the information to be provided.

If the representation contains other matter, such as words or images, it is not a colour per se mark but a figurative mark. For information on correction of the mark type, see paragraph 10.9 below.

When applying for a colour per se mark, the provision of a mere sample of the colour on its own is not sufficient; the colour or colours that are the subject of the mark must be described in words in the 'Indication of Colour(s)' field. Furthermore, it is highly recommended also to provide internationally recognised colour codes (judgment of 06/05/2003, C-104/01, Libertel, EU:C:2003:244, § 31-38). For more on indication of colour see paragraph 12 below.

Pursuant to Rule 3(3) EUTMIR, an application for a colour per se mark may be represented by showing the colour or colours as they will be applied to the goods and services concerned. In such cases, a mark description is required in order to clarify the nature of the mark.

Examples of acceptable colour per se marks (for formalities' purposes)	
<p>EUTM 962 076</p> <p><u>Colour indicated:</u> Brown</p>	
<p>EUTM 31 336</p> <p><u>Colour indicated:</u> Lilac/violet</p> <p><u>Description:</u> Lilac/violet, single colour as shown in the representation. The values (specific coordinates in the colour space) for the present mark are: L => 53,58 /- 08; A => 15,78 /- 05; B => 31,04 /- 05. The mark can be located in Pantone's Process Book between the shades with number E 176-4 and E 176-3.</p>	
<p>EUTM 8 298 499</p> <p><u>Colours indicated:</u> Green, Pantone 368 C, anthracite, Pantone 425 C, orange, Pantone 021 C</p> <p><u>Description:</u> The trade mark consists of the colours green: Pantone 368 C; anthracite: Pantone 425 C; orange: Pantone 021 C, as shown in the illustration; the colours are applied to a basic component of the exterior of vehicle service stations (petrol stations) in the ratio green 60 %, anthracite 30 % and orange 10 %, creating the impression of a green and anthracite-coloured petrol station (green predominating) with small orange accents.</p>	
<p>EUTM 4 381 471</p> <p><u>Colours indicated:</u> Blue (Pantone 2747 C) and silver (Pantone 877 C)</p> <p><u>Description:</u> Protection is claimed for the colours blue (Pantone 2747 C) and silver (Pantone 877 C) juxtaposed as shown in the representation of the colour mark applied for. The ratio of the colours is approximately 50 %-50 %.</p>	
<p>EUTM 11 055 811</p> <p><u>Colours indicated:</u> Very light green, light green, medium green, dark green, very dark green</p> <p><u>Description:</u> The mark consists of five stripes of colours positioned horizontally directly one above the other, their length being several times larger than their height. The colour distribution from the top to the bottom is the following: very light green, light green, medium green, dark green and very dark green. Proportion of the five colours: 20 % each.</p>	

10.6 Holograms

Holograms are particularly difficult to represent graphically since a paper representation does not allow the image to 'change' as it would naturally on holographic paper. However, with a clear mark description and sufficient views of the mark, a hologram can be graphically represented. Therefore, where a hologram is applied for, more than one mark representation can be filed, provided all different views are on a single A4 sheet in the case of paper filings or in a single JPEG file in the case of e-filing.

10.7 Smell/Olfactory marks

Smell or olfactory marks are not currently acceptable. This is because a graphic representation must be clear, precise, self-contained, easily accessible, intelligible, durable and objective (judgment of 12/12/2002, C-273/00, Methylcinnamat, EU:C:2002:748). As in the case of all the other types of marks, a mark description cannot replace the graphic representation. Although it may be graphic, a description of a smell is neither clear, precise nor objective and therefore no filing date can be attributed because the mark cannot be graphically represented. Such cases (decision of 04/08/2003, R 0120/2001-2, The taste of artificial strawberry flavour) will not be rejected but rather deemed not filed. Where a purported graphic representation is filed, the application will be refused under absolute grounds for refusal (see the Guidelines, Part B, Examination, Section 4, Absolute Grounds for Refusal).

10.8 Other marks

Other marks must contain an indication in the mark description of what is meant by 'other'. 'Other' marks can be, for example, animated marks (movement marks), position marks or tracer marks (coloured stripes or threads applied to certain products).



For more information refer to the Guidelines, Part B, Examination, Section 4, Absolute Grounds for Refusal.

10.8.1 Animated marks (movement)

The number of mark representations is practically unlimited as long as they are all on a single A4 sheet in the case of paper filings, or in a single JPEG document in the case of e-filing. As the applicant's aim is to protect the specific movement of the mark, a mark description indicating that it is a 'movement mark' is a formality requirement.

The representations together with the mark description must clearly explain the movement that is to be protected. Where the movement cannot be perceived (e.g. the representations are out of sequence), or the mark description does not match the sequence of representations, the Office will issue a deficiency allowing two months for the representations and/or description to be clarified. If the deficiency is not remedied within the time limit, the application will be rejected.

Where the representations include colour, the colour(s) used must be indicated in words.

Examples of acceptable animated marks (movement) (for formalities' purposes)	
<p>EUTM 5 338 629</p> <p><u>Description:</u> The mark is an animated sequence with two flared segments that join in the upper right portion of the mark. During the animation sequence, a geometric object moves up adjacent to the first segment and then down adjacent to the second segment, while individual chords within each segment turn from dark to light. Stippling down in the mark is for shading only. The entire animated sequence lasts between one and two seconds.</p>	 <p><u>Representations:</u> Mark representation in black and white and shades of grey only; no colour indication.</p>
<p>EUTM 13 225 107</p> <p><u>Description:</u> All of the representations are on a white surface. At the outset only the text 'Hotel?' is readable on the white background. This text is in blue, yellow and red. The characters are divided into pairs of characters, with each pair being in a single colour. The entirety of the text is tilting forwards towards the viewer. As a result of the rotation, the previous text 'Hotel?' turns into 'trivago'. This text has the same colours (blue, yellow and red) as the previous text.</p> <p>Colours: Blue, red, black, white, yellow.</p>	

10.8.2 Position marks

A position mark is a sign positioned on a particular part of a product in a constant size or particular proportion to the product. The sign must be represented graphically. As the applicant is aiming to protect the placement or 'position' of the mark, a mark description detailing its positioning is a formality requirement. The mark description must also contain an indication that it is a 'position mark' and, where a representation in colour is submitted, the colour(s) used must be indicated in words.

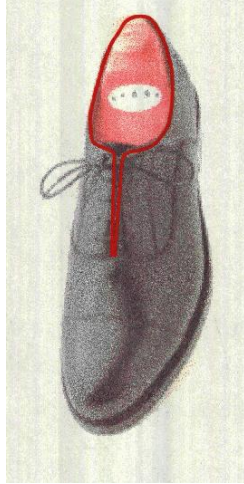
Examples of acceptable position marks (for formalities' purposes)	
<p>EUTM 4 717 914</p> <p><u>Colour indication:</u> Red</p> <p><u>Description:</u> Red edging, 2 mm in width, running along the edge of the ankle opening and the lace-up section.</p>	

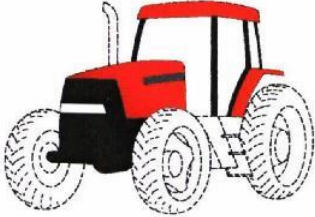
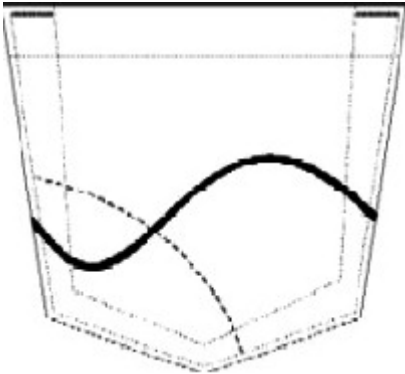
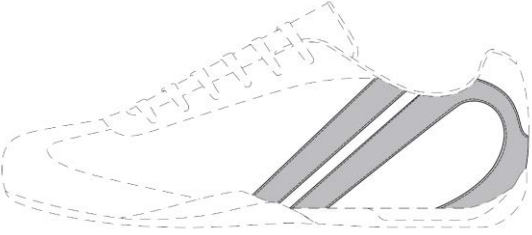
Examples of acceptable position marks (for formalities' purposes)	
<p style="text-align: center;">EUTM 9 045 907</p> <p><u>Colours indicated:</u> Red, black and grey</p> <p><u>Description:</u> The mark consists of the combination of the colours red, black and grey as applied to the exterior surfaces of a tractor, namely red as applied to the bonnet, roof and wheel arches, light and dark grey as applied to the bonnet in a horizontal stripe and black as applied to the front bonnet grill, chassis and vertical trim — as depicted in the illustrative representation attached to the application.</p>	
<p style="text-align: center;">EUTM 6 900 898</p> <p><u>Description:</u> Two Curves Crossed in One Point Design inserted in a Pocket; the mark consists of a decorative stitching made of Two Curves Crossed in One Point Design inserted in a Pocket; one of the curves is characterized by an arched form, drawn with a fine stroke, while the second one is characterized by a sinusoidal form, drawn with a thick stroke; the unevenly broken lines represent the perimeter of the pocket to which the applicant makes no claim and which serves only to indicate the position of the mark on the pocket.</p>	
<p style="text-align: center;">EUTM 8 586 489</p> <p><u>Description:</u> The trade mark is a position mark. The mark consists of two parallel lines positioned on the outside surface of the upper part of a shoe. The first line runs from the middle of the sole edge of a shoe and slopes backwards towards the instep of a shoe. The second line runs parallel with the first line and continues in a curve backwards along the counter of a shoe to the heel of a shoe and ends at the sole edge of a shoe. The dotted line marks the position of the trade mark and does not form part of the mark.</p>	

Position marks are not acceptable if the description shows that the position may vary — e.g. ‘The mark consists of [description of the device] applied to the outside of the goods’. The position of the mark must be clearly defined and evident from the representation and description.

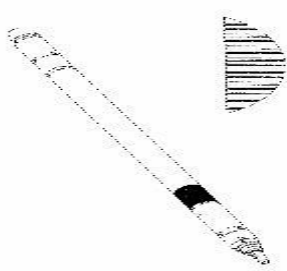
Examples of unacceptable position marks/descriptions (for formalities' purposes)	
<p>EUTM 8 682 213</p> <p><u>Description:</u> Trade mark protection is claimed for a stripe positioned on the casing of a soil displacement hammer (so-called displacement mole), the stripe being shown in the isometric overall view of the soil displacement hammer as a black, circular band, which is set off from the other parts of the casing by means of the pattern visible in the additional view, which shows an enlarged (semi-circular) detail of this stripe in a side view of the soil displacement hammer, the pattern being formed by a multitude of circular grooves; the stripe is positioned on a section of the casing, which, viewed from the cone point of the soil displacement hammer, equals the second quarter of the total length of the soil displacement hammer; other forms visible in the representation and/or arrangements are not part of the mark.</p>	<p>Depiction together with description do not clearly define what the sign is and how it is to be placed on the goods:</p>  <p>(It is unclear from the representation from which perspective a semi-circular detail should be visible.)</p>

10.8.3 Tracer marks

Tracer marks are coloured lines or threads applied to certain products. These marks are popular in the textile industry. Other examples are coloured lines on hoses or cables. The mark description should indicate that the mark is a 'tracer mark' and any colours must be indicated in words.

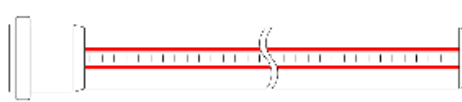
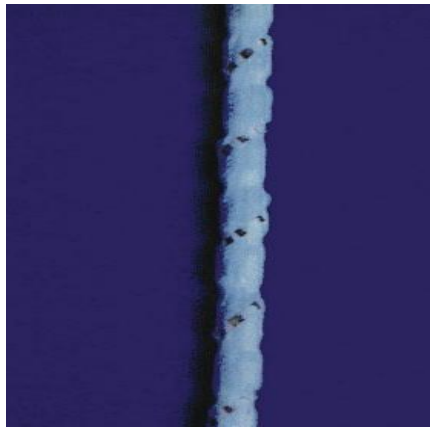
Examples of acceptable tracer marks (for formalities' purposes)	
<p>EUTM 7 332 315</p> <p><u>Description:</u> The trade mark consists of a pipe, tube or extruded profile with continuous thin black horizontal lines set at an equal distance apart on the exterior of the pipe, tube or extruded profile, between two parallel red lines running along the length of the pipe, tube or extruded profile.</p>	
<p>EUTM 3 001 203</p> <p><u>Colours indicated:</u> Gold on a light background</p> <p><u>Description:</u> Golden band incorporated into a light-coloured functional band, in particular a lead band, for curtains, drapes, table covers and similar goods as an identifying marking.</p>	

10.9 Correction of the mark type

10.9.1 General rules

Where the indication of the mark type in the application is clearly wrong or where there is an obvious contradiction between the mark type selected and the representation, including any mark description, the Office will correct the mark type and inform the applicant, giving a two-month time limit for observations. If there is no response, the correction made by the Office is considered accepted by the applicant. If the applicant disagrees with the amendment, the Office will restore the original indication of type of mark; however, the application may then be rejected as the nature of the mark is not clear.

10.9.2 Examples of recurring mark type deficiencies

10.9.2.1 Word marks

Where the mark type chosen is 'word', but the mark is actually a 'figurative' mark such as in the examples in paragraph 10.2 above (representation in several lines, stylised fonts, etc.), the Office will correct the mark type and update the figurative image in the system. The Office will send a letter to the applicant informing them of the amendment and setting a two-month time limit for observations. If the applicant does not reply within the time limit, the amendment will be deemed to have been accepted. If the applicant files observations objecting to the amendment, and the Office disagrees with the observations, the mark type will be changed back to 'word' mark, but the application will be rejected.

10.9.2.2 Figurative marks

If no mark type has been indicated at all and the mark is clearly figurative corresponding to the examples given above, the type of mark is inserted by the Office and the applicant is informed accordingly.

Sometimes 'figurative' marks in colour are erroneously filed as 'colour marks'. Furthermore, the differences in typology of the miscellaneous marks within the EU Member States may lead to a mark type deficiency, in particular with regard to marks combining a word and a figurative element, which are often incorrectly filed as 'other' rather than as 'figurative' marks. In such cases, the Office will correct the mark type to 'figurative' and inform the applicant, setting a two-month time limit for observations.



Example 1

A **figurative** mark applied for as a **colour per se** mark.

The Office will change the mark type from **colour per se** to **figurative** and send a letter confirming the amendment. If the applicant disagrees, they may submit observations. If the Office disagrees with the observations, it will restore the original indication of the mark type, but the application will then be rejected. If, however, there is no response within the time limit, the change of mark type will be considered as accepted and the application will proceed.

Example 2

The following marks were applied for as mark type 'other':

EUTM 9 328 121	
EUTM 9 323 346	

When the applicant has chosen as the type of mark 'other', instead of ticking 'figurative', and has added in the explanatory field of the 'other mark' terms like 'text and logo', 'marque sémi-figurative', 'marca mixta', 'Wort-Bild-Marke', or even 'colour per se' (because its mark contains elements in colour), but the mark applied for is clearly a figurative trade mark as defined above, the Office will change the mark type from **other** to **figurative** and send a letter to the applicant informing them of the amendment and giving two months for observations to be filed. If the applicant does not reply within the two-month time limit, the change of mark type will be deemed to have been accepted and the application will proceed. If the applicant files observations objecting to the amendment, and the Office disagrees with the observations, the Office will restore the original indication of the mark type, but the application will then be rejected.

Example 3

In some cases, marks may be filed as, for example, 'figurative', but the representation and/or mark description show that a three-dimensional mark is intended.

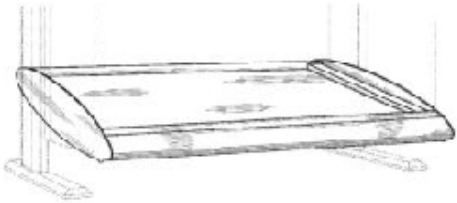
<p>EUTM application 10 318 897</p> <p><u>Mark type chosen:</u> Figurative</p> <p><u>Description:</u> The mark consists of a shape for a shelf for the goods. The ends of the shelf have an elliptical shape. The front edge of the shelf has a tapered shape. The portion of the mark shown in dotted lines is not part of the mark and serves only to show positioning or placement of the mark.</p>	
---	--

In this case the mark description, which refers to 'a shape for a shelf', is contradictory to the mark type 'figurative'. Therefore, the applicant was requested to amend the mark type to 'three-dimensional' or to delete the mark description.

11 Series Marks

Unlike some national systems, the EUTMR does not allow for series marks. When different versions of a trade mark are required, a separate EUTM application is required for each of those versions.

Example 1

A **word** mark filed as 'BRIGITTE brigitte Brigitte' will **not** be 'interpreted' as 'the word 'Brigitte', written either in upper case letters or in lower case letters or in 'normal' script'; it will be seen as the word mark containing the female name 'Brigitte' three times. No deficiency letter will be sent and no changes to the mark will be accepted.

Example 2

A **word** mark filed as 'Linea Directa/Direct Line/Ligne Directe' will **not** be 'interpreted' as 'the term 'direct line', either in Spanish or in English or in French'; it will be seen as a word mark containing all three language versions in the same sequence as applied for. No deficiency letter will be sent and no changes to the mark will be accepted.

11.1 Multiple figurative representations

In an application submitted through e-filing, the reproduction of the mark must be uploaded as a single JPEG file. When the paper application form is used, the mark reproduction must be attached on a single A4 sheet.

The A4 sheet or JPEG file must contain only one representation of the mark as applied for and no additional information whatsoever (except the indication of the correct position of the mark where this is not obvious, see Rule 3(2) EUTMIR).

When a paper-filed application contains more than one A4 sheet showing different marks, albeit very similar ones, the Office issues a deficiency letter requesting the applicant to choose one mark from among the different variations. If the applicant wants to protect the others as well, it will have to file a new application for each of the other marks it wishes to register. When there is no response to the deficiency letter within the time limit set therein, the application will be rejected.

Where an application, filed electronically or on paper, contains a JPEG file or an A4 sheet showing what might be seen as more than one mark representation, the combination as a whole of all those variations, as they appear on that one page, will be deemed as the mark for which protection is sought. Changes to the mark representation are not allowed.

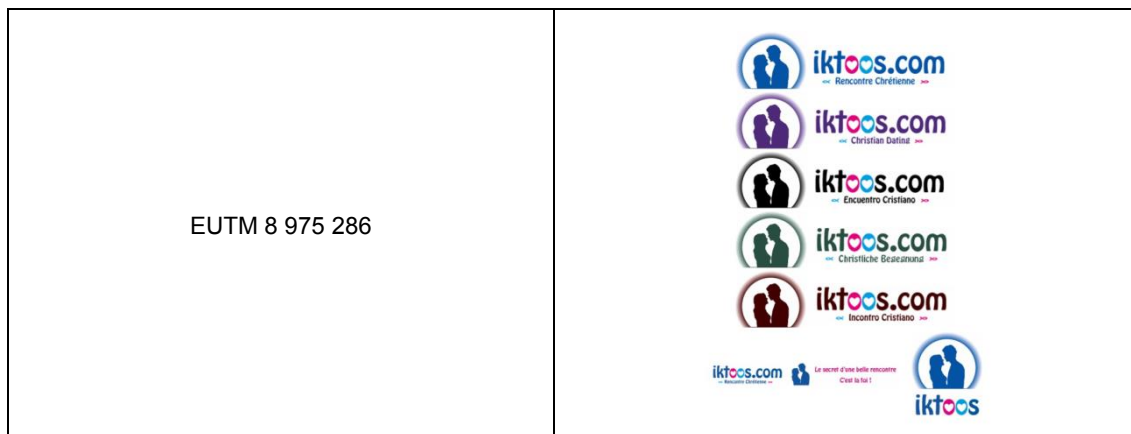

Since the JPEG file attached to the above application contained all of the above images on a single page, the entirety of variations of logos and colours and texts is deemed one single trade mark.

12 Indication of Colour

Rule 3(5) and Rule 80 EUTMIR

Word marks and sound marks cannot be in colour, since it is the word(s) and the sound(s) that are protected even if a sonograph is represented in colour.

Figurative, three-dimensional, holograms and other marks can be applied for in colour or without colour.

Colour per se marks are a specific type of trade mark and are explained in paragraph 10.5 above.

When a mark is to be registered in colour, a coloured mark representation must be filed with the application and the colours used indicated in words. An international colour code such as a Pantone number can be added to the colour indication, although it cannot replace the indication in words (green, blue, red).

Black, grey and white may be claimed as 'colours'. The indication of the colours made by the applicant ('black and white' or 'black, grey and white', etc.) is subject to the same rules as any other colour indication.

Where a coloured representation is supplied, the Office considers that the applicant implicitly claims colour and the application is therefore considered to be for registration of a mark in colour. After filing in colour, it is not possible to change the application to a black and white mark (decision of 25/08/2010, R 1270/2010-4, Form von Prüfköpfen (3D)). The only option for the applicant is to file a new application with a black and white representation.

If, in an application for a mark in colour, the colours grey, black and white are used other than for contrasting or delimiting, these must also be claimed.

Expressions like ‘multicolour’, ‘of various colours’, ‘in any possible combination’ or ‘in any proportion’ are not acceptable (decision of 25/08/2010, R 1270/2010-4, Form von Prüfköpfen (3D)).

Where the indication of colour(s) has been omitted, the Office will propose the colour(s) to the applicant, setting a time limit for reply. If no reply is received before expiry of the time limit, the insertion of the colour(s) indicated by the Office will be deemed to have been accepted. If the applicant disagrees with the insertion of the colours, the Office will delete the indication. However, in such cases if the applicant fails to indicate the colours accurately, the application will be rejected.

If it is not possible to establish the colour(s), the Office will request that the applicant provides the colours. If the applicant fails to submit an accurate colour indication within the time limit, the application will be rejected (Rules 9(4) and 3(5) EUTMIR).





If the application contains a colour claim but no mark representation in colour has been received, there is a formal discrepancy between the trade mark applied for and the colour(s) claimed. Any colour indication will be corrected by the Office (i.e. to black, white and/or grey) and the applicant will be informed.

The **only exception to this rule** is when the application is filed by fax, in which case the applicant must (on its own motion) send a representation in colour by post within one month of sending the application. This one-month time limit cannot be extended. When the representation in colour is received within this time limit, the original representation in black and white will be substituted by the new representation in colour. If the applicant does not send the representation of the mark in colour, the Office will not request it. If a colour representation is not submitted within the one-month time limit, any colour indication will be corrected to black, white and/or grey as appropriate and the applicant will be informed.

When the mark representation is filed by other means than fax and in black and white — including grey — it cannot be altered into a mark in colour even if the black and white mark was filed along with a colour claim, a colour indication and /or a description referring to colours.

It is to be noted that indications like ‘transparent’ or ‘without colour’, ‘colourless’ are not indications of colours and will not be accepted. When a mark representation shows, for example, a ‘colourless’ object made of glass or a similar material before a coloured background, the mark description is the appropriate place to explain that the object in question is colourless and shown in front of a coloured background that is not part of the mark.

Examples of colour indications (for formalities' purposes)	
EUTM 10 275 519	
<p><u>No colour indication</u></p> <p>No colour indication required. However, black and white may be claimed by the applicant if these colours are to be considered a feature of the mark.</p>	

Examples of colour indications (for formalities' purposes)	
<p>EUTM 8 401 572</p> <p><u>Colour indication:</u> Cream, blue, orange, brown, red, pink, yellow, black, green, maroon</p> <p>Black must be indicated as the application is for a mark in colour and black is not only used for contrasting and delimiting, but also for the tail, eye, nose and ears.</p>	
<p>EUTM 10 456 762</p> <p><u>No colour indication</u></p> <p>No colour indication required. However, black, white and grey may be claimed if these colours are to be considered a feature of the mark.</p>	
<p>EUTM 9 732 793</p> <p><u>Colour indication:</u> Red, orange, yellow, mint green, sea green, blue, purple, pink</p> <p>Black should be claimed in this application as this is a mark in colour and black is used other than for contrasting and delimiting, i.e. for the letters.</p>	
<p>EUTM 10 336 493</p> <p><u>Colour indication:</u> Purple, blue, yellow, white, orange, red and black.</p> <p>Black is claimed, however, the Office would accept the colour indication without black as it is used only for delimiting — around the words 'POP-UP!'</p>	

In cases where the colour indication includes information that is not relevant to this field but is relevant to another field of the application, the Office will move the text to the relevant field. Examples of this are where the colour indication includes a mark description or list of goods and services.

13 Mark Descriptions

Rule 3(3) EUTMIR

A mark description is mandatory for EUTM applications for mark type 'other'. This is because an explanation of what is meant by 'other' is required to clarify the scope of protection (define the nature of what is to be protected). If the description is missing or unclear, a deficiency will be raised. If it is not remedied, the mark will be rejected.

Likewise, where colour per se combinations are applied for, the specification of the ratio of the colours must be provided.

Word marks cannot have a mark description; if a description is included, it will be removed by the Office and the applicant will be informed.

For the remaining mark types, a mark description is not mandatory, but it may be useful in assisting the Office to determine the nature of the mark or clarify the representation. If the description does not match the representation of the mark, the applicant will be asked to delete or amend it. The representation cannot be changed to match the mark description.

Where the EUTM application is intended to be used as the basis for an international application, the applicant should consider including a mark description in its EUTM application, since a description is a formality requirement in some countries. For more information on international applications, see the Guidelines, Part M, International Marks.

A mark description can only define what can be seen in the mark representation or heard in a sound mark. It must not contain an interpretation of what is meant by a certain combination of letters or graphic elements or what the designer had in mind or an indication that the mark will only be used in certain Member States, etc. Nor is it possible to state in a mark description that the mark can contain, for example, the colours blue and green or red and yellow; the description should state either blue/green or red/yellow — namely what can be seen in the coloured mark representation.

The representation of the mark together with a description, if any, must be sufficient for the Office to see and understand what is being sought to be registered.

A mark that consists of or includes letters from a non-EU alphabet, for which the applicant provides a transliteration or translation together with a transliteration of the term in the mark description, is acceptable.

Where the mark description does not match the representation of the mark, the Office will raise a deficiency, which the applicant will have two months to remedy. If the deficiency is not remedied:

1. the Office will reject the EUTM application (for ‘colour **per se** combinations’ and ‘other’ marks that require a mark description to explain the scope of protection);
2. the Office will delete the description (in all other cases, as the description is not mandatory).

When a mark description is deleted, the applicant will be informed. In no case can the mark representation be changed to match the mark description.

Where the mark description includes information that is not a relevant description and the information is not relevant to any other field on the application form (e.g. the text interprets the meaning/symbolism of the mark or indicates in which Member States the mark will be used), the Office will delete the mark description and inform the applicant.





Where the mark description includes information that is not a relevant description and the information is relevant to another field, the Office will move the text to the relevant field.



Examples of this are where colours are mentioned in the mark description field, are valid as a colour indication and will be keyed-in in the relevant field for the indication of colours. Where goods and services are mentioned in the mark description field rather than in the field for goods and services, the Office will delete them from the mark

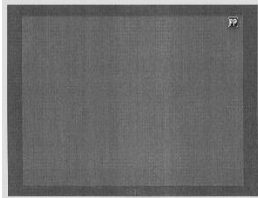

description and, if the goods and services are not already covered in the specification, the Office will inform the applicant that it may add the goods and services.

This principle applies *mutatis mutandis* in all cases where necessary information on the mark is included in the wrong field of the application.

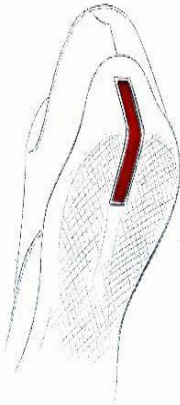
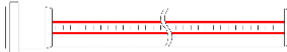
A mark description can be amended or added after the filing of the mark in order to more clearly describe the content of the mark, for example, the movement depicted. However, such an amendment must not alter the nature of the mark substantially. An amendment of the description is not possible after registration.

Examples of accepted mark descriptions (for formalities' purposes)	
<p>EUTM 1 915 248</p> <p><u>Mark type:</u> Figurative</p> <p><u>Description:</u> Trade mark consisting of the word 'ALBALUNA' written in special lettering, in which the letter 'L' is superimposed on the outline of a quarter moon.</p>	
<p>EUTM 2 023 950</p> <p><u>Mark type:</u> Figurative</p> <p><u>Description:</u> The trade mark consists of the word 'AIA' in red, stylised upper case lettering, with the letter 'I' surmounted by a red circle, inserted in a white oval delimited by a green rectangular frame, the whole outlined by a gold border.</p>	
<p>EUTM 8 837 502</p> <p><u>Mark type:</u> Other (Position)</p> <p><u>Description:</u> The position mark consists of a logo comprising a rectangle with rounded corners with an encircling light-coloured border and the two light-coloured letters PP arranged next to one another on a dark background. The logo is displayed on a screen during the broadcasting of a television programme or other programme in the upper right-hand corner of the screen.</p>	
<p>EUTM 6 453 104</p> <p><u>Mark type:</u> Three-dimensional</p> <p><u>Description:</u> Three-dimensional trade mark consisting of a bottle shape that is wider in the centre than at the base. This bottle has a distinctive spiral decoration made up of a golden dotted line, interrupted by golden butterflies; at the end of the line, at the front, there are two butterfly figures, one large and one small, in red with a black and gold double outline. Below these two figures is the word 'BELLAGIO' in upper case white letters with a red outline; below this are the words 'The Beautiful Life' in gold. The bottle is closed with a burgundy red cap on which there are several aligned golden butterflies.</p>	

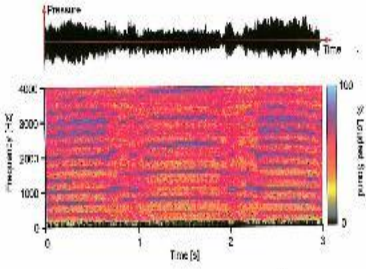
Examples of accepted mark descriptions (for formalities' purposes)	
<p style="text-align: center;">EUTM 1 027 747</p> <p><u>Mark type:</u> Other (position)</p> <p><u>Description:</u> Red stripe placed longitudinally along an item of footwear partly covering the rear area of the sole and partly the rear area of the item of footwear. Any moulding seen on the sole or on the rear part of the item of footwear and/or production characteristics are not part of the trade mark.</p>	
<p style="text-align: center;">EUTM 7 332 315</p> <p><u>Mark type:</u> Other (tracer mark)</p> <p><u>Description:</u> The trade mark consists of a pipe, tube or extruded profile with continuous thin black horizontal lines set at an equal distance apart on the exterior of the pipe, tube or extruded profile, between two parallel red lines running along the length of the pipe, tube or extruded profile.</p>	
<p style="text-align: center;">EUTM 2 818 334</p> <p><u>Mark type:</u> Other (movement)</p> <p><u>Description:</u> Two hands form a 'T', in which, from the position of the viewer, the right hand, stretched out flat with fingertips pointing upwards (so that only the narrow edge of the hand is visible) moves from the upper left of the image to the centre, while the left hand, also stretched out flat with fingertips pointing upwards and viewed from the side, moves from the upper right of the image to the centre; both hands then meet in the centre of the image with the upwards-pointing fingertips of the right hand touching the surface of the left hand roughly in the centre; the viewer therefore sees a side view of the descending left hand coming to rest on the fingertips of the ascending right hand; as a result of this movement, the viewer is able at this point to recognise the letter 'T'.</p>	

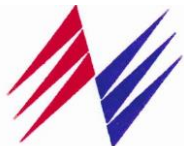
Examples of accepted mark descriptions (for formalities' purposes)	
<p style="text-align: center;">EUTM 5 090 055</p> <p><u>Mark type:</u> Sound</p> <p><u>Description:</u> The mark consists of the yell of the fictional character TARZAN, the yell consisting of five distinct phases, namely sustain, followed by ululation, followed by sustain, but at a higher frequency, followed by ululation, followed by sustain at the starting frequency, and being represented by the representations set out below, the upper representation being a plot, over the time of the yell, of the normalised envelope of the air pressure waveform and the lower representation being a normalised spectrogram of the yell consisting of a three-dimensional depiction of the frequency content (colours as shown) versus the frequency (vertical axis) over the time of the yell (horizontal axis), the mark also being reproduced in the attached electronic file containing the sound.</p>	
<p><u>Mark type:</u> Figurative</p> <p><u>Description:</u> The mark consists of three blue shapes and three red shapes, facing in opposite directions.</p>	
Example of a mark description that would not be accepted (for formalities' purposes)	
<p><u>Mark type:</u> Figurative</p> <p>Mark Description: The mark consists of two hands grasping the air.</p>	

14 Disclaimer

A disclaimer is a statement by the applicant that they disclaim any exclusive right to an element of the trade mark representation that is not distinctive. As from 23/03/2016, due to the amending Regulation, disclaimers can no longer be applied for and the Office can no longer request them.

For more details on disclaimers see the Guidelines, Part C, Opposition, Section 2, Double Identity and Likelihood of Confusion, Chapter 4, Comparison of Signs.

15 (Convention) Priority

Articles 29 and 31 EUTMR
Rules 6 and 9 EUTMIR
Decision EX-03-5 and Decision EX-05-05 of the President of the Office

The effect of the right of priority is that the date of priority will count as the date of filing of the European Union trade mark application for the purposes of establishing which rights take precedence.

The principles of priority were first laid down in the Paris Convention for the Protection of Industrial Property of March 20, 1883, which has been revised several times and was last amended in 1979 and ratified by many Contracting States. Article 4 of this Convention — with regard to trade marks — corresponds to Article 29 EUTMR.

The ‘convention priority’ right is a right limited in time, which is triggered by the first regular filing of a trade mark. A regular national filing is any filing that is adequate to establish the date on which the application was filed in the country concerned, whatever may be the subsequent fate of the application. (Article 4(3) of the Paris Convention). It may be claimed during the six months following the first filing, provided the country of first filing was a party to the Paris Convention or to the WTO, or a country with a reciprocity agreement (cf. Rule 101 EUTMIR — reciprocity findings by the Commission).

The States and other entities mentioned below, inter alia, are not members of any of the relevant conventions nor do they benefit from reciprocity findings. Therefore, priority claims based on filings in these countries will be **rejected**.

Independent States (not member of PC, WTO or reciprocity agreement):

- Afghanistan (AF)
- Aruba (AW)
- Cook Islands (CK)
- Eritrea (ER)
- Ethiopia (ET)
- Kiribati (KI)
- Marshall Islands (MH)
- Micronesia (Federated States of) (FM)
- Nauru (NR)
- Palau (PW)
- Somalia (SO)
- Tuvalu (TV).

Other entities (not member of PC, WTO or reciprocity agreement):

- Abkhazia (GE-AB)
- American Samoa (AS)
- Anguilla (AI)
- Bermuda (BM)
- Cayman Islands (KY)
- Falkland Islands (FK)
- Guernsey (Channel Island) (GC)

- Isle of Man (IM)
- Jersey (Channel Island) (JE)
- Montserrat (MS)
- Pitcairn Island (PN)
- Saint Helena (SH)
- Somalia (SO)
- Turks and Caicos Islands (TC)
- (British) Virgin Islands (VG).

A priority claim of a previous EUTM is acceptable if that EUTM was granted a filing date. A priority claim of an international registration is not acceptable. This is because the principle of first filing applies (Article 29(4) EUTMR — see paragraph 15.1 below) and the priority claim can only be based on the relevant basic mark.

The applicant may claim the priority of one or more previous trade mark applications, namely a national (or Benelux) application filed in or for a State party to the Paris Convention, a Member of WTO, a State for which the Commission has confirmed reciprocity, or an EUTM application. See paragraph 15.1, 'Principle of first filing' for information on applications that claim the priority of more than one earlier application.

Any filing that is equivalent to a regular national filing under the domestic law applicable to it will be recognised as giving rise to the right of priority.

Priority claims may be filed either in the EUTM application or subsequent to the filing of the application, in which case the applicant must submit the declaration of priority, indicating the date on which and the country in which the previous application was made, within a time limit of two months from the filing date.

The claim may be implicit so that the submission of the priority documents (within the time limit of two months) will be construed as a declaration of priority. Simple filing receipts containing the **country** and **date** of the earlier application(s) are accepted.

Within three months of the receipt of the declaration of priority at the Office, the applicant must provide the Office with the **file number(s)** of the previous application(s).

If the mark concerned is in colour, the submission of colour photocopies concerning the earlier application(s) is mandatory.

Priority will be granted if the following requirements are met:

1. the previous application(s) is a first regular filing ('first filing');
2. the mark in the earlier application(s) and the EUTM applied for are the same;
3. the goods and services are identical or are contained within those of the earlier application(s) (it is sufficient that one good or service is the same);
4. the proprietor is the same;
5. the filing date of the EUTM is within six months of the filing date of the earlier application;
6. the priority must be claimed with the application or within two months from the filing date.

It is possible to claim both priority and seniority based on the same prior application/registration if the first filing was registered in due time.

15.1 Principle of first filing

The previous application must be a first regular filing and cannot bear the same date as the EUTM application. The Office will therefore check (i) that there was no priority claim made on the prior application(s) and (ii) that no seniority claim made for the EUTM application relates to a mark that has a filing date prior to that of the application(s) from which priority is claimed. The Office will also check that the EUTM application is filed no later than six months from the date of filing of the earlier application(s).

Where priority of more than one earlier application is claimed, the goods and/or services covered by each of those applications must be different in order for the principle of first filing to be met. For examples, please see paragraph 15.8.1 below.

15.2 Triple identity

The Office will check that the EUTM application and the priority documents contain the same mark, refer to the same applicant and have at least one product or service in common.

15.2.1 Identity of the marks

The Office and a number of trade mark offices of the European Union have agreed on a common practice under the European Trade Mark and Design Network concerning the identity of trade marks filed in black and white and/or greyscale as compared to those filed in colour. The offices believe that the Common Practice Note is a reflection of the current case-law that a trade mark filed in black and white and/or greyscale is, for the purposes of assessing priority, not identical to the same mark filed in colour unless the differences in colour or in the shades of the grey are so insignificant that they could go unnoticed by the average consumer (judgments of 19/01/2012, T-103/11, Justing, EU:T:2012:19, § 24, 20/02/2013, T-378/11, Medinet, EU:T:2013:83 and 09/04/2014, T-623/11, Milanówek cream fudge, EU:T:2014:199). An insignificant difference between two marks is one that a reasonably observant consumer will perceive only upon examining the marks side by side.

The principle described above applies to all cases where marks are compared for the purpose of priority claims. In relation to word marks, the mark applied for will in most cases be deemed to be the same as the earlier mark where there is a difference only in respect of typeface or where one mark is in upper case letters and the other in lower case. Furthermore, a difference in punctuation or the addition of a space separating two words will not usually prevent the marks from having identity (decisions of 09/10/2012, R 0797/2012-2, Water Jel and 15/07/1998, R 0010/1998-2, THINKPAD).

The Office will also check the mark type of the earlier application, because a different mark type may mean that the EUTM application is different from the earlier mark. For example, a figurative mark is not the same as a three-dimensional mark or a position mark. However, a word mark can be considered to be the same as a figurative mark if standard type is used in the figurative mark (see the examples in paragraph 15.8.2 below).

In assessing the marks, the Office will also consider any colour indication in the earlier application.

15.2.2 Identity of the goods and services

The Office will check that there is at least one corresponding product or service in the lists covered by the first filing and the EUTM application. The examination will not extend to all the goods and services covered under the lists, nor will it be limited to class numbers only.

15.2.3 Identity of the owner

Priority can be claimed by the applicant of the first application or its successor in title. In the latter case, the transfer must have taken place prior to the filing date of the EUTM application and documentation to this effect must be provided. The right of priority as such may be transferred independently of whether or not the first application as a whole is transferred. Priority can therefore be accepted even if the owners of the EUTM application and the earlier right are different, provided evidence of the assignment of the priority right is supplied; in this case, the execution date of the assignment must be prior to the filing date of the EUTM application.

Subsidiary or associated companies of the applicant are not considered the same as the EUTM applicant.

Where the applicant of the first application states that it has changed its name since the first filing and files the EUTM application under its new name, the applicant is considered to be the same person.

For the distinction between a change of name and a transfer, see the Guidelines, Part E, Register Operations, Section 3, EUTMs as Objects of Property, Chapter 1, Transfer.

15.3 Priority requirements not satisfied

If the priority claim does not satisfy any of the above requirements, the applicant will be invited to remedy the deficiency or make observations within the time limit set by the Office.

If there is no response, or if the deficiencies are not remedied within the time limit set, the Office will notify the loss of rights to the applicant and set a two-month time limit during which the applicant may request a formal, appealable decision on the loss of rights.

If the applicant formally requests a decision within the time limit, the Office will issue a formal decision on the loss of rights.

15.4 Priority documents not provided

If the priority documents are not submitted with the application, the Office will check to determine if the relevant information can be found online. If the information to grant the priority claim cannot be found online, the Office will send a letter to the applicant requesting it. The applicant will be given a time limit of two months to remedy the deficiency; as a rule, this time limit will not be extended. Usually, the deficiency letter

will be issued before expiry of the original time limit to submit the priority documents (three months from date of receipt of the priority claim). In this case, the two-month deficiency time limit will be calculated from the date of expiry of the original time limit for submission of the priority documents. In accordance with Decision EX-03-5, certified copies are not necessary. Simple filing receipts that do not contain all the necessary information for examining the priority claim (e.g. they only contain class numbers for the goods and services of the prior application and not the full text version indicating all the goods and services) are not acceptable.

15.5 Language of previous application

If the language of the previous application is not one of the official EU languages, the Office will invite the applicant to file a translation within three months. The time limit for filing the translation may be extended at the request of the applicant. An extension in this case may be for up to two months.

15.6 Priority date check after changing of the filing date

If the EUTM application has a filing date change, the Office must check that the new filing date is still within six months of the priority claim.

15.7 Examples of priority claims

15.7.1 First filing

In the example below, the priority claim of more than one earlier application is acceptable because the goods covered by each of those earlier applications are different and therefore the principle of first filing is met.

First filing	Country	Goods/services	EUTM filed	Goods/services
6 April	Italy	Perfumes	11 September	Perfumes, Bags, Clothing
9 May	Germany	Bags		
23 May	Spain	Clothing		

In the example below, the two earlier trade mark applications were filed for exactly the same goods. The priority claim based on the Greek application has to be rejected since the trade mark was applied for in Spain first; thus the Greek application is no longer a first filing.







First filing	Country	Goods/services	EUTM filed	Goods/services
6 April	Spain	Cheese, wine		Cheese, wine
7 April	Greece	Cheese, wine	4 October	Cheese, wine



In the example below, priority cannot be claimed from a first filing in Somalia, since Somalia is not a Member State of the Paris Convention or the World Trade Organisation and has no reciprocity agreement confirmed by the EU Commission.



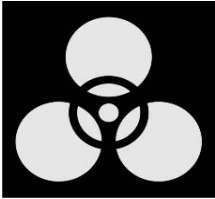

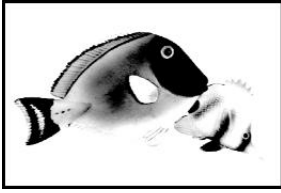
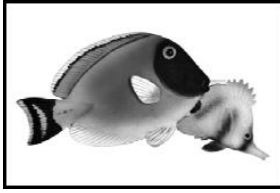

Therefore, the first filing in Italy is the one considered for the priority claim; the other filing cannot be taken into consideration.









First filing	Country	Goods/services	EUTM filed	Goods/services
5 April	Somalia	<i>Cars, T-shirts</i>		<i>Cars, T-shirts</i>
7 July	Italy	<i>Cars, T-shirts</i>	2 October	<i>Cars, T-shirts</i>

15.7.2 Comparison of the marks

Examples of acceptable priority claims (for formalities' purposes)	
EUTM application (word mark) EVAL	Priority claim (word mark) EVAL
EUTM application (word mark) Luna	Priority claim (word mark) Luna
EUTM application (figurative mark) 	Priority claim (figurative mark) 
EUTM application (figurative mark) 	Priority claim (figurative mark) 
EUTM application (figurative mark) 	Priority claim (figurative mark) 

Examples of acceptable priority claims (for formalities' purposes)	
<p>EUTM application (figurative mark)</p> 	<p>Priority claim (figurative mark)</p> 
<p>EUTM application (figurative mark)</p> 	<p>Priority claim (figurative mark)</p> 

Examples of unacceptable priority claims (for formalities' purposes)	
<p>EUTM application (colour per se)</p> 	<p>Priority claim (colour per se)</p> 
<p>EUTM application (word mark)</p> <p>Chocolate Dream</p>	<p>Priority claim (word mark)</p> <p>Chocalate Dream</p>
<p>EUTM application (figurative mark)</p> 	<p>Priority claim (figurative mark)</p> 
<p>EUTM application (figurative mark)</p> 	<p>Priority claim (figurative mark)</p> 

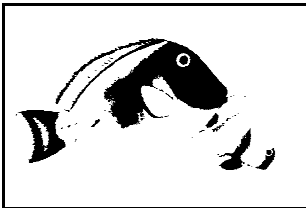
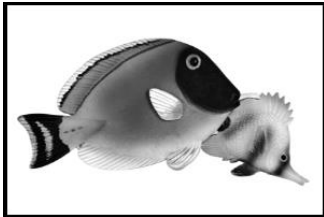





Examples of unacceptable priority claims (for formalities' purposes)	
<p>EUTM application (figurative mark)</p> 	<p>Priority claim (figurative mark)</p> 
<p>EUTM application (figurative mark)</p> 	<p>Priority claim (figurative mark)</p> 
<p>EUTM application (figurative mark)</p> 	<p>Priority claim (figurative mark)</p> 
<p>EUTM application (figurative mark)</p> 	<p>Priority claim (figurative mark)</p> 
<p>EUTM application (figurative mark)</p> 	<p>Priority claim (figurative mark)</p> 

Further examples with regard to word marks (for formalities' purposes)			
First trade mark	EUTM application	the same	not the same
Word mark Percy & Reed	Word mark Percy + Reed		X
Word mark Percy & Reed	Word mark Percy and Reed		X
Word mark Percy & Reed	Word mark Percy & Reed	X	
Word mark Percy & Reed	Word mark Percy & REED	X	
Word mark Percy & Reed	Word mark PERCY & REED	X	
Word mark Percy & Reed	Word mark <i>Percy & Reed</i>	X	
Word mark POPEYE	Word mark POPeYe	X	
Word mark POPEYE	Word mark PopEye	X	
Word mark POPEYE	Word mark POP-EYE	X	
Word mark: POPEYE	Word mark: POP EYE	X	
Word mark POPEYE®	Word mark POPEYE	X*	
Word mark POPEYE	Word mark POPEYE!?		X
Word mark POPEYE	Word mark POPEYE·	X	

*The symbols ™ and ® are not considered parts of the mark.

Examples regarding identity between figurative signs as compared to word marks (for formalities' purposes)			
First trade mark	EUTM application	the same	not the same
Word mark Percy & Reed	Figurative mark Percy & Reed (figurative mark in standard type face)	X	

Examples regarding identity between figurative signs as compared to word marks (for formalities' purposes)			
First trade mark	EUTM application	the same	not the same
Word mark Percy & Reed	Figurative mark Percy & Reed (words distributed over several lines)		X
Word mark Percy & Reed	Figurative mark Percy & Reed (colour claim)		X

Further examples with regard to figurative marks (for formalities' purposes)			
First trade mark	EUTM application	the same	not the same
			X
			X
		X*	

*The symbols TM and ® are not considered parts of the mark.

15.7.3 Comparison of the goods and services

The first example below is the most usual situation: The prior application corresponds fully to the EUTM application.

First filing	Country	G&S	EUTM filed	G&S EUTM
5 April	UK	<i>Hats, shoes</i>	1 October	<i>Hats, shoes</i>

In the next example, both priority claims can be accepted since application number XY 1234 is the first filing with respect to 'cars' and application number XY 1235 is the first filing with regard to 'airplanes'.

First filing	Country	JP application No	G&S	EUTM filed	G&S EUTM
5 April	Japan	XY 1234	<i>Cars</i>		

First filing	Country	JP application No	G&S	EUTM filed	G&S EUTM
5 April	Japan	XY 1235	<i>Airplanes</i>	2 October	<i>Cars, airplanes</i>

In the next example, the priority claim concerns 'hats' and 'shoes', which are common to the first filing and the EUTM application. No priority will apply with respect to 'bags'.



First filing	Country	G&S	EUTM filed	G&S EUTM
5 April	USA	<i>Cars, hats, shoes</i>	1 October	<i>Hats, shoes, bags</i>

In the last example, priority is claimed for first filings in France, Canada and China. The EUTM application has been filed within six months of each of the first filings and the priority claims will be accepted although, the Canadian application does not constitute a first filing for *hats* (*hats* appear in the French application, which had been filed before). Comparing the dates and the lists of goods and services of the three priorities, the priority claims will be accepted.

First filing	Country	G&S	EUTM filed	G&S EUTM
5 April	France	<i>Hats, shoes</i>		
6 April	Canada	<i>Cars, hats, beer</i>	5 October	
7 April	China	<i>Wine, telecommunication services</i>		<i>Hats, shoes, cars, beer, wine, telecommunication services</i>

15.7.4 Priority claims based on series marks

A series of trade marks means a number of trade marks that resemble each other in material details and differ only in terms of non-distinctive character. Whereas the EUTMR does not allow for the filing of series marks, some national offices (e.g. the United Kingdom, Australia, etc.) do, and such a series of marks filed in one single application can contain numerous very similar marks. When the first filing consists of a series mark, two or more slightly different mark representations will be seen. The priority claim is acceptable with regard to the one reproduction that is identical to that showing the mark applied for as an EUTM.

Examples of priority claims based on series marks		
First filing	EUTM	Priority claim acceptable
Series of marks 		Yes
Series of marks Café@Home CAFÉ@HOME Café@Home CAFÉ@HOME	CAFÉ@HOME	Yes

15.7.5 Claiming priority for three-dimensional or 'other' marks

Some national IP offices do not allow the filing of more than four representations in the case of three-dimensional or other marks.

If an EUTM application claims priority of such a first filing, and six (or more, in the case of 'other' marks) depictions/perspectives of the mark are filed with the EUTM application, the marks in question will still be considered identical if the presentations of the first filing coincide with a part of what was sent for the EUTM application and if the object is undoubtedly the same.

15.7.6 Priority claims involving collective marks

Priority can be claimed from a collective mark when applying for an individual European Union trade mark and vice versa.

16 Exhibition Priority

Article 33 EUTMR; Rule 7 EUTMIR

Exhibition priority entails claiming as priority date of the EUTM application the date on which the goods or services covered by the EUTM application were displayed at an officially recognised exhibition under the mark as filed. The applicant can claim exhibition priority within six months of the first display. Evidence of the display must be filed.

Like 'convention priority', exhibition priority can be claimed either in the application or subsequently to the filing of the EUTM application. Where the applicant wishes to claim an exhibition priority subsequent to the filing of the application, the declaration of priority indicating the name of the exhibition and the date of first display of the goods or services must be submitted within a time limit of two months of the filing date.

Within three months of the receipt of the declaration of priority the applicant must provide the Office with a certificate issued at the exhibition by the responsible authority. This certificate must state that the mark was in fact used for the goods or services, the opening date of the exhibition and, where the first public use did not coincide with the opening date of the exhibition, the date of the first public use. The certificate must be accompanied by an identification of the actual use of the mark, duly certified by the authority.

Priority can only be granted where the application for an EUTM is filed within six months of first display at an exhibition recognised for this purpose, namely a world exhibition within the meaning of the Convention of 22 November 1928. These exhibitions are very rare and Article 33 EUTMR does not protect the display at other, national, exhibitions. The exhibitions can be found on the website of the Paris Bureau International des Expositions: <http://www.bie-paris.org/site/en/>.

As to the triple identity of the trade mark, applicant and list of goods and services, the same criteria apply as for 'convention priorities' mentioned in paragraph 15 above.

The claim may be implicit. Where there is no indication of the claim in the application, the submission of the exhibition priority documents (within the time limit of two months) will be construed as a declaration of priority.

17 Seniority

Article 34 EUTMR
Rules 8 and 28 and Rule 96(2) EUTMIR
Communication 2/00, Decision EX-03-5 and Decision EX-05-5 of the President of the Office

The proprietor of an earlier trade mark registered in a Member State, including a trade mark registered in the Benelux countries, or registered under international arrangements having effect in a Member State, who applies for an identical trade mark for registration as an EUTM for goods or services that are identical to or contained within those for which the earlier trade mark has been registered, may claim for the EUTM application the seniority of the earlier trade mark in respect of the Member State in or for which it is registered.

Seniority has the sole effect that, where the proprietor of an EUTM surrenders the earlier trade mark for which seniority has been claimed or allows it to lapse, the proprietor will be deemed to continue to have the same rights as he or she would have had if the earlier trade mark had continued to be registered.

This means that the EUTM application represents a consolidation of earlier national registrations. If an applicant claims seniority for one or more earlier registered national marks and the seniority claim is accepted, the applicant may decide not to renew the earlier national registrations but still be in the same position as if the earlier trade mark had continued to be registered in those Member States where the earlier marks were registered.

Seniority under Article 34 EUTMR must be claimed with the application or within two months from the filing date of the EUTM application. The documents in support of the claim must be submitted within three months of the claim. The seniority claim may be implicit. If the applicant sends only the documents concerning the earlier registrations within two months from the filing date of the EUTM application, the Office will construe this as a seniority claim concerning these earlier registrations.

Seniority may be claimed not only for earlier national registrations, but also for an international registration with effect in an EU country. No seniority claim is possible, however, for an earlier EUTM registration or local registrations, even if the territory is part of the European Union (e.g. Gibraltar).

17.1 Harmonised seniority information

In order to be able to properly manage seniorities, all seniority entries in the system need to have the same format as that used in the databases of the national offices.

To enhance harmonisation between the Office and participating IP offices, a list with the required format for seniorities has been established (see Annex 1 below). This list

provides a description of the format/formats used in each of the national offices, insofar as this has been determined.

Therefore, when checking seniority, the Office must verify if the format of the seniority corresponds to the format used at the national level.

17.2 Seniority examination

A valid claim must contain the indications of:

1. the Member State or Member States of the EU in or for which the earlier mark for which seniority has been claimed is registered;
2. the filing date of the relevant registration;
3. the number of the relevant registration;
4. the goods or services for which the mark is registered.

Pursuant to Decision EX-05-5 of 01/06/2005, the proprietor is not required to file a copy of the registration if the required information is available online. If the copy of the registration is not submitted, the Office will first search for the necessary information on the respective website and only if the information is not available there will ask the proprietor for a copy by means of a deficiency letter. Pursuant to Article 3 of Decision EX-03-5, the copy of the relevant registration must consist of a copy (simple photocopies suffice) of the registration and/or renewal certificate or extract from the Register, or an extract from the relevant national gazette, or an extract or printout from an official database. Extracts and printouts from private databases are not accepted. Examples of extracts that are not accepted are DEMAS, MARQUESA, COMPUSERVE, THOMSON, OLIVIA, PATLINK or COMPUMARK, and SAEGIS.

Seniority may only be claimed for an earlier **registration**, not for an earlier application.

The Office must check both that the earlier mark was registered at the time the EUTM application was filed and that the earlier registration had not lapsed at the moment the claim was made (on the duration of protection of national marks see the Guidelines, Part C, Opposition, Section 1, Procedural Matters).

If the earlier registration had lapsed at the moment the claim was made, seniority cannot be claimed, even if the relevant national trade mark law provides for a six-month 'grace' period for renewal. While some national legislation allows for a grace period, if the renewal is not paid, the mark is considered to be not registered from the day it was due for renewal. Therefore, the claim is not acceptable, unless the applicant shows that it has renewed the earlier registration(s).

The seniority claimed for the EU trade mark will lapse if the earlier trade mark the seniority of which is claimed is declared to be invalid or revoked. If the earlier trade mark is revoked, the seniority will lapse provided that the revocation takes effect prior to the filing date or priority date of that EU trade mark (Article 34(3) EUTMR).

In the context of an **enlargement** of the EU, the following details have to be borne in mind. Where a national trade mark of, or an international registration with effect in, a new Member State was registered before the seniority claim is made, **seniority may be claimed even though the priority, filing or registration date of the EUTM to which the seniority claim relates predates the priority, filing or registration date of the national mark/IR with effect in the new Member State**. This is because the

EUTM at issue only has effect in the new Member State from the date of accession. The national trade mark/IR with effect in the new Member State for which seniority is claimed is therefore 'earlier' than the EUTM within the sense of Article 35 EUTMR, **provided** the national trade mark/IR with effect in the new Member State enjoys a priority, filing or registration date **prior to the accession date**.

Examples of acceptable seniority claims for new Member States			
EUTM	Filing date	Seniority claim country	Filing date of earlier right
2 094 860 TESTOCAPS	20/02/2001	Cyprus	28/02/2001
2 417 723 PEGINTRON	19/10/2001	Hungary	08/11/2001
352 039 REDIPEN	02/04/1996	Bulgaria	30/04/1996
7 073 307 HydroTac	17/07/2008	Croatia	13/10/2009

Explanation: In all cases, although the filing date of the EUTM application is earlier than the filing date of the mark for which seniority is claimed, as all countries concerned acceded to the European Union after the filing date of the EUTM application (i.e. on 01/05/2004 for Cyprus and Hungary and on 01/01/2007 for Bulgaria and Romania) and it is from that date that the EUTM application has protection in those Member States, seniority can be claimed for any national marks filed prior to the date of accession.

If the claim to seniority is in order, the Office will accept it and — once the EUTM application has been registered — inform the relevant central industrial property office(s) of the Member State(s) concerned (Rule 8(3) EUTMIR).

Seniority can also be claimed after the EUTM is registered under Article 35. For further details, see the Guidelines, Part E, Register Operations, Section 1, Changes in a Registration.

17.3 Identity of the marks

Examination of seniority claims is limited to the formal requirements and to the identity of the marks (see Communication of the President No 2/00 of 25/02/2000).

As regards the triple-identity requirement (same owner, same mark, same goods and services), it is for the applicant to ensure that these requirements are met. The Office will examine only whether the marks are the same.

The comparison of the mark representations for the purposes of seniority claims is the same as that for priority claims detailed in paragraph 15.2.1 above.

17.4 Goods and services

Applicants may claim seniority for part of the goods and services of the earlier registration(s). Effectively, the claim to seniority will be valid to the extent that there is an overlap between the goods and services of the EUTM application and the registration relied on. The applicant is not required to specify those goods and services, but may simply claim 'seniority for all the goods that are found in the earlier mark to the extent they are also found in the EUTM application' (generic seniority claim).

17.5 Treatment of seniority examination deficiencies





If the claim is not valid, the earlier registration is not identical to the EUTM application, the seniority is claimed out of time (i.e. after the two-month time limit following the filing of the EUTM application) or the seniority documents are not acceptable and the relevant information cannot be found online, the Office will issue a deficiency letter.

If the deficiencies are not remedied within the time limit set by the Office, the applicant will be notified in writing of the loss of rights. At the same time the applicant will be informed that it can ask for a formal decision within two months of the notification.

If the applicant formally requests a decision within the time limit, the Office will issue a formal decision on the rejection of the seniority claim.

17.6 Examples of seniority claims

Example of an acceptable seniority claim (for formalities' purposes)	
EUTM application (word mark) CELOTAPE	Seniority claim (word mark) Celotape
EUTM application (word mark) Daisys Gingerbread	Seniority claim (word mark) Daisy's Gingerbread

Examples of unacceptable seniority claims (for formalities' purposes)	
CMTA: 9 817 735 (figurative mark) 	Seniority Claim (figurative mark) 
EUTM application (word mark) Great changes in education PLC	Seniority claim (word mark) Grate changes in education PLC
EUTM application 8 786 485 (figurative mark) 	Seniority claim (figurative mark) 

For further examples of acceptable and unacceptable seniority claims, see paragraph 15.8.2 above.

18 Transformation

Transformation is a legal feature introduced in the Madrid Protocol to soften the consequences of the five-year dependency period between the international registration and the basic mark. In the event that the international registration designating the EU is cancelled at the request of the office of origin in respect of all or some of the goods and services, the holder of the international registration may file an EUTM application for the registration of the same mark in relation to the goods and services that have been cancelled. That application will be treated as if it had been filed on the date of the designation of the EU in the international registration and will enjoy the same priority, if any. For more details on transformation, see the Guidelines, Part M, International Marks.

19 Amendments to the EUTM Application

Articles 43 and 44 EUTMR
Rule 3 and Rule 13(a) EUTMIR

The applicant may at any time withdraw its EUTM application or restrict the list of goods and services covered by it. Other changes are only foreseen to correct certain mistakes.

Any change requested on the same day of filing of the EUTM application will be accepted.

This part of the Guidelines will only describe the Office practice concerning amendments of the mark representation. For further details on withdrawal or restrictions, see the Guidelines, Part B, Examination, Section 1, Proceedings.

19.1 Amendments to the representation of the mark

The Office's practice on amendments of the mark representation is very strict. The two conditions for allowing a change to the mark once filed are cumulative:

- the mistake must be obvious, **and**
- the amendment must not substantially change the mark as filed.

Even if the amendment is not a substantial one, if the mistake is not obvious, the Office will not accept the amendment.

In cases where the desired positioning of a mark is not obvious, the representation of the mark must indicate the correct position by adding the word 'top' to the reproduction of the sign. Where the application is filed by electronic means, the unusual positioning may be indicated in the mark description.

In cases where the desired positioning of a mark is not obvious (e.g. a mark containing a verbal element is filed in a vertical position) and there is no indication of the intended positioning in the application, the applicant will be allowed to amend the position of the mark upon request. This is because the unusual positioning of the mark will be considered an obvious mistake.



If a priority or seniority claim is filed at the same time as the EUTM application, an obvious error may be proven by comparing the 'correct' mark in the claim with the mark on the EUTM application. However, if the priority or seniority claim is filed after the EUTM application, no evidence from these claims can be taken into account.

If the mistake is obvious, the mark must then be assessed by the next criterion, namely whether the requested change substantially alters the mark as filed.

Example of an acceptable amendment (for formalities' purposes)	
EUTM 546 010 Mark filed as 'TOPFLOW'	Proposed change 'TOP FLOW'
In the application form, the applicant claimed priority for the mark 'TOP FLOW', meaning that it was obvious that a typographical error had been made. The amendment was not considered to be a substantial alteration of the mark as the addition of a space between the words 'TOP' and 'FLOW' does not alter the meaning and pronunciation of the mark and the visual impact of the amendment is low (decision of 05/08/2002, R 0851/1999-2, TOP FLOW)	

Examples of unacceptable amendments (for formalities' purposes)	
EUTM 321 109 Mark filed as 'RANIER'	Proposed change 'RAINIER'
This change will not be allowed since the correction shows the addition of another letter 'I', which would substantially change the mark as filed. 'RANIER' and 'RAINIER' are two different words.	
EUTM 6 013 668 Mark filed as 'ELECTROLITIC BOLUS'	Proposed change 'ELECTROLITYC BOLUS'
This change will not be allowed as the correct English spelling for this word is 'ELECTROLYTIC'. Consequently the mark as filed had one erroneous letter whilst the amendment proposal would have two erroneous letters. This would substantially alter the mark and therefore is unacceptable.	

In the case of figurative elements, only elements of minor importance can be amended and this will be dealt with on a case-by-case basis. Giving a 'fresh look' to a figurative mark (this is a frequent practice in the industry to adapt the appearance of a figurative mark to current design and fashion trends from time to time) will not be allowed.

<p>EUTM 6 538 524</p> <p>EUTM as filed</p> 	<p>Proposed change</p> 
<p>The applicant filed a priority claim with the EUTM application which showed that the first filing consisted of the single representation of the mark. In addition, the EUTM application contained a mark description that described the single representation and not the two images that had been filed. Therefore, the mistake was considered to be obvious. The amendment request was, however, rejected as the amendment would substantially change the mark from that which was filed.</p>	

Notwithstanding the aforementioned principles and examples, any alteration of the mark that would be allowable after registration will also be allowable in respect of an EUTM application.

Regarding alterations of a registered EUTM, please refer to the Guidelines, Part E, Register Operations, Section 1, Changes in a Registration.

20 Conversion

Articles 112(1) and 113(1) EUTMR
 Rule 44(1)(f) EUTMIR

The applicant of an EUTM application or proprietor of a registered EUTM may request the conversion of its EUTM application or registered EUTM. For more information on conversion see the Guidelines, Part E, Section 2, Conversion.

Annex 1:

Required format for seniorities

Color key	Registration number	Complete with given letter	Zeros must added in front if the registration number of digits is lower than expected.
	Complete as per example	Complete if value is given	
	Please give year	Unused or undefined box (for the moment)	

AT Example: 0 0 2 9 1 A
Position: 1 2 3 4 5 6 7 8 9 10 11 12 13

AT: The number could be followed by one letter (A, B, C ... representing the first, second ... partial transfer)

BG Example: B 0 0 0 0 3 6 5 5 Y A S T
Position: 1 2 3 4 5 6 7 8 9 10 11 12 13

BG: If there is, the first letter indicates it is a 'mirror entry' in the Bulgarian registry. In that case the number ends also with 'ST' (which stands for 'seniority'). The number could be followed by one or two letters before the letters ST: letter 'Y' was used until 1999 to differentiate trade marks registered only for services AND/OR letter A, B, C, D ... indicates a partial transfer of the trade mark.

BX Example: 1 9 2 8 6 9 7
Position: 1 2 3 4 5 6 7 8 9 10 11 12 13
Since 1971

CY Example: 6 5 3 1 4
Position: 1 2 3 4 5 6 7 8 9 10 11 12 13

CZ Example: 6 1 3 1 5 9 A
Position: 1 2 3 4 5 6 7 8 9 10 11 12 13

CZ: The number could be followed by one letter (A, B, C ... representing the first, second, third ... partial transfer)

DE Example: D D 6 5 2 3 8 4
Position: 1 2 3 4 5 6 7 8 9 10 11 12 13
Used in GDR only

DE: The first two positions must always be two 'D' followed by the digits in the number.

DE Example: 6 1 3 5 2 3
Position: 1 2 3 4 5 6 7 8 9 10 11 12 13
Until 10/1994

DE Example: 3 9 5 0 1 3 2 5
Position: 1 2 3 4 5 6 7 8 9 10 11 12 13
From 1994 to 2007

DE: The first position must always be '3', the next obligatory 2 positions identify the year 'yy' followed by 5 obligatory digits (zeros must be added in front if the number has less than 5 digits). If number ends with a 'dot' and a 'number' then delete both.

DE Example: 3 0 2 0 1 1 0 1 3 3 6 0
Position: 1 2 3 4 5 6 7 8 9 10 11 12 13
Since 2008

DE: The first 2 positions must always be '3' and '0', the next obligatory 4 positions identify the year 'yyyy' followed by 6 obligatory digits (zeros must be added in front if the number has less than 6 digits). If number ends with a 'dot' and a 'number' then delete both.

DK Example: V R 2 0 1 0 0 0 3 8 2
Position: 1 2 3 4 5 6 7 8 9 10 11 12 13
Since 1894

DK: The first 3 positions must always be 'VR' (registered individual trade mark), 'VG' (registered regular trade mark in old law), or 'FR' (registered collective trade mark) AND a space ' ', the next obligatory four positions identify the year 'yyyy' followed by a space ' ', followed by 5 obligatory digits (zeros must be added in front if the number has less than 5 digits).

EE Example: 0 1 3 1 5
Position: 1 2 3 4 5 6 7 8 9 10 11 12 13

ES Example: M 0 0 0 0 3 6 5 B 1
Position: 1 2 3 4 5 6 7 8 9 10 11 12 13
Since 10/03/1982

ES: The first position must always be 'M', the next obligatory seven digits identify the registration identifier (zeros must be added in front if the number has less than 7 digits), followed by a letter 'B', 'C', 'D' ... and a number if there are and used in case of partial transfer / division.

FI Example: 2 5 0 8 4 1 E
Position: 1 2 3 4 5 6 7 8 9 10 11 12 13

FI: The number could be followed by one letter (A, B, C ... representing the first, second, third ... partial transfer/division)

FR Example: 1 8 5 8 0 0 4
Position: 1 2 3 4 5 6 7 8 9 10 11 12 13
From 1976 to 1991 and as from 2000

FR Example: 9 2 4 5 6 8 0 1
Position: 1 2 3 4 5 6 7 8 9 10 11 12 13
From 1992 to 1999

FR: Two obligatory positions which identify the year 'yy' followed by 6 obligatory digits

GB Example: 4 1 1 0 0 2 3 A
Position: 1 2 3 4 5 6 7 8 9 10 11 12 13

GB: The number could be followed by one letter (A, B, C ..., depending on how many parts - used in case the ID is divided).

GR Example: 2 5 1 1 1 2
Position: 1 2 3 4 5 6 7 8 9 10 11 12 13

HR Example: Z 9 5 0 0 3 2
Position: 1 2 3 4 5 6 7 8 9 10 11 12 13
Until 2000

HR Example: Z 2 0 0 0 1 0 2 2
Position: 1 2 3 4 5 6 7 8 9 10 11 12 13
From 2000

HR: The first position must always be 'Z', the next obligatory positions identify the year (2 or 4 digits) followed by 4 obligatory digits.

HU Example: 0 2 0 8 6 9
Position: 1 2 3 4 5 6 7 8 9 10 11 12 13

IE Example: 7 7 0 8 6 9 B
Position: 1 2 3 4 5 6 7 8 9 10 11 12 13
Since 1989

IE: The number could be followed by one letter.

IT Example: 0 0 0 1 3 7 5 2 6 2
Position: 1 2 3 4 5 6 7 8 9 10 11 12 13

LT Example: 3 4 6 8 8 A
Position: 1 2 3 4 5 6 7 8 9 10 11 12 13
Since 10/1993

LT: The number could be followed by one letter (A, B, C ... representing the first, second, ... partial transfer)

LV Example: M 1 0 1 2 6
Position: 1 2 3 4 5 6 7 8 9 10 11 12 13
Since 1992

LV: The first two positions must always be 'M', and a space ' ', the next two positions are obligatory (zeros must be added in front if the number has less than 2 digits) and are followed by a space ' '. The last 3 positions are obligatory (zeros must be added in front if the number has less than 3 digits).

MT Example: 4 5 6 8
Position: 1 2 3 4 5 6 7 8 9 10 11 12 13
Since 05/1900

PL Example: 1 7 4 8 4 6
Position: 1 2 3 4 5 6 7 8 9 10 11 12 13
Since 28/12/1918

PL: Only the number must appear (letters or characters must NOT be considered)

PT Example: 5 5 1 1 1
Position: 1 2 3 4 5 6 7 8 9 10 11 12 13

RO Example: 0 4 8 9 0 3 A
Position: 1 2 3 4 5 6 7 8 9 10 11 12 13

RO: If there are, the first 2 positions (one digit and/or letter 'R' e.g. '2R') must NOT be considered. The number could be followed by one letter (A, B, C ... representing the first, second, third ... partial transfer).

SE Example: 6 9 2 5 6 6
Position: 1 2 3 4 5 6 7 8 9 10 11 12 13

SI Example: 9 9 7 5 6 8 0
Position: 1 2 3 4 5 6 7 8 9 10 11 12 13
Until 1999

SI: Two obligatory digits which identify the year of registration 'yy' followed by the number (a value greater or equal than 70000).

SI Example: 2 0 0 0 8 5 6 8 0
Position: 1 2 3 4 5 6 7 8 9 10 11 12 13
Since 2000

SI: Four obligatory digits which identify the year of registration 'yyyy' followed by the number (a value greater or equal than 70000).

SK Example: 1 3 3 1 9 6 F
Position: 1 2 3 4 5 6 7 8 9 10 11 12 13

SK: The number could be followed by one letter (A, B, C ... representing the first, second ... partial transfer).

INTERNATIONAL REGISTRATION (WIPO)
Example: 0 1 6 5 7 1 2 B
Position: 1 2 3 4 5 6 7 8 9 10 11 12 13

If there are, the first 2 positions (one digit and/or letter 'R' e.g. '2R') must NOT be considered. The number could be followed by one letter A, B, C, ... indicating that the IR was subject to a partial transfer ('partial assignment' in the language of the Madrid Agreement)

***GUIDELINES FOR EXAMINATION OF
EUROPEAN UNION TRADE MARKS***

***EUROPEAN UNION
INTELLECTUAL PROPERTY OFFICE
(EUIPO)***

PART B

EXAMINATION

SECTION 3

CLASSIFICATION

Table of Contents

1	Introduction	3
2	The Nice Classification	3
3	Administrative Tools for Classification Purposes	4
4	Building a List of Goods and Services	5
4.1	Clarity and precision	5
4.1.1	General principles.....	5
4.1.2	Use of expressions (e.g. 'namely', 'in particular') to determine the scope of the list of goods/services	6
4.1.3	Use of the term 'and/or'	6
4.1.4	Punctuation.....	7
4.1.5	Inclusion of abbreviations and acronyms in lists of goods and services	7
4.2	General indications and terms and expressions lacking clarity and precision	8
4.2.1	Interpretation of general indications of the class headings of the Nice Classification.....	8
4.2.2	Vague terms	12
4.2.3	The claim for all goods/services in this class or all goods/services of the alphabetical list in this class	13
4.2.4	Reference to other classes within the list	13
4.2.5	Trade marks in a list of goods/services	14
4.2.6	Inclusion of the terms <i>parts and fittings</i> ; <i>components</i> and <i>accessories</i> in lists of goods and services	14
4.2.7	Use of indefinite qualifiers	14
5	Procedure of Examination	14
5.1	Parallel applications	14
5.2	Objections	15
5.3	Amendments	15
5.4	Addition of classes	17
6	Annex 1	18

1 Introduction

Every EUTM application must contain a list of goods and services as a condition for a filing date to be accorded (Article 26(1)(c) EUTMR). The list must be classified in accordance with the Nice Agreement (Article 28 EUTMR).

The list of goods and services for which protection is sought must be (a) identified by the applicant with sufficient clarity and precision to enable the competent authorities and economic operators to determine the extent of the protection sought, and (b) grouped according to the classes of the Nice Classification (Article 28(2) and (6) EUTMR).

The use of the Office's administrative IT tools for classification (see paragraph 3 below) is highly recommended. Any part of the list of goods and services that does not match the data from the tools will be examined following the principles as set out in these Guidelines. Whenever the applicant selects a term from the available tools, it will **not be examined** any further and will **speed up the registration procedure**.

The purpose of this part of the Guidelines is to describe Office practice in the examination of classification of goods and services.

The first part (paragraphs 1 to 4) sets out the principles applied by the Office. The second part (paragraph 5) summarises the procedure of examining the list of goods and services.

In short, when examining the classification of a list of goods and services the Office does four tasks:

- it checks that each of the goods and services is clear and precise enough;
- it checks that each term is proper to the class in which it is applied for;
- it notifies any deficiency;
- it refuses the application, in whole or in part, where the deficiency is not remedied (Rule 9(4) and (8) EUTMR).

2 The Nice Classification

The version of the classification under the Nice Agreement in force at the filing date will be applied to the classification of the goods or services in an application (available at: <http://tmclass.tmdn.org>). Article 28 EUTMR requires the applicant to provide a list of goods and services in the following manner.

- The list must be identified by the applicant with sufficient clarity and precision to enable the competent authorities and economic operators to determine the extent of the protection sought.
- The goods or services must be grouped according to the Nice Classification, each group preceded by the number of the class to which the goods or services belong and presented in the order of the classes.

The Nice Classification consists, for each class, of the following.

1. **Class headings:** the class headings are general indications relating to the field to which, in principle, the goods or services belong.
2. **Explanatory notes:** the explanatory notes explain which goods or services are meant or not meant to fall under the class headings and are to be considered an integral part of the classification.
3. **The alphabetical list:** the alphabetical list shows how individual goods or services are appropriate to a class.
4. **General remarks:** the general remarks explain what criteria should be applied if a term cannot be classified in accordance with the class headings or alphabetical list.

More information regarding the Nice Classification can be found on the website of the World Intellectual Property Organization (WIPO) at <http://www.wipo.int>.

3 Administrative Tools for Classification Purposes

When filing an electronic application through e-filing, users can select pre-approved terms to build their list of goods and services. All those selectable terms originate from a harmonised database and will automatically be accepted for classification purposes. Using these pre-approved terms will facilitate a smoother trade mark registration process. The harmonised database brings together terms which are accepted for classification purposes in all EU offices.

Should the applicant use a list of goods and services containing terms that are not found in the harmonised database, the Office will verify through an examination procedure whether they can be accepted.

Before filing an application the content of the harmonised database can be searched through the Office's tool TMclass (<http://tmclass.tmdn.org/ec2/>). This tool brings together classification databases of participating offices within and outside the EU and shows whether a term can be accepted by the office concerned. Within TMclass goods and services are grouped according to shared characteristics from a market perspective, starting from the more general and ending with the more specific. In this way, the user is provided with a simplified search, and is given a better overview of the content of each class, thus facilitating the selection of appropriate terms.

This grouping and ranking, also called Taxonomy, has no legal effect. In particular, the scope of protection of a European Union trade mark is always defined by the natural and usual meaning of the chosen terms, not by the position of the terms in the Office's classification tools.

4 Building a List of Goods and Services

4.1 Clarity and precision

4.1.1 General principles

The goods and services for which the protection of the trade mark is sought should be identified by the applicant with sufficient clarity and precision to enable the competent authorities and economic operators, on that basis alone, to determine the extent of the protection sought (Article 28(2) EUTMR).

A description of goods and services is sufficiently clear and precise when its scope of protection can be understood from its natural and usual meaning. If this scope of protection cannot be understood, sufficient clarity and precision may be achieved by identifying factors such as characteristics, purpose and/or identifiable market sector. Elements that could help to identify the market sector¹ may be, but are not limited to, the following:

- consumers and/or sales channels;
- skills and know-how to be used/produced;
- technical capabilities to be used/produced.

A term may be part of the description of goods and services in a number of classes; it may be clear and precise in a particular class without further specification. For example: *furniture* (Class 20), *clothing* (Class 25), *gloves* (Class 25).

If protection is sought for a specialised category of goods and services or a specialised market sector belonging to a different class, further specification of the term may be necessary.

For example: *furniture especially made for medical purposes* (Class 10);

furniture especially made for laboratories (Class 9);

protective clothing (Class 9);

clothing especially for operating rooms (Class 10);

clothing for pets (Class 18);

gardening gloves (Class 21);

baseball gloves (Class 28).

Tools such as TMclass (<http://tmclass.tmdn.org/ec2/>) are available to determine whether the particular category of goods and services needs this further specification or not.

¹. Market sector describes a set of businesses that are buying and selling such similar goods and services that they are in direct competition with each other.

4.1.2 Use of expressions (e.g. 'namely', 'in particular') to determine the scope of the list of goods/services

The use of the words 'namely' or 'being' is acceptable, but must be understood to be a restriction to the specific goods and services which are listed thereafter. For example, *pharmaceutical preparations, namely analgesics* in Class 5 means that the application only covers analgesics and not any other type of pharmaceuticals.

The expression 'in particular' can also be accepted as it serves to indicate an example of the goods and services which are applied for. For example, *pharmaceutical preparations, in particular analgesics* means that the application covers any kind of pharmaceuticals, with *analgesics* being an example.

The same interpretation applies to the use of the terms 'including', 'including (but not limited to)', 'especially' or 'mainly' as in the example *pharmaceutical preparations, including analgesics*.

A term that would normally be considered unclear or imprecise can be made acceptable provided that it is further specified, for example, by using 'namely' and a list of acceptable terms. An example would be *electrical apparatus, namely computers* for goods in Class 9.

Further examples of acceptable use

Class 29: <i>Dairy products namely cheese and butter.</i>	This would restrict the goods to only cheese and butter and exclude all other dairy products.
Class 41: <i>Provision of sports facilities, all being outdoors.</i>	This would restrict the services to cover only outdoor facilities and exclude any indoor facilities.
Class 25: <i>Clothing, all being underwear.</i>	This would restrict the goods covered to only that which is considered underwear and will exclude all other types of clothing.

Other words or phrases may only point out that certain goods are important, and the inclusion of the term does not restrict the further listing in any way. Examples include:

Class 29: <i>Dairy products, in particular cheese and butter.</i>	The coverage would include all dairy products; cheese and butter are probably the TM owner's most successful goods.
Class 41: <i>Provision of sports facilities, for example outdoor running tracks.</i>	The coverage now merely gives an example of one of several possibilities.
Class 25: <i>Clothing, including underwear.</i>	The coverage extends to all clothing and not just underwear.

4.1.3 Use of the term 'and/or'

The use of oblique strokes is acceptable in lists of goods and services; the most common use is in the phrase '*and/or*', meaning that both goods/services referred to fall in the same class. For example:

- *chemical/biochemical products;*
- *chemical and/or biochemical products;*
- *chemicals for use in industry/science;*

- *chemicals for use in industry and/or science;*
- *import/export agency services.*

4.1.4 Punctuation

The use of correct punctuation is very important in a list of goods and services, almost as important as the words.

The use of commas serves to separate items within a similar category or expression. For example, *flour and preparations made from cereals, bread, pastry and confectionery* in Class 30 must be read as that the goods can be or are made from any of those materials.

The use of a semi-colon means a separation between expressions. For example, *flour and preparations made from cereals, bread, pastry and confectionery, ices; honey, treacle; yeast, baking-powder* in Class 30 must be interpreted that the terms *honey and treacle* are independent from the other terms and do not form part of *preparations made from ...*

The separation of terms with incorrect punctuation can lead to changes in meaning and incorrect classification.

Take the example of *computer software for use with textile machinery; agricultural machines* in Class 9. In this list of goods and services the inclusion of a semi-colon means that the term *agricultural machines* must be considered as an independent category of goods. However, these are proper to Class 7, regardless of whether the intention was to protect computer software to be used in the field of textile machinery and agricultural machines.

A further example would be *retail services in relation to clothing; footwear; headgear* in Class 35. The use of a semi-colon renders the terms *footwear* and *headgear* as goods, which are separate and not included in the retail services. In such cases, the terms should be separated by commas.

4.1.5 Inclusion of abbreviations and acronyms in lists of goods and services

Abbreviations within lists of goods and services should be accepted with caution. Trade marks could have an indefinite life, and the interpretation of an abbreviation could vary over time. However, provided that an abbreviation has only one meaning in relation to the class of goods or services applied for, it can be allowed. The very well-known examples *CD-ROMs* and *DVDs* are acceptable in Class 9. If the abbreviation is well known in the field of activity it will be acceptable, but a more practical solution would be for examiners to initially carry out an internet search for the abbreviation to determine whether it needs to be expanded into words or the abbreviation or acronym followed by the abbreviation in square brackets (following WIPO's example).

Example

Class 45 *Services offering advice on the application and registration of EUTMs.*

This could be expanded to:

Class 45 *Services offering advice on the application and registration of European Union trade marks;*

or

Class 45 *Services offering advice on the application and registration of EUTMs [European Union trade marks].*

Acronyms can be accepted in a list of goods or services as long as they are comprehensible and appropriate to the class applied for.

4.2 General indications and terms and expressions lacking clarity and precision

4.2.1 Interpretation of general indications of the class headings of the Nice Classification

In accordance with Article 28(3) EUTMR, general indications included in the class headings of the Nice Classification or other general terms may be used provided that they comply with the requisite standards of clarity and precision set out in Article 28(2) EUTMR.

For the sake of completeness it is noted that, in accordance with Article 28(5) EUTMR, the use of general terms, including general indications of the class headings of the Nice Classification, will be interpreted as including all goods or services clearly covered by the literal meaning of the indication or term². The use of such terms or indications will not be interpreted as comprising a claim to goods or services that cannot be understood in this way.

In collaboration with the trade mark offices of the European Union, other (inter)national organisations, offices and various user associations, the Office has established a list of general indications of the class headings of the Nice Classification which are deemed not to be sufficiently clear and precise in accordance with the judgment of 19/06/2012, C-307/10, 'IP Translator'.

In February 2014, the 197 general indications of the Nice class headings were examined for the requisites of clarity and precision. Of these, 11 were considered to lack the clarity and precision needed to specify the scope of protection that they would give. Consequently, they could not be accepted without further specification. These are set out below in bold.

Class 6 ***Goods of common metal not included in other classes.***

Class 7 ***Machines and machine tools.***

² The Office's former practice, according to which use of all the general indications listed in the class heading of a particular class constituted a claim to all goods or services falling under the class was abandoned in June 2012, following the judgment of 19/06/2012, C-307/10, 'IP Translator'.

- Class 14 *Precious metals and their alloys and **goods in precious metals or coated therewith**, not included in other classes.*
- Class 16 *Paper, cardboard and **goods made from these materials [paper and cardboard]**, not included in other classes.*
- Class 17 *Rubber, gutta-percha, gum, asbestos, mica and **goods made from these materials [rubber, gutta-percha, gum, asbestos and mica]** and not included in other classes.*
- Class 18 *Leather and imitations of leather, and **goods made of these materials [leather and imitations of leather]** and not included in other classes.*
- Class 20 ***Goods (not included in other classes) of wood, cork, reed, cane, wicker, horn, bone, ivory, whalebone, shell, amber, mother-of-pearl, meerscham and substitutes for all these materials, or of plastics.***
- Class 37 ***Repair.***
- Class 37 ***Installation services.***
- Class 40 ***Treatment of materials.***
- Class 45 ***Personal and social services rendered by others to meet the needs of individuals.***

The remaining 186 Nice class heading terms comply with the requisites of clarity and precision and are therefore acceptable for classification purposes.

The reasons why each of the 11 Nice class heading terms were not found clear and precise are described below.

Class 6 ***Goods of common metal not included in other classes.***

In light of the need for clarity and precision, this term does not provide a clear indication of what goods are covered as it simply states what the goods are made of, and not what the goods are. It covers a wide range of goods that may have very different characteristics and/or purposes, that may require very different levels of technical capabilities and know-how to be produced and/or used, could target different consumers, be sold through different sales channels, and therefore relate to different market sectors.

Class 7 ***Machines and machine tools.***

In light of the need for clarity and precision, the term *machines* does not provide a clear indication of what machines are covered. Machines can have different characteristics or different purposes, they may require very different levels of technical capabilities and know-how to be produced and/or used, could target different consumers, be sold through different sales channels, and therefore relate to different market sectors.

Class 14 ***Precious metals and their alloys and **goods in precious metals or coated therewith**, not included in other classes.***

In light of the need for clarity and precision, the term *goods in precious metals or coated therewith, not included in other classes* does not provide a clear indication of what goods are covered, as it simply states what the goods are made of or coated with, and not what the goods are. It covers a wide range of goods that may have very different characteristics, that may require very different levels of technical capabilities and know-how to be produced, could target different consumers, be sold through different sales channels, and therefore relate to different market sectors.

Class 16 *Paper, cardboard and goods made from these materials, not included in other classes.*

In light of the need for clarity and precision, the term *goods made from these materials [paper and cardboard], not included in other classes* does not provide a clear indication of what goods are covered, as it simply states what the goods are made of, and not what the goods are. It covers a wide range of goods that may have very different characteristics and/or purposes, that may require very different levels of technical capabilities and know-how to be produced and/or used, could target different consumers, be sold through different sales channels, and therefore relate to different market sectors.

Class 17 *Rubber, gutta-percha, gum, asbestos, mica and goods made from these materials and not included in other classes.*

In light of the need for clarity and precision, the term *goods made from these materials [rubber, gutta-percha, gum, asbestos and mica] and not included in other classes* does not provide a clear indication of what goods are covered as it simply states what the goods are made of, and not what the goods are. It covers a wide range of goods that may have very different characteristics and/or purposes, that may require very different levels of technical capabilities and know-how to be produced and/or used, could target different consumers, be sold through different sales channels, and therefore relate to different market sectors.

Class 18 *Leather and imitations of leather, and goods made of these materials and not included in other classes.*

In light of the need for clarity and precision, the term *goods made of these materials [leather and imitations of leather] and not included in other classes* does not provide a clear indication of what goods are covered, as it simply states what the goods are made of, and not what the goods are. It covers a wide range of goods that may have very different characteristics and/or purposes, that may require very different levels of technical capabilities and know-how to be produced and/or used, could target different consumers, be sold through different sales channels, and therefore relate to different market sectors.

Class 20 *Goods (not included in other classes) of wood, cork, reed, cane, wicker, horn, bone, ivory, whalebone, shell, amber, mother-of-pearl, meerschaum and substitutes for all these materials, or of plastics.*

In light of the need for clarity and precision, this term does not provide a clear indication of what goods are covered as it simply states what the

goods are made of, and not what the goods are. It covers a wide range of goods that may have very different characteristics and/or purposes, that may require very different levels of technical capabilities and know-how to be produced and/or used, that could target different consumers, be sold through different sales channels, and therefore relate to different market sectors.

Class 37 *Repair.*

In light of the need for clarity and precision, this term does not provide a clear indication of the services being provided, as it simply states that these are repair services, and not what is to be repaired. As the goods to be repaired may have different characteristics, the repair services will be carried out by service providers with different levels of technical capabilities and know-how, and may relate to different market sectors.

Class 37 *Installation services.*

In light of the need for clarity and precision, this term does not provide a clear indication of the services being provided, as it simply states that these are installation services, and not what is to be installed. As the goods to be installed may have different characteristics, the installation services will be carried out by service providers with different levels of technical capabilities and know-how, and may relate to different market sectors.

Class 40 *Treatment of materials.*

In light of the need for clarity and precision, this term does not give a clear indication of the services being provided. The nature of the treatment is unclear, as are the materials to be treated. These services cover a wide range of activities performed by different service providers on materials of different characteristics requiring very different levels of technical capabilities and know-how, and may relate to different market sectors.

Class 45 *Personal and social services rendered by others to meet the needs of individuals.*

In light of the need for clarity and precision, this term does not give a clear indication of the services being provided. These services cover a wide range of activities performed by different service providers requiring very different levels of skill and know-how, and may relate to different market sectors.

With the deletion of six general indications from the 2016 version of the 10th edition of the Nice Classification, the list of unacceptable general indications is reduced to five:

Class 7 *Machines and machine tools.*

Class 37 *Repair.*

Class 37 *Installation services.*

Class 40 *Treatment of materials.*

Class 45 *Personal and social services rendered by others to meet the needs of individuals.*

EUTM applications, including any of the abovementioned 11 general indications contained in the current or earlier editions of the Nice Classification, will be objected to as being too vague. The applicant will be asked to specify the vague term.

Non-acceptable general indications can become clear and precise if the applicant follows the principles set out under paragraph 4.1 above. The following is a non-exhaustive list of acceptable specifications.

Not a clear and precise term	Example of a clear and precise term
<i>Goods of common metal not included in other classes</i> (Class 6)	<i>Construction elements of metal</i> (Class 6) <i>Building materials of metal</i> (Class 6)
<i>Machines</i> (Class 7)	<i>Agricultural machines</i> (Class 7) <i>Machines for processing plastics</i> (Class 7) <i>Milking machines</i> (Class 7)
<i>Goods in precious metals or coated therewith</i> (Class 14)	<i>Works of art of precious metal</i> (Class 14)
<i>Goods made from paper and cardboard</i> (Class 16)	<i>Filtering materials of paper</i> (Class 16)
<i>Goods made from rubber, gutta-percha, gum, asbestos and mica</i> (Class 17)	<i>Rings of rubber</i> (Class 17)
<i>Goods made of these materials [leather and imitations of leather]</i> (Class 18)	<i>Briefcases [leather goods]</i> (Class 18)
<i>Goods (not included in other classes) of wood, cork, reed, cane, wicker, horn, bone, ivory, whalebone, shell, amber, mother-of-pearl, meerschaum and substitutes for all these materials, or of plastics</i> (Class 20)	<i>Door fittings, made of plastics</i> (Class 20) <i>Figurines of wood</i> (Class 20)
<i>Repair</i> (Class 37)	<i>Shoe repair</i> (Class 37) <i>Repair of computer hardware</i> (Class 37)
<i>Installation services</i> (Class 37)	<i>Installation of doors and windows</i> (Class 37) <i>Installation of burglar alarms</i> (Class 37)
<i>Treatment of materials</i> (Class 40)	<i>Treatment of toxic waste</i> (Class 40) <i>Air purification</i> (Class 40)
<i>Personal and social services rendered by others to meet the needs of individuals</i> (Class 45)	<i>Personal background investigations</i> (Class 45) <i>Personal shopping for others</i> (Class 45) <i>Adoption agency services</i> (Class 45)

Note that vague terms would not be made specific, or acceptable, by the addition of such terms as *including* or *in particular*. The example *machines, including milking machines* would not be acceptable as it remains vague (see paragraph 4.1.2 above).

4.2.2 Vague terms

The same principles regarding clarity and precision as described above are applicable to all the goods and services listed in the application. Terms that do not provide a clear indication of the goods covered should be objected to. Examples of such expressions are:

- *Electric/electronic apparatus/instruments;*

- *Association services;*
- *Facilities management services.*

They all must be specified as described above, that is to say, by identifying factors such as characteristics, purpose and/or identifiable market sector.

4.2.3 The claim for all goods/services in this class or all goods/services of the alphabetical list in this class

If the applicant intends to protect all goods or services included in the alphabetical list of a particular class, it has to expressly indicate this by listing these goods or services explicitly and individually. In order to assist applicants, the use of the hierarchical structure (see paragraph 3 above, Administrative Tools for Classification Purposes) is encouraged.

Applications are sometimes submitted for *all goods in Class X, all services in Class X, all goods/services in this class or all goods/services of the alphabetical list in this class* (or the like). This specification does not comply with Article 26(1)(c) EUTMR, which requires a list of the goods or services in respect of which the registration is requested. Consequently, no filing date is awarded.

On other occasions the applicant has correctly listed some goods and/or services to be covered and added, at the end of the listing in each class, the expression *and all other goods/services in this class or and all goods/services of the alphabetical list in this class* (or the like). Such expressions do not constitute a valid claim within the meaning of Article 28(2) EUTMR and will be rejected. In those cases, the application may proceed **only** for the part of the goods and/or services that is correctly listed. The Office will inform the applicant that those statements are not acceptable for classification purposes and thus will be deleted.

4.2.4 Reference to other classes within the list

References to other class numbers within a class are not acceptable for classification purposes. For example, the descriptions (in Class 39) *transport services of all goods in Classes 32 and 33* or (in Class 9) *computer software in the field of services in Classes 41 and 45* are not acceptable, as in both cases the terms are considered to be unclear and imprecise and lack legal certainty as to what goods and services are covered. The only way to overcome the objection to these lists of goods and services will be for the respective goods of Classes 32 and 33, and the services of Classes 41 and 45 to be specified.

The term ... *goods not included in other classes* ... is not acceptable in service classes because this expression only makes sense in its original goods class.

For example, the heading of Class 22 reads *ropes, string, nets, tents, awnings, tarpaulins, sails, sacks and bags (not included in other classes)*. In that context the reference to ... *not included in other classes* is meaningful. However, if that same term is used in a service class list of goods and services it cannot make sense. For example, *transport services of ropes, string, nets, tents, awnings, tarpaulins, sails, sacks and bags (not included in other classes)* in Class 39 could not be accepted. The mention of ... *(not included in other classes)* must be deleted.

4.2.5 Trade marks in a list of goods/services

Trade marks cannot appear within a list of goods and services as if they were a generic term or a category of goods. In such cases, the Office will object to the inclusion of the term, and request its replacement by a generic term for the goods or services.

Example

Class 9: *Electronic devices for transmission of sound and images; video players; CD players; iPods.*

Since iPod™ is a trade mark, the applicant will be requested to replace it by a synonym such as *a small portable digital audio player for storing data in a variety of formats including MP3.*

Other examples are Caterpillar™ (the correct classification would be *crawler type vehicle*), Discman™ (*portable compact disc player*), Band-Aid™ (*sticking plasters*), Blu Ray discs™ (*optical storage discs*) or Teflon™ (*non-stick coating based on polytetrafluoroethylene*). This list is not exhaustive and in cases of doubt examiners should refer cases to a relevant expert within the Office.

4.2.6 Inclusion of the terms *parts and fittings; components* and *accessories* in lists of goods and services

The terms *parts and fittings; components* and *accessories* are, on their own or in combination with each other, neither clear nor precise enough for classification purposes. Each of the terms requires further qualification to become acceptable in its proper class. Such terms would become acceptable by identifying factors such as characteristics, purpose and/or identifiable market sector. For example:

- *Parts and fittings for motor vehicles* is acceptable in Class 12;
- *Building components made of wood* is acceptable in Class 19;
- *Musical accessories* is acceptable in Class 15.

4.2.7 Use of indefinite qualifiers

The use of qualifiers such as: ‘the like’, ‘ancillary’, ‘associated goods’, ‘and related goods’ and ‘etc.’ in a list of goods or services is unacceptable, since they do not comply with the requirements of clarity and precision (see paragraph 4.1 above).

5 Procedure of Examination

5.1 Parallel applications

While the Office will always strive for consistency, the fact that a list of goods and services has been previously accepted, but which is wrongly classified, does not have to lead to the acceptance of the same list in any subsequent applications.

5.2 Objections

Where the Office considers that there is a need to amend the list of goods and services it should, if possible, discuss the issue with the applicant. Whenever reasonably possible the examiner should offer a proposal for a correct classification. If the applicant submits a long list of goods/services that is not grouped under class numbers or classified at all, then the examiner should simply object under Article 28 EUTMR, and ask the applicant to provide the list in a form that complies.

The response from the applicant must, under no circumstances, extend the scope or range of goods or services (Article 43(2) EUTMR).

Where the applicant has failed to identify any classes, or has incorrectly identified the class(es) for the goods or services, then any further explanation of the scope of the application may extend the number of classes required to accommodate the list of goods and services. It does not automatically follow that the list itself has been extended.

Example

An application covering *beer, wine and tea* in Class 33 should be corrected to:

Class 30: *Tea*;

Class 32: *Beer*;

Class 33: *Wine*.

Although there are now three classes covering the goods, the list of goods has not been extended.

When the applicant has correctly attributed a class number to a particular term, this limits the goods to those falling under that class. For example, an application for *tea* in Class 30 may not be amended to *medicinal tea* in Class 5 as that would extend the goods beyond those applied for.

Where there is a need to amend the classification, the Office will send a reasoned communication pointing out the error(s) detected in relation to the list of goods and services. The applicant will be requested to amend and/or to specify the list and the Office may propose the way in which the items should be classified.

The original time limit allowed to submit observations on the classification deficiency letter can only be extended once. No further extensions will be granted unless exceptional circumstances apply.

The Office will send a letter informing the applicant of the definitive agreed list of accepted terms.

5.3 Amendments

See also the Guidelines, Part E, Register Operations, Section 1, Changes in a Registration.

Article 43(1) and (2) EUTMR allows for the amendment of an application. This includes the amendment of the list of goods and services provided that 'such a correction does not substantially change the trade mark or extend the list of goods and services'.

The amendment can be listed in either positive or negative terms, the following examples are both acceptable:

- *Alcoholic beverages all being whisky and gin;*
- *Alcoholic beverages none being whisky or gin.*

Since an amendment cannot extend the list of goods and services, it must be in the nature of a restriction or deletion of some of the terms originally contained in the application. Once such amendments (deletions) have been received (and later accepted) by the Office, the deleted terms cannot be re-introduced, nor can the remaining list of goods and services be extended.

A restriction should respect certain criteria:

1. The applicant cannot exclude goods and services that are not covered in the application and/or not covered by the relevant class.

For example the following would **not** be acceptable:

Class 32: *Syrups (original application) to syrups with the exception of fruit juices.*

Class 3: *Cosmetics with the exception of disinfecting substances (Class 5).*

2. The restriction must be **comprehensible** and give a sufficiently clear and precise (see also paragraph 4.2 above) indication of the goods or services to be excluded in the list or a sufficiently clear and precise indication of those goods and services which remain after the restriction.

For example the following would **not** be acceptable:

Class 16: *Typewriters, only related to financial services.*

3. The restriction must not contain references to trade marks.

For example the following would **not** be acceptable:

Class 9: *Apparatus for the reproduction of sound, namely iPods.*

4. The restriction must not contain a territorial limitation which contradicts the unitary nature of the EUTM.

For example the following would **not** be acceptable:

Class 7: *Washing machines, only for sale in France.*

A restriction may result in a longer list of goods and services than that filed. For example, the original list of goods and services may have been filed as *alcoholic beverages*, but it could be restricted to *alcoholic beverages being wines and spirits, but not including whisky or gin and not including liqueurs, cocktails or combinations of beverages containing elements of whisky or gin.*

5.4 Addition of classes

Under the provisions of Article 43(2) EUTMR (listed above), it is possible to add a class or classes to an application, but only where the goods or services detailed in the original application were clearly included in the wrong class or when a good or service has been clarified and needs to be classified in new class(es).

For example, assume the original list of goods reads:

Class 33: *Alcoholic beverages including beer, wines and spirits.*

Since *beer* is proper to Class 32, the applicant will be requested to transfer the term to Class 32, even if Class 32 was not listed in the original application. If the applicant agrees then the application will cover goods in Classes 32 and 33.

When classes are added, additional fees may be payable and the applicant must be informed accordingly.

6 Annex 1**Table of Contents**

Introduction.....	20
Advertising services.....	20
Air freshening and perfuming preparations.....	20
Amusement apparatus and electronic games	20
Association services or services provided by an association to its members	21
Beauty apparatus.....	21
Bringing together of services	21
Broadcasting and/or transmission services	21
Brokerage services.....	22
Cases (and carrying bags)	22
Charitable services	22
Collection and storage services	23
Computer games and computer games apparatus	23
Curtains and blinds	24
Custom manufacture/manufacturing for third parties.....	24
Data services.....	24
Design services	25
Digital imaging services	25
Downloadable goods.....	25
Electricity and energy.....	25
Electronic and electric apparatus.....	26
Electronic cigarettes.....	26
Franchising	26
GPS systems – location, tracking and navigating.....	27
Hair styling	28
Hire services	28
Humanitarian aid services.....	28
Internet services, on-line services.....	28
Kits and sets	29
Leasing	30
Mail order	30
Manuals (for computers, etc.)	30
Manufacturing services.....	30
News services	31
On-line services	31
Ordering of services	31
Perfuming and air freshening preparations.....	31
Personal and social services rendered by others to meet the needs of individuals.....	32
Precious metal goods.....	32

Protective clothing	33
Rental services	33
Retail and wholesale services	33
Satellite tracking	35
Sets	35
Social networking services	36
Software publishing	36
Solar power	36
Storage services	36
Supply of	36
Systems	37
Tickets (for travel, entertainment etc.)	37
Video games	37
Virtual environment	37

Introduction

When classifying the general principles of the Nice Classification must be applied.

The purpose of this Annex is to clarify the classification of certain problematic terms. It also provides notes on classification practice (including words or phrases that should not be used).

The Office's classification database TMclass is available at <http://tmclass.tmdn.org>.

Advertising services

In principle, advertising services belong to Class 35. The main entries on advertising services in the list of services in the Nice Classification are:

- *Advertising*
- *Radio advertising*
- *Radio commercials*
- *Television advertising*
- *Television commercials*
- *Layout services for advertising purposes*
- *Publication of publicity texts*
- *Production of advertising films.*

These entries cover the design of advertising material and production of commercials, as they are services which will be provided by advertising agencies.

Air freshening and perfuming preparations

See *perfuming and air freshening preparations*.

Amusement apparatus and electronic games

Following changes to the Nice Classification on 1 January 2012 (10th edition), all *games* (whether electronic or not) are classified in Class 28.

These are shown in the alphabetical list as follows:

- *Games (Apparatus for-)*
- *Video game machines*
- *Arcade video game machines.*

Most of these Class 28 devices come loaded with the games. However, if these games are not loaded on the devices, they will be recorded on data carriers or they will be downloadable. In these cases, the games are considered to be game programmes which are especially adapted for use with gaming devices and thus will be classified in Class 9.

See also *computer games*.

Association services or services provided by an association to its members

These, and similar terms are too vague to be acceptable. The type, or scope, of the service being provided needs to be mentioned. Examples of **acceptable** specifications are:

Class 35: *Association services in the nature of business administration services*

Class 45: *Services provided by an association to its members in the form of legal services*

See also *charitable services*.

Beauty apparatus

Class 7: *Sprayers (machines) for applying artificial sun tanning preparations*

Class 8: *Hand-operated instruments/tools for beauty purposes*
Tattooing needles/apparatus
Depilatory apparatus (electric and non-electric)

Class 10: *Massage apparatus*
Microdermabrasion apparatus
Apparatus for the treatment of cellulite
Lasers for cosmetic beauty treatments
Laser hair removal apparatus
Photoepilation apparatus

Photoepilation is a procedure carried out by pulsed light devices. These devices use the same principle as lasers (i.e. heating up the hair follicle), yet they are not lasers.

Class 11: *Ultra-violet ray lamps for cosmetic purposes*
Sun beds
Steam apparatus for cleaning the skin

Class 21: *Cosmetic brushes and applicators*

Bringing together of services

See *ordering of services* and *retail and wholesale services*.

Broadcasting and/or transmission services

These services are proper to Class 38; both mean the same thing. The services provided in this area only cover the provision of the means of communication (e.g. the provision of a network of fibre optic cables; the provision of broadcasts or transmissions via geo-stationary satellite transmission facilities, the rental of communications apparatus and systems). Class 38 does **not** cover any programmes, advertising, information or advice which may be transmitted by means of

telecommunications or broadcasting technology. Those services would remain in the appropriate classes.

Brokerage services

These are services provided by an individual or company whereby they buy and sell commodities for a fee or commission. The fee may be charged to the buyer or the seller of the commodity (or both). The broker may never see the goods or services in question.

There are three listed classes for brokerage services. These are:

Class 35: *Brokerage of name and address based lists*

Class 36: [A large number of listings for] *brokerage of futures, carbon offsets, real estate, bonds, securities and other financial based items*

Class 39: *Brokerage services relating to distribution, transport, and storage*

Cases (and carrying bags)

Cases (and bags) adapted to carry or transport the product they are intended to contain are in principle, classified in the same class as the product they are adapted to carry. For instance *laptops bags* are proper to Class 9.

All non-adapted carrying bags are in Class 18.

Charitable services

This term is too vague to be accepted in any class without further qualification.

Charitable services are defined by the service which is being offered. Therefore, they can be classified in any of the service classes, given the correct definition. For example:

Class 35: *Charitable services, namely administration and general office work*

Class 36: *The organisation of charitable collections; charitable fund raising*

Class 38: *Telecommunications services for charitable purposes*

Class 39: *Charitable services, namely ambulance transport*

Class 40: *Charitable services, namely water treatment services*

Class 41: *Charitable services, namely education and training*

Class 42: *Charitable services, namely environmental protection services*

Class 43: *Charitable services, namely providing food and drink and temporary accommodation*

Class 44: *Charitable services, namely providing medical services*

Class 45: *Charitable services, namely mentoring [personal or spiritual]*

Collection and storage services

In the case of physical goods, both collection and storage services would be proper to Class 39. This class includes *transport* and *warehousing* in its listings. This would also include the collection and physical storage of data, whether in written form or recorded on media (the Nice Classification has *physical storage of electronically stored data or documents* in Class 39).

Office services of electronically collecting, collating and manipulating data are all proper to Class 35.

Storage of digital data and *electronic data storage* are seen to be in analogy with hosting services, and so are proper to Class 42. *Cloud computing data storage services* are also proper to Class 42.

Computer games and computer games apparatus

The terms *computer games* and *video games* are highly similar and are treated as the same way.

The dictionary reference for computer games is as follows:

- 1 (Noun) 'any of various games, recorded on cassette or disc for use in a home computer, that are played by manipulating a mouse, joystick, or the keys on the keyboard of a computer in response to the graphics on the screen' (*Collins English Dictionary*).

The terms *computer games/video games*, as such, are therefore only acceptable in Class 9. The dictionary reference of the term clearly states that it must be a game, thus software. The terms can therefore be accepted in Class 9 without any further clarification.

Games which are acceptable in Class 28 come loaded with the games software. For example, the following terms can all be accepted in Class 28:

- *Arcade games*
- *Arcade video machines*
- *Computer game consoles*
- *Games (apparatus for)*
- *Hand held computer game devices*
- *Video game machines*

Curtains and blinds

Blinds, in all their forms, can be used on windows both internally and externally. The classification of these goods depends upon the purpose of the product and its material composition.

Curtains are normally found in use indoors and they are similarly classified according to their material composition.

Examples of acceptable entries are:

- Class 6: *Outdoor blinds of metal*
External metal blinds as part of a building for security purposes
- Class 17: *Curtains of asbestos (safety-)*. (The material and purpose determine the classification)
- Class 19: *Blinds [outdoor] not of metal and not of textile*. (These goods are probably made of wood)
- Class 20: *Blinds (slatted indoor)*
Venetian and vertical window blinds
Indoor window blinds
Blinds (indoor window) [shades] [furniture]
Curtains (bamboo-)
Paper blinds
Curtains (bead-)[for decoration]
- Class 24: *Outdoor blinds of textile*

The vast majority of curtains will fall under Class 24 since most domestic curtains (sometimes referred to as 'drapes') are made of textiles or plastic.

Care should be taken with any references to curtain walling, or curtain walls. These refer to a type of construction technique relating to buildings and the associated goods are building materials and are proper to Class 6 (for metal goods) or Class 19 (for non-metallic goods).

Custom manufacture/manufacturing for third parties

See *manufacturing services*.

Data services

The term cannot be accepted on its own. It must be qualified.

The provision of data can be proper to several classes depending on the way in which the data is provided or the nature of the data being provided. In each case the exact nature of the service being offered will need to be stated, *the provision of data* is not enough. The following are examples of acceptable terms and their relevant classification:

Class 44: *Provision of data (information) relating to the use of pharmaceuticals*

(This would refer to the systemised provision of data which could only be interpreted by someone with specialised medical training.)

Class 45: *Provision and interpretation of data relating to animal tracking*
(This would refer to services in relation to the relocation of a lost or stolen animal. If the data were for other purposes, then the classification would be proper to other classes, for example, Class 42 for measuring or scientific reasons.)

Design services

Design services are, as such, proper to Class 42.

Design of advertising and *design of brand names* are both proper to Class 35 as these are both part of advertising services.

Likewise *landscape design, floral design, turf design* and *planning [design] of gardens* are proper to Class 44 as these are horticultural services.

Digital imaging services

The term *digital imaging services* has been deleted from Class 41 in the 10th edition of the Nice Classification. Consequently, the term cannot be accepted in Class 41 without any specification. This is because digital imaging can be classified in more than one class depending on the field the service refers to, for example, medical, information technology or photography.

Acceptable terms include:

- *Digital imaging (photo editing)* in Class 41
- *Medical imaging services* in Class 44
- *Digital imaging (IT services)* in Class 42

Downloadable goods

All material which is downloadable is proper to Class 9. This includes publications, music, ring tones, pictures, photographs, films or film extracts. The result of the download is that the material is captured onto the drives or memory of a computer, telephone or PDA where it operates independently of the source from whence it came. These can also be called *virtual goods*. All these downloadable goods can be retailed.

Electricity and energy

The following is a guide to some of the goods and services which surround electricity.

Class 4: *Electrical energy*

Class 7: *Electrical generators*

Class 9: *Apparatus and instruments for conducting, switching, transforming, accumulating, regulating, or controlling electricity*
Solar cells for electricity generation
Photovoltaic cells and modules

Class 36: *Brokerage of electricity* (see also note under *brokerage services*)

Class 39: *Distribution of electricity*
Storage of electricity

Class 40: *Generation of electricity*

See *solar power*.

Electronic and electric apparatus

The term *electronic and electric apparatus/devices/instruments* is too vague for classification purposes; it is not acceptable in any goods class, and should be specified.

Please be aware that specifications of *electronic and electric apparatus/devices/instruments* such as listed below are considered too vague as well:

- for controlling the environment
- for household purposes
- for use in hairdresser salons

Electronic cigarettes

Electronic cigarettes, e-cigarettes or e-cigs are — for classification purposes — acceptable only in Class 34, even if they would serve a medical purpose. Non-electronic parts of these types of cigarettes, like cartridges, atomisers or (aroma) substances for these cigarettes are also classified in Class 34.

The electronic parts like batteries and a microcomputer controlled circuits for electronic cigarettes are not acceptable in these classes and belong — as usual — to Class 9.

Franchising

The verb 'franchise' refers to the giving or selling of a franchise to another party. As a noun 'franchise' means 'the authorisation granted to an individual or group by a company to sell its products or services in a particular area' (*Oxford English Dictionary*).

Without any further specification, the office will not accept the term *franchise service* or *franchising services* in Class 35. In order to be acceptable a clarification is required.

For example:

Class 35: *Business advice relating to franchising*

Class 36: *Financing services relating to franchising*

Class 45: *Legal services relating to franchising*

GPS systems – location, tracking and navigating

GPS and satellite navigation systems (Class 9) provide location, tracking and navigating services, to provide the user with information.

The easiest way to classify these services is to divide them into those services which provide the telecommunications which run the services (Class 38) and those services which provide information via the GPS device. The range of information provided goes beyond mere travel route information (Class 39). It can include information regarding restaurants and accommodation (Class 43), information regarding shopping outlets (Class 35) or telephone numbers (Class 38).

The use of GPS devices in relation to the movement of vehicles and people can also lead to classifications over a range of classes. Route planning services (Class 39) have already been mentioned. This classification would also extend to logistic or freight moving companies keeping track of their vehicles using the same devices.

GPS systems can also be used in conjunction with other technology, to locate the source of a mobile telephone signal. If this is being done as part of a telecommunication service it will be proper to Class 38. If, however, it is being done as part of a criminal investigation service it would be proper to Class 45.

There are other services that can be associated with the services listed above. For example, the creation of maps for GPS systems is proper to Class 42. The downloadable applications that run the service or provide alternative 'voices' are proper to Class 9. The retail services for providing the downloadable applications are proper to Class 35.

The examples below demonstrate how these and other terms are classified.

Class 35: *Compilation and provision of commercial directory information regarding service providers for GPS navigation*

Class 38: *Satellite transmissions*
Providing public subscribers directory information for GPS navigation
Providing access to general information supplied via satellite transmission
Telecommunications services for location and tracking of persons and objects
Tracking of mobile telephone via satellite signals
Location of mobile telephones via satellite signals
Providing access to GPS navigation services via satellite transmission
Satellite transmission of navigation data

Class 39: *Providing GPS navigation services*
Providing traffic information services via satellite transmission
Providing road information services via satellite transmission
Location services for logistics purposes of vehicles and goods
Tracking services for logistics purposes of vehicles and goods

Class 42: *Providing weather information via satellite transmission*
Creation of GPS maps

Class 45: *Providing public amenity and civic directory information for GPS navigation*
Tracing and locating of missing persons via satellite transmission
Tracking of persons carrying electronic tagging devices
Security tracking services of vehicles
Security location services of vehicles

Hair styling

Most *electric and non-electric hair styling apparatus* is classified in Class 8 (e.g. *electric hair curling irons; hair tongs* [non-electric hand implements]; *crimping irons for the hair* etc.). Except:

Class 26: *Electric hair curlers/rollers* (e.g. CARMEN™ CURLERS)

Class 26: *Hair curlers/rollers, other than hand implements*

Class 11: *Hair dryers*

Class 21: *Combs and brushes* (non-electric and electric)

Hire services

See *rental services*.

Humanitarian aid services

Office practice on *humanitarian aid services* is the same as that on *charitable services*; the nature of the services must be specified (see *charitable services*).

Internet services, on-line services

The term *internet services* is neither clear nor precise for acceptance in any class. It must be further defined.

There are a range of services, offered by individuals and business to other individuals and businesses, which relate to the setting up, operation and servicing of internet web-sites and these are covered by appropriate entries in a number of classes.

There is an even wider range of services offered to customers through the medium of telecommunications including via the internet. It is possible to shop over the internet, obtain banking advice, learn a new language, or listen to a 'local' radio station which is situated on the other side of the world.

The application of the Nice Classification system generally applies regardless of whether the service is provided face-to-face, in dedicated premises, over a telephone, on-line from a database or from an internet web site.

Acceptable terms include:

Class 35: *Advertising services provided over the internet*

Class 36: *On-line banking services*

Class 38: *Internet provider services*

Class 41: *On-line gaming services*

Class 42: *Providing on-line support services for computer program users*

Class 45: *On-line social networking services*

Kits and sets

It is common in trade for certain goods to be sold in groups of more than one item. If the items are all the same, for example, a pack of three toothbrushes, then the classification is simple. However, sometimes the collection of goods could be component parts of another item, or have a function which is not defined by the individual goods. These groups of goods sometimes have collective names such as kit or set. These small words can have a big impact on (1) the acceptability as collection of goods and (2) the appropriate classification.

A kit can mean either:

1. a set of parts ready to be made into something (for example: *a kit for a model plane*) or
2. a set of tools or equipment that is to be used for a particular purpose (for example: *a first-aid kit*).

A set is a number of articles that are thought of as a group. This may have a defined number or not (e.g. *a set of keys, a set of saucepans, a set of golf clubs; a cutlery set*).

Kits appear in the Nice Classification, for example, as in the following example:

Class 3: *Cosmetic kits*

Class 5: *First aid kits* (seen as a collection of plasters and treatments)

It sometimes happens that the individual goods which make up the kit or set would normally be classified in more than one class. However, the Office will not object to acceptance of such collective terms, provided that they make sense and/or are in common usage.

When determining the correct classification for a kit or set, it is necessary to understand either; what the kit is going to be used for, or alternatively, if it going to make or construct something from its components, what the finished article will be.

Examples of acceptable terms would be:

Class 8: *Manicure and pedicure sets*

Class 9: *Hands free kits for phones*

Class 12: *Tyre repair kits* (for repairing a vehicle part that is in Class 12)

Class 27: *Rug making kit*

Class 28: *Scale model kits [toys]*
Toy model kits

Class 32: *Beer making kits*

Class 33: *Wine making kits*

Leasing

The general remarks in the Nice Classification (10th edition) say, 'Leasing services are analogous to rental services and therefore should be classified in the same way. However, hire- or lease-purchase financing is classified in Class 36 as a financial service.'

See also *rental services*.

Mail order

See *retail and wholesale services*.

Manuals (for computers, etc.)

Electronic items such as computers, printers, photocopiers and other electronic items are often delivered as new goods to the customer with a list of operating instructions. The instructions can be in paper (printed) format, or in an electronic format, such as a recording on a disc, or as a downloadable or non-downloadable document available at the manufacturer's website.

Examples of this would be:

Class 9: *Computer software and hardware and associated manuals **in electronic format** sold as unit therewith*

Class 16: *Manuals sold as a unit with computer software and hardware*

Manufacturing services

Manufacturing is only seen as a service when it is undertaken for third parties and must be specified as such. Custom manufacturing of certain single, 'one-off' products for third parties, for example a sailing boat or a sports car, by a specialist in that field would be proper to Class 40. Custom construction of, for example, made-to-measure kitchen units would be included in Class 40, but their installation would be proper to Class 37.

News services

News agency services are proper to Class 38. They are essentially a hub or collection point through which journalists and others can file and obtain newsworthy materials (in the form of stories, script or photographs). They do not perform any other function such as editing or verification services.

News reporting services are proper to Class 41. News has no boundaries, the subject could be anything.

Other examples include:

Class 38: *News broadcasting services*

Class 40: *Printing of newspapers*

Class 41: *Presentation of news (programmes)*
Publication of news
Editing of news

As far as electronic news publications are concerned, *downloadable news pod casts, news clips, news items, news publications*, etc. are all goods which are proper to Class 9.

On-line services

See *internet services*.

Ordering of services

The ordering of goods/services for others can be accepted in Class 35 as a business service/office function. There are individuals and companies who offer services of providing solutions to a variety of problems on behalf of others; for example, if you need a leaking tap to be fixed, the intermediary (service provider) will arrange the services of a plumber for you. This classification is in analogy with the Nice Classification entry *procurement of services for others [purchasing goods and services for other business]*.

Perfuming and air freshening preparations

There are preparations which serve to merely mask unpleasant smells (perfume) and there are also preparations which chemically 'wrap-up' and remove unpleasant odours (deodorisers) and their apparatus. They are properly classified as follows:

Class 3: *Air fragrancing preparations*
Incense
Potpourris [fragrances]
Sachets for perfuming linen
Scented wood
Fumigation preparations [perfumes]

Room sprays

Class 5: *Air deodorising preparations*
Air purifying preparations

Class 11: *Air deodorising apparatus*

Other goods which may release pleasant odours include *perfumed candles* which are proper to Class 4 (the release of perfume is a secondary characteristic) and *perfumed drawer liners* (proper to Class 16 as being analogous to *packaging material* and usually made of paper).

Personal and social services rendered by others to meet the needs of individuals

The general indication *personal and social services rendered by others to meet the needs of individuals* is not clear and precise enough and will not be accepted by the Office (see also paragraph 4.2).

The wording needs to be specified by the applicant.

There are many personal and social services that are classifiable, but are proper to classes other than Class 45. These include:

Class 36: *Personal insurance services* (such as life assurance)

Class 41: *Personal tuition*

Class 44: *Personal medical services*

Class 45: *Personal body guarding*
Consultancy services relating to personal appearance
Personal tour guide services
Personal shopping services

Precious metal goods

The general indication *goods of precious metals or coated therewith, not included in other classes* in Class 14 is not clear and precise enough and will not be accepted by the Office (see also paragraph 4.2). The applicant needs to specify the wording of the term.

Caution needs to be applied when classifying goods made from precious metals.

Historically, virtually all goods which were made from, or coated with, precious metals were grouped together in Class 14. It was considered that the material had an influence on why the goods were bought, and that in turn determined where the goods were classified.

Since 1 January 2007, the classification of many goods that would have been in Class 14 has been re-classified. The reclassification of the goods is based upon their function, rather than the material from which they are made.

The following goods are examples of goods which are classified according to their function or purpose:

Class 8: *Cutlery of precious metal*

Class 16: *Pen nibs of gold*

Class 21: *Teapots of precious metal*

Class 34: *Cigarette and cigar boxes made of precious metals*

Protective clothing

If items that are worn (or sometimes carried) have their **primary** function as the prevention of serious and/or permanent injury, or death or if that protection is offered against, for example contact with or exposure to extremes of temperature, chemicals, radiation, fire, or environmental or atmospheric hazards, then those goods would be proper to Class 9.

Examples of such protective goods would include hard-hats worn on building sites, and helmets worn by security guards, horse riders, motorcyclists, and American football players. Bullet-proof vests, metal toe-capped shoes, fireproof jackets and metal butchers' gloves are examples of these: they are not clothing as such. Aprons, smocks and overalls which merely protect against stains and dirt are not proper to Class 9 but to Class 25 as general clothing. Protective sporting articles (except helmets) are proper to Class 28: none of these protect against loss of life or limb.

Rental services

Rental or hire services are classified, in principle, in the same class as the services provided. For example, the rental of cars falls in Class 39 (*transport*), rental of telephones in Class 38 (*telecommunications*), rental of vending machines in Class 35 (*retail services*). The same principle applies to *leasing services* which are found on TMclass in all of the service classes.

Retail and wholesale services

A retail service is defined as 'The action or business of selling goods in relatively small quantities for use or consumption' (*Oxford English Dictionary*); this defines the scope of the services covered by this term.

There is an indication in the explanatory note to the listing of Class 35 in the Nice Classification that the term *the bringing together, for the benefit of others, of a variety of goods (excluding the transport thereof), enabling customers to conveniently view and purchase these goods* is acceptable in Class 35. *Retail services* are classified in analogy to this entry.

However, as regards *retail services* or similar services in Class 35 relating to the sale of goods, such as *wholesale services*, *mail order services* and *e-commerce services*, the Office applies judgment of 07/07/2005, C-418/02, 'Praktiker': the term *retail services* is only acceptable where the type of goods or services to be sold or brought

together for the benefit of others, is indicated with sufficient clarity and precision (see paragraph 4.1 above). The term *retail services of a supermarket* and, by extension, *retail services of a department store* and similar terms are not acceptable as the goods to be sold are not defined.

The 10th edition of the Nice Classification (version 2013) includes *retail or wholesale services for pharmaceutical, veterinary and sanitary preparations and medical supplies*, which shows how terms can be expressed.

Examples of categories of goods which do not fulfil the requirements of clarity and precision:

- *Merchandising articles*
- *Fair-trade goods*
- *Lifestyle accessories*
- *Gift articles*
- *Souvenirs*
- *Collectors' articles*
- *Housewares*

Retail services for non-acceptable general indications of the class headings (see paragraph 3.4.2 above) are not acceptable. For example, the Office will not accept *retail services for machines*. However, *retail services in relation to agricultural machines* would be sufficiently precise and acceptable.

As regards 'retail of services', (i.e. *services which consist of bringing together, for the benefit of others, of a variety of services, enabling consumers to conveniently compare and purchase those services*), the Court has held that these must also be formulated with sufficient clarity and precision so as to allow the competent authorities and other economic operators to know which services the applicant intends to bring together (see judgment of 10/07/2014, C-420/13, 'Netto Marken-Discount').

This decision confirms that the '*bringing together of services*' is an activity that is entitled to protection. The Court placed greater emphasis on the importance of defining the services being brought together, than on defining the action of 'bringing together' itself (thereby echoing its earlier judgment of 07/07/2005, C-418/02, 'Praktiker').

Terms expressing this should satisfy two requirements, firstly, using the familiar terms '*bringing together, for the benefit of others... enabling customers to compare and purchase...*' in order to 'frame' the services being brought together and describe the actual retail activity itself, and secondly, in describing the services which are being brought together, employing terms which are understood and acceptable in their own right (e.g. legal services, broadcasting services, slimming club services etc.). In order to meet the fundamental requirements for clarity and precision under Article 28(2) EUTMR, any claim to the retailing or 'bringing together' of services must be worded in this manner.

The following are example specifications which will now be deemed acceptable:

The bringing together, for the benefit of others, of a variety of legal services, enabling customers to conveniently compare and purchase those services.

The bringing together, for the benefit of others, of slimming club services, video-on-demand services, and detective agency services, enabling customers to conveniently compare and purchase those services.

The bringing together, for the benefit of others, of a variety of broadcasting services, enabling customers to conveniently compare and purchase those services.

In the case of the bringing together of services, wordings including ‘*retail services connected with...*’, ‘*retail services connected with the sale of...*’ and ‘*electronic shopping retail services connected with...*’ do not provide a clear distinction between the retailing of services and the provision of those services in their own right.

The following examples will therefore not be accepted and will be subject to an objection:

Retail services connected with takeaway services.

Retail services connected with the sale of legal services.

Mail order retail services connected with the sale of detective agency services.

The CJEU’s ruling is not to be interpreted as providing a means for obtaining duplicative protection of services intended to be provided in their own right (whether proper to Class 35 or elsewhere). Nor should it be perceived as an alternative means for providing protection for the advertising of one’s own services. Thus, if an application covers ‘*the bringing together for the benefit of others of telecommunication services enabling customers to conveniently compare and purchase those services*’, these services do not cover the actual provision of telecommunication services (which belongs to Class 38), but only the bringing together of a variety of telecommunication service providers enabling consumers to conveniently compare and purchase those services.

Finally, the specification of the goods or services by terms such as ‘including, in particular, for example, featuring, specifically, such as, is not precise enough since all these terms mean, in principle, ‘for example’. They do not restrict the goods or services which follow. Consequently, the abovementioned terms should be replaced by ‘namely or being’ as it will restrict the goods or services which follow those terms.

Satellite tracking

See *GPS systems – location, tracking and navigating*.

Sets

See *kits and sets*.

Social networking services

Social networking services is an acceptable term in Class 45. It would be seen as a personal service which includes the identification and introduction of like-minded people for social purposes.

There are other aspects of the *social networking* industry which could be proper to classes other than Class 45, for example:

Class 38: *The operation of chat room services*
The provision of on-line forums

Software publishing

Software publishing belongs to Class 41. A software publisher is a publishing company in the software industry between the developer and the distributor. Publishing, according to its definition, includes *newspaper publishing* and *software publishing*.

Solar power

Solar power is energy that is derived from the sun and converted into heat or electricity.

Goods relating to the generation and storage of electricity from solar energy are classified in Class 9.

Goods relating to the generation and storage of heat from solar energy are classified in Class 11.

Services relating to the generation of electricity from solar energy are classified in Class 40.

Class 9: *Photovoltaic cells*
Solar panels, modules and cells

Class 11: *Solar collectors for heating*

Class 40: *Production of energy*

See *electricity and energy*.

Storage services

See *collection and storage services*.

Supply of ...

Care should be taken in the acceptance of this term when it is used to qualify services. It is acceptable in some circumstances, for example, *supply of electricity* in Class 39, where the term is often closely allied to *distribution*. It is also acceptable in the term

catering services for the supply of meals (in Class 43) because the material being supplied, and the nature of the service, have both been given.

In the term *supply of computer software* (in Class 42) it is not clear what services are being provided. Whilst this class does include the services of *design, rental, updating and maintaining computer software*, it is not clear if any of those services are included in the general term *supply*. The word is often used as an apparent synonym for retail services but Class 42 does not include such services, they would be proper to Class 35.

Systems

This is another term which can be too unclear or too imprecise to be accepted.

It can be accepted only when qualified in a way that has a clear and unambiguous meaning. For example, the following are acceptable:

Class 7: *Exhaust systems*

Class 9: *Telecommunication systems*
Computer systems
Alarm systems

Class 16: *Filing systems*

Tickets (for travel, entertainment etc.)

A ticket is a 'promise to supply' in relation to a service, or a reservation service, the right to a service. Examples include:

Class 39: *Issuing of airplane tickets*

Class 41: *Ticket agency services (box office)*

Note that tickets are not seen as goods retailed in Class 35.

Video games

See *computer games*.

Virtual environment

The term *providing a virtual environment* is neither clear nor precise enough as it can relate to different areas of activities and classes. The term must be further defined.

Acceptable terms include:

Class 38: *Providing a virtual chatroom*
Providing access to a virtual environment

Class 42: *Hosting of a virtual environment*
Maintenance of a virtual environment

***GUIDELINES FOR EXAMINATION OF
EUROPEAN UNION TRADE MARKS***

***EUROPEAN UNION
INTELLECTUAL PROPERTY OFFICE
(EUIPO)***

PART B

EXAMINATION

SECTION 4

ABSOLUTE GROUNDS FOR REFUSAL

Table of Contents

1	General Principles	5
1.1	Reasoned objection	5
1.2	Dialogue with the applicant	5
1.3	Decision	6
1.4	European criteria	7
1.5	Irrelevant criteria	7
1.5.1	Term not used.....	7
1.5.2	Need to keep free	8
1.5.3	Factual monopoly	8
1.5.4	Double meaning	8
1.6	Scope of objections on the goods and services	9
1.7	Timing of objections	10
1.8	Disclaimers	10
2	Absolute Grounds (Article 7 EUTMR)	11
2.1	Article 7(1)(a) EUTMR	11
2.1.1	General remarks	11
2.1.2	Examples of trade mark applications refused or accepted under Article 7(1)(a) EUTMR	13
2.1.2.1	Smell/olfactory marks	13
2.1.2.2	Taste marks.....	14
2.1.2.3	Sound marks	14
2.2	Distinctiveness (Article 7(1)(b) EUTMR)	14
2.2.1	General remarks	14
2.2.2	Word elements.....	15
2.2.3	Titles of books.....	16
2.2.4	Colours	17
2.2.4.1	Single colours	17
2.2.4.2	Colour combinations.....	18
2.2.5	Single letters	19
2.2.5.1	General considerations.....	19
2.2.5.2	Examples.....	20
2.2.6	Slogans: assessing distinctive character.....	21
2.2.7	Simple figurative elements	24
2.2.8	Commonplace figurative elements	25
2.2.9	Typographical symbols	26
2.2.10	Pictograms.....	27
2.2.11	Common/non-distinctive labels.....	28
2.2.12	Three-dimensional trade marks.....	29
2.2.12.1	Preliminary remarks	29
2.2.12.2	Shapes unrelated to the goods or services themselves	29
2.2.12.3	Shape of the goods themselves or shapes related to the goods or services	29
2.2.12.4	Shape of the packaging.....	34
2.2.13	Pattern marks	36

2.2.14	Position marks	39
2.2.15	Sound marks.....	40
2.3	Descriptiveness (Article 7(1)(c) EUTMR)	42
2.3.1	General remarks	42
2.3.1.1	The notion of descriptiveness.....	42
2.3.1.2	The reference base	43
2.3.1.3	Characteristics mentioned under Article 7(1)(c) EUTMR.....	44
2.3.2	Word marks	45
2.3.2.1	One word.....	45
2.3.2.2	Combinations of words.....	46
2.3.2.3	Misspellings and omissions.....	49
2.3.2.4	Abbreviations and acronyms	50
2.3.2.5	Slogans	51
2.3.2.6	Geographical terms	52
2.3.2.7	Terms describing subject matter in goods or services.....	55
2.3.2.8	Single letters and numerals	58
2.3.2.9	Names of colours	60
2.3.2.10	Plant variety names.....	60
2.3.2.11	Names of banks and newspapers/magazines	62
2.3.2.12	Names of hotels	62
2.3.2.13	Combinations of names of countries/cities with a number indicating a year	63
2.3.2.14	INN codes.....	63
2.3.3	Figurative marks	64
2.3.4	Figurative threshold	65
2.3.4.1	Preliminary remarks	65
2.3.4.2	Assessment of the figurative threshold.....	66
2.4	Customary signs or indications (Article 7(1)(d) EUTMR).....	71
2.4.1	General remarks	71
2.4.2	Point in time of a term becoming customary	72
2.4.3	Assessment of customary terms	72
2.4.4	Applicability of Article 7(1)(d) EUTMR in relation to plant variety names.....	73
2.5	Shapes or other characteristics with an essentially technical function, substantial value or resulting from the nature of the goods (Article 7(1)(e) EUTMR).....	74
2.5.1	General remarks	74
2.5.2	Shape or other characteristic that results from the nature of the goods	76
2.5.3	Shape or other characteristic of goods necessary to obtain a technical result.....	76
2.5.4	Shape or other characteristic that gives substantial value to the goods	79
2.6	Acquired distinctiveness	80
2.6.1	Introduction	80
2.6.2	Request	81
2.6.3	The point in time	81
2.6.3.1	Examination proceedings	81
2.6.3.2	Cancellation Proceedings.....	82
2.6.4	Consumer	82
2.6.5	Goods and Services	82
2.6.6	Territorial Aspects.....	83
2.6.6.1	Special provisions with respect to the accession of new Member States ..	83
2.6.6.2	3D marks, colours per se and figurative trade marks	84
2.6.6.3	Language area	84
2.6.6.4	Extrapolation	85
2.6.7	Standard of proof.....	86
2.6.8	Assessment of the evidence.....	87

2.6.8.1	Opinion polls and surveys	89
2.6.8.2	Market share, advertising and turnover	89
2.6.8.3	Declarations, affidavits and written statements	90
2.6.8.4	Prior registrations on acquired distinctiveness	91
2.6.8.5	Other means of evidence	91
2.6.8.6	Manner of use	91
2.6.8.7	Length of use.....	92
2.6.8.8	Post-filing date evidence	93
2.6.9	Consequences of Acquired Distinctiveness	93

1 General Principles

1.1 Reasoned objection

When there is an absolute ground for refusal, a reasoned objection will be issued that specifies the individual grounds for refusal and provides clear and distinct reasoning **for each ground separately**. Piecemeal objections (so-called step-by-step objections) should be avoided.

Each of the grounds for refusal listed in Article 7(1) EUTMR is independent of the others and calls for separate examination.

Even when some grounds for refusal overlap, each ground of refusal must be given separate reasoning in the light of the general interest underlying each of them.

For example, where a word mark is found to have a semantic meaning that makes it objectionable under both Article 7(1)(b) and (c) EUTMR, the notification of grounds of refusal should deal with each of these grounds in separate paragraphs. In such a case, it will be clearly indicated whether the lack of distinctiveness arises out of the same, or different, considerations from those that lead to the mark being deemed descriptive.

Any one of the grounds listed in Article 7(1) EUTMR is sufficient for refusal of an EU trade mark. However, the Office will list all the grounds for refusal that are applicable at each stage.

Occasionally, arguments brought forward by the applicant, or a restriction (partial withdrawal) of the list of goods and services will lead to the application of other grounds for refusal. In these cases, the party will always be given the opportunity to comment thereon.

1.2 Dialogue with the applicant

During examination proceedings, the Office will seek a dialogue with the applicant.

At all stages of the proceedings, the observations submitted by the applicant will be considered carefully.

The Office will likewise consider, of its own motion, new facts or arguments that plead in favour of acceptance of the mark. The application can only be refused if the Office is convinced that the objection is well founded at the point in time when the decision is taken.

If several grounds for refusal are raised, the applicant must overcome all of them, since a refusal can be based on a single ground for refusal (judgment of 19/09/2002, C-104/00 P, Companyline, EU:C:2002:506, § 28).

- No observations submitted by the applicant

Where the applicant has not submitted any observations, if the application is to be refused, the notification to the applicant will include the original objection letter(s), state that the application is 'hereby refused', and contain a notice on the availability of an appeal.

- Observations submitted by the applicant

If the applicant contests the reasons given in the original notification, the refusal will first provide the original reasoning given, and then address the arguments of the applicant.

Where the Office needs to provide new facts or arguments to sustain a refusal, the applicant must be given the opportunity of commenting on these before a final decision is taken.

- Restriction of goods and services

Where the applicant tries to overcome the objection by restricting the list of goods and services, it is possible that the restriction may give rise to a new ground for refusal, for example, deceptiveness in addition to descriptiveness. In this case another objection letter will be issued, so as to give the applicant the opportunity to comment on all grounds for refusal found pertinent.

A specification of goods or services that is restricted by a condition that the goods or services do not possess a particular characteristic should not be accepted (judgment of 12/02/2004, C-363/99, Postkantoor, EU:C:2004:86, § 114). For example, in respect of the trademark 'Theatre', a specification claiming '*books, except for books about theatre*' should not be accepted. In contrast, restrictions that are worded in a positive way are usually acceptable, such as 'books about Chemistry'.

- Proof of acquired distinctiveness

As regards the proof of acquired distinctiveness (Article 7(3) EUTMR), the applicant has the right to claim that its mark has acquired distinctiveness through use and submit the relevant proof of use.

The point in time where the applicant must send its proof of use is after the objection letter and before the final decision is taken by the Office. In that regard, the applicant may file a request for an extension of time limits after the objection letter pursuant to Rule 71 EUTMR.

If the mark is accepted on the basis of Article 7(3) EUTMR, then no refusal letter will be sent.

If the proof of use does not demonstrate acquired distinctiveness, the refusal will contain the reasoning as to why the mark falls foul of any of the grounds mentioned in Article 7(1) EUTMR and separate reasoning as to why the applicant's claim of acquired distinctiveness has failed.

1.3 Decision

After the dialogue with the applicant has taken place, the Office will take a decision to refuse the application if it considers that the objection is well founded despite the facts and arguments submitted by the applicant.

The decision will include the original objection, summarise the applicant's arguments, address the applicant's arguments and submissions, and give reasons and a detailed explanation as to why they are not convincing.

If the applicant has submitted evidence of acquired distinctiveness by use and this is considered **sufficient** to overcome the objection, then the Office will issue a communication that rebuts any new argument raised by the applicant and maintains the objection(s), but accepts the trade mark based on the acquisition of distinctiveness by use. If the evidence is **not considered sufficient**, a decision will be issued. It will contain a separate reasoning on the claim of acquired distinctiveness.

The objection can be waived in part if the Office considers that (i) **some** of the grounds have been overcome or (ii) **all** grounds have been overcome for some of the goods and services.

The decision will state that the application has been refused (either in its entirety or partly, with an indication of the rejected goods and services) and will contain a notice of the availability of an appeal.

1.4 European criteria

Article 7(1) EUTMR is a European provision and has to be interpreted on the basis of a common European standard. It would be incorrect to apply different standards of distinctiveness, based on different national traditions, or to apply different (i.e. more lenient or stricter) standards on the breach of public order or morality, depending on the country concerned.

However, Article 7(2) EUTMR excludes an application from registration if a ground for refusal pertains in only part of the European Union ('EU').

That means that it suffices for a refusal if the trade mark is descriptive, or lacks distinctive character, in any official language of the EU (judgment of 03/07/2013, T-236/12, Neo, EU:T:2013:343, § 57).

As regards other languages, a refusal will be raised if the trade mark is objectionable under Article 7(1) EUTMR in a language understood by a significant section of the relevant public in at least a part of the European Union (see below under paragraph 2.3.1.2. The reference base, and judgment of 13/09/2012, T-72/11, Espetec, EU:T:2012:424, § 35-36).

Where the objection is not based on a semantic meaning of a word, the ground for refusal will normally pertain to the European Union as a whole. However, the perception of the sign by the relevant public, the practice in trade, or the use of the goods and services claimed may be different in some parts of the European Union.

1.5 Irrelevant criteria

Applicants often advance arguments that have already been declared irrelevant by the courts. These arguments should be rejected and the corresponding passages of the applicable judgments cited.

1.5.1 Term not used

The fact that a descriptive use of the term applied for cannot be ascertained is irrelevant. Examination of Article 7(1)(c) EUTMR has to be made by means of

prognostics (assuming that the mark will be used with respect to the goods or services claimed). It follows clearly from the text of Article 7(1)(c) EUTMR that it suffices if the mark 'may serve' to designate characteristics of the goods and services (judgment of 23/10/2003, C-191/01 P, Doublemint, EU:C:2003:579, § 33).

1.5.2 Need to keep free

It is frequently claimed that other traders do not need the term applied for, can use more direct and straightforward indications or have synonyms at their disposal to describe the respective characteristics of the goods. All these arguments must be refused as irrelevant.

Although there is a public interest underlying Article 7(1)(c) EUTMR that descriptive terms should not be registered as trade marks so as to remain freely available to all competitors, it is not necessary for the Office to show that there is a present or future need or concrete interest of third parties to use the descriptive term applied for (no 'konkretes Freihaltebedürfnis') (judgments of 04/05/1999, C-108/97 and C-109/97, Chiemsee, EU:C:1999:230, § 35; 12/02/2004, C-363/99, Postkantoor, EU:C:2004:86, § 61).

Whether there are synonyms or other even more usual ways of expressing the descriptive meaning is thus irrelevant (judgment of 12/02/2004, C-265/00, Biomild, EU:C:2004:87, § 42).

1.5.3 Factual monopoly

The fact that the applicant is the only person offering the goods and services for which the mark is descriptive is not relevant for Article 7(1)(c) EUTMR. However, in this case the applicant will be more likely to succeed on acquired distinctiveness.

1.5.4 Double meaning

The frequent argument of applicants that the terms applied for have more than one meaning, one of them not being descriptive for the goods/services, should be rejected. It suffices for a refusal under Article 7(1)(c) EUTMR if at least one of the possible meanings of the term is descriptive in relation to the relevant goods and services (judgment of 23/10/2003, C-191/01 P, Doublemint, EU:C:2003:579, § 32; confirmed by judgment of 12/02/2004, C-363/99, Postkantoor, EU:C:2004:86, § 97).

Given that the examination must focus on the goods/services covered by the application, arguments concerning other possible meanings of the word/s making up the trade mark applied for (which are unrelated to the goods/services concerned) are irrelevant. Equally, when the trade mark applied for is a composite word mark, what matters for examination purposes is the meaning, if any, associated with the sign considered as a whole, and not the possible meanings of its individual elements considered separately (judgment of 08/06/2005, T-315/03, Rockbass, EU:T:2005:211, § 56).

1.6 Scope of objections on the goods and services

Almost all absolute grounds for refusal, and in particular the most pertinent ones of lack of distinctiveness, descriptiveness, genericness and deceptiveness, have to be assessed with respect to the goods and services actually claimed.

If an objection is raised, the Office must state specifically which ground (or grounds) for refusal apply to the mark in question, for each product or service claimed.

It is sufficient that a ground for refusal applies to a **single homogenous category** of goods and/or services. A homogenous category is considered a group of goods and/or services that have a sufficiently direct and specific link to each other (judgment of 02/04/2009, T-118/06, Ultimate fighting championship, EU:T:2009:100, § 28). Where the same ground or grounds for refusal is/are given for a category or group of goods or services, only **general reasoning** for all of the goods and/or services concerned may be used (judgment of 15/02/2007, C-239/05, The Kitchen Company, EU:C:2007:99, § 38).

Sign	Case number
BigXtra	C-253/14 P
The Court confirmed the refusal in respect of goods and services in Classes 16, 35, and 41 to 43 by means of a general reasoning because of a sufficiently concrete and direct link for all these goods and services. For all of them, 'BigXtra' will be perceived as indicating price reductions or other advantages (para. 48).	
Sign	Case number
PIONEERING FOR YOU	T-601/13
The Court allowed general reasoning in respect of goods and services in Classes 7, 9, 11, 37 and 42 because the promotional meaning of the sign applied for would be perceived identically for each of them (paras 36-37).	

As regards descriptiveness, an objection applies not only to those goods/services for which the term(s) making up the trade mark applied for is/are directly descriptive, but also to the **broad category** that (at least potentially) contains an identifiable subcategory or specific goods/services for which the mark applied for is directly descriptive. In the absence of a suitable restriction by the applicant, the descriptiveness objection necessarily affects the broad category as such. For example, 'EUROHEALTH' is to be refused for 'insurances' as a whole and not only for health insurances (judgment of 07/06/2001, T-359/99, EuroHealth, EU:T:2001:151, § 33).

An objection also arises for those goods and services that **are directly linked** to those for which the descriptive meaning pertains. Furthermore, if the descriptive meaning applies to an activity involving the use of several goods or services mentioned separately in the specification, then the objection arises for all of them (see judgment of 20/03/2002, T-355/00, Tele Aid, EU:T:2002:79, for a number of goods and services that are in conjunction with, or are applied in, offering aid to car drivers at a distance).

It is possible to claim goods and services as so-called **auxiliary goods or services** in the sense that they are meant to be used with, or support the use of, the main goods or

services. Typically, this covers paper and instruction manuals for the goods to which they belong or which are packed in them, advertisement or repair. In these cases, the auxiliary goods are by definition intended to be used and sold together with the main product (e.g. vehicles and instruction manuals). It follows that if the EUTM is found to be descriptive of the main goods, logically it is also descriptive of the auxiliary goods which are so closely related.

1.7 Timing of objections

Objections should be raised **as early as possible**. In the majority of cases, the Office raises its objection *ex officio* before the publication of the EUTM application.

The Office can reopen the examination of absolute grounds:

- on its **own initiative at** any time before registration (Article 40(3) EUTMR);
- upon receiving observations from third parties relating to the existence of an absolute ground for refusal.

These observations must be submitted before the end of the opposition period or before the final decision on an opposition is taken when an opposition has been filed (Article 40(2) EUTMR). The Office can then decide to reopen the examination procedure as a result of these observations. See the Guidelines, Part B, Examination, Section 1, Proceedings, paragraph 3.1.

In the case of **international registrations** designating the EU, the Office can raise an objection as long as the opposition period (six months after republication) has not started (Rule 112(5) EUTMR) and any interim status declaration previously sent would be revoked.

1.8 Disclaimers

Pursuant to Regulation No 2015/2424 amending Regulation No 207/2009 on the Community trade mark, it is no longer possible to file a disclaimer to indicate that protection is not requested for a specific element of a mark.

The Office will assess disclaimers filed **before** the date of entry into force of the abovementioned Regulation according to the applicable former practice.

- As a general rule, a disclaimer will not help to overcome an absolute grounds objection.
- Where a trade mark consists of a combination of elements, each of which in itself is clearly not distinctive, there is no need for a disclaimer of the separate elements. For example, if a periodical had as its trade mark 'Alicante Local and International News' with a figurative distinctive element, the individual word elements within it would not need to be disclaimed.
- If the applicant's disclaimer does not overcome the ground for refusing registration, the application must be refused to the extent that is required.

- Where the applicant has made a disclaimer of a non-distinctive element in its application, the disclaimer will stay even if the Office does not consider it necessary. **Disclaimers of distinctive elements will be refused by the Office** since they would result in a trade mark with an unclear scope of protection.

The following paragraphs address each individual subsection of Article 7(1) EUTMR in alphabetical order, beginning with Article 7(1)(a) EUTMR and ending with Article 7(1)(e) EUTMR. This is followed by a paragraph regarding Article 7(3) EUTMR (acquired distinctiveness).

The second part addresses the remaining individual subsections of Article 7(1) EUTMR from Article 7(1)(f) to (m) EUTMR and ends with a paragraph covering collective marks.

2 Absolute Grounds (Article 7 EUTMR)

2.1 Article 7(1)(a) EUTMR

2.1.1 General remarks

Article 7(1)(a) EUTMR reflects the Office's obligation to refuse signs that do not conform to the requirements of Article 4 EUTMR.

According to Article 4 EUTMR, an EU trade mark may consist of any sign capable of being represented graphically, particularly words, including personal names, designs, letters, numerals, the shape of goods and their packaging, provided that such signs are capable of distinguishing the goods or services of one undertaking from those of other undertakings.

To be capable of constituting a trade mark for the purposes of Article 4 EUTMR, the subject matter of an application must satisfy three conditions:

- (a) it must be a sign,
- (b) it must be capable of being represented graphically,
- (c) it must be capable of distinguishing the goods or services of one undertaking from those of others (judgment of 25/01/2007, C-321/03, Transparent bin, EU:C:2007:51, § 28).

a) Signs

According to Article 4 EUTMR, a trade mark may consist of any sign, subject to certain conditions. Although the particular examples listed in this provision are all signs that are two- or three-dimensional and are capable of being perceived visually, the list is not exhaustive.

However, in order not to deprive Article 4 EUTMR of any substance, this provision cannot be interpreted so broadly as to allow any non-specific subject matter to necessarily qualify as a sign. Thus, abstract concepts and ideas or general characteristics of goods are not specific enough to qualify as a sign, as they could apply to a variety of different manifestations (judgment of 21/04/2010, T-7/09, Spannfutter, EU:T:2010:153, § 25).

For this reason, the Court rejected, for example, an application for a 'transparent collecting bin forming part of the external surface of a vacuum cleaner', as the subject

matter was not a particular type of a bin, but rather, in a general and abstract manner, all conceivable shapes of a transparent bin with a multitude of different appearances (judgment of 25/01/2007, C-321/03, Transparent bin, EU:C:2007:51, § 35, 37).

b) Graphic representation

A sign that is not capable of being represented graphically will be excluded from registration as an EU trade mark under Article 7(1)(a) EUTMR.

The function of the requirement of graphic representation is to define the mark itself in order to determine the precise subject matter of the protection afforded by the registered mark to its proprietor.

It has been clearly established by case-law that a graphic representation in terms of Article 2 of the Trade Mark Directive, which corresponds to Article 4 EUTMR, must enable the sign to be represented visually, particularly by means of images, lines or characters, and that the representation is clear, precise, self-contained, easily accessible, intelligible, durable and objective (judgment of 12/12/2002, C-273/00, Methylcinnamat, EU:C:2002:748, § 46-55, and judgment of 06/05/2003, C-104/01, Libertel, EU:C:2003:244, § 28-29).

The requirement of ‘objectivity’ means that the sign must be perceived unambiguously and consistently over time in order to function as a guarantee of indication of origin. The object of the representation is specifically to avoid any element of subjectivity in the process of identifying and perceiving the sign. Consequently, the means of graphic representation must be unequivocal and objective.

Moreover, in cases where a sign is defined by both a graphic representation and a textual description, in order for the representation to be precise, intelligible, and objective, it must coincide with what can be seen in the graphic representation (decision of 23/09/2010, R 443/2010-2, RED LIQUID FLOWING IN SEQUENCE OF STILLS (al)).

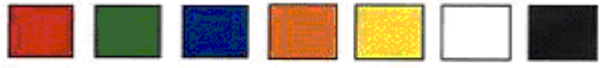
Sign	Case number
 <p data-bbox="231 1460 847 1657"><u>Description:</u> ‘Six surfaces being geometrically arranged in three pairs of parallel surfaces, with each pair being arranged perpendicularly to the other two pairs characterised by: (i) any two adjacent surfaces having different colours and (ii) each such surface having a grid structure formed by black borders dividing the surface into nine equal segments’.</p>	<p data-bbox="916 1460 1310 1547" style="text-align: center;">EUTM 8 316 184 14/06/2012, T-293/10, Colour per se, EU:T:2012:302</p>
<p data-bbox="231 1697 1366 1861">The General Court considered that the mark’s description was too difficult to understand. A sign so defined is not a colour mark per se but a three-dimensional mark, or figurative mark, that corresponds to the external appearance of a particular object with a specific form — a cube covered in squares with a particular arrangement of colours. Even if the description had been clear and easily intelligible — which it was not — it would still have contained an inherent contradiction insofar as the true nature of the sign is concerned (paras 64 and 66).</p>	

c) Distinguishing character

Article 4 EUTMR refers to the capacity of a sign to distinguish the goods of one undertaking from those of another. Unlike Article 7(1)(b) EUTMR, which concerns the distinctive character of a trade mark with regard to specific goods or services, Article 4 EUTMR is merely concerned with the abstract ability of a sign to serve as a badge of origin, regardless of the goods or services.

Only in very exceptional circumstances is it conceivable that a sign could not possess even the abstract capacity to distinguish the goods or services of one undertaking from those of another. A conceivable example for the lack of abstract capacity in the context of any goods or services could be, e.g. the word 'Trademark'.

2.1.2 Examples of trade mark applications refused or accepted under Article 7(1)(a) EUTMR

For formalities issues regarding some of the types of marks mentioned below, see the Guidelines, Part B, Examination, Section 2, Formalities, paragraph 9.

2.1.2.1 Smell/olfactory marks

The requirements of graphic representation of an olfactory mark are not satisfied by a chemical formula, by a description in written words, by the deposit of an odour sample or by a combination of those elements (judgment of 12/12/2002, C-273/00, Methylcinnamat, EU:C:2002:748, § 69-73).

There is currently no means of graphically representing smells in a satisfactory way. There is no generally accepted international classification of smells that would make it possible, as with international colour codes or musical notation, to identify an olfactory sign objectively and precisely through the attribution of a name or a precise code specific to each smell (judgment of 27/10/2005, T-305/04, Odeur de fraise mûre, EU:T:2005:380, § 34).

The following are examples of possible ways of graphically representing a smell but none is satisfactory:

- *Chemical formula*

Few people would recognise the odour in question from such a formula.

- *Odour sample*

A deposit of an odour sample would not constitute a graphic representation for the purposes of Article 4 EUTMR, as an odour sample is not sufficiently stable or durable.

- *Graphic representation and description in word*

The requirements of graphical representation are not satisfied by:

- a graphic representation of the smell
- a description of the smell in words
- a combination of both (graphic representation and description in words).

Sign	Case No
<div style="text-align: center;">  </div> <p>Mark description: Smell of ripe strawberries</p>	<p>EUTM application 1 122 118</p>
<p>27/10/2005, T-305/04, Odeur de fraise mûre, EU:T:2005:380, § 34 The Court considered that the smell of strawberries varies from one variety to another and the description 'smell of ripe strawberries' can refer to several varieties and therefore to several distinct smells. The description was found neither unequivocal nor precise and did not eliminate all elements of subjectivity in the process of identifying and perceiving the sign claimed. Likewise, the image of a strawberry represents only the fruit that emits a smell supposedly identical to the olfactory sign at issue, and not the smell claimed, and therefore does not amount to a graphic representation of the olfactory sign.</p>	

2.1.2.2 Taste marks

The arguments mentioned above under paragraph 2.1.2.1 are applicable in a similar way for taste marks (decision of 04/08/2003, R 120/2001-2, The taste of artificial strawberry flavour (gust.)).

2.1.2.3 Sound marks

According to the judgment of 27/11/2003, C-283/01, Musical notation, EU:C:2003:641, § 55, a sound must be represented graphically 'particularly by means of images, lines or characters' and its representation must be 'clear, precise, self-contained, easily accessible, intelligible, durable and objective'.

2.2 Distinctiveness (Article 7(1)(b) EUTMR)

2.2.1 General remarks

According to settled case-law, distinctiveness of a trade mark within the meaning of Article 7(1)(b) EUTMR means that the sign serves to identify the product and/or services in respect of which registration is applied for as originating from a particular undertaking, and thus to distinguish that product from those of other undertakings (judgments of 29/04/2001, joined cases C-468/01 P to C-472/01 P, Tabs, EU:C:2004:259, § 32; 21/10/2004, C-64/02 P, Das Prinzip der Bequemlichkeit, EU:C:2004:645, § 42; and 08/05/2008, C-304/06 P, Eurohypo, EU:C:2008:261, § 66; and 21/01/2010, C-398/08 P, Vorsprung durch Technik, EU:C:2010:29, § 33). According to settled case-law, such distinctiveness can be assessed only by reference first to the goods or services in respect of which registration is sought and, second, to the relevant public's perception of that sign (judgments of 29/04/2001, joined cases C-468/01 P - C-472/01 P, Tabs, EU:C:2004:259, § 33; of 08/05/2008, C-304/06 P, Eurohypo, EU:C:2008:261, § 67; and of 21/01/2010, C-398/08 P, Vorsprung durch Technik, EU:C:2010:29, § 34) (judgments of 14/06/2012, T-293/10, Colour per se, EU:T:2012:302; and of 12/07/2012, C-311/11 P, Wir machen das Besondere einfach, EU:C:2012:460, § 23).

According to the case-law of the European courts, a word mark that is descriptive of characteristics of goods or services for the purposes of Article 7(1)(c) EUTMR is, on

that account, necessarily devoid of any distinctive character with regard to the same goods or services for the purposes of Article 7(1)(b) EUTMR (judgment of 12/06/2007, T-190/05, TWIST & POUR, EU:T:2007:171, § 39).

In a similar vein, even though a given term might not be clearly descriptive with regard to the goods and services concerned, as to the point that an objection under Article 7(1)(c) EUTMR would not apply, it would still be objectionable under Article 7(1)(b) EUTMR on the ground that it will be perceived by the relevant public as only providing information on the nature of the goods and/or services concerned and not as indicating their origin. This was the case with the term 'medi', which was considered as merely providing information to the relevant public about the medical or therapeutic purpose of the goods or of their general reference to the medical field (judgment of 12/07/2012, T-470/09, Medi, EU:T:2012:369, § 22).

An objection under Article 7(1)(b) EUTMR would also apply in those cases where the lexical structure employed, although not correct from a grammatical point of view, can be considered to be common in advertising language and in the commercial context at issue. This was the case of the combination 'ECO PRO', where the laudatory element PRO is placed after the descriptive element ECO and which would be perceived by the relevant public as an indication that the designated goods are intended for 'ecological professionals' or are 'ecological supporting' (judgment of 25/04/2013, T-145/12, ECO PRO, EU:T:2013:220, § 29-32).

2.2.2 Word elements

Words are non-distinctive or cannot convey distinctiveness to a composite sign if they are so frequently used that they have lost any capacity to distinguish goods and services. The following terms, alone or in combination with other unregistrable elements, fall foul of this provision.

Terms merely denoting a particular **positive or appealing quality or function** of the goods and services should be refused if applied for either alone or in combination with descriptive terms:

- **ECO** as denoting 'ecological' (judgments of 24/04/2012, T-328/11, EcoPerfect, EU:T:2012:197, § 25 and of 15/01/2013, T-625/11, ecoDoor, EU:T:2013:14, § 21);
- **MEDI** as referring to 'medical' (judgment of 12/07/2012, T-470/09, medi, EU:T:2012:369);
- **MULTI** as referring to 'much, many, more than one' (decisions of 21/07/1999, R 0099/1999-1, MULTI 2 'n 1; 17/11/2005, R 0904/2004-2, MULTI);
- **MINI** as denoting 'very small' or 'tiny' (decision of 17/12/1999, R 0062/1999-2, MINIRISC);
- **Premium/PREMIUM** as referring to 'best quality' (judgments of 22/05/2012, T-60/11, Patrizia Rocha, EU:T:2013:162, § 46-49, 56 and 58; and of 17/01/2013, joined cases T-582/11 and T-583/11, PREMIUM XL/ PREMIUM L, EU:T:2013:24, § 26);

- **PLUS**, as denoting ‘additional, extra, of superior quality, excellent of its kind’. (decision of 15/12/1999, R 0329/1999-1, PLATINUM PLUS);
- **ULTRA**¹ as denoting ‘extremely’ (decision of 09/12/2002, R 333/2002-1, ULTRAFLEX);
- **UNIVERSAL** as referring to goods that fit for general or universal use (judgment of 02/05/2012, T-435/11, UniversalPHOLED, EU:T:2012:210, § 22 and 28).

Top level domain endings, such as ‘.com’, only indicate the place where information can be reached on the internet and thus cannot render a descriptive or otherwise objectionable mark registrable. Therefore, www.books.com is as objectionable for printed matter as the term ‘books’ alone. This has been confirmed by the General Court in its judgment of 21/11/2012, T-338/11, photos.com, EU:T:2012:614, § 22, where it was stated that the element ‘.com’ is a technical and generic element, the use of which is required in the normal structure of the address of a commercial internet site. Furthermore, it may also indicate that the goods and services covered by the trade mark application can be obtained or viewed online, or are internet-related. Accordingly, the element in question must also be considered to be devoid of distinctive character in respect of the goods or services concerned.

Abbreviations of the legal form of a company such as Ltd., GmbH, etc. cannot add to the distinctiveness of a sign.

Names of individual persons are distinctive, irrespective of the frequency of the name and even in the case of the most common surnames (such as Jones or García, judgment of 16/09/2004, C-404/02, Nichols, EU:C:2004:538, § 26 and 30) or in the case of prominent persons (including heads of states). However, an objection will be raised if the name can **also** be perceived as a non-distinctive term in relation to the goods and services (e.g. ‘Baker’ for pastry products).

2.2.3 Titles of books

Trade marks consisting solely of a famous story or book title may be non-distinctive under Article 7(1)(b) EUTMR in relation to goods and services that could have that story as their subject matter. The reason for this is that certain stories (or their titles) have become so long established and well known that they have ‘entered into the language’ and are incapable of being ascribed any meaning other than that of a particular story.

For example, ‘Peter Pan’ or ‘Cinderella’ or ‘The Iliad’ are perfectly capable of being distinctive trade marks for paint, clothing or pencils, for instance. However, they are incapable of performing a distinctive role in relation to books or films, for example, because consumers will simply think that these goods refer to the story of Peter Pan or Cinderella, this being the only meaning of the terms concerned.

Objections should only be raised in such cases where the title in question is famous enough to be truly well known to the relevant consumer and where the mark can be

¹ Amended on 23/06/2010.

perceived in the context of the goods/services as primarily signifying a famous story or book title. A finding of non-distinctiveness in this regard will be more likely where it can be shown that a large number of published versions of the story have appeared and/or where there have been numerous television, theatre and film adaptations reaching a wide audience.

Depending on the nature of the mark in question, an objection may be taken in relation to printed matter, films, recordings, plays and shows (this is not an exhaustive list).

2.2.4 Colours

This paragraph is concerned with single colours or combinations of colours as such ('colour per se').

Where colours or colour combinations as such are applied for, the appropriate examination standard is whether they are distinctive either if applied to the goods or their packaging, or if used in the context of delivery of services. It is a sufficient ground for a mark to be refused if the mark is not distinctive in either of these situations. For colour combinations, examination of distinctiveness should be based on the assumption that the colour combination in the way it is filed appears on the goods or their packaging, or in advertisements or promotional material for the services.

2.2.4.1 Single colours

As regards the registration as trade marks of colours per se, the fact that the number of colours actually available is limited means that a small number of trade mark registrations for certain services or goods could exhaust the entire range of colours available. Such an extensive monopoly would be incompatible with a system of undistorted competition, in particular because it could have the effect of creating an unjustified competitive advantage for a single trader. Nor would it be conducive to economic development or the fostering of the spirit of enterprise for established traders to be able to register the entire range of colours that is in fact available for their own benefit, to the detriment of new traders (judgment of 06/05/2003, C-104/01, Libertel, EU:C:2003:244).

As has been confirmed by the Court of Justice, consumers are not in the habit of making assumptions about the origin of goods based on their colour or the colour of their packaging, in the absence of any graphic or word element, because as a rule a colour per se is not used as a means of identification in current commercial practice (judgment of 06/05/2003, C-104/01, Libertel, EU:C:2003:244). A colour is not normally inherently capable of distinguishing the goods of a particular undertaking (para. 65). Therefore, single colours are not distinctive for any goods and services except under very special circumstances.

Such very special circumstances require the applicant to demonstrate that the mark is absolutely unusual or striking in relation to these specific goods. These cases will be extremely rare, for example in the case of the colour black for milk. It is not necessary for a refusal that one of the factors listed in paragraph 2.2.4.2 below is present, but if this is the case, it should be used as a further argument in support of the refusal. Where the single colour is found to be commonly used in the relevant sector(s) and/or to serve a decorative or functional purpose, the colour must be refused. The public interest is, according to the Court, an obstacle to the monopolisation of a single colour

irrespective of whether the relevant field of interest belongs to a very specific market segment (judgment of 13/09/2010, T-97/08, Orange II, EU:T:2010:396, § 44-47).

2.2.4.2 Colour combinations

Where a combination of colours per se is applied for, the graphic representation filed must spatially delineate these colours so as to determine the scope of the right applied for. The graphic representation should clearly indicate the proportion and position of the various colours, thus systematically arranging them by associating the colours in a predetermined and uniform way (judgments of 24/06/2004, C-49/02, Blau/Gelb, EU:C:2004:384, § 33 and of 14/06/2012, judgment of 06/05/2003, C-104/01, Libertel, EU:C:2003:244).

For example, a mark comprising a small yellow stripe on top of red is different from red and yellow presented in even proportions, with red on the left side. An abstract claim, in particular to two colours 'in any possible combination' or 'in any proportion', is not allowable and leads to an objection under Article 7(1)(a) EUTMR (decision of 27/07/2004, R 0730/2001-4, 'GELB/BLAU/ROT', § 34). This must be distinguished from the indication of how the colour combination would appear on the product, which is not required because what matters in connection with the assessment of inherent distinctiveness is the subject matter of the registration, not the way it is or can be used on the product.

In the case of colour combination, a refusal can only be based on specific facts or arguments, and where such specific arguments to refuse are not established, the mark must be accepted. If one of the two colours is either the commonplace colour for the product or the natural colour of the product, that is to say, a colour is added to the usual or natural colour of the product, an objection applies in the same way as if there were only one colour. Example: grey is the usual colour for the grip of gardening tools, and white is the natural colour of washing tablets. Therefore, a washing tablet which is white with another layer in red is in fact to be judged as a case that involves the addition of a colour.

The situations in which a combination of two colours should nevertheless be refused include the following.

- In many instances, a colour would merely be a decorative element of the goods or comply with the consumer's request (e.g. colours of cars or T-shirts), irrespective of the number of colours concerned.
- A colour can be the nature of the goods (e.g. for tints).
- A colour can be technically functional (e.g. colour red for fire extinguishers, various colours used for electric cables).
- A colour may also be usual or generic (e.g. again, red for fire extinguishers, yellow for postal services).
- A colour may indicate a particular characteristic of the goods such as a taste (yellow for lemon taste, pink for strawberry taste).
- A colour combination should also be refused if the existence of the colour combination can already be found on the market, in particular if used by several

different competitors (e.g. we were able to demonstrate that the colour combination red and yellow is used by various enterprises on beer or soft drink cans).

In all these cases the trade mark should be objected to but with careful analysis of the goods and services concerned and the situation on the market.

The criteria to assess the distinctiveness of colour marks designating services should not be different from those applicable to colour marks designating goods (as recalled by the General Court in its judgment of 12/11/2010, T-404/09, *Grau/Rot*, EU:T:2010:466). In this case, the colour combination applied for was considered not to differ for the relevant consumer in a perceptible manner from the colours usually used for the services concerned. The General Court concluded that the colour combination applied for was very close to the combination 'white/red' used on the railway crossing gates and traffic signs associated with train traffic and that the sign, as a whole, would be recognised by the relevant public as a functional or decorative element and not as an indication of the commercial origin of the services.

The higher the number is, the less distinctiveness is likely, because of the difficulty of memorising a high number of different colours and their sequence.

For the names of colours see paragraph 2.3.2.9 below.

2.2.5 Single letters²

2.2.5.1 General considerations

In its judgment of 09/09/2010, C-265/09 P (α), EU:C:2010:508, the Court of Justice ruled that, in the case of trade marks consisting of single letters represented in standard characters with no graphic modifications, it is necessary to assess whether the sign at issue is capable of distinguishing the different goods and services in the context of an examination, based on the facts, focusing on the goods or services concerned (para. 39).

The Court recalled that, according to Article 4 EUTMR, letters are among the categories of signs of which an EU trade mark may consist, provided that they are capable of distinguishing the goods or services of one undertaking from those of other undertakings (para. 28), and emphasised that registration of a sign as a trade mark does not require a specific level of linguistic or artistic creativity or imaginativeness on the part of the applicant.

Although acknowledging that it is legitimate to take into account the difficulties in establishing distinctiveness that may be associated with certain categories of trade marks because of their very nature, and that it may prove more difficult to establish distinctiveness for marks consisting of a single letter than for other word marks (para. 39), the Court clearly stated that these circumstances do not justify laying down specific criteria supplementing or derogating from application of the criterion of distinctiveness as interpreted in the case-law (paras 33-39).

² This part deals with single letters under Article 7(1)(b) EUTMR. For single letters under Article 7(1)(c) EUTMR, see paragraph 2.3.2.8 below.

As to the burden of proof, the Court stated that when examining absolute grounds for refusal, the Office is required under Article 76(1) EUTMR to examine, of its own motion, the relevant facts that might lead it to raise an objection under Article 7(1) EUTMR and that that requirement cannot be made relative or reversed to the detriment of the EUTM applicant (paras 55-58). Therefore, it is for the Office to explain, with motivated reasoning, why a trade mark consisting of a single letter represented in standard characters is devoid of any distinctive character.

It is therefore necessary to carry out a thorough examination based on the specific factual circumstances of the case in order to assess if a given single letter represented in standard characters can function as a trade mark in respect of the goods/services concerned. This need for a factual assessment implies that it is not possible to rely on assumptions (such as that consumers are generally not accustomed to seeing single letters as trade marks).

Consequently, when examining single letter trade marks, generic, unsubstantiated arguments such as those relating to the availability of signs should be avoided, given the limited number of letters. The Office is obliged to establish, on the basis of a factual assessment, why the applied for trade mark would be objectionable.

It is therefore clear that the examination of single letter trade marks should be thorough and stringent, and that each case calls for careful examination of whether a given letter can be considered inherently distinctive for the goods and/or services concerned.

2.2.5.2 Examples

For instance, in technical domains such as those involving computers, machines, motors and tools, it is more likely that single letters will be perceived as technical, model or catalogue references rather than as indicators of origin, although the fact that this is the case should result from a factual assessment.

Depending on the outcome of the prior examination, a trade mark consisting of a single letter represented in standard characters might be objectionable under Article 7(1)(b) EUTMR on the ground that it is devoid of inherent distinctiveness for the goods and/or services concerned or part thereof.

This would be the case, for example, for a trade mark consisting of the single letter 'C' for 'fruit juices', as this letter is commonly used to designate vitamin C. The relevant public would not perceive it as a sign distinguishing the commercial origin of the goods in question.

Other examples of lack of distinctiveness would be single-letter trade marks applied for in respect of toy cubes, which are often used to teach children how to construct words by combining letters appearing on the cubes themselves, without however describing the product as such, or single letters applied for in respect of lottery services, a sector in which letters are often used to indicate different series of numbers.

Although in both the above cases there is no direct descriptive relationship between the letters and the goods/services, a trade mark consisting of a single letter would lack distinctiveness, because when it comes to toy cubes and lotteries, consumers are more used to seeing single letters as having either a functional or a utilitarian connotation, rather than as indicators of commercial origin.

However, if it cannot be established that a given single letter is devoid of any distinctive character for the goods and/or services concerned, then it should be accepted, even if represented in standard characters or in a fairly basic manner.

W

For example, the letter **W** was accepted in respect of 'transport; packaging and storage of goods; travel arrangement' in Class 39 and 'services for providing food and drink; temporary accommodation' in Class 43 (decision of 30/09/2010, R 1008/2010-2, § 12-21).

For further examples see paragraph 2.3.2.8 below.

2.2.6 Slogans: assessing distinctive character

The Court of Justice has ruled that it is inappropriate to apply to slogans stricter criteria than those applicable to other types of signs when assessing their distinctive character (judgment of 12/07/12, C-311/11 P, WIR MACHEN DAS BESONDERE EINFACH, EU:C:2012:460 and case-law cited).

Advertising slogans are objectionable under Article 7(1)(b) EUTMR when the relevant public perceives them as a mere promotional formula. However, they are deemed to be distinctive if, apart from their promotional function, the public perceives them as an indication of the commercial origin of the goods or services in question.

The Court of Justice has provided the **following criteria** that should be used when assessing the distinctive character of a slogan (judgments of 21/01/2010, C-398/08 P, VORSPRUNG DURCH TECHNIK, EU:C:2010:29, § 47, and of 13/04/2011, T-523/09, WIR MACHEN DAS BESONDERE EINFACH, EU:T:2011:175, § 37).

An advertising slogan is likely to be distinctive whenever it is seen as more than a mere advertising message extolling the qualities of the goods or services in question because it:

- has a number of meanings and/or
- constitutes a play on words and/or
- introduces elements of conceptual intrigue or surprise, so that it may be perceived as imaginative, surprising or unexpected, and/or
- has some particular originality or resonance and/or
- triggers in the minds of the relevant public a cognitive process or requires an interpretative effort.

In addition to the above, the following characteristics of a slogan may contribute towards a finding of distinctiveness:

- unusual syntactic structures
- the use of linguistic and stylistic devices such as alliteration, metaphors, rhyme, paradox, etc.

However, the use of unorthodox grammatical forms must be carefully assessed because advertising slogans are often written in a simplified form, in such a way as to make them more concise and snappier (inter alia, judgment of 24/01/2008, T-88/06, SAFETY 1ST, EU:T:2008:15, § 40). This means that a lack of grammatical elements such as definite articles or pronouns (THE, IT, etc.), conjunctions (OR, AND, etc.) or

prepositions (OF, FOR, etc.) may not always be sufficient to make the slogan distinctive. In ‘SAFETY 1ST’, the Court considered that the use of ‘1ST’ instead of ‘FIRST’ was not sufficiently unorthodox to add distinctiveness to the mark.

A slogan whose meaning is vague or impenetrable or whose interpretation requires considerable mental effort on the part of the relevant consumers is also likely to be distinctive since consumers would not be able to establish a clear and direct link with the goods and services claimed.

The fact that the **relevant public is a specialist one** and its degree of attention is higher than average cannot decisively influence the legal criteria used to assess the distinctive character of a sign. As stated by the Court of Justice, ‘it does not necessarily follow that a weaker distinctive character of a sign is sufficient where the relevant public is specialist’ (judgment of 12/07/12, C-311/11 P, WIR MACHEN DAS BESONDERE EINFACH, EU:C:2012:460, § 48).

Moreover, according to well-established case-law from the General Court, the level of attention of the relevant public may be **relatively low** when it comes to promotional indications, whether what is involved are average end consumers or a more attentive public made up of specialists or circumspect consumers. This finding is applicable even for goods and/or services where the level of attention of the relevant public is generally high, such as financial and monetary services (judgments of 29/01/2015, T-609/13 SO WHAT DO I DO WITH MY MONEY, EU:T:2015:54, § 27 and T-59/14 INVESTING FOR A NEW WORLD, EU:T:2015:56, § 27 and quoted case-law).

The following examples show some of the different functions that slogans may serve and the arguments that can support an **objection** under Article 7(1)(b) EUTMR.

EUTM	Main function	Case No
EUTM No 5 904 438 MORE THAN JUST A CARD for Class 36 <i>(bank, credit and debit card services)</i>	Customer service statement	R 1608/2007-4
Objected to under Article 7(1)(b) EUTMR The slogan merely conveys information about the goods and services applied for. It is the kind of language an English speaker would use to describe a bank card that is a little out of the ordinary. It conveys the notion that the card has welcome features that are not obvious at first sight. The fact that the slogan leaves open what these features are, that is to say that the mark does not describe a specific service or characteristic of the ‘card’, does not make the mark distinctive.		
EUTM	Main function	Case No
EUTM No 7 394 414 WE PUT YOU FIRST. AND KEEP YOU AHEAD for Class 40	Customer service statement	(Examiner’s decision without BOA case)
Objected to under Article 7(1)(b) EUTMR The mark is a promotional laudatory message, highlighting the positive aspects of the services, namely that they help to procure the best position in the business and maintain this position in the future.		

EUTM	Main function	Case No
EUTM No 6 173 249 SAVE OUR EARTH NOW for Classes 3, 17, 18, 20, 22, 24, 25 and 28	Value statement or political motto	R 1198/2008-4
<p>Objected to under Article 7(1)(b) EUTMR</p> <p>The sign is a simple and straightforward appeal to take action and contribute to the earth's well-being by favouring the purchase of environment-friendly products. Contrary to the appellant's contentions that the word 'now' constitutes an original element since nobody will believe that by purchasing the goods in question they will literally save the Earth now, the word 'NOW' is an emotional word commonly used in marketing to urge consumers to consume, to get what they want without waiting; it is a call to action. The relevant consumer will immediately recognise and perceive the sign as a promotional laudatory expression indicating that the goods represent an environment-friendly alternative to other goods of the same sort, and not as an indication of commercial origin.</p>		
EUTM	Main function	Case No
EUTM No 4 885 323 DRINK WATER, NOT SUGAR for Classes 32 and 33	Inspirational or motivational statement	R 718/2007-2
<p>Objected to under Article 7(1)(b) EUTMR</p> <p>The mark is a banal slogan that merely conveys the idea that the consumer will be drinking real water rather than a sugary drink. The mark lacks any secondary or covert meaning, has no fanciful elements, and its message to the consumer is plain, direct and unambiguous. For these reasons, it is unlikely to be perceived as a sign of trade origin. It is easily seen that the mark consists merely of good counsel, namely that it is better from a health point of view to drink water that has not been sugared. What better way to promote such goods than by an expression such as DRINK WATER, NOT SUGAR? Consumers will read this with approval, but will look elsewhere on the product for the trade mark.</p>		
EUTM	Main function	Case No
DREAM IT, DO IT! Classes 35, 36, 41 and 45	Inspirational or motivational statement	T-186/07
<p>The relevant English-speaking public will see this as an invitation or encouragement to achieve their dreams and will understand the message that the services covered by that trade mark will allow them to do so.</p>		
EUTM	Main function	Case No
VALORES DE FUTURO for Class 41	Value statement	Judgment of 06/12/2013, T-428/12
<p>Objected to under Article 7(1)(b) EUTMR</p> <p>The relevant public when confronted with the expression VALORES DE FUTURO will perceive a laudatory message whose only objective is to give a positive view of the services involved.</p>		
EUTM	Main function	Case No
INVESTING FOR A NEW WORLD Classes 35 and 36	Value statement	Judgment of 29/01/2015, T-59/14
<p>Objected to under Article 7(1)(b) EUTMR</p> <p>The sign INVESTING FOR A NEW WORLD, considered as a whole, may be easily understood by the relevant public, in view of the common English words of which it consists, as meaning that the services offered are intended for a new world's needs. Given that the services covered by the mark applied for are all related to activities connected with finance and have a close link with the word 'investing', the Board of Appeal was right to find that the message conveyed by the expression 'investing for a new world' was that, when purchasing the services in question, the money or capital invested created an opportunity in a new world, which carried a positive connotation. The Court also found that the fact that the expression at issue could be interpreted in a number of ways did not alter its laudatory nature.</p>		

EUTM	Main function	Case No
SO WHAT DO I DO WITH MY MONEY Classes 35 and 36	Value statement	Judgment of 29/01/2015, T-609/13
<p>Objected to under Article 7(1)(b) EUTMR</p> <p>The expression 'so what do I do with my money' prompts consumers to ask themselves what they should do with their financial resources and assets. In the present case, the average reasonably well-informed and reasonably observant and circumspect consumer of the services covered by the application for registration will, on reading or hearing that expression, ask himself/herself whether he/she is using his/her money effectively.</p>		
EUTM	Main function	Case No
PIONEERING FOR YOU Classes 7, 9, 11, 37 and 42	Value statement	Judgment of 12/12/2014, T-601/13
<p>Objected to under Article 7(1)(b) EUTMR</p> <p>The sign would be understood as 'innovative for you'. The meaning of the sign is clear and does not leave any doubts. The structure of the sign is grammatically correct and does not trigger any mental process in order to arrive at its meaning. It is, as a whole, a simple message that could be attributed to any producer or service provider with the natural consequence that it does not indicate the origin of the goods or services</p>		

Some examples of **accepted** slogans:

EUTM	Classes	Case No
SITEINSIGHTS	Classes 9 and 42	R 879/2011-2, EUTM No 9 284 597
EUTM	Classes	Case No
THE PHYSICIAN DRIVEN IMAGING SOLUTION	Classes 9, 16 and 42	IR No 01 096 100
EUTM	Classes	Case No
WET DUST CAN'T FLY	Classes 3, 7 and 37	T-133/13
<p>The concept of 'wet dust' is literally inaccurate, since dust is no longer dust when it is wet. Consequently, the juxtaposition of those two words gives that concept a fanciful and distinctive character.</p>		





A slogan is objectionable under Article 7(1)(c) EUTMR if it immediately conveys information about the kind, quality, intended purpose or other characteristics of the goods or services (see paragraph 2.3.2.5 below).

2.2.7 Simple figurative elements

Simple geometric devices such as circles, lines, rectangles or common pentagons are unable to convey any message that can be remembered by consumers and will accordingly not be seen by them as a trade mark.

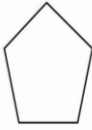
As set out by the Court, an extremely simple sign, composed of a basic geometric figure such as a circle, a line, a rectangle or a pentagon is not capable, as such, of conveying a message that consumers can remember, with the result that they will not consider it as a trade mark (T-304/05, § 22).

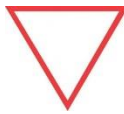
Examples of refused trade marks

Sign	G&S	Reasoning	Case
	Class 33	The sign consists merely of a normal pentagon, a simple geometric figure. The geometric form, if it happened to be the form of the label, would be perceived as having a functional or aesthetic purpose rather than an origin function.	Judgment of 12/09/2007, T-304/05, Pentagon, EU:T:2007:271
	Classes 9, 14, 16, 18, 21, 24, 25, 28, 35-39, 41-45	The sign will be perceived as an excessively simple geometric shape, essentially as a parallelogram. To fulfil the identification function of a trade mark, a parallelogram should contain elements which singularise it in relation to other parallelograms' representations. The two characteristics of the sign are the fact that it is slightly inclined towards the right and that the base is slightly rounded and stretched out towards the left. Such nuances would not be perceived by the general consumer.	Judgment of 13/04/2011, T-159/10, Parallelogram, EU:T:2011:176
	Classes 14, 18, 25	The sign does not contain any elements that may be easily and instantly memorised by an attentive relevant public. It will be perceived only as a decorative element, regardless of whether it relates to goods in Class 14 or to those in Classes 18 and 25.	Judgment of 29/09/2009, T-139/08, Smiley, EU:T:2009:364
	Class 9	The sign consists of a basic equilateral triangle. The inverted configuration and red outline of the triangle do not serve to endow the sign with distinctive character. The sign's overall impact remains that of a simple geometric shape that is not capable of transmitting a trade mark message prima facie.	International registration No 01 091 415
	Classes 3, 18, 24, 43, 44	The sign consists of merely a simple geometric figure in green. The specific colour is commonly and widely used in advertising and in the marketing of goods and services for the power to attract without giving any precise message.	Judgment of 09/12/2010, T-282/09, Carré convexe vert, EU:T:2010:508

Example of an accepted trade mark

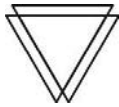
Sign	G&S	Reasoning	Case
	Classes 35, 41	The sign consists of a design featuring overlapping triangular elements. The overall impression created is far more complex than that of a simple geometric shape.	EUTM No 10 948 222

2.2.8 Commonplace figurative elements

The following representation of a vine leaf is not distinctive for wine:



Similarly, the following representation of a cow for milk products is not distinctive:



EUTM No 11 345 998, claiming Classes 29 (milk and milk products, etc.) and 35.

The above sign was refused, as representations of cows are commonly used in relation to milk and milk products. The fact that the subject mark consists of an 'aerial' picture of a cow is not sufficient to confer distinctive character to the sign, as slight alterations to a commonplace sign will not make that sign distinctive. The same reasoning would be applicable also to related goods such as 'milk chocolate'.

2.2.9 Typographical symbols

Typographical symbols such as a dot, comma, semicolon, quotation mark or exclamation mark will not be considered by the public as an indication of origin. Consumers will perceive them as a sign meant to catch the consumer's attention but not as a sign that indicates commercial origin. A similar reasoning applies to common currency symbols, such as the €, £, \$ signs; depending on the goods concerned, these signs will only inform consumers that a specific product or service is traded in that currency.

The following marks were objected to.



Sign	G&S	Reasoning	Case
	Classes 14, 18 and 25	The GC confirmed the finding of the BoA that the trade mark applied for is devoid of the necessary degree of distinctive character. It consists merely of a punctuation mark with no special additional features immediately apparent to customers, and is a commonplace sign that is frequently used in business or in advertising. In view of its frequent use, the relevant consumer will see the exclamation mark as being merely laudatory advertising or something to catch the eye (see judgment of 30/09/2009, T-75/08, !, EU:T:2009:374).	EUTM No 5 332 184

Sign	G&S	Reasoning	Case
	<p>Classes 29, 30, 31 and 32</p>	<p>The sign applied for was refused because, in the case of the claimed goods (foodstuff and beverages), percentages are particularly important in relation to the price. For example, the percentage sign indicates clearly that there is a favourable cost/benefit ratio because the price has been reduced by a particular percentage in comparison with the normal price. Such a per cent sign in a red circle is also frequently used in connection with clearance sales, special offers, stock clearances or cheap no-name products, etc. The consumer will regard the sign merely as a pictogram conveying the information that the goods claimed are sold at a reduced price (see decision of 16/10/2008, R 998/2008-1, 'Prozentzeichen').</p>	<p>EUTM No 5 649 256</p>

2.2.10 Pictograms

Pictograms are basic and unornamented signs and symbols that will be interpreted as having purely informational or instructional value in relation to the goods or services concerned. Examples would be signs that indicate mode of use (like a picture of a telephone in relation to pizza delivery services) or that convey a universally understandable message (like a knife and fork in relation to the provision of food).



Commonly used pictograms, for example a white 'P' on a blue background to designate a parking place (this sign could also be objectionable under Article 7(1)(d)) or the design of an ice cream to designate that ice cream is sold in the vicinity, are not distinctive in relation to the goods or services in respect of which they are used.

Sign	Reasoning	Case
	<p>Taking into account the kind of goods and services applied for in Classes 9, 35, 36, 38 and 42 (for example cash dispensers, banking services), the public will see the sign as a practical indication or as directional arrows showing where the magnetic card has to be inserted into the distributor. The association of the triangles to the other elements of the trade mark applied for means that the public concerned will perceive them as directional arrows. Consumers see this type of practical information every day in all kinds of places, such as banks, supermarkets, stations, airports, car parks, telephone boxes, etc. (paras 37-42).</p>	<p>Judgment of 02/07/2009, T-414/07, Main tenant une carte, EU:T:2009:242</p>
 <p>EUTM No 9 894 528 for goods in Class 9</p>	<p>The above sign was refused as it is identical to the core of the international safety symbol known as 'high voltage symbol' or 'caution, risk of electric shock'. It has been officially defined as such by ISO 3864 as the standard high voltage symbol, whereby the device applied for is contained within the triangle that denotes that it is a hazard symbol. Because this sign essentially coincides with the customary international sign to indicate a risk of high voltage, it was refused under Article 7(1)(b) EUTMR.</p>	<p>Decision of 21/09/2012, R 2124/2011-5, 'Device of lightning bolt'</p>

2.2.11 Common/non-distinctive labels

A figurative sign may be composed of shapes, designs or figures that will be perceived by the relevant public as non-distinctive labels. Moreover, in this case the reason for the refusal lies in the fact that such figurative elements are not capable of impressing themselves in the consumer’s mind, since they are too simple and/or commonly used in connection with the goods/services claimed.

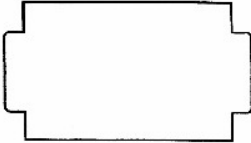
See the following examples

Sign	Reasoning	Case
 EUTM No 4 373 403, filed as a three-dimensional mark claiming goods in Class 16 (Adhesive labels; adhesive labels for use with hand labelling appliances; and labels (not of textile))	The mark applied for is ‘devoid of any distinctive character’ and was refused under Article 7(1)(b) EUTMR as it is as banal and ordinary as it is possible to get in relation to adhesive labels. The sign says a lot about the nature of the goods and very little, if anything, about the identity of the producer (para. 11).	Decision of 22/05/2006, R 1146/2005-2
 EUTM No 9 715 319 for goods in Classes 6, 7, 8, 9 and 20	The mark was refused, as its basic shape combined only with a bright colour yellow could not, in the minds of the relevant professional and general public, serve to distinguish the goods applied for as originating from a particular undertaking. Here, the colour yellow may be perceived as a decoration for the goods, as well as for the purpose of attracting attention to the goods without giving any specific information or precise message as to the commercial origin of the goods. In addition, as is generally known, the bright colour yellow is commonly used in a functional way in relation to a wide range of goods, i.e., inter alia, for increasing the visibility of objects, highlighting or warning. For these reasons, the relevant consumers will not recognise this colour as a trade mark, but will perceive it in its alerting function or its decorative function.	Decision of 15/01/2013, R 0444/2012-2, Device of a label in yellow colour

In the same way, the following marks were rejected.

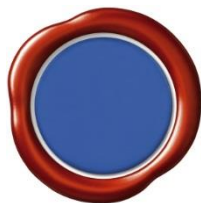

EUTM No 11 177 912 claiming Classes 29, 30 and 31



EUTM No 11 171 279 claiming Classes 29, 30 and 31



EUTM No 10 776 599 claiming, inter alia, goods in Classes 32 and 33

In the three preceding cases, both the colour and the shape of the labels are quite commonplace. The same reasoning applies to the stylised representation of the fruits

in the last of the three cases. Furthermore, the said figurative element represents or at least strongly alludes to the ingredients of some of the claimed goods, such as, for example, fruit juices.

2.2.12 Three-dimensional trade marks

2.2.12.1 Preliminary remarks

Article 7(1)(b) EUTMR does not distinguish between different categories of trade marks in determining whether a trade mark is capable of distinguishing the goods or services of one undertaking from those of other undertakings (see judgment of 05/03/2003, T-194/01, Soap device, EU:T:2003:53, § 44). In applying this uniform legal standard to different trade marks and categories of trade marks, a distinction must be made in accordance with consumer perception and market conditions.

For signs consisting of the shape of the goods themselves, no stricter criteria shall apply than for other marks, but it may be more difficult to come to a finding of distinctiveness, as such marks will not necessarily be perceived by the relevant public in the same way as a word or figurative mark (see judgment of 08/04/2002, C-136/02 P, Torches, EU:C:2004:592, § 30).

Three-dimensional trade marks can be grouped into three categories:

- shapes unrelated to the goods and services themselves
- shapes that consist of the shape of the goods themselves or part of the goods
- the shape of packaging or containers.

2.2.12.2 Shapes unrelated to the goods or services themselves

Shapes that are unrelated to the goods or services themselves (e.g. the Michelin Man) are usually distinctive.

2.2.12.3 Shape of the goods themselves or shapes related to the goods or services.

The case-law developed for three-dimensional marks that consist of the representation of the shape of the product itself is also relevant for figurative marks consisting of two-dimensional representations of the product or elements of it (see judgment of 14/09/2009, T-152/07, Uhr, EU:T:2009:324).

For a shape that is the shape or the packaging of the goods applied for, the examination should be conducted in the three following steps.

Step 1: Article 7(1)(e) EUTMR analysis

In principle, the examiner should first examine whether one of the grounds for refusal under Article 7(1)(e) EUTMR applies, as those cannot be overcome through acquired distinctiveness. With regard to this first step, see paragraph 2.5 below.

Step 2: Identifying the elements of the three-dimensional trade mark

In the second step, the examiner should determine whether the representation of the three-dimensional trade mark contains **other elements** such as words or labels that might give the trade mark a distinctive character. As a general principle, any element that on its own is distinctive will lend the 3D trade mark distinctive character as long as it is perceivable in the normal use of the product. Typical examples are words or figurative elements or a combination of these that appear on the exterior of the shape and remain clearly visible, such as labels on bottles. Consequently, even the standard shape of a product can be registered as a 3D trade mark if a distinctive word mark or label appears on it.

Sign	Case
	<p>R 1354/2007-1</p>
<p>The clearly legible words 'BEN BRACKEN' on the base of the bottle suffice on their own to impart distinctive character to the trade mark as a whole (para. 19).</p>	

However, non-distinctive elements or descriptive elements combined with a standard shape will not endow distinctiveness upon that shape (judgment of 18/01/2013, T-137/12, Vibrator, EU:T:2013:26, § 34-36).

Sign	Case
	<p>T-323/11</p>
<p>An image depicting certain stones is embossed on the central part of the bottle.</p> <p>The Court confirmed the BoA decision when it considered that the applicant had failed to prove that European consumers have sufficient information and knowledge to recognise that the embossing on the central part of the bottle at issue depicts the twelve-angle stones used in Inca constructions. Without that proof, European consumers will merely perceive the embossing as such without being aware of its significance, from which it follows that they will simply perceive it as a mere decoration without any distinctive character, because it is not particularly original or striking and, therefore, it will not serve to differentiate the bottle in question from the other bottles widely used in the packaging of beers (para. 25 and following).</p>	

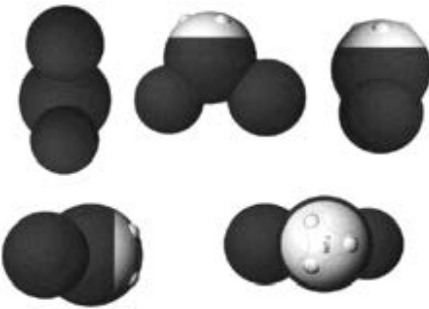
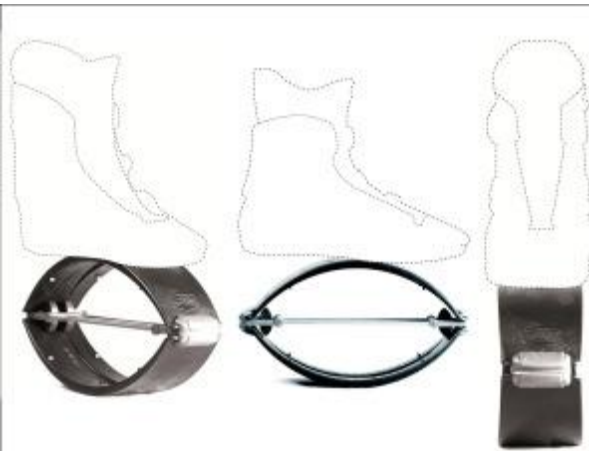
Sign	Case
	<p>T-137/12</p>
<p>The Court considered that the descriptive element 'fun' could not confer distinctiveness on the 3D sign. Moreover, BoA was right not to take into account the element 'factory' written above the word 'fun' as it was illegible in the application (para. 34 and following).</p>	
Sign	Case
	<p>R 1511/2013-2 (T-390/14 appeal pending)</p>
<p>BoA confirmed that the figurative element 'KANGOO JUMPS' (in both the upper spring layer and the lower spring layer) and the letters 'KJ' and 'XR' (at the ends of the intermediate elastic plastic straps) could only be seen with great difficulty or were not visible at all. Therefore, parts that can only be noticed by detailed analysis, like the present ones, will, in general, not be perceived as an indication of origin (para. 29).</p>	

Step 3: Criteria for distinctiveness of the shape itself

Lastly, the criteria for **distinctiveness of the shape itself** must be checked. The basic test is whether the shape is so materially different from basic, common or expected shapes that it enables a consumer to identify the goods just by their shape and to buy the same item again if he has had positive experiences with the goods. Frozen vegetables in the form of a crocodile are a good example for this.

The following criteria are relevant when examining the distinctiveness of three-dimensional trade marks consisting exclusively of the shape of the goods themselves:

- A shape is non-distinctive if it is a basic shape (judgment of 19/09/2001, T-30/00, TABS-SQUARE/RED/WHITE, EU:T:2001:223) or a combination of basic shapes (see BoA decision of 13/04/2000, R 0263/1999-3).
- To be distinctive, the shape must depart significantly from the shape which is expected by the consumer, and it must depart significantly from the norm or customs of the sector. The more closely the shape resembles the shape that is

most likely to be taken by the product in question, the greater the likelihood that it is not distinctive (judgment of 08/04/2002, C-136/02 P, *Torches*, EU:C:2004:592, § 31).

- It is not enough for the shape to be just a variant of a common shape or a variant of a number of shapes in an area where there is a huge diversity of designs (judgments of 08/04/2002, C-136/02 P, *Torches*, EU:C:2004:592, § 32 and 07/02/2002, T-88/00, *Torches*, EU:T:2002:28, § 37).
- Functional shapes or features of a three-dimensional mark will be perceived by the consumer as such. For example, for washing tablets, bevelled edges avoid damage to the laundry, and layers of different colours represent the presence of different active ingredients.

While the public is accustomed to recognising a three-dimensional mark as an indicator of source, this is not necessarily the case where the three-dimensional sign is indistinguishable from the product itself. Consequently, an assessment of distinctive character cannot result in different outcomes for a three-dimensional mark consisting of the design of the product itself and for a figurative mark consisting of a faithful representation of the same product (judgment of 19/09/2001, T-30/00, *TABS-SQUARE/RED/WHITE*, EU:T:2001:223, § 49).

Specific case: 3D toys, dolls and play figures

Applications for 3D marks in respect of toys, dolls and play figures in Class 28, or for figurative marks consisting of a faithful representation of such goods, must be assessed in the **same way as other 3D marks**.



To be distinctive, the shape must depart significantly from the shape that is expected by the consumer. In other words, it must depart significantly from the norm or customs of the sector so that it enables a consumer to identify the goods just by their shape.

This may be complicated by the sheer volume and proliferation of toy animals, figures, dolls and assorted characters in this market sector. Simply adding a **basic set of clothing or basic human characteristics** such as eyes or a mouth to a common plush toy such as a rabbit or a cat will generally not suffice. It is commonplace to present toy dolls and animals in clothing and to provide separately a range of clothing options, so that the user of such goods can change the appearance of the toy. It is also common to humanise the toys to make them more attractive. Within such a high-volume marketplace, the presentation of these goods in such a way will invariably leave the relevant consumer struggling, without prior exposure, to perceive a badge of origin in such marks.

The more basic the character, the more unusual the additional elements must be in order to create a whole that serves to ensure that the relevant public is able to distinguish the applicant's goods from similar goods provided by other undertakings. The final conclusion must be based on the **appearance of the sign as a whole**.

Examples:

The following is a list of examples of shapes of goods applied for and an analysis of them.

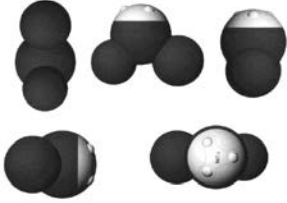
Sign	Reasoning	Case
	<p>Figurative marks showing a graphic representation of a naturalistic reproduction of the goods themselves are not distinctive in relation to such goods. The representation of a tablet for 'washing or dishwashing preparations in tablet form' was refused. The shape, namely a rectangular tablet, is a basic shape and an obvious one for a product intended for use in washing machines or dishwashers. The slightly rounded corners of the tablet are not likely to be perceived by the consumer as a distinctive feature of the shape at issue (judgment of 19/09/2001, T-30/00, TABS-SQUARE/RED/WHITE, EU:T:2001:223, § 44 and 53). The same approach has been confirmed by several judgments, including the judgment of 04/10/2007, C-144/06 P, Tabs, EU:C:2001:577.</p>	<p>Judgment of 19/09/2001, T-30/00, TABS - SQUARE/RED/WHITE EU:T:2001:223</p>
	<p>This shape was refused as it is merely a variant of a common shape of this type of product, i.e. flashlights (para. 31).</p>	<p>Judgment of 08/04/2002, C-136/02 P, Torches, EU:C:2004:592</p>
	<p>This shape was refused because it does not depart significantly from the norm or customs of the sector. Even though the goods in this sector typically consist of long shapes, various other shapes exist in the market that are spherical or round (para. 29). The addition of the small descriptive word element 'fun factory' does not remove the overall shape from the scope of non-distinctiveness (para. 36).</p>	<p>Judgment of 18/01/2013, T-137/12, Vibrator, EU:T:2013:26.</p>

Sign	Reasoning	Case
	<p>The Court of Justice confirmed the refusal of this three-dimensional sign as being not sufficiently different from the shapes and colours of those commonly used in the sweets and chocolate sectors. The combination with figurative elements will not lead to the application of the criteria for two-dimensional marks.</p>	<p>Judgment of 06/09/2012, C-96/11 P, Milchmäuse, EU:C:2012:537</p>
	<p>This three-dimensional mark consisting of a handle, applied to goods in Class 8 (hand-operated implements used in agriculture, horticulture and forestry, including secateurs, pruning shears, hedge clippers, shearers (hand instruments)), was refused.</p>	<p>Judgment of 16/09/2009, T-391/07, Teil des Handgriffes, EU:T:2009:336</p>
	<p>The Court confirmed the case-law on non-distinctiveness of three-dimensional trade marks in the form of a product or its packaging. Even if the oval shape in the EUTM application has a complex hollow on its surface, this cannot be considered as a significant difference to the shapes of confectionery available on the market.</p>	<p>Judgment of 12/12/2013, T-156/12 Oval, EU:T:2013:642</p>
	<p>The parrot figure applied for, on its own, does not depart from the usual form of parrot toys sufficiently to be seen as a trade mark. Its coat colour resembles the green colour quite common among parrots. Its head is bigger than normal and it is standing on its hind legs, but in the Board's opinion, the majority of consumers would perceive the parrot shape as an ordinary parrot-shaped toy design, a rather banal toy, but not as an indication of origin (para. 16).</p>	<p>R 2131/2013-5</p>
	<p>Accepted</p>	<p>EUTM No 10 512 218</p>

Analogous criteria, *mutatis mutandis*, apply to shapes related to services, for example the device of a washing machine for laundry services.

2.2.12.4 Shape of the packaging

The same criteria apply for the shape of bottles or containers for the goods. The shape applied for must be materially different from a combination of basic or common elements and must be striking. Also in the area of containers, regard must be had to

any functional character of a given element. As in the field of containers and bottles, the usage in trade might be different for different types of goods, it is recommended to make a search as to which shapes are on the market, by choosing a sufficiently broad category of the goods concerned (i.e. in order to assess the distinctiveness of a milk container, the search must be carried out in relation to containers for beverages in general; see, in that regard, the opinion of the Advocate General of 14/07/2005 in C-173/04, Standbeutel, EU:C:2006:20).

Sign	Reasoning	Case
	<p>The shape applied for was refused as it was considered that bunny-shaped chocolate with gold wrapping is a common phenomenon on the market corresponding to the concerned industry. An analysis of the individual elements, that is, the shape of a rabbit, the gold foil wrapping and the red ribbon with a bell, were held both individually and cumulatively devoid of distinctive character (paras 44-47).</p>	<p>Judgment of 24/05/2012, C-98/11 P, Hase, EU:C:2012:307</p>
	<p>The mark, the representation of a twisted wrapper serving as packaging for sweets (and thus not the product itself) was refused registration as it is a 'normal and traditional shape for a sweet wrapper and ... a large number of sweets so wrapped could be found on the market' (para. 56). The same applies in respect of the colour of the wrapper in question, namely 'light brown (caramel)'. This colour is not unusual in itself, and neither is it rare to see it used for sweet wrappers (para. 56). Therefore, the average consumer will not perceive this packaging in and of itself as an indicator of origin, but merely as a sweet wrapper.</p>	<p>Judgment of 10/11/2004, T-402/02, Bonbonverpackung, EU:T:2004:330</p>
	<p>The refusal of the shape applied for was confirmed by the General Court. The elongated neck and the flattened body do not depart from the usual shape of a bottle containing the claimed goods, namely food products including <i>juices, condiments and dairy products</i>. In addition, neither the length of the neck, its diameter nor the proportion between the width and thickness of the bottle is in any way individual (para. 50). Furthermore, even if the ridges around the sides of the bottle could be considered distinctive, these alone are insufficient to influence the overall impression given by the shape applied for to such an extent that it departs significantly from the norm or customs of the sector (para. 53).</p>	<p>Judgment of 15/03/2006, T-129/04, Plastikflaschenform, EU:T:2006:84</p>
	<p>It is a well-known fact that bottles usually contain lines and creases on them. The relief at the top is not sufficiently striking but will be perceived as a mere decorative element. As a whole, a combination of the elements is not sufficiently distinctive. The average consumer of the goods in Class 32 would not consider the shape as an indicator of origin of goods in Class 32.</p>	<p>Judgment of 19/04/2013, T- 347/10, Getränkeflasche, EU:T:2013:201 'Shape of a drinking bottle'</p>

2.2.13 Pattern marks

A figurative trade mark can be considered as a 'pattern' mark when it consists of a set of elements that are repeated regularly.

Pattern marks may cover any kind of goods and services. However, in practice they are more commonly filed in relation with goods such as paper, fabrics, clothing articles, leather goods, jewellery, wallpaper, furniture, tiles, tyres, building products, etc., that is to say, goods that normally feature designs. In these cases, the pattern is nothing else than the outward appearance of the goods. In this regard it must be noted that, although patterns may be represented in the form of square/rectangular labels, they should nonetheless be assessed as if they covered the entire surface of the goods applied for.

It must also be taken into account that when a pattern mark claims goods such as beverages or fluid substances in general, that is to say goods that are normally distributed and sold in containers, the assessment of the design should be made as if it covered the outward surface of the container/packaging itself.

It follows from the above that, as a rule, in the assessment of the distinctive character of patterns the examiner should use the same criteria that are applicable to three-dimensional marks that consist of the appearance of the product itself (see judgment of 19/09/2012, T-329/10, Stoffmuster, EU:T:2012:436).

With regard to services, examiners should bear in mind that pattern marks will be used in practice on letterheads and correspondence, invoices, internet web sites, advertisements, shop signs, etc.

In principle, if a pattern is commonplace, traditional and/or typical, it is devoid of distinctive character. In addition, patterns that consist of basic/simple designs usually lack distinctiveness. The reason for the refusal lies in the fact that such patterns do not convey any 'message' that could make the sign easily memorable for consumers. Paradoxically, the same applies to patterns composed of extraordinarily complex designs. In these cases the complexity of the overall design will not allow the design's individual details to be committed to memory (judgment of 09/10/2002, T-36/01, Glass pattern, EU:T:2002:245, § 28). Indeed, in many cases the targeted public would perceive patterns as merely decorative elements.



In this regard, it must be taken into account that usually the average consumer tends not to look at things analytically. A trade mark must therefore enable average consumers of the goods/services in question, who are reasonably well informed and reasonably observant and circumspect, to distinguish the product concerned from those of other undertakings without conducting an analytical or comparative examination and without paying particular attention (judgments of 12/02/2004, C-218/01, Perwoll, EU:C:2004:88, § 53, and of 12/01/2006, C-173/04, Standbeutel, EU:C:2006:20, § 29).

The fact that the pattern may also have other functions and/or effects is an additional argument to conclude that it lacks distinctive character. By contrast, if a pattern is fanciful, unusual and/or arbitrary, departs from the norm or customs of the sector or is, more generally, capable of being easily memorised by the targeted consumers, it usually deserves protection as an EUTM.



As seen above, the distinctive character of pattern marks must usually be assessed with regard to goods. Nevertheless, a pattern mark that has been considered devoid of

distinctive character for the goods it covers must also be regarded as lacking distinctiveness for services that are closely connected to those goods. For example, a stitching pattern that is devoid of distinctive character for clothing articles and leather goods must be regarded as lacking distinctiveness also for retail services concerning those goods (see by analogy decision of 29/07/2010, R 868/2009-4, Device of a pocket). The same considerations would apply to a fabric pattern with regard to services such as *manufacture of fabrics*.

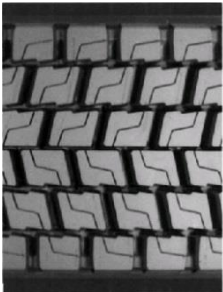
The following is a non-exhaustive list of examples of pattern marks.

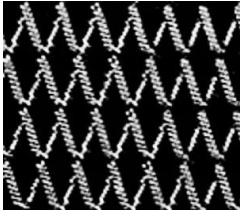
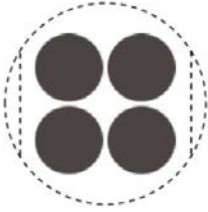
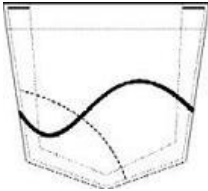
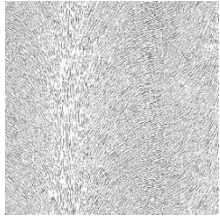
Sign	Reasoning	Case
 <p data-bbox="236 891 523 972">EUTM No 8 423 841, filed as a figurative mark in Classes 18, 24 and 25</p>	<p data-bbox="547 600 1085 958">The criteria for three-dimensional marks consisting of the appearance of the product itself are also applicable to figurative marks consisting of the appearance of the product itself. In general, a mark consisting of a decorative pattern that is simple and commonplace is considered devoid of any element that could attract the consumers' attention, and insufficient to indicate the source or origin of goods or services. The above pattern mark was a textile pattern and therefore considered to comprise the appearance of the products itself, as the mark was applied for in Classes 18, 24 and 25.</p>	<p data-bbox="1109 712 1348 846">Judgment of 19/09/2012, T-326/10, Stoffmuster, EU:T:2012:436, § 47 and 48</p>
 <p data-bbox="236 1303 523 1384">EUTM No 8 423 501, filed as a figurative mark in Classes 18, 24 and 25</p>	<p data-bbox="547 1169 1085 1214">In this case, similarly to the previous case, the General Court confirmed the refusal of the mark.</p>	<p data-bbox="1109 1137 1348 1249">Judgment of 19/09/2012, T-329/10, Stoffmuster, EU:T:2012:436</p>
 <p data-bbox="228 1729 531 1809">EUTM No 5 066 535 filed as a figurative mark in Class 12 (tyres)</p>	<p data-bbox="547 1473 1085 1751">Where the mark consists of a stylised representation of the goods or services, the relevant consumer will see prima facie the mere representation of a specific part of or the entire product. In this case of an application for <i>tyres</i>, the relevant consumer would perceive the mark as merely a representation of the grooves of a tyre, and not an indication of source or origin. The pattern is banal and the mark cannot fulfil its function as indicator of origin.</p>	<p data-bbox="1117 1585 1332 1639">Examiner's decision without BOA case</p>

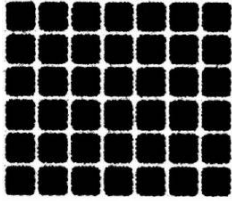
Sign	Reasoning	Case
 <p>EUTM No 9 526 261, filed as a figurative mark (Series of stylised V letters), claiming goods in Classes 16, 18, 25</p>	<p>The mark was rejected for Classes 18 and 25. It was accepted for Class 16. Though the sign was described as a 'series of stylised V letters', the sign would most probably be perceived by the relevant public either as a series of zigzag stitching or as a set of rhomboidal geometric figures. In any case, the pattern is quite simple and banal and thus devoid of any distinctive character.</p>	<p>Examiner's decision without BOA case</p>
 <p>EUTM No 9 589 219, filed as a figurative mark for goods in Class 9</p>	<p>The sign, applied for in respect of 'multi-well plates that can be used in chemical or biological analysis using electrochemiluminescence for scientific, laboratory or medical research use', was refused as it does not serve the purpose of indicating origin. The application described the mark as corresponding to a pattern contained on the bottom of the goods, and the examiner was found to be correct in stating that due to the lack of any eye-catching features, the consumer would be unable to perceive it as anything other than a mere decoration of the goods.</p>	<p>Decision of 09/10/2012, R 412/2012-2, Device of four identically sized circles</p>
 <p>EUTM No 6 900 898, for goods in Classes 18 and 25</p>	<p>The above mark was refused, as patterns stitched on pockets are commonplace in the fashion sector, and this particular pattern does not contain any memorable or eye-catching features likely to confer a minimum degree of distinctive character such as to enable a consumer to perceive it as anything other than a mere decorative element.</p>	<p>Judgment of 28/09/2010, T-388/09, DESIGN OF TWO CURVES CROSSED AT ONE POINT INSERTED ON A POCKET (FIG. MARK) EU:T:2010:410, § 19-27</p>
 <p>EUTM No 3 183 068, filed as a figurative mark, for goods in Classes 19 and 21</p>	<p>The mark, which was to be applied to glass surfaces, was refused under Article 7(1)(b) EUTMR. It was reasoned that the relevant consumer is not used to perceiving designs applied to glass surfaces as an indication of origin and that the design is recognisable as a functional component to make the glass opaque. Furthermore, the complexity and fancifulness of the pattern are insufficient to establish distinctiveness, attributable to the ornamental and decorative nature of the design's finish, and do not allow the design's individual details to be committed to memory or to be apprehended without the product's inherent qualities being perceived simultaneously.</p>	<p>Judgment of 09/10/2002, T-36/01, Glass pattern, EU:T:2002:245, § 26-28</p>

Sign	Reasoning	Case
 <p data-bbox="229 551 531 663">EUTM No 10 144 848, filed as a figurative mark for goods in Classes 3, 5, 6, 10, 11, 12, 16, 18, 20 and 21</p>	<p data-bbox="549 241 1085 736">The mark was refused as it is composed of very simple elements and is a basic and banal sign as a whole. For the claimed goods, such as <i>cleaning cloths</i> and <i>antiseptic wipes</i>, the sign applied for can represent their appearance in the sense that the fabric used may have this structure. The sign is merely a repetition of identical squares that does not display any element or noticeable variation, in particular in terms of fancifulness or as regards the way in which its components are combined, that would distinguish it from the usual representation of another regular pattern consisting of a different number of squares. Neither the shape of each individual square nor the way they are combined are immediately noticeable features that could catch the average consumer's attention and cause the consumer to perceive the sign as a distinctive one.</p>	<p data-bbox="1102 423 1350 562">Decision of 14/11/2012, R 2600/2011-1, Device of a black and white pattern</p>
 <p data-bbox="280 1066 481 1122">EUTM No 370 445 Class 18</p>	<p data-bbox="549 754 1085 1191">The chequerboard pattern is a basic and commonplace figurative pattern, since it is composed of a regular succession of squares of the same size that are differentiated by alternating different colours, in this case brown and beige. The pattern thus does not contain any notable variation from the conventional representation of chequerboards and is the same as the traditional form of such a pattern. Even applied to goods such as those falling within Class 18, the pattern in question does not differ from the norm or customs of the sector inasmuch as such goods are generally covered with fabrics of different kinds, and the chequerboard pattern, due to its great simplicity, might constitute precisely one of those patterns (para. 37).</p>	<p data-bbox="1110 880 1342 1070">T-359/12, Device of a chequered pattern (maroon & beige), EU:T:2015:215 and T-360/12, Coty Germany, EU:C:2014:1318</p>



2.2.14 Position marks

Applications for position marks effectively seek to protect a sign that consists of elements (figurative, colour, etc.) positioned on a particular part of a product and in a particular proportion to the size of the product. The representation of the mark applied for must be accompanied by a description indicating the exact nature of the right concerned.

The factors to be taken into account when examining three-dimensional marks are also relevant for position marks. In particular, the examiner must consider whether the relevant consumer will be able to identify a sign that is different from the normal appearance of the products themselves. A further relevant consideration in dealing with position marks is whether the positioning of the mark upon the goods is likely to be understood as having a trade mark context.

Note that even where it is accepted that the relevant public may be attentive to the different aesthetic details of a product, this does not automatically imply that they will perceive it as a trade mark. In certain contexts, and given the norms and customs of particular trades, a position mark may appeal to the eye as an independent feature being distinguishable from the product itself and thus communicating a trade mark message.

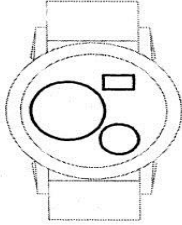
The following are examples of the assessment of position marks.

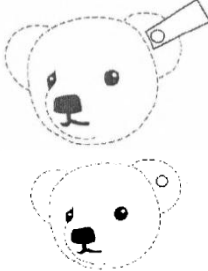
Sign	Reasoning	Case
	<p>In this case, the General Court upheld an objection under Article 7(1)(b) EUTMR. The mark description specified that 'The mark consists of the position of the circular and rectangular fields on a watch face'. The Court considered that the mark was not independent or distinguishable from the form or design of the product itself and that the positioned elements were considered not substantially different from other designs on the market.</p>	<p>Judgment of 14/09/2009, T-152/07, Uhr, EU:T:2009:324</p>
	<p>In this case involving hosiery consisting of an orange strip covering the toe area, the General Court considered that there was no evidence to suggest that the colouring of this part of the product would normally be perceived as having trade mark character. On the contrary it was considered that this feature would be likely to be perceived as a decorative feature falling within the norms and customs of the market sector. The Article 7(1)(b) EUTMR objection was therefore maintained.</p>	<p>Judgment of 15/06/2010, T-547/08, Strumpf, EU:T:2010:235</p>
	<p>Buttons are common decorative elements of soft toys. A button is a simple geometrical form which does not depart from the norm or customs of the sector. It is not uncommon to attach badges, rings, ribbons, loops and embroideries to the ears of a soft toy. The relevant public will therefore perceive the two signs applied for as ornamental elements but not as an indication of commercial origin.</p>	<p>Judgments of 16/01/2014 T-433/12, Knopff im Stofftierohr, EU:T:2014:8 and T-434/12, Fähnchen im Stofftierohr, EU:T:2014:6</p>

2.2.15 Sound marks

The acceptability of a sound mark must, like words or other types of trade marks, depend upon whether the sound is distinctive per se, that is, whether the average consumer will perceive the sound as a memorable one that serves to indicate that the goods or services are exclusively associated with one undertaking.

Consumers are not in the habit of making assumptions about the origin of goods in the absence of any graphic or word element, because generally a sound per se is not commonly used in any field of commercial practice as a means of identification.





The perception of the relevant public is not necessarily the same in the case of a sign consisting of a sound per se as it is in the case of a word or figurative mark consisting of a sign that bears no relation to the appearance of the goods it denotes. While the public is accustomed to perceiving word or figurative marks instantly as signs identifying the commercial origin of the goods, the same is not necessarily true where the sign is merely a sound (by analogy, judgment of 04/10/2007, C-144/06 P, Tabs, § 36). By the same token, **only a sound that departs significantly from the norm or customs of the sector and thereby fulfils its essential function of indicating origin** is not devoid of any distinctive character for the purposes of Article 7(1)(b) EUTMR (by analogy, judgment of 24/05/2012, C-98/11 P, Hase, EU:C:2012:307, § 42).



The kinds of sound marks that are **unlikely** to be accepted without evidence of factual distinctiveness include:

- a) very simple pieces of music consisting of only one or two notes (see examples below);
- b) sounds that are in the common domain (e.g. La Marseillaise, Für Elise);
- c) sounds that are too long to be considered as an indication of origin;
- d) sounds typically linked to specific goods and services (see examples below).

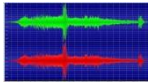
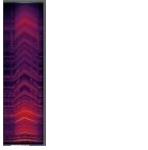
Where the sign applied for consists of a non-distinctive sound but includes **other distinctive elements**, such as words or lyrics, it will be considered as a whole.

Examples

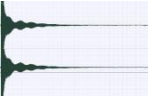
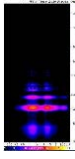
Sign	Description	G&S	Result	Reasoning	Case
	sequence of four different tones initially falling by a fourth and then rising and ending on the mediant	16, 35, 42	Distinctive	jingle-like sound sequences, are capable of identifying goods and services.	R 2056/2013-4
	The first two shorter A notes sound less powerful than the following long and higher C note. The higher and longer C note is thus accentuated on account of its pitch, length and strength.	9, 16, 35, 36, 41, 42	Distinctive	According to general life experience, jingle-like sound sequences, enable distinction between goods and services.	R 0087/2014-5
	Piece of music, three seconds long, combining different tones	9, 14, 16, 21, 25, 28, 35, 38, 41, 43	Distinctive		EUTM 11 074 705
	Computer-generated sound of ten seconds	9, 28, 41	Distinctive		EUTM 11 654 209
	Computer-generated sound of nearly 30 seconds including the sounds of animals followed by the sound of a motor	9, 12	Distinctive		EUTM 10 654 374
	Two musical notes, F and C	35, 36, 38, 39, 41, 42	Not distinctive	A two note 'tune' has no impact on the consumer and will only be perceived by the consumer as a very banal sound, such as the 'ding-dong' of a doorbell.	EUTM 4 010 336

Sign	Description	G&S	Result	Reasoning	Case
	Two extremely short blips	9, 38	Not distinctive	Machine generated blip that is commonly emitted by computers and other electronic devices	EUTM 9 199 167
	'Ping' sound, resembling a warning signal	9, 16, 28	Not distinctive	Sound constitutes a warning signal and a direct characteristic of the goods applied for	R 2444/2013-1
	Machine-generated synthesised sound	9, 12, 35	Not distinctive	Sound typically linked to the goods and services applied for	R 1338/2014-4
	The first 13 notes of 'La Marseillaise'	Any	Not distinctive	A national anthem is in the public domain	Invented example

2.3 Descriptiveness (Article 7(1)(c) EUTMR)

2.3.1 General remarks

2.3.1.1 The notion of descriptiveness

A sign must be refused as descriptive if it has a meaning which is immediately perceived by the relevant public as providing information about the goods and services applied for. This is the case where the sign provides information about, among other things, the quantity, quality, characteristics, purpose, kind and/or size of the goods or services. The relationship between the term and the goods and services must be sufficiently direct and specific (judgments of 20/07/2004, T-311/02, Limo, EU:T:2004:245, § 30; 30/11/2004, T-173/03, Nurseryroom, EU:T:2004:347, § 20), as well as concrete, direct and understood without further reflection (judgment of 26/10/2000, T-345/99, Trustedlink, EU:T:2000:246, § 35). If a mark is descriptive, it is also non-distinctive.

Article 7(1)(c) EUTMR does not apply to those terms that are only suggestive or allusive as regards certain characteristics of the goods and/or services. Sometimes this is also referred to as vague or indirect references to the goods and/or services (judgment 31/01/2001, T-135/99, Cine Action, EU:T:2001:30, § 29).

The public interest underlying Article 7(1)(c) EUTMR is that exclusive rights should not exist for purely descriptive terms that other traders might wish to use as well. However, it is not necessary for the Office to show that there is already a descriptive use by the applicant or its competitors. Consequently, the number of competitors that could be affected is totally irrelevant. Therefore, if a word is descriptive in its ordinary and plain meaning, this ground for refusal cannot be overcome by showing that the applicant is the only person who produces, or is capable of producing, the goods in question.

2.3.1.2 The reference base

The **reference base** is the ordinary understanding of the relevant public of the word in question. That can be corroborated by **dictionary entries**, examples of the use of the term in a descriptive manner found on internet **websites**, or it may clearly follow from the **ordinary understanding** of the term.

It is not necessary for the Office to prove that the word is the subject of a dictionary entry in order to refuse a sign. In particular for composite terms, dictionaries do not mention all possible combinations. What matters is the ordinary and plain meaning. In addition, terms used as specialised terminology to designate the respective relevant characteristics of the goods and services are to be considered descriptive. In these cases it is not required to demonstrate that the meaning of the term is immediately apparent to the relevant consumers to which the goods and services are addressed. It suffices that the term is meant to be used, or could be understood by part of the relevant public, as a description of the claimed goods or services, or a characteristic of the goods and services (judgment of 17/09/2008, T-226/07, PranaHaus, EU:T:2008:381, § 36).

The following **principles** in respect of both language and dictionary use apply, with regards to the reference base.

- The sign must be refused if it is descriptive in any of the **official languages of the European Union**, regardless of the size or population of the respective country. Systematic language checks are only performed in the official languages of the European Union.
- Should there be convincing evidence that a given term has a meaning in a **language other than the official languages of the Union** and is understood by a significant section of the relevant public in at least a part of the European Union, this term must also be refused pursuant to Article 7(2) EUTMR (judgment of 13/09/2012, T-72/11, Espetec, EU:T:2012:424, § 35-36). For example, the term HELLIM is the Turkish translation of the word 'Halloumi', a type of cheese. Since Turkish is an official language in Cyprus, it is a language that is understood and spoken by part of the population of Cyprus, and therefore the average consumer in Cyprus may understand that HELLIM is a descriptive term for cheese (judgment of 13/06/2012, T-534/10, Hellim, EU:T:2012:292).

The **evidence** can come by individual knowledge of the particular examiner, or is produced via third-party observations or by way of documentation included in cancellation requests.

- An internet search is also a valid means of evidence for the descriptive meaning, in particular for new terms, technical jargon or slang words, but the evidence should be carefully assessed in order to find out whether the word is actually used in a descriptive manner, as often the difference between descriptive and trade mark use on the internet is vague and the internet contains a vast amount of unstructured, unverified information or statements.
- The objection should clearly state which language or languages are concerned, which makes the ground for refusal applicable at least for the Member State in which this language is the official language or one of the official languages, and excludes conversion for that Member State (see Rule 45(4) EUTMIR).

Article 7(1)(c) EUTMR also applies to **transliterations**. In particular, transliterations into Latin characters of Greek words must be treated in the same way for the purpose of examining absolute grounds for refusal as words written in Greek characters and vice versa (judgment of 16/12/2010, T-281/09, Chroma, EU:T:2010:537, § 34). This is because the Latin alphabet is known to Greek-speaking consumers. The same applies to the Cyrillic alphabet, which is used in the EU by Bulgarians, who are also familiar with Latin characters.

2.3.1.3 Characteristics mentioned under Article 7(1)(c) EUTMR

Kind of goods and services

This includes the goods or services themselves, that is, their type or nature. For example, 'bank' for financial services, 'Perlé' for wines and sparkling wines (judgment of 01/02/2013, T-104/11, 'Perle') or 'Universaltelefonbuch' for a universal telephone directory (judgment of 14/06/2001, T-357/99 and T-358/99, Universaltelefonbuch, EU:T:2001:162) or constituent parts or components of the goods (judgment of 15/01/2013, T-625/11, EcoDoor, EU:T:2013:14, § 26).

Quality

This includes both laudatory terms, referring to a superior quality of the respective goods or services, as well as the inherent quality of the goods or services. It covers terms such as 'light', 'extra', 'fresh', 'hyper light' for goods that can be extremely light (decision of 27/06/2001, R 1215/00-3, Hyperlite). In addition, figures may refer to the quality of a product or a service, such as 24/7 for service availability; '2000', which refers to the size of the motor or '75', which refers to the horse power (kW) of the motor.

Quantity

This covers indications of the quantity in which the goods are usually sold, such as 'six pack' for beer, 'one litre' for drinks, '100' (grams) for chocolate bars. Only quantity measurements relevant in trade, not those that are hypothetically possible, count. For example, 99.999 for bananas would be acceptable.

Intended purpose

The intended purpose is the function of a product or service, the result that is expected from its use or, more generally, the use for which the good or service is intended. An example is 'Trustedlink' for goods and services in the IT-sector aimed at securing a safe (trusted) link (judgment of 26/10/2000, T-345/99, Trustedlink, EU:T:2000:246). Marks that have been refused registration on this basis include 'Therapy' for massage tools (decision of 08/09/1999, R 0144/99-3, THERAPY) and 'SLIM BELLY' for fitness training apparatus, sport activities, medical and beauty care services (judgment of 30/04/2013, T-61/12, Slim belly, EU:T:2013:226). This objection also applies as regards accessories: a term that described the type of goods also describes the intended purpose for accessories to those goods. Therefore, 'New Born Baby' is objectionable for accessories for dolls and 'Rockbass' for accessories for rock guitars (judgment of 08/06/2005, T-315/03, Rockbass, EU:T:2005:211 (appeal C-301/05 P settled)).

Value

This covers both the (high or low) price to be paid, as well as the value in quality. It covers therefore not only expressions such as 'extra' or 'top', but also expressions such as 'cheap' or 'more for your money'. It also covers expressions indicating, in common parlance, goods or services that are superior in quality.

Geographical origin

See paragraph 2.3.2.6 below.

Time of production of the goods or of rendering of the service

This covers expressions concerning the time at which services are rendered, either expressly ('evening news', '24 hours') or in a usual manner (24/7). It also covers the time at which goods are produced if that is relevant for the goods (late vintage for wine). For wine, the numeral '1998' indicating the vintage year would be relevant, but not for chocolate.

Other characteristics

This covers other characteristics of the goods or services and shows that the preceding list of items in Article 7(1)(c) is not exhaustive. In principle, any characteristic of the goods and services must lead to a refusal under Article 7(1)(c) EUTMR. It does not matter whether the characteristics of the goods or services are commercially essential or merely ancillary or whether there are synonyms of those characteristics (judgments of 12/02/2004, C-363/99, Postkantoor, EU:C:2004:86, § 102; 24/04/2012, T-328/11, EcoPerfect, EU:T:2012:197, § 41).

Examples of 'other characteristics'

- the subject matter contained within the claimed goods or services: (see paragraph 2.3.2.7 below)
- the identification of the targeted consumer: 'children' or 'ellos' (judgment of 27/02/2002, T-219/00, Ellos, EU:T:2002:44) for *clothing*.

2.3.2 Word marks

2.3.2.1 One word

Descriptive terms are those that merely consist of information about the characteristics of the goods and services. This means that descriptive terms cannot fulfil the function of a trade mark. Consequently, the ground for refusal applies irrespective of whether a term is already used by other competitors in a descriptive manner for the goods and services at issue.

In particular, a word is descriptive if either for the general public (if the goods or services target them) or for a specialised public (irrespective of whether the goods or services also target the general public) the trade mark has a descriptive meaning:

- The term 'RESTORE', is descriptive for surgical and medical instruments and apparatus; stents; catheters; and guide wires (judgment of 17/01/2013, C-21/12 P, Restore, EU:C:2013:23)

- 'CONTINENTAL' is descriptive for 'live animals, i.e., dogs' and 'the keeping and breeding of dogs, i.e. puppies and animals for breeding'. Indeed, the word 'Continental' indicates a breed of bulldogs (judgment of 17/04/2013, T-383/10, Continental, EU:T:2013:193).

Furthermore, as seen above, objections should also be raised against terms that describe desirable characteristics of the goods and services.

However, it is important to distinguish laudatory terms that describe — although in general terms — desirable characteristics of goods and services as being cheap, convenient, of high quality, etc. and which are excluded from registration, from those terms that are laudatory in a broader sense, that is to say, they refer to vague positive connotations or to the person of the purchaser or producer of the goods without specifically referring to the goods and services themselves.

Not descriptive:

- 'BRAVO', as it is unclear who says 'BRAVO' to whom, and what is being praised (judgment of 04/10/2001, C-517/99, Bravo, EU:C:2001:510).

2.3.2.2 Combinations of words

As a general rule, a **mere combination of elements**, each of which is descriptive of characteristics of the goods or services themselves, remains descriptive of those characteristics. Merely bringing those elements together without introducing unusual variations, in particular as to syntax or meaning, cannot result in anything other than a descriptive sign.

However, if due to the **unusual nature of the combination** in relation to the goods or services a combination creates an **impression that is sufficiently far removed** from that produced by the mere combination of meanings lent by the elements of which it is composed, that combination will be considered **more than the sum of its parts** (judgment of 12/02/2004, C-265/00, Biomild, EU:C:2004:87, § 39 and 43). These notions, 'unusual nature of the combination', 'impression sufficiently far removed' and 'more than the sum of its parts' have to be interpreted as meaning that Article 7(1)(c) EUTMR does not apply when the way in which the two descriptive elements are combined is in itself fanciful.

The following examples have been **refused** registration:

- 'Biomild' for yoghurt being mild and organic (judgment of 12/02/2004, C-265/00, Biomild, EU:C:2004:87);
- 'Companyline' for insurance and financial affairs (judgment of 19/09/2002, C-104/00 P, Companyline, EU:C:2002:506);
- 'Trustedlink' for software for e-commerce, business consulting services, software integration services and education services for e-commerce technologies and services (judgment of 26/10/2000, T-345/99, Trustedlink, EU:T:2000:246);
- 'Cine Comedy' for the broadcast of radio and television programmes, production, showing and rental of films, and allocation, transfer, rental and other exploitation

of rights to films (judgment of 31/01/2001, T-136/99, Cine Comedy, EU:T:2001:31);

- 'Teleaid' for electronic devices for transferring speech and data, repair services for automobiles and vehicle repair, operation of a communications network, towing and rescue services and computing services for determining vehicle location (judgment of 20/03/2002, T-355/00, Tele Aid, EU:T:2002:79);
- 'Quickgripp' for hand tools, clamps and parts for tools and clamps (order of 27/05/2004, T-61/03, Quick-Grip, EU:T:2004:161);
- 'Twist and Pour' for hand held plastic containers sold as an integral part of a liquid paint containing, storage and pouring device (judgment of 12/06/2007, T-190/05, Twist & Pour, EU:T:2007:171);
- 'CLEARWIFI' for telecommunications services, namely high-speed access to computer and communication networks (judgment of 19/11/2009, T-399/08, Clearwifi, EU:T:2009:458);
- 'STEAM GLIDE' for electric irons, electric flat irons, electric irons for ironing clothes, parts and fittings for the aforementioned goods (judgment of 16/01/2013, T-544/11, Steam Glide, EU:T:2013:20);
- 'GREENWORLD' for, inter alia, gas fuels, fuels, electric power, gas for lighting, retail services in the areas of fuels, transmission and transport of electrical energy, heat, gas or water (judgment of 27/02/2015, T-106/04, Greenworld, EU:T:2015:123);
- 'ecoDOOR' for products on which doors have a significant impact, such as dishwashers, washing machines, vending machines, apparatus for cooking (judgment of 10/07/2014, C-126/13 P, EcoDoor, EU:C:2014:2065).

In the same way, combinations of the **prefix 'EURO'** with purely descriptive terms must be refused where the 'EURO' element reinforces the descriptiveness of the sign as a whole or where there is a reasonable connection between that term and the goods or services concerned. This is in line with the judgment of 07/06/2001, T-359/99, EuroHealth, EU:T:2001:151.

The following examples have been **accepted for** registration:

- GREENSEA for goods and services in Classes 1, 3, 5 and 42;
- MADRIDEXPORTA for Classes 16, 35, 36, 38, 39, 41 and 42 (judgment of 16/09/2009, T-180/07, Madridexporta, EU:T:2009:334);
- DELI FRIENDS for Classes 29, 30 and 35.

Combinations not following grammatical rules

A combination of words can be considered a descriptive indication even though it does not follow the usual grammatical rules. If, however, the combination does amount to more than the mere sum of its parts, it may be acceptable (judgment of 17/10/2007, T-105/06, WinDVD Creator, EU:T:2007:309, § 34).

- 'HIPERDRIVE' is considered descriptive of the intended purpose of setting devices for tools, despite the misspelling of the adjective 'hyper' as 'hiper' (judgment of 22/05/2014, T-95/13, Hiperdrive, EU:T:2014:270, § 33-42).
- 'CARBON GREEN' is descriptive for reclaimed rubber, namely, recycled carbonaceous materials, namely plastic, elastomeric, or rubber filled materials obtained from pyrolysed tire char and plastic, elastomeric, or rubber compounds formulated using such filler material, even though adjectives precede nouns in English (judgment of 11/04/2013, T-294/10, Carbon green, EU:T:2013:165).

Furthermore, in the world of advertising, definite articles and pronouns (the, it, etc.), conjunctions (or, and, etc.) or prepositions (of, for, etc.) are frequently omitted. This means that a lack of these grammatical elements will sometimes not be sufficient to make the mark distinctive.

Combinations of adjectives + nouns or verbs

For combinations consisting of **nouns and adjectives**, it should be assessed whether the meaning of the combination changes if its elements are inverted. For example, 'Vacations direct' (not registrable, decision of 23/01/2001, R 0033/2000-3) is tantamount to 'direct vacations', whereas 'BestPartner', is not the same thing as 'PartnerBest'.

The same reasoning applies to words consisting of the **combination of an adjective and a verb**. Therefore, the word 'ULTRAPROTECT' must be considered descriptive for sterilising and sanitary preparations, even though it consists of the combination (grammatically incorrect) of an adjective (ULTRA) with a verb (PROTECT), since its meaning remains clearly understandable (decision of 03/06/2013, R 1595/2012-1; see also judgment of 06/03/2012, T-565/10, Highprotect, EU:T:2012:107).

Combinations of words in different languages

Combinations made up of words from different languages may still be objectionable if the relevant consumers will understand the descriptive meaning of all the elements without further effort. This may be the case, in particular, when the sign contains basic terms in a language that will be understood easily by the speakers of another language, or if the terms are similar in both languages. For instance, if a mark is composed of one basic descriptive term belonging to language 'A' and another descriptive word in language 'B', the sign as a whole will remain descriptive when it is assumed that the speakers of language 'B' will be able to grasp the meaning of the first term.

Applications that consist of descriptive words or expressions repeated in various languages are a special case in the sense that they are mere translations of each other. These trade marks should be considered descriptive if the relevant consumer will grasp that each of the words or expressions is in fact merely the translation of a descriptive meaning, for example, because the proximity of the terms contained in the mark to each other will lead the consumer to understand that they all have the same descriptive meaning in different languages. For instance:

- EUTM No 3 141 017 'Le salon virtuel de l'industrie — Industry virtual exhibition — Die virtuelle Industriemesse — Il salon virtuale dell'industria — El salon virtual de la industria' for services in Classes 35, 38 and 42.

The following examples have been **refused** registration.

- EUTM No 12 596 169 ‘BABYPATAUGEOIRE’ for Classes 20 and 42 related to chairs and design of chairs for babies. The sign is composed of an EN and a FR term that will be immediately understood by the French-speaking part of the public (the term ‘baby’ will be understood by the French-speaking part of the public).
- ‘EURO AUTOMATIC PAIEMENT’, for Classes 9 and 36 (judgment of 05/09/2012, T-497/11, Euro automatic paiement, EU:T:2012:402, combination of English and French terms).

2.3.2.3 Misspellings and omissions

A misspelling does not necessarily change the descriptive character of a sign. First of all, words may be misspelt due to influences of another language or the spelling of a word in non-EU areas, such as American English, in slang or to make the word more fashionable. Examples of signs that have been refused:

- ‘Xtra’ (decision of 27/05/1998, R 0020/1997-1),
- ‘Xpert’ (decision of 27/07/1999, R 0230/1998-3),
- ‘Easi-Cash’ (decision of 20/11/1998, R 0096/1998-1),
- ‘Lite’ (judgment of 27/02/2002, T-79/00, Lite, EU:T:2002:42),
- ‘Rely-able’ (judgment of (30/04/2013, T-640/11, Rely-able, EU:T:2013:225),
- ‘FRESHHH’ (judgment of 26/11/2008, T-147/06, Freshhh, EU:T:2008:528).

Furthermore, consumers will, without further mental steps, understand the ‘@’ as the letter ‘a’ or the word ‘at’ and the ‘€’ as the letter ‘e’. Consumers will replace specific numerals by words, for example, ‘2’ as ‘to’ or ‘4’ as ‘for’.

However, if the misspelling is fanciful and/or striking or changes the meaning of the word (accepted: ‘D’LICIOUS’, EUTM No 13 729 348 (instead of ‘delicious’), ‘FANTASTICK’, EUTM No 13 820 378 (instead of ‘fantastic’)), the sign is acceptable.

As a rule, misspellings endow the sign with a sufficient degree of distinctive character when:

- they are striking, surprising, unusual, arbitrary and/or,
- they are capable of changing the meaning of the word element or require some mental effort from the consumer in order to make an immediate and direct link with the term that they supposedly refer to.

The following marks were refused:

Sign	Reasoning	Case
<p>ACTIVMOTION SENSOR</p> <p>EUTM No 10 282 614 for goods in Class 7 (swimming pool and spa cleaning equipment, namely, sweepers, vacuums, and parts therefor)</p>	<p>The mark merely consists of ‘ACTIV’, an obvious misspelling of the word ‘ACTIVE’, ‘MOTION’ and ‘SENSOR’. Combined, the words form a perfectly comprehensible and plainly descriptive combination, and was thus refused.</p>	<p>Decision of 06/08/2012, R 0716/2012-4 – ‘ACTIVMOTION SENSOR’, § 11</p>

Sign	Reasoning	Case
<p>XTRAORDINARIO</p> <p>International registration designating the EU No 930 778, for goods in Class 33 (tequila)</p>	<p>The above term is a non-existent word but closely resembles the Spanish adjective 'extraordinario'. Spanish and Portuguese consumers will perceive the sign as a misspelling of a word meaning 'remarkable', 'special', 'outstanding', 'superb' or 'wonderful', and as such, attribute a descriptive meaning to the sign.</p>	<p>Decision of 08/03/2012, R 2297/2011-5 – 'Xtraordinario', § 11-12</p>

However, the following marks were **accepted**:

Sign	Reasoning	Case
<p>LINQ</p> <p>EUTM No 1 419 415 covering goods and services in Classes 9 and 38</p>	<p>This word is an invented word, not existing in any known dictionary, and it was not shown that this word is a common misspelling used in the trade circles of interest to the appellant. Additionally, because the word is short, the ending letter 'Q' will be noticed as a peculiar element, and thus the fanciful spelling is obvious</p>	<p>Decision of 04/02/2002, R 0009/2001-1 – 'LINQ', § 13</p>
<p>LIQID</p> <p>EUTM No 5 330 832 initially covering goods in Classes 3, 5 and 32</p>	<p>In this word mark, the combination 'QI' is highly uncommon in the English language, as the letter 'Q' is normally followed by a 'U'. The striking misspelling of the word 'liquid' would allow even a consumer in a hurry to notice the peculiarity of the word 'LIQID'. Furthermore, the spelling would not only have an effect on the visual impression produced by the sign, but also the aural impression, as the sign applied for will be pronounced differently from the word 'liquid'.</p>	<p>Decision of 22/02/2008, R 1769/2007-2 – 'LIQID', § 25</p>

2.3.2.4 Abbreviations and acronyms

Abbreviations of descriptive terms are in themselves descriptive if they are used in that way, and the relevant public, whether general or specialised, recognises them as being identical to the full descriptive meaning. The mere fact that an abbreviation is derived from a descriptive term is not sufficient (judgment of 13/06/2014, T-352/12, Flexi, EU:T:2014:519).

The following signs were refused because the descriptive meaning for the relevant public could clearly be shown:

- SnTEM (judgment of 12/01/2005, T-367/02 to T-369/02, SnTEM, SnPUR & SnMIX, EU:T:2005:3),
- TDI (judgment of 03/12/2003, T-16/02, TDI, EU:T:2003:327 (appeal C-82/04 P was settled),
- LIMO (judgment of 20/07/2004, T-311/02, Limo, EU:T:2004:245),
- BioID (judgment of 05/12/2002, T-91/01, BioID, EU:T:2002:300 (appeal C-37/03 P set aside GC judgment and dismissed decision of 2nd BoA)).

Note that use of internet databases such as 'AcronymFinder.com' as a reference base should be made with the greatest care. Use of technical reference books or scientific literature are preferable, for example, in the field of computing. Alternatively, use of the abbreviation by a number of traders in the appropriate field on the internet is sufficient to substantiate actual use of the abbreviation.

Signs consisting of an independently non-descriptive acronym that precedes or follows a descriptive word combination should be objected to as descriptive if it is perceived by the relevant public as merely a word combined with an abbreviation of that word combination, for example ‘Multi Markets Fund MMF’. This is because the acronym and word combination together are intended to clarify each other and to draw attention to the fact that they are linked (judgment of 30/06/2009, T-285/08, Natur-Aktien-Index, EU:T:2009:230, § 32 and 40). This will be the case even where the acronym does not account for the mere ‘accessories’ in the word combination, such as articles, prepositions or punctuation marks, demonstrated in the following examples:

- ‘NAI – Der Natur-Aktien-Index’,
- ‘The Statistical Analysis Corporation – SAC’.

While the above rule will cover most cases, not all instances of descriptive word combinations juxtaposed with an abbreviation of that word will be considered descriptive as a whole. This will be the case where the relevant public will not immediately perceive the acronym as an abbreviation of the descriptive word combination, but rather as a distinctive element that will make the sign as a whole more than the sum of its individual parts, as demonstrated in the following example:

- ‘The Organic Red Tomato Soup Company — ORTS’.

2.3.2.5 Slogans

A slogan is objectionable under Article 7(1)(c) EUTMR when it immediately conveys the kind, quality, intended purpose or other characteristics of the goods or services.

The criteria established by case-law for the purpose of determining whether a slogan is descriptive or not are identical to those applied in the case of a word mark containing only a single element (judgment of 06/11/2007, T-28/06, Vom Ursprung her vollkommen, EU:T:2007:330, § 21). It is inappropriate to apply criteria to slogans that are stricter than those applicable to other types of signs, especially considering that the term ‘slogan’ does not refer to a special subcategory of signs (judgment of 12/07/2012, C-311/11 P, Wir machen das Besondere einfach, EU:C:2012:460, § 26 and 40).

Example of a descriptive slogan

- An application in Class 9 (*satellite navigation systems*, etc.) for ‘FIND YOUR WAY’, (decision of 18/07/2007, R 1184/2006-4) was objected to under Article 7(1)(b) and (c) EUTMR. The expression FIND YOUR WAY in relation to the goods applied for in Class 9 is clearly intended to inform the relevant consumer that the appellant’s goods help consumers to identify geographical locations in order to find their way. The message conveyed by the sign applied for directly refers to the fact that consumers will discover the route for travelling from one place to another when using the specified goods.
- BUILT TO RESIST could have only one possible meaning in relation to *paper*, *paper goods* and *office requisites* in Class 16, *leather*, *imitations of leather*, *travel articles not included in other classes* and *saddlery* in Class 18 and *clothing*, *footwear and headgear* in Class 25, namely that the goods are manufactured to last and are, therefore, tough and resistant to wear and tear (judgment of 16/09/2009, T-80/07, Built to resist, EU:T:2009:332, § 27-28).

2.3.2.6 Geographical terms

A geographical term is every existing name of a place, for example a country, region, city, lake or river. This list is not exhaustive. Adjectival forms are not sufficiently different from the original geographical term to cause the relevant public to think of something other than that geographical term (judgment of 15/10/2003, T-295/01, Oldenburger, EU:T:2003:267, § 39). For example, 'German' will still be perceived as referring to Germany, and 'French' will still be perceived as referring to France. Furthermore, outdated terms such as 'Ceylon', 'Bombay' and 'Burma' fall within this scope if they are still commonly used or generally understood by consumers as a designation of origin.

It is in the **public interest** that signs that may serve to designate the geographical origin of goods or services remain available, not least because they may be an indication of the quality and other characteristics of the categories of goods concerned, and may also, in various ways, influence consumer preferences by, for instance, associating the goods or services with a place that may elicit a favourable response (judgments of 15/01/2015, T-197/13, MONACO, EU:T:2015:16, § 47; 25/10/2005, T-379/03, Cloppenburg, EU:T:2005:373, § 33).

This paragraph (2.3.2.6.) uses the words 'geographical term' to refer to **any** geographical indication in an EU trade mark application, whereas the terms 'protected geographical indication' and 'protected designation or appellation of origin' are used **only** in the context of specific legislation protecting them. Designations of origin and geographical indications protected under specific EU Regulations are dealt with under the section on Article 7(1)(j) EUTMR.

If the sign **contains other non-descriptive or distinctive elements**, the registrability of the combination (of the sign in its entirety) must be assessed in the same manner as in cases where descriptive elements are coupled with distinctive or non-descriptive elements (see paragraph 2.3.4 below).

Assessment of geographical terms

The registration of geographical names as trade marks is not possible where such a geographical name is either **already famous**, or is **known for the category of goods concerned**, and is therefore **associated** with those goods or services in the mind of the relevant class of persons, or is liable to be used by undertakings and must remain available to such undertakings as indications of the geographical origin of the goods and services concerned (judgments of 15/01/2015, T-197/13, MONACO, EU:T:2015:16, § 48; 25/10/2005, T-379/03, Cloppenburg, EU:T:2005:373, § 34).

As with all other descriptive terms, the test is whether the geographical term **describes objective characteristics of the goods and services**. The assessment must be made with reference to the claimed goods and services and with reference to the perception by the relevant public. The descriptive character of the geographical term may relate to:

- the place of production of the goods;
- the subject matter of a good (e.g. the city or region a travel guide is about);
- the place where the services are rendered;
- the kind of cuisine (for restaurants); or
- the place that influences consumer preferences (e.g. lifestyle) by eliciting a favourable response (15/01/2015, T-197/13, MONACO, EU:T:2015:16, § 47 and Cloppenburg, EU:T:2005:373, § 33).

a) *First step: term understood by the relevant public*

The **first step** in assessing a geographical term is to determine whether it is understood as such by the relevant public. Article 7(1)(c) EUTMR does not in principle preclude the registration of geographical names that are unknown to the relevant public — or at least unknown as the designation of a geographical location (15/01/2015, T-197/13, MONACO, EU:T:2015:16, § 49; T-379/03, Cloppenburg, EU:T:2005:373, § 36). Whether or not this is the case will be determined by taking as a basis a reasonably well-informed consumer who has sufficient common knowledge but is not a specialist in geography. For an objection to be raised, the Office must prove that the geographical term is known by the relevant public as designating a place (15/01/2015, T-197/13, MONACO, EU:T:2015:16, § 51).

b) *Second step: term designates a place associated with the goods and services*

The **second step** is to determine whether the geographical term applied for designates a place that is currently associated with the claimed goods or services in the mind of the relevant public or whether it is reasonable to assume that such a name may, in the mind of the relevant public, designate the geographical origin of that category of goods or services (15/01/2015, T-197/13, MONACO, EU:T:2015:16, § 51, T-379/03, Cloppenburg, EU:T:2005:373, § 38), or if it will reasonably be associated with those goods or services in the future (judgment of 04/05/1999, C-108/97 & C-109/97, Chiemsee, EU:C:1999:230, § 31).

In establishing whether such an association exists, the Court has clarified that the following **factors** should be taken into account (judgment of 04/05/1999, C-108/97 & C-109/97, Chiemsee, EU:C:1999:230, § 32 and 37, T-379/03, EU:T:2005:373, § 38 *in fine*):

- the degree of familiarity of the relevant public with the geographical term
- the characteristics of the place designated by the term, and
- the category of goods or services.

It is **not necessary** to establish that the name actually designates the **true** geographical origin of the goods. It is enough to demonstrate that the connection between the name of the place and the goods may enable the relevant public to perceive the contested sign as an indication of the origin of those goods (judgment of 15/10/2003, T-295/01, Oldenburger, EU:T:2003:267, § 43). For example, ‘Milano’ should be refused for *clothing*, Switzerland for *financial services* and Islas Canarias for *tourist services*.

With regard to **reasonable future association**, an Article 7(1)(c) EUTMR refusal cannot be based solely on the argument that the goods or services can theoretically be produced or rendered in the place designated by the geographical term (judgment of 08/07/2009, T-226/08, Alaska, EU:T:2009:257). The abovementioned factors should be assessed (degree of familiarity of the relevant public with the geographical term, the characteristics of the place designated by the term, and the category of goods or services). In particular, such an assessment must take into account the **relevance** of the geographical origin of the goods in question, and the **customs of the trade** in using geographical names to indicate the origin of the goods or to refer to certain qualitative and objective criteria of the goods.

Sign	Reasoning	Case
BRASIL	The Board recognised that the mere existence of whisky production in Brazil was not sufficient in itself to presume that relevant consumers of whisky will associate the sign with the goods. However, it had to be assessed whether it was reasonable to assume that such an association might be established in the future. The BoA assessed a number of factors, including the fact that it is current practice in trade to indicate the geographical origin of whiskies and whisky-based beverages. It concluded that the designation 'Brasil' would be understood as an informative indication for whisky and whisky-based beverages (para. 29).	R 0434/2013-1
Class 32: Beers; Mineral and aerated waters and other non-alcoholic beverages; Fruit beverages and fruit juices; Syrups and other preparations for making beverages. Class 33: Whisky; whisky-based beverages.		

Sign	Reasoning	Case
THE SPIRIT OF CUBA	The GC considered that the sign would be understood by the relevant public as a reference to the alcoholic spirit of Cuba or to an alcoholic beverage from Cuba, despite the structure of the sign ('the', singular form, 'of' instead of 'from') (para. 26)	T-207/13
Class 33: Alcoholic beverages.		

Sign	Reasoning	Case
PORT LOUIS	The GC annulled a BoA decision because it had not established that the city of Port Louis (capital of the Republic of Mauritius) was sufficiently known by the relevant public of the former colonial powers of France and the United Kingdom. Nor was it established that Port Louis had a reputation for the relevant goods (textile manufacture) amongst the relevant public (paras 40-54)	T-230/06, 'Port Louis'
Class 18: Leather and imitations of leather, goods made of these materials and not included in other classes; animal skins, hides; trunks and traveling bags; umbrellas, parasols, canes and walking sticks; saddlery, harness and whips; horse blankets Class 24: Household textiles; bed and table covers; bedclothes; bath linen (except clothing); household linens; shower curtains of textile; curtains of textile or plastic; blinds of textile; coverlets; wax table cloths Class 25: Clothing, footwear, headgear.		

Geographical terms that are **merely allusive or fanciful should not be objected to on this basis**. For example, while the North Pole and Mont Blanc are commonly known

geographical terms, they would not be understood in the context of ice cream or sports cars as possible places of production, but as merely allusive and fanciful terms. The same applies to the fashionable use of city/country names for goods and services unrelated to what the city/country is known for (e.g. 'Hollywood' for *chewing gum*, 'Greenland' for *fresh fruits and vegetables* (R 0691/2000-1, GREENLAND), 'Sudan' for *paints* (R 0594/1999-2, SUDAN), and 'Denver' for *lighting equipment* (R 2607/2011-2, DENVER)) and the use of names of fashionable suburbs or shopping streets ('Champs Élysées' for *bottled water*, 'Manhattan' for *tomatoes*). The same applies by analogy to 'Port Louis' for *textiles*.

Finally, there are some geographical terms, such as **major geographical places or regions as well as countries**, which may be refused merely because of their **widespread recognition and fame for the high quality** of their goods or services. In such cases no detailed assessment of the association between the place and the goods and services is necessary (judgment of 15/12/2011, T-377/09, *Passionately Swiss*, EU:T:2011:753, § 43-45).

Sign	Reasoning	Case
Passionately Swiss	The GC held that BoA did not need to go into a detailed assessment of the association between the sign and each of the goods and services. It based its finding on Switzerland's reputation for quality, exclusiveness and comfort, which can be associated with the services in Classes 35, 41, 43 and 44 and the goods in Class 16 (para. 45).	T-377/09

Sign	Reasoning	Case
MONACO	The General Court found that the word 'monaco' corresponds to the name of a globally known principality, not least due to the renown of its royal family and its organisation of a Formula 1 Grand Prix and a circus festival. The Court considered that the trade mark MONACO had to be refused for goods and services in Classes 9, 16, 39, 41 and 43 as the word 'monaco' could be used, in trade, to designate origin, geographical destination or the place of supply of services. The trade mark was thus descriptive for the goods and services concerned.	T-197/13

The mere fact that a geographical term is used by only one producer is not sufficient to overcome an objection, although it is an important argument to be taken into account in assessing acquired distinctiveness.

2.3.2.7 Terms describing subject matter in goods or services

Where a sign consists exclusively of a word that describes what may be the subject matter or content of the goods or services in question, it should be objected to under Article 7(1)(c) EUTMR. Commonly known terms likely to be linked to a particular thing, product or activity by the relevant public are capable of describing subject matter and should therefore be kept free for other traders (judgment of 12/06/2007, T-339/05, *Lokthread*, EU:T:2007:172, § 27).

The essential question is whether the sign applied for **may be used in trade in relation to the goods or services applied for** in a manner that will be undoubtedly

perceived by the relevant public as descriptive of the subject matter of those claimed goods or services, and should therefore be kept free for other traders.

For example, a widely known name such as 'Vivaldi' will immediately create a link to the famous composer, just as the term 'skis' will immediately create a link to the sport of skiing. While Class 16 (books) is a prime example of a category of goods which contains subject matter or content, an objection made under this section may occur also with respect to other goods and services, such as data carriers, DVDs, CD-ROMs or editorial services. With regard to this section, the terms 'subject matter' and 'content' are used interchangeably. See also paragraph 2.2.3 above.

Names of famous persons (in particular musicians or composers) can indicate the category of goods, if due to wide spread use, the time lapse, the date of death, or the popularisation, recognition, multiple performers, or musical training, the public can understand them as generic. This would be the case, for example, with respect to 'Vivaldi', whose music is played by orchestras all over the world and the sign 'Vivaldi' will not be understood as an indicator of origin for music.

Objections based on the above:

- will apply only to goods (e.g. books) or services (e.g. education) that contain subject matter regarding other things, products and/or activities (e.g. a book about history, or an educational course on history),
- when the sign consists exclusively of the word identifying that subject matter (e.g. 'VEHICLES' or 'HISTORY'), and
- will be made on a case-by-case basis by assessing multiple factors, such as the relevant public, the degree of attention or the descriptive character of the term in question (see below).

Goods and services that may contain subject matter

For most cases, the goods or services that may consist of or contain objectionable subject matter are the following:

- Class 9: *Magnetic data carriers, software, recording discs, electronic publications (downloadable).*
 - Objectionable
 - STATISTICAL ANALYSIS for software
 - ROCK MUSIC for CDs.
- Class 16: Printed matter, photographs and teaching materials as long as these include printed matter.
 - Objectionable
 - HISTORY for books
 - PARIS for travel guides
 - CAR for magazines
 - ANIMALS for photographs
 - TRANSCENDENTAL MEDITATION for *instructional and teaching material.*

- Class 28: Board *games*
 - Objectionable
 - ‘Memory’ (order of 14/03/2011, C-369/10).
- Class 35: Trade fairs, advertising, retail services.
 - Objectionable
 - ELECTRONICA for trade fairs related to electronic goods (judgment of 05/12/2000, T-32/00, Electronica, EU:T:2000:283, § 42-44)
 - LIVE CONCERT for advertising services
 - CLOTHING for retail services.
- Class 38: Telecommunications
 - Objectionable
 - NEWS for telecommunications
 - MATH for providing online forums.
- Class 41: Education, training, entertainment, electronic publications (non-downloadable).
 - Objectionable
 - GERMAN for language courses
 - HISTORY for education
 - COMEDY for television programmes
 - TRANSCENDENTAL MEDITATION for *education services*.

The above list of Nice classes is not exhaustive, although it will apply to the vast majority of cases. Consequently, objections based on descriptive subject matter should be raised primarily in the context of the goods and services listed above.

Where the sign applied for is a descriptive term for a particular characteristic of goods or services, a designation of goods or services that excludes that particular characteristic described by the sign applied for will not avoid an objection based on subject matter. This is because it is unacceptable for an applicant to make a claim of goods or services subject to the condition that they do not possess a particular characteristic (judgment of 12/02/2004, C-363/99, Postkantoor, EU:C:2004:86, § 114-116). The following invented examples illustrate designations of goods or services that will not avoid an objection:

- COMEDY for television broadcasting, except for *comedy programming*
- PENGUINS (in plural!) for books, except for books about *penguins*
- TECHNOLOGY for classes, except for classes about computers and *technology*.

Distinguishable from the examples above are positive claims of goods or services, under which it is impossible for the sign applied for to describe any subject matter or content. For example, the following invented examples would not be objectionable, at least with regards to signs being descriptive of subject matter:

- COMEDY for television broadcasting of economic news, politics and *technology*
- PENGUIN for comic books with country western, medieval and ancient Roman *themes*
- TECHNOLOGY for classes about creative fiction *writing*.

2.3.2.8 Single letters and numerals

Single letters³

General considerations

In its judgment of 09/09/2010, C-265/09 P ('*α*'), the Court stated that when examining absolute grounds for refusal, the Office is required, under Article 76(1) EUTMR, to examine, of its own motion, the relevant facts which might lead it to raise an objection under Article 7(1) EUTMR and that that requirement cannot be made relative or reversed, to the detriment of the EUTM applicant (paras 55-58). Therefore, it is for the Office to explain, with motivated reasoning, why a trade mark consisting of a single letter represented in standard characters is descriptive.

Consequently, when examining single letter trade marks, generic, unsubstantiated arguments such as those relating to the availability of signs, given the limited number of letters, should be avoided. Similarly, it would not be appropriate to base an objection on speculative reasoning as to the different meanings that a sign could possibly have. The Office is obliged to establish, **on the basis of a factual assessment**, why the trade mark applied for would be objectionable.

It is therefore clear that the examination of single letter trade marks should be thorough and stringent, and that each case calls for a careful examination.

Examples

For instance, in **technical domains** such as those involving computers, machines, motors and tools, it may be that particular letters have a descriptive connotation if they convey sufficiently precise information about the goods and/or services concerned.

The **letter 'E'** was also considered to be descriptive in respect of 'wind power plants and parts thereof, generators, rotor blades for wind power plants, rotors for wind power plants' in Class 7, 'control switches for wind power plants, frequency converters, measuring, signalling and checking (supervision) instruments' in Class 9 and 'towers for wind power plants' in Class 19, since it may be seen as a reference to 'energy' or 'electricity' (judgment of 21/05/2008, T-329/06, E, EU:T:2008:161, § 24-31 and decision of 08/09/2006, R 0394/2006-1, § 22-26).

An objection might be justified also in respect of goods and/or services meant for a broader public. For example, **the letters 'S', 'M' or 'L'** in respect of clothing would be objectionable as these letters are used to describe a particular size of clothing, namely as abbreviations for 'Small', 'Medium' or 'Large'.

³ This part deals with single letters under Article 7(1)(c) ~~CTMREUTMR~~. For single letters under Article 7(1)(b) ~~CTMREUTMR~~, see paragraph 2.2.5.

However, if it cannot be established that a given single letter is descriptive for the goods and/or services concerned, and provided that the applied for trade mark is not open to objection under another provision of Article 7(1) EUTMR, then the application should be **accepted**.

See paragraph 2.2.5.2 above for further examples of where an objection under Article 7(1)(b) EUTMR may be raised.

Numerals

In its judgment of 10/03/2011, C-51/10 P, ‘1000’, the Court of Justice ruled that signs composed exclusively of numerals with no graphic modifications may be registered as trade marks (paras 29-30).

The Court referred by analogy to its previous judgment of 09/09/2010, C-265/09 P, (α) in respect of single letters (para. 31) and emphasised that trade marks consisting of numerals must be examined by with specific reference to the goods and/or services concerned (para. 32).

Therefore, a numeral may be registered as an EU trade mark only if it is distinctive in relation to the goods and services covered by the application for registration (para. 32) and is not merely descriptive or otherwise non-distinctive in respect of those goods and services.

For example, the Board confirmed the refusal of the trade mark ‘15’ applied for in respect of ‘clothing, footwear, headgear’ in Class 25, on the ground that the numeral ‘15’ is linked directly and specifically to these goods, as it contains obvious and direct information regarding their size. The Board also confirmed the refusal of this sign in respect of ‘beers’ in Class 32, as practical experience of the marketing of the relevant goods — relied upon by the Office — showed that a number of very strong beers with an alcohol content of 15 % vol. exist on the EU market (decision of 12/05/2009, R 0072/2009-2 ‘15’, § 15-22).

It is well known that numerals are often used to convey relevant information as to the goods and/or services concerned. For example, in the following scenarios an objection would apply on the ground that the sign applied for is descriptive since it refers to:

- the **date** of production of goods/provision of services, when this factor is relevant in respect of the goods/services concerned. For instance, 1996 or 2000 for *wines* would be objectionable, since the age of the wine is a very relevant factor when it comes to the purchasing choice; 2020 would be objectionable also for ‘events’ as it could be considered the year of an event.
- **size**: 1600 for cars, 185/65 for tyres, 10 for women’s clothing in the UK, 32 for women’s clothing in France,
- **quantity**: 200 for cigarettes,
- **telephone codes**: 0800 or 0500 in the UK, 800 in Italy, 902 in Spain, etc.,
- the **time** of provision of services: 24/7,
- the **power** of goods: 115 for engines or cars,

- **alcoholic content:** 4.5 for lager, 13 for wines,
- **the number of pieces:** 1 000 for puzzles.

However, where the numeral does not appear to have any possible meaning in respect of the goods and services, it is acceptable, that is to say, '77' for financial services or '333' for 'clothing'.

2.3.2.9 Names of colours

A sign consisting exclusively of the name of a colour must be objected to under Article 7(1)(c) EUTMR when the application claims any goods for which the colour can reasonably be perceived by the public as a description of one of its characteristics. For example, the name of the colour BLUE in relation to cheese describes a specific kind of cheese, the colour GREEN describes a specific kind of tea. The name of the colour BROWN in relation to sugar describes the colour and kind of the sugar. This rule applies mainly to common colours, for example, primary colours or SILVER and GOLD. When the claimed goods concern colorants, such as paint, ink, dyes, cosmetics, etc., the name of colours may describe the actual colour of the goods, and signs consisting exclusively of a colour should be objected to under Article 7(1)(c) EUTMR. In these cases, names of colours would not be seen as trade marks but merely as elements describing the principal characteristic of the goods.

The following guidelines should generally be applied:

- Where colour is a typical feature of the goods and relevant for consumer choice, such as clothing and motor cars, colour names such as EMERALD or APRICOT, which, although having alternative meanings, are recognised as having a strong connotation with definite colours, and should be objected to;
- Words such as SAPPHIRE, FLAMINGO or LAPISLAZULI do not have a sufficiently strong colour connotation to overwhelm the other non-colour meaning, and thus should generally not be objected to if they are not likely to be perceived as having a colour meaning with respect to the claimed goods or services (decision of 12/12/2013, 7950 C).

Colours in combination with other words may be registrable if the sign as a whole is distinctive: ICE COFFEE, VANILLA ICE and MISTY BLUE. Descriptive combinations such as DEEP BLUE should not be accepted. Dictionary words that are descriptive but obscure and unlikely to be used by others can be accepted: LUNA (alchemists' name for silver) and CARNELIAN (an alternative name for CORNELIAN, a red gem stone that is less well known).

2.3.2.10 Plant variety names

Plant variety names describe cultivated varieties or subspecies of live plants or agricultural seeds. As such, they will not be perceived as trade marks by the relevant public.

This section only concerns plant variety names that happen to be used in trade but which are **not simultaneously registered by the Community Plant Variety Office** in accordance with Council Regulation (EC) No 2100/94 of 27/07/1994 or registered in accordance with national law or international agreements to which the Union or the Member State concerned is a party. How to deal with EUTMs applied for that contain or

consist of a registered plant variety name is explained in another section of the Guidelines, in the context of Article 7(1)(m) EUTMR (see paragraph 2.6.1.2 below).

The criteria for assessing the descriptiveness of a trade mark for plants are no different from those applicable to other categories of trade marks. The provisions of trade mark law apply to plants in the same way as they apply to other categories of goods. It follows that the name of a plant variety must be rejected under Article 7(1)(c) EUTMR unless it has acquired distinctiveness under the conditions of Article 7(3) EUTMR.

Whenever an EUTM application consists of wordings for live plants, agricultural seeds, fresh fruits, fresh vegetables or equivalent ones, the Office will have to verify, by means of a search on the internet, whether the term making up the trade mark applied for coincides with the name of a specific plant variety that happens to be already used in trade.

If the search discloses that the term in question is already used in trade either in the EU or in another jurisdiction, then the Office must raise an **objection** under Article 7(1)(c) EUTMR, objecting that the term in question describes the nature of the goods concerned.

Depending on the circumstances of the case, and provided the evidence available demonstrates that the term in question has been used to such an extent as to have become **customary** in trade in the EU, then an objection both under Article 7(1)(c) and (d) EUTMR would be appropriate (see also paragraph 2.4.4 below).

For **example**, in its decision of 01/03/2012, R 1095/2011-5 SHARBATI, the Fifth Board of Appeal confirmed the refusal of the trade mark 'SHARBATI' applied for in respect of *rice; flour and preparations made from cereals, bread, pastry and confectionery* in Class 30, since it is descriptive thereof: Sharbati is a type of rice as well as a type of wheat that gives its name to a certain kind of flour, known in India.

Even though most of the evidence provided had its source in India, part of it referred to export trade on commodities markets. Therefore, the fact that a certain word is the name of a rice variety in India was already a strong indication that the product would be distributed in the European Union.

However, the Board considered that there was not sufficient evidence that the term SHARBATI had become generic in the European Union. Even though it had been demonstrated that Sharbati rice or Sharbati wheat had been offered to traders in the European Union, actually imported into the European Union and that there was no other precise name for that product, there was insufficient evidence that, at the filing date of the EUTM application, the products were known to the extent required under Article 7(1)(d) EUTMR.

An objection should also be raised when the applied for trade mark is only a **slight variation** (i.e. minor differences that do not alter the visual and aural perception of the sign) of the plant variety name used in trade, thus inducing consumers to believe that they are confronted with the descriptive or generic name of a plant variety.

Another **example** in this respect is to be found in decision of 03/12/2009, R 1743/2007-1, VESUVIA. The Board held that evidence that had its source in the United States and Canada was sufficient to conclude that the name 'Vesuvius' of a variety of roses *may* become a descriptive indication within the European Union in the sense of Article 7(1)(c) EUTMR and that the trade mark applied for, 'VESUVIA', came

close to it. The Board justified its refusal with the fact that roses are usually referred to in the feminine form.

Lastly, it should be noted that an objection should be raised not only in respect of applied for trade marks that are identical to (or are slight variations of) a plant variety name that is already used in trade, but also **in respect of any good and/or service that can be directly linked to the plant variety name in question** (for example, import-export of the plant variety in question).

2.3.2.11 Names of banks and newspapers/magazines

In the field of banks, newspapers and magazines, consumers are accustomed to recognising descriptive combinations of terms as badges of origin. This is due to:

- the relevant entity being identified as the only one with the right to use the combination (see, for example 'BANK OF ENGLAND' or 'BANCO DE ESPAÑA' or other central/national banks names) or
- the combination being likely to identify a specific entity (see, for example, 'DIARIO DE LAS PROVINCIAS DE VALENCIA', 'BANCO AZTECA' or 'BANCO GALLEGO')

In these cases, no objection should be raised. Nevertheless, descriptive combinations such as 'ONLINEBANK', 'E-BANK' or 'INTERNETNEWS' remain objectionable since they do not create, at least prima facie, the impression of a clearly identifiable entity.

2.3.2.12 Names of hotels

In the hotel sector, hotel names often consist of the combination of the word 'HOTEL' together with a geographical term (i.e. the name of an island, a city, a country etc.). They usually indicate specific establishments that **do not have any link with the geographical term they refer to**, since they are not situated in that specific location. Consequently, due to these trade habits, consumers would not perceive expressions such as 'HOTEL BALI', 'HOTEL BENIDORM' or 'HOTEL INGLATERRA' as descriptive indications (describing that the services are provided by a hotel that is situated in that specific location) but rather as badges of origin.

Indeed, such expressions are not equivalent to the grammatically correct ones 'HOTEL IN BALI', 'HOTEL DE BENIDORM' or 'HOTEL EN INGLATERRA', which are clearly objectionable. This is even truer in cases where the hotel name consists of the names of two different cities, (or of two geographical terms in general), for example 'HOTEL LONDRES SAN SEBASTIAN'. Indeed, in this case the presence of the wording SAN SEBASTIAN (a city in the north of Spain) clearly indicates that 'HOTEL LONDRES' must be regarded as a fanciful expression. Therefore, no objection should be raised.

Nevertheless, in those **cases where the geographical term precedes the word 'HOTEL', the situation may change according to the different languages**. For example, in English the wording 'BALI HOTEL', would be perceived as an expression merely indicating any hotel located in the island of Bali, which is clearly objectionable. Consequently, each case should be assessed on its own merits. Finally, descriptive combinations such as 'LEADING HOTELS' remain objectionable since they do not create, at least prima facie, the impression of a clearly identifiable entity.

2.3.2.13 Combinations of names of countries/cities with a number indicating a year

Marks consisting of the combination of the name of a country/city with a number indicating a year must be refused under Article 7(1)(b) and (c) EUTMR **for all the goods and services claimed.**

As an example, the mark ‘GERMANY 2006’ has been considered as a descriptive indication for a wide list of goods and services, ranging from *unexposed films* in Class 1 to *vehicle maintenance* in Class 37. In particular, the decision in case R 1467/2005-1 of 21/07/2008 stated that this mark:

- is descriptive of the kind and content of those services ‘of actually preparing, organising and promoting an event in Germany in 2006’ (*ibidem*, para. 29, referring to the organisation of sporting events related to or associated with football championships, etc.);
- is descriptive of ‘the purpose and thereby in part the level of quality of goods or services, during such competitions in Germany in the year 2006, as being suitable for competitions of the highest standard or that it has been successfully used in the context of such competitions’ (*ibidem*, para. 30, referring to medical instruments, soccer balls, etc.);
- qualifies the goods as souvenir articles (*ibidem*, para. 31, referring to goods such as stickers, confetti, pyjamas, etc.).

With regard to **souvenir articles**, the Board underlined that ‘merchandising and co-branding is not limited to “classic” souvenir products. It is public knowledge that there is a tendency to try to find new markets by combining various goods with the brand of some other unrelated popular event or names’ (*ibidem*, para. 34, referring to goods such as eyeglasses, televisions, toilet paper, etc., all related to or associated with football championships).

2.3.2.14 INN codes

International Nonproprietary Names (INN) are assigned to pharmaceutical substances by the World Health Organisation (WHO), so that each substance can be recognised by a unique name. These names are needed for the clear identification, safe prescription and dispensing of medicines, and for communication and exchange of information among health professionals. INNs can be used freely because they are in the public domain. Examples of INNs are alfacalcido, calcifediol, calcipotriol.

Stems define the pharmacologically related group to which the INN belongs. INN stems serve to indicate the mode of action of groups of drugs. These stems and their definitions have been selected by WHO experts and are used when selecting new international non-proprietary names. An example of a stem is ‘calci’.

The criteria for assessing the descriptiveness of a trade mark for pharmaceuticals are no different from those applicable to other categories of trade marks. The provisions of trade mark law apply to pharmaceuticals in the same way as to other categories of goods. The European Medicines Agency (EMA) assesses the single name under which a medicinal product will be marketed as part of its marketing authorisation for the European Union. EMA’s assessment is based on public health concerns and takes into account the WHO World Health Assembly resolution (WHA46.19) on protection of INNs/INN stems to prevent any potential risk of confusion. The Office’s assessment of the registrability of pharmaceutical trade marks, however, has no specific legal basis

for taking such health-related concerns into consideration (by analogy, judgment of 05/04/2006, T 202/04, Echinaid, EU:T:2006:106, § 31-32).

Considering the descriptive nature of INN codes and stems, an objection should be raised for Class 5 in the following scenarios:

- where the EUTM is an INN (the general rules on misspellings also apply, see paragraph 2.3.2.3 above); or
- where an INN appears within an EUTM and the other elements of the EUTM are descriptive/non-distinctive too (for instance BIO, PHARMA, CARDIO, MED, DERMA); or
- where the EUTM consists only of a stem.

A list of INN codes can be accessed after online registration on MedNet (<https://mednet-communities.net>). A list of common stems is available at the following link: http://www.who.int/medicines/services/inn/StemBook_2011_Final.pdf.

Office practice is to accept figurative trade marks containing INN codes or stems, applying the same criteria as to any other figurative trade mark containing descriptive word elements (i.e. whether the stylisation and/or the graphical features of a sign are sufficient for it to act as a trade mark).

An objection may also be based on Article 7(1)(g) EUTMR in the unlikely scenario that the list of goods in Class 5 refers to a different kind of drug from that covered by the INN. Where the list in Class 5 includes *pharmaceuticals*, the Office assumes good faith and no objection under Article 7(1)(g) EUTMR will be raised.

2.3.3 Figurative marks

Signs represented in languages other than Latin, Greek or Cyrillic are considered for formality purposes as figurative trade marks. However, this does not mean that the semantic content of these signs will not be taken into consideration for the purpose of the application of Article 7(1)(c).

Where a figurative mark consists exclusively of a basic natural form that is not significantly different from a true-to-life portrayal that serves to indicate the kind, intended purpose or other characteristic of the goods or services, it should be objected to under Article 7(1)(c) EUTMR as descriptive of a characteristic of the goods or services in question.

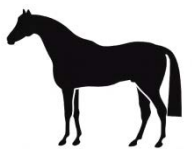
Sign	Case
	<p>Judgment of 08/07/2010, T-385/08 'Representation of a dog'</p>
	<p>Judgment of 08/07/2010, T-386/08 'Representation of a horse'</p>

In these cases the General Court held that for goods in Classes 18 and 31, the depiction of a dog or horse, respectively, serves to indicate the type of animal for which the goods are intended.

In the first case, the Court noted that the goods in Class 18 were specially produced for dogs, such as dog leads, dog collars and other dog accessories including bags. In the field of animal accessories, it is common practice for true-to-life or stylised but realistic portrayals of animals to be used for indicating the type of animal concerned. Therefore, for the goods in Class 18, the relevant public will immediately perceive the image's message that those goods are for dogs, without any further mental steps. The portrayal of a dog, therefore, indicates an essential characteristic of the goods concerned. The sign applied for is, therefore, descriptive (paras 25-28).

The same applies to goods in Class 31. As foodstuffs for domestic animals include dog food, the mark applied for is a descriptive indication for the goods at issue that will be immediately understood by the relevant public (para. 29).

In the second case, the Court held that for *clothing, headgear and belts* in Class 25, the portrayal of a horse was descriptive of the kind or intended purpose of the goods, namely that they are particularly developed or suitable for horse riding. As the relevant public would make a direct link between a horse and horse riding, the Court maintained that there was an immediate and concrete link between the portrayal of a horse and the goods concerned (paras 35-38).

By way of example, the sign below was held to be sufficiently highly stylised to significantly differ from a true-to-life portrayal serving to indicate the kind or intended purpose of the goods or services, and, thus, was registered.

Sign	EUTM No	Goods and services
	EUTM No 844	Classes 1, 3, 5, 6, 7, 8, 9, 11, 16, 17, 18, 19, 20, 21, 22, 26, 28, 31, 41, 42

2.3.4 Figurative threshold

2.3.4.1 Preliminary remarks

Terms or signs that are non-distinctive, descriptive or generic may be brought out of the scope of a refusal based on Article 7(1)(b), (c) or (d) EUTMR if combined with other elements that make the sign as a whole distinctive. In other words, refusals based on Article 7(1)(b), (c) and/or (d) may not apply to signs consisting of a non-distinctive, descriptive or generic element combined with other elements that take the sign as a whole beyond a minimum level of distinctiveness.

In practice this means that one of the main questions that the Office must answer is whether the mark is figurative enough to reach the minimum degree of distinctive character that is required for registration.

Finally, the fact that a sign contains figurative elements does not prevent it from still being misleading or contrary to public order or accepted principles of morality or from

falling under other grounds of refusal, such as those set forth by Article 7(1)(h), (i), (j) and (k) EUTMR.

Sign	EUTM No	Goods and services
	<p>EUTM No 8 384 653</p>	<p>Classes 33, 35 and 39</p>
<p>(09/03/2012, T-417/10, ¡Que bueno ye! Hijoputa, EU:T:2012:120)</p> <p>The application was rejected since 'Hijoputa' is an offensive and vulgar word in Spanish. The application was considered to be against accepted principles of morality (irrespective of the figurative elements of the sign) protected under Article 7(1)(f) EUTMR.</p>		

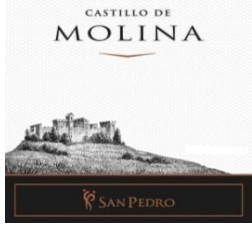
Sign	EUTM No	Goods and services
	<p>EUTM No 11 402 781</p>	<p>Class 33</p>
<p>The application was refused on the basis of Article 7(1)(j) EUTMR, because it contains the protected geographical indication for wines 'MOLINA' (protected under the agreement <i>establishing an association between the European Community and its Member States, of the one part, and the Republic of Chile, of the other part</i>). The distinctive figurative elements of the sign are irrelevant.</p>		

2.3.4.2 Assessment of the figurative threshold

The presence of figurative elements may give distinctive character to a sign consisting of a descriptive and/or non-distinctive word element so as to render it eligible for registration as an EUTM. Therefore, the question to be considered is whether the stylisation and/or the graphical features of a sign are sufficiently distinctive for the sign to act as a badge of origin.

The examples below are taken from CP3 (Convergence Programme 3), where The IP offices of the European Trade Mark and Design Network agreed on a Common Practice in relation to when a figurative mark, containing purely descriptive/non-distinctive words, should pass the absolute grounds examination because the figurative element renders sufficient distinctive character.

The signs containing 'Flavour and aroma' seek protection for coffee in Class 30, the signs containing 'Fresh sardine' and 'Sardines' seek protection for sardines in Class 29, the sign containing 'DIY' seeks protection for **kits of parts for assembly**

into furniture in Class 20 the signs containing 'Pest control services' seek protection for pest control services in Class 37, and the sign containing 'Legal advice services' seeks protection for legal services in Class 45.

Stylised word elements

- Typeface and font

In general, descriptive/non-distinctive word elements appearing in basic/standard typeface, lettering or handwritten style typefaces — with or without font effects (bold, italics) — are not registrable.

Non-distinctive examples:

Fresh Sardine *Fresh Sardine* FrEsh SaRdine
Flavour and aroma *Flavour and aroma* *Flavour and aroma*

Where standard typefaces incorporate elements of graphic design as part of the lettering, those elements need to have sufficient impact on the mark as a whole to render it distinctive. When these elements are sufficient to distract the attention of the consumer from the descriptive meaning of the word element or likely to create a lasting impression of the mark, the mark is registrable.

Distinctive examples:

flavour and aroma **FLAVOUR AND AROMA** **DIY**

- Combination with colour

The mere 'addition' of a single colour to a descriptive/non-distinctive word element, either to the letters themselves or as a background, will not be sufficient to give the mark distinctive character.

Use of colours is common in trade and would not be seen as a badge of origin. However, it cannot be excluded that a particular arrangement of colours, which is unusual and can be easily remembered by the relevant consumer, could render a mark distinctive.

Non-distinctive examples:

Flavour and aroma **Flavour and aroma** **Flavour and aroma** **Flavour and aroma**

- Combination with punctuation marks and other symbols

In general, the addition of punctuation marks or other symbols commonly used in trade does not add distinctive character to a sign consisting of descriptive/non-distinctive word elements.

Non-distinctive examples:

FreshSardine .™ “**Flavour and aroma**”

- Position of the word elements (sideways, upside-down, etc.)

In general, the fact that the word elements are arranged in vertical, upside-down or in one or more lines is not sufficient to endow the sign with the minimum degree of distinctive character that is necessary for registration.

Non-distinctive examples:

Flavour and Aroma
Flavour and Aroma
Flavour and Aroma

However the way in which the word elements are positioned can add distinctive character to a sign when the arrangement is of such a nature that the average consumer focuses on it rather than immediately perceiving the descriptive message.

Distinctive examples:

F d
l n And
a a r
v m Flavour
o m
r u m
A r a

Word element(s) and additional figurative element(s)

- Use of simple geometric shapes

Descriptive or non-distinctive verbal elements combined with simple geometric shapes such as points, lines, line segments, circles, triangles, squares, rectangles, parallelograms, pentagons, hexagons, trapezia and ellipses are unlikely to be acceptable, in particular when the abovementioned shapes are used as a frame or border.

Non-distinctive examples:



However, geometric shapes can add distinctiveness to a sign when their presentation, configuration or combination with other elements creates a global impression that is sufficiently distinctive.

Distinctive examples:

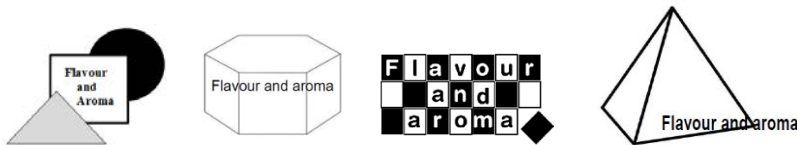

- Position and proportion (size) of the figurative element in relation to the word element

In general, when a figurative element that is distinctive on its own is added to a descriptive and/or non-distinctive word element, then the mark is registrable, provided that said figurative element is, due to its size and position, clearly recognisable in the sign.

Non-distinctive examples:

Flavour and aroma *Fresh Sardine*

Distinctive example:



- the figurative element is a representation of, or has a direct link with, the goods and/or services

A figurative element is considered to be descriptive and/or devoid of distinctive character whenever:

- It is a true-to-life portrayal of the goods and services.
- It consists of a symbolic/stylised portrayal of the goods and services that does not depart significantly from the common representation of said goods and services.

Non-distinctive examples:



Distinctive examples:



A figurative element that does not represent the goods and services but has a direct link with the characteristics of the goods and services will not render the sign distinctive, unless it is sufficiently stylised.

Non-distinctive example:



Distinctive example:



- the figurative element is commonly used in trade in relation to the goods and/or services applied for

In general, figurative elements that are commonly used or customary in trade in relation to the goods and/or services claimed do not add distinctive character to the mark as a whole.

Non-distinctive examples:



Stylised word elements and additional figurative element(s)

In general, a combination of figurative elements and word elements, which if considered individually are devoid of distinctive character, does not give rise to a distinctive mark.

Nevertheless, a combination of such elements when considered as a whole could be perceived as a badge of origin due to the presentation and composition of the sign. This will be the case when the combination results in an overall impression that is

sufficiently far removed from the descriptive/non-distinctive message conveyed by the word element.

Examples: In order for a sign to be registrable, it must have a minimum level of distinctiveness. The purpose of the scale is to illustrate where that threshold is. The examples below from left to right contain elements with an increasing impact on the distinctiveness of the marks, resulting in marks which are either non-distinctive in their totality (red column) or distinctive in their totality (green column).

<p>1.</p>	
<p>2.</p>	
<p>3.</p>	

2.4 Customary signs or indications (Article 7(1)(d) EUTMR)

2.4.1 General remarks

Article 7(1)(d) EUTMR excludes from registration signs that consist **exclusively** of words or indications that have become customary in the current language or in the bona fide and established practices of the trade at the relevant point in time (see paragraph 2.4.2 below). In this context, the customary nature of the sign usually refers to something **other than** the properties or characteristics of the goods or services themselves.

Although there is a clear overlap between the scope of Article 7(1)(d) and Article 7(1)(c) EUTMR, signs covered by Article 7(1)(d) EUTMR are excluded from registration not because they are descriptive, but on the basis of their **current usage** in trade sectors covering the goods or services for which the mark is applied for (judgment of 04/10/2001, C-517/99, Bravo, EU:C:2001:510, § 35).

Moreover, signs or indications that have become customary in the current language or in the bona fide and established practices of the trade to designate the goods or services covered by that sign are not capable of distinguishing the goods or services of one undertaking from those of other undertakings and do not, therefore, fulfil the essential function of a trade mark (judgment of 16/03/2006, T-322/03, Weisse Seiten, EU:T:2006:87, § 52).

This ground for refusal **also covers words that originally had no meaning** or had another meaning, for example, 'weiße Seiten' (= 'white pages'). It also covers certain

abbreviations that have entered informal or jargon usage and have thereby become customary in trade.

Furthermore, a refusal based on Article 7(1)(d) EUTMR also covers **figurative elements** that are either frequently used pictograms or similar indications or have even become the standard designation for goods and services, for example a white ‘P’ on a blue background for parking places, the Aesculapian staff for pharmacies, or the silhouette of a knife and fork for restaurant services.

Sign	Reasoning	Case No
 <p data-bbox="240 808 520 864">EUTM No 9 894 528 covering goods in Class 9</p>	<p data-bbox="549 544 1086 875">‘This device is identical to the international safety symbol known as “high voltage symbol” or “caution, risk of electric shock” ... It has been officially defined as such by the ISO 3864 as the standard high voltage symbol, whereby the device applied for is contained within the triangle which denotes that it is a hazard symbol ... Consequently, since it essentially coincides with the customary international sign to indicate a risk of high voltage, the Board deems it to be ineligible for registration as an EUTM in accordance with Article 7(1)(d) EUTMR’ (paragraph 20)</p>	<p data-bbox="1145 667 1310 696">R 2124/2011-5</p>

2.4.2 Point in time of a term becoming customary

The customary character must be assessed with reference to the **filing date of the EUTM application** (judgments of 05/03/2003, T-237/01, BSS, EU:T:2003:54, § 46; 05/10/2004, C-192/03 P, BSS, EU:C:2004:587, § 39-40). Whether a term or figurative element was non-descriptive or distinctive long before that date, or when the term was first adopted, will in most cases be immaterial, since it does not necessarily prove that the sign in question had not become customary by the filing date (judgment of 05/03/2003, T-237/01, BSS, EU:T:2003:54, § 47; similarly, judgment of 21/05/2014, T-553/12, BATEAUX MOUCHES, EU:T:2014:264).

In some cases, a sign applied for may become customary **after the filing date**. Changes in the meaning of a sign that lead to a sign becoming customary after the filing date do not lead to a declaration for invalidity *ex tunc* under Article 52(1)(a) EUTMR, but can lead to a **revocation** with effect *ex nunc* under Article 51(1)(b) EUTMR. For example, the EUTM registration ‘STIMULATION’ was cancelled on the grounds that it had become a term customarily used in relation to energy drinks. For further information, see the Guidelines, Part D, Cancellation, Section 2, Substantive Provisions.

2.4.3 Assessment of customary terms

Whether a mark is customary must be assessed, firstly, by reference to the goods or services in respect of which registration is sought, and, secondly, on the basis of the target public’s perception of the mark (judgment of 07/06/2011, T-507/08, 16PF, EU:T:2011:253, § 53).

As regards the **link with the goods and services** in respect of which registration is sought, Article 7(1)(d) EUTMR will not apply where the mark consists of a more general laudatory term that has no particular customary link with the goods and services concerned (judgment of 04/10/2001, C-517/99, Bravo, EU:C:2001:510, § 27, 31).

As regards the **relevant public**, the customary character must be assessed by taking account of the expectations that the average consumer, who is deemed to be reasonably well informed and reasonably observant and circumspect, is presumed to have in respect of the type of goods in question (judgment of 16/03/2006, T-322/03, *Weisse Seiten*, EU:T:2006:87, § 50). The Court has clarified a number of issues in this respect:

- The relevant public to be taken into account in determining the sign's customary character comprises not only all consumers and end users but also, depending on the features of the market concerned, **all those in the trade who deal with that product commercially** (judgments of 29/04/2004, C-371/02, *Bostongurka*, EU:C:2004:275, § 26; 06/03/2014, C-409/12, *Kornspitz*, EU:C:2014:130, § 27).
- Where the trade mark targets both **professionals and non-professionals** (such as intermediaries and end users), it is sufficient for a sign to be refused or revoked if it is perceived to be a usual designation by any one sector of the relevant public, notwithstanding the fact that another sector may recognise the sign as a badge of origin (judgment of 06/03/2014, C-409/12, *Kornspitz*, EU:C:2014:130, § 23-26).
- The General Court has held that Article 7(1)(d) EUTMR is not applicable when the sign's use in the market is by **one sole trader** (other than the EUTM applicant) (judgment of 07/06/2011, T-507/08, 16PF, EU:T:2011:253). In other words, a mark will not be regarded as customary purely for the simple reason that a competitor of the EUTM applicant also uses the sign in question. For customary character to be demonstrated, it is necessary for the examiner to provide evidence (which will generally come from the internet) that the relevant consumer has been exposed to the mark in a non-trade mark context and that, as a result, they recognise its customary significance vis-à-vis the goods and services claimed.

2.4.4 Applicability of Article 7(1)(d) EUTMR in relation to plant variety names

The issue of generic character may arise in the context of the examination of trade marks that consist exclusively of the name of a plant variety that is **not simultaneously registered** by the Community Plant Variety Office in accordance with Regulation No 2100/94 or registered in accordance with national law or international agreements to which the Union or the Member State concerned is a party. In the latter case, the mark would be objectionable under Article 7(1)(m) EUTMR.

Therefore, if the evidence available shows that a given plant variety name has become customary in the European Union as the generic denomination of the variety in question, then the examiners — in addition to objecting to the trade mark applied for under Article 7(1)(c) and (b) EUTMR on the ground that the trade mark applied for is descriptive — should also object under Article 7(1)(d) EUTMR on the additional ground that the trade mark consists exclusively of a term that has become generic in the relevant field of trade in the European Union. See paragraphs 2.3.2.10 and 2.6.1.2, Plant variety names.

2.5 Shapes or other characteristics with an essentially technical function, substantial value or resulting from the nature of the goods (Article 7(1)(e) EUTMR)

2.5.1 General remarks

Article 7(1)(e) EUTMR excludes from registration signs that consist exclusively of (i) the shape or other characteristic that results from the nature of the goods themselves; (ii) the shape or other characteristic of goods that is necessary to obtain a technical result; or (iii) the shape or other characteristic of the goods that gives substantial value to the goods.

The wording of this provision infers that it does not apply to signs for which registration is sought in respect of services.

Regulation No 2015/2424 amending Regulation No 207/2009 of the Community trade mark introduced the reference to ‘another characteristic’ of the goods. To the Office’s understanding, most of the trade marks that fall foul the new wording of this provision are currently objectionable under Article 7(1)(b) and/or (c) EUTMR, as they are descriptive or otherwise non-distinctive. However, an important practical difference lies in the fact that an objection under Article 7(1)(e) EUTMR cannot be overcome by invoking Article 7(3) EUTMR.

Importantly, unlike in the situation covered by Article 7(1)(b) EUTMR, the **average consumer’s perception is not a decisive element** when applying the ground for refusal under Article 7(1)(e) EUTMR, but, **at most**, may be a relevant criterion for assessment by the Office when the latter identifies the sign’s essential characteristics (judgment of 18/09/2014, C-205/13, Hauck, EU:C:2014:2233, § 34).

For these reasons, **an objection under Article 7(1)(e) EUTMR** to marks consisting of shapes or other characteristics that follow from the nature of the goods, shapes or other characteristics that are necessary to obtain a technical result or shapes or other characteristics giving substantial value to the goods **cannot be overcome** by demonstrating that they have **acquired distinctive character**. In other words, Article 7(3) EUTMR is not applicable to such shapes or other characteristics, regardless of whether that particular shape or other characteristic might actually be distinctive in the marketplace.

It is therefore advisable to **undertake a prior examination of the sign under Article 7(1)(e) EUTMR where several of the absolute grounds for refusal provided for in Article 7(1) EUTMR may apply** (judgment of 6/10/2011, T-508/08, Loudspeaker, EU:T:2011:575, § 44).

For the sake of sound administration and economy of proceedings, the Office will raise any objections to registration of the sign under Article 7(1) EUTMR, including Article 7(1)(e) EUTMR, as soon as possible and preferably all at once, even if an objection under Article 7(1)(e) EUTMR based on the facts in question is less evident than, for instance, an objection for a lack of distinctiveness under Article 7(1)(b) EUTMR.

It may also be the case that following an initial objection under Article 7(1)(b) and/or (c) EUTMR, the evidence submitted by the applicant shows that the sign consists exclusively of a shape or other characteristic as listed in Article 7(1)(e) EUTMR. In these cases, a further objection under Article 7(1)(e) should be raised as well.

Article 7(1)(e) EUTMR does not define the category of mark that must be considered as a shape within the meaning of that provision. **It makes no distinction between 2D or 3D shapes, or 2D representations of 3D shapes.** Therefore, the applicability of Article 7(1)(e) EUTMR is not confined to 3D shapes but also applies to other categories of marks such as figurative signs representing shapes (judgment of 06/03/2014, C-337/12, Surface covered with circles, EU:C:2014:129, § 55).

The **objective** pursued by Article 7(1)(e) EUTMR is the same for all of its three grounds, namely to prevent the exclusive and permanent rights that a trade mark confers from serving to extend the life of other rights indefinitely, such as patents or designs, which the EU legislature has sought to make subject to limited periods (judgments of 18/09/2014, C-205/13, Hauck, EU:C:2014:2233, § 19-20; 14/09/2010, C-48/09 P, Lego brick, EU:C:2010:516, § 43; 06/10/2011, T-508/08, Loudspeaker, EU:T:2011:575, § 65).

A sign consists '**exclusively**' of the shape of goods or other characteristics when all its essential characteristics — that is to say, its most important elements — result from the nature of the goods (Article 7(1)(e)(i) EUTMR), perform a technical function (Article 7(1)(e)(ii) EUTMR) or give substantial value to the goods (Article 7(1)(e)(iii) EUTMR). The presence of one or more minor arbitrary elements, therefore, will not alter the conclusion (judgments of 18/09/2014, C-205/13, Hauck, EU:C:2014:2233, § 21-22; and 14/09/2010, C-48/09 P, Lego brick, EU:C:2010:516, § 51-52). However, an objection under Article 7(1)(e) EUTMR would not be justified if the sign applied for were to consist of a shape or other characteristic combined with additional, distinctive matter (whether word and/or figurative elements) as the sign in its entirety would then not consist exclusively of a shape or other characteristic (see paragraph 2.2.12.3, Step 3 above).

The correct application of Article 7(1)(e) EUTMR requires that **the essential characteristics of the sign at issue be properly identified**, and that the assessment may be based either on the overall impression that it produces or an examination of each of its components (judgments of 18/09/2014, C-205/13, Hauck, EU:C:2014:2233, § 21; 14/09/2010, C-48/09 P, Lego brick, EU:C:2010:516, § 70).

This identification may, depending on the case and particularly in view of its degree of difficulty, be carried out by means of a simple visual analysis of the sign or, on the other hand, be based on a detailed examination in which relevant assessment criteria may be taken into account, such as surveys or expert opinions, or data relating to intellectual property rights conferred previously for the goods concerned such as patents (judgment of 14/09/2010, C-48/09 P, Lego brick, EU:C:2010:516, § 71, 85).

Once the sign's essential characteristics have been identified, it will have to be established **whether they all fall under the respective ground set out in Article 7(1)(e) EUTMR** (judgment of 14/09/2010, C-48/09 P, Lego brick, § 72). In this respect, each of the three grounds must be applied independently of the others. In addition, where none of those grounds is fully applicable for the entire shape or other characteristic, they do not preclude registration of the sign (judgment of 18/09/2014, C-205/13, Hauck, EU:C:2014:2233, § 39, 42). Therefore, if parts of the shape or other characteristic are necessary to obtain a technical result within the meaning of Article 7(1)(e)(ii) EUTMR, for instance, and the remaining parts merely give substantial value to the goods under Article 7(1)(iii) EUTMR, neither of these two provisions bars the registration of the shape or other characteristic as a sign.

2.5.2 Shape or other characteristic that results from the nature of the goods

Under Article 7(1)(e)(i) EUTMR, signs that consist exclusively of the shape or other characteristic that results from the nature of the goods themselves cannot be registered.

This ground of refusal will apply when the sign, whether 2D or 3D, consists exclusively of the only natural shape or other characteristic possible for the goods: for example, the realistic representation below of a banana for bananas:



Furthermore, the application of Article 7(1)(e)(i) EUTMR cannot be limited to apply only to signs that consist exclusively of shapes or to other characteristics that are indispensable to the function of the goods in question. Apart from **'natural' products** (which have no substitute) and **'regulated' products** (the shape or other characteristic of which is prescribed by legal standards), all shapes or other characteristics that are **inherent to the generic function or functions** of such goods must, in principle, also be denied registration (judgment of 18/09/2014, C-205/13, Hauck, EU:C:2014:2233, § 23-25).

The Court of Justice has not given any further guidance about exactly when a shape or other characteristic is inherent to the generic function(s) of goods. In the absence of any case-law in this respect, the examples given by the Advocate General may be referred to: legs with a horizontal level for a table; an orthopaedic-shaped sole with a V-shaped strap for flip-flops (opinion of 14/05/2014, C-205/13, § 59). Even considering that the opinion of the Advocate General is not binding, it can give useful guidance.

There is no practice yet on cases where a trade mark consists of 'other characteristics' that result from the nature of the goods. As an invented example, a sound mark representing the sound of a motorbike for *motorbikes* could be captured by Article 7(1)(e)(i) EUTMR if the sound results from the nature of the goods (in the sense of its technical performance).

In all cases where the EUTM applied for consists exclusively of the shape or other characteristic of the goods that follows from their nature, an objection may additionally be raised under Article 7(1)(b) and/or (c) EUTMR, on the ground that the shape or other characteristic in question lacks distinctive character and/or is descriptive of the nature of the goods.

2.5.3 Shape or other characteristic of goods necessary to obtain a technical result

Article 7(1)(e)(ii) EUTMR excludes from registration signs that consist exclusively of the shape or other characteristic of goods that is necessary to obtain a technical result.

The Courts have not yet ruled on the interpretation of 'another characteristic' of the goods. However, the Court of Justice has rendered two leading judgments concerning

the subject of essentially functional shapes, which provide guidance concerning the examination of trade marks consisting exclusively of functional shapes or other characteristics of the goods (preliminary ruling of 18/06/2002, C-299/99, Remington, EU:C:2002:377, and judgment of 14/09/2010, C-48/09 P, Lego brick, EU:C:2010:516), interpreting, inter alia, Article 3(1) TMD, which is the equivalent of Article 7(1) EUTMR.

A sign consists ‘exclusively’ of the shape of goods that is necessary to obtain a technical result when **all the essential characteristics of a shape perform a technical function**, the presence of non-essential characteristics with no technical function being irrelevant in that context (judgment of 14/09/2010, C-48/09 P, Lego brick, § 51). The fact that there may be **alternative shapes**, with other dimensions or another design, capable of achieving the same technical result does not in itself preclude the application of this provision (judgment of 14/09/2010, C-48/09 P, Lego brick, EU:C:2010:516, § 53-58).

In assessing an EUTM application against Article 7(1)(e)(ii) EUTMR, consideration should be given to the meaning of the **expression ‘technical result’**. This expression should be interpreted broadly and includes shapes or other characteristics that, for example:

- fit with another article;
- give the most strength;
- use the least material;
- facilitate convenient storage or transportation.

Other characteristics of the goods that are necessary to obtain a technical result may include particular sounds. For instance, as an invented example, a sound mark for insect repellents may be objected to under Article 7(1)(e)(ii) EUTMR if the sound in fact repels insects.

In the ‘Red Lego Brick’ case, following a cancellation action, two instances of the Office declared the 3D shape of a building block in a construction toy set as invalid:

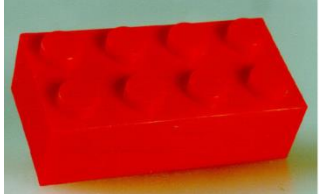
Sign	EUTM No	Goods and services
	EUTM No 107 029 R 856/2004 G T-270/06 C-48/09 P	Class 28 (construction toys)

In particular, the Grand Board held that the various features of the ‘Red Lego brick’ all performed particular technical functions, namely (i) *the bosses [studs]*: height and diameter for clutch power; number for fixing versatility; layout for fixing arrangement; (ii) *the secondary projections*: clutch-power; the number for best clutch-power in all positions; the thickness of the wall to act as a spring; (iii) *the sides*: connected with sides of other bricks to produce a wall; (iv) *the hollow skirt*: to mesh with the bosses and to enable fixing for clutch power and (v) *the overall shape*: brick shape for building; size for children to hold (decision of 10/07/2006, R 0856/2004-G, § 54).

The General Court dismissed the appeal against the above decision and confirmed the findings of the Grand Board, holding that the latter had correctly applied

Article 7(1)(e)(ii) EUTMR (judgment of 12/11/2008, T-270/06, Lego brick, EU:T:2008:483).

Following an appeal, the Court of Justice, in its ruling of 14/09/2010, C-48/09 P, ‘Lego brick’, confirmed the judgment of the General Court, holding that:

... the solution incorporated in the shape of goods examined is the technically preferable solution for the category of goods concerned. If the three-dimensional sign consisting of such a shape were registered as a trade mark, it would be difficult for the competitors of the proprietor of that mark to place on the market shapes of goods constituting a real alternative, that is to say, shapes which are not similar and which are nevertheless attractive to the consumer from a functional perspective’ (para. 60).

The fact that the shape concerned is, or has been, the subject of a claim in a **registered patent or patent application** constitutes prima facie evidence that those aspects of the shape identified as being functional in the patent claim are necessary to achieve a technical result (this approach has been followed by the Boards of Appeal, for example, in their decision of 17/10/2013, R 0042/2013-1).

A case regarding the following shape for ‘knives and knife handles’ provides an example of how to identify the essential characteristics of a shape and how to assess if all of those characteristics perform a technical function:

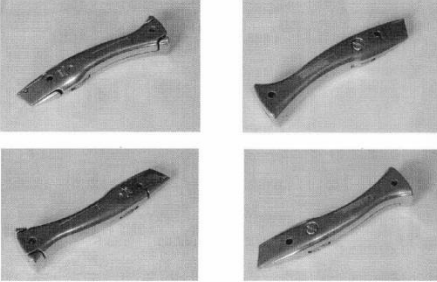
Sign	Case
	<p>Judgment of 19/09/2012, T-164/11, ‘Shape of knife handles’</p>

In this case, the shape applied for was described as

... a slightly curved knife handle characterised by a small angle of 5 to 10 degrees between the knife blade and the longitudinal axis of the shell grip, which has a middle section with a somewhat rounded outer cross section, which broadens towards a tapered rear end. The handle also incorporates a knurled screw in the shell of the knife.

The Court stated that

As is apparent from that patent [relied upon by the invalidity applicant], the technical effect of the angle between the knife blade and the longitudinal axis of the mother-of-pearl handle is to facilitate cutting. The intermediate section is of particular importance for long cuts. It makes the cut more precise while allowing greater pressure to be exerted. Finally, the knurled screw allows the shell to be opened and the blades of the knife to be changed without using other tools and without hindering manipulation of the knife during use (para. 30).

and concluded that the most important elements of the sign, constituting its essential characteristics, are all exclusively functional (para. 33).

2.5.4 Shape or other characteristic that gives substantial value to the goods

Under Article 7(1)(e)(iii) EUTMR, signs that consist exclusively of the shape or other characteristic that gives substantial value to the goods cannot be registered, or if registered they are liable to be declared invalid.

Whereas the same shape or other characteristic can, in principle, be protected both as a design and as a trade mark, Article 7(1)(e)(iii) EUTMR only refuses trade mark protection for shapes or other characteristics in certain specific cases, namely, when the sign consists exclusively of a shape or other characteristic that gives substantial value to the product.

The **concept of 'value'** should be interpreted not only in commercial (economic) terms, but also in terms of 'attractiveness', that is to say, the likelihood that the goods will be purchased **primarily because of** their particular shape or of another particular characteristic. When other characteristics may give the product significant value in addition to this aesthetic value, such as functional value (for instance safety, comfort and reliability), Article 7(1)(e)(iii) EUTMR cannot be ruled out automatically. Indeed, the concept of 'value' cannot be limited purely to the shape or other characteristic of products having only artistic or ornamental value (judgment of 18/09/2014, C-205/13, Hauck, EU:C:2014:2233, § 29-32).

The concept of 'value' should not be interpreted as meaning 'reputation', since application of this absolute ground for refusal is justified exclusively by the effect on the value added to the goods **by the shape** or other characteristic and not by other factors, such as the reputation of the word mark that is also used to identify the goods in question (see in this regard, decision of 16/01/2013, R 2520/2011-5, § 19).

Furthermore, the fact that the shape or other characteristic may be **pleasing or attractive** is not sufficient to exclude it from registration. If that were the case, it would be virtually impossible to imagine any trade mark of a shape or other characteristic, given that in modern business there is no product of industrial utility that has not been the subject of study, research and industrial design before its eventual launch on the market (decision of 03/05/2000, R 0395/1999-3, Gancino quadrato singolo, § 1-2 and 22-36).

In assessing the value of the goods, account may be taken of **criteria** such as the nature of the category of goods concerned, the artistic value of the shape or other characteristic in question, its dissimilarity from other shapes in common use on the market concerned, a substantial price difference compared with similar products, and the development of a promotion strategy that focuses on accentuating the aesthetic characteristics of the product in question (judgment of 18/09/2014, C-205/13, Hauck, EU:C:2014:2233, § 35).

For the examination of these trade marks, a **case-by-case approach is necessary**. In most of these cases a proper examination will only be possible where there is evidence that the aesthetic value of the shape or other characteristic can, in its own right, determine the commercial value of the product and the consumer's choice to a large extent.

If a shape or other characteristic derives its appeal from the fame of its designers and/or marketing efforts rather than from the aesthetic value of the shape or other characteristic itself, Article 7(1)(e)(iii) EUTMR will not apply (decision of 14/12/2010, R 0486/2010-2, SHAPE OF CHAIR, § 20-21).

A leading case when it comes to shapes bestowing substantial value on the goods concerns the three-dimensional representation below of a loudspeaker.

Sign	Case	Goods
	<p>Decision of 10/09/2008, R 0497/2005-1</p> <p>Judgment of 06/10/2011, T-508/08</p> <p>'Representation of a loudspeaker'</p>	<p>Apart from loudspeakers, other apparatus for the reception, processing, reproduction, regulation or distribution of sound signals in Class 9 as well as music furniture in Class 20.</p>

The General Court confirmed the Board of Appeal's finding that the sign at issue fell within the scope of Article 7(1)(e)(iii) EUTMR (judgment of 06/10/2011, T-508/08, Loudspeaker, EU:T:2011:575).

The General Court held that for goods such as those listed above, the design was an element that would be very important in the consumer's choice even if the consumer took other characteristics of the goods at issue into account. After having stated that the shape for which registration was sought revealed a very specific design and that it was an essential element of the applicant's branding, which increased the appeal of the product and, therefore, its value, the General Court also noted that it was apparent from the evidence on record, namely extracts from the distributors' websites and online auction or second-hand websites, that the aesthetic characteristics of that shape were emphasised first and that the shape was perceived as a kind of pure, slender, timeless sculpture for music reproduction, which made it an important selling point (judgment of 06/10/2011, T-508/08, Loudspeaker, EU:T:2011:575, § 75). The General Court thus concluded that, independently of the other characteristics of the goods at issue, the shape for which registration was sought bestowed substantial value on the goods concerned.

It follows from the above judgment that it is important to determine whether **the aesthetic value of a shape or other characteristic can, in its own right, determine the commercial value of the product and the consumer's choice to a large extent.** It is immaterial whether the overall value of the product is also affected by other factors, if the value contributed by the shape or other characteristic itself is substantial.

2.6 Acquired distinctiveness

2.6.1 Introduction

In accordance with Article 7(3) EUTMR, a trade mark may still be registered despite the fact that it does not comply with Article 7(1)(b), (c) or (d) EUTMR, provided that it 'has

become distinctive in relation to the goods or services for which registration is requested in consequence of the use which has been made of it'.

Article 7(3) EUTMR constitutes an exception to the rule laid down in Articles 7(1)(b), (c) or (d) EUTMR, whereby registration must be refused for trade marks that are per se devoid of any distinctive character, for descriptive marks, and for marks that consist exclusively of indications that have become customary in the current language or in the bona fide and established practices of the trade.

Distinctive character acquired through use means that although the sign *ab initio* lacks inherent distinctiveness with regard to the goods and services claimed, owing to the use made of it on the market, the relevant public has come to see it as identifying the goods and services claimed in the EUTM application as originating from a particular undertaking. Thus, the sign has become capable of distinguishing goods and services from those of other undertakings because they are perceived as originating from a particular undertaking. In this way, a sign originally unable to be registered under Article 7(1)(b), (c) or (d) EUTMR can acquire a new significance, and its connotation, no longer purely descriptive or non-distinctive, permits it to overcome those absolute grounds for refusal of registration as a trade mark.

2.6.2 Request

The Office will only examine acquired distinctive character following a request from the EUTM applicant. This request may be filed at any time during the examination proceedings. The Office is not bound to examine facts showing that the mark claimed has become distinctive through use within the meaning of Article 7(3) EUTMR unless the applicant has pleaded them (judgment of 12/12/2002, T-247/01, *Ecopy*, EU:T:2002:319, § 47).

2.6.3 The point in time

The evidence must prove that distinctiveness through use was acquired prior to the EUTM application's filing date. In the case of an IR, the relevant date is the date of registration by the International Bureau or, if the designation takes place at a later stage, the designation date. Where priority is claimed, the relevant date is the priority date. Hereafter, all these dates are referred to as the 'filing date'.

2.6.3.1 Examination proceedings

Since a trade mark enjoys protection as of its filing date, and since the filing date of the application for registration determines the priority of one mark over another, a trade mark must be registrable on that date. Consequently, the applicant must prove that distinctive character has been acquired through use of the trade mark prior to the date of application for registration (judgments of 11/06/2009, C-542/07 P, *Pure Digital*, EU:C:2009:362, § 49 and 51; and 07/09/2006, C-108/05, *Europolis*, EU:C:2006:530, § 22). Evidence of use made of the trade mark after this date should not be automatically disregarded, to the extent that it may provide indicative information regarding the situation prior to the date of application (judgment of 28/10/2009, T-137/08, *Green/Yellow*, EU:T:2009:417, § 49).

2.6.3.2 Cancellation Proceedings

In cancellation proceedings, a trade mark that was registered in breach of the provisions of Article 7(1)(b), (c) or (d) EUTMR may nevertheless no longer be declared invalid if, in consequence of the use that has been made of it, it has, after registration, acquired distinctive character for the goods or services for which it is registered (Article 52(2) EUTMR).

The precise purpose of this norm is to maintain the registration of those marks that, due to the use that has been made of them, have in the meantime — that is to say, after their registration and in any event before the application for an invalidity request — acquired distinctive character for the goods or services for which they were registered, in spite of the fact that, when registration took place, it was contrary to Article 7 EUTMR (judgments of 14/12/2011, T-237/10, Clasp lock, EU:T:2011:741, § 52, 53 and 86; 15/10/2008, T-405/05, Manpower, EU:T:2008:442, § 127, 146; 10/12/2008 T-365/06, Bateaux Mouches, EU:T:2008:559, § 37 and 38).

2.6.4 Consumer

Distinctive character of a sign, including that acquired through use must be assessed in relation to the presumed perception of the average consumer for the category of goods or services in question. These consumers are deemed to be reasonably well informed, and reasonably observant and circumspect. The definition of the relevant public is linked to an examination of the intended purchasers of the goods or services concerned, since it is in relation to those purchasers that the mark must perform its essential function. Consequently, such a definition must be arrived at by reference to the essential function of a trade mark, namely to guarantee the identity of the origin of the goods or services covered by the mark to consumers or end users by enabling them, without any possibility of confusion, to distinguish the goods or services from others of another origin (judgment of 29/09/2010, T-378/07, RED/BLACK/GREY (Surface of a tractor), EU:T:2010:413, § 33, 38).

The relevant consumer includes, therefore, not only persons who have actually purchased the goods and services but also any potentially interested person in the strict sense of prospective purchasers (judgment of 29/09/2010, T-378/07, RED/BLACK/GREY (Surface of a tractor), EU:T:2010:413, § 41 et seq.).

Prospective purchasers are defined by the precise product or service for which registration is sought. If the claimed goods or services are broad (for example, bags or watches), it is irrelevant that the actual products offered under the sign are extremely expensive luxury items — the public will include all the prospective purchasers for the goods claimed in the EUTM application, including non-luxury and cheaper items if the claim is for the broad category.

2.6.5 Goods and Services

Since one of the main functions of a trade mark is to guarantee the origin of goods and services, acquired distinctiveness must be assessed in respect of the goods and services at issue. Consequently, the applicant's evidence must prove a link between the sign and the goods and services for which the sign is applied for, establishing that the relevant class of persons, or at least a significant proportion thereof, identify goods as originating from a particular undertaking because of the trade mark (judgments of

04/05/1999, C-108/97 & C-109/97, Chiemsee, EU:C:1999:230, § 52; and 19/05/2009, T-211/06, Cybercrédit et al., EU:T:2009:160, § 51).

2.6.6 Territorial Aspects

Pursuant to Article 1 EUTMR, an European Union trade mark has a unitary character and has equal effect throughout the European Union. Article 7(2) EUTMR provides that a trade mark must be refused registration if an absolute ground exists only in part of the European Union.

As a logical consequence, acquired distinctiveness must be established throughout the territory in which the trade mark did not, *ab initio*, have such character (judgments of 22/06/2006, C-25/05 P, Bonbonverpackung, EU:C:2006:422, § 83, 86; and 29/09/2010, T-378/07, RED/BLACK/GREY (Surface of a tractor), EU:T:2010:413, § 30). Evidence from Non-EU states is irrelevant, except insofar as it might enable conclusions to be drawn about use within the EU (judgment of 24/07/2014, T-273/12, Ab in den Urlaub, EU:T:2014:568, § 45).

This is because the unitary character of the European Union trade mark requires a sign to possess distinctive character, inherent or acquired through use, throughout the European Union (judgment of 17/05/2011, T-7/10, ‘υγεία’, EU:T:2011:221, § 40). It would be paradoxical to accept, on the one hand, pursuant to Article 3(1)(b) TMD, that a Member State refuses to register as a national mark a sign that is devoid of any distinctive character in its territory and, on the other, that the same Member State has to respect a European Union trade mark relating to that sign for the sole reason that it has acquired distinctive character in the territory of another Member State (judgment of 14/12/2011, T-237/10, Clasp lock, EU:T:2011, § 100).

Examples:

Evidence of acquired distinctiveness of the word mark ‘PHOTOS.COM’ in **four Member States** (DK, FI, SE and UK) was considered **insufficient** to draw valid conclusions with regard to acquired distinctiveness in a substantial part of the territory of the European Union (judgment of 21/10/2012, T-338/11, Photos/com, EU:T:2012:614, § 49).

Evidence of acquired distinctiveness of a ‘shape of two packaged goblets’ relating to **eight Member States** (BE, DE, FR, IT, NL, AT, SE and UK) was considered **insufficient** to draw valid conclusions with regard to acquired distinctiveness in a substantial part of the European Union (decision of 26/07/2012, R 1301/2011-1, shape of goblets, § 62, application dismissed in T-474/12, on other grounds).

2.6.6.1 Special provisions with respect to the accession of new Member States

In accordance with the provisions of the EU Accession Treaties, an EUTM applied for before the date of accession of a given Member State may only be rejected for reasons that already existed before the date of accession. Hence, in the Office’s examination proceedings, acquired distinctiveness must be demonstrated only with respect to Member States of the EU at the time of the EUTM application, and not those that have joined the EU subsequently.

2.6.6.2 3D marks, colours per se and figurative trade marks

If the objection exists throughout the European Union, as is normally the case for 3D marks, colours per se and figurative trade marks consisting exclusively of the depiction of the goods in question, acquired distinctiveness must be proven throughout the entire European Union (judgment of 25/09/2014, T-474/12, Shape of goblets, EU:T:2014:813, § 58). For the possibility of extrapolating the evidence, see paragraph 2.6.6.4 below.

2.6.6.3 Language area

Where the EUTM applied for is rejected with respect to its meaning in a specific language, acquired distinctiveness through use must be shown with respect to the Member States in which that language is an official language.

Particular care should be taken when a language is an official language in more than one EU Member State. In such cases, when dealing with an absolute grounds objection based on the meaning of wording in a certain language, acquired distinctiveness through use must be proven for each of the Member States where that language is official (as well as any other Member States or markets where it will be understood).

- (a) Examples of languages being official languages in more than one EU Member State

Language	Official language in the following Member States
German	Germany, Austria, Luxembourg and Belgium
Greek	Greece and Cyprus
English	United Kingdom, Ireland, Malta
French	France, Belgium, Luxembourg
Dutch	Netherlands and Belgium
Swedish	Sweden and Finland (judgment of 09/07/2014, T-520/12 Giffjar, EU:T:2014:620, upholding the decision of the Second Board of Appeal from 18/09/2012, R 0046/12-2, Giffjar)

Any claim that acquired distinctiveness through use enables the EUTM application to overcome an absolute grounds objection that is based on its meaning in any of the above languages must automatically be examined for all the countries where the language in question is an official one.

- (b) Understanding of a Member State language in Member States where it is not an official language

In addition to the Member States where the language of a sign's wording is an official language, consideration must also be given to other Member States where it is not an official language but is understood. This may be because, depending on the goods and services claimed in the EUTM application, the relevant public in that Member State has an elementary understanding of the language in question, or because the relevant public consists of specialists for whom certain technical terms in another EU Member State's official language are understood. If so, then acquired distinctiveness must be proven for the relevant public in these other EU Member States as well as in the Member States where the language is an official one.

By way of example, the GC has held that a very large proportion of European consumers and professionals have an elementary knowledge of English (judgment of 26/09/2012, T-301/09, Citigate, EU:T:2012:473, § 41). Accordingly, depending on the relevant consumer of the goods and services in question and whether the sign consists of an elementary English word or not, acquired distinctiveness may also have to be assessed with respect to further Member States.

Moving from the general public to a more specialist public for goods and services, the GC has held that certain English terms in the medical field (judgment of 29/03/2012, T-242/11, 3D eXam, EU:T:2012:179, § 26), in technical fields (judgment of 09/03/2012, T-172/10, Base-seal, EU:T:2012:119, § 54) and in financial matters (judgment of 26/09/2012, T-301/09, Citigate, EU:T:2012:473, § 41) will be understood by the relevant professionals throughout the European Union, as English is the commonly used professional language in these areas.

On the other hand, since the understanding of languages is not strictly limited by geographical borders, it may well be that, for historical, cultural or cross-border market reasons, certain (usually elementary) vocabulary of a given language may spread and could be widely understood by the general public in other Member States, particularly those with contiguous land borders. By way of example, German and French are commonly used in the Italian regions of Trentino-Alto Adige and Valle d'Aosta, while Denmark has a substantial German-speaking minority (judgment of 24/06/2014, T- 273/12, Ab in den Urlaub, EU:T:2014:568, § 44).

2.6.6.4 Extrapolation

As indicated above, the acquisition of distinctive character through use must be proven for the part of the European Union in which the trade mark concerned did not **initially** have such character. This may prove difficult and burdensome for the applicant, particularly with regard to three-dimensional or colour marks, where consumer perception of a potential lack of inherent distinctiveness will most likely be the same in each and every Member State of the European Union.

In this respect, the Court has held that, despite the fact that acquired distinctiveness must be shown **throughout the European Union**, it would be unreasonable to require proof of acquired distinctiveness for **each individual Member State** (judgment of 24/05/2012, C-98/11 P, 'Hase', EU:C:2012:307, § 62). This principle implies that, if one considers the European territory as a puzzle, failure to prove acquired distinctiveness for one or more specific national markets may not be decisive provided that the 'missing piece' of the puzzle does not affect the general picture that a significant proportion of the relevant European public perceives the sign as a trade mark in the various parts or regions of the European Union.

In this context the question arises whether the Office can **extrapolate** from selective evidence to draw broader conclusions. This concerns the extent to which evidence showing distinctiveness acquired through use in certain Member States can be used to make inferences with regard to the market situation in other Member States not covered by the evidence.

Extrapolating in this way to make broader inferences is of particular relevance to an enlarged European Union comprising many Member States, since it is highly likely that a party will not be able to provide evidence with respect to the whole European Union, but will rather tend to concentrate on some areas.

Extrapolation is possible where the following two conditions are met.

- **The market is homogenous** (i.e. the area where acquired distinctiveness is proven and the area where evidence is extrapolated): market conditions and consumer habits have to be comparable. Consequently, it is particularly important that the applicant submits data concerning the size of the market, its own market share and, if possible, that of its main competitors, as well as its marketing expenses. Only if all data is comparable, may the Office extrapolate the results from one territory to another.
- **At least some evidence of use is submitted for the area where the evidence is extrapolated.** Therefore, where the EUTM is used in the entire relevant territory but most of the evidence only refers to part of it, inference is possible if the circumstances are comparable and some evidence of use in another part/other parts of the relevant territory is submitted.

Evidence of acquired distinctiveness for the 'combination of the colours green and yellow' throughout the European Union was **accepted** despite a **lack of evidence** with regard to current turnover figures and no official statements on the relevant public's perception for **two Member States** (judgment of 28/10/2009, T-137/08, Green/Yellow, EU:T:2009:417, § 38 et seq.)

On the other hand, the GC rejected the claim of acquired distinctiveness for a 'chequerboard pattern' because the applicant had not provided any relevant evidence in **4** out of the then 15 relevant Member States, without examining the evidence filed for the other 11 Member States (judgment of 21/04/2015, T-359/12, Device of a chequered pattern (maroon & beige), EU:T:2015:215, § 101 et seq., not yet final).

Finally, the Court has held that the case-law relating to Article 7(3) EUTMR must not be confused with the case-law relating to the acquisition of reputation (which must be shown in a substantial part of the European Union and not in every Member State). The applicant must prove the acquisition of distinctive character through use in the part of the European Union in which the contested mark was devoid of any distinctive character. The case-law related to Article 7(3) EUTMR must therefore not be confused with the test on acquisition of reputation (judgment of 21/04/2015, T-359/12, Device of a chequered pattern (maroon & beige), EU:T:2015:215, § 119-120 and case-law quoted therein, not yet final).

2.6.7 Standard of proof

The requirements to prove acquired distinctiveness through use pursuant to Article 7(3) EUTMR are not the same as those to prove genuine use pursuant to Article 42(2) EUTMR. Whilst under Article 7(3) EUTMR it is necessary to prove qualified use, such that the relevant public perceives as distinctive a sign that per se is devoid of distinctive character, the reason behind the proof of genuine use is completely different, namely to restrict the number of trade marks registered and protected, and consequently the number of conflicts between them.

Therefore, the EUTM applicant must submit evidence that enables the Office to find that at least a significant proportion of the relevant section of the public identifies the products or services concerned as originating from a particular undertaking because of the trade mark (judgment of 15/12/2015, T-262/04, Briquet Pierre, EU:T:2005:463, § 61 and the case-law cited therein).

The evidence must be clear and convincing. The EUTM applicant must clearly establish all the facts necessary to safely conclude that the mark has been used as a badge of origin, that is to say, that it has created a link in the mind of the relevant public with the goods or services provided by a specific company, despite the fact that, in the absence of such use, the sign at issue would lack the necessary distinctiveness to create such a link.

For example, the combination of the colours green and yellow was found to have acquired distinctiveness through use because it referred to the machines manufactured by a certain company. The means of evidence were a number of statements from professional associations according to which such combination referred to agricultural machines manufactured by that company and the fact that such company had been using the same combination of colours on its machines consistently in the European Union for a considerable time prior to 1996 (judgment of 28/10/2009 T-137/08, Green/Yellow, EU:T:2009:417, § 36-37).

Therefore, acquired distinctiveness must be the result of the use of the mark as a trade mark, not as purely functional packaging (judgment of 25/09/2014, T-474/12, Shape of goblets, EU:T:2014:813, § 56-58 and the case-law cited therein) or as a descriptive indication on packaging. For example, use of the sign 'Gifflar' (which indicates a kind of bread in Swedish) on the packaging of pastries, together with descriptive indications of flavours, is made in a descriptive context, not as a badge of origin (judgment of 09/07/2014, T-520/12, Gifflar, EU:T:2014:620, § 44-45).

For a finding of acquired distinctiveness through use, the case-law does not prescribe fixed percentages of market penetration or of recognition by the relevant public (judgment of 19/06/2014, C-217/13 and C-218/13, Oberbank & Banco Santander, EU:C:2014:2012, § 48). Rather than using a fixed percentage of the relevant public in a given market, the evidence should show that a significant proportion of the public perceives the mark as identifying specific goods or services from a particular undertaking.

The evidence must relate to each of the goods and services claimed in the EUTM application. After an initial absolute grounds objection under Article 7(1)(b), (c) or (d) EUTMR, only the goods and services claimed for which acquired distinctiveness through use has been proven may proceed to registration.

2.6.8 Assessment of the evidence

In establishing acquired distinctiveness, account may be taken of, inter alia, the following **factors**:

- the market share held by the mark with regard to the relevant goods or services;
- how intensive, geographically widespread and long-standing use of the mark has been;
- the amount invested by the undertaking in promoting the mark for the relevant goods or services;
- the proportion of the relevant public who, because of the mark, identifies the goods or services as originating from a particular undertaking.

See judgments of 04/05/1999, C-108/97 & C-109/97, Chiemsee, EU:C:1999:230, § 31; and 29/09/2010, T-378/07, 'RED/BLACK/GREY (Surface of a tractor)', § 32.

Article 78 EUTMR contains a non-exhaustive list of **means of giving or obtaining evidence** in proceedings before the Office, which may serve as guidance to applicants. Examples of evidence that may help to show acquired distinctiveness include, inter alia:

- sales brochures
- catalogues
- price lists
- invoices
- annual reports
- turnover figures
- advertising investment figures and reports
- advertisements (press cuttings, billboard posters, TV adverts) together with evidence of their intensity and reach
- customer and/or market surveys
- affidavits.

For further details on means of evidence, see by analogy the Guidelines, Part C, Opposition, Section 5, Trade Marks with Reputation (Article 8(5) EUTMR), paragraph 3.1.4.4.

The basic rules on the **evaluation of evidence** are also applicable here. The Office must make an **overall assessment of all the evidence** submitted (judgment of 04/05/1999, C-108/97 & C-109/97, Chiemsee, EU:C:1999:230, § 49), weighing up each indication against the others.

Applicants should take great care to make sure not only that the evidence shows use of the **mark applied for** but also that it is sufficient to identify the **dates** of such use and the specific **geographical** territory of use within the EU. Evidence that cannot be related to a certain point in time will normally be insufficient to show that distinctiveness had been acquired before the filing date, and evidence of use outside the EU cannot show the required market recognition of the relevant public within the EU. Furthermore, evidence that mixes material relating to EU with that relating to non-EU territories, and does not permit the Office to identify the specific extent of EU-only use will be similarly devoid of probative value for the relevant EU public.

The General Court has declared that direct evidence such as declarations by professional associations and market studies are usually the most relevant means for proving acquired distinctiveness through use. Invoices, advertising expenditure, magazines and catalogues may help to corroborate such direct evidence (judgment of 29/01/13, T-25/11, Cortadora de cerámica, EU:T:2013:40, § 74).

In order to assess the evidential value of a document, regard should be had to its **credibility**. It is also necessary to take into account the person from whom the document originates, the circumstances in which it came into being, the person to whom it was addressed and whether, superficially, the document appears sound and reliable (judgments of 07/06/2005, T-303/03, Salvita, EU:T:2005:200, § 42; and 16/12/2008, T-86/07, DEITECH, EU:T:2008:577, § 46 et seq.).

2.6.8.1 Opinion polls and surveys

Opinion polls concerning the level of recognition of the trade mark by the relevant public on the market in question can, if conducted properly, constitute one of the most direct kinds of evidence, since they can show the actual perception of the relevant public. However, it is not an easy matter to correctly formulate and implement an opinion poll so that it can be seen to **be truly neutral and representative**. Leading questions, unrepresentative samples of the public, and undue editing of responses should be avoided, as these can undermine the probative value of such surveys.

Accordingly, any opinion poll evidence must be assessed carefully. It is important that the questions asked are not leading ones (judgment of 13/09/12, Case T-72/11, *Espetec*, EU:T:2012:424, § 79). The criteria for selecting the public interviewed must be assessed carefully. The sample must be indicative of the entire relevant public and must be selected randomly (judgment of 29/1/13, T-25/11, *Cortadora de cerámica*, EU:T:2013:40, § 88).

The Court does not exclude that a survey compiled some time before or after the filing date could contain useful indications, although it is clear that its evidential value is likely to vary depending on whether the period covered is close to or distant from the filing date or priority date of the trade mark application at issue. Furthermore, its evidential value depends on the survey method used (judgment of 12/07/2006, T-277/04, *Vitacoat*, EU:T:2006:202, § 38-39).

However, the Court of Justice has made it clear that the results of a consumer survey cannot be the only decisive criterion in support of the conclusion that distinctive character has been acquired through use (judgment of 19/06/2014, C-217/13 and C-218/13, *Oberbank & Banco Santander*, EU:C:2014:2012, § 48). They must therefore be complemented by other means of evidence.

For further details on the assessment of opinion polls, see the Guidelines, Part C, Opposition, Section 5, Trade Marks with Reputation Article 8(5) EUTMR, paragraph 3.1.4.4.

2.6.8.2 Market share, advertising and turnover

The **market share** held by the trade mark in relation to the goods and/or services applied for may be relevant for assessing whether that mark has acquired distinctive character through use, since such market penetration might enable the Office to infer that the relevant public would recognise the mark as identifying the goods or services as originating from a specific undertaking, and thus distinguishing them from the goods and services of other undertakings.

The **investment** in advertising or promoting the mark in the relevant market for the goods or services claimed may also be relevant for assessing whether the mark has acquired distinctive character through use (judgment of 22/06/2006, C-25/05 P, *Bonbonverpackung*, EU:C:2006:422, § 76 et seq.). However, many attempts to prove distinctiveness acquired through use fail because the evidence provided by the applicant is not sufficient to prove a link between the market share and advertising, on the one hand, and consumer perceptions on the other.

Information concerning **turnover** and advertising expenses is one of the most readily available forms of evidence. These figures can have a significant impact on the assessment of the evidence, but in the great majority of cases are not sufficient alone

to prove acquired distinctiveness of a trade mark through use. This is because turnover/advertising costs alone, without additional corroborative details, are frequently too general to allow specific conclusions to be drawn about the use of one particular trade mark. It is thus necessary to identify with precision the turnover/advertising figures and evidence relating to the mark applied for, as well as their link to the relevant goods and services. Furthermore, it is desirable that the figures be segregated on an annual and market-by-market basis. The evidence should show the specific period(s) of use (including details of when use commenced), so that the Office is able to establish whether the evidence proves that the trade mark acquired distinctiveness before the filing date.

Goods and services are often marketed under several trade marks, which makes it difficult to see the relevant customer's perception of the EUTM applied for on its own, that is to say, without such perception being affected by the other marks present. Turnover and advertising figures can often include sales or promotion of other trade marks, or of significantly different forms of the trade mark at issue (for example, figurative trade marks rather than word marks, or differing word elements in a figurative mark), or are too general to allow identification of the specific markets under consideration. As a consequence, broadly consolidated turnover or advertising figures may not be sufficient to prove whether the relevant public perceives the trade mark at issue as a badge of origin or not.

For further details on the assessment of market share, advertising and turnover, see the Guidelines, Part C, Opposition, Section 5, Trade Marks with Reputation Article 8(5) EUTMR, paragraph 3.1.4.4.

2.6.8.3 Declarations, affidavits and written statements

Pursuant to Article 78(1)(f) EUTMR, 'statements in writing, sworn or affirmed or having a similar effect under the law of the State in which [they are] drawn up', are valid means of evidence. With regard to **admissibility**, it is necessary only in cases where the statements have not been sworn or affirmed to consider the rules of law of the national jurisdiction as to the effects of a written statement (judgment of 07/06/2005, T-303/03, SALVITA, EU:T:2005:200, § 40). In case of doubt as to whether a statement has been sworn or affirmed, it is up to the applicant to submit evidence in this regard.

The weight and **probative value** of statutory declarations is determined by the general rules applied by the Office to the assessment of such evidence. In particular, both the capacity of the person giving the evidence and the relevance of the contents of the statement to the particular case must be taken into account.

Statements from **independent trade associations, consumer organisations and competitors** are an important means of evidence insofar as they come from independent sources. However, they must be examined carefully, as they might not be enough to prove distinctiveness acquired through use if, for example, they refer to 'the trade marks of the applicant' instead of to the specific mark in question (judgment of 13/09/12, Case T-72/11, Espetec, EU:T:2012:424, § 83-84).

Evidence from **suppliers or distributors** should, generally, be given less weight, since it is less likely that their evidence will be from an independent perspective. In this regard, the degree of independence of the latter will influence the weight to be given to the evidence by the Office (judgment of 28/10/2009 T-137/08, Green/Yellow, EU:T:2009:417, § 54-56).

Insofar as a declaration is **not made by an independent third party**, but by a person connected to the applicant through an employment relationship, it cannot in itself constitute sufficient evidence that the mark applied for has acquired distinctive character through use. In consequence, it must be treated as merely indicative and needs to be corroborated by other evidence (judgment of 21/11/2012 T-338/11, Photos/com, EU:T:2012:614, § 51)

For further details on the assessment of opinion polls, see the Guidelines, Part C, Opposition, Section 5, Trade Marks with Reputation Article 8(5) EUTMR, paragraph 3.1.4.4.

2.6.8.4 Prior registrations on acquired distinctiveness

For evidence that consists of or includes Member State registrations **obtained on the basis of acquired distinctiveness**, the date to which the evidence filed at national level refers will usually be different from the filing date of the EUTM application. These registrations are not binding, but may be taken into account, provided that the Office is able to assess the evidence submitted to the national IP office in question.

The applicant may also refer to **prior national registrations** where no acquired distinctiveness is claimed. Nevertheless, it is established case-law that such registrations do not bind the Office. Moreover, the Office is not bound by its previous decisions and such cases must be assessed on their own merits (judgment of 21/5/2014, T-553/12, EU:T:2014:264, Bateaux-Mouches, EU:T:2014:264, § 72 and 73).

2.6.8.5 Other means of evidence

Other means of evidence include **statements from chambers of commerce and industry or other trade and professional associations and certifications and awards**. The Court has noted that such statements and certifications must identify precisely the trade mark applied for (judgment of 13/09/2012, T-72/11, 'Espetec', EU:T:2012:424, § 82 et seq.).

See further details on other means of evidence in the Guidelines, Part C, Opposition, Section 5, Trade Marks with Reputation (Article 8(5) EUTMR), paragraph 3.1.4.4.

However, **cease and desist letters** against competitors or letters to newspapers complaining against the use of the sign in a generic sense have been considered evidence against acquired distinctiveness (judgment of 21/5/2014, T-553/12, Bateaux-Mouches, EU:T:2014:264, § 66)

2.6.8.6 Manner of use

Acquired distinctiveness must be demonstrated with respect to the sign applied for. The evidence should show examples of how the trade mark is actually used (brochures, packaging, samples of the goods, etc.). Use of a substantially different trade mark should not be given any weight. However, in accordance with Article 15(1)(a) EUTMR, minor amendments to the sign that do not alter its distinctive character may be allowed (decisions of 15/01/2010, R 0735/2009-2, PLAYNOW; and 09/02/2010, R 1291/2009-2, EUROFLORIST).

It is possible to prove acquired distinctiveness of a sign that has been used together with other trade marks (judgment of 28/10/2009, T-137/08, Green/Yellow, EU:T:2009:417, § 27), provided that the relevant consumer attributes to the sign in question the function of identification (judgments of 07/07/2005, C-353/03, Have a break, EU:C:2005:432; 30/09/2009, T-75/08, '!' (fig.), EU:T:2009:374, § 43; and 28/10/2009, T-137/08, Green/Yellow, EU:T:2009:417, § 46). For instance, the Court considered that the use of the sign 'Giffjar' (which indicates a kind of bread in Swedish) on the packaging of pastries, together with the trade mark Pågen, was made in a descriptive context, not as a badge of origin (judgment of 09/07/2014, T-520/12, Giffjar, EU:T:2014:620, § 44-45).

2.6.8.7 Length of use

The evidence should indicate when use commenced and should also show that the use was continuous or indicate reasons if there are gaps in the period of use.

As a general rule, long-standing use is likely to be an important persuasive element in establishing acquired distinctiveness. The longer customers and potential customers have been exposed to a mark the more likely they are to have made the connection between that mark and a particular source in trade.

Considering, however, that length of use is only one of the factors to be taken into account, there may be situations where exceptions to the above rule are justified, in particular when other factors may also come into play that are capable of making up for a short length of use. For example, where products or services are the subject of a major advertising launch and/or the sign applied for is a mere variant of a sign already in long use, it may be the case that acquired distinctiveness can be achieved quite quickly.

This could be the case, for instance, where a new version of an existing and widely used computer-operating system is launched under a sign that essentially reproduces the structure and/or contents of the trade mark applied to previous versions of the product. The trade mark for such a product would be capable of achieving widespread acquired distinctiveness within a fairly short period of time simply because all existing users will be immediately made aware that the sign applied for refers to the upgrading to the new version.

In the same vein, it is in the nature of certain major sporting, musical or cultural events that they take place at regular intervals and are known to have extremely wide appeal. These major events are anticipated by millions, and the knowledge that the event is due on a particular date precedes the formal announcement of where it will take place. This circumstance creates intense interest in the nominated location of such events and in the announcement thereof ('city/country+year' marks). It is therefore reasonable to suppose that the moment a particular event, tournament or games is announced as having been allocated to a particular city or country, it is likely to become known instantly to practically all relevant consumers with an interest in the sector concerned or to professionals in the sector. This may thereby give rise to the possibility of very rapid acquired distinctiveness of a mark concerning a forthcoming event, in particular where the sign reproduces the structure of previously used trade marks with the result that the public immediately perceives the new event as a sequel to a series of well-established events.

The assessment of such rapid acquired distinctiveness will follow the general criteria regarding, for instance, extent of use, territory, relevant date or targeted public, as well

as regarding the onus on the applicant to provide evidence thereof. The only particularity refers to length of use and the possibility that, under certain circumstances, the acquisition of acquired distinctiveness may occur very rapidly, or even instantaneously. As under any other claim for acquired distinctiveness, it is for the applicant to demonstrate that the public is able to perceive the trade mark in question as a distinctive sign.

2.6.8.8 Post-filing date evidence

The evidence must show that prior to the filing date, the trade mark had acquired distinctive character through use.

However, this does not preclude the possibility that account may be taken of evidence that, although subsequent to the filing date, enables conclusions to be drawn regarding the situation as it was on the filing date (judgment of 19/06/2014, C-217/13, Oberbank & Banco Santander, EU:C:2014:2012, § 60). Therefore, evidence cannot be rejected merely because it post-dates the filing date. Accordingly, such evidence must be assessed and given due weight.

As an example, a trade mark that enjoys particularly relevant recognition on the market or a substantially relevant market share a few months after the filing date may have had acquired distinctiveness also on the filing date.

2.6.9 Consequences of Acquired Distinctiveness

A trade mark registered in accordance with Article 7(3) EUTMR enjoys the same protection as any other trade mark that was found inherently registrable upon examination.

If the EUTM application is accepted based on Article 7(3) EUTMR, this information is published in the EUTM Bulletin, using INID code 521.

***GUIDELINES FOR EXAMINATION OF
EUROPEAN UNION TRADE MARKS***

***EUROPEAN UNION
INTELLECTUAL PROPERTY OFFICE
(EUIPO)***

PART B

EXAMINATION

SECTION 4

ABSOLUTE GROUNDS FOR REFUSAL

Table of Contents

2.7 Public policy or morality, Article 7(1)(f) EUTMR	4
2.7.1 ‘Public policy’	4
2.7.1.1 Concept and categories.....	4
2.7.2 Accepted principles of morality.....	5
2.8 Deceptiveness: Article 7(1)(g) EUTMR	8
2.8.1 Examination of the deceptive character	8
2.8.2 Market reality and consumers’ habits and perceptions	9
2.8.3 Trade marks with geographical connotations relating to the location of the applicant or the place of origin of the goods/services	10
2.8.4 Trade marks making reference to an ‘official’ approval, status or recognition	11
2.8.5 Relation with other EUTMR provisions.....	12
2.9 Protection of flags and other symbols — Article 7(1)(h) and (i) EUTMR	13
2.9.1 Protection of armorial bearings, flags, other state emblems, official signs and hallmarks indicating control and warranty under Article 7(1)(h) EUTMR — Article 6ter(1)(a) and (2) PC.....	14
2.9.1.1 Examination of marks consisting of or containing a state flag	17
2.9.1.2 Examination of marks consisting of or containing armorial bearings and other state emblems.....	21
2.9.1.3 Examination of marks consisting of or containing official signs and hallmarks indicating control and warranty.....	24
2.9.2 Protection of armorial bearings, flags, other emblems, abbreviations and names of international intergovernmental organisations under Article 7(1)(h) EUTMR — Article 6ter(1)(b) and (c) PC.....	24
2.9.3 Protection of badges, emblems or escutcheons other than those covered by Article 6ter of the Paris Convention under Article 7(1)(i) EUTMR	31
2.10 Article 7(1)(j) EUTMR	37
2.10.1 General remarks on EU Regulations.....	38
2.10.1.1 Definition of geographical indications under EU Regulations	38
2.10.1.2 Relevant provisions governing conflicts with trade marks	39
2.10.2 Relevant PDOs/PGIs under EU Regulations	41
2.10.2.1 Relevant point in time	41
2.10.3 Situations covered by the EU Regulations	42
2.10.3.1 EUTM consists solely of a whole PDO/PGI (‘direct use’).....	43
2.10.3.2 EUTM contains a whole PDO/PGI in addition to other word or figurative elements (‘direct or indirect use’).....	43
2.10.3.3 EUTM contains or consists of an imitation or evocation of a PDO/PGI	46
2.10.3.4 Other misleading indications and practices	49
2.10.3.5 The exploitation of the reputation of PDOs/PGIs.....	50
2.10.3.6 Limits to the scope of protection.....	51
2.10.3.7 Trade marks in conflict with two or more PDOs/PGIs.....	52
2.10.4 Relevant goods under EU Regulations	55
2.10.4.1 Comparable products	55
2.10.4.2 Restrictions of the list of goods.....	57
2.10.5 PDOs/PGIs not protected under EU Regulations.....	60
2.10.5.1 PDOs/PGIs protected at national level in an EU Member State	60
2.10.5.2 PDOs/PGIs from third countries	61
2.10.5.3 Relationship with other EUTMR provisions	64
2.11 Article 7(1)(k) EUTMR	64
2.11.1 General remarks on EU Regulations.....	64
2.11.1.1 Definition of traditional terms for <i>wine</i> under EU Regulations.....	65

2.11.1.2	Relevant provisions governing conflicts with trade marks	66
2.11.2	Relevant TTWs under EU Regulations	67
2.11.2.1	Relevant point in time	67
2.11.3	Situations covered by Article 113(2) of Regulation No 1308/2013.....	67
2.11.4	Relevant goods.....	68
2.11.4.1	Restrictions of the list of goods.....	69
2.11.5	International agreements.....	69
2.11.6	Relationship with other EUTMR provisions	69
2.12	Article 7(1)(l) EUTMR	69
2.12.1	General remarks on EU Regulations.....	70
2.12.1.1	Definition of traditional specialities guaranteed under EU Regulations	70
2.12.1.2	Relationship with trade marks	71
2.12.2	Relevant goods under EU Regulations	71
2.12.2.1	Relevant point in time.....	71
2.12.3	Situations covered by Article 24 of Regulation (EU) No 1151/2012.....	71
2.12.4	Relevant goods.....	72
2.12.4.1	Restrictions of the list of goods.....	72
2.12.5	International agreements.....	72
2.12.6	Relationship with other EUTMR provisions	73
2.13	Article 7(1)(m) EUTMR	73
2.13.1	Legislative framework.....	73
2.13.2	Definition of plant variety denomination	74
2.13.3	Situations covered by Article 7(1)(m) EUTMR	74
2.13.3.1	Registered plant variety denominations	74
2.13.3.2	Relevant point in time.....	75
2.13.3.3	The EUTM application consists of, or reproduces in its essential elements, the plant variety denomination	75
2.13.3.4	Plant varieties of the same or closely related species	76
2.13.4	Relationship with other EUTMR provisions.....	77
2.14	European Union collective marks.....	78
2.14.1	Character of collective marks	78
2.14.2	Ownership.....	79
2.14.3	Particularities as regards absolute grounds for refusal	80
2.14.3.1	Descriptive signs	80
2.14.3.2	Misleading character as to its nature.....	81
2.14.3.3	Regulations of use contrary to public policy and morality	81

2.7 Public policy or morality, Article 7(1)(f) EUTMR

Article 7(1)(f) EUTMR excludes from registration trade marks that are contrary to public policy or to accepted principles of morality. The rationale of Article 7(1)(f) EUTMR is to preclude trade marks from registration where granting a monopoly would contravene the state of law or would be perceived by the relevant public as going directly against the basic moral norms of society.

The Office considers that ‘public policy’ and ‘accepted principles of morality’ are two different concepts, which often overlap.

The question whether the goods or services applied for can be legally offered in a particular Member State’s market is irrelevant for the question whether the sign itself falls foul of Article 7(1)(f) EUTMR (judgment of 13/09/2005, T-140/02, ‘Intertops’, para. 33). Whether or not a mark is contrary to public policy or accepted principles of morality must be determined by the intrinsic qualities of the mark applied for and not by the circumstances relating to the conduct of the person applying for the trade mark (judgment of 13/09/2005, T-140/02, ‘Intertops’, para. 28). In its judgment of 20/09/2011, T-232/10, ‘Soviet Coat of Arms’, the General Court held that the concepts of ‘public policy’ and ‘acceptable principles of morality’ must be interpreted not only with reference to the circumstances common to all Member States but by taking into account ‘the particular circumstances of **individual Member States** which are likely to influence the perception of the relevant public within those States’ (para. 34).

The legislation and administrative practice of certain Member States can also be taken into account in this context (i.e. for assessing subjective values), not because of their normative value, but as evidence of facts which make it possible to assess the perception of the relevant public in those Member States (judgment of 20/09/2011, T-232/10, ‘Soviet Coat of Arms’, para. 57). In such a case, the illegality of the EUTM applied for is not the determining factor for the application of Article 7(1)(f) EUTMR but rather is of evidential value with regard to the perception of the relevant public in the Member State(s) in question.

Considering that the specific circumstances of **individual** Member States may not be widely known in the European territory, the objection letter should explain these circumstances clearly in order to make sure that the applicant is able to fully understand the reasoning behind the objection and is able to respond accordingly.

2.7.1 ‘Public policy’

2.7.1.1 Concept and categories

This objection derives from an assessment based on objective criteria. ‘Public policy’ refers to the body of Union law applicable in a certain area, as well as to the legal order and the state of law as defined by the Treaties and secondary EU legislation, which reflect a common understanding on certain basic principles and values, such as human rights. As indicated above, national legislation may also be taken into account, not because of its normative value, but as evidence of facts which make it possible to assess the perception of the relevant public in those Member States.

The following is a non-exhaustive list of examples of when signs will be caught by this prohibition.

1. On 27/12/2001 the Council of the European Union adopted Common Position 2001/931/CFSP on the application of specific measures to combat terrorism (OJ L 344, 28/12/2001, p. 93) later updated by Council Common Position 2009/64/CFSP (OJ L 23, 27/01/2009, p. 37 and available online at: <http://eur-lex.europa.eu/LexUriServ/LexUriServ.do?uri=OJ:L:2009:023:0025:0029:EN:PDF>) which contains a list of individuals and groups facilitating, attempting to commit or committing terrorist acts in EU territory. Any EUTM applied for which can be deemed to support or benefit an individual or a group on that list will be rejected as being against public policy.
2. Use of the symbols and names of Nazi organisations is prohibited in Germany (§ 86a dt. StGB (German Criminal Code), BGBl. Nr. I 75/1998) and in Austria (§ 1 öst. Abzeichengesetz (Austrian Law on Insignias), BGBl. Nr. 84/1960 in conjunction with § 1 öst. Verbotsgesetz (Austrian Prohibition Law), BGBl. Nr. 25/1947). Any EUTM applied for which uses such symbols or names will be rejected as being against public policy.

2.7.2 Accepted principles of morality

This objection concerns subjective values, but these must be applied as objectively as possible by the examiner. The provision excludes registration as European Union trade marks of blasphemous, racist or discriminatory words or phrases, but only if that meaning is clearly conveyed by the mark applied for in an unambiguous manner; the standard to be applied is that of the reasonable consumer with average sensitivity and tolerance thresholds (judgment of 09/03/2012, T-417/10, ‘¡Que bueno ye! Hijoputa’, para. 21).

It is normally necessary to consider the goods and services for which registration of the mark is sought, since the relevant public may be different for different goods and services and, therefore, may have different thresholds with regard to what is clearly unacceptably offensive. For example, as the Grand Board held in its decision of 06/07/2006, R 0495/2005-G – ‘SCREW YOU’, para. 29, ‘a person who is sufficiently interested in [sex toys] to notice the trade marks under which they are sold is unlikely to be offended by a term with crude sexual connotations.’ Nevertheless, although the Court has held that the goods and services applied for are important for identifying the relevant public whose perception needs to be examined, it has also made it clear that the relevant public is not necessarily only that which buys the goods and services covered by the mark, since a broader public than just the consumers targeted may encounter the mark (judgment of 05/10/2011, T-526/09, ‘Paki’, paras 17 and 18 respectively). Accordingly, the commercial context of a mark, in the sense of the public targeted by the goods and services, is not always the determining factor in whether that mark would breach accepted principles of morality (judgment of 09/03/2012, T-417/10, ‘¡Que bueno ye! Hijoputa’, para. 24). See also decision of 15/03/2013, R 2073/2012-4, – ‘CURVE’, paras 17-18 (T-266/13 – pending).

It is not only signs with ‘negative’ connotation that can be offensive. The banal use of some signs with a highly positive connotation can also be offensive (e.g. terms with a religious meaning or national symbols with a spiritual and political value, like ATATURK for the European general public of Turkish origin (decision of 17/09/2012, R 2613/2011-2 – ATATURK, para. 31)).

There need not be illegality for this part of Article 7(1)(f) EUTMR to be applied: there are words or signs that would not lead to proceedings before the relevant authorities

and courts, but that are sufficiently offensive to the general public to not be registered as trade marks (decision of 01/09/2011, R 0168/2011-1 – ‘fucking freezing! by TÜRPIZ’, para. 16). Furthermore, there is an interest in ensuring that children and young people, even if they are not the relevant public of the goods and services in question, do not encounter offensive words in shops that are accessible to the general public. Dictionary definitions will in principle provide a preliminary indication as to whether the word in question carries an offensive meaning in the relevant language (decision of 01/09/2011, R 0168/2011-1 – ‘fucking freezing! by TÜRPIZ’, para. 25) but the key factor must be the perception of the relevant public in the specific context of how and where the goods or services will be encountered.

On the other hand, the Boards of Appeal took the view that the word KURO did not convey to the Hungarian public the offensive meaning of the word ‘kúró’ (meaning ‘fucker’ in English), since the vowels ‘ó’ and ‘ú’ are separate letters which are distinct from ‘o’ and ‘u’ and they are pronounced differently (decision of 22/12/2012, R 482/2012-1 – ‘kuro’, paras 12 et seq.).

There is a clear risk that the wording of Article 7(1)(f) EUTMR could be applied subjectively so as to exclude trade marks that are not to the examiner’s personal taste. However, for the word(s) to be objectionable, it (they) must have a clearly offensive impact on people of normal sensitivity (judgment of 09/03/2012, T-417/10, ‘¡Que buenu ye! Hijoputa’, para. 21).



The concept of morality in Article 7(1)(f) EUTMR is not concerned with bad taste or the protection of individuals’ feelings. In order to fall foul of Article 7(1)(f) EUTMR, a trade mark must be perceived by the relevant public, or at least a significant part of it, as going directly against the basic moral norms of the society.

There is no need to establish that the applicant *wants* to shock or insult the public concerned; the objective fact that the EUTM applied for *might* be seen as such a shock or insult is sufficient (decision of 23/10/2009, R 1805/2007-1 – ‘Paki’, para. 27, confirmed by judgment of 05/10/2011, T-526/09, ‘Paki’ para. 20 et seq.).

Finally, application of Article 7(1)(f) EUTMR is not limited by the principle of freedom of expression (Article 10 European Convention on Human Rights) since the refusal to register only means that the sign is not granted protection under trade mark law and does not stop the sign being used — even in business (judgment of 09/03/2012, T-417/10, ‘HIJOPUTA’, para. 26).

Examples of rejected EUTM applications (public policy and/or morality)

Sign	Relevant Consumer	Public policy/morality	Case No
BIN LADIN	General consumer	Morality & public policy — the mark applied for will be understood by the general public as the name of the leader of the notorious terrorist organisation Al Qaeda; terrorist crimes are in breach of public order and moral principles (para. 17).	R 0176/2004-2
CURVE 300	General consumer	Morality — ‘CURVE’ is an offensive and vulgar word in Romanian (it means ‘whores’).	R 0288/2012-2
CURVE	General consumer	Morality — ‘CURVE’ is an offensive and vulgar word in Romanian (it means ‘whores’).	R 2073/2012-4 (T-266/13 – pending)

Sign	Relevant Consumer	Public policy/morality	Case No
	General consumer	Morality — ‘fucking’ is an offensive and vulgar word in English.	R 0168/2011-1
	General consumer	Morality — ‘HIJOPUTA’ is an offensive and vulgar word in Spanish.	T-417/10
	General consumer	Public policy — the Hungarian criminal code bans certain ‘symbols of despotism’, including the hammer and sickle as well as the 5-pointed red star symbolising the former USSR. This law is not applicable by reason of its normative value but rather as evidence of the perception of the relevant public (paras 59-63).	T-232/10
PAKI	General consumer	Morality — ‘PAKI’ is a racist insult in English.	T-526/09
SCREW YOU	General consumer (for products other than sex products)	Morality — a substantial proportion of ordinary citizens in Britain and Ireland would find the words ‘SCREW YOU’ offensive and objectionable (para. 26).	R 0495/2005-G
FICKEN	General consumer	Morality — ‘FICKEN’ is an offensive and vulgar word in German (it means ‘fuck’).	T-52/13
ATATURK	Average consumer in the European general public of Turkish origin	Banal use of signs with a highly positive connotation can be offensive under Article 7(1)(f) EUTMR. ATATURK is a national symbol with a spiritual and political value for the European general public of Turkish origin.	R 2613/2011-2

Examples of accepted EUTM applications

Sign	Relevant Consumer	Public policy/morality	Case No
KURO	General consumer	The fact that a foreign term, name or abbreviation displays certain similarities with an offensive word (like kúró) is not in itself sufficient reason to refuse the EUTM applied for (para. 20). Hungarian vowels ‘ò’ and ‘ù’ are clearly different from ‘o’ and ‘u’ without accent. Furthermore, Hungarian words never end with ‘o’ without accent (paras 15-18).	R 482/2012-1
SCREW YOU	General consumer (for sex products)	A person entering a sex shop is unlikely to be offended by a trade mark containing crude, sexually charged language (para. 26).	R 495/2005-G
DE PUTA MADRE	General consumer	Although ‘puta’ means ‘whore’ in Spanish, the expression DE PUTA MADRE means ‘very good’ in Spanish (slang).	EUTM 3 798 469 EUTM 4 781 662 EUTM 5 028 477

2.8 Deceptiveness: Article 7(1)(g) EUTMR

2.8.1 Examination of the deceptive character

Article 7(1)(g) EUTMR provides that marks which are of such a nature as to deceive the public, for instance, as to the nature, quality or geographical origin of the goods or services, must not be registered.

According to the case-law relating to Article 3(1)(g) of the First Trademark Directive (TMD), the wording of which is identical to that of Article 7(1)(g) EUTMR, the circumstances for refusing registration referred to in Article 7(1)(g) EUTMR presuppose the **existence of actual deceit or a sufficiently serious risk that the consumer will be deceived** (judgment of 30/05/2006, C-259/04, 'Elizabeth Emanuel', para. 47 and the case-law cited therein).

Pursuant to the above, the Office, as a matter of practice, makes the twin assumptions that:

1. There is no reason to assume that a trade mark is intentionally applied for to deceive customers. No deceptiveness objection should be raised if a non-deceptive usage of the mark is possible *vis-à-vis* the goods and services specified: i.e. an assumption is made that non-deceptive use of the sign will be made if possible,
2. The average consumer is reasonably attentive and should not be regarded as particularly vulnerable to deception. An objection will generally only be raised where the mark leads to a **clear** expectation which is **patently contradictory** to, for instance, the nature or quality or geographical origin of the goods.

An objection should be raised when the list of goods/services is worded in such a way that a non-deceptive use of the trade mark is impossible.

The following are two examples of marks that were found to be deceptive with regard to all or part of the claimed goods¹.

Mark and goods	Reasoning	Case
LACTOFREE for <i>lactose</i> in Class 5	The nature of the sign would immediately lead the relevant consumer to believe that the product in question, i.e. 'lactose', does not contain any lactose. It is clear that if the good being marketed under the sign 'LACTOFREE' is actually <i>lactose</i> itself, then the mark would be clearly misleading. NB: The mark is also objectionable under 7(1)(c)	R 892/2009-1

¹ These examples address only the issue of whether a deceptiveness objection should be raised or not. This paragraph does not deal with possible objections under other absolute grounds for refusal. Therefore, the possibility that a given trade mark might appear to be *prima facie* objectionable under Article 7(1)(b) and/or (c) EUTMR (or other provisions for that matter) is not contemplated here.

Mark and goods	Reasoning	Case
<p style="text-align: center;">TITAN (German word for 'titanium')</p> <p><i>for portable and relocatable buildings; modular portable building units for use in the construction of prefabricated relocatable buildings; prefabricated relocatable buildings constructed of modular portable building units, none of the aforesaid goods being made from or including titanium</i> in Classes 6 and 19.</p>	<p>The applicant, during the appeal proceedings, in an attempt to overcome an objection of descriptiveness, offered to restrict the specifications in both classes by adding, at the end, the indication <i>none of the aforesaid goods being made from or including titanium</i>. The Board held that such a restriction, if accepted, would have had the effect of rendering the trade mark deceptive from the standpoint of the German-speaking public, as they would assume that the goods were made from titanium when in reality this is not the case.</p>	<p style="text-align: center;">R 789/2001-3</p>

An objection should be raised when the list of goods/services, worded in a detailed manner, contains goods/services for which a non-deceptive use is impossible.

In the (invented) case of a trade mark 'KODAK VODKA' for *vodka, rum, gin, whisky*, an objection should be raised for the specific goods for which a non-deceptive use of the trade mark is not possible, i.e. *rum, gin, whisky*. Such cases are substantially different from those (see here below) where broad wording/categories are used and where a non-deceptive use of the sign is possible. For example, no objection would be raised for 'KODAK VODKA' filed for *alcoholic beverages*, since this broad category includes vodka, for which the trade mark is not deceptive.

No objection should be raised when the list of goods/services is worded in such a broad way that a non-deceptive use is possible.

When **wide categories** in the list of goods/services are used, the question arises whether an objection should be raised in relation to an entire category due to the mark being deceptive in relation to only some goods/services falling within that category. The policy of the Office is not to object in these circumstances. The examiner should assume that the mark will be used in a non-deceptive manner. In other words they will not object on the basis of deceptiveness wherever they can pinpoint (in a category) a non-deceptive use.

Therefore, the rule is that **Article 7(1)(g) EUTMR does not apply if the specification consists of wide categories which include goods/services for which use of the trade mark would be non-deceptive**. For example, in the case of a trade mark 'ARCADIA' applied for *wines*, an objection under Article 7(1)(g) EUTMR would not be appropriate, since the broad category *wines* also covers *wines* originating from Arcadia (and since Arcadia — which identifies a *wine*-producing region in Greece — is not a protected geographical indication at Community level, there is no obligation on the part of the applicant to restrict the specification only to *wines* originating from Arcadia).

2.8.2 Market reality and consumers' habits and perceptions

When assessing if a given trade mark is deceptive or not, **account should be taken of market reality and consumers' habits and perceptions**.

In order to evaluate the deceptiveness of a trade mark under Article 7(1)(g) EUTMR, account must be taken of the **reality of the market** (i.e. the way the goods and services are normally distributed/held out for sale/purchased/rendered, etc.) as well as of the **consumption habits and perception of the relevant public**, which is normally composed of reasonably well-informed, observant and circumspect persons.

For example, in the (invented) trade mark '**ELDORADO CAFÈ LATINO**' covering *coffee, preparations for use as substitutes for coffee, artificial coffee, chicory, chicory flavourings; chocolate, preparations for use as substitutes for chocolate; tea, cocoa; sugar, rice, tapioca, sago; flour and preparations made from cereals, bread, pastry and confectionery, ices; honey, treacle; yeast, baking-powder; salt, mustard; vinegar, sauces (condiments); spices; ice* in Class 30, the examination should lead to the following conclusions.

- An objection under Article 7(1)(g) EUTMR would be justified in relation to preparations for use as substitutes for coffee, artificial coffee, chicory, chicory flavourings because use of the mark on these goods would be necessarily deceptive. One would assume one was purchasing coffee and this would not in fact be the case.
- An objection under Article 7(1)(g) EUTMR would also be justified for tea. Given that such goods may be sold in packaging quite similar to those used for coffee, and are often bought rather hastily, it is likely that many consumers will not indulge in analysing the wording on the packaging, but will choose these goods from the shelf in the (erroneous) belief that they are *coffee*.
- However, as far as coffee is concerned, there is no 'clear contradiction' between the claim for *coffee* and the wording 'CAFÈ LATINO', since the general category *coffee* may include also coffee originating from Latin America. Hence no Article 7(1)(g) EUTMR objection arises for the category of *coffee* itself. The same logic applies in relation to goods which could be flavoured with coffee (such as *chocolate, ices* and *pastry and confectionery*) — an assumption of non-deceptive use should be made, and no contradiction between the said wording and the goods necessarily arises.
- Finally, for the remainder of the goods are concerned, i.e. honey, bread, vinegar etc., the presence of the wording 'CAFÈ LATINO' will not give rise to any expectations at all. In relation to such goods, this wording will be seen as clearly non-descriptive and hence there is no potential for actual deception. In the 'real' market, coffee is not displayed on the same shelves or shop sections as bread, honey or vinegar. Furthermore, the goods in question have a different appearance and taste and are normally distributed in different packaging.

2.8.3 Trade marks with geographical connotations relating to the location of the applicant or the place of origin of the goods/services

When it comes to trade marks having certain 'geographical' connotations relating to the location of the applicant or the place of origin of the goods/services, the following should be noted.

As a general rule, the Office will not raise an objection on deceptiveness based upon the applicant's geographical location (address). Indeed, such a geographical location bears, in principle, no relation to the geographical origin of the goods and services, i.e. the actual place of production/offering of the goods and services covered by the mark.

As an example, a figurative mark containing the words **MADE IN USA** for *clothing* in Class 25 filed by a company having its seat in Sweden would not be open to an objection under Article 7(1)(g) EUTMR. In such cases, the Office assumes a non-deceptive use of the mark on the part of the proprietor.

Deceptiveness would nonetheless arise in the hypothetical event that a figurative mark containing the words **MADE IN USA**, filed by a company having its seat in the United States of America, were filed for a specifically limited list of goods: *clothing articles made in Vietnam* — although, in practice, such cases seem unlikely to arise.

In certain cases, the sign could evoke in the consumers' minds some impressions/expectations as to the geographical origin of the goods or of the designer thereof and which may not correspond to reality. For example, trade marks such as **ALESSANDRO PERETTI** or **GIUSEPPE LANARO** (invented examples) covering clothing or fashion goods in general may suggest to the relevant public that these goods are designed and produced by an Italian stylist, which may not be the case.

However, such a circumstance is not sufficient per se to render those marks misleading. Indeed, 'false impressions/expectations' caused by the trade mark are not tantamount to actual deceptiveness when the sign is merely evocative. In such cases there is no clear contrast between the impression/expectation a sign may evoke and the characteristics/qualities of the goods and services it covers.

2.8.4 Trade marks making reference to an 'official' approval, status or recognition

It should be noted that, under the Office's practice, trade marks that could evoke official approval, status or recognition without giving the firm impression that the goods/services issue from, or are endorsed by, a public body or statutory organisation, are acceptable.

The following are two examples where the marks concerned, although allusive or suggestive, were not found to be deceptive:

Mark and services	Reasoning	Case
<p>THE ECOMMERCE AUTHORITY for <i>business services, namely, providing rankings of and other information regarding electronic commerce vendors, goods and services via the Internet</i> in Class 35 and <i>providing research and advisory services and information in the area of electronic commerce</i> in Class 42.</p>	<p>The Board found that the trade mark was not deceptive, as it did not convey the firm impression that the services issue from a governmental or statutory organisation (the Board, however, confirmed the refusal under Article 7(1)(b) EUTMR on the grounds that the mark lacked distinctive character, as it would be perceived by the English-speaking public merely as a simple statement of self-promotion which claims something about the level of competence of the service providers).</p>	<p>R 803/2000-1</p>

Mark and services	Reasoning	Case
 <p>for, among other things, teaching of ski in Class 41.</p>	<p>The Board held that the French consumers would understand that the trade mark alludes to the fact that the services are supplied in France, by a French teaching centre, and relate to learning skiing 'in the French way'. It added that the French public had no reason to believe, simply because of the presence of a tricolour logo (not being a reproduction of the French flag), that the services are supplied by public authorities or even authorised by such authorities.</p>	<p>R 235/2009-1 confirmed by the General Court in T-41/10</p>

2.8.5 Relation with other EUTMR provisions

The above explanations aim to define the scope of application of Article 7(1)(g) EUTMR. Although addressed in their respective sections of the Guidelines, in the context of absolute grounds examination and of possible deceptiveness scenarios, the following provisions may be of particular relevance.

Article 7(1)(b) and (c) EUTMR

Under the current practice of the Office, if, following a descriptiveness and/or lack of distinctiveness objection, the EUTM applicant proposes a limitation in an attempt to overcome it, and provided the proposed limitation meets the prescribed requirements (unconditional request and suitably worded), the original list of goods and/or services will be limited accordingly. However, if the limitation in question (albeit overcoming the initial objection) has the effect of rendering the trade mark applied for deceptive, then the examiner will have to raise a deceptiveness objection under Article 7(1)(g) EUTMR. The following example illustrates such a scenario:

The trade mark '**ARCADIA**' was originally applied for *wines, spirits (beverages) and liqueurs* in Class 33. The examiner objected because the trade mark was descriptive of the geographical origin of *wines*, to the extent that Arcadia is a Greek region known for its *wine* production (however, it should be noted that Arcadia is not a protected geographical indication). The applicant offered to limit the specification of goods to exclude *wines* made in Greece or, if preferred, to include only *wines* produced in Italy. The examiner held that the proposed limitation would render the trade mark deceptive since it would convey false information as to the origin of the goods. On appeal, the Board confirmed the reasoning of the examiner (see decision of 27/03/2000, R 246/1999-1 – 'ARCADIA', para. 14).

Article 7(1)(h) EUTMR

This provision excludes from registration those EUTMs which consist of/contain flags and other symbols of States, on the one hand, and flags and other symbols of international intergovernmental organisations on the other, which are protected according to Article 6ter of the Paris Convention and the inclusion of which in the trade mark has not been expressly authorised by the competent authorities. When it comes to the flags and other symbols of international intergovernmental organisations, the problem arises when the public might erroneously believe that, in view of the goods/services concerned, there is a connection between the EUTM applicant and the international organisation whose flag or symbol appears in the EUTM.

Article 7(1)(j) EUTMR (protected geographical indications)

This provision excludes trade marks in conflict with protected geographical indications (PGIs) or protected geographical denominations (PDOs) protected under EU law, national law or international agreements to which the EU or the Member State concerned is party, where the list of the respective goods does not specify that they have the purported geographical origin. The Office must object to EUTM applications where the protected geographical indication is misused or which convey any other false or misleading indication as to the provenance, origin, nature or essential qualities of the products concerned.

Article 7(1)(k) and (l) EUTMR (traditional terms for *wines* and traditional specialities guaranteed)

Article 7(1)(k) and (l) EUTMR exclude from registration trade marks that are in conflict with traditional terms for *wine* (TTW) and traditional specialities guaranteed (TSG), respectively, protected by either EU legislation or international agreements to which the EU is party. The Office must object to EUTM applications where the TTW or the TSG is misused or which convey any other misleading indications, such as the products qualifying for the protected TTW or TSG.

Article 17(4) EUTMR (transfer)

Under this provision, where it is clear from the transfer documents that, because of the transfer, the EUTM is likely to mislead the public concerning the nature, quality or geographical origin of the goods or services for which it is registered, the Office will not register the transfer unless the successor agrees to limit (the) registration of the EUTM to goods or services for which it is not likely to mislead (see also Part E, Section 3, Chapter 1, paragraph 3.6).

Article 51(1)(c) EUTMR (grounds for revocation)

Whereas in examining a trade mark under Article 7(1)(g) EUTMR an examiner must confine the assessment to the meaning conveyed by the sign vis-à-vis the goods/services concerned (meaning that the way the sign is actually used is of no relevance), under Article 51(1)(c) EUTMR the way the sign is used is decisive, given that according to this provision a registered EUTM may be declared revoked if, in consequence of the use made of the sign by its proprietor or with their consent, the trade mark is liable to mislead the public, particularly as to the nature, quality or geographical origin of the goods/services concerned.

2.9 Protection of flags and other symbols — Article 7(1)(h) and (i) EUTMR

The objective of Article 6^{ter} Paris Convention (PC) is to exclude the registration and use of trade marks that are identical or in some way similar to state emblems or the emblems, abbreviations and names of international intergovernmental organisations.

‘The reasons for this are that such registration or use would violate the right of the State to control the use of symbols of its sovereignty and furthermore might mislead the public with respect to the origin of goods to which such marks would be applied.’ (G.H.C. Bodenhausen, Guide to the application of the Paris Convention for the Protection of Industrial Property as revised in Stockholm in 1967, page 96.). Origin in

this regard must be understood as coming from or endorsed by the relevant administration, not as being produced in the territory of that state or, in the case of the EU, in the EU.

Article 7(1)(h) EUTMR therefore refers to the following symbols:

- Armorial bearings, flags, other emblems, official signs and hallmarks that belong to states and have been communicated to WIPO, although, in the case of flags, such communication is not mandatory.
- Armorial bearings, flags, other emblems, abbreviations and names of international intergovernmental organisations that have been communicated to WIPO, with the exception of those already the subject of international agreements for ensuring their protection (see, for example, the Geneva Convention for the Amelioration of the Condition of the Wounded and Sick in Armed Forces of 12/08/1949, Article 44 of which protects the emblems of the Red Cross on a white ground, the words 'Red Cross' or 'Geneva Cross', and analogous emblems).

The Court of Justice has made clear that these provisions can be applied regardless of whether the application concerns goods or services, and that the scopes of application of Article 7(1)(h) and 7(1)(i) EUTMR are analogous. Both articles should therefore be assumed to grant at least an equivalent level of protection, since they pursue the same objective, that is, to prohibit the use of specific emblems of public interest without the consent of the competent authorities (judgment of 16/07/2009 in Joined Cases C-202/08 P and C-208/08 P, 'RW feuille d'érable', paras 78, 79 and 80).

2.9.1 Protection of armorial bearings, flags, other state emblems, official signs and hallmarks indicating control and warranty under Article 7(1)(h) EUTMR — Article 6ter(1)(a) and (2) PC

In accordance with Article 6ter(1)(a) PC, the registration, either as a trade mark or as an element thereof, of armorial bearings, flags, and other state emblems of the countries of the Union (i.e. the countries to which the PC applies), or of official signs and hallmarks adopted by states as an indication of control and warranty, as well as any imitation from a heraldic point of view will be refused if no authorisation has been granted by the competent authority.

The members of the World Trade Organization (WTO) enjoy the same protection pursuant to Article 2(1) TRIPs, according to which members of the WTO must comply with Articles 1 to 12 and 19 PC.

Therefore, to fall foul of Article 7(1)(h) EUTMR, a trade mark:

- must consist solely of an identical reproduction or a 'heraldic imitation' of the abovementioned symbols;
- must contain an identical reproduction or a 'heraldic imitation' of the abovementioned symbols.

Furthermore, the competent authority must not have given its authorisation.

Armorial bearings consist of a design or image depicted on a shield. See the following example.



Bulgarian armorial bearing – 6ter database No BG2

State flags usually consist of a distinctive rectangular design that is used as the symbol of a nation. See the following example.



Croatian flag

The expression 'other State emblems' is rather vague. It usually indicates any emblems constituting the symbol of the sovereignty of a state, including the escutcheons of reigning houses as well as emblems of states included in a federal state that is party to the Paris Convention. See the following example.

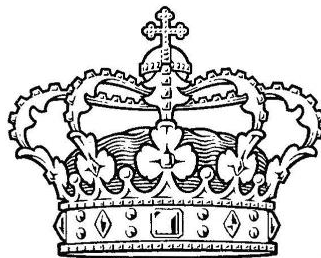

Danish state emblem — 6ter database No DK3

The purpose of official signs and hallmarks indicating control and warranty is to certify that a state or an organisation duly appointed by a state for that purpose has checked that certain goods meet specific standards or are of a given level of quality. There are official signs and hallmarks indicating control and warranty in several states for *precious metals* or products such as *butter, cheese, meat, electrical equipment, etc.* Official signs and hallmarks may also apply to services, for instance those relating to *education, tourism, etc.* See the following examples.



Official Spanish sign for export promotion No ES1



UK hallmark for platinum articles No GB 40

It must be noted that Article 6ter PC does not protect the abovementioned symbols against all imitations, only 'heraldic imitations'. The notion of 'heraldic imitation' must be construed in the sense that '... the prohibition of the imitation of an emblem applies only to imitations of it from a heraldic perspective, that is to say, those which contain heraldic connotations which distinguish the emblem from other signs. Thus, the protection against any imitation from a heraldic point of view refers not to the image as such, but to its heraldic expression. It is therefore necessary, in order to determine whether the trade mark contains an imitation from a heraldic point of view, to consider the heraldic description of the emblem at issue' (see CJEU judgment of 16/07/2009 in Joined Cases C-202/08 P and C-208/08 P, para. 48).

Consequently, when making a comparison 'from a heraldic point of view' within the meaning of Article 6ter PC, account must be taken of the heraldic description of the emblem concerned and not any geometric description of the same emblem, which is by nature much more detailed. Indeed, if the geometric description of the emblem were taken into account, this '... would lead to the emblem being refused protection under Article 6ter(1)(a) of the Paris Convention in the event of any slight discrepancy between the two descriptions. Secondly, the case of graphic conformity with the emblem used by the trade mark is already covered by the first part of that provision, so that the expression "any imitation from a heraldic point of view" must be different in its scope' (see *ibidem*, para. 49).

For example, an examiner should take into account the heraldic description of the



European emblem — 'on an azure field a circle of twelve golden mullets, their points not touching' — and not its geometrical description: 'the emblem is in the form of a blue rectangular flag of which the fly is one and a half times the length of the hoist. Twelve gold stars situated at equal intervals form an invisible circle whose centre is the point of intersection of the diagonals of the rectangle. The radius of the circle is equal to one third of the height of the hoist. Each of the stars has five points

which are situated on the circumference of an invisible circle whose radius is equal to one eighteenth of the height of the hoist. All the stars are upright — that is to say, with the one point vertical and two points in a straight line at right angles to the mast. The circle is arranged so that the stars appear in the position of the hours on the face of a clock. Their number is invariable.’

Furthermore, armorial bearings and other heraldic emblems are drawn on the basis of a relatively simple description of the layout and background colour that also lists the different elements (such as a lion, an eagle, a flower, etc.) constituting the emblem and gives information on their colour and position within the emblem. However, a heraldic description does not give details of the design of the emblem and the specific elements that constitute it, with the result that a number of artistic interpretations of one and the same emblem on the basis of the same heraldic description are possible. Although there may be differences in detail between each of those interpretations, the fact remains that they will all be imitations ‘from a heraldic point of view’ of the emblem concerned (T-215/06, 28/02/2008, paras 71-72).

It follows that a trade mark that does not exactly reproduce a state emblem can nevertheless be covered by Article 6ter(1)(a) PC where it is perceived by the relevant public as imitating such an emblem. So far as the expression ‘imitation from a heraldic point of view’ in that provision is concerned, a difference detected by a specialist in heraldic art between the trade mark applied for and the State emblem will not necessarily be perceived by the average consumer who, in spite of differences at the level of certain heraldic details, can see in the trade mark an imitation of the emblem in question (see CJEU judgment of 16/07/2009 in Joined Cases C-202/08 P and C-208/08 P, paras 50-51).

Furthermore, for Article 6ter(1)(a) PC to apply, it is not necessary to examine the overall impression produced by the mark by taking into account also its other elements (words, devices, etc.).

Indeed, Article 6ter(1)(a) PC applies not only to trade marks but also to elements of marks that include or imitate state emblems. It is sufficient, therefore, for a single element of the trade mark applied for to represent such an emblem or an imitation thereof for that mark to be refused registration as an European Union trade mark (see also judgment of 21/04/2004, T-127/02, ‘ECA’, paras 40-41).

2.9.1.1 Examination of marks consisting of or containing a state flag

There are three steps to examining marks that consist of or contain a state flag:

- 1 Find an official reproduction of the protected flag.
- 2 Compare the flag with the mark applied for. Does the mark applied for consist solely of or contain an identical reproduction of the flag (b)? Or does the mark consist solely of or contain a heraldic imitation of that flag (b)?
- 3 Check whether there is any evidence on file to show that registration of the flag has been authorised by the competent authority.

- 1 Find the protected flag

As seen above, states are not obliged to include flags in the list of emblems to be communicated to WIPO. This is because flags are supposed to be well known.

Nevertheless, some flags have been included in the list, which is accessible via the 'Article 6ter Structured Search' tool made available by WIPO. Otherwise, examiners should refer to the official websites of the relevant governments, and to encyclopaedias and/or dictionaries for an accurate reproduction of the state flag.

2 Compare the flag with the mark applied for



- (a) Does the mark applied for consist solely of or contain an identical reproduction of a flag? If so, proceed to the next step.
- (b) Does the mark consist solely of or contain a heraldic imitation of a flag?

In the case of flags, the mark must be compared with the heraldic description of the flag at issue. For example, in Case T-41/10 of 05/05/2011 (ESF Ecole du ski français), the French flag was described as a rectangular or square flag made up of three equal vertical bands of the colours blue, white and red.



The examiner will use the heraldic description, which gives details of the layout and background colour, lists the different elements (such as a lion, an eagle, a flower, etc.) that constitute the flag and specifies the colour, position and proportions of the latter to reach a conclusion on heraldic imitation.

As a rule, the flag and the mark (or the part of the mark in which the flag is reproduced) must be quite similar in order for a heraldic imitation to be found.

See the following example where a 'heraldic imitation' of a flag was found:

Flag	Refused EUTM application
	
Swiss flag	EUTM application 8 426 876

The use of a flag in black and white may still be considered a heraldic imitation when the flag consists of or contains unique heraldic features. For example, the black-and-white representation of the Canadian flag in the following example is considered to be a heraldic imitation.

Flag	Refused EUTM application
	
Canadian flag	EUTM application 2 793 495

On the other hand, for flags consisting only of stripes of three colours (whether vertical or horizontal) a black-and-white reproduction will not be considered a heraldic imitation because flags of that kind are quite common.

As seen above, the presence of other elements in the marks is irrelevant; this is confirmed by the Board of Appeal's refusal of EUTM application 10 502 714.

Flag	Sign
<p>The flags of, for example, Belgium, the Czech Republic, France, Italy, Latvia, Austria, Finland and Sweden.</p>	 <p>EUTM application 10 502 714, R 1291/2012-2</p>
<p>'... the flags ... are all represented in the mark and will be immediately recognized as such by the public coming from those parts of the EU, as well as many others across the relevant territory. ... they do not merge into each other in a way which dissipates their individual characteristics. It must also be noted that the flags appearing at the bottom of the mark ... are not upside down, but are presented exactly as they would be normally.</p> <p>As noted by the Court in the judgment of 16 July 2009, C-202/08 P and C-208/08 P, 'RW feuille d'érable' at para. 59, Article 6ter(1)(a) of the Paris Convention applies not only to trade marks but also to elements of marks which include or imitate State emblems. It is sufficient, therefore, for a single element of the trade mark applied for to represent such an emblem or an imitation thereof for that mark to be refused registration as a Community trade mark ... Therefore the applicant's arguments that although the mark contains various national flags, this is only a small part of the mark which is overwhelmed by the presence of the additional elements and that these elements are more dominant and distinctive, fail.' (paras 18-19)</p>	

If an element is a different shape from a flag (e.g. circular), it is not considered to be a heraldic imitation. Other different shapes that are not heraldic imitations are shown in the following examples:

Flag	Accepted EUTM application
	
	<p>EUTM application 5 851 721</p>
	
<p>Italian flag</p>	<p>EUTM application 5 514 062</p>
	
<p>Swiss flag</p>	<p>EUTM application 6 015 473</p>
	
<p>Finnish flag</p>	<p>EUTM application 7 087 281</p>
Flag	Accepted EUTM application
	
<p>Swedish flag</p>	<p>EUTM application 8 600 132</p>

	
<p>Danish flag</p>	<p>EUTM application 8 600 173</p>
	
<p>French flag</p>	<p>CTM 4 624 987, T-41/10</p>

The distinction between the cases examined in EUTM application No 8 426 876 (objected to) and EUTM application No 6 015 473 (not objected to) should be noted. In the latter, it was decided not to object because of the number of changes: a change in the shape (from a square to a circle), a change in proportions (the white lines of the cross in EUTM application No 6 015 473 are longer and thinner than in the flag) and a change of colour, since the cross in EUTM application No 6 015 473 has a shadow.

3 Check whether registration has been authorised

Once the examiner has found that the mark consists of or contains a flag or a heraldic imitation thereof, he/she must check whether there is any evidence on file to show that the registration has been authorised by the competent authority.

Where there is no such evidence, the examiner will object to the registration of the mark applied for. The objection will reproduce the official flag in colour and indicate the source of the reproduction.

Such an objection can only be waived if the applicant produces evidence that the competent authority of the state concerned has authorised registration of the mark.

Extent of the refusal: In the case of state flags, trade marks that fall foul of Article 7(1)(h) EUTMR must be refused for all goods and services applied for.

2.9.1.2 Examination of marks consisting of or containing armorial bearings and other state emblems

The same steps mentioned in relation to state flags are followed also when examining marks that consist of or contain armorial bearings or other state emblems.

Nevertheless, to be protected, armorial bearings and other state symbols must be contained in 'the list of armorial bearings and state emblems'. This list is accessible via





the ‘Article 6ter Structured Search’ tool made available by WIPO at <http://www.wipo.int/ipdl/en/6ter/>.

The WIPO Article 6ter database gives details of written elements and contains references to the categories of the Vienna Classification code. Therefore, the best way to search is by using that code.

In these cases, the protected symbol, which very often consists of or contains recurring devices such as crowns, unicorns, eagles, lions, etc., and the mark (or the part of the mark in which the symbol is reproduced) must be closely similar.

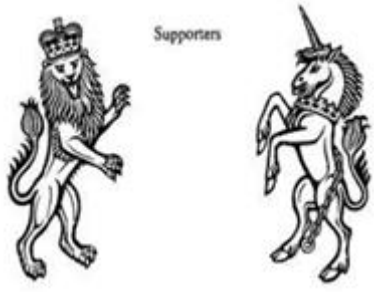
For background on this and heraldic descriptions, please see the explanation in paragraph 2.8.1.1 ‘Examination of marks consisting of or containing a state flag’ above.



Here are two examples where a ‘heraldic imitation’ of a state symbol was found:

Protected emblem	Refused EUTM application
 <p>British emblem: 6ter Number: GB4</p>	 <p>EUTM application 5 627 245, T-397/09</p>
 <p>Canadian emblem: 6ter Number: CA2</p>	 <p>EUTM application 2 785 368 (CJEU C-202/08)</p>

The General Court noted that the supporters contained in EUTM application No 5 627 245 were almost identical to those in the emblem protected under sign GB4. The only difference lay in the crowns in both signs. However, the GC ruled that any difference between the mark and the state emblem detected by an expert in heraldry would not necessarily be perceived by the average consumer who, despite some differences in heraldic details, can see in the mark an imitation of the emblem. Therefore, the GC concluded that the Board was right to find that the mark applied for contained an imitation from a heraldic perspective of emblem GB4, protected under Article 6ter of the Paris Convention (Case T-397/09, paras 24-25).

In the example reproduced below a ‘heraldic imitation’ of state emblems was found by the examiner. However, the decision was annulled by the Board which considered that the sign applied for is not identical to the national emblem of Ireland. It does not contain

an imitation of the national emblems of Ireland either and it does not reproduce characteristic heraldic features of these emblems (R 0139/2014-5, para. 16):



State emblem	EUTM application
	
Irish state emblems: 6ter Numbers: IE 11 — IE 14	EUTM application 11 945 797

It should also be noted that black-and-white reproductions of armorial bearings and other state emblems may still be considered heraldic imitations when the protected symbol consists of or contains unique heraldic features (see the example of the Canadian emblem).



Furthermore, the presence of other elements in the rejected marks is irrelevant.

There is even a heraldic imitation when the protected symbol is only partially reproduced as long as what is partially reproduced represents the significant element(s) of the protected symbol and (a) unique heraldic feature(s).

The following is an example of a partial heraldic imitation because the significant element of the protected symbol, the eagle with the arrows over the emblem, is a unique heraldic device and its heraldic characteristics are imitated in the EUTM application:

Protected emblem	Refused EUTM applications
	
Emblem of the Justice Department of the USA; 6ter Number: US40	EUTM application 4 820 213

In the following example there is no heraldic imitation of a state emblem:

Protected emblem	Accepted EUTM application
	
6ter number: AT10	EUTM application 8 298 077

EUTM application No 8 298 077 is not a heraldic imitation of the Austrian symbol because its shape is different and the lines inside the white cross in the Austrian symbol are not present in the EUTM application.

Once the examiner has found that a mark reproduces a symbol (or is a heraldic imitation thereof), they must check whether there is any evidence on file to show that registration has been authorised by the competent authority.

Where there is no such evidence, the examiner will object to the registration of the mark applied for. The objection will reproduce the protected symbol, quoting its 6ter number.

Such an objection can only be waived if the applicant produces evidence that the competent authority of the state concerned has authorised registration of the mark.

Extent of the refusal: In the case of state symbols, trade marks that fall foul of Article 7(1)(h) EUTMR must be refused for all goods and services applied for.

2.9.1.3 Examination of marks consisting of or containing official signs and hallmarks indicating control and warranty

The steps to be followed by the examiner are the same as for the state flags, protected armorial bearings and other state emblems mentioned above.

However, the extent of the refusal is limited. Trade marks that consist of or contain an identical reproduction/heraldic imitation of official signs and hallmarks indicating control and warranty will be refused only for goods that are identical or similar to those to which said symbols apply (Article 6ter(2) PC).

2.9.2 Protection of armorial bearings, flags, other emblems, abbreviations and names of international intergovernmental organisations under Article 7(1)(h) EUTMR — Article 6ter(1)(b) and (c) PC

In accordance with Article 6ter(1)(b) and (c) PC, the registration, either as a trade mark or as an element thereof, of armorial bearings, flags, other emblems, abbreviations and names of international intergovernmental organisations (of which one or more countries

of the Paris Union is/are member(s)) or any imitation from a heraldic point of view will be refused if no authorisation has been granted by the competent authority.

The members of the WTO enjoy the same protection pursuant to Article 2(1) TRIPs, according to which members of the WTO must comply with Articles 1 to 12 and 19 of the Paris Convention.

Furthermore, the trade mark should be of such a nature as to suggest to the public that there is a connection between the organisation concerned and the armorial bearings, flags, emblems, abbreviations or names, or to mislead the public as to the existence of a connection between the owner and the organisation.

International intergovernmental organisations (IGOs) include bodies such as the United Nations, the Universal Postal Union, the World Tourism Organization, WIPO, etc.

In this respect, the European Union must be considered neither as an international organisation in the usual sense nor as an association of states, but rather as a 'supranational organisation', i.e. an autonomous entity with its own sovereign rights and a legal order independent of the Member States, to which both the Member States themselves and their nationals are subject within the EU's areas of competence.

On the one hand, the Treaties have led to the creation of an independent Union to which the Member States have ceded some of their sovereign powers. The tasks allotted to the EU are very different from those of other international organisations. While the latter mainly have clearly defined tasks of a technical nature, the EU has areas of responsibility that together constitute essential attributes of statehood.



On the other hand, the EU institutions too only have powers in certain areas to pursue the objectives specified in the Treaties. They are not free to choose their objectives in the same way as a sovereign state. Moreover, the EU has neither the comprehensive jurisdiction enjoyed by sovereign states nor the powers to establish new areas of responsibility ('jurisdiction over jurisdiction').

Notwithstanding the particular legal nature of the EU, and for the sole purpose of the application of Article 7(1)(h) EUTMR, the European Union is likened to an international organisation. In practice, account will be taken of the fact that the EU's field of activity is so broad (judgment of 15/01/2013, T-413/11, 'EUROPEAN DRIVESHIFT SERVICES', para. 69) that the examiner is very likely to find a link between the goods and services in question and the EU's activities.



The most relevant EU flags and symbols, protected by the Council of Europe, are shown here:

	
6ter number: QO188	6ter number: QO189

The following have been protected for the Commission:

		
6ter number: QO245	6ter number: QO246	6ter number: QO247

The following have been protected for the European Central Bank:

	
6ter number: QO852	6ter number: QO867

There are four steps to examining marks that contain the armorial bearing, flag or other symbols of an international intergovernmental organisation.

- 1 Find an official reproduction of the protected symbol (which may be an abbreviation or name).
- 2 Compare the symbol with the mark applied for.
- 3 Check whether the mark applied for suggests to the relevant public that there is a connection between the owner and the international organisation or misleads the public as to the existence of such a connection.
- 4 Check whether there is any evidence on file to show that registration has been authorised by the competent authority.

- 1 Find the protected symbol (or abbreviation or name)

To be protected, the symbols of international intergovernmental organisations must be incorporated in the relevant list. Unlike the situation with state flags, this requirement also applies to international organisations' flags.

The relevant database is accessible via the 'Article 6ter Structured Search' tool provided by WIPO. In this case too, the best way to search is by using the Vienna Classification code.

2 Compare the symbol with the mark applied for







Does the mark applied for consist solely of or contain an identical reproduction of the protected symbol of an international intergovernmental organisation Or does the mark applied for consist of or contain a heraldic imitation thereof?

- (a) Does the mark applied for consist solely of or contain an identical reproduction of the protected symbol? If so, proceed to the next step.
- (b) Does the mark applied for consist solely of or contain a heraldic imitation thereof?

The test is the same as that for state flags and symbols, that is, the protected symbol and the mark (or the part of the mark in which the protected symbol is reproduced) must be closely similar. The same applies to abbreviations and names of international intergovernmental organisations (see decision R 1414/2007-1 – ‘ESA’).

The following marks were rejected because they were considered to contain ‘heraldic imitations’ of the European Union flag protected under QO188:



		
EUTM application 2 305 399	EUTM application 448 266	EUTM application 6 449 524
		
EUTM application 7 117 658	EUTM application 1 106 442 (T-127/02)	EUTM 4 081 014 (1640 C)
		
	EUTM application 2 180 800 (T-413/11)	

For heraldic imitations of the European Union flag (QO188 above), it is considered relevant that (a) there are 12 five-pointed stars, (b) the stars are in a circle and are not touching each other, and (c) the stars contrast with a darker background.

In particular, it must be taken into account that the 'device in the form of twelve stars arranged in a circle is the most important element of the European Union emblem ('the emblem') because it conveys strong messages: (a) the circle of gold stars symbolises solidarity and harmony between the peoples of Europe and (b) the number twelve evokes perfection, completeness and unity. The other element of the emblem is a background suitably coloured to highlight the device' (see BoA decision in case R 1401/2011-1, para. 21).

It follows from the above that the representation of the EU flag in black and white may still be considered a heraldic imitation when the stars contrast with a dark background in such a way as to give the impression of being a black-and-white reproduction of the EU flag (see EUTM application 1 106 442 above).

In contrast, the following example illustrates a case where the black-and-white reproduction of a circle of stars does not give the impression of being a black-and-white reproduction of the EU flag:

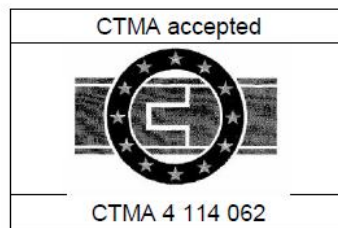

The following three cases are not considered to be heraldic imitations of the European Union flag because they do not reproduce twelve stars in a circle (i.e. both marks were accepted):



The following is not a heraldic imitation because, although the stars are yellow, there is no blue (or dark-coloured) background:

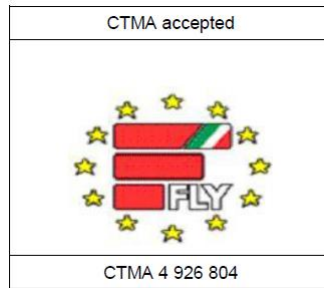

- 3 Check whether the mark applied for suggests to the relevant public that there is a connection between the owner and the international organisation or misleads the public as to the existence of such a connection.

A connection is suggested not only where the public would believe that the goods or services originate with the organisation in question, but also where the public could believe that the goods or services have the approval or warranty of, or are otherwise linked to, that organisation (see judgment of 15/01/2013, T-413/11, 'EUROPEAN DRIVESHAFT SERVICES', para. 61).

In order to assess the circumstances properly, the examiner must take into account the following:

- the goods and/or services covered by the EUTM application;
- the relevant public;
- the overall impression conveyed by the mark.

With regard to the European Union flag, the examiner must evaluate whether there is any overlap between the claimed goods and/or services and the European Union's activities, bearing in mind that the European Union is active in numerous sectors and regulates goods and services in all fields of industry and commerce, as is clear from the wide variety of Directives that it has adopted. Likewise, the examiner must take into account that even average consumers could be aware of such activities, which means, in practice, that the examiner is very likely to find a link in most cases.

Finally, in contrast to Article 6*ter*(1)(a) PC, for which it is sufficient for the sign to consist of or contain the emblem or a heraldic imitation thereof, Article 6*ter*(1)(c) PC requires an overall assessment.

It follows that, unlike for state emblems and flags, the examiner must take into account also the other elements of which the mark is composed. For it cannot be ruled out that all the other elements of the sign could lead to the conclusion that the public would not connect the sign with an international intergovernmental organisation (judgment of 15/01/2013, T-413/11, 'EUROPEAN DRIVESHAFT SERVICES', para. 59).

Still with regard to the EU flag, it must be noted that, as a rule, word elements such as 'EURO'/'EUROPEAN' in an EUTM application are likely to suggest a connection even more, since they could be perceived as implying an official EU agency's approval, quality control or warranty services for the claimed goods and services.

Here are two examples of where a connection with the EU was found:

	
G&S	<p>Class 16: <i>Periodical and other publications</i> Class 42: <i>Preparation of reports or studies relating to cars, motorcycles and bicycles</i></p>
Reasoning	<p>The mark was refused for all the goods and services for the following reasons: (26) Consumers in this market are aware of how important it is for companies that provide surveys and reports on expensive and potentially dangerous goods like vehicles to be credible. Consumers may also be aware that the European Union itself is involved in such activities through its association with Euro NCAP, which provides motoring consumers with independent assessments of the safety and performance of cars sold on the European market. Given these facts, and the fact that the proprietor's mark contains a recognisable heraldic element of the European emblem, it is likely that the public would assume that the inclusion of the twelve gold stars of the EU emblem in the EUTM pointed to a connection between the proprietor and the EU.</p>

	
G&S	<p>Class 9: <i>Computer hardware, computer software, recorded data carriers.</i> Class 41: <i>Arranging and conducting of colloquiums, seminars, symposiums, congresses and conferences; providing of tuition, instruction, training; consultancy on training and further training.</i> Class 42: <i>Creating, updating and maintenance of computer programs; computer program design; consultancy in the field of computers; rental of computer hardware and computer software; leasing access time to a computer database.</i></p>
Reasoning	<p>The mark was refused for all the goods and services for the following reasons: The Board of Appeal found that, contrary to what the applicant claimed, there was some overlap between the goods and services offered by the applicant and the activities of the Council of Europe and the European Union. The Board of Appeal referred, inter alia, to the Official Journal of the European Union, which is available on CD-ROM (i.e. compact disc with a read-only memory), to seminars, training programmes and conferences offered by the Council of Europe and the European Union in a variety of areas, and to a large number of databases made available to the public by those institutions, in particular EUR-Lex. Given the wide variety of services and goods that may be offered by the Council of Europe and the European Union, it cannot be ruled out, for the kind of goods and services for which registration was sought, that the relevant public might believe that there is a connection between the applicant and those institutions. Accordingly, the Board of Appeal was right to find that registration of the mark sought was likely to give the public the impression that there was a connection between the mark sought and the institutions in question.</p>

4 Check whether registration has been authorised

Where there is no evidence that registration of the mark applied for has been authorised, the examiner will object to its registration. The objection must reproduce the protected symbol, quoting its *6ter* number.

The examiner must also indicate the refused goods and services clearly and give reasons why the mark suggests to the public a connection with the organisation concerned.

Such an objection can only be waived if the applicant provides evidence that the competent authority has authorised registration of the mark.

Extent of the refusal: In the case of flags and symbols of international intergovernmental organisations, the refusal must specify the goods and/or services affected, that is, those for which the public would, according to the examiner, see a connection between the mark and an organisation.

2.9.3 Protection of badges, emblems or escutcheons other than those covered by Article 6*ter* of the Paris Convention under Article 7(1)(i) EUTMR

In accordance with Article 7(1)(i) EUTMR, trade marks will not be registered if they include badges, emblems or escutcheons other than those that are covered by Article 6*ter* of the Paris Convention and are of particular public interest, unless the competent authority has consented to their registration.

As seen above, Article 7(1)(i) EUTMR refers to all other badges, emblems or escutcheons that have not been communicated in accordance with Article 6*ter*(3)(a) PC regardless of whether they are the emblems of a state or international intergovernmental organisation within the meaning of Article 6*ter*(1)(a) or (b) PC or of public bodies or administrations other than those covered by Article 6*ter* PC, such as provinces or municipalities.

Furthermore, according to the case-law, Article 7(1)(i) and Article 7(1)(h) EUTMR both have a similar scope of application and grant at least equivalent levels of protection.

This means that Article 7(1)(i) EUTMR applies not only where the abovementioned symbols are reproduced identically as a trade mark or a part thereof, but also where the mark consists of or contains a heraldic imitation of those symbols. Any other interpretation of this provision would result in less protection being provided by Article 7(1)(i) EUTMR than by Article 7(1)(h) EUTMR. Following the same line of reasoning, Article 7(1)(i) EUTMR applies where the mark is liable to mislead the public as to the existence of a connection between the owner of the trade mark and the body to which the abovementioned symbols refer. In other words, the protection afforded by Article 7(1)(i) EUTMR is conditional on a link between the mark and the symbol. Otherwise, trade marks to which Article 7(1)(i) EUTMR applies, would obtain broader protection than under Article 7(1)(h) EUTMR (judgment of 10/07/2013, Case T-3/12 'MEMBER OF EURO EXPERTS').

Article 7(1)(i) EUTMR does not define symbols of 'particular public interest'. However, it is reasonable to assume that the nature of these could vary and could include, for example, religious symbols, political symbols or symbols of public bodies or

administrations other than those covered by Article 6^{ter} PC, such as provinces or municipalities. In any case, the ‘particular public interest’ involved must be reflected in a public document, for example a national or international legal instrument, regulation or other normative act.

The General Court stated that a ‘particular public interest’ existed when the emblem had a particular link with one of the activities carried out by an international intergovernmental organisation (judgment of 10/07/2013, T-3/12, ‘MEMBER OF EURO EXPERTS’, para. 44). In particular, the Court specified that Article 7(1)(i) EUTMR applied also when the emblem merely evoked one of the fields of activity of the European Union, and even if that activity concerned only some of the EU states (see *ibidem*, paras 45-46).

This confirms that the protection afforded by Article 7(1)(i) EUTMR applies also to symbols that are of particular public interest in only a single Member State or part thereof (Article 7(2) EUTMR).

There are four steps to examining marks that contain badges, emblems and escutcheons of particular public interest.

- 1 Find the symbol of particular public interest.
- 2 Compare the symbol with the mark applied for.
- 3 Check whether the mark applied for suggests to the relevant public that there is a connection between the owner and the authority to which the symbol refers or misleads the public as to the existence of such a connection.
- 4 Check whether there is any evidence on file to show that registration has been authorised by the appropriate authority.

- 1 Find the symbol of particular public interest.

At present, there is no list or database allowing examiners to identify which symbols are of particular public interest, especially in a Member State or part thereof. Therefore, third party observations are likely to remain the source of many objections to such symbols.

One example of a symbol of particular public interest is the Red Cross, which is protected by the Convention for the Amelioration of the Condition of the Wounded and Sick in Armed Forces in the Field, signed in Geneva (<http://www.icrc.org/> and <http://www.icrc.org/Web/Eng/siteeng0.nsf/htmlall/genevaconventions>).

The following symbols are protected under the Geneva Convention:



Apart from the symbols, their names are also protected (from left to right) as follows:

‘Red Cross’, ‘Red Crescent’ and ‘Red Crystal’.

Another example of a symbol of particular public interest is the Olympic symbol as defined in the Nairobi Treaty on the Protection of the Olympic Symbol. According to the definition in the Nairobi Treaty, 'the Olympic symbol consists of five interlaced rings: blue, yellow, black, green and red, arranged in that order from left to right. It consists of the Olympic rings alone, whether delineated in a single colour or in different colours.'



The following symbol was considered not to be a symbol of particular public interest:

RESPONSIBLE RECYCLING PACKAGING

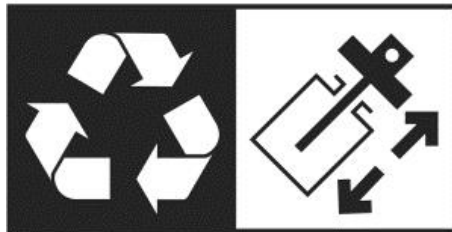

SEPARATE GLASS FROM PLASTIC

The recycling symbol (on the left) was not considered to be protected under this provision because it is a commercial symbol.

2 Compare the symbol with the mark applied for.

Does the mark applied for consist solely of or contain an identical reproduction of the symbol of particular public interest? Or does the mark applied for consist of or contain a heraldic imitation thereof?



- (a) Does the mark applied for consist solely of or contain an identical reproduction of the symbol? If so, proceed to the next step.
- (b) Does the mark applied for consist solely of or contain a heraldic imitation of the symbol?

The test is the same as the one for flags and symbols of international intergovernmental organisations, that is, the symbol and the mark (or the part of the mark in which the symbol is reproduced) must be quite similar.

The following are examples of marks that were rejected because they contained the Red Cross symbol or a heraldic imitation thereof.

Refused EUTM application s		
		
WO 964 979	EUTM application 2 966 265	EUTM application 5 988 985



On the other hand, a number of well-known red crosses have traditionally been used and are still in use, the incorporation of which in a mark would not be considered a reproduction of the 'Red Cross'. Examples of these famous crosses include the following:

		
Templar cross	St George's cross	Maltese cross

The following EUTM was accepted because it contained two reproductions of the Templar cross.



A mark which contains a cross in black and white (or shades of grey) is not objectionable. Nor is a cross in a colour other than red objectionable under Article 7(1)(i) EUTMR.

Accepted EUTM application s		
		
EUTM application 8 986 069	EUTM application 9 019 647	EUTM application 9 025 768

- 3 Check whether the mark applied for suggests to the relevant public that there is a connection between the owner and the authority to which the symbol refers or misleads the public as to the existence of such a connection.

A connection is suggested not only where the public would believe that the goods or services originate with the authority in question, but also where the public could believe that the goods or services have the approval or warranty of, or are otherwise linked to, that authority (see GC judgment of 10/07/2013, T-3/12, ‘MEMBER OF EURO EXPERTS’, para. 78).

In order to assess the circumstances properly, the examiner must, as above, take into account the following:

- the goods and/or services covered by the EUTM application;
- the relevant public;
- the overall impression conveyed by the mark.

The examiner must evaluate whether there is any overlap between the claimed goods and/or services and the activities of the authority at issue and whether the relevant public could be aware of it.

In particular, with regard to the European Union, the examiner must take into account that the latter is active in numerous fields, as is clear from the wide variety of Directives that it has adopted.

Furthermore, the examiner must also take into account the other elements of which the mark is composed. For it cannot be ruled out that all the other elements of the sign could lead to the conclusion that the public would not connect the sign with the authority concerned (see judgment of 10/07/2013, T-3/12, ‘MEMBER OF EURO EXPERTS’, para. 107).

Still with regard to the EU, it must be noted that, as a rule, word elements such as ‘EURO’/‘EUROPEAN’ in an EUTM application are likely to suggest a connection even more, since they could be perceived as implying EU approval (see judgment of 10/07/2013, T-3/12, ‘MEMBER OF EURO EXPERTS’, para. 113).

For example, the General Court (in Case T-3/12) confirmed that the following mark (C EUTM application TMA No 6 110 423, covering Classes 9, 16, 35, 36, 39, 41, 42, 44 and 45)



fell foul of Article 7(1)(i) EUTMR since it contained a (heraldic) imitation of the 'Euro' symbol.



4 Check whether registration has been authorised.

Is there any evidence on file that the appropriate authority has authorised registration?

Where there is no such evidence, the examiner will object to the registration of the mark applied for. The objection will reproduce the symbol and provide the applicant with all necessary details and, in particular, information on why the symbol is of 'particular public interest' (for example, if protected by an international instrument, a reference to that instrument; in the case of the Red Cross this is the Convention for the Amelioration of the Condition of the Wounded and Sick in Armed Forces in the Field, signed in Geneva (<http://www.icrc.org/> and <http://www.icrc.org/Web/Eng/siteeng0.nsf/htmlall/genevaconventions>)).

Such an objection can only be waived if the applicant submits evidence that the appropriate authority has consented to registration of the mark.

Extent of the refusal: In the case of symbols of particular public interest, the refusal must specify the goods and/or services affected, that is, those for which the public would, according to the examiner, see a connection between the mark and the authority.

2.10 Article 7(1)(j) EUTMR

Article 7(1)(j) EUTMR provides for the refusal of EUTMs that are excluded from registration pursuant to national or EU legislation or international agreements to which the EU or the Member State concerned is party, providing for protection of designations of origin and geographical indications.

As regards **EU legislation** protecting designations of origin and geographical indications, the following EU regulations are currently in place:

- Regulation (EU) No 1308/2013² on the protection of geographical indications for *wines*
- Regulation (EU) No 251/2014³ on the protection of geographical indications for *aromatised wines*
- Regulation (EC) No 110/2008⁴ on the protection of geographical indications for *spirit drinks*
- Regulation (EU) No 1151/2012⁵ on the protection of geographical indications for *agricultural products and foodstuffs*

As a consequence, Article 7(1)(j) EUTMR applies where protected designations of origin (PDOs) or protected geographical indications (PGIs) have been registered under the procedure laid down by these EU regulations. Importantly, PDOs/PGIs registered at EU level can originate from EU Member States, but also from third countries.

Article 7(1)(j) EUTMR also applies to EUTMs that are in conflict with third-country PGIs/PDOs that enjoy protection in the EU through **international agreements to which the EU is a party** (see paragraph 2.10.5 below).

As regards **national legislation** referred to in Article 7(1)(j) EUTMR, it is the Office interpretation that it exclusively relates to national legislation providing for the protection of PDOs/PGIs in those areas where there is not an uniform system of EU protection, namely those areas not covered by the abovementioned EU regulations. For the purposes of these Guidelines, they will be referred to as '**non-agricultural PDOs/PGIs**' (e.g. *handicrafts*).

As regards **international agreements concluded by Member States only**, and by analogy to the Office's interpretation of Article 7(1)(j) EUTMR as far as national law is concerned, the Office considers that the reference to an 'international agreement to which the Member State concerned is party' should be interpreted as international agreements (including the Lisbon Agreement) in those areas where no uniform EU protection is in place, namely *non-agricultural products* (see paragraph 2.10.5 below).

² Regulation (EU) No 1308/2013 of the European Parliament and of the Council of 17 December 2013 establishing a common organisation of the markets in agricultural products.

³ Regulation (EU) No 251/2014 of the European Parliament and of the Council of 26 February 2014 on the definition, description, presentation, labelling and the protection of geographical indications of aromatised wine products and repealing Council Regulation (EEC) No 1601/91

⁴ Regulation (EC) No 110/2008 of the European Parliament and of the Council of 15 January 2008 on the definition, description, presentation, labelling and the protection of geographical indications of spirit drinks and repealing Council Regulation (EEC) No 1576/89.

⁵ Regulation (EU) No 1151/2012 of the European Parliament and of the Council of 21 November 2012 on quality schemes for agricultural products and foodstuffs. It replaced and repealed Regulation (EC) No 510/2006.

2.10.1 General remarks on EU Regulations

2.10.1.1 Definition of geographical indications under EU Regulations

As regards *spirit drinks*, according to Article 15(1) of Regulation (EC) No 110/2008, a 'geographical indication' is an indication that identifies a spirit drink as originating in the territory of a country, or a region or locality in that territory, where a given quality, reputation or other characteristic of that spirit drink is essentially attributable to its geographical origin.

As regards *wines*, according to Article 93 of Regulation (EU) No 1308/2013:

- (a) 'designation of origin' means the name of a region, a specific place or, in exceptional cases, a country used to describe a *wine* that complies with the following requirements:
- (i) its quality and characteristics are essentially or exclusively due to a particular geographical environment with its inherent natural and human factors;
 - (ii) the grapes from which it is produced come exclusively from this geographical area;
 - (iii) its production takes place in this geographical area; and
 - (iv) it is obtained from vine varieties belonging to *Vitis vinifera*.
- (b) 'geographical indication' means an indication referring to a region, a specific place or, in exceptional cases, a country, used to describe a *wine* that complies with the following requirements:
- (i) it possesses a specific quality, reputation or other characteristics attributable to that geographical origin;
 - (ii) at least 85 % of the grapes used for its production come exclusively from this geographical area;
 - (iii) its production takes place in this geographical area; and
 - (iv) it is obtained from vine varieties belonging to *Vitis vinifera* or a cross between the *Vitis vinifera* species and other species of the genus *Vitis*.

As regards *aromatised wines*, according to Article 2 of Regulation (EU) No 251/2014, a 'geographical indication' means an indication that identifies an *aromatised wine* product as originating in a region, a specific place, or a country, where a given quality, reputation or other characteristics of that product is essentially attributable to its geographical origin.

Finally, as regards **agricultural products and foodstuffs**, pursuant to Article 5 of Regulation (EU) No 1151/2012, a 'designation of origin' is a name that identifies a product:

1. originating in a specific place, region or, in exceptional cases, a country;
2. whose quality or characteristics are essentially or exclusively due to a particular geographical environment with its inherent natural and human factors; and
3. the production steps of which all take place in the defined geographical area.

A 'geographical indication' is a name that identifies a product:

1. originating in a specific place, region or country;

2. whose given quality, reputation or other characteristic is essentially attributable to its geographical origin; and
3. of which at least one of the production steps takes place in the defined geographical area.

The difference between PGIs and PDOs is that the latter have a **closer link** with the area. In the foodstuffs sector, PDO is the term used to describe foodstuffs that are produced, processed and prepared in a given geographical area using recognised know-how. A PGI indicates a link with the area in at least one of the stages of production, processing or preparation. PDOs therefore have a stronger link with the area.

This distinction, however, does not affect the scope of protection, which is the same for PDOs and PGIs. In other words, Article 7(1)(j) EUTMR applies equally to all designations covered by Regulation (EU) No 1308/2013 on *wines* and Regulation (EU) No 1151/2012 on *agricultural products and foodstuffs*, regardless of whether they are registered as PDOs or as PGIs. Regulation (EC) No 110/2008 on *spirits* and Regulation (EU) No 251/2014 on *aromatised wines*, however, cover only PGIs, not PDOs.

In this respect, it must also be underlined that the concepts of PDO and PGI differ from a **'simple indication of geographical provenance'**. For the latter, there is no direct link between a specific quality, reputation or other characteristic of the product and its specific geographical origin, with the result that it does not come within the scope of Article 93 of Regulation (EU) No 1308/2013, Article 2 of Regulation (EU) No 251/2014, Article 15(1) of Regulation (EC) No 110/2008 and Article 5(2) of Regulation (EU) No 1151/2012 (see, by analogy, judgment of 07/11/2000, C-312/98, 'Warsteiner Brauerei Haus Cramer', paras 43-44). For example, 'Rioja' is a PDO for *wines* since it designates a *wine* with particular characteristics that comply with the definition of a PDO. However, *wine* produced in 'Tabarca' (a 'simple geographical indication' designating a small island close to Alicante) cannot qualify for a PDO/PGI unless it meets specific requirements. Similarly, 'Queso Manchego' is a PDO for *cheese* since it designates a product with particular characteristics that comply with the definition of a PDO. However, 'Queso de Alicante' (a 'simple geographical indication') cannot qualify for a PDO/PGI since it does not enjoy such characteristics and requirements

Protection is granted to PDOs/PGIs in order, inter alia, to protect the **legitimate interests of consumers and producers**. In particular, the specific objectives of protecting designations of origin and geographical indications are to secure a fair return for farmers and producers for the qualities and characteristics of a given product, or of its mode of production, and to provide clear information on products with specific characteristics linked to geographical origin, thereby enabling consumers to make more informed purchasing choices (see recital 18 of Regulation (EU) No 1151/2012). Moreover, their protection aims at ensuring that they are used fairly and at preventing practices liable to mislead consumers (see recital 29 of Regulation (EU) No 1151/2012).

2.10.1.2 Relevant provisions governing conflicts with trade marks

As regards *wines*, according to Article 102(1) of Regulation (EU) No 1308/2013, the registration of a trade mark that contains or consists of a protected designation of origin or a geographical indication that does not comply with the product specification concerned or the use of which falls under Article 103(2), and that relates to a product

falling under one of the categories listed in Part II of Annex VII must be refused if the application for registration of the trade mark is submitted after the date of submission of the application for protection of the designation of origin or geographical indication to the Commission and the designation of origin or geographical indication is subsequently protected.

As regards *aromatised wines*, according to Article 19(1) of Regulation (EU) No 251/2014, the registration of a trade mark, the use of which falls under Article 20(2) and relates to an *aromatised wine* product must be refused if the application for registration of the trademark is submitted after the date of submission of the application for protection of the geographical indication to the Commission and the geographical indication is subsequently protected.

As regards *spirit drinks*, according to Article 23(1) of Regulation (EC) No 110/2008, 'the registration of a trade mark which contains or consists of a geographical indication registered in Annex III shall be refused or invalidated if its use would lead to any of the situations referred to in Article 16'.

Finally, according to Article 14(1) of Regulation (EU) No 1151/2012, *agricultural products and foodstuffs*, 'Where a designation of origin or a geographical indication is registered under this Regulation, the registration of a trade mark the use of which would contravene Article 13(1) and which relates to a product of the same type must be refused if the application for registration of the trade mark is submitted after the date of submission of the registration application in respect of the designation of origin or the geographical indication to the Commission'.

Article 103(2) of Regulation (EU) No 1308/2013, Article 20 of Regulation (EU) No 251/2014, Article 16 of Regulation (EC) No 110/2008 and Article 13(1) of Regulation (EU) No 1151/2012 set out the situations that infringe the rights deriving from a PDO/PGI: (i) direct or indirect commercial use of the PDO/PGI; (ii) misuse, imitation or evocation; (iii) other misleading practices.

In light of the above provisions, **three cumulative conditions** are necessary for Article 7(1)(j) EUTMR in combination with the EU Regulations to apply.

1. The PDO/PGI in question must be registered at EU level (see paragraph 2.10.2 below).
2. Use of the EUTM that consists of or contains a PDO/PGI for *wines* or *agricultural products and foodstuffs*, or a PGI for *spirits* must constitute one of the situations provided for in Article 103(2) of Regulation (EU) No 1308/2013, Article 20(2) of Regulation (EU) No 251/2014 or in Article 16 of Regulation (EC) No 110/2008 (see paragraph 2.10.3 below).
3. The EUTM application must include goods that are identical or 'comparable' to the goods covered by the PDO/PGI. Reference is also made below to how goods can be restricted in order to waive an objection (see paragraph 2.10.4 below).

2.10.2 Relevant PDOs/PGIs under EU Regulations

Article 7(1)(j) EUTMR in combination with the EU Regulations applies where PDOs/PGIs (either from an EU Member State or from a third country) have been **registered** under the procedure laid down by Regulations No 1308/2013, No 251/2014, No 110/2008 and No 1151/2012.

- Relevant information about PDOs/PGIs for *wines* can be found in the 'E-Bacchus' database maintained by the Commission, which can be accessed through the internet at <http://ec.europa.eu/agriculture/markets/wine/e-bacchus/>.
- Currently, there are only five PGI's for *aromatised wines*: Nürnberger Glühwein, Samoborski bermet, Thüringer Glühwein, Vermouth de Chambéry, Vermouth di Torino⁶. In the future, and pursuant to Article 21 of Regulation (EU) No 251/2014, the Commission will establish an electronic register of the PGIs protected under this Regulation. This register is not in place yet.
- PGI's for *spirit drinks* are listed in Annex III of Regulation No 110/2008 (Article 15(2) of Regulation No 110/2008), as amended, which can be accessed at <http://eur-lex.europa.eu/legal-content/EN/TXT/PDF/?uri=CELEX:32012R0164&from=EN>. The Commission also maintains a database, 'E-Spirit-Drinks', accessible at <http://ec.europa.eu/agriculture/spirits/>. However, this is not an official register and is, therefore, only informative in character.
- Relevant information about PDOs/PGIs for *agricultural products and foodstuffs registered* under Regulation (EU) No 1151/2012 can be found in the database 'DOOR' maintained by the Commission, which can be accessed at <http://ec.europa.eu/agriculture/quality/door/list.html>.

Protection is granted solely to the name of a PDO/PGI as registered (see Article 13(1) of Regulation (EU) No 1151/2012) and does not extend *ipso iure* to the **names of subregions, subdenominations, local administrative areas or localities** in the area covered by that PDO/PGI. In this respect, and in particular as regards *wines*, a distinction must be made between the doctrine of the General Court in judgment of 11/05/2010, T-237/08, 'Cuvée Palomar' and the current legal framework. That judgment refers to a system of Member State competencies on the designation of geographical indications for *wines* that existed under previous Regulation (EC) No 1493/1999 but is no longer in force. According to Article 67 of Commission Regulation (EC) No 607/2009 (see also Article 120(1)(g) of Regulation (EU) No 1308/2013), the names of those small geographical areas are now considered merely optional particulars on labels.

2.10.2.1 Relevant point in time

Article 7(1)(j) EUTMR applies only for PDOs/PGIs that were **applied for** before the EUTM application **and** are **registered** at the time the EUTM application is examined. The relevant dates to establish the priority of a trade mark and a PDO/PGI are the date of application of the EUTM application (or the so-called Paris Convention priority, if claimed) and the date of application for protection of a PDO/PGI to the Commission respectively.

Notwithstanding the above, and in view of the fact that the vast majority of applications for PDO/PGI usually mature in a registration, **an objection will be raised** when the

⁶ See http://ec.europa.eu/agriculture/quality/documents-links/pdf/rqi-aromatised-wine-products_en.pdf.

PDO/PGI was applied for **before** the filing date (or the priority date, if applicable) of the EUTM application **but** had not yet been registered at the time of examining the EUTM application. However, if the EUTM applicant indicates that the PDO/PGI in question has not yet been registered, the proceedings will be suspended until the outcome of the registration procedure of the PDO/PGI.

Therefore, **no objection will be raised** under Article 7(1)(j) EUTMR when the PDO/PGI was applied for **after** the filing date (or priority date, if applicable) of the EUTM application.

- For *wines*, where there is no relevant date information in the 'E-Bacchus' extract, this means that the PDO/PGI in question was already in existence on 01/08/2009, the date on which the register was set up. For any PDOs/PGIs for *wines* added subsequently, the 'E-Bacchus' extract includes a reference to the publication in the Official Journal, which gives the relevant information.
- For *spirit drinks*, the initial publication of Annex III of Regulation (EC) No 110/2008 contained all PGIs for *spirit drinks* that existed on 20/02/2008, the date of entry into force of that regulation. For any PGIs for *spirit drinks* added subsequently, the corresponding amendment of the regulation contains the relevant information.
- Similarly, for *aromatised wines*, the initial publication of Annex II of Regulation (ECC) No 1601/91 contained all PGIs for *aromatised wines* that existed on 17/06/1991, the date of entry into force of that regulation. For any PGIs for *aromatised wines* added subsequently, the corresponding amendment of the regulation contains the relevant information. However, with the reform brought by Regulation (EU) No 251/2014, in force as of 27/03/2014, any future PGI should be included in an electronic register established by the Commission (see Article 21). This register is not in place yet.
- Details of the date of application for the PDO/PGI for *agricultural products and foodstuffs* are available in the 'DOOR' database.

2.10.3 Situations covered by the EU Regulations

Article 7(1)(j) EUTMR applies (provided that the other conditions also apply) in all of the following situations:

1. the EUTM application consists solely of a whole PDO/PGI ('direct use');
2. the EUTM application contains a whole PDO/PGI in addition to other word or figurative elements ('direct or indirect use');
3. the EUTM application contains or consists of an imitation or evocation of a PDO/PGI;
4. other misleading indications and practices;
5. the use of the EUTM application would exploit the reputation of PDOs/PGIs.

A number of limits to the scope of protection however are possible (see paragraph 2.10.3.6 below) and special rules apply to trade marks in conflict with more than one PGI/PDO (see paragraph 2.10.3.7 below).

2.10.3.1 EUTM consists solely of a whole PDO/PGI ('direct use')

This situation covers the 'direct use' of a PDO/PGI as an EUTM, that is, the trade mark consists **solely** of the name of the PDO/PGI.

Examples

PDO/PGI	European Union trade mark
MADEIRA (PDO-PT-A0038)	MADEIRA (Collective EUTM No 3 540 911)
MANZANILLA (PDO-ES-A1482)	MANZANILLA (Collective EUTM No 1 723 345)
DRESDNER CHRISTSTOLLEN (DE/PGI/005/0704)	DRESDNER CHRISTSTOLLEN (Collective EUTM No 262 949)
PROSCIUTTO DI PARMA (IT/PDO/0117/0067)	PROSCIUTTO DI PARMA (Collective EUTM No 1 116 458)

If the mark consists solely of the PDO/PGI, the EUTM also falls under **Article 7(1)(c)** EUTMR, since it is considered descriptive of the geographical origin of the goods in question. This means that the examiner's objection will **simultaneously** raise absolute grounds for refusal under both Article 7(1)(c) and (j) EUTMR.

There is an exception to the application of Article 7(1)(c) EUTMR, pursuant to Article 66(2) EUTMR, when the EUTM is a **collective trade mark** and the regulations governing use thereof include the particulars foreseen in Article 67(2) EUTMR (for the contrary situation, where the mark had been applied for as an individual mark, see decision of 07/03/2006, R 1073/2005-1 – 'TEQUILA', para. 15).

While **restricting the relevant goods** (to comply with the specifications of the PDO/PGI) is usually a means of waiving the objection under Article 7(1)(j) EUTMR (see paragraph 2.10.4 below), this restriction is irrelevant for Article 7(1)(c) EUTMR.



For example, an application for the word mark 'Bergerac' for *wines* will simultaneously be objected to under both Article 7(1)(c) and (j) EUTMR: it consists solely of the PDO 'Bergerac' and is therefore descriptive. If the goods are subsequently limited to *wines complying with the specifications of the PDO 'Bergerac'*, the objection under Article 7(1)(j) EUTMR will be waived but the trade mark is still descriptive and can be objected to under Article 7(1)(c) EUTMR, unless it is applied for as a collective trade mark that complies with Article 67(2) EUTMR.

2.10.3.2 EUTM contains a whole PDO/PGI in addition to other word or figurative elements ('direct or indirect use')

This situation also covers the '**direct use**' of a PDO/PGI in an EUTM through reproduction of the name of the PDO/PGI together with other elements.

The following EUTMs are considered to fall under Article 7(1)(j) EUTMR since they contain the whole denomination of a PDO/PGI.

PDO/PGI	European Union trade mark
<p>BEAUJOLAIS (PDO-FR-A0934)</p>	<p>BEAUX JOURS BEAUJOLAIS (EUTM No 1 503 259)</p>
<p>CHAMPAGNE (PDO-FR-A1359)</p>	<p>CHAMPAGNE VEUVE DEVANLAY (EUTM No 11 593 381)</p>
<p>BEAUJOLAIS (PDO-FR-A0934)</p>	 <p><i>La Maison des Beaujolais</i> (EUTM No 1 561 646)</p>
<p>PROSCIUTTO DI PARMA (IT/PDO/0117/0067)</p>	<p>CONSORZIO DEL PROSCIUTTO DI PARMA (EUTM No 6 380 141)</p>
<p>DRESDNER CHRISTSTOLLEN (DE/PGI/005/0704)</p>	 <p>(EUTM No 5 966 668)</p>
<p>PARMIGIANO REGGIANO (IT/PDO/0117/0016)</p>	 <p>(EUTM No 6 380 141)</p>

PDO/PGI	European Union trade mark
<p>WELSH BEEF (UK/PGI/0005/0057)</p>	 <p>(EUTM No 10 513 729)</p>
<p>WELSH LAMB (UK/PGI/0005/0081)</p>	 <p>(EUTM No 11 927 472)</p>

Under Article 7(1)(j) EUTMR, it is irrelevant whether or not the other word or figurative elements may give the trade mark distinctive character. The sign can be acceptable as a whole under Article 7(1)(b) and (c) EUTMR and can still be objected to (as in the cases above) under Article 7(1)(j) EUTMR.

There is '**indirect use**' of a PDO/PGI, for example, when the PDO/PGI appears in a complex trade mark (such as the representation of a label) in smaller characters as information about the origin or type of the product or as part of the producer's address. In such cases the trade mark can be objected to irrespective of the position or the size of the PDO/PGI within the trade mark as a whole, provided that it is visible.

PDO/PGI	European Union trade mark
<p>OPORTO (PDO-PT-A1540)</p>	 <p>EUTMs No 11 907 334 and No 2 281 970)</p>

<p>QUESO MANCHEGO (ES/PDO/0117/0087)</p>	 <p>(EUTM No 5 582 267)</p>
---	---

There must be a logical separation of the PDO/PGI from the rest of the term for it to be identifiable and objectionable. A trade mark will not be objectionable when it contains the PDO/PGI as part of a word element which does not trigger in the mind of the consumer that of the product whose designation is protected. This is normally the case when the term has its own meaning.

Examples where an objection should not be raised: TORONTO, EXCAVADORA, IMPORT.

Examples where an objection was raised: R 2462/2013-2 – ‘TOROLOCO’ and R 1900/2013-5 – PARMATUTTO.

2.10.3.3 EUTM contains or consists of an imitation or evocation of a PDO/PGI

Neither the EUTMR nor the EU Regulations define the meaning of ‘imitation’ or ‘evocation’. To a large extent, they are closely related concepts.

According to the Court, ‘evocation’ covers ‘a situation where the term used to designate a product incorporates part of a protected designation, so that when the consumer is confronted with the name of the product, **the image triggered in his mind is that of the product whose designation is protected**’ (judgments of 04/03/1999, C-87/97, ‘Cambozola’, para. 25; 26/02/2008, C-132/05, para. 44).

According to the Advocate General (opinion of 17/12/1998, C-87/97, ‘Cambozola’, para. 33), ‘the term “evocation” is **objective**, so that it is not necessary to show that the owner of the mark intended to evoke the protected name’.

In this respect, and for the purposes of Article 7(1)(j) EUTMR, the Office will assess in an equally objective way the situations described below, under paragraphs (a) to (d), **regardless of the EUTM applicant’s actual intention**.

Furthermore, the Office considers the terms ‘imitation’ and ‘evocation’ as two corollaries of essentially the same concept. The mark ‘imitates’ (mimics, reproduces elements of, etc.), with the result that the product designated by the PDO/PGI is ‘evoked’ (called to mind).

In the light of the above, the Office finds that there is evocation or imitation of a PDO where:

- (a) the EUTM incorporates the geographically significant part (in the sense that it is not the generic element) of the PDO/PGI;

- (b) the EUTM contains an equivalent adjective/noun that indicates the same geographical origin;
- (c) the PDO/PGI is translated;
- (d) the EUTM includes a 'de-localiser' expression in addition to the PDO/PGI or its evocation.

a) The EUTM incorporates the geographically significant part of the PDO/PGI

As indicated above, according to the Court (judgment of 04/03/1999, C-87/97, 'Cambozola', and judgment of 26/02/2008, C-132/05, cited above), the EUTM must trigger in the consumer's mind the image of the product whose designation is protected.

The Court has also stated that 'it is possible ... for a protected designation to be evoked where there is no likelihood of confusion between the products concerned' (judgment of 04/03/1999, C-87/97, 'Cambozola', para. 26).

Importantly, evocation is **not assessed in the same way as likelihood of confusion** (see opinion of the Advocate General of 17/12/1998, C-87/97, 'Cambozola', para. 37). **A link must be made with the product whose designation is protected.** Therefore, whether or not there is evocation will not be analysed according to the principles laid down by the CJEU in judgment of 11/11/1997, C-251/95, 'Sabèl'.

Evocation is understood as encompassing not only when the EUTM **incorporates (one of) the geographically significant word(s)** (as opposed to generic) element(s) of a PDO/PGI, but also when the EUTM **reproduces other parts of that PDO/PGI**, such as a characteristic root or ending.

PDO/PGI	Trade Mark	Explanation
<p>CHIANTI CLASSICO (IT/PDO/0005/0108)</p>	 <p>(EUTM 9 567 851)</p>	<p>The term 'chianti' evokes the PDO 'Chianti Classico' protected for oils and fats. (R 1474/2011-2, 'AZIENDA OLEARIA CHIANTI', paras 14-15)</p>
<p>NÜRNBERGER BRATWÜRSTE/NÜRNBERGER ROSTBRATWÜRSTE (DE/PGI/0005/0184)</p>	<p>NUERNBERGA (EUTM No 9 691 577)</p>	<p>'due to the phonetic equivalence, NUERNBERGA is understood in the sense of the geographical indication Nürnberger' (R 1331/2011-4, 'NUERNBERGA', para. 12)</p>

b) Equivalent adjectives/nouns

The use of an equivalent adjective/noun to indicate the same origin constitutes an evocation of a PDO/PGI.

PDO/PGI	European Union trade mark (invented examples)	Explanation
IBIZA	IBICENCO	Noun in the PDO → Adjective in the EUTM

(PGI-ES-A0110)		
AÇORES (PGI-PT-A1447)	AÇORIANO	Noun in the PDO → Adjective in the EUTM
BORDEAUX (PDO-FR-A0821)	BORDELAIS	Noun in the PDO → Adjective in the EUTM
JAGNIĘCINA PODHALAŃSKA (PL/PGI/0005/00837)	JAGNIĘCINA Z PODHALA	Adjective in the PGI → Noun in the EUTM
MEL DO ALENTEJO (PT/PDO/0017/0252)	MEL ALENTEJANA	Noun in the PDO → Adjective in the EUTM
SCOTTISH WILD SALMON (GB/PGI/0005/00863)	WILD SALMON FROM SCOTLAND	Adjective in the PGI → Noun in the EUTM

c) Translated PDOs/PGIs

Likewise, there is evocation or imitation of the PDO/PGI when the EUTM contains or consists of a translation of the whole or part of a PDO/PGI in any of the EU languages.

PDO/PGI	European Union trade mark	Explanation
COGNAC	KONJAKKI (invented example)	An EUTM that contains the term 'Konjakkii' will be considered to evoke 'Cognac' in Finnish.
BOURGOGNE	 EUTM 2417269	'Borgoña' is the Spanish translation of the French PDO 'Bourgogne'
PÂTES D'ALSACE (FR/PGI/0005/0324)	ALSATIAN PASTA (invented)	An EUTM that contains the expression 'Alsation Pasta' will be considered to evoke the PGI 'Pâtes d'Alsace'

Trade marks consisting of these terms must be refused under both Article 7(1)(c) and(j) EUTMR rather than solely under Article 7(1)(c) EUTMR.

d) Expressions used as 'de-localisers'

According to Article 103(2)(b) of Regulation (EU) No 1308/2013, Article 20(2)(b) of Regulation (EU) No 251/2014, Article 16(b) of Regulation (EC) No 110/2008 and Article 13(1)(b) of Regulation (EU) No 1151/2012, PDOs/PGIs are protected 'even if the true origin of the product ... is indicated or if the protected name is ... accompanied by an expression such as "style", "type", "method", "as produced in", "imitation" ... or similar'.

Therefore, the fact that the PDO/PGI reproduced or evoked in the EUTM is accompanied by these expressions does not cancel out the application of Article 7(1)(j) EUTMR.

In other words, **even if the public is thereby informed about the actual origin of the product, an objection will still be raised** under Article 7(1)(j) EUTMR. Notwithstanding this, the trade mark will be **misleading** under Article 7(1)(g) EUTMR since there is a contradiction between the goods (restricted to the specific PDO/PGI) and the message conveyed by the mark (that the goods are not 'genuine' PDO/PGI products), which will thus necessarily lead to a further objection under that article.

PDO/PGI	European Union trade mark (invented examples)	Explanation
<p style="text-align: center;">RIOJA (PDO-ES-A0117)</p>	<p style="text-align: center;">RIOJA STYLE RED WINE</p>	<p>An EUTM that contains an expression such as 'Rioja Style Red <i>Wine</i>' will be considered to evoke the PDO 'Rioja' even if it conveys the idea that the product in question is not a 'genuine' PDO Rioja <i>wine</i>.</p>
<p style="text-align: center;">FETA (EL/PDO/0017/0427)</p>	<p style="text-align: center;">GREEK STYLE PLAIN FETA ARABIAN FETA</p>	<p>An EUTM that contains expressions such as 'Greek Style Plain Feta' or 'Arabian Feta', will be considered to evoke the PDO 'Feta', even if it conveys the idea that the product in question is not a 'genuine PDO Feta' <i>cheese</i></p>

Where the applicant has its legal seat is irrelevant for assessing Article 7(1)(j) EUTMR. Article 103(1) of Regulation (EU) No 1308/2013, Article 20(1) of Regulation (EU) No 251/2014 and Article 12(1) of Regulation (EU) No 1151/2012 set out that protected designations of origin and protected geographical indications may be used by any operator marketing a product that conforms to the corresponding specification. Hence, provided that the goods comply with the specification of the PDO/PGI in question (which is guaranteed by restricting the goods appropriately), the location of the applicant's legal seat as indicated in the EUTM application is irrelevant. For example, a company with legal domicile in Poland can own a vineyard located in Spain that produces *wine* complying with the product specification of the PDO 'Ribera del Duero'. Similarly, a company with its legal domicile in Lithuania can own a factory located in Spain that elaborates products complying with the PGI 'Chorizo de Cantimpalos'.

2.10.3.4 Other misleading indications and practices

Article 103(2)(c) and (d) of Regulation (EU) No 1308/2013, Article 20(2)(c) and (d) of Regulation (EU) No 251/2014, Article 16(c) and (d) of Regulation (EC) No 110/2008 and Article 13(1)(c) and (d) of Regulation (EU) No 1151/2012 protect the PDO/PGI against a number of false or misleading indications about the origin, nature or essential qualities of the product.

Although it very much depends on the particularities of each case, each of which must therefore be assessed individually, an EUTM may be considered misleading when, for example, it contains figurative elements that are typically associated with the geographical area in question (such as well-known historical monuments) or when it reproduces a particular shape of the product.

The above must be interpreted in a **restrictive way**: it refers solely to EUTMs that depict a well-known and singular image that is generally taken as a symbol of the particular place of origin of the products covered by the PDO/PGI or a singular shape of the product that is described in the specifications of the PDO/PGI.

PDO/PGI	European Union trade mark (invented examples)	Explanation
<p style="text-align: center;">PORTO (PDO-PT-A1540)</p>	<p style="text-align: center;">EUTM depicting the 'Dom Luís I Bridge' in the city of Porto</p>	<p>A picture of the Dom Luís I Bridge and its riverside is a well-known emblem of the city of Porto. Use of this image for <i>wines</i> other than those covered by the PDO 'Porto' would fall under Article 103(2)(c) and (d) of Regulation (EU) No 1308/2013.</p>
<p style="text-align: center;">MOULES DE BOUCHOT DE LA BAIE DU MONT-SAINT-MICHEL (FR/PDO/0005/0547)</p>	<p>An EUTM which contains an image of the Mont-Saint-Michel Abbey</p>	<p>A picture of the Mont-Saint-Michel Abbey is a well-known emblem of the city and island of Mont Saint Michel in Normandy. Use of this image for seafood other than that covered by the PDO 'Moules de Bouchot de la Baie du Mont-Saint-Michel' would fall under Article 13(1)(c) and (d) of Regulation (EU) No 1151/2012</p>
<p style="text-align: center;">QUESO TETILLA (ES/PDO/0017/0088)</p>	<p>An EUTM which depicts a <i>cheese</i> conical in shape</p>	<p>The singular shape of the product is described in the specifications of the PDO 'Queso Tetilla'</p>

Given the inherent difficulty in identifying evocative figurative elements, particularly in less obvious cases, the Office will in such cases rely principally on observations by third parties.

2.10.3.5 The exploitation of the reputation of PDOs/PGIs

According to Article 103(2)(a) of Regulation (EU) No 1308/2013, Article 20(2)(a) of Regulation (EU) No 251/2014, Article 16(a) of Regulation (EC) No 110/2008 and Article 13(1)(a) of Regulation (EU) No 1151/2012, registered names are protected against use that exploits the reputation of the protected name. This protection extends even to different products (see by analogy judgment of 12/06/2007, joined cases T-53/04 to T-56/04, T-58/04 and T-59/04, 'Budweiser', para. 175).

However, as regards *wines* the scope of such protection must be read in line with the mandate contained in Article 102 of Regulation (EU) No 1308/2013, which limits the refusal of trade marks to products listed in its Annex VII, Part II. As regards *aromatised wines*, Article 19 of Regulation (EU) No 251/2014 limits the refusal to trade marks relating to an *aromatised wine product*. For *agricultural products and foodstuffs*, Article 14 of Regulation (EU) No 1151/2012 limits the refusal of trade marks to products 'of the same type'.

For *spirit drinks*, Regulation (EC) No 110/2008 does not contain any specification but the Offices follows a systematic approach and considers that in the context of examining absolute grounds for refusal, the PDO/PGI's protection under all EU Regulations is limited to **identical or comparable products**. Other products and services are not objected to.

However, the extended scope of protection of a PDO/PGI with reputation can be invoked in the context of Article 8(4) EUTMR (see the Guidelines, Part C, Opposition, Section 4, Rights under Article 8(4) EUTMR).

2.10.3.6 Limits to the scope of protection

If a PDO/PGI contains or evokes the name of a product that is considered **generic**, protection does not extend to the generic element (see Article 13(1) of Regulation (EU) No 1151/2012, *in fine* and judgment of 12/09/2007, T-291/03, ‘Grana Biraghi’, paras 58 and 60).

In the PGI ‘Ron de Málaga’, it is a well-known fact that the term ‘ron’ (the Spanish word for rum) is generic and therefore does not deserve protection. Accordingly, no objection will be raised to the mere fact that an EUTM contains a generic term that is part of a PDO/PGI.

In the PGIs ‘Maçã de Alcobaça’ and ‘Jambon d’Ardenne’, it is a well-known fact that the terms ‘maçã’ (the Portuguese word for apple) and ‘jambon’ (the French word for ham) are generic and therefore they do not deserve protection. Accordingly, no objection will be raised to the mere fact that an EUTM contains those generic terms that are part of a PDO/PGI.

In particular, it must also be mentioned that the terms ‘camembert’ and ‘brie’ are generic (judgment of 26/02/2008, C-132/05, para. 36). See the PDOs Camembert de Normandie (FR/PDO/0017/0112), Brie de Meaux (FR/PDO/0017/0110) and Brie de Melun (FR/PDO/0017/0111).

Other examples are ‘cheddar’ or ‘gouda’ (see Regulation (EC) No 1107/96, footnotes to the PDOs ‘West Country Farmhouse Cheddar’ and ‘Noord-Hollandse Gouda’). Therefore, no objection was raised in the following case:

PDO/PGI	European Union trade mark
<p>(none, because ‘camembert’ is not a geographical indication, but a generic term)</p>	 <p>(EUTM No 7 389 158)</p>

Where the generic nature of an element in a PDO/PGI can be determined by standard dictionary definitions, the perspective of the public in the country of origin of the PDO/PGI is determinative. For instance, in the examples cited above, it suffices that the term ‘ron’ is generic for Spanish consumers and ‘maçã’ and ‘jambon’ for Portuguese and French consumers, for it to be concluded that it is generic, regardless of whether or not it can be understood by other parts of the public in the European Union.

By contrast, where no definition can be found in a standard, well-known dictionary, the generic nature of the term in question should be assessed following the criteria laid down by the Court (judgment of 26/02/2008, C-132/05 and judgment of 12/09/2007, T-291/03, ‘Grana Biraghi’), such as relevant national and EU legislation, how the term is perceived by the public, and circumstances relating to the marketing of the product in question.

In addition, if a PDO/PGI contains or evokes a term which is **commonly used in trade** (and it is not protected as a traditional term for *wine* or as a traditional speciality guaranteed) to designate the goods concerned, objections should not automatically be raised against trade marks containing/evoking that term (e.g. ‘Torre’, see judgment of 18/12/2008, T-287/06 ‘Torre Albéniz’, para. 58 and judgment of 11/07/2006, T-247/03 ‘Torre Muga’, para. 57). In particular, the Office will assess whether, by including the terms in the sign, the image triggered in the mind of the consumer is that of the product whose designation is protected.

PDO/PGI	CASTELLÓ (PGI) for wines
European Union trade mark	CASTELL DE LA BLEDA for wines
Comment	<p>In the <i>wine</i> sector, the term ‘castello’ (without accent, castle in Italian) is frequently used.</p> <p>It is considered that the term ‘CASTELL’ does not constitute, strictly speaking, an evocation of the PGI in question. While it is admitted that the difference is only in one letter, terms such as ‘castillo/castello’, ‘torre’, etc. are commonly used in the presentation of <i>wines</i>. In view of this, it is doubtful that the relevant consumers would associate the EUTM in question with the <i>wines</i> protected under the PGI. It is rather more likely that they will first make an immediate association with a common term in the marketing of <i>wines</i>.</p>

A PGI/PDO that coincides with **surnames or family names**, when used in combination with other elements, is unlikely remind the relevant consumer of the product protected under the relevant PDO/PGI. For instance, the term ‘Leon’ is included in the PDO ‘Tierra de León’ and the PGI ‘Castilla y León’, both for *wines*. However, in combination with a first name, it is more likely to be perceived as a family name rather than an indication of geographical origin (R 0227/2011-4 – MICHEL LEON but see on the contrary R 1944/2014-2 FRAY LEON, which was rejected).

The term ‘Lorenzo’ is included in the PDO ‘Castel San Lorenzo’ for *wines*. However, in combination with other elements, it is more likely to be perceived as a first name rather than an indication of geographical origin. See EUTM 14 095 228 Organic Casa Lorenzo (figurative).

2.10.3.7 Trade marks in conflict with two or more PDOs/PGIs

In some cases an EUTM application may constitute direct/indirect use or evocation of more than one PDO/PGI at the same time. This is likely to happen when the EUTM application contains an element (not being a generic one) that appears in more than one PDO/PGI.

In these cases, provided that the EUTM application covers the relevant goods, an objection should be raised for all the PDOs/PGIs concerned **to the extent that the objection cannot be overcome by limiting the goods.**

A number of scenarios can be identified:

- Use/evocation of two (or more) **different** PGIs/PDOs for **identical** products: the objection cannot be overcome by limiting the goods to those that comply with either one of or all of the PDOs/PGIs as this would necessarily trigger another objection under Article 7(1)(j) EUTMR, since such a limitation would inevitably and confusingly identify the goods with a geographical origin other than that of the PDO/PGI in question.

PDO/PGI	RIOJA (PDO-ES-A0117) SANTIAGO (Chilean PGI) For <i>wines</i>
European Union trade mark	RIOJA SANTIAGO for <i>wines</i>
Explanation	<p>The trade mark applied for consists of the terms 'RIOJA' and 'SANTIAGO', each of which coincides with a protected designation of origin for <i>wines</i>, the former ('RIOJA') being protected by the European Union and the latter ('SANTIAGO'), a geographical indication for a <i>wine</i> originating from Chile, protected under a bilateral agreement between the European Union and the Republic of Chile (...)</p> <p>It is not possible to accept any limitation that includes <i>wine</i> originating from the territory of one of the two designations of origin since such a limitation automatically excludes <i>wines</i> originating from the other designation of origin, which inevitably means that the trade mark applied for will lead to confusion. By the same token, a hypothetical limitation of the list of goods to <i>wine</i> from the geographical area covered by either of the designations of origin, e.g. '<i>wines</i> from the Rioja designation of origin and <i>wines</i> from the Santiago designation of origin', in Class 33, would be covered by the prohibition of Article 7(1)(j) EUTMR insofar as the trade mark would inevitably — and confusingly — identify <i>wines</i> with a geographical origin other than that of the respective designations of origin included under the trade mark. Preventing such an eventuality is the principal purpose of that article.</p> <p>(R 0053/2010-2, 'RIOJA SANTIAGO')</p>

PDO/PGI	PAUILLAC (PDO-FR-A0713) BORDEAUX (PDO-FR-A0821) For <i>wines</i>
European Union trade mark	PAUILLAC BORDEAUX for <i>wines</i>
Explanation	<p>A limitation is not possible, as a limitation of one or another will be deceptive. The quality and characteristics of the PDO are not the same and the consumers would be misled as to the geographical origin of the product.</p> <p>The above, notwithstanding that Pauillac is geographically located within the Bordeaux region.</p>

- Use/evocation of two (or more) PGIs/PDOs sharing common term(s) for **identical** products: the objection can be waived if a limitation for one of the PGIs/PDOs is introduced.

PDO/PGI	ACETO BALSAMICO DI MODENA (PGI) ACETO BALSAMICO TRADIZIONALE DI MODENA (PDO) Both for <i>vinegar</i>
European Union trade mark	MARIOLA ACETO BALSAMICO DI MODENA (invented) for <i>vinegar</i>
Comment	The sign reproduces in its integrity the PGI 'aceto balsámico di Modena'.

	<p>A limitation should be introduced for <i>vinegars complying with the specifications of the PGI ACETO BALSAMICO DI MODENA</i>. The public will not be deceived as to the geographical origin of the products.</p> <p>However, a limitation for 'aceto balsamico tradizionale di Modena' should not be accepted as the sign expressly refers to the PGI and not to the PDO.</p>
--	--

PGI	ACETO BALSAMICO DI MODENA (PGI) ACETO BALSAMICO TRADIZIONALE DI MODENA (PDO) Both for <i>vinegar</i>
European Union trade mark	MARIOLA MODENA (invented) for <i>vinegar</i>
Comment	<p>A limitation should be introduced either for the PGI ACETO BALSAMICO DI MODENA or for the PDO ACETO BALSAMICO TRADIZIONALE DI MODENA or for both.</p> <p>The public will not be deceived as to the geographical origin of the products.</p>

PDO/PGI	Alpes-de-Haute-Provence (PGI) Coteaux d'Aix-en-Provence (PDO) Coteaux Varois en Provence (PDO) Côtes de Provence (PDO) Les Baux de Provence (PDO) All for <i>wines</i>
European Union trade mark	CHATEAU LABEL PONT EN PROVENCE for <i>wines</i>
Comment	<p>A limitation should be introduced with respect to one or several of the PGIs/PDOs</p> <p>e.g. <i>wines complying with the specifications of the PGI Alpes-de-Haute-Provence; wines complying with the specifications of the PDO Coteaux d'Aix-en-Provence; wines complying with the specifications of the PDO Côtes de Provence.</i></p> <p>This EUTM application is different from the EUTM application Pauillac Bordeaux, where the EUTM application expressly refers to two PGIs/PDOs. In the present case the sign only refers to the common term in all the PGIs/PDOs, 'PROVENCE' so a fair use of any of the PGIs/PDOs including 'PROVENCE' is possible. This is without prejudice to the applicable legislation on labelling.</p>

- Use/evocation of two (or more) PGIs/PDOs sharing common term(s) for different products: an objection can be waived for those goods where an appropriate limitation is introduced.

PDO/PGI	Sobrasada de Mallorca (PGI) (type of processed <i>meat</i> product) Ensaimada de Mallorca (PGI) (type of pastry)
European Union trade mark	MALLORCA SUN (invented) applied for in Class 29 <i>meat, eggs and milk</i> and Class 30 <i>bread, pastry</i> .
Comment	<p>A limitation can be introduced for both PGIs. The public will not be deceived as to the geographical origin of the products.</p> <p>Class 29: <i>meat complying with the specifications of the PGI sobrasada de Mallorca; eggs; milk.</i></p> <p>Class 30: <i>bread, pastry complying with the specifications of the PGI ensaimada de Mallorca.</i></p>

- Use/evocation of two (or more) PGIs/PDOs sharing common term(s) for comparable products: an objection can be waived if a limitation is properly introduced and the deceptive goods deleted from the list.

PDO/PGI	HIERBAS DE MALLORCA (PGI) — <i>for aniseed-flavoured spirit drinks</i> PALO DE MALLORCA (PGI) — <i>for liqueur</i>
European Union trade mark	SUNNY MALLORCA HIERBAS (invented) for <i>alcoholic beverages</i> in Class 33
Comment	The application can be accepted if a limitation is introduced for ‘ <i>aniseed-flavoured spirit drinks complying with the specification of the PGI “hierbas de Mallorca”</i> ’ and the other <i>spirits</i> (similar goods) are deleted.

PDO/PGI	Champagne (PDO) for <i>wine</i> Ratafia de Champagne (PGI) for <i>liqueur</i> Cognac de Champagne (PGI) for <i>wine spirit</i> Marc de Champagne (PGI) for <i>grape marc spirit</i>
European Union trade mark	AXM CHAMPAGNE for <i>alcoholic beverages</i> in Class 33
Comment	Wine and spirits are not considered comparable. The application can be accepted if a limitation is introduced for one or various PGIs/DPOs and the deceptive goods are deleted e.g. Class 33: <i>wines complying with the specifications of the PDO ‘Champagne’; liqueur complying with the specifications of the PGI ‘Ratafia de Champagne’; wine spirit complying with the specifications of the PGI ‘Cognac the Champagne’</i> If the EUTM application fully includes a different PGI/PDO with the term ‘Champagne’ (e.g. AXM RATAFIA DE CHAMPAGNE), it can be accepted if the goods are properly limited: e.g. Class 33: <i>liqueur complying with the specifications of the PGI Ratafia de Champagne.</i>
PDO/PGI	Prosciutto di Modena (PDO) Zampone di Modena (PGI) Cotechino di Modena (PGI)
European Union trade mark	AXM MODENA (invented) for <i>meat</i> in Class 29
Comment	The application can be accepted if a limitation is introduced for one or various PGIs/DPOs and the deceptive goods are deleted e.g. <i>ham complying with the specification of the PDO Prosciutto di Modena, zampone complying with the specification of the PGI zampone di Modena and cotechino complying with the specification of the PGI cotechino di Modena.</i> The rest of the <i>meat</i> products are deleted. The limitation <i>meat complying with the specifications of the PDO prosciutto di Modena</i> is not acceptable.

2.10.4 Relevant goods under EU Regulations

2.10.4.1 Comparable products

Objections based on Article 7(1)(j) EUTMR can be raised **only** for specific goods of the EUTM application, namely those that are identical or ‘comparable’ to ones covered by

the PDO/PGI. The Office does not raise objections against different goods or against services.

Specifically for *wines*, the different terms used in Articles 102(1) and 103(2) of Regulation (EU) No 1308/2013 ('product falling under one of the categories listed in Part II of Annex VII' and 'comparable products' respectively) are interpreted by the Office as synonyms referring to the same concept. For ease of reference, the categories listed in Part II of Annex VII can be grouped in: (i) *wine*; (ii) *sparkling wine*; (iii) *grape must*; (iv) *wine vinegar*.

For *aromatised wines*, Article 19(1) of Regulation (EU) No 251/2014 refers to products relating to 'an *aromatised wine* product'. According to Article 3(1) of the Regulation, *aromatised wine* products are obtained from the *wine* sector as referred to in Regulation (EU) No 1308/2013 that have been flavoured. They are classified into the following categories: *aromatised wines*; *aromatised wine-based drinks*; and *aromatised wine-product cocktails*.

For *spirit drinks*, Regulation (EC) No 110/2008 does not contain this specification.

For *agricultural products and foodstuffs*, the different terms used in Articles 13 and 14 of Regulation (EU) No 1151/2012 ('comparable products', and 'products of the same type' respectively) are interpreted by the Office as synonyms referring to the same concept.

The notion of **comparable goods** must be understood restrictively and it is independent of the analysis of similarity between goods in trade mark law. Accordingly, the criteria set out in judgment of 29/09/1998, C-39/97, 'Canon', should not necessarily be adhered to, although some of them may be useful. For example, given that a PDO/PGI serves to indicate the geographical origin and the particular qualities of a product, criteria such as the nature of the product or its composition are more relevant than, for instance, whether or not goods are complementary.

In particular, the CJEU (in judgment of 14/07/2011, joined cases C-4/10 and C-27/10, 'BNI Cognac', para. 54) has listed the following criteria for determining whether goods are comparable:

- whether or not they have common objective characteristics (such as method of elaboration, physical appearance of the product or use of the same raw materials);
- whether or not they are consumed, from the point of view of the relevant public, on largely identical occasions;
- whether or not they are distributed through the same channels and subject to similar marketing rules.

Although it is not possible in these Guidelines to list all the possible scenarios, the following are some examples of comparable products.

Products covered by the PDO/PGI	Comparable products
<i>Wine</i>	All types of <i>wines</i> (including <i>sparkling wine</i>); <i>grape must</i> ; <i>wine vinegar</i> ; <i>wine-based beverages</i> (e.g. <i>sangría</i>)
<i>Aromatised wines</i>	All types of <i>wines</i> ; <i>aromatised wines</i> (e.g. <i>vermouth</i>); <i>aromatised wine-based drinks</i> (e.g. <i>sangría</i>); and <i>aromatised wine-product cocktails</i> (e.g. <i>sparkling wine cocktail</i>).
<i>Spirits</i>	All types of <i>spirits</i> ; <i>spirit-based drinks</i>
<i>Specific meat and specific meat preparations</i>	Any <i>meat</i> and any <i>meat preparation</i> (R 659/2012-5, p.14-17)
<i>Cheese</i>	<i>Milk and other milk products</i>
<i>Fresh fruit</i>	<i>Preserved, frozen, dried and cooked fruits</i> (<i>jellies, jams, compotes</i> are not 'comparable products', but the fruit covered by the PDO/PGI can be a commercially relevant ingredient, see below under 'Products used as ingredients')
<i>Fresh vegetables</i>	<i>Preserved, frozen, dried and cooked vegetables</i> (<i>jellies, jams</i> are not 'comparable products', but the vegetable covered by the PDO/PGI can be a commercially relevant ingredient, see below under 'Products used as ingredients')

2.10.4.2 Restrictions of the list of goods

According to Article 103(1) of Regulation (EU) No 1308/2013 and Article 20(1) of Regulation (EU) No 251/2014, protected designations of origin and protected geographical indications may be used by any operator marketing a *wine* or *aromatised wine* conforming to the corresponding specification.

According to Article 12(1) of Regulation (EU) No 1151/2012, 'protected designations of origin and protected geographical indications may be used by any operator marketing an [agricultural or foodstuff] product conforming to the corresponding specification'.

Objections raised under Article 7(1)(j) EUTMR may be waived if the relevant goods are restricted to comply with the specifications of the PDO/PGI in question.

Restriction of goods can be a complex task, which may depend to a large extent on a case-by-case examination.

- **Products of the same type** as those covered by the PDO/PGI must be restricted in order to meet the specifications of the PDO/PGI. The proper wording is '[name of the product] complying with the specifications of the [PDO 'X']/PGI 'X']'. No other wording should be proposed or allowed. Restrictions such as '[name of the product] with the [PDO 'X']/PGI 'X']' or '[name of the product] originating in [name of a place]' are not acceptable.

PDO/PGI in the European Union trade mark	Acceptable list of goods
Slovácká (PDO-CZ-A0890)	<i>Wine</i> complying with the specifications of the PDO 'Slovácká'
WELSH BEEF (UK/PGI/0005/0057)	<i>Beef meat</i> complying with the specifications of the PGI 'Welsh Beef'

The products covered by Regulation (EU) No 1151/2012 mostly refer to *foodstuffs and beverages* in Classes 29, 30, 31 and 32. However, there are a number of exceptions. For example:

- Class 3 *essential oils* (e.g. Bergamotto di Reggio Calabria)
 - Class 22 *wool* (e.g. Native Shetland Wool)
 - Class 31 *flowers and ornamental plants* (e.g. Flemish laurier) or *hay* (e.g. Foin de Crau).
- The **category of products** that includes those covered by the PDO/PGI should be restricted to designate *wines* and *aromatised wines* that comply with the specifications of the PDO/PGI. The category of products is found in the Extract from the E-Bacchus Register under "registered as". For *spirit drinks*, the restriction should designate the exact category of product (e.g. *whisky, rum, fruit spirit*, in accordance with Annex III of Regulation (EC) No 110/2008) that complies with the specifications of the PDO/PGI. For *agricultural products and foodstuffs*, the category of products that includes those covered by the PDO/PGI should be restricted to designate exactly the products covered by the PDO/PGI and that comply with its specifications. The category of products that includes those covered by the PDO/PGI in question can be consulted in the 'DOOR' database. The exact product covered can be found in the application document attached to the publication in the Official Journal, also accessible through 'DOOR'

PDO/PGI in the European Union trade mark	Original specification (not acceptable)	Acceptable list of goods	Explanation
TOKAJI (PDO-HU-A1254)	<i>Wines</i>	<i>Wine</i> complying with the specifications of the PDO 'Tokaji'	The EUTM can be accepted only for <i>wine</i> covered by the PDO
WELSH BEEF (UK/PGI/0005/0057)	<i>Meat</i>	<i>Beef meat</i> complying with the specifications of the PGI 'Welsh Beef'	' <i>Meat</i> ' includes products (e.g. pork) which cannot comply with the specifications of a particular PDO/PGI that covers the specific product <i>beef meat</i>
POMME DU LIMOUSIN (FR/PDO/0005/0442)	<i>Fruits</i>	Apples complying with the specifications of the PDO 'Pomme du Limousin'	The category <i>fruits</i> includes products such as <i>pearl</i> or <i>peaches</i> which cannot meet the specifications of a PDO that exclusively covers apples

- **Comparable products** are restricted to those products, within the category of comparable products, covered by the PDO/PGI.

PDO/PGI in the European Union trade mark	Original specification (not acceptable)	Acceptable list of goods	Explanation
MOSLAVINA (PDO-HR-A1653)	<i>Alcoholic beverages (except beers)</i>	<i>Wine complying with the specifications of the PDO 'Moslavina'; alcoholic beverages other than wines</i>	The EUTM can be accepted only for <i>wine</i> covered by the PDO, and for <i>alcoholic beverages other than wines, and wine-based beverages</i> .
POMME DU LIMOUSIN (FR/PDO/0005/0442)	<i>Preserved, frozen, dried and cooked fruits</i>	<i>Preserved, frozen, dried and cooked apples complying with the specifications of the PDO 'Pomme du Limousin'</i>	<i>Preserved, frozen, dried and cooked fruits</i> includes products made of other fruits which cannot meet the specifications of a PDO which exclusively covers <i>apples</i> . Also to note that the limitation should not be for <i>apples</i> .

There may be cases where the objection cannot be overcome by a limitation, for example when the goods applied for, although 'comparable', do not include the product covered by the PDO/PGI (e.g. where the PGI covers *whisky* and the goods applied for are *rum* or the PDO covers *cheese* and the goods applied for are *milk*).

- **Products used as ingredients:** if the goods covered by the PDO/PGI can be used as a commercially relevant ingredient (in the sense that it may determine the choice of the main product) of any of the goods included in the EUTM application, a restriction will be requested. This is because Article 13(1)(a) and (b) of Regulation (EU) No 1151/2012 expressly extend the scope of protection of a PDO/PGI registered for a given product 'when those products are used as an ingredient'.

PDO/PGI in the EUTM	Original specification (which is not acceptable)	Acceptable list of goods	Explanation
POMME DU LIMOUSIN (FR/PDO/0005/0442)	<i>Jams and compotes</i>	<i>Jams and compotes of apples complying with the specifications of the PDO 'Pomme du Limousin'</i>	The <i>fruit</i> is the main ingredient of <i>jams and compotes</i>
PROSCIUTTO DI PARMA (IT/PDO/0117/0067)	<i>Pizzas</i>	<i>Pizzas with ham complying with the specifications of the PDO 'Prosciutto di Parma'</i>	This topping is the main ingredient of a <i>pizza</i> and the one which determines the consumer's choice

A restriction is not necessary if the goods covered by the PDO/PGI are used as a secondary, not commercially relevant ingredient of the claimed goods.

PDO/PGI in the EUTM	Original specification	Acceptable list of goods	Explanation
<p>ACEITE DE LA ALCARRIA</p> <p>(ES/PDO/0005/0562)</p>	<p><i>Pastry</i></p>	<p><i>Pastry</i></p>	<p>The goods do not need to be restricted by the mere fact that <i>oil</i> is used in their preparation. <i>Oil</i> is a secondary ingredient which is not commercially relevant</p>

2.10.5 PDOs/PGIs not protected under EU Regulations

2.10.5.1 PDOs/PGIs protected at national level in an EU Member State

The Court of Justice has stated (judgment of 08/09/2009, C-478/07, ‘Bud’) that the EU system of protection for PDOs/PGIs for *agricultural products and foodstuffs* laid down in Regulation (EC) No 510/2006 [then in effect] is ‘**exhaustive in nature**’.

The Office applies an analogous approach for PDOs/PGIs for *wines, aromatised wines* and *spirit drinks* for the following reasons. The former protection at national level of geographical indications for *wines, aromatised wines* and *spirit drinks* that now qualify for a PDO/PGI under Regulation (EU) No 1308/2013, Regulation (EU) No 251/2014 and Regulation (EC) No 110/2008 respectively was **discontinued** once those geographical indications were registered at EU level (see Article 107 of Regulation (EU) No 1308/2013, Article 26 of Regulation (EU) No 251/2014, Articles 15(2) and 20(1) of Regulation (EC) No 110/2008 and Article 9 of Regulation (EU) No 1151/2012 read in conjunction with recital 24).

Moreover, reference must also be made to Council Regulation (EEC) No 2081/92 on the protection of geographical indications and designations of origin for *agricultural products and foodstuffs*. That regulation (which preceded and was repealed by Regulation (EC) No 510/2006) set out in Article 17(1) that Member States had to ‘inform the Commission which of their legally protected names ... they wish[ed] to register’ pursuant to that regulation. Paragraph 3 added that Member States could ‘maintain national protection of the names communicated in accordance with paragraph 1 until such time as a decision on registration has been taken’ (see in this respect judgment of 04/03/1999, C-87/97, ‘Cambozola’, para. 18).

In other words, the EU system of protection comprising the above EU Regulations **overrides and replaces** national protection of PDOs/PGIs for *agricultural products and foodstuffs, wines, aromatised wines* and *spirit drinks*.

In light of the foregoing:

- Geographical indications for *wines, spirits* and *agricultural products and foodstuffs* that now qualify for a PDO/PGI under EU Regulations and in the past enjoyed protection by means of national legislation do not fall within the scope of Article 7(1)(j) EUTMR. Accordingly, they do not constitute as such, and for that reason alone, a ground for refusal under Article 7(1)(j) EUTMR, unless they have **also been registered at EU level**. Therefore, if, for example, a third party argues that an EUTM contains or consists of a geographical indication for *wines* that was

registered in the past at national level in an EU Member State, the examiner will check whether the geographical indication is also registered at EU level as a PDO/PGI. If not, the third-party observations will be deemed not to raise serious doubts as regards Article 7(1)(j) EUTMR.

- For *aromatised wines*, pursuant to Article 26 of Regulation (EU) No 251/2014, a transitory period applies. Member States have until 28/03/2017 to submit all relevant information for the protection of national PGIs at EU level to the Commission. After that date, existing national PGIs that have not been notified to the Commission will lose protection. As a consequence, until 28/03/2017 both EU and national PGIs fall within the scope of Article 7(1)(j) EUTMR.

However, in those areas where no uniform EU system of protection is in place, PDOs/PGIs protected under national law fall within the scope of Article 7(1)(j) EUTMR. This is the case, in particular, for PDOs/PGIs for *non-agricultural products*.

Currently, neither the Commission nor the Office keeps a database listing the PDOs/PGIs protected under national law for *non-agricultural products*. Given the inherent difficulty in identifying such PDOs/PGIs, the Office will in these cases rely principally on observations by third parties.

2.10.5.2 PDOs/PGIs from third countries

The following situations refer to PDOs/PGIs from third countries that are not simultaneously registered at EU level. In the case the third country PDO/PGI is registered at EU level, paragraphs 2.10.3 and 2.10.4 of these Guidelines apply (e.g. Café de Colombia, Ron de Guatemala).

- a) The geographical indication is protected only in the third country of origin under its national legislation

Article 7(1)(j) EUTMR does not apply since the third-country geographical indication is not recognised and protected *expressis verbis* under EU legislation. In this respect, note that the provisions of the TRIPs Agreement are not such as to create rights upon which individuals may rely directly before the courts by virtue of EU law (judgment of 14/12/2000, joined cases C-300/98 and C-392/98, para. 44).

Example: 'Miel Blanc d'Okou' or 'Poivre de Penja' from Cameroon.

For third-country PDOs/PGIs protected in a Member State by virtue of an international agreement signed by that Member State (and not the EU), see paragraph 2.10.5.2 c) below.

Nevertheless, when the EUTM application contains or consists of one such protected geographical indication, it must also be assessed whether or not the EUTM may be considered descriptive and/or deceptive under Article 7(1)(c) and (g) EUTMR in accordance with the general rules set out in these Guidelines. For example, where a third party observes that an EUTM application consists of the term 'Murakami' (invented example), which is a PGI for *spirits* in accordance with the national legislation of country X, Article 7(1)(j) EUTMR will not apply for the reasons set out above, but it must be examined whether or not the EUTM will be perceived as a descriptive and/or deceptive sign by the relevant EU consumers.

- b) The geographical indication is protected under an agreement to which the European Union is a contracting party

The EU has signed a number of trade agreements with third countries that protect geographical indications. These instruments typically include a list of the geographical indications, as well as provisions on their conflicts with trade marks. The content and degree of precision may nevertheless vary from one agreement to another. Geographical indications from third countries are protected at EU level after the relevant agreement has entered into force.

In this respect, it is settled case-law that a provision of an agreement entered into by the EU with non-member countries must be regarded as being directly applicable when, in view of the wording, purpose and nature of the agreement, it may be concluded that the provision contains a **clear, precise and unconditional obligation that is not subject, in its implementation or effects, to the adoption of any subsequent measure** (judgment of 14/12/2000, joined cases C-300/98 and C-392/98, para. 42).

The scope of protection given to these PGIs by third countries is defined through the substantive provisions of the agreement concerned. While the oldest agreements usually contained only general provisions, the 'latest generation' of free trade agreements refer to the relationship between trade marks and PGIs in similar terms to Articles 102 and 103 of Regulation (EU) No 1308/2013 (see, for example, Articles 210 and 211 of the 'Trade Agreement between the European Union and its Member States, of the one part, and Colombia and Peru, of the other part', OJ L 354, 21/12/2012).

In the light of this, EUTMs that contain or consist of a third-country PDO/PGI that is protected by an agreement to which the EU is a contracting party (and is not simultaneously registered under the EU Regulations) are examined, on a case-by-case basis, in accordance with the specific substantive provisions of the agreement in question on the refusal of conflicting trade marks, taking into account the case-law cited above. The mere fact that a PDO/PGI from a third country is protected by those instruments **does not automatically** imply that an EUTM that contains or consists of the PDO/PGI must be refused: this will depend on the **content and scope** of the agreement's relevant provisions.

As regards the **relevant point in time** for the protection of such PDOs/PGIs, a case-by-case approach is necessary. PDOs/PGIs included in the initial agreement are normally protected as of the date when the agreement enters into force. However, the list of protected PDOs/PGIs can subsequently be updated in the so-called 'second generation agreements'. In these cases, the relevant priority date varies from agreement to agreement: in some cases the priority date can be the date of the third-country request to update the list and not the date when the Commission accepts the inclusion of the PDOs/PGIs.

The Office keeps a public database where information on third-country PDO/PGIs protected in the EU under international agreements is included. It is accessible here: https://oami.europa.eu/tunnel-web/secure/webdav/guest/document_library/contentPdfs/law_and_practice/Geographical_indications/geographical_indications.xls

It should be noted that the trade agreements signed by the EU with third countries typically have annexed to them a list of the PDOs/PGIs registered at EU level that are also to be protected in the third countries in question (judgment of 11/05/2010,

T-237/08, 'Cuvée Palomar', paras 104-108 and decision of 19/06/2013, R 1546/2011-4 – 'FONT DE LA FIGUERA'). However, the Office **does not use those lists** as a source of information about EU PDOs/PGIs, it uses the database cited above. Firstly, the lists of EU PDOs/PGIs to be protected abroad may vary from one agreement to another, depending on the particularities of the negotiations. Secondly, the annexes to the agreements are usually amended and updated through an 'Exchange of Letters'.

Examples:

PDO/PGI	Country of origin	Products
Aguardiente chileno	Chile	<i>Spirit drinks</i>
Brandy/Brandewyn	South Africa	<i>Spirit drinks</i>
Breede River Valley	South Africa	<i>Wine</i>
Abricot du Valais	Switzerland	<i>Spirit drinks</i>

c) The geographical indication is protected under an international agreement signed only by Member States (i.e. the EU is not a party)

Article 7(1)(j) EUTMR applies to PDOs/PGIs protected by international agreements to which a Member State is a party. However, by analogy to the Office's interpretation of Article 7(1)(j) EUTMR as far as national law is concerned, the Office considers that the reference to 'international agreements to which the ... Member State concerned is party' should be interpreted as international agreements in those areas where no uniform EU protection is in place, namely *non-agricultural products* (see paragraph 2.10.5.1 above).

In C-478/07, 'BUD', the Court discussed the exhaustive nature of EU law as regards PGIs originating from Member States. In the Office's interpretation, this also applies to third-country PDOs/PGIs in the relevant product fields that enjoy protection in the territory of a Member State through an international agreement concluded between that Member State and a non-EU-country.

This interpretation also applies to international agreements signed exclusively by Member States with third countries (in particular, the Lisbon Agreement for the Protection of Appellations of Provenance and their International Registration). For the sole purpose of the examination of absolute grounds for refusal, the EU is not a contracting party to these agreements, and they do not impose any obligations on the EU (see, by analogy, the preliminary ruling of 14/10/1980, C-812/79, Attorney General v Juan C. Burgoa, para. 9). Therefore, Article 7(1)(j) EUTMR only applies to PDOs/PGIs for *non-agricultural products* protected under such agreements.

In light of the foregoing, for the purposes of Article 7(1)(j) EUTMR, international agreements concluded by Member States are not applicable except:

- To the extent that they cover PDOs/PGIs for *non-agricultural products*. Currently, neither the Commission nor the Office keeps a database listing the PDOs/PGIs for *non-agricultural products* protected under international agreements concluded by Member States.
- International agreements concluded with third countries by a Member State before its accession to the EU. This is because the obligations arising out of an international agreement entered into by a Member State before its accession to

the EU have to be respected. However, Member States are required to take all appropriate steps to eliminate the incompatibilities between an agreement concluded before a Member State's accession and the Treaty (see Article 307, Treaty Establishing the European Community, now Article 351 TFEU, as interpreted by the Court in its judgment of 18/11/2003, C-216/01 'BUD', paras. 168-172).

- International agreements concluded with a third country by a Member State after its accession to the EU, but before the entry into force of the uniform EU system of protection in the given product area.

Given the inherent difficulty in identifying such PDOs/PGIs, the Office will in these cases rely principally on observations by third parties.

2.10.5.3 Relationship with other EUTMR provisions

When the mark can be objected to under Article 7(1)(j) EUTMR, further examination may still be necessary under the remaining possible grounds for refusal, such as Article 7(1)(k) or 7(1)(l) EUTMR.

In other words, an EUTM application may be in conflict with both, a PDO/PGI in the *wine* sector and a protected traditional term for *wines* or with a PDO/PGI in the agricultural and foodstuffs sector and a protected traditional speciality guaranteed.

PDO/PGI	TTW/TSG	EUTM application (invented)
Jamón de Serón	Jamón serrano	ABC Jamón serrano de Serón for <i>ham</i>
Alicante	Fondillón	ABC Fondillón Alicante for <i>wine</i>

2.11 Article 7(1)(k) EUTMR

Regulation No 2015/2424 amending Regulation No 207/2009 on the Community trade mark introduced Article 7(1)(k) as a specific ground for objecting to trade marks in conflict with earlier traditional terms for *wine*.

Article 7(1)(k) EUTMR applies to EUTMs that are in conflict with traditional terms for *wine* (TTWs), protected by either EU legislation or international agreements to which the EU is party.

It is a ground for refusal of EUTMs, introduced for reasons of coherence, in order to offer an equivalent degree of protection to traditional terms for *wine* as to designations of origin and geographical indications for *wines*.

2.11.1 General remarks on EU Regulations

Protection of TTWs is provided for in Council Regulation No 1308/2013, and Commission Regulation No 607/2009, which lays down certain detailed rules for the implementation of the Council Regulation (implementing act).

2.11.1.1 Definition of traditional terms for *wine* under EU Regulations

As regards the definition of TTWs, recital 104 of Regulation No 1308/2013 indicates that ‘Certain terms are traditionally used in the Union to convey information to consumers about the particularities and the quality of *wines*, complementing the information conveyed by protected designations of origin and geographical indications. In order to ensure the working of the internal market and fair competition and to avoid consumers being misled, those traditional terms should be eligible for protection in the Union’.

Similarly, recital 12 of Commission Regulation No 607/2009 states that ‘The use, regulation and protection of certain terms (other than designations of origin and geographical indications) to describe *wine* sector products is a long-established practice in the Community. Such traditional terms evoke in the minds of consumers a production or ageing method or a quality, colour or type of place or a particular event linked to the history of the *wine*. So as to ensure fair competition and avoid misleading consumers, a common framework should be laid down regarding the definition, the recognition, protection and use of such traditional term’.

According to Article 112 of Regulation No 1308/2013, a traditional term is a term traditionally used in a Member State to designate:

- that the product has a protected designation of origin or a protected geographical indication under EU or national law
- or
- the production or ageing method or the quality, colour, type of place, or a particular event linked to the history of the product with a protected designation of origin or a protected geographical indication

It follows that **two different types** of traditional terms for *wines* are distinguished:

The first is used in place of a PDO (e.g. ‘appellation d’origine contrôlée (AOC)’, ‘denominación de origen protegida (DO)’, ‘denominazione di origine controllata (DOC)’, ‘Landwein’) or a PGI (‘Vin de Pays’, ‘Vino de la Tierra’, ‘Indicazione Geografica Tipica’, ‘Vinho Regional’, ‘Landwein’) under a Member State law.

The second type is a description of product characteristics used for production or ageing methods, quality, colour, type of place, or for a particular event linked to the history of the product with a PDO or PGI (e.g. ‘château’, ‘grand cru’, ‘añejo’, ‘clásico’, ‘crianza’, ‘riserva’, ‘fino’, ‘Federweisser’).

That said, TTWs convey information to consumers about the particularities and the quality of *wines*, in principle complementing the information conveyed by protected designations of origin and geographical indications, for example, ‘Gran Reserva de Fondillón’ for *wine* of overripe grapes of PDO Alicante, ‘Cru bourgeois’ for *wine* from PDO Médoc.

According to Article 40 of Commission Regulation 607/2009, traditional terms are listed and defined in the ‘E-Bacchus’ database, and must mention the following:

- (a) the language of protection;
- (b) the grapevine product category or categories concerned by the protection;
- (c) a reference to the national legislation of the Member State or third country in which the traditional term is defined and regulated, or to the rules applicable to

wine producers in the third country, including those originating from representative trade organisations, in the absence of national legislation in those third countries;

- d) a summary of the definition or conditions of use;
- (e) the name of the country or countries of origin;
- (f) the date of inclusion in the electronic database 'E-Bacchus'.

2.11.1.2 Relevant provisions governing conflicts with trade marks

As regards the scope of protection, Article 113(2) of Regulation No 1308/2013 and Article 40(2) of Commission Regulation No 607/2009 state that

Traditional terms shall be protected, only in the language and for the categories of grape vine products claimed in the application, against:

- (a) any misuse of the protected term, including where it is accompanied by an expression such as "style", "type", "method", "as produced in", "imitation", "flavour", "like" or similar;
- (b) any other false or misleading indication as to the nature, characteristics or essential qualities of the product, placed on the inner or outer packaging, advertising material or documents relating to it;
- (c) any other practice likely to mislead the consumer, in particular to give the impression that the *wine* qualifies for the protected traditional term.

A specific provision for the relationship of traditional terms for *wines* with trade marks (a provision analogous to Article 102 of Regulation No 1308/2013 governing PGI/PDOs) is found in Article 41 of Commission Regulation No 607/2009:

1. Where a traditional term is protected under this Regulation, the registration of a trademark, which corresponds to one of the situations referred to in Article 40, shall be refused if the application for registration of the trademark does not concern wines qualified to use such a traditional term and is submitted after the date of submission of the application for protection of the traditional term to the Commission and the traditional term is subsequently protected.

Trademarks registered in breach of the first subparagraph shall be declared invalid on application in accordance with the applicable procedures as specified by Directive 2008/95/EC of the European Parliament and of the Council or Council Regulation (EC) No 40/94.

2. A trademark, which corresponds to one of the situations referred to in Article 40 of this Regulation, and which has been applied for, registered or established by use, if that possibility is provided for by the legislation concerned, in the territory of the Community before 4 May 2002 or before the date of submission of the application for protection of the traditional term to the Commission, may continue to be used and renewed notwithstanding the protection of the traditional term.

In such cases the use of the traditional term shall be permitted alongside the relevant trademark.

In light of the above provisions, the following cumulative conditions must be fulfilled in order for Article 7(1)(k) EUTMR to apply:

1. The traditional term in question must be protected within the meaning of Article 112 of Regulation No 1308/2013 (see paragraph 2.10.2 above).
2. Use of the EUTM must constitute one of the situations provided for in Article 113(2) of Regulation (EU) No 1308/2013 (see paragraph 2.10.3 above).

2.11.2 Relevant TTWs under EU Regulations

Article 7(1)(k) EUTMR applies where a TTW (either from an EU Member State or from a third country) has been **registered** under the procedure laid down by Regulations No 1308/2013 and No 607/2009.

Relevant information about traditional terms for *wines* can be found in the 'E-Bacchus' database maintained by the Commission, which can be accessed using the internet at <http://ec.europa.eu/agriculture/markets/wine/e-bacchus/>.

2.11.2.1 Relevant point in time

Article 7(1)(k) EUTMR applies only for TTWs that were applied for before the EUTM application and are registered at the time of examining the EUTM application.

The relevant dates for establishing the priority of a trade mark and of a TTW are the date of application of the EUTM (or the so-called Paris Convention priority, if claimed) and the date of application for protection of a TTW to the Commission respectively.

[Where there is no relevant date information in the 'E-Bacchus' extract, this means that the TTW in question was already in existence on 01/08/2009, the date on which the register was set up. For any TTW added subsequently, the 'E-Bacchus' extract includes a reference to the publication in the Official Journal, which gives the relevant information.]

[By analogy with the current practice for PGI/PDOs, and in view of the fact that the vast majority of applications for TTWs usually mature in a registration, **an objection will be raised** when the TTW was applied before the filing date (or the priority date, if applicable) of the EUTM application **but** had not yet been registered at the time of examination of the EUTM application. However, if the EUTM applicant indicates that the TTW in question has not yet been registered, the proceedings will be suspended until the outcome of the registration procedure of the TTW.]

2.11.3 Situations covered by Article 113(2) of Regulation No 1308/2013

Traditional terms will be protected, **only in the language and for the categories of grape vine products claimed in the application**, against:

1. any misuse of the protected term, including where it is accompanied by an expression such as 'style', 'type', 'method', 'as produced in', 'imitation', 'flavour', 'like' or similar;

2. any other false or misleading indication as to the nature, characteristics or essential qualities of the product, placed on the inner or outer packaging, advertising material or documents relating to it;
3. any other practice likely to mislead the consumer, in particular to give the impression that the *wine* qualifies for the protected traditional term.

In view of the wording of Article 113(2) of Regulation No 1308/2013, the scope of protection of protected TTWs seems narrower than that of PDO/PGIs. Still, the Office considers that a systematic approach should be followed and analogies be drawn, to the extent possible, between the protection of PDO/PGI and TTWs. In particular:

PDO/PGI — Article 103(2)	TTW — Article 113(2)
The EUTM consists solely of a whole PDO/PGI ('direct use');	'Misuse' also covers direct use. The practice for the assessment of 'direct use' of a PDO/PGI should apply by analogy.
The EUTM contains a whole PDO/PGI in addition to other word or figurative elements ('direct or indirect use');	'Misuse' also covers indirect use. The practice for the assessment of 'indirect use' of a PDO/PGI should apply by analogy.
The EUTM contains or consists of an imitation or evocation of a PDO/PGI, including <ul style="list-style-type: none"> - the EUTM incorporates the geographically significant part (in the sense that it is not the generic element) of the PDO/PGI; - the EUTM contains an equivalent adjective/noun that indicates the same geographical origin; - the PDO/PGI is translated; - the EUTM includes a 'de-localiser' expression in addition to the PDO/PGI or its evocation. 	Only misuse is covered by Article 113(2) with the caveat that such misuse refers to a use in the language claimed in the application.
Other misleading indications and practices;	Any other false or misleading indication as to the nature, characteristics or essential qualities of the product, placed on the inner or outer packaging, advertising material or documents relating to it;
The reputation of PDOs/PGIs.	Not covered.

2.11.4 Relevant goods

Article 113(2) of Regulation No 1308/2013 and Article 40 (2) of Commission Regulation No 607/2009 refer to '**categories of grape vine products claimed in the TTW application**'. It is the Office interpretation that, unlike the case of PGI/PDOs, objections based on conflicts with TTWs cannot be raised for comparable goods. However, objections should be raised against any relevant product referred to in Article 92(1) of Regulation No 1308/2013 for the following reasons.

According to Article 92(1) of Regulation No 1308/2013 the rules on, inter alia, traditional terms should apply to the products referred to in points 1, 3 to 6, 8, 9, 11, 15 and 16 of Part II of Annex VIII. Such products are *wine*, *liqueur wine*, *sparkling wine*, *quality sparkling wine*, *quality aromatic sparkling wine*, *semi-sparkling wine*, *aerated semi-sparkling wine*, *partially fermented grape must*, *wine from raisined grapes*, *wine of overripe grapes*.

Since all these products are *wine*-based and in view of the fact that most of the EUTM applications applied for are *wines* without specifying the category of *wines*, objections should be raised against any relevant product referred to in Article 92(1) of Regulation

No 1308/2013. For instance, in cases of an EUTM application containing TTW Fondillon, applying for *wine* in Class 33, the objection should not only be raised against *wine of overripe grapes* that is protected by the TTW, but also for *wine* as such.

2.11.4.1 Restrictions of the list of goods

Objections raised due to conflicts with PDO/PGIs may be waived if the relevant goods are restricted to comply with the specifications of the PDO/PGI in question.

For TTWs, there are no such specifications but their registration in the 'E-Bacchus' database must, in accordance with Article 40 of Commission Regulation 607/2009, include a 'summary of definition/conditions of use'. Therefore objections should be waived if the relevant goods are restricted to comply with the definition/conditions of use of the TTW in question. The proper wording is '[name of the product] complying with the definition/conditions of use of the [TTW 'X']'. No other wording should be proposed or allowed. Restrictions such as '[name of the product] with the [TTW 'X']' are not acceptable.

2.11.5 International agreements

By analogy to PDO/PGIs where international agreements to which the EU is party can serve as a basis for raising an objection against a trade mark application, TTWs that may be protected under international agreements to which the EU is a party should be taken into account in the assessment of conflicts of a TTW with an EUTM application.

2.11.6 Relationship with other EUTMR provisions

When the mark can be objected to under Article 7(1)(k) EUTMR, further examination may still be necessary under the remaining possible grounds for refusal, such as Article 7(1)(j) EUTMR.

In other words, an EUTM application may be in conflict with both, a PDO/PGI in the *wine* sector and a TTW.

PDO/PGI	TTW	EUTM application (invented)
Alicante	Fondillón	ABC Fondillón Alicante

2.12 Article 7(1)(l) EUTMR

Regulation No 215/2424 amending Regulation No 207/2009 on the Community trade mark introduced Article 7(1)(l) EUTMR as a specific ground for objecting to trade marks in conflict with traditional specialities guaranteed.

Article 7(1)(l) EUTMR applies to EUTMs that are in conflict with traditional specialities guaranteed (TSGs) protected by either EU legislation or international agreements to which the EU is party.

Just as in the case of TTWs, it is a ground for refusal of EUTMs, introduced for reasons of coherence, in order to offer an equivalent degree of protection to traditional specialities guaranteed to designations of origin and geographical indications.

2.12.1 General remarks on EU Regulations

2.12.1.1 Definition of traditional specialities guaranteed under EU Regulations

Protection of TSGs is provided for in Title III of Regulation (EU) No 1151/2012.

As regards the definition of TSGs, Article 17 of Regulation (EU) No 1151/2012 indicates that 'A scheme for traditional specialities guaranteed is established to safeguard traditional methods of production and recipes by helping producers of traditional product[s] in marketing and communicating the value-adding attributes of their traditional recipes and products to consumers'.

According to Article 18(1) of the regulation 'A name shall be eligible for registration as a traditional speciality guaranteed where it describes a specific product or foodstuff that:

- (a) results from a mode of production, processing or composition corresponding to traditional practice for that product or foodstuff; or
- (b) is produced from raw materials or ingredients that are those traditionally used'.

Hence, TSGs highlight the traditional characteristics of a product either in its production process or composition, for instance, 'Lambic, Gueuze-Lambic, Gueuze' for *Belgian acid beer during production of which spontaneous fermentation occurs*, 'Jamón Serrano' for *Spanish ham produced in accordance with a traditional method of salting, drying/maturing and ageing*.

Unlike PGI/PDOs, the TSG quality scheme does not certify that the protected food product has a link to a specific geographical area, for instance, TSG 'Mozzarella' for *Italian fresh pulled-curd cheese* and PDO 'Mozzarella di Bufala Campana' for *mozzarella cheese* originating from a particular geographical area.

To qualify for a TSG a product must, according to Article 18(2) of the regulation, be of specific character: '2. For a name to be registered as a traditional speciality guaranteed, it shall:

- (a) have been traditionally used to refer to the specific product; or
- (b) identify the traditional character or specific character of the product'.

In this context, it is referred to in Article 3 of Regulation (EU) No 1151/2012, which defines:

- i) 'specific character' as 'the characteristic production attributes which distinguish a product clearly from other similar products of the same category',
- ii) 'traditional' as 'proven usage on the domestic market for a period that allows transmission between generations; this period is to be at least 30 years'.

According to Article 23 of Regulation (EU) No 1151/2012, 'a name registered as a traditional speciality guaranteed may be used by any operator marketing a product that conforms to the corresponding specification'.

Article 24 of Regulation (EU) No 1151/2012 establishes the scope of protection of TSGs — 'registered names shall be protected against any misuse, imitation or evocation, or against any other practice liable to mislead the consumer'.

2.12.1.2 Relationship with trade marks

In contrast with PGI/PDOs, Regulation (EU) No 1151/2012 does not include a specific provision for the relationship of TSGs with trade marks (i.e. a provision analogous to Article 13). Article 24(1) only prohibits the use of the TSG in a number of situations but not the registration of a trade mark.

Article 7(1)(l) EUTMR however refers to ‘trade marks which are excluded from registration pursuant to Union legislation’.

The Office considers that a systematic approach should be followed and draws an analogy with Article 7(1)(j) EUTMR: the registration of an EUTM application should be refused or the registration of an EUTM invalidated if there is conflict with a TSG.

2.12.2 Relevant goods under EU Regulations

Article 7(1)(l) EUTMR applies where a TSG has been registered under the procedure laid down by Regulation (EU) No 1151/2012.

Relevant information about traditional specialities guaranteed can be found in the ‘DOOR’ database maintained by the Commission, which can be accessed online at <http://ec.europa.eu/agriculture/quality/door/list.html>.

2.12.2.1 Relevant point in time

Article 7(1)(l) EUTMR applies only for TSGs that were applied for before the EUTM application and are registered at the time of examining the EUTM application.

By analogy with the current practice for PGIs/PDOs, and in view of the fact that the vast majority of applications for TSG usually mature in a registration, an objection will be raised when the TSG was applied before the filing date (or the priority date, if applicable) of the EUTM application but had not yet been registered at the time of examining the EUTM application. However, if the EUTM applicant submits that the TSG in question has not yet been registered, the proceedings will be suspended until the outcome of the registration procedure of the TSG.

2.12.3 Situations covered by Article 24 of Regulation (EU) No 1151/2012

In view of the wording of Article 13 of Regulation (EU) No 1151/2012, the scope of protection of protected TSGs seems narrower than that of PDO/PGIs. However, the Office considers that a systematic approach should be followed and analogies drawn, to the extent possible, between the protection of PDO/PGI and TSGs, in particular:

PGI/PDO — Article 13	TSG — Article 24
The EUTM consists solely of a whole PDO/PGI ('direct use');	'Imitation, evocation or misuse' includes direct use.
The EUTM contains a whole PDO/PGI in addition to other word or figurative elements ('direct or indirect use');	'Imitation, evocation or misuse' includes direct or indirect use.
The EUTM contains or consists of an imitation or	The practice for the assessment of 'imitation or

<p>evocation of a PDO/PGI, including</p> <ul style="list-style-type: none"> • the EUTM incorporates the geographically significant part (in the sense that it is not the generic element) of the PDO/PGI; • the EUTM contains an equivalent adjective/noun that indicates the same geographical origin; • the PDO/PGI is translated; • the EUTM includes a 'de-localiser' expression in addition to the PDO/PGI or its evocation. 	<p>evocation' of a PDO/PGI should apply by analogy</p>
<p>Other misleading indications and practices;</p>	<p>The practice for the assessment of 'misleading indications and practice' of a PDO/PGI should apply by analogy</p>
<p>The reputation of PDOs/PGIs.</p>	<p>Not covered</p>

2.12.4 Relevant goods

Pursuant to Articles 13 and 14 of Regulation (EU) No 1151/2012, objections based on conflicts with PGI/PDO can be raised only for specific goods of the EUTM application, namely those that are identical or 'comparable' to ones covered by the PDO/PGI.

Article 19 of Regulation (EU) No 1151/2012 requires that a TSG must comprise a 'description of the product including its main physical, chemical, microbiological or organoleptic characteristics, showing the product's specific character'.

In light of the absence to any reference to 'comparable' goods in Article 24 of Regulation (EU) No 1151/2012, objections should be raised only to products covered by the TSG.

2.12.4.1 Restrictions of the list of goods

Objections raised due to conflicts with PDO/PGIs may be waived if the relevant goods are restricted to comply with the specifications of the PDO/PGI in question.

For TSGs, there are no such specifications but they must, in accordance with Article 20 of Regulation (EU) No 1151/2012, comprise a product specification. Therefore objections should be waived if the relevant goods are restricted to comply with the product specification of the TSG. The proper wording is '[name of the product] complying with the product specification of the [TSG 'X']'. No other wording should be proposed or allowed. Restrictions such as '[name of the product] with the [TSG 'X']' are not acceptable.

The TSG product specifications are published in the Official Journal and are accessible via the 'DOOR' database.

2.12.5 International agreements

By analogy to PDO/PGIs, where international agreements to which the EU is party can serve as a basis for raising an objection against a trade mark application, TSGs that may be protected under international agreements to which the EU is a party should be taken into account in the assessment of conflict of a TSG with an EUTM application.

Currently, the Office does not keep a record of TSGs protected under international agreements. Moreover, the ‘DOOR’ database does not include them either. Given the difficulty in identifying such TSGs, the Office will in these cases rely, in principle, on observations by third parties.

2.12.6 Relationship with other EUTMR provisions

When the mark can be objected to under Article 7(1)(l) EUTMR, further examination may still be necessary under the remaining possible grounds for refusal, such as Article 7(1)(j) EUTMR.

In other words, an EUTM application may be in conflict with both — a PDO/PGI in the agricultural and foodstuff sector and a protected traditional speciality guaranteed.

PDO/PGI	TSG	EUTM application (invented)
Jamón de Serón	Jamón serrano	ABC Jamón serrano de Serón

2.13 Article 7(1)(m) EUTMR

Regulation No 2015/2424 amending Regulation No 207/2009 on the Community trade mark introduced Article 7(1)(m) as a specific ground for objecting to trade marks in conflict with earlier plant variety denominations.

In particular, Article 7(1)(m) EUTMR provides for the refusal of EUTMs that consist of, or reproduce in their essential elements, an earlier plant variety denomination registered in accordance with Union legislation or national law or international agreements to which the Union or the Member State concerned is a party, providing for protection of plant variety rights, and which are in respect of plant varieties of the same or closely related species.

2.13.1 Legislative framework

As regards **Union legislation** protecting plant variety rights, Council Regulation (EC) No 2100/94 on Community plant variety rights (CPVRR) establishes a system of Community plant variety rights (CPVR) as the sole and exclusive form of Community industrial property rights for plant varieties.

Since 2005, the European Union has been party to the International Convention for the Protection of New Varieties of Plants (**UPOV Convention**), which has become an integral part of the Union’s legal order. Under Article 20(1) UPOV Convention, a variety ‘shall be designated by a denomination which will be its generic designation’. Furthermore, each Contracting Party must ensure that no rights in the designation registered as the denomination of the variety will hamper the **free use of the denomination** in connection with the variety, even after the expiration of the breeder’s right.

Therefore, both the CPVRR and the UPOV Convention impose the **obligation to use** the variety denominations in order to commercialise protected varieties or varieties whose protection has ended.

Moreover, pursuant to Article 7(1)(m) EUTMR, plant variety denominations registered following **national law** or **international agreements** to which Member States are a party must also be taken into account.

2.13.2 Definition of plant variety denomination

Plant variety denominations describe cultivated varieties or subspecies of live plants or agricultural seeds. A variety denomination must ensure clear and unambiguous identification of the variety and fulfil several criteria (Article 63 CPVRR). The applicant for a CPVR must indicate a suitable variety denomination, which will be used by anyone who markets such variety in the territory of a member of the International Union for the Protection of New Varieties of Plants (UPOV), even after termination of the breeder's right (Article 17 CPVRR).

Protection is granted to plant variety denominations in order, inter alia, to protect the **legitimate interest** of consumers and producers in knowing the variety they are using or purchasing, as well as possibly the breeder and origin of that variety. The obligation to use the variety denominations contributes to the regulation of the market and to the safety of transactions in the agricultural and food sector, thus preventing counterfeiting and any potential misleading of the public.

2.13.3 Situations covered by Article 7(1)(m) EUTMR

Article 7(1)(m) EUTMR applies if the following requirements are met:

- 1 there is a registered plant variety denomination (at EU or at national level, including in third countries that are party to UPOV);
- 2 the plant variety denomination was registered prior to the EUTM application;
- 3 the EUTM application consists of, or reproduces in its essential elements, the earlier plant variety denomination;
- 4 the EUTM application includes plant varieties of the same species as, or of species closely related to, those protected by the registered plant variety denomination.

2.13.3.1 Registered plant variety denominations

The Community Plant Variety Office (CPVO), based in Angers (France), is the European Union agency responsible for managing a system for the protection of plant variety rights.

The CPVO maintains a register of protected plant varieties. The protected varieties and the varieties whose CPVR has been terminated can be searched, based on their variety denomination and/or other search criteria, through the CPVO Variety Finder⁷, available on the Office's website. This reference tool can be consulted whenever the type of goods and/or services covered by the EUTM application so dictate (see paragraph 3.4 below).

⁷ <http://www.cpvo.europa.eu/main/en/home/databases/cpvo-variety-finder>.

In particular, whenever the specification of an EUTM application refers to *live plants, agricultural seeds, fresh fruits, fresh vegetables* or equivalent wording, the Office will verify in the CPVO Variety Finder whether the term(s) making up the essential elements of the trade mark coincide(s) with a registered variety denomination or with the denomination of a variety for which protection has expired or been surrendered or terminated.

The search should extend to variety denominations registered for the European Union, Member States and third countries on the basis of Union legislation, national law or international agreements to which the Union or the Member State concerned is a party.

A plant variety right is **surrendered** when, pursuant to Article 19(3) of Regulation (EC) No 2100/94, before expiry of the term of the right, the holder surrenders it by sending a written declaration to such effect to the CPVO, in which case the right lapses with effect from the day following the day on which the declaration is received by the CPVO.

Pursuant to Article 19(1) of Regulation (EC) No 2100/94, plant variety rights **expire** at the end of 25th calendar year, or 30th year, in the case of varieties of vine and tree species, following the year of grant.

Plant variety rights are **terminated** *ex tunc* when the Office declares the Community plant variety right null and void pursuant to Article 20 CPVRR and with effect *in futurum* if the Office cancels the Community plant variety right pursuant to Article 21 CPVRR.

2.13.3.2 Relevant point in time

Article 7(1)(m) EUTMR applies only in respect of plant variety denominations that were **registered** (or, as explained above, had expired or been surrendered or terminated) at the time when the EUTM application was examined. The relevant dates are the date of filing of the EUTM application (or the 'Paris Convention priority', if claimed) and the date of registration of the plant variety denomination.

2.13.3.3 The EUTM application consists of, or reproduces in its essential elements, the plant variety denomination

Pursuant to Article 7(1)(m) EUTMR, objections are to be raised only if the EUTM consists of, or reproduces in its essential elements, the plant variety denomination.

The following situations may therefore arise:

- a) The EUTM applied for **consists** of an earlier plant variety denomination, for example the word mark 'ANTONIO' for *fruits and vegetables*. Since 'ANTONIO' is an earlier plant variety denomination for *peppers*, the Office will object with regard to peppers. For 'closely related species', see paragraph 3.4 below.
- b) The EUTM **contains** an earlier plant variety denomination. Whether the application is objectionable or not will require a more detailed assessment. In particular, the Office will examine whether the plant variety denomination is one of the **essential elements** of the EUTM application.

Examples:

EU trade mark	Goods	Comment
<p>ANTONIO MARIN VEGETABLES</p>	<p>Fruits and vegetables</p>	<p>ANTONIO is a registered plant variety denomination for <i>peppers</i>. ANTONIO is an essential element of the trade mark. The Office will object with regard to peppers, including closely related species.</p>
	<p>Fruits and vegetables</p>	<p>ANTONIO is a registered plant variety denomination for <i>peppers</i>. ANTONIO is not considered to be an essential element of the trade mark. Therefore, the Office will not object.</p>

2.13.3.4 Plant varieties of the same or closely related species

A check is to be made whenever the specification of an EUTM application refers to *live plants, agricultural seeds, fresh fruits, fresh vegetables* or equivalent.

If the check shows that the word or figurative EUTM applied for consists of, or reproduces in its essential elements, an earlier plant variety denomination registered under Union law, national law or relevant international agreements, the examiner must raise an objection under Article 7(1)(m) EUTMR in respect of the relevant product. Taking as an example the scientific name of the product ‘oats’, *Avena sativa*, the term *Avena* describes the genus and in principle includes the closely related species *Avena abyssinica*, *Avena byzantine*, *Avena fatua*, *Avena nuda*, etc. Similarly, the scientific name of the most common pepper is *capsicum annuum*. The term *capsicum* describes the genus and in principle includes the closely related species [Capsicum baccatum](#), [Capsicum chinense](#), [Capsicum pubescens](#), etc.

RULE: The objection should refer to the genus of the scientific name of the plant variety denomination, which in principle covers closely related species.





EXCEPTION: There are cases where some species within the same genus are not closely related to the others, or where species from different genera are closely related. Exceptions will be examined by the Office upon request from the EUTM applicant and/or on the basis of third-party observations.

See also Annex of the [CPVO Guidelines on Article 63 CPVRR](#) on the meaning of ‘closely related species’.

Finally, when more than one plant variety denomination appear as an essential element in a trade mark application, for example a plant variety denomination for ‘apples’ and another one for ‘strawberries’, the list of goods will have to be limited in order to exclude the goods covered by each plant variety denomination, that is to say, apples and strawberries. This also applies where the two plant variety denominations are joined in the same term, for example MARINEGOLD, where both MARINE and

GOLD are protected; the list of goods will have to be limited in order to exclude the goods covered by each plant variety denomination.

Examples of objections and limitations:

European Union trade mark	Goods	Comment
EUTM application No 13 473 665 	Class 31	TROPICAL is protected at European level (QZ code) in the CPVO database for 'Solanum lycopersicum L.' (tomato), 'Chrysanthemum L.' (chrysanthemum) and 'Tulipa L.' (tulips). Registered with the following limitation in Class 31: '[t]he aforesaid goods not being or containing chrysanthemums, tulips or tomatoes, or materials for vegetative multiplication or reproduction of chrysanthemums, tulips or tomatoes'.
EUTM application  No 13 714 803	Wheat in Class 31	'Africa' is protected at European level (QZ code) for 'wheat'. The objection was overcome through a limitation ('not including wheat seeds').
EUTM application  No 13 784 021	Class 31	'Nike' is protected at European level (QZ code) for 'Avena sativa' and 'chrysanthemum'. The objection was overcome through a limitation.
EUTM application No 14 487 896 	Class 31	'Nature' is protected at European level (QZ code), for 'Diplotaxis tenuifolia' (a kind of rocket). However, due to the small size of the term 'nature' and to the integration into a longer phrase, the word 'nature' plays a secondary role and will not be perceived as a CPVO. The mark is accepted.

2.13.4 Relationship with other EUTMR provisions.

Where a plant variety denomination is used in the market but has not been registered or published in the CPVO or at national level, Article 7(1)(c) and (d) EUTMR might be applicable (see paragraphs 2.3 and 2.4).

2.14 European Union collective marks

2.14.1 Character of collective marks

A European Union collective mark (EU collective mark) is a specific type of EUTM which, pursuant to Article 66(1) EUTMR, 'is described as such when the mark is applied for and is capable of distinguishing the goods or services of the members of the association which is the proprietor of the mark from those of other undertakings'.

A European Union collective mark is aimed at distinguishing the goods and services of the members of the association that owns the mark from those of other companies that do not belong to that association. Therefore, the European Union collective mark qualifies the commercial origin of certain goods and services by informing the consumer that the producer of the goods or the service provider belongs to a certain association and that it has the right to use the mark.

An EU collective mark is typically used by companies, together with their own individual marks, to indicate that they are members of a certain association. For example, Spain's Association of Shoe Manufacturers may want to apply for the collective trade mark 'Asociación Española de Fabricantes de Calzado', which, while belonging to the association, is going to be used by all its members. A member of the association may want to use the collective mark in addition to its own individual mark, for example, 'Calzados Luis'.

Collective marks do not necessarily certify the quality of the goods, although this is sometimes the case. For example, regulations governing use frequently contain provisions to certify the quality of the goods and services of the members of the association and this is acceptable (see decision of 10/05/2012, R 1007/2011-2, para. 13).

It is up to the applicant to decide whether the trade mark fulfils the requirements of a collective mark or of an individual mark. This means that, in principle, the same sign could be applied for either as an individual EUTM or, if the conditions described in this chapter are met, as a collective EUTM. Differences between individual and collective marks do not depend on the signs per se, but rather on other characteristics such as the ownership or the conditions of use of the mark.

For example, an association can file an application for the word mark 'Tamaki' either as an individual mark or as a collective mark, depending on the use that is intended to be made of the mark (only by the association itself or also by the members thereof). If it is applied for as an EU collective mark, certain additional formalities must be met, such as the submission of regulations of use, etc.

After filing, changes of the kind of mark (from collective to individual or vice versa) are accepted only under certain circumstances (see the Guidelines, Part B, Examination, Section 2, Examination of Formalities, paragraph 8.2.5).

The EUTMR provisions apply to EU collective marks, unless Articles 67-74 EUTMR provide otherwise. EU collective marks are thus subject, on the one hand, to the general EUTM regime and, on the other hand, to some exceptions and particularities.

It follows, firstly, that an EU collective mark is subject to broadly the same examination procedure and conditions as individual marks. In general terms, the classification of

goods and services, examination of formalities and of absolute grounds for refusal is done according to the same procedure as that applied to individual trade marks.

For example, examiners will check the list of goods and services or the language requirements in the same way as they do with individual trade marks. Likewise, whether the EU collective mark falls under one of the grounds for refusal of Article 7 EUTMR will also be examined.

The regulations provided by the applicant governing the use of its EU collective mark **must cover its use for all the goods and services** included in the list of the EU collective mark application. For instance, the applicant may do so by reproducing the list of goods and services in the regulations of use or by referring to the list of goods and services of the EU collective mark application.

With respect to EU collective marks conflicting with PGIs/PDOs, traditional terms for wine or traditional specialities guaranteed, the regulations governing the use of a EU collective mark should accurately reflect **any limitation** introduced to overcome such conflicts. For example, the regulations of use of the EU collective mark 'XYZ Designation of Origin' for 'wines' should accurately reflect the fact that they refer to the use of the trade mark for *wines complying with the PDO 'XYZ'*.

Secondly, the examination of an EU collective mark will also consider the exceptions and particularities of this kind of mark. These exceptions and particularities refer both to the formal and substantive provisions. As regards formalities, the requirement of the regulations governing use of the mark is, for example, a specific characteristic of an EU collective mark. (For further details of the examination of formalities of EU collective marks, including the regulations of use of the mark, see the Guidelines, Part B, Examination, Section 2, Examination of Formalities, paragraph 8.2.)

The substantive exceptions and particularities which apply to an EU collective mark are described below.

2.14.2 Ownership

Ownership of EU collective marks is limited to (i) associations of manufacturers, producers, suppliers of services, or traders which, under the terms of the law governing them, have the capacity in their own name to have rights and obligations of all kinds, to make contracts or accomplish other legal acts and to sue and be sued; and (ii) legal persons governed by public law.

The first type of owner typically comprises private associations with a common purpose or interest. They must have their own legal personality and capacity to act. Therefore, private companies such as *sociedades anónimas*, *Gesellschaften mit beschränkter Haftung*, etc., multiple applicants with separate legal personality or temporary unions of companies cannot be owners of an EU collective mark. As set out in the Guidelines, Part B, Examination, Section 2, Examination of Formalities, paragraph 8.2.1, 'collective does not mean that the mark belongs to several persons (co-applicants/co-owners) nor that it designates/covers more than one country'.

As regards the second type of owners, the concept 'legal persons governed by public law' must be interpreted broadly. This concept includes, on the one hand, associations, corporations and other entities governed by public law. This is, for example, the case of 'Consejos Reguladores' or 'Colegios Profesionales' under Spanish Law. On the other

hand, it also includes other legal persons governed by public law, for example, the European Union, States or municipalities, which do not necessarily have a corporative or an associative structure but which can nevertheless be owners of EU collective marks. In these cases, the requirement concerning the conditions for membership under Article 67(2) EUTMR is not applicable (see decision of 22/11/2011, R 828/2011-1, para. 18 and decision of 10/05/2012, R 1007/2011-2, paras 17-18). That is to say, when the applicant for an EU collective mark is a legal person governed by public law that does not necessarily have a corporative or an associative structure, such as the European Union, a State or a municipality, the regulations governing use of the mark need not contain details concerning membership.

2.14.3 Particularities as regards absolute grounds for refusal

The absolute grounds for refusal listed in Article 7(1) EUTMR apply to EU collective marks. This means that these marks will first be examined under those provisions to verify, for example, whether or not they are distinctive, deceptive or have become a customary sign. If, for instance, a mark is not inherently distinctive under Article 7(1)(b) EUTMR, it will be refused (see decision of 18/07/2008, R 229/2006-4, para. 7).

However, there are some exceptions and particularities that must also be taken into account when examining the absolute grounds for refusal for EU collective marks. In addition to the grounds for refusal of an EUTM application contained in Article 7(1) EUTMR, examiners also assess the following specific grounds:

- descriptive signs
- misleading character as to its nature
- regulations of use contrary to public policy and morality.

These specific grounds for refusals can also be the subject of observations filed by third parties.

2.14.3.1 Descriptive signs

Signs or indications which may serve, in trade, to designate the geographical origin of the goods or services may constitute Community collective marks (see judgment of 15/10/2003, T-295/01, para. 32 and judgment of 25/10/2005, T-379/03, para. 35).

As a result, a sign that exclusively describes the geographical origin of the goods or services (and that must be refused if it is applied for as an individual CTM) can be accepted if (i) it is validly applied for as an EU collective mark and (ii) it complies with the authorisation foreseen in Article 67(2) CTMR (see decision of 05/10/2006, R 280/2006-1, paras 16, 17).

According to this provision, the regulations governing use of an EU collective mark that is descriptive must authorise any person whose goods or services originate in the geographical area concerned to become a member of the association that is the proprietor of the mark.

For example, an application for the word mark 'Alicante', specifying *tourist services* should be refused under Article 7(1)(c) EUTMR if it is applied for as an individual CTM, given that it describes the geographical origin of the services. However, as an exception, if it is validly applied for as an EU collective mark (i.e. it is applied for by an

association or a legal person governed by public law and it complies with the other requirements of European Union collective marks) and the regulations governing use of the mark contain the authorisation foreseen in Article 67(2) EUTMR, it will be accepted under Article 7(1)(c) EUTMR.

This exception exclusively applies to those signs that are descriptive of the geographical origin of the goods and services. If the EU collective mark is descriptive of other characteristics of the goods or services, this exception does not apply and the application will be refused under Article 7(1)(c) EUTMR.

For example, if the word mark 'Do-it-yourself' is applied for as an EU collective mark for tools in Class 7, it will be considered descriptive of the intended purpose of the goods. Since the sign is descriptive of certain characteristics of the goods other than their geographical origin, it will be refused under Article 7(1)(c) EUTMR despite having been applied for as an EU collective mark (see decision of 08/07/2010, R 0934/2010-1, para. 35).

2.14.3.2 Misleading character as to its nature

The examiner must refuse the application if the public is liable to be misled as regards the character or the meaning of the mark, in particular if it is likely to be perceived as something other than a collective mark.

A collective mark that is available for use only by members of an association that owns the mark could be liable to mislead if it gives the impression that it is available for use by anyone who is able to meet certain objective standards.

2.14.3.3 Regulations of use contrary to public policy and morality

If the regulations governing use of the mark are contrary to public policy or to accepted principles of morality, the EU collective mark application must be refused.

This ground for refusal must be differentiated from that contained in Article 7(1)(f) EUTMR, which prohibits registration of those trade marks that are by themselves contrary to public policy or to accepted principles of morality.

The refusal foreseen in Article 68(1) EUTMR refers to situations where, regardless of the trade mark, the regulations governing use of the mark contain a provision that is contrary to public policy or to accepted principles of morality, for instance rules that discriminate on the grounds of sex, creed or race. For example, if the regulations contain a clause that prohibits women from using the mark, the EU collective mark application will be refused, even if the trade mark does not fall under Article 7(1)(f) EUTMR.

The examiner's objection can be waived if the regulations are amended in order to remove the conflicting provision. In the above example, the EU collective mark application will be accepted if the clause that prohibits women from using the mark is deleted from the regulations.

***GUIDELINES FOR EXAMINATION OF
EUROPEAN UNION TRADE MARKS***

***EUROPEAN UNION
INTELLECTUAL PROPERTY OFFICE
(EUIPO)***

PART C

OPPOSITION

SECTION 0

INTRODUCTION

Table of Contents

1	Overview of Opposition Proceedings – the Difference Between ‘Absolute Grounds’ and ‘Relative Grounds’ for Refusal of an EUTM Application	3
2	The Grounds for Opposition.....	3
3	The ‘Earlier Rights’ upon which Opposition must be Based	4
4	The Purpose of Opposition Proceedings and the most Expedient way to Treat them	5

1 Overview of Opposition Proceedings – the Difference Between ‘Absolute Grounds’ and ‘Relative Grounds’ for Refusal of an EUTM Application

‘Opposition’ is a procedure that takes place before the EUIPO when a third party, on the basis of the earlier rights it holds, requests the Office to reject a European Union trade mark application (EUTM application) or an international registration designating the EU.

When an opposition is filed against an international registration designating the EU, any reference in these Guidelines to EUTM applications must be read to cover international registrations designating the EU. Specific Guidelines have been drafted for International Marks including specificities about oppositions.

Under Council Regulation (EU) No 207/2009 of 26 February 2009 on the European Union trade mark (EUTMR), an opposition must be based on rights held by the opponent in an earlier trade mark or other form of trade sign. The grounds on which an opposition may be based are called ‘relative grounds for refusal’, and the relevant provisions are found in Article 8 EUTMR, which bears that title. Unlike absolute grounds for refusal, which are examined *ex officio* by the Office (and which may take into account third parties’ observations although third parties do not become parties to the proceedings), relative grounds for refusal are *inter partes* proceedings based on likely conflict with earlier rights. Such relative grounds objections are not raised *ex officio* by the Office. The onus is therefore on the earlier right owner to be vigilant concerning the filing of EUTM applications by others which could clash with such earlier rights, and to oppose conflicting marks when necessary.

When an opposition is filed within a prescribed time limit and the relevant fee has been paid, the proceedings are managed by the Office’s specialist service (the Opposition Division) and will normally include an exchange of observations from both the opponent and the applicant (the ‘parties’). After considering these observations, and if agreement has not been reached between the parties, the Opposition Division will decide (in an appealable ‘Decision’) either to reject the contested application totally or in part or to reject the opposition. If the opposition is not well founded, it will be rejected. If the EUTM application is not totally rejected, and provided there are no other oppositions pending, it will proceed to registration.

2 The Grounds for Opposition

The grounds on which an opposition may be made are set out in Article 8 EUTMR.

Article 8 EUTMR enables the proprietors to base oppositions on their earlier rights to prevent the registration of EUTMs in a range of situations progressing from that of absolute (i.e. double) identity both between goods and/or services and between marks (**Article 8(1)(a) EUTMR**, where likelihood of confusion is presumed, and need not be proved) to that of similarity (**Article 8(1)(b) EUTMR**, where there must be a likelihood of confusion) (see the Guidelines, Part C, Opposition, Section 2, Double Identity and Likelihood of Confusion).

Article 8(3) EUTMR allows the proprietor of a mark to prevent the unauthorised filing of its mark by its agent or representative (see the Guidelines, Part C, Opposition, Section 3, Trade Mark Filed by an Agent).

Article 8(4) EUTMR enables the proprietor of earlier non-registered trade marks or other signs used in the course of trade of more than mere local significance to prevent registration of a later EUTM application if the proprietor has the right to prohibit the use of the EUTM application. It enables right holders to invoke a wide variety of rights protected under EU legislation or Member State laws, subject to the conditions of their acquisition and scope of protection under the applicable laws, and further provided that the right invoked also fulfils the EU law condition of use in the course of trade of more than mere local significance (see the Guidelines, Part C, Opposition, Section 4, Rights under Article 8(4) and 8(4a) EUTMR).

Article 8(4a) EUTMR enables beneficiaries of the protection of designations of origin and geographical indications under the Union legislation or Member State laws to oppose the registration of a later EUTM application even beyond the limited scope of *ex officio* protection of such rights on absolute grounds (Article 7(1)(j) EUTMR). In order to be eligible as a 'relative' ground for refusal, the right invoked must vest in its beneficiary a direct right of action against unauthorised use (see the Guidelines, Part C, Opposition, Section 4, Rights under Article 8(4) and 8(4a) EUTMR).

Article 8(5) EUTMR enables the proprietors of an earlier reputed registered trade mark to prevent registration of a later EUTM application that, without due cause, would encroach on the earlier reputed mark. Likelihood of confusion is not a condition for the application of this article. This is because Article 8(5) EUTMR specifically (but not exclusively) protects functions and uses of trade marks that fall outside the ambit of the badge of origin protection offered by likelihood of confusion and, as such, is more directed at protecting the heightened effort and financial investment that is involved in creating and promoting trade marks to the extent that they become reputed and to facilitate full exploitation of the value of the marks (see the Guidelines, Part C, Opposition, Section 5, Trade Marks with Reputation).

3 The 'Earlier Rights' upon which Opposition must be Based

An opposition must be based on at least one earlier right owned by the opponent.

The meaning of 'earlier' rights for Article 8(1) and 8(5) EUTMR is defined in **Article 8(2) EUTMR**, meaning such rights having an earlier date (not hour or minute, as confirmed by the Court in its judgment of 22/03/2012, C-190/10, 'Génesis Seguros') of application for registration than the EUTM application, including applicable claimed priority dates, or have become well known in a Member State before the EUTM application or, if appropriate, its claimed priority date. See the Guidelines, Part C, Opposition, Section 1, Procedural Matters.

In essence, these rights consist of EU registered trade marks and applications for such, and 'well known' marks in the sense Article 6bis of the Paris Convention (which need not be registered). For a detailed explanation of these 'well known' marks under Article 8(2)(c) EUTMR, and how they differ from Article 8(5) marks with reputation, see the Guidelines, Part C, Opposition, Section 5: Trade Marks with Reputation, paragraph 2.1.2.

Under Article 8(3) EUTMR, the opponent must show that it is the proprietor of a trade mark, acquired anywhere in the world by registration or by use (to the extent that the

law of the country of origin recognises this kind of trade mark right), for which an agent or representative of the proprietor has applied for registration in its own name without the proprietor's consent.

Article 8(4) EUTMR is the ground for opposition based on earlier non-registered trade marks or other signs used in the course of trade of more than mere local significance protected under EU legislation or Member State laws that confer on their proprietor the right to prohibit the unauthorised use of a subsequent trade mark. The opponent must prove that it acquired the right invoked (which may be use or registration based) before the application date or, as the case may be, before the priority date of the contested mark, in accordance with the conditions of protection of the applicable law. In addition, the opponent must also prove use of more than mere local significance of such a right before the date of priority of the contested mark.

Article 8(4a) EUTMR is the ground for opposition based on designations of origin or geographical indications protected under EU legislation or Member State laws that confer on the person authorised under such laws the right to prohibit the unauthorised use of a subsequent trade mark. The opponent must prove that the designation of origin or geographical indication invoked is earlier than the date of application or, as the case may be, the priority date of the contested mark.

Various legal grounds, based on different earlier rights, may be alleged in either the same or multiple oppositions to the same EUTM application.

The Office's practice is based on the legal provisions of the EUTMR applied directly or by analogy, as confirmed by the case-law of the General Court (judgment of 16/09/2004, T-342/02, 'MGM' and 11/05/2006, T-194/05, 'TeleTech'). Namely:

- **Multiple oppositions:** Rule 21(2) and (3) EUTMIR allows the Office to examine only the 'most effective' opposition(s), suspending the rest and eventually deeming them to have been dealt with if the application is rejected on the basis of the chosen opposition. With regards to the 'most effective' opposition, see below.
- **Multiple earlier rights in one opposition:** the Court has observed that grouping various earlier rights in one opposition is, for practical purposes, the same as presenting multiple oppositions, making it possible for the Office to base the rejection of the application on the 'most effective' right(s). With regards to the 'most effective' earlier right, see below.
- **Multiple legal grounds in opposition(s):** if the opposition is successful in its entirety on the basis of the 'most effective' legal ground(s), it is not necessary to examine the remaining legal grounds. If a necessary requirement of a legal ground is not fulfilled, it is not necessary to examine the remaining requirements of that provision. With regards to the 'most effective' legal ground(s), see below.

4 The Purpose of Opposition Proceedings and the most Expedient way to Treat them

The Court of Justice has stated that the sole purpose of opposition proceedings is to decide whether the application may proceed to registration and not to pre-emptively settle potential conflicts (e.g. at a national level arising from the possible conversion of

the EUTM application) (judgment of 11/05/2006, T-194/05, 'TeleTech', paragraphs 25-27).

The Court of Justice has confirmed clearly that the Office is under no obligation to examine all the earlier oppositions, rights and legal grounds invoked against the same EUTM application, if one of them suffices to reject the EUTM application. Nor is it obliged to choose the earlier right with the widest territorial scope so as to prevent the eventual conversion of the application in as many territories as possible (judgment of 16/09/2004, T-342/02, 'MGM' and 11/05/2006, T-194/05, 'TeleTech').

This principle allows for a more expedient treatment of oppositions. The Office is free to choose what it regards as the 'most effective' opposition(s), earlier right(s) and legal ground(s) and which one to examine first in light of the principle of procedural economy.

The 'most effective' opposition can normally be defined as the opposition which allows the Office to refuse the registration of the opposed EUTM application to the broadest possible extent and in the simplest manner.

The 'most effective' earlier right can normally be defined as the most similar (the closest) sign covering the broadest scope of goods and services and/or the right covering the most similar goods and services.

The 'most effective' legal ground can normally be defined as the opposition ground which presents the Office with the simplest manner of refusing the registration of the opposed EUTM application to the broadest possible extent.

Generally speaking, if applicable, Article 8(1)(a) will be the simplest ground in terms of procedural economy on which to reject an EUTM application, since the Office will not need to enter into an analysis of similarities and differences between the signs or goods/services, nor will a finding of likelihood of confusion be necessary. Failing that, the factual circumstances of each opposition will determine whether Article 8(1)(b), 8(3), 8(4), 8(4a) or 8(5) are the next 'most effective' grounds (for example, if the goods and services of the earlier right and the EUTM application are different, Articles 8(1)(b) and (3) cannot serve as a valid basis of opposition, the former requiring at least some similarity in this respect, and the latter requiring at least closely related or commercially equivalent goods and services).

If evidence of use has been requested by the applicant in relation to some of the earlier rights, the Office will normally firstly consider if one earlier right not yet under the use obligation is capable of fully sustaining the opposition. If not, other earlier rights not yet under the use obligation will be examined to see if the opposition can be fully sustained on such a cumulative basis. In these cases, the EUTM application will be rejected without it being necessary to consider proof of use. Only if no such earlier right(s) is (are) available, will the Office consider those earlier rights against which proof of use was requested.

***GUIDELINES FOR EXAMINATION OF
EUROPEAN UNION TRADE MARKS***

***EUROPEAN UNION
INTELLECTUAL PROPERTY OFFICE
(EUIPO)***

PART C

OPPOSITION

SECTION 1

PROCEDURAL MATTERS

Table of Contents

1	Introduction: General Outline of Opposition Proceedings	6
2	Admissibility Check.....	7
2.1	Notice of opposition in writing	7
2.1.1	Early oppositions against an international registration	7
2.1.2	Early opposition against an EUTM application.....	8
2.2	Payment	8
2.2.1	Notice of opposition late, payment within the opposition period	8
2.2.2	Time of payment.....	9
2.2.2.1	Payment by bank transfer.....	9
2.2.2.2	Payment by current account.....	9
2.2.3	Consequences in the event of non-payment.....	10
2.3	Languages and translation of the notice of opposition	10
2.3.1	Language of proceedings	10
2.3.2	Language of the notice of opposition and translations	11
2.3.3	Examples	12
2.4	Admissibility check	12
2.4.1	Absolute admissibility requirements	13
2.4.1.1	Identification of the contested EUTM application.....	13
2.4.1.2	Identification of the earlier marks/rights	14
2.4.1.3	Identification of grounds	18
2.4.2	Relative admissibility requirements	18
2.4.2.1	Dates	19
2.4.2.2	Representation of earlier marks/signs	19
2.4.2.3	Goods and services.....	21
2.4.2.4	Earlier mark with a reputation: scope of reputation	22
2.4.2.5	Identification of the opponent	23
2.4.2.6	Professional representation.....	27
2.4.2.7	Signature	28
2.4.2.8	Relative admissibility requirements: sanctions	29
2.4.3	Optional indications	29
2.4.3.1	Extent of the opposition	29
2.4.3.2	Reasoned statement	30
2.5	Notification of the notice of opposition	30
3	Cooling-Off Period.....	31
3.1	Setting the cooling-off period in motion.....	31
3.2	Extension of the cooling-off period.....	32
4	Adversarial Stage	33
4.1	Completion of the opposition.....	33
4.2	Substantiation	33
4.2.1	EUTMs and EUTM applications	34
4.2.2	Converted EUTMs and EUTM applications.....	34
4.2.2.1	Opposition based on EUTM (application) (to be) converted	34
4.2.2.2	Opposition based on EUTM (application) that is subsequently converted.....	34
4.2.3	Trade mark registrations or applications that are not EUTMs	35
4.2.3.1	Certificates issued by the appropriate official body	35
4.2.3.2	Extracts from official databases.....	36

4.2.3.3	Extracts from official bulletins of the relevant national trade mark offices and WIPO.....	37
4.2.3.4	Duration of a trade mark registration.....	37
4.2.3.5	Verification of evidence.....	39
4.2.3.6	Renewal certificates.....	40
4.2.3.7	Entitlement to file the opposition.....	40
4.2.4	Substantiation of well-known marks, claims of reputation, trade marks filed by an agent, earlier signs used in the course of trade, designations of origin or geographical indications.....	42
4.2.4.1	Well known marks.....	42
4.2.4.2	Marks with reputation.....	42
4.2.4.3	Non-registered trade mark or another sign used in the course of trade.....	42
4.2.4.4	Protected designations of origin, protected geographical indications.....	43
4.2.4.5	Mark filed by an agent or representative.....	44
4.2.5	Sanction.....	44
4.3	Translation/changes of language during the opposition proceedings. 44	
4.3.1	Translations of evidence of trade mark registrations and of facts, evidence and arguments submitted by the opponent to complete its file....	45
4.3.1.1	Sanction.....	46
4.3.2	Translation of further observations.....	46
4.3.3	Translation of documents other than observations.....	47
4.3.4	Proof of use.....	48
4.3.5	Change of language during opposition proceedings.....	49
4.4	Documents not readable/reference to other files..... 49	
4.4.1	Documents not readable.....	49
4.4.2	No return of original documents.....	49
4.4.3	Confidential information.....	50
4.4.4	References made to documents or items of evidence in other proceedings.....	50
4.5	Further exchanges..... 51	
4.5.1	Additional evidence for proof of use.....	52
4.6	Observations by third parties..... 52	
5	Termination of Proceedings..... 53	
5.1	Friendly settlement..... 53	
5.2	Restrictions and withdrawals..... 54	
5.2.1	Restrictions and withdrawals of EUTM applications.....	54
5.2.1.1	Withdrawal or restriction before the admissibility check is made.....	55
5.2.1.2	Restrictions and withdrawals of EUTM applications before the end of the cooling-off period.....	55
5.2.1.3	Restrictions and withdrawals of EUTM applications after the end of the cooling-off period.....	56
5.2.1.4	Restrictions and withdrawals of EUTM applications after a decision has been taken.....	57
5.2.1.5	Language.....	57
5.2.2	Withdrawal of oppositions.....	58
5.2.2.1	Withdrawal of the opposition before the end of the cooling-off period.....	58
5.2.2.2	Withdrawal of the opposition after the end of the cooling-off period.....	58
5.2.2.3	Withdrawal of the opposition after a decision has been taken.....	58
5.2.2.4	Language.....	59
5.2.3	Withdrawals of withdrawals/restrictions.....	59
5.3	Decision on substance..... 59	
5.3.1	Earlier right not proven.....	59
5.3.2	Ceasing of existence of the earlier right.....	59

5.4	Fee refund	60
5.4.1	Opposition deemed not entered	60
5.4.1.1	Opposition and withdrawal of the opposition filed the same date	60
5.4.1.2	Refund after republication	60
5.4.2	Refund in view of withdrawals/restrictions of EUTM application	60
5.4.2.1	EUTM application withdrawn/restricted before the end of the cooling-off period	60
5.4.2.2	Opposition withdrawn due to restriction of EUTM application within the cooling-off period	61
5.4.3	Multiple oppositions and refund of 50 % of the opposition fee	61
5.4.4	Cases where the opposition fee is not refunded	61
5.4.4.1	Opposition withdrawn before the end of the cooling-off period NOT due to a restriction	61
5.4.4.2	Opponent's withdrawal is earlier	62
5.4.4.3	Settlement between the parties before commencement of proceedings	62
5.4.4.4	Termination of proceedings for other reasons	62
5.5	Decision on the apportionment of costs	63
5.5.1	Cases in which a decision on costs must be taken	63
5.5.2	Cases in which a decision on costs is not taken	63
5.5.2.1	Agreement on costs	63
5.5.2.2	Information from potential 'successful party'	63
5.5.3	Standard cases of decisions on costs	64
5.5.4	Cases that did not proceed to judgment	64
5.5.4.1	Multiple oppositions	64
5.5.4.2	Rejection of an application on the basis of absolute grounds or formalities	65
5.5.4.3	Cases of joinder	66
5.5.4.4	The meaning of 'bear one's own costs'	66
5.6	Fixing of costs	66
5.6.1	Amounts to be reimbursed/fixed	66
5.6.2	Procedure if the fixing of costs is contained in the main decision	67
5.6.3	Procedure if a separate fixing of costs is needed	67
5.6.3.1	Admissibility	68
5.6.3.2	Evidence	68
5.6.4	Review of fixing of costs	68
6	Procedural Issues	69
6.1	Correction of mistakes	69
6.1.1	Correction of mistakes in the notice of opposition	69
6.1.2	Correction of mistakes and errors in publications	69
6.2	Time limits	70
6.2.1	Extension of time limits in opposition proceedings	70
6.2.1.1	Non-extendable and extendable time limits	70
6.2.1.2	Request made in time	70
6.2.1.3	Extension of a time limit by the Office on its own initiative	71
6.2.1.4	Signature	72
6.3	Suspension	72
6.3.1	Suspension requested by both parties	72
6.3.2	Suspensions by the Office <i>ex officio</i> or at the request of one of the parties	73
6.3.2.1	Explanation of the basic principle, timing of suspension	73
6.3.2.2	Earlier EUTM applications or registrations	74
6.3.2.3	Earlier national/international marks (applications or registrations/rights)	74
6.3.2.4	Examples	75
6.3.3	Multiple oppositions	75
6.3.3.1	After rejection of the EUTM application	75

6.3.4	Procedural aspects.....	76
6.3.4.1	Monitoring suspended files.....	76
6.3.4.2	Resuming the proceedings.....	76
6.3.4.3	Calculation of time limits.....	76
6.4	Multiple oppositions.....	77
6.4.1	Multiple oppositions and restrictions	77
6.4.2	Multiple oppositions and decisions	78
6.4.3	Joinder of proceedings	79
6.5	Change of parties (transfer, change of name, change of representative, interruption of proceedings).....	80
6.5.1	Transfer and opposition proceedings	80
6.5.1.1	Introduction and basic principle	80
6.5.1.2	Transfer of earlier EUTM.....	80
6.5.1.3	Transfer of earlier national registration.....	82
6.5.1.4	Opposition based on a combination of EUTM registrations and national registrations.....	83
6.5.1.5	Transfer of the contested EUTM application	83
6.5.1.6	Partial transfer of a contested EUTM application	83
6.5.2	Parties are the same after transfer	84
6.5.3	Change of names	84
6.5.4	Change of representatives	84
6.5.5	Interruption of the proceedings due to death or legal incapacity of the applicant or its representative.....	85
6.5.5.1	Death or legal incapacity of the applicant.....	85
6.5.5.2	Applicant prevented from continuing the proceedings before the Office owing to legal reasons (e.g. bankruptcy).....	85
6.5.5.3	Death or prevention for legal reasons of the representative of the applicant before the Office to act.....	86

1 Introduction: General Outline of Opposition Proceedings

Opposition proceedings start with receipt of the notice of opposition. The applicant is notified of the notice of opposition filed and receives a copy of the documents on file.

Thereafter, once the payment of the opposition fee has been checked, the notice of opposition is checked for compliance with other formal requirements of the Regulations.

In general, two kinds of admissibility deficiencies can be distinguished:

1. *Absolute deficiencies*, i.e. deficiencies that cannot be remedied after the expiry of the opposition period. If the opponent does not remedy these deficiencies on its own initiative within the opposition period, the opposition is inadmissible.
2. *Relative deficiencies*, i.e. deficiencies that can be remedied after the expiry of the opposition period. The Office invites the opponent after the expiry of the opposition period to remedy the deficiency within a non-extendable time limit of two months, failing which the opposition will be rejected as inadmissible.

It is important to note that in order to safeguard the principle of impartiality, the Office will not send any communication concerning the payment of the opposition fee or admissibility deficiencies during the opposition period.

After the examination of admissibility of the opposition, a notification is sent to both parties to set the time limits for the proceedings. This starts with a period during which the parties are incentivised to negotiate an agreement because, if certain conditions are met, the opposition fee will be refunded — this is known as the ‘cooling-off’ period. The cooling-off period is set to expire two months from the notification of admissibility. It can be extended once by 22 months and last up to a total of 24 months.

Once the cooling-off period has expired, the adversarial part of the proceedings begins. The opponent is then allowed two more months to submit all evidence and observations it considers necessary to make its case. After these two months have lapsed, and once the submitted evidence and observations (if any) have been forwarded, the applicant has two months to reply to the opposition.

At this stage, the applicant can require the opponent to prove that any earlier marks registered for more than five years have been used by filing a request for proof of use. If such a request is made, the applicant may wait until the opponent has adduced such proof before filing its evidence and observations. The opponent is then given the opportunity to comment on the applicant’s observations.

If the applicant does not request proof of use but submits evidence and observations, the opponent is given two months to comment on the applicant’s submissions and after these exchanges the opposition is normally ready for decision.

In some cases it may be necessary or useful to have another exchange of observations. This may occur when the case deals with complex issues or when the opponent raises a new point that is admitted to the proceedings. In this case the applicant may be given a possibility of replying. It is then up to the examiner to decide if another round should be given to the opponent.

The Office may request the parties to restrict their observations to particular issues, permitting observations on other issues at a later point in time.

Once the parties have submitted their observations, the proceedings are closed, the file is ready for taking a decision on substance and the parties are informed accordingly.

When an opposition is filed against an international registration designating the EU, all references in the Guidelines to EUTM applications must be read as including international registrations designating the EU. Part M of the Guidelines, International Marks, which has been drafted specifically for international marks, also refers to oppositions.

2 Admissibility Check

2.1 Notice of opposition in writing

Article 41 EUTMR Rule 16a EUTMIR Rule 82 and Decision EX-132 of the President of the Office

The notice of opposition has to be received by the Office in written form within the opposition period, namely within three months from the publication of the contested EUTM application.

A notice of opposition may be filed by using the electronic form available in the User Area of the Office's website. Once submitted, the electronic form will be processed automatically and a receipt for the opponent will be issued. A notice of opposition may also be filed by fax, post or personal delivery, and in all these cases the opponent will also be sent a receipt after the notice of opposition has been keyed into the Office's IT system.

The applicant receives a copy of the notice of opposition (and of any document submitted by the opposing party) for information purposes. If the opposition is based on a European Union trade mark, the applicant is also informed that it can access information about earlier European Union trade marks via the online search tools, which are available on the Office's website.

2.1.1 Early oppositions against an international registration

Article 156(2) EUTMR Rule 114(3) EUTMIR
--

Opposition against an international registration designating the EU (IR) may be filed within a period of three months starting one month after the date of first republication. For example, if first republication is on 15/04/2016, then the opposition period starts on 16/05/2016 and ends on 15/08/2016.

For international registrations, whose date of first republication falls before the entry into force on 23/03/2016 of the amendment of Article 156(2) EUTMR brought about by Regulation No 2015/2424, the previous time limit applies, according to which an opposition is filed within a period of three months starting six months after the date of first republication. For example, if first republication is on 22/03/2016, then the opposition period starts on 23/09/2016 and ends on 22/12/2016.

However, oppositions filed after the republication of the IR but prior to the start of the opposition period will be kept on hold and be deemed to have been filed on the first day of the opposition period. The opponent will be informed accordingly. If the opposition is withdrawn before that date, the opposition fee will be refunded.

2.1.2 Early opposition against an EUTM application

Articles 39 and 41 EUTMR

Any notice of opposition against an EUTM application received before commencement of the opposition period will be kept on hold and be deemed to have been filed on the first day of the opposition period, namely the first day after the publication of the EUTM application in Part A.1 of the EUTM Bulletin. The opponent will be informed accordingly. If the opposition is withdrawn before that date or the EUTM application is refused or withdrawn before publication, the opposition fee will be refunded.

2.2 Payment

For general rules on payments, refer to the Guidelines, Part A, General Rules, Section 3, Payment of Fees, Costs and Charges.

2.2.1 Notice of opposition late, payment within the opposition period

Rule 17(2) EUTMIR

If the payment was received by the Office within the opposition period but the notice of opposition was received late, the opposition is inadmissible. In this case the Office will keep the opposition fee. The opponent must be notified and may comment on the finding of inadmissibility within the time limit set by the Office.

If the opponent submits convincing evidence, such as fax reports, confirmation of receipt by messenger and/or delivery slips for registered mails that proves that the notice of opposition was not late and was in fact correctly received by the Office within the three-month opposition period, the Office must reconsider its finding and accept the opposition as having been received within the opposition period. In this case the admissibility check can continue. If the evidence submitted by the opponent does not prove that the notice of opposition was received within the opposition period or if the opponent does not reply within the set time limit, a decision ruling the opposition inadmissible has to be taken. When notifying the opponent of the decision, the applicant must be sent a copy.

2.2.2 Time of payment

Article 41(3) and (4) EUTMR
Article 144b EUTMR
Rule 17(1) EUTMIR

The Office has to receive the full amount of the opposition fee within the opposition period. If the opposition fee was not received within the opposition period, the notice of opposition is deemed not to have been entered.

2.2.2.1 Payment by bank transfer

Payments by bank transfer received after the opposition period are considered to be made within the opposition period if the opponent (i) files evidence showing that it gave the transfer order to a banking establishment within the opposition period and (ii) pays a surcharge of 10 % of the opposition fee. No surcharge will be payable if the evidence shows that the order to the bank was given no less than 10 days before the expiry of the opposition period.

2.2.2.2 Payment by current account

Articles 144a(1) and 144b(1) EUTMR
Decision EX-06-1 of the President of the Office

If the opponent or its representative hold a current account, the payment is considered effective on the day the opposition is received.

Since a payment by current account is considered to have been made on the date of receipt of the opposition, if the notice of opposition arrived late, the payment is also late. Therefore, the opposition is deemed not to have been entered.

The absence of an indication or incorrect indication of the amount of the opposition fee does not have any negative effect on the opposition, because it is clear that the opponent wanted to pay the amount of the opposition fee.

Even if there is no express request from the opponent, the existence of a current account will in such case be sufficient for the account to be debited. This is true regardless of whether the opposition form is used or not.

The only exception to this rule is made when the holder of a current account who wishes to exclude the use of the current account for a particular fee or charge informs the Office thereof in writing (e.g. indicating bank transfer).

Fee payment by debiting a current account held by a third party

Payment of an opposition fee by debiting a current account held by a third party requires an explicit authorisation of the holder of the current account that its account can be debited for the benefit of the particular fee. In such cases the opponent must file an authorisation within the opposition period.

Payment is considered to be made on the date the Office receives the authorisation.

2.2.3 Consequences in the event of non-payment

Rule 17(1) and (4) and Rule 54 EUTMIR

An opposition for which the payment is not made within the opposition period will be deemed not to have been entered and the opponent must be notified of this finding.

A copy of this letter must be sent to the applicant for information purposes at the same time.

If, within the time limit allowed, the opponent submits evidence that the Office finds that the loss of rights was inaccurate, and it proves that the payment was made on time, a notification has to be sent with a copy to the applicant, together with the evidence provided by the opponent.

If an opposition is deemed not to have been entered, the opponent has the right to request a formal decision within two months. If it does so, the decision must be sent to both parties.

For cases in which the opposition fee has not been paid in full or after the opposition period, see paragraph 5.4.1 below.

2.3 Languages and translation of the notice of opposition

Article 119(5) and (6) EUTMR Rule 16 and Rules 17(3), 83(3) and 95(b) EUTMIR

2.3.1 Language of proceedings

The rules regarding the language of proceedings are explained in detail in the Guidelines, Part A, General Rules, Section 4, Language of Proceedings.

According to these rules, in opposition proceedings there are cases where the opponent has a choice between two possible languages of proceedings (the first and second languages of the contested EUTM application, both being languages of the Office), and cases where there is only one possible language of proceedings (when the first language is not one of the five languages of the Office, the language of the opposition proceedings will be the second language of the contested EUTM application).

In cases where there is a choice, the language of proceedings will be that expressly indicated by the opponent in the notice of opposition or, in the absence of an express indication, the language in which the notice of opposition was filed, provided in both cases that it is one of the two possible languages of proceedings. If the opponent indicates a language that is incorrect, or does not indicate any language and the notice of opposition is not filed in one of the two possible languages of proceedings, the Office will send a letter to the opponent asking it to indicate the language of proceedings within a specified time limit. The letter will be sent in the first language of the contested

EUTM application. If no reply is received to this letter, the opposition will be rejected as inadmissible.

In cases where there is no choice, there is no need to ask the opponent to indicate a language of proceedings, so the Office will consider that the language of proceedings is the second language of the EUTM application, regardless of any possible incorrect indication of a different language in the notice of opposition.

2.3.2 Language of the notice of opposition and translations

The notice of opposition is filed in one of the five languages of the Office.

If the notice of opposition is filed in a language that cannot be the language of proceedings, in accordance with what has been explained in the previous section, a distinction will be made depending on whether it has been filed using one of the official opposition forms provided by the Office or not.

1. **When the Office's official opposition form has been used**, in any of the official languages of the EU, there is no need to submit a translation of the notice of opposition as such, since when the opposition is notified, a blank form in the language of the proceedings will be annexed by the Office.

If the textual elements important for admissibility do not need to be translated (e.g. numbers, names or addresses) and all the appropriate boxes are ticked, the opposition will be admissible.

If there are some textual elements important for admissibility that need to be translated into the language of proceedings (e.g. the goods and services on which the opposition is based, see paragraph 2.4.2.3 below), the corresponding admissibility deficiency will be issued.

Finally, if there are some textual elements that are not translated but are not relevant for admissibility purposes, such as an explanation of grounds (optional indication), they will be deemed not to 'exist'. For more information see paragraph 2.4, Admissibility check, below.

2. **When the Office's official opposition form has not been used:**

If the notice of opposition is in one of the languages of the Office that cannot be the language of proceedings, and in accordance with Article 119(6) EUTMR and Rule 16(1) EUTMIR, the opponent will on its own initiative file a translation in the language of proceedings within one month from the expiry of the opposition period. If none is received the opposition is inadmissible.

If the notice of opposition is not in one of the five languages of the Office, and in accordance with Article 119(5) EUTMR, the opposition is inadmissible.

In both cases, if no language of proceedings (or an incorrect one) has been indicated in the notice of opposition, the notification of the inadmissibility will be sent in the first language of the contested EUTM application if it is a language of the Office, or otherwise in the second language of the contested EUTM application.

2.3.3 Examples

As an illustration of what has been explained in paragraphs 2.3.1 and 2.3.2, here are some examples:

- a) The languages of the EUTM application are PT and EN. The Portuguese language version of the official form has been used, none of the textual elements relevant for admissibility need to be translated and the appropriate boxes are ticked. The opposition is admissible. As the language of proceedings can only be EN, it is not necessary to ask the opponent to indicate the language of the opposition proceedings. When the opposition is notified a blank official form in EN must be attached, and the language of the proceedings indicated.
- b) The languages of the EUTM application are DE and EN. The French language version of the official form has been used, none of the textual elements need to be translated and the appropriate boxes are ticked. As the language of proceedings can be either DE or EN, the opponent must be asked to indicate the language of the opposition proceedings. Once the opponent has indicated one of the possible languages of proceedings, the opposition will be admissible. When the opposition is notified, a blank official form in the indicated language must be attached.
- c) The languages of the EUTM application are DE and EN. The notice of opposition has not been filed using the official form, it is in French and no choice of language of proceedings has been indicated. The opponent will submit on its own initiative a translation of the notice of opposition into either DE or EN within a period of one month of the expiry of the opposition period. Otherwise the opposition will be rejected as inadmissible, and the corresponding notification will be sent in DE.
- d) The languages of the EUTM application are CZ and EN. The notice of opposition has not been filed using the official form and is in Czech. The opposition will be rejected as inadmissible and the corresponding notification will be sent in EN.

2.4 Admissibility check

Rules 15 and 17 EUTMIR

The admissibility check covers both absolute and relative requirements:

- absolute requirements are the indications and elements that must be present in the notice of opposition or submitted by the opponent on its own initiative within the opposition period, as laid down in Rule 15(1) and Rule 15(2)(a)-(c) EUTMIR;
- relative requirements are the indications and elements which, if they are not provided within the opposition period, trigger a deficiency notice by the Office, allowing the opponent to remedy this within a non-extendable time limit of two months, as laid down in Rule 15(2)(d)-(h) EUTMIR;
- optional indications (that determine the scope of the opposition but do not in principle lead to a finding of non-admissibility) are laid down in Rule 15(3) EUTMIR.

For the purposes of assessing the admissibility of the opposition the Office must base itself solely on the claims contained in the documents submitted by the opponent within the opposition period (decision of 21/07/2014, R 1573/2013-4, OKAY/O-Key).

2.4.1 Absolute admissibility requirements

If the opposition is inadmissible due to absolute admissibility requirements, the opponent must be informed and invited to comment on the admissibility. If the inadmissibility is confirmed, a decision rejecting the opposition is sent and copied to the applicant.

Oppositions against EUTM applications

The earlier marks/rights are examined to see if at least one is clearly identified. If the only earlier right on which the opposition is based is not duly identified, the opposition is inadmissible and the opponent is invited to comment on the inadmissibility before the decision on inadmissibility is taken. If the only earlier right on which the opposition is based is duly identified (absolute requirements), the Office will examine whether it also meets the relative admissibility requirements.

If the opposition is based on more than one earlier right and at least one of them has been correctly identified, the examination of admissibility (relative requirements) can proceed based on that earlier right. The parties are informed thereof when the notification of the time limits of the opposition proceedings is sent to the parties.

If necessary, the admissibility issue will be dealt with in the decision on the opposition.

Oppositions against IRs with EU designation

Concerning oppositions against IRs with EU designation, a full admissibility check is carried out. This check must extend to all earlier rights. If none of the earlier rights is duly identified, the opposition is inadmissible and the opponent is invited to comment on the inadmissibility before the decision on inadmissibility is taken.

2.4.1.1 Identification of the contested EUTM application

Rule 15(2)(a) and Rule 17 EUTMIR

The mandatory elements for identifying the contested EUTM application are the application number and the name of the applicant.

If, for example, the application number indicated does not correspond to the name of the applicant indicated, the Office will decide if it can be established without any doubt which is the contested EUTM application. If the applicant's name is not indicated, it can be found in the Office's IT system.

The date of publication is an optional indication, which helps to double-check the identification of the EUTM application. Even if it is missing, the EUTM application can be sufficiently identified through the other indications.

Only one EUTM application can be contested in one notice of opposition.

If the EUTM application cannot be identified, this deficiency can only be remedied on the opponent's initiative during the three-month opposition period, otherwise the opposition is inadmissible and an invitation to comment on the inadmissibility has to be sent. If the inadmissibility is confirmed, a decision rejecting the opposition is sent and copied to the applicant.

2.4.1.2 Identification of the earlier marks/rights

Article 8(2) EUTMR Rule 15(2)(b) and Rule 17(2) EUTMIR

Identification elements are to be looked for not only in the notice of opposition, but also in annexes or other documents filed together with the opposition or any documents submitted within the opposition period.

An opposition can be based on six types of earlier rights: (1) earlier trade mark registrations or applications, (2) earlier trade mark registrations or applications with a reputation, (3) earlier well-known marks, (4) earlier unregistered trade marks, (5) earlier signs used in the course of trade and (6) protected designation of origin and protected geographical indications.

Earlier rights that are not earlier

Articles 8(2) and 41(1) EUTMR

For an earlier right to be earlier it must have, in the absence of any priority, an application date that is prior to the day on which the contested EUTM application was filed. In the case of conflict between a national mark and an EUTM application, the hour and the minute of filing of the national mark is not relevant for determining which mark is earlier (judgment of 22/03/2012, C-190/10, Rizo, EU:C:2012:157).

Sometimes an opposition is based on one or more marks or other rights that are not earlier than the EUTM application. Establishing whether a right is earlier takes place at the admissibility stage.

When the only earlier mark is or all earlier marks are not earlier, the Office will inform the opponent of the inadmissibility and invite it to comment on that issue before a decision on inadmissibility is taken.

Where the opposition is based on more than one right, one being earlier and one or more not earlier, the Office will notify the admissibility of the opposition on the basis of the earlier one.

Earlier trade mark registrations or applications

Article 8(2)(a) and (b) and Article 34(2) EUTMR
Rule 15(2)(b) and Rules 17(2) and 19(1) and (3) EUTMIR

These rights are European Union trade mark registrations or applications, international registrations designating the European Union, national or Benelux trade mark registrations or applications (including 'ex-European Union trade marks' for which a request for conversion has been filed) and international registrations under the Madrid Agreement or Protocol having effect in a Member State.

The seniority claimed in an EUTM can be taken into account within the meaning of Article 8(2)(a) EUTMR provided that the proprietor of the EUTM has surrendered the earlier mark or allowed it to lapse within the meaning of Article 34(2) EUTMR and that this fact is proved by the opponent.

In such a case, the opponent must base its opposition on the European Union trade mark, explicitly claiming within the three-month opposition period that the national mark continues to exist through the seniority claimed in the EUTM. A clear link must be established between the EUTM indicated and the earlier mark for which the seniority was claimed in the EUTM. Within the time limit set according to Rule 19(1) EUTMIR, the opponent must provide sufficient proof, emanating from the Office, that the seniority claim has been accepted and proof, emanating from the administration by which the national trade mark was registered, that the national mark has been surrendered or allowed to lapse according to Article 34(2) EUTMR.

The absolute identification elements for earlier trade mark registrations and applications are:

- the registration/application number;

National applications deriving from the conversion of an earlier EUTM (application) are considered to come into existence as soon as a valid conversion request is submitted. Such rights will be properly identified for admissibility purposes if the opponent indicates the number of the EUTM (application) under conversion and the countries for which it has requested the conversion.

- the indication whether the earlier mark is registered or applied for;
- the Member State, including Benelux, where the earlier mark is registered/applied for or, if applicable, the indication that it is an EUTM.

If the Member State is not indicated in the opposition notice but a certificate is attached, it is considered that the Member State is sufficiently identified, even if the certificate is not in the language of the proceedings. A translation of the certificate should not be asked for at this stage in the proceedings. Where a certificate of an international registration is concerned it is assumed that the opposition is based on this mark in all the designated Member States and/or the Benelux countries indicated in the certificate. However, the basic registration is an independent earlier right, which may be claimed separately.

Trade marks filed by an agent

Article 8(3) EUTMR
Rule 15(2)(b)(i) EUTMIR

A trade mark filed by an agent is a contested EUTM application in relation to which the opponent claims that the applicant, who has or had a business relationship with the opponent (its agent or its representative), applied for the mark without its consent.

The earlier marks or rights on which the opposition is based must be identified according to the same criteria as earlier trade mark registrations or applications, that is to say, the country and registration or application number must be given. The representation of the mark (in colour if applicable) must be given only if the proprietor's earlier mark is an unregistered mark, because in this case no registration number can be provided to clearly identify the earlier mark. For unregistered word marks, the word that makes up the mark must be indicated. For unregistered figurative or other marks, the representation of the mark as it is used and claimed by the proprietor must be provided. See also the Guidelines, Part C, Opposition, Section 3, Unauthorised Filing by Agents of the TM Proprietor (Article 8(3) EUTMR).

Earlier trade mark registrations or applications with reputation

Article 8(5) EUTMR
Rule 15(2)(c) and (g) EUTMIR

Under Article 8(5) EUTMR an opposition can be based on a mark with reputation, invoked against goods and services that are dissimilar and/or similar. The mark with a reputation can be an earlier European Union, international, Benelux and national registration, and an earlier application subject to its registration.

The same identification requirements apply as for registered marks invoked under Article 8(1)(b) EUTMR: number and Member State/region of protection. The indication where and for which goods/services the mark is reputed is a relative admissibility requirement.

Earlier well-known mark

Article 8(2)(c) EUTMR
Rule 15(2)(b)(i) and (ii) and Rule 17(2) EUTMIR

Article 8(2)(c) EUTMR protects well-known marks within the meaning of Article 6*bis* of the Paris Convention. This can be a registered or an unregistered mark or a mark that is not registered in the territory where it is to be protected (irrespective of registration in the territory of origin).

The absolute indications are:

- An indication of the Member State where the mark is well known: if this indication cannot be deduced from the documents on file, the mark is inadmissible as a basis for opposition.

- If the mark is a registered mark, the indications referred to in Rule 15(2)(b)(i) EUTMIR, i.e. the registration number and the Member State where the mark is registered.
- If the mark is not registered, a representation of the mark. For word marks, this is the indication of the word that makes up the mark. For figurative or other marks, the representation of the mark (in colour if applicable) as it is used and claimed to be well-known must be provided. If the opposition is furthermore based on one registered trade mark, but no representation of the well-known mark is given, the Office assumes that both trade marks refer to the same sign and that the opponent claims the registered mark to be well-known (decision of 17/10/2007, R 0160/2007-1, QUART/Quarto).

Earlier non-registered marks and earlier signs used in the course of trade

Article 8(4) EUTMR
Rule 15(2)(b)(iii) and Rule 17(2) EUTMIR

This category consists of signs that are unregistered and used as trade marks or of a great number of different earlier rights, inter alia rights to a company name, trade name, business sign, ensigns, titles of protected literary/artistic work and the right to a sign under passing off.

The absolute indications are:

- an indication of the kind or nature of the right. The nature of the right determines the scope of the opposition and the applicant's defence depends on it. 'Trade name', 'company name', 'business sign', 'passing off', 'titles of protected literary/artistic works' are acceptable indications of the nature of rights. By contrast, general terms such as 'common law' and 'unfair competition' without an indication of the specific nature of the right are not accepted. This list is not exhaustive. If the opponent bases its opposition on a right that cannot be an earlier right under Article 8(4) EUTMR, for example a copyright or a design, the opposition is admissible. However, after the proceedings have commenced the opposition will be rejected on substance;
- an indication of the Member State where the right is claimed to exist;
- a representation of the earlier right (in colour if applicable).

In the absence of the previous indications, the relevant right will be inadmissible.

Protected designation of origin and/or geographical indications

Article 8(4a) EUTMR
Rule 15(2)(b)(iii) and Rule 17(2) EUTMIR

Under Article 8(4a) EUTMR an opposition can be based on an earlier protected designation of origin or a geographical indication provided that a) the opponent is authorised under the relevant law to exercise the rights arising from the invoked designation of origin or geographical indication and b) the protected designation of

origin or geographical indication confers the right to prohibit the use of a subsequent trade mark.

The absolute indications are:

- an indication of the nature of the right, namely protected designation of origin or geographical indication;
- an indication of the territory where the protected designation of origin or geographical indication is claimed to be protected, namely the Union or a Member State;
- a representation of the protected designation of origin or geographical indication (word only).

In the absence of the previous indications, the relevant right will be inadmissible.

2.4.1.3 Identification of grounds

Article 41(3) and Article 75 EUTMR Rule 15(2)(c) and Rule 17(2) EUTMIR

An opposition without any indication of grounds is inadmissible if this deficiency is not remedied before the expiry of the opposition period.

The specification of the grounds should consist of a statement to the effect that the respective requirements under Article 8 EUTMR are fulfilled. Arguments and evidence are voluntary at this point in the proceedings.

In particular, the grounds are to be considered as properly indicated if:

- one of the relevant boxes in the opposition form is checked;
- the relevant box is not checked, but the earlier mark is identified and the opposition can be considered to be based on Article 8(1) EUTMR.

In both cases it is possible to identify the grounds from the notice of opposition without any doubt and the opposition is admissible.

Otherwise, before rejecting the opposition, a careful assessment of the entire notice of opposition must be made: whether indicated in the opposition form, its annexes or its supporting documents, the grounds must be unequivocally clear.

In all other cases, the opponent will be invited to present comments on inadmissibility before taking the decision rejecting the opposition.

2.4.2 Relative admissibility requirements

Rule 15(2)(d)-(h) EUTMIR

Relative deficiencies are those that can be remedied after the expiry of the opposition period. The Office invites the opponent to remedy the deficiency within two months

from notification of the deficiencies. If the opponent remedies the deficiencies, the opposition is considered admissible; if not, it will be rejected on the grounds of inadmissibility.

2.4.2.1 Dates

Rule 15(2)(d) and Rule 17(4) EUTMIR

These include the filing date and, where available, the registration date and the priority date of the earlier mark.

This requirement applies to the following rights:

- earlier European Union or national or international trade mark applications or registrations invoked under Article 8(1)(a) or (b) EUTMR,
- earlier well-known marks invoked under Article 8(2)(c) EUTMR, if they are registered in the European Union,
- earlier marks under Article 8(3) EUTMR if they are registered,
- earlier marks with a reputation invoked under Article 8(5) EUTMR.

These indications can be important in order to be able to eliminate possible errors when identifying the earlier mark. It is sufficient that these elements can be found in enclosed documents. If these elements are missing the opponent must be notified of the deficiency.

2.4.2.2 Representation of earlier marks/signs

Rule 15(2)(e) and Rules 80(2) and 17(4) EUTMIR
--

For rights that are not subject to registration this is an absolute admissibility requirement as otherwise the earlier right cannot be determined at all (see above).

The relative admissibility requirement to provide a representation of the mark under Rule 15(2)(e) EUTMIR applies to the following rights:

- earlier national or international trade mark applications or registrations invoked under Article 8(1)(a) or (b) EUTMR,
- earlier well-known marks invoked under Article 8(2)(c) EUTMR, if they are registered in the European Union,
- earlier marks with a reputation invoked under Article 8(5) EUTMR,
- marks filed by an agent (Article 8(3) EUTMR, if they are registered marks).

If a proper representation of the mark/sign has not been enclosed in the opposition notice, the opponent will be notified of the deficiency. If the opponent does not comply within the two-month time limit given, the earlier right will be rejected as inadmissible.

If the earlier mark is an EUTM, no representation is requested since it is available in the Office's databases.

If the mark is a word mark, an indication of the word is sufficient to consider that a proper representation of the mark has been submitted.

For the same purpose, if the mark is figurative, 3-D, other mark, etc., the representation of the mark as applied for or registered must be filed. When the trade mark is in colour, at least a representation of the mark in colour must be submitted.

An earlier mark will be identified as a trade mark in colour only when a representation of the mark in colour is enclosed, or an indication in this regard is mentioned in the opposition notice or in the documents attached to it. Therefore, when an indication in this regard is contained in the submitted documents without it being accompanied by a representation of the mark in colour (i.e. no graphical representation of the mark or a representation of the mark in B&W is filed), the Office will notify this deficiency. If the opponent does not comply within the two-month time limit given, the earlier right will be rejected as inadmissible.

A colour representation of the mark is not compulsory if the national mark was not published (for technical reasons) in colour, as is the practice, for example, in Cyprus and Latvia. In these cases the Office neither asks for a colour representation nor requests the opponent to file a translation of the colour indications submitted in the original language.

The following countries have either always published in colour or have done so since the date indicated:

- Belgium
- Bulgaria
- Czech Republic (1999)
- Denmark
- Germany
- Estonia (2003)
- Ireland (2003)
- Greece (2007)
- Spain (as of 31/07/2002)
- France (1992)
- Croatia (2009)
- Italy
- Lithuania (as of July 2009)
- Luxembourg
- Hungary
- Malta
- Netherlands
- Austria
- Poland (2003)
- Portugal (2006)
- Romania
- Slovenia (1992)
- Slovakia (2008)
- Finland (2005)
- Sweden

- United Kingdom (2004).

International marks have been published in colour since 1989.

If the representation on file is not clear, the Office may ask for a clearer one. If the representation that is received is incomplete or illegible and the request to provide a clear one is not complied with, the representation will be deemed not to have been received and the right will be rejected as inadmissible.

2.4.2.3 Goods and services

Rule 15(2)(f) and Rule 17(4) EUTMIR Communication No 5/07 of the President of the Office

Rule 15(2)(f) EUTMIR stipulates that the notice of opposition must contain an indication of the goods and services on which the opposition is based in the language of the proceedings. This applies to all types of earlier rights.

The opposition can be based on all the goods and services for which the earlier mark is registered or applied for, or only some of the goods and services.

According to Communication No 5/07 of the President of the Office of 12/09/2007 on changes of practice in opposition proceedings, an indication of the class number(s) is accepted as sufficient indication of the goods and services of the earlier rights on which the opposition is based. This is implemented as described below.

Part of the goods and services

If the opposition is based on part of the goods and services for which the earlier mark(s) is/are registered/applied for, these goods and services need to be listed in the language of the proceedings.

The Office will also accept an indication of the relevant class number(s), provided that a registration certificate or extract from an official source is attached (the registration certificate or extract must either be in the language of the proceedings or be translated into the language of the proceedings or make use of national or INID codes so as to clearly identify the relevant class number(s)).

If the goods and services on which the opposition is based are fewer than the goods and services for which the mark is registered, the goods and services on which the opposition is not based need not be indicated, as they are irrelevant to the proceedings.

All of the goods and services

If the opposition is based on all of the goods and services for which the earlier mark(s) is/are registered/applied for, these must be listed in the language of the proceedings.

However, instead of listing them, the opponent may refer to 'all goods and services for which the earlier mark is registered', provided that a registration certificate or extract from an official source is attached (the registration certificate or extract must either be

in the language of the proceedings or be translated into the language of the proceedings or make use of national or INID codes).

The Office will also accept an indication of the relevant class number(s) provided that a registration certificate or extract from an official source is attached (the registration certificate or extract must either be in the language of the proceedings or be translated into the language of the proceedings or make use of national or INID codes so as to clearly identify the relevant class number(s)).

Additionally, where the opponent indicates in the opposition form that the opposition is based on 'all goods and services for which the earlier right is registered' but then lists only 'part' of these goods and services (when compared with the registration certificate or relevant official extract attached to the opposition form) the Office will, in order to overcome the contradictory information contained in the notice of opposition, assume that the opposition is based on 'all goods and services for which the earlier right is registered'.

Even if the opponent has not indicated, or has not clearly indicated, on which goods and/or services it bases its opposition, it is sufficient that a registration certificate in the language of the proceedings is attached; it is then assumed that the opposition is based on the goods and services that appear in the certificate.

However, if the certificate is in a language other than the language of the proceedings or if no certificate is attached, the deficiency must be notified.

If an opposition is based on 'all identical/similar goods and services', clarification must be requested since this wording is not sufficiently clear to identify the basis of the opposition.

If an indication like 'the opposition is based on all the goods in Class 9' is used and no certificate in the language of the proceedings is attached, the Office will require a specification in the language of the proceedings.

An indication of this type is only acceptable when the opponent replies that it owns a registration with a description that mentions that the sign is registered for 'all goods in Class 9'.

For oppositions based on earlier unregistered trade marks or rights, the opponent must indicate the commercial activities in the course of which they are used.

Specific aspects: oppositions filed against international registrations designating the EU

For admissibility purposes, with regard to oppositions filed against international registrations designating the EU, an indication of the class number(s) only in the notice of opposition is not sufficient to identify the goods and services on which the opposition is based. If the opposition is based on all or part of the goods and services for which the earlier mark(s) is/are registered/applied for, these goods and services need to be listed in the language of the opposition proceedings. This list must include all the goods or services covered by that mark or at least the relevant goods or services on which the opposition is based.

2.4.2.4 Earlier mark with a reputation: scope of reputation

Rule 15(2)(g) EUTMIR

A specific requirement applies to marks with a reputation within the meaning of Article 8(5) EUTMR: an indication of the Member State in which, and the goods and services for which, the mark has a reputation must be provided.

2.4.2.5 Identification of the opponent

Article 41(1) EUTMR
Rule 1(1)(b) and Rule 15(2)(h)(i) EUTMIR

The opponent can either be a natural or a legal person. In order to be able to identify the opponent, there must be an indication of its name and address.

Until now there have been no oppositions where the opponent was not identified. If only the name of the opponent and, for example, a fax number is indicated, the opponent must be asked to give the particulars of its address.

When examining whether the opponent is clearly identified, attention should be given to the nature of the opponent, that is to say whether it is a natural or legal person. If it is unclear whether the opponent is a natural or a legal person, or when the type of legal person (for example GmbH, KG, SA, Ltd) is not indicated, the deficiency must be notified.

Entitlement

Rule 1(1)(b) and Rule 15(2)(h)(i) and (iii) EUTMIR

It is assumed that the opponent claims to be the owner of the earlier right, unless otherwise stated. Only if the opponent acts in the capacity of an authorised licensee or a person authorised under national law, does it have to make a statement to that effect, and it has to specify the basis on which it is so entitled or authorised. If those details are not given, a deficiency must be notified.

In accordance with Rule 15(2)(h)(i) EUTMIR an opponent who acts as a licensee or authorised person has to indicate its name and address in accordance with Rule 1(1)(b) EUTMIR.

- If the notice of opposition is based on the grounds of Articles 8(1) or 8(5) EUTMR and thus on trade mark registrations or applications, the notice of opposition may be filed by the owner and by the licensees of these registrations or applications, provided they are authorised by the owner.
- If the notice of opposition is based on the grounds of Article 8(3) EUTMR (an agent trade mark), it may be filed by the owner of that trade mark.
- If the notice of opposition is based on the grounds of Article 8(4) EUTMR (earlier marks or signs), it may be filed by the owner of that earlier mark or sign and by persons authorised under the relevant national law to exercise the rights to the earlier mark or sign.

- If the notice of opposition is based on the grounds of Article 8(4a) EUTMR, it may be filed by any person authorised under the relevant EU legislation or national law to exercise the rights to the earlier protected designation of origin or geographic indication.

As long as the opponent claims to own a right or registration in one of the Member States of the European Union, it is entitled to file an opposition, irrespective of its country of origin.

Change of owner (transfer of earlier mark) before the opposition is filed

Where the earlier mark has been transferred before the opposition is filed, a distinction has to be made between oppositions based on an earlier EUTM and oppositions based on national trade mark registrations (or applications).

Oppositions based on an earlier EUTM

An opposition based on European Union registrations or applications may be entered by the successor in title of an EUTM only if the conditions set out in Article 17(6) EUTMR are met, namely, only if the opponent has submitted a request for the registration of the transfer when the opposition is filed. According to Article 17(7) EUTMR, where there are time limits to be observed vis-à-vis the Office, the successor in title may make the corresponding statements to the Office once the request for registration of the transfer has been received by the Office.

It is up to the opponent to provide this information, and it will not be checked by the Office during the admissibility check. However, if the opponent mentions in the explanation of its opposition that it is the new owner (or uses similar terms), the Office must request the opponent to indicate the date the request for registration of the transfer was sent to or received by the Office.

Opposition based on a national registration or application

An opposition based on a national registration or application may be entered by the 'old' owner or by the successor in title, as there are different practices in the different Member States regarding the need to register the transfer in the national trade mark register in order to be able to claim rights arising from the registration.

In some cases the opposition is filed by opponent A whereas, after a transfer of the earlier mark on which the opposition is based, the mark is owned by B. As A may still appear in the relevant register as the owner, the Office will accept the opposition as valid with A as opponent, even though it is no longer the owner of the earlier mark.

If the opposition is filed with B as opponent and a copy of the registration certificate shows A as owner of the earlier mark, the opposition is accepted as admissible on the assumption that the earlier mark was transferred to B before the opposition was filed (or it is indicated in the notice of opposition that it opposes in its capacity as licensee). However, the entitlement to file the opposition (e. g. evidence of the transfer or of the granting of a licence before the opposition was filed) has to be proved within the time limit for substantiation.

Multiple opponents

Rules 15(1) and 75(1) EUTMIR
Decision of 11/10/2000, R 0623/1999-1, Emultech

In some cases there is more than one opponent indicated in the notice of opposition. There are only two situations in which the Office accepts two or more separate persons (either natural or legal) as multiple opponents, namely:

- if they are co-owners of the earlier mark or right;
- if the opposition is filed by the owner or co-owner of an earlier mark or right together with one or more licensees of these earlier marks/rights.

If there is no indication that the multiple opponents fulfil one of the two requirements mentioned above, they will be asked to indicate their relationship (co-ownership or owner/licensee) or to indicate one of the multiple opponents as the only opponent.

If an earlier mark and/or an earlier right has more than one proprietor (co-ownership), the opposition may be filed by any or all of them.

However, if the opponents inform the Office that, for example, Company A B.V. owns five of the earlier rights and Company A PLC owns another five, they will have to indicate with whom the opposition will continue. As a consequence, five out of the ten earlier rights will not be taken into account. If the opponents do not respond appropriately within the two-month time limit set, the opposition will be rejected as inadmissible.

Acceptable

Earlier trade marks	1	2	3	4	5
Owner	A/B	A	A	A	A

Earlier trade marks	1	2	3	4	5
Owners	A/B	A/C	A	A	A

The second combination is acceptable only if at least A is one of the opponents.

Not acceptable

Earlier trade marks	1	2	3	4	5
Owners	A	A	B	B	B

The opponents will have to be asked to indicate whether they want to continue the proceedings with A or B as an opponent.

Earlier trade marks	1	2	3	4	5
Owners	A/B	A	A	B	B

The opponents will have to be asked to continue the opposition either as multiple opponents based on the first three earlier trade marks or as multiple opponents based on the first, fourth and fifth earlier trade marks.

Earlier trade marks	1	2	3	4	5
Owners	A/B/C	B/C	A	A	A

The opponents will have to be asked to continue the opposition either as multiple opponents A, B and C based on the first and the second earlier trade marks or as multiple opponents A and B based on the first, third, fourth and fifth earlier trade marks.

Indication of relationships other than co-ownership

Where two opponents are mentioned in the notice of opposition, one as owner of the earlier right, and another as licensee (authorised by the owner to file opposition), no objections will be raised if the owner of all earlier rights on which the opposition is based is the same legal or natural person, regardless of how many licensees join it in the case.

In the following example the opposition is acceptable with A, B and C as multiple opponents:

Earlier trade marks	1	2	3
Owner	A	A	A
Licensees	B	C	None

By contrast, in the following case, although B is accepted as a multiple opponent as licensee for earlier mark 1, it cannot be accepted as a multiple opponent as owner of earlier mark 3. The Office will ask the opponents to indicate whether they want to continue the opposition with A or with B as an opponent. If the opponents do not reply, the opposition is inadmissible.

Earlier trade marks	1	2	3
Owner	A	A	B
Licensees	B	C	A

Evidence

In cases where the opposition is based on earlier registered marks, the most common means to provide evidence of co-ownership is to submit a copy of the registration certificate or an extract from an official database. If the opposition is based on several earlier marks/rights but the opponents have already submitted evidence of co-ownership of one earlier registered mark, the opponents will still be required to confirm the ownership of the other earlier rights. As at this stage of the opposition proceedings the opponents are not obliged to submit evidence of their earlier marks/rights, a statement confirming their capacity to file an opposition together will be considered sufficient for admissibility purposes.

2.4.2.6 Professional representation

Representative

Articles 92 and 93 EUTMR
Rule 15(2)(h)(ii) EUTMIR

Rule 15(2)(h)(ii) EUTMIR provides that if the opponent has designated a representative, it must provide the name and business address of the representative in accordance with Rule 1(1)(e) EUTMIR.

If the opponent is from the European Economic Area (EEA) (not obliged to be represented under Article 92 EUTMR), failure to appoint a representative, or failure to indicate the name or business address of the representative, merely has the consequence that the Office will communicate with the opponent directly.

If the opponent is obliged to be represented under Article 92 EUTMR, failure to appoint a representative, or failure to indicate the name or business address of the representative, constitutes a relative admissibility deficiency. The Office will invite the opponent to appoint a representative and/or to indicate the name and address of the representative, failing which the opposition will be rejected as inadmissible.

Rule 77 EUTMIR

Any Office notification sent to the duly authorised representative has the same effect as if it had been addressed to the represented person.

Any notification or letter of the duly authorised representative sent to the Office has the same effect as if it originated from the represented person.

In addition, if the represented person itself files documents with the Office while being represented by a duly authorised representative, these documents will be accepted by the Office as long as the represented person has its domicile or its principal place of business or a real and effective industrial or commercial establishment in the EEA. If this is not the case, the documents submitted will be rejected.

For further information, see the Guidelines, Part A, General Rules, Section 5, Professional Representation.

Multiple representatives, common representative

Rule 75 EUTMIR

It is possible for each party to have more than one representative, who may act either jointly or separately. There is no fixed maximum number of representatives.

The Office, however, will communicate only with the first named representative. If there is more than one opponent and the notice of opposition does not name a common representative, the representative first named in the opposition notice will be considered to be the common representative.

However, if one of the opponents is obliged to appoint a representative (because he or she is from outside the European Economic Area), this representative will be considered to be the common representative, unless the opponent first named in the opposition notice has appointed a representative.

Rule 76(8) EUTMIR

Where there is more than one opponent/applicant, the representative of the person named first will be the common representative of all these persons. If the person first named has not appointed a representative and one of those persons is obliged to appoint a representative and has done so, that representative will be considered to be the common representative for all these persons.

For further information, see the Guidelines Part A, General Rules, Section 5, Professional Representation.

Change of representative

Rule 76 EUTMIR

During the opposition proceedings the opponent's and the applicant's representative may change. For further information, see the Guidelines, Part A, General Rules, Section 5, Professional Representation.

Authorisation

Articles 92(3) and 93(1) EUTMR
Rule 76 EUTMIR

Where there are several parties to the proceedings in which a representative acts before the Office, representatives must file a signed authorisation for entry into the file, either as an individual or as a general authorisation, only if the Office or the other party expressly asks for it. When it is required that a signed authorisation is filed, the Office will specify a time limit within which such an authorisation must be filed.

Details on representation and authorisations are set out in the Guidelines Part A, General Rules, Section 5, Professional Representation.

2.4.2.7 Signature

Rules 80(3) and 82(3) EUTMIR

A notice of opposition sent by fax or by mail must be signed by the opponent or, if it is submitted by a representative, by the representative.

A notice of opposition sent by electronic means need not be signed and it is sufficient that the name of the sender is indicated.

2.4.2.8 Relative admissibility requirements: sanctions

Rule 17(4) EUTMIR

If relative admissibility requirements are missing or not complied with, the opponent or its representative is given two months to remedy this deficiency. This time limit cannot be extended.

If the deficiency is not remedied in time, the opposition must be rejected as inadmissible or, if the deficiency concerns part of the earlier rights, the opponent will be notified that the opposition is admissible but that the earlier rights concerned cannot be taken into account.

2.4.3 Optional indications

2.4.3.1 Extent of the opposition

Rule 15(3)(a) EUTMIR

The opposition may contain an indication of the goods and services against which the opposition is directed; in the absence of such an indication, the opposition will be considered to be directed against all of the goods and services of the opposed mark.

If the opponent indicates that the opposition is only directed against part of the goods and services of the EUTM application, it will have to list these goods **clearly**. If it does not do so, either in the notice of opposition or in the explanation, it must be notified of the deficiency. If the deficiency is not remedied by listing the goods and/or services against which the opposition is directed within the time limit given, the opposition will be rejected as inadmissible.

There are cases where, in reply to the Office's letter asking the opponent to list exactly which part of the goods and services it opposes, the opponent indicates 'all the goods and services which the contested mark is applied for'. The Office cannot accept this indication as valid and the opposition must be rejected as inadmissible. This is because by indicating that the opposition is directed only against part of the goods and services of the EUTM application, the opponent has clearly limited its opposition in this respect and cannot extend its scope after the opposition period of three months.

The extent of the opposition is correctly indicated where the goods are specific goods encompassed by a broader term used in the contested specification (e.g. opposition directed against *trousers* and the EUTM application is filed for *clothing* — in this example, the only contested goods are considered to be *trousers*). However, when the opponent uses ambiguous wording like 'the opposition is directed against all goods similar to ...', when the opponent's goods are substituted for applicant's goods, or any other indication that does not clearly identify the contested goods and services, a clarification must be requested. If the opponent does not respond appropriately to this request, the opposition will be rejected as inadmissible.

Additionally, where the opponent indicates in the opposition form that the opposition is directed against 'part of the goods and services of the contested mark' but then lists 'all' of these goods and services in the notice of opposition or in the annexes, the Office

will, in order to overcome the contradictory information contained in the notice of opposition, assume that the opposition is directed against 'all the goods and services'.

2.4.3.2 Reasoned statement

Rule 15(3)(b) EUTMIR

It is now clear from the wording of Rule 15 EUTMIR that a distinction must be made between:

- the basis of the opposition, i.e. the earlier right invoked; it must be properly identified and cannot be changed after expiry of the opposition period,
- the indication of the grounds of the opposition, e.g. 'likelihood of confusion',
- and a reasoned statement, i.e. any indication of arguments, facts or evidence in support of the opposition.

'Reasoned statement' includes proof of the existence of the earlier right, which (unlike the identification of the earlier right) is a matter of substance rather than admissibility.

The reasoned statement is optional at the stage of filing of the opposition; it has nothing to do with the admissibility check. It is acceptable if it is included in the opposition, but otherwise it may be provided after expiry of the cooling-off period (Rule 19(1) EUTMIR) and concerns the substance, not the admissibility, of the opposition.

2.5 Notification of the notice of opposition

Rules 16a, 17 and 18 EUTMIR Decision EX-13-2 of the President of the Office
--

Any notice of opposition and any document submitted by the opposing party, as well as any communication addressed to one of the parties by the Office prior to the commencement of the cooling-off period, will be sent by the Office to the other party for information purposes.

Once the opposition has been found admissible, the Office will send a notification to the parties informing them that the proceedings are deemed to commence two months after receipt of the communication. The notification will also set the time limit for the opponent to present the facts, evidence and arguments in support of its opposition, as well as the time limit for the applicant to submit its observations in reply. It is important to note that due to different means of communication (e-communication, fax and post) the time limits mentioned in this notification are set according to the 'slowest' communication channel. For example, if one of the parties is notified by e-communication through the official web page of the Office, notification is deemed to have taken place on the fifth calendar day following the day on which the document was created by the Office's systems. Therefore, if the notification to the other party is sent by fax, this latter party will also be granted the five additional days so that the time limits granted in the notifications coincide.

Whenever the opposition is based on an earlier trade mark registered or applied for in colour, the Office will ensure that the colour representation is received by the applicant. In some cases this may require notification by post.

Notification is not carried out before the expiry of the opposition period.

3 Cooling-Off Period

3.1 Setting the cooling-off period in motion

Rule 17, Rule 18(1), Rule 19 and Rule 20(2), (6) and (7) EUTMIR
Communication 1/06 of the President of the Office

When the opposition is found admissible, the Office sends a notification to the parties informing them that the opposition is deemed admissible and that the proceedings are deemed to commence two months after receipt of the notification (a two-month 'cooling-off' period is granted before the proceedings officially start, with legal consequences as regards the opposition fees in particular).

According to the judgment of the Court of Justice of 18/10/2012 in case C-402/11 P, REDTUBE (EU:C:2012:649), the notification sent to the parties informing them that the opposition is admissible in accordance with Rule 18(1) EUTMIR constitutes a decision that may be appealed together with the final decision on the case as stated in Article 58(2) EUTMR. Consequently, the Office is bound by this decision.

The cooling-off period will be set to expire two months from the notification. The exact date of expiry is indicated in the Office's notification. This date will always be two months from the notification date, even if this is a day on which the Office is not open, for example a Saturday or Sunday.

The cooling-off period may last up to a total of 24 months if both parties submit requests for an extension before the period expires. The Office will grant an extension of 22 months, irrespective of what length of extension is requested.

It is not possible to circumvent the limitation of the cooling-off period to 24 months by requesting a suspension. Requests can be accepted at this stage but will only have effect once the cooling-off period has expired. When the parties invoke on-going negotiations, the proceedings will not be suspended during the cooling-off period, but a request for such a suspension may be made after the expiry of the cooling-off period.

The opponent will be given a time limit of two months after the expiry of the cooling-off period to submit facts, evidence or arguments irrespective of whether it has already submitted such facts, evidence or arguments together with the notice of opposition. Within the same time limit, the opponent must also substantiate its earlier right(s).

The request to the opponent is a **general invitation** to complete the file within the meaning of Rule 19 EUTMIR. The Office will **not** indicate the nature and type of the material necessary for completion of the file (see expressly Rule 20(6), second sentence, EUTMIR). Rather, it will be for the opponent to decide what it wishes to submit. In order to facilitate the task of opponents, the Office has prepared a list that enumerates the type of evidence generally required, depending on the nature of each right. This list is forwarded to the opponents as an annex to the notification of the

admissibility of the opposition and it may be referred to by opponents as a checklist in preparing their oppositions.

In practice, the time limit for submitting such additional material will be set at four months from the date of notification. Therefore, opponents should be aware that the time limit for submitting such additional material is not a time limit of two months beginning after the cooling-off period has expired, but a time limit of four months from the notification.

The applicant will be given an additional time limit of two months for replying to the opposition. Rather than setting a separate time limit of two months (two months for the cooling-off period, two months for completing the opposition, two months for replying), the time limit for replying to the opposition will be set at six months from the notification of admissibility (day of the start of the cooling-off period).

When the opponent completes its opposition any time after the notification and before the expiry of the four months available to it, the additional material will be forwarded to the applicant without any change in the time limit available for responding to the opposition. However, if the additional material arrives at the Office without sufficient time to forward it to the applicant within the time limit set for the opponent, the additional material will then be forwarded to the applicant together with the setting of a new time limit of two months for replying to the opposition. This separately set two-month time limit will run from the date of the receipt of the notification of the additional material in order to ensure that the applicant always has a full time limit of two months to prepare its reply.

3.2 Extension of the cooling-off period

Article 119(5) and (6) EUTMR Rules 18(1) and 96(1) EUTMIR Communication 1/06 of the President of the Office

The cooling-off period may be extended up to a total of 24 months.

To extend the cooling-off period the following is necessary.

- A signed request from both parties. This may take the form of either two separate requests or one joint request. It is not necessary to state a reason for the extension.
- The request must be in the language of the proceedings. Alternatively, the request can be filed in one of the Office languages. However, a translation must be filed within one month of filing on the parties' own initiative. The Office does not send any letter requesting a translation of the request for extension.
- The request must be filed before the expiry of the cooling-off period. Any request filed after the expiry of the cooling-off period will have to be rejected. If one party files the request within but the other after expiry of the cooling-off period, the extension is also to be refused.

The extension of the cooling-off period must be distinguished from requests for extension of a time limit or a suspension. In the event that the request for extension is inadmissible because it has been filed late or because the cooling-off period had

already been extended, it will be treated as a request for suspension provided that the conditions of such a request are fulfilled.

The extension is granted for a period of 24 months to be counted from the date of the start of the cooling-off period. This procedure avoids multiple extensions and at the same time leaves the parties maximum freedom to decide when they want to continue with the adversarial stage of the proceedings.

Any party can then bring the extended cooling-off period to an end (opt out) by expressly indicating this in writing.

It is immaterial whether the other party agrees with this or not.

When one of the parties opts out before expiry of the extended cooling-off period, the Office will confirm this to both parties and set the cooling-off period to expire two weeks after said notification. The adversarial part of the proceedings will commence the day after. In the same notification new time limits are notified for the substantiation of the opposition and the reply of the applicant, which will be two and four months from the end of the cooling-off period.

Opting out is irrevocable. Opting out during the last month before commencement of the proceedings will not be accepted.

4 Adversarial Stage

4.1 Completion of the opposition

Within two months after expiry of the cooling-off period, the opponent may submit additional facts, evidence and arguments in support of its opposition.

Within the same time limit, the opponent must prove the existence and validity of its invoked earlier rights.

4.2 Substantiation

Article 41 EUTMR Rule 19, Rule 20(1) and Rule 79 EUTMIR
--

Substantiation is defined by Rule 19(2) EUTMIR and refers to the proof of existence, validity and scope of protection of the earlier mark(s) or right(s) as well as the proof of entitlement to file the opposition.

After the parties have been notified of the admissibility of the opposition, the opponent has two months counted from the end of the cooling-off period in which not only to complete its file, that is, present all the evidence in support of its opposition, but also to prove the existence and validity of the earlier rights invoked and its entitlement to file the opposition. Where relevant for the opposition, the opponent must also submit evidence of reputation, enhanced distinctiveness or any other aspect affecting the scope of protection of its earlier right(s).

The evidence must be in the language of the proceedings or accompanied by a translation for substantiation purposes. The translation must be provided within the

time limit for submitting the original. The Office will not take into account documents or parts thereof that have not been submitted or that have not been translated into the language of the proceedings within the time limit set by the Office.

Unless submitted by fax transmission or electronic communication, any supporting document or other evidence must be presented in two copies, one being for transmission to the other party. Exceptions to this rule are all paper documents (such as loose sheets of evidence) up to and including A3 size. However, any other item of evidence (larger than A3 or not being paper, such as CDs, DVDs, USBs, product samples, etc.) that has been submitted to the Office by post or personal delivery must be accompanied by a second copy. If no copy is provided, these documents or items of evidence will not be taken into account.

If the opponent has not proven the existence of at least one earlier right, the opposition will be refused as unfounded.

If the earlier right that has been found admissible is not substantiated at the substantiation stage and there is/are another/other earlier right(s) that is/are substantiated, the absolute admissibility requirements for that/those earlier right(s) must be checked.

The opponent has to show its entitlement to file the opposition for the purpose of substantiation (see paragraph 4.2.3.7 below).

4.2.1 EUTMs and EUTM applications

If the earlier mark or application is an EUTM, the opponent does not have to submit any documents as far as the existence and validity of the EUTM (application) is concerned. The examination of the substantiation will be done *ex officio* with respect to the data contained in the Office's database.

4.2.2 Converted EUTMs and EUTM applications

Article 112(1) EUTMR

This section will deal only with specific aspects of conversion in opposition proceedings. For further information on conversion, see the Guidelines, Part E, Register Operations, Section 2, Conversion.

4.2.2.1 Opposition based on EUTM (application) (to be) converted

National applications deriving from the conversion of an earlier EUTM or EUTM application are considered to come into existence as soon as a valid conversion request is submitted. Such rights will be properly substantiated under Rule 19(2) EUTMR if the opponent indicates the number of the EUTM (or EUTM application) under conversion and the countries for which it has requested the conversion.

4.2.2.2 Opposition based on EUTM (application) that is subsequently converted

When during opposition proceedings the EUTM application (or EUTM) on which the opposition is based ceases to exist (or the list of goods and services is restricted), and

a request for conversion is submitted, the proceedings can continue. This is because national trade mark registrations resulting from a conversion of an EUTM application can constitute the basis of the opposition procedure originally made on the basis of that EUTM application (decision of 15/07/2008, R 1313/2006-G, CARDIVA/CARDIMA).

In such a case the Office will request the opponent in writing to inform the Office whether it maintains the opposition in view of the withdrawal, surrender or rejection of the earlier EUTM application(s) or registration(s) and whether it intends to rely on the national applications that result from the conversion of the earlier EUTM. If the opponent does not inform the Office within the established time limit that it wishes to rely on the national applications, the opposition will be rejected as unfounded.

Evidence of the existence of the earlier national applications must be submitted by the opponent as soon as they become available.

4.2.3 Trade mark registrations or applications that are not EUTMs

Rule 19(2)(a)(i)-(ii) EUTMIR

To substantiate an earlier trade mark application or registration the opponent must provide the Office with evidence of its filing or registration. The Office accepts the following documents:

- certificates issued by the appropriate official body
- extracts from official databases
- extracts from official bulletins of the relevant national trade mark offices and WIPO.

4.2.3.1 Certificates issued by the appropriate official body

Any registration certificate or the most recent renewal certificate showing the validity of the earlier mark beyond the time limit that was given to the opponent to substantiate its opposition, issued by a national office, or by WIPO if it concerns an international registration, constitutes valid evidence. For further requirements relating to renewal certificates, see below.

If the opposition is based on an application, the opponent must submit evidence that the application was filed at the national office or that an international application was filed with WIPO. Once the earlier application has proceeded to registration, the opponent must submit evidence of registration. If, after the adversarial part of the proceedings, the opponent provides evidence that the national application in fact proceeded to registration before the time limit set in Rule 19(1) EUTMIR, the earlier mark will be rejected as unfounded under Rule 20(1) EUTMIR. An application certificate is not sufficient to prove that the trade mark has been registered. In other words, it cannot serve to prove the existence of a trade mark registration.

Some certificates present only a few differences between an application form and the registration certificate and have to be checked carefully.

Equivalent documents are also accepted if they are issued by the administration with which the mark is registered (such as a certificate of registration).

4.2.3.2 Extracts from official databases

Extracts from databases are accepted only if their origin is an official database, that is to say, the official database of one of the national offices or WIPO, and if they are equivalent to a certificate of registration or last renewal. The unaltered electronic image of an online database extract reproduced on a separate sheet is also acceptable as long as it contains an official identification of the authority or database from which it originates. Extracts from commercial databases are not accepted, even if they reproduce exactly the same information as the official extracts. Examples of extracts that are not accepted are DEMAS, MARQUESA, COMPUSERVE, THOMSON, OLIVIA, PATLINK, SAEGIS or COMPUMARK.

Officially accepted databases include:

- **TMview**: for EUTMs and trade marks applied for or registered with the participating offices (as long as it contains the relevant data). For further information see: <http://www.tmview.europa.eu/tmview/welcome.html>.
- **BENELUX-MERKEN** (for Benelux trade marks),
- **DPINFO** (for German trade marks),
- **SITADEX** (for Spanish trade marks),
- **OPTICS** and extracts from the UKIPO website (for UK trade marks),
- **S.A.R.A, UIBM** on-line from the UIBM website and Telemaco from the Italian Chambers of Commerce (for Italian marks).

As regards international registrations, the following databases are accepted (judgment of 26/11/2014, T-240/13, Alifoods, EU:T:2014:994)¹:

- **ROMARIN** (the 'short' version of the extract being sufficient as long as it contains all the necessary information, but the extended or long version of the WIPO extract being preferable as it contains all the individual indications for each designated country, including the Statement of Grant of Protection)
- **TMview** (as far as it contains all the relevant data, see above).

When the extract from an official database does not contain all the required information, the opponent must supplement it with other documents from an official source showing the missing information.

¹ The practice of the Office has been to accept printouts of the CTM-Online database for international registrations with EU designation. This approach contravenes Rule 19(2)(a) EUTMR. No exception to this rule is provided in Title XIII of the EUTMR. The current practice came into force on 01/07/2012 and applies to all oppositions filed as from this date (on or after). The information contained in the standard letters for the notification of admissible oppositions was updated as from 01/07/2012. The old practice will only apply to oppositions with a filing date before 01/07/2012.

Examples

Extracts from SITADEX (Spanish Office official database) sometimes do not contain the list of goods and/or services; in such cases, the opponent must submit an additional document (e.g. a publication in the official bulletin) showing the list of goods and services.

SITADEX extracts sometimes do not show the image on the same page when the mark is figurative. The image sometimes appears on a separate page. Consequently, as regards figurative Spanish trade marks, when opponents file an extract from SITADEX as evidence they must ensure that the representation of the mark appears on the same page and, if not, an additional document/page showing the image must be filed. This can be from SITADEX itself (which reproduces the image on a separate page that, when printed or saved as PDF, for example, includes an identification of the source) or from another official source (such as its publication in the official bulletin). Copying the image from SITADEX and including it electronically or otherwise in the notice of opposition form is not sufficient.

When English is the language of the proceedings, and a Portuguese trade mark is concerned, INPI also provides an English version of the Portuguese trade mark extract so, in principle, no translation would be necessary. However, as regards the list of goods and/or services, the extract itself only gives the class headings along with a warning indicating that this reference to the class heading does not necessarily reflect the goods and/or services protected under the trade mark. In this regard, the opponent must always file the original list in Portuguese (from an official source) and, where the list does not consist of a class heading, an accurate translation into English. The same also applies to official extracts from other national offices that provide an English version of their extracts, such as in Slovenia.

4.2.3.3 Extracts from official bulletins of the relevant national trade mark offices and WIPO

In all Member States the trade mark application and/or registration is published in an official bulletin. Copies of the publication are accepted as long as the document (or the accompanying observations of the opponent) indicates the origin of the publication. If this indication is missing, the evidence is insufficient to prove the validity of the mark.

Furthermore, a copy of the publication of the application is not sufficient to prove that the trade mark has been registered. In other words, it cannot serve to prove the existence of a trade mark registration.

The Office accepts the first WIPO publication of the international registration as sufficient evidence of registration although, once registered, it can still be refused by national offices during the following 12 to 18 months. Only if the applicant contests the protection of the mark in question in a given territory or for certain goods and services will the opponent have to provide evidence that the mark was not refused.

4.2.3.4 Duration of a trade mark registration

In general, the registration of a mark lasts 10 years. After this period has elapsed, the registration of the mark can be renewed every 10 years. In most of the countries, the starting point of the 10 years is the filing date, but there are exceptions.

Countries	Term of protection	Starting point
Benelux (Belgium, Luxembourg, The Netherlands)	10 years	Filing date
Bulgaria	10 years	Filing date
Czech Republic	10 years	Filing date
Denmark	10 years	Registration date
Germany	10 years	Filing date
Estonia	10 years	Registration date
Ireland	10 years for TM registered since 01/07/1996 (7/14 years renewal before that)	Registration date = filing date
Greece	10 years	Filing date
Spain	10 years for trade marks applied for since 12/05/89 (20 years for trade marks applied for before that, counting from the date of registration, and with a renewal from the filing date)	Filing date
France	10 years	Filing date
Croatia	10 years	Filing date
Italy	10 years	Filing date
Cyprus	7 years first term/14 years renewal	Filing date = registration date
Latvia	10 years	Filing date
Lithuania	10 years	Filing date
Hungary	10 years	Filing date
Malta	10 years	Registration date = filing date
Austria	10 years	Registration date
Poland	10 years	Filing date
Portugal	10 years	Registration date
Romania	10 years	Filing date
Slovenia	10 years	Filing date
Slovakia	10 years	Filing date
Finland	10 years	Registration date
Sweden	10 years	Registration date
United Kingdom	10 years since 31/10/94 (trade marks applied for prior to that were, upon the completion of the registration formalities, in force for 7 years from the date of the application. Trade marks with renewal date prior to 31/10/1994 renewed for a period of 14 years)	Filing date = registration date
International registration	10 years (even if 20 years for Madrid Agreement registrations, fees must be paid in two instalments of 10 years equivalent to a renewal fee)	International registration date

According to Rule 19(2)(a)(ii) EUTMIR, if the trade mark is registered, the opponent must provide evidence of registration. If the evidence submitted does not prove that an application is registered and, later, one of the parties proves that upon expiry of the time limit set under Rule 19(1) EUTMIR the opponent failed to prove this, Rule 19(2)(a)(ii) EUTMIR will apply, and the earlier mark will be rejected as unfounded.

4.2.3.5 Verification of evidence

It must be verified that the claims submitted by the opponent within the three-month opposition period are reflected in the evidence submitted.

The number in square brackets is the international code number used to identify the information on many, but not all, registration certificates. The opponent is not obliged to submit an explanation of the codes, either for the INID or for the national codes.

The following should be checked:

- the issuing authority;
- the filing [210] and/or registration numbers [111] (in certain countries these are, or were, different);
- the territorial extent for international registrations (i.e. in which countries the mark is protected and for what goods and services);
- the filing [220], priority [300] and registration dates [151] (in certain countries, e.g. France, the filing and registration dates found on the certificate are the same);
- a representation of the sign as filed or registered [531, 540, 541, 546, 554, 556, 557, 571, 591] and as claimed in the notice of opposition;

Where the earlier mark has been identified as being in colour during the three-month opposition period, there are two acceptable scenarios.

- 1) An official colour representation of the mark such as a registration certificate, renewal certificate, official extract, etc. is submitted that contains a reproduction of the mark in colour.
- 2) An official document is presented with the representation of the mark in black and white, together with a colour claim and a colour indication, both of which are translated into the language of the proceedings.
 - a. Where the national trade mark office does not provide a detailed colour claim identifying the colours, and instead says 'Colours claimed' (or similar wording), this is acceptable as long as this entry is translated into the language of the proceedings.
 - b. Where the national office (e.g. the Portuguese Trade Mark Office) does not provide any indication of a colour claim on its certificate or official extract, further official documents must be submitted to prove this claim (e.g. a copy of the publication of the mark in the bulletin).

However, the latter scenario is only acceptable if the opponent has also submitted a colour representation of the mark from an unofficial origin (separate sheet of paper, within the observations, attached to the notice of opposition, etc.).

Therefore, if the opponent has identified during the three-month opposition period that its figurative mark is in colour and has only submitted a black and white representation to the Office with no further evidence of a colour claim, the opposition based on that earlier right will be rejected as not substantiated in accordance with Rule 20(1) EUTMIR.

Likewise, if the opponent has provided no indication during the opposition period that the earlier mark is in colour (representation in colour, or colour claim), and has only submitted a colour representation to the Office in order to substantiate its opposition, the opposition based on that earlier right will be rejected as not substantiated in accordance with Rule 20(1) EUTMIR.

- the goods and services covered [511];
- the expiry date of the registration (if given);
- the owner [731, 732];
- other entries in the register affecting the legal or procedural status or the scope of protection of the mark (e.g. disclaimers [526], restrictions, renewals, transfers, pending actions, the fact that the mark was registered due to acquired distinctiveness through use, etc.).

4.2.3.6 Renewal certificates

Rule 19(2)(a)(ii) EUTMIR

If the opponent has submitted a certificate of registration but the registration is due to expire before the expiry of the time limit for substantiation, it must file a renewal certificate or equivalent document in order to prove that the term of protection of the trade mark extends **beyond** the time limit or an extension thereof has been given to it to substantiate its opposition. What counts is the date on which the registration would expire, and not the possibility to renew the mark within the six-month grace period under the Paris Convention.

When an earlier right on which the opposition is based reaches the end of protection after expiry of the time limit set by the Office to substantiate the opposition, the opposition is not automatically rejected in the absence of further communications or proof from the opponent. Rather a communication is issued to the opponent in which it is invited to submit evidence of renewal which is communicated to the applicant (judgment of 05/05/2015, T-715/13, Castello (fig.) / Castelló y Jaun S.A. (fig.) et al., EU:T:2015:256, § 68 and following).

Only if the renewal certificate contains all the necessary data that determines the scope of the protection of the earlier mark, will it suffice to file the renewal certificate without a copy of the registration certificate. For example, German renewals and sometimes Spanish renewals do not contain all the necessary data and therefore are not alone sufficient to substantiate the earlier mark.

If there is no proper evidence of renewal, the earlier registration is not substantiated and will not be taken into account.

4.2.3.7 Entitlement to file the opposition

Article 41 EUTMR Rule 19(2) and Rule 15(2)(h)(iii) EUTMIR
--

Depending on the ground invoked the following are entitled to file an opposition:

1. proprietors and authorised licensees for Article 8(1) and Article (5) EUTMR;
2. proprietors (only) for trade marks referred to in Article 8(3) EUTMR;
3. proprietors of earlier rights referred to in Article 8(4) EUTMR and persons authorised under the relevant applicable national law;
4. any person authorised under the relevant European Union legislation or national law to exercise the rights referred to in Article 8(4a) EUTMR.

Example

If the opponent is a corporation, the name of the corporation must be carefully compared with the name of the corporation that owns the prior trade mark. For instance with British companies, John Smith Ltd, John Smith PLC and John Smith (UK) Ltd are different legal entities.

If the opposition is filed with B as opponent and a copy of the registration certificate shows A as owner of the earlier mark, the opposition will be rejected as not substantiated, unless the opponent has provided evidence of the transfer and, if already available, the registration of the transfer in the relevant register or the opponent has shown that A and B are the same legal entity, which has merely changed its name.

If the opponent is a licensee of the trade mark proprietor, the extract of the registration will normally show when a licence has been registered. However, some Member States do not record licences in their registers. In all cases, it is up to the opponent to demonstrate that it is a licensee and also that it is authorised by the trade mark owner to file an opposition. There are no restrictions on what evidence can be submitted to support such an authorisation: for example, any express authorisation on behalf of the trade mark proprietor, such as the licence contract, is deemed sufficient, so long as it contains indications concerning the authorisation or entitlement to file the opposition.

The same applies to any person authorised under the relevant applicable European Union legislation or national law for the grounds of Articles 8(4) and 8(4a) EUTMR. The opponent must prove its entitlement to file the opposition under the applicable European Union legislation or national law.

According to Article 22 EUTMR and Rules 33, 34 and 35 EUTMIR, the Office registers and publishes licence agreements in respect of European Union trade marks. If the earlier mark basis of the opposition subject to the licence agreement is an EUTM, the opponent does not have to submit any evidence of the licence contract as long as the licence has been registered and published at the Office according to Article 22 EUTMR. On the other hand, the opponent will still have to submit evidence that proves that this licence agreement entitles it to act in defence of the mark if the licence is registered and published at the Office, if this evidence was not attached to the original request filed according to Article 22(5) EUTMR. For more information of licences, see the Guidelines, Part E, Register Operations, Section 3, EUTMs as Objects of Property, Chapter 2, Licences. It is not sufficient to prove the registration of the licence agreement — the opponent's entitlement to defend the EUTM must also be submitted in writing.

4.2.4 Substantiation of well-known marks, claims of reputation, trade marks filed by an agent, earlier signs used in the course of trade, designations of origin or geographical indications

4.2.4.1 Well known marks

Article 8(2) EUTMR Rule 19(2)(b) EUTMIR
--

An earlier well-known mark is a trade mark that is well known in a Member State, in the sense in which the words ‘well known’ are used in Article 6*bis* of the Paris Convention. Such a mark may be unregistered, but it may also be registered.

The opponent needs to demonstrate that it is the owner of an earlier trade mark that has become well known in the relevant territory, for the goods and services on which the opposition is based. In order to substantiate its mark it will have to submit evidence of the mark being well known.

If the opponent invokes a registered trade mark and claims the same mark in the same country as a well-known mark, this will in general be taken as a claim that its registered mark has acquired a high degree of distinctiveness by use.

It is very common for opponents to confuse ‘well-known’ marks with ‘marks with a reputation’ under Article 8(5) EUTMR. Depending on the ground of opposition that is indicated, the case will have to be considered under Article 8(2) and/or Article 8(5) EUTMR. See also the Guidelines, Part C, Opposition, Section 5, Trade Marks with Reputation, Article 8(5) EUTMR.

4.2.4.2 Marks with reputation

Article 8(5) EUTMR Rule 19(2)(c) EUTMIR
--

An opposition under Article 8(5) EUTMR is based on an earlier trade mark that has a reputation. See also the Guidelines, Part C, Opposition, Section 5, Trade Marks with Reputation, Article 8(5) EUTMR.

The earlier trade mark in these cases is a registered trade mark. The opponent therefore has to submit registration certificates, etc. as set out above.

In order to make its case under Article 8(5) EUTMR, the opponent has to submit evidence of reputation. In addition, the opponent has to allege and demonstrate that the use of the mark that is the subject-matter of the contested EUTM application would take unfair advantage of, or be detrimental to, the distinctive character or the repute of the earlier trade mark or to indicate that this is probable in the ordinary course of events.

4.2.4.3 Non-registered trade mark or another sign used in the course of trade

Article 8(4) EUTMR
Rule 19(2)(d) EUTMIR

For these rights the Office applies the protection provided by the relevant law.

Not all Article 8(4) EUTMR rights are unregistered. For example, in some countries company and commercial names are registered. If it is a matter of a registered right, then copies of the registration and renewal certificates, etc. are required, as set out above for trade mark registrations. In the case of unregistered marks or signs the opponent must provide evidence of the acquisition of the earlier right. It must further show that it may prohibit the use of a subsequent trade mark.

The opponent must submit evidence that it use of its sign (earlier right, either registered or not) has been of more than local significance. Furthermore, it also needs to provide the wording of the provisions of the national law on which it bases its case and make out its case under this law. See in detail the Guidelines, Part C, Opposition, Section 4, Rights under Articles 8(4) and 8(4a) EUTMR.

4.2.4.4 Protected designations of origin, protected geographical indications

Article 8(4a) EUTMR
Rule 19(2) EUTMIR

Under Article 8(4a) EUTMR, protected designations of origin and protected geographical indications applied for prior to the date of application of the EUTM (or the date of priority claimed, if applicable) can be invoked as the basis for oppositions. For these rights the Office applies the protection provided by the relevant European Union legislation or national law.

In order to substantiate these rights the opponent must provide the Office with evidence of the existence, validity and scope of protection of the earlier right. It must further show that it may prohibit the use of a subsequent trade mark.

To prove the existence, validity and scope of protection of the earlier right, the opponent must submit pertinent documents emanating from the competent authority proving the application, registration or grant (if the protected designation of origin or protected geographical indication was granted through administrative means other than registration) for the right in question. If these documents do not provide sufficient information of the opponent's entitlement to file the opposition, further documents must be submitted.

Furthermore, to prove the opponent is entitled to prohibit use of a subsequent trade mark under the relevant law, it must provide reference to and wording of any national law on which it bases its case. The wording is not required if the opposition is based on European Union legislation. The opponent must also prove that the case fulfils all the conditions under the relevant provisions.

Unlike for earlier rights invoked under Article 8(4) EUTMR, the requirement to submit evidence that use of the sign has been of more than local significance does not apply to earlier rights invoked under Article 8(4a) EUTMR.

For more details regarding substantiation of protected designations of origin and protected geographical indications, see the Guidelines, Part C, Opposition, Section 4, Rights under Article 8(4) and 8(4a) EUTMR, Chapter 5, Article 8(4a) – The Protection of Geographical Indications.

4.2.4.5 Mark filed by an agent or representative

Article 8(3) EUTMR
Rule 19(2)(e) EUTMIR

This concerns the case where an agent or representative of the proprietor of a trade mark applies for its registration at the Office. The proprietor can oppose the application of the disloyal applicant. See also the Guidelines, Part C, Opposition, Section 3, Unauthorised Filing by Agents of the TM Proprietor (Article 8(3) EUTMR).

The opponent has to prove its ownership of the trade mark and the time of acquisition of that mark. As the trade mark can be either a registered trade mark or an unregistered trade mark, the opponent will have to submit evidence of registration anywhere in the world or evidence of acquisition of rights through use. The opponent also has to submit evidence of an agent-representative relationship.

4.2.5 Sanction

Rule 20(1) EUTMIR

To the extent that the invoked earlier rights have not been substantiated, the opposition will be refused as unfounded. When the evidence check reveals that none of the earlier rights on which the opposition is based has been substantiated, that is to say that the opponent has not provided sufficient evidence to prove that it owns a valid earlier right, the whole opposition must be rejected immediately after expiry of the two-month substantiation time limit, without waiting for the applicant's reply.

In no case is the Office required to inform the parties which facts or evidence could be or have not been submitted. This will be detailed in the final decision, which can be appealed.

4.3 Translation/changes of language during the opposition proceedings

Most submissions of the parties in opposition proceedings have to be in the language of the proceedings in order to be taken into account. For different submissions there are different rules to be applied.

The general rule is Rule 96 EUTMIR. Rule 96(1) EUTMIR applies to written statements/submissions filed within the opposition procedure. Rule 96(2) EUTMIR applies to evidence attached to a written submission filed within the opposition procedure. However, Rule 96 EUTMIR does not apply if there is a *lex specialis*. Rule 19(3) EUTMIR for facts, evidence and arguments submitted by the opponent and Rule 22(6) EUTMIR for evidence of use (always submitted by the opponent) are examples of such a *lex specialis*.

4.3.1 Translations of evidence of trade mark registrations and of facts, evidence and arguments submitted by the opponent to complete its file

Rules 19(3) and (4), 20(1) and 98(1) EUTMIR

The Office can only consider evidence that is submitted in the language of the opposition proceedings within the time limit specified for submitting the original document. Rule 19(3) EUTMIR is a *lex specialis* to any other rule on the language regime.

Therefore, both the evidence submitted by the opponent for the first time at the end of the time limit for substantiation of the opposition, as well as any other previously submitted document or certificate, must be either in the language of the proceedings, or be accompanied by a translation. Only what is submitted and translated within this time limit is taken into account. If no translation or an insufficient translation has been submitted, the opposition will be partially or entirely rejected as unfounded.

Rule 98(1) EUTMIR requires that the translation reproduces the structure and contents of the original document.

Therefore, the principle is that the entire document must be translated and follow the structure of the original document.

The Office does not consider that information already given in the language of the proceedings in the notice of opposition, or in documents attached thereto or submitted later (e.g. explanation of grounds, lists of earlier marks etc.) amounts to a valid translation of a registration document, such as a registration certificate, even where such indications have been accepted for admissibility purposes. The translation has to be on a stand-alone basis and cannot be assembled from fragments taken from other documents.

Extracts from commercial databases cannot be considered valid translations of an official document, unless they reproduce the structure and contents of the original document.

The Office accepts that no translation of the information headers in the extracts/certificates (such as, 'filing date' 'colour claim', etc.) is needed, provided that they are also identified using standard INID codes or national codes.

The list of INID codes and their explanations are attached as Appendix 1 to Standard ST 60 ('Recommendation concerning bibliographic data relating to marks'), available on WIPO's website.

Only irrelevant administrative indications (e.g. previous transfers of ownership that do not affect the opposition, administrative entries on fees, etc.) with no bearing on the case may be omitted from the translation (judgment of 29/09/2011, T-479/08, Shoe with two stripes, EU:T:2011:549).

Where the opposition is based on only some of the goods and services covered by the earlier right, it is sufficient to provide a translation of only the goods and services on which the opposition is based.

When the entire original document is in the language of the proceedings except for the list of goods and services, there will be no need to provide a complete translation

following the structure of the original document. In this case, it is acceptable if only the goods and services on which the opposition is based have been translated separately in the notice of opposition, or in documents attached thereto or submitted later within the time limit to substantiate the opposition. The same applies to extracts/certificates that make use of INID or national codes, where the only information that still needs to be translated into the language of the proceedings is the list of goods and services.

Rule 98(1) EUTMIR

The Office accepts simple translations, drawn up by anybody. The Office normally does not make use of its faculty to require the translation to be certified by a sworn or official translator unless serious doubts arise regarding the accuracy or content of the translation. Where the representative adds a declaration that the translation is true to the original, the Office will, in principle, not question this. The Office even accepts handwritten text on the copies of the original certificates giving the meaning of the various entries in the language of the proceedings, provided of course that they are complete and legible.

The Office does not oblige the opponent to provide translations of the evidence depending on the applicant's reaction because Rule 19(3) EUTMIR does not provide for any exception to the principle that the evidence needs to be translated.

4.3.1.1 Sanction

Rules 19(3), 19(4) and 20(1) EUTMIR

If the submissions are not in the language of the proceedings, they must be translated within the time limit specified for submitting the original document.

If this is not done, the legal consequence is that documents that have not been translated in this time limit are not taken into account. However, if documents proving the existence and validity of the earlier right have not been translated, the opposition must be refused as unfounded straight away.

4.3.2 Translation of further observations

Rules 20(2) and (4) and 96(1) EUTMIR

There is no special rule for translations of the applicant's first reply or other observations drawn up by the applicant or opponent at a later stage in the proceedings. Consequently, for these submissions Rule 96(1) EUTMIR applies. This means that the applicant's first reply or the opponent's reply to the applicant's observations may be in any language of the Office.

It is to be noted that if the applicant's first reply or the opponent's counter reply is not in the language of proceedings but in one of the languages of the Office, the submission will not be taken into account unless the applicant or the opponent submits a translation of these documents in the language of the proceedings within the time limit of one month from the date of receipt of the original by the Office. The Office will not request the parties to send a translation; the parties have to send one on their own initiative.

Example 1

The language of opposition is English and the applicant has until 26/06/2012 to submit observations in reply to the notice of opposition. If, on 20/06/2012, it submits its observations in reply to the opposition in German, it must file its translation by 20/07/2012. If it then files the translation on or before 20/07/2012, both the original submission and the translation must be taken into account, notwithstanding that the original time limit for filing observations expired on 26/06/2012.

Example 2

The language of opposition is English and the applicant has until 26/06/2012 to submit observations in reply to the notice of opposition. If, on 18/05/2012, it submits its observations in reply to the opposition in German, it must file its translation by 18/06/2012. However, as its time limit only finishes on 26/06/2012, if it has not filed a translation by 18/06/2012, it can still validly file documents until 26/06/2012. If it then files the translations before the end of the time limit, the Office considers the translation as valid observations filed in the language of the proceedings within the set time limit.

Rule 98(2) EUTMIR

If no translation has been submitted, the observations are deemed not to have been received by the Office and they will not be taken into account.

4.3.3 Translation of documents other than observations

Rules 96(2) and 98(2) EUTMIR

All evidence, with the exception of the evidence that the opponent must provide within the time limit given to substantiate its opposition, can be submitted in any official language of the European Union, as Rule 96(2) EUTMIR applies. This evidence concerns all documents, other than observations, submitted by the parties after the time limit for the opponent to complete its file.

Examples of this type of evidence are catalogues, magazine articles, decisions of national courts or signed agreements that are submitted by the applicant together with its observations in reply to the opposition.

For this evidence, a translation is needed only if the Office requests it. Therefore, the parties are not automatically obliged to file a translation.

The Office exercises its discretion as follows (this practice corresponds *mutatis mutandis* to that concerning evidence of use).

In principle, the Office does not *ex officio* require a translation. However, it is vital that the party to whom the documents are addressed should be able to understand the meaning of their substantive content. If this is doubtful or contested by the party addressed, the Office requires a translation within a specified time limit.

Rule 98(2) will apply only if the Office requires a translation, with the effect that translations that are filed late must be disregarded; likewise the original for which a translation is late or missing must also be disregarded.

Together with the invitation to file a translation, the Office will draw the attention of the party concerned to the fact that it is up to that party to evaluate whether a complete translation of all the evidence submitted may be necessary. However, the documents in question will only be taken into account insofar as a translation is submitted or insofar as the documents are self-explanatory, regardless of their word components.

Example

In the case of a national court decision it may be sufficient to translate only those parts that are relevant for the opposition proceedings.

4.3.4 Proof of use

Rule 22(2) and (6) EUTMIR

For proof of use, Rule 22(6) EUTMIR is *lex specialis* as regards translations. If the evidence is submitted in an EU language that is not the language of the proceedings, the Office may require the opponent to submit a translation of the evidence into the language of the proceedings within a specified time limit.

Therefore, it is at the Office's discretion whether or not to request a translation. In exercising this discretion, the Office balances the interests of both parties.

It is vital that the applicant should be able to understand the meaning of the substantive content of the evidence submitted. If this is doubtful or contested by the applicant, the Office may require a translation within a specified time limit. However, a rejection of such a request is feasible where it appears that the applicant's request, in view of the self-explanatory character of the submitted evidence, is exaggerated or even unjust.

For further information on proof of use, see the Guidelines, Part C, Opposition, Section 6, Proof of Use.

Rule 22(2) EUTMIR has the effect that the opposition must be rejected if (1) no proof of use is submitted within the time limit given, or (2) proof of use was submitted within the time limit given but the Office requested it to be translated and no translation was submitted within the time limit set.

If the opponent provides evidence of use in a language other than the language of the proceedings within the time limit established and then on its own initiative submits a translation of this evidence into the language of the proceedings after the expiry of the time limit but before the time limit set for the applicant to submit observations in reply has expired, this evidence will be taken into account. This applies even if the Office has not required the opponent to file a translation and even if the applicant has not contested the evidence yet.

4.3.5 Change of language during opposition proceedings

Article 119(7) EUTMR
Rule 16(2) EUTMIR

According to Article 119(7) EUTMR, the parties to opposition proceedings may agree to change the procedural language and choose any official language of the European Union for that purpose.

Rule 16(2) EUTMIR sets forth the conditions under which such a change of language may occur. It requires that the opposition be filed in a language of the Office at the outset. It states that the parties may agree to change the procedural language and are required to inform the Office accordingly prior to the expiry of the cooling-off period. A request to change the language after the expiry of the cooling-off period will not be accepted by the Office.

When the opponent and the applicant agree to change the language of the proceedings before the start of the adversarial part of the proceedings, Rule 16(2) EUTMIR requires the opponent to 'file a translation of the notice of opposition in that language'. It has to do so within one month of expiry of the cooling-off period.

Where the translation is not filed or filed late, the language of the proceedings will remain unchanged.

4.4 Documents not readable/reference to other files

4.4.1 Documents not readable

Rule 80(2) EUTMIR

Where a communication received by fax is incomplete or illegible, or where the Office has reasonable doubts as to the accuracy of the transmission, the Office will inform the sender accordingly and invite it, within a time limit to be specified by the Office, to retransmit the original by fax or to submit the original in accordance with Rule 79(a) EUTMIR.

When this request is complied with within the time limit specified, the date of receipt of the retransmission is deemed to be the date of receipt of the original communication.

4.4.2 No return of original documents

Original documents become part of the file and therefore cannot be returned to the person who submitted them.

However, the party always has the possibility of obtaining a certified or uncertified copy of the original documents, subject to the payment of a fee. For further details, see information displayed on the Office's web page under 'Inspection of files and copies'.

4.4.3 Confidential information

Rule 88(c) EUTMIR

In some cases one of the parties requests the Office to keep certain documents confidential even from the other party in the proceedings. Although the Office can keep documents confidential vis-à-vis third parties (inspection of files), it can under no circumstances keep documents confidential with regard to the other party in *inter partes* proceedings.

Each party to the proceedings must always have a right to defend itself. That means that it should have full access to all material submitted by the other party.

It follows that all material submitted by a party should be disclosed to the other party of the proceedings. The Office has an obligation to communicate all material received to the other party. Therefore, if one of the parties requests certain documents be kept confidential without mentioning whether this should be vis-à-vis third parties, the Office will take it for granted that this is the case and will forward them to the other party and mark them as confidential in the electronic file.

If in the course of opposition proceedings the Office receives documents with a request that they be kept confidential *inter partes*, the sender should be informed that the documents cannot be kept confidential with respect to the other party to the proceedings.

To this end, a letter has to be sent, clearly explaining that the sender may choose between disclosure of the documents or withdrawal of the documents. It is up to the party to decide which of these possibilities is appropriate for its case and inform the Office accordingly.

If it confirms confidentiality, the documents will not be sent to the other party and will not be taken into account. They will be marked as confidential in the electronic file.

If it wants the documents to be taken into account but not available for third parties, the documents can be forwarded to the other party, but must be marked confidential in the electronic file.

If it does not reply within the time limit specified, the documents will not be sent to the other party and will not be taken into account. They will be marked as confidential in the electronic file.

4.4.4 References made to documents or items of evidence in other proceedings

Rule 79(a) and Rule 91 EUTMIR Decision EX-13-4 of the President of the Office
--

The Office may receive observations from the opponent or applicant in which they refer to documents or evidence submitted in other proceedings, for instance to evidence of use that has already been submitted in a different opposition.

Such requests are accepted at any stage of the proceedings when the opponent/applicant clearly identifies the documents that it refers to. The party must indicate the following: (1) the number of the opposition it refers to; (2) the title of the document it refers to; (3) the number of pages of this document; and (4) the date this document was sent to the Office. For example, ‘the statutory declaration that was submitted to the Office on dd/mm/yy in opposition proceedings B XXX XXX, together with exhibits 1 to 8, consisting of XX pages’.

Should the documents referred to by the opponent or the applicant consist originally of items of evidence not having been filed in paper format up to and including A3 size and should this evidence not be available in the electronic file of the Office, in accordance with Rule 79a EUTMIR the party concerned must submit by mail a second copy for transmission to the other party within the original time limit. If no copy is provided, these items of evidence will not be taken into account.

In addition, it should be noted that the documents or evidence referred to might need translation into the language of the opposition proceedings. Rules 19(4) and 22(6), and Rule 96 EUTMIR apply accordingly.

A general reference to documents or evidence submitted in other proceedings will not be accepted. In such a situation the party making general reference to other documents or evidence may be invited to be sufficiently specific within a given time limit. The party should be informed that the time limit granted by the Office is only meant for the clear and precise indication of the documents or evidence referred to and that under no circumstances will an extension of the original time limit be granted. Moreover, the party should also be informed that if it does not specify which documents are being referred to within the time limit set, those other documents will not be considered.

The parties should be aware that material submitted in other proceedings may have been destroyed five years after their receipt in accordance with Rule 91 EUTMIR and Decision EX-13-4 of the President of the Office of 26 November 2013 concerning the keeping of files. In this case, the reference to documents or evidence submitted in other opposition proceedings has no effect.

4.5 Further exchanges

Rules 20(2), (4) and (6), 22(5), 96(2) and 98(2) EUTMIR

The Office invites the applicant to file observations within the time limit set by it in accordance with Rule 20(2) EUTMIR.

In appropriate cases, the Office may invite the parties to limit their observations to particular issues. In that case, the party is allowed to raise the other issues at a later stage of the proceedings. For example, the applicant can request proof of use of the earlier right with or without submitting observations at the same time on the grounds on which the opposition is based. In that case, the observations may be submitted together with the observations in reply to the proof of use.

Once the applicant has submitted its observations in reply, the opponent is granted a final time limit to submit its counter reply if the Office considers it necessary. After this, the adversarial part of the proceedings is usually closed and the opposition is ready for decision.

The Office may, however, grant the possibility of another exchange of observations. This can be when the case deals with complex issues or when the opponent raises a new point that is admitted to the proceedings. In this case the applicant must be given a possibility of replying. It is at the discretion of the Office to decide if another round of observations should be granted to the opponent.

Therefore, a further exchange of observations may only be granted where the opponent's final observations are purely in reply to the applicant's observations and are supported by evidence that is not meant to remedy flaws such as those related to substantiation, e.g. if the applicant raises new issues such as the coexistence of the marks, the invalidity of the earlier right or an agreement between parties. If the opponent submits evidence to the contrary, the applicant may be granted a second chance to submit further observations. Nevertheless, this is not automatic as it depends on the circumstances of the case.

4.5.1 Additional evidence for proof of use

The Office may take into account additional evidence for proof of use that is submitted after the expiry of the corresponding time limit under certain circumstances, namely where the opponent submitted relevant evidence within the time limit and the additional evidence is only supplementary (judgment of 18/07/2013, C-621/11 P, Fishbone, EU:C:2013:484, § 28-30). Additional evidence will be examined on a case-by-case basis. If necessary, a second round of observations will be granted. For further details, see the Guidelines, Part C, Opposition, Section 6, Proof of Use.

4.6 Observations by third parties

Article 40 EUTMR Communication 2/09 of the President of the Office

Third parties can make observations explaining why the EUTM application should not be registered under Article 5 EUTMR or on the basis of one of the absolute grounds of Article 7 EUTMR. For further details, see the Guidelines, Part B, Examination, Section 4, Absolute Grounds for Refusal and Collective Marks, and the Guidelines, Part B, Examination, Section 1, Proceedings.

Anybody can submit third party observations; even the opponent is entitled to do so. However, it should do so in a manner that leaves no doubt that they are third party observations. According to the abovementioned Communication of the President of the Office, the observations must be submitted separately. However, in practice (decision of 30/11/2004, R 0735/2000-2, SERIE A), the 'separate submission' requirement is deemed to be satisfied when the observations are clearly separable from the grounds and arguments supporting the opposition, even if they are included in the same document. As long as the opponent expressly mentions that it wishes to make observations under Article 40 EUTMR, these will be dealt with, even if they are not submitted separately. However, if in its submission the opponent argues that the EUTM application should have been refused under Articles 5 and 7 EUTMR, without any reference to the contents of Article 40 EUTMR, this submission will not be regarded as third party observations under Article 40 EUTMR.

When an opponent makes third party observations, the Office will consider if the observations raise serious doubts as to the registrability of the EUTM application, or if they will only be sent to the applicant for information purposes.

If the observations raise serious doubts, the Office must suspend the opposition proceedings until a decision on the observations is taken. In cases where the observations do not raise serious doubts (i.e. when the observations have only been sent to the applicant for information purposes) or do not affect the contested goods or services, the opposition proceedings will not be suspended. If the opposition proceedings need to be suspended, the suspension will take effect from the date when the Office issues the objection under Article 7, and proceedings will remain suspended until a final decision has been taken. For cases where the third party observations are received within the three-month opposition period, the Office will deal with the admissibility of the opposition and, once the decision on admissibility has been notified, the opposition proceedings will be suspended.

For oppositions closed due to third party observations, the opposition fee will not be refunded, as such refund is not foreseen in the regulations (see Rule 18(5) EUTMIR).

5 Termination of Proceedings

5.1 Friendly settlement

Article 42(4) EUTMR Rule 18(2) EUTMIR
--

The parties are free to decide on the measure that brings the opposition proceedings to conclusion. While they can decide on the withdrawal of the opposition, they can also simply ask the Office to close the case without giving specific reasons. It suffices to communicate the written signed agreement of the parties, which does not have to include a statement of grounds. The Office then takes the steps needed to close the proceedings on the basis of this agreement.

Regarding the refund of fees and decision on costs in case of friendly settlement, please see the relevant paragraph below.

The Office may, if it thinks fit, invite the parties to make a friendly settlement. The Office, as well as the parties, may therefore initiate a settlement procedure.

To this end it may issue proposals for friendly settlement. As, in principle, the Office cannot (and does not wish to) replace the parties, it will only take action in very rare cases where a settlement between the parties appears desirable and if there are good reasons for considering that the proceedings can be ended by a settlement.

If expressly requested by the parties, the Office can also offer assistance with their negotiations, for instance by acting as an intermediary or by providing them with any material resources that they need. Any costs incurred are borne by the parties. Friendly settlement may be preceded by a request for suspension.

5.2 Restrictions and withdrawals

Articles 58(1) and 64(3) and Article 85 EUTMR
Rules 18(2), (3) and (4) and 95(a) and 96(1) EUTMIR

5.2.1 Restrictions and withdrawals of EUTM applications

Article 43 EUTMR
Rule 18(5) EUTMIR

It is possible for the applicant to restrict the goods and services of its application or to withdraw the entire application at any stage of the opposition proceedings.

Withdrawals and restrictions must be explicit and unconditional. Silence on the part of the EUTM applicant during the proceedings will never be considered as a tacit withdrawal.

A conditional or ambiguous withdrawal or restriction will not be accepted and will be forwarded to the other party merely for information purposes, informing the parties that it will not be taken into account.

The Office does not accept restrictions that are conditional. For example, the applicant argues in its observations in reply to the opposition that the signs are dissimilar. However, the applicant adds that if the examiner finds them similar, it will restrict the list of goods and services of the EUTM application. In this case the restriction is not acceptable, and the applicant must be informed that the restriction must be express and unconditional.

For further information on restrictions of an EUTM application, see the Guidelines, Part B, Examination, Section 3, Classification and Part B, Examination, Section 1, Proceedings, paragraph 5.2.

If the restriction is not acceptable the applicant must be notified.

If a restriction is partly acceptable and partly unacceptable (see the Guidelines, Part B, Section 3, Classification for further information on what constitutes an acceptable amendment), the Office will proceed with the restriction for the acceptable part and will inform the applicant of the part that cannot be accepted, giving a time limit of two months to react. The opponent must be sent a copy of the restriction and the reply of the Office to the applicant. If within the two months the applicant reacts with a new proposal for the unacceptable part of the restriction, which the Office can now accept, the restriction will be processed taking into account the date of filing of the first request for the restriction. On the other hand, if the applicant does not react, the restriction is only processed insofar as it is acceptable (judgment of 11/12/2014, C-31/14 P, Premeno, EU:C:2014:2436, § 43-51).

If the opponent withdraws its opposition after an unacceptable restriction has been filed, the withdrawal will not be taken into account if it clearly refers to the unacceptable restriction. Once the restriction has become acceptable, the opponent will be informed of the new list of goods and services and will be granted a new time limit to confirm the withdrawal of the opposition.

If the restriction is acceptable, a confirmation is sent to the applicant.

Depending on the moment in the proceedings, the restriction or withdrawal has different consequences, described below.

5.2.1.1 Withdrawal or restriction before the admissibility check is made

Restriction covers the whole extent of opposition/withdrawal

When the EUTM application is withdrawn or restricted to non-contested goods and services before notification of admissibility of the opposition, the opposition proceedings are closed and the opposition fee is refunded. In other words dealing with the withdrawal or restriction in these cases has priority over the admissibility.

No decision on costs will be taken.

Restriction does not (seem to) cover the whole extent of the opposition

In the case of a restriction that may still include contested goods and services, an admissibility check is done.

The restriction is notified to the opponent together with the notification of the admissibility or with the communication informing the opponent of an absolute or relative admissibility deficiency.

If the opposition is withdrawn, the opposition fee is refunded. This is the case even if irremediable deficiencies exist.

The opponent's letter does not have to make an express reference to the restriction, as long as it is later in time than the applicant's restriction.

No decision on costs will be taken.

5.2.1.2 Restrictions and withdrawals of EUTM applications before the end of the cooling-off period

Restriction covers the whole extent of the opposition/withdrawal

If it is absolutely clear that the restriction covers the whole extent of the opposition or when the EUTM application is withdrawn, this is notified to the parties and the proceedings are closed. The opponent is refunded the opposition fee.

No decision on costs will be taken.

Restriction does not (seem to) cover the whole extent of opposition/withdrawal

If it is not completely clear that the restriction covers the whole extent of the opposition or the restriction does not cover the whole extent of the opposition, the opponent is invited to inform the Office whether it wishes to maintain or withdraw its opposition. The parties are notified of its reply. If the opposition is withdrawn, the opposition fee is refunded to the opponent.

No decision on costs will be taken.

The relevant time to assess whether the opposition proceeding is closed during the cooling-off period is the date a request for restriction was filed before the Office.

If the withdrawal of the opposition is received by the Office before the official notification of the restriction is copied to the opponent, the withdrawal is considered to be a consequence of the restriction and the opposition fee is also refunded.

The opponent's letter does not have to make an express reference to the restriction, as long as it is later in time than the applicant's restriction.

The initial reaction of the opponent to the notification does not matter, as long as the withdrawal is declared later.

Examples

- The opponent does not reply within the time limit given to it but subsequently withdraws its opposition within the cooling-off period (which has been extended).
- The opponent responds by maintaining its opposition, but nevertheless withdraws the opposition still within the extended cooling-off period.

5.2.1.3 Restrictions and withdrawals of EUTM applications after the end of the cooling-off period

Restriction covers the whole extent of the opposition/withdrawal

If it is absolutely clear that the restriction covers the whole extent of the opposition, the case is closed by the Office and the parties will be notified. At the same time the restriction is forwarded to the opponent.

Unless the parties submit an agreement on costs, the Office will take a decision on costs. For information on the apportionment of costs, see paragraph 5.5.3 of these Guidelines below.

Restriction does not (seem to) cover the whole extent of opposition/withdrawal

If it is not completely clear that the restriction covers the whole extent of the opposition or the restriction does not cover the whole extent of the opposition, the opponent is invited to inform the Office whether it wishes to maintain or withdraw its opposition. The parties are notified of any reply. If the opposition is maintained, the proceedings continue. If the opposition is withdrawn, the opposition proceedings are closed. If the opponent first maintains its opposition and then subsequently withdraws, this is treated as a withdrawal of the opposition in accordance with paragraph 5.2.2.2 below.

Unless the parties submit an agreement on costs, the Office will take a decision on costs. For information on the apportionment of costs, see paragraph 5.5.3 below.

5.2.1.4 Restrictions and withdrawals of EUTM applications after a decision has been taken

Following the decision of the Grand Board of Appeal of 27/09/2006 in case R 0331/2006-G, Optima, the Office accepts withdrawals and restrictions received during the appeal period after a decision on the opposition has been rendered, even if no appeal has been filed. However, the withdrawal or restriction will not have any effect on the decision, which remains valid.

This means that the Office will take note of the withdrawal and close the case. Confirmation of the withdrawal is sent to the parties (however, no decision on costs is included in this communication). The part on costs of the initial decision remains valid and can be enforced by the winning party. The Office's database is updated accordingly to reflect the withdrawal of the EUTM application.

For further information, see the Guidelines, Part B, Examination, Section 1, Proceedings and the Guidelines, Part E, Register Operations, Section 2, Conversion.

An EUTM application cannot be withdrawn once a decision rejecting the EUTM application in full has become final, that is to say after the two-month period for appeal.

If the decision rejected the opposition, the application can be withdrawn or restricted at any time.

5.2.1.5 Language

Rule 95(a) EUTMIR

During opposition proceedings a restriction may be submitted either in the first or the second language of the EUTM application.

When the restriction is submitted in the first language of the EUTM application, which is not the language of proceedings, and when the restriction does not cover the whole extent of the opposition, the restriction is forwarded to the opponent, requesting it to inform the Office whether or not it maintains its opposition. The opponent can object to the language of the restriction and ask for a translation into the language of proceedings. The Office will then provide for the translation.

If an acceptable restriction is submitted in the first and the second language, the examiner must reflect this restriction in the two languages in the Office's database and confirm the new list of goods and services in the two languages to the applicant.

5.2.2 Withdrawal of oppositions

The opponent can withdraw its opposition at any time during the proceedings.

A withdrawal of the opposition must be explicit and unconditional. A conditional or ambiguous withdrawal will not be accepted and will be forwarded to the applicant merely for information purposes, informing the parties that it will not be taken into account.

If the opponent withdraws its opposition independent of any restriction of the EUTM application, three situations can arise depending on the status of the opposition (for information about the consequences of the withdrawal of an opposition following a restriction of the EUTM application, see paragraph 5.2.1 above.)

5.2.2.1 Withdrawal of the opposition before the end of the cooling-off period

If the opposition is withdrawn before the end of the cooling-off period the parties are notified. Unlike a withdrawal of the opposition following a restriction of the EUTM application during the cooling-off period (see paragraph 5.2.1.2 above), the Office neither refunds the opposition fee nor takes a decision on costs.

5.2.2.2 Withdrawal of the opposition after the end of the cooling-off period

If the opposition is withdrawn after the end of the cooling-off period the parties are notified. The opposition fee is not refunded. Unless the parties submit an agreement on costs, the Office will take a decision on costs. For information on the apportionment of costs, see paragraph 5.5.3 below.

5.2.2.3 Withdrawal of the opposition after a decision has been taken

Following decision of the Grand Board of Appeal of 27/09/2006 in case R 0331/2006-G, Optima, the Office accepts withdrawals of the opposition received during the appeal period after a decision on the opposition has been taken, even if no appeal has been filed. However, the withdrawal will not have any effect on the decision, which remains valid.

This means that the Office will take note of the withdrawal and close the case. Confirmation of the withdrawal is sent to the parties (however, there is no decision on costs included in this communication). The part on costs of the initial decision remains valid and can be enforced by the winning party. The database of the Office is updated accordingly to reflect the withdrawal of the opposition and the application is sent to registration.

For further information on withdrawals during appeal proceedings, see the Guidelines, Part B, Examination, Section 1, Proceedings, paragraph 5.1.

5.2.2.4 Language

Rule 96(1) EUTMIR

A withdrawal of the opposition must be in the language of the proceedings. Should the withdrawal be submitted in a language that is not the language of proceedings a translation must be filed within one month from the date of submission of the original document. Otherwise the withdrawal will be refused.

5.2.3 Withdrawals of withdrawals/restrictions

A party is only permitted to withdraw a previously submitted withdrawal/restriction if the Office receives its letter withdrawing the earlier withdrawal/restriction on the same day as the first submission.

5.3 Decision on substance

The decision on substance is taken once all the required submissions of the parties have been filed. It should deal only with those issues or earlier rights that are relevant for the outcome.

There are two exceptions:

- earlier right not proven;
- ceasing of existence of the earlier right.

5.3.1 Earlier right not proven

Rule 20(1) EUTMIR

If proof of existence and validity has not been filed properly for any of the earlier rights invoked, the opposition is rejected as soon as the time limit given to the opponent to complete its file has expired.

However, if the existence and validity of at least one earlier right has been proven, the proceedings will continue normally, and the non-substantiated rights will not be taken into account in the final decision on substance.

5.3.2 Ceasing of existence of the earlier right

If, in the course of the proceedings, the earlier right ceases to exist (e.g. because it has been declared invalid, or it has not been renewed), the final decision cannot be based on it. The opposition may only be upheld with respect to an earlier right that is valid at the moment when the decision is taken. The reason why the earlier right ceases to have effect does not matter. Since the EUTM application and the earlier right that has ceased to have effect cannot coexist anymore the opposition cannot be upheld to this extent. Such a decision would be unlawful (judgment of 13/09/2006, T-191/04, Metro, EU:T:2006:254, § 33-36).

Invalidation of any earlier right other than an EUTM cannot be detected by the Office. However, if one of the parties informs the Office that this is the case, the other party must be heard, and eventually, the opposition will not be able to proceed on the basis of that earlier right.

Before the decision is taken, the Office will check whether the earlier right invoked has become due for renewal in the meantime. If so, the Office will invite the opponent to prove the renewal of the mark. This is the case even if the mark is still within the grace period for renewal, if applicable. If the opponent does not submit the proof, the opposition will not be able to proceed on the basis of that earlier right.

Before the decision is taken, the Office may also check the documents on file to see whether the earlier right invoked is the subject of national post-registration proceedings. If so, the Office will invite the opponent to provide evidence of the final outcome of the national proceedings. If the opponent provides evidence showing that the national proceedings are still pending, the Office may suspend the opposition proceedings until a final decision has been taken in the proceedings that led to the suspension.

5.4 Fee refund

5.4.1 Opposition deemed not entered

Article 41(3) EUTMR Article 114c(1) EUTMR Rule 17(1) EUTMIR

If an opposition is deemed as not entered because of late or insufficient payment (see paragraph 2.2.2 above, Time of payment), the opposition fee, including any surcharge, must be refunded to the opponent.

5.4.1.1 Opposition and withdrawal of the opposition filed the same date

In cases where the opposition is withdrawn the same day it was filed, the Office refunds the opposition fee.

5.4.1.2 Refund after republication

If after republication of the EUTM application in part A.2 of the Bulletin due to a mistake by the Office, a 'first publication opponent' wishes to withdraw its opposition as a consequence of the republication, the proceedings should be closed. As the Office made a mistake with the first publication, the opposition fee will be reimbursed.

5.4.2 Refund in view of withdrawals/restrictions of EUTM application

5.4.2.1 EUTM application withdrawn/restricted before the end of the cooling-off period

Rule 18(2), (4) and (5) EUTMIR

If the applicant withdraws its EUTM application or withdraws all those goods and services against which the opposition is directed before or during the cooling-off period, the opposition proceedings are closed, there is no decision on costs and the opposition fee must be refunded.

5.4.2.2 Opposition withdrawn due to restriction of EUTM application within the cooling-off period

Rule 18(3)-(5) EUTMIR

If the applicant withdraws some of the goods and services against which the opposition is directed during the cooling-off period, the Office invites the opponent to state whether it maintains the opposition (and, if yes, against which of the remaining goods and services,) or if it withdraws it in view of the restriction.

If the opposition is then withdrawn, the opposition proceedings are closed, there is no decision on costs and the opposition fee must be refunded.

5.4.3 Multiple oppositions and refund of 50 % of the opposition fee

Rule 21(4) EUTMIR

In certain special cases concerning multiple oppositions, it is possible to refund 50 % of the opposition fee to an opponent. Two conditions must be met:

- one of the opposition proceedings was terminated by the rejection of the contested EUTM application in parallel opposition proceedings. For example, if there are four oppositions A, B, C and D (opponents A, B, C, D) against EUTM application X, and EUTM application X is rejected due to opposition A, and
- the other oppositions (B, C and D) had been suspended at an early stage of the proceedings (i.e. before the expiry of the cooling-off period) because a preliminary examination revealed that EUTM application X would probably be rejected in its entirety because of opposition A.

In this case, opponents B, C and D are refunded 50 % of the opposition fee.

5.4.4 Cases where the opposition fee is not refunded

5.4.4.1 Opposition withdrawn before the end of the cooling-off period NOT due to a restriction

Rule 18(3)-(5) EUTMIR

If the opponent withdraws its opposition before the end of the cooling-off period and there has been no restriction of the EUTM application, the Office neither refunds the opposition fee nor takes a decision on costs.

5.4.4.2 Opponent's withdrawal is earlier

Rule 18(3) and (5) EUTMIR

When the opposition is withdrawn before the applicant restricts its application, the fee is not refunded. For example, if the applicant withdraws its application following (as a reaction to) the withdrawal of the opposition, the fee is not refunded, as this is the opposite situation.

The same applies when the applicant restricts the application following a partial withdrawal of the opposition.

5.4.4.3 Settlement between the parties before commencement of proceedings

Rule 18(2), (4) and (5) EUTMIR

As regards the refund of the opposition fee, Rule 18(5) EUTMIR only mentions this possibility if there is either a withdrawal or a restriction of the EUTM application. Therefore, if the proceedings end by an agreement that contains a mention of a withdrawal or restriction of the EUTM application, the opposition fee is refunded. In the other cases, the opposition fee is not refunded.

5.4.4.4 Termination of proceedings for other reasons

Articles 7 and 40 and Article 92(2) EUTMR
Rules 17-18 and Rule 76(1) and (4) EUTMIR

In cases where the application is rejected in accordance with:

- Article 7 EUTMR (rejection of an application on absolute grounds; on the Office's own initiative or because of third party observations)
- Article 92(2) EUTMR (representation for non-EEA applicants) and
- Rule 76(4) EUTMIR (authorisations when expressly asked for by one of the parties),

the opposition fee is not refunded as none of these situations is contemplated in the EUTMIR as a reason for refunding the opposition fee.

5.5 Decision on the apportionment of costs

5.5.1 Cases in which a decision on costs must be taken

Article 85 EUTMR Rule 18(4) EUTMIR

A decision on costs is taken in opposition proceedings that have passed the cooling-off period, that is to say, where the adversarial part of the proceedings has started and come to an end.

If a decision on substance is taken, the decision on apportionment of costs is given at the end of the decision. In all other cases where the Opposition Division closes the case a decision on costs is issued together with the closure letters unless the parties have informed the Office about an agreement on costs.

5.5.2 Cases in which a decision on costs is not taken

No decision on costs is taken for oppositions that are closed before or during the cooling-off period.

5.5.2.1 Agreement on costs

Article 85(5) EUTMR

Whenever the parties have settled the opposition proceedings with an agreement that includes the costs, the Office will not issue a decision on costs. The same is true if the Office receives information signed by both parties stating that the parties have agreed on costs. Such a request can also be sent in two separate letters to the Office. This information must be received before the Office has confirmed the closure of the proceedings.

If the parties settle the opposition by mutual agreement, they are free not to include the cost issue. If no indication is given as to whether the parties have agreed on the costs, the Office will take a decision on costs immediately, together with the confirmation of the withdrawal/restriction. If the parties inform the Office that they have reached an agreement on costs after the withdrawal/restriction, the decision already issued on costs will not be revised by the Office. It is left to the parties to respect the agreement and not to 'execute' the Office's decision on costs.

5.5.2.2 Information from potential 'successful party'

When the party that would be entitled to be awarded costs according to the general rules described in paragraph 5.5.3 below informs the Office that it accepts each party bearing their own costs, no decision on costs is necessary. The Office will refrain from taking a decision on costs whenever the potential 'successful party' informs the Office that it agrees to share the costs even if the 'losing party' does not confirm its agreement. The latest letters from both parties have therefore to be checked carefully before issuing a decision.

If, however, the losing party sends such a request to the Office, it will simply be forwarded to the other party, but the decision on costs will be taken *ex officio* under normal rules.

5.5.3 Standard cases of decisions on costs

Article 85(1)-(3) EUTMR Rule 94 EUTMIR

The general rule is that the party that terminates the proceedings, by withdrawing the EUTM application (wholly or partially) or by withdrawing the opposition, will bear the fees incurred by the other party as well as all costs incurred by it that are essential to the proceedings.

If both parties lose in part, a 'different apportionment' has to be decided. As a general rule, it is equitable that each party bears its own costs.

A party that terminates the proceedings is deemed to have given in. The hypothetical outcome of the case if a decision on substance had become necessary is absolutely irrelevant.

In standard cases the result is the following.

- The applicant withdraws or restricts its application to the goods and services the opposition is not directed at (partial withdrawal). In these cases the applicant has to pay the costs.
- The opponent withdraws its opposition without any restriction of the EUTM application as regards the contested goods and services after the cooling-off period. The opponent has to pay the costs.
- Restriction of the application followed by withdrawal of the opposition (judgment of 28/04/2004, T-124/02 and T-156/02, Vitataste, EU:T:2004:116, § 56). In principle each party bears its own costs.

A different apportionment of costs can however be justified for reasons of equity (for example, if the application was restricted only to a very small extent).

The Office will not take into account parties' arguments as to who should pay.

5.5.4 Cases that did not proceed to judgment

5.5.4.1 Multiple oppositions

Complete rejection of the EUTM application

In cases where there are multiple oppositions against the same EUTM application that have not been suspended by the Office in accordance with Rule 21(2) EUTMIR, and one opposition leads to the rejection of the EUTM application, the Office does not take any action in the other oppositions until the appeal period has elapsed.

If the appeal period elapses without an appeal being filed, the Office closes the other opposition proceedings and the cases do not proceed to judgment.

In this case, the determination of costs is at the discretion of the Opposition Division (Article 85(4) EUTMR). The Office is not able to determine who the 'winning or losing party' is, and the applicant should not be required to pay the costs of several other opponents if it loses in one decision on substance. Therefore, applying a principle of equity, each party will be ordered to bear its own costs.

Partial rejection of the EUTM application

In cases of multiple oppositions that are partially directed against the same goods and services of the contested trade mark, the decision in relation to the opposition that is taken first may affect the other oppositions.

Example

Opposition A is directed against Class 1 and opposition B against Classes 1 and 2 of the contested EUTM application. A decision is taken first in opposition A rejecting the contested application for Class 1. When the decision is notified to the parties of opposition A, opposition B must be suspended until the decision in opposition A is final and binding. Once the decision is final, the opponent of opposition B will be invited to inform the Office whether it wishes to maintain or withdraw its opposition in view of the amendment of the list of goods. If the opponent withdraws the opposition, the case is closed.

In this situation, and if the case is closed after commencement of the adversarial part of the proceedings, the Office will issue a decision on costs in accordance with Article 85(2) EUTMR. The opponent withdrew its opposition following the partial rejection of the contested trade mark. To this extent the opponent was successful in the proceedings. However, the partial rejection of the trade mark was more restricted than the scope of the opposition. To this extent the applicant/holder was also successful in the proceedings. Consequently, it is equitable that each party should bear its own costs.

If the opponent maintains its opposition after the partial rejection, the proceedings continue and in the final decision on the substance the decision on costs is taken according to the normal rules.

5.5.4.2 Rejection of an application on the basis of absolute grounds or formalities

An EUTM application can be rejected during an opposition procedure on absolute grounds for refusal (either on the basis of third-party observations, Article 40 EUTMR, or even *ex officio* if the case is re-opened) or on formalities (e.g. if an applicant from outside the EEA is no longer represented under Article 92(2) EUTMR).

Once the rejection becomes final, the opposition proceedings are closed by issuing a notification.

In these situations the practice on costs is as follows:

If the refusal becomes final after the expiry of the cooling-off period, a decision on costs is taken pursuant to Article 85(4) EUTMR. If the same situation arises before commencement of the adversarial part, no decision on costs is to be taken.

5.5.4.3 Cases of joinder

Rule 21 EUTMIR

For further information on joinder, see paragraph 6.4.3, Joinder of proceedings, below.

In cases where the joint opposition succeeds in its entirety the applicant should pay the opposition fees paid by each of the opponents but representation costs only once. If the applicant wins, its representation costs will be awarded once but each of the joint opponents will be liable for them. A different apportionment of costs might be equitable. In cases of partial success or if equitable for other reasons, each party should bear its own costs.

5.5.4.4 The meaning of 'bear one's own costs'

The notion of costs comprises the opposition fee and the costs essential to the proceedings, as referred to in Article 85(1) EUTMR and Rule 94(6) and (7) EUTMIR. In most cases the costs cover the remuneration of an agent within the limits of the scales set by the Regulation.

'Each party shall bear their own costs' means that no party has a claim against the other party.

5.6 Fixing of costs

Article 85(6) EUTMR Rule 94 EUTMIR

Where the costs are limited to representation costs and the opposition fee, the decision fixing the amount of costs will be included in the decision on the apportionment of the costs (i.e. as a rule, in the decision on substance).

This means that in the vast majority of cases, it will not be necessary to fix the amount of costs separately.

The only exceptions are:

- when an oral hearing took place;
- when the fixing of costs was inadvertently omitted ('forgotten') in the main decision.

5.6.1 Amounts to be reimbursed/fixed

Rule 94(3) and (6) EUTMIR

The amount to be reimbursed is always fixed in EUR, regardless of the currency in which the party had to pay its representative.

If the opponent wins, the opposition fee of EUR 320 will be reimbursed.

As regards representation costs, the amount is limited to EUR 300. This applies both to the opponent and the applicant, provided that they were represented in the opposition procedure by a professional representative within the meaning of Article 93(1) EUTMR, irrespective of whether these costs have actually been incurred. If the winning party was represented at some stage of the proceedings by a professional representative, but is no longer represented at the time of taking the decision on costs, it is also entitled to an award of costs regardless of when in the proceedings professional representation ceased.

Representation costs for employees, even from another company with economic connections, are not reimbursable and will not be fixed. They will not be addressed in the decision on costs.

For further information on representation, see the Guidelines, Part A, General Rules, Section 5, Professional Representation.

In the case of a joinder under Rule 21(1) EUTMIR, where the oppositions are successful, the Office will fix both (or all) opposition fees (one for each opposition) but only one representation fee, in which case the costs to be paid by the applicant to the opponents would be EUR 940.

As regards the costs of the opposition procedure, one single decision on the apportionment and on the fixing of costs must be taken for the opposition procedure as a whole.

When a decision is annulled by the Boards of Appeal and remitted to the Opposition Division, the Opposition Division has to decide on the case again and will take a decision on and fix the costs in the usual way.

If this decision is appealed again (and not remitted for a second time) the Board will decide on and fix the costs in the usual way.

5.6.2 Procedure if the fixing of costs is contained in the main decision

Rule 94(3) EUTMIR

Where the decision fixing the amount of costs is included in the decision on the apportionment of the costs, no bill or proof whatsoever is needed. The Office knows that the opposition fee was paid and, if there is a representative, EUR 300 must be awarded irrespective of any evidence. It is assumed that the costs of representation have been of at least EUR 300.

Therefore, no correspondence with the parties about the amount to be fixed is necessary. The fixing of the amount is automatic.

5.6.3 Procedure if a separate fixing of costs is needed

The following procedural requirements apply in the rare cases where a separate fixing of costs must be made (including when it was inadvertently omitted; in that case the party concerned must also comply with the applicable requirements):

- admissibility

- evidence.

5.6.3.1 Admissibility

Article 85(6) EUTMR

The request for fixation of costs is only admissible once the decision in respect of which the fixing of costs is required has become final and until two months after that date.

5.6.3.2 Evidence

Rule 94(3) EUTMIR

For awarding the opposition fee, no evidence is needed.

For awarding the representation costs at the standard rate, an assurance by the representative that the costs have been incurred is sufficient. A fortiori, if a bill is presented, it suffices that it shows at least the reimbursable amount; it does not matter whether it is addressed to the party to the proceedings, as submitting a bill equals an assurance.

For all other costs (which will apply in extremely rare cases), a bill and supporting evidence are needed, but it suffices that these make it plausible (rather than provide fully-fledged proof) that the costs have been incurred.

5.6.4 Review of fixing of costs

Article 85(6) EUTMR Rule 94(4) EUTMIR

If one of the parties disagrees with the amounts fixed, it can ask for a review of the decision. The request must state the reasons and be filed within one month after the date of notification of the fixation. The request is only deemed to be filed when the fee for review of EUR 100 has been paid.

There are no reimbursable costs in the review procedure (decision of 16/12/2004, R 0503/2001-4, BIOLACT/BIO).

6 Procedural Issues

6.1 Correction of mistakes

Article 43(2) EUTMR Rule 53 EUTMIR

6.1.1 Correction of mistakes in the notice of opposition

There are no special provisions in the Regulations on correction of mistakes in the notice of opposition. Applying Article 43(2) EUTMR, which refers to the EUTM application, by analogy, obvious mistakes in the notice of opposition may be corrected.

The Office defines ‘obvious error’ in relation to Article 43(2) EUTMR and Rule 53 EUTMIR as in No B.16 of the Joint Statements by the Council and the Commission entered in the minutes of the Council meeting at which the EUTMR was adopted: ‘... the words ‘obvious mistake’ should be understood as meaning mistakes which obviously require correction, in the sense that nothing else would have been intended than what is offered as the correction’.

For example, if the opponent’s details appear where the representative’s should appear, this can be considered an obvious mistake.

6.1.2 Correction of mistakes and errors in publications

Rule 14 EUTMIR

Where the publication of the application contains a mistake or error attributable to the Office, the Office will correct the mistake or error on its own initiative or at the request of the applicant.

The corrections effected under this rule have to be published. If the correction concerns mistakes that do not affect the opposition, it will be published when the EUTM is registered. Where the correction leads to an extension of the list of goods or services or concerns the representation of the mark, a new opposition period is opened, but only in respect of the corrected parts.

If oppositions were filed after the ‘first’ publication of the EUTM application, the opponents will have to be informed of the republication. The opponents that opposed the ‘first’ publication do not have to file a new opposition. The proceedings must be suspended until the opposition period following the ‘second’ publication has expired.

If a ‘first publication opponent’ wishes to withdraw its opposition as a consequence of the republication, the proceedings should be closed and the opposition fee should be refunded (see paragraph 5.4.1.2 above).

6.2 Time limits

Rule 71(1), Rule 79 and Rules 80(3), 82(3) and 96(1) EUTMIR

Time limits are an essential tool for conducting orderly and reasonably swift proceedings. They are a matter of public policy, and rigorous compliance with them is necessary for ensuring clarity and legal certainty.

For general information on time limits and continuation of proceedings, see the Guidelines, Part A, General Rules, Section 1, Means of Communication, Time Limits.

6.2.1 Extension of time limits in opposition proceedings

6.2.1.1 Non-extendable and extendable time limits

Rule 71(1) EUTMIR

A time limit cannot be extended if its length is set by the Regulation. Non-extendable time limits include:

Article 41(1) EUTMR

- the three-month opposition period to file an opposition;

Article 41(3) EUTMR

- the three-month time limit to pay the opposition fee;

Article 114b(3) EUTMR

- the one-month time limit to pay the surcharge where payment arrives late and no proof is made that it was initiated at least 10 days before expiry of the time limit for payment;

Rule 17(4) EUTMIR

- the two-month time limit to remedy deficiencies according to Rule 17(4) EUTMIR.

Rule 71(1) EUTMIR

The length of extendable time limits is specified by the Office. For example, the time limit to submit observations in reply to the notice of opposition is an extendable time limit.

6.2.1.2 Request made in time

Note: Extensions of the cooling-off period have a special regime. For further details, see above under paragraph 3.2, Extension of the cooling-off period.

For **an extension to be granted** the request has to fulfil the following conditions:

- the time limit must be extendable;
- the extension has to be requested by the party concerned or jointly by both parties;
- the request has to be signed;
- the original time limit must not have expired already;
- the language regime must be respected, i.e. if the request is not in the language of the proceedings a translation must be submitted within one month of filing, otherwise the request will not be taken into account.

An extension will only be possible if the relevant request is filed and received before the expiry of the original term (order of 30/01/2014, C-324/13 P, Patricia Rocha, EU:C:2014:60). If a request for extension is received by the Office after the expiry of the time limit, it must be rejected.

As a general rule, the first request for an extension that is received in time will be considered appropriate and will be granted for a period of two months (or less if so requested). However, any subsequent request for an extension of the same time limit will be refused, unless the party requesting it duly explains and justifies the exceptional circumstances that prevented it from meeting the original time limit and the first extension and why a further extension is necessary. General or vague explanations will not justify a second extension. The request must always be accompanied by evidence and/or supporting documentation.

On the other hand, circumstances that are within the control of the party concerned are not 'exceptional circumstances'. For example, last-minute discussions with the other party are not 'exceptional circumstances'. They are within the control of the parties.

The request has to be filed by the party affected by the time limit. For example, if the applicant has to submit observations in reply to the notice of opposition, it can only be the applicant that asks for an extension.

For more information on extensions of time limits, consult the Guidelines, Part A, General Rules, Section 1, Means of Communication, Time Limits, paragraph 3.1.3.

6.2.1.3 Extension of a time limit by the Office on its own initiative

The Office can extend a time limit on its own initiative, if and when particular reasons make it necessary. For example, a request to extend a time limit without any justification is received by the Office 20 days before the end of the time limit to file observations but was not dealt with until after expiry of the time limit. Because the refusal of the request after expiry of the time limit will disproportionately harm the interests of the party who requested the extension, the Office extends the time limit by the number of days that were left when the party sent in its request, in this case 20 days. This practice is based on the rules of fair administration.

Where a request for extension of an extendable time limit has been filed and received before the expiry of this time limit (order of 30/01/2014, C-324/13 P, Patricia Rocha, EU:C:2014:60), the party concerned will be granted at least one day, even if the request for extension arrived on the last day of this time limit.

6.2.1.4 Signature

If one of the requests is not signed, it has to be checked if a second, signed, request was received at a later time but still within the time limit. This is because parties sometimes forget to sign, but realise their error after having sent the request, so they sign it and send it again.

A joint request has to be signed by both parties and has to be received within the time limit for which an extension is requested. A request signed by one of the representatives, assuring the Office that the other party agrees to the extension is not acceptable.

6.3 Suspension

Rules 20(7) and 21(2) EUTMIR

The Office can suspend opposition proceedings either *ex officio*, or at the request of either one or both parties.

According to Rule 20(7) EUTMIR, the Office 'may' suspend opposition proceedings. Therefore, the decision to suspend is always taken at the discretion of the Office.

6.3.1 Suspension requested by both parties

If both parties request suspension after expiry of the cooling-off period, they do not have to give any specific justification, and the suspension is always granted. In this case, and regardless of the period requested by the parties, the first suspension will be granted for a period of one year, with the parties being given the possibility of opting out. The process for opting out is the same as for the extension of the cooling-off period: if one party opts out, the suspension will end 14 days after the parties have been informed thereof. The proceedings will resume the day after and the party whose time limit was pending at the moment of suspension will be granted a time limit of two months. It is not possible to opt out during the last month of the suspended period and any requests to do so will be rejected.

A joint request for suspension because of ongoing negotiations will not be granted if it is received within the cooling-off period because the purpose of the cooling-off period is to set a time frame for negotiations before the adversarial stage begins.

In principle, the parties may jointly request extensions of the suspension for negotiations. Such requests will be granted automatically for further one-year periods. However, after three years of suspension the parties are expected to provide an explanation as to why the negotiations have still not come to an end. In order to avoid any possible abuse, the Office may apply its discretion and decide not to further suspend the proceedings.

Requests submitted by only one of the parties will in principle be rejected. It is common for parties to negotiate during opposition proceedings. However, it may be the case that one party wishes to negotiate only provided that such negotiations do not delay the proceedings. This is why negotiations do not give either of the parties the right to ignore a pending time limit, to obtain an extension thereof or to obtain a suspension of the proceedings. Such requests are therefore rejected.

6.3.2 Suspensions by the Office *ex officio* or at the request of one of the parties

The Office may suspend the opposition proceedings *ex officio* or at the request of one party under a variety of circumstances.

The EUTMIR contemplates two specific cases where proceedings may be suspended:

- The opposition is based on an application for registration of a trade mark (including conversion).
- The opposition is based on an application for registration for a geographical indication or designation of origin.

In addition, according to the EUTMIR, the proceedings may be suspended where appropriate under the circumstances, for example in the following situations:

- The earlier right is at risk (under opposition or cancellation).
- There are third-party observations that raise serious doubts as to the registrability of the EUTM application (see p. 51).
- There are errors in the publication of the contested application that require the mark to be republished.
- A transfer is pending on earlier EUTMs/EUTM applications or contested EUTM applications.
- The representative withdraws.

It should be noted that there is no obligation in any of the abovementioned cases to suspend the proceedings. The decision is at the Office's discretion.

6.3.2.1 Explanation of the basic principle, timing of suspension

Rule 20(7) EUTMIR

In principle, oppositions based on (i) applications or (ii) earlier rights that are at risk are not to be suspended *ex officio* at the very beginning of the proceedings. The assumption is that in most cases applications mature into registrations, and oppositions or cancellation actions against earlier rights might be solved during the proceedings.

In these cases the opposition proceeds until a decision is ready to be taken. Consideration must then be given as to whether the earlier right in question could make a difference, in a prima facie opinion, to the outcome of the opposition. If the opposition is deemed to be successful or rejected anyway, regardless of the fate of the earlier right at risk, the proceedings should not be suspended. If, in contrast, the earlier right at risk must necessarily be taken into account in the decision on the opposition, the proceedings will be suspended and, in the case of a national application or an earlier national mark at risk, the opponent must be requested to provide information on the status of the application or registration. For earlier EUTMs, the Office has this information at its disposal.

However, the Office may suspend the proceedings earlier if this is **requested by one of the parties** and the earlier right is an application or is at risk. If the earlier right is a national one the parties must provide evidence that it is facing problems. In this case the outcome of the proceedings against the earlier mark must have some impact on the opposition. Therefore, the probable outcome of the opposition will be considered in

order to decide on suspension — in particular, whether the final decision on the opposition cannot be issued without taking into account the earlier application or earlier registration. This will be the case if the circumstances of the case do not allow the Office to say that the opposition will be rejected (e.g. because there is no likelihood of confusion) or upheld (because there are other earlier rights that are sufficient to reject the contested mark for all the contested goods and services).

When an opposition is based on an application for registration, it may be appropriate to suspend the opposition proceedings under Rule 20(7) EUTMIR to await registration of the opponent's earlier mark. However, if an opposition is to be rejected, either for formal or for substantive reasons, a suspension would be meaningless and would simply prolong the proceedings unnecessarily.

When there are no other earlier rights to take into account (because there are no other earlier rights or they were not substantiated) or when the application or registration must nevertheless be taken into account (because the other earlier rights are not 'winners'), an assessment must be made of whether the opposition will be successful on the basis of the application, in order to decide on the suspension. Proceedings will only be suspended if it is found that the earlier application, if registered, will lead to the total or partial rejection of the contested EUTM application.

6.3.2.2 Earlier EUTM applications or registrations

The opposition is based on an application but is not suspended because there is another earlier right (a registered trade mark) on the basis of which the contested application may be rejected. If the opponent fails to substantiate this other earlier right, the earlier application becomes crucial for the decision. If, according to the records, the only earlier application or registration is facing problems, the opposition should be suspended.

6.3.2.3 Earlier national/international marks (applications or registrations/rights)

The issue of suspension will have to be raised by the parties (normally the applicant). In this case the party has to submit evidence that the earlier mark (application or registration/right) is facing problems. This evidence must be official, it must clearly identify the proceedings leading to the suspension and it must indicate the relief sought. In particular, the evidence must be clear as to the possible consequences for the earlier right on which the opposition is based. If necessary, the party may be requested to submit a translation of the evidence.

Upon such a request the Office will consider whether under the circumstances of the case it is advisable to suspend the proceedings.

If no one raises the question, then the general principle applies and the Office only has to decide on the suspension if the proceedings reach the end of the adversarial part and there is no information that the application has matured to registration or that national proceedings against the earlier mark have come to an end. In this case the opponent should be required to inform the Office on the status of its earlier application or registration.

6.3.2.4 Examples

Here are some examples where, according to the general practice indicated above, the situation apparently does not require suspension of the proceedings but the suspension can nevertheless be decided if the Office finds it appropriate.

- The opposition is based on a French mark and on an EUTM application, neither of which faces problems. Both cover the same sign and the same goods, which are confusingly similar to the contested trade mark. Therefore, the opposition may be dealt with on the basis of the French mark only. If likelihood of confusion can occur only in Member States other than France, the decision will be more solid if based on the EUTM application and therefore it is appropriate to suspend the proceedings to await the outcome of the EUTM application.
- The earlier application does not make any difference to the outcome, but the applicant requests a suspension. If the earlier right is an EUTM application and the Office concludes that it is facing problems or, in the case of a national application, if the applicant submits evidence that the opponent's application is facing problems, the proceedings may be suspended.

The following examples fall into the category of earlier national marks facing problems:

- the applicant (or a third party) has filed an action or a counterclaim seeking the invalidation or revocation of the earlier registration;
- the applicant (or a third party) has filed an action or a counterclaim seeking the transfer of the earlier right to its own name.

6.3.3 Multiple oppositions

Rule 21(2) EUTMIR

Except for under exceptional circumstances, such as where one opposition clearly leads to the rejection of the contested mark including all goods and services, the Office will not suspend the other proceedings.

6.3.3.1 After rejection of the EUTM application

When the EUTM application is subsequently rejected because of an 'active' opposition, the suspended oppositions are deemed to have been disposed of after the decision becomes final. If the decision has become final, the parties to the other proceedings must be informed, the oppositions that were suspended at an early stage (before the cooling-off period) will be closed, and 50 % of the opposition fee will be refunded to each opponent, in accordance with Rule 21(4) EUTMIR.

If an appeal has been filed against the decision, the oppositions remain suspended. If BoA reverses the decision, the other proceedings will be resumed immediately, without having to wait for that decision to become final.

6.3.4 Procedural aspects

Letters suspending the proceedings should always indicate the date the suspension takes effect — generally the date when a valid request was submitted.

6.3.4.1 Monitoring suspended files

In cases where the proceedings are suspended for an indefinite period, the Office will monitor the opposition every six months.

In cases where the earlier right is an application for a national registration or a national/international registration that faces problems, the resumption of proceedings will always depend on the reaction of the parties, which are expected to inform the Office about any changes in the status of the application or registration and submit evidence to this effect. Nevertheless, the Office issues reminders every six months in which the parties may also be requested to submit the evidence.

6.3.4.2 Resuming the proceedings

In all cases the parties will be informed of the resumption of the proceedings and of any pending time limit if applicable. Any time limit that was pending at the moment of the suspension will be set again with a full two-month time limit with the exception of the cooling-off period, which can never exceed 24 months according to Rule 18(1) EUTMIR.

Proceedings must be resumed as soon as a final decision has been rendered in the course of the national proceedings or an earlier application has been registered or refused. If the decision taken in the national proceedings invalidates, revokes, or results in some other way in the extinguishment of the right, or transfers the opponent's earlier right, the opposition is deemed unfounded insofar as it is based on that earlier right. If all the earlier rights on which an opposition is based cease to exist, the opponent will be granted the opportunity to withdraw its opposition. If it does not do so, the Office will take a decision rejecting the opposition.

6.3.4.3 Calculation of time limits

If the suspension is decided for a definite period of time, the letters must also indicate the date when the proceedings are to be resumed, and what happens after that. When the suspension is requested by both parties because there are ongoing negotiations, the period will always be one year, regardless of the period requested by the parties.

If on 30/01/2015 a request for a two-month suspension signed by both parties and submitted on 15/01/2015 (five days before the expiry of the time limit of the opponent for completing the opposition — 20/01/2015) is dealt with, the result will be that:

- the Office has suspended the opposition proceedings at the request of both parties;
- this suspension takes effect as from 15/01/2015 (the date when the suspension request was received at the Office) and will expire on 15/01/2016;

- the proceedings will be resumed on 16/01/2016 (one year, irrespective of the period requested by the parties), with no further notification from the Office;
- the time limit for the opponent is now 15/03/2016 (two full months for the opponent to complete the file);
- the time limit for the applicant is now 15/05/2016 (two full months after the opponent's time limit).

6.4 Multiple oppositions

Rule 21 EUTMIR

Multiple oppositions are when different oppositions are filed against the same EUTM application.

In the case of multiple oppositions, some extra factors have to be taken into account.

First of all, unless there is a major delay during the admissibility stage concerning one of the oppositions, the practice is to notify the applicant of the admissibility of all the oppositions at the same time. Secondly, multiple oppositions may lead to suspension of some of them for reasons of economy of proceedings. Thirdly, a restriction made by the applicant in the course of one of the proceedings may have an impact on the other oppositions. Furthermore, it may be practical to take the decisions in a certain order.

Finally, under certain circumstances, multiple oppositions may be joined and dealt with in one set of proceedings.

6.4.1 Multiple oppositions and restrictions

When there are multiple oppositions and the applicant restricts the goods and services in one of the opposition proceedings, all the other opponents will have to be informed by sending the appropriate letter insofar as the restriction concerns contested goods or services of the other oppositions.

However, if there is no relation between the goods or services in the restriction and the contested goods and services, the opponent should not be informed.

For example, there are four oppositions against the same EUTM application, applied for in respect of goods in Classes 3, 14, 18 and 25. The oppositions are directed against the following classes:

Opposition	Extent
No 1	Class 3
No 2	Class 25
No 3	Classes 18 and 25
No 4	Classes 14 and 25

The applicant sends a restriction in opposition 2, deleting *clothing* and *headgear*. Apart from the relevant letters in opposition 2, the relevant letters should also be sent in

oppositions 3 and 4. As the restriction does not affect the contested goods of opposition 1, no action is necessary in this opposition.

6.4.2 Multiple oppositions and decisions

Once an opposition reaches the decision stage, it is important to take account of the possible multiple oppositions that are pending against the same EUTM application. Before a ruling can be given on the opposition, the stage of proceedings of the multiple oppositions must be analysed and, depending on the situation, a decision may be taken or the opposition must be suspended. The general principle to be applied is that contested goods and services should not be rejected more than once at different points in time. The three situations that may occur are described in the following.

1. All oppositions against the same EUTM application are ready for decision at the same time

The order in which the decisions are taken is at the discretion of the examiner. However, the following has to be taken into account.

If all oppositions will fail, the decisions can be taken in any order, as the rejection of the opposition does not affect the EUTM application. Even if one of the decisions were to be appealed before the others are taken, it would seem preferable not to suspend as the procedure before the Board of Appeal can take some time.

If several oppositions will be successful against overlapping goods and services, first the decision eliminating most goods and services of the EUTM application (the widest extent of the opposition) should be taken and the remaining oppositions suspended. Once the first decision is final, the opponents in the remaining oppositions must be consulted on whether they wish to maintain or withdraw their oppositions.

Assuming that the oppositions are maintained, the next 'widest' opposition is decided and the same process continues until all of the oppositions are dealt with.

When two oppositions are of the same extent, the general principles apply when taking the decisions.

In the example mentioned above under paragraph 6.4.1, the first decision should either be taken in opposition 3 or in opposition 4. Opposition 1 has no overlapping goods and services and can therefore be taken independently.

Suppose the first decision is taken in opposition 4, and the EUTM application is rejected for Classes 14 and 25. In this case, oppositions 2 and 3 need to be suspended.

If the appeal period has expired and no appeal is filed, opposition 2 is disposed of, as it no longer has an object. The parties should be informed and the opposition must be closed. The case is considered to be a case that has not proceeded to judgment within the meaning of Article 85(4) EUTMR. Consequently, the costs are at the discretion of the Office. If the parties inform the Office that they agree on the costs, a decision on costs will not be taken. Generally, the decision will be that each party bears its own costs.

2. Only one opposition is ready for decision and the other oppositions are still in the adversarial phase of the proceedings

If the opposition is to be rejected, a decision can be taken without further impact on the pending multiple oppositions because the rejection does not have any effect on the EUTM application.

If the opposition is successful and the decision rejects the contested EUTM application in its entirety, the pending multiple oppositions must be suspended until the decision is final. If the appeal period has expired and no appeal is filed, the multiple oppositions are disposed of, as they no longer have an object. The parties should be informed and the opposition must be closed. The case is considered to be a case that has not proceeded to judgment within the meaning of Article 85(4) EUTMR. Consequently, the costs are at the discretion of the Office. If the parties inform the Office that they agree on the costs, a decision on costs will not be taken. Generally, the decision will be that each party bears its own costs.

The same applies if the decision on the opposition rejects **part** of the goods and services of the contested EUTM application but **all** of the goods and services against which the multiple oppositions are directed.

However, multiple oppositions must be suspended if the decision on the opposition rejects **part** of the goods and services of the contested EUTM application but only **part** of the goods and services against which the multiple oppositions are directed. The suspension will last until the decision has become final. If this is the case, the opponents of the multiple oppositions will be invited to inform the Office whether they wish to maintain or withdraw the opposition. In the case of a withdrawal of the opposition, the proceedings are closed and both parties are informed. If the proceedings are closed after the expiry of the cooling-off period, the Office will decide on the costs in accordance with Article 85(2) EUTMR that each party bears its own costs. If the parties inform the Office before the closure of proceedings that they agree on the costs, a decision on costs will not be taken.

3. Two or more oppositions are ready for decision and others are still in the adversarial phase of the proceedings

It may happen that some of the oppositions against an EUTM application are ready for a ruling and some are still at different stages of the adversarial phase. In this situation the principles described under 1 and 2 apply in combination. It depends on the outcome of the decisions and on the scope of the pending cases whether a decision may be taken in some oppositions and whether the multiple oppositions must be suspended.

6.4.3 Joinder of proceedings

Rule 21(1) EUTMIR

Rule 21(1) EUTMIR allows the Office to deal with multiple oppositions in one set of proceedings. If it is decided to join the oppositions, the parties must be notified.

Oppositions may be joined upon the request of one of the parties if they are directed against the same EUTM application. It is more likely that the Office would join them if, in addition, they were filed by the same opponent or if there is an economic link between the opponents, for example a parent and subsidiary company. The oppositions must be at the same procedural stage.

When it is decided to join the oppositions it should be verified whether the opponents have the same representative. If not, they must be asked to appoint one single representative. In addition, the earlier rights must be identical or very similar. If the representatives do not reply or do not want to appoint a single representative, the joinder must be undone and the oppositions dealt with separately.

If at any stage these conditions are no longer fulfilled, for example the one and only earlier right of one of the joined oppositions is transferred to a third party, the joinder may be undone.

Unless the joinder is undone before the decision is taken, only one decision is taken.

6.5 Change of parties (transfer, change of name, change of representative, interruption of proceedings)

6.5.1 Transfer and opposition proceedings

6.5.1.1 Introduction and basic principle

Article 17 EUTMR

A transfer or assignment of an earlier right is a change of ownership of this right. For further information see the Guidelines, Part E, Register Operations, Section 3, EUTMs as Objects of Property, Chapter 1, Transfer.

The basic principle is that the new owner substitutes the old owner in the proceedings. The Office's practice for dealing with transfers is described in paragraphs 6.5.1.2 (the earlier registration is an EUTM registration), 6.5.1.3 (the earlier registration is a national registration), 6.5.1.4 (the earlier registrations are a combination of EUTM registrations and national registrations) and 6.5.1.5 (transfer of a contested EUTM application during opposition proceedings).

A transfer can be made in several ways, including a simple sale of an earlier mark from A to B, a company C that gets bought (trade marks included) by company D, a merger of companies E and F into company G (universal succession), or legal succession (after the owner has died, the heirs become the new owners). This is not an exhaustive list.

When a transfer is made during opposition proceedings, several situations can arise. Whereas for earlier EUTM registrations or applications on which the opposition is based the new owner can only become party to the proceedings (or file observations) once the request for registration of the transfer has reached the Office, for earlier national registrations or applications it suffices that the new owner files evidence of the transfer.

6.5.1.2 Transfer of earlier EUTM

Article 17(6) and (7) EUTMR

Concerning earlier EUTMs or EUTM applications, according to Article 17(6) EUTMR, as long as a transfer has not been entered in the Register, the successor in title may

not invoke the rights arising from the registration of the EUTM (application). However, in the period between the date of reception of the request for registration of the transfer and the date of registration of the transfer, the new owner may already make statements to the Office with a view to observing time limits.

Opposition based on one EUTM only

When an opposition is based on one earlier EUTM only and this EUTM is/has been transferred during the opposition proceedings the new owner becomes the new opponent. The new owner will substitute the old owner.

To this end, either the old or the new owner will have to inform the Office that the EUTM on which the opposition is based has been transferred and it must submit a request for registration of the transfer. As mentioned above, as soon as the request is received by the Office, the new owner may already make statements. However, it only becomes party to the proceedings once the transfer is registered.

In practice, once the Office is informed that a request for registration is received, the proceedings can continue with the new owner. Nevertheless, the transfer has to be registered before a decision on the opposition is taken. If the opposition is ready for decision but the transfer has not been registered, the opposition must be suspended.

If the new owner informs the Office that it does not want to continue the proceedings, the opposition is considered withdrawn.

Partial transfer of the only EUTM on which the opposition is based

In cases of a partial transfer one part of the earlier EUTM remains with the original owner and another part is transferred to a new owner. The same principles apply to partial transfers as to the transfer of only one of a number of EUTM registrations on which the opposition is based, as described in the paragraph immediately below.

Opposition based on more than one earlier EUTM

When an opposition is based on more than one earlier EUTM and all these marks are/have been transferred to the same new owner during the opposition proceedings, the situation is the same as for an opposition based on a single EUTM, as described above.

The situation is, however, different when only one of the earlier EUTMs is/has been transferred. In this case the new owner may also become an opponent, with the result that there are two opponents. The new opponents will be treated as 'joint opponents', meaning that the Office will continue dealing with the case in exactly the same way as before, that is to say, as one opposition, albeit with more than one opponent. Moreover, the Office will consider the original representative as the 'common' representative for all the opponents and will not invite the new opponents to appoint a new one. However, the new opponents always have the option of appointing a representative of their choice.

Common representation does not mean that opponents may not act independently, to the extent that their earlier rights remain independent: if, for instance, one of the opponents enters into a friendly settlement with the applicant, the opposition will be treated as partially withdrawn in respect of the earlier rights owned by this opponent.

If one of the joint opponents wants to withdraw, this will be accepted independently of whether the other wants to continue. Should the proceedings be continued, they will only be based on the rights of the opponent that did not withdraw. No separate decision on costs will be taken.

6.5.1.3 Transfer of earlier national registration

Opposition based on one national registration only

When an opposition is based on one earlier national registration only and this registration is/has been transferred during the opposition proceedings, the new owner also becomes the new opponent. The new owner will substitute the old owner.

To this end, either the old or the new owner will have to inform the Office that the earlier national registration on which the opposition is based has been transferred and must file evidence thereof, i.e. the deed of transfer or any other evidence showing the agreement of the parties to the transfer/change of ownership.

The Office does not require the new owner to confirm that it wishes to continue the proceedings. As long as the evidence of the transfer is in order, the new owner is accepted as the new opponent. If it informs the Office of the transfer, but does not submit (sufficient) evidence thereof, the opposition proceedings have to be suspended while the new owner is given a time limit within which to provide evidence of the transfer.

As there are different national practices, it is not always obligatory to submit a copy of the request to register the transfer with the national office. Nevertheless, in those Member States where there is a requirement for a transfer to have effect against third parties, the transfer must have been registered before a decision on the opposition is taken. If the opposition is ready for decision but the transfer has not been registered, the opposition must be suspended and the opponent is to be required to provide evidence of registration of the transfer.

If the new owner does not provide the required evidence, the proceedings must be continued with the old owner. If the old owner maintains that it is not the owner any more, the opposition has become unfounded, as the opponent is no longer the owner of the earlier right. The old owner must be informed that the opposition will be rejected as such unless it withdraws the opposition.

If the new owner provides the required evidence and informs the Office that it does not want to continue the proceedings, the opposition is considered withdrawn.

Partial transfer of the only national registration on which the opposition is based

In cases of a partial transfer, one part of the earlier national registration remains with the original owner and another part with a new owner. The same principles apply to partial transfers as to transfers of only one of a number of national registrations on which the opposition is based, as described in the paragraph immediately below.

Opposition based on more than one earlier national registration

When an opposition is based on more than one earlier national registration and these are/have been transferred to the same new owner during the opposition proceedings,

the situation is the same as for the transfer of a single mark upon which an opposition is based, as described above.

The situation is, however, different when only one of the earlier national rights is/has been transferred. In this case the new owner may also become an opponent, with the result that there are two opponents. The new opponents will be treated as 'joint opponents', meaning that the Office will continue dealing with the case in exactly the same way as before, that is to say, as **one** opposition, albeit with more than one opponent. Moreover, the Office will consider the original representative as the 'common' representative for all the opponents and will not invite the new opponents to appoint a new one. However, the new opponents always have the option of appointing a representative of their choice.

If one of the joint opponents wants to withdraw, this is to be accepted independently of whether the other wants to continue. Of course, if the proceedings are continued it will be based only on the rights of the opponent that did not withdraw. No separate decision on costs will be taken.

6.5.1.4 Opposition based on a combination of EUTM registrations and national registrations

When an opposition is based on one or more EUTM registrations **and** one or more national registrations at the same time and one of these marks are/have been transferred to the same new owner during the opposition proceedings, the principles set out above apply *mutatis mutandis*.

In all of these situations, once the Office becomes aware of the transfer of ownership, it will update the official database to include the new opponent/both opponents, and it will inform the parties for information purposes only. However, the mere fact that the earlier registrations have been transferred will never justify the granting of a new time limit for submitting observations or any other documents when the original time limit has expired.

6.5.1.5 Transfer of the contested EUTM application

When during opposition proceedings the contested EUTM application is/has been transferred, the opposition follows the application, that is to say, the opponent is informed of the transfer and the proceedings continue between the new owner of the EUTM application and the opponent.

6.5.1.6 Partial transfer of a contested EUTM application

Rule 32(4) EUTMIR

When there has been a partial transfer of a (contested) EUTM application, the Office must create a separate file for the new registration (application) with a new registration (application) number.

In this case, when the transfer is recorded in the Register and a new EUTM application is created, the opposition examiner also has to create a new opposition file against the

new EUTM application, since it is not possible to deal with one opposition against two separate EUTM applications.

However, this is only the case when some of the originally contested goods and services are maintained in the 'old' EUTM application and some in the newly created EUTM application. For example: Opponent X opposes all the goods of EUTM application Y, applied for in Class 12 for *apparatus for locomotion by land and air*, and for *clothing and footwear* in Class 25. EUTM application Y is partially transferred, and split into old EUTM application Y for *apparatus for locomotion by land* and *clothing*, and new EUTM application Y for *apparatus for locomotion by air*, and *footwear*.

Articles 17 and 23 EUTMR

Since there was only one opposition fee to be paid when the opponent filed its opposition, a second fee for the new opposition created after the split of the EUTM application is not required because, at the time of filing, the opposition was only directed against one EUTM application.

Regarding the apportionment of costs, the opposition examiner will take into account the fact that only one opposition fee was paid.

Moreover, depending on the circumstances of the case, it could be possible to join the proceedings (e.g. when the representative of the 'old' and 'new' applications is the same).

6.5.2 Parties are the same after transfer

In the event that, as a result of a transfer, the opponent and applicant become the same person or entity, the opposition becomes devoid of any purpose and will accordingly be closed *ex officio* by the Office.

6.5.3 Change of names

As mentioned above, a change of name does not imply a change of ownership.

6.5.4 Change of representatives

Article 92 EUTMR

When there is a change of representative during opposition proceedings, the other party will have to be informed by sending it a copy of the letter and of the authorisation (if submitted).

For detailed information please refer to the Guidelines, Part A, General Rules, Section 5, Professional Representation.

6.5.5 Interruption of the proceedings due to death or legal incapacity of the applicant or its representative

Rule 73 EUTMIR

Rule 73 EUTMIR deals with interruption of proceedings. Paragraph 1 distinguishes three situations:

Opposition proceedings before the Office will be interrupted:

1. when the EUTM *applicant* has died or is under legal guardianship;
2. when the EUTM *applicant* is subject to bankruptcy or any similar proceedings;
3. when *the representative of an applicant* has died or is otherwise prevented from representing the applicant. For further information see the Guidelines, Part A, General Rules, Section 5, Professional Representation.

Rule 73 EUTMIR only refers to the applicant and its representative and does not mention anything about other parties, such as opponents. In the absence of relevant provisions, the Office will apply this provision only to cases where the applicant (or its representative) is not able to continue the proceedings. Therefore, if, for example, the opponent is declared bankrupt, the proceedings will not be interrupted (even where the opponent is the applicant/proprietor of an earlier EUTM application/EUTM). The uncertainty of the legal status of an opponent or its representative will not be to the detriment of the applicant. In such a case, when the notification is returned to the Office as undeliverable, the normal rules for public notification apply.

6.5.5.1 Death or legal incapacity of the applicant

In the event of the death of the applicant or of the person authorised by national law to act on their behalf, because of the legal incapacity of the applicant, the proceedings are only interrupted when this is requested by the representative of the applicant/authorised person or when the representative resigns.

6.5.5.2 Applicant prevented from continuing the proceedings before the Office owing to legal reasons (e.g. bankruptcy)

Rule 73(1)(b) and Rule 73(4) EUTMIR

Rule 73(1)(b) EUTMIR applies from the point in time from which the party to the proceedings is no longer entitled to dispose of the procedure, i.e. to dispose of its assets, until the point in time a liquidator or trustee is appointed who will then continue to represent the party under the law.

When the applicant is represented by a professional representative who does not resign, there is no need to interrupt the proceedings. The Office considers the applicant's representative to be entitled to represent the applicant until the Office is informed otherwise by the representative itself, by the designated trustee or the court dealing with the legal action in question.

If the representative informs the Office that it resigns, it depends whether the representative further indicates who acts as the trustee or liquidator in the bankruptcy.

- If the representative does so, the Office will continue to correspond with the trustee or liquidator. If there were time limits affecting the applicant that had not yet expired when it went bankrupt, the Office will re-start these time limits. Therefore, in this case, the proceedings are interrupted and immediately resumed. For example, if the applicant still had ten days to file observations when it went bankrupt, the new letter of the Office to the trustee will give a fresh time limit of two months to file those observations.
- If there is no information as to a liquidator or trustee, the Office has no choice but to declare an interruption of the proceedings. A communication to that effect will be sent to the bankrupt applicant directly and to the opponent. Although it is not up to the Office to investigate who the liquidator is, the Office will keep on trying to communicate with the bankrupt applicant with the aim of resuming the proceedings. This is because, although the bankrupt applicant is not allowed to undertake binding legal acts, generally it still receives correspondence, or, if not, the correspondence is delivered automatically to the trustee as long as there is one. The Office might also consider information on the identity of the trustee provided by the opponent.

When the notification is returned to the Office as undeliverable, the normal rules for public notification apply.

If evidence about the appointment of the liquidator or trustee is submitted, this need not be translated into the language of the proceedings.

Once the Office is informed of who the liquidator or trustee is, the proceedings are resumed from a date to be fixed by the Office. The other party must be informed.

Time limits that had not yet expired when the proceedings were interrupted start running again when the proceedings are resumed. For example, when the proceedings were interrupted ten days before the applicant had to submit observations, a new time limit of two months starts again, not the ten days it had left at the moment of the interruption. For clarification, the letter sent by the Office informing the parties about the resumption will fix a new time limit.

6.5.5.3 Death or prevention for legal reasons of the representative of the applicant before the Office to act.

Article 92(2) EUTMR Rule 73(1)(c) EUTMIR

In the case referred to in Rule 73(1)(c) EUTMIR, the proceedings must be interrupted and will be resumed when the Office is informed of the appointment of a new representative of the EUTM applicant.

This interruption will last a maximum of three months and, if no representative is appointed before the end of this period, the proceedings will be resumed by the Office. When resuming the proceedings, the Office will proceed as follows:

1. If the appointment of a representative is compulsory under Article 92(2) EUTMR because the applicant has neither its domicile nor its seat in the EEA, the Office will contact the applicant and inform it that the EUTM application will be refused if it does not appoint a representative within a specified time limit.
2. If appointment of a representative is **not** compulsory under Article 92(2) EUTMR, the Office will resume the proceedings and will send all the communications to the applicant directly.

In both cases resuming the proceedings will mean that any time limits pending for the applicant when the proceedings were interrupted start running again when the proceedings are resumed.

***GUIDELINES FOR EXAMINATION OF
EUROPEAN UNION TRADE MARKS***

***EUROPEAN UNION INTELLECTUAL
PROPERTY OFFICE
(EUIPO)***

PART C

OPPOSITION

SECTION 2

***DOUBLE IDENTITY AND LIKELIHOOD OF
CONFUSION***

CHAPTER 1

GENERAL PRINCIPLES

Table of Contents

1	Introduction.....	3
2	Article 8(1) EUTMR	4
2.1	Article 8(1)(a) EUTMR – double identity	4
2.3	Interrelation of Articles 8(1)(a) and 8(1)(b) EUTMR	5
3	The Notion of Likelihood of Confusion.....	5
3.1	Introduction	5
3.2	Likelihood of confusion and likelihood of association	6
3.3	Likelihood of confusion and enhanced distinctiveness	7
3.4	Likelihood of confusion: questions of fact and questions of law	8
3.4.1	Fact and law – similarity of goods/services and of signs	8
3.4.2	Fact and law – evidence	9
4	Evaluation of the relevant Factors for establishing a likelihood of confusion	9
4.1	The relevant point in time	9
4.2	List of factors for assessing the likelihood of confusion	10
Annex	11

1 Introduction

This chapter provides an introduction to and overview of the concepts of (i) double identity and (ii) likelihood of confusion that are applied in situations of conflict between trade marks in opposition proceedings under Article 8(1) of Council Regulation (EU) No 207/2009 of 26 February 2009 on the European Union trade mark (the 'EUTMR').

The paragraphs below set out the nature of these concepts and their legal underpinning as determined by the relevant laws and as interpreted by the Court of Justice of the European Union (the 'Court')¹.

The legal concepts of double identity and likelihood of confusion are used to protect trade marks and, at the same time, to define their scope of protection. It is thus important to bear in mind what aspects or functions of trade marks merit protection. Trade marks have various functions. The most fundamental one is to act as 'indicators of origin' of the commercial provenance of goods/services. This is their 'essential function'. In the 'Canon' judgment the Court held that:

... according to the settled case-law of the Court, the **essential function of the trade mark is to guarantee the identity of the origin of the marked product** to the consumer or end user by enabling him, without any possibility of confusion, to distinguish the product or service from others that have another origin (emphasis added).

(Judgment of 29/09/1998, C-39/97, Canon, EU:C:1998:442, § 28).

The essential function of trade marks as indicating origin has been emphasised repeatedly and has become a precept of EU trade mark law (judgments of 18/06/2002, C-299/99, Remington, EU:C:2002:377, § 30; 06/10/2005, C-120/04, Thomson Life, EU:C:2005:594, § 23).

Whilst indicating origin is the essential function of trade marks, it is not the only one. Indeed, the term, 'essential function' implies other functions. The Court alluded to the other functions of trade marks several times (e.g. judgments of 16/11/2004, C-245/02, Budweiser, EU:C:2004:717, § 59; 25/01/2007, C-48/05, Opel, EU:C:2007:55, § 21) but addressed them directly in the 'L'Oréal' judgment, where it stated that the functions of trade marks include:

... **not only the essential function** of the trade mark, which is to guarantee to consumers the origin of the goods or services, **but also its other functions, in particular that of guaranteeing the quality of the goods or services in question and those of communication, investment or advertising** (emphasis added).

(Judgment of 18/06/2009, C-487/07, L'Oréal, EU:C:2009:378, § 58-59; 23/03/2010, C-236/08 –).

In examining the concepts of double identity and likelihood of confusion, this chapter touches upon several themes that are explained comprehensively in the chapters of

¹The Court was in fact often interpreting Articles 4 and 5 of Directive 2008/95/EC of the European Parliament and of the Council of 22 October 2008 (the 'Directive') that for the purposes of interpretation are broadly comparable to Articles 8 and 9 EUTMR.

the Guidelines that follow. A summary of the key cases from the Court dealing with the core principles and concepts of likelihood of confusion is added in Annex.

2 Article 8(1) EUTMR

Article 8 EUTMR enables the proprietor of an **earlier right** to oppose the registration of later EUTM applications in a range of situations. The present chapter will concentrate on the interpretation of double identity and likelihood of confusion within the meaning of Article 8(1) EUTMR.

An opposition pursuant to Article 8(1) EUTMR can be based on earlier trade mark registrations or applications (Article 8(2)(a) and (b) EUTMR) and earlier well-known marks (Article 8(2)(c) EUTMR)².

2.1 Article 8(1)(a) EUTMR – double identity

Article 8(1)(a) EUTMR provides for oppositions based on identity. It provides that, upon opposition by the proprietor of an earlier trade mark within the meaning of Article 8(2) EUTMR, a EUTM application will not be registered:

if it is identical with the earlier trade mark and the goods or services for which registration is applied for are identical with the goods or services for which the earlier trade mark is protected.

The wording of Article 8(1)(a) EUTMR clearly requires identity between **both** the signs concerned **and** the goods/services in question. This situation is referred to as ‘double identity’. Whether there is double identity is a **legal finding** to be established from a direct comparison of the two conflicting signs and the goods/services in question³. Where double identity is established, the opponent is not required to demonstrate likelihood of confusion in order to prevail; the protection conferred by Article 8(1)(a) EUTMR is absolute. Consequently, where there is double identity, there is no need to carry out an evaluation of likelihood of confusion, and the opposition will automatically be upheld.

2.2 Article 8(1)(b) EUTMR – likelihood of confusion

Article 8(1)(b) EUTMR states that, upon opposition, a EUTM application shall not be registered:

...if because of its identity with or similarity to the earlier trade mark and the identity or similarity of the goods or services covered by the trade marks **there exists a likelihood of confusion** on the part of the public in the territory in which the earlier trade mark is protected; the **likelihood of**

² Further guidance on earlier well-known trade marks is found in the Guidelines, Part C, Opposition, Section 5, Trade Marks with Reputation (Article 8(5) EUTMR).

³ Comprehensive guidance on the criteria to find identity between goods and services and between signs can be found in the respective paragraphs of the Guidelines, Part C, Opposition, Section 2, Double Identity and Likelihood of Confusion, Chapter 2, Comparison of Goods and Services and Chapter 4, Comparison of Signs.

confusion includes the likelihood of association with the earlier trade mark (emphasis added).

Hence, in contrast to situations of double identity as seen above, in cases of mere similarity between the signs and the goods/services, or identity of only one of these two factors, an earlier trade mark may successfully oppose a EUTM application under Article 8(1)(b) **only if** there is a likelihood of confusion.

2.3 Interrelation of Articles 8(1)(a) and 8(1)(b) EUTMR

Although the specific conditions under Articles 8(1)(a) and 8(1)(b) EUTMR differ, they are related. Consequently, in oppositions dealing with Article 8(1) EUTMR, if Article 8(1)(a) is the only ground claimed but identity between the signs and/or the goods/services cannot be established, the Office will still examine the case under Article 8(1)(b) EUTMR that requires at least similarity between signs and goods/services and likelihood of confusion. Similarity covers situations where both marks and goods/services are similar and also situations where the marks are identical and the goods/services are similar or vice versa.

Likewise, an opposition based only on Article 8(1)(b) EUTMR that meets the requirements of Article 8(1)(a) EUTMR will be dealt with under the latter provision without any examination under Article 8(1)(b) EUTMR.

3 The Notion of Likelihood of Confusion

3.1 Introduction

The assessment of likelihood of confusion is a calculus applied in situations of conflict between trade marks in proceedings before the Office, the General Court and the Court of Justice as well as in infringement proceedings before the courts of the Member States. However, neither the EUTMR nor the Directive contains a definition of likelihood of confusion or a statement as to precisely what ‘confusion’ refers to.

As shown below, it has been settled case-law for some time now that fundamentally the concept of likelihood of confusion refers to situations where:

- (1) the public directly confuses the conflicting trade marks, i.e. mistakes the one for the other;
- (2) the public makes a connection between the conflicting trade marks and assumes that the goods/services in question are from the same or economically linked undertakings (likelihood of association).

These two situations are further discussed below (paragraph 3.2). The mere fact that the perception of a later trade mark brings to mind an earlier trade mark does not constitute likelihood of confusion.

The Court has also established the principle that ‘marks with a highly distinctive character, enjoy broader protection than marks with a less distinctive character’ (see paragraph 3.3 below).

Finally, the concept of likelihood of confusion as developed by the Court must be regarded as a legal concept rather than purely an empirical or factual assessment despite the fact that its analysis requires taking into account certain aspects of consumer cognitive behaviour and purchasing habits (see paragraph 3.4 below).

3.2 Likelihood of confusion and likelihood of association

The Court considered likelihood of confusion comprehensively in ‘Sabèl’ (judgment of 11/11/1997, C-251/95, Sabèl, EU:C:1997:528). The Directive’s equivalents of Article 8(1)(b) EUTMR and the eighth recital of the EUTMR clearly indicated that likelihood of confusion relates to confusion about the origin of goods/services, but the Court was required to consider what precisely this meant because there were opposing views on the meaning of, and the relationship between, ‘likelihood of confusion’ and ‘likelihood of association’, both of which are referred to in Article 8(1)(b) EUTMR.

This issue needed to be resolved because it was argued that likelihood of association was broader than likelihood of confusion as it could cover instances where a later trade mark brought an earlier trade mark to mind but the consumer did not consider that the goods/services had the same commercial origin⁴. Ultimately, the issue in ‘Sabèl’ was whether the wording ‘the likelihood of confusion includes the likelihood of association’ meant that ‘likelihood of confusion’ could cover a situation of association between trade marks that did not give rise to confusion as to origin.

The Court found that likelihood of association **is not an alternative** to likelihood of confusion, but that it merely serves to define its scope. Therefore, a finding of likelihood of confusion requires that there be confusion as to origin.

In ‘Canon’ (paras 29-30), the Court clarified the scope of confusion as to origin when it held that:

... the risk that the public might believe that the goods and services in question come **from the same undertaking or, as the case may be, from economically linked undertakings**, constitutes a likelihood of confusion ... there can be no such likelihood where it does not appear that the public could believe that the goods or services come from the same undertaking or, as the case may be, from economically-linked undertakings (emphasis added).

As seen above, likelihood of confusion relates to confusion as to commercial origin including economically-linked undertakings. What matters is that the public believes that the **control** of the goods or services in question is in the hands of a single undertaking. The Court has not interpreted **economically-linked undertakings** in the context of likelihood of confusion, but it has done so with respect to the free movement of goods/services. In ‘Ideal Standard’ the Court held:

... A number of situations are covered: products put into circulation by the same undertaking, by a licensee, by a parent company, by a subsidiary of the same group, or by an exclusive distributor.

⁴The concept came from Benelux case-law and applied inter alia to non-reputed marks.

... In all the cases mentioned, control [is] in the hands of a single body: the group of companies in the case of products put into circulation by a subsidiary; the manufacturer in the case of products marketed by the distributor; the licensor in the case of products marketed by a licensee. In the case of a licence, the licensor can control the quality of the licensee's products by including in the contract clauses requiring the licensee to comply with his instructions and giving him the possibility of verifying such compliance. The origin that the trade mark is intended to guarantee is the same: it is not defined by reference to the manufacturer but by reference to the point of control of manufacture.

(Judgment of 22/06/1994, C-9/93, Ideal Standard, EU:C:1994:261, § 34 and 37).

Consequently, economic links will be presumed where the consumer assumes that the respective goods or services are marketed under the control of the trade mark proprietor. Such control can be assumed to exist in the case of enterprises belonging to the same group of companies and in the case of licensing, merchandising or distribution arrangements as well as in any other situation where the consumer assumes that the use of the trade mark is normally possible only with the agreement of the trade mark proprietor.

Therefore, the likelihood of confusion covers situations where

- (i) the consumer directly confuses the trade marks themselves or where
- (ii) the consumer makes a connection between the conflicting signs and assumes that the goods/services covered are from the same or economically-linked undertakings.

Hence, if the perception of a later trade mark merely brings to mind an earlier trade mark, but the consumer does not assume the same commercial origin, then this link does not constitute likelihood of confusion despite the existence of a similarity between the signs⁵.

3.3 Likelihood of confusion and enhanced distinctiveness

The distinctiveness of the earlier trade mark has been held by the Court to be an important consideration when assessing likelihood of confusion, since:

- the more distinctive the earlier trade mark, the greater will be the likelihood of confusion (see 'Sabèl', para. 24);
- trade marks with a highly distinctive character enjoy broader protection than trade marks with a less distinctive character (see in this regard 'Canon', para. 18).

One consequence of these findings is that the enhanced distinctiveness of the earlier mark may be a decisive factor towards establishing a likelihood of confusion when the similarity between the signs and/or the goods and services is low (judgment of 11/11/1997, C-251/95, Sabèl, EU:C:1997:528, § 22).

⁵Although such a situation could take unfair advantage of, or be detrimental to, the distinctive character or the reputation of an earlier mark under Article 8(5) EUTMR, see the Guidelines Part C, Opposition, Section 5, Trade marks with reputation Article 8(5) EUTMR.

3.4 Likelihood of confusion: questions of fact and questions of law

The concept of likelihood of confusion is a legal concept rather than a mere factual evaluation of the rational judgments and emotional preferences that inform the consumer's cognitive behaviour and purchasing habits. Therefore, assessment of likelihood of confusion depends on both legal questions **and** facts.

3.4.1 Fact and law – similarity of goods/services and of signs

Determining the relevant factors for establishing likelihood of confusion and whether they exist is a question of law, that is to say, these factors are established by the relevant legislation, namely, the EUTMR and case-law.

For instance, Article 8(1) EUTMR establishes that the identity/similarity of goods/services is a condition for likelihood of confusion. The identification of the relevant factors for evaluating whether this condition is met is also a question of law.

The Court has identified the following factors for determining whether goods/services are similar:

- their nature
- their intended purpose
- their method of use
- whether they are complementary or not
- whether they are in competition or interchangeable
- their distribution channels/points of sale
- their relevant public
- their usual origin.

(See C-39/97 'Canon').

All these factors are legal concepts and determining the criteria to evaluate them is also a **question of law**. However, it is a **question of fact** whether, and to what degree, the legal criteria for determining, for instance, 'nature', are fulfilled in a particular case.

By way of example, *cooking fat* does not have the same nature as *petroleum lubricating oils and greases* even though both contain a fat base. *Cooking fat* is used in preparing food for human consumption, whereas *oils and greases* are used for lubricating machines. Considering 'nature' to be a relevant factor in the analysis of similarity of goods/services is a matter of **law**. On the other hand, it is a matter of **fact** to state that cooking fat is used in preparing food for human consumption and that oils and greases are used for machines.

Similarly, when it comes to the comparison of signs, Article 8(1) EUTMR establishes that the identity/similarity of signs is a condition for likelihood of confusion. It is a **question of law** that a conceptual coincidence between signs may render them similar for the purposes of the EUTMR, but it is a **question of fact**, for instance, that the word 'fghryz' does not have any meaning for the Spanish public.

3.4.2 Fact and law – evidence

In opposition proceedings, the parties must allege and, where necessary, prove the facts in support of their arguments. This follows from Article 76(1) EUTMR, according to which, in opposition proceedings, the Office shall be restricted in its examination to the facts, evidence and arguments provided by the parties and the relief sought.

Therefore, it is up to the opponent to state the facts on which the claim of similarity is based and to submit supporting evidence. For instance, where *wear-resistant cast iron* is to be compared with *medical implants*, it is not up to the Office to answer the question of whether *wear-resistant cast iron* is actually used for *medical implants*. This must be demonstrated by the opponent as it seems improbable (decision of 14/05/2002, R 0684/2000-4, Tinnox).

An admission by the applicant of legal concepts is irrelevant. It does not relieve the Office from analysing and deciding on these concepts. This is not contrary to Article 76(1) EUTMR that is binding on the Office **only** as regards the facts, evidence and arguments and does not extend to the legal evaluation of the same. Therefore, the parties may agree as to which facts have been proven or not, but they may not determine whether or not these facts are sufficient to establish the respective legal concepts, such as similarity of goods/services, similarity of the signs, and likelihood of confusion.

Article 76(1) EUTMR does not prevent the Office from taking into consideration, on its own initiative, facts that are already notorious or well known or that may be learned from generally accessible sources, for example, that PICASSO will be recognised by EU consumers as a famous Spanish painter (judgments of 22/06/2004, T-185/02, Picaro, EU:T:2004:189; 12/01/2006, C-361/04 P, Picaro, EU:C:2006:25). However, the Office cannot quote *ex officio* new facts or arguments (e.g. reputation or degree of knowledge of the earlier mark, etc.).

Moreover, even though certain trade marks are sometimes used in daily life as generic terms for the goods and services that they cover, this should never be taken as a fact by the Office. In other words, trade marks should never be referred to (or interpreted) as if they were a generic term or a category of goods or services. For instance, the fact that in daily life part of the public refers to 'X' when talking about *yoghurts* ('X' being a trade mark for *yoghurts*) should not lead to using 'X' as a generic term for *yoghurts*.

4 Evaluation of the relevant Factors for establishing a likelihood of confusion

4.1 The relevant point in time

The relevant moment in time for assessing a likelihood of confusion is the date the opposition decision is taken.

Where the opponent relies on enhanced distinctiveness of an earlier trade mark, the conditions for this must have been met on or before the filing date of the EUTM application (or any priority date) and must still be fulfilled at the point in time the decision is taken. Office practice is to assume that this is the case, unless there are indications to the contrary.

Where the EUTM applicant relies on a reduced scope of protection (weakness) of the earlier trade mark, only the date of the decision is relevant.

4.2 List of factors for assessing the likelihood of confusion

The likelihood of confusion is assessed in the following steps, taking into account multiple factors:

- Comparison of goods and services
- Relevant public and degree of attention
- Comparison of signs
- Distinctiveness of the earlier mark
- Any other factors
- Global assessment of likelihood of confusion

A separate chapter of the Guidelines is dedicated to each of the above factors and its specifics.

Annex

General principles coming from case-law (these are not direct citations)

Judgment of 11/11/1997, C-251/95, Sabèl, EU:C:1997:528
<ul style="list-style-type: none">- The likelihood of confusion must be appreciated globally, taking into account all factors relevant to the circumstances of the case (para. 22).- The appreciation of the likelihood of confusion depends on numerous elements and, in particular, on the recognition of the trade mark on the market, on the association that the public might make between the two marks and on the degree of similarity between the signs and the goods (para. 22).- The global appreciation of the visual, aural or conceptual similarity of the marks in question must be based on the overall impression given by the marks, bearing in mind their distinctive and dominant components (para. 23).- The average consumer normally perceives a mark as a whole and does not proceed to analyse its various details (para. 23).- The more distinctive the earlier mark, the greater will be the likelihood of confusion (para. 24).- It is not impossible that the conceptual similarity resulting from the fact that two marks use images with analogous semantic content may give rise to a likelihood of confusion where the earlier mark has a particularly distinctive character (para. 24).- However, where the earlier mark is not especially well known to the public and consists of an image with little imaginative content, the mere fact that the two marks are conceptually similar is not sufficient to give rise to a likelihood of confusion (para. 25).- The concept of likelihood of association is not an alternative to likelihood of confusion, but serves to define its scope (para. 18).- The mere association that the public might make between two marks as a result of their analogous semantic content is not in itself a sufficient ground for concluding that there is a likelihood of confusion (para. 26).
Judgment of 29/09/1998, C-39/97, Canon, EU:C:1998:442
<ul style="list-style-type: none">- The risk that the public might believe that the goods or services in question come from the same undertaking or, as the case may be, from economically-linked undertakings, constitutes a likelihood of confusion (para. 29).- By contrast, there can be no such likelihood where the public does not think that the goods come from the same undertaking (or from economically-linked undertakings) (para. 30).- In assessing the similarity of the goods and services, all the relevant factors relating to those goods or services themselves should be taken into account (para. 23).- Those factors include, inter alia, their nature, the purpose for which they are used (the translation 'end users' in the official English language version is not correct) and their method of use, and whether they are in competition with each other or are complementary (para. 23).- A global assessment of the likelihood of confusion implies some interdependence between the relevant factors and in particular a similarity between the marks and between these goods or services. A lesser degree of similarity between the goods may be offset by a greater degree of similarities between the marks and vice versa (para. 17).- Marks with a highly distinctive character, either per se or because of the reputation they possess on the market, enjoy broader protection than marks with a less distinctive character (para. 18).- Registration of a trade mark may have to be refused, despite a lesser degree of similarity between the goods or services covered, where the marks are very similar and the earlier mark, in particular its reputation, is highly distinctive (para. 19).- The distinctive character of the earlier mark and in particular its reputation must be taken into account when determining whether the similarity between the goods and services is enough to give rise to the likelihood of confusion (para. 24).- There may be a likelihood of confusion, even if the public thinks that these goods have different places of production (para. 30).

Judgment of 22/06/1999, C-342/97, Lloyd Schuhfabrik, EU:C:1999:323

- The level of attention of the average consumer, who is deemed to be reasonably well-informed and reasonably observant and circumspect, varies according to the category of the goods and services in question (para. 26).
- However, account should be taken of the fact that the average consumer only rarely has the chance to make a direct comparison between the different marks and must place his trust in the imperfect picture of them that he has kept in his mind (para. 26).
- When assessing the degree of visual, phonetic and conceptual similarity it can be appropriate to evaluate the importance attached to each by reference to the category of goods and the way they are marketed (para. 27).
- It is possible that mere aural similarity could lead to likelihood of confusion (para. 28).
- In determining the distinctive character of a mark and, accordingly, in assessing whether it is highly distinctive, an overall assessment needs to be made of the greater or lesser capacity of the mark to identify the goods and services for which it has been registered as coming from a particular undertaking (para. 22).
- In making that assessment, account should be taken, in particular, of the inherent characteristics of the mark, including the fact that it does or does not contain an element descriptive of the goods or services for which it has been registered; the market share held by the mark; how intensive, geographically widespread and long-standing use of the mark has been; the amount invested by the undertaking in promoting the mark; the proportion of the relevant section of the public who, because of the mark, identifies the goods and services as originating from a particular undertaking; and statements from chambers of commerce and industry or other trade and professional associations (para. 23).
- It is not possible to state in general terms, for example by referring to given percentages relating to the degree of recognition attained by the mark within the relevant section of the public, when a mark has a strong distinctive character (para. 24).

Judgment of 22/06/2000 C-425/98, Marca, EU:C:2000:339

- The reputation of a mark does not give grounds for presuming the existence of a likelihood of confusion simply because of the existence of a likelihood of association in the strict sense (para. 41).
- Article 5(1)(b) of the Directive cannot be interpreted as meaning that where:
 - a trade mark has a particularly distinctive character, either per se or because of the reputation it enjoys with the public, and
 - a third party, without the consent of the proprietor of the mark, uses, in the course of trade in goods or services that are identical with, or similar to, those for which the trade mark is registered, a sign that so closely corresponds to the mark as to give the possibility of its being associated with that mark,the exclusive right enjoyed by the proprietor entitles him to prevent the use of the sign by that third party if the distinctive character of the mark is such that the possibility of such association giving rise to confusion cannot be ruled out (emphasis added) (para. 42).

Judgment of 06/10/2005, C-120/04, Thomson Life, EU:C:2005:594

- Where the goods or services are identical there may be a likelihood of confusion on the part of the public where the contested sign is composed by juxtaposing the company name of another party and a registered mark that has normal distinctiveness and which, without alone determining the overall impression conveyed by the composite sign, still has an independent distinctive role therein (para. 37).

***GUIDELINES FOR EXAMINATION OF
EUROPEAN UNION TRADE MARKS***

***EUROPEAN UNION
INTELLECTUAL PROPERTY OFFICE
(EUIPO)***

PART C

OPPOSITION

SECTION 2

***DOUBLE IDENTITY AND
LIKELIHOOD OF CONFUSION***

CHAPTER 2

***COMPARISON OF
GOODS AND SERVICES***

Table of Contents

1	Introduction.....	6
1.1	Relevance	6
1.2	Nice Classification: a starting point.....	7
1.2.1	Its nature as a classification tool.....	7
1.2.2	Its structure and methodology	7
1.2.3	Conclusions to be drawn from the structure of the Nice Classification	8
1.2.4	Changes in the classification of goods/services.....	8
1.3	The Similarity Tool (ETMDN) for the comparison of goods/services.....	9
1.4	Definition of goods and services (terminology).....	9
1.4.1	Goods	9
1.4.2	Services	10
1.4.3	Products.....	10
1.5	Determining the goods/services	11
1.5.1	The correct wording.....	11
1.5.1.1	European Union trade marks.....	11
1.5.1.2	Earlier national marks and international registrations.....	11
1.5.2	The relevant scope	12
1.5.3	The meaning of goods/services.....	13
1.6	Objective approach	14
1.7	Statement of reasons	14
2	Identity.....	15
2.1	General principles	15
2.2	Identical terms or synonyms	15
2.3	Terms included in general indication or broad category.....	16
2.3.1	The earlier mark includes the goods/services of the contested mark	16
2.3.2	The contested mark includes the goods/services of the earlier mark	17
2.4	Overlap.....	18
2.5	Practice on the use of general indications of the class headings	19
3	Similarity of Goods and Services.....	21
3.1	General principles	21
3.1.1	Similarity factors	21
3.1.2	Defining relevant factors.....	22
3.2	The specific similarity factors	23
3.2.1	Nature	23
3.2.1.1	Indicative value of class headings and categories.....	23
3.2.1.2	Features of the goods defining their nature	24
3.2.1.3	Nature of services	25
3.2.1.4	Nature of goods versus nature of services	25
3.2.2	Intended purpose.....	25
3.2.3	Method of use	26
3.2.4	Complementarity	27
3.2.4.1	Use in combination: not complementary	28

3.2.4.2	Ancillary goods/services: not complementary.....	29
3.2.4.3	Raw materials, parts, components and fittings: not complementary.....	29
3.2.5	In competition	30
3.2.6	Distribution channel	30
3.2.7	Relevant public	31
3.2.8	Usual origin (producer/provider)	32
3.2.8.1	Features defining a common origin	33
3.3	Relation between different factors	34
3.3.1	Interrelation of factors.....	35
3.3.2	Importance of each factor.....	35
3.3.3	Different types of comparisons: goods versus goods, services versus services and goods versus services.....	36
3.3.4	Degree of similarity.....	36
Annex I	38
1	Parts, Components and Fittings	38
2	Raw Materials and Semi-Processed Goods	38
3	Accessories	39
4	Installation, Maintenance and Repair Services	40
5	Advisory Services	41
6	Rental and Leasing.....	42
6.1	Rental/leasing versus related services	42
6.2	Rental/leasing versus goods	42
Annex II	44
1	Chemicals, Pharmaceuticals and Cosmetics.....	44
1.1	Chemicals (Class 1) versus chemical products (Classes 3 and 5)	44
1.2	Pharmaceuticals versus pharmaceuticals.....	44
1.3	Pharmaceuticals versus dietetic substances adapted for medical use.....	46
1.4	Pharmaceuticals versus cosmetics	46
1.5	Pharmaceuticals versus services	46
2	Automobile Industry.....	46
3	Electric Apparatus/Instruments	47
4	Fashion and Textile Industries	47
4.1	Raw or semi-processed materials versus finished goods	47
4.2	Textile goods (Class 24) versus clothing (Class 25).....	48
4.3	Clothing, footwear and headgear (Class 25)	48

4.4	Fashion accessories	48
4.5	Sports clothing, footwear and headgear (Class 25) versus sporting and gymnastic articles (Class 28)	49
4.6	Fashion design (Class 42) and tailoring services (Class 40) versus clothing (Class 25)	50
5	Food, Beverages and Restaurant Services	50
5.1	Ingredients of prepared food	50
5.2	Main ingredient	50
5.3	Non-alcoholic beverages (Class 32) versus alcoholic beverages (except beers) (Class 33)	51
5.4	Beers (Class 32), alcoholic beverages (except beers) (Class 33)	51
5.5	Provision of food and drinks versus food and drinks	51
6	Services to Support Other Businesses	52
7	Retail Services	54
7.1	Retail services versus any product: dissimilar	55
7.2	Retail services of specific goods versus same specific goods: similar to a low degree	55
7.3	Retail services of specific goods versus different or similar specific goods: dissimilar	56
7.4	Retail services versus retail services or retail services of specific goods: identical	56
7.5	Retail services of specific goods versus retail services of other specific goods: similar	56
7.6	Services to which the same principles apply	56
7.7	Services to which the same principles do not apply	56
8	Financial Services	57
8.1	Banking services (Class 36) versus insurance services (Class 36)	57
8.2	Real estate affairs (Class 36) versus financial affairs (Class 36)	58
8.3	Credit cards (Class 9) versus financial services (Class 36)	58
9	Transport, Packaging and Storage	59
9.1	Transport of goods (Class 39) versus any product	59
9.2	Packaging and storage of goods (Class 39) versus any product	59
10	Information Technology	59
10.1	Computers versus software	59
10.2	Software versus apparatus that use software	60
10.3	Software, downloadable ‘apps’ and downloadable electronic publications	60

10.4 Specific software versus specific software	61
10.5 Computers and software (Class 9) versus computer programming (Class 42)	61
10.6 Apparatus for recording, transmission, reproduction of sound or images, computers and software (Class 9) versus telecommunication services (Class 38).....	62

1 Introduction

1.1 Relevance

The comparison of goods and services is primarily of relevance for the assessment of identity according to Article 8(1)(a) EUTMR and likelihood of confusion according to Article 8(1)(b) EUTMR. One of the main conditions for Article 8(1)(a) EUTMR is the identity of goods/services, while Article 8(1)(b) EUTMR requires the identity or similarity of goods/services. Consequently, if all goods/services are found to be dissimilar, one of the conditions contained in Article 8(1) EUTMR is not fulfilled and the opposition must be rejected without addressing the remaining sections of the decision¹.

The criteria for the assessment of identity or similarity might also play a role when proof of use has been requested and the evidence has to be assessed in order to conclude whether the opponent showed use for the goods/services as registered. In particular, it is important to determine whether the goods and services for which the mark has been used belong to the category of goods and services for which the trade mark was registered. This is because, under Article 42(2) EUTMR, proof of use for a good or service that is merely similar to the good or service registered does not prove use for the registered good or service (see the Guidelines, Part C, Opposition, Section 6, Proof of Use).

Likewise, evidence of use of goods/services might also be relevant when examining a claim to enhanced distinctiveness. In such cases it is often necessary to examine whether the enhanced distinctiveness covers goods/services for which the earlier trade mark enjoys protection and which are relevant for the specific case, that is to say, which have been considered to be identical or similar to the goods/services of the contested EUTM (see the Guidelines, Part C, Opposition, Section 2, Double Identity and Likelihood of Confusion, Chapter 5, Distinctiveness of the Earlier Mark).

Furthermore, the outcome of the comparison of goods/services plays an important role for defining the part of the public for whom likelihood of confusion is analysed because the relevant public is that of the goods/services found to be identical or similar (see the Guidelines, Part C, Opposition, Section 2, Double Identity and Likelihood of Confusion, Chapter 3, Relevant Public and Degree of Attention).

The comparison of goods/services may also be relevant under Article 8(3) EUTMR, which requires the identity or 'close relation or equivalence in commercial terms' of goods/services (see the Guidelines, Part C, Opposition, Section 3, Unauthorised Filing by Agents of the TM Proprietor (Article 8(3) EUTMR)), and under the applicable provisions of national law under Article 8(4) EUTMR, since identity or similarity of the goods/services is often a condition under which the use of a subsequent trade mark may be prohibited (see the Guidelines, Part C, Opposition, Section 4, Rights under Article 8(4) EUTMR). Furthermore, under Article 8(5) EUTMR, the degree of similarity or dissimilarity between the goods or services is a factor that must be taken into account when establishing whether or not the consumer will perceive a link between the marks. For example, the goods or services may be so manifestly dissimilar that use of the later mark on the contested goods or services is unlikely to bring the earlier mark

¹ Equally, the comparison of goods and services is of relevance in invalidity proceedings, since pursuant to Article 53(1)(a) EUTMR, a registered European Union trade mark is declared invalid where the conditions set out in Article 8(1) EUTMR are fulfilled.

to the mind of the relevant public (see the Guidelines, Part C, Opposition, Section 5, Trade Marks with Reputation (Article 8(5) EUTMR)).

1.2 Nice Classification: a starting point

Article 28(1) EUTMR requires that the goods/services to be compared are classified according to the Nice Classification. Currently the Nice Classification consists of 34 classes (1-34) to categorise goods and 11 classes (35-45) to categorise services.

1.2.1 Its nature as a classification tool

The Nice Classification was set up with the aim of harmonising national classification practices. Its first edition entered into force in 1961. Although it has undergone several revisions, it sometimes lags behind the rapid changes in product developments in the markets. Furthermore, the wording of the headings is sometimes unclear and imprecise.

The Nice Classification serves purely administrative purposes and, as such, does not provide in itself a basis for drawing conclusions as to the similarity of goods and services.

In accordance with Article 28(7) EUTMR, the fact that the respective goods or services are listed in the same class of the Nice Classification is not, in itself, an indication of similarity.

Examples

- *Live animals* are dissimilar to *flowers* (Class 31).
- *Advertising* is dissimilar to *office functions* (Class 35).

The fact that two specific goods/services fall under the same general indication of a class heading does not per se make them similar, let alone identical: *cars* and *bicycles* — although both fall under *vehicles* in Class 12 — are considered dissimilar.

Furthermore, goods/services listed in different classes are not necessarily considered dissimilar (judgment of 16/12/2008, T-259/06, Manso de Velasco, EU:T:2008:575, § 30-31).

Examples

- *Meat extracts* (Class 29) are similar to *spices* (Class 30).
- *Travel arrangement* (Class 39) is similar to *providing temporary accommodation* (Class 43).

1.2.2 Its structure and methodology

Classification may serve as a tool to identify the common characteristics of certain goods/services.

Many classes of the Nice Classification are structured according to factors such as function, composition and/or purpose of use which may be relevant in the comparison of goods/services. For example:

- Class 1 comprises chemical goods primarily based on their chemical properties (nature), rather than on their specific application. In contrast, Class 3 covers all items that are either cleaning preparations or for personal hygiene or beautification. Although they can by their nature also be classified as chemical products, it is their specific purpose that allows a distinction and thus a different classification.
- Equally, it is because of their nature that most items made of leather are classified in Class 18, whereas clothing made of leather falls under Class 25 since it serves a very specific purpose, namely for wear by people and as protection from the elements.

1.2.3 Conclusions to be drawn from the structure of the Nice Classification

The structure of the class headings is not uniform and does not follow the same logic. Some classes consist of only one general indication that by its definition already covers nearly all the goods/services included in this class (Class 15 *musical instruments*; Class 38 *telecommunications*). Some others include many general indications, some being very broad and others very specific. For example, the heading of Class 9 includes more than 30 terms, ranging from *scientific apparatus and instruments* to *fire-extinguishing apparatus*.

Exceptionally, there are class headings containing general indications that include another general indication and are thus identical.

Example: *materials for dressing* in Class 5 include *plasters* in Class 5.

Other specific indications in a class heading are only mentioned to clarify that they do not belong to another class.

Example: *adhesives used in industry* are included in *chemicals used in industry* in Class 1. Its reference is mainly thought to distinguish them from *adhesives* classified in Class 16, which are for stationery or household purposes.

To conclude, the Nice Classification gives indications that can be used in the assessment of identity or similarity of goods/services. However, its structure and content is not coherent. Therefore, each heading or specific term has to be analysed according to the specific class under which it is classified. As stated before, the Nice Classification mainly serves to categorise the goods/services for administrative purposes and is not decisive for their comparison.

1.2.4 Changes in the classification of goods/services

Normally, with each revision of the Nice Classification there are changes in the classification of goods/services (in particular the transfer of goods/services between various classes) or in the wording of headings. In such cases the list of goods/services of both the earlier and the contested mark must be interpreted according to the edition of the Nice Classification at its moment of filing.

Example

- *Legal services* were transferred from Class 42 to Class 45 with the eighth edition of the Nice Classification. The nature of these services has not changed.
- *Vending machines* were transferred from Class 9 to Class 7 in the 10th edition of the Nice Classification, since a vending machine is basically a powered machine and as such was considered more appropriately classified in Class 7 with other machinery. However, since the nature of these goods has not changed, *vending machines* classified in different classes due to different filing dates of the respective applications are regarded as identical.

1.3 The Similarity Tool (ETMDN) for the comparison of goods/services

The [Similarity Tool](#) for the comparison of goods and services is a search tool to help and support examiners in assessing the similarity of goods and services. The Similarity Tool serves to harmonise practice on the assessment of similarity of goods and services and to guarantee coherence of opposition decisions. The Similarity Tool must be followed by examiners.

The Similarity Tool is based on the comparison of specific pairs of goods and services. A 'pair' compares two 'terms'. A 'term' consists of a class number from the Nice Classification (1-45) and a textual element, that is to say, a specific good or service (including general categories of goods and services, such as *clothing* or *education*). There are five possible results of the search: identity, high degree of similarity, similarity, low degree of similarity and dissimilarity. For each of the degrees of similarity, the tool indicates which criteria lead to each result.

The Similarity Tool is constantly updated and if necessary revised in order to create a comprehensive and reliable source of reference.

Since the tool gives, or will give, answers to specific comparisons, the Guidelines concentrate on defining the general principles and their application in practice.

1.4 Definition of goods and services (terminology)

1.4.1 Goods

The EUTMR does not give a definition of goods and services. Although the Nice Classification gives some general explanations to this effect in its introductory remarks, it refrains from clearly setting criteria for the distinction between goods and services.

In principle, the word 'goods' refers to any kind of item that may be traded. Goods comprise raw materials (unprocessed plastics in Class 1), semi-finished products (plastics in extruded form for use in manufacture in Class 17) and finished products (plastic household containers in Class 21). They include natural and manufactured goods, such as agricultural products in Class 31 and machines and machine tools in Class 7.

However, sometimes it is not clear whether goods only comprise tangible physical products as opposed to services, which are intangible. The definition and thus the scope of protection are particularly relevant when it comes to ‘goods’ such as *electricity*, which are intangible. This question is already answered during the examination on classification and will usually not cause any problems in the comparison of goods and services.

1.4.2 Services

A service is any activity or benefit that one party can offer to another that is intangible and does not result in the transfer of ownership of any physical object. In contrast to goods, a service is **always** intangible.

Importantly, services comprise economic activities provided to **third parties**.

- Advertising one’s own goods is not a service but running an advertisement agency (designing advertisement campaigns for third parties) is. Similarly *shop window dressing* is only a service when provided for third parties, not when done in one’s own shop.
- Selling or distributing one’s own goods is not a service. Retail services are meant to cover the services around the actual sale of goods, such as providing the customer with an opportunity to conveniently see, compare or test the goods. For more detailed information, see Annex II, paragraph 7, Retail services.

One indication for an activity to be considered a service under trade mark law is its independent economic value, that is to say, that it is usually provided in exchange for some form of (monetary) compensation. Otherwise, it could be a mere ancillary activity provided together with or after the purchase of a specific good.

Example

- Delivery, including the transport of furniture that has previously been purchased (either in a physical establishment or online), is not an independent service falling under *transport services* in Class 39.

However, the intention to make profit is not necessarily a criterion for defining whether an activity can qualify as a ‘service’ (judgment of 09/12/2008, C-442/07, Radetzky, EU:C:2008:696, § 16-18). It is more a question of whether the service has an independent market area and targeted public rather than the way or form in which compensation is made.

1.4.3 Products

In common parlance the term ‘products’ is used for both goods and services, e.g. ‘financial products’ instead of financial services. Whether terms in common parlance are described as ‘products’ is immaterial for them being classified as goods or services.

1.5 Determining the goods/services

1.5.1 The correct wording

As a preliminary matter, the correct wording of the lists of goods/services under consideration must be identified.

1.5.1.1 European Union trade marks

An application for an EUTM will be published in all the official languages of the Union (Article 120(1) EUTMR). Likewise, all entries in the Register of European Union trade marks (the Register) will be in all these languages (Article 120(2) EUTMR). Both applications and entries in the Register are published in the EUTM Bulletin (Rule 85(1) and (2) EUTMIR).

In practice, occasional discrepancies may be found between:

- the translation of the wording of the list of goods and/or services of an EUTM (application or registration) published in the EUTM Bulletin, and
- the original wording as filed.

In cases of such a discrepancy, the definitive version of the list of goods and services is:

- the text in the first language if the first language is one of the five languages of the Office.
- the text in the second language indicated by the applicant (see Article 120(3) EUTMR) if the first language of the application is not one of the five languages of the Office.

This applies regardless of whether the EUTM (or EUTM application) is the earlier right or the contested application.

1.5.1.2 Earlier national marks and international registrations

The list of goods and services of the earlier marks on which the opposition is based must be submitted in the language of the opposition proceedings (Rule 19(3) EUTMIR). The Office does not require any certified translation and accepts simple translations, drawn up by the opponent or its representative. The Office normally does not make use of its faculty under Rule 98(1) EUTMIR, second sentence, to require the translation to be certified by a sworn or official translator. Where the representative adds a declaration that the translation is true to the original, the Office will in principle not question this. The other party may, however, question the correctness of the translation during the adversarial part of the proceedings. (See the Guidelines, Part C, Opposition, Section 1, Procedural Matters).

For international registrations under the Madrid Agreement or Protocol, the language in which the international registration was registered is definitive (French, English or Spanish). However, where the language of the opposition procedure is not the

language of the international registration, a translation must be supplied as for earlier national marks.

1.5.2 The relevant scope

The comparison of the goods and services must be based on the wording indicated in the respective lists of goods/services. Any actual or intended use not stipulated in the list of goods/services is not relevant for the comparison since this comparison is part of the assessment of likelihood of confusion in relation to the goods/services on which the opposition is based and directed against; it is not an assessment of actual confusion or infringement (judgment of 16/06/2010, T-487/08, Kremezin, EU:T:2010:237, § 71).

However, if proof of use of the earlier mark is validly requested and the submitted evidence is sufficient only for part of the goods/services listed, the earlier mark is deemed to be registered for only those goods/services (Article 42(2) EUTMR), and consequently the examination is restricted to those goods/services (see the Guidelines, Part C, Opposition, Section 6, Proof of Use).

Moreover, in the case of the earlier mark, only the goods and services on which the opposition is validly based are pertinent. Hence, no account will be taken of the goods/services:

- that cannot be taken into account for reasons of admissibility,
- that have not been properly substantiated (e.g. only a partial translation of the list of goods/services was filed), or
- on which the opposition is not, or is no longer, based.

Similarly, only those goods and services of the contested application against which the opposition is directed are taken into consideration. Consequently, restrictions during the proceedings of either the list of goods/services of the application, or the goods/services on which the opposition is based, or of both, will limit the goods and services to be compared.

Furthermore, an analysis of the wording of the list of goods/services might be required to determine the scope of protection of those goods and services. This is especially true where terms such as **in particular**, **namely**, or equivalents are used in order to show the relationship of an individual product with a broader category.

The term **in particular** (or **for example**, **such as**, **including** or other equivalent) indicates that the specific goods/services are only examples of items included in the category, and that protection is not restricted to them. In other words, it introduces a non-exhaustive list of examples (on the use of **in particular** see the reference in judgment of 09/04/2003, T-224/01, Nu-tride, EU:T:2003:107).

On the other hand, the term **namely** (or **exclusively** or other equivalent) is exclusive and restricts the scope of the registration only to the specifically listed goods.

For example, in the case of *chemicals used in industry, namely raw materials for plastics* only the *raw materials for plastics* need to be compared with the goods of the other mark.

It should be recalled that the use of commas in the list of goods/services serves to separate items within the same or a similar category. The use of a semicolon means a separation between terms. The separation of terms by different punctuation can lead to changes in their meaning and may lead to a different assessment when comparing the goods/services. For more information on punctuation in lists of goods and services, see the Guidelines, Part B, Examination, Section 3, Classification.

For example, in *computer software for use with industrial machines; fire extinguishers* in Class 9, the inclusion of a semicolon means that the term '*fire extinguishers*' must be considered as an independent category of goods, regardless of whether the intention was to protect computer software to be used in the field of industrial machines and fire extinguishers.

1.5.3 The meaning of goods/services

Once the wording of the goods and services to be considered has been identified, their meaning must be determined.

In some cases the exact meaning is immediately obvious from the list of goods and/or services of the marks where a more or less detailed description of the goods and services will often be given. For example, the wording *belts, being articles of clothing* excludes by definition safety or industrial belts.

In cases of doubt about the exact meaning of the terms used in the list of goods and/or services, these terms have to be interpreted both in the light of the Nice Classification and from a commercial perspective.

Therefore, *belts* in Class 25 are due to their classification *articles of clothing*.

Where the meaning of terms in a semantic context, a commercial context and/or under the Nice Classification are ambiguous or leave some doubts, the meaning they have under the Nice Classification prevails.

Clothing, for instance, refers to 'clothes collectively' (see e.g. *Oxford English Dictionary*) and thus to items worn to cover the body, such as shirts, dresses, pants, etc. Although the definition found in standard dictionaries does not explicitly exclude *footwear*, the fact that it appears in the Nice Classification as a separate item in the same Class 25 leads to the conclusion that *clothing* and *footwear* are not identical but similar (confirmed by judgment of 13/07/2004, T-115/02, 'a' in a black ellipse, EU:T:2004:234, § 26).

However, that does not mean that two general indications of one class heading can never be considered identical. As mentioned above, the structure of the class headings is not uniform. Some general indications included in the class headings may encompass others.

Example

- *Meat* and *poultry* are identical (Class 29).

1.6 Objective approach

The comparison of the goods/services in question must be made **without** taking into account the degree of similarity of the conflicting signs or the distinctiveness of the earlier mark. It is only in the overall assessment of a decision that the examiners will take into account all the relevant factors.

The classification of the goods or services is not conclusive, because similar goods/services may be classified in different classes, whereas dissimilar goods/services may fall within the same class.

Identity or similarity of the goods/services in question must be determined on an objective basis.

It is necessary to base the findings on the realities of the marketplace, such as established customs in the relevant field of industry or commerce. These customs, especially trade practices, are dynamic and constantly changing. For instance, mobile phones nowadays combine many functions such as being communication tools as well as photographic apparatus.

The degree of similarity of the goods and services is a matter of law, which must be assessed *ex officio* by the Office even if the parties do not comment on it². However, the Office's *ex officio* examination is restricted to well-known facts, that is to say, 'facts that are already well known or which may be learned from generally accessible sources', which excludes facts of a highly technical nature (judgment of 03/07/2013, T-106/12, Alpharen, EU:T:2013:340, § 51). Consequently, what does not follow from the evidence/arguments submitted by the parties or is not commonly known should not be speculated on or extensively investigated *ex officio* (judgment of 09/02/2011, T-222/09, Alpharen, EU:T:2011:36, § 31-32). This follows from Article 76(1) EUTMR, according to which, in opposition proceedings, the Office is restricted in its examination to the facts, evidence and arguments provided by the parties and the relief sought. (See also the Guidelines, Part C, Opposition, Section 2, Double Identity and Likelihood of Confusion, Chapter 1, General Principles).

1.7 Statement of reasons

The examiner is required to reason the outcome of the comparison (identity, similarity or dissimilarity) for each of the individual goods and services specified in the application for registration. However, the examiner may use only general reasoning for groups of the goods or services concerned as long as the goods or services present analogous characteristics (see by analogy order of 18/03/2010, C-282/09 P, P@yweb card/Payweb card, EU:C:2010:153, § 37-38, judgments of 12/04/2011, T-28/10, Euro automatic payment, EU:T:2011:158, § 54; 17/10/2013, C-597/12 P, Zebexir, EU:C:2013:672, § 26-27).

² Judgment of 16/01/2007, T-53/05, Calvo, EU:T:2007:7, § 59.

2 Identity

2.1 General principles

Identity is generally defined as ‘the quality or condition of being the same in substance, composition, nature, properties, or in particular qualities under consideration’ (*Oxford English Dictionary*).

Identity exists not only when the goods and services completely coincide (the same terms or synonyms are used), but also when and insofar as the contested mark’s goods/services fall within the broader category of the earlier mark, or when and insofar as — conversely — a broader term of the contested mark includes the more specific goods/services of the earlier mark. There might also be identity when two broad categories under comparison coincide partially (‘overlap’). Hence a distinction can be made between cases of ‘full identity’ and ‘partial identity’.

Identity should not be established on the basis of similarity factors (see paragraph 3.1.1 below).

2.2 Identical terms or synonyms

Identity between the goods/services in dispute must be established on the basis of the wording of the relevant parts of the lists of goods and/or services of the two marks that have been identified in accordance with the principles set out above. Identity is obvious where the goods/services to be compared are listed in exactly the same terms.

Example

- *Vehicles* are identical to *vehicles*.

Where this is not the case, the terms of the respective lists of goods and/or services must be interpreted in order to show that they are in fact synonyms; that their meaning is the same. The interpretation can be made based on dictionary definitions, expressions from the Nice Classification and in particular taking into account the commercial perspective.

Examples

- *Bicycle* is a synonym for *bike*. The goods are identical.
- The meaning of the words *smokers’ articles* in Class 34 refers to individual objects that are used in close connection with tobacco or tobacco products. In former editions of the Nice Classification these products were called *smokers’ requisites*. Therefore, despite a different term used in the current heading, these goods are identical.
- From a commercial perspective, *health spa services* and *wellness services* are the same and are therefore identical.

However, if an identical wording is used but the goods are classified in different classes, this generally means that these goods are not identical.

Examples

- *Drills* (machine tools) in Class 7 are not identical to *drills* (hand tools) in Class 8.
- *Lasers* (not for medical treatment) in Class 9 are not identical to *lasers* (for curative purposes) in Class 10.

Even though they might be similar, the classification in different classes indicates that they have a different nature, purpose or method of use, etc.

The same reasoning does not apply if the different classification is only due to a revision of the Nice Classification or where it is clear that the goods/services are wrongly 'classified' due to an obvious mistake.

Examples

- *Playing cards* (Class 16 — 7th edition) are identical to *playing cards* (Class 28 — 10th edition).
- *Pharmaceutical preparations* (Class 15, obvious typing error) are identical to *pharmaceutical preparations* (Class 5).

2.3 Terms included in general indication or broad category

2.3.1 The earlier mark includes the goods/services of the contested mark

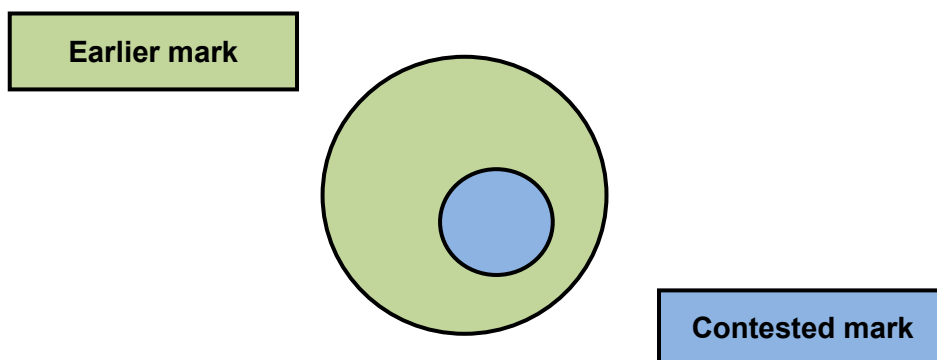

Where the list of goods/services of the earlier right includes a general indication or a broad category that covers the goods/services of the contested mark in their entirety, the goods/services will be identical (judgment of 17/01/2012, T-522/10, Hell, EU:T:2012:9, § 36).

Examples

- *Temporary accommodation* (earlier right, Class 43) includes *youth hostel services* (contested mark, Class 43). Therefore, the services are identical.

- *Pasta* (earlier right, Class 30) includes *spaghetti* (contested mark, Class 30). The conflicting goods are considered identical.

2.3.2 The contested mark includes the goods/services of the earlier mark

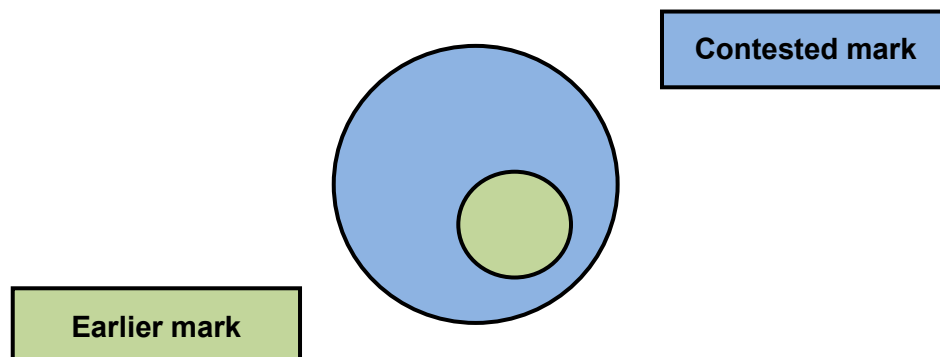

If the goods/services designated in the earlier mark are covered by a general indication or broad category used in the contested mark, these goods/services must be considered identical since the Office cannot dissect *ex officio* the broad category of the applicant's/holder's goods/services (judgment of 07/09/2006, T-133/05, Pam-Pim's Baby-Prop, EU:T:2006:247, § 29).

Examples

- The earlier mark's *jeans* (Class 25) are included in *articles of clothing* (contested mark, Class 25). The goods are considered identical.
- The earlier mark's *bicycles* (Class 12) are included in *vehicles* (contested mark, Class 12). The goods are considered identical.

The applicant/holder may however restrict the list of goods/services in a way that excludes identity, but could still lead to similarity (judgment of 24/05/2011, T-161/10, E-Plex, EU:T:2011:244, § 22).

- The earlier mark's *jeans* (Class 25) are included in *articles of clothing* (Class 25). The applicant/holder restricts the specification to *articles of clothing, excluding jeans*. The goods are no longer identical but remain similar.
- The earlier mark's *bicycles* (Class 12) are included in *vehicles* (contested mark, Class 12). The applicant/holder restricts the specification to *vehicles, namely automobiles*. The goods are no longer identical or similar.

If the applicant/holder does not restrict the list of goods/services, or does so in an insufficient way, the Office will treat the contested mark's general indication or broad term/category as a single unit and find identity.

If the contested mark covers a general indication or a broad term/category as well as specific items that fall under that general indication or broad term/category, all of these will need to be compared with the specific earlier goods/services. The result of identity

found with the general indication or broad term/category does not automatically extend to the specific items.

Example

- The contested mark covers *vehicles* (general indication) as well as *bicycles*, *aircraft*, *trains* (included in vehicles). Where the earlier mark is protected for *bicycles*, identity will be found with respect to *vehicles* and to *bicycles* but not for *aircraft or trains*.

However, if the contested mark covers a general indication or broad term/category and specific terms that are not listed independently but only as examples, the comparison differs insofar as only the general indication or broad term/category has to be compared.

Example

- The contested mark covers *vehicles*, ***in particular bicycles, aircraft, trains***. The earlier mark is protected for *bicycles*. The goods in conflict are considered identical.

The applicant/holder can avoid this result by deleting the general indication *vehicles*, the expression *in particular*, and the specific category *bicycles*.

Where the list of goods and/or services of the contested mark reads: *vehicles, namely bicycles, aircraft, trains*, the comparison differs insofar as only the specific items have to be compared. In this case only the contested *bicycles* are identical to the earlier goods.

2.4 Overlap

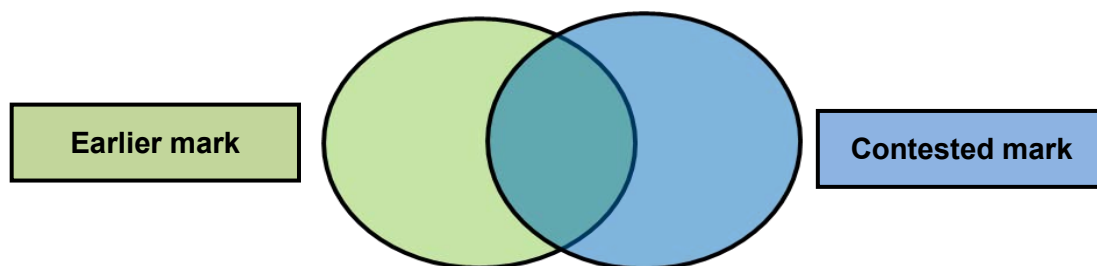

If two categories of goods/services coincide partially ('overlap') there might be identity if:

- a. they are classified in the same class;
- b. it is impossible to clearly separate the two goods/services.

Examples

Earlier goods	Contested goods	Coinciding part
<i>Outdoor clothing for women.</i>	<i>Clothing made of leather</i>	Outdoor clothing for women made of leather
<i>Components and spare parts for land vehicles</i>	<i>Vehicle seats</i> ³	Seats for land vehicles
<i>Bread</i>	<i>Long-life bakery products.</i>	Long-life bread
<i>Electric kitchen utensils</i>	<i>Thermometers</i> ⁴	Electric kitchen thermometers
<i>Soap</i>	<i>Cleaning preparations</i>	Soaps for cleaning purposes
<i>Scientific instruments</i>	<i>Optical instruments</i>	Scientific optical instruments, e.g. microscopes
<i>Online banking services</i>	<i>Commercial banking services</i>	Online commercial banking services

In such cases, it is impossible for the Office to filter these goods from the abovementioned categories. Since the Office cannot dissect *ex officio* the broad category of the applicant's/holder's goods, they are considered to be identical.

In the fifth example given above, the outcome changes of course if *soap* is limited to *soaps for personal use*. In this case the goods are no longer included in the heading *cleaning preparations* in Class 3 since the latter is only for household use.

2.5 Practice on the use of general indications of the class headings

In accordance with Article 28(3) EUTMR the Office does not object to the use of any of the general indications of the class headings provided that this identification is sufficiently clear and precise⁵.

In accordance with Article 28(5) EUTMR, the use of general terms or general indications of the class headings will be interpreted as including all the goods or services clearly covered by the literal meaning of the indication or term. The use of such terms will not be interpreted as comprising a claim to goods or services that cannot be so understood.

Under Article 28(8) EUTMR, during the six-month period after the entry into force of the Amending Regulation, proprietors of EU trade marks filed before 22/06/2012 and registered for the entire heading of a Nice class have the opportunity to declare that their intention at the time of filing was to cover goods and services beyond the literal meaning of that class heading, provided that the goods or services declared are included in the alphabetical list for the class of the edition of the Nice Classification in force on the date of filing.

³ Judgment of 09/09/2008, T-363/06, Magic seat, EU:T:2008:319, § 22.

⁴ Judgment of 19/01/2011, T-336/09, Topcom, EU:T:2011:10, § 34.

⁵ See the 'Common Communication on the Common practice on the General Indications of the Nice Class headings'.

During that six-month period, President's Communication No 2/12 of 20/06/2012 remains in force and therefore trade marks filed before 22/06/2012 and registered for an entire class heading are considered to cover the literal meaning of the general indications, as well as the goods and services of the alphabetical list of that class in the edition of the Nice Classification in force at the time of filing.

In accordance with Article 28(8) EUTMR, last sentence, from the expiry of the six-month period following the entry into force of the Amending Regulation, all EU trade marks registered in respect of the entire heading of a Nice class for which no declaration has been filed, will be deemed to extend only to goods or services clearly covered by the literal meaning of the indications included in the heading of the relevant class.

Declarations for EU trade marks filed within the relevant period will take effect from the moment of their entry in the Register.

Where the declaration is accepted and the Register is amended, Article 28(9) EUTMR will apply.

In accordance with Article 28(9) EUTMR, the amendment of a list of goods or services, recorded in the Register following a declaration under Article 28(8) EUTMR made during the six-month period after the entry into force of the Regulation, cannot give the proprietor of an EU trade mark the right to oppose or to apply for a declaration of invalidity of a later mark where and to the extent that (i) that later trade mark was in use, or an application had been made to register the later trade mark, for goods or services before the register was amended for the earlier mark and (ii) the use in relation to those goods or services did not infringe, or would not have infringed, the proprietor's rights based on the literal meaning of the goods or services recorded in the register at that time.

In practice, this means that where the earlier mark is an EU trade mark and the contested mark was filed, or was in use, before the register was amended under Article 28(8) EUTMR in relation to the earlier EU trade mark, the goods and services identified as going beyond the literal meaning of the class heading will not be taken into account in oppositions or declarations of invalidity filed after the entry into force of the Amending Regulation.

As regards the scope of protection of national marks, the Office and all national trade mark offices of the European Union issued a Common Communication on the implementation of the 'IP Translator' judgment (in the 'Common Communication on the implementation of IP Translator'). According to that Communication, the Office interprets the scope of protection of national marks containing class headings as follows:

- **Earlier national trade marks filed before the 'IP Translator' judgment:** In principle, the Office accepts the filing practice of all national trade mark offices in the European Union. National trade marks filed before the 'IP Translator' judgment have the scope of protection awarded by the national office(s). The majority of the national offices interpret the class headings of their marks literally. For those marks, the Office also interprets the class headings on the basis of the natural and usual meaning of each general indication.
- Only **eight** national trade mark offices do **not** interpret the class headings of their own marks filed before the 'IP Translator' judgment on the basis of their natural

and usual meaning: **Bulgaria, Finland, Greece, Hungary, Italy, Lithuania, Malta and Romania** (see Table 1 of the Common Communication). The Office interprets those national marks as covering the class headings plus the alphabetical list of the Nice edition at the time of filing (even if the national office interprets the class heading to cover all goods and services in the class).

- **Earlier national marks filed after the ‘IP Translator’ judgment:** the Office interprets all goods and services covered by the national marks on the basis of their natural and usual meaning (see Table 5 of the Common Communication).

In order to determine the scope of protection the abovementioned principles have to be applied. Only those goods or services deemed to be covered following these principles will be considered when making the comparison between the goods/services.

3 Similarity of Goods and Services

3.1 General principles

3.1.1 Similarity factors

Generally speaking, two items are defined as being similar when they have some characteristics in common. The similarity of goods and services does not depend on any specific number of criteria that could be determined in advance and applied in all cases.

The similarity of goods and services has been addressed in the case-law of the Court of Justice in Canon (judgment of 29/09/1998, C-39/97, Canon, EU:C:1998:442). The Court of Justice held that in assessing the similarity of goods **all** the relevant factors relating to those goods themselves should be taken into account. Those factors include, inter alia, their nature, their end users [**should read ‘intended purpose’**], their method of use and whether they are in competition with each other or are complementary (para. 23).

The term **inter alia** shows that the enumeration of the above factors by the Court is only indicative. There may be other factors in addition to or instead of those mentioned by the Court that may be pertinent for the particular case.

This leads to the conclusion that the following factors should be taken into account:

Canon factors

- nature
- intended purpose
- method of use
- complementarity
- in competition.

Additional factors

- distribution channels

- relevant public
- the usual origin of the goods/services.

These factors will be further explained below (see ‘The specific similarity factors’); they are also used in the Office’s database on the comparison of goods and services. It should be noted, however, that even though the database is restricted to these eight factors, there might be specific cases where other criteria are relevant.

3.1.2 Defining relevant factors

The comparison should focus on identifying the relevant factors that specifically characterise the goods/services that are to be compared. Therefore, the relevance of a particular factor depends on the respective goods/services to be compared.

Example

- When comparing *skis* and *ski-boots* it is evident that they do not coincide in their nature or method of use and they are not in competition. Therefore, the comparison should focus on their purpose, their complementary character, their distribution channels, their usual origin and/or the relevant public.

Therefore, the relevant factors and features characterising a product or a service may be different depending on the goods and services they have to be compared with.

It is not necessary to list all possible factors. What does matter, however, is whether the connections between the relevant factors are sufficiently close to find similarity.

The following questions could be asked:

- How will the goods/services be used?
- What is their purpose?
- How likely is it that they coincide in producer?
- Are they usually found in the same outlet, department store or in the same section of a supermarket?

If the factors cannot already be defined from the wording of the goods/services, information may be derived from dictionary entries. However, dictionary entries have to be analysed against commercial realities and in particular taking into account the Nice Classification.

Example

- According to the dictionary, *ice* is the singular of *ices* and means inter alia ‘(an) ice cream’ or ‘water ice’ (*The Oxford English Dictionary, online edition*). If the comparison of *ices* and *ice* in Class 30 was done on the basis of the definition from the dictionary alone, it would lead to an erroneous conclusion that *ice* is identical to *ices*. However, since both *ices* and *ice* are mentioned in the list of goods in Class 30, *ices* are to be understood as ‘edible ices’, whereas *ice* is to be understood as ‘cooling ice’. Although they coincide in the composition to the extent that both consist (partly) of frozen water, their commercial nature is different: while one is a foodstuff the other is an auxiliary good for preserving

and/or cooling foodstuffs. It shows that the Nice Classification together with the commercial perspective prevail over the dictionary definition.

Once the relevant factors have been identified, the examiner must determine the relation between and the weight attributed to the relevant factors (see 'Relation between different factors' below).

3.2 The specific similarity factors

The following paragraphs define and illustrate the various factors for similarity of goods and services.

3.2.1 Nature

Nature of a product/service can be defined as the essential qualities or characteristics by which this product/service is recognised. Nature often corresponds to a particular type or sort of product/service or a specific category to which this product/service belongs and which is usually used to define it. In other words, it is the answer to the question 'What is it?'

Examples

- *Yoghurt* is a milk product;
- *Car* is a vehicle;
- *Body lotion* is a cosmetic product.

3.2.1.1 Indicative value of class headings and categories

The fact that the goods/services to be compared fall under the same general indication of a class heading or broad category does not automatically mean that they have the same nature. An example of such a broad category is *foodstuffs for human consumption*.

Examples

- *Fresh fruit* (Class 31) on the one hand and *coffee, flour, and bread* (Class 30) on the other hand have a different nature despite being foodstuffs.
- *Meat, fish, poultry and game* (Class 29) are foodstuffs of animal origin. *Fruits and vegetables* (Class 31) are foodstuffs of plant origin. This slight connection, namely all being foodstuffs, does not preclude that their nature is different.

The fact that the goods/services to be compared fall under a sufficiently narrow general indication of a class heading favours an identical or similar nature.

Example

- *Condensed milk* and *cheese* (both in Class 29) share the same nature because they belong to the same product category, namely milk products, which are a subcategory of foodstuffs (judgment of 4/11/2003, T-85/02, Castillo, EU:T:2003:288, § 33).

3.2.1.2 Features of the goods defining their nature

A variety of features of the goods in question may be useful for defining their nature. These include the following:

Composition: e.g. ingredients, materials of which the goods are made.

Example

- *Yoghurt* (Class 29) is a milk product (the nature of yoghurt may be defined by its basic ingredient).

Composition may be the most relevant criterion for defining nature. However, an identical or similar composition of the goods is not per se an indicator of the same nature.

Example

- A *chair* (Class 20) and a *doll* (Class 28) can both be made of plastic, but they do not have the same nature since one is a piece of furniture and the other is a toy. They belong to different categories.

Functioning principle: e.g. mechanical functioning, with or without engine/motor, optical, electrical, biological, or chemical functioning.

Example

- *Telescope* (Class 9) is an optical device (the nature of a telescope may be defined by its functioning principle, which is optical).

Although the functioning principle may help to define the nature of some goods, it is not always conclusive. There are cases where goods, in particular technology-related ones, with the same functioning principle have a different nature.

Example

- A *blender* and an *electric toothbrush* have the same functioning principle of rotation, but they do not have the same nature.

In contrast, there are goods with different functioning principles but the same nature.

Example

- The functioning principle of *washing machines using washing powder* is chemical, which is not the same as the functioning principle of *washing machines using magnetic waves*. However, these goods have the same nature as they are both washing machines.

Physical condition: for example, liquid/solid, hard/soft, flexible/rigid

The physical condition is another feature of the goods that may be used to define nature but, like the functioning principle, it is not conclusive.

Examples

- All drinks are liquid. Their nature is different from the nature of solid foodstuffs. However, when comparing two different drinks, their physical condition should not be conclusive: *milk* (Class 29) does not have the same nature as an *alcoholic beverage* (Class 33).
- *Yoghurt* is marketed both in solid and liquid form. However, the nature of this good is not defined by its physical condition, but — as mentioned above — by its basic ingredient (milk). In both cases, the nature of a solid yogurt and of a liquid yogurt is the same (a milk product).

3.2.1.3 Nature of services

When defining the nature of services, the features (composition, functioning principle, physical condition) cannot be used since services are intangible.

The nature of services can be defined, in particular, by the kind of activity provided to third parties. In most cases, it is the category under which the service falls that defines its nature.

Example

- *Taxi services* (Class 39) have the same nature as *bus services* (Class 39) as they are both transport services.

3.2.1.4 Nature of goods versus nature of services

By their *nature*, goods are generally dissimilar to services. This is because goods are articles of trade, wares or merchandise. Their sale usually entails the transfer in title of something physical. Services, on the other hand, consist of the provision of intangible activities.

3.2.2 Intended purpose

Purpose is generally defined as the reason for which something is done or created or for which something exists (*Oxford Dictionary Online*).

As a Canon factor, purpose means the intended use of the goods or services and not any other possible use.

Example

- A *plastic bag* can be used as protection against the rain. However, its intended purpose is to carry items.

The purpose is defined by the function of the goods/services. In other words, it answers the questions: What need do these goods/services satisfy? What problem do they solve?

It is sometimes difficult to determine the proper level of abstraction for determining the purpose. As in the case of defining the nature, the purpose must be defined in a sufficiently narrow way.

Example

- In the case of *vinegar*, the intended purpose should not be defined as ‘human consumption’, which is the general purpose that all foodstuffs share, but as ‘everyday seasoning’.

3.2.3 Method of use

The method of use determines the way in which the goods/services are used to achieve their purpose.

The question to be asked is: How are these goods/services used?

Method of use often follows directly from the nature and/or intended purpose of the goods/services and therefore has no or little significance of its own in the similarity analysis.

Example

- The method of use of newspapers and books is the same in the sense that they are both read. However, similarity can already be concluded from the facts that they are both printed matter (same nature) and that they both serve to entertain or to inform (same purpose).

Notwithstanding the explanation above, the method of use may be important, independent of nature and purpose, where it characterises the goods:

Example

- *Pharmaceutical preparations for treating skin diseases* in Class 5 can take the form of creams. They have the same method of use as *cosmetic creams* in Class 3.

However, even where the method of use characterises the goods under comparison and where it is identical for both goods, this fact alone will not be sufficient to establish similarity.

Example

- *Chewing gum* (Class 30) and *chewing tobacco* (Class 34) have an identical method of use. However, this fact alone does not render them similar.

3.2.4 Complementarity

Goods (or services) are complementary if there is a close connection between them, in the sense that one is indispensable (essential) or important (significant) for the use of the other in such a way that consumers may think that responsibility for the production of those goods or provision of those services lies with the same undertaking (see, to that effect, judgments of 11/05/2011, T-74/10, Flaco, EU:T:2011:207, § 40; 21/11/2012, T-558/11, Artis, EU:T:2012:615, § 25; 04/02/2013, T-504/11, Dignitude, EU:T:2013:57, § 44).

The complementary relation between the goods/services can be, for example, functional.

Example

- *Internet site hosting services* in Class 42 cannot exist without *computer programming services* in Class 42. There is a functional complementarity between those services, which, by their nature, belong to the field of information technology. Moreover, these services are aimed at the same public and use the same distribution channels. They are therefore similar (judgment of 29/09/2011, T-150/10, Loopia, EU:T:2011:552, § 36 and 43).

By definition, goods intended for different publics cannot be complementary (judgments of 22/06/2011, T-76/09, Farma Mundi Farmaceuticos Mundi, EU:T:2011:298, § 30; 12/07/2012, T-361/11, Dolphin, EU:T:2012:377, § 48). See also paragraph 3.3.1, Interrelation between factors.

Example

- *Textile products* in Class 24 (aimed at the public at large) and *treatment services relating to textile products* in Class 40 (aimed at professionals) cannot be complementary (judgment of 16/05/2013, T-80/11, Ridge Wood, EU:T:2013:251, § 28-32). These goods and services are not similar.

Complementarity is not conclusive on its own for finding a similarity between goods and/or services. Although a degree of complementarity may exist, goods and/or services may be dissimilar.

Example

- There is a degree of complementarity between *wine* (Class 33) and *wineglasses* (Class 21) insofar as wineglasses are intended to be used for drinking wine.

However, that complementarity is not sufficiently pronounced to conclude that these goods are similar. Furthermore, these goods do not have the same nature or usual origin nor do they usually share distribution channels (judgment of 12/07/2007, T-105/05, Waterford Stellenbosch, EU:T:2007:170, § 34, confirmed by judgment of 07/05/2009, C-398/07 P, Waterford Stellenbosch, EU:C:2009:288, § 45).

However, when the complementarity between goods/services has been identified in combination with other factors, such as 'usual origin' and/or 'distribution channel', similarity may be found:

Examples

- *Skis* (Class 28) and *ski boots* (Class 25) are complementary because the use of one is indispensable for the use of the other. The relevant public may think that the production of these goods lies with the same undertaking. In addition, they share the same public and distribution channels. These goods are consequently considered similar.
- *Teaching material* in Class 16 (such as, printed matter, pre-recorded data carriers and audio/video cassettes) is essential and thus complementary to *educational courses* in Class 41. Generally the material is issued by the same undertaking; they share the same public and distribution channels. These goods are similar to the services in question (for example judgment of 23/10/2002, T-388/00, ELS, EU:T:2002:260).
- *Services of an architect (designing of buildings)* (Class 42) are indispensable for *building construction* (Class 37). These services are often offered together through the same distribution channels, by the same providers and to the same public. Consequently, these services are complementary and similar (judgment of 09/04/2014, T-144/12, Comsa, EU:T:2014:197, § 65-67).

3.2.4.1 Use in combination: not complementary

Complementarity has to be clearly distinguished from use in combination where goods/services are merely used together whether by choice or convenience (e.g. bread and butter). This means that they are not essential for each other (decision of 16/12/2013, R 0634/2013-4, ST LAB, § 20). In such cases similarity can only be found on the basis of other factors, but not on complementarity.

Example

- Even if the functioning of *transmission belts* in Class 12 can be measured with the help of a *device for motor-vehicle testing* in Class 9, this does not mean that the goods are complementary. It can be convenient in certain cases to measure the performance of one or the other parameter but simple convenience is not sufficient to conclude that one product is indispensable for the other (decision of 03/10/2013, R 1011/2012-4, SUN, § 39).

Certain goods that are often coordinated with each other but do not fall within the scope of other similarity factors, were determined by the Court to have 'aesthetic

complementarity' (judgments of 01/03/2005, T-169/03, Sissi Rossi, EU:T:2005:72, § 62; 11/07/2007, T-150/04, Tosca Blu, EU:T:2007:214, § 35-39; 11/07/2007, T-443/05, Pirañam, EU:T:2007:219, § 49-50; 20/10/2011, T-214/09, Cor II, EU:T:2011:612, § 32-37). This relationship between the goods falls outside the existing definition of complementarity.

Example

- *Handbags* (Class 18) and *clothing* (Class 25) are closely connected but not complementary, since one is not essential for the use of the other. They are merely often used in combination. They are, however, similar because of the fact that they may well be distributed by the same or linked manufacturers, bought by the same public and can be found in the same sales outlets.

3.2.4.2 Ancillary goods/services: not complementary

When certain goods and/or services only support or supplement another product or service, they are not considered to be complementary within the meaning of the case-law. Ancillary goods are typically those used for packaging (e.g. bottles, boxes, cans, etc.) or for promotion (e.g. leaflets, posters, price lists, etc.). Equally, goods/services offered for free in the course of a merchandising campaign are usually not similar to the primary product or service.

Examples

- *Organisation and conducting of exhibitions* is not similar to *printed matter, including event notes* (Class 16), since these goods merely serve to promote and announce the specific event. These goods and services are not complementary.
- *Herbal nutritional supplements* in Class 5 are not indispensable or important for the use of *beers, mineral and aerated waters and other non-alcoholic drinks, fruit drinks and fruit juices, syrups and other preparations for making beverages* in Class 32. Any combined consumption of those products is merely ancillary. Therefore, these goods are not complementary. Furthermore, since their purpose, distribution channels and usual producers are different, and they are not in competition, these goods are not similar (judgment of 23/01/2014, T-221/12, Sun fresh, EU:T:2014:25, § 84).

3.2.4.3 Raw materials, parts, components and fittings: not complementary

Lastly, where the goods concern raw materials the criterion complementarity is not applicable in the analysis of similarity.

Raw materials as a significantly important basic component of an end product may be found similar to that product, but not on the basis of complementarity. Similar considerations apply to parts, components and fittings (see also Annex I, paragraphs 1 and 2, and Annex II, paragraphs 5.1 and 5.2).

Example

- *Plastic or synthetic products used as raw or semi finished material* (in Classes 1 and 17) cannot be regarded as complementary to *finished products* (made from these materials in Classes 9 and 12) on the ground that the raw materials are intended to be turned into the finished products (see, to that effect, judgment of 09/04/2014, T 288/12, Zytel, EU:T:2014:196, § 39).

3.2.5 In competition

Goods/services are in competition with each other when one can substitute the other. That means that they serve the same or similar purpose and are offered to the same actual and potential customers. In such a case, the goods/services are also defined as 'interchangeable' (judgment of 04/02/2013, T-504/11, DIGNITUDE, EU:T:2013:57, § 42).

Examples

- *Wallpaper* (Class 27) and *paints* (Class 2) are in competition because both cover or decorate walls.
- *Rental of movies* (Class 41) and *services of a cinema* (Class 41) are in competition because they both allow you to watch a movie.
- *Electric shavers* and *razor blades* (both in Class 8) are in competition because they serve the same purpose.

In some cases the price of goods/services in competition may differ significantly, but this fact alone does not affect the analysis of whether they are in competition with each other or not.

Example

- *Jewellery made of gold* and *fashion jewellery*⁶ (both in Class 14) are in competition even though their price (and value) may greatly differ.

3.2.6 Distribution channel

Although 'distribution channel' is not explicitly mentioned in the Canon judgment, it is widely used internationally and nationally in the assessment of whether two goods/services are similar. As an additional factor it has been taken into account in several judgments of the European Courts (see amongst others judgment of 21/04/2005, T-164/03, monBeBé, EU:T:2005:140, § 53). The reasoning for this is as follows.

⁶ Fashion/costume jewellery is understood to be jewellery made from inexpensive metals and imitation gems or semiprecious stones, worn for decorative purposes.

If the goods/services are made available through the same distribution channels, the consumer may be more likely to assume that the goods or services are in the same market sector and are possibly manufactured by the same entity and vice versa.

The term 'distribution channel' does not refer so much to the way of selling or promoting a company's product but rather to the place of distribution. For the analysis of the similarity of goods/services, the distribution system — whether direct or indirect — is not decisive. The question to be asked is rather:

Do the goods/services have the same points of sale, or are they usually provided or offered at the same or similar places?

However, not too much emphasis should be placed on this factor as modern supermarkets, drugstores and department stores sell goods of all kinds. The relevant public is aware that the goods sold in these places come from a multitude of independent undertakings. Therefore, the point of sale is less decisive when deciding whether the relevant public considers that goods share a common origin merely because they are sold at the same outlet.

Only where the goods in question are offered in the same **section** of such shops, where homogeneous goods are sold together, will this favour similarity. In such cases it must be possible to identify the section by its territorial and functional separation from other sections (e.g. dairy section of a supermarket, the cosmetic section of a department store).

Similarly, the factor may be valid in cases in which goods are sold exclusively or commonly in specialised shops. In that event, consumers may tend to believe the origin of the goods to be the same if they are both sold in the same specialised shops and may tend to deny that mutual origin if they are not usually sold in the same shops.

Conversely, different sales outlets may weigh against the similarity of goods.

Example

- *Wheelchairs versus bicycles*

Although both fall under *vehicles* in *Class 12*, they will not be found at the same sales points. Bicycles are usually sold either in specialist bicycle stores or in a retail store where sporting equipment is available. In contrast, the distribution channels of *wheelchairs* are specialised distributors of medical equipment and devices supplying hospitals and specialised shops where devices for disabled or physically handicapped people are sold.

3.2.7 Relevant public

The relevant public, such as the actual and potential customers of the goods and services in dispute, constitutes another factor to be dealt with in the analysis of their similarity (see the Guidelines, Part C, Opposition, Section 2, Double Identity and Likelihood of Confusion, Chapter 3, Relevant Public and Degree of Attention).

The relevant public can be composed of:

- the general public (public at large) or

- professional public (business customers or specialised public).

The relevant public does not necessarily mean the end user; for instance, the end users of food for animals in Class 31 are animals, not the relevant public. The relevant public in this case would be the general consumer.

The mere fact that the potential customers coincide does not automatically constitute an indication of similarity. The same group of customers may be in need of goods or services of the most divergent origin and nature. The fact that, for example, television sets, cars and books are bought by the same relevant public, namely the public at large, has no impact on the similarity analysis. In many cases, either one or both lists of goods/services under comparison target the public at large, but the purpose (customers' needs covered) in each case is different. Such circumstances weigh against similarity.

While a coincidence in the relevant public is not necessarily an indication of similarity, largely diverging publics weigh heavily against similarity.

Diverging customers can be found in the following cases where:

- (a) the goods/services of both lists are directed at the public at large, which can however be clearly categorised by their different (personal) needs, ages, etc.
 - Example: *wheelchairs* versus *bicycles* (Class 12).
- (b) the goods/services of both lists target business customers, however acting in a very different market sector.
 - Example: *chemicals used in forestry* versus *solvents for the lacquer industry* (Class 1).
- (c) one relevant public consists of general consumers and the other of business customers.
 - Example: *containers for contact lenses* (in Class 9) versus *surgical apparatus and instruments* (in Class 10).

3.2.8 Usual origin (producer/provider)

Although the Court of Justice did not explicitly mention this factor in its Canon judgment, it follows from the general concept of likelihood of confusion that the usual origin of the goods and services is of particular importance for the analysis of similarity. As the Court has stated, it is 'the risk that the public might believe that the goods or services in question come from the same undertaking or, as the case may be, from economically linked undertakings, [that] constitutes a likelihood of confusion' (*Canon*, para. 29). Hence, there is a strong indication of similarity when, in the mind of the relevant public, the goods/services have the same usual origin.

However, this should not be misinterpreted as turning the examination of likelihood of confusion and similarity of goods/services upside down: the finding of a likelihood of confusion depends on many other factors (such as the similarity of signs, the distinctiveness of the earlier mark) and is not exclusively determined by the usual

origin, which as such is only one factor in the analysis of the similarity of goods/services.

A finding that consumers will not be confused about the origin of the goods/services is not an argument appropriate to the comparison of goods/services. This finding should be mentioned in the overall assessment of likelihood of confusion. Origin, in this context, relates mainly to the manufacturing sector (industry) or kind of undertaking producing the goods or offering the services in question rather than to the identity of the producer.

The 'origin' is not merely defined by the actual place of production/provision (e.g. factory, workshop, institute or laboratory) but primarily by taking into consideration who manages and/or controls the production/provision of the goods/services. In other words, the question to be asked is: who is responsible for manufacturing the product or providing the service?

The geographical origin (e.g. China) is not relevant for the finding of similarity of goods/services.

In the ELS judgment the Court held that even goods and services can have the same origin if it is common that the same type of company is responsible for the production/provision of both. *Educational textbooks* (Class 16) were considered to have the same origin as *provision of correspondence courses* (Class 41) since 'undertakings offering any kind of course often hand out those products to pupils as support learning materials' (judgment of 23/10/2002, T-388/00, ELS, EU:T:2002:260, § 55).

The criterion 'usual origin' has to be applied in a restrictive way in order not to dilute it. If all kinds of goods/services deriving from one big (multinational) company or holding were found to have the same origin, this factor would lose its significance.

Example

- *Cosmetics* (Class 3) and *foodstuffs* (Classes 29 to 31) might be produced under the umbrella of one company but this does not reflect common trade custom, according to which these types of goods have different producers, each belonging to a specific industry.

3.2.8.1 Features defining a common origin

When determining the usual origin of a product/service the following features might be relevant.

Manufacturing sites

Example

- *Varnishes, lacquers colorants and mordants* (Class 2) are typically produced in the same production enterprises, normally by specialised chemical companies.

The place of production can be a strong indicator that the goods/services in question come from the same source. However, while the same manufacturing sites suggest a common usual origin, different manufacturing sites do not exclude that the goods come

from the same or economically linked undertakings. For instance, *books* (Class 16) and *electronic media* (Class 9) (goods in competition, e-media substituting books) are both goods of a publishing house.

Methods of manufacture

Example

- *Leather belts* (Class 25) and *leather handbags* (Class 18) are not only manufactured in the same sites, for example, leather workshops, but also use the same tools and machines for the treatment of leather.

(Technical) know-how

Example

- *Computer virus protection services* (Class 42) and *software design* (Class 42) involve similar technical know-how in the field of information technology.

Established trade custom known to the public

An established trade custom, such as when manufacturers expand their businesses to adjacent markets, is of particular importance for concluding that goods/services of different nature have the same origin. In such situations it is necessary to determine whether such expansion is common in the industry or, conversely, whether it may occur in exceptional cases only.

Example where extension has become customary

- *Shoes* (Class 25) and *handbags* (Class 18): It is customary on the market that the producers of shoes are also involved in the manufacture of handbags.

Example where extension is not (yet) common

- *Clothing* (Class 25) and *perfumes* (Class 3): Even though some couturiers that make fashion clothes nowadays also sell perfumes under their marks, this is not the rule in the clothing industry, and rather applies to (economically) successful designers.

3.3 Relation between different factors

The Canon criteria were enumerated in the relative judgment without any hierarchy (weight) between them and without indicating any relation between them. They were considered one by one. However, they cannot be considered independently since some criteria are interrelated and some criteria are more important than others, regardless of whether goods are being compared with goods, services with services or goods with services. As a result of weighing all these factors in accordance with their respective importance in relation to the goods/services at issue, similarity may be found to various degrees: low, average or high (see paragraph 3.3.4 below).

3.3.1 Interrelation of factors

In many cases there will be relationships between the factors in the sense that where one is shared another one might coincide as well.

Examples

- Based on the purpose, it is also possible to determine who the actual and potential customers (i.e. the relevant public) are.
- The purpose, together with the relevant public, may also reveal whether goods/services are in competition.
- The same distribution channel goes hand in hand with the same public. In other words, where the distribution channels are different, the public may be different as well.
- Goods/services intended for different publics cannot be complementary (judgments of 11/05/2011, T-74/10, Flaco, EU:T:2011:207, § 40, 22/06/2011; T-76/09, Farma Mundi Farmaceuticos Mundi, EU:T:2011:298, § 30).
- The method of use usually depends on the nature and purpose of the goods.

There are cases in which a distinction between various factors will be difficult to draw. This is particularly true as far as 'nature', 'purpose' and 'method of use' are concerned. Where the examiner encounters such difficulties, it is sufficient to treat these factors jointly.

Example

- An *engine* is a machine for converting any of various forms of energy into mechanical force and motion. In such a case, it is difficult to distinguish the nature from the purpose of the product. Therefore, a distinction between what — in this case — is nature and what is purpose is not necessary.

3.3.2 Importance of each factor

In assessing the similarity of goods and services, **all** relevant factors characterising the relationship between them should be taken into account. However, depending on the kind of goods and services a particular criterion may be more or less important. In other words, the various criteria do not have a standard value, but rather their specific importance should be determined in the context of each individual case.

In general, the weight of each factor will depend on the impact it has on a possible confusion of the origin. Criteria clearly suggesting that the goods/services come or do not come from the same undertaking or economically linked undertakings should take precedence.

Generally strong factors

- Usual origin (because it has a strong impact on likelihood of confusion which relates to common commercial origin).
- Purpose (because it is decisive for the choice of the customer buying or selecting goods/services).
- Nature (because it defines the essential qualities and characteristics of the goods/services).
- Complementarity (because the close connection between the use of the goods/services makes the public believe that they share the same source).
- In competition (usually goods/services that are in competition have the same purpose and target the same public).

Less important factors

- Method of use (even dissimilar goods can be used in the same manner, e.g. *baby carriages* and *shopping trolleys*).
- Distribution channels (even dissimilar goods can be sold in the same section of stores depending on different display practices, e.g. *chewing gum* (Class 30) and *cigarettes* (Class 34)).
- Relevant public (especially when goods/services target the general public).

3.3.3 Different types of comparisons: goods versus goods, services versus services and goods versus services

In principle, the same factors for comparing goods with goods are relevant for the comparison of services with services. However, in applying these factors, the basic difference between goods and services (tangible v intangible) must be considered.

Furthermore, the same principles that apply for the comparison between goods and goods and between services and services apply in cases where goods are compared with services.

By their nature goods are generally dissimilar to services. They can, however, be complementary. Services can also have the same purpose and thus be in competition with goods. It follows that under certain circumstances similarity between goods and services can be found.

3.3.4 Degree of similarity

Goods and/or services can be found similar to different degrees (low, average, high) depending on how many factors they share and the weight given to each of them. The degree of similarity found between the goods and services is of relevance when finally deciding on the likelihood of confusion.

Generally, one factor on its own is not sufficient to find a low degree of similarity between the goods/services, even if it is a strong factor.

Examples of dissimilarity

- *Cars* and *bicycles* (both in Class 12) share the same purpose (taking oneself from A to B), but this does not render them similar.
- Although *window glass* (Class 19) and *glasses for spectacles* (Class 9) have the same nature, they are not similar, since they do not coincide in other relevant factors, such as purpose, producers, distribution channels and relevant public.

It is the combination of various factors and their weight that allows the final conclusion on similarity. The combination of two strong factors, such as nature and producer, or the combination of one strong and two weak factors will often lead to similarity. In contrast, the combination of two weak factors, such as distribution channel and relevant public are, in principle, not conclusive for a finding of similarity between the goods and services.

Examples of similarity

- *Milk* and *cheese* (both in Class 29) have a different purpose and method of use; they are not in competition or complementary. However, the fact that they share the same nature (dairy goods) and usual origin (dairy company) is decisive for a finding of similarity.
- Although *pharmaceuticals* and *plasters* (both in Class 5) have a different nature, they share a similar purpose; the cure of diseases, disabilities or injuries. Furthermore, they have the same distribution channels and relevant public. Therefore, they are similar.

The amount of coinciding factors found together with their importance/weight establishes the degree of similarity. Generally speaking, the higher the number of common factors the higher the degree of similarity. A similarity found on the basis of only two factors would normally not be high, contrary to cases where the goods/services coincide in four or more relevant factors.

However, no mathematical analysis is possible since it always depends on the specific circumstances of each case.

Annex I

Specific Questions as to the Similarity of Goods and Services

This part does not establish new criteria for finding a similarity between goods and services. It merely helps to clarify how to compare specific groups of goods and services where, apart from the Canon criteria, some general rules and exceptions apply.

1 Parts, Components and Fittings

The mere fact that a certain product can be composed of several components does not establish automatic similarity between the finished product and its parts (judgment of 27/10/2005, T-336/03, Mobilix, EU:T:2005:379, § 61).

Examples of dissimilarity

- *Fan blades* (Class 7) and *hair dryer* (Class 11)
- *Electric cable* (Class 9) and *lamp* (Class 11)
- *Buttons* (Class 26) and *clothing* (Class 25).

Similarity will only be found in exceptional cases and requires that at least some of the main factors for a finding of similarity, such as producer, public and/or complementarity are fulfilled.

Such an exception is based on the fact that parts and fittings are often produced and/or sold by the same undertaking that manufactures the end product and target the same purchasing public, as in the case of spare or replacement parts. Depending on the product concerned, the public may also expect the component to be produced by, or under the control of, the 'original' manufacturer, which is a factor that suggests that the goods are similar.

In general, a variety of factors may be significant in each particular case. For instance, if the component is also sold independently, or if it is particularly important for the functioning of the machine, this will favour similarity.

Examples of similarity

- *Electric toothbrush* (Class 21) and *replacement brush heads* (Class 21)
- *Printer* (Class 9) and *ink jet cartridges* (Class 2)
- *Sewing machines* (Class 7) and *walking feet for sewing machines* (Class 7).

2 Raw Materials and Semi-Processed Goods

A similar approach is also followed in relation to raw materials and semi-processed goods on the one hand and finished goods on the other.

In most cases, the mere fact that one product is used for the manufacture of another will not be sufficient in itself to show that the goods are similar, as their nature,

purpose, relevant public and distribution channels may be quite distinct (judgment of 13/04/2011, T-98/09, T Tumesa Tubos del Mediterráneo S.A., EU:T:2011:167, § 49-51). According to case-law, the raw materials subject to a transformation process are essentially different from the finished products that incorporate, or are covered by, those raw materials, in terms of nature, aim and intended purpose (see, to that effect, judgment of 03/05/2012, T-270/10, Karra, EU:T:2012:212, § 53). Furthermore, they are not complementary since one is manufactured with the other, and raw material is in general intended for use in industry rather than for direct purchase by the final consumer (judgment of 09/04/2014, T-288/12, Zytel, EU:T:2014:196, § 39-43).

Examples of dissimilarity

- *Leather, animal skins* (Class 18) and *clothing* (Class 25)
- *Precious metals* (Class 14) and *jewellery* (Class 14).

However, the final conclusion may depend on the specific circumstances of the case, such as the degree of transformation of the raw material or whether it is the basic component of the end product. The greater the significance of the raw material for the end product, the more likely the goods will be similar. Consequently, similarity might be established when the raw material or the semi-finished product can be decisive for the form, character, quality or value of the end product. In these cases, the raw material can often be obtained separately from the end product through the same distribution channels.

Example of similarity

- *Precious stones* (Class 14) and *jewellery* (Class 14). Contrary to *precious metals*, *precious stones* can be obtained in jewellery shops independently of the end product.

A subcategory of raw materials is *ingredients used for the preparation of foodstuffs* (see *ingredients* below).

3 Accessories

An accessory is something extra that improves or completes the main product it is added to. Unlike parts, components and fittings an accessory does not constitute an integral part of the main product, although it is usually used in close connection. An accessory usually fulfils a useful technical or decorative purpose.

The rules in respect of parts, components and fittings are to a certain extent also valid in the case of accessories. The mere fact that a certain product is used in combination with another is not necessarily conclusive for a finding of similarity.

Examples of dissimilarity

- *Clothing* (Class 25) and *hair ornaments* (Class 26)
- *Car sun blinds* (Class 12) and *vehicles* (Class 12).

However, it is common that some accessories are also produced by the manufacturer of the main product. Consequently the consumer may expect that the main product and the accessories are produced under the control of the same entity, especially when they are distributed through the same channels of trade. In such cases there is a strong indication for similarity.

Examples of similarity

- *Bicycles* (Class 12) and *panniers for bicycles* (Class 12)
- *Glasses* (Class 9) and *cases for glasses* (Class 9).

4 Installation, Maintenance and Repair Services

These services belong to the category of goods-related services.

Since by nature goods and services are dissimilar, a similarity between goods and their installation, maintenance and repair can only be established when:

- it is common in the relevant market sector for the manufacturer of the goods to also provide such services; **and**
- the relevant public coincides; **and**
- installation, maintenance and repair of these goods are provided independently of the purchase of the goods (not aftersales services).

The installation of virtually all goods is classified in Class 37, such as *installation of air conditioning apparatus, electric appliances, elevators or lifts, fire alarms, freezing equipment, kitchen equipment, and machinery*. The *installation and repair of computer hardware* is also in Class 37 as it is a physical repair and installation activity. However, *installation and repair of computer software* is classified in Class 42 because it involves computer programming without any physical installation or repair.

Examples of similarity

- *Data processing equipment and computers* (Class 9) and *installation and repair of electronic apparatus* (Class 37)
- *Air conditioning apparatus* (Class 11) and *installation, maintenance and repair services* (Class 37)
- *Vending machines* (Class 7) and *maintenance services* (Class 37).

Examples of dissimilarity

- *Building materials* (Class 19) and *installation services* (Class 37)
- *Shoes* (Class 25) and *repair of shoes* (Class 37)
- *Vehicles* (Class 12) and *dent removal for motor vehicles* (Class 37) (judgment of 15/12/2010, T-451/09, Wind, EU:T:2010:522, § 28-30).

5 Advisory Services

Advisory services refers to providing advice that is tailored to the circumstances or needs of a particular user and that recommends specific courses of action for the user. *Provision of information*, on the other hand, refers to providing a user with material (general or specific) about a matter or service but not advising the user on specific courses of action.

With the 8th edition of the Nice Classification, *professional consultation services* in Class 42 were eliminated. Since then consultation services — as well as *advisory and information services* — are classified in the class of the service that corresponds to the subject matter of the consultation. For instance, *transportation consultancy* belongs to Class 39, *business management consultancy* falls under Class 35, *financial consultancy* is classified in Class 36 and *beauty consultancy* in Class 44. The rendering of the advice, information or consultancy by electronic means (e.g. telephone, computer) does not affect the classification of these services.

Advisory, consultancy and information services are in principle always similar, or even identical, to the *services* to which they relate.

Examples

- *Financial information services* (Class 36) are included in *financial affairs* (Class 36) and thus identical (judgment of 27/02/2008, T-325/04, Worldlink, EU:T:2008:51, § 58).
- *Computer software advisory* (Class 42) is similar to the *installation and maintenance of software* (Class 42) because although they may not necessarily be included in *installation and maintenance of software* they are often complementary.
- When it comes to the comparison of advisory, consultancy and information services with goods, similarity can be found under conditions akin to those concerning maintenance, installation and repair (see paragraph 4 above).

Examples of similarity

- *Advisory services in computer technologies (hard-and software)* (Class 42) and *computer software* (Class 9)
- *Beauty consultancy* (Class 44) and *cosmetics* (Class 3).

Examples of dissimilarity

- *Information services concerning the purchase of fashion articles (shoppers guide information)* (Class 35) and *clothing, footwear and headgear* (Class 25), as it is not common in the market for the manufacturer of articles in Class 25 to provide such information services.

- *Providing information in the field of entertainment* (Class 41) and *toys* (Class 28), as it is not common in the market for the manufacturer of toys in Class 28 to provide such information services.

6 Rental and Leasing

Rental services are classified in the same classes as the service provided by means of the rented objects:

- *rental of telephones* is Class 38 because *telecommunication services* are in Class 38;
- *rental of cars* is in Class 39 because *transport services* are in this class.

Leasing services are analogous to rental services and therefore are classified in the same way. However, hire- or lease-purchase financing is classified in Class 36 as a financial service.

Based on the understanding that *leasing* in English means rental, these services must be clearly distinguished from any financial services. The comparison of rental and leasing services leads to the outcomes shown in the following paragraphs.

6.1 Rental/leasing versus related services

Even though rental services are classified in the same classes as the service provided by means of the rented objects, they are not automatically identical to this service. The comparison between these services has to be done applying normal criteria for identity and similarity.

Examples

- There is identity between *rental of flats* (Class 36) and *real estate affairs* (Class 36) because *rental of flats* is included in *real estate affairs*.
- The same reasoning cannot apply to *rental of bulldozers* (Class 37) and the related services of *building construction* (Class 37). *Rental of bulldozers* is not included in *building construction* and therefore these services are not considered to be identical.

6.2 Rental/leasing versus goods

Rental/leasing services are in principle always dissimilar to the goods rented/leased.

Examples

- *Vehicle rental* (Class 39) and *vehicles* (Class 12)
- *Rental of films* (Class 41) and *DVDs* (Class 9).

Exceptions exist where it is common for the manufacturer of the goods to provide rental services.

- *Rental and leasing of computer software* (Class 42) and *computer software* (Class 9) are considered to be similar to a low degree.
- *Rental of automatic vending machines* (Class 35) and *automatic vending machines* (Class 7) are considered to be similar to a low degree.

Annex II

Specific Industries

1 Chemicals, Pharmaceuticals and Cosmetics

1.1 Chemicals (Class 1) versus chemical products (Classes 3 and 5)

Although major chemical companies are usually involved in the production of all kinds of basic chemicals, speciality chemicals and life science products, including pharmaceuticals and pesticides, as well as consumer products, such as cleaning preparations and cosmetics, the mere fact that their nature coincides — as all of them can be broadly classified as chemical products — is not sufficient to find them similar. Special attention must be drawn to the specific purpose of these chemicals as well as to their public and distribution channel. What has been said above as to the relation between raw materials, semi-processed and finished products particularly applies to these products.

Consequently, although goods in Class 3 and Class 5 are usually combinations of various chemicals, they are in principle not considered similar to goods included in Class 1. Their purpose as a finished product usually differs from goods in Class 1, which are mainly in their raw, unfinished state and not yet mixed with other chemicals and inert carriers into a final product. The finished products in Class 3 and Class 5 usually also target a different public and do not share the same distribution channels.

On the other hand, it cannot be excluded that goods such as *chemicals used in agriculture, horticulture and forestry* require few processing steps to be considered a finished product such as *fungicides*. Such chemicals may be considered to already share the inherent purpose of *fungicides*: to kill or inhibit fungi or fungal spores, in particular when they consist of the fungicide's active ingredient. Furthermore, the same (agro-)chemical companies may produce the semi-processed goods as well as the final product. There is therefore a low degree of similarity between *chemicals used in agriculture, horticulture and forestry* and *fungicides* (decision of 08/10/2012, R 1631/2012-1, QUALY/QUALIDATE, § 27-28).

Furthermore, there are also goods in Class 1 that are not mere chemicals but are semi-finished or even finished products with a specific purpose of use, which is an important factor that must be taken into account when comparing goods in Class 1 to goods in other classes.

For example *manures* in Class 1 on the one hand and *pesticides, fungicides and herbicides* in Class 5 on the other are not only chemical products but also finished products with a specific use in the agricultural industry. They therefore have a similar purpose as the specific goods in Class 5 can be considered growth-enhancing by preventing conditions that could inhibit plant growth. As such they are similar to a low degree.

1.2 Pharmaceuticals versus pharmaceuticals

A pharmaceutical preparation refers to any kind of medicine, that is to say, a substance or combination of substances for treating or preventing diseases in human beings or

animals. From its definition it can already be concluded that *veterinary preparations* — though separately mentioned in the class heading — are included in the broader term of *pharmaceutical preparations*. Therefore they are identical.

The same applies to herbal and homoeopathic medicines since they are comprised in the broad term of *pharmaceutical preparations*.

Equally, testing preparations, that is to say, chemical reagents for medical — including veterinary — purposes, also fall under the general indication of *pharmaceutical preparations*.

Specific pharmaceuticals are considered to be similar to other specific pharmaceuticals. This is because several, if not all, criteria for similarity are usually met: they share the same nature because they are specific chemical products; their purpose is, broadly speaking, healing and/or curing; they are sold in the same places, namely, pharmacies; and they come from the same source, which is the pharmaceutical industry. This industry manufactures a wide variety of drugs with various therapeutic indications, something the general public is aware of. Furthermore, their method of use can be the same and they can be in competition with one another (judgment of 17/11/2005, T-154/03, Alrex, EU:T:2005:401, § 48).

However, the degree of similarity found between specific pharmaceuticals may vary depending on their specific therapeutic indications.

Example 1

- *Sedatives versus pain killers*. These pharmaceuticals are highly similar.

Example 2

- *Anti-epileptics versus pharmaceutical preparations, except medicines to combat diseases in connection with the central nervous system*. These pharmaceutical preparations are considered to be similar (judgment of 24/05/2011, T-161/10, E-Plex, EU:T:2011:244, § 24-25).

Example 3

- *Contraceptives versus eye-washes*. These pharmaceutical preparations are only similar to a low degree. In this regard, it should be noted that a low degree of similarity should only be established in exceptional cases, e.g. when it can be clearly established that they have different therapeutic indications and different methods of use.

Whether a specific pharmaceutical is sold under prescription is not of particular relevance for the comparison of the goods. Therefore, a prescription medicine is generally to be considered similar to an over-the-counter drug for the reasons stated above. (For information on the relevant public and the degree of attention in relation to pharmaceuticals, see the Guidelines, Part C, Section 2, Double Identity and Likelihood of Confusion, Chapter 3, Relevant Public and Degree of Attention).

1.3 Pharmaceuticals versus dietetic substances adapted for medical use

Dietetic substances and food supplements adapted for medical use are substances prepared for special dietary requirements with the purpose of treating or preventing a disease. Bearing this in mind, their purpose is similar to those of *pharmaceutical products* (substances used in the treatment of diseases) insofar as they are used to improve the patient's health. The relevant public coincides and these goods generally share the same distribution channel. For the above reasons, these goods are considered to be similar.

1.4 Pharmaceuticals versus cosmetics

The general categories *pharmaceuticals* and *cosmetics* are considered to be similar. Cosmetics include a list of preparations used to enhance or protect the appearance or odour of the human body. Pharmaceuticals on the other hand comprise products, such as skin or haircare preparations, with medical properties. They may coincide in purpose with cosmetics. Moreover, they share the same distribution channels since they can be found in pharmacies or other specialised shops. They target the same public and are often manufactured by the same companies.

However, when comparing specific pharmaceuticals with cosmetics they may only show a low degree of similarity or they may even be entirely dissimilar. In such cases this will depend on the specific drug and its specific purpose (medical indication/effect) or its method of use.

Example

- A *painkiller* is dissimilar to *nail polish*.

1.5 Pharmaceuticals versus services

Although pharmaceutical companies are heavily involved in research and development activities, they usually do not provide such services to third parties. Consequently, Class 5 goods are generally dissimilar to all services covered by Class 42.

Dissimilarity should also be found when comparing *pharmaceutical preparations* and *medical (including veterinary) services* in Class 44. Even though a certain link cannot be denied due to the common goal of treating diseases, the differences in nature and especially in the usual origin clearly outweigh any similarities. The relevant public does not expect a doctor to develop and market a drug.

2 Automobile Industry

The automotive industry is a complex industry involving various kinds of companies, including car manufacturing companies as well as suppliers that might provide the car manufacturer with their raw materials (metal, aluminium, plastics, paints, etc.), parts, modules or complete systems. Several areas of production can be distinguished: drive engineering, chassis, electronic, interior and exterior.

The complexity of the industry and the fact that the final product incorporates some component parts and accessories complicates the examination of similarity between the end product (e.g. a car) and the various parts or materials used for its production. Furthermore, when purchasing a car, the general public knows that the car incorporates many items from many sources and that the car manufacturer might assemble components that have been manufactured by others. However, as far as the consumer of a car is concerned, the goods are normally offered under only one sign, which makes it almost impossible for the general public to identify other manufacturers or to differentiate their source of production. Exceptions include car batteries or tyres, where other signs are usually visible.

As with other industries, the Canon criteria apply accordingly and in particular the general principles set out for the comparison of parts, components, and fittings have to be taken into consideration.

In particular, it should be kept in mind that there are goods that will only be purchased by the automobile industry without any possibility of them ever reaching or being purchased by the general public (end consumer). An example is the common metal (Class 6) used to form the chassis. Such goods are clearly dissimilar to the car and probably dissimilar to all other parts, components and fittings. On the other hand, there are spare parts that might also be purchased by the general public for repair or maintenance purposes. Assessment of the similarity of these goods will mainly depend on whether the specific spare part is commonly produced by the car manufacturer.

3 Electric Apparatus/Instruments

The expression *electric apparatus and instruments* in Class 9 cannot be interpreted as covering all apparatus powered by electricity. Indeed, there are apparatus powered by electricity in various classes. The term *electric apparatus* included in the list of goods in Class 9 is to be understood as only covering apparatus and instruments for conducting, switching, transforming, accumulating, regulating or controlling electricity.

4 Fashion and Textile Industries

Goods classified in Classes 22, 23, 24 and 25 are textile-related. There is a certain progression through these classes: *raw fibrous textile materials*, such as *fibres* (Class 22), are further made into *yarns and threads* (Class 23), then into *textiles*, such as *fabrics* (Class 24), and end up as *finished goods made of textile* (Class 24) or *clothing* (Class 25).

Moreover, Class 18 goods such as *goods made of leather and imitations of leather* are also related to the fashion and textile industries.

4.1 Raw or semi-processed materials versus finished goods

Since the relationship between the abovementioned classes is often based on the fact that one product is used for the manufacture of another (e.g. *textiles* in Class 24 are used for the manufacture of *clothing* in Class 25), in comparisons of this kind, general rules concerning raw materials apply (see Annex I, paragraph 2, on 'Raw materials and semi-processed goods' above).

For example, raw materials such as *leather and imitations of leather, animal skins and hides* (Class 18) are dissimilar to clothing, footwear and headgear (Class 25). The mere fact that leather is used for the manufacture of footwear (shoes made of leather) is not sufficient in itself to conclude that the goods are similar, as their nature, purpose and relevant public are quite distinct: raw materials are intended for use in industry rather than for direct purchase by the final consumer.

However, a low degree of similarity is found between *textiles* and *textile goods* such as *bed sheets* and *table covers*, in Class 24. In such cases, the degree of transformation required from material to end product is often insignificant: the fabric is merely cut into shape and/or sewn to obtain the finished product. Furthermore, many establishments allow customers to purchase the base material or ready-made cushions, etc. made from such material. Therefore, the relevant public may expect these goods to come from the same undertakings.

4.2 Textile goods (Class 24) versus clothing (Class 25)

The main point of contact between *textile goods* in Class 24 and *clothing* in Class 25 is that they are made of textile material. However, this is not enough to justify a finding of similarity. They serve completely different purposes: *clothing* is meant to be worn by people, or serves as a fashion article, whereas *textile goods* are mainly for household purposes and interior decoration. Therefore, their method of use is different. Moreover, the distribution channels and sales outlets of *textile goods* and *clothing* are different and the relevant public will not think that they originate from the same undertaking. Therefore, *textile goods* are considered to be dissimilar to *clothing* see decisions of 31/05/2012, R 1699/2011-4, GO/GO GLORIA ORTIZ, § 16; 26/07/2012, R 1367/2011-1, PROMO TEXTILE/Promodoro, § 17; 01/08/2012, R 2353/2010-2, REGRIGUE FOR COLD/REFRIGIWEAR et al., § 26).

4.3 Clothing, footwear and headgear (Class 25)

Class 25 goods, namely *clothing, footwear and headgear* are of an identical or very similar nature. They serve the same purpose since they are used to cover and protect various parts of the human body against the elements. They are also articles of fashion and are often found in the same retail outlets. Consumers, when seeking to purchase clothes, will expect to find footwear and headgear in the same department or shop and vice versa. Moreover, many manufacturers and designers will design and produce all of the aforementioned items. Therefore, these goods are similar to each other.

4.4 Fashion accessories

As explained in the paragraph on 'Accessories' (see Annex I, paragraph 3 above), the mere fact that a certain product is used in combination with another is not necessarily conclusive for a finding of similarity. However, it is common for some accessories also to be produced by the manufacturer of the main product. Consequently, the consumer may expect that the main product and the accessories are produced under the control of the same entity, especially when they are distributed through the same trade channels. In such cases, there is a strong indication for similarity. Therefore, not all goods that are considered as fashion accessories will be found to be similar to *clothing, footwear and headgear* (Class 25).

The broad category of *goods made of leather and imitations of leather* in Class 18 includes goods such as (hand)bags, sports bags, briefcases, wallets, purses, key cases, etc. These goods are related to articles of *clothing, headgear and footwear* in Class 25, in the sense that they are likely to be considered by the consumers as aesthetic complementary accessories to articles of outer clothing, headgear and even footwear because they are closely co-ordinated with these articles and may well be distributed by the same or linked manufacturers, and it is not unusual for clothing manufacturers to directly produce and market them. Moreover, these goods can be found in the same retail outlets. Therefore, these goods are considered to be similar to *clothing, headgear and footwear*.

In contrast, hair accessories such as *hair pins* and *ribbons* are dissimilar to *clothing*. Even though these goods might have some distant link to the fashion market, the mere fact that someone might want to match hair pins and clothing is not sufficient to conclude that these goods are complementary and therefore similar. The goods can only be considered to be complementary if there is a close connection between them, in the sense that one is indispensable or important for the use of the other and is not merely ancillary. In the present case, these conditions are not fulfilled. Furthermore, the nature and method of use of these goods is different. They are not in competition with each other. The production of these goods involves different know-how, they do not belong to the same category of goods and they are not regarded as components of a general array of goods that potentially have the same commercial origin (decision of 03/10/2011, R 1501/2010-4, Wild Nature/WILD NATURE, § 18).

Likewise, luxury goods such as glasses (Class 9) and jewellery (Class 14) are considered to be dissimilar to clothing, footwear and headgear. The nature and the main purpose of these goods are different. The main function of clothing is to dress the human body whilst the main purpose of glasses is to improve eyesight, and jewels are worn for personal adornment. They do not have the same distribution channels and they are neither in competition nor complementary (decisions of 30/05/2011, R 0106/2007-4, OPSEVEN2/SEVEN, § 14; 12/09/2008, R 0274/2008-1, Penalty/PENALTY, § 20; 05/10/2011, R 0227/2011-2, OCTOPUSSY/OCTOPUSSY ET AL, § 23-26).

The same reasoning applies to luxury goods such as perfumes (Class 3) — the main purpose of which is to impart a long-lasting scent to the body, stationery, etc. — and goods such as travelling bags (Class 18), which are intended to carry things when travelling. Even though couturiers nowadays also sell perfumes, fashion accessories (such as glasses and jewellery) and travel accessories under their marks, this is not the rule, and rather applies only to (economically) successful designers.

4.5 Sports clothing, footwear and headgear (Class 25) versus sporting and gymnastic articles (Class 28)

The general category of *clothing, footwear and headgear* includes sports clothing, footwear and headgear, which are garments or items of apparel designed specifically to be used when performing an activity or sport. Although the nature of these goods is different from those of *sporting and gymnastic articles*, which are articles and apparatus for all types of sports and gymnastics, such as weights, halters, tennis rackets, balls and fitness apparatus, there are undertakings that manufacture both *sporting and gymnastic articles* as well as *sports clothing/sports footwear*. Therefore, the distribution channels can be the same. There is a low degree of similarity when *sports clothing/sports footwear* is compared to *sporting and gymnastic articles*.

4.6 Fashion design (Class 42) and tailoring services (Class 40) versus clothing (Class 25)

There is a low degree of similarity between *clothing* and *fashion design* and *tailoring* services since they share the same relevant public and might coincide in the same usual origin (producer/provider). Producers of ready-made clothing (especially suits and wedding dresses) frequently provide *tailoring* services, which are closely related to *fashion design*, which is an earlier step in the clothing production process.

5 Food, Beverages and Restaurant Services

5.1 Ingredients of prepared food

Ingredients used for the preparation of foodstuffs are a subcategory of raw materials and treated in the same way as raw material in general. Consequently, the mere fact that one ingredient is needed for the preparation of a foodstuff will generally not be sufficient in itself to show that the goods are similar, even though they all fall under the general category of foodstuffs (judgment of 26/10/2011, T-72/10, Naty's, EU:T:2011:635, § 35-36).

Examples of dissimilarity

- *Eggs* (Class 29) and *ice cream* (Class 30)
- *Yeast* (Class 30) and *bread* (Class 30).

5.2 Main ingredient

When the ingredient can be considered as being the main ingredient of the prepared dish, a similarity will exist only if the goods share some other relevant criterion or criteria, in particular the usual origin, nature, purpose or method of use.

Examples of similarity (main ingredient plus other criteria)

- *Milk* (Class 29) and *yoghurt* (Class 29)
- *Fish* (Class 29) and *fish sticks* (Class 29)
- *Dough* (Class 30) and *pizzas* (Class 30).

See also judgment of the General Court of 04/05/2011, T-129/09, *Apetito*, EU:T:2011:193, where the Court confirms the finding of similarity between a particular foodstuff and prepared meals **mainly** consisting of the same particular foodstuff.

There is no complementarity in these cases simply because one ingredient is needed for the production/preparation of another foodstuff. Complementarity applies only to the use of goods and not to their production process (see chapter 'Complementarity' and judgment of 11/05/2011, T-74/10, *Flaco*, EU:T:2011:207, § 40 and decision of 11/12/2012, R 2571/2011-2, *FRUITINI*, § 18).

5.3 Non-alcoholic beverages (Class 32) versus alcoholic beverages (except beers) (Class 33)

Non-alcoholic beverages on the one hand, and *alcoholic beverages (except beers)*, are sold side by side in shops, bars and on drinks menus, etc. These goods target the same public and may be in competition. It must be concluded that these goods are similar to a low degree (judgment of 05/10/2011, T-421/10, Rosalia de Castro, EU:T:2011:565, § 31).

5.4 Beers (Class 32), alcoholic beverages (except beers) (Class 33)

There is a similarity between different alcoholic beverages in Class 33, as well as between the broad category of *alcoholic beverages* and *beer* in Class 32. Although their production processes are different, these goods all belong to the same category of alcoholic drinks (nature) intended for the general public. They can be served in restaurants and in bars and are on sale in supermarkets and grocery stores. These drinks can be found in the same area of supermarkets, even if some distinction according to their respective subcategory can be made. Furthermore, some alcoholic beverages may originate from the same undertakings.

Examples

- *Beers* are similar to *alcoholic beverages (except beers)*
- *Wines* are similar to *alcoholic beverages (except wines)*.

5.5 Provision of food and drinks versus food and drinks

The provision of food and drinks in Class 43 mainly covers services of a restaurant or similar services, such as catering, cafeterias and snack bars. These services are intended to serve food and drinks directly for consumption.

The mere fact that food and drinks are consumed in a restaurant is not enough reason to find similarity between them (judgment of 09/03/2005, T-33/03, Hai, EU:T:2005:89, § 45 and decision of 20/10/2011, R 1976/2010-4, THAI SPA/SPA et al., § 24-26).

Nevertheless, in certain situations these goods and services can be complementary (judgments of 17/03/2015, T-611/11 Manea Spa EU:T:2015:152, § 52; 15/02/2011, T-213/09, Yorma's, EU:T:2011:37, § 46). As shown in paragraph 3.2.4 above, goods or services are complementary if one is indispensable or important for the use of the other in such a way that consumers may think that responsibility for the production of those goods or provision of those services lies with the same undertaking.

The mere fact that food and/or drinks are essential to the services of restaurants, bars, cafeterias, etc. does not in itself lead consumers to think that responsibility for the production of those goods and provision of those services lies with the same undertaking (e.g. salt in restaurants).

On the other hand, consumers may think that responsibility lies with the same undertaking if the market reality is that the provision of food and drinks and the

manufacture of such goods are commonly offered by the same undertaking under the same trade mark (e.g. coffee in their coffee shops, ice cream in their ice cream parlours, beer in pubs). In such cases, there is a low degree of similarity.

6 Services to Support Other Businesses

All services listed in the class heading of Class 35 are aimed at supporting or helping other businesses to do or improve their business. They are therefore in principle directed at the professional public.

When comparing specific services falling within Class 35 it is very useful to focus on the question: Who is providing this kind of service? Is it an advertising agency, a management consultant, a human resources consultant, an accountant, an auditor, a sales agent or a tax advisor? Once the usual origin has been established it is easier to find the general indication to which the specific service belongs.

Advertising services consist of providing others with assistance in the sale of their goods and services by promoting their launch and/or sale, or of reinforcing the client's position in the market and acquiring competitive advantage through publicity. In order to fulfil this target, many different means and products might be used. These services are provided by advertising companies, which study their client's needs, provide all the necessary information and advice for the marketing of their products and services, and create a personalised strategy regarding the advertising of their goods and services through newspapers, websites, videos, the internet, etc.

Examples of advertising services are *rental of advertising time on communication media, telemarketing services, marketing, public relations and demonstration of goods*, since they are all intended to promote other companies' goods/services albeit via different means.

Example

Marketing research is the collection and analysis of information about a particular market to assess the viability of a product or service.

The nature and purpose of advertising services are fundamentally different from the manufacture of goods or from the provision of many other services. Therefore, advertising is generally dissimilar to the goods or services being advertised. The same applies to the comparison of advertising services versus goods that can be used as a medium for disseminating advertising, such as DVDs, software, printed matter, flyers and catalogues.

Management services are in Class 35 when they relate to the business aspects of an entity. As there are management services in other classes, a management service in Class 35 is taken to relate to business purposes.

Business management services are intended to help companies manage their business by setting out the strategy and/or direction of the company. They involve activities associated with running a company, such as controlling, leading, monitoring, organising, and planning. They are usually rendered by companies specialised in this specific field such as business consultants. They gather information and provide tools

and expertise to enable their customers to carry out their business or to provide businesses with the necessary support to acquire, develop and expand market share.

Examples of business management are business research and appraisals, cost price analysis and organisation consultancy, since they are all intended to help in the strategy of a commercial undertaking. These services also include any 'consultancy', 'advisory' and 'assistance' activity that may be useful in the management of a business, such as how to efficiently allocate financial and human resources; improve productivity; increase market share; deal with competitors; reduce tax bills; develop new products; communicate with the public; do marketing; research consumer trends; launch new products and how to create a corporate identity; etc.

Examples

Business research is the analysis and interpretation of economic information, such as income, employment, taxes, and demographics. This research information is used by entrepreneurs to make business decisions such as establishing marketing strategies.

Business appraisals involve an investigation into the nature and potential of a business and an assessment of its performance in relation to its competitors.

A *cost price analysis* is a combination of both an evaluation of the proposed total price of a project and the cost of the separate elements of that project (e.g. labour, materials, etc.) to determine if they are permissible, related to the project requirements and reasonable. It is used to determine whether going ahead with a project is a sound business decision. It is therefore considered as a service that helps in the management of the business affairs or commercial functions of an industrial or commercial enterprise. Using the information gained from a cost price analysis, a business may then go on to make the financial decisions associated with engaging in the project.

When comparing *business management* to *advertising* it should be noted that advertising is an essential tool in business management because it makes the business itself known in the market. As stated above, the purpose of advertising services is 'to reinforce the [business] position in the market' and the purpose of business management services is to help a business in 'acquiring, developing and expanding market share'. There is not a clear-cut difference between 'reinforcing a business position in the market' and 'helping a business to develop and expand market share'. A professional who offers advice regarding how to efficiently run a business may reasonably include advertising strategies in that advice because there is little doubt that advertising plays an essential role in business management. Furthermore, business consultants may offer advertising (and marketing) consultancy as a part of their services and therefore the relevant public may believe that these two services have the same professional origin. Consequently, considering the above these services are similar to a low degree (decision R 2163/2010-1, INNOGAME/INNOGAMES, § 13-17). This clear overlap between the two services also follows from the definitions given above of marketing research (an advertising service) and business research (a business management service).

Business administration services are intended to help companies with the performance of business operations and, therefore, the interpretation and implementation of the policy set by an organisation's board of directors. These services consist of organising people and resources efficiently so as to direct activities toward common goals and objectives. They include activities such as personnel recruitment, payroll preparation, drawing up account statements and tax preparation, since they

enable a business to perform its business functions and are usually carried out by an entity that is separate from the business in question. They are rendered by inter alia employment agencies, auditors and outsourcing companies.

Example

Business auditing involves the evaluation of a variety of business activities. It encompasses a review of organisational structures, management, processes, etc.

When comparing *business administration* to *advertising* it should be noted that these services are usually dissimilar, since a professional who helps with the execution of business decisions or the performance of business operations will not offer advertising strategies. However, the *organization of trade fairs for commercial or advertising purposes* is similar to a low degree to advertising, since they are both aimed at promoting the launch and/or sale of a company's products/services, and may target the same undertaking seeking help with the promotion of their products/services.

The line between *business management* and *business administration* is blurred, and it is sometimes very difficult to clearly distinguish between them. They both fall under the broader category of business services. As a general rule it can be said that business administration services are performed in order to organise and run a business, whereas business management follows a higher approach aimed at setting the common goals and the strategic plan for a commercial enterprise.

Office functions are the internal day-to-day operations of an organisation including the administration and the support services in the 'back office'. They mainly cover activities that assist in the working of a commercial enterprise. They include activities typical of secretarial services, such as shorthand and typing, compilation of information into computer databases, invoicing, administrative processing of purchase orders as well as support services, such as the rental of office machines and equipment.

Example

Book-keeping is the act of recording financial transactions.

7 Retail Services

Retail is commonly defined as the action or business of selling goods or commodities in relatively small quantities for use or consumption rather than for resale (as opposed to wholesale, which is the sale of commodities in quantity, usually for resale).

However, it should be noted that the sale of goods is not a service within the meaning of the Nice Classification. Therefore, the activity of retail in goods as a service for which protection of an EUTM can be obtained does not consist of the mere act of selling the goods, but in the services rendered around the actual sale of the goods, which are defined in the explanatory note to Class 35 of the Nice Classification by the terms 'the bringing together, for the benefit of others, of a variety of goods (excluding the transport thereof), enabling customers to conveniently view and purchase those goods'.

Moreover, the Court has held that the objective of retail trade is the sale of goods to consumers, which includes, in addition to the legal sales transaction, all activity carried

out by the trader for the purpose of encouraging the conclusion of such a transaction. That activity consists, inter alia, in selecting an assortment of goods offered for sale and in offering a variety of services aimed at inducing the consumer to conclude the abovementioned transaction with the trader in question rather than with a competitor (judgment of 07/07/2005, C-418/02, Praktiker, EU:C:2005:425, § 34).

Retail services allow consumers to satisfy different shopping needs at one stop and are usually directed at the general consumer. They can take place in a fixed location, such as a department store, supermarket, boutique or kiosk, or in the form of non-shop retailing, such as through the internet, by catalogue or mail order.

The following principles apply as regards the similarity of the goods or services at issue.

7.1 Retail services versus any product: dissimilar

Retail services in general⁷ (i.e. the specification is not limited to the sale of particular goods) are not similar to any goods that are capable of being sold by retail. Apart from being different in nature, given that services are intangible whereas goods are tangible, they serve different needs. Furthermore, the method of use of those goods and services is different. They are neither in competition with, nor necessarily complementary to, each other.

The specification of retail services relating to the sale of goods using terms such as 'including, in particular, for example, featuring, specifically, such as' is not precise enough since all these terms mean, in principle, 'for example'. They do not restrict the goods that follow. Consequently, formulations such as 'retail services, in particular of footwear' will be treated in the same way as 'retail services in general', without any specification.

7.2 Retail services of specific goods versus same specific goods: similar to a low degree

Retail services concerning the sale of particular goods are similar (to a low degree) to these particular goods (judgment of 05/10/2011, T-421/10, Rosalia de Castro, EU:T:2011:565, § 33). Although the nature, purpose and method of use of these goods and services are not the same, it should be noted that they display similarities, having regard to the fact that they are complementary and that those services are generally offered in the same places as those where the goods are offered for sale. Furthermore, they are directed at the same public.

The goods covered by the retail services and the specific goods covered by the other mark have to be identical in order to find a similarity, that is to say, they must either be exactly the same goods or fall under the natural and usual meaning of the category (e.g. *retail of sunglasses v sunglasses* and *retail of optical apparatus v sunglasses*).

⁷ 'Retail services' as such are not acceptable for classification purposes by the Office, unless further specified (see the Guidelines, Part B, Examination, Section 3, Classification).

7.3 Retail services of specific goods versus different or similar specific goods: dissimilar

Retail services relating to the sale of particular goods and other goods are not similar. It should be remembered that in principle goods are not similar to services. Too broad a protection would be given to retail services if similarity is found where the goods sold at retail are only highly similar or similar to the goods covered by the other mark.

7.4 Retail services versus retail services or retail services of specific goods: identical

Retail services in general, those that are not limited in the list to the sale of particular goods, are identical to retail services in general or retail services relating to the sale of specific goods.

7.5 Retail services of specific goods versus retail services of other specific goods: similar

Retail services relating to specific goods are considered to be similar to retail services relating to other specific goods independently of whether or not there is similarity between the goods in question. The services under comparison share the same nature as both are retail services, have the same purpose of allowing consumers to conveniently satisfy different shopping needs, and have the same method of use. Furthermore, depending on whether the goods in question are commonly retailed in the same outlets, they may coincide in relevant public and distribution channels, in which case they must be considered similar.

7.6 Services to which the same principles apply

The principles set out above apply to the services rendered in connection with different forms exclusively consisting of activities around the actual sale of goods, such as **retail store services, wholesale services, internet shopping, catalogue or mail order services**, etc. (to the extent that these fall into Class 35).

7.7 Services to which the same principles do not apply

In contrast, the principles set out above do not apply to other services that are not limited to services around the sales of goods, or that do not fall into Class 35, such as **auctioneering services** (Class 35), **import and export services** (Class 35), **distribution services** (Class 39), **transport or repair services** (Class 37), etc.

Example

- **Auctioneering services**

Auctions are public sales in which goods are sold to the highest bidder. Similarity between these services and the retail of specific products will only be found insofar as

the retail services relate to goods that are commonly sold in auctions, such as objects of art.

Therefore, the specific retail or wholesale services of *pharmaceuticals, veterinary and sanitary preparations and medical supplies* for example, would be considered dissimilar to auctioneering services, since it is not common on the market for pharmaceuticals, etc. to be sold to the highest bidder.

Example

- **Import and export services**

Import and export services are not considered to be a sales service and thus cannot be subject to the same arguments as the comparison of goods with retail services.

Import and export services relate to the movement of goods and normally require the involvement of customs authorities in both the country of import and the country of export. These services are often subject to import quotas, tariffs and trade agreements. As they are classified in Class 35, they are considered to relate to business administration. These services do not relate to the actual retail or wholesale of the goods; they would be preparatory or ancillary to the commercialisation of such goods. For these reasons, goods are to be considered dissimilar to import and export services for those goods. The fact that the subject matter of the import/export services and the goods in question are the same is not a relevant factor for finding a similarity.

Example

- *Import and export of tobacco products* (Class 35) is dissimilar to *tobacco products* (Class 34).

Judgment of 09/06/2010, T-138/09, Riojavina, EU:T:2010:226, where a low degree of similarity was found between import/export of vinegar and wine, is not followed.

8 Financial Services

Financial services refer to services provided by the finance industry. The finance industry encompasses a broad range of organisations that deal with the management, investment, transfer, and lending of money. Among these organisations are, for example, banks, credit card companies, insurance companies, consumer finance companies, stock brokerages and investment funds.

8.1 Banking services (Class 36) versus insurance services (Class 36)

Providing *banking services* consists of the provision of all those services carried out for savings or commercial purposes concerning the receiving, lending, exchanging, investing and safeguarding of money, issuing of notes and transacting of other financial business.

Providing *insurance services* consists of accepting liability for certain risks and respective losses. Insurers usually provide monetary compensation and/or assistance in the event that a specified contingency occurs, such as death, accident, sickness, breaking of a contract and, in general, any event capable of causing damages.

Insurance services have different purposes from the services usually provided by banks, such as providing credit or asset management, credit card services, financial evaluation or stocks and bonds brokerage. Nevertheless, they have some significant aspects in common.

Insurance services are of a financial nature, and insurance companies are subject to similar rules of licensing, supervision and solvency as banks and other institutions providing financial services. Most banks also offer insurance services, including health insurance, or act as agents for insurance companies, with which they are often economically linked. Additionally, it is not unusual to see financial institutions and an insurance company in the same economic group.

Therefore, although *insurance services* and *banking services* have different purposes, they have a similar nature, may be provided by the same undertaking or related undertakings and share the same distribution channels. These circumstances show that *insurance services* are similar to *banking services*.

8.2 Real estate affairs (Class 36) versus financial affairs (Class 36)

The term 'real estate affairs' comprises real estate property management and evaluation, and real estate agency services, as well as the consultancy and provision of information related thereto. This mainly involves finding property, making it available for potential buyers and acting as an intermediary. Consumers clearly distinguish real estate agents' services from those of financial institutions. They do not expect a bank to find housing or a real estate agent to manage their finances.

The mere fact that real estate may have to be financed in order to be purchased is not enough to find similarity between real estate affairs and financial services. Even if financial services can be important for the acquisition of real estate, the consumers usually turn first to a real estate agent to search for a property, and secondly to a financial institution to finance the property.

Any other conclusion would mean that all non-financial transactions subject to funding would be complementary to a financial service. It must therefore be concluded that these services are dissimilar even if financial services are essential or important for the use of real estate. The consumers would not attribute responsibility for both services to the same company. (judgment of 11/07/2013, T-197/12, Metro, EU:T:2013:375, § 47-51).

8.3 Credit cards (Class 9) versus financial services (Class 36)

A credit card is a small plastic card issued to users as a system of payment. It allows its holder to buy goods and services based on the holder's promise to pay for these goods and services. The issuer of the card creates a revolving account and grants a line of credit to the consumer (or the user) from which the user can borrow money for payment to a merchant or as a cash advance to the user.

Financial services are offered by institutions like banks for the facilitation of various financial transactions and other related activities in the world of finance.

Even though credit cards are related to some extent to financial services, for example they can be used to withdraw money from the cash dispenser of a bank, this link is too remote to render the goods and services similar. The customers are aware of the fact that financial institutions are not responsible for the technological aspects of issuing magnetic or chip cards (decision of 07/05/2012, R 1662/2011-5, CITIBANK, § 29).

9 Transport, Packaging and Storage

9.1 Transport of goods (Class 39) versus any product

Services of *transport* are not considered to be similar to goods. These services are provided by specialist transport companies whose business is not the manufacture and sale of those goods. As regards the nature of the goods and services, *transport services* refer to a fleet of trucks or ships used to move goods from A to B.

Example

- *Pastry and confectionery* are dissimilar to *transport services*. They are different in terms of their nature, intended purpose and method of use; they are neither complementary nor in competition. All these differences explain why the service of transport and the goods of pastry and confectionery target different consumers. Transport is predominantly aimed at professionals (those who need to move goods) whereas pastry and confectionery target non-professional consumers (ordinary people who require food) (decision of 07/01/2014, R 1006/2012-G, PIONONO, § 28-36).

9.2 Packaging and storage of goods (Class 39) versus any product

Equally, *packaging and storage services* merely refer to the service whereby a company's or any other person's goods are packed and kept in a particular place for a fee. Those services are not similar to any kind of goods, including any of the goods that may be packaged and stored (judgments of 07/02/2006, T-202/03, Comp USA, EU:T:2006:44; 22/06/2011, T-76/09, Farma Mundi Farmaceuticos Mundi, EU:T:2011:298, § 32 and decision of 07/01/2013, R 1006/2012-G, PIONONO, § 38).

10 Information Technology

10.1 Computers versus software

What we call a *computer* is actually a 'system', a combination of components that work together. The hardware devices are the physical components of that system. The hardware is designed to work hand in hand with *computer programs*, referred to as *software*. Computer hardware companies also manufacture software, share the same distribution channels and target the professional public (e.g. for use in banking and finance, education, medicine, business and entertainment/recreation) and/or the

general public. Moreover, they are complementary (see paragraph 10.2 below). These goods are considered to be similar.

10.2 Software versus apparatus that use software

In today's high-tech society almost all *electronic or digital apparatus* function using integrated *software*. This does not, however, lead to the automatic conclusion that software is similar to goods that use software to function successfully (see also Annex I, paragraph 1, Parts, components and fittings).

Example of dissimilarity

- Although a *digital scale* functions using integrated *software*, this does not lead to the conclusion that software and scales are similar. One could argue that the software is important for the use of the scale; however, they are not complementary because they are not aimed at the same public. The digital scale is for the general public, whereas the software is aimed at the actual manufacturer of these scales. The producers are not the same, nor are the distribution channels, and they do not have the same purpose.

However, when the software is not an integrated part of an apparatus, can be purchased independently from it and serves, for example, to give more or different functionalities, similarity can be established.

Example of similarity

- A *digital camera* and *software* to increase its functionalities are both aimed at the same public and produced by the same or related undertakings. They are distributed through the same channels and use of the one is indispensable for use of the other. Consequently, *digital cameras* and *software* (which includes software to e.g. increase functionalities of a digital camera) are considered to be similar.

10.3 Software, downloadable 'apps' and downloadable electronic publications

Application software, also known as 'an app', is *computer software* that is designed to help the user perform various tasks on the computer. Application software differs from system software in that it can be accessed by the user and run on the computer. Application software is usually designed with the user in mind. The new definition of *application* is used to refer to the small 'apps' that are designed for mobile phones; however, the definition covers all applications on smart phones, tablets and computers. Consequently, *software*, *application software* and *downloadable applications* are considered to be identical.

Downloadable electronic publications are electronic versions of traditional media, like e-books, electronic journals, online magazines, online newspapers, etc. It is becoming common to distribute books, magazines and newspapers to consumers through tablet reading devices by means of so-called 'apps' in the form of electronic publications. Consequently, there is a complementary relationship between software/'apps' and

downloadable electronic publications. Their producers can be the same; they follow the same distribution channels and the public is generally also the same. These goods are considered to be similar.

10.4 Specific software versus specific software

There are many types of software, and although software by nature (a set of instructions that enables a computer to perform a task) is the same, this does not mean that their specific purpose is the same. This implies that very specific software could even be dissimilar to another type of software.

Example

The field of application of *computer games software* is not the same as *software for apparatus that diagnose diseases*. Due to these significantly different fields of application, the expertise needed to develop these types of software is not the same, nor are their end users or distribution channels. These goods are therefore dissimilar.

10.5 Computers and software (Class 9) versus computer programming (Class 42)

Computer programming consists, inter alia, of the process of writing source code (judgment of 29/03/2012, T-417/09, Mercator Studios, EU:T:2012:174 § 26), and a computer program is a set of coded instructions that enables a machine, especially a computer, to perform a desired sequence of operations.

Computers are devices that compute, especially programmable electronic machines that perform high-speed mathematical or logical operations or that assemble, store, correlate, or otherwise process information. Computers need programs to operate.

Software is composed of programs, routines, and symbolic languages that control the functioning of the hardware and direct its operation.

Therefore, *computer programming services* are closely linked to *computers* and *software*. This is because in the field of computer science, producers of computers and/or software will also commonly provide computer and/or software-related services (as a means of keeping the system updated, for example).

Consequently, and in spite of the fact that the nature of the goods and services is not the same, both the end users and the producers/providers of the goods and services coincide. Furthermore, they are goods and services that are complementary. For these reasons these goods and services are considered similar.

10.6 Apparatus for recording, transmission, reproduction of sound or images, computers and software (Class 9) versus telecommunication services (Class 38)

Apparatus for recording, transmission or reproduction of sound or images are apparatus and devices used to communicate audio or video information over a distance via radio waves, optical signals, etc., or along a transmission line.

Telecommunication services are those that allow people to communicate with one another by remote means.

Since the 1990s the boundary between *telecoms equipment* and *IT hardware/software* has become blurred as a result of the growth of the internet and its increasing role in the transfer of telecoms data. Equipment used for purposes of telecommunication, like modems, mobile phones, landline telephones, answering machines, fax machines, pagers, routers, etc. is also considered to cover the telecommunications control software that must be in place to successfully support telecommunications activities. Any software that provides the ability to perform telecommunication activities operations can be considered telecommunications control software.

Clearly, a link exists between the above goods in Class 9 and telecommunication services in Class 38. These goods and services are similar given their complementary character; although their nature is different, their purpose and distribution channels are the same (judgment of 12/11/2008, T-242/07, Q2web, EU:T:2008:488, § 24-26).

***GUIDELINES FOR EXAMINATION OF
EUROPEAN UNION TRADE MARKS***

***EUROPEAN UNION
INTELLECTUAL PROPERTY OFFICE
(EUIPO)***

PART C

OPPOSITION

SECTION 2

***DOUBLE IDENTITY AND
LIKELIHOOD OF CONFUSION***

CHAPTER 3

***RELEVANT PUBLIC AND
DEGREE OF ATTENTION***

Table of Contents

1	Introduction.....	3
2	Defining the Relevant Public	4
3	Defining the Degree of Attention.....	8
3.1	Higher degree of attention	9
3.1.1	Expensive purchases	9
3.1.2	Potentially hazardous purchases.....	10
3.1.3	Brand loyalty	10
3.1.4	Pharmaceuticals	11
3.2	Lower degree of attention.....	11

1 Introduction

With regard to the relevant public, the Court of Justice has held that a likelihood of confusion (including a likelihood of association) exists if there is a risk that the public might believe that the goods or services in question come from the same undertaking or, as the case may be, from economically linked undertakings (judgment of 29/09/1998, C-39/97 Canon, EU:C:1998:442, § 29). The Court has also held that it is the **perception of marks in the mind of the relevant public of the goods or services in question** that plays a decisive role in the global assessment of the likelihood of confusion (judgments of 11/11/1997, C-251/95, Sabèl, EU:C:1997:528, § 23; 22/06/1999, C-342/97, Lloyd Schufabrik, EU:C:1999:323, § 25).

Accordingly, the first task is to define the consumer circles that are relevant for the purposes of the case. The method for identifying the relevant public is discussed in paragraph 2. Thereafter, the relevant public's degree of attention and sophistication must be established. The impact of the relevant public's attention and sophistication on the assessment of the likelihood of confusion is discussed in paragraph 3.

In addition, the relevant public plays an important role in establishing a number of other factors that are relevant for the assessment of the likelihood of confusion.

- **Comparison of the goods and services**

The actual and potential customers of the goods and services in dispute constitute one of the factors to be dealt with in the analysis of their similarity. While a coincidence in the relevant public is not necessarily an indication of similarity of the goods or services, largely diverging publics weigh heavily against similarity¹.

Example

Leather, animal skins and hides are raw materials that go to industry for further processing, whereas *goods made of leather* are final products targeted at the general public. The relevant public is different, which is a fundamental factor in the assessment of similarity and which leads to the conclusion that the goods in question are dissimilar. Similar reasoning applies to *precious metals* and *jewellery*.

- **Comparison of the signs**

The question of the relevant public also plays a role in the comparison of the signs. The same word may be pronounced differently depending on the relevant public. Conceptually, the public in one part of the European Union may understand the meaning of the sign, while consumers in other parts may not understand it².

¹ See the Guidelines, Part C, Opposition, Section 2, Double Identity and Likelihood of Confusion, Chapter 2, Comparison of Goods and Services.

² See the Guidelines, Part C, Opposition, Section 2, Double Identity and Likelihood of Confusion, Chapter 3, Comparison of Signs.

Example

The Court has already confirmed that the general public in the Scandinavian countries, the Netherlands and Finland has a basic understanding of English (judgment of 26/11/2008, T-435/07, New Look, EU:T:2008:534, § 23).

- **Distinctive elements of the signs/distinctiveness of the earlier mark**

The inherent distinctiveness of a sign or one of its elements also depends on the relevant public for the goods and services. For example, depending on the relevant public's knowledge, background and language, an element contained in a trade mark may be non-distinctive or have a low degree of distinctiveness, or it may be distinctive because, inter alia, it is perceived as a fanciful term without any meaning claimed³.

Example

The French word 'cuisine' will not be understood as a descriptive indication for goods in Classes 29 and 30 in some Member States (decision of 23/06/2010, R 1201/2009-1, GREEN CUISINE, § 29-33).

Example

Professionals in the IT field and scientific field are in general more familiar with the use of technical and basic English words than the general public: In Gateway versus Activy Media Gateway, the Court held that the common word 'gateway' directly evokes, in the mind of the relevant consumer, the concept of a gateway, which is commonly used in the computing sector (judgment of 27/11/2007, T-434/05, Activy Media Gateway, EU:T:2007:359, § 38, 48, confirmed by appeal, C-57/08 P).

2 Defining the Relevant Public

In accordance with Article 8(1)(b) [CTMREUTMR](#), it must be determined whether a likelihood of confusion exists 'on the part of the public in the territory where the earlier mark is protected'.

According to the Court, this wording shows that the perception of the marks in the mind of the **average consumer** of the type of goods or services in question plays a decisive role in the overall appreciation of the likelihood of confusion (judgments of 11/11/1997, C-251/95, Sabèl, EU:C:1997:528, § 23; 22/06/1999, C-342/97, Lloyd Schuhfabrik, EU:C:1999:323, § 25).

The term '**average consumer**' is a legal concept that is used in the sense of the '**relevant consumer**' or '**relevant public**'. It should not be confused with the 'general public' or 'public at large', although the Courts sometimes use it in this sense. However, in the context of relative grounds, the term 'average consumer' must not be used as a synonym of 'general public' as it can refer to both, **professional** and **general public**. In this respect, in cases concerning the likelihood of confusion, the Court normally distinguishes between the **general public** (or **public at large**), and a **professional or**

³ See the Guidelines, Part C, Opposition, Section 2, Double Identity and Likelihood of Confusion, Chapter 5, Distinctiveness of the Earlier Mark.

specialised public (or **business customers**), based on the goods and services in question.

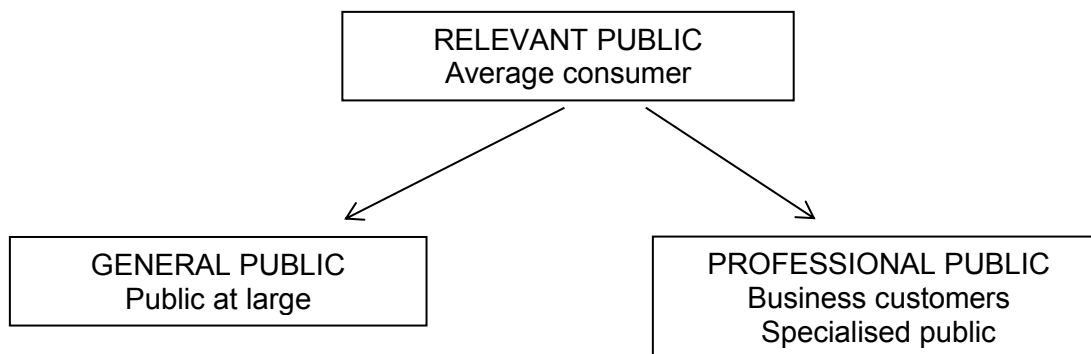

In order to properly define the relevant public in the context of relative grounds, two factors have to be taken into account:

- **the territory defined by the earlier mark:** the relevant public is always the public in the territory(ies) where the earlier right(s) is/are protected. Consequently, in the case of an earlier national right, the relevant public concerned is the one of that particular EU Member State (or Member States in the case of Benelux trade marks). For an earlier ~~Community~~ [EU/European Union](#) trade mark, the public in the whole European Union has to be taken into account. For an international registration, it is the public in each of the Member States where the mark is protected.
- **the goods and services that have been found identical or similar:** likelihood of confusion is always assessed against the perception of the consumers of the goods and services that have been found identical or similar. Depending on the goods or services, the relevant public is the general public or a professional/specialised public.

The relevant public always includes both the **actual** and the **potential** consumers, that is, the consumers who are currently purchasing the goods/services or who may do so in the future.

If a **significant part of the relevant public** for the goods or services at issue may be confused as to the origin of the goods, this will be sufficient to establish a likelihood of confusion. It is not necessary to establish that all actual or potential consumers of the relevant goods or services are likely to be confused.

As stated by the Court, the relevant public for the assessment of the likelihood of confusion is composed of **users likely to use both the goods and services covered by the earlier mark and the product covered by the mark applied for that were found to be identical or similar** (see judgment of 01/07/2008, T-328/05, Quartz, EU:T:2008:238, § 23, C-416/08 P, appeal dismissed).

When defining the part of the public **by reference to which a likelihood of confusion is assessed** the following applies:

- If the goods or services of both marks target the general public, the relevant public by reference to which a likelihood of confusion will be assessed is the general public.

Example

In a case in which both the earlier and the contested mark concerned articles of clothing, the Court held that 'clothing for men and women are everyday consumer items and the trade mark on which the opposition is based is registered as a European Union trade mark. It follows that the relevant public by reference to which the likelihood of confusion must be assessed is composed of the general public in the European Union' (judgments of 06/10/2004, T-117/03 to T-119/03 and T-171/03, NL, EU:T:2004:293, § 25).

- If the goods and services of **both marks** are directed at the same or a similar **professional public**, the likelihood of confusion will be assessed from the perspective of those specialists.

Example

The relevant goods of both the earlier and the contested mark were raw plastic materials, chemical products, resins and the like. These are goods for industrial use. The targeted consumers are, therefore, engineers and/or chemists, that is to say, highly skilled professionals who will process these products and use them in manufacturing activities. The relevant public was considered to be professional (decision of 15/02/2012, R 2077/2010-1, PEBAFLEX, § 18. See also decision of 16/09/2010, R 1370/2009-1, CALCIMATT, § 20, confirmed by judgment of 29/03/2012, T-547/10, EU:T:2012:178).

- If the goods or services of **both marks** target **both the general public and specialists**, the likelihood of confusion will be assessed against the perception of the part of the public displaying the lower degree of attentiveness as it will be more prone to being confused. If this part of the public is not likely to be confused, it is even more unlikely that the part of the public with a higher degree of attention will be.

Example

In a case in which both the earlier and the contested mark concerned goods in Classes 3 and 5 that targeted both the general public and professionals (e.g. doctors for pharmaceuticals in Class 5), the Court assessed the likelihood of confusion for the general public only, because it is the one displaying the lower degree of attention (judgment of 15/07/2011, T-220/09, ERGO, EU:T:2011:392, § 21).

- If the goods and services of the earlier mark target the **general and professional public** and the contested goods and services target a **professional public** exclusively (or vice versa), the relevant public for assessing likelihood of confusion will be the professional public only.

Example

The goods of the earlier mark are *polish for metals*, while the goods of the application are *preparations for cleaning waste pipes for the metal-working industry*. As stated in the relevant GC judgment: ‘Although “polish for metals” can consist equally well of everyday consumer goods as of goods intended for a professional or specialised public, it is not disputed that the goods to which the trade mark application relates must be regarded as directed solely at persons operating in the metal-working industry. Therefore, the only public likely to confuse the trade marks in question is formed of such operators’ (judgment of 14/07/2005, T-126/03, Aladin, EU:T:2005:288, § 81).

Example

Paints in general are sold both to professional painters (i.e. for business purposes) and to the public at large for ‘do-it-yourself purposes’. By contrast, *paints for industry* do not target the general public. Therefore, when the specifications of the two marks cover paints and paints for industry respectively, only professionals constitute the relevant public since they are likely to be the only consumers who encounter both marks.

Example

The services of the earlier mark are *telecommunications*. The contested services are *telecommunication services, namely collocation, telehousing and interconnection services* addressed at professionals only. The definition of the relevant public must be adjusted to the more specific list, and likelihood of confusion should be assessed for professionals only (judgment of 24/05/2011, T-408/09, ancotel, EU:T:2011:241, § 38-50).

- If the relevant goods are pharmaceuticals the following applies:

The average consumer of **non-prescription** pharmaceuticals (sold over the counter) is the general public, and the likelihood of confusion will be assessed in relation to that public.

According to the case-law, the general public cannot be excluded from the relevant public, also in the case of pharmaceuticals that require a **doctor’s prescription** prior to their sale to end-users in pharmacies. Thus, the relevant public comprises both general public and health professionals, such as doctors and pharmacists. Consequently, even though the choice of those products is influenced or determined by intermediaries, a likelihood of confusion can also exist for the general public, since they are likely to be faced with those products, even if that takes place during separate purchasing transactions for each of those individual products at various times (judgments of 09/02/2011, T-222/09, Alpharen, EU:T:2011:36, § 42-45; 26/04/2007, C-412/05 P, Travatan, EU:C:2007:252, § 56-63). In practice, this means that the likelihood of confusion will be assessed against the perception of the general public, which is more prone to confusion.

In the case of pharmaceutical goods **targeted only at specialists** for professional use (e.g. *sterile solutions for ophthalmic surgery*), the likelihood of confusion must be assessed from the point of view of that specialist public only (judgment of 26/04/2007, C-412/05 P, Travatan, EU:C:2007:252, § 66).

In cases where the pharmaceutical goods of the [CTM-EUTM](#) application are **sold over the counter**, while the pharmaceutical goods covered by the earlier registration would **only be available on prescription, or vice versa**, the Office must assume that the relevant public consists of both qualified professionals and the general public, without any specific medical and pharmaceutical knowledge. The likelihood of confusion will be assessed in relation to the general public, which is more prone to confusion.

Example

The goods covered by the earlier mark were pharmaceutical preparations with *digoxin for human use for cardiovascular illnesses*, while the contested goods were *pharmaceutical preparations for the treatment of metabolic disorders adapted for administration only by intravenous, intra-muscular or subcutaneous injection*.

Although both the goods of the earlier mark and the goods of the contested mark are prescribed by and administered under the supervision of healthcare professionals, the GC held that the relevant public comprises both healthcare professionals and the general public.

(Judgment of 23/09/2009, in joined cases T-493/07, T-26/08 and T-27/08, Famoxin, EU:T:2009:355, § 50-54 (C-461/09 P, appeal dismissed).

3 Defining the Degree of Attention

The Court has indicated that for the purposes of the global assessment, the average consumer of the products concerned is deemed to be **reasonably well-informed** and **reasonably observant and circumspect**, and that the relevant public's degree of attention is likely to vary according to the category of goods or services in question (C-342/97, Lloyd Schuhfabrik, EU:C:1999:323, § 26).

Whether its degree of attention will be **higher or lower will depend, inter alia, on the nature of the relevant goods and services and the knowledge, experience and purchase involvement of the relevant public**.

The fact that the relevant public consists of the **general public** does not necessarily mean that the degree of attention cannot be high (for instance, when expensive, potentially hazardous or technically sophisticated goods are purchased). Likewise, the fact that the goods at issue target **specialists** does not necessarily mean that the degree of attention is high. In some cases the professional public may have a high degree of attention when purchasing a specific product. This is when these professional consumers are considered to have special background knowledge or experience in relation to the specific goods and services. Moreover, purchases made by professional consumers are often more systematic than the purchases made by the general public. However, this is not always the case. For example, if the relevant goods or services are used by a given professional on a daily basis, the level of attention paid may be average or even low.

Properly defining the degree of attention of the relevant public is necessary, as this factor can weigh for or against a finding of a likelihood of confusion. Whilst the relevant public only rarely has the chance to make a direct comparison between the

different signs and must rely on an ‘imperfect recollection’ of them, a high level of attention of the relevant public may lead to conclude that it will not confuse the marks, despite the lack of direct comparison between the trade marks (judgment of 22/03/2011, T-486/07, CA, EU:T:2011:104, § 95). Therefore, the degree of attention will be established in the decision.

However, **a high degree of attention does not automatically lead to a finding of no likelihood of confusion**. All the other factors have to be taken into account (*interdependence principle*)⁴. For example, in view of the specialised nature of the relevant goods and/or services and the high degree of attention of the relevant public, likelihood of confusion may be ruled out (judgment of 26/06/2008, T-79/07, Polaris, EU:T:2008:230, § 50-51). However, a likelihood of confusion can exist despite a high degree of attention. For example, when there is a strong likelihood of confusion created by other factors, such as identity or close overall similarity of the marks and the identity of the goods, the attention of the relevant public alone cannot be relied upon to prevent confusion (judgment of 21/11/2013, T-443/12, ancotel, EU:T:2013:605, § 53-56; decision of 06/09/2010, R 1419/2009-4, Hasi).

3.1 Higher degree of attention

A higher degree of attention is usually connected with the following types of purchases: expensive purchases, the purchase of potentially hazardous or technically sophisticated goods. The average consumer often seeks professional assistance or advice when choosing or buying certain types of goods and services (e.g. cars, pharmaceutical products).

A higher degree of attention can also apply to goods when brand loyalty is important for the consumer.

3.1.1 Expensive purchases

When purchasing expensive goods, the consumer will generally exercise a higher degree of care and will buy the goods only after careful consideration. Non-specialised or non-professional consumers often seek professional assistance or advice when choosing or buying certain types of goods and services. The attention may be enhanced in cases of luxury goods and where the specific product is regarded as reflecting the social status of its owner.

⁴ See the Guidelines, Part C, Opposition, Section 2, Double Identity and Likelihood of Confusion, Chapter 8, Global Assessment.

Examples

- **Cars.** Taking into consideration their price, consumers are likely to pay a higher degree of attention than for less expensive purchases. It is to be expected that these consumers will not buy a car, either new or second-hand, in the same way as they would buy articles purchased on a daily basis. The consumer will be an informed one, taking all relevant factors into consideration, for example, price, consumption, insurance costs, personal needs or even prestige. See in this respect the GC judgments of 22/03/2011, T-486/07, CA, EU:T:2011:104, § 27-38; 21/03/2012, T-63/09, Swift GTi, EU:T:2012:137, § 39-42.
- **Diamonds, precious and semi-precious stones.** In its decision of 09/12/2010, R 0900/2010-1, Leo Marco, § 22, the Board held that consumers generally put a certain amount of thought into the selection of these goods. In many cases the goods will be luxury items or will be intended as gifts. A relatively high degree of attention on the part of the consumer may be assumed.
- **Financial services.** These services target the general public, which is reasonably well-informed and reasonably observant and circumspect. However, since such services are specialised services that may have important financial consequences for their users, the consumers' level of attention would be rather high when choosing them (decision of 03/02/2011, R 0719/2010-1, f@ir Credit, § 15) (Appeal before GC, T-220/11, dismissed. Appealed C-524/12 P dismissed).

In the overall impression combined by the signs at issue, the visual and conceptual differences between the signs are sufficient to outweigh their limited phonetic similarity, particularly since the relevant public is highly attentive and well informed (judgment of 22/06/2010, T-563/08, Carbon Capital Markets, EU:T:2010:251, § 33, 61).

- **Real-estate services.** The purchase and sale of property are business transactions that involve both risk and the transfer of large sums of money. For these reasons, the relevant consumer is deemed to possess a higher-than-average degree of attention, since the consequences of making a poor choice through lack of attentiveness might be highly damaging (decision of 17/02/2011, R 817/2010-2, FIRST THE REAL ESTATE, § 21).

3.1.2 Potentially hazardous purchases

The impact on safety of goods covered by a trade mark (for example lights for vehicles, saws, electric accumulators, electric circuit breakers, electric relays, etc.) may result in an increase in the relevant consumer's degree of attention (judgment of 22/03/2011, T-486/07, CA, EU:T:2011:104, § 41).

3.1.3 Brand loyalty

Furthermore, a higher degree of attention can be the consequence of brand loyalty.

Example

Although tobacco products are relatively cheap articles for mass consumption, smokers are considered particularly careful and selective about the brand of cigarettes they smoke, so a higher degree of brand loyalty and attention is assumed when tobacco products are involved. Therefore, in the case of tobacco products a higher degree of similarity of signs may be required for confusion to occur. This has been confirmed by several Board decisions: decision of 26/02/2010, R 1562/2008-2, victory slims, where it was stated that the consumers of Class 34 goods are generally very attentive and brand loyal, and decision of 25/04/2006, R 0061/2005-2, Granducato.

3.1.4 Pharmaceuticals

It is apparent from the case-law that, insofar as pharmaceutical preparations are concerned, the relevant public's degree of attention is relatively high, whether or not issued on prescription (judgments of 15/12/2010, T-331/09, Tolposan, EU:T:2010:520, § 26; 15/03/2012, T-288/08, Zydus, EU:T:2012:124, § 36 and quoted case-law).

In particular, *medical professionals* have a high degree of attentiveness when prescribing medicines. With regard to *non-professionals*, they also show a higher degree of attention, regardless of whether the pharmaceuticals are sold without prescription, as these goods affect their state of health.

3.2 Lower degree of attention

A *lower degree of attention* can be associated, in particular, with habitual buying behaviour. Purchase decisions in this area relate to, for example, inexpensive goods purchased on a daily basis (judgment of 15/06/2010, T-547/08, Strumpf, EU:T:2010:235, § 43).

The mere fact that the relevant public makes an impulse purchase of some goods (for example, sweets) does not mean that the level of that public's attention is lower than average (judgment of 09/04/2014, T-623/11, Milanówek cream fudge, EU:T:2014:199, § 34).

***GUIDELINES FOR EXAMINATION OF
EUROPEAN UNION TRADE MARKS***

***EUROPEAN UNION
INTELLECTUAL PROPERTY OFFICE
(EUIPO)***

PART C

OPPOSITION

SECTION 2

***DOUBLE IDENTITY AND LIKELIHOOD OF
CONFUSION***

CHAPTER 4

COMPARISON OF SIGNS

Table of Contents

1	General Principles of the Trade Mark Comparison.....	4
1.1	Overview	4
1.2	Structure	4
1.3	Three aspects: visual, aural and conceptual	5
1.4	Possible outcome of the comparison	5
1.5	Signs to be compared and negligible elements	6
1.6	Relevant territory and relevant public.....	8
2	Identity of Signs.....	9
2.1	The concept of identity	9
2.2	Threshold for a finding of identity.....	9
2.3	Identity of word marks	10
2.4	Word marks and figurative marks	12
2.5	Identity of figurative marks.....	12
2.6	Identity of an earlier black and white (B&W) or greyscale mark with a colour mark application	13
3	Similarity of Signs	15
3.1	Introduction	15
3.2	Distinctive elements of the marks	15
3.2.1	What is a component of a sign?	16
3.2.2	Examination of distinctiveness	16
3.2.2.1	What is distinctiveness?	16
3.2.2.2	Relevant point in time	17
3.2.2.3	Relevant goods and services	18
3.2.2.4	General principles of examination of distinctiveness	18
3.2.2.5	Examples of descriptive components	20
3.2.2.6	Examples of laudatory components	21
3.2.2.7	Examples of allusive components	22
3.2.3	Specific cases.....	22
3.2.3.1	One-letter components, numerals and short components	22
3.2.3.2	Commonplace and banal elements	23
3.2.3.3	Disclaimers.....	23
3.2.3.4	Earlier marks consisting of one element that is distinctive to a low degree	24
3.3	Dominant elements of the marks	24
3.4	Comparison of signs.....	27
3.4.1	Visual comparison	27
3.4.1.1	Word mark v word mark	27
3.4.1.2	Word mark v figurative mark with word elements	29
3.4.1.3	Purely figurative v purely figurative signs	29
3.4.1.4	Stylised mark v stylised mark	30
3.4.1.5	Word/figurative sign v figurative sign.....	32
3.4.1.6	Signs consisting of a single letter	33
3.4.1.7	Three-dimensional marks	35
3.4.2	Phonetic comparison	36
3.4.2.1	Signs and elements in signs that must be assessed	37

3.4.2.2	Identical/similar sounds in different order	41
3.4.2.3	Signs consisting of or including foreign or invented words	42
3.4.3	Conceptual comparison: practical criteria	44
3.4.3.1	The semantic content of words	44
3.4.3.2	The semantic content of parts of words	47
3.4.3.3	The semantic content of misspelled words	49
3.4.3.4	The semantic content of names and surnames	50
3.4.3.5	The semantic content of figurative signs, symbols, shapes and colours ...	52
3.4.3.6	The semantic content of numbers and letters	53
3.4.3.7	The semantic content of geographical names	53
3.4.3.8	The semantic content of onomatopoeias	54
3.4.4	How to make a conceptual comparison	54
3.4.4.1	Both marks share a word and/or expression	55
3.4.4.2	Two words or terms have the same meaning but in different languages ...	57
3.4.4.3	Two words refer to the same semantic term or variations thereof	58
3.4.4.4	Two figurative signs, symbols and/or shapes represent the same object or idea	58
3.4.4.5	When there is a word v a figurative sign, symbol, shape and/or colour representing the concept behind the word	59
3.4.5	Impact of the distinctive and dominant character of the components on the similarity of signs	59
3.4.5.1	Identifiable common element/coincidence	60
3.4.5.2	Distinctiveness and dominant character of the common elements	61
3.4.5.3	Importance of additional (not common) elements	63
3.4.6	Other principles to be taken into account in the comparison of signs	64
3.4.6.1	Impact of word elements v figurative elements on the visual and conceptual comparison	64
3.4.6.2	Beginning of the signs in the visual and phonetic comparison	68
3.4.6.3	Short signs	70
3.5.	Conclusion on similarity	73
4	Dissimilarity of Signs	75
4.1	Introduction	75
4.2	Scenarios for dissimilarity	76
4.2.1	No element in common	76
4.2.2	Overlap in a negligible element	76
4.2.3	Overlap in a verbal element not noticeable due to high stylisation	77
4.2.4	Overlap in other irrelevant aspects	78
4.2.5	Overlap in a non-distinctive element	79

1 General Principles of the Trade Mark Comparison

1.1 Overview

This chapter deals with the comparison of signs. The purpose of comparing signs is to determine if the signs are identical (see paragraph 2 below), similar (see paragraph 3 below), or dissimilar (see paragraph 4 below).

The identity of trade marks is a prerequisite for applying the provision of Article 8(1)(a) EUTMR ('double identity'). Goods or services have to be identical too.

The similarity (or identity) of signs is a necessary condition for it to be found that there is a likelihood of confusion for the purposes of Article 8(1)(b) EUTMR (judgment of 23/01/2014, C-558/12 P, *Western Gold*, EU:C:2014:22, § 44). If the signs are dissimilar, an examination of likelihood of confusion will stop at this point.

Whether a likelihood of confusion exists depends on an assessment of several interdependent factors, including (i) similarity of the goods and services, (ii) the relevant public, (iii) **similarity of the signs**, taking into account their distinctive and dominant elements and (iv) the distinctiveness of the earlier mark.

1.2 Structure

A global appreciation of the visual, aural or conceptual similarity of the marks in question must be based on the overall impression given by them, bearing in mind their distinctive and dominant components (C-251/95, *Sabèl*, EU:C:1997:528, § 23). A comparison of trade marks must integrate, therefore, an assessment of the distinctive character and dominance of their elements, and the impact of their overall impression.

A comparison of trade marks must contain the following considerations: an assessment of the distinctive and dominant character of the coinciding and differing elements, their commonalities and differences, and a final conclusion that is reached after the assessment of the impact of distinctive/dominant elements on the overall impression of the signs.

The order of the examination at the '**comparison of signs**' stage **should not be predetermined** but rather, depending on the particular context, adjusted to provide logical coherence to the decision. Nevertheless, with the aim of having a consistent decision format that follows, where possible, a similar structure, the following order is apt for the majority of cases when signs are not identical (see paragraph 2 below):

i. Representation/Description of the signs:

As a preliminary step, the signs should be portrayed in a table, followed by a short description of the marks (no need for word marks). The purpose of this chapter is to identify the type of signs (words marks, figurative marks) and their elements in order to establish a framework for comparison ('what is there?').

ii. Inherent distinctiveness/dominance of elements of both marks:

As a second step, an assessment of **inherent distinctiveness and dominance of the components** is carried out. The purpose of this chapter is to identify the degree of

relevance of the components for the comparison of signs, for example, whether the distinctiveness of the common element is limited.

Importantly, the **distinctiveness of the earlier mark as a whole (including the issue of acquired distinctiveness)** should **not** be taken into account when comparing signs. The assessment of the distinctiveness of the earlier mark **as a whole** is addressed under a separate heading¹.

iii. Comparison of signs taking into account the previously established inherent distinctiveness and the dominant character of the components and final conclusion:

The third step entails the comparison of marks at a **visual, aural and conceptual** level, considering and integrating the previous findings on the distinctiveness/dominance of the components.

1.3 Three aspects: visual, aural and conceptual

Signs are compared at three levels, namely visually (see paragraph 3.4.1 below), aurally (see paragraph 3.4.2 below) and conceptually (see paragraph 3.4.3 below). This is because one can perceive signs visually, aurally and conceptually (if they evoke a concept). Only when it is not possible to compare at one level (e.g. the aural comparison when both marks are purely figurative) will this aspect be left out. If there is similarity at one or more of the three levels, then the signs are similar (judgment of 02/12/2009, T-434/07, Solvo, EU:T:2009:480, § 50-53).

1.4 Possible outcome of the comparison

The comparison of signs leads to the finding of one of the following three outcomes: identity, similarity or dissimilarity. The result is decisive for further examination of the opposition as it has the following implications.

- A finding of **identity** between signs leads to absolute protection according to Article 8(1)(a) EUTMR if the goods and/or services are also identical.
- A finding of **similarity (or identity)** leads to the opening of the examination on likelihood of confusion in accordance with Article 8(1)(b) EUTMR.
- The finding of **dissimilarity** in all three aspects excludes the likelihood of confusion. There is no need to examine further prerequisites of Article 8(1)(b) EUTMR.

The comparison has to lead to a finding on the **degree of this similarity** in every aspect of the comparison.

- The **finding on the level of similarity of the marks can be decisive** for the outcome of the decision. The examiner should be aware, that not 'any similarity' can lead to likelihood of confusion, even for identical goods and/or services (interdependence principle). The finding of the level of similarity of the marks will make the decision more understandable. For example, the final finding that there is no likelihood of confusion for identical/highly similar goods and/or services is

¹ The Guidelines, Part C, Opposition, Section 2, Double Identity and Likelihood of Confusion, Chapter 5, Distinctiveness of the Earlier Mark.

easier to understand in the overall assessment if the marks were previously held as only ‘similar to a low degree’.

- **It is especially important to emphasise in each comparison the degree of similarity of marks if it is high (above average) or low (below average). However, even if the level of similarity is average, the decision should state this, to avoid misunderstandings.** A mere statement that ‘the marks are similar’ is not clear as it can be interpreted in two ways — either in the sense that they are similar to an average degree, or just in the general sense that there is (some) similarity allowing for further examination. If the word ‘similar’ is used without further qualification, the meaning must be explained.

The three levels of similarity are low/average/high. Synonyms can be used as far as they are clear (e.g. average = medium), however, it has to be noted that the term ‘enhanced’ is not a synonym for ‘high’. Moreover, nothing prohibits examiners from assessing the similarity further, like ‘only very low’ or ‘high degree of similarity, almost identical’ if this supports the outcome. The wording, however, must be as clear as possible. This is not the case for expressions like ‘not particularly high’, which can be understood in two ways — in this example not as high as ‘average’ or just ‘low’.

- The **level of similarity must be established for each aspect of the comparison** (visual/phonetic/conceptual) separately. The particular field (e.g. the visual or phonetic similarity) may be decisive depending on how the goods are purchased².
- After the level of similarity has been defined (individually for the visual, phonetic and conceptual comparison), a conclusion can be added (if applicable), stating that ‘since the marks have been found similar in at least one aspect of comparison’, the examination of the likelihood of confusion will proceed.

1.5 Signs to be compared and negligible elements

When assessing identity or similarity, the signs have to be compared in the form in which they are protected, that is, in the form in which they are registered/applied for. The actual or possible use of the registered marks in another form is irrelevant when comparing signs (judgment of 09/04/2014, T-623/11, Milanówek cream fudge, EU:T:2014:199, § 38)³.

The comparison must **cover signs in their entirety**. Consequently, it is wrong to discard comparing elements of signs just because they are, for example, smaller than other elements in the signs (unless they are negligible as explained below) or because they are non-distinctive (judgments of 12/06/07, C-334/05 P, Limoncello, EU:C:2007:333, § 41-42; 13/12/2011, T-61/09, Schinken King, EU:T:2011:733, § 46).

Exceptionally, in the event of **negligible elements**, the Office may decide not to take such elements for the purposes of the actual comparison, after **having duly reasoned** why they are considered negligible (judgment of 12/06/2007, C-334/05 P, Limoncello, EU:C:2007:333, § 42). This is especially important where the negligible element is the





² See the Guidelines, Part C, Opposition, Section 2, Double Identity and Likelihood of Confusion, Chapter 7, Global Assessment, paragraph 4, Impact of the method of purchase of goods and services.

³ For the effect of disclaimers, see paragraph 3.2.3.3 of this Chapter below.

common element in the signs. The notion of negligible elements should be interpreted strictly and, in the event of any doubt, the decision should cover the signs in their entirety.

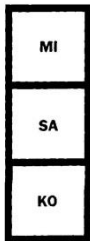
The Office considers that a negligible element refers to an element that, due to its size and/or position, is not noticeable at first sight or is part of a complex sign with numerous other elements (e.g. beverage labels, packaging, etc.) and, therefore, very likely to be disregarded by the relevant public.

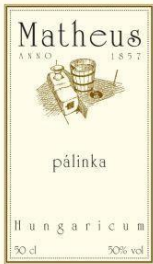
Examples:

Earlier sign	Contested sign	Case No
		<p>T-162/08</p> <p>The words 'by missako' are almost illegible: the size and script make them difficult to decipher.</p>
	<p>LUNA</p>	<p>R 02347/2010-2</p> <p>The element 'Rótulos Luna S.A.' was considered negligible.</p>
<p>MATHEUS MÜLLER</p>		<p>R 0396/2010-1</p> <p>The Board did not assess the elements '50cl', '50 % vol.' 'ANNO' or '1857' phonetically or conceptually.</p>
<p>MAGNA</p>		<p>R 1328/2005-2</p> <p>The Board described the contested sign in full, but negligible elements such as '70cl' were not included in the comparison.</p>

		<p style="text-align: center;">T-472/08</p> <p>The elements other than 'cachaca'/'pirassununga' and '51', the latter written in white within a circle that is itself partially within a broad band running from one side of the sign to the other, are negligible in the overall impression created by those marks (para. 65).</p>
---	---	--

1.6 Relevant territory and relevant public

Similarity must be assessed for the territory in which the earlier mark is protected. The relevant territory must be indicated. Moreover, the perception of the relevant public plays an important role when comparing signs⁴.

Where the earlier mark is a national mark, the relevant criteria must be analysed for the relevant public in that particular EU Member State (or Member States in the case of Benelux trade marks). The perception of similarity may differ from one Member State to another because of differences in pronunciation and/or meaning/understanding.

When the earlier mark is an EUTM registration, the analysis must in principle extend to the **whole** EU. However, in situations where there is likelihood of confusion in at least one Member State **and** when justifiable for reasons of economy of procedure (such as to avoid examining specific pronunciations or meanings of marks in several languages), the Office's analysis need not extend to the whole EU but may instead focus on only one **part or parts** where there is a likelihood of confusion.

The unitary character of the EU trade mark means that an earlier EU trade mark can be relied on in opposition proceedings against any application for registration of a EU trade mark that would adversely affect the protection of the first mark, even if only in the perception of consumers in part of the European Union (judgment of 18/09/2008, C-514/06 P, *Armacell*, § 56-57 and subsequent case-law, inter alia judgment of 18/09/2011, T-460/11, *Bürger*, EU:T:2012:432, § 52 and the case-law quoted therein).

If the opposition is based on an international registration, the territory for which the basic mark is protected is not to be considered as the relevant territory of the earlier international registration designating or subsequently designating other relevant territories (except if the owner has protection in the whole EU — IR designating or subsequently designating the EU where the same country of the basic registration is covered).

⁴ The Guidelines, Part C, Opposition, Section 2, Double Identity and Likelihood of Confusion, Chapter 3, Relevant Public and Degree of Attention.

2 Identity of Signs

2.1 The concept of identity

As indicated above, a finding of identity between signs will lead to the success of the opposition pursuant to Article 8(1)(a) EUTMR if the goods and services are also identical.

The differences between Article 8(1)(a) EUTMR and protection in the event of likelihood of confusion, pursuant to Article 8(1)(b) EUTMR, must be borne in mind in order to understand the concept of identity and the requirements attached thereto.

Protection pursuant to Article 8(1)(a) EUTMR is absolute, because registration of a later identical sign for identical goods or services would compromise the function of the earlier mark as a means of identifying commercial origin. Where absolutely identical signs or marks are registered for identical goods or services, it is impossible to conceive of circumstances in which all likelihood of confusion could be ruled out. There is no need to consider any other factors, such as the degree of attention of the public or the distinctiveness of the earlier trade mark.

However, pursuant to Article 8(1)(b) EUTMR, the earlier trade mark is protected against the likelihood of confusion: even if the trade marks differ in some elements, their similarity — in combination with further elements that have to be assessed globally — may lead to the assumption that the relevant goods and services originate from the same or an economically linked undertaking.

Due to the absolute protection conferred by Article 8(1)(a) EUTMR, the concept of identity between trade marks must be interpreted strictly. The absolute protection in the case of an EUTM application ‘which is identical with the [earlier] trade mark in relation to goods or services which are identical with those for which the trade mark is registered [pursuant to Article 8(1)(a) EUTMR] cannot be extended beyond the situations for which it was envisaged, in particular, to those situations which are more specifically protected by [Article 8(1)(b) EUTMR]’ (judgment of 20/03/2003, C-291/00, Arthur et Félicie, EU:C:2003:169, § 50-54 in relation to the corresponding provisions of the TM Directive).

2.2 Threshold for a finding of identity

The very definition of identity implies that the two signs should be the same in all respects. There is, therefore, identity between trade marks where the EUTM application reproduces, without any modification or addition, all the elements constituting the earlier trade mark.

However, since the perception of identity between the two signs is not always the result of a direct comparison of all the characteristics of the elements compared, insignificant differences between trade marks may go unnoticed by the average consumer.

Therefore, **the EUTM application should be considered identical to the earlier trade mark ‘where it reproduces, without any modification or addition, all the elements constituting the trade mark or where, viewed as a whole, it contains differences so insignificant that they may go unnoticed by an average consumer’** (judgment of 20/03/2003, C-291/00, Arthur et Félicie, EU:C:2003:169, § 50-54).

An insignificant difference between two marks is a difference that a reasonably observant consumer will perceive only upon examining the marks side by side. ‘Insignificant’ is not an objective term, and its interpretation depends on the level of complexity of the trade marks being compared. Insignificant differences are those that, because they concern elements that are very small or are lost within a complex mark, cannot be readily detected by the human eye upon observing the trade mark concerned, bearing in mind that the average consumer does not normally indulge in an analytical examination of a trade mark but perceives it in its entirety.

The finding that an element is ‘insignificant’ should be accompanied by sufficient reasoning for its lack of impact on the global perception of the trade mark.

It follows from the definition of identity above that the following conditions have to be met in order for trade marks to be considered identical in accordance with Article 8(1)(a) EUTMR.

- **Complete identity of the signs taken as a whole.** Partial identity is not sufficient under Article 8(1)(a) EUTMR; however, a coincidence in any part of the mark may lead to similarity between the signs and should be addressed when carrying out the examination of Article 8(1)(b) EUTMR.

Any additional element is sufficient for concluding that the marks are not identical; it is immaterial whether the added element is a word, a figurative device or a combination of the two.

Consequently, two word marks will not be considered identical if one is contained within the other but is accompanied by further characters (see paragraph 2.4 below) or by words — irrespective of distinctiveness or possible descriptive character.

Earlier sign	Contested sign and comments	Case No
Millenium	MILLENIUM INSURANCE COMPANY LIMITED It was found that ‘the signs at stake were obviously not identical’, even if ‘Insurance company limited’ was descriptive in English for the related services.	R 0696/2011-1
INDIVIDUAL		R 0807/2008-4

- **identity on all levels of comparison.** There must be identity between the signs at all relevant levels of trade mark comparison, that is, visual, phonetic and conceptual. If the trade marks are identical in some aspects (visual, phonetic or conceptual) but not in others, they are not identical overall. In the latter case, they may be similar and, therefore, likelihood of confusion must be examined.

2.3 Identity of word marks

Word marks are identical if both are purely word marks and coincide exactly in the string of letters or numbers. Word marks are marks consisting of letters, numbers and other signs (e.g. ‘+’, ‘@’, ‘!’) reproduced in the standard typeface used by the

respective office. This means that they do not claim any particular figurative element or appearance. Where both marks are registered as word marks, the typeface actually used by the respective office in the official publication (e.g. the EUTM Bulletin) is immaterial. Differences in the use of lower or upper case letters are immaterial, even if lower case and upper case letters alternate.

The following word marks are identical:

Earlier sign	Contested sign	Case No
MOMO	MoMo	B 1 802 233
BLUE MOON	Blue Moon	R 0835/2010-1
GLOBAL CAMPUS	Global Campus	R 0719/2008-2
ZEUS	Zeus	R 0760/2007-1
JUMBO	Jumbo	R 0353/2007-2
DOMINO	Domino	R 0523/2008-2
Apetito	APETITO	T-129/09

In general, it should be checked whether the sign has been registered as a word mark. For example, examining only the graphic representation of the trade mark (for instance, in the Madrid System) can be misleading because, depending on the graphic representation of the signs used in the certificates, bulletins, etc., a mark *claimed as a word mark* may include figurative or stylised elements or fonts. In these cases, the claim will prevail over the exact reproduction in the certificate, bulletins, etc.

Marks in non-Latin characters must be considered as word marks in the designated jurisdictions where those characters are officially used (e.g. Cyrillic in the case of an EUTM or an IR designating Bulgaria or the EU, in accordance with the indication of category No 28.05 'inscriptions in Cyrillic characters' of the Vienna Classification of figurative elements). The following Cyrillic word marks are identical:

Earlier sign	Contested sign	Case No
ВАСИЛЬКИ	Васильки	B 1 827 537



A difference of just one letter is sufficient for a finding of non-identity. The same applies to a space or a punctuation mark (e.g. hyphen, full stop), since the presence of either may change how the sign is perceived (see the first example below). The following word marks **are not** identical:

Earlier sign	Contested sign	Case No
She, SHE	S-HE	T-391/06
TELIA	teeli	B 13 948
NOVALLOY	NOVALOY	B 29 290
HERBO-FARMA	HERBOFARM	R 1752/2010-1



2.4 Word marks and figurative marks

A **word mark and a figurative mark**, even when both consist of the same word, will not be identical unless the differences go unnoticed by the relevant public.

In the following examples the signs are clearly not identical:

Earlier sign	Contested sign	Case No
	IHotel	T-277/11
	ELCO	R 0803/2008-1
eClear		R 1807/2010-1
BIG BROTHER		R 0932/2010-4

However, the finding that trade marks are not identical can be more difficult if the figurative trade mark is written in normal typeface. Nevertheless, in the following examples the trade marks were found **not** to be **identical**:





Earlier sign	Contested sign	Case No
	THOMSON	R 0252/2008-1
	Klepper	R 0964/2009-1

2.5 Identity of figurative marks

Two figurative marks are identical when both signs match in all their figurative elements (shape, colours, contrast, shadowing, etc.).

It goes without saying that use of the same word will not suffice for a finding of identity when the figurative element is not the same. The following marks are not identical:

Earlier sign	Contested sign	Case No
		R 0558/2011-1

		R 1440/2010-1
		7078 C

However, since in the following case the difference in the presentation of the letters 'TEP' in italics would go unnoticed by the public, the marks were considered **identical**:



Earlier sign	Contested sign	Case No
		B 2 031 741

2.6 Identity of an earlier black and white (B&W) or greyscale mark with a colour mark application

In the framework of the European Trade Mark and Design Network, the Office and a number of Trade Mark Offices in the European Union have agreed on a common practice with regard to the scope of identity of earlier B&W or greyscale marks with coloured versions of the same sign.



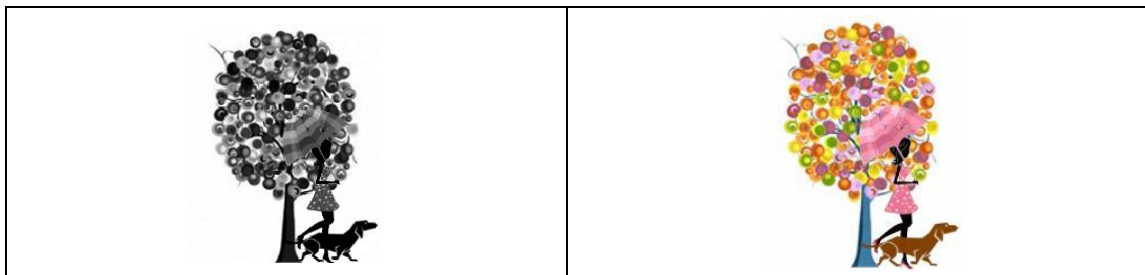

According to this converged practice, the **differences** between an earlier B&W or greyscale mark and a coloured version of the same sign **will normally be noticed** by the average consumer, with the consequence that the marks are not considered identical. It is only under **exceptional circumstances** that the signs will be considered identical, namely where the differences in the colours or in the contrast of shades are so **insignificant** that a reasonably observant consumer will perceive them only upon examining the marks side by side. In other words, for the finding of identity the differences in the colour of the signs in question must be hardly noticeable by the average consumer.

Invented examples of **significant** differences with the consequence of no identity:



Earlier sign	Contested sign
	



Invented examples of **insignificant** differences with the consequence of identity:

Earlier sign	Contested sign
	
	

In relation to the findings above, the issue as to whether a trade mark registered in B&W or greyscale should be considered to cover all colours has also been addressed by the Court in a subsequent judgment (judgment of 09/04/2014, T-623/11, Milanówek cream fudge, EU:T:2014:199):

Earlier sign	Contested sign	Case No
		<p>T-623/11</p>
<p>The Court considered that the fact that ‘the proprietor of a mark may use it in a colour or a combination of colours and obtain for it, as the case may be, protection under the relevant applicable provisions ... does not mean ... that the registration of a mark which does not designate any specific colour covers all colour combinations which are enclosed with the graphic representation’ (para. 39).</p> <p>In this particular case, the Court considered that the Board was right in finding ‘that one difference between the mark applied for and the first and second earlier marks lay in the fact that the mark applied for consisted, in part, of a yellow background with white vertical stripes’ (para. 40).</p>		

3 Similarity of Signs

3.1 Introduction

The similarity of signs depends on the distinctiveness (see paragraph 3.2 below) and dominant character (see paragraph 3.3 below) of their components, which are defined in the opposition decision. In the comparison of marks, the visual, phonetic and conceptual similarity must be assessed by weighing up the coinciding and the differing elements, and by taking into consideration their distinctiveness and dominance (see paragraph 3.4 below) and whether and to what degree these elements coin the overall impression produced by the marks. All these considerations will lead to a conclusion on the degree of similarity in each (visual, phonetic and conceptual) aspect (see paragraph 3.5 below).

3.2 Distinctive elements of the marks

In its judgment of 11/11/1997, C-251/95, Sabèl, EU:C:1997:528, § 23, the Court held that ‘... (the) global appreciation of the visual, aural or conceptual similarity of the marks in question, must be based on the overall impression given by the marks, bearing in mind, in particular, their distinctive and dominant components’. Therefore, the degree of distinctiveness of the various components of composite marks is an important criterion that must be considered within the trade mark comparison.

When assessing the similarity of signs, an analysis of whether the coinciding components are descriptive, or otherwise non-distinctive is carried out in order to calculate the extent to which these coinciding components have a lesser or greater capacity to indicate commercial origin. This recognises that the consumer is more likely to consider that a descriptive, allusive or otherwise weak element of a mark is not being used to identify a particular undertaking, and thus to distinguish goods or services from those of other undertakings.

Consequently, although trade mark proprietors commonly use descriptive, allusive or otherwise weak elements as part of a trade mark to inform consumers about certain characteristics of the relevant goods or services, it may be more difficult to establish that the public may be confused as to origin due to similarities that solely pertain to weak elements.

The distinctiveness of the components of both the earlier **and** of the contested mark must be examined.

It is important to distinguish between the analysis of the distinctive character of (i) the component of a mark and (ii) the earlier mark as a whole. Analysing the components determines whether the signs in conflict coincide in a component that is distinctive (and therefore important) or weak (therefore being of less importance in the trade mark comparison). The analysis of the earlier mark as a whole determines the scope of protection afforded to that mark, which is a separate consideration within the likelihood of confusion, independent from the comparison of the trade marks (dealt with in Chapter 5, Distinctiveness of the Earlier Mark)⁵.

⁵ The Guidelines, Part C, Opposition, Section 2, Double Identity and Likelihood of Confusion, Chapter 5, Distinctiveness of the Earlier Mark.

If either mark consists of one element only, the decision in the part dealing with the comparison of signs will establish whether its distinctiveness is normal or lower than normal. In this case, it cannot be found that a mark lacks distinctiveness. Regarding the earlier mark, this would amount to denying its distinctive character (for details, see paragraph 3.2.3.4 below). As regards the contested sign, this would mean that a new examination on absolute grounds would have to be carried out.

3.2.1 What is a component of a sign?

The Court has not defined what is to be regarded as a ‘component’ or ‘element’ of a sign. It is easy to identify components when a sign is visually divided into different parts (e.g. separate figurative and verbal components). However, the term ‘component’ encompasses more than these visual distinctions. Ultimately, the perception of the sign by the relevant public is decisive and a component exists wherever the relevant public perceives one. For example, the relevant public will often regard one-word signs as being composed of different components, in particular, where one part has a clear and evident meaning while the rest is meaningless or has a different meaning (e.g. in the mark EUROFIRT, ‘Euro’ will be widely understood as referring to Europe whereas ‘Firt’ is meaningless, giving this word mark two components: ‘Euro’ and ‘Firt’). In such cases, the elements of one-word signs could be regarded as ‘components’ in the terminology of the Court.

However, **word marks should not be artificially dissected**. Dissection is not appropriate unless the relevant public will clearly perceive the components in question as separate elements. A case-by-case assessment is required as to whether the division of a sign into components is artificial (e.g. whether splitting the word ‘LIMEON’ for fruit into the components ‘LIME’ and ‘ON’ would be artificial or not).

3.2.2 Examination of distinctiveness

3.2.2.1 What is distinctiveness?

The Court has defined distinctiveness in the following manner:

In determining the distinctive character of a mark and, accordingly, in assessing whether it is highly distinctive, the national court must make an overall assessment of the greater or lesser capacity of the mark to identify the goods or services for which it has been registered as coming from a particular undertaking, and thus to distinguish those goods or services from those of other undertakings (emphasis added).

(Judgment of 22/06/1999, C-342/97, Lloyd Schuhfabrik, EU:C:1999:323, § 22).

Importantly, distinctive character is a matter of degree and, when analysing distinctiveness, a sliding scale applies whereby a component of a sign can lack distinctiveness entirely, be fully distinctive (to a normal degree) or be at any point in-between.

At this point, it must be noted that it is not, in principle, the Office’s practice to recognise a higher than average degree of inherent distinctiveness for individual components of signs. Any higher degree of distinctiveness (enhanced distinctiveness, reputation) is related to actual recognition of the mark by the relevant public, and is

eventually examined only with respect to the earlier mark (see Chapter 5, Distinctiveness of the Earlier Mark). A mark will not have a higher degree of distinctive character just because there is no conceptual link to the relevant goods and services (order of 16/05/2013, C-379/12 P, H/Eich, EU:C:2013:317, § 71).

An element of a sign is **not distinctive** if it is exclusively descriptive of the goods and services themselves or of the characteristics of those goods and services (such as their quality, value, purpose, provenance, etc.) and/or if its use in trade is common for those goods and services. Similarly, an element of a sign that is generic (such as a common shape of a container or a common colour) will also lack distinctiveness.

An element of a sign may be **distinctive to a low degree if it refers to** (but it is not exclusively descriptive of) characteristics of the goods and services. If the allusion to the goods and services is sufficiently imaginative or clever, the mere fact that there is an allusion to characteristics of the goods might not materially affect distinctiveness. For example:

- ‘Billionaire’ for *gaming services* is allusive in a manner that would affect distinctiveness, because it implies for instance that you may become a billionaire.
- ‘Billy O’Naire’, which sounds identical to ‘billionaire’ in English, would be allusive for *gaming services* as a clever word-play on Irish names, in a manner that would not affect distinctiveness in a material way; it would be considered to have a ‘normal’ degree of distinctiveness.

An element of a sign that is neither non-distinctive nor weakly distinctive possesses a **‘normal’ degree of inherent distinctiveness**. This means that the element of a sign in question is fully distinctive, in the sense that its capacity to identify the goods and services covered by the mark as coming from a particular undertaking is not in any way diminished or impaired.

One of the most frequent arguments brought by applicants is that the earlier trade mark or one of its components has a low distinctive character given that there are many trade marks that consist of, or include, the element in question. Where this argument is supported only by the applicant referring to trade mark registrations, the Office takes the view that the existence of several trade mark registrations is not per se particularly conclusive, as it does not necessarily reflect the situation in the market. In other words, on the basis of registered data only, it cannot be assumed that all the trade marks have been effectively used.

It follows that the evidence submitted must demonstrate that consumers have been exposed to widespread use of, and become accustomed to, trade marks that include the element in question in order to prove that the element in question has a low degree of distinctive character.

3.2.2.2 Relevant point in time

The inherent distinctiveness of the components should be assessed at the time of the decision.

Establishing the precise point in time for evaluating distinctiveness is important because the degree of distinctiveness of the marks is not constant, but varies depending on the perception of the public. This perception may change not only due to the nature of the use of the specific mark, but also due to other factors (all these

elements can only be considered from the evidence submitted by the parties). For instance, the public's perception may change where a mark or some component thereof has been used in the meantime in a similar way by various businesses/traders in the relevant market sector. This common use of a sign can erode the uniqueness of a sign and, consequently, its ability to indicate the origin of the goods and services. In this context, it is important to assess carefully whether the situation described exists in all the relevant geographical areas and with regard to all the relevant goods and services.

As an example, due to technological changes in the field of IT, there has been an increased number of instances where components such as 'I' (internet), 'E' (electronic) and 'M' (mobile) are used adjoined to a meaningful word. In the context of electronic communications, they are currently found to be descriptive (decision of 19/04/2004, R 0758/2002-2, ITUNES, § 11), whereas previously they were considered distinctive.

3.2.2.3 Relevant goods and services

The assessment of the **inherent distinctiveness** of the components is carried out only for the goods or services that are identical or similar, that is:

- the earlier mark is assessed with respect to the registered goods and services that are identical or similar to the contested goods and services;
- the contested trade mark is assessed with respect to the contested goods or services that are identical or similar to those of the earlier mark.

3.2.2.4 General principles of examination of distinctiveness

The examination of inherent distinctiveness is carried out in two phases: first, it should be determined whether the relevant public recognises semantic content of the element at issue and, second, whether or not the semantic content perceived is related to and/or commonly used in trade for the identical or similar goods and services.

As regards the **first phase**, that is to say, whether the relevant public recognises a semantic content, this is assessed in the conceptual comparison of signs, which is described in detail in paragraph 3.4.3 below, Conceptual comparison.

The inherent distinctiveness of the components of the marks has to be evaluated by taking into account (each of) the relevant geographical area(s) and their different linguistic and cultural backgrounds. As such, the public in some parts of the relevant territory might not understand the descriptive content that a mark may have in other parts. In these cases, the distinctiveness of the mark in one area is not affected by the fact that it may be perceived differently in other areas.

Below is an example of a case where linguistic considerations were vital to the issue of distinctiveness:

Earlier sign	Contested sign	Case No
FRUTISOL	Solfrutta	T-331/08
<p>G&S: Classes 29, 30 and 32 Territory: EU Assessment of the components 'frut' and 'sol': '... it is necessary to distinguish between the perception by the public in those Member States, such as Italy and Spain, where the elements "sol" and "frut" are generally recognisable and can be understood as alluding to "sun" and "fruit" respectively, and the perception by the public in those Member States, such as Hungary, Finland and Lithuania, where those elements have no such close equivalent in their national languages'. In the first category of Member States, consumers are liable to associate both marks with the notions of 'fruit' and 'sunshine'. There will consequently be a certain level of conceptual similarity between them. In Member States of the second category, consumers will not perceive any conceptual similarity between the signs since they will not attach any particular meaning to the constituent parts of either sign (paras 21-24).</p>		

The **second phase** consists of correlating any meaning that the public perceives in the components with the identical or similar goods and services in dispute. If the relevant public perceives this meaning as descriptive, laudatory or allusive (in a manner that materially affects distinctiveness), etc. for these goods and services, then its distinctiveness will be diminished accordingly. It may be necessary to distinguish between the various goods and services involved because the finding of no or limited distinctiveness might relate to only part of those goods and services.

The criteria applied to examining the inherent distinctiveness of a component of a sign are the same as the relevant principles applied when examining marks on absolute grounds⁶. However, in relative grounds disputes, the question is not merely whether a component is distinctive or not (i.e. whether it reaches the minimum distinctiveness threshold for registration), but also to what degree it is distinctive within the sliding scale previously mentioned. Therefore, for instance, a term that is not descriptive but merely allusive for the goods or services in question might be distinctive enough to pass the absolute grounds test, but still have less than normal distinctiveness for the purposes of relative grounds.







The outcome of the examination of inherent distinctiveness will be one of the following:

- The component has **less than normal or no distinctiveness** because it is descriptive, laudatory of characteristics of identical or similar goods or services or because it is otherwise weak. See the examples below.
- The component has normal distinctiveness because it is neither non-distinctive nor weak for identical or similar goods or services.

As noted in paragraph 2.1 above, word marks consisting of a single word may still contain various components, some of which may be more distinctive than others (see T-331/08, Solfrutta above).



⁶ These are described in the Guidelines, Part B, Examination. See also Objective 2 of the Common Practice on the Impact of Non-Distinctive/Weak Components on Likelihood of Confusion agreed in the Framework of the European Trade Mark and Design Network.

3.2.2.5 Examples of descriptive components



Earlier sign	Contested sign	Case No
BYLY		T-514/08
G&S: Class 3 Territory: EU Assessment of the element 'products': '... the term "products" is not distinctive enough to be taken into consideration by the consumers' (para. 39).		
Earlier sign	Contested sign	Case No
		T-490/08
G&S: Class 36 Territory: EU Assessment of 'CAPITAL MARKETS': 'the relevant public, consisting of consumers who are very attentive, well informed and familiar with basic English financial terminology, will attach little significance to the meaning of the words "capital" and "markets", which are descriptive of those services and which do not enable the commercial origin of the trade marks at issue to be identified' (para. 59).		
Earlier sign	Contested sign	Case No
		R 0834/2009-1
G&S: Classes 3 and 5 Territory: EU Assessment of the earlier right: even though the signs have some similarities, the expression 'NATURAL BRONZE' is descriptive of the purpose of the goods (tanning) for the goods in Class 3 (para. 31).		
Earlier sign	Contested sign	Case No
	CINETAIN	R 1306/2009-4
G&S: Classes 38 and 41 Territory: Spain Assessment of the element 'CINE': The word 'cine' has a descriptive meaning in the sense of 'cinema (film)'. Therefore, this component has only limited relevance in the perception of the signs (para. 36).		
Earlier sign	Contested sign	Case No
	NATURAL BEAUTY FROM WITHIN	R 0991/2010-2
G&S: Classes 3 and 5 Territory: Germany Assessment of the element 'NATURAL BEAUTY': The element 'NATURAL BEAUTY' is a plain and essential indication of the kind and quality of the goods. The German public understands the meaning of these two basic words as well as the combination thereof (paras 31-35).		
Earlier sign	Contested sign	Case No
FORCE-X	FSA K-FORCE	T-558/13

G&S: Classes 9 and 12
 Territory: EU
 Assessment: The word 'force', synonymous with strength and power, can describe one of the characteristics of the goods concerned. Furthermore, for some goods in Class 12, it must be held that that word can also designate one of their purposes. Furthermore, as is apparent from the evidence adduced by the applicant, the word 'force' is commonly used, on the European market, in trade marks in the domain of cycling, thus rendering it banal (paras 38-39).

3.2.2.6 Examples of laudatory components

Earlier sign	Contested sign	Case No
	MAGIC SEAT	T-363/06
<p>G&S: Class 12 Territory: Spain Assessment of the element 'MAGIC': The word 'magic' will be perceived by the relevant public as a simple qualifier for the word 'seat' on account of its resemblance to the Spanish word 'mágico', which is purely laudatory (para. 39).</p>		
Earlier sign	Contested sign	Case No
STAR SNACKS		T-492/08
<p>G&S: Classes 29, 30 and 32 Territory: EU Assessment of the element 'STAR': The word element 'STAR' is laudatory, as it merely constitutes (together with the remaining elements of the signs) a reference to high-quality food products (para. 52).</p>		

3.2.2.7 Examples of allusive components

Earlier sign	Contested sign	Case No
EL COTO		T-332/04
<p>G&S: Classes 33, 35 and 39 Territory: EU Assessment of distinctiveness of the image in the contested EUTM application: The figurative element of the mark evokes a vineyard; this component has little distinctive value as regards wines (para. 38).</p>		
Earlier sign	Contested sign	Case No
	WORLDBLINK	T-325/04
<p>G&S: Class 36 Territory: EU Assessment of the element 'LINK': the element 'LiNK' is not immediately descriptive of inter alia 'banking services for the dispensing of cash; funds transfer and payment services; financial information services' (Class 36) covered by the earlier mark, but merely allusive in relation to them.</p>		

3.2.3 Specific cases

3.2.3.1 One-letter components, numerals and short components

The Court, in its judgment of 09/09/2010, C-265/09 P, 'α', held that the distinctiveness of single-letter trade marks must be assessed according to an examination based on the facts, focusing on the goods or services concerned and the **same criteria that apply to other word marks** (paras 33-39). Although that judgment deals with absolute grounds, the Office considers that the principle established by the Court (i.e. that the application of the criterion of distinctiveness must be the same for all marks) also applies in *inter partes* cases when it comes to determining the distinctiveness of single-letter components in trade marks.

The Court, although acknowledging that it may prove more difficult to establish distinctiveness for marks consisting of a single letter than for other word marks, held that these circumstances do not justify laying down specific criteria supplementing or derogating from application of the criterion of distinctiveness as interpreted in the case-law.

In the context of analysis of distinctiveness of components of signs, the Office considers the ruling to mean that, when establishing the distinctiveness of a single letter, being a component of a sign, it is not correct to rely on assumptions such as a priori statements that consumers are not in the habit of perceiving single letters as trade marks or on generic arguments such as that relating to the availability of signs, given the limited number of letters.

The General Court has since stated in a number of cases that a trade mark containing a **single letter** or a single numeral may indeed be inherently distinctive (judgments of 08/05/2012, T-101/11, G, EU:T:2012:223, § 50; 06/10/2011, T-176/10, seven for all mankind, EU:T:2011:577, § 36; 05/11/2013, T-378/12, X, EU:T:2013:574, § 37-51).

In its judgment of 10/05/2011, T-187/10, G, EU:T:2011:202 the General Court dismissed the applicant’s argument that single letters are generally per se devoid of distinctive character and that, therefore, only their graphic representation would be protected (see paras 38-49).

The above considerations apply both to single-letter/numeral trade marks depicted in standard characters (i.e. word marks) and to stylised single-letter/numeral trade marks.

Furthermore, in accordance with the ‘α’ judgment, as regards these components, unless the letter combination itself is descriptive or otherwise related to the goods and services (e.g. ‘S’, ‘M’, ‘XL’ for goods in Class 25), these components are not necessarily limited in their distinctiveness. The same rules apply to numerals.

3.2.3.2 Commonplace and banal elements

There are instances where signs are composed of one (or various) distinctive verbal element(s) and one (or various) figurative element(s) that are perceived by the relevant public as being commonplace or banal. These figurative elements frequently consist of a simple geometrical shape (e.g. frames, labels) or of colours frequently used in the market sector (e.g. red for fire extinguishers, yellow or red or orange for the postal sector depending on the Member State concerned). For this reason, these commonplace and banal elements are considered non-distinctive.

Earlier sign	Contested sign	Case No
ARCO		R 1929/2010-2
<p>G&S: Class 9 Territory: EU Assessment of figurative elements: the verbal elements of the two signs coincide. Even if it is not negligible in terms of its size, the figurative element of the contested EUTM is likely to be perceived by consumers essentially as a mere decorative element, and not as an element indicating the commercial origin of the goods (para. 43).</p>		

3.2.3.3 Disclaimers

Pursuant to former Article 37(2) CTMR (deleted by the Amending Regulation), the Office could impose a disclaimer if the mark contained an element that was not distinctive and if inclusion of that element would have led to doubts as to the scope of protection. The Office also accepted disclaimers entered voluntarily. Some national trade mark systems also provide for disclaimers.

Following the entry into force of the Amending Regulation, the Office will no longer be able to request disclaimers; similarly, no requests for disclaimers entered by the EUTM applicant will be accepted.

However, disclaimers in marks registered by the Office before the entry into force of the Amending Regulation and in earlier national marks will still be binding on the Office and must be taken into account even if the element might appear distinctive when analysed independently.



The effect of a disclaimer is:

- if the earlier mark contains a disclaimer, that the proprietor is prevented from successfully invoking rights in the disclaimed element. Therefore, similarity between two signs cannot be induced or increased because of coincidence or similarity in the disclaimed element (decision of 06/10/2008, R 0021/2008-4, AUTENTICO JABUGO, § 17, where JABUGO was disclaimed).
- if the earlier figurative mark contains two words and both are disclaimed, that the scope of protection is reduced to the precise manner and sequence in which the two words are combined.

Disclaimers in the contested EUTM application (irrespective of whether they were requested by the Office or entered voluntarily by the applicant before the entry into force of the Amending Regulation) cannot bind the owner of the earlier mark, that is to say, the applicant cannot unilaterally reduce the scope of protection of the earlier mark (decisions of 11/02/2010, R 0229/2009-2, DOUGHNUT THEATER, § 58; 29/03/2012, R 2499/2010-1, ACETAT Silicon 101E (fig.), § 18-19).

3.2.3.4 Earlier marks consisting of one element that is distinctive to a low degree

If the earlier mark only consists of one element whose distinctiveness is put in question, the Office applies the practice clarified in the judgment of 24/05/2012, C-196/11, F1-LIVE, EU:C:2012:314, namely that in proceedings opposing the registration of an EU trade mark, the validity of earlier trade marks may not be called into question.

Earlier sign	Contested sign	Case No
		<p>R 2306/2012-1</p>
<p>G&S: Classes 29, 30 and 32 Territory: Czech Republic Assessment: 'The Board also notes that the earlier mark "Glanc" is registered in the Czech Republic for the goods in question and, therefore, for the purpose of the present proceedings, it must be deemed to be endowed with at least some degree of distinctive character.'</p>		

3.3 Dominant elements of the marks

It is the Office's practice to restrict the notion of dominant element to the visual impact of the elements of a sign, that is, to use it exclusively to mean '**visually outstanding**'.

For a finding that there is a dominant element within a sign, the sign should have at least two identifiable components⁷. The rules explained in paragraph 3.2.1 above apply accordingly.

The decision must identify which of the components of a sign is the dominant one.

Even though, according to the established case-law of the Court, aspects other than the visual one (such as a possible semantic meaning of part of a one-word sign) may come into play when defining the notion of the dominant element of a sign, it is the practice of the Office to restrict the notion of dominant element to the visual impact of the elements of a sign, that is, to use it exclusively to mean 'visually outstanding' and to leave any other considerations for the overall assessment. As a result, the Office's practice is that the dominant character of a component of a sign **is mainly determined by its position, size, dimensions and/or use of colours**, to the extent that they affect its visual impact. As stated by the Court:

With regard to the assessment of the dominant character of one or more given components of a complex trade mark, account must be taken, in particular, of the intrinsic qualities of each of those components by comparing them with those of other components. In addition and accessorially, account may be taken of the relative position of the various components within the arrangement of the complex mark.

(Judgment of 23/10/2002, T-6/01, Matratzen, EU:T:2002:261, § 35, confirmed by order of 28/04/2004, C-3/03 P, Matratzen, EU:C:2004:233).

In addition, the Court has held that:

... the weak distinctive character of an element of a complex mark does not necessarily imply that that element cannot constitute a dominant element since, because, in particular, of its position in the sign or its size, it may make an impression on consumers and be remembered by them.

(Judgment of 13/06/2006, T-153/03, Peau de vache, EU:T:2006:157, § 32).

Consequently, the fact that a component of a mark may or may not be considered non-distinctive (or as having a low degree of distinctiveness) has no bearing on the assessment of dominant character.



As a rule of thumb, the following should be considered:

- The assessment of dominant character applies to both the signs under comparison.
- For a finding that there is a dominant component, the sign should have at least two identifiable components.
- Word marks have no dominant elements because by definition they are written in standard typeface. The length of the words or the number of letters is not an issue of dominance but of overall impression⁸.



⁷ In this text the words 'component' and 'element' are used interchangeably.

- Figurative elements may be dominant in signs where word elements are also present.
- Whether or not an element is visually outstanding may be determined in the visual comparison of the signs; if that is the case, it must be consistent with a subsequent evaluation of dominant character.
- Lastly, if it is difficult to decide which of the (at least) two components is dominant, this may be an indication that there is no dominant element or that no element is more dominant than the other (which includes cases of co-dominance). The establishment of dominant character implies that one component is visually outstanding compared to the other component(s) in the mark; if that assessment is difficult to make, it is because there is no dominant element.

Examples of cases:

Sign	Dominant component and reasoning	Case No
	<p>RPT: ‘the dominant element of the earlier marks is the acronym RPT, in which the letter “p” predominates’ (para. 33).</p>	T-168/07
	<p>Free: ‘the word “free” dominates the visual impression created by the mark of which it forms part, because it is considerably larger than the other components and, in addition, is much easier to remember and pronounce than the slogan in question’ (para. 39).</p>	T-365/09
	<p>Xtreme: ‘On the visual level, it must be concluded that in the mark applied for, the term “XTREME” occupies a central position. Indeed, the size of its typeface is bigger than that of the other verbal elements, and the word is highlighted with a white outline ... The other verbal components “RIGHT GUARD” and “SPORT”, are written in a much smaller type and are shifted to the right and towards the edge of the sign’ (para. 55).</p>	T-286/03

⁸ See the Guidelines, Part C, Opposition, Section 2, Double Identity and Likelihood of Confusion, Chapter 7, Global Assessment.

	<p>GREEN by missako: ‘It must be noted, as a first point, that the representation of the sun has an important place within the mark applied for, in that it is positioned in the centre and covers almost two thirds of the area. Next, the position of the word element “green” is also important within the mark, as it is portrayed in large-typeface, stylised upper case letters in black and takes up about one third of the area. As observed by the Board of Appeal in para. 28 of the contested decision, those two elements thus occupy the major portion of the mark applied for and are, therefore, striking in the overall impression of the mark. Lastly, as regards the word element “by missako”, the Board of Appeal correctly held, in para. 28 of the contested decision, that those words were almost illegible because of their size and that the handwriting made them difficult to decipher. It follows, first, that the dominant nature of the word “green” and of the representation of the sun are thereby further reinforced and, secondly, that the word element “by missako” is negligible in nature’ (paras 37-39).</p>	<p>T-162/08</p>
	<p>BÜRGER: The dominant element of the mark applied for is undeniably the word element in upper case letters that stands out, simply because of its position and the very large size of its lettering, from all the other elements that make up the label (para. 38).</p>	<p>T-460/11</p>

3.4 Comparison of signs

In the following paragraphs the application of the principles explained above will be explained with regard to the visual (see paragraph 3.4.1 below), phonetic (see paragraph 3.4.2 below) and conceptual comparison (see paragraphs 3.4.3 and 3.4.4 below). Thereafter, the impact of distinctiveness and dominant character of the common and differing elements (see paragraph 3.4.5 below) and other principles to be taken into account in the comparison of signs (see paragraph 3.4.6 below) will be presented.

3.4.1 Visual comparison

Within the visual comparison it is important to note first that the public perceives word elements of a mark in a different way than other elements. Word elements can be read or associated with a sequence of letters. Other elements are just assessed as to their graphical or figurative characteristics. In the following, the principles of visual comparison will be presented depending on the type of trade marks involved.

3.4.1.1 Word mark v word mark

When at least one word mark is involved, the word as such is protected, not its written form.

According to the case-law, a word mark is a mark consisting entirely of letters, of words or of associations of words, written in printed characters in normal font, without any specific graphic element (judgments of 20/04/2005, T-211/03, Faber, EU:T:2005:135,

§ 33; 13/02/2007, T-353/04, Curon, EU:T:2007:47, § 74). The protection offered by the registration of a word mark applies to the word stated in the application for registration and not to the individual graphic or stylistic characteristics which that mark might possess (judgment of 22/05/2008, T-254/06, RadioCom, EU:T:2008:165, § 43).

Therefore, it is irrelevant whether the word mark is depicted in lower or upper case letters:

Earlier sign	Contested sign	Case No
BABIDU	babilu	T-66/11 (§ 57)
BALLYMANOR	BallyM	R 0391/2010-1

For word marks, the visual comparison is based on an analysis of the number and sequence of the letters/characters, the position of the coinciding letters/characters, the number of words and the structure of the signs (e.g. whether word elements are separated or hyphenated).

However, the average consumer normally perceives a sign as a whole and does not proceed to analyse its various details. Therefore, small differences in the (number of) letters are often not sufficient to exclude a finding of visual similarity, particularly when the signs have a common structure.

In the following cases the marks were held to be visually similar:

Earlier sign	Contested sign	Case No (level of similarity)
MEDINETTE	MESILETTE	T-342/10 (average)
FORTIS	FORIS	R 0049/2002-4 (high)
ARTEX	ALREX	T-154/03 (very high)
MARILA	MARILAN	R 0799/2010-1 (high)
EPILEX	E-PLEX	T-161/10 (average)
CHALOU	CHABOU	T-323/10 (high)

The following word marks are visually dissimilar:

Earlier sign	Contested sign	Case No
CAPOL	ARCOL	C-193/09 P and T-402/07



The Board held that although those marks shared the letter 'a' and the ending 'ol', they 'clearly differ[ed]' visually. The General Court agreed. It held that **the same number of letters in two marks is not, as such, of any particular significance for the relevant public**, even for a specialised public. Since the alphabet is made up of a limited number of letters, which, moreover, are not all used with the same frequency, it is inevitable that many words will have the same number of letters and even share some of them, but they cannot, for that reason alone, be regarded as visually similar. In addition, the public is not, in general, aware of the exact number of letters in a word mark and, consequently, will not notice, in the majority of cases, that two conflicting marks have the same number of letters (paras 81-82). The Court held that **what matters in the assessment of the visual similarity of two word marks is the presence, in each of them, of several letters in the same order** (para. 83). The ending 'ol' of the marks at issue constituted a common element of the marks but comes at the end and is preceded by completely different groups of letters (respectively, 'arc' and 'cap'), so the Board of Appeal correctly concluded that that this commonality does not render the marks visually similar (para. 83). The Court of Justice upheld this assessment from a visual perspective (para. 74).

3.4.1.2 Word mark v figurative mark with word elements



When figurative marks with word elements and word marks are compared visually, what matters is whether the signs share a significant number of letters in the same position and whether the word element in the figurative sign is highly stylised. Similarity may be found despite the fact that the letters are graphically portrayed in different typefaces, in italics or bold, in upper or lower case or in colour.

In principle, when the same letters are depicted in the same sequence, any variation in stylisation has to be high in order to find visual dissimilarity.

The following marks were considered visually **similar** because there was no high variation in the stylisation of the word elements in the figurative marks and the word element was easily recognisable and legible:

Earlier sign	Contested sign	Case No (level of similarity)
VITAFIT		T-552/10 (average)
COTO DE IMAZ		R 0409/2009-1 (high)
vendus sales & communication group		R 0994/2009-4 (high)





However, where the word in the figurative mark is highly stylised, the marks should be found visually **dissimilar**, as in the following examples:

Earlier sign	Contested sign	Case No
NEFF		R 1242/2009-2
	NODUS	R 1108/2006-4





3.4.1.3 Purely figurative v purely figurative signs

When comparing signs in conflict in terms of their **purely figurative elements**, the Office considers the latter as images: if they match in one, separately recognisable, element or have the same or a similar contour, it is likely that some visual similarity will be found.

The following purely figurative signs were found to be visually **similar**.

Earlier sign	Contested sign	Case No (level of similarity)
		T-379/08 (average)
		B 1 157 769 (medium)





The following purely figurative signs were deemed to be visually **dissimilar**:

Earlier sign	Contested sign	Case No
		B 1 572 059
		T-502/11

3.4.1.4 Stylised mark v stylised mark

When comparing signs in terms of their **word elements**, the Office considers signs similar insofar as they share a significant number of letters in the same position and when they are not highly stylised or when they are stylised in the same or a similar manner. Similarity may be found despite the fact that the letters are graphically portrayed in different typefaces, in italics or bold, in upper or lower case or in colour (judgments of 18/06/2009, T-418/07, LIBRO, EU:T:2009:208; 15/11/2011, T-434/10, Alpine Pro Sportswear & Equipment, EU:T:2011:663, appeal C-42/12 P, Alpine Pro Sportswear & Equipment, EU:C:2012:765 dismissed). In the following examples, the marks were considered visually **similar** because they share some words or sequences of letters and the typeface was deemed not to be highly stylised:

Earlier sign	Contested sign	Case No (level of similarity)
		R 1454/2005-4 confirmed by T-418/07 (average similarity)

		<p>R 1148/2008 (high)</p>
		<p>T-383/12 (high)</p>

In the following examples, however, the marks were considered visually **dissimilar** in spite of the fact that they shared some words and/or letters and/or figurative devices, because the shared letters are highly stylised, placed differently and/or there are additional figurative devices:

Earlier sign	Contested sign	Case No
		<p>T-390/03</p>
		<p>T-106/06</p>
		<p>R 1109/2008-1</p>
		<p>R 0111/2010-4</p>

When comparing figurative signs visually, it is still possible to find visual similarity when the figurative elements are different (i.e. they do not match or have the same or similar contour) and the word elements are different. Similarity will be found when the overall stylisation, structure and colour combination render the signs visually similar overall.





The following example illustrates how similar structure, stylisation and colour combination render signs visually similar:

Earlier sign	Contested sign	Case No (level of similarity)
		B 1 220 724 (high)

3.4.1.5 Word/figurative sign v figurative sign

A coincidence in a figurative element that is visually perceived in an identical or similar way may lead to a visual similarity.

The following examples are cases where there are visual similarities because of matching figurative elements:

Earlier sign	Contested sign	Case No (level of similarity)
		T-81/03, T-82/03 and T-103/03 (significant)
(i) 	(ii) 	R 0144/2010-2 (low)

In the following example the figurative elements were different and the signs were considered visually **dissimilar**:



Earlier sign	Contested sign	Case No
		B 134 900 The marks were considered visually dissimilar

3.4.1.6 Signs consisting of a single letter



As explained previously in this chapter (see paragraph 3.2.3.1 above), in cases of conflicting signs containing the same single letter, the visual comparison is normally of decisive importance, these signs usually being phonetically and conceptually identical.

The fact that the conflicting signs comprise the same single letter can lead to a finding of visual similarity between them, depending on the particular way the letters are depicted.

In the following examples, the signs were found to be visually similar **to a high or medium degree**.

Earlier sign	Contested sign	Case No
		T-115/02
<p>G&S: Classes 9, 16, 25, 35, 41 Territory: EU Assessment: As regards the visual similarity of the conflicting signs, the Board of Appeal rightly considered that both marks in question include as a dominant element the lower-case white letter 'a', of a commonplace typeface, on a black background. That dominant element makes an immediate impression and is remembered. Conversely, the graphic differences between the trade marks in question — namely the shape of the background (oval for the trade mark applied for and square for the earlier trade mark), the position of the letter on that background (in the centre in the case of the trade mark applied for and in the lower right-hand corner in the case of the earlier trade mark), the thickness of the line used to represent that letter (the trade mark applied for uses a slightly broader line than that used in the earlier trade mark) and the calligraphic details of the letters of the respective marks — are minor and do not constitute elements that will be remembered by the relevant public as effective distinguishing features. Consequently, the conflicting signs are very similar from the visual point of view.</p>		
Earlier sign	Contested sign	Case No
A		R 1508/2010-2
<p>G&S: Classes 9, 18, 24, 25, 28 Territory: Germany Assessment: The Board found the signs visually similar to a medium degree.</p>		

In the following cases, the signs were found to be visually similar **to a low degree** (that resulted, depending on a particular case, both in likelihood of confusion and no likelihood of confusion).

Earlier sign	Contested sign	Case No (level of similarity)
(i)  (ii) 	 <small>G Line</small>	T-187/10

G&S: Classes 9, 18, 25
 Territory: EU, Italy
 Assessment: The signs were found to be similar to a low degree from a visual point of view (likelihood of confusion).



Earlier sign	Contested sign	Case No (level of similarity)
A		T-174/10 (appeal dismissed C-611/11 P)

G&S: Classes 18, 25
 Territory: Germany
 Assessment: On the basis of the particular graphic design of the contested trade mark the Court only found a low degree of visual and conceptual similarity (para. 31). A phonetic comparison was not possible, as it was found that the public would most likely not pronounce the contested trade mark given the particular graphic design (para. 32). Please note that the outcome in this case was that of no likelihood of confusion, although the Court found low visual similarity between the signs — no likelihood of confusion.

Earlier sign	Contested sign	Case No (level of similarity)
F		R 1418/2006-2



G&S: Class 25
 Territory: EU
 Assessment: Visually, the earlier mark is an upper case letter 'F' written in a standard typeface, whereas the contested mark is a stylised letter 'F', in which the horizontal line is embellished with a distinctive drawing that amounts to a relevant visual difference. The outcome of this case was that of no likelihood confusion.

Finally, in the examples below the signs were found to be **visually dissimilar** due to the different stylisations or graphic elements of the single-letter signs. The final outcomes of these cases were those of no likelihood of confusion.

Earlier sign	Contested sign	Case No
		R 1655/2006-4

G&S: Class 25
 Territory: Spain
 Assessment: Even though the marks share the presence of the letter 'm', they cannot be considered visually similar since the overall visual impression that each mark makes on the relevant public is clearly distinct. The EUTM applied for is a complex graphic device that includes a black lowercase letter 'm' and in addition, other significant figurative elements, namely a bold curved dark line placed above a background circle in which the letter 'm' is almost included. These additional elements are of particular importance since the heavy bold line echoes the form of the background circle and the dark shade of the letter 'm', which is placed over the background. In the earlier mark, the letter 'm' appears in outline font with a characteristic inclination to the right and an uneven height so that the right-hand size of the letter is lower. Consequently, these dissimilarities between the signs are sufficient for it to be held that they do not give the consumer the same visual impression (para. 18).

Earlier sign	Contested sign	Case No
--------------	----------------	---------

		<p>R 576/2010-2 (confirmed by T-593/10)</p>
<p>G&S: Classes 25, 41, 43 <i>Territory:</i> Germany <i>Assessment:</i> Due to the different colours, figurative element and stylisation, the marks were found to be visually dissimilar. Visually, the earlier mark can be perceived as a boomerang, accompanied by the letter 'B', which is the first letter of 'boomerang'.</p>		





It should be pointed out that the verbal representation of 'one-letter/one-digit sign' is not to be considered equivalent to the sign (e.g. 'ONE' is not equal to '1' or 'EM' to 'M'). Therefore, the aforementioned arguments are not directly applicable to such cases.

Finally, it must be noted that the above considerations also apply to signs consisting of single numbers.

3.4.1.7 Three-dimensional marks

When comparing three-dimensional and two-dimensional signs, the same basic principles as for two-dimensional marks are to be applied. Although the comparative rarity of the three-dimensional sign will usually particularly affect the visual impact of the sign, this must be considered in relation to the overall impression.

In contrast, there is a low degree of visual **similarity** between the following marks:

Earlier sign	Contested sign	Case No (level of similarity)
		<p>R 0806/2009-4, para. 19 (low)</p>
		<p>T-24/08 (low)</p>

The following marks are visually **dissimilar**:

Earlier sign	Contested sign	Case No
		R 0806/2009-4, para. 34

3.4.2 Phonetic comparison

When the opposition is based on earlier signs that enjoy protection in different EU Member States, in principle, account must be taken of all the different pronunciations of the signs by the relevant public in all official languages of those Member States. Local accents are not taken into account. Nevertheless, as already mentioned, when the earlier mark is an EUTM registration, the analysis must in principle extend to the *whole* EU. However, where there is a likelihood of confusion for at least one Member State *and* it is justifiable for reasons of economy of procedure (such as to avoid examining specific pronunciations or meanings of marks in several languages), the Office's analysis need not extend to the whole EU but may instead focus on only a *part or parts* where there is a likelihood of confusion.







The overall phonetic impression produced by a sign is particularly influenced by the number and sequence of its syllables. The common rhythm and intonation of signs play an important role in how signs are perceived phonetically. The Collins English Dictionary defines 'rhythm' as 'the arrangement of words into a more or less regular sequence of stressed and unstressed or long and short syllables'. 'Intonation' is defined as 'the sound pattern of phrases and sentences produced by pitch variation in the voice'.

Therefore, the key elements for determining the overall phonetic impression of a trade mark are the syllables and their particular sequence and stress. The assessment of common syllables is particularly important when comparing marks phonetically, as a similar overall phonetic impression will be determined mostly by those common syllables and their identical or similar combination.

The following are examples of phonetically **dissimilar** marks:

Earlier sign	Contested sign	Relevant territory	Case No
CLENOSAN	ALEOSAN	ES	R 1669/2010-2
GULAS	MARGULIÑAS	ES	R 1462/2010-2

The following are examples of phonetically similar/identical marks:





Earlier sign	Contested sign	Relevant territory	Case No (level of similarity)
CAMEA	BALEA	EU	T-195/13 (low similarity)
		PT: the part of the relevant public that has some knowledge of the English language will read and pronounce the earlier mark in the same way as the mark applied for insofar as the latter uses the English word 'forever' (para. 70). The marks at issue share the same ending 'ever'; the Board of Appeal did not err in finding that those marks were phonetically similar to an average degree for the part of the relevant public with no knowledge of the English language (para. 72).	T-528/11 (identity/average similarity)
FEMARA		EU	R 0722/2008-4 (above average)
	FOR US	BX	R 0166/2010-1 (identity)
		DE	R 1071/2009-1 similar to a low degree

3.4.2.1 Signs and elements in signs that must be assessed

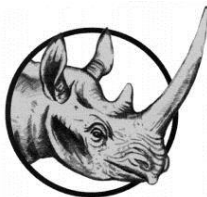

A figurative mark without word elements cannot, by definition, be pronounced. At the very most, its visual or conceptual content can be described orally (judgment of 07/02/2012, T-424/10, *Eléphants dans un rectangle*, EU:T:2012:58, § 46).

In other words, purely figurative marks (i.e. those not containing any word element) are not subject to a phonetic assessment. The 'meaning' that the image evokes or its 'description' will be assessed visually and conceptually.

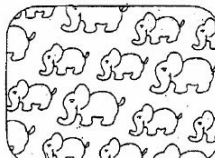
The following are examples where no phonetic comparison could be made because the marks are purely figurative:

Earlier sign	Contested sign	Case No
		R 0131/2010-4
		R 0403/2009-2
		T-424/10

Furthermore, when one of the signs has elements that can be read and the other has only figurative elements not subject to a phonetic assessment, the outcome should be that no phonetic comparison can be made. For example:

Earlier sign	Contested sign	Case No
		R 0144/2010-2

With regard to the pronunciation of figurative elements reminiscent of a letter, it should be noted that the relevant public will tend to read these figurative elements only when they are linked to or form part of a word known to the relevant public, such as in the following examples:

Earlier sign	Contested sign	Case No
OLI SONE		B 1 269 549
ROCK		T-146/08

In the following case, however, the figurative element will not be recognised and read as 'X' and the contested sign read as 'be light':

Earlier sign	Contested sign	Case No
BECKs		T-172/12

Finally, while words, letters and numbers must always be assessed phonetically, some symbols and abbreviations give rise to uncertainty.

For example, the logogram '&' (ampersand) will generally be read and pronounced and, therefore, should be included in the phonetic comparison. However, the pronunciation of a given symbol may differ where different languages are concerned.

Earlier sign	Contested sign	Case No
	DNG	R 0160/2010-2 The ampersand '&' will be pronounced in most European Union languages and is recognised as the corresponding translation of the conjunction 'and'.

The same goes for the typographic character '@', which in principle will be pronounced. Obviously, the pronunciation of a given symbol may differ where different languages are concerned.

Earlier sign	Contested sign	Case No
	VODAFONE AT HOME	R 138/2010-2 @ will be pronounced as 'at' or 'arobase' in the Benelux (para. 21).



In the above case, it cannot be denied that a part of the relevant public — in particular English speakers — would read the 'at' symbol and thus pronounce the trade mark as 'at home'. This possibility must, therefore, be taken into consideration, together with other possibilities such as 'a home' or simply 'home'. Naturally, in other languages the symbol may be read in a different way (for example 'arroba' in Spanish and Portuguese).

However, compare this with:

Earlier sign	Contested sign	Case No
<i>FERCREDIT</i>	<i>f@ir Credit</i>	R 0719/2010-1 (T-220/11 dismissed, C-524/12 P dismissed) The @ will be perceived as the letter 'a' by (at least) the EN public (para. 25).

The plus (+) and minus/hyphen (-) symbols may also be pronounced by the relevant public, depending on the circumstances. The minus symbol may be pronounced when used in combination with a number, for example '-1', but it will not be pronounced if used as a hyphen (as in 'G-Star').





In the following examples, the symbol '+' in the contested EUTM application would be pronounced as 'plus':

Earlier sign	Contested sign	Case No
AirPlus International		T-321/07 (C-216/10 P dismissed)
		T-400/06

Currency symbols (€, \$, £, etc.), too, may be pronounced when the relevant mark is pronounced. As an example (fictional), in the United Kingdom the sign '£ 20' would be pronounced as '20 pounds'. Therefore, the signs '£ 20', '20 pounds' and 'twenty pounds' are phonetically identical.

However, sometimes the way in which symbols — or letters — are used makes it unrealistic to assume that they will be read and pronounced, for example, when in a figurative mark a symbol is repeated in order to create a pattern or is highly distorted or otherwise not clearly legible. This is illustrated by the following examples:

Mark	Explanation
	T-593/10 In this figurative mark, the letter 'B' can be read. The mark must, therefore, be assessed phonetically.

	<p style="text-align: center;">T-593/10</p> <p>In this figurative mark the letter 'B' is so highly distorted that the Court found that for part of the public it is difficult to clearly identify if it is indeed the letter 'b' or the figure '8'.</p>
	<p style="text-align: center;">R 1779/2010-4</p> <p>It is very difficult to determine the pronunciation of the sign. An aural comparison may, therefore, lead to very different results, ranging from identity to dissimilarity.</p>
	<p style="text-align: center;">B 1 127 416</p> <p>In this figurative mark the letter 'H' can be read and, therefore, must be assessed phonetically.</p>
	<p style="text-align: center;">B 1 127 416</p> <p>In this sign, the pattern makes it unlikely that consumers will read an 'H' (or rather several 'H's). This mark cannot be assessed phonetically.</p>
	<p style="text-align: center;">T-282/12</p> <p>The Court held that, although hardly legible at first sight, the words 'FREE' and 'STYLE' in both of the signs are pronounced identically regardless of the language of the public.</p>

In summary, whether or not a given symbol/letter is pronounceable depends on the type of character in question, how it is depicted, and how it is combined with other elements of the sign.

3.4.2.2 Identical/similar sounds in different order

Where the opposing trade marks are formed of syllables or words that are identical or highly similar but in a different order, so that if just one of the syllables or words were rearranged the signs would be identical or highly similar phonetically, the conclusion should be that the signs are phonetically similar.

For example:

Earlier sign	Contested sign	Case No (level of similarity)
VITS4KIDS	Kids Vits	T-484/08 (C-84/10 P dismissed) (significant similarity)
		T-67/08 (high)

3.4.2.3 Signs consisting of or including foreign or invented words

When a sign contains foreign words, it should be assumed, in principle, that the relevant public is unfamiliar with how foreign native speakers pronounce their own language. Accordingly, the public will tend to pronounce a foreign word in accordance with the phonetic rules of their own language.

Earlier sign	Contested sign	Case No
LIDL	LIFEL	R 0410/2010-1 The first two letters and the last one are the same in both marks. Aurally, the similarity is even stronger because LIDL will often be pronounced as if spelt LIDEL. For phonological reasons, 'D' and 'L' are nearly impossible to pronounce in most languages without inserting a vowel between them. Therefore, the marks would be pronounced LIFEL and LIDEL in languages like Spanish, Italian, German and French.
KAN-OPHTAL PAN-OPHTAL	BAÑOFTAL	T-346/09 The relevant territory is Germany. The Court found a phonetic similarity. The German consumer will probably pronounce the letters 'N' and 'Ñ' in the same way. Moreover, the letters 'P' and 'B' are pronounced with both lips and their sound can be confused if they are accompanied by the same vowel; the signs PAN-OPHTAL and BAÑOFTAL are aurally very similar.
GLANZ	GLÄNSA	T-88/10 The GC concluded that the umlaut would not alter the overall phonetic impression for EN, FR and ES speakers, since the languages in question do not have the letter 'ä' (para. 40).

However, this will not be the case when the relevant public is familiar with a word, for example in the following scenarios.

- When it is an established fact that a foreign language is known by the relevant public. For example, the Court has already confirmed that there is at least a basic understanding of the English language by the general public in the Scandinavian countries, the Netherlands and Finland (judgment of 26/11/2008, T-435/07, New Look, EU:T:2008:534, § 23).
- When certain terminology is clearly known by the relevant public for certain classes of goods and/or services. For example, IT professionals and scientists are generally considered to be more familiar with the use of technical and basic English vocabulary than the average consumer, irrespective of territory

(judgments of 27/11/2007, T-434/05, Activy Media Gateway, EU:T:2007:359, § 38 and 48 for the IT field (C-57/08 P dismissed); 09/03/2012, T-207/11, Isense, EU:T:2012:121, § 21-22 for German professionals in the medical field).

- When very basic words will be understood in all Member States, such as the English words ‘baby’, ‘love’, ‘one’, ‘surf’, the Italian word ‘pizza’, which has also entered the English language, etc.

Earlier mark	Contested sign	Case No
Babylove Baby Love		R 0883/2010-2

- Finally, when any one of the parties provides compelling evidence that a word is known by a significant portion of the relevant public.

Where a significant part of the relevant public pronounces the foreign word correctly, but another significant part applies the rules of their mother tongue, any assessment of phonetic similarity should mention both pronunciations and provide reasoning. For example:



Earlier sign	Contested sign	Case No
WRITE	RIGHT	(example only) English: highly similar aurally Spanish: dissimilar aurally
	ZIRH	T-355/02 (appeal C-206/04 P dismissed.) Similar in English-speaking countries and Spain.

As regards **invented or fanciful words** (words that do not correspond to any existing word in the EU), the relevant consumer might pronounce them not only as they would sound according to the rules of pronunciation of their mother tongue but also as they are written.

Earlier sign	Contested sign	Case No
BAMIX	KMIX	T-444/10 The GC noted that the word element ‘kmix’ does not correspond to any existing word in the European Union and that it may be pronounced by part of the relevant public as it is written, as a single syllable. However, it also considered it possible that the mark applied for would be pronounced as a two-syllable word, namely ‘ka’ and ‘mix’. In certain languages of the European Union (in particular French and German), the letter ‘k’ is pronounced as ‘ka’ and the pronunciation ‘km’ is not usual (para. 32).

3.4.2.4 Single letter signs

Marks consisting of a single letter can be compared phonetically. The following marks are phonetically identical insofar as they both reproduce the letter ‘A’:

Earlier mark	Contested sign	Case No
		T-115/02

3.4.3 Conceptual comparison: practical criteria

Two signs are identical or similar conceptually when they are perceived as having the same or analogous semantic content (judgment of 11/11/1997, C-251/95, Sabèl, EU:C:1997:528, § 24). The ‘semantic content’ of a mark is what it means, what it evokes or, when it is an image or shape, what it represents. In this text the expressions ‘semantic content’ and ‘concept’ will be used indiscriminately.

If a mark consists of various elements (for example, a word and a figurative element) the concept of each of the elements must be defined. However, if the mark is a meaningful expression (made up of two or more words), what matters is the meaning of the expression as a whole and not of each of the words in isolation.

Not every concept has to be defined: only those concepts likely to be known by the relevant public, as defined by the relevant territory, matter. For example, if the relevant territory is Spain, the fact that the word has a meaning in Polish is normally irrelevant.

As a rule, the conceptual comparison is not influenced by the relevant goods and services. However, if a term has many meanings, one of which is of particular significance to the relevant goods and services, the conceptual comparison may focus on this meaning. In any event, what matters is how the term is perceived by the relevant public. A link between the goods and services and what the sign means, evokes or represents must not be forced or artificially constructed. For example, if the relevant goods relate to *lighting* and the sign is or contains the element ‘LED’, ‘light-emitting diode’ is one of the various possible meanings of ‘LED’. Therefore, the conceptual comparison may focus on this meaning.

3.4.3.1 The semantic content of words

When the mark consists of or contains a word, the first step for an examiner is to look up the explanation of that word in dictionaries and/or encyclopaedias in the language(s) of the relevant territory. If the word is in the dictionary/encyclopaedia, the described meaning will be its semantic content.

As a starting point, it should be noted that the relevant public in the various Member States of the EU mainly speak the languages predominant in their respective territories (judgment of 23/10/2002, T-6/01, Matratzen, EU:T:2002:261, § 27). These languages are normally the official languages of the relevant territory.

Earlier mark	Contested sign	Case No
HALLOUMI	HELLIM	T-534/10
<p>'Hellim' is the Turkish translation of 'Halloumi' (Greek) (a type of cheese). The relevant territory was Cyprus. The Court held that while Turkish is not an official language of the EU, it is one of the official languages of the Republic of Cyprus. Therefore, Turkish is understood and spoken by part of the population of Cyprus (para. 38). Therefore, the Court found that the average consumer in Cyprus, where both Greek and Turkish are official languages, will understand that the words HALLOUMI or HELLIM both refer to the same specialty cheese from Cyprus. Consequently, there is some conceptual similarity between these words (para. 41).</p>		



However, the Court has made equally clear that this rule only concerns the primary linguistic understanding of the public in those territories. This is not an inflexible rule. The relevant public should not automatically be considered as having as its mother tongue the language that is predominant in the Member State concerned, or to have no particular knowledge of other languages (order of 03/062009, C-394/08 P, Zipcar, EU:C:2009:334, § 51).

For instance, in the following scenarios, languages other than the predominant one are to be taken into account.

- When the word in another language is very close to the equivalent word in the official language of the relevant territory. For example, the English word 'bicycle' will be understood in Spain because it is very close to the Spanish equivalent word, 'bicicleta'.
- When the word in a foreign language is commonly used in the relevant territory. For example, the Spanish word 'bravo' is commonly used as a term denoting praise, in the sense of 'well done' in Germany.
- When it is known that the relevant public is familiar with a foreign language. For example, the Court has already confirmed that the general public, in the Scandinavian countries, the Netherlands and Finland, has at least a basic understanding of the English language (judgment of 26/11/2008, T-435/07, New Look, EU:T:2008:534, § 23).
- When it is known that the relevant public is familiar with a certain language for certain classes of goods and/or services. For example, English IT terms are normally understood by the relevant public for IT goods, irrespective of territory.
- Very basic words, which will be understood in all Member States because they have become internationally used, such as 'baby', 'love', 'one', 'surf', the Italian word 'pizza', which has also entered the English language, etc.
- Finally, when any one of the parties provides evidence that a word is known by a relevant portion of the relevant public.

The following are **examples** of concepts behind words:

Mark	Territory	Concept	Case No
Mirto	ES	[in EN: myrtle] in Spanish describes a shrub of the family Myrtaceae, two to three metres high.	T-427/07
Peer	EN	Lord	T-30/09

Storm	EN	Bad weather	T-30/09
 --- STAR SNACKS	EU	The terms 'star snacks' and 'star foods' will be understood as referring to quality food not only by English speakers, but also by most of the relevant public.	T-492/08 (Star foods I) T-333/11 (Star Foods II)
 - 	EU	There is some degree of conceptual similarity, based on 'Mc' and the words 'baby' and 'kids' that both refer to children (para. 42).	T-466/09

As shown in some of the examples above, it is not always necessary to give a complete dictionary definition of what a word means. It is sufficient to use a synonym, such as Peer=Lord or Storm=Bad weather.

Additionally, when part of the public will perceive the concept while another part either will not or will perceive a different meaning, a distinction should be made accordingly.

When the mark conveys a **meaningful expression**, the meaning of the expression as a whole, as long as it is understood as such by the relevant public, and not that of the individual words, is the one that is relevant for the conceptual comparison (however, note the exception below concerning expressions in foreign languages). Fictional example: 'KING'S DOMAIN' v 'KING SIZE'.

Incorrect assessment: KING means 'a male sovereign', 'DOMAIN' means 'a territory over which rule or control is exercised' and 'SIZE' means 'the physical dimensions, proportions, magnitude, or extent of an object'. The marks are conceptually similar insofar as they share the notion of 'king'.

Correct assessment: 'KING'S DOMAIN' means 'a territory under the control of a king'; 'KING SIZE' means 'larger or longer than the usual or standard size'. The marks are conceptually dissimilar even though they share the word 'KING'.

This is illustrated by the following examples where the marks were found to be conceptually dissimilar:

Earlier sign	Contested sign	Case No
MOUNTAIN BIKER	MOUNTAIN	B 1 950
Goldband	GoldGips	R 0975/2009-4
ALTA FIDELIDAD	ALTA	B 112 369

The abovementioned rule on meaningful expression has the following **exception**: when signs are in a foreign language, a significant part of the relevant public may have only a limited command of the relevant foreign language and, therefore, might not be able to distinguish the difference in meaning between two expressions. In these instances it

may be that the meaning of an expression as such is not perceived; only the meanings of the individual elements. This may, therefore, lead to a finding of similarity insofar as the public understands only the common part. In the example above, if it is found that (part of the) public will understand only KING, the finding should be that the signs are conceptually similar.

Earlier mark	Contested sign	Case No
ICEBERG	ICEBREAKER	T-112/09
<p>The GC considered that 'icebreaker' would be understood only by that part of the Italian public with command of the English language. However, 'iceberg' is a common word with an immediately obvious meaning to the relevant public. Therefore the earlier mark ICEBERG will have a clear meaning for the Italian public, whereas the mark applied for ICEBREAKER would be devoid of any clear meaning for that public.</p> <p>The GC further indicated that the marks at issue have the prefix 'ice' in common. The GC considered that this is a basic English word, understandable for most of the relevant public. It concluded that since the prefix 'ice' had a certain evocative force, it must be regarded as limiting the conceptual difference between the marks at issue, acting as a 'semantic bridge' (paras 41-42).</p>		

Similar considerations apply to expressions that include a combination of technical words understood by only part of the relevant public (e.g. Latin words, words belonging to highly specialised language) and commonly used words. In these cases, it may be that only the meaning of the commonly used words is perceived, and not the meaning of the expression as such.

3.4.3.2 The semantic content of parts of words

In this regard, the Court has held that, although the average consumer normally perceives a mark as a whole and does not proceed to analyse its various details, the fact remains that, when perceiving a word sign, they will break it down into elements which, for them, suggest a specific meaning or which resemble words known to them (judgment of 13/02/2007, T-256/04, *Respicur*, EU:T:2007:46, § 57).

Consequently, while the rule is that marks are perceived as a whole, the exception to the rule is that, under certain circumstances, consumers could break them down into smaller parts. Since this is an exception, it has to be applied restrictively.

It will be applied in the following cases:

- when the sign itself is broken down visually into various parts (e.g. through the use of upper case letters, as in *AirPlus*);
- when all the parts suggest a concrete meaning known to the relevant public (e.g. *Ecoblue*); or
- when only one part has a clear meaning (e.g. *Dermaclin*).

Examples of signs visually broken down:

Sign	Territory	Concept	Case No
VITS4KIDS	EU	The mark contains VITS (allusive of 'vitamins') and KIDS.	T-484/08

	EU	AGRO: reference to agriculture HUN: reference to Hungary UNI: reference to universal or union.	T-423/08
RNAiFect	EU	The relevant public, particularly the specialist public, will perceive the first three letters as a reference to the English abbreviation for ribonucleic acid.	T-80/08
nfon	EU	The relevant public will isolate the syllable 'fon' in the sign 'nfon', and perceive this term as relating equally to the words 'telephone' or 'phone.' (para. 60).	T-283/11 (C-193/13 P dismissed)

Examples of cases that are not broken down visually but where all the parts suggest a concrete meaning known to the relevant public:

Sign	Territory	Concept	Case
Ecoblue	EU	The word element 'eco' is a common prefix or abbreviation in many languages spoken in the European Union, while the word 'blue' is English for the colour blue and part of the basic English vocabulary known to the relevant public.	T-281/07 (C-23/09 P dismissed)
Solfrutta/ FRUTISOL	EU	The elements 'sol' and 'frut' are generally recognisable and can be understood as alluding to 'sun' and 'fruit' respectively.	T-331/08
RIOJAVINA	EU	The term 'riojavina' in the mark applied for refers directly, so far as the relevant public is concerned, to grapevine products and, more particularly, Rioja wine.	T-138/09 (C-388/10 P rejected)

Finally, cases where only one part has a clear meaning are usually ones where there is a common prefix or suffix, for example:

Sign	Territory	Concept	Case
	DE	'DERMA' may be perceived as referring to goods of a dermatological nature.	B 1 249 467

As explained above, all three exceptions have to be construed narrowly; therefore, where it is not obvious that a part or parts suggest(s) a concrete meaning known to the relevant public, examiners should refrain from looking for these meanings *ex officio*. In the examples below, no concept was found in the signs:



Sign	Territory	Concept	Case
ATOZ	DE, ES, FR, IT, AT	The TM will not be perceived as 'from A to Z'. The letters 'to' (corresponding to an English preposition) do not stand out in any way from the letters 'a' and 'z'.	T-100/06 (C-559/08 P dismissed)
SpagO	BX	The word 'SpagO' is an invented word that has no meaning in any of the official languages of Benelux countries. It should not be perceived as a combination formed by SPA + GO.	T-438/07

CITRACAL --- CICATRAL	ES	The word elements 'cica' and 'citra' do not have any concrete meaning, any more than the endings 'tral' and 'cal'. The signs at issue are, therefore, not likely to be broken down by the public into word elements that have a concrete meaning or resemble words known to it and that, together, would form a coherent whole giving a meaning to each of the signs at issue or to any one of them.	T-277/08
-----------------------------	----	--	----------

3.4.3.3 The semantic content of misspelled words

It is not necessary for a word to be written properly for its semantic content to be perceived by the relevant public. For example, while the written word 'XTRA' is visually not the same as the 'correct' word 'EXTRA', because it is aurally identical to it, the concept of the 'correct' word (extra) will normally be transferred to the misspelled word (xtra).

The following examples illustrate this point:

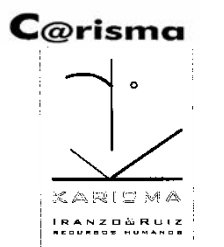
Sign	Territory	Concept	Case
	EU	Part of the relevant public will regard it as a reference to the English word 'store', meaning 'shop, storage'.	T-309/08
CMORE	EN	CMORE will, in view of the common practice of sending text messages, probably be associated by a significant part of the general public in Denmark and Finland with an abbreviation or misspelling of the verb 'to see' in English, with the concept being perceived as 'see more'.	T-501/08 'SEE MORE/CMORE'
	EN	The word 'ugli' in the earlier mark is likely to be associated with the English word 'ugly' by the relevant public.	T-488/07
	EU	The term contained in the mark will bring to consumers' minds the idea of 'yogurt', i.e. 'a semi-solid, slightly sour, food prepared from milk fermented by added bacteria'.	B 1 142 688
	ES	The words 'KARISMA' and 'C@RISMA' refer to 'charisma' or 'charism', i.e. a special personal quality or power of an individual, making him/her capable of influencing or inspiring large numbers of people.	B 1 012 857

Examiners should take care when attaching meaning to a misspelled word: the meaning is not likely to be transferable when the words are not (aurally) identical and/or when the misspelled element cannot be perceived independently:

Mark	Territory	Concept	Case
Bebimil	EU	The mark applied for does not contain the word 'baby' but a fanciful word, which is further removed and without any clear and specific meaning, i.e. 'bebi'.	T-221/06

3.4.3.4 The semantic content of names and surnames

The General Court has accepted that names have a concept. Therefore, a conceptual comparison must be made when conflicting signs are composed of names (see examples below).

Nevertheless, there are few situations where the fact that a trade mark contains a family name has conceptual significance. In particular, conceptual similarity cannot result from the mere fact that both trade marks contain a name, even the same kind of name (Celtic family name, Dutch name, etc.).

Mark	Territory	Concept	Case No
MCKENZIE/ McKINLEY	EU	The relevant public recognises the prefix 'Mc', signifying 'son of', as a prefix to many Scottish or Irish family names. That public will, therefore, regard the word elements of the marks at issue as Celtic family names of no conceptual significance, unless the name is particularly well known as that of a famous person.	T-502/07
VANGRACK/ VAN GRAF	DE	The fact that both marks may be perceived as lower German or Dutch surnames is on its own neutral for comparison purposes.	R 1429/2010-4

The mere fact that two names can be grouped under a common generic term of 'names' does not constitute conceptual similarity. For example, if FRANK and MIKE are compared: the fact that both are names would not lead to a finding of conceptual similarity; this is because the public is not likely to make the conceptual link between the two words. By contrast, the fact that FRANK and FRANKIE are the same name but the latter is the diminutive of the former is relevant and should lead to a finding of conceptual similarity.

Marks	Territory	Concept	Case No
SILVIAN HEACH (FIG.) H. EICH	Italy and other territories	Whereas 'HEACH' would be perceived as a surname of Anglo-Saxon origin, the element 'EICH' would be perceived as a surname of German origin (para. 66). In view of this, the consumers would realise that these surnames distinguish different persons. The signs are conceptually different (para. 69).	T-557/10

The fact that a trade mark contains a name may have an impact on conceptual comparison in the following situations:

- (a) When it is the name/surname of a well-known person (CERVANTES, MARCO POLO, PICASSO):

Mark	Territory	Concept	Case No
PICASSO	EU	The word sign PICASSO has a clear and specific semantic content for the relevant public. The reputation of the painter Pablo Picasso is such that it is not plausible to consider, in the absence of specific evidence to the contrary, that the sign PICASSO as a mark for motor vehicles would, in the perception of the average consumer, override the name of the painter.	T-185/02 (C-361/04 P dismissed)

- (b) Where the two marks represent the same name but in different versions (FRANK, with FRANKIE as a diminutive) or languages, such as in the following examples:

Marks	Territory	Concept	Case No
	EU	The relevant public is certain to regard these as highly similar female names derived from the same root. In certain Member States, notably the United Kingdom, Ireland, Germany and Austria, they will certainly be perceived by the relevant public as diminutives of the full forename Elizabeth.	T-130/09
PEPEQUILLO/PE PE	ES	The Spanish public will understand 'Pepequillo' as a diminutive of 'Pepe', leading to conceptual identity.	T-580/08
JAMES JONES/JACK JONES	EU	Both trade marks may be understood as referring to the same person.	T-11/09

- (c) When both trade marks can be understood as referring to the same person, especially when the earlier trade mark is composed solely of a family name. This could be the case when one name is more important than the other:



Mark	Territory	Concept	Case No
EUTM application: Julián Murúa Entrena Earlier mark: MURUA,	ES	The EUTM application contains a Spanish name (a forename and two surnames). The first surname, which for the Spanish public is the more important one, coincides with the earlier TM.	T-40/03
EUTM application: MANSO DE VELASCO Earlier mark: VELASCO	ES	Velasco is a Spanish surname. The EUTM application can be understood as being composed of two surnames.	T-259/06
EUTM application: Antonio Basile Earlier mark: BASILE	IT	The signs are conceptually similar in that they share the same surname (para. 60).	T-133/09 and T-134/09

- (d) If the name contained in the trade marks is meaningful in some language, the coincidence in this meaning may lead to conceptual similarity:



Mark	Territory	Concept	Case No
peerstorm/PETER STORM	EU, UK	English-speaking consumers will associate the surname Storm with bad weather (para. 67).	T-30/09

3.4.3.5 The semantic content of figurative signs, symbols, shapes and colours

The concepts of marks consisting of or containing figurative elements and marks consisting of shapes (three-dimensional marks) will be what those figurative elements or shapes represent, such as in the following examples:

Mark	Territory	Concept	Case No
	BX, DE, ES, FR, IT, AT, PT	The representation of a red mug on a bed of coffee beans.	T-5/08 to T-7/08
	DE	Part of the relevant public may recognise a peacock.	T-361/08
	BX	The contested trade mark will be described as a businessman playing football.	R 0403/2009-2

Consequently, when a mark has both words and images, all concepts have to be assessed.

Mark	Territory	Concepts	Case No
	EN	The word 'ugli' in the earlier mark is likely to be associated with the English word 'ugly' by the relevant public. A bulldog with a citrus fruit in front of it.	T-488/07
	EU	The term 'Rioja' in the earlier mark, which is itself conceptually strengthened by the representation of a bunch of grapes and a vine leaf, refers directly to grapevine products and, more particularly, to Rioja wine.	T-138/09 (C-388/10 P rejected)
	BL, BX, CY, DE, ES, FR, HU, RO, SK, IT	The mark depicts a type of fish (a shark). The majority of the relevant language speakers will understand the term SPAIN in the contested mark as referring to that country. The word 'Tiburón' means 'shark' in Spanish but will not be understood by the rest of the relevant public. The remaining term, SHARK, will probably be understood by English-speaking consumers in the relevant territories.	B 1 220 724

Finally, the semantic content (concept) of colour marks *per se* is that of the colour they reproduce.



3.4.3.6 The semantic content of numbers and letters

The concept of a word representing a number is the figure it identifies, such as in the example below:

Mark	Territory	Meaning	Case No
	DE	The word zero evokes the cardinal number 0.	T-400/06
TV2000 (fig.)/TV1000	LT	The signs are conceptually similar to the extent that they both share the idea of 'television' combined with a round four-digit number, that furthermore correlate in the order of thousands (para. 47).	R 2407/2011-2
7 (fig.)/7 (fig.)	EU	The BoA found that '7' had a meaning (para. 25).	R 0782/2011-2

The concept of a figure is the number it identifies, unless it suggests another concept such as a specific year.



The Office follows the approach that single letters can have an independent conceptual meaning. The Court has confirmed this approach (judgment of 08/05/2012, T-101/11, G, EU:T:2012:223, § 56, appealed as C-341/12 P, G, EU:C:2013:206), finding conceptual identity where both trade marks can be seen as the same letter:

Mark	Territory	Meaning	Case No
	DE	For the part of the relevant public that interprets the signs as the letter 'e' and the part of the relevant public that interprets them as the letter 'c', the signs are conceptually identical (para. 99).	T-22/10
	EU	The signs were considered conceptually identical (paras 60-61).	T-187/10

3.4.3.7 The semantic content of geographical names

The names of cities, villages, regions and other geographic areas evoke a concept that may be relevant for conceptual comparison if it is likely that the relevant public will recognise them as such. Usually, the general public in Europe is familiar with the names of capitals and bigger cities as well as holiday or travel destinations. If the perception of the public in a particular Member State is relevant, knowledge of the names of small cities and towns in that country can also be assumed.

A lack of evidence or indication that the relevant public recognises the geographical name does not influence the conceptual comparison. See the following example:

Mark	Territory	Concept	Case No
 v 	DE	The result of conceptual comparison is neutral. It is not possible to infer from the appellant's argument that the name Chtaura designates an agricultural area in Lebanon renowned for its agricultural products that this meaning will also be familiar to trade circles in Germany.	R 1213/2008-4

3.4.3.8 The semantic content of onomatopoeias

The analysis of the semantic content of onomatopoeias follows the general rules for conceptual comparison: their concept will be that depicted by the onomatopoeia in question, provided it can be established that it will be recognised as such by the relevant public. For instance, 'WOOF WOOF' represents the bark of a dog for English speakers; 'MUUU' represents the mooing of a cow for Spanish speakers.

Mark	Territory	Concept	Case No
CLICK	DE	Conceptually, the contested mark 'CLICK' is an English onomatopoeia that expresses a short, sharp sound. This word will be readily understood in Germany given its close equivalent in German, 'Klick' (para. 45).	R 1394/2006-2

In some cases, the context in which the onomatopoeia will be used can be decisive for establishing whether the relevant public will recognise its meaning. For instance, in the following case, the Board considered that the relevant public would not interpret the sign 'PSS' as onomatopoeia in the context of information technology services:

Mark	Territory	Concept	Case No
PSS	ES	The applicant's argument that the earlier mark could also be pronounced as an onomatopoeia [prompting another to be quiet] is far-fetched in view of the relevant information technology services at issue and the relevant public, who is accustomed, as noted by the applicant itself, to acronyms in this field (para. 42).	R 1433/2007-2

3.4.4 How to make a conceptual comparison

In essence, when making a conceptual comparison, the examiner has first to determine if the signs have a concept in accordance with the principles described in the previous paragraph.

If none of the signs have any concept, the outcome will be that a **conceptual comparison is not possible**.

If only one of the signs evokes a concept, the outcome will be that the signs are **not conceptually similar**.

When both signs have a concept, the concept(s) will be compared to establish whether the signs are conceptually **identical** or **similar** (i.e. they refer to the same or similar concepts) or **dissimilar** (i.e. the signs refer to different concepts).



The signs will be conceptually dissimilar where there are two words for which a generic term covering both of them exists and/or when the two signs fall under the same general category of signs. If the semantic meanings are too different, the signs may share a general concept, but one so broad that the conceptual relationship is not relevant. In these cases no conceptual similarity will be found. For example:



- The mere fact that the two words or symbols can be **grouped under a common generic term** by no means constitutes a case of conceptual similarity. For example, in the case of ‘Jaguar’ v ‘Elephant’, the fact that both are animals would not lead to a finding of conceptual similarity because the public is not likely to make a conceptual link between the two words. In fact, because the words refer to different animals, they should be considered conceptually dissimilar.
- The same happens when two signs belong to the **same type of mark or word**: the fact that ‘TDI’ and ‘LNF’ are three-letter abbreviations is conceptually irrelevant. The signs should be considered conceptually dissimilar.
- Another example of signs ‘belonging to the same category’ concerns **names** and surnames that have a similar semantic content (see paragraph 3.4.3.4 above). If FRANK and MIKE are compared, the fact that they are both names is conceptually irrelevant (since they are on completely different levels); by contrast, the fact that FRANK and FRANKIE are the same name but the latter is the diminutive of the former is relevant and should lead to a finding of conceptual similarity in that case.

In particular, the marks will be conceptually identical or similar in the following situations.





3.4.4.1 Both marks share a word and/or expression



When the two marks share the same word or expression, the marks will be conceptually similar, as in the following examples:

Earlier sign	Contested sign	Opposition No
		B 1 209 618 (ES)
Similar: the marks share the concept of SOL (= sun: ‘the star that is the source of light and heat for the planets in the solar system’).		
Earlier sign	Contested sign	Case No
BLUE	ECOBBLUE	T-281/07 (C-23/09 P dismissed) (EU)
The marks at issue are conceptually similar because they both refer to the colour blue.		

Earlier sign	Contested sign	Opposition No
T-MUSIC		B 1 081 167 (EU)
The marks above are conceptually similar because both refer to the concept of MUSIC (= 'the art of arranging sounds in time so as to produce a continuous, unified, and evocative composition, as through melody, harmony, rhythm, and timbre').		
Earlier sign	Contested sign	Opposition No
		B 1 220 724 (BL, BX, CY, CZ, DE, ES, FR, HU, RO, SK and IT)
The marks above are conceptually similar because both signs have an image of the same fish (a shark) and a reference to the word SHARK (= 'any of numerous chiefly marine carnivorous fishes of the class Chondrichthyes (subclass Elasmobranchii) ...').		
Earlier sign	Contested sign	Case No
EL CASTILLO	CASTILLO	T-85/02 (ES)
The Court found that the signs were almost identical conceptually.		
Earlier sign	Contested sign	Case No
Servus et al.	SERVO SUO	T-525/10 (EU, IT in particular)
The signs are conceptually similar from the point of view of the average Italian consumer insofar as both signs share a reference to 'servant'. The Court confirmed the BoA finding that the Italian public was likely to perceive the meaning of the Latin word 'SERVUS', given its proximity to the Italian word 'SERVO'.		

As already mentioned, misspellings may also have a semantic content and in such cases can be compared, as in the following examples:

Earlier mark	Contested sign	Case No
		T-485/07 (ES)
For the relevant Spanish public both signs invoke the concept of an olive. There is no evidence that the relevant Spanish consumer will understand the English word 'live'.		
Earlier sign	Contested sign	Opposition No
		B 1 142 688 (EU)
Both marks refer to the word yogurt and consequently share the concept of 'a dairy product produced by bacterial fermentation of milk'.		

Earlier sign	Contested sign	Opposition No
		B 1 012 857 (ES)
<p>The above marks are conceptually similar because they both refer to the concept of 'charisma' (= 'the ability to develop or inspire in others an ideological commitment to a particular point of view').</p>		

3.4.4.2 Two words or terms have the same meaning but in different languages

It is possible for the relevant public to assign a conceptual similarity or even identity in cases of marks with elements in different languages, as long as the meanings of the words in those languages are known to that public.

In the following example, it was found that the marks were conceptually identical because a substantial part of the Portuguese public would understand the words constituting the marks at issue given (i) the close proximity of the English word 'vitamin' to the Portuguese equivalent term 'vitamina', (ii) 'water' is a basic English word likely to be understood by that part of the Portuguese public that has sufficient knowledge of the English language (iii) that 'aqua' is a widespread Latin expression and resembles the Portuguese equivalent term 'água' (paras 56-60):

Earlier mark	Contested sign	Case No
VITAMINWATER (relevant territory Portugal)		T-410/12

As it is the actual understanding of the relevant public that matters, the mere fact that one term is objectively the foreign-language equivalent of the other may not be relevant at all in the conceptual comparison.

Earlier mark	Contested sign	Case No
	LE LANCIER	T-265/09
<p>The relevant territory is Spain. 'El lancero' (in Spanish) means 'le lancier' in French. Conceptually, the GC concluded that the average Spaniard only had a limited knowledge of French and that the expression 'le lancier' did not belong to the basic vocabulary of that language. Conceptually, the signs are not similar.</p>		

3.4.4.3 Two words refer to the same semantic term or variations thereof

There is conceptual identity where synonyms are involved, that is to say where two words exist for the same semantic meaning (invented examples where English is the reference language: baggage/luggage; bicycle/bike; male horse/stallion).





Conceptual similarity was found in the following cases:

Earlier mark	Contested mark	Case No
SECRET PLEASURES	PRIVATE PLEASURES	R 0616/1999-1
	ORPHAN INTERNATIONAL	R 1142/2009-2

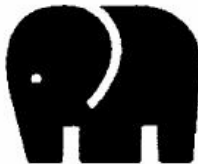
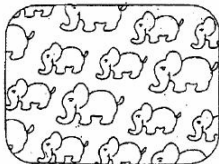

3.4.4.4 Two figurative signs, symbols and/or shapes represent the same object or idea

When two marks consist of or contain figurative elements and/or shapes and they represent the same or similar objects or ideas, the signs will be conceptually identical or similar.



The following are cases where conceptual identity or similarity was found:

Earlier mark	Contested mark	Case No
		T-424/10 (identity)
		R 0703/2011-2 (identity)
		R 1107/2010-2 (identity)

However, the fact that both signs contain the same object does not lead to a finding of conceptual similarity if the way in which the object is depicted in the conflicting trade marks is different.

Earlier mark	Contested mark	Case No
		T-593/10
<p>The GC considered that the Board was right in finding that the signs are conceptually different given that the earlier mark, due to its figurative element and the way in which the letter 'b' is depicted, could evoke a boomerang whereas this is not the case for the mark applied for (para. 36).</p>		

Furthermore, even if both signs contain the same element, they may be found **dissimilar** if they evoke different concepts due to their overall impression:

Earlier mark	Contested mark	Case No
		T-143/11
<p>The mark applied for resembles an armorial emblem recalling the distinctive symbol associated with nobility or guilds used to identify people or professions, whereas the earlier marks are more akin to a seal indicating the mark of a sovereign authority such as that of the State and are designed to certify, or even seal, a particular object. (para. 48).</p>		

3.4.4.5 When there is a word v a figurative sign, symbol, shape and/or colour representing the concept behind the word

Conceptual identity also exists between a word and an image showing what the word represents (fictional examples: word mark 'TIGER' compared with a figurative mark depicting a tiger; or word mark 'orange' and a mark for the colour orange per se).

Earlier mark	Contested mark	Case No
		T-389/03 (EU, identity for part of the public)

3.4.5 Impact of the distinctive and dominant character of the components on the similarity of signs

At each level (visual, phonetic and conceptual) the comparison of signs will lead to a decision as to whether the marks are similar and if so, to what degree. In general, the more commonalities there are between marks, the higher their degree of similarity.

However, this finding depends, first, on whether the coincidence is recognisable or rather remains unnoticed in the overall impression of both marks (paragraph 3.4.5.1 below), and furthermore, on the distinctiveness and dominant character of the common elements (paragraph 3.4.5.2 below), and also the impact of the remaining elements in the overall impression of the marks (paragraph 3.4.5.3 below).

3.4.5.1 Identifiable common element/coincidence

Two marks are similar when, from the point of view of the relevant public, they are at least partly identical as regards one or more relevant aspects (judgment of 23/10/2002, T-6/01, Matratzen, EU:T:2002:261, § 30). The coincidence must be, therefore, 'relevant' from the perspective of the consumer who usually perceives a mark as a whole and does not proceed to analyse its various details (judgment of 13/02/2008, T-146/06, Aturion, EU:T:2008:33, § 58).

The coincidence is clearly perceived when the commonality forms an independent word element or when it is separated in the way of writing (use of an upper case letter, special character, hyphen or other punctuation mark):

Earlier sign	Contested sign	Reason	Case No
BEYOND VINTAGE	BEYOND RETRO	Coinciding first word	T-170/12
SCHUHPARK	JELLO SCHUHPARK	The earlier TM is identical to the second word of the EUTM application.	T-32/03
ip_law@mbp	MBP	The sign '@' separates the earlier mark in 'ip-law' and 'mbp' (para. 53).	T-338/09

Sometimes the graphical representation allows the separation of different elements of the mark and identification:

Earlier sign	Contested sign	Reason	Case No
		The letters 'FLK' have an independent role in the EUTM application due to the red colour (para. 48).	T-19/12

Furthermore, the common word can be identified as such in an isolated manner because of its clear meaning. An average consumer perceiving a word sign will break it down into elements that suggest a concrete meaning or resemble known words (judgment of 06/10/2004, T-356/02, Vitakraft, EU:T:2004:292, § 51, confirmed by C-512/04 P). In the following examples, the common element is a part of a word, but could be identified since the public will logically split the word according to the meaning of its elements:

Earlier sign	Contested sign	Reason	Case No
MARINE BLEU	BLUMARINE	The part 'marine' in the EUTM application will be understood as a reference to the sea and 'blu' as a misspelling of 'blue'.	T-160/12

CADENACOR	COR	The Spanish-speaking public will identify the elements 'cadena' and 'cor' in the earlier TM (para. 47) — likelihood of confusion.	T-214/09
BLUE	ECOBUE	The relevant public will split the EUTM application into the commonly used prefix 'eco' and the word 'blue' (para. 30) — likelihood of confusion.	T-281/07 confirmed by C-23/09 P)

On the contrary, if it remains unnoticed, the mere coincidence in a string of letters is not enough for a finding of similarity. The rule remains that the public compares the marks as a whole and will not artificially dissect them. In the following cases **the similarity of the marks was denied** despite an overlap in some letters (see also paragraph 4 below, 'Dissimilarity of signs', especially paragraph 4.2.4, 'Overlap in other irrelevant aspects'.

Earlier sign	Contested sign	Reason	Case No
AAVA MOBILE	JAVA	The resemblances that result from the presence of the common letters 'ava' are completely offset by the significant differences between those signs (para. 45).	T-554/12
CS	CScreen	The contested sign will probably be broken down into the elements 'C' and 'Screen', which is highly relevant for computers and their peripherals. It will not be perceived as containing the separate entity 'CS' corresponding to the earlier mark.	R 545/2009-4

3.4.5.2 Distinctiveness and dominant character of the common elements

For the conclusion of similarity, the **degree of distinctiveness of the common element** (or elements) must be taken into account. The more distinctive the common element is, the higher the degree of similarity in each aspect of the comparison (visual, phonetic and conceptual). A finding that the common element has a limited distinctiveness will lower the similarity, with the consequence that if the only common element of both marks is non-distinctive, the degree of similarity at all levels of comparison will be low or that even — depending on the impact of the elements that differentiate the marks — the similarity will be entirely denied⁹.

In the following examples, the common element was considered descriptive or otherwise non-distinctive, with the consequence that the level of similarity was considered low:

Earlier sign	Contested sign	Case No
FSA K-FORCE.	FORCE-X	T-558/13

⁹ See paragraph 4.2.5 below, Overlap in a non-distinctive element.



The element 'force' has a weak distinctive character for the goods concerned. Low visual, phonetic and conceptual similarity — no likelihood of confusion.

Earlier sign	Contested sign	Case No
ACTU+	News+	T-591/13

The presence of the '+' sign in both signs cannot generate a visual similarity as this is a mathematical symbol that implies a concept of increase, so it only enjoys a weak distinctive character (para. 29). The signs share a weak similarity on the phonetic side because of the presence of the '+' sign (paras 35-36) — no likelihood of confusion.

Earlier sign	Contested sign	Case No
VISCOPEX	VISCOTECH	T-138/13

As regards the common initial part of the marks 'visco', it is descriptive for the German public with relation to one of the main characteristics of the relevant goods (oils, greases and fuels), namely its viscosity (para. 57). The marks are only vaguely similar visually and phonetically — no likelihood of confusion.

Earlier sign	Contested sign	Case No
		T-60/11

The word premium is laudatory (para. 44). The coincidence leads only to a low visual and phonetic and an average conceptual similarity — no likelihood of confusion.

Earlier sign	Contested sign	Case No
	ULTIMATE GREENS	R-1462/2012-G

The word 'ultimate' is a promotional word used to indicate the superior quality of the latest goods available on the market and, has no distinctive character at all (para. 22). Even if both trade marks share this element, there is only a low visual and phonetic similarity (paras 47-48). No conceptual similarity overall (para. 49) — no likelihood of confusion.

The fact that the coinciding element is a non-distinctive element, does not, however, suffice to deny any similarity between the marks, unless there are further factors differentiating them (see paragraph 4.2.5 below). If the public will notice the overlap, it must be taken into account in the comparison. The fact that an element is descriptive or otherwise non-distinctive is not on its own sufficient to conclude that that word is negligible in the overall impression produced by that mark (judgment of 08/02/2011, T-194/09, Líneas aéreas del Mediterráneo, EU:T:2011:34, § 30).

(For the impact of common weak or non-distinctive components on likelihood of confusion see Chapter 7, Global Assessment).

The conclusion on visual similarity has to be taken further into account **if the common element is dominant** (visually outstanding) or at least co-dominant in the overall impression of the marks. As explained above (see paragraph 3.3) within the assessment of the dominant character of one or more components, the intrinsic

qualities (size, striking graphical representation, etc.) of each of those components have to be compared with the intrinsic qualities of the other components. In addition and accessorially, account may be taken of the relative position of the various components within the arrangement of the composite mark (23/09/2014, T-341/13, So'bio etic, EU:T:2014:802, § 67).

The distinctiveness and dominant character of the common element(s) are separate but co-related terms. According to the Court:

It should also be noted that where some elements of a trade mark are descriptive or non-distinctive, they are not generally regarded by the public as being dominant in the overall impression conveyed by that mark, unless, particularly because of their position or their size, they appear likely to make an impression on consumers and to be remembered by them.



(Judgment of 31/01/2013, T-54/12, Sport, EU:T:2013:50, § 24 and the case-law cited).

3.4.5.3 Importance of additional (not common) elements



Within the comparison of trade marks as a whole, the impact of the non-common elements in their overall impression also has to be taken into account in order to reach a conclusion on similarity. The more differences the remaining elements of the marks present, the lower would be the similarity resulting from the common element.

It cannot be generally assumed that the elements of difference between the marks would tend to become less marked in the consumer's memory in favour of the elements of similarity. In accordance with settled case-law, the extent of the similarity or difference between the signs at issue may depend, in particular, on the inherent qualities of the signs (13/05/2015, T-169/14, Koragel/CHORAGON, EU:T:2015:280, § 84).

The distinctiveness and dominant character of the differentiating elements has to be, therefore, taken into account. If these elements are the distinctive ones and dominate the overall impression of the marks, the level of similarity will decrease:

Earlier sign	Contested sign	Case No
		T-338/12
<p>As regards the visual comparison, the figurative element representing a dog in the earlier mark constitutes the dominant one. Given that the respective graphic elements are different, the coincidence in the word element 'K9' leads to a visual similarity only to a low degree. The marks are phonetically similar to a high degree. As to the conceptual comparison, the contested mark does not contain any figurative element conveying the concept of a dog, the marks are not conceptually similar (paras 27-34).</p>		

On the contrary, if the element in which the marks differ is of less inherent distinctiveness than the common element, this will increase the level of similarity:

Earlier sign	Contested sign	Case No
	 (NEGRA MODELO)	R-0536/2001-3 (confirmed: T-169/02)
The earlier TM was a Portuguese registration. 'Negra' is descriptive for the relevant goods in Class 33, since it may be used in Portuguese to designate brown beer, i.e. the type of beer sold under the trade mark NEGRA MODELO. The attention of the average Portuguese consumer will be focused on the coinciding word 'modelo'. Low visual, average phonetic and strong conceptual similarity — likelihood of confusion.		

3.4.6 Other principles to be taken into account in the comparison of signs

3.4.6.1 Impact of word elements v figurative elements on the visual and conceptual comparison



When signs consist of both verbal and figurative components, in principle, the verbal component of the sign usually has a stronger impact on the consumer than the figurative component. This is because the public does not tend to analyse signs and will more easily refer to the signs in question by their verbal element than by describing their figurative elements (judgment of 14/07/2005, T-312/03 Selenium-Ace, EU:T:2005:289, § 37; decisions of 19/12/2011, R 0233/2011-4, Best Tone, § 24; and 13/12/2011, R 0053/2011-5, Jumbo, § 59).



However, the verbal element of a sign does not automatically have a stronger impact (judgment of 31/01/2013, T-54/12, Sport, EU:T:2013:50, § 40).

Moreover, in assessing the impact of the verbal element of a composite trade mark, account should be taken of the distinctiveness of this element.

- (a) Signs with an identical or very similar verbal element and different figurative elements





When the verbal elements are identical or similar and the figurative element has neither semantic meaning nor striking stylisation, the signs are usually similar. In this scenario, the figurative element will be considered not to have a significant influence in the relevant public's perception of the sign:

Earlier sign	Contested sign	Case No (level of similarity)
<p>(i)</p>  <p>(ii)</p> 	<p>PUKKA</p>	<p>T-483/10 (high visual and phonetic similarity. No conceptual similarity)</p>
<p>G&S: Class 18 Territory: Spain, EU Assessment: The figurative elements of the earlier EU trade mark — namely, the oval and the geometric shape vaguely recalling a five-point star superimposed thereon — do not convey any identifiable conceptual content. Consequently, it is highly unlikely that these figurative elements will hold the attention of the relevant consumer. By contrast, although the verbal element does not convey any conceptual content either, the fact remains that it may be read and pronounced and that it is, therefore, likely to be remembered by consumers. Therefore, the verbal element of the earlier EU trade mark must be considered to dominate the visual impression made by that mark (para. 47).</p>		

Earlier sign	Contested sign	Case No (level of similarity)
		<p>T-216/11 (average visual and high phonetic similarity. No conceptual comparison possible)</p>
<p>G&S: Class 29 Territory: EU Assessment: Visual similarity results from the fact that both have a unique verbal element very similar only differing in the final letter. Both figurative signs had the representation of a bird, an element that added to the similarity of the signs. The signs have little and minor differences only. On the aural comparison both signs have a high degree of aural similarity having only one final letter difference. The conceptual comparison is not relevant as the verbal element of the signs had no meaning in some parts of the European Union (para. 38).</p>		
Earlier sign	Contested sign	Case No
<p>CINEMA 4D</p>		<p>R 1691/2014-2</p>
<p>G&S: Class 9</p>		





Territory: EU
Assessment:
 'In respect of the figurative elements of which the sign is comprised, the Board considers that there is nothing in these elements that adds anything different to the contested sign other than some elements of decoration. The mere addition of banal figurative elements will not affect the perception of the sign by the relevant public' (para. 24).

In contrast, when the common verbal elements are likewise weak or even less distinctive than the figurative elements, the coincidence in the verbal elements leads to only low similarity, if there are differences in the figurative elements:

Earlier sign	Contested sign	Case No (level of similarity)
		T-60/11 (low visual and phonetic and average conceptual similarity)
<p>G&S: Classes 30, 31, 42 <i>Territory: EU</i> <i>Assessment:</i> The similarity of the marks is based solely on a word that has no distinctive character and would not be remembered by consumers as the key element of the marks at issue (para. 53).</p>		
Earlier sign	Contested sign	Case No (level of similarity)
		R 1357/2009-2 (no visual or conceptual similarity, remote phonetic similarity)
<p>G&S: Classes 5, 29, 30, 32 <i>Territory: EU</i> <i>Assessment:</i> The BoA took into account the non-distinctive and descriptive character of the word 'Lactofree' for the relevant goods. The Board found the notable visual and conceptual differences between the signs (para. 98).</p>		

(b) Signs with an identical or very similar figurative element and different verbal elements

In general, the identity or similarity of the figurative component of signs will not lead to a considerable level of similarity where at least one of the signs contains a further verbal component that is not contained in the other sign. The outcome will however depend on the particular circumstances in each individual case.





Earlier sign	Contested sign	Case No (level of similarity)
	 (IBIZA REPUBLIC)	T-311/08 (low visual similarity, phonetic and conceptual dissimilarity)
<p>G&S: Classes 25, 41, 43 Territory: France Assessment: Taking into account the dominant character of the verbal element in the mark applied for, there is no phonetic and conceptual similarity and only a low degree of visual similarity between the signs (para. 58) — no likelihood of confusion.</p>		
Earlier sign	Contested sign	Case No (level of similarity)
		R 0280/2009-4 (visual, phonetic and conceptual dissimilarity)
<p>G&S: Classes 16, 36, 41 Territory: Germany Assessment: The only thing the two signs have in common is that they depict a cross with eight characteristic points, known as a 'Maltese cross', referring to the Order of Malta. Even in the area in question, 'charitable fundraising; education, periodicals; medical services' (Classes 16, 36, 41, 45), the specific Maltese cross shape is not used exclusively by the appellant. The EUTM application contains the unreservedly distinctive word sequence 'Pro concordatia populorum' and cannot be reduced to its figurative element. The signs are also dissimilar phonetically, as the opposing sign has no verbal elements. There is no conceptual similarity, as the EUTM application means 'for the understanding of the peoples', a phrase that has nothing in common with the earlier sign. Therefore, there can be no likelihood of confusion, even in the case of the identical goods found only in Class 16.</p>		

This rule does not apply to the cases where the verbal element is of limited distinctiveness and not dominant:

Earlier sign	Contested sign	Case No (level of similarity)
		Joint R 0068/2001-4 and R 0285/2001-4 (high visual similarity)
<p>G&S: Classes 18, 24, 25, 28 Territory: Benelux, Germany, Spain, France, Italy, Austria Assessment: the wording 'La Maison de la Fausse Fourrure' is not sufficient to reduce the impression of similarity between the conflicting marks. In addition to its possibly descriptive nature, the Board notes that the wording is given, relative to the footprint device, a secondary position (it is placed under the device), a relatively limited size (four times smaller) and a conventional writing style (para. 22).</p>		

- (c) Signs with figurative elements corresponding to the meaning of the verbal elements

The figurative element may ‘cooperate’ with the verbal part in defining a particular **concept** and may even help with the understanding of words that, in principle, might not be widely known to consumers. This will strengthen the conceptual similarity:

Earlier sign	Contested sign	Case No
		B 210 379
<p>G&S: Class 3 Territory: Germany, Spain Assessment: The figure of a moon, present in both signs, made the equivalence between the Spanish and English words ‘LUNA’ and ‘MOON’ clearer to Spanish consumers.</p>		
Earlier sign	Contested sign	Case No
		R 1409/2008-2
<p>G&S: Classes 18, 25, 35 Territory: EU Assessment: Visually, the trade marks are highly similar. An aural comparison is not possible. Conceptually, the word ‘horse’ will be understood by English-speaking consumers as a direct reference to the figurative element of the contested EUTM. Therefore, the marks are conceptually identical.</p>		

3.4.6.2 Beginning of the signs in the visual and phonetic comparison

In word signs or in signs containing a verbal element, the first part is generally the one that primarily catches the consumer’s attention and, therefore, will be remembered more clearly than the rest of the sign. This means that in general the beginning of a sign has a significant influence on the general impression made by the mark (judgments of 15/12/2009, T-412/08, Trubion, EU:T:2009:507, § 40; 25/03/2009 T-109/07, Spa Therapy, EU:T:2009:81, § 30).

Nevertheless, the concept ‘beginning of the sign’ is undetermined, as there is no particular indication of what forms the beginning, what is the end or even if there is or is not a middle part of the sign. Again, this perception mostly depends on the circumstances of the case (length of sign, syllabic distribution, use of typeface, etc.) and not on a set rule. It could even be that a sign is perceived as having a short beginning and ending and a proportionally much larger middle or central part. Consequently, depending on the circumstances, the rule of the relevance of the beginning of the sign could have less weight to the benefit of a more relevant central part.

As it is usually the beginning of a sign that catches consumers’ attention, where signs only differ in their endings, this difference is often insufficient to exclude similarity. However, this is not a fixed rule and the outcome depends on the circumstances of the case. Moreover, this rule only applies when the sign contains a verbal element (which would explain the reading from left to right) and when this verbal element is not very

short (otherwise the sign will be perceived immediately in its entirety). The Office considers signs consisting of three or fewer letters/numbers as very short signs (see in more detail paragraph 3.4.6.3 below).

In principle, coincidences at the beginning of signs increase their similarity more than in the middle or at the end:

Earlier sign	Contested sign	Case No
ALENTIS	ALENSYS	R 1243/2010-1
<p>G&S: Class 42 Territory: Spain Assessment: While both marks do not have any meaning and, thus, no conceptual comparison can be made, the trade marks are visually and phonetically highly similar, in particular because they coincide in their first four letters 'ALEN'. It is generally accepted that people pay more attention to the first part of a trade mark, at least when they perceive the mark visually (para. 33).</p>		
Earlier sign	Contested sign	Case No
AZURIL	AZULIB	R 1543/2010-1
<p>G&S: Class 5 Territory: Greece Assessment: The signs share five of their six letters and the first two syllables are identical. There is a certain degree of visual similarity. Aurally the signs are highly similar as the initial part, which is normally the most important, is identical. Neither sign has a meaning in Greek (paras 35-36).</p>		

However, the degree of similarity will usually be lower, despite identical beginnings, if those are the weak elements in the signs or if the remaining elements have a clearly different meaning:

Earlier sign	Contested sign	Case No
CALSURA	CALSORIN	R 0484/2010-2
<p>G&S: Class 5 Territory: EU Assessment: Visually, the marks share some similarity due to the coinciding letters 'C', 'A', 'L', 'S' and 'R' placed in the same order. Aurally, there is a low degree of similarity. Conceptually, the marks are similar insofar as they both contain the component 'CAL'. However, since this element clearly alludes to the kind of goods (containing 'calcium'), not much weight can be given to this conceptual similarity (paras 21-23) — no likelihood of confusion.</p>		
Earlier sign	Contested sign	Case No
NOBLESSE	NOBLISSIMA	R 1257/2010-4
<p>G&S: Class 30 Territory: Denmark, Finland, Sweden Assessment: The signs differ in the fifth letter and in their ending. They are visually similar to an average degree. In view of the length of the EUTM application, the signs differ in rhythm and intonation and are thus aurally similar to a low degree. The earlier signs 'NOBLESSE' do have a clear connotation in both Finland and Sweden. In these territories, the word 'NOBLISSIMA' lacks any meaning. They are, therefore, conceptually dissimilar. The earlier marks are laudatory in nature and to a certain extent descriptive of the characteristics of the goods 'chocolate', namely describing their superior character. The distinctive character is below average.</p>		
Earlier sign	Contested sign	Case No
ALBUMAN	ALBUNORM	R 0489/2010-2

G&S: Class 5

Territory: EU

Assessment: Visually, phonetically and conceptually the signs are similar insofar as they have the prefix 'ALBU' (abbreviation of 'albumin' or 'albumen') in common. But this similarity is of little significance because the prefix is generic and so devoid of distinctiveness. The second element of the earlier mark, 'MAN', is visually, phonetically and conceptually completely different from the second element, 'NORM', of the contested mark.

3.4.6.3 Short signs

The comparison of signs must be based on the **overall impression** given by the marks.

The length of signs may influence the effect of the differences between them. In principle, the shorter a sign, the more easily the public is able to perceive all its single elements. In contrast, the public is usually less aware of differences between longer signs. **However, each case must be judged on its own merits, having regard to all the relevant factors.**

The Courts have not exactly defined what a short sign is. However, signs with three or less than three letters/numbers are considered by the Office as short signs. The paragraphs below thus analyse the impact on the overall impression, and thus, on the similarity of the respective signs for one-, two- and three-letter/number signs.

The comparison between signs consisting of a single letter or a combination of three or less than three letters not recognisable as a word, **follows the same rules** as that for word signs comprising a word, a name or an invented term (judgments of 06/10/2004, T-117/03 to T-119/03 and T-171/03, NL, EU:T:2004:293, § 47-48; 10/05/2011, T-187/10, G, EU:T:2011:202, § 49).





(a) Single-letter/Single-number signs

It follows from the case-law of the Court that in the assessment of likelihood of confusion between signs comprising the same single letter, **visual comparison** (see paragraph 3.4.1.6 above) is, in principle, decisive. The aural and conceptual identity may be overridden, in the assessment of likelihood of confusion, by sufficient visual differences between the signs (see Chapter 7, Global Assessment, paragraph 7.1, 'Short signs').



(b) Two-letter/number signs

The over-mentioned rule on the importance of visual comparison applies to two-letter/number marks accordingly. The comparison of these signs depends on their stylisation and, especially, on whether the letters are recognisable as such in the sign. Consequently, the visual overall impression of the signs may be different when two conflicting signs, albeit containing or consisting of the same combination of two-letters, are stylised in a sufficiently different way or contain a sufficiently different figurative element, so that their different overall graphical representation eclipses the common verbal element.

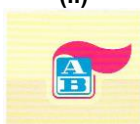

In the following examples, the **marks were found visually similar** due to the graphic representations/visual similarities of the same two-letter combinations:

Earlier sign	Contested sign	Case No
<p>(i)</p>  <p>(ii)</p> 		B 61 046
<p>G&S: Class 36 Territory: Spain Assessment: The overall visual impression of the conflicting marks is that they consist of two letters in an arbitrary figurative design that conveys the same impression. The trade marks are considered similar.</p>		
Earlier sign	Contested sign	Case No
<p>GE</p>		T-520/11
<p>G&S: Classes 6, 7, 9, 11, 17 Territory: UK Assessment: It cannot be excluded that part of the relevant public will interpret the contested mark as the letter combination 'GE' (paras 33-35). The marks are phonetically identical and visually similar to a medium degree. As regards the conceptual comparison, it cannot be excluded that part of the relevant public will interpret the contested mark as the letter combination 'GE'.</p>		

In the following example, **the signs were found visually and phonetically dissimilar** due to the different graphic representation and the fact that they may not be read as the same letters.

Earlier sign	Contested sign	Case No
<p>(i)</p>  <p>(ii)</p> 		R 0082/2011-4
<p>G&S: Class 33 Territory: EU Assessment: From a visual point of view, the graphic stylisation of the earlier marks is very different compared with the contested mark. The mere fact that one or both letters of the marks are identical is not enough to render the marks visually similar. There is no aural similarity if the contested mark will be pronounced as 'B' or 'PB' as in short signs differences have a higher impact on the overall impression than in longer marks. Conceptually, the contested mark and the earlier marks with no additional elements to the letter combination 'AB' do not have a meaning in any of the relevant languages: the conceptual comparison remains thus neutral (paras 17-19).</p>		

As to the difference in one of the letters see the following examples:



Earlier sign	Contested sign	Case No
(i) CX (ii) 	KX	R 0864/2010-2
<p>G&S: Class 7 Territory: EU Assessment: Visually, the initial letters 'K' and 'C' show a clearly different shape and can be considered only visually similar to a low degree. The same degree of similarity — low — applies for the phonetic comparison. Aurally, the signs will be pronounced 'K-X' and 'C-X' respectively, and not as words. Neither of the marks has a conceptual meaning (paras 25-27).</p>		
Earlier sign	Contested sign	Case No
KA		T-486/07
<p>G&S: Classes 9, 11, 12 Territory: EU Assessment: It must be concluded that, for each of the possible perceptions by the relevant public of the mark applied for, that public will perceive significant visual differences for each of the earlier marks (para. 65). Some degree of phonetic similarity between the marks at issue must be recognised, but it is not very high. Without making an error, the Board of Appeal, therefore, could find that the phonetic similarity between the marks at issue was not 'notable' (para. 71). As both marks have no meaning, no conceptual comparison can be made (para. 72).</p>		

(c) Three-letter/number signs

When the signs in conflict are three-letter/number signs, a difference of one letter does not exclude similarity, especially if this letter is phonetically similar.

Earlier sign	Contested sign	Case No
	ELS	T-388/00
<p>G&S: Classes 16, 35, 41 Territory: Germany Assessment: Two of the three letters are identical and in the same sequence; the difference in a single letter does not constitute a significant visual and aural difference. The letters 'E' and 'I' in Germany are pronounced similarly (paras 66-71).</p>		
Earlier sign	Contested sign	Case No
Ran	R.U.N.	T-490/07
<p>G&S: Classes 35, 38, 42 Territory: EU, Germany Assessment: The Court held that the signs in the mind of the relevant consumer, having a good command of the English language, are visually, aurally and conceptually similar (para. 55).</p>		

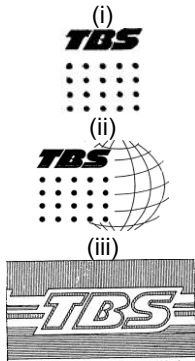
In contrast, when trade marks are composed of only three letters, with no meaning, the difference of one letter may be sufficient to render them not similar:

Earlier sign	Contested sign	Case No
		R 0393/1999-2
<p>G&S: Class 25 Territory: Benelux, Germany, Spain, France, Italy, Portugal, Austria Assessment: In this case the pronunciation of the first letters of the marks in dispute, i.e. 'J' and 'T', is different in all relevant languages. These letters are also visually dissimilar. Furthermore, the figurative elements of the compared marks do not resemble each other (paras 17-18).</p>		
Earlier sign	Contested sign	Case No
	COR	T-342/05
<p>G&S: Class 3 Territory: Germany Assessment: The GC considered that the signs were only aurally similar to a low degree (paras 47 and 50). The relevant public in Germany will certainly notice the differences in the beginning of the signs.</p>		

3.5. Conclusion on similarity

Each aspect of (visual, phonetic and conceptual) the comparison of signs leads to a decision as to whether the marks are similar and if so, to what degree. In general, the more commonalities that exist between marks, the higher the degree of similarity.

An assessment of similarity between two marks means more than taking just one component of a composite trade mark and comparing it with another. On the contrary, the comparison must be made by examining each of the marks in question as a whole, which does not mean that the overall impression conveyed to the relevant public by a composite trade mark may not, in certain circumstances, be dominated by one or more of its components.

The conclusion as to the degree of similarity of the signs at each of the three levels is the result of an evaluation of all of the relevant factors. The main factors that may impact on an assessment of similarity have been explained in the previous paragraphs of this chapter. It should be borne in mind that in an assessment of similarity, the relevant factors (dominance, distinctiveness, etc.) are considered not only for the purpose of determining the common elements of marks, but also to establish any differing and/or additional elements in conflicting signs.

In general, the following should be considered when assessing similarity and degrees of similarity:

- Impact of the distinctiveness of the elements

The greater or lesser degree of distinctiveness of the elements is common to signs, and is one of the relevant factors in assessing the similarity between signs.

For example, if the coincidences between the signs of each of the three aspects of comparison derive from an element with limited distinctiveness, the established degree of visual, aural and/or conceptual similarity will be lower than where the elements in common have a normal distinctiveness.

- Impact of the dominant elements

The conclusion on visual similarity has to be taken further into account if the common element is dominant (visually outstanding) or at least co-dominant in the overall impression of the marks.

It should also be noted that where some elements of a trade mark are descriptive or non-distinctive, they are not generally regarded by the public as being dominant in the overall impression conveyed by that mark, unless, particularly because of their position or their size, they appear likely to make an impression on consumers and to be remembered by them.

It should be emphasised that the abovementioned factors may not be applicable to all cases and the assessment of similarity is always undertaken on a case-by-case basis and a consideration of further factors may be necessary. Furthermore, it should be noted that the above factors and principles do not call into question the principle that the examination of the similarity of trade marks must take into account the overall impression produced by them on the relevant public.

- Impact of word v figurative elements

When signs consist of both verbal and figurative components, in principle, the verbal component of the sign usually has a stronger impact on the consumer than the figurative component. Therefore, if the coincidences between composite signs (signs comprising word and figurative elements) lie within the verbal elements and the differences arise out of the figurative elements, the degree of visual and aural similarity is likely to be higher than average.

In general, the identity or similarity of the figurative component of the signs is insufficient to establish a considerable level of similarity where at least one of the signs contains a further verbal component that is not contained in the other sign.

However, although the word elements of a mark may have a greater impact, this is not necessarily the case where the figurative element visually dominates the overall impression made by the mark.

- Beginning of signs

In principle, coincidences at the beginning of signs increase their similarity more than coincidences in the middle or at the end of signs.

Therefore, consumers attach less importance to the end of the mark and coincidences located at the end of signs would lead to a finding of a lower degree of visual similarity than common elements at the beginning of signs. Likewise, the position of the coinciding/similar phonemes or syllables at the beginning of the conflicting signs would increase the degree of aural similarity.

However, the degree of similarity will usually be lower, despite identical beginnings, if those are the weak elements in the signs or if the remaining elements have a clearly different meaning.

- Short signs

The length of the signs may influence their overall impression and thus the effect of the differences between them. In principle, the shorter a sign, the more easily the public is able to perceive all its single elements. In contrast, the public is usually less aware of differences between longer signs.

The application of the abovementioned principles and factors should not be automatic. The decision has to explain their relevance for the particular case and weigh them up.

However, the rules explained in this chapter have a general character and the particularities of a specific case may justify different findings. However, in such cases it is of even greater importance to provide a clear and thorough reasoning in the decision.

4 Dissimilarity of Signs

4.1 Introduction

The similarity of signs is a necessary condition for a finding of a likelihood of confusion under Article 8(1)(b) EUTMR. An assessment of the similarity between two marks must be based on the **overall impression** created by them, in particular, by their distinctive and dominant components (judgment of 23/10/2002, T-6/01, Matratzen, EU:T:2002:261, § 32 and the case-law cited therein). Where the overall impression is that the signs are dissimilar, this excludes the likelihood of confusion.

The finding as to whether signs are similar or dissimilar overall is the result of a combined assessment of (i) the visual, phonetic, conceptual overlaps and differences and (ii) the significance of the overlaps and differences in the perception of the relevant public.

Where the signs at issue are dissimilar,

- the general rule is that the goods and services do not need to be compared. Only the signs are compared and the examination stops upon concluding on the dissimilarity of the signs.

Nevertheless, reasoning strategy may justify a comparison of some of the goods and services and continue the assessment of the similarity of signs for the remaining goods and services only, where the signs are otherwise dissimilar due to an overlap exclusively in a descriptive or non-distinctive element (see paragraph 4.2.5 below). For example, in the case of long lists of goods and services, it may prove more efficient to first rule on the dissimilarity of some of the goods and services, and continue to the

comparison of the signs (including the assessment of distinctive components in several languages) only for the remaining, shorter list of goods and services.

- any claim of enhanced distinctiveness is not examined. If the signs are dissimilar, the opposition under Article 8(1)(b) EUTMR must be rejected regardless of any enhanced distinctiveness of the earlier mark. Where the marks in question are not similar, there is no need to take account of the reputation of the earlier mark, since it does not fall within the scope of the test of similarity and cannot serve to increase the similarity between those marks (order of 14/03/2011, C-370/10 P, EDUCA Memory game, EU:C:2011:149, § 50-51 and the case-law cited therein).
- there is no global assessment of factors. The decision concludes that in the absence of one of the conditions, the opposition under Article 8(1)(b) EUTMR must be rejected.

4.2 Scenarios for dissimilarity

4.2.1 No element in common



The signs are obviously dissimilar if they have nothing in common in any of the three aspects of comparison. This is more a hypothetical scenario as the signs at issue in an opposition under Article 8(1)(b) EUTMR normally have something in common. What is rather debated by the parties is the significance of the overlap in an element.

4.2.2 Overlap in a negligible element

The signs are dissimilar if the only element they have in common is **negligible** in one or both of the marks in the sense that, due to its size and/or position, it will be likely to go **unnoticed** or **disregarded** by the relevant public. Negligible elements, after **having duly reasoned** why they are considered negligible, will not be compared (judgment of 12/06/2007, C-334/05 P, Limoncello, EU:C:2007:333, § 42). The notion of negligible elements should be strictly interpreted and, in the event of any doubt, the assessment should cover all the elements of the sign (see paragraph 1.5 above).

Concerning the assessment as to whether an element is negligible, the test is not whether the Office can, in a meticulous side-by-side examination of the signs, decipher the element concerned. The question is rather whether, in the overall impression of the sign, the element is noticeable by the average consumer who normally perceives a sign as a whole and does not proceed to analyse its various details.

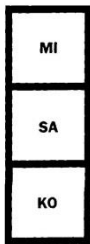
Examples:

Earlier sign	Contested sign	Case No
		<p>T-162/08</p> <p>The words 'by missako' are almost illegible: the size and script make them difficult to decipher</p>
 <p>(RL RÓTULOS LUNA S.A.)</p>	<p>LUNA</p>	<p>R 02347/2010-2</p> <p>The element 'Rótulos Luna S.A.' was considered negligible</p>

4.2.3 Overlap in a verbal element not noticeable due to high stylisation

The signs are dissimilar if the verbal element, which would give rise to similarity, is not discernible due to its high stylisation. Sometimes the way in which letters or symbols are used makes it unrealistic to assume that they will be read and pronounced, for example, when in a figurative mark a symbol or letter is repeated in order to create a pattern or is highly distorted or otherwise not clearly legible. If the verbal element is not recognisable in the overall impression of the sign, thus, not legible and not pronounceable, it will not be taken into account in the comparison.

Again, the test is not whether the Office can, in a meticulous side-by-side examination of the signs, identify the verbal element concerned. It is irrelevant if the verbal element is recognised only with the help of the other mark, as the consumer normally does not have the opportunity to compare signs side by side. Furthermore, it is irrelevant that the party refers to its mark by a particular verbal element in its submissions or if the particulars of the mark indicate a verbal element, because the consumer will not be assisted by that information on encountering the sign as registered or applied for.

Examples:

Earlier sign	Contested sign	Case No
<p>KA</p>		<p>R 1779/2010-4</p>

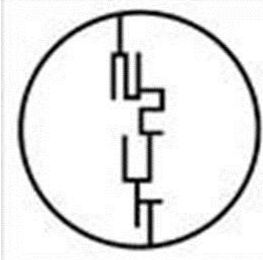
intuit		R 0164/2015-2
---------------	--	---------------

The question whether the verbal element is indeed ‘lost’ in the stylisation must be carefully assessed. The consumer intuitively looks for pronounceable elements in figurative signs by which the sign can be referred to. The high stylisation of one or more letters of a word may not prevent the consumer from identifying the verbal element as a whole, particularly, if it suggests a concrete meaning. It should also be emphasised that if the complex stylisation of the verbal element of a sign does not make it totally illegible, but merely lends itself to various interpretations, the comparison must take into account the different realistic interpretations. Thus, it is only in the — rather rare — case where the legibility of the sign is truly unrealistic, without being assisted by a mark description or the other mark, that the verbal element will be disregarded in the comparison.



4.2.4 Overlap in other irrelevant aspects

The fact that there is some coincidence between the signs does not necessarily lead to a finding of similarity. This is in particular the case when the overlapping part is not perceived independently within the overall impression of the marks. The Court considered the following signs dissimilar despite the overlap in a sequence of letters:

Examples:





Earlier sign	Contested sign	Case No
AAVA MOBILE	JAVA	T-554/12
The resemblances that result from the presence of the common letters ‘ava’ are completely offset by the significant differences between those signs (para. 45).		

Earlier sign	Contested sign	Case No
ALDI		T-240/13
The conflicting signs are visually different. The figurative elements and the additional word ‘foods’, must not be disregarded when comparing the signs (paras 54-55). The overall visual impression of the conflicting signs is clearly different (paras 59-60). The signs are also phonetically different bearing in mind, in particular, the additional element ‘foods’ of the contested mark (para. 64). Finally, the marks are also conceptually not similar (para. 73).		

Earlier sign	Contested sign	Case No
		T-524/11

		
<p>The figurative elements of the earlier figurative marks further distinguish those marks from the mark applied for (para. 36). The signs at issue have a different rhythm of pronunciation (paras 43-44). The words have no meaning, it is not possible to carry out a conceptual comparison (para. 54).</p>		

The same applies to similarities in the figurative elements that are of minor impact:

Earlier sign	Contested sign	Case No
		T-36/13
<p>The figurative elements of the signs have the same outline but will be perceived as different by the relevant public (paras 45-47). The word elements are visually different since they have only two letters in common, which are also placed in distinct positions.</p>		
Earlier sign	Contested sign	Case No
		B 1 837 106
<p>The marks coincide only in that the verbal elements are written in white on a contrasting grey background and the white frame that separates the verbal and the landscape elements in equal parts. These are commonplace figurative elements, omnipresent in marks in virtually all fields of trade. The consumer's attention is not caught by any of these details, but rather by the fanciful term 'tukaş' in the earlier mark and by the word 'Ekonomik' in the contested mark. As the signs visually overlap only in irrelevant aspects and have nothing in common aurally and conceptually, they are dissimilar overall.</p>		

The decision must contain a thorough reasoning, in the comparison of signs, as to why the overlap in particular aspects is considered irrelevant.

4.2.5 Overlap in a non-distinctive element

If the signs overlap exclusively in an element that is **descriptive** or otherwise **non-distinctive** for the relevant goods and services in all parts of the relevant territory, and they contain other distinctive element(s) capable of differentiating between the signs, they can be considered dissimilar.

It follows that two signs may be dissimilar for part of the goods and services but not for others. If in part of the relevant territory the overlapping element is not perceived as descriptive or non-distinctive (e.g. due to non-understanding of the term), the signs cannot be considered dissimilar.

Invented examples:

Earlier sign	Contested sign
HOTEL FRANCISCO	HOTEL PARIS
<i>Goods and services:</i> provision of accommodation <i>Territory:</i> European Union	
CASA ENRIQUE	CASA RACHEL
<i>Goods and services:</i> provision of restaurant services <i>Territory:</i> Spain (where 'casa' has also the meaning 'bar', 'restaurant')	
MARKET.COM	FITNESS.COM
<i>Goods and services:</i> telecommunications services <i>Territory:</i> European Union	

Examples from case-law:

Earlier sign	Contested sign	Case No
	CARBON CAPITAL MARKETS	T-563/08 (paras 39-61)
<i>Goods and services:</i> Class 36 <i>Territory:</i> European Union (relevant public considered to be familiar with basic English financial terminology) The common element 'capital markets' directly describes the services.		
MAX&Co.	M&Co.	T-272/13
<i>Goods and services:</i> Classes 25 and 35 <i>Territory:</i> European Union <i>Assessment:</i> The common element '&Co.' is non-distinctive and always used in the same position — after the distinctive part of the company name.		

However, despite a lack of distinctive character of the elements in common, it would not be appropriate to conclude on dissimilarity, where

- the particular combination of the elements confer distinctiveness on the signs (i.e. the combination would be protected);
- the other element that is supposed to distinguish between the signs is (i) perceived as an insignificant figurative detail, or is (ii) otherwise non-distinctive;
- the non-distinctive elements constituting (forming exclusively) the sign are entirely incorporated in the other sign.

In summary, the finding of 'dissimilar overall' on account of an overlap exclusively in non-distinctive elements should be limited to evident cases where the other element serves to safely distinguish between the signs.

Less evident cases should not be solved at the stage of the comparison of signs, but rather in the global assessment (see the Guidelines, Part C, Opposition, Section 2, Double Identity and Likelihood of Confusion, Chapter 7, Global Assessment, paragraph 6, Impact of weak or non-distinctive elements on likelihood of confusion, subparagraph 6.2, Common elements with no distinctiveness).

***GUIDELINES FOR EXAMINATION OF
EUROPEAN UNION TRADE MARKS***

***EUROPEAN UNION INTELLECTUAL
PROPERTY OFFICE
(EUIPO)***

PART C

OPPOSITION

SECTION 2

***DOUBLE IDENTITY AND
LIKELIHOOD OF CONFUSION***

CHAPTER 5

DISTINCTIVENESS OF THE EARLIER MARK

Table of Contents

1	General Remarks	3
2	Assessment of Distinctiveness of the Earlier Mark.....	3
2.1	General issues	4
2.1.1	Distinctiveness.....	4
2.1.2	Inherent and enhanced distinctiveness	5
2.1.3	Relevant point in time	6
2.1.4	Relevant goods and services	6
2.2	Examination of inherent distinctiveness of the earlier mark.....	6
2.2.1	General principles.....	6
2.2.2	Specific themes	7
2.2.2.1	One-letter signs, numerals and short signs	7
2.2.2.2	Collective marks	9
2.3	Examination of enhanced distinctiveness.....	9

1 General Remarks

The European Court of Justice (the Court) held in its judgment of 29/09/1998, C-39/97, Canon, EU:C:1998:442, § 18 and 24:

... marks with a highly distinctive character, either *per se* or because of the reputation they possess on the market, enjoy broader protection than marks with a less distinctive character.

... the distinctive character of the earlier trade mark, and in particular its reputation, must be taken into account when determining whether the similarity between the goods or services covered by the two trade marks is sufficient to give rise to the likelihood of confusion.

It is important to distinguish between (i) the analysis of the distinctive character of the earlier mark as a whole, which determines the scope of protection afforded to that mark, and (ii) the analysis of the distinctive character of a component of the marks within their comparison¹.

Whereas distinctive character must be assessed for the components of both the earlier mark and the contested mark, distinctiveness of the mark as a whole is assessed only in respect of the earlier mark². The distinctiveness of the contested mark as a whole is not relevant, as such, to the assessment of likelihood of confusion, as explained in more detail in paragraph 2.1.2 below. Therefore, any reference below to the distinctiveness of the mark **as a whole** refers exclusively to the earlier mark.

The impact of the distinctiveness of the earlier mark **as a whole** comes into play when the global assessment is conducted, because the Court has held that it is not appropriate to take account of what may be a low or high degree of distinctiveness of the earlier mark at the stage of assessing the similarity of the signs (judgments of 23/01/2014, C-558/12 P, Western Gold, EU:T:2012:1257, § 42-45; 25/03/2010, T-5/08 and T-7/08, Golden Eagle/Golden Eagle Deluxe, EU:T:2010:123, § 65; 19/05/2010, T-243/08, EDUCA Memory game, EU:T:2010:210, § 27).

2 Assessment of Distinctiveness of the Earlier Mark

The Canon judgment makes clear that (i) the more distinctive the earlier mark, the greater will be the likelihood of confusion and (ii) earlier marks with a highly distinctive character because of the reputation they possess on the market, enjoy broader protection than marks with a less distinctive character. Consequently, the distinctive character of the earlier mark as a whole determines the strength and breadth of its protection and must be taken into consideration for the purposes of assessing likelihood of confusion (but not for assessing similarity between the marks — see ‘Western Gold’ et al. above).

¹ See the Guidelines, Part C, Section 2, Double Identity and Likelihood of Confusion, Chapter 3, Comparison of the Signs.

² See also Objective 1 of the Common Practice on the impact of non-distinctive/weak components on likelihood of confusion agreed within the framework of the European Trade Mark and Design Network (ETMDN).

2.1 General issues

2.1.1 Distinctiveness

The Court has defined distinctiveness in the following manner:

In determining the distinctive character of a mark and, accordingly, in assessing whether it is highly distinctive, the national court must make an overall assessment of the **greater or lesser capacity of the mark to identify the goods or services for which it has been registered as coming from a particular undertaking, and thus to distinguish those goods or services from those of other undertakings** (emphasis added).

(Judgment of 22/06/1999, C-342/97, Lloyd Schuhfabrik, EU:C:1999:323, § 22).

Importantly, distinctive character is a matter of degree and, when analysing distinctiveness, a sliding scale applies, whereby a sign can lack distinctiveness entirely, be highly distinctive or be at any point in-between.

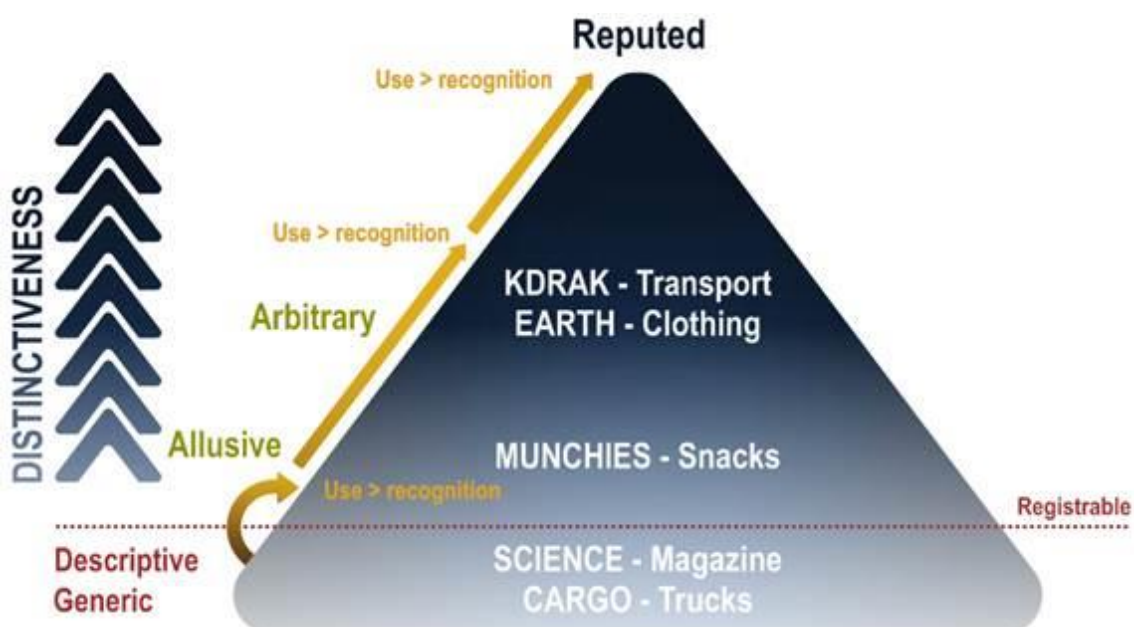

A sign is **not distinctive** if it is exclusively descriptive of the goods and services themselves or of the characteristics of those goods and services (such as their quality, value, purpose, provenance, etc.) and/or if its use in trade is common for those goods and services. Similarly, a sign that is generic (such as a common shape of a container or a common colour) will also lack distinctiveness.

A sign may be **distinctive to a low degree** if it alludes to (but is not exclusively descriptive of) characteristics of the goods and services. If the allusion to the goods and services is sufficiently imaginative or clever, the mere fact that there is an allusion to characteristics of the goods and/or services might not materially affect distinctiveness. For example:

- 'Billionaire' for *gaming services* is allusive in a manner that would affect distinctiveness, because it implies for instance that you may become a billionaire.

- ‘Billy O’Naire’, which sounds identical to ‘billionaire’ in English, would be allusive for *gaming services* as a clever wordplay on Irish names, in a manner that would not affect distinctiveness in a material way; it would be considered to have a ‘normal’ degree of distinctiveness.

A sign that is neither descriptive nor allusive is deemed to possess a **‘normal’ degree of inherent distinctiveness**. This means that the sign in question is fully distinctive, in the sense that its capacity to identify the goods and services for which it has been registered as coming from a particular undertaking is not in any way diminished or impaired.

Any **higher degree of distinctiveness** acquired by the earlier mark has to be proven by its proprietor by submitting appropriate evidence (see paragraph 2.3 below). A mark will not necessarily have a higher degree of distinctive character just because there is no conceptual link to the relevant goods and services (order of 16/05/2013, C-379/12 P, H/Eich, EU:C:2013:317, § 71).

Likewise, a EUTM applicant may argue that the earlier sign is distinctive to a low degree. One of the most frequent arguments brought by applicants is that the earlier trade mark or one of its components has low distinctive character given that there are many trade marks that consist of, or include, the element in question. Where this argument is supported only by the applicant’s referring to trade mark registrations, the Office takes the view that the existence of several trade mark registrations is not per se particularly conclusive, as it does not necessarily reflect the situation in the market. In other words, on the basis of register data only, it cannot be assumed that all the trade marks have been effectively used.

It follows that the evidence filed must demonstrate that consumers have been exposed to widespread use of, and become accustomed to, trade marks that include the element in question in order to prove that this element has a low degree of distinctive character.

When dealing with the distinctiveness of the **earlier mark as a whole**, the latter should always be considered **to have at least a minimum degree of inherent distinctiveness**. Earlier marks, whether EUTMs or national marks, enjoy a ‘presumption of validity’. The Court made it clear, in its judgment of 24/05/2012, C-196/11, F1-Live, EU:C:2012:314, § 40-41, that ‘in proceedings opposing the registration of a European Union trade mark, the validity of national trade marks may not be called into question’. The Court added that ‘it should be noted that the characterisation of a sign as descriptive or generic is equivalent to denying its distinctive character’³.

2.1.2 Inherent and enhanced distinctiveness

The Office must consider, as a first step, the overall **inherent distinctiveness** of the earlier mark (see paragraph 2.2 below) and, as a second step, if claimed and relevant for the outcome, whether the earlier mark has **acquired enhanced distinctiveness** as a consequence of the use the opponent has made of it (see paragraph 2.3 below).

³ See also Objective 1 of the Common Practice on the impact of non-distinctive/weak components on likelihood of confusion agreed within the framework of the ETMDN.

The degree of distinctiveness of the earlier sign is one of the factors to be taken into account in the overall assessment (judgment of 11/11/1997, C-251/95, Sabèl, EU:C:1997:528, § 23). It is a matter of law, which must be examined by the Office even if the parties do not comment on it. In contrast, the degree of enhanced distinctiveness acquired through use of the earlier sign is a matter of law **and** fact, which the Office cannot examine unless the opponent claims and substantiates it in due time (see the Guidelines, Part C, Opposition, Section 1, Procedural Matters, paragraph 4.2, Substantiation).

The inherent distinctiveness of the **contested** trade mark **as a whole** is not examined within the framework of the opposition proceedings, as it is the scope of protection of the earlier mark that is relevant for the purposes of likelihood of confusion. Likewise, the enhanced distinctiveness of the contested sign is also irrelevant because likelihood of confusion requires a consideration of the scope of protection of the earlier mark rather than that of the mark applied for. If an earlier mark is recognised as having a broader scope of protection by reason of its enhanced distinctiveness, the reputation acquired by the **mark applied for** is, as a matter of principle, irrelevant for the purpose of assessing likelihood of confusion (judgment of 03/09/2009, C-498/07 P, La Española, EU:C:2013:302, § 84).

2.1.3 Relevant point in time

The inherent distinctiveness of the earlier mark(s) should be assessed at the time of the decision. The enhanced distinctiveness of the earlier trade mark(s) (if claimed) should exist (i) at the time of filing of the contested EUTM application (or any priority date) **and** (ii) at the time of the decision.

2.1.4 Relevant goods and services

The assessment of the **inherent distinctiveness** of the earlier mark is carried out only for the goods or services that have been found to be identical or similar to the contested goods and services.

Assessment of the **enhanced distinctiveness** of the earlier mark is carried out only in respect of the goods or services protected by the sign for which enhanced distinctiveness is claimed.

Furthermore, it is the perception of the relevant public for these goods and services that is of relevance (e.g. whether a specialist public is involved or not).

2.2 Examination of inherent distinctiveness of the earlier mark

2.2.1 General principles

The first step in examining the distinctiveness of the earlier mark is to examine its inherent distinctiveness. The same rules and principles apply as those for the examination of distinctiveness of components, in terms of the relevant public and its linguistic and cultural background, relevant territory, relevant goods and services, etc. (see Chapter 4, paragraph 3.2 of this Section).

At the stage of determining the distinctiveness of the earlier mark as a whole, distinctiveness of its various components (or its only component) has already been established in the section on comparison of signs. In principle, if an earlier mark contains a normally distinctive component, then the inherent distinctiveness of such an earlier mark as a whole is also normal, regardless of the possible presence of other non-distinctive or weak components. If the most distinctive component of the earlier mark is distinctive only to a low degree, then in principle the overall inherent distinctiveness of that mark will be no more than low.

As mentioned above, earlier registered trade marks are presumed to have **at least a minimum degree** of inherent distinctiveness⁴, even where persuasive evidence is submitted to challenge this presumption. If the EUTM applicant proves that it has started a cancellation action against the earlier registered mark, then it might be necessary to suspend the opposition proceedings pending the outcome of said action.

The outcome of the examination of inherent distinctiveness of the earlier mark as a whole will be one of the following.

- The earlier mark has **less than normal distinctiveness** because, as a whole, it is allusive (in a way that materially affects distinctiveness) or laudatory of the characteristics of identical or similar goods or services (or because it is otherwise weak). As set out above, the Office will not conclude that an earlier mark as a whole is descriptive and/or non-distinctive.
- The earlier mark has **normal distinctiveness** because, as a whole, it is not descriptive, allusive (in a way that materially affects distinctiveness) or laudatory (or is not otherwise weak) in relation to identical or similar goods or services.

It should be noted that it is Office practice, when an earlier mark is not descriptive (or is not otherwise non-distinctive), to consider it as having no more than a normal degree of inherent distinctiveness. As indicated above, this degree of distinctiveness can be further enhanced if appropriate evidence is submitted showing that a higher degree of distinctiveness of the earlier mark has been acquired through use or because it is highly original, unusual or unique (26/03/2015, T-581/13, Royal County of Berkshire POLO CLUB (fig.)/BEVERLEY HILLS POLO CLUB *et al.*, EU:T:2015:192, § 49, last alternative). It should, however, be recalled that a mark will not necessarily have a higher degree of distinctive character just because there is no conceptual link to the relevant goods and services (order of 16/05/2013, C-379/12 P, H/Eich, EU:C:2013:317, § 71).

2.2.2 Specific themes

2.2.2.1 One-letter signs, numerals and short signs

The Court, in its judgment of 09/09/2010, C-265/09 P, α , EU:C:2010:508 held that the distinctiveness of single-letter trade marks must be assessed according to an examination based on the facts, focusing on the goods or services concerned and the **same criteria that apply to other word marks** (paragraphs 33-39). Although that judgment deals with absolute grounds, the Office considers that the principle established by the Court (i.e. that the application of the criterion of distinctiveness must

⁴ See the judgment of 24/05/2012, C-196/11, F1-Live, EU:C:2012:314, cited in paragraph 2.1.1 above.

be the same for all marks) also applies in *inter partes* cases when it comes to determining the distinctiveness of single-letter trade marks.

The Court, while acknowledging that it may prove more difficult to establish distinctiveness for marks consisting of a single letter than for other word marks, held that these circumstances do not justify laying down specific criteria supplementing or derogating from application of the criterion of distinctiveness as interpreted in the case-law.

The Office considers the ruling to mean that, when establishing the distinctiveness of an earlier mark, it is not correct to rely on assumptions such as a priori statements that consumers are not in the habit of perceiving single letters as trade marks or on generic arguments such as that relating to the availability of signs, given the limited number of letters.

The General Court has since stated in a number of cases that a trade mark containing a **single letter** or a single numeral may indeed be inherently distinctive (judgments of 08/05/2012, T-101/11, G, EU:T:2012:223, § 50; 06/10/2011, T-176/10, Seven for all mankind, EU:T:2011:577, § 36; 05/11/2013, T-378/12, X, EU:T:2013:574, § 37-51).

In its judgment of 10/05/2011, T-187/10, G, EU:T:2011:202, the General Court dismissed the applicant's argument that single letters are generally per se devoid of distinctive character and that therefore only their graphic representation would be protected (see paragraphs 38 and 49).

Consequently, whilst registered **earlier trade marks consisting of a single letter (or numeral) represented in standard characters** enjoy a presumption of validity, ultimately their degree of inherent distinctiveness will have to be assessed with reference to the goods and/or services concerned.

If the corresponding claim is made, account should be taken of evidence submitted by the opponent that demonstrates that its registered trade mark consisting of a single letter has acquired **enhanced distinctiveness**. This circumstance could lend the earlier trade mark a broader scope of protection.

The above considerations apply both to single-letter/-numeral trade marks represented in standard characters (i.e. word marks) and to stylised single-letter/-numeral trade marks.

Where the opponent has successfully proven that its single-letter trade mark has acquired enhanced distinctiveness through intensive use, the impact thereof on the final outcome has to be carefully assessed. Firstly, enhanced distinctiveness on the part of the earlier single-letter trade mark cannot justify a finding of likelihood of confusion if the overall visual impression conveyed by the signs is so different as to safely set them apart. Secondly, if the evidence shows use of a single-letter trade mark that is stylised or accompanied by additional figurative elements, the benefit of the resulting broader scope of protection accrues to the form in which it was used and not to the single letter as such or any other stylised variation.

Furthermore, in accordance with the 'α' judgment, as regards **short signs**, unless a letter combination, as such, is intrinsically non-distinctive for the goods and services (e.g. 'S' or 'XL' for goods in Class 25), these signs are not necessarily distinctive only to a low degree. The same rules apply to numerals.

2.2.2.2 Collective marks

Where the mark on which the opposition is based is a collective mark, its inherent distinctiveness is to be assessed in the usual way. The mark may have a low or even very low degree of inherent distinctiveness when it refers to the nature or other characteristics of the goods concerned. The fact that the mark is a collective mark does not imply that its scope of protection is broader (judgments of 13/06/2012, T-534/10, Hellim, EU:T:2012:292, § 49-52 and 05/12/2012, T-143/11, F.F.R. EU:T:2012:645, § 61).

2.3 Examination of enhanced distinctiveness

After the obligatory **examination of inherent distinctiveness** (see paragraph 2.1.3 above), the second step is to check — provided the opponent has made the corresponding claim⁵ — whether the earlier mark has acquired enhanced distinctiveness at the time of filing (or priority date) of the contested EUTM application as a consequence of the use that the opponent has made of it.

The distinctiveness of the earlier mark always has to be taken into account when deciding on likelihood of confusion. The more distinctive the earlier trade mark, the greater will be the likelihood of confusion (judgment of 11/11/1997, C-251/95, Sabèl, EU:C:1997:528, § 24). Therefore, marks with a highly distinctive character, enjoy broader protection than marks with a less distinctive character (judgment of 29/09/1998, C-39/97, Canon, EU:C:1998:442, § 18).

In practice, this means that the fact that an earlier trade mark enjoys enhanced distinctive character or reputation is an argument in favour of finding likelihood of confusion.

Enhanced distinctiveness requires recognition of the mark by the relevant public. This recognition may enhance the distinctiveness of marks with little or no inherent distinctiveness or those that are inherently distinctive.

Earlier mark	Contested sign	Case No
CRISTAL		R 0037/2000-2
<p>G&S: Class 33 Territory: France Assessment of the earlier mark 'CRISTAL': 'As regards the claim that 'Cristal' is a descriptive word for the goods at issue (sparkling wines with crystalline character), the Board cannot accept it. On the one hand, it is an evocative indication which suggests the crystalline character of wines, but which in no way describes the product. On the other hand, [the Board] considers that a highly distinctive character of the mark CRISTAL on the French market had been shown' (paragraph 31)</p>		

⁵ See the Guidelines, Part C, Opposition, Section 1, Procedural Matters.

The Court has given some guidance in respect of the evaluation of distinctiveness acquired through use of the earlier mark and provided a non-exhaustive list of factors:

In making that assessment, account should be taken, in particular, of the inherent characteristics of the mark, including the fact that it does or does not contain an element descriptive of the goods or services for which it has been registered; the market share held by the mark; how intensive, geographically widespread and long-standing use of the mark has been; the amount invested by the undertaking in promoting the mark; the proportion of the relevant section of the public which, because of the mark, identifies the goods or services as originating from a particular undertaking; and statements from chambers of commerce and industry or other trade and professional associations.

(Judgment of 22/06/1999, C-342/97, Lloyd Schuhfabrik, EU:C:1999:323, § 23)

The evidence of enhanced distinctiveness acquired through use must refer to both (i) the relevant geographical area and (ii) the relevant goods and services. The opponent may claim enhanced distinctive character of the earlier mark for only part of the registered goods and services. According to the evidence submitted, the Office must establish precisely for which goods and services distinctiveness has been acquired. The nature, factors, evidence and assessment of enhanced distinctiveness are the same as for reputation. For further details on the evidence required and its assessment see the Guidelines, Part C, Opposition, Section 5, Trade Marks with Reputation (Article 8(5) EUTMR).

However, a finding of reputation requires that a certain threshold of recognition be met whilst, as set out above, the threshold for a finding of enhanced distinctiveness may be lower.

Enhanced distinctiveness is anything above inherent distinctiveness.

Earlier mark	Contested sign	Case No
EL COTO	<p style="text-align: center;">Coto D'Arcis</p> 	T-332/04
<p><i>G&S: Classes 33, 35, 39</i> <i>Territory: EU</i> <i>Assessment of the enhanced distinctiveness of the trade mark 'EL COTO':</i> The Board of Appeal took into account the market knowledge of the earlier mark 'EL COTO' and made a proper assessment of the relevant case-law principles to conclude that the earlier mark 'EL COTO' has a highly distinctive character; it based its finding on the following facts: the certificate issued by the Secretary General of the Consejo Regulador de la Denominación de Origen Calificada 'Rioja', which certifies that the owner markets its wines, among others, under the brand names 'El Coto' and 'Coto de Imaz' since 1977 and that these marks 'enjoy a significant well-known character' in Spain, various decisions of the Spanish Patent and Trade Mark Office acknowledging that the mark 'EL COTO' is well known in Spain, a document on sales evolution, indicating that they had sold under the mark 'El Coto' 339,852, 379,847, 435,857 and 464,080 boxes of twelve bottles of wine in 1995, 1996, 1997 and 1998, respectively' (paragraph 50).</p>		

Importantly, acquisition of enhanced distinctive character by a mark may be a result of its use as part of another registered trade mark (judgments of 07/07/2005, C-353/03, *Have a break*, EU:C:2005:432, § 30-32; and 07/09/2006, T-168/04, *Aire Limpio*, EU:T:2006:245, § 74).

The outcome of the examination of enhanced distinctiveness will be one of the following.

- Where there is no evidence of enhanced distinctiveness as regards the relevant goods and services or the territory, or the evidence is insufficient, the level of distinctiveness of the earlier mark will be its inherent distinctiveness (less than normal or normal).
- Where there is evidence of enhanced distinctiveness as regards all or some of the relevant goods and services and the territory, and the evidence is sufficient:
 - if the earlier mark has less than normal inherent distinctiveness, the mark/component may have acquired a normal or even a high degree of distinctiveness, depending on the evidence submitted⁶; or
 - if the earlier trade mark has normal inherent distinctiveness, it may have acquired high distinctiveness.

It must be recalled that although a mark as a whole may have acquired enhanced distinctiveness, there may be descriptive elements that will have less than normal or no distinctiveness. For example, the enhanced distinctiveness of the mark ‘Coca Cola’ as a whole does not alter the fact that the element ‘Cola’ remains entirely descriptive for certain products.

⁶ For further details on the evidence required and its assessment see the Guidelines, Part C, Opposition, Section 5, Trade Marks with Reputation (Article 8(5) EUTMR).

***GUIDELINES FOR EXAMINATION OF
EUROPEAN UNION TRADE MARKS***

***EUROPEAN UNION INTELLECTUAL
PROPERTY OFFICE
(EUIPO)***

PART C

OPPOSITION

SECTION 2

***DOUBLE IDENTITY AND
LIKELIHOOD OF CONFUSION***

CHAPTER 6

OTHER FACTORS

Table of Contents

1. Introduction.....	3
2. Family of Marks/Series of Marks	3
3. Coexistence of the Conflicting Marks on the Market in the Same Territory.....	6
3.1. Coexistence between the marks involved in the opposition	6
4. Incidences of Actual Confusion	8
5. Prior Decisions by EU or National Authorities Involving Conflicts Between the Same (or Similar) Trade Marks	9
5.1. Prior Office decisions.....	9
5.2. Prior national decisions and judgments	10
6. Irrelevant Arguments for Assessing Likelihood of Confusion	11
6.1. Specific marketing strategies.....	11
6.2. Reputation of EUTM application	11

1. Introduction

The Office normally examines the most salient and habitually relevant factors relating to likelihood of confusion under separate headings before the chapter on Global Assessment. These factors have been treated in the preceding chapters of these Guidelines.

However, Global Assessment also takes into account **other factors, based on arguments and evidence submitted by the parties**, which are relevant for deciding on likelihood of confusion. This chapter deals with the frequent arguments/claims raised by the parties.

2. Family of Marks/Series of Marks

When an opposition to a EUTM application is based on several earlier marks and those marks display characteristics that give grounds for regarding them as forming part of a single 'series' or 'family', a likelihood of confusion may be created by the possibility of association between the contested trade mark and the earlier marks forming part of the series. The Courts have given clear indications on the two cumulative conditions that have to be satisfied (judgment of 23/02/2006, T-194/03, Bainbridge, EU:T:2006:65, § 123-127, confirmed by judgment of 13/09/2007, C-234/06 P, Bainbridge, EU:C:2007:514, § 63).

- Firstly, the proprietor of a series of earlier marks must submit **proof of use** of all the marks belonging to the series or, at the very least, of a number of marks capable of constituting a 'series' (i.e. at least three).
- Secondly, the trade mark applied for must **not only be similar** to the marks belonging to the series, but must also display characteristics capable of **associating** it with the series. Association must lead the public to believe that the contested trade mark is also part of the series, that is to say, that the goods and services could originate from the same or connected undertakings. This may not be the case where, for example, the element common to the earlier series of marks is used in the contested trade mark, either in a different position from that in which it usually appears in the marks belonging to the series, or with a different semantic content.

The argument that there is a 'family of marks' must be claimed before the expiry of the **time limit set for substantiating the opposition**. The opponent must prove within the same time limit that it has used the marks forming the alleged family in the marketplace to such an extent that the relevant public has become familiar with this family of marks as designating the goods and/or services of a particular undertaking.

A positive finding that the opponent has a family of marks entails **the use of at least three marks**, the minimum threshold for such an argument to be taken into due consideration. Proof of use relating to only two trade marks cannot substantiate the existence of a series of marks.

Normally, the trade marks constituting a 'family' and used as such are all registered marks. However, it cannot be precluded that the 'family of marks' doctrine may include **non-registered trade marks** as well.

When the opponent has proven the existence of a family of marks, it would be wrong to compare the contested application individually with each of the earlier marks making up the family. Rather, the assessment of similarity **should be conducted to make a comparison between the contested mark and the family taken as a whole**, in order to establish if the contested sign displays those characteristics that are likely to trigger in the consumers' minds the association with the opponent's family of marks. In fact, an individual comparison between the conflicting signs might even lead to a finding that the signs are not sufficiently similar to lead to a likelihood of confusion, whereas the association of the contested sign with the earlier family of marks might be the decisive factor that tips the balance to a finding of likelihood of confusion.

An assumption of a family of marks on the part of the public requires that the **common denominator of the contested application and the earlier family of marks must have a distinctive character**, either per se or acquired through use, to allow a direct association between all of these signs. Likewise, there will be no assumption of a family of marks where the further components of the earlier signs have a greater impact in the overall impression of those signs.

Earlier signs	Contested sign	Case No
Ophtal, Crom-Ophtal, Visc-Ophtal, Pan-Ophtal	ALERGOFTAL	R 0838/2001-1
<p>G&S: Class 5 Territory: Germany Assessment: The Board held that the differences between the signs were such as to exclude the likelihood that the contested mark would be perceived as belonging to the opponent's family of marks (assuming the existence of this had been established). In particular, the Board considered that, whereas the claimed 'series' depended upon the presence in every case of the suffix '-ophtal' (and not 'oftal') preceded by a hyphen, the contested sign did not contain exactly the same suffix nor reflect exactly the same principles of construction. When 'ophtal' is combined with 'Pan-', 'Crom-' and 'Visc-', these partly disjointed prefixes become of greater distinctive value, affecting quite significantly the overall impression made by each of the marks as a whole, and in each case providing initial elements quite clearly different from the first half – 'Alerg' – of the mark applied for. The German consumer, upon seeing 'Alergoftal' would not think of dividing it into two elements, as opposed to being invited to do so when encountering marks made up of two elements separated by a hyphen (paragraphs 14 and 18).</p>		
Earlier signs	Contested sign	Case No
TIM OPHTAL, SIC OPHTAL, LAC OPHTAL etc.	OFTAL CUSI	T-160/09
<p>G&S: Class 5 Territory: EU Assessment: The element 'Ophtal', which denotes ophthalmologic preparations, is a weak element in the family of marks. The elements TIM, SIC and LAC are the distinctive elements (paragraphs 92-93).</p>		

The finding that a particular mark forms part of a family of marks requires that the **common component of the signs is identical or very similar**. The signs must contain the same distinctive element, and this element must play an independent role in the sign as a whole. Minor graphical differences in the common component may not exclude an assumption of a series of marks, when these differences may be understood by the public to be a modern presentation of the same product line. In contrast, letters that are different from or additional to the common component generally do not allow an assumption of a family of marks.

Normally, the **common element that characterises the family appears in the same position within the marks**. Therefore, the same (or very similar) element appearing in the same position in the contested sign will be a strong indicator that the later mark could be associated with the opponent's family of marks. However, the common

element appearing in a different position in the contested sign weighs heavily against such an association being established in the consumers' minds. For example, the contested sign ISENBECK is not likely to be associated with a family of BECK- marks where the element BECK is at the beginning of the signs making up the family.

Earlier signs	Contested sign	Case No
UNIZINS, UNIFONDS and UNIRAK	UNIWEB	C-317-10 P
<p>G&S: Class 36 (financial services) Territory: Germany Assessment: In this judgment the Court annulled a decision of the GC since it has not duly assessed the structure of the marks to be compared, nor the influence of the position of their common element on the perception of the relevant public (paragraph 57).</p>		

Examples where the Boards considered that a family of marks had been established:

Earlier signs	Contested sign	Case No
UniSECTOR UniSTARTUP UniSTRATEGIE	uni-gateway	R 0031/2007-1
<p>G&S: Class 36 (financial services) Territory: Germany Assessment: The Board considered that the opponent had in fact submitted sufficient evidence, by submitting, in particular, references from the relevant specialist press, such as FINANZtest, and by referring to its considerable 17.6 % market share of 'Uni' investment funds amongst German fund management companies, to show that it uses the prefix 'UNI' for a number of well-known investment funds. There is a likelihood of confusion from the point of view of the family of trade marks since the relevant trade circles would include in the series the trade mark applied for, since it is constructed in accordance with a comparable principle (paragraphs 43-44).</p>		
Earlier signs	Contested sign	Case No
UNIFIX, BRICOFIX, MULTIFIX, CONSTRUFIX, TRABAFIX, etc.	ZENTRIFIX	R 1514/2007-1
<p>G&S: Classes 1, 17 and 19 (adhesives) Territory: Spain Assessment: The Board considered that the opponent had proven the existence of a family of marks. Firstly, the Board discarded that the common element 'FIX' would be non-distinctive, given that it is not a Spanish word and even its Spanish meaning 'fijar' is not one that spontaneously comes to mind to average Spanish consumers in the context of glues and adhesives, since verbs like 'pegar', 'encolar' or 'adherir' are used more regularly in this context. Secondly, the opponent duly proved that all the marks forming the family are being used. Invoices and promotional literature duly show that goods bearing these marks are available to consumers on the market. Consumers, therefore, are aware that there is a family of marks. Thirdly, ZENTRIFIX has characteristics that replicate those of the trade marks in the family. The FIX element is placed at the end; the element that precedes it alludes to something that has some relevance to glues; the two elements are juxtaposed without any punctuation signs, dashes or physical separation; the typeface used for the two elements is the same (paragraphs 43-44).</p>		
Earlier signs	Contested sign	Case No
CITIBANK, CITIGOLD, CITICORP, CITIBOND, CITICARD, CITIEQUITY, etc.	CITIGATE	R 0821/2005-1 (confirmed by the GC T-301/09)

G&S: Classes 9, 16 (potentially finance-related goods)

Territory: EU

Assessment: The Board considered that the evidence – consisting in particular of extracts from the opponents' websites, annual reports, press advertisements and so forth – is littered with references to the trade marks CITICORP, CITIGROUP, CITICARD, CITIGOLD, CITIEQUITY. The evidence demonstrates that CITIBANK is in the nature of a 'house mark' or basic brand and that the opponents have developed a whole series of sub-brands based on the CITI concept. The contested mark CITIGATE is the sort of mark that the opponents might add to their portfolio of CITI marks, in particular if they wished to offer a new service to customers and place the emphasis on the idea of access (paragraphs 23-24).

3. Coexistence of the Conflicting Marks on the Market in the Same Territory

The EUTM applicant may claim that the conflicting trade marks coexist in the relevant territory. Usually the coexistence argument comes up when the applicant owns a national trade mark corresponding to the EUTM application in the territory where the opposing trade mark is protected. The applicant may also refer to coexistence with a trade mark owned by a third party.

Therefore, two different situations, both referred to as 'coexistence' by the parties, should be distinguished:

- coexistence between the two marks involved in the opposition can be persuasive of the absence of a likelihood of confusion in the relevant public's perception (see below);
- where many similar marks (other than the two marks involved in the opposition) are used by competitors, the coexistence may affect the scope of protection of the earlier right. See the Guidelines, Part C, Opposition, Section 2, Double Identity and Likelihood of Confusion, Chapter 5, Distinctiveness of the Earlier Mark.

3.1. Coexistence between the marks involved in the opposition

In opposition proceedings, it is most commonly argued by the EUTM applicant that the conflicting marks coexist on a national level and that the coexistence is tolerated by the opponent. Occasionally, it is argued that coexistence is accepted by the parties in a coexistence agreement.

The possibility cannot be ruled out that the coexistence of two marks on a particular market might, together with other elements, contribute to diminishing the likelihood of confusion between those marks on the part of the relevant public (judgment of 03/09/2009, C-498/07P, La Española, EU:C:2013:302, § 82). In certain cases, the coexistence of earlier marks in the market could reduce the likelihood of confusion that the Office finds between two conflicting marks (judgment of 11/05/2005, T-31/03, Grupo Sada, EU:T:2005:169, § 86).

However, the indicative value of coexistence should be treated with **caution**. There might be different reasons why the two signs coexist on a national level, e.g. a different legal or factual situation in the past or prior rights agreements between the parties involved.

Therefore, whilst the impact of coexistence on the finding of likelihood of confusion is accepted in theory, the conditions for this coexistence to be persuasive of the absence of a risk of confusion are, in practice, very difficult to establish and seldom prevail.

For the EUTM applicant to prove that the coexistence was based upon the absence of any likelihood of confusion on the part of the relevant public certain conditions must be met.

- **Comparable situation.** The earlier ('co-existing') marks and the marks at issue are **identical** to those involved in the opposition before the Office (judgments of 11/05/2005, T-31/03, Grupo Sada, EU:T:2005:169, § 86; 18/09/2012, T-460/11, Bürger, EU:T:2012:432, § 60-61) and cover the same goods or services as those in conflict (decision of 30/03/2010, R 1021/2009-1, Eclipse, § 14).
- The coexistence concerns the **countries** relevant in the case (e.g. alleged **coexistence in Denmark is irrelevant when the opposition is based on a Spanish** trade mark; judgment of 13/07/2005, T-40/03, Julián Murúa Entrena, EU:T:2005:285, § 85). If the earlier trade mark is a EUTM, the EUTM applicant must show coexistence in the entire EU.
- Only the coexistence in the **marketplace** can be taken into account. The mere fact that both trade marks exist in the national register (formal coexistence) is insufficient. The EUTM applicant has to prove that the trade marks were **actually used** (decision of 13/04/2010, R 1094/2009-2, Business Royals, § 34). Coexistence should be understood as 'co-use' of concurrent and supposedly conflicting marks (decisions of 08/01/2002, R 0360/2000-4, No Limits, § 13; 05/09/2002, R 0001/2002-3, Chee.Tos, § 22).
- The **period of coexistence** must be taken into consideration: in the judgment of 01/03/2005, T-185/03, 'Enzo Fusco', the alleged coexistence of only four months was considered obviously too short. Moreover, the coexistence of the trade marks has to relate to a period close to the filing date of the EUTM application (decision of 12/05/2010, R 0607/2009-1, Elsa Zanella, § 39).
- The absence of a likelihood of confusion may be only inferred from the '**peaceful**' nature of the coexistence of the marks at issue on the market concerned (judgments of 03/09/2009, C-498/07P, La Española, EU:C:2013:302, § 82; 08/12/2005, T-29/04, Cristal Castellblanch, EU:T:2005:438, § 74; 24/11/2005, T-346/04, Arthur et Félicie, EU:T:2005:420, § 64). This is not the case when the conflict has been an issue before the national courts or administrative bodies (infringement cases, oppositions or applications for annulment of a trade mark).
- Moreover, the peaceful coexistence of the trade marks in the relevant national market does not outweigh the likelihood of confusion if it is based on prior right agreements between the parties including agreements settling disputes before national courts, since these agreements, even if based on the assessment of the legal situation made by the parties, may have purely economic or strategic reasons.

However, exceptional situations are possible. In its preliminary ruling of 22/09/2011, C-482/09, Budweiser, EU:C:2011:605, the Court of Justice ruled that two identical trade marks designating identical goods can coexist on the market to the extent that there has been a long period of **honest concurrent use** of those trade marks and that

use neither has nor is liable to have an adverse effect on the essential function of the trade mark which is to guarantee consumers the origin of the goods and services.

As regards **coexistence agreements** between the parties, when assessing likelihood of confusion the Office's policy is that these agreements may be taken into account like any other relevant factor, but they are **in no way binding for the Office**. This is particularly true when the application of the relevant provisions of the EUTMR and the established case-law lead to a conclusion that is not in accordance with the content of the agreement.

If an agreement is disputed before national instances or there are pending court proceedings and the Office estimates that the outcome could be relevant for the case at issue, it may decide to suspend the proceedings.

In addition, as a general rule, nothing precludes the opponent from filing an opposition against a EUTM application, whether or not it previously opposed other (national) marks of the applicant. This cannot be considered as 'contradictory behaviour' and interpreted to the opponent's disadvantage, especially since in the opposition proceedings, unlike the invalidity proceedings, the defence of 'acquiescence' is not available (the rules for opposition proceedings do not contain an equivalent to Article 54 EUTMR, according to which a EUTM proprietor may invoke as a defence the fact that the applicant for invalidity has acquiesced to the use of the EUTM for more than five years).

4. Incidences of Actual Confusion

Likelihood of confusion means a probability of confusion on the part of the relevant consumer and does not require **actual** confusion. As expressly confirmed by the Court: '... it is not necessary to establish the existence of actual confusion, but the existence of a likelihood of confusion' (judgment of 24/11/2005, T-346/04, Arthur et Félicie, EU:T:2005:420, § 69).

In the global assessment of likelihood of confusion all relevant factors have to be taken into consideration. Evidence of actual confusion is a factor that may weigh in favour of likelihood of confusion; its indicative value should not, however, be overestimated for the following reasons:

- in everyday life there are always people who confuse and misconstrue everything, and others who are extremely observant and very familiar with every trade mark. Therefore, there is no legal value in highlighting the existence of these people since it could lead to subjective results;
- insofar as the targeted consumer's perception is concerned, the assessment is normative. The average consumer is assumed to be 'reasonably well-informed and reasonably observant and circumspect', even though in purely factual terms some consumers are extremely observant and well-informed, whilst others are careless and credulous (decision of 10/07/2007, R 0040/2006-4, SDZ Direct World, § 32).

Therefore, incidences of actual confusion can influence the finding of likelihood of confusion only if it is proven that these incidences usually accompany the existence of the conflicting trade marks in the market in the typical situation in trade involving the goods and/or services concerned.

To properly weigh evidence on the number of occasions when actual confusion has arisen, the assessment must be made in the light of the number of opportunities for confusion. If the business transactions are voluminous but the instances of confusion are sparse, this evidence will have little weight in the assessment of likelihood of confusion.

Lack of actual confusion has been treated in the context of coexistence, in paragraph 4 above.

5. Prior Decisions by EU or National Authorities Involving Conflicts Between the Same (or Similar) Trade Marks

5.1. Prior Office decisions

As regards previous decisions of the Office in conflicts between identical or similar trade marks, the General Court has stated that:

... it is settled case-law ... that the legality of the decisions of the [Office] is to be assessed purely by reference to [the EUTMR] and not the Office's practice in earlier decisions.

(Judgment of 30/06/2004, T-281/02, Mehr für Ihr Geld, EU:T:2004:198, § 35.)

Accordingly, the Office is **not bound by its previous decisions**, since each case has to be dealt with separately and with regard to its particularities.

Notwithstanding the fact that previous decisions of the Office are not binding, their reasoning and outcome should still be **duly considered** when deciding upon the case in question. This was reinforced in the judgment of 10/03/2011, C-51/10 P, 1000, EU:C:2011:139, § 73-75:

The Office is under a duty to exercise its powers in accordance with the general principles of European Union law, such as the principle of equal treatment and the principle of sound administration.

In the light of those two principles, the Office must, when examining an application for registration of a EU trade mark, take into account the decisions already taken in respect of similar applications and consider with special care whether it should decide in the same way or not ...

That said, the way in which the principles of equal treatment and sound administration are applied must be consistent with respect for legality.



The indicative value of the previous decisions will in principle be limited to cases that bear a sufficiently close resemblance to the case in question. However, according to Article 76(1) EUTM R, in opposition proceedings the Office shall be restricted in the examination of the case to the facts, evidence and arguments submitted by the parties. For this reason, even in cases based on comparable facts and involving similar legal problems, the outcome may still vary due to the different submissions made by the parties and the evidence they present.

5.2. Prior national decisions and judgments

Decisions of national courts and of national offices in cases regarding conflicts between identical or similar trade marks on the national level **do not have a binding effect** on the Office. According to case-law, the EU trade mark regime is an autonomous system with its own set of objectives and rules peculiar to it and applies independently of any national system. Accordingly, the registrability of a sign as a EU trade mark is to be assessed on the basis of the relevant legislation alone (judgments of 13/09/2010, T-292/08, *Often*, EU:T:2010:399, § 84; 25/10/2006, T-13/05, *Oda*, EU:T:2006:335, § 59).

Therefore, the decisions adopted in a Member State or in a State that is not a member of the European Union are not binding for the Office (judgment of 24/03/2010, T-363/08, *Nollie*, EU:T:2010:114, § 52).

Still, their reasoning and outcome should be **duly considered**, particularly when the decision has been taken in the Member State that is relevant to the proceedings. National courts have a thorough knowledge of the specific characteristics of their Member State, in particular as regards the marketplace reality in which goods and services are marketed and the customer perception of signs. This may, in particular cases, be relevant for the assessment made by the Office.

Earlier sign	Contested sign	Case No
MURUA		T-40/03
<p>G&S: Class 33 Territory: Spain Assessment: The Court took into consideration the reasoning of a judgment of the national court as far as it explained the perception of family names on the part of the public in the relevant country: regarding the question whether the relevant public in Spain will generally pay greater attention to the surname 'Murúa' than to the surname 'Entrena' in the trade mark applied for, the Court considers that, while it is <u>not binding</u> on EU bodies, Spanish case-law can provide a <u>helpful source of guidance</u> (paragraph 69).</p>		
Earlier sign	Contested sign	Case No
	OFTEN	T-292/08
<p>G&S: Class 14 Territory: Spain Assessment: The Court did not see the relevance of Spanish case-law, according to which an average member of the Spanish public has some knowledge of English for the assessment of the particular case:</p> <p>In the present case, the applicant has not put forward any factual or legal consideration, deriving from the national case-law relied upon, which is capable of providing helpful guidance for determination of the case The mere finding that certain English words are known to the Spanish consumer, namely the words 'master', 'easy' and 'food', even if that is clear from the national case-law in question, cannot lead to the same conclusion as regards the word 'often' (paragraph 85).</p>		

Whilst it is, in principle, permissible to take into account decisions of national courts and authorities, these decisions should be examined **with all the required care and in a diligent manner** (judgment of 15/07/2011, T-108/08, Good Life, EU:T:2011:391, § 23). Usually the understanding of such a decision will require the submission of sufficient information, in particular about the facts on which the decision was based. Their indicative value will, therefore, be limited to the rare cases when the factual and legal background of the case was presented completely in the opposition proceedings and is conclusive, clear and not disputed by the parties.

The above guidelines are without prejudice to the effects of the judgments of EU trade mark courts dealing with counterclaims for revocation or for a declaration of invalidity of EUTM s.

6. Irrelevant Arguments for Assessing Likelihood of Confusion

6.1. Specific marketing strategies

The examination of the likelihood of confusion carried out by the Office is a prospective examination. In contrast to trade mark infringement situations – where the courts deal with specific circumstances in which the particular facts and the specific nature of use of the trade mark are crucial – the deliberations of the Office on likelihood of confusion are carried out in a more abstract manner.

For this reason, specific marketing strategies are not relevant. The Office must take the usual circumstances in which the goods covered by the marks are marketed as its benchmark, that is, those circumstances that are expected for the category of goods covered by the marks. The particular circumstances in which the goods covered by the marks are actually marketed have, as a matter of principle, no impact on the assessment of the likelihood of confusion because they may vary in time depending on the wishes of the proprietors of the trade marks (judgments of 15/03/2007, C-171/06 P, Quantum, EU:C:2007:171, § 59; 22/03/2012, C-354/11 P, G, EU:C:2012:167, § 73; 21/06/2012, T-276/09, Yakut, EU:T:2012:313, § 58).

For example, the fact that one party offers its everyday consumer goods (wines) for sale at a higher price than competitors is a purely subjective marketing factor that is, as such, irrelevant when assessing the likelihood of confusion (judgment of 14/11/2007, T-101/06, Castell del Remei Oda, EU:T:2007:340, § 52).

6.2. Reputation of EUTM application

Applicants sometimes argue that there will be no likelihood of confusion with the earlier mark because the EUTM application has a reputation. This argument cannot prosper because the right to a EUTM begins on the date when the EUTM application is filed and not before, and it is from that date onwards that the EUTM has to be examined with regard to opposition proceedings. Therefore, when considering whether or not the EUTM falls under any of the relative grounds for refusal, events or facts that happened before the filing date of the EUTM are irrelevant because the opponent's rights, insofar as they predate the EUTM, are earlier than the applicant's EUTM.

***GUIDELINES FOR EXAMINATION OF
EUROPEAN UNION TRADE MARKS***

***EUROPEAN UNION
INTELLECTUAL PROPERTY OFFICE
(EUIPO)***

PART C

OPPOSITION

SECTION 2

***DOUBLE IDENTITY AND
LIKELIHOOD OF CONFUSION***

CHAPTER 7

GLOBAL ASSESSMENT

Table of Contents

1	Introduction	3
1.1	Nature of global assessment	3
2	Interdependence Principle	3
3	Imperfect Recollection	4
4	Impact of the Method of Purchase of Goods and Services	4
4.1	Visual similarity	5
4.2	Aural similarity	7
4.3	Conclusion	8
5	Impact of the Conceptual Similarity of the Signs on Likelihood of Confusion	8
6	Impact on Likelihood of Confusion of Components that are Non-distinctive or Distinctive only to a Low Degree	10
6.1	Common components with low distinctiveness	10
6.2	Common components with no distinctiveness	12
7	Specific Cases	13
7.1	Short signs	13
7.2	Name/Surnames	14
7.2.1	Names	14
7.2.2	Business names in combination with other components	14
7.2.3	First and family names	14
7.3	Colour marks per se	19

1 Introduction

1.1 Nature of global assessment

A likelihood of confusion (including a likelihood of association) exists if there is a risk that the public might believe that the goods or services in question, under the assumption that they bear the marks in question, come from the same undertaking or, as the case may be, from economically-linked undertakings. If a significant part of the relevant public of the goods or services at issue may be confused as to the origin of the goods or services, this is sufficient. Therefore, there is no need to establish that all actual or potential consumers of the relevant goods or services are likely to be confused.

The Court has stated that likelihood of confusion must be appreciated globally, taking into account all the factors relevant to the circumstances of the case; this appreciation depends on numerous elements and, in particular, on the degree of recognition of the mark on the market, the association that the public might make between the two marks and the degree of similarity between the signs and the goods and services (judgment of 11/11/1997, C-251/95, Sabèl, EU:C:1997:528, § 22).

The Office normally examines the most salient and habitually relevant factors relating to likelihood of confusion and establishes their degrees:

- (i) similarity of goods and services;
- (ii) the relevant public and the level of attention;
- (iii) similarity of the signs taking into account their distinctive and dominant elements;
- (iv) the distinctiveness of the earlier mark.

In the last section of a decision containing the global assessment, those factors are weighed up. However, the global assessment can weigh up many other factors that are relevant to deciding on likelihood of confusion (see Chapter 6, 'Other Factors').

2 Interdependence Principle

The Court has set out the essential principle that evaluating likelihood of confusion implies some **interdependence between the relevant factors** and, in particular, between the previously established findings on the degree of similarity between the marks and that between the goods or services. Therefore, a lesser degree of similarity between goods and services may be offset by a greater degree of similarity between the marks and vice versa (judgment of 29/09/1998, C-39/97, Canon, EU:C:1998:442, § 17). This principle of interdependence is crucial to the analysis of likelihood of confusion.

The interdependence of those factors is expressly referred to in recital 8 in the preamble to the EUTMR, according to which the concept of similarity is to be interpreted in relation to the likelihood of confusion, the assessment of which depends on numerous elements and, in particular, on the recognition of the mark on the market, the association that can be made with the used or registered sign, the degree of similarity between the mark and the sign and that between the goods or services identified (judgment of 10/09/2008, T-325/06, Capiro, EU:T:2008:338, § 72 and the case-law cited).

The requirement for a global appreciation and the principle of interdependence means that where there is at least some degree of similarity between the signs and the relevant goods/services, there will be an assessment of likelihood of confusion involving an iterative process that weighs up all the relevant factors. This process takes place in the global assessment section.

In practice, this means that the **Office will weigh up**, inter alia, the degree of similarity between the goods and services and the degree of attention paid by the relevant public to those goods and services, the degree of similarity between the signs, and whether the impression produced by any one of the levels of comparison (visual/aural/conceptual) is more important, and the distinctiveness of the earlier mark

Moreover, the factors evaluated in the global assessment **will vary** according to the particular circumstances. For example, in clear-cut cases where goods/services and the signs are highly similar or identical, the Office may find a likelihood of confusion without assessing all factors – such as enhanced distinctiveness, family of marks, etc.

Importantly, it is not possible to set out in the abstract whether one factor carries more weight than another because these factors will have varying degrees of relative importance depending on the circumstances. For instance, the degree of visual similarity may weigh more heavily in connection with goods that are usually examined visually, whilst the degree of aural similarity may be more relevant to goods normally ordered orally.

3 Imperfect Recollection

Although, the average consumer of the category of products concerned is deemed to be reasonably well-informed and reasonably observant and circumspect, account is taken of the fact that the average consumer only rarely has the chance to make a direct comparison between the different marks and must place trust in the imperfect picture of them that he or she has kept in mind. It should also be borne in mind that the average consumer's level of attention is likely to vary according to the category of goods or services in question (judgment of 22/06/1999, C-342/97, Lloyd Schuhfabrik, EU:C:1999:323, § 26). Even consumers with a high level of attention need to rely on their imperfect recollection of trade marks (judgment of 21/11/2013, T-443/12, ancotel, EU:T:2013:605, § 54).

4 Impact of the Method of Purchase of Goods and Services

The Court has stated that, when evaluating the importance attached to the degree of visual, aural and conceptual similarity between the signs, it is appropriate to take into account the category of goods or services in question and the way they are marketed (judgment of 22/09/1999, C-342/97, Lloyd Schuhfabrik, EU:C:1999:323, § 27).

The category of goods and services involved may increase the importance of one of the different aspects of similarity between signs (visual, phonetic and conceptual) because of how goods and services are ordered and/or purchased. An aural or conceptual comparison between signs may be less important in the case of goods and services that are usually examined visually or may be tried on before being bought. In such cases, the visual impression of signs counts more in the assessment of likelihood of confusion.

However, it is important to emphasise that, as with all of the factors that are relevant to likelihood of confusion, the factors are interlinked and each set of circumstances must be examined on a case-by-case basis. This means that no general rule should be applied to broad categories of goods or services.

4.1 Visual similarity

A good example of where visual similarity can play a greater – but not an exclusive – role in the global assessment of the likelihood of confusion is **clothing**. Generally, in clothing shops, customers can either choose the clothes they wish to buy themselves or be assisted by the sales staff. Whilst oral communication in respect of the product and the trade mark is not excluded, the choice of the item of clothing is generally made visually. Therefore, visual perception of the marks in question will generally take place prior to purchase. Accordingly, the visual aspect plays a greater role in the global assessment of the likelihood of confusion (judgments of 14/10/2003, T-292/01, Bass, EU:T:2003:264, § 55; 06/10/2004, T-117/03-T-119/03 & T-171/03, NL, EU:T:2004:293, § 50; 18/05/2011, T-502/07, McKenzie, EU:T:2011:223, § 50; 24/01/2012, T-593/10, B, EU:T:2012:25, § 47). These considerations played a role in finding no likelihood of confusion between the marks below for, inter alia, certain goods in Class 25.

Earlier sign	Contested sign	Case No
		T-502/07
		T-593/10

The same considerations were central to a finding of likelihood of confusion in the following cases also for, inter alia, certain goods in Class 25.

Earlier sign	Contested sign	Case No
		R 1050/2008-4
PETER STORM	PEERSTORM	T-30/09
		T-376/09

However, granting preferential consideration to the visual perception does not mean that identical verbal elements can be overlooked due to the presence of striking

figurative elements, as can be seen in the case below, where likelihood of confusion was found for goods in Class 25.

Earlier sign	Contested sign	Case No
	FISHBONE	T-415/09 (appeal dismissed C-621/11P)

In a similar way, the visual impression for marks covering **video games** has also been held to be particularly relevant because these goods are normally purchased after a comprehensive examination of their respective specifications and technical characteristics, firstly upon the basis of information that appears in specialist catalogues or on the internet, and then at the point of sale. For these reasons, the visual differences were key to the finding of no likelihood of confusion below (judgment of 08/09/2011, T-525/09, Metronia, EU:T:2011:437, § 38-47).

Earlier sign	Contested sign	Case No
		T-525/09

The visual similarity between signs may also have an increased importance where the goods are **ordinary consumer products (e.g. goods in Classes 29 and 30)** that are most commonly purchased in supermarkets or establishments where goods are arranged on shelves and where consumers are guided more by the visual impact of the mark they are looking for. Consequently, for such goods the visual differences were central to a finding of no likelihood of confusion in the UK between the marks below.

Earlier sign	Contested sign	Case No
	EGLÉFRUIT	T-488/07

However, the broad principle above does not mean that for goods that are normally purchased visually, the phonetic impression can be overlooked. This latter point was highlighted in a case involving the marks below where the General Court, confirming the finding of a likelihood of confusion, held that although **computers and computer accessories** are sold to consumers 'as seen' on shelves in self-service areas, the phonetic identity between the marks at issue was, in this case, at least as important as their visual similarity because an oral discussion of the characteristics of the goods and their mark is also likely to take place at the time of purchase. Furthermore, those goods could be advertised orally, on radio or by other consumers.

Earlier sign	Contested sign	Case No
CMORE		T-501/08

4.2 Aural similarity

In contrast to the cases above, where visual similarity played a stronger role, similarity on the phonetic level may have more weight than similarity on the visual level when the goods at issue are traditionally ordered orally. This consideration came into play in the finding of likelihood of confusion in the case below, which dealt with **vehicle rental and associated services**, which are recommended and chosen orally in a significant number of cases.

Earlier sign	Contested sign	Case No
CICAR	ZIPCAR	T-36/07

Where goods are ordered orally, the phonetic perception of the sign may also be influenced by factors such as the likely presence of various other sounds perceived by the recipient of the order at the same time. Such considerations are relevant where the goods in question are normally ordered at sales points with an increased noise factor, such as **bars or nightclubs**. In such cases, attaching particular importance to the phonetic similarity between the signs at issue may be appropriate. These considerations came into play in the finding of likelihood of confusion between the marks below for certain goods in Class 33 (judgment of 15/01/2003, T-99/01, *Mystery*, EU:T:2003:7, § 48).

Earlier sign	Contested sign	Case No
MIXERY		T-99/01

Similarly, a particular method or customary way of ordering goods may mean increased importance being attributed to the phonetic similarity between the signs. For instance, the General Court has held that in the **wines sector**, consumers usually describe and recognise wine by reference to the verbal element that identifies it, in particular in bars and restaurants, in which wines are ordered orally after their names have been seen on the wine list (judgments of 23/11/2010, T-35/08, *Artesa Napa Valley*, EU:T:2010:476, § 62; 13/07/2005, T-40/03, *Julián Murúa Entrena*, EU:T:2005:285, § 56; 12/03/2008, T-332/04, *Coto d’Arcis*, EU:T:2008:69, § 38). Accordingly, in such cases, it may be appropriate to attach particular importance to the phonetic similarity between the signs at issue. These considerations came into play in the finding of likelihood of confusion between the marks below for wine despite their considerable visual differences.

Earlier sign	Contested sign	Case No
<p>MURÚA</p>		<p>T-40/03</p>
		<p>T-35/08</p>

Nevertheless, the broad principle above does not mean that the visual impression can be overlooked for goods normally purchased orally. Indeed, the General Court has held that although preponderant importance had sometimes been accorded to the phonetic perception of marks for beverages, the phonetic dissimilarities of the marks did not merit particular importance where the specific beverages were widely distributed and sold not only in specialist shops, where they would be ordered orally, but in large shopping centres as well, where they would be purchased visually (judgment of 03/09/2010, T-472/08, 61 a nossa alegria, EU:T:2010:347, § 106).



4.3 Conclusion

The circumstances set out above demonstrate that in certain situations the Office should grant preferential consideration to the visual or aural perception of marks depending on how the goods and services at issue are ordered or purchased. However, even in these situations identical or highly similar visual or aural elements cannot be entirely overlooked because all the relevant factors are interlinked and interdependent, and each set of circumstances must be examined on a case-by-case basis.

5 Impact of the Conceptual Similarity of the Signs on Likelihood of Confusion

A conceptual **similarity** between signs with **analogous** semantic content may give rise to a likelihood of confusion where the earlier mark is particularly distinctive (judgment of 11/11/1997, C-251/95, Sabèl, EU:C:1997:528, § 24, where the signs shared the broader concept of a 'bounding feline', but did not evoke the same animal: a puma in the earlier mark and a cheetah in the contested mark).

However, exceptionally, where the signs have the **same** distinctive concept in common accompanied by visual similarities between the signs, this may lead to a likelihood of confusion even in the absence of a particularly high distinctiveness of the earlier mark, as illustrated by the following example.

Earlier sign	Contested sign	Case No
		<p>Joined Cases T-81/03, T-82/03 and T-103/03</p>
<p>G&S: Classes 32, 33 <i>Territory:</i> Spain (where 'venado' means 'deer') <i>Assessment:</i> The Court found that the signs had the same concept and that there was significant visual similarity. In the absence of a clear semantic link between a deer or a deer's head and alcoholic or non-alcoholic beverages, the Court found it impossible to deny that the concept of a deer's head portrayed facing forward inside a circle had at least average distinctive character for designating beverages (para. 110.). Enhanced distinctiveness was not considered – likelihood of confusion (for the Spanish public).</p>		

A conceptual similarity between the signs may not be sufficient to outweigh the visual and phonetic differences, where the concept in common is non-distinctive.

Earlier sign	Contested sign	Case No
<p>K2 SPORTS</p>		<p>T-54/12</p>
<p>G&S: Classes 18, 25, 28 <i>Territory:</i> Germany and the UK <i>Assessment:</i> Contrary to the Board's finding that there is no conceptual similarity, the term 'sport', notwithstanding its descriptive character, refers to the same concept and leads to the conclusion that there is a degree of conceptual similarity. The Court concluded that this similarity was weak in the context of the overall impression of the signs and in particular of the very weak distinctive character of this term. However, the weak conceptual similarity did not offset the significant visual and phonetic differences between the signs (para. 49) – no likelihood of confusion.</p>		

According to case-law, the conceptual differences between signs may counteract their visual and phonetic similarity (judgment of 12/01/2006, C-361/04, PICARO, ECLI:EU:C:2006:25, § 20). According to Office practice, when a similarity is found in one aspect (visual/phonetic/conceptual), the examination of likelihood of confusion must continue¹. Therefore, the question whether the conceptual dissimilarity is sufficient to counteract the visual and/or phonetic similarity between the marks has to be examined in the global assessment of the likelihood of confusion. Furthermore, as explained above in Chapter 4, 'Comparison of signs', paragraph 3.4.4, the conceptual

¹ See the Guidelines, Part C, Opposition, Section 2, Double Identity and Likelihood of Confusion, Chapter 4, Comparison of Signs, paragraph 1.3.

dissimilarity can be found only if each trade mark has a clear concept that may be immediately grasped by the public and these concepts are different.

The conceptual difference between the signs may not be sufficient to neutralise the visual and phonetic similarities.

Earlier sign	Contested sign	Case No
MUNDICOLOR	MUNDICOR	Joined Cases T-183/02 and T-184/02
<p>G&S: Class 2 Territory: Spain Assessment: Whilst 'MUNDICOLOR' is to a certain extent evocative of 'colours of the world' or 'the world in colours' for the Spanish public, it cannot be regarded as having any clear and specific meaning. In the mark applied for, the same prefix is accompanied by the suffix 'cor', a term which has no meaning in the Spanish language. Therefore, notwithstanding the evocative nature of the prefix 'mundi' (world), the latter is ultimately devoid of any concept for that public. As neither of the signs has a clear and specific meaning likely to be grasped immediately by the public, any conceptual difference between them is not such as to counteract their visual and aural similarities (paras 90-99) – likelihood of confusion.</p>		

The finding of conceptual similarity must therefore be followed by a careful assessment of the inherent and acquired distinctiveness of the earlier trade mark.

6 Impact on Likelihood of Confusion of Components that are Non-distinctive or Distinctive only to a Low Degree

When assessing the similarity of the signs, an analysis of whether the coinciding components are descriptive, allusive or otherwise weak is carried out in order to calculate the extent to which these coinciding components have a lesser or greater capacity to indicate commercial origin. It may be more difficult to establish that the public may be confused as to origin due to similarities that solely pertain to non-distinctive elements.²

The Office and a number of trade mark offices of the European Union have agreed on a **Common Practice** under the European Trade Mark and Designs Network with regard to the impact on likelihood of confusion of components that are non-distinctive or Distinctive only to a low degree.

6.1 Common components with low distinctiveness

According to the Common Practice, when the marks share an element with **low distinctiveness**, the assessment of likelihood of confusion will focus on the impact of the non-coinciding components on the overall impression of the marks. The assessment will take into account the similarities/differences and distinctiveness of the non-coinciding components.



² See the Guidelines, Part C, Opposition, Section 2, Double Identity and Likelihood of Confusion, Chapter 5, Distinctiveness of the earlier mark.

A coincidence in an element with a low degree of distinctiveness **will not normally on its own lead to likelihood of confusion**. However, there may be likelihood of confusion if the other components are of a lower (or equally low) degree of distinctiveness or are of insignificant visual impact and the overall impression of the marks is similar. There may also be likelihood of confusion if the overall impression of the marks is highly similar or identical.

The following are examples agreed in the context of the Common Practice, where the common component(s) is/are considered to possess a low degree of distinctiveness³.

Earlier mark	Contested mark	Goods/services	Outcome
MORELUX	INLUX	Class 44: Beauty Treatment	No likelihood of confusion
DURALUX	VITALUX	Class 44: Beauty Treatment	No likelihood of confusion
		Class 32: Fruit juices	No likelihood of confusion
		Class 9: Credit cards	No likelihood of confusion
		Class 32: Fruit juices	No likelihood of confusion
		Class 30: Tea	No likelihood of confusion
		Class 9: Credit cards	No likelihood of confusion
COSMEGLOW	COSMESHOW	Class 3: Cosmetics	Likelihood of confusion
		Class 11: Refrigerators	Likelihood of confusion

³ For the purposes of the Common Practice, all the other factors that may be relevant for the global appreciation of likelihood of confusion are deemed not to affect the outcome. It is also considered that the goods and services are identical.



		Class 43: Holiday accommodation services	Likelihood of confusion
---	---	--	-------------------------

6.2. Common components with no distinctiveness



According to the Common Practice, when marks share an element with **no distinctiveness**, the assessment of likelihood of confusion will focus on the impact of the non-coinciding components on the overall impression of the marks. The assessment will take into account the similarities/differences and distinctiveness of the non-coinciding components.

A coincidence only in non-distinctive components **does not lead to likelihood of confusion**. However, when marks also contain other figurative and/or word elements that are similar, there will be likelihood of confusion if the overall impression of the marks is highly similar or identical.

The following are examples agreed in the context of the Common Practice, where the common component(s) is/are considered to possess no distinctiveness⁴.

Earlier mark	Contested mark	Goods/services	Outcome
GREENGRO	GREENFLUX	Class 19: Building materials Class 37: Construction services	No likelihood of confusion
BUILDGRO	BUILDFLUX	Class 19: Building Materials Class 37: Construction Services	No likelihood of confusion
	SMARTPHONES.NET	Class 9: Mobile phones	No likelihood of confusion
		Class 36: Financial Services	No likelihood of confusion
		Class 29: Fish	No likelihood of confusion

⁴ For the purposes of the Common Practice, all the other factors that may be relevant for the global appreciation of likelihood of confusion are deemed not to affect the outcome. It is also considered that the goods and services are identical.

CRE-ART	PRE-ART	Class 41: Art gallery services	Likelihood of confusion
TRADENERGY	TRACENERGY	Class 9: Solar energy collectors for electricity generation	Likelihood of confusion
		Class 9: Solar energy collectors for electricity generation	Likelihood of confusion

7 Specific Cases

7.1 Short signs

As indicated before, the Courts have not exactly defined what a short sign is. However, signs with three or fewer letters/numbers are considered by the Office as short signs.

It should be noted that the General Court held that the global assessment of the likelihood of confusion between signs consisting of a single letter (or a combination of letters not recognisable as a word) **follows the same rules** as that in respect of word signs comprising a word, a name or an invented term (judgments of 06/10/2004, T-117/03-T-119/03 and T-71/03, NL, EU:T:2004:293, § 47-48, and 10/05/2011, T-187/10, G, EU:T:2011:202, § 49).

In the assessment of the likelihood of confusion it is important to establish the degree of **inherent distinctiveness** of the earlier trade mark, and therefore its scope of protection. See in this respect Chapter 5 of this Section, Distinctiveness of the earlier mark, and the specific section on short signs.

As to the overall assessment of likelihood of confusion, the Court made it clear that the fact that two trade marks consisting of the same letter (or of the same sequence of letters) are found to be identical from an aural and a conceptual point of view is relevant when it comes to assessing the existence of a likelihood of confusion. In such cases, it is only when the later trade mark causes a **sufficiently different visual impression** that a likelihood of confusion can be safely ruled out (judgment of T-187/10, G, EU:T:2011:202, § 60).

Consequently, a likelihood of confusion can be safely excluded when two conflicting signs, albeit containing or consisting of the same single letter or a combination of letters not recognisable as a word, are stylised in a sufficiently different way or contain a sufficiently different figurative element, so that their different overall graphical representation eclipses the common verbal element.

Where the opponent has successfully proven that its earlier mark has acquired enhanced distinctiveness through intensive use or reputation, the impact thereof on the final outcome has to be carefully assessed. Firstly, enhanced distinctiveness on the part of an earlier mark containing or consisting of a single letter or a combination of letters cannot justify a finding of a likelihood of confusion if the overall visual impression of the signs is so different as to safely set them apart. Secondly, if the evidence shows

use of a single letter or combination of letters stylised or accompanied by additional figurative elements, the benefit of the resulting broader scope of protection accrues to the form in which it was used and not to the single letter as such or any other stylised variation.

7.2 Name/Surnames

7.2.1 Names



In principle, there are no specific criteria to be taken into account when likelihood of confusion between names is assessed. However, because of the very nature of names and surnames, there are certain aspects that come into play (as we shall see below), such as whether a given name and/or surname is common or not in the relevant territory, that have to be carefully considered and balanced.

7.2.2 Business names in combination with other components

When assessing likelihood of confusion in relation to composite signs that contain several verbal elements, one of which might be seen as being a business name, i.e. indicating the company 'behind' the trade mark, an overall assessment must be done in order to identify which element functions as the trade mark of the goods and services concerned. Factors to be taken into account include the distinctiveness of each element as well as the size and/or space they occupy in a figurative mark, which determine the dominant element of the conflicting signs.

Where the business name is not the dominant element, although each of the elements making up the sign might have their own independent distinctive role, consumers are likely to focus more on the element that would be seen as identifying the specific product line rather than on the element that would be perceived (because it is preceded by 'by' or another equivalent term) as identifying either the company who has control of the products concerned or the designer who created the product line.

Therefore, whenever there is a sufficient degree of similarity between the component that would be perceived as the trade mark and a conflicting sign, in principle there will be likelihood of confusion (provided the other relevant factors are met).

Earlier sign	Contested sign	Case No
		T-43/05
<p>G&S: Class 25 Territory: Denmark, Finland, Sweden Assessment: 'The element "by CAMPER" will be perceived as subsidiary, also due to the fact that the relevant public will perceive it as a mere indication of the undertaking producing the goods in question.' Therefore, the relevant consumer will focus their attention on the word 'BROTHERS' and might attribute a common origin to the goods concerned (paras 65 and 86) – likelihood of confusion.</p>		

7.2.3 First and family names

The perception of signs made up of personal names may vary from country to country within the European Union. Family names have, in principle, a higher intrinsic value as

indicators of the origin of goods or services than first names. This is because common experience shows that the same first names may belong to a great number of people who have nothing in common, whereas the presence of the same surname (provided it is not common in the relevant territory) could imply the existence of some link between them (identity of the persons or a family link). In determining whether, in a particular country, the relevant public generally attributes greater distinctiveness to the surname than the forename, the case-law of that country, although not binding on the Office or the EU courts, may provide useful guidelines (judgment of 01/03/2005, T-185/03, Enzo Fusco, EU:T:2005:73, § 52).

There are instances where the applicants invoke, as a defence, their right to use their name. However, such arguments are not valid in opposition proceedings, since it does not influence the issue of whether there will be likelihood of confusion on the part of the public. Furthermore, the registration of trade marks does not hinder the use of names of natural persons, due to the special protection provided by Article 12(a) EUTMR and the relevant national trade mark laws according to Article 6(1)(a) of the Trade Mark Directive.

- **First name against the same first name or slight variations thereof**

The rule of thumb is that when two conflicting signs consist exclusively of the same first name, consumers are likely to perceive the similar/identical goods/services marketed under those marks as coming from the same source. It is clear that in the absence of any differentiating element, **likelihood of confusion** is the necessary conclusion.

Earlier sign	Contested sign	Case No
GIORDANO	GIORDANO	T-483/08
<p>G&S: Classes 18, 25 Territory: Portugal Assessment: The two word marks at issue are identical, which increases the likelihood that consumers might perceive the goods marketed under those marks as coming from the same source. Moreover, the applicant has not shown that the Italian first name 'Giordano' which makes up both trade marks is common in Portugal (para. 32) – likelihood of confusion.</p>		
Earlier sign	Contested sign	Case No
ELISE		T-130/09
<p>G&S: Classes 9, 42 Territory: Portugal Assessment: The Court considers that even if it is not certain that the relevant public throughout the European Union will necessarily perceive the signs at issue as being specifically diminutives of the name 'Elizabeth', the relevant public will certainly regard them as highly similar female names derived from the same root. In certain Member States, notably the United Kingdom, Ireland, Germany and Austria, they will certainly be perceived by the relevant public as being diminutives of the full forename Elizabeth (para. 36) – likelihood of confusion.</p>		
Earlier sign	Contested sign	Case No
GISELA	GISELE	R 1515/2010-4
<p>G&S: Class 25 Territory: EU Assessment: The marks compared are both variations of the female first name Giselle of old German and French origin and are overall very similar, so that a likelihood of confusion exists (paras 14, 15 and 20) – likelihood of confusion.</p>		

- **First name against identical first name plus surname**

Whenever two signs share the same first name and one of the two also contains a surname, and when the **first name** is likely to be perceived as a **common** (let alone very common) name in the relevant territory, the rule of thumb is that there will be **no likelihood of confusion**, since consumers will be aware that there are many people with that name.

Earlier sign	Contested sign	Case No
LAURA	LAURA MERCIER	R 0095/2000-2
<p>G&S: Class 3 Territory: Spain Assessment: In the Board's view, the average Spanish consumer who is familiar with the trade mark 'LAURA' for perfumes will not be confused. Conceptually, 'LAURA' will be seen as a common first name in Spain. It is highly unlikely that the average Spanish consumer would consider linking the more specific name 'LAURA MERCIER' with 'LAURA' (para. 16) – no likelihood of confusion.</p>		

An **exception** applies when a given first name is likely to be perceived as **uncommon** in the relevant territory. In such cases, the presence of this uncommon element is likely to focus the consumers' attention and they could be misled into attributing a common origin to the goods/services concerned.

Earlier sign	Contested sign	Case No
AMANDA	AMANDA SMITH	R 1892/2007-2
<p>G&S: Classes 29, 30 Territory: Spain Assessment: The term 'SMITH' in the trade mark application will be perceived by the Spanish consumers as a common Anglo-Saxon surname and will have less weight than the first name 'AMANDA' (which is less common in Spain) (para. 31) – likelihood of confusion.</p>		
Earlier sign	Contested sign	Case No
ROSALIA	ROSALIA DE CASTRO	T-421/10 (appeal dismissed C-649/11P)
<p>G&S: Classes 32, 33, 35 Territory: Spain Assessment: The signs are visually and conceptually similar, and aurally very similar. The products are identical. The services are similar. Neither the name ROSALIA nor the surname DE CASTRO is common in Spain. None of these elements has a higher distinctive character than the other (paras 50-51) – likelihood of confusion.</p>		



- **First name plus surname against identical first name plus different surname**

When two conflicting signs contain the same first name but are followed by clearly different surnames, the rule of thumb is that there is **no likelihood of confusion**. Consumers will realise that they distinguish goods/services of different, unconnected undertakings.

Invented example: 'Michael Schumacher'/'Michael Ballack' (no likelihood of confusion).

However, when the overall impression created by the signs is one of clear similarity, i.e. the differences between the signs are lost in the overall impression created by the

signs, then, applying the normal criteria, the outcome will be that there is **likelihood of confusion**.

Earlier sign	Contested sign	Case No
 (Emidio Tucci fig.)		T-8/03 and joined cases R 0700/2000-4 and R 0746/2000-4 Confirmed by C-104/05 P
G&S: Classes 3, 18, 24, 25 Territory: Spain Assessment: Both marks consist of the combination of a first name and a surname and make a similar overall impression – likelihood of confusion.		

- **First name plus surname against different first name plus identical surname**

When the conflicting signs contain the same surname preceded by different first names, the outcome will very much depend on the perception of the surname in the relevant territory. The less common a surname is, the more likely it is that it will attract the consumers' attention (regardless of whether the first names are common or not).

Earlier sign	Contested sign	Case No
ANTONIO FUSCO	ENZO FUSCO	T-185/03
G&S: Classes 18, 25 Territory: Italy Assessment: Since it was contested that 'Fusco' was not one of the most common surnames in Italy, the Court considered that, since the Italian consumer generally attributes greater distinctiveness to the surname than the forename, it will keep in mind the (neither rare nor common) surname 'Fusco' rather than the (common) forenames 'Antonio' or 'Enzo'. Therefore, a consumer faced with goods bearing the trade mark applied for, ENZO FUSCO, might confuse it with the earlier trade mark, ANTONIO FUSCO, so that there is a likelihood of confusion (paras 53 and 67) – likelihood of confusion.		

In contrast, when two marks have the same surname and this is likely to be perceived as common (let alone very common) in the relevant territory, consumers will not normally be misled into attributing a common origin to the goods/services concerned (judgments of 01/03/2005, T-169/03, Sissi Rossi, EU:T:2005:72, § 82-83; and 24/06/2010, C-51/09 P, Barbara Becker, EU:C:2010:368, § 36). Consumers are used to trade marks that contain common surnames and will not blindly assume that every time a common surname occurs in two conflicting signs the goods/services in question all emanate from the same source.

Earlier sign	Contested sign	Case No
VITTORIO ROSSI	CHRISTIAN ROSSI	R 0547/2010-2
G&S: Classes 18, 25 Territory: EU Assessment: Not only are consumers throughout the EU aware of the fact that people share the same surname without being necessarily related, but they will also be able to distinguish the Italian surname 'ROSSI' bearing two different first names in the fashion field (paras 33-35) – no likelihood of confusion.		

- **First name plus surname against different first name plus identical surname conjoined in a single word**

In cases where one of the conflicting signs consists of a name and surname and the other of a single word that will however be broken down into separate components by at least part of the relevant public, due to the recognisable presence of a name and surname combined to form the one word making up that sign, the result will be one of likelihood of confusion whenever the overall impression created by the marks is one of similarity.

Earlier sign	Contested sign	Case No
PETER STORM	Peerstorm	T-30/09
<p>G&S: Class 25 Territory: EU Assessment: Both of the marks at issue are made up of a first name and a surname. It is common ground that the element 'storm' in the two marks at issue can be a surname. The elements 'peer' and 'peter' in the mark applied for and the earlier mark respectively are first names. In particular in the Nordic countries and in Germany, Peer is a first name. The fact that the mark applied for is written as one word cannot cast doubt on the finding that the two marks at issue are made up of a first name and a surname (para. 66) – likelihood of confusion.</p>		

- **Surname against first name plus identical surname**

When two signs contain the same surname but only one of them also contains a given first name, the rule of thumb is that normally there will be **likelihood of confusion**. Consumers might be misled and attribute a common origin to the goods/services concerned. The presence of a first name in one of the conflicting signs will not suffice to safely distinguish the signs in the minds of the consumers. The surname alone will be perceived as the short version of the full name, thus identifying the same origin.



Earlier sign	Contested sign	Case No
MURÚA		T-40/03
<p>G&S: Class 33 Territory: Spain Assessment: It is common ground that the Spanish public will perceive the verbal element making up the trade mark applied for as a proper name (first name plus surnames) and the earlier trade mark as a surname. It is quite likely that the relevant public will regard the addition, in the trade mark applied for, of the first name 'Julián' and the surname 'Entrena' merely as a way of distinguishing a range of wines produced by the undertaker that owns the earlier trade mark or, at least, an undertaking economically linked to the intervener (paras 42 and 78) – likelihood of confusion.</p>		
Earlier signs	Contested sign	Case No
BRADLEY	VERA BRADLEY	R 1918/2010-1
<p>G&S: Class 11 Territory: EU Assessment: The sign for which the EUTM applied for seeks protection consists of the term 'Vera Bradley', which will most probably be seen as the name (forename and family name) of a person, fictitious or real. It is composed of the first name 'VERA', which is a common name for women in many</p>		

EU countries such as, e.g. the Czech Republic, Germany, Ireland, the Netherlands, Austria, Slovenia and the United Kingdom, and the surname 'BRADLEY', which is an English family name. The latter surname is not a common family name, neither in English-speaking countries nor in any other countries within the European Union. Even if consumers might be able to distinguish between the signs due to the element 'Vera', which has no counterpart in the earlier trade mark, they will see a specific line of products or an extended form of the mark. Consequently, consumers might believe that the trade marks belong to the same undertakings or economically linked undertakings (paras 36-37 and 52) – likelihood of confusion.

7.3 Colour marks per se

When likelihood of confusion of two colour marks per se is assessed, a phonetic or conceptual comparison of the signs cannot be made and the visual similarities will depend on the colour of the signs.

In the overall assessment, the Office takes into account the fact that there is a 'public interest in not unduly restricting the availability of colours for other traders who market goods or services of the same type as those in respect of which registration is sought' (judgments of 24/06/2004, C-49/02 Blau/Gelb, EU:C:2004:384, § 41, and 06/05/2003, C-104/01, Libertel, EU:C:2003:244, § 52-56). The inherent distinctiveness of colour marks per se is limited. The scope of protection should be limited to identical or almost identical colour combinations.

Earlier sign	Contested sign	Case No
		<p>R 0755/2009-4</p>
<p>G&S: Class 8 Territory: EU Assessment: In the case at hand, the colour combinations, identified by different colour codes, are not sufficiently close to lead to a likelihood of confusion, taking into account that the inherent distinctiveness is limited (para. 18). The BoA referred to CJEU judgments and public interest in ensuring that colours remain available to competitors (para. 19). The opponent did not prove enhanced distinctive character (para. 25) – no likelihood of confusion.</p>		

***GUIDELINES FOR EXAMINATION OF
EUROPEAN UNION TRADE MARKS***

***EUROPEAN UNION INTELLECTUAL
PROPERTY OFFICE
(EUIPO)***

PART C

OPPOSITION

SECTION 3

***UNAUTHORISED FILING
BY AGENTS OF THE TM PROPRIETOR
(ARTICLE 8(3) EUTMR)***

Table of Contents

1	Preliminary Remarks	3
1.1	Origin of Article 8(3) EUTMR	3
1.2	Purpose of Article 8(3) EUTMR.....	3
2	Entitlement of the Opponent	4
3	Scope of Application	5
3.1	Kinds of mark covered	5
3.2	Origin of the earlier mark.....	6
4	Conditions of Application	7
4.1	Agent or representative relationship	7
4.1.1	Nature of the relationship	7
4.1.2	Form of the agreement	9
4.1.3	Territorial scope of the agreement	10
4.1.4	Relevant points in time	11
4.2	Application in the agent's name	12
4.3	Application without the proprietor's consent.....	14
4.4	Absence of justification on the part of the applicant.....	16
4.5	Applicability beyond identical signs – goods and services	18

1 Preliminary Remarks

According to Article 8(3) EUTMR, upon opposition by the proprietor of an earlier trade mark, a trade mark shall not be registered:

where an agent or representative of the proprietor of the trade mark applies for registration thereof in his own name without the proprietor's consent, unless the agent or representative justifies his action.

1.1 Origin of Article 8(3) EUTMR

Article 8(3) EUTMR has its origin in Article 6^{septies} of the Paris Convention which was introduced into the Convention by the Revision Conference of Lisbon in 1958. The protection it affords to trade mark proprietors consists of the right to prevent, cancel, or claim as their own unauthorised registrations of their marks by their agents or representatives, and to prohibit use thereof, where the agent or representative cannot justify its acts. Article 6^{septies} reads as follows:

(1) If the agent or representative of the person who is the proprietor of the mark in one of the countries of the Union applies, without such proprietor's authorisation, for the registration of the mark in his own name, in one or more countries of the Union, the proprietor shall be entitled to oppose the registration applied for, or demand its cancellation or, if the law of the country so allows, the assignment in his favour of the said registration, unless such agent or representative justifies his action.

(2) The proprietor of the mark shall, subject to the provisions of paragraph (1), above, be entitled to oppose the use of his mark by his agent or representative if he has not authorised such use.

(3) Domestic legislation may provide an equitable time limit within which the proprietor of a mark must exercise the rights provided for in this Article.

Article 8(3) EUTMR implements this provision only to the extent it gives the rightful proprietor the right to oppose applications filed without its authorisation. The other elements of Article 6^{septies} of the Paris Convention are implemented by Articles 11, 18 and 53(1)(b) EUTMR. Article 53(1)(b) EUTMR gives the proprietor the right to cancel unauthorised registrations, whereas Articles 11 and 18 EUTMR enable the proprietor to prohibit the use thereof and/or to request the transfer of the registration to its own name.

Since Article 41 EUTMR provides that an opposition may only be based on the grounds provided for in Article 8, the additional rights conferred on the proprietor by the above provisions may not be invoked in opposition proceedings. Hence, any request by the opponent, either for the prohibition of use of the agent's mark, or for an assignment of the application to itself, will be dismissed as inadmissible.

1.2 Purpose of Article 8(3) EUTMR

The unauthorised filing of the proprietor's trade mark by its agent or representative is contrary to the general obligation of trust underlying commercial co-operation

agreements of this type. Such a misappropriation of the proprietor's mark is particularly harmful to its commercial interests, as the applicant may exploit the knowledge and experience acquired during its business relationship with the proprietor and, thus, improperly benefit from the proprietor's effort and investment (confirmed by judgment of 06/09/2006, T-6/05, 'First Defense (I)', para. 38 and subsequent references in, inter alia, Board of Appeal decisions of 16/05/2011, R 0085/2010-4, 'Lingham's', para. 14, of 03/08/2010, R 1231/2009-2, 'Berik', para. 24, and of 30/09/2009, R 1547/2006-4, 'Powerball', para. 17).

Therefore, the purpose of Article 8(3) EUTMR is to safeguard the legitimate interests of trade mark proprietors against the arbitrary appropriation of their trade marks, by granting them the right to prohibit registrations by agents or representatives that are applied for without their consent.

Article 8(3) EUTMR is a manifestation of the principle that commercial transactions must be conducted in good faith. Article 52(1)(b) EUTMR, which allows for the declaration of invalidity of a EUTM on the ground that the applicant was acting in bad faith, is the general expression of this principle.

However, the protection granted by Article 8(3) EUTMR is narrower than the one afforded by Article 52(1)(b) EUTMR, because the applicability of Article 8(3) EUTMR is subject to the fulfilment of a number of additional conditions laid down in this provision.

Consequently, the fact that the applicant filed the application in bad faith will not be in itself sufficient for the purposes of Article 8(3) EUTMR. Therefore, the opposition will be rejected if, despite being based exclusively on the bad faith of the applicant, it does not fulfil the necessary cumulative conditions required by Article 8(3) EUTMR (set out in paragraph 4 below). Such a filing may only be sanctioned under Article 52(1)(b) EUTMR by requesting the cancellation of the mark after it has been registered.

2 Entitlement of the Opponent

According to Article 41(1)(b) EUTMR, the right to file an opposition on the grounds of Article 8(3) EUTMR is reserved only for the proprietors of the earlier trade marks. This is in contrast both to Article 41(1)(a) EUTMR, which stipulates that oppositions based on Article 8(1) EUTMR or 8(5) EUTMR may also be filed by authorised licensees, and to Article 41(1)(c) EUTMR, which stipulates that for oppositions based on Article 8(4) EUTMR the right to file an opposition is also extended to persons authorised by national law to exercise the relevant rights.

It follows that since the right to oppose a EUTM application on the grounds of Article 8(3) EUTMR belongs exclusively to the proprietors of the earlier trade marks, oppositions filed in the name of third persons, be they licensees or otherwise authorised by the relevant national laws, will be dismissed as inadmissible due to lack of entitlement.

Case No	Comment
Decision of 30/09/2009, R 1547/2006-4 'Powerball' (confirmed by judgment of 16/11/2011, T-484/09, 'Powerball')	The Board confirmed OD's decision rejecting the opposition based on Article 8(3) EUTMR to the extent that the opponent was not the proprietor of the earlier right but merely claimed to be the licensee of the company Nanosecond Technology Co. Ltd.

Case No	Comment
Decision of 14/06/2010, R 1795/2008-4 'ZAPPER-CLICK' (on appeal, judgment of 03/10/2012, T-360/10, 'ZAPPER-CLICK')	The respondent failed to meet the requirement regarding ownership of the trade mark, namely of the ownership of the registered mark ZAPPER-CLICK. On appeal, the Court did not address this point.

Likewise, if the opponent fails to prove that it was the rightful proprietor of the mark when the opposition was filed, the opposition will be dismissed without any examination of its merits due to lack of substantiation. The evidence required in each case will depend on the kind of right relied upon. The current proprietor may also invoke the rights of its predecessor in title if the agency/representation agreement was concluded between the previous proprietor and the applicant, but this needs to be duly substantiated by evidence.

3 Scope of Application

3.1 Kinds of mark covered

Article 8(3) EUTMR applies to earlier 'trade marks' that have been applied for as EU trade marks without their proprietor's consent. However, Article 8(2) EUTMR does not apply to oppositions based on this ground, as it only enumerates the kinds of earlier rights on which an opposition may be entered under paragraphs (1) and (5) of the same article. Therefore, the kinds of rights on which an opposition based on Article 8(3) EUTMR may be entered needs to be determined in more detail, both as regards their nature and their geographical origin.

In the absence of any restriction in Article 8(3) EUTMR and in view of the need to provide effective protection to the legitimate interests of the real proprietor, the term 'trade marks' should be interpreted broadly and must be understood as including **pending applications**, since there is nothing in this provision restricting its scope exclusively to registered trade marks.

For the same reasons **unregistered marks or well-known marks** within the meaning of Article 6^{bis} of the Paris Convention also fall within the term 'trade marks' within the sense of Article 8(3) EUTMR. Consequently, both registered and unregistered trade marks are covered by this provision, to the extent of course that the law of the country of origin recognises rights of the latter kind.

In contrast, the express reference to 'trade marks' means that Article 8(3) EUTMR **does not apply to mere signs used in the course of trade**, *other* than unregistered trade marks. Likewise, **other kinds of intellectual property rights** that could be used as a basis for an invalidity action cannot be invoked in the context of Article 8(3) EUTMR either.

Case No	Comment
Decision of 08/06/2010, B 1 461 948 'Gu Tong Tie Gao'	As Article 8(3) EUTMR refers only to earlier trade marks, the evidence filed by the opponent with regard to rights in respect of copyright law in the territory of China was not relevant. This is another kind of intellectual property right which is excluded as a result of the express reference in the article to 'trade marks'.

It is clear from the wording of Article 8(3) EUTMR that the trade mark on which the opposition is based must be **earlier** than the EUTM application. Hence, the **relevant point in time** that should be taken into account is the **filing or priority date** of the contested application. The rules according to which the priority should be determined depends on the kind of right relied upon. If the earlier right has been acquired by registration, it is its priority date that should be taken into account for assessing whether it precedes the application, whereas if it is a user-based right, it must have been acquired before the filing date of the EUTM application. In the case of earlier well-known marks, the mark must have become well-known by the time the EUTM application is applied for.

Case No	Comment
Decision of 21/12/2009, R 1621/2006-4, 'D-Raintank'	The Board noted that the trade mark applications filed by the cancellation applicant in 2003 were all later than the filing date of the contested EUTM and even later than its date of registration, and could not serve to establish that the cancellation applicant owned a 'mark' in the sense of a registered mark, be it anywhere in the world, for the sign at issue when the EUTM was filed. It went on to affirm that 'Obviously, nobody can base a claim on relative grounds for refusal or declaration of invalidity on rights which are younger than the contested EUTM' (para. 53).
Decision of 19/06/1999, B 3 436, 'NORAXON'	The period to be taken into account in order to determine the applicability of Article 8(3) EUTMR starts on the date on which the EUTM application in question came into force, i.e. 26/10/1995. This was the <u>priority date</u> in Germany, claimed by the applicant, granted by the Office and subsequently published, and not the filing date of the EUTM application at the Office.

3.2 Origin of the earlier mark

As Article 8(2) EUTMR does not apply to oppositions based on Article 8(3) EUTMR, it cannot serve to define the territorial extent of protection granted by Article 8(3) EUTMR. In the absence of any other reference in Article 8(3) EUTMR to a 'relevant territory', it is **immaterial whether the earlier trade mark rights reside in the European Union or not**.

The practical importance of this provision lies precisely in the legal capacity it confers on holders of trade mark rights **outside the European Union** to defend these rights against fraudulent filings, since proprietors of trade mark rights within the European Union may rely on the other grounds provided for in Article 8 EUTMR to defend their earlier rights from such acts. Of course, EU trade marks or national marks, which provide a basis for opposition pursuant to Article 8 EUTMR, also qualify as earlier marks that can be invoked as a basis for an Article 8(3) EUTMR opposition.

Case No	Comment
Decision of 19/12/2006, B 715 146, 'SQUIRT'	For the purpose of Article 8(3) EUTMR, it is immaterial where in the world the rights of proprietorship reside. Indeed, if in the Paris Convention <u>the proprietorship in a Paris Union member country</u> is required, in the absence of any reference in the EUTMR to any territory in which such proprietorship shall exist, one must conclude that it is sufficient that the opponent complies with the requirements of Article 5 EUTMR concerning 'Persons who can be proprietors of European Union trade marks'. In the present case, the opponent complied with such a requirement, as it was a company based in the USA.

Case No	Comment
Decision of 10/01/2011, 3253 C, 'MUSASHI' (fig. mark) Cancellation proceedings	The fact that the earlier registrations were from non-EU countries has no bearing on the invalidity ground at issue, since Article 8(2) EUTMR, imposing this territorial condition, does not apply to proceedings based on Article 8(3) EUTMR and cannot serve to define the territorial extent of protection granted by that article. 'In the absence of any reference to a "relevant territory" in Article 8(3) EUTMR, the Cancellation Division must presume that earlier trade marks registered in countries outside the EU may constitute the basis for an invalidity request based on Article 8(3) EUTMR' (para. 33).
Decision of 26/01/2012, R 1956/2010-1 'Heatstrip' (confirmed by T-184/12)	The opposition was based on an unregistered mark protected, inter alia, in Australia. The Board considered that the evidence submitted by the opponent supports that it has been using the mark in Australia to a substantial extent (paras 3 and 34 respectively).
Decision of 19/05/2011, R 0085/2010-4 'Lingham's' (fig. mark)	The opposition was based on a registered mark protected in Malaysia. By filing the Malaysian registration certificate, it was proven that the opponent is the owner of the Malaysian trade mark.

4 Conditions of Application

Article 8(3) EUTMR entitles trade mark proprietors to oppose the registration of their marks as EU trade marks, provided the following substantive cumulative requirements are met (see judgment of 13/04/2011, T-262/09, 'First Defense' (II), para. 61):

1. The applicant is or was an agent or representative of the proprietor of the mark;
2. The application is in the name of the agent or representative;
3. The application was filed without the proprietor's consent;
4. The agent or representative fails to justify its acts;
5. The signs are identical or with slight modifications and the goods and services are identical or closely related.

4.1 Agent or representative relationship

4.1.1 Nature of the relationship

In view of the purpose of this provision, which is to safeguard the legal interests of trade mark proprietors against the misappropriation of their trade marks by their commercial associates, the terms 'agent' and 'representative' should be **interpreted broadly** to cover all kinds of relationships based on any business arrangement (governed by written or oral contract) where one party is representing the interests of another, regardless of the *nomen juris* of the contractual relationship between the principal-proprietor and the EUTM applicant (confirmed by judgment of 13/04/2011, T-262/09 'First Defense' (II), para. 64).

Therefore, it is sufficient for the purposes of Article 8(3) EUTMR that there is some agreement of commercial co-operation between the parties of a kind that gives rise to a **fiduciary relationship** by imposing on the applicant, whether expressly or implicitly, a general duty of **trust and loyalty** as regards the interests of the trade mark proprietor. It follows that Article 8(3) EUTMR may also extend, for example, to licensees of the proprietor, or to authorised distributors of the goods for which the mark in question is used. The **burden of proof** regarding the existence of an agent-principal relationship

lies with the opponent (confirmed by the judgment of 13/04/2011, T-262/09 'First Defense' (II), paras 64 and 67).

Case No	Comment
Judgment of 09/07/ 2014, T-184/12 'Heatstrip'	The Board of Appeal concluded that, although there was no written co-operation agreement between the parties, their relationship on the date of the application for the EUTM was, in view of the business correspondence between them, more than that of merely buyer and seller. There was, rather, a tacit cooperation agreement that led to a fiduciary obligation on the part of the EUTM applicant (para. 67).
Decision of 29/02/2012, B 1 818 791, 'HOVERCAM' (fig. mark)	The Opposition Division found that the evidence submitted by the opponent showed that the relationship and its ultimate purpose constituted an example of commercial cooperation, through which a general duty of trust and loyalty was imposed on the applicant and was the type of relationship envisioned under Article 8(3) EUTMR (p. 5).

Given the variety of forms that commercial relationships may acquire in practice, a **case-by-case approach** is applied, focusing on whether the contractual link between the proprietor-opponent and the applicant is only limited to a series of occasional transactions, or if, conversely, it is of such a duration and content to justify the application of Article 8(3) EUTMR (as regards the points in time which are crucial for the relationship, see below, paragraph 4.1.4). The material question should be whether it was the co-operation with the proprietor that gave the applicant the possibility to get to know and appreciate the value of the mark and incited the applicant to subsequently try to register the mark in its own name.

Nevertheless, some kind of co-operation agreement has to exist between the parties. If the applicant acts completely **independently**, without having entered into any kind of fiduciary relationship with the proprietor, it cannot be considered an agent within the meaning of Article 8(3) EUTMR (confirmed by judgment of 13/04/2011, T-262/09 'First Defense' (II), para. 64).

Case No	Comment
Decision of 16/06/2011, 4103 C, 'D'Angelico' (fig. mark) Cancellation proceedings.	The Cancellation Division found that rather than an agent or representative relationship, at the time of filing the EUTM the parties held parallel and independent rights to the marks in the USA and Japan. For these reasons, Article 8(3) EUTMR was not applicable.

Case No	Comment
Decision of 17/03/2000, B 26 759 'EAST SIDE MARIO'S'	A mere desire to establish a commercial relationship with the opponent cannot be considered as a concluded agreement between the parties regarding the use of the contested trade mark.

Therefore, a **mere customer or a client** of the proprietor cannot amount to an 'agent or representative' for the purposes of Article 8(3) EUTMR, since such persons are under no special obligation of trust to the trade mark proprietor.

Case No	Comment
Judgment of 13/04/2011, T-262/09, 'First Defense' (II)	The opponent did not submit any evidence showing the existence of an agent-principal relationship with the applicant. The opponent provided invoices and order forms addressed to itself, on the basis of which the existence of a business agreement between the parties could, in other circumstances, be assumed. However, in the present case, the GC concluded that the evidence does not show that the applicant acted on behalf of the opponent, but merely that there was a seller-customer relationship which could have been established without a prior agreement between them. Such a relationship is not sufficient for Article 8(3) EUTMR to be applicable (para. 67).
Decision of 26/06/2009, B 955 528 'FUSION' (fig. mark)	The Office considered that the evidence on the kind of commercial link between the opponent and the applicant was inconclusive, that is, it could not be established whether the applicant was really an agent or representative or a mere purchaser of the opponent's goods. Accordingly, the Office was unable to hold that Article 8(3) EUTMR applied.

It is irrelevant for the purposes of Article 8(3) EUTMR whether an **exclusive** agreement exists between the parties, or just a simple, non-exclusive commercial relationship. Indeed, a commercial co-operation agreement entailing an obligation of loyalty can exist even in the absence of an exclusivity clause (see judgment of 09/07/2014, T-184/12 'Heatstrip', para. 69).

Article 8(3) EUTMR also applies to **analogous** forms of business relationships that give rise to an obligation of trust and confidentiality between the trade mark proprietor and the professional, as is the case with legal practitioners and attorneys, consultants, trade mark agents etc. However, the legal representative or manager of the opponent's company cannot be considered as an agent or representative within the meaning of Article 8(3) EUTMR, given that such persons are not business associates of the opponent. The purpose of this provision is not to protect the proprietor from infringing acts coming from within its company. It may well be that such acts can be sanctioned under the general bad faith provision in Article 52(1)(b) EUTMR.

Case No	Comment
Decision of 20/03/2000, B 126 633 'Harpoon' (fig. mark)	In this case, the applicant was a legal representative of the opponent's company. The opposition was rejected.

4.1.2 Form of the agreement

It is not necessary that the agreement between the parties assumes the form of a written contract. Of course, the existence of a formal agreement between the parties will be of great value in determining exactly what kind of relationship exists between them. As mentioned above, the title of such an agreement and the terminology chosen by the parties should not be taken as conclusive. What counts is the kind of commercial co-operation established in substance and not its formal description.

Even in cases where a written contract does not exist, it may still be possible to infer the existence of a commercial agreement of the kind required by Article 8(3) EUTMR by reference to indirect indications and evidence, such as the commercial correspondence between the parties, invoices and purchase orders for goods sold to the agent, or credit notes and other banking instruments (always bearing in mind that a

mere customer relationship is insufficient for Article 8(3) EUTMR). Even dispute resolution agreements may be relevant to the extent they give sufficient information about the past relationship between the parties.

Case No	Comment
Decision of 07/07/2003, R 336/2001-2 'GORDON and SMITH' (fig. mark)	The Opposition Division was correct to conclude that there was an agency relationship between the applicant and the opponents, on the basis of correspondence indicating that the two parties had a long and close commercial relationship. The applicant company acted as a distributor of the opponents' goods (para. 19).

Furthermore, circumstances such as sales targets imposed on the applicant, or payment of royalties, or production of the goods covered by the mark under license or help in the setting up of a local distribution network, will be strong indications in the direction of a commercial relationship of the type covered by Article 8(3) EUTMR.

The Court also decided that active co-operation between a EUTM applicant and an opponent in the advertising of the product, in order to optimise the marketing thereof, could give rise to the fiduciary relationship required under Article 8(3) EUTMR.

Case No	Comment
Decision of 26/01/2012, R 1956/2010-1 'Heatstrip' (appealed confirmed by T-184/12)	The Court confirmed the findings of the Board, who considered that a binding contractual relationship could be established by means of <u>business letters exchanged</u> by the parties, including by email. The Board examined the e-mail correspondence between the parties to determine what each party asked from the other (para. 50). The Board concluded that the emails showed that both parties were actively cooperating in the promotion of the product, by advertising it in brochures and exhibiting it at a fair, in order to create the best conditions for its successful marketing: the opponent supplied the material for these purposes and the applicant adapted it to the German market (para. 54). The Board thus concluded that the e-mail correspondence denoted an agreement of commercial co-operation between the parties of a kind that gives rise to a fiduciary relationship (para. 56). The Court dismissed the applicant's arguments that there was no co-operation between the parties (because the applicant was not integrated in the opponent's sales structure, was not subject to a no-competition clause and had to bear the costs of sale and promotion) and confirmed the Board's decision (para. 67 et seq).

On the other hand, the mere desire of the applicant to enter into a commercial relationship with the opponent cannot be considered as a concluded agreement between the parties. Prospective agents or representatives are not covered by Article 8(3) EUTMR (see B 26 759 'East Side Mario's', quoted above).

4.1.3 Territorial scope of the agreement

Even though the letter of Article 8(3) EUTMR does not refer to the territorial scope of the agreement between the trade mark proprietor and its agent or representative, **an inherent limitation to relationships covering the EU or a part thereof must be read in this provision.**

This is more in line with the economic considerations underlying Article 8(3), which are to prevent agents or representatives from unduly exploiting a commercial relationship covering a given territory, by filing an unauthorised application for the principal's mark precisely in that territory, that is, in the territory where the applicant will be more able to benefit from the infrastructure and know-how it possesses as a result of its prior relationship with the proprietor. Therefore, as the filing prohibited by Article 8(3) EUTMR is an application for the acquisition of trade mark rights in the EU, the agreement must also concern the same territory.

Hence, a purposive interpretation must be followed in this regard, according to which Article 8(3) EUTMR only applies to agreements which cover the territory of the EU, whether in whole or in part. In practice, this means that world-wide or pan-European agreements are covered by this provision, as are agreements extending to one or more Member States, or only covering part of their territory, irrespective of whether they also include third territories. Conversely, agreements exclusively applying to third territories are not covered.

4.1.4 Relevant points in time

The agent-representative relationship must have been established **prior to the filing date** of the EUTM application. Therefore, it is immaterial whether after that time the applicant entered negotiations with the opponent, or made unilateral proposals with the purpose of becoming a representative or agent of the latter.

Case No	Comment
Decision of 19/05/2011, R 0085/2010-4 'Lingham's'	<p>The opponent granted the applicant a special power of attorney (PoA), consenting to the applicant's filing of trade mark applications. Subsequent to this PoA, the applicant filed a EUTM. After the filing, the opponent revoked the PoA and filed the opposition.</p> <p>The Board considered that the relevant point in time is the filing date. At that moment, the owner's consent was present. The revocation had effects <i>ex nunc</i> (and does not affect the validity of actions performed under the PoA) and not <i>ex tunc</i> (as if the PoA had never existed) (para. 24).</p>
Judgment of 06/09/2006, T-6/05 'FIRST DEFENSE' (I)	The Board of Appeal ought to have examined whether, on the day of the application for registration of the mark, the intervener was still bound by the consent (para. 50).

However, even if the agreement between the parties was formally concluded **after the filing date** of the application, it may still be possible to deduce from the evidence that the parties were already in some form of commercial co-operation before the signature of the relevant contract and that the applicant was already acting as the opponent's agent, representative, distributor or licensee.

On the other hand, the agreement between the parties **does not have to be technically still in force** when the application is filed. The reference to a filing made by an 'agent or representative' should not be understood as a formal requirement that must be present at the time the EUTM application is filed. Article 8(3) also applies to **agreements that expired before the filing date of the EUTM application**, provided that the time that has lapsed is of such duration that it can be reasonably assumed that

the obligation of trust and confidentiality was still present when the EUTM application was filed (confirmed by judgment of 13/04/2011, T-262/09 'First Defense' (II), para. 65).

Article 8(3) EUTMR and Article 6^{septies} of the Paris Convention do not protect a trade mark proprietor who is careless and makes no efforts to secure trade mark protection on its own. Post-contractual fiduciary obligations mean that none of the parties may use the termination of an agreement as a pretext for getting rid of its obligations, for example by terminating an agreement and immediately afterwards filing a trade mark. The rationale of Article 8(3) EUTMR and Article 6^{septies} of the Paris Convention is to prevent a situation where a representative in country A of a principal who owns trade marks in country B, and who is meant to market the trade-marked goods and observe the interests of the latter in country A, uses the filing of a trade mark application in country A as a weapon against the principal, for example to force the principal to continue with the representative and to prevent him from entering the market in country A. This rationale likewise applies if an agreement exists but the representative terminates it to take advantage and file a trade mark for the same reasons. However, this does not create absolute rights for the principal to obtain trade mark protection in other countries. The mere fact that the principal holds a trade mark in country B does not give him an absolute right to obtain trade marks in all other countries; the trade marks registered in different countries are in principle independent from each other and may have different proprietors, in accordance with Article 6(3) of the Paris Convention. Article 6^{septies} of the Paris Convention is an exception to this principle and only to the extent that the contractual or de facto obligations of the parties involved justify this. Only to that extent is it justified that the ensuing EUTM would 'belong' to the principal under Article 18 EUTMR (decision of 19/11/2007, R 0073/2006-4 'Porter', para. 26).

This should be assessed on a case-by-case basis, and the decisive factor should be whether it is still possible for the applicant to take commercial advantage of its expired relationship with the trade mark proprietor by exploiting the know-how and contacts it acquired because of its position.

Case No	Comment
Decision of 19/11/2007, R 0073/2006-4 'Porter'	The contested application was not filed during the validity of the agreements between Gallant (owner of shares in Porter, the applicant) and Yoshida (opponent) which allowed Gallant to file a EUTM, but nearly <u>one year</u> after the termination of the last agreement (para. 25). The Board noted that post-termination fiduciary obligations are not meant to last forever but for a certain transitional period after the termination of the agreement in which the parties may re-define their commercial strategies and concluded, inter alia, that any post-contractual relationship between Yoshida and Gallant was phased out at the time of the filing of the EUTM (para. 27).
Decision of 21/02/2002, B 167 926 'AZONIC'	In this case, less than <u>three months</u> after the expiry of a contract relationship, such as a license agreement, is a period within which it was still considered that the fiduciary relationship between the parties exists and imposes on the applicant a duty of loyalty and confidence.

4.2 Application in the agent's name

According to Article 8(3) EUTMR, the trade mark applied for shall not be registered where the agent or representative applies for registration thereof in its own name. It will usually be easy to assess whether this requirement has been fulfilled, by comparing

the name of the applicant with that of the person appearing in the evidence as the agent or representative of the proprietor.

However, there may be cases where the agent or representative will try to **circumvent** this provision by arranging for the application to be filed by a third person, whom it either controls, or with whom it has entered into some form of understanding to that effect. In such cases adopting a more flexible approach is justified. Therefore, if it is clear that because of the nature of the relationship between the person filing the application and the agent, the situation is effectively the same as if the application had been filed by the agent himself, it is still possible to apply Article 8(3) EUTMR, notwithstanding the apparent discrepancy between the applicant's name and the name of the proprietor's agent.

Such a case could arise if the application is filed not in the name of the agent's company, but in the name of a natural person that **shares the same economic interests** as the agent, as for example its president, vice-president or legal representative. Given that in this case the agent or representative could still benefit from such a filing, it should be considered that the natural person is bound by the same limitations as the company.

Case No	Comment
Decision of 21/02/2002, B 167 926 'AZONIC'	The Opposition Division considered that, even though the EUTM application was applied for in the name of the natural person Mr Costahaude instead of directly in the name of the legal person STYLE'N USA, INC., the situation was effectively the same as if it had been filed in the name of the legal person.
Decision of 28/05/2003, B 413 890 'CELLFOOD'	If it is clear that because of the nature of the relationship between the person filing the application and the agent, the situation is effectively the same as if the application had been filed by the agent himself, it is still possible to apply Article 8(3) EUTMR, notwithstanding the apparent discrepancy between the applicant's name and the name of the owner's agent.

Moreover, if the person filing the contested application had also **signed the agency agreement** on behalf of the company, this would have to be considered a strong argument in favour of the application of Article 8(3) EUTMR, since in such a case the applicant cannot possibly deny direct knowledge of the relevant prohibitions. Similarly, if an agency agreement contained a **clause** holding the management of the company personally responsible for the observance of the contractual obligations undertaken by the agent, this would also have to be considered a further indication that the filing of the application is covered by the prohibition of Article 8(3) EUTMR.

Case No	Comment
Decision of 21/02/2002, B 167 926 'AZONIC'	<p>Bearing in mind the position of the authorised representative of the Licensee Company, the Office considered that despite the fact that the EUTM application was made in the name of this natural person, the situation was effectively the same as if it had been filed by the legal person, i.e. the Licensee Company. The EUTM application in the name of the former could have a direct effect on the latter due to their professional relationship, and, furthermore, the President or Vice-President of a company should be considered obliged by the same limitations as their company, or at least temporarily obliged in the case of the expiry of their professional relationship.</p> <p>This position is strengthened by the fact that in the present case there is a clause in the renewed agreement that establishes the licensor's immediate termination right in the case that '... control of STYLE'N (the licensee) is transferred and the management thereby changed', which shows that the management of the licensee company was also bound by the terms of the agreement.</p>

A similar case arises where the agent or the representative and the applicant are distinct legal entities, but the evidence shows that they are **controlled, managed or run** by the same natural person. For the reasons given above it is appropriate to 'lift the corporate veil' and apply Article 8(3) also to these cases.

4.3 Application without the proprietor's consent

Even though the absence of the proprietor's consent is a **necessary condition** for the application of Article 8(3), the **opponent does not have to submit evidence which shows that the agent was not permitted** to file the EUTM application. A mere **statement** that the filing was made without its consent is generally **sufficient**. This is because the opponent cannot be expected to prove a 'negative' fact, such as the **absence** of consent. In these cases the **burden of proof is reversed** and it is up to the applicant to prove that the filing was authorised, or to give some other justification for its acts.

In view of the need to provide effective protection to the legitimate proprietor from unauthorised acts of its agents, the application of Article 8(3) should be denied only where the proprietor's consent is sufficiently **clear, specific and unconditional** (see, for example, judgment of 06/09/2006, T-6/05, 'First Defense' (I), para. 40).

Therefore, even if the proprietor has expressly authorised the filing of the EUTM application, its consent cannot be considered sufficiently clear if it has not also explicitly specified that the application may be in the name of the agent.

Case No	Comment
Decision of 07/07/2003, R 336/2001-2 'GORDON and SMITH' (fig. mark)	'In view of its serious effect in extinguishing the exclusive rights of the proprietors of the trade marks in issue in the main proceedings (rights which enable them to control the initial marketing in the EEA), consent must be so expressed that an intention to renounce those rights is unequivocally demonstrated' (para. 18).

Likewise, even if the proprietor has expressly authorised the filing of a EUTM application, its consent cannot be considered specific enough for the purposes of

Article 8(3) EUTMR if there is no indication of the specific signs which the applicant has permission to file as EU trade mark.

It will be generally easier to assess whether the filing was authorised by the proprietor where the conditions under which an agent or representative may apply for a EUTM application are adequately regulated by **contract**, or are given by other kinds of **direct evidence** (letters, written representations etc.). In most cases, such evidence will be sufficient to show whether the proprietor has given its express consent, or if the applicant has exceeded the limits of its authorisation.

In other cases a contract will either not exist or it will be inadequate on the subject. Although the wording of Article 8(3) is in principle broad enough to include cases of **tacit or implied consent**, such consent should only be inferred if the evidence is sufficiently clear as to the intentions of the proprietor. If the **evidence is completely silent** as to the existence of an express or implied authorisation, **lack of consent should be generally presumed**.

Notwithstanding **indirect indications** and evidence pointing to implied consent, any **ambiguity or doubt** should be **interpreted in favour of the opponent**, as it will usually be quite difficult to assess whether such consent is sufficiently clear and unequivocal.

For example, the mere fact that the proprietor tolerated unauthorised applications in the name of the agent in third jurisdictions cannot alone create legitimate expectations on the part of the applicant that the proprietor will not object to the filing of a EUTM application either.

Case No	Comment
Decision of 31/01/2001, B 140 006 'GORDON and SMITH' (fig. mark) (confirmed by decision of 07/07/2003, R 336/2001-2)	The mere fact that the opponents failed to immediately oppose the applicant's action to register the trade mark after they received notice of the fact did not constitute consent.

The fact that the proprietor tolerates conduct outside the boundaries of a contract (such as use of the sign) cannot lead to the conclusion that filing the EUTM did not breach the established fiduciary duty if consent is not clear, specific and unconditional.

Case No	Comment
<p>Joined cases T-537/10 and T-538/10, 'FAGUMIT'</p>	<p>The applicant (the EUTM owner in cancellation proceedings) focused her line of argument on the consent allegedly granted by the proprietor of the mark. The Court held (like the Board of Appeal) that the consent for the purposes of the registration of the mark in the name of the representative or agent must be clear, specific and unconditional (paras 22-23).</p> <p>The document relied upon by the EUTM owner does not show consent within the meaning of Article 8(3) EUTMR (para. 28). The EUTM owner was not mentioned in the document and it did not refer to the possibility of registration of the sign as a trade mark. The EUTM owner cannot rely on the fact that the cancellation applicant did not object to the use of the sign by companies other than those referred to in the document. Use of the marks occurred during the course of marketing the goods produced by the cancellation applicant. However, such use is the logical consequence of the cooperation between the cancellation applicant and the distributors of its goods and does not show any abandonment of the sign, which would enable anyone to make an application for the registration of that sign – or its dominant element – as a EUTM (para. 27)</p>

Even where consent of the proprietor has been deemed to be clear, specific and unconditional, it will be a question of fact to determine if such consent survives a **change of proprietor** by way of an asset sale.

Case No	Comment
<p>Judgment of 06/09/2006, T-6/05, 'FIRST DEFENSE' (I)</p>	<p>The General Court remitted a case of this nature back to the Board of Appeal in order to determine whether the consent obtained by the EUTM applicant had survived the purchase of the assets of the former trade mark holder and whether, on the day of the application for registration of the mark, the new holder of the trade mark in the USA (the opponent) was <u>still bound</u> by that consent.</p> <p>If the opponent was no longer bound by the consent, the GC indicated that the Board ought then to determine whether the applicant had a <u>valid justification</u> which could offset the lack of such consent.</p>

4.4 Absence of justification on the part of the applicant

As mentioned above, since it is not possible for the opponent to prove the absence of consent, the burden of proof is reversed and it is up to the applicant to show that the filing of the application was authorised by the proprietor. Although Article 8(3) EUTMR treats the lack of the proprietor's consent and the absence of a valid justification on the part of the applicant as two separate conditions, these requirements largely overlap to the extent that if the applicant establishes that the filing of the application was based on some agreement or understanding to this effect, then it will have also provided a valid justification for its acts.

In addition, the applicant may invoke any other kind of circumstance showing that it was justified to file the EUTM application in its own name. However, in the absence of evidence of direct consent, only exceptional reasons are accepted as valid justifications, in view of the need to avoid a violation of the proprietor's legitimate

interests without sufficient indications that its intention was to allow the agent to file the application in its own name.

For example, it could be possible to infer that the proprietor has tacitly consented to the filing of the application if it does not react within a reasonable period of time after having been informed by the applicant that it intends to apply for a EUTM in its own name. However, even in such a case it will not be possible to assume that the application has been authorised by the proprietor if the agent had not made it sufficiently clear to the proprietor in advance in whose name it would file the application.

Another case of valid justification could be if the proprietor causes its agent to believe that it has abandoned the mark, or that it is not interested in obtaining or maintaining any rights in the territory concerned, for example by suspending the use of the mark over a relatively long period of time.

The fact that the proprietor does not want to spend money on a registration of its trade mark does not give the agent a right to act on its own initiative, as the proprietor might still have an interest in using its trade mark in the territory although it is not registered. Such a business decision cannot be taken in itself as a sign that the proprietor has given up the rights in its mark.

Justifications exclusively linked to applicant's economic interests, such as the need to protect its investment in setting up a local distribution network and promoting the mark in the relevant territory, cannot be considered valid for the purposes of Article 8(3) EUTMR.

Nor can the applicant successfully argue in its defence that it is entitled to some financial remuneration for its efforts and expenditure in building-up goodwill for the mark. Even if such remuneration were well deserved or is expressly stipulated in the agency agreement, the applicant cannot use the registration of the mark in its own name as a means of extracting money from the opponent or in lieu of financial compensation, but should try to settle its dispute with the proprietor either by way of agreement or by suing for damages.

Finally, if the applicant does not provide any justification for its actions, it is not for the Office to make any speculations in that regard (see judgment of 09/07/2014, T-184/12 'Heatstrip', paras 73 and 74).

Case No	Comment
Decision of 04/10/2011, 4443 C, 'CELLO'	As to the justificatory argument that the EUTM application was filed in order to protect the goodwill of the mark in the EU, which had been established solely as a result of its trading activities, the Cancellation Division considered that the fact that a distributor, exclusive or otherwise, develops the goodwill of the trade mark of the owner in its allocated territory forms part of the usual duties of a distributor and cannot constitute, in itself and in the absence of other circumstances, a valid justification for the appropriation of the owner's mark by the distributor.

Case No	Comment
Decision of 10/01/2011, 3253 C, 'MUSASHI' (fig. mark)	As regards justification concerning economic claims of the party filing the EUTM and its arguments that it is entitled to some financial remuneration for permitting the sign to enjoy protection at EU level, and that it could be transferred to the Cancellation applicant, it was held that this could not be valid justification within the meaning of Article 8(3). 'Even if remuneration were well deserved, the EUTM proprietor cannot use the registration of a mark in its own name as a means of receiving payment' (from the Cancellation applicant) (para. 47).
Decision of 07/07/2003, R 336/2001-2 'GORDON and SMITH' (fig. mark)	An act which compromises the interests of the trade mark proprietor, such as the filing of a trade mark application in the agent's or a representative's name without the proprietor's consent, and is driven solely by an intention to safeguard the agent's or a representative's own interests, is not considered justifiable for the purposes of Article 8(3) EUTMR. The same applies to the applicant's second argument, that is, that it was justified in doing so because it bore the registration costs. The interests of the trade mark proprietor cannot be subordinate to an agent's or a representative's financial expenses. The fact that an opponent might be unwilling to incur any financial expenses to register a trade mark does not automatically grant a right to the agent or representative to proceed with the registration of the trade mark in its own name. This would constitute a violation of the agent's or representative's duty of trust and loyalty towards the trade mark proprietor (para. 24).

4.5 Applicability beyond identical signs – goods and services

Article 8(3) EUTMR provides that a EUTM application will not be registered where 'an agent or representative of the proprietor of the mark applies for registration thereof in his own name'. Such an explicit reference to the principal's trade mark gives the prima facie impression that the EUTM applied for must be the same as the earlier mark.

Hence, a literal interpretation of Article 8(3) EUTMR would lead to the conclusion that its application is only possible where the agent or representative intends to register a mark identical to that of the proprietor.









Moreover, the text of Article 8(3) EUTMR does not refer to the goods and services for which the application has been filed and for which the earlier mark is protected and, thus, gives no guidance as to what the exact relationship between the respective goods and services should be for the article to apply.

However, applying Article 8(3) EUTMR exclusively to identical signs for identical goods or services would render this provision largely ineffective, as it would allow the applicant to escape its consequences by merely making slight modifications either to the earlier mark or to the specification of goods and services. In such a case, the proprietor's interests would be seriously prejudiced, especially if the earlier mark were already in use and the variations made by the applicant were not significant enough to rule out confusion. What is more, if the application were allowed to proceed to registration despite its similarity to the earlier mark, the applicant would be in a position to prevent any subsequent registration and/or use of the earlier mark by the original proprietor within the EU, by relying on Articles 8(1) or 9(2) EUTMR, or the equivalent provisions of national law.

To sum up, in view of the need to effectively protect the legitimate proprietor against unfair practices by its representatives, a restrictive interpretation of Article 8(3) EUTMR must be avoided. Therefore, Article 8(3) EUTMR must be applied not only where the respective **marks are identical, but also:**

- when the sign applied for by the representative or agent essentially reproduces the earlier mark with slight modifications, additions or deletions, which do not substantially affect its distinctiveness; and
- when the goods and services in conflict are closely related or equivalent in commercial terms. In other words, what finally counts is that the goods or services of the applicant may be perceived by the public as ‘authorised’ products, the quality of which is still somehow ‘guaranteed’ by the opponent, and which it would have been reasonable for the opponent to market in view of the goods and services protected under the earlier mark.

The following are examples of conflicting **signs** where the Office considered that Article 8(3) EUTMR is applicable:

Earlier mark	EUTM application	Case No
<p>FIRST DEFENSE</p>  <p>(2 US earlier rights)</p>		<p>Decision of 04/05/2009, R 0493/2002-4, 'First Defense' (II)</p> <p>Judgment of 13/04/2011, T-262/09, 'FIRST DEFENSE' (II)</p>
		<p>Decision of 03/05/2012, R 1642/2011-2 'Maritime Acopafi' (fig. mark)</p>
 <p>BERIK (word mark) (2 earlier rights)</p>		<p>Decision of 03/08/2010, R 1367/2009-2 'BERIK DESIGN' (fig. mark)</p>
 <p>BERIK (word mark) (2 earlier rights)</p>		<p>Decision of 03/08/2010, R 1231/2009-2 'BERIK' (fig. mark)</p>
	<p>NORAXON</p>	<p>Decision of 19/06/1999, B 3 436 'NORAXON'</p>

Earlier mark	EUTM application	Case No
	APEX	Decisions of 26/09/2001, B 150 955 and B 170 789, 'APEX'

The following are examples of **goods and services** in conflict where the Office considered that Article 8(3) EUTMR is applicable:

Case No	Comment
Decision of 04/05/2009, R 0493/2002-4 – 'FIRST DEFENSE' (II)	<p>The Board held that the contested <i>disabling sprays</i> in Class 13 were covered by the proprietor's <i>non-explosive defense weapons in the nature of an organic irritant packaged in an aerosol (or pressurized spray) canister</i>.</p> <p>However, it considered that protection did not extend to the contested <i>side arms, ammunition, projectiles</i>. These are goods for which commercial activity from the proprietor cannot be reasonably expected. Side arms and ammunition are far too different from pepper sprays to be covered by Article 8(3) EUTMR given that the opponent markets a very specific product (paras 19 to 24).</p> <p>In its judgment of 13/04/2011, T-262/09, the GC did not examine the arguments of the parties regarding the similarity of the goods.</p>
Decision of 03/05/2012, R 1642/2011-2 'Maritime Acopafi' (fig. mark)	<p>The Board held that the wording suggests only if the mark applied for is essentially identical to the earlier right, in terms of both signs and goods/services, it can be prohibited. On the other hand, a too-literal reading of that provision would fatally weaken its utility by allowing fraudulent agents to register their principals' marks by merely making minor modifications or unimportant additions to them. Despite these considerations, however, the provision must apply only where the signs and the goods/services are essentially the same, or largely equivalent (para. 18).</p> <p>In view of this, the Board upheld OD's findings that the earlier mark's use for <i>installation of marine accommodation</i> was fundamentally different from the applicant's services in Class 42 (<i>scientific and technological services and research and design relating thereto; industrial analysis and research services; design and development of computer hardware and software</i>).</p>
Decision of 03/08/2010, R 1367/2009-2 'Berik' (fig. mark)	<p>The Board agreed with the Cancellation Division that the cancellation applicant's goods in Class 25 could not be considered closely related or equivalent in commercial terms to the applicant's goods in Class 18, <i>leather or imitation leather</i>. The latter are raw materials for producers of goods made of leather or imitation of leather and, thus, target a different public and have different distribution channels from the goods covered by the cancellation applicant's marks (paras 30 and 31).</p> <p>It further agreed with the Cancellation Division that the cancellation applicant's goods in Class 25 could not be considered closely related or equivalent in commercial terms to the applicant's goods in Class 16 even if, for example, some of the contested goods could be used as merchandising items for a line of clothing (paras 28-30).</p>

Case No	Comment
<p>Decision of 27/02/2012, B 1 302 530 'GEOWEB / NEOWEB'</p>	<p>'In view of the necessity to effectively protect the legitimate proprietor against unfair practices by its representatives, a restrictive interpretation of Article 8(3) EUTMR must be avoided. Therefore, this provision must be applied not only where the respective marks are identical, but also where the mark applied for by the representative or agent essentially reproduces the earlier mark with slight modifications, additions or deletions, which do not substantially affect its distinctiveness.</p> <p>In line with the aforementioned reasoning, Article 8(3) EUTMR does not only cover cases where the respective lists of goods and services are strictly identical, but it also applies where the goods and services in conflict are closely related or equivalent in commercial terms. In other words, what finally counts is that the goods or services of the applicant may be perceived by the public as 'authorised' products, the quality of which is still somehow "guaranteed" by the opponent' (p. 20).</p>

***GUIDELINES FOR EXAMINATION OF
EUROPEAN UNION TRADE MARKS***

***EUROPEAN UNION
INTELLECTUAL PROPERTY OFFICE
(EUIPO)***

PART C

OPPOSITION

SECTION 4

***RIGHTS UNDER ARTICLES 8(4) AND 8(4a)
EUTMR***

Table of Contents

1	Introduction	3
2	Structure of Article 8(4) EUTMR	3
3	Conditions of Article 8(4) EUTMR	4
3.1	Entitlement: direct right conferred on the opponent	5
3.2	Types of rights falling under Article 8(4) EUTMR	5
3.2.1	Introduction	5
3.2.2	Non-registered trade marks.....	6
3.2.3	Other signs used in the course of trade	7
3.3	Use requirements	10
3.3.1	National standard	10
3.3.2	European standard — use in the course of trade of more than mere local significance	10
3.4	Earlier right	19
3.5	Scope of protection	20
4	Proof of the Applicable Law Governing the Sign	21
4.1	The burden of proof	21
4.2	Means of evidence and standard of proof	22
4.2.1	National law	22
4.2.2	European Union law	24
5	Article 8(4a) EUTMR — The Protection of Geographical Indications..	24
5.1	Relationship between Articles 8(4) and 8(4a) EUTMR	25
5.2	Types of GIs falling under Article 8(4a) EUTMR	26
5.2.1	GIs protected under EU law	26
5.2.2	GIs protected under the laws of Member States	28
5.2.3	GIs protected under international agreements	29
5.3	Scope of protection of GIs	31
	TABLE ON NATIONAL RIGHTS THAT CONSTITUTE ‘EARLIER RIGHTS’ IN THE SENSE OF ARTICLE 8(4) EUTMR	33

1 Introduction

The relationship between the European Union trade mark system and national law is characterised by the **principle of coexistence**. This means that both the European Union trade mark system and the national laws exist and operate side by side. The same sign can be protected by the same proprietor as an EUTM and as a national trade mark in one (or all) of the Member States. The principle of coexistence further implies that the EUTM system actively acknowledges the relevance of national rights and their scope of protection. Where conflicts arise between EUTMs and national trade marks or other national rights, there is no hierarchy determining that one system prevails over the other; instead, these conflicts apply the principle of priority. If the respective requirements are met, earlier national trade marks or other earlier national rights can prevent registration of, or invalidate a later EUTM.

Although the TM Directive and its subsequent implementation have harmonised the laws relating to **registered trade marks**, no such harmonisation has taken place on an EU scale with regard to **non-registered trade marks** nor for most **other earlier rights** of a similar nature. These un-harmonised rights remain completely governed by national laws. Furthermore, there are rights, other than trade marks whose acquisition and/or scope of protection is governed by Union law.

Article 8(4) EUTMR is the ground of opposition against an EUTM application based on an earlier non-registered trade mark or other sign used in the course of trade protected under Union law or the laws of the Member States, subject to the conditions of that provision. Article 8(4a) EUTMR is the ground of opposition against an EUTM application based on an earlier designation of origin or geographical indication protected under Union law or the laws of the Member States, subject to the conditions of that provision.

2 Structure of Article 8(4) EUTMR

Article 8(4) EUTMR reads:

Upon opposition by the **proprietor of a non-registered trade mark or of another sign used in the course of trade of more than mere local significance**, the trade mark applied for shall not be registered where and to the extent that, pursuant to the Union legislation or the law of the Member State governing that sign:

- (a) rights to that sign were **acquired prior** to the date of application for registration of the EU trade mark, or the date of the priority claimed for the application for registration of the EU trade mark;
- (b) that sign confers on its proprietor the **right to prohibit the use of a subsequent trade mark**.

Article 8(4) EUTMR means that in addition to the earlier trade marks specified in Article 8(2) EUTMR, non-registered trade marks and other signs protected at Union or Member State level used in the course of trade of more than mere local significance can be invoked in an opposition provided that such rights confer on their proprietors the right to prohibit the use of a subsequent trade mark.

Article 8(4) EUTMR does not expressly or exhaustively enumerate the particular rights which can be invoked under this provision, but rather outlines a broad spectrum of rights that might serve as basis for an opposition against an EUTM application. Therefore, Article 8(4) EUTMR can be regarded as a general ‘catch-all-provision’ for oppositions based on non-registered trade marks and other signs used in the course of trade.

Nevertheless, the broad scope of earlier rights to be relied upon in opposition proceedings under Article 8(4) EUTMR is subject to a number of restrictive conditions: these rights must confer an entitlement to the proprietor to exercise them, they must be of more than local significance, they must be protected by the applicable law governing them against the use of a subsequent trade mark and the rights must have been acquired prior to the EUTM application under the applicable law governing that sign.

The ‘more than mere local significance’ requirement aims at restricting the number of potential opposing non-registered rights, thus avoiding the risk of a collapse or paralysis of the EUTM system by being flooded with opposing, relatively insignificant rights.

The ‘national protection’ requirement is deemed necessary as the non-registered national rights are not easily identifiable and their protection is not harmonised on an EU level. Consequently, only national law governing the earlier signs may define the scope of their protection.

While the requirements of ‘use in the course of trade’ and ‘use of more than mere local significance’ are to be interpreted in the context of Union law (European standard), national law applies when determining whether a particular right is recognised and protected under the national law, whether its holder is entitled to prohibit the use of a subsequent trade mark, and what conditions need to be met under national law for the right to be successfully exercised.

As a consequence of this dualism, the Office must apply both the relevant provisions of the EUTMR and the national law governing the earlier opposing right. In view of the two-tier examination to be applied under Article 8(4) EUTMR, this provision, as the link between Union and national law, displays a somewhat ‘hybrid’ nature.

3 Conditions of Article 8(4) EUTMR

The conditions for successfully invoking Article 8(4) EUTMR are:

- a) the opponent must be the proprietor of a non-registered trade mark or of another sign used in the course of trade or a person authorised under the applicable law to exercise such a right;
- b) use in the course of trade of more than mere local significance;
- c) acquisition prior to the EUTM application under the applicable law governing that sign;
- d) right to prohibit the use of a subsequent trade mark under the applicable law governing that sign.

3.1 Entitlement: direct right conferred on the opponent

The legal systems of the EU Member States provide various means of preventing the use of later marks on the basis of earlier signs used in the course of trade. However, in order to come within the meaning of Article 8(4) EUTMR, the earlier right must be vested in a particular owner or a precise class of user that has a **quasi-propiertorial interest** over it, in the sense that it can exclude or prevent others from unlawfully using the sign. This is because Article 8(4) EUTMR is a 'relative' ground for opposition and Article 41(1)(c) EUTMR provides that oppositions may be filed only by the proprietors of earlier marks or signs referred to in Article 8(4) EUTMR and by persons authorised under the relevant national law to exercise these rights. In other words, only persons having an interest directly recognised by law in initiating proceedings are entitled to file an opposition within the meaning of Article 8(4) EUTMR.

For example, in some Member States, the use of a sign may be prohibited if it results in unfair or misleading business practices. In such cases, if the earlier right lacks any 'proprietary quality', it will not fall within Article 8(4) EUTMR. It does not matter whether these signs are protected against misleading or unfair use under trade mark law, the law relating to unfair competition, or any other set of provisions. An example in this respect is the German Regulation governing the use of the geographical indication 'Solingen' for specific goods (cutlery scissors, knives etc.). This law would not be a proper basis for an opposition under Article 8(4) EUTMR because the sign in question lacks any proprietary quality and, as such, is more public in nature.

Earlier right	Case No
A.O. CUBA	R 51/2007-4
Where the national law does not confer on a legal entity (whether public or private) a subjective right allowing it to prohibit the use of a subsequent trade mark, the 'proprietary requirement' is not met. The Board found that the Spanish law giving effect to the bilateral Agreement between Spain and Cuba for the protection of the appellation of origin 'Cuba' was not sufficient to grant such a subjective right (paras 23-27).	

In assessing the proprietorship of a sign used in the course of trade, the Office must analyse specifically whether the opponent has acquired rights over the sign 'in accordance with the national law' (judgment of 18/01/2012, T-304/09, BASmALI, EU:T:2012:13).

3.2 Types of rights falling under Article 8(4) EUTMR

3.2.1 Introduction

When assessing which kind of intellectual property rights can be invoked under Article 8(4) EUTMR and which cannot, a European standard applies. The distinction follows from the scheme of the EUTMR and, in particular, from the differentiation made between the kinds of earlier signs upon which an opposition may be based under Article 8(4) EUTMR and the types of further rights that may be the basis for invalidity under Article 53(2) EUTMR. While Article 8(4) EUTMR refers to **signs** ('non-registered trade mark or ... another sign'), Article 53(2) EUTMR refers to a broader set of rights: (a) a right to a name; (b) a right of personal portrayal; (c) a copyright; and (d) an industrial property right.

Therefore, although the signs covered by Article 8(4) EUTMR fall within the broad category of 'industrial property rights', not all industrial property rights are 'signs' for the purposes of Article 8(4) EUTMR. Since this distinction is contained in the EUTMR, the classification of a right under the respective national law is not decisive, and it is immaterial whether the national law governing the respective sign or industrial property right treats both types of rights in one and the same law.

The types of rights falling under Article 8(4) EUTMR are:

- 'non-registered trade marks'; and
- 'other signs used in the course of trade' such as:
 - trade names
 - corporate names
 - establishment names
 - titles of publications or similar works
 - domain names.

The category of 'other signs used in the course of trade' within the meaning of Article 8(4) EUTMR mainly covers non-registered signs. However, the fact that a sign is also registered in accordance with the requirements of the respective national law does not bar it from being invoked under Article 8(4) EUTMR.

3.2.2 Non-registered trade marks

Non-registered use-based trade marks exist in a number of the Member States¹ (see the Table at the end of the document for an overview) and are signs that indicate the commercial origin of a product or service. Therefore, they are signs which function as a trade mark. The rules and conditions governing acquisition of rights under the relevant national law vary from simple use to use having acquired a reputation. Neither is their scope of protection uniform, although it is generally quite similar to the scope of protection under the provisions in the EUTMR concerning registered trade marks.

Article 8(4) EUTMR reflects the existence of such rights in Member States and grants the proprietors of non-registered marks the possibility of preventing the registration of an EUTM application where they would succeed in preventing use of that EUTM application under the relevant national law, by showing that the conditions set by the national law for prohibiting use of the later EUTM are satisfied and the other conditions of Article 8(4) EUTMR are met.

Example: R 1529/2010-1 'Gladiator', where a non-registered trade mark in the Czech Republic was invoked and R 1446/2006-4 'RM2007', where a non-registered trade mark in Belgium was invoked and the opposition rejected as unfounded because non-registered trade marks are not protected in Belgium.

¹ Benelux, Cyprus, Croatia, Estonia, France, Lithuania, Poland, Romania, Slovenia and Spain do not protect unregistered trade marks (unless, for some jurisdictions, they are considered well-known within the meaning of Article 6*bis* of the Paris Convention).

3.2.3 Other signs used in the course of trade

'Other signs used in the course of trade' is a broad category that is not enumerated in Article 8(4) EUTMR. In order for such signs to come within the ambit of Article 8(4) EUTMR, they must have an identifying function as to commercial origin, that is to say, they must serve to identify an economic activity engaged in by its proprietor (judgment of 29/03/2011, C-96/09 P, Bud, EU:C:2011:189, § 149). Article 8(4) EUTMR does not cover other types of intellectual property rights that are not 'commercial signs' — such as patents, copyrights or design rights which do not have a primarily identifying function but which protect technical or artistic achievements or the 'appearance' of something.

Some examples of cases dealing with whether a right is a 'sign' for the purposes of Article 8(4) EUTMR are set out below.

Earlier right	Case No
JOSE PADILLA (copyright)	T-255/08
The Court found that copyright cannot constitute a 'sign used in the course of trade' within the meaning of Article 8(4) EUTMR. It is apparent from the scheme of Article 53 EUTMR that copyright is not such a sign. Article 53(1)(c) EUTMR provides that an EU trade mark is to be declared invalid where there is an earlier right as referred to in Article 8(4) EUTMR and the conditions set out in that paragraph are fulfilled. Article 53(2)(c) EUTMR provides that an EU trade mark is also to be declared invalid where the use of such a trade mark may be prohibited pursuant to any 'other' earlier right and in particular a copyright. <u>It follows that copyright is not one of the earlier rights referred to in Article 8(4) EUTMR.</u>	

Earlier right	Case No
Dr. No (copyright)	T-435/05
In addition, it is clear from Article 8(4) EUTMR read in conjunction with Article 53(2) EUTMR that the protection provided for by <u>copyright cannot be relied on in opposition proceedings</u> , but only in proceedings for a declaration of invalidity of the EU trade mark in question (para. 41).	

Earlier rights	Case No
 <p>and</p> <p>(Community designs)</p>	B 1 530 875
Designs are a form of intellectual property dealing with the ornamental or aesthetic aspects of an article's appearance. Designs are deemed to be the result of a creative work which needs to be protected against unauthorised copying or imitation by third parties in order to ensure a fair return on investment. <u>They are protected as intellectual property, but they are not business identifiers or trade signs. Therefore, designs do not qualify as signs used in the course of trade for the purpose of Article 8(4) EUTMR.</u>	

3.2.3.1 Trade names

Trade names are the names used to identify businesses, as distinguished from trade marks which identify goods or services as produced or marketed by a particular undertaking.

A trade name is not necessarily identical with the corporate name or commercial name entered in a commercial or similar register as trade names can cover other non-registered names such as a sign which identifies and distinguishes a certain establishment. Trade names are protected as exclusive rights in all Member States.

Pursuant to Article 8 of the Paris Convention, trade names enjoy protection without any registration requirement. If national legislation requires registration for national trade names, the respective provision is not applicable by virtue of Article 8 of the Paris Convention with respect to trade names held by a national of another Contracting Party to the Paris Convention. This applies as well in respect of nationals of a member of the WTO Agreement.

As regards the application of Article 8(4) EUTMR to trade names, where the trade name is invoked on the basis of the law of one of the Member States where a registration is a condition for the enforcement of rights in a trade name, the Office will apply this requirement where the Member State and the nationality of the opponent are the same, but will not apply this requirement in all other cases, since this would violate the provisions of Article 8 of the Paris Convention.

Examples: R 1714/2010-4 where the Spanish trade name 'JAMON DE HUELVA' was invoked.

3.2.3.2 Corporate names

A corporate name or company name is the official designation of an undertaking, in most cases registered in the respective national commercial register.

Article 8(4) EUTMR requires that actual use be shown, even if national law vests in the holder of such a name the right to prohibit the use of a subsequent trade mark on the basis of registration alone. However, if under national law registration is a prerequisite for protection, registration must be shown as well. Otherwise, there would be no national right that the opponent could invoke.

Examples: judgment of 14/09/2011, T-485/07, O-live, EU:T:2011:467, where the Spanish commercial name 'OLIVE LINE' was invoked and R 21/2011-1 where the French company name 'MARIONNAUD PERFUMERIES' was invoked.

3.2.3.3 Domain names

A domain name is a combination of typographical characters corresponding to one or several numeric IP addresses that are used to identify a particular web page or set of web pages on the internet. As such, a domain name functions as an 'address' used to refer to a specific location on the internet (euipo.europa.eu) or an email address (@euipo.europa.eu).

Domain names are registered with organisations or commercial entities called 'domain

name registrars'. Although a domain name is unique and may be a valuable commercial asset, a domain name registration per se is not an intellectual property right. Such registrations do not create any form of exclusive right. Instead, 'registration' in this context refers to a contractual agreement between a domain name registrant and the domain name registrar.

However, the **use** of a domain name may give rise to rights that can be the basis for an opposition under Article 8(4) EUTMR. This can occur if through the use of the domain name it acquires protection as a non-registered trade mark or a trade sign identifying commercial origin under the applicable national law.

Examples: R 275/2011-1, where rights based on the use of the German domain name 'lucky-pet.de' were invoked; B 1 719 379, where rights based on the use of the French domain name 'Helloresto.fr' were invoked; T-321/11 and T-322/11, where rights based on the use of the Italian domain name 'partidodellaliberta.it' were invoked and the Court considered that references to this site in the Italian press did not in themselves substantiate its use in the context of a commercial activity.

3.2.3.4 Titles

Titles of magazines and other publications, or titles of similar categories of works such as films, television series, etc. fall under Article 8(4) EUTMR only if, under the applicable national law, they are protected as a trade sign identifying commercial origin.

The fact that the copyright in a title of a work can be invoked under the respective national law against a subsequent trade mark is not material for the purposes of Article 8(4) EUTMR. As set out above, whilst a right in copyright may be used to invalidate an EUTM under Article 53(2) EUTMR, it is only where a title has an 'identifying' function and acts as a trade sign identifying commercial origin that it comes within the scope of Article 8(4) EUTMR. Therefore, for such signs to be relied on under Article 8(4) EUTMR in the context of opposition proceedings, the national law must foresee a protection which is independent from that recognised by copyright law (judgment of 30/06/2009, T-435/05, Dr. No, EU:T:2009:226, § 41-43.)

As with all rights under Article 8(4) EUTMR, the title must have been used in the course of trade. This will normally require that the work to which the title relates must have been placed on the market. Where the title relates to a service (such as a television programme), that service must have been made available. However, there will be circumstances where pre-use advertising may be sufficient to create rights, and where such advertising will constitute 'use' within the meaning of Article 8(4) EUTMR. In all cases, the title must have been used as an indicator of the commercial origin of the goods and services in question. Where a title is used only to indicate the artistic origin of a work, such use falls outside the scope of Article 8(4) EUTMR (judgment of 30/06/2009, T-435/05, Dr. No, EU:T:2009:226, § 25-31).

Example: R 181/2011-1 where the magazine title 'ART' was invoked.

3.3 Use requirements

In order to successfully invoke Article 8(4) EUTMR in opposition proceedings, the earlier rights must be used. There are two different use requirement standards which must be taken into account:

- National standard
- European standard.

The two use requirement standards, however, clearly overlap. They must not be viewed in isolation but have to be assessed together. This applies, in particular, to the 'intensity of use' under the national standard and 'use in trade of more than mere local significance' under the European standard.

3.3.1 National standard

National standard is relevant as it defines the scope of protection of the earlier rights which are often not easily identifiable, all the more so since their protection is not harmonised on an EU level (see further below paragraph 3.5 on the scope of protection). This standard determines the existence of the national right and the conditions of protection. For non-registered trade marks and other trade signs identifying commercial origin that do not require registration, use constitutes the only factual premise justifying the existence of the right, including the ascertainment of the beginning of its existence. The national standard also prescribes the intensity of use under the relevant national law which may vary from mere first use in trade to use requiring recognition or reputation.

For example, right to an unregistered trade mark in Denmark is acquired by **mere commencement of use of the mark** in Danish territory.

In Germany, however, the right to an unregistered trade mark is acquired through **use that has led to recognition by the relevant public of it as a trade mark** ('Verkehrsgeltung'). According to case-law distinctive signs require 20 to 25 % recognition whereas non-distinctive signs must acquire recognition by 50 % of the relevant public.

3.3.2 European standard — use in the course of trade of more than mere local significance

Under Article 8(4) EUTMR, the existence of an earlier non-registered trade mark or of another sign gives good grounds for opposition if the sign satisfies, inter alia, the following conditions: it must be **used in the course of trade and** the use must be of **more than mere local significance**.

The above two conditions are apparent from the very wording of Article 8(4) EUTMR and must, therefore, be interpreted in the light of Union law. The common purpose of the two conditions laid down in Article 8(4) EUTMR is to limit conflicts between signs by preventing an earlier right which is not sufficiently definite — that is to say, important and significant in the course of trade — from preventing registration of a new EU trade mark. A right of opposition of that kind must be reserved to signs which actually have a

real presence on their relevant market (judgment of 29/03/2011, C-96/09 P, Bud, EU:C:2011:189, § 157).

3.3.2.1 Use in the course of trade

The first requirement under Article 8(4) EUTMR is that the sign must be used in the course of trade.

The notion of '**use in the course of trade**' in accordance with Article 8(4) EUTMR is not the same as '**genuine use**' in accordance with Article 42(2) and (3) EUTMR (judgment of 30/09/2010, T-534/08, Granuflex, EU:T:2010:417, § 24-27). The aims and conditions connected with proof of genuine use of registered EU or national trade marks are different from those relating to proof of use in the course of trade of the signs referred to in Article 8(4) EUTMR (judgments of 09/07/2010, T-430/08, Grain Millers, EU:T:2010:304, § 26; 29/03/2011, C-96/09 P, Bud, EU:C:2011:189, § 143). Therefore, use must be interpreted according to the particular type of right at issue.

The Court of Justice ruled that the 'use of the sign in the course of trade' within the meaning of Article 8(4) EUTMR refers to the use of the sign 'in the course of a commercial activity with a view to economic advantage and not as a private matter' (judgments of 12/11/2002, C-206/01, Arsenal, EU:C:2002:651, § 40; 25/01/2007, C-48/05, Opel, EU:C:2007:55, § 18; 11/09/2007, C-17/06, Céline, EU:C:2007:497, § 17).

However, the Court of Justice also ruled that deliveries made without charge may be taken into account in order to ascertain whether the requirement for use of the earlier right in the course of trade has been met, since those deliveries could have been made in the context of a commercial activity with a view to economic advantage, namely to acquire new outlets (judgment of 29/03/2011, C-96/09 P, Bud, EU:C:2011:189, § 152).

As far as the **time of use** of the sign is concerned, an opponent must prove that use took place before the filing of the EUTM application or the priority date if relevant (judgment of 29/03/2011, C-96/09 P, Bud, EU:C:2011:189, § 166-168).

Earlier sign	Case No
BUD	C-96/09 P
<p>The Court discussed whether use which takes place exclusively or to a large extent between the filing of an application for registration and its publication was sufficient to meet the use requirement. One of the parties had argued that only the <i>acquisition</i> of the right had to take place before filing of the EUTM application but not its <i>use</i>. The Court applied the same temporal condition as to the acquisition of the right and concluded that use had to take place before the filing of the application. The Court of Justice considered that in view of the considerable period of time which may elapse between the filing of an application for registration and its publication, the obligation of use in the course of trade of the sign before the filing of the application guarantees that the use claimed for the sign concerned is real and not an exercise whose sole aim has been to prevent registration of a new trade mark (paras 166-168).</p>	

In the case of unregistered signs, the use must be continuous and uninterrupted until the filing of the opposition, since otherwise there is no certainty that the rights in the unregistered sign have not lapsed. In this context, Rule 19(2)(d) EUTMIR expressly states that if an opposition is based on an earlier right within the meaning of Article 8(4)

EUTMR, the opponent shall provide evidence of its acquisition, **continued existence** (emphasis added) and scope of protection of that right.

The following is an example of an *inter partes* case relating to invalidity proceedings. The reasoning and the findings also apply to oppositions, given that Article 8(4) EUTMR is a ground that can be invoked both in opposition and in invalidity:

Earlier sign	Case No
'BAMBOLINA' (non-registered mark in a number of MS)	Cancellation decision No 3 728 C (confirmed by BoA R 1822/2010-2, and judgment T-581/11)
<p>The evidence showed use in the course of trade of the non-registered trade mark for three years, not covering the last two years before the date of filing of the invalidity request. The Cancellation Division held that an earlier non-registered sign relied on in an invalidity action must be in use at the time of filing the request. Since for these signs use constitutes the factual premise justifying the existence of the right, the same factual premise must still exist, and be proven, on the date of filing of the invalidity request (paras 25-28 of the Cancellation decision). The Board confirmed the finding of the Cancellation Division, adding that Rules 19(1) and (2)(d) EUTMIR state that where an opposition is based on Article 8(4) EUTMR, evidence of, inter alia, its 'continued existence' must be adduced within the period given by the Office for presenting or completing facts, evidence or arguments in support of the opposition. Failure to prove the existence, validity and scope of protection of the earlier mark or right within that period will lead to the opposition being rejected as unfounded (Rule 20(1) EUTMIR). In the Board's opinion, these Rules apply <i>mutatis mutandis</i> to cancellation proceedings (para. 15 of the BoA decision).</p>	

The requirement that the sign be used in the course of trade must, as stated above, be interpreted in the light of Union law. It must be distinguished from the requirements provided for under the applicable national laws which might set specific requirements as far as the **intensity of the use** is concerned.

The European use requirement as prescribed by Article 8(4) EUTMR applies independently of whether national law allows prohibition of a subsequent trade mark on the basis of the registration of a sign alone, that is, without any requirement relating to use. The following is an example where the opponent relied on the registration, at national level, of a trade name, but failed to prove that the sign was used in trade:

Earlier sign	Case No
'NACIONAL' (Portuguese name of establishment)	R 693/2011-2
<p>Under Article 8(4) EUTMR, the fact that the opponent may, in accordance with the law of Portugal, have acquired exclusive rights plainly enforceable against subsequent trade marks on the basis of the registration of a 'name of establishment', does not exempt it from the burden of proving that the sign in question has been used in the course of trade of more than local significance. The mere fact that the sign is registered in accordance with the requirements of the respective Portuguese law is not in itself sufficient for the application of Article 8(4) EUTMR (paras 20-26).</p>	

Depending on the applicable national law, an opponent might have to prove not only that the sign relied on is used in the course of trade (this being, as stated, a requirement under Union law), but also that it has been **registered with the competent national authorities**. It would not be sufficient that the European requirement of 'use in trade' is met if the registration requirement is not fulfilled. However, under certain national laws, rights in a company name may be invoked, as

long as the company name has been used, prior to the registration of the entity in the companies register. The following is an example where the opponent invoked prior rights in a company name used in the course of trade in Germany that was not registered at the time of filing the contested EUTM application:

Earlier sign	Case No
'Grain Millers GmbH & Co. KG' (German company name)	T-430/08
<p>The opponent invoked under Article 8(4) EUTMR the company name 'Grain Millers GmbH & Co. KG' used in the course of trade in Germany for 'flour, in particular wheat flour and rye flour'. Therefore, the opponent claimed the name of a GmbH (Gesellschaft mit beschränkter Haftung, 'limited liability company' in English). The applicant argued that, according to Article 11(1) German Limited Companies Act (GmbH Gesetz), a GmbH does not exist before its registration and that the opponent was therefore not entitled, in support of its opposition, to rely on its business name, because the company was registered only after the filing of the contested EUTM application. The GC took a different view and held that, according to the case-law of the German courts, the right to a business name exists pursuant to paragraph 5(2) of the Markengesetz from the first use in the course of trade, without the obligation to register (para. 36).</p>	

A sign is used in the course of trade where that use occurs in the context of **commercial activity with a view to economic advantage** and not as a private matter.

Therefore, the Office will reject an opposition in the absence of actual use of the invoked sign. The following are examples where the opponent failed to meet this basic requirement:

Earlier sign	Case No
Octopussy (film title)	R 526/2008-4
<p>The opponent merely submitted general information explaining the content of the film, its characters, gross figures, video offers on the internet and advertisements without any details as regards the relevant market. The information as regards turnover is also insufficient since it is too broad a general reference to the activities carried out by the opponent and does not specify either the type of activity or the territories concerned. For the same reason, the figures from a periodical, relating to the box office receipts generated by the film, have no bearing on the use of the sign in Germany. The remaining press articles furnished by the opponent concern subjects which cannot corroborate the use of the sign in the Member States indicated. The licence agreements for merchandising do not constitute any evidence with regard to the use of the sign as a film title. Lastly, the mere fact that the film was a worldwide success cannot substitute the obligation of the opponent to file concrete evidence with regard to the Member States in which it claims protection under Article 8(4) EUTMR (para. 26).</p>	

Earlier sign	Case No
'lucky-pet.de' (German domain name)	R 275/2011-1
The opponent invoked under Article 8(4) EUTMR the domain name 'lucky-pet.de' used in the course of trade in Germany for 'mats for animals; retail services with respect to pet supplies'. It has not been proven that the domain has been used with more than local significance for the claimed goods and services. The invoices provided and the catalogue only show the internet address www.lucky-pet.de. However, they do not prove that the website www.lucky-pet.de has been visited and, if so, to what extent. It has neither been stated nor proven by any document how many people visited the website and ordered products via email (para. 31).	

3.3.2.2 Significance of the use

Rights falling under Article 8(4) EUTMR may only be invoked if their use is of more than mere local significance. This requirement applies for all the rights within the scope of Article 8(4) EUTMR, that is, both to unregistered trade marks and to other trade signs identifying commercial origin. The proprietors of rights the use of which is of mere local significance retain their exclusive rights under the applicable national law pursuant to Article 111 EUTMR.

The question whether the use of a non-registered sign is of more than mere local significance will be answered by applying a uniform European standard (judgment of 18/04/2013, T-506/11 & T-507/11, Peek & Cloppenburg, EU:T:2013:197, § 19, 47-48).

The General Court held that the significance of a sign used to identify specific business activities must be established in relation to the identifying function of that sign. That consideration means that account must be taken, firstly, of the **geographical dimension** of the sign's significance, that is to say of the territory in which it is used to identify its proprietor's economic activity, as is apparent from a textual interpretation of Article 8(4) EUTMR. Account must be taken, secondly, of the **economic dimension** of the sign's significance, which is assessed in view of the length of time for which it has fulfilled its function in the course of trade and the degree to which it has been used, of the group of addressees among which the sign in question has become known as a distinctive element, namely consumers, competitors or even suppliers, or even of the exposure given to the sign, for example, through advertising or on the internet (judgments of 24/03/2009, T-318/06 - T-321/06, General Optica, EU:T:2009:77, § 36-37; 30/09/2010, T-534/08, Granuflex, EU:T:2010:417, § 19).

The Court of Justice clarified that the significance of a sign cannot be a function of the mere geographical extent of its protection, since, if that were the case, a sign whose protection is not merely local could, by virtue of that fact alone, prevent registration of a EU trade mark, even though the sign might be used only to a very limited extent in the course of trade. The sign must be used in a sufficiently significant manner in the course of trade and its geographical extent must not be merely local, which implies, where the territory in which that sign is protected may be regarded as other than local, that the sign must be used in a **substantial part of that territory** (judgment of 29/03/2011, C-96/09 P, Bud, EU:C:2011:189, § 158-159).

However, it is not possible to establish a priori, in an abstract manner, which part of a territory must be used to prove that the use of a sign is of more than mere local

significance. Therefore, the assessment of the sign's significance must be made *in concreto*, according to the circumstances of each case.

Therefore, the criterion of '**more than mere local significance**' is more than just a **geographical examination**. The **economic impact** of the use of the sign must also be evaluated. Consideration must be given, and the evidence must relate, to these elements:

- a) the intensity of use (sales made under the sign)
- b) the length of use
- c) the spread of the goods (location of the customers)
- d) the advertising under the sign and the media used for that advertising, including the distribution of the advertising.

In the following examples, both the geographic and the economic dimension of use of the sign were found to meet the standards:

Earlier sign	Case No
GLADIATOR (non-registered trade mark in the Czech Republic)	R 1529/2010-1
<p>The around 230 invoices are sufficient to conclude that the sign 'GLADIATOR' has been used in the course of trade for 'all terrain vehicles'. They are issued to the opponent's clients in Czech cities such as 'Praha', 'Kraslice', 'Dolní Lánov', 'Pelhrimov', 'Opava', 'Bozkov', 'Plzeň' and many other Czech cities which cover many different areas of the Czech Republic. Furthermore, the catalogues and the magazines '4X4 Style' from 2007 are written in Czech and it is very likely that they are distributed in different venues within the Czech Republic. The documents such as the list of distributors, catalogues and magazines support the findings that the sign has been used in the course of trade (paras 22-33).</p>	

Earlier sign	Case No
'FORGE DE LAGUIOLE' (French company name)	R 181/2007-1 (appealed T-453/11)
<p>The company name 'FORGE DE LAGUIOLE', which the invalidity applicant adopted in 1994, appears on all the documents supplied, in particular on the articles of association and on the extract from the company's certificate of registration, on the company's letterhead, on the 1998 price lists and on the correspondence and invoices, dated from 1998, sent to addressees throughout France. The very rapid expansion of the invalidity applicant's activities and its sales network, as well as its sales turnover, is proved by the documents filed. From the list of customers for 2001 it is clear that the applicant had gained a clientele covering the whole of the French territory. This finding is also confirmed by the invoices produced, made out to customers all over France as well as in other European countries. Finally, the fact is established that the company is mentioned in a number of articles both in the French press and in the European and international press (paras 52-68).</p>	

Earlier sign	Case No
'PORTO' (Portuguese appellation of origin)	Opposition B 998 510 (confirmed by the BoA in R 1101/2009-2)
<p>The evidence filed, and the amount and content of the legislation, regulation and registration certificates indicate that Port wine has been and is being used as an appellation of origin for wine. It is clear from the evidence in its totality that the significance of the appellation of origin is not merely local, but rather has an international impact, as reflected in its history and its use as a tool to attract tourists. The promotion of the appellation of origin has taken place, among others, through the establishments 'SOLAR DO VINHO DO PORTO' in Lisbon and Oporto, as well as through the 'PORT WINE ROUTE', in the Douro region. Taking this into consideration, the Office finds that the opponent has proved that it has used its appellations of origin in the course of trade and that the use is of more than mere local significance.</p>	

Earlier sign	Case No
BRADBURY (non-registered trade mark in the UK)	R 66/2008-2
<p>As regards goodwill of the mark, the BoA held that <u>the evidence submitted by the opponent was sufficient to prove that the BRADBURY non-registered sign enjoyed goodwill</u>: 1) The invoice evidence shows sales of a range of goods to various entities in the UK and in other countries. 2) The amounts of those invoices vary from a little over GBP 100 to several thousand pounds sterling. This evidence proves sales of products bearing the earlier non-registered mark to various entities. 3) The declarations and market survey also demonstrate that the sign has enjoyed a degree of recognition among the relevant public for the right holder's goods. 4) The fact that the sign appears in a number of catalogues and advertisements and that after sales service centres are located in various major towns and cities throughout the UK demonstrates that the trade mark has been brought to the attention of a wide public in terms of geographic spread (paras 31-33).</p>	

Earlier sign	Case No
'GOLDEN ELEPHANT fig.' (non-registered trade mark in the UK)	T-303/08
<p>The party relying on the earlier non-registered trade mark had sold rice consistently under the sign since 1988, i.e. for a period of eight years prior to the date on which the applicant filed the application for the contested EU trade mark. The quantity of rice sold — between 42 and 84 tonnes per year from 1988 to 1996 — cannot be regarded as totally insignificant. The mere fact that the party's market share was very small in comparison with the total amount of rice imported into the United Kingdom is not sufficient to justify a finding that those rice sales were below the <i>de minimis</i> threshold. In that context, it should be observed that the courts in the United Kingdom are very unwilling to assume that a business can have customers but no goodwill. 'Even if it were to be assumed that that goodwill had to be regarded as low on account of the limited quantities of the sales, it cannot, on any view, be regarded as non-existent' (paras 112-116).</p>	

As far as the use of the sign is concerned, in general, neither the territory of a city alone, even a big one, is of more than mere local significance, and nor is a regional district or province. It will depend on the circumstances of the case (see examples below). The leading judgment in this respect is the one rendered by the General Court in the *General Optica* case, where use of the sign was confined to a specific locality and was, therefore, insufficient to meet the prescribed requirements:

Earlier sign	Case No
Generalóptica (Portuguese establishment name)	Joined Cases T-318/06 to T-321/06
<p>It is not apparent from the evidence provided by the opponent that the significance of the sign relied on in the present case is more than merely local within the meaning of Article 8(4) EUTMR. As the Board of Appeal stated in paragraph 33 of the contested decisions, it is apparent from the documents submitted by the opponent that at the time when registration of the first two EU trade marks was applied for, the sign in question had been used for almost 10 years merely to designate a business establishment open to the public in the Portuguese town of Vila Nova de Famalicão, which has 120 000 inhabitants. In spite of its explanations at the hearing, the applicant did not provide any evidence of recognition of the sign by consumers or of its business relationships outside the abovementioned town. Likewise, the applicant has not shown that it had developed any advertising activity in order to ensure that its business establishment was promoted outside that town. It must therefore be held that the business establishment name Generalóptica is of mere local significance within the meaning of Article 8(4) EUTMR (para. 44).</p>	
Earlier sign	Case No
FORTRESS FORTRESS INVESTMENTS FORTRESS INVESTMENT GROUP (non-registered trade marks in the UK)	R 354/2009-2 R 355/2009-2
<p>The fact that the invalidity applicant was involved in the acquisition, lease-back and management of nationwide property portfolios of major UK institutions and companies proves that the use was of more than mere local significance. The fact that use is limited to London is relevant in the sense that London is the seat of nearly all governmental institutions and bodies and home to the City of London, one of the leading financial centres of the world. The economic dimension of the sign's significance was important since by mid-2000 the invalidity applicant had already an equity capital under management in excess of US\$1 billion. Furthermore, the group of addressees among which the sign was known is significant since it included major players in the financial field and UK public institutions. The exposure given to the sign was also significant, cf. the national and specialised press coverage. Therefore, use in the course of trade was of more than mere local significance (paras 49-51).</p>	

The notion that the use in trade of the sign relied on must be proven in the territory of the Member State/s where protection is sought is not incompatible with use of the sign in connection with **cross-border commercial transactions**:

Earlier sign	Case No
GRAIN MILLERS (German business name)	T-430/08
<p>The use of a business name in the context of the importation of goods from another State (in this case, documents of the transaction concluded by opponent concerning the import of wheat from Romania to Germany) is indeed use in the context of a commercial activity with a view to economic advantage, since import-export constitutes a normal, everyday activity of an undertaking, necessarily involving at least two States (para. 41).</p>	

The following are examples where the opponent failed to prove that the **economic dimension** of the use of the signs concerned was sufficient to meet the prescribed legal requirements:

Earlier sign	Case No
BUD (appellation of origin)	T-225/06 RENV, T-255/06 RENV, T-257/06 RENV, T-309/06 RENV
Four very small invoices for only three cities, without any advertisements, did not meet the requirement for use in the course of trade of a sign of more than mere local significance (para. 56). The same conclusion applied to Austria since the GC found that use was limited to deliveries of 12-25 hectolitres per year, for a marginal turnover (around EUR 1 200), almost exclusively in Vienna (paras 59-61).	

Earlier sign	Case No
BRIGHTON (non-registered mark in several MS)	R 408/2009-4
The sales chart provided by the opponent shows that the sale activities in the Member States concerned were not consistent over time to the extent that for certain years no sales at all appear to have taken place and that for others the sales revenue was very low indeed. Therefore, the sales figures show that the opponent was not able to maintain an intensity of use of the signs over three consecutive years. It is unlikely in those cases that the public was able to memorise the mark as an indication of origin. The opponent did not submit any evidence relating to the advertising and promotion of the marks invested in the concerned Member States, or other material showing that the signs in question had established themselves in the marketplace to such an extent as to justify the acquisition of exclusive rights in non-registered trade marks (paras 12-21).	

Earlier sign	Case No
 (Greek non-registered mark)	R 242/2010-1
Although the documents confirm the geographical extent of the trade mark to Greece, the evidence regarding the extent of time of the alleged use is clearly insufficient. The last dated document is from 1997, i.e. seven years before the contested application was submitted. Moreover, the most recent documents in which the trade mark 'ESKIMO' can be seen are the invoices dating from 1991 to 1994. They only reflect the sales of a little less than 100 units throughout these four years, which cannot be deemed sufficient to prove the use of the mark as a business identifier by the opponent (paras 27-28).	

Earlier sign	Case No
Up Way Systems – Representações Unipessoal LDA (Portuguese company name)	R 274/2012-5
Three invoices, addressed to companies in the Porto region of Portugal, for a total sales amount of EUR 16 314, are not sufficient to show that the sign was used in the course, considering the price level of building materials and building services in general (paras 20-23).	

Use of a sign relied on under Article 8(4) EUTMR must be made in accordance with the essential **function** of such a sign. This means that if an opponent relies on a non-registered trade mark, proof of use of the sign as a company name would not be sufficient to substantiate the earlier right.

The following is an example where the evidence shows use of a sign whose function does not correspond to that of the sign relied on:

Earlier sign	Case No
JAMON DE HUELVA (Spanish trade name)	R 1714/2010-4
<p>The proof furnished in order to substantiate the use of 'Jamón de Huelva' almost exclusively relates to the designation of origin 'Jamón de Huelva'. Designations of origin are very different legal concepts from trade names, as, instead of identifying a particular commercial origin, they are geographical indications relating to an agricultural or food product of which the quality or characteristics are fundamentally or exclusively due to the geographical environment in which they are produced, processed or prepared. The opposition based on the use in Spain of the trade name 'Jamón de Huelva' must be dismissed in view of the fact that the proof furnished does not relate to this legal concept and does not identify a specific commercial activity, but instead the activities relating to a designation of origin and the Supervisory Council thereof (paras 34-37).</p>	

The requirement that the sign must be used in trade for its own particular economic function does not exclude that the same sign might be used for several purposes.

It is common market practice to also use company or trade names as trade marks, either alone, or together with other product identifiers. This is the case when use of a 'house mark' is concerned, that is, an indication which usually coincides with the manufacturer's company or trade name and which not only identifies the product or service as such, but also provides a direct link between one or more product/service lines and a specific undertaking.

Therefore, depending on the specific circumstances of the case, in a case where an opponent relies on a non-registered trade mark, the use of the same sign as a company name or trade name may well also accomplish the function of indicating the origin of the goods/services concerned (thus, a trade mark function), as long as the sign is used in such a way that a link is established between the sign which constitutes the company or trade name and the goods marketed or the services provided (see, by analogy, judgment of 11/09/2007, C-17/06, Céline, EU:C:2007:497, § 22-23).

As Article 8(4) EUTMR continues to apply to oppositions based on geographical indications filed before the entry into force on 23/03/2016 of Regulation (EU) 2015/2424 amending Regulation No 207/2009 on the Community trade mark, the opponent is still required to **prove that the geographical indication is used in the course of trade of more than mere local significance** (see paragraph 5.1 below). Use must be made in accordance with the essential function of such a sign, namely to **guarantee to consumers in the course of trade the geographical origin of the goods and the special qualities inherent in them** (judgment of 29/03/2011, C-96/09 P, Bud, EU:C:2011:189, § 147 and 149, respectively). Therefore, documents mentioning a geographical indication exclusively in a non-trade context are not sufficient for the purposes of Article 8(4) EUTMR.

3.4 Earlier right

The right invoked under Article 8(4) EUTMR must be earlier than the EUTM application. In order to determine which of the conflicting rights is earlier, the relevant dates on which the rights were obtained must be compared.

- For the **EUTM application**, this is the filing date or any priority date validly claimed (hereinafter the 'EUTM date'). Seniority claims, even if they relate to

the Member State where the other earlier right is claimed to exist, are not relevant.

- As regards the **right falling under Article 8(4) EUTMR**, the relevant date of acquisition of exclusive rights under the national law is decisive (judgment of 07/05/2013, T-579/10, makro, EU:T:2013:232, where the Court confirmed the Board's rejection of evidence submitted by the invalidity applicant, which related to periods subsequent to the owner's application for the EUTM (§ 70).

Where under the national law mere use is sufficient, this must have begun before the EUTM date. Where recognition in the trade or reputation are required, these must have been acquired before the EUTM date. Where these conditions are fulfilled only after the EUTM date, the opposition will have to be rejected.

3.5 Scope of protection

Earlier rights falling under Article 8(4) EUTMR are protected only if they confer on their proprietors under the applicable law the right to prohibit the use of a later trade mark.

This requires a finding that under the applicable national law rights of the type involved, in the abstract, are exclusive rights enforceable by means of an injunction vis-à-vis later marks and a finding that in the actual case under consideration the conditions for obtaining such injunctive relief, if the mark that is the subject of the opposed EUTM application were used in the territory in question, are present (scope of protection). Both questions have to be answered in accordance with the applicable law. The Office will apply the laws of the Member States, Union law or International agreements.

For many, if not most, of the rights falling under Article 8(4) EUTMR, the prerequisites of national regulations are quite similar to those applied in conflicts between trade marks which Office examiners are familiar with, namely, likelihood of confusion, or damage to reputation or distinctiveness.

For example, unregistered marks are generally protected against subsequent marks in the event of a likelihood of confusion and, thus, in accordance with the same criteria that are applicable to conflicts between registered marks, namely, identity or similarity of the signs, identity or similarity of the goods or services, etc. In these cases, the criteria developed by the courts and by the Office for applying Article 8(1) EUTMR may easily be transported into Article 8(4) EUTMR, unless the party can provide relevant case-law of the national courts proving a different approach.

Where the applicable national law provides protection for unregistered trade marks, which is different from that found in Article 8(1) EUTMR, the scope of protection of the earlier right invoked follows from national law. If, for example, the applicable national law grants protection to unregistered marks also for dissimilar goods and services under certain conditions, the same protection will be granted under Article 8(4) EUTMR.

4 Proof of the Applicable Law Governing the Sign

4.1 The burden of proof

According to Article 76(1) EUTMR, in all *inter partes* cases, the burden is on the party making a particular claim or allegation to provide the Office with the necessary facts and arguments in order to substantiate the claim. Unlike other grounds in Article 8 EUTMR, Article 8(4) EUTMR does not specify the conditions governing the acquisition and scope of protection of the earlier right invoked. It is a framework provision where the particulars of the applicable law must be provided by the opponent.

Rule 19(2)(d) EUTMIR provides that if an opposition is based on an earlier right within the meaning of Article 8(4) EUTMR, the opponent shall provide evidence of its acquisition, continued existence and scope of protection.

It follows from the law as interpreted by the Court that the opponent must provide the relevant national law and show that it would succeed under that national law in preventing the use of a subsequent trade mark:

In that regard, it should be observed that Article 8(4)(b) Regulation No 40/94 [now Article 8(4)(b) EUTMR] lays down the condition that, pursuant to the law of the Member State governing the sign relied on under Article 8(4), that sign confers on its proprietor the right to prohibit the use of a subsequent trade mark.

Furthermore, in accordance with Article 74(1) of Regulation No 40/94 [now Article 76(1) EUTMR], the burden of proving that that condition is met lies with the opponent before the Office.

In that context and in relation to the earlier rights relied on ... regard must be had, in particular, to the national rules advanced in support of the opposition and to the judicial decisions delivered in the Member State concerned and that, on that basis, the opponent must establish that the sign concerned falls within the scope of the law of the Member State relied on and that it allows use of a subsequent mark to be prohibited.

(Judgment of 29/03/2011, C-96/09 P, Bud, EU:C:2011:189, § 188-190.)

The Court held that in applications for a declaration of invalidity brought under Article 53(2) EUTMR, it is for the party who seeks to rely on an earlier right protected under national law

to provide the Office not only with particulars showing that he satisfies the necessary conditions, in accordance with the national law of which he is seeking application, in order to be able to have the use of an EU trade mark prohibited by virtue of an earlier right, but also particulars establishing the content of that law.

(Judgments of 05/07/2011, C-263/09 P, Elio Fiorucci, EU:C:2011:452, § 50; 27/03/2014, C-530/12 P, Mano, EU:C:2014:186, § 34.)

Although these judgments referred to invalidity proceedings under Article 53(2) EUTMR, since Article 8(4) EUTMR also concerns the application of earlier rights protected under European Union legislation or under the law of the Member State

governing the sign at issue, the cited case-law also applies to oppositions brought under Article 8(4) EUTMR.

The information on the applicable law must allow the Office to understand and apply the content of that law, the conditions for obtaining protection and the scope of this protection, and allow the applicant to exercise the right of defence. It may also be particularly useful to submit evidence of relevant case-law and/or jurisprudence interpreting the law invoked.

The Office must effectively assess the applicability of the ground for refusal invoked. In order to ensure the correct application of the law invoked, the Office has the power to verify, by whatever means it deems appropriate, the content, the conditions governing the application and the scope of the provisions of the applicable law relied upon by the opponent (judgment of 27/03/2014, C-530/12 P, *Mano*, EU:C:2014:186, §44-46), while respecting the parties' right to be heard. If, after verifying the evidence submitted, the Office is of the opinion that the parties' proposed interpretation or application of the law invoked was inaccurate, it can introduce new and/or additional elements. In order to respect the parties' rights to be heard, the Office will invite the parties to comment on these elements, where appropriate.

This power of verification is limited to ensuring the **accurate application of the law relied upon by the opponent**. It does not therefore discharge the opponent from the burden of proof and it cannot serve to substitute the opponent in adducing the appropriate law for the purposes of its case (see decision of 02/06/2014, R 1587/2013-4, 'GROUP', § 26, and decision of 30/06/2014, R 2256/2013-2 'ENERGY', § 26).

4.2 Means of evidence and standard of proof

Pursuant to Article 8(4) EUTMR, the applicable law may be the law of a Member State or European Union law.

4.2.1 National law

As regards national law, the opponent must provide:

a) **the provisions of the applicable law:**

- on the **conditions governing acquisition of rights** (whether there is a requirement of use and, if so, the standard of use required; whether there is a registration requirement, etc.); and
- on the **scope of protection of the right** (whether it confers the right of prohibition of use; the injury against which protection is provided, e.g. likelihood of confusion, misrepresentation, unfair advantage, evocation).

b) **particulars proving fulfilment of the conditions:**

- of **acquisition** (entitlement; earlier acquisition; whether it is in force; evidence of use if use-based; evidence of registration if registration-based, etc.); and

- of **the scope of protection** (facts, evidence and/or arguments that the requirements laid down by the applicable law for a prohibition of use are met, e.g. the nature of the goods, services or business activity protected by the earlier right and their relation with the contested goods or services; a cogent argument showing that there is a risk of injury).

First, as regards the provisions of the applicable law (see point a) above), the opponent must provide the reference to and content of the applicable law invoked. The opponent must provide the *reference* to the relevant legal provision (article number and the number and title of the law) and the *content* (text) of the legal provision either in its submission or by highlighting it in another publication attached to the submission (e.g. excerpts from an official journal, a legal commentary or a court decision). If the relevant provision refers to a further provision of law, this must also be provided to enable the applicant and the Office to understand the full meaning of the provision invoked and to determine the possible relevance of this further provision.

As the opponent is required to **prove** the content of the applicable law, **it must provide the applicable law in the original language**. If that language is not the language of the proceedings, the opponent must also provide a **complete translation** of the legal provisions invoked in accordance with the standard rules of substantiation. However, a mere translation of the applicable law does not itself constitute proof and cannot substitute the original; therefore, the translation alone is not considered sufficient to prove the law invoked. See Rule 19(2)(d) EUTMIR, which requires **evidence** to be submitted and Rule 19(3) EUTMIR, which requires translations be submitted within the time limit specified **for submitting the original document**.

Where the opponent seeks to rely on national case-law or jurisprudence interpreting the law invoked, it must provide the relevant information in sufficient detail (e.g. a copy of the decision invoked or excerpts from the legal literature) and not merely by reference to a publication. The translation rules apply equally to that evidence.

Second, as regards the particulars proving fulfilment of the conditions of the applicable law (see point b) above), apart from providing appropriate evidence of acquisition of the right invoked, the opponent must submit evidence that the conditions of protection vis-à-vis the contested mark are actually met and, in particular, put forward a cogent line of argument as to why it would succeed in preventing the use of the contested mark under the applicable law. Merely providing the applicable law itself is not considered sufficient, as it is not up to the Office to make the relevant argument on behalf of the opponent.

Furthermore, in an opposition under Article 8(4) EUTMR, what matters is whether the relevant provisions of the law conferring on the opponent the right to prohibit the use of a subsequent trade mark would apply to the contested mark in the abstract, and not whether the use of the contested mark could actually be prevented. Therefore, the applicant's argument in defence that the opponent had not hitherto invoked or had not hitherto been able to prevent the actual use of the contested mark in the relevant territory cannot succeed (judgment of 29/03/2011, C-96/09 P, Bud, EU:C:2011:189, § 191 and 193).

At the end of this Section of the Guidelines, there is an overview **Table** with the essentials of national laws applicable in the Member States. It is included in these Guidelines for information purposes only. As this table contains a description of the legal provisions for information purposes only, merely referring to the table does not discharge the opponent from the duty of proving the relevant law governing the sign

that confers on it the right to prohibit the use of a later trade mark, as described above (see decision of 22/01/2013, R 1182/2011-4, 'Crown Lounge (fig. mark)', § 48-50).

Based on the above, the Office will reject the opposition if:

- the opponent invokes a right but does not include a **reference** to any specific national law and/or legal provision protecting that right (e.g. the opponent only indicates that the opposition is based on a commercial designation in Germany or that the opposition based on a commercial designation in Germany is protected under DE-TMA); or
- the opponent provides a reference to the applicable national law and legal provision(s) but the reference is not complete: the legal provision only indicates the conditions governing the **acquisition** of the right but not the **scope of protection** of the right (or vice-versa) (e.g. the opponent indicates that the opposition is based on a commercial designation in Germany protected under Article 5 DE-TMA, which establishes the conditions for acquisition of the right, but the reference to the conditions governing the scope of protection, Article 15 DE-TMA, is missing); or
- the opponent provides the reference to the relevant legal provision but does not provide the **content** (text) of the legal provision (e.g. the opponent's submission refers to the DE-TMA but does not include the content of the law); or
- the opponent provides the content of the legal provision only in the language of the proceedings but not in the **original language** (e.g. the language of the proceedings is English but the text of the DE-TMA is submitted only in English, not in German); or
- the opponent does not provide any or sufficient evidence of the acquisition of the right invoked or does not provide arguments as to why it fulfils the conditions governing the scope of protection (e.g. the opponent refers to the relevant legal provisions and provides their content both in the original language and translated into the language of the proceedings, but does not provide any or sufficient evidence of the acquisition of protection or does not state whether it fulfils the conditions of the scope of protection).

4.2.2 European Union law

The above requirements also apply to European Union law, except that the opponent is not obliged to provide the content (text) of the law invoked. However, the opponent has to provide particulars proving the fulfilment of the conditions under the relevant provisions of European Union law (paragraph b) above).

5 Article 8(4a) EUTMR — The Protection of Geographical Indications

The essential function of the protection of a geographical indication is to guarantee to the consumer the geographical origin of the goods and the special qualities connected therewith (judgment of 29/03/2011, C-96/09 P, Bud, EU:C:2011:189, § 147).

A geographical indication identifies a product originating in a particular geographical area, where a given quality, reputation or other characteristic of that product is essentially attributable to its geographical origin.

EU legislation distinguishes between ‘protected designations of origin’ (PDOs), where the quality or characteristics of the product are **essentially or exclusively due to** a particular geographical environment, and ‘protected geographical indications’ (PGIs), where a **given** quality, reputation or other characteristic of the product is **essentially attributable** to its geographical origin, without the stages of production, processing or preparation all necessarily taking place in the same area². In essence, PDOs have a closer link with the geographical area of production. The distinction, however, does not affect their scope of protection, which is the same for PDOs and PGIs. For the purposes of this chapter, the term ‘geographical indication’ (GI) is used to refer to both PDOs and PGIs in general.

For a general overview of geographical indications see the Guidelines, Part B: Examination, Section 4 Absolute Grounds for Refusal, Article 7(1)(j).

5.1 Relationship between Articles 8(4) and 8(4a) EUTMR

Regulation (EU) 2015/2424 amending Regulation No 207/2009 on the Community trade mark (‘Amending Regulation’) introduced Article 8(4a) EUTMR as a specific ground of opposition for GIs. Prior to that, GIs could form the basis of an opposition pursuant to Article 8(4) EUTMR as ‘another sign used in the course of trade’. However, the introduction of this specific ground means that as of the entry into force of Article 8(4a) EUTMR, GIs can only be invoked under the new ground. GIs can no longer form the basis of an opposition under Article 8(4) EUTMR, even though the wording of that provision has not changed.

However, if an opponent files an opposition based on a GI after entry into force of the Amending Regulation, in which it indicates incorrectly Article 8(4) EUTMR as a ground for opposition, the Office will examine the opposition, to the extent that it is clearly based on a GI, as if the ground invoked were Article 8(4a) EUTMR. In such a case, the notice of opposition leaves no doubt as to the opponent’s intention to invoke the ground for opposition protecting earlier GIs.

Oppositions based on GIs filed before the date of entry into force of Article 8(4a) EUTMR will continue to be assessed under the conditions of Article 8(4) EUTMR. In the absence of transitory provisions, Article 8(4a) EUTMR applies in oppositions filed on or after its entry into force, regardless of whether the contested EUTM application was filed, or had a date of priority before or after such entry into force.

Article 8(4a) EUTMR reads:

Upon opposition by any person authorised under the relevant law to exercise the rights arising from a designation of origin or a geographical indication, the trade mark applied for shall not be registered where and to the extent that, pursuant to the Union legislation or national law providing for the protection of designations of origin or geographical indications:

² GIs for spirit drinks and aromatised wine products are protected under EU law only as PGIs, not PDOs.

- (i) an application for a designation of origin or a geographical indication had already been submitted, in accordance with Union legislation or national law, prior to the date of application for registration of the EU trade mark or the date of the priority claimed for the application, subject to its subsequent registration;
- (ii) that designation of origin or geographical indication confers the right to prohibit the use of a subsequent trade mark.

The new ground of opposition for GIs specifies this particular type of earlier right, its beneficiary and its date of priority. However, apart from those evident specificities, the only substantial difference between Articles 8(4) and 8(4a) EUTMR is that the latter **does not require the opponent to prove use in the course of trade of more than mere local significance**.

The other conditions, namely, entitlement and proof of the applicable law, apply as explained in paragraphs 3.1 and 4 above, respectively.

The rest of this chapter addresses the particularities of GIs as a basis of opposition.

5.2 Types of GIs falling under Article 8(4a) EUTMR

GIs are protected on various levels, under EU law, national law or international agreements, and cover various product areas such as foodstuffs or handicrafts.

5.2.1 GIs protected under EU law

At EU level, there is protection for GIs for the following categories of products:

1. **certain foodstuffs and certain non-food agricultural products** (pursuant to Regulation No 1151/2012³, the 'Foodstuffs Regulation');
2. **wines and sparkling wines** (pursuant to Regulation No 1308/2013⁴, the 'Wines Regulation');
3. **spirit drinks** (pursuant to Regulation No 110/2008⁵, the 'Spirit Drinks Regulation'); and
4. **aromatised wine products** (pursuant to Regulation No 0251/2014⁶, the 'Aromatised Wines Regulation').

³ Replaced and repealed Regulation No 0510/2006, which had replaced and repealed Regulation No 2081/92.

⁴ Replaced and repealed Regulation No 1234/2007, which had integrated, through codification by Regulation No 0491/2009, Regulation No 0479/2008 which was repealed at the same time.

⁵ Replaced and repealed Regulation No 1576/89.

⁶ Replaced and repealed Regulation No 1601/91.

5.2.1.1 GIs covered by the EU Regulations

The Foodstuffs Regulation protects GIs that existed in Member States and have been applied to be registered in the EU system of protection (in a simplified registration procedure) within a six-month period between 24/07/1993 to 23/01/1994⁷ (with similar application periods provided to any new Member State on accession) subject to its registration, and any further GIs applied for and registered pursuant to the EU system of protection thereafter.

The Wines Regulation protects GIs that were already protected in a Member State on 01/08/2009⁸ (or on the date of accession of a new Member State) subject to further conditions⁹, and any further GIs applied for and registered pursuant to the EU system of protection thereafter.

The Spirit Drinks Regulation protects GIs that were already protected in a Member State on 20/02/2008¹⁰ (or on the date of accession of a new Member State) subject to further conditions¹¹, and any further GIs applied for and registered pursuant to the EU system of protection thereafter.

The Aromatised Wines Regulation protects GIs that were already protected in a Member State on 27/03/2014¹² subject to further conditions¹³, and any further GIs applied for and registered pursuant to the EU system of protection thereafter.

GIs protected under the above Regulations are, thus, **‘existing GIs’ from Member States** that have existed before the uniform EU system of protection (subject to further conditions of full EU protection) and **‘new GIs’ from Member States** that have been applied for and registered under the uniform system of EU protection. Furthermore, **GIs originating from third countries** are also protected under the above Regulations pursuant to direct applications filed with the Commission (as an alternative to their protection through international agreements, discussed in paragraph 5.2.3 below).

5.2.1.2 Specificities of substantiation

GIs protected under the above Regulations may be a valid basis for an opposition under Article 8(4a) EUTMR, to the extent that they allow the person authorised under the applicable law to exercise those rights **to prevent the use** of a subsequent mark. Their ability to prevent use is governed by the relevant provisions of the Regulations cited above (Articles 13(1), Article 103(2), Article 16 and Article 20(2) of the Foodstuffs, Wines, Spirit Drinks and Aromatised Wines Regulations, respectively). In this context, it is important to distinguish the latter provisions preventing use from those that prevent

⁷ See Article 17(1), first sentence, of Regulation No 2081/1992 (in the version effective before 24/04/2003).

⁸ See Article 51(1) of Regulation No 479/2008, and after its codification, Article 118s(1) of Regulation No 1234/2007.

⁹ Namely, forwarding the technical files and the national decisions of approval to the Commission by 31/12/2011 and final scrutiny by the Commission by 31/12/2014 (see Articles 51(2)-(4) of Regulation No 479/2008, and after its codification, Articles 118s(2)-(4) of Regulation No 1234/2007 and subsequently, Article 107(3) of Regulation No 1308/2013).

¹⁰ See Article 20(1) of Regulation No 110/2008.

¹¹ Namely, forwarding the technical files to the Commission by 20/02/2015 (see Article 20(1) of Regulation No 110/2008).

¹² See Article 26(1) of Regulation No 251/2014.

¹³ Namely, forwarding the technical files and the national decisions of approval to the Commission by 28/03/2017 and final scrutiny by the Commission by 28/03/2018 (see Article 26(2)-(4) of Regulation No 251/2014).

registration¹⁴ of a trade mark, which are not a basis for opposition under Article 8(4a) EUTMR.

In order to substantiate its right, the opponent must provide the Office with the necessary facts and evidence regarding the existence of its right. A mere extract of the relevant online EU databases (DOOR, E-Bacchus or E-Spirit-Drinks) or in the case of spirit drinks, an extract from Annex III in the Spirit Drinks Regulation, is not sufficient, as they do not contain sufficient data to determine all the relevant particulars of the earlier right (e.g. entitlement of the opponent or goods protected by the GI). For example, the E-Bacchus and E-Spirit Drinks extracts, or Annex III of the Spirits Drinks Regulation merely indicate the country of origin of the GI, which is not sufficient to prove the opponent's entitlement.

Where available, the opponent must provide the Office with **copies of the publication and registration of the GI in the Official Journal**, and, if these documents are not available or lack information about the opponent's entitlement, further documents must be submitted proving entitlement to file the opposition as an **authorised person under the relevant law to exercise the rights arising from a GI** (Article 41(1)(d) EUTMR and Rule 19(2) EUTMIR). In this respect, see decision of 17/10/2013, R 1825/2012-4, 'Dresdner StriezelGlühwein/Desdner Stollen', § 37. For example, until such time that the so-called 'single documents' summarising the particulars of the GI are available in E-Bacchus and E-Spirit-Drinks, opponents seeking to rely on the relevant GIs must provide any means of proof to substantiate their entitlement and other relevant particulars of the GI, including national laws or administrative decisions granting GI protection in force at the time of the automatic extension of EU protection¹⁵.

5.2.1.3 The exhaustive nature of the EU system of protection

The EU system of protection of GIs for foodstuffs, wines and spirit drinks is **exhaustive in nature and supersedes national protection** for those goods. This arises from the findings of the Court in the judgment of 08/09/2009, C-478/07, Bud, EU:C:2009:521, § 95-129. Here the Court held that the aim of Regulation No 0510/2006 (the predecessor of the current Foodstuffs Regulation) was to provide a uniform and exclusive system of protection of GIs for agricultural products and foodstuffs that superseded national laws for the relevant products¹⁶. Although the Court has not specifically pronounced upon the exhaustive nature of the Wines, Spirit Drinks and Aromatised Wines Regulations, the same principle must apply because they contain substantively similar provisions to the Foodstuffs Regulation and they have the same purpose for the respective products.

5.2.2 GIs protected under the laws of Member States

GIs protected under the laws of Member States may be a basis for opposition under Article 8(4a) EUTMR **only to the extent that no uniform EU protection is in place**

¹⁴ Articles 14, 102, 23 and 19 of the Foodstuffs, Wines, Spirit Drinks and Aromatised Wines Regulations respectively.

¹⁵ The date of automatic extension of EU protection of national GIs for wines occurred on 01/08/2009 (see Article 51(1) of Regulation No 479/2008, and after its codification, Article 118s(1) of Regulation No 1234/2007) and for spirit drinks, on 20/02/2008 (see Article 20(1) of Regulation No 110/2008).

¹⁶ For additional information, see the Guidelines, Part B, Examination, Section 4, Absolute Grounds for Refusal (Article 7(1)(j) EUTMR).

for the given category of goods. This is the case, for example, for handicraft products (e.g. 'HEREND' for porcelain goods originating from Herend, Hungary).

For the reasons set out above, in the areas of foodstuffs, wines, spirit drinks and aromatised wine products, protection at EU level is exhaustive in nature which means that opposition under Article 8(4a) EUTMR cannot be based on national rights in these areas. This is because the EU system of protection comprising the above regulations **overrides and replaces** national protection of GIs for foodstuffs, wines, spirit drinks and aromatised wine products.

Consequently, GIs for certain foodstuffs¹⁷ and certain non-food agricultural products¹⁸ (as set out in Annex I of the Treaty on the Functioning of the European Union (TFEU) and Annex I of the Foodstuffs Regulation), wines and grapevine products¹⁹ (as set out in Annex VII, part 2 of the Wines Regulation), spirit drinks²⁰ (as set out in Annex II of the Spirit Drinks Regulation) and aromatised wine products²¹ (as set out in Annex II of the Aromatised Wines Regulation) that may claim protection under national laws are not a proper basis for opposition under Article 8(4a) EUTMR. For the latter products, the opponent must invoke the relevant EU legislation in the notice of opposition.

Article 8(4a)(i) EUTMR requires proof of registration of the GI invoked. Accordingly, the opponent must submit the relevant registration certificate or equivalent documents emanating from the competent national registration authority. By way of analogy, this provision applies also to national GIs granted not in a registration procedure, but through other administrative means (such as a law or administrative decision granting protection). The evidence must prove all the particulars of the GI, including its name, that it is protected as a GI, the goods covered, that it was acquired prior to the date of priority of the contested mark, proof of entitlement and proof that protection pursuant to national law confers on the beneficiary of the GI a direct right of action against unauthorised use. Further, the opponent must prove the conditions of the scope of protection and particulars proving that those conditions are fulfilled in the given case.

5.2.3 GIs protected under international agreements

Notwithstanding that Article 8(4a) EUTMR does not explicitly mention GIs protected under international agreements, the reference to 'Union legislation' and 'national law' naturally includes international agreements as they form part of the legal order of the Union or the Member State who is a party to the international agreement.

In order for an opposition under Article 8(4a) EUTMR to be successful on the basis of a right deriving from any international agreement, the provisions under the international agreement must be directly applicable and they must allow the beneficiary of the relevant GI to take direct legal action to prohibit the use of a subsequent trade mark²².

In the latter respect, international agreements are **not always self-executing**. This depends on the characteristics of the agreement itself and on how they have been

¹⁷ e.g. *meat, cheese, pastry, edible oils, vegetables, fruits, beverages made from plant extracts, vinegar (including wine vinegar), unmanufactured tobacco, beer, confectionery.*

¹⁸ e.g. *wool, leather, essential oils.*

¹⁹ e.g. *wine, sparkling wine, liqueur wine, wine must, but not wine vinegar.*

²⁰ e.g. *grain spirit, wine spirit, fruit spirit, brandy, liqueurs, rum, whisky, gin.*

²¹ e.g. *vermouth, Glühwein, sangría.*

²² See paragraph 3.1 above concerning the requirement of a direct right of action.

interpreted in the relevant jurisdiction. For example, the Office considers that the provisions of the Lisbon Agreement (in particular Articles 3 and 8) are not self-executing. As expressly indicated by Article 8 of the Lisbon Agreement, it is the relevant national legislation that must determine which type of legal actions may be taken, their scope and whether these legal actions include allowing the proprietor of an appellation of origin to prohibit the use of a subsequent trade mark. Therefore, in such cases, the requisite national legislation must be adduced as this is a necessary component in order for the opponent to prove that the GI in question can prevent use of the subsequent mark and that the opponent is entitled by the law governing the right to exercise this right.

International agreements entered into by the EU

GIs deriving from agreements between the EU and third countries can be invoked under Article 8(4a) EUTMR if the provisions of these agreements vest the GI **in a particular beneficiary or a precise class of users** that have direct right of action.

International agreements entered into by Member States including the Lisbon Agreement²³

For the reasons set out in paragraph 5.2.1.3 above, a GI protected under an international agreement concluded by Member States (either among Member States or with third countries) cannot be invoked as an earlier right under Article 8(4a) EUTMR if it encroaches upon the exhaustive nature of EU law in the relevant areas (currently certain foodstuffs and other agricultural products, wines, spirit drinks and aromatised wine products).

In C-478/07, Bud, EU:C:2009:521, the Court discussed the exhaustive nature of EU law as regards GIs originating from Member States. In the Office's interpretation, this also applies a fortiori to third-country GIs in the relevant product fields that enjoy protection in the territory of a Member State through an international agreement concluded between that Member State and a non-EU country²⁴.

This equally applies to the Lisbon Agreement. The Lisbon Agreement creates an international registration and protection system for 'appellations of origin' (Article 2(1)). The definition of 'appellations of origin' for food and beverage products under this agreement is largely equivalent to that of a 'designation of origin' under the relevant EU regulations. Therefore, appellations of origin protected in a Member State by virtue of the Lisbon Agreement cannot be a basis for opposition under Article 8(4a) EUTMR.

The only exceptions in this regard are the following.

- International agreements which cover GIs that do not relate to foodstuffs, wines, spirit drinks or aromatised wine products.
- International agreements concluded with third countries by a Member State before its accession to the EU. This is because the obligations arising out of an international agreement entered into by a Member State before its accession to

²³ Some Member States (Bulgaria, Czech Republic, France, Hungary, Italy, Portugal and Slovakia) are party to the Lisbon Agreement for the Protection of Appellations of Origin and their International Registration of 1958 (as revised at Stockholm 1967, and as amended on 28/09/1979). The European Union is **not** a signatory to the Lisbon Agreement.

²⁴ To which the EU is not a contracting party.

the EU have to be respected. However, Member States are required to take all appropriate steps to eliminate the incompatibilities between an agreement concluded before a Member State's accession and the Treaty (see Article 307, Treaty Establishing the European Community, now Article 351, Treaty on the Functioning of the European Union (TFEU), as interpreted by the Court in its judgment of 18/11/2003, C-216/01, Bud, EU:C:2003:618, § 168-172).

- International agreements concluded with a third country by a Member State after its accession to the EU, but before the entry into force of the uniform EU system of protection in the given product area.

As Member States are under obligation to eliminate incompatibilities with EU law, the Office will apply the last two exceptions (which exclusively concern third country GIs in the fields of foodstuffs, wines, spirit drinks or aromatised wine products) **only when the opponent expressly refers to the exception and supports it by a coherent line of argument and relevant evidence** (in particular, concerning the date of entry into force of the cited international agreement in the EU Member State where protection is claimed and its continued validity). General allegations by the opponent (such as merely citing the relevant international agreement) will not be sufficient in themselves for the Office to consider that one of the latter two exceptions applies.

Although Article 8(4a)(i) EUTMR requires registration of the GI, it can be applied by way of analogy to third-country GIs protected under international agreements. In the case of international agreements to which the EU is a party, the date of entry into force of the international agreement is deemed to be the date of priority of such a GI (and in the case of a third-country GI added subsequently to the list, the date of entry into force of the amendment), unless the international agreement stipulates an earlier date of priority.

5.3 Scope of protection of GIs

The **scope of protection of GIs protected under EU law** is governed by Articles 13(1), 103(2), 16 and 20(2) of the Foodstuffs, Wines, Spirit Drinks and Aromatised Wines Regulations, respectively. The provisions preventing registration, Articles 14(1), 102(1), 23(1) and 19(1) of the Foodstuffs, Wines, Spirit Drinks and Aromatised Wines Regulations respectively, are not a basis for opposition under Article 8(4a) EUTMR²⁵; such an opposition cannot depend on whether the opponent fulfilled the conditions required to prohibit registration under the said provisions²⁶. Therefore, under Article 8(4a) EUTMR, a GI can prevail if the conditions set out in the provisions preventing use are met.

It must be emphasised that it is the specific conditions of the scope of protection as laid down in the applicable provisions that apply and not, for example, the 'similarity of signs', 'similarity of goods and services' or 'likelihood of confusion'. Detailed information on the scope of protection of GIs protected under the relevant EU Regulations is included in the Guidelines, Part B, Examination, Section 4 Absolute Grounds for Refusal, Article 7(1)(j) EUTMR (e.g. definitions of direct and indirect use, imitation, evocation, comparable products).

²⁵ See, in this sense, judgment of 12/06/2007, joined cases T-60/04 to T-64/04, Bud, EU:T:2007:169, § 78.

²⁶ Judgment of 18/09/2015, T-387/13, COLOMBIANO HOUSE / CAFE DE COLOMBIA, EU:T:2015:647, § 40 et seq.

The provisions of the EU Regulations preventing use contemplate situations where a GI can be invoked against goods or services that do not necessarily fall within the scope of objectionable goods and services under the *ex officio* examination of absolute grounds, subject to the conditions of the relevant provisions of the corresponding EU Regulations.

For instance, under Articles 13(1)(a), 103(2)(a)(ii), 16(a) and 20(2)(a)(ii) of the Foodstuffs, Wines, Spirit Drinks and Aromatised Wines Regulations respectively, a GI can be invoked against products and services that would not be *ex officio* objectionable under absolute grounds, subject to proof of reputation of the GI in the EU and proof that the use of the contested mark in relation to the contested goods and services would exploit the reputation of the GI. The mere existence of protection as a GI and references to its reputation in the registration documents, even if such a reputation had been a factor in granting GI protection, is not sufficient; independent and conclusive evidence attesting to the reputation of the GI within the European Union is required for the purposes of applying the wider scope of protection. As regards the standard of proof, the territorial and temporal scope of reputation, the standards for assessment of the reputation of an EUTM are applicable by way of analogy (with the obvious difference that any use must be in accordance with the function of a GI and not a trade mark). As regards the specific condition of ‘exploitation of reputation’, the established standards for assessment of the link between the signs and taking unfair advantage of the reputation of a trade mark are applicable by way of analogy²⁷.

The **scope of protection of GIs protected under national law or international agreements** is governed by the relevant provisions. (For example, for the abovementioned Hungarian GI ‘HEREND’, Article 109 of Act XI of 1997 on the protection of trade marks and geographical indications.)

Nevertheless, either under EU or national legislation, the scope of protection of GIs cannot exceed what is required in order to safeguard the function of the GI; the function in question is to designate goods as being from a particular **geographic origin and the special qualities connected therewith**. Unlike other signs, GIs are not used to indicate the commercial origin of goods and they afford no protection in this regard. Therefore, where the specification of an EUTM application **is limited to goods in conformity with the specification of the relevant protected GI**, the function of the GI in question is safeguarded in relation to those products because the EUTM application only covers products from the particular **geographic origin and the special qualities connected therewith**. Consequently, opposition against an EUTM application which has been appropriately limited will not succeed. See in this regard Article 12(1) of the Foodstuffs Regulation or Article 103(1) of the Wines Regulation.

²⁷ See the Guidelines, Part C, Opposition, Section 5, Trade Marks with Reputation (Article 8(5) EUTMR).

TABLE ON NATIONAL RIGHTS THAT CONSTITUTE 'EARLIER RIGHTS' IN THE SENSE OF ARTICLE 8(4) EUTMR

FOR INFORMATION PURPOSES²⁸

Table of Contents

1	Benelux	34
2	Bulgaria	35
3	Czech Republic	36
4	Denmark	37
5	Germany	38
6	Estonia	40
7	Ireland	41
8	Greece	42
9	Spain	44
10	France	45
11	Croatia	46
12	Italy	47
13	Cyprus	48
14	Latvia	49
15	Lithuania	50
16	Hungary	50
17	Malta	51
18	Austria	51
19	Poland	53
20	Portugal	54
21	Romania	56
22	Slovenia	57
23	Slovakia	57
24	Finland	58
25	Sweden	60
26	United Kingdom	61

²⁸ The contents of the table above are largely based on information and feedback from trade mark offices and user associations in 2013/2014. However, it is not a legal source and is made available for information purposes only. It may not contain the latest legislative developments or an exhaustive list of all national rights that can be invoked under Article 8(4) EUTMR.

1 Benelux

1.1 Unregistered trade marks

Unregistered trade marks (TMs) are not recognised under the uniform Benelux Convention on Intellectual Property (BCIP).

1.2 Other signs used in the course of trade

For the Benelux territory each state must be considered separately.

1.2.1 Belgium

Trade name (nom commercial)/Company name (dénomination sociale)

Article 2.19 BCIP

Article 95 of 'Loi du 6 avril 2010 relative aux pratiques du marché et à la protection du consommateur'

Article 1382 of the 'Code Civil' (Civil Code)

Conditions for protection

Trade name is acquired by its first use in trade. Protection is limited to the geographical area where the trade name or company name is used.

Company name is acquired, in principle, from the date of the establishment of the company. Protection extends to the whole national territory.

Rights conferred

Right to prohibit use of subsequent (registered) trade marks.

1.2.2 Luxembourg

Trade name (nom commercial)/company name (dénomination sociale)

Article 2.19 BCIP

Article 14 of 'Loi du 30 juillet 2002 réglementant certaines pratiques commerciales, sanctionnant la concurrence déloyale et transposant la directive 97/55/CE du Parlement Européen et du Conseil modifiant la directive 84/450/CEE sur la publicité trompeuse afin d'y inclure la publicité comparative'

Rights conferred

Right to prohibit use of subsequent (registered) trade marks.

1.2.3 Netherlands

Trade name

Article 2.19 BCIP

Law of 5 July 1921 on trade names (Handelsnaamwet)

Article 6:162, Dutch Civil Code (Burgerlijk Wetboek)

Conditions for protection

Right is acquired by the first use of the trade name in trade. Protection is limited to the geographical area where the trade name is used. Trade names may be registered voluntarily with the Trade Register at the Chamber of Commerce but doing so does not confer any rights on the owner. There is no particular requirement that the trade name be distinctive and non-descriptive.

Rights conferred (a) and conditions (b)

- (a) Right to prohibit use of subsequent (registered) trade marks.
- (b) Likelihood of confusion must be found.

2 Bulgaria

2.1 Unregistered trade marks

Unregistered trade marks (TMs) are protected in Bulgaria in two ways.

Unregistered TMs

Article 12(6) Bulgarian Trade Mark Law on Marks and Geographical Indications (2010)

Conditions for protection

The TM must have been used in the course of trade in the territory of Bulgaria prior to the filing date of the contested trade mark.

Rights conferred (a) and conditions (b)

- (a) Right to prohibit registration of a subsequent trade mark.
- (b) The subsequent trade mark must be identical or similar and must cover identical or similar goods and/or services.

Well-known TMs

Article 12(2)7 Bulgarian Trade Mark Law on Marks and Geographical Indications (2010)

Conditions for protection

The TM must be well-known in the territory of Bulgaria within the meaning of Article 6bis of the Paris Convention prior to the filing date of the contested trade mark.

Rights conferred (a) and conditions (b)

- (a) Right to prohibit registration of a subsequent trade mark.
- (b) The subsequent trade mark must be identical or similar and must cover identical or similar goods and/or services.

2.2 Other signs used in the course of trade

Other signs used in the course of trade are not included by Bulgarian trade mark law as prior rights that could form a basis for opposition.

3 Czech Republic

3.1 Unregistered trade marks

Unregistered trade marks are protected in the Czech Republic:

Article 7(1)(g) of the Czech Trade Marks Act (CZ-TMA).

Conditions for protection

Unregistered signs that have acquired distinctiveness through use in the course of trade of more than mere local significance prior to the filing of the contested application.

Rights conferred (a) and conditions (b)

- (a) Right to prohibit subsequent trade marks.
- (b) Signs must be identical or similar (interpreted as likelihood of confusion) and must cover identical or similar goods and/or services. Scope of protection is identical to that of a Czech registered mark.

3.2 Other signs used in the course of trade

Article 7(1)(g) CZ-TML

Trade names and other related signs (e.g. names of non-commercial organisations)

Conditions for protection

These names/signs must have acquired distinctiveness through use in the course of trade of more than mere local significance prior to the filing of the contested application.

Rights conferred (a) and conditions (b)

- (a) Right to prohibit subsequent trade marks.
- (b) Signs must be identical or similar (interpreted as likelihood of confusion) and must cover identical or similar goods and/or services. Scope of protection is identical to that of a Czech registered mark.

4 Denmark

4.1 Unregistered trade marks

Unregistered trade marks (TMs) are protected in Denmark:

§ 3(1)(ii) of the Danish Trade Mark Act (DK-TML)

§ 4(1), (2) and § 15(4)(ii) DK-TML

Conditions for protection

Rights to an unregistered TM are acquired by starting to use the TM in Denmark.

Rights conferred (a) and conditions (b)

- (a) Right to prohibit use of subsequent (registered) TMs.
- (b) The unregistered TM must continue to be used for the goods and/or services for which it was first used. The scope of protection is the same as for Danish registered TMs, i.e. corresponding to Article 9(2)(a), (b) and (c) EUTMR.

4.2 Other signs used in the course of trade

Company names

The term 'company name' is to be interpreted broadly and covers not only private companies such as private firms, limited liability companies, other commercial companies and secondary trade names but also foundations, unions, associations, museums and public institutions.

§ 18 Danish Marketing Practices Act

§ 2(ii) Danish Companies Act

§ 6(ii) Consolidated Act on Certain Commercial Undertakings

Conditions for protection

Company name protection does not require registration. However, the person concerned must have legal title to the company name.

Rights conferred (a) and conditions (b)

(a) Right to prohibit use of subsequent (registered) trade marks.

(b) Signs must be identical or similar.

Signs used in the course of trade such as business names and shop facades

The term 'signs used in the course of trade' is to be interpreted broadly and, according to Danish law, covers any commercial name or symbol that can serve as a connecting link between a business and its customers/users, including, inter alia, business names and shop facades.

§ 18 Danish Marketing Practices Act

5 Germany

5.1 Unregistered trade marks

§ 4 No 2 German Trade Mark Act (DE-TMA), § 12, 14 DE-TMA

Conditions for protection

Protection is acquired through use leading to recognition by the relevant public as a trade mark ('Verkehrsgeltung') (§4 No 2 DE-TMA). According to case-law, 20 to 25% recognition by the relevant public is normally sufficient, rising to 50% or more if a sign is not distinctive.

Rights conferred (a) and conditions (b)

- (a) Right to prohibit the use of a subsequent trade mark if recognition is established in the whole of Germany, i.e. not if recognition is only established for a particular town or region (§§ 12, 14 DE-TMA).
- (b) The same as for registered German trade marks, i.e. protection corresponds to Article 9(2)(a), (b) and (c) EUTMR (§ 14(2) No 1, 2 and 3 DE-TMA).

5.2 Other signs used in the course of trade

§5(1), (2), (3) DE-TMA

Commercial designations ('geschäftliche Bezeichnungen') is a broad category that includes the following.

Company symbols ('Unternehmenskennzeichen') are signs used in the course of trade as a name, company name or special designation of a business operation or enterprise. Business symbols and other signs that are intended to distinguish one business operation from others and are regarded as symbols of the business operation by the relevant public are deemed equivalent to the special designation of a business operation.

A **name or firm** is a trader's official or officially registered designation. A business symbol is a sign used by a trader to identify its business or undertaking as such, which functions as the name of the business or enterprise.

Titles of works are the names or special designations of printed publications, cinematic works, music works, stage works or other comparable works. This can be an individual work, a series of works, or a periodical publication. This also includes titles of radio or television series, computer games and video games, possibly also computer programs. It is not required that the work designated by the title is protected under copyright law.

Conditions for protection

Company symbols – If the sign is inherently distinctive, protection is acquired through use in the course of trade as a company symbol. According to case-law the required degree of inherent distinctiveness is low. 'Use in the course of trade as a company symbol' covers every external business activity in Germany aimed at long-term commercial activity. If the sign is not inherently distinctive, protection is acquired through recognition as a sign of the undertaking by the relevant public ('Verkehrsgeltung').

Business symbols and other signs for distinguishing business operations – Protection is acquired through recognition as a sign of the undertaking by the relevant public.

Titles of works: if the title of work is inherently distinctive, acquisition through use in the course of trade, i.e. normally as from the appearance of the work. The required degree of inherent distinctiveness is low. If the work title is not inherently distinctive, acquisition of the right through market recognition ('Verkehrsgeltung').

Rights conferred (a) and conditions (b)

- (a) Right to prohibit use of a subsequent trade mark.
- (b) Likelihood of confusion (§ 15(2) DE-TMA); in the case of a business designation with reputation, if use would take unfair advantage of, or would be detrimental to, the distinctive character or repute of a commercial designation (§ 15(3) DE-TMA).

6 Estonia

6.1 Unregistered trade marks

Unregistered trade marks are not protected under Estonian law unless the marks are considered to be well-known in Estonia within the meaning of Article 6^{bis} of the Paris Convention.

6.2 Other signs used in the course of trade

Business names

Article 10(1)(4) of the Estonian Trade Mark Act (EST-TMA)

Conditions for protection

Entry in the commercial register prior to the filing date of the application, the date of international registration or the priority date. Protection for a business name is acquired from the date of entry in the commercial register.

Rights conferred (a) and conditions (b)

- (a) Right to prohibit use of subsequent (registered) trade marks.
- (b) Signs must be identical or similar and the area of activity for which a notation has been made in the commercial register must include the goods and/or services for which the contested trade mark is used or is going to be used (designates).

Names of proprietary medicinal products

Article 10(1)(5) EST-TMA

Conditions for protection

The names must be registered in Estonia prior to the filing date of the trade mark application, the date of international registration or the date of priority.

Rights conferred (a) and conditions (b)

- (a) Right to prohibit use of subsequent (registered) trade marks.
- (b) The contested sign must be identical or confusingly similar to the name of a proprietary medicinal product registered in Estonia and the goods for which the trade mark is used or is going to be used must belong to the field of medicine.

7 Ireland

7.1 Unregistered trade marks

Unregistered trade marks (TMs) used in the course of trade are protected in Ireland.

Section 10(4)(a) IE-TMA

Conditions for protection

Must be used in the course of trade if protected by any rule of law, including that of passing off.

Rights conferred (a) and conditions (b)

- (a) Right to prohibit the use of subsequent trade mark if protected by any rule of law, in particular the law of passing off.
- (b) The later sign must constitute a misrepresentation likely to lead to deception or confusion, with consequent likelihood of damage to the goodwill or business of the proprietor of the earlier sign. The plaintiff must prove that its goodwill and business suffered or are likely to suffer damage as a result of the defendant's activities.

The action for passing off is based upon goodwill acquired by use of the earlier sign. Goodwill is sometimes referred to as reputation. In Ireland, goodwill can be acquired without necessarily trading within the territory, provided that a reputation in Ireland or customers in Ireland can be proven. The tort arises if a later sign constitutes a misrepresentation likely to lead to deception or confusion, with consequent likelihood of damage to the goodwill or business of the proprietor of the earlier sign. The law is explained in 'Intellectual Property Law in Ireland' by Robert Clark, Shane Smyth, Niamh Hall, Bloomsbury Professional, 3rd edition 2010 (see <http://www.bloomsburyprofessional.com/1155/Bloomsbury-Professional-Intellectual-Property-Law-in-Ireland-3rd-edition.html>).. Authoritative statements of the law are found in court judgments, for example in *C. & A. Modes vs C. & A. (Waterford)* [1978] Fleet Street Reports 126; *Adidas K.G. v. O'Neill & Co Limited* [1983] Fleet Street Reports 76; *Guinness Ireland Group v. Kilkenny Brewing Co Limited* [2000] Fleet Street Reports 112; *Allergan Inc. v Ocean Healthcare Ltd* [2008] IEHC 189; *Jacob Fruitfield Food Group Ltd v United Biscuits (UK) Ltd* [2007] IEHC 368; and *McCambridge v Brennan Bakeries Ltd* [2012] IESC 46.

7.2 Other signs used in the course of trade

Business sign used in the course of trade

Section 10(4)(a) and (5), IE-TMA

Right to prohibit use of subsequent TMs if protected by any rule of law, in particular the law of passing off. On the law of passing off, see remarks above under point A.

Conditions for protection

As under Section 7.1 above.

a) Rights conferred (a) and conditions (b)

As under Section 7.1 above.

8 Greece

8.1 Unregistered trade marks

There are two sets of provisions dealing with the protection of unregistered trade marks and related signs: (a) trade mark law confers on the owner the right to prohibit registration of a later trade mark, whereas (b) the law on unfair competition and other specific provisions deal with the issue of use. As the complementary application of trade mark law for any matter not directly dealt with in other statutes is generally accepted, both sets of rules are indicated.

Article 124(3)(a) GR-TML (Law No 4072/2012); Article 13(1) of Law 146/1914 on Unfair Competition

Conditions for protection

Protection is acquired through use in the course of trade. If not inherently distinctive, unregistered trade marks must also be 'established in the market'.

Rights conferred (a) and conditions (b)

- (a) Right to prohibit registration of a subsequent trade mark.
- (b) Prior use, likelihood of confusion as to origin.

8.2 Other signs used in the course of trade

Company names

Article 58 Civil code

Articles 4-8 Law 1089/1980, as amended by 1746/1988

Conditions for protection

Protection is acquired exclusively through use in the course of trade. Registration is not relevant for protection; it only serves administrative purposes.

Rights conferred (a) and conditions (b)

- (a) Right to prohibit subsequent trade marks.
- (b) Prior use, likelihood of confusion as to origin.

Trade names and commercial establishment insignia

Article 124(3)(a) GR-TML (Law No 4072/2012)

Article 13(1)(2) Law 146/1914 on Unfair Competition

Conditions for protection

Protection is acquired exclusively through use in the course of trade. If not inherently distinctive, the trade name or insignia must also be 'established in the market'.

Rights conferred (a) and conditions (b)

- (a) Right to prohibit subsequent trade marks.
- (b) Prior use, likelihood of confusion as to origin.

Other distinctive signs

Article 124(3)(a) GR-TML

The peculiar shape of the goods or of their packaging, as well as the peculiar get-up or decoration thereof (Ιδιαίτερος διασχηματισμός, διακόσμηση).

Conditions for protection

The signs must be known in the relevant commercial sector as product identifiers of a given trader. Protection is acquired through use in the course of trade. The signs must be capable of performing a trade mark-like function (i.e. they must have distinctive character as a result of a certain degree of originality).

Rights conferred (a) and conditions (b)

- (a) Right to prohibit subsequent trade marks.
- (b) Prior use, likelihood of confusion as to origin.

General note: All the exclusive signs referred to above are also protected under **Article 1 of Law 146/1914 on 'Unfair Competition'**, especially as regards infringing acts not covered by the above provisions (e.g. **protection of reputed signs for dissimilar goods** – dilution of, or unfair advantage to, their distinctiveness or repute, that is, where likelihood of confusion is not relevant).

9 Spain

9.1 Unregistered trade marks

Unregistered trade marks are not protected in Spain unless they are considered to be well known in Spain within the meaning of Article 6^{bis} of the Paris Convention.

9.2 Other signs used in the course of trade

Business names (Nombres comerciales)

Article 7(1)(a) and (b), 7(2)(a) and (b) ES -TML

Conditions for protection

The name must be registered or applied for at the Spanish Patent and Trade Mark Office.

Rights conferred (a) and conditions (b)

- (a) Right to oppose and prohibit the use of subsequent trade marks.
- (b) Identical or similar signs and identical or similar goods or services and likelihood of confusion.

Business names, designations or corporate names of legal persons

Article 9(1)(d) ES–TML

Conditions for protection

The names do not have to be registered or applied for at the Spanish Patent and Trade Mark Office provided that they identify a person (enterprise) for the purposes of trade. Evidence of use or evidence that the sign is well known in the national territory must be provided.

Rights conferred (a) and conditions (b)

- (a) Right to prohibit the use of subsequent trade marks.
- (b) Identical or similar signs and identical or similar goods or services and likelihood of confusion.

10 France

10.1 Unregistered trade marks

Unregistered trade marks are not recognised under French law with the exception of well-known trade marks in the sense of Article 6bis of the Paris Convention (Article L711-4(a) French Intellectual Property Code (FR-IP CODE))

10.2 Other signs used in the course of trade

Article L711-4 FR-IP Code provides a non-exhaustive list of signs that, if qualified as earlier, might prohibit use of a later trade mark.

Company name or style of a company ('dénomination sociale', "raison sociale")

Article L711-4(b) FR-IP Code

Conditions for protection

Protection of the company name is acquired upon completion of the documents founding the company. Must be known throughout the French territory.

Rights conferred (a) and conditions (b)

- (a) Right to prohibit use of a subsequent trade mark.
- (b) There must be a risk of confusion in the mind of the public.

Trade name (nom commercial)

Article L711-4(c) FR-IP CODE

Conditions for protection

Protection acquired from first use in trade.

Rights conferred (a) and conditions (b)

- (a) Right to prohibit use of a subsequent trade mark.
- (b) There must be a risk of confusion in the mind of the public.

Business sign ('enseigne')

Article L711-4(c) FR-IP CODE

Conditions for protection

Protection acquired from first use in trade. Must be known throughout the territory of France (enseigne notoire).

Rights conferred (a) and conditions (b)

- (a) Right to prohibit use of a subsequent trade mark.
- (b) There must be a risk of confusion in the mind of the public.

Domain names ('noms de domaine')

Conditions for protection

The domain name is protected when it is reserved and used.

Rights conferred (a) and conditions (b)

- (a) Right to prohibit use of a subsequent trade mark for identical or similar products and/or in the event of unfair advantage or dilution of reputations.
- (b) There must be a likelihood of confusion or damage to first user.

11 Croatia

11.1 Unregistered trade marks

Unregistered trade marks are protected in Croatia.
Article 6(2), (4) Croatian Trade Marks Act and the Act on Amendments to the Trade Mark Act

Conditions for protection

The unregistered trade mark must be **well-known** in the Republic of Croatia prior to the filing/priority date of the contested trade mark in the sense in which the words 'well-known' are used in Article 6^{bis} of the Paris Convention.

Rights conferred (a) and conditions (b)

- (a) Right to oppose the registration of a subsequent trade mark.
- (b) The subsequent trade mark must be identical or similar and have applied for identical or similar goods and/or services.

11.2 Other signs used in the course of trade

Earlier firm

Article 6(6) Croatian Trade Marks Act and the Act on Amendments to the Trade Mark Act.

Conditions for protection

It must be registered.

Rights conferred (a) and conditions (b)

- (a) Right to oppose the registration of a subsequent trade mark.
- (b) The firm or the essential part thereof must be identical or similar to the sign in respect of which registration is sought, and the goods and/or services must be identical or similar, unless the applicant had the identical or similar firm at the time of filing the application for registration of a trade mark.

12 Italy

12.1 Unregistered trade marks

An **unregistered trade mark** ('marchio di fatto') is defined as a sign known as a trade mark or as a sign that is distinctive for manufactured goods or services on the market. Prior use must be notoriously known.

Article 12(1)(a) IT-IP CODE

Conditions for protection

The unregistered trade mark must be used to the extent that it is 'notoriously known throughout Italy or a substantial part thereof.'

Rights conferred (a) and conditions (b)

- (a) Right to prohibit use of subsequent trade marks.

- (b) Identical or similar signs and identical or similar goods or services and likelihood of confusion including likelihood of association.

12.2 Other signs used in the course of trade

Article 12(1)(b) IT-IP Code

Company name, corporate name, trade name or business signs, domain name adopted by others ('ditta', 'denominazione sociale', 'ragione sociale', 'insegna', 'nome a dominio')

Conditions for protection

Used to the extent that it is 'notoriously known throughout Italy or a substantial part thereof.

Rights conferred (a) and conditions (b)

- (a) Right to prohibit use of subsequent trade mark, provided it is known by the relevant public throughout Italy or a substantial part thereof.
- (b) Identical or similar signs and identical or similar goods or services and likelihood of confusion including likelihood of association.

13 Cyprus

13.1 Unregistered trade marks

Unregistered trade marks are not recognised under the law of Cyprus.

14 Latvia

14.1 Unregistered trade marks

Unregistered trade marks are protected in Latvia.
Article 9(3) No 4 LV-TML

Conditions for protection

The unregistered mark must have been used in good faith and lawfully prior to the date of filing of the application for registration of the trade mark (or the priority date respectively) in commercial activities in Latvia in connection with identical or similar goods or services.

Rights conferred (a) and conditions (b)

- (a) Right to prohibit subsequent trade marks.
- (b) Identical or similar signs and identical or similar goods or services; use of the subsequent trade mark must also be capable of misleading consumers as to the origin of the goods and services.

14.2 Other signs used in the course of trade

Trade names originating in Latvia or in a foreign country (**commercial designations, names of a mass medium, or other similar signs**) that are well-known in Latvia.

Article 9(3) No 3, LV-TML

Conditions for protection

The trade name must be acquired through fair and lawful use in the course of trade in Latvia before the filing/priority date of a subsequent trade mark used in an identical or similar business sector. A 'well-known' trade name must have become well known in Latvia before the filing/priority date of the subsequent trade mark.

Rights conferred (a) and conditions (b)

- (a) Right to prohibit subsequent trade marks.
- (b) The signs must be the same or confusingly similar and must cover identical or similar goods and services.

15 Lithuania

15.1 Unregistered trade marks

Article 7(1), (3), 9 LT-TML.

Conditions for protection

Unregistered trade marks are protected only if recognised as well known by a court decision.

15.2 Other signs used in the course of trade

Trade names/business names and other business identifiers

Rights conferred (a) and conditions (b)

- (a) Right to invalidate subsequent (registered) trade marks.
- (b) Registration of a mark will be declared invalid if the mark is identical to a legal person's business name or is likely to be confused with a legal person's business name.

Article 7(1), No 4 LT-TML

16 Hungary

16.1 Unregistered trade marks

An unregistered trade mark is not protected under Hungarian trade mark law unless it has been used effectively in the country where use of the sign without the consent of the prior user would be contrary to law.

Article 5(2)(a) HU-TML

Article 6 of Act LVII of 1996 on the prohibition of unfair and restrictive market practices prohibits the manufacture, distribution or advertising of goods and services without the consent of competitors if the goods and services concerned have a characteristic presentation, packaging or labelling (including designation of origin), and the use of a name, mark or designation by which a competitor or its goods and services are usually recognised.

The abovementioned provisions are only an example.

17 Malta

17.1 Unregistered trade marks

Chapter 26 of Malta's Trade Mark Act; Article 6(4) MT-TMA

Conditions for protection

Protection is acquired through continuous prior use.

Rights conferred (a) and conditions (b)

- (a) Right to prohibit subsequent trade marks.
- (b) Signs must be likely to be confused and must cover identical or similar goods and services.

17.2 Other signs used in the course of trade

Article 11(3) MT-TMA

Conditions for protection

Protection is acquired through continuous use.

Rights conferred (a) and conditions (b)

- (a) Right to prohibit subsequent trade marks (Article 6(2) MT-TMA).
- (b) Likelihood of confusion.

In view of Articles 6(4) and 11(3) MT-TMA, other signs used in the course of trade are regarded as earlier rights.

18 Austria

18.1 Unregistered trade marks

Unregistered trade marks (TMs) are protected in Austria:

§ 31 Austrian Trade Mark Protection Act (1970)

Conditions for protection

An unregistered TM must have acquired a certain recognition in the course of trade ('Verkehrsgeltung') before the owner of a subsequent (registered) TM applied for registration of its TM, unless the owner of the subsequent (registered) TM has used its TM in trade without registering it for at least as long as the owner of the unregistered TM.

Rights conferred (a) and conditions (b)

- (a) Right to apply for cancellation of a subsequent (registered) TM.
- (b) The owner of the unregistered TM must not have tolerated use in trade of the subsequent registered TM during five successive years ('Verwirkung'). This applies only to those goods and/or services for which the registered trade mark was used and only if the application for the registered trade mark was not filed in bad faith. Likelihood of confusion must be found.

18.2 Other signs used in the course of trade

§ 32 Austrian Trade Mark Protection Act (1970)

§ 9 of the Federal Act Against Unfair Competition (1984)

Corporate signs ('Unternehmenskennzeichen'), i.e. names, firms (trade names) ('Firma') or specific designations of an undertaking ('besondere Bezeichnung eines Unternehmens'), or similar designations

Conditions for protection

The entrepreneur must be the owner of the corporate sign(s).

Rights conferred (a) and conditions (b)

- (a) Right to apply for cancellation of a subsequent (registered) TM.
- (b) The entrepreneur must not have tolerated use in trade of the registered TM during five successive years ('Verwirkung'). This applies only to those goods and/or services for which the registered trade mark was used and only if the application for the registered trade mark was not filed in bad faith. Use of the trade mark could entail a likelihood of confusion in trade with one of the petitioner's aforementioned corporate signs.

Business signs ('Geschäftsabzeichen') and other facilities designed to distinguish the enterprise from other enterprises including the get-up or packaging of goods or the presentation of business stationery

Conditions for protection

The business signs must be perceived as designations of the enterprise by the market participants involved or have acquired such recognition through use ('Verkehrsgeltung').

Rights conferred (a) and conditions (b)

- (a) [Only] the right to sue the infringer to cease and desist [from such action] as well as to claim damages if the infringement was carried out with intent or in a negligent way. [In addition to the above, with registered TMs the owner also has the right to sue for cease and desist [use of its TM] and to claim damages before a civil court.]
- (b) The entrepreneur must not have tolerated use in trade of the registered TM during five successive years ('Verwirkung'). This applies only to those goods and/or services for which the registered trade mark was used and only if the application for the registered trade mark was not filed in bad faith. The trade mark must be used in such a way that it is likely to be confused in trade with one of the entrepreneur's business signs.

19 Poland

19.1 Unregistered trade marks

Article 132(1)(ii) PL-IP Law

Conditions for protection

Unregistered trade marks (TMs) are protected only if they are well known and used in the course of trade.

Rights conferred (a) and conditions (b)

- (a) Right to prohibit the use of subsequent trade marks.
- (b) Unregistered TM must be well known and used in the course of trade; likelihood of confusion.

Additional protection is available to **well-known unregistered marks with a reputation (renowned trade mark)**. The owner of such a TM may request that the registration of a later identical or similar TM be declared invalid, irrespective of the goods or services for which it is registered, if the use thereof without due cause would take unfair advantage of, or be detrimental to, the distinctive character or repute of the earlier TM. A trade mark owner is prohibited from bringing such an action if the owner has been aware of and tolerated use of the later TM for five consecutive years.

19.2 Other signs used in the course of trade

Article 131(1), (5) PL-IP Law

Article 156(1)(i) PL-IP Law, Article 158(1) PL-IP Law

Name or address under which a person runs his business activity

Conditions for protection

Name under which a person runs their business activity.

Rights conferred (a) and conditions (b)

- (a) Right to prohibit the filing of a trade mark.
- (b) There must have been prior use of the name for business activity for identical or similar goods such as to be likely to mislead the public as to the origin of the product.

20 Portugal

20.1 Unregistered trade marks

The following unregistered trade marks (TMs) are protected in Portugal.

Unregistered TMs that are being used

Article 227 PT-IP Code

Conditions for protection

The unregistered TM must have been used in Portugal during the six months prior to the filing of an application for registration.

Rights conferred (a) and conditions (b)

- (a) Right to oppose registration of the same trade mark by other entities.
- (b) The signs and the goods and/or services must be the same.

Well-known marks

Article 241, PT-IP Code

Conditions for protection

The mark in question must be well known in Portugal.

Rights conferred (a) and conditions (b)

- (a) Right to prohibit subsequent trade marks.
- (b) The signs must be identical or similar and the goods and/or services identical or similar; likelihood of confusion or association with the holder of the earlier right must be established; the interested party must have applied for registration of the well-known mark.

Prestigious trade marks

Article 241 PT-IP Code

Conditions for protection

The mark in question must enjoy prestige in Portugal.

Rights conferred (a) and conditions (b)

- (a) Right to prohibit subsequent trade marks.
- (b) The signs must be identical or similar or, even if the goods and services are dissimilar, use of the trade mark applied for must be likely to take unfair advantage of, or be detrimental to, the distinctive character or repute of the earlier prestigious trade mark; the interested party must have applied for registration of the prestigious trade mark.

20.2 Other signs used in the course of trade

Trade names, company names

Article 239(2)(a) PT-IP Code

Rights conferred (a) and conditions (b)

- (a) Right to prohibit the use of subsequent trade marks.
- (b) The name in question must be likely to mislead or confuse the consumer.

Logotypes (name and emblem/insignia of an establishment)

(Word and figurative signs identifying an entity trading products or providing services)

Article 304-N PT-IP Code

Conditions for protection

The sign in question must be registered.

Rights conferred (a) and conditions (b)

- (a) Right to prohibit the use of subsequent signs.
- (b) The proprietor must not have given its consent, and the subsequent sign must be identical or similar to the proprietor's sign.

21 Romania

21.1 Unregistered trade marks

As a general rule, unregistered trade marks (TMs) are not protected under Romanian TM Law (Law No 84/1998 on trade marks and geographical indications). As an exception to that rule, in the case of an opposition, an unregistered trade mark may be regarded as an earlier right if it is well-known in Romania within the meaning of Article 6bis of the Paris Convention).

Article 3(d) and Article 6(2)(f) of the RO-IP Law

Conditions for protection

The unregistered TM must be well known in Romania within the meaning of Article 6bis of the Paris Convention.

Rights conferred (a) and conditions (b)

- (a) Right to prohibit the use of subsequent trade marks.
- (b) It must be well-known in Romania and there must be a likelihood of confusion.

21.2 Other signs used in the course of trade

Other signs used in the course of trade that are considered to be earlier rights are **trade names**.

Only the owner of a trade name, can oppose a trade mark or request the competent judicial body to cancel that trade mark.

Rights conferred (a) and conditions (b)

- (a) Right to prohibit subsequent trade marks. Only the owner of a trade name can oppose a trade mark or request the competent judicial body to cancel that trade mark right.
- (b) Prior use on the market.

22 Slovenia

22.1 Unregistered trade marks

Unregistered trade marks are not directly recognised under the Slovenian IP Act.

Nevertheless, under Article 44(1)(d) SL-IP Act, a sign is not eligible for registration as a mark if it is identical or similar to a mark or unregistered sign; in the Republic of Slovenia, the latter is regarded as a **well-known mark** within the meaning of Article 6bis of the Paris Convention.

22.2 Other signs used in the course of trade

Article 44(1)(f) SL-IP Act

Registered trade names (registered company names), where the term 'company name' is interpreted broadly and covers not only private companies such as private firms, limited liability companies, other commercial companies, and secondary trade names, but also foundations, unions, associations, museums and public institutions.

23 Slovakia

23.1 Unregistered trade marks

Article 7(f) SK-TML

Unregistered marks are defined as non-registered signs acquired and used in the course of trade prior to the filing of a subsequent application. They must be distinctive and of more than mere local significance.

Conditions for protection

The unregistered mark must have been used earlier in the course of trade of more than mere local significance and must have acquired distinctiveness through use in the course of trade in the territory of the Slovak Republic of more than mere local significance prior to the filing of the contested application.

Rights conferred (a) and conditions (b)

- (a) Right to prohibit the use of subsequent trade marks.
- (b) Signs must be identical or similar and must cover identical or similar goods and/or services.

23.2 Other signs used in the course of trade

Article 7(f) SK-TML

Trade names and other related signs.

Conditions for protection

Recordal in the Register of Companies or a similar register.

These signs must have acquired distinctiveness through use in the course of trade in the territory of the Slovak Republic of more than mere local significance prior to the filing of the contested application.

Rights conferred (a) and conditions (b)

- (a) Right to prohibit the use of subsequent trade marks.

- (b) Signs must be identical or similar and must cover identical or similar goods and/or services.

24 Finland

24.1 Unregistered trade marks

Unregistered trade marks are protected in Finland:

§ 1, § 2(3), § 6, § 14(1), (6) of the Finnish Trade Mark Act (FI-TML)

Conditions for protection

Use leading to an unregistered mark becoming established on the market. A mark is considered established if it has become generally known in the appropriate business or consumer circles in Finland as a symbol specific to its proprietor's goods and/or services.

Rights conferred (a) and conditions (b)

- (a) Right to prohibit use of subsequent (registered) trade marks.
- (b) The scope of protection is identical to that of a Finnish registered trade mark, i.e. corresponding to Article 9(2)(a), (b) and (c) EUTMR.

24.2 Other signs used in the course of trade

§ 1, § 2(2), 3(2), § 6, § 14(1), (6) FI-TML

Trade names (*toiminimi, firma*: any name that a natural or legal person uses in business activities), including **secondary trade names** (*aputoiminimi, bifirma*: natural or legal persons can carry out part of their business under a secondary trade name) and **secondary symbols** (*toissijainen tunnus, sekundärt kännetecken*: signs, including figurative signs, used in the course of trade).

Conditions for protection

Use leading to a trade name becoming established on the market.

Rights conferred (a) and conditions (b)

- (a) Right to prohibit subsequent trade marks.
- (b) The signs must relate to identical or similar goods and/or services and there must be a likelihood of confusion.

Trader's name

§ 1, 6, § 14(1), (6) FI-TML

Rights conferred (a) and conditions (b)

- (a) Right to prohibit subsequent trade marks.
- (b) The signs must relate to identical or similar goods and/or services and there must be a likelihood of confusion.

25 Sweden

New Swedish Trade Marks Act (2010:1877)

25.1 Unregistered trade marks

Chapter 1, Article 7 and Chapter 2, Article 8 SE-TMA

Conditions for protection

The unregistered trade mark must have been used in such a way that it has become established on the market.

Rights conferred (a) and conditions (b)

- (a) The same as for registered trade marks: right to prohibit the use of subsequent trade marks.
- (b) A mark is considered to have become established on the market when it is, within a significant portion of the circle for which it is intended, known as a symbol for the goods being made available under it.

25.2 Other signs used in the course of trade

Trade names/Company names

Chapter 1, Article 7(1); Chapter 1, Article 8; Chapter 2, Article 9 SE-TMA

Conditions for protection

The name must be registered as a company name or used in such a way that it has become established on the market. May be limited to the part of the country in which it is established on the market.

Rights conferred (a) and conditions (b)

- (a) Right to prohibit the use of subsequent trade marks.
- (b) There must be a likelihood of confusion and the signs must cover identical or similar goods and services.

26 United Kingdom

General note for unregistered signs: passing off is not in any way a 'proprietary right' that 'protects an unregistered trade mark or other sign used in the course of trade'. It refers rather to a 'wrongful invasion' of a property right, but the property protected in this case is the goodwill and reputation of a business that is likely to be harmed by misrepresentation. Whether, e.g., an opposition based on Section 5(4)(a) is successful will, then, depend on a number of cumulative factors: (demonstration and scope of goodwill; misrepresentation, damage to goodwill). On that basis, any distinction between 'protection' given to 'unregistered trade marks' and to 'other signs used in the course of trade' in the context of the UK's common-law right of 'passing off' is meaningless. The right of 'passing off' could potentially (and more often than not does) arise purely at local level (relative to the UK as a whole). (See below, 'The particularities of the action of passing off').

26.1 Unregistered trade marks

Unregistered trade marks used in the course of trade

Section 5(4)(a) UK-TMA

Conditions for protection

Must be used in the course of trade if protected by any rule of law, including that of passing off.

Rights conferred (a) and conditions (b)

- (a) Right to prohibit the use of subsequent trade marks.
- (b) **Goodwill** must be demonstrated in the UK at the relevant date, the scope of which **must extend to the goods or services** of the application; **misrepresentation as regards the 'signs'** at issue; **damage to the opponent's goodwill** can be inferred by use of the sign applied for.

26.2 Other signs used in the course of trade

Section 5(4)(a) UK-TMA

Sign used in the course of trade.

Sign used in the course of trade, protected by any rule of law, including that of passing off.

Conditions for protection

Same as under Section 26.1.

Rights conferred (a) and conditions (b)

Same as under Section 26.1.

Remarks: The Olympic Symbol Protection Act 1995 contains provisions on the exclusive use for commercial purposes of the Olympic symbol and certain words associated with the Olympic games by an individual nominated by the Secretary of State; such entitlement is not a basis for Article 8(4) EUTMR.

The particularities of the action of passing off

Passing off is an economic tort in the common-law jurisdictions, the essential elements of which are (i) a misrepresentation (ii) causing damage to (iii) the goodwill of a trader or traders. It is a form of intellectual property enforcement against unauthorised use of an intellectual property right.

The purpose of this section is not to analyse the substantive requirements of passing-off actions as developed by the jurisprudence of the common-law courts but rather to set out which rights that can be protected by passing-off actions fall within the scope of Article 8(4) EUTMR, and to show how the European judicature has applied the key requirements of Article 8(4) EUTMR as regards passing off.

Historically, and in their most common form, passing-off actions offer protection similar to that for registered trade marks to non-registered trade marks in that they prevent use of a name, word, device or get-up that leads to the goods or services of one trader being misrepresented as those of another. In doing so, passing-off actions protect the goodwill that traders accrue by using signs rather than protecting signs per se.

The tort of passing off covers a broad set of situations ranging from its usual form above to an extended form which may prevent the use of generic terms where such use misrepresents goods or services as possessing a characteristic or quality that they do not have (e.g. Vodkat used on a type of drink that is not Vodka).

In passing-off actions, the opponent (claimant) must prove three elements, the so-called classical trinity:

- (a) **goodwill** attached to the goods or services that it supplies;
- (b) **misrepresentation** by the defendant to the public (intentional or not) leading or likely to lead the public to believe that the goods or services offered are those of the opponent (claimant);

(c) **damage** (actual or potential) by reason of the erroneous belief engendered by the defendant's misrepresentation.

***GUIDELINES FOR EXAMINATION OF
EUROPEAN UNION TRADE MARKS***

***EUROPEAN UNION INTELLECTUAL
PROPERTY OFFICE
(EUIPO)***

PART C

OPPOSITION

SECTION 5

***TRADE MARKS WITH REPUTATION
ARTICLE 8(5) EUTMR***

Table of Contents

1	Introduction	3
1.1	Purpose of Article 8(5) EUTMR	3
1.2	Legal framework	3
2	Scope of Applicability	4
2.1	Applicability to registered marks	4
2.1.1	The requirement of registration	4
2.1.2	Relationship between marks with reputation (Article 8(5) EUTMR) and well-known marks (Article 8(2)(c) EUTMR)	5
2.2	Applicability to similar and identical goods and services	7
3	Conditions of Application	7
3.1	Earlier mark with reputation	7
3.1.1	Nature of reputation	7
3.1.2	Scope of reputation	8
3.1.2.1	Degree of recognition	8
3.1.2.2	Relevant public	9
3.1.2.3	Goods and services covered	11
3.1.2.4	Relevant territory	12
3.1.2.5	Relevant point in time	13
3.1.3	Assessment of reputation — relevant factors	15
3.1.3.1	Trade mark awareness	16
3.1.3.2	Market share	17
3.1.3.3	Intensity of use	19
3.1.3.4	Geographical extent of use	21
3.1.3.5	Duration of use	22
3.1.3.6	Promotional activities	22
3.1.3.7	Other factors	24
3.1.4	Proof of reputation	26
3.1.4.1	Standard of proof	26
3.1.4.2	Burden of proof	26
3.1.4.3	Evaluation of the evidence	27
3.1.4.4	Means of evidence	28
3.2	The similarity of the signs	36
3.2.1	Notion of ‘similarity’ pursuant to Article 8(5) EUTMR compared with Article 8(1)(b) EUTMR	37
3.3	The link between the signs	38
3.4	The risk of injury	43
3.4.1	Protected subject matter	43
3.4.2	Assessment of the risk of injury	44
3.4.3	Types of injury	46
3.4.3.1	Taking unfair advantage of distinctiveness or repute	47
3.4.3.2	Detriment to distinctiveness	53
3.4.3.3	Detriment to repute	57
3.4.4	Proving the risk of injury	63
3.4.4.1	Standard and burden of proof	63
3.4.4.2	Means of evidence	66
3.5	Use without due cause	66

1 Introduction

1.1 Purpose of Article 8(5) EUTMR

Whereas under Article 8(1)(a) EUTMR double identity of signs and goods/services and under Article 8(1)(b) EUTMR a likelihood of confusion are the necessary preconditions for the protection of a registered trade mark, Article 8(5) EUTMR requires neither identity/similarity of goods/services nor a likelihood of confusion. Article 8(5) EUTMR grants the protection for registered trade marks not only as regards identical/similar goods/services but also in relation to dissimilar goods/services without requiring any likelihood of confusion, provided the signs are identical or similar, the earlier mark enjoys a reputation and the use without due cause of the trade mark applied for would take unfair advantage of, or be detrimental to, the distinctive character or the repute of the earlier mark.

The rationale behind the extended protection under Article 8(5) EUTMR is the consideration that the function and value of a trade mark are not confined to its being an indicator of origin. A trade mark can also convey messages other than an indication of the origin of the goods and services, such as a promise or reassurance of quality or a certain image of, for example, luxury, lifestyle, exclusivity etc. ('advertising function') (judgment of 18/06/2009, C-487/07 L'Oréal and others). Trade mark owners frequently invest large sums of money and effort to create a certain brand image associated with their trade mark. This image associated with a trade mark confers on it an — often significant — economic value, which is independent of that of the goods and services for which it is registered.

Article 8(5) EUTMR aims at protecting this advertising function and the investment made in creating a certain brand image by granting protection to reputed trade marks, irrespective of the similarity of the goods or services or of a likelihood of confusion, provided it can be demonstrated that the use of the contested application without due cause would take unfair advantage of, or be detrimental to, the distinctive character or the repute of the earlier mark. Consequently, the main focus of Article 8(5) EUTMR is not the protection of the general public against confusion as to origin, but rather the protection of the trade mark proprietor against taking unfair advantage of, or being detrimental to, the distinctive character or repute of a mark for which it has made significant investments.

1.2 Legal framework

According to **Article 8(5) EUTMR**, upon opposition by the proprietor of a registered earlier trade mark, within the meaning of paragraph 2, the trade mark applied for will not be registered:

where it is identical with or similar to the earlier trade mark irrespective of whether the goods or services for which it is applied are identical with, similar to, or not similar to those for which the earlier trade mark is registered, where in the case of an earlier EU trade mark, the trade mark has a reputation in the Union or, in the case of an earlier national mark, the trade mark has a reputation in the Member State concerned and where the use without due cause of the trade mark applied for would take unfair

advantage of, or be detrimental to, the distinctive character or the repute of the earlier trade mark.

The same wording is used in the parallel provisions of the **Trade Mark Directive** (Directive EU 2015/2436 of the European Parliament and of the Council of 16 December 2015 to approximate the laws of the Member States relating to trade marks 'TMD'), namely **Article 4(3) TMD**, which deals with the protection of EU trade marks with reputation, and **Article 4(4)(a) TMD**, the equivalent provision for national marks.

The wording of Article 8(5) EUTMR is also very similar to the one used in **Article 9(2)(c) EUTMR** and **Article 5(2) TMD**, that is, the provisions determining the exclusive rights of a trade mark proprietor, with a slight difference in the way these refer to the condition of detriment. Unlike the conditional form in Article 8(5) EUTMR, which applies where use of the trade mark applied for **would take** unfair advantage of, **or be** detrimental to the distinctiveness or repute of the earlier mark', Article 9(2)(c) EUTMR and Article 5(2) TMD read **takes** unfair advantage of **or is** detrimental to'. The reason for this difference is that in the first case — Article 8(5) EUTMR — registrability is at stake, which may have to be decided upon without any use of the later mark having been made, while in the second case the prohibition of use is at issue. The impact of this difference on the kind of evidence required for proving detriment in either case is discussed in paragraph 3.4 below.

2 Scope of Applicability

The previous wording of Article 8(5) EUTMR, which was applicable until 23/03/2016, has given rise to some controversy as regards its applicability exclusively to (a) earlier registered marks and (b) dissimilar goods and services. As these issues directly affected the scope of its application, it was necessary to clarify whether it was possible to also apply Article 8(5) EUTMR to (a) unregistered/well-known marks and (b) similar or identical goods and services.

2.1 Applicability to registered marks

2.1.1 The requirement of registration

According to the clear wording of the current version of Article 8(5) EUTMR, as introduced by the Amending Regulation, this norm protects a 'registered earlier mark'. Even if the requirement of the registration was not expressly mentioned in the previous version of the norm, the Office interpreted it in this way, since according to its wording the applicability of the provision was restricted, indirectly but clearly to **earlier registered marks** by prohibiting registration where [the application] is identical or similar to the earlier trade mark and is to be registered for goods and services that are not similar to those for which the **earlier trade mark is registered**. It follows that the existence of an **earlier registration** has always been a **necessary condition** for the application of Article 8(5) EUTMR and that, as a consequence, the reference to Article 8(2) EUTMR should be limited to earlier registrations and to earlier applications subject to their registration (judgment of 11/07/2007, T-150/04, 'Tosca Blu', para. 55).

2.1.2 Relationship between marks with reputation (Article 8(5) EUTMR) and well-known marks (Article 8(2)(c) EUTMR)

The requirement of **registration** serves to mark the border between Article 8(5) EUTMR and Article 8(2)(c) EUTMR. However, neither Article 8(2)(c) EUTMR nor Article 6bis of the Paris Convention stipulate expressly that the well-known mark has to be a non-registered mark. The reason for the principle that only non-registered marks are covered by these latter provisions results indirectly both from the spirit and the *ratio legis* of these provisions.

As regards the Paris Convention, the purpose of the provision of Article 6bis, introduced for the first time in the Convention in 1925, was to prevent the registration and use of a trade mark liable to create confusion with another mark already well known in the country of such registration, although the latter well-known mark was not, or not yet, protected in that country by registration.

As regards the EUTMR, the purpose was to avoid a legal gap as Article 8(5) EUTMR protects only registered EUTMs. Without Article 8(2)(c) EUTMR, reputed non-registered trade marks would have remained without protection (apart from that of Article 8(4) EUTMR). In order to avoid this legal gap, the EUTMR foresaw the protection of well-known marks within the sense of Article 6bis of the Paris Convention as this article was drawn up mainly to grant protection to non-registered trade-marks with a well-known character.

Consequently, on the one hand, **well-known marks** which are **not registered** in the relevant territory cannot be protected under Article 8(5) EUTMR against dissimilar goods. They can only be protected against **identical or similar goods** if there exists a likelihood of confusion pursuant to Article 8(1)(b) EUTMR, to which Article 8(2)(c) EUTMR refers for determining the scope of protection. However, this is without prejudice to the fact that well-known marks, to the extent they are not registered, may also be protected under Article 8(4) EUTMR. Therefore, if the relevant national law affords them protection against dissimilar goods and services, such enhanced protection may also be invoked under Article 8(4) EUTMR.

On the other hand, where well-known marks have been **registered**, either as EUTMs, or as national marks in one of the Member States, they **can be invoked under Article 8(5) EUTMR**, but only if they also **fulfil the requirements of reputation**.

Even though the terms ‘well-known’ (a traditional term used in Article 6^{bis} of the Paris Convention) and ‘reputation’ denote distinct legal concepts, there is a **substantial overlap** between them, as shown by a comparison of the way well-known marks are defined in the WIPO Recommendations with the way reputation was described by the Court in its judgment of 14/09/1999, C-375/97 ‘General Motors’ (concluding that the different terminology is merely a ‘...nuance, which does not entail any real contradiction...’, para 22).

In practical terms, the threshold for establishing whether a trade mark is well-known or enjoys reputation will usually be the same. Therefore, it will not be unusual for a mark which has acquired well-known character to have also reached the threshold laid down by the Court in *General Motors* for marks with reputation, given that in both cases the assessment is principally based on quantitative considerations regarding the degree of knowledge of the mark among the public, and that the thresholds required for each case are expressed in quite similar terms (‘known or well-known at the relevant sector

of the public¹ for well-known marks, as against 'known by a significant part of the relevant public' as regards marks with reputation').

This has also been confirmed by case-law. In its judgment of 22/11/2007, C-328/06 'Fincas Tarragona', the Court qualified the notions of 'reputation' and 'well-known' as kindred notions ('notions voisines'), underlining in this way the substantial overlap and relationship between them (see para. 17). See also the judgment of 11/07/2007, T-150/04 'TOSCA BLU' (paras. 56-57).

The overlap between marks with reputation and registered well-known marks has a repercussion on the raising of the ground of opposition, in the sense that it should not matter for the applicability of Article 8(5) EUTMR if the opponent calls its earlier registration a well-known mark instead of a mark with reputation. For this reason, the terminology used must be carefully scrutinised, especially where the grounds of the opposition are not clearly explained, and a flexible approach should be taken where appropriate.

In the context of Article 8(2)(c) EUTMR, the requirements for applying Article 6bis of the Paris Convention and Article 8(1)(a)/(b) EUTMR are the same, although the terminology used is different. Both provisions require similarity or identity between the goods or services and similar or identical signs (Article 6bis uses the terms 'reproduction' which is equivalent to identity and 'imitation' which refers to similarity). Both articles also require a likelihood of confusion ('liable to create confusion' is the term used in Article 6bis). However, while according to Article 8(2)(c) EUTMR a well-known mark can serve as an earlier right and, thus, as the **basis** of an opposition, the **grounds** for an opposition under Article 8(2)(c) EUTMR are (solely) Article 8(1)(a) or (b) EUTMR.

For example, if the opponent bases the opposition on (i) an earlier registration invoking Article 8(1)(b) EUTMR and Article 8(5) EUTMR and (ii) an identical earlier well-known mark in the same territory under Article 8(2)(c) EUTMR, the earlier right must be examined:

1. under Article 8(1)(b) EUTMR as an earlier **registration** with enhanced distinctiveness (in view of its well-known character);
2. under Article 8(5) EUTMR, as an earlier **registration** with reputation;
3. under Article 8(2)(c) EUTMR in conjunction with Article 8(1)(b) EUTMR as an earlier **non-registered well-known mark** (which will only be useful if registration is not proven, as otherwise the outcome is the same as in (1) above).

Even if the opponent has not expressly based its opposition on Article 8(5) EUTMR, the contents of the notice and the wording of the explanation of grounds must be carefully analysed with a view to objectively establishing whether the opponent also wants to rely on Article 8(5) EUTMR.

¹ Article 2(2)(b) and 2(2)(c) of the WIPO Recommendations.

2.2 Applicability to similar and identical goods and services

According to the clear wording of the current version of Article 8(5) EUTMR the protection provided in this norm is 'irrespective of whether the goods or services for which the later mark is applied are identical with, similar to, or not similar to those for which the earlier trade mark is registered'. This is a codification of the case-law² of the Court of Justice interpreting the previous version of the provision.

3 Conditions of Application

The following conditions need be met for Article 8(5) EUTMR to apply (judgment of 16/12/2010 joined cases T-345/08 and T-357/08 'BOTOCYL', confirmed by the Court of Justice in judgment of 10/05/2012 C-100/11 P):

1. earlier **registered mark with reputation** in the relevant territory;
2. **identity or similarity** between the contested EUTM application and the earlier mark;
3. use of the sign applied for must be capable of taking an unfair advantage of, or being detrimental to, the distinctiveness or the repute of the earlier mark;
4. such use must be **without due cause**.

These conditions are **cumulative** and failure to satisfy any one of them is sufficient to render that provision inapplicable (judgment of 25/05/2005, T-67/04, 'SPA-FINDERS', para. 30; judgment of 22/03/ 2007, T-215/03, 'VIPS', para. 34; judgment of 16/12/2010 joined cases T-345/08 and T-357/08 'BOTOCYL', para. 41).

The order of the examination of these requirements may change depending on the circumstances of each case. For instance, the examination may start with the assessment of the similarities between the signs, especially in cases where there is little or nothing to say about it, either because the marks are identical or because they are patently similar or dissimilar.

3.1 Earlier mark with reputation

3.1.1 Nature of reputation

The nature and scope of reputation are not defined by either the EUTMR or the TMD. Furthermore, the terms used in the different language versions of these texts are not fully equivalent, which has led to considerable confusion as to the true meaning of the term reputation, as admitted by Advocate General Jacobs in his opinion of 26/11/1998 in C-375/97 'General Motors', paras 34-36.

Given the lack of statutory definition, the Court defined the nature of reputation by reference to the purpose of the relevant provisions. In interpreting Article 5(2) TMD the Court held that the text of the TMD 'implies a **certain degree of knowledge of the**

² Judgment of 09/01/2003, C-292/00, 'Davidoff'.

earlier mark among the public' and explained that it 'is only where there is a sufficient degree of knowledge of that mark that the public, when confronted by the later trade mark, may possibly make an association between the two trade marks ... and the earlier mark may consequently be damaged' (judgment of 14/09/1999, C-375/97 'General Motors', para. 23).

In view of these considerations, the Court concluded that reputation is a **knowledge threshold requirement**, implying that it must be principally assessed on the basis of **quantitative** criteria. In order to satisfy the requirement of reputation, the earlier mark must be known by a significant part of the public concerned by the goods or services covered by that trade mark (judgment of 14/09/1999, C-375/97 'General Motors', paras 22, 23, judgment of 25/05/2005, T-67/04 'Spa-Finders', para. 34).

Moreover, if reputation is to be assessed on the basis of quantitative criteria, arguments or evidence relating to the esteem that the public might have for the mark, rather than to its recognition, are not directly relevant for establishing that the earlier mark has acquired sufficient reputation for the purposes of Article 8(5) EUTMR. However, as the economic value of reputation is also the protected subject-matter of this provision, any **qualitative aspects** thereof are relevant when assessing the possibility of detriment or unfair advantage (see also paragraph 3.4 below). Article 8(5) EUTMR protects 'famous' marks not as such, but rather for the success and renown ('goodwill') they have acquired in the market. A sign does not enjoy any reputation inherently, for example, simply because it refers to a renowned person or event, but only for the goods and services it designates and the use that has been made of it.

Case No	Comment
R 0011/2008-4, 'CASAS DE FERNANDO ALONSO (fig.)'	All the evidence submitted by the opponent related to the fame of Fernando Alonso as a champion racing driver and to the use of his image made by different undertakings to promote their goods and services. However, there was no proof of reputation for the use of the earlier mark as it is registered for the relevant goods and services (paras 44, 48).
R 0201/2010-2 'BALMAIN ASSET MANAGEMENT'	The only items of evidence regarding reputation of the earlier mark submitted within the time limit, namely a page showing websites containing the word 'BALMAIN', a Wikipedia extract about the French designer Pierre Balmain and five extracts from the website www.style.com containing 'BALMAIN' wear collection, were clearly not sufficient to establish reputation of the earlier mark in the EU. Therefore, the opposition was rejected as unsubstantiated (paras 36, 37).

3.1.2 Scope of reputation

3.1.2.1 Degree of recognition

Having defined reputation as a knowledge threshold requirement, the question that necessarily follows is **how much awareness** the earlier mark must attain among the public in order to pass this threshold. The Court held in this respect that the 'degree of knowledge required must be considered to be reached when the earlier trade mark is **known by a significant part** of the public' and added that it 'cannot be inferred from either the letter or the spirit of Article 5(2) [TMD] that the trade mark must be known by a given percentage of the public' (judgment of 14/09/1999, C-375/97 'General Motors', paras 25, 26, judgment of 16/11/2011, T-500/10 'Dorma', para. 45).

By refraining from defining in more detail the meaning of the term ‘significant’ and by stating that the trade mark does not have to be known by a given percentage of the public, the Court in substance advised **against the use of fixed criteria** of general applicability, since a predetermined degree of recognition may not be appropriate for a realistic assessment of reputation if taken alone.

Hence, in determining whether the earlier mark is known by a significant part of the public, account must be taken not only of the degree of awareness of the mark, but also of **any other factor** relevant to the specific case. For more about the relevant factors and their interplay, see paragraph 3.1.3 below.

However, where goods or services concern quite **small groups of consumers**, the limited overall size of the market means that a significant part thereof is also restricted in absolute numbers. Hence, the limited size of the relevant market should not be regarded in itself as a factor capable of preventing a mark from acquiring a reputation within the meaning of Article 8(5) EUTMR, as reputation is more a question of proportions and less of absolute numbers.

The need for the earlier mark to be known by a significant part of the public also serves to mark the difference between the notions of **reputation** as necessary condition for the application of Article 8(5) EUTMR and **enhanced distinctiveness through use** as a factor for evaluating likelihood of confusion for the purposes of Article 8(1)(b) EUTMR.

Even though both terms are concerned with the recognition of the mark among the relevant public, in the case of **reputation** a **threshold** exists below which extended protection cannot be granted, whereas in the case of **enhanced distinctiveness** there is **no threshold**. It follows that in the latter case any indication of enhanced recognition of the mark should be taken into account and evaluated according to its significance, regardless of whether it reaches the limit required by Article 8(5) EUTMR. Therefore, a finding of ‘enhanced distinctiveness’ under Article 8(1)(b) EUTMR will not necessarily be conclusive for the purposes of Article 8(5) EUTMR.

Case No	Comment
R 1054/2007-4 ‘mandarino (fig.)’	The documents submitted by the opponent showed promotional efforts in such a manner that the distinctiveness is increased through use. However, the use was not enough to reach the threshold of reputation. None of the documents referred to the recognition of the earlier trade mark by the relevant end consumers, nor was evidence about the market share of the opponent’s goods filed (para. 61).

3.1.2.2 Relevant public

In defining the kind of public that should be taken into account for assessing reputation, the Court held that the ‘public amongst which the earlier trade mark must have acquired a reputation is **that [public] concerned by that trade mark**, that is to say, depending on the product or service marketed, either the public at large or a more specialised public, for example traders in a specific sector’ (C-375/97 ‘General Motors’, para. 24, ‘SPA-FINDERS’, paras 34, 41).

Hence, if the goods and services covered by the mark are **mass consumption** products, the relevant public will be the **public at large**, whereas if the designated goods have a very **specific application** or exclusively target **professional or industrial users**, the relevant public will be limited to the **specific purchasers** of the products in question.

Case No	Comment
R 1265/2010-2 'MATTONI (fig.)'	Taking into account the nature of the goods for which the opponent claims reputation, namely <i>mineral water</i> , the relevant public is the public at large (para. 44).
R 2100/2010-1 'SEXIALIS'	The goods for which the sign enjoys reputation are <i>medicinal preparations for the treatment of sexual dysfunction</i> . The relevant public is the general public and professionals with a high level of attention (para. 64).
Joined cases T-345/08 and T-357/08 'BOTOCYL', confirmed by C-100/11 P	The goods for which the earlier mark enjoys reputation are <i>pharmaceutical preparations for the treatment of wrinkles</i> . The evidence of the promotion of the earlier mark 'BOTOX' in English in scientific and general-interest press was sufficient to establish reputation of the mark amongst both the general public and health-care professionals (paras 65-67 in C-100/11 P). Therefore, both these categories of consumers have to be taken into account.

In addition to the actual buyers of the relevant goods, the notion of relevant public extends to the **potential purchasers** thereof, as well as to those members of the public that only come **indirectly into contact** with the mark, to the extent that such consumer groups are also targeted by the goods in question, for instance, sports fans in relation to athletic gear, or frequent air-travellers as regards air carriers, etc.

Case No	Comment
T-47/06 'NASDAQ'	The relevant services are stock exchange price quotation services in Classes 35 and 36, which normally target professionals. The opponent submitted evidence showing that the mark 'NASDAQ' appears almost daily in many newspapers and on many television channels that can be read/viewed throughout Europe. Therefore, the Board was right to hold that the reputation of the trade mark 'NASDAQ' had to be determined for the European consumers not only among the professional public, but also to an important subsection of the general public (paras 47, 51).
T-60/10 'ROYAL SHAKESPEARE'	The evidence of reputation supports and reinforces the fact that the relevant public for <i>theatre productions</i> is the public at large and not a limited and exclusive circle. The intervener's activities were advertised, presented and commented on in numerous newspapers targeting the public at large. The intervener toured different regions throughout the United Kingdom and performed before a wide public in the United Kingdom. An activity on a large scale and, hence, a service offered to the public at large, is reflected both in the high turnover and the high box office sales. Furthermore, it is clear from the documents submitted by the intervener that the intervener received substantial annual sponsorship income from undertakings in diverse sectors which also reach the public at large, such as banks, undertakings in the alcoholic drinks sector and car manufacturers (paras 35, 36).

Quite often, a given product will concern **various purchaser groups** with different profiles, as in the case of multipurpose goods or goods that are handled by several

intermediates before they reach their final destination (distributors, retailers, end-users). In such cases the question arises whether reputation has to be assessed within each separate group or if it should cover all the different types of purchaser. The example given by the Court in C-375/97, 'General Motors', (traders in a specific sector) implies that reputation within one single group may suffice.

Likewise, if the earlier trade mark is registered for quite **heterogeneous goods** and services, different segments of the public may be concerned by each type of goods, and, therefore, the overall reputation of the mark will have to be assessed separately for each category of goods involved.

The foregoing only deals with the kind of public to be taken into account in assessing whether the earlier mark has reached the threshold of reputation laid down by the Court in *General Motors*. However, a relevant question arises when assessing detriment or unfair advantage, namely whether the earlier mark must also be known to the public concerned by the goods and services of the later mark, since otherwise it is difficult to see how the public will be in a position to associate the two. This issue is discussed in paragraph 3.4 below.

3.1.2.3 Goods and services covered

The goods and services must be first of all those for which the earlier trade mark is registered and for which reputation is claimed.

Case No	Comment
R 1473/2010-1 'SUEDTIROL'	The opposition was dismissed since the earlier marks were not registered for the services which, according to the opponent, enjoy a reputation. Article 8(5) EUTMR can only be invoked if the trade mark affirmed to be well known/renowned is a registered trade mark and if the goods/services for which this reputation/renown is claimed appear on the certificate (para. 49).

The goods and services to which the evidence refers have to be identical (not only similar) to the goods and services for which the earlier trade mark is registered.

Case No	Comment
R 1033/2009-4 'PEPE'	The goods which were assessed to be reputed in Germany by the decision and order referred to only concern articles of skin and body care and children's cream. These articles are not identical to the earlier mark's goods in Class 3, <i>make-up products; nail treating products; namely nail lacquer and remover</i> . Therefore, the opponent did not prove reputation for the earlier German mark in the relevant territories (para. 31).

Where the earlier mark is registered for a wide range of goods and services targeting different kinds of public, it will be necessary to assess reputation separately for each category of goods. In such cases the earlier mark may not have a reputation for all of them, as it may not have been used at all for some of the goods, whereas for others it may not have reached the degree of knowledge necessary for the application of Article 8(5) EUTMR.

Hence, if the evidence shows that the earlier mark enjoys **partial reputation**, that is, the reputation only covers some of the goods or services for which it is registered, it is only to that extent that this mark may be protected under Article 8(5) EUTMR. Consequently, it is **only these goods** that may be taken into account for the purposes of the examination.

Case No	Comment
R 1588/2009-4 'PINEAPPLE'	The Board concluded that the enhanced distinctiveness and reputation of the earlier marks did not concern the opponent's G&S which were considered to be identical or similar to the contested G&S. For these G&S no enhanced distinctiveness or reputation was proven, with the exception of <i>computer software</i> in Class 9 (para. 43).
R 1466/2008-2 and R 1565/2008-2, 'COMMERZBANK ARENA'	The evidence submitted sufficiently demonstrated that the 'ARENA' brand was known by a significant part of the relevant public. However, the evidence did not include any relevant information which could allow the level of brand awareness of the 'ARENA' brand in sectors other than <i>swimwear and swimming articles</i> to be determined (paras 58, 60).

3.1.2.4 Relevant territory

According to Article 8(5) EUTMR, the **relevant territory** for establishing the reputation of the earlier mark is the territory of protection: the earlier mark must **have a reputation in the territory where it is registered**. Therefore, for national marks the relevant territory is the Member State concerned, whereas for EUTMs the relevant territory is the European Union.

In *General Motors*, the Court stated that a national trade mark cannot be required to have a reputation throughout the entire territory of the Member State concerned. It is sufficient if reputation exists in a substantial part of that territory. For the Benelux territory in particular, the Court held that a substantial part thereof may consist of a part of one of the Benelux countries (judgment of 14/09/1999, C-375/97 'General Motors', paras 28, 29).

The Court has clarified that for an earlier EU trade mark reputation throughout the territory of a single Member State may suffice.

Case No	Comment
C-301/07 'PAGO'	The case concerned an EU trade mark with a reputation throughout Austria. The Court indicated that an EU trade mark must be known in a substantial part of the EU by a significant part of the public concerned by the goods or services covered by that trade mark. In view of the facts of the particular case, the territory of the Member State in question (Austria) was considered to constitute a substantial part of the territory of the EU (paras 29, 30).

In general, however, when evaluating whether the part of the territory in question is a substantial one, account must be taken both of the size of the geographical area concerned and of the proportion of the overall population living there, since both these criteria may affect the overall significance of the specific territory.

Case No	Comment
R 1283/2006-4 'RANCHO PANCHO (fig.)'	Although the evidence submitted showed use of the mark in 17 restaurants in France in 2002, this figure was considered rather low for a country of 65 million inhabitants. Therefore, the reputation was not proven (para. 22).

Opponents often indicate in the notice of opposition that the earlier mark has a reputation in an area that extends beyond the territory of protection (e.g. a pan-European reputation is alleged for a national mark). In such a case the opponent's claim must be examined with regard to the relevant territory.

Similarly, the submitted **evidence must specifically concern the relevant territory**. For example, if the evidence relates to Japan for instance, or to undefined regions, it will not be able to show reputation in the EU or in a Member State. Therefore, figures concerning sales in the EU as a whole, or world-wide sales, are not appropriate for showing reputation in a specific Member State, if the relevant data are not broken down by territory. In other words, a 'wider' reputation must also be specifically proven for the relevant territory if it is to be taken into account.

Case No	Comment
R 1718/2008-1 'LINGLONG'	Most of the documents submitted related to countries outside the European Union, mainly China, the opponent's home country, and other Asian countries. Consequently, the opponent cannot successfully claim to hold a well-known mark in the EU (para. 53).
R 1795/2008-4 'ZAPPER-CLICK' (appeal dismissed T-360/10)	The respondent sustained in the notice of cancellation that reputation was claimed for the territory of the UK. However, the international registration only designated Spain, France and Portugal and, therefore, did not extend to the territory of the UK. In addition, the respondent did not file any evidence of a reputation in the Member States designated by the international registration (para. 45).

However, where reputation is claimed as extending beyond the territory of protection and there is evidence to this effect, this must be taken into account because it may reinforce the finding of reputation in the territory of protection.

3.1.2.5 Relevant point in time

The opponent must show that the earlier mark had acquired a reputation by the **filing date** of the contested EUTM application, taking account, where appropriate, of any **priority** claimed, on condition of course that the priority claim has been accepted by the Office.

In addition, the reputation of the earlier mark must subsist until the decision on the opposition is taken. However, in principle it will be sufficient for the opponent to show that its mark already had a reputation on the filing/priority date of the EUTM application, while any subsequent **loss of reputation** is for the applicant to claim and prove. In practice, such an occurrence will be rather exceptional, since it presupposes a dramatic change of market conditions over a relatively short period of time.

Where the opposition is based on an **earlier application**, there is no formal obstacle for the application of Article 8(5) EUTMR, which encompasses earlier applications by reference to Article 8(2) EUTMR. Although in most cases the earlier application will not have acquired sufficient reputation in so short a time, it cannot be *a priori* excluded that a sufficient degree of reputation may be achieved in an exceptionally short period. In addition, the application may be for a mark which was already in use long before the application was filed and has had sufficient time to acquire a reputation. In any event, as the effects of registration are retroactive, the applicability of Article 8(5) EUTMR to earlier applications cannot be regarded as a deviation from the rule that Article 8(5) EUTMR only applies to earlier registrations, as concluded in paragraph 2.1 above.

In general, the **closer to the relevant date** the evidence is, the **easier** it will be to assume that the earlier mark had **acquired reputation** at that time. The evidential value of a particular document is likely to vary depending on how close the period covered is to the filing date. Evidence of reputation with regard to a later point in time than the relevant date might nevertheless allow the drawing of conclusions as to the reputation of the earlier mark at the relevant date (see, by analogy, order of 27/01/2004, C-259/02 'La Mer Technology', para. 31; judgment of 17/04/2008, C-108/07 'Ferro', para 53; judgment of 15/12/2005, T-262/04 'Shape of a lighter', para. 82).

For this reason, the materials filed with a view to proving reputation must be dated, or at least **clearly indicate when** the facts attested therein took place. Consequently, undated documents, or documents bearing a date added afterwards (e.g. hand-written dates on printed documents), are not apt for giving reliable information about the material time.

Case No	Comment
R 0055/2009-2 'BRAVIA'	The evidence showed that the mark 'BRAVIA' was used for LCD televisions in Poland, the Czech Republic, Slovakia, Hungary, Germany, Turkey, Portugal, Austria, France, Italy and the Netherlands. However, none of the documents were dated. The opponent failed to submit any information regarding duration. Therefore, the evidence, taken as whole, was insufficient to prove the reputation in the European Union (paras 27, 28).
R 1033/2009-4 'PEPE'	In the Board's view, a judgment from 1972 was not able to prove enhanced distinctiveness at the time of filing the mark, that is, 20/10/2006. Furthermore, 'it follows from the decision of the Court [T-164/03] that the reputation of the earlier mark has been assessed as from 13 June 1996, i.e. more than ten years before the reputation date to be taken into consideration' (para. 31).

If the **period elapsed** between the latest evidence of use and the filing of the EUTM application is quite **significant**, the relevance of the evidence should be carefully assessed by reference to the kind of goods and services concerned. This is because changes in consumer habits and perceptions may take some time to happen, usually depending on the particular market involved.

For instance, the clothing market is strongly tied to yearly seasons and to the different collections issued every quarter. This will have to be taken into account in assessing a possible loss of reputation in this particular field. Likewise, the market for internet providers and e-commerce companies is very competitive and knows rapid growth, as

well as rapid demise, which means that reputation in this area may be diluted faster than in other market sectors.

Case No	Comment
R 0883/2009-4 'MUSTANG'	The appellant failed to prove that its earlier mark was already well known on the application date of the contested mark. The certificates regarding the reputation of the 'Mustang designation' refer neither to the asserted 'Calzados Mustang' figurative mark nor to the time when reputation must be determined (para. 28).

A similar question arises in the case of **evidence that post-dates the filing date** of the EUTM application. Even though such evidence will not usually be sufficient on its own to prove that the mark had acquired a reputation when the EUTM was filed, it is not appropriate to reject it as irrelevant either. Given that reputation is usually built up over a period of years and cannot simply be switched on and off, and that certain kinds of evidence (e.g. opinion polls, affidavits) are not necessarily available before the relevant date, as they are usually prepared only after the dispute arises, such evidence must be evaluated on the basis of its contents **and in conjunction with the rest of the evidence**. For example, an opinion poll conducted after the material time but showing a sufficiently high degree of recognition might be sufficient to prove that the mark had acquired a reputation on the relevant date if it is also shown that the market conditions have not changed (e.g. the same levels of sales and advertising expenditure were maintained before the opinion poll was carried out).

Case No	Comment
Joined cases T-345/08 and T-357/08 'BOTOCYL', confirmed by C-100/11 P	Although the reputation of an earlier mark must be established at the filing date of the contested mark, documents bearing a later date cannot be denied evidential value if they enable conclusions to be drawn with regard to the situation as it was on that date (para. 52).

The possibility cannot automatically be ruled out that a document drawn up some time before or after that date may contain useful information in view of the fact that the reputation of a trade mark is, in general, acquired progressively. The evidential value of such a document is likely to vary depending on how close the period covered is to the filing date (see, by analogy, order of 27/01/2004, C-259/02 'La Mer Technology', para. 31; judgment of 17/04/2008, C-108/07 P 'Ferro', para. 53; judgment of 15/12/2005, T-262/04 'Shape of a lighter', para. 82).

Case No	Comment
Joined cases T-345/08 and T-357/08 'BOTOCYL', confirmed by C-100/11 P	The press articles submitted proved that there was significant media coverage of the products marketed under the trade mark BOTOX on the filing date of the disputed marks (para. 53).

3.1.3 Assessment of reputation — relevant factors

Apart from indicating that 'It cannot be inferred from either the letter or the spirit of Article 5(2) of the [TMD] that the trade mark must be known by a **given percentage** of the public', the Court also held that **all the relevant facts** must be considered in assessing the reputation of the earlier mark, **'in particular the market share** held by

the trade mark, the **intensity, geographical extent** and **duration** of its use, and the **size of investment** made by the undertaking in promoting it' (judgment of 14/11/1999, C-375/97 'General Motors', paras 25, 27).

If these two statements are taken together, it follows that the level of knowledge required for the purposes of Article 8(5) EUTMR cannot be defined in the abstract, but should be evaluated on a **case-by-case** basis, taking into account **not only the degree of awareness of the mark, but also any other fact relevant to the specific case**, that is, any factor capable of giving information about the performance of the mark in the market.

The list of factors to be taken into consideration in order to ascertain the reputation of an earlier mark (such as the market share held by the trade mark, the intensity, geographical extent and duration of its use, and the amount spent by the undertaking in promoting it) only serve as examples.

Case No	Comment
T-47/06 'Nasdaq'	<p>The opponent provided detailed evidence relating to the intensity, geographical extent and duration of the use of its trade mark NASDAQ and the amount spent in promoting it, demonstrating that it was known by a significant part of the public concerned by it. The Court considered that the fact that it did not produce figures regarding the market share did not call this finding into question (para. 51).</p> <p>The Court concluded that the list of factors to be taken into consideration in order to ascertain the reputation of an earlier mark only serve as examples, as all the relevant evidence in the case must be taken into consideration and, second, the other detailed and verifiable evidence produced by the intervener is already sufficient in itself to conclusively prove the reputation of its mark NASDAQ (para. 52).</p>

Moreover, the relevant factors should be assessed with a view not only to establish the degree of recognition of the mark amongst the relevant public, but also to ascertain whether the **other requirements** related to reputation are fulfilled, for example, whether the alleged reputation covers a significant part of the territory concerned or whether the reputation had indeed been acquired by the filing/priority date of the contested EUTM application.

The same kind of test is applied to ascertain whether the trade mark has acquired **enhanced distinctiveness** through use for the purposes of Article 8(1)(b) EUTMR, or whether the mark is **well-known** within the meaning of Article 6^{bis} of the Paris Convention, since the subject-matter of proof in all these cases is in substance the same, namely the degree to which the mark is known by the relevant public, without prejudice to the threshold required in each case.

3.1.3.1 Trade mark awareness

The statement of the Court that 'it is not necessary for the mark to be known by a given percentage of the public', cannot be taken in itself as meaning that figures of trade mark awareness are irrelevant for, or that they should be given a lower probative value in, the assessment of reputation. It only implies that percentages of awareness defined in the abstract may not be appropriate for all cases and that, consequently, it is **not**

possible to fix a priori a generally applicable threshold of recognition beyond which it should be assumed that the mark is reputed (see, to that effect and by analogy, judgment of 04/05/1999, joined cases C-108/97 and C-109/97 ‘Windsurfing Chiemsee’, para. 52; judgment of 22/06/1999, C-342/97 ‘Lloyd Schuhfabrik Meyer’, para. 24, judgment of 16/11/2011 T-500/10, ‘DORMA’, para. 52).

Therefore, even though not expressly listed by the Court among the factors to be taken into account for assessing reputation, the **degree of recognition** of the mark amongst the relevant public is **directly relevant** and can be particularly helpful in evaluating whether the mark is sufficiently known for the purposes of Article 8(5) EUTMR, provided of course that the method of its calculation is reliable.

As a rule, the **higher the percentage** of trade mark awareness, the **easier** it will be to accept that the **mark has a reputation**. However, in the absence of a clear threshold, only if the evidence shows a **high degree** of trade mark awareness, will percentages of recognition be **persuasive**. Percentages alone are not conclusive. Rather, as explained before, reputation has to be evaluated by making an overall assessment of all the factors relevant to the case. The higher the degree of awareness, the less additional evidence may be required to prove reputation and vice versa.

Case No	Comment
R 0765/2009-1 ‘BOB THE BUILDER (fig.)’	The evidence submitted proved that the earlier mark enjoyed a very significant reputation in Sweden for <i>jellies’, jams, fruit stews, fruit drinks, concentrates for production of drinks and juice’</i> . According to the survey conducted by TNS Gallup, the spontaneous awareness (answers by telephone to the question ‘What brands for — ‘the relevant group of products is mentioned’ — have you heard about or do you know about?’) for the trade mark ‘BOB’ varied between 25 and 71% depending on the goods: <i>apple sauces, jams, marmalades, soft drinks, fruit drinks and fruit juices</i> . The supported awareness (answer to a questionnaire showing the products bearing the mark) varied between 49 and 90% depending on the goods. Furthermore, the market share for 2001 to 2006 averaged 30-35% in the above product groups (para. 34).

Where the evidence shows that the mark only enjoys a **lesser degree of recognition**, it should not be automatically assumed that the mark is reputed, which means that, most of the time, **mere percentages will not be conclusive** in themselves. In such cases, only if the evidence of awareness is coupled with sufficient indications of the overall performance of the mark in the market will it be possible to evaluate with a reasonable degree of certainty whether the mark is known by a significant part of the relevant public.

3.1.3.2 Market share

The **market share** enjoyed by the goods offered or sold under the mark and the **position** it occupies in the market are valuable indications for assessing reputation, as they both serve to indicate the **percentage of the relevant public that actually buys** the goods and to measure the success of the mark against competing goods.

Market share is defined as the **percentage of total sales** obtained by a brand in a particular sector of the market. When defining the relevant market sector, the goods and services for which the **mark has been used** must be taken into account. If the

scope of such goods and services is narrower than those for which the mark is registered, a situation of partial reputation arises, similar to the one where the mark is registered for a variety of goods, but has acquired a reputation only for part of them. This means that in such a case, only **the goods and services for which the mark has actually been used and acquired a reputation will** be taken into account for the purposes of the examination.

Therefore, a very **substantial market share**, or a **leader position** in the market, will usually be a **strong indication of reputation**, especially if combined with a reasonably high degree of trade mark awareness. Conversely, a **small market share** will in most cases be an **indication against reputation**, unless there are other factors which suffice on their own to support such a claim.

Case No	Comment
Joined cases T-345/08 and T-357/08 'BOTOCYL', confirmed by C-100/11 P	'... the size of the market share of BOTOX in the United Kingdom, 74.3% in 2003 , like the degree of awareness of the trade mark of 75% among the specialised public accustomed to pharmaceutical treatments against wrinkles, is sufficient to substantiate the existence of a considerable degree of recognition on the market' (para. 76).
T-08/03 'Emilio Pucci'	The Court considered that the opponent failed to prove the enhanced distinctiveness or reputation of its earlier trade marks, since the evidence submitted (advertisements, seven letters from a number of advertising directors and a video cassette) did not include adequately substantiated or verifiable objective evidence to make it possible to assess the market share held by the marks EMIDIO TUCCI in Spain, how intensive, geographically widespread and long-standing use of the marks had been or the amount invested by the undertaking in promoting them (para. 73).

Another reason why a **moderate market share will not always be conclusive against reputation** is that the percentage of the public that in reality knows the mark may be much higher than the number of actual buyers of the relevant goods. This would be the case, for example, for goods that are normally used by more than one user (e.g. family magazines or newspapers) (judgment of 06/07/2012, T-60/10, 'ROYAL SHAKESPEARE' paras 35, 36 and judgment of 10/05/2007, T-47/06 'NASDAQ' paras 47, 51) or for luxury goods, which many may know, but few can buy (e.g. a high percentage of European consumers know the trade mark 'Ferrari' for cars, but only few own one). For this reason, the market share proved by the evidence should be assessed taking into account the particularities of the specific market.

Case No	Comment
R 1659/2011-2 'KENZO'	'KENZO' identifies, in the eyes of the European public, a pre-eminent provider of recognised fashion and luxury items in the form of perfumes, cosmetics and clothing. The relevant public however was considered to be the general public (para. 29).

In certain cases it will **not be easy to define the market share** of the earlier mark, for example when the exact size of the relevant market cannot be measured accurately, owing to peculiarities of the goods or services concerned.

Case No	Comment
R 0446/2010-1 'TURBOMANIA'	The limited presence of the product on the market by no means prevented it from becoming well known by the relevant public. The evidence clearly showed that the trade mark appeared continuously in specialist magazines for the market from December 2003 to March 2007 (the date of the EU trade mark application). That meant that the public targeted by the magazines had constant, on-going exposure to the opponent's trade mark over a long period covering more than three years prior to the relevant date. Such a huge presence in the press specifically targeting the relevant public was more than sufficient evidence that the relevant public was aware of the trade mark (para. 31).

In such cases, **other similar indications** may be relevant, such as TV audience rates, as in the case of motor racing and other sporting or cultural events.

Case No	Comment
T-47/06 'NASDAQ'	The opponent submitted evidence showing that the mark 'NASDAQ' appeared almost daily, particularly by reference to the Nasdaq indices, in many newspapers and on many television channels that can be read/viewed throughout Europe. The opponent also submitted evidence of substantial investments in advertising . The Court found reputation proven, even though the opponent did not submit any market share figures (paras 47-52).

3.1.3.3 Intensity of use

The intensity of use of a mark may be demonstrated by **sales volumes** (i.e. the number of units sold) and **turnover** (i.e. the total value of those sales) attained by the opponent for goods bearing the mark. Usually, the relevant figures correspond to sales in one year, but there may be cases where the time unit used is different.

Case No	Comment
R 2100/2010-1 'SEXIALIS'	The documents submitted (press articles, sales figures, surveys) showed that the earlier sign 'CIALIS' was intensively used before the filing date of the EUTM application, that the products under the mark 'CIALIS' were marketed in several Member States where they enjoyed a consolidated position among the leading brands, and that there was a high degree of recognition in comparison to the market leader 'VIAGRA'. Large and constantly growing market share and sales numbers also showed 'the vast expansion of 'CIALIS'' (para. 55).

In evaluating the importance of a given turnover or sales volume, account should be taken of **how large the relevant market is in terms of population**, as this has a bearing on the number of potential purchasers of the products in question. For example, the relative value of the same number of sales will be much bigger, for example, in Luxembourg than in Germany.

Moreover, whether or not a given sales volume or turnover is substantial will depend on the **kind of product** concerned. For example, it is much easier to achieve a high sales volume for everyday, mass consumption goods than for luxury or durable products that

are bought rarely, without this meaning that in the former case more consumers have come into contact with the mark, as it is likely that the same person has bought the same product more than once. It follows that the **kind, value and durability** of the goods and services in question should be taken into consideration in determining the significance of a given sales volume or turnover.

Figures of turnover and sales will be more useful as **indirect indications** that should be assessed in conjunction with the rest of the evidence, rather than as direct proof of reputation. In particular, such indications can be especially helpful for **completing the information given by percentages** as regards market share and awareness, by giving a more **realistic impression** of the market. For example, they may reveal a very large amount of sales behind a not-so-impressive market share, which may be useful in assessing reputation in the case of competitive markets, where it is in general more difficult for a single brand to account for a substantial portion of the overall sales.

In contrast, where the market share of the products for which the mark is used is not given separately, it will not be possible to determine whether a given turnover corresponds to a substantial presence in the market or not, unless the opponent also submits evidence showing the **overall size of the relevant market in terms of money**, so that its percentage in it may be inferred.

Case No	Comment
R 1054/2007-4 'mandarino' (fig.)	The reputation was not sufficiently proven in particular because none of the documents referred to the recognition of the earlier trade mark by the relevant end consumers. Nor was any evidence about the market share of the opponent's goods submitted. Information about the market share is particularly important in the sector in which the opponent had its core business (<i>handbags, transport items, accessories and clothing</i>) which is 'a quite atomized and competitive sector' and there are many different competitors and designers in that product range (paras 59-61).

This does not mean that the importance of turnover figures or volume of sales should be underestimated, as both are significant indications of **the number of consumers** that are expected to have encountered the mark. Therefore, it **cannot be excluded** that a **substantial** amount of turnover or sales volume may, in certain cases, be **decisive** for a finding of reputation, either alone, or in conjunction with very little other evidence.

Case No	Comment
R 0445/2010-1 'FLATZ'	Although, for reasons of force majeure, it was not possible for the earlier trade mark to become well known by traditional methods, that is, through selling the product, it did become extremely well known as a result of promotional activities, by publicising the trade mark extensively, continually and constantly in the specialist press and at sectorial fairs, thereby reaching virtually the whole of the three relevant sectors of the public. The limited presence of the product on the market by no means prevented it from becoming well known by the relevant public that, on the relevant date, FLATZ was the trade mark with which the opponent identified its <i>electronic bingo machines</i> (paras 41, 42, 50, 51).

Case No	Comment
R 1466/2008-2 and R1565/2008-2, 'COMMERZBANK ARENA'	The lack of figures regarding the market share held by the trade mark 'ARENA' in the relevant countries was not in itself capable of calling the finding of reputation into question. First, the list of factors to be taken into consideration in order to ascertain the reputation of an earlier mark only serves to illustrate examples, as all the relevant evidence in the case must be taken into consideration and, second, the other detailed and verifiable evidence submitted by the opponent is already sufficient in itself to prove conclusively the substantial degree of recognition of the 'ARENA' mark amongst the relevant public (para. 59).

However, as this would deviate from the rule that reputation has to be evaluated by making an overall assessment of all factors relevant to the case, findings of reputation based almost exclusively on such figures should be generally avoided, or at least confined to exceptional cases that would really justify such a finding.

3.1.3.4 Geographical extent of use

Indications of the territorial extent of use are mainly useful for determining whether the alleged reputation is **widespread enough to cover a substantial part** of the relevant territory, within the sense given in paragraph 3.1 above. In this assessment, account should be taken of the density of population in the respective areas, as the critical criterion is the proportion of consumers knowing the mark, rather than the size of the geographical area as such. Similarly, what is important is public awareness of the mark rather than availability of goods or services. A mark may, therefore, have a territorially widespread reputation on the basis of advertising, promotion, media reports, etc.

In general, the more widespread the use, the easier it will be to conclude that the mark has passed the required threshold, whereas any indication showing use beyond a substantial part of the relevant territory will be a positive sign in the direction of reputation. Conversely, a very limited amount of use in the relevant territory will be a strong indication against reputation, as for example where the vast majority of the goods are exported to a third jurisdiction in sealed containers, directly from their place of production.

Case No	Comment
R 0966/2010-1 'ERT (fig.)'	If the earlier mark were so well known in the 27 Member States of the EU for TV broadcasting and magazines, it should have been easy for the opponent to provide information about 'the reach of the mark' just before 2008, when the EUTM application was filed. The magazine sales figures did not cover the right period. The submitted documents did not give any indication of the extent to which the public was aware of the mark (paras 16, 18).

However, evidence of actual use in the relevant territory should not be regarded as a necessary condition for the acquisition of reputation, as what matters most is knowledge of the mark and not how it was acquired.

Such knowledge may be generated by, for example, intensive advertising prior to the launching of a new product, or in the case of important cross-border shopping it may be fuelled by a significant price difference in the respective markets, a phenomenon often

referred to as **‘territorial spill-over’ of reputation** from one territory to another. However, when it is claimed that such circumstances have occurred, the corresponding evidence must demonstrate this. For example, it cannot be assumed, merely because of the principle of free trade in the European Union, that goods put in the market in Member State X have also penetrated the market of Member State Y in significant numbers.

3.1.3.5 Duration of use

Indications of the duration of use are particularly useful for determining the **longevity** of the mark. The longer the mark has been used in the market, the larger will be the number of consumers that are likely to have encountered it, and the more likely it is that such consumers will have encountered the mark more than once. For example, a market presence of 45, 50 or 100-plus years is considered a strong indication of reputation.

Case No	Comment
R 1466/2008-2 and R 1565/2008-2, ‘COMMERZBANK ARENA’	The evidence submitted showed a particularly impressive duration of use (over thirty years) and geographical extent of use (over seventy-five countries worldwide, including the Member States concerned) of the ‘ARENA’ brand (para. 55).
T-369/10 ‘BEATLE’ (appeal dismissed in C-294/12 P)	The Beatles group was considered to be a group with an exceptional reputation lasting for more than 40 years (para. 36).

The duration of use of the mark should not be inferred by mere reference to the term of its registration. Registration and use do not necessarily coincide, as the mark may have been put to actual use either before or after it was filed. Therefore, where the opponent invokes actual use, going beyond the term of registration, it must prove that such use actually began before it applied for its mark.

Nevertheless, a long registration period may sometimes serve as an indirect indication of a long presence on the market, as it would be unusual for a proprietor to maintain a registered mark for many decades without any economic interest behind it.

In the end, the decisive element is whether the earlier mark had acquired a reputation at the time of filing of the contested application. Whether that reputation also existed at some earlier point in time is legally irrelevant. Therefore, evidence of **continuous use up to the filing date** of the application will be a positive indication in the direction of reputation.

In contrast, if the **use of the mark was suspended** over a significant period, or if the period elapsed between the latest evidence of use and the filing of the EUTM application is quite long, it will be more difficult to conclude that the reputation of the mark survived the interruption of use, or that it subsisted until the filing date of the application (see paragraph 3.1.2.5 above).

3.1.3.6 Promotional activities

The **nature and scale of the promotional activities** undertaken by the opponent are useful indications in assessing the reputation of the mark, to the extent that these

activities were undertaken to build-up a brand image and enhance trade mark awareness among the public. Therefore, **a long, intensive and widespread** promotional campaign may be a **strong indication** that the mark has acquired a reputation among the potential or actual purchasers of the goods in question, and may actually have become known beyond the circle of the actual purchasers of those goods.

Case No	Comment
C-100/11 P 'BOTOCYL'	Evidence of the promotion of 'BOTOX' in English in scientific and general-interest press was sufficient to establish reputation of the mark both amongst the general public and amongst health-care professionals (paras 65, 66).
R 0445/2010-1 'FLATZ'	Although, for reasons of force majeure, it was not possible for the earlier trade mark to become well known by traditional methods, that is, through selling the product, it did become extremely well known as a result of promotional activities, by publicising the trade mark extensively, continually and constantly in the specialist press and at sectorial fairs, thereby reaching virtually the whole of the three relevant sectors of the public. The limited presence of the product on the market by no means prevented it from becoming well known by the relevant public that, on the relevant date, FLATZ was the trade mark with which the opponent identified its <i>electronic bingo machines</i> (paras 41, 42, 50, 51).
R 1659/2011-2 'KENZO' and R 1364/2012-2 'KENZO'	The opponent's goods have been advertised and articles have been written about them in many of the world's leading fashion-related lifestyle magazines, and in some of Europe's leading mainstream periodicals. In line with the case-law, the reputation of 'KENZO' for the said goods is confirmed. The goods for which the earlier mark has reputation are cosmetics, perfumes and clothing. Because of its substantial reputation, the earlier mark 'KENZO' possesses an 'undisputable allure' that can be transferred to nearly any luxury product (para. 33). Subsequent case confirmed reputation (para. 33).

Even though it cannot be ruled out that a mark acquires a reputation before any actual use, promotional activities will usually not be sufficient on their own for establishing that the earlier mark has indeed acquired a reputation (see paragraph 3.1.3.4 above). For example, it will be difficult to prove knowledge amongst a significant part of the public exclusively by reference to promotion or advertising, carried out as preparatory acts for the launching of a new product, as the actual impact of publicity on the perception of the public will be difficult to measure without reference to sales. In such situations, the only means of evidence available to the opponent are opinion polls and similar instruments, the probative value of which may vary depending of the reliability of the method used, the size of the statistical sample etc. (for the probative value of opinion polls, see paragraph 3.1.4 below).

The impact of the opponent's promotional activities may be shown either **directly**, by reference to the **amount of promotional expenditure**, or **indirectly**, by way of inference from the **nature of the promotional strategy** adopted by the opponent and **the kind of medium used** for advertising the mark.

For example, advertising on a nation-wide TV channel or in a prestigious periodical should be given more weight than campaigns of a regional or local scope, especially if coupled with high audience or circulation figures. Likewise, the sponsoring of

prestigious athletic or cultural events may be a further indication of intensive promotion, as such schemes often involve a considerable investment.

Case No	Comment
R 1673/2008-2 'FIESTA'	It is apparent from Ferrero's various advertising campaigns on Italian television (including Rai) that the earlier mark was widely exposed to viewers in 2005 and 2006. Many of these spots appear to have been broadcast in peak viewing times (e.g. during Formula 1 Grand Prix coverage) (para. 41).

Furthermore, the **contents of the advertising strategy** chosen by the opponent can be useful for revealing the **kind of image** the opponent is trying to create for its brand. This may be of particular importance when assessing the possibility of detriment to, or of taking unfair advantage of, a particular image allegedly conveyed by the mark, since the existence and contents of such an image must be abundantly clear from the evidence submitted by the opponent (see paragraph 3.4 below).

Case No	Comment
T-332/10 'VIAGUARA' ('VIAGRA')	The General Court found that in regard to the nature of the goods concerned, the BoA rightly considered that the aphrodisiac and stimulating properties claimed for commercial purposes for the non-alcoholic beverages covered by Class 32 coincide with the therapeutic indications of the earlier mark's goods or at least with the images it projects, namely an image of pleasure, vitality, strength and youth (para. 66).
R 0306/2010-4 'CARRERA' (under appeal T-0173/11)	The opponent's trade mark is not only known per se, but due to the high price of sports cars and the opponent's intensive expenditure on advertising and against the background of its successes in racing, the public associates it with an image of luxury, high tech and high performance (para. 31).

3.1.3.7 Other factors

The Court has made clear that the above list of factors is only indicative and has underlined that all the facts relevant to the particular case must be taken into consideration in assessing the reputation of the earlier mark (judgment of 14/09/1999, C-375/97 'General Motors', para. 27). Other factors may be found in the case-law of the Court dealing with enhanced distinctiveness through use, or in the WIPO Recommendations on the protection of well-known marks. Therefore, depending on their relevance in each case, the following may be added to the above factors: record of successful enforcement; number of registrations; certifications and awards; and the value associated with the mark.

Record of successful enforcement

Records of successful enforcement of a mark against dissimilar goods or services are important because they may demonstrate that, at least in relation to other traders, there is acceptance of protection against dissimilar goods or services.

Such records may consist of successful prosecution of complaints outside the courts, such as acceptance of cease and desist requests, delimitation agreements in trade mark cases, and the like.

Furthermore, evidence showing that the reputation of the opponent's mark has been repeatedly recognised and protected against infringing acts by **decisions of judicial or administrative authorities** will be an important indication that the mark enjoys a reputation in the relevant territory, especially where such decisions are recent. That effect may be reinforced when the decisions of this kind are substantial in number (on the probative value of decisions, see paragraph 3.1.4.4 below). This factor is mentioned in Article 2(1)(b)(5) of the WIPO Recommendations.

Number of registrations

The **number** and **duration of registrations** and applications of the mark around Europe or the world is also relevant, but in itself it is a weak indication of the degree of recognition of the sign by the relevant public. The fact that the opponent has many trade mark registrations and in many classes may indirectly attest to an international circulation of the brand, but cannot be decisively prove in itself a reputation. This factor is mentioned in Article 2(1)(b)(4) of the WIPO Recommendations, where the need of actual use is made clear: the duration and geographical area of any registrations, and/or any applications for registration, of the mark are relevant 'to the extent that they reflect use or recognition of the mark'.

Certifications and awards

Certifications, awards, and similar public recognition instruments usually provide information about the history of the mark, or reveal certain quality aspects of the opponent's products, but as a rule they will not be sufficient in themselves to establish reputation and will be more useful as indirect indications. For example, the fact that the opponent has been a holder of a royal warrant for many years may perhaps show that the mark invoked is a traditional brand, but cannot give first-hand information about trade mark awareness. However, if the certification concerns facts that are related to the performance of the mark, its relevance will be much higher. This factor is mentioned by the Court in 'Lloyd Schuhfabrik Meyer' and 'Windsurfing Chiemsee' in relation to the assessment of enhanced distinctiveness through use.

Case No	Comment
R 1637/2011-5 'APART'	The new evidence submitted by the appellant and accepted by BoA shows that the earlier mark had consistently been granted a high brand rating as well as prizes in surveys carried out by specialised companies in Poland between 2005 and 2009 (para. 30). It was therefore considered that the appellant successfully proved reputation in Poland for jewellery, but did not prove reputation for the other goods and services covered by its earlier signs.

The value associated with the mark

The fact that a mark is solicited by third companies for reproduction on their products, either as a trade mark, or as mere decoration, is a strong indication that the mark possesses a high degree of attractiveness and an important economic value.

Therefore, the extent to which the mark is exploited through **licensing, merchandising and sponsoring**, as well as the importance of the respective schemes, are useful indications in assessing reputation. This factor is mentioned in Article 2(1)(b)(6) of the WIPO Recommendations.

3.1.4 Proof of reputation

3.1.4.1 Standard of proof

The opponent must submit evidence enabling the Office to reach a **positive finding** that the earlier mark has acquired a reputation in the relevant territory. The wording used in Article 8(5) EUTMR and Rule 19(2)(c) CTMIR is quite clear in this respect: the earlier mark deserves enlarged protection only if it 'has a reputation'.

It follows that the **evidence must be clear and convincing**, in the sense that the opponent must clearly establish all the facts necessary to safely conclude that the mark is known by a significant part of the public. The reputation of the earlier mark must be established to the satisfaction of the Office and not merely assumed.

3.1.4.2 Burden of proof

According to the second sentence of Article 76(1) EUTMR, in *inter partes* proceedings the Office is restricted in its examination to the facts, evidence and arguments provided by the parties. It follows that in assessing whether the earlier mark enjoys reputation, the Office may **neither take into account** facts known to it as a result of its own **private knowledge** of the market **nor conduct an ex-officio investigation**, but should exclusively base its findings on the information and evidence submitted by the opponent.

Exceptions to this rule apply where particular facts are so well-established that they can be considered as universally known and, thus, are also presumed to be known to the Office (e.g. the fact that a particular country has a certain number of consumers, or the fact that food products target the general public). However, whether or not a mark has passed the threshold of reputation established by the Court in *General Motors* is not in itself a pure question of fact, since it requires the legal evaluation of several factual indications, and, as such, the reputation of the earlier mark may not be simply assumed to be a universally known fact.

Case No	Comment
T-185/02 'PICARO' (confirmed by C-361/04 P)	The Board of Appeal, in addition to the facts expressly put forward by the parties, may take into consideration facts which are well known, that is, which are likely to be known by anyone or which may be learnt from generally accessible sources. 'It must be borne in mind, at the outset, that the legal rule stated in Article 76(1) in fine of Regulation No 40/94 constitutes an exception to the principle of examination of the facts by the Office of its own motion, laid down in limine by that provision. That exception must therefore be given a strict interpretation, defining its extent so as not to exceed what is necessary for achieving its object' (paras 29-32).

Case No	Comment
R 1472/2007-2 'El Polo'	It is common knowledge that the earlier mark is indeed a very famous brand, not only in France, but in most European countries, in large part due to the public's exposure to products at airport and duty free boutiques as well as long-standing advertising in widely circulated magazines. The weight of evidence required to support statements which are universally known to be true need not be great (para. 32).

Rule 19(2)(c) CTMIR provides that the burden of putting forward and proving the relevant facts lies with the opponent, by expressly requiring it to provide 'evidence attesting that the earlier mark **has a reputation**'. According to Rule 19(1) and Rule 19(2)(c) CTMIR and Office practice, such evidence may be submitted either together with the notice of opposition, or subsequently within four months of the date of notification of the opposition to the applicant. The opponent may also refer to facts and evidence submitted in the course of another opposition, provided that the relevant materials are indicated in a clear and unambiguous way and that the language of proceedings is the same in both cases.

If the evidence of reputation is not in the correct **language**, it will have to be translated into the language of the proceedings within the same period of four months, as required by Rules 16(1) and 17(3) CTMIR. However, in view of the volume of documents often needed for proving reputation, it is sufficient to translate only the material parts of long documents or publications. Similarly, it is not necessary to translate in their entirety documents or parts of documents that contain mainly figures or statistics, the meaning of which is evident, as is often the case with invoices, order forms, diagrams, brochures, catalogues etc.

Case No	Comment
R 1472/2007-2 'El Polo'	Although there is a requirement to adduce evidence to substantiate the existence of an earlier right in the language of the opposition proceedings, it is not specified that such translations have to be in any specific format. Many opponents simply provide their own, often hand-written, translations of the registration details. It is primarily for the Office and, to a lesser extent, for the applicant to check the accuracy of these translations. If a translation is incorrect, the document cannot be relied upon (para. 17).

3.1.4.3 Evaluation of the evidence

The basic rules on the evaluation of evidence are also applicable here: the evidence should be assessed **as a whole**, that is, each indication should be weighed-up against the others, whereas information confirmed by more than one source will generally be more reliable than facts derived from isolated references. Moreover, the more independent, reliable and well-informed the source of the information is, the higher the probative value of the evidence will be.

Therefore, information **deriving directly from the opponent** is unlikely to be enough on its own, especially if it only consists of **opinions** and **estimates** instead of facts, or if it is of an **unofficial character** and lacks objective confirmation, as for example when the opponent submits internal memoranda or tables with data and figures of unknown origin.

Case No	Comment
R 0295/2009-4 'PG PROINGEC CONSULTORIA (fig.)'	The content of the documentation submitted does not clearly demonstrate that the earlier marks enjoy a reputation. The documentation emanates, in the main, from the respondent directly and contains information taken from the respondent's trade catalogues, and its own advertising and documents downloaded from its website. There is insufficient documentation/information from third parties to reflect clearly and objectively what the respondent's position on the market precisely is. Reputation not proved (para. 26).
T-500/10 'doorsa FÁBRICA DE PUERTAS AUTOMÁTICAS' (fig.)	As regards documents in the case-file which come from the company itself, the General Court has held that to assess the evidential value of such a document, first and foremost account should be taken of the credibility of the account it contains. The Court added that it is then necessary to take account, in particular, of the person from whom the document originates, the circumstances in which it came into being, the person to whom it was addressed and whether, prima facie, the documents appear sound and reliable (para. 49).

However, if such information is publicly available or has been compiled for official purposes and contains information and data that have been objectively verified, or reproduces statements made in public, its probative value is generally higher.

As regards its contents, the more indications the evidence gives about the various factors from which reputation may be inferred, the more relevant and conclusive it will be. In particular, evidence which as a whole gives **little or no quantitative data and information** will not be appropriate for providing indications about **vital factors**, such as trade mark awareness, market share and intensity of use and, consequently, will not be sufficient to support a finding of reputation.

3.1.4.4 Means of evidence

There is no direct indication in the Regulations as to which kind of evidence is more appropriate for proving reputation, as for instance the one in Rule 22(4) CTMIR about evidence of use. The opponent may avail itself of **all the means of evidence of Article 78(1) EUTMR**, provided they are capable of showing that the mark has indeed the required reputation.

The following means of evidence are more frequently submitted by opponents in opposition proceedings before the Office (this list does not reflect their relative importance or probative value):

1. sworn or affirmed statements
2. decisions of Courts or Administrative authorities
3. decisions of the Office
4. opinion polls and market surveys
5. audits and inspections
6. certifications and awards
7. articles in the press or in specialised publications
8. annual reports on economic results and company profiles
9. invoices and other commercial documents

10. advertising and promotional material.

Evidence of this kind may also be submitted under Article 8(1)(b) EUTMR in order to prove that the earlier mark has obtained a higher degree of distinctiveness, or under Article 8(2)(c) EUTMR in relation to well-known marks.

Sworn or affirmed statements

The weight and probative value of statutory declarations is determined by the general rules applied by the Office to the assessment of such evidence. In particular, both the capacity of the person giving the evidence and the relevance of such evidence to the particular case must be taken into account. For further details on the weight and probative value of affidavits, see the Guidelines, Part C, Opposition, Section 6, Proof of Use.

Case No	Comment
R 0729/2009-1 'SKYBLOG'	The statement submitted by an expert consultancy firm in the area of digital media strategy in the UK attests to the opponent 'as the leading supplier of digital television in the UK' and that 'Sky' has an enormous and impressive reputation (para. 37).

Decisions of Courts or Administrative authorities

Opponents often invoke decisions of national authorities or Courts which have accepted the reputation of the earlier mark. Even though national decisions are admissible evidence and may have evidentiary value, especially if they originate from a Member State the territory of which is also relevant for the opposition at hand, they are not binding for the Office, in the sense that it is not mandatory to follow their conclusion.

Case No	Comment
T-0192/09 'SEVE TROPHY'	As far as judgments of Spanish courts are concerned, the EU trade mark system is an autonomous system, consisting of a set of rules and objectives that are specific, and applied independently of any national system (para. 79).

Since such decisions may serve to indicate reputation and to record successful enforcement of the mark, their relevance should be addressed and examined. Relevance should be given to the type of proceedings involved, to whether the issue was in fact reputation within the sense of Article 8(5) EUTMR, to the level of the court, as well as to the number of such decisions.

Case No	Comment
C-100/11 P 'BOTOCYL'	Decisions of the UK national office related to the reputation of 'BOTOX' are facts that may, if relevant, be taken into account by the General Court, despite the EUTM owners not being parties in those decisions (para. 78).

There might be differences between the substantive and procedural conditions applicable in national proceedings and those applied in opposition proceedings before the Office. Firstly, there may be differences as to how the requirement of reputation is defined or interpreted. Secondly, the weight the Office gives to the evidence is not necessarily the same as the weight given to it in national proceedings. Furthermore, national instances may be able to take into account *ex officio* facts known to them directly, whereas the Office may not, pursuant to Article 76 EUTMR.

For these reasons, the probative value of national decisions will be considerably enhanced if the conditions of law and facts on the basis of which they were taken are made abundantly clear. This is because, in the absence of these elements, it will be more difficult both for the applicant to exercise its right of defence and for the Office to assess the decision's relevance with a reasonable degree of certainty. Similarly, if the decision is not yet final, or if it is outdated due to the time that has elapsed between the two cases, its probative value will be diminished accordingly.

Consequently, the probative value of national decisions should be assessed on the basis of their contents and it may vary depending on the case.

Decisions of the Office

The opponent may also refer to earlier decisions of the Office, on condition that such a reference is clear and unambiguous, and that the language of the proceedings is the same. Otherwise, the opponent must also file a translation of the decision within the four-month period to file further facts, evidence and arguments, in order to allow the applicant to exercise its right of defence.

As regards the relevance and probative value of previous Office decisions, the same rules as for national decisions apply. Even where the reference is admissible and the decision is relevant, the Office is not bound to come to the same conclusion and must examine each case on its own merits.

It follows that previous Office decisions only have a relative probative value and should be evaluated in conjunction with the rest of the evidence, especially where the reference of the opponent does not extend to the materials filed in the first case, that is, where the applicant has not had a chance to comment on them, or where the time that has elapsed between the two cases is quite long.

Case No	Comment
R 0141/2011-1 'GUSSACI GUSSACI GUSSACI GUSSACI' (fig.)	The finding of reputation is confirmed by the previous decision of the Boards of Appeal , according to which 'GUCCI' was considered to be one of the world's leading brands in the field of luxury goods, and reputation of the mark 'GUCCI' as well as the letter 'G', in its various configuration as an abbreviation for 'GUCCI', was found. In particular, reputation was found for the following goods: <i>watches and jewellery</i> (decision of 14/042011, R 143/2010-1, 'GUDDY / GUCCI'), <i>clothing, handbags, leather goods, luggage, shoes, gift, jewellery, fragrance and eyewear</i> (decision of 11/02/2010, R 1281/2008-1 'G' (fig.) / 'G' (fig.) et al.), <i>clothing, handbags, leather goods, luggage and shoes</i> (decision of 17/03/2011, R 543/2010-1, 'G' (fig.) / 'G' (fig.) et al.) (para. 18).

Opinion polls and market surveys

Opinion polls and market surveys are the most suitable means of evidence for providing information about the degree of knowledge of the mark, the market share it has, or the position it occupies in the market in relation to competitors' goods.

The probative value of opinion polls and market surveys is determined by the status and degree of independence of the entity conducting it, by the relevance and the accuracy of the information it provides, and by the reliability of the applied method.

More particularly, in evaluating the credibility of an opinion poll or market survey, the Office needs to know the following.

1. Whether or not it has been conducted by an independent and recognised research institute or company, in order to determine the reliability of the source of the evidence.
2. The number and profile (sex, age, occupation and background) of the interviewees, in order to evaluate whether the results of the survey are representative of the different kinds of potential consumers of the goods in question. In principle, samples of 1 000 – 2 000 interviewees are considered sufficient, provided they are representative of the type of consumer concerned.
3. The method and circumstances under which the survey was carried out and the complete list of questions included in the questionnaire. It is also important to know how and in what order the questions were formulated, in order to ascertain whether the respondents were confronted with leading questions.
4. Whether the percentage reflected in the survey corresponds to the total amount of persons questioned or only to those who actually replied.

Unless the above indications are present, the results of a market survey or opinion poll should not be considered of high probative value, and will not in principle be sufficient on their own to support a finding of reputation.

Case No	Comment
R 0925/2010-2 '1 CLEAN! 2 FRESH! 3 STRONG!' (fig.)	The cancellation applicant did not submit sufficient proof of the reputation of its trade marks. According to the extracts from the 2001 survey conducted in Italy, although the level of 'prompted recognition' stands at 86 %, the rate of 'spontaneous recognition' is only 56 %. Moreover, no indication is given of the questions put to the people surveyed, making it impossible to determine whether the questions were really open and unassisted. The survey further fails to state for which goods the trade mark is known (para. 27).

Likewise, if the above indications are given, but the reliability of source and method are questionable or the statistical sample is too small, or the questions were leading, the credibility of the evidence will be diminished accordingly.

Case No	Comment
R 1191/2010-4 'MÁS KOLOMBIANA ...Y QUÉ MÁS!! (fig.)'	The survey submitted by the opponent does not provide conclusive information to demonstrate that the earlier sign is well-known to the Spanish public for <i>aerated waters</i> as the interviewees were carefully selected on the basis of their origin, that is, Colombians resident in Spain. This is only a very small part of the population living in Spain. The sales figures, publicity investment and presence in publications directed at the immigrant public, contained in the statement before a notary public, are likewise in insufficient amounts for a finding that the earlier sign is well-known. Moreover, the statements are not corroborated by conclusive data on the extent or turnover of the goods (para. 23).
R 1345/2010-1 'Fukato Fukato (fig.)'	In support of its claim under Article 8(5) EUTMR, the opponent relies exclusively on an opinion poll that was carried out in 2007. That opinion poll was conducted by an independent company. In principle, samples of 1 000–2 000 interviewees are considered sufficient, provided they are representative of the type of consumer concerned. The opponent's opinion poll was based on a sample of 500 interviewees, which is not sufficient in respect of the services for which reputation is claimed. According to the opinion poll, the logo of the earlier mark has been associated especially with services in the financial and insurance fields. Since the opposition is only based on Class 42 with regard to the earlier EU trade mark, it does not cover financial and insurance services. Consequently, the submitted opinion poll is not suitable proof of the reputation of the opponent's EU trade mark (para. 58).

Conversely, opinion polls and market surveys that fulfil the above requirements (independence and trustworthiness of source, reasonably large and widespread sample and reliable method) will be a strong indication of reputation, especially if they show a high degree of trade mark awareness.

Audits and inspections

Audits and inspections of the opponent's undertaking may provide useful information about the intensity of use of the mark, as they usually comprise data on financial results, sales volumes, turnovers, profits etc. However, such evidence will be pertinent only if it specifically refers to the goods sold under the mark in question, rather than to the opponent's activities in general.

Audits and inspections may be carried out on the initiative of the opponent itself, or may be required by company law and/or financial regulations. In the former case, the same rules as for opinion polls and market surveys apply, that is, the status of the entity conducting the audit and the reliability of the applied method will be of essence for determining its credibility, whereas the probative value of official audits and inspections will be as a rule much higher, since they are usually conducted by a state authority or by a recognised body of auditors, on the basis of generally accepted standards and rules.

Certifications and awards

This kind of evidence includes certifications and awards by public authorities or official institutions, such as chambers of commerce and industry, professional associations and societies, consumer organisations etc.

The reliability of certifications by authorities is generally high, as they emanate from independent and specialised sources, which attest facts in the course of their official tasks. For example, the average circulation figures for periodicals issued by the competent press-distribution associations are conclusive evidence about the performance of a mark in the sector.

Case No	Comment
R 0907/2009-2 'O2PLS'	The many brand awards won by the mark were considered an important part of the evidence to show reputation together with the huge advertising investments and the number of articles published in different publications (para. 9(iii) and para. 27).

The same applies to quality certifications and awards granted by such authorities, as the opponent usually has to meet objective standards in order to receive the award. Conversely, prizes and awards offered by unknown entities, or on the basis of unspecified or subjective criteria, should be given very little weight.

The relevance of a certification or award to the specific case largely depends on its contents. For example, the fact that the opponent is a holder of an ISO 9001 quality certificate, or of a royal warrant, does not automatically mean that the sign is known to the public. It only means that the opponent's goods meet certain quality or technical standards or that it is a supplier of a royal house. However, if such evidence is coupled with other indications of quality and market success, it may lead to the conclusion that the earlier mark has a reputation.

Articles in the press or in specialised publications

The probative value of press articles and other publications concerning the opponent's mark mainly depends on whether such publications are covert promotional matter, or if, on the contrary, they are the result of independent and objective research.

Case No	Comment
Joined cases T-345/08 and T-357/08 'BOTOCYL', confirmed by C-100/11 P	The very existence of articles in a scientific publication or the general-interest press constitutes a relevant factor in establishing the reputation of the products marketed under the trade mark BOTOX with the general public, irrespective of the positive or negative content of those articles (para. 54).

Case No	Comment
R 0555/2009-2 'BACI MILANO' (fig.)	The reputation of the earlier trade mark in Italy was proven by the copious amount of documentation submitted by the opponent, which included, inter alia, an article from <i>Economy</i> revealing that in 2005 the 'BACI & ABBRACCI' trade mark was one of the fifteen most counterfeited fashion brands in the world; an article published in <i>Il Tempo</i> on 05/08/2005, in which the 'BACI & ABBRACCI' trade mark is mentioned alongside others, including Dolce & Gabbana, Armani, Lacoste and Puma, as being targeted by counterfeiters; an article published in <i>Fashion</i> on 15/06/2006, in which the trade mark is defined as 'a true market phenomenon'; publicity campaigns from 2004 to 2007, with testimonials from entertainment and sports celebrities; a market survey conducted by the renowned independent agency Doxa in September 2007, from which it emerges that the trade mark is at the top of mind in the fashion sector for 0.6% of the Italian public (para. 35).

Hence, if such articles appear in publications of a high status or are written by independent professionals, they will have a quite high value, as for example when the success of a specific brand becomes the object of a case study in specialised journals or in scientific publications. The presence of a mark in a dictionary (which is not a press article but is still a publication) is a means of evidence with high value.

Case No	Comment
Joined cases T-345/08 and T-357/08 'BOTOXYL', confirmed by C-100/11 P	The inclusion of a word in a dictionary is the expression of a fair amount of recognition on the part of the public. The references in the 2002 and 2003 editions of a number of dictionaries published in the United Kingdom constitute one of the items of evidence which may establish the reputation of the trade mark BOTOX in that country or amongst the English-speaking public of the European Union. (paras 55, 56).

Annual reports on economic results and company profiles

This type of evidence includes all kinds of internal publications giving varied information about the history, activities and perspectives of the opponent's company, or more detailed figures about turnovers, sales, advertising etc.

To the extent that such evidence derives from the opponent and is mainly intended to promote its image, its probative value will mostly depend on its contents and the relevant information should be treated with caution, especially if it mainly consists of estimates and subjective evaluations.

However, where such publications are circulated to clients and other interested circles and contain objectively verifiable information and data, which may have been compiled or revised by independent auditors (as is often the case with annual reports), their probative value will be substantially enhanced.

Invoices and other commercial documents

All kinds of commercial documents may be grouped under this heading, such as invoices, order forms, distribution and sponsoring contracts, samples of

correspondence with clients, suppliers or associates etc. Documents of this sort may provide a great variety of information as to the intensity of use, the geographical extent and duration of the use of the mark.

Even though the relevance and credibility of commercial documents is not disputed, it will be generally difficult to prove reputation on the basis of such materials alone, given the variety of factors involved and the volume of documents required. Furthermore, evidence such as distribution or sponsoring contracts and commercial correspondence are more appropriate for giving indications about the geographical extent or the promotional side of the opponent's activities, than for measuring the success of the mark in the market and thus may only serve as indirect indications of reputation.

Case No	Comment
R 1272/2010-1 'GRUPO BIMBO' (fig.) (T-357/11)	The evidence submitted shows a high level of recognition of the mark on the Spanish market. The total invoices on the Spanish tin-loaf market in 2004 amounted to EUR 346.7 million, of which the opponent's invoices amounted to EUR 204.9 million. The submitted invoices cover advertisements on TV, as well as in newspapers and magazines. Therefore, the reputation of 'BIMBO' in Spain for <i>industrially produced bread</i> has been substantiated (para. 64). The Court did not address this point.

Advertising and promotional material

This kind of evidence may take various forms, such as press cuttings, advertising spots, promotional articles, offers, brochures, catalogues, leaflets etc. In general, such evidence cannot be conclusive of reputation on its own, due to the fact that it cannot give much information about actual trade mark awareness.

However, some conclusions about the degree of exposure of the public to advertising messages concerning the mark may be drawn by reference to the kind of the medium used (national, regional, local) and to the audience rates or circulation figures attained by the relevant spots or publications, if of course this kind of information is available.

Case No	Comment
R 0043/2010-4 'FFR' (fig.) (T-143/11)	The documents submitted show that the device of a black rooster has acquired reputation and will be associated with wines from the Chianti Classico-region. The opponent provided several copies of advertisements in newspapers and magazines showing its promotional activity as well as independent articles displaying a black rooster in connection with the Chianti Classico region. However, given that the reputation only pertains to the device of a black rooster and given that this device is only one part of the earlier marks, serious doubts arise about whether reputation can be attributed to the marks as a whole. Moreover, for the same reason, doubt also arises about which marks the reputation could be attributed to, given that the opponent owns several marks. (paras 26, 27). The Court did not assess the evidence on reputation.

In addition, such evidence may give useful indications of the kind of goods covered, the form in which the mark is actually used and the kind of image the opponent is trying to create for its brand. For example, if the evidence shows that the earlier registration for

which reputation is claimed covers a device, but in reality this device is used combined with a verbal element, it would not be consistent to accept that the device by itself has a reputation.

Case No	Comment
R 1308/2010-4 'WM GRAND PRIX'	In all the examples of actual use on the podia, media kits, posters, race cards, letter head, programme covers, tickets, passes etc., submitted by the opponent, the words GRAND PRIX are always used in combination with other elements. No evidence of use was submitted of the use of the trade mark GRAND PRIX in an independent way (paras 53, 54).
T-10/09, 'F1-LIVE' (C-196/11 P)	The evidence of reputation makes reference to the earlier figurative mark 'F1 Formula 1' and not to the earlier word marks. Without its particular logotype the text 'Formula 1' and its abbreviation 'F1' are perceived as descriptive elements for a category of racing cars or races involving those cars. The reputation was not proven for the word marks which are not identical or similar (paras 53, 54, 67). The Court did not address this point.

3.2 The similarity of the signs

A 'certain degree of similarity between the signs' must be found for an opposition under Article 8(5) EUTMR to succeed (judgment of 24/03/2011, C-552/09 P, 'TiMi KINDERJOGHURT', para.53). If the signs are found **dissimilar** overall, the examination aimed at establishing whether the other requirements under Article 8(5) EUTMR are met **should not be carried out**, as the opposition cannot succeed.

A subject of some uncertainty is the relationship between 'similarity' within the meaning of Article 8(5) EUTMR and the meaning of the same term used in Article 8(1)(b) EUTMR. According to the clear wording of these two provisions, **a similarity (or identity) between the signs is a precondition for the application of both Article 8(1)(b) and Article 8(5) EUTMR**. The use of the same term in both provisions is an argument in favour of the need to interpret this term in the same way and the case-law has confirmed this.

Accordingly, the assessment of similarity should be made according to the **same criteria** that apply in the context of Article 8(1)(b) EUTMR, thus taking into account elements of **visual, aural or conceptual similarity** (judgment of 23/10/2003, C-408/01, 'Adidas', para. 28, relating to the interpretation of Article 5(2) TMD, and judgment of 24/03/2011, C-552/09P, 'TiMi KINDERJOGHURT', para. 52). See the Guidelines, Part C, Opposition, Section 2, Identity and Likelihood of Confusion, Chapter 4, Comparison of Signs.

The general rules for assessing the signs established for the examination of this criterion under Article 8(1)(b) EUTMR apply, such as the rule that consumers perceive the sign as a whole and only rarely have the chance to make a direct comparison between the different marks and must place their trust in the imperfect image of them that they have kept in mind (judgment of 25/01/2012, T-332/10 'Viaguara', paras 33, 34) (see the Guidelines, Part C, Opposition, Section 2, Identity and Likelihood of Confusion, Chapter 7, Global Assessment, paragraph 3, Imperfect recollection).

3.2.1 Notion of ‘similarity’ pursuant to Article 8(5) EUTMR compared with Article 8(1)(b) EUTMR

Despite application of the same criteria for similarity of the signs in Article 8(1)(b) and Article 8(5) EUTMR, the purposes underlying these Articles are different: for Article 8(1)(b) EUTMR, the aim is to prevent the registration of a later trade mark that, if used, could confuse the relevant public as regards the commercial origin of the goods or services concerned, whereas for Article 8(5) EUTMR, the aim is to prevent the registration of a later trade mark that, if used, could take unfair advantage of, or be detrimental to, the reputation or distinctiveness of the earlier reputed trade mark.

The relationship between the notion of ‘similarity’ under the two provisions was addressed by the Court in *TiMi KINDERJOGHURT*: ‘It should be noted at the outset that ... the existence of a similarity between the earlier mark and the challenged mark is a precondition for the application both of Article 8(1)(b) [EUTMR] and of Article 8(5) [EUTMR]’ (para. 51).

In the context both of Article 8(1)(b) and of Article 8(5) EUTMR, a finding of similarity between the marks in question requires the existence, in particular, of elements of visual, aural or conceptual similarity (judgment of 23/10/2003, C-408/01 ‘Adidas-Salomon and Adidas Benelux’, para. 28).

However, those provisions differ in terms of the degree of similarity required. Whereas the protection provided for under Article 8(1)(b) EUTMR is conditional upon a finding of a degree of similarity between the marks at issue such that there is a likelihood of confusion between them on the part of the relevant section of the public, the existence of such a likelihood is not necessary for the protection conferred by Article 8(5) EUTMR. Accordingly, the types of injury referred to in Article 8(5) EUTMR may result from a lesser degree of similarity between the marks in question, provided that it is sufficient for the relevant section of the public to make a connection between those marks that is to say, to establish a link between them (judgment of 23/10/2003, C-408/01 ‘Adidas-Salomon and Adidas Benelux’, paras 27, 29, 31, and judgment of 27/11/2008, C-252/07 ‘Intel Corporation’, paras 57, 58, 66).

Nevertheless, it is not apparent either from the wording of those provisions or from the case-law that the similarity between the marks at issue must be assessed in a different way, depending on whether the assessment is carried out under Article 8(1)(b) EUTMR or under Article 8(5) EUTMR.

To sum up, the application of both Article 8(1)(b) and Article 8(5) EUTMR requires a finding of similarity between the signs. Consequently, if in the examination of Article 8(1)(b) EUTMR the signs were found to be **dissimilar**, the opposition will necessarily fail under Article 8(5) EUTMR too.

However, once the signs have been found to be **similar**, depending on whether Article 8(1)(b) or Article 8(5) EUTMR are involved, the examiner will independently assess whether the degree of similarity is sufficient for the relevant provision to apply (and in correlation with the further relevant factors).

Therefore, a degree of similarity between the marks that, after an overall assessment of the factors, led to a partial finding of likelihood of confusion under Article 8(1)(b) EUTMR does not **necessarily** trigger a link between the signs under Article 8(5) EUTMR, for example because the markets concerned are completely distinct. A full

analysis must take place. This is because **the similarity of the signs is only one of the factors to be considered when assessing whether there is such a link** (see the relevant criteria listed under paragraph 3.3 below on the ‘link’).

Depending on the case, the following scenarios are possible.

- Article 8(1)(b) EUTMR fails because the signs are **dissimilar** — Article 8(5) EUTMR fails too, since the same conclusion applies.
- Likelihood of confusion pursuant to Article 8(1)(b) EUTMR is excluded (e.g. because the goods or services are dissimilar or very remotely similar), but the signs are similar — the examination of Article 8(5) EUTMR must be carried out (see T-143/11 ‘CHIANTI CLASSICO’ paras 66-71).
- The similarity of the signs together with the other relevant factors justifies the *exclusion* of likelihood of confusion pursuant to Article 8(1)(b) EUTMR, but the similarity between the signs might be sufficient to establish a *link* between them under Article 8(5) EUTMR, in view of the other relevant factors to be taken into account.

3.3 The link between the signs

The Court has made it clear that in order to assess whether the use of the contested mark would be likely to cause detriment to, or take unfair advantage of, the distinctive character or repute of the earlier mark, it is **necessary to establish** – once the signs have been found to be similar – **if, given all the relevant factors, a link (or association) between the signs will be established in the mind of the relevant public**. The subsequent case-law has made it clear that such an analysis should precede the final assessment of the existence of a risk of injury.

The notion of a link between the signs was addressed by the Court in its judgment of 27/11/2008, C-252/07 ‘Intel Corporation’, para. 30 (and the case-law cited therein), which, although referring to the interpretation of Article 4(4)(a) TMD, is applicable to Article 8(5) EUTMR which is the equivalent provision in the EUTMR. In *Intel*, the Court, stated the following (para. 30):

The types of injury referred to in Article 4(4)(a) of the Directive, where they occur, are the consequence of a certain degree of similarity between the earlier and later marks, by virtue of which the relevant section of the public makes a connection between those two marks, that is to say, establishes a link between them even though it does not confuse them (see, in relation to Article 5(2) of the Directive, *General Motors*, para. 23; *Adidas-Salomon and Adidas Benelux*, para. 29, and *adidas and adidas Benelux*, para. 41).

The term ‘**link**’ is often also referred to as ‘**association**’ in other paragraphs of this part of the Guidelines as well as in case-law. These **terms** are, at times, **used interchangeably**.

The Court made it clear that the mere fact that the marks in question are similar **is not sufficient** for it to be concluded that there is a link between them. Rather, **whether or not there is a link between the marks at issue must be appreciated globally**, taking into account all factors relevant to the circumstances of the case.

According to *Intel*, (para. 42), the following may be **relevant factors** when assessing whether such a link exists.

- The degree of similarity between the conflicting marks. The more similar they are, the more likely it is that the later mark will bring the earlier mark with a reputation to the mind of the relevant public (judgment of 06/07/2012, T-60/10, 'ROYAL SHAKESPEARE', para. 26 and, by analogy, preliminary ruling of 27/11/2008, C-252/07, *Intel*, para. 44).
- The nature of the goods or services for which the earlier mark is reputed and the later mark seeks registration, including the degree of similarity or dissimilarity between those goods or services, and the relevant section of the public. The goods or services may be so dissimilar that the later mark is unlikely to bring the earlier mark to the mind of the relevant public (*Intel*, para. 49).
- The strength of the earlier mark's reputation.
- The degree of the earlier mark's distinctive character, whether inherent or acquired through use. The more inherently distinctive the prior mark, the more likely it will be brought to a consumer's mind when encountering a similar (or identical) later mark.
- The existence of likelihood of confusion on the part of the public.

This list is not exhaustive. A link between the marks at issue may be established or excluded on the basis of only some of those criteria.

The question of whether the relevant public will establish a link between the marks at issue is a **question of fact** which must be answered in the light of the facts and circumstances of each individual case.

The assessment of whether a 'link' will be established must take into account all the relevant factors that will then need to be balanced. Therefore, even a faint or remote degree of similarity between the signs (which might not be sufficient for a finding of likelihood of confusion under Article 8(1)(b) EUTMR) still justifies assessing all the relevant factors to determine if it is likely that a link between the signs will be established in the mind of the relevant public. In this respect, in its judgment of 24/03/2011, C-552/09 P, 'TiMi Kinderjoghurt', paras 65, 66, the Court stated the following:

Although that global assessment implies some interdependence between the relevant factors, and a low degree of similarity between the marks may therefore be offset by the strong distinctive character of the earlier mark ... the fact remains that where there is no similarity between the earlier mark and the challenged mark, the reputation or recognition enjoyed by the earlier mark and the fact that the goods or services respectively covered are identical or similar are not sufficient for it to be found that the relevant public makes a link between them ...

... It is only if there is some similarity, even faint, between the marks at issue that the General Court must carry out a global assessment in order to ascertain whether, notwithstanding the low degree of similarity between

them, there is, on account of the presence of other relevant factors such as the reputation or recognition enjoyed by the earlier mark, a likelihood of confusion or a link made between those marks by the relevant public.

Case-law has made it clear that a link is not sufficient, in itself, to establish that there may be one of the forms of damage referred to in Article 8(5) EUTMR (judgment of 26/09/ 2012, T-301/09, 'Citigate', para. 96, and the case-law cited therein). However, as will be explained in detail under paragraph 3.4 'The risk of injury' below, the existence of the link (or association) between the signs is necessary before determining whether detriment or unfair advantage are likely.

Examples where a link was found between the signs

The following are examples where it was found that the degree of similarity between the signs (together with further factors) was sufficient to conclude that consumers would establish a link between them.

Earlier reputed sign	EUTM application	Case No
BOTOX	BOTOLYST and BOTOCYL	Joined Cases T-345/08 and T-357/08 confirmed in C-100/11P)
<p>The trade mark BOTOX had a reputation for pharmaceutical preparations for the treatment of wrinkles in the United Kingdom on the filing date of the contested marks, which cover a range of goods in Class 3. The General Court confirmed the Board's finding that there is a certain overlap between the goods, namely a low degree of similarity between the opponent's <i>pharmaceutical preparations for the treatment of wrinkles</i> and the contested <i>cosmetics among other creams</i>, whereas the remaining contested goods, namely <i>perfumes, sun-tanning milks, shampoos, bath salts</i>, etc., are dissimilar. Nevertheless, the goods at issue concern related market sectors. The General Court confirmed the Board's finding that the relevant public – practitioners as well as the general public – would not fail to notice that both the applied for trade marks, BOTOLIST and BOTOCYL, begin with 'BOTO-', which comprises almost the whole of the mark BOTOX, which is well known to the public. The General Court pointed out that 'BOTO-' is not a common prefix, either in the pharmaceutical field or in the cosmetic field and that it has no descriptive meaning. Even if the sign BOTOX could be broken down into 'bo' for 'botulinum' and 'tox' for 'toxin' in reference to the active ingredient which it uses, that word would then have to be considered to have acquired a distinctive character, inherent or through use, at least in the United Kingdom. In light of all the relevant factors, the public would naturally be led to establish a link between the marks BOTOLIST and BOTOCYL and the reputed mark BOTOX (paras 65-79).</p>		



Earlier reputed sign	EUTM application	Case No
RED BULL		R 0070/2009-1
<p>The Board found that a link would be established between RED DOG and RED BULL because (i) the marks have some relevant common features, (ii) the conflicting goods in Classes 32-33 are identical, (3) the RED BULL mark is reputed, (iv) the RED BULL mark has acquired a strong distinctive character through use and (v) there might be a possibility of confusion (para 19). It is reasonable to assume that the average consumer of beverages, who knows the reputed RED BULL mark and sees the RED DOG marks on the same kind of beverages would immediately recall the earlier mark. According to the <i>Intel</i> judgement, this is 'tantamount to the existence of a link' between the marks (para 24).</p>		



Earlier reputed sign	EUTM application	Case No
VIAGRA	VIAGUARA	T-332/10
<p>The trade marks are highly similar overall (para. 42). Visually, all the letters of the earlier trade mark are present in the contested one, the first four and the final two are in the same sequence. There is a visual similarity, especially since the public tends to pay more attention to the beginnings of words (para 35, 36). The identity of the first and the last syllable, together with the fact that the middle syllables have in common the sound [g], leads to a high degree of phonetic similarity (paras 38, 39). Neither of the signs has a meaning and, therefore, the public will not differentiate them conceptually (para. 40).</p> <p>The earlier mark covers <i>pharmaceuticals for the treatment of erectile dysfunctions</i> in Class 5, whereas the contested mark covers <i>non-alcoholic and alcoholic drinks</i> in Classes 32 and 33. The reputation of the earlier sign for the mentioned goods is not disputed. The General Court found that although no direct connection can be established between the goods covered by the marks in dispute since they are dissimilar, an association with the earlier mark remains possible, taking into account the high degree of similarity between the signs and the strong reputation acquired by the earlier mark. Therefore, the General Court concludes that a link is likely to be established between the marks (para. 52).</p>		

Earlier reputed sign	EUTM application	Case No
RSC-ROYAL SHAKESPEARE COMPANY	ROYAL SHAKESPEARE	T-60/10
<p>As the contested trade mark is exclusively made up of the central and distinctive element of the earlier trade mark, namely the expression 'royal shakespeare', the signs at issue are visually, phonetically and conceptually similar. Therefore, the average consumer will establish a link between those signs (para 29). The earlier mark covers services in Class 41, including <i>theatre productions</i>, whereas the contested mark covers <i>non-alcoholic and alcoholic drinks</i> in Classes 32 and 33 and <i>providing of food and drink, restaurants, bars, pubs, hotels; temporary accommodation</i> in Class 42. The General Court confirmed the Board's finding of the 'exceptional' reputation of the earlier mark in the United Kingdom for theatre productions. The relevant public for the contested trade mark is the same as the relevant public for the earlier trade mark, namely the public at large (para 58). Although the contested goods in Classes 32-33 do not appear to be directly and immediately linked to the opponent's theatre productions, there is a certain proximity and link between them. The General Court refers to the judgment of 04/11/2008, T-161/07 'Ugly (COYOTE UGLY)', paras 31-37, where a certain similarity between <i>entertainment services</i> and <i>beer</i> was found due to their complementarity. The General Court added that it is common practice, in theatres, for bar and catering services to be offered either alongside and in the interval of a performance. Moreover, irrespective of the above, in view of the established reputation of the earlier trade mark, the relevant public, namely the public at large in the United Kingdom, would be able to make a link with the intervener when seeing a beer with the contested trade mark in a supermarket or in a bar (para. 60).</p>		

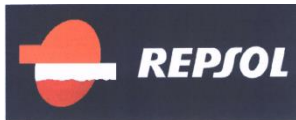
Examples where no link was found between the signs

The following are examples where an overall assessment of all of the relevant factors showed that it was unlikely that a link would be established between the signs.

Earlier reputed sign	EUTM application	Case No
		R 0724/2009-4
<p>The signs only have a certain degree of visual and aural similarity. The Board confirms that the reputation of the earlier marks has been proven solely for <i>distribution of energy services</i>. These services are completely different from the goods for which protection is requested in Classes 18, 20, 24 and 27. The relevant section of the public is the same, given that the services for which a reputation has been proven, namely <i>distribution of energy services</i>, are aimed at the general public and the goods in dispute are also aimed at the average consumer who is reasonably observant and circumspect. However, even if the relevant section of the public for the goods or services for which the conflicting marks are registered is the same or overlaps to some extent, those goods or services may be so dissimilar that the later mark is unlikely to bring the earlier mark to the mind of the relevant public. The huge differences in usage between the goods in dispute and the services for which a reputation has been proven make it very unlikely that the public will make a link between the signs in dispute, which is essential for the application of Article 8(5) EUTMR and for unfair advantage to be taken of the distinctive character or repute of the earlier mark. It is even less likely that, when intending to purchase a bag or item of furniture, the relevant public will link these goods to a trade mark that is very well known, but for services in the energy sector (paras 69-79).</p>		

Earlier reputed sign	EUTM application	Case No
G-STAR and 		T-309/08
<p>Visually the signs cause a different overall impression, due to the figurative element of a Chinese dragon's head placed at the beginning of the mark applied for. Aurally, there is a rather close aural similarity between the marks at issue. The signs are conceptually different, since the element 'star' of the earlier marks is a word which is part of basic English vocabulary, the meaning of which is widely understood throughout the EU. Therefore, the earlier marks will be perceived as referring to a star or a famous person. It is possible that a part of the relevant public will attribute to the element 'stor' of the contested mark the sense of the Danish and Swedish word 'stor', meaning 'big, large', or will regard it as a reference to the English word 'store' meaning 'shop, storage'. It is, however, more likely that the majority of the relevant public will not attribute any particular meaning to that element. Therefore, the relevant public will perceive the marks at issue as conceptually different inasmuch as the earlier marks have a clear meaning throughout the EU, while the mark applied for has either a different meaning for part of the relevant public or has no meaning. According to settled case-law, where the meaning of at least one of the two signs at issue is clear and specific so that it can be grasped immediately by the relevant public, the conceptual differences between those signs may counteract the visual and aural similarities between them. The Board of Appeal was right to find that the visual and conceptual differences between the marks prevented any assumption of a possible link between them (paras 25-36).</p>		

Earlier reputed sign	EUTM application	Case No
ONLY		R 1556/2009-2 (confirmed by T-586/10)
<p>The goods in Class 3 are identical and target the same public. There is a slight degree of visual and conceptual similarity between the signs at issue and a moderate degree of aural similarity. Even if the earlier marks had a reputation, the differences between the signs, in particular due to the conceptual unit created by the combination of the element 'only' and the distinctive dominant element 'givenchy', would be significant enough for the public not to make any connection between them. Therefore, the Board of Appeal was correct in finding that one of the conditions for applying Article 8(5) EUTMR, namely that the signs be sufficiently similar to lead the relevant public to make a connection between them, has not been met (paras 65, 66).</p>		

Earlier reputed sign	EUTM application	Case No
KARUNA		R 696/2009-4 (confirmed by T-357/10)
<p>The goods concerned, <i>chocolate</i> in Class 30, are identical. The signs differ visually not only because of the figurative elements in the sign applied for, but also because of their verbal elements. Even though the verbal elements of the marks at issue have three letters out of six in common, a difference arises because the earlier marks begin with the letters 'ka' while the mark applied for begins with the letters 'co' and because the consumer normally attaches more importance to the first part of words. There is a low degree of phonetic similarity between the signs taken as a whole. Conceptually, the word 'corona', meaning 'crown' in Spanish, does not have any meaning in Estonian, Latvian or Lithuanian. Accordingly, no conceptual comparison is possible between the signs at issue in the three Baltic States. The mere fact that the Lithuanian word 'karūna' means 'crown' is not sufficient to establish that the relevant public associates the terms 'karuna' or 'karūna' with the word 'corona', which remains a foreign word. To conclude, the General Court reiterated that if the condition of similarity of the signs is not met under Article 8(1)(b) EUTMR, it must also be held, on the basis of the same analysis, that that condition is not met under Article 8(5) EUTMR either (paras 30-34 and 49).</p>		

3.4 The risk of injury³

3.4.1 Protected subject matter

Article 8(5) EUTMR does **not protect the reputation** of the earlier mark **as such**, in the sense that it does **not intend to prevent the registration of all marks identical with or similar to a mark with reputation**. In addition, there must be a likelihood that use of the contested application without due cause would take unfair advantage of, or would be detrimental to, the distinctive character or the repute of the earlier mark. The Court confirmed this by stating that 'once the condition as to the existence of reputation is fulfilled, the examination has to proceed with the **condition that the earlier mark must be detrimentally affected** without due cause' (see judgment of 14/09/1999, C-375/97, 'General Motors', para. 30).

The Court did not set out in more detail exactly what would count as detriment or unfair advantage, even though it stated in *Sabel* that Article 8(5) EUTMR '[does] not require

³ For the purposes of these Guidelines, the term 'injury' covers taking 'unfair advantage' even though in such cases there is not necessarily an 'injury' in the sense of detriment either to the distinctive character or repute of the mark or, more generally, to its proprietor.

proof of likelihood of confusion', thereby stating the obvious, namely that the enlarged protection granted to reputed marks is not concerned with their function of origin (see judgment of 11/11/1997, C-251/95, 'Sabel', para. 20).

However, in a series of previous decisions the Court stated that apart from indicating origin, a trade mark may also fulfil other functions worthy of protection. More particularly, it confirmed that a trade mark can offer a guarantee that all the goods coming from a single undertaking have the same quality (**guarantee function**) and that it can serve as an advertising instrument by reflecting back the goodwill and prestige it has acquired in the market (**advertising function**) (judgment of 17/10/1990, C-10/89 CNL-SUCAL v HAG, judgment of 11/07/1993, joined cases C-427/93, C-429/93 and C-436/93, 'Bristol-Myers Squibb and Others v Paranova', judgment of 11/11/1997, C-349/95, 'Loendersloot v Ballantine & Son and Others', judgment of 04/11/1997, C-337/95, 'Parfums Christian Dior v Evora', and judgment of 23/02/1999, C-63/97, 'BMW').

It follows that trade marks do not only serve to indicate the origin of a product, but also to convey a certain **message or image** to the consumer, which is **incorporated in the sign** mostly through use and, once acquired, forms part of its distinctiveness and repute. In most cases of reputation these features of the trade mark will be particularly developed, as the commercial success of a brand is usually based on product quality, successful promotion, or both and, for this reason, they will be especially valuable to the trade mark owner. This **added value** of a mark with reputation is precisely what Article 8(5) EUTMR intends to protect against undue detriment or unfair advantage.

Hence, the protection under Article 8(5) EUTMR extends to all cases where the use of the contested trade mark applied for is likely to have an adverse effect on the earlier mark, in the sense that it would diminish its attractiveness (detriment to distinctiveness) or devalue the image it has acquired among the public (detriment to repute), or the use of the contested mark is likely to result in misappropriation of its powers of attraction or exploitation of its image and prestige (unfair advantage of the distinctive character or repute).

Given also that a **very strong reputation** is both easier to harm and more tempting to take advantage of, owing to its great value, the Court underlined that 'the stronger the earlier mark's distinctive character and reputation, the easier it will be to accept that detriment has been caused to it' (judgment of 27/11/2008, C-252/07 'Intel', paras 67, 74, judgment of 25/05/2005, T-67/04, 'Spa-finders', para. 41). Even though the Court did not say so expressly, the same must be accepted as regards the unfair advantage that the applicant might enjoy at the expense of the earlier mark.

3.4.2 Assessment of the risk of injury

In *General Motors* the Court did not deal with the assessment of detriment and unfair advantage in great detail, as this issue was not part of the question referred to it. It only stated that it 'is only where there is a sufficient degree of knowledge of that mark that the public, when confronted by the later trade mark, may possibly make an **association between the two trade marks ... and that the earlier trade mark may consequently be damaged**' (judgment of 14/09/1999, C-375/97, 'General Motors', para. 23).

Even though this statement is too limited to serve as a basis for a comprehensive analysis of the existence of a risk of injury, it gives at least a significant indication, namely that detriment or unfair advantage must be the **consequence of an association** between the conflicting marks in the minds of the public, made possible by the similarities between the marks, their distinctiveness, the reputation and other factors (see paragraph 3.3 above).

The need for an association capable of causing detriment has a two-fold consequence for the assessment of detriment or unfair advantage.

- Firstly, if the alleged detriment or unfair advantage is not the result of an association between the marks, but is due to other, extraneous reasons, it is not actionable under Article 8(5) EUTMR.
- Secondly, if in view of the overall circumstances of the case, an association between the marks is not likely, the necessary link between the use of the later mark and the detrimental effect will be missing. Therefore, the similarities between the signs and the reputation of the earlier mark must be of such a nature and degree that, considering all factors, the consumer will associate the signs, in the sense that encountering one of them will bring to mind the other.

Furthermore, as the Court observed, an association between the marks requires that the part of the **public which is already familiar with the earlier mark** is also **exposed to the later mark**. This will be easier to establish where the earlier mark is known to the public at large, or where the consumers of the respective goods and services largely overlap. However, in cases where the goods and services are significantly different from each other and such a connection between the respective publics is not obvious, the opponent must justify why the marks will be associated, by reference to some other link between its activities and those of the applicant, for example where the earlier mark is exploited outside its natural market sector, for instance, by licensing or merchandising (see paragraph 3.3 above).

Earlier reputed sign	EUTM application	Case No
TWITTER		R 1074/2011-5
Repute for services in Classes 38, 42 and 45, inter alia, a <i>website for social networking</i>	Classes 14, 18 and 25	
<p>The Board defined the relevant public as the average European consumer of the goods applied for, which are ordinary goods meant for the general public.</p> <p>The Board found it likely that the applicant's goods could be seen as merchandising products coming from the opponent. Items such as t-shirts, key chains, watches, hand bags, jewellery, caps etc. are very frequently used as marketing means bearing trade marks which relate to entirely distinct goods and services. Upon encountering the sign TWITTER used on a watch, a scarf or a t-shirt, the relevant consumer would inevitably make a mental connection with the opponent's sign and the services it offers on account of the reputation of the opponent's mark. This would give the applicant a competitive advantage since its goods would benefit from the extra attractiveness they would gain from the association with the opponent's older mark. Buying a TWITTER watch as a present for someone who is known to be a TWITTER user is, for example, an action motivated by the fondness for the earlier mark (para. 40).</p>		

The more immediately and strongly the earlier mark is brought to mind by the later sign, the greater the likelihood that the current or future use of the sign is taking, or will take, unfair advantage of the distinctive character or the repute of the mark or is, or will be, detrimental to it (judgments of 27/11/2008, C-252/07 'Intel', paras 67-69; judgment of 18/06/2009, C-487/07 'L'Oréal', paras 41, 43).

Therefore, the evaluation of detriment or unfair advantage must be based on an overall assessment of all the factors relevant to the case (including in particular the similarity of signs, the reputation of the earlier mark, the respective consumer groups and market sectors), with a view to determining whether the marks may be associated in a way which may adversely affect the earlier trade mark.

3.4.3 Types of injury

Article 8(5) EUTMR refers to the following types of injury: 'take unfair advantage of, or be detrimental to, the distinctive character or the repute of the earlier trade mark'. Therefore, Article 8(5) EUTMR applies if any of the following **three alternative requirements** is fulfilled, namely if use of the contested mark would:

- take unfair advantage of the distinctiveness, or the repute of the earlier mark;
- cause detriment to the distinctiveness;
- cause detriment to the repute.

As regards the first type of injury, the wording of Article 8(5) EUTMR suggests the existence of two kinds of unfair advantage, but settled case-law treats both as a single injury under Article 8(5) EUTMR (see, for example, judgment of 06/07/2012, T-60/10, 'RSC-Royal Shakespeare Company', para. 47). For the sake of completeness, both aspects of the same injury will be dealt with under paragraph 3.4.3.1 below.

As demonstrated in the Guidelines, Part C, Opposition, Section 2, Identity and Likelihood of Confusion, likelihood of confusion relates *only* to confusion about the commercial origin of goods and services. Article 8(5) EUTMR, in contrast, protects earlier *reputed* marks in cases of association or confusion that does not necessarily relate to the commercial origin of goods/services. Article 8(5) EUTMR protects the heightened effort and financial investment that is involved in creating and promoting trade marks to the extent that they become reputed by protecting these marks against later similar marks taking unfair advantage of, or being detrimental to, the distinctive character or the repute of the earlier trade mark. There is a rich lexicon of vocabulary that is used in relation to this area of trade mark law. The most common terms are set out below.

Terms in Article 8(5) EUTMR	Commonly used equivalents
Unfair advantage	Free-riding, riding on the coat-tails
Detriment to distinctiveness	Dilution by blurring, dilution, blurring, watering down, debilitating, whittling away
Detriment to repute	Dilution by tarnishing, tarnishment, degradation

3.4.3.1 Taking unfair advantage of distinctiveness or repute

The nature of the injury

The notion of taking **unfair advantage of distinctiveness or repute** covers cases where the applicant benefits from the attractiveness of the earlier right by affixing on its goods/services a sign which is similar (or identical) to one widely known in the market and, thus, misappropriating its attractive powers and advertising value or exploiting its reputation, image and prestige. This may lead to unacceptable situations of commercial parasitism where the applicant is allowed to take a 'free-ride' on the investment of the opponent in promoting and building-up goodwill for its mark, as it may stimulate the sales of the applicant's products to an extent which is disproportionately high in comparison with the size of its promotional investment.

In its judgment of 18/06/2009, C-487/09, 'L'Oréal and others', the Court indicated that unfair advantage exists where there is a transfer of the image of the mark or of the characteristics which it projects to the goods identified by the identical or similar sign. By riding on the coat-tails of the reputed mark, the applicant benefits from its power of attraction, its reputation and its prestige. It also exploits, without paying any financial compensation, the marketing effort expended by the proprietor of the mark in order to create and maintain the image of that mark (paras 41, 49).

Earlier reputed sign	EUTM application	Case No
SPA LES THERMES DE SPA	SPA-FINDERS	T-67/04
The concept of taking unfair advantage of the distinctive character or the repute of the earlier mark must be intended to encompass instances where there is clear exploitation and free-riding on the coattails of a famous mark or an attempt to trade upon its reputation (see to that effect Opinion of Advocate General Jacobs in Adidas in Adidas, point 39) (para. 51).		

Earlier reputed sign	EUTM application	Case No
RSC-ROYAL SHAKESPEARE COMPANY 	ROYAL SHAKESPEARE	T-60/10
The unfair advantage taken of the distinctive character or the repute of the earlier trade mark consists in the fact that the image of the mark with a reputation or the characteristics which it projects will be transferred to the goods covered by the mark applied for, with the result that the marketing of those goods can be made easier by that association with the earlier mark with a reputation (para. 48).		

Relevant consumer

The concept of 'unfair advantage' focuses on benefit to the later mark rather than harm to the earlier mark; what is prohibited is the exploitation of the earlier mark by the proprietor of the later mark. Accordingly, the existence of the injury consisting of unfair advantage obtained from the distinctive character or the repute of the earlier mark must be assessed **by reference to average consumers of the goods or services for which the later mark is applied for** (judgment of 27/11/2008, C-252/07, 'Intel',

paras 35, 36; judgment of 12/03/2009, C-320/07P, 'nasdaq', paras 46-48; judgment of 07/12/2010, T-59/08, 'NIMEI LA PERLA MODERN CLASSIC', para. 35).

The assessment of unfair advantage

In order to determine whether the use of a sign takes unfair advantage of the distinctive character or the repute of the mark, it is necessary to undertake an **overall assessment** which takes into account all the factors relevant to the circumstances of the case (judgment of 10/05/2007, T-47/06, 'nasdaq', para. 53, confirmed, on appeal, by judgment of 12/03/2009, C-320/07P, 'nasdaq'; see also judgment of 23/10/2003, C-408/01 'Adidas', paras 29, 30, 38; judgment of 27/11/2008, C-252/07 'Intel', paras 57, 58, 66; and judgment of 24/03/2011, C-552/09P, 'Kinder', para. 53).

The misappropriation of the distinctiveness and repute of the earlier mark presupposes an **association** between the respective marks, which **makes possible the transfer of attractiveness and prestige** to the sign applied for. An association of this kind will be more likely in the following circumstances.

1. Where the earlier mark possesses a **strong reputation or a very strong (inherent) distinctive character**, because in such a case it will be both more tempting for the applicant to try to benefit from its value and easier to associate it with the sign applied for. Such marks will be recognised in almost any context, exactly because of their outstanding distinctiveness or 'good' or 'special' reputation, in the sense that it reflects an image of excellence, reliability or quality, or some other positive message, which could positively influence the choice of the consumer as regards goods of other producers (judgment of 12/07/2011, C-324/09, 'L'Oréal and others', para. 44). The stronger the distinctive character of the earlier mark, the more likely it is that, when encountering a later identical or similar mark, the relevant public will associate it with that earlier mark (judgment of 06/07/2012, T-60/10, 'ROYAL SHAKESPEARE', para. 27).
2. Where the degree of similarity between the **signs** at issue is high. The more similar the marks are, the more likely it is that the later mark will bring the earlier mark with a reputation to the mind of the relevant public (judgment of 06/07/2012, T-60/10, 'ROYAL SHAKESPEARE', para. 26; see, by analogy, judgment of 27/11/2008, C-252/07, 'Intel', para. 44).
3. Where there is a **special connection** between the goods/services which allows for some of the qualities of the opponent's goods/services to be attributed to those of the applicant. This will be particularly so in the case of **neighbouring markets**, where a 'brand extension' would seem more natural, as in the example of *pharmaceuticals* and *cosmetics*; the healing properties of the former may be presumed in the latter when it bears the same mark. Similarly, the Court has held that certain drinks (Classes 32 and 33) commercialised as improving sexual performance were linked to the properties of the goods in Class 5 (pharmaceutical and veterinary products and substances) for which the earlier mark, Viagra, was registered (judgment of 25/01/2012, T-332/10 'VIAGUARA', para. 74). Conversely, such a link was not found between *credit card services* and *cosmetics*, as it was thought that the image of the former is not transferable to the latter, even though their respective users largely coincide.

4. Where, in view of its special attractiveness and prestige, the earlier mark may be **exploited even outside its natural market sector**, for example, by licensing or merchandising. In this case, if the applicant uses a sign identical or similar to the earlier mark, for goods for which the latter is already exploited, it will obviously profit from its de facto value in that sector (see decision of 16/03/2012, R 1074/2011-5, 'Twitter').

The applicant's intention is not a material factor. Taking unfair advantage of the distinctiveness or the repute of a trade mark may be a **deliberate decision**, for example where there is a clear exploitation and free riding on the coat-tails of a famous mark, or an attempt to trade upon the reputation of a famous mark. However, taking unfair advantage does **not necessarily** require a deliberate intention to exploit the goodwill attached to someone else's trade mark. The concept of taking unfair advantage 'concerns the risk that the image of the mark with a reputation or the characteristics which it projects are transferred to the goods covered by the mark applied for, with the result that the marketing of those goods is made easier by that association with the earlier mark with a reputation' (judgment of 19/06/2008, T-93/06, 'Mineral Spa', para. 40, judgment of 22/03/2007, T-215/03, 'VIPS', para. 40, judgment 30/01/2008, T-128/06, 'Camelo', para. 46).

Therefore, bad faith is not in itself a condition for the application of Article 8(5) EUTMR, which only requires that the advantage be '**unfair**', in that there is **no justification** for the applicant's profit. However, where the evidence shows that the applicant is clearly acting in bad faith, there will be a strong indication of unfair advantage. The existence of bad faith may be inferred from various factors, such as an obvious attempt by the applicant to imitate an earlier sign of great distinctiveness as closely as possible, or where there is no apparent reason why it chose for its goods a mark which includes such a sign.

Finally, the concept of unfair advantage in Article 8(5) EUTMR does not relate to the **detriment** caused to the reputed mark. Accordingly, an advantage taken by a third party of the distinctive character or the repute of the mark may be unfair, even if the use of the identical or similar sign is not detrimental to the distinctive character or to the repute of the mark or, more generally, to its proprietor. It is, therefore, not necessary for the opponent to show that the applicant's benefit is detrimental to its economic interests or to the image of its mark (unlike with tarnishing, see below), as in most cases the 'borrowed' distinctiveness/prestige of the sign will principally affect the applicant's competitors, that is, traders dealing in identical/similar/neighbouring markets, by putting them at a competitive disadvantage. However, the possibility of simultaneous detriment to the opponent's interests should not be ruled out completely, especially in instances where use of the applied-for sign could affect the opponent's merchandising schemes, or would hinder its plans to penetrate a new market sector.

Cases on unfair advantage*Risk of unfair advantage established*

Earlier reputed sign	EUTM application	Case No
INTEL	INTELMARK	C-252/07 (Advocate General Opinion)
<p>In her opinion in the <i>Intel</i> preliminary ruling, Advocate General Sharpston referred to unfair advantage as follows: ‘The concepts of taking unfair advantage of the distinctive character or repute of the mark in contrast must be intended to encompass “instances where there is clear exploitation and free-riding on the coat-tails of a famous mark or an attempt to trade upon its reputation”. Thus by way of example Rolls Royce would be entitled to prevent a manufacturer of whisky from exploiting the reputation of the Rolls Royce mark in order to promote his brand. It is not obvious that there is any real difference between taking advantage of a mark’s distinctive character and taking advantage of its repute; since however nothing turns on any such difference in the present case, I shall refer to both as free-riding’ (para. 33).</p>		

Earlier reputed sign	EUTM application	Case No
CITIBANK et al		T-181/05
<p>‘...the reputation of the trade mark CITIBANK in the EU in regard to banking services is not disputed. That reputation is associated with features of the banking sector, namely, solvency, probity and financial support to private and commercial clients in their professional and investment activities.</p> <p>‘...there is a clear relationship ... between the services of customs agencies and the financial services offered by banks such as the applicants, in that clients who are involved in international trade and in the import and export of goods also use the financial and banking services which such transactions require. It follows that there is a probability that such clients will be familiar with the applicants’ bank given its extensive reputation at international level.</p> <p>‘In those circumstances, the Court holds that there is a high probability that the use of the trade mark applied for, CITI, by customs agencies, and therefore for financial agency activities in the management of money and real estate for clients, may lead to free-riding, that is to say, it would take unfair advantage of the well-established reputation of the trade mark CITIBANK and the considerable investments undertaken by the applicants to achieve that reputation. That use of the trade mark applied for, CITI, could also lead to the perception that the intervener is associated with or belongs to the applicants and, therefore, could facilitate the marketing of services covered by the trade mark applied for. That risk is further increased because the applicants are the holders of several trade marks containing the component “citi” (paras 81-83).</p>		

Earlier reputed sign	EUTM application	Case No
SPA	MINERAL SPA	T-93/06
<p>MINERAL SPA (for soaps, perfumeries, essential oils, preparations for body and beauty care, preparations for the hair, dentifrices in Class 3) could take unfair advantage of the image of the earlier trade mark SPA and the message conveyed by it in that the goods covered by the contested application would be perceived by the relevant public as supplying health, beauty and purity. It is not a question of whether toothpaste and perfume contain mineral water, but whether the public may think that the goods concerned are produced from or with mineral water (paras 43, 44).</p>		

Earlier reputed sign	Case No
L'Oréal et al	C-324/09 (preliminary ruling)
<p>According to L'Oréal et al, the defendants manufactured and imported perfume which was 'smell-like' of L'Oréal's fragrances but sold at a considerably lower price, using packaging which 'took a wink' at the get-up covered by L'Oréal's marks. The comparison lists used by the defendants present the perfumes which they market as being an imitation or a replica of goods bearing a trade mark with repute. Under Directive 84/450, comparative advertising which presents the advertiser's products as an imitation of a product bearing a trade mark is inconsistent with fair competition and thus unlawful. Therefore, any advantage gained by the advertiser through such advertising will have been achieved as a result of unfair competition and must be regarded as taking unfair advantage of the reputation of that mark (para. 79).</p>	



Earlier reputed sign	EUTM application	Case No
NASDAQ		T-47/06
<p>'Taking account of the fact that the financial and stock market listing services supplied by the intervener under its trade mark NASDAQ and, therefore, the trade mark NASDAQ itself, undeniably presents a certain image of modernity and that image can be transferred to sports equipment and, in particular, to the high tech composite materials which would be marketed by the applicant under the mark applied for, which the applicant appears to recognise implicitly by stating that the word 'nasdaq' is descriptive of its main activities.</p> <p>Therefore, in light of that evidence, and taking account of the similarity of the marks at issue, the importance of the reputation and the highly distinctive character of the trade mark NASDAQ, it must be held that the intervener has established prima facie the existence of a future risk, which is not hypothetical, of unfair advantage being drawn by the applicant, by the use of the mark applied for, from the reputation of the trade mark NASDAQ. There is therefore no need to set aside the contested decision on that point' (paras 60, 61).</p>		

Earlier reputed sign	EUTM application	Case No
RSC-ROYAL SHAKESPEARE COMPANY 	ROYAL SHAKESPEARE	T-60/10
<p>There is a certain proximity and link between <i>entertainment services</i> and <i>beer</i>, even a certain similarity due to their complementarity. The public in the United Kingdom would be able to make a link with the Royal Shakespeare Company (RSC) when seeing a beer with the contested mark ROYAL SHAKESPEARE in a supermarket or in a bar. The contested mark would benefit from the power of attraction, the reputation and the prestige of the earlier mark for its own goods and services, which would attract the consumers' attention thanks to the association with RSC, thereby gaining a commercial advantage over its competitors' goods. The economic advantage would consist of exploiting the effort expended by RSC to establish the reputation and the image of its earlier mark without paying any compensation in exchange. That equates to an unfair advantage (para. 61).</p>		

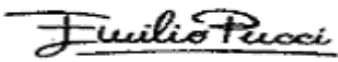
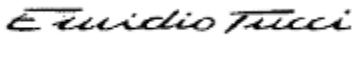
Earlier reputed sign	EUTM application	Case No
VIAGRA	VIAGURA	T-332/10
<p>While recognising that the primary function of a trade mark was as an indicator of origin, the General Court held that a mark could also serve to transmit other messages, concerning particular qualities or characteristics of the designated goods or services, or the images and sensations projected by the mark itself, such as luxury, lifestyle, exclusivity, adventure or youth. In this sense, a trade mark possessed an intrinsic economic value that was autonomous and distinct to that of the goods or services for which it was registered (para. 57).</p> <p>The risk of taking unfair advantage encompasses cases of manifest exploitation or parasitism of a mark with reputation, namely the risk of transferring the image of the mark with reputation or the characteristics projected by it to the goods covered by the mark applied for, thus facilitating the marketing of those goods through association with the earlier mark with reputation (para. 59).</p> <p>The Court concluded that, even if the drinks claimed by the mark applied for would not in reality produce the same benefit as the 'immensely well-known' pharmaceutical for the treatment of erectile dysfunction, what was important was that the consumer, because of the transfer of positive associations projected by the image of the earlier mark, would be inclined to purchase such drinks in the expectation of finding similar qualities, such as an increase in libido (paras 52 and 67).</p>		

Earlier reputed sign	EUTM application	Case No
EMILIO PUCCI 		T-373/09 (cases R 770/2008-2 and R 826/2008-2)
<p>Although the applicant's cosmetic products are dissimilar to the opponent's clothes, they both fall squarely within the realm of products which are often sold as luxury items under famous marks of well-known designers and manufacturers. Taking into account that the earlier mark is very well known and that the commercial contexts in which the goods are promoted are relatively close, BoA concluded that consumers of luxury clothes will make a connection between the applicant's mark for soaps, perfumery, essential oils, cosmetics and hair lotions in Class 3 and the famous mark 'EMILIO PUCCI', an association which will produce a commercial benefit as per the Board's findings (BoA para. 129).</p> <p>BoA concluded that there was a strong likelihood that the applicant could exploit the reputation of the opponent's mark for its own benefit. The use of the mark applied for in connection with the goods and services mentioned above will almost certainly draw the relevant consumer's attention to the opponent's highly similar and very well-known mark. The applicant will become associated with the aura of luxury that surrounds the 'EMILIO PUCCI' brand. Many consumers are likely to think that there is a direct connection between the goods of the applicant on the one hand, and the famous Italian fashion house on the other, perhaps in the form of a licensing agreement. The applicant could take unfair advantage of the fact that the public knows the trade mark 'EMILIO PUCCI' well in order to introduce its own highly similar trade mark without incurring any great risk and the costs of introducing a totally unknown trade mark onto the market (BoA para. 130).</p> <p>The General Court confirmed the BoA findings.</p>		

Risk of unfair advantage denied

Earlier reputed sign	EUTM application	Case No
O2 		R 2304/2010-2
<p>The Board of Appeal found that (1) the marks have very limited similarities and are dissimilar overall; (2) the use of the common designation 'O2' is descriptive in the mark applied for; and (3) taking the completely different areas of use – and the descriptive use of the common element – there can be no possibility of the applicant benefiting from the distinctive character of the earlier mark, even if there may be an overlap in the relevant public (para. 55).</p>		

Earlier reputed sign	EUTM application	Case No
VIPS	VIPS	T-215/03
<p>The earlier mark VIPS has a reputation for restaurants, in particular fast food chains. However, it was not proven that it also enjoys any particular prestige. The term VIPS is laudatory in itself and extensively used in this manner. Therefore, it cannot be 'diluted'. There is no explanation as to how the sales of software products under the mark VIPS could possibly benefit from their association with a fast-food chain, even if a link were made.</p>		

Earlier reputed sign	EUTM application	Case No
SPA	SPA-FINDERS	T-67/04
<p>SPA has a reputation for <i>mineral water</i> in the Benelux. The contested mark, SPA FINDERS, covers <i>publications, catalogues, magazines, newsletters, travel agency services</i>. The General Court declared that there was no detrimental link between the signs. The sign SPA is also used to denote the town of SPA and the racing circuit of the same name. There is no evidence of unfair advantage or any kind of exploitation of the fame of the earlier mark. The word SPA in the mark applied for only denotes the kind of publication concerned.</p>		

3.4.3.2 Detriment to distinctiveness

The nature of the injury

Detriment to the distinctive character of an earlier reputed mark (also referred to as 'dilution', 'whittling away' or 'blurring') is caused when that mark's ability to identify the goods/services for which it is registered and used as coming from its proprietor is weakened because use of a later similar mark leads to dispersion of the identity of the earlier reputed mark by making it less distinctive or unique (judgment of 27/11/2008, C-252/07, 'Intel', para. 29).

Article 8(5) EUTMR states that a proprietor of a reputed mark may oppose EUTM applications which, without due cause, 'would be detrimental to the *distinctive character* of earlier reputed marks' (emphasis added). Clearly, therefore, the object of protection is the **distinctiveness** of the earlier reputed mark. As demonstrated in the Guidelines, Part C, Opposition, Section 2, Double Identity and Likelihood of Confusion, Chapter 5, Distinctiveness of the earlier mark, 'distinctiveness' refers to the greater or lesser capacity of a mark to identify the goods/services for which it has been registered as coming from a particular undertaking. Therefore, Article 8(5) EUTMR protects reputed

marks against a reduction of their distinctive quality by a later similar mark even where the later mark relates to dissimilar goods/services.

Although the former wording of Article 8(5) EUTMR only referred to conflicts between dissimilar goods/services, in its judgments of 09/01/2003, C-292/00, 'Davidoff' and 23/10/2003, C-408/01, 'Adidas', the Court held that this article also covers similar or identical goods/services.

The protection provided in Article 8(5) EUTMR, therefore, acknowledges that the unrestrained use of a reputed mark by third parties, even on dissimilar goods, will eventually reduce the distinctive quality or uniqueness of that reputed mark. For example, if Rolls Royce were used on restaurants, pants, candy, plastic pens, yard brushes etc. its distinctiveness would eventually be dispersed and its special hold upon the public would be reduced – even in relation to cars for which it is reputed. Consequently, the Rolls Royce mark's ability to identify the goods/services for which it is registered and used as coming from its proprietor would be weakened in the sense that consumers of the goods for which the reputed mark is protected and reputed will be less inclined to associate it **immediately** with the owner who has built up the trade mark's reputation. This is because, for those consumers, the mark now has several or many 'other' associations where it previously had one.

Relevant consumer

Detriment to the distinctive character of the earlier reputed mark must be assessed by reference to the average consumers of the goods and services *for which that mark is registered*, who are reasonably well informed and reasonably observant and circumspect (judgment of 27/11/2008, C-252/07 'Intel', para. 35).

The assessment of detriment to distinctiveness

Detriment to the distinctiveness of the earlier reputed mark occurs where use of a later similar mark reduces the distinctive quality of the earlier reputed mark. However, this cannot be found to occur merely because the earlier mark has a reputation and is identical with or similar to the mark applied for – such an approach would apply an automatic and indiscriminate finding of likelihood of dilution against all marks that are similar to reputed trade marks and would negate the requirement of proving detriment.

The Court held in 'Intel' that Article 4(4)(a) TMD (the equivalent to Article 8(5) EUTMR) must be interpreted as meaning that proof that the use of the later mark would be detrimental to the distinctive character of the earlier mark requires evidence of a 'change in the economic behaviour' of the average consumer of the goods/services for which the earlier mark was registered, or a serious likelihood that such a change will occur in the future.

The Court has further elaborated on the concept of 'change in the economic behaviour of the average consumers' in its judgment of 14/11/2013 C-383/12P 'Wolf head image'. It indicated that it is an objective condition which cannot be deduced solely from subjective elements such as consumer's perceptions. The standard of proof is higher. Therefore, in order to find a detriment or risk of detriment to the distinctiveness of the earlier trade mark, the mere fact that consumers note the presence of a new sign similar to an earlier sign is not sufficient of itself (paras 35-40).

Whilst the opponent does not need to submit evidence of *actual* detriment, it must convince the Office by adducing evidence of a serious future risk – which is not merely hypothetical – of detriment. The opponent may do this by submitting evidence that proves a likelihood of detriment on the basis of logical deductions made from an analysis of the probabilities (and not mere suppositions) and by taking account of the normal practice in the relevant commercial sector as well as all the other circumstances of the case (see judgment of 16/04/2008, T-181/05, ‘Citi’, para. 78 as cited in judgment of 22/05/2012, T-570/10, ‘Wolf head image’, para. 52 and confirmed in the appeal by judgment of 14/11/2013, C-383/12P, paras 42-43).

First use

Detriment to the distinctive character is characterised by an ‘avalanche effect’, meaning that the first use of a similar mark in a distinct market may not, in itself, dilute the identity or ‘uniqueness’ of the reputed mark but, over time, this would be the result because this first use may trigger further acts of use by different operators, thus leading to its dilution or detriment to its distinctive character.

The Court has held that the first use of an identical or similar mark may suffice to cause actual and present detriment to the distinctive character of the earlier mark or to give rise to a serious likelihood that such detriment will occur in the future (judgment of 27/11/2008, C-252/07 ‘Intel’, para. 75). In opposition proceedings before the Office, use of the contested sign may not have occurred at all. In this regard, the analysis that the Office carries out assumes that the future use of the contested sign, even if it were first use, may trigger further acts of use by different operators, thus leading to dilution by blurring. As seen above, the wording of Article 8(5) EUTMR provides for this by stating that use of the applied-for mark without due cause **‘would ... be detrimental to the distinctiveness or repute of the earlier mark’**.

Nevertheless, as set out above, the opponent bears the burden of showing that the actual or future use caused, or is likely to cause, detriment to the distinctiveness of the earlier reputed mark.

Inherent distinctiveness of the earlier mark

The Court has stated that ‘the more “unique” the earlier mark appears, the greater the likelihood that the use of a later identical or similar mark will be detrimental to its distinctive character’ (judgment of 27/11/2008, C-252/07 ‘Intel’ para. 74 and judgment of 28/10/2008, T-131/09 ‘Botumax’). Indeed, the earlier mark must possess an exclusive character in the sense that it should be associated by the consumers with a single source of origin – since it is only in this case that a likelihood of detriment to distinctiveness may be envisaged. If the same sign, or a variation thereof, is already in use in connection with a range of different goods, there can be no immediate link with any of the goods it distinguishes and, thus, there will be little or no room for further dilution.

Accordingly, ‘... the risk of dilution appears, in principle, to be lower if the earlier mark consists of a term which, because of a meaning inherent in it, is very common and frequently used, irrespective of the earlier mark consisting of the term at issue. In such

a case, re-use of the term in question by the contested trade mark is less likely to result in a dilution of the earlier mark' (judgment of 22/03/2007, T-215/03, 'VIPS', para. 38).

If, therefore, the mark is suggestive of a characteristic shared by a wide range of goods, the consumer is more likely to associate it with the specific feature of the product that it alludes to rather than with another mark.

In its judgment of 25/05/2005, T-67/04, 'Spa-Finders', the General Court confirmed the finding that the use of the mark SPA-FINDERS for *publications* and *travel agency* services would neither blur the distinctiveness, nor tarnish the reputation, of the mark SPA for *mineral water*. The term 'spa' in SPA-FINDERS may be used otherwise than in a trade mark context since it 'is frequently used to designate, for example, the Belgian town of Spa and the Belgian racing circuit of Spa-Francorchamps or, in general, places for hydrotherapy such as hammams or saunas, [and consequently] the risk of detriment to the distinctive character of the mark SPA seems to be limited' (para. 44).

Thus, if the applicant shows that the earlier sign or the element that gives rise to similarity is commonplace and is already used by different undertakings in various sectors of the market, it may successfully refute the existence of a likelihood of dilution because it will be difficult to accept that the attractiveness of the earlier mark risks being diluted if it is not particularly unique.

Cases on dilution by blurring

Dilution established

Earlier reputed sign	EUTM application	Case No
BOTOX	BOTUMAX	T-131/09
Reputed for <i>pharmaceuticals for the treatment of wrinkles</i>	<i>Cosmetics, pharmaceuticals, and other health-related goods, and printed matters</i>	
<p>'However, in the present case, the word element "botox" has no inherent meaning, but is a fanciful term with which the public will be faced only in relation to the goods covered by the widely known earlier trade mark. Consequently, the use of that word element or a similar word element by another trade mark registered for goods which may concern the general public will unquestionably result in the dilution of the distinctive character of the widely known earlier trade mark' (para. 99).</p> <p>'That is the position with regard, first, to the cosmetics and pharmaceutical preparations in Classes 3 and 5 and, secondly, to the goods in Class 16 covered by the earlier marks, which include magazines or journals, the distribution of which may be widespread. The risk that the use of an identical or similar trade mark would be detrimental to the distinctive character of a widely known earlier trade mark is greater where that other mark will be used in respect of goods intended for a wide public' (para. 100).</p>		

Dilution denied

Earlier reputed sign	EUTM application	Case No
VIPS	VIPS	T-215/03
Reputed for <i>fast food restaurant chain</i> in Class 42	<i>Computer programming for hotel services</i> in Class 42	
<p>'So far as concerns, first, detriment to the distinctive character of the earlier mark by the use without due cause of the mark applied for, that detriment can occur where the earlier mark is no longer capable of arousing immediate association with the goods for which it is registered and used (<i>SPA-FINDERS</i>, paragraph 34 above, paragraph 43). That risk thus refers to the "dilution" or "gradual whittling away" of the earlier mark through the dispersion of its identity and its hold upon the public mind (Opinion of Advocate General Jacobs in <i>Adidas-Salomon and Adidas-Benelux</i>, paragraph 36 above, point 37)' (para. 37).</p> <p>'As far as concerns, first, the risk that the use of the mark applied for would be detrimental to the distinctive character of the earlier mark, in other words the risk of "dilution" and "gradual whittling away" of that mark, as explained in paragraphs 37 and 38 above, it must be pointed out that the term "VIPS" is the plural form, in English, of the abbreviation VIP ("Very Important Person"), which is widely and frequently used both internationally and nationally to describe famous personalities. In those circumstances, the risk that the use of the mark applied for would be detrimental to the distinctive character of the earlier mark is limited' (para. 62).</p> <p>'That same risk is also even less probable in the present case as the mark applied for covers the services "Computer programming relating to hotel services, restaurants, cafés", which are directed at a special and necessarily more limited public, namely the owners of those establishments. The consequence is that the mark applied for, if registration is allowed, will probably be known, through use, only by that relatively limited public, a factor which certainly reduces the risk of dilution or gradual whittling away of the earlier mark through the dispersion of its identity and its hold upon the public mind' (para. 63).</p>		

Earlier reputed sign	EUTM application	Case No
SPA	SPA-FINDERS	T-67/04
Reputed for <i>mineral waters</i> in Class 32	<i>Printed publications including catalogues, magazines, newsletters</i> in Class 16, <i>Travel agency</i> in Class 39	
<p>'In the present case, the Court finds that the applicant does not put forward any evidence to support the conclusion that there is a risk of detriment to the distinctive character of the mark SPA by the use of the mark SPA-FINDERS. The applicant stresses the alleged immediate link which the public will establish between SPA and SPA-FINDERS. It infers from that link that there is detriment to the distinctive character. As the applicant acknowledged at the hearing, the existence of such a link is not sufficient to demonstrate the risk of detriment to the distinctive character. The Court notes, moreover, that since the term "spa" is frequently used to designate, for example, the Belgian town of Spa and the Belgian racing circuit of Spa-Francorchamps or, in general, places for hydrotherapy such as hammams or saunas, the risk of detriment to the distinctive character of the mark SPA seems to be limited' (para. 44).</p>		

3.4.3.3 Detriment to repute

The nature of the injury

The final type of damage under Article 8(5) EUTMR concerns harming the earlier mark by way of detriment to its repute. It can be seen as a step beyond blurring in that the mark is not merely weakened but actually degraded by the link which the public makes with the later mark. Detriment to repute, also often referred to as 'dilution by tarnishing' or simply as 'tarnishing', relates to situations where use of the contested mark without due cause is likely to devalue the image or the prestige that a mark with reputation has acquired among the public.

The reputation of the earlier trade mark may be tainted or debased in this way, either when it is reproduced in an obscene, degrading or inappropriate context, or in a context which is not inherently unpleasant but which proves to be incompatible with a particular image the earlier trade mark has acquired in the eyes of the public, due to the promotional efforts of its owner. The likelihood of such detriment may arise in particular from the fact that the goods or services offered by the third party possess a characteristic or a quality which is liable to have a negative impact on the image of the mark (judgment of 18/06/2009, C-487/07, 'L'Oréal', para. 40). For example, if a reputed mark for gin were used by a third party on liquid detergent, this would reverberate negatively on the reputed mark in a way that makes it less attractive.

In short, tarnishment occurs where there is an association between the earlier reputed mark, either at the level of signs or at the level of goods, which is injurious to the earlier trade mark's repute.

Relevant consumer

As with dilution by blurring, detriment to the reputation of the earlier mark must be assessed by reference to average consumers of the goods and services for which that mark is registered, who are reasonably well informed and reasonably observant and circumspect (judgment of 27/11/2008, C-252/07 'Intel', para. 35 and judgment of 07/12/2010, T-59/08, 'Nimei La Perla Modern Classic', para. 35).

The assessment of tarnishment

In order to establish detriment to the repute of an earlier mark, the mere existence of a connection in the mind of the consumer between the marks is neither sufficient nor determinative. Such a connection must certainly exist, but, *in addition*, the goods/services covered by the later mark must provoke the kind of negative or detrimental impact set out below when associated with the reputed mark.

Tarnishment occurs most frequently where the reputed mark is linked to goods which evoke undesirable or questionable mental associations which conflict with the associations or image generated by legitimate use of the reputed trade mark by its proprietor (decision of 12/03/2012, R 297/2011-5, 'KAPPA', para. 36).

Therefore, to prove tarnishment, the opponent must show that use of the applicant's trade mark would prompt inappropriate or negative mental associations with the earlier trade mark, or associations conflicting with the image it has acquired in the market (decision of 23/11/2010, R 240/2004-2, 'WATERFORD', para. 89).

For example, if a mark that is associated in the minds of the public with an image of health, dynamism and youth is used for *tobacco products*, the negative connotation conveyed by the latter would contrast strikingly with the image of the former (see further examples below). For tarnishment to occur, therefore, there must be some characteristic or qualities of the goods/services on which the contested mark is used that are potentially detrimental to the reputation of the earlier mark (judgment of 22/03/2007, T-215/03, 'VIPS', para. 67).

Earlier reputed sign	EUTM application	Case No
WATERFORD		R 0240/2004-2
Reputed for <i>crystal products, including glassware</i> in Class 21	<i>Alcoholic beverages, namely wines produced in the Stellenbosch district, South Africa</i> in Class 33	
<p>'Tarnishment or debasement of a trade mark's image through association with something inappropriate may happen when the trade mark is used, on the one hand, in an unpleasant, obscene or degrading context or, on the other hand, in a context which is not inherently unpleasant but which proves to be incompatible with the trade mark's image. This may be the case when the reputed mark might be linked with goods of poor quality or which evoke undesirable or questionable mental associations which conflict with the associations or image generated by legitimate use of the reputed trade mark by its proprietor, or when the reputed mark is linked to goods which are incompatible with the quality and prestige associated with that mark, even though it is not a matter of inappropriate use of the mark itself, or, eventually, when the reputed mark's verbal or figurative element is amended or altered in a negative way' (para. 88).</p>		

Frequently opponents argue that the goods/services of the applicant are of inferior quality or that the opponent cannot control the quality of such goods/services. The Office does not accept such an argument, *per se*, as a means of demonstrating detriment. Proceedings before the Office do not provide for assessing the quality of goods and services which, apart from being highly subjective, would not be feasible in cases where the goods and services are not identical or in situations where the contested sign has not yet been put to use.

Therefore, in assessing whether the use of the contested trade mark is likely to damage the reputation of the earlier trade mark, the Office can only consider the goods and services as indicated in the specification of each trade mark. Consequently, for the purposes of the analysis by the Office, the harmful effects of the use of the contested sign in connection with the goods and services applied for must derive from the nature and usual characteristics of the goods at issue in general, not their quality in particular instances. This approach does not leave the opponent without protection because, in any event, where a later mark is used on low quality goods/services in a manner that calls to mind an earlier reputed mark, this would normally take unfair advantage of the distinctive character or the repute of the earlier trade mark or be detrimental to its distinctiveness.

Cases on dilution by tarnishing*Tarnishment established*

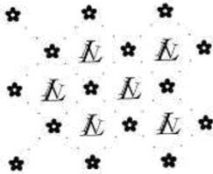

Earlier reputed sign	EUTM application	Case No
<p>KAPPA</p> 	KAPPA	R 0297/2011-5
Reputed for <i>sports clothing and footwear</i>	<i>tobacco products, cigarettes, cigars amongst others</i>	
<p>The contested application was filed for tobacco and related goods in Class 34. Smoking tobacco is universally considered to be an extremely unhealthy habit. For this reason, the use of the sign 'KAPPA' for tobacco and related goods is likely to prompt negative mental associations with the respondent's earlier marks or associations conflicting with and detrimental to their image of a healthy lifestyle (para. 38).</p>		

Earlier reputed sign	EUTM application	Case No
	SPA ^{CE} NK	R 0417/2008-1
Reputed for <i>mineral waters</i>	<i>Scouring and polishing preparations and substances; pot pourri; incense; incense sticks; room fragrances and articles for perfuming rooms</i>	
<p>The pleasant notions conveyed generally by mineral water do not mix seamlessly with detergents and scouring preparations. Use of marks that contain the word SPA for goods conveying such different connotations is likely to damage, or tarnish, the distinctive character of the earlier mark (para. 101).</p> <p>'Mineral water is not pleasantly associated by most consumers with incense or pots pourris. The use, in order to distinguish fragrances and incense, of a mark containing a word (SPA) that Belgian consumers strongly associate to bottled drinking water is therefore likely to damage the attractive and suggestive power that the brand, according to the evidence, currently enjoys' (para. 103).</p>		

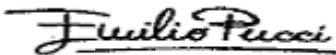
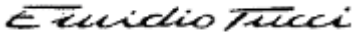
Earlier reputed sign	EUTM application	Case No
		R 2124/2010-1
Reputed for goods in Classes 18 and 25	<i>Scientific, nautical, surveying, weighing, measuring, signalling, checking (supervision), life-saving and teaching apparatus and instruments; amongst others.</i>	
<p>The opponent demonstrated that the prestigious image of its trade marks is linked to the traditional manufacturing method of its fine leather goods, which are handmade by master craftsmen who work only with top-quality raw materials. It is this image of luxury, glamour and exclusivity, combined with the exceptional quality of the product that the opponent has always striven to convey to the public, as the evidence adduced testifies. In fact, this image would be quite incompatible with goods of a strongly industrial and technological nature, such as electric meters, scientific microscopes, batteries, supermarket cash registers, fire-extinguishing apparatus or other instruments, for which the applicant intends to use its trade mark (para. 28).</p> <p>What would be detrimental to the image of its trade marks, which the opponent has carefully fostered for decades, is the use of a trade mark that recalls its own and is applied to goods characterised, in the public's perception, by a significant technological content (whereas a fine-leather article is rarely associated with technology) or as having an industrial origin (whereas fine leather goods are traditionally associated with craftsmanship) (para. 29).</p> <p>The use of a trade mark that is practically identical to a trade mark that the public has come to perceive as synonymous with fine leather goods of excellent manufacture for technical apparatus or electrical tools of all kinds will diminish its attraction, that is, its reputation, amongst the public who knows and values the earlier trade marks (para. 30).</p>		

Earlier reputed sign	EUTM application	Case No
EMILIO PUCCI 		
Reputed for <i>clothing and footwear for women</i>	Class 3: <i>Bleaching preparations and other substances for laundry use; cleaning, polishing, scouring and abrasive preparations; (abrasive preparations) soaps; perfumery, essential oils, cosmetics, hair lotions; dentifrices.</i> Class 21: <i>Materials for cleaning purposes and steelwool</i>	T-373/09 (cases R 770/2008-2 and R 826/2008-2)
<p>In its decisions of 18/06/2009 in R 0770/2008-2 and R 0826/2008-2, the Board stated that the risk of detriment to repute can occur where the goods and services covered by the mark applied for have a characteristic or a quality which may have a negative influence on the image of an earlier mark with a reputation on account of it being identical or similar to the mark applied for. The General Court confirmed the Board's finding, adding that due to the great similarity between the signs at issue, the strong distinctive character of the Italian mark and its notoriety in the Italian market, it can be concluded that there is a link between the signs in conflict, a link which could damage the idea of exclusivity, luxury and high quality and therefore be a detriment to the notoriety of the Italian mark (para. 68).</p>		

Tarnishment denied

Earlier reputed sign	EUTM application	Case No
 SEVE TROPHY		T-192/09
Reputed for <i>organisation of sports competitions</i>	Class 9	
<p>The Court noted that the opponent had not demonstrated any risk of injury to the reputation of the earlier marks, since it did not indicate how the attractiveness of the earlier marks would be diminished by the use of the contested mark on the contested goods. Specifically, it did not allege that the contested goods have any characteristic or quality that could have a negative influence on the image of the earlier marks (para. 68).</p>		

Earlier reputed sign	EUTM application	Case No
SPA	SPA-FINDERS	
Reputed for <i>mineral waters</i> in Class 32	<i>Printed publications including catalogues, magazines, newsletters in Class 16, Travel agency in Class 39</i>	T-67/04
<p>'This detriment is made out where the goods for which the mark applied for is used appeal to the public's senses in such a way that the earlier mark's power of attraction is diminished' (para. 46).</p> <p>'In the present case, SPA and SPA-FINDERS designate very different goods consisting, on the one hand, in mineral waters and, on the other, in publications and travel agency services. The Court finds that it is therefore unlikely that the goods and services covered by the mark SPA-FINDERS, even if they turn out to be of lower quality, would diminish the power of attraction of the mark SPA' (para. 49).</p>		

Earlier reputed sign	EUTM application	Case No
VIPS	VIPS	T-215/03
Reputed for <i>fast food restaurant chain</i> in Class 42	<i>Computer programming for hotel services</i> in Class 42	
<p>'The risk of that detriment (to the repute of the earlier mark) can, inter alia, occur where those goods or services have a characteristic or a quality which may have a negative influence on the image of an earlier mark with a reputation on account of its being identical or similar to the mark applied for' (para. 39).</p> <p>'It must be pointed out in this connection that, although some fast food chain marks have an indisputable reputation, they do not, in principle and failing evidence to the contrary, convey a particularly prestigious or high quality image, the fast food sector being associated with other qualities such as speed or availability and, to a certain extent, youth, since many young people frequent that type of establishment' (para. 57)</p> <p>'... it is appropriate to examine the risk that the use of the mark applied for could be detrimental to the reputation of the earlier mark. As was explained in paragraph 39 above, at issue is the risk that the association of the earlier mark with a reputation with the goods or services covered by the identical or similar mark applied for results in the earlier mark being damaged or tarnished, as a result of the fact that the goods or services covered by the mark applied for have a characteristic or a particular quality which may have a negative influence on the earlier mark's image' (para. 66)</p> <p>'In that regard, it must be stated that the services covered by the mark applied for do not have any characteristic or quality capable of establishing the likelihood of detriment of that type to the earlier mark. The applicant neither cited, nor a fortiori proved, any characteristic or quality of that kind. The mere existence of a connection between the services covered by the conflicting marks is neither sufficient nor determinative. It is true that the existence of such a connection strengthens the probability that the public, faced with the mark applied for, would also think of the earlier mark. However, that factor is not, in itself, sufficient to diminish the earlier mark's power of attraction. Such an outcome can arise only if it is established that the services covered by the mark applied for have characteristics or qualities which are potentially detrimental to the reputation of the earlier mark. Such evidence has not been adduced in the present case' (para. 67).</p>		

3.4.4 Proving the risk of injury

3.4.4.1 Standard and burden of proof

In opposition proceedings **detriment or unfair advantage may be only potential**, as confirmed by the conditional wording of Article 8(5) EUTMR, which requires that the use of the applied-for mark without due cause '**would take** unfair advantage of, **or be** detrimental to the distinctiveness or repute of the earlier mark'.

In opposition proceedings **actual detriment or unfair advantage** will occur only exceptionally given that in most cases the applicant will not have effectively used its mark when the dispute arises. Nevertheless, such a possibility should not be ruled out completely and if there is evidence of actual use or damage, it will have to be considered and given appropriate weight.

However, the fact that detriment or unfair advantage may be only potential does not mean that a mere possibility is sufficient for the purposes of Article 8(5) EUTMR. The risk of detriment or unfair advantage must be **serious**, in the sense that it is **foreseeable (i.e. not merely hypothetical) in the ordinary course of events**. Therefore, it is not enough to merely show that detriment or unfair advantage cannot be excluded in general, or that it is only remotely possible. The proprietor of the earlier mark **must adduce prima facie evidence** of a future risk, which is **not hypothetical**, of unfair advantage or of detriment (judgment of 06/06/2012, T-60/10 'ROYAL SHAKESPEARE', para. 53). As explained below, it is insufficient for the opponent only

to refer in general terms to an unfair advantage of, or detriment to, the distinctive character or reputation of its earlier marks without submitting convincing evidence of actual detriment or cogent arguments establishing a serious, not merely hypothetical, potential risk of detriment.

As a rule, **general allegations** (such as merely citing the relevant EUTMR wording) of detriment or unfair advantage will **not be sufficient** in themselves for proving potential detriment or unfair advantage: the opponent must adduce evidence and/or develop a cogent line of argument to demonstrate specifically how, taking into account both marks, the goods and services in question and all the relevant circumstances, the alleged injury might occur. **Merely showing the reputation and good image of the earlier marks, without further substantiation by way of evidence and/or reasoning is not sufficient** (decision of 15/2/2012, R 2559/2010-1 'GALLO', paras 38, 39, and the Court case-law cited therein). This is shown in the following paragraphs.

The precise threshold of proof which must be satisfied to show that the risk of potential detriment or unfair advantage is **serious** and not merely hypothetical will be determined case by case, following the criteria indicated below.

As mentioned in paragraph 3.1.4.2 above when discussing the burden of proof for establishing reputation, Article 76(1) EUTMR requires the opponent to submit and prove all the facts on which its opposition is based. Moreover, Rule 19(2)(c) CTMIR requires the opponent to **submit evidence or arguments** showing that use without due cause of the trade mark applied for would take unfair advantage of, or be detrimental to, the distinctive character or the repute of the earlier trade mark.

Therefore, within the period for completing the substantiation of the opposition, the **opponent bears the burden** of showing that the actual or future use of the applied-for mark has caused, or is likely to cause, detriment to the distinctiveness or the repute of the earlier mark, or that it has taken, or is likely to take, unfair advantage thereof.

In discharging this burden of proof, the opponent cannot merely contend that detriment or unfair advantage would be a necessary consequence flowing automatically from the use of the sign applied for, owing to the strong reputation of the earlier mark. Even where the earlier mark is highly reputed, unfair advantage or detriment must be **properly proved and/or argued** taking into account both marks and the relevant goods and services, since otherwise marks with reputation would enjoy blanket protection against identical or similar signs for virtually any kind of product. This would be clearly inconsistent with the wording and spirit of Article 8(5) EUTMR, because in such a case reputation would become the sole requirement, rather than being only one of the several conditions provided for therein.

Therefore, where the opponent claims **actual detriment or unfair advantage**, it must submit indications and evidence of the **kind** of detriment suffered, or of the nature of the unfair advantage taken by the applicant. The opponent must also show that this **resulted from the use** of the sign applied for. In doing so, the opponent may rely on a variety of indications, depending on the kind of detriment or unfair advantage pleaded, such as a considerable decrease in sales of the goods bearing the mark, or a loss of clientele, or a decline of the degree of recognition of the earlier mark among the public.

However, in the case of **potential detriment or unfair advantage**, the exercise will necessarily be more abstract, as the detriment or unfair advantage in question has to be evaluated *ex ante*.

To that end, the proprietor of the earlier mark is not required to demonstrate actual and present harm to his mark. When it is foreseeable that such injury would ensue from the use that might be made of the EUTM application, the proprietor of the earlier mark is not required to wait for it actually to occur in order to be able to prohibit registration of the EUTM application. The proprietor of the earlier mark must, however, prove that there is a **serious risk** that such an injury will occur in the future (judgment of 27/11/2008, C-252/07 'Intel', para. 38, judgment of 07/12/2010, T-59/08, 'NIMEI LA PERLA MODERN CLASSIC', para. 33, judgment of 29/03/2012, T-369/10 'BEATLE', para. 61, judgment of 06/07/2012 (appeal dismissed in C-294/12 P), T-60/10 'ROYAL SHAKESPEARE' para. 53 and judgment of 25/01/2012, T-332/10 'VIAGUARA', para. 25).

Such a finding may be established, in particular, on the basis of logical deductions made from an analysis of the probabilities and by taking account of the normal practice in the relevant commercial sector as well as all the other circumstances of the case (judgment of 10/05/2007, T-47/06, 'nasdaq' para. 54, upheld on appeal (C-320/07 P), judgment of 16/04/2008, T-181/05 'CITI' para. 78, and judgment of 14/11/2013, C-383/12P 'Wolf head image' paras 42-43).

However, considering that in such cases the matter to be proved is the likelihood of a future event and that, by definition, the opponent's arguments cannot in themselves amount to evidence, it will often be necessary to base certain conclusions on **legal presumptions**, that is, on logical assumptions or deductions resulting from the application of the rules of probability to the facts of the specific case. One such presumption was mentioned by the Court, when it stated that 'the stronger the earlier mark's distinctive character and reputation, the easier it will be to accept that detriment has been caused to it' (judgment of 14/09/1999, C-375/97, 'General Motors', para. 30). It is also clear from case-law that the more immediately and strongly the mark is brought to mind by the sign, the greater the likelihood that the current or future use of the sign is taking, or will take, unfair advantage of the distinctive character or the repute of the mark (judgment of 06/07/2012, T-60/10 'ROYAL SHAKESPEARE', para. 54, judgment of 18/06/2009, C-487/07 'L'Oréal and Others' para. 44, and judgment of 27/11/2008, C-252/07 'Intel', paras 67-69).

These are rebuttable presumptions, which the applicant may contest and disprove by submitting appropriate evidence; they are not conclusive presumptions.

In addition, if the type of detriment or unfair advantage argued in the specific case is of such a nature that presupposes the fulfilment of certain **particular conditions of fact** (e.g. exclusive character of the earlier mark, qualitative aspects of reputation, a given image etc.), these facts will also have to be proven by the opponent, who must submit appropriate evidence.

Finally, as noted by the Court in its judgment of 07/12/2010, T-59/08, 'NIMEI LA PERLA MODERN CLASSIC' (paras 57, 58), although a likelihood of confusion between the two marks at issue is not required to demonstrate that the later mark takes unfair advantage of the earlier mark, where such likelihood is established on the basis of facts, this will be taken as proof that unfair advantage has been taken or that, at least, there is a serious risk of such injury in the future.

3.4.4.2 Means of evidence

Where the opponent claims **potential** detriment or unfair advantage, it must prove any conditions of fact that might be necessary in particular cases for giving rise to a serious, non-hypothetical risk of detriment or unfair advantage, by submitting evidence of the kind mentioned in the paragraph below on proving actual detriment or unfair advantage.

Conclusions as to the risk of future injury may also be established on the basis of **logical deductions** made from an analysis of the probabilities and by taking account of the normal practice in the relevant commercial sector as well as all the other circumstances of the case (judgment of 16/12/2010, joined cases T-345/08 and T-357/08 'BOTOLIST' para. 82 and judgment of 06/07/2012, T-60/10, 'ROYAL SHAKESPEARE', para. 53, and judgment 14/11/13, C-383/12 P 'Wolf head image', paras 42-43).

Where the opponent claims **actual** detriment or unfair advantage, it can use all the means of evidence provided for in **Article 78 EUTMR** for proving this. For example, it may prove an actual decrease of trade mark awareness by reference to opinion polls and other documentary evidence. The rules governing the evaluation and probative value of such evidence are the same as those mentioned in paragraph 3.1.4.3 and paragraph 3.1.4.4 above in relation to the evidence required for proving reputation.

3.5 Use without due cause

The last condition for the application of Article 8(5) EUTMR is that use of the sign applied for should be without due cause.

However, if it is established that none of the three types of injury exists, the registration and use of the mark applied for cannot be prevented, as the existence or absence of due cause for the use of the mark applied for is, in those circumstances, irrelevant (judgment of 22/03/2007 T-215/03 'VIPS', para. 60, and judgment of 07/07/2010, T-124/09 'Carlo Roncato', para. 51).

The existence of a cause justifying the use of the trade mark applied for is a **defence** which the applicant may raise. Therefore, it **is up to the applicant to show that it has due cause to use the mark applied for**. This is an application of the general rule according to which 'he who asserts must prove' which is the expression of the ancient rule *ei qui affirmat incumbit probatio* (decision of 01/03/2004, R 145/2003-2 – 'T CARD OLYMPICS (FIG. MARK)/OLYMPIC', para. 23). Case-law clearly establishes that when the proprietor of the earlier mark has shown that there is either actual and present injury to its mark or, failing that, a serious risk that such injury will occur in the future, it is for the proprietor of the later mark to establish that there is due cause for the use of that mark (judgment of 06/07/2012, T-60/10, 'ROYAL SHAKESPEARE', para. 67 and, by analogy, judgment of 27/11/2008, C-252/07 'Intel', para. 39).

In the absence of any indications in the evidence providing an apparent justification for the applicant's use of the contested mark, the lack of due cause must be generally **presumed** (see to that effect judgment of 29/03/2012, T-369/10, 'Beatle', para. 76 and the case-law there cited, appeal C-294/12 P dismissed). However, the applicant may avail itself of the possibility of rebutting such a presumption by showing that it has a legitimate justification that entitles it to use the mark.

For example, such a situation could be envisaged if the applicant had been using the sign for dissimilar goods in the relevant territory before the opponent's mark was applied for, or acquired a reputation, especially where such a coexistence has not in any way affected the distinctiveness and repute of the earlier mark.

Interpreting Article 5(2) of Directive 89/104 (whose legislative content is essentially identical to that of Article 8(5) EUTMR), the Court ruled that the proprietor of a trade mark with a reputation might be obliged, pursuant to the concept of 'due cause' within the meaning of that provision, to tolerate the use by a third party of a sign similar to that mark in relation to a product that was identical to that for which that mark had been registered, if it was demonstrated that that sign was being used before that mark had been filed and that the use of that sign in relation to the identical product was in good faith (judgment of 06/02/2014, C-65/12, 'The Bulldog', para. 60). The Court gave further detailed factors to be considered in the assessment of due cause on account of prior use.

The case-law below shows that due cause may be found where the applicant establishes that it cannot reasonably be required to abstain from use of the mark (for example, because its use of the sign is a generic use to indicate the type of goods and services — whether by generic words or generic figurative devices), or where it has some specific right to use the mark for the goods and services (for example, it shows that a relevant coexistence agreement permits its use of the sign).

The condition of due cause is not fulfilled merely by the fact that (a) the sign is particularly suitable for identifying the products for which it is used, (b) the applicant has already used this sign for these products or similar products within and/or outside the relevant territory of the European Union, or (c) the applicant invokes a right ensuing from a filing over which the filing of the opponent's trade mark takes precedence (see, inter alia, decision of 23/11/2010, R 0240/2004-2 'WATERFORD (fig.)' and decision of 15/06/2009, R 1142/2005-2 'MARIE CLAIRE (fig.)'). Mere use of the sign is not enough — what must be shown is a valid reason justifying that use.

Examples of due cause

Due cause was accepted

Case No	Comment
Decision of 02/06/2010, R 1000/2009-1, 'FLEX (fig.)', para. 72	The Board confirmed that the applicant had a due cause within the meaning of Article 8(5) EUTMR for inserting the term 'FLEX' in the mark applied for, holding that this term was free from monopolies, since nobody holds exclusive rights in it and it is a suitable abbreviation, in many languages of the EU, to indicate that beds and mattresses are flexible.
Decision of 26/02/2008, R 320/2007-2, 'biscuit packet (3D)/OREO(3D)'	The Board held that the applicant had due cause to represent the series of sandwich-type biscuits in the three-dimensional mark applied for, namely, to indicate to consumers the type of biscuits concerned, as defined by the relevant Spanish legislation.
Decision of 30/07/2007, R 1244/2006-1, 'M FRATELLI MARTINI (fig.)'	The Board confirmed that the applicant had two good reasons to use the name MARTINI in the mark applied for: (i) 'MARTINI' is the family name of the founder of the applicant's company, and (ii) the existence of a coexistence agreement from 1990.

Case No	Comment
Decision of 20/04/2007, R 710/2006-2, 'CAL SPAS'	The Board confirmed that the applicant had due cause to use the term 'SPAS' as it corresponds to one of the generic uses of the term 'spa' as indicated by the Court of First Instance in the 'Mineral Spa' judgment Case T-93/06.
Decision of 23/01/2009, R 237/2008 & R 263/2008-1, 'CARLO RONCATO'	The business affairs of the Roncato family, showing that both parties had the right to use the name 'RONCATO' as a trade mark in the suitcase and trunk sector, were held to constitute 'due cause' for use of the 'RONCATO' name in the contested trade mark.
Decision of 25/08/2011, Opposition decision B 1 708 398 'Posten AB v Česká pošta s.p.',	It was held that the applicant had due cause to use the figurative element of a postal horn since that device is widely used as a long-standing and historical symbol of postal services (trade mark registrations and internet evidence were submitted showing 29 European countries use the postal horn as a symbol for their postal services).

Due cause was not accepted

Case No	Comment
Judgment of 06/07/2012, T-60/10, 'ROYAL SHAKESPEARE', paras 65-69	The General Court held that, in order to establish due cause, it is not use per se of the contested trade mark that is required, but a reason justifying the use of that trade mark. In this case, the applicant merely claimed to have 'demonstrated how and for which product the contested trade mark has been used in the past' but, even assuming that that aspect is relevant, provided no additional indication or explanation. Accordingly, the Court held that the applicant had not established due cause for such use.
Judgment of 25/03/2009, T-21/07, 'L'Oréal SA', para. 43	The General Court held that there was no due cause, since it had not been shown that the word 'spa' had become so necessary to the marketing of cosmetic products that the applicant could not reasonably be required to refrain from use of the mark applied for. The argument that 'spa' was of descriptive and generic character for cosmetic products was rejected, since such character does not extend to cosmetic products but only to one of their uses or destinations.
Judgment of 16/04/2008, T-181/05 'CITI', para. 85	The General Court held that the use of the trade mark CITI in just one EU Member State (Spain) could not constitute due cause because, first, the extent of geographical protection of the national trade mark did not correspond to the territory covered by the trade mark applied for, and, second, the legal validity of that national registration was subject to dispute before the national courts. By the same token, the ownership of the domain 'citi.es' was held to be irrelevant.
Judgment of 10/05/2007, T-47/06, 'NASDAQ', para. 63, confirmed by CJ, C-327/07 P	The Court held that the only argument put forward before the Board of Appeal in respect of due cause (namely, that the word 'nasdaq' had been chosen because it is an acronym for 'Nuovi Articoli Sportivi Di Alta Qualità') was not convincing, noting that prepositions are not generally included in acronyms.

Case No	Comment
Decision of 23/11/2010, R 240/2004-2 'WATERFORD (fig.)'	<p>Contrary to the applicant's arguments that there was due cause because the term 'WATERFORD' was allegedly very common in names and trade marks, the Board held that the applicant had failed to give any evidence of market coexistence of WATERFORD marks nor had it submitted any element from which it would be possible to infer that the relevant general public (in the UK) considers Waterford as a commonplace geographical name.</p> <p>To the extent that such arguments play a role in the assessment of uniqueness of a sign in order to establish the existence of the necessary link in the mind of the relevant public between the signs at issue, the Board held that, nevertheless, once such uniqueness had been established, such arguments cannot serve as due cause.</p> <p>Further, the Board noted that the condition of due cause is not fulfilled merely by the fact that (a) the sign is particularly suitable for identifying the products for which it is used, (b) the applicant has already used this sign for these products or similar products within and/or outside the relevant territory of the European Union, or (c) the applicant invokes a right ensuing from a filing over which the filing of the opponent's trade mark takes precedence.</p>
Decision of 06/10/2006, R 428/2005-2 'TISSOT'	<p>The Board held that the applicant's claim (unsubstantiated by any evidence) that the sign TISSOT is derived from the name of a trading company associated with the applicant's company since the early 1970s, would, even if proven, not amount, on its own, to 'due cause', within the meaning of Article 8(5) EUTMR. People who inherit a surname that happens to coincide with a famous trade mark should not assume that they are entitled to use it in business in a manner that would unfairly take advantage of the reputation that has been built up by the efforts of the brand owner.</p>
Decision of 18/08/2005, R 1062/2000-4, 'GRAMMY'	<p>The applicant argued that 'GRAMMY' is an internationally easy and nice-sounding abbreviation of the applicant's family name (Grammatikopoulos). The Board rejected this argument as insufficient to establish the due cause that could prevent the application of Article 8(5) EUTMR.</p>

Case No	Comment
Decision of 15/06/2009, R 1142/2005-2, 'MARIE CLAIRE (fig.)'	<p>Due cause under Article 8(5) EUTMR means that notwithstanding the detriment caused to, or the unfair advantage taken of, the distinctive character or reputation of the earlier trade mark, the registration and use by the applicant of the mark for the goods applied for may be justified, if the applicant cannot be reasonably required to abstain from using the contested mark, or if the applicant has a specific right to use the mark for with such goods which takes precedence over the earlier trade mark invoked in the opposition proceedings. In particular, the condition of due cause is not fulfilled merely by the fact that (a) the sign is particularly suitable for identifying the products for which it is used, (b) the applicant has already used this sign for these products or similar products within and/or outside the relevant territory of the EU, or (c) the applicant invokes a trade mark with a filing date which is earlier than the opponent's trade mark (decision of 25/04/2001 in R 283/1999-3 HOLLYWOOD / HOLLYWOOD).</p> <p>With regards to the tolerance of the proprietor of the earlier mark, the Board held that such tolerance was merely for magazines and not for goods closer to its market sector (i.e. textiles). It noted that national case-law showed that while protection exists for each party within its own field of business, extension should be refused when they come closer to the other party's field of activities and could infringe upon their rights.</p> <p>In light of these factors, the Board held that the coexistence did not constitute due cause permitting registration of a EUTM.</p>
Judgment of 26/09/2012, T-301/09, 'Citigate', paras 116, 125 and 126	<p>As regards the applicant's argument that it has due cause to use the mark applied for (CITIGATE), because it has used a variety of marks consisting of or containing CITIGATE in relation to the goods and services for which registration is sought, the Court stated the following: it should be noted that the documents produced by the applicant simply show that there are various companies whose business name contains the word CITIGATE and a number of domain names which also contain that word. That evidence is not sufficient to establish due cause, because it does not demonstrate actual use of the CITIGATE mark.</p> <p>As regards the applicant's argument that it has due cause to use the mark applied for since <u>the interveners have acquiesced to the use</u> of CITIGATE in relation to the goods and services covered by the application for registration, the Court stated that <u>the possibility cannot be excluded that, in certain cases, the coexistence of earlier marks on the market could reduce (...) the likelihood of a connection being made between two marks in accordance with Article 8(5).</u></p> <p>In the present case, coexistence was not proven.</p>

***GUIDELINES FOR EXAMINATION OF
EUROPEAN UNION TRADE MARKS***

***EUROPEAN UNION
INTELLECTUAL PROPERTY OFFICE
(EUIPO)***

PART C

OPPOSITION

SECTION 6

PROOF OF USE

Table of Contents

1	General Considerations	5
1.1	Function of proof of use	5
1.2	Legislative framework.....	5
1.2.1	EUTMR and IR.....	5
1.2.1.1	Article 15 EUTMR — obligation to use registered marks.....	5
1.2.1.2	Article 42 EUTMR — consequences of lack of use	6
1.2.1.3	Rule 22 EUTMIR — procedural rules, evidence and language	7
1.2.2	Trade Marks Directive and national law implementing the Directive.....	8
2	Substantive Law	8
2.1	Genuine use: the principles of the Court of Justice	8
2.2	Genuine use: standard of proof applied by the Office.....	9
2.3	Nature of use: use as a mark in the course of trade	11
2.3.1	The term ‘nature of use’	11
2.3.2	Use as a mark	11
2.3.3	Public use in the course of trade	13
2.3.3.1	Public use v internal use.....	13
2.3.3.2	Commercial activity v promotional activity	14
2.3.4	Use in relation to goods or services	14
2.3.4.1	Use in relation to goods.....	14
2.3.4.2	Use in relation to services	15
2.3.4.3	Use in advertising	16
2.3.4.4	Use on the internet	17
2.4	Place of use	19
2.4.1	Use on the ‘domestic’ market.....	19
2.4.2	EUTMs: use in the European Union	20
2.4.3	National marks: use in the relevant Member State	21
2.4.4	Use in import and export trade	21
2.5	Time of use	22
2.5.1	Oppositions filed on or after 23/03/2016	22
2.5.2	Oppositions filed before 23/03/2016	22
2.6	Extent of use.....	23
2.6.1	Criteria 23	
2.6.2	Examples of insufficient use	24
2.6.3	Examples of sufficient use	26
2.7	Use of the mark in forms different from the one registered	27
2.7.1	Introduction.....	27
2.7.2	Criteria of the Court.....	28
2.7.3	Office practice.....	28
2.7.3.1	Additions.....	29
2.7.3.2	Omissions.....	37
2.7.3.3	Other alterations	41
2.8	Use for the goods or services for which the mark is registered	47
2.8.1	Comparison between goods/services used and specification of goods/services	48

2.8.2	Relevance of the classification	49
2.8.3	Use and registration for general indications in ‘class headings’	49
2.8.4	Use for subcategories of goods/services and similar goods/services 50	
2.8.4.1	Earlier mark registered for broad category of goods/services	50
2.8.4.2	Earlier mark registered for precisely specified goods/services	51
2.8.4.3	Examples.....	52
2.8.5	Use of the mark as regards integral parts and after-sales services of the registered goods	54
2.9	Use by the proprietor or on its behalf	55
2.9.1	Use by the proprietor	55
2.9.2	Use by authorised third parties.....	55
2.9.3	Use of collective marks.....	56
2.10	Legal use.....	56
2.11	Justification of non-use	56
2.11.1	Business risks	57
2.11.2	Government or Court intervention	57
2.11.3	Defensive registrations	59
2.11.4	<i>Force majeure</i>	59
2.11.5	Consequences of justification of non-use.....	59
3	Procedure.....	59
3.1	Admissibility of the request for proof of use.....	59
3.1.1	Time of request.....	60
3.1.2	Earlier mark registered for not less than five years	60
3.1.2.1	Earlier EUTMs	60
3.1.2.2	Earlier national marks.....	61
3.1.2.3	Earlier International registrations designating a Member State	61
3.1.2.4	Earlier International registrations designating the European Union.....	63
3.1.2.5	Summary of calculation of the grace period	63
3.1.3	Request must be explicit, unambiguous and unconditional	63
3.1.4	Applicant’s interest to deal with proof of use first	65
3.1.5	Reaction if request is invalid.....	65
3.2	Express invitation by the Office	65
3.3	Reaction from the opponent: providing proof of use	66
3.3.1	Time limit for providing proof of use.....	66
3.3.2	Means of evidence.....	67
3.3.2.1	Principles.....	67
3.3.2.2	References	69
3.3.2.3	Declarations	69
3.4	Reaction from the applicant	71
3.4.1	Forwarding of evidence	71
3.4.2	No evidence or no relevant evidence submitted.....	72
3.4.3	No reaction from applicant.....	72
3.4.4	Formal withdrawal of the request	72
3.5	Further reaction from the opponent.....	72
3.6	Languages in proof of use proceedings.....	72
3.7	Decision	73
3.7.1	Competence of the Office	73

3.7.2	Need for assessing proof of use	74
3.7.3	Overall assessment of the evidence presented	74
3.7.4	Examples	75
3.7.4.1	Genuine use accepted	75
3.7.4.2	Genuine use not accepted.....	77
Annex	78
Five-year period for assessing use of national trade marks	78

1 General Considerations

1.1 Function of proof of use

Union legislation on trade marks establishes an ‘obligation’ for the owner of a registered trade mark to use that mark in a genuine manner. The obligation of use is not applicable immediately after registration of the earlier mark. Instead, the owner of a registered mark has a so-called ‘grace period’ of five years during which it is not necessary to demonstrate use of the mark in order to rely upon it — including in opposition proceedings before the Office. After this grace period, the owner may be required to demonstrate use of the earlier mark for the relevant goods and services. Before this period lapses, the mere formal registration gives the mark its full protection.

The reason behind the requirement that earlier marks can be required to demonstrate that they have been put to genuine use is to restrict the number of trade marks registered and protected and, consequently, the number of conflicts between them. This interpretation is supported by the ninth recital in the preamble to Directive 2008/95, which explicitly refers to that objective (judgment of 12/03/2003, T-174/01, Silk Cocoon, EU:T:2003:68, § 38).

When it comes to the requirement to prove use in opposition proceedings before the Office, it is important to bear in mind that the purpose of Article 42(2) and (3) EUTMR is not to assess commercial success or to review the economic strategy of an undertaking, nor is it to restrict trade-mark protection to only large-scale commercial use of the marks (judgments of 08/07/2004, T-334/01, Hipoviton, EU:T:2004:223, § 32; 08/07/2004, T-203/02, Vitafruit, EU:T:2004:225, § 38).

The Office does not inquire *ex officio* whether the earlier mark has been used. Such examination takes place only when the EUTM applicant makes an explicit request for proof of use. Such a request, if the legal requirements are met, triggers the procedural and substantive consequences laid down in the EUTMR and the EUTMIR.

1.2 Legislative framework

The legislative framework consists of provisions in the EUTMR, in the EUTMIR, and in the Trade Marks Directive as implemented in the national law of the Member States.

1.2.1 EUTMR and IR

1.2.1.1 Article 15 EUTMR — obligation to use registered marks

Article 15 EUTMR stipulates the basic substantive requirement for the obligation to use registered marks and Article 15(1) EUTMR reads:

If, within a period of five years following registration, the proprietor has not put the EU trade mark to genuine use in the Union in connection with the goods or services in respect of which it is registered, or if such use has been suspended during an uninterrupted period of five years, the EU trade mark shall be subject to the sanctions provided for in this Regulation, unless there are proper reasons for non-use.

In accordance with Article 15(1)(a) and (b) EUTMR, use of the EU trade mark in a form differing in elements that do not alter the distinctive character of the mark in the form in which it was registered, regardless of whether or not the trade mark in the form as used is also registered in the name of the proprietor, and the affixing of the EU trade mark to goods or to the packaging thereof in the Union solely for export purposes, also constitute use within the meaning of Article 15(1) EUTMR.

In accordance with Article 15(2) EUTMR, use of the EU trade mark with the consent of the proprietor will be deemed to constitute use by the proprietor.

1.2.1.2 Article 42 EUTMR — consequences of lack of use

The consequences of a lack of use in opposition proceedings are dealt with in Article 42(2) and (3) EUTMR. According to Article 42(2) EUTMR:

If the applicant so requests, the proprietor of an earlier EU trade mark who has given notice of opposition shall furnish proof that, during the five-year period preceding the date of filing or the date of priority of the EU trade mark application, the earlier EU trade mark has been put to genuine use in the Union in connection with the goods or services in respect of which it is registered and which he cites as justification for his opposition, or that there are proper reasons for non-use, provided the earlier EU trade mark has at that date been registered for not less than five years. In the absence of proof to this effect, the opposition shall be rejected. If the earlier EU trade mark has been used in relation to only part of the goods or services for which it is registered it shall, for the purposes of the examination of the opposition, be deemed to be registered in respect only of that part of the goods or services.

This wording is the result of Regulation No 2015/2424 amending Regulation No 207/2009 ('Amending Regulation'), which entered into force on 23/03/2016. Previously, the five-year period was computed backwards from the date of publication of the contested EUTM application. For oppositions filed before the date of entry into force of the Amending Regulation, the relevant period will continue to be counted from the date of publication of the contested EUTM application.

In accordance with Article 42(3) EUTMR:

Paragraph 2 shall apply to earlier national trade marks referred to in Article 8(2)(a), by substituting use in the Member State in which the earlier national trade mark is protected for use in the Union.

There is no express provision in the EUTMR that such forms of use as mentioned in Article 15(1) and (2) EUTMR may also be regarded as use of earlier national trade marks. However, the concept of the obligation to use the registered mark is harmonised as a consequence of Article 10(2) and (3) of Directive 2008/95/EC of the European Parliament and of the Council of 22 October 2008 to approximate the laws of the Member States relating to trade marks ('Directive'). Hence, it is appropriate to apply the same substantive provision as Article 15(1) and (2) EUTMR to the use of earlier national trade marks, with the only difference being that such use must be made in the Member State in which the national mark is registered.

Moreover, it results from the wording of Article 42(2) and (3) EUTMR that proof of use can only be requested if the earlier right is an **EUTM** or other **trade mark** having effect in the EU or an EU Member State, as defined in Article 8(2)(a) EUTMR. Since oppositions brought under **Article 8(4) EUTMR** cannot be based on either EUTMs or other trade marks referred to in Article 8(2)(a) EUTMR, the EUTM applicant is not entitled to request proof of use for earlier rights relied upon in oppositions brought under this provision. Nevertheless, Article 8(4) EUTMR requires the opponent to prove use in the course of trade of more than mere local significance for the earlier rights in question.

As for **Article 8(3) EUTMR**, the Office's practice is that requests for proof of use of the earlier right cannot be made. The reason is that such earlier rights include both trade marks having effect in the EU/EU Member States (EUTMs, national trade marks, IRs) **and** national non-EU trade marks, requests for proof of use of the latter not being possible under the EUTMR. It would be discriminatory to request proof of use for some countries' trade marks but not for others. Accordingly, and in view of the specific subject matter for protection under Article 8(3) EUTMR, while the use or lack of use made of the earlier rights may have a bearing on arguments regarding the justification for applying for the EUTM, the opponent cannot be obliged to provide proof of use under Article 42(3) EUTMR for any earlier rights thereby relied upon.

1.2.1.3 Rule 22 EUTMIR — procedural rules, evidence and language

In accordance with Rule 22(2) EUTMIR, where, pursuant to Article 42(2) or (3) EUTMR, the opponent has to submit proof of use or show that there are proper reasons for non-use, the Office will invite the opponent to provide the proof required within a period specified by the Office. If the opponent does not provide such proof before the time limit expires, the Office will reject the opposition.

In accordance with Rule 22(3) EUTMIR, the indications and evidence required in order to submit proof of use must consist of indications concerning the place, time, extent and nature of use of the opposing trade mark for the goods and services in respect of which it is registered and on which the opposition is based, and evidence in support of these indications in accordance with paragraph 4.

In accordance with Rule 22(4) EUTMIR, the evidence must consist of written documents and in principle be confined to the submission of supporting documents and items such as packages, labels, price lists, catalogues, invoices, photographs, newspaper advertisements, and statements in writing as referred to in Article 78(1)(f) EUTMR.

In accordance with Rule 22(5) EUTMIR, a request for proof of use may be made with or without submitting, at the same time, observations on the grounds on which the opposition is based. Such observations may be filed together with the observations in reply to the proof of use.

In accordance with Rule 22(6) EUTMIR, where the evidence supplied pursuant to paragraphs 1, 2 and 3 is not in the language of the opposition proceedings, the Office may require the opponent to submit a translation of that evidence in that language, within a period specified by the Office.

1.2.2 Trade Marks Directive and national law implementing the Directive

Article 10 of the Directive contains provisions identical to Article 15 EUTMR, with 'use in the Union' being replaced by 'use in the Member State'.

2 Substantive Law

2.1 Genuine use: the principles of the Court of Justice

Neither the EUTMR nor the EUTMIR defines what is to be regarded as 'genuine use'. However, the Court of Justice (the 'Court') has laid down several important principles as regards the interpretation of this term.

In the '**Minimax**' 2003 (judgment of 11/03/2003, C-40/01, Minimax, EU:C:2003:145), the Court established the following principles:

- genuine use means **actual** use of the mark (paragraph 35);
- genuine use must, therefore, be understood to denote use that is **not merely token**, serving solely to preserve the rights conferred by the mark (paragraph 36);
- genuine use must be consistent with the **essential function** of a trade mark, which is to guarantee the identity of the origin of goods or services to the consumer or end user by enabling the latter, without any possibility of confusion, to distinguish the product or service from others that have another origin (paragraph 36);
- genuine use entails use of the mark **on the market** for the goods or services protected by that mark and not just internal use by the undertaking concerned (paragraph 37);
- genuine use must relate to **goods or services** already marketed or about to be marketed and for which preparations by the undertaking to secure customers are under way, particularly in the form of advertising campaigns (paragraph 37);
- when assessing whether there has been genuine use, regard must be had to all the facts and circumstances relevant to establishing whether the commercial exploitation of the mark is **real**, in particular whether such use is viewed as warranted in the economic sector concerned to **maintain or create a share in the market** for the goods or services protected by the mark (paragraph 38);
- the circumstances of the case may, therefore, include giving consideration, inter alia, to the **nature** of the goods or services at issue, the **characteristics of the market** concerned and the scale and **frequency** of use of the mark (paragraph 39);
- use need **not**, therefore, always be **quantitatively significant** for it to be deemed genuine, as that depends on the characteristics of the goods or services concerned on the corresponding market (paragraph 39).

In **La Mer 2004** (order of 27/01/2004, C-259/02, Laboratoire de la mer, EU:C:2004:50), the Court further elaborated the ‘Minimax’ criteria as follows:

- the question whether use is sufficient to preserve or create market share for those goods or services depends on several factors and on a case-by-case assessment. The **characteristics** of those goods and services, the **frequency or regularity** of the use of the mark, whether the mark is used for the purpose of marketing **all** the identical goods or services of the proprietor or merely some of them, or evidence that the proprietor is able to provide, are among the factors that may be taken into account (paragraph 22);
- use of the mark by a single client which **imports** the goods for which the mark is registered can be sufficient to demonstrate that such use is genuine, if it appears that the import operation has a genuine commercial justification for the proprietor of the mark (paragraph 24);
- a **de minimis rule** cannot be laid down (paragraph 25).

2.2 Genuine use: standard of proof applied by the Office

Article 42 EUTMR requires **proof** of genuine use of the earlier mark. Genuine use of a trade mark cannot be proved by means of probabilities or suppositions, but must be demonstrated by solid and objective evidence of effective and sufficient use of the trade mark on the market concerned (judgment of 18/01/2011, T-382/08, Vogue, EU:T:2011:9, § 22).

Moreover, the Office cannot determine *ex officio* the genuine use of earlier marks. Even proprietors of purportedly well-known marks must submit evidence to prove genuine use of the earlier mark(s).

The Office does not necessarily require a high threshold of proof of genuine use. The Court has indicated that it is not possible to prescribe, in the abstract, **what quantitative threshold should be chosen** in order to determine whether use was genuine or not, and accordingly there can be no objective *de minimis* rule to establish a priori the level of use needed in order for it to be ‘genuine’. So, whilst a minimum extent of use must be shown, what exactly constitutes this minimum extent depends on the circumstances of each case. The general rule is that, when it serves a real commercial purpose, **even minimal use of the trade mark could be sufficient to establish genuine use**, depending on the goods and services, and the **relevant market** (judgments of 23/09/2009, T-409/07, acopat, EU:T:2009:354, § 35 and the quoted case-law; 02/02/2012, T-387/10, Arantax, EU:T:2012:51, § 42).

In other words, it will be sufficient if the evidence of use proves that the trade mark owner has seriously tried to acquire or maintain a commercial position in the relevant market as opposed to having solely used the mark with the intention of preserving the rights conferred by the mark (token use). For instance, in some cases, relatively few sales might be sufficient to conclude that the use is not merely token, in particular with regard to expensive goods (decision of 04/09/2007, R 0035/2007-2, DINKY, § 22). Nonetheless, even if inter alia a very modest amount of use can suffice in certain circumstances, proprietors should adduce **comprehensive evidence of use**.

In accordance with Rule 22(3) EUTMIR, the indications and evidence required in order to provide proof of use must consist of indications concerning the **place, time, extent and nature of use** of the opponent's trade mark for the relevant goods and services.

These requirements for proof of use are **cumulative** (judgment of 05/10/2010, T-92/09, STRATEGI, EU:T:2010:424, § 43). This means that the opponent is obliged not only to indicate but also to prove each of these requirements. However, the sufficiency of the indication and proof as to the place, time, extent and nature of use has to be considered in view of the **entirety** of the evidence submitted. A separate assessment of the various relevant factors, each considered in isolation, is not suitable (judgment of 17/02/2011, T-324/09, Friboi, EU:T:2011:47, § 31).

Thus, the Office evaluates the evidence submitted in **an overall assessment**. All the circumstances of the specific case have to be taken into account and all the materials submitted must be assessed **in conjunction with each other**. Therefore, although pieces of evidence may be insufficient by themselves to prove the use of an earlier trade mark, they may contribute to proving use in combination with other documentation and information.

Evidence of use may be **of an indirect/circumstantial nature**, such as evidence about the share in the relevant market, the import of the relevant goods, the supply of the necessary raw material or packaging to the owner of the mark, or the expiry date of the relevant goods. Such indirect evidence can play a decisive role in the overall assessment of the evidence submitted. Its probative value has to be carefully assessed. For instance, the judgment of 08/07/2010, T-30/09, Peerstorm, EU:T:2010:298, § 42 et seq. found that catalogues in themselves could — under certain circumstances — be conclusive evidence of sufficient extent of use.

It is necessary to take into account **the specific kind of the goods and services involved** when assessing the probative value of the evidence submitted. For example, it may be common in a particular market sector for the samples of the goods and services themselves not to bear indications of the place, time, extent and nature of use. In these cases it is obviously inappropriate to disregard such evidence of use if indications in this respect can be found in the other evidence submitted.

Each of the documents submitted has to be carefully evaluated as to whether it really reflects use in the five years preceding the date of filing or the date of priority¹ of the EUTM application (see paragraph 2.5 below) or use in the relevant territory (see paragraph 2.4 below). In particular, the dates and place of use shown on orders, invoices and catalogues are carefully examined.

Material submitted **without any indication of date of use** may, in the context of an overall assessment, still be relevant and taken into consideration **in conjunction with other pieces** of evidence that are dated (judgment of 17/02/2011, T-324/09, Friboi, EU:T:2011:47, § 33). This is the case in particular if it is common in a particular market sector for the samples of the goods and services themselves not to bear indications of time (decision of 05/09/2001, R 0608/2000-4, Palazzo, § 16, noting that ice-cream menus are rarely dated).

¹ Publication date of the contested EUTM application in case of oppositions filed before 23/03/2016, see paragraph 2.5.2 below.

For implementation of the abovementioned general principles in practice, see the examples in paragraph 3.7.4 below.

2.3 Nature of use: use as a mark in the course of trade

2.3.1 The term 'nature of use'

The required 'nature of use' of the sign refers to:

- its use as a trade mark in the course of trade;
- the use of the mark as registered, or of a variation thereof according to Article 15(1)(a) EUTMR (paragraph 2.7 below); and
- the use for the goods and services for which it is registered (paragraph 2.8 below).

2.3.2 Use as a mark

Articles 15 and 42(2) EUTMR require proof of genuine use in connection with the goods or services for which the trade mark is registered and which the opponent cites as justification for its opposition. Hence, the opponent has to show that the mark has been used as a trade mark on the market.

As a trade mark has, inter alia, the function of operating as a link between the goods and services and the person responsible for their marketing, the proof of use must establish a **clear link between the use of the mark and the relevant goods and services**. As clearly indicated in Rule 22(4) EUTMIR, it is not necessary for the mark to be affixed to the goods themselves (judgment of 12/12/2014, T-105/13 TrinkFix, EU:T:2014:1070, § 28-38) A representation of the mark on packaging, catalogues, advertising material or invoices relating to the goods and services in question constitutes direct evidence that the mark has been put to genuine use (see also paragraph 2.3.3.2 below).

Genuine use requires that use is made as a **trade mark**:

- not for purely illustrative purposes or on purely promotional goods or services.
- in accordance with its essential function, which is to guarantee the identity of the origin of the goods or services for which it is registered (judgment of 11/03/2003, C-40/01, Minimax, EU:C:2003:145, § 43).

Therefore, by way of example, the following are **not suitable** for supporting genuine use of the trade mark.

- (1) Use as a **certification mark**. Certification marks can be obtained in some jurisdictions for compliance with defined standards. The holder of a certification mark is not the authorised user, producer or provider of the certified goods or services, but rather the certifier, who exercises legitimate control over the use of the certification mark. Certification marks may be used together with the individual trade mark of the producer of the certified goods or of the provider of

the certified services. The essential function of a certification mark is different from the essential function of an individual trade mark: while the latter primarily serves to identify the origin of goods and services, the former serves to certify that the goods or services meet certain established standards and possess particular characteristics. Therefore, use as certification mark does not serve as use as individual trade mark, which is the use required by Article 42(2) and (3) EUTMR (decision of 16/08/2011, R 0087/2010-2, DVC-DVB, § 32).

- (2) Use as a **Protected Geographical Indication (PGI)/Protected Denomination of Origin (PDO)**. The essential function of PGIs/PDOs is to designate the origin of goods as being from a particular region or locality. This is in contrast with the main function of an individual trade mark, namely to serve as an indicator of commercial origin. When a PGI/PDO has been registered as an individual mark (and not, for example, as a collective mark), the opponent has to submit proof about the use as an individual mark. Evidence of use as PGI/PDO (e.g. general statements of Regulatory Councils) cannot serve for proving use as an individual mark. If the PGI/PDO is registered as a collective mark, evidence of use must be provided to show that the PGI/PDO is used according to the essential function of collective marks, which is to distinguish the goods or services of the members of the association that is the proprietor of the mark from those of other undertakings (decision of 23/11/2011, R 1497/2010-2, YECLA, § 34 and 45).

Depending on the circumstances, the following situations may be suitable for supporting genuine use of the registered trade mark. That is because the use of the sign can serve more than one purpose at the same time. Consequently, the following uses can also be use of the sign as a trade mark. However, the purpose for which a sign is used needs to be assessed individually.

- (1) The **use of a sign as a business, company or trade name** can be regarded as trade mark use provided that the relevant goods or services themselves are identified and offered on the market under this sign (judgment of 13/04/2011, T-209/09, Alder Capital, EU:T:2011:169, § 55-56). In general, this is not the case when the business name is merely used as a shop sign (except when proving use for retail services), or appears on the back of a catalogue or as an incidental indication on a label (judgment of 18/01/2011, T-382/08, Vogue, EU:T:2011:9, § 47).

In principle, the use of the sign as a **company name or trade name**, is not, of itself, intended to distinguish goods or services. The purpose of a **company name** is to identify a company, whereas the purpose of a **trade name or a shop name** is to designate a business which is being run. Accordingly, where the use of a company name, trade name or shop name is limited to identifying a company or designating a business which is being run, such use cannot be considered as being 'in relation to goods or services' (judgments of 11/09/2007, C-17/06, Céline, EU:C:2007:497, § 21; 13/05/2009, T-183/08, Jello Schuhpark II, EU:T:2009:156, § 31-32).

The use of a business, company or trade name can be regarded as **use 'in relation to goods'** where:

- (a) a party **affixes the sign** constituting its company name, trade name or shop name to the goods or;

- (b) even though the sign is not affixed, that party uses that sign in such a way that a **link is established** between the company, trade or shop name and the goods or services (judgment of 11/09/2007, C-17/06, Céline, EU:C:2007:497, § 21-23).

Provided that either of these two conditions is met, the fact that a word element is used as the company's trade name does not preclude its use as a mark to designate goods or services (judgment of 30/11/2009, T-353/07, Coloris, EU:T:2009:475, § 38).

For example, the presentation of the business name at the top of **order forms or invoices**, depending on how the sign appears on them may be suitable to support genuine use of the registered trade mark (judgment of 06/11/2014, T-463/12, MB, EU:T:2014:935, § 44-45).

However, mere use of a business name at the top of invoices without a clear reference to specific products/services is not sufficient.

- (2) Use of a **sign as a domain name or as part of a domain name** primarily identifies the website as such. However, depending on the circumstances, such use may also be use of a registered mark (which presupposes that it connects to a site on which the goods and services appear).

The mere fact that the opponent has registered a domain name containing the earlier trade mark is not sufficient in itself to prove genuine use of this trade mark. It is necessary for the party to prove that the relevant goods or services are offered under the trade mark contained in the domain name.

2.3.3 Public use in the course of trade

2.3.3.1 Public use v internal use

The use must be public, that is to say it must be external and apparent to actual or potential customers of the goods or services. Use in the private sphere or purely internal use within a company or a group of companies does not amount to genuine use (judgments of 09/12/2008, C-442/07, Radetzky, EU:C:2008:696, § 22; 11/03/2003, C-40/01, Minimax, EU:C:2003:145, § 37).

The mark must be used **publicly and outwardly** in the context of commercial activity with a view to economic advantage for the purpose of ensuring an outlet for the goods and services that it represents (judgments of 12/03/2003, T-174/01, Silk Cocoon, EU:T:2003:68, § 39; 30/04/2008, T-131/06, Sonia Sonia Rykiel, EU:T:2008:135, § 38). Outward use does not necessarily imply use aimed at end consumers. For instance, the relevant evidence can validly stem from an **intermediary**, whose activity consists of identifying professional purchasers, such as distribution companies, to whom the intermediary sells products it has had manufactured by original producers (judgment of 21/11/2013, T-524/12, RECARO, EU:T:2013:604, § 25-26).

Relevant evidence can also validly come from a **distribution company** forming part of a group. Distribution is a method of business organisation that is common in the course of trade and implies use of the mark that cannot be regarded as purely internal use by a group of companies, since the mark is also used outwardly and publicly (judgment of 17/02/2011, T-324/09, Friboi, EU:T:2011:47, § 32).

Use of the mark must **relate to goods or services** already marketed or about to be marketed and for which preparations by the undertaking to secure customers are under way. Mere preparation to use the mark — such as the printing of labels, producing of containers, etc. — is internal use and, therefore, not use in the course of trade for the present purposes (judgment of 11/03/2003, C-40/01, Minimax, EU:C:2003:145, § 37).

2.3.3.2 Commercial activity v promotional activity

Where the mark is protected for goods or services of **not-for-profit enterprises**, and the mark has been used, the fact that there is no profit motive behind the use is irrelevant: 'The fact that a charitable association does not seek to make profit does not mean that its objective cannot be to create and, later, to preserve an outlet for its goods or services' (judgment of 09/12/2008, C-442/07, Radetzky, EU:C:2008:696, § 17).

Goods and services offered **free of charge** may constitute genuine use when they are offered commercially, that is to say with the intention of creating or maintaining an outlet for those goods or services in the EU, as opposed to the goods or services of other undertakings, and therefore of competing with them (judgment of 09/09/2011, T-289/09, Omnicare Clinical Research, EU:T:2011:452, § 67-68).

Mere use of the mark on **promotional material for other goods** cannot normally be considered as sufficient (indirect) evidence of use within the meaning of trade mark law for the type of promotional items on which the mark is or has been used. For example, giving away articles of clothing such as T-shirts and baseball caps at promotional events with the purpose of marketing a certain other product, such as a drink, cannot be considered as genuine use of the mark at issue for clothing.

The Office practice concerning 'genuine use' with regard to promotional articles has been confirmed by the Court:

Earlier sign	Case No
WELLNESS	C-495/07 (preliminary ruling)
<p>The opponent owned the mark 'WELLNESS' in Classes 25 and 32. In the context of selling its 'WELLNESS' clothing, it also used the mark to designate an alcohol-free drink, which was handed out in small bottles as a gift along with the clothing sold. No drinks were sold separately under the 'WELLNESS' mark.</p> <p>The Court held that, where promotional items are handed out as a reward for the purchase of other goods and to encourage the sale of the latter, the mark loses its commercial raison d'être for the promotional goods and cannot be considered to have been genuinely used on the market for goods in that class (paragraph 22).</p>	

2.3.4 Use in relation to goods or services

2.3.4.1 Use in relation to goods

Trade marks have traditionally been used on goods (printed on the goods, on labels, etc.) or their packaging. However, showing use on goods or their packaging is not the only way of proving use in relation to goods. It is sufficient, if there is a proper connection between the mark and the goods, for the mark to be used 'in relation to' the goods or services, such as on brochures, flyers, stickers, signs inside places of sale, etc.

For example, when the opponent sells its goods only through catalogues (mail-order sales) or the internet, the mark may not always appear on the packaging or even on the goods themselves. In such cases, use on the (internet) pages where the goods are presented — provided it is otherwise genuine in terms of time, place, extent and nature (see paragraph 2.3.4.4 below) — will generally be considered sufficient. The owner of the mark will not have to provide proof that the mark actually appeared on the goods themselves.

Earlier sign	Case No
PETER STORM	T-30/09
The evidence produced to show genuine use of the mark at issue may include catalogues. (...) it must be pointed out that, in addition to items of clothing designated by different marks, more than 80 different items are offered for sale in that catalogue under the mark PETER STORM. They comprise men's and women's jackets, jumpers, trousers, T-shirts, footwear, socks, hats and gloves, the respective characteristics of which are briefly described. The earlier mark appears, in stylised characters, next to each item. In that catalogue, the prices of the items in GBP and the reference number for each item are stated (paragraphs 38-39).	

However, a situation is different, when a trade mark is used, for example, in a catalogue, on advertisements, bags or invoices to designate the retailer of the goods and not the goods themselves:

Earlier sign	Case No
Schuhpark	T-183/08
The GC found that the use of the sign <i>Schuhpark</i> for footwear on advertisements, bags and invoices was not meant to identify the origin of the shoes (which bore their own mark or no mark at all) but rather the company name or trade name of the shoe retailer. This was considered insufficient to establish a link between the sign <i>Schuhpark</i> and the shoes. In other words, <i>Schuhpark</i> may well be a mark for the retail of shoes, but it was not used as a trade mark for goods (paragraphs 31-32).	

2.3.4.2 Use in relation to services

Marks cannot be directly used 'on' services. Therefore, as regards marks registered for services, their use will generally be on business papers, in advertising, or in some other way directly or indirectly related to the services. Where the use on such items demonstrates genuine use, such use will be sufficient.

Earlier sign	Case No
M&P	T-463/12
Earlier trade mark registered in Class 42 for, inter alia, services of a patent attorney. The use of the earlier mark on invoices, business cards, business correspondence was considered sufficient to show genuine use in connection to the services of a patent attorney.	
STRATEGIES	T-92/09
Where an earlier mark was registered for <i>business management</i> services and used as the title of business magazines, the GC did not exclude that such use be considered genuine for the services in question. This could be the case if it is shown that the magazine provides support for the supply of the <i>business management</i> services, i.e. if these services are provided through the medium of a magazine. The fact that there is no 'direct bilateral link' between the publisher and the recipient of the services does	

not impair such a finding of genuine use. This is because the magazine is not distributed free of charge, which could give credibility to the claim that the payment of the price of the magazine constitutes remuneration for the service provided (paragraphs 31-35).

2.3.4.3 Use in advertising

Trade marks fulfil their function of indicating the commercial origin of goods or services and symbols of the goodwill of their owner not only when they are actually used on or for goods or services, but also when they are used in advertising. In fact, the advertising or market communication function of trade marks is one of their most important functions.

Therefore, use in advertising will generally be considered as amounting to genuine use:

- if the volume of advertising is sufficient to constitute genuine public use of the mark; and
- if a relation can be established between the mark and the goods or services for which the mark is registered.

The Court confirmed this approach in the ‘Minimax’ case, where it held that use of the mark must relate to goods or services already marketed or about to be marketed and for which preparations by the undertaking to secure customers are under way, **particularly in the form of advertising campaigns** (judgment of 11/03/2003, C-40/01, Minimax, EU:C:2003:145, § 37).

However, the outcome in a particular case will depend very much on the individual circumstances, as demonstrated by the following examples:

Earlier sign	Case No
BLUME	R 0681/2001-1
<p>Services: services of a publishing company in Class 41.</p> <p>The Board confirmed that the evidence (consisting of catalogues, press notes and advertisements) read in conjunction was enough to prove genuine use of the trade mark.</p> <p>‘Although the order record and the receipt of the bank account do not provide any information on how and to what extent the mark was used in Spain, the remaining documents, namely the catalogues, press notes and advertisements, when read in conjunction, demonstrate that during the relevant period, the opponent has published in Spain books and magazines under the trade mark BLUME. Even if the opponent does not provide any invoices, orders or sales figures, there is some reason to assume that it advertised its books and magazines, promoted and sold them under the trade mark BLUME. Although the advertising documents and the press notes were identified and dated by the opponent, the trade mark BLUME is always mentioned in the press notes and on the cover page of the quoted books. In addition, the text is in the Spanish language and the price mentioned in pesetas. When read together with the catalogues, these press notes demonstrate that they refer to some of the books expressly quoted in the catalogues ...’ (paragraph 23).</p>	

Earlier sign	Case No
BIODANZA	R 1149/2009-2 (confirmed by T-298/10)
<p>G&S: Classes 16 and 41.</p> <p>The Board rejected the Opposition Division's finding that the evidence (only advertisements) proved genuine use.</p> <p>It follows clearly from the finding of the contested decision that the evidence of use submitted by the opponent consists solely of advertisements that can prove only that the opponent advertised a yearly 'BIODANZA' festival during the whole of the relevant period and workshops on both a regular and irregular basis from 2002.</p> <p>However, contrary to the finding of the contested decision, such advertisements cannot provide proof of their distribution to a potential German clientele. Nor can they prove the extent of any distribution or the number of sales or contracts made for the services protected by the mark. The mere existence of advertisements could, at most, make it probable or credible that the services advertised under the earlier mark were sold or, at least, offered for sale within the relevant territory, but it cannot prove this, as was unduly supposed by the contested decision.</p>	

Where advertising is carried out in parallel to the marketing of goods and services and there is proof of both activities, advertising will support the genuineness of the use.

Advertising in advance of the actual marketing of goods and services — if it is with a view to establishing a market for the goods or services — will generally be considered to constitute genuine use.

Whether mere advertising, without any current or future plans to actually market goods or services, constitutes genuine use appears doubtful. As in most other situations, the outcome will depend on the circumstances of each case. For example, where the goods or services are available abroad, such as holiday accommodation or particular products, advertising alone may be sufficient to amount to genuine use.

2.3.4.4 Use on the internet

The standard applied when assessing evidence in the form of printouts from the internet is no stricter than when evaluating other forms of evidence. Consequently, the presence of the trade mark on websites can show inter alia the nature of its use or the fact that products or services bearing the mark have been offered to the public. However, the mere presence of a trade mark on a website is, of itself, not sufficient to prove genuine use unless the website also shows the place, time and extent of use or unless this information is otherwise provided.

Earlier sign	Case No
SHARP	R 1809/2010-4
<p>The opponent submitted 'extracts from the opponent's websites for different countries'. The Board considered that 'simple print-outs from a company's own Internet page is not able to prove use of a mark for certain goods without complementary information as to the actual use of the Internet site by potential and relevant consumers or complementary advertising and sales figures regarding the different goods, photos of the goods with the corresponding mark etc.' (paragraph 33).</p>	

Earlier sign	Case No
WALZERTRAUM	T-355/09 (confirmed by C-141/13 P)
The opponent, a confectionary, who owns the German trade mark 'WALZERTRAUM' for goods in Class 30, in order to prove the extent of use of its mark, submitted evidence regarding an advertising brochure published on the internet, which gives general information about its working methods, the ingredients used for its products and the product range, including its 'WALZERTRAUM' chocolate. The goods could, however, not be ordered online on the web page. For this reason the GC held that a connection between the website and the number of items sold could not be established (paragraph 47).	

In particular, the value in terms of evidence of internet extracts can be strengthened by submitting evidence that the specific website has been visited and, in particular, that orders for the relevant goods and services have been made through the website by a certain number of customers in the relevant period. For instance, useful evidence in this regard could be records that are generally kept when operating a business web page, for example records relating to the hits attained at various points in time or, in some cases, the countries from which the web page has been accessed.

As to the **relevant period**, information on the internet or in online databases is considered to be of the date on which the information was posted. Internet websites often contain highly relevant information. Certain information may even be available only on the internet from such websites. This includes, for example, online catalogues that are not available in printed format.

The nature of the internet can make it difficult to establish the actual date on which information was in fact made available to the public. For instance, not all web pages mention when they were published. In addition, websites are easily updated, yet most do not provide any archive of previously displayed material, nor do they display records which enable members of the public to establish precisely what was published when.

In this context, the date of use on the internet will be considered reliable in particular where:

- the website time-stamps each entry and thus provides information relating to the history of modifications applied to a file or web page (for example, as available for Wikipedia or as automatically appended to content, e.g. forum messages and blogs); or
- indexing dates are given to the web page by search engines (e.g. from the Google™ cache); or
- a screenshot of a web page bears a given date.

The evidence submitted must show that the online transactions were **connected with the goods or services** designated by the mark.

Earlier sign	Case No
ANTAX	T-387/10
The opponent has submitted, inter alia, internet extracts from the home pages of several tax consultancies using the opposing mark. The GC considered that the indications on the internet pages allowed the reader to establish a link between the trade mark and the services provided (paragraphs 39-40).	

Whereas the **nature of the mark** and, to a certain extent, the **time** (as seen above) and **place** are less complex elements to prove, the **extent of the use** presents more difficulties if only evidence of internet use is provided. It should be taken into account that transactions on the internet tend to eliminate most of the ‘traditional’ evidence of sales such as invoices, turnover, taxation documents, etc. New ‘electronic’ evidence tends to substitute them, or has already substituted them, as certified means of payment, orders and confirmations thereof, registrations of safe transactions, etc.

Earlier sign	Case No
Skunk funk (fig.)	R 1464/2010-2
<p>[E]xcerpts from third parties’ websites, despite having been printed out on 10/06/2008, contain consumers’ comments about ‘SKUNKFUNK’ clothes and shops dated within the relevant period. In particular, as regards the relevant territory, the documents show various comments made by consumers in Spain and dated December 2004 and February-March-April-May-July 2007. Moreover, as the Opposition Division pointed out, a blog comment (dated 4/03/2007) on the internet page www.cybereuskadi.com mentions that the opponent (‘designer of Skunkfunk’) ‘exports surf clothes worldwide and has a turnover of nearly 7 million euros per year’ (paragraph 21).</p>	

2.4 Place of use

2.4.1 Use on the ‘domestic’ market

Trade marks must be used in the territory where they are protected (European Union for EUTMs, the territory of the Member State for national marks or Benelux for Benelux marks and the territories of the relevant countries for international registrations).

As the Court held in ‘Leno Marken’ ‘the territorial scope of the use is only one of several factors to be taken into account in the determination of whether that use is genuine or not’ (judgment of 19/12/2012, C-149/11, Leno, EU:C:2012:816, § 30). The Court further indicated that use of the mark in non-EU territories cannot be taken into account (paragraph 38).

In view of the globalisation of trade, an indication of the registered seat of the owner of the mark may not be regarded as sufficient indication that the use has taken place in that particular country. Even though Article 15(1)(b) EUTMR stipulates that the affixing of the trade mark to goods or to the packaging thereof in the European Union solely for export purposes is considered as use of the mark, mere indication of the opponent’s seat as such does not constitute evidence of such acts. On the other hand, the fact that clients who have their seats outside the relevant territory are listed in the documents for proving use of the earlier mark is in itself not sufficient to rule out that services (e.g. promotion services) may actually have been rendered in the relevant territory for the benefit of these companies located in other territories (decision of 09/06/2010, R 952/2009-1, Global Tabacos, § 16).

2.4.2 EUTMs: use in the European Union

If the earlier mark is a European Union mark, it must be used 'in the Union' (Articles 15(1) and 42(2) EUTMR). Following 'Leno Marken', Article 15(1) EUTMR must be interpreted as meaning that the territorial borders of the Member States should be disregarded when assessing whether an EUTM has been put to 'genuine use' in the Union (paragraph 44).

In territorial terms and in view of the unitary character of the EUTM, the appropriate approach is not that of political boundaries but of market(s). Moreover, one of the aims pursued by the EUTM system is to be open to businesses of all kinds and sizes. Therefore, the size of an undertaking is not a relevant factor to establish genuine use.

As the Court indicated in 'Leno Marken', it is impossible to determine a priori and in the abstract what territorial scope should be applied in order to determine whether the use of the mark is genuine or not (paragraph 55). All the relevant facts and circumstances must be taken into account, including the characteristics of the market concerned, the nature of the goods or services protected by the trade mark and the territorial extent and scale of the use as well as its frequency and regularity (paragraph 58). For example, a Board of Appeal decision (decision of 07/03/2013, R 0234/2012-2, NOW, confirmed by the judgment of 30/01/2015, T-278/13, now, EU:T:2015:57) considered the use of an EUTM for wireless broadband services in Class 42 **in the geographical area comprising London and the Thames Valley** sufficient to constitute genuine use in the United Kingdom and also in the European Union, taking into account: the 'territorial extent' [being London 'the largest city in the United Kingdom and the largest urban zone in the European Union' with 'a metropolitan area of an estimated total population of between 12 million and 14 million people', 'the world's leading financial centre along with New York', 'a leading centre of arts, science, tourism and media and information technology', with a profile on the European commercial scene 'disproportionately high in respect to the services in question' (R 234/2012-2, § 47) and being the Thames Valley '200 miles long and 30 miles wide' including 'populous towns and cities of significant economic activity' (R 0234/2012-2, § 45-46)], the 'scale, frequency, regularity of use' and the 'characteristics' of the market concerned (R 234/2012-2, § 52).

The Office must determine on a case-by-case basis whether the various indications and evidence can be combined for the purpose of assessing the genuine character of use, the geographical dimension of which is only one of the aspects to be considered.

In any event, it must be underlined that the European requirements or standards for genuine use are applicable (i.e. the conditions of Article 15 EUTMR) and not national standards or practices applied to EUTMs.

2.4.3 National marks: use in the relevant Member State

If the earlier mark is a national mark with effect in one of the Member States of the European Union, the mark must have been genuinely used in the country where it is protected (Article 42(3) EUTMR). Use in a part of the Member State, provided it is genuine, may be considered sufficient:

Case No	Earlier trade mark	Comment
C-416/04 P	VITAFRUT	Use considered sufficient, even though the earlier Spanish mark was not present in a substantial part of the territory of Spain, given that the evidence referred to the sale of everyday consumer goods (concentrated fruit juices) to only a single customer in Spain (paragraphs 60, 66 and 76).

If the earlier mark is a international mark or a Benelux mark, the mark must have been genuinely used in the territory of the relevant countries of the international registration or in Benelux.

2.4.4 Use in import and export trade

According to Article 15(1)(b) EUTMR, the affixing of the European Union trade mark to goods or to the packaging thereof in the Union solely for **export** purposes also constitutes use within the meaning of Articles 15(1) EUTMR. The mark has to be used (i.e. affixed to goods or their packaging) in the relevant market — that is, the geographical area where it is registered.

Case No	Earlier trade mark	Comment
T-34/12	Herba Shine	The Court ruled that the Board of Appeal should have reasoned why it disregarded evidence of sales outside the relevant territory (invoices addressed to clients outside the EU). In fact, such sales outside the EU cannot be simply discarded for that reason only (paragraphs 48-49 and 54).
R 0602/2009-2	RED BARON	The Board indicated that sales in Austria and Great Britain from the Netherlands also constituted genuine use in the Netherlands within the meaning of Article 15(1)(b) EUTMR (paragraph 42).

Evidence that only relates to the **import** of the goods in the relevant area may, depending on the circumstances of the case, suffice as proof of use in this area (see by analogy judgment of 09/07/2010, T-430/08, Grain Millers, EU:T:2010:304, § 33, 40 et seq. regarding the proof of use in the course of trade of a sign on the basis of imports from Romania to Germany).

The Court has held that **transit**, which consists in transporting goods lawfully manufactured in a Member State to a non-member country by passing through one or more Member States, does not involve any marketing of the goods in question and is therefore not liable to infringe the specific subject matter of the trade mark (regarding the transit through France of goods originating in Spain and destined for Poland, see judgments of 23/10/2003, C-115/02, Rioglass and Transremar, EU:C:2003:587, § 27; 09/11/2006, C-281/05, Diesel, EU:C:2006:709, § 19). Therefore, mere transit through a Member State cannot constitute genuine use of the earlier mark in that territory.

2.5 Time of use

2.5.1 Oppositions filed on or after 23/03/2016

If the earlier mark is subject to the use requirement at all (registered for not less than five years), the actual period for which use must be shown can simply be computed backwards from the **filing or, if the contested EUTM application has a priority date, from the priority date** of the contested EUTM application. For example, if the contested EUTM application was filed on 15/06/2016, or if this date was the priority date of the contested EUTM application, the opponent would have to prove genuine use of its mark within the period beginning on 15/06/2011 and ending on 14/06/2016.

If the contested mark is an international registration designating the Union, the actual period for which use must be proven can simply be computed backwards from the date of registration (INID code 891) or the date of priority (INID code 300), or, as the case may be, the date of subsequent designation of the Union (INID code 891). For example, if the contested international registration were registered, or if the Union were subsequently designated, on 15/06/2016, the opponent would have to prove genuine use of its mark within the period beginning on 15/06/2011 and ending on 14/06/2016.

Evidence referring to use made outside the relevant time frame is in general immaterial, unless it constitutes conclusive indirect proof that the mark must have also been put to genuine use during the relevant period. The Court held in this context that circumstances subsequent to the relevant point of time may make it possible to confirm or better assess the extent to which the trade mark was used during the relevant period and the real intentions of the proprietor during that time (order of 27/01/2004, C-259/02, *Laboratoire de la mer*, EU:C:2004:50, § 31).

Where a mark has not been genuinely used for more than five years before the filing or priority date of the contested EUTM application, the fact that there may be remaining goodwill or knowledge of the mark in the mind of the trade or customers does not 'save' the mark.

The use need not have been made throughout the period of five years, but rather within the five years. The provisions on the use requirement do not require continuous use (judgment of 16/12/2008, T-86/07, *Deitech*, EU:T:2008:577, § 52).

2.5.2 Oppositions filed before 23/03/2016

Before the entry into force of the Amending Regulation, the five-year period was computed backwards from the **date of publication** of the contested EUTM application. In the case of contested IRs, the equivalent date was the beginning of the opposition period (which is, pursuant to Article 152(1) EUTMR, six months after the date of publication of the international registration or subsequent designation).

For example, if the contested international registration or its subsequent designation of the Union was published on 15/06/2009, the opponent would have to prove genuine use of their mark within the period beginning on 15/12/2004 and ending on 14/12/2009.

2.6 Extent of use

2.6.1 Criteria

In this regard, it has to be evaluated whether, in view of the market situation in the particular industry or trade concerned, it can be deduced from the material submitted that **the owner has seriously tried to acquire a commercial position in the relevant market**. The trade mark has to be used for goods or services already marketed or about to be marketed and for which preparations by the undertaking to secure customers are under way, particularly in the form of advertising campaigns (judgment of 11/03/2003, C-40/01, Minimax, EU:C:2003:145, § 37). This does not mean that the opponent has to reveal the total volume of sales or turnover figures.

Concerning the extent of the use made of the earlier mark, account must be taken, in particular, of the **commercial volume** of all the acts of use on the one hand and the **duration** of the period in which those acts of use occurred as well as the **frequency** of those acts on the other (judgment of 08/07/2004, T-334/01, Hipoviton, EU:T:2004:223, § 35).

The assessment entails a **degree of interdependence between the factors** taken into account. Thus, the fact that commercial volume achieved under the mark was not high may be offset by the fact that use of the mark was extensive or very regular, and vice versa (judgment of 08/07/2004, T-203/02, Vitafruit, EU:T:2004:225, § 42).

Under certain circumstances, even **circumstantial evidence** such as catalogues featuring the trade mark, despite not providing direct information on the quantity of goods actually sold, can be sufficient by themselves to prove the extent of use in an overall assessment (judgment of 08/07/2010, T-30/09, Peerstorm, EU:T:2010:298, § 42 et seq.).

Use does not have to be made during a minimum period of time to qualify as 'genuine'. In particular, **use does not have to be continuous** during the relevant period of five years. It is sufficient if the use had been made at the very beginning or end of the period, provided that this use was genuine (judgment of 16/12/2008, T-86/07, Deitech, EU:T:2008:577).

The exact **decisive threshold** proving genuine use cannot be defined out of context. The turnover and volume of sales of the product must always be assessed in relation to all the other relevant factors, such as the volume of business, production or marketing capacity or the degree of diversification of the undertaking using the trade mark and the characteristics of the products or services on the relevant market. Use need not always be quantitatively significant for it to be deemed genuine, as that depends on the characteristics of the goods or service concerned on the corresponding market (judgments of 11/03/2003, C-40/01, Minimax, EU:C:2003:145, § 39; 08/07/2004, T-203/02, Vitafruit, EU:T:2004:225, § 42).

Low turnover and sales, in absolute terms, of a medium- or low-priced product might support the conclusion that use of the trade mark in question is not genuine. However, with regard to expensive goods or an exclusive market, low turnover figures can be sufficient (decision of 04/09/2007, R 0035/2007-2, Dinky, § 22). It is, therefore, always necessary to take the characteristics of the market in question into account (judgment of 08/07/2004, T-334/01, Hipoviton, EU:T:2004:223, § 51).

A *de minimis* rule cannot be laid down. Use of the mark by a single client, which imports the products for which the mark is registered, can be sufficient to demonstrate that such use is genuine if it appears that the import operation has a genuine commercial justification for the proprietor of the mark (order of 27/01/2004, C-259/02, *Laboratoire de la mer*, EU:C:2004:50, § 24 et seq.).

The genuine use is not excluded only because the use has been made with the same customer, as long as the trade mark is used publicly and outwardly and not solely within the undertaking which owns the earlier trade mark or within a distribution network owned or controlled by that undertaking (judgments of 08/07/2004, T-203/02, *Vitafruit*, EU:T:2004:225, § 50; 8/10/2014, T-300/12, *Fairglobe*, EU:T:2014:864, § 36).

The smaller the commercial volume of the exploitation of the mark, the more necessary it is for the opposing party to produce additional evidence to dispel possible doubts as to its genuineness (judgment of 08/07/2004, T-334/01, *Hipoviton*, EU:T:2004:223, § 37).

Concerning the ratio between the turnover generated by the sales of products under the earlier mark and the applicant's annual turnover, it should be noted that the degree of diversification of the activities of undertakings operating in one and the same market varies. Moreover, the obligation to produce evidence of genuine use of an earlier trade mark is not designed to monitor the commercial strategy of an undertaking. It may be economically and objectively justified for an undertaking to market a product or a range of products even if their share in the annual turnover of the undertaking in question is minimal (judgment of 08/07/2004, T-334/01, *Hipoviton*, EU:T:2004:223, § 49).

Special circumstances, for example, lower sales figures during the initial marketing phase of a product, could be of relevance when assessing the genuineness of the use (judgment of 08/07/2004, T-334/01, *Hipoviton*, EU:T:2004:223, § 53).

2.6.2 Examples of insufficient use

Case No	Comment
Judgment of 16/07/2014, T-196/13, <i>NAMMU</i> , EU:T:2014:1065	The applicant provided an affidavit signed by the Head of the Import Department and Quality Manager; photos, including one of a <i>Nanu-Nana</i> shop front, and others, undated, of various goods such as folded paper boxes, albums, calendars, stickers, blocks, artists' materials, cards and other paper products, napkins, recipe books, furniture and home decor articles. The goods depicted all bear labels and stickers with the earlier mark on their packaging. No evidence was submitted to prove the turnover figures given in the affidavits, and the photos were undated (paragraph 33).
' <i>WALZERTRAUM</i> ', paragraph 32 ff. (confirmed by C-141/13 P)	The opponent, a German bakery located in a city of 18 000 inhabitants, proved constant monthly sales of approximately 3.6 kg of exclusive, handmade chocolates over a period of 22 months. Despite being advertised on a web page accessible throughout the world, the chocolates could only be ordered and bought in the opponent's bakery. In view of the territorial and quantitative limits, the GC considered that use had not been sufficiently proven.
Judgment of 30/04/2008, T-131/06, <i>Sonia Sonia Rykiel</i> , EU:T:2008:135	54 units of women's slips and 31 units of petticoats were sold over a period of 13 months, for a total sum of EUR 432. The GC considered these modest quantities with regard to the relevant market (everyday consumption goods, sold at a very reasonable price) to be insufficient.
Decision of 27/02/2009,	500 plastic balloon kits given away as 'samples' free of charge cannot

Case No	Comment
R 0249/2008-4, AMAZING ELASTIC PLASTIC II	constitute genuine use.
Decision of 20/04/2001, R 0378/2000-1, Renacimiento	The Board of Appeal confirmed the decision of the Opposition Division that the submission of one bill of lading showing the delivery of 40 packages of sherry is insufficient to prove genuine use.
Decision of 09/02/2012, R 0239/2011-1, GOLF WORLD (B 1 456 443, Golf World)	As the only evidence of use for <i>printed matter</i> , the opponent submitted evidence which proved 14 subscribers for a magazine in Sweden. The OD held that this is insufficient to prove genuine use in Sweden, particularly taking account of the fact that magazines are not high-priced articles.
R 2132/2010-2, SUSURRO (fig.)	Nine invoices concerning the sale of wine in 2005, 2006, 2007 and 2008 showing that over a period of 36 months goods marketed under the earlier mark and worth EUR 4 286.36 were sold, as well as an undated sample of a product label were not considered as sufficient proof of genuine use of a Spanish trade mark registered for 'alcoholic drinks (except beers)' in Class 33. The evidence showed that the sales of wine had been made in a small, very provincial, part of Spain. For a country with over 40 million inhabitants, the amount sold of a relatively cheap wine was found to be too small to create or preserve an outlet for goods (wine) that are consumed in large quantities by the average Spanish consumer.
Decision of 07/07/2011, R 0908/2010-2, ALFA-REN	Table of sales figures for ALFACALCIDOL products in Lithuania between 2005 and 2008, indicating products sold by Teva Corp. under the trade mark 'ALPHA D3' (source: IMS health database, Lithuania); an undated copy of packaging for a product 'ALPHA D3' (undated); and a copy of an advertisement for 'ALPHA D3' products sold in Lithuania (not translated) were found insufficient to show genuine use of the mark in Lithuania. It could not be seen from the evidence submitted whether the marked goods were actually distributed and, if so, the quantities involved.
Decision of 16/03/2011, R 0820/2010-1, BE YOU	Sales of goods with profits below EUR 200 during the 9-month period of use were not considered sufficient proof of genuine use of the opposing mark in respect of the goods in Class 14.
Decision of 06/04/2011, R 0999/2010-1, TAUTROPFEN CHARISMA (fig.)	Eleven invoices showing that 13 units of 'perfumery' goods were sold in Spain between 2003 and 2005, for a total amount of EUR 84.63, were deemed as insufficient proof of genuine use of the sign. Account has been taken of the fact that the goods were intended for daily use and available at a very affordable price.
Decisión of 27/10/2008, B 1 118 605, Viña la Rosa	Photocopies of three independent wine guides mentioning the opponent's trade mark (without further explanation as to the volume, edition, publisher, etc.) were not considered sufficient to prove use for wines.
Decision of 21/06/1999, B 70 716, Oregon	The Opposition Division found an invoice for 180 pairs of shoes as insufficient to prove genuine use.
Decision of 30/01/2001, B 193 716, Lynx	As evidence of use the opponent filed two invoices for a total amount of 122 items of clothing and four undated labels with no indication of what goods they were to be affixed to. The Opposition Division considered them insufficient.

2.6.3 Examples of sufficient use

Case No	Comment
Judgment of 16/11/2011, T-308/06, Buffalo Milke, EU:T:2011:675, § 68	Nine invoices dated between April 2001 and March 2002 representing sales of around EUR 1 600 (with a turnover figure barely above EUR 1 000 000 per year) and showing that items were delivered to different customers in small quantities (12, 24, 36, 48, 60, 72 or 144 pieces), for widely-used products like shoe polish, in the largest European market, Germany, with approximately 80 million potential consumers, were deemed as providing evidence of use that objectively is such as to create or preserve an outlet for polishing cream and leather conditioner. Furthermore, the volume of sales, in relation to the period and frequency of use, was deemed to be significant enough not to be concluded as merely token, minimal or notional for the sole purpose of preserving the rights conferred by the mark. Confirmed by the GC.
Judgment of 10/09/2008, T-325/06, Capio, EU:T:2008:338, § 48, 60	Evidence (invoices, lists of sales) proving that the intervener sold 4 hollow-fibre oxygenators with detachable hard-shell reservoirs in Finland in 1998, 105 in 1999 and 12 in 2001, for a total amount of EUR 19 901.76, was deemed sufficient proof of genuine use of the EUTM registered for <i>oxygenators with integrated pump; controllers for integrated pump; regulating devices of air pressure for integrated pump; suction pumps; blood flow meters</i> , in Class 10.
Judgment of 27/09/2007, T-418/03, La Mer, EU:T:2007:299, § 87-90	Ten invoices over a period of 33 months, regarding several product ranges, the packaging of which bears the trade mark concerned, with numbers very far apart (22 214 for the invoice of 3/01/1995, 24 085 for that of 4/05/1995, 24 135 for that of 10/05/1995 and 31 348 for that of 26/03/1997), showing that the sales were made to different persons, were deemed as permitting the inference that they had been submitted merely by way of illustration of total sales but not as showing that the trade mark was used publicly and outwardly rather than solely within the undertaking that owned the earlier trade mark or within a distribution network owned or controlled by that undertaking. Nevertheless, the sales effected, while not considerable, were deemed as constituting use that objectively was such as to create or preserve an outlet for the products concerned and entailing a volume of sales that, in relation to the period and frequency of use, was not so low as to allow the conclusion that the use was merely token, minimal or notional for the sole purpose of preserving the rights conferred by the mark.
Judgment of 25/03/2009, T-191/07, Budweiser, EU:T:2009:83	The Board of Appeal (decision of 20/03/2007, R 0299/2006-2 — ‘BUDWEISER/earlier international word mark BUDWEISER’, § 26) found, essentially, that the documents presented to it during the administrative proceedings — invoices proving the sale of beer in France amounting to more than 40 000 litres between October 1997 and April 1999, 23 invoices issued in Austria between 1993 and 2000 to a single buyer in Austria, and 14 invoices issued in Germany between 1993 and 1997 — were sufficient to demonstrate the extent of use of the earlier international word mark BUDWEISER (IR No 238 203) in those countries. The Board’s findings were confirmed by the GC.
Judgment of 11/05/2006, C-416/04 P, Vitafruit, EU:C:2006:310, § 68-77	Evidence of the sale to a single customer in Spain of concentrated fruit juices during a period of eleven and a half months with a total volume of sales of EUR 4 800, corresponding to the sale of 293 cases of 12 items each, was considered sufficient use of the earlier Spanish trade mark.
Judgment of 08/07/2010, T-30/09, Peerstorm, EU:T:2010:298, § 42-43	As evidence of use, the opponent (merely) provided several catalogues for end consumers, featuring the relevant trade mark on clothing articles. The Court held that ‘...it is true that those catalogues provide no information on the quantity of goods actually sold by the intervener under the trade mark PETER STORM.

Case No	Comment
	However, it is necessary to take into account ... the fact that a large number of items designated by the trade mark PETER STORM were offered in the catalogues and that those items were available in more than 240 shops in the United Kingdom for a significant part of the relevant period. Those factors support the conclusion, in the context of a global assessment ... that the extent of its use was fairly significant.'
Decision of 04/09/2007, R 0035/2007-2, DINKY	The sale of approximately 1 000 miniature toy vehicles was considered sufficient extent of use in light of the products being sold mainly to collectors at a high price in a particular market.
Decision of 11/10/2010, R 0571/2009-1, VitAmour	The sale of 500 kg of milk proteins for a total value of EUR 11 000 was considered sufficient to prove genuine use for <i>milk proteins for human consumption</i> . In view of the nature of the products, which are not consumer goods but ingredients for use by the food processing industry, the amount and values shown did demonstrate a market presence above the threshold required.
Decision of 27/07/2011, R 1123/2010-4, Duracryl	Eleven invoices made out to different undertakings in various regions of Spain, showing that the proprietor of the mark sold, in the relevant period and under the mark, 311 containers of the product, in different sizes, for a net amount of EUR 2 684, were deemed sufficient to prove genuine use of a mark registered for <i>preservatives against deterioration of wood</i> in Class 2.
Decision of 01/02/2011, B 1 563 066	An annual turnover of more than EUR 10 million over several years was claimed for medical preparations. The corresponding invoices (one per relevant year) only proved actual sales of about EUR 20 per year. In an overall assessment, and in the context of further material submitted such as price lists, a sworn statement, packaging and advertising material, the Office found this sufficient to prove genuine use.
Decision of 26/01/2001, B 150 039	The Opposition Division regarded evidence of sales for around 2 000 furry toy animals in a high-priced market sector as sufficient.
Decision of 18/06/2001, B 167 488	The opponent submitted one invoice referring to the sale of one high-precision laser cutting machine for FRF 565 000, a catalogue describing its performance and some photographs depicting the product. The Opposition Division considered them as sufficient evidence taking into account the nature of the product, the specific market and its considerably high price.

2.7 Use of the mark in forms different from the one registered

2.7.1 Introduction

Article 15 EUTMR states that use of the mark in a form different from the one registered still constitutes use of the trade mark as long as the differing elements do not alter the distinctive character of the trade mark, and regardless of whether or not the trade mark in the form as used is also registered in the name of the proprietor.

The purpose of this provision is to allow its proprietor to make variations in the sign which, without altering its distinctive character, enable it to be better adapted to the marketing and promotion requirements of the goods or services concerned (judgment of 23/02/2006, T-194/03, EU:T:2006:65, § 50).

The General Court (the 'GC') further mentioned that strict conformity between the sign as used and the sign registered is not necessary. However, the difference must be in

negligible elements and the signs as used and registered must be broadly equivalent (judgment of 23/02/2006, T-194/03, Bainbridge, EU:T:2006:65, § 50).

In order to decide whether the sign as used and the sign as registered are broadly equivalent, it must first be established which elements are negligible. The GC has developed criteria for doing so in several judgments.

Paragraph 2.7.2 will deal with these criteria. Paragraph 2.7.3 will describe Office practice in relation to the 'variation' of marks, 'additions' of elements to marks and 'omissions' of elements of marks.

2.7.2 Criteria of the Court

In brief, the test developed by the Court consists of first determining what the distinctive and dominant elements of the registered sign are and then verifying if they are also present in the sign as used.

The GC has held that:

the assessment of the distinctive or dominant character of one or more components of a complex trade mark must be based on the intrinsic qualities of each of those components, as well as on the relative position of the different components within the arrangement of the trade mark (judgment of 24/11/2005, T-135/04, Online Bus, EU:T:2005:419, § 36).

With regard to **additions**:

- several signs may be used simultaneously without altering the distinctive character of the registered sign (judgment of 08/12/2005, T-29/04, Cristal Castellblanch, EU:T:2005:438, § 34);
- if the addition is not distinctive, is weak and/or is not dominant, it does not alter the distinctive character of the registered trade mark (judgments of 30/11/2009, T-353/07, Coloris, EU:T:2009:475, § 29-33 et seq.; 10/06/2010, T-482/08, Atlas Transport, EU:T:2010:229, § 36 et seq.).

With regard to **omissions**:

- if the omitted element is in a secondary position and not distinctive, its omission does not alter the distinctive character of the trade mark (judgment of 24/11/2005, T-135/04, Online Bus, EU:T:2005:419, § 37).

2.7.3 Office practice

In general, it has to be assessed whether the use of the mark constitutes an acceptable or unacceptable 'variation' of its registered form.

Therefore, there are two questions to be answered. Firstly, it must be clarified what is to be regarded as the distinctive character of the mark as registered². Secondly, it must be evaluated whether the mark as used alters this distinctive character. These questions have to be answered on a case-by-case basis.

There is **interdependence** between the strength of the distinctive character of a mark and the effect of alterations. Marks of strong distinctive character may be less influenced by changes than marks of limited distinctiveness. Adding elements to or omitting elements from the mark are more likely to affect the distinctive character of marks of limited distinctiveness.

Where a mark is composed **of several elements**, only one or some of which are distinctive and have rendered the mark as a whole registrable, an alteration of that distinctive element(s) or its omission or replacement by another element will generally mean that the distinctive character is altered.

In order to determine whether the use of a variation of the mark should be accepted or whether the distinctive character is altered, account must be taken of the practices in the branch of business or trade concerned and the relevant public.

Case No	Registered mark	Actual use	Comment
T-105/13 TrinkFix	Drinkfit		Relevant goods were beverages in Classes 29 and 32. The labels on bottles of beverages are narrow, so it is not unusual to write one word mark in two lines (paragraph 47).

The following paragraphs contain a number of practical guidelines for assessing whether additions (paragraph 2.7.3.1), omissions (paragraph 2.7.3.2) and alterations (paragraph 2.7.3.3) in the form of the sign as used alter the distinctive character of the registered trade mark.

2.7.3.1 Additions

As indicated above, with regard to additions, (i) several signs may be used simultaneously without altering the distinctive character of the registered sign and (ii) if the addition is non-distinctive or weak and/or not dominant, it does not alter the distinctive character of the registered trade mark.

The following paragraphs provide examples of these two types of scenarios:

- use of several signs simultaneously;
- additions of other verbal elements;
- additions of figurative elements.

² See the Guidelines, Part C, Opposition, Section 2, Double identity and Likelihood of Confusion, Chapter 4, Comparison of Signs.

Use of several marks or signs simultaneously

It is quite common in some market areas for goods and services to bear not only their individual mark, but also the mark of the business or product group ('house mark'). In these cases, the registered mark is not used in a different form, but the two independent marks are validly used at the same time.

There is no legal precept in the European Union trade mark system that obliges the opponent to provide evidence of the earlier mark alone when genuine use is required within the meaning of Article 42 EUTMR. Two or more trade marks may be used together in an autonomous way, or with the company name, without altering the distinctive character of the earlier registered trade mark (T-463/12, MB, EU:T:2014:935, § 43). It is common practice in the trade to depict independent marks in different sizes and typeface, so these clear differences, which emphasise the house mark, indicate that two different marks are used jointly but autonomously (decision of 07/08/2014, R 1880/2013-1, HEALTHPRESSO/PRESSO, § 42).

The Court has confirmed that the condition of genuine use of a registered trade mark may be satisfied both where it has been used as part of another composite mark or where it is used in conjunction with another mark, even if the combination of marks is itself registered as a trade mark (judgment of 18/04/2013, C-12/12, SM JEANS/LEVI'S, EU:C:2013:253, § 36.). Similarly, the Court has clarified that use can be genuine where a figurative mark is used in conjunction with a word mark superimposed over it, even if the combination of those two marks is itself registered, to the extent that the differences between the form in which that trade mark is used and that in which it was registered do not change the distinctive character of that trade mark as registered (judgment of 18/07/2013, C-252/12, Specsavers, EU:C:2013:497, § 31).

Registered form	Actual use	Case No
CRISTAL		T-29/04

'In the present case the mark CRISTAL appears clearly four times on the neck of the bottle marketed by the intervener and twice on the main label, accompanied by the symbol ®. On the neck, that mark is separate from the other elements. In addition, the mark CRISTAL appears alone on the boxes in which bottles of the mark CRISTAL are marketed. Equally, on the invoices produced by the intervener reference is made to the term "cristal" with the mention "1990 coffret". It should be noted that the mark CRISTAL thus identifies the product marketed by the intervener' (paragraph 35).



'As regards the mention "Louis Roederer" on the main label, it merely indicates the name of the manufacturer's company, which may provide a direct link between one or more product lines and a specific undertaking. The same reasoning applies to the group of letters "lr", which represents the initials of the intervener's name. As pointed out by the Office, joint use of those elements on the same bottle does not undermine the function of the mark CRISTAL as a means of identifying the products at issue' (paragraph 36).







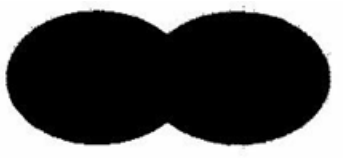

'Furthermore, the Office's finding that the use of the word mark together with the geographical indication "Champagne" cannot be considered to be an addition capable of altering the distinctive character of the trade mark when used for champagne must be endorsed. In the wine sector the consumer is often particularly interested in the precise geographical origin of the product and the identity of the wine producer, since the reputation of such products often depends on whether the wine is produced in a certain geographical region by a certain winery' (paragraph 37).

'In those circumstances it must be held that the use of the word mark CRISTAL together with other indications is irrelevant and that the Board of Appeal did not infringe Article 15(2)(a) of Regulation No 40/94, Article 43(2) and (3) thereof, or Rule 22(2) of the implementing regulation' (paragraph 38).

Registered form	Actual use	Case No
L.114	Lehning L114	T-77/10 & T-78/10
<p>L.114 is a French trade mark registered for <i>pharmaceutical products</i> in Class 5.</p> <p>The Court found that:</p> <ol style="list-style-type: none"> 1) the missing full-stop between the capital letter 'L' and the number 114 constituted a minor difference that did not deprive earlier mark L.114 of its distinctive character (paragraph 53). 2) 'Lehning' was the house mark. The fact that earlier mark 'L.114' was used together with that house mark did not alter its distinctive character within the meaning of Article 15(1)(a) EUTMR' (paragraph 53). 		

Registered form	Actual use	Case No
YGAY	YGAY together with a number of other verbal and figurative elements	R 1695/2007-1 (confirmed by T-546/08)
<p>In the Board's decision (confirmed by the Court in T-546/08, § 19, 20) it was pointed out that the trade mark YGAY appears in many photographs on both the label and the box in which the bottle is sold. On the labels, the trade mark in question is separated from the other elements. On some labels, it appears on its own, beneath the phrase MARQUES DE MURRIETA, written in large bold letters. On others, the phrase BODEGAS MARQUES DE MURRIETA is written in small letters in the upper part, while the elements CASTILLO YGAY are written in large, stylised letters across the label. The trade mark YGAY also appears on its own or together with the phrase CASTILLO YGAY on the boxes in which the bottles are sold. Reference is also made, on the invoices submitted by the opponent, to the trade mark YGAY, along with general information such as the year of production and origin, etc. It follows, therefore, that the sign YGAY functions as the trade mark identifying the goods, <i>wine</i>, sold by the opponent (paragraph 15).</p> <p>The mention of MARQUES DE MURRIETA in this context might merely be an indication of the name of the manufacturer's company or the vineyard that produces and sells the wine, which might provide a direct link between one or more product lines and a specific undertaking (judgment of Court of First Instance (CFI) of 08/12/2005, T-29/04, Cristal Castellblanch, EU:T:2005:438, § 36) (§ 16).</p>		

Registered form	Actual use	Case No
 <p>Mark No 1</p>	<p>LEVI'S</p>  <p>Mark No 2</p>	C-12/12
<p>Levi Strauss is the proprietor of the two EUTMs reproduced above. Mark No 1 is always used in conjunction with the word mark LEVI'S, i.e., as in Mark No 2. The Court found that the condition of 'genuine use' may be fulfilled where an EU figurative mark is used only in conjunction with an EU word mark that is superimposed over it, and the combination of those two marks is, furthermore, itself registered as a European Union trade mark, to the extent that the differences between the form in which that trade mark is used and that in which it was registered do not change the distinctive character of that trade mark as registered.</p>		

Registered form	Actual use	Case No
		C-252/12
<p>Specsavers commenced proceedings for trade mark infringement and passing off on the basis of the earlier EUTMs SPECSAVERS (word mark), as well as the figurative signs  earlier EUTMs SPECSAVERS (word mark), as well as the figurative signs , and , against ASDA, a supermarket chain which relaunched its optical business and targeted Specsavers in its marketing campaign. Specsavers used in colour its B&W registrations and acquired reputation in the UK for the colour green, using its sign as follows:  .</p> <p>ASDA also acquired reputation in the UK for another shade of green in its supermarket business and applied it to the optical business:  .</p> <p>The Court found that the use of  with the superimposed word sign may be considered genuine use of the wordless logo mark to the extent that the wordless logo mark as it was registered always refers in that form to the goods of the Specsavers group (to be determined by the referring court) (paragraph 24).</p>		

It is up to the opponent **to provide evidence** that the additional sign is in fact an independent mark or sign, which refers, for instance, to the company mark, the manufacturer, etc.

Registered form	Actual use	Case No
MINUTO	DUBOIS MINUTO	R 0206/2000-3
<p>The Board of Appeal regarded the presentation of the two words as the use of two separate marks, since the evidence submitted by the opponent showed that one of them was an old brand of the opponent with its own identity and that this mark was present on the market with a number of accompanying signs, as is common practice in the labelling of the specific products (wine).</p> <p>'DUBOIS' and 'MINUTO' are separate marks that are affixed together in the concrete product, as is common practice in the labelling of wine products (name of the winery and name of the product). As regards Spanish brands, see for example 'TORRES' — 'Sangre de Toro', 'TORRES' — 'Acqua d'Or'. When asking for 'MINUTO' wine, the relevant consumer will be aware that such wine is included within the line of products 'DUBOIS', however, 'MINUTO' will be perceived as a trade mark of its own, even if it may appear next to the sign 'DUBOIS' in the invoices, brochures and/or product labels' (paragraph 18).</p>		

On the other hand, the genuineness of use could be put into doubt in cases where used together with another mark, the registered mark is perceived as a **mere decorative element**.

Addition of other verbal elements

In principle, a difference in words or even letters constitutes an alteration of the distinctive character of the mark. However, in the following three paragraphs a number

of situations are described where additions are acceptable. The fourth paragraph provides examples of unacceptable additions.

Addition of non-dominant elements



Registered form	Actual use	Case No
<p>COLORIS</p>		<p>T-353/07</p>
<p>The GC confirmed that the use of the mark <i>Coloris</i> with additional word elements such as ‘global coloring concept’ or ‘gcc’ did not alter its distinctive character because the additional elements were merely used together with the mark <i>Coloris</i> and positioned below it and were of such a size that they were not predominant in that mark.</p> <p>The same finding applies with even greater force to the additional words (global coloring concept) as ‘they are words with a general meaning and the word “coloring” refers to the goods concerned and, consequently, has a certain descriptive character’.</p>		

Additions with generic or descriptive meaning

Use of a registered word mark (or any other mark) together with a generic indication of the product or descriptive term will be considered as use of the registered mark. Additions that are just indications of characteristics of the goods and services, such as their kind, quality, quantity, intended purpose, value, geographical origin or the time of production of the goods or of rendering of the services, do not in general constitute use of a variant but use of the mark itself.

For example:

Registered form	Actual use	Case No
<p>HALDER</p>	<p>HALDER I, HALDER II, HALDER III, HALDER IV, HALDER V</p>	<p>T-209/09</p>
<p>The Court indicated that ‘the fact that, in that newspaper article, the names of the funds are composed of the term “halder”, to which a number in Roman numerals has been added, is not such as to call into question the conclusion on use of the mark, since, because of their brevity, their weak distinctive character and their ancillary position, those additions do not alter the distinctive character of the mark in the form in which it was registered’ (paragraph 58).</p>		

Registered form	Actual use	Case No
		<p>R 1190/2011-4</p>

The figurative signs reproduced in the evidence of use contain the distinctive elements of the earlier mark and those elements are clearly visible on the labels. The inversion of the figurative and word elements of the sign and the additional indication of the respective appellation of origin (Soave, Soave Superior and Chianti) do not alter the distinctive character of the earlier mark, which appears reproduced in the sign with all its distinctive elements. Consumers of wines are particularly interested in knowing the precise geographical origin of these products; however, the addition of this information about the geographical origin of the goods is not capable of altering the distinctive character of a trade mark in its essential function of identifying a particular commercial origin (judgment of 08/12/2005, T-29/04, Cristal Castellblanch, EU:T:2005:438, § 19).

Other acceptable additions

The addition of **insignificant elements** such as punctuation marks does not alter distinctive character:

Registered form	Actual use	Case No
<p>PELASPAN-PAC</p>	<p>PELASPAN PAC</p>	<p>R 1986/2011-4</p>
<p>The use of the earlier mark 'PELASPAN-PAC' without the hyphen connecting the elements 'PELASPAN' and 'PAC' does not alter the distinctive character of the earlier mark as registered and therefore counts for the genuine use assessment.</p>		

In the same way, the use of **plural or singular forms** or vice versa in meaningful words (for instance, by adding/omitting a letter 's' in English or other languages) **normally** does not alter distinctive character:

Registered form	Actual use	Case No
Tentation	Tentations	R 1939/2007-1
<p>'In the present case, and after examination of the evidence submitted, which focuses essentially on the Spanish market, the Board is of the opinion that use of the registered trade mark "TENTATION" through use of the sign "TENTATIONS" does not alter the distinctive character of the original registered trade mark. Specifically, the mere addition of the letter "S" to the end of the trade mark neither substantially alters the visual appearance or pronunciation of the registered trade mark nor creates a different conceptual impression on the Spanish market. The trade mark in question will be perceived merely as being in the plural instead of the singular. Therefore, this change does not alter the distinctive character of the sign' (paragraph 17).</p>		

The addition of the '**type of enterprise**' is also acceptable:

Registered form	Actual use	Case No
	<p>The form used contained the logo plus the words 'SOCIEDAD LIMITADA' (in small letters) underneath the term 'SISTEMAS' and/or the 'E' device with the words 'epco SISTEMAS, S.L.' in bold</p>	<p>R 1088/2008-2 Confirmed by T-132/09</p>
<p>'... these signs are not, as the applicant seems to suggest, significant alterations of the distinctive character of the earlier mark as registered' (paragraph 24).</p>		

Unacceptable additions

Registered form	Actual use	Case No
VILA VITA PARC	vila vita hotel & ferierendorf panno[n]ja	T-204/12
<p>'whereas the German word "Feriendorf", meaning "holiday village", can be perceived as having a descriptive character for the relevant [hotel] services, this does not apply to the word element "panno[n]ja" (paragraph 30). Consequently, the addition of the word 'panno[n]ja' alters the distinctive character of the mark.</p>		

Registered form	Actual use	Case No
Captain	Captain Birds Eye	R 0089/2000-1
<p>'It cannot be considered ... that the use of CAPTAIN BIRDS EYE constitutes use of the mark CAPTAIN in a form which does not alter the distinctive character of the mark as registered, since the two signs appear essentially different' (paragraph 20).</p>		

Addition of figurative elements

In cases where the figurative element plays only a minor role, being merely decorative, the distinctive character of the sign as registered is not affected.

Registered form	Actual use	Case No
DRINKFIT		T-105/13
The addition of the circular graphical element does not change the overall impression of the sign (paragraph 49).		

Registered form	Actual use	Case No
SEMBELLA		T-551/12
The figurative elements are only decorative or even negligible and do not alter the distinctive character of the mark (paragraph 43).		



BIONSEN		R 1236/2007-2
<p>'Moreover, this material shows that the respondent's products also contain other elements, in particular a Japanese character within a small circle, which is depicted either above or below the word "BIONSEN" (paragraph 19).</p> <p>'However, in the present case, the combination of the stylised form of the word "BIONSEN" and the Japanese character, independently of whether it is above or under the word "BIONSEN", constitutes at the most use which differs from the form in which it was registered only in negligible elements. The word "BIONSEN" as used is merely a slight and banal stylisation of the word 'BIONSEN'. As to the addition of the figurative element in the form of a circular element with a Japanese character, this will hardly be noticed by the average consumer due to its relatively small size and position, either under or on the right side above the word "BIONSEN" (paragraph 23).</p>		

2.7.3.2 Omissions

When considering 'omissions' of elements of a mark in its used form, care has to be taken to check that the distinctive character of the mark has not been altered.

If the omitted element is in a **secondary position and not distinctive**, its omission does not alter the mark (judgment of 24/11/2005, T-135/04, Online Bus, EU:T:2005:419).



Omissions of non-dominant elements

Registered form	Actual use	Case No
		T-135/04
<p>The GC considered that both the registered form of the earlier mark and the form used included the word 'BUS' and the figurative element of 'three interlaced triangles'. The presentation of the elements is not particularly original or unusual in either form. The variation in them does not affect the distinctive character of the trade mark. As regards the omission of 'Betreuungsverbund für Unternehmer und Selbständige e.V.', the latter was 'a string of words, written in small characters and occupying a secondary position, at the bottom of the sign. Its meaning (Association for the assistance of businessmen and the self-employed, registered association) refers to the services in question. Therefore, in the light of the descriptive content of that element and its accessory position in the presentation of the sign, it must be held that it is not distinctive ... It follows from the foregoing that the form used of the earlier trade mark used does not contain any differences such as to alter the distinctive character of that trade mark' (paragraph 34 et seq.).</p>		

Omissions of generic or descriptive elements

Where a registered mark contains a **generic** indication of the product or **descriptive** term, and this term is omitted in the used form of the sign, such use will be considered as use of the registered mark.

Omissions that are just indications of characteristics of the goods and services, such as their kind, quality, quantity, intended purpose, value, geographical origin or the time of production of the goods or of rendering of the services, in general constitute use of an acceptable variant.

Registered form	Actual use	Case No
		T-415/09 (confirmed by C-621/11 P)
<p>The Board considered that although in some pieces of evidence the earlier mark did not include the word 'beachwear' 'this does not alter the distinctiveness of the earlier mark because it is plainly descriptive of the nature of the goods' (<i>T-shirts, beachwear</i>).</p> <p>The GC held:</p> <p>'In the present case, the earlier mark is a composite mark, representing a ship's wheel, that is to say, a sign with a rounded shape. In the centre of the sign there is a fish skeleton, at the top of which is written the term "fishbone", and at the bottom the term "beachwear". ... [A]lthough the use of the earlier mark varies in certain items of evidence and is used in a form different from that under which it was registered, in the sense that the sign does not include the term "beachwear", such a fact does not affect its distinctive character. The term "beachwear", which means "beach clothing" in English, is descriptive of the</p>		

nature of the goods covered by the earlier mark [emphasis added]. That descriptive character is obvious in the case of the “beach clothing” covered by the earlier mark, but also in the case of “t-shirts”, for which the term “beachwear” will immediately be perceived as meaning that it refers to a t-shirt to be worn in casual situations, for example, on the beach in summer. Consumers will thus understand that term as designating the type of goods and will not perceive it as an indication of their commercial origin. The fact that the term “beachwear” is written in a more fanciful font than that of the term “fishbone”, which is written in ordinary capital letters, cannot alter such an assessment. Furthermore, the font of the term “beachwear” cannot be regarded as uncommon, since it comprises printed lower-case characters. As for the horizontal position of the term “beachwear” in the earlier mark, which runs in a perpendicular sense across the bottom of a ship’s wheel, it is no more graphically incisive than that of the term “fishbone” which, also written horizontally, follows the rounded shape of that wheel’ (paragraphs 62-63).

Other acceptable omissions

The omission of **insignificant prepositions** does not alter the distinctive character:

Registered form	Actual use	Case No
CASTILLO DE PERELADA	CASTILLO PERELADA	B 103 046
It is not considered that absence of use of the word ‘de’ affects the distinctive character of the trade mark.		

There are instances where the earlier sign is composed of a distinctive verbal element (or several) **and** a figurative element (or several), with the latter perceived by the relevant public as banal. Such banal elements are considered non-distinctive, and their omission does not change the distinctive character of the sign. Therefore, it is important to establish which elements influence the distinctive character of the mark and how consumers will perceive them.

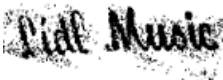
Registered form	Actual use	Case No
		T-225/12, paragraphs 49-53 (appeal pending C-237/14P).
The Court confirmed (paragraph 53) the finding of the Board that ‘distinctiveness of the mark is largely dominated by the wording ‘LIDL MUSIC’ and only marginally influenced by the figurative elements used to represent the letters and the small monogram underneath’ (decision of 21/03/2012, R 02379/2010-1, LIDL express (fig.)/LIDL MUSIC (fig.), paragraph 17).		

The omission of the **transliteration of a term** is generally considered as an acceptable alteration.



Registered form	Actual use	Case No
ΑΡΑΛΙΑ-ΑΠΑΛΙΑ	APALIA	R 2001/2010-1
The omission of the transliteration of the term in Greek characters does not alter the distinctive character of the mark as the form used contains the term APALIA, which is distinctive and dominant.		

Unacceptable omissions

In principle, a difference in **words or even letters** constitutes an alteration of the distinctive character of the mark.

Registered form	Actual use	Case No
TONY HAWK	HAWK 	B 1 034 208

'[T]he absence of the word element 'TONY' in the first two marks significantly alters the distinctive character of the registered earlier mark 'TONY HAWK'. Therefore, these marks shall be perceived as separate marks and their use cannot be considered as the use of the word mark 'TONY HAWK'.

Registered form	Actual use	Case No
 (in Spain)		R 1625/2008-4 (appeal T-143/10 did not refer to the Spanish trade marks)

'In the present case, the Board has been able to verify that none of the items of proof of use supplied reproduces the earlier Spanish signs in the form in which they were registered, since either the mark is represented in its purely visual form, that is, without the expression "light technology", or the visual element is accompanied only by the term "Light" and other word elements or the expression "LT Light-Technology", which is also in the form of a word lacking the visual element which obviously characterises the earlier Spanish marks on which the opposition is based ... Under these circumstances, and in view of the fact that the modifications made to the representation of earlier marks modify their distinctive character, it is considered that, in any case, the proof submitted does not demonstrate use of the Spanish marks on which the opposition is based' (paragraphs 15-16).

Registered form	Actual use	Case No
SP LA SPOSA	LA SPOSA LA SPOSA COLLECTION	R 1566/2008-4

'The earlier trade mark is registered as "SP LA SPOSA". The documents submitted as proof of use refer only to female wedding dresses. The element "LA SPOSA" is a common term, which will be understood by the Italian and Spanish public as "the bride" and has a weak distinctive character for the goods in issue, namely wedding dresses. The opponent itself, in its price list "tarifa de precios" which is drafted in various official languages of the EC, translated this term into the respective languages; underneath the term "LA SPOSA", the terms "novia" are mentioned in the Portuguese version of the list, "bride" in the English version, "Braut" in the German version, and so on. This shows that even the respondent itself understands the term "LA SPOSA" as a reference to the consumer targeted, namely the bride' (paragraph 18).

'Therefore the element "SP" at the beginning of the earlier mark is a distinctive element and cannot be disregarded. This element cannot be neglected, first and foremost as it is placed at the beginning of the mark. Also, it is meaningless and distinctive on its own, in all the languages of the European Union' (paragraph 19).

'[T]he omission of the letter "SP" in the word "LA SPOSA" or "LA SPOSA COLLECTION" is not an acceptable variation of the earlier mark but a significant modification to the distinctive character of the mark. The documents submitted by the respondent are insufficient to prove that the mark "SP LA SPOSA" has been put to genuine use' (paragraph 26).

In cases where the **figurative element** is the dominant or distinctive element and not merely decorative or banal, its omission can alter the distinctive character of the sign.

Registered form	Actual use	Case No
	<p>ESCORPION</p>	<p>R 1140/2006-2</p>
<p>'The earlier trade marks are strongly characterised by the presence of the figurative element. However, the documents submitted during the opposition proceedings and, even if they were to be taken into account, the appeal proceedings, do not show any use of the figurative element contained in the earlier trade marks' (paragraph 19).</p> <p>'Therefore, the Office considers that the alteration of the opponent's trade mark appearing in the way it is currently used is not an acceptable alteration and consequently use of the registered mark is not shown. The opponent has not complied with the requirements of Article 43(2) and (3) EUTMR and thus the opposition must be rejected, as far as it was based on the Spanish trade mark registrations' (paragraph 20).</p>		

2.7.3.3 Other alterations

Acceptable alterations

Word marks

Word marks are considered used as registered regardless of typeface, use of upper/lower case or colour. It would not be correct to analyse this type of use from the perspective of whether distinctive character is altered. However, a **very particular typeface** (highly stylised) may lead to a different conclusion.

Changing the **letter size** or switching between **upper/lower case** is customary when using word marks. Therefore, such use is considered use of the registered mark.

Registered form	Actual use	Case No
<p>PALMA MULATA</p>		<p>T-381/12</p>
<p>The Court confirmed that the use of a [standard] typeface does not alter the distinctive character of a word mark. It rather helps to distinguish the mark from the descriptive elements 'ron' and 'de Cuba' (paragraph 34).</p>		

Registered form	Actual use	Case No
MILENARIO		R 0289/2008-4
<p>The Board confirmed OD's views that use of the word mark 'MILENARIO' written in stylised bold characters did not affect the distinctive character of the mark, as the word 'MILENARIO' was considered to be the dominant element of the mark registered for 'sparkly wines and liquors' in Class 33 (paragraph 13).</p>		

Registered form	Actual use	Case No
AMYCOR		R 1344/2008-2
<p>Representation of the word mark, registered for <i>pharmaceutical and sanitary preparations; plasters; materials for dressings; fungicides; disinfectants</i> covered by the earlier trade mark in Class 5, in a stylised form together with figurative elements was not considered as substantially changing the distinctive character of the word trade mark 'AMYCOR' as registered.</p>		

Registered form	Actual use	Case No
THE ECONOMIST		R 0056/2011-4
<p>'The applicant's argument that the proof of use is insufficient because it refers to the device mark ... and not to the word mark 'THE ECONOMIST' fails. First, the submitted evidence refers to both earlier marks (i.e. the word mark and the device mark). Furthermore, use of the earlier device mark constitutes use of the earlier word mark. In this respect it should be noted that word marks are considered used as registered, also if the typeface is different (this may be different if the typeface is a very particular one), if there is a usual change in the letter size or a usual change between lower-case and capital letters, if used in a specific colour or if used in combination with generic additions. Use of the word "THE ECONOMIST" in a standard typeface, with the usual use of capitals at the beginning of the words "The" and "Economist", in a white colour on a contrasting background is considered use, not only of the earlier device mark but of the earlier word mark as well' (paragraph 14).</p>		

Word marks are registered in black and white. It is customary to use marks in **colour**. Such use does not constitute a variant but use of the registered mark.

Registered form	Actual use	Case No
BIOTEX	(various)	R 0812/2000-1
<p>'The mark, as shown in those documents, has been variously depicted in the following styles:</p> <ul style="list-style-type: none"> – The word BIOTEX in white block capitals on a dark background in advertisements. – Reference in newspaper articles to the word BIOTEX in plain typeface. – The word BIOTEX in white block capitals with the top-most point of the letter 'l' in darker colouring. – The word BIOTEX in plain block white capitals on the labels and packaging of detergent products. – The word BIOTEX in plain typeface on shipping invoices. – The word BIOTEX in white upper and lower cases block letters on a darker background incorporating a figurative 'wave' device' (paragraph 14). <p>'The evidence of use shows the mark has remained, in spite of various stylistic changes, essentially BIOTEX. The letters forming the mark have in general been mere block capitals, lacking anything fanciful. Sometimes the capitals are plain and two-dimensional, at other times they are shadowed to give the impression of being three-dimensional. Sometimes the letter "l" has a different colour tip. The Board considers these variations minimal and routine and that they demonstrate a practice that is commonplace</p>		

not only in the particular business field of relevance here, but in other fields also. The Board does not consider that these variations invalidate use of the mark BIOTEX and therefore the contested decision must be annulled at this point' (paragraph 17).



Registered form	Actual use	Case No
SILVER		B 61 368

'The actual use of the trade mark which can be seen on the beer pack, the newspaper extract and on the calendar is not the use of the registered **word** mark SILVER, but of the **colour device** mark, namely a beer label with the word SILVER written in white capital letters in a red banner which overlaps a golden circle which contains the word elements "Bière sans alcool", "Bière de haute qualité", "pur malt" and "Brassée par le Brasseries Kronenbourg". This does not automatically mean that the mark was not used as registered. Each case must be looked at on its own merits. In this case, the Office finds that the mark SILVER is the actual trade mark. The appearance of the other word elements "Bière sans alcool", "Bière de haute qualité", "pur malt" and "Brassée par le Brasseries Kronenbourg" and the figurative element is only secondary to the mark SILVER. It is also clear from the marketing study, the newspaper extract and the invoices that the actual trade mark is SILVER. The Office finds that the use of the word SILVER is so dominant in the figurative mark that it fulfils the requirements of having been used as registered.'

Figurative marks

Using a **purely figurative mark** (without word elements) in a form other than registered often constitutes an unacceptable alteration.

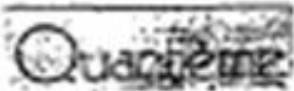
In the case of **composite marks** (i.e. marks composed of word and figurative elements), **changes to certain figurative elements do not** normally affect the distinctive character of the marks.

Registered form	Actual use	Case No
		T-147/03 (C-171/06 P dismissed)

'[T]he only elements which differentiate the earlier national mark, as it was registered, from the sign used by the applicant are the stylisation of the letter "q", suggesting the face of a watch, and the use of capital letters to write the verbal element of the earlier national mark ... In the first place, although it is true that the stylisation of the letter "q" is more pronounced in the representation of the sign used than in that of the earlier national mark, the distinctive character of the earlier mark is still based on the entire verbal element of that mark. In any case, since the stylisation of the letter "q" suggests, as has just been said, the face of a watch, it is not particularly distinctive for goods in Class 14, the only goods for which the applicant has furnished proof of use of the earlier mark. In the second place, as regards the use of capital letters, it suffices to note that that is not at all original and also does not alter the distinctive character of the earlier national mark ... It follows that the proof furnished by the applicant which refers to the sign reproduced in paragraph 10 above for the Class 14 goods "watches and watch bands or straps" could legitimately be taken into account by the Board of Appeal for the purposes of assessing whether the applicant had shown genuine use of the earlier national mark' (paragraphs 28-30).



This is particularly relevant in cases where the figurative element is **mainly descriptive** of the relevant goods and services.



Registered form	Actual use	Case No
GRECO TAVERNA		R 2604/2011-1
<p>'In relation to the "FETA" product, as regards the two Greek flags next to the word "TAVERNA" it should be noted that the obligation of using a trade mark as registered does not require its proprietor to use the mark in isolation in the course of trade. Article 15(1) EUTMR does not preclude the possibility of the trade mark's proprietor adding further (decorative or descriptive) elements, or even other marks such as its house mark on the packaging of the product, as long as the trade mark 'as registered' remains clearly recognisable and in an individual form. The two Greek flags do not possess any distinctive character in relation to the products at hand which are commonly known to be food specialities originating from Greece. This is supported by the whole get-up of the product, coloured in blue and white in accordance with the colours of the Greek flag, the depiction of scenery which calls to mind a Mediterranean scene and the symbol for a Protected Designation of Origin below the picture' (paragraph 39).</p>		



This is also the case where the dominant elements remain unchanged (see T-135/04, 'Online bus' above).

For specifically **alterations in colour**, the main question that needs to be addressed is whether the mark as used alters the distinctive character of the registered mark, that is to say whether use of the mark in colour, while being registered in black and white or greyscale (and vice versa) constitutes an alteration of the registered form. The Office and a number of Trade Mark Offices of the European Union have agreed on a common practice under the European Trade Mark and Designs Network whereby a change only in colour does not alter the distinctive character of the trade mark as long as:

- the word/figurative elements coincide and are the main distinctive elements;
- the contrast of shades is respected;
- the colour or combination of colours does not have distinctive character in itself;
- the colour is not one of the main contributors to the overall distinctiveness of the sign.

Registered form	Actual use	Case No
		T-152/11
<p>The Court took the view that, if no colour is claimed in the application, the use of different colour combinations 'must be allowed, as long as the letters contrast against the background.' The Court also noted that the letters M, A, D were arranged in a particular way in the EUTM. Accordingly, representations of the sign which do not alter the arrangement of the letters, or the contrast of colour, constitute genuine use (paragraphs 41 and 45).</p>		

Registered form	Actual use	Case No
		R 1479/2010-2
<p>The word element was considered to be the dominant feature of the figurative mark, since it was in a central position and in large letters. It was considered that the distinctive character was not changed (paragraph 15).</p>		

Registered form	Actual use	Case No
		R 0877/2009-1
<p>'The orange background is the colour of packaging of the products. The mark is used in black on a white background, outlined in silver similar to the earlier registered mark. The typeface has been slightly modernised and the small hyphen between "Bi" and "Fi" has been deleted. Nevertheless, these may be considered as minor changes that do not alter the distinctive character of the mark in the form in which it is registered in the sense of Article 15(1)(a) EUTMR. The typeface has been modernised but the letters keep their rounded shape and the deletion of the hyphen may pass unnoticed. The distinctive character of the earlier mark is still based on the large black letters "Bi Fi", the "B" and "F" being in capital letters and the two "i" letters in lower case, on a white background and outlined in silver' (paragraph 45).</p>		

3D marks

The use of a 3D mark in varying sizes usually amounts to use of the mark as registered. The addition of a word/figurative element to such a mark does not generally alter the distinctive character of the sign.



Colour marks

Colour marks are marks consisting of one or more colours per se. Where the mark is a colour combination, the registration must indicate the proportion of each colour and specify how they will appear.

Colour marks must be used with the colours as registered. Insignificant variations in the colour shade and strength will not alter distinctive character.

Where a colour combination is registered without specifying the respective proportions, use in **varying proportions** will not affect distinctive character. The case is different when particular proportions were claimed and these are substantially altered in the variant as used.



Where a colour or colour combination is registered, use in combination with a **distinctive or descriptive word** will not affect distinctive character. See, by analogy, the Court judgment below regarding the proof of acquired distinctiveness of a mark (examination):

Registered form	Actual use	Case No
	(with word mark John Deere)	T-137/08 (AG case)
<p>'The colours covered by the application for registration were designated using the Munsell system as: 9.47 GY3.57/7.45 (green) and 5.06 Y7.63/10.66 (yellow). The arrangement is described as being 'green for the vehicle body and yellow for the wheels', as is shown by a picture attached to the application and reproduced below  (paragraph 3).</p> <p>'It follows from the above that, although it is true that the disputed mark was used and promoted in conjunction with the word mark John Deere [underlining added] and that the intervener's advertising expenditure in the European Union was presented as a whole and not individually for each country, the applicant is wrong to claim that it was not proved to the required legal standard that the intervener had used the combination of the colours green and yellow on its goods as a trade mark and that the market penetration of its goods had been deep and long-lasting in all the Member States of the European Union as at 1 April 1996' (paragraph 46).</p>		

Unacceptable alterations

Where a mark is composed of several elements, only one or some of which are distinctive and have rendered the mark as a whole registrable, an alteration of that element or its omission or replacement by another element will generally mean that the distinctive character is altered.

Registered form	Actual use	Case No
MEXAVIT	MEXA-VIT C	R 0159/2005-4
<p>In this case the use of the mark with a different spelling and the addition of the letter 'C' alter the distinctive character of the registered sign, because the letters 'VIT' are now seen as a descriptive element, namely 'VIT C' (which refers to 'Vitamin C').</p>		

Registered form	Actual use	Case No
		R 2066/2010-4
<p>'[T]he 'NOVEDADES' catalogues dated 2004-2009 consistently show the mark  and only this version. This does not constitute use of the mark [as registered] (with or without colour) as admissible</p>		

under Article 15(1)(a) EUTMR. The mere fact that both marks include a word element LLOYD'S is not enough for that purpose, also the figurative elements of the earlier mark must appear in the form as used. The form as used is in a different font, lacks the single letter L at the end and surrounded by an orbital device, and lacks the circular or orbital device around the word 'LLOYD'S'. In other words, all its figurative elements are missing in the form as used. On top, the form as used contains the conspicuous device of a flying bird with a long beak. The omission of all the figurative elements of the mark as registered and the addition of another figurative element does alter, in the form as used, the distinctive character of the mark and is much more than a mere variation or modernization' (paragraph 35).

2.8 Use for the goods or services for which the mark is registered

In accordance with Article 15 EUTMR, the mark must be used for the goods or services for which it is registered in order to be enforceable. In accordance with the first sentence of Article 42(2) EUTMR, the earlier registered mark must have been put to genuine use in connection with the goods or services in respect of which it is registered and which the opponent cites as justification for its opposition. The third sentence of Article 42(2) EUTMR stipulates that if the earlier trade mark has been used for part only of the goods or services for which it is registered it will, for the purposes of the examination of the opposition, be deemed to be registered for only that part of the goods or services.

As the GC stated in the 'Aladin' case:

[The provisions of Article 42 EUTMR] allowing an earlier trade mark to be deemed to be registered only in relation to the part of the goods or services in respect of which genuine use of the mark has been established (i) are a **limitation on the rights** which the proprietor of the earlier trade mark gains from his registration ..., and (ii) must be reconciled with the legitimate interest of the proprietor in being able in the future to **extend his range of goods or services**, within the confines of the terms describing the goods or services for which the trade mark was registered, by using the protection which registration of the trade mark confers on him. That is particularly so when, as here, the goods and services for which the trade mark has been registered form a sufficiently narrowly-defined category.

(Judgment of 14/07/2005, T-126/03, Aladin, EU:T:2005:288, § 51, emphasis added.)

The analysis of genuine use must in principle extend to all of the registered goods and/or services on which the opposition is based and for which the EUTM applicant has made an explicit request for proof of use. However, in situations where it is clear that likelihood of confusion can be established on the basis of **some** of the earlier goods and/or services, the Office's analysis of genuine use need not extend to all the earlier goods and/or services but instead may focus on only those goods and/or services sufficient for establishing identity/similarity to the contested goods and/or services.

In other words, since likelihood of confusion can be established on the basis of a finding of genuine use for some of the earlier goods and/or services, it is unnecessary to examine the evidence of use filed by the opponent with respect to the remaining earlier goods and/or services.

The following sections include a number of guidelines to help establish whether the earlier trade mark has been effectively used for the registered goods and services. For

further details see the Guidelines, Part C, Opposition, Section 2, Double identity and Likelihood of Confusion, Chapter 2, Comparison of Goods and Services and in particular the practice regarding the use of all the general indications in the class heading, and the Guidelines, Part B, Examination, Section 3, Classification.

2.8.1 Comparison between goods/services used and specification of goods/services

It must always be carefully assessed whether the goods and services for which the mark has been used fall within the category of the registered goods and services.

Examples:

Case No	Registered G&S	Used G&S	Comment
T-382/08, VOGUE	<i>Footwear.</i>	<i>Retail of footwear.</i>	Not OK (paragraphs 47-48).
T-183/08, SCHUHPARK	<i>Footwear.</i>	<i>Retail services regarding footwear.</i>	Not OK (paragraph 32)
R 0807/2000-3, Demara	<i>Pharmaceuticals, veterinary and disinfectant products.</i>	<i>Napkins and napkin pants for incontinence.</i>	Not OK, even though the specific goods might be distributed by pharmacies (paragraphs 14-16).
R 1533/2007-4, GEO MADRID	<i>Telecommunication services in Class 38.</i>	<i>Providing an internet shopping platform.</i>	Not OK (paragraph 16).
R 0068/2003-2, Sweetie	<i>Preserved, dried and cooked fruits and vegetables; concentrated citrus fruit and fruit extracts, preserves; sugar, biscuits, cakes, pastry and confectionery.</i>	<i>Dessert toppings that are strawberry, caramel or chocolate flavoured.</i>	Not OK (paragraph 20).
R 1519/2008-1, DODOT et al.	<i>Baby diapers of textile in Class 25.</i>	<i>Disposable diapers of paper and cellulose (Class 16).</i>	Not OK (paragraph 29).
R 0594/2009-2, BANIF	<i>Administration, representation and general counsel in Class 35 Technical, economic and administrative projects in Class 42.</i>	<i>Administration of funds and personal assets or real estate affairs (Class 36).</i>	Not OK (paragraph 39).
B 1 589 871 OXIL	<i>Electric switches and 'parts of lamps'.</i>	<i>Apparatus for lighting.</i>	Not OK.
B 253 494 CAI/Kay	<i>Education services.</i>	<i>Entertainment services.</i>	Not OK.
B 1 259 136, LUPA	<i>Transportation and distribution services in Class 39.</i>	<i>Home delivery of goods purchased in a retail store.</i>	Not OK as the registered services are provided by specialist transport companies whose business is not the provision of other services, while the home delivery of goods purchased in a retail store is just an additional auxiliary service integrated in retail services.

R1330/2011-4, AF (fig.)	<i>Advertising, business management, business administration, office functions</i> in Class 35.	<i>Retail services.</i>	Not OK. If a trade mark is registered for the general indications in Class 35, but use is proven only for <i>retail services</i> for particular goods, this cannot amount to valid proof of use for any of the specific indications of Class 35 or the class heading as a whole (paragraph 25 by analogy).
----------------------------	---	-------------------------	--

2.8.2 Relevance of the classification

It is relevant to establish whether the specific goods or services for which a mark has been used fall under any **general indication** listed in the **class heading** of a particular class of goods or services, and if so, which.

For instance, in Class 25, the class heading is *clothing, footwear, and headgear* and each of these three items constitutes a 'general indication'. Whereas, in general, classification does not serve more than administrative purposes, it is relevant, in order to assess the nature of the use, to establish whether the goods for which a mark has been used fall under the general indication of *clothing, footwear or headgear*.

This is apparent when similar categories of goods have been classified differently for certain reasons. For instance, shoes have been classified in various classes according to their intended purpose: *orthopaedic shoes* in Class 10 and *ordinary shoes* in Class 25. It must be established, according to the evidence provided, to which kind of shoes the use relates.

2.8.3 Use and registration for general indications in 'class headings'

Where a mark is registered under **all** or **part of** the general indications listed in the class heading of a particular class and where it has been used for several goods or services that are properly classified in the same class under one of these **general indications**, the mark will be considered as having been used for that specific **general indication**.

Example: The earlier mark is registered for *clothing, footwear, headgear* in Class 25. The evidence relates to 'skirts', 'trousers' and 'T-shirts'.

Conclusion: The mark has been used for *clothing*.

On the other hand, when a mark is registered for only **part** of the **general indications** listed in the class heading of a particular class but has been used only for goods or services which fall under **another** general indication of that same class, the mark will not be considered as having been used for the registered goods or services (see also paragraph 2.8.4 below).

Example: The earlier mark is registered for *clothing* in Class 25. The evidence relates to 'boots' only.

Conclusion: The mark has not been used for the goods for which it is registered.

2.8.4 Use for subcategories of goods/services and similar goods/services

This part deals with the extent of protection granted where there is use for subcategories of goods and of 'similar' goods (or services).

In general, it is not appropriate to accept proof of use for 'different' but somehow 'linked' goods or services as automatically covering registered goods and services. In particular, the concept of **similarity of goods and services is not a valid consideration** within this context. The third sentence of Article 42(2) EUTMR does not provide any exception in this regard.

Example: The earlier mark is registered for *clothing* in Class 25. The evidence relates to 'boots' only.

Conclusion: The mark has not been used for the goods for which it is registered.

2.8.4.1 Earlier mark registered for broad category of goods/services

In the Aladin case, the GC held:

if a trade mark has been registered for a category of goods or services which is sufficiently broad for it to be possible to identify within it a number of subcategories capable of being viewed independently, proof that the mark has been put to genuine use in relation to a part of those goods or services affords protection, in opposition proceedings, only for the subcategory or subcategories to which the goods or services for which the trade mark has actually been used belong.

(Judgment of 14/07/2005, T-126/03, Aladin, EU:T:2005:288, § 45.)

Therefore, if the earlier mark has been registered for a **broad category** of goods or services but the opponent provides evidence of use only for specific goods or services **falling within this category**, this raises the question of whether the submitted evidence is to be regarded strictly as proof of use only for the particular goods or services, which are not mentioned as such in the list of goods or services, or for the broad category as specified in the registration.

The GC further pointed out, on the one hand, that it is necessary to interpret the last sentence of Article 42(2) EUTMR as seeking to deny a trade mark extensive protection if it has only been used in relation to part of the goods or services for which it is registered merely because it has been registered for a wide range of goods or services. Therefore, it is necessary to take account of the breadth of the categories of goods or services for which the earlier mark is registered, in particular the extent to which the categories concerned are described in general terms for registration purposes, and to do this in the light of the goods or services for which genuine use has actually been established (paragraph 44).

On the other hand, it is not necessary for the opponent to file evidence of all the commercial variations of similar goods or services but merely of those goods or services which are sufficiently distinct to constitute coherent categories or subcategories (paragraph 46). The underlying reason is that in practice it is impossible for the proprietor of a trade mark to prove that the mark has been used for all conceivable variations of the goods concerned by the registration.

Thus, protection is available **only** for the subcategory or subcategories to which the used goods or services belong if:

1. a trade mark had been registered for a **category** of goods or services:
 - (a) which is sufficiently broad to cover a number of subcategories other than in an arbitrary manner;
 - (b) that are capable of being perceived as being independent from each other;

and
2. it can be shown that the mark has been genuinely used in relation to only **part** of the initial broad specification.

Appropriate reasoning should be given for defining the subcategories and, on the basis of the evidence submitted by the opponent, it must be explained whether use has been shown in relation to only **part** of the initial broad specification/subcategory(ies). See examples in paragraph 2.8.4.3 below.

This is especially important in the case of trade marks registered for *pharmaceutical preparations*, which are usually used only for one kind of medicine for treating a certain disease (see the examples of *pharmaceutical preparations* in paragraph 2.8.4.3 below).

On the other hand, the use for a whole category has to be accepted if there are examples of different kinds of products belonging to this category and there is no other subcategory that covers the different products.

Contested sign	Case No
CARRERA	R 0260/2009-4 (revocation)
<p>The proven use of a trade mark for:</p> <ul style="list-style-type: none"> • decorative lettering; • increased performance packages; • covers for storage compartments; • wheel sets and complete wheel sets for summer and winter; and • door sill cover plates <p>was considered sufficient proof of use for <i>motor vehicle and land vehicle parts</i> overall, for which the mark was registered. The main arguments were that it was used for numerous different motor vehicle parts and the goods for which use had been proven thus covered a wide spectrum of motor vehicle parts: elements of the chassis, the bodywork, the engine, the interior design and decorative elements.</p>	

2.8.4.2 Earlier mark registered for precisely specified goods/services

In contrast, proof of genuine use of the mark for some of the specified goods or services necessarily covers the **entire category** if:

- (1) a trade mark has been registered for goods or services **specified** in a relatively precise manner; so that

- (2) it is not possible, without any artificiality, to make any significant subdivisions within the category concerned (judgment of 14/07/2005, T-126/03, Aladin, EU:T:2005:288, § 45).

The decision should duly indicate in which cases it is considered impossible to make subdivisions and, if necessary, why.

2.8.4.3 Examples

In order to define adequate subcategories of general **indications**, the **criterion of the purpose or intended use of the product or service** in question is of fundamental importance, as consumers do employ this criterion before making a purchase (judgments of 13/02/2007, T-256/04, Respicur, EU:T:2007:46, § 29-30; 23/09/2009, T-493/07, Famoxin, EU:T:2009:355, § 37). Other applicable criteria for defining adequate subcategories could be the characteristics of the product or service, for instance the nature of the product or service or the target consumer of the product or service.

Earlier sign	Case No
ALADIN	T-126/03
<p>G&S: <i>polish for metals</i> in Class 3.</p> <p>Assessment of PoU: the earlier mark was registered for <i>polish for metals</i> in Class 3, but was actually used genuinely only for <i>magic cotton</i> (a product for polishing metals consisting of cotton impregnated with a polishing agent). The Court held that 'polish for metals', which in itself is already a subcategory of the class heading term <i>polishing preparations</i>, is sufficiently precise and narrowly-defined in terms of the function and intended purpose of the claimed goods. No further subcategory can be established without being artificial, and thus, use for the entire category of <i>polish for metals</i> was assumed.</p>	

Contested sign	Case No
Turbo	R 0378/2006-2 Revocation
<p>G&S: <i>clothing</i> in Class 25.</p> <p>Assessment of PoU: the Board found that, in addition to swimwear, other types of clothing were referred to in the invoices and could be found in the catalogues. Thus, the Board found that use of the contested mark had been proved for <i>clothing</i> (paragraph 22). The Board, moreover, found it almost impossible and certainly unduly onerous to impose on the proprietor of a registered EUTM for <i>clothing</i> the obligation to demonstrate use in all possible subcategories that could be endlessly subdivided by the applicant (paragraph 25).</p>	

Earlier sign	Case No
	R 1088/2008-2 (confirmed by T-132/09)
<p>G&S: <i>measuring apparatus and instruments</i> in Class 9.</p> <p>Assessment of PoU: the mark was used for apparatus and parts thereof for the measurement of temperature, pressure and level. The contested decision considered that the original specification of the earlier mark for <i>measuring apparatus and instruments</i> was a 'very wide' one, and determined, applying the criteria established in the Aladin judgment, that use had in fact only been shown for a subcategory of goods, namely: <i>measuring apparatus, all being for the measurement of temperature, pressure and level; parts for the aforesaid apparatus</i>. The Board found that approach to be a reasonable one in the</p>	

circumstances of the case and endorsed the reasoning and findings of the contested decision in this regard (paragraph 29).

Contested sign	Case No
ICEBERG	R 1166/2008-1 Revocation
<p>G&S: <i>apparatus for heating, steam generating, refrigerating, drying, ventilating and water supply purposes</i> in Class 11.</p> <p>Assessment of PoU: the Board concluded that the trade mark use was only proven for fridges, freezers and air-conditioning modules for yachts and boats (paragraph 26). These goods were included in the subcategories <i>apparatus for heating</i> (insofar as an air-conditioning machine can also perform as a heater), <i>apparatus for refrigerating</i> (insofar as an air-conditioning machine, a fridge and a freezer can keep air/things cold), and <i>apparatus for ventilating</i> (insofar as an air-conditioning machine, a fridge and a freezer all include ventilation circuits) for which the mark was registered. Therefore, the Board thought it should remain registered for those subcategories (paragraph 27). However, the Board did not consider it appropriate to limit the scope of protection of the trade mark to <i>yachts and boats</i>. This would have further split the 'subcategories' and would amount to unjustified limitation (paragraph 28).</p> <p>Conclusion: use was considered proven for <i>apparatus for heating, refrigerating and ventilating</i>.</p>	

Contested sign	Case No
LOTUS	R 1295/2007-4 Revocation
<p>G&S: <i>outerwear and underwear, hosiery, corsets, neckties, braces, gloves, underclothes</i> in Class 25.</p> <p>Assessment of PoU: no evidence was submitted in respect of the goods <i>corsets, neckties, braces</i>. None of the pieces of evidence submitted mentions these goods or refers to them. Use must be demonstrated for all goods or services for which the trade mark is registered. The trade mark is registered for <i>outerwear and underwear</i>, but also for specific products within this category — inter alia <i>corsets, neckties, braces</i>. Use for other goods is not sufficient to maintain protection under trade mark law for these goods, even if these other goods also fall under the category <i>outerwear and underwear</i>. The Invalidity Division, however, considered use to be sufficient, because according to the principles of the Aladin judgment (judgment of 14/07/2005, T-126/03, Aladin, EU:T:2005:288) the <i>corsets, neckties, braces</i> fall under the generic term of <i>outerwear and underwear</i>. While this is indeed true, this question is subordinate to examining whether the goods used can be subsumed under the claimed term at all. This is not the case for <i>corsets, neckties, braces</i>. If alongside the broad generic term the trade mark also explicitly claims specific goods covered by the generic term, it must also have been used for these specific goods in order to remain registered for them (paragraph 25).</p>	

Earlier sign	Case No
GRAF-SYTECO	R 1113/2009-4
<p>G&S: <i>electric instruments (included in Class 9); optical, weighing, measuring, signalling and checking (supervision) instruments; data processing equipment and computers, in particular for operating, monitoring and checking machines, installations, vehicles and buildings; recorded computer programs; electronic counters</i> in Class 9, <i>repair services</i> in Class 37 and <i>computer programming</i> in Class 42.</p> <p>Assessment of PoU: the devices which the opponent has proven to have placed on the market fall under the wording of <i>hardware</i> as specified in Class 9. This is, however, a vast category, especially considering the massive development and high specialisation taking place in this field, which can be divided into subcategories according to the actual goods produced. In the present case the goods must be limited to the automotive industry. As the opponent is obliged to provide a legal guarantee to clients, it can be considered that it has also proven use of the service relating to repair of the hardware in question (Class 37). The Board also found that <i>recorded computer programs</i> in Class 9 were a very broad category and had to be limited to the actual field of activity of the opponent (paragraphs 30-31). No evidence was submitted for Class 42.</p>	

Earlier sign	Case No
HEMICELL	R 0155/2010-2
<p><i>G&S: foodstuffs for animals in Class 31, and animal foodstuffs, animal feed and non-medicated additives for animal feed; all included in Class 31.</i></p> <p>Assessment of PoU: the contested decision erred in considering that the earlier mark had been put to genuine use for <i>foodstuffs for animals</i> in Class 31, and <i>animal foodstuffs, animal feed and non-medicated additives for animal feed; all included in Class 31</i>, since this finding is contrary to the findings of the Court in ALADIN. The reason given by the contested decision is not acceptable because it should have been tested whether or not the category of goods covered by the earlier mark was susceptible of being divided into independent subcategories and whether the goods for which use of the earlier mark had been proven could be classified in one of those. Therefore, the Board considers that the earlier EUTM is, for the purposes of examination of the opposition, deemed to be registered in respect of <i>additives for animal feed</i> only in Class 31.</p>	

Pharmaceutical preparations

In a number of cases, the Court had to define adequate subcategories for *pharmaceutical preparations* in Class 5. It held that the purpose and intended use of a therapeutic preparation are expressed in its therapeutic indication. Thus, the *therapeutic indication* is the key for defining the relevant subcategory of pharmaceutical products. Other criteria (such as dosage form, active ingredients, whether it is sold on prescription or over the counter) are irrelevant in this regard.

The following subcategories for *pharmaceutical preparations* were assumed to be adequate by the Court:

Case No	Adequate	Non-adequate
T-256/04, RESPICUR	<i>Pharmaceutical preparations for respiratory illnesses.</i>	<i>Multi-dose dry powder inhalers containing corticoids, available only on prescription.</i>
T-493/07, FAMOXIN	<i>Pharmaceutical preparations for cardiovascular illnesses.</i>	<i>Pharmaceutical preparations with digoxin for human use for cardiovascular illnesses.</i>
T-487/08 KREMIZIN	<i>Pharmaceutical preparations for heart treatment.</i>	<i>Sterile solution of adenosine for use in the treatment of specific heart condition, for intravenous administration in hospitals.</i>
T-483/04, GALZIN	<i>Calcium-based preparations.</i>	<i>Pharmaceutical preparations.</i>

2.8.5 Use of the mark as regards integral parts and after-sales services of the registered goods

In the 'Minimax' judgment, the Court held that, in certain circumstances, use of the mark may be considered genuine also for 'registered' goods that had been sold at one time and were no longer available (judgment of 11/03/2003, C-40/01, Minimax, EU:C:2003:145, § 40 et seq.).

- This may apply where the proprietor of the trade mark under which such goods had been put on the market **sells parts** that are integral to the make-up or structure of the goods previously sold.

- The same may apply where the trade mark proprietor makes actual use of the mark for **after-sales services**, such as the sale of accessories or related parts, or the supply of maintenance and repair services.

Sign	Case No
Minimax	C-40/01
<p><i>G&S: fire extinguishers and associated products v components and after-sales services.</i></p> <p>Assessment of PoU: the authorisation for the fire extinguishers sold by Ansul under the Minimax trade mark expired in the 1980s. Since then, Ansul has not been selling fire extinguishers under that mark. However, Ansul nonetheless sold component parts and extinguishing substances for fire extinguishers bearing the mark to undertakings with responsibility for maintaining them. During the same period it also maintained, checked and repaired equipment bearing the Minimax mark itself, used the mark on invoices relating to those services and affixed stickers bearing the mark and strips bearing the words 'Gebruiksklaar Minimax' (Ready for use Minimax) to the equipment. Ansul also sold these stickers and strips to undertakings that maintain fire extinguishers.</p>	

However, this finding of the Court should be interpreted **strictly** and applied only in very exceptional cases. In Minimax, the Court accepted use for goods other than those registered, which runs counter to the general rule laid down in Article 42(2) EUTMR.

2.9 Use by the proprietor or on its behalf

2.9.1 Use by the proprietor

According to Articles 42(2) and 15(1) EUTMR, it is in general the owner who has to put the earlier registered mark to genuine use. These provisions also cover use of the mark by the previous owner during its ownership (decision of 10/12/1999, case B 74 494).

2.9.2 Use by authorised third parties

According to Article 15(2) EUTMR, use of the mark with the consent of the proprietor is deemed to constitute use by the proprietor. This means that the owner must have given its consent **prior** to the use of the mark by the third party. Acceptance later is insufficient.

A typical case of use by third parties is use made by **licensees**. Use by companies **economically related** to the trade mark proprietor, such as members of the same group of companies (affiliates, subsidiaries, etc.) is similarly to be considered as authorised use. Where goods are produced by the trade mark proprietor (or with its consent), but subsequently placed on the market by **distributors** at wholesale or retail level, this is to be considered as use of the mark (judgments of 17/02/2011, T-324/09, Friboi, EU:T:2011:47, § 32; 16/11/2011, T-308/06, Buffalo Milke, EU:T:2011:675, § 73).

At the **evidence** stage it is prima facie sufficient that the opponent only submits evidence that a third party has used the mark. The Office infers from such use, combined with the opponent's ability to present evidence of it, that the opponent has given prior consent.

This position of the Office was confirmed by judgment of 08/07/2004, T-203/02, Vitafruit, EU:T:2004:225, § 25 (and confirmed by the Court in C-416/04 P). The Court pointed out that it was unlikely that the proprietor of a trade mark would be in a position

to submit evidence if the mark had been used against its wishes. There was all the more reason to **rely on that presumption**, given that the applicant did not dispute the opponent's consent.

However, if there are **doubts** on the part of the Office or, in general, in cases where the applicant explicitly contests the opponent's consent, the burden is on the opponent to submit further evidence that it gave its consent prior to use of the mark. In such cases the Office gives the opponent a further period of two months for the submission of such evidence.

2.9.3 Use of collective marks

Collective marks are generally used not by the proprietor but by members of an association.

According to Article 70 EUTMR, use by (at least) one authorised person satisfies the user requirement, provided use is otherwise genuine.

The specific characteristic of collective trade marks is that their main objective is not to indicate that the goods or services originate from a specific source but that they originate from a certain region and/or comply with certain characteristics or qualities ('geographical and complementary indications of origin or quality'). This different function has to be taken into account when evaluating the proof of use in accordance with Article 70 EUTMR.

Mere lists of persons authorised to use the collective mark and lists of products that are certified under the collective mark are generally not sufficient on their own to prove any genuine use (decisions of 25/05/2009, B 1 155 904; 24/02/2009, R 0970/2008-2, NFB).

2.10 Legal use

Whether a mark has been used in a way that satisfies the use requirements of Articles 15 and 42 EUTMR requires a factual finding of genuine use. Use will be 'genuine' in this context even if the user violates legal provisions.

Use that is **deceptive** within the meaning of Article 7(1)(g) or Article 51(1)(c) EUTMR or under provisions of national law remains 'genuine' for the purpose of asserting earlier marks in opposition proceedings. The sanctions for deceptive use are invalidation or revocation, as the case may be, or a prohibition of use (provided for pursuant to Article 110(2) EUTMR).

The same principle applies where use is made under an illegal licensing arrangement (for example arrangements violating the competition rules of the Treaty or national rules). Similarly, the fact that use may infringe third-party rights is also irrelevant.

2.11 Justification of non-use

According to Article 42(2) EUTMR, the opponent may alternatively prove that there are justifiable reasons for non-use of its earlier registered mark. These reasons cover, as mentioned in the second sentence of Article 19(1) of the TRIPS agreement,

circumstances arising independently of the will of the owner of the trade mark that constitute an obstacle to the use of the trade mark.

As an exception to the obligation of use, the concept of proper reasons for non-use is to be interpreted rather narrowly.

'Bureaucratic obstacles' as such, which arise **independently of the will** of the trade mark proprietor, are not sufficient, unless they have a **direct relationship** with the mark, so much so that the use of the trade mark depends on successful completion of the administrative action concerned. However, the criterion of a direct relationship does not necessarily imply that use of the trade mark is impossible; it might suffice that use is **unreasonable**. It must be assessed on a case-by-case basis whether a change in the undertaking's strategy to circumvent the obstacle under consideration would make use of the mark unreasonable. Thus, for example, the proprietor of a mark cannot reasonably be required to change its corporate strategy and sell its goods in its competitors' sales outlets (judgment of 14/06/2007, C-246/05, *Le Chef de Cuisine*, EU:C:2007:340, § 52).

2.11.1 Business risks

The concept of proper reasons must be considered to refer to circumstances arising independently of the will of the owner that make use of the mark impossible or unreasonable, rather than to circumstances associated with commercial difficulties it is experiencing (decision of 14/05/0008, R 0855/2007-4, *PAN AM*, § 27; judgment of 09/07/2003, T-162/01, *Giorgio Beverly Hills*, EU:T:2003:199, § 41).

Thus, financial difficulties encountered by a company as a result of an economic recession or due to its own financial problems are not considered to constitute proper reasons for non-use within the meaning of Article 42(2) EUTMR, as these kinds of difficulties constitute a natural part of running a business.

2.11.2 Government or Court intervention

Import restrictions or other government requirements are two examples of proper reasons for non-use that are explicitly mentioned in the second sentence of Article 19(1) of the TRIPS agreement.

Import restrictions include a trade embargo affecting the goods protected by the mark.

Other *government requirements* can be a State monopoly, which impedes any kind of use, or a State prohibition of the sale of goods for reasons of health or national defence. Typical cases in this respect are regulatory procedures such as:

- clinical trials and authorisation for new medicines (decision of 18/04/2007, R 0155/2006-1, *LEVENIA*); or
- the authorisation of a Food Safety Authority, which the owner has to obtain before offering the relevant goods and services on the market.

Earlier sign	Case No
HEMICELL	R 0155/2010-2
The evidence filed by the opponent duly shows that use of the earlier marks for a food additive, namely, <i>zootechnical digestibility enhancer (feed enzyme)</i> was conditional upon prior authorisation, to be issued by the European Food Safety Authority following an application filed before that body. Such a requirement is to be deemed a government requirement in the sense of Article 19(1) of TRIPS.	

With regard to Court proceedings or interim injunctions the following must be differentiated:

On the one hand, the mere threat of litigation or a pending cancellation action against the earlier mark should, in general, not exempt the opponent from the obligation to use its trade mark in the course of trade. It is up to the opponent, being the attacking party in opposition proceedings, to conduct an adequate risk assessment of its chances to prevail in the litigation proceedings and to draw the appropriate conclusions from this evaluation as to whether or not to continue with use of its mark (decision of 18/02/2013, R 1101/2011-2, SMART WATER, § 40).

Earlier sign	Case No
HUGO BOSS	R 0764/2009-4
The national [French cancellation] proceedings brought against the opposing trade mark cannot be acknowledged as a proper reason for non-use (paragraph 19).	
The fact remains that proper reasons for non-use are only those outside the sphere and influence of the trade mark proprietor, for instance national authorisation requirements or import restrictions. These are neutral with regard to the trade mark to be used; they concern not the trade mark but the goods and services that the proprietor wishes to use. Such national authorisation requirements or import restrictions apply to the type or properties of the product to which the trade mark is affixed, and cannot be circumvented by choosing a different trade mark. In the present case, conversely, the trade mark proprietor could have readily manufactured cigarettes in France or imported them into France if it had chosen a different trade mark (paragraph 25).	

Earlier sign	Case No
MANPOWER	R 0997/2009-4
According to Article 9 EUTMR and Article 5 of the Trade Marks Directive, the trade marks of third parties must not be infringed. The requirement not to infringe trade marks applies to any person using a name in the course of trade, regardless of whether it has itself applied for or been granted trade mark protection for that name. A person refraining from such infringements is acting not for 'proper reasons' but as ordered by law. Hence even refraining from use that would otherwise infringe a right is not a proper reason (decision of the Boards of Appeal of 09/03/2010, R 0764/2009-4, HUGO BOSS/BOSS, § 22) (§ 27).	
Nor is use in such instances 'unreasonable'. Persons who, as trade mark proprietors, are threatened with proceedings or an interim injunction if they start using it, must consider the prospects of the action against them succeeding and can either capitulate (not start using the trade mark) or defend themselves against the complaint. In any event they have to accept the decision of the independent courts, which may be in expedited proceedings. Nor, pending a decision at final instance, can they object that they must be protected by the fact that, until that decision becomes final, uncertainty is to be recognised as a proper reason for non-use. In fact, the issue of what should happen in the period between the filing of an action or the application for an interim injunction and the conclusive final decision is again to be left to the courts, in that they take decisions that are not yet final on provisional enforceability. The defendant is not entitled to ignore those decisions and be put in a position as if there were no courts (paragraph 28).	

On the other hand, for example, an interim injunction or a restraining court order in insolvency proceedings, imposing a general prohibition of transfers or disposals on the trade mark owner, can be a proper reason for non-use because it obliges the opponent

to refrain from using its mark in the course of trade. Use of the mark contrary to such a court order would make the trade mark owner liable to damage claims (decision of 11/12/2007, R 0077/2006-1, Miss Intercontinental (fig.), § 51).

2.11.3 Defensive registrations

The GC has clarified that the existence of a national provision recognising what are known as 'defensive' registrations (i.e. of signs not intended to be used in trade on account of their purely defensive function in relation to another sign that is being commercially exploited) cannot constitute a proper reason for non-use of an earlier trade mark invoked as a basis of an opposition (judgment of 23/02/2006, T-194/03, Bainbridge, EU:T:2006:65, § 46).

2.11.4 *Force majeure*

Further justifiable reasons for non-use are cases of *force majeure* that hinder the normal functioning of the owner's enterprise.

2.11.5 Consequences of justification of non-use

The existence of justified reasons does not mean that non-use during the period concerned is treated as equivalent to actual use, which would result in a new grace period beginning after the end of the period of justified non-use.

Rather, non-use during such period merely stops the five-year period from running. This means that the period of justified non-use is not taken into account in calculating the grace period of five years.

In addition, the length of time during which justified reasons existed may be significant. Reasons for non-use existing during only part of the relevant five-year-period may not always be considered justification for setting the proof-of-use requirement aside. In this context, the period of time during which these reasons were pertinent and the elapse of time since they no longer applied are of particular importance (decision of 01/07/1999, B 2 255).

3 Procedure

3.1 Admissibility of the request for proof of use

According to Article 42(2) EUTMR, use of the earlier mark needs be shown — and only be shown — if the applicant requests proof of use. The institution of proof of use is, therefore, designed in opposition proceedings as a **defence plea of the applicant**.

The Office may neither inform the applicant that he could request proof of use nor invite him to do so. In view of the Office's impartial status in opposition proceedings it is left to the parties to provide the factual basis and to argue and defend their respective positions (see second sentence of Article 76(1) EUTMR).

Article 42(2) EUTMR is not applicable when the opponent, on its own motion, submits material relating to use of the invoked earlier mark (see paragraph 3.1.3 below for an exception to this rule). As long as the EUTM applicant does not request proof of use, the issue of genuine use will not be addressed by the Office *ex officio*. In such cases, in principle, it is even irrelevant that the evidence produced by the opponent might demonstrate only a particular type or manner of use, or use that is limited to only part of the goods or services for which the earlier mark is registered.

The request to submit proof of use is only valid if the earlier mark is under the use requirement at all, that is to say if it had been registered for not less than five years.

3.1.1 Time of request

Pursuant to Rule 22(1) EUTMR, the request for proof of use pursuant to Article 42(2) EUTMR will be admissible only if the applicant submits such a request within the period specified by the Office. The request for proof of use must be made within the first time limit for the applicant to reply to the opposition under Rule 20(2) EUTMR.

If the request for proof of use is submitted during the cooling-off period or during the two-month period given to the opponent for filing or amending facts, evidence and arguments, it is forwarded to the opponent without delay.

3.1.2 Earlier mark registered for not less than five years

In accordance with Article 42(2) EUTMR, the obligation to provide proof of use requires that the earlier registered mark has, at the date of filing or the date of priority³ of the EUTM application, been registered for not less than five years.

For oppositions filed against international registrations designating the EU, the opponent's mark is under use obligation if on the date of registration (INID code 891) or on the date of priority (INID code 300), or, as the case may be, the date of subsequent designation of the Union (INID code 891)⁴, it has been registered for not less than five years.

3.1.2.1 Earlier EUTMs

The decisive date for establishing whether a trade mark has been registered for not less than five years at the relevant date is, according to Article 15 and Article 42(2) EUTMR, the registration date of the earlier EUTM. If five years or more have elapsed between the registration date of the earlier EUTM and the relevant date, the applicant (or in the case of a contested IR, the holder) is entitled to request proof of use.

³ For oppositions filed before 23/03/2016, the relevant date is the date of publication.

⁴ For oppositions filed before 23/03/2016, the relevant date is six months after the date of the first re-publication by the Office.

3.1.2.2 Earlier national marks

For national marks, it is necessary to determine the date that is equivalent to the registration date for EUTMs. In interpreting this term, it should be taken into account that there are national trade mark systems that have an opposition procedure **after** registration.

In view of these differing national proceedings, Article 10(1) of the Directive (which is the equivalent of Article 42 EUTMR) refers, as concerns the use requirement for national marks, to the period of 'five years following the date of the completion of the registration procedure'.

The date of the completion of the registration procedure (Article 10(1) of Directive 2008/95) that serves for calculating the starting point of the five year period for the obligation of use for national and international registrations (Article 42(2) and (3) EUTMR) is determined by each Member State according to their own procedural rules (judgment of 14/06/2007, C-246/05, Le Chef de Cuisine, EU:C:2007:340, § 26-28).

The owner of a mark is not expected to make genuine use of the mark while examination or opposition proceedings are pending, before the five-year grace period mentioned. This is in harmony with the approach towards earlier EUTMs, since the registration date of an EUTM, which is mentioned in Article 42(2) EUTMR as the decisive date for the beginning of the grace period, is always the date of completion of the registration procedure. Furthermore, this interpretation keeps the use requirement under the EUTMR in line with the relevant national laws (decisions of 06/05/2004, R 463/2003-1, Wrap House, § 19; 18/06/2010, R 236/2008-4, RENO).

The completion of the registration procedure occurs after a pre-registration opposition or in some Member States even after completion of a post-registration opposition. The exact relevant dates can be found in the table in the Annex, on p. 78.

The Office does not investigate on its own initiative the actual date of completion of the registration proceedings. Without evidence to the contrary, the Office assumes that the registration procedure was completed on the date that is indicated as the registration date in the evidence submitted. The opponent has to rebut this presumption by proving the exact date when the registration procedure was completed.

3.1.2.3 Earlier International registrations designating a Member State

Under Article 5(2)(a) and (b) of the Madrid Protocol, the Designated Offices have a period of 12 or 18 months from the date of notification of the designation to issue provisional refusals.

Where the Member State has not been designated in the international application but in a subsequent designation, the 12 or 18 months start from the date the subsequent designation was notified to the Designated Offices.

Member States that use the **12-month deadline** to issue a provisional refusal under the Protocol when acting as a designated party are: Benelux, Croatia, Czech Republic, Germany, Spain, France, Latvia, Hungary, Austria, Portugal, Romania and Slovenia.

Member States that have opted for the **18-month deadline** to issue a provisional refusal under the Protocol when acting as a designated party are: Denmark, Estonia, Ireland, Greece, Lithuania, Finland, Sweden and the United Kingdom.

The applicable deadline (12 or 18 months) for Bulgaria, Italy, Cyprus, Poland and Slovakia when acting as a designated party depends on whether (i) such country was designated or subsequently designated before or after 01/09/2008 and (ii) the Office of origin is bound by both the Agreement and the Protocol (deadline: 12 months) or only the Protocol (deadline: 18 months).

See overview table below:

Designated country ⁵	Country of origin	Deadline to issue a refusal
<i>Benelux, Czech Republic, Croatia, Germany, Spain, France, Latvia, Hungary, Austria, Portugal, Romania and Slovenia</i> (Contracting EU parties bound by both the Agreement and the Protocol).	<i>All contracting parties</i> [Status 15/04/2015: 95 Member States] ⁶ (Irrespective of whether they are bound by both the Agreement and the Protocol or the Protocol only).	12 months
<i>Denmark, Estonia, Ireland, Greece, Lithuania, Finland, Sweden, UK</i> (Contracting EU parties bound by the Protocol only).	<i>All contracting parties</i> [Status 15/04/2015: 95 Member States] (Irrespective of whether they are bound by both the Agreement and the Protocol or the Protocol only).	18 months
<i>Bulgaria, Italy, Cyprus, Poland, Slovakia; if designated or subsequently designated before 01/09/2008</i> ⁷ (Contracting EU parties bound by both the Agreement and the Protocol which have opted for an extended deadline).	<i>All contracting parties</i> [Status 15/04/2015: 95 Member States] (Irrespective of whether they are bound by both the Agreement and the Protocol or the Protocol only).	18 months
<i>Bulgaria, Italy, Cyprus, Poland, Slovakia; if designated or subsequently designated on or after 01/09/2008</i> (Contracting EU parties bound by both the Agreement and the Protocol which have opted for an extended deadline).	<i>Contracting parties bound by both the Agreement and the Protocol</i> [Status 15/04/2015: 54 Member States].	12 months
	<i>Contracting parties bound by the Protocol only</i> [Status 15/01/2013: 33 Member States].	18 months

The Office will, on its own motion, apply the 12-month or 18-month deadline according to the above rules. Deadlines are calculated by adding the relevant periods to the date of notification from which the time limit to notify the refusal starts, indicated by INID code 580 on the ROMARIN extract (i.e. not the date of international registration or subsequent designation) (Rule 18(1)(a)(iii) and Rule 18(2)(a) of the Common Regulations).

Only when it is decisive for determining whether the earlier mark is subject to the proof of use obligation is it for the opponent to claim a date that is later (e.g. when a provisional refusal has been lifted after these dates or if the designated country opted for a period even longer than 18 months for notifying a refusal based on an opposition

⁵ Malta is not part of the Madrid System.

⁶ For the full list of all Member States to the Madrid Agreement and to the Madrid Protocol see: http://www.wipo.int/export/sites/www/treaties/en/documents/pdf/madrid_marks.pdf.

⁷ The date of entry into force of Article 9 *sexies* (1)(b) of the Protocol, which rendered inoperative any declaration under Article 5(2)(b) or (c) of the Protocol (extension of the time limit for notifying a provisional refusal) between Contracting Parties bound by both the Agreement and the Protocol.

pursuant to Article 5(2)(c) of the Protocol) and for the applicant or holder to claim a date that is earlier than these dates (e.g. when a Statement of Grant of Protection has been issued before these dates) and to provide the Office with conclusive documentation thereof.

In particular, the Court has confirmed, in relation to an earlier international registration designating Germany, that the date on which an earlier international registration is deemed to have been 'registered' has to be established in accordance with the German law giving effect to the earlier right, and not by reference to the date of registration with the International Bureau of WIPO. Under German trade mark law, if protection for an internationally registered trade mark is provisionally refused but subsequently granted, the registration is regarded as having taken place on the date of receipt by the International Bureau of WIPO of the final notification that protection has been granted. Proper application of Article 42(2) and (3) EUTMR and of Article 4(1) of the Madrid Agreement cannot lead to a breach of the principle of non-discrimination (order of 16/09/2010, C-559/08 P, Atoz, EU:C:2010:529, § 44, 53-56).

3.1.2.4 Earlier International registrations designating the European Union

For international registrations designating the Union, Article 160 EUTMR provides that:

For the purposes of applying Article 15(1), Article 42(2), Article 51(1)(a) and Article 57(2), the date of publication pursuant to Article 152(2) shall take the place of the date of registration for the purpose of establishing the date as from which the mark which is the subject of an international registration designating the Union must be put to genuine use in the Union.

As from that publication the international registration has the same effects as a registered EUTM pursuant to Article 151(2) EUTMR.

3.1.2.5 Summary of calculation of the grace period

Earlier mark	Calculation of the beginning of the 5-year period (grace period)
EUTM	Date of registration.
National mark	By default, date of registration or of completion of registration proceedings if proven by opponent.
IR designating Member States	By default, 12 or 18 months after the date of notification from which the time limit to notify the refusal starts (INID code 580). Can be earlier or later if proven by parties.
IR designating the EU	Date of the second re-publication of the EU designation in part M.3. of the Bulletin.

3.1.3 Request must be explicit, unambiguous and unconditional

The applicant's request is a formal declaration with important procedural consequences.

Therefore, it has to be **explicit and unambiguous**. In general, the request for proof of use must be expressed in positive wording. As use or non-use can be an issue in manifold constellations (for example, to invoke or deny a higher degree of

distinctiveness of the earlier mark), mere observations or remarks by the applicant in respect of the (lack of) use of the opponent's mark are not sufficiently explicit and do not constitute a valid request for proof of genuine use (judgment of 16/03/2005, T-112/03, Flexi Air, EU:T:2005:102).

Examples:

Sufficiently explicit and unambiguous request:

- 'I request the opponent to submit proof of use ...';
- 'I invite the Office to set a time limit for the opponent to prove use ...';
- 'Use of the earlier mark is hereby contested ...';
- 'Use of the earlier mark is disputed in accordance with Article 42 EUTMR.';
- 'The applicant raises the objection of non-use.' (decision of 05/08/2010, R 1347/2009-1, CONT@XT).

Not sufficiently explicit and unambiguous request:

- 'The opponent has used its mark only for ...';
- 'The opponent has not used its mark for ...';
- 'There is no evidence that the opponent has ever used his mark ...';
- '[T]he opponents' earlier registrations cannot be "validly asserted against the EUTM Application...", since "...no information or evidence of use ... has been provided..." (decision of 22/09/2008, B 1 120 973).

An **implicit request** is accepted **as an exception** to the above rule, when the opponent spontaneously sends evidence of use before the applicant's first opportunity to file arguments and, in its first reply, the applicant challenges the evidence of use filed by the opponent (judgment of 12/06/2009, T-450/07, Pickwick Colour Group, EU:T:2009:202). In such a case, there can be no mistake as to the nature of the exchange, and the Office should consider that a request for proof of use has been made and give the opponent a deadline for completing the evidence. In the event that proceedings have been closed and the existence of a request for proof of use is found out only when a decision has been taken, the examiner should re-open the proceedings and give the opponent a deadline for completing the evidence.

In any event, the request has to be **unconditional**. Phrases such as 'if the opponent does not limit its goods/services in Classes 'X' or 'Y', we demand proof of use', 'if the Office does not reject the opposition because of lack of likelihood of confusion, we request proof of use' or 'if considered appropriate by the Office, the opponent is invited to file proof of use of its trade mark' present conditional or auxiliary claims, are not valid requests for proof of use (decision of 26/05/2010, R 1333/2008-4, RFID SOLUTIONS).

3.1.4 Applicant's interest to deal with proof of use first

Under Rule 22(5) EUTMIR, the applicant may limit its first observations to requesting proof of use. It must then reply to the opposition in its second observations, namely when it is given the opportunity to reply to the proof of use submitted. It may also do this if only one earlier right is subject to the use requirement, as the applicant should not be obliged to split its observations.

If, however, the request is completely invalid, the Office will close proceedings without granting the applicant a further opportunity to submit observations (see paragraph 3.1.5 below).

3.1.5 Reaction if request is invalid

If the request is invalid on any of the above grounds or if the requirements of Article 42(2) and (3) EUTMR are not met, the Office nevertheless forwards the applicant's request to the opponent but advises both parties of the invalidity of the request.

The Office will immediately terminate the proceedings if the request is completely invalid and not accompanied by any observations by the applicant. However, the Office can extend the time limit established in Rule 20(2) EUTMIR if such an invalid request was received before expiry of the time limit set for the applicant but was not dealt with by the Office until after expiry thereof. Because refusal of the request for proof of use after expiry of the time limit will disproportionately harm the interests of the applicant, the Office extends the time limit by the number of days that were left when the party submitted its request. This practice is based on the rules of fair administration.

If the request is only invalid as regards part of the earlier rights on which the opposition is based, the Office expressly limits the invitation to the opponent to submit proof of use to the rights that are subject to the use requirement.

3.2 Express invitation by the Office

If the applicant's request for proof of use is valid, the Office gives the opponent two months to submit proof of use or show that there are proper reasons for non-use. Taking a decision on use in the absence of an explicit invitation by the Office to submit proof of use constitutes a substantive procedural violation, even if the applicant's request is clear, the opponent understands it and submits the requested evidence of use (decisions of 28/02/2011, R 0016/2010-4, COLORPLUS, § 20; 19/09/2000, R 0733/1999-1, Affinité/Affinage).

In cases where the request for proof of use arrives during the cooling-off period and is communicated to the opponent during that period, the deadline for submitting proof of use will coincide with the deadline for providing initial or additional facts, evidence and arguments. The time limit will be extended automatically if the cooling-off period is extended.

If the request reaches the Office before the end of the period for submitting or amending facts, evidence and arguments, and is dealt with in this period, the deadline for submitting such facts, evidence and arguments will be extended to coincide with the deadline of two months for submitting proof of use.

3.3 Reaction from the opponent: providing proof of use

3.3.1 Time limit for providing proof of use

The Office gives the opponent two months to submit proof of use. The opponent may request an extension of the deadline in accordance with Rule 71 EUTMIR. The common practice on extensions is applicable to these requests⁸.

Rule 22(2) EUTMIR expressly states that the Office will reject the opposition if the opposing party does not provide proof of use before the time limit expires.

Three scenarios are to be differentiated.

- Any evidence that has been submitted by the opponent at any time during the proceedings before the expiry of the time limit for providing proof of use, even before the applicant's request for proof of use, has to be taken automatically into account when assessing proof of use.
- The opponent has not submitted **any or any relevant evidence** within the time limit: the submission of relevant evidence of proof of use for the first time after the expiry of the time limit results in rejection of the opposition **without the Office having any discretionary powers**. In that regard the Court has held that Rule 22(2) EUTMIR is an essentially procedural provision and that it is apparent from the wording of that provision that when no proof of use of the mark concerned is submitted within the time limit set by the Office, the opposition must automatically be rejected (judgment of 18/07/2013, C-621/11 P, Fishbone, EU:C:2013:484, § 28-29).
- The opponent has submitted **relevant evidence** within the time limit and presents **additional** evidence after the time limit has expired: in such a case, where the additional evidence merely strengthens and clarifies the prior relevant evidence submitted within the time limit, and provided the opponent does not abuse the time-limits set by knowingly employing delaying tactics or by demonstrating manifest negligence, the Office may take into account the evidence submitted out of time as a result of an **objective, reasonable exercise of the discretion** conferred on it by Article 76(2) EUTMR (judgment of 29/09/2011, T-415/09, Fishbone, EU:T:2011:550, § 31; confirmed by judgment of 18/07/2013, C-621/11 P, Fishbone, EU:C:2013:484, § 28, 30). The Court made it clear that, *mutatis mutandis*, the same considerations apply to revocation proceedings (judgment of 26/09/2013, C-610/11 P, Centrotherm, EU:C:2013:912, § 87 applying Rule 40(5) EUTMIR).

The Office will duly motivate why it rejects or takes into account 'additional evidence' in the decision. General statements, such as 'the evidence is not relevant' or 'the opponent has not justified why the additional evidence has been submitted after the expiry of the time limit' will not suffice (judgment of 26/09/2013, C-610/11 P, Centrotherm, EU:C:2013:912, § 111).

⁸ See the Guidelines, Part C, Opposition, Section 1, Procedural Matters, paragraph 6.2.1, Extension of time limits in opposition proceedings.

As regards the exercise of that discretion taking such facts and evidence into account, it is particularly likely to be justified where the Office considers, first, that the material produced late is, on the face of it, likely to be relevant to the outcome of the opposition and, second, that the stage of the proceedings at which that late submission takes place and the circumstances surrounding it do not preclude such matters being taken into account (judgment of 13/03/2007, C-29/05 P, Arcol, EU:C:2007:162, § 44).

3.3.2 Means of evidence

3.3.2.1 Principles

The evidence of use must be provided in a structured manner.

Article 76(1) EUTMR provides that ‘...in proceedings relating to relative grounds for refusal of registration, the Office shall be restricted in this examination to the facts, evidence and arguments provided by the parties ...’ The filing of evidence must be sufficiently clear and precise to enable the other party to exercise its right of defence and the Office to perform its examination, without reference to extraneous or supportive information.

Essentially, the Office is prevented from making the case for one or other party and cannot take the place of the opponent, or its counsel, by itself trying to locate and identify among the documents on file the information that it might regard as supporting proof of use. This means that the Office should not seek to improve the presentation of any party’s evidence. Responsibility for putting evidence in order rests with the party. Failure to do so leaves open the possibility that some evidence may not be taken into account.

In terms of format and content of evidence submitted, the Office recommends that the following be taken into account as key aspects of a structured presentation:

1. the corresponding **file number** (EUTM, Opposition, Cancellation, and Appeal) should be included at the top of all correspondence;
2. a separate communication for documents with Proof of Use should be provided. Nevertheless, if correspondence includes urgent issues such as a request for limitation, suspension, extension of time, withdrawal, etc. indication of this should also be included on the front page;
3. the total **number of pages** of correspondence should be stated. **Page numbering** of annexes is equally important;
4. the Office strongly recommends that the opponent does **not exceed a maximum of 110 pages** in its correspondence;
5. if the documentation is sent in different packages, an **indication of the number of packages** is recommended,
6. if a large amount of documentation is submitted by fax in different batches, an indication of the total number of pages, number of batches and identification of the pages contained in each batch is recommended;

7. use plain **DIN-A4** sheets in preference to other formats or devices for all the documents submitted **including separators** between annexes or enclosures, as they can also be scanned;
8. physical specimens, containers, packaging, etc. should not be sent. Instead, a picture should be taken of them, which should be printed (if relevant in colour, if not in black and white) and sent as a document;
9. original documents or items sent to the Office should not be stapled, bound or placed in folders;
10. **the second copy** for forwarding to the other party should be **clearly identified**;
11. if the original is submitted to the Office only by fax, **no second fax copy** should be sent;
12. the front page should clearly indicate whether the correspondence submitted contains **colour elements** of relevance to the file;
13. a second set of colour elements should be included for sending to the other party.

These recommendations are also sent to the opponent together with the Office's communication of the applicant's request for proof of use.

According to Rule 22(4) EUTMIR, the evidence is to be filed in accordance with Rules 79 and 79a and, in principle, is confined to the submission of supporting documents and items such as packages, labels, price lists, catalogues, invoices, photographs, newspaper advertisements, and statements in writing as referred to in Article 78(1)(f) EUTMR. Rule 22(4) EUTMIR also allows market surveys and quotations of the mark in lists and publications of associations of the relevant profession as suitable means of evidence (decisions of 14/03/2011, B 1 582 579; 18/06/2010, B 1 316 134).

Price lists and catalogues are examples of 'material stemming directly from the party itself'. A company's 'annual report and accounts' would also come under that heading.

Rule 22(4) EUTMIR is to be read in conjunction with Rule 79a EUTMIR. This means that material that cannot be scanned or photocopied (such as CDs, physical items) cannot be taken into account unless submitted in two copies so that it can be forwarded to the other party.

The requirement of proof of use always raises the question of the **probative value** of the submitted material. The evidence must at least have a certain degree of reliability. As a general rule, the Office considers material produced by third parties as being of a higher probative value than material produced by the owner himself or by its representative. Reference by the opponent to internal print-outs or hypothetical surveys or orders is particularly problematic. However, where material must regularly be produced for use by the public and/or authorities according to statutory rules, for instance, company law and/or Stock Exchange Regulations, and where it may be assumed that such material is subject to certain official verification, its probative value is certainly higher than ordinary 'personal' material produced by the opponent (see also paragraph 3.3.2.3, 'Declarations', below).

3.3.2.2 References

The opponent may avail itself of findings of national offices and courts in parallel proceedings. Although the Office is not bound by findings of the national offices and courts, such decisions must be taken into account and may influence the Office's decision. It is important for the Office to have the possibility of considering the kind of evidence that led to the relevant decision at national level. The Office takes into account the different procedural and substantive requirements that may exist before the respective national body (decisions of 25/08/2003, R 1132/2000-4, VANETTA, § 16; 18/10/2000, R 0550/1999-3, DUKE, § 23).

The opponent may wish to refer to material filed as proof of use in previous proceedings before the Office (confirmed by the GC in 'ELS' quoted above). The Office accepts such references on condition that the opponent clearly identifies the material referred to and the proceedings in which it was filed. If the reference does not sufficiently identify the relevant material, the Office requires the opponent to clearly specify the material referred to or to file it (decision of 30/11/2010, B 1 080 300). See further details on the conditions for identifying the relevant material in the Guidelines, Part C, Opposition, Section 1, Procedural Matters.

The onus of providing proof of use is on the opponent and not on the Office or the applicant. Therefore, a mere indication of the website where the Office can find further information is insufficient, as this does not provide the Office with sufficient indications about place, nature, time and extent of use (decision of 31/10/2001, B 260 192).

3.3.2.3 Declarations

Whereas the means of evidence listed, such as packages, labels, price lists, catalogues, invoices, photographs and newspaper advertisements, do not present any particular problems, it is necessary to consider in some detail declarations as referred to in Article 78(1)(f) EUTMR.

The opposing party is not obliged to submit an affidavit concerning the sales made under the earlier trade mark. It is up to the opposing party to select the form of evidence that it considers suitable for the purpose of establishing that the earlier trade mark was put to genuine use during the relevant period (judgment of 08/07/2004, T-203/02, Vitafruit, EU:T:2004:225, § 37).

The role of the affidavit is to inform about facts or give explanation of the supporting documents, not to give a legal opinion (judgment of 06/11/2014, T-463/12, MB, EU:T:2014:935, § 56).

Distinction between admissibility and relevance (probative value)

The importance of declarations has been much debated. In this regard, there must be a clear differentiation between the admissibility and the probative value of such evidence.

As far as **admissibility** is concerned, Rule 22(4) EUTMIR expressly mentions written statements referred to in Article 78(1)(f) EUTMR as admissible means of proof of use. Article 78(1)(f) EUTMR cites means of giving evidence, amongst which are sworn or affirmed written statements or other statements that have a similar effect according to

the law of the State in which they have been drawn up Therefore, it has to be evaluated whether the statement submitted constitutes a statement within the sense of Article 78(1)(f) EUTMR. Only in cases where the statements have not been sworn or affirmed it is necessary to consider the rules of law of the national jurisdiction as to the effects of a written statement (judgment of 07/06/2005, T-303/03, Salvita, EU:T:2005:200, § 40, recently confirmed in judgment of 09/12/2014, T-278/12, PROFLEX, EU:T:2014:1045, § 49). In cases of doubt as to whether a statement has been sworn or affirmed, it is up to the opponent to submit evidence in this regard. Failing this the statement will not be considered a statement within the sense of Article 78(1)(f) EUTMR.

Article 78(1)(f) EUTMR does not specify by whom these statements should be signed so that there is no reason to consider that statements signed by the parties to the proceedings themselves are not covered by this provision (judgment of 16/12/2008, T-86/07, Deitech, EU:T:2008:577, § 46).

Neither the EUTMR nor the EUTMIR supports the conclusion that the evidential value of items of evidence of use of the mark, including affirmations, must be assessed in the light of the national law of a Member State (judgments of 28/03/2012, T-214/08, Outburst, EU:T:2012:161, § 33; 09/12/2014, T-278/12 PROFLEX, EU:T:2014:1045, § 53). The probative value of a statement depends first and foremost on the credibility of the account it contains. It is then necessary to take account, in particular, of the person from whom the document originates, the circumstances in which it came into being, the person to whom it was addressed and whether, on the face of it, the document appears sound and reliable (judgment of 07/06/2005, T-303/03, Salvita, EU:T:2005:200, § 42).

As far as the **probative value** of this kind of evidence is concerned, the Office makes a distinction between statements coming from the sphere of the opponent themselves or their employees and statements drawn up by an independent source; following the established case-law (judgments of 09/12/2014, T-278/12, PROFLEX, EU:T:2014:1045, § 51; 06/11/2014, T-463/1, MB, EU:T:2014:935, § 54).

Declarations by the proprietor or its employees

Statements coming from the sphere of the owner of the earlier mark (drawn up by the interested parties themselves or their employees) are generally given less weight than independent evidence. This is because the perception of the party involved in the dispute may be more or less affected by personal interests in the matter (decision of 11/01/2011, R 0490/2010-4, BOTODERM, § 34; decisions of 27/10/2009, B 1 086 240 and of 31/08/2010, B 1 568 610).

Such a statement cannot in itself sufficiently prove genuine use (judgment of 9/12/2014, T-278/12, PROFLEX, EU:T:2014:1045, § 54) However, this does not mean that such statements are totally devoid of all probative value (judgment of 28/03/2012, T-214/08, Outburst, EU:T:2012:161, § 30). Generalisation should be avoided, since the exact value of such statements always depends on its concrete form and content. Statements including detailed and concrete information have a higher probative value than very general and abstractly drafted statements.

The final outcome depends on the overall assessment of the evidence in each individual case. In general, further material is necessary for establishing evidence of use, since such statements have to be considered as having less probative value than

physical evidence (labels, packaging, etc.) or evidence originating from independent sources. Therefore, the probative strength of the further material submitted is very important. An assessment should be made of whether the content of the affidavit is sufficiently supported by the further material (or vice versa). The fact that the national office concerned may adopt a certain practice in assessing such kind of evidence of use does not mean that it is applicable in the proceedings concerning European Union trade marks (judgment of 07/06/2005, T-303/03, *Salvita*, EU:T:2005:200, § 41 et seq.).

A change of ownership that took place after the filing or priority date of the EUTM application may render declarations made by the new owners void as the latter generally do not have any direct knowledge as a basis for making declarations concerning use of the mark by the previous owner (decision of 17/06/2004, R 0016/2004-1, Reporter).

Nevertheless, in the case of a transfer or other succession in title, any new owner may rely on use within the grace period concerned by their predecessor(s). Use made by the predecessor may be evidenced by the predecessor and by all other reliable means, for instance, information from business records if the predecessor is not available.

Declarations by third parties

Statements (such as e.g. surveys) drawn up **by an independent source**, for example by experts, professional organisations, Chambers of Commerce, suppliers, customers or business partners of the opponent, are given more probative weight (decisions of 19/01/2011, R 1595/2008-2, *FINCONSUMO*, § 9(ii); 30/03/2010, R 0665/2009-1, *EUROCERT*, § 11 and decision of 12/08/2010, B 1 575 615).

This practice is in line with the case-law of the Court of Justice in the ‘Chiemsee’ judgment (judgment of 04/05/1999, joined cases C-108/97 and C-109/97, *Chiemsee*, EU:C:1999:230), where the Court gave some indications of appropriate evidence proving the acquired distinctiveness of a mark in the market place. Although acquisition of distinctiveness is not per se the same as genuine use, the former does comprise elements of evidence of use of a sign on the market. Consequently, case-law relating to these can be used by analogy.

Statements drawn up by the parties themselves are not ‘third party evidence’ whereas all other evidence, such as opinion polls, statements from Chambers of Commerce, or from professional organisations or from experts, originates from third parties.

3.4 Reaction from the applicant

3.4.1 Forwarding of evidence

After having received the evidence of use submitted by the opponent, the Office forwards the complete evidence to the applicant.

The Office, in general, allows the applicant two months to file its observations in reply to the evidence of use (and to the opposition).

3.4.2 No evidence or no relevant evidence submitted

However, the Office may close the proceedings immediately if the opponent has submitted **no evidence, or the evidence is manifestly of no relevance** within the time limit given and all the earlier rights of the opposition are affected. The rationale behind this practice is to avoid the continuation of the proceedings when their outcome is already known, that is, the rejection of the opposition for lack of proof of use (principle of economy and good administration of proceedings).

In all other cases it is forwarded to the applicant giving the party two months to file its observations. The Office must not indicate to the opponent that the sufficiency of the evidence is doubtful, or even invite the opponent to file further evidence in such cases. Such acts would be against the impartial position of the Office in adversarial proceedings (decision of 01/08/2007, R 0201/2006-4, OCB/O.C.B., § 19).

3.4.3 No reaction from applicant

If the applicant does not react within this time limit, the Office will give a decision on the basis of the evidence before it. The fact that the applicant does not reply does not mean that it accepts the submitted evidence as sufficient proof of use (judgment of 07/06/2005, T-303/03, Salvita, EU:T:2005:200, § 79).

3.4.4 Formal withdrawal of the request

Where the applicant reacts to the proof of use by formally withdrawing its request for proof of use, the issue will no longer be relevant. As it is the applicant who sets in motion the respective procedure, the applicant logically is in a position to bring an end to this part of the proceedings by formally withdrawing its request (decision of 21/04/2004, R 174/2003-2, Sonnengarten, § 23).

3.5 Further reaction from the opponent

The opponent is entitled to file observations in reply to the applicant's observations. This is of particular importance in cases where the decision to be taken might be based in part on the arguments put forward by the applicant to the effect that the evidence does not prove the use of the mark.

The Board of Appeal has regarded failure to allow the opponent to comment in such a case as a substantial procedural violation (decision of 28/02/2011, R 16/2010-4, COLORPLUS, § 20).

For further details on the submission of additional evidence, see paragraph 3.3.1 above.

3.6 Languages in proof of use proceedings

According to Rule 22(6) EUTMIR, where the evidence supplied pursuant to paragraphs 1, 2 and 3 is not in the language of the opposition proceedings, the Office **may** require the opponent to submit a translation of that evidence in that language, within a period specified by the Office.

It is left to the discretion of the Office whether the opponent has to submit a translation of the evidence of use into the language of the proceedings. In exercising its discretion, the Office balances the interests of both parties.

It has to be borne in mind that it might be extremely costly and burdensome for the opponent to translate the evidence of use submitted into the language of the proceedings.

On the other hand, the applicant has the right to be informed about the content of the evidence filed in order to be capable of defending its interests. It is absolutely necessary that the applicant is able to assess the content of the evidence of use submitted by the opponent. In this regard, the nature of the documents submitted has to be taken into account. For example, it might be considered that 'standard' invoices and samples of packaging do not require a translation in order to be understood by the applicant (judgment of 15/12/2010, T-132/09, Epcos, EU:T:2010:518, § 51 et seq.; decisions of 30/04/2008, R 1630/2006-2, DIACOR, § 46 et seq. (under appeal T-258/08); 15/09/2008, R 1404/2007-2, FAY, § 26 et seq.).

If the applicant explicitly requests a translation of the evidence in the language of the proceedings, the Office, in principle, will require a translation from the opponent. However, a rejection of such a request is feasible where it appears that the applicant's request, in view of the self-explanatory character of the submitted evidence, is exaggerated or even abusive.

Where the Office requires translation of the evidence, it gives the opponent a period of two months to submit it. Where the evidence of use filed by the opponent is voluminous, the Office may explicitly invite the opponent to translate only the parts of the submitted material that the opponent regards as sufficient for establishing genuine use of the mark within the relevant period. It is in general up to the opponent to evaluate whether a complete translation of all the evidence submitted is necessary. The means of evidence will only be taken into account insofar as a translation has been produced or insofar as the means of evidence are self-explanatory regardless of their textual components.

3.7 Decision

3.7.1 Competence of the Office

The Office makes its own evaluation of the evidence of use submitted. This means that the probative value of the evidence submitted is evaluated independently of the observations submitted by the applicant in this respect. Assessment of the relevance, pertinence, conclusiveness and efficacy of evidence lies within the discretion and power of judgment of the Office, not the parties, and falls outside the adversarial principle which governs *inter partes* proceedings (decisions of 01/08/2007, R 0201/2006-4, OCB, § 19; 14/11/2000, R 0823/1999-3, SIDOL).

A declaration by the applicant concluding that use has been proved does not, therefore, have any effect on the Office's findings. The request for proof of use is a defence plea by the applicant. However, once the defence plea has been raised by the applicant, it is solely up to the Office to carry out the subsequent procedure and evaluate whether the evidence submitted by the opponent is to be regarded as of

sufficient probative value. However, the applicant does have the possibility of formally withdrawing the request for proof of use (see paragraph 3.4.4 above).

This is not contrary to Article 76(1) EUTMR, which stipulates that in *inter partes* proceedings the Office is restricted in its examination to the facts, evidence and arguments provided by the parties and the relief sought. However, although the Office is bound by the facts, evidence and arguments provided by the parties, it is not bound by the legal value that the parties may give thereto. Hence, the parties may agree as to which facts have been proved or not, but may not determine whether or not these facts are sufficient to establish genuine use (decisions of 01/08/2007, R 0201/2006-4, OCB, § 19; 14/11/2000, R 0823/1999-3, SIDOL, § 20; 13/03/2001, R 0068/2000-2, NOVEX PHARMA).

3.7.2 Need for assessing proof of use

A decision on fulfilment of the obligation of having genuinely used the registered mark is not always necessary.

When **proof of use** of the earlier rights has been requested by the applicant, the Office will also examine whether, and to what extent, use has been proved for the earlier marks, provided this is relevant for the outcome of the decision in question. The examination of proof of use is always necessary and obligatory in the cases where the opposition is fully or partially successful on the basis of the earlier mark that was subject to the proof of use obligation.

The Office may decide not to assess the submitted proof of use where the question whether the earlier mark concerned was genuinely used for the respective registered goods and/or services is irrelevant for the outcome of the opposition, for example:

- under the ground of Article 8(1)(b) EUTMR, if there is no likelihood of confusion between the contested mark and the earlier mark that is subject to the proof of use obligation;
- if the opposition is fully successful on the basis of another earlier mark which is not subject to the proof of use obligation;
- if the opposition is fully successful on the grounds of Article 8(3) and/or Article 8(4) EUTMR;
- under the ground of Article 8(5) EUTMR, if one of the necessary conditions for application of this ground is not fulfilled.

However, in the event that the earlier trade mark that was subject to the proof of use obligation was examined in the decision but the assessment of the proof of use has been omitted, this will be expressly stated in the decision with a brief justification.

3.7.3 Overall assessment of the evidence presented

As stated in more detail above (see paragraph 2.2 above), the Office has to evaluate the evidence submitted with regard to place, time, extent and nature of use in an **overall assessment**. A separate assessment of the various relevant factors, each

considered in isolation, is not suitable (judgment of 17/02/2011, T-324/09, Friboi, EU:T:2011:47, § 31).

The **principle of interdependence** applies, meaning that weak evidence with regard to one relevant factor (e.g. low sales volume) might be compensated by solid evidence with regard to another factor (e.g. continuous use over a long period of time).

All the circumstances of the specific case have to be taken into account **in conjunction with each other** in order to determine whether the mark in question has been genuinely used. The particular circumstances can include, for example, the specific features of the goods/services in question (e.g. low/high-priced; mass products v special products) or the particular market or business area.

Indirect/circumstantial evidence, under certain conditions even on its own, can also be suitable for proving genuine use.

As the Office does not assess commercial success, even minimal use (but not mere token or internal use) can be sufficient to be deemed 'genuine', as long as it is viewed as warranted in the economic sector concerned to maintain or acquire a share in the market.

The decision indicates what **evidence** was filed. However, in general, only the evidence relevant for the conclusion is mentioned. If the evidence is found convincing, it suffices for the Office to indicate those documents that were used to come to this conclusion and why. If an opposition is rejected because the proof of use was not sufficient, likelihood of confusion is not to be addressed, nor Article 8(5) EUTMR if claimed.

3.7.4 Examples

The following cases present some of the decisions of the Office or the Court (with different outcomes) where the overall assessment of the submitted evidence was important.

3.7.4.1 Genuine use accepted

Case No	Comment
Judgment of 17/02/2011, T-324/09, Friboi, EU:T:2011:47	The opponent (Fribo Foods Ltd.) submitted several invoices relating to large quantities of goods, addressed to its distribution company (Plusfood Ltd.), which belongs to the same group (Plusfood Group). It is not disputed that the distribution company put the products on the market later. Furthermore, the opponent presented undated brochures , a press clip and three price lists . With regard to the 'internal' invoices, the Court held that the chain producer-distributor-market was a common method of business organisation, which could not be regarded as purely internal use. The undated brochures had to be seen in conjunction with other dated evidence such as invoices and price lists and, therefore, might still be taken into consideration. The Court accepted genuine use and stressed that an overall assessment implied that all the relevant factors be viewed as a whole and not in isolation.

<p>Decision of 02/05/2011, R 0872/2010-4, CERASIL</p>	<p>The opponent submitted inter alia about 50 invoices, not in the language of proceedings. The names of the addressees as well as the quantities sold were blacked out. The Boards held that standard invoices containing the usual information (date, indication of seller's and buyer's name/address, product concerned, price paid) did not require a translation. Even though the names of the addressees and the quantities sold were blacked out, the invoices nevertheless confirmed the sale of 'CERATOSIL' products, measured in kilograms, to companies throughout the relevant territory during the relevant period. Together with the remaining evidence (brochures, affidavit, articles, photographs), this was considered sufficient to prove genuine use.</p>
<p>Decision of 29/11/2010, B 1 477 670</p>	<p>The opponent, who was active in the field of vehicle maintenance and the management of businesses associated with buying and selling vehicles, provided several Annual Reports giving a general overview of its overall commercial and financial activities. The OD found that these reports, by themselves, did not provide sufficient information on actual use for the majority of services claimed. However, in conjunction with advertisements and publicity displaying the mark in question for particular services, the OD concluded that the evidence as a whole provided sufficient indications as to the scope, nature, period and place of use for these services.</p>
<p>Decision of 29/11/2010, R 0919/2009-4, GELITE</p>	<p>The documents submitted by the appellant show use of the trade mark for 'coating materials based on artificial resin (base, intermediate and top coatings) and industrial lacquers'. The attached labels show use of the trade mark for various base, primer and top coatings. This information coincides with the attached price lists. The associated technical information sheets describe these goods as corrosion coatings based on artificial resin, which are offered for sale in various colours. The attached invoices show that these goods were supplied to various customers in Germany. Although the turnover figures stated in the written declaration in relation to the period from 2002 to 2007 do not expressly refer to Germany, it must be concluded that they were obtained at least in part also in Germany. Consequently, the earlier mark is deemed to be used for the goods <i>lacquer, lacquer paints, varnishes, paints; dispersions and emulsions to coat and repair surfaces</i> because it is not possible to create any further subcategories for these goods.</p>
<p>Decision of 20/04/2010, R 0878/2009-2, SOLEA</p>	<p>The solemn declaration refers to high sales figures (over EUR 100 million) for marked products from 2004 to 2006 and attaches internet extracts of pictures of the products sold during the relevant period (soap, shampoo, deodorant (for feet and body), lotions, and cleaning items). Although the internet extracts bear a copyright date of 2008, the credibility of what the declaration affirms is reinforced by the judgment of the State Court of Mannheim, a copy of which had been adduced previously by the opponent in order to demonstrate the enhanced distinctiveness of the earlier mark and which referred to the market share enjoyed by products bearing the opponent's mark for ladies' face care products (6.2 %), caring lotions (6.3 %), shower soaps and shampoos (6.1 %) and men's face care and shaving products (7.9 %). Moreover, the judgment states that according to a GfK study one fifth of German citizens purchase at least one BALEA product per annum. Reference is also made to two further studies that demonstrate that the brand is well known in Germany. Thus, proof of use for the mark has been demonstrated sufficiently for the products on which the opposition is based.</p>
<p>Decision of 25/03/2010, R 1752/2008-1, ULUDAG</p>	<p>The evidence provided to substantiate use of the earlier Danish trade mark appears to be sufficient. The Board is satisfied that the invoice provided shows place and time of use, as it proves the sale to a Danish company of 2 200 cartons of products within the relevant date. The labels filed show use on soft drinks bearing the mark as represented on the registration certificate. As to the question whether proof consisting of one single invoice is sufficient in terms of extent of use, in the Board's view, the content of that invoice, in the context of the remaining pieces of evidence, serves to conclude that the use made of the mark in Denmark is sufficient and genuine in connection with <i>aerated water, aerated water with fruit taste and soda water</i>.</p>

3.7.4.2 Genuine use not accepted

Case No	Comment
Judgment of 18/01/2011, T-382/08, VOGUE, EU:T:2011:9	The opponent submitted a declaration from the opponent's managing partner and 15 footwear manufacturers ('footwear has been produced for the opponent under the trade mark VOGUE over a number of X years'), 35 photographs of VOGUE footwear models, photographs of stores and 670 invoices issued to the opponent by footwear manufacturers. The Court held that the declarations did not provide sufficient evidence concerning the extent, place and time of use. The invoices concerned the sale of footwear to the opponent, not the sale of footwear to end consumers and, therefore, were not suitable for proving external use. Mere presumptions and suppositions ('highly unlikely', 'unreasonable to think', '... which probably explains the absence of invoices ...', 'reasonable to assume', etc.) cannot replace solid evidence. Therefore, genuine use was denied.
Decision of 19/09/2007, 1359 C (confirmed by R 1764/2007-4)	The owner of the mark owned a US-based airline, operating solely in the US. The fact that flights could also be booked via internet from the European Union could not alter the fact that the actual services of transportation (Class 39) were rendered exclusively outside the relevant territory. Furthermore, the lists submitted of passengers with addresses in the European Union could not prove that the flights had actually been booked from Europe. Finally, the website was exclusively written in English, the prices were announced in US dollars and the relevant telephone and fax numbers were from within the US. Therefore, genuine use in the relevant territory was denied.
Decision of 04/05/2010, R 0966/2009-2, COAST	There are no special circumstances which might justify a finding that the catalogues submitted by the opponent, on their own or in combination with the website and magazine extracts , prove the extent of use of any of the earlier signs for any of the G&S involved. Although the evidence submitted shows use of the earlier sign in connection with <i>clothing for men and women</i> , the opponent did not produce any evidence whatsoever indicating the commercial volume of the exploitation of this sign to show that such use was genuine.
Decision of 08/06/2010, R 1076/2009-2, EURO CERT	It is well established in the case-law that a declaration , even if sworn or affirmed in accordance with the law under which it is rendered, must be corroborated by independent evidence. The declaration in this case, drawn up by an employee of the opponent's company, contains an outline of the nature of the relevant services, but only general statements concerning trade activities. It contains no detailed sales or advertising figures or other data that might show the extent and use of the mark. Furthermore, a mere three invoices with important financial data blanked out and a list of clients can hardly be considered corroborative evidence. Therefore, no genuine use of the earlier mark has been demonstrated.
Decision of 01/09/2010, R 1525/2009-4, OFFICEMATE	The spreadsheets with turnover figures and the Analysis and Review reports concerning sales figures are documents drawn up by or commissioned by the appellant itself and, therefore, have less probative value. None of the evidence filed contains any clear indication concerning the place of use of the earlier mark. The spreadsheets and the Analysis and Review Reports, which contain data compiled on the total value of estimated sales (in SEK) between the years 2003 to 2007, contain no information on where the sales took place. There is no reference to the territory of the European Union, where the earlier trade mark is registered. The invoices do not cover any sales of goods made by the appellant. Therefore, the evidence submitted is clearly insufficient to prove the genuine use of the earlier mark.
Judgment of 12/12/2002, T-39/01, HIWATT, EU:T:2002:316	A catalogue showing the mark on three different models of amplifiers (but not indicating place, time or extent), a catalogue of the Frankfurt International trade fair showing that a company called HIWATT Amplification International exhibited at that fair (but not indicating any use of the trade mark) and a copy of the 1997 HIWATT Amplification Catalogue showing the mark on different models of amplifiers (but not indicating place or extent of use) were not considered sufficient to prove genuine use, principally because of lack of extent of use.

Annex

Five-year period for assessing use of national trade marks

According to Article 42(2) EUTMR the proprietor of an earlier EUTM who has given notice of opposition against the registration of an EUTM application must, where the EUTM applicant so requests, submit proof that his earlier EUTM has been put to genuine use in the Union in connection with the goods or services for which it was registered during the period of five years preceding the filing or priority⁹ date of the EUTM application, provided the earlier EUTM has at that date been registered for more than five years ('5-year grace period').

Equally, the proprietor of an earlier national mark who has given notice of opposition against the registration of a European Union trade mark must, according to Article 42(3) EUTMR and where the EUTM applicant so requests, submit proof that his earlier national trade mark has been put to genuine use in the Member State in connection with the goods and services for which it was registered during a period of five years preceding the filing or priority date¹⁰ of the EUTM application, provided the earlier national mark has at that date been registered for more than five years.

The date of registration of an EUTM is the date on which it is entered in the Register of European Union trade marks. Consequently, the five-year grace period of an EUTM commences from its entry in the Register of European Union trade marks.

In order to determine the date of commencement of the five-year grace period in respect of a national mark, national law is relevant. The commencement of this period depends on the registration procedure of the Member States and, in particular, whether a Member State applies a post registration opposition procedure (this being the case in respect of DE, DK, FI and SE).

The following table makes reference to the relevant national provisions¹¹ on non-use of a national trade mark and specifies the relevant point in time when the five-year grace period for a national trade mark commences.

Member State	Relevant legal provisions	Quotation of the relevant legal provisions	Summary / Comments
Austria	Article 33a(1), AT-TML	<i>'registered for a minimum of five years where it has not been used ... in Austria during the five years preceding submission of the request.'</i>	Date of entry in the Register of trade marks.
Benelux	Article 2.26(2)(a) BCIP	<i>'insofar as no normal use has been made of the mark on the Benelux territory for the goods for which the mark is registered, without valid reason, during an uninterrupted period of five years.'</i>	Date of registration of the trade mark.
Bulgaria	Article 19(1), BG-TML	<i>'...within a period of five years following registration...'</i>	Date of registration of the trade mark.
Croatia	Article 29(2) HR-TMA	<i>'... the earlier trade mark has, on the date of publication of the application for the registration of the trade mark, been registered for not less than five years.'</i>	Date of registration of the trade mark.
Cyprus	Section 28A, CY-	<i>'If, within a period of five years</i>	Date of entry of the mark in

⁹ Date of publication of the contested EUTM application in case of oppositions filed before 23/03/2016, see paragraph 2.5.2

¹⁰ Date of publication of the contested EUTM application in case of oppositions filed before 23/03/2016, see paragraph 2.5.2

¹¹ The references are made to the national provisions as valid on 1/06/2015.

Member State	Relevant legal provisions	Quotation of the relevant legal provisions	Summary / Comments
	TML	<i>from the date of entry of the mark in the Register of trade marks, the proprietor has not put the mark to genuine use in connection with the goods and services [...] in respect of which it is registered...</i>	the Register of Trade Marks.
Czech Republic	Section 13(1), CZ-TML	<i>'...five years following the registration, the proprietor of the trade mark has not put the trade mark to genuine use...'</i>	Date of entry of the mark in the Register of Trade Marks. Comment: please note that the relevant date of entry in the Register is shown on the extracts from the official database of the CZ Office under INID code 151 (registration date).
Denmark	Paragraph 25(1), DK-TML	<i>'... Within a period of five years following the date of the termination of the registration procedure [when]the proprietor [...] has not put the trade mark to genuine use [...], or if such use has been suspended during an uninterrupted period of five years [...] unless there are proper reasons for non-use.'</i>	Where no opposition has been lodged: 2 months after the publication of the registration (post-registration opposition procedure). Where an opposition has been lodged: a. date where the decision on the opposition becomes final (i.e. in cases of final refusal of the opposition, namely where time limit for appeal has expired or where possibilities for appeal have been exhausted); or b. date of withdrawal of the opposition.
Estonia	Paragraph 53(1)(3), (4), paragraph 53(2) and (3), EST-TML	<i>'...during five consecutive years after the making of the registration, without good reason...'</i>	Date of entry of the mark in the Register of Trade Marks.
Finland	Section 26, FI-TML Section 20 FI-FML	<i>'... if the trade mark has not been used for the last five years ...' '... the registering authority shall enter the trade mark in the register and give public notice thereof. Any opposition to the registration of the trade mark shall be filed in writing with the registering authority within two months of the date of the public notice.'</i>	Where no opposition has been lodged: date of registration (post registration opposition procedure). Where opposition has been lodged: date of closure of the opposition proceedings (i.e. final refusal of the opposition or disposal, otherwise, e.g. by withdrawal of the opposition).
France	Article L. 714-5, FR-IP CODE	<i>'... use during an uninterrupted period of five years.'</i>	Date of publication of the registration in the 'Bulletin officiel de la propriété industrielle'.
Germany	Section 26(5), DE-TML	<i>'Insofar as use within five years from the point in time of the registration is necessary, in cases in which an opposition has been lodged against the registration, the time of the registration shall be substituted by the point in time of the conclusion of the opposition proceedings.'</i>	Where no opposition has been lodged: date of registration (post registration opposition procedure). Where an opposition has been lodged: date of closure of the opposition proceedings (i.e. final refusal of the opposition

Member State	Relevant legal provisions	Quotation of the relevant legal provisions	Summary / Comments
			or disposal, otherwise, e.g. by withdrawal of the opposition).
Greece	Article 147(2) read jointly with Article 143(1), GR-TML Article 160(1)(a) GR-TML	<i>'Once the decision accepting the TM is final, the filing date constitutes the registration date.'</i> <i>'The mark is revoked if it is not used within five years from the registration...'</i>	Date of filing the application.
Hungary	Article 18(1), HU-TML Article 64(1), HU-TML	<i>'...within a period of five years following the date of registration...'</i> <i>'[...] The date of the decision on registration shall be the date of registration of the trade mark.'</i>	Date of registration of the mark.
Ireland	Article 51(1)(a), (b), IE-TMA	<i>'... within the period of five years following the date of publication of the registration.'</i>	Date of publication of the registration of the mark.
Italy	Article 24(1), IT— IP CODE	<i>'within five years from registration.'</i>	Date of issuing of the registration certificate.
Latvia	Article 23(3) LV-TML	<i>'...within five years from the date of registration...and there are not sufficient reasons for non-use.'</i>	Date of entry of the mark in the Register of trade marks.
Lithuania	Article 47(2), LT-TML	<i>'The registration of a mark may be revoked if, within a period of five years after the issue of the <u>registration certificate</u>, a genuine use of the mark has not been started by the proprietor of the mark in the Republic of Lithuania or the proprietor has not expressed serious intention to use the mark in respect of the goods and/or services for which it is registered, or if the mark has not been put to genuine use for a period of five continuous years, except in cases where the use of the mark was prevented by serious reasons.'</i>	Date of issuing of the registration certificate.
Malta	Article 42(1)(a), MT-TMA	<i>'...within the period of five years following the date of completion of the registration procedure it has not been put to genuine use...'</i>	
Poland	Article 169(1)(i), PL-IPL	<i>'The right of protection for a trade mark shall also lapse on failure to put to genuine use of the registered trade mark for the goods covered by the registration for a period of five successive years after a decision on the grant of a right of protection has been taken, unless serious reasons of non-use thereof exist ...'</i>	Date of the registration. Comment: the Polish examination includes also examination of relative grounds <i>ex officio</i> and the decision on the grant of a right of protection is issued after a complete examination has taken place.
Portugal	Article 269(i), PT-IP Code	<i>'... the registration shall lapse if the trade mark is not put to</i>	Date of registration.

Member State	Relevant legal provisions	Quotation of the relevant legal provisions	Summary / Comments
	Article 269(5), PT-IP Code.	<i>serious use over a period of five consecutive years.'</i> <i>The five years period starts running as from the date of registration.</i>	
Romania	Article 46(1)(a), RO — TML	<i>'...during five consecutive years, following the date of entry (i.e. of the mark) in the Trade marks Register, the mark was not put to genuine use in Romania for the goods or services for which it was registered'</i>	Date of entry of the mark in the Trade marks Register. Comment: the Romanian TM Law does not explicitly define 'the date of entry in the Register' or 'the registration date' of the mark, terms which are used interchangeably in the Law. In any case, please note that the relevant date is shown on the extracts from the official database of the RO Office under INID code 151 (registration date).
Slovakia	Section 34(1), SK-TML	<i>'...if the trade mark was not put in genuine use in Slovakia for the goods and services for which it has been registered for a continuous period of five years ...'</i>	Date of entry of the mark in the Register of trade marks.
Slovenia	Article 120(1), SL-IP ACT	<i>'...within a continuous period of five years from the date of entry of the right in the register.'</i>	Date of entry of the mark in the Register of trade marks.
Spain	Article 39 ES-TML	<i>'five years following the publication, the proprietor of the trade mark has not put the trade mark to genuine use in Spain for the registered goods and services or if within a continuous period of five years the trade mark has not been put to genuine use.'</i>	Date of publication of the registration.
Sweden	Chapter 3, paragraph 2 SE-TML	<i>'Within a period of five years following the date of the completion of the registration Procedure.'</i>	Where no opposition has been lodged: 3 months after the publication of the registration (post registration opposition procedure). Where an opposition has been lodged: on the date where the decision on the opposition becomes final.
United Kingdom	Section 46(1)(a), (b), UK-TML	<i>'... within a period of five years following the date of completion of the registration procedure ...'</i>	Date of entry of the mark in the Register of Trade marks.

***GUIDELINES FOR EXAMINATION OF
EUROPEAN UNION TRADE MARKS***

***EUROPEAN UNION
INTELLECTUAL PROPERTY OFFICE
(EUIPO)***

PART D

CANCELLATION

SECTION 1

PROCEEDINGS

Table of Contents

1	Introduction: General Outline of Cancellation Proceedings	3
2	Application for Cancellation	4
2.1	Persons entitled to file an application for cancellation	4
2.2	Written applications	4
3	Payment of the Fee	5
4	Admissibility Check	5
4.1	Relative admissibility requirements (Rule 37 EUTMIR)	7
4.1.1	Registration number of the contested EUTM and name and address of its owner (Rule 37(a)(i) and (ii) EUTMIR)	7
4.1.2	Extent of the application for cancellation (Rule 37(a)(iii) EUTMIR).....	7
4.1.3	Grounds of the application for cancellation and facts, evidence and arguments presented in support of those grounds (Rule 37(b) EUTMIR)	8
4.1.4	Identification of the applicant (Rule 37(c) EUTMIR).....	10
4.2	Invitation to remedy deficiencies	10
5	Notification of the Application to the EUTM Proprietor and Further Exchanges between the Parties	11
6	Languages Used in Cancellation Proceedings	12
6.1	Translation of the application for cancellation	13
6.2	Translation of the evidence submitted by the applicant in support of the application	13
6.3	Translation of observations submitted by the parties in the course of the proceedings	14
6.4	Translation of evidence submitted by the EUTM proprietor in the course of the proceedings	14
6.5	Translation of proof of use	15
7	Other Issues	15
7.1	Continuation of proceedings	15
7.2	Suspensions	16
7.3	Surrenders and withdrawals	16
7.3.1	Surrenders covering all the contested goods and/or services	16
7.3.2	Surrenders covering only a part of the contested goods and/or services	17
7.3.3	Withdrawals	18
7.4	Applications for revocation and for invalidity against the same EUTM	18
7.5	Contested international registrations designating the EU	18

1 Introduction: General Outline of Cancellation Proceedings

Proceedings in the Office concerning the revocation or invalidity of a registered European Union trade mark (EUTM) are grouped under the general heading of 'cancellation proceedings' and are managed in the first instance by the Cancellation Division. The basic rules regarding these proceedings are mainly contained in Articles 56 and 57 EUTMR and in Rules 37 to 41 EUTMIR.

Cancellation proceedings are initiated with the submission of an application for revocation or for a declaration of invalidity (the 'application for cancellation') against a registered EUTM. An application for cancellation against an EUTM application that has not yet been registered is not admissible.

Once the application for cancellation is received, the Office checks that the corresponding cancellation fee has been paid. If the fee has not been paid, the application is deemed not to have been filed. Next, the Office carries out a preliminary assessment of the admissibility requirements, which includes, in particular, those stated under Rule 37 EUTMIR. The Office also notifies the EUTM proprietor of the application. If there are any deficiencies related to relative admissibility requirements, the Office will ask the cancellation applicant (the applicant) to remedy them within a specified time limit.

Once the admissibility check has been completed, the Office will make an entry in the Register of the pending cancellation proceedings for the contested EUTM (Article 87(3)(n) EUTMR). This is to inform third parties about them. In parallel, the adversarial part of the proceedings is opened and the parties are invited to submit observations (and, if applicable, proof of use).

There are usually two rounds of observations, after which the adversarial part is closed and the file is ready for a decision. Once the decision becomes final (i.e. if no appeal has been filed within the prescribed time limit or when the appeal proceedings are closed), the Office will make the corresponding entry in the Register, in accordance with Article 57(6) EUTMR.

In many respects, cancellation proceedings follow the same or analogous procedural rules as those established for opposition proceedings (e.g. friendly settlement, restrictions of the contested EUTM and withdrawals of the application for cancellation, correction of mistakes and revocation, time limits, multiple cancellations, change of parties, *restitutio*, etc.). For all these matters, see the relevant sections of the Guidelines and in particular Part C, Opposition, Section 1, Procedural Matters. This part of the Guidelines will, therefore, only focus on those aspects of the cancellation proceedings that are different from opposition proceedings.

2 Application for Cancellation

2.1 Persons entitled to file an application for cancellation

Articles 41(1) and 56(1) EUTMR

Cancellation proceedings can never be initiated *ex officio* by the Office but only upon receipt of an application from a third party.

Applications for revocation or for invalidity based on absolute grounds (Articles 51 and 52 EUTMR) may be filed by:

1. any natural or legal person, or
2. any group or body set up for the purpose of representing the interests of manufacturers, producers, suppliers or services, traders or consumers, which under the terms of the law governing it has the capacity in its own name to sue and be sued.

As regards applications for revocation or for invalidity based on absolute grounds, the applicant does not need to show an individual interest in bringing proceedings (judgment of 08/07/2008, T-160/07, COLOR EDITION, EU:T:2008:261, § 22-26, confirmed by judgment of 25/02/2010, C-408/08 P, COLOR EDITION, EU:C:2010:92, § 37-40). This is because, while relative grounds for invalidity protect the interests of proprietors of certain earlier rights, the absolute grounds for invalidity and for revocation aim to protect the general interest (including, in the case of revocations based on lack of use, the general interest in revoking the registration of trade marks that do not satisfy the use requirement) (judgment of 30/05/2013, T-396/11, ULTRAFILTER INTERNATIONAL, EU:T:2013:284, § 17-18).

In contrast, applications for invalidity based on relative grounds (Article 53 EUTMR) may only be filed by the persons mentioned in Article 41(1) EUTMR (in the case of applications based on Article 53(1) EUTMR) or by those entitled under the law of the Member State concerned to exercise the rights in question (in the case of applications based on Article 53(2) EUTMR).

Applications for revocation or invalidity based on Articles 73 or 74 EUTMR (in particular specific revocation and absolute grounds for collective marks) follow the same rules, with regard to entitlement, as applications for revocation or for invalidity based on absolute grounds (Article 66(3) EUTMR).

2.2 Written applications

Article 56(2) EUTMR

An application for cancellation has to be filed in writing. It is not obligatory to use the forms provided by the Office, as long as all the admissibility requirements are met. However, the use of the official forms is highly recommended.

3 Payment of the Fee

Article 56(2) EUTMR Rule 39(1) EUTMIR Article 144b(3) EUTMR

For general rules on payments, see the Guidelines, Part A, General Rules, Section 3, Payment of Fees, Costs and Charges.

An application for cancellation is not deemed to have been filed until the fee has been paid. For this reason, before examining the admissibility of the application, the Office will first check that the fee has been received.

Where the Office finds that the fee has not been paid, it will invite the applicant to pay it within a given time limit (in practice usually one month). If the required fee is not paid within the time limit, the Office will inform the applicant that the application for cancellation is deemed not to have been filed. If the fee is paid, but after the specified time limit, it will be refunded to the applicant. In cases where the fee is received after the expiry of the time limit specified by the Office but the applicant provides proof that, within the time limit, it duly gave an order to a banking establishment to transfer the amount of the payment in a Member State, Article 144b(3) EUTMR will be applied, including the payment of a surcharge where applicable (see the Guidelines, Part A, General Rules, Section 3, Payment of Fees, Costs and Charges).

The filing date of an application for cancellation is not affected by the date of payment of the fee, since Article 56(2) EUTMR is a rule of order in the context of cancellation proceedings and does not establish any consequence as regards the filing date of the application. Therefore, when the fee is paid before the expiry of the time limit specified by Rule 39(1) EUTMIR, the application is deemed to be filed and the filing date will be that on which the written statement was received by the Office.

As a general principle, the cancellation fee is an application fee due for the filing of the application regardless of the outcome of the proceedings. Therefore, it will not be refunded in cases of inadmissibility.

Neither will the cancellation fee be refunded in cases where the application for cancellation is withdrawn at any stage.

In this context, the only provision that foresees the refund of the cancellation fee is Rule 39(1) EUTMIR, applicable only in cases where the application is deemed not to have been filed as a result of a late payment.

4 Admissibility Check

Article 51 and Articles 53(4) and 56(3) EUTMR Rule 37 and Rule 38(1) EUTMIR
--

Once the Office has established that the corresponding fee has been duly paid, it proceeds with an admissibility check of the application.

In contrast to opposition proceedings, there is no cooling-off period and no subsequent time limit for substantiation in cancellation proceedings. This means, in particular, that in the case of an application for invalidity based on relative grounds the proof of the existence, validity and scope of protection of all the earlier rights and the evidence proving the applicant's entitlement to them have to be filed, in principle, together with the application.

The admissibility check may result in the identification of absolute and/or relative admissibility deficiencies in the application.

Absolute admissibility deficiencies are those that cannot be remedied by the applicant and will automatically lead to the application being considered inadmissible, such as the following:

- The application is filed against an EUTM that has not yet been registered. An application for cancellation can only be filed against a registered EUTM. A request directed against an application that has not yet been registered is premature and should be rejected as inadmissible (decision of 22/10/2007, R 0284/2007-4, VISION).
- The application is filed against an EUTM that no longer exists at the time of filing, since it has already been surrendered, has expired, or has been revoked or invalidated by a final decision.
- There is a previous final decision by the Office or by a court in a Member State on a cancellation application or counterclaim relating to the same subject matter and cause of action, and involving the same parties that has been adjudicated on its own merits (Article 56(3) EUTMR). For more details on this admissibility deficiency, see the corresponding section in the Guidelines, Part D, Cancellation, Section 2, Substantive Provisions, paragraph 5.
- In cases of invalidity based on relative grounds, where the applicant owns several earlier rights and has previously applied for the invalidity of the same EUTM (or made a counterclaim) on the basis of another of those earlier rights that could have been invoked in the previous application or counterclaim (Article 53(4) EUTMR). For more details on this admissibility deficiency, see the corresponding section in the Guidelines, Part D, Cancellation, Section 2, Substantive Provisions, paragraph 4.5.2.
- An application for revocation based on non-use is filed against a trade mark that has not been registered for five years at the date of the application (Article 51 EUTMR).
- An application for cancellation filed without having used the official form, which is neither in the correct language as established in Article 119 EUTMR nor translated into that language within one month of the filing of the application for cancellation (Rule 38(1) EUTMR).

Where an absolute admissibility deficiency is found, the Office will invite the applicant to comment on the inadmissibility within two months. If, after hearing the applicant, the Office still maintains that there is an absolute admissibility deficiency, a decision will be issued rejecting the application for cancellation as inadmissible.

Relative admissibility deficiencies, on the other hand, are those that can in principle be remedied by the applicant. They include non-compliance with one or more of the relative admissibility requirements contained in Rule 37 EUTMIR (which are described in detail in paragraph 4.1 below). In these cases, in accordance with Rule 39(3) EUTMIR, the Office will invite the applicant to remedy the deficiency within two months (see paragraph 4.2 below).

Where one or more relative admissibility deficiencies have been found and they are not remedied within the specified time limit, a decision will be issued rejecting the application for cancellation as inadmissible.

Any decision to reject an application for cancellation in its entirety as inadmissible will be communicated to the applicant and the proprietor of the EUTM (Rule 39(4) EUTMIR) and can be appealed by the applicant.

However, if the result of the admissibility check is that the application is considered partially admissible (i.e. admissible for at least some of the grounds and/or earlier rights on which it is based), the proceedings will continue. If one of the parties disagrees with the result of the admissibility check, it can appeal against it together with the final decision terminating the proceedings (Article 58(2) EUTMR).

4.1 Relative admissibility requirements (Rule 37 EUTMIR)

The relative admissibility requirements laid down by Rule 37 EUTMIR are set out below.

4.1.1 Registration number of the contested EUTM and name and address of its owner (Rule 37(a)(i) and (ii) EUTMIR)

An application for cancellation must contain the EUTM registration number and the name and address of its proprietor (please note that this is different in opposition proceedings, where Rule 15(2)(a) EUTMIR only requires the opponent to identify the contested EUTM application and the name of the applicant, but not its address).

The Office will check that the proprietor's name and address correspond to the EUTM identified by its registration number. In the event of discrepancies (or omission of one of these details), a deficiency letter will be sent to the applicant inviting it to remedy this deficiency (see the paragraphs on deficiencies below).

4.1.2 Extent of the application for cancellation (Rule 37(a)(iii) EUTMIR)

The applicant must indicate whether the request is filed against all the goods and services or against part of the goods and services in the contested registration. In the latter case, the applicant will have to clearly identify the specific goods and services in a list.

An applicant is entitled to limit the scope of its application by excluding subcategories of the goods and/or services for which the contested mark is registered (see, as regards applications for revocation, judgment of 09/12/2014, T-307/13, ORIBAY, EU:T:2014:1038, § 25).

Please note the difference from opposition proceedings where, for the purposes of admissibility, the extent of the opposition is only an optional indication (Rule 15(3)(a) EUTMIR).

4.1.3 Grounds of the application for cancellation and facts, evidence and arguments presented in support of those grounds (Rule 37(b) EUTMIR)

The EUTMR and EUTMIR clearly distinguish between an application for revocation and an application for a declaration of invalidity. Therefore, revocation and invalidity grounds cannot be combined in a single application but must be subject to separate applications and entail the payment of separate fees. However, an application for revocation can be based on several revocation grounds and an application for invalidity can be based on a combination of absolute and relative grounds. If an applicant files a single application based on revocation and invalidity grounds, the Office will send a deficiency letter inviting the applicant to choose one or the other type of grounds and will inform the applicant that another cancellation application can be filed subject to the payment of an additional application fee. If the applicant does not indicate which type of grounds it wishes to choose within the time limit specified, the application will be rejected as inadmissible (Rule 39(3) EUTMIR).

An application for cancellation must contain an indication of the grounds on which it is based, that is to say the specific provisions of the EUTMR that justify the requested cancellation. The applicant may limit the grounds on which the application was initially based but may not enlarge the scope of the application by claiming any additional grounds during the course of the proceedings.

In addition, where an application for invalidity is based on relative grounds (Article 53 EUTMR), the application must contain particulars of the right or rights on which the application is based and, if necessary, particulars showing that the applicant is entitled to adduce the earlier right as grounds for invalidity (meaning all the indications contained in Rule 15(b), (d), (e), (f), (g) and (h) EUTMIR, which are applied by analogy).

According to Rule 37(b)(iv) EUTMIR, an application for cancellation must also contain an indication of the facts, evidence and arguments presented in support of the cancellation grounds. This means that the mere submission of an application form in which all the relevant boxes are ticked, but that does not include any explanation on the ground(s) in the relevant box or attach any observations or evidence, such as a certificate, will lead to an admissibility deficiency. The only exception is for applications for revocation based on non-use (Article 51(1)(a) EUTMR), in which the burden of proof is on the EUTM proprietor.

Finally, an important distinction should be drawn between admissibility and substantiation requirements. As already mentioned in the introduction to paragraph 4, even though in invalidity proceedings based on relative grounds there is no time limit for the substantiation of the earlier rights, and the proof of the existence, validity and scope of protection of all the earlier rights and the evidence proving the applicant's entitlement to them have to be filed together with the application, this does not mean that there is no distinction between admissibility and substantiation requirements. If, for instance, an applicant clearly identifies the earlier mark on which the application is based (Rule 37(b)(ii) EUTMIR) and indicates the evidence or submits some arguments in support of those grounds (Rule 37(b)(iv) EUTMIR), the application will be admissible. If the evidence or arguments provided are later found insufficient to substantiate the

earlier right (e.g. the certificate is not from an official source or not translated into the language of proceedings), the application will be rejected as unfounded (see, by analogy, Rule 20(1) EUTMIR) and not as inadmissible (decisions of 12/07/2013, R 1306/2012-4, URB EUROPE, § 21; 12/07/2013, R 1310/2012-4, URB Bearings, § 21; 12/07/2013, R 1309/2012-4, URB, § 20, confirmed by judgment of 07/11/2014, T-506/13, URB, EU:T:2014:940).

However, the absence of a time limit for the substantiation of the earlier rights means that at any subsequent stage of the proceedings (before the closure of the adversarial part) the applicant can remedy, on its own motion, any deficiency as regards substantiation.

Examples to illustrate the difference between admissibility and substantiation, in particular as regards earlier rights:

- 1) An application for cancellation pursuant to Article 53(1) EUTMR does not contain a representation of the earlier right on which it is based, neither in the corresponding box in the form nor in the attached documentation. Since a representation of the mark (in colour if applicable) is one of the requirements for clearly identifying the earlier right (Rule 15(2)(e) EUTMIR by analogy), there will be a relative admissibility deficiency in accordance with Rule 37(b)(ii) EUTMIR, which the applicant will be invited to remedy (see paragraph 4.2 below).
- 2) An application for cancellation pursuant to Article 53(1)(a) in conjunction with Article 8(1)(b) EUTMR includes all the necessary particulars of the earlier national mark (e.g. all the relevant boxes of the corresponding page of the official form are correctly filled in), including the indications as to the entitlement of the applicant. However, the certificate attached to the application indicates that the owner is a different person. In this case the applicant has complied with both Rule 37(b)(ii) and (iv) EUTMIR, that is to say it has given particulars of the earlier right and of its entitlement, and submitted evidence in support. Whether the evidence submitted is sufficient to substantiate its claims is not a matter of admissibility, but of substantiation. The applicant will not be invited to remedy the substantiation deficiency, but must do so on its own motion before the closure of the adversarial part of the proceedings (e.g. by submitting evidence that the transfer of the earlier national mark to the applicant had taken place before the filing of the cancellation application).
- 3) An application for cancellation pursuant to Article 53(1)(c) and (d) in conjunction with Article 8(4) and (4a) EUTMR includes all the necessary particulars about the earlier right and also contains evidence in support of the cancellation grounds, but the evidence is clearly insufficient (e.g. the applicant does not provide any indication regarding the applicable national law). Again, and for the same reasons as in the previous example, the application would be admissible but unsubstantiated, unless the applicant were to remedy the substantiation deficiency on its own motion before the closure of the adversarial part of the proceedings.

As regards substantiation requirements of earlier rights, see the section on proof of existence of earlier rights in the Guidelines, Part C, Opposition, Section 1, Procedural Matters and the section on invalidity proceedings based on relative grounds in the Guidelines, Part D, Cancellation, Section 2, Substantive Provisions.

4.1.4 Identification of the applicant (Rule 37(c) EUTMIR)

An application for cancellation must contain the applicant's name and address and, if the applicant has appointed a representative, the representative's name and address. Applicants that do not have either their domicile or their principal place of business or a real and effective industrial or commercial establishment in the European Economic Area (EEA) must be represented by a professional representative (Article 92(2) EUTMR). For more information, see the Guidelines, Part A, General Rules, Section 5, Professional Representation.

Concerning multiple applicants, applications for invalidity based on relative grounds follow the same rules as oppositions (see the Guidelines, Part C, Opposition, Section 1, Procedural Matters). These rules are directly connected to the entitlement requirements of Articles 41(1) and 56(1) EUTMR (see above).

In contrast, in the case of applications for invalidity based on absolute grounds and for revocation there are no particular requirements regarding multiple applicants, except that they have to be clearly indicated in the application.

Please note that in all cases concerning multiple applicants, Rule 75 and Rule 94(7)(e) EUTMIR will be applied (appointment of a common representative and fixing of costs).

4.2 Invitation to remedy deficiencies

Rule 39(3) and (4) EUTMIR

In accordance with Rule 39(3) EUTMIR, if the Office finds that an application for cancellation does not comply with Rule 37 EUTMIR, it will invite the applicant to remedy the deficiencies within a specific time limit. Please note that this only applies to deficiencies as regards admissibility requirements, and not to deficiencies as regards substantiation requirements, which the applicant must remedy on its own motion (see paragraph 4.1.3 above).

If the deficiencies are not remedied before the expiry of the time limit, the Office will issue a decision rejecting the application as inadmissible. In cases where the application for cancellation is based on several grounds and/or earlier rights and the deficiencies only relate to some of them, the proceedings can continue in relation to the other grounds or earlier rights for which there are no admissibility deficiencies (partial admissibility).

As mentioned above in connection with the grounds of the application, in the context of Rule 39(3) EUTMIR, the fact that the applicant is invited to remedy a deficiency cannot lead to enlargement of the scope of the proceedings (earlier rights, goods and services, etc.) determined by the initial request.

Finally, Rule 39(3) EUTMIR is only applicable to the list of relative admissibility requirements contained in Rule 37 EUTMIR. Deficiencies in relation to absolute admissibility requirements are not covered by Rule 39(3) EUTMIR and cannot be remedied (i.e. they lead to the rejection of the application in question as inadmissible).

5 Notification of the Application to the EUTM Proprietor and Further Exchanges between the Parties

Article 57 EUTMR
Rule 40 EUTMIR

Rule 40(1) EUTMIR states that every application for cancellation that is deemed to have been filed must be notified to the proprietor of the contested EUTM and that when the Office has found the application admissible, it will invite the proprietor to file its observations within such time limit as it may specify.

Therefore, once the Office has verified that payment has been received (and thus the application is deemed to have been filed) and has carried out the admissibility check, it notifies the EUTM proprietor of the application for cancellation.

If no deficiencies are detected in the admissibility check, the notification of the application to the EUTM proprietor will also contain an invitation to file observations (and in the case of an application for revocation based on Article 51(1)(a) EUTMR, an invitation to submit proof of genuine use — see Rule 40(5) EUTMIR). In practice, the Office grants the EUTM proprietor three months for its first reply to the application.

If the admissibility check reveals that there are deficiencies to be remedied, the EUTM proprietor will still be notified of the application and will be informed of the deficiencies that the applicant has to remedy. However, in this case just the notification of the application is sent and the Office will not invite the EUTM proprietor to file observations (or, where applicable, proof of use) until the applicant has remedied the deficiencies.

According to the judgment of the Court of Justice of 18/10/2012 in case C-402/11 P, REDTUBE, EU:C:2012:649 (applicable by analogy to cancellation proceedings), the notification sent to the parties after the admissibility check informing them that the cancellation is admissible in accordance with Rule 37 EUTMIR constitutes a decision that may be appealed together with the final decision on the case as stated in Article 58(2) EUTMR. Consequently, the Office is bound by this decision and may only revoke it at a later stage of the proceedings provided that the requirements stated in Article 80 EUTMR for the revocation of decisions are met. This means that, for instance, if an admissibility deficiency is found after the application has been notified, it should first be determined whether the decision on admissibility can still be revoked and, if so, the Office will issue the corresponding deficiency letter once the previous decision on admissibility has been revoked.

Revocation does not occur where the cause of inadmissibility arises **after** the initial admissibility check (e.g. when an applicant outside the EEA ceases to have a representative and does not appoint one or when res judicata applies because a pertinent decision becomes final during the cancellation proceedings). In such cases the Office will again check the admissibility and issue the corresponding deficiency letter without revoking the previous admissibility decision (which did not contain any error at the time it was adopted).

According to Article 57(1) EUTMR, the Office may invite the parties to file observations as often as it considers this necessary. In practice, and in the interest of avoiding an unnecessary prolongation of the proceedings, the Office will usually grant two rounds of observations, usually ending with those of the EUTM proprietor (i.e. application for cancellation — EUTM proprietor's observations — applicant's observations — EUTM

proprietor's observations). Nevertheless, in cases when one of the parties, within the time limit to file observations, does not submit any evidence or observations and/or indicates that it has nothing more to comment, the Office may directly proceed to closure of the adversarial part of the proceedings, notifying the parties that a decision will be taken.

However, additional rounds of observations may be granted in exceptional cases, in particular when additional relevant evidence, which could not have been filed beforehand, is filed in the last round. It is the Office's practice to give the parties a time limit of two months to file their observations (except for the first submission of the EUTM proprietor, see above).

As regards applications for invalidity based on relative grounds, the EUTM proprietor may also file a request for proof of use of the earlier trade marks on which the application is based. If the request is admissible (for the rules on the admissibility of a request for proof of use, see the Guidelines, Part C, Opposition, Section 6, Proof of Use), the Office will invite the applicant to submit the proof (Article 57(2) and (3) EUTMR and Rule 40(6) EUTMIR). In contrast to opposition proceedings (Rule 22(1) EUTMIR), in cancellation proceedings, the request can be filed by the EUTM proprietor together with its first reply to the application or in any of the subsequent rounds of observations.

Once the parties have submitted their observations and/or proof of use (if applicable), the adversarial part is closed and the file is ready for decision.

If at any stage of the proceedings one of the parties does not file observations within the specified time limit, the Office will close the adversarial part and take a decision on the basis of the evidence before it (Rule 40(2) EUTMIR, applicable by analogy to both parties).

In cases of invalidity based on relative grounds, before the Office issues a decision, it will check whether any of the earlier rights invoked that were correctly substantiated by the applicant have become due for renewal afterwards. If so, and provided it could be relevant for the outcome of the proceedings, the Office will invite the applicant to prove the renewal of the earlier right. If the applicant does not submit the proof, the application will be rejected as non-substantiated to the extent it is based on the earlier right.

As regards the rules on time limits, extensions, notification or change of parties in the course of proceedings, etc., see the Guidelines, Part C, Opposition, Section 1, Procedural Matters, as the rules are applicable *mutatis mutandis*.

6 Languages Used in Cancellation Proceedings

Article 119(5), (6) and (7) EUTMR
 Rules 38(1) and (3); 39(2) and (3); 96(1) and (2) EUTMIR

The language of cancellation proceedings will in general be determined by the applicant in the cancellation application and has to comply with Article 119 EUTMR (i.e. it has to be one of the five languages of the Office and one of the two languages chosen by the EUTM proprietor when it applied for the contested trade mark). For

detailed rules on how to determine the language of proceedings, see the Guidelines, Part C, Opposition, Section 1, Procedural Matters, paragraph 2.3.

The parties to cancellation proceedings may also agree on a different official language of the European Union as the language of the proceedings (Article 119(7) EUTMR). This agreement has to be communicated to the Office within two months of the notification of the application for cancellation to the EUTM proprietor. In this case, the applicant must file a translation of the application into the language chosen by both parties (where it was not already filed in that language) within one month of the date on which the agreement is communicated to the Office. Where the translation is not filed or filed late, and where the request to change the language is filed late (after the expiry of the two months), the language of the proceedings will remain unchanged (Rule 38(3) EUTMIR).

6.1 Translation of the application for cancellation

Article 119(6) EUTMR
 Rules 38(1) and (3) and 39(2) EUTMIR

If the application is filed in a language of the Office that is not one of the two languages of the contested EUTM, on its own motion the applicant has to file a translation into the correct language (either of the two languages of the contested EUTM, if they are both languages of the Office, or the second language of the contested EUTM, when the first is not a language of the Office) within one month of the filing date of the application for cancellation, failing which the application will be rejected as inadmissible (Article 119(6) EUTMR, Rules 38(1) and 39(2) EUTMIR).

Rule 39(3) EUTMIR, regarding the invitation to the applicant to remedy deficiencies, does not refer to Rule 38(1) EUTMIR and, therefore, in these cases the Office will not send a deficiency letter and will wait for one month after the filing date for the translation of the cancellation application to be submitted.

Where the applicant uses the official form for revocation or invalidity, and this form is in the wrong language, there may be exceptions concerning the translation of the application. Please see the different scenarios described in the Guidelines, Part C, Opposition, Section 1, Procedural Matters, paragraph 2.3.

6.2 Translation of the evidence submitted by the applicant in support of the application

Rules 38(2) and 39(3) EUTMIR

According to Rule 38(2) EUTMIR, where the evidence in support of the application is not filed in the language of the revocation or invalidity proceedings, the applicant must file, on its own motion, a translation into that language within two months of the filing date of the evidence in support of the application. This applies to all the evidence submitted by the applicant in the course of the proceedings, whether it is filed together with the application or at a later stage.

The Office will not send a deficiency letter and it is up to the applicant to submit the translation of the evidence in support of the application on its own motion.

If the applicant does not file a translation of evidence in support of the application that is required to evaluate the admissibility of the case (e.g. the particulars of the earlier right on which the application is based, or the indication of the facts, evidence and arguments in support of the grounds are not translated), the Office will invite the applicant to remedy the deficiency pursuant to Rule 39(3) EUTMIR (decision of 02/03/2007, R 0300/2006-4, ACTILON/AC TELION). If the deficiency is not remedied, the application for cancellation will be rejected as totally or partially inadmissible (Article 119(6) EUTMR, Rules 38(2) and 39(3) EUTMIR).

If the applicant does not provide translations for the other evidence, which would not affect the admissibility of the case, any document in support of the application that is not translated by the applicant into the language of proceedings within the time limit specified in Rule 38(2) EUTMIR will be deemed not to have been received by the Office and, therefore, will not be taken into account (Rule 98(2) EUTMIR) (decision of 05/03/2012, R 0826/2010-4, MANUFACTURE PRIM 1949 (fig.), § 25).

6.3 Translation of observations submitted by the parties in the course of the proceedings

Rules 96(1) and 98(2) EUTMIR

A party who submits observations in a language of the Office other than the language of the proceedings has to file a translation of those observations in the language of the proceedings within **one month** of the submission date (Rule 96(1) EUTMIR).

The Office will not ask for the translations and will proceed with the case. It is up to the party to submit the requisite translations.

If the translations are not submitted within the time limit of one month, the observations will be deemed not to have been received by the Office and, therefore, will not be taken into account (Rule 98(2) EUTMIR).

6.4 Translation of evidence submitted by the EUTM proprietor in the course of the proceedings

Rules 96(2) and 98(2) EUTMIR

The documents submitted by the EUTM proprietor in the course of the proceedings (except for proof of use, see below) are subject to Rule 96(2) EUTMIR and, therefore, may be submitted in any official language of the European Union.

In accordance with this provision, the EUTM proprietor is not automatically obliged to file a translation, but **the Office may require it to do so within a time limit.** In exercising its discretion in this matter, the Office will take into account the nature of the evidence and the interests of the parties.

In cases where the Office does invite the EUTM proprietor to submit translations of the evidence, failure to do so within the specified time limit will mean that the non-translated documents will not be taken into account (Rule 98(2) EUTMIR).

6.5 Translation of proof of use

Rule 22(6) EUTMIR

Although Rule 40(5) and (6) EUTMIR only expressly refer to Rule 22(2), (3) and (4) EUTMIR, it is considered that Rule 22(6) EUTMIR should also be applied by analogy in cancellation proceedings, since the underlying logic is the same, that is to say to request translation of evidence, which for proof of use tends to be quite lengthy, only to the extent to which it is considered necessary (decision of 11/03/2010, R 0167/2009-1, INA/INA (fig.), § 24-25). Consequently, Rule 22(6) EUTMIR applies as *lex specialis*, vis-à-vis the *lex generalis* contained in Rule 38(2) EUTMIR (evidence submitted by the applicant) and Rule 96(2) EUTMIR (evidence submitted by the EUTM proprietor), as regards proof of use submitted by either of the parties (judgment of 13/02/2015, T-287/13, HUSKY, EU:T:2015:99, § 55).

According to Rule 22(6) EUTMIR, where the evidence of use filed by one of the parties is not in the language of the proceedings, the Office **may** require the party that filed it to submit a translation of the evidence in that language within a time limit of two months. In exercising its discretion in this matter, the Office will take into account the nature of the evidence and the interests of the parties. In cases where the Office does invite the EUTM proprietor to submit translations of the evidence, failure to do so within the specified time limit will mean that the non-translated documents will not be taken into account (except those that are considered to be self-explanatory). For further guidance on the application of Rule 22(6) EUTMIR, see the Guidelines, Part C, Opposition, Section 1, Procedural Matters and Part C, Opposition, Section 6, Proof of Use.

7 Other Issues

7.1 Continuation of proceedings

Article 82 EUTMR

According to Article 82(1) EUTMR, any party to proceedings before the Office that has omitted to observe a time limit vis-à-vis the Office may, upon request, obtain the continuation of proceedings, provided that at the time the request is made the omitted act has been carried out. The request for continuation of proceedings will be admissible only if it is presented within two months of the expiry of the unobserved time limit and will not be deemed to have been filed until the corresponding fee has been paid.

This provision is applicable to all the proceedings before the Office. For more details, see the Guidelines, Part A, General Rules, Section 1, Means of Communication, Time Limits.

However, the reason why it is specifically mentioned in relation to cancellation proceedings is to highlight the difference with opposition proceedings. As regards opposition, Article 82(2) EUTMR establishes that continuation of proceedings is not

applicable, inter alia, to the time limits laid down in Articles 41 and 42 EUTMR (period for filing notice of opposition, time limits given by the Office to file facts, evidence and arguments or observations). In cancellation proceedings, by contrast, continuation of proceedings can be requested for any of the different time limits within the cancellation proceedings (except for the time limit established in Article 60(1) EUTMR to file an appeal).

7.2 Suspensions

Article 104 EUTMR

In the matter of suspensions, see in general the Guidelines, Part C, Opposition, Section 1, Procedural Matters (taking into account, however, that in cancellation proceedings there is no cooling-off period). Rule 20(7) EUTMR is applicable by analogy.

The main particularity of cancellation proceedings in this matter concerns the specific rules on related actions before European Union trade mark courts. According to Article 104(2) EUTMR, the Office, when hearing an application for cancellation will, unless there are special grounds for continuing the hearing, of its own motion after hearing the parties or at the request of one of the parties and after hearing the other parties, suspend the proceedings where the validity of the contested EUTM is already in issue on account of a counterclaim before a European Union trade mark court.

Article 104(2) EUTMR also states that if one of the parties to the proceedings before the European Union trade mark court so requests, the European Union trade mark court may, after hearing the other parties to these proceedings, suspend the proceedings. The Office will in this case continue the proceedings pending before it.

A request for suspension pursuant to Article 104(2) EUTMR should be supported by relevant evidence. Suspension requests are only considered relevant to the proceedings and might be granted under Article 104(2) EUTMR in cases where they refer to the contested EUTM and not where they refer to other EUTMs contested in parallel cancellation proceedings.

7.3 Surrenders and withdrawals

The Office's practice on the surrender of EUTMs is described in the Guidelines, Part E, Register Operations, Section 1, Changes in a Registration.

7.3.1 Surrenders covering all the contested goods and/or services

In principle, the consequences in cancellation proceedings of a total surrender of the contested EUTM (or of a partial surrender covering all the goods and/or services against which the application for cancellation is directed) are similar to those of the withdrawal of an EUTM application in opposition proceedings.

However, unlike what happens with the withdrawal of an EUTM application, the effects of the surrender of a registered EUTM are not the same as those of the decision on the substance terminating the proceedings in question. While the surrender of an EUTM

only becomes effective on the date on which the surrender is registered, a decision cancelling the EUTM produces its effects from an earlier date, be it from the outset (in the case of invalidity) or from the date on which the cancellation request was filed (in the case of revocation). Consequently, as a rule, and despite the surrender of the contested EUTM, the applicant is deemed still to have a legitimate interest in continuing the cancellation proceedings in order to obtain a decision on the substance (judgment of 24/03/2011, C-552/09 P, TiMi KiNDERJOGHURT, EU:C:2011:177, § 39 and decision of 22/10/2010, R 0463/2009-4, MAGENTA, § 25-27).

In practice, when there is a surrender of an EUTM that is subject to cancellation proceedings, the Office will suspend the registration of the surrender and, in parallel, the Cancellation Division will notify the cancellation applicant of the surrender, inviting it to submit observations within two months and to indicate whether it wishes to continue the proceedings or whether it agrees to the closure of the proceedings without a decision on the substance. This letter will also inform the applicant that, if it does not reply, the cancellation proceedings will be closed without a decision on the substance.

If the applicant replies and expressly agrees with the closure of the proceedings, the surrender will be recorded, the cancellation action will be deemed to have been withdrawn and the proceedings will be closed without a decision on the substance. The costs will be borne by the EUTM proprietor (Article 85(3) EUTMR).

If the applicant does not submit any observations on the closure of the cancellation proceedings, the Cancellation Division will send both parties a letter closing the proceedings and informing the applicant of its possible loss of rights for the purposes of Rule 54(2) EUTMR. If the applicant does not explicitly apply for a decision on the matter within the time limit established in this rule, the surrender will be recorded in the Register.

If the applicant does request the continuation of the cancellation proceedings (either in reply to the Office's invitation to submit observations or when applying for a decision under Rule 54(2) EUTMR), the cancellation proceedings will continue until there is a final decision on the substance. In these cases, the costs will be borne by the losing party and not necessarily the party terminating proceedings as indicated in Article 85(3) EUTMR. After the decision on the cancellation has become final, the surrender will be recorded only for the goods and/or services for which the contested EUTM has not been revoked or declared invalid, if any.

7.3.2 Surrenders covering only a part of the contested goods and/or services

The EUTM proprietor may partially surrender its EUTM for part of the contested goods and/or services. In such cases the Office will notify the cancellation applicant and will invite it to indicate if it wishes to maintain its cancellation application. If the cancellation applicant does request the continuation of proceedings and maintains its application for cancellation, proceedings will continue despite the partial surrender of the EUTM in the Register. If the cancellation applicant does not wish to maintain its application for cancellation, the Office will close the proceedings and take a decision on costs indicating that each party will bear its own costs (Article 85(2) EUTMR).

7.3.3 Withdrawals

The cancellation applicant can withdraw its application for cancellation at any time of the proceedings. The Office will inform the EUTM proprietor about the withdrawal, close the proceedings and take a decision on costs, which will be borne by the applicant (Article 85(3) EUTMR), except in cases where the withdrawal immediately follows a surrender (see above).

The parties may indicate that a surrender or a withdrawal is a consequence of an agreement they have reached and that a decision on costs is not necessary. The Office will not issue a decision on costs if such a request is received together with a request for surrender or withdrawal and is signed by both parties. Such a request can also be sent in two separate letters to the Office. In cases where no indication is given as to whether the parties have agreed on the costs, the Office will take a decision on costs immediately. The decision on costs already issued will not be revised by the Office in the event that the parties provide such information after the date of the decision. It is left to the parties to respect the agreement and not to 'execute' the Office's decision on costs.

7.4 Applications for revocation and for invalidity against the same EUTM

If the same EUTM is subject to both revocation and invalidity proceedings, the Office has the power of discretion to decide in each case, taking into account the principles of economy of proceedings and administrative efficiency, whether one of the proceedings has to be suspended until the other is terminated or in which order the proceedings should be decided.

If it is first decided that the EUTM is totally invalid (or partially, but for all the goods/services against which the revocation is directed), and once this decision becomes final, the parallel revocation proceedings will be automatically closed since they no longer have any object. The costs are at the discretion of the Office (Article 85(4) EUTMR), which will usually conclude that each party has to bear its own costs.

However, taking into account the different effects of a revocation (*ex nunc*) and of a declaration of invalidity (*ex tunc*), when it is first decided that the EUTM should be totally revoked (or partially, but for all the goods/services against which the invalidity is directed), the Office will inform the applicant of this decision when it becomes final and will invite it to submit its observations on the closure of the invalidity proceedings. If the applicant demonstrates a sufficient legal interest in obtaining a declaratory invalidity decision, the proceedings will continue.

7.5 Contested international registrations designating the EU

Article 152(2) and Article 158 EUTMR

Cancellation proceedings can also be directed against international registrations (IRs) designating the European Union. The specific rules that are applicable in these cases (in particular in connection with the filing date and the relevant time limit for proof of use) can be found in the Guidelines, Part M, International Marks.

A cancellation application against an IR may be filed after the date of the publication of the IR designating the European Union in the Official Bulletin of the Office (M.3.1. - International registrations with or without amendments since their publication under Article 152(1) of the EUTMR).

As regards WIPO representatives of the holders of contested IRs, the Office will as a general rule communicate with them, irrespective of the IR holder's location, when they comply with the criteria of Article 93 EUTMR.

Where the WIPO representative of the IR holder does not comply with the criteria of Article 93 EUTMR, the notification of the cancellation application will be sent directly to the IR holder, and a copy will be sent to its WIPO representative for information purposes.

The notification of the cancellation application will also invite the IR holder to appoint a professional representative in accordance with Article 93 EUTMR within three months of its receipt. In cases of obligatory representation (Article 92(2) EUTMR), the notification will indicate the consequences of not complying with this requirement (namely, that any communications sent by the IR holder in the course of the proceedings will not be taken into account).

***GUIDELINES FOR EXAMINATION OF
EUROPEAN UNION TRADE MARKS***

***EUROPEAN UNION
INTELLECTUAL PROPERTY OFFICE
(EUIPO)***

PART D

CANCELLATION

SECTION 2

SUBSTANTIVE PROVISIONS

Table of Contents

1	General Remarks	4
1.1	The grounds for cancellation.....	4
1.2	<i>Inter partes</i> proceedings.....	4
1.3	The consequences of revocation and invalidity.....	4
2	Revocation	5
2.1	Introduction	5
2.2	Non-use of the EUTM — Article 51(1)(a) EUTMR.....	5
2.2.1	Burden of proof	5
2.2.2	Genuine use	6
2.2.3	Period of time to be considered.....	6
2.2.4	Proper reasons for non-use.....	6
2.3	EUTM becoming the common name (generic term) — Article 51(1)(b) EUTMR	7
2.3.1	Burden of proof	7
2.3.2	Point in time to be considered	7
2.3.3	Relevant public	7
2.3.4	Common name	8
2.3.5	Defence for the proprietor.....	8
2.4	EUTM becoming misleading — Article 51(1)(c) EUTMR	8
2.4.1	Burden of proof	8
2.4.2	Point in time to be considered	9
2.4.3	Standards to be applied.....	9
2.4.4	Examples	9
3	Absolute Grounds for Invalidity	10
3.1	EUTM registered contrary to Article 7 — Article 52(1)(a) EUTMR	10
3.1.1	Burden of proof	10
3.1.2	Points in time to be considered	10
3.1.3	Standards to be applied.....	11
3.2	Defence against a claim of lack of distinctiveness	11
3.3	Bad faith — Article 52(1)(b) EUTMR	11
3.3.1	Relevant point in time	12
3.3.2	Concept of bad faith	12
3.3.2.1	Factors likely to indicate the existence of bad faith	12
3.3.2.2	Factors unlikely to indicate the existence of bad faith	16
3.3.3	Proof of bad faith	17
3.3.4	Relation to other EUTMR provisions	17
3.3.5	Extent of invalidity.....	17
4	Relative Grounds for Invalidity.....	18
4.1	Introduction	18
4.2	Grounds under Article 53(1) EUTMR.....	19

4.2.1	Standards to be applied.....	19
4.2.2	Points in time to be considered	19
4.2.2.1.	For the assessment of enhanced distinctiveness or reputation	19
4.2.2.2.	Application based on Article 53(1)(c) in conjunction with Article 8(4) EUTMR.....	19
4.2.2.3	Temporal scope of application of Article 53(1)(d) EUTMR in conjunction with Article 8(4a) EUTMR and relationship to Article 53(1)(c) EUTMR in conjunction with Article 8(4) EUTMR.....	20
4.3	Grounds under Article 53(2) EUTMR — other earlier rights	21
4.3.1	A right to a name/right of personal portrayal	21
4.3.2	Copyright	22
4.3.3	Other industrial property rights	24
4.4	Non-use of the earlier mark	25
4.5	Defences against an invalidity application based on relative grounds	25
4.5.1	Consent to registration	25
4.5.2	Earlier applications for declaration of invalidity or counterclaims.....	26
4.5.3	Acquiescence	26
4.5.3.1	Examples rejecting the acquiescence claim	28
4.5.3.2	Examples (partially) accepting the acquiescence claim	29
5	Res Judicata	29

1 General Remarks

1.1 The grounds for cancellation

Pursuant to Article 56(1) EUTMR, cancellation proceedings comprise applications for revocation and for declarations of invalidity.

The grounds for revocation are established in Article 51 EUTMR. The grounds for invalidity are established in Article 52 EUTMR (absolute grounds) and Article 53 EUTMR (relative grounds). The EUTMR deals with revocation and invalidity in Rules 37 to 41.

1.2 *Inter partes* proceedings

Cancellation proceedings are never initiated by the Office itself. The initiative lies with the applicant for cancellation, even in cases based on absolute grounds for invalidity.

Article 56(1) EUTMR establishes the *locus standi* that the applicant must have in order to file an application for revocation or for a declaration of invalidity. For further details, please see the Guidelines, Part D, Cancellation, Section 1, Cancellation Proceedings, paragraphs 2.1 and 4.1.

1.3 The consequences of revocation and invalidity

According to Article 55(1) EUTMR, in the event of **revocation**, and to the extent that the rights of the proprietor have been revoked, the EUTM will be deemed not to have the effects specified in the EUTMR as from the date of the application for revocation. This is particularly relevant in cases where a request for revocation on grounds of non-use is followed by the surrender of the EUTM. In this regard, the General Court has declared that the party that applies for revocation has a legitimate interest in continuing the revocation proceedings in spite of the surrender of the EUTM by its proprietor, as the continuation of the revocation proceedings may result in a declaration of non-use preventing, pursuant to Article 112(2)(a) EUTMR, the proprietor of the EUTM from requesting the conversion of their mark (order of 24/10/2013, T-451/12, Stormberg, EU:T:2013:575, § 48) (for the Office's new practice on surrenders, see the Guidelines, Part D, Cancellation, Section 1, Cancellation Proceedings, paragraphs 7.3.1 and 7.3.2).

An earlier date on which one of the grounds for revocation occurred may be fixed by the Office if this is requested by one of the parties, provided that the requesting party shows a legitimate legal interest in this respect. On the basis of information available in the relevant case file, it must be possible to determine the earlier date accurately. The earlier date should, in any event, be set after the five-year 'grace period' that the EUTM proprietor has after the registration of an EUTM pursuant to Article 15 EUTMR (see decision of 28/07/2010, 3349 C, Alphatrad, confirmed by decision of 08/10/2012, R 444/2011-1, § 48-50 and judgment of 16/01/2014, T-538/12, Alphatrad, EU:T:2014:9).

According to Article 55(2) EUTMR, in the event of a **declaration of invalidity**, the EUTM will be deemed not to have had, as from the outset, the effects specified in the EUTMR.

2 Revocation

2.1 Introduction

According to Article 51(1) EUTMR, there are three grounds for revocation.

- The EUTM has not been put to genuine use during a continuous period of five years.
- The EUTM has become generic due to acts/inactivity of its proprietor.
- The EUTM has become misleading due to the use made by its proprietor or with its consent.

These grounds are examined in further detail in the paragraphs below. According to Article 51(2) EUTMR, where the grounds for revocation exist only for some of the registered goods and services, the EUTM proprietor's rights will be revoked only for those goods and services.

2.2 Non-use of the EUTM — Article 51(1)(a) EUTMR

According to Article 51(1)(a) EUTMR, if within a continuous period of five years after the EUTM has been registered and before the filing of the application for cancellation the EUTM has not been put to genuine use, within the meaning of Article 15 EUTMR, then the EUTM must be revoked unless there are proper reasons for non-use.

Pursuant to Article 51(2) EUTMR, if the EUTM has been used for only some of the goods and services for which it is registered, the revocation will be limited to the non-used goods and services.

As regards **procedural aspects** of the submission of the evidence (time limits for submitting evidence, additional rounds for observations and submission of additional relevant evidence, translation of evidence, etc.), see the Guidelines, Part D, Cancellation, Section 1, Cancellation Proceedings.

The practice rules applicable to the **substantive assessment** of proof of use of earlier rights in opposition proceedings are applicable to the assessment of requests for revocation based on non-use (see the Guidelines, Part C, Opposition, Section 6, Proof of Use, paragraph 2). However, there are a number of particularities to be taken into account in the context of revocation proceedings, which will be examined below.

2.2.1 Burden of proof

Pursuant to Rule 40(5) EUTMR, the burden of proof lies with the EUTM proprietor.

The role of the Office is to assess the evidence put before it in the light of the parties' submissions. The Office cannot determine *ex officio* genuine use of earlier marks. It has no role in collecting evidence itself. Even proprietors of purportedly well-known marks must submit evidence to prove genuine use of their marks.

2.2.2 Genuine use

According to Rule 40(5) in conjunction with Rule 22(3) EUTMIR, the indications and evidence for submitting proof of use must consist of indications concerning the place, time, extent and nature of use of the contested trade mark for the goods and services for which it is registered.

As indicated above, the assessment of genuine use (including place, time, extent and nature of use) is the same in cancellation proceedings and in opposition proceedings. The detailed considerations in the Guidelines, Part C, Opposition, Section 6, Proof of Use, paragraph 2 should be followed.

Lack of genuine use for some of the contested goods/services in a revocation case implies the revocation of the registered EUTM for those goods/services. Consequently, great care must be taken when assessing the evidence of use in revocation proceedings regarding **the use for the registered (and contested) goods/services**.

Case No	Comment
R 1857/2011-4 AQUOS	The EUTM was registered for <i>angling articles; angling equipment; angling accessories</i> in Class 28. The Board confirmed the Cancellation Division decision and maintained the EUTM for <i>fishing rods</i> and the unchallenged <i>fishing lines</i> in Class 28. The Board concurred with the Cancellation Division that the evidence furnished in order to prove use of the contested EUTM showed genuine use in relation to 'fishing rods' and that these goods are sufficiently distinct from the broad categories of <i>angling articles</i> and <i>angling equipment</i> to form coherent subcategories. This finding was not challenged by the appellant.

2.2.3 Period of time to be considered

The relevant date is the date on which the **application for revocation** was filed.

- The EUTM is subject to revocation only if it has been registered for more than five years on that date.
- If this condition is fulfilled, the EUTM must have been genuinely used within the five years preceding that date (i.e. the five-year period is always counted backwards from the relevant date).

There is one **exception**: where genuine use of the EUTM started or was resumed within the three months preceding the date on which the application for revocation was filed, such use will be disregarded where preparations for the commencement or resumption of use only began after the EUTM proprietor became aware that the request for revocation might be filed (Article 51(1)(a) EUTMR).

The burden of proof for this exception is on the applicant for revocation, who must file evidence that it made the EUTM proprietor **aware of its intention** to file an application for revocation.

2.2.4 Proper reasons for non-use

The detailed considerations in the Guidelines, Part C, Opposition, Section 6, Proof of Use, paragraph 2 and in particular paragraph 2.11 should be followed.

2.3 EUTM becoming the common name (generic term) — Article 51(1)(b) EUTMR

An EUTM will be revoked if, as a result of action or inaction on the part of the proprietor, it has become the common name in trade for a product or service for which it was registered.

2.3.1 Burden of proof

The burden is on the applicant for revocation to prove that the term has become the common name in the trade as a result of either:

- action; or
- inaction

on the part of the proprietor.

The Office will examine the facts in accordance with Article 76(1) EUTMR within the scope of factual submissions made by the revocation applicant (judgment of 13/09/2013, T-320/10, Castel, EU:T:2013:424, § 28). In doing so, it may take into consideration obvious and well-known facts. However, it will not go beyond the legal arguments presented by the revocation applicant. If a request for revocation is based only on Article 51(1)(b) EUTMR, the trade mark could not then be revoked due to being, for example, against public order and morality.

2.3.2 Point in time to be considered

The applicant for revocation must prove that the trade mark has become the common name in trade for the product or service in question after the date of registration of the EUTM, although facts or circumstances that took place between application and registration can be taken into account. The fact that the sign was, at the date of application, the common name used in trade for the goods or services in respect of which registration was sought would only be relevant in the context of an invalidity action.

2.3.3 Relevant public

An EUTM is liable to be revoked in accordance with Article 51(1)(b) EUTMR if it has become the common name for the product or service not just among some but among the vast majority of the relevant public, including those involved in the trade for the product or service in question (judgment of 29/04/2004, C-371/02, Bostongurka, EU:C:2004:275, § 23 and 26). It is not necessary for the sign to become the common name for a product from the point of view of both sellers and end users of the product (judgment of 06/03/2014, C-409/12, Kornspitz, EU:C:2014:130, § 30). It is sufficient that the sellers of the finished product do not inform their customers that the sign has been registered as a trade mark or offer their customers assistance, which includes an indication of the origin of the goods for sale (judgment of 06/03/2014, C-409/12, Kornspitz, EU:C:2014:130, § 23-25).

2.3.4 Common name

A sign is regarded as the ‘common name in the trade’ if it is established practice in the trade to use the term in question to designate the goods or services for which it is registered (see the Guidelines, Part B, Examination, Section 4, Absolute Grounds for Refusal and European Union Collective Marks, paragraph 2.4). It is not necessary to prove that the term directly describes a quality or characteristic of the goods or services, but merely that it is actually used in the trade to refer to those goods or services. The distinctive force of a trade mark is always more likely to degenerate when a sign is suggestive or apt in some way, especially if it has positive connotations that lead others to latch on to its suitability for designating not just a particular producer’s product or service but a particular type of product or service (decision of 30/01/2007, 1 020 C, Stimulation, § 22, 32 et seq.).

The fact that a trade mark is used as a synonym for a specific product or service is an indication that it has lost its ability to differentiate the goods or services in question from those of other undertakings. One indication that a trade mark has become generic is when it is commonly used verbally to refer to a particular type or characteristic of the goods or services. However, this is not in itself decisive: it must be established whether the trade mark is still capable of differentiating the goods or services in question from those of other undertakings.

The absence of any alternative term or the existence of only one long, complicated term may also be an indication that a sign has become the common name in the trade for a specific product or service.

2.3.5 Defence for the proprietor

Where the proprietor of the EUTM has done what could reasonably have been expected in the particular case (e.g. organised a TV campaign or placed advertisements in newspapers and relevant magazines), the EUTM cannot be revoked. The proprietor must then check whether its trade mark appears in dictionaries as a generic term; if it does, the proprietor can request from the publisher that in future editions the trade mark will be accompanied by an indication that it is a registered trade mark (Article 10 EUTMR).

2.4 EUTM becoming misleading — Article 51(1)(c) EUTMR

If, as a result of use made of the mark by the proprietor or with its consent, the mark is liable to mislead the public, particularly concerning the nature, quality or geographical origin of the goods or services for which it is registered, the EUTM can be revoked. In this context, quality refers to a characteristic or attribute rather than a degree or standard of excellence.

2.4.1 Burden of proof

The Office will examine the facts in accordance with Article 76(1) EUTMR within the scope of factual submissions made by the revocation applicant (judgment of 13/09/2013, T-320/10, Castel, EU:T:2013:424, § 28). In doing so, it may take into consideration obvious and well-known facts. However, it will not go beyond the legal arguments presented by the applicant for revocation.

The burden of proof that the mark has become misleading rests on the applicant for revocation, who must further prove that it is the use made by the proprietor that causes the misleading effect. If the use is made by a third party, the burden is on the applicant for revocation to prove that the proprietor has consented to that use, unless the third party is a licensee of the proprietor.

2.4.2 Point in time to be considered

The applicant for revocation must prove that the trade mark has become liable to mislead the public, particularly concerning the nature, quality or geographical origin of the goods or services in question, after the date of registration of the EUTM. If the sign was already deceptive or liable to deceive the public at the date of application, this would be relevant in the context of an invalidity action.

2.4.3 Standards to be applied

The Guidelines concerning Examination contain details of the criteria to be applied when assessing whether an EUTM application complies with Article 7(1)(g) EUTMR (see the Guidelines, Part B, Examination, Section 4, Absolute Grounds for Refusal and European Union Collective Marks, paragraph 2.7). The criteria are comparable to those applied in revocation proceedings under Article 51(1)(c) EUTMR.

2.4.4 Examples

A trade mark composed of, or containing, a geographical indication will, as a rule, be perceived by the relevant public as a reference to the place from where the goods originate. The only exception to this rule is where the relationship between the geographical name and the products is manifestly so fanciful (e.g. because the place is not known, and unlikely to become known, to the public as the place of origin of the goods in question) that consumers will not make such a connection.

In this regard, the trade mark MÖVENPICK OF SWITZERLAND was revoked because the goods in question were produced (according to the facts) solely in Germany, not in Switzerland (decision of 12/02/2009, R 697/2008-1, MÖVENPICK OF SWITZERLAND).

Moreover, where a trade mark containing the word elements 'goats' and cheese' and a figurative element clearly depicting a goat is registered for 'goats' cheese', and use is proven for cheese not made from goats' milk, the EUTM will be revoked.

Where a trade mark containing the word elements 'pure new wool' is registered for 'clothing' and use is proven for clothing manufactured from artificial fibres, the EUTM will be revoked.

Where a trade mark containing the words 'genuine leather' or the corresponding pictogram is registered for 'shoe wear' and use is proven for shoes not made of leather, the EUTM will be revoked.



3 Absolute Grounds for Invalidity

3.1 EUTM registered contrary to Article 7 — Article 52(1)(a) EUTMR

If, at the time of its application, an objection could be raised to the EUTM under any of the grounds listed in Article 7 EUTMR, it can be declared invalid.

3.1.1 Burden of proof

The purpose of invalidity proceedings is, inter alia, to enable the Office to review the validity of the registration of a trade mark and to adopt, where necessary, a position that it should have adopted of its own motion in the registration process in accordance with Article 37(1) EUTMR (judgment of 30/05/2013, T-396/11, Ultrafilter international, EU:T:2013:284, § 20).

Article 76(1) EUTMR, second sentence, explicitly states that in invalidity proceedings pursuant to Article 52 EUTMR, the Office will **limit its examination to the grounds and arguments submitted by the parties**. The EUTM enjoys a **presumption of validity and it is for the invalidity applicant to invoke before the Office the specific facts that call the validity of a trade mark into question** (judgment of 13/09/2013, T-320/10, Castel, EU:T:2013:424, § 27-29).

Consequently, the Office will examine the facts in accordance with Article 76(1) EUTMR, second sentence, within the **scope of factual submissions** made by the applicant for the declaration of invalidity (judgment of 13/09/2013, T-320/10, Castel, EU:T:2013:424, § 28). In doing so, it may take into consideration obvious and well-known facts. However, it will **not go beyond the legal arguments presented by the applicant** for the declaration of invalidity.

One of the arguments that the EUTM proprietor may put forward against the invalidity applicant's claim is evidence that the EUTM has acquired distinctive character following use. See paragraph 3.2 below.

3.1.2 Points in time to be considered

The General Court has held that whether a trade mark should be registered or should be declared invalid must be assessed on the basis of the situation at the date of its application, not of its registration (judgment of 03/06/2009, T-189/07, Flugbörse, EU:T:2009:172; confirmed by order of 23/04/2010, C-332/09 P, Flugbörse, EU:C:2010:225).

Generally speaking, any developments or events after the date of application or priority date will not be taken into consideration. For example, the fact that a sign has, after the date of application, become the common term used in the trade for the goods or services for which registration was sought is in principle irrelevant for the purposes of examining an invalidity action (it would only be relevant in the context of a revocation action). However, such facts can nevertheless be taken into account where and to the extent that they allow conclusions to be drawn regarding the situation at the date of application of the EUTM.

3.1.3 Standards to be applied

The Guidelines concerning Examination contain details of the criteria to be applied when assessing whether an EUTM application complies with Article 7 EUTMR. The criteria are identical to those applied in invalidity proceedings under Article 52(1)(a) EUTMR.

3.2 Defence against a claim of lack of distinctiveness

A trade mark that falls foul of Article 52(1)(a) in conjunction with Article 7(1)(b), (c) or (d) EUTMR will not be declared invalid where it has acquired distinctiveness through use (Articles 7(3) and 52(2) EUTMR).

The distinctive character acquired following use is, in the context of invalidity proceedings, an exception to the grounds for invalidity of Article 52(1)(a) in conjunction with Article 7(1)(b), (c) and (d) EUTMR. Since it is an exception, the **onus of proof** is on the party seeking to rely on it, namely the proprietor of the contested mark. The proprietor of the contested mark is best placed to adduce evidence in support of the assertion that its mark has acquired a distinctive character following the use which has been made of it (e.g. concerning the intensity, geographical extent, duration of use, promotional investment). Consequently, where the proprietor of the contested mark is requested to adduce evidence of distinctive character acquired through use, but fails to do so, the mark must be declared invalid (judgment of 19/06/2014, joined cases C-217/13 and C-218/13, *Oberbank e.a.*, EU:C:2014:2012, § 68-71).

The situation will be assessed in accordance with the relevant part of the Guidelines concerning Examination.

The proprietor must demonstrate that either:

- the trade mark acquired distinctive character on or before the date of application, or the priority date (Article 7(3) EUTMR); or
- distinctive character was acquired after registration (Article 52(2) EUTMR).

Evidence of use during the period between the date of application and the date of registration can serve to support a finding of acquired distinctiveness after registration.

3.3 Bad faith — Article 52(1)(b) EUTMR

The EUTMR considers bad faith only as an absolute ground for the **invalidity** of an EUTM, to be relied on either before the Office or by means of a counterclaim in infringement proceedings. Therefore, bad faith is not relevant in examination or opposition proceedings (for opposition proceedings, see judgment of 17/12/2010, T-192/09, *Seve Trophy*, EU:T:2010:553, § 50).

3.3.1 Relevant point in time

The relevant point in time for determining whether there was bad faith on the part of the EUTM owner is the **time of filing of the application for registration**. However, it must be noted that:

- facts and evidence dated prior to filing can be taken into account for interpreting the owner's intention at the time of filing the EUTM. Such facts include, in particular, whether there is already a registration of the mark in a Member State, the circumstances under which that mark was created and the use made of it since its creation (see paragraph 3.3.2.1, point 3 below).
- facts and evidence dated subsequent to filing can sometimes be used for interpreting the owner's intention at the time of filing the EUTM, in particular whether the owner has used the mark since registration (see paragraph 3.3.2.1, point 3 below).

3.3.2 Concept of bad faith

As observed by Advocate General Sharpston (opinion of 12/03/2009, C-529/07, Lindt Goldhase, EU:C:2009:361, § 36), the concept of bad faith referred to in Article 52(1)(b) EUTMR is not defined, delimited or even described in any way in the legislation. However, the Court of Justice provided some guidance on how to interpret this concept in its judgment in the same case, as did the General Court in several cases (judgments of 01/02/2012, T-291/09, Pollo Tropical chicken on the grill, EU:T:2012:39; 14/02/2012, T-33/11, BIGAB, EU:T:2012:77; and 13/12/2012, T-136/11, Pelikan, EU:T:2012:689). In its preliminary ruling of 27/06/2013, C-320/12, Malaysia Dairy, EU:C:2013:435, the Court of Justice declared that the concept of bad faith is an autonomous concept of European Union law, which must be given a uniform interpretation in the European Union.

One way to describe bad faith is 'conduct which departs from accepted principles of ethical behaviour or honest commercial and business practices' (opinion of Advocate General Sharpston of 12/03/2009, C-529/07, Lindt Goldhase, EU:C:2009:361, § 60; similar decision of 01/04/2009, R 529/2008-4, FS (fig.), § 14).

In order to find out whether the owner had been acting in bad faith at the time of filing the application, an **overall assessment** must be made in which all the relevant factors of the individual case must be taken into account. A **non-exhaustive** list of such factors is given below.

3.3.2.1 Factors likely to indicate the existence of bad faith

Case-law shows three cumulative factors to be particularly relevant:

1. **Identity/confusing similarity of the signs:** The EUTM allegedly registered in bad faith must be identical or confusingly similar to the sign to which the invalidity applicant refers. Although the fact that marks are identical or confusingly similar is not in itself sufficient to show bad faith (regarding identity, see judgment of 01/02/2012, T-291/09, Pollo Tropical chicken on the grill, EU:T:2012:39, § 90), a dissimilar or not confusingly similar mark will not support a finding of bad faith.

2. **Knowledge of the use of an identical or confusingly similar sign:** The EUTM owner knew or must have known about the use of an identical or confusingly similar sign by a third party for identical or similar products or services.

There is knowledge, for example, where the parties have been in a business relationship with each other ('could not ignore, and was probably aware that the invalidity applicant had been using the sign for a long time', judgment of 11/07/2013, T-321/10, Gruppo Salini, EU:T:2013:372, § 25), or when the reputation of the sign, even as a 'historical' trade mark, is a well-known fact (judgment of 08/05/2014, T-327/12, Simca, EU:T:2014:289, § 50).

Knowledge may be presumed to exist ('must have known') on the basis, *inter alia*, of general knowledge in the economic sector concerned or duration of use. The longer the use of a sign, the more likely it is that the EUTM owner had knowledge of it (judgment of 11/06/2009, C-529/07, Lindt Goldhase, EU:C:2009:361, § 39). However, a presumption of knowledge is less likely if the sign was registered in a non-EU country and there was only a short time between the application for registration in that non-EU country and an application for registration in an EU country (judgment of 01/02/2012, T-291/09, Pollo Tropical chicken on the grill, EU:T:2012:39, § 61).

Knowledge of an identical or similar earlier sign for identical or similar goods or services is not sufficient **in itself** to support a finding of bad faith (judgment of 11/06/2009, C-529/07, Lindt Goldhase, EU:C:2009:361, § 40, 48 and 49). For example, it cannot be excluded that, where a number of producers use, on the market, for identical or similar goods, identical or similar signs that could give rise to confusion with the sign for which registration is sought, the EUTM owner's registration of the sign may be in pursuit of a legitimate objective. This could be the case where the EUTM owner knows, at the time of filing the EUTM application, that a third undertaking is making use of the mark covered by that application by giving its clients the impression that it officially distributes the goods sold under that mark, even though it has not received authorisation to do so (judgment of 14/02/2012, T-33/11, Bigab, EU:T:2012:77, § 27).

Similarly, the fact that the applicant knows or should know that, at the time of filing of its application, a third party is using a mark **abroad** that is liable to be confused with the mark whose registration has been applied for is not sufficient, **in itself**, to permit the conclusion that the applicant is acting in bad faith within the meaning of that provision (preliminary ruling of 27/06/2013, C-320/12, Malaysia Dairy, EU:C:2013:435, § 37).

Knowledge or presumption of knowledge of an existing sign is not required where the EUTM owner misuses the system with the intention of preventing **any** similar sign from entering the market (see, for example, the artificial extension of the grace period for non-use in paragraph 3.3.2.1, point 3(c) below).

3. **Dishonest intention on the part of the EUTM owner:** This is a subjective factor that has to be determined by reference to objective circumstances (judgment of 11/06/2009, C-529/07, Lindt Goldhase, EU:C:2009:361, § 42). Again, several factors can be relevant. See, for example, the following case scenarios:
- (a) Bad faith is found when it can be inferred that the purpose of the EUTM applicant is to 'free-ride' on the reputation of the invalidity applicant's registered marks and

to take advantage of that reputation (judgment of 08/05/2014, T-327/12, Simca, EU:T:2014:289, § 56).

- (b) While it is not a requirement of the EUTM system that an EUTM owner must at the time of applying for an EUTM also have the intention of using it, it could be seen as an indication of dishonest intention if it subsequently becomes apparent that the owner's sole objective was to prevent a third party from entering the market (judgment of 11/06/2009, C-529/07, Lindt Goldhase, EU:C:2009:361, § 44).

On the other hand, if there is commercial logic to the filing of the EUTM and it can be assumed that the EUTM owner intended to use the sign as a trade mark, this would tend to indicate that there was no dishonest intention. For example, this could be the case if there is a 'commercial trajectory', such as the registration of an EUTM after registration of the mark in a Member State (judgment of 01/02/2012, T-291/09, Pollo Tropical chicken on the grill, EU:T:2012:39, § 58), if there is evidence of the EUTM owner's intention to develop its commercial activities, for example by means of a licensing agreement (judgment of 01/02/2012, T-291/09, Pollo Tropical chicken on the grill, EU:T:2012:39, § 67), or if the EUTM owner had a commercial incentive to protect the mark more widely, for example an increase in the number of Member States in which the owner generates turnover from goods marketed under the mark (judgment of 14/02/2012, T-33/11, Bigab, EU:T:2012:77, § 20 and 23).

The existence of a direct or indirect relationship between the parties prior to the filing of the EUTM, for example a pre-contractual, contractual or post-contractual (residual) relationship, can also be an indicator of bad faith on the part of the EUTM owner (judgment of 01/02/2012, T-291/09, Pollo Tropical chicken on the grill, EU:T:2012:39, § 85 to 87; judgment of 11/07/2013, T-321/10, Gruppo Salini, EU:T:2013:372, § 25 to 32). The EUTM owner's registration of the sign in its own name in such cases can, depending on the circumstances, be considered a breach of honest commercial and business practices.

- (c) One example of a situation that may be taken into account in order to assess whether the proprietor acted in bad faith is where an EUTM owner tries to artificially extend the grace period for non-use, for example by filing a repeat application of an earlier EUTM in order to avoid the loss of a right as a result of non-use (judgment of 13/12/2012, T-136/11, Pelikan, EU:T:2012:689, § 27).

This case needs to be distinguished from the situation in which the EUTM owner, in accordance with normal business practice, seeks to protect variations of its sign, for example, where a logo has evolved (judgment of 13/12/2012, T-136/11, Pelikan, EU:T:2012:689, § 36 et seq.).

In addition to the three factors mentioned above, **other potentially relevant factors** identified in case-law and/or Office practice to assess the existence of bad faith include:

- (i) the circumstances under which the contested sign was created, the use made of it since its creation and the commercial logic underlying the filing of the application for registration of that sign as an EUTM (judgments of 14/02/2012, T-33/11, Bigab, EU:T:2012:77, § 21 et seq.; 08/05/2014, T-327/12, Simca, § 39).

- (ii) the nature of the mark applied for. Where the sign for which registration is sought consists of the entire shape and presentation of a product, the fact that the EUTM owner was acting in bad faith at the time of filing might more readily be established where the competitor's freedom to choose the shape of a product and its presentation is restricted by technical or commercial factors, with the result that the EUTM owner is able to prevent its competitors not merely from using an identical or similar sign, but also from marketing comparable products (judgment of 11/06/2009, C-529/07, Lindt Goldhase, EU:C:2009:361, § 50).
- (iii) the degree of inherent or acquired distinctiveness enjoyed by the invalidity applicant's sign and the EUTM owner's sign, as well as its degree of reputation, even if this is only residual (judgment of 08/05/2014, T-327/12, Simca, EU:T:2014:289, § 40, 46 and 49).
- (iv) the fact that the national mark on which the EUTM owner has based a priority claim has been declared invalid due to bad faith (decision of 30/07/2009, R 1203/2005-1, BRUTT).
- (v) a request for financial compensation made by the EUTM owner to the invalidity applicant if there is evidence that the EUTM owner knew of the existence of the earlier identical or confusingly similar sign and expected to receive a proposal for financial compensation from the invalidity applicant (judgment of 08/05/2014, T-327/12, Simca, EU:T:2014:289, § 72). However, in a previous case, the Court considered that even a seemingly disproportionate request for compensation does not **in itself** establish bad faith if the invalidity applicant does not provide evidence that the EUTM owner could not have been unaware of the existence of the earlier mark. In this particular case, the Court took into account the fact that in 1994, the EUTM owner had registered a trade mark identical to the contested EUTM in the Spanish trade mark office (judgment of 01/02/2012, T-291/09, Pollo Tropical chicken on the grill, EU:T:2012:39, § 1-22 and 88).

Finally, the case-law and/or the Office have identified a number of factors that, considered in isolation, are not enough to find bad faith but that, in combination with other relevant factors (to be identified on a case-by-case basis), might indicate the existence of bad faith:

- The fact that an earlier, very similar, EUTM was revoked for goods or services in a number of classes is not, in itself, sufficient to allow any conclusions to be drawn as to the EUTM owner's intentions at the time of filing the EUTM application for the same goods or services (judgment of 13/12/2012, T-136/11, Pelikan, EU:T:2012:689, § 45).
- The fact that the application for registration of the contested EUTM is filed three months before expiry of the period of grace for the earlier EUTMs is not sufficient to counteract factors that show that the EUTM owner's intention was to file a modernised trade mark covering an updated list of services (judgment of 13/12/2012, T-136/11, Pelikan, EU:T:2012:689, § 50 and 51).
- The filing of applications for declarations that the invalidity applicant's marks are invalid constitutes the legitimate exercise of an EUTM owner's exclusive right and cannot in itself prove any dishonest intent on its part (judgment of 13/12/2012, T-136/11, Pelikan, EU:T:2012:689, § 66).

- The fact that, after successfully registering the EUTM at issue, the EUTM owner serves formal notice on other parties to cease using a similar sign in their commercial relations is not in itself an indication of bad faith. Such a request falls within the scope of the rights attaching to the registration of an EUTM; see Article 9 EUTMR (judgment of 14/02/2012, T-33/11, Bigab, EU:T:2012:77, § 33). However, in circumstances where this request is connected with other factors (e.g. the mark is not being used), it might be an indication of the intention to prevent another party from entering the market.
- The fact that the signs at issue are identical does not establish bad faith where there are no other relevant factors (judgment of 01/02/2012, T-291/09, Pollo Tropical chicken on the grill, EU:T:2012:39, § 90). Furthermore, the mere fact that the differences between the EUTM at issue and the previous EUTM registered by the same proprietor are so insignificant as not to be noticeable to the average consumer cannot establish that the contested EUTM is a mere repeat application made in bad faith (judgment of 13/12/2012, T-136/11, Pelikan, EU:T:2012:689, § 33-34). The evolution over time of a logo intended as the graphic representation of a mark constitutes normal business practice (judgment of 13/12/2012, T-136/11, Pelikan, EU:T:2012:689, § 36).

3.3.2.2 Factors unlikely to indicate the existence of bad faith

Case-law has identified several factors that, in general, are unlikely to prove bad faith.

- Extending the protection of a national mark by registering it as an EUTM falls within a company's normal commercial strategy (judgment of 14/02/2012, T-33/11, Bigab, EU:T:2012:77, § 23; judgment of 01/02/2012, T-291/09, Pollo Tropical chicken on the grill, EU:T:2012:39, § 58).
- Bad faith cannot be found on the basis of the length of the list of goods and services set out in the application for registration (judgment of 07/06/2011, T-507/08, 16PF, EU:T:2011:253, § 88). As a rule, it is legitimate for an undertaking to seek registration of a mark not only for the categories of goods and services that it markets at the time of filing the application but also for other categories of goods and services that it intends to market in the future (judgment of 14/02/2012, T-33/11, Bigab, EU:T:2012:77, § 25; judgment of 07/06/2011, T-507/08, 16PF, EU:T:2011:253, § 88).
- The fact that the owner of several national marks decides to apply for an EUTM for only one and not all of them cannot be an indication of bad faith. The decision to protect a mark at both national and EU level is a choice dictated by the proprietor's marketing strategy. It is not for the Office or the Court to interfere with this choice (judgment of 14/02/2012, T-33/11, Bigab, EU:T:2012:77, § 29).
- If a sign enjoys a reputation at national level and the owner applies for an EUTM, the extent of the sign's reputation might justify the owner's interest in ensuring broader legal protection (judgment of 11/06/2009, C-529/07, Lindt Goldhase, EU:C:2009:361, § 51 and 52).

3.3.3 Proof of bad faith

Article 76(1) EUTMR, second sentence, explicitly states that in invalidity proceedings pursuant to Article 52 EUTMR, the Office will **limit its examination to the grounds and arguments submitted by the parties**. Good faith is presumed until proof to the contrary is adduced (judgment of 13/12/2012, T-136/11, Pelikan, EU:T:2012:689, § 57). The invalidity applicant needs to prove that there was bad faith on the part of the EUTM owner at the time of filing the EUTM, for example that the EUTM owner had no intention of using the EUTM or that its intention was to prevent a third party from entering the market.

3.3.4 Relation to other EUTMR provisions

Whilst Article 8(3) EUTMR is a manifestation of the principle that commercial transactions must be conducted in good faith, Article 52(1)(b) EUTMR is the general expression of that principle (see p. 4 et seq. of the Guidelines on Article 8(3) EUTMR).

3.3.5 Extent of invalidity

When bad faith of the EUTM owner is established, the whole EUTM is declared invalid, even for goods and services that are unrelated to those protected by the invalidity applicant's mark. The only exception is where the applicant has directed its invalidity application against only some of the goods and services covered by the contested EUTM, in which case a finding of bad faith will invalidate the EUTM only for the goods and services that have been contested.

For example, in its decision R 219/2009-1 (GRUPPO SALINI / SALIN'), the Board of Appeal concluded that bad faith had been proven and declared the contested EUTM invalid in its entirety, that is to say also for services (insurance, financial and monetary services in Class 36 and software and hardware-related services in Class 42) that were dissimilar to the invalidity applicant's building, maintenance and installation services in Class 37.

The General Court confirmed the Board of Appeal's decision and stated that a positive finding of bad faith at the time of filing the contested EUTM could only lead to the invalidity of the EUTM in its entirety (judgment of 11/07/2013, T-321/10, Gruppo Salini, EU:T:2013:372, § 48).

Whereas the Court did not expand on the reasons for this conclusion, it can be safely inferred that it took the view that the protection of the general interest in business and commercial matters being conducted honestly justifies invalidating an EUTM also for goods/services that are dissimilar to the invalidity applicant's ones and do not even belong to an adjacent or neighbouring market.

Therefore, it seems only logical that the invalidity, once declared, should extend to all the goods and/or services covered by the contested EUTM, even those that, in a pure Article 8(1)(b) scenario, would be found to be dissimilar.

4 Relative Grounds for Invalidity

4.1 Introduction

Article 53 EUTMR enables proprietors of earlier rights to apply for a declaration of invalidity of an EUTM in a range of situations (grounds), which are detailed below.

- The same grounds as in opposition proceedings.
 - An earlier trade mark, within the meaning of Article 8(2) EUTMR, is identical or similar to the contested EUTM and covers identical or similar goods and services or is reputed (Article 53(1)(a) EUTMR in conjunction with Article 8(1)(a) or (b) and Article 8(5) EUTMR).
 - A trade mark has been filed without authorisation by an agent or representative of its proprietor (Article 53(1)(b) EUTMR in conjunction with Article 8(3) EUTMR).
 - A non-registered trade mark or other sign used in the course of trade can invalidate an EUTM registration if EU or national legislation allows the proprietor of the earlier sign to prohibit the use of the subsequent EUTM (Article 53(1)(c) EUTMR in conjunction with Article 8(4) EUTMR).
 - A designation of origin or a geographical indication can invalidate an EUTM registration if EU or national legislation allows the person authorised under the relevant law to exercise the rights arising from a designation of origin or a geographical indication to prohibit the use of the subsequent EUTM (Article 53(1)(d) EUTMR in conjunction with Article 8(4a) EUTMR).
- An additional ground based on **another earlier right**, to the extent that EU law or national law (including rights deriving from international agreements having effect in a Member State) entitle the proprietor to prohibit the use of the contested EUTM (Article 53(2) EUTMR), in particular:
 - a right to a name
 - a right of personal portrayal
 - a copyright
 - an industrial property right.

These **grounds** are further developed below (paragraphs 4.2 and 4.3).

As in opposition proceedings, the proprietor of the contested EUTM may require the invalidity applicant to submit **proof of genuine use** of its earlier trade mark. The particularities regarding the relevant period for assessing genuine use in invalidity proceedings are explained in paragraph 4.4.

Finally, the EUTMR includes a number of provisions that can be invoked by the EUTM proprietor against the invalidity application, depending on the type of earlier right invoked (e.g. whether or not it is an earlier EUTM or national trade mark). These provisions are dealt with under paragraph 4.5.

4.2 Grounds under Article 53(1) EUTMR

4.2.1 Standards to be applied

The substantive conditions for considering an earlier right referred to in Article 53(1) EUTMR in conjunction with Article 8 EUTMR as a relative ground for a declaration of invalidity are the same as in opposition proceedings. The practice rules in the Guidelines, Part C, Opposition, in particular Section 2, Double Identity and Likelihood of Confusion; Section 3, Unauthorised Filing by Agents of the TM Proprietor, paragraph 4; Section 4, Rights under Articles 8(4) and 8(4a) EUTMR; and Section 5, Trade Marks with Reputation (Article 8(5) EUTMR) should be applied accordingly.

4.2.2 Points in time to be considered

4.2.2.1. For the assessment of enhanced distinctiveness or reputation

In line with opposition proceedings, in invalidity proceedings an invalidity applicant relying on enhanced distinctiveness or reputation must prove that its earlier right has acquired **enhanced distinctiveness or reputation** by the **filing** date of the contested EUTM, taking account, where appropriate, of any priority claimed. In addition, the reputation or the enhanced distinctive character of the earlier mark must still exist when the **decision on invalidity is taken**.

In opposition proceedings, due to the short time span between the filing of the EUTM application and the opposition decision, it is normally presumed that the enhanced distinctiveness or reputation of the earlier trade mark still exists at the time of the decision¹. In invalidity proceedings, however, the time span can be considerable. In this case, the invalidity applicant must show that its earlier right continues to enjoy enhanced distinctive character or reputation at the time the decision on invalidity is taken.

4.2.2.2. Application based on Article 53(1)(c) in conjunction with Article 8(4) EUTMR

In the event of an application for invalidity based on Article 53(1)(c) in conjunction with Article 8(4) EUTMR, the invalidity applicant must show the earlier sign's **use in the course of trade of more than local significance** by the **filing date** of the contested EUTM (or the priority date if relevant). In **invalidity proceedings**, the applicant also has to prove that the sign was used in the course of trade of more than local significance at another point in time, namely **at the time of filing of the invalidity request**. This condition stems from the wording of Article 53(1)(c) EUTMR, which states that an EUTM will be declared invalid 'where there **is** an earlier right as referred to in Article 8(4) and the conditions set out in that paragraph are fulfilled' (decisions of 05/10/2004, 606 C, ANKER, and 03/08/2011, R 1822/2010-2, Baby Bambolina (fig.), § 15). Once proved, this requirement is considered still to be fulfilled at the **time the decision on invalidity is taken** unless there is evidence to the contrary (e.g. a company name is invoked but the company has ceased to exist).

There are further particularities regarding **substantiation and admissibility**, which are dealt with in the Guidelines, Part D, Section 1, Cancellation Proceedings.

¹ See the Guidelines, Part C, Opposition, Section 5, Trade Marks with Reputation (Article 8(5) EUTMR).

4.2.2.3 Temporal scope of application of Article 53(1)(d) EUTMR in conjunction with Article 8(4a) EUTMR and relationship to Article 53(1)(c) EUTMR in conjunction with Article 8(4) EUTMR

Regulation (EU) 2015/2424 amending Regulation No 207/2009 on the Community trade mark (Amending Regulation) introduced Article 53(1)(d) EUTMR in conjunction with Article 8(4a) EUTMR as a specific ground of invalidity for designations of origin and geographical indications (GIs) protected under EU or national law.

Prior to that, GIs could form the basis of an application for invalidity pursuant to Article 53(1)(c) EUTMR in conjunction with Article 8(4) EUTMR. However, the introduction of this specific ground means that as of the entry into force of Article 53(1)(d) EUTMR, GIs can only be invoked under the new ground. GIs can no longer form the basis of an application for invalidity under Article 53(1)(c) EUTMR, even though the wording of that provision has not changed. Nevertheless, if an invalidity request based on a GI is filed after entry into force of the Amending Regulation, incorrectly indicating Article 53(1)(c) EUTMR as a ground for invalidity, the Office will examine the request to the extent that it is clearly based on a GI, as if the ground invoked were Article 53(1)(d) EUTMR. In such a case, there is no doubt as to the intention of the invalidity applicant to invoke the provision protecting earlier GIs.

Article 53(1)(c) EUTMR in conjunction with Article 8(4) EUTMR continues to apply in invalidity proceedings based on GIs pending at the time of entry into force of the Amending Regulation.

As stated above, only Article 8(4a) EUTMR can be invoked in applications for invalidity based on GIs as of the date of entry into force of the Amending Regulation. In the absence, on the one hand, of any transitory provisions and temporal restrictions as regards contested European Union trade marks in the Amending Regulation, and, on the other hand, considering that GIs were also a ground for refusal under the previous regime and that their use in the course of trade is inherent in their function, as of its entry into force, Article 53(1)(d) EUTMR in conjunction with Article 8(4a) EUTMR can be invoked against EUTMs regardless of their filing or priority date, and therefore even against EUTMs filed and registered with the Office before the entry into force of the Amending Regulation.

The protection afforded to GIs by Article 53(1)(d) EUTMR in conjunction with Article 8(4a) EUTMR is therefore a continuation of the protection previously afforded by Article 53(1)(c) EUTMR in conjunction with Article 8(4) EUTMR. GIs thus invoked under Article 53(1)(d) EUTMR in conjunction with Article 8(4a) EUTMR had to already be protected at the time of filing the contested EUTM and be entitled to prohibit use of a subsequent trade mark. Furthermore, the essential conditions for protection of such earlier GIs as provided for by relevant EU or national legislation (that is, for example, protection against any direct or indirect commercial use; misuse, imitation or evocation; false or misleading indication or other misleading practice) applied already at the filing or priority date of the contested EUTM, even if filed before the entry into force of the Amending Regulation. Article 8(4a) EUTMR better reflects the requirements of EU legislation, which does not require that a GI is used in the course of trade in order for it to be entitled to prevent unauthorised use.

Nevertheless, Article 56(3) EUTMR prevents an applicant whose previous request for invalidity based on a GI under Article 53(1)(c) EUTMR has been adjudicated on its merits from filing a new application for invalidity under Article 53(1)(d) EUTMR on the basis of the same GI against the same contested mark.

4.3 Grounds under Article 53(2) EUTMR — other earlier rights

An EUTM is liable to be declared invalid on the basis of the rights below where use of the trade mark could be prohibited under the EU or national law governing their protection. This is **not an exhaustive list** of such earlier rights.

Article 53(2) EUTMR applies only where the rights invoked are of such a nature that they are not considered typical rights to be invoked in cancellation proceedings under Article 53(1) EUTMR (decision of 13/12/2011, 4 033 C, § 12).

4.3.1 A right to a name/right of personal portrayal

Not all Member States protect the right to a person's name or portrayal. The exact scope of protection of the right will follow from the national law (e.g. whether the right is protected irrespective of the goods and services the contested mark covers).

The invalidity applicant will have to provide the necessary **national legislation in force** and put forward a **cogent line of argument** as to why it would succeed under the specific national law in preventing the use of the contested mark. A mere reference to the national law will not be considered sufficient: it is not for the Office to make that argument on the applicant's behalf (see, by analogy, judgment of 05/07/2011, C-263/09 P, Elio Fiorucci, EU:C:2011:452).

Earlier right	Contested sign	Case No
TELESIS	TELESIS	R 134/2009-2
<i>Right to a name under Austrian law</i>		
<p>Under Austrian law (Section 43 AGBG), 'the person whose right to use his name has been contested or whose name is used without due [cause] to his detriment, infringing his protectable interests, can request the infringer to cease and desist and to compensate any damages. Such protection extends as well to distinctive designations of traders, even if they deviate from the civil name of that trader ... Even if Section 43 AGBG may also apply to a trader's name, the scope of protection does not go beyond the field of activity of the sign used. The remaining contested services are dissimilar to the services of the earlier right as ... they concern different branches of activity (paras 61-63)'. Thus, the requirements under Austrian law were not fulfilled and the request for invalidity based on Article 53(2)(a) EUTMR in conjunction with Austrian law was rejected.</p>		

Earlier right	Contested sign	Case No
'MARQUÉS DE BALLESTAR' Nobility title (título nobiliario)	 MARQUÉS DE BALLESTAR	R 1288/2008-1
<p><i>Right to a name under Spanish law</i></p> <p>In Spain, noble titles are protected under Law 1/1982 as if they were persons' names. The applicant for cancellation proved that this noble title exists and that it is held by her. The European Union trade mark comprises a small coat of arms and the words MARQUÉS DE BALLESTAR in large letters. The wine could not be correctly identified in any business transaction without mentioning the words MARQUÉS DE BALLESTAR. The right conferred by the EUTM consists of using this in the following ways: placing it on the product container, putting the product bearing the trade mark onto the market, and using it in publicity (Article 9 EUTMR). Consequently, trade mark use is use 'for publicity, commercial or similar purposes', within the meaning of Article 7(6) of Law 1/1982. Since these uses are considered by this Law as 'unlawful intrusions', the protection provided by Article 9(2) of that same Law would be admissible. This Article allows the adoption of measures to 'put an end to the unlawful intrusion'. The EUTM must be declared invalid because its use can be prohibited as a result of a right to a name in accordance with the Spanish legislation on protection of the right to honour, personal and family privacy and own image (paras 14 et seq.).</p>		

Earlier right	Contested sign	Case No
DEF-TEC	DEF-TEC	R 871/2007-4
<p><i>Right to a name under German law</i></p> <p>The Board considers that 'what could eventually be protected under § 12 BGB is the name of the cancellation applicant, which is 'DEF-TEC Defense Technology GmbH', but not the sign 'DEF-TEC' which is not the cancellation applicant's name ... the registration, and eventual use as a trade mark, of the designation 'DEF-TEC' on pepper sprays cannot infringe the right to the cancellation applicant's name. ... § 12 BGB protects the names of physical persons and as there is no absolute prohibition to bear a name which is similar to another person's name, its protection is limited to cases where the right to the other person's name is denied or misappropriated ... and nothing else applies to the extended application of § 12 BGB to the names of legal persons ... The request for declaration of invalidity fails on account of all the earlier rights invoked' (para. 38 et seq.).</p>		

4.3.2 Copyright



According to Article 53(2)(c) EUTMR, a European Union trade mark will be declared invalid on application to the Office where the use of such trade mark may be prohibited pursuant to another earlier right under the EU legislation or national law governing its protection, and in particular copyright.



Pursuant to Rule 37 EUTMR, the application for a declaration of invalidity must contain particulars of the right on which the application is based and particulars showing that the applicant is the proprietor of an earlier right as referred to in Article 53(2) EUTMR or that it is entitled under the applicable national law to claim that right.



Although the EU legislator has harmonised certain aspects of copyright protection (see Directive 2001/29/EC of the European Parliament and of the Council of 22/05/2001 on the harmonisation of certain aspects of copyright and related rights in the information society, OJ L 167, 22/06/2001, pp 10-19), so far there is no full-scale harmonisation of the copyright laws of the Member States, nor is there a uniform EU copyright. However, all the Member States are bound by the *Berne Convention for the Protection of Literary and Artistic Works* and the *Agreement on Trade-Related Aspects of Intellectual Property Rights* (TRIPS).

The invalidity applicant will have to provide the necessary **national legislation in force** and put forward a **cogent line of argument** as to why it would succeed under the specific national law in preventing the use of the contested mark. A mere reference to the national law will not be considered sufficient: it is not for the Office to make that argument on the applicant's behalf (see, by analogy, judgment of 05/07/2011, C-263/09 P, Elio Fiorucci, EU:C:2011:452).

The notion of copyright protection is applicable irrespective of the goods and services the contested mark covers and merely requires a 'copying' of the protected work without a requirement that the contested mark **as a whole** has to be 'similar' to the protected work.

Earlier right	Contested sign	Case No
		R 1235/2009-1
<p><i>Copyright under Italian law</i></p> <p>The Board indicates that this ground of invalidity is relative and, therefore, only holders of earlier rights — or other parties, if allowed by the law governing those rights — are entitled to invoke it (Article 56(1)(c) EUTMR). The right relied upon here is copyright. Therefore, the party entitled to act is the holder of the copyright in the flower design or another party authorised by the law governing copyright. The invalidity applicant acknowledges that ownership of the copyright in the design 'belongs to third parties' (in fact to one third party: Corel Corporation, the graphic design company). The invalidity applicant does not own the right it seeks to rely upon. It solely has the right to use clip art with the flower shape and use it for purely private purposes. The ground was rejected (para. 32 et seq.).</p>		

Earlier right	Contested sign	Case No
		R 1757/2007-2
<p><i>Copyright under French law</i></p> <p>'... the mere fact that the stylization of the letter 'G' is 'simple', does not exclude its protection under French copyright law ... Indeed, for a work of the mind to be protected, it is sufficient for it to be "original" ... While it is true that the contested EUTM is not an exact copy of the earlier work, it must be borne in mind that the partial reproduction and adaptation without the consent of the owner of the copyright is also prohibited. The Board considers this to be the case here. The contested EUTM has taken all the essential characteristic features of the prior work: a stand-alone capital 'G' in straight, thick, black lines, in a perfectly square flattened shape ... the 'G' of the contested EUTM is drawn in a thick, black line of equal width and its inner part reaches further inside, than is the case in the prior work. However, the difference in these minor details constitute minimal modifications which do not affect the overlap in the essential characteristic features of the earlier work, namely, a stand-alone capital 'G' with a perfectly rectangular form, a flattened shape and thick, black lines ... As the partial reproduction or adaptation of the prior work has been done without the owner's consent, it is unlawful. Therefore, the contested decision must be annulled and the request for a declaration of invalidity ... must be upheld' (para. 33 et seq.).</p>		



Earlier right	Contested sign	Case No
		<p>R 1925/2011-4</p>
<p><i>Copyright under German law</i></p> <p>'Pursuant to § 1 of the German Copyright Act, copyright protection is granted to the 'authors' of 'works of literature, science, or art'. § 2 of the Act lists various types of work considered works of art. Pursuant to §§ 16 et seq., the copyright law protects the author. Under the assumption that the claimed subject-matter constituted a 'work' in the sense of those provisions, the cancellation applicant failed to demonstrate and to prove who was its author, and, how the cancellation applicant (a legal person with its seat in Japan) acquired the exclusive rights from the author' (paras 12-13). The Board examined each of these aspects. Moreover, it describes the differences between trade mark similarity and copying for the purposes of copyright infringement. The cancellation applicant had mixed up both concepts (paras 22-24).</p>		

4.3.3 Other industrial property rights

Other industrial property rights and prior works at national or EU level, such as a Registered Community design (RCD), may be invoked.

The invalidity applicant will have to provide the necessary **national legislation in force** and put forward a **cogent line of argument** as to why it would succeed under the specific national law in preventing the use of the contested mark. A mere reference to the national law will not be considered sufficient: it is not for the Office to make that argument on the applicant's behalf (see, by analogy, judgment of 05/07/2011, C-263/09 P, Elio Fiorucci, EU:C:2011:452).

In the case of an RCD there is no need to prove what protection is given under the law. The Cancellation Division will apply the standards of the RCD.

Earlier right	Contested sign	Case No
 <p>(earlier RCD)</p>	 <p>(shape of a teabag)</p>	<p>R 2492/2010-2</p>
<p>'Article 19(1) Council Regulation CDR states that a registered Community design confers on its holder the exclusive right to use it and to prevent any third party not having his consent from using it. The aforementioned use covers, in particular, the making, offering, putting on the market, importing, exporting or using of a product in which the design is incorporated or to which it is applied, or stocking such a product for those purposes. According to Article 10(1) CDR the scope of the protection conferred by a Community design includes any design which does not produce on the informed user a different overall impression. The earlier RCD and the contested EUTM provoke a different overall impression. ... Furthermore, it is observed that the earlier RCD introduces additional differences, such as the presence of a remarked base that does not form part of the contested EUTM. Consequently, the Board confirms the Cancellation Division finding that the rights conferred by RCD No 241 427 pursuant to Article 19(1) CDR cannot be invoked against the contested EUTM' (paras 59-64).</p>		

4.4 Non-use of the earlier mark

According to Article 57(2) and (3) EUTMR, where the **earlier mark has been registered for five years or more** when the application for a declaration of invalidity is filed, the proprietor of the EUTM may request that the proprietor of the earlier mark submit proof that the earlier mark has been put to genuine use in the EU in connection with the goods or services for which it is registered or that proper reasons for non-use exist.

According to Rule 40(6) in conjunction with Rule 22(3) EUTMR, the indications and evidence for submitting proof of use must consist of indications concerning the place, time, extent and nature of use of the earlier trade mark for the goods and services for which it is registered and on which the application for a declaration of invalidity is based.

The practice rules applicable to the **substantive assessment** of proof of use of earlier rights in opposition proceedings are applicable to the assessment of proof of use in invalidity proceedings (see the Guidelines, Part C, Opposition, Section 6, Proof of Use, paragraph 2). In particular, when the EUTM proprietor requests proof of use of the earlier rights, the Office will examine whether, and to what extent, use has been proved for the earlier marks, provided this is relevant for the outcome of the decision.

Finally, there is a particularity to be taken into account in the assessment of proof of use in the context of invalidity proceedings. It regards the **relevant time of use**. Pursuant to Article 57(2) EUTMR in conjunction with Article 42(2) EUTMR, in contrast to opposition proceedings, there are two relevant periods during which use has to be established.

- In all cases where the earlier trade mark had been registered for more than five years prior to the application for invalidity: the period of five years preceding the date of **filing** of the application for a declaration of invalidity (first relevant period).
- Additionally, in cases where the earlier trade mark had been registered for at least five years on the date of filing or, where applicable, the date of priority, of the contested EUTM application: the period of five years preceding that date (second relevant period).

These two relevant periods do not necessarily overlap: they may totally or partially overlap or follow on from each other (with or without a gap).

4.5 Defences against an invalidity application based on relative grounds

4.5.1 Consent to registration

According to Article 53(3) EUTMR, the EUTM may not be declared invalid if the owner of the earlier right consents expressly to the registration of the EUTM before filing the application for a declaration of invalidity.

Consent does not have to be given before the date of registration of the EUTM. It is sufficient if it is given before the application for invalidity is filed. For these purposes,

the Office will take into account, for instance, a contract to this effect between the parties.

Earlier right	Contested sign	Case No
SKYROCK		R 1736/2010-2
<p>The EUTM proprietor argued that by virtue of the coexistence agreement, the cancellation applicant had effectively consented to the registration of the contested EUTM pursuant to Article 53(3) EUTMR. BoA examined the coexistence agreement and the interpretation thereof by the French courts. It concluded that the French courts construed the coexistence agreement as conferring a right on the part of the EUTM proprietor to register marks, other than 'SKYROCK' and 'SKYZIN', that contain the prefix 'SKY'. 'That agreement has a worldwide scope of application and therefore applies to EUTM applications or registrations, such as the one in dispute in the present case' (para. 32).</p>		

Evidence of express consent must take the form of a statement (and not of conduct). The statement must come from the applicant (and not from third parties). The consent must be 'express' (and not implicit or presumed) (decision of 23/07/2009, R 1099/2008-1, § 46)

Merely withdrawing an opposition unilaterally does not necessarily imply that the opponent consents to the registration of the EUTM application (decision of 14/10/2008, R 946/2007-2 and R 1151/2007-2, VISION, § 26). As Article 53(3) EUTMR requires express consent, the withdrawal of the opposition has not been considered as consent for registration (decision of 01/12/2012, R 1883/2011-5, PENSA PHARMA, § 30, appealed).

4.5.2 Earlier applications for declaration of invalidity or counterclaims

According to Article 53(4) EUTMR, where the proprietor of an earlier right has previously made an application for a declaration of invalidity of an EUTM or has made a counterclaim for invalidity in infringement proceedings on the basis of rights in Article 53(1) or (2) EUTMR before an EUTM court, it may not submit a new application for a declaration of invalidity on the basis of other rights referred to in Article 53(1) or (2) EUTMR that it could have invoked in the original proceedings.

Article 100 EUTMR imposes an obligation on EUTM courts or the interested party to notify the Office of the initiation of counterclaims for invalidity and their outcome. Where this is not done, an EUTM proprietor wishing to rely on the defence provided for by Article 53(4) EUTMR must submit evidence from the EUTM court to support its claim.

4.5.3 Acquiescence

According to Article 54 EUTMR, where the proprietor of an earlier EUTM or national trade mark has acquiesced in the use of the EUTM for a period of five successive years, while being aware of the use, the EUTM is not liable to be declared invalid, unless registration of the later EUTM was applied for in bad faith.

The aim of Article 54 EUTMR is to penalise the proprietors of earlier trade marks that have acquiesced, for a period of five successive years, in the use of a later EUTM while being aware of such use, by excluding them from seeking a declaration of invalidity of that trade mark, which will then therefore be able to coexist with the earlier

trade mark (judgments of 28/06/2012, T-133/09, B. Antonio Basile 1952, EU:T:2012:327, and T-134/09, B. Antonio Basile 1952, EU:T:2012:328, § 32).

The burden of proof is on the proprietor of the contested EUTM to show that:

- the contested EUTM was used in the European Union (or in the Member State where the earlier trade mark is protected) during a period of at least five successive years;
- the invalidity applicant was aware of this or could reasonably be presumed to be aware of it;
- although the invalidity applicant could have stopped the use, it nevertheless remained inactive. This is not the case where there was a licence or distribution relationship between the parties, so that use by the EUTM proprietor was for goods it lawfully obtained from the invalidity applicant (judgment of 22/09/2011, C-482/09, Budweiser, EU:C:2011:605, § 44; decision of 20/07/2012, R 2230/2010-4, AQUA FLOW).

All three conditions must be fulfilled. If they are, the limitation on acquiescence will apply only to the contested goods or services for which the later EUTM has been used.

The period of limitation in consequence of acquiescence starts running from the time when the proprietor of the earlier trade mark **becomes aware** of the use of the later EUTM. It is at this point that it has the option of not acquiescing in its use and, therefore, opposing it or seeking a declaration of invalidity of the later trade mark (judgment of 28/06/2012, T-133/09, B. Antonio Basile 1952, EU:T:2012:327, and T-134/09, B. Antonio Basile 1952, EU:T:2012:328, § 33).

An example of where the proprietor could reasonably be presumed to be aware of the use of the contested EUTM is where both proprietors have exhibited goods or services under the respective marks at the same event.

Article 54 EUTMR is not applicable when the contested EUTM was filed in bad faith. This exception will only be considered if it is argued and proven by the applicant.

Article 54 EUTMR does not refer to the possible consequences of acquiescence by a person authorised to exercise the rights arising from a designation of origin or a geographic indication. Therefore, the proprietor of an EUTM cannot rely on acquiescence where an invalidity application is based on an earlier designation of origin or a geographical indication pursuant to Article 8(4a) EUTMR.

4.5.3.1 Examples rejecting the acquiescence claim

Earlier right	Contested sign	Case No
BASILE		T-133/09 and T-134/09 (C-381/12 P dismissed the action)
<p>The appeal applicant did not adduce 'any evidence capable of establishing when the intervener became aware of the use of the contested trade mark after its registration. It merely stated that the contested trade mark had been used for more than five years in Italy and that the intervener must have been aware of that use. Nevertheless, ... less than five years had elapsed between the date of registration of the contested trade mark and the date when the application for a declaration of invalidity was filed, as use of that mark prior to its registration is not relevant since it had not yet been registered' (para. 34).</p>		

Earlier right	Contested sign	Case No
DIABLO	DIABLO	R 1022/2011-1
<p>'In the case at hand, the contested European Union trade mark was registered on 11 April 2007 and the request for invalidity was filed on 7 July 2009. Thus, the contested mark had been registered as a European Union trade mark for less than five years. Given that one of the conditions provided for in Article 54(2) EUTMR is not fulfilled, the Board concludes that the Cancellation Division was right in holding that the applicant has not acquiesced in the use of the EUTM' (paras 25-26).</p>		

Earlier right	Contested sign	Case No
VAGUA FLOW		R 2230/2010-4 (confirmed by T-417/12)
<p>'The late evidence [filed] by the EUTM proprietor shows that in 2005 'AQUA FLOW' branded products were being distributed by various companies in Spain including Hydro Sud. It is claimed that the cancellation applicant was aware of that use. The EUTM proprietor furnished three invoices to third companies located in Spain: 'Hydro Sud', 'Tonocolor SL Hydro Sud' and 'H2O Problematica del Agua'. These invoices are dated 18 June 2004, 31 May 2005 and 31 July 2006 and contain headings with a representation of the mark 'AQUA FLOW'. However, all these invoices postdate May 2004. Under the assumption that the cancellation applicant had knowledge of them, or of the underlying commercial transactions, this would not be enough for the finding that there was an uninterrupted period of five years preceding the cancellation request in the meaning of Article 54(2) EUTMR' (paras 21-22). Therefore, the EUTM proprietor's claim of acquiescence was dismissed.</p>		

Earlier right	Contested sign	Case No
	PURELL	R 1317/2009-1
<p>'Article 54(2) EUTMR requires that the contested European Union trade mark be used for five successive years in Germany and that the cancellation applicants have acquiesced in this use for this period. In the present case, the arguments and materials submitted by the parties do not allow for the conclusion that the contested mark was used in Germany and that the cancellation applicants could reasonably be presumed to be aware of that use and to have acquiesced, for five successive years, in that use ... the sole elements that would suggest some connection with Germany and on which the EUTM proprietor relies primarily on appeal (i.e. the figures related to the unique local distributor and the Internet excerpts examined in light of the correspondence of 2001 between the parties) are insufficient to hold that the cancellation applicants have acquiesced in the long and well-established honest use of the contested mark in Germany' (para. 47).</p>		

4.5.3.2 Examples (partially) accepting the acquiescence claim

Earlier right	Contested sign	Case No
CITYBOND	CITIBOND	3971 C R 1918/2011-5 (appeal withdrawn; the Cancellation Division decision has become final)
Taking the evidence as a whole, it showed that all the conditions for acquiescence were met for some of the contested services. In particular, the exchange of letters between the parties showed that the applicant was aware of the existence of the EUTM 'CITIBOND' for some of the services. Moreover, the extracts and the statutory declaration (2003) included in proceedings in the UK, and the rest of the financial information, demonstrated that the applicant was conscious of the use of the EUTM 'CITIBOND' in the UK, bearing in mind that the financial market is very specific and highly specialised.		

Earlier right	Contested sign	Case No
Ghibli Et al		R 1299/2007-2
The cancellation applicant acknowledged that he was aware of the use of this sign, in Italy. The legal issue was whether — for the purposes of applying Article 53(2) EUTMR — the cancellation applicant also had to be aware of the legal status of the sign used, namely, that it had been used as a registered EUTM in Italy. In the Board's view, Article 53(2) EUTMR cannot be interpreted to require the EUTM proprietor to prove — in addition to the five years' concurrent use, knowingly tolerated by the proprietor of the earlier right — that the cancellation applicant also knew, for at least five years, that the later mark was protected as an EUTM. What matters in this context is the objective circumstance that the sign (the use of which has been knowingly tolerated by the cancellation applicant), must have existed, for at least five years, as an EUTM. In view of the evidence in the file, it was proven that when the request for a declaration of invalidity was filed, the cancellation applicant had been aware and tolerated the use of the contested EUTM in Italy for more than five years, irrespective of whether or not he was aware of the fact of registration (para. 35 et seq.).		

5 Res Judicata

Pursuant to Article 56(3) EUTMR, in addition to any particular defence that an EUTM proprietor may raise against an application for a declaration of invalidity or against a revocation application (see paragraphs above), an invalidity or revocation application is inadmissible where an application relating to the **same subject matter and cause of action, and involving the same parties**, has been adjudicated on its own merits by an EUTM court or by the Office and a final decision has been taken. This is what is known as the 'triple-identity' requirement.

The defence of res judicata only applies where there is a previous **final decision on the substance** in a counterclaim or cancellation application. The bar to admissibility does not apply, for instance, when a cancellation application was withdrawn before the corresponding decision became final (decision of 12/05/2014, R 1616/2013-4, PLAYSEAT, § 13) or when the previous final decision declared the application inadmissible (e.g. because the contested EUTM was not yet registered) and did not adjudicate on the substance.

(i) Same subject matter

Res judicata does not apply to a request for revocation where the previous final decision refers to another request for revocation submitted on a different date. This is because the points in time at which the circumstances leading to the revocation have to be established (lack of use, EUTM becoming generic or

subject to misleading use) are different and the subject matter cannot therefore be deemed to be the same (decision of 31/01/2014, 7 333 C).

(ii) Same cause of action

A prior decision by the Office in **opposition proceedings** between the same parties and relating to the same mark does not preclude a later cancellation request based on the same earlier rights (judgment of 14/10/2009, T-140/08, TiMiKinderjoghurt, EU:T:2009:400, § 36, appeal to the Court dismissed, and judgment of 23/09/2014, T-11/13, Mego, EU:T:2014:803, § 12), since the cause of action is different. However, a different outcome in invalidity or revocation proceedings is unlikely to arise except where one or more of the following conditions is fulfilled.

- New facts are proven (e.g. proof of use or reputation of the earlier mark, not made available during opposition proceedings).
- The manner in which key legal assessments are made has changed (e.g. with regard to the standards for assessing likelihood of confusion), for example as a result of intervening judgments of the Court of Justice of the European Union.

(iii) Same parties

The triple identity required by *res judicata* also means that the parties to both proceedings (the one in question and the one that led to the previous final decision) have to be the same.

***GUIDELINES FOR EXAMINATION OF
EUROPEAN UNION TRADE MARKS***

***EUROPEAN UNION
INTELLECTUAL PROPERTY OFFICE
(EUIPO)***

PART E

REGISTER OPERATIONS

SECTION 1

CHANGES IN A REGISTRATION

Table of Contents

1	Surrender	4
1.1	General principles	4
1.2	Legal effect	4
1.3	Formal requirements	5
1.3.1	Form	5
1.3.2	Language	5
1.3.3	Fees	5
1.3.4	Necessary particulars	5
1.3.5	Partial surrender	6
1.3.6	Signature	6
1.3.7	Representation, authorisation	6
1.3.8	Requirements where a licence or other right in the European Union trade mark has been registered	6
1.4	Examination	7
1.4.1	Competence	7
1.4.2	Registration or rejection	8
2	Alteration of a Trade Mark	8
2.1	General principles	8
2.2	Formal requirements	9
2.2.1	Form and language	9
2.2.2	Fees	9
2.2.3	Mandatory indications	9
2.3	Substantive conditions for alteration	10
2.3.1	Examples of acceptable alterations	10
2.3.2	Examples of unacceptable alterations	11
2.4	Publication	12
3	Changes of Name or Address	12
4	Changes in Collective Trade Mark Regulations	13
4.1	Registration of the amended regulations	14
5	Division	14
5.1	General provisions	14
5.2	Formal requirements	15
5.2.1	Form and language	15
5.2.2	Fees	15
5.2.3	Mandatory indications	15
5.3	Registration	16
5.4	New file, publication	17
6	Post-Registration Seniority Claims	18

6.1	General principles	18
6.2	Legal effect	18
6.3	Formal requirements	18
6.3.1	Form	18
6.3.2	Language	19
6.3.3	Fees	19
6.3.4	Mandatory indications	19
6.4	Examination	20
6.4.1	Substantive examination	20
6.4.2	Triple identity	21
6.4.3	Harmonised seniority information	22
6.5	Registration and publication	22
6.6	Cancellation of seniority claims	22
7	Replacement of an EUTM Registration by an IR	23

1 Surrender

Article 50 EUTMR
Rule 36 EUTMIR

1.1 General principles

At any time after registration a European Union trade mark (EUTM) may be surrendered by its proprietor in respect of some or all of the goods and services. The surrender must be declared to the Office in writing. (For information on the withdrawal of European Union trade mark applications, i.e. prior to registration, please see the Guidelines, Part B, Examination, Section 1, Proceedings, paragraph 5.1.)

1.2 Legal effect

Article 50(2) EUTMR
Rule 36 EUTMIR

Surrenders only become legally effective on the date of entry in the Register of European Union trade marks (the Register). The registration procedure for the surrender may be suspended during ongoing proceedings (see paragraph 1.4.1 below).

The proprietor's rights in the registered EUTM, as well as those of its licensees and any other holders of rights in the mark, lapse with an *ex nunc* effect on the date of the registration of the surrender in the Register. Therefore, the surrender has no retroactive effect.

The surrender has procedural and substantive effects.

In procedural terms, when the surrender is entered in the Register, the European Union trade mark ceases to exist and any proceedings involving the mark before the Office terminate.

The substantive effects of surrender vis-à-vis third parties comprise the EUTM proprietor renouncing any rights arising from its mark in the future.

The declarant is bound by the declaration of surrender during its registration procedure, provided that the following circumstances are present.

- a) No revocation of the declaration reaches the Office on the same day as the receipt of the declaration of surrender. That means that if a declaration of surrender and a letter revoking that declaration reach the Office on the same day (regardless of the hour and minute of their receipt), they cancel each other out. Once it becomes effective, the declaration may not be revoked.
- b) The declaration meets all the formal requirements, in particular those identified in paragraph 1.3.8 below.

1.3 Formal requirements

1.3.1 Form

Rules 79, 79a, 80 and 82 EUTMIR
Decision No°EX-11-03 of the President of the Office

The proprietor must declare the surrender to the Office in writing. The general rules for communication with the Office apply (see the Guidelines, Part A, General Rules, Section 1, Means of Communication, Time Limits).

The declaration of surrender is void where it contains conditions or time limitations. For example, it may not be made under the condition that the Office takes a particular decision or, in *inter partes* proceedings, that the other party makes a procedural declaration. For instance, during cancellation proceedings the mark may not be (partially) surrendered on the condition that the cancellation applicant withdraws its cancellation action. However, this does not exclude the possibility of an agreement between the parties, or that both parties request successive actions (for example, surrender of the trade mark and withdrawal of the cancellation action) in the same letter to the Office.

1.3.2 Language

Rule 95(b) EUTMIR
Article 119(2) EUTMR

The declaration of surrender must be filed in one of the five languages of the Office.

1.3.3 Fees

There is no fee for a declaration of surrender.

1.3.4 Necessary particulars

Rule 36(1) EUTMIR

The declaration of surrender must contain the particulars referred to in Rule 36(1) EUTMIR. These are:

- the EUTM registration number
- the EUTM proprietor's name and address or simply the proprietor's ID number
- where the surrender is only for some of the goods or services for which the mark is registered, either the goods and services for which the surrender is declared or an indication of the goods and services for which the mark is to remain registered or both (see paragraph 1.3.5 below).

1.3.5 Partial surrender

An EUTM may be surrendered in part, that is, for some of the goods and services for which it is registered. A partial surrender only becomes effective on the date it is entered in the Register.

For a partial surrender to be accepted, the following two conditions relating to the goods and services must be met:

- a) the new wording must not constitute an extension of the list of goods and services;
- b) the partial surrender must constitute a valid description of goods and services.

For further details on acceptable restrictions and for the practice regarding the declaration referred to in Article 28(8) EUTMR, please see the Guidelines, Part B, Examination, Section 3, Classification.

1.3.6 Signature

Except where Rule 79 EUTMIR allows otherwise, the declaration of surrender must be signed by the EUTM proprietor or its duly appointed representative (see paragraph 1.3.7 below). If the declaration is submitted by electronic means, the indication of the sender's name is deemed to be equivalent to a signature.

If an unsigned declaration is sent to the Office, the Office will invite the party concerned to correct the irregularity within a two-month time limit. If the deficiency is not remedied within the time limit, the surrender will be rejected.

1.3.7 Representation, authorisation

As far as representation of the EUTM proprietor who is declaring the surrender is concerned, the normal rules apply (see the Guidelines, Part A, General Rules, Section 5, Professional Representation).

The procedural rules applicable in certain Member States that an authorisation does not cover the right to declare the surrender of a trade mark unless expressly specified are not applicable under the EUTMR.

1.3.8 Requirements where a licence or other right in the European Union trade mark has been registered

Surrender cannot be registered if third parties have registered rights in the EUTM (such as licensees, pledgees, etc.) without first fulfilling certain additional requirements.

Where a licence, or another right in the EUTM, is entered in the Register, the following additional requirements apply.

- a) The EUTM proprietor must submit sufficient proof that it has informed the licensee, pledgee, etc. of its intention to surrender.

If the proprietor proves to the Office that the licensee, pledgee, etc. has given its consent to the surrender, the surrender will be registered upon receipt of that notice.

If the EUTM proprietor merely submits proof that it has informed the licensee/pledgee of its intention to surrender, the Office will inform the proprietor that the surrender will be registered three months after the date on which the Office received the evidence (Rule 36(2) EUTMIR).

The Office will consider a copy of the letter from the proprietor to the licensee/pledgee as sufficient evidence, provided that there is a reasonable likelihood that the letter was actually sent and received by the licensee/pledgee. The same applies to a written statement signed by the licensee/pledgee that it has been informed. An affidavit by the proprietor is not necessary. The term 'prove' in Article 50(3) EUTMR does not refer to absolute certainty but to a reasonable probability, as follows from the other language versions of the regulations (French version of Article 50(3): *justifie*, Italian *dimostre*, German *glaubhaft macht*). The documents may be in any of the 23 official languages of the European Union. However, the Office may require a translation into the language chosen for the declaration of surrender or, at the choice of the declarant, into any of the five languages of the Office.

If the proof is missing or insufficient, the Office will ask for it within a time limit of two months.

- b) Where a levy of execution is entered in the Register, the declaration of surrender must be accompanied by a declaration of consent to the surrender signed by the authority competent for the levy of execution (see the Guidelines, Part E, Register Operations, Section 3, EUTMs as Objects of Property, Chapter 4, Levy of Execution).
- c) Where insolvency or similar proceedings are entered in the Register, the declaration of surrender must be requested by the liquidator (see the Guidelines, Part E, Register Operations, Section 3, EUTMs as Objects of Property, Chapter 5, Insolvency).

1.4 Examination

1.4.1 Competence

The Office is competent for examining the declaration of surrender.

Where surrender (or a partial surrender covering all the goods and/or services against which the application for cancellation is directed) is declared during ongoing revocation or invalidity proceedings against the validity of the EUTM that is being surrendered, the relevant department (for example, the Cancellation Division) will be informed and the Office will suspend the registration of the surrender. The Cancellation Division will invite the cancellation applicant to indicate whether it wishes to continue with the proceedings and if so, the cancellation proceedings will continue until there is a final decision on substance. After the decision on the cancellation has become final, the surrender will be registered only for the goods and/or services for which the contested EUTM has not been revoked or declared invalid, if any (see judgment of 24/03/2011, C-552/09 P, 'TiMiKinderjoghurt', para. 39, decision of 22/10/2010, R 0463/2009-4 –

'MAGENTA', paras 25-27 and decision of 07/08/2013, R 2264/2012-2 – 'SHAKEY'S'). (See the Guidelines, Part D, Cancellation, Section 1, Cancellation Proceedings, paragraph 7.3).

Where the EUTM is subject to a case pending before the Boards of Appeal (BoA), the competent chamber will decide on the surrender.

Where the EUTM is subject to a case pending before the General Court (GC) or the Court of Justice (CJEU), the surrender must be filed at the Office (not before the GC or the CJEU). The Office will then inform the GC or the CJEU whether or not it finds the surrender acceptable and valid. However, the surrender proceedings will be suspended until the GC or the CJEU has rendered a final decision on the issue (by analogy, see judgment of 16/05/2013, T-104/12, 'VORTEX').

1.4.2 Registration or rejection

In the event of a deficiency, the Office will give the declarant two months to remedy the deficiency.

Where the deficiency which is brought to the attention of the declarant is not remedied within the time limit specified, the Office will entirely reject the request to record the surrender in the Register.

Where the Office enters the surrender in the Register, it will inform the EUTM proprietor and all right holders registered for that trade mark accordingly.

When notifying the registration of a partial surrender, a copy of the new list of goods and services will be given in the confirmation letter in the language of the proceedings.

2 Alteration of a Trade Mark

2.1 General principles

Article 48 EUTMR Rule 25 EUTMIR

This section of the Guidelines and the provisions cited above deal solely with alterations of the EUTM that are requested by the proprietor of its own accord.

There is a difference between an amendment of an EUTM application and an alteration of a registered EUTM. The amendment of an EUTM application is governed by Article 43 EUTMR and Rules 13 and 26 EUTMIR. The alteration of a registered EUTM is governed by Article 48 EUTMR, and Rules 25 and 26 EUTMIR (for more information on amendments of an EUTM application, see the Guidelines, Part B, Examination, Section 2, Examination of Formalities).

This section does not apply to corrections of obvious errors by the Office in its publications or in the EUTM Register; such corrections are made *ex officio*, or at the proprietor's request, pursuant to Rules 14 and 27 EUTMIR (for more information, see the Guidelines, Part A, General Rules, Section 6, Revocation of Decisions and Cancellation of Entries in the Register and Correction of Errors).

The Regulations provide for the possibility of applying for an amendment of the representation of the mark (alteration of the mark) providing such alteration relates to the proprietor's name and address **and** does not substantially affect the identity of the trade mark as originally registered.

The Regulations do not provide for the possibility of altering other elements of the EUTM registration.

2.2 Formal requirements

2.2.1 Form and language

Article 48(2) EUTMR

The application to alter the mark, that is, the representation of the mark, must be made in writing in one of the five languages of the Office.

2.2.2 Fees

Article 48 (4) EUTMR
Annex I A(28) EUTMR

The application is subject to a fee of EUR 200; the request is deemed not to have been filed until the fee is paid (see the Guidelines, Part A, General Rules, Section 3, Payment of Fees, Costs and Charges).

2.2.3 Mandatory indications

Article 48 (3) EUTMR
Rule 25(1) EUTMIR

The application for alteration must contain:

- the EUTM registration number
- the EUTM proprietor's name and address in accordance with Rule 1(1)(b) EUTMIR; if the proprietor has previously been allocated an ID number, it is sufficient to indicate that ID number together with the proprietor's name
- an indication of the element in the representation of the mark to be altered and the altered version of the element
- a representation of the mark as altered that complies with the formal requirements laid down in Rule 3 EUTMIR.

One single application for alteration may be filed for several EUTM registrations, provided that both the EUTM proprietor and the element to be altered are the same in each case. However, the fee has to be paid for each registration to be altered.

2.3 Substantive conditions for alteration

Article 48(2) EUTMR allows the alteration of the representation of the mark only under extremely limited conditions, namely only when:



- the EUTM includes the EUTM proprietor's name and address, **and**
- these are the elements for which alteration is sought, **and**
- the alteration would not substantially affect the identity of the trade mark as originally registered.

Strict rules apply: where the proprietor's name or address is part of the distinctive elements of the mark, for example, part of a word mark, an alteration is excluded since the identity of the mark would be substantially affected. An exception can only be accepted for usual abbreviations relating to the legal structure of the company. An alteration of the mark is only possible if the EUTM proprietor's name or address appears on a figurative mark, for example, the label of a bottle, as a subordinate element in small letters. Such elements would normally not be taken into account in determining the scope of protection or the fulfilment of the use requirement. The rationale of Article 48 EUTMR is precisely to exclude any alteration of the registered EUTM that could affect its scope of protection or the assessment of the use requirement, so that rights of third parties cannot be affected.

No other element of the mark may be altered, even if it is only a subordinate element in small letters of a descriptive nature, such as the indication of the percentage of alcohol on a label of a bottle of wine.

Furthermore, Article 48(2) EUTMR does not allow for the alteration of the list of goods and services (see decision of 09/07/2008, R 0585/2008-2 – 'SAGA', para. 16). After registration, the only way to change the list of goods and services is through partial surrender under Article 50 EUTMR (see paragraph 1.3.5 above).

2.3.1 Examples of acceptable alterations

MARK AS REGISTERED	PROPOSED ALTERATION
<p data-bbox="416 1469 600 1491">EUTM 7 389 687</p> 	

<p>EUTM 4 988 556</p> 	
---	--

2.3.2 Examples of unacceptable alterations

MARK AS REGISTERED	PROPOSED ALTERATION
<p>EUTM 11 058 823</p> <p>ROTAM – INNOVATION IN POST PATENT TECHNOLOGY’</p>	<p>ROTAM – INNOVATION IN POST PATENT TECHNOLOGY</p>
<p>EUTM 9 755 307</p> <p>MINADI MINADI Occhiali</p>	<p>MINADI</p>
<p>EUTM 10 009 595</p> <p>CHATEAU DE LA TOUR SAINT-ANNE</p>	<p>CHATEAU DE LA TOUR SAINTE-ANNE</p>
<p>EUTM 9 436 072</p> <p>SLITONE ULTRA</p>	<p>SLITONEULTRA</p>
<p>EUTM 2 701 845</p> 	
<p>EUTM 3 115 532</p> 	

<p>EUTM 7 087 943</p> 	
<p>EUTM 8 588 329</p> 	

2.4 Publication

Where the alteration of the registration is allowable, it will be registered and published in Part C.3.4 of the Bulletin; the publication will contain a representation of the EUTM as altered.

Within three months of the publication of the alteration, third parties whose rights may be affected by the alteration may challenge the registration thereof. For this procedure, the provisions on the opposition procedure apply *mutatis mutandis*.

3 Changes of Name or Address

Articles 48a and 87 EUTMR and Rule 26 EUTMIR

It is possible to alter the name, address or nationality of the proprietor of a registered EUTM or its representative. The application to record the change must be made in one of the five languages of the Office. The alteration will be entered in the Register and published.

Pursuant to Rule 26 EUTMIR, the name, including the indication of the legal form, and address of the proprietor or representative may be amended freely, provided that:

- as regards the proprietor's name, the change is not the consequence of a transfer
- as regards the representative's name, there is no substitution of one representative by another.

Pursuant to Article 87 EUTMR, the indication of the nationality or the State of incorporation of a legal person may also be altered or added, provided that it is not the consequence of a transfer.

A change of the proprietor's name within the sense of Rule 26(1) EUTMIR is a change that does not affect the identity of the proprietor, whereas a transfer is a change from one proprietor to another. For details and the applicable procedure in case of doubt as to whether the change falls under Article 17 EUTMR, see the Guidelines, Part E, Register Operations, Section 3, EUTMs as Objects of Property, Chapter 1, Transfer.

Likewise, a change of a representative's name within the sense of Rule 26(6) EUTMIR is limited to a change which does not affect the identity of the appointed representative, for example, where the name changes as a result of marriage. Rule 26(6) EUTMIR also applies where the name of an association of representatives changes. Such a change of name has to be distinguished from the substitution of one representative by another, which is subject to the rules governing appointment of representatives; for details, see the Guidelines, Part A, General Rules, Section 5, Professional Representation.

A change of name or address under Rule 26 EUTMIR, or of nationality, may be the result of changed circumstances or of an error made when filing.

To record a change of name and address, the proprietor or its representative must submit an application to the Office. The application must contain the EUTM number as well as the name and address of the proprietor (in accordance with Rule 1(1)(b) EUTMIR) or of the representative (in accordance with Rule 1(1)(e) EUTMIR), both as recorded in the file and as amended.

Normally no proof or evidence of the change is necessary. However, in the event of doubt, the examiner may ask for proof such as a certificate from a trade register. The application to record the change of name or address is not subject to a fee.

Legal persons can only have one official address. In the event of doubt, the examiner may ask for evidence of the legal form or the address in particular. The official name and address are also used as the address for service by default. Ideally, a proprietor should have only one address for service. A change in the proprietor's official designation or official address will be registered for all EUTMs and RCDs in the name of that proprietor. A change in the official designation or address cannot be recorded just for specific portfolios of rights, contrary to the address for service. These rules apply to representatives by analogy.

4 Changes in Collective Trade Mark Regulations

Article 71 EUTMR

According to Article 71 EUTMR, the proprietors of European Union collective marks must submit to the Office any amended regulations governing use.

The application to enter in the Register an amendment of the regulations governing the use of a collective trade mark must be made in writing in one of the five languages of the Office.

4.1 Registration of the amended regulations

Article 67(2), Articles 68 and 69 EUTMR, Article 71(3) and (4) and Article 87 EUTMR

The amendment will not be entered in the Register if the amended regulations do not satisfy the requirements of Article 67(2) EUTMR or involve one of the grounds for refusal referred to in Article 68 EUTMR.

Where the registration of the amendment of the regulations is accepted, it will be registered and published.

The recordal applicant will specify the part of the amended regulations to be entered in the Register, which can be:

- the applicant's name and office address
- the purpose of the association or the purpose for which the legal person governed by public law is constituted
- the bodies authorised to represent the association or the legal person
- the conditions for membership
- the persons authorised to use the mark
- where appropriate, the conditions governing use of the mark, including sanctions
- if the mark designates the geographical origin of goods or services, authorisation for any person whose goods or services originate in the geographical area concerned to become a member of the association.

Within three months of the publication of the amended regulations, third parties whose rights may be affected by the amendment may challenge the registration thereof. For this procedure, the provisions on third party observations apply *mutatis mutandis*.

5 Division

5.1 General provisions

Article 49 EUTMR
Rule 25a EUTMIR
Annex I A(25) EUTMR

A registration can be split into different parts not only as the result of a partial transfer (see the Guidelines, Part E, Register Operations, Section 3, EUTMs as Objects of Property, Chapter 1, Transfer), but also on the EUTM proprietor's own motion. A division of a trade mark is particularly useful in order to isolate a disputed trade mark for certain goods or services and maintain the registration for the remainder. For information on the division of EUTM applications, see the Guidelines, Part B, Examination, Section 1, Proceedings.

Whereas a partial transfer is free of charge but involves a change of proprietorship, the request for division of a trade mark is subject to a fee of EUR 250 and the trade mark remains in the hands of the same proprietor. If the fee is not paid, the request is deemed not to have been filed. The request must be made in one of the five languages of the Office.

Division is not available for international registrations under the Madrid Protocol designating the EU. The Register of International Registrations is kept exclusively at WIPO. The EUIPO does not have the authority to divide an international registration.

5.2 Formal requirements

5.2.1 Form and language

The application to divide the EUTM must be made in writing in one of the five languages of the Office.

5.2.2 Fees

Annex I A(25) EUTMR

The application is subject to a fee of EUR 250; the request is deemed not to have been filed until the fee is paid (see the Guidelines, Part A, General Rules, Section 3, Payment of Fees, Costs and Charges).

5.2.3 Mandatory indications

Article 48 (4) EUTMR Rule 25a EUTMIR

The request must contain:

- the registration number of the EUTM to be divided
- the proprietor's name and address; if the proprietor has previously been allocated an ID, it is sufficient to indicate that ID number together with the proprietor's name
- the list of goods and services for the divisional registration, or, if more than one new registration is to be created, for each divisional registration
- the list of those goods and services that will remain in the original EUTM.

The goods and services must be distributed between the original EUTM and the new EUTM so that the goods and services in the original and the new EUTM do not overlap. The two specifications taken together must not be broader than the original specification.

Therefore, the indications must be clear, precise and unequivocal. For example, when a EUTM for goods or services in several classes is involved, and the 'split' between the old and new registration concerns whole classes, it is sufficient to indicate the respective classes for the new registration or for the remaining one.

When the application for a division indicates goods and services which are explicitly mentioned in the original list of goods and services, the Office will automatically retain

the goods and services which are not mentioned in the division application for the original EUTM. For example, the original list contains goods A, B, and C and the division application relates to C; the Office will keep goods A and B in the original registration and create a new registration for C.

For the assessment of whether there is limitation or a broadening of scope of the list, the rules generally applicable in such situations apply (see the Guidelines, Part B, Examination, Section 3, Classification).

In all cases it is highly recommended to file a clear and precise list of goods and services to be divided as well as a clear and precise list of goods and services to remain in the original registration. Furthermore, the original list must be clarified. For example, if the original list related to *alcoholic beverages* and the division relates to *whisky* and *gin*, the original list must be amended by restricting it to *alcoholic beverages, except whisky and gin*.

The Office will notify the proprietor of any deficiency in this regard and will give the proprietor two months to remedy the deficiency. If the deficiency is not remedied, the declaration of division will be refused (Rule 25a(2) EUTMIR).

There are also certain periods during which, for procedural economy or to safeguard third party rights, a declaration of division is not admissible. These periods are prescribed by Article 49(2) EUTM and Rule 25a(3) EUTMIR and are the following.

- As long as cancellation proceedings are pending before the Office (application for revocation or declaration of invalidity), only those goods and services against which the cancellation request is not directed may be divided from the original EUTM. The Office interprets Article 49(2)(a) EUTMR as not only excluding a division where some of the contested goods are divided from the original EUTM, with the effect that the cancellation proceedings would have to be split, but also as excluding that all the contested goods are divided from the original EUTM. However, in this case, the EUTM proprietor will be given the opportunity to amend the declaration of division by dividing the other goods and services from the original EUTM, that is, those which are not contested in the cancellation proceedings.
- As long as proceedings are pending before the Boards of Appeal, the General Court or the European Court of Justice only those goods and services not affected by the proceedings may be divided from the original EUTM due to the suspensive effect of the proceedings.
- Likewise, as long as a counterclaim for revocation or declaration of invalidity is pending before a EUTM court, the same conditions apply. This covers the period starting on the day the counterclaim was lodged before the EUTM court and ending on the date on which the Office mentions the EUTM court's judgment in the EUTM Register pursuant to Article 100(6) EUTMR.

5.3 Registration

If the Office accepts the declaration of division, a new registration is created as of that date and not retroactively as from the date of the declaration.

The new registration keeps the filing date as well as any priority or seniority dates, depending on the goods and services; the seniority effect may become partial.

All requests and applications submitted and all fees paid prior to the date on which the Office receives the declaration of division are also deemed to have been made or paid for the resulting divisional registration. However, fees duly paid for the original registration will not be refunded (Article 49(6) EUTMR). The practical effects of this provision can be exemplified as follows.

- Where an application for the registration of a licence was submitted and the payment of the fee for its registration was received by the Office prior to the declaration of division, the licence will be recorded in the Register of both the original and the divisional EUTM if the licence covers goods and/or services in the original and divisional EUTM. No further fees need to be paid.
- Where an EUTM registration containing two classes is to be divided into two registrations, no additional class fees for the renewal are payable as from the date on which the division is entered in the Register, but instead two basic renewal fees will be payable, one for each registration.

Where the division is not accepted, the original registration remains unchanged. It does not matter whether:

- the declaration of division was deemed not to have been filed in the absence of the fee
- the declaration was refused because it failed to comply with the formal requirements (see paragraph 5.2 above).

In neither of the latter two cases will the fee be reimbursed.

Where the final decision of the Office is that the declaration of division is not acceptable for any of the above reasons, the applicant may re-apply for the declaration of division, **which will be subject to a new fee.**

5.4 New file, publication

Article 87 (3) EUTMR

A new file has to be created for the divisional registration. It must contain all the documents which were on file for the original registration, plus all the correspondence related to the declaration of division, as well as all future correspondence for the new registration. The division will be published in the EUTM Bulletin.

6 Post-Registration Seniority Claims

Article 35 EUTMR
Rule 28 EUTMIR
Communication No 2/00 of 25/02/2000
Decision No EX-03-5 of 20/01/2003
Decision No EX-05-5 of 01/06/2005

6.1 General principles

The proprietor of an earlier trade mark registered in a Member State, including a trade mark registered under international arrangements having effect in a Member State, who holds an identical EUTM for goods or services which are identical with or contained within those for which the earlier trade mark has been registered, may claim for the EUTM the seniority of the earlier trade mark in respect of the Member State in or for which it is registered.

Seniority may be claimed at any time after the registration of the EUTM.

6.2 Legal effect

Seniority has the sole effect that where the holder of an EUTM surrenders their earlier national trade mark registration or allows it to lapse, they will be deemed to continue to have the same rights as they would have had if the earlier trade mark had continued to be registered.

This means that the EUTM represents a prolongation of earlier national registrations. If a proprietor claims seniority from one or more earlier registered national marks, the owner may decide not to renew the earlier national registrations but still be in the same position as if the earlier trade mark had continued to be registered in those Member States where the earlier marks were registered. The Office recommends the proprietor to wait until it receives confirmation of the acceptance of the seniority claim before allowing the national mark to lapse (see also paragraph 6.4.2 below).

Seniority may be claimed not only for earlier national registrations, but also for an international registration designating an EU country. However, no seniority claim is possible for an earlier EUTM registration or local registrations, even if the territory is part of the European Union (e.g. Gibraltar).

6.3 Formal requirements

6.3.1 Form

Rules 79, 79a, 80 and 82 EUTMIR
Decision No°EX-11-03 of the President of the Office

The seniority claim must be declared to the Office in writing. The general rules for communication with the Office apply (see the Guidelines, Part A, General Rules, Section 1, Means of Communication, Time Limits).

The Office has made available to the public, free of charge, a form for the purpose of requesting the recordal of post-registration seniority claims. This form is the Recordal Application and may be downloaded from the Office's website (<http://oami.europa.eu>).

6.3.2 Language

Rule 95(b) EUTMIR

The seniority claim must be filed in one of the five languages of the Office.

6.3.3 Fees

There is no fee for an application for a seniority claim.

6.3.4 Mandatory indications

Rule 28 EUTMIR Decision No EX-05-5 of 01/06/2005

The application must indicate:

- the EUTM registration number
- the EUTM proprietor's name and address in accordance with Rule 1(1)(b) EUTMIR; if the proprietor has previously been allocated an ID number, it is sufficient to indicate that ID number and the proprietor's name
- the Member State or Member States of the European Union in or for which the earlier mark, for which seniority is claimed, is registered
- the registration number and filing date of the relevant earlier registration(s).

Pursuant to Decision No EX-05-5 of 01/06/2005, the proprietor is not required to file a copy of the registration if the required information is available to the Office on the website of the respective national office. If the copy of the registration is not submitted, the Office will first search for the necessary information on the respective website and only if the information is not available there will it ask the proprietor for a copy. Pursuant to Article 3 of Decision No EX-03-5, the copy of the relevant registration must consist of a copy (simple photocopies suffice) of the registration and/or renewal certificate or extract from the Register, or an extract from the relevant national Gazette, or an extract or printout from a database. Examples of extracts that are not accepted are DEMAS, MARQUESA, COMPUSERVE, THOMSON, OLIVIA, PATLINK or COMPUMARK, SAEGIS.

6.4 Examination

6.4.1 Substantive examination

Seniority may only be claimed from an earlier **registration**, not an earlier application. The date of the earlier trade mark must be before the respective dates of the EUTM (filing date or, if available, the priority date).

The examiner must check both that the earlier mark was registered and that it had not lapsed at the moment the claim was made (on the duration of protection of national marks see the Guidelines, Part C, Opposition, Section 1, Procedural Matters, paragraph 4.2.3.4).

If the earlier registration had lapsed at the moment the claim was made, seniority cannot be claimed, even if the relevant national trade mark law provides for a six-month grace period for renewal. While some national legislations allow for a 'grace' period, if the renewal is not paid the mark is considered to have lapsed from the day it was due for renewal. Therefore, the seniority claim is acceptable only if the applicant shows that it has renewed the earlier registration(s).

In the context of an **enlargement** of the EU, the following details have to be borne in mind. Where a national trade mark of, or an international registration with effect in, a new Member State was registered before the seniority claim is made, **seniority may be claimed even though the priority, filing or registration date of the EUTM to which the seniority claim relates predates the priority, filing or registration date of the national mark/IR with effect in the new Member State**. This is because the EUTM at issue only has effect in the new Member State from the date of accession. The national trade mark/IR with effect in the new Member State for which seniority is claimed is therefore 'earlier' than the EUTM within the sense of Article 35 EUTMR, **provided** the national trade mark/IR with effect in the new Member State enjoys a priority, filing or registration date **prior to the accession date** (see the Guidelines, Part A, General Rules, Section 9, Enlargement, Annex 1).

Examples of acceptable seniority claims for new Member States				
EUTM	Filing date	Seniority claim country	Accession date	Filing date of earlier right
2 094 860 TESTOCAPS	20/02/2001	Cyprus	01/05/2004	28/02/2001
2 417 723 PEGINTRON	19/10/2001	Hungary	01/05/2004	08/11/2001
352 039 REDIPEN	02/04/1996	Bulgaria	01/01/2007	30/04/1996
7 073 307 HydroTac	17/07/2008	Croatia	01/07/2013	13/10/2009

Explanation: In all cases, although the filing date of the EUTM application is earlier than the filing date of the mark for which seniority is claimed, all the countries concerned acceded to the European Union after the filing date of the EUTM application. It is from the accession date that the EUTM application has protection in those Member States. Therefore, seniority can be claimed for any national marks filed prior to the date of accession.

If the claim to seniority is in order, the Office will accept it and – once the EUTM application has been registered – inform the relevant central industrial property office(s) of the Member State(s) concerned (Rule 8(3) EUTMIR).

6.4.2 Triple identity

A valid seniority claim requires triple identity:

- the registered mark must be identical to the European Union trade mark
- the goods and services of the EUTM must be identical or contained within those for which the mark is registered
- the proprietor must be the same.

(See judgment of 19/01/2012, T-103/11, ‘Justing’.)

Examination of seniority claims is limited to the formal requirements and to the identity of the marks (see Communication of the President No 2/00 of 25/02/2000).

It is up to the owner to make certain that the triple identity requirements are met. The Office will normally only examine whether the marks are identical. The identity of owner, goods and services will not be examined.

As regards the identity of the marks, word marks will generally be considered without reference to the typeface in which they are registered. In considering whether word marks are identical the Office will not object if, for example, one mark is in uppercase and the other in lowercase. The addition or subtraction of a single letter in a word mark is sufficient for marks not to be considered identical. As far as figurative marks are concerned, the General Court has held that

Even although the objectives of Article 8(1)(a) and of Article 34 of that regulation [EUTMR] are not the same, it is a condition for the application of both of them that the marks at issue must be identical ...

It must be stated at the outset that the fact that a mark is registered in colour or, on the contrary, does not designate any specific colour cannot be regarded as a negligible element in the eyes of a consumer. The impression left by a mark is different according to whether that mark is in colour or does not designate any specific colour.

(See judgment of 20/02/2013, T-378/11 ‘Medinet’, paras 40 and 52).

For full details of Office practice in relation to identity between trade marks filed in black and white and/or greyscale as compared to those filed in colour for the purposes of seniority claims, please see the Guidelines, Part B, Examination, Section 2 Formalities, paragraph 14.2.1, in relation to priority claims, which applies by analogy.

If the claim to seniority does not satisfy the formal requirements or if the marks are not identical, the Office will notify the proprietor and give it two months to remedy the deficiency or submit observations.

If the deficiency is not remedied, the Office will inform the proprietor that the right to claim seniority has been rejected.

For examples of acceptable and unacceptable seniority claims see the Guidelines, Part B, Examination, Section 2, Formalities, paragraph 16.6.

6.4.3 Harmonised seniority information

In order to properly manage seniorities, all seniority entries in the system need to have the same format as that used in the databases of the national offices.

To enhance harmonisation between the EUIPO and participating IP offices, a list with the required format for seniorities has been established. This list provides a description of the format/formats used in each of the national offices, insofar as this has been determined.

Therefore, when examining seniority claims, examiners must verify that the format of the seniority in the Office's system corresponds to the format used at national level.

6.5 Registration and publication

Article 87(3)(f) EUTMR

If the claim to seniority is in order, the Office will register it and inform the relevant central industrial property office(s) of the Member State(s) concerned (Rule 8(3) EUTMR).

The seniority claim will be published in the EUTM Bulletin.

The publication will contain the following data:

- the EUTM registration number
- the seniority claim details: country, registration number, registration date, filing date, date of priority
- the date and number of the entry of the seniority claim
- the date the entry is published in the EUTM Bulletin.

6.6 Cancellation of seniority claims

The EUTM proprietor may at any time request the cancellation of the seniority claim from the Register of its own motion.

Seniority claims may also be cancelled by a decision of a national court (see Article 14 Directive 2008/95/EC).

The cancellation of the seniority claim will be published in the EUTM Bulletin. Article 87(3)(f) EUTMR provides that the cancellation of seniority will be registered.

7 Replacement of an EUTM Registration by an IR

Article 157 EUTMR
Article 87(3)(t) EUTMR
Article 4 bis MP
Rule 21 Common Regulations under the Madrid Agreement and Protocol (CR)

In accordance with Article 4 bis of the Madrid Agreement and the Protocol, the holder of an international registration designating the European Union (IR) may request the Office to take note in its Register that an EUTM registration is replaced by a corresponding IR. The holder's rights in the EU will be deemed to start from the date of the earlier EUTM registration. Therefore, the Office will enter in the Register that an EUTM has been replaced by a designation of the EU through an IR and that entry will be published in the EUTM Bulletin.

For more information on replacement, see the Guidelines, Part M, International Marks.

***GUIDELINES FOR EXAMINATION OF
EUROPEAN UNION TRADE MARKS***

***EUROPEAN UNION INTELLECTUAL
PROPERTY OFFICE
(EUIPO)***

PART E

REGISTER OPERATIONS

SECTION 2

CONVERSION

Table of Contents

1	Introduction.....	3
2	Conversion of EUTMs and IRs Designating the EU.....	3
2.1	Conversion of EUTMs	3
2.2	Conversion of IRs designating the EU.....	4
3	Valid EUTM Application as a Condition for Conversion	5
4	Grounds Precluding Conversion	5
4.1	Revocation on the grounds of non-use	6
4.2	Ground for refusal limited to a Member State or extended to the entire EU	6
4.3	Withdrawal/surrender after a decision has been rendered	7
4.4	Competence to decide on grounds precluding conversion	8
5	Formal Requirements for the Request of Conversion.....	8
5.1	Time limit	8
5.1.1	Start of time limit where the Office issues a notification	8
5.1.2	Start of time limit in other cases	8
5.2	Request for conversion.....	9
5.3	Language	12
5.4	Fee.....	12
6	Examination by the Office.....	13
6.1	Stages of the procedure, competence	13
6.2	Examination.....	13
6.2.1	Fees.....	13
6.2.2	Time limit	13
6.2.3	Language.....	14
6.2.4	Formalities	14
6.2.5	Grounds	14
6.2.6	Representation	15
6.2.7	Partial conversion	15
6.3	Publication of the request and entry in the Register	16
6.4	Submission to designated offices.....	17
7	Effects of Conversion.....	18

1 Introduction

Conversion is the process of turning an EUTM into one or more national applications. Its main features are laid down in Articles 112 to 114 EUTMR and Rules 44 to 47 EUTMIR. If an EUTM ceases to exist it can, depending on the precise reason for that, be converted into trade marks that are valid in certain Member States. Conversion is particularly useful for overcoming possible problems with the EUTM's unitary character. For example, if the European Union trade mark faces a registrability problem in only one or certain countries on absolute grounds or due to an opposition based on an earlier right valid in only one country or certain countries, the EUTM applicant can apply to convert the EUTM into individual, national trade mark applications in the other countries not affected by these grounds.

The European Union Trade Mark system is based on the principle that the Union and national trade mark systems are complementary. They are notably linked to each other by seniority and conversion procedures. The system is construed in such a way that the earlier filing date of a registered right will always prevail in the territory in which it is valid, irrespective of whether the registered trade mark results from a national filing, an international designation or a EUTM application (decision of the Grand Board of Appeal, 15/07/2008, R 1313/2006-G, and decision of 22/09/2008, R 0207/2007-2, Restoria, § 34).

Conversion is a two-tier system involving, firstly, the payment of the conversion fee of EUR 200 and the examination of the conversion application before the Office and, secondly, the conversion procedure itself before the national offices. Depending on national law, the converted trade mark will either be registered immediately or enter the national examination, registration and opposition procedure like a normal national trade mark application.

Where the EU is designated in an IR and to the extent that the designation has been withdrawn, refused or has ceased to have effect, a request may also be made for conversion into national trade mark applications in one, more or all of the Member States or through a subsequent designation of the Member States under the Madrid system.

Conversion of IRs designating the EU is not to be confused with 'Transformation', which is a legal feature introduced by the Madrid Protocol (MP) in order to soften the consequences of the five-year dependency period existing under the Madrid Agreement (see Article 6(3) MP). Transformation allows for a centrally attacked mark to be transformed into a direct EUTM application but it does not allow for the conversion of an EU designation into national filings. For more information on Transformation see the Guidelines, Part M, International Marks.

2 Conversion of EUTMs and IRs Designating the EU

2.1 Conversion of EUTMs

Articles 112(1), 113(1), Article 159 EUTMR Rule 44(1)(e), (f), Rules 122, 123 EUTMIR

The applicant of a European Union trade mark (EUTM) application or proprietor of a registered EUTM may request the conversion of its EUTM application or registered

EUTM. The request may be into national trade mark applications in one, more or all of the Member States, it being understood that the term ‘national applications’ or ‘national office’ includes Benelux trade mark applications or the Benelux Trade Mark Office, as far as Belgium, Luxembourg and The Netherlands are concerned.

Conversion is possible in the following circumstances (‘grounds for conversion’):

- where a EUTM application has been finally refused by the Office (Article 112(1)(a) EUTMR), in a decision on absolute or relative grounds for refusal during examination or opposition proceedings;
- where a EUTM application has been withdrawn by the applicant (Article 112(1)(a), Article 44 EUTMR);
- where a EUTM application is deemed to be withdrawn, namely when class fees are not paid within the relevant time limit after filing the application (Article 112(1)(a), Article 36(5) EUTMR);
- where a EUTM registration ceases to have effect (Article 112(1)(b) EUTMR), which applies in the following circumstances:
 - where a EUTM registration has been validly surrendered (Article 50 EUTMR);
 - where a EUTM registration has not been renewed (Article 47 EUTMR);
 - where a EUTM registration has been declared invalid by the Office or by a European Union trade mark court (Articles 55 and 100 EUTMR);
 - where the rights of the proprietor of a EUTM registration have been revoked by the Office or by a European Union trade mark court (Article 55 EUTMR) except in the case of revocation due to non-use (Article 112(2) EUTMR).

2.2 Conversion of IRs designating the EU

The holder of an IR designating the EU may request the conversion of the designation of the EU:

- into national trade mark applications in one, more or all of the Member States;
- into subsequent designations of one or more Member States under the Madrid Agreement or Protocol (‘optingback’), provided that the Member State was a party to either Treaty not only at the point in time of the conversion request, but already on the date of the IR designating the EU;
- into national trade mark applications for some Member States and subsequent designations for other Member States, it being understood that the same Member State can only be designated once.

IR conversion is possible in the following circumstances (‘grounds for conversion’) where the designation of the EU in an IR ceases to have effect, which applies in the following circumstances:

- where the effects of an IR designating the EU have been invalidated by the Office or a EUTM court (Article 158 EUTMR, Rule 117 EUTMIR);
- where a renunciation of the designation of the EU has been recorded in the International Register (Rule 25(1), Rule 27 CR¹);
- where a cancellation of the IR has been recorded in the International Register (Rule 25(1), Rule 27 CR): in such cases opting-back conversion is not possible; only national conversion is available where the Office is informed by WIPO that the IR has not been renewed, provided that the grace period for the renewal is over (Rule 31(4)(a) or (b) CR).
- where an IR designating the EU has been definitively refused by the Office (Rules 113(2)(b), (c), 115(5)(b), (c) EUTMIR).

Conversion may be requested for all or for some of the goods or services to which the act or decision mentioned above relates.

Where the abovementioned decision or act relates only to some of the goods and services for which the application was filed or registered, conversion may be requested only for those specific goods or services, or a part of those goods or services.

3 Valid EUTM Application as a Condition for Conversion

Article 112(1) EUTMR

Where conversion is requested on the basis of a EUTM application, conversion is possible only if there is a valid EUTM application (See the Guidelines, Part B, Examination, Section 2, Formalities).

4 Grounds Precluding Conversion

Article 112(2) and Article 159 EUTMR
Rules 45 and 123 EUTMIR

Conversion will not take place in the following two cases: first, when a registered EUTM or IR designating the EU is revoked on grounds of non-use (see paragraph 4.1 below) and, second, where the particular ground for which the EUTM application or registered EUTM or IR designating the EU ceasing its effects would preclude registration of the same trade mark in the Member State concerned (see paragraph 4.2 below). Therefore, a request for conversion of a rejected EUTM application will not be admissible in respect of the Member State to which the grounds of refusal, invalidity or revocation apply.

¹ Common Regulations under the Madrid Agreement concerning the IR of Marks and the Protocol relating to that Agreement.

Even if the ground for conversion is the withdrawal of an application, if such a withdrawal takes place after a decision has been rendered refusing the mark on the basis of a ground that would preclude registration in the Member State concerned, such a request for conversion will be refused if no appeal has been filed.

Even if the ground for conversion is the surrender of a registration, if such a surrender takes place after a decision revoking a EUTM or IR on grounds of non-use, or refusing the mark on the basis of a ground that would preclude registration in the Member State concerned has been rendered, such a request for conversion will be refused if no appeal has been filed (see paragraph 4.3 below).

4.1 Revocation on the grounds of non-use

Article 112(2)(a) EUTMR

The first reason for precluding conversion is when the rights of the EUTM proprietor or IR holder have been revoked on the grounds of non-use.

Conversion will not take place where the rights of the proprietor of the European Union trade mark, or the holder of the IR, have been revoked on the grounds of non-use, unless in the Member State for which conversion is requested the European Union trade mark has been put to use that would be considered genuine under the laws of that Member State.

No subsequent allegations by the conversion applicant regarding the substance of the case will be allowed. For instance, if the EUTM was revoked for non-use, the conversion applicant cannot plead before the Office that it is able to prove use in a particular Member State.

4.2 Ground for refusal limited to a Member State or extended to the entire EU

Article 112(2)(b) EUTMR
Rule 45(4) EUTMIR

The second reason for precluding conversion is related to a ground for refusal, for revocation (other than for non-use) or for a declaration of invalidity. It applies when the decision of the Office or of a European Union trade mark court expressly states that the ground for refusal, for revocation or for invalidity applies in respect of a particular Member State, and precludes conversion for that Member State (decision of 05/03/2009, R 1619/2008-2, orange colour mark, § 23-24).

Examples

- Where an absolute ground for refusal exists only for one language, conversion will not take place in respect of Member States where that language is an official language. For example, if an absolute ground for refusal was raised in relation to the English-speaking public, conversion would not take place in respect of the United Kingdom, Ireland and Malta (see Rule 54(4) EUTMIR).

- Where an absolute ground for refusal exists only for one Member State, which may be the case because the trade mark is descriptive or deceptive only in a particular Member State and not in other Member States (see the Guidelines, Part B, Examination, Section 4, Absolute Grounds for Refusal), conversion will not take place in respect of that Member State, whereas conversion may be requested for all Member States in which the ground for refusal has not been expressly found to exist.
- Where a EUTM application or IR designating the EU has been refused in an opposition based on an earlier national trade mark in a given Member State, conversion will not take place in respect of that Member State. When the opposition is based on a number of earlier rights from different Member States but the final decision rejects the EUTM application or the IR designating the EU on the basis of only one of those earlier rights, conversion may be requested for the remaining Member States. For example, if in an opposition based on a UK, an Italian and a French national right, the opposition is successful insofar as it is based on the UK national right, and there is no analysis of the remaining earlier rights, conversion will not take place for the United Kingdom, but may take place for Italy and France (and all remaining Member States) (judgments of 16/09/2004, T-342/02, Moser Grupo Media, S.L., EU:T:2004:268, and 11/05/2006, T-194/05, Teletch International, EU:T:2006:124).
- According to Rule 45(4) EUTMIR, applicable by analogy to IRs designating the EU in accordance with Rule 123(2) EUTMIR, where a EUTM application has been refused or a EUTM registration has been invalidated on relative grounds based on an earlier EUTM, or, in the cases of invalidation, another European Union industrial property right, this has the effect of excluding conversion for the entire Union, even if likelihood of confusion exists only in part of it

4.3 Withdrawal/surrender after a decision has been rendered

Where, in any of the above cases, the applicant withdraws the EUTM application or the owner surrenders the EUTM, or the holder renounces the designation of the EU before the decision becomes final (i.e. during the appeal period) and subsequently requests conversion of the mark into national trade marks in some or all of the Member States for which a ground for refusal, for revocation or invalidity applies, such a request for conversion will be refused for those Member States.

If the applicant/owner/holder files an appeal and subsequently withdraws the refused application/surrenders the invalidated/revoked EUTM/designation and then requests a conversion, the withdrawal/surrender will be forwarded to the competent Board and may be put on hold pending the outcome of the appeal proceedings (judgment of 24/03/2011, C 552/09 P, TiMiKinderjoghurt, EU:C:2011:177, § 43, decisions of 22/10/2010, R 0463/2009-4, MAGENTA, § 25-27 and 07/08/2013, R 2264/2012-2, SHAKEY'S). Only once the withdrawal/surrender is processed will the conversion be forwarded as admissible to all the Member States applied for or refused, depending on the outcome of the case. (See also the Guidelines, Part D, Cancellation and Part E, Register Operations, Section 1, Changes in a Registration).

4.4 Competence to decide on grounds precluding conversion

Article 113(1) and (3) EUTMR

The Office will decide whether the request for conversion fulfils the conditions set out in the Regulations in conjunction with any final decisions (their operative part and reasons) that gave rise to the conversion.

If one of the grounds precluding conversion exists, the Office will refuse to forward the conversion request to the respective national office (or, in the case of an opting-back conversion, will refuse to forward the conversion to WIPO as a subsequent designation for the Member States for which conversion is so precluded). This decision will be subject to appeal.

5 Formal Requirements for the Request of Conversion

5.1 Time limit

A general time limit of three months for requesting conversion applies. The start of the time limit depends on the ground for conversion.

The time limit may not be extended.

Furthermore, continuation of proceedings cannot be requested for this time limit, according to Article 82(2) EUTMR. However, *restitutio in integrum* is, in principle, possible.

5.1.1 Start of time limit where the Office issues a notification

Article 112(4) EUTMR

Where a EUTM application is deemed to be withdrawn, a request for conversion may be filed within three months from the date of the corresponding confirmation from the Office.

The notification will be contained in the communication on the loss of rights.

5.1.2 Start of time limit in other cases

Article 112(5) and (6) EUTMR

In all other cases the time limit of three months for requesting conversion starts automatically, namely:

- where the EUTM application is withdrawn, on the day the withdrawal is received by the Office;

- where the EUTM is surrendered, on the day on which the surrender is entered in the EUTM Register (which is the day on which it becomes effective pursuant to Article 50(2) EUTMR);
- where protection of the IR has been limited or renounced with effect for the EU, on the day as of which it has been recorded by WIPO pursuant to Rule 27(1)(b) CR;
- where the EUTM registration was not renewed, on the day following the last day of the period within which a request for renewal may be submitted pursuant to Article 47(3) EUTMR, i.e. six months after the last day of the month in which protection has expired;
- where the IR was not renewed with effect for the EU, on the day following the last day on which renewal may still be effected before WIPO pursuant to Article 7(4) MP;
- where the EUTM application or IR designating the EU is refused, on the day on which the decision becomes final;
- where the EUTM or IR designating the EU is declared invalid or revoked, on the day on which the decision of the Office or the judgment of the EUTM court becomes final.

A decision of the Office becomes final:

- where no appeal is lodged, at the end of the two-month time limit for appeal pursuant to Article 60 EUTMR;
- following a decision of the Boards of Appeal at the end of the time limit for appeal to the General Court, or, where applicable, with the final decision of the Court of Justice.

A decision of a EUTM court becomes final:

- where no appeal is lodged, at the end of the time limit for appeal under national law;
- otherwise, with the final decision of the EUTM court of final (second or third) instance.

For example, if a EUTM is rejected by a decision of the Office on absolute grounds for refusal that is notified on 11/11/2011, the decision becomes final on 11/01/2012. The three-month period for requesting conversion ends on 11/04/2012.

5.2 Request for conversion

Article 113(1) EUTMR Rule 83(2) EUTMIR

The request for conversion will be filed at the Office. The 'Application for Conversion' form can be found on the Office's website. The use of this form is recommended.

The 'Application for Conversion of an IR designating the EC' form can be found on the Office's website. This form may also be used in the event of opting back. WIPO's MM16 form may also be used; however, the Office will send the conversion data to WIPO in electronic format and not the form itself.

Using the forms made available by the Office enables the latter to extract the relevant information concerning the converted EUTM and the data concerning the applicant and representative from its database and to submit them, together with the Conversion Form, to the designated offices.

Rule 44(1) and (2) EUTMIR

Applicants or their representatives may use forms of a similar structure to those made available by the Office provided that the following basic information is submitted:

- the name and address of the applicant for conversion, i.e. the applicant/proprietor of the EUTM application or registration or the holder of the IR;
- the representative's name, if any;
- the filing number of the EUTM application or the registration number of the EUTM or the IR;
- the filing date of the EUTM application or registration or, for an IR designating the EU, the date of the IR or the subsequent designation;
- particulars of any priority or seniority claim;
- the indication of the Member State or the Member States for which conversion is requested; for an IR it must also be indicated whether conversion is requested into a national application for that Member State or into a designation of the Member State under the Madrid Agreement or Protocol. As far as Belgium, the Netherlands and Luxembourg are concerned, conversion may be requested only for these three countries together, and not independently; the conversion form made available by the Office only allows for Belgium, the Netherlands and Luxembourg to be designated together; where the applicant nevertheless indicates only one of these three countries, the Office will take that as a request for conversion for Belgium, the Netherlands and Luxembourg and forward the request to the Benelux Trade Mark Office;
- the indication of the ground on which conversion is requested:
 - where conversion is requested following the withdrawal of the application, the date of withdrawal must be indicated;
 - where conversion is requested following failure to renew the registration, the date on which protection expired must be indicated;
 - where conversion is requested following the surrender of a EUTM, the date on which it was entered in the Register must be indicated;

- where conversion is requested following a partial surrender, the goods/services for which the EUTM no longer has protection and the date on which the partial surrender was entered in the Register must be indicated;
- where conversion is requested following a limitation, the goods/services for which the EUTM application no longer has protection and the date of limitation must be indicated;
- where conversion is requested because the mark ceases to have effect as a result of a decision of a European Union trade mark court, the date on which that decision became final must be indicated, and a copy of that decision, which may be in the language in which the decision was given, must be supplied;
- where conversion is requested because an IR designating the EU has been finally refused by the Office, the date of the decision must be indicated;
- where conversion is requested because the effects of an IR designating the EU have been invalidated by the Office or by a EUTM Court, the date of the decision of the Office or the date on which the judgment of the EUTM Court became final must be indicated together with a copy of the judgment attached;
- where conversion is requested because the designation of the EU has been renounced or cancelled before WIPO, the date on which it has been recorded by WIPO must be indicated;
- where conversion is requested because the IR designating the EU has not been renewed, and provided that the grace period for the renewal is over, the date of expiry of protection must be indicated.

The request for conversion may contain:

- an indication that it relates only to a part of the goods and services for which the application was filed or registered, in which case the goods and services for which conversion is requested must be indicated;
- an indication that conversion is requested for different goods and services with respect to different Member States, in which case the respective goods and services must be indicated for each Member State.

The request for conversion may also contain an appointment of a representative before a designated national office, by ticking the relevant boxes in the Annex to the Conversion Form. This indication is voluntary and not of relevance for the conversion procedure before the Office but will be useful for the national offices once they receive the conversion request, so that they can immediately communicate with a representative who is authorised to practise before that national office (see paragraph 6 below).

5.3 Language

Rule 95(a), Rule 126 EUTMIR

Where the request for conversion is made in respect of a EUTM application, it must be filed in the language in which the EUTM application was filed or in the second language indicated therein.

Where the request for conversion is made in respect of an IR designating the EU before the point in time when a statement of grant of protection was issued pursuant to Rule 116 EUTMIR, the request must be filed in the language in which the international application was filed with WIPO or in the second language indicated therein.

Rule 95(b), Rule 126 EUTMIR

Where the request is made in respect of a EUTM registration, it may be filed in any of the five languages of the Office.

Where the request for conversion is made in respect of an IR designating the EU after a statement of grant of protection has been issued, the request may be filed in any of the five languages of the Office, except in the case of an 'opting-back' conversion, when the request must be filed in English, French or Spanish.

However, when the request for conversion is filed by using the form provided by the Office pursuant to Rule 83 EUTMIR, the form may be used in any of the official languages of the Union, provided that the form is completed in one of the languages of the Office as far as textual elements are concerned. This concerns, in particular, the list of goods and services in the event of a request for partial conversion.

5.4 Fee

Article 113(1) EUTMR
Rule 45(2) EUTMIR
Article 144b(3) and Annex I A (23) EUTMR

The request for conversion is subject to payment of a fee of EUR 200, including for conversion of an IR designating the EU. The request will not be deemed to be filed until the conversion fee has been paid. This means that the conversion fee has to be paid within the abovementioned time limit of three months. A payment made after the expiry of the period will be considered to have been made in due time if the person concerned submits evidence that, in a Member State and within the period of three months, the payment had been made to a bank or a transfer order placed, and if at the same time of payment a surcharge of ten per cent of the total amount due was paid (see the Guidelines, Part A, General Rules, Section 3, Payment of Fees, Costs and Charges).

6 Examination by the Office

6.1 Stages of the procedure, competence

The Office will deal with requests for conversion by:

Article 113(2) and (3) EUTMR Rules 45-47 EUTMIR
--

- examining them;
- publishing them; and
- submitting them to the designated offices.

6.2 Examination

The examination of the request for conversion by the Office relates to the following points:

- fees;
- time limit;
- language;
- formalities;
- grounds;
- representation;
- partial conversion.

6.2.1 Fees

Rules 45(2) and 122(3) EUTMIR

The Office will examine whether the conversion fee has been paid within the applicable time limit.

Where the conversion fee has not been paid within the applicable time limit, the Office will inform the applicant that the application for conversion will be deemed not to have been filed. Any fees paid late will be reimbursed.

6.2.2 Time limit

Rules 45(1) and 122(3) EUTMIR

The Office will examine whether the request has been filed within the time limit of three months.

The Office will reject the request for conversion where the request was not filed within the relevant time limit of three months. Any fees paid late will not be reimbursed.

6.2.3 Language

Rule 95(a), Rule 126 EUTMIR

The Office will examine whether the request has been filed in the correct language.

When the request is filed in a language which is not one of the acceptable languages for the conversion procedure (see paragraph 5.3 above), the Office will send a deficiency letter to the applicant and specify a period within which it may amend the application for conversion. If the applicant fails to respond, the request will not be dealt with and will be considered not to have been filed. Any fees paid will not be reimbursed.

6.2.4 Formalities

Rule 44(1)(b), (d) and (e) EUTMIR

The Office will examine whether the request complies with the formal requirements of the Implementing Regulation (see paragraph 5 above).

Where the conversion applicant has not used the Conversion Form made available by the Office and where the deficiency lies in not having indicated the elements referred to in Rule 44(1)(b), (d) or (e) EUTMIR, the conversion applicant will be invited to either submit the missing indications or, where such indications may be readily ascertained from data available to the Office, will be considered as having authorised the Office to make available to the designated offices the relevant extracts from its database.

6.2.5 Grounds

The Office will examine:

- whether one of the grounds for conversion mentioned in paragraph 2 above exists;
- whether one of the grounds precluding conversion referred to in paragraph 4 above exists;

Rule 123(2) EUTMIR

- for an opting-back conversion, whether it would have been possible at the date of the IR to designate the Member State concerned in an international application;
- for partial conversion, whether the goods and services to be converted were in fact contained in, and do not go beyond, the goods and services of the EUTM or IR designating the EU at the point in time when it lapsed or ceased to have effect (see paragraph 6.3 below);

- for partial conversion in the sense that part of the EUTM or IR designating the EU remains alive, whether the goods and services to be converted overlap with the goods and services for which the mark remains alive (see paragraph 6.3 below).

The aim of these last two examination steps is to avoid conversion for more or broader goods and services than have been refused or cancelled.

When the request for conversion does not comply with any of the other mandatory elements and indications referred to in paragraphs 4 and 5.2 above, the Office will send a deficiency letter to the applicant and specify a period within which it may amend the application for conversion. If the applicant fails to respond, the request will not be dealt with and will be considered not to have been filed. Any fees paid will not be reimbursed.

6.2.6 Representation

Rule 76(1)-(4) EUTMIR

The general rules on representation apply (see the Guidelines, Part A, General Rules, Section 5, Professional Representation). The person requesting conversion may appoint a new or an additional representative (legal practitioner or Office professional representative) for the conversion procedure.

Any authorisation to act on behalf of the applicant or proprietor extends only to acts before the Office. Whether a representative appointed for proceedings before the Office may act before the national office in respect of the resulting national application and, if so, whether they need to present an additional authorisation, is determined by the national law concerned. In the event of an opting-back conversion, the name of the representative appointed before the Office will be submitted to WIPO.

6.2.7 Partial conversion

Article 112(1) EUTMR Rule 44(1)(e) EUTMIR
--

Where conversion is requested only for some of the goods and services, or for different goods and services for different Member States ('partial conversion'), the Office will examine whether the goods and services for which conversion is requested are contained within the goods and services for which the ground of conversion applies. For this assessment the same criteria apply as in similar procedural situations, such as restriction of an application or partial refusal in an opposition proceeding.

Where an application is refused in part or a registration is invalidated or revoked in part, conversion may be requested only for the goods or services for which the application was refused or the registration was invalidated or revoked, and not for the goods or services for which the application or registration remains valid.

Where an application is limited, or a registration is partially surrendered, conversion may be requested only for the limited/partially surrendered goods or services, and not

for the goods or services for which the application or registration remains valid. However, please refer to paragraph 4.3 above when such a limitation/partial surrender takes place following a decision.

The applicant must indicate in the abovementioned cases the goods and services for which conversion is requested. Expressing the limitation in a negative way, such as by using expressions of the type ‘beverages with the exception of ...’, is admissible in the same way that such an expression is admissible when filing or restricting a EUTM application or partially surrendering a EUTM registration (see the Guidelines, Part B, Examination, Section 3, Classification).

6.3 Publication of the request and entry in the Register

Article 113(2) EUTMR
Rule 84(3)(p) EUTMIR

Upon acceptance of a request for conversion that is deemed to have been filed because the required fee has been paid, the Office will make an entry in the Register of European Union Trade Marks recording the receipt of the request for conversion, provided that the request for conversion is of a published EUTM application or a registered EUTM.

Article 113(2) EUTMR
Rule 46(1) EUTMIR

After having examined the request for conversion and having found it in order, the Office will register and publish the request for conversion in the European Union Trade Marks Bulletin in Part E.1. for EUTMs and Part E.3. for IRs designating the EC. However, no such publication will be made when the request for conversion is submitted at a time when the EUTM application has not already been published in accordance with Article 39 EUTMR.

Rule 46 EUTMIR

The request for conversion is published only after the Office has completed examination of it and found it to be in order. The request is not in order if there is no payment.

Rule 46(2) EUTMIR

The publication of the application for conversion must contain the indications referred to in Rule 46(2) EUTMIR and, unless it concerns an IR designating the EC, include a reference to the previous publication in the European Union Trade Marks Bulletin and the date of the application for conversion.

Rule 46(2), Rules 122 and 123 EUTMIR

Lists of goods and services for which conversion is requested will not be published if the conversion is for an IR designating the EC.

6.4 Submission to designated offices

Articles 113(3) and 114(1) EUTMR
Rule 47 EUTMIR

Once the Office has completed examination of the request for conversion and has found it to be in order, it will submit the request without delay to the designated offices. The submission will be made irrespective of whether any required publication has already taken place.

The Office will send a copy of the request for conversion and make available an extract of its database containing the data referred to in Rule 84(2) EUTMIR of the converted EUTM or IR. Any central industrial property office to which the request for conversion is submitted may obtain from the Office any additional information concerning the request, enabling that office to make a decision regarding the national trade mark resulting from the conversion.

Rule 47 EUTMIR

At the same time, the Office will inform the conversion applicant of the date of submission to national offices.

In the case of an opting-back conversion, WIPO will deal with the request as a subsequent designation in accordance with Rule 24(6), (7) CR.

If a national office is the designated office, conversion will result in a national application or registration.

Article 114(3) EUTMR

The national law in force for the Member States concerned may provide that the request for conversion be subject to one, or all, of the following requirements:

- payment of a national application fee;
- filing of a translation in one of the official languages of the Member State in respect of the request and its accompanying documents; in particular, for applications for conversion prior to publication of the EUTM, the national office will usually require a translation of the list of goods and services;
- indication of an address for service in the Member State in question;
- submission of a representation of the mark in a number of copies specified by that Member State.

National rules on the appointment of a domestic representative remain applicable. Where use is made of the option to indicate, in the Conversion Form, a representative for the purposes of the procedure before a given national office, that national office will be in a position to communicate directly with that representative so that no separate communication to appoint a domestic representative will be necessary.

Article 114(2) EUTMR

National law may not subject the request for conversion to any formal requirements different from or additional to the requirements provided for in the EUTMR and EUTMIR.

7 Effects of Conversion

Article 112(3) EUTMR

In each Member State concerned, the national trade mark application resulting from the conversion will enjoy the filing date or, if any, the priority date of the EUTM application, as well as the seniority of an earlier trade mark with effect for that State validly claimed for the EUTM application or registration under Article 34 or 35 EUTMR. For information on conversion of a EUTM into national trade mark applications for new Member States see the Guidelines, Part A, General Rules, Section 9, Enlargement.

In the event of an opting-back conversion, the international application resulting from the subsequent designation of the Member State under Rule 24(6)(e), (7) CR will enjoy the original date of the IR designating the EC, that is, either the actual date of the IR (including, if appropriate, its priority date) or the date of the subsequent designation of the EC.

However, there is no harmonised procedure for how national offices will proceed with the examination of the converted EUTM. As mentioned in the introduction, the conversion procedure is a two-tier system, where the second tier, the conversion procedure itself, is dealt with by the national trade mark and patent offices. Depending on national law, the converted trade mark will either be registered immediately or will enter the national examination, registration and opposition procedure like any other national trade mark application.

National applications deriving from the conversion of an earlier EUTM (application) are considered to come into existence as soon as a valid conversion request is filed. Therefore, in opposition proceedings, such rights will be considered properly identified for admissibility purposes under Rule 18(1) EUTMIR if the opponent indicates the number of the EUTM (application) under conversion and the countries for which it has requested conversion.

When, during opposition or invalidity proceedings on relative grounds, the EUTM application (or EUTM) on which the opposition is based ceases to exist (or the list of goods and services is restricted), but at the same time a request for conversion is filed, the opposition or invalidity proceedings can continue. This is because national trade mark registrations resulting from a conversion of a EUTM application (or EUTM) can constitute the basis of the opposition or invalidity procedure originally made on the basis of that EUTM application or registration (see decision of the Grand Board of Appeal in R 1313/2006-G) (see also the Guidelines, Part C, Opposition, Section 1, Procedural Matters).

***GUIDELINES FOR EXAMINATION OF
EUROPEAN UNION TRADE MARKS***

***EUROPEAN UNION
INTELLECTUAL PROPERTY OFFICE
(EUIPO)***

PART E

REGISTER OPERATIONS

SECTION 3

EUTMs AS OBJECTS OF PROPERTY

CHAPTER 1

TRANSFER

Table of Contents

1	Introduction	4
1.1	Transfers	5
1.1.1	Assignment.....	5
1.1.2	Inheritance.....	5
1.1.3	Merger.....	5
1.1.4	Applicable Law.....	5
1.2	Application to record a transfer	6
2	Transfers v Changes of Name	6
2.1	Erroneous application to record a change of name	7
2.2	Erroneous application to record a transfer	8
3	Formal and Substantive Requirements of an Application to Record a Transfer	8
3.1	Languages	8
3.2	Application filed for more than one mark	9
3.3	Parties to the proceedings	10
3.4	Formal requirements	10
3.4.1	Indication of the registration number.....	10
3.4.2	Particulars of the new proprietor.....	10
3.4.3	Name and address of the representative.....	11
3.4.4	Signatures.....	12
3.5	Proof of transfer	13
3.6	Substantive requirements	14
3.7	Procedure to remedy deficiencies	14
4	Partial Transfers	15
4.1	Rules on the distribution of the lists of goods and services	15
4.2	Objections	16
4.3	Creation of a new EUTM application or registration	17
5	Transfer During the Course of Other Proceedings and Fees Issues ..	17
5.1	Specific issues of partial transfers	17
5.2	Transfer and <i>inter partes</i> proceedings	19
6	Entry in the Register, Notification and Publication	19
6.1	Entry in the Register	19
6.2	Notification	20
6.3	Publication	21

7	Transfers for Registered Community Designs	21
7.1	Rights of prior use for an RCD	21
7.2	Fees	22
8	Transfers for International Trade Marks	22

1 Introduction

Articles 1(2), Article 17(1) and Article 24 EUTMR
Article 28 CDR
Article 23 CDIR

A transfer is the change in ownership of the property rights in a European Union trade mark (EUTM) or an EUTM application from one entity to another. EUTMs and EUTM applications may be transferred from the current proprietor to a new proprietor, primarily by way of assignment or legal succession. The transfer may be limited to some of the goods or services for which the mark is registered or applied for (partial transfer). In contrast to a licence or conversion, a transfer of an EUTM cannot affect the unitary character of the EUTM. Therefore, an EUTM cannot be 'partially' transferred for **some** territories or Member States.

The provisions in the CDR and CDIR dealing with the transfer of designs are almost identical to the equivalent provisions of the EUTMR and EUTMIR, respectively. Therefore, the following applies *mutatis mutandis* to Community designs, with the few exceptions and particularities laid down in paragraph 7 below.

Article 16, Article 17(5), (6) and (8), Article 24 and Article 87(1) to Article 87(3)(g) EUTMR
Rule 31(8) EUTMIR

Upon request, transfers of registered EUTMs are entered in the Register and transfers of EUTM applications are noted in the files.

The rules on registering transfers and on legal effects of transfers apply both to EUTMs and to EUTM applications. The major difference is that the regulations stipulate that when an EUTM application is transferred, the transfer will be recorded in the file of the application rather than in the Register. However, in practice, changes in the ownership of an EUTM application or EUTM are recorded in the same database. While these Guidelines generally make no distinction between the transfer of EUTMs and EUTM applications, special references will be included where the treatment of EUTM applications differs from that of EUTMs.

According to Article 17 EUTMR, registering a transfer is not a condition for its validity. However, if a transfer is not registered by the Office, the entitlement to act remains with the registered proprietor, meaning, *inter alia*, that the new proprietor will not receive communications from the Office, in particular during *inter partes* proceedings or the notification of the renewal term of the mark. Furthermore, according to Article 16 EUTMR, in all aspects of the EUTM as an object of property that are not further defined by provisions of the EUTMR, the proprietor's address defines the applicable subsidiary national law. For all these reasons, it is important to register a transfer at the Office to ensure that entitlement to EUTMs and applications is clear.

1.1 Transfers

Article 17(1) and (2) EUTMR

A transfer of an EUTM involves two aspects, namely the validity of the transfer between the parties and the impact of a transfer on proceedings before the Office, such impact being triggered only after the entry of the transfer in the Register (or the files) (see paragraph 1.2 below).

As concerns the validity of the transfer between the parties, the EUTMR allows an EUTM to be transferred independently of any transfer of the undertaking to which it belongs (see also judgment of 30/03/2006, C-259/04, 'Elizabeth Emanuel', paras 45 and 48).

1.1.1 Assignment

Article 17(3) EUTMR

When a transfer is made by an assignment, except where the assignment is the result of a court decision, the former is only valid where the assignment is made in writing and is signed by both parties. This formal requirement for the validity of the transfer of an EUTM is applicable irrespective of whether, under the national law governing transfers of (national) trade marks, an assignment is valid even without observing a particular form, such as the need for the transfer to be in writing and have the signatures of both parties.

1.1.2 Inheritance

When the proprietor of an EUTM or EUTM application dies, the heirs will become proprietors of the registration or application by way of individual or universal succession. This is also covered by the rules on transfers.

1.1.3 Merger

Similarly, a universal succession exists when there is a merger between two companies that leads to the formation of a new company or an acquisition by one company taking over another. Where the whole of the undertaking to which the mark belongs is transferred, there is a presumption that the transfer includes the EUTM unless, in accordance with the law governing the transfer, an agreement to the contrary was made or unless circumstances clearly dictate otherwise.

1.1.4 Applicable Law

Article 16 EUTMR

Unless provided otherwise by the EUTMR, transfers are subject to the national law of a Member State determined by Article 16 EUTMR. The national law declared applicable

in that provision is the national law in general and, therefore, also includes private international law, which in turn may refer to the law of another State.

1.2 Application to record a transfer

Article 17(5) to (8) EUTMR
Rule 31 EUTMIR

A transfer becomes relevant in proceedings before the Office if an application to record a transfer has been made and the transfer has been entered in the Register or, for EUTM applications, recorded in the EUTM application file.

Article 17(7) EUTMR

However, in the period between the date when the Office receives the application to record a transfer and the date of registering the transfer, the new proprietor may already make submissions to the Office with a view to observing time limits. If, for example, a party has applied to register the transfer of an EUTM application for which the Office has raised objections on absolute grounds, the new proprietor may reply to the objections (see paragraph 5 below).

This part of the Guidelines covers proceedings relating to the recordal of transfers. In the course of the examination of an application for recordal of a transfer, the Office will only examine whether sufficient evidence of the transfer has been submitted. The Office will not examine whether the transfer itself is valid.

2 Transfers v Changes of Name

Rule 26 EUTMIR and Article 48a EUTMR

A transfer must be distinguished from a change of name of the proprietor.

An application for the change of name of a proprietor of an EUTM registration or application is dealt with in separate proceedings. For more information on changes of name see the Guidelines, Part B, Examination, Section 2, Formalities, paragraph 7.3.

Rule 26(1) EUTMIR

In particular, no transfer is involved when a natural person changes their name due to marriage, or following an official procedure for changing a name, or when a pseudonym is used instead of the civil name, etc. In all these cases, the identity of the proprietor is not affected.

Where the name or the corporate status of a legal person changes, the criterion for distinguishing a transfer from a mere change of name is whether or not the identity of the legal person remains the same (in which case it will be registered as a change of name) (see decision of 06/09/2010, R 1232/2010-4 – ‘Cartier’, paras 12-14). In other words, where there is no termination of the legal entity (e.g. in the event of a merger by

acquisition, where one company is completely absorbed by the other and ceases to exist) and no start-up of a new legal entity (e.g. following the merger of two companies leading to the creation of a new legal entity), there is only a change in the formal corporate organisation that already existed, and not in the actual identity itself. Therefore, the change will be registered as a change of name, where necessary.

For example, if an EUTM is in the name of Company A and as the result of a **merger** this company is absorbed by Company B, there is a **transfer** of assets from Company A to Company B.

Likewise, during a **division** of Company A into two separate entities, one being the original Company A and the other being a new Company B, if the EUTM in the name of Company A becomes the property of Company B, there is a **transfer** of assets.

Normally, there is no transfer if the company registration number in the national register of companies remains the same.

Likewise, there is in principle the prima facie presumption that there is a transfer of assets if there is a change of country (see, however, decision of 24/10/2013, R 0546/2012-1 – ‘LOVE et al’).

If the Office has any doubt about the applicable national law governing the legal person concerned, it may require appropriate information from the person applying to register the change of name.

Therefore, unless it is ruled to the contrary under the national law concerned, the change of company type, provided that it is not accompanied by a transfer of assets carried out by means of a merger or an acquisition, will be treated as a change of name and not as a transfer.

On the other hand, if the change of company type is the result of a merger, a division or a transfer of assets, depending on which company absorbs or is separated from the other or on which company transfers which assets to the other, this may be a case of transfer.

2.1 Erroneous application to record a change of name

Article 133(1) EUTMR Rule 26(1), (5) and (7) EUTMIR and Article 48a EUTMR
--

When an application is made to record a change of name, but the evidence shows that what is involved is actually a transfer for an EUTM or EUTM application, the Office informs the recordal applicant accordingly and invites it to file an application to record a transfer, which is free of charge. Such a transfer is, however, subject to the payment of a fee when related to the transfer of a Design (see paragraph 7 below). The communication sets a time limit, in general, of two months starting from the date of its notification. If the recordal applicant agrees or does not submit evidence to the contrary and files the corresponding application to record a transfer, the transfer will be recorded. If the recordal applicant does not modify its request, that is to say if it insists on recording the change as a change of name, or if it does not respond, the application to record a change of name will be rejected. The party concerned may file an appeal

against this decision. (See Decision 2009-1 of 16 June 2009 of the Presidium of the Boards of Appeal regarding Instructions to Parties in Proceedings before the Boards of Appeal).

A new application to record the transfer may be filed at any time.

2.2 Erroneous application to record a transfer

Rule 31(1) and (6) EUTMIR

When an application is made to record a transfer, but what is involved is actually a change of name for an EUTM or EUTM application, the Office informs the recordal applicant accordingly and invites it to give its consent to record the indications concerning the proprietor in the files kept by the Office or in the Register as a change of name. That communication sets a time limit, in general, of two months starting from the date of its notification. If the recordal applicant agrees, the change of name will be recorded. If the recordal applicant does not agree, that is to say, if it insists on recording the change as a transfer, or if it does not respond, the application to record a transfer will be rejected.

3 Formal and Substantive Requirements of an Application to Record a Transfer

The Office strongly recommends that the online Recordal application form be used when applying to record a transfer. The form is free of charge and can be downloaded from the Office's web site (<http://www.oami.europa.eu>).

Since the entry into force of Regulation No 1042/05 there is no need to pay a fee to register a transfer.

3.1 Languages

The application for registration of a transfer must be filed:

Rule 95 and Rule 96(1) EUTMIR

- when it relates to an EUTM application, in the first or the second language indicated in the EUTM application;
- when it relates to a registered EUTM, in one of the languages of the Office.

When the application relates to more than one EUTM application, the recordal applicant must select a language for the application that is common to all the EUTMs concerned. If there is no common language, separate applications for transfer must be filed.

When the application relates to at least one EUTM registration, the recordal applicant must select one of the five languages of the Office.

Rule 76(3) EUTMIR

When expressly required by the Office, authorisations may be filed in any official language of the Union.

Rule 96(2) EUTMIR

Any supporting documents may be filed in any official language of the Union. This applies to any document submitted as proof of the transfer such as a countersigned transfer document or a transfer certificate, a deed of assignment or an extract from a trade register or a declaration agreeing to record the successor in title as the new proprietor.

Rule 98 EUTMIR

When the supporting documents are not submitted in either an official language of the Union or in the language of the proceedings, the Office may require a translation into the language of the proceedings or, at the choice of the recordal applicant, into any language of the Office. The Office will set a time limit of two months from the date of notification of the respective communication. If the translation is not submitted within the time limit, the document will not be taken into account and will be deemed not to have been submitted.

3.2 Application filed for more than one mark

Rule 31(7) EUTMIR

Provided that both the original proprietor and the new one are the same in each case, then the recordal applicant can file a single application to record a transfer for several EUTMs or EUTM applications. This has the advantages that the various references only have to be given once and that only one decision needs to be taken.

Separate applications are necessary when the original proprietor and the new one are not strictly identical for each mark. This is the case, for example, where there is one successor in title for the first mark and there are multiple successors in title for another mark, even if the successor in title for the first mark is among the successors in title for the other mark. It is immaterial whether the representative is the same in each case.

When a single application is filed in such cases, the Office will issue a deficiency letter. The recordal applicant may overcome the objection either by limiting the application to those EUTMs or EUTM applications for which there is but one and the same original proprietor and one and the same new proprietor, or by declaring its agreement that its application should be dealt with in two or more different proceedings. Otherwise, the application will be rejected in its entirety. The party concerned may file an appeal against this decision.

3.3 Parties to the proceedings

Article 17(5) EUTMR
Rule 31(5) EUTMIR

The application to record a transfer may be filed by the original proprietor(s) (the EUTM owner(s) as appearing in the Register or the EUTM applicant(s) as appearing in the EUTM application file) or by the new proprietor(s) (the 'successor in title', that is to say, the person(s) who will appear as the proprietor(s) when the transfer is recorded).

The Office will usually communicate with the recordal applicant(s). In cases of doubt, the Office may require clarification from all the parties.

3.4 Formal requirements

Rule 1(1)(b), Rule 31(1) and (2), Rule 79 EUTMIR

An application to record a transfer must contain:

- the registration or application number of the EUTM registration or application;
- the new proprietor's particulars;
- where the new proprietor appoints a representative, the representative's name and business address;
- the signature(s) of the person(s) requesting the recordal;
- proof of the transfer as set out in paragraph 3.5 below.

For additional requirements in cases of a partial transfer, see paragraph 4.

3.4.1 Indication of the registration number

Rule 31(1)(a) EUTMIR

The registration number of the trade mark must be indicated.

3.4.2 Particulars of the new proprietor

Rules 1(1)(b) and 31(1)(b) EUTMIR

The particulars of the new proprietor that have to be indicated are the name, address and nationality in the case of a physical person. In the case of a legal entity, the recordal applicant must indicate the official designation and must include the legal form of the entity, which may be abbreviated in a customary manner (for example, S.L., S.A, Ltd., PLC, etc.). Both natural persons and legal entities must indicate the State in which they are domiciled or have their seat or an establishment. **The Office strongly recommends indicating the State of Incorporation for US companies, where applicable, in order to differentiate clearly between different owners in its database.** These particulars correspond to the indications required in respect of an

applicant for a new EUTM application. However, where the Office has already attributed an ID number to the new proprietor, indicating that number together with the name of the new proprietor is sufficient.

The form made available by the Office also requests an indication of the original proprietor's name. This indication will facilitate both the Office's and the parties' handling of the file.

3.4.3 Name and address of the representative

Rule 77 EUTMIR
Article 93(1) EUTMR
Rule 76(4) EUTMIR

Applications to record a transfer may be filed and signed by representatives on behalf of the EUTM proprietor or the new proprietor.

When the new proprietor appoints a representative, who signs the application, either the Office or, in the context of *inter partes* proceedings, the other party to the proceedings may request an authorisation. In this event, if the representative does not submit an authorisation, the proceedings will continue as if no representative had been appointed.

When the original proprietor's representative is also appointed as the new proprietor's representative, the representative may sign the application on behalf of both the original proprietor and the new one. The representative may also be called upon to file an authorisation signed by the new proprietor.

Articles 92(3) and 93(1) EUTMR

The foregoing applies not only to representatives within the meaning of Article 93 EUTMR (legal practitioners and professional representatives whose names are entered on the list maintained by the Office), but also to any employee acting on behalf of the employer or, under the conditions of Article 92(3) EUTMR, on behalf of a legal person (company) that has economic connections with the employer.

Rule 77 and Rule 83(1)(h) EUTMIR

A general authorisation in the form made available by the Office will be considered sufficient for granting authorisation to file and sign applications for registration of transfers.

An individual authorisation will be checked to see that it does not exclude the authority to apply for a registration of a transfer.

Article 92(2) EUTMR

When the recordal applicant is the new proprietor and that new proprietor does not have either its domicile or its principal place of business or a real and effective

industrial or commercial establishment in the European Economic Area, for the purposes of the procedure to register the transfer it must be represented by a person entitled to represent third parties before the Office (legal practitioner or professional representative whose name is entered on the list maintained by the Office). For details of who may represent, see the Guidelines, Part A, General Rules, Section 5, Professional Representation.

3.4.4 Signatures

Article 92(4) EUTMR
Rule 31(1)(d), Rule 31(5) and Rule 79 EUTMIR

The requirements concerning the person entitled to file the application and the signature must be seen in conjunction with the requirement to submit proof of the transfer. The principle is that the signatures of the original proprietor or proprietors and the new proprietor or proprietors must appear together or separately on the application or in an accompanying document. In the case of co-ownership, all co-owners must sign or appoint a common representative.

Rule 31(5)(a) EUTMIR

When the original proprietor and the new proprietor both sign the application, this is sufficient and no additional proof of the transfer is necessary.

Rule 31(5)(b) EUTMIR

When the new proprietor is the recordal applicant and where the application is accompanied by a declaration signed by the original proprietor that it agrees to the recording of the successor in title as the new proprietor, this is also sufficient and no additional proof is necessary.

When the original proprietor's representative is also appointed as the new proprietor's representative, the representative may sign the application on behalf of both the original proprietor and the new one, and no additional proof is necessary. However, when the representative signing on behalf of both the original and the new proprietor is not the representative on file (i.e. in an application simultaneously appointing the representative and transferring the EUTM), the Office will contact the recordal applicant to request evidence of the transfer (authorisation signed by the original proprietor, proof of transfer, confirmation of the transfer by the original owner or its representative on file).

3.5 Proof of transfer

Article 17(2) and (3) EUTMR
Rules 31(1)(d) and (5)(a) to (c) and 83(1)(d) EUTMIR

A transfer may be registered only when it is proven by documents duly establishing the transfer, such as a copy of the deed of transfer. However, as already highlighted above, filing a copy of the deed of transfer is not necessary:

- when the new proprietor or its representative submits the application to record the transfer on its own and when the application is accompanied by a written declaration signed by the original proprietor (or its representative) that it agrees to the recordal of the transfer; or
- when the application to record the transfer is signed by both the original proprietor (or its representative) and by the new proprietor (or its representative); or
- when the application to record the transfer is accompanied by a completed transfer (recordal) form or document signed by both the original proprietor (or its representative) and by the new proprietor (or its representative).

Parties to the proceedings may also use the forms established under the Trademark Law Treaty available on WIPO's web site (<http://www.wipo.int/treaties/en/ip/tlt/forms.html>). These forms are the transfer document — a document conceived as constituting the transfer (assignment) itself — and the transfer certificate — a document in which the parties to a transfer declare that a transfer has taken place. Either of these documents, duly completed, constitutes sufficient proof of transfer.

However, other means of proof are not excluded. Therefore, the agreement (deed) itself or any other document proving the transfer may be submitted.

When the mark has been subject to multiple successive transfers and/or changes of the owner's name and these have not been previously recorded in the register, it is sufficient to submit the chain of evidence showing the events leading to the relationship between the old proprietor and the new proprietor without the need to file separate individual recordal applications for each change.

When the transfer of the mark is the consequence of the transfer of the whole of the undertaking of the original proprietor, and unless proof is provided as indicated above, the document showing the transfer or assignment of the whole undertaking must be submitted.

When the transfer is due to a merger or another universal succession, the original proprietor will not be available to sign the application. In these cases, the application must be accompanied by supporting documents that prove the merger or universal succession, such as extracts from the trade register, etc. The Office may abstain from requiring additional proof where the facts are already known to the Office, for example in parallel proceedings.

When the transfer of the mark is a consequence of a right *in rem*, levy of execution or insolvency proceedings, the original proprietor will not be able to sign the application. In

these cases, the application must be accompanied by a final court judgment transferring the ownership of the mark to the beneficiary.

Supporting documents need not be legalised, nor is it necessary to submit the original of a document. Original documents become part of the file and, therefore, cannot be returned to the person who submitted them. Simple photocopies are sufficient.

If the Office has reason to doubt the accuracy or veracity of the document, it may require additional proof.

The Office will examine the documents only to the extent that they actually prove what is indicated in the application, namely the identity of the marks concerned and the identity of the parties, and whether a transfer is involved. The Office does not consider or rule on contractual or legal questions arising under national law (see judgment of 09/09/2011, T-83/09, 'Craic', para. 27). If doubts arise, it is the national courts that deal with the legality of the transfer itself.

3.6 Substantive requirements

Article 17(4) EUTMR

The Office will not register the transfer where it is clear from the transfer documents that because of the transfer the European Union trade mark is likely to mislead the public concerning the nature, quality or geographical origin of the goods or services for which it is registered unless the new proprietor agrees to limit registration of the European Union trade mark to goods or services for which it is not likely to be misleading.

For more information on Office practice in relation to Article 7(1)(g) EUTMR, see the Guidelines, Part B, Examination, Section 4, Absolute Grounds for Refusal.

3.7 Procedure to remedy deficiencies

Article 17(7) EUTMR
Rules 31(6) and 67(1) EUTMIR

Where any of the deficiencies outlined above are noted, the Office will invite the recordal applicant to remedy the deficiency within a time limit of two months, starting from the date of the notification. The notification will be addressed to the person who filed the application to record the transfer or, where that person has appointed a representative, to the representative. The Office will not automatically inform the other party to the transfer, unless this is appropriate under the circumstances.

When the recordal applicant fails to remedy the deficiency or to submit the necessary additional proof, or where it is unable to convince the Office that the objections are not well founded, the Office will reject the application. The party concerned may file an appeal against this decision.

4 Partial Transfers

Article 17(1) EUTMR
Rule 32 EUTMIR

A partial transfer concerns only some of the goods and services in the EUTM or EUTM application. It involves the distribution of the original list of goods and services between the remaining EUTM registration or application and a new one. When partial transfers are involved, the Office uses particular terminology to identify the marks. At the beginning of the proceedings there is the 'original' mark. This is the mark for which a partial transfer has been applied for. After the registration of the transfer, there are two marks: one is a mark that now has fewer goods and services, and is called the 'remaining' mark, and one is a 'new' mark that has some of the goods and services from the original mark. The 'remaining' mark retains the EUTM number of the 'original' mark while the 'new' mark has a new EUTM number.

Transfer cannot affect the unitary character of the EUTM. Therefore, an EUTM cannot be 'partially' transferred for **some** territories.

When there are doubts as to whether the transfer is partial or not, the Office will inform the transfer recordal applicant and invite it to make the necessary clarifications.

Partial transfers may also be involved when the transfer application concerns more than one EUTM or EUTM application. The following rules apply for each EUTM or EUTM application included in the transfer application.

4.1 Rules on the distribution of the lists of goods and services

Articles 28 and 43 EUTMR
Rule 32(1) EUTMIR

In the application to record a partial transfer, the goods and services to which the partial transfer relates must be indicated (the list of goods and services for the 'new' registration). The goods and services must be distributed between the original EUTM or EUTM application and a new EUTM or EUTM application so that the goods and services in the original EUTM or EUTM application and the new one do not overlap. The two specifications taken together must not be broader than the original specification.

Therefore, the indications must be clear, precise and unequivocal. For example, when an EUTM for goods or services in several classes is involved, and the 'split' between the old and new registration concerns entire classes, it is sufficient to indicate the respective classes for the new registration or for the remaining one.

When the application for a partial transfer indicates goods and services that are explicitly mentioned in the original list of goods and services, the Office will automatically retain the goods and services that are not mentioned in the transfer application for the original EUTM or EUTM application. For example, the original list contains goods A, B and C, and the transfer application relates to C; the Office will keep goods A and B in the original registration and create a new registration for C.

In accordance with Communication No 2/12 of the President of the Office of 20/06/2012, EUTMs filed prior to the 21/06/2012 claiming a particular class heading are considered to cover all the goods and services of the alphabetical list of that class in the edition of the Nice Classification in force at the time when the filing was made (see Communication No 2/12, paras V and VI).

When the application for a partial transfer indicates goods or services that are not expressly mentioned in the original list but fall under the literal meaning of a general indication contained therein, this will be acceptable provided that the list is not broadened. For the assessment of whether there is limitation or a broadening of scope of the list, the rules generally applicable in such situations apply (see the Guidelines, Part B, Examination, Section 3, Classification).

However, marks filed on or after 21/06/2012 claiming only the general indications of a particular class heading will be considered to cover the literal meaning of that class heading and may only be partially transferred accordingly (see Communication No 2/12 paras VII and VIII).

Marks filed after 21/06/2012 claiming the general indications of a particular class heading plus the alphabetical list will be considered to cover the literal meaning of that class heading plus the alphabetical list of goods and services concerned of that class in the edition of the Nice Classification in force at the time when the filing was made and may only be partially transferred accordingly (see Communication No 2/12 paras VII and VIII).

In all cases it is highly recommended to file a clear and precise list of goods and services to be transferred as well as a clear and precise list of goods and services to remain in the original registration. Furthermore, the original list must be clarified. For example, if the original list related to 'alcoholic beverages' and the transfer relates to 'whisky' and 'gin', the original list must be amended by restricting it to 'alcoholic beverages, except whisky and gin'.

4.2 Objections

Rules 31(6) and 32(3) EUTMIR

When the application does not comply with the rules explained above, the Office will invite the recordal applicant to remedy the deficiency. If the deficiencies are not remedied, the Office will reject the application. The party concerned may file an appeal against this decision.

When the exchange of communications leads to a list of goods and services for the remaining registration that is different from the list filed in the EUTM application, the Office will communicate not only with the new proprietor, if it is the party requesting the registration of the partial transfer, but also with the original proprietor, who remains the person who may dispose of the list of goods and services of the original registration. The Office will make any change to the original list of goods and services subject to the agreement of the original proprietor. If the agreement is not submitted within the time limit set by the Office, the application to record a transfer will be rejected. The party concerned may file an appeal against this decision.

4.3 Creation of a new EUTM application or registration

Article 88 EUTMR
Rule 32(4) EUTMIR

A partial transfer leads to the creation of a new EUTM application or registration. For this ensuing EUTM application or registration, the Office will establish a separate file, which will consist of a complete copy of the electronic file of the original EUTM application or registration, the application for registration of a transfer, and all the correspondence related to the transfer application. The ensuing EUTM application or registration will be given a new file number. It will have the same filing date and, where applicable, priority date as the original EUTM application or registration. If the partial transfer relates to an EUTM application, the ensuing EUTM application is subject to the provisions for inspection of files in Article 88 EUTMR.

As far as the original EUTM application or registration is concerned, the Office will include a copy of the application to record a transfer in its files, but will generally not include copies of the further correspondence relating to that application.

5 Transfer During the Course of Other Proceedings and Fees Issues

Article 17(6) and (7) EUTMR

Without prejudice to the right to act from the time when the application for registration of a transfer is received by the Office where time limits are involved, the new proprietor will automatically become party to any proceedings involving the mark in question from the time the transfer is registered.

The filing of an application to record a transfer has no effect on time limits already running or set by the Office, including time limits for the payment of fees. New time limits for payment will not be set. From the date of registration of the transfer, the new proprietor becomes liable to pay any fees due.

Therefore, during the period between filing the application to record a transfer and the Office's confirmation of its actual entry in the Register or in the file, it is important that the original proprietor and the new proprietor actively collaborate in communicating time limits and correspondence received during *inter partes* proceedings.

5.1 Specific issues of partial transfers

Rule 32(5) EUTMIR

In cases of partial transfers, the ensuing EUTM or EUTM application will be at the same procedural stage as the original (remaining) EUTM or EUTM application. Any time limit still pending for the original EUTM or EUTM application will be deemed to be

pending for both the remaining EUTM or application and the new one. After the registration of the transfer the Office will treat each EUTM or EUTM application separately and will decide on them separately.

When an EUTM or EUTM application is subject to the payment of fees and these fees have been paid by the original proprietor, the new proprietor will not be liable to pay any additional fees for the new EUTM or EUTM application. The relevant date is the entry date of the transfer in the register or in the files; therefore, when the fee for the original pending EUTM or EUTM application is paid after filing an application to record a transfer but before the recordal of the transfer itself, no additional fees are due.

Article 26(2) EUTMR
Rule 9(3) and (5) EUTMIR
Annex I A(3) and (4), Annex I A(7) and (8) EUTMR

When the partial transfer involves an EUTM application and class fees have not yet been paid or have not been paid in full, the Office will proceed to record the transfer in the files of the remaining EUTM application and to create a new EUTM application as described above.

Where additional class fees have to be paid for an EUTM application, the examiner will deal with such cases after recording the transfer in the files and creating a new EUTM application, as described below.

When additional class fees were paid prior to recording the transfer but no additional class fees were due for the remaining EUTM application, no reimbursement will be made because the fees were paid correctly at the time of payment.

In all other cases, the examiner will treat the remaining EUTM application and the new one separately, but without requesting a further basic fee to be paid for the new application. Class fees for the remaining EUTM application and for the new one will be determined pursuant to the situation existing after the registration of the transfer. For example, when the original application had seven classes and after the transfer the remaining application has only one class while the new application has six, no additional class fees will be due for the remaining application, but the corresponding additional class fees must be paid for the new application. When some of the goods and services of a particular class are transferred and others are not, then the fees for that class become payable for both the remaining application and the new one. When a time limit to pay additional class fees has already been set but not yet expired, it will be set aside by the Office to allow the determination to be made on the basis of the situation after the registration of the transfer.

Article 47(1), (3) to (5) and (7) to (8) EUTMR

When the application to record a partial transfer relates to an EUTM registration that is due for renewal, that is, within six months prior to the expiry of the original registration and up to six months after that expiry, the Office will proceed to record the transfer and deal with the renewal and renewal fees as described below.

When no renewal request has been filed and no fees have been paid prior to the recording of the transfer, the general rules including the rules relating to payment of

fees are applicable both to the remaining EUTM registration and to the new one (separate requests, separate payment of fees, as necessary).

When a renewal request has been filed prior to the registration of the transfer, that request is also valid for the new EUTM. However, while the original proprietor remains a party to the renewal proceedings for the remaining EUTM, the new proprietor automatically becomes party to the renewal proceedings for the new registration.

In these situations, when a renewal request has been filed but the relevant fees have not been paid prior to the registration of the transfer, the fees to be paid are determined pursuant to the situation after the registration of the transfer. This means that both the proprietor of the remaining EUTM and the proprietor of the new EUTM must pay the basic renewal fee and any class fees.

When not only a renewal request has been filed prior to the registration of the transfer but also all the applicable renewal fees have been paid prior to this date, no additional renewal fees are due after the registration of the transfer. Furthermore, no reimbursement is made of any class fees already paid.

5.2 Transfer and *inter partes* proceedings

When an application to record a transfer is filed during *inter partes* proceedings, several different situations can arise. For earlier EUTM registrations or applications on which the opposition/cancellation is based, the new proprietor can only become party to the proceedings (or file observations) once the application to record the transfer has reached the Office. The basic principle is that the new proprietor substitutes the original proprietor in the proceedings. The practice of the Office when dealing with transfers in oppositions is described in the Guidelines, Part C, Opposition, Section 1, Procedural Matters, paragraph 6.5.

6 Entry in the Register, Notification and Publication

6.1 Entry in the Register

Article 17(5) and Article 87(3)(g) EUTMR Rule 31(8) EUTMIR

When the application to record a transfer fulfils all requirements, if it concerns a registered EUTM, the transfer will be entered in the Register, while if it concerns an EUTM application, the Office will record the transfer in the corresponding file.

The entry in the Register will contain the following data:

- the registration date of the transfer,
- the new proprietor's name and address,
- the name and address of the new proprietor's representative, if any.

For partial transfers, the entry will also contain the following data:

- a reference to the number of the original registration and the number of the new registration,
- the list of goods and services remaining in the original registration, and
- the list of goods and services of the new registration.

6.2 Notification

The Office will notify the recordal applicant of the recordal of the transfer.

If the application for recordal of a transfer is related to at least one EUTM application, the notification will contain the appropriate reference to the relevant recording of the transfer in the files kept by the Office.

As regards notifying the other party, there is a distinction between total transfers and partial transfers.

Articles 17(5) and 87(6) EUTMR

In cases of a total transfer, the notification will be sent to the party who submitted the application to register the transfer, that is to say, to the recordal applicant.

There will be no information to the other party:

- when the original proprietor's representative is also the new proprietor's appointed representative (in such a case the representative will receive one communication on behalf of both parties); or
- when the original proprietor has ceased to exist (death, merger).

In all other cases, the other party will be informed of the outcome of the procedure, that is, the registration of the transfer. The other party will not receive information during the course of the proceedings unless serious doubts arise concerning the legality of the application to record the transfer or the transfer itself.

Rule 32(3) and (4) EUTMIR

In cases of a partial transfer, both the proprietor of the remaining EUTM and the proprietor of the new EUTM must receive notification, because necessarily two EUTM applications or registrations are concerned. Therefore, a separate notification will be sent to the new applicant for each EUTM application that has been transferred partially. In the case of a partial transfer of an EUTM registration, the Office will notify the new proprietor for each registration, containing, as appropriate, indications concerning the payment of renewal fees. A separate notification will be issued to the proprietor of the remaining EUTM registration.

Furthermore, where in the case of a partial transfer the list of goods and services that are to remain in the original EUTM application or registration needs to be clarified or amended, such clarification or amendment requires the agreement of the proprietor of the remaining EUTM application or registration (see paragraph 4.2 above).

6.3 Publication

Article 17(5), Article 87(3)(g) and Article 87a(3) EUTMR

For EUTM registrations, the Office publishes the entry in the Register of transfers in Part C of the European Union Trade Marks Bulletin.

Article 39 EUTMR
Rule 12 and Rule 31(8) EUTMIR

When the application to record a transfer relates to an EUTM application that has been published pursuant to Article 39 EUTMR and Rule 12 EUTMIR, the publication of the registration of the mark and the entry in the Register will mention the new proprietor from the outset. The publication of the registration will contain a reference to the earlier publication.

Article 39 EUTMR
Rule 12 EUTMIR

When the transfer relates to an EUTM application that has not been published, the publication pursuant to Article 39 EUTMR and Rule 12 EUTMIR will contain the name of the new proprietor without any indication that the application has been transferred. This also applies when the transfer of an unpublished EUTM application is a partial transfer.

7 Transfers for Registered Community Designs

Article 1(3) and Articles 27, 28, 33 and 34 and Article 107(2)(f) CDR
Article 23 and Article 61(2) and Articles 68(1)(c) and 69(2)(i) CDIR
Annex Nos 16, 17 CDFR

The legal provisions contained in the CDR, CDIR and CDFR for transfers correspond to the respective provisions in the EUTMR and EUTMIR.

Therefore, both the legal principles and the procedure for recording trade mark transfers apply *mutatis mutandis* to Community designs.

There are only a few exceptions and specificities, which are detailed below.

7.1 Rights of prior use for an RCD

Article 22(4) CDR

The right of prior use for an RCD cannot be transferred except where the third person, who owned the right before the filing or priority date of the application for an RCD, is a

business, along with that part of the business in the course of which the act was done or the preparations were made.

7.2 Fees

Annex Nos 16 and 17 CDFR

The fee of EUR 200 for recording a transfer applies per design and not per multiple application. The same is true for the ceiling of EUR 1 000 if multiple requests are submitted.

Example 1: Out of a multiple application for 10 designs, 6 designs are transferred to the same successor in title. The fee is EUR 1 000, provided either that only one application to record these 6 transfers is filed or that several applications to record transfers are filed on the same day.

Example 2: Out of a multiple application for 10 designs, 5 designs are transferred to the same successor in title. The transfer refers also to another design not contained in that multiple application. The fee is EUR 1 000 provided that:

- only one application to record these 6 transfers is filed or several requests are filed on the same day, and
- the holder of the Community design and the successor in title is the same in all 6 cases.

8 Transfers for International Trade Marks

The Madrid System allows for the 'change of ownership' of an international registration. All applications to record a change in ownership should be submitted on form MM5 either directly to the International Bureau by the holder on record or to the national office of the holder on record or to the national office of the new proprietor (transferee). The application to record a transfer cannot be filed directly with the International Bureau by the new proprietor. EUIPO's own Recordal application form should **not** be used.

Detailed information on changes in ownership can be found in paras B.II.60.01 to 67.02 of the Guide to the International Registration of Marks under the Madrid Agreement and the Madrid Protocol (www.wipo.int/madrid/en/guide/).

***GUIDELINES FOR EXAMINATION OF
EUROPEAN UNION TRADE MARKS***

***EUROPEAN UNION
INTELLECTUAL PROPERTY OFFICE
(EUIPO)***

PART E

REGISTER OPERATIONS

SECTION 3

EUTMs AS OBJECTS OF PROPERTY

CHAPTER 2

LICENCES

Table of Contents

1	Introduction.....	3
1.1	Licence contracts.....	3
1.2	Applicable law.....	3
1.3	Advantages of the registration of a licence.....	4
2	Registration of a Licence for an EUTM or EUTM application.....	5
2.1	Form, requests for more than one licence.....	5
2.2	Languages.....	5
2.3	Fees.....	6
2.4	Applicants and mandatory content of the application.....	6
2.4.1	Applicants.....	6
2.4.2	Mandatory indications concerning the licensed EUTM and the licensee.....	7
2.4.3	Requirements concerning the person who makes the request – Signature, proof of the licence, representation.....	7
2.4.3.1	Request made by the EUTM proprietor alone.....	7
2.4.3.2	Request made jointly by the EUTM proprietor and the licensee.....	8
2.4.3.3	Request made by the licensee alone.....	8
2.4.3.4	Proof of the licence.....	8
2.4.4	Representation.....	9
2.5	Optional contents of the request.....	10
2.6	Examination of the request for registration.....	11
2.6.1	Fees.....	11
2.6.2	Examination of the mandatory formalities.....	11
2.6.3	Examination of optional elements.....	12
2.7	Registration procedure and publications.....	14
3	Cancellation or Modification of a Licence for an EUTM or an EUTM application.....	15
3.1	Competence, languages, presentation of the request.....	15
3.2	Person making the request.....	15
3.2.1	Cancellation of a licence.....	15
3.2.2	Modification of a licence.....	16
3.3	Contents of the request.....	17
3.4	Fees.....	17
3.4.1	Cancellation of a licence.....	17
3.4.2	Modification of a licence.....	17
3.5	Examination of the request.....	17
3.5.1	Fees.....	17
3.5.2	Examination by the Office.....	18
3.6	Registration and publication.....	18
4	Transfer of a Licence for an EUTM or EUTM application.....	18
4.1	Definition of the transfer of a licence.....	18
4.2	Applicable rules.....	19
5	Registration of Licences for Registered Community Designs.....	19
5.1	Registered Community designs.....	19
5.2	Multiple applications for registered Community designs.....	20
6	Registration of Licences for International Trade Marks.....	20

1 Introduction

Articles 22, 23 and 24 EUTMR Articles 27, 32 and 33 CDR
--

Both registered EUTMs and EUTM applications may be the subject of licensing contracts (licences).

Both registered Community designs (RCDs) and applications for a registered Community design may be the subject of licences.

Paragraphs 1 to 4 below deal with trade mark licences concerning EUTMs and EUTM applications. The provisions in the CDR and CDIR dealing with design licences are almost identical to the equivalent provisions of the EUTMR and EUTMIR respectively. Therefore, the following applies *mutatis mutandis* to Community designs. Exceptions and specificities to Community designs are detailed in paragraph 5 below. Exceptions and specificities to international trade marks are laid down under paragraph 6 below.

1.1 Licence contracts

A trade mark licence is a contract by virtue of which the proprietor or applicant, (hereinafter referred to as the 'proprietor') of a trade mark (the licensor), whilst retaining his proprietorship, authorises a third person (the licensee) to use the trade mark in the course of trade, under the terms and conditions set out in the contract.

A licence refers to a situation where the rights of the licensee in the EUTM arise from a contractual relationship with the proprietor. The proprietor's consent to, or tolerance of, a third party using the trade mark does not amount to a licence.

1.2 Applicable law

Article 16 EUTMR

The EUTMR does not have the competence to establish unified and complete provisions applicable to licences for EUTMs or EUTM applications. Rather, Article 16 EUTMR refers to the law of a Member State, as far as the acquisition, validity and effects of the EUTM as an object of property are concerned. To this end, a licence for an EUTM is, in its entirety and for the whole territory of the Union, assimilated to a licence for a trade mark registered in the Member State in which the EUTM proprietor or applicant has its seat or its domicile. If the proprietor does not have a seat or domicile in a Member State, it will be dealt with as a licence for a trade mark registered in the Member State in which the proprietor has an establishment. If the proprietor does not have an establishment in a Member State, it will be dealt with as a licence for a trade mark registered in Spain.

This, however, applies only to the extent that Articles 17 to 24 EUTMR do not provide otherwise.

Article 16 EUTMR is limited to the effects of a licence as an object of property and does not extend to contract law. Article 16 EUTMR does not govern the applicable law or the

validity of a licensing contract, which means that the freedom of the contracting parties to submit the licensing contract to a given national law is not affected by the EUTMR.

1.3 Advantages of the registration of a licence

Articles 22(5), 23(1) and (2) and 50(3) EUTMR

It is not compulsory to request an entry in the Register when there is a licence agreement. Moreover, when a party to proceedings before the Office has to prove use of a European Union trade mark, if such use has been made by a licensee, it is not necessary for the licence to have been entered in the Register for that use to be deemed to be use with the proprietor's consent pursuant to Article 15(2) EUTMR. However, such a registration has particular advantages.

- a) In view of the provision of Article 23(1) EUTMR, vis-à-vis third parties who might have acquired, or have entered in the Register, rights in the trade mark which are incompatible with the registered licence, the licensee may avail itself of the rights conferred by this licence only:
- if the licence was entered in the EUTM Register, or
 - in the absence of registration of the licence, if the third party had acquired such rights after the date of any legal acts such as referred to in Articles 17, 19 and 22 EUTMR (such as a transfer, a right in rem or a previous licence) knowing of the existence of the licence.
- b) In the case where a licence for an EUTM is entered in the Register, the surrender or partial surrender of that mark by its proprietor will only be entered in the Register if the proprietor establishes that it has informed the licensee of its intention to surrender.

The holder of a licence which is registered has, therefore, the right to be informed in advance by the proprietor of the trade mark of its intention to surrender the trade mark.

- c) In the case where a licence for a European Union trade mark is entered in the Register, the Office will notify the licensee at least six months before the expiry of the registration that the registration is approaching expiry. The Office will also notify the licensee of any loss of rights and of the expiry of the registration, where applicable.
- d) Registering licences and their modification and/or cancellation is important for maintaining the veracity of the Register, particularly in the event of *inter partes* proceedings.

2 Registration of a Licence for an EUTM or EUTM application

Article 22(5) and Article 87(3) EUTMR
Rules 33 and 34 EUTMIR

Both EUTM applications and EUTMs may be the subject of the registration of a licence.

The application for registration of a licence must comply with the following conditions.

2.1 Form, requests for more than one licence

Rule 83(1)(e) and Rule 95(a) and (b) EUTMIR

It is strongly recommended that the request for registration of a licence for an EUTM be submitted on the Office's Recordal Application form. This form is available free of charge in the official languages of the Union. It can be downloaded from the EUIPO website.

Any language version of this form may be used, provided that it is completed in one of the languages referred to in paragraph 2.2 below. This concerns, in particular, the list of goods and services and/or the territory.

Rules 31(7) and 33(1) EUTMIR

A single request for the registration of a licence in respect of two or more registered EUTMs or EUTM applications may be made only if the respective registered proprietor and the licensee are the same and the contracts have the same conditions, limitations and terms in each case (see paragraph 2.5 below).

2.2 Languages

Rule 95(a) EUTMIR

The application for the registration of a licence for an EUTM application may be made in the first or second language of the EUTM application.

Rule 95(b) EUTMIR

The application for the registration of a licence for a registered EUTM must be made in one of the five languages of the Office, namely, English, French, German, Italian or Spanish.

2.3 Fees

Rule 33(1) and (4) EUTMIR
Annex I A(26) EUTMR

The application for the registration of a licence is considered not to have been made until the fee is paid. The amount of this fee is EUR 200 for each EUTM for which the registration of a licence is requested.

However, where several registrations of licences have been requested in one single request and the respective registered proprietor and the licensee are the same and the contractual terms are the same in all cases, the fee is limited to a maximum of EUR 1 000.

The same maximum amount applies where several registrations of licences are applied for at the same time, provided that they could have been filed in one single request and where the respective registered proprietor and the licensee are the same in all cases. Furthermore, the contractual terms must be the same. For example, an exclusive licence and a non-exclusive licence cannot be filed in the same request, even if they are between the same parties.

Once the corresponding fee is paid, the fee will not be reimbursed if the application for registration of the licence is refused or withdrawn.

2.4 Applicants and mandatory content of the application

2.4.1 Applicants

Article 22(5) EUTMR

The registration of a licence may be requested at the Office by:

- a) the proprietor(s) of the EUTM, or
- b) the proprietor(s) of the EUTM jointly with the licensee(s), or
- c) the licensee(s).

The formal conditions with which the request must comply depend on who is making the request. It is recommended that the first or the second of these options be used, since these allow for a speedier and smoother treatment of the request for registration of the licence.

2.4.2 Mandatory indications concerning the licensed EUTM and the licensee

Rule 31 and Rule 33(1) EUTMIR

The request for registration of a licence must contain the following information:

Rule 31(1)(a) and Rule 33(1) EUTMIR

- a) the registration number of the EUTM concerned. If the request relates to several EUTMs, each of the numbers must be indicated.

Rules 1(1)(b) and 31(1)(b) and Rule 33(1) EUTMIR

- b) the licensee's name, address and nationality and the State in which it is domiciled or has its seat or an establishment.

Rule 1(1)(e) and Rules 31(2) and 33(1) EUTMIR

- c) if the licensee designates a representative, the representative's name and ID number allocated by the Office should be indicated. If the representative has not yet been assigned an ID number, the business address must be indicated.

2.4.3 Requirements concerning the person who makes the request – Signature, proof of the licence, representation

Rule 79 and Rule 82(3) EUTMIR

The requirements concerning signature, proof of the licence and representation vary depending on the person who makes the request. Where the requirement of a signature is referred to, in electronic communications, the indication of the sender's name will be deemed to be equivalent to the signature.

2.4.3.1 Request made by the EUTM proprietor alone

Rule 1(1)(b) and Rule 33(1) EUTMIR

When a request is made by the EUTM proprietor alone, it must be signed by the EUTM proprietor. In the case of co-ownership, all co-owners must sign or appoint a common representative.

No proof of the licence is necessary.

The Office will not inform the licensee that the registration of the licence has been requested. It will, however, inform the licensee when the licence is recorded in the Register.

Where the licensee files a statement with the Office in which it opposes the registration of the licence, the Office will transmit the statement to the EUTM proprietor for

information purposes only. The Office will not take any further action on the statement but will register the licence. Following the registration of the licence, any licensee who disagrees with the registration of the licence may use the procedure for requesting the cancellation or amendment of the licence (see paragraph 3 below).

The Office will not take into account whether or not the parties, although having agreed on a licence contract, have agreed to register it at the Office. Any dispute on whether or not and in what manner the licence will be registered is a matter that must be resolved among the parties concerned under the rules of the relevant national law (Article 16 EUTMR).

2.4.3.2 Request made jointly by the EUTM proprietor and the licensee

When the request is made jointly by the EUTM proprietor and its licensee, it must be signed both by the EUTM proprietor and the licensee. In the case of co-ownership, all co-owners must sign or appoint a common representative.

In this case, the signature of both parties constitutes proof of the licence.

Where there is a formal deficiency regarding the signature of the licensee or regarding the representative, the request will still be accepted as long as it would have also been acceptable if it had been presented by the EUTM proprietor alone.

The same applies where there is a deficiency regarding the signature of the EUTM proprietor or regarding its representative but where the request would have been acceptable if it had been presented by the licensee alone.

2.4.3.3 Request made by the licensee alone

The request may also be made by the licensee alone. In this case, it must be signed by the licensee.

In addition, proof of the licence must be submitted.

2.4.3.4 Proof of the licence

There is sufficient proof of the licence if the request for registration of the licence is accompanied by any of the following evidence.

- A declaration that the EUTM proprietor agrees to the registration of the licence, signed by the EUTM proprietor or its representative.

In accordance with Rule 31(5)(a) EUTMIR, it is also considered sufficient proof if the request for registration of the licence is signed by both parties. This case has already been dealt with in paragraph 2.4.3.2 above.

- The licence agreement, or an extract therefrom, indicating the parties and the EUTM being licensed and bearing their signatures.

It suffices if the licence agreement is filed. In many instances, the parties to the licence agreement will not wish to disclose all the details, which may contain

confidential information on the licence royalties or other terms and conditions of the licence. In these cases, it suffices if only a part or an extract of the licence agreement is submitted, as long as it contains the identification of the persons who are parties to the licence agreement, the fact that the EUTM in question is the subject of a licence and the signatures of both parties. All other elements may be omitted or blacked out.

- An uncertified statement of licence using the complete WIPO Model International Form for the Request for Recordal of a Licence (found in the annex to the Joint Recommendation concerning trade mark licences adopted by the Assembly of the Paris Union and the General Assembly of WIPO on 25/09—03/10/2000). The form must be signed by both the EUTM proprietor, or its representative, and the licensee, or its representative. It can be found at:

<http://www.wipo.int/edocs/pubdocs/en/marks/835/pub835.pdf>

It suffices if an uncertified statement of licence on the WIPO model form is filed.

Original documents become part of the file and, therefore, cannot be returned to the person who submitted them. Simple photocopies are sufficient. The original or photocopy does not need to be authenticated or legalised.

Rule 95 and Rule 96(2) EUTMIR

The evidence of the licence must be:

- a) in the language of the Office which has become the language of the proceedings for the registration of the licence, see paragraph 2.1 above;
- b) in any official language of the Union other than the language of the proceedings; in this case the Office may require a translation of the document into a language of the Office to be filed within a period specified by the Office.

Where the supporting documents are not submitted in either an official language of the Union or in the language of the proceedings, the Office may require a translation into the language of the proceedings or, at the choice of the party requesting the registration of the licence, into any language of the Office. The Office will fix a time limit of two months from the date of notification of that communication. If the translation is not submitted within that time limit, the document will not be taken into account and will be deemed not to have been submitted.

2.4.4 Representation

Articles 92(2) and 93(1) EUTMR

The general rules on representation apply (see the Guidelines, Part A, General Rules, Section 5, Professional Representation).

Where the recordal applicant has no domicile or principal place of business or a real and effective industrial or commercial establishment inside the European Economic Area and has made the request alone, failure to fulfil the requirement of representation will lead to the request not being processed. The recordal applicant will be notified in

the form of an information letter and any fees paid will be refunded. The recordal applicant is then free to submit a new request.

2.5 Optional contents of the request

Rule 34 EUTMIR

Depending on the nature of the licence, the request for registration may contain the request to register the licence together with other indications, namely those referred to under paragraphs a) to e) below. These indications may be individual or in any combination, for one licence (e.g. an exclusive licence limited in time) or for several licences (e.g. one exclusive licence for A as regards Member State X and another for B as regards Member State Y). They are entered in the Register by the Office only if the request for registration of the licence itself clearly requests that they be registered. Without such an explicit request, the Office will not enter in the Register any indications contained in the licence agreement that are submitted, for example, as evidence of the licence.

However, if one or more of these indications are requested to be entered in the Register, the following details must be indicated.

Rule 34(1)(c) and Rule 34(2) EUTMIR

- a) Where registration of a licence limited to only some of the goods or services is requested, the goods or services for which the licence has been granted must be indicated.

Rule 34(1)(d) and Rule 34(2) EUTMIR

- b) Where the request is to register the licence as a territorially limited licence, the request must indicate the part of the Union for which the licence has been granted. A part of the Union may consist of one or several Member States or one or several administrative districts in a Member State.

Article 22(1) EUTMR Rule 34(1)(a) EUTMIR

- c) Where registration of an exclusive licence is sought, a statement to this effect must be made in the request for registration.

Rule 34(1)(e) EUTMIR

- d) Where the registration of a licence granted for a limited period of time is requested, the expiry date of the licence must be specified. In addition, the date of the commencement of the licence may be indicated.

Rule 34(1)(b) EUTMIR

- e) Where the licence is granted by a licensee whose licence is already entered in the Register of EUTMs, the request for registration may indicate that it is for a sub-licence. Sub-licences cannot be recorded without first recording the parent licence.

2.6 Examination of the request for registration

2.6.1 Fees

Rule 33(2) EUTMIR

Where the required fee has not been received, the Office will notify the recordal applicant that the request is deemed not to have been filed because the relevant fee has not been paid. However, a new request may be submitted at any time providing the correct fee is paid from the outset.

2.6.2 Examination of the mandatory formalities

Rule 33(3) EUTMIR

The Office will check whether the request for registration of the licence complies with the formal conditions mentioned in paragraph 2.4 above (indication of the EUTM number(s), the required information concerning the licensee, the representative of the licensee where applicable).

The validity of the licence agreement will not be examined.

Article 93(1) EUTMR
Rules 33 and 77 EUTMIR

The Office will check whether the request for registration of the licence has been duly signed. Where the request is signed by the licensee's representative, an authorisation may be required by the Office or, in the context of *inter partes* proceedings, by the other party to those proceedings. In this event, if no authorisation is submitted, the proceedings will continue as if no representative had been appointed. Where the request for registration of the licence is signed by the proprietor's representative who has already been designated as the representative for the EUTM in question, the requirements relating to signature and authorisations are fulfilled.

Articles 92(2) and 93(1) EUTMR

The examination will include whether the recordal applicant (i.e. the EUTM proprietor or the licensee) is obliged to be represented before the Office (see paragraph 2.4.4 above).

Rule 33(3) EUTMIR

The Office will inform the recordal applicant in writing of any deficiencies in the application. If the deficiencies are not remedied within the time limit fixed in that communication, which will normally be two months following the date of the notification, the Office will reject the request for registration of the licence. The party concerned may file an appeal against this decision. (See Decision 2009-1 of 16 June 2009 of the Presidium of the Boards of Appeal regarding Instructions to Parties in Proceedings before the Boards of Appeal).

Where the request has been made jointly by the EUTM proprietor and the licensee, the Office will communicate with the EUTM proprietor and send a copy to the licensee.

Where the licensee has also made and signed the request, it will not be allowed to contest the existence or scope of the licence.

Where the request for registration of the licence is filed by the EUTM proprietor alone, the Office will not inform the licensee of the recordal request. The examination of proof of the licence will be done *ex officio*. The Office will disregard any statements or allegations of the licensee regarding the existence or scope of the licence or its registration; the licensee cannot oppose the registration of a licence.

Rule 33(3) EUTMIR

If the request is filed by the licensee on the basis of a copy of the licence contract, and where the Office has reasonable doubts as to the veracity of the documents, it will write to the licensee inviting it to remove those doubts. The licensee will then have the burden of proving that the licence exists, that is, it has to convince the Office of the veracity of the documents and their contents. In such a case, the Office may, within the scope of its *ex officio* power of examination (Article 76(1) EUTMR), invite the EUTM proprietor to submit observations. If the proprietor claims that the documents are falsified, this will be enough for the Office to reject the registration of a licence unless the licensee produces a final Court order from an EU Member State in its favour. Where the doubts cannot be removed, the registration of the licence will be refused. In such a case, the procedure always remains *ex parte* even though the EUTM proprietor is heard; it is not a party to the proceedings.

2.6.3 Examination of optional elements

Article 22a(3) EUTMR and Rule 34 EUTMIR

Where it is requested that the licence be registered as one of the following:

- an exclusive licence,
- a temporary licence,
- a territorially limited licence,
- a licence limited to certain goods or services, or
- a sub-licence,

the Office will examine whether the particulars mentioned in paragraph 2.4 above are indicated.

Rule 34(1) and (2) EUTMIR

As concerns the indication 'exclusive licence', the Office will only accept this term and will not accept any other wordings. If 'exclusive licence' is not expressly indicated, the Office will consider the licence to be non-exclusive.

Where the request for the registration indicates that it is for a licence limited to certain goods or services covered by the EUTM, the Office will check whether the goods and services are properly grouped and are actually covered by the EUTM.

Rule 34(1)(b) EUTMIR

As concerns a sub-licence, the Office will check whether it has been granted by a licensee whose licence is already entered in the Register. The Office will refuse the registration of a sub-licence when the main licence has not been entered in the Register. However, the Office will not check the validity of the request for the registration of a sub-licence as an exclusive licence when the main licence is not an exclusive licence nor will it examine whether the main licence contract excludes granting sub-licences.

It is up to the licensor to pay attention not to conclude and to register incompatible contracts and to cancel or modify records that are no longer valid. For example, if an exclusive licence has been registered without limitation as to the goods and the territory, and the registration of another exclusive licence is requested, the Office will register that second licence, even though both licences seem incompatible at first sight. It is to be assumed that the second licence contract is compatible with the first licence contract either from the very beginning (and the recordal is simply not precise as to the territory or the goods) or following a change in the contractual situation that was not communicated to the Register for European Union trade marks.

Parties are, however, encouraged to update all register information regularly and swiftly by means of the cancellation or modification of existing licences (see paragraph 3 below).

Article 22(1) EUTMR
Rule 33(3) and Rule 34 EUTMIR

If the particulars mentioned in paragraph 2.5 are missing, the Office will invite the recordal applicant for registration of the licence to submit the supplementary information. If the recordal applicant does not reply to that communication, the Office will not take into account the abovementioned indications and will register the licence without mentioning them. The recordal applicant will be notified of this by an appealable decision.

2.7 Registration procedure and publications

Rule 33(4) EUTMIR

As concerns EUTM applications, the licence will be mentioned in the files kept by the Office for the European Union trade mark application concerned.

Article 87(3) EUTMR
Rule 85(2) EUTMIR

When the mark is registered, the licence will be published in the European Union Trade Marks Bulletin and mentioned in the Register of European Union trade marks.

Article 87(6) EUTMR

The Office will notify both parties of the entry of the licence in the files kept by the Office. Where both parties have named a common representative, this representative will be notified.

Articles 22(5) and 87(3) EUTMR
Rule 85(2) EUTMIR

As concerns EUTMs, the Office will enter the licence in the Register of European Union trade marks and publish it in the European Union Trade Marks Bulletin.

Where applicable, the entry in the Register will mention that the licence is:

- an exclusive licence,
- a temporary licence,
- a territorially limited licence,
- a sub-licence, or
- a licence limited to certain goods or services covered by the EUTM.

Only these bare facts will be mentioned. The following details will not be published:

- the period of validity of a temporary licence,
- the territory covered by a territorially limited contract,
- the goods and services covered by a partial licence.

Access to this information may be obtained through inspection of files (see the Guidelines, Part E, Register Operations, Section 5, Inspection of Files).

Licences are published in part C.4. of the European Union Trade Marks Bulletin.

Article 87(6) EUTMR

The Office will inform the recordal applicant of the registration of the licence. When the request for registration of the licence was filed by the licensee, the Office will also inform the EUTM proprietor of the registration.

3 Cancellation or Modification of a Licence for an EUTM or an EUTM application

Rule 35(1) EUTMIR

The registration of a licence will be cancelled or modified on the request of an interested party, that is, the applicant or proprietor of the EUTM or the registered licensee.

The Office will refuse the cancellation, transfer and/or modification of a licence or a sub-licence when the main licence has not been entered in the Register.

3.1 Competence, languages, presentation of the request

Article 133 EUTMR
Rule 35(3), (6) and (7) EUTMIR

Paragraphs 2.1 and 2.2 above are applicable.

It is strongly recommended that the request for cancellation of a licence be presented on the Recordal Application form. This form is available free of charge in the official languages of the Union. It can be downloaded from the EUIPO website. Parties to the proceedings may also use the WIPO Model International Form No 1, Request for Amendment/Cancellation of a License, which can be downloaded at <http://www.wipo.int/edocs/pubdocs/en/marks/835/pub835.pdf>, or a form with a similar content and format.

3.2 Person making the request

Rule 35(1) EUTMIR

The request for the cancellation or modification of the registration of a licence may be filed by:

- a) the applicant or proprietor of the EUTM and the licensee jointly,
- b) the applicant or proprietor of the EUTM, or
- c) the registered licensee.

3.2.1 Cancellation of a licence

Rule 35(4) EUTMIR

In the case of a joint request filed by the EUTM applicant or proprietor and the licensee, or of a request filed by the licensee, no proof for the cancellation of the licence is required since this implies a statement from the licensee that it consents to the cancellation of the registration of the licence. When the request for cancellation is filed by the EUTM applicant or proprietor, alone, the request must be accompanied by

evidence establishing that the registered licence no longer exists or by a declaration from the licensee to the effect that it consents to the cancellation.

Where the registered licensee makes the request for cancellation alone, the EUTM applicant or proprietor will not be informed of this request. Any observations filed by the proprietor will be forwarded to the licensee but will not preclude the cancellation of the licence. Paragraph 2.4.3.1 applies *mutatis mutandis*.

If the EUTM proprietor alleges fraud on the part of the licensee, it must provide a final Court order to this effect. In fact it is not up to the Office to carry out any investigation in that respect.

Where several licences have been requested simultaneously, it is possible to cancel one of these licences individually. In such a case a new entry number will be created in respect of the cancelled licence.

The entry in the Register of licences which are limited in time, that is, temporary licences, does not automatically expire and must instead be cancelled from the Register.

3.2.2 Modification of a licence

Rule 35(6) EUTMIR

In the case of a joint request from the EUTM applicant or proprietor and the licensee, no further proof for the amendment of the licence is required.

If the request is made by the EUTM applicant or proprietor, proof of the amendment of the licence is required only where the amendment for which entry in the Register is sought is of such a nature that it would diminish the rights of the registered licensee under the licence. This would be the case, for example, where the licensee's name were to change, where an exclusive licence were to become a non-exclusive licence, or where the licence were to become restricted regarding its territorial scope, the period of time for which it is granted, or the goods or services to which it applies.

If the request is made by the registered licensee, proof of the amendment of the licence is required only where the amendment for which entry in the Register is sought is of such a nature that it would extend the rights of the registered licensee under the licence. This would be the case, for example, where a non-exclusive licence were to become an exclusive licence, or where any registered restrictions of the licence as to its territorial scope, to the period of time for which it is granted, or to the goods or services to which it applies, were to be cancelled fully or in part.

If proof of the amendment of the licence is necessary, it is sufficient if any of the documents referred to above in paragraph 2.4.3.4 are submitted, subject to the following requirements.

- The written agreement must be signed by the other party to the licence contract and must relate to the registration of the amendment of the licence as requested.
- The Request for Amendment/Cancellation of a Licence must indicate how the licence has been amended.

- The copy or extract of the licence agreement must be of the licence as amended.

3.3 Contents of the request

Rules 26 and 35 EUTMIR

Paragraph 2.4 applies, save that the data concerning the licensee need not be indicated except in the case of a modification of the registered licensee's name.

Paragraph 2.5 applies if a modification of the scope of the licence is requested, for example, if a licence becomes a temporary licence or if the geographical scope of a licence is changed.

3.4 Fees

3.4.1 Cancellation of a licence

Rule 35(3) EUTMIR
Annex I A(27) EUTMR

The request for the cancellation of the registration of a licence is not deemed to have been filed until the required fee is paid, which amounts to EUR 200 for each EUTM for which the cancellation is requested. Where several cancellations are requested simultaneously or within the same request, and where the respective EUTM applicant or proprietor and the licensee are the same in each case, the fee is limited to a maximum of EUR 1 000.

Once the corresponding fee has been paid, the fee will not be reimbursed if the request is refused or withdrawn.

3.4.2 Modification of a licence

Rule 35(6) EUTMIR

The modification of the registration of a licence is not subject to a fee.

3.5 Examination of the request

3.5.1 Fees

Rule 35(3) EUTMIR

Where the required fee for the request for the cancellation of a licence has not been received, the Office will notify the recordal applicant that the request is deemed not to have been filed.

3.5.2 Examination by the Office

Rule 35(2) and (4) EUTMIR

As for the mandatory elements of the request, paragraph 2.6.2 applies *mutatis mutandis*, including in respect of proof of the licence, to the extent that such proof is required.

The Office will notify the recordal applicant of any deficiency, setting a time limit of two months. If the deficiencies are not remedied, the Office will refuse the request for cancellation or modification.

Article 87(6) EUTMR Rule 35(6) EUTMIR

Paragraph 2.6.3 above applies to the extent that the modification of the licence would affect its nature or its limitation to a part of the goods and services covered by the EUTM/EUTM application.

The registration of the cancellation or modification of the licence will be communicated to the person who made the request; if the request was filed by the licensee, the EUTM applicant or proprietor will receive a copy of that communication.

3.6 Registration and publication

Article 87(3)(s) EUTMR Rule 85(2) EUTMIR

In the case of a registered EUTM, the creation, cancellation or modification will be entered in the Register of European Union trade marks and published in the European Union Trade Marks Bulletin under C.4.

In the case of an EUTM application, the cancellation or modification of the licence will be mentioned in the files of the EUTM application concerned. When the registration of the EUTM is published, no publications will be made in respect of licences that have been cancelled, and in the case of the modification of the licence, the data as modified will be published under C.4.

4 Transfer of a Licence for an EUTM or EUTM application

4.1 Definition of the transfer of a licence

Article 22(5) EUTMR

A licence concerning an EUTM application or an EUTM may be transferred. The transfer of a licence is different from a sub-licence insofar as the former licensee loses all its rights under the licence, and will be replaced by a new licensee, whereas in the

case of a transfer of sub-licence, the main licence remains in force. Likewise, the transfer of a licence is different to a change of name of the owner where no change of ownership is implied (see the Guidelines, Part E, Section 3, EUTMs as Objects of Property, Chapter 1, Transfer).

4.2 Applicable rules

Rule 33(1) EUTMIR

The procedure for the registration of a transfer of a licence follows the same rules as the registration of a licence set out in paragraphs 2 and 3 above.

Rule 33(1) and (4) EUTMIR Annex I A(26)(b) EUTMR

The transfer of a licence is subject to the payment of a fee. Paragraph 2.3 above applies *mutatis mutandis*.

To the extent that a declaration or a signature of the EUTM applicant or EUTM proprietor is required in accordance with the rules, its place will be taken by a declaration or signature of the registered licensee (the former licensee).

5 Registration of Licences for Registered Community Designs

Articles 27, 32 and 33 and Article 51(4) CDR Articles 24, 25 and 26 and Article 27(2) CDIR Annex Nos 18 and 19 CDFR

The legal provisions contained in the CDR, CDIR and CDFR for licences correspond to the respective provisions in the EUTMR and EUTMIR.

Therefore, both the legal principles and the procedure for the registration, cancellation or amendment of trade mark licences apply *mutatis mutandis* to Community designs, save for the following exceptions and specificities.

5.1 Registered Community designs

There is no use requirement in the Community design law, so that the issue of whether use by a licensee is use with the consent of the right holder does not arise.

The CDR and CDIR require the indication of the products in which the design is intended to be incorporated or applied.

It is not possible to register a licence for a registered Community design for only part of the products it covers.

Any such limitations of the scope of the licence will be disregarded by the Office, and the licence will be registered as if the restriction were not present.

5.2 Multiple applications for registered Community designs

Article 37 CDR
Article 24(1) CDIR

An application for a registered Community design may be in the form of a multiple application containing several designs.

For the purposes of the legal effect of licences, as well as of the procedure for registering licences, the individual designs contained in a multiple application will be dealt with as if they were separate applications, and the same continues to apply after registration of the designs contained in the multiple application.

In other words, each design contained in a multiple application may be licensed independently of the others.

The optional indications as to the kind of licence and the procedure for their examination referred to above in paragraphs 2.5 and 2.6.1 (with the exception of a licence limited to some products, which is not possible) apply to each of the individual designs contained in a multiple application separately and independently.

Annex Nos 18 and 19 CDFR

The fee of EUR 200 for the registration of a licence, the transfer of a licence or the cancellation of a licence applies per design and not per multiple application. The same is true for the ceiling of EUR 1 000 if multiple requests are submitted.

Example 1: Out of a multiple application for 10 designs, 6 designs are licensed, in favour of the same licensee. The fee is EUR 1 000 provided that one single request for registration of these 6 licences is submitted or several requests are submitted on the same day. The request may indicate that for three out of these six designs the licence is an exclusive licence, without affecting the fees to be paid.

Example 2: Out of a multiple application for 10 designs, 5 designs are licensed in favour of the same licensee. A licence is also granted for another design not contained in that multiple application. The fee is EUR 1 000 provided that

- one single request for registration of these 6 licences is submitted or several requests are submitted on the same day, and
- the holder of the Community design and the licensee are the same in all 6 cases.

6 Registration of Licences for International Trade Marks

The Madrid System allows for the recording of licences against an international registration. All requests for recording a licence should be submitted on form MM13 either directly to the International Bureau by the recorded holder or through the Office of the recorded holder or through the Office of a contracting party in respect of which

the licence is granted or through the Office of the licensee. The request cannot be submitted directly to the International Bureau by the licensee. The Office's own Recordal Application form should not be used.

Detailed information on the recording of licences can be found in Sections B.II.93.01 to 99.04 of the Guide to the International Registration of Marks under the Madrid Agreement and the Madrid Protocol (www.wipo.int/madrid/en/guide/). For further information on international trade marks, see the Guidelines, Part M.

***GUIDELINES FOR EXAMINATION OF
EUROPEAN UNION TRADE MARKS***

***EUROPEAN UNION
INTELLECTUAL PROPERTY OFFICE
(EUIPO)***

PART E

REGISTER OPERATIONS

SECTION 3

EUTMs AS OBJECTS OF PROPERTY

CHAPTER 3

RIGHTS IN REM

Table of Contents

1	Introduction.....	4
1.1	Applicable Law	4
1.2	Advantages of the registration of a right in rem	5
2	Requirements for a Request for the Registration of a Right in Rem.....	6
2.1	Application form and requests for more than one right in rem.....	6
2.2	Languages	6
2.3	Fees	7
2.4	Applicants and mandatory content of the application.....	7
2.4.1	Applicants	7
2.4.2	Mandatory indications concerning the EUTM and the pledgee.....	7
2.4.3	Requirements concerning the person who submits the request – signature, proof of the right in rem, representation	8
2.4.3.1	Request submitted by the EUTM proprietor alone.....	8
2.4.3.2	Request submitted jointly by the EUTM proprietor and the pledgee.....	9
2.4.3.3	Request submitted by the pledgee alone	9
2.4.3.4	Proof of the right in rem	9
2.4.4	Representation	10
2.5	Examination of the request for registration.....	10
2.5.1	Fees.....	10
2.5.2	Examination of the mandatory formalities	10
2.6	Registration procedure and publications	12
3	Procedure for the Cancellation or Modification of the Registration of a Right in Rem	13
3.1	Competence, languages, submission of the request.....	13
3.2	Person submitting the request.....	13
3.2.1	Cancellation of the registration of a right in rem	13
3.2.2	Modification of the registration of a right in rem	14
3.3	Contents of the request	14
3.4	Fees	15
3.4.1	Cancellation of the registration of a right in rem	15
3.4.2	Modification of the registration of a right in rem	15
3.5	Examination of the request.....	15
3.5.1	Fees.....	15
3.5.2	Examination by the Office.....	15
3.6	Registration and publication	16
4	Procedure for the Transfer of a Right in Rem	16
4.1	Provision for the transfer of a right in rem	16
4.2	Applicable rules.....	16
5	Rights in Rem for Registered Community Designs.....	17

5.1	Multiple applications for registered Community designs.....	17
6	Rights in Rem for International Trade Marks	18

1 Introduction

Article 19 EUTMR Rules 33, 35 EUTMIR Article 24 CDR

Both registered European Union trade marks (EUTMs) and European Union trade mark applications (EUTM applications) may be the subject of rights in rem.

Both registered Community designs (RCDs) and registered Community design applications may be the subject of rights in rem.

Paragraphs 1 to 4 of this chapter deal with rights in rem concerning EUTMs and EUTM applications. The provisions in the CDR and CDIR dealing with rights in rem concerning designs are almost identical to the equivalent provisions of the EUTMR and EUTMIR respectively. Therefore, the following applies *mutatis mutandis* to Community designs. Procedures specific to Community designs are detailed in paragraph 5 below. Procedures specific to international trade marks are detailed in paragraph 6 below.

A 'right in rem' or 'real right' is a limited property right which is an absolute right. Rights in rem refer to a legal action directed toward property, rather than toward a particular person, allowing the owner of the right the opportunity to recover, possess or enjoy a specific object. These rights may apply to trade marks or designs. They may consist, inter alia, in use rights, usufruct or pledges. 'In rem' is different from 'in personam,' which is directed toward a particular person.

The most common rights in rem for trade marks or designs are pledges or securities. They secure the repayment of a debt of the proprietor of the trade mark or design (i.e. the debtor) in such a way that, where it cannot repay the debt, the creditor (i.e. the owner of the pledge or security) may receive repayment of the debt by, for example, selling the trade mark or design. Other examples are DE: Pfand, Hypothek; EN: Guarantees, Warranties, Bails and Sureties; ES: Hipoteca; FR: Nantissement, Gage, Hypothèque, Garantie, Caution; IT: Pegno, Ipoteca.

There are two types of right in rem that the applicant can ask to be noted in the file or entered in the Register:

- rights in rem that serve the purpose of guaranteeing securities (pledge, charge, etc.)
- rights in rem that do not serve as a guarantee (usufruct).

1.1 Applicable Law

Article 16 EUTMR

The EUTMR does not establish unified and complete provisions applicable to rights in rem for EUTMs or EUTM applications. Rather, Article 16 EUTMR refers to the law of a Member State regarding the acquisition, validity and effects of the EUTM as an object of property. To this end, a right in rem for a EUTM is, in its entirety and for the whole territory of the Union, assimilated to a right in rem for a trade mark registered in the Member State in which the EUTM proprietor or applicant has its seat or its domicile, or,

if this is not the case, to a right in rem for a trade mark registered in the Member State in which the proprietor has an establishment, or if this is not the case, to a right in rem for a trade mark registered in Spain (Member State in which the seat of the Office is situated).

This, however, applies only to the extent that Articles 17 to 24 EUTMR do not provide otherwise.

Article 16 EUTMR is limited to the effects of a right in rem as an object of property, and does not extend to contract law. Article 16 EUTMR does not govern the applicable law, or the validity, of a right in rem contract, which means that the freedom of the contracting parties to submit the right in rem contract to a given national law is not affected by the EUTMR.

1.2 Advantages of the registration of a right in rem

Articles 19(2), 23(1) EUTMR

It is not compulsory to register rights in rem, nor is registration a condition for considering the use of a trade mark by a pledgee under the terms of the right in rem contract to have been made with the consent of the proprietor pursuant to Article 15(2) EUTMR,. However, such a registration has particular advantages.

- a) In view of the provision of Article 23(1) EUTMR, vis-à-vis third parties who might have acquired or have entered in the Register rights in the trade mark which are incompatible with the registered right in rem, the pledgee may avail itself of the rights conferred by this right in rem only:
- if the right in rem was entered in the Register of European Union trade marks, or
 - in the absence of registration of the right in rem, if the third party had acquired its rights after the date of the acquisition of the rights in rem knowing of the existence of the right in rem.
- b) In the event that a right in rem for a European Union trade mark entered in the Register, the surrender of that mark by its proprietor will only be entered in the Register if the proprietor establishes that it has informed the pledgee of its intention to surrender.

The pledgee of a right in rem which is registered has, therefore, the right to be informed in advance by the trade mark's proprietor of its intention to surrender the trade mark.

- c) In the event that a right in rem for a European Union trade mark is entered in the Register, the Office will notify the pledgee at least six months before the expiry of the registration that the registration is approaching expiry. The Office will also notify the pledgee of any loss of rights and of the expiry of the registration, where applicable.
- d) Recording rights in rem is important for maintaining the veracity of the Register, particularly in the event of *inter partes* proceedings.

2 Requirements for a Request for the Registration of a Right in Rem

Article 19(2) EUTMR
Rule 33, Rule 84(3)(h) EUTMIR

Both EUTM applications and EUTMs may be the subject of the registration of a right in rem.

The application for registration of a right in rem must comply with the following conditions.

2.1 Application form and requests for more than one right in rem

Rule 95(a) and (b) EUTMIR

It is strongly recommended that the request for registration of a right in rem for a EUTM be submitted on the Recordal Application form. This form is available free of charge in the official languages of the European Union. It can be downloaded from EUIPO's website.

Any language version of this form may be used, provided that it is completed in one of the languages referred to in paragraph 2.2 below.

Rules 31(7), 33(1) EUTMIR

A single request for the registration of a right in rem for two or more registered EUTMs or EUTM applications may be submitted only if the respective registered proprietor and pledgee are the same in each case.

2.2 Languages

Rule 95(a) EUTMIR

The application for the registration of a right in rem for a EUTM application may be submitted in the first or second language of the EUTM application.

Rule 95(b) EUTMIR

The application for the registration of a right in rem for a EUTM must be submitted in one of the five languages of the Office, namely, English, French, German, Italian or Spanish.

2.3 Fees

Article 162(2)(c) and (d) EUTMR
Rule 33(1) and (4) EUTMIR
Annex I A (26) EUTMR

The application for the registration of a right in rem is considered not to have been submitted until the fee is paid. The fee is EUR 200 for each European Union trade mark for which the registration of a right in rem is requested.

However, where several registrations of rights in rem have been requested in a single request and the registered proprietor and the pledgee are the same in all cases, the fee is limited to a maximum of EUR 1 000.

The same maximum amount applies where several registrations of rights in rem are applied for at the same time, provided that they could have been filed in a single request and where the registered proprietor and the pledgee are the same in all cases.

Once the corresponding fee is paid, the fee will not be reimbursed if the application for registration of the right in rem is refused or withdrawn (file classified).

2.4 Applicants and mandatory content of the application

2.4.1 Applicants

Article 19(2) EUTMR

The registration of a right in rem may be requested by:

- a) the proprietor(s) of the EUTM, or
- b) the proprietor(s) of the EUTM jointly with the pledgee(s), or
- c) the pledgee(s).

The formal conditions with which the request must comply depend on who submits the request. It is recommended that the first or the second of these options be used, since these allow for a speedier and smoother treatment of the request for registration of the right in rem.

2.4.2 Mandatory indications concerning the EUTM and the pledgee

Rule 31, Rule 33(1) EUTMIR

The request for registration of a right in rem must contain the following information.

Rule 31(1)(a), Rule 33(1) EUTMIR

- a) The registration number of the EUTM concerned. If the request relates to several EUTMs each of the numbers must be indicated.

Rules 1(1)(b), 31(1)(b), Rule 33(1) EUTMIR

- b) The pledgee's name, address and nationality and the State in which it is domiciled or has its seat or an establishment.

Rule 1(1)(e), Rules 31(2), 33(1) EUTMIR

- c) If the pledgee designates a representative, the representative's name and business address must be indicated; the indication of the address may be replaced by the indication of the ID number allocated by the Office.

2.4.3 Requirements concerning the person who submits the request – signature, proof of the right in rem, representation

Rule 79, Rule 82(3) EUTMIR

The requirements concerning signature, proof of the right in rem and representation vary depending on the person who submits the request. Where the requirement of a signature is referred to, pursuant to Rule 79 and Rule 82(3) EUTMIR, in electronic communications, the indication of the sender's name will be deemed equivalent to the signature.

2.4.3.1 Request submitted by the EUTM proprietor alone

Rule 1(1)(b), Rule 33(1) EUTMIR

When a request is submitted on behalf of the EUTM proprietor alone, it must be signed by the EUTM proprietor. In the case of co-ownership, all co-owners must sign or appoint a common representative.

No proof of the right in rem is necessary.

The Office will not inform the pledgee that the registration of the right in rem has been requested. It will, however, inform the pledgee when the right in rem is recorded in the Register.

Where the pledgee files a statement with the Office in which it opposes the registration of the right in rem, the Office will forward the statement to the EUTM proprietor for information purposes only. The Office will not take any further action on such a statement. Following the registration of the right in rem, any pledgee who disagrees with the registration of the right in rem may request the cancellation or modification of the registration of the right in rem (see paragraph 3 below).

The Office will not take into account whether the parties have agreed to register a right in rem contract at the Office. Any dispute on whether or not and in what manner the right in rem should be registered is a matter that must be resolved between the parties concerned under the relevant national law (Article 16 EUTMR).

2.4.3.2 Request submitted jointly by the EUTM proprietor and the pledgee

When the request is submitted jointly by the EUTM proprietor and the pledgee, it must be signed by both parties. In the case of co-ownership, all co-owners must sign or appoint a common representative.

In this case, the signature of both parties constitutes proof of the right in rem.

Where there is a formal deficiency regarding the signature or the representative of the pledgee, the request will still be accepted as long as it would have also been acceptable if it had been submitted by the EUTM proprietor alone.

The same applies where there is a deficiency regarding the signature or representative of the EUTM proprietor but where the request would have been acceptable if it had been submitted by the pledgee alone.

2.4.3.3 Request submitted by the pledgee alone

The request may also be submitted by the pledgee alone. In this case, it must be signed by the pledgee.

In addition, proof of the right in rem must be submitted.

2.4.3.4 Proof of the right in rem

There is sufficient proof of the right in rem if the request for registration of the right in rem is accompanied by any of the following evidence.

- A declaration, signed by the EUTM proprietor, that it agrees to the registration of the right in rem.

In accordance with Rule 31(5)(a) EUTMIR, it is also considered sufficient proof if the request for registration of the right in rem is signed by both parties. This case has already been dealt with under paragraph 2.4.3.2 above.

- The right in rem contract, or an extract therefrom, indicating the EUTM at issue and the parties, and bearing their signatures.

It suffices if the right in rem agreement is submitted. In many instances, the parties to the right in rem contract will not wish to disclose all the details of the contract, which may contain confidential information about the terms and conditions of the pledge. In these cases it suffices if only a part or an extract of the right in rem agreement is submitted, as long as it identifies the parties to the right in rem agreement and the EUTM that is subject to a right in rem, and bears the signatures of both parties. All other elements may be omitted or blacked out.

- An uncertified statement of a right in rem, signed by both the EUTM proprietor and the pledgee.

Original documents become part of the file and, therefore, cannot be returned to the person who submitted them. Simple photocopies are sufficient. The original

or photocopy does not need to be authenticated or legalised unless the Office has reasonable doubts as to the veracity of the documents.

Rule 95(a) and (b), Rule 96(2) EUTMIR

The evidence of the right in rem must be:

- a) in the language of the Office which has become the language of the proceedings for the registration of the right in rem, see paragraph 2.2 above;
- b) in any official language of the European Union other than the language of the proceedings; in this case the Office may require a translation of the document into a language of the Office to be filed within a period specified by the Office.

Where the supporting documents are not submitted in either an official language of the European Union or in the language of the proceedings, the Office may require a translation into the language of the proceedings or, at the choice of the party requesting the registration of the right in rem, in any language of the Office. The Office will set a time limit of two months from the date of notification of that communication. If the translation is not submitted within that time limit, the document will not be taken into account and will be deemed not to have been submitted.

2.4.4 Representation

Articles 92(2), 93(1) EUTMR

The general rules on representation apply (see the Guidelines, Part A, General Rules, Section 5, Professional Representation).

2.5 Examination of the request for registration

2.5.1 Fees

Rule 33(2) EUTMIR

Where the required fee has not been received, the Office will notify the recordal applicant that the request is deemed not to have been filed because the relevant fee has not been paid. However, a new request may be submitted at any time providing the correct fee is paid from the outset.

2.5.2 Examination of the mandatory formalities

Rule 33(3) EUTMIR

The Office will check whether the request for registration of the right in rem complies with the formal conditions mentioned in paragraph 2.4 above (indication of the EUTM number(s), the required information concerning the pledgee, the representative of the pledgee where applicable).

The validity of the right in rem agreement will not be examined.

Article 93(1) EUTMR
Rules 33, 76, 77 EUTMIR

The Office will check whether the request for registration of the right in rem has been duly signed. Where the request is signed by the pledgee's representative, an authorisation may be required by the Office or, in the context of *inter partes* proceedings, by the other party to those proceedings. In this event, if no authorisation is submitted, the proceedings will continue as if no representative had been appointed. Where the request for registration of the right in rem is signed by the proprietor's representative who has already been designated as the representative for the EUTM in question, the requirements relating to signature and authorisations are fulfilled.

Articles 92(2), 93(1) EUTMR

The examination will include whether the recordal applicant (i.e. the EUTM proprietor or the pledgee) is obliged to be represented before the Office (see paragraph 2.4.4 above).

Rule 33(3) EUTMIR

The Office will inform the recordal applicant in writing of any deficiencies in the application. If the deficiencies are not remedied within the time limit set in that communication, which will normally be two months following the date of the notification, the Office will reject the request for registration of the right in rem. The party concerned may file an appeal against this decision. (See Decision 2009-1 of 16 June 2009 of the Presidium of the Boards of Appeal regarding Instructions to Parties in Proceedings before the Boards of Appeal).

Where the request has been submitted jointly by the EUTM proprietor and the pledgee, the Office will communicate with the EUTM proprietor and send a copy to the pledgee.

Where the pledgee has also submitted and signed the request, it will not be allowed to contest the existence or scope of the right in rem agreement.

Where the request for registration of the right in rem is submitted by the EUTM proprietor alone, the Office will not inform the pledgee. The examination of evidence of the right in rem will be done *ex officio*. The Office will disregard any statements or allegations of the pledgee regarding the existence or scope of the right in rem or its registration; the pledgee cannot oppose the registration of a right in rem.

Rule 33(3) EUTMIR

If the request is filed by the pledgee on the basis of a copy of the right in rem agreement, and where the Office has reasonable doubts as to the veracity of the documents, it will write to the pledgee inviting it to remove those doubts. The pledgee will then have the burden of proving that the right in rem exists, that is, it has to convince the Office of the veracity of the documents. In such a case, the Office may, within the scope of its *ex officio* power of examination (Article 76(1) EUTMR), invite the

EUTM proprietor to submit observations. If the proprietor claims that the documents are falsified, this will be enough for the Office to reject the registration of a right in rem unless the pledgee produces a Court order from an EU Member State in its favour. In any case, if the doubts cannot be removed, the registration of the right in rem will be refused. In such a case, the procedure always remains *ex parte* even though the EUTM proprietor is heard; it is not a party to the proceedings. The party concerned may file an appeal against this decision.

2.6 Registration procedure and publications

Rule 33(4) EUTMIR

The right in rem for EUTM application will be mentioned in the files kept by the Office for the European Union trade mark application concerned.

Rule 84(3)(h), Rule 85(2) EUTMIR

When the mark is registered, the right in rem will be published in the European Union Trade marks Bulletin and entered in the Register of European Union trade marks.

Rule 84(5) EUTMIR

The Office will notify the recordal applicant of the entry of the right in rem in the files kept by the Office. Where applicable, the EUTM applicant will also be notified.

Article 22(5) EUTMR Rule 84(3)(h), Rule 85(2) EUTMIR

For EUTMs, the Office will enter the right in rem in the Register of European Union trade marks and publish it in the European Union Trade Marks Bulletin.

Access to this information may be obtained through inspection of files (see the Guidelines, Part E, Register Operations, Section 5, Inspection of Files).

Rights in rem are published in Part C.5. of the Bulletin.

Rule 84(5) EUTMIR

The Office will inform the recordal applicant of the registration of the right in rem. When the request for registration of the right in rem was filed by the pledgee, the Office will also inform the EUTM proprietor of the registration.

3 Procedure for the Cancellation or Modification of the Registration of a Right in Rem

Rule 35(1) EUTMIR

The registration of a right in rem will be cancelled or modified at the request of an interested party, that is, the applicant or proprietor of the EUTM or the registered pledgee.

3.1 Competence, languages, submission of the request

Article 133 EUTMR
Rule 35(3), (6) and (7) EUTMIR

Paragraphs 2.1 and 2.2 above apply.

There is no Office form for registering the cancellation or modification of a right in rem.

3.2 Person submitting the request

Rule 35(1) EUTMIR

The request for the cancellation or modification of the registration of a right in rem may be submitted by:

- a) the EUTM applicant/proprietor and the pledgee jointly,
- b) the EUTM applicant/proprietor, or
- c) the registered pledgee.

3.2.1 Cancellation of the registration of a right in rem

Rule 35(4) EUTMIR

If the EUTM applicant/proprietor and the pledgee submit a joint request or if the pledgee alone submits a request, no proof of the cancellation of the registration of the right in rem is required since the application itself implies a statement by the pledgee that it consents to the cancellation of the registration of the right in rem. When the request for cancellation is submitted by the EUTM applicant/proprietor, the request must be accompanied by evidence establishing that the registered right in rem no longer exists or by a declaration by the pledgee that it consents to the cancellation.

Where the registered pledgee submits the request for cancellation by itself, the EUTM applicant/proprietor will not be informed of this request. Any observations filed by the proprietor will be forwarded to the pledgee but will not preclude the cancellation of the registration of the right in rem. Paragraph 2.4.3.1 above applies *mutatis mutandis*.

If the EUTM proprietor alleges fraud on the part of the pledgee, it must provide a Court order to this effect. It is not up to the Office to carry out any investigation into such a claim.

Where the registration of several rights in rem has been requested simultaneously, it is possible to cancel one of these registrations individually. In such an event, a new recordal number will be created for the cancelled right in rem.

3.2.2 Modification of the registration of a right in rem

Rule 35(6) EUTMIR

If the EUTM applicant/proprietor and the pledgee submit a joint request, no further proof for the modification of the registration of the right in rem is required.

If the request is submitted by the EUTM applicant/proprietor, proof of the modification of the registration of the right in rem is required only where the modification is of such a nature that it would diminish the rights of the registered pledgee under the right in rem. This would be the case, for example, of a change of the pledgee's name.

If the request is submitted by the registered pledgee, proof of the modification of the registration of the right in rem is required only where the modification, is of such a nature that it would extend the rights of the registered pledgee under the right in rem.

If proof of the modification of the registration of the right in rem is necessary, it is sufficient if any of the documents referred to above under paragraph 2.4.3.4 are submitted, subject to the following requirements.

- The written agreement must be signed by the other party to the right in rem agreement and must relate to the registration of the modification of the right in rem as requested.
- The request for modification/cancellation of the registration of a right in rem must show the right in rem in its amended form.
- The copy or extract of the right in rem agreement must show the right in rem in its amended form.

3.3 Contents of the request

Rules 26, 35 EUTMIR

Paragraph 2.4 above applies, except that the data concerning the pledgee need not be indicated except in the event of a modification of the registered pledgee's name.

3.4 Fees

3.4.1 Cancellation of the registration of a right in rem

Article 162(2) EUTMR
Rule 35(3) EUTMIR
Annex I A (27) EUTMR

The request for the cancellation of the registration of a right in rem is not deemed to have been filed until the required fee of EUR 200 per cancellation is paid. Where several cancellations are requested simultaneously or within the same request, and where the EUTM applicant/proprietor and the pledgee are the same in each case, the fee is limited to a maximum of EUR 1 000.

Once the corresponding fee has been paid, the fee will not be reimbursed if the request is refused or withdrawn.

3.4.2 Modification of the registration of a right in rem

Rule 35(6) EUTMIR

The modification of the registration of a right in rem is not subject to a fee.

3.5 Examination of the request

3.5.1 Fees

Rule 35(3) EUTMIR

Where the required fee for the request for the cancellation of the registration of a right in rem has not been received, the Office will notify the recordal applicant that the request is deemed not to have been filed.

3.5.2 Examination by the Office

Rule 35(2) and (4) EUTMIR

Paragraph 2.5.2 applies *mutatis mutandis* to the mandatory elements of the request, even for proof of the right in rem, to the extent that such proof is required.

The Office will notify the recordal applicant of any deficiency, setting a time limit of two months. If the deficiencies are not remedied, the Office will refuse the request for registering the cancellation or modification.

Rules 35(6), 84(5) EUTMIR

The registration of the cancellation or modification of the right in rem will be communicated to the person who submitted the request; if the request was submitted

by the pledgee, the EUTM applicant/proprietor will receive a copy of the communication.

3.6 Registration and publication

Rule 84(3)(s), Rule 85(2) EUTMIR

For a registered EUTM, the creation, cancellation or modification of a registration of a right in rem will be entered in the Register of European Union trade marks and published in the European Union Trade Marks Bulletin under C.5.

For a EUTM application, the cancellation or modification of the right in rem will be mentioned in the files of the EUTM application concerned. When the registration of the EUTM is published, no publications will be made for rights in rem that have been cancelled, and if a right in rem has been modified, the data as modified will be published under C.5.

4 Procedure for the Transfer of a Right in Rem

4.1 Provision for the transfer of a right in rem

Rule 33(1) EUTMIR

A right in rem may be transferred.

4.2 Applicable rules

Rule 33(1) EUTMIR

The procedure for the registration of a transfer of a right in rem follows the same rules as the registration of a right in rem set out in paragraph 2 above.

Rule 33(1) and (4) EUTMIR
Annex I A (26) (b) EUTMR

The transfer of a right in rem is subject to the payment of a fee. Paragraph 2.3 above applies *mutatis mutandis*.

To the extent that a declaration or a signature of the EUTM applicant/proprietor is required in accordance with the rules, it must be replaced by a declaration or signature of the registered pledgee (the former pledgee).

5 Rights in Rem for Registered Community Designs

Articles 27, 29, and 33, Article 51(4) CDR
Articles 24 and 26, Article 27(2) CDIR
Annex (18) and (19) CDFR

The legal provisions contained in the CDR, CDIR and CDFR in respect of rights in rem correspond to the respective provisions in the EUTMR and EUTMIR.

Therefore, both the legal principles and the procedure in respect of the registration, cancellation or modification of trade mark rights in rem apply *mutatis mutandis* to Community designs, except for the following specific procedures.

5.1 Multiple applications for registered Community designs

Article 37 CDR
Article 24(1) CDIR

An application for a registered Community design may be in the form of a multiple application, applying for several designs.

For the purposes of the legal effect of rights in rem, as well as of the procedure for registering rights in rem, individual designs contained in a multiple application will be dealt with as if they were separate applications, and the same continues to apply after registration of the designs contained in the multiple application.

In other words, each design contained in a multiple application may be pledged independently of the others.

Annex (18) and (19) CDFR

The fee of EUR 200 for the registration of a right in rem or the cancellation of a right in rem applies per design and not per multiple application. The same is true for the ceiling of EUR 1 000 if multiple requests are submitted.

Example 1

Out of a multiple application for 10 designs, 6 designs are pledged, in favour of the same pledgee. The fee is EUR 1 000 provided that either a single request for registration of these 6 rights in rem is submitted or several requests are submitted on the same day.

Example 2

Out of a multiple application for 10 designs, 5 designs are pledged, in favour of the same pledgee. The registration for a right in rem is also requested for another design not contained in that multiple application. The fee is EUR 1 000 Euro provided that:

- either a single request for registration of these 6 rights in rem is submitted or several requests are submitted on the same day, and
- the holder of the Community design and the pledgee are the same in all 6 cases.

6 Rights in Rem for International Trade Marks

The Madrid System allows for the recording of rights in rem against an international registration (see Rule 20 [Common Regulations under the Madrid Agreement Concerning the International Registration of Marks and the Protocol Relating to that Agreement](#)). For the convenience of the users, the [MM19](#) form is available for requesting that a restriction of the holder's right of disposal be entered in the International Register. The use of this form is strongly recommended to avoid irregularities. Requests should be submitted either directly to the International Bureau by the holder or to the national IP Office of the holder or to the Office of a contracting party to whom the right in rem is granted or to the Office of the pledgee. The request cannot be submitted directly to the International Bureau by the pledgee. EUIPO's own Recordal Application form should not be used.

Detailed information on the recording of rights in rem can be found in Part B, Chapter II, paragraphs 92.01 to 92.04 of the Guide to the International Registration of Marks under the Madrid Agreement and the Madrid Protocol (www.wipo.int/madrid/en/guide). For further information on international trade marks, see the Guidelines Part M, International Marks.

***GUIDELINES FOR EXAMINATION OF
EUROPEAN UNION TRADE MARKS***

***EUROPEAN UNION
INTELLECTUAL PROPERTY OFFICE
(EUIPO)***

PART E

REGISTER OPERATIONS

SECTION 3

EUTMs AS OBJECTS OF PROPERTY

CHAPTER 4

LEVY OF EXECUTION

Table of Contents

1	Introduction.....	3
1.1	Applicable Law	3
1.2	Advantages of the registration of a levy of execution	3
2	Requirements for a Request for the Registration of a Levy of Execution	4
2.1	Application form and requests for more than one levy of execution	4
2.2	Languages	5
2.3	Fees	5
2.4	Applicants and mandatory content of the application.....	6
2.4.1	Applicants	6
2.4.2	Mandatory indications concerning the EUTM and the beneficiary	6
2.4.3	Requirements concerning the person who submits the request – signature, proof of the levy of execution, representation	6
2.4.3.1	Request submitted by the EUTM proprietor	7
2.4.3.2	Request submitted by the beneficiary	7
2.4.3.3	Request submitted by a Court or Authority.....	7
2.4.3.4	Proof of the levy of execution	7
2.4.4	Representation	8
2.5	Examination of the request for registration.....	8
2.5.1	Fees.....	8
2.5.2	Examination of the mandatory formalities	9
2.6	Registration procedure and publications	10
3	Procedure for the Cancellation or Modification of the Registration of a Levy of Execution	10
3.1	Competence, languages, submission of the request.....	10
3.2	Person submitting the request	11
3.2.1	Cancellation of the registration of a levy of execution	11
3.2.2	Modification of the registration of a levy of execution	11
3.3	Contents of the request	11
3.4	Fees	12
3.4.1	Cancellation of the registration of a levy of execution	12
3.4.2	Modification of the registration of a levy of execution	12
3.5	Examination of the request.....	12
3.5.1	Fees.....	12
3.5.2	Examination by the Office.....	12
3.6	Registration and publication	13
4	Levy of Execution for Registered Community Designs	13
4.1	Multiple applications for registered Community designs.....	13
5	Levy of Execution for International Trade Marks.....	14

1 Introduction

Article 20 EUTMR
Rules 33, 35 EUTMIR
Article 29 CDR

Both registered European Union trade marks (EUTMs) and European Union trade mark applications (EUTM applications) may be levied in execution.

Both registered Community designs (RCDs) and registered Community design applications may be levied in execution.

Paragraphs 1 to 3 of this chapter deal with levies of execution concerning EUTMs and EUTM applications. The provisions in the CDR and CDIR dealing with levy of execution concerning designs are almost identical to the equivalent provisions of the EUTMR and EUTMIR respectively. Therefore, the following applies *mutatis mutandis* to Community designs. Procedures specific to Community designs are detailed in paragraph 4 below. Procedures specific to international trade marks are detailed in paragraph 5 below.

A levy of execution is the act by which a court officer appropriates a debtor's property, following a judgment of possession obtained by a plaintiff from a court. In this way a creditor can recover its claim from all the property of the debtor, including from its trade mark rights.

1.1 Applicable Law

Article 16 EUTMR

The EUTMR does not establish unified and complete provisions applicable to the levy of execution for EUTMs or EUTM applications. Rather, Article 16 EUTMR refers to the law of a Member State, regarding the procedure for levy of execution. To this end, a levy of execution on a EUTM is, in its entirety and for the whole territory of the European Union, assimilated to a levy of execution for a trade mark registered in the Member State in which the EUTM proprietor or applicant has its seat or its domicile, or, if this is not the case, to a levy of execution for a trade mark registered in the Member State in which the proprietor has an establishment, or if this is not the case, to a levy of execution for a trade mark registered in Spain (Member State in which the seat of the Office is situated).

This, however, applies only to the extent that Articles 17 to 24 EUTMR do not provide otherwise.

1.2 Advantages of the registration of a levy of execution

Articles 20(2), 50(3), 23(3) EUTMR
Rule 36(2) EUTMIR

Registration of a levy of execution is not compulsory; however, such a registration has particular advantages:

- a) In view of the provision of Article 23(3) EUTMR, vis-à-vis third parties who might have acquired or have entered in the Register rights in the trade mark which are incompatible with the registered levy of execution, the beneficiary may avail itself of the rights conferred by this levy of execution, if national law so permits, only:
- if the levy of execution was entered in the Register of European Union trade marks, or
 - in the absence of registration of the levy of execution, if the third party had acquired its rights after the date of the adjudication of the levy of execution knowing of the existence of the levy of execution.
- b) In the event that a levy of execution against a European Union trade mark is entered in the Register, the surrender of that mark by its proprietor will only be entered in the Register if the proprietor establishes that it has informed the beneficiary of its intention to surrender.

The beneficiary of a levy of execution which is registered has, therefore, the right to be informed in advance by the trade mark's proprietor of its intention to surrender the trade mark.

- c) In the event where a levy of execution against a European Union trade mark is entered in the Register, the Office will notify the beneficiary at least six months before the expiry of the registration that the registration is approaching expiry. The Office will also notify the beneficiary of any loss of rights and of the expiry of the registration, where applicable.
- d) Recording a levy of execution is important for maintaining the veracity of the Register, particularly in the event of *inter partes* proceedings.

2 Requirements for a Request for the Registration of a Levy of Execution

Article 20(3) EUTMR Rule 33, Rule 84(3)(i) EUTMIR
--

Both EUTM applications and EUTMs may be the subject of the registration of a levy of execution.

The application for registration of a levy of execution must comply with the following conditions.

2.1 Application form and requests for more than one levy of execution

Rule 95(a) and (b) EUTMIR

It is strongly recommended that the request for registration of a levy of execution for a EUTM be submitted on the Recordal Application form. This form is available free of

charge in the official languages of the European Union. It can be downloaded from EUIPO's website.

Any language version of this form may be used, provided that it is completed in one of the languages referred to in paragraph 2.2 below.

Rules 31(7), 33(1) EUTMIR

A single request for the registration of a levy of execution for two or more registered EUTMs or EUTM applications may be submitted only if the respective registered proprietor and beneficiary are the same in each case.

2.2 Languages

Rule 95(a) EUTMIR

The application for the registration of a levy of execution against a EUTM application may be submitted in the first or second language of the EUTM application.

Rule 95(b) EUTMIR

The application for the registration of a levy of execution against a EUTM must be submitted in one of the five languages of the Office, namely, English, French, German, Italian or Spanish.

2.3 Fees

Article 162(2)(c) and (d) EUTMR
Rule 33(1) and (4) EUTMIR
Annex I A (26) EUTMR

The application for the registration of a levy of execution is considered not to have been submitted until the fee is paid. The fee is EUR 200 for each European Union trade mark for which the registration of a levy of execution is requested.

However, where several registrations of levy of execution have been requested in a single request and the registered proprietor and the beneficiary are the same in all cases, the fee is limited to a maximum of EUR 1 000.

The same maximum amount applies where several registrations of levy of execution are applied for at the same time, provided that they could have been filed in a single request and where the registered proprietor and the beneficiary are the same in all cases.

Once the corresponding fee is paid, the fee will not be reimbursed if the application for registration of the levy of execution is refused or withdrawn (file classified).

Where the recordal applicant (see paragraph 2.4.1 below) is a Court or an Authority, no fee is to be paid and administrative cooperation is applied.

2.4 Applicants and mandatory content of the application

2.4.1 Applicants

Article 20(3) EUTMR

The registration of a levy of execution may be requested by:

- a) the proprietor(s) of the EUTM,
- b) the beneficiary of the levy of execution,
- c) a Court or Authority.

The formal conditions with which the request must comply depend on who submits the request.

2.4.2 Mandatory indications concerning the EUTM and the beneficiary

Rule 31, Rule 33(1) EUTMIR

The request for registration of a levy of execution must contain the following information.

Rule 31(1)(a), Rule 33(1) EUTMIR

- a) The registration number of the EUTM concerned. If the request relates to several EUTMs each of the numbers must be indicated.

Rules 1(1)(b), 31(1)(b), Rule 33(1) EUTMIR

- b) The beneficiary's name, address and nationality and the State in which it is domiciled or has its seat or an establishment.

Rule 1(1)(e), Rules 31(2), 33(1) EUTMIR

- c) If the beneficiary designates a representative, the representative's name and business address must be indicated; the indication of the address may be replaced by the indication of the ID number allocated by the Office.

2.4.3 Requirements concerning the person who submits the request – signature, proof of the levy of execution, representation

Rule 79, Rule 82(3) EUTMIR

The requirements concerning signature, proof of the levy of execution and representation vary depending on the person who submits the request. Where the requirement of a signature is referred to, pursuant to Rule 79 and Rule 82(3) EUTMIR,

in electronic communications, the indication of the sender's name will be deemed equivalent to the signature.

2.4.3.1 Request submitted by the EUTM proprietor

Rule 1(1)(b), Rule 33(1) EUTMIR

When a request is submitted on behalf of the EUTM proprietor, it must be signed by the EUTM proprietor. In the case of co-ownership, all co-owners must sign or appoint a common representative.

The Office will not inform the beneficiary that the registration of the levy of execution has been requested. It will, however, inform the beneficiary when the levy of execution is recorded in the Register.

Where the beneficiary files a statement with the Office in which it opposes the registration of the levy of execution, the Office will forward the statement to the EUTM proprietor for information purposes only. The Office will not take any further action on such a statement. Following the registration of the levy of execution, any beneficiary who disagrees with the registration of the levy of execution may request the cancellation or modification of the registration of the levy of execution (see paragraph 3 below).

Any dispute on whether or not and in what manner the levy of execution should be registered is a matter that must be resolved between the parties concerned under the relevant national law (Article 16 EUTMR).

2.4.3.2 Request submitted by the beneficiary

The request may also be submitted by the beneficiary. In this case, it must be signed by the beneficiary.

In addition, proof of the levy of execution must be submitted.

2.4.3.3 Request submitted by a Court or Authority

The request may also be submitted by the Court or Authority issuing the judgment. In this case, it must be signed by the Court or Authority.

In addition, proof of the levy of execution must be submitted.

2.4.3.4 Proof of the levy of execution

There is sufficient proof of the levy of execution if the request for registration of the levy of execution is accompanied by the Court judgment.

In many instances, the parties to the levy of execution proceedings will not wish to disclose all the details of the judgment, which may contain confidential information. In these cases it suffices if only a part or an extract of the levy of execution judgment is

submitted, as long as it identifies the parties to the levy of execution proceedings, the EUTM that is subject to the levy of execution and that the judgment is final. All other elements may be omitted or blacked out.

Original documents become part of the file and, therefore, cannot be returned to the person who submitted them. Simple photocopies are sufficient. The original or photocopy does not need to be authenticated or legalised unless the Office has reasonable doubts as to the veracity of the documents.

Rule 95(a) and (b), Rule 96(2) EUTMIR

The evidence of the levy of execution must be:

- a) in the language of the Office which has become the language of the proceedings for the registration of the levy of execution, see paragraph 2.2 above.
- b) in any official language of the European Union other than the language of the proceedings; in this case the Office may require a translation of the document into a language of the Office to be filed within a period specified by the Office.

Where the supporting documents are not submitted in either an official language of the European Union or in the language of the proceedings, the Office may require a translation into the language of the proceedings or, at the choice of the party requesting the registration of the levy of execution, in any language of the Office. The Office will set a time limit of two months from the date of notification of that communication. If the translation is not submitted within that time limit, the document will not be taken into account and will be deemed not to have been submitted.

2.4.4 Representation

Articles 92(2), 93(1) EUTMR

The general rules on representation apply (see the Guidelines, Part A, General Rules, Section 5, Professional Representation).

2.5 Examination of the request for registration

2.5.1 Fees

Rule 33(2) EUTMIR

Where the required fee has not been received, the Office will notify the recordal applicant (unless the recordal applicant is a Court or Authority, in which case no fee is required, see paragraph 2.3 above) that the request is deemed not to have been filed because the relevant fee has not been paid. However, a new request may be submitted at any time providing the correct fee is paid from the outset.

2.5.2 Examination of the mandatory formalities

Rule 33(3) EUTMIR

The Office will check whether the request for registration of the levy of execution complies with the formal conditions mentioned in paragraph 2.4 above (indication of the EUTMs number(s), the required information concerning the beneficiary, the representative of the beneficiary where applicable).

The validity of the levy of execution judgment will not be examined.

Article 93(1) EUTMR Rules 33, 76, 77 EUTMIR

The Office will check whether the request for registration of the levy of execution has been duly signed. Where the request is signed by the beneficiary's representative, an authorisation may be required by the Office or, in the context of *inter partes* proceedings, by the other party to those proceedings. In this event, if no authorisation is submitted, the proceedings will continue as if no representative had been appointed. Where the request for registration of the levy of execution is signed by the proprietor's representative who has already been designated as the representative for the EUTM in question, the requirements relating to signature and authorisations are fulfilled.

Articles 92(2), 93(1) EUTMR

The examination will include whether the recordal applicant (i.e. the EUTM proprietor or the beneficiary) is obliged to be represented before the Office (see paragraph 2.4.4 above).

Rule 33(3) EUTMIR

The Office will inform the recordal applicant in writing of any deficiencies in the application. If the deficiencies are not remedied within the time limit set in that communication, which will normally be two months following the date of the notification, the Office will reject the request for registration of the levy of execution. The party concerned may file an appeal against this decision. (See Decision 2009-1 of 16 June 2009 of the Presidium of the Boards of Appeal regarding Instructions to Parties in Proceedings before the Boards of Appeal).

Where the request for registration of the levy of execution is submitted by the EUTM proprietor alone, the Office will not inform the beneficiary. The examination of evidence of the levy of execution will be done *ex officio*. The Office will disregard any statements or allegations of the beneficiary regarding the existence or scope of the levy of execution or its registration; the beneficiary cannot oppose the registration of a levy of execution.

2.6 Registration procedure and publications

Rules 33(4), 84(5) EUTMIR

The levy of execution for EUTM application will be mentioned in the files kept by the Office for the European Union trade mark application concerned.

The Office will notify the recordal applicant of the entry of the levy of execution in the files kept by the Office. Where applicable, the EUTM applicant will also be notified.

Rule 84(3)(i), Rule 85(2) EUTMIR

When the mark is registered, the levy of execution will be published in the European Union Trade Marks Bulletin and entered in the Register of European Union trade marks. The Office will inform the recordal applicant of the registration of the levy of execution. Where applicable, the EUTM proprietor will also be informed.

Access to this information may be obtained through inspection of files (see the Guidelines, Part E, Register Operations, Section 5, Inspection of Files).

Levies of execution are published in Part C.7. of the Bulletin.

3 Procedure for the Cancellation or Modification of the Registration of a Levy of Execution

Rule 35(1) EUTMIR

The registration of a levy of execution will be cancelled or modified at the request of an interested party, that is, the applicant or proprietor of the EUTM or the registered beneficiary.

3.1 Competence, languages, submission of the request

Article 133 EUTMR
Rule 35(3), (6) and (7) EUTMIR

Paragraphs 2.1 and 2.2 above apply.

There is no Office form for registering the cancellation or modification of a levy of execution.

3.2 Person submitting the request

Rule 35(1) EUTMIR

The request for the cancellation or modification of the registration of a levy of execution may be submitted by:

- a) the EUTM applicant/proprietor and the beneficiary jointly,
- b) the EUTM applicant/proprietor, or
- c) the registered beneficiary.

3.2.1 Cancellation of the registration of a levy of execution

Rule 35(4) EUTMIR

The request for cancellation of the registration of a levy of execution must be accompanied by evidence establishing that the registered levy of execution no longer exists. This proof comprises the final Court judgment.

Where the registered beneficiary alone submits the request for cancellation, the EUTM applicant/proprietor will not be informed of this request. Any observations filed by the proprietor will be forwarded to the beneficiary but will not preclude the cancellation of the registration of the levy of execution. Paragraph 2.4.3.1 above applies *mutatis mutandis*.

Where the registration of several levies of execution has been requested simultaneously, it is possible to cancel one of these registrations individually. In such an event, a new recordal number will be created for the cancelled levy of execution.

3.2.2 Modification of the registration of a levy of execution

Rule 35(6) EUTMIR

A levy of execution may be modified upon submission of the corresponding Court judgment showing such a modification.

3.3 Contents of the request

Rule 35 EUTMIR

Paragraph 2.4 above applies, except that the data concerning the beneficiary need not be indicated except in the case of a modification of the registered beneficiary's name.

3.4 Fees

3.4.1 Cancellation of the registration of a levy of execution

Article 162(2) EUTMR
Rule 35(3) EUTMIR
Annex I A (27) EUTMR

The request for the cancellation of the registration of a levy of execution is not deemed to have been filed until the required fee of EUR 200 per cancellation is paid (unless the recordal applicant is a Court or Authority, in which case no fee is required, see paragraph 2.3 above). Where several cancellations are requested simultaneously or within the same request, and where the EUTM applicant/proprietor and the beneficiary are the same in each case, the fee is limited to a maximum of EUR 1 000.

Once the corresponding fee has been paid, the fee will not be reimbursed if the request is refused or withdrawn.

3.4.2 Modification of the registration of a levy of execution

Rule 35(6) EUTMIR

The modification of the registration of a levy of execution is not subject to a fee.

3.5 Examination of the request

3.5.1 Fees

Rule 35(3) EUTMIR

Where the required fee for the request for the cancellation of the registration of a levy of execution has not been received, the Office will notify the recordal applicant that the request is deemed not to have been filed.

3.5.2 Examination by the Office

Rule 35(2), (4) EUTMIR

Paragraph 2.5.2 applies *mutatis mutandis* to the mandatory elements of the request, even for proof of the levy of execution, to the extent that such proof is required.

The Office will notify the recordal applicant of any deficiency, setting a time limit of two months. If the deficiencies are not remedied, the Office will refuse the request for registering the cancellation or modification.

Rules 35(6), 84(5) EUTMIR

The registration of the cancellation or modification of the levy of execution will be communicated to the person who submitted the request; if the request was submitted by the beneficiary, the EUTM applicant/EUTM proprietor will receive a copy of the communication.

3.6 Registration and publication

Rule 84(3)(s), Rule 85(2) EUTMIR

In the case of a registered EUTM, the creation, cancellation or modification of a registration of a levy of execution will be entered in the Register of European Union trade marks and published in the European Union Trade Marks Bulletin under C.7.

In the case of a EUTM application, the cancellation or modification of the levy of execution will be mentioned in the files of the EUTM application concerned. When the registration of the EUTM is published, no publications will be made for levies of execution that have been cancelled, and if a levy of execution has been modified, the data as modified will be published under C.7.2.

4 Levy of Execution for Registered Community Designs

Articles 27, 30, 33, Article 51(4) CDR
Articles 24, 26, Article 27(2) CDIR
Annex (18) and (19) CDFR

The legal provisions contained in the CDR, CDIR and CDFR in respect of levies of execution correspond to the respective provisions in the EUTMR and EUTMIR.

Therefore, both the legal principles and the procedure in respect of the registration, cancellation or modification of trade mark levies of execution apply *mutatis mutandis* to Community designs, except for the following specific procedures.

4.1 Multiple applications for registered Community designs

Article 37 CDR
Article 24(1) CDIR

An application for a registered Community design may be in the form of a multiple application, applying for several designs.

For the purposes of the legal effect of a levy of execution, as well as of the procedure for registering a levy of execution, individual designs contained in a multiple application will be dealt with as if they were separate applications, and the same continues to apply after registration of the designs contained in the multiple application.

In other words, each design contained in a multiple application may be levied independently of the others.

Annex (18), (19) CDFR

The fee of EUR 200 for the registration of a levy of execution or the cancellation of a levy of execution applies per design and not per multiple application. The same is true for the ceiling of EUR 1 000 if multiple requests are submitted.

Example 1

Out of a multiple application for 10 designs, 6 designs are levied, in favour of the same beneficiary. The fee is EUR 1 000 provided that either a single request for registration of these 6 levies of execution is submitted or several requests are submitted on the same day.

Example 2

Out of a multiple application for 10 designs, 5 designs are levied, in favour of the same beneficiary. The registration of a levy of execution is also requested for another design not contained in that multiple application. The fee is EUR 1 000 provided that

- either a single request for registration of these 6 levies of execution is submitted, or several requests are submitted on the same day, and
- the holder of the Community design and the beneficiary are the same in all 6 cases.

5 Levy of Execution for International Trade Marks

The Madrid System allows for the recording of a levy of execution against an international registration (see Rule 20 Common Regulations [under the Madrid Agreement Concerning the International Registration of Marks and the Protocol Relating to that Agreement](#)). For the convenience of the users, the [MM19](#) form is available for requesting that a restriction of the holder's right of disposal be entered in the International Register. The use of this form is strongly recommended to avoid irregularities. Requests should be submitted either directly to the International Bureau by the holder or to the national IP Office of the recorded holder or to the Office of a contracting party to whom the levy of execution is granted or to the Office of the beneficiary. The request cannot be submitted directly to the International Bureau by the beneficiary. EUIPO's own Recordal Application form must not be used.

Detailed information on the recording of levies of execution can be found in Part B, Chapter II, paragraphs 92.01 to 92.04 of the Guide to the International Registration of Marks under the Madrid Agreement and the Madrid Protocol (www.wipo.int/madrid/en/guide). For further information on international trade marks, see the Guidelines, Part M, International Marks.

***GUIDELINES FOR EXAMINATION OF
EUROPEAN UNION TRADE MARKS***

***EUROPEAN UNION
INTELLECTUAL PROPERTY OFFICE
(EUIPO)***

PART E

REGISTER OPERATIONS

SECTION 3

EUTMs AS OBJECTS OF PROPERTY

CHAPTER 5

***INSOLVENCY PROCEEDINGS OR SIMILAR
PROCEEDINGS***

Table of Contents

1	Introduction.....	3
1.1	Applicable law	3
1.2	Advantages of the registration of insolvency proceedings.....	4
2	Requirements for a Request for the Registration of Insolvency Proceedings or Similar Proceedings	4
2.1	Application form.....	5
2.2	Languages	5
2.3	Fees	5
2.4	Applicants and mandatory content of the application.....	6
2.4.1	Applicants	6
2.4.2	Mandatory indications concerning the EUTM and the liquidator.....	6
2.4.3	Requirements concerning the person who submits the request – signature, proof of appointment, representation.....	7
2.4.4	Representation	7
2.5	Examination of the request for registration.....	8
2.6	Registration procedure and publications	9
3	Procedure for the Cancellation or Modification of the Registration of Insolvency Proceedings.....	9
3.1	Competence, languages, submission of the request.....	9
3.2	Person submitting the request.....	10
3.2.1	Cancellation of the registration of an insolvency	10
3.2.2	Modification of the registration of an insolvency.....	10
3.3	Contents of the request	10
3.4	Fees	11
3.4.1	Cancellation of the registration of insolvency proceedings	11
3.4.2	Modification of the registration of insolvency proceedings	11
3.5	Examination of the request.....	11
3.6	Registration and publication	11
4	Insolvency Proceedings for International Trade Marks	12

1 Introduction

Articles 16, 21 EUTMR
Rules 33, 35 EUTMIR
Article 31 CDR
Council Regulation (EC) No 1346/2000 of 29 May 2000 on insolvency proceedings

Both registered European Union trade marks (EUTMs) and European Union trade mark applications (EUTM applications) may be affected by insolvency proceedings or similar proceedings.

Both registered Community designs (RCDs) and registered Community design applications may be affected by insolvency proceedings or similar proceedings.

Paragraphs 1 to 3 of this chapter deal with recording insolvency proceedings or similar proceedings against EUTMs and EUTM applications. The provisions in the CDR and CDIR dealing with insolvency proceedings and similar proceedings concerning designs are identical to the equivalent provisions of the EUTMR and EUTMIR respectively. Therefore, the following applies *mutatis mutandis* to Community designs. Procedures specific to international trade marks are detailed in paragraph 4 below.

For the purposes of these guidelines ‘**insolvency proceedings**’ are understood as the collective proceedings which entail the partial or total divestment of a debtor and the appointment of a liquidator. In the United Kingdom, for example, such proceedings include the winding up by or subject to the supervision of the court, creditors’ voluntary winding up (with confirmation by the court), administration, voluntary arrangements under insolvency legislation and bankruptcy or sequestration; ‘**liquidator**’ is understood as any person or body whose function is to administer or liquidate assets of which the debtor has been divested or to supervise the administration of their affairs. In the United Kingdom, for example, such persons or bodies include liquidators, supervisors of a voluntary arrangement, administrators, official receivers, trustees and judicial factors; ‘**Court**’ is understood as the judicial body or any other competent body of a Member State empowered to open insolvency proceedings or to take decisions in the course of such proceedings; ‘**judgment**’ in relation to the opening of insolvency proceedings or the appointment of a liquidator is understood as including the decision of any Court empowered to open such proceedings or to appoint a liquidator (for terminology in other territories, please see Council Regulation (EC) No 1346/2000 of 29 May 2000 on insolvency proceedings).

1.1 Applicable law

These guidelines serve to explain the procedure before the Office for registering the opening, modification or closure of insolvency proceedings or similar proceedings. In accordance with Article 16 EUTMR, all other provisions are covered by national law. In addition, Council Regulation (EC) No 1346/2000 of 29 May 2000 on insolvency proceedings regulates the provisions on jurisdiction, recognition and applicable law in the area of insolvency proceedings.

Article 21(1) EUTMR

The Regulations specifically state that a European Union trade mark may only be involved in insolvency proceedings opened in the Member State in the territory of which the debtor has its centre of main interests, the only exception being when the debtor is an insurance undertaking or credit institution in which case the European Union trade mark may only be involved in those proceedings opened in the Member State where that undertaking or institution has been authorised. The '**centre of main interests**' should correspond to the place where the debtor conducts the administration of its interests on a regular basis and is, therefore, ascertainable by third parties.

1.2 Advantages of the registration of insolvency proceedings

Articles 21(3), 23(4) EUTMR

Registration of the opening, modification and closure of insolvency proceedings is not compulsory, however, such a registration has particular advantages.

- a) In view of the provision of Article 23(4) EUTMR, vis-à-vis third parties who might have acquired or have entered in the Register rights in the trade mark which are incompatible with the registered insolvency, the effects shall be governed by the law of the Member State in which such proceedings are first brought within the meaning of national law or of conventions applicable in this field.
- b) In the event that insolvency proceedings against a European Union trade mark are entered in the Register, the EUTM proprietor loses its right to act and, therefore, may not perform any actions before the Office (such as withdraw, surrender, transfer, , act in *inter partes* proceedings, etc.).
- c) In the event that insolvency proceedings against a European Union trade mark are entered in the Register, the Office will notify the liquidator at least six months before the expiry of the registration that the registration is approaching expiry. The Office will also notify the liquidator of any loss of rights and of the expiry of the registration, where applicable.
- d) Recording insolvency proceedings is important for maintaining the veracity of the Register, particularly in the event of *inter partes* proceedings. In this respect please see the Guidelines, Part C, Opposition, Section 1, Procedural Matters, paragraph 6.5.5.2.

The Office strongly recommends that liquidators withdraw, surrender or transfer the EUTMs and EUTM applications subject to insolvency proceedings prior to the final winding up.

2 Requirements for a Request for the Registration of Insolvency Proceedings or Similar Proceedings

Article 21(3), Article 24 EUTMR
Rule 33, Rule 84(3)(i) EUTMIR

Both EUTM applications and EUTMs may be the subject of the registration of insolvency proceedings.

The application for registration of insolvency proceedings must comply with the following conditions.

2.1 Application form

Rule 95(a) and (b) EUTMIR

The application must be a formal request for registering insolvency proceedings or similar proceedings.

It is strongly recommended that the request for registration of insolvency proceedings against a EUTM be submitted on the Recordal Application form using the 'others' option in the 'Type of recordal' section of the form. This form is available free of charge in the official languages of the European Union. It can be downloaded from the Office's website.

Any language version of this form may be used, provided that it is completed in one of the languages referred to in paragraph 2.2 below.

2.2 Languages

Rule 95(a) EUTMIR

The application for the registration of insolvency proceedings against a EUTM application may be submitted in the first or second language of the EUTM application.

Rule 95(b) EUTMIR

The application for the registration of insolvency proceedings against a EUTM must be submitted in one of the five languages of the Office, namely, English, French, German, Italian or Spanish.

2.3 Fees

Article 162(2)(c) and (d) EUTMR
Rule 33(1) and (4) EUTMIR
Annex I A (26) EUTMR

There is no fee for registering insolvency proceedings or similar proceedings.

2.4 Applicants and mandatory content of the application

2.4.1 Applicants

Article 20(3) EUTMR

The registration of insolvency proceedings or similar proceedings may be requested by:

- a) the liquidator,
- b) the Court,
- c) the applicant/owner/holder.

2.4.2 Mandatory indications concerning the EUTM and the liquidator

Rule 31, Rule 33(1) EUTMIR

The request for registration of insolvency proceedings or similar proceedings must contain the following information.

Article 21(2) EUTMR
Rule 31(1)(a), Rule 33(1) EUTMIR

- a) The registration number of the EUTM concerned.

Where the recordal applicant indicates only some of the EUTMs owned by the proprietor, the Office will register the insolvency proceedings against all EUTMs and EUTM applications linked to the owner's ID number at the Office.

Where the owner is joint proprietor of a EUTM or EUTM applications, the insolvency proceedings will apply to the share of the joint proprietor.

Rules 1(1)(b), 31(1)(b), Rule 33(1) EUTMIR

- b) The liquidator's name, address and nationality and the State in which it is domiciled or has its seat or an establishment.

Rule 1(1)(e), Rules 31(2), 33(1) EUTMIR

- c) If the liquidator designates a representative, the representative's name and business address must be indicated; the indication of the address may be replaced by the indication of the ID number allocated by the Office.

2.4.3 Requirements concerning the person who submits the request – signature, proof of appointment, representation

Rule 79, Rule 82(3) EUTMIR

Where the requirement of a signature is referred to, pursuant to Rule 79 and Rule 82(3) EUTMIR, in electronic communications, the indication of the sender's name will be deemed equivalent to the signature.

There is sufficient proof of the appointment of a liquidator and of the insolvency proceedings if the request for registration of the insolvency proceedings is accompanied by the Court judgment.

It suffices if the insolvency judgment is submitted. In many instances, the parties to the insolvency proceedings will not wish to disclose all the details of the judgment, which may contain confidential information. In these cases it suffices if only a part or an extract of the judgment is submitted, as long as it identifies the parties to the proceedings. All other elements may be omitted or blacked out.

Original documents become part of the file and, therefore, cannot be returned to the person who submitted them. Simple photocopies are sufficient. The original or photocopy does not need to be authenticated or legalised unless the Office has reasonable doubts as to the veracity of the documents.

Rule 95(a) and (b), Rule 96(2) EUTMIR

The evidence of the insolvency proceedings must be:

- a) in the language of the Office which has become the language of the proceedings for the registration of the insolvency, see paragraph 2.2 above.
- b) in any official language of the European Union other than the language of the proceedings; in this case the Office may require a translation of the document into a language of the Office to be filed within a period specified by the Office.

Where the supporting documents are not submitted in either an official language of the European Union or in the language of the proceedings, the Office may require a translation into the language of the proceedings or, at the choice of the party requesting the registration of the insolvency, in any language of the Office. The Office will set a time limit of two months from the date of notification of that communication. If the translation is not submitted within that time limit, the document will not be taken into account and will be deemed not to have been submitted.

2.4.4 Representation

Articles 92(2), 93(1) EUTMR

The general rules on representation apply (see the Guidelines, Part A, General Rules, Section 5, Professional Representation).

2.5 Examination of the request for registration

Article 21(1) EUTMR

The Office will check that there are no other pending recordals and that no insolvency proceedings have already been registered for the proprietor concerned. Only a request relating to the Member State in which insolvency proceedings or similar proceedings were first brought may be recorded.

Rule 33(3) EUTMIR

The Office will check whether the request for registration of the insolvency proceedings complies with the formal conditions mentioned in paragraph 2.4 above (indication of the EUTM number(s), the required information concerning the liquidator, the liquidator's representative where applicable).

The validity of the insolvency judgment will not be examined.

Article 93(1) EUTMR Rules 33, 76, 77 EUTMIR

The Office will check whether the request for registration of the insolvency proceedings has been duly signed. Where the request is signed by the liquidator's representative, an authorisation may be required by the Office or, in the context of *inter partes* proceedings, by the other party to those proceedings. In this event, if no authorisation is submitted, the proceedings will continue as if no representative had been appointed.

Articles 92(2), 93(1) EUTMR

The examination will include whether the recordal applicant (i.e. the liquidator, the Court or the applicant/proprietor/holder) is obliged to be represented before the Office (see paragraph 2.4.4 above).

Rule 33(3) EUTMIR

The Office will inform the recordal applicant in writing of any deficiencies in the application. If the deficiencies are not remedied within the time limit set in that communication, which will normally be two months following the date of the notification, the Office will reject the request for registration of the insolvency proceedings. The party concerned may file an appeal against this decision. (See Decision 2009-1 of 16 June 2009 of the Presidium of the Boards of Appeal regarding Instructions to Parties in Proceedings before the Boards of Appeal).

2.6 Registration procedure and publications

Rule 33(4), 84(5) EUTMIR

The insolvency proceedings for EUTM application will be mentioned in the files kept by the Office for the European Union trade mark application(s) concerned.

The Office will notify the recordal applicant of the entry of the insolvency proceedings in the files kept by the Office. Where applicable, the EUTM applicant will also be notified.

Rule 84(3)(i), Rule 85(2) EUTMIR

When the mark is registered, the insolvency proceedings will be published in the European Union Trade Marks Bulletin and entered in the Register of European Union trade marks. The Office will inform the recordal applicant of the registration of the insolvency proceedings.

The liquidator's contact details are recorded as the proprietor's 'correspondence address' in EUIPOs owners and representatives database and third parties may consult the full details of the insolvency proceedings through an application for inspection of files (see the Guidelines, Part E, Register Operations, Section 5, Inspection of Files).

Insolvency proceedings are published in part C.6. of the Bulletin. The publication contains the EUTM registration number(s), the name of the authority requesting the entry in the Register, the date and number of the entry and the publication date of the entry in the EUTM Bulletin.

3 Procedure for the Cancellation or Modification of the Registration of Insolvency Proceedings

Rule 35(1) EUTMIR

The registration of insolvency proceedings will be cancelled or modified at the request of an interested party, that is, the applicant or proprietor of the EUTM or the registered liquidator.

3.1 Competence, languages, submission of the request

Article 133 EUTMR
Rules 35(3), (6), (7) EUTMIR

Paragraphs 2.1 and 2.2 above apply.

There is no Office form for registering the cancellation or modification of insolvency proceedings.

3.2 Person submitting the request

Rule 35(1) EUTMIR

The request for the cancellation or modification of the registration of insolvency proceedings may be submitted by:

- a) the registered liquidator,
- b) the Court,
- c) the applicant/owner/holder.

3.2.1 Cancellation of the registration of an insolvency

Rule 35(4) EUTMIR

The request for registering the cancellation of insolvency proceedings must be accompanied by evidence establishing that the registered insolvency no longer exists. This proof comprises the final Court judgment.

Where the registered liquidator alone submits the request for cancellation, the EUTM applicant/proprietor will not be informed of this request. Any observations filed by the proprietor will be forwarded to the liquidator but will not preclude the cancellation of the registration of the insolvency proceedings.

3.2.2 Modification of the registration of an insolvency

Rule 35(6) EUTMIR

The registration of insolvency proceedings may be modified upon submission of the corresponding Court judgment showing such a modification.

3.3 Contents of the request

Rule 35 EUTMIR

Paragraph 2.4 above applies, except that the data concerning the liquidator need not be indicated except in the event of a modification of the registered liquidator's name.

3.4 Fees

3.4.1 Cancellation of the registration of insolvency proceedings

Article 162(2) EUTMR
Rule 35(3) EUTMIR
Annex I A (27) EUTMR

The request for the cancellation of the registration of insolvency proceedings is not subject to a fee.

3.4.2 Modification of the registration of insolvency proceedings

Rule 35(6) EUTMIR

The modification of the registration of insolvency proceedings is not subject to a fee.

3.5 Examination of the request

Rule 35(2), (4) EUTMIR

Paragraph 2.5 applies *mutatis mutandis* to the mandatory elements of the request, even for proof of the insolvency proceedings.

The Office will notify the recordal applicant of any deficiency, setting a time limit of two months. If the deficiencies are not remedied, the Office will refuse the request for registering the cancellation or modification.

Rules 35(6), 84(5) EUTMIR

The registration of the cancellation or modification of the insolvency proceedings will be communicated to the person who submitted the request; if the request was submitted by the liquidator, the EUTM applicant/proprietor will receive a copy of the communication.

3.6 Registration and publication

Rule 84(3)(s), Rule 85(2) EUTMIR

In the case of a registered EUTM, the creation, cancellation or modification of a registration of an insolvency will be entered in the Register of European Union trade marks and published in the European Union Trade Marks Bulletin under C.6.

In the case of a EUTM application, the cancellation or modification of the insolvency proceedings will be mentioned in the files of the EUTM application concerned. When the registration of the EUTM is published, no publications will be made for insolvency

proceedings that have been cancelled, and if the insolvency proceedings have been modified, the data as modified will be published under C.6.2.

4 Insolvency Proceedings for International Trade Marks

The Madrid System allows for the recording of insolvency proceedings against an international registration (see Rule 20 Common Regulations [under the Madrid Agreement Concerning the International Registration of Marks and the Protocol Relating to that Agreement](#)). For the convenience of the users, the MM19 form is available for requesting that a restriction of the holder's right of disposal be entered in the International Register. The use of this form is strongly recommended to avoid irregularities. Requests should be submitted either directly to the International Bureau by the holder or to the national IP Office of the recorded holder or to the Office of a contracting party in respect of whom the insolvency is granted or to the Office of the liquidator. The request cannot be submitted directly to the International Bureau by the liquidator. EUIPO's own Recordal Application form must not be used.

Detailed information on the recording of insolvency proceedings can be found in Part B, Chapter II, paragraphs 92.01 to 92.04 of the Guide to the International Registration of Marks under the Madrid Agreement and the Madrid Protocol (www.wipo.int/madrid/en/guide). For further information on international trade marks, see the Guidelines, Part M, International Marks.

***GUIDELINES FOR EXAMINATION OF
EUROPEAN UNION TRADE MARKS***

***EUROPEAN UNION
INTELLECTUAL PROPERTY OFFICE
(EUIPO)***

PART E

REGISTER OPERATIONS

SECTION 4

RENEWAL

Table of Contents

1	Fraud Warning	4
1.1	Private companies sending misleading invoices	4
1.2	Renewal by unauthorised third persons.....	4
2	Terms of Registration.....	4
3	Notification of Expiry of Registration	5
4	Renewal of an EUTM Application	5
5	Fees and Other Formal Requirements for the Request for Renewal	5
5.1	Persons who may submit a request for renewal	6
5.2	Content of the request for renewal.....	6
5.2.1	Name and address and other particulars of the person submitting a request for renewal	7
5.2.1.1	Request filed by the proprietor of the European Union trade mark.....	7
5.2.1.2	Request filed by a person authorised to do so by the proprietor	7
5.2.2	Registration number of the European Union trade mark.....	7
5.2.3	Indication as to the extent of the renewal	7
5.3	Languages	8
5.4	Time limit	8
5.4.1	Six month period for renewal before expiry (basic period).....	8
5.4.2	Six month grace period following expiry (grace period)	8
5.4.3	Transitional arrangements when the basic period for renewal started before the entry into force of Regulation No 2015/2424 amending Regulation No 207/2009 on the Community trade mark.	9
5.5	Fees	10
5.5.1	Fees payable	10
5.5.2	Time limit for payment	10
5.5.3	Payment by third parties	11
5.5.4	Fee refund	11
6	Procedure Before the Office	12
6.1	Examination of formal requirements.....	12
6.1.1	Observation of time limits	12
6.1.1.1	Payment during the basic period or the grace period	12
6.1.1.2	Payment after the expiry of the grace period.....	13
6.1.1.3	Situation where the proprietor holds a current account	13
6.1.1.4	Continuation of proceedings.....	14
6.1.1.5	<i>Restitutio in integrum</i>	14
6.1.2	Compliance with formal requirements of the Implementing Regulation	14
6.1.2.1	Renewal requested by authorised person	14
6.1.2.2	Further requirements	15
6.2	Items not to be examined.....	16
6.3	Alteration	16

7	Entries in the Register.....	16
8	Date of Effect of Renewal or Expiry, Conversion	17
8.1	Date of effect of renewal	17
8.2	Conversion of lapsed EUTMs	17
9	Renewal of International Marks Designating the EU	18

1 Fraud Warning

1.1 Private companies sending misleading invoices

The Office is aware that users in Europe are receiving an increasing amount of unsolicited mail from companies requesting payment for trade mark and design services such as renewal.

A list of letters from firms or registers, which users have complained are misleading, is published on the Office website. These services are not connected with any official trade mark or design registration services provided by IP Offices or other public bodies within the European Union such as the EUIPO.

If a user receives a letter or invoice, he or she should carefully check what is being offered, and its source. It must be pointed out that the **EUIPO never sends invoices to users or letters requesting direct payment for services** (see the Guidelines, Part A, General Rules, Section 3, Payment of Fees, Costs and Charges).

1.2 Renewal by unauthorised third persons

The Office is also aware that fraudsters have targeted the e-Renewal module applying for renewal without the consent of the proprietor and thus blocking renewal via the module for persons legitimately authorised to do so. This technical block is designed to prevent a renewal being paid for twice. If, upon filing a request for e-Renewal a user discovers that the mark is 'blocked', as renewal has already been requested for the mark, they should contact the Office.

2 Terms of Registration

Article 46 EUTMR Articles 26 and 27 EUTMR Rule 9 EUTMIR

The term of registration of a European Union trade mark (EUTM) is 10 years from the filing date of the application. For example, an EUTMR with a filing date of 16/04//2006 will expire on 16/04/2016.

The filing date of the application is determined according to Articles 26, 27 EUTMR and Rule 9 EUTMIR.

Registration may be renewed indefinitely for further periods of 10 years.

3 Notification of Expiry of Registration

Article 47(2) EUTMR
Communication No 5/05 of the President of the Office of 27/07/2005

At least six months before the expiry of the registration, the Office will inform:

- the registered proprietor of the European Union trade mark and
- any person having a registered right in respect of the European Union trade mark

that the registration is approaching expiry. Persons having a registered right include the holders of a registered licence, the proprietors of a registered right *in rem*, the creditors of a registered levy of execution or the authority competent to act on behalf of the proprietor in insolvency procedures.

Failure to give such information does not affect the expiry of the registration and does not involve the responsibility of the Office.

4 Renewal of an EUTM Application

Communications No 5/05 and 8/05 of the President of the Office of 27/07/2005 and 21/12/2005
Annex I A(19) EUTMR

In the exceptional circumstance where an application has not yet matured to registration because of pending proceedings, the Office will not send the notice referred to in Article 47(2) EUTMR. The applicant is not obliged to renew its application during proceedings that last for more than 10 years and where the outcome of registration is uncertain. Only once the trade mark is registered will the Office invite the owner to renew the EUTM and pay the renewal fee. The owner will then have two months to pay the renewal fee (including any additional class fees). If the renewal fee is not paid within this first time limit, the owner will be given a second time limit of two additional months (a total of four months from the date of the first letter) in which to pay the renewal fee. During this further time limit of two months, the surcharge for the renewal fee of 25 % pursuant to Annex I A(19) EUTMR does not apply. If the renewal fee is not paid within the additional time limit given, the Office will issue a notice that the registration has expired. The expiry will take effect from the date of registration of the EUTM.

5 Fees and Other Formal Requirements for the Request for Renewal

Rules 79, 80 and 82 EUTMIR
Communication No 8/05 of the President of the Office of 21/12/2005

The general rules concerning communications to the Office apply (see the Guidelines, Part A, General Rules, Section 1, Means of Communication, Time Limits), which means that the request may be submitted as follows:

- by electronic means available on the EUIPO website (e-renewal). There is a reduction of EUR 150 in the renewal basic fee for an individual mark in case of e-renewal (EUR 300 for a collective mark). Entering the name and surname in the appropriate place on the electronic form is deemed to be a signature. In addition to the fee reduction, using e-renewal offers additional advantages such as the receipt of immediate electronic confirmation of the renewal request automatically or the use of the renewal manager feature to complete the form quickly for as many EUTMs as needed.
- by transmitting a signed original form by fax, mail, or any other means (see the Guidelines, Part A, General Rules, Section 1, Means of Communication, Time Limits). A standard form is available on the EUIPO website. Forms have to be signed but annexes need not be.

5.1 Persons who may submit a request for renewal

Articles 17(7) and 47(1) EUTMR
Communication No 8/05 of the President of the Office of 21/12/2005 EUTMs

The request for renewal may be submitted by:

- a) the registered proprietor of the European Union trade mark;
- b) where the EUTM registration has been transferred, the successor in title as from the point in time a request for registration of the transfer has been received by the Office;
- c) any person expressly authorised by the proprietor of the European Union trade mark to do so. Such a person may, for instance, be a registered licensee, a non-registered licensee or any other person who has obtained the authorisation of the EUTM proprietor to renew the mark.

An authorisation will have to exist in its favour; however, it does not need to be filed with the Office unless the Office requests it (see paragraph 6.1.2.1 below). If the Office receives fees from two different sources, neither of which is the owner or its representative on file, the owner will be contacted in order to know which person is authorised to file the renewal request. Where no reply is received from the owner, the Office will validate the payment that reached the Office first (judgment of 12/05/2009, T-410/07, Jurado, EU:T:2009:153, § 33-35; and decision of 13/01/2008, R 0989/2007-4 Elite glass-seal, § 17-18).

Representation pursuant to Article 92(2) EUTMR is not mandatory for renewal.

5.2 Content of the request for renewal

Article 47(4) EUTMR

The request for renewal must contain the following: name and address of the person requesting the renewal and the registration number of the renewed EUTM. The extent of the renewal is deemed total by default.

Payment alone can constitute a valid request for renewal providing such payment reaches the Office and contains the name of the payer, the registration number of the EUTM and the indication 'renew'. In such circumstances no further formalities need be complied with (see the Guidelines, Part A, General Rules, Section 3, Payment of Fees, Costs and Charges).

5.2.1 Name and address and other particulars of the person submitting a request for renewal

5.2.1.1 Request filed by the proprietor of the European Union trade mark

Where the request is filed by the EUTM proprietor, its name must be indicated.

If the Office has attributed an ID number to the proprietor, this number should be indicated together with the name.

5.2.1.2 Request filed by a person authorised to do so by the proprietor

Article 47(4) EUTMR
Rule 1(1)(b) and (e) EUTMIR

Where the request for renewal is filed by a person authorised by the proprietor to do so, the name and address or the ID number and name of the authorised person in accordance with Rule 1(1)(b) EUTMIR must be indicated.

If the selected payment method is Bank Transfer a copy of the renewal request is sent to the proprietor.

5.2.2 Registration number of the European Union trade mark

Article 47(4) EUTMR

The registration number of the European Union trade mark must be indicated.

5.2.3 Indication as to the extent of the renewal

Article 47(4) EUTMR

Where renewal is total, that is to say, it is requested for all the goods and services for which the mark is registered, an indication to that effect is required; if nothing is indicated, the renewal is deemed to be total by default.

Where renewal is requested for only some of the goods or services for which the mark is registered:

- an indication of those classes or those goods and services for which renewal is requested in a clear and unequivocal way. E-renewal only allows for deleting whole classes and not only part of the class.

Or, alternatively,

- an indication of those classes or those goods and services for which renewal is not requested in a clear and unequivocal way (this is only possible when filed on the paper form).

5.3 Languages

Rule 95(b) EUTMIR

The request for renewal may be filed in any of the five languages of the Office. This language becomes the language of the renewal proceedings. However, when the request for renewal is filed by using the form provided by the Office pursuant to Rule 83(1)(f) EUTMIR, such a form may be used in any of the official languages of the European Union, provided that the form is completed in one of the languages of the Office, as far as textual elements are concerned. This concerns, in particular, the list of goods and services in the event of a partial renewal.

5.4 Time limit

Article 46 and Article 47(3) EUTMR

Rule 72(1) EUTMIR

Communication No 2/2016 of the President of the Office of 20/01/2016 concerning the calculation of the amount of renewal fees in view of the entry into force of Regulation (EU) 2015/2424

5.4.1 Six month period for renewal before expiry (basic period)

The request for renewal and the renewal fee must be submitted within a period of six months ending on the day on which protection ends.

For example, where the European Union trade mark has a filing date of 10/06/2007, the day on which protection ends will be 10/06/2017. Therefore, a request for renewal must be introduced and the renewal fee paid as from 11/12/2016 until 10/06/2017 or, where this is a Saturday, Sunday or other day on which the Office is closed, or does not receive ordinary mail within the meaning of Rule 72(1) EUTMIR, the first following working day on which the Office is open to the public and receives ordinary mail.

5.4.2 Six month grace period following expiry (grace period)

Where the European Union trade mark is not renewed within the basic period, the request may still be submitted and the renewal fee may still be paid, upon payment of an additional fee (see paragraph 5.5 below), within a further period of six months following the day on which protection ends.

For example, where the European Union trade mark has a filing date of 10/06/2007 the day on which protection ends will be 10/06/2017. Therefore, the grace period during which a request for renewal may still be introduced upon payment of the renewal fee plus the additional fee is counted from the day after 10/06/2017, namely from 11/06/2017, and ends on 10/12/2017 or, if 10/12/2017 is a Saturday, Sunday or other day on which the Office is closed, or does not receive ordinary mail within the meaning of Rule 72(1) EUTMIR, the first following working day on which the Office is open to the public and receives ordinary mail. This also applies if in the above example 11/06/2017 was a Saturday or Sunday; the rule that a time limit to be observed vis-à-vis the Office is extended until the next working day applies only once and to the end of the basic period, and not to the starting date of the grace period.

5.4.3 Transitional arrangements when the basic period for renewal started before the entry into force of Regulation No 2015/2424 amending Regulation No 207/2009 on the Community trade mark.

Where the basic six-month period for renewal started to run before entry into force of Regulation No 2015/2424 amending Regulation No 207/2009 on the Community trade mark, the Practice of the Office is laid down in Communication No 2/2016 of the President of the Office of 20/01/2016 concerning the calculation of the amount of renewal fees in view of the entry into force of Regulation (EU) 2015/2424.

The provisions contained in the former Article 47(3) CTMR, in the version prior to amendment, will apply for calculating both the basic period and, where applicable, the grace period.

For example, where the EUTM has a filing date of 10/05/2006, the basic period will run up to and including the last day of the month in which protection ends, namely 31/05/2016. Therefore, a request for renewal must be introduced and the renewal fee paid between 01/12/2015 and 31/05/2016 (both dates inclusive) or, where the latter date is a Saturday, Sunday or other day on which the Office is closed or not receiving ordinary mail within the meaning of Rule 72(1) EUTMIR, the first following working day on which the Office is open to the public and receiving ordinary mail. The grace period would then run from 01/06/2016 up to and including 30/11/2016 (or the first working day thereafter).

For those EUTMRs that expire on or after 22/09/2016 the new calculation of the renewal periods (initial and grace period) will apply.

For example, where the EUTM has a filing date of 10/12/2006, it will expire on 10/12/2016. The basic period for renewal will run from 11/06/2016 up to and including 10/12/2016 (date of expiry). or, where the latter date is a Saturday, Sunday or other day on which the Office is closed or not receiving ordinary mail within the meaning of Rule 72(1) EUTMIR, the first following working day on which the Office is open to the public and receiving ordinary mail. The grace period would then run from 11/12/2016 up to and including 10/06/2017 (or the first working day thereafter).

5.5 Fees

5.5.1 Fees payable

Article 47(3) EUTMR
Annex I A(11), (12), (13), (14), (15), (16), (17) and (18) EUTMR
Communication No 2/2016 of the President of the Office of 20/01/2016 concerning the calculation of the amount of renewal fees in view of the entry into force of Regulation (EU) 2015/2424

As regards the calculation of the amount of the renewal fees, the due date for the renewal fees is the date of expiry of the registration (Article 47(5) EUTMR, which is not modified by the reform). Consequently, EUTMs expiring before 23/03/2016 will pay the renewal fee according to the old fee schedule.

Those EUTMs expiring on or after 23/03/2016 will pay it according to the new fee schedule. This principle applies regardless of the moment in which renewal is actually requested and paid for. Owners who have already paid for the renewal of an EUTM expiring on or after 23/03/2016 (according to the old fee schedule) will be refunded the excess fee they have paid (difference between the old and the new fee schedule).

The new fees payable for the renewal of an EUTM consist of a basic fee and where appropriate one or more class fees for each class of goods/services exceeding the first one.

The basic fee is

- for an individual mark: EUR 1 000/EUR 850 in the event of e-renewal and
- for a collective mark: EUR 1 800/EUR 1 500 in the event of e-renewal.

The class fees:

- for the second class: EUR 50
- for each class exceeding two: EUR 150.

5.5.2 Time limit for payment

The fee must be paid within a period of six months ending on the day on which protection ends (for calculation of the period, see the example given in paragraph 5.4.1 above).

Article 47(3) EUTMR
Annex I A(19); Article 144b(3) EUTMR

The fee may be paid within a further period of six months following the day on which protection ends (see paragraph 5.4.2 above), provided that an additional fee is paid, which amounts to 25 % of the total renewal fee, including any class fees, but which is subject to a maximum of EUR 1 500.

Renewal will be effected only if payment of **all** fees (renewal fees and additional fees for late payment, where applicable) reaches the Office within the grace period (see paragraph 5.4.2 above).

Fees which are paid **before** the start of the basic period of renewal (first six-month period) will not, in principle, be taken into consideration and will be refunded.

Where the EUTM proprietor has a current account at the Office, the renewal fee will only be debited once a request for renewal is filed and the renewal fee (including any class fees) will be debited on the last day of the time limit of six months provided for in Article 47(3) EUTMR, that is to say, on the day on which protection ends, unless other instructions are given.

Article 7(1)(d) of Decision No EX-96-1 of the President of the Office of 11/01/1996, as amended by Decision No EX-03-1 of 20/01/2003 and by Decision No EX-06-1 of 12/01/2006

In the event of the belated filing of a request for renewal (see paragraph 5.4.2 above), and where the EUTM proprietor has a current account at the Office, the renewal fee and surcharge will be debited on the last day of the grace period (namely the further period of six months provided for in Article 47(3) EUTMR, third sentence), unless other instructions are given.

5.5.3 Payment by third parties

Payment may also be made by the other persons identified in paragraph 5.1 above.

Payment by debiting a current account held by a third party requires an explicit authorisation of the holder of the current account that the account can be debited for the benefit of the particular fee. In such cases the Office will check if there is an authorisation. If there is no authorisation, a letter will be sent to the renewal applicant asking them to submit the authorisation to debit the account held by a third party. In such cases, payment is considered to be effected on the date the Office receives the authorisation.

5.5.4 Fee refund

Article 47(8) EUTMR

Renewal fees and, where applicable, the additional fee for late payment may be refunded under certain circumstances. For full information, please see the Guidelines, Part A, General Rules, Section 3, Payment of Fees, Costs and Charges.

6 Procedure Before the Office

6.1 Examination of formal requirements

The examination of the request for renewal is limited to formalities and relates to the following points:

6.1.1 Observation of time limits

Article 47(3) and (4) EUTMR

6.1.1.1 Payment during the basic period or the grace period

Where the request for renewal is filed and the renewal fee is paid within the basic period, the Office will record the renewal, provided that the other conditions laid down in the EUTMR and EUTMIR are fulfilled (see paragraph 6.1.2 below).

Article 47(3) EUTMR Communication No 8/05 of the President of 21/12/2005

Where no request for renewal has been filed, but a payment of the renewal fee reaches the Office that contains the minimum indications (name and address of the person requesting the renewal and the registration number of the renewed EUTM), this constitutes a valid request and no further formalities need be complied with.

However, where no request for renewal has been filed but a renewal fee has been paid that does not contain the minimum indications (name and address of the person requesting the renewal and the registration number of the renewed EUTM), the Office will invite the EUTM proprietor to submit a request for renewal and pay, where applicable, the additional fee for late submission of the request for renewal. A letter will be sent out as early as is reasonably possible after receipt of the fee, so as to enable filing of the request before the additional fee becomes due.

Where a request has been submitted within the basic period, but the renewal fee has not been paid or has not been paid in full the Office will invite the person requesting renewal to pay the renewal fee or the remaining part thereof and the additional fee for late payment. In the case of incomplete payment of the fee, the EUTM proprietor may, instead of paying the missing amount, restrict its request for renewal to the corresponding number of classes.

If the request for renewal is filed by a person authorised by the proprietor of the EUTM (according to paragraph 5.1c), the proprietor of the EUTM will receive a copy of the notification.

6.1.1.2 Payment after the expiry of the grace period

Article 47(5) and (8) EUTMR, Rule 54 EUTMIR

Where a request for renewal has not been submitted or is submitted only after the expiry of the grace period, the Office will determine that the registration has expired and will issue a notification on loss of rights to the proprietor and any person recorded in the Register as having rights in the mark.

Where the fees are not paid or are paid only after expiry of the grace period, the Office will determine that the registration has expired and will issue a notification on loss of rights to the proprietor and any person recorded in the Register as having rights in the mark.

Where the fee paid amounts to less than the basic fee and the fee for late payment/late submission of the request for renewal, the Office will determine that the registration has expired and will issue a notification on loss of rights to the proprietor and any person recorded in the Register as having rights in the mark.

Where the fee paid covers the basic fee and the fee for late payment, but not all class fees, the Office will only renew the registration for some classes. The determination of which classes of goods and services are to be renewed will be made according to the following criteria.

- Where the request for renewal is expressly limited to particular classes, only those classes will be renewed.
- Where it is otherwise clear from the request which class or classes are to be covered by the request, that class or those classes will be renewed.
- The Office may contact the proprietor to ask for the class preferences in the event of partial payment.
- In the absence of other criteria, the Office will take the classes into account in the numerical order of classification, beginning with the class having the lowest number.

Where not all class fees are paid and the Office determines that the registration has expired for some of the classes of goods or services, it will issue, together with the renewal confirmation, a notification of loss of rights for those classes of goods or services to the proprietor and, where appropriate, the person requesting renewal and the person recorded in the Register as having rights in the mark. If the person concerned finds that the finding of the Office is inaccurate, they may, within two months of the notification of the loss of rights, apply for a decision on the matter.

6.1.1.3 Situation where the proprietor holds a current account

The Office will not debit a current account unless there is an express request for renewal. It will debit the account of the person who has acted (EUTM proprietor or third person).

Where the request is filed within the basic period, the Office will debit the renewal fees (basic renewal fee plus applicable class fees) without surcharge.

Where the request is filed within the grace period, the Office will debit the renewal fee plus the 25 % surcharge (see paragraph 5.5 above).

6.1.1.4 Continuation of proceedings

Article 82(2) EUTMR
Communication No°6/05 of the President of the Office of 16/09/2005.

The time limit for requesting renewal is specifically excluded from continuation of proceedings.

6.1.1.5 *Restitutio in integrum*

Article 81 EUTMR
Article 67 CDR

Restitutio in integrum is available for the time limit for requesting renewal. For more information see the Guidelines, Part A, General Rules, Section 8, *Restitutio in Integrum*.

The incorrect functioning of renewal software is normally not a reason to justify *restitutio in integrum* (judgments of 13/05/2009, T-136/08, Aurelia, EU:T:2009:155; 19/09/2012, T-267/11, VR, EU:T:2012:1249; 28/06/2012, T-314/10, Cook's, EU:T:2012:329).

In the case of failure to submit a request for renewal or to pay the renewal fee, the time limit of one year starts on the day on which the protection ends, and not on the date of expiry of the grace period of six months.

6.1.2 Compliance with formal requirements of the Implementing Regulation

6.1.2.1 Renewal requested by authorised person

Communication No 8/05 of the President of the Office of 21/12/2005

Where a renewal request is filed on behalf of the trade mark proprietor there is no need to file an authorisation. However, such an authorisation should exist in favour of the person filing the request should the Office request it.

6.1.2.2 Further requirements

Article 47(4) and (7) EUTMR

Where the request for renewal does not comply with other formal requirements, namely where the name and address of the person requesting renewal has not been sufficiently indicated, where the registration number has not been indicated, where it has not been properly signed or, if partial renewal was requested but the goods and services to be renewed have not been properly indicated, the Office will invite the person requesting renewal to remedy the deficiencies within a time limit of two months. The time limit applies even if the grace period has already expired.

The Office will consider the request to be made for the renewal for all goods and services unless partial renewal is expressly requested. In the event of a partial renewal, please refer to paragraph 5.2.3 above.

If the request for renewal is filed by a person authorised by the proprietor of the EUTM (according to paragraph 5.1c), the proprietor of the EUTM will receive a copy of the notification.

Where a request for renewal has been submitted by two different persons claiming to be authorised by the proprietor of the EUTM ('authorised person'), the Office will seek clarification of who the authorised person is by contacting the owner directly.

Article 47(5) and (8) EUTMR Rule 54 EUTMIR

Where these deficiencies are not remedied before the expiry of the relevant time limit, the Office will proceed as follows.

- If the deficiency consists of failing to indicate the goods and services of the EUTM to be renewed, the Office will renew the registration for all the classes for which the fees have been paid, and if the fees paid do not cover all the classes of the EUTM registration, the determination of which classes are to be renewed will be made according to the criteria set out in paragraph 6.1.1.2 above. The Office will issue, together with the renewal confirmation, a notification of loss of rights for those classes of goods or services the Office deems expired, to the proprietor and any person recorded in the Register as having rights in the mark.
- If the deficiency consists of the Owner's failure to respond to a request for clarification of who the authorised person is, the Office will accept the request for renewal filed by the authorised representative on file. If neither of the requests for renewal has been filed by an authorised representative on file, the Office will accept the renewal request that was first received by the Office.
- In the case of the other deficiencies, it will determine that the registration has expired and will issue a notification of loss of rights to the proprietor or, where applicable, the person requesting renewal and any person recorded in the Register as having rights in the mark.

6.2 Items not to be examined

No examination will be carried out on renewal for the registrability of the mark, nor will any examination be carried out as to whether the mark has been put to genuine use.

No examination will be carried out by the Office on renewal as to the correct classification of the mark, nor will a registration be reclassified that has been registered in accordance with an edition of the Nice Classification that is no longer in force at the point in time of renewal. All of this is without prejudice to the application of Article 50 EUTMR.

6.3 Alteration

Article 48 EUTMR

The European Union trade mark will not be altered in the Register on renewal. Since renewal is considered a simple prolongation of the period of protection of the EUTMR upon payment of the necessary fees, it may not include changes in relation to the representation of the mark in its latest form, that is to say, at the expiry of the current period of protection.

Any other changes that do not alter the mark itself (changes of name, of address, etc.) that the owner wishes to have recorded in the Register when the registration is renewed must be communicated separately to the Office according to the applicable procedures (see the Guidelines, Part E, Register Operations, Section 1, Changes in a Registration). They will be included in the data recorded at renewal only if they are recorded in the EUTM Register no later than the date of expiry of the EUTM registration.

7 Entries in the Register

Article 47(5) EUTMR Article 87(3) and (6) EUTMR
--

Where the request for renewal complies with all the requirements, the renewal will be registered.

The Office will notify the EUTM proprietor of the renewal of the EUTM registration and its entry in the Register. The renewal will take effect from the day following the date on which the existing registration expires (see paragraph 8 below).

Where renewal has taken place only for some of the goods and services contained in the registration, the Office will notify the proprietor and any person recorded in the Register as having rights in the mark of the goods and services for which the registration has been renewed and the entry of the renewal in the Register and of the date from which renewal takes effect (see paragraph 8 below). Simultaneously, the Office will notify the expiry of the registration for the remaining goods and services and of their cancellation from the Register.

Article 47(5) and (8) EUTMR
Rule 54(2) EUTMIR

Where the Office has made a determination pursuant to Article 47(8) EUTMR that the registration has expired, the Office will cancel the mark from the Register and notify the proprietor accordingly. The proprietor may apply for a decision on the matter under Rule 54(2) EUTMIR within two months.

Article 87(3) and (6) EUTMR

The Office will inform the proprietor and any person recorded in the Register as having rights in the mark of the expiry of the registration and its cancellation from the Register.

8 Date of Effect of Renewal or Expiry, Conversion

8.1 Date of effect of renewal

Article 47(6) and (8) EUTMR
Rule 70(3) EUTMIR

Renewal will take effect from the day following the date on which the existing registration expires.

For example, where the filing date of the registration is 01/04/2006, the registration will expire on 01/04/2016. Therefore, renewal takes effect from the day following 01/04//2016, namely 02/04/2016. Its new term of registration is ten years from this date, which will end on 01/04/2026. It is immaterial whether any of these days is a Saturday, Sunday or official holiday. Even in cases where the renewal fee is paid within the grace period, the renewal takes effect from the day following the date on which the existing registration expires.

Where the mark has expired and is removed from the Register, the cancellation will take effect from the day following the date on which the existing registration expired.

For example, where the filing date of the registration is 01/04/2006, the registration will expire on 01/04/2016. Therefore, the removal from the Register takes effect from the day following 01/04//2016, namely 02/04/2016.

8.2 Conversion of lapsed EUTMs

Articles 47(3) and 112(5) EUTMR

Where the owner wants to convert its lapsed EUTM into national marks, the request must be filed within three months from the day following the last day of the period within which a request for renewal may be presented pursuant to Article 47(3) EUTMR, that is to say, six months after the day on which protection has expired. The time limit of three months for requesting conversion starts automatically without notification (see the Guidelines, Part E, Register Operations, Section 2, Conversion).

9 Renewal of International Marks Designating the EU

Article 159(1) EUTMR
Rule 107 EUTMIR

The principle is that any changes relating to the international registration will be filed directly at WIPO by the holder of the international registration. The Office will not deal with renewal requests or payment of renewal fees.

The procedure for renewal of international marks is managed entirely by the International Bureau. The International Bureau will send notice for renewal, receive the renewal fees and record the renewal in the International Register. The effective date of the renewal is the same for all designations contained in the international registration, irrespective of the date on which such designations were recorded in the International Register. Where the international registration designating the EU is renewed, the Office will be notified by the International Bureau.

If the international registration is not renewed, it can be converted into national marks or into subsequent designations of Member States under the Madrid Protocol. The three-month time limit for requesting conversion starts on the day following the last day on which renewal may still be effected before WIPO pursuant to Article 7(4) of the Madrid Protocol (see the Guidelines, Part E, Register Operations, Section 2, Conversion).

***GUIDELINES FOR EXAMINATION OF
EUROPEAN UNION TRADE MARKS***

***EUROPEAN UNION
INTELLECTUAL PROPERTY OFFICE
(EUIPO)***

PART E

REGISTER OPERATIONS

SECTION 5

INSPECTION OF FILES

Table of Contents

1	General Principles	4
2	The Registers of European Union Trade Marks and Community Designs.....	5
3	Inspection of the Registers.....	5
3.1	Information contained in the Registers	5
3.1.1	The Register of European Union trade marks.....	5
3.1.2	The Register of Community designs	5
4	Inspection of Files	6
4.1	Persons/Entities authorised to request access to the files	6
4.2	Documents that constitute the files	6
4.2.1	The files relating to European Union trade mark applications.....	7
4.2.2	The files relating to Community design applications	8
4.2.3	The files relating to registered European Union trade marks.....	8
4.2.4	The files relating to registered Community designs	8
4.2.5	The files relating to international registrations designating the European Union	9
5	Parts of the File Excluded from Inspection	9
5.1	Excluded documents	9
5.1.1	Documents relating to exclusion or objection.....	10
5.1.2	Draft decisions and opinions and internal documents.....	10
5.1.3	Parts of the file for which the party concerned expressed a special interest in keeping confidential.....	11
5.2	Access for applicant or proprietor to excluded documents.....	12
6	Procedures Before the Office Relating to Applications for Inspection of Files	12
6.1	Certified or uncertified extracts of the registers	12
6.1.1	Extracts from the Register of European Union trade marks.....	12
6.1.2	Extracts from the Register of Community Designs.....	13
6.2	Certified or uncertified copies of file documents.....	13
6.3	Online access to the files.....	14
6.4	Downloadable certified copies	14
6.5	Online applications for inspection of files.....	15
6.6	Written applications for inspection of files.....	15
6.7	Languages	16
6.7.1	For EUTM or CD applications.....	16
6.7.2	For registered EUTMs or RCDs	16
6.8	Representation and authorisation.....	17
6.9	Contents of the application for inspection of files.....	17

6.10	Deficiencies	17
6.11	Fees for inspection and communication of information contained in the files	18
6.11.1	Communication of information contained in a file	18
6.11.2	Inspection of the files	18
6.11.3	Consequences of failure to pay	19
6.11.4	Refund of fees	19
6.12	Requirements concerning the right to obtain inspection of files concerning an unpublished EUTM application, or a deferred RCD filed by a third party	20
6.12.1	Consent	20
6.12.2	Statement that EUTM or RCD rights will be invoked	21
6.13	Grant of inspection of files, means of inspection	21
6.13.1	Communication of information contained in a file	21
6.13.2	Copies of file documents	22
7	Procedures to Give Access to the Files to Courts or Authorities of the Member States	22
7.1	No fees	22
7.2	No restriction as to unpublished applications	23
7.3	Means of inspection	23

1 General Principles

Articles 87(1) and (5), 88 and 90(1) and (2) EUTMR
Articles 72, 74, and 75 CDR
Rules 92 and 93 EUTMIR
Article 69(1), Articles 74, 75, 77 and 78 CDIR
Annex I A(30) EUTMR

The principle established under the European Union trade mark and design system is that:

- the ‘Register of European Union Trade Marks’ and the ‘Register of Community Designs’ contain all particulars relating to European Union trade mark and Community design applications and registered European Union trade marks and Registered Community designs; and
- the ‘files’ contain all correspondence and decisions relating to those trade marks and designs.

Both the Registers and the files of the Office are in principle open to inspection by the public. However, before publication of an EUTM application, a Community Design registration or when a Registered Community Design (RCD) is subject to deferred publication, inspection of files is possible only in exceptional cases (see paragraphs 4.2.1 and 4.2.2 below).

All the information in the Registers is stored in the Office’s databases and, where applicable, published in the EUTM/RCD Bulletin in electronic format.

This section of the Guidelines deals specifically with inspection of files.

Inspection of the files may involve:

- inspection of the registers;
- obtaining certified or uncertified extracts of the registers;
- inspection of the actual file document(s);
- the communication of information contained in the files, implying communication of specific information contained in the files without supplying the actual file document(s);
- obtaining certified or uncertified copies of documents contained in the files.

In these Guidelines, the term ‘inspection of the files’ is used to cover all of the abovementioned forms of inspection of files, unless otherwise stated.

The provisions in the CDR and CDIR dealing with inspection of files of Community designs are almost identical to the equivalent provisions of the EUTMR and EUTMIR, respectively. Therefore, the following applies *mutatis mutandis* to Community designs. Where the procedure is different, these differences are specified under a separate sub-heading.

2 The Registers of European Union Trade Marks and Community Designs

Article 87(1) and (5) EUTMR
Article 72 CDR
Article 69 CDIR

The Registers are maintained electronically and consist of entries in the Office's database systems. They are available on the Office website for public inspection, except, in the case of Community designs, to the extent that Article 50(2) CDR provides otherwise. Insofar as some data contained in the Registers are not yet available online, the only means of access is by a request for information or by obtaining certified or uncertified extracts or copies of the file documents from the Registers subject to the payment of a fee.

3 Inspection of the Registers

3.1 Information contained in the Registers

3.1.1 The Register of European Union trade marks

Article 87(2),(3) and (4) EUTMR
Decision No EX-00-1 of the President of the Office of 27 November 2000 concerning entries in the Register of Community Trade Marks
Decision No EX-07-1 of the President of the Office of 16 March 2007 concerning entries in the Register of Community Trade Marks

The Register of European Union Trade Marks contains the information specified in Article 87(2),(3) and (4) EUTMR and any other items determined by the Executive Director of the Office.

3.1.2 The Register of Community designs

Article 50 CDR
Articles 69 and 73 CDIR
Decision No EX-07-2 of the President of the Office of 16 March 2007 concerning entries in the Register of Community Designs

The Register of Community Designs contains the information specified in Article 69 CDIR and any other items determined by the Executive Director of the Office.

In accordance with Article 73(a) CDIR, where the registered Community designs are subject to a deferment of publication pursuant to Article 50(1) CDR, access to the Register to persons other than the holder shall be limited to the name of the holder, the name of any representative, the date of filing and registration, the file number of the application and the mention that publication is deferred.

4 Inspection of Files

4.1 Persons/Entities authorised to request access to the files

The rules and degree of access to the files vary according to who requests inspection.

The Regulations and the Implementing Regulations differentiate between the following three categories:

- the applicant/proprietor of the European Union trade mark or Community design;
- third parties;
- courts or authorities of the Member States.

Inspection of the files by courts or authorities of the Member States is covered by the system of administrative cooperation with the Office (see paragraph 7 below).

4.2 Documents that constitute the files

The files relating to an EUTM or RCD consist of all correspondence between the applicant/proprietor and the Office and all documents established in the course of examination, as well as any correspondence concerning the ensuing European Union trade mark or Community design. The file does not include trade mark search reports provided by national Offices.

Documents relating to opposition, cancellation, invalidity and appeal proceedings before the Office or other proceedings, such as recordals (transfer, licence etc.), also form part of the files.

Where the parties make use of the mediation services offered by the Office in accordance with Decision No 2011-1 of the Presidium of the Boards of Appeal of 14 April 2011 on the amicable settlement of disputes, or the conciliation services in accordance with Decision No 2014-2 of the Presidium of the Boards of Appeal of 31 January 2014, on the friendly settlement of disputes by the competent Board, all correspondence relating to that mediation or conciliation are excluded from inspection of files.

Article 88a EUTMR Article 76 CDIR

Even where an EUTM application is no longer pending or an EUTM registration or CD registration cease to have effect, inspection of the respective files remains possible just as if the application or registration were still pending or effective, as long as the files are kept. An EUTM application or CD application ceases to be pending when it is rejected, or when the application has been withdrawn or deemed to be withdrawn, and an EUTM registration or CD registration ceases to have effect when it expires or is surrendered, declared invalid or revoked. The Office will keep the complete files for at least five years from the end of the year in which such an event occurs.

4.2.1 The files relating to European Union trade mark applications

Articles 39 and 88 EUTMR
Rules 12 and 85 EUTMIR

The files relating to European Union trade mark applications are available for inspection of files once the application has been published by the Office in the European Union Trade Marks Bulletin. The day of publication is the date of issue shown in the European Union Trade Marks Bulletin and is reflected under the INID code 442 in the Register. The dissemination of data relating to unpublished EUTM applications by means of online access or otherwise does not constitute publication of the application within the meaning of Article 39 EUTMR and Rule 12 EUTMIR.

Before the publication of the application, inspection of the files is restricted and possible only if one of the following conditions is fulfilled:

- the applicant for inspection is the EUTM applicant/proprietor; or
- the EUTM applicant has consented to inspection of the file relating to the EUTM application (see paragraph 6.12.1 below); or
- the applicant for inspection can prove that the EUTM applicant has stated that it will invoke the rights under the EUTM, once registered, against the applicant for inspection (see paragraph 6.12.2 below).

Articles 36(3) and 88a EUTMR

The applicant always has access to the files relating to its own EUTM application. This comprises the following:

- the EUTM application, even where the Office has refused to attribute a filing date to it or where the application does not fulfil the minimum requirements for the attribution of a filing date, in which case the application will not be dealt with as an EUTM application and, legally speaking, there is no EUTM application;
- the files for as long as they are kept (see paragraph 4.2), even after the EUTM application has been rejected or withdrawn.

4.2.2 The files relating to Community design applications

Articles 50 and 74 CDR Article 70 and Article 74(2) CDIR

The files relating to Community design applications, or applications for a registered Community design that are subject to deferment of publication, which have been surrendered before or on the expiry of that period or, pursuant to Article 50(4) CDR, are deemed from the outset not to have had the effects specified in that Regulation, are available for inspection only if one of the following conditions is fulfilled:

- the applicant for inspection is the CD applicant/proprietor; or
- the applicant for the Community design has consented to inspection of the file relating to the Community design application; or
- the applicant for inspection has established a legitimate interest in the inspection of the Community design application, in particular where the applicant for the Community design has stated that after the design has been registered he/she will invoke the rights under it against the person requesting the inspection.

In the case of an application for multiple Community designs, this inspection restriction will only apply to information relating to the Community designs subject to deferment of publication, or to those that are not eventually registered, either due to rejection by the Office or withdrawal by the applicant.

4.2.3 The files relating to registered European Union trade marks

The files relating to European Union trade marks after registration are available for inspection.

4.2.4 The files relating to registered Community designs

The files relating to registered Community designs are available for inspection once the registration has been published by the Office in the Community Designs Bulletin. The day of publication is the date of issue shown in the Community Designs Bulletin and is reflected under the INID code 45 in the Register.

Where inspection of the files relates to a registered Community design that is subject to deferment of publication under Article 50 CDR, or which, being subject to such deferment, has been surrendered before or on the expiry of that period or which, pursuant to Article 50(4) CDR, is deemed from the outset not to have had the effects specified in that Regulation, inspection of files of the registration is restricted and possible only if one of the following conditions is fulfilled:

- the holder of the Community design has consented to inspection of the file relating to the Community design registration;
- the applicant for inspection has established a legitimate interest in the inspection of the files of the Community design registration, in particular where the holder of

the Community design has taken steps with a view to invoking the rights under it against the person requesting the inspection.

In the case of an application for multiple Community designs, this inspection restriction will apply only to information relating to the Community designs subject to deferment of publication, or to those that are not eventually registered either due to rejection by the Office or withdrawal by the applicant.

4.2.5 The files relating to international registrations designating the European Union

Articles, 88(8), 151 and 152 EUTMR Article 106(d) CDR Article 71 CDIR

International registrations are exclusive rights administered by the International Bureau of the World Intellectual Property Organization (WIPO) in Geneva according to the Madrid Protocol (in the case of trade marks) and the Geneva Act (in the case of designs). WIPO processes the applications and then sends them to the Office for examination in accordance with the conditions specified in the EUTMR and in the CDR. These registrations have the same effect as applying directly for a European Union trade mark or a registered Community design.

The files kept by the Office relating to international trade mark registrations designating the European Union may be inspected on request as from the date of publication referred to in Articles 152(1) and 88(8) EUTMR.

The Office provides information on international registrations of designs designating the EU in the form of an electronic link to the searchable database maintained by the International Bureau (<http://www.wipo.int/designdb/hague/en/>). The files kept by the Office may relate to refusal of international design pursuant to Article 106e CDR and the invalidation of the international design pursuant to Article 106f CDR. They may be inspected subject to the restrictions pursuant to Article 72 CDIR (see paragraph 5, Parts of the File Excluded from Inspection below).

5 Parts of the File Excluded from Inspection

5.1 Excluded documents

Articles 88(4) and 137 EUTMR Article 72 CDIR

Certain documents contained in the files are excluded from inspection of files, namely:

- documents relating to the exclusion of or objection to Office staff, for example on the grounds of suspicion of partiality;
- draft decisions and opinions and all other internal documents used for preparing decisions and opinions;

- parts of the file for which the party concerned expressed a special interest in keeping confidential;
- all documents relating to the invitation of the Office to find a friendly settlement, except those that have an immediate impact on the trade mark or design, such as limitations, transfers etc., and have been declared to the Office. (For mediation and conciliation proceedings, see paragraph 4.2 above).

5.1.1 Documents relating to exclusion or objection

Article 88(4) EUTMR
Article 72(a) CDIR

This exception relates to documents in which an examiner states that they consider themselves excluded from participating in the case, as well as documents in which such a person makes observations about an objection by a party to the proceedings on the basis of a ground for exclusion or suspicion of partiality. However, it does not relate to letters in which a party to the proceedings raises, either separately or together with other statements, an objection based on a ground for exclusion or suspicion of partiality, or to any decision on the action to be taken in the cases mentioned above. The decision taken by the competent instance of the Office, without the person who withdraws or has been objected to, will form part of the files.

5.1.2 Draft decisions and opinions and internal documents

Article 88(4) EUTMR
Article 72(b) CDIR

This exception relates to documents used for preparing decisions and opinions, such as reports and notes drafted by an examiner that contain considerations or suggestions for dealing with or deciding on a case, or annotations containing specific or general instructions on dealing with certain cases.

Documents that contain a communication, notice or final decision by the Office in relation to a particular case are not included in this exception. Any document to be notified to a party to the proceedings will take the form of either the original document or a copy thereof, certified by or bearing the seal of the Office, or a computer print-out bearing that seal. The original communication, notice or decision or copy thereof will remain in the file.

The Notes and the Guidelines of the Office relating to general procedure and treatment of cases, such as these Guidelines, do not form part of the files. The same is true for measures and instructions concerning the allocation of duties.

5.1.3 Parts of the file for which the party concerned expressed a special interest in keeping confidential

Article 88(4) EUTMR Article 72(c) CDIR

Point in time for the request:

Keeping all or part of a document confidential may be requested on its submission or at a later stage, as long as there is no pending request for an inspection of files. During inspection of files proceedings confidentiality may not be requested.

Parts of the file for which the party concerned expressed a special interest in keeping confidential before the application for inspection of files was made are excluded from inspection of files, unless their inspection is justified by an overriding legitimate interest of the party seeking inspection.

The party concerned must have expressly invoked, and sufficiently justified, a special interest in keeping the document confidential. The official forms of the Office are excluded from inspection of files.

Where the party concerned requests confidentiality but does not justify its interest in keeping the document confidential, the Office will reject the request for confidentiality and will invite the party concerned to file observations within two months.

If a special interest in keeping a document confidential is invoked, the Office must check whether that special interest is sufficiently demonstrated. The documents falling into this category must originate from the party concerned (e.g. EUTM/RCD applicant, opponent). The special interest must be due to the confidential nature of the document or its status as a trade or business secret. This may be the case, for example, where the applicant has submitted underlying documentation as evidence in respect of a request for registration of a transfer or licence. Where the Office concludes that the requirements for keeping documents confidential are not met, it will communicate with the person who filed the documents and make a decision. The applicant may submit evidence in such a way that avoids revealing parts of the document or information that the applicant considers confidential, as long as the parts of the document submitted contain the required information. For example, where contracts or other documents are submitted as evidence for a transfer or licence, certain information may be blacked out before being submitted to the Office, or certain pages may be omitted altogether.

In the event that the Office invites the parties to opposition, cancellation or invalidity proceedings to consider a friendly settlement, all corresponding documents referring to those proceedings are considered confidential and in principle not open to inspection of files.

Access to documents that the Office has accepted as being confidential and thus, excluded from inspection, may nevertheless be granted to a person who demonstrates an overriding legitimate interest in inspecting the document. The overriding legitimate interest must be that of the person requesting inspection.

If the file contains such documents, the Office will inform the applicant for inspection of files about the existence of such documents within the files. The applicant for

inspection of files may then decide whether or not it wants to file a request invoking an overriding legitimate interest. Each request must be analysed on its own merits.

The Office must give the party requesting inspection the opportunity to present its observations.

Before taking a decision, the request, as well as any observations, will have to be sent to the party concerned, who has a right to be heard.

Article 59 EUTMR
Article 56 CDR

The Office must make a decision as to whether to grant access to such documents. Such a decision will be subject to appeal by the adversely affected party.

5.2 Access for applicant or proprietor to excluded documents

Article 88(4) EUTMR
Article 72 CDIR

Where an applicant or proprietor requests access to their own file, this will mean all documents forming part of the file, excluding only those documents referred to in Article 88(4) EUTMR and Article 72(a) and (b) CDIR.

In *inter partes* proceedings where the other party concerned (the opponent or applicant for revocation or declaration of invalidity) has shown a special interest in keeping its document confidential vis-à-vis third parties, it will be informed that the documents cannot be kept confidential with respect to the other party to the proceedings and it will be invited to either disclose the documents or withdraw them from the proceedings. If it confirms the confidentiality, the documents will not be sent to the other party and will not be taken into account by the Office in the decision.

If, on the other hand, it wants the documents to be taken into account but not available for third parties, the documents can be forwarded by the Office to the other party to the proceedings, but will not be available for inspection by third parties (for opposition proceedings, see the Guidelines, Part C, Opposition, Section 1, Procedural Matters).

6 Procedures Before the Office Relating to Applications for Inspection of Files

6.1 Certified or uncertified extracts of the registers

6.1.1 Extracts from the Register of European Union trade marks

Article 87(7) EUTMR

The Office shall provide certified or uncertified extracts from the Register on request, on payment of a fee.

Requests for an extract from the Register of European Union Trade Marks may be submitted by filing the official 'Application for an Inspection of File' form, available in all languages of the Office or any equivalent request.

Any language version of this form may be used, provided that it is completed in one of the languages referred to in paragraph 6.7 below.

Rules 80 and 82 EUTMIR

An application for inspection of files may be submitted as a signed original form by fax, post or electronic means (see paragraph 6.5 below).

6.1.2 Extracts from the Register of Community Designs

Article 50 CDR Articles 69 and 73 CDIR

Subject to Article 73 CDIR, the Office shall provide certified or uncertified extracts from the Register on request, on payment of a fee.

Where the registration is subject to a deferment of publication, pursuant to Article 50(1) CDR, certified (or uncertified) extracts from the Register shall contain only the name of the holder, the name of any representative, the date of filing and registration, the file number of the application and the mention that publication is deferred, except where the request has been made by the holder or his/her representative.

Requests for an extract from the Register of Community Designs may be submitted by filing the official 'Application for an Inspection of File' form, available in all languages of the Office or any equivalent request.

Any language version of this form may be used, provided that it is completed in one of the languages referred to in paragraph 6.7 below.

Articles 65, 66, 67 CDIR

An application for inspection of files may be submitted as a signed original by fax, post or electronic means (see paragraph 6.5 below).

6.2 Certified or uncertified copies of file documents

The Office shall provide certified or uncertified copies of documents constituting the files (see paragraph 4.2 above) on request, on payment of a fee.

Requests for certified or uncertified copies of documents may be submitted by filing the official 'Application for an Inspection of File' form, available in all languages of the Office or any equivalent request.

Any language version of this form may be used, provided that it is completed in one of the languages referred to in paragraph 6.7 below.

Certified and uncertified copies of the EUTM and RCD applications, registration certificates, extracts of the Register and copies of the documents in the file (available only for EUTM), may also be requested as an alternative to the downloadable copies available free of charge (see paragraph 6.4 below).

Certified copies of the EUTM application or the RCD registration certificate will only be available when a filing date has been accorded (for EUTM filing date requirements, see the Guidelines, Part B, Examination, Section 2, Formalities; for RCD filing date requirements, see the Guidelines on Examination of Applications for Registered Community Designs).

In the case of an application for multiple designs, certified copies of the application will only be available for those designs that have been accorded a filing date.

Where the EUTM application or RCD registration has not yet been published, a request for certified or uncertified copies of the file documents will be subject to the restrictions listed in paragraphs 4.2.1 to 4.2.4 above.

It should be borne in mind that the certified copy of the application or registration only reflects the data on the date of application/registration. The trade mark or design may have been the subject of a transfer, surrender, partial surrender or other act affecting its scope of protection, which will not be reflected in the certified copy of the EUTM application form or EUTM/RCD registration certificate. Up-to-date information is available from the electronic database or by requesting a certified extract of the Register (see paragraph 6.1 above).

6.3 Online access to the files

The contents of the files are available in the 'Correspondence' section of the file in the Office's online tool on the Office's website.

Providing the EUTM application or the CD registration (not subject to a deferment) has been published, registered users of the website can consult these files free of charge.

6.4 Downloadable certified copies

Decision No EX-13-2 of the President of the Office of 26 November 2013 concerning electronic communication with and by the Office ('Basic Decision on Electronic Communication'), Article 6.

Certified and uncertified copies of the EUTM and RCD applications, registration certificates, extracts of the Register and copies of the documents in the file (available only for EUTM) can be automatically generated and downloaded via a direct link from the Office's website via the Office's online tool, from within the Inspection of Files e-filing form and from within the files for a selected EUTM or RCD.

In the list of documents, an icon appears next to the document for which a certified or uncertified copy can be downloaded. Clicking on the icon will generate a certified or uncertified copy of the document in PDF format.

The PDF document is composed of a cover page in the five Office languages, introducing the certified document and containing a unique identification code for the original document, followed by the certified document itself (EUTM application form, EUTM registration certificate or RCD registration certificate). Each page of the document should bear a header and footer containing important elements in order to guarantee the authenticity of the certified copy: a unique identification code, a 'copy' stamp, the signature of the Office staff member responsible for issuing certified copies, the date of the certified copy, the EUTM/RCD number and page number. The date indicated is the date when the certified copy was automatically generated.

The automatically generated certified copies have the same value as certified copies sent on paper upon request, and can either be used in electronic format or printed.

When an authority receives a certified copy, it can verify the original document online using the unique identification code given in the certified copy. A link 'Verify certified copies' is available under the 'Databases' section of the Office's website. Clicking on the link will bring up a screen with a box in which the unique identification code can be entered in order to retrieve and display the original document from the Office's online systems.

It should be borne in mind that the certified copy only reflects the data on the date of application/registration. The trade mark or design may have been the subject of a transfer, surrender, partial surrender or other act affecting its scope of protection, which will not be reflected in the certified copy of the EUTM application form or EUTM/RCD registration certificate. Up-to-date information is available from the electronic database or by requesting a certified extract of the Register or database.

6.5 Online applications for inspection of files

Applications for inspection may be filed online. Users may access the application form by clicking on the icon in the detail page of a selected EUTM or RCD. They will then be re-directed to their user account where they will be invited to login and complete the application for inspection of files requesting certified or uncertified copies of specific documents.

6.6 Written applications for inspection of files

Rule 79 EUTMIR Article 65 CDIR

Applications for inspection may be submitted by filing the official 'Application for an Inspection of File' form, available in all languages of the Office or any equivalent request.

Any language version of this form may be used, provided that it is completed in one of the languages referred to in paragraph 6.7 below.

Rules 80 and 82 EUTMIR
Article 67 CDIR

An application for inspection of files may be submitted as a signed original form by fax, post or electronic means (see paragraph 6.5 above).

6.7 Languages

Applications for inspection of files must be filed in one of the languages indicated below.

6.7.1 For EUTM or CD applications

Rule 95(a), Rules 96 and 98 EUTMIR
Articles 80, 81, 83 and 84 CDIR

Where the application for an inspection of files relates to a European Union trade mark application or Community design application, whether already published or not, it must be filed in the language in which the EUTM application or CD application was filed (the 'first' language) or in the second language indicated by the EUTM applicant or CD applicant in their application (the 'second' language).

Where the application for inspection is filed in a language other than indicated above, the applicant for inspection must, of its own motion, submit a translation into one of the languages indicated above within one month. If such a translation is not submitted within the deadline, the application for inspection of files will be deemed not to have been filed.

This does not apply where the applicant for inspection could not have been aware of the languages of the EUTM application or RCD application (which can be the case only where such information is not available in the online register and the application can immediately be dealt with). In this case, the application for inspection may be filed in any of the five languages of the Office.

6.7.2 For registered EUTMs or RCDs

Rule 95(b), Rules 96 and 98 EUTMIR
Article 80(b), Rules 81, 83 and 84 CDIR

Where the application for inspection of files relates to a registered EUTM or RCD, it must be filed in one of the five languages of the Office.

The language in which the application for inspection was filed will become the language of the inspection proceedings.

Where the application for inspection of files is made in a language other than indicated above, the party requesting inspection must, on its own motion, submit a translation into one of the languages indicated above within one month, or the application for inspection of files will be deemed not to have been filed.

6.8 Representation and authorisation

Representation is not mandatory for filing an application for inspection of files.

Where a representative is appointed, the general rules for representation and authorisation apply. See the Guidelines, Part A, General Rules, Section 5, Professional Representation.

6.9 Contents of the application for inspection of files

The application for inspection of files mentioned in paragraphs 6.5 and 6.6 above must contain the following:

- an indication of the file number or registration number for which inspection is applied for;
- the name and address of the applicant for inspection of files;
- if appropriate, an indication of the document or information for which inspection is applied for (applications may be made to inspect the whole file or specific documents only). In the event of an application to inspect a specific document, the nature of the document (e.g. 'application', 'notice of opposition') needs to be stated. Where communication of information from the file is applied for, the type of information needed must be specified. Where the application for inspection relates to an EUTM application that has not yet been published, the application for a registered Community design that has not yet been published or a registered Community design that is subject to deferment of publication in accordance with Article 50 CDR or which, being subject to such deferment, has been surrendered before or on the expiry of that period, and inspection of the files is applied for by a third party, an indication and evidence to the effect that the third party concerned has a right to inspect the file;
- where copies are requested, an indication of the number of copies requested, whether or not they should be certified and, if the documents are to be presented in a third country requiring an authentication of the signature (*legalisation*), an indication of the countries for which authentication is needed;
- the applicant's signature in accordance with Rule 79 EUTMIR and Article 65 CDIR.

6.10 Deficiencies

Where an application for inspection of the files fails to comply with the requirements concerning the contents of applications, the applicant for inspection will be invited to remedy the deficiencies. If deficiencies are not remedied within the fixed time limit, the application for inspection will be refused.

6.11 Fees for inspection and communication of information contained in the files

All fees are due on the date of receipt of the application for inspection (see paragraphs 6.5 and 6.6 above).

6.11.1 Communication of information contained in a file

Article 88(9) and Annex I A(32) EUTMR
Article 75 CDIR
Article 2 CDFR in conjunction with Annex(23) CDFR

Communication of information in a file is subject to payment of a fee of EUR 10.

6.11.2 Inspection of the files

Article 88(6) and Annex I A (30) EUTMR
Article 74(1) CDIR
Article 2 CDFR in conjunction with Annex(21) CDFR

A request for inspection of the files on the Office premises is subject to payment of a fee of EUR 30.

Article 88(7) and Annex I A (31)(a) EUTMR
Article 74(4) CDIR
Article 2 CDFR in conjunction with Annex(22) CDFR

Where inspection of a file is obtained through the issuing of **uncertified** copies of file documents, those copies are subject to payment of a fee of EUR 10 plus EUR 1 for every page exceeding ten.

Rule 24(2)EUTMIR
Articles 87(7), 88(7) and Annex I A (29)(a) EUTMR
Articles 17(2), 69(6) and 74(5) CDIR
Article 2 CDFR in conjunction with Annex(20) CDFR

An **uncertified** copy of an EUTM application or RCD application, an **uncertified** copy of the certificate of registration, an **uncertified** extract from the Register or an **uncertified** extract of the EUTM application or RCD application from the database is subject to payment of a fee of EUR 10 per copy or extract.

Article 88(7) and Annex I A (31)(b) EUTMR
Article 74(4) CDIR
Article 2 CDFR in conjunction with Annex(22) CDFR

Where inspection of a file is obtained through the issuing of **certified** copies of file documents, those copies are subject to payment of a fee of EUR 30 plus EUR 1 for every page exceeding ten.

Rule 24(2) EUTMIR
Articles 87(7), 88(7) and Annex I A (29)(b) EUTMR
Articles 17(2), 69(6) and 74(5) CDIR
Article 2 CDFR in conjunction with Annex(20) CDFR

A **certified** copy of a EUTM application or RCD application, a **certified** copy of the certificate of registration, a **certified** extract from the Register or a **certified** extract of the EUTM application or RCD application from the database is subject to payment of a fee of EUR 30 per copy or extract.

However, registered users of the website can obtain electronic certified copies of EUTM or RCD applications or registration certificates free of charge through the website.

6.11.3 Consequences of failure to pay

Article 88(6) EUTMR
Article 74(1) CDIR

An application for inspection of files will be deemed not to have been filed until the fee has been paid. The fees apply not only where the application for inspection has been filed by a third party, but also where it has been filed by the EUTM or RCD applicant or proprietor. The Office will not process the inspection application until the fee has been paid.

However, if the fee is not paid or is not paid in full, the Office will notify the applicant for inspection:

- if no payment is received by the Office for a certified or uncertified copy of a EUTM application or RCD application, a certificate of registration or an extract from the Register or from the database;
- if no payment is received by the Office for inspection of the files obtained through the issuing of certified or uncertified copies of file documents;
- if no payment is received by the Office for the communication of information contained in a file.

The Office will issue a letter indicating the amount of fees to be paid. If the exact amount of the fee is not known to the applicant for inspection because it depends on the number of pages, the Office will either include that information in the standard letter or inform the applicant for inspection by other appropriate means.

6.11.4 Refund of fees

Where the application to obtain certified or uncertified copies or information contained in the files is withdrawn before the Office has dealt with it, the fee will be refunded or, in the case of a current account, the account will not be debited.

Where an application for inspection of the files is rejected, the corresponding fee is not refunded. However, where, subsequent to the payment of the fee the Office finds that

not all the certified or uncertified copies requested may be issued, any fees is paid in excess of that which is eventually due will be refunded.

6.12 Requirements concerning the right to obtain inspection of files concerning an unpublished EUTM application, or a deferred RCD filed by a third party

Article 88(1) and (2) EUTMR Article 74 CDR Article 74(2) CDIR

Where an application for inspection of files for a EUTM application that has not yet been published, or for files relating to an RCD subject to deferment of publication in accordance with Article 50 CDR, or for those which, subject to such deferment, have been surrendered before or on the expiry of that period, (see paragraphs 4.2.1 and 4.2.2 above) is filed by a third party (*that is by a person other than the EUTM or RCD applicant or its representative*), different situations may arise.

If the application by a third party is based on the grounds specified in Article 88(1) and (2) EUTMR (see paragraph 4.2.1 above), or in Article 74(2) CDIR or Article 74(2) CDR (see paragraph 4.2.2 above) it must contain an indication and evidence to the effect that the EUTM applicant or RCD applicant or holder has consented to the inspection, or has stated that it will invoke the rights under the RCD, once registered, against the applicant for inspection.

6.12.1 Consent

The EUTM applicant RCD applicant or holder's consent must be in the form of a written statement in which it consents to the inspection of the particular file(s). Consent may be limited to inspection of certain parts of the file, such as the application, etc., in which case the application for inspection of files may not exceed the scope of the consent.

Where the applicant for inspection of files does not submit a written statement from the EUTM applicant, RCD applicant or holder consenting to the inspection of the files, the applicant for inspection will be notified and given two months from the date of notification to remedy the deficiency.

If, after expiry of the time limit, no consent has been submitted, the Office will refuse the application for inspection of files. The applicant for inspection will be informed of the decision to refuse the application for inspection.

The decision may be appealed by the applicant for inspection (Articles 59 and 60 EUTMR and 56 CDR).

6.12.2 Statement that EUTM or RCD rights will be invoked

Article 88(2) EUTMR Article 74(2) CDR Article 74(2) CDIR
--

Where the application relies on the allegation that the EUTM or RCD proprietor will invoke the rights under the EUTM or RCD, once registered, it is up to the applicant for inspection to prove this allegation. The evidence to be submitted must take the form of documents, for example, statements by the EUTM applicant or RCD applicant or holder for the EUTM application, RCD application or registered and deferred Community design in question, business correspondence, etc. Filing an opposition based on a EUTM application against a national mark constitutes a statement that the EUTM will be invoked. Mere assumptions on the part of the applicant for inspection of the file will not constitute sufficient proof.

The Office will first examine whether the proof is sufficient.

If so, the Office will send the application for inspection of files and the supporting documents to the EUTM applicant or RCD applicant or holder and invite it to comment within two months. If the EUTM applicant or RCD applicant or holder consents to an inspection of the files, it will be granted. If the EUTM applicant or RCD applicant or holder submits comments contesting inspection of the files, the Office will send the comments to the applicant for inspection. Any further statement by the applicant for inspection will be sent to the EUTM applicant or RCD applicant or holder and vice versa. The Office will take into account all submissions made on time by the parties and decide accordingly. The Office's decision will be notified to both the applicant for inspection of the files and the EUTM applicant or RCD applicant or holder. It may be appealed by the adversely affected party (Articles 59 and 60 EUTMR and 56 CDR).

6.13 Grant of inspection of files, means of inspection

When inspection is granted, the Office will, as appropriate, send the requested copies of file documents, or requested information, to the applicant for inspection or invite it to inspect the files at the Office's premises.

6.13.1 Communication of information contained in a file

Article 88(9) EUTMR Article 75 CDIR
--

The Office may, upon request, communicate information contained in any file relating to EUTM or RCD applications or registrations.

Information contained in the files will be provided without an inspection application, inter alia, where the party concerned wishes to know whether a given EUTM application has been filed by a given applicant, the date of such application, or whether the list of goods and services has been amended in the period between the filing of the application and publication.

Having obtained this information, the party concerned may then decide whether or not to request copies of the relevant documents, or to apply for inspection of the actual file.

Where the party concerned wishes to know, inter alia, which arguments an opponent has brought forward in opposition proceedings, which seniority documents have been filed, or the exact wording of the list of goods and services as filed, such information will not be provided. Instead the Office will advise the party to apply for inspection of the actual file.

In such cases, the quantity and complexity of the information to be supplied would exceed reasonable limits and create an undue administrative burden.

6.13.2 Copies of file documents

Where inspection of the files is granted in the form of the provision of certified or uncertified copies of file documents, the requested documents will be sent by post.

Where inspection of files is granted on the Office premises, the applicant will be given an appointment to inspect the files.

7 Procedures to Give Access to the Files to Courts or Authorities of the Member States

Article 90(1) EUTMR Article 75 CDR Rules 92 and 93 EUTMR Articles 77 and 78 CDIR

For the purposes of administrative co-operation, the Office will, upon request, assist courts or authorities of the Member States by communicating information or opening files for inspection.

For the purposes of administrative co-operation, the Office will also, upon request, communicate relevant information about the filing of EUTM or RCD applications and proceedings relating to such applications and the marks or designs registered as a result thereof to the central industrial property offices of the Member States.

7.1 No fees

Rules 92(3) and 93(1), (2) EUTMIR Articles 77(3) and 78(1), (2) CDIR

Inspection of files and communication of information from the files requested by the courts or authorities of the Member States are not subject to the payment of fees.

Rule 93(2) EUTMIR
Article 78(2) CDIR

Courts or public prosecutors' offices of a Member State may open to inspection by third parties files, or copies thereof that have been transmitted to them by the Office. The Office will not charge any fee for such inspection.

7.2 No restriction as to unpublished applications

Articles 88(4) and 90(1) EUTMR
Article 75 CDR
Rule 92(1) EUTMIR
Article 72 and Article 77(1) CDIR

Inspection of files and communication of information from the files requested by the courts or authorities of the Member States is not subject to the restrictions contained in Article 88 EUTMR and Article 74 CDR. Consequently, these bodies may be granted access to files relating to unpublished EUTM applications (see paragraph 4.2.1 above) and RCD's subject to deferment of publication (see paragraph 4.2.2 above) as well as to parts of the files for which the party concerned has expressed a special interest in keeping confidential. However, documents relating to exclusion and objection, as well as the documents referred to in Article 88(4) EUTMR and Article 72(b) CDIR, will not be made available to these bodies.

Article 88(4) EUTMR
Rule 93(2) EUTMIR
Article 74 CDR and Article 72 and Article 78(2) CDIR

Courts or public prosecutors' offices of the Member States may open to inspection by third parties files or copies that have been transmitted to them by the Office. Such subsequent inspection shall be subject to the restrictions contained in Article 88(4) EUTMR or Article 74 CDR, as if the inspection had been requested by a third party.

Rule 93(3) EUTMIR
Article 78(4) CDIR

When transmitting files or copies thereof to the courts or public prosecutors' offices of the Member States, the Office will indicate the restrictions imposed on inspection of files relating, on the one hand to EUTM applications or registered Community trade marks pursuant to Article 88 EUTMR, and on the other hand to CD applications or RCD registrations pursuant to Article 74 CDR and Article 72 CDIR.

7.3 Means of inspection

Rule 93(1) EUTMIR
Article 78(1) CDIR

Inspection of the files relating to EUTM/RCD applications or registrations by courts or authorities of the Member States may be granted by providing copies of the original

documents. As the files contain no original documents as such, the Office will provide printouts from the electronic system.

***GUIDELINES FOR EXAMINATION OF
EUROPEAN UNION TRADE MARKS***

***EUROPEAN UNION
INTELLECTUAL PROPERTY OFFICE
(EUIPO)***

PART E

REGISTER OPERATIONS

SECTION 6

OTHER ENTRIES IN THE REGISTER

CHAPTER 1

COUNTERCLAIMS

Table of Contents

1	Introduction.....	3
2	Application to Register the Filing of a Counterclaim Before an EUTM or a CD Court	3
3	Application to Register a Judgment on a Counterclaim Before an EUTM or a CD Court	4

1 Introduction

Counterclaims, as provided for in Article 100 EUTMR or Article 84 CDR, are defence claims made by a defendant that is being sued for the infringement of an EUTM or Registered Community Design (RCD). By way of such a counterclaim, the defendant asks the European Union trade mark court (EUTM court) or Community design court (CD court) to declare the revocation or invalidity of the EUTM or the invalidity of the RCD that it is alleged to have infringed.

The purpose of recording the filing and the final judgment of the counterclaim in the Office Register lies in the general interest of making all the relevant information on counterclaims concerning EUTMs and RCDs, in particular the final judgments thereof, publicly available. In this way the Office can implement these final judgments, in particular those that declare the total or partial revocation or invalidity of an EUTM as well as those that declare the total invalidity of an RCD.

By entering such counterclaims and their final judgments in the Register, the Office strives to comply with the principles of conformity to truth, public faith and the legal certainty of a public register.

2 Application to Register the Filing of a Counterclaim Before an EUTM or a CD Court

Article 100(4) EUTMR
Rule 84(3)(n) EUTMIR
Article 86(2) CDR
Article 69(3)(p) CDIR
Communication No 9/05 and No 10/05 of the President

According to Article 100(4) EUTMR and Article 86(2) CDR, the EUTM or CD court before which a counterclaim for revocation of an EUTM or for a declaration of invalidity of an EUTM or RCD has been filed must inform the Office of the date on which the counterclaim was filed.

The Regulations provide that the EUTM court with which a counterclaim for revocation or for a declaration of invalidity of an EUTM has been filed must not proceed with the examination of the counterclaim until either the interested party or the court has informed the Office of the date on which the counterclaim was filed.

Communications No 9/05 and No 10/05 of 28/11/2005 concern the designation of EUTM and CD courts in the Member States pursuant to Article 95(2) EUTMR.

The Office also allows any party to the counterclaim proceedings to request the entry of a counterclaim in the Register, if not yet communicated by the EUTM or CD court.

The recordal applicant (the EUTM or CD court or one of the parties in the counterclaim proceedings) must:

- indicate the date on which the counterclaim was filed;
- quote the number of the EUTM or RCD concerned;
- state whether the request is for revocation or for declaration of invalidity;

- if the recordal applicant is one of the parties, submit official confirmation from the EUTM or CD court with authority to rule on the counterclaim, including, where possible, the case or reference number from the court.

If the recordal applicant does not submit official confirmation from the EUTM or CD court, or if the information submitted by the applicant requires clarification, the Office will request this in writing.

The Office will notify the EUTM or RCD proprietor and the EUTM or CD court that the counterclaim has been entered in the Register. If the request was made by one of the parties to the counterclaim proceedings, the Office will also inform this party.

If an application for revocation or for a declaration of invalidity of an EUTM had already been filed with the Office before the counterclaim was filed, the Office will inform the courts before which a counterclaim is pending in respect of the same mark. The courts must stay the proceedings in accordance with Article 104(1) EUTMR until the decision on the application is final or the application is withdrawn.

The entry in the relevant Register will be published in Part C.9.3. of the EUTM Bulletin or Part B.3.1 of the RCD Bulletin.

3 Application to Register a Judgment on a Counterclaim Before an EUTM or a CD Court

Article 100(6) EUTMR Rule 84(3)(o) EUTMIR Article 86(4) CDR Article 69(3)(q) CDIR
--

Where an EUTM or a CD court has delivered a judgment, which has become final, on a counterclaim for revocation of an EUTM or for invalidity of an EUTM or RCD, a copy of the judgment must be sent to the Office.

The Office also allows any party to the counterclaim proceedings to request the entry of a judgment on the counterclaim action in the Register, if not yet communicated by the EUTM or CD court.

The recordal applicant (the EUTM or CD court or one of the parties in the counterclaim proceedings) must:

- submit a copy of the judgment, together with confirmation from the EUTM or CD court that the judgment has become final;
- indicate the date on which the judgment became final;
- quote the number of the EUTM or RCD concerned;
- state whether the request is for revocation or for declaration of invalidity;
- in the event of partial cancellation or invalidity, indicate the list of goods and services affected by the judgment, if relevant.

The Office needs confirmation that the judgment is final (*rechtskräftig/adquirido fuerza de cosa juzgada/passée en force de chose jugée*, etc.). If the Office requires clarification, it will request this in writing.

The Office must mention the judgment in the Register and take the necessary measures to comply with its operative part.

Where the final judgment partially cancels an EUTM, the Office will alter the list of goods and services according to the EUTM court judgment and, where necessary, send the amended list of goods and services for translation.

The Office will notify the EUTM or RCD proprietor and the EUTM or CD court that the judgment has been entered in the Register. If the request was made by one of the parties to the counterclaim proceedings, the Office will also inform this party.

The entry in the relevant Register will be published in Part C.9.4. of the EUTM Bulletin or Part B.3.2. of the RCD Bulletin.

***GUIDELINES FOR EXAMINATION OF
EUROPEAN UNION TRADE MARKS***

***EUROPEAN UNION
INTELLECTUAL PROPERTY OFFICE
(EUIPO)***

PART M

INTERNATIONAL MARKS

Table of Contents

1	Introduction.....	4
2	The EUIPO as Office of Origin	4
2.1	Examination and forwarding of international applications.....	4
2.1.1	Identification of international applications.....	5
2.1.2	Fees.....	5
2.1.2.1	Handling fee.....	5
2.1.2.2	International fees.....	5
2.1.3	Forms.....	6
2.1.3.1	Entitlement to file.....	7
2.1.3.2	Basic mark.....	7
2.1.3.3	Priority claim(s).....	9
2.1.3.4	Designated contracting parties.....	9
2.1.3.5	Signature.....	9
2.1.3.6	Form for the designation of the USA	10
2.1.4	Examination of the international application by the EUIPO.....	10
2.1.5	Irregularities found by WIPO	10
2.2	Subsequent designations	11
2.3	Notification of facts affecting the basic registration.....	12
2.4	Forwarding of changes affecting the international mark.....	13
2.4.1	Cases where applications for changes can be forwarded without examination	14
2.4.2	Cases where applications for changes will be forwarded after examination	14
3	The EUIPO as Designated Office.....	15
3.1	Overview	15
3.2	Professional representation	16
3.3	First republication, searches and formalities	16
3.3.1	First republication	16
3.3.2	Searches.....	17
3.3.3	Formalities examination.....	17
3.3.3.1	Languages.....	18
3.3.3.2	Collective marks.....	18
3.3.3.3	Seniority claims.....	19
3.3.3.4	Vague terms.....	21
3.4	Absolute grounds for refusal.....	22
3.5	Third-party observations	23
3.6	Opposition	24
3.6.1	Timing.....	24
3.6.2	Receipt and informing the international holder.....	24
3.6.3	Fees.....	25
3.6.4	Admissibility check	25
3.6.5	Language of proceedings	25
3.6.6	Representation of the IR holder.....	26
3.6.6.1	Opposition receipts.....	26
3.6.6.2	Notification of commencement of opposition proceedings	26
3.6.7	Provisional refusal (based on relative grounds)	27

3.6.8	Suspension of opposition where there is a pending provisional refusal on the specification of goods and services and/or absolute grounds.....	27
3.7	Cancellation of the IR or renunciation of the EU designation	28
3.8	Limitations of the list of goods and services	28
3.9	Confirmation or withdrawal of provisional refusal and issue of Statement of Grant of Protection	29
3.10	Second republication	29
3.11	Transfer of the designation of the EU	30
3.12	Invalidity, revocation and counterclaims.....	30
4	Conversion, Transformation, Replacement	31
4.1	Preliminary remarks	31
4.2	Conversion.....	31
4.3	Transformation	32
4.3.1	Preliminary remarks.....	32
4.3.2	Principle and effects	32
4.3.3	Procedure	33
4.3.4	Examination	33
4.3.4.1	Application for transformation of an IR designating the EU where no particulars have been published.....	33
4.3.4.2	Application for transformation of an IR designating the EU where particulars have been published.....	34
4.3.5	Transformation and seniority	34
4.3.6	Fees.....	34
4.4	Replacement.....	35
4.4.1	Preliminary remarks.....	35
4.4.2	Principle and effects	35
4.4.3	Procedure	35
4.4.4	Fees.....	36
4.4.5	Publication	36
4.4.6	Replacement and seniority.....	37
4.4.7	Replacement and transformation	37
4.4.8	Replacement and conversion	37

This part of the Guidelines focuses specifically on the examination of international marks. For further details on normal aspects of procedure, please also consult the other relevant parts of the Guidelines (examination, opposition, cancellation, etc.).

1 Introduction

The purpose of this part of the Guidelines is to explain how, in practice, the link between the EU trade mark (EUTM) and the Protocol Relating to the Madrid Agreement Concerning the International Registration of Marks ('Madrid Protocol' or MP) affects procedures and standards of examination and opposition at the EUIPO. Paragraph 2 deals with the EUIPO's tasks as an office of origin, that is, with 'outgoing' international applications. Paragraph 3 deals with its tasks as a designated office, that is, with 'incoming' international registrations designating the EU (IR). Paragraph 4 deals with conversion, transformation and replacement.

The Guidelines are not intended to, and cannot, add to or subtract from the substance of Title XIII EUTMR. The EUIPO is also bound by the provisions of the Madrid Protocol and the Common Regulations (CR). Reference may also be made to the 'Guide to the International Registration of Marks' published by WIPO as the Guidelines do not intend to repeat what is said there.

2 The EUIPO as Office of Origin

The tasks of the EUIPO as office of origin chiefly comprise:

- examining and forwarding international applications;
- examining and forwarding subsequent designations;
- handling notices of irregularity issued by WIPO;
- notifying WIPO of certain facts affecting the basic mark during the five-year dependency period;
- forwarding certain requests for changes in the international register.

2.1 Examination and forwarding of international applications

Article 146 EUTMR Rule 102(3) EUTMIR

International applications filed with the EUIPO are subject to:

- payment of the handling fee;
- the existence of (a) basic EUTM registration(s) or application(s) ('basic mark(s)');
- identity between the international application and the basic mark(s);
- proper completion of the MM2 or EM2 form;
- an entitlement to file the international application through the EUIPO.

2.1.1 Identification of international applications

An international application will be identified in the EUIPO database under the basic EUTM or EUTM application number followed by the suffix **_01** (e.g. 012345678_01) if it relates to a first international application. Further applications based on the same basic EUTM or EUTM application will be identified by **_02**, **_03**, etc. International applications based on more than one EUTM or EUTM application will be identified by the number of the older EUTM or EUTM application.

Upon receipt of an international application, the examiner will send a receipt to the applicant, quoting the file number.

2.1.2 Fees

2.1.2.1 Handling fee

Article 147(4) and Article 150 EUTMR
Annex I A(34) EUTMR
Rule 103(1) and Rule 104 EUTMIR

An international application is only deemed to have been filed if the handling fee of EUR 300 has been paid.

Payment of the handling fee must be made to the EUIPO by one of the accepted means of payment (for details, see the Guidelines, Part A, General Rules, Section 3, Payment of Fees, Costs and Charges, paragraph 2).

Where the applicant chooses to base the international application on an EUTM once it is registered, the application for the IR is deemed to have been received on the date of registration of the EUTM; therefore, the handling fee will be due on the date of registration of the EUTM.

The means of payment used may be communicated to the EUIPO by ticking the appropriate boxes on the EM2 form or by giving this information in the letter accompanying the MM2 form.

If, in the course of examination of the international application, the examiner finds that the handling fee has not been paid, the examiner will inform the applicant and ask it to pay the fee within two months. If payment is made within the two-month time limit set by the EUIPO, the date of receipt that the EUIPO will communicate to WIPO will be the date the payment reaches the EUIPO. If payment is still not made within the two-month time limit set by the EUIPO, the EUIPO will inform the applicant that it considers the international application not to have been filed and will close the file.

2.1.2.2 International fees

All international fees must be paid directly to WIPO. None of the fees payable directly to WIPO will be collected by the EUIPO. Any such fees paid by error to the EUIPO will be reimbursed to the sender.

If the applicant uses EM2 forms, the Fee Calculation Sheet (Annex to WIPO form MM2) must be submitted in the language in which the international application is to be transmitted to WIPO. Alternatively, the applicant can attach a copy of the payment to WIPO. However, the EUIPO will not examine whether the Fee Calculation Sheet is attached, whether it is correctly filled in, or whether the amount of the international fees has been correctly calculated. Any questions regarding the amount of the international fees and related means of payment should be addressed to WIPO. A fee calculator is available on WIPO's website.

2.1.3 Forms

Article 147(1) EUTMR Rules 83(2)(b) and 103(2)(a) EUTMIR

Use of one of the official forms is compulsory. The official form is either WIPO form MM2, available in English, French or Spanish, or the EUIPO form EM2 (the EUIPO's adaptation of MM2), which is available in all official EU languages. Applicants may not use other forms or change the contents and layout of the forms. However, both the WIPO MM2 form and the EUIPO EM2 form are available in .doc format allowing as much text as necessary to be entered for each item.

If the application is filed in a language that is not one of the Madrid Protocol languages (English, French or Spanish), the applicant must indicate in which of these three languages the application is to be forwarded to WIPO. All items on the form must be completed in the same language; it is not possible to choose a language other than the language of the form.

The Office recommends using the EUIPO EM2 form. The EUIPO EM2 form in English, French and Spanish has almost the same layout and numbering as the WIPO MM2 form but is specifically adapted to the EUTM environment:

- applicants can indicate payment details (item 0.4) to the EUIPO in the introductory item 0 and the number of pages (item 0.5) the application contains;
- certain choices are limited to what is applicable to the Office (e.g. the EUIPO is always the office of origin (item 1), and the applicant must be a national of an EU Member State (item 3));
- item 4b has been added for including the representative before the EUIPO;
- the reproduction of the mark need not be submitted in item 7, as the EUIPO will use the reproduction available in the basic EUTM or EUTM application;
- the option of seeking protection for the same goods and services contained in the basic mark by ticking a box has been added in item 10;
- since self-designation is not possible, the EU is not included in the list of Contracting Parties to be designated in item 11;
- item 13 has been deleted, as the EUIPO certifies the international application electronically.

Where the applicant chooses the EUIPO EM2 form in a language version other than English, French or Spanish, the following additional sections of the form have to be completed:

- tick boxes in item 0.1 for indicating the MP language in which the international application is to be transmitted to WIPO;

- tick boxes in item 0.2 for selecting the language in which the EUIPO is to communicate with the applicant on matters concerning the international application, that is, either the language in which the international application is filed or the language in which it is to be transmitted to WIPO (see Article 147(1), second sentence, EUTMR);
- tick boxes in item 0.3 for indicating either that a translation of the list of goods and services is included or that the EUIPO is authorised to produce the translation;
- a final item A with tick boxes for specifying annexes (attached translations).

The appropriate boxes in items 0.1, 0.2 and 0.3 must be ticked. If none of the boxes in item 0.2 is ticked, the EUIPO will communicate with the applicant in the language of the EM2 form.

All applicable items in the form must be completed following the indications provided on the form itself and in the 'Guide to the International Registration of Marks' published by WIPO.

2.1.3.1 Entitlement to file

Article 2(1)(i) Madrid Protocol (MP)

Under item 3 of the official form, an indication must be given regarding entitlement to file. An applicant is entitled to file with the EUIPO as office of origin if it is a national of, or has domicile or a real and effective industrial or commercial establishment in an EU Member State. The applicant may choose on which criterion/criteria to base the right to file. For example, a Danish national domiciled in Germany can choose to base entitlement to file either on nationality or domicile. A French national domiciled in Switzerland is entitled to file only based on nationality (however, in this case a representative before the EUIPO must be appointed). A Swiss company with no domicile or real and effective industrial or commercial establishment in an EU Member State is not entitled to file an international application through the EUIPO.

Where there are multiple applicants, each must fulfil at least one of the entitlement criteria.

The expression 'real and effective industrial or commercial establishment in an EU Member State' is to be interpreted in the same way as in other instances, such as in the context of professional representation (see the Guidelines, Part A, General Rules, Section 5, Professional Representation, paragraph 3.1.1).

2.1.3.2 Basic mark

Rule 103(2)(c), (d) and (e) EUTMIR Rule 9(4)(a)(v), (vii) and (viii) and (viii) and Rule 11(2) CR
--

The Madrid System is founded on the requirement of a basic national or regional trade mark application or registration. Under the MP, an international application may be based on either a mark that has already been registered ('basic registration'), or a trade mark application ('basic application') at any point in the trade mark examination procedure.

An applicant may choose to base its international application on several basic marks providing it is the applicant/proprietor of all the basic EUTM applications and EUTMs even where, although containing identical marks, the goods and services covered are different.

All the basic EUTM applications or EUTM(s) must have been accorded a filing date, and must be in force.

The international applicant must be identical to the EUTM holder/EUTM applicant. The international application may not be filed by a licensee or an affiliated company of the holder of the basic mark(s). A deficiency in this respect may be overcome by transferring the basic mark to the international application applicant, or by recording a change of name, as applicable (see the Guidelines, Part E, Register Operations, Section 3, EUTMs as Objects of Property, Chapter 1, Transfer). Where there are multiple holders or applicants in the basic EUTM(s) or EUTM application(s), the international application must be submitted by the same persons.

The reproduction of the mark must be identical. For full details of the Office practice for the identity of trade marks filed in black and white and/or greyscale as compared to those filed in colour please see the Guidelines, Part B, Examination, Section 2, Formalities, paragraph 14.2.1, for priority claims which applies by analogy. Particular attention should be paid to the following:

- Item 7 c) of the official form must be ticked if the mark is in standard characters (word mark).
- Item 8 a) of the official form foresees the possibility of making a colour claim. Where the basic EUTM(s) or EUTM application(s) contain(s) an indication of colours, the same indication must be made in the international application (see the Guidelines, Part B, Examination, Section 2, Formalities, paragraph 11). Where the basic EUTM(s) or EUTM applications(s) is/are in colour but do(es) not contain an indication of colours the applicant may choose to indicate the colours for the international application.
- If the basic mark is
 - a mark for a colour or colour combination as such,
 - a three-dimensional mark,
 - a sound mark, and/or
 - a collective mark,

the international application must be the same, and item 7 d) or 9 d) must be ticked. If the basic mark is a sound mark, only the graphic representation, for example, of the musical notation will be transmitted to WIPO as WIPO does not accept electronic sound files.

- If the basic mark includes a description, the same description may be included in the international application (item 9 e)). However, a description of the mark may not be added in the international application if the basic mark(s) do(es) not contain one.
- A disclaimer may be included even if the basic mark(s) do(es) not include one (item 9 g)).

- WIPO requires a transliteration in Latin characters if the mark contains characters other than Latin. If no transliteration is given, WIPO will raise an irregularity, which must be remedied directly by the applicant. This is true for all types of trade marks, not just word marks.

The list of goods and services must be identical to or narrower than the list contained in the basic mark(s) on the day the international application is filed.

- The applicant must specify the list of goods and services by class (item 10).
- The list may also be limited for some designated parties.

If the applicant does not provide a translation into the WIPO language chosen by it (English, French or Spanish) but instead authorises the EUIPO to provide the translation or to use the one available for the basic mark(s), it will not be consulted on the translation.

2.1.3.3 Priority claim(s)

If priority is claimed under item 6 of the official form, the office of earlier filing, the filing number (if available) and the filing date must be indicated. Priority documents should not be submitted. Where the earlier filing claimed as a priority right in an international application does not relate to all the goods and services, those to which it does relate should be indicated. Where priority is claimed from several earlier filings with different dates, the goods and services to which each earlier filing relates should be indicated. The validity of the claim will in principle not be challenged by the examiner, as in most cases either the basic EUTM or EUTM application is the first filing for which priority is claimed or the priority of another earlier mark has already been claimed and examined in relation to the basic EUTM application. However, if there is evidence in the file that priority is claimed for a right that is not a first filing, the examiner will object and request that the priority claim be deleted.

2.1.3.4 Designated contracting parties

An international application filed at the EUIPO is governed exclusively by the Madrid Protocol. Only contracting parties that are party to the protocol can be designated, regardless of whether they are also bound by the Madrid Agreement.

2.1.3.5 Signature

Rule 9(2)(b) CR

The signature in item 12 of the official form is optional since the data will be forwarded only electronically to WIPO and not as an original document or facsimile copy of the form.

2.1.3.6 Form for the designation of the USA

Where the United States of America is designated, a duly completed and signed WIPO MM18 form must be attached (see item 11, footnote **). This form, which contains the declaration of intention to use the mark, is available only in English and must be submitted in that language irrespective of the language of the international application.

2.1.4 Examination of the international application by the EUIPO

Article 147 EUTMR Rule 103(2) and Rule 104 EUTMIR Article 3(1) MP

Where examination of the international application reveals deficiencies, the EUIPO will invite the applicant to remedy them within one month. In principle, this short time limit should enable the EUIPO to forward the international application to WIPO within two months from the date of receipt and thus maintain that date as the date of international registration.

Examiners may try solving minor deficiencies or seeking clarification over the phone in order to speed up the process.

If the deficiencies are not remedied, the EUIPO will inform the applicant that it refuses to forward the international application to WIPO. The handling fee will not be refunded.

This does not preclude the filing of another international application at a later date.

As soon as the EUIPO is satisfied that the international application is in order, it will transmit it to WIPO electronically, with the exception of documents such as the fee calculation sheet or the MM18, which will be transmitted as scanned attachments. The electronic transmission will contain the certification by the office of origin referred to in Article 3(1) MP.

2.1.5 Irregularities found by WIPO

Rule 11(4) and Rules 12 and 13 CR

If WIPO detects irregularities in the application, it will issue an irregularity notice, which will be forwarded to both the applicant and the EUIPO as office of origin. The irregularities must be remedied by the EUIPO or the applicant, depending on their nature. Irregularities relating to the payment of the international fees must be remedied by the applicant. Any of the irregularities mentioned in Rule 11(4) CR must be remedied by the EUIPO.

Where there are irregularities in the classification of the goods and services, in the indication of the goods and services, or in both, the applicant cannot present its arguments directly to WIPO. Instead, they must be communicated through the EUIPO. In this case, the EUIPO will forward the applicant's communication just as it is to WIPO, as the EUIPO does not make use of either the option under Rule 12(2) CR to express a different opinion or that under Rule 13(2) CR to make a proposal to remedy the irregularity.

2.2 Subsequent designations

Article 149 EUTMR
Rule 1(xxvibis) and Rule 24(2) CR
Article 2(1)(ii) MP
Rule 83(2)(b) and Rule 105(1)(a), (c) and (d) and Rule 105(2) and (4) EUTMIR

Within the framework of the Madrid System, the holder of an international registration can extend the geographical scope of a registration's protection. There is a specific procedure called 'subsequent designation to a registration', which extends the scope of the international registration to other members of the Madrid Union for whom either no designation has been recorded to date or the prior designation is no longer in effect.

Unlike international applications, subsequent designations need not be filed through the office of origin but may be filed directly with WIPO. Direct filing with WIPO is recommended for a speedier process.

Where an IR is transferred to a person who is not entitled to make a subsequent designation through the EUIPO, the application for such a subsequent designation cannot be filed through the EUIPO, but must instead be filed through WIPO or the corresponding office of origin (for more information on entitlement to file, see paragraph 2.1.3.1 above).

Subsequent designations may only be made after an initial international application has been made and has resulted in an international registration.

Subsequent designations are not subject to payment of a handling fee to the EUIPO.

Subsequent designations must be filed on the official form: the WIPO MM4 form in English, French or Spanish or the EUIPO EM4 form in the other EU languages. There is no specific EUIPO form in English, French and Spanish as no special indications for the EUIPO are needed in those languages and the WIPO MM4 form is, therefore, sufficient.

The fee calculation sheet (Annex to the WIPO MM4 form) must be submitted in the language in which the subsequent designation is to be transmitted to WIPO. Alternatively, the applicant can attach a copy of the payment to WIPO. However, the EUIPO will not examine whether the fee calculation sheet is attached, whether it is correctly filled in, or whether the amount of the international fees has been correctly calculated. Any questions regarding the amount of the international fees and related means of payment should be addressed to the International Bureau. A fee calculator is available on WIPO's website.

In the MM4 or EM4 forms, the indications to be made are limited to indications concerning the applicant and its entitlement to file, indications concerning the representative, the list of goods and services, and the designation of additional contracting parties to the Madrid Protocol. These indications must be made in the same way as in the MM2 form. The only difference in the entitlement to file is that a subsequent designation may be filed at the EUIPO if the international registration is transferred to a person who is a national of an EU Member State or has their domicile or an establishment in the EU (the EUIPO as 'office of the contracting party of the holder').

A subsequent designation may also be used to extend the scope of the IR to enlarge the goods and/or services coverage of a prior designation.

The list of goods and services may be the same as in the international registration (item 5 a) of the official form) or narrower (item 5 b) or c)). It may not be broader than the scope of protection of the international registration even if covered by the basic mark.

For example, an IR for Classes 18 and 25 designating China for Class 25 can subsequently be extended to China for Class 18; however, that same IR could not be subsequently extended to China for Class 9, as this class is not covered by the international registration, even if it is covered by the basic mark.

Within these limitations, different lists may be submitted for different, subsequently designated, contracting parties.

The mark must be the same as in the initial international registration.

Subsequent designations must be made in the same language as the initial international application, failing which the EUIPO will refuse to forward the subsequent designation.

If the application is not in English, French or Spanish, the applicant must tick item 0.1 on the EUIPO EM4 form and indicate the language in which the subsequent designation is to be transmitted to WIPO. That language may be different from the language of the international registration. Items 0.2 and 0.3 regarding the translation of the list of goods and services and the language of correspondence between the applicant and the EUIPO must also be completed.

Where the holder/applicant so requests, a subsequent designation may take effect after specific proceedings have been concluded, namely the recording of a change or a cancellation in respect of the IR concerned or the renewal of the IR.

2.3 Notification of facts affecting the basic registration

Articles 44 and 49 EUTMR Rule 106(1)(a), (b) and (c) and Rule 106(2), (3) and (4) EUTMIR

If, within five years of the date of the international registration, the basic mark(s) ceases to exist in whole or in part, the international registration is cancelled to the same extent since it is 'dependent' thereon. This occurs not only in the event of a 'central attack' by a third party, but also if the basic mark(s) lapse(s) due to action or inaction on the part of its proprietor.

For EUTMs, this covers cases where, either fully or partially (for only some goods or services),

- the EUTM or EUTM application(s) on which the IR is based is (are) withdrawn, deemed to be withdrawn or refused;
- the EUTM(s) on which the IR is based is (are) surrendered, not renewed, revoked or declared invalid by the EUIPO or, upon a counterclaim in infringement proceedings, by an EUTM court.

Where the above occurs as a result of a decision (by the EUIPO or an EUTM court), the decision must be final.

If the above occurs within the five-year period, the EUIPO must notify WIPO accordingly.

The EUIPO must check that the international application has actually been registered before notifying WIPO that the basic EUTM has ceased to have effect.

WIPO must also be notified in certain cases where a procedure has been initiated prior to expiry of the five-year period but is not finally decided within that period. This notification is to be made immediately after expiry of the five-year period. The cases involved are:

- a pending refusal of the basic EUTM application(s) on absolute grounds (including ensuing appeals before the Boards of Appeal or the GC/CJEU);
- pending opposition proceedings (including ensuing appeals before the Boards of Appeal or the GC/CJEU);
- pending cancellation proceedings before EUIPO (including ensuing appeals before the Boards of Appeal or the GC/CJEU);
- a counterclaim in infringement proceedings against an EUTM, according to the EUTM Register, which is pending before an EUTM court.

Once a final decision has been taken or the proceedings have been terminated, a further notification must be sent to WIPO stating whether and to what extent the basic mark(s) has (have) ceased to exist or remained valid.

If, within five years of the date of the international registration, the basic EUTM(s) or EUTM application(s) is (are) divided or partially transferred, this must also be notified to WIPO. However, in those cases, there will be no effect on the validity of the international registration. The purpose of the notification is merely to keep record of the number of mark(s) on which the IR is based.

No other changes in the basic mark(s) will be notified to WIPO by the EUIPO. Where the applicant/holder wishes to record the same changes in the international register it should apply for this separately (see paragraph 2.4 below)

2.4 Forwarding of changes affecting the international mark

Rule 107 EUTMIR

The international register is kept at WIPO. The possible changes listed below may only be recorded once the mark has been registered.

The EUIPO will not process requests for renewal or payments of renewal fees.

In principle, most changes relating to international registrations can be filed either directly with WIPO by the holder of the international registration on record or through the office of origin. However, some applications for changes can be filed by another party and through another office, as detailed below.

2.4.1 Cases where applications for changes can be forwarded **without** examination

Rules 20, 20*bis*, Rule 25(1) CR

The following applications for changes relating to an international registration can be presented to the EUIPO as an 'office of the contracting party of the holder':

- WIPO form MM5: change of ownership, either total or partial, submitted by the IR holder on record (in EUTM terminology, this corresponds to a transfer);
- WIPO form MM6: limitation of the list of goods and services for all or some contracting parties;
- WIPO form MM7: renunciation of one or more contracting parties (not all);
- WIPO form MM8: full or partial cancellation of the international registration;
- WIPO form MM9: change of the name or address of the holder;
- WIPO forms MM13/MM14: new licence or amendment to a licence submitted by the IR holder on record;
- WIPO form MM15: for cancelling the recording of a license
- WIPO form MM19: restriction of the holder's right of disposal submitted by the IR holder on record (in EUTM terminology, this corresponds to a right *in rem*, levy of execution, enforcement measure or insolvency proceedings contemplated in Articles 19, 20 and 21 EUTMR).

Such applications made to the EUIPO by the IR holder will simply be forwarded to WIPO without further examination. The provisions under the EUTMR and EUTMIR for the corresponding proceedings do not apply. In particular, the language rules applicable are those under the CR, and there is no EUIPO fee to be paid.

These applications can only be filed through the EUIPO if it is the office of origin or if it acquires competence in respect of the holder as the result of a transfer of the international registration (see Rule 1(xxv*bis*) CR). However, this condition will not be examined by EUIPO because the latter will simply forward the request, which could have been filed with WIPO directly.

No use will be made of the options provided in Rule 20(1)(a) CR that allow an office of the contracting party of the holder to notify the International Bureau of a restriction of the holder's right of disposal on its own motion.

2.4.2 Cases where applications for changes will be forwarded after examination

Rule 20(1)(a) and Rule 20*bis*(1) and Rule 25(1)(b) CR
Rule 120 EUTMIR

The Common Regulations provide that applications for recording a change of ownership, a licence or a restriction of the holder's right of disposal may only be filed directly with WIPO by the holder of the international registration. It would be practically impossible to record a change of ownership or licence with WIPO where:

- the original holder no longer exists (merger, death), or

- the holder is either not cooperating with its licensee or (even more likely) is the beneficiary of an enforcement measure.

For these reasons, the new holder, licensee or beneficiary of the right of disposal has no choice but to file their application with the office of the contracting party of the holder. WIPO will register such applications without any substantive examination on the basis that they have been transmitted by that office.

To avoid a third person becoming the owner or licensee of an international registration, it is imperative that the EUIPO examine all applications presented by any person other than the holder of the IR in order to verify that there is proof of the transfer, licence or other right, as provided in Rule 120 EUTMIR. The EUIPO limits itself to examining proof of the transfer, licence or other right, and Rule 31(1), (5) EUTMIR and the corresponding parts of the EUIPO Guidelines on transfers, licences, rights *in rem*, levy of execution and insolvency proceedings apply by analogy. If no proof is submitted, the EUIPO will refuse to forward the application to WIPO.

This decision is open to appeal.

In all other respects, the rules under the EUTMR and EUTMIR do not apply. In particular, the application must be in one of the WIPO languages and on the appropriate WIPO form, and no fee is payable to the EUIPO.

3 The EUIPO as Designated Office

3.1 Overview

Since 01/10/2004, any person who is a national of, or has a domicile or commercial establishment in, a state that is party to the Madrid Protocol and who is the owner of a national application or registration in that same state (a 'basic mark') may, through the national office where the basic mark is applied for or registered (the 'office of origin'), file an international application or a subsequent designation in which they can designate the European Union.

Once it has examined classification and checked certain formalities (including payment of fees), WIPO will publish the IR in the International Gazette, issue the certificate of registration and notify the designated offices of the international registration. The EUIPO receives the data from WIPO exclusively in electronic form.

International registrations designating the EU are identified by the EUIPO under their WIPO registration number preceded by a '**W**' and followed by a **0** in the case of a new IR (e.g. **W01** 234 567) and a **1** in the case of a subsequent designation (e.g. **W10** 987 654). Further designations of the EU for the same IR will be identified as **W2**, **W3**, etc. However, when searching in EUIPO databases online the 'W' should not be indicated.

The EUIPO has 18 months to inform WIPO of all possible grounds for refusal of the EU designation. The 18-month period starts on the day on which the EUIPO is notified of the designation.

Where corrections are received from WIPO that affect the mark itself, the goods and services or the designation date, it is up to EUIPO to decide if a new 18-month period is to start running from the new notification date. Where a correction affects only part of

the goods and services, the new time limit applies only to that part and the EUIPO would have to republish the IR in part in the EUTM Bulletin and reopen the opposition period only for that part of the goods and services.

The main tasks performed by the EUIPO as designated office are:

- first republication of IRs designating the EU;
- drawing up of European Union search reports;
- examination of formalities, including seniority claims;
- examination of absolute grounds;
- examination of oppositions against IRs;
- processing of communications from WIPO concerning changes to the IRs.

3.2 Professional representation

Article 92(2) and Article 93 EUTMR

In principle, the IR holder does not need to appoint a representative before the EUIPO.

Holders outside the EEA are, however, required to be represented (a) further to a provisional refusal, (b) for filing seniority claims directly before the EUIPO, or (c) further to an objection on a seniority claim (see the Guidelines, Part A, General Rules, Section 5, Professional Representation, and Articles 92 and 93 EUTMR).

If the non-EEA IR holder has appointed a representative before WIPO who also appears in the database of representatives maintained by the EUIPO, this representative will automatically be considered to be the representative of the IR holder before the EUIPO.

Where the non-EEA IR holder has not appointed a representative or has appointed a representative before WIPO who does not appear in the database of representatives maintained by the EUIPO, any notifications of provisional refusal or objection will contain an invitation to appoint a representative in compliance with Articles 92 and 93 EUTMR. For the particularities of representation in each of the proceedings before the EUIPO, see paragraphs 3.3.3, 3.4 and 3.6.6 below.

3.3 First republication, searches and formalities

3.3.1 First republication

Article 152 EUTMR

Upon receipt, IRs will immediately be republished¹ in Part M.1 of the EUTM Bulletin, except where the second language is missing.

Publication will be limited to bibliographic data, the reproduction of the mark and the class numbers, and will not include the actual list of goods and services. This means, in

¹ IRs are published first in the International Gazette and then 'republished' by the Office.

particular, that the EUIPO will not translate international registrations or the list of goods and services. The publication will also indicate the first and second languages of the IR and contain a reference to the publication of the IR in the WIPO Gazette, which should be consulted for further information. For more details, reference is made to the EUTM Bulletin on the EUIPO's website.

The international registration has, from the date of first republication, the same effect as a published EUTM application.

3.3.2 Searches

Article 155 EUTMR

Upon request of the IR holder within a period of one month from when WIPO informs the EUIPO of the designation, the EUIPO will draw up a European Union search report for each IR, which will cite similar EUTMs and IRs designating the EU. The owners of the earlier marks cited in the report will receive a surveillance letter in accordance with Article 155(4) EUTMR, unless they request the Office not to send them such surveillance letters. In addition, upon request by the international holder, the EUIPO will send the IR to the participating national offices to have national searches carried out (see the Guidelines, Part B, Examination, Section 1, Proceedings).

The national search request must be filed directly with the EUIPO. Holders of IRs designating the EU must request the national searches and pay the corresponding fee within a period of one month from when WIPO informs the EUIPO of the designation. Late or missing payments of search fees will be dealt with as if the request for national searches had not been filed.

Payment can be made using any of the means of payment accepted by the EUIPO (for details, see the Guidelines, Part A, General Rules, Section 3, Payment of Fees, Costs and Charges, paragraph 2).

The requested search reports will be sent directly to the IR holder or, if the latter has appointed a representative before WIPO, to that representative, irrespective of location. The holder will not be required to appoint a representative before the EUIPO for the sole purpose of requesting or receiving the search reports.

3.3.3 Formalities examination

The formalities examination carried out by the EUIPO on IRs is limited to whether a second language has been indicated, whether the application is for a collective mark, whether there are any seniority claims and whether the list of goods and/or services meets the requirements of clarity and precision as described in the Guidelines, Part B, Examination, Section 3, Classification.

3.3.3.1 Languages

Article 119(3) and (4) and Article 154 EUTMR
Rule 96(1) and Rule 126 EUTMIR
Rule 9(5)(g)(ii) CR

Rule 9(5)(g)(ii) CR and Rule 126 EUTMIR require the applicant for an international application designating the EU to indicate a second language, different from the first one, selected from the four remaining languages of the EUIPO by ticking the appropriate box in the contracting parties' section of WIPO forms MM2/MM3 or MM4.

Under the terms of Rule 126 EUTMIR, the language of filing of the international application will be the language of the proceedings within the meaning of Article 119(4) EUTMR. If the language chosen by the international registration holder in written proceedings is not the language of the international application, the holder must supply a translation into that language within one month from when the original document was submitted. If the translation is not received within this time limit, the original document is deemed not to have been received by the EUIPO.

The second language indicated in the international application will be the second language within the meaning of Article 119(3) EUTMR, that is, a possible language of proceedings for opposition, revocation or invalidity proceedings before the EUIPO.

Where no second language has been indicated, the examiner will issue a provisional refusal of protection and give the holder two months from the day on which the Office issues the provisional refusal pursuant to Article 154 EUTMR to remedy the deficiency. Where the IR holder is required to be represented in proceedings before the EUIPO and its representative before WIPO does not appear in the database of representatives maintained by the EUIPO, the notification of provisional refusal will invite the holder to appoint a representative in compliance with Articles 92 and 93 EUTMR. This notification will be recorded in the international register, published in the Gazette and sent to the IR holder. The reply to the provisional refusal must be addressed to the EUIPO.

If the IR holder remedies the deficiency and complies with the requirement to appoint a representative before the EUIPO, if applicable, within the prescribed time limit, the IR will proceed to republication.

If the deficiency has not been remedied and/or a representative has not been appointed (if applicable), the EUIPO will confirm the refusal to the IR holder. The holder has two months within which to lodge an appeal. Once the decision is final, the EUIPO will inform WIPO that the provisional refusal is confirmed.

3.3.3.2 Collective marks

Articles 66 and 67 EUTMR
Rule 43 and Rule 121(1) to (3) EUTMIR

In the EUTM system, there are only two kinds of mark: individual marks and collective marks (for more details see the Guidelines, Part B, Examination, Section 2, Formalities).

The international application form contains one single indication grouping collective marks, certification marks and guarantee marks. Therefore, if the IR designating the EU is based on a national certification mark, guarantee mark or collective mark, it will be dealt with as an EU collective mark before the EUIPO. This entails the payment of higher fees.

The conditions applying to European Union collective marks will also apply to IRs designating the EU as a collective mark.

In accordance with Rule 121(2) EUTMIR, the holder must submit the regulations governing use of the mark directly to the EUIPO within two months of the date on which the International Bureau notified the EUIPO of the designation.

If, by then, the regulations on use have not been submitted or contain irregularities, or the holder does not comply with the requirements of Article 66, the examiner will issue a provisional refusal of protection and give the holder two months from the day on which the EUIPO issues the provisional refusal pursuant to Rule 121(3) EUTMIR to remedy the deficiency. Where the IR holder is required to be represented in proceedings before the EUIPO and its representative before WIPO does not appear in the database of representatives maintained by the EUIPO, the notification of provisional refusal will invite the holder to appoint a representative in compliance with Articles 92 and 93 EUTMR. This notification will be recorded in the international register, published in the Gazette and sent to the IR holder. The reply to the provisional refusal must be addressed to the EUIPO.

If the IR holder remedies the deficiency and complies with the requirement to appoint a representative before the EUIPO, if applicable, within the prescribed time limit, the international registration will proceed.

If the deficiency has not been remedied and/or a representative has not been appointed (if applicable), the Office will confirm the refusal to the IR holder, and grant a two-month time limit for lodging an appeal. Once the decision is final, the Office will inform WIPO that the provisional refusal is confirmed.

When, in the answer to the provisional refusal, elements are submitted satisfying the EUIPO that the basic mark is a certification mark or guarantee mark and the IR holder is not qualified to be the owner of a European Union collective mark, the EUIPO will examine the designation as an individual mark. The IR holder will be informed accordingly and will also be reimbursed with the difference in euros between the fees for an individual designation of the EU and for a collective one.

3.3.3.3 Seniority claims

Seniority claims filed together with the designation

Article 153(1) EUTMR Rule 9(3)(d) and Rule 9(7) and Rule 108 and Rule 109 EUTMIR Rule 9(5)(g)(i) and Rule 21 <i>bis</i> CR
--

The applicant may, when designating the EU in an international application or a subsequent designation, claim the seniority of an earlier mark registered in a Member

State. Such a claim must be submitted by attaching form MM17 to the international application or subsequent designation request, which should include for each claim:

- the EU Member State in which the earlier right is registered;
- the registration number;
- the filing date of the relevant registration.

There is no equivalent provision to Rule 8(2) EUTMIR applicable to direct EUTM filings.

No certificates or documents in support of the seniority claims must be attached to the MM17 form, as they will not be transmitted to the EUIPO by WIPO.

Seniority claims submitted together with the international application or subsequent designation will be examined in the same way as seniority claims submitted with an EUTM application. For more information, please refer to the Guidelines, Part B, Examination, Section 2, Formalities.

If it is necessary to file documentation in support of the seniority claim, or if the claim contains irregularities, the examiner will issue a deficiency letter giving the IR holder two months within which to remedy the deficiency. Where the IR holder is required to be represented in proceedings before the EUIPO and its representative before WIPO does not appear in the database of representatives maintained by the EUIPO, the holder will also be invited to appoint a representative before the EUIPO.

If the seniority claim is accepted by the EUIPO, the IP offices concerned will be informed. WIPO need not be informed since no change in the international register is required.

If the deficiency has not been remedied and/or a representative has not been appointed (if applicable), the right of seniority will be lost pursuant to Rule 109(2) EUTMIR. The IR holder may request a decision, which can be appealed. Once it is final, the EUIPO will inform WIPO of any loss, refusal or cancellation of the seniority right or of any withdrawal of the seniority claim. Those changes will be recorded in the international register and published by WIPO.

Seniority claims submitted directly before the EUIPO

Article 153(2) EUTMR Rule 110(1), (2), (4), (5) and (6) EUTMIR Rule 21 <i>bis</i> (2) CR
--

The IR holder may also claim the seniority of an earlier mark registered in a Member State directly before the EUIPO upon publication of the final acceptance of the IR. Where the IR holder is required to be represented in proceedings before the EUIPO and its representative before WIPO does not appear in the database of representatives maintained by the EUIPO, the EUIPO will invite the holder to appoint a representative in compliance with Articles 92 and 93 EUTMR.

The reply to the deficiency letter must be addressed to the EUIPO.

Any seniority claim submitted in the interval between the filing of the international application and the publication of the final acceptance of the IR will be deemed to have

been received by the EUIPO on the date of publication of the final acceptance of the IR and will therefore be examined by the EUIPO after that date.

If it is necessary to submit documentation in support of the seniority claim or if the claim contains irregularities, the examiner will issue a deficiency letter giving the IR holder two months within which to remedy the deficiency. Where the holder of the international registration is required to be represented in proceedings before the EUIPO and its representative before WIPO does not appear in the database of representatives maintained by the EUIPO, the holder will also be requested to appoint a representative before the EUIPO.

If the seniority claim is accepted by the Office, it will inform WIPO, which will record this fact in the international register and publish it.

The IP offices concerned will be informed pursuant to Rule 110(6) EUTMIR.

If the deficiency is not remedied and/or a representative has not been appointed (if applicable), the seniority right will be refused and the IR holder will be given two months within which to lodge an appeal. In such cases, WIPO is not informed. The same applies if the seniority claim is abandoned.

3.3.3.4 Vague terms

Articles 28, 36 and 145 EUTMR Rule 9 EUTMIR
--

International registrations designating the EU must be examined for the specification of broad or vague terms in the list of goods and services in the same way as direct EUTM applications (for details please consult the Guidelines, Part B, Examination, Section 3, Classification).

Where the IR contains vague terms in the list of goods and/or services that lack clarity or precision, the Office will issue a provisional refusal of protection and give the holder two months from the day on which the EUIPO issues the provisional refusal pursuant to Article 28 EUTMR and Rule 9 EUTMIR to remedy the deficiency. Where the IR holder is required to be represented in proceedings before the EUIPO and its representative before WIPO does not appear in the database of representatives maintained by the EUIPO, the notification of provisional refusal will invite the holder to appoint a representative in compliance with Articles 92 and Article 93 EUTMR. This notification will be recorded in the international register, published in the Gazette and sent to the IR holder. The reply to the provisional refusal must be addressed to the EUIPO.

Once the provisional refusal has been sent, further examination is the same as for a direct EUTM application; there will be direct exchanges with the holder or its representative as often as is required. The terms that need to be clarified by the IR holder should always be in the same class as the original wording in the International Register.

If, after re-examining the case, the objection is waived or the IR holder remedies the deficiency and complies with the requirement to appoint a representative before the EUIPO, if applicable, within the prescribed time limit, the Office will issue an interim status of the mark to WIPO; provided that no other provisional refusal is pending and that the opposition period is still running, the IR will then proceed.

Replies received by the IR holder or its representative will not be addressed where both are located outside the EU.

If the holder fails to overcome the objections or convince the examiner that they are unfounded, or fails to respond to the objection, the provisional refusal will be confirmed. In other words, if the provisional refusal concerned only some of the goods and services, only those goods and services will be refused but the remaining goods and services will be accepted. The IR holder will be given two months within which to lodge an appeal.

Once the decision is final and provided that there is a total refusal, the EUIPO will inform WIPO that the provisional refusal is confirmed. If the refusal is only partial, the communication to WIPO will be issued once all the other procedures (absolute grounds/oppositions) have been completed or the opposition period is over without any opposition being received (see paragraph 3.9 below).

3.4 Absolute grounds for refusal

Article 154 and Article 156(2) EUTMR Rule 18 <i>bis</i> (1) CR Rule 113 EUTMIR
--

International registrations designating the EU will be subject to examination of absolute grounds for refusal in the same way as direct EUTM applications (for details, please consult the Guidelines, Part B, Examination, Section 4, Absolute Grounds for Refusal and Collective Marks).

If the EUIPO finds that the mark is eligible for protection, and provided that no other provisional refusal is pending, it will send an interim status of the mark to WIPO, indicating that the *ex officio* examination has been completed, but that the IR is still open to oppositions or third-party observations. This notification will be recorded in the international register, published in the Gazette and communicated to the IR holder.

If the EUIPO finds that the mark is not eligible for protection, it will send a provisional refusal of protection, giving the holder two months from the day on which the provisional refusal is sent to file observations. Where the holder of the international registration is obliged to be represented in proceedings before the EUIPO and its representative before WIPO does not appear in the database of representatives maintained by the EUIPO, the notification of provisional refusal will also invite the holder to appoint a representative in compliance with Articles 92 and 93 EUTMR. This notification will be recorded in the international register, published in the Gazette and communicated to the IR holder. The reply to the provisional refusal must be addressed to the EUIPO.

If, after re-examining the case, the objection is waived, the examiner will issue an interim status of the mark to WIPO, provided that no other provisional refusal is pending and the opposition period is still running.

Where no provisional refusal has been issued by the EUIPO before the start of the opposition period (one month after republication), an interim status of the mark will be issued automatically.

However, the Office still has the possibility of reopening the examination of absolute grounds on its own initiative at any time before the final statement of grant of protection.

Once the provisional refusal has been sent, further examination is the same as for a direct EUTM application; direct exchanges with the holder or its representative will be held as often as required.

Replies received by the IR holder or its representative will not be addressed where both are located outside the EU.

If the holder fails to overcome the objections or convince the examiner that they are unfounded, or fails to respond to the objection, the refusal will be confirmed. In other words, if the provisional refusal concerned only some of the goods and services, only those goods and services will be refused but the remaining goods and services will be accepted. The IR holder will be given two months within which to lodge an appeal.

Once the decision is final and provided that there is a total refusal, the EUIPO will inform WIPO that the provisional refusal is confirmed. If the absolute grounds refusal is only partial, the communication to WIPO will be issued once all other procedures (specification of goods and services/oppositions) are terminated or the opposition period is over with no opposition received (see paragraph 3.9 below).

3.5 Third-party observations

Article 40 and Article 154(7) EUTMR

Third-party observations can be validly filed at the EUIPO from the date of notification of the IR to the EUIPO until at least the end of the opposition period and, if an opposition was filed, as long as the opposition is pending, but not beyond the 18-month period the EUIPO has for informing WIPO of all possible grounds for refusal (see paragraph 3.1 above).

If third-party observations are received before the EUIPO communicates the outcome of the absolute grounds examination to WIPO and the EUIPO considers the observations justified, a provisional refusal will be issued without mentioning the third-party observations.

If third-party observations are received after a provisional refusal on absolute grounds has been issued for goods and services other than those to which the observations relate and the EUIPO considers the observations justified, a further provisional refusal will be issued without mentioning the third-party observations.

If third-party observations are received after an interim status of the mark has been issued and the EUIPO considers them justified, a provisional refusal further to third-party observations will be issued. The observations will be attached to the provisional refusal.

The further examination procedure is identical to the procedure described in the Guidelines, Part B, Examination, Section 1, Proceedings, paragraph 3.1.

If the EUIPO considers the observations unjustified, they will simply be forwarded to the applicant without WIPO being informed.

3.6 Opposition

Article 156 EUTMR Rules 114 and 115 EUTMIR

3.6.1 Timing

Oppositions may be filed against the international registration between the first month and the fourth month following the date of first republication. For example, if the first republication is on 15/02/2017, the opposition period starts on 16/03/2017 and ends on 15/06/2017.

The opposition period is fixed and is independent of the outcome of the procedure on absolute grounds. Nevertheless, the start of the opposition procedure depends on the outcome of the absolute grounds examination insofar as the opposition procedure may be suspended if an absolute grounds refusal is issued.

Oppositions filed after the republication of the IR but prior to the start of the opposition period will be kept on hold and be deemed to have been filed on the first day of the opposition period. If the opposition is withdrawn before that date, the opposition fee is refunded.

For full details on the opposition procedure, please consult the Guidelines, Part C, Opposition, Section 1, Procedural Matters.

3.6.2 Receipt and informing the international holder

Rule 16a and Rule 114(3) EUTMIR

The EUIPO will issue a receipt to the opponent. If the opposition has been received before the beginning of the opposition period, a letter will be sent to the opponent, informing it that the opposition will be deemed to have been received on the first day of the opposition period and that the opposition will be put on hold until then.

The EUIPO will also send a copy of the notice of opposition to the IR holder or, if the latter has appointed a representative before WIPO and the EUIPO holds sufficient contact information, to that representative, irrespective of location, for information purposes.

3.6.3 Fees

Article 156(2) EUTMR
Rule 54 EUTMIR

The opposition will not be treated as duly entered until the opposition fee has been paid. If payment of the fee within the opposition period cannot be established, the opposition will be deemed not to have been entered.

If the opponent disagrees with this finding, it has the right to request a formal decision on loss of rights. If the EUIPO decides to confirm the finding, both parties will be informed thereof. If the opponent appeals this decision, the EUIPO will issue a provisional refusal to WIPO, even if incomplete, for the sole purpose of meeting the 18-month time limit. If the decision becomes final, the provisional refusal will be reversed. Otherwise, the opposition procedure will start in the normal manner.

3.6.4 Admissibility check

Article 92(2) EUTMR
Rules 17 and 115 EUTMIR

The EUIPO will examine whether the opposition is admissible and whether it contains the particulars required by WIPO.

If the opposition is considered inadmissible, the EUIPO will inform the IR holder accordingly and no provisional refusal based on an opposition will be sent to WIPO.

For full details on opposition proceedings see the Guidelines, Part C, Opposition, Section 1, Procedural Matters.

3.6.5 Language of proceedings

Article 119(6) EUTMR
Rule 16(1) EUTMIR

Oppositions (like cancellation requests) must be filed in the language of the international registration (the first language) or in the second language that the international holder is obliged to indicate when designating the EU. The opponent may choose one of these two languages as the language of the opposition proceedings. The opposition may also be filed in any of the other three EUIPO languages, provided that a translation into the language of the proceedings is filed within one month.

The EUIPO will use:

- the language of the opposition proceedings chosen by the opponent in all communications made directly to the parties;
- the language in which the IR was registered by WIPO (first language) in all communications with WIPO, for instance, the provisional refusal.

3.6.6 Representation of the IR holder

3.6.6.1 Opposition receipts

Rule 16a EUTMIR

If applicable, in the opposition receipts the EUIPO will inform the IR holder that if it does not appoint a representative who complies with the requirements stipulated in Articles 92(3) or 93 EUTMR within one month of receipt of the communication, the EUIPO will communicate the formal requirement to appoint a representative to the IR holder together with the opposition deadlines once the opposition is found admissible.

Where the IR holder has a WIPO representative **within** the EU who does not appear in the database of representatives maintained by the EUIPO, the EUIPO will inform this representative that if they wish to represent the IR holder before the EUIPO, they must specify the basis of their entitlement (i.e. whether they are a legal practitioner or professional representative within the meaning of Article 93(1)(a) or (b) EUTMR or an employee representative within the meaning of Article 92(3) EUTMR) (see also the Guidelines, Part A, General Rules, Section 5, Professional Representation).

3.6.6.2 Notification of commencement of opposition proceedings

Rule 18(1) EUTMIR

If the opposition has been found admissible and where, despite the invitation pursuant to paragraph 3.6.6.1 above, the IR holder fails to appoint a representative before the opposition has been notified as admissible, further processing of the file will depend on whether or not the **IR holder** is required to be represented before the EUIPO pursuant to Article 92(2) EUTMR.

- If the IR holder is **not** required to be represented before the EUIPO, the proceedings will continue directly with the IR holder, that is to say, the IR holder will be sent notification of the admissibility of the opposition and the time limits set for substantiation.
- If the IR holder **is** required to be represented before the EUIPO, the IR holder will be notified of the admissibility of the opposition and will be formally requested to appoint a representative within two months of receipt of the communication (Rule 114(4) EUTMIR), failing which the IR will be refused with a right to appeal. Once the decision is final the opposition proceedings will be closed and WIPO will be informed. For the attribution of costs, the normal rules apply. This means that no decision on costs will be taken and the opposition fee will not be refunded.

3.6.7 Provisional refusal (based on relative grounds)

Article 156(2) EUTMR
Rule 18 and Rule 115(1) EUTMIR
Article 5(1) and Article 5(2)(a) and (b) MP
Rule 17(1)(a) and (2)(v) CR

Any opposition that is deemed to have been entered and is admissible will lead to a notification of provisional refusal being sent to WIPO based on the pending opposition. WIPO will be informed of every admissible opposition duly entered within the opposition period by means of a separate provisional refusal for each opposition.

The provisional refusal may be partial or total. It will contain the earlier rights invoked, the relevant list of goods and services on which the opposition is based and, in the case of a partial refusal, the list of goods and services against which the opposition is directed.

The opponent must provide the list of goods and services on which the opposition is based in the language of the opposition proceedings. The EUIPO will send this list to WIPO in that language and will not translate it into the language in which the international registration was registered.

This notification will be recorded in the international register, published in the Gazette and communicated to the IR holder. It will not, however, contain any time limit, as the time limit for commencement of the proceedings will be set in the direct notification to the parties made in parallel by the EUIPO, as in the case of a normal EUTM.

3.6.8 Suspension of opposition where there is a pending provisional refusal on the specification of goods and services and/or absolute grounds

Rules 18(2) and 20(7) EUTMIR

If the opposition was filed after the EUIPO had already sent a notification of provisional refusal on the specification of goods and services (see paragraph 3.3.3.4 above) and/or absolute grounds (see paragraph 3.4 above) for the same goods and services, the EUIPO will inform WIPO of the provisional refusal and communicate to the parties that, as from the date of the communication, the opposition procedure is suspended until a final decision on the specification of goods and services and/or absolute grounds is issued.

If the provisional refusal on the specification of goods and services and/or absolute grounds leads to a final refusal of protection for all goods and services or for those contested by the opposition, the opposition procedure is closed without proceeding to a decision and the opposition fee is refunded.

If the refusal on the specification of goods and services and/or absolute grounds is not maintained or is only partially maintained, the opposition procedure is resumed for the remaining goods and services.

3.7 Cancellation of the IR or renunciation of the EU designation

If, further to a provisional refusal on the specification of goods and services and/or absolute or relative grounds, the holder requests the cancellation of the IR from the international register or renounces its designation of the EU, the file is closed upon receipt of the notification by WIPO. If this happens before the start of the adversarial part of the opposition proceedings, the opposition fee is reimbursed to the opponent, since it is equivalent to withdrawal of the EUTM application. The IR holder must submit such requests to WIPO (or through the office of origin) using the official form (MM7/MM8). The EUIPO cannot act as an intermediary and will not forward these requests to WIPO.

However, cancellation of the IR at the request of the office of origin (due to a 'central attack' during the five-year dependency period) is considered equivalent to rejection of the EUTM application in parallel proceedings under Rule 18(2) EUTMIR, in which case the opposition fee is not reimbursed.

3.8 Limitations of the list of goods and services

Article 9 <i>bis</i> (iii) MP Rule 25 CR

The EUIPO cannot communicate limitations as such to WIPO.

Therefore, further to a provisional refusal on the specification of goods and services and/or absolute or relative grounds, the IR holder can choose to limit the list of goods or services:

- either through WIPO, using the appropriate form (MM6/MM8) (in which case, provided the limitation allows the objection to be waived, the EUIPO will communicate to WIPO that the provisional refusal is withdrawn), or
- directly with the EUIPO. In this case the EUIPO will simply confirm the provisional refusal. In other words, WIPO's register will reflect the partial refusal, not the limitation as such.

Where there is no provisional refusal pending, all limitations must be filed only through WIPO. WIPO will record the limitation and forward it to the EUIPO for examination.

Limitations will be examined in the same way as limitations or partial surrenders of an EUTM or EUTM application (see the Guidelines, Part B, Examination, Section 3, Classification, and Part E, Register Operations, Section 1, Changes in a Registration). When the limitation has been submitted through WIPO and is considered unacceptable by the EUIPO, a declaration that the limitation has no effect in the territory of the EU will be issued pursuant to Rule 27(5) CR. This declaration will not be subject to review or appeal.

Partial cancellations at the request of the office of origin (further to a 'central attack' during the five-year dependency period) will be recorded, as they are by the EUIPO.

If the limitation is submitted before the start of the adversarial part of the opposition proceedings and allows the opposition proceedings to be terminated, the opposition fee is reimbursed to the opponent.

3.9 Confirmation or withdrawal of provisional refusal and issue of Statement of Grant of Protection

Rules 113(2)(a) and 115(5)(a) and Rule 116(1) EUTMIR
Rule 18ter(1) to (3) CR

If one or several notifications of provisional refusal have been sent to WIPO, the EUIPO must, once all procedures have been completed and all decisions are final,

- either confirm the provisional refusal(s) to WIPO,
- or send a Statement of Grant of Protection to WIPO indicating that the provisional refusal(s) is/are partially or totally withdrawn. The Statement of Grant of Protection must specify for which goods and services the mark is accepted.

If, upon expiry of the opposition period, the IR has not been the subject of any provisional refusal, the EUIPO will send a Statement of Grant of Protection to WIPO for all the goods and services.

The Statement of Grant of Protection must include the date on which the IR was republished in Part M.3 of the EUTM Bulletin.

The EUIPO will not issue any registration certificate for IRs.

3.10 Second republication

Articles 151(2) and (3) and 152(2) and Article 160 EUTMR
Rule 116(2) EUTMIR

The second republication by the EUIPO will take place when, upon conclusion of all procedures, the IR is (at least in part) protected in the EU.

The date of the second republication will be the starting point for the five-year use period and the date from which the registration may be invoked against an infringer.

From the date of second republication, the international application has the same effects as a registered EUTM. These effects may therefore come into force before the 18-month time limit has elapsed.

Only the following data will be published in Part M.3.1 of the EUTM Bulletin:

- 111 Number of the international registration;
- 460 Date of publication in the International Gazette (if applicable);
- 400 Date(s), number(s) and page(s) of previous publication(s) in the EUTM Bulletin;
- 450 Date of publication of the international registration or subsequent designation in the EUTM Bulletin.

3.11 Transfer of the designation of the EU

Rule 120 EUTMIR

The IR represents a single registration for administrative purposes since it is one entry in the international register. However, in practice, it is a bundle of national (regional) marks with regard to substantive effects and the trade mark as an object of property. As regards the link with the basic mark, while the IR must originally be in the name of the proprietor of the basic mark, it may thereafter be transferred independently of the basic mark.

In fact, a 'transfer of the international registration' is nothing more than a transfer of the mark with effect for one, several or all designated Contracting Parties. In other words, it is equivalent to a transfer of the corresponding number of national (regional) marks.

Transfers may not be submitted directly to the EUIPO in its capacity as designated office; they must be submitted to WIPO or through the office of the contracting party of the holder using the WIPO MM5 form. Once recorded by WIPO, the change of ownership of the designation of the EU will be notified to the EUIPO and automatically integrated into the EUIPO database.

In its capacity as designated office, the EUIPO has nothing to examine in relation to the transfer. Rule 27(4) CR allows a designated office to declare to WIPO that, as far as its designation is concerned, a change of ownership has no effect. However, the EUIPO does not apply this provision since it does not have the authority to re-examine whether the change in the international register was based on proof of the transfer. Furthermore, the EUIPO does not re-examine the mark for potential deceptiveness either (Article 17(4) EUTMR), unless the transfer is filed during the absolute grounds examination phase.

3.12 Invalidity, revocation and counterclaims

Articles 51, 52 and 53 and Articles 151(2) and 152(2) and Articles 158 and 160 EUTMR Rule 117 EUTMIR

The effects of an IR designating the EU may be declared invalid; the application for invalidation of the effects of an IR designating the EU corresponds to an application for declaration of revocation or for invalidity in EUTM terminology.

There is no time limit for filing an application for invalidity/revocation with the following exceptions:

- an application for invalidity of an IR designating the EU is only admissible once the designation has been finally accepted by the EUIPO, namely once the Statement of Grant of Protection has been sent.
- an application for revocation on the basis of non-use of an IR designating the EU is only admissible if, at the date of filing the request, the final acceptance of the IR had been republished by the EUIPO at least five years earlier (see Article 160 EUTMR, stating that the date of publication pursuant to Article 152(2) takes the place of the date of registration for the purpose of establishing the date as from

which the mark that is the subject of an IR designating the EU must be put to genuine use in the European Union).

The EUIPO will examine the request as if it were directed against a direct EUTM (for further information, see the Guidelines, Part D, Cancellation).

If the IR designating the EU is totally or partially invalidated/revoked further to a final decision or a counterclaim action, the EUIPO will notify WIPO according to Article 5(6) MP and Rule 19 CR. WIPO will record the invalidation/revocation and publish it in the International Gazette.

4 Conversion, Transformation, Replacement

4.1 Preliminary remarks

Conversion or transformation

Both apply when an IR designating the EU ceases to have effect, but for different reasons:

- When an IR ceases to have effect because the mark of origin has been the subject of a 'central attack' during the five-year dependency period, **transformation** into a direct EUTM application is possible. Transformation is not available when the IR has been cancelled at the holder's request or the holder has renounced in part or in whole the designation of the EU. The EU designation must still be effective when the transformation is requested, that is, it must not have been finally refused by the EUIPO; otherwise, there will be nothing left to transform and conversion of the designation would be the only possibility.
- When the IR designating the EU is finally refused by the EUIPO or ceases to have effect for reasons independent of the basic trade mark, only **conversion** is available. Conversion is possible within the prescribed time limit even if, in the meanwhile, the IR has also been cancelled from the international register at the request of the office of origin, that is to say, via a 'central attack'.

4.2 Conversion

Articles 112 to 114 and 159 EUTMR Rule 24(2)(a)(iii) CR
--

The legal option of conversion² has its origins in the EUTM System, which has been adapted to allow a designation of the EU through an IR to be converted into a national trade mark application, just like for a direct EUTM. The EUTM system and Madrid System have also been adapted to allow for conversion into a designation of Member

² In English, 'conversion' is used to describe a specific legal provision of the EUTM System (Article 112 et seq. EUTMR) while 'transformation' is used to describe that in Article 9*quinquies* MP. In other languages, only one word is used to describe these two different legal provisions (e.g. in Spanish 'transformación'). In order to avoid confusion, the English word 'conversion' could be used in parentheses when, for example, the Spanish word 'transformación' is used within the meaning of Article 112 EUTMR.

States party to the Madrid System (known as 'opting back'). Malta is not party to the Madrid System.

The latter is forwarded to WIPO as a request for subsequent designation of the Member State(s). This type of subsequent designation is the only one that, instead of being filed with the office of origin or with WIPO directly, has to be filed through the designated office.

For full details on Conversion, see the Guidelines, Part E, Register Operations, Section 2, Conversion.

4.3 Transformation

Article 6(3) and Article 9 <i>quinquies</i> MP Article 161 EUTMR Rule 84(2)(p) and Rule 124 EUTMIR
--

4.3.1 Preliminary remarks

Transformation has its origins solely in the Madrid Protocol. It was introduced in order to soften the consequences of the five-year dependency period already set in place by the Madrid Agreement. Where an IR is cancelled in whole or in part because the basic mark has ceased to have effect, and the holder files an application for the same mark and same goods and services as the cancelled registration with the office of any contracting party for which the IR had effect, that application will be treated as if it had been filed on the date of the IR or, where the contracting parties had been designated subsequently, on the date of the subsequent designation; it will also enjoy the same priority, if any.

This filing is not governed by the protocol, nor is WIPO involved in any way. Unlike conversion, transformation of the EU designation into national applications is not possible. Nor is it possible to transform an EU designation into individual Member State designations. If the EU has been designated, the IR has effect in the EU and not in individual Member States as such.

The EU designation must still be effective when the transformation is requested, that is, it must not have been finally refused by the EUIPO; otherwise, there will be nothing left to transform and conversion of the designation would be the only possibility.

4.3.2 Principle and effects

Article 27 EUTMR

Following a **cancellation in whole or in part of an IR designating the EU at the request of the office of origin** under Article 9 *quinquies* MP (i.e. following a 'central attack' during the five-year dependency period), the holder may file a 'direct' EUTM application for the same mark and the same goods and services as the cancelled mark.

The application resulting from the transformation will be treated by the EUIPO as if it had been filed on the date of the original IR or, where the EU was designated

subsequently to the IR, on the date of the subsequent designation; it will also enjoy the same priority, if any.

The date of the IR or of the subsequent designation will not become the filing date of the European Union trade mark application. Article 27 EUTMR, which applies *mutatis mutandis*, lays down clear conditions for the granting of a filing date, subject also to payment of the application fee within one month. However, the date of the IR or subsequent designation will be the date that determines the ‘earlier right effect’ of the EUTM for the purposes of priority searches, oppositions, etc.

Unlike for priority and seniority claims (Rule 9(8) EUTMR), it is not possible to have a ‘split’ or ‘partial’ date, with one date being only for those goods that were contained in the IR and the filing date of the European Union trade mark application being the relevant date for the additional goods and services. No such partial transformation effect is foreseen in Article 9 *quinquies* of the Madrid Protocol or Article 161 EUTMR.

Renewal starts to run from the filing date of the transformed EUTM.

4.3.3 Procedure

The conditions for invoking a transformation right under Article 9 *quinquies* MP are:

- that the application is filed within a period of three months from the date on which the IR was cancelled in whole or in part, and
- that the goods and services of the ensuing application are in fact covered by the list of goods and services of the designation of the EU.

The applicant needs to claim this right in the relevant section provided in the EUTM e-filing or EUTM application form. The following indications must be given in this section:

1. number of the IR that has been cancelled in whole or in part;
2. date on which the IR was cancelled in whole or in part by WIPO;
3. date of the IR pursuant to Article 3(4) MP or date of territorial extension to the EU made subsequently to the IR pursuant to Article 3~~ter~~(2) MP;
4. date of priority claimed in the IR, if any.

The EUIPO will invite the applicant to remedy any deficiencies detected within a period of two months.

If the deficiencies are not remedied, the right to the date of the IR or the territorial extension and, if any, of the priority of the IR will be lost. In other words, if the transformation is finally refused, the EUTM application will be examined as a ‘normal’ application.

4.3.4 Examination

4.3.4.1 Application for transformation of an IR designating the EU where no particulars have been published

When the application for transformation relates to an IR designating the EU for which the particulars have not been published pursuant to Article 152(2) EUTMR (in other

words that has not been finally accepted by the EUIPO), the EUTM resulting from transformation will be treated as a normal EUTM application; it will be examined as to classification, formalities and absolute grounds and published for opposition purposes. Nothing in the regulations allows the EUIPO to omit the examination process.

Nevertheless, since this case presupposes that an IR designating the EU had already existed, the EUIPO can take advantage of the classification of the list of goods and services of the cancelled IR (as far as it complies with the EUIPO rules) as well as the European Union search reports already issued for that IR (since the date of the ensuing EUTM application is the same as the date of the original IR, the search report must by definition come to the same results).

The EUTM will be published in Part A of the EUTM Bulletin for opposition purposes with an additional field under INID code 646, mentioning the details of the transformation. The remainder of the procedure will be the same as for a normal EUTM filing, including if an opposition procedure had already been initiated against the IR designating the EU without reaching the final decision stage. In such a case, the previous opposition procedure would be closed and a new opposition would need to be filed.

4.3.4.2 Application for transformation of an IR designating the EU where particulars have been published

When the application for transformation relates to an IR designating the EU for which the particulars have already been published pursuant to Article 152(2) EUTMR, the examination and opposition stage are omitted (Articles 37 to 42 EUTMR).

Nevertheless, the list of goods and services will have to be translated into all languages. The EUTM will then be published in Part B.2 of the EUTM Bulletin with the translations and the additional INID code 646, and the registration certificate will be issued immediately.

4.3.5 Transformation and seniority

If seniority claims have been accepted by the EUIPO and are registered by WIPO in the file for the transformed IR designating the EU, there is no need to claim seniority again in the EUTM resulting from transformation. This is not explicitly foreseen in Rule 124(2) EUTMIR (only priority is mentioned under (d)) but is extended by analogy to seniority in view of the fact that:

- the EUIPO has already accepted the claims and WIPO has published them,
- where the owner had let the earlier marks lapse in the meanwhile, it would not be able to file new claims before the EUIPO (one condition of a valid seniority claim being that the earlier right is both registered and in force when the claim is made).

4.3.6 Fees

There is no specific 'transformation' fee. The EUTM application resulting from the transformation of the IR designating the EU is subject to the same fees as a 'normal' EUTM application, namely the basic fee.

The basic fee for the EUTM application must be paid to the EUIPO within one month of the filing of the EUTM requesting transformation in order for the request to comply with Article 27 EUTMR and Article 9 *quinquies*(iii) MP and the transformation to be accepted. For example, if the end of the three-month time limit for transformation is 01/04/2012 and transformation into an EUTM application is filed on 30/03/2012, the deadline for payment of the basic fee is 30/04/2012. If payment occurs after that date, the conditions for transformation are not met, transformation will be refused and the filing date given to the EUTM application will be the date of the payment.

4.4 Replacement

Article 157 EUTMR
Rule 84(2) EUTMIR
Article 4*bis* MP
Rule 21 CR

4.4.1 Preliminary remarks

Replacement has its origins in the Madrid Agreement and Madrid Protocol. A mark that is registered with the office of a contracting party is, under certain conditions, deemed to be replaced by an international registration of the same mark without prejudice to the rights already acquired (earlier date). The wording of Article 4*bis*(1) MP clearly provides that replacement is deemed to take place automatically, without the need for any action by the holder and without any record having to be made of the replacement. Nevertheless, it is possible to ask the EUIPO to take note of the replacement in its Register (Rule 21 CR). The purpose of this procedure is to ensure that the relevant information concerning the replacement is made available to third parties in the national or regional registers as well as in the international register. In other words, it is not an obligation to have the replacement registered in order to be able to invoke it, but it can be useful.

Apart from the qualification relating to earlier acquired rights, neither the agreement nor the protocol elaborates further on replacement.

4.4.2 Principle and effects

In accordance with Article 4*bis* of the Madrid Agreement and the Protocol, the holder **may** request the EUIPO to take note in its Register that **an EUTM registration is replaced by a corresponding IR. The holder's rights in the EU should be deemed to start from the date of the earlier EUTM registration.** A reference will therefore be introduced in the EUTM Register that a direct EUTM has been replaced by a designation of the EU through an IR and published.

4.4.3 Procedure

A request for replacement may be filed at the EUIPO by the international holder at any time after notification of the EU designation by WIPO.

Once a request to record a replacement has been received, the EUIPO will carry out a formal examination, checking that the marks are identical, that all the goods and

services listed in the EUTM are listed in the IR designating the EU, that the parties are identical and that the EUTM has been registered prior to the designation of the EU. The IR need not have an identical list of goods and services: the list may be broader in scope. It cannot, however, be narrower. If the list is narrower, a deficiency will be issued. This deficiency may normally be overcome by partially surrendering the goods and services of the EUTM falling outside the scope of the IR.

The EUIPO considers it sufficient for noting the replacement in the Register if the IR and EUTM coexist on the date of the IR. In particular, should the designation of the EU through an IR not yet be finally accepted, the EUIPO will not wait for final acceptance before recording the replacement. It is up to the international holder to decide when to request the replacement.

If all conditions are met, the EUIPO will note the replacement in the EUTM Register and inform WIPO that an EUTM has been replaced by an IR in accordance with Rule 21 CR, indicating:

- the number of the IR
- the EUTM number
- the EUTM application date
- the EUTM registration date
- the priority date(s) (if relevant)
- the seniority number(s), filing date(s) and country/countries (if relevant)
- the list of goods and services of the replacement (if relevant).

After the replacement has been recorded, the EUTM is maintained normally in the Register as long as the holder renews it. In other words, there is coexistence between the replaced EUTM in force and the IR designating the EU.

According to Rule 21(2) of the Common Regulations under the Madrid Agreement and Protocol, WIPO will record the indications notified under paragraph (1) of that rule in the international register, publish them and inform the holder accordingly, in order to ensure that the relevant information concerning replacement is made available to third parties. Nevertheless, there is no obligation for the EUIPO to communicate further changes affecting the replaced EUTM.

4.4.4 Fees

The request for taking note of a replacement is free of charge.

4.4.5 Publication

Rule 84(2) and Rule 85 EUTMIR

The replacement is entered in the EUTM Register and published in the EUTM Bulletin under Part C.3.7.

4.4.6 Replacement and seniority

Article 4 <i>bis</i> (1) MP

Since replacement occurs ‘without prejudice to any rights acquired’ by virtue of the earlier registration, the EUIPO will include information on the seniority claims contained in the replaced EUTM registration within the content of the notification to be sent to WIPO under Rule 21 CR.

4.4.7 Replacement and transformation

If the IR that replaced the direct EUTM ceases to have effect following a ‘central attack’, and provided that the conditions laid down by Article 9*quinquies* MP are met, the holder can request a transformation of the IR under Article 9*quinquies* MP while maintaining the effects of the replacement of the EUTM and its earlier date effects, including priority or seniority if applicable.

4.4.8 Replacement and conversion

The IR and the EUTM should coexist on the date of the IR if the replacement is to be effective. Therefore, if the IR that replaces the direct EUTM is finally refused by the EUIPO (e.g. further to an opposition), the holder can request conversion of the designation of the EU and should be able to maintain the effects of the replacement of the EUTM and its earlier date effects, including priority or seniority if applicable.

***GUIDELINES FOR EXAMINATION OF
REGISTERED COMMUNITY DESIGNS***

***EUROPEAN UNION
INTELLECTUAL PROPERTY OFFICE
(EUIPO)***

***EXAMINATION OF APPLICATIONS FOR
REGISTERED COMMUNITY DESIGNS***

Table of Contents

1	Introduction	7
1.1	Purpose of the Guidelines	7
1.2	General principles	7
1.2.1	Duty to state reasons	7
1.2.2	Right to be heard	8
1.2.3	Compliance with time limits	8
1.2.4	Scope of the examination carried out by the Office	9
1.2.5	User-friendliness	9
2	Filing an Application at the Office	9
2.1	Introduction	9
2.2	Form of the application	10
2.2.1	Different means of filing	10
2.2.2	Use of the official form	10
2.2.3	Applications sent by post or personal delivery	10
2.2.4	E-filing	11
2.2.5	Fax	11
2.3	Content of the application	11
2.4	Language of the application	11
2.5	Representation of the applicant	12
2.5.1	When is representation mandatory?	12
2.5.2	Who may represent?	12
2.6	Date of receipt, file number and issue of receipt	13
2.6.1	Applications filed through national offices (intellectual property office of a Member State or Benelux Office for Intellectual Property (BOIP))	13
2.6.2	Applications received directly at the Office	13
2.7	Registration or examination report	13
2.7.1	Registration	13
2.7.2	Examination report and informal communication on possible deficiencies ('preliminary examination report')	14
2.7.2.1	Priority claims and supporting documents	14
2.7.2.2	Priority claims made subsequent to filing	15
2.7.2.3	Application filed by fax	15
2.7.2.4	Payment of fees	15
2.7.2.5	Multiple applications and request for partial deferment	16
3	Allocation of a Filing Date	16
3.1	Request for registration	16
3.2	Information identifying the applicant	17
3.3	Representation of the design suitable for reproduction	17
3.3.1	General requirements	17
3.3.2	Neutral background	17
3.3.3	Designs retouched with ink or correcting fluid	18
3.3.4	Quality	19
3.3.4.1	Fax	19

3.3.4.2	E-filing	20
3.3.5	Specimens	21
4	Examination of the Substantive Requirements	21
4.1	Compliance with the definition of a design	22
4.1.1	Blueprints, plans for houses or other architectural plans and interior or landscape designs	22
4.1.2	Colours per se and combinations of colours	22
4.1.3	Icons	22
4.1.4	Mere verbal elements	23
4.1.5	Music and sounds	23
4.1.6	Photographs	23
4.1.7	Living organisms	23
4.1.8	Teaching materials	23
4.1.9	Concepts	23
4.2	Public policy and morality	24
4.2.1	Common principles	24
4.2.2	Public policy	24
4.2.3	Morality	24
4.3	Objections	24
5	Additional Requirements Regarding the Reproduction of the Design	25
5.1	Number of views	26
5.2	Consistency of the views	27
5.2.1	Complex products	28
5.2.2	Details	28
5.2.3	Sets of articles	29
5.2.4	Variations of a design	30
5.2.5	Colours	30
5.2.6	Elements external to the design	31
5.3	Use of identifiers to exclude features from protection	32
5.3.1	Broken lines	32
5.3.2	Boundaries	32
5.3.3	Colour shading and blurring	33
5.3.4	Separations	33
5.4	Explanatory text, wording or symbols	34
5.5	Amending and supplementing views	34
5.6	Specific requirements	35
5.6.1	Repeating surface patterns	35
5.6.2	Typographic typefaces	35
6	Additional Elements that an Application Must or May Contain	36
6.1	Mandatory requirements	36
6.1.1	Identification of the applicant and its representative	36
6.1.2	Specification of the languages	37
6.1.3	Signature	37

6.1.4	Indication of products	37
6.1.4.1	General principles	37
6.1.4.2	The Locarno and Eurolocarno Classifications	38
6.1.4.3	How to indicate products	38
6.1.4.4	<i>Ex officio</i> change of indication	39
6.1.5	Long lists of products.....	40
6.1.6	Objections to product indications.....	41
6.1.6.1	No product indication.....	41
6.1.6.2	Deficient product indication	41
6.1.6.3	Obvious mismatch.....	42
6.2	Optional elements	42
6.2.1	Priority and exhibition priority	42
6.2.1.1	Priority	42
6.2.1.2	Exhibition priority	48
6.2.2	Description.....	49
6.2.3	Indication of the Locarno Classification	49
6.2.3.1	General principles	49
6.2.3.2	Multiple applications and the requirement of 'unity of class'	50
6.2.4	Citation of the designer(s)	50
6.2.5	Request for deferment.....	51
6.2.5.1	General principles	51
6.2.5.2	Request for deferment.....	51
6.2.5.3	Request for publication.....	52
6.2.5.4	Observation of time limits	52
6.2.5.5	Deficiencies	53
7	Multiple Applications.....	54
7.1	General principles	54
7.2	Formal requirements applying to multiple applications	54
7.2.1	General requirements.....	54
7.2.2	Separate examination.....	55
7.2.3	The 'unity of class' requirement.....	55
7.2.3.1	Principle.....	55
7.2.3.2	Products other than ornamentation	55
7.2.3.3	Ornamentation.....	56
7.2.3.4	Deficiencies	57
8	Payment of Fees	57
8.1	General principles	57
8.2	Currency and amounts.....	58
8.3	Means of payment, details of the payment and refund.....	58
9	Withdrawals and Corrections	59
9.1	Introduction	59
9.2	Withdrawal of the application	59
9.3	Corrections to the application	60
9.3.1	Elements subject to correction	60
9.3.2	Elements that cannot be corrected.....	60
9.3.3	Procedure for requesting correction	60
9.3.4	Deficiencies	61
10	Registration, Publication and Certificates.....	61

10.1	Registration	61
10.2	Publication.....	62
	10.2.1 General principles.....	62
	10.2.2 Format and structure of the publication	62
10.3	Registration certificate.....	64
11	Corrections and Changes in the Register and in the Publication of Community Design Registrations	64
11.1	Corrections	64
	11.1.1 General principles.....	64
	11.1.2 The request for correction	65
	11.1.3 Publication of corrections	66
11.2	Changes in the Register.....	66
	11.2.1 Introduction.....	66
	11.2.2 Surrender of the registered Community design.....	66
	11.2.2.1 General principles	66
	11.2.2.2 Formal requirements for a declaration of surrender	67
	11.2.3 Changes in the name and address of the applicant/holder and/or its representative	68
	11.2.4 Transfers.....	69
	11.2.4.1 Introduction.....	69
	11.2.4.2 Rights of prior use in respect of a registered Community design	69
	11.2.4.3 Fees	69
	11.2.5 Licences.....	69
	11.2.5.1 General principles	69
	11.2.5.2 Registered Community designs.....	69
	11.2.5.3 Multiple applications for registered Community designs.....	70
	11.2.5.4 Fees	70
12	International Registrations	70
12.1	General overview of the Hague System.....	71
	12.1.1 The Hague Agreement and the Geneva Act	71
	12.1.2 Procedure for filing international applications.....	71
	12.1.2.1 Particularities.....	71
	12.1.2.2 Deferment of publication.....	71
	12.1.2.3 Fees	72
	12.1.3 Examination carried out by the International Bureau	72
12.2	The role of the Office as designated office.....	72
	12.2.1 Receipt of the international registration designating the European Union ...	73
	12.2.2 Grounds for non-registrability	73
	12.2.2.1 Compliance with the definition of a design, public policy and morality	73
	12.2.2.2 Time limits	73
	12.2.2.3 Languages.....	74
	12.2.2.4 Professional representation.....	74
	12.2.2.5 Renunciation and limitation	74
	12.2.2.6 Grant of protection.....	75
	12.2.2.7 Refusal.....	75
12.3	Effects of international registrations	75
13	Enlargement and the Registered Community Design	76
13.1	The automatic extension of the Community design to the territories of the new Member States	76

1 Introduction

1.1 Purpose of the Guidelines

The Guidelines explain how, in practice, the requirements of the Community Design Regulation¹ (CDR), the Community Design Implementing Regulation² (CDIR), and the Fees Regulation³ (CDFR) are applied by the Office's Design Service from the receipt of an application for a registered Community design (RCD) up to its registration and publication. The Office has no competence with regard to **unregistered** Community designs.

The purpose of the Guidelines is to ensure consistency among the decisions taken by the Designs Service and to ensure a coherent practice in file handling. These Guidelines are merely a set of consolidated rules setting out the line of conduct which the Office itself proposes to adopt, which means that, to the extent that those rules comply with the legal provisions of a higher authority, they constitute a self-imposed restriction on the Office, in that it must comply with the rules which it has itself laid down. However, these Guidelines cannot derogate from the CDR, the CDIR or the CDFR, and it is solely in the light of those regulations that the applicant's capacity to file an application to register a Community design must be assessed.

The Guidelines are structured to follow the sequence of the examination process with each section and subsection constituting a step in the registration proceedings from the receipt of the application up to registration and publication. The general principles (see paragraph 1.2 below) should be kept in mind throughout the whole examination process.

1.2 General principles

1.2.1 Duty to state reasons

The decisions of the Office must state the reasons on which they are based (Article 62 CDR). The reasoning must be logical and it must not lead to internal inconsistencies.

The Office is, however, not required to give express reasons for its assessment of the value of each argument and each piece of evidence submitted to it, in particular where it considers that the argument or evidence in question is unimportant or irrelevant to the outcome of the dispute (see, by analogy, judgment of 15/06/2000, C-237/98 P, 'Dorsch Consult Ingenieurgesellschaft mbH', para. 51). It is sufficient if the Office sets out the

¹ [Council Regulation \(EC\) No 6/2002 of 12 December 2001 on Community Designs](#)), amended by Council Regulation No 1891/2006 of 18 December 2006 amending Regulations (EC) No 6/2002 and (EC) No 40/94 to give effect to the accession of the European Community to the Geneva Act of the Hague Agreement concerning the international registration of industrial designs.

² [Commission Regulation \(EC\) No 2245/2002 of 21 October 2002 implementing Council Regulation \(EC\) No 6/2002 on Community designs](#), as amended by Commission Regulation (EC) No 876/2007 on 24 July 2007 amending Regulation (EC) No 2245/2002 implementing Council Regulation (EC) No 6/2002 on Community designs following the accession of the European Community to the Geneva Act of the Hague Agreement concerning the international registration of industrial designs.

³ [Commission Regulation \(EC\) No 2246/2002 of 16 December 2002 on the fees](#), as amended by Commission Regulation (EC) No 877/2007 of 24 July 2007 amending Regulation (EC) No 2246/2002 concerning the fees payable to the Office for Harmonization in the Internal Market (Trade Marks and Designs) following the accession of the European Community to the Geneva Act of the Hague Agreement concerning the international registration of industrial designs.

facts and legal considerations with decisive importance in the context of the decision (judgment of 12/11/2008, T-7/04, 'Limoncello', para. 81).

Whether the reasoning satisfies those requirements is a question to be assessed with reference not only to its wording, but also to its context and the legal rules governing the matter in question (judgment of 07/02/2007, T-317/05, 'Guitar', para. 57).

1.2.2 Right to be heard

The decisions of the Office shall be based only on reasons or evidence on which the applicant has had an opportunity to present its comments (Article 62 CDR, second sentence).

The right to be heard covers all the factual and legal evidence that form the basis for the act of taking the decision, but it does not apply to the final position that the Office intends to adopt.

The obligation to state reasons has two purposes: to allow interested parties to know the justification for the measure taken so as to enable them to protect their rights and to enable the next instance to exercise their power to review the legality of the decision. Moreover, the obligation to state reasons is an essential procedural requirement, as distinct from the question whether the reasons given are correct, which goes to the substantive legality of the contested measure (judgment of 27/06/2013, T-608/11, 'Instrument for writing II', paras 67-68 and the case-law cited there).

1.2.3 Compliance with time limits

Applicants must respond to the Office's communications within the time limits set by those communications.

Any written submission or document that has not been submitted within the time limits set by the Office is belated. The same applies to supplementary materials attached only to the confirmation copy of a letter that was in itself sent on time (usually by fax), where this confirmation mail arrives after the expiry of the time limit. This is irrespective of whether such materials are specifically mentioned in the initial letter (for specific rules as regards applications filed by fax, see paragraph 2.7.2.3 below).

The Office may disregard facts or evidence that the applicant does not submit in due time (Article 63(2) CDR).

For calculation of time limits see Article 56 CDIR.

A request to extend a time limit by an applicant has to be made before its expiry (Article 57(1) CDIR).

As a general rule, a first request to extend a time limit will be granted. Further extensions will not automatically be granted. Reasons in support of any further request for extension must be submitted to the Office. The request for extension of the time limit must indicate the reasons why the **applicant** cannot meet the deadline. The obstacles faced by the parties' **representatives** do not justify an extension (see, by analogy, order of 05/03/2009, C-90/08 P, 'Corpo Livre', paras 20-23).

The extension cannot result in a time limit longer than six months (Article 57(1) CDR). The applicant is informed about any extension.

Applicants failing to observe the time limits run the risk that their observations may be disregarded, which may result in a loss of rights. In such a case, the applicant may file a request for *restitutio in integrum* (Article 67 CDR. See also the Guidelines, Part A, General Rules, Section 8, *Restitutio in integrum*).

1.2.4 Scope of the examination carried out by the Office

When examining an application for a Community design, the Office shall examine the facts of its own motion (Article 63(1) CDR).

The examination procedure is kept to a minimum, that is, mainly an examination of the formalities. However, the grounds for non-registrability foreseen in Article 47 CDR must be examined *ex officio* by the Office:

- (a) whether the subject matter of the application corresponds to the definition of a design as set forth in Article 3(a) CDR; and
- (b) whether the design is contrary to public policy or accepted principles of morality.

Where one of these two grounds is applicable, the procedure explained below in paragraph 4 will apply.

Other protection requirements are not examined by the Office. A Community design that has been registered in breach of the protection requirements laid down in Article 25(1)(b) to (g) CDR is liable to be invalidated if an interested party files a request for a declaration of invalidity (see the Guidelines on Examination of Design Invalidity Applications).

1.2.5 User-friendliness

One of the fundamental objectives of the CDR is that the registration of Community designs should present the minimum cost and difficulty to applicants, so as to make it readily available to any applicant including small and medium-sized enterprises and individual designers.

To that end, examiners are encouraged to contact the applicant or, if a representative has been appointed (see paragraph 2.5 below), its representative by phone, in order to clarify issues arising from the examination of an application for a Community design, before or after an official deficiency letter has been sent.

2 Filing an Application at the Office

2.1 Introduction

There are two ways of applying for registration of a Community design, that is, (i) either via a direct filing, at the Office or at the central industrial property office of a Member State or, in Benelux countries, at the Benelux Office for Intellectual Property (BOIP) (Article 35 et seq. CDR) or (ii) via an international registration filed with the International

Bureau of the World Intellectual Property Organisation and designating the European Union (Article 106a et seq. CDR).

This section will deal with direct filings. The examination of the formalities relating to international registrations designating the European Union will be explained in paragraph 12 below.

2.2 Form of the application

2.2.1 Different means of filing

An application for a registered Community design may be directly filed at the Office by fax, post, personal delivery or e-filing. It may also be filed at the central industrial property office of a Member State or in Benelux countries, at the Benelux Office for Intellectual Property (BOIP) (Article 35 CDR).

2.2.2 Use of the official form

The Office provides a form (Article 68(1)(a) CDIR) that may be downloaded from the Office's website⁴. The use of the form is not mandatory but it is strongly recommended (Article 68(6) CDIR), in order to facilitate the processing of the application and to avoid errors.

Applicants may use forms of a similar structure or format, such as forms generated by computers on the basis of the information contained in the official form.

2.2.3 Applications sent by post or personal delivery

Applications can be sent to the Office by ordinary post or private delivery services to the following address:

Office for Harmonization in the Internal Market
Avenida de Europa, 4
E-03008 Alicante
SPAIN

Applications can also be handed in personally at the reception of the Office from Monday to Friday, except on official holidays, from 08.30 to 13.30 and from 15.00 to 17.00.

The application has to be signed by the applicant or its representative. The name of the signatory must be indicated and the authority of the signatory must be specified (see paragraph 6.1.3 below).

⁴ <https://oami.europa.eu/ohimportal/en/forms-and-filings>.

2.2.4 E-filing

E-filing is a recommended means of filing to the extent that the system gives guidance to the applicant, thus reducing the number of potential deficiencies and speeding up the examination procedure.

Where a communication is sent to the Office by electronic means, the indication of the sender's name will be deemed to be equivalent to the signature (see paragraph 6.1.3 below).

2.2.5 Fax

Applications can be sent by fax to the following fax number: +34 965131344.

However, filing an application by fax is not recommended because the quality of the representation of the design may deteriorate in the course of the transmission or on receipt by the Office.

Moreover, applicants must be aware of the fact that the processing of their application will be delayed by up to **one month** (see paragraph 2.7.2.3 below).

2.3 Content of the application

The application must satisfy all the mandatory requirements set out in Articles 1 ('content of the application'), 3 ('indication of products'), 4 ('representation of the design') and 6 CDIR ('fees for the application').

Additional requirements apply where the applicant selects one of the following options: a multiple application is filed (Article 2 CDIR), specimens are filed (Article 5 CDIR), a priority or an exhibition priority is claimed (Articles 8 and 9 CDIR), or where the applicant chooses to be, or must be, represented (Article 77 CDR).

2.4 Language of the application

The application may be filed in any of the official languages of the European Union (language of filing) (Article 98(1) CDR; Article 1(1)(h) CDIR)⁵.

The applicant must indicate a second language, which must be a language of the Office that is, English (EN), French (FR), German (DE), Italian (IT) or Spanish (ES). The second language must be different from the language of filing.

⁵ The European Union has 24 official and working languages, including Irish. Irish became a full EU language on 01/01/ 2007. There is however a temporary derogation for a renewable period extending until 31/12/2016 during which 'the institutions of the European Union shall not be bound by the obligation to draft all acts in Irish and to publish them in that language in the *Official Journal of the European Union*' (see Council Regulation (EC) No 920/2005 of 13/06/2005 (OJ L 156, 18.6.2005, p. 3) and Council Regulation (EU) No 1257/2010 (OJ L 343, 29/12/2010, p. 5). Until then, it is not possible to file an application for a registered Community design in Irish. Croatian became an official language on 01/07/2013 (see paragraph 13).

All written communications have to be drafted in the language of filing, unless the first language chosen is not one of the five working languages of the Office and the applicant agrees to receive the communication in the second language of the application. The consent to the use of the second language must be given for each individual application for a Community design. It may not be given for all existing or future files.

This language regime applies throughout the application and examination procedure until registration.

2.5 Representation of the applicant

2.5.1 When is representation mandatory?

Where the applicant does not have its domicile or its principal place of business or a real and effective industrial or commercial establishment in the European Union, it must be represented by a representative in all proceedings before the Office other than in filing an application (Article 77(2) CDR, Article 10(3)(a) CDIR).

If this requirement is not complied with, the applicant will be requested to appoint a representative within a time limit of two months. Where the applicant does not comply with the request, the application is rejected as inadmissible (Article 77(2) CDR; Article 10(3)(a) CDIR).

In examining whether an applicant has a real and effective industrial or commercial establishment in the European Union, the Office follows the guidance of the Court of Justice of 22/11/1978, C-33/78, 'Somafer SA', para. 12 ('... the concept of branch, agency or other establishment implies a place of business which has the appearance of permanency, such as the extension of a parent body, has a management and is materially equipped to negotiate business with third parties ...'). Proof that an applicant has a real and effective industrial or commercial establishment in the European Union may consist, inter alia, of articles of incorporation, annual reports, statements in writing, and other business documents.

2.5.2 Who may represent?

Representation of applicants before the Office may be effected only by a legal practitioner or by a professional representative who fulfils the requirements of Article 78(1) CDR.

A natural or legal person whose domicile, principal place of business, or real and effective industrial or commercial establishment is in the European Union may act before the Office through an employee. Employees of such a legal person may also represent another legal person having neither its domicile nor its principal place of business nor a real and effective industrial or commercial establishment within the European Union, provided there exist economic connections between the two legal persons (Article 77(3) CDR). The Office may request evidence in this respect.

Employees acting on behalf of natural or legal persons pursuant to Article 77(3) CDR must submit a signed authorisation for insertion in the file (Article 62(2) CDIR).

2.6 Date of receipt, file number and issue of receipt

2.6.1 Applications filed through national offices (intellectual property office of a Member State or Benelux Office for Intellectual Property (BOIP))

If a Community design application is filed at the central industrial property office of a Member State or at the Benelux Office for Intellectual Property (BOIP), it will have the same effect as if it has been filed at the Office on that same day, provided that it is received at the Office within two months from the date it was filed at the national office or, as the case may be, the Benelux Office for Intellectual Property (BOIP) (Article 38(1) CDR).

If the Community design application does not reach the Office within this two-month time limit, it will be deemed to have been filed on the date that it is received by the Office (Article 38(2) CDR).

Where the Community design application is received shortly after the expiry of this two-month period, the examiner will check whether this time limit is to be extended under one of the conditions provided for at Article 58(3) CDR.

2.6.2 Applications received directly at the Office

The date of receipt is the date on which the application reaches the Office. This date may not coincide with the 'date of filing' where the requirements for such a date to be allocated are not met (see paragraph 3).

The Office is open for the receipt of applications sent by post or private delivery services from Monday to Friday, except on official holidays. An annual decision of the Executive Director of the Office specifies the days on which the Office is not open for the receipt of documents and on which ordinary post is not delivered.

Applications sent by fax or e-filing will be received on the date of successful transmission.

Where the application is sent by post or fax, the applicant will not have any confirmation of a date of receipt or file number until a first communication from an examiner is received (see below).

For electronically filed Community design applications, the system issues an immediate automatic filing receipt which appears on the screen of the computer from which the application was sent. In principle, the applicant should save or print out the automatic receipt. The Office will not send an additional receipt. Receipts for electronically filed applications already contain their provisional filing dates and the file number.

2.7 Registration or examination report

2.7.1 Registration

If the application for a Community design satisfies all requirements for registration, it will normally be registered within **ten working days**.

The registration of an application complying with all requirements may, however, be delayed where the indication of the products in which the design is intended to be incorporated, or to which it is intended to be applied, was not made by reference to the list of products included in the Eurolocarno database available on the website of the Office (<https://oami.europa.eu/eurolocarno/>). In such a case, the indication of the products may have to be sent for translation into the official languages of the Union (see paragraph 6.1.4.4 below).

An application complying with all registration requirements can be registered within **two working days** if the following conditions are met:

- the application is filed electronically (e-filing)
- both the indication of product(s) and its/their classification are made by using the Eurolocarno system (see paragraph 6.1.4.4)
- priority documents, where a priority is claimed, are included with the e-filing application
- the owner and the representative, if any, are registered in the Office's database and reference is made to the Office's internal ID number
- fees are to be debited from a current account with the Office or paid by credit card
- no deficiency is found in the application.

2.7.2 Examination report and informal communication on possible deficiencies ('preliminary examination report')

Where a deficiency has been detected in the application, the examiner will issue an examination report summing up the irregularities noted and giving a time limit for the applicant, or the appointed representative, to remedy them.

Before sending such an examination report, the examiner can send an informal communication, called 'preliminary examination report', highlighting some potential deficiencies and aiming at speeding up the examination procedure. This informal communication informs the applicant that the examination procedure is pending due to any of the following circumstances.

2.7.2.1 Priority claims and supporting documents

Where the application contains a claim of priority of one or more previous applications without submitting a certified copy thereof, the applicant may still submit a copy within three months of the filing date (Article 42 CDR; Article 8(1) CDIR; see paragraph 6.2.1.1 below).

In such circumstances, the examiner will inform the applicant that the examination of the application will be put on hold until the missing certified copy of the previous application(s) is submitted. The examination will proceed **three months** after the filing date, unless a copy of the previous application(s), or a declaration that the priority claim is withdrawn, is received earlier.

2.7.2.2 Priority claims made subsequent to filing

Where the applicant states in the application its intention to claim the priority of one or more previous applications without submitting any details about them, it may still submit, within one month of the filing date, the declaration of priority, stating the date on which, and the country in or for which the previous application was made (Article 42 CDR; Article 8(2) CDIR; see paragraph 6.2.1.1 below).

In such circumstances, the examiner will inform the applicant that the examination of the application will be put on hold until the missing information is submitted. The examination will proceed **one month** after the filing date, unless a declaration of priority, or a declaration that the priority claim is withdrawn, is received earlier.

2.7.2.3 Application filed by fax

Where an application is filed by fax, the examiner will inform the applicant that the examination will proceed **one month** after the date of receipt of the fax unless a confirmation copy of the application is received earlier by post, private delivery services or personal delivery.

This course of action attempts to avoid situations in which the examination is carried out on the basis of a faxed representation of a design which does not fully disclose all of its features (such as colours) or whose quality is not optimal.

2.7.2.4 Payment of fees

All fees (that is, the registration and publication fees and additional fees in the event of multiple applications) relating to an application must be paid at the time when the application is submitted to the Office (Article 6 CDIR; see paragraph 8 below).

Lack of payment or unidentified payment

Where the application has not yet been linked with a payment of the corresponding fees, the examiner will inform the applicant that the examination will proceed as soon as the payment has been identified and linked to this specific application.

If the applicant does not respond to the Office's communication, and the payment remains unidentifiable, a deficiency letter will be sent.

Lack of funds

Where the full amount of the fees relating to the application cannot be debited from the current account due to insufficient funds, the examiner will inform the applicant that the examination will begin as soon as the current account has been credited with the missing amount.

If the applicant does not respond to the Office's communication, and the payment remains incomplete, a deficiency letter will be sent.

The above also applies to credit card payments where the transaction fails due to reasons not attributable to the Office. In such cases, the applicant will have to use another method of payment.

For more information on the payment of fees, see paragraph 8 below.

2.7.2.5 Multiple applications and request for partial deferment

Where a multiple application contains a request for deferment in respect of *some* designs (see paragraph 6.2.5 below), the examiner will send the applicant a summary of the application containing a representation of the first view of each design to be published without delay. The applicant will be requested to confirm the correctness of this summary within one month. In the absence of any reply or contrary instruction from the applicant, the examination will proceed on the basis of the information on file.

3 Allocation of a Filing Date

The date on which a document is 'filed' is the date of receipt by the Office rather than the date on which this document was sent (Article 38(1) CDR and Article 7 CDIR).

Where the application has been filed at the central industrial property office of a Member State or at the Benelux Office for Intellectual Property (BOIP), the date of filing at that office will be deemed the date of receipt by the Office, unless the application reaches the Office more than two months after such date. In this case, the date of filing will be the date of receipt of the application by the Office (Article 38 CDR).

Pursuant to Article 36(1) CDR, the allocation of a filing date requires that the application contain at least:

- (a) a request for registration of a Community design, and
- (b) information identifying the applicant, and
- (c) a representation of the design suitable for reproduction pursuant to Article 4(1)(d) and (e) CDIR or, where applicable, a specimen (Article 10 CDIR).

Payment of fees is not a requirement for allocating a filing date. It is, however, a requirement for the registration of the application (see paragraph 8 below).

3.1 Request for registration

A request for registration is filed where the applicant has completed (at least partly) the application form provided by the Office or its own form, or made use of e-filing (see paragraph 2.2 above).

Where it is obvious that the document received from the applicant is not an application for a Community design, but an application for registration of a **European Union trade mark**, the examiner will forward this document to the competent department of the Office and the examiner will inform the applicant accordingly without delay.

3.2 Information identifying the applicant

The information identifying the applicant, for the purpose of allocating a filing date, does not have to satisfy all the requirements set out in Article 1(1)(b) CDIR (see paragraph 6.1.1 below). It is enough that information is supplied regarding the surname and forename(s) of natural persons or the corporate name of legal entities, and that an address for service be indicated or any other data communication link that allows the applicant to be contacted.

3.3 Representation of the design suitable for reproduction

3.3.1 General requirements

The representation of the design must consist of a graphic and/or photographic reproduction of the design, either in black and white or in colour (Article 4(1) CDIR).

Irrespective of the form used for filing the application (paper, e-filing, or fax), the design must be reproduced on a **neutral background** and **must not be retouched** with ink or correcting fluid.

It must be of a quality permitting all the details of the matter for which protection is sought to be clearly distinguished and permitting it to be reduced or enlarged to a size no greater than 8 cm by 16 cm per view for entry in the Register of Community Designs and for publication in the Community Designs Bulletin (Article 4(1)(e) CDIR).

The purpose of that requirement is to allow third parties to determine with accuracy all the details of the Community design for which protection is sought.

Drawings, photographs (except slides), computer-made representations or any other graphical representations are accepted provided they are suitable for reproduction, including on a registration certificate in paper format. 3D computer-animated design generating motion simulation is not accepted for that very reason. CD-ROMs and other data carriers are not accepted.

3.3.2 Neutral background

The background in a view is considered neutral as long as the design shown in this view is clearly distinguishable from its environment without interference from any other object, accessory or decoration, whose inclusion in the representation could cast doubt on the protection sought (decision of 25/04/2012, R 2230/2011-3 – ‘Webcams’, paras 11-12).

In other words, the requirement of a neutral background neither demands a ‘neutral’ colour nor an ‘empty’ background (see also paragraph 5.2.6 below). It is instead decisive that the design stands out so clearly from the background that it remains identifiable (decision of 25/01/2012, R 284/2011-3 – ‘Tool chest’, para. 13).

The views, among the seven allowed for representing a design (Article 4(2) CDIR), which do not have a neutral background will be objected to.

The examiner will issue a deficiency letter. The examiner will give the applicant the possibility to remedy the deficiencies within a two-month period by:

- withdrawing those views (which will not form part of the Community design); or
- submitting new views on a neutral background; or



- amending the objected views in such a way that the design will be isolated from its background. This latter option will make use of identifiers such as boundaries or colour shading clarifying the features of the design for which protection is sought (see paragraph 5.3 below), as in the seventh view of RCD 2038216-0001 (courtesy of BMC S.r.l.):



Provided the deficiencies are remedied within the time limit set by the Office, the date on which all the deficiencies are remedied will determine the date of filing (Article 10(2) CDIR).

If the deficiencies are not remedied within the time limit set by the Office, the application will not be dealt with as a Community design application. The file will be closed by a decision of the examiner and the applicant will be notified. The examiner will notify the Finance Department that a refund of any fees paid should be made to the applicant (Article 10(2) CDIR).

3.3.3 Designs retouched with ink or correcting fluid

The design must not be retouched with ink or correcting fluid (Article 4(1)(e) CDIR).

Examiners do not see the paper version of the representation but only scanned representations thereof. Therefore, it is only where the use of ink or correcting fluid leaves doubt as to whether the visible correction is or not an ornamental feature forming part of the design, that corrected representations will be objected to and refused for the purpose of allocating a filing date.

The applicant may remedy a deficiency in the same manner as described above under paragraph 3.3.2 below.

3.3.4 Quality

The requirement that the design must be of a quality permitting all the details of the matter for which protection is sought to be clearly distinguished, for publication purposes, applies equally to all applications, irrespective of the means of filing.

Applications sent by fax and e-filing, however, raise specific issues.

3.3.4.1 Fax

Transmission by telecopy (fax) may not be appropriate for filing design applications, because the representation of the design may be distorted or blurred or otherwise damaged. Where an application is transmitted by fax, it is highly recommended that a paper confirmation copy be filed without delay, by ordinary mail, private delivery services or personal delivery.

Where an application is transmitted by fax, the examiner will in any event await a confirmation copy for a period of up to one month from the date of receipt of the fax transmission before further processing the application. Once this period has lapsed, the examiner will continue the examination on the basis of the documents on file.

Two deficiencies caused by unsatisfactory fax transmissions may arise:

- (i) the reproduction of a design as transmitted by fax is not of a quality permitting all the details of the matter for which protection is sought to be clearly distinguished
- (ii) the application is incomplete and/or illegible.

As far as the issue of allocating a filing date is concerned, these two hypotheses must be distinguished.

The Office distinguishes an illegible transmission from one of insufficient quality as follows. Where a comparison between the initial transmission and the original reproduction allows drawing a conclusion on whether these documents relate to the representation of one and the same design, it must be considered that the initial transmission was merely of insufficient quality. Where such a comparison is not possible at all, the initial transmission was illegible.

- (i) The reproduction of a design as transmitted by fax is not of a quality permitting all the details of the matter for which protection is sought to be clearly distinguished

The original date of filing will be retained if the applicant sends on its own motion or in reply to the Office's informal communication (see paragraph 2.7.8 above) the original reproduction of the design within **one month** following the fax transmission, provided its quality permits all the details of the matter for which protection is sought to be clearly distinguished (Article 66(1), second paragraph, CDIR).

The confirmation copy has to consist of the same document which was used initially for the fax transmission. The examiner will reject a 'confirmation copy' that is not strictly

identical to the document that was used for the fax transmission. This would be the case for instance if the applicant submitted in its confirmation amended views or additional views of the design(s).

In the event of any discrepancy between the original and the copy previously submitted by fax, only the submission date of the original will be taken into consideration.

If no original reproduction is received within the one-month time limit following the receipt of the fax, the Office will send a formal notification inviting the applicant to submit the original reproduction within a two-month period.

If that request is complied with in due time, the date of filing will be the date on which the Office receives the original reproduction, provided its quality permits all the details of the matter for which protection is sought to be clearly distinguished (Article 66(1), third paragraph, CDIR).

If the deficiencies are not remedied within the time limit set by the Office in its notification, the application will not be dealt with as a Community design application. The file will be closed by a decision of the examiner and the applicant will be notified. The examiner will notify the Finance Department that a refund of any fees paid should be made to the applicant (Article 10(2) CDIR).

Where the Office receives a reproduction of a design where **some of the views** are deficient due to fax transmission and where the confirmation copy is received later than one month after the date of receipt of the fax transmission, the applicant will be left with the choice of

- having as the date of filing the date of receipt of the confirmation copy; or
- keeping the date of receipt of the fax transmission as the date of filing, but only for the non-deficient views; in such a case, the deficient views will be withdrawn.

(ii) The application is incomplete and/or illegible.

In the case where the fax was incomplete or illegible and where the missing or illegible parts concern the information identifying the applicant or the representation of the design, the Office will issue a formal notification requesting the applicant to resend the application by fax, post or personal delivery within a **two-month** time limit. If that request is complied with in due time, the date of filing will be the date on which the Office receives the complete and legible documents (Article 66(2) CDIR).

If the deficiencies are not remedied within the time limit set by the Office, the application will not be dealt with as a Community design application. The file will be closed by a decision of the examiner and the applicant will be notified. The examiner will notify the Finance Department that a refund of any fees paid should be made to the applicant (Article 10(2) CDIR).

3.3.4.2 E-filing

The representation of the design must be filed as an attachment to the electronic application form. Each view must be filed as a **single attachment** to the electronic application form and must be in .jpeg data format. The size of each attachment cannot exceed five MB (see Decision No EX-11-3 of the President of the Office, of 18/04/2011, concerning electronic communication with and by the Office).

Low resolution attachments are likely to be objected to due to their insufficient quality for reproduction and publication purposes where the enlargement of the views to a size of 8 cm by 16 cm causes the details of the design to be blurred.

Where it is clear that the electronic filing was deficient due to technical problems attributable to the Office, such as the partial uploading of all views, the Office will allow the applicant to resubmit the missing views (or all views) by letter, attaching a copy of the e-filing receipt. The original filing date via e-filing will be retained, provided that no other deficiency affecting the filing date exists.

3.3.5 Specimens

The graphic or photographic reproduction of the design can be substituted by a specimen of the design provided the following cumulative conditions are met:

- the application relates to a two-dimensional design, and
- the application contains a request for deferment (Article 36(1)(c) CDR; Article 5(1) CDIR).

In the event of a multiple application, the substitution of the representation by a specimen may apply only to some of the designs, provided these designs are two-dimensional and are subject to a request for deferment (see paragraph 6.2.5 below).

A specimen is usually a sample of a piece of material such as textile, wallpaper, lace, leather, etc.

Specimens must not exceed 26.2 cm x 17 cm in size, 50 g in weight or 3 mm in thickness. They must be capable of being stored and unfolded (Article 5(2) CDIR).

Five samples of every specimen must be filed; in the case of a multiple application, five samples of the specimen must be filed for each design (Article 5(3) CDIR).

The application and the specimen(s) have to be sent in a single delivery either by post or personal delivery. A date of filing will not be accorded until both the application and the specimen(s) have reached the Office.

Where the applicant submits a specimen relating to an application that does not contain a request for deferment, the specimen is not admissible. In such a case, the date of filing will be determined by the date on which the Office receives a suitable graphic or photographic reproduction of the design, provided the deficiency is remedied within two months of receipt of the Office's notification (Article 10(2) CDIR).

4 Examination of the Substantive Requirements

The Office carries out an examination of the substantive protection requirements which is limited to two absolute grounds for refusal.

An application will be refused if the design does not correspond to the definition provided for in Article 3(a) CDR or if is contrary to public policy or to accepted principles of morality (Article 9 CDR).

4.1 Compliance with the definition of a design

A 'design' means the appearance of the whole or a part of a product resulting from the features of, in particular, the lines, contours, colours, shape, texture and/or materials of the product itself and/or its ornamentation (Article 3(a) CDR).

A 'product' means any industrial or handicraft item, including, inter alia, parts intended to be assembled into a complex product, packaging, get-up, graphic symbols and typographic typefaces, but excluding computer programs (Article 3(b) CDR).

Whether the product claimed is actually made or used, or can be made or used, in an industrial or handicraft manner will not be examined.

Whether a design discloses the appearance of the whole or a part of a 'product' will be examined in the light of the design itself, insofar as it makes clear the nature of the product, its intended purpose or its function, and of the indication of the products in which the design is intended to be incorporated or to which it is intended to be applied (Article 36(2) CDR).

The following examples, albeit non-exhaustive, illustrate the Office's practice.

4.1.1 Blueprints, plans for houses or other architectural plans and interior or landscape designs

Blueprints, plans for houses or other architectural plans and interior or landscape designs (e.g. gardens) will be considered 'products' for the purpose of applying Article 7(1) CDR and will be accepted only with the corresponding indication of 'printed matters' in Class 19-08 of the Locarno Classification.

An objection will be raised if the product indicated in an application for a design consisting of a blueprint of a house is 'houses' in Class 25-03 of the Locarno Classification. This is because a blueprint does not disclose the appearance of a finished product such as a house.

4.1.2 Colours per se and combinations of colours

A single colour may of course be an element of a design, but on its own it does not comply with the definition of a design because it does not constitute the 'appearance of a product'.

Combinations of colours may be accepted if it can be ascertained from the contours of the representation that they relate to a product such as, for instance, a logo or a graphic symbol in Class 32 of the Locarno Classification.

4.1.3 Icons

Designs of screen displays and icons and other kinds of visible elements of a computer program are eligible for registration (see Class 14-04 of the Locarno Classification).

4.1.4 Mere verbal elements

Mere words per se and sequences of letters (written in standard characters in black and white) do not comply with the definition of a design because they do not constitute the appearance of a product.

The use of fanciful characters and/or the inclusion of a figurative element, however, render(s) the design eligible for protection either as a logo/graphic symbol in Class 32 of the Locarno Classification, or as the ornamental representation of a part of any product to which the design will be applied.

4.1.5 Music and sounds

Music and sounds per se do not constitute the appearance of a product and, therefore, do not comply with the definition of a design.

However, the graphical representation of a musical composition, in the form of a musical string, would qualify as a design, if applied for as, for example, *other printed matter* in Class 19-08 or *graphic symbols* in Class 32 of the Locarno Classification.

4.1.6 Photographs

A photograph per se constitutes the appearance of a product and, therefore, complies with the definition of a design, irrespective of what it discloses. The indication of the product can be *writing paper, cards for correspondence and announcements* in Class 19-01, *other printed matters* or *photographs* in Class 19-08 of the Locarno Classification, or any product to which the design will be applied.

4.1.7 Living organisms

Living organisms are not 'products', that is, industrial or handicraft items. A design that discloses the appearance of plants, flowers, fruits etc. in their natural state will, in principle, be refused. Even if the shape at issue deviates from that of the common corresponding living organism, the design should be refused if nothing suggests prima facie that the shape is the result of a manual or industrial process (see by analogy decision of 18/02/2013, R 0595/2012-3 – 'Groente en fruit', para. 11). However, no objection will be raised if the indication of the product specifies that this product is artificial (see in particular Class 11-04 of the Locarno Classification).

4.1.8 Teaching materials

Teaching materials such as graphs, charts, maps etc. can be representations of products in Class 19-07 of the Locarno Classification.

4.1.9 Concepts

A design application is refused where the representation is of a product that is simply one example amongst many of what the applicant wishes to protect. An exclusive right cannot be granted to a 'non-specific' design that is capable of taking on a multitude of

different appearances. This is the case where the subject matter of the application relates, inter alia to a concept, an invention or a method for obtaining a product.

4.2 Public policy and morality

4.2.1 Common principles

The concepts of public policy and morality may vary from one country to another. A restrictive measure based on public policy or morality may be based on a conception that is not necessarily shared by all Member States (judgment of 14/10/2004, C-36/02, 'Omega', paras 33 and 37).

Given the unitary character of the registered Community design (Article 1(3) CDR), it is enough that a design be found contrary to public policy in at least part of the Union for this design to be refused under Article 9 CDR (see, by analogy, judgment of 20/09/2011, T-232/10, 'Coat of arms of the Soviet Union', paras 37 and 62). This finding can be supported by the legislation and administrative practice of certain Member States.

It is not necessary that the use of the design would be illegal and prohibited. However, illegality of the use of the design under European or national legislation is a strong indication that the design should be refused under Article 9 CDR.

4.2.2 Public policy

The safeguard of public policy may be relied on to refuse a Community design application only if there is a genuine and sufficiently serious threat to a fundamental interest of society (judgment of 14/03/2000, C-54/99, 'Église de scientologie', para. 17).

Designs that portray or promote violence or discrimination based on sex, racial or ethnic origin, religion or belief, disability, age or sexual orientation will be refused on that account (Article 10 of the Treaty on the Functioning of the European Union).

4.2.3 Morality

The safeguard of morality may be relied on to refuse a Community design application if the design is perceived as sufficiently obscene or offensive from the perspective of a reasonable person of normal sensitivity and tolerance (see, by analogy, judgment of 09/03/2012, T-417/10, '¡Que bueno ye! Hijoputa', para. 21).

Bad taste, as opposed to contrariety to morality, is not a ground for refusal.

4.3 Objections

Where an objection is raised by the examiner in respect of one or the other of the two above absolute grounds for refusal, the applicant will be given the opportunity of withdrawing or amending the representation of the design or of submitting its observations within a two-month time limit (Article 47(2) CDR, Article 11 CDIR).

If the objection relates to the compliance with the definition of a design and if this objection can be overcome by amending the indication of the products in which the design is intended to be incorporated or to which it is intended to be applied, the examiner will propose such an amendment in the communication to the applicant.

Where the applicant opts for submitting an amended representation of the design, this representation will be admissible under the condition that 'the identity of the design is retained' (Article 11(2) CDIR).

Maintenance in an amended form will, therefore, be limited to cases in which the removed or disclaimed features are so insignificant in view of their size or importance that they are likely to pass unnoticed in the perception of the informed user.

Features can be removed or disclaimed by making use of the identifiers referred to in paragraph 5.3 below.

Provided the deficiencies are remedied within the time limit set by the Office, the date on which all the deficiencies are remedied will determine the date of filing (Article 10(2) CDIR).

Where the applicant fails to overcome the grounds for non-registrability within the time limit, the Office will refuse the application. If those grounds concern only some of the designs contained in a multiple application, the Office will refuse the application only insofar as those designs are concerned (Article 11(3) CDIR).

5 Additional Requirements Regarding the Reproduction of the Design

Applicants are reminded that the requirements concerning the format of the representation of the design may vary according to the manner in which the application was filed (paper, e-filing, use of a specimen). These requirements are set out in Articles 4 and 5 CDIR.

The following instructions supplement the requirements regarding the quality of the reproduction and the neutral background (see paragraph 3.3 above).

The following instructions apply to all designs, irrespective of the manner in which the application was filed.

Even where a representation of the design has been replaced by a specimen in accordance with Article 5 CDIR (see paragraph 3.3.5 above), the applicant must file a graphic or photographic reproduction of the design at the latest three months before the 30-month deferment period expires (Article 15(1)(c) CDIR; see paragraph 6.2.5.3 below).

Any deficiency found in an application and relating to one or the other of the requirements under this section will have no bearing on the granting of a filing date. However, if the deficiencies are not remedied within the time limit set by the Office in its examination report, the application will be refused (Article 46(3) CDR). If the deficiencies concern only some of the designs contained in a multiple application, the Office will refuse the application only insofar as those designs are concerned (Article 11(3) CDIR).

Once a date of filing has been granted, refusal of the application does not give rise to a refund of the fees paid by an applicant (Article 13 CDIR).

5.1 Number of views

The purpose of the graphic representation is to disclose the features of the design for which protection is sought. The graphic representation must be self-contained, in order to determine with clarity and precision the subject-matter of the protection afforded by the registered Community design to its proprietor. This rule is dictated by the requirement of legal certainty.

It is the responsibility of the applicant to disclose as thoroughly as possible the features of its design. The Office will not examine whether additional views would be required to fully disclose the appearance of the design, with the exceptions listed under paragraphs 5.2.1 to 5.2.3 below.

A maximum of seven different views can be filed in order to represent the design (Article 4(2) CDIR). The views may be plain, in elevation, cross-sectional, in perspective or exploded. Only one copy of each view should be filed.

An exploded view is a view in which all the components of a complex product are shown disassembled in order to explain how these components can be assembled together, as in the example below (RCD 380969-0002, courtesy of Aygaz Anonim Sirketi, designer Zafer Dikmen).



The alternative positions of the moveable or removable parts of a design can be shown in separate views, as in the example below (RCD 588694-0012, courtesy of Fujitsu Toshiba Mobile Communications, designer Hideki Hino).

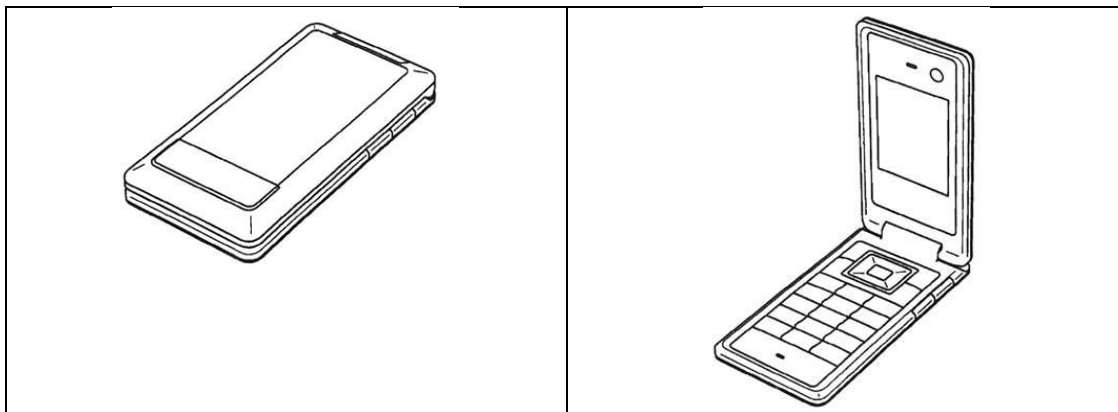

Each of the views must be numbered by the applicant in Arabic numerals by figures separated by a dot, the first being the number of the design, the second being the number of the view. For instance, the 6th view of the second design of a multiple application must be numbered: 2.6.

In cases where more than seven views are provided, the Office will disregard any of the extra views for registration and publication purposes (decision of 27/10/2009, R 571/2007-3 – ‘Frames for cycles or motorcycles’, para. 13). The Office will take the views in the consecutive order in which the views are numbered by the applicant (Article 4(2) CDIR).

Where a reproduction comprises less than seven views and the views are not numbered, the examiner will number the views according to the sequence given in the application.

The examiner will not change the order of the views as appearing in the application, or their orientation.

5.2 Consistency of the views

The examiner will check whether the views relate to the same design, that is, to the appearance of one and the same product or of its parts.

Where the views are inconsistent and relate to more than one design, the applicant will be invited either to withdraw some views or to convert the application into a multiple application for different designs, and pay the corresponding fees.

To submit a correct and complete application (including representations of the design) falls within the applicant’s responsibility. The Office is not entitled to remedy any deficiencies in respect of incongruent views once the Community design is registered and published (see decision of 03/12/2013, R 1332/2013-3 – ‘Adapters’, para. 14 et seq.)

The consistency of the views may be particularly difficult to assess when examining applications for designs relating to complex products, to details of products and to sets of articles.

5.2.1 Complex products

A complex product is a product which is composed of multiple components that can be replaced permitting disassembly and reassembly of the product (Article 3(c) CDR).

Applicants must submit, among the seven views allowed, at least one view showing the complex product in its assembled form. See the example below (RCD 238092-0001 courtesy of Eglo Leuchten GmbH):

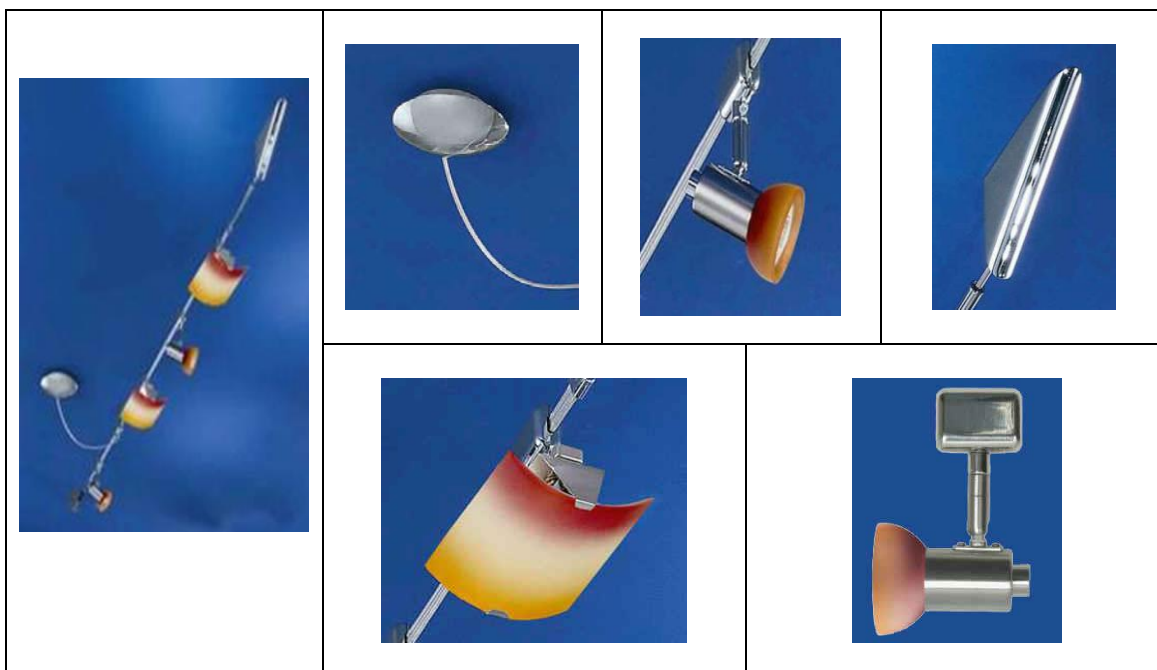

Each of the component parts could in themselves be a 'design'. Therefore, where all the views disclose different component parts, **without showing these parts connected to each other**, the examiner will issue a deficiency letter giving the applicant two options:

- the applicant can convert its application into a multiple application combining the separate designs for each component part in question and pay the corresponding fees; or
- the applicant can limit its application to just one design by withdrawing the views representing other designs.

5.2.2 Details

The same reasoning applies to a design that is not intended to be incorporated in a complex product where the views only show individual details that cannot be related to the appearance of the product as a whole.

Each of the individual details of the product could in themselves be a 'design'. Therefore, where all the views disclose different detailed features, **without showing these features connected to each other**, the examiner will issue a deficiency letter giving the applicant two options:

- the applicant can convert its application into a multiple application combining the separate designs for each individual detail in question and pay the corresponding fees; or
- the applicant can limit its application to just one design by withdrawing the views representing other designs.

5.2.3 Sets of articles

A set of articles is a group of products of the same kind which are generally regarded as belonging together and are so used. See the example below (RCD 685235-0001, courtesy of Zakłady Porcelany Stolarowej KAROLINA Sp. z o.o.).



The difference between a complex product and a set of articles is that, in contrast to a complex product, the articles of a 'set of articles' are not mechanically connected.

A set of articles can be a 'product' in itself within the meaning of Article 3 CDR. It can be represented in a single design application if the articles making up this set are linked by **aesthetic and functional complementarity** and are, in normal circumstances, sold altogether as one single product, like a chess board and its pieces or sets of knives, forks and spoons.

It must, however, be clear from the representation that protection is sought for a design resulting from the combination of the articles making up the set.

Applicants must submit, among the seven views allowed, at least one view showing the set of articles in its entirety.

Otherwise, the examiner will issue a deficiency letter giving the applicant two options:

- the applicant can convert its application into a multiple application combining the separate designs for each article in question and pay the corresponding fees; or
- the applicant can limit its application to just one design by withdrawing the views representing other designs.

5.2.4 Variations of a design

Sets of products should not be confused with variations of a design. The different embodiments of a same concept cannot be grouped in a single application because each embodiment is a design on its own, as in the example below (RCD 1291652-0001; -0002; -0003; -0004, courtesy of TESCOVA s.r.o.).

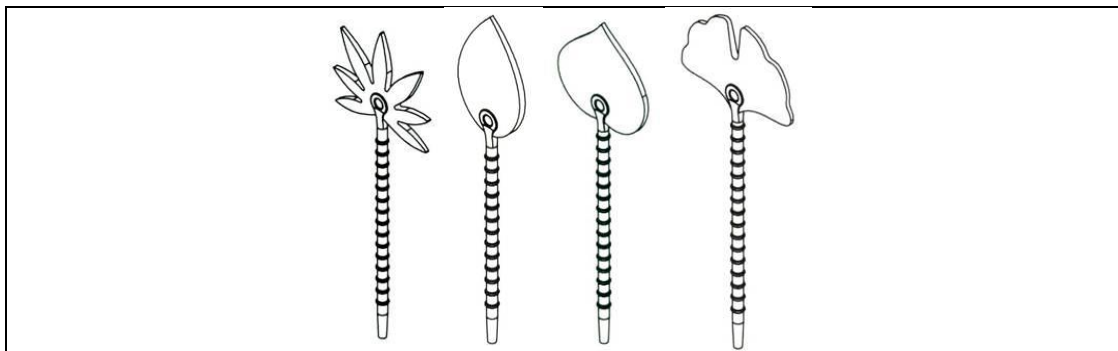

Where, in an application for a single registered Community design, the views relate to more than one design, the examiner will issue a deficiency letter giving the applicant two options:

- the applicant can convert its application into a multiple application combining the separate designs and pay the corresponding fees; or
- the applicant can limit its application to just one design by withdrawing the views representing other designs.

5.2.5 Colours

The representation of the design may be submitted **either** in black and white (monochrome) **or** in colour (Article 4(1) CDIR).

Representations combining black and white views with colour views will be objected to due to their inconsistency and the resulting legal uncertainty as to the protection sought.

The same reasoning applies where the same features of a design are represented in different colours in the various views. Such an inconsistency illustrates the fact that the application relates to more than one design (decisions of 31/03/2005, R 0965/2004-3 – ‘Tape measure’, paras 18-20; 12/11/2009, R 1583/2007-3 – ‘Bekleidung’, paras 9-10).

The applicant will, therefore, be invited either to withdraw some of the colour views in order to maintain consistency between the remaining ones, or to convert the application into a multiple application, and pay the corresponding fees.

However, as an exception to the above principle, the same features of a design can be represented in different colours in the various views if the applicant submits evidence that the change of colours at different points in time, while the product is in use, is one of the relevant features of the design, as in the example below (RCD 283817-0001, courtesy of ASEM Industrieberatung und Vermittlung).



Where the reproduction is in colour, the registration and the publication will also be in colour (Article 14(2)(c) CDIR).

5.2.6 Elements external to the design

Views can include external and foreign matter in the design provided their inclusion does not cast any doubt on the protection sought and serves only an illustrative purpose (see paragraph 3.3.2 above).

See for instance the following two RCDs, No 210166-0003 (courtesy of Karl Storz GmbH & Co. KG) and No 2068692-0002 (courtesy of Tenzi Sp. z o.o.) in which the inclusion of a hand or buildings and vegetation in some of the views serves the purpose of clarifying how the product in which the design is incorporated will be used or the context in which it will be used:

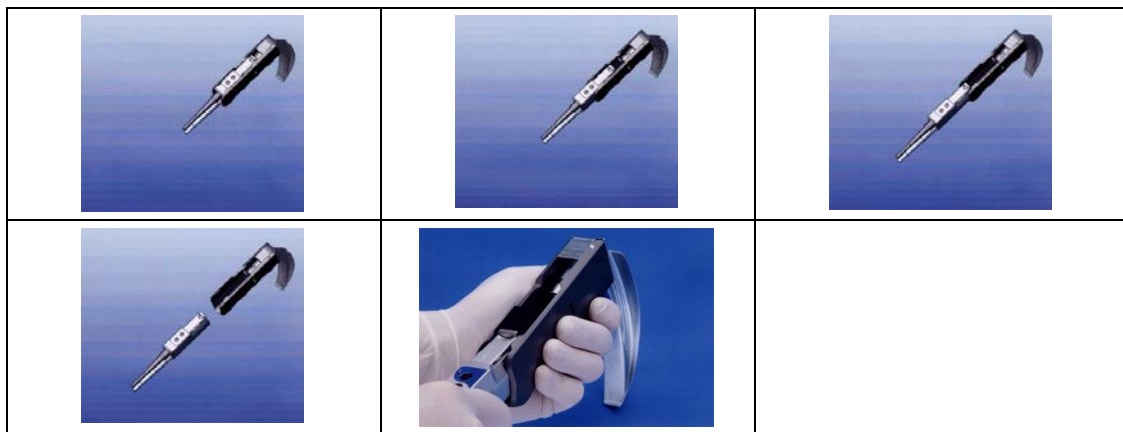



5.3 Use of identifiers to exclude features from protection

Neither the CDR nor the CDIR provides rules for the possibility of including in the application a statement that the applicant disclaims any exclusive right to one or more features disclosed in the views.

Use of a description, within the meaning of Article 36(3)(a) CDR, is not appropriate in this regard since a description 'shall not affect the scope of protection of the design as such' according to Article 36(6) CDR. Moreover, only an indication that a description has been filed is published, not the description as such (Article 14(2)(d) CDIR).

Disclaimers must therefore be apparent from the representation of the design itself.

In an application for registration of a Community design the following identifiers will be allowed:

5.3.1 Broken lines

Broken lines may be used in a view either to indicate the elements for which no protection is sought (for example, ornamentation applied to the surface of a given product whose shape is disclaimed) or to indicate portions of the design that are not visible in that particular view, that is, non-visible lines.

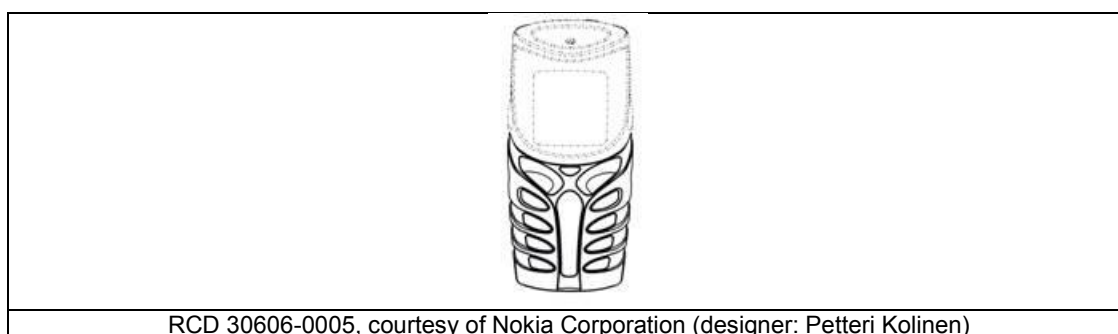

5.3.2 Boundaries

Boundaries may be used to surround features of the design for which protection is sought, the remaining parts being considered as having a purely illustrative purpose, that is, to show the environment in which the claimed features are placed.

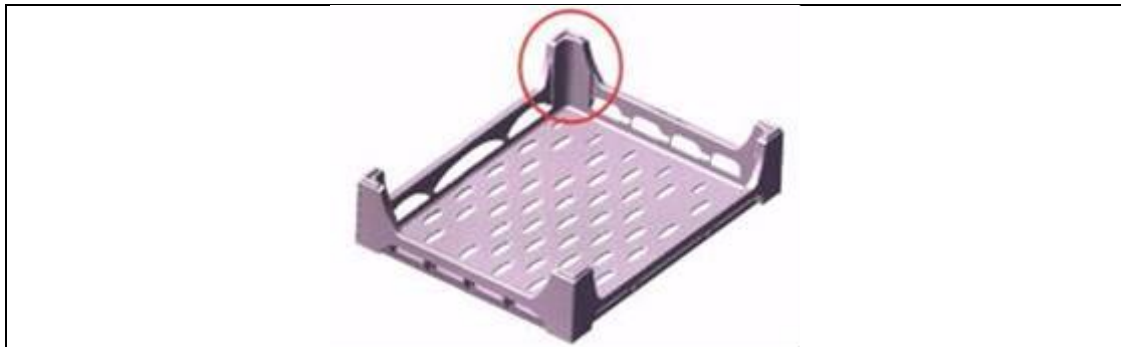

RCD 164611-0004, courtesy of Valio Oy (designer: Aki Liukko)



RCD 2038216-0001 courtesy of BMC S.r.l.

5.3.3 Colour shading and blurring

Colour shading and blurring may be used to exclude a number of features from protection and thus to highlight claimed features.

<p>RCD 244520-0002, courtesy of Nokian Tyres plc</p>	<p>RCD 222120-0002, courtesy of Altia Plc</p>	<p>RCD 220405-0003, courtesy of KUBOTA CORPORATION (designer: Yoshitaka Higashikawa)</p>

5.3.4 Separations

Separations can be used to indicate that, for ease of illustration, the precise length of the design is not claimed (indeterminate length).

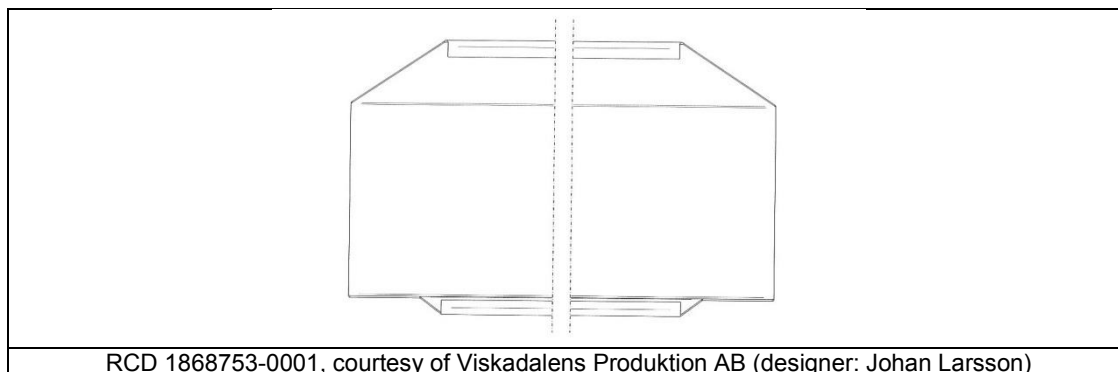

5.4 Explanatory text, wording or symbols

No explanatory text, wording or symbols, other than the indication 'top' or the name or address of the applicant may be displayed in the views (Article 4(1)(c) CDIR).

Where words, letters, numbers and symbols (such as arrows) are **clearly** not part of the design, the examiner may cut them from the views using the specific IT tool available for this. If the examiner is not able to cut them out for technical reasons, the applicant will be requested to send in clean views or to withdraw the deficient ones.

Where the words, letters, numbers, etc. are part of the design (graphical symbol), the design is acceptable.

Verbal elements displayed in the representation that are part of the design will be keyed in and entered in the file. Where several verbal elements are displayed, the examiner will only take into account the most prominent one.

Indications such as 'side', 'front view', etc. will be cut for publication purposes. If the applicant considers such indications to be relevant, it may wish to include them in the 'Description' box at the time of filing. Further amendments or the addition of a description will not be allowed.

5.5 Amending and supplementing views

As a matter of principle, the representation may not be altered after the application has been filed. The submission of additional views or the withdrawal of some views will therefore not be accepted (Article 12(2) CDIR), unless expressly allowed or required by the Office.

In particular, the views initially filed may not be replaced with better-quality ones. The representations examined and published will be those that the applicant provided in its original application.

The submission of amended or additional views, where allowed, must be made by electronic communication via the Office's website (not by email), by post or fax (the latter is, however, not recommended; see paragraph 2.2.5 above).

5.6 Specific requirements

5.6.1 Repeating surface patterns

Where the application concerns a design consisting of a repeating surface pattern, the representation of the design must disclose the complete pattern and a sufficient portion of the repeating surface (Article 4(3) CDIR), in order to show how this pattern is infinitely multiplied.

Where the application does not contain a description making clear that the design consists of a repeating surface pattern, the Office will assume that this is not the case and will not request a sufficient portion of the repeating surface.

If additional views represent the pattern applied to one or more specific products for illustrative purposes, the applicant must make sure that the shape of such products is not claimed as part of the design by using any method referred to under paragraph 5.3 above (RCD 002321232-0002, courtesy of Textiles Visatex SL.):



5.6.2 Typographic typefaces

Where the application concerns a design consisting of a typographic typeface, the representation of the design must consist of a string of all the letters of the alphabet, upper case and lower case, and of all the Arabic numerals, as well as of a text of five lines produced using that typeface, all in 16-pitch font (Article 4(4) CDIR).

Where the application does not include a text of five lines using the typeface concerned (Article 4(4) CDIR), the applicant will be requested to submit such a text or to accept a change in the indication of products to 'set of characters' in Locarno Class 18.03.

6 Additional Elements that an Application Must or May Contain

6.1 Mandatory requirements

In addition to the requirements for the grant of a filing date (see paragraph 3 above), the application must properly identify the applicant and, if applicable, its representative (Article 1(b) and (e) CDIR), specify the two languages of the application (Article 1(h) CDIR), contain a signature (Article 1(i) CDIR) and indicate the products in which the design is intended to be incorporated or to which it is intended to be applied (Article 1(d) CDIR).

Even after a date of filing has been granted, the examiner will issue an objection if a deficiency with regard to any of the above requirements is noted in the course of examining the Community design application (Article 10(3)(a) CDIR).

6.1.1 Identification of the applicant and its representative

Pursuant to Article 1(b) CDIR, an application will be objected to if it does not contain the following information regarding the applicant: its name, address and nationality and the State in which it is domiciled or, if the applicant is a legal entity, in which it has its seat or establishment. If the Office has given the applicant an identification number, it is sufficient to mention that number together with the applicant's name.

Where the application is filed in the name of more than one applicant, the same requirement applies to each one.

Names of natural persons must give both the family name and the given name(s). Legal entities must be indicated by their official designation. The State whose law governs such entities must also be indicated.

If the applicant does not have a representative, it is highly recommended that an indication be given of telephone numbers as well as fax numbers and details of other data-communications links, such as electronic mail.

Each applicant must, in principle, indicate only one address. Where several addresses are indicated, only the first address mentioned will be taken into account, except where the applicant designates one of the addresses as an address for service.

If there is more than one applicant, the Office will send its communications to the applicant mentioned first in the application.

If the applicant has appointed a representative, the application must indicate the name of that representative and the address of their place of business. If an appointed representative has been given an identification number by the Office, it will be sufficient to mention that number together with the representative's name.

If the representative has more than one business address or if there are two or more representatives with different business addresses, the application must indicate which address is to be used as the address for service. Where no such indication is made, the address for service will be taken to be the first address mentioned.

If there is more than one applicant, the application may appoint one representative to be the common representative for all applicants.

6.1.2 Specification of the languages

The application may be filed in any of the official languages of the European Union (language of filing) (Article 98(1) CDR, see paragraph 2.4). The language used in the application form does not affect the language of the application. It is the language of the content supplied by the applicant that is decisive. The language of filing will be the first language of the application.

The applicant must indicate a second language, which must be an Office language, that is, English (EN), French (FR), German (DE), Italian (IT) or Spanish (ES).

The second language must be different from the language of filing.

The two-letter ISO codes (codes set up for identifying languages by the International Organisation for Standards) may be used in the box provided in the application form.

6.1.3 Signature

The application must be signed by the applicant or its representative (Article 1(i) CDIR). Where there is more than one applicant or representative, the signature of one of them will be sufficient.

If an application is filed electronically, it is sufficient for the name and authority of the signatory to be indicated. If an application is filed by fax, a facsimile signature is considered valid.

For representatives, the signature consisting of the name of the law firm is acceptable.

6.1.4 Indication of products

6.1.4.1 General principles

Pursuant to Article 36(2) CDR, an application for a Community design must indicate the products in which the design is intended to be incorporated or to which it is intended to be applied. Pursuant also to Article 1(1)(d) and Article 3(3) CDIR, the indication of products must be worded in such a way as to indicate clearly the nature of the products and to enable each product to be classified in only one class of the Locarno classification, preferably using the terms appearing in the list of products set out therein, or in the Eurolocarno database (see below).

Neither the product indication nor the classification affects the scope of protection of a Community design as such (Article 36(6) CDR). Classification serves exclusively administrative purposes, in particular allowing third parties to search the registered Community designs databases (Article 3(2) CDIR).

Applicants do not themselves have to classify the products in which their design is intended to be incorporated or to which it is intended to be applied (Article 36(3)(d))

CDR). This is, however, highly recommended in order to speed up the registration procedure (see paragraph 6.2.3).

The considerations that follow here below only refer to single design applications. As far as multiple design applications are concerned, the 'unitary class' requirement applies (see paragraph 7.2.3 below).

6.1.4.2 The Locarno and Eurolocarno Classifications

The Locarno Classification is an international classification for industrial designs. It exists in two official languages, namely English and French. Its structure and contents are adopted and amended by the Committee of Experts from the countries party to the Locarno Agreement. The Classification is administered by the World Intellectual Property Organization (WIPO). The current, tenth, edition contains 32 classes and 219 subclasses.

Eurolocarno is the Office's design classification tool. It is based on, and has the same structure as, the Locarno Classification (i.e. the same classes and subclasses). It contains the alphabetical list of products of the Locarno Classification and is supplemented by a large number of additional product terms. Eurolocarno is available in all the official languages of the EU at the Office's website.

In order to speed up and simplify the registration procedure, it is highly recommended that products be indicated using the terms listed in the Eurolocarno database.

Using the terms listed in the Eurolocarno database obviates the need for translations and thus prevents long delays in the registration procedure. Using these product terms whenever possible will improve the transparency and searchability of the registered Community designs databases.

6.1.4.3 How to indicate products

More than one product can be indicated in the application.

When more than one product is indicated in the application, the products do not have to belong to the same class of the Locarno Classification, unless several designs are combined in a multiple application (Article 37(1) CDR; Article 2(2) CDIR; see paragraph 7.2.3 below).

Each class and subclass of the Locarno Classification and Eurolocarno has a 'heading'. The class and subclass headings give a general indication of the fields to which the products belong.

In any event, the product(s) must be indicated in such a way as to allow classification in both the relevant class and subclass of the Locarno Classification (Article 1(2)(c) CDIR).

The use of terms listed in the heading of a given class of the Locarno Classification is not per se excluded, but it is not recommended. Applicants should **not** choose generic terms referred to in the heading of the relevant class (e.g. 'articles of clothing' in Class 2), but, instead, select terms listed in the heading of the subclass (e.g. 'garments')

in subclass 02-02) or more specific terms from among those listed in the subclasses of the class in question (e.g. 'jackets' in subclass 02-02).

Where the product indication does not allow classification in a subclass, the examiner will determine the relevant subclass by reference to the product disclosed in the graphical representation (see paragraph 6.2.3.1 below). For example, where an application contains as a product indication the term 'Furnishing' in Class 6 of the Locarno Classification, the examiner will assign a subclass by taking account of the design itself insofar as it makes clear the nature of the product, its intended purpose or its function. If the design discloses the appearance of a bed, the examiner will assign the subclass 06-02 to the generic indication 'Furnishing'.

The use of adjectives in product indications is not per se excluded, even if such adjectives are not part of the alphabetical list of products of the Locarno Classification or of Eurolocarno (e.g. '**electric** tools for drilling' in subclass 08-01, or '**cotton** pants' in subclass 02-02). However, it may cause delays in processing the application where a translation of the adjective into all the Union languages is required.

6.1.4.4 *Ex officio* change of indication

Product terms not listed in the Locarno Classification or Eurolocarno

Where an applicant uses terms that are not in Eurolocarno, the examiner will, in straightforward cases, substitute *ex officio* the wording used by the applicant with an equivalent or more general term listed in the Locarno Classification or Eurolocarno. The purpose of this is to avoid having to translate terms into all the EU languages, which would result in delays in processing the application.

For instance, where an applicant chooses the term 'Running trainers' (a term not listed in Eurolocarno) to indicate the products in which the design will be incorporated, the examiner will change this indication to 'Footwear' (which is the heading of subclass 02-04) or 'Shoes' (which is listed under subclass 02-04).

Even though the product indication does not affect the scope of protection of a Community design as such, the examiner will refrain from replacing the terms chosen by the applicant with more specific terms.

Products and their parts; sets

Where a design represents the appearance of one part of a product, and that product as a whole is indicated in the application (e.g. an application for the design of a knife handle specifies that the products in which this design will be incorporated are 'knives' in subclass 08-03), the examiner will replace that product indication by the indication 'Product(s) X (Part of -)', provided both the part in question and the product as a whole belong to the same class of the Locarno Classification.

Where a design represents a set of products, and these products are indicated in the application (e.g. an application for the design of a set of dishes specifies that the products in which this design will be incorporated are 'dishes' in subclass 07-01), the examiner will replace that indication by 'Product(s) X (Set of -)'.

Ornamentation

The same reasoning applies where the design represents ornamentation for a given product, and that product as a whole is indicated in the application. The examiner will replace that product indication by the indication 'Product(s) X (Ornamentation for -)'. The product will thus be classified under Class 32-00 of the Locarno Classification.

Moreover, where the product indication is 'Ornamentation' and the design does not limit itself to representing this ornamentation but also discloses the product to which the ornamentation is applied, or part of that product, without its contours being disclaimed, this product will be added to the product indication, and the classification will be amended accordingly.

A list of products combining 'Ornamentation' with other products belonging to different classes of the Locarno Classification will give rise to an objection where several designs are combined in a multiple application (see paragraph 7.2.3 below).

Notification of the *ex officio* change of indication

Provided there is no deficiency, the examiner will register the Community design(s) and notify the applicant of the *ex officio* change of product indication.

Where the applicant objects to such *ex officio* change, it can apply for correction of the corresponding entry in the Register (see paragraph 11.1 below) and request that the original terms used in the application be maintained, provided there are no issues concerning the clarity and precision of these terms or their classification (Article 20 CDIR; see decision of 05/07/2007, R 1421-2006-3 – 'Cash registers'). In this case, however, applicants are informed that translation of the original terms into all official languages of the Union is likely to delay registration of the Community design(s).

6.1.5 Long lists of products

More than one product can be indicated in an application.

However, in order to ensure that the Community Designs Register remains searchable and to save translation costs, where an application indicates more than five different products belonging to the same subclass of the Locarno Classification, the examiner will suggest replacing the product indication by the heading of the subclass in question.

For example, let us assume an application contains the following product indication: *Locking or closing devices, Keys for vehicles, Anti-theft interlocking strips for doors, Anti-theft posts for motorcycles, Padlocks (part of -), Keepers of locks, Latches, Handcuffs, Handbag frames, Hasps, Lock bolts, Closing devices for doors and windows, Door openers [electric], Door bolts, Locks, Clasps for purses and handbags, Flat bolts [locks], Padlocks, Locking devices, Clasps for leather goods, Door closers, Casement bolts for windows or doors, Catches for venetian blinds, Keys for electric contacts, Cable-type padlocks for cycles, Theftproof locks, Keys, Box fasteners, Door check brakes, Tumbler locks, Door locks for vehicles, Fastenings for motor truck loading gates, Safety locks for bicycles, Clasps for cigarette cases, Shutter turnbuckles, Wheel clamps [boots], Manacles, Locks (part of -).*

Since all these products are classified in the same subclass of the Locarno Classification, the examiner will propose replacing this list by the heading of subclass 08-07, that is, 'Locking or closing devices'.

Where the product indication contains more than five products that do not belong to the same subclass of the Locarno Classification, the examiner will suggest that the applicant limit the number of products to five and select products accordingly.

If, within the time limit indicated in the examiner's communication, the applicant expresses its wish to maintain the original list of products, the examination will proceed on the basis of that list.

If the applicant does not respond within the time limit or expressly agrees with the examiner's proposal, the examination will proceed on the basis of the product indication as proposed by the examiner.

6.1.6 Objections to product indications

Where the examiner raises an objection, the applicant will be given two months to submit its observations and remedy any deficiencies noted (Article 10(3) CDIR).

The examiner may invite the applicant to specify the nature and purpose of the products in order to allow proper classification, or may suggest product terms from Eurolocarno in order to assist the applicant.

If the deficiency is not remedied within the time limit, the application will be rejected (Article 10(4) CDIR).

6.1.6.1 No product indication

An objection will be raised where the application gives no indication of the products concerned (Article 36(2) CDR). However, if an indication can be found in the description or in the priority document, the examiner will record this as the product indication (decision of 21/03/2011, R 2432/2010-3 – 'Kylkropp för elektronikbärare', para. 14).

6.1.6.2 Deficient product indication

The examiner will also object to the product indication if it does not enable each product to be classified in only one class and subclass of the Locarno classification (Article 3(3) CDIR).

This will be the case where the indication is too vague or ambiguous to allow the nature and purpose of the products in question to be determined, for example *merchandise, novelty items, gifts, souvenirs, home accessories, electric devices*, etc.

This will also be the case where the indication concerns a service rather than a product, for example *sending or processing of information*.

6.1.6.3 Obvious mismatch

Since one of the main objectives of the product indication and classification is to make the Community Designs Register searchable by third parties, the examiner will raise an objection where the product indication clearly does not match the product as disclosed in the representation of the design.

6.2 Optional elements

An application may contain a number of optional elements, as listed in Article 1(1)(f) and (g) CDIR and Article 1(2) CDIR, that is,

- a priority or exhibition priority claim;
- a description;
- an indication of the Locarno Classification of the products contained in the application;
- the citation of the designer(s);
- a request for deferment.

6.2.1 Priority and exhibition priority

6.2.1.1 Priority

General principles

An application for a Community design may claim the priority of one or more previous applications for the same design or utility model in or for any state party to the Paris Convention or to the Agreement establishing the World Trade Organization, or in or for another State with which there is a reciprocity agreement (Article 41 CDR; Article 8 CDIR). This 'Convention priority' is of six months from the date of filing of the first application.

The effect of the right of priority is that the date of priority counts as the date of filing of the application for a registered Community design for the purposes of Articles 5, 6, 7 and 22, Article 25(1)(d) and Article 50(1) CDR (Article 43 CDR).

Priority claims are subject to the following requirements:

- priority may be claimed within six months from the date of filing of the first application;
- a priority may be claimed only from the first filing of a design or a utility model in a country that is a member of the Paris Convention or the World Trade Organization (WTO), or in another State with which there is a reciprocity agreement;
- the proprietor must be the same, or a transfer document establishing the Community design applicant's right to claim the priority of a previous application originally filed by another applicant must be provided;
- the priority declaration (containing date, number and country of the first application) must be submitted not later than one month from the date of filing of the RCD application;

- the details and the certified copy of the previous application must be submitted not later than three months from the date of submission of the declaration of priority.

As a substantive requirement, the Community design must relate to the 'same design or utility model' as the one for which priority is claimed (Article 41(1) CDR). This means that the subject-matter of the previous application must be identical to that of the corresponding Community design, without the addition or suppression of any features. A priority claim is however valid if the Community design and the previous application for a design right or a utility model differ only in immaterial details within the meaning of Article 5 CDR.

When examining an application for a Community design, the Office does not verify whether the application relates to the 'same design or utility model' as the one whose priority is claimed. Therefore, the applicant alone is responsible for ensuring that this requirement is satisfied, failing which the validity of the priority claim could be challenged at a later stage.

A priority claim will be examined for the purposes of Articles 5, 6 and 7 and Article 25(1)(d) CDR by the Office during invalidity proceedings if a third party challenges the validity of such a priority claim or if the holder challenges the effects of the disclosure of a design, where this disclosure occurred within the priority period (see the Guidelines on the Examination of Design Invalidity Applications, paragraph 5.5.1.8, Disclosure within the priority period).

During the examination phase of an application for a Community design, the Office will limit itself to verifying whether the formalities relating to a priority claim are complied with (Article 45(2)(d) CDR).

Claiming priority

The applicant may claim the priority of one or more previous design or utility model applications. Thus, the priority of more than one previous application can be claimed where two or more Community designs are combined in a multiple application.

If the priority of the same previous application is claimed for all designs of a multiple application, the box 'Same priority for all designs' should be ticked in the (paper) application form.

Any filing that is equivalent to a standard national filing under the domestic law applicable to it will be recognised as giving rise to the right of priority. A standard national filing means any filing that is suitable for establishing the date on which the application was filed in the country concerned, whatever the subsequent outcome of that application (Article 41(3) CDR).

Priority may be claimed either when filing the Community design application or within a period of one month of the filing date. During this one-month period, the applicant must submit the declaration of priority and indicate the date on which and the country in which the previous application was made (Article 8(2) CDR).

Where there is no indication of the claim in the application, the submission of priority documents within one month of the filing date will be construed as a declaration of priority.

Unless it is expressly indicated in the application that a priority claim will be made subsequently, the application will be examined without delay and, if no deficiency is found, will be registered without waiting one month for any potential declaration of priority. If a declaration of priority is validly filed after registration of the Community design application, a corresponding entry will subsequently be made in the Register.

The applicant must provide the Office with the file number(s) of the previous application(s) and a certified copy of the previous application(s) (Article 8 CDIR) within three months of either the filing date or, as the case may be, receipt of the declaration of priority by the Office.

Deficiencies

The Office will limit itself to verifying whether the formalities relating to a priority claim have been complied with (Article 45(2)(d) CDR), that is,

- whether priority was claimed within six months of filing the first application;
- whether priority was claimed when filing the application or within one month of the filing date;
- whether the details and the copy of the previous application were submitted in due time (within three months of either the filing date or, as the case may be, receipt of the declaration of priority);
- whether the previous application concerns a design or a utility model;
- whether the previous application was filed in a country that is a member of the Paris Convention or the World Trade Organization (WTO), or in another state with which there is a reciprocity agreement;
- whether the previous application was a first filing (meaning that a priority claim should be rejected if the priority application in turn claimed priority);
- whether the proprietor is the same or whether a transfer document establishes the Community design applicant's right to claim the priority of a previous application originally filed by another applicant.

Where remediable deficiencies are found, the examiner will request the applicant to remedy them within two months.

If the deficiencies are not remedied in due time or cannot be remedied, the Office will inform the applicant of the loss of the priority right and of the possibility of requesting a formal (i.e. appealable) decision on that loss (Article 46(1) and (4) CDR; Article 40(2) CDIR).

If the deficiencies that are not remedied concern only some of the designs contained in a multiple application, the right of priority will be lost in respect only of the individual designs concerned (Article 10(8) CDIR).

Whether priority is claimed within six months of filing the first application

The examiner will examine whether the date of filing allocated to the Community design is no later than six months from the filing date of the first application. Applicants should note that the date of **filing** allocated by the Office may not always correspond to the date of **receipt** of the Community design application (see paragraph 3).

In order to speed up registration proceedings, where the date of filing of the Community design application is indisputably and irremediably well beyond this six-month period, the Office will reject the priority claim without formally notifying the applicant of this deficiency.

Where the date of filing of the Community design application is only slightly beyond the six-month period, the examiner will check whether the period has to be extended under one of the conditions provided for in Article 58 CDIR.

The priority right claimed must always be a previous application, which, for this very reason, cannot bear the same date as the Community design application.

Whether priority is claimed when filing the application or within one month of the filing date

The examiner will check that priority has been claimed no later than one month after the filing date of the Community design.

Whether the details of the previous application and the copy of the priority document were submitted in due time

Where priority is claimed when filing or by submitting a declaration of priority, the applicant must indicate the date on which, and the country in or for which the previous application was made (Article 1(1)(f) CDIR). Failure to do so will, however, not lead to an objection: the examiner will wait for the priority document to be submitted.

The file number and the priority document must be submitted within three months of the filing date of the Community design application or submission of the declaration of priority (Article 8 CDIR).

The priority document must consist of a certified copy of the previous application or registration, issued by the authority that received it, and be accompanied by a certificate stating the filing date of that application. The priority document may be filed in the form of an original or as an accurate photocopy. Insofar as the original document contains a representation of the design in colour, the photocopy must also be in colour (Decision No EX-03-05 of the President of the Office of 20/01/2003 concerning the formal requirements of a priority or seniority claim). Applicants claiming the priority of a U.S. patent (design) application are allowed to submit the certified copy of this application in CD-ROM format (Communication No 12/04 of the President of the Office of 20/10/2004).

Where the priority of a previous registered Community design is claimed, the applicant must indicate the number of the previous application and its date of filing. No additional information or document is required (Decision No EX-03-05 of the President of the Office of 20/01/2003 concerning the formal requirements of a priority or seniority claim).

If the language of the previous application is not one of the five Office languages, the examiner may invite the applicant to file a translation within two months (Article 42 CDR). It is not necessary for the whole document to be translated, but only that information allowing the examiner to check the nature of the right (design or utility model), the country of filing, the file number, the filing date and the applicant's name.

In order to speed up registration proceedings, where an examiner detects deficiencies in the priority claim, a deficiency letter will be issued before the time limit expires for submitting all the details of the previous application, including the file number and priority document. The time limit for remedying deficiencies will be no less than three months from the filing date or date of receipt of the declaration of priority.

Whether the previous application concerns a design or a utility model

The priority of a previous design or utility model application may be claimed, including that of a previous Community design or an international design registration.

Many national laws do not provide for the protection of utility models, for example the laws of the United States of America. In the European Union, utility models can be registered in, inter alia, Austria, Czech Republic, Denmark, Finland, Germany, Italy, Hungary, Poland, Portugal, Slovakia and Spain. Utility models can also be registered in Japan.

A priority claim based on a previous **patent** application will in principle be refused. However, the priority of an international application filed under the Patent Cooperation Treaty (PCT) can be claimed since Article 2 of the PCT defines the term 'patent' in a broad sense that covers utility models.

A priority claim can be based on a previous application filed with the United States Patent and Trademark Office (USPTO) only if the subject-matter of the previous application relates to a 'design patent', not a 'patent'.

Whether the previous application was filed in a country that is member of the Paris Convention or the World Trade Organization (WTO), or in another State with which there is a reciprocity agreement

The states and other territories listed below are not members of any of the relevant conventions, nor do they benefit from reciprocity agreements. Therefore, priority claims based on filings in the following countries and territories will be refused:

Afghanistan (AF)
Abkhazia
American Samoa (AS)
Anguilla (AI)
Aruba (AW)
Bermuda (BM)
Cayman Islands (KY)
Cook Islands (CK)
Eritrea (ER)
Ethiopia (ET)
Falkland Islands (FK)
Guernsey (Channel Islands) (GG)
Isle of Man (IM)
Jersey (Channel Islands) (JE)
Kiribati (KI)
Marshall Islands (MH)
Micronesia (Federated States of) (FM)
Montserrat (MS)

Nauru (NR)
Palau (PW)
Pitcairn (Island) (PN)
Saint Helena (SH)
Somalia (SO)
Turks and Caicos Islands (TC)
Tuvalu (TV)
Virgin Islands, British (VG)

In order to speed up registration proceedings, where the previous application was filed indisputably and irremediably in one of the above countries or territories, the Office will reject the priority claim without formally notifying the applicant of the deficiency.

Whether the previous application is a first filing

As a matter of principle, the previous application must be a first filing. The examiner will therefore check that the priority document does not refer to priority being claimed in respect of an even earlier application.

As an exception, a subsequent application for a design that was the subject of a previous first application and has been filed in or in respect of the same state, will be considered as a first application for the purpose of determining priority, provided that, at the date of filing of the subsequent application, the previous application had been withdrawn, abandoned or refused without being open to public inspection and without leaving any rights outstanding, and had not served as a basis for claiming priority. The previous application may not thereafter serve as a basis for claiming a right of priority (Article 41(4) CDR).

Whether the proprietor is the same or a transfer has occurred

Priority can be claimed by the applicant of the first application or its successor in title. In the latter case, the first application must have been transferred prior to the filing date of the Community design application, and documentation to this effect must be provided.

The right of priority as such may be transferred independently of the first application. Priority can therefore be accepted even if the owners of the Community design and the previous application are different, provided that evidence of assignment of the priority right is supplied. In this case, the execution date of the assignment must be prior to the filing date of the Community design application.

Subsidiary or associated companies of the applicant are not considered to be the same legal entity as the Community design applicant itself.

When, in reply to an objection by the examiner on a discrepancy between the identity of the applicant and that of the previous application holder, the applicant explains that this is due to a corporate name change, a document establishing this change of corporate name must be submitted within two months.

6.2.1.2 Exhibition priority

General principles

The effect of exhibition priority is that the date on which the design was displayed at an officially recognised exhibition is deemed to be the date of filing of the application for a registered Community design for the purposes of Articles 5, 6, 7 and 22, Article 25(1)(d) and Article 50(1) CDR (Article 43 CDR).

The applicant can claim exhibition priority within six months of the first display. Evidence of the display must be filed (Article 44(1) and (2) CDR).

Exhibition priority cannot extend the six-month period of 'Convention priority' (Article 44(3) CDR).

Claiming exhibition priority

Like 'Convention priority' (see paragraph 6.2.1 above), exhibition priority can be claimed either when filing a Community design application or subsequently. Where the applicant wishes to claim exhibition priority after having filed an application, the declaration of priority, indicating the name of the exhibition and the date of first display of the product, must be submitted within a period of one month of the filing date (Article 9(2) CDIR).

The applicant must, within three months of the filing date or receipt of the declaration of priority, provide the Office with a certificate issued at the exhibition by the responsible authority. This certificate must state that the design was disclosed at the exhibition, specify the opening date of the exhibition and, where first public use did not coincide with the opening date of the exhibition, the date of first public use. The certificate must be accompanied by identification of the actual disclosure of the product in which the design is incorporated, duly certified by the authority (Article 9(1) and (2) CDIR).

Priority can only be granted where the application for a Community design is filed within six months of first display at an exhibition recognised for this purpose, namely a world exhibition within the meaning of the Convention on International Exhibitions signed in Paris on 22/11/1928. These exhibitions are rare and Article 44 CDR does not cover display at other, national or international, exhibitions. The exhibitions can be found on the website of the Paris 'Bureau International des Expositions': <http://www.bie-paris.org/site/en/>.

Deficiencies

The Office will limit itself to verifying whether the formalities relating to an exhibition priority claim have been satisfied (Article 45(2)(d) CDR), that is,

- whether the filing date of the Community design falls within the six-month period following the first display of the product;
- whether priority was claimed when filing the application or within one month of the filing date;
- whether the application or the subsequent declaration of priority gives details of the name of the exhibition and the date of first display of the product;

- whether the exhibition was a world exhibition within the meaning of the Convention on International Exhibitions of 22/11/1928;
- whether the certificate issued at the exhibition by the responsible authority was submitted in due time;
- whether the proprietor named in this certificate is the same as the applicant.

Where remediable deficiencies are found, the examiner will request the applicant to remedy them within a time limit no shorter than the three-month time limit for submitting the certificate referred to above.

If the deficiencies are not remediable or are not remedied in due time, the Office will inform the applicant of the loss of the priority right and of the possibility of requesting a formal (i.e. appealable) decision on that loss (Article 46(1) and (4) CDR; Article 40(2) CDIR).

If the deficiency concerns only some of the designs contained in a multiple application, the right of priority shall be lost in respect only of the individual designs concerned (Article 10(8) CDIR).

6.2.2 Description

The application may include a description not exceeding 100 words explaining the representation of the design or the specimen (see paragraph 3.3.5 above). The description must relate only to those features that appear in the reproductions of the design or the specimen. It may not contain statements concerning the purported novelty or individual character of the design or its technical value (Article 1(2)(a) CDIR).

The description does not affect the scope of protection of a Community design as such (Article 36(6) CDR).

The description may, however, clarify the nature or purpose of some features of the design in order to overcome a possible objection. For instance, where different views of the same design display different colours, thus raising doubts as to consistency between them (see paragraph 5.2.5 above), the description may explain that the colours of the design change when the product in which this design is incorporated is in use.

Descriptions submitted after the date of filing of the application will not be accepted.

The Register will include a mention that a description has been filed, but the description as such will not be published. The description, however, will remain part of the administrative file of the application and will be open to public inspection by third parties under the conditions set out at Article 74 CDR and Articles 74 and 75 CDIR.

6.2.3 Indication of the Locarno Classification

6.2.3.1 General principles

The applicant may itself identify the classification, in accordance with the Locarno Classification, of the products indicated in the application (see paragraph 6.1.4 above).

If the applicant provides a classification, the products must be grouped in accordance with the classes of the Locarno Classification, each group being preceded by the number of the relevant class, and presented in the order of the classes and subclasses (Article 3 CDIR).

Since classification is optional, no objection will be raised if the applicant does not submit a classification or does not group or sort the products as required, provided that no objection is raised with regard to the indication of products (paragraph 4.6 above). If no such objection is raised, the examiner will classify the products *ex officio* according to the Locarno Classification.

Where the applicant has indicated only the main class and no subclass, the examiner will assign the subclass that appears suitable in view of the design shown in the representation. For instance, where a design application indicates *packaging* in Class 9 of the Locarno Classification, and the design represents a bottle, the examiner will assign subclass 09-01 (the heading of which is *Bottles, flasks, pots, carboys, demijohns, and containers with dynamic dispensing means*).

Where the applicant has given the wrong classification, the examiner will assign the correct one *ex officio*.

Products that combine different elements so as to perform more than one function may be classified in as many classes and subclasses as the number of purposes served. For instance, the product indication *Refrigerating boxes with radios and CD players* will be classified under Classes 14-01 (*Equipment for the recording or reproduction of sounds or pictures*), 14-03 (*Communications equipment, wireless remote controls and radio amplifiers*) and 15-07 (*Refrigeration machinery and apparatus*) of the Locarno Classification.

6.2.3.2 Multiple applications and the requirement of 'unity of class'

If the same product indication applies to all designs contained in a multiple application, the relevant box 'Same indication of product for all designs' should be ticked in the (paper) application form and the field 'Indication of product' left blank for the subsequent designs.

Where several designs other than ornamentation are combined in a multiple application, the application will be divided if the products in which the designs are intended to be incorporated or to which they are intended to be applied belong to more than one class of the Locarno Classification (Article 37(1) CDR; Article 2(2) CDIR; see paragraph 7.2.3 below).

6.2.4 Citation of the designer(s)

The application may include

- (a) a citation of the designer(s), or
- (b) a collective designation for a team of designers, or
- (c) an indication that the designer(s) or team of designers has/have waived the right to be cited (Article 18 CDR; Article 1(2)(d) CDIR).

The citation, the waiver and an indication regarding the designer(s) are merely optional and are not subject to examination.

If the designer or the team of designers is the same for all designs applied for in a multiple application, this should be indicated by ticking the box 'Same designer for all designs' in the (paper) application form.

Since the right to be cited as the designer is not limited in time, the designer's name can also be entered into the Register after registration of the design (Article 69(2)(j) CDIR).

6.2.5 Request for deferment

6.2.5.1 General principles

The applicant for a registered Community design may, when filing the application, request that its publication be deferred for **30 months** from the date of filing or, if a priority is claimed, from the date of priority (Article 50(1) CDR).

Where no deficiency is found, the Community design will be registered. The information published in Part A.2 of the Community Designs Bulletin consists of the file number, date of filing, date of entry in the Register, registration number, name and address of the holder and name and business address of the representative (if applicable). No other particulars such as the representation of the design or the indication of products are published (Article 14(3) CDIR).

Nevertheless, third parties may inspect the entire file if they have obtained the applicant's prior approval or if they can establish a legitimate interest (Article 74(1) and (2) CDR).

In particular, there is a legitimate interest where an interested person submits evidence that the holder of the registered Community design whose publication is deferred has taken steps with a view to invoking the right against them.

No registration certificate will be made available as long as the publication of a design is deferred. The holder of the design registration subject to deferment may, however, request a certified or uncertified extract of the registration, containing the representation of the design or other particulars identifying its appearance (Article 73(b) CDIR), for the purpose of invoking its rights against third parties (Article 50(6) CDR).

The procedure described in this section does **not** apply to international registrations designating the European Union (see paragraph 12 below).

6.2.5.2 Request for deferment

Deferment of publication must be requested in the application (Article 50(1) CDR). Subsequent requests will not be accepted, even if received on the same day.

Applicants should be aware that designs can be registered and accepted for publication within two working days and even sometimes on the day that the application is received (see paragraph 2.7.1 above). If, by mistake, an application does not contain a request for deferment, the application should be withdrawn in order to

prevent publication. Given the speed of the registration and publication processes, this should be done **immediately** after filing. The applicant should also contact an examiner on the day of the withdrawal.

A request for deferment of publication may concern only some of the designs of a multiple application. In this case, the designs to be deferred must be clearly identified by ticking the box 'Request for deferment of publication' on the (paper) form or the box 'Publication to be deferred' (e-filing) for each individual design.

The applicant must pay a fee for deferment of publication along with the registration fee (see paragraph 8 below). Payment of the publication fee is optional at the filing stage.

6.2.5.3 Request for publication

When applying, or at the latest **three months before the 30-month period expires** (that is, on the last day of the 27th month following the filing date or priority date, as the case may be), the applicant must comply with what are known as the 'publication request requirements' (Article 15 CDIR), by:

- paying the publication fee for the design(s) to be deferred (see paragraph 8);
- in cases where a representation of the design has been replaced by a specimen in accordance with Article 5 CDIR (see paragraph 3.3.5 above), filing a representation of the design in accordance with Article 4 CDIR (see paragraph 5);
- in the case of a multiple registration, clearly indicating which of the designs among those identified for deferment are to be published or surrendered, or for which designs deferment is to be continued, as the case may be.

Where the Community design holder notifies the Office, **any time before the 27 months have expired**, of its wish to have the design(s) published ('request for anticipated publication'), it must specify whether publication should take place as soon as technically possible (Article 16(1) CDIR) or when the 30-month deferment period expires. Where there is no specific request from the applicant, the designs will be published when the deferment period expires.

If the holder, despite a previous request for publication, decides that the design should not be published after all, it must submit a written request for surrender well before the design is due to be published. Any publication fees already paid will not be refunded.

6.2.5.4 Observation of time limits

Community design holders should be aware that the Office will not issue reminders regarding the expiry of the 27-month period before which the publication request requirements must be complied with. It is therefore the responsibility of the applicant (or, as the case may be, its representative) to make sure that the time limits are observed.

Particular attention must be paid where a priority date was claimed either at the time of or after filing, since this priority date will determine the time limits applicable to deferment. Moreover, the time limits applicable to deferment may differ for each of the designs of a multiple registration, if different priority dates are claimed for each individual design.

Where the time limit for complying with ‘the publication request requirements’ is not met, thus resulting in a loss of rights, the Community design holder may file a request for *restitutio in integrum* (Article 67 CDR; see also the Guidelines, Part A, Section 8, *Restitutio in Integrum*).

6.2.5.5 Deficiencies

Deficiencies at the examination stage

If the information contained in the application is contradictory (e.g. the deferment fee has been paid, but the applicant has not ticked the box ‘Request for deferment of publication’) or inconsistent (e.g. the amount of the deferment fees paid for a multiple application does not correspond to the number of designs to be deferred), the examiner will issue a deficiency letter asking the applicant to confirm that deferment is requested and, where applicable, for which specific design(s) of a multiple application, and/or to pay the corresponding fees.

Deficiencies relating to the ‘publication request requirements’

If, once the 27-month period following the filing date or priority date of the Community design registration has expired, the holder has failed to comply with the ‘publication request requirements’, the examiner will issue a deficiency letter giving two months for the deficiencies to be remedied (Article 15(2) CDR).

Where a deficiency concerns the payment of publication fees, the applicant will be requested to pay the correct amount plus fees for late payment (that is, EUR 30 for a design and, in the case of a multiple application, 25 % of the fees for publication for each additional design; Article 15(4) CDR; Articles 8 and 10 of the Annex to the CDFR).

Applicants should be aware that the time limit set by the examiner cannot be extended beyond the 30-month period of deferment (Article 15(2) CDR).

If deficiencies are not remedied within the set time limit, the registered Community design(s) to be deferred will be deemed from the outset not to have had the effects specified in the CDR (Article 15(3)(a) CDR).

The examiner will notify the holder accordingly, after the 30-month period of deferment has expired.

In the case of a ‘request for anticipated publication’ (see paragraph 6.2.5.3 above), failure to comply with the publication request requirements will result in the request being deemed not to have been filed (Article 15(3)(b) CDR). The publication fee will be refunded if it has already been paid. Where there are still more than 3 months before the 27-month period expires, the holder may, however, submit another request for publication.

Where the deficiency concerns a payment that is insufficient to cover the publication fees for all the designs that are to be deferred in a multiple application, including any fees for late payment, the designs not covered by the amount paid will be deemed from the outset not to have had the effects specified in the CDR. Unless the holder made it

clear which designs were to be covered by the amount paid, the examiner will take the designs in consecutive numerical order (Article 15(4) CDIR).

Publication after deferment

Where there are no deficiencies or deficiencies have been overcome in due time, the registration will be published in Part A.1 of the Community Designs Bulletin.

The holder may request that only some of the designs of a multiple application are published.

Mention will be made in the publication of the fact that deferment was originally applied for and, where applicable, that a specimen was initially filed (Article 16 CDIR).

7 Multiple Applications

7.1 General principles

A multiple application is a request for the registration of more than one design within the same application. Each of the designs contained in a multiple application or registration is examined and dealt with separately. In particular, each design may, separately, be enforced, be licensed, be the subject of a right *in rem*, a levy of execution or insolvency proceedings, be surrendered, renewed or assigned, be the subject of deferred publication or be declared invalid (Article 37(4) CDR).

Multiple applications are subject to specific registration and publication fees, which decrease in proportion to the number of designs (see paragraph 8 below).

7.2 Formal requirements applying to multiple applications

7.2.1 General requirements

All the designs in a multiple application must have the same owner(s) and the same representative(s) (if any).

The number of designs contained in a multiple application is unlimited. The designs need not be related to one another or be otherwise similar in terms of appearance, nature or purpose.

The number of designs should not be confused with the 'number of views' that represent the designs (see paragraph 5.1 above).

Applicants must number the designs contained in a multiple application consecutively, using Arabic numerals (Article 2(4) CDIR).

A suitable representation of each design contained in a multiple application must be provided (see paragraph 5 above) and an indication given of the product in which the design is intended to be incorporated or to be applied (Article 2(3) CDIR, see paragraph 6.1.4 above).

7.2.2 Separate examination

Each of the designs contained in a multiple application is examined separately. If a deficiency concerning some of the designs contained in a multiple application is not remedied within the time limit set by the Office, the application will be refused only insofar as those designs are concerned (Article 10(8) CDIR).

The decisions on the registration or refusal of the designs contained in a multiple application will all be taken at the same time.

Even if some of the designs in a multiple application already comply with both the substantive and formal requirements, they will not be registered until any deficiencies affecting other designs have been remedied or the designs in question have been refused by the decision of an examiner.

7.2.3 The 'unity of class' requirement

7.2.3.1 Principle

As a rule, all the product(s) indicated for the designs contained in a multiple application must be classified in only one of the 32 Locarno classes.

As an exception, the indication *Ornamentation* or *Product(s) X (Ornamentation for -)* in Class 32-00 can be combined with indications of products belonging to another Locarno class.

7.2.3.2 Products other than ornamentation

The products indicated for each design in a multiple application may differ from those indicated for others.

However, except in cases of *ornamentation* (see paragraph 7.2.3.3 below), any products that are indicated for each and every design of a multiple application must belong to the same class of the Locarno Classification (Article 37(1) CDR; Article 2(2) CDIR). This 'unity of class' requirement is considered to be complied with even if the products belong to different subclasses of the same class of the Locarno Classification.

For instance, a multiple application is acceptable if it contains one design with the product indication *Motor vehicles* (Class 12, subclass 08) and one design with the product indication *Vehicle interiors* (Class 12, subclass 16), or if both designs indicate both these terms. This is an example of two designs in different subclasses but in the same class, namely Class 12 of the Locarno Classification.

An objection would, however, be raised if, in the above example, the products indicated were *Motor vehicles* (Class 12, subclass 08) and *Lights for vehicles*, since the second term belongs to Class 26, subclass 06 of the Locarno Classification. The examiner would then require the multiple application to be divided, as explained under paragraph 7.2.3.4 below.

A multiple application cannot be divided unless there is a deficiency affecting the 'unity of class' requirement (Article 37(4) CDR).

7.2.3.3 Ornamentation

Ornamentation is a decorative element capable of being applied to the surface of a variety of products without affecting their contours. It can be a two-dimensional pattern or a three-dimensional moulding or carving, in which the design stands out from a flat surface.

Although ornamentation is, in itself, a product within the meaning of the Locarno Classification (Class 32), its primary purpose is to constitute one of the features of other products.

A multiple application can therefore combine designs for ornamentation with designs for products such as those to which this ornamentation will be applied, provided that all the products belong to the same class of the Locarno Classification.

For some designs, the indication *Ornamentation* or *Product(s) X (Ornamentation for)* in Class 32 of the Locarno Classification is neutral and therefore ignored for the purpose of examining whether the product indication for the remaining designs meets the 'unity of class' requirement.

The same reasoning applies to the following product indications in Class 32 of the Locarno Classification: *Graphic symbols, Logos* and *Surface patterns*.

For example, a multiple application is acceptable if it combines designs for *Ornamentation* or *China (Ornamentation for)* in Class 32 with designs representing pieces of a tea set for *China* in Class 7, subclass 01. In turn, if *Linen (Table -)* were indicated as a product for one of these designs, an objection would be raised as this product belongs in Class 6, subclass 13 of the Locarno Classification, that is, a different class.

Where the applicant has indicated the product as *Ornamentation* or *Product(s) X (Ornamentation for)*, the examiner will prima facie examine whether it is really for ornamentation by looking at the design in question. Where the examiner agrees that it is for ornamentation, the product will be classified in Class 32.

Where the examiner does not agree that the design is for ornamentation, a deficiency letter must be sent on the grounds of an obvious mismatch between the products indicated and the design (see paragraph 6.1.6.3 above).

Where the representation of the design is not limited to ornamentation itself but also discloses the product to which such ornamentation is applied, without the contours of this product being disclaimed, this specific product must be added to the list of products and the classification must be amended accordingly (see paragraph 6.1.4.4 above).

This may lead to an objection where a multiple application combines a number of such designs applied to products that belong to different classes of the Locarno Classification.

7.2.3.4 Deficiencies

For example, let us assume that three designs representing cars are combined in one multiple application, and the product indication for each design is *Motor cars* (subclass 12-08) and *Scale models* (subclass 21-01).

The examiner will issue an objection and request the applicant to:

- delete some of the product indications so that the remaining products can be classified in only one Locarno class; or
- divide the application into two multiple applications for each of the Locarno classes concerned, and pay the corresponding additional fees; or
- divide the application into three single applications for each design concerned, and pay the corresponding additional fees.

In some cases, it will not be possible to delete product indications, for example where a given product must be classified in two or more classes on account of the plurality of purposes it serves (see paragraph 6.2.3.1 above).

The applicant will be invited to comply with the examiner's request within two months and pay the total amount of fees for all applications resulting from the division of the multiple application or to delete some products in order to meet the 'unity of class' requirement.

The total amount to be paid is calculated by the examiner and notified to the applicant in the examination report. The examiner proposes the most cost-effective option between dividing the multiple application into as many applications as Locarno classes concerned or as many applications as designs concerned.

Where the applicant does not remedy the deficiencies in due time, the multiple application is refused **in its entirety**.

8 Payment of Fees

8.1 General principles

Community design applications are subject to various fees, which the applicant must pay **at the time of filing** (Article 6(1) CDIR), including the registration fee and the publication fee or, where the application includes a request for deferment of the publication, the deferment fee.

In the case of multiple applications, additional registration, publication or deferment fees must be paid for each additional design. If payment has not been made when filing the application, late payment fees must also be paid.

In the case of deferment, applicants can, when filing, choose to pay not only the registration and deferment fee, but also the publication fee.

For the fee payable with respect to an international application designating the European Union see paragraph 12.1.2.3 below.

8.2 Currency and amounts

Fees must be paid in euros. Payments made in other currencies are not accepted.

The fees for filing an application are as follows:

Registration fees

Single design or first design in a multiple application	€230
2nd to 10th design in a multiple application	€115 per design
11th+ design in a multiple application	€50 per design

Publication fees

Single design or first design to be published in a multiple application	€120
2nd to 10th design to be published in a multiple application	€60 per design
11th+ design to be published in a multiple application	€30 per design

Deferment fees (where deferment of publication is requested)

Single design or first design with deferment of publication in a multiple application	€40
2nd to 10th design with deferment of publication in a multiple application	€20 per design
11th+ design with deferment of publication in a multiple application	€10 per design

Example of fees due for the filing of a multiple application where the publication of only some designs is to be deferred

Design number	Deferment	Registration fee	Publication fee	Deferment fee
xxxxxxx-0001	Yes	€230	-	€40
xxxxxxx-0002	Yes	€115	-	€20
xxxxxxx-0003	No	€115	€120	-
xxxxxxx-0004	No	€115	€60	-
xxxxxxx-0005	No	€115	€60	-

If, after registration, publication is requested for design xxxxxxx-0001, this will in effect be the fourth design to be published and the publication fee will be EUR 60.

8.3 Means of payment, details of the payment and refund

The means of payment, the details to accompany the payment and the conditions for a refund of fees paid are explained in the Guidelines, Part A, General Rules, Section 3, Payment of Fees, Costs and Charges.

Fees are refunded when the application is withdrawn or refused without a filing date having been granted (application 'not dealt with as a Community design application').

The Office also refunds amounts paid that are insufficient to cover the registration and publication (or deferment) fees for the design or at least one design of a multiple application.

9 Withdrawals and Corrections

9.1 Introduction

The applicant may at any time during the examination withdraw an application for a registered Community design or, in the case of a multiple application, withdraw some of the designs contained in the multiple application. Corrections are allowed only in some specific situations.

Any correction or change to the Register and/or publication, that is after the design has been registered by the examiner, must be dealt with in accordance with paragraph 11 below.

9.2 Withdrawal of the application

Prior to registration the applicant may at any time withdraw an application for a Community design or, in the case of a multiple application, withdraw some of the designs contained in the multiple application (Article 12(1) CDIR). The examiner will send confirmation of the withdrawal.

Requests for withdrawal must be submitted in writing and include:

- the file number of the application for a registered Community design or, where the request for withdrawal is submitted before an application number has been allocated, any information enabling the application to be identified, such as the reference number of the applicant/representative and/or the provisional file number referred to in the automatic receipt for applications filed via the e-filing system;
- in the case of a multiple application, an indication of the design(s) that the applicant wants to withdraw if only some are to be withdrawn; and
- the name and address of the applicant and/or, if applicable, the name and address of the representative.

The 'date of withdrawal' is the date on which the Office receives the request for withdrawal.

Fees will not be refunded if a filing date has been granted, except where the amount of fees paid by the applicant is insufficient to cover the fees relating to registration and publication (or deferment as the case may be) for the design, or for at least one design of a multiple application.

Requests for withdrawal received by the Office on or after the date of registration of the design will be dealt with as requests for surrender.

Requests for withdrawal received by the Office on the filing date of the design application will be accepted even if the design is registered that same day.

9.3 Corrections to the application

9.3.1 Elements subject to correction

Only the name and address of the applicant or the representative, errors of wording or of copying, or obvious mistakes may be corrected, at the request of the applicant (Article 12(2) CDIR).

Apart from the name and address of the applicant or representative, the following elements may be corrected at the applicant's request if they contain errors of wording or of copying or obvious mistakes:

- the date of filing, where the application was filed with the central industrial property office of a Member State or, in Benelux countries, with the Benelux Office for Intellectual Property (BOIP), upon notification by the office concerned that an error regarding the date of receipt has been made;
- the name of the designer or team of designers;
- the second language;
- an indication of the product(s);
- the Locarno Classification of the product(s) contained in the application;
- the country, date and number of the prior application where Convention priority is claimed;
- the name, place and date of the first exhibition of the design where exhibition priority is claimed;
- the description.

9.3.2 Elements that cannot be corrected

As a matter of principle, the representation of the design(s) cannot be altered after the application has been filed (Article 12(2) CDIR). The submission of additional views or the withdrawal of any views at a later stage will not be accepted, unless expressly required or proposed by the Office (see paragraphs 5.2 and 5.5 above).

Where a request for correction amends the representation of the design(s), the applicant will be informed that its request is not acceptable. The applicant must decide whether it wishes to continue the registration process or to file a fresh application for which it will have to pay the applicable fees.

9.3.3 Procedure for requesting correction

A request for correction of the application must contain:

- a) the file number of the application;
- b) the name and address of the applicant;
- c) where the applicant has appointed a representative, the name and business address of the representative;

- d) an indication of the element of the application to be corrected and the corrected version of that.

A single request may be made for correction of the same element in two or more applications belonging to the same applicant.

If all the requirements are met, the examiner will send confirmation of the correction.

Corrections and amendments after registration are dealt with by the Operations Department (see paragraph 11 below).

9.3.4 Deficiencies

Where a request for correction does not meet the above requirements and the deficiency found can be remedied, the examiner will invite the applicant to remedy the deficiency within two months. If the deficiency is not remedied in due time, the examiner will refuse the request for correction.

Requests for correction that would have the effect of amending the representation of the design(s) will be refused irremediably.

Descriptions submitted after the date of filing of the application are not accepted (see paragraph 6.2.2 above). Requests for correction that involve submitting a description after the date of filing of the application will therefore be refused.

10 Registration, Publication and Certificates

10.1 Registration

Once examination of absolute grounds for refusal and formalities is completed, the examiner must ensure that all the particulars referred to in Article 14 CDIR have been provided (particulars that are mandatory for the applicant and that must be indicated in the application are in bold type):

- (a) the filing date of the application;
- (b) the file number of the application and of each individual design included in a multiple application;
- (c) the date of publication of the registration;
- (d) **the name, address and nationality of the applicant and the state in which it is domiciled or has its seat or establishment;**
- (e) **the name and business address of the representative**, other than an employee acting as representative in accordance with the first sentence of Article 77(3) CDR; where there is more than one representative, only the name and business address of the first-named representative, followed by the words 'et al', will be recorded; where an association of representatives is appointed, only the name and address of the association will be recorded;
- (f) **the representation of the design;**
- (g) **an indication of the product(s)** by name, preceded by the number(s) of and grouped according to the class(es) and subclass(es) of the Locarno Classification;
- (h) particulars of priority claims pursuant to Article 42 CDR;
- (i) particulars of exhibition priority claims pursuant to Article 44 CDR;

- (j) the citation of the designer or team of designers or a statement that the designer or team of designers has waived the right to be cited;
- (k) **the language in which the application was filed and the second language** indicated by the applicant pursuant to Article 98(2) CDR;
- (l) the date of registration of the design in the Register and the registration number;
- (m) a mention of any request for deferment of publication pursuant to Article 50(3) CDR, specifying the date of expiry of the period of deferment;
- (n) a mention that a specimen has been filed pursuant to Article 5 CDIR;
- (o) a mention that a description was filed pursuant to Article 1(2)(a) CDIR;
- (p) a mention that the representation of the design contains a verbal element.

Once all the particulars in the checklist are on file, the examiner will check whether all the applicable fees have been paid.

Where no deficiency is found, the application is registered.

10.2 Publication

10.2.1 General principles

All registered Community designs are published in the Community Designs Bulletin, which is published in electronic format only, on the Office's website.

However, international registrations designating the European Union are published by WIPO (Hague Express Bulletin) (see paragraph 12 below).

Unless an application contains a request for deferment of publication, publication will take place immediately after registration; publication is daily.

Where an application contains a request for deferment of publication, publication is made in Part A.2 of the Bulletin and is limited to the following particulars: the design number, filing date, registration date and the names of the applicant and the representative, if any.

Where an application contains a request for deferment of publication for only some of the designs of a multiple application, only the designs for which deferment has not been requested are published in full.

10.2.2 Format and structure of the publication

The Community Designs Bulletin is available in two formats:

- HTML
- PDF.

Both formats are equally valid for publication and search purposes.

The Community Designs Bulletin comprises the following four parts:

- **Part A** deals with Community design registrations and consists of three sections:

- Part A.1: Community design registrations in accordance with Articles 48 and 50 CDR.
- Part A.2: Community design registrations with requests for deferment and their first publication in accordance with Article 50 CDR and Article 14(3) CDR.
- Part A.3: Errors in Part A (mistakes and errors in registrations). A.3.1: absolute errors; A.3.2: relative errors.
- **Part B** deals with entries in the Register subsequent to registration, such as amendments, transfers, licences, etc. and consists of eight sections:
 - Part B.1: mistakes and errors
 - Part B.2: transfers
 - Part B.3: invalidity and entitlement proceedings
 - Part B.4: surrenders and designs without effects
 - Part B.5: licences
 - Part B.6: rights *in rem*
 - Part B.7: insolvency proceedings
 - Part B.8: levy of execution (seizures).
- **Part C** deals with renewals and information on expired registrations and is subdivided into three sections:
 - Part C.1: Renewals in accordance with Article 13(4) CDR and Article 69(3)(m) CDR.
 - Part C.2: Expired registrations according to Articles 22(5) and 69(3)(n) CDR.
 - Part C.3: Correction of errors or mistakes in renewals and expired registrations.
- **Part D** deals with *Restitutio in integrum* (Article 67 CDR) and is divided into two sections:
 - Part D.1: *Restitutio in integrum*.
 - Part D.2: Correction of errors or mistakes in Part D.

In the Bulletin, each item is preceded by the corresponding **INID code** in accordance with WIPO standard ST.80. Where appropriate, information is published in all official EU languages (Article 70(4) CDR).

The **INID codes** used for items published in for example Part A.1 of the Bulletin are as follows:

- 21 File number
- 25 Language of filing and second language
- 22 Date of filing
- 15 Date of entry into the Register
- 45 Date of publication
- 11 Registration number
- 46 Date of expiry of the deferment
- 72 Name(s) of designer(s) or team of designers
- 73 Name and address of the holder
- 74 Name and business address of the representative
- 51 Locarno classification

- 54 Indication of the product(s)
- 30 Country, date and number of application for which priority is claimed (Convention priority)
- 23 Name, place and date on which the design was first exhibited (exhibition priority)
- 29 Indication that a specimen was filed
- 57 Indication that a description was filed
- 55 Representation of the design.

The publication is made in all EU languages that are official on the date of the application.

10.3 Registration certificate

A registration certificate is issued after the registered Community design has been published in full (i.e. publication in Part A.1).

However, the Office does not issue registration certificates for international registrations designating the European Union (see paragraph 12 below).

Since 15/11/2010, registration certificates have been issued only as online e-certificates. Holders of Community design registrations are invited to download the certificate from the day after publication, using the 'eSearch plus' tool on the Office's website. No paper copy of the certificate of registration will be issued. However, certified or uncertified copies of the registration certificate may be requested.

The certificate contains all the particulars entered in the Community Designs Register at the date of registration. No new certificate is issued following changes made in the Register after the date of registration. However, an extract from the Register, which reflects the current administrative status of the design(s), may be requested.

A corrected certificate is issued after publication of a relative error detected in a design registration (Part A.3.2) or after publication of a relative error detected in a recordal (Part B.1.2). A relative error is an error attributable to the Office that modifies the scope of the registration.

11 Corrections and Changes in the Register and in the Publication of Community Design Registrations

11.1 Corrections

11.1.1 General principles

Only the name and address of the applicant, errors of wording or of copying, or obvious mistakes may be corrected, at the request of the applicant and provided that such correction does not change the representation of the design (Article 12(2) CDIR) (decision of 03/12/2013, R 1332/2013-3 — 'Adapters', para. 14 et seq.). There is no fee for such requests.

Where the registration of a design or the publication of the registration contains a mistake or error attributable to the Office, the Office will correct the error or mistake of

its own motion or at the request of the holder (Article 20 CDIR). There is no fee for such requests.

A request for correction of mistakes made by the Office can only refer to the contents of the publication of the registration (Articles 49, 73 and 99 CDR and Articles 14 and 70 CDIR) and the entries in the Register (Articles 48, 72 and 99 CDR and Articles 13 and 69 CDIR).

Unless the Office itself made an error when publishing the representation of the design(s) (e.g. by distorting or truncating the representation), the holder will not be allowed to request the correction of its Community design if this has the effect of altering the representation (Article 12(2) CDIR) (decision of 03/12/2013, R 1332/2013-3 'Adapters', para. 14 et seq.).

Corrections will be made as soon as the mistake is detected, including, where necessary, years after the original entry in the Register.

11.1.2 The request for correction

According to Articles 12 and 19 CDIR, requests for the correction of mistakes and errors in the Register and in the publication of the registration must contain:

- a) the registration number of the registered Community design;
- b) the name and address of the holder as registered in the Register or the name of the holder and the identification number assigned to the holder by the Office;
- c) where the holder has appointed a representative, the name and business address of the representative or the name of the representative and the identification number assigned to the representative by the Office; and
- d) an indication of the entry in the Register and/or of the content of the publication of the registration to be corrected and the corrected version of the element in question.

A single request may be made for the correction of errors and mistakes in respect of two or more registrations belonging to the same holder (Article 19(4) CDIR and Article 20 CDIR).

If the requirements for such corrections are not fulfilled, the Office will inform the applicant of the deficiency. If the deficiency is not remedied within the two months specified by the Office, the request for correction will be refused (Article 19(5) CDIR and Article 20 CDIR).

Requests for the correction of mistakes or errors that are not entries in the Register and/or that do not concern the contents of the publication of registrations will be refused. Accordingly, requests for correction of the description explaining the representation of the design or the specimen will be refused.

Errors in the translation of the product indication into the official EU languages are considered attributable to the Office and will be corrected because the translations are considered as entries in the Register and as part of the contents of the publication of the registration, despite the fact that the translations are done not by the Office but by the Translation Centre for the Bodies of the European Union (Communication No 4/05 of the President of the Office of 14/06/2005 concerning the correction of mistakes and errors in the Register and in the publication of the registration of Community designs).

In cases of doubt, the text in the Office language in which the application for a registered Community design was filed will be authentic (Article 99(3) CDR). If the application was filed in an official EU language other than one of the Office languages, the text in the second language indicated by the applicant will be authentic.

11.1.3 Publication of corrections

The holder will be notified of any changes in the Register (Article 69(5) CDIR).

Corrections will be published by the Office in Part A.3 of the Community Designs Bulletin and entered in the Register together with the date on which they were recorded (Article 20 CDIR and Article 69(3)(e) CDIR).

Where the mistake or error is attributable to the Office, the Office will, after publication of the mistake or error, issue the holder with a certificate of registration containing the entries in the Register (Article 69(2) CDIR) and a statement to the effect that those entries have been recorded in the Register (Article 17 CDIR).

In cases where the mistake or error is the holder's, a certificate of registration reflecting the corrected mistake or error will be issued only where no certificate has previously been issued. In any event, holders can always request the Office to issue an extract of the Register (in certified or simple form) to reflect the current status of their design(s).

11.2 Changes in the Register

11.2.1 Introduction

This section describes the changes in the Community Designs Register, as follows:

- surrender of a Community design with or without deferment, in particular partial surrender;
- changes in the name and address of the applicant and/or of the representative, where applicable, of which the Office was notified before registration of the Community design (i.e., before issue of the notification of registration);
- changes in the name and address of the holder and/or of the representative, where applicable, for a Community design with deferred publication that has not been published yet;
- recordal of transfers;
- recordal of licences.

11.2.2 Surrender of the registered Community design

11.2.2.1 General principles

A Community design may be surrendered by the holder at any time after registration. A surrender must be declared to the Office in writing (Article 51 CDR).

However, a request for renunciation of an international design designating the European Union must be filed with, and recorded by, the International Bureau (see Article 16 of the Geneva Act and paragraph 12.2.2.5 below).

Surrender can also be declared for only some of the designs contained in a multiple registration (Article 27(1)(d) CDR).

The effect of a declaration of surrender begins on the date on which the surrender is entered in the Community Designs Register, without any retroactive effect (Article 51(1) CDR). However, if a Community design for which publication has been deferred is surrendered, it will be deemed from the outset not to have had the effects specified in the CDR (Article 51(2) CDR).

A registered Community design may be partially surrendered provided that its amended form complies with the requirements for protection and the identity of the design is retained (Article 51(3) CDR). Partial surrender will therefore be limited to cases in which the features removed or disclaimed do not contribute to the novelty or individual character of a Community design, in particular:

- where the Community design is incorporated in a product that constitutes a component part of a complex product, and the removed or disclaimed features are invisible during normal use of this complex product (Article 4(2) CDR); or
- where the removed or disclaimed features are dictated by a function or by interconnection purposes (Article 8(1) and (2) CDR); or
- where the removed or disclaimed features are so insignificant in view of their size or importance that they are likely to go unnoticed by the informed user.

The surrender will be entered in the Register only with the agreement of the proprietor of a right entered in the Register (Article 51(4) CDR). Persons having a registered right include the holders of a registered licence, the proprietors of a registered right *in rem*, the creditors of a registered levy of execution or the authority competent for the registered bankruptcy or similar procedures.

In the case of licences registered in the Community design Register, the surrender of a Community design is entered in the Register only upon receipt of evidence that the right holder has informed licensee(s) of the surrender accordingly. The surrender is entered in the Register three months after the date on which the Office obtains proof that the holder has informed licensee(s) of the surrender accordingly or earlier if proof is obtained of the licensee's(licensees') consent to the surrender (Article 51(4) CDR; Article 27(2) CDR).

Where a claim relating to the entitlement to a registered Community design has been brought before a court pursuant to Article 15 CDR, the surrender is entered in the Register only with the agreement of the claimant (Article 27(3) CDR).

11.2.2.2 Formal requirements for a declaration of surrender

A declaration of surrender must contain the particulars referred to in Article 27(1) CDR:

- a) registration number of the registered Community design;
- b) name and address of the holder;
- c) name and address of the representative, where appointed;
- d) indication of the designs for which the surrender is declared in the case of multiple registrations;
- e) representation of the amended design in accordance with Article 4 CDR in the case of partial surrender.

In the case of a partial surrender, the holder must submit a representation of the Community design as amended (Article 27(1)(e) CDIR).

If a declaration of surrender does not contain all the particulars listed above and does not fulfil all the above requirements, depending on the situation, the Office will notify the holder of the deficiencies and request that they be remedied within the prescribed time limit. Where the deficiencies are not remedied within the time limit, the surrender will not be entered in the Register and the Community design holder will be informed thereof in writing (Article 27(4) CDIR).

11.2.3 Changes in the name and address of the applicant/holder and/or its representative

The Community design holder may request recordal of the change of name or address in the Register by submitting a written request to the Office. Recordals of changes of name and/or address are free of charge.

The request for recordal of a change of name or address in respect of an international design designating the European Union must be filed with the International Bureau (see Article 16 of the Geneva Act).

For the differences between a change of name and a transfer, see the Guidelines for Examination, Part E, Section 3, Chapter 1, on 'Transfers and changes of name'.

A single request may be made for a change of name or address in respect of two or more registrations belonging to the same holder.

A request for a change of name or address by a Community design holder must contain:

- a) the registration number of the Community design;
- b) the holder's name and address as recorded in the Register or the holder's identification number;
- c) an indication of the holder's name and address as changed;
- d) the name and address of the representative, where appointed.

If the above requirements are not fulfilled, the Office will send a deficiency letter. If the deficiency is not remedied within the specified time limit, the Office will refuse the request (Article 19(5) CDIR).

Changes of name and address for Community design applicants in connection with applications for Community designs are not entered in the Register but must be recorded in the files kept by the Office concerning Community design applications (Article 19(7) CDIR).

Changes in the holders of Community design registrations are published in Part B.2.2 of the Community designs Bulletin, while transfers of rights are published in Part B.2.1. Changes in the representatives are published in Part B.9 of the Community designs Bulletin.

11.2.4 Transfers

11.2.4.1 Introduction

A Community design registration may be transferred by the holder, and transfers are recorded upon request in the Register. However, the request for recording a transfer in respect of an international design designating the European Union must be filed with the International Bureau (see Article 16 of the Geneva Act).

The legal provisions contained in the CDR, CDIR and CDFR in respect of transfers correspond to the provisions in the EUTMR and EUTMIR respectively (see the Guidelines for Examination, Part E, Chapter 1, on Transfer).

The legal principles and procedure for the recordal of trade mark transfers apply *mutatis mutandis* to Community designs with the following particularities.

11.2.4.2 Rights of prior use in respect of a registered Community design

The right of prior use in respect of a registered Community design cannot be transferred except, where the third person, who claimed said right before the filing or priority date of the application for a registered Community design, is a business, along with that part of the business in the course of which the act was done or the preparations were made (Article 22(4) CDR).

11.2.4.3 Fees

The fee of EUR 200 for the recordal of a transfer applies per design, with an upper limit of EUR 1 000 if multiple requests are submitted in the same application (points 16 and 17 of the annex to the CDFR).

11.2.5 Licences

11.2.5.1 General principles

Community design registrations may be licensed by the holder and the licences recorded upon request in the Register. The provisions of the CDR and CDIR dealing with Community design licences (Articles 27, 32 and 33, and Article 51(4) CDR; Articles 24 and 25, and Article 27(2) CDIR) are almost identical to those in the EUTMR and EUTMIR (see the Guidelines for Examination, Part E, Chapter 2, on Licences).

The legal principles and procedure for the recordal of licences in respect of European Union trade marks apply *mutatis mutandis* to Community designs (Article 24(1) CDIR) with the following particularities.

11.2.5.2 Registered Community designs

There is no use requirement in Community design law. Therefore, the issue of whether use by a licensee is use with the consent of the right holder does not arise.

The CDR and CDIR require an indication of the products in which the design is intended to be incorporated or applied (see paragraph 6.1.4 above.). A partial licence

for only some of the products in which the design is intended to be incorporated or applied is not possible.

Any limitations of the scope of the licence will therefore be disregarded by the Office, and the licence will be registered as if there were no such limitations.

11.2.5.3 Multiple applications for registered Community designs

An application for a registered Community design may take the form of a multiple application combining several designs (Article 37 CDR).

Each design contained in a multiple application may be licensed independently of the others (Article 24(1) CDR).

11.2.5.4 Fees

The fee of EUR 200 for the recordal, transfer or cancellation of a licence applies per design, not per application, with a ceiling of EUR 1 000 if multiple requests are submitted in the same application (points 18 and 19 of the annex to the CDFR).

Example 1: From a multiple application for ten designs, six designs are licensed to the same licensee. The fee for registering the licences is EUR 1 000, provided that

- all six licences are included in a single registration request, or
- all the relevant requests are submitted on the same day.

The request may indicate that, for three of these six designs, the licence is an exclusive one, without this having any impact on the fees to be paid.

Example 2: From a multiple application for ten designs, five designs are licensed to the same licensee. A licence is also granted for another design not contained in that multiple application. The fee is EUR 1 000, provided that:

- all six licences are included in a single registration request, or that all the relevant requests are submitted on the same day, and
- the holder of the Community design and the licensee are the same in all six cases.

12 International Registrations

This part of the Guidelines deals with the particularities of examining international registrations designating the European Union that result from applications filed with the International Bureau of the World Intellectual Property Organisation (hereinafter referred to as 'international registrations' and 'the International Bureau') under the Geneva Act of 02/07/1999 of the Hague Agreement concerning the international registration of industrial designs.

12.1 General overview of the Hague System

12.1.1 The Hague Agreement and the Geneva Act

The Hague Agreement is an international registration system that makes it possible to obtain protection for designs in a number of States and/or intergovernmental organisations, such as the European Union or the African Intellectual Property Organization, by means of a **single** international application filed with the International Bureau. Under the Hague Agreement, a single international application replaces a whole series of applications which, otherwise, would have had to be filed with different national intellectual property offices or intergovernmental organisations.

The Hague Agreement consists of three separate international treaties: the London (1934) Act, the application of which has been frozen since 01/01/2010, the Hague (1960) Act and the Geneva (1999) Act. Each Act has a different set of legal provisions, which are independent of one another.

International registrations designating the European Union are governed by the Geneva Act.

Unlike the Madrid 'Protocol Relating to the Madrid Agreement Concerning the International Registration of Marks', neither the Geneva Act nor the CDR provides for procedures for converting or transforming an international registration into Community or national designs or into designations of Member States party to the Hague System, or for replacing Community or national designs by an international registration designating the contracting party in question.

12.1.2 Procedure for filing international applications

12.1.2.1 Particularities

Another difference with the Madrid System is that the Geneva Act does neither allow nor require an international registration to be based on a previously filed Community or national design. The Office can only be a 'designated office', not an 'office of origin'. International applications must therefore be filed directly with the International Bureau (Article 106b CDR).

The Geneva Act and the Common Regulations under the 1999 Act and the 1960 Act of the Hague Agreement ('CR') contain specific rules, which may differ from those applicable to 'direct filings' of Community designs, that is, applications filed directly with the Office or via the central industrial property office of a Member State or, in Benelux countries, the Benelux Office for Intellectual Property (BOIP) (see paragraph 2.2.1 above). These specific rules relate, in particular, to entitlement to file an international application, the contents of an international application, fees, deferment of publication, the number of designs that may be included in a multiple application (up to 100), representation before the International Bureau and the use of languages (an international application must be in English, French, or Spanish).

12.1.2.2 Deferment of publication

An international application may contain a request that publication of the design, or of **all** the designs contained in a multiple application, be deferred. The Geneva Act does

not allow deferment of publication to be requested for only some of the designs contained in a multiple application (Article 11 of the Geneva Act).

The period of deferment of publication for an international application designating the European Union is 30 months from the filing date or, where priority is claimed, the priority date. The application will be published at the end of this 30-month period, unless the holder submits a request for earlier publication to the International Bureau (Article 11 of the Geneva Act).

The procedure described in paragraph 6.2.5 above does **not** apply as the Office is not responsible for publishing international registrations designating the European Union.

12.1.2.3 Fees

Three types of fees⁶ must be paid for an international application designating the European Union, namely:

- a basic fee
- a publication fee
- an individual designation fee, that is, EUR 62 per design, converted into Swiss francs (Article 106c CDR; Article 1a to the Annex of the CDFR; Rule 28 CR).

12.1.3 Examination carried out by the International Bureau

When it receives an international application, the International Bureau checks that it complies with the prescribed **formal** requirements, such as those relating to the quality of the reproductions of the design(s) and the payment of the required fees. The applicant is informed of any deficiency, which must be corrected within the prescribed time limit of three months, failing which the international application is considered to be abandoned.

Where an international application complies with the prescribed formal requirements, the International Bureau records it in the International Register and (unless deferment of publication has been requested) publishes the corresponding registration in the 'International Designs Bulletin'. Publication takes place electronically on the website of the World Intellectual Property Organization ('WIPO') and contains all relevant data concerning the international registration, including a reproduction of the design(s).

The International Bureau notifies the international registration to all designated offices, which then have the option of refusing protection on substantive grounds.

12.2 The role of the Office as designated office

It will be explained below how international registrations are dealt with by the Office from notification by the International Bureau through to the final decision to accept or refuse the designation of the European Union.

The main steps before the Office as designated office are:

⁶ See www.wipo.int/hague/en/fees.

- receipt of the international registration designating the European Union;
- examination of the grounds for non-registrability.

12.2.1 Receipt of the international registration designating the European Union

Communications between the Office and the International Bureau are by electronic means (Article 43(3) CDIR).

12.2.2 Grounds for non-registrability

Once the international registration designating the European Union has been notified to the Office by the International Bureau, the rules laid down under Title XIa CDR and Article 11a CDIR (Examination of grounds for refusal) apply (Article 106a(1) CDR).

12.2.2.1 Compliance with the definition of a design, public policy and morality

An international registration may not be refused on the grounds of non-compliance with **formal** requirements, since such requirements are to be considered as already satisfied following examination by the International Bureau.

The Office limits its examination to the two grounds for non-registrability (Article 11a CDIR). An international application will be refused if a design does not correspond to the definition in Article 3(a) CDR or if it is contrary to public policy or accepted principles of morality (Article 9 CDR) (see paragraph 4 above).

The examination of grounds for non-registrability for international registrations will be carried out as if the design(s) had been applied for directly with the Office. The time limits and other general procedural aspects governing said examination are the same as those that apply in the case of design applications filed directly at the Office (see Introduction, paragraph 1.2.3, and paragraph 4.3 above).

12.2.2.2 Time limits

The Office must inform the International Bureau of any refusal of protection within **six months** of publication of the international registration on the WIPO website (Article 11a(1) CDIR).

A preliminary refusal must be reasoned and state the grounds on which refusal is based, and the holder of the international registration must be given an opportunity to be heard (Article 106e(1) and (2) CDR).

Thus, within two months of the date of receipt of the notification of provisional refusal by the international registration holder, the latter will be given the opportunity to renounce the international registration, to limit the international registration to one or some of the designs for the European Union or to submit observations (Article 11a(2) CDIR).

The International Bureau will forward the notification of provisional refusal to the holder (or to its representative before WIPO if applicable). The holder must reply direct to the Office or, if applicable, through his representative (see paragraph 12.2.2.4 below).

For time-limit extensions, see Introduction, paragraph 1.2.3.

12.2.2.3 Languages

An international application must be filed in English, French or Spanish (Rule 6(1) CR). The recording and publication of the international registration will indicate the language in which the international application was received by the International Bureau (Rule 6(2) CR). In practice, this language can be identified from the product indication (INID code 54): the first language used in the product indication is the language in which the international application was received by the International Bureau. The indications given in the other two languages are translations provided by the International Bureau (Rule 6(2) CR).

The language in which the international application was received by the International Bureau will be the first language of the EU designation and will therefore become the language of the examination proceedings (Article 98(1) and (3) CDR).

In all communications with the International Bureau, the Office will therefore use the language in which the international registration was filed.

If the holder wishes to use a different Office language, it must supply a translation into the language in which the international registration was filed, within one month of the date of submission of the original document (Article 98(3) CDR; Article 81(1) CDIR). If no translation is received within this time limit, the original document is deemed not to have been received by the Office.

12.2.2.4 Professional representation

The holder may, if representation is mandatory under Article 77(2) CDR (see paragraph 2.5 above), be requested to appoint, within two months, a professional representative before the Office in accordance with Article 78(1) CDR (Article 11a(3) CDIR).

If the holder fails to appoint a representative within the specified time limit, the Office will refuse protection of the international registration (Article 11a(4) CDIR).

12.2.2.5 Renunciation and limitation

Where the holder renounces the international registration or limits it to one or some of the designs for the European Union, it must inform the International Bureau by way of recording procedure in accordance with Article 16(1)(iv) and (v) of the Geneva Act. The holder can inform the Office by submitting a corresponding statement (Article 11a(6) CDIR).

12.2.2.6 Grant of protection

Where the Office finds no grounds for refusing protection or where a preliminary refusal is withdrawn, the Office must inform the International Bureau accordingly without delay.

12.2.2.7 Refusal

Where the holder does not submit observations that satisfy the Office within the specified time limit or does not withdraw the application, the Office will confirm its decision refusing protection for the international registration. If the refusal concerns only some of the designs contained in a multiple international registration, the Office will refuse the latter only insofar as those designs are concerned (Article 11(3) CDIR).

There is no legal provision in the CDR or CDIR allowing an applicant to request an amendment of the design in order to overcome an objection concerning an international registration. On the other hand, an applicant may renounce the designation of the European Union by addressing WIPO directly, who will then notify the Office.

The holder of the international registration has the same remedies available to it as it would have had if it had filed the design(s) in question directly with the Office. The ensuing procedure takes place solely at Office level. An appeal against a decision to refuse protection must be submitted by the holder to the Boards of Appeal, within the time limit and in accordance with the conditions set out in Articles 55 to 60 CDR and Articles 34 to 37 CDIR (Article 11a(5) CDIR). The International Bureau is not involved in this procedure at all.

Once the decision to refuse or accept the international registration is final, a final notification will be sent to the International Bureau, indicating whether the design(s) has/have been finally refused or accepted.

Where the final refusal relates to only some of the designs contained in a multiple application, the notification to the International Bureau will indicate which designs have been refused and which accepted.

12.3 Effects of international registrations

If no refusal is notified by the Office within six months of the publication of the international registration on the WIPO website, or if a notice of preliminary refusal is withdrawn, the international registration will, from the date of registration granted by the International Bureau, as referred to in Article 10(2) of the Geneva Act (Article 106a(2) CDR), have the same effect as if it had been applied for with, and registered by, the Office.

International registrations can be subject to invalidity proceedings under the same conditions and procedural rules as 'direct filings' (Article 106f CDR; see the Guidelines on the Examination of Design Invalidation Applications). Since the language of filing of an international registration designating the European Union is necessarily an Office language, an application for a declaration of invalidity against such an international registration must be filed in this language.

The Office will notify the holder or their representative direct of any request for a declaration of invalidity. The holder must reply direct to the Office or, if applicable, through a representative who is on the Office's list in accordance with Article 78 CDR (see paragraph 2.5 above).

Where the Office declares the effects of an international registration invalid in the territory of the European Union, it must inform the International Bureau of its decision as soon as the latter becomes final (Article 106f(2) CDR; Article 71(3) CDIR).

The particularities of the procedures governing the renewal of international registrations and records of changes of name, transfers, renunciation or limitation of certain designs, for any or all of the designated contracting parties, are dealt with in the Guidelines Concerning Proceedings before the Office on Renewal of Registered Community Designs and at paragraphs 11.2.2 to 11.2.4 (Articles 16 and 17 of the Geneva Act; Article 22a CDIR).

13 Enlargement and the Registered Community Design

This section discusses the rules relating to the accession of new Member States to the European Union and the consequences thereof for applicants for, and holders of, registered Community designs.

Ten new Member States joined the European Union on 01/05/2004 (Czech Republic, Estonia, Cyprus, Latvia, Lithuania, Hungary, Malta, Poland, Slovenia and Slovakia), two on 01/01/2007 (Bulgaria and Romania) and one on 01/07/2013 (Croatia), bringing the number of Member States up to 28.

Article 110a CDR contains provisions relating to enlargement as regards registered Community designs. These provisions were inserted in the CDR when the EU was enlarged in 2004 and remain applicable for successive enlargements. The only modification to the text of the CDR is the addition of the names of the new Member States.

As far as registrability and validity of Community designs are concerned, the effects of the enlargement of the European Union on registered Community design rights are the following.

13.1 The automatic extension of the Community design to the territories of the new Member States

Pursuant to Article 110a(1) CDR, the effects of all Community design rights filed before 01/05/2004, 01/01/2007 or 01/07/2013 extend automatically to the territories of the Member States that acceded on those dates (Article 110a(1) CDR).

Extension is automatic in the sense that it does not have to undergo any administrative formality and does not give rise to any extra fees. Moreover, it cannot be opposed by the Community design holder or any third party.

13.2 Other practical consequences

13.2.1 Filing with national offices

As from the enlargement date, a Community design application may also be filed through the industrial property office of a new Member State.

13.2.2 Professional representation

As from the accession date, applicants (as well as other parties to proceedings before the Office) who have their seat or domicile in a new Member State no longer need to be represented by a professional representative. As from the accession date, professional representatives from a new Member State may be entered on the list of professional representatives maintained by the Office pursuant to Article 78 CDR and may then represent third parties before the Office.

13.2.3 First and second language

Since 01/01/2004 there have been nine new official EU languages, namely Czech, Estonian, Latvian, Lithuanian, Hungarian, Maltese, Polish, Slovak and Slovenian. A further two languages (Bulgarian and Romanian) were added on 01/01/2007⁷ and a further one (Croatian) on 01/07/2013.

These languages may be used as the first language only for Community design applications filed on or after the accession date concerned.

13.2.4 Translation

Community design applications with a filing date prior to the accession date, or existing Community design registrations, will neither be translated into, nor republished in the language of the new Member State(s). Community design applications filed after the accession date will be translated and published in all official EU languages.

13.3 Examination of grounds for non-registrability

The Office limits its examination of the substantive protection requirements to only two grounds for non-registrability (Article 47(1) CDR). An application will be refused if the design does not correspond to the definition provided for at Article 3(a) CDR or if it is contrary to public policy or to accepted principles of morality (Article 9 CDR) (see paragraph 4 above).

An application for a registered Community design cannot be refused on the basis of any of the grounds for non-registrability listed in Article 47(1) CDR if these grounds become applicable merely because of the accession of a new Member State (Article 110a(2) CDR).

⁷ For Irish, see paragraph 2.4

Whether a Community design is in conformity with Article 3 CDR or complies with public order and accepted principles of morality is normally assessed without reference to any particular national or linguistic context.

However, where a Community design contains an offensive word element in a language which, as a result of the accession of a new Member State, becomes an official language of the European Union after the date of filing, the absolute ground of refusal provided for under Article 9 CDR does not apply.

13.4 Immunity against cancellation actions based on grounds of invalidity which become applicable merely because of the accession of a new Member State

13.4.1 General principles

Community designs filed or registered before 01/05/2004, 01/01/2007 or 01/07/2013 will not be cancelled on the basis of grounds for invalidity that exist in one of the Member States acceding to the European Union on those dates if the ground for invalidity only became opposable as from the accession date in question (Article 110a(3) CDR). This is an expression of the need to respect acquired rights.

Not all grounds of invalidity set out in Article 25(1) CDR may become ‘applicable merely because of the accession of a new Member State’.

13.4.1.1 Grounds of invalidity that are applicable independently of the enlargement of the EU

The accession of a new Member State has no effect on the applicability of the following four grounds for invalidity. Article 110a(3) CDR therefore does not offer any protection against their application to Community designs filed before 01/05/2004, 01/01/2007 or 01/07/2013 respectively.

Non-visibility and functionality

The non-visibility of a Community design applied to a part of a complex product and the restrictions applying to features of a design that are solely dictated by technical function or the requirements of interconnection, are grounds of invalidity that must be evaluated on the basis of the design itself and not of a factual situation that exists in any given Member State (Article 25(1)(b) CDR read in combination with Article 4 and 8 CDR).

Novelty and individual character

Under normal circumstances, lack of novelty or individual character of a Community design will not be affected by enlargement of the EU (Article 25(1)(b) CDR read in combination with Article 5 and 6 CDR).

The disclosure of a design prior to the filing or priority date of a Community design can destroy the latter’s novelty or individual character, even if such disclosure took place in a country before the date of its accession to the EU. The sole requirement is that such disclosure could ‘reasonably have become known in the normal course of business in

the circles specialised in the sector concerned operating in the Community' (Article 7(1) CDR).

Entitlement to the Community design

The fact that the holder is not entitled to the Community design as a result of a court decision is another ground for invalidity that is not affected by enlargement (Article 25(1)(c) CDR). Article 14 CDR does not impose any nationality requirement for the person claiming to be entitled to the Community design, nor does it require that the court decision originates from a court located in a Member State.

Improper use of one or more of the elements listed in Article 6ter of the Paris Convention

The invalidity ground of improper use of one or more of the elements listed in Article 6ter of the Paris Convention is not affected by enlargement of the EU either. There is no requirement for the sign of which use is prohibited to come from a Member State (Article 25(1)(g) CDR).

13.4.1.2 Grounds of invalidity resulting from enlargement of the EU

A Community design filed on or before 30/04/2004, 31/12/2006 or 30/06/2013 respectively cannot be invalidated on the basis of the four grounds of invalidity referred to below where any of these grounds becomes opposable as a result of the accession of a new Member State on those dates (Article 110a(3) CDR).

Conflict with a prior design right protected in a new Member State (Article 25(1)(d) CDR)

A Community design filed before the date of accession of a Member State cannot be invalidated on the basis of a conflict with an earlier design that has enjoyed protection in the new Member State since a date prior to the filing or priority date of the Community design but that was disclosed to the public at a later date.

Use of an earlier distinctive sign (Article 25(1)(e) CDR)

A Community design filed before the date of accession of a Member State cannot be invalidated on account of the use of a distinctive sign that has enjoyed protection in the new Member State since a date prior to the filing or priority date of the Community design.

Unauthorised use of a work protected under the copyright law of a Member State (Article 25(1)(f) CDR)

A Community design filed before the date of accession of a Member State cannot be invalidated on account of the non-authorized use of a work that has been protected by the copyright law of the new Member State since a date prior to the filing or priority date of the Community design.

Improper use of signs, emblems, coats of arms, other than those covered by Article 6ter of the Paris Convention (Article 25(1)(g) CDR)

A Community design filed before the date of accession of a Member State cannot be invalidated on account of the improper use of signs, emblems or coats of arms, other than those covered by Article 6ter of the Paris Convention, which are of particular public interest for the new Member State.

Public policy and morality

A Community design filed before the date of accession of a new Member State cannot be invalidated on account that it is contrary to public policy or morality in the territory of that new Member State.

13.4.2 Effects of a priority claim

Community designs with a filing date on or after 01/05/2004, 01/01/2007 or 01/07/2013 respectively may be invalidated on the basis of the four grounds mentioned above.

This applies even if the priority date of the Community design in question precedes the relevant accession date. The priority right does not protect the Community design holder against any change in the law that is applicable to the validity of its design.

***GUIDELINES FOR EXAMINATION OF
REGISTERED COMMUNITY DESIGNS***

***EUROPEAN UNION
INTELLECTUAL PROPERTY OFFICE
(EUIPO)***

***RENEWAL OF REGISTERED COMMUNITY
DESIGNS***

Table of Contents

1. Introduction.....	3
2. Fraud Warning	3
2.1. Private companies sending misleading invoices.....	3
2.2. Renewal by unauthorised third persons.....	4
2.3. Contact.....	4
3. Term of Protection.....	4
4. Notification of Expiry of Registration	4
5. Fees and Other Formal Requirements for the Request for Renewal	5
5.1 Persons who may submit a request for renewal	5
5.2 Content of the request for renewal.....	6
5.3 Languages	6
5.4 Fees	7
5.5 Time limits	7
5.5.1 Six months period for renewal before expiry (basic period)	7
5.5.2 Six months grace period following expiry (grace period)	8
5.6 Means of payment	8
6 Procedure before the Office	9
6.1 Competence.....	9
6.2 Examination of formal requirements.....	9
6.2.1 Observance of time limits	9
6.2.2 Compliance with formal requirements	11
6.3 Items not to be examined.....	11
6.4 Alteration	12
6.5 Restitutio in integrum	12
7 Entries in the Register.....	12
8 Date of Effect of Renewal or Expiry	13
9 Renewal of International Design Registrations Designating the European Union.....	13

1. Introduction

There are two ways of applying for a registered Community design: either (i) via a 'direct filing' at the Office or a national Office (Article 35 et seq. CDR) or (ii) via an international registration filed with the International Bureau of the World Intellectual Property Organisation and designating the European Union (Article 106a et seq. CDR).

The purpose of the Guidelines is to explain how, in practice, the requirements of the Community Design Regulation¹ (CDR), the Community Design Implementing Regulation² (CDIR) and the Fees Regulation³ (CDFR) are applied by the Office in respect of renewal procedures relating to 'direct filings' of Community designs (see paragraphs 3 to 8 below). The Guidelines are not intended to, and cannot, add to or subtract from the legal contents of the Regulations.

Paragraph 9 below makes reference to the relevant instruments applicable to the renewal of international registrations designating the European Union.

2. Fraud Warning

2.1. Private companies sending misleading invoices

The Office is aware that users in Europe are receiving an increasing amount of unsolicited mail from companies requesting payment for trade mark and design services such as renewal.

A list of letters from firms or registers, which users have complained are misleading, is published on the Office website. Please note that these services are not connected with any official trade mark or design registration services provided by IP Offices or other public bodies within the European Union such as the EUIPO.

If you receive a letter or invoice please check carefully what is being offered to you, and its source. Please note that the **EUIPO never sends invoices to users or letters requesting direct payment for services** (see the Guidelines, Part A, General Rules, Section 3, Payment of fees, cost and charges).

¹ [Council Regulation \(EC\) No 6/2002 of 12 December 2001 on Community Designs](#), as amended by Council Regulation No 1891/2006 of 18 December 2006 amending Regulations (EC) No 6/2002 and (EC) No 40/94 to give effect to the accession of the European Community to the Geneva Act of the Hague Agreement concerning the international registration of industrial designs

² [Commission Regulation \(EC\) No 2245/2002 of 21 October 2002 implementing Council Regulation \(EC\) No 6/2001 on Community designs](#), as amended by Commission Regulation (EC) No 876/2007 of 24 July 2007 amending Regulation (EC) No 2245/2002 implementing Council Regulation (EC) No 6/2002 on Community designs following the accession of the European Community to the Geneva Act of the Hague Agreement concerning the international registration of industrial designs

³ [Commission Regulation \(EC\) No 2246/2002 of 16 December 2002 on the fees](#), as amended by Commission Regulation (EC) No 877/2007 of 24 July 2007 amending Regulation (EC) No 2246/2002 concerning the fees payable to the Office for Harmonization in the Internal Market (Trade Marks and Designs) following the accession of the European Community to the Geneva Act of the Hague Agreement concerning the international registration of industrial designs

2.2. Renewal by unauthorised third persons

The Office is also aware that fraudsters have targeted the e-renewal module, applying for renewal without proprietors' consent and thus blocking renewal via the module for persons legitimately authorised to renew in this way. The technical block is designed to prevent a renewal being paid for twice. If, when you file a request for e-renewal, you discover that the mark is 'blocked' because renewal has already been requested, please contact the Office.

2.3. Contact

If you have any doubts or detect any new cases, please check with your legal advisers or contact us by telephone on +34 965 139 100 or by e-mail at information@oami.europa.eu

3. Term of Protection

Articles 12, 38 CDR Article 10 CDIR
--

The term of protection of a registered Community design (RCD) is five years from the **date of filing** of the application (Article 12 CDR).

The date of filing of the application is determined according to Article 38 CDR and Article 10 CDIR (see the Guidelines concerning Applications for Registered Community Designs, Section 2, 'Allocation of a filing date').

Registration may be renewed for one or more periods of 5 years each, up to a total of 25 years from the date of filing.

4. Notification of Expiry of Registration

Article 13(2) CDR Article 21 CDIR

At least six months before the expiry of the registration, the Office will inform:

- the holder of the Community design and
- any person having a registered right in respect of the Community design

that the registration is approaching expiry. Persons having a registered right include the holders of a registered licence, the proprietors of a registered right *in rem*, the creditors of a registered levy of execution or the authority competent to act on behalf of the proprietor in insolvency procedures.

Failure to give such information does not affect the expiry of the registration and does not involve the responsibility of the Office.

5. Fees and Other Formal Requirements for the Request for Renewal

Article 22(8), Articles 65, 66, 67, Article 68(1) (e) CDIR

The general rules concerning communications to the Office apply, which means that the request for renewal may be submitted as follows:

- by electronic means available on the EUIPO Website (e-renewal). Entering the name and surname in the appropriate place on the electronic form is deemed to be a signature. Using e-renewal offers advantages such as the receipt of immediate electronic confirmation of the renewal request automatically or the use of the renewal manager feature to complete the form quickly for as many registered Community designs as needed.
- by transmitting a signed original form by fax, mail, or by any other means. A standard form is available on the EUIPO website. Forms have to be signed but annexes need not be.

It is strongly recommended to renew Community design registrations by electronic means ('e-renewal'). The process of electronic renewal automatically checks and validates the requirements laid down in the CDIR.

A single application for renewal may be submitted for two or more designs, whether or not part of the same multiple registration, upon payment of the required fees for each of the designs, provided that the Community design holders or the representatives are the same in each case.

For Fees see paragraph 5.4, for Compliance with formal requirements see paragraph 6.2.2.

5.1 Persons who may submit a request for renewal

Article 13(1) CDR

Requests for renewal may be submitted by:

- the registered proprietor of a Community design;
- the successor in title where a Community design has been transferred, with effect from when the request for registration of the transfer was received by the Office;
- a person authorised by the proprietor of a Community design to do so. Such a person may, for instance, be a registered licensee, a non-registered licensee or any other person who has obtained the proprietor's authorisation to renew the Community design;
- a representative acting on behalf of any of the above persons.

Persons obliged to be represented before the Office pursuant to Article 77(2) CDR can submit a request for renewal directly.

When the renewal request is submitted by a person other than the registered proprietor, an authorisation will have to exist in its favour; however, it does not need to be filed with the Office unless the Office requests it. For example, if the Office receives fees from two different sources, the owner will be contacted in order to know which

person is authorised to file the renewal request. Where no reply is received from the owner, the Office will validate the payment that reached the Office first (see, by analogy, judgment of 12/05/2009, T-410/07, 'Jurado', paras 16-24).

5.2 Content of the request for renewal

Article 22(1) CDIR

A request for renewal of registration must contain the following:

- The name of the person requesting renewal (that is, the Community design proprietor or an authorised person or representative; see paragraph 5.1). If the Office has allocated an ID number to the applicant for renewal, it is sufficient to indicate this number.
- The registration number of the registered Community design. This number is always composed of a nine-digit root, followed by a four-digit ending (e.g. XXXXXXXXX-YYYY).
- In the case of a multiple registration, an indication that renewal is requested for all the designs covered by the multiple registration or, if the renewal is not requested for all the designs, an indication of those for which it is requested.

Where the Community design holder has appointed a representative, the name of the representative should be mentioned. If the representative is already on record, the indication of their ID number is sufficient. If a new representative is appointed in the request for renewal, their name and address must be given in accordance with Article 1(1)(e) CDIR

Payment alone can constitute a valid request for renewal providing such payment timely reaches the Office and contains the name of the payer, the registration number of the Community design and the indication 'renew'. In such circumstances no further formalities need be complied with (see *The Guidelines Concerning Proceedings Before The Office for Harmonization In The Internal Market (Trade Marks And Designs) Part A, General Rules, Section 3, Payment of Fees, Costs and Charges*).

5.3 Languages

Article 80(b) CDIR

The request for renewal may be filed in any of the five languages of the Office. This language becomes the language of the renewal proceedings. However, when the request for renewal is filed by using the form provided by the Office pursuant to Article 68 CDIR, such a form may be used in any of the official languages of the European Union, provided that the form is completed in one of the languages of the Office, as far as textual elements are concerned.

5.4 Fees

Article 13(3) CDR Article 22(2) (a), (b) CDIR Article 7(1) CDFR Annex to the CDFR, points 11 and 12
--

The fees payable for the renewal of a Community design consist of:

- a renewal fee, which, where several designs are covered by a multiple registration, is proportionate to the number of designs covered by the renewal;
- any additional fee applicable for late payment of the renewal fee or late submission of the request for renewal.

The amount of the renewal fee, per design, whether or not included in a multiple registration, is as follows:

- for the first period of renewal: EUR 90
- for the second period of renewal: EUR 120
- for the third period of renewal: EUR 150
- for the fourth period of renewal: EUR 180.

The fee must be paid within a period of six months ending on the last day of the month in which protection ends (see paragraph 5.5 below).

The fee may be paid within a further period of six months following the last day of the month in which protection ends, provided that an additional fee of 25% of the total renewal fee is paid (see paragraph 5.5.2 below).

When the payment is made by transfer or payment to an Office bank account, the date on which payment is deemed to have been made is the date on which the amount is credited to the Office's bank account.

5.5 Time limits

Article 13 CDR Articles 22(2), 58(1) CDIR
--

5.5.1 Six months period for renewal before expiry (basic period)

The request for renewal and the renewal fee must be submitted within a period of six months ending on the last day of the month in which protection ends (hereinafter referred to as 'the basic period').

If this time limit expires on a day on which the Office is not open for receipt of documents or on which ordinary mail is not delivered in Alicante, it will extend until the first day thereafter on which the Office is open for receipt of documents and on which ordinary mail is delivered. Other exceptions are provided for at Article 58(2) and (4) CDIR.

For example, where the Community design has a filing date of 01/04/2013, the last day of the month in which protection ends will be 30/04/2018. Therefore, a request for renewal must be introduced and the renewal fee paid between 01/11/2017 and

30/04/2018 or, where this is a Saturday, Sunday or other day on which the Office is closed or does not receive ordinary mail, the first following working day on which the Office is open to the public and does receive ordinary mail.

5.5.2 Six months grace period following expiry (grace period)

Where the relevant time limit is not met, the request for renewal may still be submitted and the renewal fee may still be paid within a further period (hereinafter the 'grace period') of six months following the last day of the month in which the basic period ends, provided that an additional fee of 25% of the total renewal fee is paid within the grace period (see Article 13.3 CDR). Thus, renewal will only be successfully effected if payment of all fees (renewal fees and additional fees for late payment, where applicable) reaches the Office within the grace period.

In the above example, the grace period during which a request for renewal may still be introduced upon payment of the renewal fee plus the additional fee is counted from the day after 30/04/2018, namely from 01/05/2018, and ends on 31/10/2018 or, if 31/10/2018 is a Saturday, Sunday or other day on which the Office is closed or does not receive ordinary mail, the first following working day on which the Office is open to the public and does receive ordinary mail. This applies even if, in the above example, 30/04/2018 was a Saturday or Sunday; the rule that a time limit to be observed vis-à-vis the Office is extended until the next working day applies only once and to the end of the first period, not to the starting date of the grace period.

Fees which are paid before the start of the first six-month period will not, in principle, be taken into consideration and will be refunded.

5.6 Means of payment

Article 5 CDFR

The admissible means of payment are bank transfers, credit cards (only if renewal is applied for electronically via the e-renewal module) and deposits in current accounts held with the Office. Payment cannot be made by cheque. Fees and charges must be paid in euros.

Where the Community design proprietor has a current account at the Office, the fee will be debited automatically from the account once a request for renewal is filed. Unless different instructions are given, the renewal fee will be debited on the last day of the six-month time limit provided for in Article 13(3) CDR, i.e. on the last day of the month in which protection ends.

If a request for renewal is filed late (see paragraph 5.5.2 above), the debit will take place, unless different instructions are given, with effect from the day on which the belated request was filed, and will be subject to a surcharge.

Where the request is submitted by a professional representative within the meaning of Article 78 CDR, who represents the Community design proprietor, and the representative has a current account before the Office, the renewal fee will be debited from the representative's current account.

Payment may also be made by the other persons identified in paragraph 5.1 above.

Payment by debiting a current account held by a third party requires explicit authorisation from the holder of the current account that the account can be debited for the fee in question. In such cases, the Office will check if authorisation has been given. If none has been given, a letter will be sent to the renewal applicant asking them to submit the authorisation to debit the third party account. In such cases, payment is considered to be made on the date the Office receives the authorisation.

Where the fees (renewal fees and, where applicable, additional fee for late payment) have been paid, but the registered Community design is not renewed (i.e. where the fee has been paid only after expiry of the grace period, or where the fee paid amounts to less than the basic fee plus the fee for late payment/late submission of the request for renewal, or where certain other deficiencies have not been remedied; see paragraph 6.2.2 below), the fees in question will be refunded.

6 Procedure before the Office

6.1 Competence

Article 104 CDR

The Operations Support Department is responsible for treating renewal requests and entering them in the Register.

6.2 Examination of formal requirements

Examination of a request for renewal is limited to formalities as follows.

6.2.1 Observance of time limits

(a) Before expiry of the basic period

Article 13 CDR Article 22(3) CDIR Article 5, Article 6(1) CDFR
--

Where the request for renewal is filed and the renewal fee paid within the basic period, the Office will record the renewal, provided the other conditions laid down in the CDR and CDIR are fulfilled.

Where no request has been filed before the basic period expires, but the Office receives a payment of the renewal fee that contains the minimum indications (name of the person requesting the renewal and the registration number of the renewed Community design(s)), this will constitute a valid request and no further formalities will need to be complied with.

However, where no request for renewal has been filed but a renewal fee has been paid that does not contain the minimum indications (name of the person requesting the

renewal and the registration number of the renewed Community design(s)), the Office will invite the Community design proprietor to submit a request for renewal and pay, where applicable, the additional fee for late submission of the request for renewal. A letter will be sent out as early as possible after receipt of the fee, so as to enable the request to be filed before the additional fee becomes due.

Where a request has been submitted within the basic period, but the renewal fee has not been paid or has not been paid in full, the Office will invite the person requesting renewal to pay the renewal fee or the remaining part thereof along with the additional fee for late payment.

If the request for renewal is filed by a person authorised by the proprietor of the Community design, the proprietor of the Community design will receive a copy of the notification.

(b) Before expiry of the grace period

Article 13(3) CDR Article 22(4) CDIR

Where a request has been submitted within the additional grace period, but the renewal fee has not been paid or has not been paid in full, the Office will invite the person requesting renewal to pay the renewal fee or the remaining part thereof along with the additional fee for late payment.

Renewal will be effected only if payment of all fees (renewal fees and additional fee for late payment) is made or considered to be made before expiry of the grace period (see paragraphs 5.5 and 5.6 above).

(c) Situation where the proprietor or representative holds a current account

The Office will not debit a current account unless there is an express request for renewal. It will debit the account of the person performing the action (the Community design proprietor, the representative thereof or a third person).

Where the request is filed within the basic period, the Office will debit the renewal fees without any surcharge.

Where the request is filed within the additional period, the Office will debit the renewal fee along with a 25% surcharge (see paragraph 5.4).

6.2.2 Compliance with formal requirements

Article 22, and Article 40 CDIR

Where a request for renewal does not comply with formal requirements (see paragraph 5 Fees and Other Formal Requirements for the Request for Renewal) but such deficiencies can be remedied, the Office will invite the renewal applicant to remedy the deficiencies within a time limit of two months. This time limit applies even if the additional period has already expired.

If the request for renewal is filed by a person authorised by the proprietor of the Community design, the proprietor of the Community design will receive a copy of the notification.

Where a request for renewal has been submitted by two different persons claiming to be authorised by the proprietor of the Community design, the Office will seek clarification on who is the authorised person by contacting the proprietor directly.

Where the deficiencies are not remedied before the relevant time limit expires, the Office will proceed as follows:

- If the deficiency lies in the fact that there is no indication of the designs of a multiple registration to be renewed, and the fees paid are insufficient to cover all the designs for which renewal is requested, the Office will establish which designs the amount paid is intended to cover. In the absence of any other criteria for determining which designs are intended to be covered, the Office will take the designs in the numerical order in which they are represented. The Office will check that the registration has expired for all designs for which the renewal fees have not been paid in part or in full.
- In the case of other deficiencies, the Office will check that the registration has expired and issue a notification of loss of rights to the proprietor or their representative or, where applicable, to the person requesting renewal and any person recorded in the Register as having rights in the Community design(s).

The proprietor may apply for a decision on the matter under Article 40(2) CDIR within two months.

Where the renewal fees have been paid but the registration is not renewed, those fees will be refunded.

6.3 Items not to be examined

No examination will be carried out on renewal in respect of the registrability of the design or correct classification of the design's products. Nor will a registration be reclassified that was registered in accordance with an edition of the Locarno Classification no longer in force at the time of renewal. Such reclassification will not even be available at the proprietor's request.

6.4 Alteration

Article 12(2) CDIR

As a matter of principle, since the representation of a Community design may not be altered after the filing of the application, the submission of additional views or withdrawal of some views at the time of renewal is not accepted.

Other changes that do not alter the representation of the Community design itself (changes of name, address, etc.), and which the owner wishes to have recorded in the Register when the registration is renewed, must be communicated separately to the Office according to the applicable procedures (see the Guidelines concerning Applications for Registered Community Designs, Section 10). They will be included in the data recorded at renewal only if they are recorded in the Register no later than the date of expiry of the Community design registration.

6.5 Restitutio in integrum

Article 67 CDR Article 15 of the Annex to the CDFR

A party to proceedings before the Office may be reinstated in their rights (restitutio in integrum) if they were unable to observe a time limit vis-à-vis the Office in spite of all due care having been taken as required by the circumstances, provided that the failure to observe the time limit had the direct consequence, by virtue of the provisions of the Regulations, of causing the loss of a right or means of redress.

Restitutio in integrum is only available upon application to the Office and is subject to a fee (EUR 200).

The application must be made within two months from removal of the cause of non-compliance but in any event not later than one year after expiry of the unobserved time limit. The act omitted must be completed within the same period.

In the case of failure to submit a request for renewal or to pay the renewal fee, the time limit of one year starts on the day on which the protection ends (basic period), not on the date of expiry of the further period of six months (additional period).

7 Entries in the Register

Article 13(4) CDR Article 40, Article 22(6), Article 69(3)(m), Article 69(5), Article 71 CDIR

Where the request for renewal complies with all the requirements, the renewal will be entered in the Register.

The Office will notify the Community design proprietor or their representative of the renewal of the design, its entry in the Register and the date from which renewal takes effect.

The Office, where it has determined that the registration has expired, will inform the Community design proprietor or their representative and any person recorded in the Register as having rights in the Community design of the expiry of the registration and its cancellation from the Register.

The proprietor may apply for a decision on the matter under Article 40(2) CDIR within two months.

8 Date of Effect of Renewal or Expiry

Article 13(4) CDR Article 22(6), Article 56 CDIR

Renewal will take effect from the day following that on which the existing registration expires.

Where the Community design has expired and is cancelled from the Register, the cancellation will take effect from the day following that on which the existing registration expired.

9 Renewal of International Design Registrations Designating the European Union

Article 17 of the Geneva Act of the Hague Agreement Concerning the International Registration of Industrial Designs (the 'Geneva Act') Article 12 CDR
--

International registrations designating the European Union are protected for an initial term of 5 years from the date of the international registration, and may be renewed for additional terms of 5 years, up to a total term of 25 years from the date of registration.

Pursuant to Article 11a of the Annex to the CDFR, the individual renewal fees for an international registration designating the European Union, per design, are as follows:

- for the first period of renewal: EUR 31
- for the second period of renewal: EUR 31
- for the third period of renewal: EUR 31
- for the fourth period of renewal: EUR 31.

International registrations must be renewed directly at the International Bureau of WIPO in compliance with Article 17 of the Geneva Act (Article 22a CDIR). The Office will not deal with renewal requests or payments of renewal fees in respect of international registrations.

The procedure for the renewal of international marks is managed entirely by the International Bureau, which sends out the notice for renewal, receives the renewal fees and records the renewal in the International Register. When international registrations designating the EU are renewed, the International Bureau also notifies the Office.

***GUIDELINES FOR EXAMINATION OF
REGISTERED COMMUNITY DESIGNS***

***EUROPEAN UNION
INTELLECTUAL PROPERTY OFFICE
(EUIPO)***

***REGISTERED COMMUNITY DESIGNS
EXAMINATION OF DESIGN INVALIDITY
APPLICATIONS***

Table of Contents

1	Purpose	5
2	Introduction – General Principles Applying to Invalidation Proceedings	5
2.1	Duty to state reasons	5
2.2	Right to be heard	6
2.3	Scope of the examination carried out by the Invalidation Division.....	6
2.4	Compliance with time limits	7
3	Filing of an Application	8
3.1	Form of the application	8
3.2	Scope of the application	8
3.3	Language of proceedings	8
3.4	Identification of the application.....	9
3.5	<i>Locus standi</i> of the applicant	9
3.6	Representation of the application	10
3.6.1	When representation is mandatory	10
3.6.2	Who may represent	10
3.7	Identification of the contested Community design	10
3.8	Lapsed registrations	11
3.9	Statement of grounds, facts, evidence and arguments	11
3.9.1	Statement of grounds	11
3.9.2	Facts, evidence and arguments	12
3.9.3	Admissibility in respect of one of the grounds relied on	13
3.10	Signing the application	13
3.11	Means of filing	14
3.12	Payment of fees	14
3.13	Treating deficiencies	15
3.14	Communication to the holder	15
3.15	Participation of an alleged infringer	15
4	Adversarial Stage of the Proceedings	16
4.1	Exchange of communications	16
4.1.1	Observations by the holder.....	16
4.1.1.1	Generalities	16
4.1.1.2	Request for proof of use of an earlier trade mark	17
4.1.2	Translation of the holder's observations.....	17
4.1.3	Scope of defence.....	17
4.1.4	Reply by the applicant	18
4.1.4.1	Generalities	18
4.1.4.2	Translation of the applicant's reply	19

4.1.4.3	Submission of evidence of use of an earlier trade mark	19
4.1.5	End of exchange of observations	20
4.1.6	Extension of time limits and suspension	20
4.1.6.1	Extension of time limits	20
4.1.6.2	Suspension	20
4.1.7	Taking of evidence	21
4.1.8	Oral proceedings	22
4.2	Examination	23
4.2.1	Commencement of examination	23
4.2.2	Examination of the grounds for invalidity	23
5	The Different Grounds for Invalidity	24
5.1	Not a design	24
5.1.1	Living Organisms	24
5.1.2	Ideas and methods of use	25
5.2	Lack of entitlement	25
5.3	Technical function	25
5.3.1	Rationale	25
5.3.2	Examination	26
5.3.3	Alternative shapes	27
5.4	Designs of interconnections	27
5.5	Lack of novelty and individual character	27
5.5.1	Disclosure of prior design	27
5.5.1.1	General principles	27
5.5.1.2	Official publications	28
5.5.1.3	Exhibitions and use in trade	29
5.5.1.4	Disclosures derived from the internet	30
5.5.1.5	Statements in writing, sworn or affirmed (affidavits)	31
5.5.1.6	Insufficient disclosure	31
5.5.1.7	Disclosure to a third person under explicit or implicit conditions of confidentiality	32
5.5.1.8	Disclosure within the priority period	32
5.5.1.9	Grace period	33
5.5.2	Assessment of novelty and individual character	33
5.5.2.1	Common principles	34
5.5.2.2	Novelty	36
5.5.2.3	Individual character	36
5.6	Conflict with a prior design right	42
5.7	Use of an earlier distinctive sign	43
5.7.1	Distinctive sign	43
5.7.2	Use in a subsequent design	43
5.7.3	Substantiation of the application under Article 25(1)(e) CDR (earlier distinctive signs)	44
5.7.4	Examination by the Invalidity Division	44
5.8	Unauthorised use of a work protected under the copyright law of a Member State	45
5.8.1	Substantiation of the application under Article 25(1)(f) CDR (earlier copyright)	45
5.8.2	Examination by the Invalidity Division	46
5.9	Partial invalidity	46

5.10	Grounds of invalidity that become applicable merely because of the accession of a new Member State.....	47
6	Termination of the Proceedings.....	47
6.1	Termination of proceedings without a decision on the merits.....	47
6.2	Decision on costs.....	48
6.2.1	Cases where a decision on costs must be taken	48
6.2.2	Cases where a decision on costs is not to be taken	48
6.2.2.1	Agreement on costs	48
6.2.2.2	Apportionment of costs.....	48
6.2.2.3	Fixing of costs	49
6.3	Correction of mistakes and entry in the Register	50
6.3.1	Correction of mistakes.....	50
6.3.2	Entry into the Register	50
7	Appeal.....	50
7.1	Right to appeal	50
7.2	Interlocutory revision.....	50

1 Purpose

The purpose of these Guidelines is to explain how, in practice, the requirements of the Community Design Regulation¹ (CDR), the Community Design Implementing Regulation² (CDIR), and the Fees Regulation³ (CDFR) are applied by the Invalidity Division of EUIPO from the receipt of an application for a declaration of invalidity of a Community design ('application') up to the point of closure of the invalidity proceedings. Their purpose is also to ensure consistency among the decisions taken by the Invalidity Division and to ensure coherent practice in the treatment of the files. These Guidelines are not intended to, and cannot, add to or subtract from the legal contents of the Regulations.

2 Introduction – General Principles Applying to Invalidity Proceedings

2.1 Duty to state reasons

The decisions of the Invalidity Division must state the reasons on which they are based (Article 62 CDR). The reasoning must be logical and it must not disclose internal inconsistencies.

The obligation to state reasons has two purposes: to allow interested parties to know the justification for the measure taken so as to enable them to protect their rights and to enable the next instance to exercise its power to review the legality of the decision. Moreover, the obligation to state reasons is an essential procedural requirement, as distinct from the question whether the reasons given are correct, which goes to the substantive legality of the contested measure (judgment of 27/06/2013, T-608/11, Instruments for writing, EU:T:2013:334, § 67-68 and the case-law cited therein).

The Invalidity Division must rule on each head of claim submitted by the parties (judgment of 10/06/2008, T-85/07, Gabel, EU:T:2008:186, § 20). However, the Invalidity Division is not required to give express reasons for its assessment of the value of each argument and each piece of evidence presented to it, in particular where it considers that the argument or evidence in question is unimportant or irrelevant to the outcome of the dispute (see by analogy judgment of 15/06/2000, C-237/98 P, ECLI:EU:C:2000:321, § 51). It is sufficient if the Invalidity Division sets out the facts and legal considerations having decisive importance in the context of the decision (judgment of 12/11/2008, T-7/04, Limoncello, EU:T:2008:481, § 81).

¹ [Council Regulation \(EC\) No 6/2002 of 12 December 2001 on Community Designs](#), by Council Regulation No 1891/2006 of 18 December 2006 amending Regulations (EC) No 6/2002 and (EC) No 40/94 to give effect to the accession of the European Community to the Geneva Act of the Hague Agreement concerning the international registration of industrial designs.

² [Commission Regulation \(EC\) No 2245/2002 of 21 October 2002 implementing Council Regulation \(EC\) No 6/2001 on Community designs](#), as amended by Commission Regulation (EC) No 876/2007 on 24 July 2007 amending Regulation (EC) No 2245/2002 implementing Council Regulation (EC) No 6/2002 on Community designs following the accession of the European Community to the Geneva Act of the Hague Agreement concerning the international registration of industrial designs.

³ [Commission Regulation \(EC\) No 2246/2002 of 16 December 2002 on the fees](#), as amended by Commission Regulation (EC) No 877/2007 of 24 July 2007 amending Regulation (EC) No 2246/2002 concerning the fees payable to the Office for Harmonization in the Internal Market (Trade Marks and Designs) following the accession of the European Community to the Geneva Act of the Hague Agreement concerning the international registration of industrial designs.

Whether the reasoning satisfies those requirements is a question to be assessed with reference not only to its wording, but also to its context and the legal rules governing the matter in question (judgment of 07/02/2007, T-317/05, *Guitar*, EU:T:2007:39, § 57).

The Invalidation Division will apply the principles explained in the Guidelines, Part A, General Rules, Section 2, General Principles to be Respected in the Proceedings, paragraph 1, Adequate reasoning.

2.2 Right to be heard

The decisions of the Invalidation Division will 'be based only on reasons or evidence on which the parties concerned have had an opportunity to present their comments' (Article 62 CDR).

To that end, the Invalidation Division will invite the parties to file observations on communications from the other parties or issued by itself as often as necessary (Article 53(2) CDR).

The right to be heard covers all the factual and legal evidence that form the basis for the act of taking the decision, but it does not apply to the final position that the Invalidation Division intends to adopt (judgment of 20/04/2005, T-273/02, *Calpico*, EU:T:2005:134, § 64-65).

The Invalidation Division may base its analysis on facts arising from practical experience generally acquired from the marketing of general consumer goods that are likely to be known by anyone and are, in particular, known by the informed users of those goods; in such a case the Invalidation Division is not obliged to give examples or evidence of such a practical experience.

The Invalidation Division will apply the principles explained in the Guidelines, Part A, General Rules, Section 2, General Principles to be Respected in the Proceedings, paragraph 2, The right to be heard.

2.3 Scope of the examination carried out by the Invalidation Division

In invalidation proceedings, the examination carried out by the Invalidation Division is restricted to the facts, evidence and arguments provided by the parties (Article 63(1) CDR). However, the Invalidation Division must weigh the facts, evidence and arguments, adjudicate on their conclusiveness, and thereafter draw legal inferences from them without being bound by the points of agreement between the parties. Alleged facts that are not supported by evidence are not taken into account (decision of 22/04/2008, ICD 4 448).

Facts, evidence and arguments are three different items not to be confused with each other. For instance, the date of disclosure of a prior design is a fact. Evidence of that fact could be the date of publication of a catalogue showing the prior design together with evidence proving that the catalogue had been made available to the public before the date of filing or the priority date of the contested Community design. The applicant's argument could be that the prior design forms an obstacle to the novelty of the contested Community design given the similar overall impression they produce on the informed user. Whether a Community design lacks novelty or not is not a fact but a

legal question to be decided by the Invalidity Division on the basis of the facts, evidence and arguments submitted by the parties.

Expert reports or expert opinions and other statements in writing fall within the means of evidence referred to in Article 65(1)(c) and (f) CDR. However, the fact that they are procedurally admissible does not automatically mean that the statement is credible and will serve as proof of the facts to be proven. Rather, such statements must be critically examined as to the accuracy and correctness of the information, as well as whether they come from an independent source and/or are fettered or supported by written information (decision of 22/04/2008, ICD 4 448).

Moreover, the legal criteria for applying a ground for invalidity are naturally part of the matters of law submitted for examination by the Invalidity Division. A matter of law may have to be ruled on by the Invalidity Division, even when it has not been raised by the parties, if it is necessary to resolve that matter in order to ensure a correct application of the CDR. The Invalidity Division will thus examine *ex officio* such matters of law that can be assessed independently of any factual background for the purpose of allowing or dismissing the parties' arguments, even if they have not put forward a view on those matters (see by analogy judgment of 01/02/2005, T-57/03, Hooligan, EU:T:2005:29, § 21). Such matters of law will include, inter alia, the definition of the informed user and the degree of freedom of the designer within the meaning of Article 6 CDR.

2.4 Compliance with time limits

The Invalidity Division may disregard facts or evidence that are not submitted in due time by the parties concerned (Article 63(2) CDR).

Parties are reminded that they must file the facts and evidence on which they rely in due time and within the time limits set by the Invalidity Division. Parties that fail to observe the time limits run the risk that the evidence may be disregarded. Parties have no unconditional right to have facts and evidence submitted out of time to be taken into consideration by the Invalidity Division.

Where the Invalidity Division exercises its discretion under Article 63(2) CDR, it must state reasons why the late facts and evidence are admissible or not, taking into consideration whether the material that has been produced late is, on the face of it, likely to be relevant to the outcome of the invalidity proceedings brought before it and, second, whether the stage of the proceedings at which that late submission takes place and the circumstances surrounding it do not argue against such matters being taken into account (judgment of 13/03/2007, C-29/05 P, Arcol, EU:C:2007:162, § 42-44).

Where a party files a submission by fax, it should indicate on the accompanying letter whether a confirmation copy (which, as the case may be, may contain documents in colours) has been sent. Both the fax and the confirmation copy should reach the Office within the time limit set. In accordance with Article 63(2) CDR, the Office may take into account a confirmation copy that was not submitted in due time by the parties concerned.

If the time limit is still running, the party may request an extension of the time limit pursuant to Article 57(1) CDR.

For general information on time limits and continuation of proceedings, see the Guidelines, Part A, General Rules, Section 1, Means of Communication, Time Limits.

As regards incomplete or illegible forms, see paragraph 3.11 below.

However, applicants should be reminded that the one-month time limit, specified under paragraph 3.11 below, only applies to the filing of a request for a declaration of invalidity (for which no time limit is set by the Office), and not to other procedural steps for which the Office sets a time limit.

3 Filing of an Application

3.1 Form of the application

For filing an application (Article 52 CDR) the Office provides a form (Article 68(1)(f) CDIR) that can be downloaded from the Office's website.

The use of the form is strongly recommended (Article 68(6) CDIR), in order to facilitate the processing of the application and to avoid errors.

The application, including the supporting documents, should be submitted in duplicate, in order that one set can be kept in the archive of the Office while the other is sent to the holder without incurring a loss of quality due to copying. If an application is submitted in one set only, the Invalidation Division may invite the applicant to file a second set within a period of one month, or two months if the applicant does not have its domicile or its principal place of business or an establishment within the European Union (Article 57(1) CDIR).

3.2 Scope of the application

In invalidation proceedings, the relief sought by the applicant can only be the declaration of invalidity of the contested Community design as registered (Article 25 CDR).

Where contested Community designs are part of a multiple registration, each of them must be contested individually and identified by reference to their full registration number (Article 37(4) CDR). A single application (and a common statement of grounds) may concern more than one Community design of a multiple registration. In such a case, the fee for the application must be paid for each contested Community design. However, for the sake of clarity the Office recommends that separate applications be lodged for each contested Community design.

3.3 Language of proceedings

The language regime in design invalidation proceedings is not identical to that governing trade mark proceedings.

The language used in filing the application for registering the contested Community design (language of filing) is the language of the invalidation proceedings (language of proceedings), provided the language of filing is one of the five languages of the Office (Article 98 CDR; Article 29 CDIR).

If the language of filing is not one of the five languages of the Office, the language of proceedings is the second language indicated in the application for the contested Community design (Article 98(4) CDR; Article 29(1) CDIR).

The application for a declaration of invalidity must be filed in the language of proceedings. Where the application is not filed in the language of proceedings, the Invalidity Division will notify the applicant requesting it to file a translation within a period of two months from the date of receipt of the notification. Where the applicant does not comply with the request, the application will be rejected as inadmissible (Article 30(1) CDIR).

The parties to the invalidity proceedings may agree on a different language of proceedings provided it is an official language of the European Union. Information as regards the agreement must reach the Office within a period of two months after the holder has been notified of the application. Where the application was not filed in that language, the applicant must file a translation of the application in that language within one month from the date when the Office was informed of the agreement (Article 98(5) CDR; Article 29(6) CDIR).

For the linguistic regime applicable to the supporting documents, see paragraph 3.9.2 below.

3.4 Identification of the application

The application must contain an indication of the name and address of the applicant (Article 28(1)(c) CDIR).

Where the information given in the application does not make it possible to identify the applicant unambiguously, and the deficiency is not remedied within two months of the Invalidity Division's request in that regard, the application must be rejected as inadmissible (Article 30(1) CDIR).

3.5 *Locus standi* of the applicant

Any natural or legal person, as well as a public authority empowered to do so, may submit an application for a declaration of invalidity of a Community design to the Invalidity Division based on Article 25(1)(a) and (b) CDR (Article 52(1) CDR).

However, where the ground for invalidity is the violation of an earlier right, within the meaning of Article 25(1)(c) to (f) CDR, or an improper use of official emblems, within the meaning of Article 25(1)(g) CDR, the admissibility of an application for a declaration of invalidity requires the applicant to be entitled to the earlier right or to be concerned by the use of the official emblem, as the case may be (Article 52(1) CDR). Entitlement will be examined on the basis of the international, national law or the law of the European Union that governs the earlier right or official emblem in question.

For substantiation of the applicant's entitlement, see paragraph 3.9.2 below.

3.6 Representation of the application

3.6.1 When representation is mandatory

As a matter of principle, the rules governing representation in European Union trade mark proceedings apply *mutatis mutandis* to invalidity proceedings for Community designs (see the Guidelines, Part A, General Rules, Section 5, Professional Representation).

Persons having their domicile or their principal place of business or a real and effective industrial or commercial establishment in the European Union are not required to be represented in any proceedings before the Office.

Where the applicant does not have its domicile or its principal place of business or a real and effective industrial or commercial establishment in the European Union, it must be represented by a representative, otherwise the applicant will be requested to appoint a representative within a time limit of two months. Where the applicant does not comply with the request, the application will be rejected as inadmissible (Article 77(2) CDR; Article 30(1) and Article 28(1)(c) CDIR).

In examining whether an applicant has a real and effective industrial or commercial establishment in the European Union, the Invalidity Division follows the guidance of the Court of Justice of 22/11/1978, C-33/78, Somafer SA, EU:C:1978:205, § 12 ('The concept of branch, agency or other establishment implies a place of business that has the appearance of permanency, such as the extension of a parent body, has a management and is materially equipped to negotiate business with third parties'). Proof that an applicant has a real and effective industrial or commercial establishment in the European Union may consist inter alia of articles of incorporation, annual reports, statements in writing, and other business documents.

3.6.2 Who may represent

Only a legal practitioner or a professional representative who fulfils the requirements of Article 78(1) CDR can represent third parties before the Office.

A natural or legal person whose domicile, principal place of business, or real and effective industrial or commercial establishment is in the European Union may be represented before the Office by an employee. Employees of such a legal person may also represent another legal person having neither its domicile nor its principal place of business nor a real and effective industrial or commercial establishment within the European Union, provided there exist economic connections between the two legal persons (Article 77(3) CDR).

3.7 Identification of the contested Community design

An application for a declaration of invalidity must contain the registration number of the contested Community design and the name and address of its holder, as entered in the Register (Article 28(1)(a) CDIR).

Where the information given by the applicant does not make it possible to identify the contested Community design unambiguously, the applicant will be requested to supply such information within a period of two months. If the applicant does not comply with this request, the application will be rejected as inadmissible (Article 30(1) CDIR).

3.8 Lapsed registrations

A Community design may be declared invalid even after the Community design has lapsed or has been surrendered (Article 24(2) CDR).

Where the contested Community design has lapsed or has been surrendered on or before the date of filing of the application, the applicant will be requested to submit evidence, within a period of two months, that it has a legal interest in the declaration of invalidity. Where the applicant does not comply with the request, the application is rejected as inadmissible (Article 30(1) CDIR) (decision of 16/06/2011, ICD 8 231).

For instance, legal interest is established where the applicant proves that the holder of the contested Community design has taken steps with the view to invoke rights under the contested Community design against it.

Where the contested Community design has lapsed or has been surrendered in the course of the invalidity proceedings, the applicant will be asked to confirm whether it maintains its application within a period of two months and, if so, to submit reasons in support of its request to obtain a decision on the merits of the case.

3.9 Statement of grounds, facts, evidence and arguments

The application must include an indication of the grounds on which the application is based (Article 52(2) CDR; Article 28(1)(b)(i) CDIR) together with a reasoned statement stating the facts, evidence and arguments in support of those grounds (Article 28(1)(b)(vi) CDIR).

3.9.1 Statement of grounds

Where the applicant uses the form provided by the Office (Article 68(1)(f) CDIR), the indication of the grounds relied on is made by ticking one or several boxes in the field 'Grounds'. The Invalidation Division will examine an application in the light of all grounds put forward in the reasoned statement of grounds, even if the corresponding boxes in the form used to lodge the action were not ticked.

Where the applicant does not use the form provided by the Office, an indication of the relevant subsection of Article 25(1) CDR, such as 'ground of Article 25(1)(a) CDR', is sufficient to establish admissibility of the application in respect of the statement of grounds.

Where the application does not make it possible to identify unambiguously the ground(s) on which the application is based, the applicant will be requested to provide further specifications in this respect within a period of two months. Where the applicant does not comply with the request, the application will be rejected as inadmissible (Article 30(1) CDIR).

Grounds for invalidity other than those specifically relied on in the application will be considered inadmissible when subsequently put forward before the Invalidation Division.

The Office strongly recommends that all grounds for invalidity be put forward in one single application. Where separate applications are lodged against the same contested Community design and based on different grounds, the Invalidity Division may deal with them in one set of proceedings. The Invalidity Division may subsequently decide to no longer deal with them in this way (Article 32(1) CDIR).

3.9.2 Facts, evidence and arguments

The applicant must indicate the facts, evidence and arguments in support of the ground(s) on which the application is based (Article 28(1)(b)(vi) CDIR).

Where the applicant claims that the contested Community design lacks novelty or individual character (Article 25(1)(b) CDR), the application must contain a representation of the prior design(s) that could form an obstacle to the novelty or individual character of the contested Community design, as well as documents proving the disclosure of the prior design(s) (Article 7 CDR; Article 28(1)(b)(v) CDIR).

Where the applicant claims that the holder is not entitled to the contested Community design (Article 25(1)(c) CDR), the application must contain particulars showing that the applicant is entitled to the contested Community design by virtue of a court decision (Article 28(1)(c)(iii) CDIR).

Where the applicant claims that the contested Community design is in conflict with a prior design (Article 25(1)(d) CDR), the application must contain a representation and particulars identifying the prior design. Furthermore, the application must contain evidence proving that the applicant is the holder of the prior design as a ground for invalidity (Article 28(1)(b)(ii) CDIR).

Where the applicant claims that the contested Community design violates an earlier right, namely that it makes unauthorised use of a distinctive sign (Article 25(1)(e) CDR) or a work protected by copyright in a Member State (Article 25(1)(f) CDR), the application must contain a representation and particulars identifying the distinctive sign or the work protected by copyright. Furthermore, the application must contain evidence proving that the applicant is the holder of the earlier right in question (Article 28(1)(b)(iii) CDIR).

Where the earlier right is **registered**, a distinction is made depending on whether the earlier design or trade mark is a RCD or an EUTM. If the earlier right is a RCD or an EUTM, the applicant does not have to submit any documents. The examination of the substantiation will be done for the data contained in the database of the Office. In all other cases, the applicant must provide the Office with evidence of the filing and registration of the earlier design or registered distinctive sign. The following documents will be accepted to substantiate the existence of an earlier design: (1) certificates issued by the appropriate official body, (2) extracts from official databases (see the Guidelines, Part C, Opposition, Section 1, Procedural Matters, paragraph 4.2.3.2, Extracts from official databases), (3) extracts from official bulletins of the relevant national offices and WIPO.

Where the earlier right is **unregistered**, this condition will be considered to be complied with for the purpose of examining the admissibility of the application, where the applicant submits evidence that the earlier distinctive sign or the earlier work protected by copyright law has been used or disclosed, as the case may be, under the applicant's name before the date of filing or the priority date of the Community design (see

paragraphs 5.7.3 and 5.8.1 below for substantiation of the proprietorship of the earlier right relied on under Article 25(1)(e) and (f) CDR).

Where the applicant claims that the contested Community design makes improper use of any of the items listed in Article 6ter of the Paris Convention or of badges, emblems and escutcheons other than those covered by Article 6ter and which are of particular interest in a Member State (Article 25(1)(g) CDR), the application must contain a representation and particulars of the relevant item and particulars showing that the application is filed by the person or entity concerned by the improper use (Article 28(1)(b)(iv) CDIR).

Where the indications required above are missing, and the deficiency is not remedied by the applicant within a period of two months following a request of the Invalidation Division, the application will be rejected as inadmissible (Article 30(1) CDIR).

Where the evidence in support of the application is not filed in the language of proceedings, the applicant must on its own motion submit a translation of that evidence into that language within two months of the filing of such evidence (Article 29(5) CDIR). The question of whether certain parts of the supporting documents may be considered irrelevant for the application, and therefore not translated, is a matter for the discretion of the applicant. In cases where a translation is not submitted, the Invalidation Division will disregard the text portions of the evidence that are not translated and base its decision solely on the evidence before it that has been translated into the language of proceedings (Article 31(2) CDIR).

Documents in support of an application should be listed in a schedule of annexes appended to the application itself. As best practice, the schedule of annexes should indicate, for each document annexed, the number of the annex (Annex A.1, A.2, etc.), a short description of the document (e.g. 'letter') followed by its date, the author(s) and the number of pages, and the page reference and paragraph number in the pleading where the document is mentioned and its relevance is described.

The documents annexed to a pleading must be paginated. This is to ensure that all pages of the annexes have been duly scanned and communicated to the other parties.

3.9.3 Admissibility in respect of one of the grounds relied on

An application based on more than one ground of invalidity is admissible if the requirements regarding admissibility are satisfied for at least one of these grounds.

3.10 Signing the application

The application for a declaration of invalidity must be signed by the applicant or its representative if it has one (Article 65(1) CDIR).

Where the signature is missing, the Invalidation Division will request the applicant to remedy the deficiency within two months. If the applicant does not comply with the request, the application will be rejected as inadmissible (Article 30(1) CDIR).

3.11 Means of filing

An application for a declaration of invalidity may be filed with the Office by post, personal delivery, or fax (Article 65 CDIR). Electronic filing of applications will be allowed by a subsequent decision of the President once the technical means are available.

Where a communication received by fax is incomplete or illegible, or where the Invalidity Division has reasonable doubts as to the accuracy of the transmission, the Invalidity Division will inform the sender accordingly and will call upon him/her, within a time limit to be specified by the Invalidity Division, to retransmit the original by fax or to submit the original. Where that request is complied with within the time limit specified, the date of the receipt of the retransmission or of the original will be deemed to be the date of the receipt of the original communication. Where the request is not complied with within the time limit specified, the communication will be deemed not to have been received (Article 66(2) CDIR).

Transmission by fax is not recommended for applications for a declaration of invalidity, in particular where lack of novelty and/or lack of individual character are claimed, because the quality of the representation of the prior design(s) may be deteriorated by fax transmission and colour information will be lost.

Where an application is transmitted by fax, the Office recommends that the applicant submits two sets of the original within one month from the date of transmission of the fax. The Invalidity Division will then forward one set to the holder. Where the applicant does not subsequently submit original documents after a fax transmission, the Invalidity Division will proceed with the documents before it.

It is the applicant's responsibility to ensure that the features of earlier designs or other rights, as they appear in the fax received by the Invalidity Division, are sufficiently visible and identifiable in order for the Invalidity Division to make its decision. An application will be dismissed as unsubstantiated if the faxed evidence of the prior designs, or of the earlier rights, without being totally illegible, is not of a sufficient quality allowing all the details to be discerned with a view to a comparison with the contested Community design (decision of 10/03/2008, R 0586/2007-3, Barbecues, § 23-26).

3.12 Payment of fees

The application for a declaration of invalidity will be deemed not to have been filed until the fee has been paid in full (Article 52(2) CDR; Articles 28(2) and 30(2) CDIR).

The methods of payment are via transfer to a bank account held by the Office (Article 5(1) CDFR) or, for current account holders, via current account. In the case of payment via a current account, the fee will be debited automatically from the applicant's current account upon receipt of the application. The date on which the amount of the payment is actually credited to the bank account of the Office will be considered to be the date of payment (Article 7(1) CDFR).

See the Guidelines, Part A, General Rules, Section 3, Payment of Fees, Costs and Charges for further reference.

Payment cannot be made by cheque.

Where the Invalidation Division finds that the fee has not been paid, it will notify the applicant requesting him/her to pay the fee within a period of two months after receipt of the notification. If the applicant does not comply with the request, the application is deemed not to have been filed and the applicant is informed accordingly. If the required fee is paid after the expiry of the time limit specified, it will be refunded to the applicant (Article 30(2) CDIR).

The date of payment of the fee determines the date of filing of the application of a declaration of invalidity (Article 52(2) CDR; Article 30(2) CDIR).

3.13 Treating deficiencies

Where the Invalidation Division finds the application inadmissible and the deficiency is not remedied within the specified time limit, the Invalidation Division will issue a decision rejecting the application as inadmissible (Article 30(1) CDIR). The fee will not be refunded.

3.14 Communication to the holder

The communication of an application for a declaration of invalidity to the RCD holder takes place only after this application has been found admissible (Article 31(1) CDIR). This communication constitutes as such a decision on the admissibility, rather than a simple measure of organisation of procedure. This decision can be appealed together with the final decision (Article 55(2) CDR).

The decision on admissibility may, however, be withdrawn, in accordance with the general principles of administrative and procedural law, if irregularities are detected *ex officio* by the Office, within a reasonable time, or by the RCD holder in its first observations (Article 31(1) CDIR), and if the applicant for invalidity fails to remedy such irregularities within the time limit prescribed by the Office (Article 30 CDIR) (see Article 68 CDR and, by analogy, judgment of 18/10/2012, C-402/11 P, Redtube, EU:C:2012:3835, § 59).

Where the Invalidation Division does not reject the application as inadmissible, the application is communicated to the holder and a time limit of two months for submitting observations in response to the application is notified (see below under paragraph 4.1.1, Observations by the holder).

3.15 Participation of an alleged infringer

As long as no final decision has been taken by the Invalidation Division, any third party that proves that proceedings for infringement based on the contested Community design have been instituted against it can join as a party in the invalidity proceedings (Article 54 CDR; Article 33 CDIR).

The alleged infringer must file its request to be joined as a party within three months of the date on which the infringement proceedings were instituted. Unless proof is submitted by the holder that another date should be retained according to the national law in question, the Invalidation Division will assume that proceedings are 'instituted' on

the date of service of the action to the alleged infringer. The alleged infringer must submit evidence in respect of the date of service of the action.

Any third party who proves that (i) the right holder of the Community design has requested that it cease an alleged infringement of the design and that (ii) the third party in question has instituted proceedings for a court ruling that it is not infringing the registered Community design (if actions for declaration of non-infringement of Community designs are permitted under national law) may also join as a party in the invalidity proceedings (Article 54 and Article 81(b) CDR).

The request to be joined as a party must be filed in a written reasoned statement and it will not be deemed to have been filed until the invalidity fee has been paid. The rules explained above in paragraphs 3.1 to 3.13 will apply to the alleged infringer (Article 54(2) CDR; Article 33 CDIR).

4 Adversarial Stage of the Proceedings

4.1 Exchange of communications

4.1.1 Observations by the holder

As a matter of principle, the rules governing representation in European Union trade marks proceedings apply *mutatis mutandis* to invalidity proceedings for Community designs (see the Guidelines, Part A, General Rules, Section 5, Professional Representation).

When representation is mandatory and the holder is no longer represented, the Invalidity Division will invite the holder to appoint a representative. If the holder does not do so, procedural statements made by the holder will not be taken into account, and the invalidity request will be dealt with on the basis of the evidence that the Invalidity Division has before it.

4.1.1.1 Generalities

The holder's observations will be communicated to the applicant without delay (Article 31(3) CDIR).

Documents in support of observations should be listed in a schedule of annexes (see paragraph 3.9.2 above).

The holder should submit its observations (including the supporting documents) in duplicate, so that one set can be kept in the archive of the Office and the other sent to the applicant. This is done to avoid a loss of quality in the observations material due to copying by the Office. Where the observations are submitted in one set only, the Invalidity Division may invite the holder to file a second set within a period of one month, or two months if the applicant does not have its domicile or its principal place of business or an establishment within the European Union (Article 57(1) CDIR).

Where the holder files no observations within the two-month time limit, the Invalidity Division will notify the parties that the written phase of the proceedings is closed and that it will take a decision on the merits on the basis of the evidence before it (Article 31(2) CDIR).

4.1.1.2 Request for proof of use of an earlier trade mark

A request for proof of use of an earlier trade mark during the period of five years preceding the date of the application for a declaration of invalidity may be submitted by the holder if the following cumulative conditions are complied with:

- the application is based on Article 25(1)(e) CDR;
- the earlier distinctive sign is a (European Union, international or national) trade mark having effect in the European Union which, on the date of the application for a declaration of invalidity, has been registered for not less than five years;
- the request for proof of use is submitted together with the holder's first submission in response to the application (judgments of 12/05/2010, T-148/08, Instruments for writing, EU:T:2010:190, § 66-72; 27/06/2013, T-608/11, Instruments for writing, EU:T:2013:334, § 87. See also decision of 15/11/2013, R 1386/2012-3, Cinturones, § 21).

'The date of the completion of the registration procedure' (Article 10(1) of Directive 2008/95/EC) that serves to calculate the starting point for the obligation of use for national and international registrations is determined by each Member State according to their own procedural rules (judgment of 14/06/2007, C-246/05, *Le Chef de Cuisine*, EU:C:2007:340, § 26-28). As regards European Union trade marks, that date is the date of registration (Article 15(1) of Council Regulation (EC) No 207/2009 of 26 February 2009 on the EU trade mark, hereafter 'EUTMR') as published in the European Union Trade Marks Bulletin (Rule 23(5) of Commission Regulation 2868/95 implementing the EUTMR, hereafter 'EUTMIR'). As regards international registrations designating the European Union, the relevant date is that of the second publication pursuant to Article 152(2) and Article 160 EUTMR.

4.1.2 Translation of the holder's observations

Where the language of proceedings is not the language of filing of the contested Community design, the holder may submit its observations in the language of filing (Article 98(4) CDR; Article 29(2) CDIR). The Invalidity Division will arrange to have those observations translated into the language of proceedings, free of charge, and will communicate the translation to the applicant without delay.

4.1.3 Scope of defence

The holder's observations must include an indication regarding the extent to which it defends the contested Community design. Where the holder does not give such an indication, it is assumed that it seeks maintenance of the Community design in the form as originally registered, i.e. in its entirety.

Where the holder requests to maintain the Community design in an amended form, its request must include the amended form. The amended form must comply with the requirements for protection, and the identity of the Community design must be retained. 'Maintenance' in an amended form may include registration accompanied by a partial disclaimer by the holder or entry in the Register of a court decision or a decision by the

Invalidation Division declaring the partial invalidity of the Community design (Article 25(6) CDR) (see paragraph 5.9 below).

The request to maintain the contested Community design in amended form must be submitted during the invalidity proceedings and before the end of the written phase. The applicant will be given the opportunity to comment on whether the Community design in its amended form complies with the requirements for protection and whether the identity of the Community design is retained. The decision on the maintenance of the Community design in an amended form will be included in the decision on the merits terminating the invalidity proceedings.

4.1.4 Reply by the applicant

4.1.4.1 Generalities

Where the parties' submissions allow the Invalidation Division to base its decision on the evidence before it, the Invalidation Division will notify the parties that the written phase of the proceedings is closed.

However, the applicant will be allowed to reply to the holder's observations within a time limit of two months (Article 53(2) CDR; Article 31(3) CDIR) in the following circumstances:

- where the holder's observations contain new facts, evidence and arguments that are prima facie relevant for a decision on the merits; or
- where the holder requests to maintain the Community design in an amended form; or
- where the holder requested proof of use of the earlier trade mark relied on under Article 25(1)(e) CDR.

Any reply from the applicant will be communicated to the holder (Article 31(4) CDIR). Where the applicant's reply is considered admissible, the holder will be invited to submit a rejoinder (Article 53(2) CDR).

Where the applicant does not reply within the specified time limit, the Invalidation Division will notify the parties that the written phase of the proceedings is closed and that it will take a decision on the merits on the basis of the evidence before it (Article 31(2) CDIR).

The subject matter of the proceedings must be defined in the application (see paragraphs 3.9 above). Reliance on additional earlier designs and/or rights is inadmissible when submitted at the belated procedural stage of the reply if the effect is to alter the subject matter of the proceedings (decision of 22/10/2009, R 0690/2007-3, Chaff cutters, § 44 et seq.). The admissibility of additional facts, evidence and arguments relating to earlier designs and/or rights already referred to in the application is subject to the discretionary powers conferred on the Invalidation Division under Article 63(2) CDR (see paragraph 2.4 above).

The applicant should submit its reply in duplicate, so that one set can be kept in the archive of the Office and the other can be sent to the holder. This is done to avoid a loss of quality due to copying. If a reply is submitted in one set only, the Invalidation Division may invite the applicant to file a second set within a period of one month, or

two months if the applicant does not have its domicile or its principal place of business or an establishment within the European Union (Article 57(1) CDIR).

4.1.4.2 Translation of the applicant's reply

Any reply of the applicant must be in the language of proceedings. Where the applicant has been invited to reply and its reply is not in the language of proceedings, the applicant must submit, on its own motion, a translation of its reply within one month of the date of the submission of the original reply (Article 81(1) CDIR). The Invalidation Division will not remind the applicant of its duty in this respect. Where the applicant submits the translation on time, it will be communicated to the holder. Where the applicant does not submit the translation on time, its reply will be deemed not to have been filed.

4.1.4.3 Submission of evidence of use of an earlier trade mark

Where the applicant is requested to submit evidence of use of its earlier trade mark, it must submit such evidence (i) in connection with the goods or services in respect of which this trade mark is registered, and which the applicant cites as justification for its application and (ii) in respect of the period of five years preceding the date of the application for a declaration of invalidity, unless there are proper reasons for non-use. Such reasons for non-use must be substantiated.

Evidence of use of an earlier mark must fulfil **all** the cumulative conditions imposed by Rule 22(3) EUTMR, that is, indications concerning **the place, time, extent and nature** of use of the earlier trade mark for the goods and services for which it is registered and on which the application is based.

Use of the trade mark in a form differing in elements that do not alter the distinctive character of the mark in the form in which it was registered is admissible (Article 5(C)2 of the Paris Convention).

Where the language of the documents submitted by the applicant is not the language of the proceedings, the Invalidation Division may require that a translation be supplied in that language, within one month, or two months if the applicant does not have its domicile or its principal place of business or an establishment within the European Union (Articles 81(2) and 57(1) CDIR).

In the absence of proof of genuine use of the earlier trade mark (unless there are proper reasons for non-use), or in the absence of a translation if so required by the Invalidation Division, the application for a declaration of invalidity will be rejected to the extent that it was based on Article 25(1)(e) CDR. If the earlier trade mark has been used in relation to only a part of the goods or services for which it is registered, it will, for the purpose of the examination of the application for a declaration of invalidity, be deemed to be registered in respect of only that part of the goods or services (see by analogy Articles 57(2) and (3) EUTMR).

When examining the evidence of use, the Invalidation Division will apply the principles explained in the Guidelines, Part C, Opposition, Section 6, Proof of Use.

4.1.5 End of exchange of observations

Where the parties' observations do not contain new facts, evidence or arguments that are prima facie relevant for a decision on the merits, the Invalidation Division will inform both parties that the written proceedings are closed and that a decision will be taken on the basis of the evidence before it (Article 53(2) CDR).

Facts, evidence or arguments submitted after notification to the parties that the written phase of the procedure is closed will be considered inadmissible, save in exceptional circumstances, for example, where the evidence was unavailable at an earlier stage or where a fact came to light in the course of the proceedings (Article 63(2) CDR, see paragraph 2.4 above).

4.1.6 Extension of time limits and suspension

4.1.6.1 Extension of time limits

Requests for an extension of a time limit by any of the parties have to be made before its expiry (Article 57(1) CDR).

As a general rule, a first request for extension of a time limit will be granted. Further extensions will not automatically be granted. In particular, the Invalidation Division may make the extension of a time limit subject to the agreement of the other party or parties to the proceedings (Article 57(2) CDR).

Reasons in support of any further request for extension must be submitted to the Invalidation Division. The request for an extension of the time limit must indicate the reasons why the **parties** cannot meet the deadline. The obstacles faced by the parties' **representatives** do not justify an extension (see, by analogy, order of 05/03/2009, C-90/08 P, *Corpo livre*, EU:C:2009:135, § 20-23).

The extension will not result in a time limit longer than six months (Article 57(1) CDR). Both parties are informed about any extension.

4.1.6.2 Suspension

The Invalidation Division will suspend the proceedings on its own motion after hearing the parties, unless there are special grounds for continuing the proceedings, where it has been brought to the attention of the Invalidation Division that the validity of the contested Community design is already in issue on account of a counterclaim before a competent national court and the national court does not stay its proceedings (Article 91(2) CDR).

The Invalidation Division may suspend the proceedings when it is appropriate in the circumstances, in particular:

- where the request for a declaration of invalidity is based on an earlier design or trade mark for which the registration process is pending, until a final decision is taken in those proceedings (Article 25(1)(d) and (e) CDR);
- where the request for a declaration of invalidity is based on an earlier design or trade mark, the validity of which is challenged in administrative or in court proceedings, until a final decision is taken in those proceedings;

- where the Invalidation Division receives a joint request for suspension signed by both parties with a view to reaching an amicable settlement (Article 31(5) CDR);
- where a number of applications for a declaration of invalidity have been filed relating to the same Community design, and where a preliminary examination reveals that the Community design may be invalid on the basis of one of these applications. The Invalidation Division will deal with this application first and it may suspend the other invalidation proceedings (Article 32(2) CDR).

The Invalidation Division has broad discretionary powers when deciding on the appropriateness of the suspension. The decision on the suspension must take into account the balance between the parties' respective interests, including the applicant's interest to obtain a decision within a reasonable period of time (see by analogy, judgment of 16/05/2011, T-145/08, Atlas, EU:T:2011:213, § 68-77).

The Invalidation Division will notify the parties of its decision to grant or refuse a suspension. Where a suspension is granted for a determined period, the Invalidation Division will indicate in its communication the date of resumption of the proceedings. The proceedings will resume the day after the expiry of the suspension. Where the Invalidation Division decides not to grant the suspension, reasons are given in support of this decision, either at the time of refusing the suspension or in the decision terminating the proceedings.

Where a suspension is granted for an undetermined period, the invalidation proceedings will be resumed when the parties inform the Invalidation Division that the event that justified the stay has occurred, or ceased to exist, as the case may be. The date of resumption will be indicated in the communication of the Invalidation Division or, in the absence of such indication, on the day following the date of that communication.

Where a time limit was running at the time of the suspension, the party concerned will be given two months from the date of resumption of the proceedings to submit its observations.

Where the suspension was requested jointly by the parties, the period will always be one year regardless of the period requested by the parties. Any party can bring an end to the suspension ('opting out'). It is immaterial whether the other party disagrees with this or has consented to it.

If one of the parties opts out, the suspension will end two weeks after informing the parties thereof. The proceedings will resume the day after. Where a time limit was running at the time of the suspension, the party concerned will be given two months from the date of resumption of the proceedings to submit its observations.

4.1.7 Taking of evidence

The parties may submit evidence in the form of documents and items of evidence, opinions by experts and witnesses, and/or statements in writing, sworn or affirmed or having a similar effect under the law of the State in which the statement is drawn up (Article 65(1) CDR).

Where a party offers evidence in the form of witness statements or expert opinions, the Invalidation Division will invite the party to provide the statement of the witness or the

opinion of the expert in writing, except where a hearing is considered expedient (Article 65 CDR; Articles 43 and 46 CDIR).

4.1.8 Oral proceedings

Oral proceedings may be held at the request of the Invalidation Division or of any of the parties (Article 64 CDR; Article 38(1) and Article 42 CDIR).

Where a party requests that they be held, the Invalidation Division enjoys broad discretionary powers as to whether oral proceedings are really necessary. A hearing will not be held when the Invalidation Division has before it all the information needed as a basis for the operative part of the decision on invalidity (decision of 13/05/2008, R 0135/2007-3, Automatic machines for games, § 14).

Where the Invalidation Division has decided to hold oral proceedings and to summon the parties, the period of notice may not be less than one month unless the parties agree to a shorter period.

Since the purpose of any oral proceedings is to clarify all points remaining to be settled before a decision on the merits is taken, it is appropriate that the Invalidation Division, in its summons, should draw the attention of the parties to the points that in its opinion need to be discussed. Insofar as the Invalidation Division considers that certain matters require it, and to facilitate the hearing, it may invite the parties to submit written observations or to produce evidence prior to the oral hearing. The period fixed by the Invalidation Division for the receipt of these observations will take account of the fact that these must reach the Invalidation Division within a reasonable period of time to enable them to be submitted to the other parties.

The parties may likewise produce evidence in support of their arguments on their own initiative. However, should such evidence have been produced at an earlier stage of the proceedings, the Invalidation Division will be the sole judge of the admissibility of these items of evidence, complying with the principle of hearing both parties where appropriate.

Oral proceedings, including delivery of the decision, are public, provided the contested Community design has been published, unless the admission of the public could entail a serious and unjustified disadvantage, in particular for a party to the proceedings. The parties are informed accordingly in the summons.

The parties will be provided with a copy of the minutes that contain the essentials of the oral proceedings and the relevant statements made by the parties (Article 46 CDIR).

The Invalidation Division will apply the principles explained in the Guidelines, Part A, General Rules, Section 2, General Principles to be Respected in the Proceedings, paragraph 5, Oral proceedings.

4.2 Examination

4.2.1 Commencement of examination

The Invalidation Division begins with the examination of the application as soon as the parties are informed that the written phase of the procedure is closed and that no further observations can be submitted (Article 53 CDR).

4.2.2 Examination of the grounds for invalidity

The grounds for declaring a Community design invalid are listed exhaustively in Article 25 CDR. An application for a declaration of invalidity based on a ground other than those listed in the CDR (e.g. a claim that the holder was acting in bad faith when applying for the registered Community design) will be rejected as inadmissible as far as the ground in question is concerned (judgment of 18/03/2010, T-9/07, Metal rappers, EU:T:2010:96, § 30-31).

More than one ground may be relied on in the application without entailing additional fees. Where the applicant uses the form supplied by the Office, it must tick the box corresponding to the ground(s) on which the application is based.

Each ground must be supported by its own set of facts, evidence and arguments.

Article 25(1)(b) CDR includes several grounds, namely the ground of failure to meet the requirements of Article 4 CDR (novelty, individual character and visibility of component parts of complex products), the grounds of Article 8(1) and (2) CDR (functionality and designs of interconnections), and the ground of Article 9 CDR (contrary to public policy or morality).

Where the 'Grounds' box in the application form corresponding to Article 25(1)(b) CDR is ticked, the Invalidation Division will determine which specific ground(s) are relied on by the applicant from the facts, evidence and arguments referred to in the reasoned statement of grounds, and will limit the scope of its examination of the application accordingly (decision of 17/04/2008, R 0976/2007-3, Radiators for heating, § 26).

The same applies to the 'Grounds' box in the application form corresponding to Article 25(1)(c), (d), (e), (f) or (g) CDR.

The Invalidation Division must examine an application in the light of all grounds put forward in the original statement of grounds, even if the corresponding boxes in the application form were not ticked. Therefore, where the applicant indicated in the statement of grounds that the contested Community design was 'not novel', that indication constitutes a valid statement of grounds even if the 'Grounds' box concerning the requirements of Articles 4 to 9 CDR was not ticked (decision of 02/08/2007, R 1456/06-3, Saucepan handle, § 10).

Where an applicant expressly challenges the novelty of a Community design and provides evidence of an earlier disclosure, it is assumed that it seeks a declaration of invalidity on the ground of Article 25(1)(b) CDR in conjunction with Article 4 CDR. Therefore, the Invalidation Division will also examine the individual character of the contested Community design (decision of 22/11/2006, R 0196/2006-3, Underwater motive device). Accordingly, if the applicant bases its application on a lack of individual

character, the Invalidation Division may examine the novelty of the contested Community design.

The applicant cannot raise new grounds for invalidity after the date of filing of the application. However, the applicant may file another application for a declaration of invalidity based on different grounds.

Where the application can be upheld on the basis of one of several grounds put forward by the applicant, the Invalidation Division will not take a decision on the others (decision of 15/12/2004, ICD 321). Where an application can be upheld on account of the existence of one of the earlier designs or rights relied on by the applicant, the remaining earlier designs or rights will not be examined (see by analogy judgment of 16/09/2004, T-342/02, Moser Grupo Media, S.L., EU:T:2004:268 and order of 11/05/2006, T-194/05, Teletel International, EU:T:2006:124).

5 The Different Grounds for Invalidation

5.1 Not a design

According to Article 25(1)(a) CDR, a Community design may be declared invalid if the design does not correspond to the definition under Article 3(a) CDR. This would be the case where the views of the Community design are inconsistent and represent different products (other than forming a 'set of products', see Article 3 CDR and the Guidelines, Examination of Applications for Registered Community Designs, Additional requirements regarding the reproduction of the design, paragraph 5.2.3, Sets of articles), or where the graphical representation consists of mere representations of nature (landscapes, fruits, animals etc.) that are not products within the meaning of Article 3(1)(b) CDR.

5.1.1. Living Organisms

A design that discloses the appearance of a living organism in its natural state, in principle, has to be refused. Even if the shape at issue deviates from that of the common corresponding living organism, the design should be refused if nothing suggests prima facie that the shape is the result of a manual or industrial process (see by analogy decision of 18/02/2013, R 0595/2012-3, Groente en fruit, § 11).



A Community design will not be declared invalid if it is apparent from the representation that the product does not show a living organism or if the indication of the product specifies that this product is artificial (see in particular Class 11-04 of the Locarno Classification).

5.1.2. Ideas and methods of use

The law relating to designs protects the appearance of the whole or a part of a product, but does not protect the underlying idea of a design (judgment of 06/06/2013, T-68/11, Watch-dials, EU:T:2013:298, § 72). Nor is the method of use or operation protected by a design (judgment of 21/11/2013, T-337/12, Sacacorchos, EU:T:2013:601, § 52).

5.2 Lack of entitlement

According to Article 25(1)(c) CDR, a Community design may be declared invalid if, by virtue of a court decision, the right holder is not entitled to the Community design under Article 14 CDR.

It is clear from the words ‘by virtue of a court decision’ in Article 25(1)(c) CDR that the Invalidation Division has no jurisdiction to determine who is entitled to a Community design under Article 14 CDR. Such jurisdiction belongs to any national court that is competent under Article 27, Articles 79(1) and (4) CDR in conjunction with Article 93 CDR. In the absence of a court decision, the Invalidation Division cannot declare the contested Community design invalid under Article 25(1)(c) CDR (decision of 11/02/2008, R 0064/2007-3, Loudspeaker, § 15).

Article 15(1) CDR, which deals with claims to become recognised as the legitimate holder of a Community design, is also irrelevant in relation to the ground of Article 25(1)(c) CDR.

Such a claim falls within the category of ‘actions relating to Community designs other than those referred to in Article 81 CDR’ and therefore lies within the jurisdiction of a national court under Article 93(1) CDR rather than within the competence of the Invalidation Division. This is confirmed by the wording of Article 27(3) CDR, which refers to such a claim being ‘brought before a court’.

5.3 Technical function

Article 8(1) CDR provides that ‘a Community design shall not subsist in features of appearance of a product that are solely dictated by its technical function’.

5.3.1 Rationale

‘Article 8(1) CDR denies protection to those features of a product’s appearance that were chosen exclusively for the purpose of allowing a product to perform its function, as opposed to features that were chosen, at least to some degree, for the purpose of enhancing the product’s visual appearance’, as was held by the 3rd Board of Appeal (decision of 22/10/2009, R 0690/2007-3, Chaff cutters, § 35 et seq.).

The fact that a particular feature of a product’s appearance is denied protection by Article 8(1) CDR does not mean that the whole design must be declared invalid, pursuant to Article 25(1)(b) CDR. The design as a whole will be invalid only if **all the essential features** of the appearance of the product in question were solely dictated by its technical function (decision of 29/04/2010, R 0211/2008-3, Fluid distribution equipment, § 36).

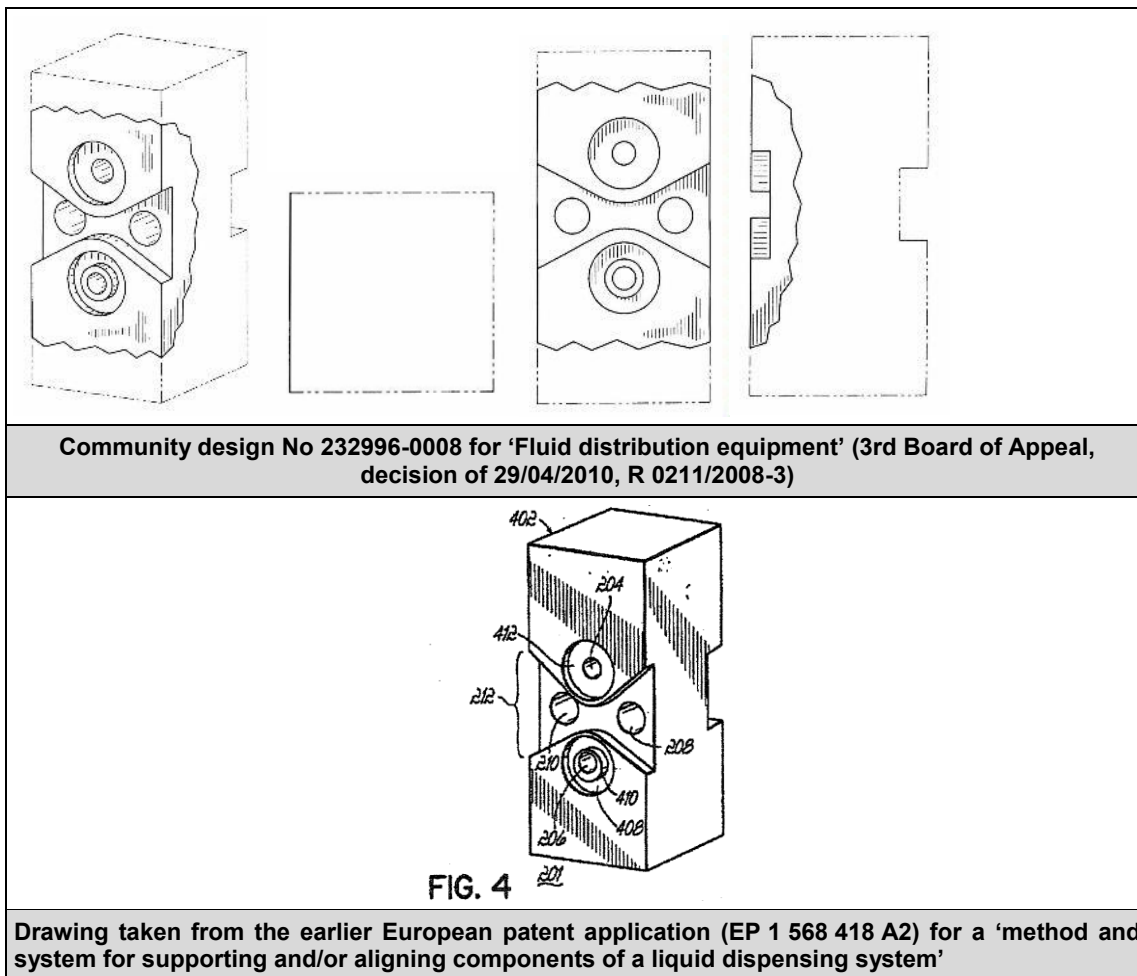

5.3.2 Examination

In order to determine whether the essential features of the appearance of the product into which the contested Community design will be incorporated are solely dictated by the technical function of the product, it is first necessary to determine what the technical function of that product is. The relevant indication in the application for registration of the design (Article 36(2) CDR) should be taken into account, but also the design itself, insofar as it makes clear the nature of the product, its intended purpose or its function (see by analogy, judgment of 18/03/2010, T-9/07, Metal rappers, EU:T:2010:96, § 56).

Whether Article 8(1) CDR applies must be assessed objectively, not in the perception of the informed user who may have limited knowledge of technical matters.

The technical functionality of the features of a design may be assessed, inter alia, by taking account of the documents relating to patents describing the functional elements of the shape concerned.

Depending on the case, and in particular in view of its degree of difficulty, the Invalidation Division may appoint an expert (Article 65(3) CDR and Article 44 CDIR).

The Invalidation Division will apply the principles explained in the Guidelines, Part A, General Rules, Section 2, General Principles to be Respected in Proceedings, paragraph 4.3, Commissioning of experts.

5.3.3 Alternative shapes

Article 8(1) CDR does not require that a given feature must be the only means by which the product's technical function can be achieved. Article 8(1) CDR applies where the need to achieve the product's technical function was the only relevant factor when the feature in question was selected (decisions of 22/10/2009, R 0690/2007-3, Chaff cutters, § 31-32; 10/06/2013, R 2466/2011-3, Blades, § 15-16).

The examination of Article 8(1) CDR must be carried out by analysing the Community design, and not designs consisting of other shapes.

5.4 Designs of interconnections

Features of a Community design are excluded from protection if they must necessarily be reproduced in their exact form and dimensions, in order to permit the product in which the design is incorporated or to which it is applied to be mechanically connected to, or placed in, around or against another product so that either product may perform its function. If Article 8(2) CDR applies to all the essential features of the Community design, the latter must be declared invalid (decision of 20/11/2007, ICD 2 970).

Proof that a Community design may be objected to based on Article 8(2) CDR rests on the applicant. The applicant must substantiate the existence of the product whose form and dimensions dictate those of the Community design and submit facts, evidence and arguments demonstrating the functions performed by this product and by this Community design individually and/or in combination.

As an exception, Article 8(2) CDR does not apply to a Community design that serves the purpose of allowing the multiple assembly or connection of mutually interchangeable products within a modular system (Article 8(3) CDR). Proof that the Community design serves such a purpose rests on the holder.

5.5 Lack of novelty and individual character

5.5.1 Disclosure of prior design

5.5.1.1 General principles

Challenging the validity of a Community design on account of its lack of novelty or of individual character requires proof that an earlier design that is identical or that produces a similar overall impression has been made available to the public before the date of filing the application for registration or, if a priority is claimed, the date of priority (Articles 5 and 6 CDR).

The public in question is made up of the members of the circles specialised in the sector concerned, operating within the European Union (Article 7(1) CDR).

The term 'circles specialised in the sector concerned' in the meaning of Article 7(1) CDR is not limited to persons that are involved in creating designs and developing or manufacturing products based on those designs within the sector concerned. Article 7(1) CDR lays down no restrictions relating to the nature of the activity of natural or legal persons who may be considered to form part of the 'circles specialised in the sector concerned'. Consequently, traders may also form part of the 'specialised circles' in the meaning of Article 7(1) CDR (see, by way of analogy, judgment of 13/02/2014, C-479/12, Gartenmöbel, EU:C:2014:75, § 27).

For the purpose of Article 7 CDR, a 'design' means the appearance of the whole or a part of a product resulting from the features of, in particular, the lines, contours, colours, shape, texture and/or materials of the product itself and/or its ornamentation (Article 3(a) CDR). Whether or not an earlier 'design' within the meaning of Article 3(a) CDR enjoys legal protection (as a design, as a trade mark, as a copyrighted work, as a utility model or otherwise) is immaterial.

The applicant must substantiate the disclosure of an earlier design.

It is assumed that a design that has been made available to the public anywhere in the world and at any point in time, as a result of publication following registration or otherwise, exhibition, use in trade or otherwise, has been disclosed for the purpose of applying Articles 5 and 6 CDR (Article 7(1) CDR).

However, acts of disclosure of an earlier design will not be taken into consideration where the holder submits convincing facts, evidence and arguments in support of the view that these events could not reasonably have become known in the normal course of business to the circles specialised in the sector concerned, operating within the European Union (Articles 7(1) and 63(1) CDR) (decision of 22/03/2012, R 1482/2009-3, Insulation blocks, § 38).

Other exceptions will be addressed in paragraphs 5.5.1.7 and 5.5.1.8 below.

5.5.1.2 Official publications

Publication of an earlier design in the bulletin of any industrial property office worldwide constitutes disclosure and it is only ('except') where this publication cannot reasonably become known to the circles specialised in the sector concerned within the European Union that the said rule is affected by an exception. Therefore, once proof of publication has been provided by the applicant, disclosure is assumed to have taken place and, considering the globalisation of the markets, it is incumbent on the holder to provide facts, arguments or evidence to the contrary, namely that publication of the earlier design could not reasonably have become known to the circles specialised in the sector concerned, operating within the European Union (decisions of 27/10/2009, R 1267/2008-3, Watches, § 35 et seq; 07/07/2008, R 1516/2007-3, Cans, § 9).

Publications in trademark and patent bulletins could equally have become known in the normal course of business to the circles in the sector concerned operating within the European Union. Therefore, where the appearance of a product has been applied for and published as a trade mark, it is to be considered as a disclosure of a 'design' for the purpose of Article 7 CDR (judgment of 16/12/2010, T-513/09, Ornamentación, EU:T:2010:541, § 20). The same applies where the representations contained in a patent application show the appearance of an industrial or handicraft item (decision of 22/03/2010, R 0417/2009-3, Drinking straws, § 21). However, the presence of a

document kept by a patent and trade mark office, which is available to the public only by means of an application for inspection of files, may not be considered to have become known in the normal course of business to the specialised circles in the sector concerned and therefore does not prove the disclosure of a prior design in the meaning of Article 7 CDR (decisions of 22/03/2012, R 1482/2009-3, Insulation blocks, § 39-43; 15/04/2013, R 0442/2011-3, Skirting Boards, § 26).

In order to substantiate the disclosure, a registration certificate must specify the date of publication independently of the date of filing or the date of registration. The publication in the Official Bulletin of a national Patent Office must be considered as having been disclosed and made available to the public in accordance with Article 7(1) CDR (judgment of 07/11/2013, T-666/11, Gatto domestico, EU:T:2013:584, § 25). Whether or not the publication takes place before or after registration is irrelevant (decision of 15/04/2013, R 0442/2011-3, Skirting Boards, § 24).

Moreover, it is enough that the date of publication can be identified by the mention of an INID code ('Internationally agreed Numbers for the Identification of (bibliographic) Data' as standardised by WIPO Standard ST.9. See decision of the Invalidation Division of 14/11/2006, ICD 2 061).

5.5.1.3 Exhibitions and use in trade

Disclosure of a design at an international exhibition anywhere in the world is an event that may become known in the normal course of business to the circles in the sector concerned, operating within the European Union, except where evidence to the contrary is provided (decisions of 26/03/2010, R 0009/2008-3, Footwear, § 73-82; 01/06/2012, R 1622/2010-3, Lamps, § 24). The question whether events taking place outside the European Union could reasonably have become known to persons forming part of those circles is a question of fact. The answer to that question has to be assessed by EUIPO on the basis of the particular circumstances of each individual case (judgment of 13/02/2014, C-479/12, Gartenmöbel, EU:C:2014:75, § 34).

Use in trade is another example given in Article 7(1) CDR as a means for disclosure of a design, irrespective of whether this use is made within or outside the EU (decision of 26/03/2010, R 0009/2008-3, Footwear, § 63-71).

Disclosure of a design can be the result of use in trade even where there is no proof on file that the products in which the earlier design is incorporated have actually been put on the market in Europe. It suffices that the goods have been offered for sale in distributed catalogues (decision of 22/10/2007, R 1401/2006-3, Ornamentation, § 25) or imported from a third country to the European Union (judgment of 14/06/2011, T-68/10, Watches, EU:T:2011:269, § 31-32) or have been the object of an act of purchase between two European operators (judgment of 09/03/2012, T-450/08, Phials, EU:T:2012:117, § 30-45).

As regards the submission of catalogues, their evidential value does not depend on their being distributed to the public at large. Catalogues that are made available to specialised circles only can also be valid means of evidence, bearing in mind that the relevant public for assessing disclosure is the 'circles specialised in the sector concerned' (Article 7(1) CDR).

The extent of, or the circumstances surrounding the distribution of the catalogues can be relevant factors (judgment of 13/02/2014, C-479/12, Gartenmöbel, EU:C:2014:75,

§ 35-36). However, what matters, in the context of Article 7 CDR, is whether the European specialised circles, taken as a whole, have had a reasonable opportunity to have access to the design irrespective of the actual number who seized this opportunity and were eventually confronted with the disclosed design.

The Office makes an overall assessment of all the documents submitted by the invalidity applicant for the purpose of assessing whether disclosure has been made, and including whether a catalogue is genuine and has been disseminated in the interested circles.

It is enough that the disclosure took place at a point in time that can be identified with reasonable certainty prior to the filing date or priority date of the contested Community design even if the exact date of disclosure is unknown (judgment of 14/06/2011, T-68/10, *Watches*, EU:T:2011:269, § 31-32).

5.5.1.4 Disclosures derived from the internet

Information disclosed on the internet or in online databases is considered to be publicly available as of the date the information was published. Internet websites often contain highly relevant information. Certain information may even be available only on the internet from such websites. This includes, for example, online publications of design registrations by industrial property offices.

The nature of the internet can make it difficult to establish the actual date on which information was in fact made available to the public. For instance, not all web pages mention when they were published. In addition, websites are easily updated, yet most do not provide any archive of previously displayed material, nor do they display records that enable members of the public to establish precisely what was published and when.

In this context, the date of disclosure on the internet will be considered reliable in particular where:

- the web site provides time stamp information relating to the history of modifications applied to a file or web page (for example, as available for Wikipedia or as automatically appended to content, e.g. forum messages and blogs); or
- indexing dates are given to the web page by search engines (e.g. from the Google cache); or
- a screenshot of a web page bears a given date; or
- information relating to the updates of a web page is available from an internet archiving service.

Neither restricting access to a limited circle of people (e.g. by password protection) nor requiring payment for access (analogous to purchasing a book or subscribing to a journal) prevents a design on a web page from being found to have been disclosed. When assessing whether such a disclosure could not reasonably have become known in the normal course of business to the circles specialised in the sector concerned, operating within the European Union, aspects such as accessibility and searchability of that web page can be taken into account.

5.5.1.5 Statements in writing, sworn or affirmed (affidavits)

As a matter of principle, affidavits in themselves are not sufficient to prove a fact such as the disclosure of an earlier design. They may, however, corroborate and/or clarify the accuracy of additional documents (decision of 14/10/2009, R 0316/2008-3, Fireplaces, § 22. See by analogy judgment of 13/05/2009, T-183/08, Jello Schuhpark II, EU:T:2009:156, § 43).

In order to assess the evidential value of an affidavit, regard should be had first and foremost to the credibility of the account it contains. It is then necessary to take account, in particular, of the person from whom the document originates, the circumstances in which it came into being, the person to whom it was addressed and whether, on its face, the document appears sound and reliable (judgment of 09/03/2012, T-450/08, Phials, EU:T:2012:117, § 39-40).

Affidavits and other documentary evidence originating from parties having an interest in having a Community design being declared invalid have a lower probative value compared to documents having a neutral source (judgment of 14/06/2011, T-68/10, Watches, EU:T:2011:269, § 33-36).

The Invalidation Division will apply the principles explained in the Guidelines, Part C, Opposition, Section 6, Proof of Use, paragraph 3.3.2.3, Declarations.

5.5.1.6 Insufficient disclosure

The issue of the disclosure of the prior design is preliminary to that of whether the two designs produce the same overall impression on the informed user. If the prior design has not been made available to the public or it has been made so but in a manner inconsistent with the requirements of Article 7(1) CDR, then there is sufficient reason for rejecting the application to the extent that it is based on Articles 5 and 6 CDR (decision of 10/03/2008, R 0586/2007-3, Barbecues, § 22 et seq).

Neither the CDR nor the CDIR provides for any specific form of evidence required for establishing disclosure, Article 28(1)(b)(v) CDIR only provides that 'documents proving the existence of those earlier designs' must be submitted. Likewise, there are no provisions as to any compulsory form of evidence that must be furnished. Article 65 CDR lists possible means of giving evidence before the Office, but it is clear from its wording that this list is not exhaustive ('shall include the following'). Accordingly, the evidence in support of disclosure is a matter for the discretion of the applicant and, in principle, any evidence able to prove disclosure can be accepted.

The Invalidation Division will carry out an overall assessment of such evidence by taking account of all the relevant factors in the particular case. Disclosure cannot be proven by means of probabilities or suppositions, but must be demonstrated by solid and objective evidence of effective and sufficient disclosure of the earlier design (judgment of 09/03/2012, T-450/08, Phials, EU:T:2012:117, § 21-24).

A global examination of the items of evidence implies that these items must be assessed in the light of each other. Even if some items of evidence are not conclusive of disclosure in themselves, they may contribute to establishing the disclosure when examined in combination with other items (judgment of 09/03/2012, T-450/08, Phials, EU:T:2012:117, § 25 and 30-45).

The Invalidation Division is not required to determine through assumptions and deductions which earlier designs among those represented in the applicant's documentary evidence may be relevant where the applicant does not provide further specifications in this respect (see paragraph 3.9.2 above). Earlier designs, other than those specifically cited as relevant prior designs by the applicant, will therefore be disregarded (decision of 04/10/2006, ICD 2 228).

Where the representation of the prior design fails to represent it adequately, thereby rendering any comparison with the contested design impossible, this does not amount to disclosure for the purpose of Article 7(1) CDR (decision of 10/03/2008, Barbecues, R 0586/2007-3, § 22 et seq.).

It is possible that disclosure to one undertaking discloses the design sufficiently to the circles specialised in the sector concerned operating within the European Union. Whether it does or not is a question to be assessed on a case-by-case basis (judgment of 13/02/2014, C-479/12, Gartenmöbel, EU:C:2014:75, § 35-36).

5.5.1.7 Disclosure to a third person under explicit or implicit conditions of confidentiality

Disclosure of the Community design to a third person under explicit or implicit conditions of confidentiality will not be deemed to have been made available to the public (Article 7(1) CDR).

Therefore, disclosure of a design to a third party in the context of commercial negotiations is ineffective if the parties concerned agreed that the information exchanged should remain secret (decision of 20/06/05, ICD 172, para. 22).

The burden of proof for facts establishing confidentiality lies with the holder of the contested Community design.

5.5.1.8 Disclosure within the priority period

An application for a Community design may claim the priority of one or more previous applications for the same design or utility model in or for any State party to the Paris Convention, or to the Agreement establishing the World Trade Organisation (Article 41 CDR; Article 8 CDIR). The right of priority is six months from the date of filing of the first application.

The effect of the right of priority shall be that the date of priority will count as the date of filing of the application for a registered Community design for the purpose of Articles 5, 6, 7 and 22; Article 25(1)(d) and Article 50(1) CDR (Article 43 CDR).

A priority claim relating to the 'same design or utility model' requires identity with the corresponding Community design without addition or suppression of features. A priority claim is however valid if the Community design and the previous application for a design right or a utility model differ only in immaterial details.

When examining an application for a Community design, the Office does not verify whether this application concerns the 'same design or utility model' whose priority is claimed.

The examination of a priority claim will, however, be carried out by the Office if the applicant challenges its validity or if the holder challenges the effects of the disclosure of a design, for the purpose of Articles 5, 6 and 7 CDR, where this disclosure occurred within the priority period.

Where the validity of the priority claim is determinative of the outcome of the application, the Office may either take position on the validity of this claim in the decision on the merits of the case, or stay the proceedings on its own motion to allow the holder to remedy possible deficiencies within a given time limit (Article 45(2)(d) CDR; Articles 1(1)(f) and 10(3)(c), and Article 10(7) and (8) CDR).

The invalidity proceedings are resumed once the deficiencies are remedied or a final decision is taken on the loss of the right of priority (Article 46(1)(4) CDR) (see paragraph 4.1.6.2 above for the resumption of the proceedings).

5.5.1.9 Grace period

Article 7(2) CDR provides for a 'grace period' of 12 months preceding the date of filing or the priority date of the contested Community design. Disclosure of the Community design within such period will not be taken into consideration if it was made by the designer or its successor in title.

As a matter of principle, the holder must establish that it is either the creator of the design upon which the application is based or the successor in title to that creator, failing which Article 7(2) CDR cannot apply (judgment of 14/06/2011, T-68/10, Watches, EU:T:2011:269, § 26-29).

However, acts of disclosure made by a third person as a result of information provided or action taken by the designer or its successor in title are also covered by Article 7(2) CDR. This can be so where a third party made public a design copied from a design that was previously disclosed within the grace period by the holder itself (decision of 02/05/2011, R 0658/2010-3, Lighting devices, § 37-39).

Article 7(2) CDR also provides for immunity against the loss of individual character pursuant to Article 6 CDR (decision of 02/05/2011, R 0658/2010-3 – 'Lighting devices', § 40). The exception provided in Article 7(2) CDR may therefore apply where the previously disclosed design is either identical to the contested Community design, within the meaning of Article 5 CDR, or the previously disclosed design does not produce a different overall impression.

The 'grace period' also applies where the disclosure of a design is the result of an abuse in relation to the designer or its successor in title (Article 7(3) CDR). Whether the disclosure is the result of fraudulent or dishonest behaviour will be assessed on a case-by-case basis on the basis of the facts, arguments and evidence submitted by the parties (decision of 25/07/2009, R 0552/2008-3, MP3 player recorder, § 24-27).

5.5.2 Assessment of novelty and individual character

A design will be protected as a Community design to the extent that it is new and has individual character (Article 4(1), 5 and 6 CDR). The novelty and individual character of a Community design must be examined on its date of filing or, as the case may be, on

its date of priority, in the light of the relevant prior designs. The relevant prior designs are made up of the earlier designs whose disclosure, according to Article 7 CDR, was substantiated by the applicant (Article 63 CDR).

5.5.2.1 Common principles

Global comparison

The Community design must be compared with each and every earlier design relied on by the applicant, individually. Novelty and individual character of a Community design cannot be defeated by combining features taken in isolation and drawn from a number of earlier designs, but by one or more earlier designs, taken individually (judgments of 19/06/2014, C-345/13, Karen Millen Fashions, EU:C:2014:2013, § 23-35; 22/06/2010, T-153/08, Communications equipment, EU:T:2010:248, § 23-24).

A combination of already disclosed features is, therefore, eligible for protection as a Community design provided this combination, as a whole, is novel and has individual character.

As a matter of principle, all the features of a Community design must be taken into consideration when examining its novelty and individual character. There are, however, a number of exceptions to this general principle.

Features dictated by a function and features of interconnection

Features that are solely dictated by a technical function and features that must necessarily be reproduced in their exact form and dimensions in order to allow interconnection with another product cannot contribute to the novelty and individual character of a Community design. Such features must therefore be disregarded when comparing the Community design with the relevant prior designs (Article 8 CDR, see paragraph 5.3.1 above).

The visibility requirement

Features of a Community design applied to, or incorporated in a 'component part of a complex product', will be disregarded if they are invisible during normal use of the complex product in question (Article 4(2) CDR).

'Complex product' means a product that is composed of multiple components that can be replaced, permitting disassembly and reassembly of the product (Article 3(c) CDR). For instance, the visibility requirement does not apply to a Community design representing the appearance of a garbage container as a whole since garbage containers may be complex products as such, but not component parts of complex products (decision of 23/06/2008, ICD 4 919).

'Normal use' means use by the end user, excluding maintenance, servicing or repair work (Article 4(3) CDR). 'Normal use' is the use made in accordance with the purpose for which the complex product is intended.

For instance, for safety reasons, an electrical connector is a component part that is normally incorporated in a casing in order to be shielded from any contact with potential

users when a complex product, such as a train or electric vehicle, is in operation. The fact that such a component part of a complex product can theoretically be made visible when inserted in a transparent casing or cover constitutes a purely hypothetical and random criterion that must be disregarded (decision of 03/08/2009, R 1052/2008-3, Electrical contractors, § 42-53).

Where none of the features of a Community design applied to a component part (e.g. a sealing ring) is visible during normal use of the complex product (e.g. a heat pump system), this Community design will be invalidated as a whole (judgment of 20/01/2015, T-616/13, Heat exchanger inserts, EU:T:2015:30, § 14-16).

However, Article 4(2) CDR does not require a component part to be clearly visible in its entirety at every moment of the use of the complex product. It is sufficient if the whole of the component can be seen some of the time in such a way that all its essential features can be apprehended (decision of 22/10/2009, R 0690/2007-3, Chaff cutters, § 21).

Where the features of a Community design applied to a component part are only partially visible during normal use of the complex product, the comparison with the relevant prior designs invoked must be limited to the visible parts.

Clearly discernible features

Features of the Community design that are not clearly discernible in its graphical representation cannot contribute to its novelty or its individual character (Directive 98/71/EC of the European Parliament and the Council of 13 October 1998 on the legal protection of designs, Recital 11). Likewise, features of the prior design that are not of a sufficient quality allowing all the details to be discerned in the portrayal of the prior design cannot be taken in consideration for the purpose of Articles 5 and 6 CDR (decision of 10/03/2008, R 0586/2007-3, Barbecues, § 23-26).

Features of a prior design can be supplemented by additional features that were made available to the public in different ways, for instance, first, by the publication of a registration and, second, by the presentation to the public of a product incorporating the registered design in catalogues. These representations must however relate to one and the same earlier design (judgment of 22/06/2010, T-153/08, Communication equipment, § 25-30).

Disclaimed features

Features of a Community design that are disclaimed are disregarded for the purposes of comparing the designs. This applies to the features of a Community design represented with dotted lines, boundaries or colouring or in any other manner making clear that protection is not sought in respect of such features (judgment of 14/06/2011, T-68/10, Watches, EU:T:2011:269, § 59-64).

In contrast, disclaimed features of an earlier registered design are taken into account when assessing the novelty and individual character of a contested Community design. In the context of Articles 5 and 6 CDR, it is immaterial whether the holder of the earlier registered design can claim protection for such disclaimed features, provided they have been disclosed together with the earlier design as a whole.

5.5.2.2 Novelty

A Community design will be considered to be new if it is not predated by an identical design disclosed pursuant to Article 7 CDR. Designs will be deemed to be identical if their features differ only in immaterial details (Article 5(2) CDR).

There is identity between the Community design and an earlier design where the latter discloses each and every element constituting the former. The framework of the comparison is limited to the features making up the Community design. It is therefore irrelevant whether the earlier design discloses additional features. A Community design cannot be new if it is included in a more complex earlier design (decision of 25/10/11, R 0978/2010-3, Part of a sanitary napkin, § 20-21).

However, the additional or differentiating features of the Community design may be relevant to decide whether this Community design is new, unless such elements are so insignificant that they may pass unnoticed.

An example of an immaterial detail is a slight variation in the shade of the colour pattern of the compared designs (decision of 28/07/2009, R 0921/2008-3, Nail files, § 25). Another illustration is the display, in one of the two compared designs, of a label that is so small in size that it is not perceived as a relevant feature (decision of 08/11/2006, R 0216/2005-3, Cafetera, § 23-26), as in the following example:

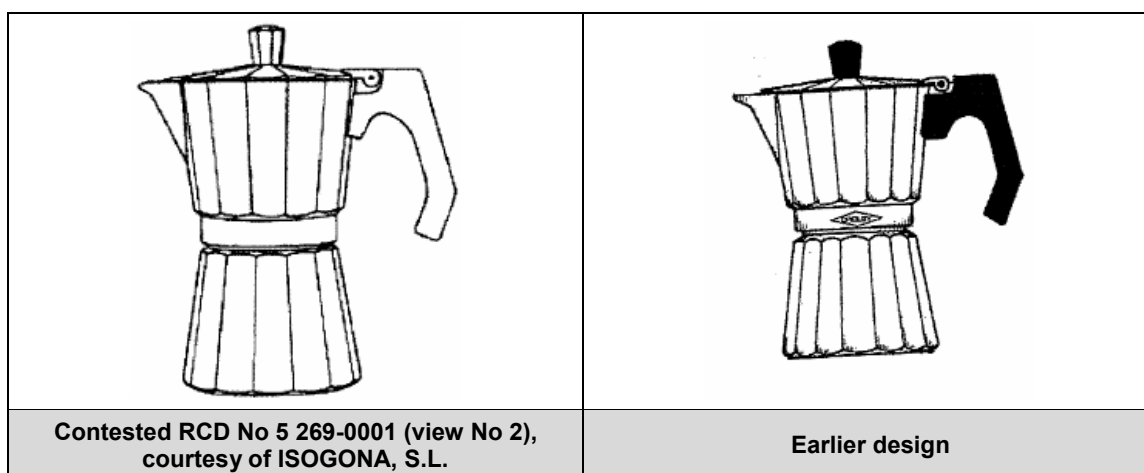

5.5.2.3 Individual character

A design will be considered to have individual character if the overall impression it produces on the informed user differs from the overall impression produced on such a user by any design that has been made available to the public before the date of filing the application for registration or, if a priority is claimed, the date of priority (Article 6(1) CDR).

In assessing individual character, the degree of freedom of the designer in developing the design will be taken into consideration (Article 6(2) CDR).

The informed user

The status of ‘user’ implies that the person concerned uses the product in which the design is incorporated, in accordance with the purpose for which that product is intended (judgments of 22/06/2010, T-153/08, Communications equipment, EU:T:2010:248, § 46; 09/09/2011, T-10/08, Internal combustion engine, EU:T:2011:446, § 24; 06/06/2013, T-68/11, Watch-dials, EU:T:2013:298, § 58).

The concept of ‘informed user’, which refers to a fictitious person, lies somewhere between that of the average consumer, applicable in trade mark matters, who need not have any specific knowledge, and the sectorial expert, who is an expert with detailed technical expertise. Without being a designer or a technical expert (and therefore without necessarily knowing which aspects of the product concerned are dictated by technical function, as found in judgment of 22/06/2010, T-153/08, Communication equipment, EU:T:2010:248, § 48) the informed user is aware of the various designs that exist in the sector concerned, possesses a certain degree of knowledge with regard to the features that those designs normally include, and, as a result of their interest in the products concerned, shows a relatively high degree of attention when using them (judgments of 20/10/2011, C-281/10 P, Metal rappers, EU:C:2011:679, § 53 and 59; T-153/08, Communications equipment, EU:T:2010:248, § 47; 06/06/2013, T-68/11, Watch-dials, EU:T:2013:298, § 59).

In other words, the informed user is neither a designer nor a technical expert. Therefore, an informed user is a person having some awareness of the existing designs in the sector concerned, without necessarily knowing which aspects of that product are dictated by technical function.

The informed user is neither a manufacturer nor a seller of the products in which the designs at issue are intended to be incorporated (judgment of 09/09/2011, T-10/08, Internal combustion engine, EU:T:2011:446, § 25-27).

However, depending on the nature of the product in which the Community design is incorporated (e.g. promotional items), the concept of informed user may include, firstly, a professional who acquires such products in order to distribute them to the final users and, secondly, those final users themselves (judgment of 20/10/2011, C-281/10 P, Metal rappers, EU:C:2011:679, § 54). The fact that one of the two groups of informed users perceives the designs at issue as producing the same overall impression is sufficient for a finding that the contested design lacks individual character (judgment of 14/06/2011, T-68/10, Watches, EU:T:2011:269, § 56).

When the nature of the product in which the compared designs are incorporated makes it possible, the overall impression left by these designs will be assessed on the assumption that the informed user can make a direct comparison between them (judgment of 18/10/2012, joint cases C-101/11 P and C-102/11 P, Ornamentation, EU:C:2012:641, § 54-55).

The overall impression

Unless the compared designs include functional or invisible or disclaimed features (see paragraph 5.5.2.1 above), the two designs must be compared globally. That does not mean, however, that the same weight should be given to all the features of the compared designs.

First, the informed user uses the product in which the design is incorporated, in accordance with the purpose for which that product is intended. The relative weight to give to the features of the compared designs may therefore depend on how that product is used. In particular, the role played by some features may be less important depending on their reduced visibility when the product is in use (judgments of 22/06/2010, T-153/08, EU:T:2010:248, § 64-66 and 72; 21/11/2013, T-337/12, Sacacorchos, EU:T:2013:601, § 45-46; 04/02/2014, T-339/12, Armchairs, EU:T:2014:54, § 30; 04/02/2014, T-357/12, Armchairs, EU:T:2014:55, § 57).

Second, when appraising the overall impression caused by two designs, the informed user will only give minor importance to features that are totally banal and common to the type of product in issue and will concentrate on features that are arbitrary or different from the norm (judgments of 18/03/2010, T-9/07, Metal rappers, EU:T:2010:96, § 77; 28/11/2006, R 1310/2005-3, Galletas, § 13; decision of 30/07/2009, R 1734/2008-3, Forks, § 26 et seq.).

Third, similarities affecting features in respect of which the designer enjoyed a limited degree of freedom will have only minor importance in the overall impression produced by those designs on the informed user (judgment of 18/03/2010, T-9/07, Metal rappers, EU:T:2010:96, § 72).

Fourth, when familiar with a saturation of the prior art due to the density of the existing design corpus, the informed user may be more sensitive to even minor differences between the designs that thus may produce a different overall impression (judgments of 13/11/2012, T-83/11 & T-84/11, Radiatori per riscaldamento, EU:T:2012:592, § 81; 12/03/2014, T-315/12, Radiatori per riscaldamento, EU:T:2014:115, § 87). In order to prove an actual impact of such saturation on the informed user's perception, the holder of the contested RCD must present sufficient evidence of the existing design corpus and its density at the date of filing of the contested RCD or its priority date (decisions of 10/10/2014, R 1272/2103-3, Radiator I, § 36, 47; 9/12/2014, R 1643/2014-3, § 51).

As illustration, it was held that the RCD No 1 512 633-0001 created an overall impression that is different from that produced by the earlier design (RCD No 52 113-0001). In an area in which the designer's degree of freedom in developing his or her design is not limited by any technical or legal restraints, the General Court upheld the decision of the Board of Appeal, which found that the differentiating features of the two designs below prevailed over their common points. In particular, the fact that the armchair of the prior design has a rectangular rather than square shape, that its seat is placed lower and that the arms are broader, was considered decisive in support of the conclusion that the contested RCD had individual character (judgment of 04/02/2014, T-339/12, Armchairs, EU:T:2014:54, § 23-37).

According to the GC, account must be taken of the difference between the designs at issue as regards the angle of the backrest and the seat of the armchair represented in the contested design, bearing in mind that the overall impression produced on the informed user must necessarily be determined in the light of the manner in which the product in question is used. Since an inclined backrest and seat will give rise to a different level of comfort from that of a straight back and seat, the use that will be made of that armchair by the circumspect user is liable to be affected thereby (judgment of 04/02/2014, T-339/12, Armchairs, EU:T:2014:54, § 30).

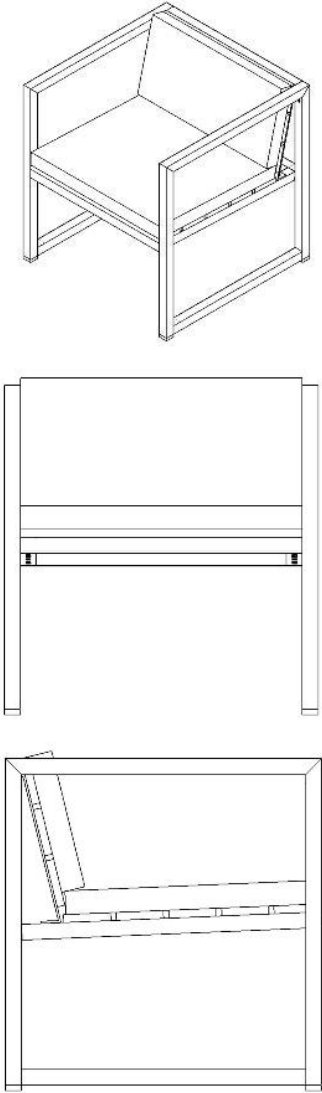
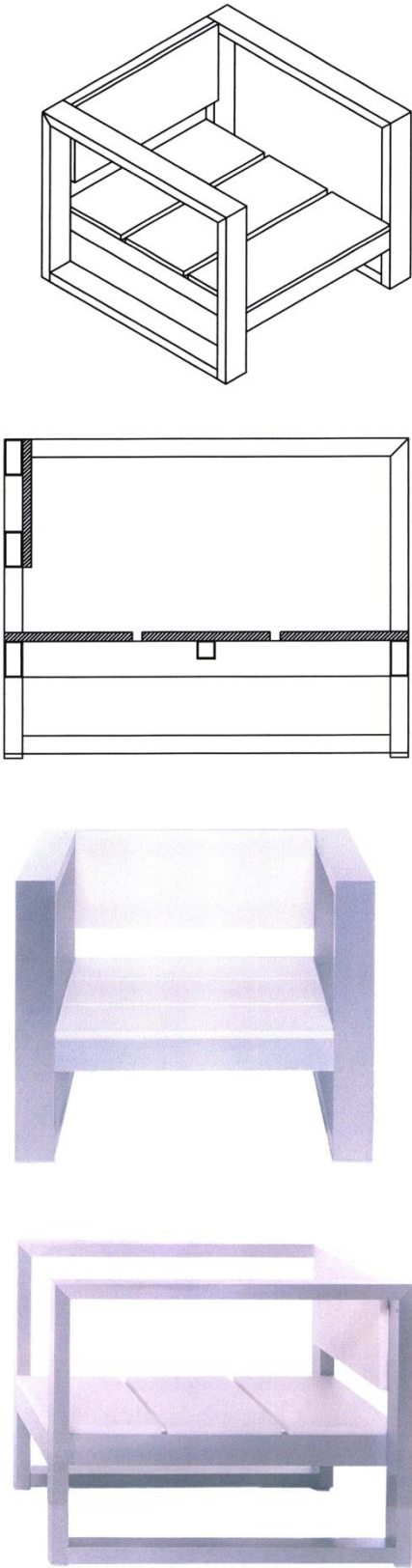
 <p>Technical drawings of a chair design. The top drawing is a perspective view showing the chair's frame and seat. The middle drawing is a front view showing the chair's profile. The bottom drawing is a side view showing the chair's profile from the side.</p>	 <p>Technical drawings and 3D renderings of a chair design. The top drawing is a perspective view showing the chair's frame and seat. The middle drawing is a front view showing the chair's profile. The bottom drawing is a side view showing the chair's profile from the side. Below the technical drawings are two 3D renderings of the chair, one in a light purple color and one in a darker purple color.</p>
<p>Contested RCD No 1 512 633-0001, courtesy of Sachi Premium – Outdoor Furniture, Lda.</p>	<p>Earlier RCD No 52 113-0001, courtesy of Mr Esteve Cambra (Designer: Mr Jose Ramón Esteve Cambra)</p>

By contrast, the GC found that the RCD No 1512633-0003 lacked individual character in respect of the same earlier design. It was held that the differentiating features between the designs, including the presence in the contested RCD of three cushions, were outweighed by their common characteristics (the rectangular shape, the flat back and seat, the seats positioned below the mid-section of the armchairs' structure etc.) (judgment of 04/02/2014, T-357/12, Armchairs, EU:T:2014:54, § 44-60).

The GC confirmed the view taken by the Board of Appeal (decision of 27/04/2012, R 0969/2011-3, Armchairs) that the cushions are less important than the structure of the armchairs when assessing the overall impression caused by the designs because the cushions are not a fixed element but can be easily separated from the main product and because they are often sold and purchased separately, at a relatively low cost compared to that of the structure of an armchair. The informed user perceives the cushions as a mere optional accessory. They can hardly be considered to be 'a significant part of the design'. Consequently the overall impression produced by the designs at issue is dominated by the structure of the armchairs itself and not by the cushions, which could be regarded as secondary elements (judgment of 04/02/2014, T-357/12, Armchairs, EU:T:2014:54, § 37-38).

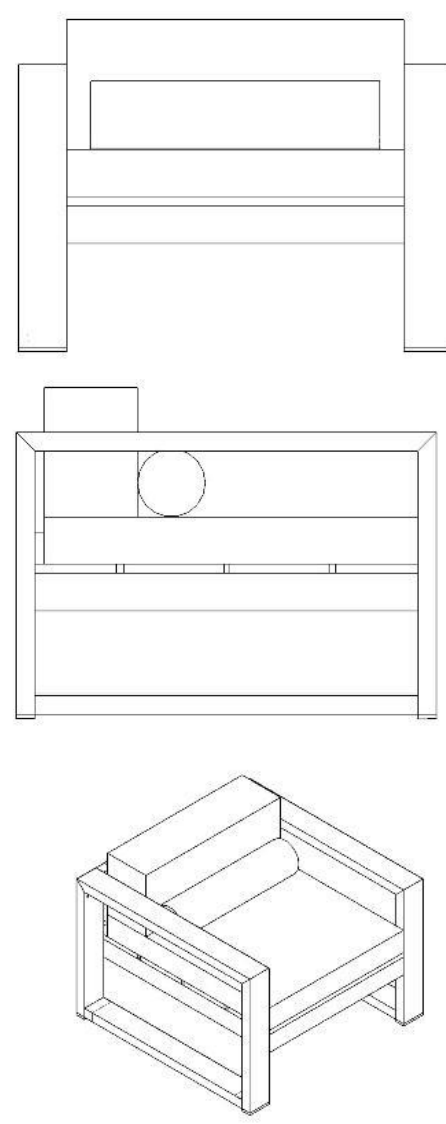
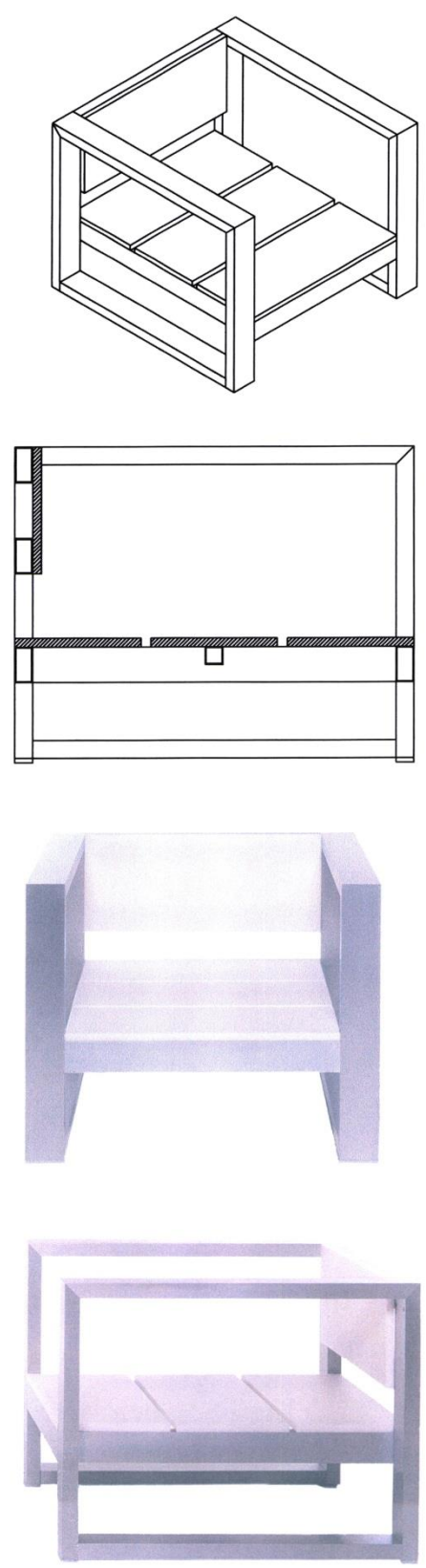
 <p>The left column contains three line drawings of a chair. The top drawing is a front view showing a high backrest with a horizontal bar and two side panels. The middle drawing is a side view showing the chair's profile, including a circular detail on the backrest. The bottom drawing is a perspective view of the chair, showing its four legs and the seat structure.</p>	 <p>The right column contains three views of a chair. The top drawing is a perspective view showing the chair's frame and seat. The middle drawing is a side view showing the chair's profile and a small detail on the backrest. The bottom drawing is a perspective view of the chair, showing its four legs and the seat structure.</p>
<p>Contested RCD No 1 512 633-0003, courtesy of Sachi Premium – Outdoor Furniture, Lda.</p>	<p>Earlier RCD No 52 113-0001, courtesy of Mr Esteve Cambra (Designer: Mr Jose Ramón Esteve Cambra)</p>

The degree of freedom of the designer

The designer's degree of freedom depends on the nature and intended purpose of the product in which the design will be incorporated, as well as on the industrial sector to which this product belongs. The Invalidity Division will take into account the indication of the products in which the design is intended to be incorporated or to which it is intended to be applied (Article 36(2) CDR), but also the design itself, in so far as it makes clear the nature of the product, its intended purpose or its function (judgment of 18/03/2010, T-9/07, Metal rappers, EU:T:2010:96, § 56).

The designer's degree of freedom in developing its design is established, inter alia, by the constraints of the features imposed by the technical function of the product or an element thereof, or by statutory requirements applicable to the product. Those constraints result in a standardisation of certain features, which will thus be common to the designs applied to the product concerned (judgments of 13/11/2012, T-83/11 & T-84/11, Radiatori per riscaldamento, EU:T:2012:592, § 44).

The greater the designer's freedom in developing the challenged design, the less likely it is that minor differences between the designs at issue will be sufficient to produce a different overall impression on an informed user. Conversely, the more the designer's freedom in developing the Community design is restricted, the more likely minor differences between the designs at issue will be sufficient to produce a different overall impression on the informed user (judgment of 18/03/2010, T-9/07, Metal rappers, EU:T:2010:96, § 67 and 72). Therefore, if the designer enjoys a high degree of freedom in developing a design, that reinforces the conclusion that the designs that do not have significant differences produce the same overall impression on an informed user (judgment of 09/09/2011, T-10/08, Internal combustion engine, EU:T:2011:446, § 33).

The fact that the intended purpose of a given product requires the presence of certain features may not imply a restricted degree of freedom of the designer where the parties submit evidence that there are possibilities of variations in the positioning of such features and in the general appearance of the product itself (judgments of 14/06/2011, T-68/10, Watches, EU:T:2011:269, § 69; 06/10/2011, T-246/10, Reductores, EU:T:2011:578, § 21-22; 09/09/2011, T-10/08, Internal combustion engine, EU:T:2011:446, § 37).

The degree of freedom of the designer is not affected by the fact that similar designs co-exist on the market and form a 'general trend' or co-exist on the registers of Industrial Property Offices (judgment of 22/06/2010, T-153/08, Communications equipment, EU:T:2010:248, § 58; decision of 01/06/2012, R 0089/2011-3, Corkscrews, § 27).

5.6 Conflict with a prior design right

Pursuant to Article 25(1)(d) CDR, a Community design will be declared invalid if it is in conflict with a prior design that has been made available to the public after the date of filing of the application or, if priority is claimed, the date of priority of the Community design, and which is protected from a date prior to the said date:

1. by a registered Community design or an application for such a design; or

2. by a registered design right of a Member State or by an application for such a right; or
3. by a design right registered under the Geneva Act of the Hague Agreement concerning the international registration of industrial designs, adopted in Geneva on 02/07/1999, hereinafter referred to as 'the Geneva Act', which was approved by Council Decision 954/2006 and which has effect in the European Union, or by an application for such a right.

Article 25(1)(d) CDR must be interpreted as meaning that a Community design is in conflict with a prior design when, taking into consideration the freedom of the designer in developing the Community design, that design does not produce on the informed user a different overall impression from that produced by the prior design relied on (judgment of 18/03/2010, T-9/07, Metal rappers, EU:T:2010:96, § 52).

When dealing with an application based on Article 25(1)(d) CDR, the Invalidation Division will therefore apply the same test as for the assessment of individual character under Article 25(1)(b) read in combination with Article 6 CDR.

The Invalidation Division will assume that the prior design is valid unless the holder submits proof that a decision that has become final declared the prior design invalid before the adoption of the decision (see by analogy, judgment of 29/03/2011, C-96/09P, Bud, EU:C:2011:189, § 94-95) (see paragraph 4.1.6.2, Suspension, above).

5.7 Use of an earlier distinctive sign

A Community design will be declared invalid if a distinctive sign is used in a subsequent design, and the law of the Union or the law of the Member State governing that sign confers on the holder of the sign the right to prohibit such use (Article 25(1)(e) CDR).

5.7.1 Distinctive sign

The notion of 'distinctive sign' encompasses registered trade marks as well as all signs that could be relied on in the context of Article 8(4) EUTMR (see the Guidelines, Part C, Opposition, Section 4, Rights under Article 8(4) EUTMR, paragraph 3.2, Types of rights falling under Article 8(4) EUTMR).

5.7.2 Use in a subsequent design

The notion of 'use in a subsequent design' does not necessarily presuppose a full and detailed reproduction of the earlier distinctive sign in a subsequent Community design. Even though the Community design may lack certain features of the earlier distinctive sign or may have different additional features, this may constitute 'use' of that sign, particularly where the omitted or added features are of secondary importance and are unlikely to be noticed by the relevant public. It is enough that the Community design and the earlier distinctive sign be similar (judgments of 12/05/2010, T-148/08, Instruments for writing, EU:T:2010:190, § 50-52; 25/04/2013, T-55/12, Cleaning device, EU:T:2013:219, § 23; decision of 09/08/11, R 1838/2010-3, Instrument for writing, § 43).

Where a Community design includes a distinctive sign without any disclaimer making clear that protection is not sought in respect of such feature, it will be considered that the Community design makes use of the earlier distinctive sign even if the latter is represented in only one of the views (decision of 18/09/2007, R 0137/2007-3, Containers, § 20).

5.7.3 Substantiation of the application under Article 25(1)(e) CDR (earlier distinctive signs)

Apart from the elements mentioned above under paragraph 3.9.2, pursuant to Article 28(1)(b)(vi) CDR an application must contain:

- particulars establishing the content of the law of the national law of which the applicant is seeking application including, where necessary, court decisions and/or academic writings (the principles established in the Guidelines, Part C, Opposition, Section 4, Rights under Article 8(4) EUTMR, paragraph 4, Proof of the Applicable Law Governing the Sign, will apply). Where an application for invalidity is based on the rights held on an earlier European Union trade mark, the submission of the law and case-law relating to European Union trade marks is not a requirement for the substantiation of this earlier right; the same applies if the applicant invokes a likelihood of confusion with an earlier national registered mark; and
- where the earlier distinctive sign is unregistered, particulars showing that rights have been acquired on this unregistered distinctive sign pursuant to the law relied on, as a result of use or otherwise, before the filing date or the priority date of the Community design (see, by analogy, judgment of 18/01/2012, T-304/09, BASmALI, EU:T:2012:13, § 22); and
- particulars showing that the applicant satisfies the necessary conditions, in accordance with that law, in order to be able to have the use of a Community design prohibited by virtue of its earlier right (see by analogy, judgment of 05/07/2011, C-263/09 P, Elio Fiorucci, EU:C:2011:452, § 50).

The applicant must establish only that it has available a right to prohibit use of the subsequent Community design and that it cannot be required to establish that that right has been exercised; in other words, that the applicant has actually been able to prohibit such use (see by analogy, judgment of 29/03/2011, C-96/09 P, Bud, EU:C:2011:189, § 191).

5.7.4 Examination by the Invalidation Division

Where the national provision relied on by the applicant represents the transposition of a corresponding provision of Directive 2008/95/EC of 22 October 2008 to approximate the laws of the Member States relating to trade marks (codified version), the former will be interpreted in the light of the case-law relating to the interpretation of the latter (judgment of 12/05/2010, T-148/08, Instruments for writing, EU:T:2010:190, § 96).

Furthermore, where the national provision relied on represents the transposition of Article 5(1) and (2) of Directive 2008/95/EC, the Invalidation Division will apply the principles established in the Guidelines, Part C, Opposition, Section 2, Double identity and Likelihood of Confusion, and Section 5, Trade Marks with Reputation, since

Article 5(1) and (2) of Directive 2008/95/EC is identical in substance to Article 8(1) and (5) EUTMR.

For the purpose of applying these provisions, the Invalidation Division will assume that the contested Community design will be perceived by the relevant public as a sign capable of being used 'for' or 'in relation to' goods or services (judgments of 12/05/2010, T-148/08, Instruments for writing, EU:T:2010:190, § 107; 25/04/2013, T-55/12, Cleaning devices, EU:T:2013:219, § 39 and 42).

The Invalidation Division will also assume that the earlier distinctive sign is valid unless the holder submits proof that a decision that has become final declared this earlier distinctive sign invalid before the adoption of the decision (judgment of 25/04/2013, T-55/12, Cleaning devices, EU:T:2013:219, § 34) (see above paragraph 4.1.6.2, Suspension).

As distinctive signs are protected for certain goods or services, the Invalidation Division will examine for which goods the contested Community design is intended to be used (judgment of 12/05/2010, T-148/08, Instruments for writing, EU:T:2010:190, § 108). For the purpose of determining whether these goods and services are identical or similar, the Invalidation Division will take into account the indication of the products in which the design is intended to be incorporated or to which it is intended to be applied (Article 36(2) CDR), and also the design itself, insofar as it makes clear the nature of the product, its intended purpose or its function (judgment of 18/03/2010, T-9/07, Metal rappers, EU:T:2010:96, § 56; decision of 07/11/11, R 1148/2010-3, Packaging, § 34-37). The assessment of the similarity of the goods will be made on the basis of the principles defined in the Guidelines, Part C, Opposition, Section 2, Identity and Likelihood of Confusion, Chapter 2, Comparison of Goods and Services).

Where the Community design is intended to be incorporated in two-dimensional 'logos', the Invalidation Division will consider that such logos may be applied to an infinite range of products and services, including the products and services in respect of which the earlier distinctive sign is protected (decision of 03/05/2007, R 0609/2006-3, logo MIDAS, § 27).

5.8 Unauthorised use of a work protected under the copyright law of a Member State

A Community design will be declared invalid if it constitutes an unauthorised use of a work protected under the copyright law of a Member State.

5.8.1 Substantiation of the application under Article 25(1)(f) CDR (earlier copyright)

Apart from the elements mentioned under paragraph 3.9.2 above, pursuant to Article 28(1)(b)(vi) CDR an application must contain:

- particulars establishing the content of the national law of which the applicant is seeking application including, where necessary, court decisions and/or academic writings (see, by analogy, judgment of 05/07/2011, C-263/09 P, Elio Fiorucci, EU:C:2011:452, § 50; decision of 11/02/2008, R 0064/2007-3, Loudspeakers, § 20); and

- particulars showing that rights have been acquired on the work pursuant to the copyright law relied on, to the benefit of the author or its successors in title, before the filing date or the priority date of the Community design (see, by analogy, judgment of 18/01/2012, T-304/09, BASmALI, EU:T:2012:13, § 22); and
- particulars showing that the applicant satisfies the necessary conditions, in accordance with that law, in order to be able to have the Community design invalidated or its use prohibited by virtue of its earlier right.

An invalidity applicant relying on copyright infringement has to prove its entitlement to the right to invoke copyright against the RCD as well as the existence and scope of the copyright under national law (decision of 17/10/2013, R 0951/2012-3, Children's chairs).

5.8.2 Examination by the Invalidity Division

Given that copyright protection may not, according to the national law relied on, depend on the publication or disclosure of the work, the Invalidity Division will only declare a Community design invalid under Article 25(1)(f) CDR in the clearest of cases.

In particular, it would not be appropriate to use Article 25(1)(f) CDR when the applicant's essential argument is that the Community design was created, not by the registered holder, but by the applicant or by an employee of the applicant (decision of 11/02/2008, R 0064/2007-3, Loudspeakers, § 20). Article 25(1)(f) CDR cannot be used as a means to circumvent the exclusive competence of national courts regarding the entitlement to the Community design (Article 15 and 25(1)(c) CDR).

The object of the examination is to ascertain whether an unauthorised use of a work protected by the copyright legislation of a member state has occurred and not to establish whether the design possesses novelty or individual character in the sense of Articles 5 and 6 CDR (see by analogy judgments of 23/10/2013, T-566/11 & T-567/11, Vajilla, EU:T:2013:549, § 73).

5.9 Partial invalidity

According to Article 25(6) CDR, a registered Community design that has been declared invalid pursuant to any of the grounds under Article 25(1)(b), (e), (f) or (g) CDR may be maintained in an amended form, if in that form it complies with the requirements for protection and the identity of the design is retained.

The request for maintenance in an amended form of a registered Community design must be made by the holder before the end of the written procedure. The request must include the amended form. The proposed amended form may consist of an amended representation of the Community design from which some features are removed or making clear by means inter alia of dotted lines or colouring that protection is not sought in respect of such features. The amended representation may include a partial disclaimer not exceeding 100 words (Article 25(6) CDR; Article 18(2) CDIR).

The applicant will be given an opportunity to comment on whether the Community design in its amended form complies with the requirements for protection and whether the identity of the design is retained (see paragraph 4.1.4.1 above).

The identity of the Community design must be retained. Maintenance in an amended form will therefore be limited to cases in which the features removed or disclaimed do not contribute to the novelty or individual character of a Community design, in particular:

- where the Community design is incorporated in a product that constitutes a component part of a complex product and the removed or disclaimed features are invisible during normal use of this complex product (Article 4(2) CDR); or
- where the removed or disclaimed features are dictated by a technical function or by interconnection purposes (Article 8(1) and (2) CDR); or
- where the removed or disclaimed features are so insignificant in view of their size or importance that they are likely to pass unnoticed in the perception of the informed user.

The decision to maintain the Community design in an amended form will be included in the decision on the merits terminating the invalidity proceedings.

5.10 Grounds of invalidity that become applicable merely because of the accession of a new Member State

See the Guidelines, Examination of Applications for Registered Community Designs, paragraph 13, Enlargement and the Registered Community Design.

6 Termination of the Proceedings

6.1 Termination of proceedings without a decision on the merits

The invalidity proceedings are terminated without a decision on the merits, where:

1. the applicant withdraws its application as a result of an amicable settlement or otherwise; or
2. the holder surrenders the Community design in its entirety and the applicant did not request the Office to adopt a decision on the merits of the case (Article 24(2) CDR; see paragraph 3.8); or
3. the contested Community design has lapsed and the applicant did not request the Office to adopt a decision on the merits of the case (Article 24(2) CDR; see paragraph 3.8 above); or
4. the Invalidity Division suspended a number of applications for a declaration of invalidity, relating to the same registered Community design. These applications will be deemed to be disposed of once a decision declaring the invalidity of the Community design has become final (Article 32(3) CDIR).

The Invalidity Division informs the parties that the proceedings are terminated without a decision on the merits.

6.2 Decision on costs

6.2.1 Cases where a decision on costs must be taken

If a decision on the merits of the case is taken, the decision on apportionment of costs is given at the end of the decision (Article 79(1) CDR).

In all other cases where the Invalidation Division closes the case without a decision on the merits, a separate decision on costs is issued on request by any of the parties. In such a case, the Invalidation Division informs both parties when it will render a decision on costs. The parties may submit arguments on the apportionment of the costs.

6.2.2 Cases where a decision on costs is not to be taken

6.2.2.1 Agreement on costs

Whenever the parties inform the Invalidation Division that they have settled the invalidation proceedings with an agreement that includes the costs, the Invalidation Division will not issue a decision on costs (Article 70(5) CDR).

If no indication is given as to whether the parties have agreed on the costs, the Invalidation Division will take a decision on costs, together with the confirmation of the withdrawal of the application. If the parties inform the Invalidation Division that they had reached an agreement on costs after the withdrawal of the application, the already issued decision on costs will not be revised by the Invalidation Division. It is, however, left to the parties to respect the agreement and not to enforce the Invalidation Division's decision on costs.

6.2.2.2 Apportionment of costs

The general rule is that the losing party, or the party who terminates the proceedings by surrendering the Community design or by maintaining it in an amended form or by withdrawing the application, must bear the fees incurred by the other party as well as all costs incurred by it essential to the proceedings (Article 70(1) and (3) CDR).

If both parties lose in part, a 'different apportionment' has to be decided (Article 70(2) CDR). As a general rule, it is equitable for each party to bear its own costs.

Where a number of applications for a declaration of invalidity relating to the same registered Community design have been suspended, they are deemed to be disposed of once a decision declaring the invalidity of the Community design has become final. Each applicant whose application is deemed to have been disposed of will bear its own costs (Article 70(4) CDR). In addition, the Office will refund 50 % of the invalidity fee (Article 32(4) CDR).

6.2.2.3 Fixing of costs

Recoverable costs regarding representation and fees

Where the costs are limited to representation costs and the application fee, the decision fixing the amount of costs will be included in the decision on the apportionment of the costs.

The amount to which the winning party is entitled to claim is mentioned in Article 70(1) CDR and Article 79(6) and (7) CDIR.

As regards fees, the recoverable amount is limited to the invalidity fee of EUR 350 if the applicant wins.

As regards representation costs, the recoverable amount is limited to EUR 400. This applies both to the applicant and the holder, under the condition that it was represented in the invalidity proceedings by a professional representative within the meaning of Article 77 CDR. The winning party who is no longer represented by a professional representative at the time of taking a decision is also entitled to an award of costs regardless of the stage of the proceedings when professional representation ceased. This is without prejudice to the need to appoint a professional representative where it is mandatory. The amount to be borne by the losing party is always fixed in euros, regardless of the currency in which the winning party had to pay its representative.

Representation costs for employees, even from another company with economic connections, are not recoverable.

Other recoverable costs

Where the costs include expenses in relation to an oral hearing or the taking of evidence, the registry of the Invalidation Division will, on request, fix the amount of the costs to be paid (Article 70(6) CDR). A bill of costs, with supporting evidence, must be attached to the request for the fixing of costs (Article 79(3) CDIR).

The amount of recoverable costs may be reviewed by a decision of the Invalidation Division on a reasoned request filed within one month of the date of notification of the awarding of costs (Article 70(6) CDR; Article 79(4) CDIR).

Fixing of costs after remittance of the case to the Invalidation Division for further prosecution

When the invalidity decision has been annulled, wholly or partly, and the case is remitted by the Boards of Appeal, the situation will be as follows:

- the first decision (which was appealed) has not become final, even not as regards apportionment or fixing of costs;
- as regards the costs of the invalidity proceedings, one single decision on the apportionment and on the fixing of costs must be taken for the invalidity procedure as a whole;

- as regards the costs of the appeal procedure, it has to be ascertained whether the Boards adjudicated on them. The notion of 'winning party' has to be applied to the outcome of the appeal proceedings with the result that the decision can be different for the two instances. The amount of reimbursable representation costs for the appeal procedure is EUR 500, which apply in addition to the representation costs for the invalidity proceedings.

6.3 Correction of mistakes and entry in the Register

6.3.1 Correction of mistakes

In decisions of the Invalidation Division, only linguistic errors, errors of transcription and obvious mistakes may be corrected. They will be corrected by the Invalidation Division, acting of its own motion or at the request of an interested party (Article 39 CDR).

6.3.2 Entry into the Register

The date and content of the decision on the application or any other termination of proceedings will be entered into the Register once it is final (Article 53(3) CDR, Article 69(3)(q) CDR).

7 Appeal

7.1 Right to appeal

Any party to invalidity proceedings has the right to appeal against a decision that affects this party adversely. A decision that does not terminate proceedings as regards one of the parties can only be appealed together with the final decision, unless the decision allows separate appeal. Any written communication of such a decision will include a notice that the decision may be appealed within two months from the date of receipt of the notification of the decision. Appeals have suspensive effect (Article 55 CDR).

7.2 Interlocutory revision

Revision can be granted where an appeal has been lodged against a decision for which the Boards of Appeal are competent pursuant to Article 55 CDR.

If the department whose decision is appealed considers the appeal to be admissible and well founded, it shall rectify its decision. However, this shall not apply where the appellant is opposed by other parties to the proceedings (Article 58(1) CDR). Therefore, a revision can only be granted if the application for declaration of invalidity is rejected as inadmissible (or deemed not to have been filed) pursuant to Article 30 CDR.

If the decision is not rectified within one month after receipt of the statement of grounds of the appeal, the appeal will be remitted to the Boards of Appeal without delay, and without comment as to its merits (Article 58(2) CDR).

The principles applying to revision in respect of decisions adopted by the Opposition Division apply *mutatis mutandis* to the decisions adopted by the Invalidity Division in the admissibility examination of the application (see the Guidelines, Part A, General Rules, Section 7, Revision).