

400 Series Windows

Positioning the Value of 400 Series Windows in the Home

Dugan Davidson

Certified Contractor Technical Specialist

12/07/2021









Goals for Today

- Understand Why Windows Matter
- Learn Andersen 400 Series Product Features
- Learn How Product Features Solve Homeowner Pain Points
- How To Position Andersen 400 Series In The Home

Why Windows Matter



WINDOWS & DOORS COMPARISON CHART

E-SERIES	A-SERIES	400 SERIES	200 SERIES	100 SERIES
Unlimited Possibilities to Create Your Original	Architectural Authenticity, Unparalleled Performance	Time-Tested, Classic Wood Craftsmanship	Warmth of Wood at an Uncommon Value	The Smart Alternative to Vinyl
Casement & Awning French Casements Push Out Casement & Awning Double-Hung [Full-Frame, Insert & Sash Kit] Monumental Single-Hung Gliding Windows Specialty Windows Bays & Bows Hinged Patio Doors (Inswing & Outswing) Gliding Patio Doors Sidelights & Transoms	Casement & Awning Complementary Casement Double-Hung Specialty Windows Hinged Patio Doors (Inswing & Outswing) Gliding Patio Doors Sidelights & Transoms Complementary Curved Top Patio Doors	Casement & Awning Complementary Casement Double-Hung Tilt-Wash [Full-Frame & Insert] Gliding Windows Specialty Windows Complementary Specialty Bays & Bows Hinged Inswing Patio Doors Gliding Patio Doors Sidelights & Transoms Complimentary Curved Top Patio Doors	Double-Hung Tilt-Wash Gliding Windows Specialty Windows Hinged Inswing Patio Doors Gliding Patio Doors	Casement & Awning Single-Hung Gliding Windows Specialty Windows Gliding Patio Doors Sidelights & Transoms
Aluminum-Clad Wood (Aluminum Exterior/Wood Interior)	Wood Interior Composite Exterior	Vinyl-Clad Wood ¹ (Vinyl Exterior/Wood Interior)	Vinyl-Clad Wood ¹ (Vinyl Exterior/Wood Interior)	Fibrex [®] Composite Interior & Exterior
 50 Exterior Colors 7 Anodized Finishes & Custom Colors Available	 11 Colors	 7 Colors ²	 2 Window Colors 6 Patio Door Colors ²	 5 Colors ²
 + Custom		 ³	 ³	NA
	 ¹	NA	NA	NA
	 ¹¹	 ⁵		 ⁴
				
 ^A	 ⁴	 ^A	 ^A	 ^A

\$\$\$

\$\$\$

\$\$\$

\$\$

\$

LEGACY OF INNOVATION

We uphold our legacy of innovation and accept change in all areas of our business as a means of obtaining and sustaining leadership.

For over 115 years, our customers have looked to Andersen as the industry leader providing unique window and door solutions. We have proven our leadership with more than 100 patents that offer true differentiation for our customers.

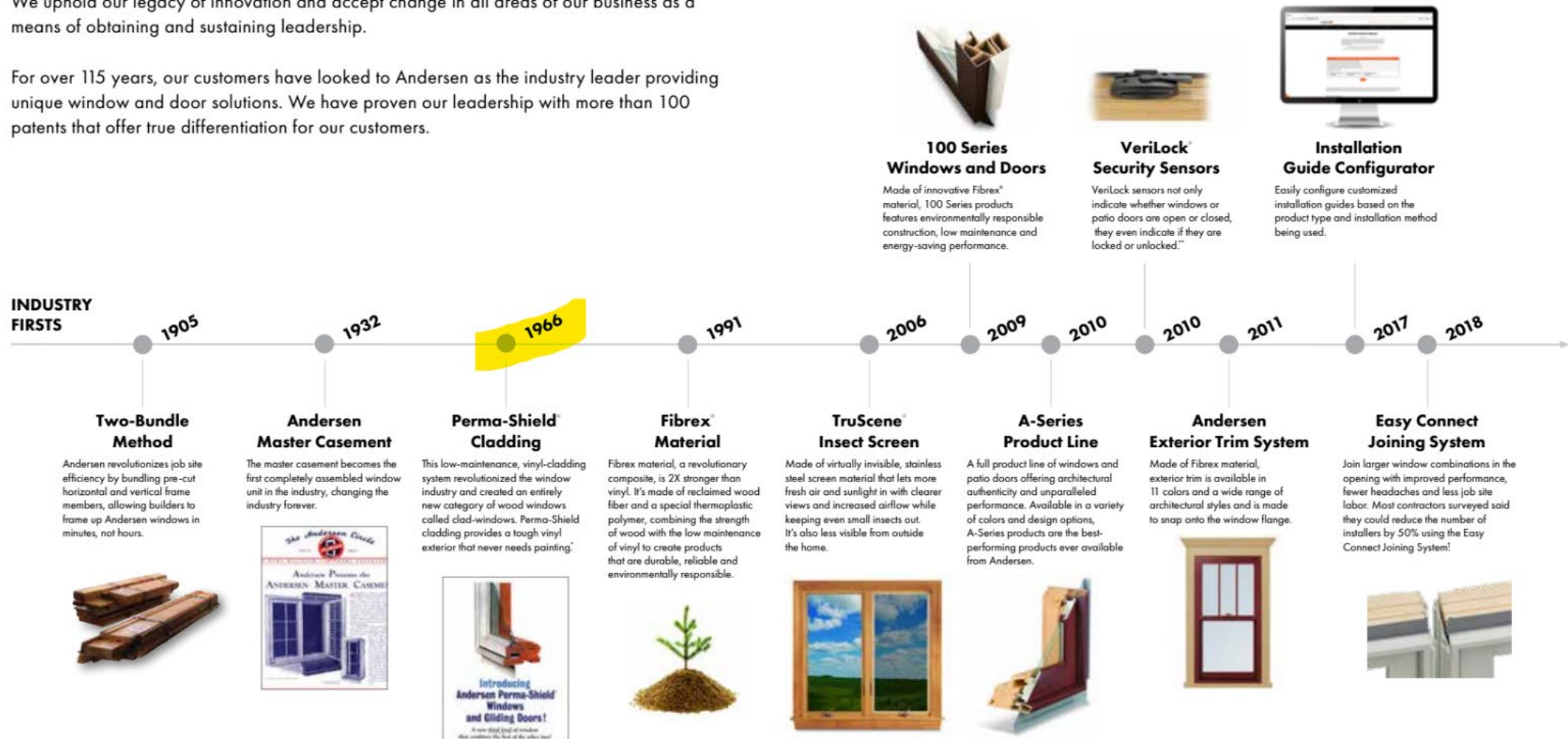

Andersen Perma-Shield Cladding vs. Others



Others



Andersen Fully Encapsulated Sash vs. Others



400 SERIES WINDOWS AND PATIO DOORS

THE WINDOW CONTRACTORS TRUST THE MOST*

With Andersen® 400 Series products, have confidence knowing you and your customers will be getting the quality and performance in which Andersen built its reputation, along with extraordinary customer service and support.

Our exclusive Owner-2-Owner® limited warranties offer homeowners peace of mind, plus real added value and with fewer callbacks, easy installation and a reputation that withstands the test of time, it's no wonder why 400 Series windows are the clad window of choice for contractors.*

That's also why contractors trust them in their own homes more than any other window.*



TIME TESTED

Our best-selling product line, 400 Series windows and patio doors are durable and stand the test of time.**



EASY TO INSTALL

400 Series windows and patio doors are designed for easy installation.



FEWER CALLBACKS

Rest assured you'll have fewer callbacks when you install 400 Series windows and patio doors.





400 SERIES DESIGNED FOR EXCEPTIONAL PERFORMANCE

ENERGY EFFICIENCY. DURABILITY. RELIABILITY.

ANDERSEN® ENERGY-SAVING GLASS

High-Performance Low-E4® glass helps save on energy costs by providing outstanding thermal protection in both hot and cold weather.

Additional glass options include:

- SmartSun™ glass, which rejects unwanted solar heat while allowing sunlight to stream through
- Sun glass, which neutralizes glare
- HeatLock® technology is a room-side glass surface coating that improves energy efficiency.

400 Series products have glass options that are ENERGY STAR® v. 6.0 certified in all climate zones.

LOW-MAINTENANCE, NEVER NEEDS PAINTING

The Perma-Shield® exteriors on Andersen windows and patio doors offer superior weather resistance and are virtually maintenance free.*

WEATHER-RESISTANT CONSTRUCTION

400 Series windows and patio doors seal out drafts, wind and water to provide comfort inside the home no matter what the weather is outside.



OWNER-2-OWNER® LIMITED WARRANTY

Fully transferable and not prorated,* and it's supported by one of the largest service networks in the industry.

OWNER2OWNER
LIMITED WARRANTY

SUPERIOR PERFORMANCE RATINGS

PG upgrades available:

- Casement windows PG70
- Tilt-wash double-hung windows PG50

Performance values vary. Visit andersenwindows.com for performance information.

STORMWATCH® PROTECTION

Most 400 Series windows are available with impact-resistant glass and structural upgrades to meet the tough building codes of hurricane-prone coastal areas.** For coastal product information, visit andersenwindows.com/coastal.

StormWATCH
PROTECTION

400 SERIES CASEMENT & AWNING WINDOWS

RELIABLE, ENERGY EFFICIENT, TIME-TESTED DESIGN

NEW CONSTRUCTION OR REPLACEMENT



Interior View

CUSTOM SIZES
Custom sizes available in 1/8" increments to enable an exact fit and easier install.



SINGLE-ACTUATION LOCK
A single handle secures the window firmly at multiple points and features a "reach out" action that pulls in the sash for a weathertight seal.



SMOOTH CONTROL HARDWARE
Available in a variety of styles and finishes, the smooth control hardware allows for easy operation with a simple turn of the handle.



Contemporary folding handle shown

HIGH-PERFORMANCE GLASS
Argon gas blend is used between the glass panes for additional insulation and the glass is heated for increased durability. Silicone bed glazing and low conductivity stainless steel spacer provides superior weathertightness and performance.

LOW-MAINTENANCE SASH
Casement sash has a wood core for stability and energy efficiency and is also wrapped in low-maintenance vinyl cladding that saves on finishing costs.

NAILING FLANGE
Integral nailing flange provides ease of installation.

REPLACEMENT OPTION
Replacement casement window available without a nailing flange and predrilled through-the-jamb installation holes for ease of installation. Thick replacement extension jambs available to help preserve the original alignment of trim and paint lines.

CORNER SECTION DETAIL

Exterior View



WEATHERTIGHT PERFORMANCE
Seamless vacuum-formed vinyl protects the frame against water penetration.

My personal favorite windows.....and my son's too!

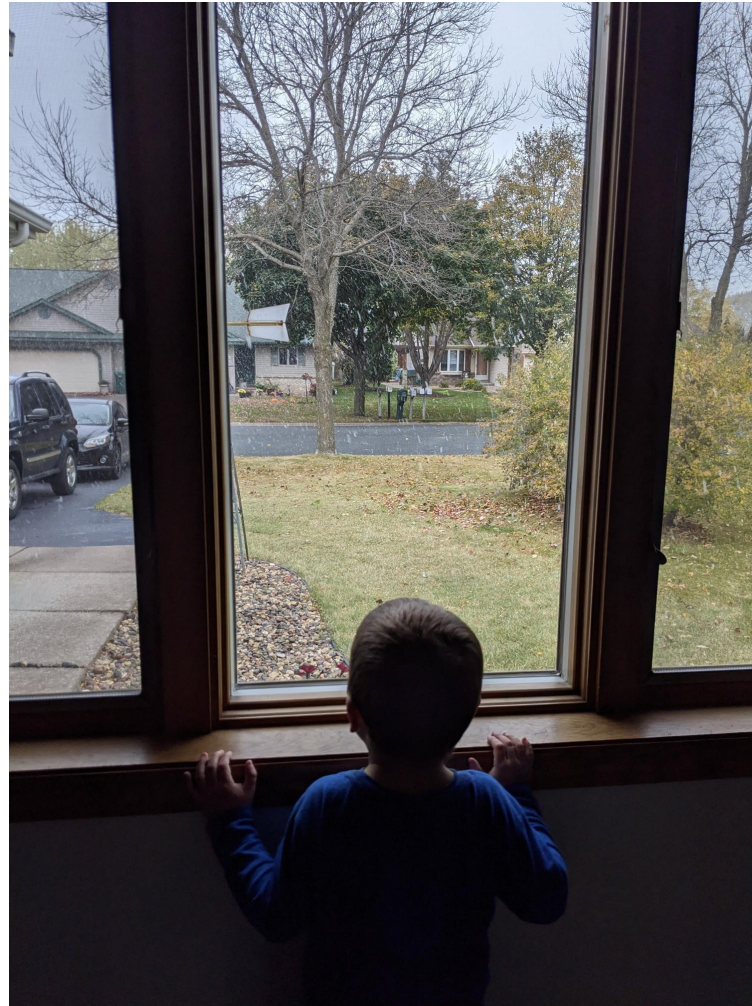

400 SERIES WINDOW HARDWARE

CASEMENT & AWNING™

Traditional Folding



Antique Brass | Black | Bright Brass
Distressed Bronze | Distressed Nickel
Gold Dust | Oil Rubbed Bronze
Satin Nickel | Stone | White

Contemporary Folding



Black | Bright Brass | Gold Dust
Oil Rubbed Bronze | **Satin Nickel**
Stone | White

Classic Series™



Stone | White

Estate™



Antique Brass | Bright Brass | Brushed Chrome
Distressed Bronze | Distressed Nickel
Oil Rubbed Bronze | Polished Chrome
Satin Nickel

Bold name denotes finish shown.

GLIDING



Antique Brass | Black
Bright Brass | **Brushed Chrome**
Distressed Bronze
Distressed Nickel
Oil Rubbed Bronze
Polished Chrome | Satin Nickel
Stone | White

FINISHES



Antique Brass



Black



Bright Brass



Brushed
Chrome



Distressed
Bronze



Distressed
Nickel



Gold Dust



Oil Rubbed
Bronze



Polished
Chrome



Satin Nickel



Stone



White



Narrow Profile for True Contemporary Look

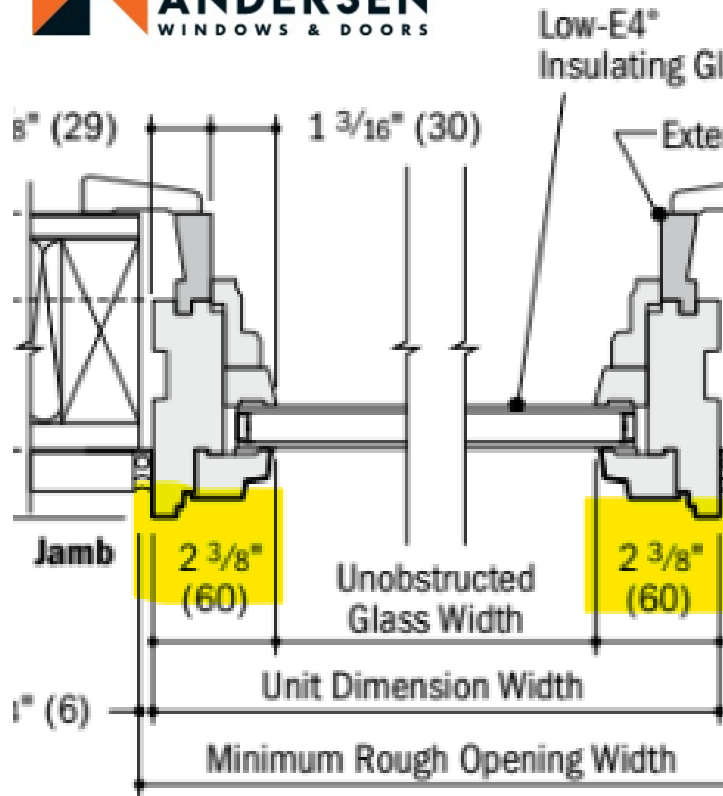

Horizontal Section



Lifestyles/Architectural

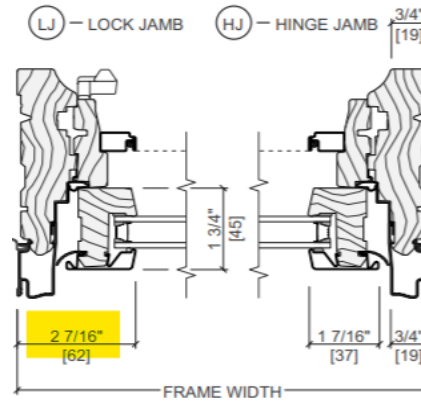

Reserve Contemporary

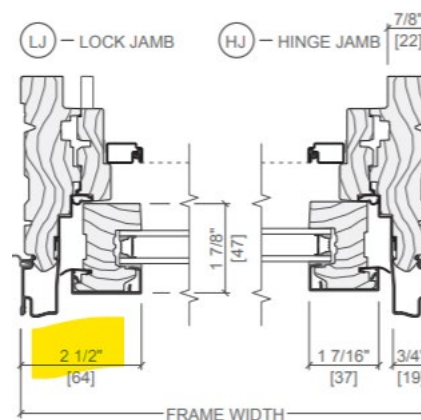

MARVIN[®] Ultimate Contemporary

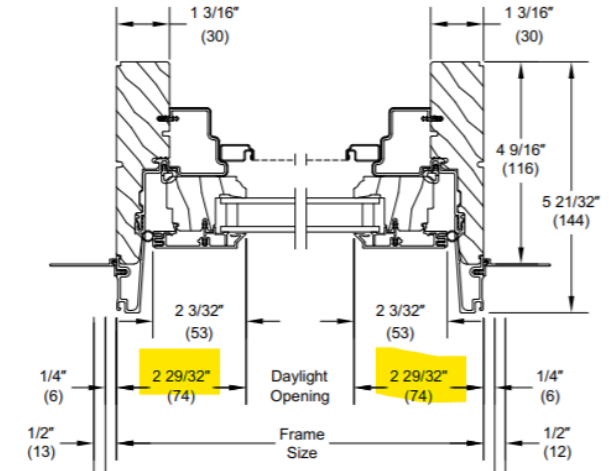

MARVIN[®] Elevate Contemporary

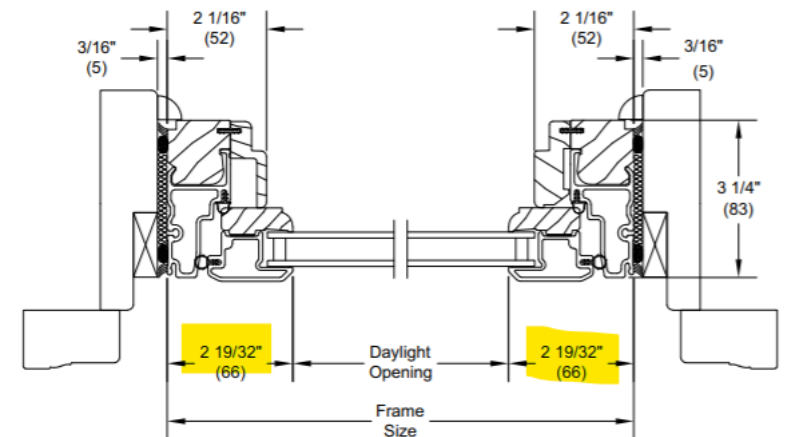

400 SERIES DOUBLE-HUNG FULL-FRAME WINDOWS

WOODWRIGHT® DOUBLE-HUNG FULL-FRAME



Interior View

CUSTOM SIZES

Custom sizes available in 1/8" increments to enable an exact fit and easier install.



WARMTH OF WOOD INTERIORS

Available in three interior wood species, maple, oak or pine, or low-maintenance prefinished white.

FIBREX® EXTERIOR CLADDING

Low-maintenance Fibrex material exterior cladding protects the unit and never needs painting.

AUTHENTIC CRAFTSMANSHIP

Wood jamb liners replicate the look of classic architecture and integrate seamlessly with existing interior window trim.



CORNER SECTION DETAIL

Exterior View

TILT-WASH DOUBLE-HUNG FULL-FRAME



Interior View

CUSTOM SIZES

Custom sizes available in 1/8" increments to enable an exact fit and easier install.



LONG-LASTING® WEATHERTIGHT PERFORMANCE

Solid wood core sash adds stability and has a Flexacron® finish that is electrostatically applied for maximum protection and is low maintenance.

Wood core sill members with Fibrex material exterior offers long-lasting performance.

DESIGNED FOR EASY INSTALLATION

Compression jamb liner flexes, providing extra forgiveness in less than perfect openings while preventing air leakage with a constant seal year-round.

Optional predrilled through-the-jamb installation holes save time during install.**

NAILING FLANGE

Factory-applied rigid vinyl flange helps secure the unit to the structure.

NARROLINE® WINDOW CONVERSION KIT

For Andersen® Narroline windows made after 1967, our quick conversion kit can easily turn them into convenient tilt-wash double-hung windows with new sash and jamb liners.



CORNER SECTION DETAIL

Exterior View

400 SERIES WINDOW HARDWARE

DOUBLE-HUNG

Woodwright® Windows



Antique Brass | **Black** | Bright Brass
Brushed Chrome | Distressed Bronze
Distressed Nickel | Gold Dust | Oil Rubbed Bronze
Polished Chrome | Satin Nickel | Stone | White

Tilt-Wash Windows



Standard: Stone | White
Optional: Black | **Gold Dust**

OPTIONAL DOUBLE-HUNG*

Traditional



Antique Brass | Black | Bright Brass | Brushed Chrome | Distressed Bronze | Distressed Nickel
Gold Dust | **Oil Rubbed Bronze** | Polished Chrome | Satin Nickel | Stone | White

Hand Lift



Finger Lift



Estate™

Lock & Keeper



Hand Lift



Finger Lift



Antique Brass | **Bright Brass** | Brushed Chrome | Distressed Bronze
Distressed Nickel | Oil Rubbed Bronze | Polished Chrome | Satin Nickel
Lock & Keeper available only for 400 Series tilt-wash double-hung windows.
Lifts only available for 400 Series Woodwright double-hung windows.

Contemporary



Bar Lift

Antique Brass | Black | Bright Brass
Brushed Chrome | Distressed Bronze | **Distressed Nickel**
Gold Dust | Oil Rubbed Bronze | Polished Chrome
Satin Nickel | Stone | White

Classic Series™

Bar Lift



Hand Lift



Finger Lift



Stone | **White**

Available only for 400 Series Woodwright double-hung windows.

FINISHES



Antique Brass



Black



Bright Brass



Brushed
Chrome



Distressed
Bronze



Distressed
Nickel



Gold Dust



Oil Rubbed
Bronze



Polished
Chrome



Satin Nickel



Stone



White



400 SERIES WOODWRIGHT® DOUBLE-HUNG INSERT

CLASSIC STYLE AND MODERN EASE



Interior View

CUSTOM SIZES

Custom sizes available in 1/8" increments to enable an exact fit and easier install.



AUTHENTIC CRAFTSMANSHIP

Wood jamb liners replicate the look of classic architecture and integrate seamlessly with existing interior trim. Predrilled through-the-jamb installation holes save time during install.

TILT-IN FEATURE

Easy Tilt-Release Lock feature allows homeowners to tilt the sash inward for easy window cleaning.



SEE IT IN ACTION.

<https://www.youtube.com/watch?v=HMySvX30Aow>

INSTALLATION KIT

Installation kit with screws, shims and flexible foam backer rod included with every insert window to make installation easier.



WOODWRIGHT REPLACEMENT TESTIMONIAL VIDEO

<https://www.youtube.com/watch?v=w8B3e6ZEIUY>

REPLACEMENT

CORNER SECTION DETAIL

Exterior View

HIGH-PERFORMANCE GLASS

Argon gas blend is used between the glass panes for additional insulation and the glass is heated for increased durability. Silicone bed glazing and low conductivity stainless steel spacer provides superior weathertightness and performance.

LOW-MAINTENANCE EXTERIORS

Low-maintenance Fibrex material exterior cladding protects the unit and never needs painting.

WOOD CORE SILL

Wood core sill members offer long-lasting performance.



EXTERIOR STOP COVER

Exterior stop covers provide a clean transition between the window and trim.

SILL ANGLE OPTIONS

Available in three sill angle options to closely match the existing sill for a tighter fit, improved performance and an authentic look.



0 Degrees



8 Degrees



14 Degrees



Download the Andersen Sill Angle Finder App on your iPhone or Android phone to determine the sill angle needed.

400 SERIES TILT-WASH DOUBLE-HUNG INSERT

OUR BEST-SELLING DOUBLE-HUNG WINDOW

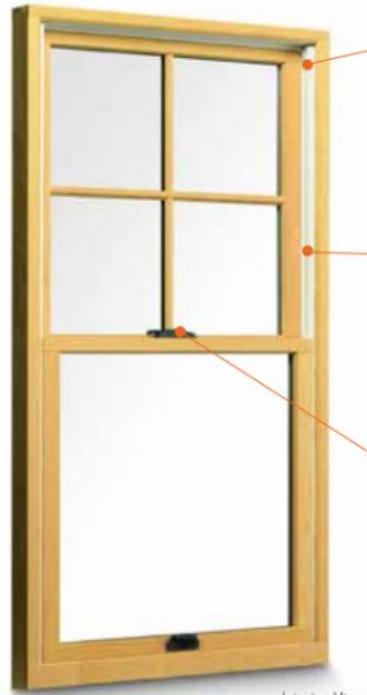

Interior View

TILT-IN FEATURE

Tilt Assists allow you to tilt the sash in and clean the windows from inside the home.



COMPRESSION JAMB LINERS

Compression Jamb Liners provide a constant seal year-round and helps prevent air leakage (Available in white or gray).

Predrilled through-the-jamb installation holes save time during install.



HARDWARE

Variety of hardware styles and options available to match any home's décor.



Standard Lock & Keeper



Optional Estate™ Lock & Keeper

INSTALLATION KIT

Installation kit with screws, shims and flexible foam backer rod included with every insert window to make installation easier.



CUSTOM SIZES

Custom sizes available in 1/8" increments to enable an exact fit and easier install.

HIGH-PERFORMANCE GLASS

Argon gas blend is used between the glass panes for additional insulation and the glass is heated for increased durability.

Silicone bed glazing and low conductivity stainless steel spacer provides superior weathertightness and performance.

LONG-LASTING WEATHERTIGHT PERFORMANCE

Solid wood core sash adds stability and has a Flexacron® finish that is electrostatically applied for maximum protection and low maintenance.

Solid wood core sill has a Fibrex® material exterior for long-lasting performances.

SILL ANGLE OPTIONS

Available in three sill angle options to closely match the existing sill for a tighter fit, improved performance and an authentic look.

CORNER SECTION DETAIL

Exterior View



EXTERIOR STOP COVER

Exterior stop covers provide a clean transition between the window and trim.



0 Degrees



8 Degrees



14 Degrees



Download the Andersen Sill Angle Finder App on your iPhone or Android phone to determine the sill angle needed.

*Visit andersenwindows.com/warranty for details.

†Flexicron™ is a registered trademark of PPG Industries Ohio, Inc.

400 SERIES EXTERIOR OPTIONS



Flat exterior trim with
cornice head, color:
red rock

Frame and sash exterior
color: Sandtone

WINDOW AND PATIO DOOR COLORS

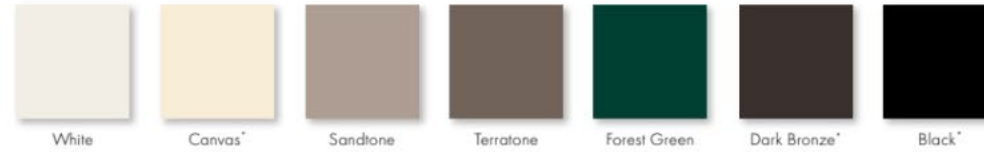

EXTERIOR TRIM STYLES

Exterior trim styles enhance the look of a home and add curb appeal.



EXTERIOR TRIM COLORS

Create a unique look – choose a different exterior trim color to match or complement the window or door color.

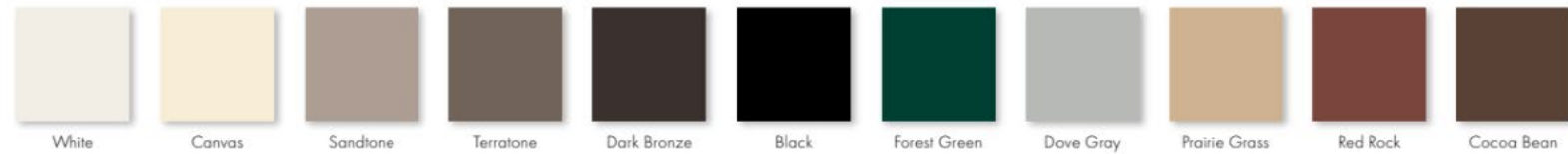



Look at how nice and bright and clean the door looks compared to the trim that was installed at the same time!

400 SERIES INTERIOR OPTIONS

Unfinished stain-grade pine or low-maintenance, factory prefinished white, dark bronze or black* interiors.

Frenchwood® patio doors and Woodwright® windows can also be ordered with unfinished oak or maple interiors.



Wood species are shown with stain to bring out grain pattern. Naturally occurring variations in grain, color and texture of wood make each window one of a kind.



400 SERIES GRILLE OPTIONS



FULL DIVIDED LIGHT



- Permanently applied to the interior and exterior of the window with a spacer between the glass

SIMULATED DIVIDED LIGHT

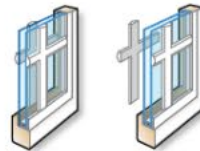

- Permanent grilles on the exterior and interior with no spacer between the glass
- Permanent exterior grilles with removable interior grilles

CONVENIENT CLEANING OPTIONS

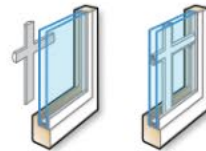

- Removable interior grilles come off for easy cleaning
- Finelight™ grilles are installed between the glass panes and feature a contoured 1" or 3/4" profile

GRILLE WIDTHS



Cross section of grilles showing standard widths and profiles.



400 SERIES GLASS & INSECT SCREEN OPTIONS

HIGH-PERFORMANCE GLASS

Glass can affect energy efficiency more than any other part of a window or patio door. Andersen offers one of the industry's widest array of glass options for any climate.

GLASS	ENERGY		LIGHT	
	U-Factor	Solar Heat Gain Coefficient	Visible Light Transmittance	UV Protection
	How well a product prevents heat from escaping.	How well a product blocks heat caused by sunlight.	How much visible light comes through a product.	How well a product blocks ultraviolet rays.
SmartSun™	● ● ● ● ○	● ● ● ● ●	● ● ● ● ○	● ● ● ● ●
SmartSun with HeatLock® Coating	● ● ● ● ●	● ● ● ● ●	● ● ● ● ○	● ● ● ● ●
Low-E4	● ● ● ● ○	● ● ● ● ○	● ● ● ● ○	● ● ● ● ○
Low-E4 with HeatLock Coating	● ● ● ● ●	● ● ● ● ○	● ● ● ● ○	● ● ● ● ○
Sun	● ● ● ● ○	● ● ● ● ●	● ○ ○ ○ ○	● ● ● ● ○
PassiveSun®	● ● ● ● ○	● ○ ○ ○ ○	● ● ● ● ○	● ● ● ● ○
PassiveSun with HeatLock Coating	● ● ● ● ○	● ○ ○ ○ ○	● ● ● ● ○	● ● ● ● ○
Clear Dual-Pane	● ○ ○ ○ ○	○ ○ ○ ○ ○	● ● ● ● ●	○ ○ ○ ○ ○

Center of glass performance only. Ratings based on glass options as of March 2019. Visit andersenwindows.com/energystar for ENERGY STAR® map and NFRC total unit performance data.



ART GLASS

Designed to fit most Andersen® windows and patio doors, these finely crafted inserts are available in two distinctly different series to complement any home's architecture.

Classic Series



Artisan Series

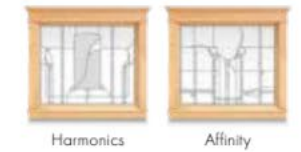

TRUSCENE® INSECT SCREENS

TruScene insect screens let in over 25% more fresh air and provide 50% greater clarity than conventional Andersen insect screens, all while keeping out unwanted small insects.

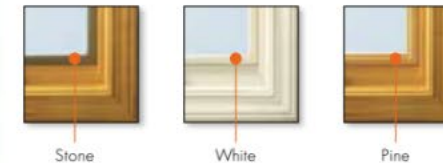

Screen frames also available in dark bronze and black.

400 SERIES

COMPLEMENTARY WINDOWS & PATIO DOORS

Beautifully handcrafted windows and patio doors complement 400 Series products with dramatic sizes and extraordinary shapes that give a home a signature look.

CASEMENT & AWNING WINDOWS

- Casement windows are available in a variety of shapes including arch, Springline™ and more
- French casements provide an unobstructed view



SPECIALTY WINDOWS

- 35 uncommon shapes, including elegant arches, striking angles and compelling curves



CURVED-TOP PATIO DOORS

- Choose features like Romanesque arches, sidelights, transoms and more



EXTERIOR COLOR OPTIONS



INTERIOR OPTIONS



Wood species are shown with stain to bring out grain pattern. Naturally occurring variations in grain, color and texture of wood make each window one of a kind.



UNTIL THE ORIGINAL THEY RECEIVED

Where to find more videos like the ones I showed today??

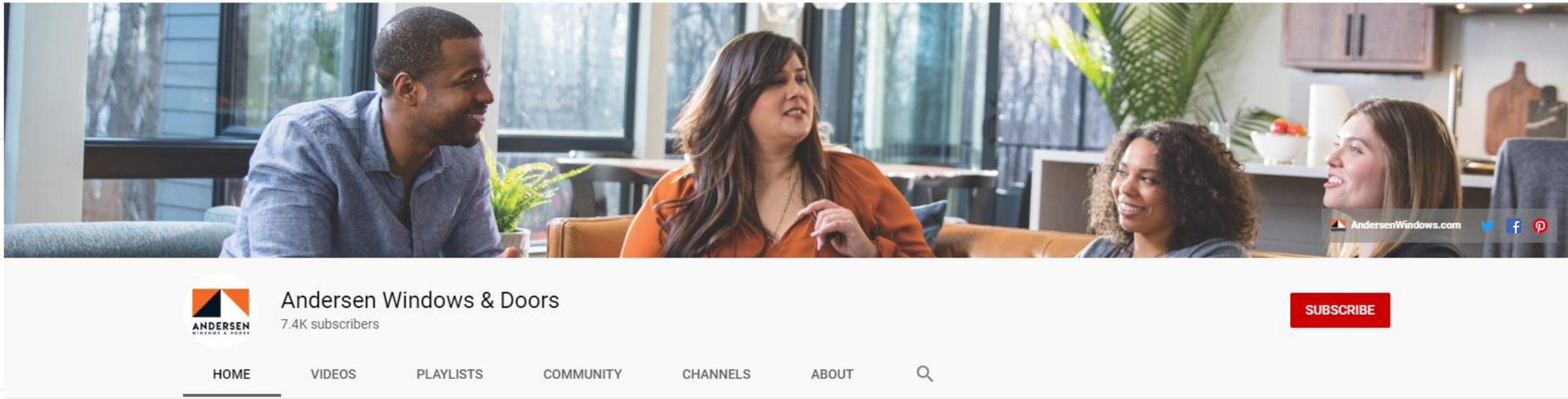

www.youtube.com/andersenwindows