

MONTAGE II[®]

Industrial Ornamental Steel Fence



FENCE PRODUCTS

AMERISTARPERIMETER.COM | 800-321-8724

Experience a safer and more open world

AMERISTAR[®]

ASSA ABLOY



MONTAGE II[®]

INDUSTRIAL ORNAMENTAL STEEL FENCE

Montage II is an industrial-grade steel fence that delivers on all levels. Superior welding techniques create a profile that lends itself to stylish design while sustaining a level of unmatched security through all-terrain flexibility.

PANEL BRACKET

Universal Boulevard Bracket enables easy installation while allowing for adjustment of panel height and positioning

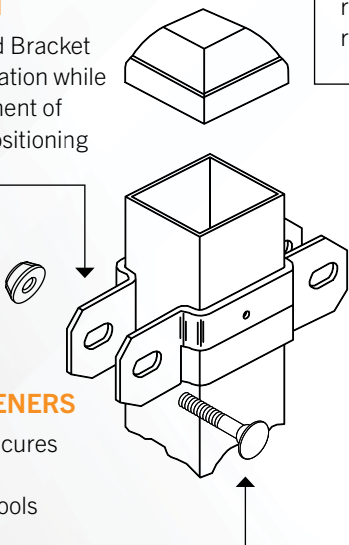

SECURITY FASTENERS

Security fastener secures the rail and deters removal by typical tools

PICKET TO RAIL PROFUSION WELDING

Each picket is welded precisely at each rail connection for ease of installation, yet remaining flexible as an all-terrain fence

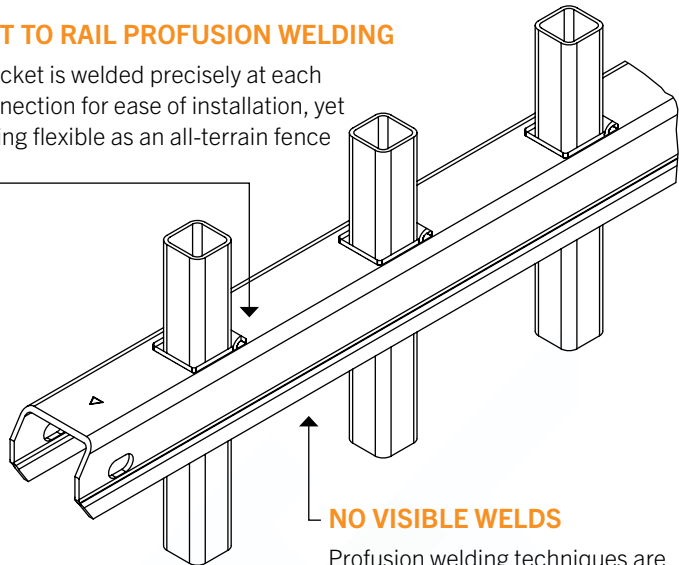

NO VISIBLE WELDS

Profusion welding techniques are both strong and hidden from view, providing a good neighbor profile

PICKETS

1" SQ. x 14 GA.

RAILS

1.75" x 1.75" x 12 GA.

POSTS

2.5" SQ. x 12 GA.
3" SQ. x 12 GA.

HEIGHTS

3', 3½', 4', 4½', 5', 6', 7', 8'

COLOR

BLACK

ENVIRONMENTALLY RESPONSIBLE

We lead the way in manufacturing programs and practices that reduce our carbon footprint — monitoring air emissions, stormwater runoff and wastewater discharge and recycling all scrap steel, wood, cardboard, plastics, paper and oil products, giving our products the opportunity to earn project LEED points.



PROFUSION WELDING

Laser and fusion welding technology create a virtually invisible structural connection at every picket to rail intersection.



RAKEABLE VS STAIR-STEP

Fully Rakeable panels eliminate any possible security risks due to large gaps under the fence panels.



**FULLY RAKEABLE
PANELS**

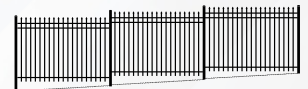

**STAIR-STEPPING
PANELS**

E-COAT™

20 YEAR WARRANTY

The Montage families of fencing products are manufactured from superior quality materials by skilled craftsmen with the highest standards of workmanship in the industry.

We are so confident in this product, it comes with a 20 year warranty.



PRE-TREATMENT

**ALKALINE
SPRAY WASH**

1

**ALKALINE
IMMERSION**

2

**WATER
IMMERSION**

3

**SPRAY
CONDITIONER**

4

**PHOSPHATE
IMMERSION**

5

EPOXY PROCESS

**ELECTRO COAT
EPOXY PRIMER**

10

**PERMEATE
SPRAY RINSE**

11

**PERMEATE
IMMERSION**

12

**PERMEATE
SPRAY RINSE**

13

**REVERSE OSMOSIS
HALO RINSE**

14

ACRYLIC FINISH

**ELECTRO COAT
ACRYLIC FINISH**

17

**PERMEATE
SPRAY RINSE**

18

**PERMEATE
IMMERSION**

19

**PERMEATE
SPRAY RINSE**

20

**REVERSE OSMOSIS
HALO RINSE**

21

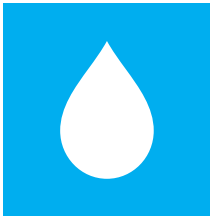
**WATER
IMMERSION**

6



**NON-CHROMATE
SPRAY SEAL**

7

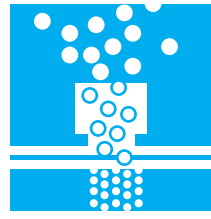

**REVERSE OSMOSIS
IMMERSION**

8



**REVERSE OSMOSIS
HALO RINSE**

9

Immersion processes coat and cleanse the inside of the fence components as thoroughly as the outside. This prevents corrosion, giving Montage products the ability to withstand the elements and be maintenance-free.



**FINISH CURING
OVEN**

15



**COOLING
TUNNEL**

16



**FINISH CURING
OVEN**

22







**COOLING
TUNNEL**

23

LAYERED PROTECTION

Protection against corrosion starts with a proven process, which is why Ameristar emulated its PermaCoat method to develop a superior E-Coat process that protects the product with complete coverage inside and out.

-  ACRYLIC TOPCOAT
-  EPOXY PRIMER
-  PHOSPHATE
-  GALVANIZED STEEL

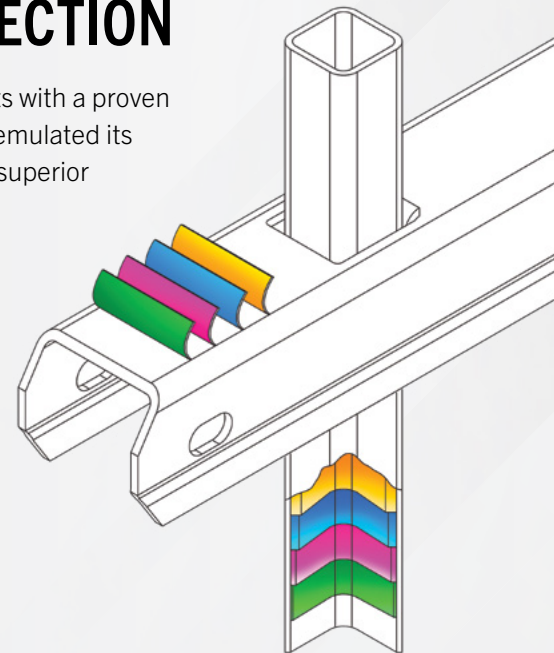



CLASSIC™

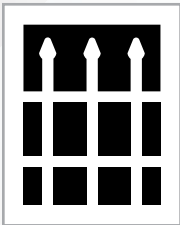

Experience traditional grace.

Extended pickets that culminate to an arrow-pointed spear capture the look of traditional wrought iron fencing. Single, double and arched gates are also available to match this style.



PANELS

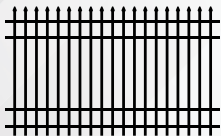

4-RAIL PANELS
Available in
6', 7' & 8' heights

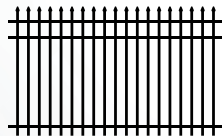

3-RAIL PANELS
Available in
3', 3½', 4', 5', 6',
7' & 8' heights

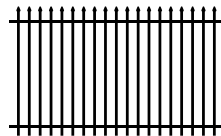

2-RAIL PANELS
Available in
3', 3½', 4', 5', 6',
7' & 8' heights

BOTTOM OPTION



**STANDARD
BOTTOM RAIL**



**FLUSH
BOTTOM RAIL**



MAJESTIC™

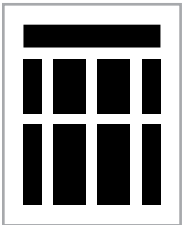

Enjoy sleek modernism.

The flush top rail projects a more modern, streamlined look, making it one of the most popular styles in the Montage family. Single, double and arched gates are also available to match this style.



PANELS

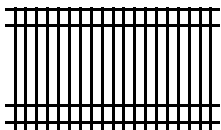

4-RAIL PANELS
Available in
6', 7' & 8' heights

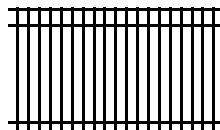

3-RAIL PANELS
Available in
3', 3½', 4', 4½', 5', 6',
7' & 8' heights

(4½' panels available in
flush bottom rail only)

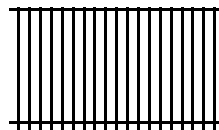

2-RAIL PANELS
Available in
3', 3½', 4', 5', 6',
7' & 8' heights

BOTTOM OPTION



**STANDARD
BOTTOM RAIL**



**FLUSH
BOTTOM RAIL**



GENESIS™

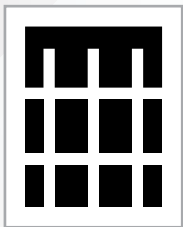

Customize your look.

The extended flat-topped pickets serve as a base for your choice of accent finials, providing a customized design. Single, double and arched gates are also available to match this style.

ADORNMENTS



**BALL
CAP**



**QUAD
FLARE**



TRIAD



ROYALTY



PANELS

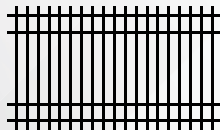

4-RAIL PANELS

Available in
6', 7' & 8' heights

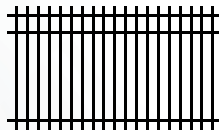

3-RAIL PANELS

Available in
3', 3½', 4', 5', 6',
7' & 8' heights

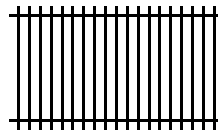

2-RAIL PANELS

Available in
3', 3½', 4', 5', 6',
7' & 8' heights

BOTTOM OPTION



**STANDARD
BOTTOM RAIL**



**FLUSH
BOTTOM RAIL**



INVINCIBLE™

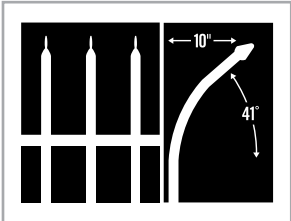

Gain intrepid fortification.

Pickets curve outward gracefully with a duality that acts as an attractive yet visually intimidating deterrent. Single, double and arched gates are also available to match this style.



PANELS

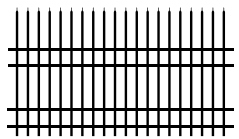

4-RAIL PANELS
Available in 6', 7' & 8' heights

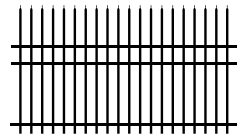

3-RAIL PANELS
Available in 3½', 7' & 8' heights
(3½' panels available with flush bottom rail only)

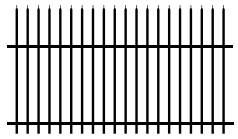

2-RAIL PANELS
Available in 3', 3½', 7' & 8' heights

BOTTOM OPTION



STANDARD BOTTOM RAIL



FLUSH BOTTOM RAIL

GATE SYSTEMS



Montage II gate options vary from swing gates for pedestrian or vehicle access to sliding gates for high-functioning points of entry. Each of these gate systems is individually constructed to provide project-specific performance.

SLIDE & SWING GATES

Ameristar Transport™ and Passport™ sliding gates perfectly match the perimeter fence system to create a seamless and stunning design while exuding a commanding presence of security built to unite perimeter and entry.





EXODUS[®] GATES

The Exodus Egress Gate system is designed to mitigate multiple trips to the job site. This all-in-one gate system has all the required panic exit device hardware pre-installed and is available in both Single and Double Swing.



- Meets IBC Group I-2 Egress Requirement
- Pre-assembled
- Quick Install



ARCHITECTURAL SUPPORT AND SOLUTION SPECIALISTS

Ameristar's Project Solution Specialists are experienced in every facet of perimeter security design. Our goal is to assist the architectural community in finding the best perimeter and entry solutions for their projects.

ameristarperimeter.com/architects

Why Choose Ameristar?

KNOWLEDGE AND EXPERIENCE

For over 40 years, we've delivered aesthetically pleasing, high-quality and innovative fencing products with superior design strength and easy installation.

PROVEN CAPABILITIES

Our integrated in-house processes, extensive raw materials and finished goods inventory translate into quality, on-time delivery.

INDUSTRY LEADERSHIP

We continually raise the bar in manufacturing customer-focused solutions. Our high standards produce premium products that go beyond merely meeting minimum industry standards.

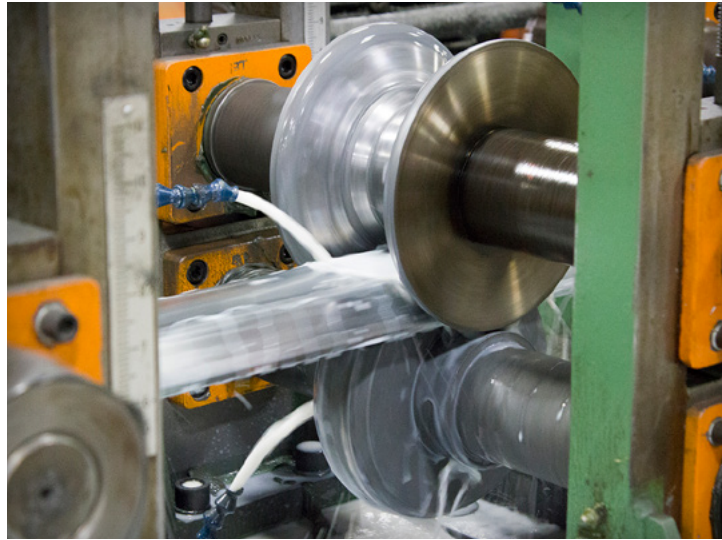

AMERISTARPERIMETER.COM | 800-321-8724

Experience a safer and more open world

#1820 | 2022

AMERISTAR®
ASSA ABLOY