

AUSTRALASIAN ANTARCTIC EXPEDITION

1911-14.

UNDER THE LEADERSHIP OF SIR DOUGLAS MAWSON, D.Sc., B.E., F.R.S.

---

SCIENTIFIC REPORTS.

SERIES C.—ZOOLOGY AND BOTANY.

EDITED BY ACTING PROFESSOR E. A. BRIGGS, M.Sc.,  
UNIVERSITY OF SYDNEY.

VOL. IX. PART I.

---

THE BRYOZOA.

SUPPLEMENTARY REPORT

BY

ARTHUR A. LIVINGSTONE, ASSISTANT ZOOLOGIST,  
THE AUSTRALIAN MUSEUM,  
SYDNEY.

WITH SEVEN PLATES AND TWENTY FIGURES IN TEXT.

---

PRICE: TEN SHILLINGS.

---

PRINTED BY ALFRED JAMES KENT, GOVERNMENT PRINTER, PHILLIP-STREET, SYDNEY—1920.

**Series C.—REPORTS ALREADY ISSUED.**

Vol. Part.		PRICE.	
		s. d.	
III.	1. FISHES. By EDGAR R. WAITE, F.L.S., Director, South Australian Museum, Adelaide ...	8	6
III.	2. PTEROBRANCHIA. By W. G. RIDWOOD, D.Sc. (Lond.) ...	2	6
III.	3. ASCIDIÆ SIMPLICES. By Sir WILLIAM A. HERDMAN, C.B.E., F.R.S., University of Liverpool ...	4	0
IV.	1. MOLLUSCA:—PELECYPODA AND GASTROPODA. By C. HEDLEY, F.L.S., Australian Museum, Sydney	8	6
IV.	2. MOLLUSCA:—CEPHALOPODA. By Dr. S. STILLMAN BERRY, Redlands, Cal.	3	6
IV.	3. BRACHIOPODA. By J. ALLAN THOMSON, M.A., D.Sc., Director, Dominion Museum, Wellington, N.Z.	6	0
V.	1. ARACHNIDA FROM MACQUARIE ISLAND. By the late W. J. RAINBOW, F.E.S., Australian Museum, Sydney	1	0
V.	2. BRACHYURA. By Miss MARY J. RATHBUN, United States National Museum, Washington, U.S.A.	1	0
V.	3. COPEPODA. By Dr. G. STEWARDSON BRADY, F.R.S. ...	5	6
V.	4. CLADOCERA AND HALOCYPRIDÆ. By Dr. G. STEWARDSON BRADY, F.R.S. ...	2	0
V.	5. EUPHAUSIACEA AND MYSIDACEA. By W. M. TATTERSALL, D.Sc., Keeper, University Museum, Manchester	1	6
V.	6. CUMACEA AND PHYLLOCARIDA. By Dr. W. T. CALMAN, D.Sc., British Museum, Natural History	1	3
V.	7. OSTRACODA. By FREDERICK CHAPMAN, A.L.S., F.R.M.S., National Museum, Melbourne	4	7
V.	8. THE INSECTS OF MACQUARIE ISLAND. By R. J. TILLYARD, M.A., D.Sc., F.L.S., F.E.S., with APPENDICES by Prof. C. T. BRUES, Ph.D., and A. M. LEA, F.E.S.	2	9
VI.	1. CALCAREOUS SPONGES. By Prof. A. S. DENDY, D.Sc., F.R.S., F.Z.S., King's College, London	2	0
VI.	2. THE CHÆTOGNATHA. By Prof. T. HARVEY JOHNSTON, M.A., D.Sc., C.M.Z.S., and B. BUCKLAND TAYLOR, F.L.S., Biology Department, University, Brisbane	1	10
VI.	3. POLYCHÆTA. By Prof. W. B. BENHAM, M.A. (Oxon.), D.Sc. (Lond.), F.R.S., F.N.Z.Inst.	12	0
VI.	4. OLIGOCHÆTA OF MACQUARIE ISLAND. By Prof. W. B. BENHAM, M.A., (Oxon.), D.Sc. (Lond.), F.R.S., F.N.Z.Inst.	3	0
VI.	5. GEPHYREA INERMIA. By Prof. W. B. BENHAM, M.A. (Oxon), D.Sc. (Lond.), F.R.S., F.N.Z.Inst.	2	0
VI.	6. POLYZOA. By L. R. THORNELY ...	2	0
VII.	1. MOSSES. By H. N. DIXON, M.A., F.L.S., and Rev. W. WALTER WATTS ...	1	0
VII.	2. THE ALGAE OF COMMONWEALTH BAY. By A. H. S. LUCAS, M.A. (Oxon.), B.Sc. (Lond.)	3	0
VII.	3. THE VASCULAR FLORA OF MACQUARIE ISLAND. By the late T. F. CHEESEMAN, F.L.S., F.Z.S., Auckland Museum, N.Z.	6	6
VII.	4. BACTERIOLOGICAL AND OTHER RESEARCHES. By the late A. L. McLEAN, B.A., M.D., Ch.M. (M.C.)	16	0
VII.	5. ECOLOGICAL NOTES AND ILLUSTRATIONS OF THE FLORA OF MACQUARIE ISLAND. By H. HAMILTON, A.O.S.M., Dominion Museum, Wellington, N.Z.	5	0
VIII.	1. ECHINODERMATA ASTEROIDEA. By Prof. R. KOEHLER, Université, Lyon	38	0
VIII.	2. ECHINODERMATA OPHIUROIDEA. By Prof. R. KOEHLER, Université, Lyon	10	6
VIII.	3. ECHINODERMATA ECHINOIDEA. By Prof. R. KOEHLER, Université, Lyon, France.	38	0
IX.	1. THE BRYOZOA. ( <i>Supplementary Report.</i> ) By A. A. LIVINGSTONE, Australian Museum, Sydney	10	0

AUSTRALASIAN ANTARCTIC EXPEDITION

1911-14.

UNDER THE LEADERSHIP OF SIR DOUGLAS MAWSON, D.Sc., B.E., F.R.S.

---

SCIENTIFIC REPORTS.

SERIES C.—ZOOLOGY AND BOTANY.

EDITED BY ACTING PROFESSOR E. A. BRIGGS, M.Sc.,  
UNIVERSITY OF SYDNEY.

VOL. IX. PART I.

---

THE BRYOZOA.

SUPPLEMENTARY REPORT

BY

ARTHUR A. LIVINGSTONE, ASSISTANT ZOOLOGIST,  
THE AUSTRALIAN MUSEUM,  
SYDNEY.

WITH SEVEN PLATES AND TWENTY FIGURES IN TEXT.

---

PRICE: TEN SHILLINGS.

---

PRINTED BY ALFRED JAMES KENT, GOVERNMENT PRINTER, PHILLIP-STREET, SYDNEY—1928.

ISSUED JULY, 1928.

# CONTENTS.

---

	PAGE.
Introduction ... ..	5
Details of each Station of the Expedition and the Bryozoa taken thereat ... ..	8
Sub-Order Cheilostomata ... ..	11
Membranipora ... ..	11
Ogivalina ... ..	12
Callopora ... ..	14
Ramphonotus ... ..	15
Chaperia ... ..	16
Flustra ... ..	18
Farciminaria ... ..	24
Notoplites ... ..	25
Beania ... ..	26
Bugula ... ..	26
Cornucopina ... ..	28
Bugularia ... ..	28
Micropora ... ..	28
Labioporella ... ..	29
Cellaria ... ..	32
Mawsonia ... ..	39
Pseudocellaria ... ..	42
Cribrilina ... ..	45
Arachnopusia ... ..	46
Figularia ... ..	47
Hippothoa ... ..	47
Systemopora ... ..	48
Cellarinella ... ..	48
Schizoporella ... ..	52
Lacerna ... ..	52
Buffonella ... ..	53
Emballotheca ... ..	54
Microporella ... ..	55

	PAGE.
Fenestrulina ... ..	56
Inversiula ... ..	59
Lepralia ... ..	60
Romancheina ... ..	60
Peristomella ... ..	61
Kymella ... ..	62
Smittina ... ..	63
Mucronella ... ..	66
Porella ... ..	66
Retepora ... ..	68
Haswellina ... ..	71
Costicella ... ..	72
Scuticella ... ..	72
Phylactella ... ..	73
Osthimosia ... ..	75
Cellepora ... ..	76
Sub-Order Cyclostomata ... ..	78
Hornera ... ..	78
Lichenopora ... ..	79
Fasciculipora ... ..	79
Filicea ... ..	80
Explanation to Plates ... ..	81
Index ... ..	85

# THE BRYOZOA.

---

Supplementary Report by ARTHUR A. LIVINGSTONE.

---

(Plates I-VII.)

## INTRODUCTION.

The first report upon the Bryozoa (Polyzoa) was made by Miss L. R. Thornely, and published in New South Wales by the Australasian Antarctic Publication Committee. The material upon which Miss Thornely's report was based was despatched from England in 1924, and upon its arrival at the Australian Museum, its final destination, it was noticed that the specimens did not represent in bulk one-tenth of the collections made in the Antarctic region and the vicinity, although nearly every species was well represented. The vast majority of the specimens then have not been examined and reported upon, and perhaps the reason for this is that they were unwittingly overlooked when a representative set was being assembled to send to a specialist. Unfortunately, the large series examined by Miss Thornely was not accompanied by labels of identification when received at this institution, and, in many cases, I am unable to state with certainty what specimens were referred to in this author's report. For instance, on page 17 of the report the name *Haswellia australiensis* appears, but nowhere in the returned collection can I find a specimen corresponding to the description of that species. There is, however, one specimen superficially resembling *H. australiensis* (Haswell) from the same locality as that species was reported from, but it is *Filicea elegans* (Hutton), a typical New Zealand species, which was not included in Miss Thornely's report. Also, in the returned collection, there are a number of species not referred to in the report, and these have been assembled and included in this supplement. The new species described by Miss Thornely can all be recognised, and any further data gathered from the specimens after examination has been added to the existing descriptions.

Taking the above facts into account, and considering the undoubted importance of the Mawson collection, I have endeavoured to place on record the full extent of the Bryozoa collected, together with corrections and additional data concerning specimens examined by the authoress of the original report and others that she presumably overlooked.

In regard to classification, it will be seen that in nearly every case the more modern ideas expressed by Levinsen, Canu and Bassler, Jullien and others have been followed. In earlier papers I adopted a more or less conservative classification, but after examination of the present collection in conjunction with other material, it was

considered advisable to introduce the latest form of arrangement and grouping into the present report. Further details regarding classification have been included under the various genera and species concerned.

I here wish to express my indebtedness to Dr. Charles Anderson, M.A., D.Sc., Director of the Australian Museum, for his assistance in translating many descriptions as well as for suggestions that have proved to be of considerable value.

To Mr. G. C. Clutton, of the Australian Museum, my thanks are due for the attention he has given to the photo-micrographs which have been produced in a very faithful manner.

Following is a list of the specimens identified by Miss Thornely and included in her report. Opposite to it is a list of the species examined and reported upon in this present work. Such comparative lists will not only serve to indicate the species examined by Miss Thornely and myself; but will also show what species were omitted by the former author and the present status of those she did examine.

List of species named by Miss Thornely in original report.	Included in this present work under the name of—*
<i>Aetea anguina</i> Linn. ....	?
<i>Catenicella hastata</i> Busk ....	<i>Costicella hastata</i> (Busk).
<i>Catenicella margaritacea</i> Busk ....	<i>Scuticella margaritacea</i> (Busk).
<i>Bugula bicornis</i> Busk ....	<i>Bugula bicornis</i> Busk.
<i>Bugula reticulata</i> Busk ....	?
<i>Bugula tricornis</i> Waters ....	<i>Bugula tricornis</i> Waters.
<i>Menipea funiculata</i> MacGillivray ....	<i>Notoplites drygalskii</i> (Kluge).
<i>Bicellaria tuba</i> Busk ....	<i>Cornucopina tuba</i> (Busk).
<i>Flustra spoliata</i> Ortmann ....	<i>Flustra angusta</i> Kluge.
<i>Flustra antarctica</i> Calvet ....	<i>Flustra antarctica</i> Calvet.
<i>Flustra ovoidea</i> Busk ....	?
<i>Flustra spinuligera</i> Hincks ....	?
<i>Carbasea elegans</i> Busk ....	?
<i>Beania erecta</i> Waters ....	<i>Beania erecta</i> Waters.
<i>Farciminaria aculeata</i> Busk ....	<i>Farciminaria aculeata</i> Busk.
<i>Membranipora corbula</i> Hincks ....	?
<i>Membranipora elongata</i> sp. nov. ....	<i>Ogivalina lata</i> (Kluge).
<i>Cellaria fistulosa</i> Linn. ....	?
<i>Cellaria wandeli</i> Calvet ....	<i>Cellaria wandeli</i> Calvet.
<i>Cellaria membranacea</i> sp. nov. ....	<i>Mawsonia membranacea</i> (Thornely).
<i>Micropora brevissima</i> Waters ....	<i>Micropora brevissima</i> Waters.
<i>Vincularia abyssicola</i> Smitt ....	<i>Labiporella adeliensis</i> sp. nov.
<i>Cribrilina projecta</i> Waters ....	?
<i>Cribrilina spatulata</i> Calvet ....	<i>Figularia spatulata</i> (Calvet).
<i>Cribrilina monoceros</i> Busk ....	<i>Arachnopusia monoceros</i> (Busk).
<i>Microporella divaricata</i> Canu ....	<i>Microporella divaricata</i> Canu.
<i>Microporella proxima</i> Waters ....	<i>Fenestulina proxima</i> (Waters).
<i>Microporella trinervis</i> Waters ....	(? <i>Microporella</i> ) <i>trinervis</i> Waters.
<i>Microporella inversa</i> Waters ....	<i>Inversiula nutrix</i> Jullien.
<i>Microporella malusii</i> Audouin ....	<i>Fenestulina malusii</i> (Aud.).
<i>Lepralia marginata</i> Calvet ....	<i>Lepralia marginata</i> Calvet.

\* Species included by Miss Thornely in her report and omitted in this present one are marked ? The specimens cannot be found. Either they have been lost or they are included in this present work under another name.

List of species named by Miss Thornely in original report.	Included in this present work under the name of—*
<i>Schizoporella tumida</i> Hincks var. <i>tricuspis</i> ... ..	<i>Schizoporella tumida</i> v. <i>tricuspis</i> .
<i>Schizoporella hyalina</i> Linn. ....	<i>Hippothoa hyalina</i> (Linn.).
<i>Schizoporella simplex</i> d'Orbigny (see text) ... ..	<i>Lacerna hosteensis</i> Jullien.
<i>Cyclicopora polaris</i> Waters ... ..	<i>Kymella polaris</i> (Waters).
<i>Systemopora contracta</i> Waters ... ..	<i>Systemopora contracta</i> Waters.
<i>Cellarinella foveolata</i> Waters ... ..	<i>Cellarinella foveolata</i> Waters.
<i>Cellarinella dubia</i> Waters ... ..	<i>Cellarinella dubia</i> Waters.
<i>Cellarinella watersi</i> Calvet ... ..	<i>Cellarinella watersi</i> Calvet.
<i>Cellarinella nodulata</i> Waters ... ..	<i>Cellarinella nodulata</i> Waters.
<i>Smittia conspicua</i> Waters ... ..	<i>Smittina conspicua</i> (Waters).
<i>Smittia antarctica</i> Waters ... ..	<i>Smittina antarctica</i> (Waters).
<i>Smittia marsupium</i> MacGillivray ... ..	<i>Smittina marsupium</i> (MacGill.).
<i>Smittia landsborovii</i> Johnston ... ..	<i>Smittina landsborovii</i> (Johnston).
<i>Smittia reticulata</i> MacGillivray ... ..	<i>Smittina reticulata</i> (MacGill.).
<i>Smittia tripora</i> Waters ... ..	<i>Smittina tripora</i> (Waters).
<i>Mucronella teres</i> Hincks ... ..	?
<i>Mucronella coronata</i> sp. nov. ... ..	<i>Chaperia coronata</i> (Thornely).
<i>Mucronella contortuplicata</i> Calvet ... ..	<i>Emballotheca contortuplicata</i> (Calvet).
<i>Phylactella lyrulata</i> Calvet ... ..	<i>Phylactella lyrulata</i> Calvet.
<i>Aspidostoma giganteum</i> Busk ... ..	<i>Cellaria mawsoni</i> sp. nov.
<i>Aspidostoma obliquum</i> sp. nov. ....	<i>Pseudocellaria obliqua</i> (Thornely).
<i>Haswellia australiensis</i> Haswell ... ..	<i>Filicea elegans</i> (Hutton).
<i>Cellepora eatonensis</i> Busk ... ..	<i>Osthimosia eatonensis</i> (Busk).
<i>Cellepora setosa</i> sp. nov. ....	(? <i>Cellepora</i> ) <i>setosa</i> Thornely.
<i>Turritigera stellata</i> Busk ... ..	?
<i>Retepora plana</i> Hincks ... ..	<i>Retepora antarctica</i> Waters.
<i>Retepora gelida</i> Waters ... ..	<i>Retepora gelida</i> Waters.
<i>Retepora lepralioides</i> Waters ... ..	<i>Retepora lepralioides</i> Waters.
<i>Retepora frigida</i> Waters ... ..	<i>Retepora frigida</i> Waters.
<i>Crisia biciliata</i> MacGillivray ... ..	?
<i>Crisia cornuta</i> Linn. ... ..	?
<i>Idmonea australis</i> MacGillivray ... ..	?
<i>Hornera foliacea</i> MacGillivray ... ..	<i>Hornera foliacea</i> MacGillivray.
<i>Hornera caespitosa</i> Busk ... ..	?
<i>Hornera antarctica</i> Waters ... ..	<i>Hornera antarctica</i> Waters.
<i>Lichenopora hispida</i> Fleming ... ..	<i>Lichenopora fimbriata</i> (Busk).
<i>Fasciculipora gracilis</i> MacGillivray ... ..	<i>Fasciculipora fruticosa</i> MacGill.
<i>Barentsia discreta</i> Busk ... ..	?

\* Species included by Miss Thornely in her report and omitted in this present one are marked? The specimens cannot be found. Either they have been lost or they are included in this present work under another name.

List of species not referred to by Miss Thornely and included in this paper.	List of species not referred to by Miss Thornely and included in this paper—contd.
<i>Membranipora ciliata</i> MacGillivray.	<i>Cellaria aurorae</i> sp. nov.
<i>Callopora onychocelloides</i> (Calvet).	<i>Cribrilina punctata</i> (Hassal).
<i>Ramphonotus inermis</i> (Kluge).	<i>Fenestrulina malusii</i> (Aud.) var. <i>thyreophora</i> (Busk).
<i>Flustra flagellata</i> Waters.	<i>Fenestrulina exigua</i> (Waters).
<i>Flustra tenuis</i> Kluge.	<i>Romancheina martiali</i> Jullien.
<i>Flustra curva</i> Kluge.	<i>Peristomella excavata</i> (MacGill.) var. <i>tridens</i> (Calvet).
<i>Flustra vanhoffeni</i> Kluge.	<i>Smittina</i> (? <i>directa</i> ) (Waters).
<i>Farciminaria simplex</i> (MacGillivray).	<i>Mucronella phylactelloides</i> Calvet.
<i>Bugula retiformis</i> Kluge.	<i>Mucronella crozetensis</i> Waters.
<i>Bugularia dissimilis</i> (Busk).	<i>Porella malouinensis</i> Jullien.
<i>Micropora coriacea</i> (Esper).	<i>Porella hyadesi</i> Jullien.
<i>Cellaria mawsoni</i> sp. nov.	<i>Retepora hippocrepis</i> Waters.
<i>Cellaria diversa</i> sp. nov.	



DETAILS OF EACH STATION OF THE EXPEDITION AND THE BRYOZOA  
TAKEN THEREAT.

Off Maria Island near Tasmania, 40 fathoms; 12th Dec., 1914—

*Farciminaria aculeata* Busk. *Cornucopina tuba* (Busk).

East of Enderby Island, Auckland Islands, New Zealand, 40 fathoms 5th July, 1912—

*Costicella hastata* (Busk). *Hornera foliacea* (MacGillivray).

*Scuticella margaritacea* (Busk). *Lichenopora fimbriata* (Busk).

*Filicea elegans* (Hutton).

Main Base, Commonwealth Bay, Antarctica, 1912 to 1914.

*Membranipora ciliata* MacGill.

*Cellarinella watersi* Calvet.

*Ogivalina lata* (Kluge).

*Fenestrulina exigua* (Waters).

*Callopora onychocelloides* (Calvet).

*Inversiula nutrix* Jullien.

*Flustra flagellata* Waters.

*Lepralia marginata* Calvet.

*Flustra tenuis* Kluge.

*Peristomella excavata* (MacGill.).

*Flustra antarctica* Calvet.

var. *tridens* (Calvet).

*Notoplites drygalskii* (Kluge).

*Kymella polaris* (Waters).

*Beania erecta* Waters.

*Smittina* (? *directa*) (Waters).

*Micropora coriacea* (Esper).

*Smittina marsupium* (MacGill.).

*Cellaria mawsoni* sp. nov.

*Retepora frigida* Waters.

*Cellaria diversa* sp. nov.

*Phylactella lyrulata* Calvet.

*Figularia spatulata* (Calvet).

*Osthimosia eatonensis* (Busk).

*Hippothoa hyalina* (Linn.).

*Hornera antarctica* Waters.

*Fasciculipora fruticosa* MacGill.

Station 1, 22nd Dec., 1913, Commonwealth Bay, Antarctica; Lat. 66° 50' S., Long. 142° 6' E., 350 to 400 fathoms; Temperature 1.85° C.; ooze.

*Ramphonotus inermis* (Kluge).

*Schizoporella tumida* var. *tricuspis*

*Notoplites drygalskii* (Kluge).

Calvet.

*Bugula bicornis* Busk.

*Emballotheca contortuplicata*

*Cribrilina punctata* (Hassal).

(Calvet).

*Phylactella lyrulata* Calvet.

*Smittina landsborovii* (Johns.).

Station 2, 28th Dec., 1913; Lat. 66° 55' S., Long. 145° 21' E., 288 to 300 fathoms; Temperature 1.8° C.; ooze with diatoms.

*Micropora brevissima* Waters.

(? *Microporella*) *trinervis* Waters.

*Cellaria mawsoni* sp. nov.

*Smittina tripora* Waters.

*Pseudocellaria obliqua* (Thornely).

*Smittina landsborovii* (Johnst.).

*Hippothoa hyalina* (Linn.).

*Smittina conspicua* Waters.

*Systemopora contracta* Waters.

*Smittina antarctica* Waters.

*Cellarinella foveolata* Waters.

*Phylactella lyrulata* Calvet.

*Cellarinella nodulata* Waters.

(? *Cellepora*) *setosa* Thornely.

*Lacerna hosteensis* Jullien.

*Hornera antarctica* Waters.

Station 3, 31st Dec., 1913, Lat. 66° 32' S., Long. 141° 39' E., 157 fathoms; Temperature 1.62° C.; ooze.

<i>Flustra flagellata</i> Waters.	<i>Emballotheca contortuplicata</i>
<i>Flustra angusta</i> Kluge.	(Calvet).
<i>Flustra antarctica</i> Calvet.	<i>Lepralia marginata</i> Calvet.
<i>Bugula bicornis</i> Busk.	<i>Smittina tripora</i> (Waters).
<i>Bugula tricornis</i> Waters.	<i>Smittina conspicua</i> (Waters).
<i>Cellaria aurorae</i> sp. nov.	<i>Smittina</i> (? <i>directa</i> ) Waters.
<i>Mawsonia membranacea</i> (Thornely).	<i>Smittina antarctica</i> (Waters).
<i>Pseudocellaria obliqua</i> (Thornely).	<i>Porella malouinensis</i> Jullien.
<i>Cellarinella nodulata</i> Waters.	<i>Retepora lepralioides</i> Waters.
<i>Cellarinella watersi</i> Calvet.	<i>Phylactella lyrulata</i> Calvet.
<i>Lacerna hosteensis</i> Jullien.	<i>Osthimosia eatonensis</i> (Busk).
(? <i>Cellepora</i> ) <i>setosa</i> Thornely.	

Station 4, 2nd Jan., 1914, Lat. 65° 48' S., Long. 137° 32' E., 230 fathoms; Temperature 1.4° C.; ooze.

<i>Flustra flagellata</i> Waters.	<i>Farciminaria simplex</i> (MacGill.).
<i>Flustra angusta</i> Kluge.	<i>Notoplites drygalskii</i> (Kluge).
<i>Flustra curva</i> Kluge.	<i>Cellaria diversa</i> sp. nov.
<i>Flustra antarctica</i> Calvet.	

Station 5, 6th Jan., 1914, Lat. 64° 34' S., Long. 127° 17' E., 1,700 fathoms; Temperature 0.3° C.; thick ooze and rocks.

No Bryozoa.

Station 6, 14th Jan., 1914, Lat. 63° 13½' S., Long. 101° 42' E., 870 fathoms; Temperature 0.2° C.; ooze and rocks.

No Bryozoa.

Station 7, 21st Jan., 1914, off Drygalski Island, Lat. 65° 42' S., Long. 92° 10' E., 60 fathoms; red algæ and a few small rocks, no ooze.

<i>Ramphonotus inermis</i> (Kluge).	<i>Buffonella simplex</i> (d'Orb.).
<i>Cellaria diversa</i> sp. nov.	<i>Lepralia marginata</i> Calvet.
<i>Cribrilina punctata</i> (Hassal).	<i>Kymella polaris</i> (Waters).
<i>Figularia spatulata</i> (Calvet).	<i>Smittina tripora</i> (Waters).
<i>Retepora frigida</i> Waters.	<i>Retepora gelida</i> Waters.
<i>Labioporella adeliensis</i> sp. nov.	

Station 7A., 22nd Jan., 1914, Lat. 66° 28½' S., Long. 92° 42' E., 350 fathoms.

No Bryozoa.

Station 8, 27th Jan., 1914, Lat. 66° 8' S., Long. 94° 17' E., 120 fathoms.

<i>Chaperia coronata</i> (Thornely).	<i>Cellarinella nodulata</i> Waters.
<i>Flustra flagellata</i> Waters.	<i>Cellarinella watersi</i> Calvet.
<i>Flustra tenuis</i> Kluge.	<i>Lacerna hosteensis</i> Jullien.
<i>Flustra angusta</i> Kluge.	(? <i>Microporella</i> ) <i>trinervis</i> Waters.
<i>Flustra curva</i> Kluge.	<i>Fenestrulina malusii</i> (Aud.).
<i>Flustra vanhoeffeni</i> Kluge.	<i>Fenestrulina malusii</i> var.
<i>Notoplites drygalskii</i> (Kluge).	<i>thyreophora</i> (Busk).
<i>Micropora brevissima</i> Waters.	<i>Smittina tripora</i> (Waters).
<i>Cellaria mawsoni</i> sp. nov.	<i>Mucronella phylactelloides</i>
<i>Cellaria diversa</i> sp. nov.	Calvet.
<i>Cellaria auroræ</i> sp. nov.	<i>Mucronella crozetensis</i> Waters.
<i>Cellaria wandeli</i> Calvet.	<i>Porella hyadesi</i> Jullien.
<i>Cribrilina punctata</i> (Hassal).	<i>Retepora antarctica</i> Waters.
<i>Arachnopusia monoceros</i> (Busk).	<i>Retepora hippocrepis</i> Waters.
<i>Systemopora contracta</i> Waters.	<i>Phylactella lyrulata</i> Calvet.
(? <i>Cellepora</i> ) <i>setosa</i> Thornely.	<i>Labioporella adeliensis</i> sp. nov.
<i>Hornera antarctica</i> Waters.	

Station 9, 28th Jan., 1914, Off Shackleton Ice-shelf, Lat. 65° 20' S., Long. 95° 27' E., 240 fathoms; Temperature 1.38° C.; ooze.

No Bryozoa.

Station 10, 29th Jan., 1914, Off Shackleton Ice-shelf, Lat. 65° 6' S., Long. 96° 13' E., 325 fathoms; Temperature 1.65° C.; ooze.

No Bryozoa.

Station 10A, 30th Jan., 1914, Lat. 65° 0' S., Long. 96° 5' E., 320 fathoms.

No Bryozoa.

Station 11, 31st Jan., 1914, Off Shackleton Ice-shelf, Lat. 64° 44' S., Long. 97° 28' E., 358 fathoms; ooze.

*Mawsonia membranacea* (Thornely). *Romancheina martiali* Jullien.

Station 12, 31st Jan., 1914, Off Shackleton Ice-shelf Lat. 64° 32' S., Long. 97° 20' E., 110 fathoms; small rocks, no ooze, animal life abundant.

<i>Flustra curva</i> Kluge.	<i>Cellarinella nodulata</i> Waters.
<i>Bugula retiformis</i> Kluge.	<i>Emballotheca contortuplicata</i>
<i>Cellaria mawsoni</i> sp. nov.	(Calvet).
<i>Cellaria diversa</i> sp. nov.	<i>Microporella divaricata</i> Canu.
<i>Cellaria auroræ</i> sp. nov.	<i>Lepralia marginata</i> Calvet.
<i>Cellaria wandeli</i> Calvet.	<i>Romancheina martiali</i> Jullien.
<i>Pseudocellaria obliqua</i> (Thornely).	<i>Smittina tripora</i> (Waters).
<i>Arachnopusia monoceros</i> (Busk).	<i>Smittina conspicua</i> (Waters).
<i>Figularia spatulata</i> (Calvet).	<i>Smittina antarctica</i> (Waters).
(? <i>Cellepora</i> ) <i>setosa</i> Thornely.	<i>Labioporella adeliensis</i> sp. nov.

## Sub-Order CHEILOSTOMATA.

MEMBRANIPORA *Blainville*.

*Membranipora*, Blainville, Dict. Sci. Nat., lx, 1830, p. 411.

*Membranipora*, Blainville, Manuel d'Actinologie ou de Zoophytologie, 1834, p. 447.

*Membranipora ciliata* MacGillivray.

*Membranipora ciliata* MacGillivray, Trans. Proc. Roy. Soc. Victoria, ix, pt. ii, 1868 (1869), p. 132.

*Membranipora ciliata* MacGillivray, Prodr. Zool. Victoria, dec. xiii, 1886, p. 106, pl. 127, fig. 6.

? *Chaperia spinosissima* Calvet, Ergebnisse der Hamburger Magalhaensischen, Sammelreise, Bd. iii, 1904, p. 12, pl. 1, figs. 2a-2d (and ref.).

(Pl. I, figs. 6 and 9).

A considerable number of small brownish and dull-cream colonies found on seaweed gathered at various depths from different localities have been associated with *Membranipora ciliata* MacGillivray. The frontal walls are not granular, as described by MacGillivray, but according to that author this character is often lacking, and the walls may, in some cases, appear smooth. The specimens before me are not exactly smooth, but present a somewhat slightly rugged appearance when incinerated.

*Synonymy*.—Busk<sup>1</sup> considered this species to be a synonym of *Membranipora spinosa* d'Orbigny<sup>2</sup>, but this latter species was later found by Miss Jelly<sup>3</sup> to be a synonym of *Membranipora echinata* d'Orbigny (*loc. cit.* p. 16), and instead of including Busk's synonymy (*M. ciliata* MacGill.) in it, she (*loc. cit.* p. 167) placed it under *M. spinosa* Quoy and Gaimard, a species according to Marcus<sup>4</sup> not described in the "Astrolabe" collections. Marcus deals with the subject of synonymy, and includes MacGillivray's *M. ciliata* in the synonymy of *Chaperia acanthina*, but with this course I cannot agree. Harmer<sup>5</sup> notes Marcus' remarks, and seems to agree with that author as to the status of *ciliata* MacG.

In specimens before me which I consider to be MacGillivray's *ciliata* there are no lateral chambers formed by vertical septa within the aperture, a character which distinguishes it from *C. acanthina*. The calcareous spines bordering the zoecial aperture, however, pierce the frontal zoecial wall, making it appear that the species possesses lateral chambers. After examining the maze of synonymy concerning the species under discussion, and other species with which it has been confused, I consider the following to be separate species.—*C. acanthina*, *M. echinata*, MacGillivray's *M. spinosa* (which has been credited to Quoy and Gaimard), and *M. ciliata*.

<sup>1</sup> Busk, "Challenger" Zool., x, pt. xxx, 1884, p. 64.

<sup>2</sup> d'Orbigny, Voy. on Amer. Merid. v, pt. 4, p. 16, pl. viii, fig. 1.

<sup>3</sup> Jelly, Syn. Cat. Rec. Marine Bryozoa, 1889, p. 149.

<sup>4</sup> Marcus, Saertryk af Vidensk. Medd. fra Dansk naturh. Foren, Bd. 73, 1921, p. 88.

<sup>5</sup> Harmer, "Siboga" Exped., Polyzoa, pt. ii, Cheilostomata Anasca, Monogr. xxviii b, 1926, p. 230.

In regard to MacGillivray's *M. spinosa*, Harmer (*loc. cit.* p. 230) considered that Marcus was right in placing it in the synonymy of *C. acanthina*, but in fact Marcus considered it distinct, for in his list of synonymy he places "non" opposite his reference to MacGillivray's *spinosa*, thus following Jelly (*loc. cit.*).

Trouble arises when questioning the status of d'Orbigny's <sup>1</sup> *ciliata* now that the *ciliata* of MacGillivray has been revived. Not being certain as to the position of d'Orbigny's *ciliata* I hesitate to use a new name for MacGillivray's form, and confine myself to pointing out that it must stand as a separate species and is not a synonym of *Chaperia acanthina*.

A figure of the *ciliata* before me has been prepared, not only to convey some understanding of the form I have withdrawn from the complicated synonymy of *C. acanthina*, but to show characters separating it from that species.

*Localities*.—Commonwealth Bay, Adelie Land, 3½ fathoms, May, June and July, 1912; 3 to 5 fathoms, 16.3.1912; 3 fathoms (Lat. S.67°, Long. E. 142° 36') 16th and 21st May, 1912; 25 fathoms, 3rd and 4th September, 1912.

OGIVALINA *Canu and Bassler.*

*Ogivalina*, Canu and Bassler, U.S. National Museum, Bull. 96, 1917, p. 16.

*Ogivalina lata* (Kluge).

*Membranipora lata* Kluge, Deutsche Südpolar Expedition, xv, Zool., Bd. vii, Heft v, 1914, p. 661, pl. xxxiv, fig. 4.

*Membranipora elongata* Thornely, Austr. Antarctic Exped. Rept., ser. C. vi, pt. 6, 1924, p. 8, text fig. 1.

(Pl. V, fig. 1; Pl. VII, fig. 5 and text fig. 1).

*Remarks*.—Representatives of this species were first described by Kluge (*loc. cit.*) who dealt with it in the Deutsche Südpolar Reports. Before me are specimens which form the second record of the species in the Antarctic, and the following remarks made after an examination of them are intended to supplement the description given by Kluge.

The zoarium resembles that of *Steganoporella magnilabris* Busk in general appearance, being comparatively thick and of a bilaminate nature. But unlike that species, *Ogivalina lata* is very poorly calcified, and its extremely fragile nature is remarkable in contrast to its sturdy appearance.

To the naked eye the oecium-bearing zoecia are in regular series or belts, between which are further belts of non-fertile zoecia. This alternate arrangement of fertile and barren zoecia appears to be fairly constant, though the width of either region may vary. Microscopical examination of a fertile zoecium reveals its oecium to be endozoecial, with a fold of the zoecial wall separating it from the zoecium.

<sup>1</sup> Orbigny, Pal. Francaise Terr. Cret. v, Bryozoaires, 1850-1852, p. 543.

Each oecium is separated into two parts by a wall which exists on a level with and in the same plane as the tops of the zooecia. The top division, which is the smaller, is again separated by a median wall or septum, which is upright and at right angles to the wall dividing the entire zooecium into two portions. As a result of this secondary division, two crescentic recesses are formed, which proceed as far back as the junction of the roof of the top section with the cryptocyst of the preceding zooecium. The domed roof of the top section is conspicuously striated or corrugated as described by Kluge, and rapidly recedes in a distal direction to the level of the surrounding zooecia, where it joins the cryptocyst of the preceding zooecium. The lower section of the oecium is not divided into two parts like the top, though it is separated from the zooecium by a fold of the zooecial wall.

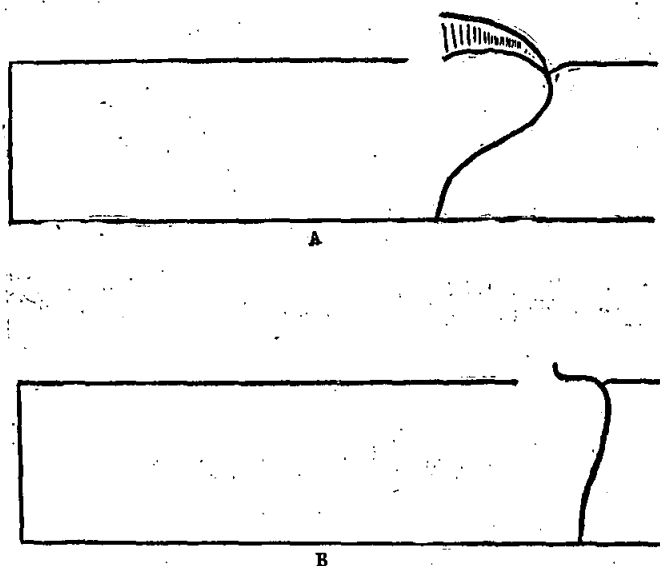

Text Fig. 1.

*Ogivalina lata* Kluge.

- A. Diagrammatic representation of an oecium-bearing zooecium in section showing the oecium divided into two separate sections and the top section divided again by a vertical septum.  
 B. Section of a barren zooecium showing the shape of the distal wall in comparison with that of an oecium-bearing zooecium.

The lateral zooecial walls are generally provided with two very large multiporous rosette plates, but in some cases only one occurs. Kluge (*loc. cit.*) states that the number of pores in each plate ranges from eight to ten. My observations, however, show that the range far exceeds this total, for as many as sixteen pores have been counted in one rosette plate. The same applies to the two plates in the distal wall referred to by the above author, although here the two sometimes tend to fuse or run into one another to form a somewhat irregular belt containing from thirty to forty pores. Such a condition may have been responsible for Kluge's following remarks: "Merkwürdigerweise kommt ganz regelmässig auf der Rückenwand jedes Zooeciums in der Nähe der beiden oberen Ecken je eine weniger verkalkte Stelle vor von unregelmässigem Umriss, mit scheinbar siebartig durchbrochener Oberfläche."

Investigation has so far led to the belief that the occurrence and formation of rosette plates in the distal walls is in no way affected by the presence or absence of oocia.

*Synonymy.*—Among the mixed collection returned by Miss Thornely after her report was written are specimens which agree well in every detail with her description of a new species, *Membranipora elongata*. The same form, however, was previously described by Kluge (*loc. cit.*) from Antarctic specimens, and that author's description and figure leave no doubt regarding the identity of the two forms. Miss Thornely's figure, besides being upside down, has been drawn from a complete and not a treated specimen, and as a result the full character of the oecium is not depicted. The "smooth area below" referred to by Miss Thornely is obviously the covering membrane over the front of the top section of the oecium where the septum occurs.

Calvet (*Ergeb. Hamb. Magalh. Sammlr.*, iii, 1904, p. 10) has referred to *Flustra renilla* Pfeffer, and the figure he gives shows a remarkable likeness to the form under discussion. As I am unable to acquaint myself with the actual form described by Pfeffer, the species cannot be discussed here, but if *O. lata* and *F. renilla* are ever found to be the same form, the former will have to be relegated to the synonymy of the latter.

Judging from Canu and Bassler's generic table of the *Membraniporae* the species under discussion is considered to be referable to the genus *Oyivalina*.

*Locality.*—Commonwealth Bay, Adelie Land, 25 fathoms, 3rd and 4th September, 1912 (specimens from the collection returned by Miss Thornely, although this author implies that she examined only "a fragment").

#### CALLOPORA Gray.

*Callopora* Gray, List of British Animals in British Museum, pt. 1, 1848, pp. 109 and 146.

#### *Callopora onychocelloides* (Calvet).

*Membranipora onychocelloides* Calvet, Exped. Antarctique Francaise, Bryozoaires, 1909, p. 15, pl. 1, fig. 9.

A solitary colony encrusting weed from 3½ fathoms has been identified as this species. The median longitudinal rib on the front of the oecium is clearly but not markedly pronounced; in addition it is often obscured by the encroachment of the avicularium, which is immediately above it.

*Synonymy and Remarks.*—Before and since the original description of this form by Calvet, the genus *Membranipora* has been studied by Waters, Norman, and others with the view of splitting it into new divisions. Although diverse opinions have been expressed, we have to-day, although incomplete, a good working basis in Canu and

Bassler's work<sup>1</sup>. From the paper cited it has been determined that the present form would come under *Callopora*, which is used in a more restricted sense than suggested by Levinsen<sup>2</sup>.

*Locality*.—Dredged in 3½ fathoms, Boat Harbour, Commonwealth Bay, Adelie Land, in 1912.

*RAMPHONOTUS Norman.*

*Ramphonotus Norman*, Ann. Mag. Nat. Hist, ser. 6, xiii, 1894, p. 122.

*Ramphonotus inermis (Kluge).*

*Membranipora inermis* Kluge, Deutsche Südpolar Expedition, Bd. xv, Zool. vii, Heft v., 1914, p. 663, pl. xxxiv, fig. 6.

*Membranipora minax* Calvet (non Busk), Exped. Antarct. Francaise, Bryozoaires, 1909, p. 16.

Sorted from the Mawson dredgings taken at Station 1 and Station 7, are several fragments of this easily recognised species. Kluge's admirable figure is a truthful representation of the form, and leaves little to be desired as regards external detail.

The two lateral tooth-like projections within the opesium are more prominent in the specimens before me and extend further inward than shown in the figure. In some zoecia the trifoliate form of the opesium may be more strongly developed than is shown in Kluge's figure.

The oecium in the present specimens is seen to be closed by a special operculum of a well chitinised nature which fits the somewhat semicircular oecial aperture perfectly.

*Synonymy and Remarks*.—Kluge cites *Membranipora minax* of Calvet as a synonym of this species, the latter author no doubt having been misled as to the true nature of the *M. minax* of Busk, the genotype of the genus *Ramphonotus* Norman<sup>3</sup> when examining the material collected by the French Antarctic Expedition.

The present form can be easily distinguished from the *minax* of Busk by the shape of the opesium as well as by the nature of the oecium, which in *minax* is described as rounded while in *inermis* it is flattened on the top, produced proximally on each side in the form of two horn-like processes, and rugged owing to the frontal deficiency of the ectoecium.

The genus *Ramphonotus* Norman has not so far been universally accepted owing, no doubt, to its close approach to *Amphiblestrum* as it differs from that genus only in

<sup>1</sup> Canu and Bassler, U.S. National Museum, Bull. 106, 1920, p. 82.

<sup>2</sup> Levinsen, Morph. Syst. Stud. Cheil. Bryozoa, 1909, p. 150.

<sup>3</sup> Norman, Ann. Mag. Nat. Hist. ser. 6, xiii, 1894, p. 122.



the presence of large avicularia situated on micro-like eminences occurring immediately below the opesium. Even though the avicularia form the main characteristic feature of the genus, there seems to be sufficient reason for retaining it, and in doing so I follow Canu and Bassler<sup>1</sup>.

*Localities.*—Station 1, 354 fathoms, 22-12-1913; Station 7, 60 fathoms 21-1-1914.

CHAPERIA *Jullien*.

*Chaperia* Jullien, Bull. Soc. Zool. France. vi, 1881, p. 162.

*Chaperia coronata* (Thornely).

*Mucronella coronata* Thornely, Austr. Antarctic Exped. Rept., ser. C, vi, pt. 6, 1924, p. 15, text fig. 3.

(Pl. II, figs. 1-3, and text fig. 2).

*Description.*—Zoarium loosely encrusting and completely surrounding the branches of a seaweed. It is heavily calcified, and to the naked eye appears to be studded with many turret-like eminences situated at regular intervals. The entire surface possesses a glistening sheen owing to the presence of an enveloping ectocyst.

The zoecia are arranged in regular longitudinal rows which break apart in such formation after prolonged incineration. They are more or less rectangular in shape and are separated externally by deep grooves, which are formed by the depressed edges of the ovate frontal zoecial walls.

The frontal zoecial wall is ovate, rough and coarse. Minute granules occur on the higher eminences, while the depressed areas, which resemble a network of winding channels, are comparatively smooth. The lateral walls are straight, and the distal and proximal walls are somewhat rounded, forming in most cases a crude concavity distally and a corresponding convexity proximally.

The aperture is sunk below the level of the zoecium. It is semicircular distally and slightly convex proximally, with the angles a little produced. It is certainly not "straight below" as described by Miss Thornely. The operculum is poorly chitinised and is of the same shape as the aperture. Within the aperture, and on each side, is a vertical septum to which the opercular muscles are attached. This seems to be the principal character of the genus.

Hiding the aperture to some extent are two branched antler-like structures, which are of considerable size and spring from the lateral borders of the aperture. Such a condition recalls the similar structure met with in *Chaperia cervicornis* Busk.

<sup>1</sup> Canu and Bassler, U.S. National Museum, Bull. 106, 1920, p. 163.

These processes are well calcified, not rough and coarse like the zoecia, but finely granulated. Below the aperture is a small eminence or umbo, which varies considerably in size in the different zoecia.

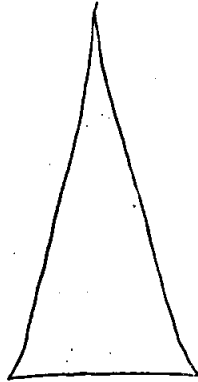

Text Fig. 2.  
Mandible of Avicularium of *Chaperia coronata* (Thornely).

The oecium shows remarkable likeness to that seen in members of the Family *Phylactellidae* Canu and Bassler, being globular and resting on the peristome (antler-like process in this case) and the distal zoecium. It does not, in any part, sink below the level of the frontal zoecial walls. It possesses a distinct aperture of considerable size, which opens through the branches of the oral processes or above them. The oecial aperture is provided with a very thin and delicate operculum, but owing to the lack of suitable material further details pertaining to this structure are unobtainable.

Miss Thornely describes the oecia as having an external "surface less coarse than that of the zoecia," but after making observations of incinerated examples I have failed to find oecia corresponding to that description. On the contrary, they resemble the frontal zoecial walls in coarseness all over their external surfaces, save for a very small area on the top of each which is finely granular.

The avicularia are very peculiar, being in the form of separate cells intercalated among the zoecia. They are hollow cone-like structures, with a long sharply tapering mandible on the top of each. Every avicularian cell examined was seen to be finely granular and the hollow interior represents the mandibular cavity. Hinge teeth or cross-bars are absent.

*Colour.*—The specimens examined are a creamy white in a dried condition.

*Remarks.*—Although Miss Thornely considered the genus *Mucronella* to be a fit resting place for this elegant species, I see no reason, save the presence of a micro, for allowing it to remain there. In the existing classification there does not seem to be a more appropriate genus into which the species should be placed than *Chaperia*<sup>1</sup>, which specially provides for the more prominent features of the species.

<sup>1</sup> Jullien, Bull. Soc. Zool. France, VI, 1881, p. 162.

It is evident from Miss Thornely's short description that some important structures escaped her notice which, had they been seen, would probably have influenced her in another direction when deciding the generic status of this species.

*Locality*.—Station 8, 120 fathoms, 27-1-1914.

FLUSTRA *Linnaeus*.

*Flustra* Linnaeus, "Fauna Svecica" 1761, p. 539 (*vide* Harmer, Journ. Linn. Soc. Zool. xxxv, 1923, p. 310).

That the genus *Flustra* should be divided is undoubted, but the task bristles with difficulties and their solution will require perfect understanding and patience. Levinsen<sup>1</sup>, following Jullien, has made a good start in this direction, but, while his observations and suggestions are of considerable value, they leave much to be accomplished.

The well-known genus *Carbasea*, which was erected by Gray in 1848, seems to have lapsed into disuse at the hands of most modern writers, while in the past it has been the source of no little comment regarding its relationship with *Flustra*. In reference to this question the opinion of Harmer<sup>2</sup> is of importance, for he maintains that the genus *Carbasea* should be retained, having *C. carbasea* as the genotype.

Nevertheless, I do not propose to enter into this field of discussion here, preferring, for the purposes of this paper, to select the old genus *Flustra* to accommodate the forms before me.

It is evident that Kluge (1914) also realised the above position when dealing with his specimens from the Antarctic.

*Flustra flagellata* Waters.

*Flustra flagellata* Waters, Res. Voy. "Belgica" Bryozoa, 1904, p. 27, pl. 2, figs. 1 a-b.

*Flustra flagellata* Calvet, Exped. Antarctique Francaise, Bryozoaires, 1909, p. 9.

*Flustra flagellata* Kluge, Deutsche Südpolar Exped., Zool., xv, Bd. vii, Heft v, 1914, p. 651, pl. xxxi, fig. 1.

Many well-preserved colonies considered referable to this species are in the collection.

If Harmer<sup>2</sup> is justified in considering that many species of *Flustra* may be separated on the character of the avicularia, this species would form the type of a new genus. Waters, (*loc. cit.*) although realising the importance of the occurrence of

<sup>1</sup> Levinsen, Morph. Syst. Stud. Cheil. Bryozoa, 1909, p. 122.

<sup>2</sup> Harmer, "Siboga" Exped., Polyzoa, pt. ii, Monogr. xxviii b, 1926, p. 249.

vibracula in *Flustra*, did not consider it a character on which a new genus could be founded, but should the time arrive when the avicularia are regarded as an important character in regrouping the species of *Flustra*, *F. flagellata* must be made the genotype of a new genus.

*Localities*.—Station 3, 157 fathoms, 31-12-1913; Station 4, 230 fathoms, 2-1-1914; Station 8, 120 fathoms, 27-1-1914; Commonwealth Bay, Antarctica, 25 fathoms, 3 and 4-9-1912; Commonwealth Bay, 55 fathoms, 21-12-1913.

*Flustra tenuis* Kluge.

*Flustra tenuis* Kluge, Deutsche Südpolar Exped., Zool., xv, Bd. vii, Heft v, 1914, p. 652, pl. xxxii, fig. 5 and text fig. 31.

(Pl. III, fig. 4).

*Description*.—Zoarium single layered, thin, in some cases consisting of branched leaf-like fronds, in others assuming a more branched and ribbon-like aspect.

Zoecia alternating, elongated and rectangular in shape; slightly broader in the middle than at the ends. The zoecial borders are considerably raised, while the frontals are sunken, a condition probably due to shrinkage during preservation.

The basal walls are slightly concave inside and convex outside, while the lateral walls are upright, though not perfectly straight. In each lateral wall there are two simple rosette plates. The distal wall is obliquely bent backwards, and possesses a single simple rosette plate.

A little below the distal border of each zoecium lies a broad semi-circular operculum.

Elongated avicularia are situated here and there on the borders of the branches, but on rare occasions they may be seen between the zoecia in the middle of the colony. Each avicularium possesses a long chamber, slightly calcified in its distal half, and more or less membranous in its proximal half. The mandible, which occupies almost the entire front of the distal half of the chamber, is tongue-shaped and usually inclined a little to one side. It is not very well chitinised, but is supported in its middle by a long semi-elliptical sclerite. The upper side of the mandible is slightly arched, while the under side sinks at the borders, then rises again and ends in an oval opening, through which the muscle system passes. This latter is composed of two sets, both of which, when leaving the mandible, pass into the interior of the proximal half of the avicularian chamber and become attached to the lateral and basal walls of that structure.

The oecia are round, arched, and radially sculptured on the surface. On both sides of the oecium arise the lateral walls of the preceding zoecium, thus surrounding the oecium to some degree.

The colony is anchored by means of chitinous root-like tubes, which mostly run lengthways, and are to be seen only on the dorsal side of the colony at or in close proximity to its base.

*Remarks.*—The foregoing description has been prepared from the specimens of the species before me, together with Kluge's description.

The lack of oecia in the Mawson specimens is unfortunate, but the remarks made by Kluge about those structures have been included in order to make the description as complete as possible.

Kluge's published observations relative to the method of anchoring possessed by the species are somewhat vague owing, as he states, to the nature of his material. The above description pertaining to that subject has been compiled after the examination of a small though nearly complete colony.

*Localities.*—Commonwealth Bay, Antarctica, 25 fathoms, 3 and 4-9-1912; Station 8, 120 fathoms, 27-1-1914.

*Flustra angusta* Kluge.

*Flustra angusta* Kluge, Deutsche Südpolar Exped., xv, Zool., Bd. vii, Heft v, 1914, p. 653, pl. xxxi, fig. 2 and text fig. 32.

*Flustra spoliata* Thornely (non Ortmann), Austr. Antarctic Exped. Rept., Ser. C., vi, pt. 6, 1924, p. 6.

*Description.*—Zoarium bilaminar, consisting of slender, delicate, ribbon-like branches.

The zoecia are alternating, elongated, broadest in the middle, and roundly quadrangular in shape. When the colony is dry, however, the zoecia become so distorted in places that these characters cannot be recognised. In each zoecium the lateral borders are raised and the semi-transparent frontal depressed. In each lateral zoecial wall there are from 4 to 6 multiporous rosette plates, while in each distal wall there are from nine to twelve uniporous rosette plates, which lie in the lower half and to the sides. The zoecial aperture is semicircular in shape.

The avicularia are, in all the specimens examined, constant in position, though their number is very limited. When present, each is situated in the base of the proximal half of the frontal, and immediately above the aperture of the lower zoecium. The mandibular chamber is strongly calcified and deep. On each lateral border of the cavity there is a hinge-tooth or pivot, on which the base of the mandible rests. The border of the proximal section of the cavity is somewhat rounded, while that of the distal section is triangular to accommodate the mandible. The distal half of the chamber is raised, causing the mandible to be almost upright. The mandible, in some cases, is set askew, thus causing it to become obliquely disposed to the long axis of the branch.

The avicularian mandible, which has been so admirably depicted by Kluge, assumes the form of an isosceles triangle, and at the tip of its free end there is a sharp tooth-like projection directed perpendicularly inwards. According to Kluge, the avicularia are inclined to be more plentiful on the edge of the branch, and the specimens before me agree with his description in this respect, and also in the degree of calcification undergone by the old mandibular chambers in that region.

The oœcia, which are endozoœcial, are globular in shape, arched, with a delicately wrinkled sculpture on the surface. On both sides of the oœcium each lateral wall of the distal zoœcium arises markedly in the form of an inwardly directed keel-like outgrowth, which envelops the oœcium to some extent.

*Synonymy.*—This is obviously the species identified as *Flustra spoliata* Ortmann and remarked upon by Miss Thornely (loc. cit.). That author gives points which she states do not occur in Ortmann's description, but those characters only go to prove the above synonymy as well as serving to differentiate the present species from the true *F. spoliata* of Ortmann.

*Colour.*—Dried examples are of a light brown hue.

*Localities.*—Station 3, 157 fathoms, 31-12-1913; Station 4, 230 fathoms, 2-1-1914; Station 8, 120 fathoms, 27-1-1914.

*Flustra curva* Kluge.

*Flustra curva* Kluge, Deutsche Südpolar Exped., xv, Zool., Bd. vii, Heft v, 1914, p. 654, pl. xxxii, fig. 4, and text fig. 34.

(Pl. III, fig. 5.)

*Description.*—Zoarium unilaminar, unusually thick and strong; dichotomously branched.

The zoœcia are hexagonal in shape, with rounded distal and lateral angles and pointed proximal angles. In the proximal end of the zoœcium and under the frontal membrane there is a more or less broad calcareous ledge or plate, which has been called by Kluge the cryptocyst.

The semi-circular zoœcial aperture, which has a strongly chitinised border around its operculum, is situated immediately below the distal edge of the zoœcium.

In each lateral wall there are usually two multi-porous rosette plates, but three may occur. Often, in addition to these, there may occur several simple uniporous rosette plates, which no doubt arise from their large multi-porous neighbours. In the distal wall, according to Kluge, there are about twenty pores, which are situated in the lower half. It is stated by Kluge that the animals are of a brown-red colour.

No avicularia.

The specimens before me, like those examined by Kluge, are without oecia. Kluge points out that it is probable that a special oecium is wanting, and that the larvæ develop in the zoecial cavities.

*Localities*.—Station 4, 230 fathoms, 2-1-1914; Station 8, 120 fathoms, 27-1-1914; Station 12, 110 fathoms, 31-1-1914.

*Flustra antarctica* Calvet.

*Flustra antarctica* Calvet, Exped. Antarctique Francaise, Bryozoaires, 1909, p. 11, pl. 1, figs. 4-6.

*Flustra antarctica* Kluge, Deutsche Südpolar Exped., xv, Zool., Bd. vii, Heft v, 1914, p. 651, text fig. 30.

*Flustra antarctica* Thornely, Austr. Antarctic Exped. Rept., Ser. C., vi, pt. 6, 1924, p. 7.

(Pl. III, fig. 9).

Calvet's description of this species has been revised in parts and added to by Kluge (loc. cit.), thus making the form more easily recognised.

The representatives in the present collection have been fully described by Miss Thornely.

*Localities*.—Commonwealth Bay, 3-5 fathoms, 25-30 fathoms, and 55 fathoms; Station 3, 157 fathoms, 31-12-1913; Station 4, 230 fathoms, 2-1-1914.

*Flustra vanhoffeni* Kluge.

*Flustra vanhoffeni* Kluge, Deutsche Südpolar Exped., xv, Zool., Bd. vii, Heft v, 1914, p. 655, pl. xxxi, fig. 4 and text fig. 35.

(Pl. III, fig. 7).

*Description*.—Zoarium bilaminate, consisting of more or less dichotomously branched ribbon-like fronds. Zoecia alternating and elongated. The distal half of each zoecium is broad and the distal lateral angles are rounded. The proximal half is much narrower than the distal half and its lateral angles are acute. The curved distal border of the zoecium is conspicuously thickened and elevated some distance above the surrounding zoecia.

The operculum, which is semi-circular in shape, is situated immediately below the raised distal border.

In the lateral zoecial walls there are from four to six rosette plates, each with from four to eight pores. In some cases a rosette plate disintegrates into several

pores, so that it loses its sharply defined boundary and increases in circumference. In the lower half of each distal zoecial wall there are from 15 to 16 pores, which are arranged in groups of from two to three. In the lower half of each distal wall of the avicularian chambers there are from ten to twelve pores.

On one or both sides of a zoecium an avicularium may occur which has an independent chamber. This chamber is much the same shape as the zoecia, but its proximal termination is sharp. The distal half of the chamber is conspicuously calcified, and the proximal section more or less membranous. Across the cavity of the chamber is a calcareous cross-bar or pivot, to which the base of the mandible is attached. This cross-bar has, for the purpose of this description, been selected to represent the boundary between the distal and the proximal sections of the chamber. The entire edge of the distal section is raised into a collar-like structure, which projects well above the surrounding zoecia. Within this raised margin lies the mandible. The mandible is tongue-shaped, moderately chitinised, and asymmetrical. It is supported by a stout marginal thickening.

The avicularia are very numerous near the margins of the branches. They can be readily distinguished, according to Kluge, by the length of their posterior halves, which exceed the length of their anterior ones three to four times, whereas in other avicularia such long posterior sections do not exist.

The peristomial oecia are longish, arched in the form of a bishop's cap, and consist of two halves with a median suture on the surface. As Kluge's figure shows, the oecium consists of two lateral fold-like outgrowths of the anterior border in the proximal part of the zoecium. These outgrowths eventually grow so close to one another that they coalesce to form a spacious arched depression, which remains open at the proximal end. The separating wall of the coalesced folds is also maintained in the adult condition. The wall of the oecium appears to be two-layered; both layers are calcified, the inner quite calcified and the outer only partly so. The uncalcified parts appear to be transparent; and give an impression of irregular slit-like openings in the outer layer. The inner and wholly calcified layer shows a radially wrinkled sculpture on the surface.

In the living condition the animals are of a pale brown colour.

*Remarks.*—As there are only three minute fragments of this species in the present collection, the above description has been based almost entirely on Kluge's observations. The absence of oecia has made it impossible to verify the original description and Kluge's references to these structures have been added here in order to make the description as complete as possible. What details can be made out of the specimens before me agree perfectly with the original description.

*Locality.*—Station 8, 120 fathoms, 27-1-1914.



*Farciminaria* Busk.

*Farciminaria* Busk, Brit. Mus. Cat. Marine Polyzoa, pt. 1, 1852, p. 32 (in part).

*Farciminaria* Levinsen, Morph. Syst. Stud. Cheil. Bryozoa, 1909, p. 117.

*Farciminaria aculeata* Busk.

*Farciminaria aculeata* Busk, Brit. Mus. Cat. Marine Polyzoa, pt. 1, 1852, p. 33, pl. lxiv, figs. 4-5; pl. lxv (bis), fig. 6.

*Farciminaria aculeata* Levinsen, Morph. Syst. Stud. Cheil. Bryozoa, 1909, p. 118.

*Farciminaria aculeata* Thornely, Austr. Antarctic Exped. Rept., Ser. C, vi, pt. 6, 1924, p. 7.

The record of this species off Maria Island adds little to the known distribution, as Busk described specimens collected in Tasmanian waters.

The present series is very much worn and in a poor condition, the marginal spines being very few in number. The characters present, however, are sufficient to identify the species.

*Locality*.—Off Maria Island, near Tasmania, 12-12-1912.

*Farciminaria simplex* MacGillivray.

*Farciminaria simplex* MacGillivray, Trans. Proc. Roy. Soc. Victoria, xxii, 1885 (1886), p. 130, pl. 1, fig. 1.

*Farciminaria simplex* MacGillivray, in McCoy, Prodr. Zool. Victoria, dec. xvi, 1888, p. 218, pl. 158, figs. 5, 5a-b.

? *Farciminaria simplex* (*sp. nov.*) Kluge, Deutsche Südpolar Exped., xv, Zool., Bd. vii, Heft v, 1914, p. 650, pl. xxviii, fig. 7.

A fragmentary series of specimens which was obtained by the Expedition at Station 4, has been determined as the species described by MacGillivray (*loc. cit.*). All characters agree with the descriptions and figures furnished by that author, with perhaps the exception of the oecia, which have been insufficiently described as regards variation.

MacGillivray describes these structures as being smooth and globular and wrinkled when dried; he further adds that an outer "envelope" (the ectoecium) also becomes shrivelled when dried, causing lateral depressions.

The wrinkling of the ectoecium has been seen in specimens of the species in the collections of the Australian Museum, but not in the Mawson series. Besides the wrinkling in the former set of specimens there is a prominent median keel on the top

of the ectoœcium which divides into two in a fork-like manner as it proceeds distally towards the back of the œcium. This character, however, can be clearly made out in the Mawson specimens. The œcia in the latter are, as described by MacGillivray, composed of two external dome-like sections, which could be described as the ectoœcium and the endoœcium, the former being the "envelope" referred to by that author. The keel referred to above appears to be formed by the union of the different sections of the ectoœcium when their growth is completed.

The colonies before me are of a hyaline nature and extremely delicate.

*Synonymy.*—The fact that the name "*simplex*" has been applied to a number of different species, all tuft-like and of a more or less branching nature, is indeed unfortunate, as it leads to no little confusion when such forms are studied. Although, strictly speaking, there is no doubt that the name may be legitimate, and even appropriate, the number of species in related genera bearing the name *simplex* is considerably more than is necessary, to say nothing of the inconvenience and constant temporary misunderstanding they create.

In the present case there are two species both named *simplex* by different authors and placed in the same genus (*Farciminaria*). The later author (Kluge), when describing his species was obviously unaware of the existence of a species of *Farciminaria* already named *simplex* by MacGillivray, for, if he had, and had known its structure, he would probably have considered his species identical with it, so closely related do they appear.

It is my contention, though expressed with a little doubt, that these two forms named independently by different authors, are synonymous. The evidence on which I doubtfully place Kluge's *simplex* in the synonymy of MacGillivray's species is based on the similarity of the zoarium, the zoœcia, and the locality; in connection with this latter the Mawson specimens of MacGillivray's form, it will be remembered, like Kluge's, came from the Antarctic. One of the most important points, however, is lacking, owing to the fact that Kluge's specimens did not possess œcia.

\**Locality.*—Station 4, 230 fathoms; 21-1-1914.

#### NOTOPLITES Harmer.

*Notoplites* Harmer, Journ. Linn. Soc. Zool., xxxv, 1923, p. 348.

#### *Notoplites drygalskii* (Kluge).

*Scrupocellaria drygalskii* Kluge, Deutsche Südpolar Exped., xv, Zool., Bd. vii, Heft v, 1914, p. 609, pl. xxvii, fig. 5.

*Notoplites drygalskii* Harmer, Journ. Linn. Soc. Zool., xxxv, 1923, p. 352.

*Menipea funiculata* Thornely (non MacGillivray), Austr. Antarctic Exped. Rept., Ser. C, vi, pt. 6, 1924, p. 6.

This species is abundantly represented in the collection before me, and agrees well with Kluge's description and figure.

Harmer (*loc. cit.*) in his valuable paper on "Cellularine and other Polyzoa" erected the genus *Notoplites* to accommodate several species previously referred to allied genera, the species under discussion being specially mentioned.

It is apparent that Miss Thornely's note on the occurrence of *Menipea funiculata*, now *Amastigia funiculata* according to Harmer (*loc. cit.* p. 335), in the Antarctic Regions is erroneous, as no specimens of the species can be traced in the returned collection. The only form likely to be confused with that species is the one now before me, and although definite evidence of the synonymy is not available owing to the absence of identification labels, the only course open is to place that record of "*Menipea*" *funiculata* in the synonymy of *Notoplites drygalskii* (Kluge). Supporting this procedure is the perfect agreement of the localities as well as the descriptive remarks made by Miss Thornely on "*Menipea*" *funiculata* MacGillivray.

*Localities.*—Commonwealth Bay, Adelie Land, 3 to 5 fathoms and 25 fathoms, 3 and 4-9-1912; Station 8, 120 fathoms (depth incorrectly given by Miss Thornely as 112 fathoms) 27-1-1914; Station 4, 230 fathoms, 2-1-1914; Station 1, 354 fathoms, 22-12-1913.

#### BEANIA *Johnston*.

*Beania Johnston*, Ann. Mag. Nat. Hist., ser. 1, v, 1840, p. 272.

#### *Beania erecta* Waters.

*Beania erecta* Waters, Results Voy. "Belgica," Bryozoa, 1904, p. 30, pl. 1, figs. 8, a-e.

*Beania erecta* Kluge, Deutsche Südpolar Exped., xv, Zool., Bd. vii, Heft v, 1914, p. 649, text fig. 29 b.

*Beania erecta* Thornely, Austr. Antarctic Exped. Rept., Ser. C, vi, No. 6; 1924, p. 7.

(Pl. V, fig. 4)

This species, which is not unlike *B. crotali* in many respects, is represented in the present collection by several fragments attached to weed like other species of the genus.

*Localities.*—25 fathoms, Commonwealth Bay, Adelie Land, 3 and 4-9-1912; 45 to 50 fathoms, Commonwealth Bay, Adelie Land, 14-12-1913.

#### BUGULA *Oken*.

*Bugula Oken*, Lehrbuch der Naturgeschichte, 3 Theil, Zool., 1 Abth., 1815, p. 89 (*vide* Harmer, Journ. Linn. Soc. Zool., xxxv, 1923, pp. 299 and 297).

*Bugula retiformis* Kluge.

*Bugula retiformis* Kluge, Deutsche Südpolar Exped., xv, Zool., Bd. vii, Heft v, 1914, p. 629, pl. xxviii, fig. 5, and text fig. 14.

Kluge's excellent representation of this species makes its identification easy.

The specimens before me agree in every detail with the information supplied by that author and do not exhibit any form of variation.

*Locality*.—Station 12, 110 fathoms, 31-1-1914.

*Bugula bicornis* Busk.

*Bugula bicornis* Busk, "Challenger" Zool., x, pt. xxx, 1884, p. 40, pl. ix, fig. 1.

*Bugula bicornis* Waters, Res. Voy. "Belgica," Bryozoa, 1904, p. 21, pl. 1, fig. 4 a-k.

*Bugula bicornis* Thornely, Austr. Antarctic Exped. Rept., Ser. C, vi, pt. 6, 1924, p. 5.

The specimens before me, which are considered referable to the above species, are in a very poor and unsatisfactory condition for study. Avicularia are extremely scarce, a fact recorded by Miss Thornely after examining the same series.

The short branches mentioned by Waters are to be seen on specimens in the present collection. Any further details that can be made out of the damaged specimens have already been given by Miss Thornely.

Kluge<sup>1</sup> has separated Waters' Antarctic material into varieties which he has dealt with, to all appearances, in a very satisfactory manner, but the present material does not lend itself to a study that would wholly support that author's deductions.

*Localities*.—Station 1, 354 fathoms, 22-12-1913; Station 3, 157 fathoms, 31-12-1913.

*Bugula tricornis* Waters.

*Bugula tricornis* Waters, Res. Voy. "Belgica," Bryozoa, 1904, p. 23, pl. 1, fig. 9, a-d; pl. viii, fig. 3.

*Bugula tricornis* Kluge, Deutsche Südpolar Exped., Zool., xv, Bd. vii, Heft v, 1914, p. 625, pl. xxix, figs. 5-6 and text fig. 12.

*Bugula tricornis* Thornely, Austr. Antarctic Exped. Rept., Ser. C, vi, pt. 6, 1924, p. 6.

As Miss Thornely states, there is only a small fragment of this species in the collection. She gives the locality of the piece she examined as Station 12, but the fragment before me came from a tube containing a locality label marked Station 3. Miss Thornely has either given a wrong locality or examined a colony from Station 12 which cannot now be traced.

*Locality*.—Station 3, 157 fathoms, 31-12-1913.

<sup>1</sup>Kluge, Deutsche Südpolar Exped., Zool., xv, Bd. vii, Heft v, 1914, pp. 622 and 623.

CORNUCOPINA *Levinsen*.

*Cornucopina* Levinsen, Morph. Syst. Stud. Cheil. Bryozoa, 1909, p. 109.

*Cornucopina tuba* (Busk).

*Bicellaria tuba* Busk, British Museum Cat. Mar. Polyzoa, 1, 1852, p. 42, pl. xxxi.

*Bicellaria tuba* Thornely, Austr. Antarctic Exped. Rept., Ser. C, vi, pt. 6, 1924, p. 6.

The present colony is no doubt that examined by Miss Thornely, who has already given what meagre details the damaged specimen permits. The existing characters, however, are sufficient to definitely determine the species.

*Locality*—Off Maria Island (near Tasmania), 12-12-1912.

BUGULARIA *Levinsen*.

*Bugularia* Levinsen, Morph. Syst. Stud. Cheil. Bryozoa, 1909, p. 108.

*Bugularia dissimilis* (Busk).

*Carbasea dissimilis* Busk, Brit. Mus. Cat. Marine Polyzoa, pt. 1, 1852, p. 51, pl. 50, figs. 4-7.

*Bugularia dissimilis* Levinsen, Morph. Syst. Stud. Cheil. Bryozoa, 1909, p. 109, pl. v., fig. 2, a-d.

This species, the only known member of the genus, is represented in the collection by a single colony of large size and with a tangled mass of delicate rootlets at its base. No variation, except in the number of spines, can be made out, the characters agreeing well in every respect with the diagnosis given by Levinsen.

*Locality*.—No data as to the station or depth at which this species was collected can be ascertained. The locality label bears only the single word "Antarctica."

MICROPORA *Gray*.

*Micropora* Gray, List of British Animals in Collection of British Museum, pt. 1, 1848, p. 115.

*Micropora brevissima* Waters.

*Micropora brevissima* Waters, Results Voy. "Belgica" Bryozoa, 1904, p. 40, pl. ii, fig. 7 a-c.

*Micropora brevissima* Thornely, Austr. Antarctic Exped. Rept., Polyzoa, Ser. C, vi, pt. 6, 1924, p. 9.

(Pl. V, fig. 3.)

The species is not abundantly represented in the present collection, but the fragments collected are sufficient to establish the identity of the species from Waters' detailed figure and description.

*Descriptive Remarks.*—The avicularia, which possess the characteristic shape described by Waters, are large and massive. The mandible of each is well chitinised and set in a special chamber, which is invariably situated immediately above the zoecial aperture. The mandibular cavity is wide and spacious, possessing a continuous bar or pivot across its middle. The cavity is rounded at its proximal end and sharply pointed at its distal end, where the sides are produced to form a "seat" for the avicularian mandible.

The oecia are more distinctly granulated than the frontal zoecial walls and rise above the latter in a dome-like manner to a considerable extent. Each oecium communicates with the exterior through the zoecial aperture.

The area immediately below the raised proximal border of the aperture appears to be faintly striated or corrugated, owing to the presence of regular longitudinal rows of granules.

*Localities.*—Station 8, 120 fathoms; Station 2, 318 fathoms, 28-12-1913.

*Micropora coriacea* (Esper).

*Flustra coriaceā* Esper, Die Pflanzenthiere, etc. (Natural History of Zoophytes), 1791, pl. vii, fig. 2.

*Micropora coriacea* Waters, Results Voy. "Belgica," Bryozoa, 1904, p. 39.

One single example of this widely-distributed form is present in the collection. It can easily be distinguished from the foregoing species of the genus by its higher aperture and operculum, as well as by the comparatively small zoecia, and heavily calcified zoecial borders. The minute avicularia on the present species form a striking contrast to the large type on *M. brevissima* Waters.

*Locality.*—Commonwealth Bay, Adelie Land.

LABIOPORELLA Harmer.

*Labioporella* nom. nov. Harmer, "Siboga" Exped., Cheil. Anasca., pt. ii, Monogr., xxviii b, 1926, p. 281.

*Labioporella adeliensis* sp. nov.

*Vincularia abyssicola* Thornely (non Smitt), Austr. Antarctic Exped. Rept., Ser. C, vi, pt. 6, 1924, p. 9.

(Pl. VI, fig. 3, and text figs. 3 and 4.)

*Description.*—Zoarium erect, bilaminate and branching. The branches are slightly curved in a spiral manner and are flat.

The zoecia, which are in longitudinal rows, are rectangular in shape and separated by well raised margins. The tube described by Harmer in the "Siboga" specimens, and so characteristic in the specimens of *L. bursaria* in the Australian Museum

collection, is not complete in this species. Indeed only a vestige of this structure can be made out in the upturned edge of the lower border of the oral aperture. All the exterior calcareous walls, including the horizontal cryptocyst, are covered by numerous minute tuberculations. The distal wall of each zoecium is provided with from six to ten uniporous rosette plates; usually eight are counted, arranged in two vertical rows, each with four plates. The lateral walls each possess from four to five, usually five, uniporous rosette plates, arranged in a longitudinal belt about midway up the wall.

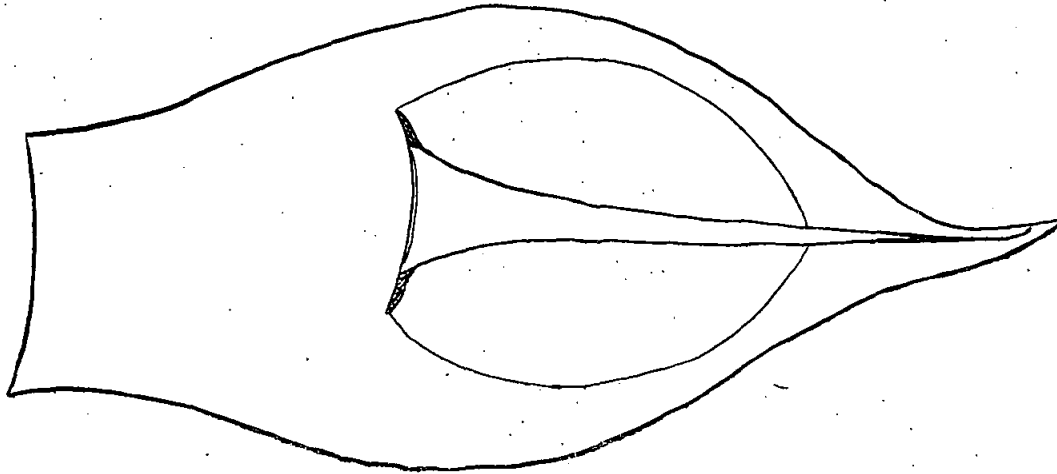

Text Fig. 3.

*Labtoporella adeliensis* sp. nov.

An avicularian cell with mandible *in situ*. The mandible is embedded in the frontal membrane which completely covers the avicularian cell as well as the surrounding zoecia.

The avicularia of the species of this genus, so far as we know them at present, serve as an excellent means by which the forms can be separated. The mandibles of the present form differ so markedly from those described in other species of the genus that recognition is greatly facilitated. The avicularia are in the form of independent cells usually sharply pointed at their distal and proximal extremities (external view), but in some cases only the distal end is pointed. When the frontal membrane has been removed the entire calcareous surfaces brought into view are seen to be covered by minute tubercles such as are seen in the zoecia.

In other species of the genus the opesia of the avicularia are large and undivided, but in the present form such a condition does not exist. Instead, there are two separate irregularly shaped openings to the avicularian cavity, usually one in the distal half and the other in the proximal half, but in some cases one is about midway and the other in the distal half. These openings or opesia may be again divided, thus creating two groups of openings—no regular condition appears to exist. The mandible, which is inserted in the frontal membrane, is operated by a muscle system which proceeds in the form of two strands from the basal sclerite of the mandible, through the proximal or middle group of opesia into the avicularian cavity. Here the two strands unite with two gigantic branched sets of muscles which are vertically arranged and attached

to the proximal and neighbouring lateral walls of the avicularian cell. The mandible is pointed at its free extremity owing to a union of two marginal sclerites which arise from a basal one. Filling in the triangular area created by the sclerites, and extending flap-like beyond it laterally, is a thin yellowish membrane, which is very broad and reaches only about midway, or a little more, up the mandible. A variation in size and width of the mandible appears to be governed by the width of the avicularian cell.

No oecia.

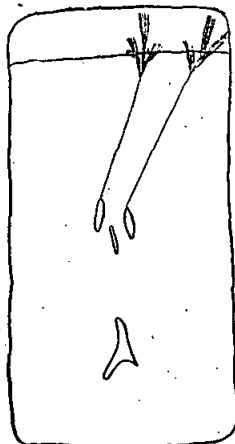

Text Fig. 4.

*Labioporella adelhensis*  
sp. nov.

Diagrammatic representation of a frontal wall of an avicularian cell from a basal aspect showing the two sets of opesia. From the top set (proximal in specimen) can be seen the two muscle strands passing through from the base of the mandible to the large muscle bundles on the proximal wall.

*Colour.*—Light putty in a dried condition.

*Remarks.*—Miss Thornely (*loc. cit.*) has recorded this species from the Antarctic under the name of *Vincularia abyssicola* Smitt, but, although the mandible of the above described species is like that of *V. abyssicola* (now *Smittipora abyssicola*), the two species are seen to differ in other characters.

I have pleasure in acknowledging the valuable assistance given me by Dr. F. Canu of Versailles, France, in determining this form, and I have acted on his advice in considering it a new species of the genus *Labioporella* Harmer.

*Localities.*—Station 7, 60 fathoms, 21-1-1914; Station 8, 120 fathoms, 27-1-1914; Station 12, 110 fathoms, 31-1-1914.



CELLARIA *Authors*.<sup>1</sup>*Cellaria mawsoni* sp. nov.

*Aspidostoma giganteum* Thornely (non Busk), Austr. Antarctic Exped. Rept., Ser. C, vi, pt. 6, 1924, p. 16.

(Pl. IV, figs. 3 and 5; Pl. VI, fig. 4, and text fig. 5.)

*Description*.—Zoarium branched, bilaminate and flat. The surface appears rough and nodulated to the naked eye owing to the presence of heavily calcified horn-like thickenings above the zoecial apertures.

The zoecia are rectangular in shape and are separated by conspicuously raised borders. They are widest distally and taper slightly towards their proximal borders within the proximal half. The frontal zoecial walls are finely granular as well as the tops and sides of the separating borders. The zoecia are covered outwardly by a membrane which is spread tightly across their borders. As a result a space occurs between the inside of the covering membrane and the frontal wall in every zoecium. The lateral zoecial walls are not common walls; instead, each zoecium has its own separate wall, and when two zoecia occur side by side their lateral walls come evenly together in close contact. Four to six multiporous rosette plates or communication pores occur in a straight belt near the top of each lateral wall. The distal and proximal zoecial walls, unlike the lateral, are common unpaired walls and possess irregularly disposed uniporous rosette plates. The basal walls are flat and even and resemble the lateral walls in being paired.

Each zoecial aperture is arched above and convex below, and occupies almost the entire width of the zoecium. It has a raised strongly tuberculated border, which is about on a level in height with the raised zoecial borders. Arising from the inside of the proximal border of the aperture are two laterally curved keel-like teeth, which appear narrow from a vertical view and squarish from a side view. They are not sharply pointed though corresponding in position to the teeth in other members of the genus. The operculum is very poorly chitinised and is the same in shape as the zoecial aperture. Rising distally to, and fusing with the distal portion of the peristome, is a mucro-like eminence, which is usually divided into two projecting horns. This eminence considerably strengthens the structures around the aperture, especially in oecium-bearing zoecia, though it is in barren zoecia that the peculiar thickening reaches its greatest development both in size and calcification. In oecium-bearing

---

<sup>1</sup> See Canu and Bassler relative to this genus, U.S. National Museum, Bull. 106, 1920, p. 272.

zoecia, however, it is considerably reduced, though two horn-like eminences occur which are of moderate size. These are situated some distance apart in order to make room for the oecial aperture which comes between them.

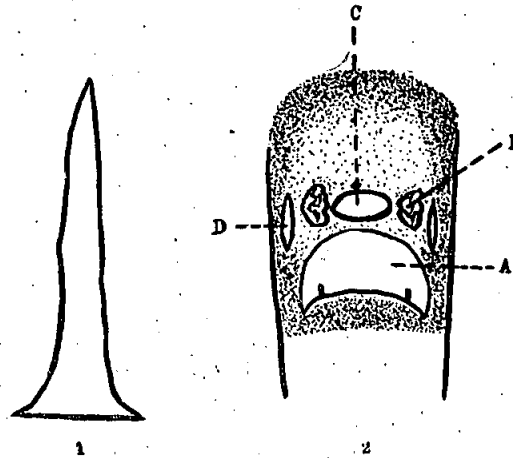

Text Fig. 5.

*Cellaria mawsoni* sp. nov.

1. Mandible of an avicularium of *Cellaria mawsoni* sp. nov.
2. Diagrammatic representation of a portion of the distal half of an oecium-bearing zoecium to show relative positions of structures:—
  - A. Zoecial aperture. B. One of the horn-like processes above the aperture. C. Oecial aperture. D. One of the elongated fissures which opens into the oecium.

The oecium is a dome-like structure lying in a distal position to the zoecial aperture. It rests on the frontal wall of the zoecium immediately distal to the oecium-bearing zoecium and rarely exceeds the zoecial borders in height. It communicates with the exterior by means of a special oecial aperture which is oval in shape and lies between the two "horns" referred to above. On each side of the oecial aperture and outside the "horns" are two narrow longitudinal fissures which penetrate the oecial walls.

The avicularia, which are extremely rare, are elongated and triangular in shape. Each possesses a special elongated avicularian chamber intercalated among the surrounding zoecia. This chamber is dome-shaped in the distal half and possesses a heart-shaped aperture into which fits the base of the avicularium. Running along the top of the elevated distal portion of the chamber is a wide "U" shaped channel in which the entire avicularium rests. The proximal half of the chamber is flat and possesses a very small round pore, which is not far removed from the heart-shaped avicularian pore referred to above. The entire surface of the chamber is strongly tuberculated.

*Colour.*—The colonies examined are a pale cream in a dried condition.

*Remarks.*—This is obviously the species referred to by Miss Thornely under the name *Aspidostoma giganteum* Busk, for nowhere in the returned collection can I find a specimen of that species. Further, her remarks upon the supposed *A. giganteum* correspond to the specimens before me, which are from the same locality, but positive proof is absent, for unfortunately Miss Thornely did not append any labels of identification to the specimens she examined.

Before placing this new species in the genus *Cellaria* I have given the matter careful consideration, and its present resting place appears to be the best that our existing classification offers.

*Localities.*—Commonwealth Bay, Adelie Land; Station 12, 110 fathoms, 31-1-1914 (specimens examined by Miss Thornely); Station 8, 120 fathoms, 27-1-1914; Station 2, 318 fathoms, 28-12-1913.

*Cellaria diversa* sp. nov.

(Pl. VI, fig. 8, and text figs. 6 and 7.)

*Description.*—The zoarium grows in a tuft 3 to 5 inches in height, and is anchored to the sea bottom by means of a long and intricate tangle of radicles which spring from the stems of the colony. The branches of the colony are cylindrical in shape and are composed of internodes which are in most cases of equal length (10 mm.). As in other members of the genus the zoecia are arranged in regular order around an imaginary central axis, and are elongate and hexagonal in shape. Externally they are separated by knife-like and elevated borders.

The frontal zoecial wall which is a cryptocyst is slightly convex, and can be distinctly seen when the shining and semi-transparent ectocyst is removed by incineration. It is externally covered by well developed and prominent tubercles or granules.

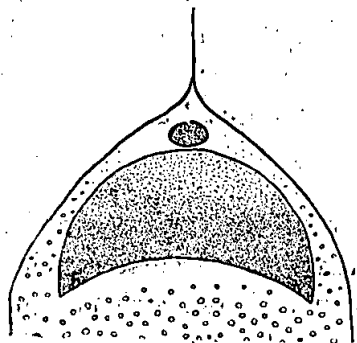

Text Fig. 6.

*Cellaria diversa* sp. nov.

Diagrammatic drawing of position of zoecial aperture and oocelial aperture, in relation to the distal zoecial border.

The lateral and basal walls are straight, and in those examined no rosette plates were distinguished. The distal and proximal walls, however, are well perforated by these structures on that account, and in many cases resemble sieves.

In every zoecium examined the zoecial aperture was seen to be constant both in shape and position, and although Waters<sup>1</sup> maintains the leading character of *C. malvinensis* Busk to be that the zoecial aperture is situated close to the distal border, the same structures in specimens before me are situated much higher than those figured by that author for *C. malvinensis*, and almost touch the distal borders (see text fig. 6). Each aperture is semicircular distally, but proximally the border is distinctly convex. Arising from the proximal border of every aperture are two projecting teeth, which assist in keeping the operculum in position. Around the aperture and coinciding with its shape is a raised border equal in height to the walls externally separating the zoecia. This structure is much stronger and better developed proximally than elsewhere.

The oecium opens to the exterior by means of a round or sometimes rounded triangular aperture.

The operculum is semicircular above and concave below, and is operated by a muscle on either side. Each muscle joins the operculum in the form of a cylindrical bundle, then proceeds in a fan-like manner towards the lateral zoecial wall, to which it becomes attached. Both muscles appear to be extremely strong in comparison to the weakly chitinised operculum. The operculum, although attached proximally to the ectocyst, can easily be detached, its true shape examined, and its relation to the zoecial aperture studied.

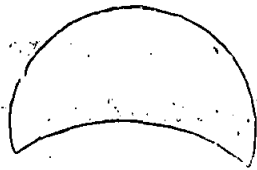

Text Fig. 7.  
*Cellaria diversa* sp., nov.  
Operculum.

The avicularia are characteristic of the genus and occupy separate cells anywhere in an internode. The mandible is elongate, roughly triangular in shape, and more heavily chitinised than the operculum. At its blunt free tip is a beak-like tooth as seen in the avicularia of other species. The avicularian or mandibular chamber is much the same in shape as the zoecia but it is smaller. Its proximal half is on a level with the surrounding frontal zoecial walls and is flat and granular. The distal half rises as it proceeds from about the midline and its distal extremity is higher than the walls externally separating the zoecia. Within the distal half is the mandibular cavity which is the same in shape as the mandible. A hinge-tooth occurs on each side of the cavity far down near the proximal extremity. Below the opening to the mandibular cavity and situated distally is a broad shelf, which gradually recedes as it proceeds proximally. This structure can easily be seen from the outside through the opening of the chamber.

<sup>1</sup> Sci. Results Voy. "Belgica," Bryozoa, 1904, p. 38.

*Colour.*—The series examined are pale cream in a dried condition.

*Remarks.*—After a prolonged study of this perplexing form hesitation is still experienced in considering it a new and distinct species, for many of its characters seem to be shared by many other representatives of the genus to a marked degree. Its operculum is of much the same shape as that of *C. bicornis* Busk<sup>1</sup> but other resemblances are lacking; its surface is strongly granular like *C. dubia* Busk<sup>2</sup>, but it does not possess the characteristic and prominent "interior ridges." Again, it closely resembles *C. malvinensis* Busk<sup>3</sup>, among other species, in the shape of the avicularian mandible, but the avicularian chamber of that species as figured by Waters<sup>4</sup> is quite different to that of the species before me. Further, *C. diversa* can be distinguished from *C. malvinensis* by the position of the zoecial aperture assuming that Waters' figure of the structure can be relied upon to represent its true nature.

Specimens of this species were in the collection examined by Miss Thornely, but I can recognise no record of it in her report.

*Localities.*—Commonwealth Bay, Adelie Land, 45 to 50 fathoms, 14-12-1913; Station 7, 21-1-1914; Station 4, 230 fathoms, 21-1-1914; Station 8, 120 fathoms, 27-1-1914; Station 12, 110 fathoms, 31-1-1914.

*Cellaria aurora* sp. nov.

(Pl. IV, fig. 7, and text fig. 8.)

*Description.*—Zoarium composed of branched cylindrical internodes of unequal length. In many cases they measure 30 mm. in length and 1 mm. in diameter. In some places the internodes have fused to form a continuous rod as in *Pseudocellaria obliqua* (Thornely), but the branches are cylindrical, not flat, as in that species.

The zoecia are arranged in a regular manner around an imaginary axis and are covered by a delicate and shining ectocyst. Externally they are almost regularly hexagonal in shape, and not elongate as in *C. mawsoni* sp. nov., though the distal angles are very often rounded. Sharp, thin, conspicuously raised borders externally differentiate the zoecia. The frontal zoecial walls are very thick, slightly depressed, and heavily covered by prominent tubercles or granules, which gives the entire surface an extremely rough appearance. Immediately below the zoecial aperture, which is the lowest part of the depressed frontal wall, an umbo-like thickening occurs, which is very rough and irregular in shape, though high enough to be easily seen.

<sup>1</sup> "Challenger" Zool. x, pt. xxx, 1884, p. 90, text fig. 9.

<sup>2</sup> "Challenger" Zool. x, pt. xxx, 1884, p. 91, text fig. 10.

<sup>3</sup> "Challenger" Zool. x, pt. xxx, 1884, p. 91, text fig. 11.

<sup>4</sup> Waters, Sci. Results Voy. "Belgica," Bryozoa, 1904, p. 37, pl. viii, fig. 5.

The zoecial aperture is situated in the distal half just beyond the middle, and is provided with a slightly raised crenulated border; it is generally perfectly square in shape, except for the lower border and the angles. The distal border is perfectly straight (except in a few cases, when it may be slightly convex), as well as the two lateral borders. The three mentioned borders, besides being straight, are situated at right angles to one another, and the angles made by their union are slightly rounded. The lower or proximal border is deeply convex. Projecting into the aperture from both the distal and proximal border is a flat and somewhat rectangular plate, which is concave on its free edge. In both plates, and from each free end, extends a tooth. Since there are two plates, one arising from the distal border and the other from the proximal, each having two teeth, there is a total of four teeth, which corresponds with the number seen in several other species of the genus.

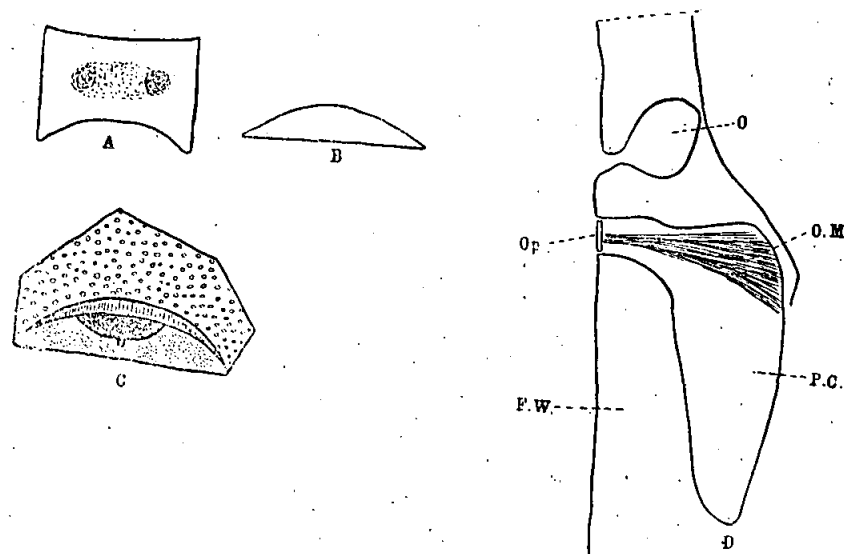

Text Fig. 8.

A Operculum of *Cellaria aurora* sp. nov.

B Avicularian mandible of *Cellaria aurora* sp. nov.

C Avicularian cell and mandibular cavity of *Cellaria aurora* sp. nov.

D Diagrammatical drawing of a longitudinal section of *Cellaria aurora* sp. nov. The broken lines represent the extent of the zoecium.

F.W. Thick frontal wall. O. Oecium. Op. Operculum. O.M. Opercular muscle.  
P.C. Cell of the polypide.

The operculum is comparatively thick and well chitinised and is of the same shape as the zoecial aperture. Its sides are straight, its top or distal border is sometimes slightly concave, sometimes perfectly straight, while the proximal border is deeply concave. All angles are sharply rounded. The edges of the operculum are slightly thickened. A very prominent and irregular thickening occurs in the middle and marks the site of the opercular muscle. Attached to the under surface in the middle of the operculum is a solitary bundle of muscles which operates that structure. This muscle, or bundle of muscles, is of considerable size and proceeds in a fan-like

manner from the operculum to the basal wall to which it becomes attached. The muscle fibres vary in thickness, some being extremely thick and isolated, while others are very thin.

The oœcia are characteristic of the genus, and each open about midway between the zoœcial aperture and the distal border by means of a circular pore of varying size and supplied with a special covering. These internal oœcia are somewhat spherical in shape, and each is situated in the thick frontal wall of the parent zoœcium, immediately above the zoœcial aperture. They have no visible means of communication with surrounding cells, their only opening being the oœcial aperture.

The avicularium, as in other members of the genus, occupies a separate cell, but the cells in a specimen before me are considerably reduced in size, being only about one-sixth the size of a normal zoœcium. Owing to their scarcity and small size the avicularia are very difficult to find. The mandible is fairly well chitinised and is faintly arched above and straight below. The frontal wall of the avicularian cell or chamber is granular and distally depressed. The mandibular cavity is situated at the extreme proximal end of the cell, the straight proximal border of the cell forming also the proximal border of the cavity. It is slit-like or elongate and oval in shape, and its distal border is distinctly arched. Within the mandibular cavity, and projecting from the proximal part of the circular oœcial wall, is a shelf, and in the middle of the free edge of this shelf a deep rounded sinus occurs with acute lateral angles.

*Affinities.*—There does not appear to be any known species with which this form could be confused, unless it be *Cellaria acutimarginata* MacGillivray<sup>1</sup>. The shape of the aperture, however, alone suffices to separate them, notwithstanding the fact that both have practically the same structure within the aperture.

*Colour.*—The colonies examined are a pale cream in a dried condition.

*Localities.*—Station 8, 120 fathoms, 27-1-1914; Station 12, 110 fathoms, 31-1-1914; Station 3, 157 fathoms, 31-12-1913.

*Cellaria wandeli* Calvet.

*Cellaria wandeli* Calvet, Exped. Antarctique Francaise, Bryozoaires, 1909, p. 23, pl. ii, figs. 3-6.

*Cellaria wandeli* Thornely, Austr. Antarctic Exped. Rept., Ser. C, vi, pt. 6, 1924, p. 9.

(Pl. IV, fig. 4.)

Specimens of the species from Station 12 were examined by Miss Thornely, but no mention was made of characters pertaining to the zoœcia in that author's report. With the aid of additional material the following characters not referred to by Calvet may be added to the existing data.

<sup>1</sup>MacGillivray, Trans. Proc. Roy. Soc. Victoria, iv, 1895, p. 28, pl. iii, fig. 17.

The raised border around the zoecial aperture is, in every specimen examined, toothed or serrated. So prominent is this character that it is difficult to understand why it has been previously overlooked, and the only alternative conclusion is that the "teeth" must occur in some colonies and not in others. Further evidence pointing to the fact that the species may vary in some characters in the absence of an avicularian cross-bar spanning the mandibular cavity on specimens before me. Calvet figures the cross-bar clearly, however, and there is apparently every reason to believe that his specimens possessed the character.

The colonies brought back by the Mawson Expedition also vary in the length and width of the internodes, but all other characters except those cited above agree well with Calvet's description and excellent representation of the form.

*Localities.*—Station 12, 110 fathoms, 31-1-1914; Station 8, 120 fathoms, 27-1-1914.

*MAWSONIA gen. nov.*<sup>1</sup>

*Definition.*—Zoarium branched, cylindrical, composed of fused internodes. Zoecia faintly defined, heavily calcified, granular, and arranged at right angles to the axis of the branch. The zoecial aperture, which greatly resembles an opesium, is oval in shape and provided with a well chitinised operculum. Within its proximal border a plate projects which has a broad and shallow sinus. The sinus is responsible for the formation of a tooth on each free angle of the plate.

Large interzoecial avicularia occur which are falciform in character.

The oecium is endotoichal.

*Genotype.*—*Mawsonia membranacea* (Thornely); *Cellaria membranacea* Thornely.

*Remarks.*—The formation of a new genus seems to be the only way to accommodate the following species which is perplexing and curious and appears to have much in common with *Cellaria bifaciata* (Canu and Bassler).<sup>2</sup>

*Mawsonia membranacea* (Thornely).

*Cellaria membranacea* Thornely, Austr. Antarctic Exped. Rept., Ser. C, vi, pt. 6, 1924, p. 9, text fig. 2.

(Pl. I, figs. 5 and 12; Pl. V, figs. 2 and 6; Pl. VII, fig. 8, and text figs. 9 and 10).

*Description.*—The zoarium is branched, cylindrical and made up of a number of fused internodes. It is anchored by means of branching cylindrical radicles attached to the colony between the zoecia. The fragments before me measure 2 mm. in diameter and the internodes measure 5 mm. in length from one fusion to another. This length, however, is variable.

<sup>1</sup> Named for Sir Douglas Mawson, O.B.E., B.E., D.Sc., F.R.S., leader of the Australasian Antarctic Expedition.

<sup>2</sup> Canu and Bassler, U.S. National Mus., Bull. 106; 1920; p. 274, pl. 40, figs. 14-17.



The zoecia, which are granular, are not well defined, being separated by very faint raised borders. They are pentagonal in shape externally, the distal border being curved, while the lateral and two proximal borders are straight. The frontal zoecial wall is, for the most part, flat except in the vicinity of the aperture, where it is raised on each side of that structure in the form of a flange. The frontal wall is depressed proximally to form a "V" shaped canal or gutter, which is deepest at the point of opening into the zoecial aperture. The canal gradually ascends as it proceeds from the aperture until it almost reaches the proximal zoecial border, where it fades out into the flat frontal wall. The remaining zoecial walls are straight. Every wall except the frontal proceeds towards the axis where they converge. The lateral walls near their tops are separated to form a slit-like chasm, which can be easily seen in a cross section of an internode. This seems to be a means of communication between the zoecia.

The zoecial aperture is oval, the major axis running parallel to the length of the zoecium. It is sunken well below the level of the frontal zoecial walls, and arising from the inside of its proximal border is a flat plate, ledge, or shelf, with a shallow sinus in its distal and free border. This shallow sinus, which runs the entire width of the ledge, forms a tooth at each free angle, a character seen in species of the genus *Cellaria*.

The operculum is oval and of the same shape as the zoecial aperture. It is operated by two somewhat fan-like muscles which are attached to it on each side and to the lateral zoecial walls.

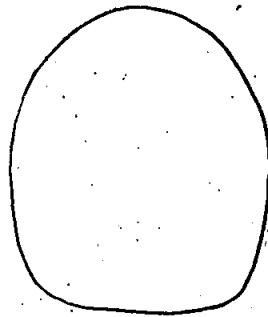

Text Fig. 9.

*Mawsonia membranacea*  
(Thornely).

Operculum of zoecial aperture.

The anterior extremity of the polypide is held in close contact with the operculum by a series of about five bundles of muscle fibres, which are attached to the lateral walls in the same manner as the opercular muscles.

The avicularia may be termed falciform in accordance with Miss Thornely's observations and are of considerable size. In old colonies the raised borders of the avicularian cavity become extensively calcified, rendering them conspicuous enough

to the unaided eye to be taken for nodules on the surface of the colony. Every avicularium is in the form of a separate cell, and, like the zoecia, their lateral walls are continued down to the axis of the branch, where they converge.

The mandibular cavity is sunken, irregularly elliptical in shape, and at its basal end bears four teeth or pivots, two on each side, facing upwards and outwards. The borders of the mandibular cavity are raised above the level of the zoecia and are shaped to accommodate the mandible. The mandible is falciform with a median supporting rib or sclerite which divides into two near the base, thus adding strength to the basal section. On each side of the central sclerite the mandible is in the form of a weakly chitinised membrane in young colonies, but in older ones the membranous expansions are of a stiffer character and more heavily chitinised. The free tip of the mandible, which is in reality the continuation of the central sclerite, is in the form of a curved beak. The mandible is operated by a huge fan-like muscle which occupies and runs the entire depth of the avicularian cell.

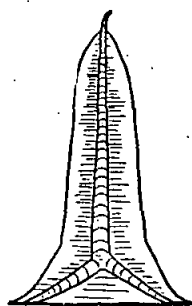

Text Fig. 10.  
*Mawsonia membranacea* (Thornely), Avicularian mandible.

The oecia are endotoichal. The frontal wall of each is somewhat dome-like, though only slightly elevated above the frontal zoecial walls. Its aperture, which is semi-elliptical in shape, is not visible in a vertical view and the colony must be observed at an angle of about forty-five degrees before it can be detected. The region immediately below the lower lip of the oecial aperture is faintly though distinctly corrugated or striated and not granular like the dome-like roof of the oecium. The oecial aperture is provided with a semi-elliptical operculum which is poorly chitinised.

*Remarks.*—This species can be readily recognised by the unusual character of the aperture and the cellaria-like form of the colony.

The appropriate specific name apparently refers to the resemblance the form bears to species of the genus *Membranipora* in the shape of the aperture.

*Localities.*—Station 3, 157 fathoms, 31-12-1913; Station 11, 351 fathoms, 31-1-1914.

\*94966—F

PSEUDOCCELLARIA *gen. nov.*

*Definition.*--Zoarium bilaminar, compressed, elongate, and tapering widely towards the free extremity. Zoarium anchored by root-like filaments as in *Cellaria*. Internodes fused to form a solid flat rod. Zoecia appear hexagonal outwardly, but inwardly are elongate, and taper towards their proximal borders. Zoecia in regular transverse series or rows; covered by an ectocyst. Teeth of distal border of aperture fused with the proximal border, thus forming two separate rods.

Oecia endotoichal, each closed by a special operculum, which is operated by an unusually strong and independent set of muscles.

Operculum crescentic. No avicularia.

*Genotype.*--*Pseudocellaria obliqua* (Thornely) [*Aspidostoma obliquum*].

*Remarks.*--Although Miss Thornely has placed the form upon which this new genus is based in the genus *Aspidostoma*, I venture to differ and erect a new genus for its reception. Representatives of the Family *Aspidostomidae* are required to possess polypide tubes, and their oecia must be hyperstomial. This being the case, and the form before me not possessing either of these main characters, it is evident that it cannot be regarded as a representative of that family. From the evidence available it is considered that *Pseudocellaria* must, for the time being at least, be relegated to the Family *Cellariidae*, despite the fact that some details of structure, such as the presence or absence of avicularia and the fusing of the teeth in the aperture, do not coincide. A species which is near this genus, but probably does not belong to it is *Cellaria dimorpha*. Canu and Bassler<sup>1</sup>.

*Pseudocellaria obliqua* (Thornely).

*Aspidostoma obliquum* Thornely, Austr. Antarctic Exp. Reports, Sér. C. vi, pt. 6, 1924, p. 16, fig. 4.

(Pl. IV, figs. 1 and 8, and text figs. 11, 12, and 13.)

*Description.*--Zoarium bilaminar, compressed, elongate and leaf-like. The site of attachment is narrow, but as the colony proceeds towards its free extremity it widens, the free extremity naturally being the widest part of the colony. The zoarium has a distinct jointed appearance as in *Mawsonia membranacea*, which is mentioned elsewhere in this report, but here it is flat. The fused internodes can be easily distinguished by the presence of shallow though distinct grooves which proceed around the colony and give it a somewhat corrugated appearance. These ring-like constrictions do not interfere with the disposal of the zoecia, but are sometimes responsible for slight distortion. The zoarium possesses a shining covering membrane, which, near the base of the colony, is modified into root-like expansions which serve to anchor the colony to the sea floor.

<sup>1</sup> Canu and Bassler, U.S. National Museum, Bull. 106, 1920, p. 273, pl. 40, figs. 11-13.

The zoecia, which are beneath the covering membrane, are regularly hexagonal in shape (when they are not near a fusion) in and around the central part of the colony, but near the edges they are somewhat distorted. They are externally differentiated by raised borders at the tops of which runs a smooth line. The frontal zoecial walls, which are well covered by prominent tubercles, are depressed, especially near the proximal border of the apertures where they are lowest.

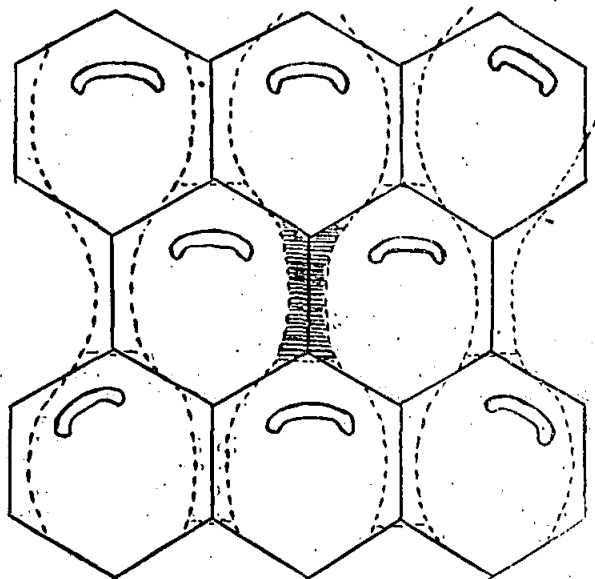

Text Fig. 11.

*Pseudocellaria obliqua* (Thornely).

Diagrammatic drawing of the species. The hard, black-lined hexagons represent the external shape of the zoecia. The dotted lines depict the true outline of the zoecia upon removal of the frontal zoecial walls. The dotted lines also represent the lateral, distal and proximal zoecial walls. The heavily lined dark area represents the lower or proximal extremity of a zoecium which is in the form of a tunnel made by the lateral walls uniting about midway up. On the top of the "tunnel" or tube the lateral walls continue in a united condition like a keel towards the frontal zoecial wall.

The foregoing description of the zoecia is from an external examination, but on removing the frontal zoecial walls by sectioning one sees that the zoecia do not maintain their outward hexagonal appearance. Instead, they present a more elongated aspect, their width being about one quarter their length. The common lateral zoecial walls are irregular in shape and each serves to separate three distinct polypides. The lateral walls can be described as being separate in the distal half, but as they approach the proximal half they unite about half way towards their tops to form a tunnel. From the top of this tube-like tunnel, the lateral walls continue in a united condition upwards like a keel until they reach and fuse with the frontal zoecial wall. The "tunnels" proceed in this condition to the proximal zoecial wall to which they are united. The lateral zoecial walls, which are high, are responsible for the raised borders externally differentiating the zoecia, and their convergence half way

down their length marks the two lower borders of each hexagonal zoecium (see text fig. 12). The basal wall is a common wall, serving as a base to zoecia on both sides of it. The distal and proximal walls, in addition to being the smallest, are the only ones possessing communication pores.

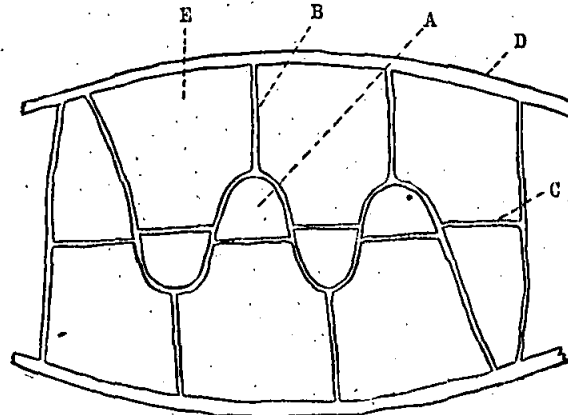

Text Fig. 12.

*Pseudocellaria obliqua* (Thornely).

Diagrammatic drawing of the species showing a portion of the character of the bilaminar colony in transverse section.

A. Proximal half of a zoecium which is in the form of a tunnel with a continuation of the fused lateral walls proceeding from its top in the form of a keel to the frontal zoecial walls. B. "Keel" referred to under previous letter. C. A common basal zoecial wall. D. Frontal zoecial walls.

The zoecial aperture is crescentic in shape, arched above and continued down on each side of a median, square, mucro-like projection, situated on the proximal border. This latter character is responsible for the zoecial aperture being more or less kidney-shaped. In position the aperture is very often set obliquely, though in some zoecia it may be normal and straight. The aperture possesses a raised border, which appears serrated owing to the strongly tuberculated nature of the cryptocyst. Within the aperture, and connecting the distal border to the proximal, are two calcareous bars, which correspond in position to the teeth in the apertures of *Cellaria*.

These bars may be the outcome of an evolutionary fusion of the teeth of *Cellaria*, or, on the other hand, the teeth of *Cellaria* may be degenerate bars.

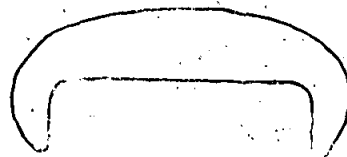

Text Fig. 13.

*Pseudocellaria obliqua* (Thornely).  
Operculum.

The operculum is crescentic like the aperture and fits this latter structure perfectly. It is chitinised, and in a dried condition is concave; because of this it has the appearance of a trough. The operculum is operated solely by two sets of muscles,

one on each side. Each set joins one end of the operculum in the form of a tight bundle, while the other end is spread fan-wise out towards the lateral zoecial walls to which it is attached.

The oecia are endotoichal, as in other species of the genus, and are always situated at the distal end of the zoecia. Each communicates with the exterior through a special aperture, the oecial aperture, which is capable of being closed by a well chitinised operculum operated by an independent set of muscles. The muscles descend from the operculum towards the bottom of the distal zoecial wall (proximal oecial wall) of the oecium-bearing zoecium where they become attached. The oecial aperture is somewhat crescentic in shape but is not so wide as a zoecial aperture. On each side of the oecial aperture is a small pore which opens into the oecium, but it is not supplied with any type of covering like the true oecial aperture. It is, however, covered by the covering membrane of the colony, whereas the oecial aperture, like the zoecial aperture, is not.

*Colour.*—The specimens before me are a pale cream in colour with a “shining surface and golden opercula,” as Miss Thornely states.

*Affinities.*—*Pseudocellaria obliqua* cannot be confused with any known species, save perhaps *Cellaria angustiloba* (Busk), which is best described by MacGillivray. But this latter species possesses avicularia, the teeth in the distal border of the aperture are not fused with the proximal border, and it does not exhibit the fused character of the zoarium shown by *P. obliqua*. I have had the opportunity of comparing Australian Museum specimens of *C. angustiloba* from the Victorian Tertiary deposits with *P. obliqua*, and the above remarks have been made after this direct comparison.

*Specimens examined.*—Several complete and incomplete colonies of this species have come under my notice, including the specimens examined by Miss Thornely. Unfortunately no type specimen was selected, and as a result I have selected the largest complete specimen, measuring 74 mm. long and 6 mm. across the widest part as the type.

*Localities.*—Station 2, 318 fathoms, 28-12-1913 (type specimens); Station 3, 157 fathoms, 31-12-1913; Station 12, 110 fathoms, 31-1-1914 (examined by Miss Thornely).

#### CRIBRILINA Gray.

*Cribrilina* Gray, List of British Animals in Collection of British Museum, pt. 1, 1848, p. 116.

#### *Cribrilina punctata* (Hassal).

*Lepralia punctata* Hassal, Ann. Mag., Nat. Hist., vii, 1841, p. 368.

*Cribrilina punctata* Hincks, British Marine Polyzoa, 1880, p. 190; pl. xxvi, figs. 1-4, pl. xxiv, fig. 3.

(Pl. II, fig. 7.)

Hincks devoted a considerable portion of his text to details regarding the variation of the species, and by his remarks one gathers that it varies widely.

The specimens before me serve to prove that this author was right in giving prominence to the "multitude of guises" adopted by the species, for they are in no way exactly similar to any figure seen by me or in accord with any existing description.

This Antarctic form may prove to be a new variety but, like Waters,<sup>1</sup> I refrain from suggesting a name on the ground that I have not seen an authentic specimen of *C. punctata*.

In order to prevent any misunderstanding as to the Antarctic form represented in the present collection, a figure has been prepared from which can be gathered some idea of its variation. It is further important that it be figured, for Waters (*loc. cit.*) considers it of considerable importance from the point of view of distribution.

*Localities*.—Station 1, 354 fathoms, 22-12-1913; Station 7, 60 fathoms, 21-1-1914; Station 8, 120 fathoms, 27-1-1914.

#### ARACHNOPUSIA Jullien.

*Arachnopusia* Jullien, Miss. Sci. du Cap Horn, Bryozoaires, vi, 1889, p. 62.

#### *Arachnopusia monoceros* (Busk).

*Lepralia monoceros*, Busk, Brit. Mus., Catalogue, pt. ii, 1854, p. 72; pl. xciii, figs. 5-6.

*Hiantopora monoceros*, Waters, Results Voy. "Belgica," Bryozoa, 1904, p. 42.

*Cribrilina monoceros*, Thornely, Austr. Antarctic Exped. Rept., Polyzoa, Ser. C, vi, pt. 6, 1924, p. 10.

*Arachnopusia monoceros*, Livingstone, Rec. Austr. Mus., xiv, 3, 1924, p. 203.

This cosmopolitan form is represented in the Mawson gatherings by several fragmentary colonies. As its distribution is very wide, its occurrence in the Antarctic is not surprising. The specimens before me possess the general characteristics of the species as seen in specimens collected off the coast of New South Wales, and differ only in that the mucro is bigger and covered with a profusion of small avicularia.

*Localities*.—Station 8, 120 fathoms, 21-1-1914; Station 12, 110 fathoms, 31-1-1914.

<sup>1</sup>Waters, Journ. Linn. Soc. Zool., xxviii, 1900, p. 62.

## FIGULARIA Jullien.

*Figularia* Jullien, Bül. Soc. Zool. France, lxxvii, 1886, p. 608.

*Figularia spatulata* (Calvet).

*Cribrilina spatulata* Calvet, Exped. Antarctique Francaise, Bryozoaires, 1909, p. 19, pl. 2, figs. 1-2 (not fig. 3).

*Cribrilina spatulata* Thornely, Austr. Antarctic Exped. Rept., Polyzoa, Ser. C, vi, pt. vi, 1924, p. 10.

(Pl. II, fig. 6.)

Many specimens of this easily distinguished species are present in the Mawson collections.

They substantiate the remarks made by Miss Thornely relative to the spines, which are five in number as compared with the four mentioned by Calvet.

*Localities*.—Commonwealth Bay, Adelie Land, 25 to 30 fathoms, 3 and 4-9-1912; Commonwealth Bay, 45 to 50 fathoms, 14-12-1913; Station 7, 60 fathoms, 21-1-1914; Station 12, 110 fathoms, 31-1-1914.

## HIPPOTHOA Lamouroux.

*Hippothoa* Lamouroux, Exposition Methodique des Genres de l'Ordre des Polypiers, 1821, p. 82.

*Hippothoa hyalina* (Linnæus).

*Cellepora hyalina* Linnæus, Systema Naturæ, Ed. xii, tom. 1, pt. ii, 1766 (1767), p. 1286.

*Schizoporella hyalina* Hincks, A History of the Brit. Marine Polyzoa, 1880, p. 271, pl. xviii, figs. 8-10.

*Schizoporella hyalina* Calvet, Exped. Antarctique Francaise, Bryozoaires, 1909, p. 25.

*Hippothoa hyalina* Marcus, The Natural History of Juan Fernandez and Easter Island, iii, 1920, p. 102, text fig. 5 (synonymy).

*Schizoporella hyalina* Thornely, Austr. Antarctic Exped. Rept., Ser. C, vi, pt. 6, 1924, p. 12.

Representatives of this well known and widely distributed species have been sorted out of the Mawson collections. They all agree with the description of the typical form, and could not, in my opinion, be assigned to any one of the numerous varieties at present in existence.



The majority of the colonies are encrusting seaweed in the same manner as other specimens found in and around Port Jackson, New South Wales.

*Localities*.—Station 2, 318 fathoms, 28-12-1913; Commonwealth Bay, 25 fathoms, 3 and 4-9-1912, and 3 to 5 fathoms, 16-5-1912.

SYSTEMOPORA *Waters*.

*Systemopora Waters*, Res. Voy. "Belgica," Bryozoa, 1904, p. 55.

*Systemopora contracta Waters*.

*Systemopora contracta Waters*, Res. Voy. "Belgica," Bryozoa, 1904, p. 56, pl. v, figs. 1a-k.

*Systemopora contracta Thornely*, Austr. Antarctic Exped. Rept., Ser. C, vi, pt. 6, 1924, p. 12.

(Pl. VI., fig. 5.)

The specimens before me exhibit the characters mentioned by Miss Thornely. Slight deviations from Waters' description and figures do not create any doubt as to the true identity of the form, as all other characters agree. The nature of the specimens in the present collection does not permit of study that would supplement the already adequate description given by Waters.

*Localities*.—Station 2, 318 fathoms, 28-12-1913; Station 8, 120 fathoms, 27-1-1914.

CELLARINELLA *Waters*.

*Cellarinella Waters*, Res. Voy. "Belgica," Bryozoa, 1904, p. 57.

*Cellarinella dubia Waters*.

*Cellarinella dubia Waters*, Res. Voy. "Belgica," Bryozoa, 1904, p. 58, pl. viii, figs. 12 a-b, and text fig. 2.

? *Cellarinella dubia Thornely*, Austr. Antarctic Exped., Rept., Ser. C, vi, pt. 6, 1924, p. 13.

Waters describes this form as having two methods of growth, and it is the cylindrical form he describes from Cape Horn that resembles the specimens before me. The two denticles arising from the proximal border of the peristomial aperture can be distinctly made out, and their presence or absence does not seem to be concerned in any way with the occurrence of avicularia. Waters (*loc. cit.*, p. 59) states "where there is no avicularium both denticles are wanting," but it has been found that the two denticles occur whether an avicularium is present or not. The denticles are so

arranged and so much curved inwards at their free extremities that they create a kind of sinus which gives the surrounding structure "the appearance of a Schizoporellidan aperture," as stated by Waters.

The pores puncturing each frontal zoecial wall are confined mostly to the lateral borders, though there may be as many as three or four scattered at random over the central area.

The oecium is only slightly raised and has the appearance of a depressed dome. It is surrounded by slit-like pores, which serve as an external indication of its limits.

Although the distal border of the peristomial aperture is raised, the "horn-like process above the orifice" mentioned by Miss Thornely cannot be detected on specimens before me considered referable to *C. dubia*. It is possible that Miss Thornely confused another form with *dubia* when she made the remark quoted above, for neither Waters nor myself have seen the structure she refers to.

The species is represented in the collection by five small fragments.

*Locality* (?).—Notwithstanding the fact that the specimens before me possess no definite locality, it is safe to assume that they are from the Antarctic Region. Miss Thornely gave the locality of the single specimen she examined as 2 miles off Macquarie Island, 60 fathoms, but for the reason stated above this record seems doubtful.

*Cellarinella foveolata* Waters.

*Cellarinella foveolata* Waters, Res. Voy. "Belgica," Bryozoa, 1904, p. 57, pl. v, figs. 2 a-h.

*Cellarinella foveolata* Thornely, Austr. Antarctic Exped. Rept., Ser. C., vi, pt. 6, 1924, p. 13.

(Pl. I, fig. 11.)

Several branched cylindrical colonies which have been identified as this species agree perfectly with Waters' description. They are heavily calcified and badly preserved, thus making it practically impossible to add anything of importance to Waters' description.

*Locality*.—Station 2, 318 fathoms, 28-12-1913.

*Cellarinella nodulata* Waters.

*Cellarinella nodulata* Waters, Res. Voy. "Belgica," Bryozoa, 1904, p. 58, pl. viii, figs. 6 a-c.

*Cellarinella nodulata* Thornely, Austr. Antarctic Exped. Rept., Ser. C., vi, pt. 6, 1924, p. 13.

(Pl. I, figs. 1, 4 and 7.)

*Description*.—The zoarium is nodulated, compressed and of an erect and branching nature. It is anchored by chitinous rootlets, which are attached to the base of the colony.

The zoecia are undefined, but the situation of each is indicated by a somewhat large opening, which is the peristomial aperture. The entire frontal area is covered by deep pits. The peristomial aperture, which is oval in outline, is considerably distorted by the presence of a rounded, triangular, avicularium, which is set almost within its proximal border and a little to one side. In a very few cases, two avicularia may occur on the one zoecium, each being placed almost within the peristomial aperture on each side of the median mucro. The avicularian chamber possesses in its middle a heavily calcified cross-bar or pivot, upon which the base of the mandible rests. The chamber is exceedingly deep, and extends through the frontal wall and down the lateral wall between the tubes<sup>1</sup> forming that structure, and can easily be distinguished from these tubes by its large size. A cross section reveals the fact that every zoecium is provided with two avicularian chambers, one on each side of the peristome, but as only one is fully developed and provided with a mandible in the vast majority of cases, it would appear that the remaining one is aborted.

The true zoecial aperture is set deep within the peristome and is covered by a delicate semi-transparent membrane. The lateral zoecial walls are composed of a number of tubes joined together, as shown in the figure of the species. Every surface, however, with which the polypide comes into contact is smooth; even the deep pore-like pits seen on the frontal zoecial walls do not completely penetrate the structure; but either end blindly or deviate to one side to form the tube system in the lateral walls.

Externally, and immediately below the peristomial aperture, there is a large projecting median mucro, which is deeply furrowed or striated longitudinally and easily detected with the naked eye. Looking down into the peristome from above when an incinerated colony is tilted under the microscope to allow such a view, a projecting plate can be seen about midway down which almost obliterates the view of the distal half of the remainder of the canal below it. When a section is made of a piece of a colony, this plate is seen to be the proximal projection of the roof of an oecium, which is otherwise invisible from an external view.

The oecium, which is internal, is globular in shape and is situated at the distal end of the zoecium. The inside of its walls, like those of the zoecia, is smooth, and it opens into the zoecium itself, at, or in close proximity to, the base of the peristomial canal.

*Remarks.*—Other characters of this perplexing species have been described by Waters (*loc. cit.*). Miss Thornely gives details concerning two fragments examined by her; but unfortunately her remarks cannot be substantiated, as no fragments wholly agreeing with her description have been seen.

*Localities.*—Station 2, 318 fathoms, 28-12-1913; Station 3, 157 fathoms 31-12-1913; Station 8, 120 fathoms, 27-1-1914; Station 12, 110 fathoms, 31-1-1914.

<sup>1</sup> The tube system, which goes to make up the larger portion of the lateral zoecial walls, appears to originate from the pits on the surface of the frontal walls which extend inwards in a tube-like manner. They are described more fully in the following paragraph and are also figured.

*Cellarinella watersi* Calvet.

*Cellarinella watersi* Calvet, Exped. Antarctique Française, Bryozoaires, 1909, p. 33, pl. iii, figs. 8-10.

*Cellarinella watersi* Thornely, Austr. Antarctic Exped. Rept., Ser. C, vi, pt. 6, 1924, p. 13.

(Pl. I, figs. 8 and 10.)

*Description.*—Zoarium compressed on two surfaces, nodulated and branched as in *C. nodulata*. It is anchored by brown, chitinous rootlets which are attached to the basal end. The zoecia are without external borders or lines of demarcation, and can be distinguished only by the peristomial apertures. The entire surface is deeply pitted and rough as in *C. nodulata*.

The peristomial aperture is almost circular, and, unlike that of *C. nodulata*, is not distorted by any neighbouring structures. In some zoecia there is a very poorly developed mucro, similar in structure to that seen in *C. nodulata*, but not so large. When this mucro is present, it is responsible for displacing to some degree the median avicularium, pushing it aside to assume the median position itself. The median avicularium has a triangular mandible, and is situated on the proximal border of the peristomial aperture. Its chamber is provided, as in *C. nodulata*, with a heavily calcified cross-bar or pivot. This avicularian chamber is very deep, and completely penetrates the frontal zoecial wall to open in a median position into the bottom of the peristomial canal. At the site of opening of the avicularian cavity or chamber into the peristomial canal, there is another mandible situated on a cross-bar. The avicularian cavity (in reality it is a tube) then possesses two mandibles, one operating externally and the other internally. The mandible of the internal avicularium is sharply triangular, and has a very conspicuously hooked point. The mandible is attached by its base to the cross bar or pivot, and when closed is bounded by thin calcareous flanges which spring from the edges of the cavity.

Sectioning shows the lateral zoecial walls to be of the same tubular nature as in *C. nodulata* near their tops, but basally they are thin and delicate, the tube-like arrangement having converged and terminated about midway. Although the shape of the zoecia cannot be distinguished on an external view, a sectioned colony will show them to be very elongate and rectangular in shape, differing entirely in this respect from *C. nodulata*. The lateral walls curve inwards towards the middle, but widen again gradually as they proceed proximally. The distal half of the polypide chamber is spacious and smooth, but the proximal half is very limited owing to the encroachment of the thick perforated frontal zoecial wall, as well as the oecium of the proximal zoecium.

The oecium is of the same nature, and is placed in the same position as in *C. nodulata*.

*Colour*.—Specimens that have been well preserved in alcohol are of a chocolate brown hue in a dried condition.

*Remarks*.—The foregoing description is intended to amplify the one given by Calvet, as well as to describe some characters not mentioned by him.

*Localities*.—Commonwealth Bay, Antarctica, 25 fathoms, 3 and 4-9-1912; Commonwealth Bay, 45 to 50 fathoms, 14-12-1913; Station 3, 157 fathoms, 31-12-1913; Station 8, 120 fathoms, 27-1-1914.

SCHIZOPORELLA *Hincks*.

*Schizoporella* Hincks, History British Marine Polyzoa, 1880, p. 237.

*Schizoporella tumida* Hincks var. *tricuspis* Calvet.

*Schizoporella tumida* Hincks, 1881, var. *tricuspis* Calvet, Exped. Antarctique Francaise, Bryozoa, 1909, p. 28, pl. iii, figs. 1-3.

*Schizoporella tumida* Hincks var. *tricuspis* Thornely, Austr. Antarctic Exped. Rept., Ser. C, Zool., vi, pt. 6, 1924, p. 12.

Representatives of this variety are included in the dredgings from Station 1. One is of an encrusting and unilaminate nature, though in other respects it presents the exact characters mentioned by Calvet. Miss Thornely described the specimen she examined as bilaminate, but a bilaminate specimen before me from the same locality does not possess a large swelling beneath the aperture, but has only a slight eminence. Avicularia occur in the usual places on both forms, and it is probable that the bilaminate specimen in the present collection is immature.

*Locality*.—Station 1, 354 fathoms, 22-12-1913.

LACERNA *Jullien*.

*Lacerna* Jullien, Miss. Sci. du Cap Horn, vi, 1889, Bryozoaires, p. 48.

*Lacerna hosteensis* Jullien.

*Lacerna hosteensis* Jullien, Miss. Sci. du Cap Horn, vi, 1889, Bryozoaires, p. 48, pl. 1, fig. 2.

*Lacerna de carforti* Jullien, *Ibid.* name on plate and explanation of plate referring to *hosteensis*.

*Schizoporella hosteensis* Waters, Res. Voy. "Belgica," Zool., Bryozoa, 1904, p. 51, pl. iii, fig. 11 a, b, c.

*Schizoporella simplex* Thornely (non d'Orbigny), Austr. Antarctic Exped. Rept., Ser. C, vi, pt. 6, 1924, p. 12 (in part).

Several encrusting colonies of this species exhibit characters which are in accordance with Waters' remarks. The zoecia are not hyaline as described by Jullien, but are, as Waters maintains, granular.

*Localities*.—Station 2, 318 fathoms, 28-12-1913; Station 3, 157 fathoms, 31-12-1913; Station 8, 120 fathoms, 21-1-1914.

A specimen encrusting *Phylactella lyrulata* Calvet from this last locality seems to have been confused by Miss Thornely with "*Schizoporella*" *simplex* d'Orbigny and recorded under that name, for she made no mention of *Lacerna hosteensis* in her report (see note under *Buffonella simplex* d'Orbigny).

*BUFFONELLA* Jullien.

*Buffonella* Jullien, Miss. Sci. du Cap Horn, vi, 1889, Bryozoaires, p. 47.

*Buffonella simplex* (d'Orbigny) (non Johnston).

*Escharina simplex* d'Orbigny, Voy. dans l'Amerique meridionale, v, pt. 4, 1839, p. 13, pl. 5, figs. 5-8 (*vide* Jelly 1889 and d'Orbigny 1851).

*Schizoporella simplex* Waters, Res. Voy. "Belgica," Bryozoa, 1904, p. 51, pl. 3, fig. 6.

*Schizoporella simplex* Thornely, Austr. Antarctic Exped. Rept., Ser. C, vi, pt. 6, 1924, p. 12 (in part).

The single example encrusts another species of Bryozoa (*Phylactella lyrulata* Calvet—obviously the same form referred to by Miss Thornely as "*Phylactella lyrulata*").

The zoecia are as described by Waters. The tube on each side of the avicularian chamber can be faintly distinguished through the frontal zoecial wall. The presence or absence of a mandible to this avicularian chamber has apparently not been definitely established and Waters considers that the chamber "seems too small to be functional." Although the structure may be degenerate it cannot be considered too small to be functional, for the presence of a minute and weakly chitinised mandible at the entrance to almost every chamber on the specimen before me indicates otherwise.

The mandible, which is triangular in shape, is very difficult to see, and, being very small and delicate, is easily dislodged. This latter fact is perhaps responsible for the mandible having, in the past, been absent in the specimens examined.

Canu and Bassler<sup>1</sup> have followed Waters' (*loc. cit.* p. 49) suggestion to group under Jullien's genus *Buffonella* several species previously associated with *Schizoporella*, including the species under discussion. The characters of *Buffonella* have been ably set out by these two authors together with a list of the recent species considered referable to it.

<sup>1</sup> Canu and Bassler, U.S. National Museum, Bull. 106, 1920, p. 348.

Miss Thornely's record of this species from Station 8 appears to be wrong; the species encrusting *Phylactella lyrulata* from that locality has been identified as *Lacerna hosteensis* Jullien and included, with other specimens, under that species. The specimen from Station 7 before me, however, is undoubtedly the form described by Waters as *Schizoporella simplex* d'Orb. after he had examined d'Orbigny's type.

*Locality*.—Station 7, 60 fathoms, 21-1-1914.

EMBALLOTHECA *Levinsen*.

*Emballotheca* Levinsen, Morph. Syst. Stud. Cheil. Bryozoa, 1909, p. 333.

*Emballotheca contortuplicata* (Calvet).

*Mucronella contortuplicata* Calvet, Exped. Antarct. Francaise, Bryozoa, 1909, p. 36, pl. iii, figs. 4-5.

*Mucronella contortuplicata* Thornely, Austr. Antarctic Exped. Rept., Ser. C, Polyzoa, vi, pt. 6, 1924, p. 15.

(Pl. V, fig. 5; Pl. VII, fig. 7.)

Three colonies of a vase or cup-like formation of this comparatively simple and easily recognisable species are in the collection. Unfortunately, no oecia are present, but in Calvet's description and figure facts are revealed about those structures which are responsible for the removal of the species from the genus under which it was described.

*Remarks*.—In the same year (1909) as this species was described, Levinsen<sup>1</sup> erected the genus *Emballotheca* which provides for forms nearest *Schizoporella* with such peculiarly formed oecia as are seen in the form before me.

While it is apparent that "*Mucronella*" *contortuplicata* is referable to *Emballotheca* it must be borne in mind that another genus, *Parmularia* of MacGillivray, which has been dealt with by me in a previous paper<sup>2</sup>, is also involved. A comparison of the two genera will reveal many important structures common to both, and this would indicate that one should be discarded. Nevertheless, it would perhaps be better to keep them both in use, for the present anyway, referring those species of a free bilaminate character, with arched rows of zoecia, and anchored by means of a special anchoring filament, to the genus *Parmularia* and the others to *Emballotheca*.

It is admitted that the type of the genus *Emballotheca* (*E. quadrata* MacGillivray) is bilaminate and possesses "S" shaped distal and proximal walls, but the arrangement of the zoecia and the formation and attachment of the zoarium is not, so far as is known, the same as in a representative of the genus *Parmularia*.

<sup>1</sup> Levinsen, Morph. Syst. Stud. Cheil. Bryozoa, 1909, p. 333.

<sup>2</sup> Livingstone, Rec. Austr. Museum, xiv, 3, 1924, p. 189.

It is further recognised that the generic value of the above suggested characters of differentiation have in some cases proved useless, but their application in the present case is desirable in view of the fact that from what we know of the existing species of *Parmularia* they are constant.

Miss Thornely evidently prefers to allow the above species to remain in the genus under which it was described, but in the light of the above facts a change is obvious.

*Localities*.—Station 1, 354 fathoms, 22-12-1913; Station 3, 157 fathoms, 31-12-1913; Station 12, 110 fathoms, 31-1-1914.

#### MICROPORELLA *Hincks*.

*Microporella* Hincks, Ann. Mag. Nat. Hist., Ser. 4, xx, 1877, p. 526.

(? *Microporella*) *trinervis* Waters.

*Microporella trinervis* Waters, Rés. Voy. "Belgica," Bryozoa, 1904, p. 45, pl. 2, fig. 17.

*Microporella trinervis* Thornely, Austr. Antarctic Exped. Rept., Ser. C, vi, pt. 6, 1924, p. 11.

(Pl. VII, fig. 3.)

The tube within the frontal zoecial wall described by Waters can be readily discerned in the present series of specimens. Unfortunately, the condition of the material does not permit of study that would assist in the understanding of the system, and although attempts have been made to seek further details nothing other than that already described can be ascertained.

The terminal opening to each lateral branch of the median tube is larger in diameter than the tube itself owing to the fact that the tube widens out into a small chamber before it ends. The terminal opening, which is circular, is closed by a chitinous flap much in the same manner as a zoecial aperture is closed by an operculum. It was obviously this structure that led Miss Thornely (*loc. cit.*) to write, "a small rounded avicularium on either side of the orifice."

Miss Thornely's remarks relative to the "avicularium" occurring only *sometimes* is misleading as they might lead one to conclude that the tube system is present only in some zoecia. Such is not the case, however, as it has been found in every zoecium so far examined.

The generic position of this curious species has been queried on account of its perplexing nature. The author of the species made known his doubt as to its correct



position and considered that a new genus would have to be erected for its reception. This, in my opinion, seems to be the only course, but the application of a name will have to be deferred until after the species has been fully understood.

*Localities.*—Station 2, 318 fathoms, 28-12-1913; Station 8, 120 fathoms, 27-1-1914.

*Microporella divaricata* Canu.

*Microporella divaricata* Waters, Res. Voy. "Belgica," Bryozoa, 1904, p. 46, pl. iii, figs. 1 a-c.

*Microporella divaricata* Canu and Bassler, U.S. National Museum, Bull. 125, 1923, p. 118, text fig. 20 m.

*Microporella divaricata* Thornely, Austr. Antarctic Exped. Rept., Ser. C, vi, pt. 6, 1924, p. 10.

(Pl. II, fig. 5.)

As already remarked by Miss Thornely (*loc. cit.*), the zoarium is erect and bilaminate, though sometimes a portion may be cylindrical. The division of the colony into internodes is remarkable and at a glance with the unaided eye it would be mistaken for a *Cellaria*. The internodes are joined together by chitinous tubes as in members of the last mentioned genus, thus creating a new feature by which the species can be recognised.

The species is represented in the present collection by a single colony; portion of which has been sectioned for further characters but without satisfactory results.

*Locality.*—Station 12, 110 fathoms, 31-1-1914.

FENESTRULINA Jullien.

*Fenestulina* Jullien, Miss. Sci. du Cap Horn, vi, Bryozoaires, 1888, p. 37.

*Fenestulina* Canu and Bassler, U.S. National Museum, Bull. 125, 1923, p. 113.

The Group *Microporellæ* introduced by Canu and Bassler includes two genera *Fenestulina* and *Microporella*, which have, since their introduction into the classification, caused much confusion and difference of opinion between various authors. To a student of the subject it is easy to understand why such diverse opinions are held, for the forms themselves appear to have acquired such a remarkable and seemingly unaccountable degree of variation that they defy all attempts to bring them into a satisfactory specific classification. So far as generic classification is concerned, there does not appear to be any better arrangement than that suggested by Canu and Bassler (*loc. cit.*), but in regards to specific classification one must confess

that to-day, with the introduction of additional species, the system is sadly in need of a thorough investigation and revision. In the genus *Fenestrulina*, now that Waters has described new species from the Antarctic, one finds a complication of forms all closely allied, some no doubt annectant with other species, but in the absence of knowledge of all the intermediate forms the question must remain for the present an unsolved enigma.

My views are in complete accordance with those of Waters (*loc. cit.* p. 45) in regard to the value of surface pores in classification, and, as previously emphasised by that author, we should exercise extreme caution when including them in a set of characters separating one species from another. As for the median pore as a generic character I can only say that I have found it practically useless for even specific distinction as shown in the text relating to the following species.

*Fenestrulina proxima* (Waters).

*Microporella proxima* Waters, Res. Voy. "Belgica," Bryozoa, 1904, p. 44, pl. ii, fig. 16.

*Microporella proxima* Thornely, Austr. Antarctic Exped. Rept., Ser. C. vi, pt. vi, 1924, p. 12.

(Pl. II, figs. 4 and 8.)

This species, which appears to have most in common with *F. parvipora* Waters, has been extremely difficult to determine. *F. proxima* has been described as possessing a "small round median pore near the oral aperture," while *F. parvipora* is credited with a crescentic median pore. On a colony before me there are two zoecia side by side, one having a crescentic median pore and the other a circular median pore. As the structures appear to be natural and not broken, one is safe in assuming that the median pore is practically useless as a character for either generic or specific separation. *F. proxima* is reputed to have six oral spines, but on specimens before me there are only two which are arranged in the same manner as in "*Microporella*" *impressa* Aud.<sup>1</sup> Instead of the oecia being smooth, as required for *E. proxima*, they are rugged, but not punctured as in "*M.*" *impressa*. The rugged appearance of the oecia on the present specimens appears to be governed by the degree of calcification, for older oecia appear to be rougher and more deeply furrowed than younger ones. In other respects the description of *F. proxima* agrees with the Mawson series, and although some would consider that the above cited differences would justify the erection of a new species, it has been deemed advisable in this case not to adopt such a course.

*Localities*.—Boat Harbour, Commonwealth Bay, Adelie Land, 3½ fathoms and 25 fathoms, 3 and 4-9-1912.

<sup>1</sup> See Hincks, Brit. Marine Polyzoa, 1880, p. 214, pl. xxvi, figs. 9-11; pl. xxix, figs. 10-11.

*Fenestrulina malusii* (Audouin).

*Cellepora malusii* Audouin, Expl. des planches de M. Savigny; Savigny, Zool. Egypt. pl. viii, fig. 8 (fide Jelly, 1889).

*Microporella malusii* Waters, Res. Voy. "Belgica," Bryozoa, 1904, p. 42, pl. iii, figs. 4 a-d.

Representatives of this cosmopolitan species resemble the form described by Waters in every character except the spines. These structures on the present series are forked and resemble those seen in *var. vitrea* Hincks<sup>1</sup>, but the specimens possess pores which are lacking in that variety.

*Locality*.—Station 8, 120 fathoms, 27-1-1914.

*Fenestrulina malusii* (Audouin) *var. thyreophora* (Busk).

*Lepralia thyreophora* Busk, Quart. Journ. Microscopical Science, v, p. 172, pl. xv, figs. 4-5.

*Microporella malusii var. thyreophora* Hincks, Brit. Marine Polyzoa, 1880, p. 212.

A solitary small and damaged colony from Station 8, answers to the description of this variety very well. The oöcia, as figured by Hincks, possess the same striated appearance on their frontal walls, and the only character which appears to be lacking is the presence of a row of pores between the median pore and the semi-circular aperture.

*Locality*.—Station 8, 120 fathoms, 27-1-1914.

*Fenestrulina exigua* (Waters).

*Microporella exigua* Waters, Res. Voy. "Belgica," Bryozoa, 1904, p. 44, pl. iii, figs. 3 a-b.

The relatively larger zoöcial aperture of this species is very striking, also the eight large spines on the distal border of the aperture. The single representative of this species before me agrees in every detail with Waters' description except as regards the shape of the median pore. Waters describes and figures this structure as round, but the present form shows it to be distinctly lunate and extremely narrow. Owing to the median pore being very delicate in construction it is often found to be broken, and it was perhaps in such a condition when described by Waters as round.

*Locality*.—Commonwealth Bay, Antarctica, 25 fathoms, 3 and 4-9-1912.

<sup>1</sup> Hincks, Brit. Marine Polyzoa, 1880, p. 212.

INVERSIULA *Jullien*.

*Inversiula* Jullien, Miss. Sci. du Cap Horn, Bryozoaires, vi, 1889, p. 44.

*Inversiula nutrix* Jullien.

*Inversiula nutrix* Jullien, Miss. Sci. du Cap Horn, Bryozoaires, vi, 1889, p. 44, pl. 4, fig. 8.

*Inversiula nutrix* Waters, Ann. Mag. Nat. Hist., iv, ser. 6; 1889, p. 7 (in text of *Microporella inversa*).

*Inversiula nutrix* Kirkpatrick, "Southern Cross" Collections, Polyzoa, 1902, p. 287.

*Microporella nutrix* Norman, Journ. Linn. Soc. Zool., xxx, No. 199, 1909, p. 298, pl. 39, fig. 1.

*Microporella inversa* Thornely (non Waters), Austr. Antarctic Exped. Rept., Ser. C, vi, pt. 6, 1924, p. 11.

Specimens of this well defined species in the collection were recorded by Miss Thornely (*loc. cit.*) as *Microporella inversa* Waters. Although this author did not label any of the specimens she examined, it is obvious that the form before me is the species she misunderstood, for there are no specimens corresponding with Waters' description of *I. inversa* in the returned collection, and the localities given by Miss Thornely for "*M.*" *inversa* agree with those of the specimens I identify as *I. nutrix*. Again, her remarks on the specimens she examined suggest *I. nutrix* rather than the species intended.

Specimens of *I. inversa* (Waters) from the type locality are in the collection of the Australian Museum, and, after comparing the present specimens of *I. nutrix* Jullien with them, it is seen that the form of the opercula serves as a good and substantial character to distinguish the two forms. The shape of the zoecial apertures as figured by the authors of the two species also serves to distinguish the forms. In *I. inversa* it is, like the operculum, straight distally, and in *I. nutrix* it is slightly rounded distally.

Again, the large size of the zoecia of *I. nutrix* as compared with the small ones of *I. inversa* readily distinguishes the forms. The large size of the zoecia of *I. nutrix* is also remarked upon by Norman (*loc. cit.*).

Kirkpatrick's (*loc. cit.*) remarks fit the specimens before me perfectly, and there is nothing to add regarding the variation of the median pore.

*Localities*.—Boat Harbour, Commonwealth Bay, Adelie Land, 3½ fathoms; Commonwealth Bay, 3-5 fathoms; Commonwealth Bay, 25 fathoms, 3 and 4-9-1912,

*LEPRALIA Johnston!*

*Lepralia* Johnston, "A History of the British Zoophytes," 1838, p. 77.

*Lepralia marginata* Calvet.

*Lepralia marginata* Calvet, Exped. Antarctique Francaise, Bryozoaires, 1909, p. 24; pl. 2; figs. 7-9.

*Lepralia marginata* Thornely, Austr. Antarctic Exped. Répt., Ser. C, vi, pt. 6, 1924, p. 11.

(Pl. VII, figs. 4 and 6.)

The specimens secured by the Mawson Expedition are hemescharan in form and often tubular as though they have, as Miss Thornely states, "apparently been folded loosely round some foreign object."

The form agrees well with Calvet's description (not Charcot's as Miss Thornely writes), and exhibits no variation whatever. The hinge teeth within each zoecial aperture are of striking size in comparison with the rather small zoecia.

The "little process on the dorsal surface of some zoecia" which has been referred to by Miss Thornely recalls a similar structure seen in *Petralia dorsiporosa*, but the structure on the form before me is not so long as in that species. In some zoecia the "process" is absent, whilst in others one or two may arise from the outside surface of the basal wall. The "process" consists of a chitinous tube-like structure arising from a circular pore in the basal wall. When the basal wall is viewed from the inside only the circular pore (or pores, as the case may be) can be seen. This feature points to a conclusion that the "process" is solely an exterior character having no functional communication with the interior organs in any way; it may be connected in some way with the method of attachment, as previously suggested by Miss Thornely.

*Localities*.—Commonwealth Bay, Adelie Land, 55 to 60 fathoms, 21-12-1913; Station 3, 157 fathoms, 31-12-1913; Station 7, 60 fathoms, 21-1-1914; Station 12, 110 fathoms, 31-1-1914.

*ROMANCHEINA Jullien.*

*Romancheina* Jullien, Miss. Sci. du Cap Horn, vi, 1889, Bryozoaires, p. 60.

*Romancheina martiali* Jullien.

*Romancheina martiali* Jullien, Miss. Sci. du Cap Horn, vi, 1889, Bryozoaires, p. 60, pl. 5, figs. 1-2.

(Pl. III, figs. 1, 2, 3 and 6.)

The zoarium of each specimen before me is branched and flattened on two surfaces, making somewhat bilaminar. The zoecia are separated into distinct areas by deep transverse grooves resembling to some extent those seen in species of *Cellarinella*.

The zoarium is anchored by means of cylindrical root-like chitinous radicles, each being attached to the base of the zoarium in the form of a flattened expansion.

The polypide is held in place by a transverse membrane of a weakly chitinised nature. Anteriorly the membrane is modified to form the operculum, which can be easily recognised by its 'more heavily chitinised' appearance.

Unfortunately the lack of suitable material prevents further investigation of this interesting species.

*Synonymy*.—*Romancheina* Jullien, although placed by Levinsen<sup>1</sup> in the synonymy of *Escharoides* Milne Edw., appears to be a genus worthy of the recognition given to it by Canu and Bassler<sup>2</sup>.

*Localities*.—Station 11, 358 fathoms, 31-1-1914; Station 12, 110 fathoms, 31-1-1914.

#### PERISTOMELLA *Levinsen*

*Peristomella* Levinsen, Videnskabelige Meddelelser fra den naturhistoriske Forening Kjobenhavn, 1902, p. 26.

*Peristomella excavata* MacGillivray var. *tridens* Calvet.

*Smittia præstans* Hincks var. *tridens* Calvet, Exped. Antarctique Francaise, Bryozoaires, 1909, p. 30, pl. iii, fig. 6.

This variety is represented in the collection by two fragments. They possess every feature described by Calvet, and in no way differ from that author's observations.

*Synonymy*.—In a previous paper<sup>3</sup> I have pointed out that *Smittia præstans* Hincks should be relegated to the synonymy of *Escharoides excavata* MacGillivray and given the reasons for that opinion.

Here I have followed Canu and Bassler<sup>4</sup> rather than Levinsen<sup>5</sup> as to the generic position of the typical species; and place it in *Peristomella*, the genus created by Levinsen and later placed by him in the synonymy of *Escharoides* Milne Edw.

*Locality*.—Commonwealth Bay, 25 to 30 fathoms, 3 and 4-9-1912.

<sup>1</sup>Levinsen, *Morph. Syst. Stud. Cheil. Bryozoa*, 1909, p. 317.

<sup>2</sup>Canu and Bassler, U.S. National Museum, Bull. 106, 1920, p. 406.

<sup>3</sup>Livingstone, *Rec. Austr. Museum*, xiv, 3, 1924, p. 197.

<sup>4</sup>Canu and Bassler, U.S. National Museum, Bull. 106, 1920, p. 408.

<sup>5</sup>Levinsen, *Morph. Syst. Stud. Cheil. Bryozoa*, 1909, p. 317.

*Kymella Canu and Bassler.*

*Kymella Canu and Bassler*, United States National Museum, Bull. 96, 1917, p. 44.

*Kymella polaris* (Waters).

*Cylicopora polaris* Waters, Res. Voy. "Belgica," Bryozoa, 1904, p. 53, pl. 3, figs. 5 a-f.

*Cylicopora polaris* Calvet, Exped. Antarctique Francaise, Bryozoaires, 1909, p. 25.

*Kymella polaris* Canu and Bassler, U.S. National Museum, Bull. 106, 1920, p. 428.

*Cylicopora polaris* Thornely, Austr. Antarctic Exped. Rept., Ser. C, vi, pt 6 1924, p. 12.

(Pl. I, fig. 3, and text fig. 14.)

Miss Thornely (*loc. cit.*) has described the peculiarities of the colonies in the present collection, giving additional data relative to the zoecia, such as the occurrence of two horn-like spines above the zoecial aperture, and the presence of a "rounded avicularium to one side of the orifice (aperture)."

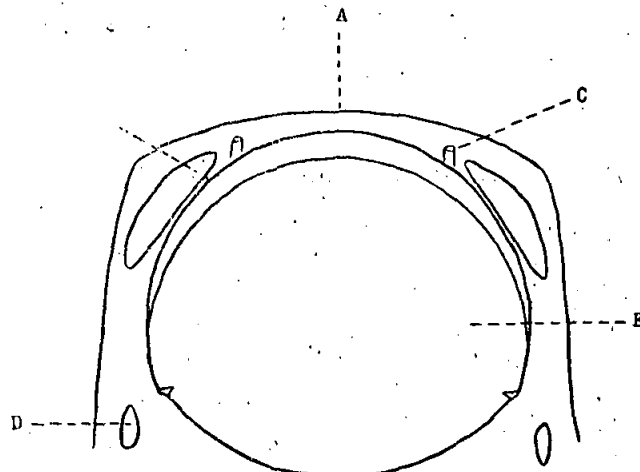

Text Fig. 14.

*Kymella polaris* (Waters).

- A. Distal border of zoecium. B. Elongated slit-like pore, the uppermost of a series which laterally perforate the frontal wall. This pore, which generally differs in shape from the rest of the series, is covered by a delicate yellow membrane. This may be what was thought an avicularium by Miss Thornely. C. Hollow horn-like calcareous spine. D. A normal pore. E. Zoecial aperture.

All characters relative to the zoarium and the zoecia have been found with the exception of the avicularium, and although prolonged search has been made for this important structure it has not been observed. It is possible, though highly improbable, that one or two zoecia examined by Miss Thornely possessed the true avicularia as described by her, but it is my opinion that she was mistaken in her belief, and was misled by the presence of an elongated slit-like pore, which can be seen on each side of the

aperture. This pore is the uppermost of a series which extends up each lateral border of the frontal wall; and, besides being more elongated than its fellows, is covered with a delicate yellow membrane. (see text fig. 14).

The hyperstomial oecium is closed by the operculum, as stated by Canu and Bassler (*loc. cit.*).

*Localities.*—Commonwealth Bay, Adelie Land; 25–30 fathoms, 3 and 4–9–1912; Station 7, 60 fathoms, 21–1–1914.

SMITTINA *Norman*.

*Smittina* Norman; Ann. Mag. Nat. Hist., Ser. 7, xii, 1903, p. 120.

*Smittina tripora* (Waters).

*Smittia tripora*, Waters, Res. Voy. "Belgica," Bryozoa, 1904, p. 67, pl. iv, figs. 2 a-c.

*Smittia tripora* Thornely, Austr. Antarctic Exped. Rept., Ser. C, vi, pt. 6, 1924, p. 14.

(Plate IV, fig. 2.)

Waters' excellent figure of this handsome species shows every external detail possessed by a young colony, but for an older and more heavily calcified kind it naturally lacks many important characters. The cardelle on each lateral border of the zoecial aperture is smaller in the figure given by Waters than in the young specimens before me. The structure in the present series is somewhat rectangular and almost the same size as the central lyrula within the proximal border of the aperture.

As previously intimated, the species can be readily recognised from the figure supplied by Waters if the colony is young and not excessively calcified, but as the colony becomes older, and calcification more heavy, its identity becomes more obscure and would not, perhaps, be recognised unless a series showing growth stages was in the hands of the observer. The series obtained by the Mawson Expedition provides sufficient material to enable a further description of the species to be given so as to enlarge our knowledge of the form and to assist in guarding against the ever present pitfalls associated with erroneous identifications caused by deceptive growth stages.

*Additional characters.*—In old zoecia the pores around the borders increase both in number and size and are arranged in two or three rows around the border, leaving a small somewhat granular central area. The frontal walls become exceedingly thick and ovate, while the inflated avicularian chamber below the peristomial aperture becomes almost obliterated; the pores bordering it below, however, can always be seen.

With the thickening of the frontal zoecial wall, the peristome naturally becomes deeper and its aperture changes its shape and becomes more or less quadrangular. The operculum is a little more rectangular in outline in the specimens before me than in Waters' figure.



The oecia becomes less conspicuous owing to intense calcification. Although the above characters appear to differ from those figured and described by Waters, there is every reason to consider them applicable to *S. tripora* rather than to a new species.

*Localities*.—Station 2, 318 fathoms, 28-12-1913; Station 3, 157 fathoms, 31-1-1914; Station 7, 60 fathoms, 21-1-1914; Station 8, 120 fathoms, 27-1-1914; Station 12, 110 fathoms, 31-1-1914.

*Smittina landsborovii* (Johnston).

*Lepralia landsborovii* Johnston, A History of the British Zoöphytes, Ed. 2, 1847, p. 310, pl. liv, fig. 9.

*Smittina landsborovii*, Thornely, Austr. Antarctic Exped. Rept., Ser. C, vi, pt. 6, 1924, p. 14.

Besides the colony growing on the back of *Smittina reticulata* described by Miss Thornely, there is a colony of the species adhering to the branches of an Alcyonarian, which is believed to be a member of the genus *Isis*.

*Localities*.—Station 1, 354 fathoms, 22-12-1913; Station 2, 318 fathoms, 28-12-1913.

*Smittina conspicua* (Waters).

*Smittina conspicua* Waters, Res. Voy. "Belgica," Bryozoa, 1904, p. 66, pl. iv, fig. 3.

*Smittina conspicua* Thornely, Austr. Antarctic Exped. Rept., Ser. C, vi, pt. 6, 1924, p. 13.

The fragmentary specimens in the collection which have been identified as this species are mostly old and worn, though sufficient in detail to establish their identity.

*Localities*.—Station 2, 318 fathoms, 28-12-1913; Station 3, 157 fathoms, 31-12-1913; Station 12, 110 fathoms, 31-1-1914.

*Smittina* (? *directa*) (Waters).

*Smittina directa* Waters, Res. Voy. "Belgica," Bryozoa, 1904, p. 69, pl. iv, figs. 10 a-d.

It is with some hesitation that I refer some old heavily calcified and loosely encrusting colonies to this species. At any rate, many characters described for *S. directa* can be distinguished in the specimens before me, though the form of the colony is not the same.

The oœcia, unfortunately, are unknown in *S. directa*, and consequently good reliable characters in this direction are lacking for a comparison with those on the present form. The oœcia on the form here doubtfully recorded as *S. directa* are almost entirely internal, there being just a slight bulge in the proximal half of the frontal zoœcial wall of the distal zoœcium. They can, however, be easily distinguished on an external view, and can be picked out by the heavily calcified and sparsely punctured areas that represent their frontal or top walls. Internally, the oœcia are seen to be somewhat globular with very thin and delicate curved lateral walls. Each oœcium opens into the peristomial canal.

*Localities*.—Commonwealth Bay, Adelie Land, 45-50 fathoms, 14-12-1913; Station 3, 157 fathoms, 31-12-1913.

*Smittina antarctica* (Waters).

*Smittina antarctica* Waters, Res. Voy. "Belgica," Bryozoa, 1904, p. 65, pl. iv, figs. 1, a-h.

*Smittina antarctica* Thornely, Austr. Antarctic Exped. Rept., Ser. C, vi, pt. 6, 1924, p. 13.

A fragmentary series of specimens referred to this species are in the Mawson collection from three different localities. There does not seem to be any variation whatever from Waters' description, nor does there appear to be any characters on the badly preserved specimens that could be added to the existing data.

*Localities*.—Station 2, 318 fathoms, 28-12-1913; Station 3, 157 fathoms, 31-12-1913; Station 12, 110 fathoms, 31-1-1914.

*Smittina marsupium* (MacGillivray).

*Lepralia marsupium*, MacGillivray in McCoy, Prod. Zool. Victoria, dec. iv, 1879, p. 22, pl. 35, fig. 4.

*Smittina marsupium* Calvet, Exped. Antarctique Francaise, Bryozoa, 1909, p. 30.

*Smittina marsupium* Thornely, Austr. Antarctic Exped. Rept., Ser. C, vi, pt. vi, 1924, p. 14.

This well known species has already been remarked upon by Miss Thornely.

*Locality*.—Commonwealth Bay, Adelie Land, 25 fathoms 3 and 4-9-1912.

MUCRONELLA *Hincks*.

*Mucronella* Hincks, Hist. Brit. Marine Polyzoa, 1880, p. 360.

*Mucronella phylactelloides* Calvet.

*Mucronella phylactelloides* Calvet, Exped. Antarct. Francaise, Bryozoa, 1909, p. 34, pl. ii, figs. 10-11.

Two broken bilaminate colonies which are considered referable to this species possess every character described by Calvet as well as agreeing perfectly with his accurate figures. The nature of the specimens is such that no additional data can be derived from them.

*Locality*.—Station 8, 120 fathoms, 27-1-1914.

*Mucronella crozetensis* (Waters).

*Smittia crozetensis* Waters, Res. Voy. "Belgica," Bryozoa, 1904, p. 64, pl. viii, figs. 15 a-b.

*Mucronella crozetensis* Canu and Bassler, U.S. National Museum, Bull. 106, 1920, p. 475.

A solitary encrusting specimen of this species is in the Mawson dredgings from Station 8. Like Waters' specimens it is granular, and within the proximal border of each aperture there is a well developed and prominent bifid lyrula. In some cases this structure bears a central projection (provided for in Waters' remark "or may support projections in various planes") which gives the lyrula a trifid appearance.

In the classification of this form I follow Canu and Bassler (*loc. cit.*) and place the species in *Mucronella*, a genus which now seems to be on a more satisfactory foundation.

*Locality*.—Station 8, 120 fathoms, 21-1-1914.

PORELLA *Gray*.

*Porella* Gray, List of British Animals in Collection of British Museum, pt. 1, 1848, pp. 127 and 148.

*Porella malouinensis* Jullien.

*Porella malouinensis* Jullien, Miss. Sci. du Cap Horn, Zool., vi, 1888, p. 57, pl. 3, fig. 6.

? *Smittia malouinensis* Calvet, Exped. Antarctique Francaise, Bryozoaires, 1909, p. 31.

(Pl. VI, fig. 7; Pl. VII, fig. 2, and text fig. 15.)

*Description*.—Zoarium unilaminate, tubular and foliated, the young zoecia forming layers on the older zoecia.

The zoecia are elongated, slightly ovate, regular in shape and separated by thin septa-like borders. Externally the zoecia are diamond-shaped, with their proximal and distal borders rounded owing to the presence of the zoecial apertures. When the frontal zoecial walls are removed, however, the zoecia are seen to be distinctly hexagonal, their lateral distal and proximal walls being almost straight.

The frontal zoecial walls are as described by Jullien, being punctured with pores which are largest near the borders. The area between the pores is distinctly granular. Almost every lateral wall is perforated by a belt of from 5 to 7 multiporous rosette plates which is situated within the basal half. The rosette plates often appear to be large and uniporous, but close scrutiny will reveal them to be as described. The external section of the peristome is slightly raised above the level of the frontal zoecial walls and is conspicuous owing to the area around it being non-perforate and highly granular in character. The opening to the peristome (peristomial aperture) is completely round, except for a small proximal portion which is deeply sinuated. Within this sinus is a minute avicularium with a rounded-triangular mandible. The peristome proceeds down into the zoecium until it reaches the true zoecial aperture where it ends.

The zoecial aperture is rounded distally, slightly bulged out laterally, and somewhat flattened proximally. From the flat proximal border of the aperture projects a central lyrula with two lateral cardelles, but they are so weakly developed that their presence could easily be overlooked.

The operculum is much the same shape as the zoecial aperture and possesses two small lateral projections within the proximal half near the base. It is operated by a special set of muscles which are attached to it and the lateral and basal walls.

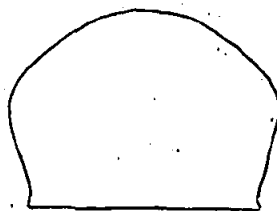

Text Fig. 15.  
*Porella malouinensis* Jullien.  
Operculum.

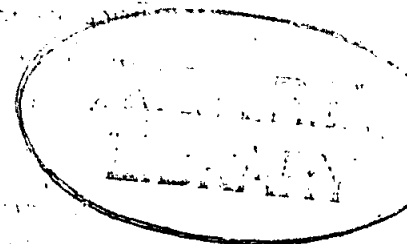

The polypide, in addition to being held in place by an elaborate muscle system, especially near its oral extremity, possesses, a semi-transparent membrane which is attached to it all along its length and to the lateral walls. The same structure can be described as a membrane running parallel with the basal and frontal walls, joining the lateral walls at its lateral edges and the polypide in its middle; it assists in holding the polypide in position.

No oecia occur on the specimens before me.

*Synonymy*.—Calvet (*loc. cit.*) has described a form which, I understand, he was inclined to regard as *P. malouinensis*. He states that his specimens are without doubt referable to *Smittia*, as each zoecial aperture bears a large lyrule. As I have pointed out in the above description that the lyrule in *P. malouinensis* is poorly developed and could on no account be considered large, it would seem that Calvet had before him another species.

*Locality*.—Station 3, 157 fathoms, 31-12-1913.

*Porella hyadesi* Jullien.

*Porella hyadesi* Jullien, Miss. Sci. du Cap Horn, Zool., vi, 1888, p. 56, pl. 3, fig. 5.

*Porella hyadesi* Kirkpatrick, "Southern Cross" Coll., Polyzoa, 1902, p. 286.

The specimens before me, like Kirkpatrick's (*loc. cit.*), differ from Jullien's description and figure to some extent. The "wall-like projection on each side of the orifice" described by Kirkpatrick occurs in the present representatives of the species, but is not by any means prominent and does not fuse in any way to form the secondary orifice described by that author. The Mawson specimens further differ in the absence of spines, which are so prominently figured by Jullien, and also in that the micro on each zoecium is more fully developed, in some cases reaching considerable dimensions. Such variable characters, however, are not considered to be of any great importance, as they have been noticed in other members of the genus.

*Locality*.—Station 8, 120 fathoms, 27-1-1914.

RETÉPORA Lamarck.

*Retepora* Imperato, Dell' historia naturale, libre xxviii, 1599 (*vide* Canu and Bassler, 1920). Pre Linnæan name.

*Retepora* Lamarck, Syst. Anim. s. Vert., Jan. 1801, p. 374.

*Retepora frigida* Waters.

*Retepora frigida* Waters, Res. Voy. "Belgica," Bryozoa, 1904, p. 82, pl. vi, figs 4 a-f.

*Retepora* (? *frigida*) Calvet, Exped. Antarctique Francaise, Bryozoaires, 1909, p. 39.

*Retepora frigida* Thornely, Austr. Antarctic Exped. Rept., Ser. C., vi, pt. 6, 1924, p. 18.

The most conspicuous character possessed by this species is the large avicularia. Even with the naked eye these gigantic structures can be readily distinguished, while their smaller and elliptical fellows can be seen only with the aid of a microscope. The characters of the species have been well described and figured by Waters, making

it comparatively easy to recognise the form. The jointed spine on each side of the aperture is, in the present fragmentary series, almost obliterated through excessive handling, but on a few zoecia the remaining basal portions can be recognised. Only one complete spine has been seen on the specimens before me, and this, although jointed, does not show the joints so conspicuously as Waters has figured them.

Calvet's description of the species which he queries as being the same as the form described by Waters does not seem to agree with the now established description of *R. frigida*, and, judging by the facts he gives, I am of the opinion that this form does not belong to the present species.

*Localities*.—Boat Harbour, Commonwealth Bay, Antarctica, 3½ fathoms; Commonwealth Bay, 25 fathoms, 3 and 4-9-1912; Commonwealth Bay, 55 fathoms, 21-12-1913; Station 7, 60 fathoms, 21-1-1914.

*Retepora antarctica* Waters.

*Retepora antarctica* Waters, Res. Voy. "Belgica," Bryozoa, 1904, p. 80, pl. vi, figs. 1 a-k.

*Retepora plana* Thornely (non Hincks), Austr. Antarctic Exped. Rept., Ser. C. vi, pt. 6, 1924, p. 18.

An incinerated portion of a solitary fragment of this species was found to exhibit all the characters described by Waters except one which relates to the oecium. Waters states that on the oecia of his specimens "no slit or other markings" could be observed, but on the fragment before me, which was found to agree well with all other characters set down for the species, there is an elongated calcareous deficiency of a slit-like shape on the front of each oecium. This structure, however, does not penetrate the oecial wall, and, as every oecium examined showed some kind of calcareous growth irregularity, there is reason to suggest that the oecia examined by Waters were, in a different growth stage to mine when they exhibited no such slit-like area described above as occurring on the Mawson example.

A character which has been previously overlooked is the finely serrate nature of the lateral borders of the zoecial aperture. A very delicate focus on a binocular microscope is necessary to observe this character.

*Synonymy*.—The remarks made by Miss Thornely relative to the species she identified as *R. plana* Hincks are clearly seen to relate to the species under discussion. The avicularia, which she describes as round, are elliptical as observed by Waters, and are elevated only in some cases on mound-like eminences. As Miss Thornely was obviously aware of the existence of *R. antarctica*, it is difficult to understand why she did not recognise at least the close relationship of that species to the specimen before her.

*Locality*.—Station 8, 120 fathoms 27-1-1914.

*Retepora hippocrepis* Waters.

*Retepora hippocrepis* Waters, Res. Voy. "Belgica," Bryozoa, 1904, p. 84, pl. vi, figs. 10 a-g and text fig. 3.

The single example before me is extremely fragile in comparison with most species of the genus. The "long, stout, solid, calcareous, spinous process" below the zoecial aperture of every zoecium gives the colony a somewhat prickly appearance when viewed with the unaided eye.

Waters states that he was unable to find any spines on his specimens but discovered a section of a tube which unmistakably looked like the joint of a spine. In some zoecia of the specimen before me two jointed spines occur, each being situated on one side of the aperture near the distal angle. The discovery of spines in the species confirms Waters' inference as to their occurrence, and also emphasises the value of his suggestion that the structures should be more closely studied by those in possession of suitable and sufficient material.

*Locality*.—Station 8, 120 fathoms, 27-1-1914.

*Retepora gelida* Waters.

*Retepora gelida* Waters, Res. Voy. "Belgica," Bryozoa, 1904, p. 84, pl. vi, figs. 7 a-d.

*Retepora gelida* Thornely, Austr. Antarctic Exped. Rept., Ser. C, vi, pt. 6, 1924, p. 18.

A single specimen which agrees with Waters' description and figure is in the collection.

*Locality*.—Station 7, 60 fathoms, 21-1-1914.

*Retepora lepralioides* Waters.

*Retepora lepralioides* Waters, Res. Voy. "Belgica," Bryozoa, 1904, p. 83, pl. vi, figs. 3 a-d.

*Retepora lepralioides* Thornely, Austr. Antarctic Exped. Rept., Ser. C, vi, pt. 6, 1924, p. 18.

This species is very closely allied to *R. antarctica* Waters, and possesses a serrated border to the zoecial aperture as in that species.

The characters given by Waters to distinguish the present species from *R. antarctica* may be supplemented by the addition of the following. The zoecia of

*R. lepralioides* are bigger than those of *R. antarctica*, a fact readily seen when comparing incinerated colonies. The lateral hinge teeth within the aperture of *R. antarctica* are far more prominent than those in *R. lepralioides*. In *R. antarctica* the lateral extensions of the peristome are far more pronounced, and more substantially formed than in *R. lepralioides*. The proximal border of the zoecial aperture is straighter in *R. lepralioides* than in *R. antarctica*.

*Locality*.—Station 3, 157 fathoms, 31-12-1913.

HASWELLINA *nom. nov.*

*Haswellia* Busk, "Challenger" Rept. Zool., x, pt. xxx, 1884, p. 171 (name preoccupied):

*Haswellia* Miers (non Busk), Rept. Zool. "Alert," Crustacea, 1884, p. 311.

*Remarks*.—I am indebted to Mr. W. H. Baker and Mr. H. M. Hale of the South Australian Museum for bringing before my notice the fact that two distinct genera are in existence each bearing the name *Haswellia*. It is unfortunate that such a name so well known among Bryozoologists should have to be erased from the classification, but as there seems to be no alternative, a name has been chosen (*Haswellina*) as near as possible to the old one in order to diminish confusion. Such a procedure was adopted by Norman when he found that the well established *Smittia* of Hincks was preoccupied, and the new name he gave (*Smittina*) has proved to be much easier to memorise and understand than an entirely new name would have been. It is not only with this end in view that the name *Haswellina* has been selected to replace the preoccupied *Haswellia*, but also to preserve the name of the eminent scientist Professor W. A. Haswell, who assisted materially in the pioneering work of the study of Australian Bryozoa.

Although there are no representatives of the genus in the present collection the subject of its status has been raised on account of its importance.

*Synonymy*.—As both publications cited above were published in the same year (1884), evidence as to the month of publication of each was sought. It was found that the "Alert" Report was published in July, but no proof of the month of publication of the "Challenger" volume could be found. The date of the preface, however, which is September, suggests that the date of publication was later than that of the "Alert" Report. In support of this Mr. Thos. Wooddisse of the British Museum informs me (*in lit.*) that—"The Report on the Zoological Collections of H.M.S. 'Alert' was published on 12th July, 1884. I have been unable to obtain the exact date of publication of Part 30, Vol. x, of the 'Challenger' Zoological Report, but it seems clear from the preface that the date of publication must have been later than that of the 'Alert' Report."



*COSTICELLA* Levinsen.

*Costicella* Levinsen, Morph. Syst. Stud. Cheil. Bryozoa, 1909, p. 233.

*Costicella hastata* (Busk).

*Catenicella hastata* Busk, Voy. "Rattlesnake," 1, 1852, p. 355.

*Catenicella hastata* Busk, Brit. Museum Cat. Mar. Polyzoa, 1, 1852, p. 7, pl. 2, figs. 3-4.

*Catenicella hastata* Thornely, Austr. Antarctic Exped. Rept., Ser. C, vi, pt. 6, 1924, p. 5.

*Costicella hastata* Levinsen, Morph. Syst. Stud. Cheil. Bryozoa, 1909, p. 236, pl. xii, figs. 1c, 1d, 1f, 1g, 1j; pl. xx, figs. 8 a-b.

I have followed Levinsen's proposal in the classification of this well described form.

*Locality*.—East of Enderby Island, Auckland Islands, New Zealand, 40 fathoms, 5-7-1912.

*SCUTICELLA* Levinsen.

*Scuticella* Levinsen, Morph. Syst. Stud. Cheil. Bryozoa, 1909, p. 221.

*Scuticella margaritacea* (Busk).

*Catenicella margaritacea* Busk, Voy. "Rattlesnake," 1, 1852, p. 356.

*Catenicella margaritacea* Busk, Brit. Museum Cat. Mar. Polyzoa, 1, 1852, p. 9, pl. vi, figs. 1-3.

*Catenicella margaritacea* Thornely, Austr. Antarctic Exped. Rept., Ser. C, vi, pt. 6, 1924, p. 5.

*Scuticella margaritacea* Levinsen, Morph. Syst. Stud. Cheil. Bryozoa, 1909, p. 229, pl. xx, fig. 3a; pl. xi, figs. 5 a-c.

Several colonies of this southern form were obtained by the expedition in New Zealand waters.

Levinsen (*loc. cit.*) made a study of the members of the old genus *Catenicella* erecting new genera as a result.

*Locality*.—East of Enderby Island, Auckland Islands, New Zealand, 40 fathoms, 5-7-1912.

PHYLACTELLA *Hincks*:

*Phylactella* Hincks, History British Marine Polyzoa, 1880, p. 356:

*Phylactella lyrulata* Calvet.

*Phylactella lyrulata* Calvet, Exped. Antarctique Francaise, Bryozoaires, 1909, p. 32.

*Phylactella lyrulata* Thornely, Austr. Antarctic Exped. Rept., Zool., Ser. C; vi; pt. 6; 1924, p. 15.

(Pl. VI, figs. 1, 2 and 6; Pl. VII, fig. 1, and text figs. 16 and 17.)

*Description*.—Zoarium unilaminar, resembling species of *Retepora* in mode of growth; but not fenestrated. To the naked eye it is prickly in appearance owing to the presence of well developed peristomes.

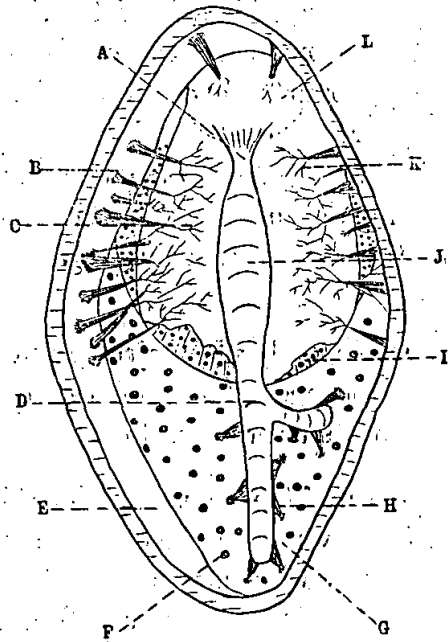

Text Fig. 16.

Diagrammatic drawing of *Phylactella lyrulata* Calvet when the basal zoecial is removed.

- A: Oral extremity of the polypide. B: Muscle supporting the membrane. C: Membrane assisting in the support of the polypide. D: Polypide. E: Lateral zoecial wall (proximal half). F: Stellate pore in the heavily calcified proximal section of the frontal zoecial wall. G: Heavily calcified proximal section of the frontal zoecial wall. H: One of the series of muscles holding the polypide tube to the under-surface. (proximal half) of the frontal zoecial wall. I: Section of the dome-shaped distal half of the frontal wall which is poorly calcified. This can be seen only when the membrane dries and shrinks in parts from its normal position. J: Polypide. K: Branching bases of a supporting muscle. L: Position of zoecial aperture covered by an extension of the supporting membrane in the form of an operculum.

The zoecia are rounded-hexagonal in outline, and are separated externally by deep furrows formed by the ovate frontal walls. The frontal zoecial wall is ovate, but much more so distally, where it presents a dome-like aspect. The proximal end is only slightly ovate. A definite line of demarcation, more prominent in an internal than an external view, separates the distal section from the proximal. The former, in addition to being more ovate than the latter, is weakly calcified, non-perforate (except at the sides), and covered by large nodules. The proximal section is much thicker and is perforated by stellate pores, which continue up the sides of the distal section. The distal section, although not entirely perforated, can be seen to be deeply pitted when viewed internally after the removal of the basal wall and the polypide.

Each lateral zoecial wall is provided with a belt of from 5 to 10 uniporous rosette plates within its frontal half.

The peristome is produced a considerable distance and is of a tubular nature. Externally it is granulated like the major section of the proximal half of the frontal wall, and has a somewhat oval aperture. The true zoecial aperture is situated at the base of the peristome, and is more rounded (although somewhat oval) than the peristomial aperture. The operculum, which fits the distal and lateral borders of the zoecial aperture perfectly, is formed by a continuation of a weakly chitinised membrane, which assists in holding the polypide in position. Further details regarding this membrane are given later.

A very large and well developed lyrula projects from the proximal border of the zoecial aperture. It is above the operculum, and can be seen quite well from the outside when the operculum is in its natural position.

The oecium, which is typical of the genus, is globular in shape and opens into the peristome through a distal deficiency in that structure. It rests on the frontal wall of the zoecium in front and is granular or nodulated like the peristome. The large oecial aperture is closed by a special operculum, which is well chitinised.

The polypide, in addition to being held in place by a muscular system, is supported by a weakly chitinised membrane, which is on the same plane as the basal wall and attached by its edges to the under-surface of the frontal wall, along the line of demarcation separating the heavily calcified area from the weakly calcified. Beneath, the membrane is held in a more or less rigid position by an irregular series of muscles, which have the lateral walls for their bases. Branched and ramifying thread-like thickenings arise from the site of a muscle attachment to the membrane. The distal extremity of this membrane is modified in shape to form the operculum, but no mark or groove exists to define its limits. This can be ascertained only by taking into consideration what area of it covers the zoecial aperture. The polypide is attached to the under-surface of the membrane distally, and to the underside of the frontal wall proximally. The oral extremity of the polypide lies immediately below the operculum. When a preserved

example with the basal wall removed is dried the membrane shrinks from its natural position and reveals in some places the weakly calcified distal portion of the frontal wall, with its deep pits and radiating thickenings.

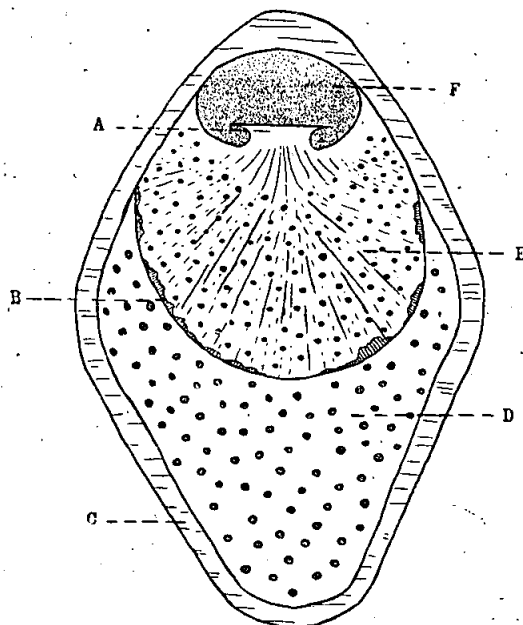

Text Fig. 17.

Diagrammatic drawing of *Phylactella lyrulata* Calvet showing the inside surface of the frontal zoecial wall when the basal wall, polypide and its attachments are removed.

A. Lyrula. B. Remaining fragments of the membrane which assists in supporting the polypide. C. Lateral zoecial wall. D. Heavily calcified proximal area. E. Weakly calcified distal area which is concave and covered by deep pits (internally). F. Zoecial aperture.

*Colour*.—Dried examples are a dull cream or light brown in colour. (One batch is a pale mauve in colour, but they may have been stained by other specimens during preservation.)

*Localities*.—Commonwealth Bay, Adelie Land, 25 fathoms, 45 to 50 fathoms, and 55 to 60 fathoms; Station 1, 354 fathoms, 22-12-1913; Station 2, 318 fathoms 28-12-1913; Station 3, 157 fathoms, 31-12-1913; Station 8, 120 fathoms, 27-1-1914.

#### OSTHIMOSIA Jullien.

*Osthimosia* Jullien, Miss. Sci. du Cap Horn, Zool., tome vi, 1889, p. 64.

#### *Osthimosia eatonensis* (Busk).

*Cellepora eatonensis* Busk, "Challenger," Zool., x, pt. xxx, 1884, p. 201, pl. xxix, figs. 4, 6, 8; pl. xxxvi, figs. 3-5.

*Cellepora eatonensis* Thornely, Austr. Antarctic Exped. Rept., Ser. C, vi, pt. 6, 1924, p. 17.

Miss Thornely has already given the characteristics of the Ma son series of the species.

*Localities*.—Commonwealth Bay, Antarctica, 45-50 fathoms; Station 3, 157 fathoms, 31st December, 1913.

## CELLEPORA Linné.

*Cellepora* Linné, Syst. Natur., Ed. xii, T. i, pt. ii, 1767, p. 1285.

(?*Cellepora*) *setosa* Thornely.

*Cellepora setosa* Thornely, Austr. Antarctic Exped. Rept., Ser. C, vi, pt. 6, 1924, p. 17, text fig. 5.

(Pl. III, fig. 8, and text figs. 18, 19, and 20.)

*Description.*—The zoarium is of a branching nature and large, the branches often measuring as much as 5.5 mm. in diameter. To the naked eye it appears to bristle with spines, but closer examination reveals the fact that the prickly appearance is due to the presence of exceedingly large, hollow, cylindrical rostra.

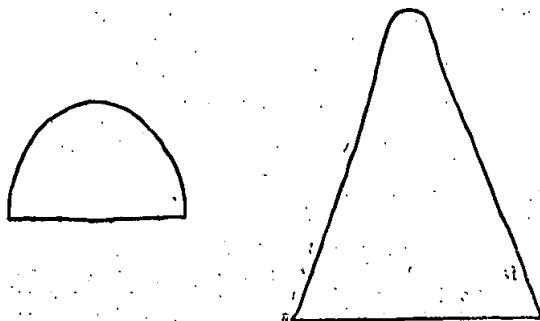

Text Fig. 18.

Avicularian mandibles of (? *Cellepora setosa*)  
Thornely.

The zoecia, which are small in comparison to the large zoarium, are not clearly defined. They are ovate, smooth, and well calcified, with small rounded avicularia cattered at random over their frontal walls.

The peristome is deep and well calcified, and has, in some cases, a circular aperture, while in others the aperture is elliptical, with the long axis running lengthways. The peristomial canal proceeds into the zoecium first vertically, then gradually curves inwards until it ends at the true zoecial aperture, which it faces in a horizontal plane. The zoecial aperture is vertical and somewhat elliptical, with its top and bottom borders only slightly curved. It is closed by an operculum which is moderately chitinised and of the same shape as the zoecial aperture itself. The operculum is attached to two hinge teeth, which are situated within the basal half of the zoecial aperture, one on each side.

The most striking character possessed by this species is the huge rostrum. Miss Thornely described this cylindrical structure in her extremely brief description as the "suboral rostrum," but I differ from her on this point, and describe the structure as occurring on the distal border of the peristomial aperture and not on the proximal border. The rostrum is of considerable size and thickness, and is usually found curved

and slanted backwards. It possesses three avicularia on its flattened trifold free extremity; the central one is triangular while the lateral are invariably semi-circular. As indicated above, this gigantic structure is hollow, and within the round hollow axis runs the muscles which operate the avicularia on the free extremity. The basal seat of this muscle system is within the hollow axis at or about the junction of the rostrum with the distal border of the peristomial aperture. The rostrum, instead of terminating at the site of its attachment, runs down the inside of the distal wall of the peristomial canal in the form of a tube. Its final destination, however, cannot be definitely traced, but it is believed to end blindly before it reaches the polypide chamber.

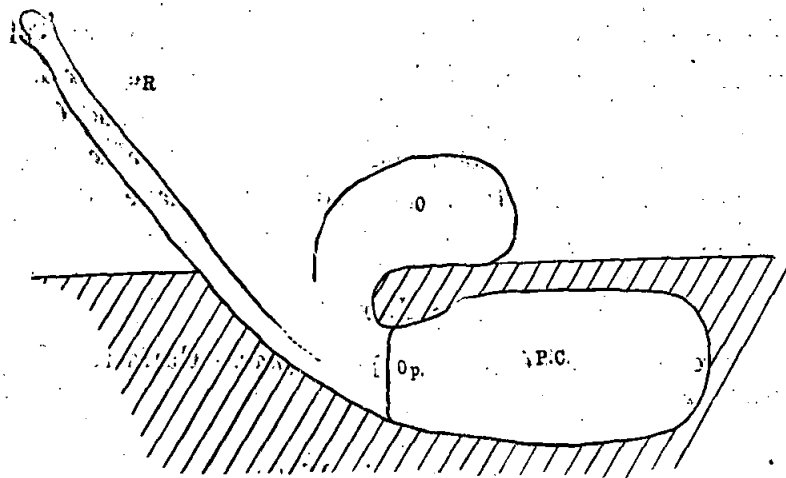

Text Fig. 19.

Diagrammatic drawing of a longitudinal vertical section through a zoecium of (*Cellepora*) *setosa* showing the curious proximal position of the oecium.

Key to Abbreviations.—O. Oecium. Op. Operculum. P.C. Polypide chamber.  
R. Rostrum.

The unusual situation of the rostrum is probably responsible for the altered position of the oecium, which, in this peculiar species, is placed just below the peristomial aperture on the frontal wall of the fertile zoecium itself. In other species, even in remotely related forms, the usual position of the rostrum in relation to the oecium is the opposite to what is seen in the present form, and the changing around of the oecium and the rostrum was evidently the cause of Miss Thornely's confusion when she called the rostrum "suboral."

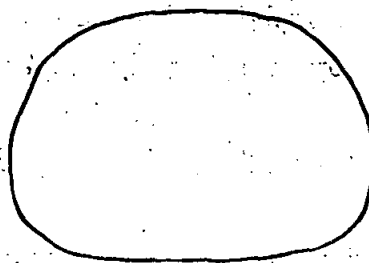

Text Fig. 20.

Operculum of (*Cellepora*) *setosa*  
Thornely.

The oecium is smooth, globular, and entirely external. A small rounded avicularium is invariably situated on each side of its frontal wall near the entrance to the cell. The oecium opens into the peristomial canal by a large aperture which faces downwards.

*Localities.*—Station 2, 318 fathoms, 28-12-1913; Station 3, 157 fathoms, 31-12-1913; Station 8, 120 fathoms, 27-1-1914; Station 12, 110 fathoms, 31-1-1914.

#### SUB-ORDER CYCLOSTOMATA.

The representatives of this Sub-Order are few in number and can all be associated with known species. Miss Thornely has recorded *Crisia biciliata* MacG., *Crisia cornuta* Linn., *Idmonea australis* MacG., and *Hornera caespitosa* Busk in the Cyclostomata, and *Barentsia discreta* Busk in the Entoprocta, but I have been unable to discover any of these species in the returned collection, and consequently have not referred to them in this present work.

#### HORNERA Lamouroux.

*Hornera* Lamouroux, Exp. Méth., 1821, p. 41 (*vide.*—Harmer, "Siboga" Exped., Polyzoa, pt. 1, 1915, p. 147).

#### *Hornera antarctica* Waters.

*Hornera antarctica* Waters, Res. Voy. "Belgica," Bryozoa, 1904, p. 93, pl. ix, figs. 1, a-l.

*Hornera antarctica* Thornely, Austr. Antarctic Exped. Rept., Ser. C, vi, pt. 6, 1924, p. 19.

This species, which is well represented in the collection, does not always branch at right angles as described by Waters and seems to be slightly erratic in this respect.

*Localities.*—Commonwealth Bay, Antarctica, 25 fathoms, 3 and 4-9-1912; Station 2, 318 fathoms, 28-12-1913; Station 8, 120 fathoms, 27-1-1914.

#### *Hornera foliacea* MacGillivray.

*Hornera foliacea* MacGillivray in McCoy, Prodr. Zool. Victoria, dec. xii, 1885, p. 71 (and references).

*Hornera foliacea* Thornely, Austr. Antarctic Exped. Rept., Ser. C, vi, pt. 6, 1924, p. 19.

Only fragmentary material of this form was obtained.

*Locality.*—East of Enderby Island, Auckland Islands, New Zealand, 40 fathoms.

LICHENOPORA *Defrance*.

*Lichenopora* Defrance, Dict. Sci. Nat., xxvi, 1823, p. 256.

*Lichenopora fimbriata* (Busk).

*Discoporella fimbriata* Busk; Brit. Mus. Catal. Marine Polyzoa, pt. iii, 1875, p. 32, pl. xvii, figs. 1-4.

*Lichenopora fimbriata* Waters, Res. Voy. "Belgica," Bryozoa, 1904, p. 96, pl. viii, fig. 20.

*Lichenopora hispida* Thornely (non Fleming) Austr. Antarctic Exped. Rept., Ser. C, vi, pt. 6, 1924, p. 20.

There is little doubt that the present species is referable to *L. fimbriata* as described by Busk, but, like Waters, I have some doubt about the relationship of the species with *L. hispida* Fleming.

*Locality* —East of Enderby Island, Auckland Islands, New Zealand, 40 fathoms.

FASCICULIPORA *d'Orbigny*.

*Fasciculipora* d'Orbigny, Voy. dans Amer. Merid. v, pt. iv, 1846, p. 20.

d'Orbigny, in Pal. Franc. Terr. Cret., 1850-52, p. 667, gives the date 1839 for his genus. Canu and Bassler have given it as 1846 in the above reference, but as I have no means of determining this question through lack of literature its solution will have to be left for the present.

*Fasciculipora fruticosa* MacGillivray.

*Fasciculipora fruticosa* MacGillivray in McCoy, Prodr. Zool. Victoria, dec. xvi, 1888, p. 214, pl. 157, fig. 3 (and reference).

*Fasciculipora gracilis* Thornely (non MacGillivray) Austr. Antarctic Exped. Rept., Ser. C, vi, pt. 6, 1924, p. 20.

The present series of the species assumes, among other necessary characters, the shrub-like growth described by MacGillivray for his specimens.

It is obviously this species that Miss Thornely records under the name of *F. gracilis*.

*Locality*.—Commonwealth Bay, Antarctica, 25 fathoms, 3 and 4-9-1912.



*FILICEA d'Orbigny.*

*Filicea* d'Orbigny, Pal. Franc. Terr. Cret., v, Bryozoaires, 1850-1852, p. 1000.

*Filicea elegans* (Hutton).

*Cinctipora elegans* Hutton, Catalogue Marine Mollusca New Zealand, 1873, p. 103.

*Cinctipora elegans* Waters, Quart. Journ. Geol. Soc., xliii, 1887, p. 341.

*Filicea elegans* Levinsen, Vidensk. Medd. fra den Naturh. Foren-i, Kjobenhavn, 1902, p. 31 (reference from reprint).

*Haswellia australiensis* Thornely (non Haswell), Austr. Antarctic Exped. Rept., Ser. C, vi, pt. 6, 1924, p. 17.

(Pl. IV, fig. 6.)

*Synonymy.*—This typical New Zealand species is represented in the Mawson gatherings by a single branched fragment, though it is large and complete enough to render the identification certain. Since its original description by Hutton the form has not received any great amount of attention at the hands of specialists, and as a result it appears to be little known.

Waters (*loc. cit.*), when giving descriptive remarks on the species, points out that its relationship with the Bryozoa "is not proved," but Levinsen (*loc. cit.*) later established its identity by considering it to belong to the genus *Filicea* d'Orbigny<sup>1</sup>. This naturally results in the elimination of the genus *Cinctipora*, which was erected by Hutton (*loc. cit.*, p. 102) to accommodate his species (*elegans*).

Miss Thornely (*loc. cit.*) records *Haswellia australiensis* (Haswell) from E. of Enderby Island, Auckland Islands, New Zealand, but as there are no representatives of that species in the collection examined by her, a search was made for a specimen that may have caused a deception. The only specimen from the above locality that could cause the confusion is *Filicea elegans*, and it is obvious that this is the form recorded under the heading of *Haswellia australiensis*.

*Locality.*—East of Enderby Island, Auckland Islands, New Zealand, 40 fathoms, 5-7-1912.

<sup>1</sup> Pal. Franc. Terr. Cret., v, Bryozoaires, 1850-1852, p. 1000.

## EXPLANATION OF PLATES.

## PLATE I.

- Fig. 1.—*Cellarinella nodulata* Waters. Portion of a colony showing an avicularium on each mucro, and other zoecial detail.
- „ 2.—*Cellaria aurora* sp. nov. Zoecial detail.
- „ 3.—*Kymella polaris* (Waters): Portion of an almost cylindrical colony showing oecia. The lateral and distal continuous flange can be seen to advantage owing to the angles at which the oecia are situated.
- „ 4.—*Cellarinella nodulata* Waters: Section showing frontal walls from a basal aspect. The oecia are seen above the zoecia in the form of circular, bowl-like hollows. The avicularian cavities can also be seen on the sides of the peristomial canals.
- „ 5.—*Mawsonia membranacea* (Thornely). Section through a colony to show (on top left-hand corner) the zoecial aperture and the neighbouring oecium embedded in the frontal wall. Owing to an optical illusion, the lowest parts, the zoecia, appear as blisters, but a side view, gradually bringing the photograph to the front will rectify this illusion.
- „ 6.—*Membranipora ciliata* MacGillivray. Showing spines and where they pierce the frontal walls. The absence of lateral chambers is obvious.
- „ 7.—*Cellarinella nodulata* Waters. A section through a colony looking on the frontal walls from a basal aspect. The two avicularian cavities can be seen on the sides of each peristomial canal as well as the tube system described in the text.
- „ 8.—*Cellarinella watersi* Calvet. Section showing the internal avicularia in the peristomial canals. The basal walls have been removed permitting a view of the frontal walls from the inside. Oecia are to be seen on the left of the illustration.
- „ 9.—*Membranipora ciliata* MacGillivray. Zoecial detail.
- „ 10.—*Cellarinella watersi* Calvet. Zoecial detail.
- „ 11.—*Cellarinella foveolata* Waters. Zoecial detail.
- „ 12.—*Mawsonia membranacea* (Thornely).—Showing form of the colony.

## PLATE II.

- „ Fig. 1.—*Chaperia coronata* (Thornely).—Enlarged zoecial detail. The turret-like peristomes are easily distinguished projecting from one side of the colony.
- „ 2.—*Chaperia coronata* (Thornely).—A complete colony illustrating the mode of growth.

- Fig. 3.—*Chaperia coronata* (Thornely). Section showing the lateral septa within the zoecial apertures.
- „ 4.—*Fenestulina proxima* Waters. Two zoecia showing the variation of the central pore.
- „ 5.—(?*Microporella*) *divaricata* Canu. Zoecial detail.
- „ 6.—*Figularia spatulata* (Calvet). Zoecial detail.
- „ 7.—*Cribrilina punctata* (Hassal). Zoecial detail.
- „ 8.—*Fenestulina proxima* (Waters). Zoecial detail.

## PLATE III.

- Fig. 1.—*Romancheina martiali* Jullien. Cross section through colony showing position of polypide and the supporting lateral membranes.
- „ 2.—*Romancheina martiali* Jullien. Showing polypides and supporting lateral membranes. Some zoecia have been removed to obtain this view.
- „ 3.—*Romancheina martiali* Jullien. Showing growth of colony and zoecial detail.
- „ 4.—*Flustra tenuis* Kluge. Zoecial detail.
- „ 5.—*Flustra curva* Kluge. Zoecial detail.
- „ 6.—*Romancheina martiali* Jullien. Basal portion of a colony showing anchoring rootlets.
- „ 7.—*Flustra vanhoffeni* Kluge. Zoecial detail.
- „ 8.—(?*Cellepora*) *setosa* Thornely. Zoecial detail showing rostra and oecia.
- „ 9.—*Flustra antarctica* Calvet. Zoecial detail.

## PLATE IV.

- Fig. 1.—*Pseudocellaria obliqua* (Thornely). Zoecial detail.
- „ 2.—*Smittina tripora* (Waters). An old colony incinerated to illustrate the lack of characters caused by intense calcification. Some of the pores immediately below the lower lip have been retouched in order to show their true position.
- „ 3.—*Cellaria mawsoni* sp. nov. Zoecial detail. The raised borders are rendered more conspicuous when the removal of the thin frontal membrane is accomplished by incineration. The granular oecia are seen in the bottom left-hand corner of the photograph.
- „ 4.—*Cellaria wandeli* Calvet. Zoecial detail.
- „ 5.—*Cellaria mawsoni* sp. nov. The two zoecia on the right illustrate the zoecial detail, while the cell on the left is the avicularian cell with the cavity and the distal "U"-shaped canal in which the mandible rests.
- „ 6.—*Filicea elegans* (Hutton). A fragment showing growth and formation of zoecia.

- Fig. 7.—*Cellaria aurora* sp. nov. A section through a colony. On the left-hand side are the zoecial apertures, three in number, and alongside of each is an oecium embedded in the thick frontal wall.
- „ 8.—*Pseudocellaria obliqua* (Thornely). A view of the inside of the zoecia when the basal walls have been removed. Within each curved aperture can be seen the fused teeth. The shape of the zoecia themselves will be noticed to differ from the external representation which is shown in Fig. 1. The smaller fragment on the lower right shows the inside of the oecial aperture immediately above the zoecial aperture.

## PLATE V.

- Fig. 1.—*Ogivalina lata* (Kluge). Zoecial detail. Oecia are shown on the top half of the photograph.
- „ 2.—*Mawsonia membranacea* (Thornely). Showing basal end of colony from which the anchoring rootlets arise and attach themselves to a piece of shell.
- „ 3.—*Micropora brevissima* Waters. Zoecial detail.
- „ 4.—*Beania erecta* Waters. Portion of a colony showing avicularia.
- „ 5.—*Emballotheca contortuplicata* (Calvet). A small colony showing mode of growth.
- „ 6.—*Mawsonia membranacea* (Thornely). Zoecia showing the teeth within the zoecial apertures and the avicularia.

## PLATE VI.

- Fig. 1.—*Phylactella lyrulata* Calvet. Portion of colony with frontal walls removed to show polypides. These can be seen held in position by lateral membranes supported by muscle strands.
- „ 2.—*Phylactella lyrulata* Calvet. Showing polypides being held in position by lateral membranes which are in turn supported by delicate muscle fibres attached to the zoecial walls.
- „ 3.—*Labioporella adeliensis* sp. nov. Zoecial detail showing avicularia.
- „ 4.—*Cellaria mawsoni* sp. nov. View of inside of zoecia when the basal walls are removed. The teeth in the proximal border of the aperture can be clearly seen from this aspect.
- „ 5.—*Systemopora contracta* Waters. Zoecial detail.
- „ 6.—*Phylactella lyrulata* Calvet. A portion of a colony showing oecia.
- „ 7.—*Porella malouinensis* Jullien. A highly magnified portion of a colony showing zoecial detail.
- „ 8.—*Cellaria diversa* sp. nov. Zoecial detail.

## PLATE V-II.

- Fig. 1.—*Phylactella lyrulata* Calvet. Showing lyrula after removal of frontal walls.
- „ 2.—*Porella malouinensis* Jullien. Showing lyrula (cardelles cannot be seen) when the frontal walls are removed.
- „ 3.—(?*Microporella*) *trinervis* Waters. Zoecial detail.
- „ 4.—*Lepralia marginata* Calvet. Zoecial detail.
- „ 5.—*Ogivalina lata* (Kluge). A colony of the species showing belted arrangement of the oecia.
- „ 6.—*Lepralia marginata* Calvet. Oecia.
- „ 7.—*Emballothea contortuplicata* (Calvet). Zoecial detail.
- „ 8.—*Mawsonia membranacea* (Thornely). Cross section through a colony to show lateral walls. These, it will be seen, separate for portion of their length to form a slit-like chasm. The flanges of the peristome are to be seen on the edge of the section.
-

## INDEX.

	PAGE.
<i>abyssicola</i> SMITTOPORA ...	31
<i>abyssicola</i> VINCULARIA ...	6, 29, 31
<i>acanthina</i> CHAPERIA ...	11, 12
<i>aculeata</i> FARCIMINARIA ...	6, 24
<i>aculimarginata</i> CELLARIA ...	38
<i>adeliensis</i> LABIOPORELLA ...	6, 9, 10, 29, 30, 31
AETEA <i>anguina</i> ...	6
AMASTIGIA <i>funiculata</i> ...	26
AMPHIBLESTRUM ...	15
<i>anguina</i> AETEA ...	6
<i>angusta</i> FLUSTRA ...	6, 9, 10, 20
<i>angustiloba</i> CELLARIA ...	45
<i>antarctica</i> FLUSTRA ...	6, 8, 9, 22
<i>antarctica</i> HORNERA ...	7, 8, 10, 78
<i>antarctica</i> RETEPORA ...	7, 10, 69, 70, 71
<i>antarctica</i> SMITTIA ...	7, 65
<i>antarctica</i> SMITTINA ...	7, 9, 10, 65
ARACHNOPUSIA ...	46
ARACHNOPUSIA <i>monoceros</i> ...	6, 10, 46
ASPIDOSTOMA <i>giganteum</i> ...	7, 32, 34
ASPIDOSTOMA <i>obliquum</i> ...	7, 42
<i>aurora</i> CELLARIA ...	7, 9, 10, 36, 37
<i>australiensis</i> HASWELLIA ...	5, 7, 80
<i>australis</i> IDMONEA ...	7, 78
BARENTSIA <i>discreta</i> ...	7, 78
BEANIA ...	26
BEANIA <i>crotali</i> ...	26
BEANIA <i>erecta</i> ...	6, 8, 26
BICELLARIA <i>tuba</i> ...	6, 28
<i>biciliata</i> CRISIA ...	7, 78
<i>bicornis</i> BUGULA ...	6, 8, 9, 27
<i>bicornis</i> CELLARIA ...	36
<i>bifaciata</i> CELLARIA ...	39
<i>brevissima</i> MICROPORA ...	6, 8, 10, 28, 29
BUFFONELLA ...	53
BUFFONELLA <i>simplex</i> ...	9, 53
BUGULA ...	26
BUGULA <i>bicornis</i> ...	6, 8, 9, 27
BUGULA <i>reticulata</i> ...	6
BUGULA <i>retiformis</i> ...	7, 10, 27
BUGULA <i>tricornis</i> ...	6, 9, 27
BUGULARIA ...	28
BUGULARIA <i>dissimilis</i> ...	7, 28
<i>bursaria</i> LABIOPORELLA ...	29
<i>caspitosa</i> HORNERA ...	7, 78
CALLOPORA ...	14, 15

	PAGE.
CALLOPORA <i>onychocelloides</i> .....	7, 8, 14
CARBASEA .....	18
CARBASEA <i>carbasca</i> .....	18
<i>carbasea</i> CARBASEA .....	18
CARBASEA <i>dissimilis</i> .....	28
CATENICELLA .....	72
CATENICELLA <i>hastata</i> .....	6, 72
CATENICELLA <i>margaritacea</i> .....	6, 72
CELLARIA .....	32, 34, 40, 42, 44, 56
CELLARIA <i>acutimarginata</i> .....	38
CELLARIA <i>angustiloba</i> .....	45
CELLARIA <i>aurora</i> .....	7, 9, 10, 36, 37
CELLARIA <i>bicornis</i> .....	36
CELLARIA <i>bifaciata</i> .....	39
CELLARIA <i>dimorpha</i> .....	42
CELLARIA <i>diversa</i> .....	7, 8, 9, 10, 34, 35, 36
CELLARIA <i>dubia</i> .....	36
CELLARIA <i>fistulosa</i> .....	6
CELLARIA <i>malvinensis</i> .....	35, 36
CELLARIA <i>mawsoni</i> .....	7, 8, 10, 32, 33, 36
CELLARIA <i>membranacea</i> .....	6, 39
CELLARIA <i>wandeli</i> .....	6, 10, 38
CELLARINELLA .....	48, 60
CELLARINELLA <i>dubia</i> .....	7, 48, 49
CELLARINELLA <i>foveolata</i> .....	7, 8, 49
CELLARINELLA <i>nodulata</i> .....	7, 8, 9, 10, 49, 51
CELLARINELLA <i>watersi</i> .....	7, 8, 9, 10, 51
CELLEPORA .....	76
CELLEPORA <i>catonensis</i> .....	7, 75
CELLEPORA <i>hyalina</i> .....	47
CELLEPORA <i>malusii</i> .....	58
CELLEPORA <i>setosa</i> .....	7, 8, 9, 10, 76, 77
<i>cervicornis</i> CHAPERIA .....	16
CHAPERIA .....	16, 17
CHAPERIA <i>acanthina</i> .....	11, 12
CHAPERIA <i>cervicornis</i> .....	16
CHAPERIA <i>coronata</i> .....	7, 10, 16, 17
CHAPERIA <i>spinosissima</i> .....	11
CHEILOSTOMATA .....	11
<i>ciliata</i> MEMBRANIPORA .....	7, 8, 11, 12
CINCTIPORA .....	80
CINCTIPORA <i>elegans</i> .....	80
<i>conspicua</i> SMITTIA .....	7, 54
<i>conspicua</i> SMITTINA .....	7, 8, 9, 10, 54
<i>contortuplicata</i> EMBALLOTHECA .....	7, 8, 9, 10, 54
<i>contortuplicata</i> MUCRONELLA .....	7, 54
<i>contracta</i> SYSTEMOPORA .....	7, 8, 10, 48
<i>corbula</i> MEMBRANIPORA .....	6
<i>coriacea</i> FLUSTRA .....	29

	PAGE.
<i>coriacea</i> MICROPORA ... ..	7, 8, 29
CORNUCOPINA ... ..	28
CORNUCOPINA <i>tuba</i> ... ..	6, 28
<i>cornuta</i> CRISIA ... ..	7, 78
<i>coronata</i> CHAPERIA ... ..	7, 10, 16, 17
<i>coronata</i> MUCRONELLA ... ..	7, 16
COSTICELLA ... ..	72
COSTICELLA <i>hastata</i> ... ..	6, 8, 72
CRIBRILINA ... ..	45
CRIBRILINA <i>monoceros</i> ... ..	6, 46
CRIBRILINA <i>projecta</i> ... ..	6
CRIBRILINA <i>punctata</i> ... ..	7, 8, 9, 10, 45, 46
CRIBRILINA <i>spatulata</i> ... ..	6, 47
CRISIA <i>biciliata</i> ... ..	7, 78
CRISIA <i>cornuta</i> ... ..	7, 78
<i>crotali</i> BEANIA ... ..	26
<i>crozetensis</i> MUCRONELLA ... ..	7, 10, 66
<i>crozetensis</i> SMITTIA ... ..	66
<i>curva</i> FLUSTRA ... ..	7, 9, 10, 21
CYCLICOPORA <i>polaris</i> ... ..	7, 62
CYCLOSTOMATA ... ..	78
<i>de carforti</i> LACERNA ... ..	52
<i>dimorpha</i> CELLARIA ... ..	42
<i>directa</i> SMITTIA ... ..	64
<i>directa</i> SMITTINA ... ..	7, 8, 9, 64, 65
DISCOPELLELLA <i>fimbriata</i> ... ..	79
<i>discreta</i> BARENTSIA ... ..	7, 78
<i>dissimilis</i> BUGULARIA ... ..	7, 28
<i>dissimilis</i> CARBASEA ... ..	28
<i>divaricata</i> MICROPORELLA ... ..	6, 10, 56
<i>diversa</i> CELLARIA ... ..	7, 8, 9, 10, 34, 35, 36
<i>dorsiporosa</i> PETRALIA ... ..	60
<i>drygalskii</i> NOTOPLITES ... ..	6, 8, 9, 10, 25, 26
<i>drygalskii</i> SCRUPOCELLARIA ... ..	25
<i>dubia</i> CELLARIA ... ..	36
<i>dubia</i> CELLARINELLA ... ..	7, 48, 49
<i>eatonensis</i> CELLEPORA ... ..	7, 75
<i>eatonensis</i> OSTMOSIA ... ..	7, 8, 9, 75
<i>echinata</i> MEMBRANIPORA ... ..	11
<i>elegans</i> CARBASEA ... ..	6
<i>elegans</i> CINCTIPORA ... ..	80
<i>elegans</i> FILICEA ... ..	5, 7, 80
<i>elongata</i> MEMBRANIPORA ... ..	6, 12, 14
EMBALLOTHECA ... ..	54
EMBALLOTHECA <i>contortuplicata</i> ... ..	7, 8, 10, 54
EMBALLOTHECA <i>quadrata</i> ... ..	54
<i>erecta</i> BEANIA ... ..	6, 8, 26
ESCHARINA <i>simplex</i> ... ..	53



	PAGE.
ESCHAROIDES ... ..	61
ESCHAROIDES <i>excavata</i> ... ..	61
<i>excavata</i> ESCHAROIDES ... ..	61
<i>excavata</i> PERISTOMELLA <i>excavata</i> var. <i>tridens</i> ... ..	7, 8, 61
<i>exigua</i> FENESTRULINA ... ..	7, 8, 58
<i>exigua</i> MICROPORELLA ... ..	58
FARCIMINARIA ... ..	24, 25
FARCIMINARIA <i>aculeata</i> ... ..	6, 24
FARCIMINARIA <i>simplex</i> ... ..	7, 9, 24, 25
FASCICULIPORA ... ..	79
FASCICULIPORA <i>fruticosa</i> ... ..	7, 79
FASCICULIPORA <i>gracilis</i> ... ..	7, 79
FENESTRULINA ... ..	56, 57
FENESTRULINA <i>exigua</i> ... ..	7, 8, 58
FENESTRULINA <i>malusii</i> ... ..	6, 10, 58
FENESTRULINA <i>malusii</i> var. <i>thyreophora</i> ... ..	7, 10, 58
FENESTRULINA <i>parvipora</i> ... ..	57
FENESTRULINA <i>proxima</i> ... ..	6, 57
FIGULARIA ... ..	47
FIGULARIA <i>spatulata</i> ... ..	6, 8, 9, 10, 47
FILICEA ... ..	80
FILICEA <i>elegans</i> ... ..	5, 7, 80
<i>fimbriata</i> LICHENOPORA ... ..	7, 8, 79
<i>fimbriata</i> DISCOPELLA ... ..	79
<i>fistulosa</i> CELLARIA ... ..	6
<i>flagellata</i> FLUSTRA ... ..	7, 8, 9, 10, 18, 19
FLUSTRA ... ..	18, 19
FLUSTRA <i>angusta</i> ... ..	6, 9, 10, 20
FLUSTRA <i>antarctica</i> ... ..	6, 8, 9, 22
FLUSTRA <i>coriacea</i> ... ..	29
FLUSTRA <i>curva</i> ... ..	7, 9, 10, 21
FLUSTRA <i>flagellata</i> ... ..	7, 8, 9, 10, 18, 19
FLUSTRA <i>ovoidea</i> ... ..	6
FLUSTRA <i>renilla</i> ... ..	14
FLUSTRA <i>spinuligera</i> ... ..	6
FLUSTRA <i>spoliata</i> ... ..	6, 20, 21
FLUSTRA <i>tenuis</i> ... ..	7, 8, 10, 19
FLUSTRA <i>vanhoffeni</i> ... ..	7, 10, 22
<i>foliacea</i> HORNERA ... ..	7, 8, 78
<i>foveolata</i> CELLARINELLA ... ..	7, 8, 49
<i>frigida</i> RETEPORA ... ..	7, 8, 9, 68, 69
<i>fruticosa</i> FASCICULIPORA ... ..	7, 79
<i>funiculata</i> AMASTIGERA ... ..	26
<i>funiculata</i> MENIPEA ... ..	6, 25, 26
<i>gelida</i> RETEPORA ... ..	7, 9, 70
<i>giganteum</i> ASPIDOSTOMA ... ..	7, 32, 34
<i>gracilis</i> FASCICULIPORA ... ..	7, 79

	PAGE.
<i>hastata</i> CATENICELLA	6, 72
<i>hastata</i> COSTICELLA	6, 8, 72
HASWELLIA	71
HASWELLIA <i>australiensis</i>	5, 7, 80
HASWELLINA	71
HIANTOPORA <i>monoceros</i>	46
<i>hippocrepis</i> RETEPORA	7, 10, 70
HIPPOTHOA	47
HIPPOTHOA <i>hyalina</i>	7, 8, 47
<i>hispidula</i> LICHENOPORA	7, 79
HORNERA	78
HORNERA <i>antarctica</i>	7, 8, 10, 78
HORNERA <i>caespitosa</i>	7, 78
HORNERA <i>foliaceae</i>	7, 8, 78
<i>hosteensis</i> LACERNA	7, 8, 9, 10, 52, 53, 54
<i>hosteensis</i> SCHIZOPORELLA	52
<i>hyadesi</i> PORELLA	7, 10, 68
<i>hyalina</i> CELLEPORA	47
<i>hyalina</i> HIPPOTHOA	7, 8, 47
<i>hyalina</i> SCHIZOPORELLA	7, 47
IDMONEA <i>australis</i>	7, 78
<i>impressa</i> MICROPORELLA	57
<i>inermis</i> MEMBRANIPORA	15
<i>inermis</i> RAMPHONOTUS	7, 8, 9, 15
<i>inversa</i> INVERSIULA	59
<i>inversa</i> MICROPORELLA	6, 59
INVERSIULA	59
INVERSIULA <i>nutrix</i>	6, 8, 59
INVERSIULA <i>inversa</i>	59
ISIS	64
KYMELLA <i>polaris</i>	7, 8, 9, 62
LABIOPORELLA	29, 31
LABIOPORELLA <i>adeliensis</i>	6, 9, 10, 29, 30, 31
LABIOPORELLA <i>bursaria</i>	29
LACERNA	52
LACERNA <i>de carforti</i>	52
LACERNA <i>hosteensis</i>	7, 8, 9, 10, 52, 53, 54
<i>landsborowii</i> LEPRALIA	64
<i>landsborowii</i> SMITTIA	7, 64
<i>landsborowii</i> SMITTINA	7, 8, 64
<i>lata</i> MEMBRANIPORA	12
<i>lata</i> OGIVALINA	6, 8, 12, 13, 14
LEPRALIA	60
LEPRALIA <i>landsborowii</i>	64
LEPRALIA <i>marginata</i>	6, 8, 9, 10, 60
LEPRALIA <i>marcupium</i>	65

	PAGE.
LEPRALIA <i>monoceros</i> ... ..	46
LEPRALIA <i>punctata</i> ... ..	45
LEPRALIA <i>thyreophora</i> ... ..	58
<i>lepralioides</i> RETEPORA ... ..	7, 9, 70, 71
LICHENOPORA ... ..	79
LICHENOPORA <i>fimbriata</i> ... ..	7, 8, 79
LICHENOPORA <i>hispida</i> ... ..	7, 79
<i>lyrulata</i> PHYLACTELLA ... ..	7, 8, 10, 53, 54, 73, 75
<i>magnilabris</i> STEGANOPORELLA ... ..	12
<i>malouinensis</i> PORELLA ... ..	7, 9, 66, 67, 68
<i>malouinensis</i> SMITTIA ... ..	66
<i>malusii</i> CELLEPORA ... ..	58
<i>malusii</i> FENESTRULINA ... ..	6, 10, 58
<i>malusii</i> FENESTRULINA <i>malusii</i> var. <i>thyreophora</i> ... ..	7, 10, 58
<i>malusii</i> MICROPORELLA ... ..	6, 58
<i>malvinensis</i> CELLARIA ... ..	35, 36
<i>margaritacea</i> CATENICELLA ... ..	6, 72
<i>margaritacea</i> SCUTICELLA ... ..	6, 8, 72
<i>marginata</i> LEPRALIA ... ..	6, 8, 9, 10, 60
<i>marsupium</i> LEPRALIA ... ..	65
<i>marsupium</i> SMITTIA ... ..	7, 65
<i>marsupium</i> SMITTINA ... ..	7, 8, 65
<i>martiali</i> ROMANCHEINA ... ..	7, 10, 60
<i>mawsoni</i> CELLARIA ... ..	7, 8, 10, 32, 33, 36
MAWSONIA ... ..	39
MAWSONIA <i>membranacea</i> ... ..	6, 9, 10, 39, 40, 41, 42
<i>membranacea</i> CELLARIA ... ..	6, 39
<i>membranacea</i> MAWSONIA ... ..	6, 9, 10, 39, 40, 41, 42
MEMBRANIPORA ... ..	11, 14, 41
MEMBRANIPORA <i>ciliata</i> ... ..	7, 8, 11, 12
MEMBRANIPORA <i>corbula</i> ... ..	6
MEMBRANIPORA <i>echinata</i> ... ..	11
MEMBRANIPORA <i>elongata</i> ... ..	6, 12, 14
MEMBRANIPORA <i>inermis</i> ... ..	15
MEMBRANIPORA <i>lata</i> ... ..	12
MEMBRANIPORA <i>minax</i> ... ..	15
MEMBRANIPORA <i>onychocelloides</i> ... ..	14
MEMBRANIPORA <i>spinosa</i> ... ..	11, 12
MEMBRANIPORÆ ... ..	14
MENIPEA <i>funiculata</i> ... ..	6, 25, 26
MICROPORA ... ..	28
MICROPORA <i>brevissima</i> ... ..	6, 8, 10, 28, 29
MICROPORA <i>coriacea</i> ... ..	7, 8, 29
MICROPORELLA ... ..	55, 56
MICROPORELLA <i>divaricata</i> ... ..	6, 10, 56
MICROPORELLA <i>exigua</i> ... ..	58

	PAGE.
MICROPORELLA <i>impressa</i> ... ..	57
MICROPORELLA <i>inversa</i> ... ..	6, 59
MICROPORELLA <i>malusii</i> ...	6, 58
MICROPORELLA <i>malusii</i> var. <i>vitrea</i> ... ..	58
MICROPORELLA <i>nutrix</i> ... ..	59
MICROPORELLA <i>proxima</i> ... ..	6, 57
MICROPORELLA <i>trinervis</i> ... ..	6, 10, 55
MICROPORELLE ... ..	56
<i>minax</i> MEMBRANIPORA ... ..	15
<i>monoceros</i> ARACHNOPUSIA ... ..	6, 10, 46
<i>monoceros</i> CRIBRILINA ... ..	6, 46
<i>monoceros</i> HIANTOPORA ... ..	46
<i>monoceros</i> LEPRALIA ... ..	46
MUCRONELLA ... ..	17, 66
MUCRONELLA <i>contortuplicata</i> ... ..	7, 54
MUCRONELLA <i>coronata</i> ... ..	7, 16
MUCRONELLA <i>crozetensis</i> ... ..	7, 10, 66
MUCRONELLA <i>phylactelloides</i> ... ..	7, 10, 66
MUCRONELLA <i>teres</i> ... ..	7
<i>nodulata</i> CELLARINELLA ... ..	7, 8, 9, 10, 49, 51
NOTOPLITES ... ..	25, 26
NOTOPLITES <i>drygalskii</i> ... ..	6, 8, 9, 10, 25, 26
<i>nutrix</i> INVERSIULA ... ..	6, 8, 59
<i>nutrix</i> MICROPORELLA ... ..	59
<i>obliqua</i> PSEUDOCCELLARIA ... ..	7, 8, 9, 10, 36, 42, 43, 44, 45
<i>obliquum</i> ASPIDOSTOMA ... ..	7, 42
OGIVALINA ... ..	12, 14
OGIVALINA <i>lata</i> ... ..	6, 8, 12, 13, 14
<i>onychocelloides</i> CALLOPORA ... ..	7, 8, 14
<i>onychocelloides</i> MEMBRANIPORA ... ..	14
OSTHIMOSIA ... ..	75
OSTHIMOSIA <i>catonensis</i> ... ..	7, 8, 9, 75
<i>ovoidea</i> FLUSTRA ... ..	6
PARMULARIA ... ..	54, 55
<i>parvipora</i> FENESTRULINA ... ..	57
PERISTOMELLA ... ..	61
PERISTOMELLA <i>excavata</i> var. <i>tridens</i> ... ..	7, 8, 61
PETRALIA <i>dorsiporosa</i> ... ..	60
PHYLACTELLA ... ..	73
PHYLACTELLA <i>lyrulata</i> ... ..	7, 8, 9, 10, 53, 54, 73, 75
<i>phylactelloides</i> MUCRONELLA ... ..	7, 10, 66
<i>plana</i> RETEPORA ... ..	7, 69
<i>polaris</i> CYCLICOPORA ... ..	7, 62
<i>polaris</i> KYMELLA ... ..	7, 8, 9, 62
PORELLA <sup>A</sup> ... ..	66

	PAGE.
PORELLA <i>hyadesi</i> ... ..	7, 10, 68
PORELLA <i>malouinensis</i> ... ..	7, 9, 66, 67, 68
<i>præstans</i> SMITTIA ... ..	61
<i>projecta</i> CRIBRILINA ... ..	6
<i>proxima</i> FENESTRULINA ... ..	6, 57
<i>proxima</i> MICROPORELLA ... ..	6, 57
PSEUDOCCELLARIA ... ..	42
PSEUDOCCELLARIA <i>obliqua</i> ... ..	7, 8, 9, 10, 36, 42, 43, 44, 45
<i>punctata</i> CRIBRILINA ... ..	7, 8, 9, 10, 45, 46
<i>punctata</i> LEPRALIA ... ..	45
<i>quadrata</i> EMBALLOTHECA ... ..	54
RAMPHONOTUS ... ..	15
RAMPHONOTUS <i>inermis</i> ... ..	7, 8, 9, 15
<i>renilla</i> FLUSTRA ... ..	14
RETEPORA ... ..	68, 73
RETEPORA <i>antarctica</i> ... ..	7, 10, 69, 70, 71
RETEPORA <i>frigida</i> ... ..	7, 8, 9, 68, 69
RETEPORA <i>gelida</i> ... ..	7, 9, 70
RETEPORA <i>hippocrepis</i> ... ..	7, 10, 70
RETEPORA <i>lepralioides</i> ... ..	7, 9, 70, 71
RETEPORA <i>plana</i> ... ..	7, 69
<i>retiformis</i> BUGULA ... ..	7, 10, 27
<i>reticulata</i> BUGULA ... ..	6
<i>reticulata</i> SMITTIA ... ..	7
<i>reticulata</i> SMITTINA ... ..	7, 64
ROMANCHEINA ... ..	60, 61
ROMANCHEINA <i>martiali</i> ... ..	7, 10, 60
SCHIZOPORELLA ... ..	52, 53, 54
SCHIZOPORELLA <i>hosteensis</i> ... ..	52
SCHIZOPORELLA <i>hyalina</i> ... ..	7, 47
SCHIZOPORELLA <i>simplex</i> ... ..	7, 52, 53, 54
SCHIZOPORELLA <i>tumida</i> var. <i>tricuspis</i> ... ..	7, 52
SCRUPOCELLARIA <i>drygalskii</i> ... ..	25
SCUTICELLA ... ..	72
SCUTICELLA <i>margaritacea</i> ... ..	6, 8, 72
<i>setosa</i> CELLEPORA ... ..	7, 8, 9, 10, 76, 77
<i>simplex</i> BUFFONELLA ... ..	9, 53
<i>simplex</i> ESCHARINA ... ..	53
<i>simplex</i> FARCIMINARIA ... ..	7, 9, 24, 25
<i>simplex</i> SCHIZOPORELLA ... ..	7, 52, 53, 54
SMITTIA ... ..	68, 71
SMITTIA <i>antarctica</i> ... ..	7, 65
SMITTIA <i>conspicua</i> ... ..	7, 64
SMITTIA <i>crozetensis</i> ... ..	66
SMITTIA <i>directa</i> ... ..	64

	PAGE.
<i>SMITTIA landsborovii</i> ... ..	7, 64
<i>SMITTIA malouinensis</i> ... ..	66
<i>SMITTIA marsupium</i> ... ..	7, 65
<i>SMITTIA præstans</i> ... ..	61
<i>SMITTIA præstans</i> var. <i>tridens</i> ... ..	61
<i>SMITTIA reticulata</i> ... ..	7
<i>SMITTIA tripora</i> ... ..	7, 63
<i>SMITTINA</i> ... ..	63, 71
<i>SMITTINA antarctica</i> ... ..	7, 8, 9, 10, 65
<i>SMITTINA conspicua</i> ... ..	7, 8, 9, 10, 64
<i>SMITTINA directa</i> ... ..	7, 8, 9, 64, 65
<i>SMITTINA landsborovii</i> ... ..	7, 8, 64
<i>SMITTINA marsupium</i> ... ..	7, 8, 65
<i>SMITTINA reticulata</i> ... ..	7, 64
<i>SMITTINA tripora</i> ... ..	7, 8, 9, 10, 63, 64
<i>SMITTIPORA abyssicola</i> ... ..	31
<i>spatulata</i> CRIBRILINA ... ..	6, 47
<i>spatulata</i> FIGULARIA ... ..	6, 8, 10, 47
<i>spinosa</i> MEMBRANIPORA ... ..	11, 12
<i>spinosissima</i> CHAPERIA ... ..	11
<i>spoliata</i> FLUSTRA ... ..	20, 21
<i>STEGANOPORELLA magnilabris</i> ... ..	12
<i>stellata</i> TURRITIGERA ... ..	7
<i>SYSTEMOPORA</i> ... ..	48
<i>SYSTEMOPORA contracta</i> ... ..	7, 8, 10, 48
<i>tenuis</i> FLUSTRA ... ..	7, 8, 10, 19
<i>teres</i> MUCRONELLA ... ..	7
<i>thyreophora</i> LEPRALIA ... ..	58
<i>thyreophora</i> FENESTRULINA <i>malusii</i> var. ... ..	7, 10, 58
<i>tricornis</i> BUGULA ... ..	6, 9, 27
<i>tricuspis</i> SCHIZOPORELLA <i>tumida</i> var. ... ..	52
<i>tridens</i> PERISTOMELLA <i>excavata</i> var. ... ..	7, 8, 61
<i>tridens</i> <i>SMITTIA præstans</i> var. ... ..	61
<i>trinervis</i> MICROPORELLA ... ..	6, 10, 55
<i>tripora</i> <i>SMITTIA</i> ... ..	7, 63
<i>tripora</i> <i>SMITTINA</i> ... ..	7, 8, 10, 63, 64
<i>tuba</i> CORNUCOPINA ... ..	6, 28
<i>tuba</i> BICELLARIA ... ..	6, 28
<i>tumida</i> SCHIZOPORELLA <i>tricuspis</i> var. ... ..	7, 52
<i>TURRITIGERA stellata</i> ... ..	7
<i>vanhoffeni</i> FLUSTRA ... ..	7, 10, 22
<i>VINCULARIA abyssicola</i> ... ..	6, 29, 31
<i>vitrea</i> MICROPORELLA <i>malusii</i> var. ... ..	58
<i>wandeli</i> CELLARIA ... ..	6, 10, 38
<i>watersi</i> CELLARINELLA ... ..	7, 8, 9, 10, 51

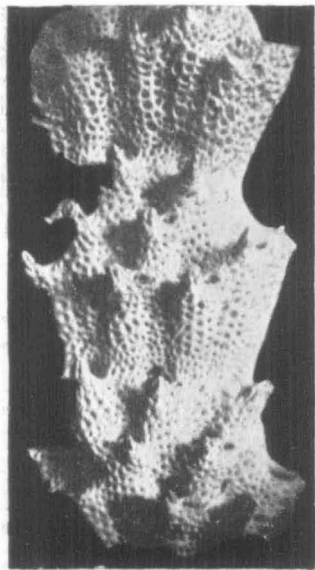

1

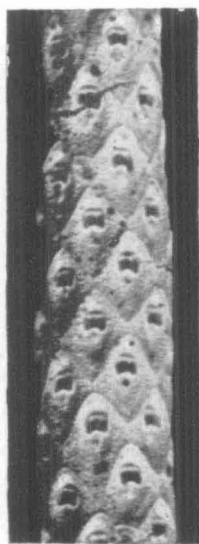

2

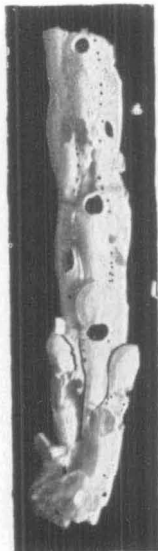

3

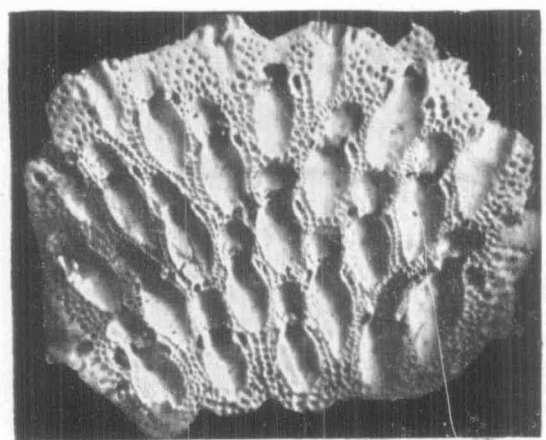

4

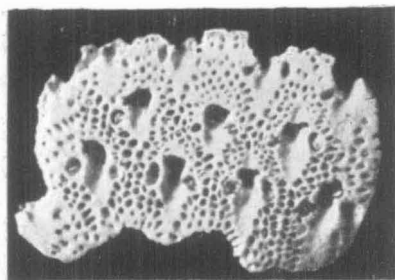

7

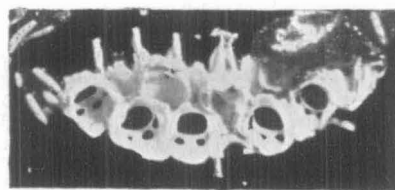

6

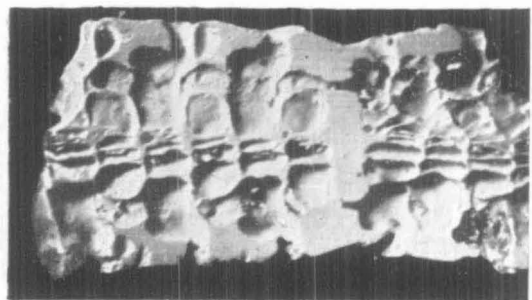

5

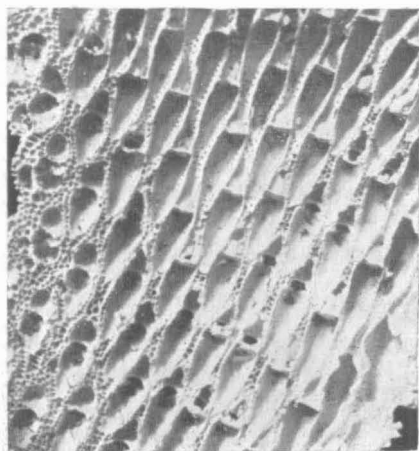

8

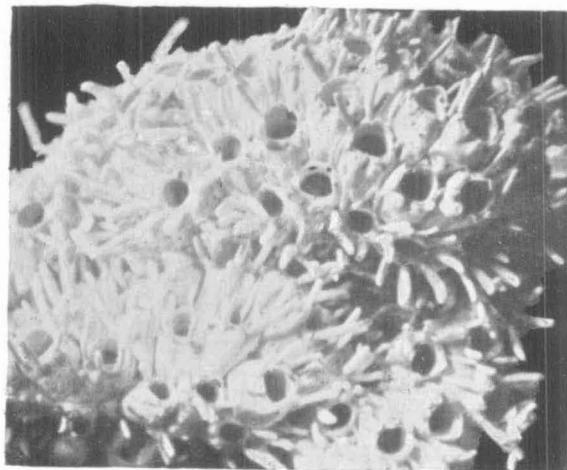

9

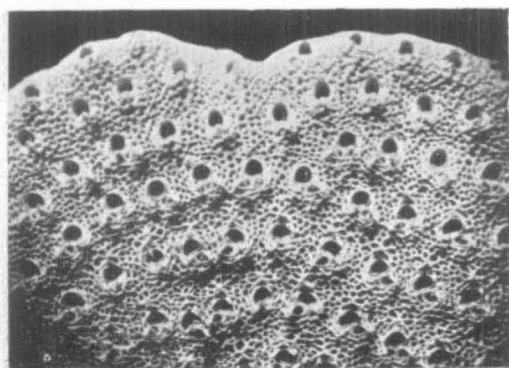

10

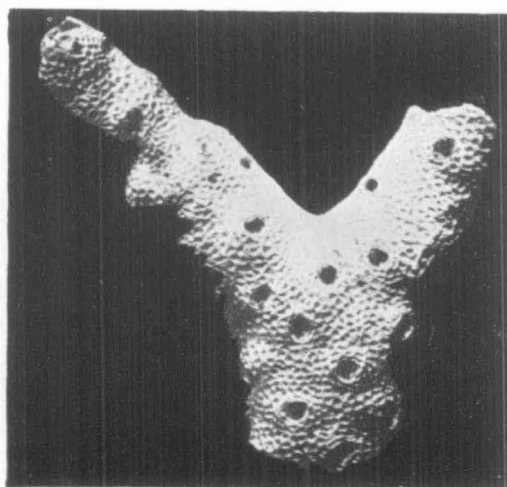

11

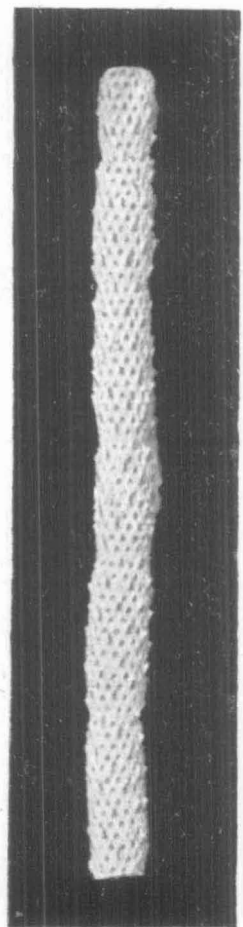

12

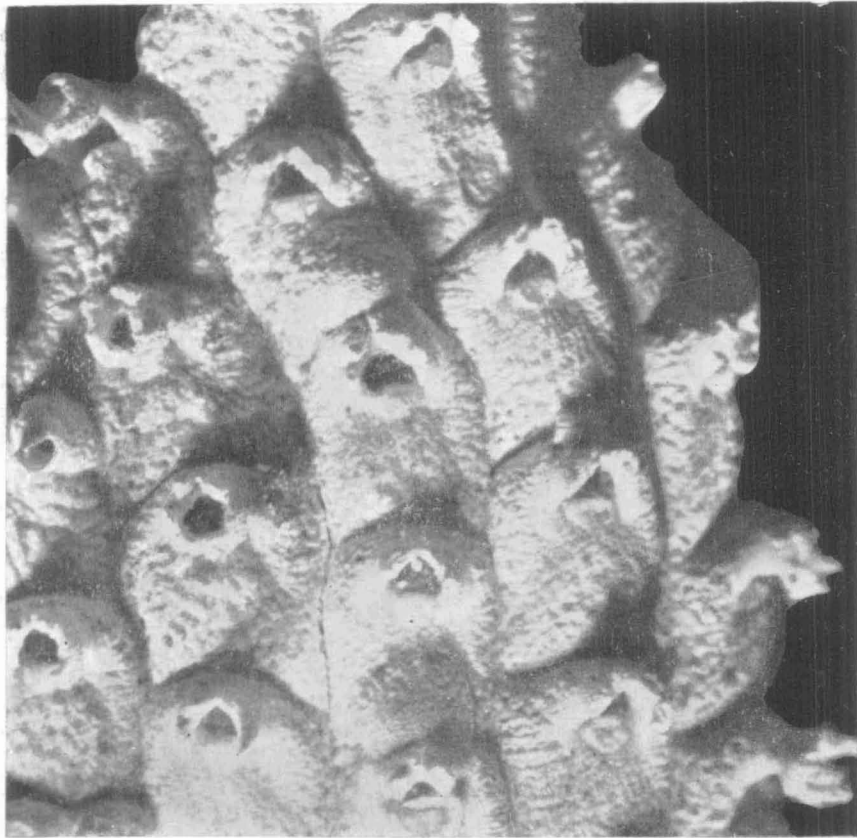

1

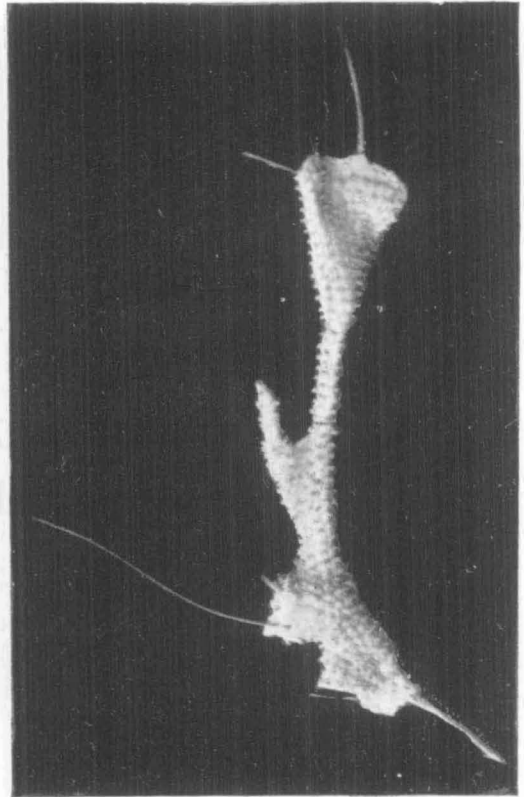

2

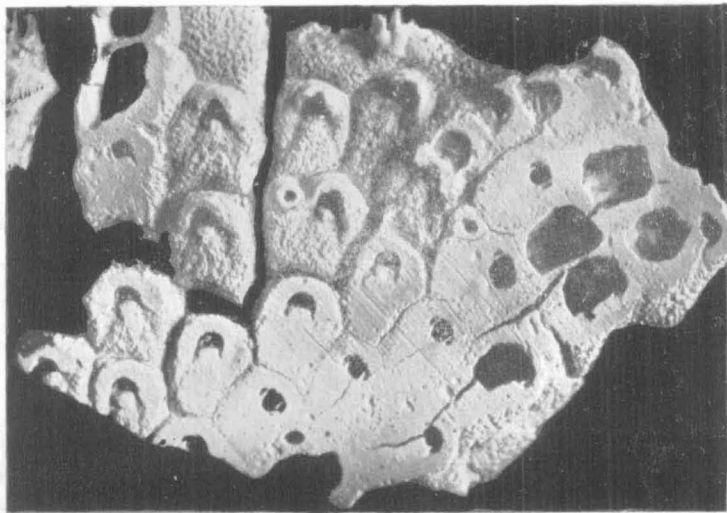

3

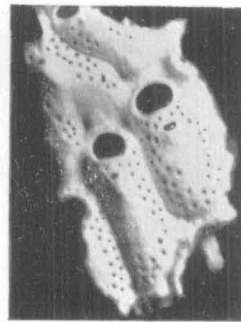

4



5

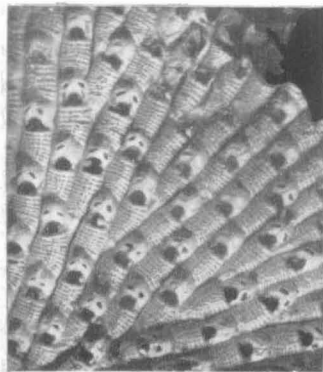

6

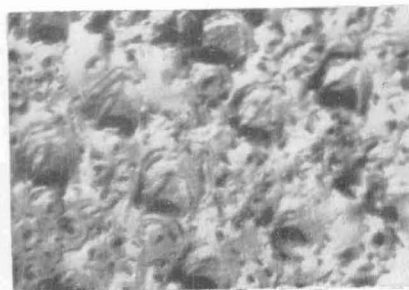

7

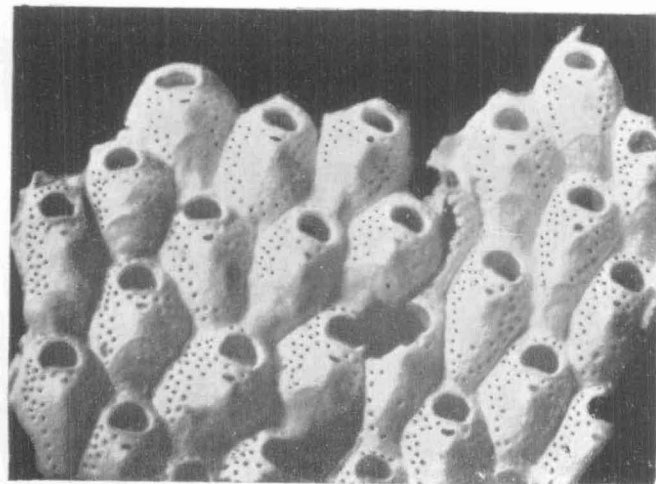

8



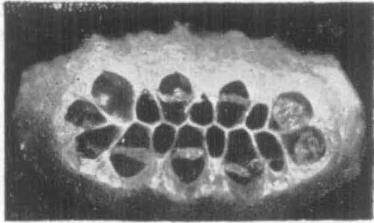

1



2

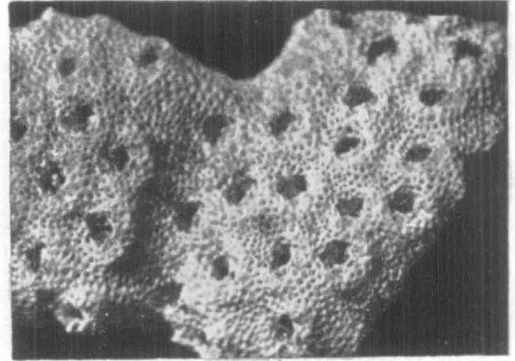

3

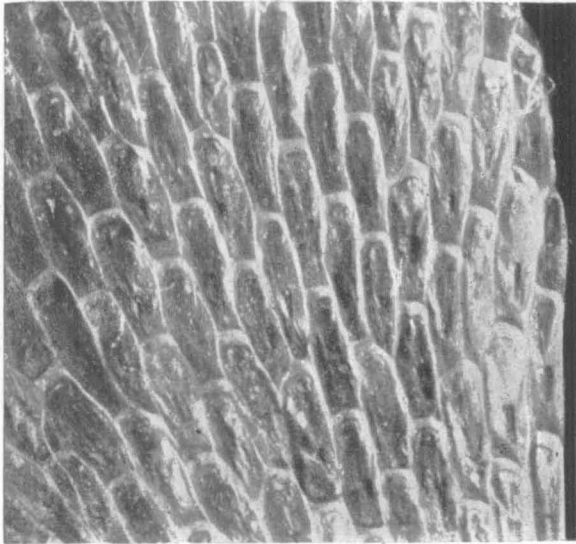

4



5

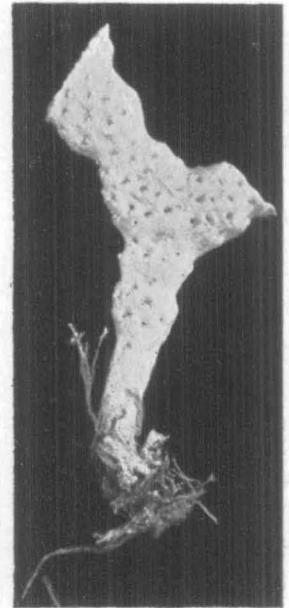

6

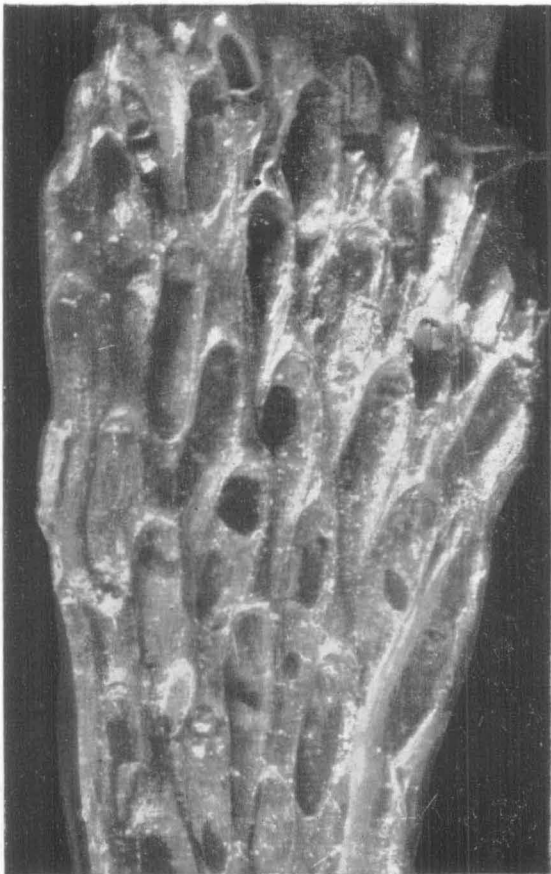

7

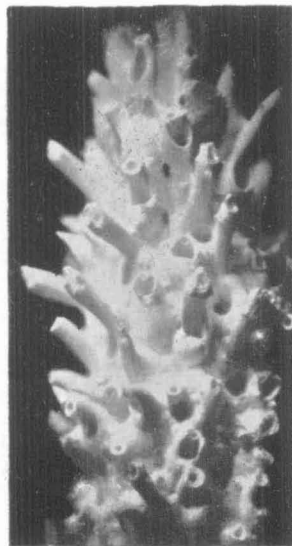

8

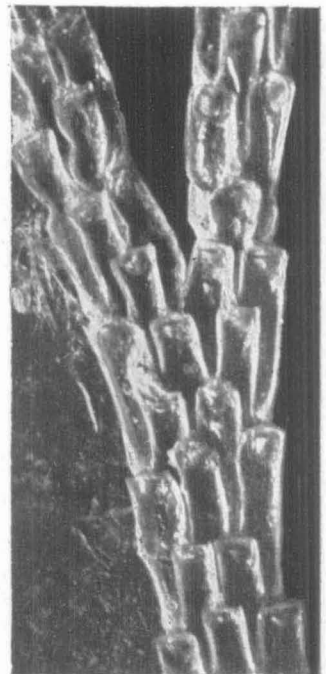

9

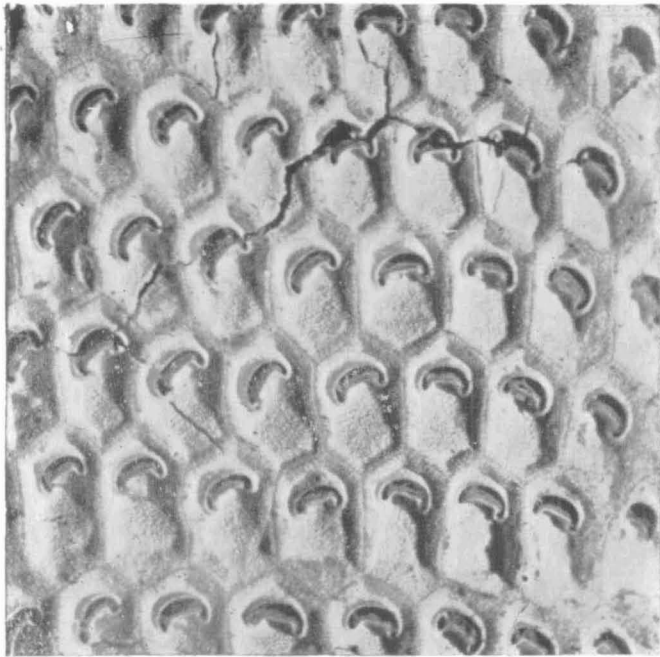

1

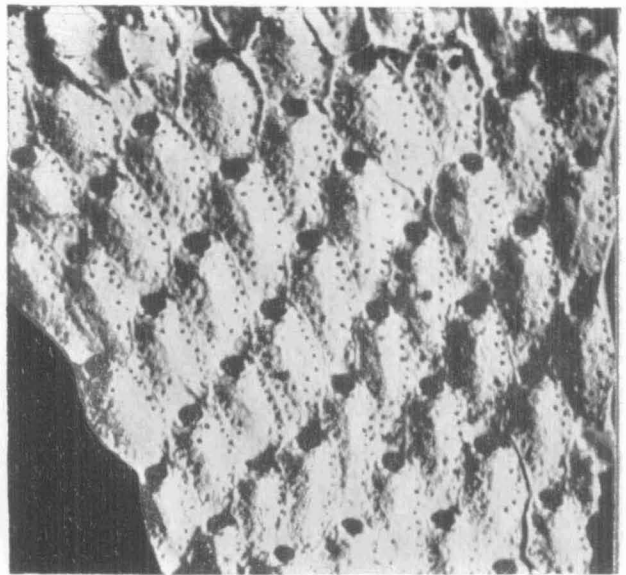

2

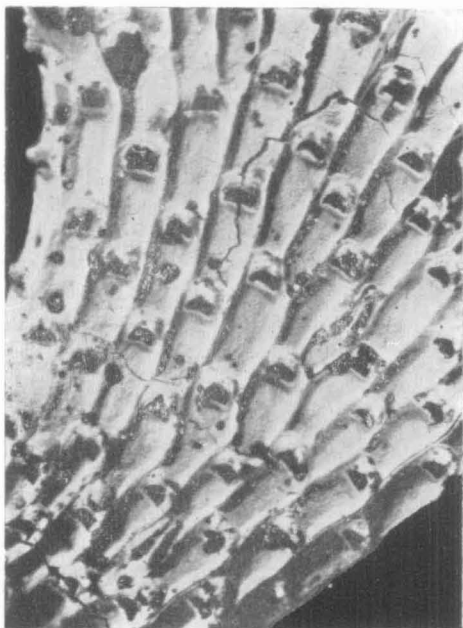

3



4

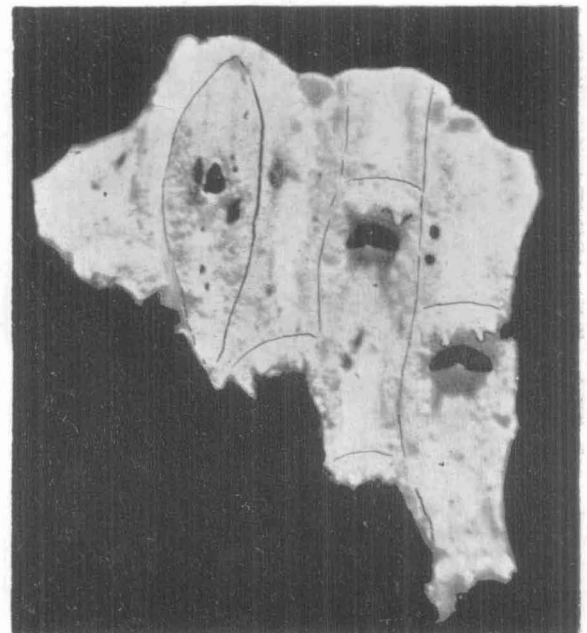

5

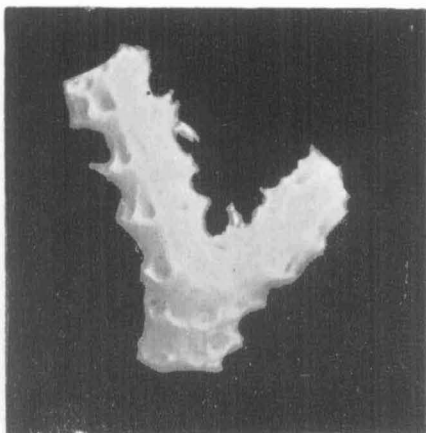

6

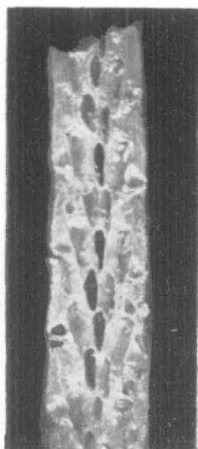

7



8

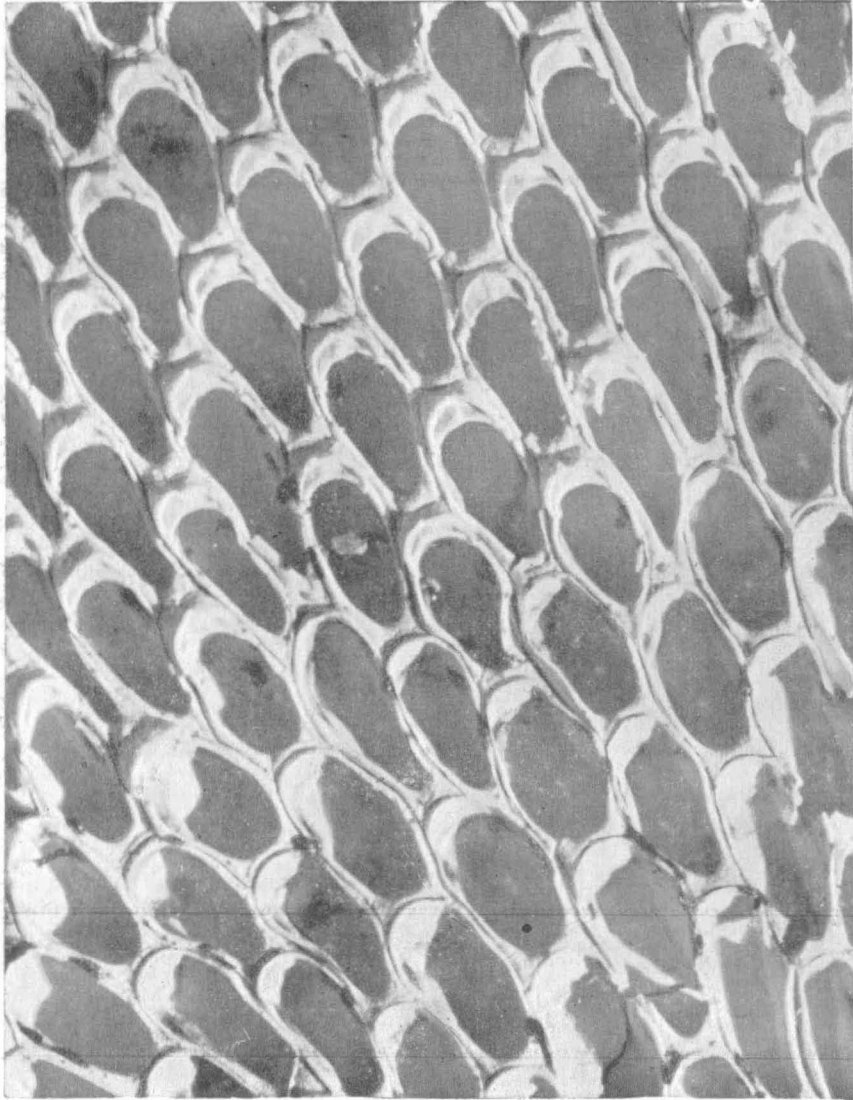

1

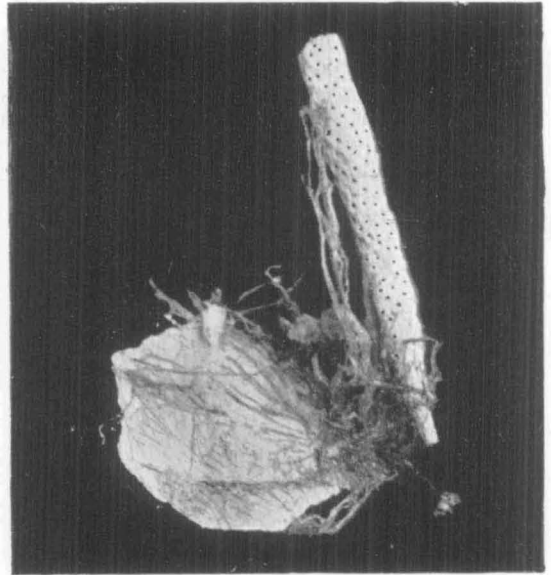

2

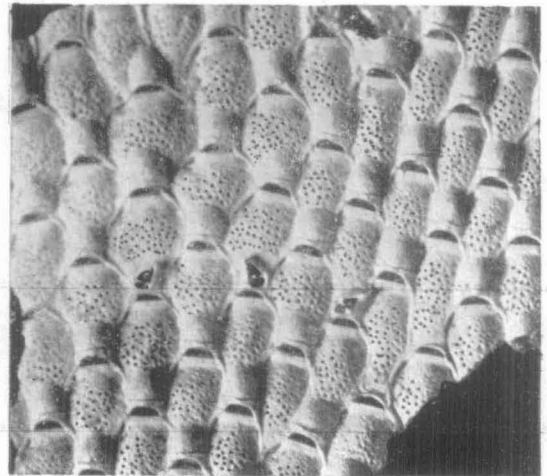

3



4

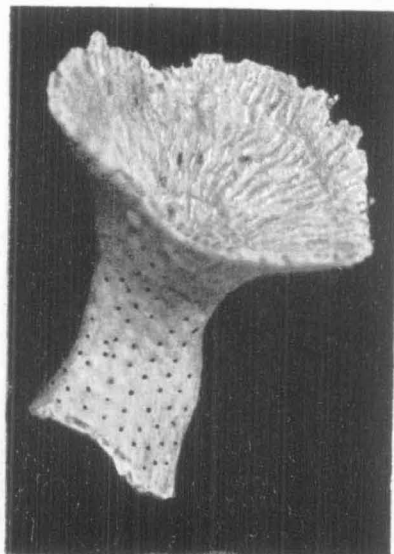

5

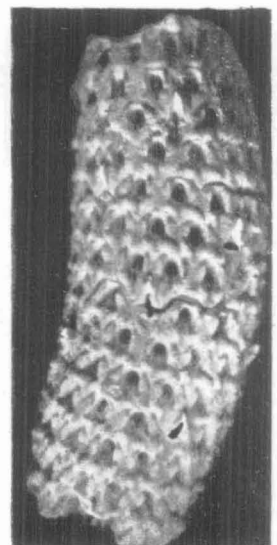

6

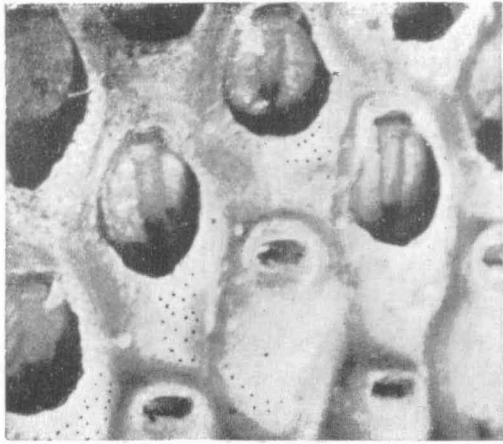

1

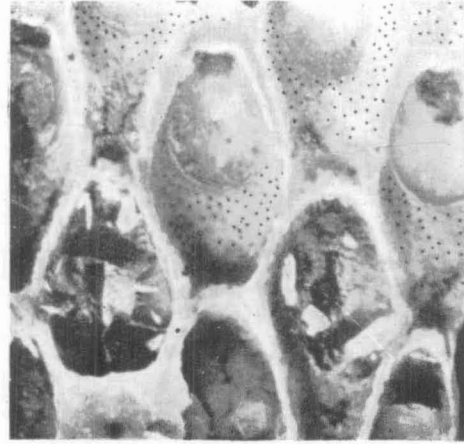

2

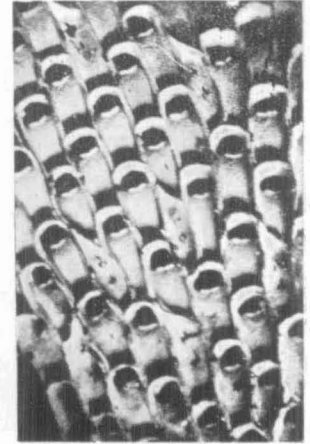

3



4

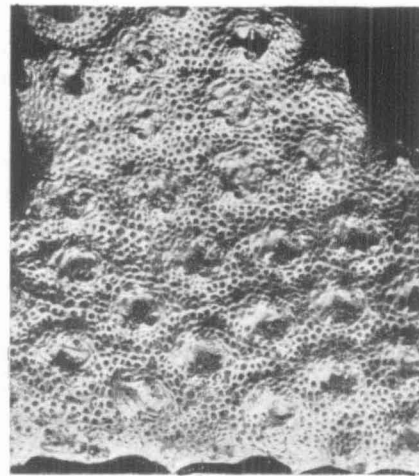

5

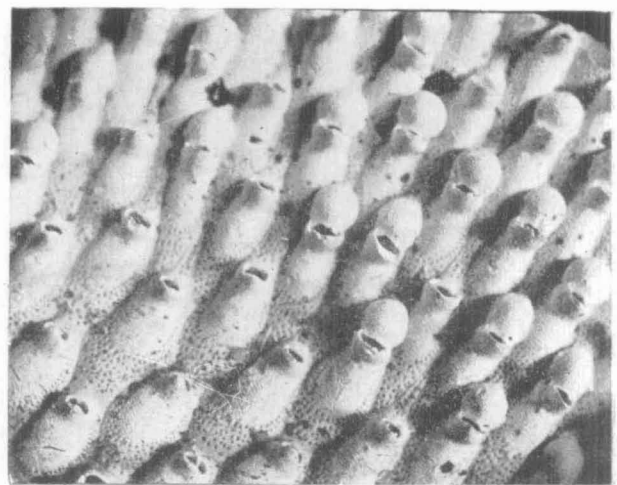

6

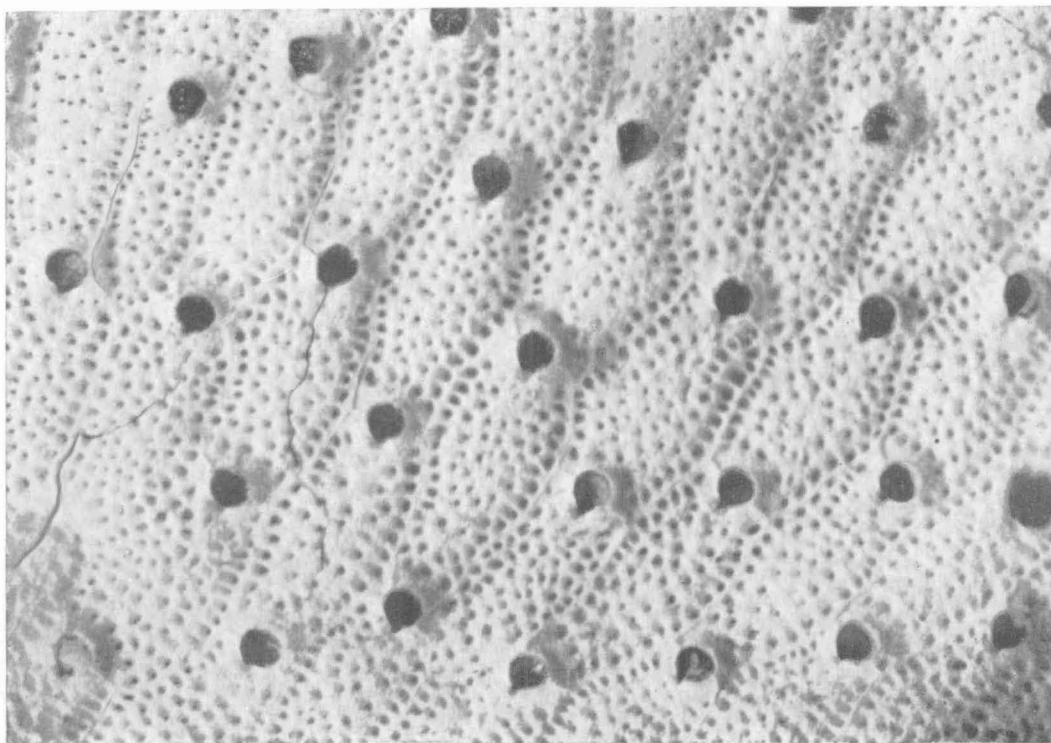

7

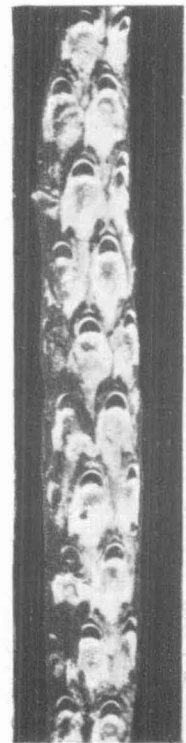

8

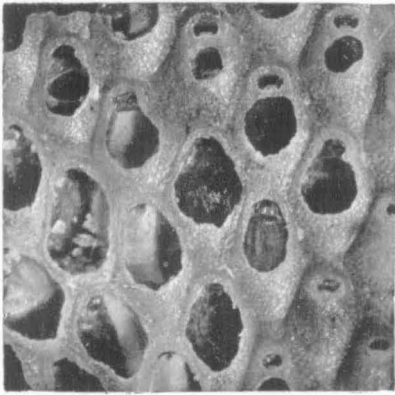

1

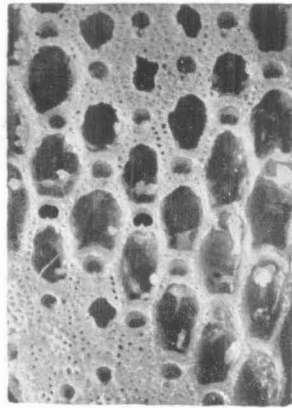

2

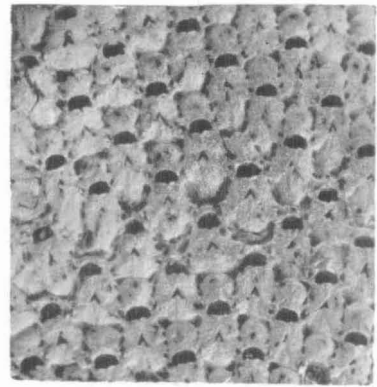

3

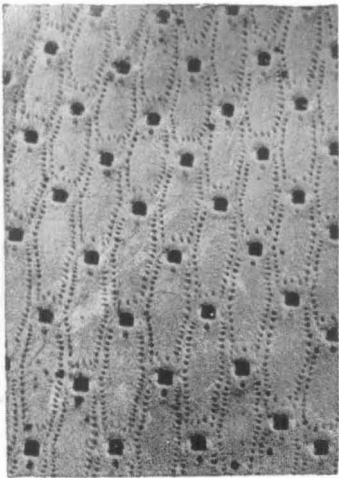

4

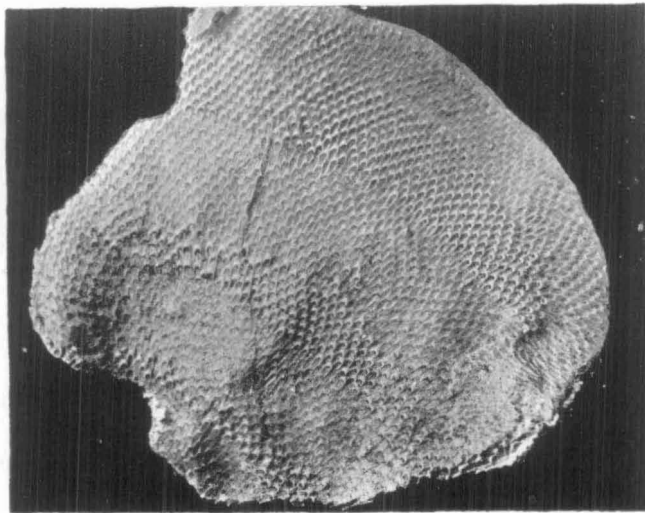

5

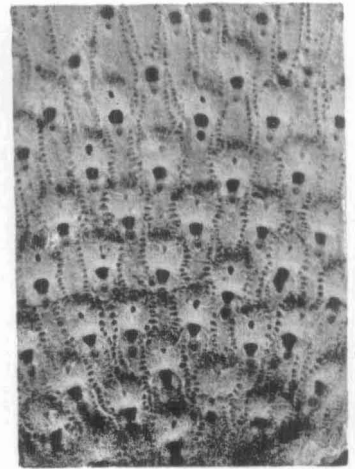

6

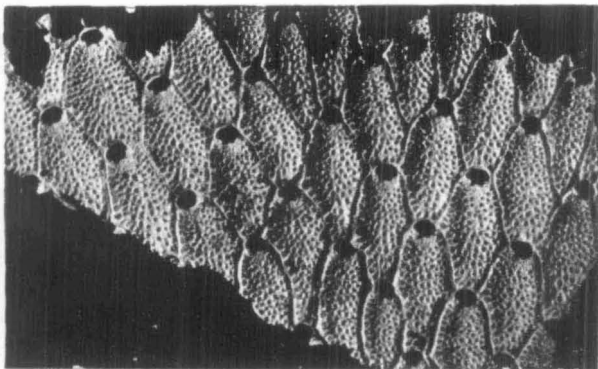

7

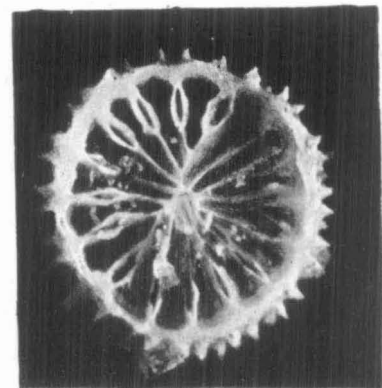

8

**Series C.—REPORTS IN COURSE OF PREPARATION.**

**ZOOLOGY.**

FORAMINIFERA ... ..	F. CHAPMAN, A.L.S., F.R.M.S., National Museum, Melbourne.
HYDROZOA ... ..	E. A. BRIGGS, M.Sc., University, Sydney.
ACTINIARIA ... ..	Prof. O. H. CARLGREN, Lund, and T. A. STEPHENSON, D.Sc., London.
ALCYONARIA ... ..	Prof. J. ARTHUR THOMSON, F.R.S., University, Aberdeen.
CESTODES ... ..	Prof. T. HARVEY JOHNSTON, D.Sc., University, Adelaide.
NEMATODES (FREE) ... ..	Dr. N. A. COBB, Bureau of Plant Industry, Washington, U.S.A.
CRINOIDEA AND HOLOTHUROIDEA ...	Prof. M. VANEY, Université, Lyon, France.
LEECHES ... ..	
CRUSTACEA AMPHIPODA AND C. ISOPODA	Prof. C. CHILTON, M.A., D.Sc., F.L.S., Canterbury College, Christchurch, New Zealand.
CRUSTACEA MACRURA AND C. CIRRIPEDA	Miss F. BAGE, M.Sc., F.L.S., University, Brisbane.
MALLOPHAGA ... ..	Prof. L. HARRISON, B.A., B.Sc., University, Sydney.
TICKS ... ..	Prof. L. HARRISON, B.A., B.Sc., University, Sydney.
PYCNOGONIDA ... ..	Prof. T. T. FLYNN, D.Sc., University of Tasmania, Hobart.
TUNICATES (COMPOSITE) ... ..	
BIRDS ... ..	
MAMMALS ... ..	H. HAMILTON, Dominion Museum, Wellington, N.Z.

**BOTANY.**

**PHYTOPLANKTON AND FRESH-WATER**

ALGÆ ... ..	A. MANN, National Museum, Washington.
-------------	---------------------------------------