



SALT- & FRESHWATER

# CATALOGUE



## 2020/2021

**AQUA MEDIC**



	page
Aquaria	5 – 12
Seasalt	13
Hydrometer	14 – 15
Saltwater supplements	16 – 20
Special nutrition	21 – 22
Algal resources	23
Freshwater supplements	24 – 25
Plankton	26
Heating / cooling	27 – 30
Pumps	31 – 40
Protein skimmer	41 – 47
Filter systems	48 – 54
Filter components	55 – 56
Filter material	57 – 60
UV-C sterilizer	61 – 62
Light	63 – 85
Measurement and control technology	86 – 94
Reverse osmosis	95 – 98
CO <sub>2</sub>	99 – 101
aqua tools	102 – 116

**AQUA MEDIC** recommends:

-  suitable for saltwater
-  suitable for freshwater
-  suitable for salt- and freshwater

Subject to technical changes and errors.

	page		page		page
AC Runner series x.2	36	EVO series	43	Qube control	71
Adapter union AM	114	extension cord DC Runner / EcoDrift	33, 35	Qube control LEDspot	79
AiptaCap	23, 110	ferreal + spureal	25	reactor 100	100
aminovit	21	filter bag	58, 106	reactor 1000	100
antiphos Fe	58	Filter accessories 15 x 15	112	Reducing T-piece	115
aqua +GH	24	filter bag multi	58, 106	Reef Construct	109
aqua +KH	24	Filter Box A/B	49	REEF LIFE antired	23
aquabiovit	21	fishknob	12	REEF LIFE series	16 – 19
aquabreed complete	26	Fish trap	105	Reef Salt / Reef Salt coral	13
aqua divider	114	floreale + iod	25	Reef Station	48
aquafit series	85	Fluidized bed filter FB 5000	55	reefdoser add 4	39
aqua gloves	103	food pipe	10, 104	reefdoser EVO 4	39
aqua grid	113	frag board	110	refill depot	54
aqualife + Vitamine	24	heat controller duo	29, 86	Refill Fix	53
aqualine T5	81 – 82	Helix Max	61	Refill System 2.0 + Refill System easy	53
aqualine series	83 – 84	hopstop	11, 111	refractometer LED	15
Aqua Medic seasalt	13	hose clip	39, 111	Regulation valve	116
aquaniveau	90	hot construct	109	regular	101
aquapHloor	25	Hydrocarbonat	19	Reverse osmosis accessories	97 – 98
aquarius control	66	hydroquick	15	rubber sucker twin	105
aquarius holder	11, 65	Kalkwasserpowder	17	RO-resin	97
aquarius holder BW	11, 65	Kauderni	9	RO-resin cartridge	98
aquarius plus	63	K series	42	Round grate	114
aquarius plant plus	64	LEDspot	73 – 78	Rust Protect	10, 117
aqua smoothy	109	LF controller	88	salimeter	14
arctic breeze	27	magnetscraper	108	scissors 60	102
Armatus	5	Mega Mag	107	scissors 60 curved	102
Armatus XD	6	Merlin plus (PRF-RO)	97	scraper	108
BactoBalls	59	midifloter	46	Silencer	47
Bali Sand	20	Mini-Deniballs	60	Silicagel	92
biobacter	60	minifloter	46	SmartDrift series x.1	32
Blenny Qube	8	Mistral II	38	SP 3000 Niveumat	40
blue	104	multi reactor Gen II series	55	spectrus / spectrus twin	72
bubble counter plus	100	mV computer-Set	90	spectrus holder BW	11, 65
Cabinet Protect	49	mV controller	88	sulfur pearls	59
Calciumreactor KR 5000	56	M-ventil	93	Systemfilter series	50 – 52
carbolit	58	Nitratreductor NR 5000	56	T5 tubes	77 – 78
catch bowl	104	NO3 reduct	17, 23	T5 reflector	80
CO <sub>2</sub>	99 – 101	Non-return valve	116	Tank union	114
combfix	113	Outlet strainer	115	T controller	88
connection cord DC 0 – 10 V	33, 35	Overflow comb	113	T controller twin	29, 86
cool control	30	Ozone	91	Test fluids	94
Coral Construct	109	Ozone Booster	92	Titan	27 – 28
coral cutter	103	Ozonizer	91	Titanium Heater	28, 86
coral fit	22	pH computer-Set	90	T-meter	89
Coral holder	111	pH controller	87	T-meter II	89
coral pins	110	pH-control-Set	87	T-meter twin	89
Coral Sand	20	pH monitor	87	Tonga Pearls	20
Coral strap	111	phosphatfilter Fe	56	Top View 200	10, 106
counter	101	pipette 35 + pipette 60	22	t-rail 60	101
Cubicus CF Qube	7	plancto	21	Trap-pest	105
DC Runner series x.3	34	plankton light reactor	26	Trickle filter T 5000	44
defroster+	110	plankton reactor	26	Trickle filter T 10000 + 20000	45
Deniballs	60	platinum line plus	95	Tri Complex compact	16
Denigran	59	plexipad	108	Turboflotor 5000 / 5000 shorty II	44
denimar	60	Potentiometer	79	Turboflotor 10000	45
Densimeter	14	power floter series	41	Turboflotor 20000	45
DensiTower	14	prefilter bag	57, 106	tweezers 60	101
Distribution box LEDspot	79	premium line	96	UV-C Professional	62
Dosing pump SP 3000	40	Pumps NK-/OK series	37	valve	115
easy line	96	Qube 30	67	variocare	33
EcoDrift series x.3	31	Qube 30 plant	68	Wooden airstones	47
Electrodes	94	Qube 50	69	Y-cable aquarius	66
Electrode holder	94	Qube 50 plant	70	Zeolith	58

**Armatus 250/300/400/450**

Rimless saltwater aquarium incl. cabinet filter system

- aquarium without brace bars made from ultra clear (low iron) glass with polished edges
- silent operation due to the "easy drain system"
- filter tank with adjustable water level and automatic refill
- fine filter area with replaceable filter bags
- transportable refill tank
- glass cabinet filter with prefilter chamber, two clear water chambers for use with additional biological and mechanical filters (e. g. skimmer, multi reactor, etc.) and filter media
- integrated emergency overflow
- elegant glass duct cover
- high-quality cabinet with softclose, white high gloss
- large base cabinet with aeration and ventilation
- incl. drip pan
- the cabinet is supplied flat packed for easy transportation and home assembly with few parts

Armatus	Armatus 250	Armatus 300	Armatus 400	Armatus 450
Dimensions aquarium (l x w x h) app.	75 x 50 x 55 cm	100 x 50 x 55 cm	125 x 50 x 55 cm	150 x 50 x 55 cm
Glass thickness front pane	10 mm	12 mm	15 mm	15 mm
Glass thickness side pane	8 mm	10 mm	10 mm	12 mm
Glass thickness back wall	8 mm	10 mm	10 mm	12 mm
Glass thickness bottom pane	10 mm	10 mm	12 mm	12 mm
Volume aquarium app.	190 l	250 l	315 l	375 l
Water level app.	50 cm	50 cm	50 cm	50 cm
Dimensions filter cabinet (l x w x h) app.	60 x 42 x 34 cm	60 x 42 x 34 cm	90 x 42 x 34 cm	90 x 42 x 34 cm
Water level filter cabinet max.	16 – 23 cm	16 – 23 cm	16 – 23 cm	16 – 23 cm
Dimensions skimmer compartment	43 x 27 cm	43 x 27 cm	51 x 40 cm	51 x 40 cm
Dimensions pump compartment	43 x 11 cm	43 x 11 cm	40 x 20 cm	40 x 20 cm
Volume filter cabinet app.	55 l	55 l	85 l	85 l
Total volume	245 l	305 l	400 l	460 l
Volume refill l tank	10 l	10 l	16 l	16 l
recommended circulation pump (not included)	DC Runner 2.2	DC Runner 3.2	DC Runner 3.2 / 5.2	DC Runner 5.2
Dimensions incl. cabinet (l x w x h) app.	75 x 50 x 145 cm	100 x 50 x 145 cm	125 x 50 x 145 cm	150 x 50 x 145 cm
Dead weight app.	99 kg	125 kg	159 kg	194 kg

For further technical details please refer to [www.aqua-medice.de](http://www.aqua-medice.de)

Item code	Item
510.014	Armatus 250 white
510.114	Armatus 300 white
510.214	Armatus 400 white
510.314	Armatus 450 white



Armatus 250



Armatus 300



Armatus 400



Armatus 450



Armatus XD 300



Armatus XD 375



Armatus XD 500



Armatus XD 575

## Armatus XD 300/375/500/575

Rimless saltwater aquarium incl. cabinet filter system

- aquarium without brace bars made from ultra clear (low iron) glass with polished edges
- 65 cm aquarium depth - more space for reef design
- integrated emergency overflow
- elegant easy-to-clean glass duct cover
- silent operation due to the „easy drain system“
- filter tank with adjustable water level and automatic refill
- fine filter area with replaceable filter bags
- transportable refill tank
- glass cabinet filter with pre-filter chamber, two clear water chambers for use with additional biological and mechanical filters (e. g. skimmer, multi reactor, etc.) and filter media
- high-quality cabinet with softclose, white high gloss
- extra stable cabinet walls of 28 mm (for the 500 and 575 version also the middle wall)
- large base cabinet with aeration and ventilation
- incl. drip pan
- the cabinet is supplied flat packed for easy transportation and home assembly with few parts

Armatus XD	Armatus XD 300	Armatus XD 375	Armatus XD 500	Armatus XD 575
Dimensions aquarium (l x w x h) app.	75 x 65 x 55 cm	100 x 65 x 55 cm	125 x 65 x 55 cm	150 x 65 x 55 cm
Glass thickness front pane	10 mm	12 mm	15 mm	15 mm
Glass thickness side pane	10 mm	10 mm	12 mm	12 mm
Glass thickness back wall	8 mm	10 mm	10 mm	12 mm
Glass thickness bottom pane	10 mm	10 mm	12 mm	12 mm
Volume aquarium app.	245 l	325 l	405 l	490 l
Water level app.	50 cm	50 cm	50 cm	50 cm
Dimensions filter cabinet (l x w x h) app.	60 x 42 x 34 cm	60 x 42 x 34 cm	90 x 42 x 34 cm	90 x 42 x 34 cm
Water level filter cabinet max.	16 – 23 cm	16 – 23 cm	16 – 23 cm	16 – 23 cm
Dimensions skimmer compartment	43 x 27 cm	43 x 27 cm	51 x 40 cm	51 x 40 cm
Dimensions pump compartment	43 x 11 cm	43 x 11 cm	40 x 20 cm	40 x 20 cm
Volume filter cabinet app.	55 l	55 l	85 l	85 l
Total volume	300 l	380 l	490 l	575 l
Volume refill l tank	10 l	10 l	16 l	16 l
recommended circulation pump (not included)	DC Runner 3.2	DC Runner 3.2 / 5.2	DC Runner 5.2	DC Runner 5.2
Dimensions incl. cabinet (l x w x h) app.	75 x 65 x 145 cm	100 x 65 x 145 cm	125 x 65 x 145 cm	150 x 65 x 145 cm
Dead weight app.	138 kg	166 kg	225 kg	256 kg

For further technical details please refer to [www.aqua-medic.de](http://www.aqua-medic.de)

Item code	Item
511.014	Armatus XD 300 white <b>NEW</b>
511.114	Armatus XD 375 white <b>NEW</b>
511.214	Armatus XD 500 white <b>NEW</b>
511.314	Armatus XD 575 white <b>NEW</b>

### Cubicus CF Qube

Saltwater aquarium incl. cabinet filter system

- aquarium made of 8 mm prime white glass front pane
- incl. glass cabinet filter, four-chamber system, prefilter chamber, two clear water chambers for putting up biological and mechanical filters (e. g. skimmer) and filter media, settling chamber  
Dimensions (l x w x h): app. 40 x 47 x 45 cm, water level max. 32 cm, volume max. 54 l
- illumination: 2 x Qube 50 - High power LED spot. Five different light colours with high energy density specially designed for strong coral growth (24 V, max. 50 W). Colour and light intensity are adjustable manually via 2 channels. Integrated 0 – 10 V connection for using external controllers.
- circulation pump DC Runner 2.3 (24 V, max. 20 W)
- protein skimmer EVO 500 (24 V, max. 7 W)
- high-quality cabinet with softclose, completely mounted, white high gloss

Options:

- Aqua Medic Refill System 2.0 (see page 53)
- Helix Max 2.0 UV-C sterilizer 9 W (see page 61)

Dimensions (l x w x h): app. 50 x 60 x 150 cm

Water level: app. 45 cm, volume app. 135 l

Dead weight: app. 94 kg



Cubicus CF Qube

Item code	Item
571.20	Cubicus CF Qube white

Water volume calculated before gravel or decoration.  
Aquaria can be produced with alternative lighting, please inquire.



Overflow Cubicus CF Qube





Blenny Qube



## Blenny Qube

Saltwater aquarium

Ready to go with proven technology and high quality components. Blenny combines the full functionality of a reef aquarium in a compact design. The integrated filter compartment guarantees easy maintenance. Made with 6 mm prime white glass.

Equipment:

- current: EcoDrift 4.3, located in the back wall, easily adjustable for desired water moment (800 – 4,000 l/hr, 24 V, 3 – 10 W).
- protein skimmer: EVO 500 (24 V, max. 7 W), efficient and near silent operation
- light: Qube 50-High power LED spot with balanced light spectrum. Five different light colours with high energy density specially designed for strong coral growth (24 V, max. 50 W). Colour and light intensity are adjustable manually via 2 channels. Integrated 0 – 10 V connection for using external controllers.

Dimensions: (l x w x h): app. 40 x 50 x 40 cm

Water level: app. 38 cm, volume: app. 76 l

Dead weight: app. 22 kg

Item code	Item
565.20	Blenny Qube



Blenny Stand

## Blenny Stand

Cabinet for Blenny

Cabinet can be used for aquaria with dimensions of around 40 x 50 cm. The cabinet is designed especially for the Blenny nano reeftank. It is built to support the weight of a full aquarium. The cabinet is of a modern and stylish design, to complement many different styles of living areas. The cabinet is supplied flat packed for easy transportation and home assembly with few parts.

Dimensions (l x w x h): app. 40 x 50 x 100 cm

Dead weight: app. 29 kg

Item code	Item
565.01	Blenny Stand white

Water volume calculated before gravel or decoration.



**Kauderni CF white**

Saltwater aquarium incl. cabinet filter system

- aquarium 8 mm float glass, front pane and side panes 8 mm made of prime white glass
- incl. glass cabinet filter, four-chamber system, prefilter chamber, two clear water chambers for putting up biological and mechanical filters (e. g. skimmer) and filter media, settling chamber  
Dimensions (l x w x h): app. 40 x 47 x 45 cm, water level max. 32 cm, volume max. 54 l
- illumination: 1 x LED light aquarius 60
- circulation pump DC Runner 2.2 (24 V, max. 20 W)
- protein skimmer EVO 500 (24 V, max. 7 W)
- high-quality cabinet with softclose, completely mounted, white high gloss

Options:

- aquarius control (see page 66)
- Aqua Medic Refill System 2.0 (see page 53)
- Helix Max 2.0 UV-C sterilizer 11 W (see page 61)

Dimensions (l x w x h): 65.5 x 60 x 146 cm (aquarium app. 65.5 x 60 x 60 cm)

Water level app. 50 cm, volume app. 195 l

Dead weight: app. 183 kg

Item code	Item
523.044	Kauderni CF white

Water Volume calculated before gravel or decoration.

Aquaria can be produced with alternative lighting, please inquire.



Kauderni CF



aquarius 60





TopView 200

## TopView 200

Aquarium Viewing and Photography Glass

- made of high quality acrylic glass
- floats on the water surface
- allows a great view through the water surface of the aquarium to the coral world
- ideal for photographing the corals, from a different perspective
- no distorted images
- current pumps do not have to be switched off
- a smartphone can be conveniently inserted directly into the glass to avoid annoying light reflections

Dimensions: Ø app. 200 mm, height: app. 50 mm

Item code	Item
65960	TopView 200 <b>NEW</b>



food pipe



## food pipe

Food station for aquaria

- for feeding fish and corals
- prevents early loss of food via the drain
- with magnetic holder for easy attachment to an aquarium pane

Item code	Item
501.91	food pipe <b>NEW</b>



Rust Protect

## Rust Protect

Anti-corrosion and maintenance spray for metallic components

In aquarium cabinets with an open filter tank, wear and corrosion on the hinges caused by splashes and condensation can hardly be avoided. If used properly, the protective film applied by Rust Protect prevents moisture from reaching the metal parts, which significantly reduces the risk of corrosion. Rust Protect does not resinify and is resistant to saltwater.

- saltwater-resistant
- no draining
- no resinification
- wear reduction
- corrosion protection
- long-term effect

Regular use is recommended.

Item code	Item
599.950	Rust Protect, 100 ml <b>NEW</b>

**hopstop**

Hop protection for open top aquaria

Helps prevent nocturnal fish from jumping out.  
Content: 6 holders (combfix) and 3 plastic plates each app. 480 x 50 mm.

Item code	Item
418.12	hopstop



hopstop

**aquarius holder**

Mounting bracket for aquarius /aquarius plus LED-lights

Item code	Item
87706	aquarius holder / pair



aquarius holder

**aquarius plus holder BW**

Rear wall bracket, only for aquarius plus LED lights

aquarius plus	30	60	90	120
Recommended number of holders	1	2	2	2

Item code	Item
89706	aquarius plus holder BW <b>NEW</b>



aquarius plus holder BW

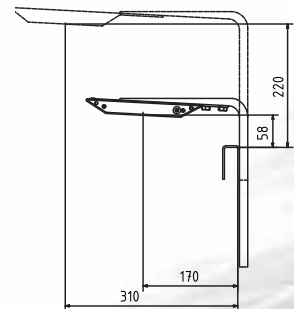

**spectrus holder BW**

Rear wall bracket, only for spectrus lights

spectrus	spectrus	spectrus twin
Recommended number of holders	1	1

Item code	Item
83020100	spectrus holder BW <b>NEW</b>



spectrus holder BW

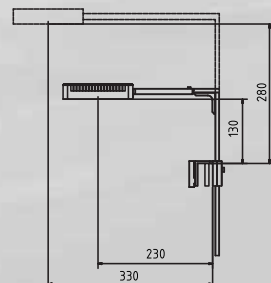



fishknob

## fishknob

Attractive door-knobs

Item code	Item
511.10	fishknob Angel / pair
511.11	fishknob Discus / pair
511.12	fishknob Seahorse / pair

### AB Reef Salt

Aquarium salt for all modern reef aquaria

Reef Salt is a dynamic new formulation, specifically designed for the needs of the modern reef aquarium. Reef Salt is blended from chemically pure raw materials, continuously quality controlled, achieves elevated levels of calcium and alkalinity reserve without resorting to harmful chelating agents, contains all the essential trace elements and enhanced levels of Strontium and Iodine, dissolves easily and leaves no residue.

Item code	Item
301.25	Reef Salt Nano 1,020 g can
301.10	Reef Salt 4 kg bucket
301.06	Reef Salt 20 kg bucket



Reef Salt

### AB Reef Salt coral

Aqua Medic Reef Salt coral is a specially made high quality formulation suitable for all modern reef aquaria.

- contains vitamin B complex for the supply of corals with the vital vitamin B12 (according to scientific investigations)
- provides ideal nature-like conditions for growth and coloration of SPS and LPS corals
- with pH buffer and high calcium and magnesium content
- contains all the essential trace elements
- blended from chemically pure raw materials, continuously quality controlled
- dissolves easily and leaves no residue, so can be used quickly

Item code	Item
301.03	Reef Salt coral 20 kg bucket



Reef salt coral

### Aqua Medic seasalt

Synthetic seasalt for aquaria

Aqua Medic seasalt is a top quality product, fulfilling all the requirements of a modern synthetic seasalt. It is formulated from highly purified compounds, and contains a pH buffer and all the essential trace elements needed for saltwater aquaria. It dissolves quickly, leaving no residue, and can be used very shortly after being mixed. Its quality has been proven by its selection by numerous public aquaria, many leading wholesalers of saltwater fish, and thousands of coral reef and fish aquaria. It is the economic solution for large scale applications.

Item code	Item
300.00	Aqua Medic seasalt 20 kg bag



Aqua Medic seasalt

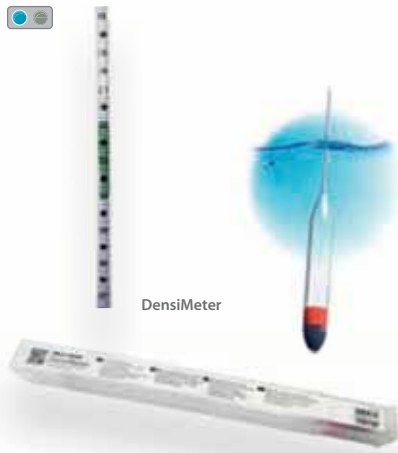

DensiMeter

### DensiMeter

Hydrometer to determine the density [g/ml] Tp. 25/4 °C in saltwater aquaria

Allow the hydrometer to float freely in sufficiently deep water for highly precise measurement, e.g. DensiTower. In this case, the water temperature of the sample should be, if possible, exactly 25 °C.

Maximum discrepancy at 25 °C: 0.001 g/ml

Measuring range: 1.018 to 1.028 g/ml

Resolution: 0.0001 g/ml

Dimensions: length app. 35.5 cm

Item code	Item
65905	DensiMeter



DensiTower

### DensiTower

Hydrometer cylinder with overflow to determine the exact density by using a hydrometer (not included)

Fill the DensiTower to the top of the inner tube with the water to be tested, place the hydrometer into the water slowly. Excess water flows into the outer ring.

After use, remove the hydrometer and empty the DensiTower.

To determine the exact density, we recommend the use of Aqua Medic DensiMeter.

Ø app. 45 mm, height app. 355 mm

Item code	Item
65906	DensiTower



salimeter

### salimeter

Density meter (hydrometer)

salimeter is a density meter (hydrometer) allowing easy measurement of the specific gravity of saltwater in aquaria. salimeter has a measuring range of 1.000 to 1.040, with graduations at every 0.001 and an accuracy of  $\pm 0.0005$  at 25 °C (77 °F). Dimensions: length app. 27 cm, Ø app. 2 cm

Item code	Item
65900	salimeter

**refractometer LED**

Temperature compensating refractometer with LED illuminated scale for salinity determination

The refractometer is a precision optical instrument used to determine the salt concentration in saltwater aquaria. Its exact value can be determined in seconds and can be read either as absolute salt concentration (‰, ppt) or as specific density. When a beam of light enters the refractometer it is bent or "refracted" by the water in the test panel. This refraction is proportional to the salinity of the sample and can be directly read by viewing the internal scale. The integrated LED illumination provides good readability even in poor lighting conditions. Included in shipment: refractometer, a pipette for the water sample, a screw driver for calibration, desalinated water, LED display and a strong plastic box.

Item code	Item
65909	refractometer LED
65920-1	Test fluid 35 ppt for refractometer 60 ml



refractometer LED

Test fluid 35 ppt

**hydroquick**

For measuring specific density in saltwater

- easy to use, the density can be easily measured
- precise water inlet helps prevent air bubbles, increasing accuracy of measurement

Item code	Item
65911	hydroquick



hydroquick



Tri Complex compact

## Tri Complex compact

Complete solution for all reef aquaria

It is really important that corals receive a balanced ratio of calcium and all vital trace elements. Tri Complex compact was developed according to the latest research and helps offer optimal conditions for healthy and steady coral growth.

Features:

- no mixing necessary
- highly concentrated
- developed according to latest research results
- Calcium supply without ion shift
- helps reduce water changes
- including all vital trace elements
- optimum coral growth



Content:

- component blue: pH-buffer + iodine and fluorine complex
- component red: calcium, magnesium, strontium + vital elements

Item code	Item
353.100	Tri Complex compact 2 x 2 l <b>NEW</b>
353.105	Tri Complex compact 2 x 5 l <b>NEW</b>
353.130	Tri Complex compact 2 x 30 l <b>NEW</b>

## REEF LIFE System Coral

The complete solution for supplying reef aquaria with calcium and trace elements without ion shift.

The 3 component system consists of the following components:

- calcium (System Coral A) for increasing the calcium content
- KH Buffer (System Coral B) for increasing the carbonate hardness
- trace (System Coral C) provides essential trace elements

For each dosing spoon of KH Buffer, 2 ml of the other two components have to be added.

### REEF LIFE System Coral A

Highly concentrated calcium additive for enhanced coral growth

Provides optimum calcium content in the aquarium that can be maintained simply with REEF LIFE System Coral Calcium.



REEF LIFE System Coral A

Item code	Item
350.001	REEF LIFE System Coral A Calcium 100 ml
350.002	REEF LIFE System Coral A Calcium 250 ml
350.010	REEF LIFE System Coral A Calcium 1,000 ml
350.050	REEF LIFE System Coral A Calcium 5,000 ml



**REEF LIFE System Coral B KH BUFFER**

Carbonate buffer stabilizes the pH value for a healthy aquarium

REEF LIFE System Coral B KH Buffer for increasing the alkalinity.

Item code	Item
351.001	REEF LIFE System Coral B KH Buffer 300 g/315 ml can
351.010	REEF LIFE System Coral B KH Buffer 1,000 g/1,000 ml can



REEF LIFE System Coral B KH BUFFER

**REEF LIFE System Coral C Trace**

Contains vital trace elements for fish, corals and invertebrates

Provides saltwater aquaria with vital trace elements such as boron, chrome, cobalt, copper, fluoride, iron, manganese, molybdenum and zinc.

REEF LIFE System Coral Trace does not contain any chelating agents.

Item code	Item
350.201	REEF LIFE System Coral C Trace 100 ml
350.202	REEF LIFE System Coral C Trace 250 ml
350.210	REEF LIFE System Coral C Trace 1,000 ml
350.250	REEF LIFE System Coral C Trace 5,000 ml



REEF LIFE System Coral C Trace

**Kalkwasserpowder**

For enhanced calcium supply during water top up

The addition of Kalkwasser has several positive effects on the water in a reef aquarium. The calcium level increases, the phosphate concentration is reduced by precipitation and the pH value increases. The growth of hair algae is decreased and the development of calcareous algae is encouraged.

Item code	Item
351.310	Kalkwasserpowder 350 g/1,000 ml can



Kalkwasserpowder

**NO3 reduct**

Nitrat + Phosphat control

NO3 reduct contains organic compounds that serve bacteria as an additional carbon source and thus stimulate greater reproduction. These bacteria are used by corals as food or are skimmed off. Previously absorbed nutrients disappear with them, so that the nitrate and phosphate content of the water gradually decreases. The corals use the bacteria as additional food that leads to an improvement in colour and polyp extension.

Item code	Item
411.80	NO3 reduct <b>NEW</b>



NO3 reduct



REEF LIFE Iodine

### REEF LIFE Iodine

3 component iodine for healthy coral growth and bright colours

REEF LIFE Iodine is an iodide additive especially developed for saltwater aquaria. It supplies both fresh and saltwater aquaria with iodide and organic and elementary iodine. Whereas iodide and elementary iodine are immediately available for the animals and plants, the organic bond releases iodine slowly and ensures a long term supply. Iodine is an essential trace element for all invertebrates and especially for crustacea which require iodide to assist in sloughing off their shell. When provided with iodine, corals show better growth and more intense colouring.

Item code	Item
350.401	REEF LIFE Iodine 100 ml
350.402	REEF LIFE Iodine 250 ml
350.410	REEF LIFE Iodine 1,000 ml
350.450	REEF LIFE Iodine 5,000 ml



REEF LIFE Strontium

### REEF LIFE Strontium

For healthy structure of skeleton of hard corals

REEF LIFE Strontium contains strontium ions in a form that can be easily assimilated by all invertebrates. It is essential for the production and the maintenance of the skeleton of hard corals, the shells of reef mussels and calcareous algae. In the sea, the strontium concentration is about 8 mg/l. There can be a lack of strontium in the aquarium if it isn't re-dosed regularly.

Item code	Item
350.501	REEF LIFE Strontium 100 ml
350.502	REEF LIFE Strontium 250 ml
350.510	REEF LIFE Strontium 1,000 ml
350.550	REEF LIFE Strontium 5,000 ml



REEF LIFE Magnesium

### REEF LIFE Magnesium

For natural structure of skeleton of corals and calcareous algae

For regular supply of saltwater aquaria with normal magnesium need. For aquaria with heavy magnesium consumption, we recommend REEF LIFE Magnesium compact.

Item code	Item
350.601	REEF LIFE Magnesium 100 ml
350.602	REEF LIFE Magnesium 250 ml
350.610	REEF LIFE Magnesium 1,000 ml
350.650	REEF LIFE Magnesium 5,000 ml

**REEF LIFE Magnesium compact**

For natural structure of skeleton of corals and calcareous algae

Concentrated magnesium additive for saltwater aquaria.

Item code	Item
351.601	REEF LIFE Magnesium compact 250 g/315 ml can
351.610	REEF LIFE Magnesium compact 800 g/1,000 ml can



REEF LIFE Magnesium compact

**REEF LIFE Calciumbuffer compact**

To increase the calcium level and alkalinity

The perfect solution for calcium supply. The Calciumbuffer compact contains calcium and carbonate buffer in an optimum relation.

Item code	Item
351.101	REEF LIFE Calciumbuffer compact 250 g/315 ml can
351.110	REEF LIFE Calciumbuffer compact 800 g/1,000 ml can



REEF LIFE Calciumbuffer compact

**Hydrocarbonat**

Highly pure calcium carbonate

It is used in calcium reactors, calcite filters, bio filters and as substrate material in saltwater and Malawi/Tanganyikan aquaria. A natural calciumcarbonic acid equilibrium is created in all aquaria with an alkaline pH value and in a calcium reactor supplied with CO<sub>2</sub>, the hydrocarbonate is completely dissolved to calcium bicarbonate. hydrocarbonate is available in 3 grain sizes: fine (1 – 2 mm) for 'hardening' filters, medium (4 – 6 mm) for Calciumreactors, coarse (6 – 8 mm) as filter material.

Item code	Item
410.91-1	Hydrocarbonat 1 l can fine (app. 0.25 gal)/1 kg
410.91-2	Hydrocarbonat 1 l can medium (app. 0.25 gal)/1 kg
410.91-3	Hydrocarbonat 1 l can coarse (app. 0.25 gal)/1 kg
410.92-1	Hydrocarbonat 5 l bucket fine (app. 1.3 gal)/8 kg
410.92-2	Hydrocarbonat 5 l bucket medium (app. 1.3 gal)/8 kg
410.92-3	Hydrocarbonat 5 l bucket coarse (app. 1.3 gal)/8 kg
410.93-1	Hydrocarbonat 15 l bucket fine (app. 3.9 gal)/21 kg
410.93-2	Hydrocarbonat 15 l bucket medium (app. 3.9 gal)/21 kg
410.93-3	Hydrocarbonat 15 l bucket coarse (app. 3.9 gal)/21 kg



Hydrocarbonat



fine



medium



coarse

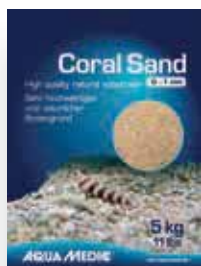

Aqua Medic Coral Sand

### Aqua Medic Coral Sand

Coral Sand (natural substrate)

Natural substrate, cleaned and without additives. Suitable for all saltwater- and malawi aquaria.

Since this is a natural product, the grain sizes and availability may vary.

Item code	Item
420.25-1	Aqua Medic Coral Sand fine, 5 kg (11 lbs) bag
420.25-2	Aqua Medic Coral Sand medium, 5 kg (11 lbs) bag
420.25-3	Aqua Medic Coral Sand coarse, 5 kg (11 lbs) bag
420.20-1	Aqua Medic Coral Sand fine, 10 kg (22 lbs) bag
420.20-2	Aqua Medic Coral Sand medium, 10 kg (22 lbs) bag
420.20-3	Aqua Medic Coral Sand coarse, 10 kg (22 lbs) bag



Aqua Medic Bali Sand

### Aqua Medic Bali Sand

- high-quality white substrate
- natural product, without additives
- supports the biodegradation of Detritus
- suitable for use in all saltwater aquaria

Aqua Medic Bali Sand is a very pure limestone that consists of about 98% of calcium carbonate as well as some zeolite-like minerals. Aqua Medic Bali Sand, like the coral reef, is a fossil natural material and is not removed from the oceans. This substrate is an alternative, producing the optimal biological effect for all aquarium inhabitants and preserving nature.

Item code	Item
420.30-1	Aqua Medic Bali Sand 0,5 – 1,2 mm, 5 kg (11 lbs) bag
420.30-2	Aqua Medic Bali Sand 2 – 3 mm, 5 kg (11 lbs) bag
420.31-1	Aqua Medic Bali Sand 0,5 – 1,2 mm, 10 kg (22 lbs) bag
420.31-2	Aqua Medic Bali Sand 2 – 3 mm, 10 kg (22 lbs) bag



Aqua Medic Tonga Pearls

### Aqua Medic Tonga Pearls

Pure, environmentally friendly substrate

Tonga Pearls is a very pure substrate made under controlled conditions. Produced lime material that consists of calcium carbonate of around 99%. Tonga Pearls is neither a fossil natural product nor is the material extracted from the sea. This resource-saving, new substrate has a corresponding crystal structure to natural coral sand so an optimal alternative. It also provides a suitable biological effect for all aquarium dwellers.

Item code	Item
420.40-1	Aqua Medic Tonga Pearls, 5 kg (11 lbs) bag
420.41-1	Aqua Medic Tonga Pearls, 10 kg (22 lbs) bag

**plancto**

Concentrated food for corals and invertebrates

plancto is a pH stabilized, high-quality concentrated food for the nutrition of plankton and saltwater invertebrates. Its unique composition and its particle size of 25 – 200 µm makes it especially suitable for plankton feeders. It is also an excellent single food source for rearing artemia. The inclusion of high taste elements results in visible stimulation of feeding tentacles to encourage high nutrient take up. Even if overdosed it is impossible to effect the animals digestive systems.

Item code	Item
340.001	plancto 100 ml
340.002	plancto 250 ml
340.010	plancto 1,000 ml
340.050	plancto 5,000 ml



plancto

**aquabiovit**

Vital vitamins for fish and invertebrates

aquabiovit is a multi vitamin compound for use in fresh and saltwater. Its formulation is suited to both, fish and invertebrates. Its regular use enhances growth, strengthens the immune system and increases the willingness to spawn.

Item code	Item
342.001	aquabiovit 100 ml
342.002	aquabiovit 250 ml



aquabiovit

**aminovit**

Contains all vital amino acids and vitamins

Amino acid concentrate for coral reef aquaria. Additional food for invertebrates, in particular for LPS, but also for gorgonians, tube worms and sponges. The animals ingest directly – the colours improve and the tissue growth is accelerated. aminovit is also ideal for enriching the dry or frozen food. Or soak the food in an equivalent quantity prior to feeding.

Item code	Item
<del>342.101</del>	<del>aminovit 100 ml</del> <b>no longer available</b>
342.102	aminovit 250 ml



aminovit



coral fit

### coral fit

Coral food

coral fit is a natural coral food suitable for SPS, LPS and soft corals. coral fit contains shell-less artemia eggs and is easily absorbed by corals.

Content: app. 210 g

Item code	Item
343.000	coral fit 210 g



pipette 35

### pipette 35

Pipette

The pipette is the ideal choice for precise feeding of fish and corals. Medications can also be dosed selectively.

Length: app. 35 cm

Item code	Item
39040	pipette 35



pipette 60

### pipette 60

Pipette

The pipette is the ideal choice for precise feeding of fish and corals. Medications can also be dosed selectively.

Length: app. 60 cm

Item code	Item
39041	pipette 60

**REEF LIFE antired**

Eliminates red slime algae

antired will successfully eliminate red slime algae in saltwater aquaria. antired is safe with invertebrates, is not harmful to nitrifying bacteria and enhances macro algae growth. During treatment, the skimmer has to remain switched on and the carbon filter has to be switched off. The dead algae should be removed rapidly by a power filter.

Item code	Item
420.001	REEF LIFE antired 100 ml
420.002	REEF LIFE antired 250 ml
420.010	REEF LIFE antired 1,000 ml
420.050	REEF LIFE antired 5,000 ml



REEF LIFE antired

**AiptaCap**

To eradicate Aiptasia &amp; Manjano anemones

AiptaCap helps prevent the spread of aiptasia and manjano anemones that can quickly become a plague in a coral aquarium, if left untreated. Once out of control, the complete removal is then virtually impossible. Therefore, it is important to act immediately. AiptaCap comes ready to use in a syringe and can be used immediately, without mixing or filling.

Item code	Item
422.000	AiptaCap



AiptaCap

**NO3 reduct**

Nitrat + Phosphat control

NO3 reduct contains organic compounds that serve bacteria as an additional carbon source and thus stimulate greater reproduction. These bacteria are used by corals as food or are skimmed off. Previously absorbed nutrients disappear with them, so that the nitrate and phosphate content of the water gradually decreases. The corals use the bacteria as additional food that leads to an improvement in colour and polyp extension.

Item code	Item
411.80	NO3 reduct <b>NEW</b>



NO3 reduct



aqua + GH

### aqua + GH

Increases the total hardness of aquarium water

aqua + GH increases the total hardness in freshwater aquaria. In connection with aqua + KH you can produce from reverse osmosis water or too soft water suitable water for fishes and plants.

Item code	Item
123.001	aqua + GH 250 g can



aqua + KH

### aqua + KH

Increases the carbonate hardness of aquarium water

Through a correct adjusted carbonate hardness you could avoid harmful pH up- and downturns. By using aqua + KH the pH level could be stabilized and the carbonate hardness could be increased. In combination with aqua + GH you can produce from reverse osmosis water fish and plant suitable water.

Item code	Item
123.101	aqua + KH 300 g can



aqualife + Vitamine

### aqualife + Vitamine

High effective water treatment preparation for freshwater aquaria

Tap water often contains heavy metal and chlorine that harms the fishes, it causes diseases and symptoms of poisoning. aqualife + Vitamine contains suitable chelates and reducer that binds the harmful substances respectively transfers it in harmless compounds. Special protective colloids that have been approved since many years, strengthens the protective function of the mucosa and keep the sensitive craw/intestinal tract of the animals from damages.

Useful vitamins improve the body's defences of the fishes and enhance their well-being.

Item code	Item
120.001	aqualife + Vitamine 100 ml
120.002	aqualife + Vitamine 250 ml
120.010	aqualife + Vitamine 1,000 ml
120.050	aqualife + Vitamine 5,000 ml



**ferreal + spureal**

Intensive iron fertilizer for freshwater aquaria

ferreal + spureal is a combination compound. It contains beside iron more essential micro elements such as manganese, molybdenum, boron, zinc and cobalt. ferreal + spureal prevents with continuous application reduced growth, the yellowing of the leaves and strengthens the plants. The colours of the plants become an intensive glow.

Item code	Item
121.001	ferreal + spureal 100 ml
121.002	ferreal + spureal 250 ml
121.010	ferreal + spureal 1,000 ml
121.050	ferreal + spureal 5,000 ml



ferreal + spureal

**floreal + iod**

High effective compound fertilizer for freshwater aquaria

floreal + iod is an indispensable instrument to ferreal + spureal that adjust the mineral balance of the plants and beyond supplies them with iodine and fluoride. Through this the growth of the plants will be increased. Furthermore iodine increases the vitality and the willingness to spawn of the fish. The contained iodine will be released slowly over several days whereby it is continued available.

Item code	Item
122.001	floreal + iod 100 ml
122.002	floreal + iod 250 ml
122.010	floreal + iod 1,000 ml
122.050	floreal + iod 5,000 ml



floreal + iod

**aquapHloor**

Nutritious substrate, decreases the pH value

aquapHloor substrate is especially suitable for plant aquaria and shrimp tanks. It is not suitable for aquaria with strong digging inhabitants. aquapHloor has pH-decreasing and stabilizing features that are preferred by many plants and animals from the soft water areas of the world. The substrate doesn't need to be washed before putting it into the aquarium. If the water is cloudy then, it will be clear again soon. It's a nutritious substrate, ensuring strong plant growth. The shape of granules with a grain size of 2 – 3 mm ensures good oxygen supply of the plant roots and also serves as a settlement substrate for vital bacteria.

Item code	Item
21135	aquapHloor 3.5 kg - Soil



aquapHloor





aquabreed complete

### aquabreed complete

Artemia cultivation unit

A cultivation unit for hatching larger quantities of artemia cysts. The unit can be installed inside or outside of the aquarium if positioned in a warm environment. The hatch time depends on the ambient temperature. Capacity app. 2,000,000 cysts per hatch. After about 2 weeks, the animals are fully grown and can be used as food. The unit may also be used for the breeding of artemia.

A stable wall holder and a pump for ventilation are included. A drain valve with a large diameter prevents clogging during emptying. The optimal installed outlet valve allows a measured removal of hatched artemia whilst the shells remain in the culture unit. The push to open lid makes filling the hatchery easier.

Contents: aquabreed complete reactor (app. volume 1 litre), support plate Ø app. 8 cm (app. 3.24")

Length: app. 52 cm (app. 17")

Hose connection: 6 mm (app. 1/4"), air pump Mistral 50 ECO

Item code	Item
35020	aquabreed complete



plankton reactor

### plankton reactor

Zooplankton cultivation unit

Many species of salt- and freshwater zooplankton can be cultivated in the plankton reactor. The zooplankton is fed with micro-algae from the plankton light reactor. The zooplankton has great growth potential: under optimal algal nutrition the number of rotifers (Brachionus) may double over four days. Brachionus is the ideal food for raising many saltwater fish larvae and invertebrates in the saltwater aquarium. Contents: plankton reactor app. volume 2.5 litre (app. 0.65 gal), wall bracket and connections for air pump. Ø 8 cm (app. 3.2"). Length: 80 cm (app. 32"). Hose connection: 6 mm (app. 1/4")

Item code	Item
35005	plankton reactor



plankton light reactor

### plankton light reactor

Phytoplankton (Micro-algae) cultivation unit

The plankton light reactor is a simple system for producing plankton in a natural food chain. Within the plankton light reactor, micro-algae are produced with light, fertiliser and CO<sub>2</sub>. The micro-algae can be fed directly to many filter-feeding invertebrates, especially to zooplankton. The growth rate of the micro-algae in the plankton light reactor is enormous. If the supply of light, CO<sub>2</sub> and nutrients is continuous, the biomass of the algae may increase four-fold within 24 hours. Both fresh- and saltwater species of phytoplankton can be cultivated.

Contents: plankton light reactor app. volume 2.5 l (app. 0.65 gal), wall bracket, connections for air pump, lighting unit with fluorescent lamp (18 W), special reflector and fixing clamps. Ø app. 8 cm (app. 3.2").

Length: app. 80 cm (app. 32"). Hose connection: 6 mm, (app. 1/4")

Item code	Item
35000	plankton light reactor

## Titan

Titan	150	500	1500	2000	4000
For aquaria up to	100 – 250 l	250 – 500 l	700 – 1,500 l	1,500 – 2,500 l	3,000 – 4,000 l
Compressor power	0.1 PS	0.25 PS	0.5 PS	1 PS	2 PS
Power supply	220 – 240 V/50 Hz				
Power uptake	150 W	190 W	375 W	550 W	1,500 W
Cooling power	200 W	395 W	790 W	1,650 W	4,000 W
Recommended water flow (l/h)	200 – 1,500	500 – 2,000	800 – 2,500	2,000 – 4,000	3,000 – 6,000
Connections	14 mm 1/2" or 20 mm 3/4"	20 mm 3/4" or 25 mm 1"			32 mm 1 1/4" or 37 mm 1 1/2"
Max. dB/ at a distance of 1 metre	49	52	53	58	69
Hysteresis	1°				
Housing material	ABS/powder-coated metal				
Heat exchanger material	Titanium				
Cooling gas	R134a				
Dimensions (l x w x h) mm, app.	350 x 300 x 350	390 x 340 x 390		400 x 500 x 440	540 x 700 x 650
Weight	13 kg	14.7 kg	16.4 kg	28.1 kg	60.5 kg



Titan 150



Titan 4000

Item code	Item
105.015	Titan 150
105.050	Titan 500
105.150	Titan 1500
105.200	Titan 2000
105.400	Titan 4000 <b>no longer available</b>

## arctic breeze

Silent long life fans, with real ball bearing and brush free motor. 12 V low voltage with adjustable transformer (3 – 12 V) for speed control. By this, the cooling power can be adjusted. High capacity fans, adjustable from 80,000 l/h (double unit at 12 V) to 240,000 l/h (6 fold unit at 12 V). Power uptake only 0.5 – 3 W per fan.

arctic breeze aquarium fans can easily be fixed at the aquarium frame. It cools down the water by increasing the evaporation. The complete construction is made from corrosion proof plastic and aluminium.

For temperature-dependent control we recommend optional the use of our T controller twin.

Dimensions (l x w x h):

arctic breeze 2-pack: app. 16 x 4 x 15 cm

arctic breeze 4-pack: app. 28 x 4 x 15 cm

arctic breeze 6-pack: app. 40 x 4 x 15 cm

Item code	Item
107.102	arctic breeze 2-pack
107.104	arctic breeze 4-pack
107.106	arctic breeze 6-pack



arctic breeze 2-pack



arctic breeze 4-pack



arctic breeze 6-pack



Titan 6000 Professional

### Titan Professional

For heating and cooling

Titan Professional	4000	6000	8000	15000
Dimensions (l x w x h) mm app.	740 x 410 x 740	740 x 410 x 740	750 x 460 x 750	850 x 550 x 980
Net weight (kg) app.	73	68	78	150
Power supply (V)	220 – 240 V/50 Hz			380 V; 3 Ph./50 Hz
Cooling capacity (W) app.	3,800	5,200	7,200	14,900
Heating capacity (W) app.	3,800	5,200	7,200	14,900
Compressor power (HP)	1.5	2	3	5
Power uptake cooling (kW) app.	1.25	1.78	2.34	3.95
Power uptake heating (kW) app.	1.08	1.40	1.75	2.9
Rated current consumption (A) app.	6.5	9.8	12.5	20.8
Recommended flow rate (l/h)	3,000 – 10,000	4,000 – 12,000	6,500 – 16,000	10,000 – 32,000
For aquaria up to (l)				
ΔT = 5 °C	4,000	6,000	8,000	15,000
ΔT = 10 °C	2,000	3,000	4,000	7,500
Cooling agent and cooling quantity (g) app.	R410A – 1,180 g	R410A – 1,080 g	R410A – 1,300 g	R410A – 2,400 g
Heat exchanger	Titanium			
Diameter water in-outlet	1 1/2" / 50 mm			
Ambient temperature app.	5 °C – 38 °C			
Temperature control range app.	5 °C – 36 °C			
Max. water pressure	≤ 0.2 bar			
Hysteresis	1 °C			
Housing material	X5CrNiMo 17-12-2 (corrosion-resistant steel (V4A))			

Item code	Item
108.040	Titan 4000 Professional <b>NEW</b>
108.060	Titan 6000 Professional
108.080	Titan 8000 Professional
108.150	Titan 15000 Professional

Larger cooling units on demand!



Titanium Heater

### Titanium Heater

Titan Aquarium Heater

Titanium heaters are the safe alternative to glass heaters in both fresh- and saltwater aquaria. The unbreakable titanium housing is saltwater resistant and the heaters have both overheat and dry running protection cutouts. The heaters must be used in combination with a temperature controller. For temperature-dependent control we recommend optional the use of our T controller twin. Ø 20 mm

Item code	Item
110.010	Titanium heater 100 W, for aquaria up 100 – 250 l, length: app. 27 cm (app. 10.6")
110.020	Titanium heater 200 W, for aquaria up 250 – 500 l, length: app. 28 cm (app. 11")
110.030	Titanium heater 300 W, for aquaria up 500 – 1,000 l, length: app. 30 cm (app. 11.8")
110.050	Titanium heater 500 W, for aquaria up 1,000 – 1,500 l, length: app. 32 cm (app. 12.6")

### T controller twin

Digital temperature monitor and controller, for the control and monitoring of heating systems and cooling units simultaneously

The temperature controller T controller twin is used for controlling both heating systems and cooling units. Measuring and switching accuracy is 0.1°C. The control range varies from 16 – 40°C, and the set value is in 0.1 °C increments. **The maximum load for heating systems is 1,200 watts and 460 watts for cooling units.** Because of the integrated double socket it is possible to connect a heating system and cooling unit simultaneously. The T controller twin is supplied with a waterproof temperature probe. The LCD display provides instant information on the current temperature. The minimum and maximum values can be easily adjusted.

Item code	Item
200.25	T controller twin



### heat controller duo II

Digital temperature monitor and controller, for controlling and monitoring of under gravel heater and other heating systems

The temperature controller heat controller duo II is used for controlling heaters and under gravel heating systems at the same time. Measuring and switching accuracy is 0.1 °C. The control range varies from 0 – 50 °C, the set value is in 0.1 °C increments and is controlled exactly to 1 °C. The maximum load for the heating systems and under gravel heater is 1,200 watts. Because of the integrated double socket it is possible to connect a heater and an under gravel heating system simultaneously. The heat controller duo II is supplied with a temperature probe attached. The LCD display provides instant information on the current temperature, time and state of the connected units. The heating cable is controlled by a timer, the on/off time can be programmed. If the set value is not reached, the under gravel heater is switched on. To avoid overheating, both sockets switch off as soon as the set value is reached.

Item code	Item
200.32	heat controller duo II <b>NEW</b>





cool control



## cool control

Digital temperature monitor and controller, for the control and monitoring of fans

The temperature controller cool control with touch screen display is used for controlling 12 or 24 volt fans with coaxial connectors (5.5 mm x 2.1 mm). The switching accuracy is 0.5 °C. The control range varies from 0 – 36 °C, and the set value is in 0.1 °C increments. The cool control is supplied with a waterproof temperature probe. The LCD display provides instant information on the current temperature. The set value and fan power (10 – 99%) are also displayed and can be easily adjusted.



- high and reliable switching accuracy
- maximum switching power: 65 W
- dimensions: l x w x h app. 120 x 62 x 28 mm
- cable length power supply to the fan: 150 cm
- cable length temperature sensor: 100 cm

Item code	Item
200.26	cool control <b>NEW</b>

**EcoDrift x.3**

High-performance current pump with App-control for adjusting the flow rate and wave frequency

- "ultra silent" due to optimized control electronics
- incl. controller
- control and programming via App (iTunes and Google Playstore) or manually via the controller
- simultaneous control of several pumps possible
- multiprogramming of pumps via master-slave or cross-flow possible
- different flow patterns can be set
- performance increase of up to 10% thanks to plug-on power diffuser
- magnetic holder with vibration-reducing rubber dampers; variable flow direction
- 0 – 10 V connection for external control options
- 24 V safety tension, incl. transformer 100 – 240 V / 50 – 60 Hz

EcoDrift	EcoDrift 4.3	EcoDrift 8.3	EcoDrift 15.3	EcoDrift 20.3
For aquaria up to	300 l	800 l	1.500 l	2.000 l
Capacity adjustable	up to 4.000 l/h	up to 8.000 l/h	up to 15.000 l/h	up to 20.000 l/h
Power consumption	3 – 10 watts	8 – 20 watts	10 – 35 watts	20 – 60 watts
Power supply	100 – 240 V/50 – 60 Hz			
Dimensions, app.	80 mm, Ø 70 mm	105 mm, Ø 85 mm	136 mm, Ø 110 mm	146 mm, Ø 110 mm
Magnet holder for glass thickness up to	15 mm	15 mm	15 mm	15 mm

Item code	Item
103.804	EcoDrift 4.3 <b>NEW</b>
103.808	EcoDrift 8.3 <b>NEW</b>
103.815	EcoDrift 15.3 <b>NEW</b>
103.820	EcoDrift 20.3 <b>NEW</b>



EcoDrift x.3





Power Diffusor



EcoDrift x.3 controller







SmartDrift x.1



SmartDrift x.1 controller



## SmartDrift x.1

Compact "ultra silent" current pump with App-control for adjusting the flow rate and wave frequency

- control and programming via App (iTunes and Google Playstore) or manually via the controller
- simultaneous control of several pumps possible
- multiprogramming of pumps via master-slave or cross-flow possible
- different flow patterns can be set
- new flow pattern due to innovative impeller technology ensures extreme smooth running
- polished ceramic shaft and bearings for quiet operation and low maintenance
- power-saving D/C motor 24 V, high efficiency
- 0 – 10 V connection for external control options
- 24 V safety tension, incl. transformer 100 – 240 V / 50 – 60 Hz

SmartDrift	SmartDrift 3.1	SmartDrift 7.1	SmartDrift 11.1
For aquaria up to	300 l	800 l	1.500 l
Capacity adjustable	up to 4.600 l/h	up to 10.500 l/h	up to 16.000 l/h
Power consumption	3 – 15 watts	8 – 25 watts	10 – 35 watts
Power supply	100 – 240 V/50 – 60 Hz		
Dimensions, app.	55 mm, Ø 65 mm	65 mm, Ø 75 mm	70 mm, Ø 85 mm
Magnet holder for glass thickness up to	10 mm	12 mm	15 mm

Item code	Item
103.203	SmartDrift 3.1 <b>NEW</b>
103.207	SmartDrift 7.1 <b>NEW</b>
103.211	SmartDrift 11.1 <b>NEW</b>



**extension cord DC Runner/EcoDrift**

For cable extension between pump and controller

**Please note:** Only one extension cord per controller may be used. If several extension cables are connected to a controller, a proper function cannot be guaranteed.

Item code	Item
100.301	extension cord DC Runner/EcoDrift 1.8 m



**connection cord DC 0 – 10 V**

Connection cable 0 – 10 V

Connection cable to connect DC-Controller to a 0 – 10 V controller

suitable for:

- EcoDrift x.1 series
- EcoDrift x.2 series
- DC Runner x.1 series
- DC Runner x.2 series

length: app. 200 cm

Item code	Item
100.302	connection cord DC 0 – 10 V <b>NEW</b>



**variocare**

Concentrate for cleaning pumps and other fresh and saltwater aquarium equipment

Mix 100 ml of variocare with 1,000 ml water. For heavy impurities, the dose can be increased or can even be used without diluting. Depending on the degree of soiling, the equipment to be cleaned can left for several hours in variocare, the maximum application time is 24 hours. Then rinse under running water and brush off residues. Repeat the procedure for persistent dirt. The cleaner must not enter the aquarium. Can be used multiple times, the solution is exhausted when the colour changes from red to yellow.

Item code	Item
100.900	variocare 1,000 ml





DC Runner 9.3



DC Runner x.3 series



DC Runner x.3 controller



## DC Runner x.3

Powerful, adjustable universal pumps with App-control for aquaria

- “ultra silent” due to optimized control electronics
- for use as a circulation or current pump in salt or freshwater aquaria
- control and programming via App (iTunes and Google Playstore) or manually via the controller
- incl. controller
- simultaneous control of several pumps possible
- 24 hour performance can be programmed
- 0 – 10 V connection for external control options
- rugged pump housing
- power-saving D/C motor 24 V, high efficiency
- polished ceramic shaft and bearings for quiet operation and low maintenance for many years
- submerged and non-submerged use is possible

DC Runner	1.3	2.3	3.3	5.3	9.3
Power supply pump	24 V				
Power supply transformer	100 – 240 V / 50 – 60 Hz				
Pump power	up to 1,200 l/h	up to 2,000 l/h	up to 3,000 l/h	up to 5,000 l/h	up to 9,000 l/h
max. head	up to 1.5 m	up to 2.2 m	up to 2.7 m	up to 3.5 m	up to 4.8 m
Power consumption	max. 12 watts	max. 20 watts	max. 25 watts	max. 50 watts	max. 65 watts
Connection suction side	25 mm / 1 inch	25 mm / 1 inch	32 mm / 1¼ inch	32 mm / 1¼ inch	40 mm / 1½ inch
Connection pressure side	20 mm / 0,8 inch	25 mm / 1 inch	25 mm / 1 inch	32 mm / 1¼ inch	40 mm / 1½ inch
Pre-filter basket	✓	✓	✓	✓	–
Hose connections	–	✓	✓	✓	✓
Screw joints	–	✓	✓	✓	✓
Protection rating	IP X8				
Dimensions in mm app. l x w x h (incl. basket)	125 x 60 x 85	140 x 68 x 100	195 x 90 x 115	190 x 95 x 125	–
Dimensions in mm app. l x w x h (without basket)	90 x 60 x 85	105 x 68 x 100	145 x 90 x 115	170 x 95 x 125	180 x 95 x 135

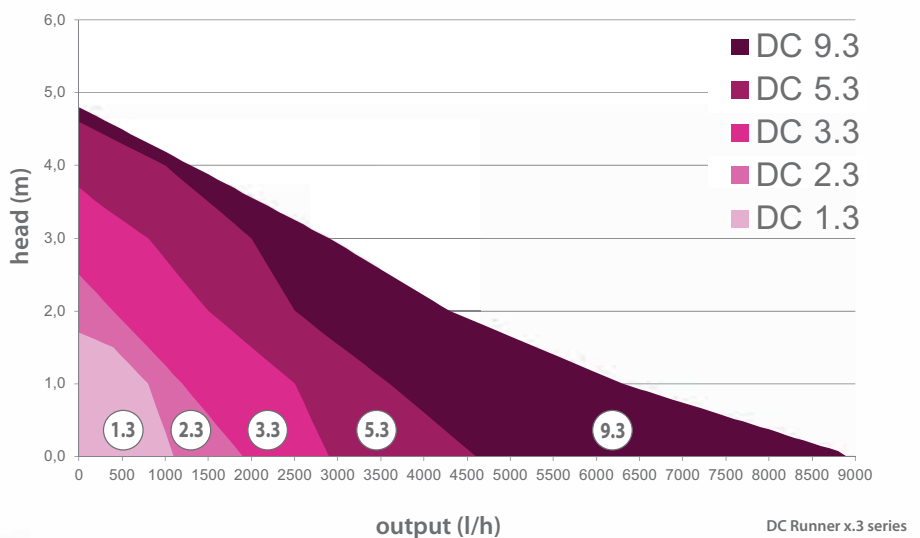

Item code	Item
100.813	DC Runner 1.3 <b>NEW</b>
100.823	DC Runner 2.3 <b>NEW</b>
100.833	DC Runner 3.3 <b>NEW</b>
100.853	DC Runner 5.3 <b>NEW</b>
100.893	DC Runner 9.3 <b>NEW</b>

**extension cord DC Runner/EcoDrift**

For cable extension between pump and controller

**Please note:** Only one extension cord per controller may be used. If several extension cables are connected to a controller, a proper function cannot be guaranteed.

Item code	Item
100.301	extension cord DC Runner/EcoDrift 1.8 m



extension cord DC Runner/EcoDrift

**connection cord DC 0 – 10 V**

Connection cable 0 – 10 V

Connection cable to connect DC-Controller to a 0–10 V controller

suitable for:

- EcoDrift x.1 series
- EcoDrift x.2 series
- DC Runner x.1 series
- DC Runner x.2 series

length: app. 200 cm

Item code	Item
100.302	connection cord DC 0 –10 V <b>NEW</b>



connection cord DC 0 – 10 V



AC Runner 9.2



### AC Runner x.2

Powerful universal pump for aquaria

220 V – 240 V / EU-Plug only

- for use as a circulation or current pump in salt or freshwater aquaria
- rugged pump housing
- polished ceramic shaft and bearings for quiet operation and low maintenance
- submerged and non-submerged use is possible
- including prefilter basket and hose connections (AC Runner 3.2 + 5.2)
- including hose connections (AC Runner 9.2 + 12.2)



AC Runner x.2 series



AC Runner	3.2	5.2	9.2	12.2
Pump power - l/h	up to 3,000	up to 5,000	up to 9,000	up to 12,000
Max. head	up to 2.7 m	up to 4.2 m	up to 5 m	up to 5.5 m
Total power consumption	max. 27 W	max. 44 W	max. 78 W	max. 92 W
Power supply pump	220 V – 240 V / 50 Hz			
Suction side Ø	32 mm/ 1 1/4 inch	32 mm/ 1 1/4 inch	40 mm/ 1 1/2 inch	40 mm/ 1 1/2 inch
Pressure side Ø	25 mm/ 1 inch	32 mm/ 1 1/4 inch	40 mm/ 1 1/2 inch	40 mm/ 1 1/2 inch
Protection rating	IP X8			
Dimensions in mm (l x w x h), app.	155 x 90 x 115 (195 x 90 x 115)	175 x 105 x 125 (195 x 105 x 125)	195 x 115 x 130 (basket not included)	195 x 115 x 130 (basket not included)

Dimensions are indicated without fittings / dimensions within brackets mean including basket



Impeller AC Runner

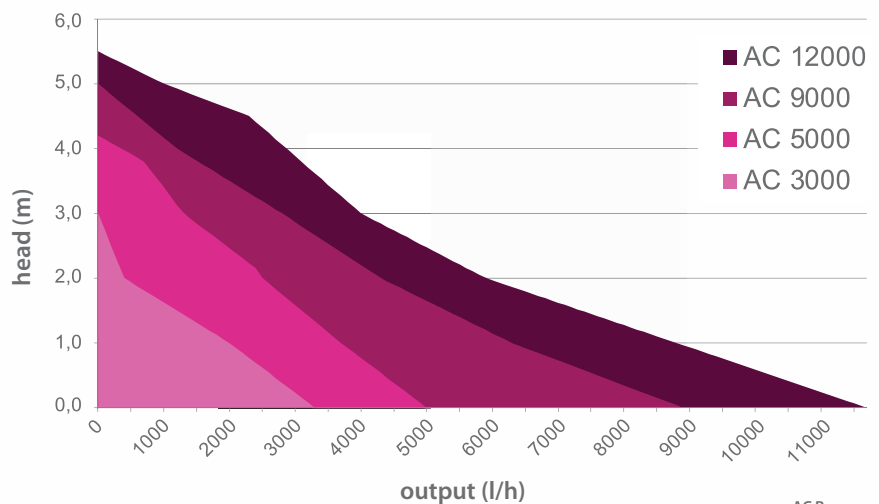

AC Runner series

Item code	Item
100.432	AC Runner 3.2 <b>NEW</b>
100.452	AC Runner 5.2 <b>NEW</b>
100.492	AC Runner 9.2 <b>NEW</b>
100.522	AC Runner 12.2 <b>NEW</b>

**Pump NK / OK, motor protection switch**

Circulation pump OK / NK

The OK and NK-series circulation pumps are powerful units having a capacity between 13 and 33 m<sup>3</sup>/h. With the housing moulded in plastic, the pumps are completely saltwater resistant. To improve the operating characteristics OK and NK pumps have an integrated prefilter and the impeller shaft has a rotating seal.



Pumpe NK/OK	NK 25	NK 33	OK 33	OK 51	OK 71	OK 100
m <sup>3</sup> /h at 10 m	–	4.0	4.8	6.6	10.0	14.5
Max. flow at 5 m	8,000 l*	11,000 l*	9,600 l	11,000 l	13,900 l	20,000 l
Max. head	9.25 m	11 m	12 m	14 m	15.5 m	15 m
Power (watts)	0.27	0.30	0.45	0.58	0.75	1.00
A			2.45	2.65	4.00	4.70
V	230	230	230	230	230	230
Dimensions cm (l x w x h), app.	43 x 21 x 27		47.5 x 24 x 31			50 x 24 x 31

\* max. flow at 3 m

Connections: 1 1/2" and/or adhesive connection (inside Ø 50 mm, outside Ø 63 mm)

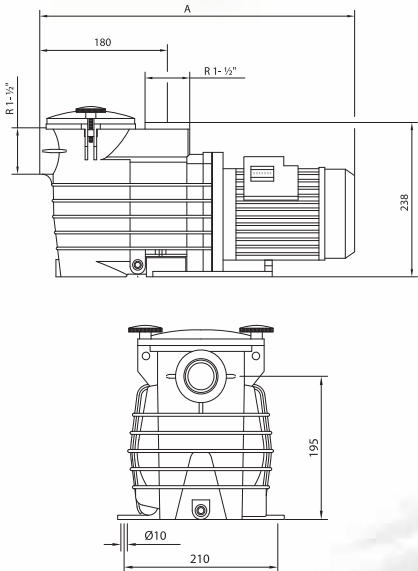
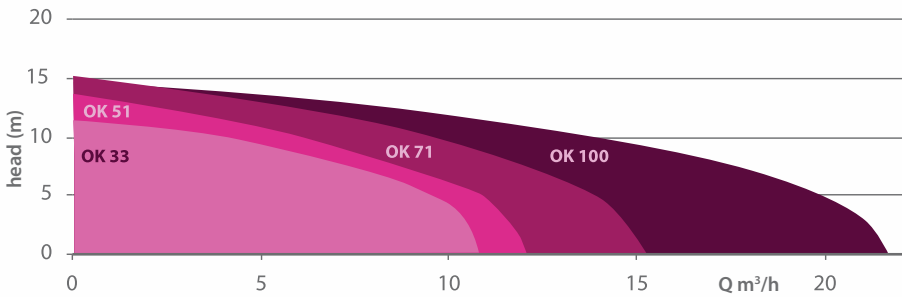

Item code	Item
400.00-19	pump NK 25.B
400.00-20	pump NK 33.B
400.00-21	pump OK 33.B
400.00-22	pump OK 51.B
400.00-23	pump OK 71.B
400.00-24	pump OK 100.B
400.01	motor protection switch pump NK 25 / NK 33 / OK 33
400.02	<del>motor protection switch pump NK 33/OK 33</del> no longer available
400.03	motor protection switch pump OK 51 / OK 71
400.04	<del>motor protection switch pump OK 71</del> no longer available
400.06	motor protection switch pump OK 100

(Necessary to use with any NK or OK pump!)  
 Warranty is void, if pumps are used without motor protection switch!



Mistral II 4000

Mistral II 2000

very stable aluminium housing

## Mistral II

Powerful diaphragm air pumps for aquaria

This family of powerful diaphragm air pumps has a cast aluminium housing to ensure long life and silent operation. The special membrane guarantees for a long life, with built-in air filter. They are ideally suited for supplying air lift filters, air stones and protein skimmers using either ceramic or wooden air diffusers.

Mistral II	2000	4000
Power requirements	220 – 240 V~/50 Hz	
Power uptake	20 watts	38 watts
Maximum capacity	2,100 l/h	3,900 l/h
Capacity at 1 m (3 ft) depth (100 mbar, 1.45 psi)	1,200 l/h (300 gph)	2,400 l/h (600 gph)
Maximum pressure	> 280 mbar (4.04 psi)	> 350 mbar (5.05 psi)
Connection pressure side	air tube 12 mm (½")	
Cable length	app. 1.8 m	
Weight	2.7 kg (app. 5.95 lbs)	3.4 kg (app. 7.50 lbs)
Housing	cast aluminium	
Dimensions in cm (l x w x h), app.	19.2 x 12.0 x 14.6	20.8 x 13.5 x 18.0

Item code	Item
101.201	Mistral II 2000 <b>NEW</b>
101.401	Mistral II 4000 <b>NEW</b>

### reefdoser EVO 4

4-channel dosing pump incl. external controller

The Aqua Medic reeferdoser EVO 4 can independently control the four dosing pumps included in the package. The dispensing of the food or additive can be achieved either manually or automatically; all pumps can be calibrated individually. The interval control allows for adjustment of the duration of the on/off cycle for each pump over a broad time span – from seconds to days. reeferdoser EVO 4 can automate many tasks in an aquarium:

- regular dispensing of trace elements and fertilizers in salt- and fresh water aquarium
- controlled addition of calcium and bicarbonate into coral reef aquaria
- accurate dosing of Kalkwasser
- automatic feeding with live zoo plankton
- the external controller can be placed in a position away from the pumps to make it easy to use and allow for very simple programming

Incl. 4 m inlet hose (can be adjusted individually) to connect the dosing pumps to the containers with the dosing liquids.

Dimensions: app. 25 x 13 x 6.4 cm (l x w x h)

Item code	Item
104.144	reeferdoser EVO 4

Options:

104.144-31	pump head (V.2)
------------	-----------------



reeferdoser EVO 4



### reeferdoser add 4

reeferdoser EVO 4 - Expandable to eight dosing pumps

Incl. 4 m inlet hose (can be adjusted individually) to connect the dosing pumps to the containers with the dosing liquids.

Dimensions: app. 25 x 13 x 6.4 cm (l x w x h)

Item code	Item
104.145	reeferdoser add 4



reeferdoser add 4

### 6-tubes

Acrylic tube holder to attach up to six tubes (max. Ø 6 mm) on to the glass edge.

Item code	Item
410.37	6-tubes

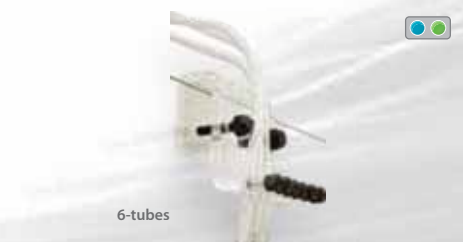

6-tubes

### hose clip

Plastic clip

Flexible plastic clip designed for the safe fastening of hoses.

Item code	Item
410.38	hose clip Ø 5 – 6 mm
410.39	hose clip Ø 6 – 7 mm

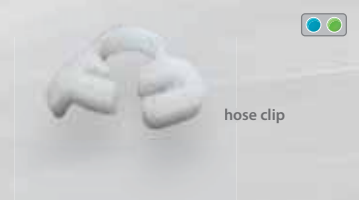

hose clip



Dosing pump

### Dosing pump SP 3000

The SP 3000 is a hose pump for pumping small amounts of water. It can be used for bypass filters such as the Nitratoreductor and the Calciumreactor, to top up evaporated water when combined with an aquaniveau and for the automatic dosing of fertilizers and minerals. In freshwater aquaria, the iron fertilizer ferreal can be added daily. The pump is supplied with a long life Santoprene® hose.

SP 3000: 3.0 l/h (app. 0.08 gph), 4.5 watts

Item code	Item
104.030	Dosing pump SP 3000



SP 3000 Niveumat

### SP 3000 Niveumat

Automatic top up unit with peristaltic pump and float switch

The SP 3000 Niveumat will automatically top up evaporated water in fresh and saltwater aquaria. It comprises a Niveumat SP 3000 peristaltic pump with a directly connected float switch. The float switch is installed in the aquarium or filter tank at the desired level using its holding unit. As the level drops the Niveumat SP 3000 automatically tops up the tank with water from a reservoir (not supplied).

Technical data Niveumat:

Capacity: 3 l/h pump, hose: Santoprene®, power consumption: 4.5 watts

Item code	Item
104.031	SP 3000 Niveumat



**power flotor**

Compact and adjustable skimmer for sump use

We offer the power flotor skimmer in three different sizes: S for aquaria up to 300 litres, M for aquaria up to 400 litres, L for aquaria up to 500 litres.

Equipment:

- integrated, adjustable 24 V pump DC Runner incl. controller with button to allow skimmer to pause for feeding. 0 – 10 V connection enabled
- optimum bubble size and shape due to the effective Power Wheel
- near silent operation with the adjustable water outlet positioned on the bottom of the housing
- silencer that can be positioned freely
- foaming is adjustable both electronically and manually
- compact design allows for use in small areas
- can be completely dismantled for easy cleaning



power flotor S

power flotor	S	M	L
For aquaria	up to 300 l	up to 400 l	up to 500 l
Total consumption	max. 13 watts	max. 13 watts	max. 13 watts
Pump	DC Runner	DC Runner	DC Runner
Air power	max. 350 l/h	max. 400 l/h	max. 450 l/h
Total height	app. 42 cm	app. 45 cm	app. 48 cm
Required space	app. 15 x 15 cm	app. 15 x 15 cm	app. 15 x 15 cm
Optimum water level in the filter sump	app. 14 – 18 cm	app. 14 – 18 cm	app. 16 – 20 cm



power flotor M

power flotor L

Item code	Item
411.210	power flotor S
411.220	power flotor M
411.230	power flotor L



K1



### K1 / K2 / K3

Motor driven skimmer

Adjustable and very powerful skimmer for the sump

- adjustable 24 V-pump DC Runner incl. controller with button to allow skimmer to pause for feeding. 0 – 10 V connection enabled
- high air entry, optimum bubble size and shape due to the Power Wheel
- near silent operation with the adjustable water outlet positioned on the bottom of the housing
- silencer that can be positioned freely
- foaming is adjustable both electronically and manually
- compact design allows for use in small areas
- can be completely dismantled for easy cleaning



K2



K3

	K1	K2	K3
For aquaria	100 – 500 l	200 – 1,000 l	300 – 1,500 l
Total consumption	max. 18 W	max. 31 W	max. 58 W
Pump	DC Runner K1	DC Runner K2	DC Runner K3
Air power	max. 1,000 l/h	max. 1,800 l/h	max. 3,100 l/h
Total height	app. 45 cm	app. 48 cm	app. 54 cm
Height foam cup	app. 48 cm	app. 51 cm	app. 57 cm
Required space	app. 31 x 25 cm	app. 40 x 26 cm	app. 45 x 30 cm
Opt. water level in filter sump	app. 14 – 18 cm	app. 18 – 23 cm	app. 18 – 23 cm

Item code	Item
412.210	K1
412.220	K2
412.230	K3



Controller

**EVO 500**

Motor driven adjustable internal skimmer

The power driven EVO 500 is especially characterized by the power-saving and efficient pump DC Runner 1.2 (incl. DC motor) with power consumption of max. 7 watts. The pump power can be continuously adjusted by the included controller. Two holding systems for individual fixing, adjustable in height making it suitable for many different styles of aquarium. 3D needle wheel will provide a large amount of air and optimum bubble structure. High skimming capacity is achieved by the special water flow with a patented conical foam cup.

EVO	EVO 500
For aquaria up to	250 l
Pump	DC Runner 1.2
Power supply pump	24 V
Power supply transformer	110 – 240 V/50 – 60 Hz
Power consumption	max. 7 W
Total height	app. 36.5 cm
Dimensions (l x w x h):	app. 14 x 8 x 36.5 cm (app. 5.6" x 3.2" x 14.6")
Immersion depth	app. 23 cm

Item code	Item
410.006	EVO 500



EVO 500



**EVO 1000**

Motor driven adjustable internal and external skimmer

The power driven skimmers are especially characterized by the power-saving and efficient DC Runner pump (incl. DC motor). The pump power can be continuously adjusted by the included controller. The skimmers are designed for installation in any mode: as a "hang on", it is simply hung over the edge of the aquarium. Only the venturi pump is inside the tank. The 3D needle wheel will provide a large amount of air and optimum bubble structure.

EVO	EVO 1000
For aquaria up to	500 l
Pump	DC Runner 1.2
Power supply pump	24 V
Power supply transformer	110 – 240 V/50 – 60 Hz
Power consumption	max. 9 W
Total height	app. 46 cm
Required space	app. 25 x 11 cm

Item code	Item
410.011	EVO 1000



EVO 1000



Turboflotor 5000 Shorty II

### Turboflotor 5000 Shorty II

Powerful skimmers for in cabinet installation

The water supply to the skimmer requires a second pump with a capacity of minimum 2,000 l/h (app. 500 gph). The skimmer may also be directly connected to the overflow of the aquarium.

Total height with foam cup Shorty II: app. 73 cm (footprint app. 30 x 50 cm)

Item code	Item
410.17	Turboflotor 5000 Shorty II for aquaria up to 1,500 l



Turboflotor 5000 baby ECO

Turboflotor 5000 single 6.0



### Turboflotor 5000

Powerful skimmer with longer contact time for aquaria from 1,500 – 5,000 l (app. 375 – 1,250 gal)

The skimmer 5000 series were developed for larger aquaria. The reaction pipe has a diameter of 200 mm. A separate pump (2,000 – 3,500 l/h) is required for the water supply, e. g. DC Runner 5.2 or AC Runner 3.2. The venturi pumps of our DC Runner-series with Power wheel have a high skimming power, are very quiet in operation and have a low power consumption.

T 5000 baby ECO: Total height app. 107 cm, required space app. 50 x 29 cm (without outlet D40). Venturi pump - app. 60 watts

T 5000 single 6.0: Total height app. 185 cm, required space app: app. 50 x 29 cm (without outlet D40). Venturi pump - app. 60 watts

Item code	Item
400.015	Turboflotor 5000 baby ECO for aquaria up to 2,000 l
400.021	Turboflotor 5000 single 6.0 for aquaria up to 5,000 l
400.016	Turboflotor 5000 baby ECO, 220 V / 50 Hz <b>NEW</b> for aquaria up to 2,000 l
400.022	Turboflotor 5000 single 6.0, 220 V / 50 Hz <b>NEW</b> for aquaria up to 5,000 l



Trickle filter T 5000 single 6.0

### Tricklefilter

for Turboflotor 5000 single 6.0

The trickle filter is suitable for the connection at the Turboflotor 5000 single 6.0, filled with BactoBalls, app. 20 cm Ø. Height: app. 155 cm, footprint: app. 30 x 35 cm

Item code	Item
410.026	Trickle filter for Turboflotor 5000 single 6.0

**Turboflotor 10000**

It is made of an acrylic pipe and is designed for flow rates up to 10,000 l/h (app. 2,500 gph). It is recommended for larger aquaria up to 10,000 litres (app. 2,500 gallons) and professional aquaculture systems.  
 Technical data: Reaction chamber Ø: 50 cm (app. 20"), total height including foam cup: 200 cm (app. 80"), injector pump power consumption incl. motor protection switch: 500 watts, max. water flow: 10,000 l/h (app. 2,500 gph)

Item code	Item
400.05	Turboflotor 10000
400.15	Turboflotor 10000 w/o pump

Turboflotor 10000



**Turboflotor 20000**

Protein Skimmer for large aquaria

With the production of this skimmer Aqua Medic enters the area of water treatment for large professional aquaria. A powerful pump is combined with a venturi to provide an injection of app. 3,500 l/h. The maximum water flow rate is 20,000 litres (5,000 gallons) per hour. The Turboflotor 20000 is designed for larger tanks in public aquaria and for commercial use for pet fish importers and distributors.  
 Technical data: Reaction chamber Ø: 50 cm (app. 20"), total height including foam collection cup: 310 cm (app. 122"), injector pump power consumption incl. motor protection switch: 900 watts, max. water flow: 20,000 l/h (app. 5,000 gph).

Item code	Item
400.00	Turboflotor 20000
400.10	Turboflotor 20000 w/o pump

Turboflotor 20000



**Trickle filter for Turboflotor**

Item code	Item
401.01	Trickle filter for Turboflotor 10000, with BactoBalls
401.01-1	Trickle filter for Turboflotor 10000, w/o BactoBalls

Total height app. 135 cm, required space app. 52 x 70 cm

401.00	Trickle filter for Turboflotor 20000, with BactoBalls
401.00-1	Trickle filter for Turboflotor 20000, w/o BactoBalls

Total height app. 235 cm, required space app. 52 x 70 cm

Trickle filter T 10000





miniflotor

### miniflotor

Air driven internal skimmer for aquaria up to 200 litres (app. 50 gal)

The miniflotor is a small but powerful air-driven internal protein skimmer. A lime wood air diffuser producing very fine air bubbles is also included. The outer reaction tube is replaceable. A second shorter reaction tube is included in shipment. A membrane air pump with at least 300 l/h is necessary.

Ø app. 5 cm (app. 2"), length: with long tube app. 45 cm (app. 18") - with short tube app. 32 cm (app. 12.8"), total width: app. 15 cm (app. 6"), immersion depth: long tube app. 33 cm (app. 13.2"), short tube app. 20 cm (app. 8")

Item code	Item
410.50	miniflotor



midiflotor

### midiflotor

Air driven internal skimmer for aquaria up to 400 litres (app. 100 gal)

The midiflotor is an air-driven counter current internal protein skimmer. The strong holding system allows movement of the skimmer vertically to adjust the foam production zone. A lime wood air diffuser, producing very fine air bubbles, is included. A membrane air pump with at least 300 l/h is necessary.

Ø app. 7.5 cm (app. 3"), length: app. 52 cm (app. 21"), total width: app. 15 cm (app. 6"), immersion depth: app. 30 – 35 cm (app. 12" – 14")

Item code	Item
410.55	midiflotor

**Wooden airstones**

For air driven protein skimmers

Wooden airstones are produced from lime wood with very fine pores. To keep the skimmer running at its optimum performance level, the bubbles have to be monitored regularly, and it is recommended that they are changed every 6 – 8 weeks. In an attractive blister pack.

Item code	Item
410.59	Wooden airstones Mini 2 pcs., app. 15 x 15 x 57 mm (l x w x h)
410.58	Wooden airstones Midi 2 pcs., app. 18 x 18 x 78 mm (l x w x h)
410.57	Wooden airstones Maxi 1 pc., app. 30 x 30 x 110 mm (l x w x h)



**Silencer**

Silencer for protein skimmer

The Silencer 100 and the Silencer 200 reduce the noise of the air intake of a protein skimmer. The noise may be avoided by the use of the Silencers. At the fitting of the Silencer you can attach tubes with a diameter of 6/8 mm without any problems.

Item code	Item
410.610	Silencer 100 up to a capacity of 200 l air/h
410.620	Silencer 200 for a capacity higher than 200 l air/h



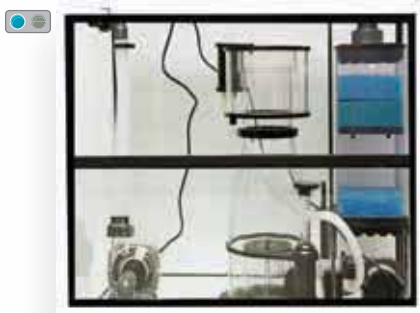

Reef Station

## Reef Station

A complete filtration system for Reef aquaria up to 1,000 litres

It comprises the following components: closed glass filter sump with sliding doors and removable cover, a prefilter for taking up activated carbon, phosphate absorbers or bioballs, the K2 protein skimmer and DC Runner 3.3 circulation pump. Pipework connections to the aquarium (left side): 32 mm flow, return 40 mm. All components are inside the filter sump.

Dimensions of the filter: app. 75.5 x 47.5 x 62 cm (l x w x h)

Item code	Item
501.010	Reef Station

optional filter features:

80718	Helix Max 2.0 18 Watt
502.73	Refill System easy



**Filter Box A/B**

Universal filter basin for salt- and freshwater aquaria

- glass filter basin in 2 sizes with 4 chambers
- holding plate including 2 pre-filter bags
- refill tank
- mechanical automatic refill
- adjustable water level in main filter chamber

Filter Box	A	B
Dimensions (l x w x h), app.	600 x 420 x 340 mm	900 x 420 x 340 mm
Refill tank	10 l	16 l

Item code	Item
510.175	Filter Box A <b>NEW</b>
510.225	Filter Box B <b>NEW</b>



Filter Box A

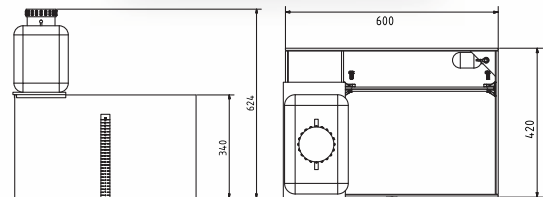

Filter Box B

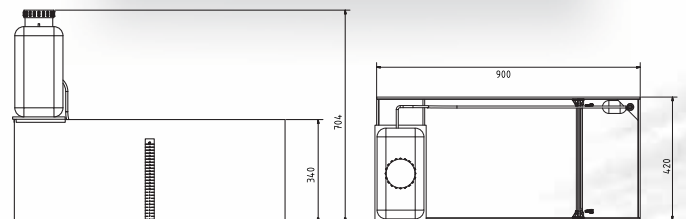

**Cabinet Protect**

Moisture protection for the base cabinet

Drip tray for drip water, suitable for Filter Box A / B

Cabinet Protect A: 700 x 440 x 30 mm  
(Filter size max.: 650 x 420 mm)

Cabinet Protect B: 950 x 440 x 30 mm  
(Filter size max.: 900 x 420 mm)

Item code	Item
502.110	Cabinet Protect A <b>NEW</b>
502.130	Cabinet Protect B <b>NEW</b>



Cabinet Protect A

Cabinet Protect B



Systemfilter 2000

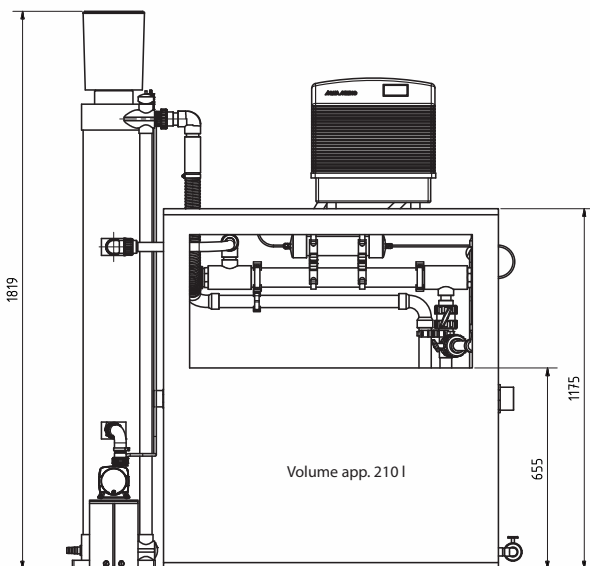

### Systemfilter 2000

A complete filter system for saltwater aquaria and holding tanks up to 5,000 litres (app. 1,319 gallons)

Systemfilter 2000 is a modular filter system delivered ready for use. It is designed for use as a centralized filter system for food fish holding tanks and for aquaria up to 5,000 l (app. 1,319 gallons).

The standard version comprises the following:

- protein skimmer Turboflotor 5000 single 6.0 incl. venturi pump, connection for external ozone supply
- prefilter chamber, post-switched biofilter, prepared to receive various filter materials
- UV-C clarifier, 1 x 80 watts, firmly integrated in the internal water cycle
- plastic vessel as filter sump, dimensions: app. 1,100 x 550 x 1,175 mm (l x w x h)
- cooling unit Titan 2000
- internal circulation pump
- recirculating pump

All components are already piped.

Total required space: app. 1,400 x 800 x 1,900 mm (l x w x h)

optional:

- cooling unit (max. Titan 4000)
- other pump combinations upon request
- the filter is also available without UV-C unit

Item code	Item
405.80	Systemfilter 2000

**Systemfilter Skim**

A complete filter system for saltwater aquaria and holding tanks up to 20,000 litres (app. 5,277 gallons)

Systemfilter Skim is a modular filter system delivered ready for use. It is designed for use as a centralized filter system for food fish holding tanks and for aquaria up to 20,000 l (app. 5,277 gallons).

The standard version comprises the following:

- protein skimmer Turboflotor 15000 incl. venturi pump, connection for external ozone supply
- trickle filter for biological filtration (filled with BactoBalls)
- pressurized sand filter as final mechanic filter with back-flush valve
- plastic vessel as filter sump, dimensions: app. 1,290 x 940 x 1,300 m (l x w x h). The tank is equipped with an underwater retaining system with 12 pcs. UV-C tubes with 20 watts each. With external switchboard for controlling.
- circulation pump capacity 12 m<sup>3</sup>/h (app. 3,000 gph)
- all components are already piped

Total required space: app. 260 x 95 x 255 cm (l x w x h)

optional:

- a second trickle filter and/or fine filter unit
- installation of a titanium heat exchanger for cooling or heating
- the filter is also available without UV-C unit

Equipment selectable upon agreement.

Item code	Item
406.50	Systemfilter Skim
406.51	Systemfilter Skim w/o UV



Systemfilter Skim

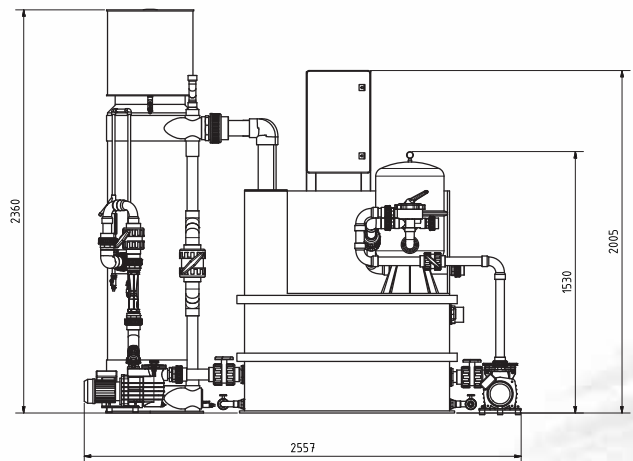



Systemfilter

### Systemfilter

A complete filter system for fresh- and saltwater aquaria and holding tanks up to 20,000 litres (app. 5,277 gallons)

Systemfilter is a modular filter system delivered ready for use. It is designed for use as a centralized filter system for food fish holding tanks and for aquaria up to 20,000 l (app. 5,277 gallons).

The standard version comprises the following:

- trickle filter for biological filtration (filled with BactoBalls)
- pressurized sand filter as final mechanic filter with back-flush valve
- plastic vessel as filter sump, dimensions: app. 1,290 x 940 x 1,300 mm (l x w x h). The tank is equipped with an underwater retaining system with 12 pcs. UV-C tubes with 20 watts each. With external switchboard for controlling.
- circulation pump capacity 12 m<sup>3</sup>/h (app. 3,000 gph)
- all components are already piped.

Total required space: app. 190 x 95 x 165 cm (l x w x h)

optional:

- a second trickle filter and/or fine filter unit
- installation of a titanium heat exchanger for cooling or heating.
- the filter is also available without UV-C unit

Equipment selectable upon agreement.

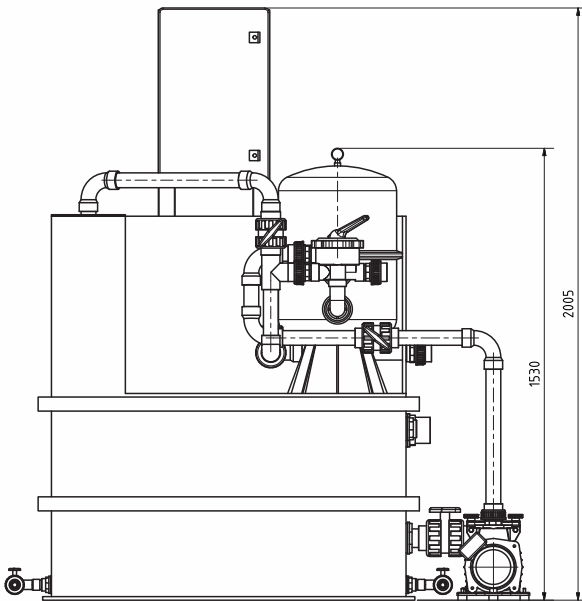

Item code	Item
405.50	Systemfilter
405.51	Systemfilter w/o UV

### Refill System 2.0

Refill System with safety circuit

Easy and safe refilling of evaporated water in the aquarium

- permanent monitoring of the water level in the aquarium by means of a trouble-free and maintenance-free Reed sensor with delay circuit (no disturbance due to surface movement)
- automatic refilling of evaporated aquarium water
- variable sensor holder allows adaptation to different water levels in the filter tank
- dry-running protection of the refilling pump – optical and acoustic alarm
- there is a warning for low water level of the refill tank
- easy installation and maintenance, plug connections on all cables (incl. cable protection against unintentional release)
- safety shutdown circuit in case of a defective level sensor
- 12 V low voltage, incl. transformer 100 – 240 V / 50 – 60 Hz

Item code	Item
502.77	Refill System 2.0



### Refill System easy

Refill system with pump and sensor

Easy and safe refilling of evaporated water in the aquarium

- permanent monitoring of the water level in the aquarium with an infrared sensor incl. delay circuit
- automatic refilling of evaporated aquarium water
- dry-running protection of the refilling pump
- easy installation and maintenance, plug connections on all cables
- sensor with magnet holder
- 12 V low voltage, incl. transformer 100 – 240 V / 50 – 60 Hz

Item code	Item
502.73	Refill System easy



### Refill Fix

Nano refill unit

For commercial PET beverage bottles up to 2 l with matching thread (thread adapter included)

- for glass thickness of 3 - 10 mm
- Product material: ABS
- Dimensions: 36 x 36 x 35 mm

Item code	Item
502.78	Refill Fix <b>NEW</b>





refill depot

### refill depot

Canister with cap and tap

Dimensions 16 l (L x B x H): app. 32 x 17 x 38 cm (w/o tap)

Dimensions 10 l (L x B x H): app. 28 x 17 x 28 cm (w/o tap)

Item code	Item
502.79-1	refill depot 16 l (1) for refill systems, canister with cut-out and cap
502.79-2	refill depot 16 l (2) for refill systems, canister with cap and tap
510.075-1	refill depot 10 l for refill systems, canister with cap and tap

**multi reactor Gen II**

All-In-One filter system

- for use in the aquarium or filter sump
- space-saving due to internal water supply
- highly efficient filtration due to high flow through your chosen filter media (sold separately) such as activated carbon (carbolit), phosphate absorber (antiphos FE), zeolithe, fine filter and so on
- adjustable water flow
- very simple maintenance due to removable filling tube, the filter housing incl. pump can remain in the aquarium for refilling and maintenance
- incl. pump of 12 V safety tension
- flexibly adjustable mounting system (multi reactor L can also be placed upright in the filter sump)
- extremely quiet in operation
- low vibration due to a decoupled pump connection
- optimized water flow with adjustable water level, low noise

Only valid for versions L + M:

- due to the new double-chamber-system two different types of filter media can be used simultaneously
- single-chamber-operation is also possible by removing the separating bottom of the reaction chamber

multi reactor Gen II	S	M	L
Dimensions (l x w x h), app.	60 x 50 x 325 mm	80 x 60 x 390 mm	100 x 100 x 465 mm
Max. filling quantity	app. 270 ml	app. 540 ml	app. 1,200 ml
Voltage	220 – 240 V/50 – 60 Hz		
Current consumption	12 V/app. 4 watts	12 V/app. 8 watts	12 V/app. 14 watts
Pump power	app. 200 l/h	app. 350 l/h	app. 450 l/h
For aquaria	up to 350 l	up to 500 l	up to 800 l
Max. glass thickness (for holder)	12 mm		

Item code	Item
409.930	multi reactor S Gen II <b>NEW</b>
409.940	multi reactor M Gen II <b>NEW</b>
409.950	multi reactor L Gen II <b>NEW</b>

**Fluidized bed filter FB 5000**

Fluidized bed sand filter

The FB 5000 fluidized bed sand filter is a powerful but compact biological sand filter. The water enters the filter from the bottom and keeps the small quartz sand grains fluidized – a huge surface area is created and is optimally supplied with water and nutrients. FB 5000 can work as biological filter for aquarium systems up to 10,000 litres (app. 2,500 gallons).

Incl. 20 kg Quartz sand

Dimensions: Ø 20 cm (app. 8"), total height: 170 cm (app. 67")

Item code	Item
410.600	Fluidized bed filter FB 5000



multi reactor S Gen II



multi reactor M Gen II

multi reactor L Gen II



FB 5000



phosphatfilter Fe

### phosphatfilter Fe

Bypass filter for the elimination of phosphate

The phosphatfilter Fe is a compact chemical filtration chamber for aquarium use. It can be installed in line with any standard canister filter or fed via a separate pump. The phosphatfilter Fe contains 400 ml of antiphos Fe. This reduces the level of phosphate and thereby curtails the growth of filamentous algae. Depending on the phosphate level, one filling of antiphos may be sufficient for an aquarium up to 600 litres (app. 150 gallons) for between 3 – 6 months. The phosphatfilter Fe can be used for fresh- and saltwater aquaria.

Ø app. 8 cm (app. 3.2"), length app. 24 cm (app. 9.45"),  
hose connection: 12 and 16 mm

Item code	Item
65024	phosphatfilter Fe



NR 5000

### Nitratreductor NR 5000

Denitrification filter for aquaria up to 3,000 litres (app. 800 gallons)

The Nitratreductor NR 5000 is an anaerobic biological reactor for removing nitrates from fresh- and saltwater aquaria. It has a volume of 30 l (app. 7.5 gal) and is supplied with an internal circulation pump plus the connection for a pressurized redox probe with a PG 13.5 thread. Feeding the bacteria can be performed manually with denimar or automatically using Deniballs in conjunction with an mV (ORP) controller. The Nitratreductor NR 5000 is a closed system and should be supplied with feed water via a bypass or a dosing pump at a rate of 12 – 30 l/h (app. 3 – 8 gph).

Dimensions excluding electrode (l x w x h): app. 50 x 30 x 96 cm (app. 20" x 12" x 38.5"). Recommended accessories: denimar-powder and Deniballs to feed the anaerobic bacteria, pressure resistant mV (Redox or ORP) probe with PG 13.5 threaded connection.

Item code	Item
410.850	Nitratreductor NR 5000



KR 5000

### Calciumreactor KR 5000

For the supply of dissolved calcium to reef aquaria up to 5,000 litres (app. 1,250 gallons)

The Calciumreactor KR 5000 is designed as a closed system. An integral pump provides internal water circulation. A PG 13.5 threaded port accepts an electrode for measuring and controlling the pH within the vessel. The reactor has a volume of 30 litres (app. 8 gallons) and is supplied with a 15 l bucket of Hydrocarbonat. Dimensions (l x w x h): app. 50 x 30 x 96 cm (app. 20" x 20" x 38.5").

Recommended accessories:  
pressure resistant pH probe threaded PG 13.5, Hydrocarbonat as refill.

Item code	Item
410.450	Calciumreactor KR 5000



**filter bag**

Zip up media bag

Filter bags are designed to contain fine filter media, such as activated carbon, antiphos Fe or other granular media. The filter bag is fitted with a zip fastener for quick and easy replacement of the media.

Item code	Item
429.01	filter bag 1, 2 pcs., 22 x 15 cm (app. 8.6" x 5.9")
429.02	filter bag 2, 2 pcs., 22 x 30 cm (app. 8.6" x 11.8")
429.03	filter bag 3, 2 pcs., 22 x 45 cm (app. 8.6" x 17.7")



**prefilter bag**

Filter bag (Ø app. 12 cm) with 200 µm for use as a prefilter in a cabinet filter. Incl. acrylic holder for max. 14 mm glass.

Item code	Item
429.10	prefilter bag
429.11	filter bag 4 (2 pcs.) - replacement Ø app. 90 mm, length app. 300 mm



**filter bag multi**

Filter bag

Filter bag (Ø app. 10.5 cm) with 1,000 µm for use as a prefilter in a cabinet filter, without holder (e.g. Armatus)

Item code	Item
429.12	filter bag multi (2 pcs.) Ø app. 90 mm, length app. 230 mm





### antiphos Fe

For the control of algal growth

Phosphate and silicate remover for freshwater and saltwater aquaria. antiphos Fe is an ideal medium for selectively extracting phosphate and silicate from aquarium water, thus counteracting unwanted algal growth. antiphos Fe is a highly active iron based product containing no aluminium and is completely non toxic to aquarium plants and animals. The binding capacity of antiphos Fe is app. 10 g phosphate/kg. Subject to the conditions 500 ml of antiphos Fe will treat a normally populated 300 l aquarium for app. 3 – 6 months.

antiphos Fe

Item code	Item
11651	antiphos Fe 500 g / app. 800 ml <b>NEW</b>
12651	antiphos Fe 1,000 g / app. 1,600 ml <b>NEW</b>



carbolit

### carbolit

For the removal of toxins and colours

Activated carbon pellets for fresh- and saltwater aquaria. carbolit comprises of highly efficient activated carbon pellets. carbolit quickly clears aquarium water and removes colouring substances, turbidity and medication residues. Yellowing substances such as phenols and tannins that can accumulate in the water are also removed. carbolit may also be used as a long-term filter material.

Item code	Item
11518	carbolit 500 g/0.65 l, 1.5 mm Pellets
12518	carbolit 500 g/0.70 l, 4 mm Pellets
11519	carbolit 3.5 kg/4.55 l, 1.5 mm Pellets
12519	carbolit 3.5 kg/4.90 l, 4 mm Pellets
11516	carbolit 25 kg/32.5 l, 1.5 mm Pellets
12516	carbolit 25 kg/35.0 l, 4 mm Pellets



Zeolith

### Zeolith

Biological filter material, also for the removal of dissolved pollutants in the water, for use in salt and freshwater aquaria and ponds

Zeolite rock is a natural mineral rock with a large, reactive surface. This acts like an ion exchanger. The absorption of ammonium prevents the rise of nitrate in the water. The porous surface of zeolite rock makes it ideal as a biological filter material.

Depending on the amount of water, we recommend using it in our multi reactor S, M or L.

Item code	Item
13001	Zeolith 900 g 10 – 25 mm/1 l can
13003	Zeolith 6 kg 10 – 25 mm/5 l bucket
13006	Zeolith 25 kg 10 – 25 mm/bag

### BactoBalls

Biological filter media

BactoBalls are the optimum filter medium for biological filters. They can be used in trickle filters and denitrification reactors and in larger aquaculture systems. The large surface area of 300 m<sup>2</sup>/m<sup>3</sup> allows a high concentration of active bacterial biomass.

Item code	Item
410.80	BactoBalls 25 l box (app. 6.25 gal)
410.81	BactoBalls 5 l bucket (app. 1.3 gal)
410.82	BactoBalls 15 l bucket (app. 3.75 gal)

Larger quantities on request!



BactoBalls

### sulfur pearls

Filter medium for Sulphur denitrification reactors

sulfur pearls are sulphur beads formed from pure sulphur. They are used in sulphur nitratereductors as the filter medium and energy source for the bacteria. They have to be replaced from time to time as they are slowly consumed by the bacteria.

**Caution:**

Use only in nitrate removing anaerobic filters having a low water flow rate.

Item code	Item
410.79	sulfur pearls app. 1,000 g/app. 1,000 ml can
410.79-1	sulfur pearls app. 5,000 g/app. 5,000 ml bucket



sulfur pearls

### Denigran

Supports the natural decomposition of nitrate in salt- & freshwater aquaria, also helps clear algae problems

Denigran is a type of granular media made of special plastic material to enhance the settlement of nitrate removing bacteria. The main nutrient, nitrate is removed from the algae without any chemical additives; additional feeding of the bacteria is not required. The optimal designed mesh bag gives the best possible water flow past the media. Depending on the population, Denigran will be effective for up to 12 months.

Content: 4 mesh bags of 50 g each

Application: 1 – 2 bags per 50 liters of aquarium water

Item code	Item
411.76	Denigran 4 x 50 g



Denigran



Deniballs

### Deniballs

A filter material and bacteria feed for the Nitratereducator

Deniballs are manufactured from a unique biologically based plastic. 1 to 2.5 l Deniballs (app. 0.2 – 0,6 gal) is enough to supply the Nitratereducator as the sole food source for 12 months. For the Nitratereducator NR 5000, about 5 litres (1.3 gal) are required. Changing the Deniballs after approximately 12 months is recommended to ensure safe and maintenance free denitrification in fresh- and saltwater aquaria.

Item code	Item
410.78-1	Deniballs 5 l bucket
410.78-3	Deniballs 25 l box



Mini-Deniballs

### Mini-Deniballs

A filter material and bacteria feed for the Nitratereducator

Mini-Deniballs are manufactured from a unique biologically based plastic. One package of 0.5 litres (app. 0.2 gal) is enough to supply a Nitratereducator as the sole food source for 12 months. Changing the Mini-Deniballs after approximately 12 months is recommended to ensure safe and maintenance free denitrification in fresh- and saltwater aquaria.

Item code	Item
411.78	Mini-Deniballs 0.5 l



denimar

### denimar

Nutrient powder for the Nitratereducator

The bacteria within an anaerobic biofilter need organic nutrients as their energy source to remove nitrate. If denimar is dosed daily, high nitrate removal rates can be achieved in the Nitratereducator. denimar is suited for salt- and freshwater aquaria. It contains no fertilizers and does not foster the growth of algae.

Item code	Item
410.76-1	denimar 150 g



biobacter

### biobacter

bacteria culture for improving nitrification and de-nitrification in aquaria

biobacter is a compound containing freeze-dried living bacteria. It is used to start new biological filters, revitalise filters after using medication, and to improve nitrification in existing aquaria. biobacter comprises a glass vial of bacteria and bacteria feed.

1 carton for 250 litres (app. 60 gallons).

Item code	Item
12411	biobacter

### Helix Max 2.0

UV-C water clarifier for salt and fresh water aquaria

- can eliminate single cell algae giving crystal clear water in salt and fresh water aquaria
- helps eradicate bacteria and other water borne parasites and decreases the risk of fish acquiring infections
- controlled water flow and the large volume of the Helix Max 2.0 ensure maximum efficacy. The water is directed in a spiral path around the quartz tube resulting in more efficient use of the UV radiation than in standard units
- the inlet fitting can be rotated by 360° for easy mounting at any angle. This allows a space-saving installation
- easy cleaning of the inner spiral by simple disassembly
- simple and safe function control through integrated viewing window
- all versions of the Helix Max 2.0 are equipped with a high frequency electronic ballast for salt and fresh water aquaria. The electronic ballasts increase the lifetime and the efficacy of the UV lamps
- incl. hose nozzles for connecting hoses



Helix Max 2.0 11 W



Helix Max 2.0 series



Helix Max 2.0	5 W	9 W	11 W	18 W	36 W	55 W
Saltwater aquarium	up to 125 l	up to 250 l	up to 350 l	up to 500 l	up to 1,000 l	up to 1,500 l
Recommended max. flow	100–200 l/h	100–200 l/h	100–400 l/h	200–600 l/h	400–1,000 l/h	600–1,500 l/h
Freshwater aquarium	up to 250 l	up to 500 l	up to 750 l	up to 1,000 l	up to 2,000 l	up to 3,000 l
Recommended max. flow	100–300 l/h	100–500 l/h	300–800 l/h	400–1,000 l/h	500–1,500 l/h	500–1,500 l/h
Capacity	1,1 W/UVC	2,4 W/UVC	3,6 W/UVC	5,8 W/UVC	12 W/UVC	18 W/UVC
Cable length	3,5 m					
Lamp type	PL-S-5 W	PL-S-9 W	PL-S-11 W	PL-L-18 W	PL-L-36 W	PL-L-55 W
Max. pressure	0,4 bar					
Power connection	220 – 240 V 50/60 Hz					
Housing dimensions without joints l x w in mm, app.	370, Ø 90	370, Ø 90	370, Ø 90	380, Ø 110	540, Ø 110	695, Ø 110

Item code	Item
80705	Helix Max 2.0 5 W
80709	Helix Max 2.0 9 W
80711	Helix Max 2.0 11 W
80718	Helix Max 2.0 18 W
80736	Helix Max 2.0 36 W
80755	Helix Max 2.0 55 W



UVC-Max

### Spare bulbs for Helix Max

Item code	Item
80805-8	UVC-Max 5 W
80809-8	UVC-Max 9 W
80811-8	UVC-Max 11 W
80818-8	UVC-Max 18 W
80836-8	UVC-Max 36 W
80855-8	UVC-Max 55 W



UV-C Professional

### UV-C Professional

Modular UV-C system

Aqua Medic water clarifiers are suitable for fresh and saltwater aquaria. Helix Max can eliminate single cell algae giving crystal clear water in aquaria. The water is directed in a spiral path around the quartz tube resulting in more efficient use of the UV radiation than in standard units. This system consists of modules with 80 watts lamps. The housing consists of solid blue PVC tubes. The electronic ballast is placed in a switchbox together with an hour meter.



UV-C Professional	2 x 80 W	4 x 80 W	8 x 80 W	12 x 80 W
Saltwater aquarium	5 – 10 m <sup>3</sup>	10 – 20 m <sup>3</sup>	25 – 35 m <sup>3</sup>	35 – 55 m <sup>3</sup>
Recommended max. flow	10 m <sup>3</sup> /h	20 m <sup>3</sup> /h	30 m <sup>3</sup> /h	60 m <sup>3</sup> /h
Freshwater aquarium	10 – 20 m <sup>3</sup>	20 – 40 m <sup>3</sup>	50 – 70 m <sup>3</sup>	70 – 110 m <sup>3</sup>
Recommended max. flow	15 m <sup>3</sup> /h	30 m <sup>3</sup> /h	50 m <sup>3</sup> /h	75 m <sup>3</sup> /h
Capacity	520 mW/cm <sup>2</sup>	1,040 mW/cm <sup>2</sup>	2,080 mW/cm <sup>2</sup>	3,120 mW/cm <sup>2</sup>
Lamp type	80 W T5			
Power connection	230 V~/50 Hz			
Dimensions l x w in mm, app.	920 x 365	1,055 x 545	982 x 787	1,055 x 585

Item code	Item
81828	UV-C Professional 2 x 80 W
81848	UV-C Professional 4 x 80 W
81888	UV-C Professional 8 x 80 W
81898	UV-C Professional 12 x 80 W



Spare bulb for UV-C Professional 80 W

### Spare bulb for UV-C Professional 80 W

Item code	Item
80891-8	Spare bulb for UV-C Professional 80 W

### aquarius plus

LED aquarium light for saltwater aquaria with app control

The aquarius plus with its flat aluminum housing offers particularly even illumination of your aquarium. The combination of the six individual light colours is specially tailored to the needs of saltwater aquaria. The 6 colour channels can be individually set in the light intensity for different color gradients using an app control. This means that time-controlled programs can be implemented for any time of day.

**Equipment:**

- LED light with 6 colours and 6 channels
- App control (IOS and Android)
- anodized aluminum housing for passive cooling (no fans)
- Safety voltage 24 V with external transformer (100 – 240 V / 50 – 60 Hz)
- variable bracket for mounting on the aquarium

**optional:**

- aquafit 2 steel wire suspension
- aquarius holder
- aquarius plus holder BW

aquarius plus	30	60	90	120
Total consumption max./W	38	77	118	155
Total Lumen app./lm	2,510	4,900	7,678	9,945
Dimensions (l x w x h) app./mm	320 x 210 x 25	580 x 210 x 25	840 x 210 x 25	1,100 x 210 x 25
Total cable length app.	3.50 m incl. power adapter			
For aquarium with length app./mm	350 – 600	600 – 900	850 – 1,100	1,150 – 1,350
Light colours – Colour temperature	white 6,000 – 6,500 K	red 620 – 625 nm	royal blue 450 – 455 nm	purple 395 – 405 nm
	blue 460 – 465 nm	UV	365 – 370 nm	

Item code	Item
89711	aquarius 30 plus <b>NEW</b>
89712	aquarius 60 plus <b>NEW</b>
89713	aquarius 90 plus <b>NEW</b>
89714	aquarius 120 plus <b>NEW</b>

**Options:**

89706	aquarius plus holder BW <b>NEW</b>
-------	------------------------------------



aquarius plus



aquarius 60 plus



optional: aquarius plus holder BW (see page 65)



## aquarius plant plus

LED aquarium light for freshwater aquaria with app control

The aquarius plant plus with its flat aluminium housing offers a particularly even illumination of your aquarium. The combination of the six individual light colours is specially tailored to the needs of freshwater aquaria. The 6 colour channels can be individually set in the light intensity for different color gradients using an app control. This means that time-controlled programs can be implemented for any time of day.

### Equipment:

- LED light with 6 colours and 6 channels
- App control (IOS and Android)
- anodized aluminium housing for passive cooling (no fans)
- Safety voltage 24 V with external transformer (100 – 240 V / 50 – 60 Hz)
- variable bracket for mounting on the aquarium

### optional:

- aquafit 2 steel wire suspension
- aquarius holder
- aquarius plus holder BW



aquarius plant plus

aquarius plant 60 plus



aquarius plant plus	60	90	120
Total consumption max./W	65	95	128
Total Lumen app./lm	4,550	6,825	9,110
Dimensions (l x w x h) app./mm	580 x 210 x 25	840 x 210 x 25	1,100 x 210 x 25
Total cable length app.	3.50 m incl. power adapter		
For aquarium with length app./mm	600 – 900	850 – 1,100	1,150 – 1,350
Light colours – Colour temperature	daylight white 6,000 – 6,500 K warm white 2,800 – 3,200 K red 640 – 660 nm	ruby red 620 – 630 nm green 520 – 530 nm blue 460 – 470 nm	



optional: aquarius plus holder BW (see page 65)

Item code	Item
89812	aquarius plant 60 plus <b>NEW</b>
89813	aquarius plant 90 plus <b>NEW</b>
89814	aquarius plant 120 plus <b>NEW</b>
Options:	
89706	aquarius plus holder BW <b>NEW</b>



**aquarius holder**

Mounting bracket for aquarius /aquarius plus LED-lights



aquarius holder

Item code	Item
87706	aquarius holder / pair

**aquarius plus holder BW**

Rear wall bracket, only for aquarius plus LED lights



aquarius plus holder BW

aquarius plus	30	60	90	120
Recommended number of holders	1	2	2	2

Item code	Item
89706	aquarius plus holder BW <b>NEW</b>

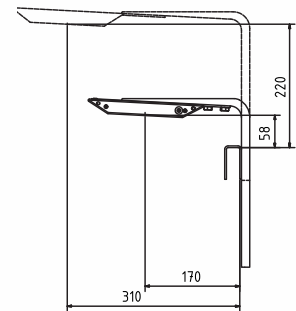

**spectrus holder BW**

Rear wall bracket, only for spectrus lights



spectrus holder BW

spectrus	spectrus	spectrus twin
Recommended number of holders	1	1

Item code	Item
83020100	spectrus holder BW <b>NEW</b>

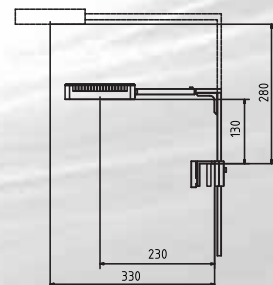



aquarius control

### aquarius control

6-channel controller for aquarius (not suitable for aquarius plus!)

- six independently programmable / dimmable channels, e. g. for sunrise, sunset and moonlight
- optional Y-cable is available meaning several aquarius lights can be controlled simultaneously
- programming is done via the aquarius control timer interface. It's not necessary to connect it to the computer
- power (24 V low voltage) is supplied via the aquarius connection on the light fixture itself, no additional power supply is required

Dimensions (l x w x h): app. 110 x 60 x 25 mm

Cable length: app. 1,800 mm

Item code	Item
87700	aquarius control



Y-cable aquarius

### Y-cable aquarius

For connecting two aquarius lights to an aquarius control

The Y-cables can also be plugged into each other to connect a further aquarius to the control unit.

Cable length: app. 50 cm

Item code	Item
87701	Y-cable aquarius

**Qube 30**

LED-Spot light for saltwater aquaria

Features:

- LED Cluster chip consisting of 12 individual LED elements with balanced light spectrum
- high energy density specially designed for strong coral growth (PAR = 790  $\mu\text{mol m}^{-2}\text{s}^{-1}$ )
- colour and light intensity are adjustable manually via 2 channels
- the compact design allows for an ideal illumination of nano aquaria as well as dark edge areas in larger aquaria.
- silent-running internal fan for reliable cooling of the LED chip
- a flexible gooseneck ensures a firm hold and easy alignment
- integrated cable feedthrough for power supply in the gooseneck

LED	cool white	12,000 K	4 pcs.
	royal blue	450 nm	4 pcs.
	sky blue	470 nm	2 pcs.
	violet	420 nm	1 pc.
	UV	395 nm	1 pc.

There is a lense with 90° scattering angle installed.

Technical data:

Dimensions (housing)	app. 80 x 80 x 25 mm
Weight incl. holder	app. 290 g
Number of light channels	2
Number of light colours	5
Illuminated area max.	app. 300 x 300 mm
PAR value	790 $\mu\text{mol m}^{-2}\text{s}^{-1}$
Total consumption	30 watts max.
Power supply transformer	100 – 240 V / 50 – 60 Hz
Power supply light	24 V

Item code	Item
83216030	Qube 30

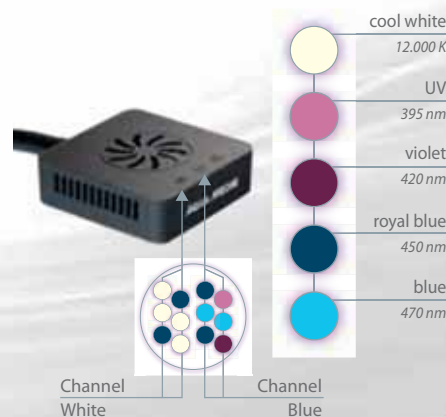



Qube 30 plant



## Qube 30 plant

LED-Spot light for freshwater aquaria

### Features:

- LED Cluster chip consisting of 12 individual LED elements with balanced light spectrum
- high energy density specially designed for strong plant growth (PAR = 805  $\mu\text{mol m}^{-2}\text{s}^{-1}$ )
- colour and light intensity are adjustable manually via 2 channels
- the compact design allows for an ideal illumination of nano aquaria as well as dark edge areas in larger aquaria.
- silent-running internal fan for reliable cooling of the LED chip
- a flexible gooseneck ensures a firm hold and easy alignment
- integrated cable feedthrough for power supply in the gooseneck

LED	daylight white	8,000 K	5 pcs.
	warm white	3,500 K	4 pcs.
	royal blue	450 nm	2 pcs.
	red	660 nm	1 pc.

There is a lense with 90° scattering angle installed.

### Technical data:

Dimensions (housing)	app. 80 x 80 x 25 mm
Weight incl. holder	app. 290 g
Number of light channels	2
Number of light colours	4
Illuminated area max.	app. 300 x 300 mm
PAR value	805 $\mu\text{mol m}^{-2}\text{s}^{-1}$
Total consumption	30 watts max.
Power supply transformer	100 – 240 V / 50 – 60 Hz
Power supply light	24 V

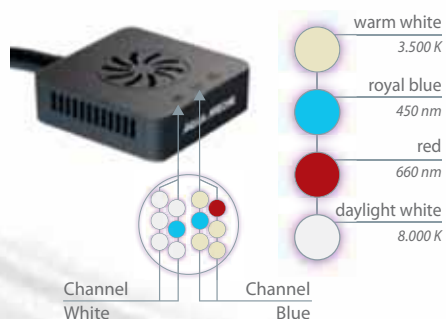

Item code	Item
83217030	Qube 30 plant

**Qube 50**

High Power LED-Spot light for saltwater aquaria

- LED Cluster chip consisting of 24 individual LED elements with balanced light spectrum
- high energy density specially designed for strong coral growth (PAR = 1,250  $\mu\text{mol m}^{-2}\text{s}^{-1}$ )
- colour and light intensity are adjustable manually via 2 channels
- integrated 0 – 10 V connection for using external controllers
- the compact design allows for an ideal illumination of nano aquaria as well as dark edge areas in larger aquaria
- silent-running internal fan for reliable cooling of high-power LED chips
- a flexible goose neck ensures a firm hold and easy alignment, a wire suspension system for mounting on the ceiling is included

LED	cool white	12,000 K	9 pcs.
	royal blue	450 – 455 nm	9 pcs.
	sky blue	465 – 470 nm	2 pcs.
	violet	420 – 430 nm	2 pcs.
	UV	400 – 405 nm	2 pcs.

There is a lense with 90° scattering angle installed.

Technical data:

Dimensions (housing)	app. 80 x 80 x 65 mm
Weight incl. holder	app. 725 g
Number of light channels	2
Number of light colours	5
Illuminated area max.	app. 500 x 500 mm
PAR value	1,250 $\mu\text{mol m}^{-2}\text{s}^{-1}$
Total lumen	834 lm
Total consumption	50 watts max.
Power supply transformer	100 – 240 V/50 – 60 Hz
Power supply light	24 V

Item code	Item
83216050	Qube 50

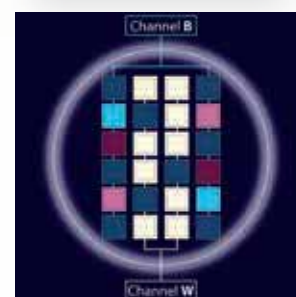

optional: Qube control



Qube 50 plant



## Qube 50 plant

High Power LED-Spot light for freshwater aquaria

- LED Cluster chip consisting of 24 individual LED elements with balanced light spectrum
- high energy density specially designed for strong growth (PAR = 1.410  $\mu\text{mol m}^{-2}\text{s}^{-1}$ )
- colour and light intensity are adjustable manually via 2 channels
- integrated 0 – 10 V connection for using external controllers
- the compact design allows for an ideal illumination of nano aquaria as well as dark edge areas in larger aquaria
- silent-running internal fan for reliable cooling of high-power LED-chips
- a flexible goose neck ensures a firm hold and easy alignment, a wire suspension system for mounting on the ceiling is included

LED	daylight white	8,000 K	10 pcs.
	warm white	3,000 K	4 pcs.
	red	660 nm	2 pcs.
	green	520 nm	1 pc.
	royal blue	450 nm	6 pcs.
	blue	420 nm	1 pc.

There is a lense with 90° scattering angle installed.

Technical data:

Dimensions (housing)	app. 80 x 80 x 65 mm
Weight incl. holder	app. 725 g
Number of light channels	2
Number of light colours	6
Illuminated area max.	app. 500 x 500 mm
PAR value	1,410 $\mu\text{mol m}^{-2}\text{s}^{-1}$
Total lumen	app. 1364 lm
Total consumption	50 watts max.
Power supply transformer	100 – 240 V/50 – 60 Hz
Power supply light	24 V

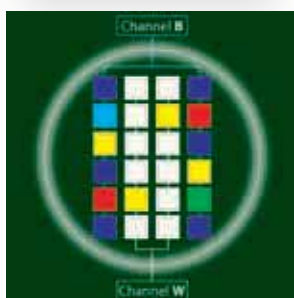

optional: Qube control

Item code	Item
83217050	Qube 50 plant

**Qube control**

2-channel light control for Qube

- two independently programmable / dimmable channels for blue phase, sunrise, sunset and moonlight
- by using a connecting cable (included in shipment) several Qubes can be connected in series to be controlled simultaneously
- programming is completed via the supplied remote control from the Qube control by timer. No connection to the PC is therefore necessary.
- power (24 V low voltage) is supplied via the Qube lights power pack, no additional power supply is required
- can be used with all 0 – 10 volt control lamps (if necessary, separate power supply required)

Dimensions (l x w x h): app. 74 x 74 x 15 mm

Cable length: app. 1,400 mm



Qube control

Item code	Item
83216000	Qube control



## spectrus / spectrus twin

Innovative LED aquarium light for saltwater aquaria with App-control

The spectrus with its elegant, slim aluminium housing offers illumination of the aquarium whilst incorporating the latest technology. Active cooling with powerful, quiet internal fans ensures maximum power output at a constant operating temperature. The compilation of the six individual light colours is specifically adjusted to the needs of animals in saltwater aquaria with a balanced light spectrum. By using an efficient lens technology, the light energy is optimally used. The growth of corals is supported and the biology in the aquarium develops in a natural way. The 8 light colours can be controlled individually with 6 colour channels via an App control in the light for different intensity and colour spectrums. Thanks to the WiFi control, several lights can be integrated into the home network and can act as master and slave with each other. This means that time-controlled programs can be implemented for any time of day.



spectrus twin

spectrus



optional: spectrus holder BW  
(see page 65)

### Equipment:

- LED light with 8 colours and 6 channels
- App-control (IOS and Android)
- several LED lights can be controlled at the same time
- anodized aluminum housing for cooling actively
- for safety 24 V with external transformer (100 – 240 V / 50 – 60 Hz)
- incl. steel wire suspension
- high-quality power pack

### optional:

- spectrus holder BW

spectrus	spectrus		spectrus twin	
Total consumption max./W	95		190	
Power supply transformer	100 – 240 V / 50 – 60 Hz			
Power supply light	24 V DC			
Number of light channels	6		6	
Number of light colours	8		8	
Total lumen app.	3.044		6.158	
PAR max.	2.400		2 x 2.400	
Illuminated area max./mm	600 x 650		1.000 x 650	
For aquarium with length app./mm	bis 650		bis 1.000	
Weight (lamp without holder) app./g	790		2.280	
Dimensions (l x w x h) app./mm	140 x 140 x 31		420 x 140 x 31	
Light colours – Colour temperature	cool white	8.300 K	red	660 nm
	royal blue	450 nm	violet	415 nm
	deep blue	460 nm	UV	405 nm
	cool blue	470 nm	UV	395 nm

Item code	Item
83020010	spectrus <b>NEW</b>
83020020	spectrus twin <b>NEW</b>

### Options:

83020100	spectrus holder BW <b>NEW</b>
----------	-------------------------------



**LED FA 100/200 W flex**

Splash-proof LED spotlight (IP65)

The LED spotlight housing is a highly efficient, low-profile cooling element designed for passive cooling. The LED lights FA 100 flex and FA 200 flex are equipped with individual LEDs in white and blue. Both colours can be dimmed separately. For optimum light spread, a special lens plate with individual lenses for each LED is installed. The Meanwell ballast guarantees for a reliable and safe power supply. The light consists of individual LEDs with a respective viewing angle of 60° per LED. By an optional manual dimming both light channels can be adjusted optimal to the individual needs. A holder for the ceiling is included.

Technical data:

LED FA	100 W flex	200 W flex
Dimensions (l x w x h) (without clamp)	290 x 180 x 130 mm	360 x 290 x 160 mm
Weight app.	4.2 kg	7.1 kg
Total luminous flux app.	6,700 Lm	13,500 Lm
Light colour	white: 8,100 K, blue: 455 nm	
Total viewing angle app.	60°	
Viewing angle per LED app.	60°	
Power supply	100 – 240 V / 50 – 60 Hz	
Total LEDs	96 pcs.	192 pcs.
LEDs per colour	48 x white, 48 x blue	96 x white, 96 x blue

Item code	Item
83618150	LED FA 100 W flex <b>NEW</b>
83618250	LED FA 200 W flex <b>NEW</b>

Options:

83414210	Potentiometer LED
83416002	Qube control 0 – 10 V LEDspot/2020



LED FA 100 W flex



LED FA 200 W flex



LEDspot 100 W



LEDspot 200 W

## LEDspot 100 W/200 W

Splash-proof LED-spotlight (IP65)

The lights are equipped with 100 W respectively 200 LED chips (Epistar). The light beam is bundled with a lense to 90°. The luminous flux of the 100 W light is app. 10,000 lumen and of the 200 W light app. 20,000 lumen. These lights could replace metal halogen damp lights from 250 W respectively from 400 W. The control gear unit is placed in a splash-proof body on the light. The control gear (Meanwell) could be dimmed with a 0 – 10 V control e.g. with the Aqua Medic Qube control LEDspot. The LEDspots will be cooled passively by a massive corrosion resistant alu-minium cooling element. It can be hang up on the central loop with a chain or attached with a holder out of polished stainless steel on the ceiling. Then you can adjust the angle. Without feed as standard.

Technical data:

LEDspot 100 W: Ø 32 cm, height: app. 38 cm, app. 8 kg

LEDspot 200 W: Ø 32 cm, height: app. 48 cm, app. 11.2 kg

Item code	Item
83413150	LEDspot 100 W 3 K 90° (app. 11,000 Lm)
83414150	LEDspot 100 W 12 K 90° (app. 12,000 Lm)
83416150	LEDspot 100 W blue 90° (app. 3,000 Lm)
83415150	LEDspot 100 W 6.5 K 90° (app. 12,000 Lm)
83413250	LEDspot 200 W 3 K 90° (app. 21,000 Lm)
83414250	LEDspot 200 W 12 K 90° (app. 20,000 Lm)
83416250	LEDspot 200 W blue 90° (app. 5,800 Lm)
83415250	LEDspot 200 W 6.5 K 90° (app. 20,000 Lm)

All versions are also available in 45, 60 and 120°.

Options:

83414210	Potentiometer LED
83416002	Qube control 0 – 10 V LEDspot/2020



## Power Supply LEDspot

Item code	Item
83414000	Power Supply / 2.5 m

Different lengths on request.



Lens LEDspot

## Lens 45°/60°/90°/120°

Lenses to change the beam angle of LEDspots

Item code	Item
83414107	Lens 45° LEDspot 100 W / 120 W flex
83414104	Lens 60° LEDspot 100 W / 120 W flex
83414105	Lens 90° LEDspot 100 W / 120 W flex
83414106	Lens 120° LEDspot 100 W / 120 W flex
83414207	Lens 45° LEDspot 200 W/LEDspot 200 W flex
83414204	Lens 60° LEDspot 200 W/LEDspot 200 W flex
83414205	Lens 90° LEDspot 200 W/LEDspot 200 W flex
83414206	Lens 120° LEDspot 200 W/LEDspot 200 W flex

### FlapSet LEDspot

Flaps suitable for Aqua Medic LEDspots 100 W/200 W and LEDspots flex 120/200 W incl. mounting ring.

Item code	Item
83414108	FlapSet LEDspot



FlapSet LEDspot

### Control cable

Control cable (app. 1.5 m) for connecting the Aqua Medic LEDspots/LEDspots flex to the Qube control  
Special lengths are available on request.  
Manifold for control on request.

Item code	Item
83400004	Control cable/2020 LEDspot and LEDspot flex



Control cable

### Lens 45°/60°/90°/120°

Lenses to change the beam angle of LEDspots

Item code	Item
83414107	Lens 45° LEDspot 100 W / 120 W flex
83414104	Lens 60° LEDspot 100 W / 120 W flex
83414105	Lens 90° LEDspot 100 W / 120 W flex
83414106	Lens 120° LEDspot 100 W / 120 W flex
83414207	Lens 45° LEDspot 200 W/LEDspot 200 W flex
83414204	Lens 60° LEDspot 200 W/LEDspot 200 W flex
83414205	Lens 90° LEDspot 200 W/LEDspot 200 W flex
83414206	Lens 120° LEDspot 200 W/LEDspot 200 W flex

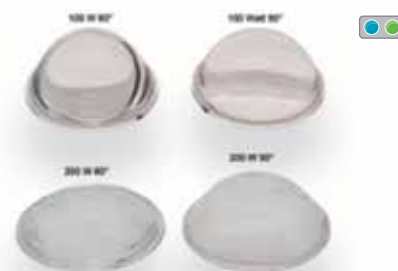

Lens LEDspot



LEDspot 200 W flex



LEDspot 120 W flex

## LEDspot 120 W flex/200 W flex

Splash-proof LED spotlight (IP65)

The LEDspot 120 W flex / 200 W flex is equipped with a two-coloured LED chip (white and blue). Both colours can be dimmed separately. Two control gears (Me-anwell) guarantee for a reliable and safe power supply. The light beam is bundled with a lens to 90°. By an optional manual dimming, the Potentiometer (incl. approx. 7.50 m cable) or Qube control (control cable LEDspot is also required) both light channels can be adjusted optimal to the individual needs. A holder for the ceiling is included. Without feed as standard.

Further colour variations can be found in the table below.

Technical data:

LEDspot	120 W flex	200 W flex
Height app.	240 mm (without clamp )	400 mm (without clamp)
Ø app.	320 mm	320 mm
Weight app.	8 kg	12 kg
Luminous flux app.	white: 8,000 Lm, blue: 1,800 Lm	white: 11,000 Lm, blue: 3,000 Lm
	red: 2,700 Lm, blue: 1,800 Lm	red: 4,500 Lm, blue: 3,000 Lm
	white: 7,500 Lm, white: 7,500 Lm	white: 10,000 Lm, white: 10,000 Lm
Light colour	white: 12,000 K, blue: 455 – 460 nm	white: 12,000 K, blue: 455 – 460 nm
	red: 620 – 625 nm, blue: 450 – 455 nm	red: 620 – 625 nm, blue: 450 – 455 nm
	white: 3,500 K, white: 6,500 K	white: 3,500 K, white: 6,500 K
Beam angle	90°, optional 60°/120°	90°, optional 60°/120°

Item code	Item
83418150	LEDspot 120 W flex 90°
83419150	LEDspot 120 W flex red/blue 90°
83420150	LEDspot 120 W flex 90° white 3.5 k / 6.5 k
83418250	LEDspot 200 W flex 90°
83419250	LEDspot 200 W flex red/bue 90°
83420250	LEDspot 200 W flex 90° white 3.5 k / 6.5 k

All versions are also available in 45, 60 and 120°.

Options:

83414108	FlapSet LEDspot
83414210	Potentiometer LED
83416002	Qube control 0 – 10 V LEDspot/2020

## Lens 45°/60°/90°/120°

Lenses to change the beam angle of LEDspots



Lens LEDspot

Item code	Item
83414107	Lens 45° LEDspot 100 W / 120 W flex
83414104	Lens 60° LEDspot 100 W / 120 W flex
83414105	Lens 90° LEDspot 100 W / 120 W flex
83414106	Lens 120° LEDspot 100 W / 120 W flex
83414207	Lens 45° LEDspot 200 W/LEDspot 200 W flex
83414204	Lens 60° LEDspot 200 W/LEDspot 200 W flex
83414205	Lens 90° LEDspot 200 W/LEDspot 200 W flex
83414206	Lens 120° LEDspot 200 W/LEDspot 200 W flex

**LEDspot 400 W flex**

Splash-proof LED spotlight (IP65)

The LEDspot 400 W is equipped with a two-coloured LED chip (white and blue). Both colours can be dimmed separately. The control gear (Meanwell) guarantees for a reliable and safe power supply. The pre-installed reflector provides a viewing angle of about 60°. Optional, the reflector supplied incl. diffuser can be mounted with an angle of about 90°. By an optional manual dimming, the Potentiometer (incl. approx. 7.50 m cable) or Qube control (control cable LEDspot is also required) both light channels can be adjusted optimal to the individual needs. A holder for the ceiling is included. Without feed as standard.

Technical data:

LEDspot	400 W flex
Height app.	500 mm
Ø app.	390 mm
Weight app.	13.5 kg
Luminous flux app.	white: 21,895 Lm, blue: 6,087 Lm
Light colour	white: 12,000 K, blue: 455 – 460 nm
Beam angle	60° / 90°, optional 25°, 45°, 100°

Item code	Item
83418450	LEDspot 400 W flex

Options:

83418400	Reflector 25°
83418401	Reflector 45°
83418406	Reflector 100°
83419403	LED-Chip white 3.5 k / 6.5 k
83414210	Potentiometer LED
83416002	Qube control 0 – 10 V LEDspot/2020



LEDspot 400 W flex





LEDspot 1000 W flex

## LEDspot 1000 W flex

Splash-proof LED spotlight (IP65)

The LEDspot 1000 W flex is equipped with a two-coloured LED chip (white and blue). Both colours can be dimmed separately. Four Meanwell ballasts ensure a reliable and safe power supply. The pre-installed reflector provides a viewing angle of about 45°. Optional, the reflector supplied incl. diffuser can be mounted with an angle of about 60°. By an optional manual dimming, the Potentiometer (incl. approx. 7.50 m cable) or Qube control (control cable LEDspot is also required) both light channels can be adjusted optimal to the individual needs. A holder for the ceiling is included. Without feed as standard.

### Technical data:

LEDspot	1000 W flex
Height without clamp app.	510 mm
Height incl. clamp app.	610 mm
Ø Reflector housing app.	445 mm
Cooling element app.	620 x 420 mm
Weight app.	33.5 kg
Luminous flux app.	white: 62,300 Lm, blue: 8,750 Lm
Light colour	white: 8,500 K, blue: 455 – 460 nm
Viewing angle	45°, optional 60°
Ballast	4 x Meanwell HLG 320H

Item code	Item
83418940	LEDspot 1000 W flex <b>NEW</b>

### Options:

83418907	Reflektor 60°
83414210	Potentiometer LED
83416002	Qube control 0 – 10 V LEDspot/2020

### Potentiometer

Manual dimming for LEDspot flex

By the potentiometer (incl. 7.5 m cable) both light channels of the LEDspots flex can be adjusted independently optimal to the individual needs. Special lengths are available on request.



Potentiometer

Item code	Item
83414210	Potentiometer LEDspot flex

### Qube Control LEDspot

2-channel light control for LEDspot/LEDspot flex

- two independently programmable/dimmable channels for blue phase, sunrise, sunset and moonlight
- by using an optional splitter (not included in shipment) several LEDspots can be controlled by one Qube Control simultaneously
- programming is completed via the supplied remote control of the Qube control by timer. No connection to the PC is therefore necessary
- power (24 V low voltage) is supplied via the included power pack

Dimensions (l x w x h): app. 74 x 74 x 15 mm

Cable length: app. 1,400 mm

Manifold for control on request.



Qube control LEDspot

Item code	Item
83416002	Qube control 0 – 10 V LEDspot /2020

### Distribution box LEDspot

Distribution box for LEDspot /LEDspot flex

Suitable for connecting up to 6 LEDspots to the Qube control LEDspot



Distribution box LEDspot

Item code	Item
83400006	Distribution box LEDspot



Ocean Blue power compact 24 W

### Ocean Blue power compact 24 W

Blue actinic power compact lamp for saltwater aquaria

For combination with metal halide lamps and Ocean White 24 W.

Item code	Item
80909	Ocean Blue power compact 24 W <b>SALE</b>



Ocean White power compact 24 W

### Ocean White power compact 24 W

Blue-white power compact lamp with a colour temperature of 10,000 K

For fresh- and saltwater aquarium.

Item code	Item
81909	Ocean White power compact 24 W <b>SALE</b>



T5 Reflektor

### T5 Reflektor

Item code	Item
83221	T5 reflector 24 W incl. clip, length app. 51.1 cm <b>SALE</b>
83231	T5 reflector 39 W incl. clip, length app. 81.1 cm <b>SALE</b>
83251	T5 reflector 54 W incl. clip, length app. 109.5 cm <b>SALE</b>
83281	T5 reflector 80 W incl. clip, length app. 140.5 cm <b>SALE</b>
83220	Clip for reflector T5 (stainless steel) <b>SALE</b>



**T5 Tubes, 16 mm Ø, FQ-series**

(Minimum order quantity 10 pieces!) Shipping of 80 W-T5 tubes is possible for an extra charge. Please contact your consultant.

**aqualine T5 Reef Blue**

Actinic blue fluorescent lamp to increase the percentage of blue light in saltwater aquaria

aqualine T5 Reef Blue is intended for use in saltwater aquaria with the lamp emitting, almost exclusively, blue light in the spectrum between 400 nm and 500 nm, peaking at 420 nm. These wavelengths enhance the growth of many coral species. In addition, when combined with Reef White 10K or 15K they give the aquarium a most natural appearance.

Item code	Item
88700	aqualine T5 Reef Blue 24 W 55 cm (app. 22") B* 26 kWh/1,000 h <b>SALE</b>
88701	aqualine T5 Reef Blue 39 W 85 cm (app. 34") B* 44 kWh/1,000 h <b>SALE</b>
88702	aqualine T5 Reef Blue 54 W 115 cm (app. 46") B* 60 kWh/1,000 h <b>SALE</b>
88703	aqualine T5 Reef Blue 80 W 145 cm (app. 58") B* 85 kWh/1,000 h <b>SALE</b>

\*Power efficiency category



aqualine T5 Reef Blue

**aqualine T5 Reef White 15 K**

A blue/white lamp for the illumination of saltwater aquaria

This lamp emits an extremely bright blue/white light, providing ideal illumination for the saltwater aquarium. The spectrum is chosen to encourage strong coral growth. aqualine T5 Reef White 15K can be used as the sole light source for an aquarium as well as in combination with aqualine T5 Reef Blue.

Item code	Item
88710	aqualine T5 Reef White 15K 24 W 55 cm (app. 22") B* 26 kWh/1,000 h <b>SALE</b>
88711	aqualine T5 Reef White 15K 39 W 85 cm (app. 34") B* 44 kWh/1,000 h <b>SALE</b>
88712	aqualine T5 Reef White 15K 54 W 115 cm (app. 46") B* 60 kWh/1,000 h <b>SALE</b>

\*Power efficiency category



aqualine T5 Reef White 15 K



aqualine T5  
Reef White 10 K

### aqualine T5 Reef White 10 K

Bright white lamp for salt- and freshwater aquaria

aqualine T5 Reef White 10K is a bright white lamp with a colour temperature of 10,000 K. The lamp simulates tropical sunlight and is the ideal basic illumination for saltwater as well as freshwater aquaria. For saltwater aquaria, we recommend combining aqualine T5 Reef White 10K with aqualine T5 Reef Blue to increase the blue spectrum whilst for freshwater the combination of aqualine T5 Reef White 10K with aqualine T5 Plant Grow will enhance plant growth.

Item code	Item
88720	aqualine T5 Reef White 10K 24 W 55 cm (app. 22") A* 26 kWh/1,000 h <b>SALE</b>
88721	aqualine T5 Reef White 10K 39 W 85 cm (app. 34") A* 44 kWh/1,000 h <b>SALE</b>
88722	aqualine T5 Reef White 10K 54 W 115 cm (app. 46") A* 60 kWh/1,000 h <b>SALE</b>
88723	aqualine T5 Reef White 10K 80 W 145 cm (app. 58") A* 85 kWh/1,000 h <b>SALE</b>

\*Power efficiency category



aqualine T5  
Plant Grow

### aqualine T5 Plant Grow

Growth lamp for plants in freshwater aquaria

The lamp accentuates the red and blue parts of the spectrum and comes close to the absorption spectrum of water plants. These wave lengths stimulate photosynthesis and so create excellent condition for luxuriant plant growth. In addition the colours become more vibrant in any fish with red pigmentation (e.g. Cardinal tetra). Combined with aqualine T5 Reef White 10K, Plant Grow gives the aquarium a brilliant natural appearance.

Item code	Item
88732	aqualine T5 Plant Grow 80 W 145 cm (app. 58") B* 85 kWh/1,000 h <b>SALE</b>

\*Power efficiency category

### aqualine 10000

Metal halide lamp for saltwater aquaria

The aqualine 10000 lamp has a colour temperature of 13,000° Kelvin and a high percentage of the light output is at the blue end of the spectrum. aqualine 10000 was the first metal halide lamp to simulate the lighting conditions on a coral reef and the new lamp gives an even more realistic looking aquarium as the improved twin getters give long term colour stability. The corals show their natural colours and the lighting intensity encourages excellent growth. aqualine 10000 helps to transform your aquarium into a perfect reef tank.

Item code	Item
80941	aqualine 10000 70 W 13K <b>SALE</b>
80942	aqualine 10000 150 W 13K <b>SALE</b>
80950	aqualine 10000 175 W E39 13K <b>SALE</b>
80943	Bulb 250 W 14K <b>SALE</b>
80951	aqualine 10000 250 W E40 13K <b>SALE</b>
80945	Bulb 1000 W E40 10K <b>SALE</b>



aqualine 10000

### aqualine 16000

A blue/white full spectrum metal halide lamp for saltwater aquaria

The aqualine 16000 lamp simulates the light spectrum in deeper waters. It is best used in combination with aqualine 10000, but as it is a full spectrum lamp it can also be used as the sole light source, if a high percentage of blue light is required. In these circumstances, there is no need for blue fluorescent lamps and the efflorescing colours of the corals are enhanced.

Item code	Item
80982	aqualine 16000 150 W 16K <b>SALE</b>
80983	aqualine 16000 250 W 16K <b>SALE</b>



aqualine 16000

### aqualine 20000

A blue metal halide lamp for saltwater aquaria

The aqualine 20000 blue lamp emits light strongly in the blue end of the spectrum. The use of this "actinic" lamp enhances the fluorescent blue and green colours of many corals. The lamp should be used in combination with aqualine 10000. This combination gives the aquarium a beautiful bluish hue.

Item code	Item
80971	aqualine 20000 70 W 20K <b>SALE</b>
80972	Bulb 150 W 20K <b>SALE</b>
80973	aqualine 20000 250 W 20K <b>SALE</b>



aqualine 20000



aqualine 5000

## aqualine 5000

Daylight metal halide lamp for freshwater aquaria

aqualine 5000 is a metal halide lamp with a colour temperature of 5,000° Kelvin – attenuated sunlight. This lamp was specially developed for the illumination of freshwater aquaria with its a high percentage of red light and a high intensity – 11,000 lumens per watts. It gives planted aquaria a natural appearance and enhances plant growth.

Item code	Item
81913	aqualine 5000 250 W 5K <b>SALE</b>

Suspension	Aqua Medic light system
aquafit	aquaspacelight 400 aquasunlight NG aquastarlight T5 Ocean Light T5 sunbeam
aquafit 2	aquareefLED aquasunLED Ocean Light T5 aquarius aquarius plant aquarius plus aquarius plant plus
aquafit 3	Ocean Light LED Ocean Light LED twin ECOplant LED ECOplant LED twin



### aquafit

#### Steel Wire Suspension

The wire suspension system aquafit provides a neat and simple method of ceiling mounting of Aqua Medic and other suitable lights. The suspension system contains 2 pcs. of the following: ceiling plate with retaining bush, stainless steel, top screw fitting, wire with ferrule, light fixing incl. top cap, plastic washer, screws and wall fixings and clips to secure the wire's end.

Item code	Item
80400	aquafit



aquafit

### aquafit 2

#### Steel Wire Suspension

Universal suspension kit for use with all suspended lighting units, provided that the screws in the housing's end plates are of adequate length & not too wide (max. Ø 4 mm). aquafit 2 consists of 2 pieces of: 2 metre stainless steel wire with stopper, ceiling plate with retaining bush, steel wire with height and angle adjustment unit attached, screws and plugs. The suspension kit allows fixing of the lighting unit to the ceiling and provides easy adjustment in both height and angle of unit.

Item code	Item
80401	aquafit 2



aquafit 2

### aquafit 3

#### Steel Wire Suspension

Suitable for Aqua Medic Ocean Light LED-, ECOplant-series, may also be suitable for other lights that have Ø M3 thread fixings to attach the cable holder onto the top of the light housing. aquafit 3 consists of 2 pieces of 2 metre stainless steel wire with stopper, ceiling plate with retaining bush, steel wire with height and angle adjustment unit attached, screws and plugs. The suspension kit allows fixing of the light unit to a suitable ceiling and provides easy adjustment in both height and angle of the unit.

Item code	Item
80402	aquafit 3



aquafit 3





T controller twin

### T controller twin

Digital temperature monitor and controller, for the control and monitoring of heating systems and cooling units simultaneously

The temperature controller T controller twin is used for controlling both heating systems and cooling units. Measuring and switching accuracy is 0.1°C. The control range varies from 16 – 40°C, and the set value is in 0.1 °C increments. **The maximum load for heating systems is 1,200 watts and 460 watts for cooling units.** Because of the integrated double socket it is possible to connect a heating system and cooling unit simultaneously. The T controller twin is supplied with a waterproof temperature probe. The LCD display provides instant information on the current temperature. The minimum and maximum values can be easily adjusted.

Item code	Item
200.25	T controller twin



heat controller duo II



### heat controller duo II

Digital temperature monitor and controller, for controlling and monitoring of under gravel heater and other heating systems

The temperature controller heat controller duo II is used for controlling heaters and under gravel heating systems at the same time. Measuring and switching accuracy is 0.1 °C. The control range varies from 0 – 50 °C, the set value is in 0.1 °C increments and is controlled exactly to 1 °C. The maximum load for the heating systems and under gravel heater is 1,200 watts. Because of the integrated double socket it is possible to connect a heater and an under gravel heating system simultaneously. The heat controller duo II is supplied with a temperature probe attached. The LCD display provides instant information on the current temperature, time and state of the connected units. The heating cable is controlled by a timer, the on/off time can be programmed. If the set value is not reached, the under gravel heater is switched on. To avoid overheating, both sockets switch off as soon as the set value is reached.



Item code	Item
200.32	heat controller duo II <b>NEW</b>



Titanium Heater

### Titanium Heater

Titan Aquarium Heater

Titanium heaters are the safe alternative to glass heaters in both fresh- and saltwater aquaria. The unbreakable titanium housing is saltwater resistant and the heaters have both overheat and dry running protection cutouts. The heaters must be used in combination with a temperature controller. For temperature-dependent control we recommend optional the use of our T controller twin. Ø 20 mm

Item code	Item
110.010	Titanium heater 100 W, for aquaria up 100 – 250 l, length: app. 27 cm (app. 10.6")
110.020	Titanium heater 200 W, for aquaria up 250 – 500 l, length: app. 28 cm (app. 11")
110.030	Titanium heater 300 W, for aquaria up 500 – 1,000 l, length: app. 30 cm (app. 11.8")
110.050	Titanium heater 500 W, for aquaria up 1,000 – 1,500 l, length: app. 32 cm (app. 12.6")

**pH controller**

pH monitor and controller

The pH controller is a precision instrument for controlling the pH value in aquaria. In combination with a CO<sub>2</sub> system and a solenoid valve the pH can be maintained at a constant level, and the CO<sub>2</sub> supply to aquatic plants or into a Calciumreactor can be controlled. The unit is supplied with a large LED display and the control range is digitally adjustable from pH 3.5 to 10.5. **The direction of adjustment can be set up or down.** The pH controller has a BNC connection for pH electrodes. The use of an original Aqua Medic plastic shafted electrode is recommended.



pH controller

Item code	Item
200.00	pH controller w/o probe

**pH monitor**

pH meter for exact measuring of the pH value

The pH monitor is a precision instrument for controlling permanently the pH value in aquaria. The LED display continuously shows the current pH value of the aquarium water. The measuring range covers pH-values from 0.00 to 14.00. The test liquids included in delivery allow an exact calibration of the electrode that is connected to the pH monitor via a BNC connection.

Included:

pH monitor, pH electrode with BNC fitting, electrode holder, test liquids for calibration



pH monitor

Item code	Item
203.00	pH monitor

**pH-control-Set**

Includes: controller, pH-sensor, sensor holder, pH-test fluid and solenoid valve



pH-control-Set

Item code	Item
200.50	pH-control-Set



mV controller

### mV controller

Redox-potential (ORP) monitor and controller

The mV controller is designed for monitoring and controlling the redox potential (or ORP - oxidation-reduction potential) in aquaria. The unit has a broad controlling range from -500 to a +500 mV, and a measuring range from -1,000 to +1,000 mV. It can be used to control the supply of ozone in saltwater aquaria and/or for the control of nitrate removal in anaerobic biological filters (Nitratereducator). The unit is supplied with a BNC connection for a mV probe. The use of an original Aqua Medic plastic shafted electrode is recommended.

Item code	Item
200.05	mV controller without probe



LF controller

### LF controller

Conductivity monitor and controller

The salt content of water can be determined by measuring the electrical conductivity. A special feature of the LF controller conductivity monitor and controller is the broad measurement and control range which is divided into 2 bands: from 0 to 2,000  $\mu$ S, the unit is used for monitoring desalinated water and freshwater, and in the range 0 to 200 mS, it is used for brackish and saltwater. The unit can therefore be used for the control of reverse osmosis units, for monitoring breeding tanks with soft water, and for the control of the salt content in saltwater aquaria. The unit is supplied with a directly connected, saltwater resistant graphite electrode.

Item code	Item
200.10	LF controller with probe



T controller

### T controller

Temperature monitor and controller

The T controller is available in 2 versions: T controller HC for the control of heating systems and T controller CC for the control of cooling units. The control range varies from 0 to 50 °C, with an accuracy of  $\pm 0.1$  °C. The maximum load is 1,000 watts for heaters and 600 watts for coolers. The units are supplied with a waterproof temperature probe.

Item code	Item
200.15	T controller CC with probe
200.20	T controller HC with probe



### T-meter

Submersible digital thermometer incl. rubber sucker and battery.

Item code	Item
203.20	T-meter



T-meter

### T-meter II

External aquarium thermometer for fixing on the aquarium glass (outside) or in the cabinet

- compact design and easy operation
- large LCD display showing the water temperature
- separate power button for turning off the display (power saving mode)
- external temperature sensor, can be hidden in the aquarium
- selectable temperature unit: °C or °F
- easy fixing on the aquarium glass by suction cups
- can also be fixed to the cabinet

Measuring range: +5~+45 °C (+41~+113 °F)

Measuring steps: 0.1 °C / 0.1 °F

Measuring accuracy: ±1 °C (2 °F)

Power supply: 1.5 V (AG13/LR44)

**Attention:** Do not immerse the display unit in water. Only the sensor is water-proof.

Display = „H °C“ – the temperature is above the measuring range

Display = „L °C“ – the temperature is below the measuring range

Item code	Item
203.22	T-meter II <b>NEW</b>



T-meter II

### T-meter twin

External double-display thermometer

Large double LCD display simultaneously showing aquarium and ambient temperature. Selectable temperature unit: °C or °F. With adhesive tape at back side for easy putting on aquarium tank.

Ambient: -10 ~ +50 °C (-14~+122 °F)

Aquarium: -50 ~ +70 °C (-58 ~ +158 °F)

Resolution: 0.1 °C / 0.1 °F

Accuracy: ±1 °C (2 °F)

Power supply: 1.5 V (AG10)

Item code	Item
203.10	T-meter twin



T-meter twin



pH computer-Set

### pH computer-Set

Microprocessor controlled pH monitor and controller

The pH computer-Set utilises a modern microprocessor, which provides high precision measurement and control. The pH computer-Set is used to control precise values of pH in the aquarium or the calcium reactor. The direction of control can be set upwards or downwards. The computer can switch up to 500 watts using the supplied external electrical socket. When the calibration key has been selected the unit will automatically calibrate itself to the electrode. A plastic shafted pH electrode with BNC fitting and the correct calibration fluids are included.

Item code	Item
201.00	pH computer-Set



mV computer-Set

### mV computer-Set

Microprocessor controlled redox-potential (ORP) monitor and controller

The mV computer-Set uses the same microprocessor technique as the pH computer-Set. Waterproof touch keys are used to set the required values and calibrate the electrode. The mV computer-Set is ideal for controlling anaerobic biological filters such as the Nitratereducator which have negative redox potential or can control the supply of ozone to the aquarium, or monitor the aquarium water's redox potential. All these functions are possible due to the computer's broad measurement and control range of  $-500$  to  $+1,000$  mV. The direction of control can be set upwards or downwards. The status of the direction of control and the output are shown on LED's. A plastic shafted mV electrode with a BNC fitting and calibration fluid is included.

Item code	Item
201.05	mV computer-Set



aquaniveau

### aquaniveau

Electronic level and refill controller

The aquaniveau electronic level controller may be used in 2 different modes: As a top up controller with one or two float switches to control the replacement of evaporated water. It is possible to control dosing pumps (e.g. SP 3000) or circulation pumps (max. 200 W). If circulation pumps shall be controlled, a second sensor can be used as dry running protection for the pump. In order to fill a storage tank by an osmosis unit, the operation with solenoid valve and two float switches as maximum/minimum control is possible.

Item code	Item
77114	aquaniveau with 2 switches

**Ozone**

The injection of ozone into the water can improve the efficiency of protein skimming and raise the ORP (redox potential). The decomposition of toxic nitrite is enhanced whilst the bacteria in the water decreases, minimising the risk of illness of the animals. The compounds that produce yellow colouring in the aquarium are broken down and the water stays crystal clear. The ozone generators in the ozone-series utilise low voltage technology for safety and reliability. Various models are available with capacities from 25 – 300 mg/h.

Ozone	Ozone 25	Ozone 50	Ozone 100	Ozone 200	Ozone 300
Ozone output in mg/h	2 – 25	5 – 50	10 – 100	50 – 200	50 – 300
Continuously adjustable %	0 – 100	0 – 100	0 – 100	0 – 100	0 – 100
Power consumption/watts	3	3.6	4.8	6	10
Air flow rate l/h	30 – 500	30 – 500	50 – 500	100 – 500	200 – 500
Freshwater amount up to/l	500	1,000	2,000	4,000	6,000
Saltwater amount up to/l	250	500	1,000	2,000	3,000
Outlet/connection in mm	4	4	4	4	4

Item code	Item
202.00	Ozone 25
202.05	Ozone 50
202.10	Ozone 100
202.15	Ozone 200
202.20	Ozone 300

**Ozonizer**

Ozonizer

The wear-resistant components offer high-power ozone production with optimum power consumption. The ceramic electrode can be easily cleaned, if necessary. The ozone quantity can be adjusted continuously via a potentiometer. The XT 2000 is equipped with a large touch display that allows convenient operation and precise adjustment of all operating parameters.

Ozonizer	Ozonizer S 500	Ozonizer S 1000	Ozonizer XT 2000
Ozone output - mg/h	0 – 500	0 – 1,000	0 – 2,000
Continuous adjustment - %	0 – 100	0 – 100	0 – 100
Power consumption - watts	12	24	42
Air flow - l/h	200 – 1,000	200 – 1,000	50 – 1,000
Freshwater quantity up to - l	10,000	20,000	40,000
Saltwater quantity up to - l	5,000	10,000	20,000

Item code	Item
202.905	Ozonizer S 500 - Sander
202.910	Ozonizer S 1000 - Sander
202.920	Ozonizer XT 2000 - Sander





Ozone Booster

## Ozone Booster

Air dryer

The air dryer is for use with any Aqua Medic Ozone Generators. Ozone output can decrease dramatically if the supply air is very humid. Ozone Booster should be used to dry the air, particularly if a protein skimmer is supplied with ozone using the humid air present in the aquarium cabinet. In some circumstances ozone production can be almost doubled. The unit utilises silicagel as drying component. The silicagel should be changed as soon as the indicator beads change their colour from orange to blue.

Item code	Item
65027	Ozone Booster

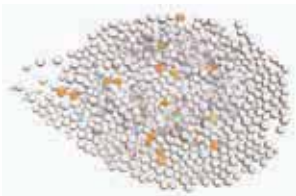

Silicagel

## Silicagel

Ozone Booster - Refill

Dry granulate with high de-hydration capacity. The indication pearls changing colour from orange to blue if wet.

Item code	Item
12730	Silicagel 600 g/app. 1,000 ml

**M-ventil ECO**Electronic shut-off valve for CO<sub>2</sub>, Eco

The M-ventil Eco is a quality valve with pressure fittings for 6 mm flexible hose with a maximum operating pressure of 1 bar. The power consumption is only 5 watts of electrical energy to prevent overheating. The valve can be connected to the corresponding CO<sub>2</sub> units. In conjunction with a pH controller, automatic control of the CO<sub>2</sub> supply and pH can be achieved. If used with a timer, the valve will provide a night shut off system. Only suitable for gases.

Item code	Item
230.32	M-ventil ECO



M-ventil ECO

**M-ventil Standard**Electronic shut off valve for CO<sub>2</sub>-Standard

M-ventil Standard has a high quality nickel plated brass body with a maximum operating pressure of 6 bar, pressure fittings for 6 mm flexible hose and can be connected to all our CO<sub>2</sub> units. The solenoid coil consumes only 2.5 watts of electric energy to prevent overheating.

Item code	Item
230.30	M-ventil Standard, nickel plated, 1/8", 2.5 watts



M-ventil Standard

**M-ventil 1/2"**

Water shut off valve

M-ventil 1/2" for water is intended for automatic control of reverse osmosis units. The brass body has connections for 1/2" BSP male fittings and is recommended only for use with tap water. The power uptake is 6 watts.

Item code	Item
230.35	M-ventil 1/2" for tap water, brass



M-ventil 1/2"



Electrodes

### Electrodes

Aqua Medic pH- and mV-electrodes (Redox-potential) are quality products designed for both accurate measurement and long, trouble free use. Both types of electrodes are available in three versions: Standard electrodes – with plastic shaft, glass electrodes – laboratory standard for extended performance. Electrodes with plastic shaft and PG 13.5 thread – pressure resistant up to 3 bar, and can be used in plumbing fittings or in a closed version of Nitratereductors and Calciumreactors.

Electrode	Length up to the top	Length incl. top
Plastic probe pH	127 mm	159 mm
Glass probe pH	120 mm	160 mm
Plastic probe pH PG 13.5	70 mm	110 mm
Plastic probe mV	120 mm	160 mm
Glass probe mV	120 mm	160 mm
Plastic probe mV PG 13.5	70 mm	110 mm

Item code	Item
220.10	Plastic probe pH
220.11	Glass probe pH
220.13	Plastic probe pH PG 13.5
220.16	Plastic probe mV
220.17	Glass probe mV
220.19	Plastic probe mV PG 13.5



Test fluids

### Test fluids

Electrode calibration fluids

The accuracy of all electrodes is dependent on their calibration. To ensure accurate readings, all electrodes need to be calibrated at regular intervals. To ensure that the fluid values used to calibrate the electrodes remain constant, regular replacement of these fluids should occur.

Item code	Item
230.004	pH 4 test fluid 60 ml
230.007	pH 7 test fluid 60 ml
230.009	pH 9 test fluid 60 ml
230.300	KCL-solution for pH + mV sensors 60 ml
230.230	230 mV test fluid 60 ml
230.400	Cleaning solution 60 ml
230.250	250 $\mu$ S test fluid 60 ml
230.050	50 mS test fluid 60 ml



Electrode holder

### Electrode holder 2 / 4

For use with up to 2 or 4 electrodes, easily attaches to the aquarium. The level of submergence of the electrodes is fully adjustable.

Item code	Item
230.62	Electrode holder 2
230.64	Electrode holder 4

**platinum line plus**

Reverse osmosis unit

- reverse osmosis unit incl. high pressure pump for producing up to 400 litres of purified water per day
- for the production of soft water with low-salt content for fresh- and saltwater aquaria, for spraying terrariums and many other applications

The reverse osmosis system platinum line plus is a compact and versatile superior unit. It is supplied with three large 10" filter housings. The filter cartridges (activated carbon, fine filter and demineralization resin) can easily be replaced. The supplied pressure gauge will display the operation pressure at any time. All components, the prefilter housings and the membrane module are mounted onto a stable powder-coated bracket. The unit has a high pressure pump and a flushing valve and therefore, can achieve a high ratio of pure to waste water output up to 1:1. The salt removal rate is up to 99%. Due to the fully automatic back flushing and continuous monitoring of the pure water, the unit requires very little maintenance.

Dimensions (l x w x h): app. 38 x 22 x 47 cm

Tube's diameter: 1/4" - 4/6

Filling capacity for resin: app. 600 ml

Item code	Item
U800.65	platinum line plus 24 V <b>NEW</b>

Options:

U605.80	Membrane 200 l / day for platinum line plus
U606.17	Sediment filter 5 µm 10" housing for premium line/platinum line plus
U606.10	Combined filter cartridge carb./sed. 10" housing for premium line/platinum line plus
U601.11	Demineralisation filter RO-resin 600 g/app. 1,000 ml can
U601.12	Demineralisation filter RO-resin 3,000 g/app. 5,000 ml bucket
U601.15	RO-resin cartridge, app. 600 ml <b>NEW</b>



platinum line plus





### premium line

For producing of app. 190 – 600 litres (app. 50 – 158 gal) of purified tap water per day

The premium line reverse osmosis units are compact and versatile superior grade products. They are supplied with two large (10") prefilter housings and their activated carbon and 5µ sediment cartridges can easily be replaced. The membrane, the heart of the unit, is offered in 3 sizes: 190 l/day and 300 l/day as well as a double membrane of 600 l/day. The membrane housing includes a combined flushing valve and flow restrictor and the system can achieve a concentrate to permeate recovery ratio of up to 3 to 1 with a rejection rate of app. 95%. The prefilter housings and the membrane module are mounted onto a strong powder coated wall mounting bracket.



Item code	Item
U800.25	premium line 190, 190 l/day
U800.30	premium line 300, 300 l/day
U800.35	premium line 600, 600 l/day

Options:

U606.17	Sediment filter 5 µm 10" housing for premium line/platinum line plus
U606.10	Combined filter cartridge carb./sed. 10" housing for premium line/platinum line plus
U606.15	Activated carbon filter cartridge 10" housing for premium line
U605.60	Membrane 190 l/day for premium line 190
U605.65	Membrane 300 l/day for premium line 300



### easy line

For producing purified tap water, app. 190/300 l/day

easy line 190 and easy line 300 reverse osmosis units are compact and powerful. A sediment filter retains all particles larger than 5 µm and a carbon filter protects the membrane by removing chlorine. In our units, only TFC (Polyamide / Polysulfone) membranes are used to provide the highest quality treated water, providing a recovery ratio of approximately up to 3 concentrate : 1 permeate, and a rejection rate of up to 98%.

Item code	Item
U700.25	easy line 190, 190 l/day
U700.30	easy line 300, 300 l/day

Options:

U605.60	Membrane 90 l/day for easy line 190
U605.65	Membrane 150 l/day for easy line 300
U605.01	Activated carbon prefilter w. fittings for easy line
U605.06	Sediment 5 µm prefilter w. fittings for easy line



**Merlin plus (PRF-RO)**

Reverse osmosis unit with a capacity of app. 2,000 l/day (app. 500 gpd)

The Merlin plus (PRF-RO) reverse osmosis unit operates using just the mains pressure of the tap water (3 – 4 bar), without the need for a high pressure pump. It has 2 high flow membranes and a combined activated carbon/sediment prefilter. Salt rejection is app. 90 – 95% and the recovery ratio (purewater:wastewater) is 3 – 4 : 1. We recommend using an aquaniveau level control with an M-ventil ½" to give automatic control of the unit.



Merlin plus (PRF-RO)

Item code	Item
U600.71	Merlin plus (PRF-RO)
Options:	
U600.70-2	Carbon postfilter Merlin II/plus (PRF-RO)
U600.70-3	Combined filter cartridge Merlin II/plus (PRF-RO)
U605.75	Membrane Merlin II/plus (PRF-RO)

ACCESSORIES FOR REVERSE OSMOSIS

**Demineralisation filter**

Used to remove the last remaining pollutants using a special ion exchange resin, and is placed after the reverse osmosis unit. It reduces the growth of diatom, if silicate level of tap water is too high.



Demineralisation filter

Item code	Item
U601.10	Demineralisation filter 10"
U601.11	Demineralisation filter RO-resin 600 g/app. 1,000 ml can
U601.12	Demineralisation filter RO-resin 3,000 g/app. 5,000 ml bucket

**RO-resin**

Ion exchange resin

Used to remove the last remaining pollutants using a special ion exchange resin, and is placed after the reverse osmosis unit. It reduces the growth of diatom, if silicate level of tap water is too high



RO-resin

Item code	Item
U601.11	Demineralisation filter RO-resin 600 g/app. 1,000 ml can
U601.12	Demineralisation filter RO-resin 3,000 g/app. 5,000 ml bucket



### Membrane, filter, cartridges

Item code	Item
U605.60	Membrane 90 l/day for easy line + premium line 190
U605.65	Membrane 150 l/day for easy line und premium line 300
U605.80	Membrane 200 l/day for platinum line plus
U605.01	Activated carbon prefilter w. fittings for easy line
U605.06	Sediment 5 µm prefilter w. fittings for easy line
U606.17	Sediment filter 5 µm 10" housing for premium line/platinum line plus
U606.10	Combined filter cartridge carb./sed. 10" housing for premium line/platinum line plus
U606.15	Activated carbon filter cartridge 10" housing for premium line
U606.65	Filter cartridge for housing 10" empty
U600.70-2	Carbon postfilter Merlin II/plus (PRF-RO)
U600.70-3	Combined filter cartridge Merlin II/plus (PRF-RO)
U605.75	Membrane Merlin II/plus (PRF-RO)
U601.15	RO-resin cartridge, app. 600 ml <b>NEW</b>



### RO-resin cartridge

Ion exchange resin cartridge for reverse osmosis system platinum line plus – with colour indicator

Used to remove the last remaining pollutants from RO water such as silicate, nitrate and other ions, by using ion exchange resin as the final stage on a reverse osmosis unit. It reduces the growth of diatom, if silicate levels in tap water are too high. The resin changes colour to indicate the efficacy of the filter material. When the conductivity of desalted osmosis water begins to rise again, the resin turns from blue to green and needs to be renewed.

Item code	Item
U601.15	RO-resin cartridge, app. 600 ml <b>NEW</b>



### PE-tube

Item code	Item
U630.00	PE-tube 4/6 mm / 1 m (price per metre), minimum quantity 10 m

**station**CO<sub>2</sub> storage bottle

station is a steel CO<sub>2</sub> storage bottle with an external shut off valve. The cylinder will be supplied with a safety cage and a base stand.

Item code	Item
71413	station 2 kg (app. 4.4 lb.) with cage



station 2 kg

**reactor compact**

CO<sub>2</sub>-reactor with integrated non-return valve and bubble counter for aquaria up to 200 liters.

Item code	Item
71630	reactor compact



reactor compact

**regular mini**

Pressure regulator with bottle pressure display and needle valve to use with CO<sub>2</sub>-bottles. Connecting thread W21,8 x 1/14".

Item code	Item
71610	regular mini



regular mini

**CO<sub>2</sub> pipe 4/6 mm, 5 m**

4/6 mm hose, 5 meter

Item code	Item
71614	CO <sub>2</sub> pipe 4/6 mm - 5 m

CO<sub>2</sub> pipe**pipe holder**

Holder for 6 mm CO<sub>2</sub>-hose to fit onto glass of up to 10 mm thickness.

Item code	Item
71615	pipe holder



pipe holder





bubble counter plus

### bubble counter plus

Bubble counter for use with CO<sub>2</sub>-systems for the supply of water plants.

Item code	Item
71650	bubble counter plus



CO<sub>2</sub> indicator

### CO<sub>2</sub> indicator

Indicator for showing the carbon dioxide content in freshwater aquaria. Incl. 10 ml CO<sub>2</sub> indicator solution.

Item code	Item
71640	CO <sub>2</sub> indicator



CO<sub>2</sub> indicator solution

### CO<sub>2</sub> indicator solution

Inject 1 ml of CO<sub>2</sub> indicator solution into CO<sub>2</sub> indicator directly. It is recommended to change the CO<sub>2</sub> indicator solution once a month. Compare the color of the CO<sub>2</sub> solution with the included scala and determine the CO<sub>2</sub> content of your aquarium water.

Item code	Item
71641	CO <sub>2</sub> indicator solution 10 ml



reactor 100

### reactor 100

Passive CO<sub>2</sub>-reactor for aquaria up to 250 litres (app. 62.5 gallons)

reactor 100 is operated without an additional pump. The CO<sub>2</sub> is forced through a ceramic diaphragm. This creates tiny bubbles that rise slowly in the water and dissolve on their way up.

Item code	Item
71130	reactor 100



reactor 1000

### reactor 1000

Closed CO<sub>2</sub>-reactor for external use for aquaria up to 2,000 litres (app. 500 gallons)

reactor 1000 is a hermetically sealed unit for introducing CO<sub>2</sub> into larger aquaria. The universal mounting plate enables it to be mounted outside the aquarium or inside the cabinet. This powerful unit can supply aquaria up to 2,000 litres (app. 500 gallons) with CO<sub>2</sub>. With 12/16 mm hose.

Required pump power: 1,500 – 2,000 l/h. (app. 375 – 500 gal.)

Total height: app. 37 cm (app. 15"); Ø app. 8 cm (app. 3")

Item code	Item
71113	reactor 1000

**regular**

Pressure regulator for precise control of CO<sub>2</sub> dosing into the aquarium

regular is chrome plated and offers: a fixed working pressure of app. 1.5 bar, a needle valve for fine adjustment, two pressure gauges to show both the cylinder and working pressures. regular fits industry standard CO<sub>2</sub> cylinders having an external valve. Connecting thread W21,8 x 1/14".

Item code	Item
71011	regular with 2 pressure gauges

**counter**

CO<sub>2</sub>-bubble counter incl. check valve

High-quality material allows longer operation life and a reliable operation. Bubble counter with combined check valve. The backflow is effectively prevented by the check valve. Suitable for hose connection 4/6 mm.

Item code	Item
71850	counter



megatools



scissors 60

**scissors 60**

Straight stainless steel scissors for pruning plants in the aquarium. Length app. 60 cm

Item code	Item
39010	scissors 60



scissors 60 curved

**scissors 60 curved**

Curved stainless steel scissors, for easy trimming of ground covering plants. Length app. 60 cm

Item code	Item
39011	scissors 60 curved



t-rail 60

**t-rail 60**

Straight stainless steel pliers with clip, for effortless planting of aquarium plants. Length app. 60 cm

Item code	Item
39020	t-rail 60



tweezers 60

**tweezers 60**

Straight stainless steel tweezers to assist in the planting of aquarium plants in inaccessible areas of the aquarium. Length app. 60 cm

Item code	Item
39030	tweezers 60

**coral cutter mini**

Coral pliers are made of stainless steel incl. scissors of 2 cm in length for fragmenting small stone corals. Rinse thoroughly in fresh water, after being in contact with saltwater. Grease the joint regularly with vegetable oil.  
Length: app. 10 cm

Item code	Item
39050	coral cutter mini



coral cutter mini

**coral cutter midi**

Coral pliers are made of stainless steel incl. scissors of 3.5 cm in length for fragmenting strong stone corals. Rinse thoroughly in fresh water, after being in contact with saltwater. Grease the joint regularly with vegetable oil.  
Length: app. 18 cm

Item code	Item
39051	coral cutter midi



coral cutter midi

**coral cutter moon type**

Coral pliers are made of stainless steel for fragmenting stone corals with particularly thick and hard coral branches. Rinse thoroughly in fresh water, after being in contact with saltwater. Grease the joint regularly with vegetable oil.  
Length: app. 20 cm

Item code	Item
39052	coral cutter moon type



coral cutter moon type

**aqua gloves**

The 75 cm long Aqua Medic aqua gloves not only offer protection against wet sleeves, they also reduce the risk of a possible infection of the aquarist with fish tuberculosis or inflammation of the hands due to minor skin injuries caused by fine needles on the reef rock or bristle worms.  
Available in sizes M and XL (contains natural latex)

Item code	Item
66300	aqua gloves M
66301	aqua gloves XL



aqua gloves



food pipe



## food pipe

Food station for aquaria

- for feeding fish and corals
- prevents early loss of food via the drain
- with magnetic holder for easy attachment to an aquarium pane

Item code	Item
501.91	food pipe <b>NEW</b>



blue

## blue

LED aluminium torch

The Aqua Medic blue makes corals fluoresce in darkness, the actinic blue colour is particularly well reflected by the natural colours of the corals. Thus, it seems like they are fluorescing. The Aqua Medic blue is ideal for watching corals feeding at nighttime as many corals show their feeding tentacles during that time.

3 watts Cree LED, app. 220 – 240 lm, app. 450 – 465 nm

Shock resistant and weatherproof, adjustable focus, incl. belt clip and wrist strap.

The individual modes can be accessed by pressing the on-off switch.

3 x Micro AAA (LR03) 1.5 V batteries are required (not included).

Item code	Item
65950	blue



catch bowl

## catch bowl

Fishing scoop for gentle and easy removal of fish and invertebrates from the aquarium

Dimensions: Length approx. 40 cm, Ø approx. 12 cm

Item code	Item
501.82	catch bowl



### Fish trap

Trap for catching a particular fish in an aquarium

Aquaria can have many hiding places making catching an individual fish extremely difficult without being time consuming and stressful to both yourself and the aquarium inhabitants and can also cause damage to invertebrates when trying to use a net.

Fish trap is baited with some food and as soon as the desired fish has entered the trap the closing mechanism is simply released – by hand. The Fish trap is constructed in such a way that when it is removed from the aquarium with the fish inside it remains half full of water. This method considerably reduces the stress on the fish. Incl. rubber sucker twin

The double sucker is made of a highly quality flexible material and is particularly suitable for fixing our Fish trap to the inside glass of an aquarium.

We recommend using three double suckers to ensure safe fixing of the fish trap.

By using this type of fixing, the fish trap does not have to be in contact with the base of the aquarium, making it easier to catch fish than was possible before.

Dimensions (l x w x h): app. 27.5 x 17 x 17 cm

Item code	Item
501.80	Fish trap



Fish trap



### rubber sucker twin

The double sucker is made of a highly quality flexible material and is particularly suitable for fixing our Fish trap to the inside glass of an aquarium.

We recommend using three double suckers to ensure safe fixing of the Fish trap. By using this type of fixing, the Fish trap does not have to be in contact with the base of the aquarium, making it easier to catch fish than was possible before.

You can also use the double sucker to connect other items with smooth surfaces to each other. (Ø app. 38 mm, h app. 25 mm)

Item code	Item
418.11	rubber sucker twin 3 pcs.



rubber sucker twin

### Trap-pest

Universal trap for crabs, snails and bristle worms – for fresh- and saltwater

Trap-pest is an automatic trap for removing undesirable bristle worms, crabs or snails from an aquarium. Bristle worms crawl through a funnel into the trap and cannot find their way out whilst crabs and snails pass through a one way curtain which blocks their return path. The Trap-pest is simply baited from the outside.

Dimensions (l x w x h): app. 27.5 x 17 x 17 cm

Item code	Item
501.81	Trap-pest



Trap-pest



filter bag multi

### filter bag multi

Filter bag

Filter bag (Ø app. 10.5 cm) with 1,000 µm for use as a prefilter in a cabinet filter, without holder

Item code	Item
429.12	filter bag multi (2 pcs.) Ø app. 90 mm, length app. 230 mm



filter bag

### filter bag

Zip up media bag

Filter bags are designed to contain fine filter media, such as activated carbon, antiphos Fe or other granular media. The filter bag is fitted with a zip fastener for quick and easy replacement of the media.

Item code	Item
429.01	filter bag 1, 2 pcs., 22 x 15 cm (app. 8.6" x 5.9")
429.02	filter bag 2, 2 pcs., 22 x 30 cm (app. 8.6" x 11.8")
429.03	filter bag 3, 2 pcs., 22 x 45 cm (app. 8.6" x 17.7")



prefilter bag



filter bag 4

### prefilter bag

Filter bag (Ø app. 10.5 cm) with 200 µm for use as a prefilter in a cabinet filter. Incl. acrylic holder for max. 14 mm glass.

Item code	Item
429.10	prefilter bag
429.11	filter bag 4 (2 pcs.) - replacement Ø app. 90 mm, length app. 300 mm



TopView 200



### TopView 200

Aquarium Viewing and Photography Glass

- made of high quality acrylic glass
- floats on the water surface
- allows a great view through the water surface of the aquarium to the coral world
- ideal for photographing the corals, from a different perspective
- no distorted images
- current pumps do not have to be switched off
- a smartphone can be conveniently inserted directly into the glass to avoid annoying light reflections

Dimensions: Ø app. 200 mm, height: app. 50 mm

Item code	Item
65960	TopView 200 <b>NEW</b>

### Mega Mag

Magnetic glass cleaners for panes between 6 and 18 mm (app. 0.24 and 0.72")

Mega Mag magnetic glass cleaners are waterproof, corrosion-resistant and suitable for use in fresh and saltwater aquaria, removes debris and algae from the aquarium glass. The floating half of the magnet that is placed within the aquarium can be easily attached to help avoid scratching due to sand and gravel being trapped between the two halves.



Mega Mag	Mega Mag S	Mega Mag M	Mega Mag L
Glass thickness up to	6 mm	12 mm	18 mm
Cleaning surface	app. 62 x 33 mm	app. 98 x 36 mm	app. 85 x 67 mm

Item code	Item
67021	Mega Mag S
67022	Mega Mag M
67023	Mega Mag L

### Mega Mag 1 + 2

Magnetic glass cleaners for panes between 10 and 32 mm (app. 0.4" and 1.25")

Mega Mag glass cleaners are completely sealed and corrosion protected and are suitable for use in fresh- and saltwater aquaria. The cleaning pads of the inner magnet and the felt pads of the outer magnet can be easily replaced. Mega Mag glass cleaners contain extremely strong magnets and have to be handled with care. Cleaning surface 8 x 11 cm.

Mega Mag 1 for glass from 10 – 19 mm (app. 0.4" – 0.75")

Mega Mag 2 for glass from 15 – 32 mm (app. 0.6" – 1.25")

Item code	Item
67000	Mega Mag 1
67001	Mega Mag 2
67101	Spare pads Mega Mag 1 & 2, 2 pcs.



### Mega Mag 3

Magnetic glass cleaner for large aquaria

Mega Mag 3 is a powerful magnetic cleaner for large aquaria with panel thicknesses up to 55 mm. As with the smaller models in the Mega Mag range, the cleaning pads are easily renewed or a plexipad can be fitted for the cleaning of acrylic aquaria. Cleaning surface 10 x 14 cm.

Item code	Item
67002	Mega Mag 3
67103	Spare pads Mega Mag 3, 2 pcs.





plexipad

### plexipad Mega Mag

Cleaning pad for Mega Mag to protect acrylic

When using Mega Mag cleaners on acrylic aquaria the existing glass cleaning pad should be replaced with plexipad. This material is specially selected for cleaning acrylic and is fixed on the inner magnet to protect the acrylic panels from scratching. plexipad can be easily changed when worn.

Item code	Item
67100	plexipad Mega Mag 1 + 2
67102	plexipad Mega Mag 3



magnetscraper

### magnetscraper

Blade accessory for Mega Mag

magnetscraper is an accessory for the Mega Mag glass cleaner. It converts the Mega Mag from a simple magnet into a bladed cleaner. Now, even the most resistant algae can be removed. The magnetscraper simply snaps onto the Mega Mag 1 or Mega Mag 2 and is secured with a single screw. It can easily be removed if required.

Item code	Item
67010	magnetscraper



magnetscraper blades

### magnetscraper blades

Spare blades for Mega Mag

Item code	Item
67011	magnetscraper blades, package 5 pcs.



scraper

### scraper

Aquarium glass cleaner

scraper is a multiple use blade cleaner. The 150 mm wide blade makes it easy to remove even the most resistant calcareous algae from the aquarium glass. Extended durability with stainless steel anti-corrosive coating – specially made sharp blade. The removable blade protector also acts as a squeegee for cleaning the outside of the aquarium glass. A unique feature of the scraper is the hinge which allows the blade head to be turned through 180°. This facility allows the user to clean the aquarium even when the tank decoration, such as rocks or roots, are very close to the glass.



Item code	Item
66000	scraper
66001	scraper blades 5 pcs.

**aqua smoothy**

Superfine micro porous fibre cloths, for smear free cleaning of the outside glass of the aquarium, lint-free. The aqua smoothy is very absorbent and can be used either wet or dry. It will safely and gently remove salt encrustation or fatty residues without the use of aggressive cleaning agents. Can also be used on most other smooth surfaces.

Contents: 2 x cloths, each approximately 40 x 40 cm

Microfiber: 80% polyester, 20% polyamide.

Item code	Item
66100	aqua smoothy



aqua smoothy

**Reef Construct**

Two-component resin

For safe and easy attachment of stones and corals in the aquarium. A two-part epoxy putty to secure rock and hard and soft corals in the aquarium. Reef Construct solves many of the problems encountered during the aqua-scaping of fresh- and saltwater aquaria. Reef Construct is a fast curing, two-part epoxy putty that can even be used underwater. It adheres to rock, wood, metal, glass, plastic, concrete and most other materials.

Item code	Item
420.60	Reef Construct, 2 x 56 g (2 x app. 2 oz) sticks
420.61	Reef Construct, 1,008 g, 18 x 56 g (18 x app. 2 oz) sticks



Reef Construct

**Coral Construct**

Under water glue

For safe and easy attachment of coral frags inside and outside the aquarium. Harden quickly in and outside of the water.

Item code	Item
420.71	Coral Construct - 5 g
420.70	Coral Construct - 20 g



Coral Construct

**hot construct**

Coral glue

hot construct is an easy-to-use glue for synthetic material for quick and easy gluing of coral fragments (layers). It is free from solvents. Unused material can be reactivated in hot water and reused. Suitable for use above and under water.

Item code	Item
420.80	hot construct



hot construct



AiptaCap

### AiptaCap

To eradicate Aiptasia & Manjano anemones

AiptaCap helps prevent the spread of aiptasia and manjano anemones that can quickly become a plague in a coral aquarium, if left untreated. Once out of control, the complete removal is then virtually impossible. Therefore, it is important to act immediately. AiptaCap comes ready to use in a syringe and can be used immediately, without mixing or filling.

Item code	Item
422.000	AiptaCap



defroster+

### defroster+

For defrosting of frozen food and enrichment with amino acids and vitamins

For salt- and freshwater fish. The frozen food is thawed in the defroster box, protected from light and vitamin saving. With the defroster+ sieve, it is separated from the nitrate and phosphate enriched thawing water and can be enriched with essential vitamins and amino acids (aminovit). Incl. defroster+ box with lid and sieve.

Item code	Item
68000	defroster+



frag board

### frag board

Retaining plate (app. 15 x 15 cm) for holding several coral pins

By using the supplied suction cups, the retaining plate can be placed anywhere on the inner side of the aquarium. Thereby, the frags can be put in an optimal position for illumination. Thus, optimal growth of the frags can be significantly stimulated. Incl. 10 x coral pins.

Item code	Item
230.04	frag board



coral pins

### coral pins

Frag stones

Item code	Item
230.06	coral pins (10 pcs.)
230.16	coral pins (100 pcs.) <b>NEW</b>

**hopstop**

Hop protection for open top aquaria

Helps prevent nocturnal fish from jumping out.

Content: 6 holders (combfix) and 3 plastic plates each app. 480 x 50 mm.



hopstop

Item code	Item
418.12	hopstop

**hose clip**

Plastic clip

Flexible plastic clip designed for the safe fastening of hoses.



hose clip

Item code	Item
410.38	hose clip Ø 5 – 6 mm
410.39	hose clip Ø 6 – 7 mm

**Coral strap**

Secure strap for soft corals and live rock

Extra wide strap with rounded and thickened edges that do not cut into the tissue of the corals. For vegetative propagation of the soft corals. Saltwater resistant and PVC-free. Re-usable! Length app. 31 cm



Coral strap

Item code	Item
39520	Coral strap (5 pcs.)

**Coral holder**

The Aqua Medic Coral holder is the solution to present invertebrates and clams in shop systems. The holder has a flexible system, adjustable on the dimensions of the animals. With a water-resistant marker, the holder can be signed with name of the species and price.



Coral holder

Item code	Item
230.03	Coral holder



Trickle plate

### Trickle plate

Trickle plate, 15 x 15 cm (app. 6" x 6"). Can be mounted on the rectangular pipe to evenly distribute the water.

Item code	Item
415.00	Trickle plate 15 x 15 cm



Lid for trickle plate

### Lid for trickle plate

Top lid for trickle plate, 15 x 15 cm (app. 6" x 6"). With a connection for 20 mm Ø pipe.

Item code	Item
415.20	Lid for trickle plate 15 x 15 cm



Bottom plate

### Bottom plate

Base for rectangular pipe, 15 x 15 cm (app. 6" x 6"). Can be glued to the bottom of the rectangular pipe.

Item code	Item
415.25	Bottom plate 15 x 15 cm



Grid for quadratic pipe

### Grid for quadratic pipe

Grate 15 x 15 cm (app. 6" x 6"). Grate for rectangular pipe, useful for holding filter material in place.

Item code	Item
415.30	Grid for quadratic pipe 15 x 15 cm



**aqua grid**

Grid plate

The aqua grid is a versatile plastic grid that can be used in many applications in the aquarium itself or within a sump/filter system. A unique highly stable plug-in system in the form of slot and key on all sides allowing multiple grids to interconnect to form a smooth surface of varying sizes depending on your needs. The aqua grid is an excellent base for live rock and can also be used on the base of the aquarium, in filtration systems or for displaying corals in the retail environment.

Dimensions: app. 305 x 305 x 10 mm, grid size: 13 x 13 mm

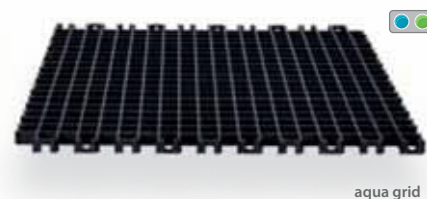

aqua grid

Item code	Item
415.80	aqua grid

**Overflow comb with holder 32 cm**

Overflow comb, for the construction of aquarium overflows

The water flows evenly and fish, plant matter and coarse detritus are prevented from entering the overflow chamber. The holder is glued on the overflow chamber and the overflow comb is pressed securely into the holder whilst leaving it easy to remove for cleaning and maintenance.

Length: app. 32 cm, (app. 12.8"), height: app. 6 cm (app. 2.4"), length of teeth: app. 2.2 cm (app. 0.88")



Overflow comb with holder 32 cm

Item code	Item
418.00	Overflow comb with holder 32 cm

**Overflow comb with holder 50 cm**

With extra long teeth. Holder can be glued to the aquarium or is designed to also be used with combfix (not included).

Length: app. 50 cm (app. 20"), height: app. 8 cm (app. 3.2"), length of teeth: app. 3.7 cm (app. 1.28")



Overflow comb with holder 50 cm

Item code	Item
418.05	Overflow comb with holder 50 cm

**combfix**

Holder for overflow comb

Optional support for fixing the overflow comb to the aquaria without the need for gluing.



combfix

Item code	Item
418.06	combfix 6 pcs.



Round grate

## Round grate

Ideal for preventing larger detritus flowing through. They are manufactured in three sizes. Ø 40 mm, 50 mm and 63 mm (app. 1.6", 2" and 2.5")

Item code	Item
415.31	Round grate 40 mm black
415.41	Round grate 40 mm transparent
415.32	Round grate 50 mm black
415.42	Round grate 50 mm transparent
415.33	Round grate 63 mm black
415.43	Round grate 63 mm transparent



Tank union

## Tank union

Tank union from ABS for the connection of aquaria to PVC hard pipes.

	D1	D2	G	L1	L2	L3	glass drilling
D 25	55	25	1"	46	22	19.5	35
D 32	65	32	1 1/4"	46	22	18	45
D 40	80	40	1 3/4"	55	26	20	55

Item code	Item
417.25	Tank union D 25
417.32	Tank union D 32
417.40	Tank union D 40



Adapter union AM

## Adapter union

Adapter union AM from ABS for pipe 25/32, 32/40 mm and 40/50 mm.

Item code	Item
416.125	Adapter union AM 25 mm
416.132	Adapter union AM 32 mm
416.140	Adapter union AM 40 mm



aqua divider

## aqua divider

With aqua divider it is possible to mount a glass sheet into an aquarium or terrarium without using any glue. The groove is holding a 4 mm glass sheet. The fastening is done by the rubber suckers. With aqua divider you can separate animals inside of the aquarium.

Item code	Item
418.10	aqua divider 4 pcs.

### Outlet strainers

Outlet strainers are manufactured out of ABS pipe and have slits to prevent coarse detritus passing through. Available in the following diameter pipe sizes: 20 mm, 25 mm, 32 mm, 40 mm, 50 mm, 63 mm

Item code	Item
418.21	Outlet strainer 20 mm, length app. 82 mm
418.20	Outlet strainer 20 mm, length app. 160 mm
418.25	Outlet strainer 25 mm, length app. 160 mm
418.32	Outlet strainer 32 mm, length app. 200 mm
418.40	Outlet strainer 40 mm, length app. 200 mm
418.50	Outlet strainer 50 mm, length app. 240 mm
418.63	Outlet strainer 63 mm, length app. 240 mm



Outlet strainers

### Reducing T-piece

Reducing T-pieces are used for the connection of bypass filters like the Nitrate-reductor and the Calciumreactor.

Item code	Item
410.41	Reducing T-piece 9/12 - 4/6
410.40	Reducing T-piece 12/16 - 4/6
410.42	Reducing T-piece 16/22 - 4/6



Reducing T-piece

### valve

The regulation valve can be used for both air and water. High quality plastic ensures a long service life.  
2 pcs. per package

Item code	Item
411.40	valve 4 – 6 mm / for 4/6 tube <b>SALE</b>
411.42	valve 12 – 14 mm / for 12/16 tube <b>SALE</b>
411.43	valve 16 – 18 mm / for 16/22 tube <b>SALE</b>
411.44	valve 20 – 22 mm / for 19/27 tube <b>SALE</b>



valve



Regulation valve FBS

### Regulation valve FBS

High quality regulation valve for hose inlet diameter in 4/6 mm and 6/8 mm – outlet diameter 4/6 mm. Connection fittings can be changed. Durable materials ensure low wear for constant adjustment. The regulation valve can be used for air and for water (e. g. Nitratereducator and Calciumreactor).

Item code	Item
410.44	Regulation valve FBS



Regulation valve 4/6



### Regulation valve 4/6

Regulation valve for tube diameter of 4/6 mm. The regulation valve can be used for both air and water (Nitratereducator and Calciumreactor). High quality plastic ensures a long service life. The flow can be easily adjusted by the fine thread. In an attractive blister pack.

Item code	Item
410.47	Regulation valve 4/6 mm 2 pcs.



Non-return valve 4/6



### Non-return valve 4/6

Check valve for a tube of 6 mm. Suitable for gas and water. In an attractive blister pack

Item code	Item
410.43	Non-return valve 4/6 mm 2 pcs.



Rust Protect



### Rust Protect

Anti-corrosion and maintenance spray for metallic components

In aquarium cabinets with an open filter tank, wear and corrosion on the hinges caused by splashes and condensation can hardly be avoided. If used properly, the protective film applied by Rust Protect prevents moisture from reaching the metal parts, which significantly reduces the risk of corrosion. Rust Protect does not resinify and is resistant to saltwater.

- saltwater-resistant
- no draining
- no resinification
- wear reduction
- corrosion protection
- long-term effect

Regular use is recommended.

Item code	Item
599.950	Rust Protect, 100 ml <b>NEW</b>



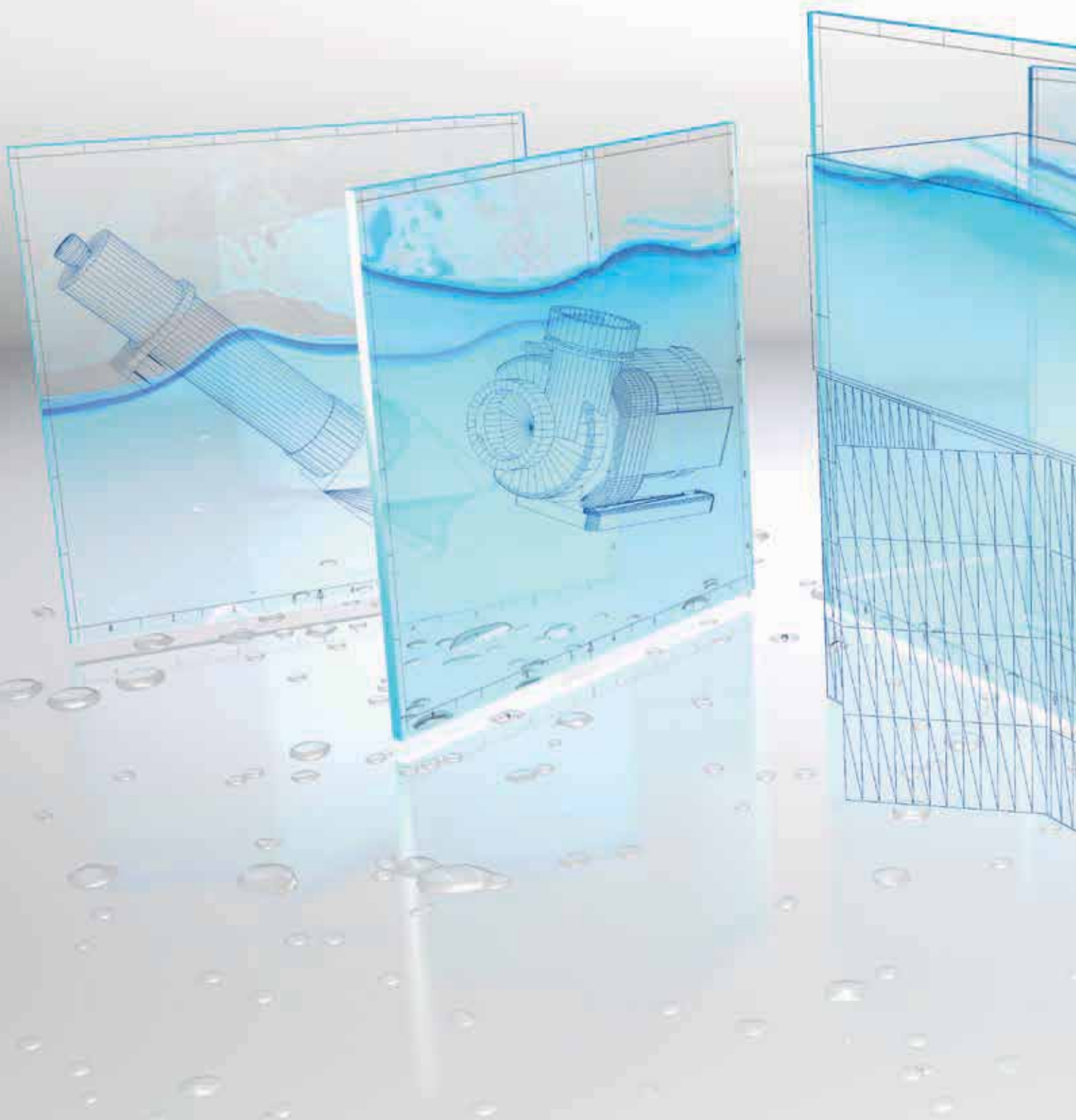

# AQUA MEDIC

E-Mail: [info@aqua-medic.de](mailto:info@aqua-medic.de)  
Managing Director: Dipl.-Ing. Oliver Wehage

HRB 16246 AG Osnabrück  
VAT No.: DE 117575590  
WEEE-Reg.-No.: DE 88550220

AB Aqua Medic GmbH  
Gewerbepark 24 | 49143 Bissendorf, Germany | Phone +49 5402 99110 | Fax +49 5402 991119

Technical changes reserved

[www.aqua-medic.de](http://www.aqua-medic.de)