

Aquatic Catalogue

Practical
Fishkeeping
MAGAZINE

READERS' POLL

Tropical Marine Centre
WINNER
MANUFACTURER
OF THE YEAR

10

Practical
Fishkeeping
MAGAZINE

READERS' POLL

Tropical Marine Centre
RUNNER-UP
MANUFACTURER
OF THE YEAR

11

Practical
Fishkeeping
MAGAZINE

READERS' POLL

Tropical Marine Centre
RUNNER UP
MANUFACTURER
OF THE YEAR

12



Signature ^{V²}
by TMC

Natureform
gamma

AQUARAY

aquaHabitats
AQUARIUM ESSENTIALS BY TMC

aquaGro
FOR PLANTED AQUARIA BY TMC

Pond Clear

Pro Clear

Pro Pond



Tropical
Marine
Centre™



Welcome to TMC's Aquatic Catalogue in which you will find full details of the very latest TMC-manufactured and own-branded products for the aquarium.

Inside is our **AquaGro** range for planted tanks, the **AquaRay** solid state lighting range, the **AquaHabitats Aquarium Essentials** range and our **Signature** Optiwhite Glass Aquariums range.

All of these products have been designed and manufactured to meet our own exacting standards of quality, performance and reliability.

contents

Practical
Fishkeeping
MAGAZINE

READERS' POLL

Tropical Marine Centre
WINNER
MANUFACTURER
OF THE YEAR

'10

Practical
Fishkeeping
MAGAZINE

READERS' POLL

Tropical Marine Centre
RUNNER-UP
MANUFACTURER
OF THE YEAR

'11

Practical
Fishkeeping
MAGAZINE

READERS' POLL

Tropical Marine Centre
RUNNER UP
MANUFACTURER
OF THE YEAR

'12

1 Livestock

3 Aquarium Products

Aquarium Spares & Accessories	37
AquaRay Lighting	41
AquaHabitats Aquarium Essentials	51

59 Planted Tank Products

71 Pond Products

Pond Spares & Accessories	77
---------------------------	----

82 Index

contents

livestock



First Class

from reef to retail

Tropical Marine Centre's pioneering work on welfare and environmental issues, relating to the collection and importation of marine fish, together with its partnerships with many worldwide conservation organisations, has given it a world renowned reputation and established it as a centre of excellence and technical expertise within the ornamental marine fish industry. Indeed TMC was the first MAC certified importer in the UK and one of the first in Europe, demonstrating TMC's commitment to best practice guidelines.



TMC
London

Our four TMC sites incorporate state-of-the-art filtration systems, and expert staff are always on hand, ensuring the best environment for livestock at all times.

Our aim is to offer our customers the widest variety of livestock available and an unsurpassed fish selection experience.



TMC
Manchester



TMC
Bristol



TMC
Iberia

First Class

Rest and Relaxation

From the moment TMC livestock is collected (with all fish being individually net caught), everything possible is done to ensure the optimum health and welfare of the livestock and to minimise stress.

Livestock is held near to the catching area in well designed and carefully managed holding facilities, often using filtration systems supplied by TMC. This local attention to detail, combined with careful packing and transportation procedures, ensures that, even after a long flight, livestock arrives in the UK in the very best condition.

Upon arrival at TMC, this high standard of care continues, with livestock carefully unpacked under red light by our expert fish house staff and gently acclimatised into TMC's holding systems supplied with Tropic Marin synthetic seawater. The livestock is then rested for as long as is necessary to ensure that when it is ready for sale it is fully acclimatised, in optimum health and readily adapts to your aquarium environment.

First Class

Accommodation

All of TMC's facilities have state of the art filtration systems incorporating large scale protein skimmers, commercial UV systems, ozone and high quality mechanical and biological filtration systems.

There is huge, on-going investment in these systems, ensuring the very best environment for our livestock at all times.

All TMC fish houses incorporate varying sizes of aquariums. This means that aggressive fish species can be kept separately and larger aquariums can be used for community or shoaling species. In addition, all aquariums have their own unique supply of filtered and UV-treated water ensuring all fish constantly receive optimum water quality. Our invert systems operate on the same principles, allowing us to hold anything from the smallest critter to the most delicate coral.

Dedicated staff, on-call 24 hours a day, ensure that livestock is cared for around the clock, and all parts of the recirculation system are alarmed so if any equipment fails action can be taken immediately to ensure no stress or harm to livestock.

First Class

Cuisine

Whilst in TMC's fish holding facilities all livestock is fed on Gamma Frozen Food which is made from only the highest quality ingredients.

As this food contains 100% natural products that are readily identified by the fish, they respond well to it and will eat it with all the vigour normally associated with live food.

Some Gamma Foods are soaked in Gamma Nutraplus, Tropic Marin Immuvit or Tropic Marin Lipovit to further enhance the nutritional content, and Gamma Dry Seaweed is also fed as a supplement for our herbivores.

Expert TMC staff ensure feeding takes place as many times as possible during the day, to try to replicate the constant grazing many marine fish are used to when on the reef, thereby minimising stress for the livestock.

This strict feeding regime, using only the highest quality feeds, means fish will be eating well and in optimum health before reaching your aquarium.

To ensure hobbyists can buy with confidence, all TMC fish and inverts are now supplied to retailers with their own unique identification label for display on in-store tanks.



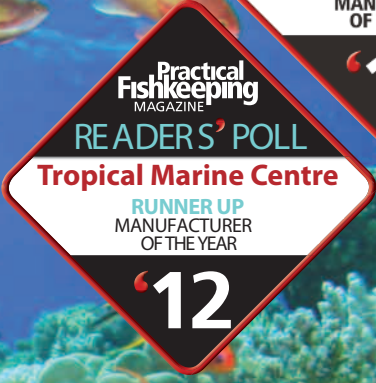

aquarium products



1	5660	80 litres/17 UK gal	single
2	5520	120 litres/26 UK gal	single

1



2



1 V²Skim 80 Micro Skimmer

Suitable for aquariums up to 80 litres/17 UK gallons with a recommended flow rate of approx 800 l/hr

Dimensions: 72mm (w) x 96mm (d) x 224mm (h)

**Available in
UK, EU and US versions**

2 V²Skim 120 Nano Skimmer

Suitable for aquariums up to approx 120 litres/26 UK gal/31 US gal with a recommended flow rate of approx 720 l/hr.

Dimensions: 80mm (w) x 75mm (d) x 210mm (h)

V²Skim 80 Micro Skimmer

- High performance protein skimmer offering all the qualities of the award-winning V²Skim range but designed specifically with the nano or micro aquarium in mind!
- Space-saving 'hang-on' design allows the V²Skim 80 to be positioned and easily hidden on the back or side of any nano or micro aquarium of up to 80 litres in volume.
- Incorporates a highly efficient Multi-Jet venturi injection system comprising 6 venturi injectors which optimise the perfect mixture of micro fine air bubbles and water and ensure intensive, efficient skimming and the removal of proteins and other harmful toxins (waste) from the aquarium.
- Unique skimmer body design allows access to most parts of the skimmer for simple cleaning.
- Easy to remove collection cup enables quick and effortless maintenance and cleaning.
- User friendly water level adjustment slide allows water level and flow to be finely tuned to ensure optimum foam consistency and highly efficient skimming.
- Requires a water supply pump with a flow rate of approximately 800 litres per hour at 0 head (NOT SUPPLIED) to deliver and ensure the optimum water flow for the Multi-Jet venturi injection system.

V²Skim 120 Nano Skimmer

- Ultra-slimline design allows the V²Skim 120 Nano to be incorporated and easily hidden in nano aquariums of up to 120 litres/26 UK gallons or smaller tanks where space is limited.
- Incorporates a highly efficient injection system which optimises the perfect mixture of micro fine air bubbles and water and ensures intensive, efficient skimming and removal of proteins and other harmful toxins (waste) from the aquarium.
- The versatile design of the V²Skim 120 Nano makes it simple to install and the mounting brackets provided ensure that it can be incorporated with nano and smaller volume aquariums.
- The unique, hinged design of the V²Skim 120 Nano skimmer body ensures that all parts of the skimmer can be accessed for simple cleaning and maintenance.
- Easy to remove collection cup enables quick and effortless maintenance and cleaning.
- User friendly water level adjustment dial allows water level and flow to be finely tuned to ensure optimum foam consistency and highly efficient skimming.
- Supplied complete with a high performance pump which delivers the optimum flow and the perfect mixture of water and micro fine air bubbles.

code	specification	sales unit	
5680	200 litres/44 UK gal	single	1
5690	300 litres/66 UK gal	single	2
5700	500 litres/110 UK gal	single	3

Available in
UK, EU and US versions

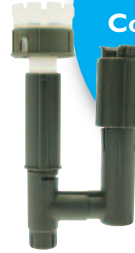

Why not incorporate a
V²Skim
Compact Surface
Skimmer?
See p. 9
for details



V²Skim Compact Protein Skimmers

V²Skim 200 Compact

- Designed specifically with the smaller aquarium in mind (up to 200 litres).
- Ultra slimline design.
- Versatile mounting brackets.
- Unique design ensures that all parts of the skimmer can be accessed for simple cleaning and maintenance.
- Integral pump.
- Water level adjustment dial.
- Easy to remove collection cup.

1 V²Skim 200 Compact

Suitable for aquariums up to 200 litres/44 UK Gal with a flow rate of approx. 720 l/hr

Dimensions: 88mm (w) x 81mm (d) x 191mm (h)

V²Skim 300 Compact & V²Skim 500 Compact

- “Hang on the back” skimmers suitable for aquariums up to 300/500 litres.
- Incorporate a space-saving integral pump and water intake system which ensures minimal visual impact on the aquarium whilst delivering the optimum flow and the perfect mixture of water and micro fine air bubbles.
- Water level adjustment dial.
- Easy to remove collection cup.

2 V²Skim 300 Compact

Suitable for aquariums up to 300 litres/66 UK Gal with a flow rate of approx. 720 l/hr

Dimensions: 120mm (w) x 133mm (d) x 332mm (h)

3 V²Skim 500 Compact

Suitable for aquariums up to 500 litres/110 UK Gal with a flow rate of approx. 1200 l/hr

Dimensions: 228mm (w) x 170mm (d) x 347mm (h)



1	5521	400 litres/90 UK gal	single
2	5522	600 litres/130 UK gal	single
3	5523	800 litres/180 UK gal	single
4	5524	1000 litres/220 UK gal	single
5	5525	1200 litres/260 UK gal	single
6	5526	1500 litres/330 UK gal	single

Available in
UK, EU and US versions



Supplied with a
**High Performance
Syncra Silent Pump**
and a
V²Bubble Stop



V²Skim 'Hang on' Skimmers

- High performance, quality protein skimmer incorporating a patented venturi injection system which optimises the perfect mixture of micro fine air bubbles and water and ensures intensive, efficient skimming and the removal of proteins and other harmful toxins (waste) from the aquarium.
- The versatile design allows the V²Skim Protein Skimmer to be used either as an external "hang-on" skimmer or internally in a sump or aquarium.
- The large, tapered collection cup improves foam concentration and is easily removable for quick and effortless cleaning.
- Specially designed inlet pipe and bracket ensures quick installation and easy maintenance.
- The water level adjustment dial allows water level and flow to be finely tuned to ensure optimum foam consistency and highly efficient skimming.
- The V²Skim's unique outlet pipe assembly allows the water to be returned to the aquarium or sump at exactly the desired angle or location.
- Ozone compatible
- 12 month guarantee.
- A full range of spares is available.

- V²Skim 400**
Suitable for aquariums up to approx 400 litres/90 UK gal/104 US gal
Dimensions: 160mm (w) x 120mm (d) x 435mm (h)
- V²Skim 600**
Suitable for aquariums up to approx 600 litres/130 UK gal/156 US gal
Dimensions: 180mm (w) x 135mm (d) x 510mm (h)
- V²Skim 800**
Suitable for aquariums up to approx 800 litres/180 UK gal/208 US gal
Dimensions: 205mm (w) x 180mm (d) x 510mm (h)
- V²Skim 1000**
Suitable for aquariums up to approx 1000 litres/220 UK gal/260 US gal
Dimensions: 205mm (w) x 180mm (d) x 610mm (h)
- V²Skim 1200**
Suitable for aquariums up to approx 1200 litres/260 UK gal/312 US gal
Dimensions: 230mm (w) x 200mm (d) x 540mm (h)
- V²Skim 1500**
Suitable for aquariums up to approx 1500 litres/330 UK gal/390 US gal
Dimensions: 230mm (w) x 200mm (d) x 640mm (h)

code	specification	sales unit	
9110	450 litres/99 UK gal	single	1
9111	900 litres/198 UK gal	single	2
9112	1350 litres/297 UK gal	single	3



V²Skim Pro 'Hang on' Cone Skimmers

- High performance, professional protein skimmer with advanced cone-shaped design and custom-designed needlewheel with venturi-driven air injection system.
- The V²Skim Pro's conical body design ensures the optimum water-to-air contact time and naturally encourages the unrestricted concentration of bubbles upwards towards the collection cup for intensive, efficient skimming.
- The unique, needlewheel injection system has been developed specifically to ensure the perfect mix of micro fine air bubbles and water within the cone-shaped body design for optimum skimming.
- The integrated bubble diffusion plate ensures uniform dispersal of micro fine air bubbles across the entire skimmer column.
- The versatile design allows the V²Skim Pro to be used either as an external 'hang-on' skimmer or internally in a sump.
- Supplied complete with a Sicce Syncra SK high performance needlewheel pump (with venturi) purpose-made to deliver the optimum flow rate required.
- Ozone compatible.
- 12 month guarantee.
- A full range of spares is available.

- 1 V²Skim Pro 450**
Suitable for aquariums up to approx 450 litres/99 UK gal/119 US gal
Dimensions: 160mm (w) x 200mm (d) x 435mm (h)
- 2 V²Skim Pro 900**
Suitable for aquariums up to approx 900 litres/198 UK gal/238 US gal
Dimensions: 180mm (w) x 215mm (d) x 515mm (h)
- 3 V²Skim Pro 1350**
Suitable for aquariums up to approx 1350 litres/297 UK gal/357 US gal
Dimensions: 220mm (w) x 240mm (d) x 550mm (h)

1	5750	V ² Skim Surface Skimmer	single
2	5715	V ² Skim 300 Modified water intake strainer	single
3	5714	V ² Skim 500 Modified water intake strainer	single

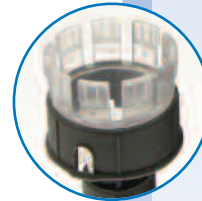

**Unique,
Patented
Intake Strainer**



**Dual Water
Intakes**



**Universal
Connection
for Easy
Installation**



**Supplied with
Securing
Suction Cups**



V²Skim Compact Surface Skimmer

In many aquariums a high percentage of accumulated dissolved proteins, detritus and waste material is found in the top few centimetres of the water.

Most conventional aquarium filters cannot process this water as they generally draw and filter the water from the lower levels of the aquarium. As a result, a build up of detritus, proteins and organics can occur on the surface of the water which can lead to poor water quality and also to the deterioration of oxygen exchange and light penetration into the aquarium.

By installing this new V²Skim Compact Surface Skimmer this problem can be simply solved. Water can be drawn into your filter or protein skimmer from both the surface and the lower levels of the aquarium providing a significant increase in the removal of dissolved proteins, detritus and waste material from the aquarium and an overall improvement in water quality.

- Unique patented floating intake strainer which automatically adjusts to changes in water level within the aquarium.
- Dual water intakes allow water to be drawn in from both the surface and lower levels within the aquarium.
- User friendly design allows for simple cleaning and maintenance.
- Universal connection allows for easy installation with 'hang on the back' type filters, external filters and also with the V²Skim 300 & 500 Compact Protein Skimmers (**modified intake strainers are required for connection to the V²Skim Compact Protein Skimmers – not supplied but sold separately**).

- 1 V²Skim Compact Surface Skimmer**
Ideal for use with V²Skim 300 and 500 Compact Protein Skimmers
- 2,3 Modified intake strainer**
For connection to V²Skim Compact Protein Skimmers

code	specification	sales unit	
V²React Compact STANDARD			
5780	300 litres/66 UK gal	single	1
V²React Compact ADVANCED			
5779	300 litres/66 UK gal	single	2
V²React - with STANDARD DIN477* Pressure Regulator			
5382	600 litres/130 UK gal	single	3
5383	1000 litres/220 UK gal	single	4
5384	1500 litres/330 UK gal	single	5
V²React - with STANDARD CGA320** Pressure Regulator			
5765	600 litres/130 UK gal	single	6
5766	1000 litres/220 UK gal	single	7
5767	1500 litres/330 UK gal	single	8
V²React ADVANCED - with DIN477* Pressure Regulator PRO			
5551	600 litres/130 UK gal	single	9
5552	1000 litres/220 UK gal	single	10
5553	1500 litres/330 UK gal	single	11
V²React ADVANCED - with CGA320** Pressure Regulator PRO			
5768	600 litres/130 UK gal	single	12
5769	1000 litres/220 UK gal	single	13
5770	1500 litres/330 UK gal	single	14

Available in
UK, EU and US versions

***DIN477 Connection**
EU standard CO₂ cylinders with fitted gas control valve

****CGA320 Connection**
American standard CO₂ cylinders with pin valve connection e.g hobby and paintball cylinders



V²React 300 Compact Calcium Reactors

- A high performance calcium reactor offering all of the qualities of the V²React Calcium Reactor range but in a space saving, hang-on design.
- Slimline profile - can be discreetly and conveniently positioned on the back or side of any aquarium or sump up to 300 litres/66 UK gallons.
- Integral pump acts as both a supply and recirculation pump – no need for a second pump or any modifications to existing pipework.
- Unique, integrated bubble counter makes it easy to measure the level of CO₂ being dosed to the calcium reactor
- Ideally used with TMC Coarse Coral Gravel (not supplied) but can also be used with other similar types of filter media.

1 V²React 300 Compact
Suitable for aquariums up to approx 300 litres/66 UK gal/80 US gal. Supplied with a 95g TMC CO₂ 'One Use' CO₂ cylinder, a TMC CO₂ 'One Use' cylinder stand and a TMC CO₂ Pressure Regulator Nano. (See pages 20 & 58 for details on these products.) Requires 0.75kg of media.
Dimensions: 96mm (w) x 112mm (d) x 325mm (h)

2 V²React 300 Compact ADVANCED
As above but supplied with a TMC CO₂ Pressure Regulator Nano Pro. (See page 20 for details.)

V²React Calcium Reactors

- High performance calcium reactor incorporating a unique water intake system using a single integral pump which acts as both a supply and recirculation pump. This allows the V²React Calcium Reactor to be easily installed in any aquarium set up without the need for a second pump or any modifications to existing pipework.
- Integral bubble counter which enables easy, measurable dosing of CO₂ to the calcium reactor.
- pH probe holder which accepts all standard sizes of pH probes and enables the calcium reactor to be used in conjunction with pH monitors or controllers for more advanced aquarium set-ups.
- CO₂ pressure regulator which allows for the precise control, adjustment and dosage of CO₂ to the V²React Calcium Reactor. Standard units are supplied with a standard Pressure Regulator and the Advanced units are supplied with a Pressure Regulator PRO (with solenoid valve and two, easy to read pressure gauges showing both working pressure and CO₂ cylinder pressure in bar and psi).
- Ideally used with TMC Coarse Coral Gravel (not supplied) but can also be used with other similar types of filter media.
- 12 month guarantee.

3, 6, 9, 12 V²React 600/V²React 600 ADVANCED
Suitable for aquariums up to approx 600 litres/130 UK gal/160 US gal. Requires 3 litres/2.5kg of media.
Dimensions: 190mm (w) x 190mm (d) x 380mm (h)

4, 7, 10, 13 V²React 1000/V²React 1000 ADVANCED
Suitable for aquariums up to approx 1000 litres/220 UK gal/260 US gal. Requires 4 litres/3kg of media.
Dimensions: 198mm (w) x 198mm (d) x 374mm (h)

5, 8, 11, 14 V²React 1500/V²React 1500 ADVANCED
Suitable for aquariums up to approx 1500 litres/330 UK gal/390 US gal. Requires 6.5 litres/4.5kg of media.
Dimensions: 243mm (w) x 243mm (d) x 370mm (h)



code	specification	sales unit
1	5209 120 litres/26 UK gal	single
2	5210 200 litres/50 UK gal	single
3	5211 300 litres/66 UK gal	single
4	5212 400 litres/90 UK gal	single
5	5213 600 litres/130 UK gal	single

Available in
UK, EU and US versions

Now supplied with a
clear 90° plastic
elbow, offering a
variety of flexible pipe
orientations!



V² Vecton UV Sterilisers

- New design, manufactured from impact resistant, translucent polycarbonate.
- Opposing inlet and outlet for easy installation and connection to the water supply.
- Four stage hositails for flexible hose from 1/2" to 1 1/4", held in place with screw on collars for easy removal when servicing and maintaining unit.
- UV shield to prevent direct viewing of the UV lamp.
- 90° pivoting clear plastic elbow, for easier and more versatile hose management.
- Compact, rigid pipe adaptors, for connection to 32mm, 40mm or 1" rigid pipe, are available.
- 36 month guarantee.

- V² Vecton 120**
Suitable for aquariums up to approx 120 litres/26 UK gal/31 US gal.
Maximum flow/hr: 360 litres/90 UK gal/105 US gal
Uses 1 x 6W G6T5 UV Lamp.
Dimensions: 300mm (w) x 70mm (d) x 130mm (h)
- V² Vecton 200**
Suitable for aquariums up to approx 200 litres/50 UK gal/60 US gal.
Maximum flow/hr: 680 litres/150 UK gal/180 US gal
Uses 1 x 8W G8T5 UV Lamp.
Dimensions: 360mm (w) x 100mm (d) x 200mm (h)
- V² Vecton 300**
Suitable for aquariums up to approx 300 litres/66 UK gal/80 US gal.
Maximum flow/hr: 960 litres/215 UK gal/255 US gal
Uses 1 x 16W G16T5 UV Lamp.
Dimensions: 460mm (w) x 100mm (d) x 200mm (h)
- V² Vecton 400**
Suitable for aquariums up to approx 400 litres/90 UK gal/110 US gal.
Maximum flow/hr: 1300 litres/290 UK gal/350 US gal
Uses 1 x 15W G15T8 UV Lamp.
Dimensions: 660mm (w) x 100mm (d) x 200mm (h)
- V² Vecton 600**
Suitable for aquariums up to approx 600 litres/130 UK gal/160 US gal.
Maximum flow/hr: 1900 litres/420 UK gal/505 US gal
Uses 1 x 25W G25T8 UV Lamp.
Dimensions: 660mm (w) x 100mm (d) x 200mm (h)

code	specification	sales unit
V²Bio Fluidised Sand Bed Filters		
5720	up to 600 litres/130 UK gal approx. media capacity 500g	single 1
5721	up to 1000 litres/220 UK gal approx. media capacity 1000g	single 2
5722	up to 1500 litres/330 UK gal approx. media capacity 1500g	single 3
5723	V ² Bio Replacement Media - Silica Sand	single 4
5724	V ² Bio Replacement Media - Marine Oolitic Sand	single 5
V²Bio React Pellet Reactor		
5785	up to 500 litres/110 UK gal	single 6



3



2



1



4

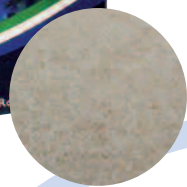

5

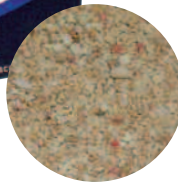

6



V²Bio Fluidised Sand Bed Filters

V²Bio React 500 Pellet Reactor

- Utilise the most efficient method of aerobic biological filtration available.
- Versatile compact design - can be installed internally in a sump or aquarium or externally as a stand alone or 'hang-on' filter.
- Can be easily incorporated with any aquarium set-up. Just connect to pump or power filter (NOT SUPPLIED) to create an advanced professional filtration system.
- Specially designed media diffuser bowl ensures uniform fluidisation of filter media.
- Supplied complete with silica sand. Marine oolitic sand is available separately.
- Can also be used to fluidise other media and is ideal for use with phosphate removing media.
- Supplied complete with useful fittings and accessories for quick and simple installation.
- Suitable for both freshwater and marine applications.

1 V²Bio 600 - Fluidised Sand Bed Filter

For aquariums up to 600 litres/130 UK gal. Requires pump with recommended flow rate of approx. 800l/hr at 0cm, max head 1.5m. Dimensions: 95mm (w) x 167mm (d) x 280mm (h)

2 V²Bio 1000 - Fluidised Sand Bed Filter

For aquariums up to 1000 litres/220 UK gal. Requires pump with recommended flow rate of approx. 1200l/hr at 0cm, max head 2m. Dimensions: 95mm (w) x 167mm (d) x 460mm (h)

3 V²Bio 1500 - Fluidised Sand Bed Filter

For aquariums up to 1500 litres/330 UK gal. Requires pump with recommended flow rate of approx. 2000l/hr at 0cm, max head 2.5m. Dimensions: 95mm (w) x 167mm (d) x 640mm (h)

4 V²Bio Replacement Media - Silica Sand

5 V²Bio Replacement Media - Marine Oolitic Sand

- Unique patented design incorporating a specially-designed flow inductor which maximises the media-to-water contact time within the reactor and ensures efficient fluidisation of media even when using lower flow rate pumps.
- The unique design of the flow inverter ensures that the media is kept in suspension and the specially designed media diffuser bowl ensures optimum fluidisation of media and upward dispersal of water.
- Versatile compact design - can be installed internally in a sump or aquarium or externally as a stand alone or 'hang-on' reactor.
- Can be used with both freshwater and marine aquariums. Just connect to a pump or power filter (not supplied) for an advanced set up.
- Ideal for 500ml of nitrate/phosphate removing pellets (flow rates through the reactor may need to be adjusted depending on media used) but can be used with many types of media.
- Supplied complete with a range of fittings for quick and simple installation (additional fittings may be required depending on individual installation).



6 V²Bio React 500 - Pellet Reactor

For aquariums up to 500 litres/110 UK gal.*
Approx. max. media capacity: 800ml (depending on media used).
Maximum flow rate: approx. 1500 l/hr.
Inlet/outlet size = 16mm.
Dimensions: 140mm (w) x 250mm (d) x 396mm (h)

* based on using 500ml of nitrate/phosphate removing pellets.



ClearView
LED Display



1	5755	50w Digital Heater	single
2	5756	100w Digital Heater	single
3	5757	200w Digital Heater	single
4	5758	300w Digital Heater	single

Available in
UK and EU versions



V²Therm Digital Heaters

- Incorporates advanced digital micro-processing technology.
 - Digitally adjustable for precise temperature setting.
 - Monitors and displays real time water temperature via a "ClearView" LED display.
 - Equipped with sophisticated "Temperature Recall" micro chip.
 - Fully submersible.
 - Temperature set range: 20°C - 34°C.
 - Tolerance ± 1°C.
 - Thermal cut-off.
 - Toughened glass heater element.
 - Reinforced plastic heater element guard.
 - Excellent heat diffusion properties.
 - Simple installation using mounting brackets and suction cup clips provided.
 - 1.8m power cable.
 - Suitable for both marine & freshwater aquariums.
- V²Therm 50 Digital Heater**
for aquariums up to 60 litres/13 UK Gallons
 - V²Therm 100 Digital Heater**
for aquariums up to 120 litres/26 UK Gallons
 - V²Therm 200 Digital Heater**
for aquariums up to 240 litres/53 UK Gallons
 - V²Therm 300 Digital Heater**
for aquariums up to 350 litres/77 UK Gallons

code	specification	sales unit	
5851	V ² Pure 50 RO System (not shown)	single	1
5852	V ² Pure 75 RO System	single	2
5853	V ² Pure 100 RO System (not shown)	single	3
5893	V ² Pure 360 RO System (not shown)	single	4
5854	V ² Pure 50 Advanced RO System inc in-Line TDS Monitor	single	5
5855	V ² Pure 75 Advanced RO System inc in-Line TDS Monitor (not shown)	single	6
5856	V ² Pure 100 Advanced RO System inc in-Line TDS Monitor (not shown)	single	7
5894	V ² Pure 360 Advanced RO System inc in-Line TDS Monitor	single	8



Compact Space-Saving Design with Wall-Mounting Bracket



Integral Pressure Gauge



Combined Flow Restrictor and Manual Flush Valve



A full range of spares and accessories is available. Please ask for details

V²Pure "Advanced" units

The "Advanced" units have all the benefits of the standard models but also incorporate a feature-packed in-line TDS monitor which measures the Total Dissolved Solids value both before AND after water passes through the V²Pure RO System, providing a visual indicator of its performance.

For more information on the TDS Monitor please see page 15.

V²Pure Reverse Osmosis System

- Three-stage, professional RO system incorporating high quality components.
- 10" sediment pre-filter which functions as a first stage filter, removing particles of up to 5 microns from the water whilst also protecting and prolonging the life of the RO membrane. This pre-filter is enclosed inside a transparent filter housing so it is easy to see when the filter needs to be changed.
- 10" activated carbon block filter which offers the highly effective removal of contaminants such as chlorine and colourants from the water.
- High quality Thin Film Composite (TFC) RO membrane, which removes contaminants such as heavy metals and hardness-forming minerals from the water, as well as a high percentage of nitrates and phosphates.
- Integral pressure gauge which helps to indicate when the RO membrane may need to be flushed or replaced, ensuring the RO system gives the optimum performance.
- Integral flow restrictor/manual flush valve which prevents excess water flow to the RO membrane and allows regular flushing of the RO membrane to prolong its life.
- Additional modules are available such as the V²Pure De-ionising Pod which can be added to further enhance the performance of the RO system.
- Compact, space-saving design incorporating a strong, metal wall-mounting bracket ensuring quick and simple installation.
- Supplied complete with a self-piercing water connector; drain clamp, 6m of 1/4" RO flexible tubing (2m white/2m red/2m blue) and a filter housing removal tool.

- 1 & 5 V²Pure 50/V²Pure 50 Advanced**
Suitable for producing up to 50 US gal/42 UK gal/190 litres of water per day*
Dimensions: 350mm (w) x 150mm (d) x 385mm (h)
 - 2 & 6 V²Pure 75/V²Pure 75 Advanced**
Suitable for producing up to 75 US gal/63 UK gal/285 litres of water per day*
Dimensions: 350mm (w) x 150mm (d) x 385mm (h)
 - 3 & 7 V²Pure 100/V²Pure 100 Advanced**
Suitable for producing up to 100 US gal/84 UK gal/380 litres of water per day*
Dimensions: 350mm (w) x 150mm (d) x 385mm (h)
 - 4 & 8 V²Pure 360/V²Pure 360 Advanced - IDEAL FOR SHOP USE!**
Suitable for producing up to 360 US gal/300 UK gal/1360 litres of water per day*
Dimensions: 350mm (w) x 150mm (d) x 450mm (h)
- PLEASE NOTE:**
- The V²Pure 360 units each have TWO high quality TFC RO membranes.
 - As the V²Pure 360 units are primarily for own use they are supplied in plain boxes (**NOT** retail colour boxes).

* **NB:** RO water production capacities and contaminant rejection rates are based on an ambient temperature of 25°C and a mains water operating pressure of 50 psi (approx 3.5 bar). Please note that the RO water production capacity and contaminant rejection rates will be reduced at lower ambient temperatures and in areas of lower mains water pressures so this must be taken into account when choosing the correct RO model for your requirements.

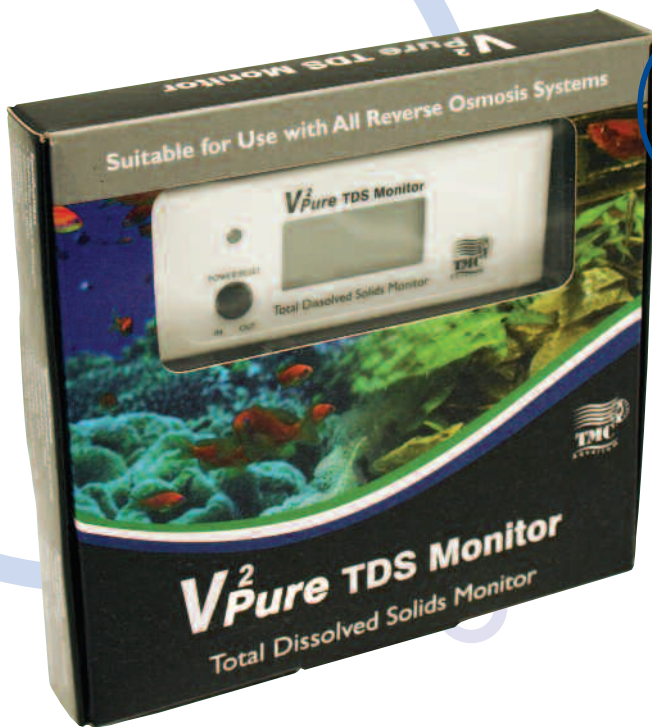

	code	specification	sales unit
1	5857	V²Pure In-Line TDS Monitor	single
V²Pure Accessories			
2	5858	V²Pure 50 Replacement RO Membrane (not shown)	single
3	5859	V²Pure 75 Replacement RO Membrane (not shown)	single
4	5860	V²Pure 100 Replacement RO Membrane (not shown)	single
5	5895	V²Pure 360 Replacement RO Membrane (not shown)	single
6	5861	V²Pure De-Ionising Pod (500ml) inc resin	single
7	5862	V²Pure Activated Carbon Block Cartridge	single
8	5863	V²Pure 5 micron Sediment Cartridge	single

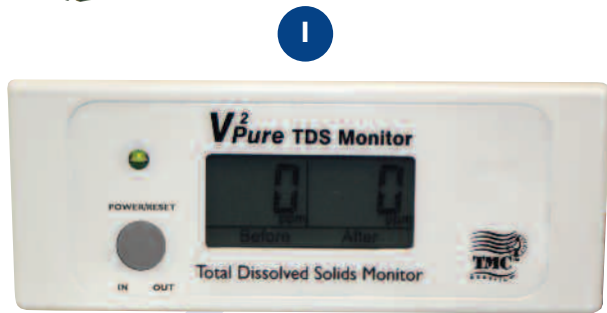

A full range of spares and accessories is available. Please ask for details.

V²Pure TDS Monitor

- In-line digital TDS monitor which measures and provides a highly accurate 'real-time' display of total dissolved solids levels before AND after water passes through the RO system, providing a visual indicator of its performance.
- 'Real-time' calculation of TDS removal rate with a removal rate indicator. When the TDS removal rate is above 80% the LED glows green and when the TDS removal rate drops below 80% the LED glows red.
- Dual, 3 digit LCD display with backlight.
- Easy to use with quick-connect fittings for simple installation.

- Selectable monitoring mode - battery saving or continuous monitoring using a mains power adapter (not supplied).
- 1 x long-life 3v lithium battery (CR2032) included.

1 V²Pure TDS Monitor

Detection Range: 0-999 ppm
Sensitivity: 1 ppm
Accuracy: ±2%
Weight 25g
Dimensions: 100mm (L) x 8mm (W) x 40mm (H)

code	specification	sales unit
5790-UK	V ² Ozone Ozone Generator	single



Programmable for
25-250mg/hr

GUARANTEE
12
MONTHS



Suitable for
Marine AND Freshwater
Aquariums

Available in
UK, EU and US versions



Unique
"High Purity Ceramic"
Ozone Cell Design

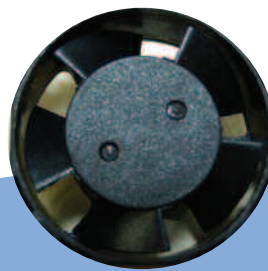

Microprocessor
Controlled
Fan Cooling



Splash-proof
Keyboard and
LED Front Panel

V²O³ Ozone Generator

- Raises oxidising levels (ORP) which helps to break down harmful waste products produced by fish, removing yellowing compounds and creating crystal clear water.
- Suppresses parasite, bacterial and fungal activity providing a healthier environment for livestock in aquariums and ponds.
- Improves skimmer efficiency by converting fish waste into more easily removable by-products.
- Programmable for 25 - 250mg/hr ozone using soft start PWM technology.
- Unique "high purity ceramic" ozone cell design with microprocessor-controlled fan cooling for highly efficient and reliable operation.
- Inbuilt timer for 1 - 10 hours ozone generation in consecutive 12 hour periods.
- Splash-proof keyboard and LED front panel.
- LED bar display for both the programmed ozone concentration and timer period.
- Blinking LED indication that ozone output is active.
- Suitable for marine and freshwater aquariums from 25 - 2500 litres and ponds up to 5000 litres.

I V²Ozone Ozone Generator



1



New Self-Priming System

2 & 3



Quick Release System



Modular Filter Baskets



Perfect Flow Control

Available in
UK and EU
versions



	code	specification	sales unit
1	9060	V ² PowerFilter 100 12mm inlet/outlet	single
2	9061	V ² PowerFilter 200 16mm inlet/outlet	single
3	9062	V ² PowerFilter 400 16mm inlet/outlet	single
4	9080	V ² Krotons Filter Media Phosphate (PO ₄) Reduction 500ml	single
5	9081	V ² Krotons Filter Media Nitrite (NO ₂) & Nitrate (NO ₃) Reduction 500ml	single
6	9082	V ² Krotons Filter Media Filtration Start Up 500ml	single
7	9083	V ² Krotons Filter Media Activated Carbon 500ml	single
8	9084	V ² Krotons Filter Media Water Clarify (Marine) 500ml	single
9	9085	V ² Krotons Filter Media Water Clarity (Freshwater) 500ml	single
10	9086	V ² Krotons Filter Media Calcium (Ca ²⁺) & Magnesium (Mg ²⁺) Supplement 500ml	single
11	9087	V ² Krotons Filter Media Ammonia (NH ₃) Reduction 500ml	single
12	9088	V ² Krotons Filter Media Trace Elements Supplement 500ml	single

V² Krotons

- A great way to add even more advanced filtration to your aquarium filter.
- Unique range of filter media developed to enhance and improve aquarium water quality.
- With 8 different varieties of filter media in the range, a combination of media can be used to meet your specific requirements.



V² PowerFilter External Filters

High quality, professional external filters providing complete multi-stage filtration for marine and freshwater aquariums up to 400 litres.

New Self-Priming System

- Easy and practical design.
- Works every time, starting filter in less than a minute.
- Can be used with any shape or size of aquarium.
- No need to move the filter and no more crawling under the tank into the cabinet to prime the filter.

Quick Release System

- The filter body can be disconnected simply by closing the valves on the IN and OUT hoses.
- Simple, easy, fast maintenance and no splashes on the living room wall!

Multi-Stage Modular Filter Baskets

- The multi-stage modular filter baskets combine both mechanical and biological filtration whilst also allowing for easy removal and replacement of the filter media.

Perfect Flow Control

- Flow rate adjustment in comfortable position on top of aquarium, with no need to open the cabinet.

Quiet, Energy-Efficient Pump

- Providing high performance at a low wattage with virtually no noise.

1 V²PowerFilter 100

Max Aquarium Size: 100 litres/22 UK Gal
Approx Flow Rate: 400 l/hr
Watts: 5w
Dimensions: 187mm diameter x 180mm (h)

2 V²PowerFilter 200

Max Aquarium Size: 200 litres/44 UK Gal
Approx Flow Rate: 700 l/hr
Watts: 7w
Dimensions: 187mm diameter x 360mm (h)

3 V²PowerFilter 400

Max Aquarium Size: 400 litres/88 UK Gal
Approx Flow Rate: 1000 l/hr
Watts: 13w
Dimensions: 187mm diameter x 360mm (h)

code	specification	sales unit	unit
9199	V ² iLumenAir 600	single	1
9200	V ² iLumen Air 900	single	2

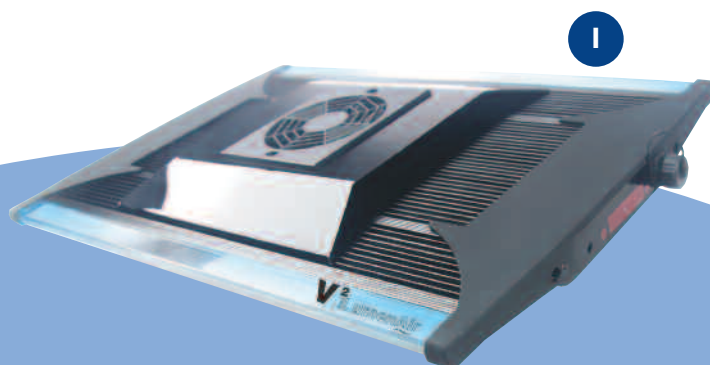
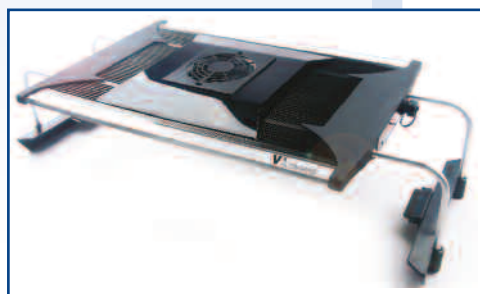
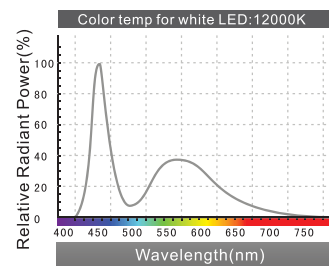
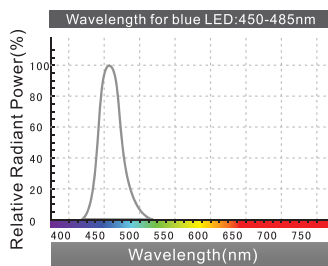

Wavelength

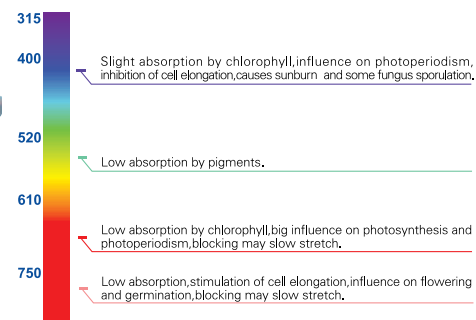

V² iLumenAir LED Luminaires

- High power LED luminaires.
- High PAR.
- Uses Bridgelux technology.
- Built in timing and dimming to allow for a full range of effects including sunrise, sunset, twilight and moonlight.
- Fully controllable via a remote control (included).
- Colour controllable.
- Low voltage.
- Power readout to tell you how much electricity is actually being used.
- Can be tank mounted (fittings included) or suspended (suspension kit sold separately).
- Quiet, temperature controlled cooling fans - only on when required, and easily serviceable.
- Thermal cut out to protect the LEDs should overheating occur.
- Lightning simulation.
- Controllable blue LED trim to enhance the look of your aquarium.

1 V² iLumen Air 600

1 x 35W White (6500K) diode, 12 x 3W Royal Blue (465nm). 80W.

Dimensions: 400mm (w) x 260mm (d) x 24mm (h).

2 V² iLumen Air 900

2 x 35W White (6500K) diodes, 24 x 3W Royal Blue (465nm), 3 x 3W Red (640nm), 3 x 3W Green (530nm), 2 x 3W Amber (605nm). 170W.

Dimensions: 690mm (w) x 260mm (d) x 24mm (h).



1



2 & 3

1	9000	V²PowerPump 800	single
2	9001	V²PowerPump 1300	single
3	9002	V²PowerPump 1500	single
4	9003	V²PowerPump 2200	single
5	9004	V²PowerPump 3000	single
6	9005	V²PowerPump 4000	single
7	9006	V²PowerPump 5500	single
8	9007	V²PowerPump 7000	single



7 & 8



4 5 & 6



V²PowerPump

- High quality, compact pumps suitable for submersible or dry* applications in salt and freshwater aquariums.
- Incorporate Sicce's "ECO technology" which combines high power and flow rates with low energy consumption.
- Unique impeller, using premium quality shaft materials, offers maximum performance and efficiency.
- Corrosion-resistant ceramic bearings ensure quiet operation and durability.
- Innovative "cooling chambers" provide air-cooling during dry use and water-cooling in wet applications.
- Internal recirculation system prevents over-heating and ensures any debris is ejected from the pump.
- Integral flow control dial for easy and precise adjustment of water flow.
- Easy to use and maintain.
- Pre-filter, hose adapters and suckers included.

*800 model is NOT suitable for dry applications.

- V²PowerPump 800**
Flow rate: 700l/h (154 UK gph)
- V²PowerPump 1300**
Flow rate: 1300l/h (286 UK gph)
- V²PowerPump 1500**
Flow rate: 1450l/h (319 UK gph)
- V²PowerPump 2200**
Flow rate: 2150l/h (473 UK gph)
- V²PowerPump 3000**
Flow rate: 3000l/h (660 UK gph)
- V²PowerPump 4000**
Flow rate: 3800l/h (836 UK gph)
- V²PowerPump 5500**
Flow rate: 5400l/h (1188 UK gph)
- V²PowerPump 7000**
Flow rate: 7000l/h (1540 UK gph)

V²PowerPump

	800	1300	1500
Volts	230/240	230/240	230/240
Hertz	50	50	50
Watts	8	20	24
Amps	0.10	0.20	0.20
Q.max (l/h)	700	1300	1450
Q.max (Gph)	154 (UK)	286 (UK)	319 (UK)
Head max (m)	1.2	1.7	2.0
Head max (ft)	3.9	5.57	6.56

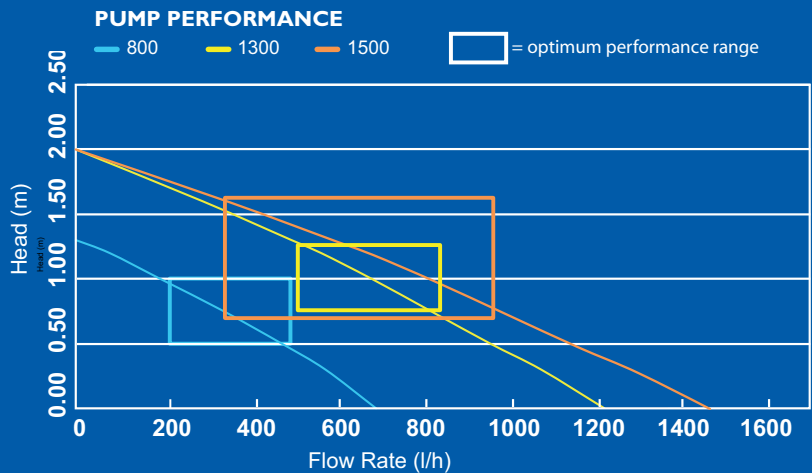

V²PowerPump

	2200	3000	4000
Volts	230/240	230/240	230/240
Hertz	50	50	50
Watts	29	50	60
Amps	0.27	0.25	0.30
Q.max (l/h)	2150	3000	3800
Q.max (Gph)	473 (UK)	660 (UK)	836 (UK)
Head max (m)	2.1	2.9	3.0
Head max (ft)	6.9	9.5	9.85

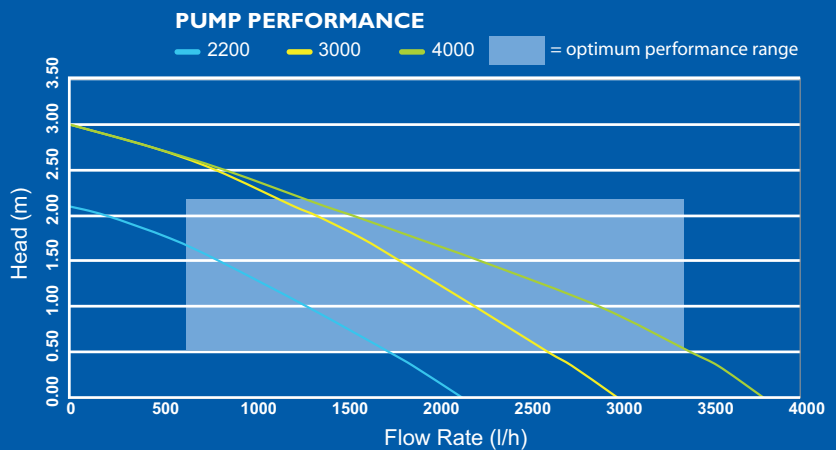

V²PowerPump

	5500	7000
Volts	230/240	230/240
Hertz	50	50
Watts	110	130
Amps	0.64	0.7
Q.max (l/h)	5400	7000
Q.max (Gph)	1188 (UK)	1540 (UK)
Head max (m)	3.8	3.65
Head max (ft)	12.46	11.97

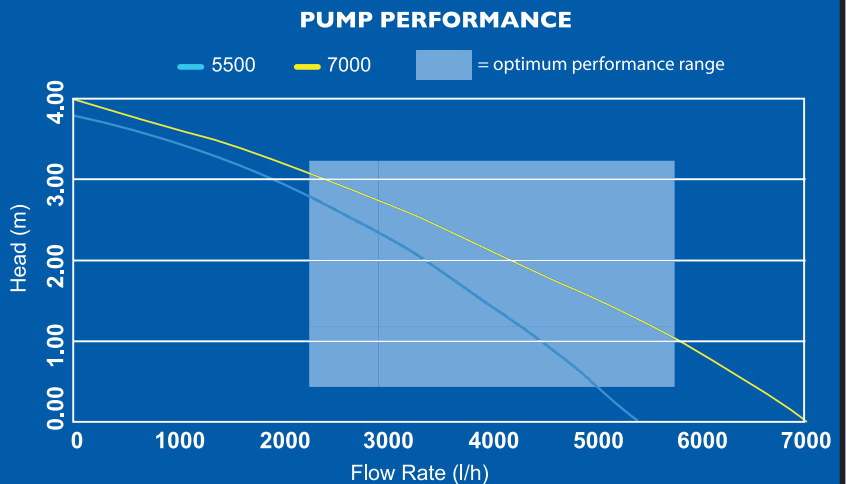

1	9030	V ² PowerFlow 1000	single
2	9031	V ² PowerFlow 2000	single
3	9032	V ² PowerFlow 3000	single
4	9033	V ² PowerFlow 4500	single
5	9034	V ² PowerFlow 6000	single



1 & 2



3 4 & 5



V²PowerFlow

Circulation Pumps

- High quality, compact water circulation pumps suitable for both salt and freshwater aquariums.
- Incorporate Sicce's "ECO technology" which combines high power and flow rates with low energy consumption.
- Innovative water flow regulator allows maximum control and regulation of water flow to create the perfect natural motion in your aquarium.
- Versatile and fully adjustable mounting options, using strong, high quality magnets. These allow the V²PowerFlow Pump to be easily positioned and hidden in any aquarium (maximum glass thickness 15mm).
- Unique bi-directional impeller, manufactured from premium quality materials, offers maximum performance, efficiency, reliability and quiet operation.
- 2.3m cable.
- Controller available (sold separately).

- 1 **V²PowerFlow 1000**
Flow rate: 1000l/h (220 UK gph)
- 2 **V²PowerFlow 2000**
Flow rate: 2000l/h (440 UK gph)
- 3 **V²PowerFlow 3000**
Flow rate: 3000l/h (660 UK gph)
- 4 **V²PowerFlow 4500**
Flow rate: 4500l/h (900 UK gph)
- 5 **V²PowerFlow 6000**
Flow rate: 6000l/h (1320 UK gph)

V²PowerFlow 1000

2000

3000

4500

6000

Max Tank Size	fresh water	salt water	fresh water	salt water	fresh water	salt water	fresh water	salt water	fresh water	salt water
	60 - 120 L 13 - 26 UK Gal 16 - 32 US Gal	30 - 80 L 7 - 18 UK Gal 8 - 21 US Gal	120 - 200 L 26 - 44 UK Gal 32 - 53 US Gal	80 - 140 L 18 - 31 UK Gal 21 - 37 US Gal	200 - 350 L 44 - 77 UK Gal 53 - 92 US Gal	60 - 200 L 13 - 44 UK Gal 16 - 53 US Gal	300 - 470 L 66 - 103 UK Gal 79 - 124 US Gal	150 - 300 L 33 - 66 UK Gal 40 - 79 US Gal	400 - 730 L 88 - 160 UK Gal 106 - 193 US Gal	200 - 400 L 44 - 88 UK Gal 53 - 106 US Gal
Watts	2.8		3		7		10		14	
Volts	230/240		230/240		230/240		230/240		230/240	
Hertz	50		50		50		50		50	
Q.max (l/h) Q.max (Gph)	1000 220 (UK)		2000 440 (UK)		3000 660 (UK)		4500 990 (UK)		6000 1320 (UK)	



	code	specification	sales unit
1	5533	V ² Control pH Controller	single
2	5532	V ² Control pH Controller/Monitor	single
3	9505	V ² Auto Top Up System	single
4	9506	V ² Auto Top Up System Plus	single
5a	9515	V ² Auto Top Up Solenoid (exc PSU)	single
5b	9516	V ² Auto Top Up Solenoid (inc PSU)	single



Available in
UK, EU and US versions

V²Control Controllers/Monitors

1 V²Control pH Controller

High precision pH controller ideal for professional advanced aquarium set-ups for easy measurement and control of pH.

- Extremely user friendly, for simple installation and use.
- Large, easy to read LED display provides clear visual indication of pH level.
- Digitally adjustable to allow for accurate adjustments and precise control.
- Includes pH probe with 2m connecting cable and handy pH probe mounting bracket allowing for quick and easy installation.
- Includes pH calibration solutions.
- Unique, versatile design allows the controller to be conveniently fixed to a wall or inside a cabinet or simply situated next to the aquarium/sump.
- Measurement Range: pH 0 to pH 14. Resolution 0.01 pH.
- Accuracy at 25°C 0.01 pH ± 2 digits (after calibration).
- Set Point Range: pH 3.5 – pH 10.5.
- Ideal for combining with the V² Pressure Regulator Pro for advanced aquarium set-ups.

2 V²Control pH Controller and Monitor

As above, but combined with an independent pH monitor ideal for professional advanced aquarium set-ups ensuring the optimum measurement, monitoring and control of pH.

- Unique design incorporates 2 x pH probes (each with a 2m connecting cable) offering precise control of pH as well as accurate measurement of pH within the aquarium.

V²Auto Top Up Systems

- Safe, low voltage auto top-up system incorporating a high quality float switch.
- Ideal for topping up evaporated water in marine and freshwater aquariums.
- Simple to install using the unique mounting bracket which incorporates a locking suction cup, float switch guard and a securing clamp to hold the top-up hosing in place.
- Supplied complete with an energy efficient 3.5w 12v DC pump capable of 200 l/hr (max head 2m) and 2m of 6mm/9mm flexible top-up hosing.
- Full range of spares and accessories available allowing additional components, such as a solenoid valve (available separately) to be easily integrated into the system.
- Two versions are available as follows:-

3 V²Auto Top Up System

Contains: 1 float switch, 12v DC Pump, 2m flexible hosing.

4 V²Auto Top Up System Plus

Contains: 2 float switches, 12v DC Pump, 2m flexible hosing.

Please Note: 2nd float switch can be used upside down in the sump as an auto shut off when the sump runs low.

5 V²Auto Top Up Solenoid

- High quality 12v DC solenoid valve for aquarium applications.
- Maximum operating pressure: 8 bar.
- Pressure fittings for 4/6mm flexible hosing.
- Energy efficient low wattage (4w).
- Can be used in CO₂ systems.
- NOT SUITABLE FOR USE IN SALT WATER.

code	specification	sales unit	
9501	V ² Refractometer	single	1
5617	CO ₂ by TMC Cylinder 567g	single	2
2963	CO ₂ by TMC One-Use Cylinder 95g	single	3
5616	CO ₂ by TMC One-Use Cyl. stand	single	4
5386	V ² Pressure Regulator (DIN477 connection*)	single	5a
5387	V ² Pressure Regulator (CGA320 connection**)	single	5b
5385	V ² Pressure Regulator Pro (DIN477 connection*)	single	6a
5388	V ² Pressure Regulator Pro (CGA320 connection**)	single	6b
2962	CO ₂ Pressure Regulator Nano	single	7

V²Refractometer



5a & 5b

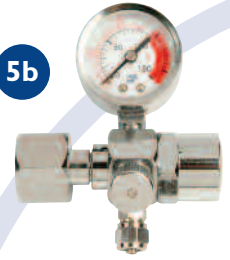

V²Pressure Regulator



2



3

Perfect for use with
V²React

6a & 6b



Supplied with a
FREE
Non
Return
Valve



Pressure Regulator Pros
available in
UK, EU and US versions

*DIN477 Connection
EU standard CO₂ cylinders with
fitted gas control valve

**CGA320 Connection
American standard CO₂ cylinders
with pin valve connection e.g hobby
and paintball cylinders

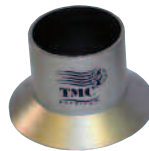

4



7



V²Miscellaneous Products

1 V²Refractometer

- Automatic temperature compensation.
- High resolution, dual scale - SG and PPT.
- Simple focus adjustment.
- Wipe-clean lens.
- Easy to calibrate using screwdriver supplied.
- Simple water application using pipette supplied.

2 CO₂ by TMC Cylinder

- 567g/20oz refillable CO₂ cylinder.

3 CO₂ by TMC "One Use" Cylinder

- 95g/3.4oz single use (non-refillable) CO₂ cylinder.
- Lasts up to 4 weeks (depending on application).

4 CO₂ by TMC "One Use" Cylinder Stand

- Moulded stand designed specifically to ensure that the 'One Use' disposable CO₂ cylinder is kept vertically upright and secure whilst in use.

5 V²Pressure Regulator

- High precision CO₂ pressure regulator designed specifically for aquarium use.
- Accurate adjustment allows for the precise dosing of CO₂.
- Easy to read pressure gauge showing both bar and psi.
- Designed for easy connection to CO₂ cylinders.

6 V²Pressure Regulator Pro

- High precision CO₂ pressure regulator with an integrated solenoid valve designed specifically for advanced aquarium use.
- Integrated solenoid valve enables the automated control of CO₂ in more advanced aquarium setups (when combined with the appropriate equipment).
- Two, easy to read pressure gauges showing both working pressure and CO₂ cylinder pressure in bar and psi.

7 CO₂ Pressure Regulator Nano

- High precision nano CO₂ pressure regulator designed specifically for aquarium use.

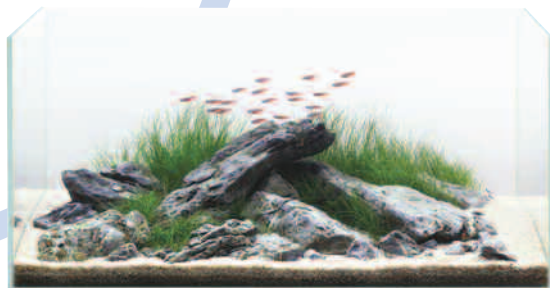

Signature
by TMC



	code	specification	sales unit
1	3020	Signature Aquarium 450 x 450 x 300mm	single
2	3021	Signature Aquarium 600 x 450 x 300mm	single
3	3022	Signature Aquarium 450 x 450 x 450mm	single
4	3024	Signature Aquarium 600 x 450 x 450mm	single
5	3030	Signature Cabinet - Carbon Grey 450 x 450 x 750mm	single
6	3031	Signature Cabinet - Carbon Grey 600 x 450 x 750mm	single
7	3032	Signature Cabinet - Charcoal Black 450 x 450 x 750mm	single
8	3033	Signature Cabinet - Charcoal Black 600 x 450 x 750mm	single
9	3034	Signature Cabinet - Glacier White 450 x 450 x 750mm	single
10	3035	Signature Cabinet - Glacier White 600 x 450 x 750mm	single



Signature
by TMC

Optiwhite Glass Aquariums and Cabinets

- Stylish, high clarity aquariums manufactured from Optiwhite (low iron) premium quality glass for super clear, true to nature viewing.
- Rimless and braceless design ensures unobstructed view from all angles and a minimalist look.
- Discreet black or clear silicone joints.
- Perfect for marine, tropical and planted displays.
- Range of co-ordinating, stylish aquarium cabinets available in Glacier White, Carbon Grey and Charcoal Black.
- 450mm or 600mm widths.

- 1 **Signature Aquarium 450 x 450 x 300mm**
6mm glass – clear silicone - undrilled - 60 Litres
- 2 **Signature Aquarium 600 x 450 x 300mm**
6mm glass – clear silicone - undrilled - 80 Litres
- 3 **Signature Aquarium 450 x 450 x 450mm**
6mm glass – black silicone - undrilled - 90 Litres
- 4 **Signature Aquarium 600 x 450 x 450mm**
8mm glass – black silicone - undrilled - 130 Litres



code	specification	sales unit
Signature 90cm Aquarium Set 1		
order:-		
3046	Drilled Aquarium 900 x 450 x 450mm	single 2
3028	900mm cabinet - Charcoal Black (not shown)	single 3
OR		
3029	900mm cabinet - Glacier White	single 4
3047	Sump	single 5
3038	Fittings Kit	single 6
Signature 60cm Aquarium Set (not shown) 7		
order:-		
3027	Drilled Aquarium 600 x 450 x 450mm	single 8
3031	600mm cabinet - Carbon Grey	single 9
OR		
3033	600mm cabinet - Charcoal Black	single 10
OR		
3035	600mm cabinet - Glacier White	single 11
3037	Sump	single 12
3038	Fittings Kit	single 13
Signature 45cm Aquarium Set (not shown) 14		
order:-		
3026	Drilled Aquarium 450 x 450 x 450mm	single 15
3030	450mm cabinet - Carbon Grey	single 16
OR		
3032	450mm cabinet - Charcoal Black	single 17
OR		
3034	450mm cabinet - Glacier White	single 18
3036	Sump	single 19
3038	Fittings Kit	single 20

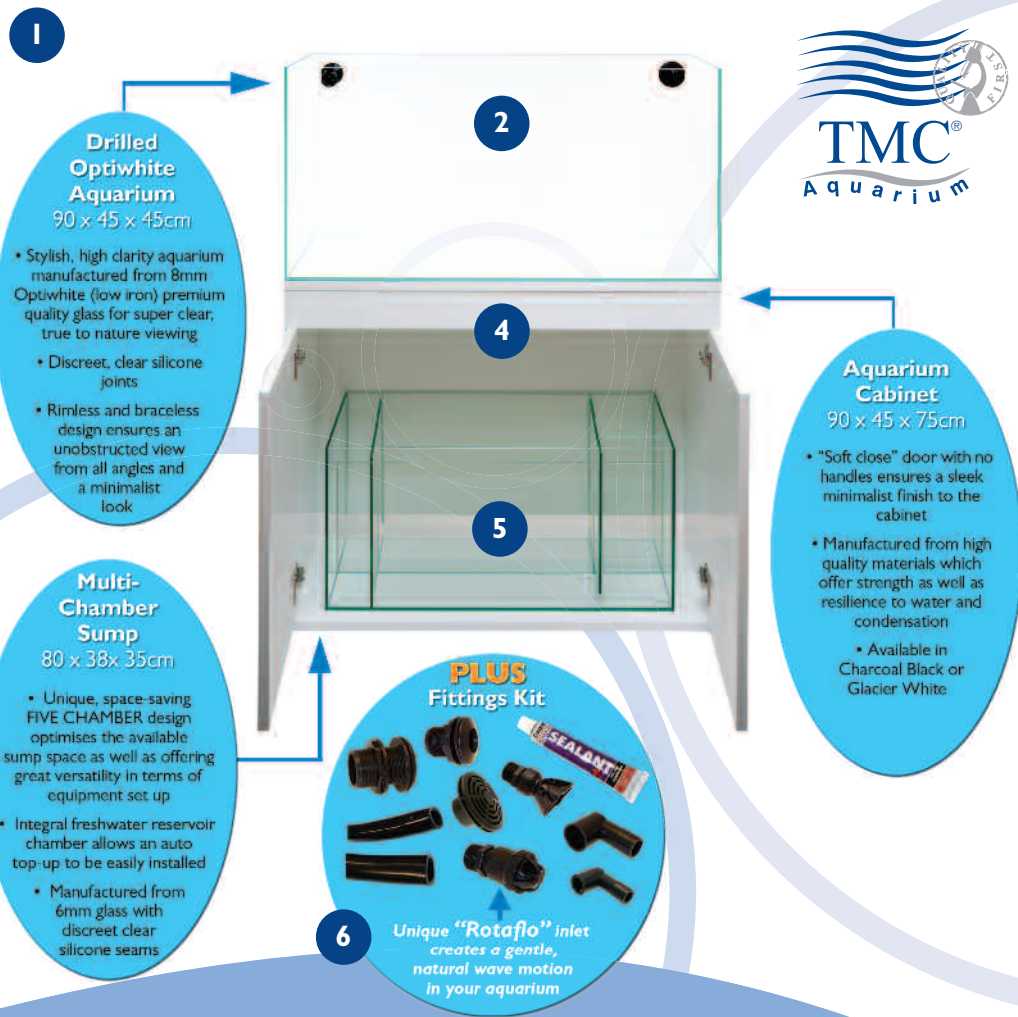

Signature by TMC

Optiwhite Glass Aquarium Sets

Aquarium Sets incorporating a drilled Optiwhite (low iron) premium quality glass tank, a cabinet, a multi-chamber sump and a fittings kit.

- 1-6 Signature Aquarium Set 900 x 450 x 450mm**
8mm glass – clear silicone - drilled - 180 Litres
- 7-13 Signature Aquarium Set 600 x 450 x 450mm**
8mm glass – black silicone - drilled - 130 Litres
- 14-20 Signature Aquarium Set 450 x 450 x 450mm**
6mm glass – black silicone - drilled - 90 Litres





Marine Fish Families Series		
1	5426 Seahorses, Pipefishes	single
2	5429 Surgeonfishes, Rabbitfishes	single
3	5436 Fairy & Rainbow Wrasses	single
4	5438 Marine Fish Families Box Set I	single
5	5439 Butterflyfishes, Bannerfishes	single
6	5440 Angelfishes	single
7	5441 Basslets, Hamlets	single
8	5442 Marine Fish Families Box Set 2	single
IKAN Guides		
9	5448 Nudibranchs of the World	single
10	5412 Mediterranean & Atlantic Fish Gde	single
11	5413 Mediterranean & Atlantic Invert Gde	single
12	5415 Red Sea Reef Gde	single
13	5417 Indian Ocean Reef Gde	single
14	5419 Crustacea Gde of the World	single
15	5425 Coral Sea Reef Gde	single
16	5427 Cephalopods A World Gde	single
17	5428 Sharks & Rays Elasmobranch Gde	single
18	5432 Asia Pacific Reef Gde	single
19	5437 Whales & Dolphins Cetacean Gde	single
20	5443 Corals Indopacific Field Gde	single
Other Titles		
21	5391 Reef Secrets	single
22	5392 Reef Life	single
23	5394 Aquarium Corals	single
24	5416 Reef Fishes Vol I	single
25	5397 Reef Fishes Vol 2 - Basslets	single
26	5399 Reef Fishes Vol 3 - Angelfishes	single



Aquatic Books

TMC Publishing is the publisher of, and has the world wide distribution rights to the English language version of the Marine Fish Families Series of books. TMC also distributes a range of other fishkeeping and aquatic titles, for both the beginner and the more advanced aquarist.

The Marine Fish Families Series EXCLUSIVE TO TMC!



All the books in this series are comprehensively illustrated with hundreds of spectacular underwater photographs and contain information on behaviour, habitats and aquarium requirements for the various groups or species. They also include an introduction to genera and subgenera and picture index pages for visual quick-find of genera, subgenera and species plus a full index of common and scientific names.

- 1 By Rudie H Kuiter. Hardback, 240 pages
- 2 By Rudie H Kuiter and Helmut Debelius. Hardback, 208 pages
- 3 By Rudie H Kuiter. Hardback, 208 pages
- 4 Box Set of three books. Contains Seahorses, Surgeonfishes & Fairy and Rainbow Wrasses
- 5 By Rudie H Kuiter. Hardback, 208 pages
- 6 By Helmut Debelius, Hiroyuki Tanaka & Rudie H Kuiter. Hardback, 204 pages
- 7 By Rudie H Kuiter. Hardback, 216 pages

- 8 Box Set of three books. Contains Butterflyfishes, Angelfishes & Basslets and Hamlets.
- 9 By Helmut Debelius. Hardback, 360 pages
- 10 By Helmut Debelius. Hardback, 305 pages
- 11 By Peter Wirtz and Helmut Debelius. Hardback, 305 pages
- 12 REVISED and UPDATED! By Helmut Debelius. Hardback, 322 pages
- 13 By Helmut Debelius. Hardback, 321 pages
- 14 By Helmut Debelius. Hardback, 321 pages
- 15 By Bob Halstead. Hardback, 321 pages
- 16 By Mark Norman. Hardback, 320 pages
- 17 By Ralf M Hennemann. Hardback, 305 pages
- 18 By Helmut Debelius. Hardback, 321 pages
- 19 By Ralf Kiefner. Hardback, 305 pages
- 20 By Harry Erhardt and Daniel Knop. Hardback, 305 pages
- 21 By Alf Jacob Nilsen & Svein A Fossa. Hardback, 224 pages
- 22 By Denise Nielsen Tackett & Larry Tackett. Hardback, 224 pages
- 23 By Eric H Borneman. Hardback, 464 pages
- 24 By Scott W Michael. Hardback, 624 pages
- 25 By Scott W Michael. Hardback, 296 pages
- 26 By Scott W Michael. Hardback, 344 pages

code	specification	sales unit	
5396	New Illustrated Guide Fish Diseases	single	27
5400	Marine Aquarium Handbook - 3rd Ed.	single	28
5403	Diseases in Marine Aquarium Fish	single	29
5398	Pocket Expert Guide Marine Inverts	single	30
5423	Pocket Expert Guide Marine Fishes	single	31
5497	Pocket Expert Guide Reef Aq Fishes	single	32
5405	Breeding the Orchid Dotyback	single	33
5406	Shore Fishes of Hawai'i	single	34
5402	Modern Coral Reef Aquarium Vol 1	single	35
5408	Modern Coral Reef Aquarium Vol 2	single	36
5421	Modern Coral Reef Aquarium Vol 3	single	37
5434	Modern Coral Reef Aquarium Vol 4	single	38
5409	Natural Reef Aquariums	single	39
5414	Clownfishes	single	40
5420	Fishwatchers Guide Book I	single	41
5422	New Marine Aquarium	single	42
5424	Guide to Angel & Butterflyfishes	single	43
5435	Fishes and Corals	single	44
5494	Super Simple Guide to Corals	single	45
5495	World Atlas of Marine Fishes	single	46
5491	Dr Burgess's Atlas Marine Aq Fishes	single	47
5492	Dr Burgess's Mini Atlas Marine Aq Fishes	single	48
5493	Reef Invertebrates An Essential Guide	single	49
5496	Advanced Marine Aq Techniques	single	50
5498	Nano-Reef Handbook	single	51
5431	Corals of the World (3 Book Set)	single	52
5446	The Conscientious Marine Aquarist - Revised and Updated 2nd Edition	single	53
5447	World Atlas of Marine Fauna	single	54
5445	The Marine Fish Health & Feeding Handbook	single	55
5395	The Simple Guide to Mini-Reef Aquariums	single	56
5444	Aquarium Plants	single	57
5490	Simple Guide to Planted Aquariums	single	58



27 By **Dr Gerald Bassleer**. Hardback, 232 pages
 28 By **Martin A Moe**. Soft Cover, 352 pages
 29 By **Gerald Bassleer**. Hardback, 96 pages
 30 By **Ronald L Shimek**. Soft Cover, 448 pages
 31 By **Scott W Michael**. Soft Cover, 448 pages
 32 By **Scott W Michael**. Soft Cover, 448 pages
 33 By **Martin A Moe**. Soft Cover, 288 pages
 34 By **John E Randall**. Soft Cover, 216 pages
 35 By **Svein A Fossa and Alf Jacob Nilsen**. Hardback, 367 pages
 36 By **Svein A Fossa and Alf Jacob Nilsen**. Hardback, 479 pages
 37 By **Svein A Fossa and Alf Jacob Nilsen**. Hardback, 448 pages
 38 By **Svein A Fossa and Alf Jacob Nilsen**. Hardback, 480 pages
 39 By **John Tullock**. Soft Cover, 336 pages
 40 By **Joyce D Wilkerson**. Soft Cover, 240 pages
 41 By **Robert M Fenner**. Soft Cover, 196 pages
 42 By **Michael S Paletta**. Soft Cover, 144 pages
 43 By **Gerald R Allen, Roger Steene and Mark Allen**. Hardback, 250 pages
 44 By **Dieter Brockmann**. Hardback, 222 pages
 45 By **James W Fatherree**. Soft Cover, 136 pages
 46 By **Rudie H Kuiter and Helmut Debelius**. Hardback, 720 pages
 47 By **Dr. Warren E. Burgess, Dr. Herbert R. Axelrod, Raymond E. Hunziker**. Hardback, 784 pages

48 By **Dr. Warren E. Burgess, Dr. Herbert R. Axelrod, Raymond E. Hunziker**. Hardback, 1023 pages
 49 By **Anthony Calfo & Robert Fenner**. Soft Cover, 398 pages
 50 By **Jay F Hemdal**. Hardback, 432 pages
 51 By **Chris R Brightwell**. Hardback, 256 pages
 52 By **J E N Veron**. Hardback, 1382 (across 3 volumes) pages
 53 By **Robert M Fenner**. Hardback, 456 pages
 54 By **Rudie H Kuiter and Helmut Debelius**. Hardback, 725 pages
 55 By **Bob Goemans and Lance Ichinotsubo**. Hardback, 232 pages
 56 By **Jeffrey Kurtz**. Softcover, 208 pages
 57 By **Dr Jurgen Schmidt**. Hardback, 80 pages
 58 By **Terry Anne Barber & Rhonda Wilson**. Softcover, 207 pages



	code	specification	sales unit
1	214106	50 x 45 x 16cm	single
2	214107	58 x 37 x 18cm	single
3	214108	40 x 34 x 10cm	single
4	214109	34 x 23 x 9cm	single
5	214110	36 x 26 x 9cm	single
6	214111	31 x 18 x 16cm	single
7	214112	32 x 24 x 12cm	single
8	214113	28 x 21 x 12cm	single
9	214114	29 x 21 x 12cm	single
10	214115	26 x 18 x 14cm	single
11	214116	21 x 21 x 8cm	single
12	214117	25 x 19 x 13cm	single
13	214118	23 x 16 x 11cm	single
14	214119	24 x 18 x 10cm	single
15	214120	62 x 37 x 62cm	single
16	214121	46 x 42 x 34cm	single
17	214122	34 x 44 x 45cm	single
18	214123	55 x 32 x 17cm	single
19	214124	45 x 36 x 24cm	single
20	214125	36 x 33 x 21cm	single
21	214126	39 x 23 x 18cm	single
22	214127	37 x 24 x 17cm	single
23	214128	31 x 23 x 14cm	single
24	214129	29 x 18 x 11cm	single
25	214130	20 x 10 x 10cm	single
26	214131	18 x 12 x 12cm	single
27	214132	17 x 14 x 19cm	single
28	214133	19 x 13 x 10cm	single
29	214134	20 x 15 x 10cm	single
30	214135	20 x 18 x 17cm	single
31	214101	52 x 44 x 19cm	single
32	214102	56 x 33 x 20cm	single
33	214103	49 x 49 x 7cm	single
34	214104	44 x 29 x 12cm	single
35	214105	32 x 23 x 13cm	single
36	RLRMIXA	Mixed Box	single
37	RLRMIXB	Mixed Box	single

Natureform Replica Live Rock

- Hand made and hand painted.
- Very realistic.
- Use to create a unique and “true to nature” reef scene.
- Colour fast and non toxic.
- Economically priced.
- Mixed boxes available.

36 Mixed Box A

Contains: 214108 214111
214112 214115
214116 214117
214119 214128
214129 214130
214131 214132

37 Mixed Box B

Contains: 214109 214110
214113 214114
214116 214118
214119 214128
214129 214130
214131 214132



code	specification	sales unit	
RLRBG	120 x 50cm	single	1
RLRBGM	90 x 45cm	single	2
RLRBGI	120 x 50cm	single	3
RLRBGT	120 x 50cm	single	4
211014	98 x 58cm	single	5
211016	118 x 58cm	single	6
211116	118 x 58cm	single	7
211154	98 x 58cm	single	8
211344	98 x 58cm	single	9
211345	118 x 48cm	single	10
211444	98 x 58cm	single	11
211446	118 x 58cm	single	12
211544	98 x 58cm	single	13
211546	118 x 58cm	single	14

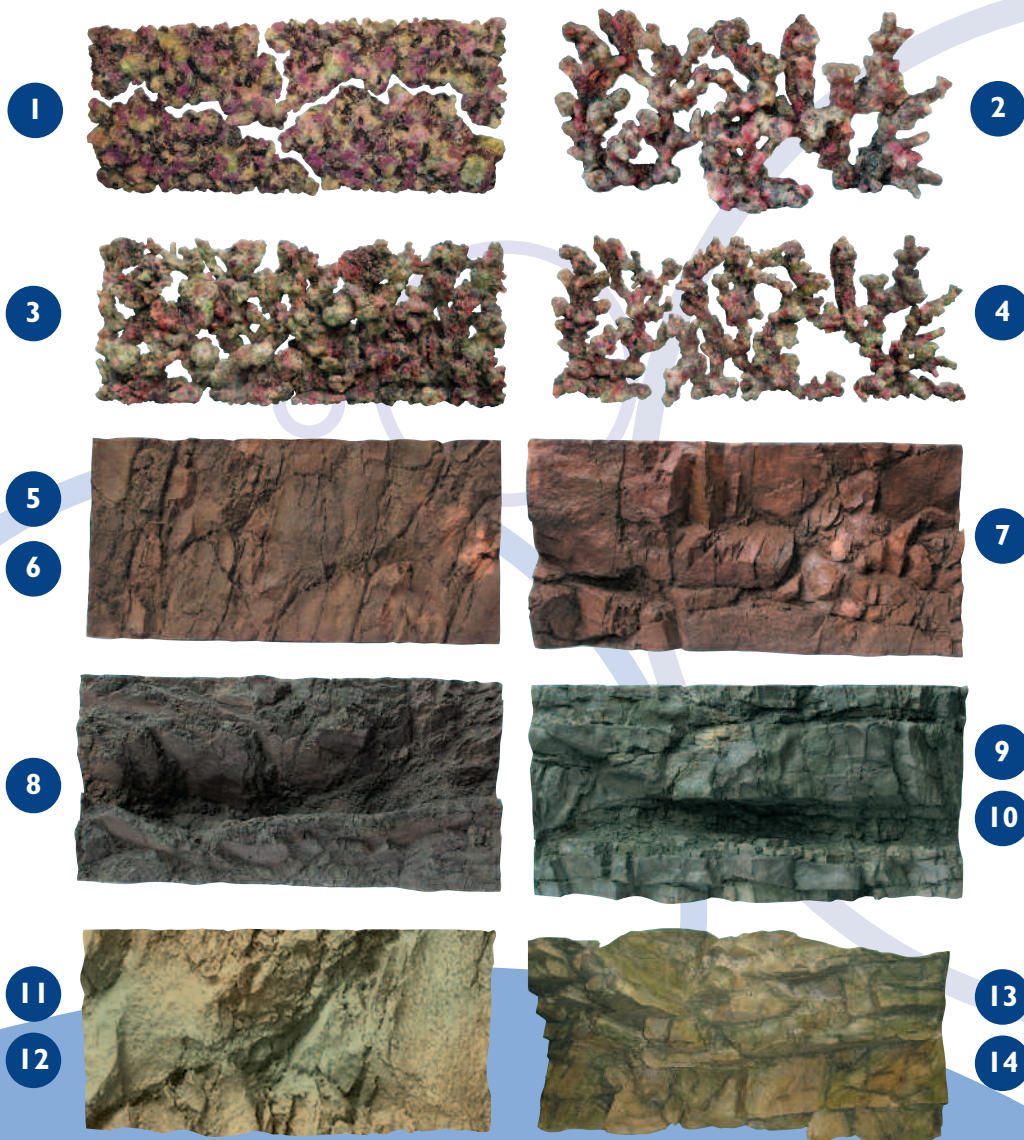

Natureform Aquarium Backgrounds

1 Marine Reef Background

Supplied in sections, which means that corals or pieces of rock can be placed between these sections to create a realistic reef scene.

2 Mini Marine Reef Background

3 Indonesian Reef Background

4 Tonga Reef Background

5 Borneo Red Background

6 Borneo Red Background

7 Kisa Red Background

8 Kisa Grey Background

9 Timor Green Background

10 Timor Green Background

11 Papua Green Background

12 Papua Green Background

13 Sumatra Green Background

14 Sumatra Green Background



	code	specification	sales unit
Blister Packs (95g net, 100g gross)			
1	8150	Mini Bloodworm (17 per outer)	single
2	8151	Daphnia (17 per outer)	single
3	8152	Brineshrimp (17 per outer)	single
4	8153	Bloodworm (17 per outer)	single
5	8154	Tubifex (17 per outer)	single
6	8155	White Mosquito Larvae (9 per outer)	single
7	8156	Mysis Shrimp (17 per outer)	single
8	8157	Red Plankton (9 per outer)	single
9	8179	Tropical Quintet (17 per outer)	single
10	8178	Marine Quintet (17 per outer)	single
11	8160	Discus Diet (9 per outer)	single
12	8161	Cichlid Diet (9 per outer)	single
13	8162	Vegetarian Diet (17 per outer)	single
14	8163	Krill Pacifica (17 per outer)	single
15	8165	Brineshrimp + Spirulina (17 per outer)	single
16	8166	Brineshrimp + Omega-3 (17 per outer)	single
17	8168	Brineshrimp + Garlic (17 per outer)	single
18	8169	Finely Chopped Prawn (17 per outer)	single
19	8170	Rotifers (17 per outer)	single
20	8171	Cyclops (17 per outer)	single
21	8172	Finely Chopped Mussel (17 per outer)	single
22	8173	Amphibian Diet (9 per outer)	single
23	8174	Nano Marine Cuisine (17 per outer)	single
24	8175	Brineshrimp Quintet (17 per outer)	single
25	8176	Brineshrimp plus Aloe Vera (17 per outer)	single
26	8177	Marine Cuisine (17 per outer)	single

gamma blister Frozen Food

- The only food used by Tropical Marine Centre at its four fish-holding facilities.
- Highest quality ingredients, rapidly packed, sealed & frozen.
- Gamma irradiated. This completely eliminates any risk of introducing harmful parasites or bacteria into your aquarium, and also means that the food is completely safe to store in your freezer.
- 100% natural products and the wide variety available ensures that individual species of fish receive a balanced, varied and interesting diet.
- Blister packs are designed to dispense one measured cube of food at a time, leaving the rest of the product sealed within their separate blisters. A quick and convenient way of feeding fish.
- Colour-coded feeding suitability guide makes it easy to find the right food for your fish!

- 1 Mini Bloodworm.** For marine, tropical, coldwater, cichlid & discus.
- 2 Daphnia.** For tropical, coldwater & cichlid.
- 3 Brineshrimp.** For marine, tropical, coldwater, cichlid & discus.
- 4 Bloodworm.** For marine, tropical, coldwater, cichlid & discus.
- 5 Tubifex.** For tropical, coldwater, cichlid & discus.
- 6 White Mosquito Larvae.** For tropical, coldwater, cichlid & discus.
- 7 Mysis Shrimp.** For marine, tropical, & coldwater.
- 8 Red Plankton.** For marine, tropical, coldwater & cichlid.
- 9 Tropical Quintet.** For tropical, cichlid & discus.
- 10 Marine Quintet.** For marine.
- 11 Discus Diet.** For tropical & discus.
- 12 Cichlid Diet.** For tropical, & cichlid.
- 13 Vegetarian Diet.** For marine, tropical & cichlid.
- 14 Krill Pacifica.** For marine, tropical & coldwater.
- 15 Brineshrimp + Spirulina.** For marine, tropical, coldwater, cichlid & discus.
- 16 Brineshrimp + Omega-3.** For marine, tropical, coldwater & cichlid.
- 17 Brineshrimp + Garlic.** For marine, tropical, coldwater & cichlid.
- 18 Finely Chopped Prawn.** For marine & cichlid.
- 19 Rotifers.** For marine.
- 20 Cyclops.** For tropical, coldwater, cichlid & discus.
- 21 Finely Chopped Mussel.** For marine.
- 22 Amphibian Diet.** For tropical & coldwater.
- 23 Nano Marine Cuisine.** For marine.
- 24 Brineshrimp Quintet.** For marine, tropical, coldwater & cichlid.
- 25 Brineshrimp plus Aloe Vera.** For marine, tropical, coldwater & cichlid.
- 26 Marine Cuisine.** For marine.

code specification

sales unit

Slice Packs (250g net)

8450	Mini Bloodworm (40 per outer)	single	1
8451	Daphnia (40 per outer)	single	2
8452	Brineshrimp (40 per outer)	single	3
8456	Mysis Shrimp (40 per outer)	single	4
8463	Krill Pacifica (40 per outer)	single	5
8465	Brineshrimp + Spirulina (40 per outer)	single	6
8466	Brineshrimp + Omega-3 (40 per outer)	single	7
8468	Brineshrimp + Garlic (40 per outer)	single	8
8469	Finely Chopped Prawn (40 per outer)	single	9
8470	Rotifers (40 per outer)	single	10
8471	Cyclops (40 per outer)	single	11
8474	Whole Fish (18 per outer)	single	12
8475	Whole Mussel (20 per outer)	single	13
8476	Whole Cockle (20 per outer)	single	14
8477	Krill Superba (40 per outer)	single	15
8478	Brineshrimp + AloeVera (40 per outer)	single	16
8479	Cockle in Shell (25 per outer)	single	17
8480	Marine Cuisine (40 per outer)	single	18



gamma slice

Frozen Food

- New 250g bulk pack.
- The only food used by Tropical Marine Centre at its three UK fish-holding facilities.
- Highest quality ingredients.
- Rapidly packed, sealed & frozen.
- Gamma irradiated. This completely eliminates any risk of introducing harmful parasites or bacteria into your aquarium, and also means that the food is completely safe to store in your freezer.
- 100% natural products and the wide variety available ensures that individual species of fish receive a balanced, varied and interesting diet.
- Colour-coded feeding suitability guide makes it easy to find the right food for your fish!

- 1 Mini Bloodworm.** For marine, tropical, coldwater, cichlid & discus.
- 2 Daphnia.** For tropical, coldwater & cichlid.
- 3 Brineshrimp.** For marine, tropical, coldwater, cichlid & discus.
- 4 Mysis Shrimp.** For marine, tropical & coldwater.
- 5 Krill Pacifica.** For marine, tropical & coldwater.
- 6 Brineshrimp + Spirulina.** For marine, tropical, coldwater, cichlid & discus.
- 7 Brineshrimp + Omega-3.** For marine, tropical, coldwater & cichlid.
- 8 Brineshrimp + Garlic.** For marine, tropical, coldwater & cichlid.
- 9 Finely Chopped Prawn.** For marine & cichlid.
- 10 Rotifers.** For marine.
- 11 Cyclops.** For tropical, coldwater, cichlid & discus.
- 12 Whole Fish.** For marine.
- 13 Whole Mussel.** For marine.
- 14 Whole Cockle.** For marine & cichlid.
- 15 Krill Superba.** For marine, tropical & coldwater.
- 16 Brineshrimp + Aloe Vera.** For marine, tropical, coldwater & cichlid.
- 17 Cockle in Shell.** For marine & cichlid.
- 18 Marine Cuisine.** For marine.

	code	specification	sales unit
1	8317	Dried Natural Green Seaweed (12g net, 17g gross)	single
2	8318	Dried Natural Red Seaweed (12g net, 17g gross)	single
3	8319	Dried Natural Green Seaweed (150g bulk pack)	single
4	8320	Dried Natural Red Seaweed (150g bulk pack)	single
5	8321	Gamma Seaweed Clip	single

Supplied in handy strips, for easy dispensing and feeding



gamma dry Enriched Dried Natural Seaweed

- Feed daily as part of a balanced diet and as a supplement to other food sources such as Gamma Frozen Foods.
- Seaweed strips may be fed dry or pre-soaked in aquarium water or for further enrichment pre-soaked in liquid feed supplements such as Gamma Nutraplus.
- **Suitable for:** All saltwater damsels, clownfish, angels, tangs and wrasses and also freshwater algae eaters, African cichlids, silver dollars and sharks.

- 1 & 3 **Dried Natural Green Seaweed (Porphyra sp.)**
Enriched with spirulina and omega 3 to naturally enhance colour and vitality.
- 2 & 4 **Dried Natural Red Seaweed (Porphyra sp.)**
Enriched with garlic and omega 3 to naturally enhance health and vitality.
- 5 **Gamma Seaweed Clip**

code	specification	sales unit
8311	Nutraplus Reef Feed 100ml	single 1
8312	Nutraplus Reef Feed 200ml	single 2
8313	Nutraplus Reef Feed 500ml	single 3
8314	Nutraplus Complete Feed 100ml	single 4
8315	Nutraplus Complete Feed 200ml	single 5
8316	Nutraplus Complete Feed 500ml	single 6



100% Natural Ingredients

- Copepods
- Microalgae
- Rotifers



100% Natural Ingredients

- Artemia
- Copepods
- Microalgae
- Rotifers

IMPROVED
24
months
SHELF LIFE



Supplied with a
feeding pipette
and a
pipette holder

gamma NutraPlus Liquid Feeds

- Now with a 24 month shelf life.
- A unique microalgae concentrate mix containing high natural levels of carotenes, minerals, vitamins and fatty acids.
- Formulated specifically for feeding livestock including herbivorous and carnivorous filter feeders in reef and mixed community marine aquarium systems.
- Clean and easy to feed using dosing pipette supplied.
- Can be stored unopened at room temperature for up to 9 months. Once opened, it is recommended that the product is stored in a fridge and used within 3 months.
- 100% natural ingredients.

1-3 Gamma Nutraplus Reef Feed

Specifically formulated for **invertebrates**.

Containing Dunaliella salina, Nannochloropsis oculata, Rotifers and Copepods.

4-6 Gamma Nutraplus Complete Feed

Specifically formulated for **fish and invertebrates**.

Containing Dunaliella salina, Nannochloropsis oculata, Artemia, Rotifers and Copepods.

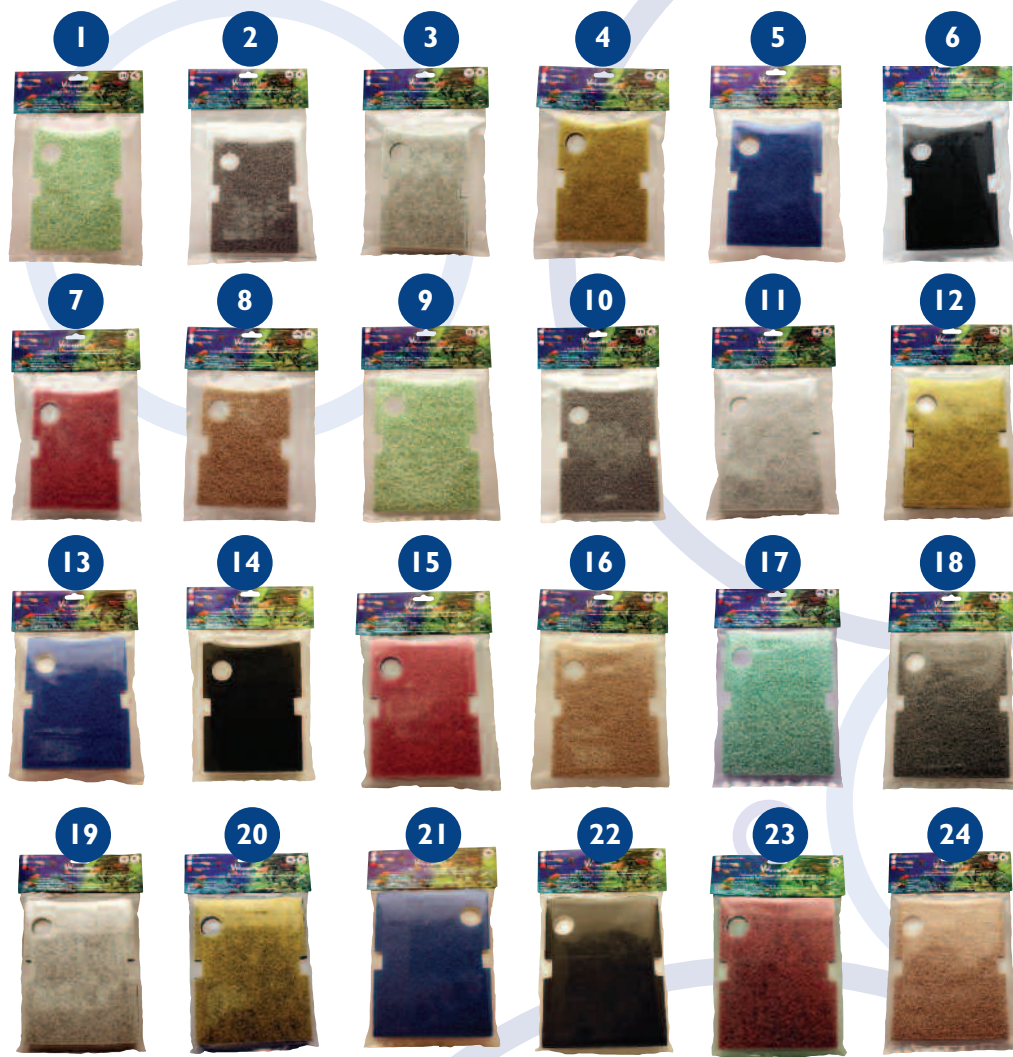

code specification sales unit

V²PowerPads for V²PowerBox 100 Nano

1	5950	Phosphate (PO ₄) Reduction Pad	single
2	5953	Nitrite (NO ₂) & Nitrate (NO ₃) Reduction Pad	single
3	5956	Filtration Start up Pad	single
4	5959	Activated Carbon Filter Pad	single
5	5962	Water Clarity Filter Pad (Marine)	single
6	5965	Water Clarity Filter Pad (Freshwater)	single
7	5968	Calcium (Ca ²⁺) & Magnesium (Mg ²⁺) Supplement Pad	single
8	5971	Ammonia (NH ₃) Reduction Pad	single

V²PowerPads for V²PowerBox 200

9	5951	Phosphate (PO ₄) Reduction Pad	single
10	5954	Nitrite (NO ₂) & Nitrate (NO ₃) Reduction Pad	single
11	5957	Filtration Start up Pad	single
12	5960	Activated Carbon Filter Pad	single
13	5963	Water Clarity Filter Pad (Marine)	single
14	5966	Water Clarity Filter Pad (Freshwater)	single
15	5969	Calcium (Ca ²⁺) & Magnesium (Mg ²⁺) Supplement Pad	single
16	5972	Ammonia (NH ₃) Reduction Pad	single

V²PowerPads for V²PowerBox 400

17	5952	Phosphate (PO ₄) Reduction Pad	single
18	5955	Nitrite (NO ₂) & Nitrate (NO ₃) Reduction Pad	single
19	5958	Filtration Start up Pad	single
20	5961	Activated Carbon Filter Pad	single
21	5964	Water Clarity Filter Pad (Marine)	single
22	5967	Water Clarity Filter Pad (Freshwater)	single
23	5970	Calcium (Ca ²⁺) & Magnesium (Mg ²⁺) Supplement Pad	single
24	5973	Ammonia (NH ₃) Reduction Pad	single



V²PowerPads

For best results:-

- Always ensure good water flow through the filter pad
- Replace every 4 weeks, or before if necessary
- Must be used in conjunction with regular testing of water parameters

1, 9 & 17 Phosphate (PO₄) Reduction Filter Pad

Absorbs and reduces phosphate (PO₄) to enhance and improve aquarium water quality.

2, 10 & 18 Nitrite (NO₂) & Nitrate (NO₃) Reduction Filter Pad

Absorbs and reduces nitrite (NO₂) and nitrate (NO₃) to enhance and improve aquarium water quality

3, 11 & 19 Filtration Start up Pad

Improves the maturation process and nitrogen cycle of a new aquarium and filtration system

- Remove once maturation process is complete and aquarium is established

4, 12 & 20 Activated Carbon Filter Pad

Absorbs and reduces dissolved organics and other toxic substances to enhance and improve aquarium water quality

5, 13 & 21 Water Clarity Filter Pad (Marine)

Releases a flocculant which clumps together fine particles suspended in the water, making them easier to filter out, enhancing and improving aquarium water clarity

- For optimum results a filter fleece should also be used in your filtration system to ensure the flocculated particles are removed

6, 14 & 22 Water Clarity Filter Pad (Freshwater)

Releases a flocculant which clumps together fine particles suspended in the water, making them easier to filter out, enhancing and improving aquarium water clarity

- For optimum results a filter fleece should also be used in your filtration system to ensure the flocculated particles are removed

7, 15 & 23 Calcium (Ca²⁺) & Magnesium (Mg²⁺) Supplement Pad

Releases Calcium and Magnesium ions to enhance and improve aquarium water quality

8, 16 & 24 Ammonia (NH₃) Reduction Filter Pad

Absorbs and reduces ammonia to enhance and improve aquarium water quality

Please note: multiple PowerPads can be used together to enhance performance.

code	specification	sales unit	
5595	Hydrometer	single	1
5596	High Precision Hydrometer	single	2
5598	High Precision Thermometer	single	3
5170	HR Carbon (720ml box)	single	4
5171	HR Carbon (20kg sack)	single	5
7054	TMC Bio-Rings 1"	litre	6
5164	Bio-Glass (1 litre bag)	single	7a
5165	Bio-Glass (3 litre bag)	single	7b
5151	Sand (6x4kg boxes)	single	8
5152	Sand (25kg sack)	single	9
5153	Coral Gravel Fine (6x4kg boxes)	single	10
5154	Coral Gravel Fine (25kg sack)	single	11
5157	Coral Gravel Med (6x4kg boxes)	single	12
5158	Coral Gravel Med (25kg sack)	single	13
5155	Coral Gravel Coarse (6x4kg boxes)	single	14
5156	Coral Gravel Coarse (25kg sack)	single	15



Tropical Marine
UV lamps available
See p. 81
for details

Miscellaneous Aquarium Products

1 TMC Hydrometer

Improved manufacturing techniques have produced a precision hydrometer which offers real value for money. Accurate to 0.002, and with comprehensive instructions including a salinity reference chart.

2 Tropic Marin High Precision Hydrometer

Accurate to 0.0005°.

3 Tropic Marin High Precision Thermometer

Accurate to 0.2°F.

4 & 5 HR Carbon

HR Carbon is a highly retentive carbon which is the result of several years' development and testing in freshwater and marine aquariums. It is made from carefully selected grades of bituminous coal, ensuring that a consistent quality is maintained.

- Recommended for the removal of organics and other toxic substances which gradually build up in marine and freshwater aquariums.
- Removes phenols and other organic compounds.
- Unlike many cheaper carbons, it does not add phosphates.
- Creates crystal clear water allowing better light penetration for maximum plant and coral growth.

6 TMC Bio-Rings

- These Bio-Rings have excellent flow-through characteristics, making them ideal for trickle filter applications.
- Designed to give a large, accessible surface area which is easily contacted by the water and gas, whilst avoiding clogging.
- Made from blue polypropylene.
- Positively buoyant.

7 Bio-Glass

- Suitable for both aerobic nitrifying bacteria and anaerobic denitrifying bacteria.
- Provides a very large surface area compared to other, ordinary bio-rings.
- Made from natural silicate - no toxins and harmless to livestock.
- Suitable for freshwater and saltwater applications.

8-15 TMC Oolitic Sand and Gravel

- Available in five different particle sizes, including our specially graded uniform particle size sand for fluidised sand bed filters.
- Ideal as both a mechanical and a high surface area biological filter media.
- Surface area >10 000m²/m³.
- Natural aragonite.

V² Vecton 200

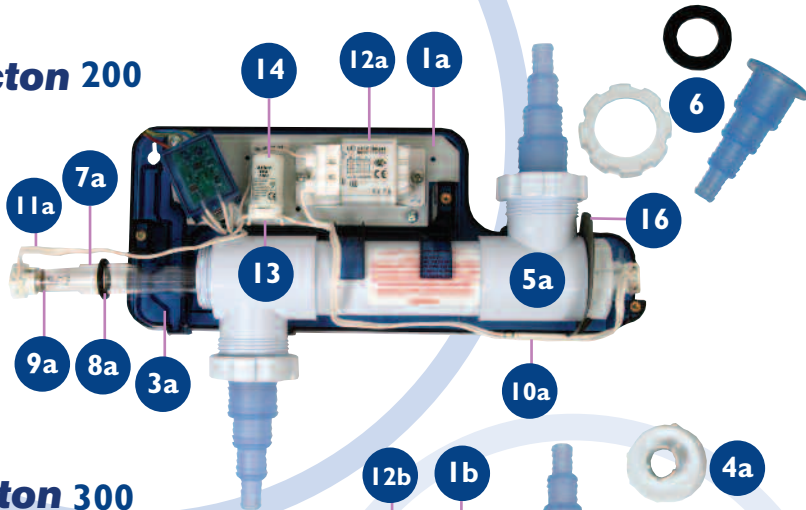

V² Vecton 300

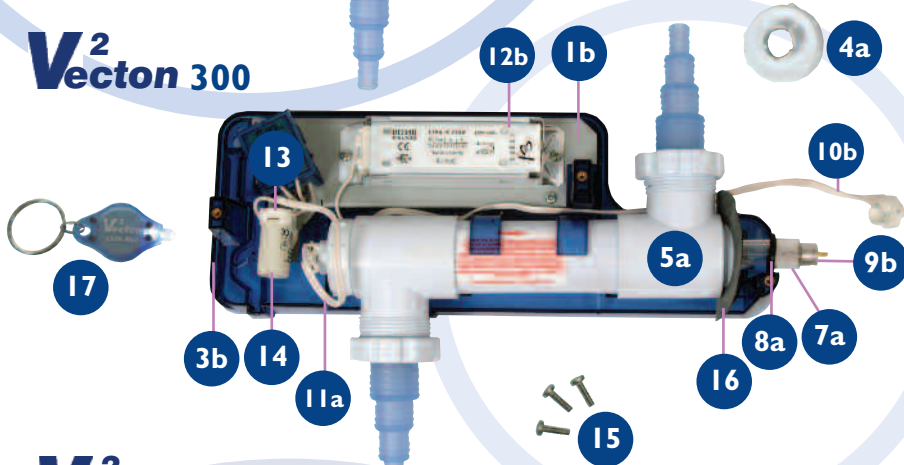

V² Vecton 400 & 600

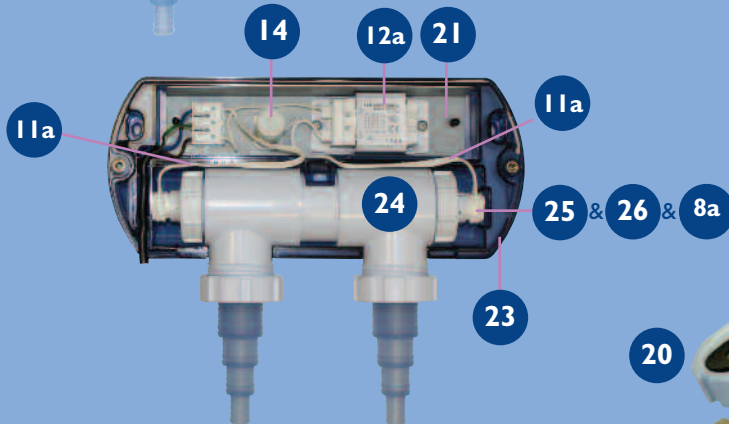
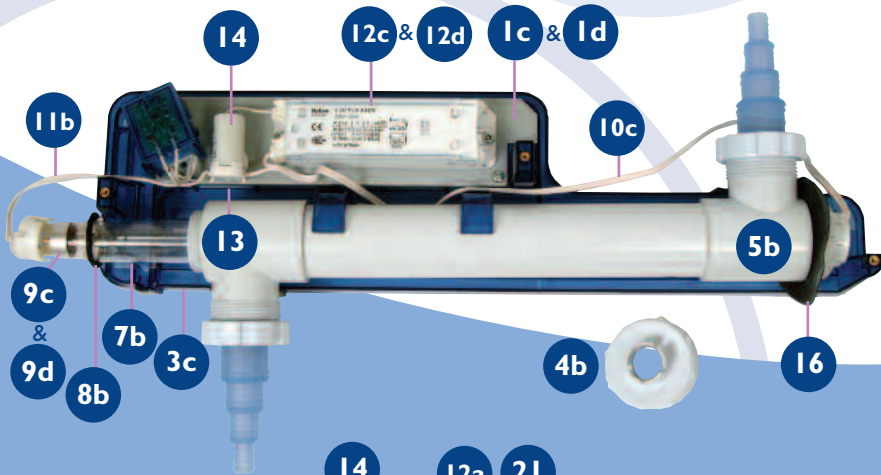

	code	specification	sales unit
1a	5210CG-UK	V ² ecton 200 control gear	single
1b	5211CG-UK	V ² ecton 300 control gear	single
1c	5212CG-UK	V ² ecton 400 control gear	single
1d	5213CG-UK	V ² ecton 600 control gear	single
2a	V28W/05L	V ² ecton 200 lid (not shown)	single
2b	V216W/05L	V ² ecton 300 lid (not shown)	single
2c	V225W/05L	V ² ecton 400/600 lid (not shown)	single
3a	V28W/05B	V ² ecton 200 base	single
3b	V216W/05B	V ² ecton 300 base	single
3c	V225W/05B	V ² ecton 400/600 base	single
4a	8WPC/LNCT94	Small locknut	single
4b	15WPC/LNCT94	Large locknut	single
5a	SHVEC2/300B	V ² ecton 200/300 plastic body	single
5b	SHVEC4/600B	V ² ecton 400/600 plastic body	single
6	5249-F	V ² ecton universal hoesetail assembly	single
7a	5275	Replacement quartz sleeve 8/16w	single
7b	5276	Replacement quartz sleeve 15/25w	single
8a	5280	O ring for quartz sleeve 6/8/16w	single
8b	5281	O ring for quartz sleeve 15/25/30/55w	single
9a	6052	TM UV lamp 8w	single
9b	6057	TM UV lamp 16w	single
9c	6053	TM UV lamp 15w	single
9d	6054	TM UV lamp 25w	single
10a	V2UV8/16LLL	V ² ecton 200 lamp lead long	single
10b	V2UV16LLL	V ² ecton 300 lamp lead long	single
10c	V2UV25LLL	V ² ecton 400/600 lamp lead long	single
11a	V2UV8/16LLS	V ² ecton 120/200/300 lamp lead short	single
11b	V2UV25LLS	V ² ecton 400/600 lamp lead short	single
12a	D468-22.2-3	6w & 8w UK ballast	single
12b	L18TL2230V	16w UK ballast	single
12c	D15-22.2-4	15w UK ballast	single
12d	L30TL2230	25w UK ballast	single
13	V2/SB11AL-08	V ² ecton sidemount starter holder	single
14	S10	S10 lamp starter	single
15	MAPPM0350082	V ² ecton lid securing screw	single
16	V2WVG/BR05	V ² ecton moisture displacement gasket	single
17	5214	V ² ecton LITE SET torch	single
18a	VEC2/300BOX	V ² ecton 200 box (not shown)	single
18b	VEC2/300BOX	V ² ecton 300 box (not shown)	single
18c	VEC4/600BOX	V ² ecton 400 box (not shown)	single
18d	VEC4/600BOX	V ² ecton 600 box (not shown)	single
19	V2/200-400IN	V ² ecton instructions (not shown)	single
20	5249-L	Clear 90° elbow	single

V²ecton 120 Nano

21	5209CG-UK	V ² ecton 120 control gear	single
22	V2/120COVER	V ² ecton 120 lid (not shown)	single
23	V2/120BASE	V ² ecton 120 base	single
24	SHVECNANO	V ² ecton 120 plastic body	single
25	5274	V ² ecton 120 quartz sleeve	single
26	6051	TM UV lamp 6w	single
27	V2/120BOX	V ² ecton 120 box (not shown)	single
28	V2120INS	V ² ecton 120 instructions (not shown)	single

Available in
UK, EU and US versions

V² Vecton Spares & Accessories

code	specification	sales unit	
5227	V ² Bubble Stop small	single	1
5228	V ² Bubble Stop large	single	2
5718	V ² Bubble Stop - new style	single	3
5229	V ² Filter Media Bag	single	4
5371	V ² Venturi Silencer	single	5
5365	V ² Skim inlet pipe hose assembly	single	6
5366	V ² Skim outlet pipe assembly	single	7
5369	V ² Skim securing screw	single	8
5368	V ² Bubble Stop securing screw	single	9
5360	V ² Bubble Stop black sponge filter (small)	single	10
5362	V ² Bubble Stop black sponge filter (large)	single	11
5361	V ² Bubble Stop white sponge filter (small)	single	12
5363	V ² Bubble Stop white sponge filter (large)	single	13
5370	Venturi air inlet connection tube	single	15
5372	V ² Skim 400 collection cup	single	15a
5373	V ² Skim 600 collection cup	single	15b
5374	V ² Skim 800/1000 collection cup	single	15c
5375	V ² Skim 1200/1500 collection cup	single	15d
5364	Collection cup O ring	single	16
5367	Collection cup drain hose	metre	17
RK-750	Pump 90° push fit elbow assembly	single	18
ITEMS BELOW ARE NOT SHOWN			
V ² SKIMINS	V ² Skim instructions	single	19
5681	V ² Skim Compact 200 collection cup lid	single	20
5682	V ² Skim Compact 200 collection cup PLUS lid	single	21
5683	V ² Skim Compact 200 skimmer body	single	22
5524	V ² Skim Compact 200/300 pump	single	23
5525	V ² Skim Compact 200 pump impeller	single	24
5655	V ² Skim Compact 200 pump impeller housing cover	single	25
5686	V ² Skim Compact 200 air intake tube	single	26
5526	V ² Skim Compact 200 securing suction cup	single	27
5684	V ² Skim Compact 200 mounting bracket A	single	28
5685	V ² Skim Compact 200 mounting bracket B	single	29
5691	V ² Skim Compact 300 collection cup lid	single	30
5692	V ² Skim Compact 300 collection cup PLUS lid	single	31
5693	V ² Skim Compact 300 collect. cup O ring	single	32
5694	V ² Skim Compact 300/500 air intake adj. dial inc. O ring	single	33
5695	V ² Skim Compact 300/500 securing screw	single	34
5696	V ² Skim Compact 300 water intake strainer	single	35
5697	V ² Skim Compact 300 water outlet bubble stop foam	single	36
5698	V ² Skim Compact 300 skimmer body	single	37
5509	V ² Skim Compact 300 pump O ring	single	38
5699	V ² Skim Compact 300 pump impeller	single	39
5673	V ² Skim Compact 300/500 hanging adjustment cam	single	40
5716	V ² Skim Compact 300/500 ozone connector	single	41
5701	V ² Skim Compact 500 collection cup lid	single	42
5702	V ² Skim Compact 500 collection cup PLUS lid	single	43
5703	V ² Skim Compact 500 push-fit access cover	single	44
5705	V ² Skim Compact 500 water outlet bubble stop foam	single	45
5707	V ² Skim Compact 500 water intake pipe assembly	single	46
5704	V ² Skim Compact 500 water intake strainer	single	47
5706	V ² Skim Compact 500 skimmer body	single	48
5717	V ² Skim Compact 500 air intake silencer inc. tubing	single	49
5710	V ² Skim Compact 500 pump impeller housing O ring	single	50
5709	V ² Skim Compact 500 pump impeller	single	51
5708	V ² Skim Compact 500 pump	single	52
5712	V ² Skim Compact 500 skimmer reaction chamber	single	53
5713	V ² Skim Compact 500 skimmer reaction chamber foam	single	54



Available in UK, EU and US
versions where applicable

V²Skim Spares & Accessories

V²Bubble Stop

- Extremely versatile and has many different uses.
- Can be used with a V²Skim Protein Skimmer to filter out any remaining micro bubbles and prevent them from flowing into the aquarium or sump.
- Can also be used to provide additional post-skimming filtration.
- Removable sponges mean the V²Bubble Stop can be incorporated with other filtration components and used to house other forms of filtration media, such as carbon, using a V²Filter Media Bag.

1 V²Bubble Stop (small)

Maximum flow rate 2400 litres/hr.
Dimensions (w x h x d): 10.2 x 10.2 x 7.7cm

2 V²Bubble Stop (large)

Maximum flow rate 3400 litres/hr.
Dimensions (w x h x d): 11.5 x 11.5 x 10cm

V²Bubble Stop - New Style

- New slimline design allows it to be hidden discreetly in the tank.

3 V²Bubble Stop - new style

V²Filter Media Bag

- Durable, fine mesh filter bag with drawstring closing top.
- Perfect for housing media such as HR Carbon (see p.38).

4 V²Filter Media Bag

Dimensions (w x h): 14.5 x 20cm

V²Venturi Silencer

- Used to reduce any noise that may occur as air is drawn into the V²Skim by the venturi injection system.

5 V²Venturi Silencer

For use with V²Skim models 400 and 600.

10 V²Bubble Stop black sponge filter

For use with V²Skim models 400 and 600.

11 V²Bubble Stop black sponge filter

For use with V²Skim models 800, 1000, 1200 and 1500.

12 V²Bubble Stop white sponge filter

For use with V²Skim models 400 and 600.

13 V²Bubble Stop white sponge filter

For use with V²Skim models 800, 1000, 1200 and 1500.



	code	specification	sales unit
1	5510	V² React pump	single
2	5508	V² React pump impeller	single
3	5509	V² React pump O ring	single
4	5505	V² React water supply intake strainer	single
5	5507	V² React water outlet flow control valve	single
6	5517	V² React CO₂ inlet tubing non return valve	single
7	5500	V² React pH probe holder assembly	single
8	5506	V² React securing suction cup	single
9	5518	V² React 5ml syringe	single
10	5503	V² React water flow indicator chamber	single
11	5511	V² React media support foam (small)	single
12	5512	V² React media support foam (med)	single
13	5513	V² React media support foam (large)	single
14	5502	V² React lid O ring	single
15	5504	V² React replacement tubing	metre
16a	5386	V² Pressure Regulator (DIN477 connection)	single
16b	5387	V² Pressure Regulator (CGA320 connection)	single
17a	5385	V² Pressure Regulator Pro (DIN477 connection)	single
17b	5388	V² Pressure Regulator Pro (CGA320 connection)	single
18a	5155	Coral gravel coarse (6x4kg boxes)	single
18b	5156	Coral gravel coarse (25kg sack)	single
19	V2REACTINS	V² React instructions (not shown)	single
20a	N/A	V² React 600 box (not shown)	single
20b	N/A	V² React 1000 box (not shown)	single
20c	N/A	V² React 1500 box (not shown)	single

V² React Spares & Accessories



code	specification	sales unit
V:Skim 120 Nano Skimmer		
5521	V:Skim 120 Nano collection cup	single 1
5522	V:Skim 120 Nano mounting bracket A	single 2
5523	V:Skim 120 Nano mounting bracket B	single 3
5524	V:Skim 120 Nano pump	single 4
5525	V:Skim 120 Nano pump impeller	single 5
5526	V:Skim 120 Nano sucker	single 6
5369	V:Skim securing screw	single 7
V:Control Monitors/Controllers		
5539	V:Control pH probe	single 8
5541	pH 4 calibration fluid	single 9
5542	pH 7 calibration fluid	single 10
5543	pH 10 calibration fluid	single 11
5544	V:Control calibrating tool	single 12
5545	V:Control probe mounting bracket	single 13
5546	V:Control probe mounting sucker	single 14
5547	V:Control stand	single 15
5548	V:Control screen cover	single 16
5549	V:Control power cable and socket	single 17
V:Auto Top Up System		
9507	V:Auto Top Up System float switch (without mounting bracket and PSU)	single 18
9508	V:Auto Top Up System mounting bracket WITH hosing securing clamp	single 19
9509	V:Auto Top Up System mounting bracket WITHOUT hosing securing clamp	single 20
9510	V:Auto Top Up System 2 way connector	single 21
9511	V:Auto Top Up System 3 way connector	single 22
9512	V:Auto Top Up System PSU	single 23
9513	V:Auto Top Up System pump	single 24
9514	V:Auto Top Up System pump impeller	single 25
CO₂ by TMC Cylinders		
5619	CO ₂ by TMC cylinder O ring (for 567g cylinder - code 5617)	single 26



V²Skim 120 & Miscellaneous V²Spares & Accessories

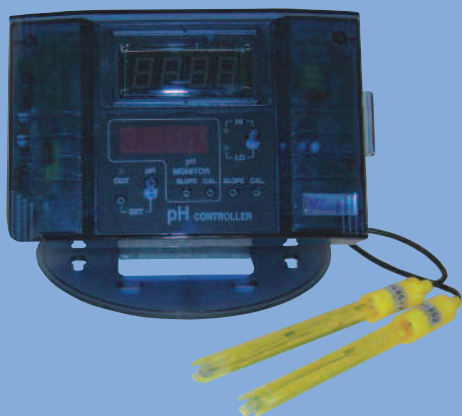

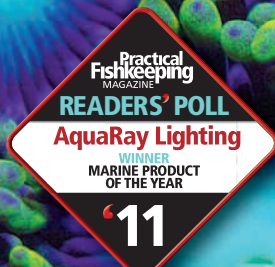
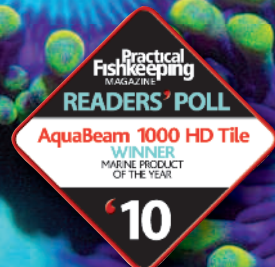

AQUARAY[®] lighting products

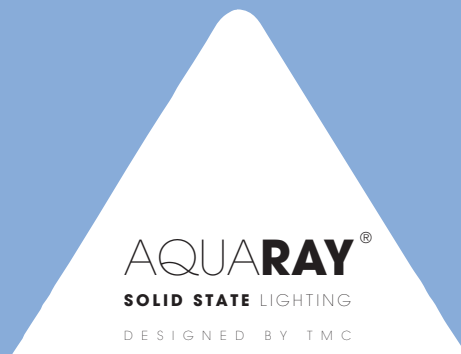

code	specification	sales unit
2704	AquaBeam 600 Ultima Strip Marine White (14000K white)	single 1
2705	AquaBeam 600 Ultima Strip Reef White (18000K white)	single 2
2706	AquaBeam 600 Ultima Strip Marine Blue (20000K white)	single 3
2707	AquaBeam 600 Ultima Strip Reef Blue (465nm blue)	single 4
2708	AquaBeam 600 Ultima Strip Fiji Blue (450nm blue)	single 5
2709	AquaBeam 600 Ultima Strip NUV (410nm violet)	single 6
2711	AquaBeam 600 Ultima Strip Marine White Twin (14000K white)	single 7
2712	AquaBeam 600 Ultima Strip Reef White Twin (18000K white)	single 8
2714	AquaBeam 600 Ultima Strip Reef Blue Twin (465nm blue)	single 9
2715	AquaBeam 600 Ultima Strip Fiji Blue Twin (450nm blue)	single 10
2716	AquaBeam 600 Ultima Strip Marine White/Reef Blue Combo	single 11
2717	AquaBeam 600 Ultima Strip Reef White/Marine Blue Combo	single 12
1886	AquaRay Cleaning Cloth (microfibre/leatherette)	single 13

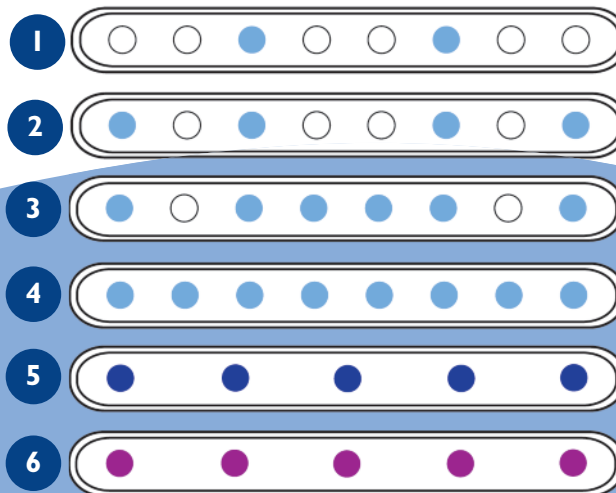
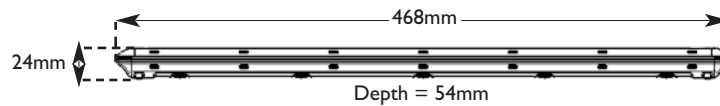

Available in
UK, EU, US and AUS
versions



AQUABEAM 600 Ultima Solid State Aquarium Lighting Strips

- New, sleek design.
- Uses the latest Cree® LED technology - 5 x Royal Blue XTE LEDs in the Fiji Blue, 5 x violet SemiLEDs in the NUV and 8 x ML-E LEDs in all other strips.
- High light output.
- Creates a natural “shimmer” effect.
- No bulb replacements and a minimum of 50,000 hours lamp life - 6x standard fluorescent lighting.
- Energy efficient with low power consumption and running costs.
- Wide angle beam (120°).
- Cool running with no noisy fans and minimal heat transfer to the aquarium water, reducing the need for expensive cooling systems.
- Rugged ABS, aluminium and acrylic housing sealed to IP67 making it completely safe for aquarists and livestock.
- Low voltage.

- Environmentally friendly - long-life, very low carbon footprint and NO MERCURY.
- Fully controllable (controllers sold separately).
- Designed and manufactured by Tropical Marine Centre in the EU.
- Wide range of mounting options available using the Aquaray MMS Modular Mounting System.
- Suitable for all marine aquaria.
- Factory serviceable.

Dimensions: 468mm (w) x 54mm (d) x 24mm (h)

Cree and the Cree logo are registered trademarks of Cree, Inc.

* 2 year guarantee on PSU and 5 year guarantee on lamp unit if unit is registered with us. If not registered, a statutory 2 year guarantee applies on both lamp unit and PSU (proof of purchase required).

I 1915	AquaBeam 1500 Ultima NP Ocean Blue (20000K blue)	single
--------	---	--------



Nature **NP**
Perfect

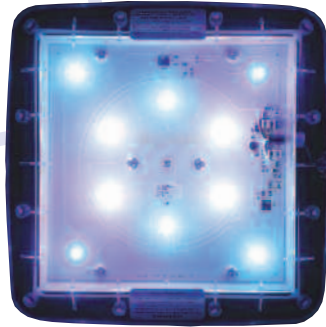

I

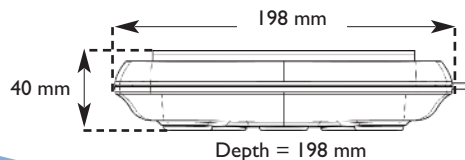
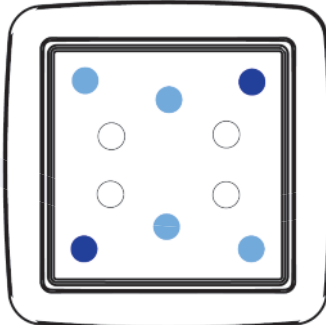
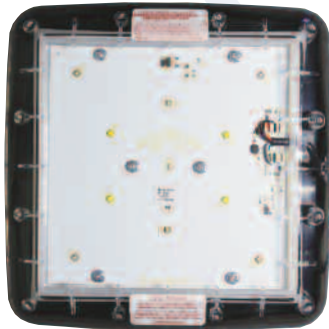

Available in
UK, EU, US and AUS
versions



* 2 year guarantee on PSU and 5 year guarantee on lamp unit if unit is registered with us. If not registered, a statutory 2 year guarantee applies on both lamp unit and PSU (proof of purchase required).

AQUABEAM 1500 *Ultima* Nature NP™ Solid State Aquarium Lighting Tile

- Featuring NEW Nature Perfect™ blue colour using the latest Osram® and Cree® technology.
- Separate Nature Perfect™ blue channel for more realistic twilight and moonlight modes, enhancing the fluorescence of your corals.
- Creates a natural “shimmer” effect.
- No bulb replacements and a minimum of 50,000 hours lamp life - 6x standard fluorescent lighting.
- Energy efficient with low power consumption (30W) and running costs.
- Wide angle beam (120°) for maximum light spread
- Cool running with no noisy fans and minimal heat transfer to the aquarium water, reducing the need for expensive cooling systems.
- Rugged ABS, aluminium and acrylic housing sealed to IP67 making it completely safe for aquarists and livestock.
- Low voltage.
- Environmentally friendly - long-life, very low carbon footprint and NO MERCURY.
- Fully controllable (controllers sold separately).
- Designed and manufactured by Tropical Marine Centre in the EU.
- Wide range of mounting options available using the Aquaray MMS Modular Mounting System.
- Suitable for soft and large polyp hard corals and fish only systems.
- Compatible with all aquarium types including NANO tanks.
- Factory serviceable.

Dimensions: 198mm (w) x 198mm (d) x 40mm (h)

Cree and the Cree logo are registered trademarks of Cree, Inc.

code specification sales unit

1913 AquaBeam 2000HD Ultima NP single ReefWhite (20000K white)

Available in
UK, EU, US and AUS
versions

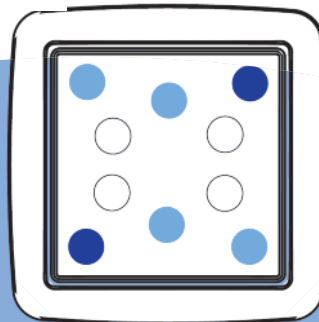
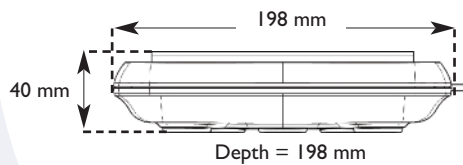

AQUABEAM 2000HD *Ultima* NP Solid State Aquarium Lighting Tile

- Lensed LEDs offering high PAR for light-loving corals and clams.
- Featuring NEW Nature Perfect™ blue colour using the latest Osram® and Cree® technology.
- Separate Nature Perfect™ blue channel for more realistic twilight and moonlight modes, enhancing the fluorescence of your corals.
- Creates a natural “shimmer” effect.
- No bulb replacements and a minimum of 50,000 hours lamp life - 6x standard fluorescent lighting.
- Energy efficient with low power consumption (30W) and running costs.
- Wide angle beam (120°) for maximum light spread
- Cool running with no noisy fans and minimal heat transfer to the aquarium water, reducing the need for expensive cooling systems.
- Rugged ABS, aluminium and acrylic housing sealed to IP67 making it completely safe for aquarists and livestock.
- Low voltage.
- Environmentally friendly - long-life, very low carbon footprint and NO MERCURY.
- Fully controllable (controllers sold separately).
- Designed and manufactured by Tropical Marine Centre in the EU.
- Wide range of mounting options available using the Aquaray MMS Modular Mounting System.
- Suitable for full reef aquariums.
- Compatible with all aquarium types including NANO tanks.
- Factory serviceable.

Dimensions: 198mm (w) x 198mm (d) x 40mm (h)

Cree and the Cree logo are registered trademarks of Cree, Inc.



Moonlight mode

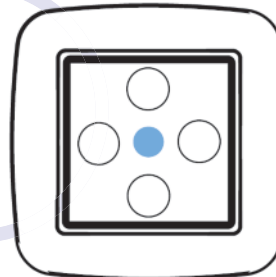

* 2 year guarantee on PSU and 5 year guarantee on lamp unit if unit is registered with us. If not registered, a statutory 2 year guarantee applies on both lamp unit and PSU (proof of purchase required).

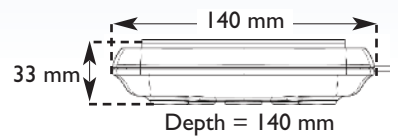
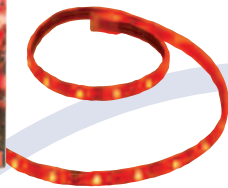

	code	specification	sales unit
1	1861	AquaRay MiniLED 500	single
2	1885	AquaRed Flexi-LED	single
3	1888	AquaBlue Flexi-LED	single
4	1889-1	AquaWhite Flexi-LED 6500K SINGLE	single
5	1889-2	AquaWhite Flexi-LED 6500K TWIN	single

All available in UK, EU and US versions.

MiniLED 500 also available in AUS version.



MiniLED 500HD Solid State Lighting Tile

- 4 x lensed 10,000K white Cree® XP-E and 1 x un-lensed blue Cree® XP-E PowerLEDs.
- White LEDs are switchable to allow blue-only moonlight.
- High PAR for full reef tanks.
- Creates a natural "shimmer" effect.
- Ideal on its own for nano tanks under 50 litres.
- Can be used alongside other AquaRay lights on larger set ups.
- Fully controllable (controllers sold separately).
- Wide range of mounting options available using the Aquaray MMS Modular Mounting System.

Dimensions: 140mm (w) x 140mm (d) x 33mm (h)

Cree and the Cree logo are registered trademarks of Cree, Inc.

1 MiniLED 500 Solid State Lighting Tile

AQUA RED FLEXI-LED

- Flexible, self-adhesive LED lighting strips.
- Waterproof and low voltage.
- High output, single colour.
- Can be fitted into an AquaRay MMS rail.
- 450mm long.
- Suitable for marine and freshwater aquaria.
- Manually dimmable with an AquaBar Dimmer Switch (sold separately - see page 55 for details).

2 AquaRed Flexi-LED

Red LEDs make it ideal for night vision, acclimation and colour enhancement. Supplementary lighting only

3 AquaBlue Flexi-LED

Blue LEDs simulate moonlight and are great for colour enhancement. This strip produces actinic light which promotes coral and invertebrate growth and accentuates fluorescence. Supplementary lighting only

4 & 5 AquaWhite Flexi-LED

Can be used as a sole lighting source.

AQUA BLUE FLEXI-LED

AQUA WHITE FLEXI-LED

code	specification	sales unit
1899	AquaRay Control	single 1
1897	AquaRay MultiControl 8	single 2

Available in
UK, EU, US and AUS
versions



AQUARAY® Control

- Two channel dimming control.
- Simple user interface.
- Easily create sunset, sunrise, daylight & moonlight phases.
- Compact design for easy mounting.
- Uses a real time clock for accurate timing.
- Compatible with all AquaRay light units including AquaBeam 500 and 1000 and GroBeam 500 and 1000.
- 2 year guarantee.

AQUARAY® MultiControl 8

- Dawn to dusk simulation
- 2 channel fade-in, fade-out
- Suitable for up to 8 x AquaBeam 500s or 4 x AquaBeam 1000/1500s or any combination
- Easily create sunset, sunrise, daylight and moonlight phases.
- 2 channels, each timed independently (6 outputs timed separately from the other 2).
- Powers up to 8 AquaBeam lights with a single socket PSU.
- Built in Storm Function to encourage breeding in certain species.
- Internal battery ensures settings are saved in the event of a power failure.
- Helps to control nuisance algae by managing photo periods.
- Long cable for ease of use.
- Compatible with all AquaBeam products.

AQUABEAM
600 Ultima Marine White

LEDs 6 x Cree® ML-E Ocean White 2 x Cree® ML-E Reef Blue	PAR at 400mm in air 50 μ Einsteins/sec/m ²
Beam Angle 120°	Illuminance at 400mm in air 2250 lux
Correlated Colour Temp. 14000 K	Total Luminous Flux 864 lumens
	Total Power Consumption (inc.PSU) 12W at 700mA
	Efficacy 79 lm/W

AQUABEAM
600 Ultima Reef White

LEDs 4 x Cree® ML-E Ocean White 4 x Cree® ML-E Reef Blue	PAR at 400mm in air 48 μ Einsteins/sec/m ²
Beam Angle 120°	Illuminance at 400mm in air 1990 lux
Correlated Colour Temp. 18000 K	Total Luminous Flux 726 lumens
	Total Power Consumption (inc.PSU) 12W at 700mA
	Efficacy 61 lm/W

AQUABEAM
600 Ultima Marine Blue

LEDs 2 x Cree® ML-E Ocean White 6 x Cree® ML-E Reef Blue	PAR at 400mm in air 45 μ Einsteins/sec/m ²
Beam Angle 120°	Illuminance at 400mm in air 1870 lux
Correlated Colour Temp. 20000 K	Total Luminous Flux 528 lumens
	Total Power Consumption (inc.PSU) 12W at 700mA
	Efficacy 44 lm/W

AQUABEAM
600 Ultima Reef Blue

LEDs 8 x Cree® ML-E Reef Blue	PAR at 400mm in air 44 μ Einsteins/sec/m ²
Beam Angle 120°	Illuminance at 400mm in air 1650 lux
Peak Wavelength 465nm	Total Luminous Flux 351 lumens
	Total Power Consumption (inc.PSU) 12W at 700mA
	Efficacy 30 lm/W

AQUABEAM
600 Ultima Fiji Blue

LEDs 5 x Cree® XT-E Fiji Blue	PAR at 400mm in air 38 μ Einsteins/sec/m ²
Beam Angle 120°	Illuminance at 400mm in air 1200 lux
Peak Wavelength 450nm	Total Luminous Flux 206 lumens
	Total Power Consumption (inc.PSU) 12W at 700mA
	Efficacy 17 lm/W

GroBEAM
600 Ultima Natural Daylight

LEDs 5 x Cree® XB-D Natural Daylight	Illuminance at 400mm in air 2650 lux
Beam Angle 120°	Total Luminous Flux 1029 lumens
Correlated Colour Temp. 6500 K	Total Power Consumption (inc.PSU) 12W at 700mA
PAR at 400mm in air 61 μ Einsteins/sec/m ²	Efficacy 86 lm/W

MiniLED 400

LEDs 4 x Osram Oslon Natural Daylight	Illuminance at 400mm in air 2040 lux
Beam Angle 80°	Total Luminous Flux 633 lumens
Correlated Colour Temperature 6603 K	Total Power Consumption (inc.PSU) 10W at 700mA
PAR at 400mm in air 62 μ Einsteins/sec/m ²	Efficacy 64 lm/W

MiniLED 500HD

LEDs 4 x Cree® XP-E Ocean White 1 x Cree® XP-E Reef Blue	Illuminance at 400mm in air 7550 lux
Beam Angle 60°	Total Luminous Flux 724 lumens
Correlated Colour Temperature 13254 K	Total Power Consumption (inc.PSU) 11W at 700mA
PAR at 400mm in air 143 μ Einsteins/sec/m ²	Efficacy 66 lm/W

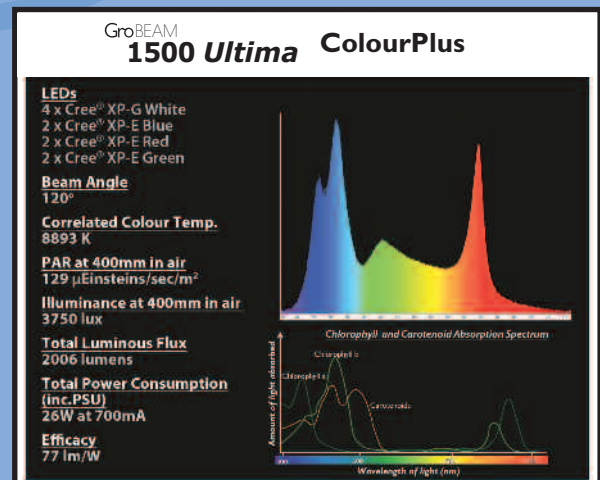
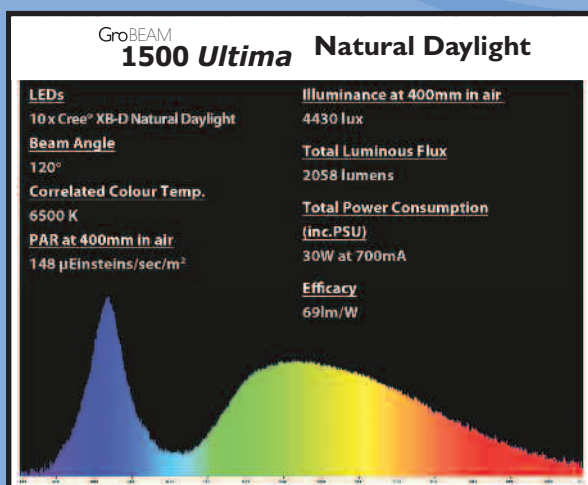
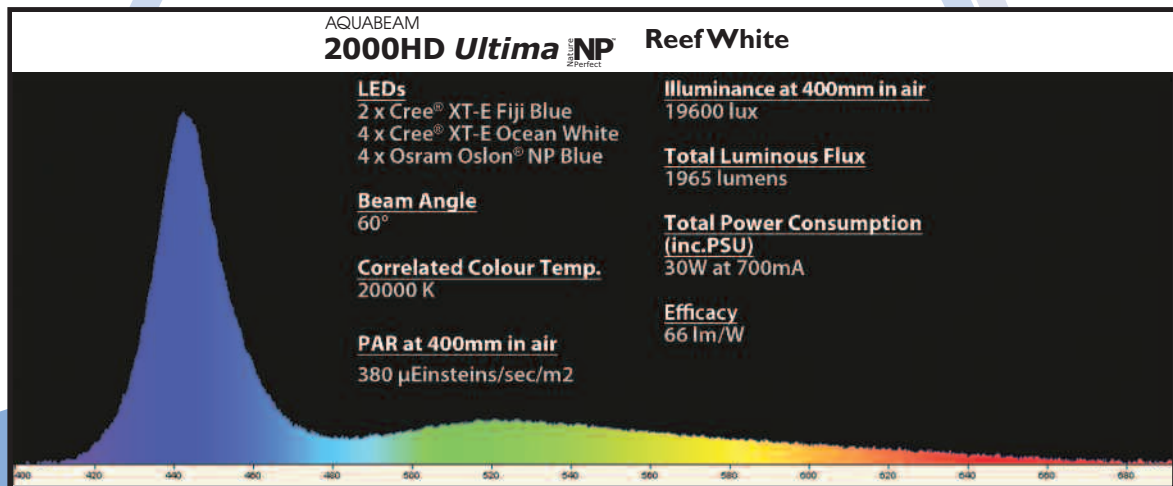
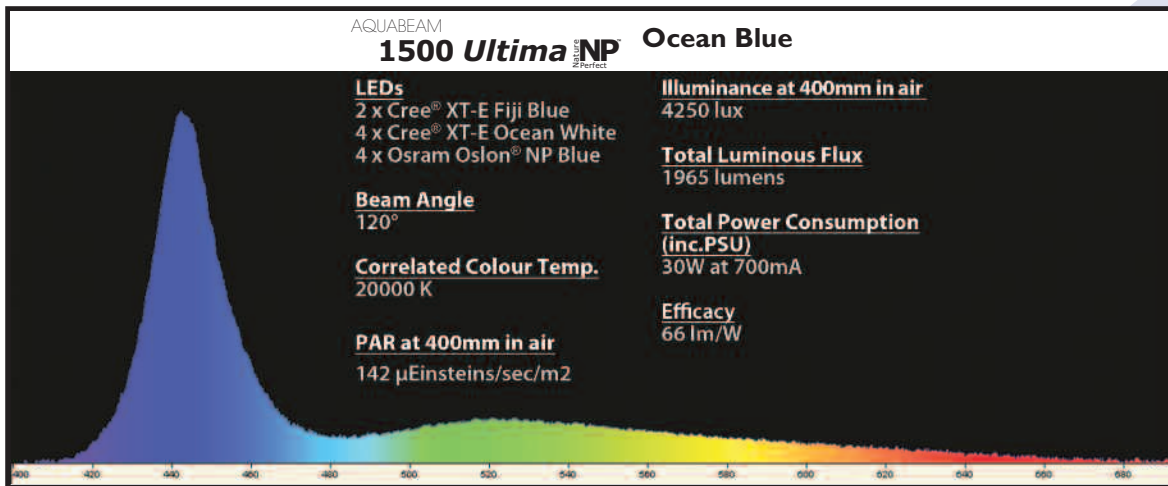

All measurements taken in TMC's own test lab with Ocean Optics' USB2000+UV-VIS fibre optic spectrometer and SpectraSuite software.

AquaRay Modular Mounting System (MMS)

This consists of a range of components (sold separately) that can be used to mount your AquaRay lighting units in a number of different ways. This MMS System also allows you to use the AquaRay lighting units in combination, to create a lighting rig which is unique to your tank's set up. This means you can tailor your lighting to fit your aquascape.



1	1831	Single MountaRay Tank Bracket for MiniLED 400/500 (Charcoal Black)	single
2	1832	Pair of MountaRay Tank Brackets (Charcoal Black)	1 pair
3	1832-W	Pair of MountaRay Tank Brackets (Glacier White)	1 pair
4	1832-G	Pair of MountaRay Tank Brackets (Carbon Grey)	1 pair
5a	1850	AquaRay MMS Rail 158mm	single
5b	1851	AquaRay MMS Rail 308mm	single
5c	1852	AquaRay MMS Rail 540mm	single
5d	1873	AquaRay MMS Rail 1090mm	single
5e	1874	AquaRay MMS Rail 1610mm	single
5f	1876	AquaRay MMS Rail 2415mm	single
6	1879	AquaRay MMS End Cap	x 2
7	1893	AquaRay MMS Rim Mount	1 pair



AquaRay MountaRay Tank Bracket

The unique design of this tank bracket makes it suitable for suspending either one MiniLED 400 tile or, when used in pairs, for supporting a range of AquaRay light units (combined with AquaRay Rails - to be purchased separately), as an over-tank luminaire.

- 1 **AquaRay MMS MountaRay Single Tank Bracket**
- suitable for suspending 1 x MiniLED 400 or 500 lighting tile
- 2-4 **AquaRay MMS Pair of MountaRay Tank Brackets**
- suitable for use as an over-tank luminaire. Colours available to complement our Signature range of tanks and cabinets.

AquaRay MMS Rail

- 5 This slides onto the heat sink of all AquaRay light units as the basis of the MMS System, whilst also improving the efficiency of the heat sink.

Available in various lengths which can be cut to size.



AquaRay MMS End Cap

This finishes the rail neatly as well as providing a thread for fixing.

- 6 **AquaRay MMS End Cap x 2**
(includes 2 x fixing screws and 2 x end cap mounting screws).



AquaRay MMS Rim Mount

- 7 **AquaRay MMS Rim Mount**
Cost effective and simple way to mount a piece of AquaRail allowing any combination of tiles and/or strips to be used.



AquaRay MMS Suspension Kit

This enables the rails to be suspended from a ceiling.

- 8 **AquaRay MMS Suspension Kit**
(includes 2 x 1m suspension wires, 2 x cable gliders, 2 x ceiling fixings, 2 x threaded washers, 2 x yellow rawl plugs and 2 x self tapping screws).

code	specification	sales unit	
1823	AquaRay MMS Suspension Kit	single	8
1824	AquaRay MMS Spiral Cable Wrap	4m	9
1877	AquaRay MMS T5 End Caps	x 2	10a
1878	AquaRay MMS T8 End Caps	x 2	10b
1881	AquaRay MMS Mounting Bracket	x 2	11
1883	AquaRay MMS Adjustable Crosslink Bar	x 2	12
1884	USB AquaRay MMS USB Ext. Cable	single	13



AquaRay lights in use in TMC London's fish house

AQUARAY®
MODULAR MOUNTING
SYSTEM

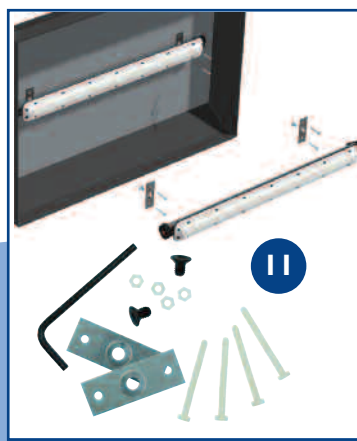

PLEASE NOTE: Crosslink Bars can be cut to length to suit your set up

AquaRay MMS Spiral Cable Wrap

This wraps around the AquaBeam/GroBeam's cables to keep them together and looking tidy.

9 AquaRay MMS Spiral Cable Wrap (4m)

AquaRay MMST5/T8 End Caps

These allow the rail to be mounted into an existing T5/T8 fluorescent fitting (when IP rated lamp holders are used).

10a AquaRay MMST5 End Caps x 2
(includes 2 x mounting screws)

10b AquaRay MMST8 End Caps x 2
(includes 2 x mounting screws)

AquaRay MMS Mounting Brackets

These allow the rail to be mounted directly onto a flat surface

11 AquaRay MMS Bracket x 2
(includes 2 x bracket fixing screws, 4 x nylon machine screws, 4 x nylon nuts and 1 x allen key).

AquaRay MMS Adjustable Crosslink Bar

This allows the rails to be connected together at any desired distance apart to form an array. It also allows the rails to be angled in order to direct the light where it is needed.

12 AquaRay MMS Adjustable Crosslink Bar x 2
(includes 6 x sliding nuts and 6 x rail fixing screws).

Integrated pendant luminaire showing how components of the AquaRay Modular Mounting System combine

This example shows two AquaBeam tiles mounted centrally, with a pair of AquaBeam strips mounted front and back to provide supplementary actinic light. However, with the flexibility that the AquaRay MMS System offers, you can arrange your lighting in any way you require, to ensure your tank is always shown at its best.

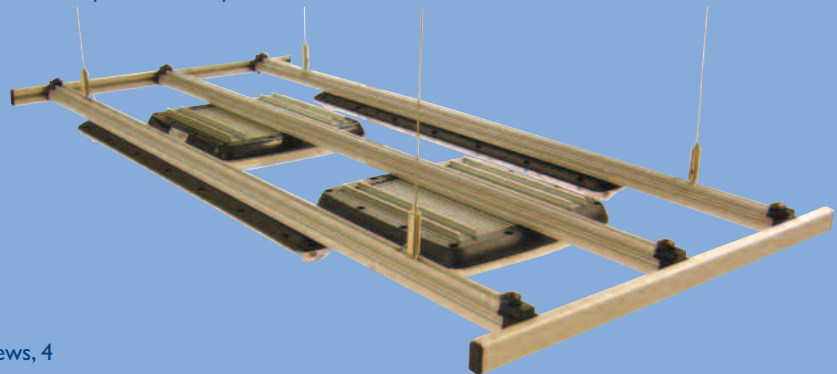

AquaRay MMS USB Extension Cable

3m extension cable with USB connector. **ONLY** suitable for use with AquaRay products.

13 AquaRay MMS USB Extension Cable



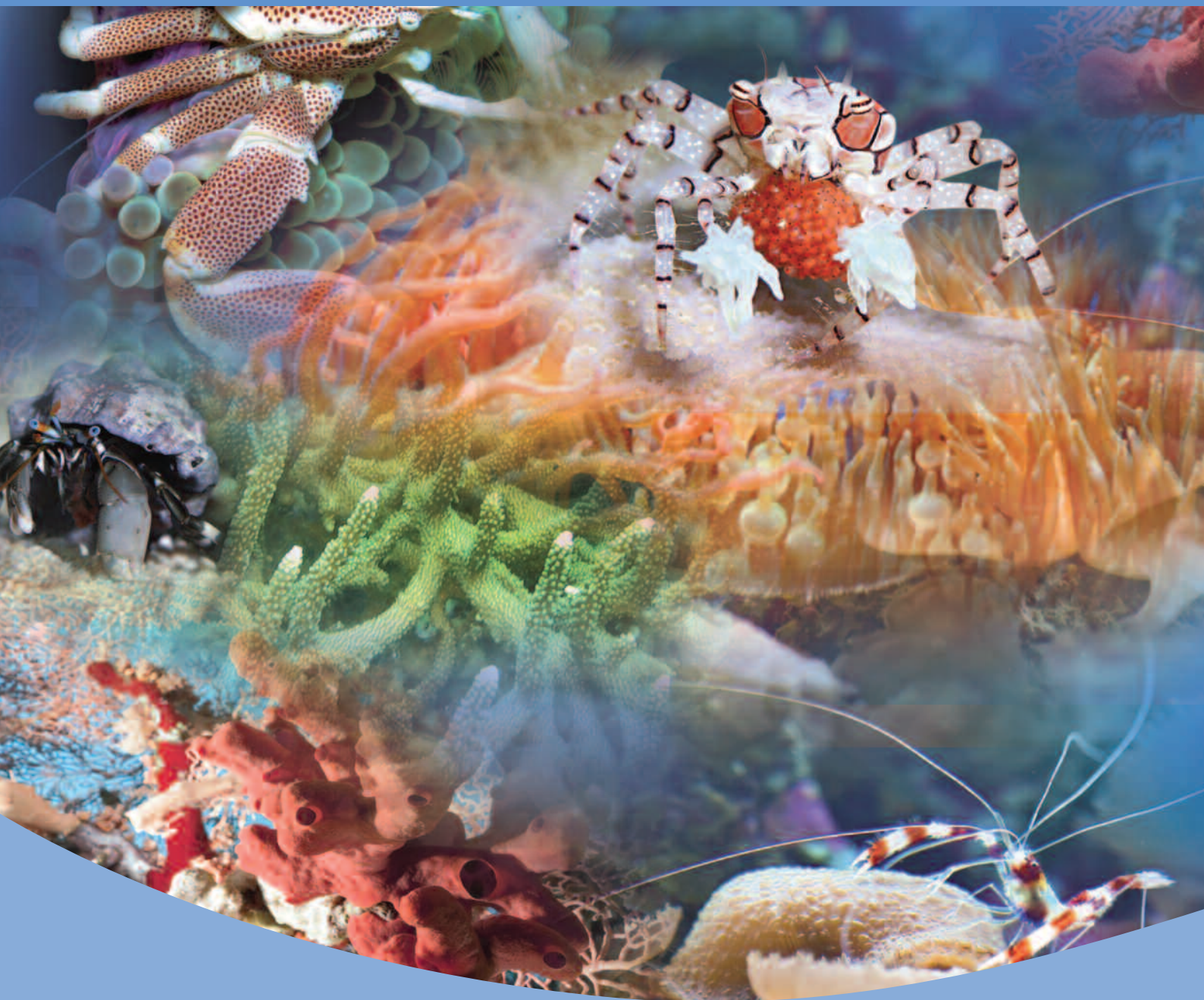

aquaHabitats BY TMC
AQUARIUM ESSENTIALS

products

code	specification	sales unit	
2995	AquaHabitats MicroHabitat 15	single	1
PowerPads (pack of two pads)			
5977	1 x Water Clarity Pad 1 x Filtration Start Up Pad	single	2
5978	1 x Nitrate/Nitrite Reduction Pad 1 x Ammonia Reduction Pad	single	3
5979	1 x Calcium/Magnesium Supplement Pad 1 x Trace Elements Pad	single	4
5980	1 x Phosphate Reduction Pad 1 x Activated Carbon Pad	single	5

**MicroHabitat 15
available in
UK, EU and US versions**



1



**GUARANTEE
12
MONTHS**



**Perfect for
Small Marine Aquascapes,
Micro Corals AND
Miniature Invertebrates**

aquaHabitats BY TMC **MicroHabitat 15**
AQUARIUM ESSENTIALS

- 15 litre (3.3 UK Gal) microhabitat.
- Perfect for small marine aquascapes, micro corals and miniature invertebrates allowing an exciting entry into the fascinating world of marines.
- High quality acrylic design ensures that the tank is not only lighter and stronger than a glass equivalent, but also allows a much clearer view.
- Compact, self-contained design makes the MicroHabitat 15 ideal for bedrooms, kitchens, living rooms and offices.
- The built in filtration system and integral pump with multi-directional outlet ensures optimum water quality and minimal maintenance.
- Unique integrated air driven protein skimmer driven by an H₂O Air60 air pump to ensure quiet, unobtrusive operation in any room in the house.
- Incorporates an AquaRay MicroLED 200 light system which uses high quality, LG TopLEDs (Ocean White 9000K) for long lasting light output (light also available separately).

- Supplied complete with a condensation lid, micro thermometer, hydrometer, air pump, micro heater, non return valve, 1m air tubing and 2g Hikari Crab Cuisine.

Dimensions: 235mm (w) x 270mm (d) x 240mm (h)

* The tank **MUST NOT** be positioned in direct sunlight as this will lead to excessive algae growth and could result in the aquarium overheating.

PowerPads

- For a more advanced set up, a PowerPad can be placed in the filtration system chamber of your MicroHabitat.
- These PowerPads are designed especially to fit the MicroHabitat 15 and MicroHabitat 30.

Please see page 18 for a full description of each PowerPad.

I	3010	AquaHabitats MicroHabitat 30	single
---	------	------------------------------	--------

MOUNTARAY

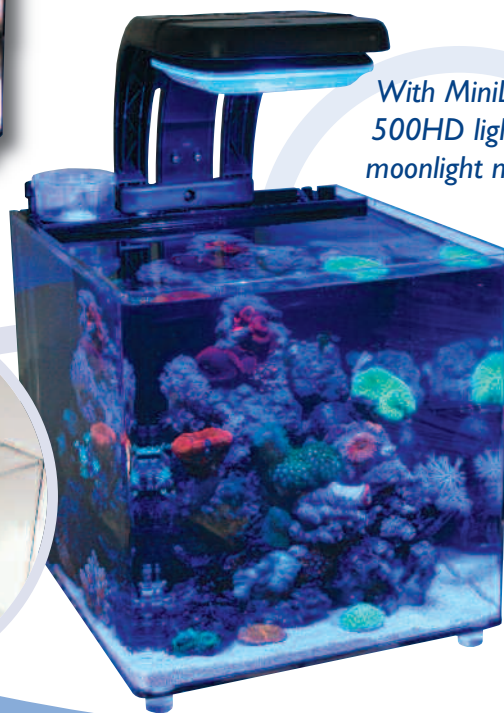

With MiniLED 500HD light in moonlight mode

Available in UK, EU and US versions



* 12 month guarantee on tank and MiniLED power supply. 5 year guarantee on lamp unit.

MicroHabitat 30

- 30 litre (6.6 UK Gal) microhabitat.
- Feature packed, plug-and-play marine set up perfect for small reef aquascapes, miniature corals, invertebrates and small fish.
- Provides an excellent introduction into the exciting and enthralling hobby of marine reefkeeping.
- Manufactured from high quality acrylic, offering a clear view and a light yet robust tank.
- Compact and self-contained - ideal for any room in the house.
- Incorporates a high PAR AquaRay MiniLED 500 light system with 4 x lensed 10,000K white Cree® XP-E and 1 x un-lensed blue Cree® XP-E PowerLEDs. The white LEDs can be switched off to give a "moonlight" mode (for full details on this light see page 41).
- MountaRay tank bracket
- Built in filtration system incorporating an integral pump with multi-directional outlet offers optimum water quality and minimal maintenance.

- Unique integrated air driven protein skimmer to ensure quiet operation.
- Supplied complete with a condensation lid, micro thermometer, hydrometer, an H₂Air 60 air pump, non return valve and a heater to allow for simple and quick installation.

Dimensions: 300mm (w) x 330mm (d) x 300mm (h)

* The tank MUST NOT be positioned in direct sunlight as this will lead to excessive algae growth and could result in the aquarium overheating.

*Cree and the Cree LEDs logo are registered trademarks of Cree, Inc.

code	specification	sales unit
1860	AquaHabitats MiniLED 400	single 1
1906	AquaHabitats ColourPlus 1000	single 2

Available in
UK, EU, US and AUS
versions



* 2 year guarantee on PSU and 5 year guarantee on lamp unit if unit is registered with us. If not registered, a statutory 2 year guarantee applies on both lamp unit and PSU (proof of purchase required).

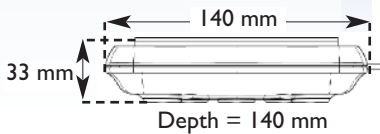
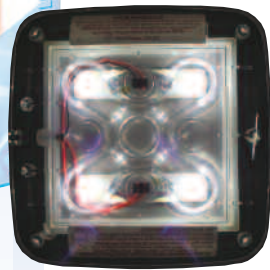
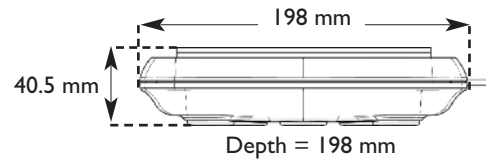

aquaHabitats
BY TMC
AQUARIUM ESSENTIALS

MiniLED 400 Solid State Lighting Tile

- Perfect for nano aquariums of less than 50 litres, but also suitable for use in larger set ups
- Uses OSRAM OSOLON SSL high power LEDs with a colour temperature of 6500K to replicate natural daylight conditions
- Suitable for freshwater and marine aquariums as well as planted tanks
- Gives a natural shimmer effect (unlike fluorescent lighting)
- Low power - just 12W - and dimmable!
- AQUARAY® technology and quality
- 5 year guarantee*

1 MiniLED 400 Solid State Lighting Tile

Dimensions: 140mm (w) x 140mm (d) x 33mm (h)

COLOURPLUS LED1000 Solid State Lighting Tile

- Uses 4 x white Cree® XP-G PowerLEDs and 2 x green, 2 x red and 2 x blue Cree® XP-E PowerLEDs
- Great for freshwater set ups, especially Cichlid and Discus show tanks, as well as planted tanks and fish only marine aquariums.
- AQUARAY® technology and quality
- 5 year guarantee*

2 ColourPlus 1000 Solid State Lighting Tile

Dimensions: 198mm (w) x 198mm (d) x 40.5mm (h)

- * 5 year guarantee on lamp unit.
1 year guarantee on power supply.

*Cree and the Cree LEDs logo are registered trademarks of Cree, Inc.



1



6



7



8



5

Easily upgrade the lighting on your MicroHabitat 15 or 30!



1	1770	AquaBar 500 Freshwater (white)	single
2	1771	AquaBar 1000 Freshwater (white)	single
3	1772	AquaBar 500 Marine (white and blue)	single
4	1773	AquaBar 1000 Marine (white and blue)	single
5	1780	AquaBar Dimmer Switch	single
6	1890	Easifit Mounting Kit 1	single
7	1891	Easifit Mounting Kit 2	single
8	1892	Easifit Mounting Kit 3	single

Available in UK, EU and US versions

See pages 41-50 for our full range of AQUARAY® lights and accessories

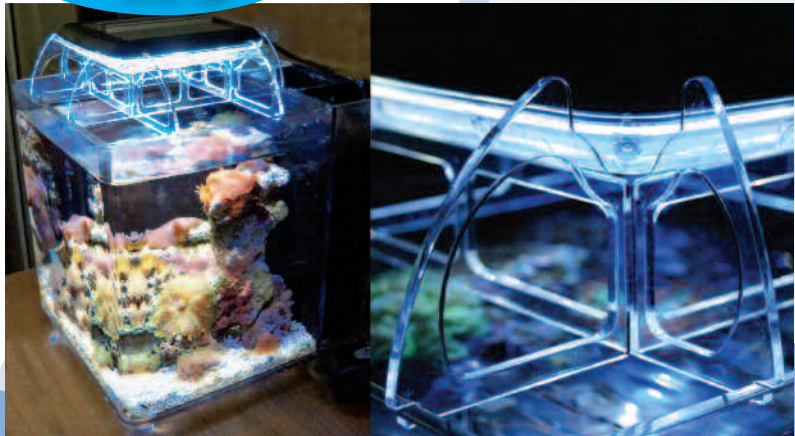

aquaHabitats BY TMC
AQUARIUM ESSENTIALS

AQUABAR Solid State Lighting Bars

- Cost effective, high output lighting strips.
- Slimline design.
- Specially designed for hooded aquariums, terrariums and vivariums.
- Two lengths - 500mm and 1000mm.
- Can be angled for directional lighting.
- Low voltage.
- Fully compatible with the AquaRay MMS range.
- Manually dimmable with an AquaBar Dimmer Switch (sold separately - see 5 above).
- Excellent sump lighting.
- Also good for other lighting applications (under-cabinet, shelf lighting, task lighting, etc..)
- Marine and freshwater versions available.

Easifit Mounting Kits

- Allows you to upgrade your nano tank to a high spec AquaRay lighting tile.
- High quality acrylic ensures minimal visual impact.
- Just slot together - no screws or tools required.

- 6 Easifit Kit 1**
Allows an AquaGro MicroHabitat 8, a biOrb or biUbe (except Baby biOrb) and other "lifestyle" tanks to upgrade to a MiniLED 400/500 tile.
- 7 Easifit Kit 2**
Allows a MicroHabitat 15 tank to use a MiniLED 400/500 tile.
- 8 Easifit Kit 3**
Allows a MicroHabitat 30 tank to use an AquaBeam 1500 or 2000 tile.

code	specification	sales unit
5990	AquaHabitats H ₂ Air 60 Air Pump	single 1
5991	AquaHabitats H ₂ Air 80 Air Pump	single 2
5992	AquaHabitats H ₂ Air 100 Air Pump	single 3
5994	AquaHabitats H ₂ Air 120 Air Pump	single 4
5761	AquaHabitats H ₂ Therm 10w Micro Heater	single 5
5762	AquaHabitats H ₂ Therm 15w Micro Heater	single 6

Available in
UK, EU and US versions



aquaHabitats
AQUARIUM ESSENTIALS
BY TMC

H₂Air Air Pumps

- High performance air pumps.
- Extremely efficient with silent operation.
- High quality components for long lasting, continuous operation.
- Compact design - simple to install and maintain.
- Air filter and diaphragms are easily replaced.

1 H₂Air 60 Air Pump

Produces 60 litres of air per hour. For tanks up to 50 litres.

2 H₂Air 80 Air Pump

Produces 80 litres of air per hour. For tanks up to 75 litres.

3 H₂Air 100 Air Pump

TWIN outlets. Produces 100 litres of air **PER OUTLET** per hour. For tanks up to 200 litres.

4 H₂Air 120 Air Pump

TWIN outlets. **Adjustable** up to 120 litres of air **PER OUTLET** per hour. For tanks up to 400 litres.

H₂Therm Micro Heaters

- Slimline heaters, measuring only 136 x 22 x 15mm, which means they can be discreetly and conveniently positioned even in the smallest of micro or nano aquariums.
- Fully submersible.
- Built in suction cups for quick and easy installation.
- Sensitive thermostat pre-set at 25°C.
- Tolerance ± 1°C.
- Reinforced plastic heater casing.
- 1.8m power cable.
- 12 month guarantee.

5 H₂Therm 10 Micro Heater

for aquariums up to 15 litres/3.3 UK Gallons

6 H₂Therm 15 Micro Heater

for aquariums up to 20 litres/4.4 UK Gallons



1	9502	Spy Lens 70mm diameter	single
2	9504	Spy Lens 90mm diameter	single
3	7879	Filter Bag System Black	single
4	7880	Filter Bag System Clear	single
5	7886	Replacement 100 micron Filter Bag	single



Spy Lens

- Locking suction cup makes the Spy Lens quick and easy to install and remove.
- Incorporates a high quality, acrylic optical lens.
- Supplied complete with a cleaning cloth.
- Two sizes available.

1 Spy Lens 70mm diameter
6x magnification macro view lens.
Ideal for nano tanks.

2 Spy Lens 90mm diameter
3x magnification main lens with increased depth of field.
Integral 6x magnification macro view lens.



Mechanical Filter Bag System

- Durable acrylic filter bag bracket plus 1 x 100 micron filter bag.
- High quality bracket, suitable for 10cm (4") diameter filter bags.
- Space-saving hang on design allows the bracket to be installed on a sump or aquarium without the need for securing screws.
- Suitable for aquarium glass up to 10mm thick.
- 10cm (4") diameter x 20cm long filter bag.

code	specification	sales unit
6270	H ₂ Fill & Go Nano 5 Litre container	single
6271	H ₂ Fill & Go 10 Litre container	single
6272	H ₂ Fill & Go 20 Litre container	single
6273	Tropic Marin Nano Pro Reef sachet	single

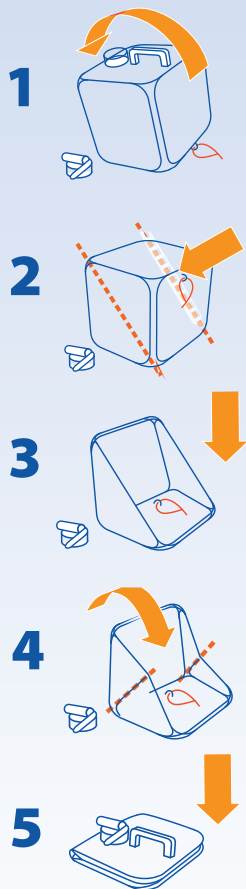

H₂ Fill & Go Collapsible Water Containers

Ideal for storing and transporting:-

- Pre-mixed seawater for marine tanks
- RO water for cichlids, discus, planted and marine tanks
- "Shake & Make" water
- Your own Tropic Marin seawater mix
- Top-up or emergency water

Refer to manufacturer's instructions for quantity of salt required.

- H₂Fill &Go Nano - 5 Litre**
Folded dimensions: 170mm (w) x 170mm (d) x 60mm (h)
Filled dimensions: 180mm (w) x 180mm (d) x 220mm (h)
- H₂Fill &Go - 10 Litre**
Folded dimensions: 200mm (w) x 200mm (d) x 60mm (h)
Filled dimensions: 225mm (w) x 225mm (d) x 270mm (h)
- H₂Fill &Go - 20 Litre**
Folded dimensions: 260mm (w) x 240mm (d) x 70mm (h)
Filled dimensions: 290mm (w) x 290mm (d) x 335mm (h)

Tropic Marin[®] NANO PRO-REEF SEA SALT

- A single dose of Tropic Marin Pro-Reef Salt, sufficient for use with the 5 litre H₂Fill & Go Nano.
 - Pro Reef salt contains all 70 trace elements found in natural sea water.
 - It contains only pure, pharmaceutical grade ingredients with consistent mix and quality in every box.
 - Specially formulated for use with RO water.
 - No nitrates or phosphates.
 - Higher levels of magnesium & calcium.
 - dKh and pH buffering capacity are also higher making water conditions more stable for delicate corals.
- Tropic Marin Nano Pro Reef Sea Salt**
Sufficient for 5 Litres

Tropical Marine Centre planted tank products

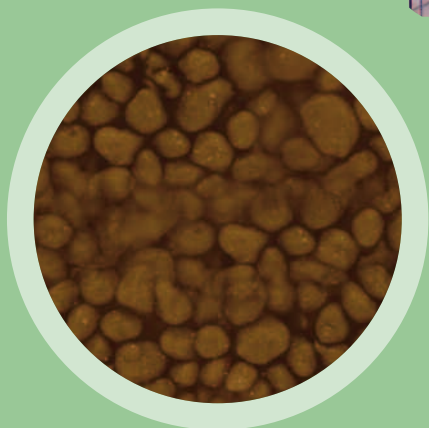



planted tank products

1	114112 Borneo Driftwood Small	single
2	114114 Borneo Driftwood Medium	single
3	114115 Borneo Driftwood Large	single

Other sizes on request



Photos show a representative sample. As these are natural products, each piece is unique

aquaGro BY TMC DECOR RANGE

FOR PLANTED AQUARIA

Borneo Driftwood

- High quality decorative wood.
- Suitable for aquariums and terrariums.
- Wide range of sizes available for nano and larger tanks.
- Each piece is unique!
- Soak any wood decor before installing to ensure it will sink after adding water.
- Some wood may require weeks of soaking to also remove excess tannins that can stain the water.
- Activated carbon filtration will also remove any staining.

- 1 Borneo Driftwood Small**
Approx 30 x 24 x 16cm
- 2 Borneo Driftwood Medium**
Approx 46 x 48 x 50cm
- 3 Borneo Driftwood Large**
Approx 75 x 33 x 56cm

code	specification	sales unit	
2970	Nutrasoil 3 litre bucket black	single	1
2971	Nutrasoil 5 litre bucket black	single	2
2972	Nutrasoil 10 litre bucket black	single	3
2973	Nutrasoil 3 litre bucket brown	single	4
2974	Nutrasoil 5 litre bucket brown	single	5
2975	Nutrasoil 10 litre bucket brown	single	6
2977	NutraFeed 250ml bottle	single	7
2978	NutraFeed 500ml bottle	single	8



nutraSoil Complete Substrate

Nutrasoil is an attractive, complete substrate which means that it not only provides an anchor for the plants but also slowly provides vital nutrients to the plants' growing root structure.

- Its soft, small granules allow plant roots to penetrate easily ensuring all the plants' energy goes into maximum stem and leaf growth.
- All-natural product with a porous structure which provides a perfect area for beneficial bacteria to colonise, helping to maintain optimum water quality and clarity.
- Lowers the pH level of the aquarium making it perfect for aquatic plants and most fish.
- Provides a comfortable home for bottom dwelling fish and shrimps.

- 1 & 4 AquaGro Nutrasoil 3 litre bucket (brown or black)**
Sufficient for a 30 litre/6.6 UK Gal aquarium
- 2 & 5 AquaGro Nutrasoil 5 litre bucket (brown or black)**
Sufficient for a 50 litre/11 UK Gal aquarium
- 3 & 6 AquaGro Nutrasoil 10 litre bucket (brown or black)**
Sufficient for a 100 litre/22 UK Gal aquarium

nutraFeed Complete Aquarium Plant Food

NutraFeed has been formulated based on the very latest knowledge of aquatic plant cultivation and has been taken a step further with the addition of organic acids not used in other brands of plant food.

- The elements in NutraFeed are chelated with organic fulvic acid, which is the key component of humic matter found in soil.
- Fulvic acid is also responsible for the transport of essential minerals and other nutrients into the plant via the root system.
- The NPK values for NutraFeed are: 5.86-1.16-27 (sulphur 6.7)
- Contains: potassium, sulphur, nitrogen, magnesium, phosphorus, manganese, boron, iron, zinc, copper, cobalt and molybdenum.
- Dosing: Min. 10ml per 80 litres of water per week.

- 7 AquaGro NutraFeed 250ml**
- 8 AquaGro NutraFeed 500ml**



1	2925	CO ₂ Starter Kit MK2	single
The following Starter Kit components are also available separately			
2	2926	CO ₂ Diffuser	single
3	2927	CO ₂ Canister 450ml	single
4	2929	CO ₂ Starter Kit Non Return Valve	single
5	2921	CO ₂ Flexible Tubing (4/6mm diam/2m length)	single

Why CO₂?

A plant is made of 40% carbon and the easiest way for plants to replenish this carbon for optimum growth is by extracting it via carbon dioxide (CO₂) present in the water. So, for vigorous plant growth and lush green plants a good CO₂ supply is essential.



aquaGro BY TMC FOR PLANTED AQUARIA CO₂ Starter Kit MK2

The lowest cost CO₂ system on the market, offering a simple, effective and compact solution for supplying CO₂ to your planted aquarium!

- Ideal for both beginners and more experienced plant keepers.
- Brought to you by TMC, Europe's leading aquatic company for over 30 years.

1 AquaGro CO₂ Starter Kit MK2

Contents:-

- A disposable 450ml CO₂ canister which provides a convenient and hassle-free supply of CO₂ allowing the immediate installation and use of the CO₂ diffuser kit.

- A highly effective and compact CO₂ diffuser with a triangular design which makes it ideal for conveniently fitting in the corner of even the smallest aquariums or nano tanks, whilst ensuring the efficient diffusion of CO₂ within the aquariums. As the diffuser is transparent, it can be easily hidden
- High quality, non return valve which prevents water siphoning back from the CO₂ diffuser to the CO₂ canister.
- 2m of highly flexible 6mm (1/4") CO₂ tubing for versatile and easy connection of all components.

code	specification	sales unit	
2960	CO ₂ Hobby Set (Plastic)	single	1
2961	CO ₂ Expert Set (Glass)	single	2
Individual Components			
2962	CO ₂ Pressure Regulator Nano	single	3
2963	CO ₂ by TMC "One Use" Cylinder	single	4
5616	CO ₂ by TMC Cylinder Stand	single	5
2929	CO ₂ Non Return Valve (plastic)	single	6
2934	Compact CO ₂ Diffuser 25mm (plastic)	single	7
5646	CO ₂ Bubble Counter (plastic)	single	8
2916	CO ₂ Non Return Valve (glass)	single	9
2902	CO ₂ Diffuser (glass)	single	10
2915	CO ₂ Bubble Counter (glass)	single	11
2921	CO ₂ Flexible Tubing (not shown) (4/6mm diam/2m length)	single	12



Professional CO₂ sets which provide all the components required for a highly efficient planted aquarium set-up



aquaGro BY TMC CO₂ Sets

FOR PLANTED AQUARIA

Sets include:-

- **TMC CO₂ 'One Use' CO₂ Cylinder 95g**

Disposable cylinder which provides a convenient and hassle-free supply of CO₂ allowing the immediate installation and use of the CO₂ kit.

- **TMC CO₂ 'One Use' Cylinder Stand**

Moulded stand designed specifically to ensure that the 'One Use' disposable CO₂ cylinder is kept vertically upright and secure whilst in use.

- **TMC CO₂ Pressure Regulator Nano**

High precision nano CO₂ pressure regulator designed specifically for aquarium use.

- **AquaGro CO₂ Diffuser**

High quality diffuser which ensures the efficient and effective diffusion of CO₂ within the aquarium.

- **AquaGro CO₂ Bubble Counter**

Good quality bubble counter which provides a simple and reliable visual indication of the amount of CO₂ being dosed to the CO₂ diffuser and allows for accurate CO₂ dosing.

- **Non Return Valve**

Effective valve which is used to prevent water flowing back from the aquarium to the CO₂ supply.

- **Dosing Pipette**

Compact pipette which allows the bubble counter to be easily filled with water.

- **AquaGro CO₂ Flexible Tubing**

4/6mm in diameter and 2m long.



1	5641	CO ₂ Power Diffuser 500 (Plastic) For aquariums up to 500l/110 UK gal Max. flow/hr 500l/110UK gal	single
2	5642	CO ₂ Power Diffuser 1000 (Plastic) For aquariums up to 1000l/220 UK gal Max. flow/hr 750l/165UK gal	single
3	5643	CO ₂ Power Diffuser 1500 (Plastic) For aquariums up to 1500l/330 UK gal Max. flow/hr 1000l/220UK gal	single
4a	2933	Compact CO ₂ Diffuser 20mm	single
4b	2934	Compact CO ₂ Diffuser 25mm	single
5	5646	CO ₂ Bubble Counter (Plastic)	single
6	5645	CO ₂ Level Indicator (Plastic)	single



aquaGro BY TMC FOR PLANTED AQUARIA **CO₂ Hobby Range**

1-3 AquaGro CO₂ Power Diffusers

- Unique, patented two-layer impellers ensure the highly efficient diffusion of CO₂.
- Innovative and compact design allows the diffuser to be easily installed inside or outside the aquarium and incorporated into any aquarium set-up.
- Robust construction, manufactured from durable, acid and alkali resistant and non-toxic plastics.
- Easy to maintain and clean.
- Includes non return valve and spray bar.
(We highly recommend that an AquaGro CO₂ Bubble Counter - NOT supplied - is used with this diffuser).
- Just connect to pump or power filter and CO₂ supply (NOT supplied) and watch your plants flourish!
- Three sizes available for tanks from 500 to 1500 litres.

4 AquaGro Compact CO₂ Diffusers

- High quality, professional grade CO₂ diffusers.
- Compact, aesthetic design making it ideal for incorporating in all sizes of aquariums including the very smallest nano tanks.

- Incorporates a replaceable extra fine pore ceramic diffusion plate, ensuring the highly efficient and effective diffusion of CO₂ within the aquarium.
- Available in 20mm and 25mm sizes.

5 AquaGro CO₂ Bubble Counter

- A simple and reliable visual indication of the amount of CO₂ being dosed to a CO₂ diffuser allowing for accurate CO₂ dosing.
- Supplied with a suction cup, making it easy to install on the side of any aquarium or sump, and a dosing pipette.
- Compact slimline design.

6 AquaGro CO₂ Level indicator

- A simple visual indicator of the CO₂ level in a planted aquarium.
- Compact design, ideal for use in all sizes of aquariums including the very smallest nano tanks.
- Supplied with a special reagent which is dosed into the CO₂ Level Indicator, providing a clear colour-changing indication of the CO₂ level within the aquarium.
- Includes an easy to read, colour comparison chart and a dosing pipette.

planted tank products

code	specification	sales unit
2901	Glass Diffuser model: 2901	single 1
2902	Glass Diffuser model: 2902	single 2
2906	Glass Diffuser model: 2906	single 3
2907	Glass Diffuser model: 2907	single 4
2909	Glass Diffuser model: 2909	single 5
2911	Glass Diffuser model: 2911	single 6
2919	Glass Diffuser model: 2919	single 7
2910	CO ₂ Glass Level Indicator model: 2910	single 8
2915	CO ₂ Glass Bubble Counter model: 2915	single 9
2916	CO ₂ Glass Non Return Valve model: 2916	single 10
2941	CO ₂ Tubing Glass Connecting Pipe	single 11
2942	Glass U-Bend small	single 12
2943	Glass U-Bend large	single 13
2945	Glass Curved Inlet Pipe 12mm	single 14
2947	Glass Curved Inlet Pipe 16mm	single 15
2949	Glass Curved Inlet Pipe 19mm	single 16
2946	Glass Curved Outlet Pipe 12mm	single 17
2948	Glass Curved Outlet Pipe 16mm	single 18
2950	Glass Curved Outlet Pipe 19mm	single 19
2956	Glass Hang On Thermometer 6mm	single 20
2957	Glass Hang On Thermometer 8mm	single 21

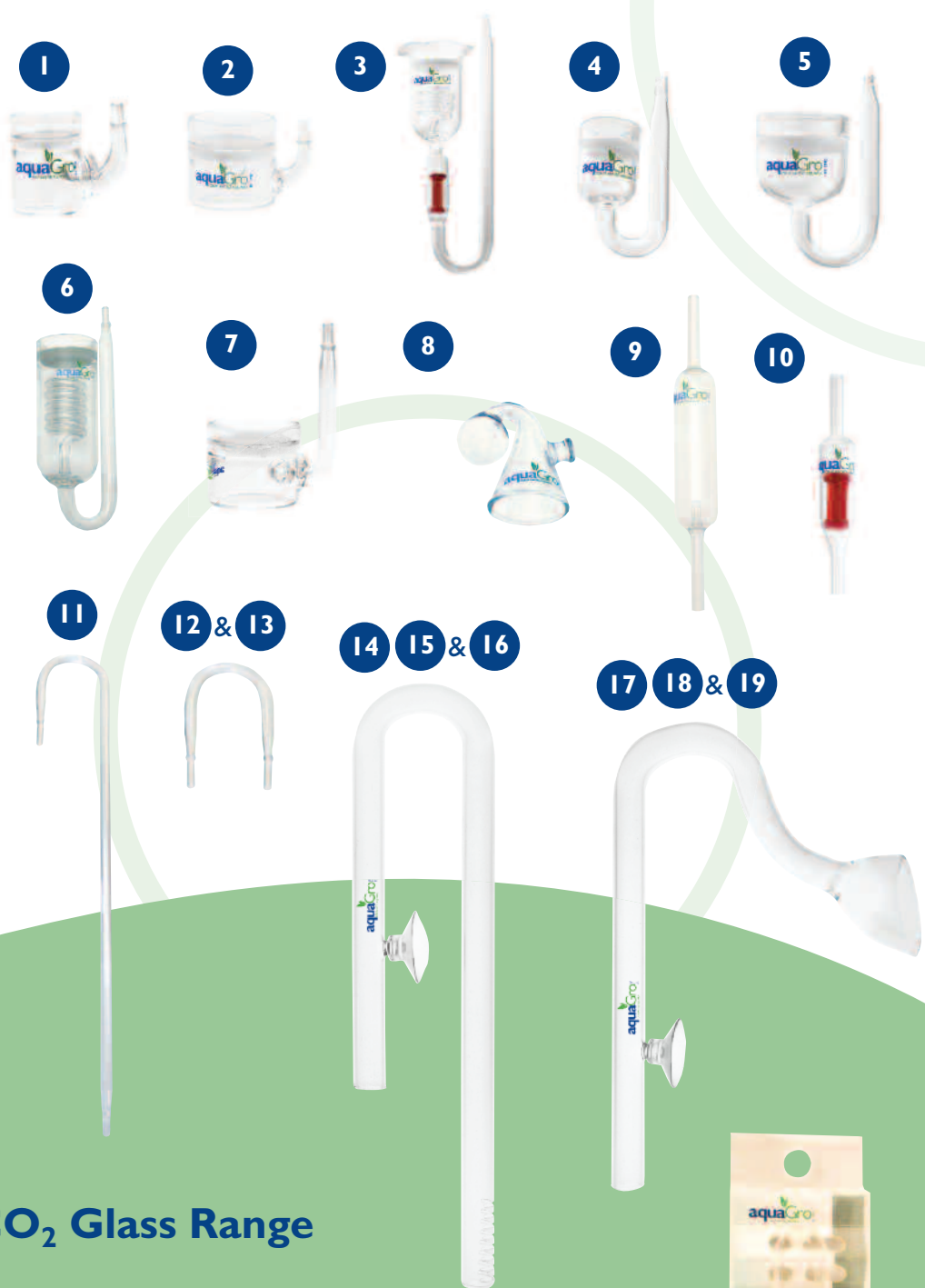

aquaGro BY TMC **CO₂ Glass Range**
FOR PLANTED AQUARIA

- High quality, professional grade glass products.
- Compact, aesthetic design makes the products ideal for incorporating in all sizes of planted aquariums, including the smallest nano tanks.
- Suitable for use with all CO₂ systems.

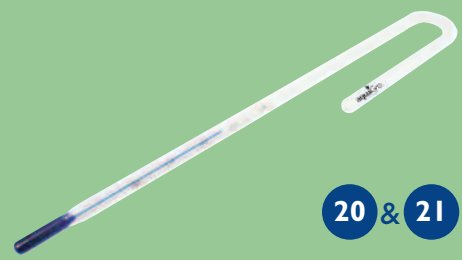

20 & 21





1	2952	Straight Tip Precision Tweezers	single
2	2953	Curved Tip Precision Tweezers	single
3	2954	Straight Tip Precision Scissors	single
4	2955	Curved Tip Precision Scissors	single

aquaGro BY TMC Accessories
 FOR PLANTED AQUARIA

1 Straight Tip Precision Tweezers

- Perfect for planting small, delicate plants.
- Ideal for those hard to reach places.
- Reduces root damage.
- High quality stainless steel.

2 Curved Tip Precision Tweezers

- Perfect for planting small, delicate plants.
- Ideal for those hard to reach places.
- Reduces root damage.
- High quality stainless steel.

3 Straight Tip Precision Scissors

- Sharp blades reduce plant recovery time after trimming.
- Extra wide mouth, ideal for trimming and shaping plants.
- High quality stainless steel.

4 Curved Tip Precision Scissors

- Sharp blades reduce plant recovery time after trimming.
- Angled mouth, ideal for trimming carpeting plants.
- High quality stainless steel.

Please note: Dry tools after every use. Not suitable for salt water aquariums.

code	specification	sales unit	
5647	Spray Bar Kit Short (47cm)	single	5
5648	Spray Bar Kit Long (61cm)	single	6
2921	CO ₂ Flexible Tubing (4/6mm diam/2m length)	single	7
2935	Compact Diffuser Plate 20mm	single	8
2936	Compact Diffuser Plate 25mm	single	9
5649	Replacement 10ml Reagent Bottle	single	10

5



6



7



aquaGro BY TMC
FOR PLANTED AQUARIA

8



9



10



aquaGro BY TMC **Accessories**
FOR PLANTED AQUARIA

- 5 AquaGro Spray Bar Kit Short (47cm)**
Suitable for use with AquaGro CO₂ Power Diffusers 500, 1000 and 1500
- 6 AquaGro Spray Bar Kit Long (61cm)**
Suitable for use with AquaGro CO₂ Power Diffusers 500, 1000 and 1500
- 7 AquaGro CO₂ Flexible Tubing (4/6mm diam/2m length)**
 - Soft and flexible
 - Non-toxic and durable
 - 4/6mm diameter
 - 2m length
- 8 AquaGro Compact Diffuser Plate 20mm**
Suitable for use with AquaGro CO₂ Compact Diffusers
- 9 AquaGro Compact Diffuser Plate 25mm**
Suitable for use with AquaGro CO₂ Compact Diffusers
- 10 AquaGro Level Indicator Replacement 10ml Reagent Bottle**
Suitable for use with the AquaGro CO₂ Level Indicator

11



12



13



14



15



16



18



17



19 & 20



21 & 22



11	2939	Dosing Pipette	single
12	2940	Suction Cups (2pk)	single
13	2937	Suction Cup Clips (2pk)	single
14	2938	90° White Elbow Connector	single
15	2963	CO ₂ by TMC "One-Use" Cylinder	single
16	5616	CO ₂ by TMC Cylinder stand	single
17	5617	CO ₂ by TMC Refillable Bottle (567g)	single
18	2962	CO ₂ Pressure Regulator Nano	single
19	5386	Pressure Regulator (DIN477)	single
20	5387	Pressure Regulator (CGA320)	single
21	5385	Pressure Regulator Pro (DIN477)	single
22	5388	Pressure Regulator Pro (CGA320)	single

aquaGro BY TMC **Accessories**
 FOR PLANTED AQUARIA

- 14 AquaGro 90° White Elbow Connector**
2 piece push fit.
- 15 CO₂ by TMC One-Use Cylinder**
95g (3.4oz) disposable cylinder which provides a convenient and hassle-free supply of CO₂.
- 16 CO₂ by TMC One-Use Cylinder Stand**
Moulded stand designed specifically to ensure that the 'One Use' disposable CO₂ cylinder is kept vertically upright and secure whilst in use.
- 21 & 22 Pressure Regulator Pro**
with integrated solenoid valve

code	specification	sales unit
2703	GroBeam 600 Ultima Single Natural Daylight (6500K white)	single 1
2710	GroBeam 600 Ultima Twin Natural Daylight (6500K white)	single 2
1911	GroBeam 1500 Ultima Natural Daylight (6500K white)	single 3
1911	GroBeam 1500 Ultima ColourPlus	single 4

Available in
UK, EU, US and AUS
versions

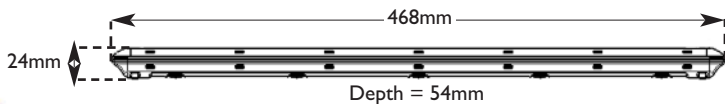

* 2 year guarantee on PSU and 5 year guarantee on lamp unit if unit is registered with us. If not registered, a statutory 2 year guarantee applies on both lamp unit and PSU (proof of purchase required).

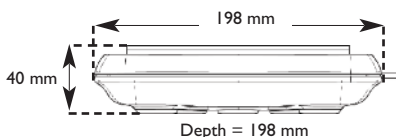

GroBEAM 600 Ultima

Solid State Aquarium Lighting Strip

- Compact 12w lighting strip, now with NEW sleek design.
- 30% brighter than the GroBeam 500.
- Uses high quality Natural Daylight Cree® XB-D PowerLEDs specified at 6500K, making this light perfect for planted tanks and tropical aquariums.
- Creates a natural "shimmer" effect.
- No bulb replacements and a minimum of 50,000 hours lamp life - 6x standard fluorescent lighting.
- Energy efficient with low power consumption and running costs.
- Wide angle beam (120°).
- Rugged ABS, aluminium and acrylic housing sealed to IP67 making it completely safe for aquarists and livestock.
- Fully controllable (controllers sold separately).
- Designed and manufactured by Tropical Marine Centre in the EU.
- Wide range of mounting options available using the Aquaray MMS Modular Mounting System.
- Factory serviceable.

GroBEAM 1500 Ultima

Solid State Aquarium Lighting Tile

- Wide-angle beam which allows the light unit to be mounted close to the aquarium surface for optimum and even light distribution.
- Can be easily hood mounted using the Aquaray MMS system.

3 GroBeam 1500 Ultima - Natural Daylight

- Uses high quality Natural Daylight Cree® XB-D PowerLEDs specified at 6500K.
- 30% brighter than the GroBeam 1000.
- Emits over 2000 lumens, for full illumination of the freshwater biotope.

4 GroBeam 1500 Ultima - ColourPlus













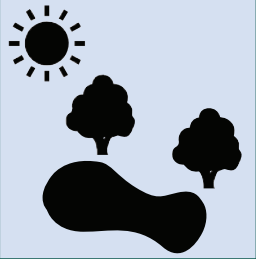
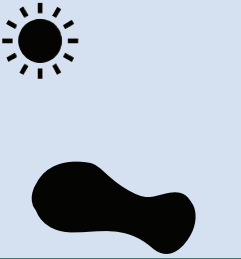
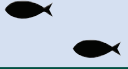
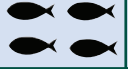
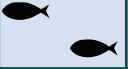

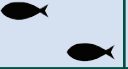
- The colour spectrum of the LEDs in this light unit matches the photosynthetically active spectrum needed for plants to grow and flourish.
- Highlights and enhances the colours in your aquarium.
- Uses 4 x white Cree® XP-G PowerLEDs and 2 x green, 2 x red and 2 x blue Cree® XP-E PowerLEDs.





pond products



							
							
	< 400 UK gallons < 1800 litres	Pond Clear UV6	Pond Clear UV6	Pond Clear UV6	Pond Clear UV6	Pond Clear UV6	Pond Clear UV6
	< 600 UK gallons < 2700 litres	Pond Clear UV6	Pond Clear UV8	Pond Clear UV8	Pond Clear UV8	Pond Clear UV8	Pond Clear UV8
	< 1200 UK gallons < 5400 litres	Pond Clear UV8	Pond Clear UV15	Pond Clear UV8	Pond Clear UV15	Pond Clear UV15	Pond Clear UV15
	< 1500 UK gallons < 6750 litres	Pond Clear UV15	Pond Clear UV15	Pond Clear UV15	Pond Clear UV15	Pond Clear UV15	Pond Clear UV25
	< 3000 UK gallons < 13500 litres	Pond Clear UV15	Pond Clear UV25	Pond Clear UV15	Pond Clear UV25	Pond Clear UV25	Pro Clear UV30
	< 4000 UK gallons < 18000 litres	Pond Clear UV25	Pro Clear UV30	Pro Clear UV30	Pro Clear UV30	Pro Clear UV30	Pro Clear UV55
	< 6000 UK gallons < 27000 litres	Pro Clear UV30	Pro Clear UV55	Pro Clear UV55	Pro Clear UV55	Pro Clear UV55	Pro Clear UV55
	< 10000 UK gallons < 45000 litres	Pro Clear UV55	Pro Clear UV55	Pro Clear UV55	Pro Pond UV110	Pro Clear UV55	Pro Pond UV110
	< 16000 UK gallons < 72000 litres	Pro Pond UV110	Pro Pond UV110	Pro Pond UV110	Pro Pond UV110	Pro Pond UV110	Pro Pond UV110

UV Pond Clarifiers

Tropical Marine Centre pioneered the development of UV water cleansing systems and has manufactured them successfully since the late 1970s. There are now three pond ranges available: Pond Clear Advantage, Pro Clear Advantage and Pro Pond Advantage.

How Do They Work?

Ultraviolet radiation at a wavelength of 254 nanometers is extremely effective in halting the reproduction of algae. The algae readily absorbs the UV light which damages its DNA structure and makes it flocculate (clump together) allowing it to be trapped in a mechanical filter.

TMC's range of UV pond clarifiers work on this principle. At the heart of each UV unit is an ultraviolet lamp sealed inside a quartz sleeve. As water is pumped through the unit, ultraviolet light from the lamp destroys the green, single-celled water borne algae (which make garden ponds murky and unattractive), leaving the water crystal clear.

Choosing the Correct Size Pond Clarifier

The main factors which govern the model you will need are:-

1. Pond size
2. Flow rate
3. Stocking level
4. The amount of sunlight the pond is subject to.

Use the table above to select the correct model for your pond.

If in doubt telephone Tropical Marine Centre for further assistance.

code	specification	sales unit	
5024	2700 litres/600 UK gal	single	1
5019	5400 litres/1200 UK gal	single	2
5020	13500 litres/3000 UK gal	single	3
5021	14400 litres/3200 UK gal	single	4
5022	18000 litres/4000 UK gal	single	5

Available in UK, EU and US versions

Now supplied with a clear 90° plastic elbow, which increases the safe visible glow from the UV lamp inside the UV unit as well as offering a variety of flexible pipe orientations!



Pond Clear Advantage



Pond Clear UV16 Advantage



Easy to Install



Easy to Use



Easy to Maintain



Pond Clear Advantage UV Pond Clarifiers

- Robust construction and ergonomic, green and black design.
- Surface, filter or wall mountable and supplied with a wall mounting kit and a filter lid fixing kit.
- Easy access to working parts making maintenance quick and easy.
- Four-stage hosetails designed to take flexible hose from 1/2" to 1 1/4".
- Includes rigid pipe adaptors for connection to 40mm solvent weld rigid pipe.
- Supplied with a 5 metre power cable (10m on UV16).

1 Pond Clear Advantage UV6 Pond Clarifier
Suitable for ponds up to approx 2700 litres/600 UK gal/720 US gal.
Maximum flow/hr: 1350 litres/300 UK gal/360 US gal
Uses 1 x 6W G6T5 UV Lamp.
Dimensions: 300mm (w) x 132mm (d) x 83mm (h)

2 Pond Clear Advantage UV8 Pond Clarifier
Suitable for ponds up to approx 5400 litres/1200 UK gal/1440 US gal.
Maximum flow/hr: 2700 litres/600 UK gal/720 US gal
Uses 1 x 8W G8T5 UV Lamp.
Dimensions: 440mm (w) x 100mm (d) x 180mm (h)

3 Pond Clear Advantage UV15 Pond Clarifier
Suitable for ponds up to approx 13500 litres/3000 UK gal/3600 US gal.
Maximum flow/hr: 6750 litres/1500 UK gal/1800 US gal
Uses 1 x 15W G15T8 UV Lamp.
Dimensions: 575mm (w) x 125mm (d) x 180mm (h)

4 Pond Clear Advantage UV16 Pond Clarifier
Suitable for ponds up to approx 14400 litres/3200 UK gal/3800 US gal.
Maximum flow/hr: 7200 litres/1600 UK gal/1875 US gal
Uses 1 x 16W G16T5 UV Lamp.
Dimensions: 480mm (w) x 130mm (d) x 175mm (h)

5 Pond Clear Advantage UV25 Pond Clarifier
Suitable for ponds up to approx 18000 litres/4000 UK gal/4800 US gal.
Maximum flow/hr: 9000 litres/2000 UK gal/2400 US gal
Uses 1 x 25W G25T8 UV Lamp.
Dimensions: 575mm (w) x 125mm (d) x 180mm (h)



Pro Clear UV30 Advantage

1



Pro Clear Ultra 55



2

Pro Pond UV110 Advantage



1	5230	Pro Clear Advantage UV30 27000 litres/6000 UK gal	single
2	5232	Pro Clear Ultra 55 45000 litres/10000 UK gal	single
3	7027	Pro Pond UV110 72000 litres/16000 UK gal	single

Available in
UK, EU and US versions



**Pro Clear
UV Pond Clarifiers**

- Professional ultraviolet pond clarifiers suitable for larger ponds, particularly Koi ponds.
- Surface, filter or wall mountable (using supplied mounting brackets)
- Suitable when high flow rates are needed - the UV30 has a maximum flow rate of 3,000 gal/13,500l per hour and the UV55 has a maximum flow rate of 4,000 gal/18,000l per hour.
- Quick and easy to maintain - replacement UV lamps and spares readily available.
- Four 1 1/2" BSP female threaded ports giving two inlet and two outlet options. These can be connected to flexible or rigid pipework and water can enter/exit unit either vertically or horizontally (or a combination of both) offering maximum flexibility with pipework configurations.

1 Pro Clear Advantage UV30 Pond Clarifier

- Supplied with universal hoesetails for flexible pipework which glow to show that the UV lamp is working.
- Suitable for ponds up to approx 27000 litres/6000 UK gal/7150 US gal.
- Uses 1 x 30W G30T8 UV Lamp.
- Dimensions: 930mm (w) x 120mm (d) x 280mm (h)

2 Pro Clear Ultra 55 Pond Clarifier

- New, ergonomic casing improves water shedding
- Acrylic end sections make it easy to see if UV lamp is working
- All wires enclosed for a sleek, discreet appearance
- Suitable for ponds up to approx 45000 litres/10000 UK gal/11900 US gal.
- Uses 1 x 55W TM G55T8 HF PRO UV Lamp.
- Dimensions: 950mm (w) x 120mm (d) x 255mm (h)

**Pro Pond Advantage
UV Pond Clarifier**

- Designed for large ponds, incorporating pressure filters or pressure circuits such as sand filters & venturis.
- New ergonomic, compact design.
- New energy efficient, electronic control gear.
- Universal 2" and 63mm solvent weld inlet and outlet ports.
- Can be connected to either flexible or rigid plumbing using the appropriate plumbing fittings (not supplied).
- Can be used for pressurised systems up to 3 bar (43.5psi).
- Individually chambered lamps for optimum efficiency and contact time.
- Fused quartz glass sleeves which ensure that germicidal lamps are able to reach their optimum 'burn temperature' where the highest amount of UVc radiation is emitted.
- Easily wall mountable.
- Supplied with a 5 metre cable.

3 Pro Pond Advantage UV110 Pond Clarifier

- Suitable for ponds up to approx 72000 litres/16000 UK gal/19000 US gal.
- Uses 2 x 55W TM HF PRO UV Lamps.
- Dimensions: 970mm (w) x 100mm (d) x 370mm (h)

code	specification	sales unit	
7907	Pro Pond FBF 80 3500-4000 litres per hr	single	1
7908	Pro Pond FBF 160 4500-5000 litres per hr	single	2
7117	Hidro Clean Cartridge Filter 105 mic/20m³ per hr	single	3
7118	Hidro Clean Cartridge Filter 125 mic/20m³ per hr	single	4
7134	Hidro Clean Cartridge Filter 105 mic/40m³ per hr	single	5
7135	Hidro Clean Cartridge Filter 125 mic/40m³ per hr	single	6

	FBF80	FBF160
Inlet Size	1.5" BSP	1.5" BSP
Outlet Size	2" BSP	2" BSP
Diameter	150mm	200mm
Diffuser Bowl Diameter	146mm	198mm
Overall Height	1560mm	1560mm
Diameter at Base	260mm	340mm
Oolitic Aragonite Media	10kg	20kg
Maximum Fish Bio Mass	80kg	160kg
Water Flow Rate	3500-4000 lph	4500-5000 lph

Pro Pond

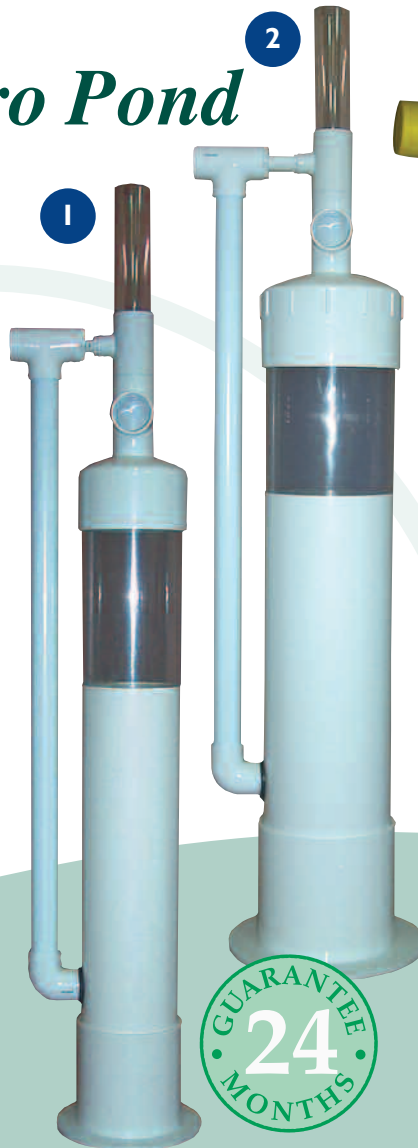

Hidro Clean



1. Triangular filtering channels progressively decreasing in size
2. Ribs
3. Axis sustaining ring
4. Anti-weed flap system

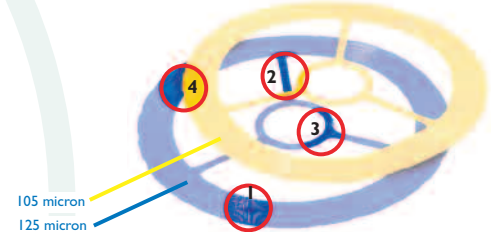

Pro Pond Fluid Bed Filters

- Pro Pond Fluid Bed Filters are low cost, maintenance free units designed specifically for the professional pond and koi keeper.
- They offer all the unique features of our commercial units including low head start up and diffuser bowl.
- Pro Pond FBF units are fitted with an anti-siphon device, preventing the oolitic aragonite media from back-siphoning into the supply pipework when the water supply pump is turned off.
- They should be used in conjunction with other filtration elements to create a well-balanced filtration package. Unlike aquaculture, koi pond filtration is based on high water volume to bio-mass ratios.
- Supplied with graded oolitic aragonite media.

- 1 Pro Pond FBF80**
Supplied with 10kg of media. Maximum fish bio mass: 80kg. Dimensions: height 156cm/diameter at base 26cm.
- 2 Pro Pond FBF160**
Supplied with 20kg of media. Maximum fish bio mass: 160kg. Dimensions: height 156cm/diameter at base 34cm.

Hidro Clean Cartridge Filters

- Hidro Clean mechanical cartridge filters offer pressurised, pump-fed mechanical filtration to a minimum particle size of 105 micron.
- They are ideal for use as a pre-filter to pump-fed bio-filters to remove solids before they are able to foul the biological media.
- Designed to be easy to maintain and the cartridge can be cleaned using a standard hose pipe.
- Two filter grades available - 105 micron (yellow cartridge) and 125 micron (blue cartridge).

- 3 Hidro Clean Cartridge Filter 105 micron**
Cartridge length: 38cm. Surface area 1370 cm². Inlet/outlet: 2"MT.
- 4 Hidro Clean Cartridge Filter 125 micron**
Cartridge length: 38cm. Surface area 1370 cm². Inlet/outlet: 2"MT.
- 5 Hidro Clean Cartridge Filter 105 micron**
Cartridge length: 49cm. Surface area 1760 cm². Inlet/outlet: 2"MT.
- 6 Hidro Clean Cartridge Filter 125 micron**
Cartridge length: 49cm. Surface area 1760 cm². Inlet/outlet: 2"MT.

Pond Clear UV6 Advantage



Pond Clear UV8 Advantage

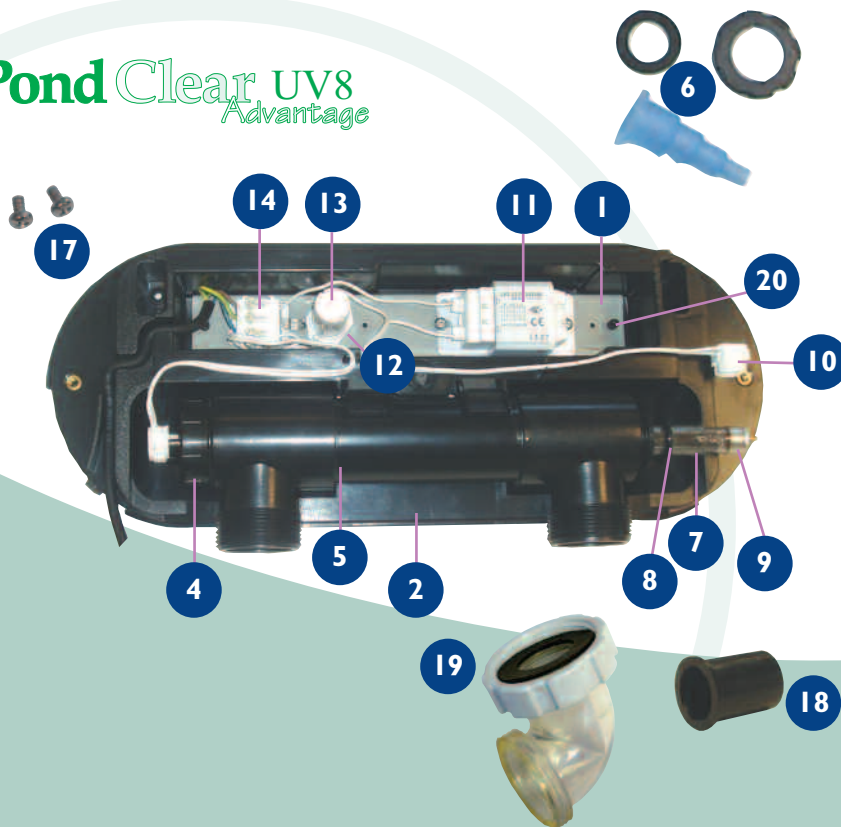

	code	specification	sales unit
Pond Clear Advantage UV6			
1	5024CG-UK	Pond Clear Adv UV6 control gear	single
2	PCADUV6BASE	Pond Clear Adv UV6 black base	single
3	PCADUV6COVER	Pond Clear Adv UV6 green lid (not shown)	single
4	8WPC/LNBCT94	Pond Clear Adv UV6 locknut	single
5	SHPC6B	Pond Clear Adv UV6 plastic body	single
6	5249-D	Pond Clear Adv UV6 hosetail	single
7	5274	Pond Clear UV6 quartz sleeve	single
8	5280	Pond Clr UV6/8/16 quartz sleeve O ring	single
9	6051	TM G6T5 UV lamp 6w	single
10	V2UV8/16LLS	Pond Clear Adv UV6 lamp lead	single
11	D468-22.2-3	Pond Clear 6/8w UK ballast	single
12	NO/19	Pond starter holder	single
13	S10	S10 lamp starter	single
14	PCA/V2MTB	Terminal block	single
15	PCADUV6BOX	Pond Clear Adv UV6 box (not shown)	single
16	PCADUV6INS	Pond Clr Adv UV6 instructions (not shown)	single
17	PCADLFSSR04	Pond Clear Adv lid fixing screw	single
18	PCADRFACT04	Pond Clr Adv rigid pipe adapter	single
19	5249-L	Clear 90° elbow	single
20	0655730	Black plastic push clips	single
Pond Clear Advantage UV8			
1	5019CG-UK	Pond Clr Adv UV8 control gear	single
2	PCA8B/MS04	Pond Clear Adv UV8 black base	single
3	PCA8C/MS04	Pond Clr Adv UV8 green lid (not shown)	single
4	8WPC/LNBCT94	Pond Clr Adv 8/16w black locknut	single
5	SHPCA8B	Pond Clear Adv UV8 plastic body	single
6	5249-D	Pond Clr Adv univ. hosetail assembly (hosetail, locknut and gasket)	single
7	5275	Pond Clr Adv UV8 quartz sleeve	single
8	5280	Pond Clr UV6/8/16 quartz sleeve O ring	single
9	6052	TM G8T5 UV lamp 8w	single
10	PC/VECLLS	Pond Clear 6/8/16w lamp lead	single
11	D468-22.2-3	Pond Clear Adv 8w UK ballast	single
12	NO/19	Pond starter holder	single
13	S10	S10 lamp starter	single
14	PCA/V2MTB	Terminal block	single
15	PCAD8BOX	Pond Clr Adv UV8 box (not shown)	single
16	PCAD8-25INS	Pond Clr Adv instructions (not shown)	single
17	PCADLFSSR04	Pond Clear Adv lid fixing screw	single
18	PCADRFACT04	Pond Clr Adv rigid pipe adapter	single
19	5249-L	Clear 90° elbow	single
20	0655730	Black plastic push clips	single

Available in
UK, EU and US versions

UV Pond Clarifiers Spares & Accessories



code specification sales unit

Pond Clear Advantage UV15 & UV25		
5020CG-UK	Pond Clear Adv UV15 control gear	single 1a
5022CG-UK	Pond Clear Adv UV25 control gear	single 1b
PCAI5B/MS04	Pond Clear Adv UV15/25 black base	single 2
PCAI5C/MS04	Pond ClrAdv UV15/25 green lid (not shown)	single 3
15WVPLNBCT04	Pond Clr Adv UV15/25 black locknut	single 4
SHPCA15/25B	Pond Clear Adv UV15/25 body	single 5
5249-D	Pond Clear Adv univ. hosetail assembly (hosetail, locknut and gasket)	single 6
5276	Pond Clear Adv UV15/25 quartz sleeve	single 7
5281	Pond Clear Adv UV15/25 quartz sleeve O ring	single 8
6053	TM G15T8 UV lamp 15w	single 9a
6054	TM G25T8 UV lamp 25w	single 9b
PC/VECLLB	Pond Clear Adv 15/25w lamp lead	single 10
D15-22.2-4	Pond Clear Adv 15w UK ballast	single 11a
L30TL2230	Pond Clear Adv 25w UK ballast	single 11b
NO/I9	Pond starter holder	single 12
S10	S10 lamp starter	single 13
PCA/V2MTB	Terminal block	single 14
PCAD15BOX	Pond Clear Adv UV15 box (not shown)	single 15a
PCAD25BOX	Pond Clear Adv UV25 box (not shown)	single 15b
PCAD8-25INS	Pond Clear Adv instructions (not shown)	single 16
PCADLFSSR04	Pond Clear Adv lid fixing screw	single 17
PCADRPACT04	Pond Clear Adv rigid pipe adaptor	single 18
5249-L	Clear 90° elbow	single 19
0655730	Black plastic push clips	single 20
Pond Clear Advantage UV16		
5286-97	Pond Clear Adv UV16 control gear	single 1
PCAD16BSB00	Pond Clear Adv UV16 base	single 2
PCAD16BSL00	Pond Clear Adv UV16 lid (not shown)	single 3
8WVPLNBCT94	Pond Clear Adv UV16 black locknut	single 4
SHPCA16B	Pond Clear Adv UV16 black PVC body	single 5
5249-D	Pond Clear Adv univ. hosetail assembly (hosetail, locknut and gasket)	single 6
5275	Pond Clear Adv UV16 quartz sleeve	single 7
5280	Pond Clear UV6/8/16 quartz sleeve O ring	single 8
6057	TM G16T5 UV lamp 16w	single 9
PC/VECLLS	Pond Clear 6/8/16w lamp lead	single 10
L18TL2230V	Pond Clear Adv UV16 UK ballast	single 11
NO/I9	Pond starter holder	single 12
S10	S10 lamp starter	single 13
PCA/V2MTB	Terminal block	single 14
PCUV16BOX	Pond Clear Adv UV16 box (not shown)	single 15
PCAD8-25INS	Pond ClrAdv UV16 instructions (not shown)	single 16
113000369902	Nylon screw rivet	single 17
SSBC/KMPOOA	S/S clip	single 18
5249-L	Clear 90° elbow	single 19
0655730	Black plastic push clips	single 20

Pond Clear Advantage UV15 & UV25

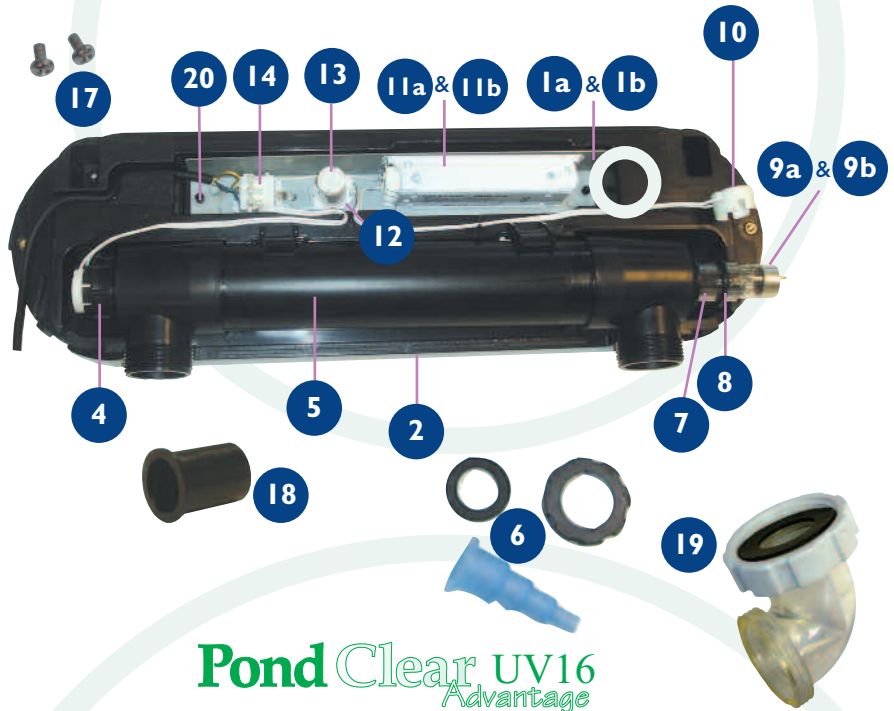

Pond Clear Advantage UV16

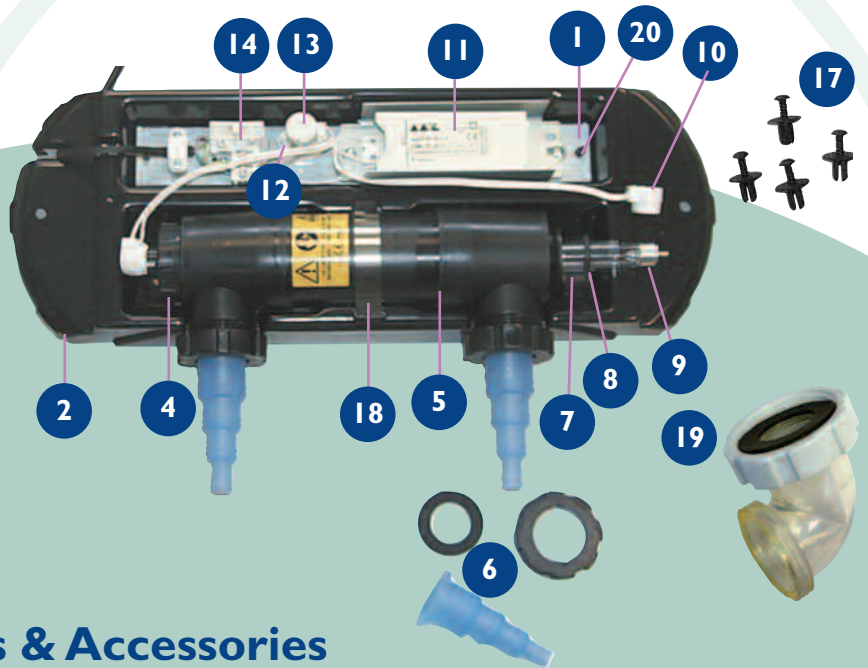

Available in
UK, EU and US versions

UV Pond Clarifiers Spares & Accessories

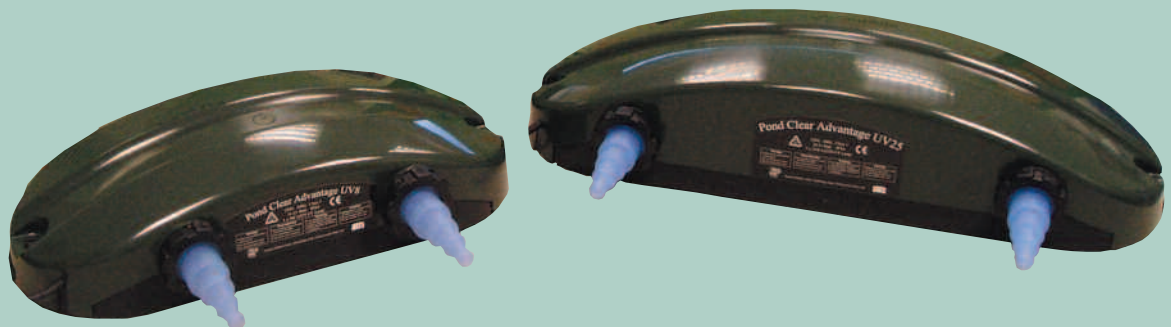

Pro Clear UV30 & UV55 Advantage

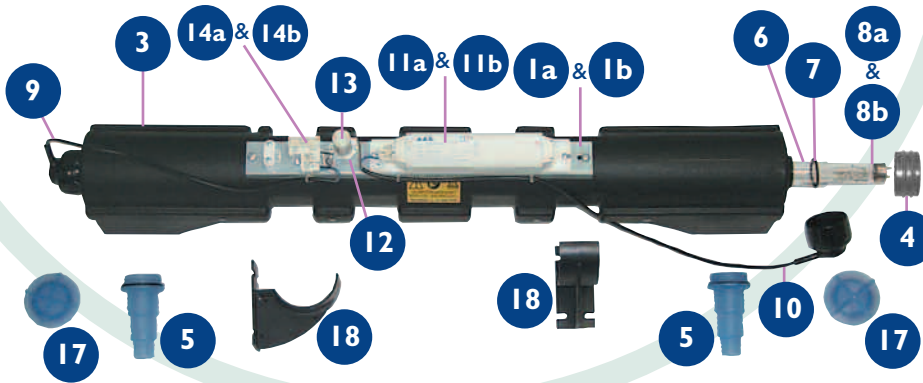

Pro Pond UV110 Advantage

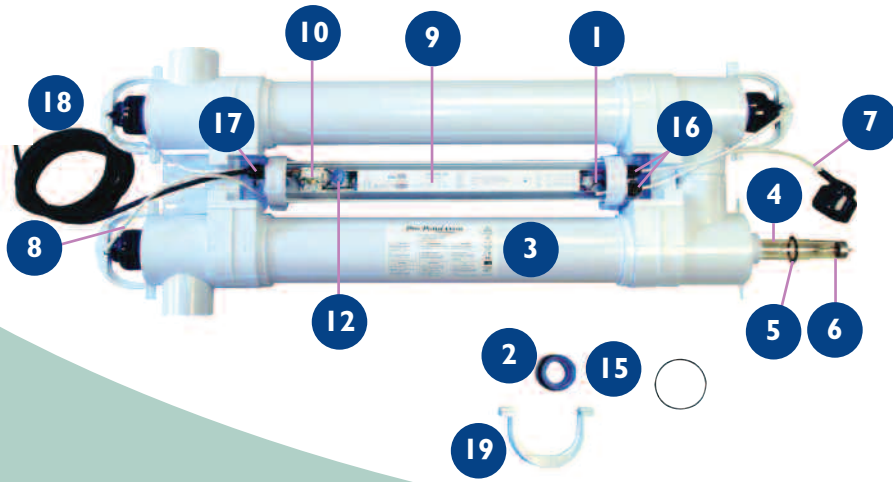

UV Pond Clarifiers Spares & Accessories

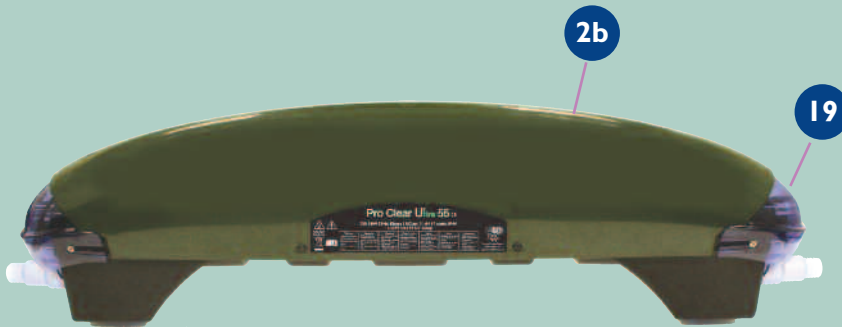

code	specification	sales unit
------	---------------	------------

Pro Clear Advantage UV30 & UV55

1a	5286-50	Pro Clear Adv UV30 control gear	single
1b	5232CG-UK	Pro Clear Ultra 55 control gear	single
2a	PROAD/COVER	Pro Clear Adv UV30 lid	single
2b	PROCLRLTLID	Pro Clear Ultra 55 lid	single
3	PROUVBFP98A	Pro Clear Adv UV30/55 black body	single
4	PROCLRL/NUT	Pro Clear Adv UV30/55 locknut	single
5	5249-C	Pro Clear Adv universal hosetail	single
6	5277	Pro Clear Adv UV30/55 quartz sleeve	single
7	5283	Pro Clear Adv quartz sleeve O ring	single
8a	6055	TM G30T8 UV lamp 30w	single
8b	6056	TM G55T8 HF PRO 55w UV Lamp	single
9	PROCLRLLS	Pro Clear Adv lamp lead short	single
10	PROCLRLLL	Pro Clear Adv lamp lead long	single
11a	D30-22.2-4	Pro Clear Adv UV30 UK ballast	single
11b	D58-29.00-4	Pro Clear Adv UV55 UK ballast	single
12	NO/19	Pond starter holder	single
13	S10	S10 lamp starter	single
14a	FUTBCAP	Fuse terminal block inc.fuse (for all pre 2007 units)	single
14b	PCA/V2MTB	Terminal block (for all post 2007 units)	single
15a	PRO30UVBOX	Pro Clear Adv UV30 box (not shown)	single
15b	PROULT55BOX	Pro Clear Ultra 55 box (not shown)	single
16a	PROADINSLH99	Pro Clear Adv 30 instructions (not shown)	single
16b	PROCLRLTINS	Pro Clear Ultra 55 instructions (not shown)	single
17	PROCLRB/PLUG	Pro Clear Adv blue blanking plug	single
18	PROUVVBT98	Pro Clear Adv black wall bracket	single
19	PROCLRLTFCAP	Pro Clear Ultra 55 blue end cap	single

Pro Pond Advantage UV110

1	PPATUBECCGUK	Pro Pond Adv UV110 control gear	single
2	PPI110WL/NUT	Pro Pond Adv UV110 locknut	single
3	PPI110ADVBODY	Pro Pond Adv UV110 body	single
4	5277	Pro Pond Adv UV110 quartz sleeve	single
5	5281	Pro Pond Adv UV110 quartz sleeve O ring	single
6	6056	TM G55T8 HF PRO 55w UV Lamp	single
7	P2/PPALLS	Pro Pond Adv UV110 lamp lead short	single
8	P2/PPALLL	Pro Pond Adv UV110 lamp lead long	single
9	HFL254-58	Digital ballast 55w 220/240v 50Hz	single
10	683-A	Fuse terminal block	single
11	F315-08	3.15 Amp time delay fuse (not shown)	single
12	579-100	Varistor	single
13	PPA110/BOX	Pro Pond Adv UV110 box (not shown)	single
14	PPA110/INS	Pro Pond Adv UV110 instructions (not shown)	single
15	5200400N50	Pro Pond Adv UV110 control gear O ring	single
16	3425000	Pro Pond Adv M12 watertight grommet	single
17	ESP09-11B-IN	Pro Pond Adv M16 watertight grommet	single
18	CSUV/MCPC00	Pro Pond Adv UV110 5m power cable	single
19	PPA/05DMR	Pro Pond Adv UV110 dipmould restraint	single

Available in
UK, EU and US versions

code	specification	sales unit	
7127	Replacement cartridge 105 micron 38cm	single	1
7128	Replacement cartridge 125 micron 38cm	single	2
7129	Replacement cartridge 105 micron 49cm	single	3
7130	Replacement cartridge 125 micron 49cm	single	4
7131	Replacement lid and O ring	single	5
7132	Replacement lid clamp	single	6
7133	Hidro Clean plastic base	single	7



Hidro Clean Cartridge Filters Spares & Accessories



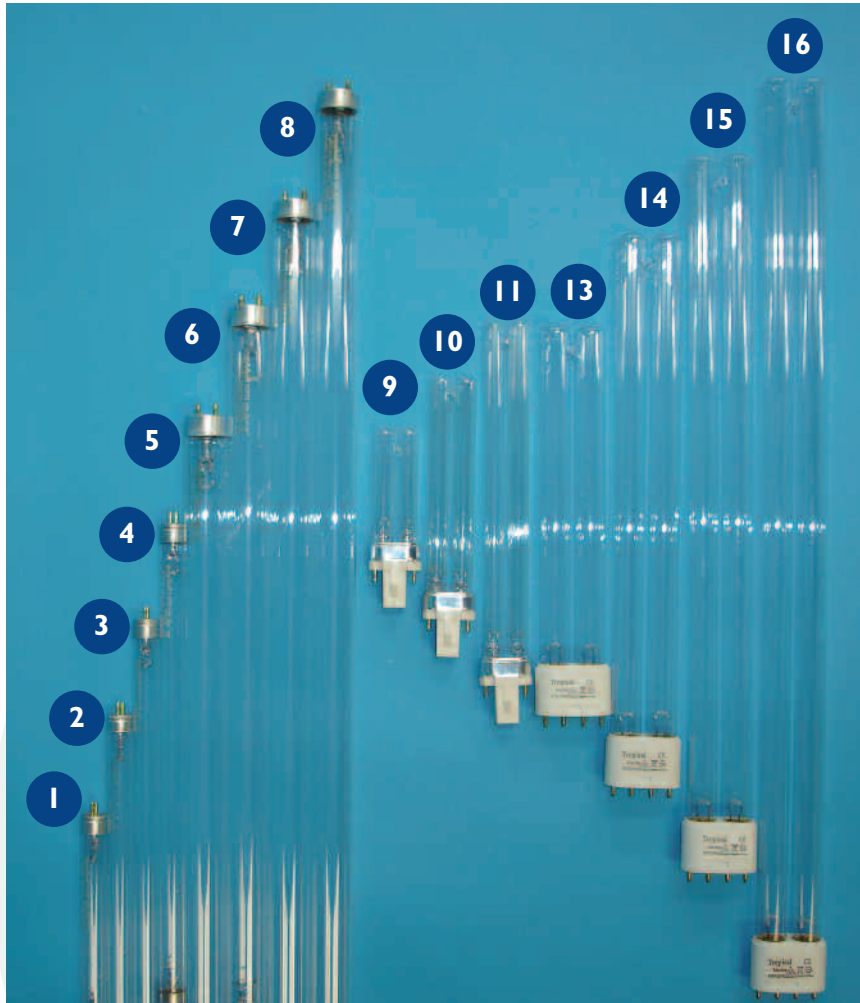

	code	specification	sales unit
1	6050	TM G4T5 UV lamp 4w	single
2	6051	TM G6T5 UV lamp 6w	single
3	6052	TM G8T5 UV lamp 8w	single
4	6053	TM G15T8 UV lamp 15w	single
5	6057	TM G16T5 UV lamp 16w	single
6	6054	TM G25T8 UV lamp 25w	single
7	6055	TM G30T8 UV lamp 30w	single
8	6056	TM G55T8 HFPRO UV lamp 55w	single
9	6059	TM PLS UV lamp 5w	single
10	6060	TM PLS UV lamp 9w	single
11	6061	TM PLS UV lamp 11w	single
12	6067	TM PLS UV lamp 13w (not shown)	single
13	6062	TM PLL UV lamp 18w	single
14	6063	TM PLL UV lamp 24w	single
15	6064	TM PLL UV lamp 36w	single
16	6065	TM PLL UV lamp 55w	single
17	6068	TMC Pond PC-4T5 lamp 4w	single
18	6069	TMC Pond PC-6T5 lamp 6w	single
19	6070	TMC Pond PC-8T5 lamp 8w	single
20	6071	TMC Pond PC-16T5 lamp 16w	single



17 to 20



Tropical Marine Replacement UV Lamps

Tropical Marine Centre offers a full range of replacement UV lamps for our pond, aquarium and commercial UV products. We are also able to supply replacement lamps for a number of other brands of UV filters. We exclusively offer our own, brand-leading TM lamp range which we have been supplying into aquaculture and industry for more than 30 years.

How often should a UV lamp be replaced?

UV lamps, used for sterilisation purposes in our V²ecton and commercial system UVs, should be replaced every 6 months (approx. 4000 hrs) to ensure the continuous high output that is required for these applications. Lamps used for clarification of ponds can be replaced once a year (approx. 8000 hrs) without detriment to the effectiveness of the unit under normal circumstances. Whilst replacing the UV lamp, the quartz sleeve should be carefully cleaned with a light acid cleaner and washed with water to remove any deposits and dirt that may have built up.

The quartz sleeve should be completely dry before replacing it in the unit. The quartz O rings should be replaced to ensure an effective seal between the quartz sleeve and the plastic body.

PLEASE NOTE:

All of our UV lamps are low mercury, in compliance with the RoHS (Restriction of Hazardous Substances) and WEEE (Waste Electrical and Electronic Equipment) guidelines.



Never look directly at an illuminated UV lamp

INDEX

AquaGro 90° White Elbow Connector	69	AquaRay AquaWhite Flexi-LED	45
AquaGro Accessories	67	AquaRay Cleaning Cloth	42
AquaGro CO ₂ Flexible Tubing	68	AquaRay Control	46
AquaGro CO ₂ Glass Accessories	66	AquaRay Lighting Products	41
AquaGro CO ₂ Hobby Accessories (plastic)	65	AquaRay MiniLED 500 Tile	45
AquaGro CO ₂ Power Diffusers	65	AquaRay MMS Modular Mounting System	49
AquaGro CO ₂ Sets & Components	64	AquaRay MountaRay Tank Bracket	49
AquaGro CO ₂ Starter Kit	63	AquaRay MultiControl 8	46
AquaGro Compact CO ₂ Diffusers	65	AquaRay Spectrum Charts	47
AquaGro Compact CO ₂ Diffuser Ceramic plates	68	Aquarium Products	3
AquaGro CO ₂ Level Indicator Reagent	68		
AquaGro Decor Range - Borneo Driftwood	61	Bio-Glass Filter Media	36
AquaGro Dosing Pipette	69	Bio-Rings Filter Media	36
AquaGro GroBeam 600 Ultima Lighting Strip	70	Books	27
AquaGro GroBeam 1500 Ultima Lighting Tile	70		
AquaGro Nutrasoil Complete Substrate	62	CO ₂ by TMC CO ₂ Cylinders	24, 69
AquaGro Nutrafeed Aquarium Plant Food	62	CO ₂ by TMC One Use CO ₂ Cylinders	24, 69
AquaGro Planted Tank Products	59	CO ₂ by TMC One Use CO ₂ Cylinder Stand	24, 69
AquaGro Scissors	67	CO ₂ Pressure Regulator Nano	24, 69
AquaGro Spray Bars	68		
AquaGro Suction Cups	69	Gamma Blister Frozen Food	31
AquaGro Tweezers	67	Gamma Dry Enriched Dried Natural Seaweed	33
AquaHabitats AquaBar Lighting Bars	55	Gamma Nutraplus Liquid Feeds	34
AquaHabitats ColourPlus LED 1000 Tile	54	Gamma Seaweed Clip	33
AquaHabitats Easifit Mounting Kits	55	Gamma Slice Frozen Food	32
AquaHabitats H ² Fill & Go Collapsible Water Containers	58	Gravel	36
AquaHabitats H ² Air Air Pumps	56		
AquaHabitats H ² Therm Micro Heaters	56	HydroClean Cartridge Filters	76
AquaHabitats PowerPads	52	HydroClean Cartridge Filter Spares	80
AquaHabitats Products	51	HR Carbon	36
AquaHabitats Mechanical Filter Bag System	57	Hydrometers	36
AquaHabitats MicroHabitat 15	52		
AquaHabitats MicroHabitat 30	53	Livestock	1
AquaHabitats MiniLED 400 Tile	54		
AquaHabitats Spy Lens	57	Natureform Aquarium Backgrounds	30
AquaRay AquaBeam 600 Ultima Lighting Strip	42	Natureform Replica Live Rock	29
AquaRay AquaBeam 2000 HD Ultima NP Lighting Tile	44		
AquaRay AquaBeam 1500 Ultima NP Lighting Tile	43	Planted Tank Products	59
AquaRay AquaBlue Flexi-LED	45	Pond Clear Advantage UV Pond Clarifiers	74
AquaRay AquaRed Flexi-LED	45	Pond Clear Advantage UV Pond Clarifier Spares	77

Pond Products	71	V ² Skim Compact Protein Skimmer Spares & Accessories	38
Pro Clear UV Pond Clarifiers	75	V ² Skim Compact Surface Skimmer	9
Pro Clear UV Pond Clarifier Spares	79	V ² Skim Hang On Protein Skimmers	7
Pro Pond Advantage UV110 UV Pond Clarifiers	75	V ² Skim Pro Hang On Cone Skimmers	8
Pro Pond Advantage UV110 UV Pond Clarifier Spares	79	V ² Skim Protein Skimmer Spares & Accessories	38
Pro Pond Fluid Bed Filters	76	V ² Therm Digital Heaters	13
Sand	36		
Signature Optiwhite Glass Tanks and Cabinets	25		
Thermometers	36		
UV Lamps	81		
UV Pond Clarifiers - Choosing the Correct size Unit	73		
V ² Auto Top Up System	23		
V ² Bio Fluidised Sand Bed Filters	12		
V ² Bio React 500 Pellet Reactor	12		
V ² Bio Replacement Media	12		
V ² Control pH Controllers/Monitors	23		
V ² ecton UV Sterilisers	11		
V ² ecton UV Steriliser Spares & Accessories	37		
V ² iLumenAir LED Luminaires	18		
V ² Krotons Filter Media	17		
V ² Ozone Ozone Generator	16		
V ² PowerFilters	17		
V ² PowerFlow Circulation Pumps	21		
V ² PowerPads	35		
V ² PowerPumps	19		
V ² Pressure Regulators	24, 69		
V ² Pure Reverse Osmosis System	14		
V ² Pure Spares	15		
V ² Pure TDS Monitor	15		
V ² React Calcium Reactors	10		
V ² React Calcium Reactor Spares & Accessories	39		
V ² React Compact Calcium Reactors	10		
V ² Refractometer	24		
V ² Skim 80 Micro Skimmers	5		
V ² Skim 120 Nano Skimmers	5		
V ² Skim 120 Nano Skimmer Spares	40		
V ² Skim Compact Protein Skimmers	6		

Social Media and Other On-line Services



www.tropicalmarinecentre.co.uk

Our main website is packed full of product information, tips and interesting articles.

Catalogues and instructions can be downloaded from this site and you can also access our "find a dealer" tool which helps you locate stockists of your specified TMC products or fish species.

Facebook & Twitter

"Like" us on Facebook
Tropical Marine Centre
 or follow us on Twitter
@TropicalMarine

to keep up to date with the latest TMC news and product releases, as well as seeing sneak peeks from the fish house.

YouTube

Video footage of our livestock is showcased on our YouTube Channel
tropicalmarinecentre

Subscribe to our channel now to be the first to see our newest arrivals!



TMC Dealer Portal

The TMC "Dealer Portal" allows our network of retailers to view our current livestock availability lists and place on-line orders for livestock and dry goods.

This means they can instantly check availability of any of the particular species you are looking for and order it in for you there and then, giving you the highest level of customer care and access to our newest arrivals.

If you are a trade customer and would like to set up a portal account please visit:-

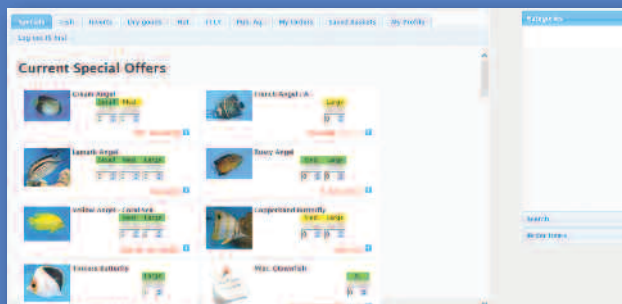

<http://dealers.tropicalmarinecentre.co.uk/Register.aspx>

To view or download a copy of this catalogue in other languages please go to <http://downloads.tropicalmarinecentre.co.uk>

Tropical Marine Centre (TMC) has been Europe's leading supplier of quality marine fish and invertebrates to the ornamental trade since 1970 and operates four large, fully re-circulated aquarium based facilities in London, Manchester, Bristol and Lisbon (TMC Iberia).

Apart from supplying livestock to the retail aquatic trade, TMC also works closely with many leading public aquariums around the World and is a member of EUAC (European Union of Aquarium Curators).



In addition, TMC is the UK's leading manufacturer and distributor of innovative commercial filtration equipment and quality branded aquatic products and, since the early 1970s, has manufactured UV sterilisers and clarifiers for both hobby and commercial applications.

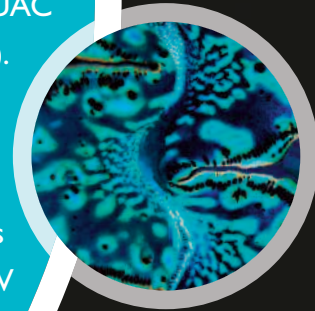

TMC

London

Solesbridge Lane,
Chorleywood,
Herts
WD3 5SX

Tel: +44 (0)1923 284151
Fax: +44 (0)1923 285840

TMC

Manchester

Unit 3, Beta Court, Harper Road,
Sharston Industrial Estate,
Wythenshawe,
Manchester
M22 4QE

Tel: +44 (0)161 9461538
Fax: +44 (0)161 9989599

TMC

Bristol

Unit 2, Cribbs Causeway Centre,
The Laurels,
Cribbs Causeway,
Bristol
BS10 7TT

Tel: +44 (0)117 9581150
Fax: +44 (0)117 9581152

TMC

Iberia

Cranswick Pet & Aquatics Ltd –
Sucursal em Portugal
Rua Cidade de Paris, n.º 6
Parque Industrial do Arneiro
2660-456 S. Julião do Tojal,
Loures, Portugal

Tel: +351 219739140
Fax: +351 219739141

www.tropicalmarinecentre.co.uk

www.tmc-publishing.com