

# Quantum Well Devices: Applications of the PIAB.

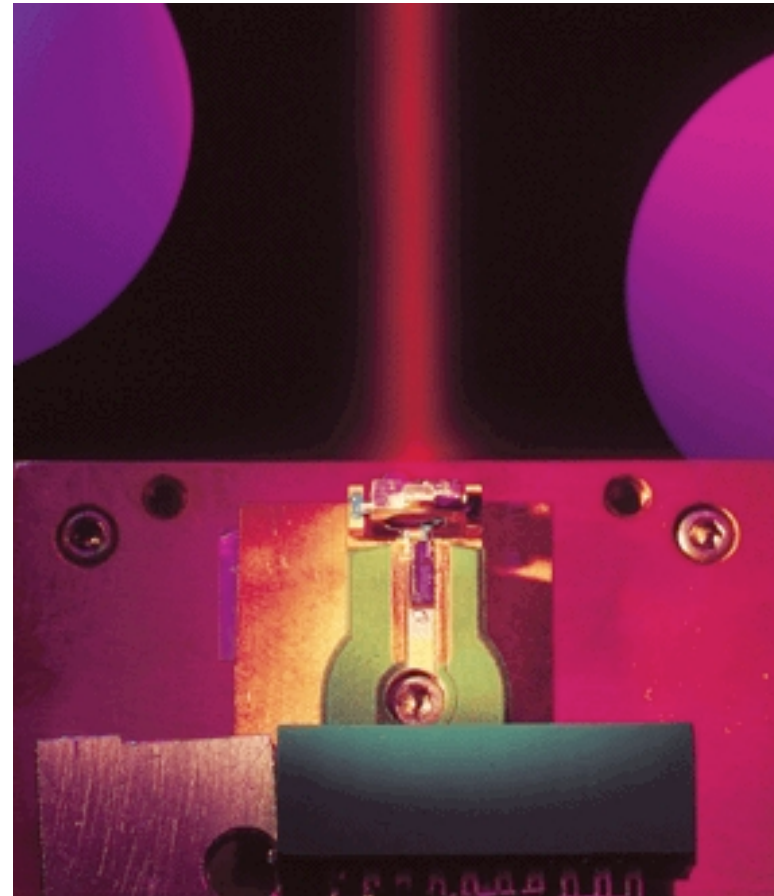

H2A Real World Friday

# What is a semiconductor?

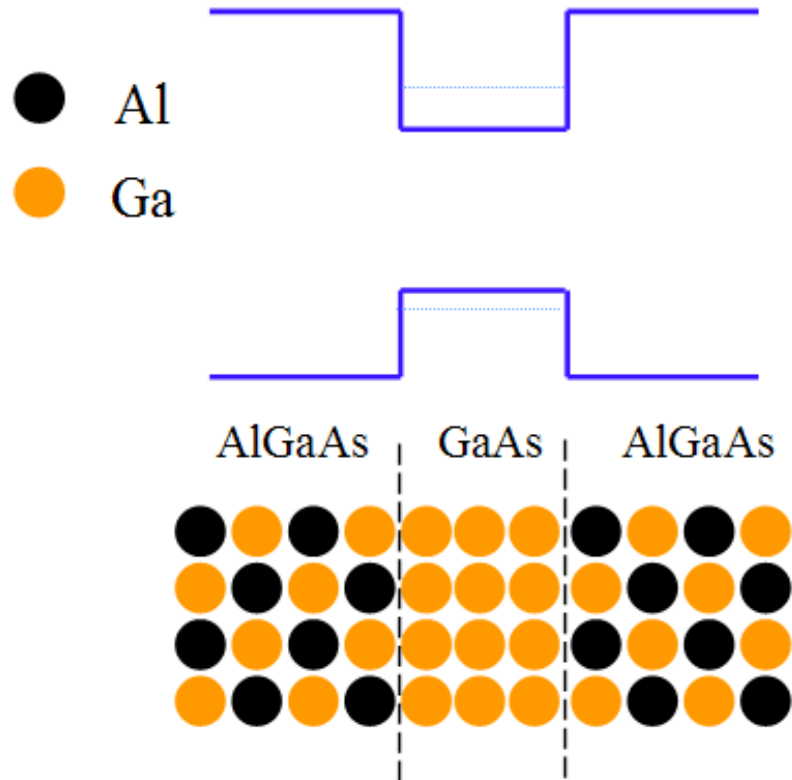
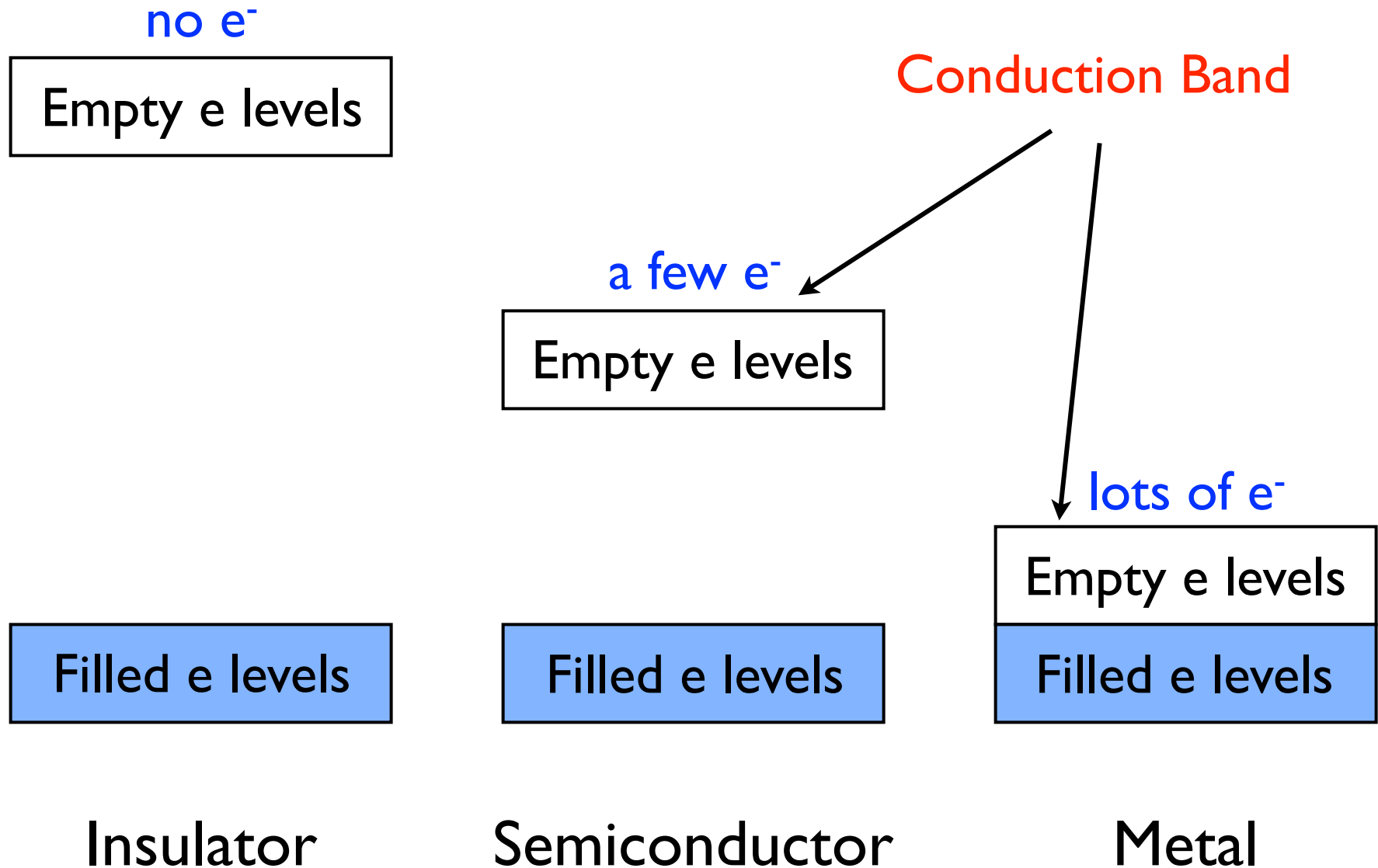

Electrons in the conduction band of semiconductors like Si or GaAs can move about freely.

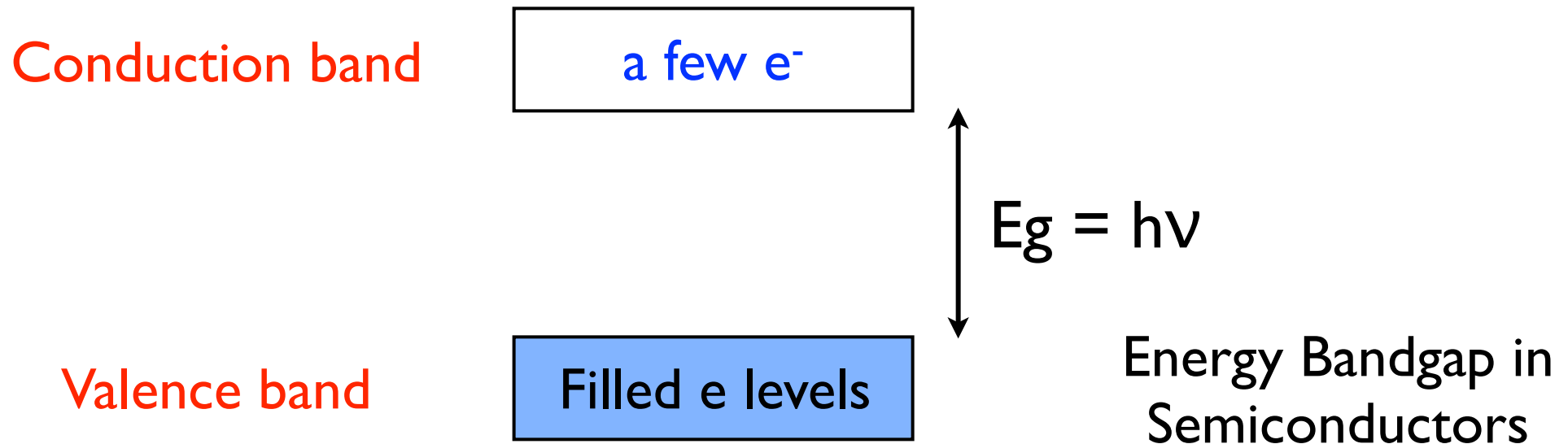

We can get electrons into the conduction band by either thermal excitation or light excitation (photons).  
Solar cells use semiconductors to convert photons to electrons.

A "quantum well" structure made from AlGaAs-GaAs-AlGaAs creates a potential well for conduction electrons.

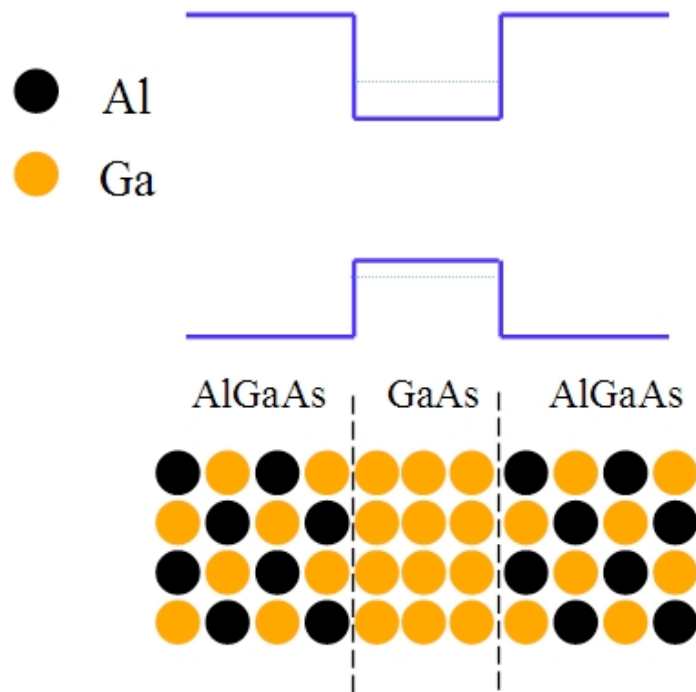

10-20 nm!

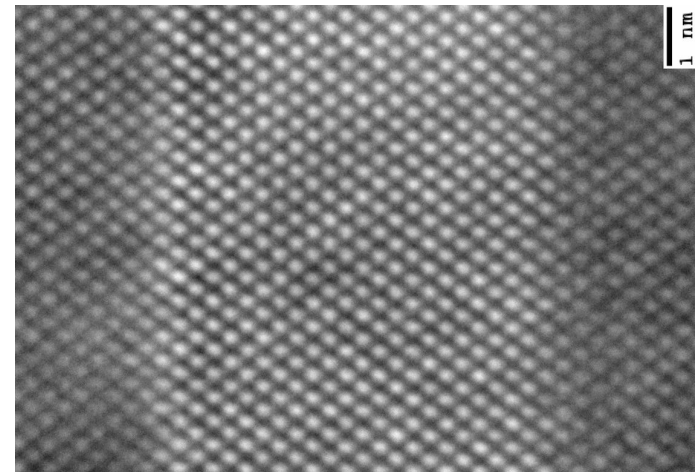

A conduction electron that get trapped in a quantum well acts like a PIAB.

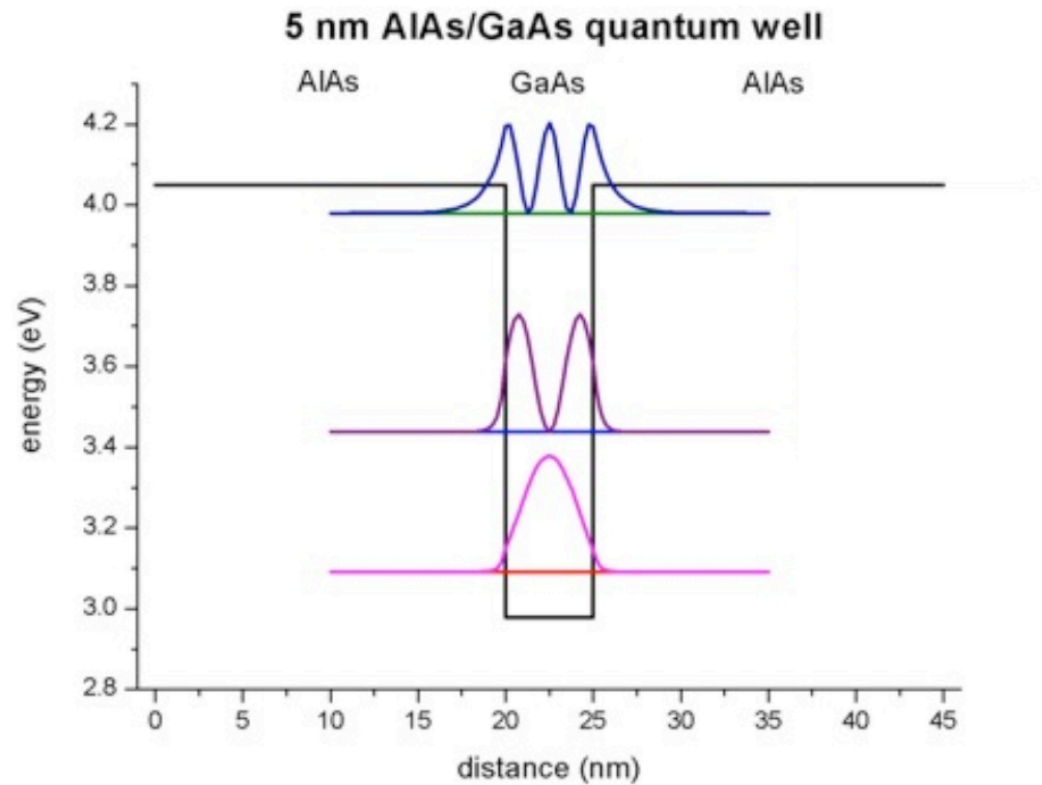
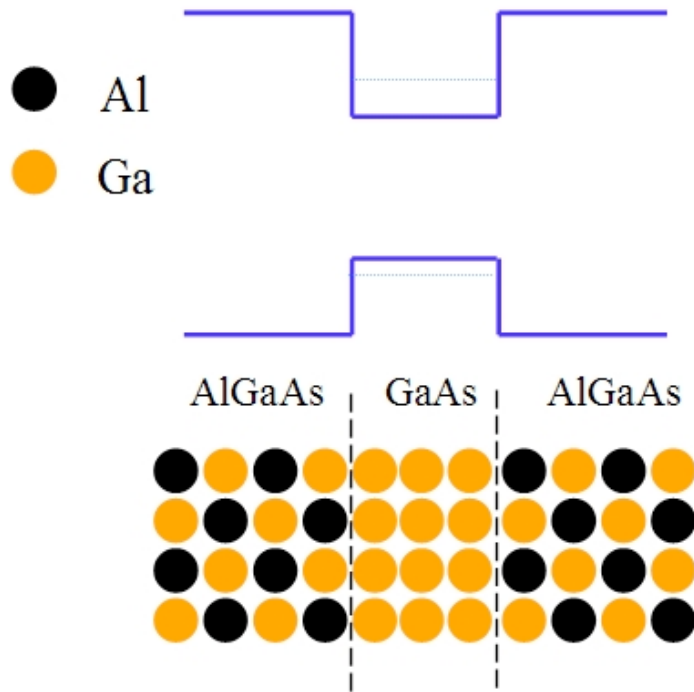

A conduction electron that get trapped in a quantum well acts like a PIAB.

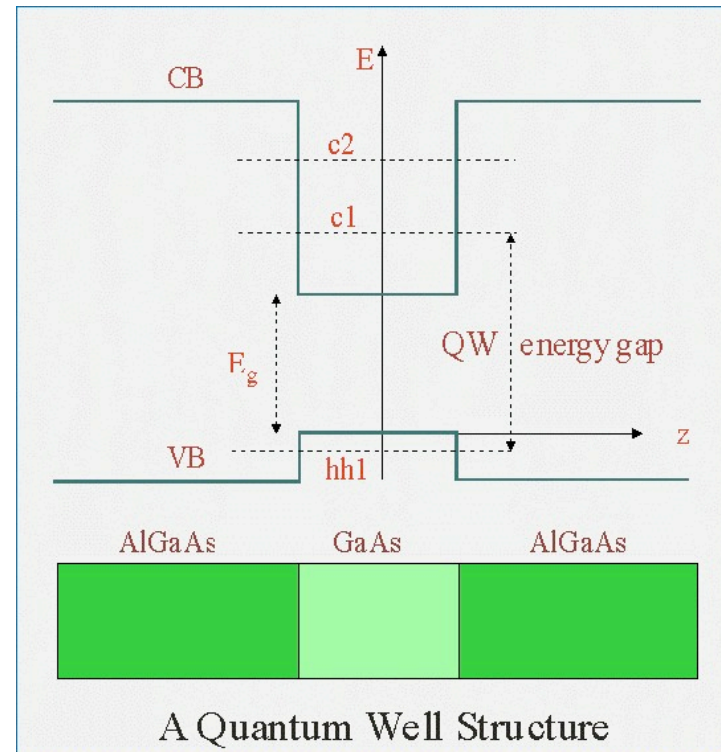
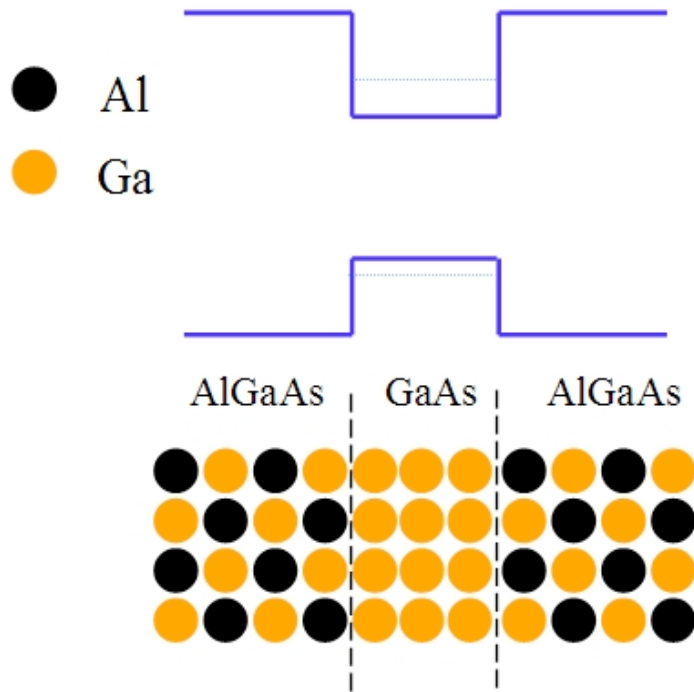

# Quantum Wells are used to make Laser Diodes

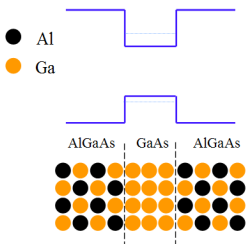
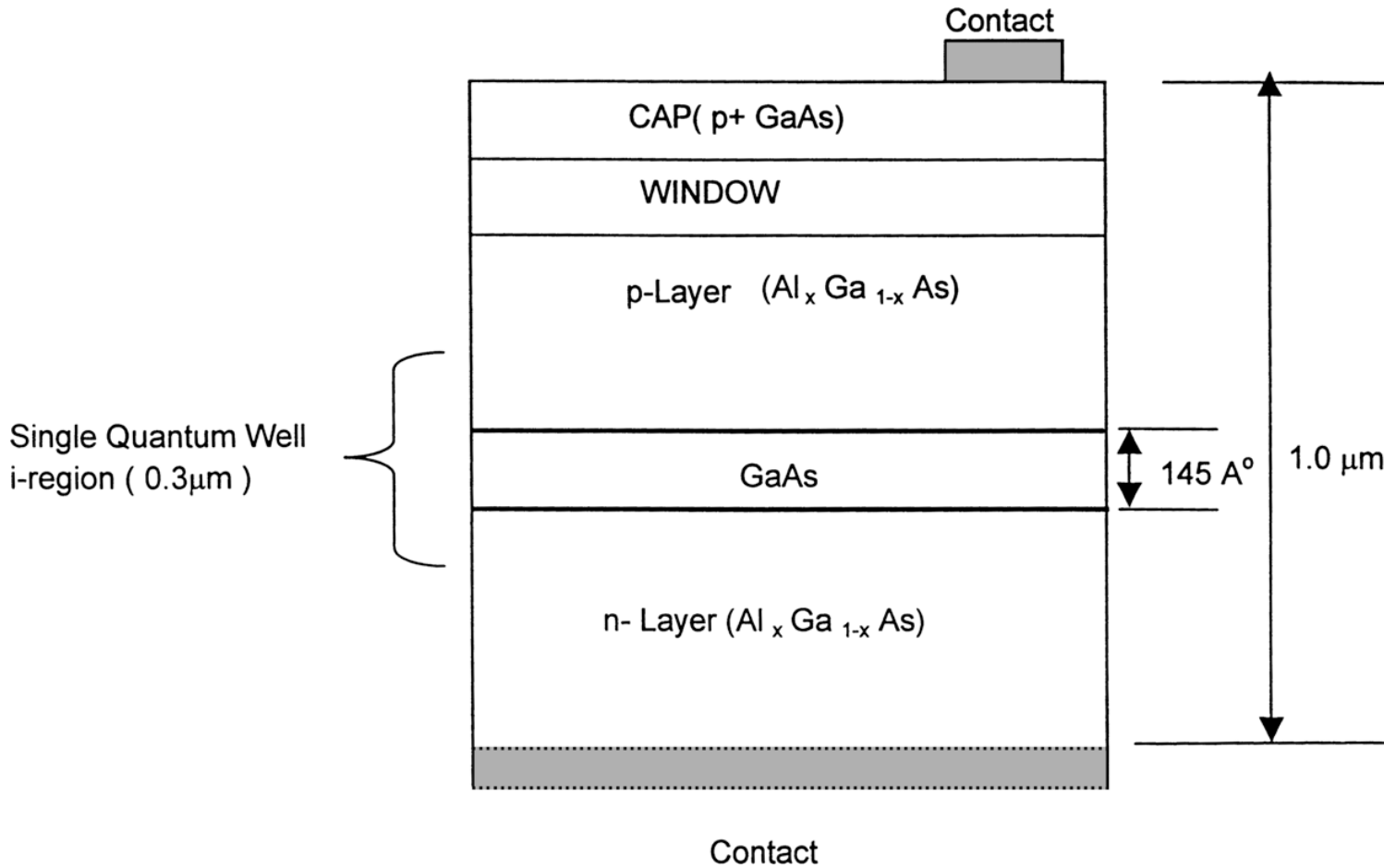

## Quantum Well Laser Diodes

# Quantum Wells are used to make Laser Diodes

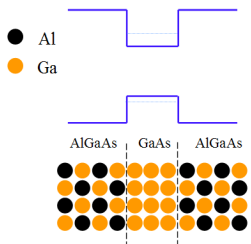
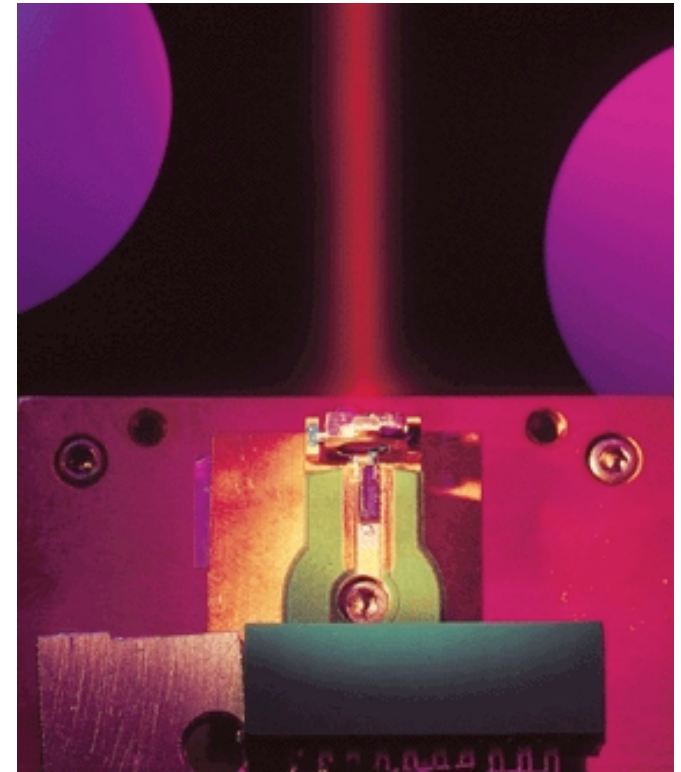
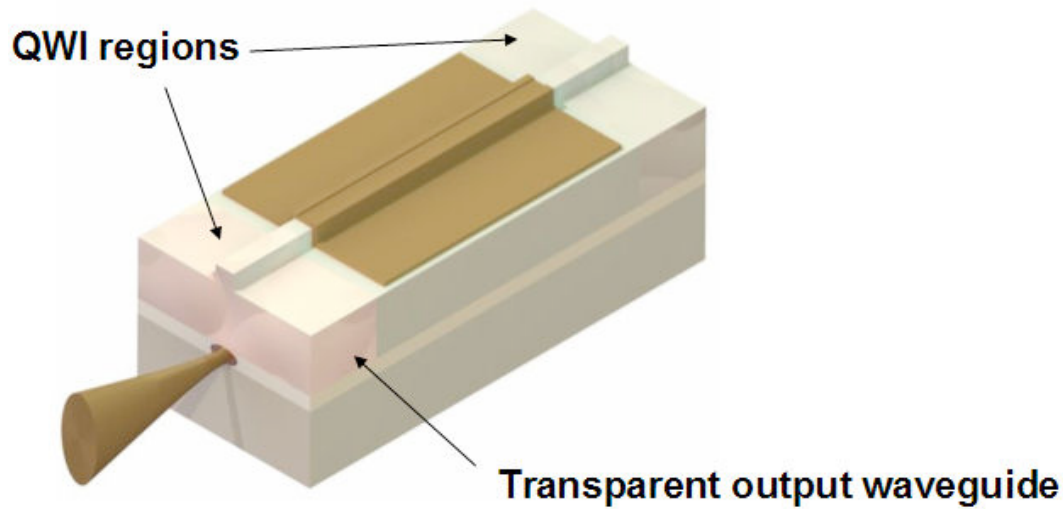

## Quantum Well Laser Diodes



# Multiple Quantum Wells work even better.

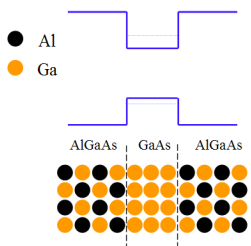
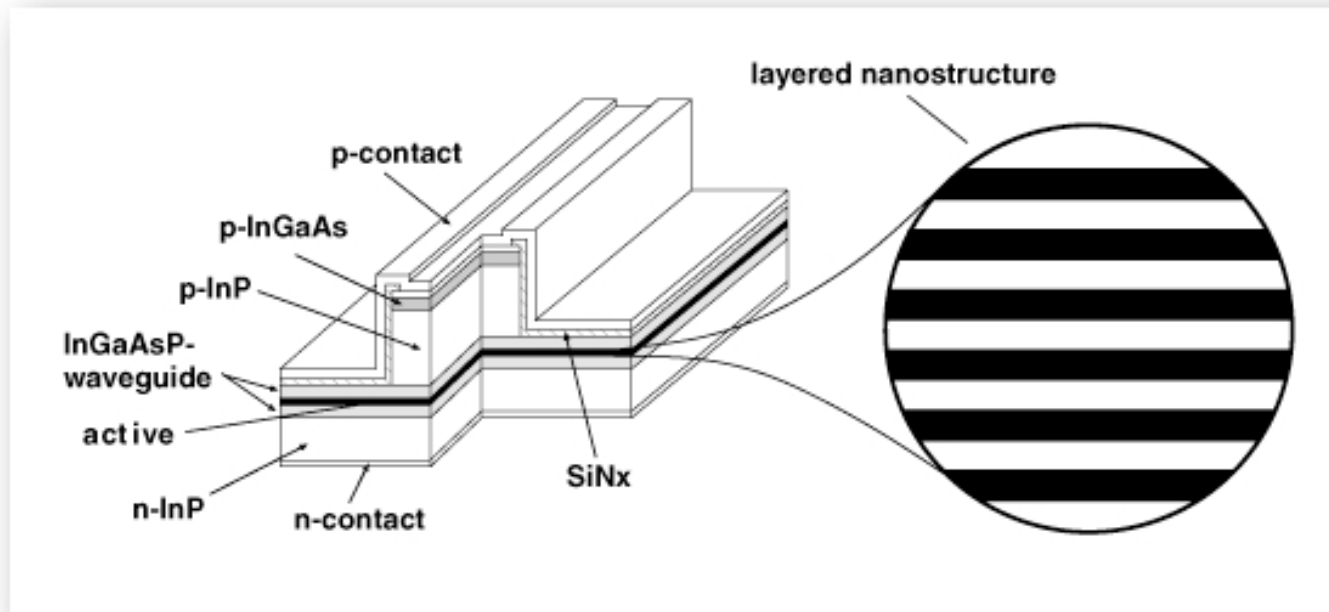

## Multiple Quantum Well Laser Diodes

# Multiple Quantum Wells work even better.

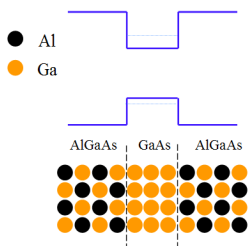
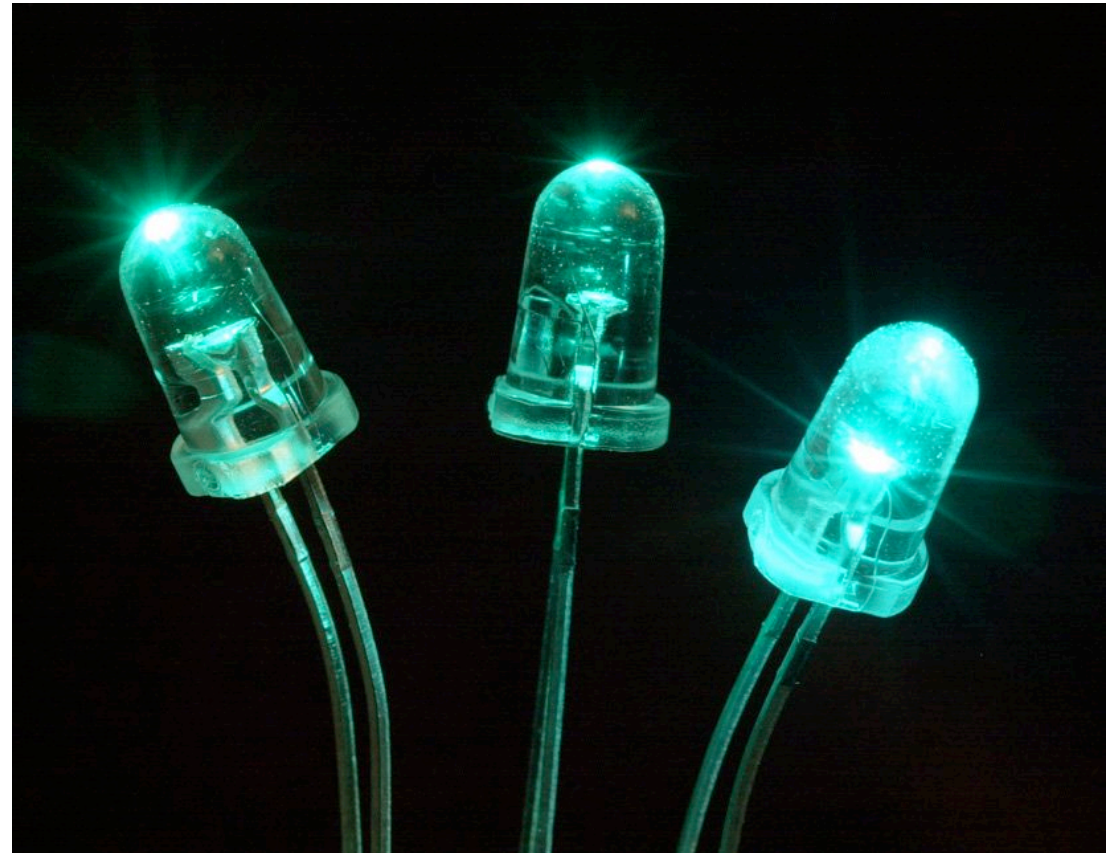
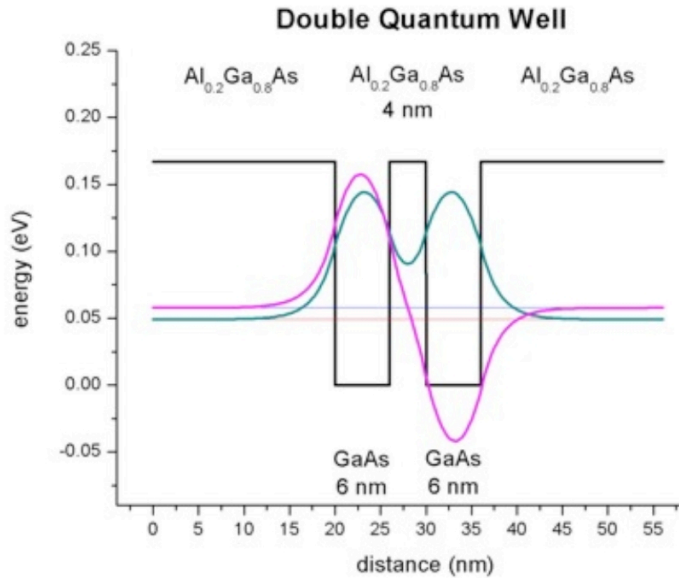

Multiple Quantum Well LEDs

# Multiple Quantum Wells work even better.

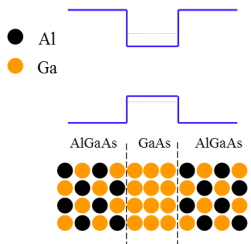

## Multiple Quantum Well Laser Diodes

# Multiple Quantum Wells also are used to make high efficiency Solar Cells.

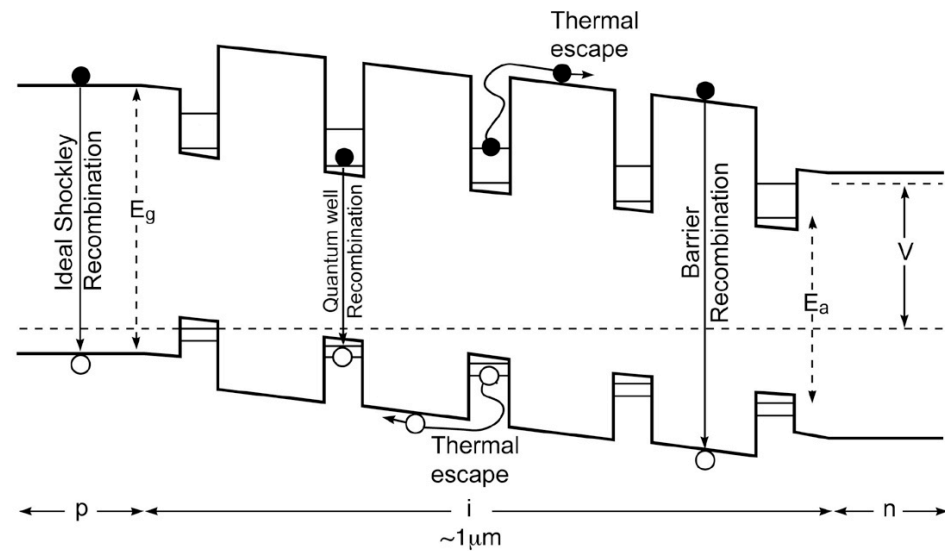
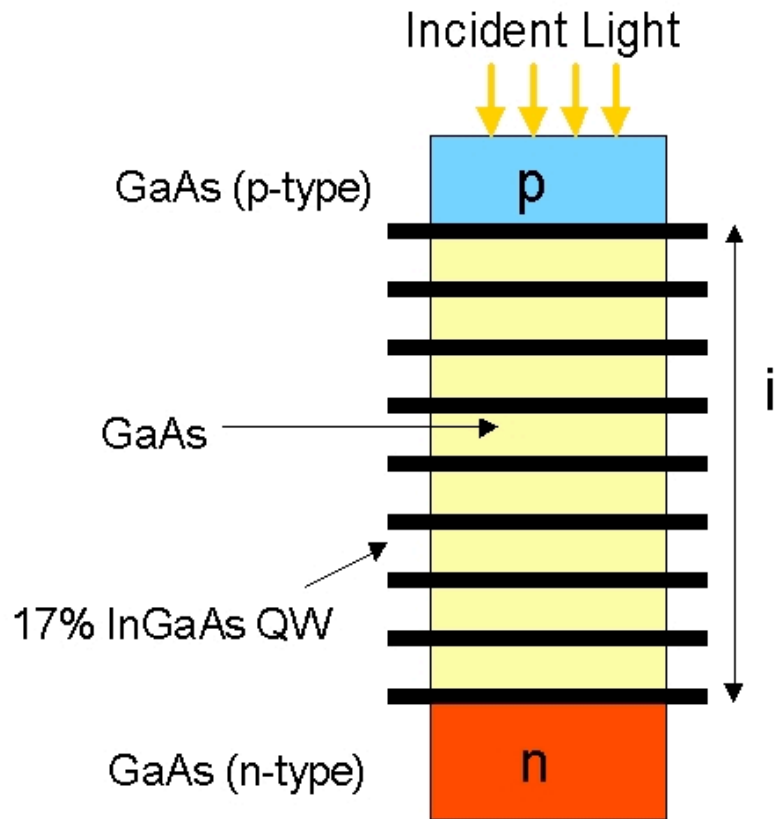

Quantum Well Solar Cells

# Multiple Quantum Wells also are used to make high efficiency Solar Cells.

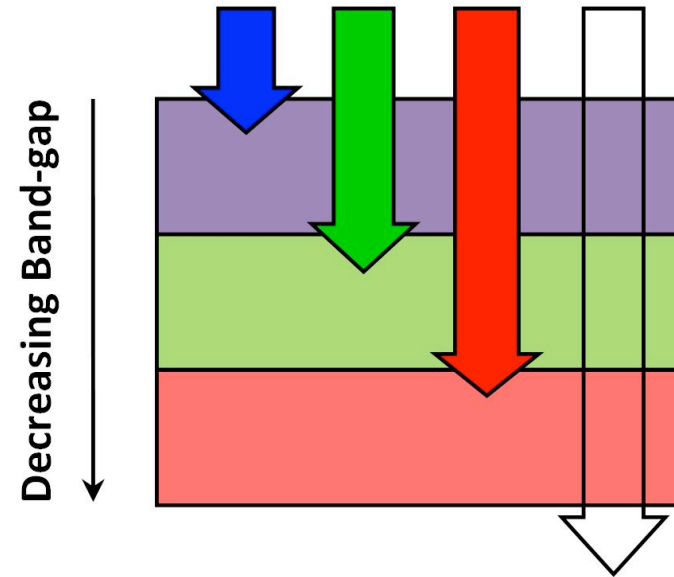
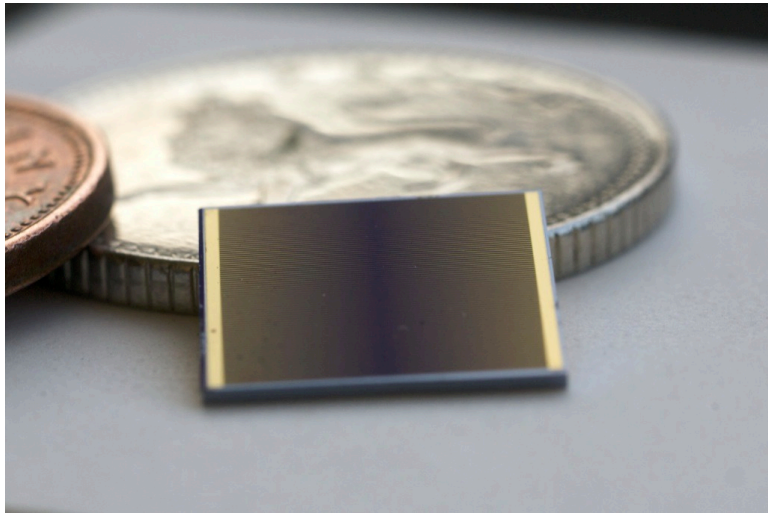

The most common approach to high efficiency photovoltaic power conversion is to partition the solar spectrum into separate bands and each absorbed by a cell specially tailored for that spectral band. This multi-junction approach requires careful control of the solar cell absorption bandwidth and we have pioneered an approach using quantum wells that enable us to optimally match our component junctions to the solar spectrum. The present world record efficiency using this approach is 41.1% set by the Fraunhofer Institute in Germany. Our best cell is 30.6% and we are working towards attaining 50% power conversion efficiency.

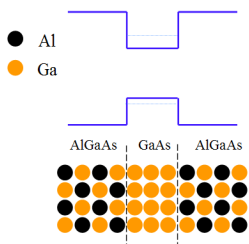

The Quantum Photovoltaic Group  
Department of Physics  
Imperial College London