

PHILIPS



Xitanium

LED indoor drivers

Spot & downlight,
Linear



Design-in Guide

Enabling **future-proof** **LED technology** for dynamic LED markets

May 2023

Published versions

26 June 2015 First version

Updated since previous version

Xitanium indoor drivers of Spot & downlight, Linear DIG 2023 version

Contents

Introduction to this guide	4		
Applications	4		
Information and support	4		
Determine which documents contain what information	4		
Safety precautions	5		
Safety warnings and installation instructions	5		
Introduction to Xitanium Indoor LED drivers	7		
Introduction	7		
Features	8		
Form factors	12		
Explanation of the driver naming	13		
Electrical design-in	15		
Xitanium Driver Operating window	15		
How to... Select an appropriate driver	16		
Driver wiring and connections	16		
Connectors	17		
Poke-in Connectors	17		
How to... Use wires and cables	19		
How to... Connect to a driver with JST connector	20		
on output	20		
Adjustable Output Current (AOC)			
– set the driver output current	21		
Default driver output current	21		
How to... Determine AOC priority with TD drivers	22		
How to... Set the output current via Rset	22		
How to... Set the output current via LEDset	24		
How to... Program the output current	29		
How to... Set the output current via DipSwitch	29		
Mains voltage fluctuations and behavior	29		
Inrush current	30		
How to... Determine the number of drivers on a MCB	31		
Surge protection	32		
Touch current	32		
Electromagnetic compatibility (EMC)	32		
How to... Improve EMI performance	33		
Electrical isolation and protective earth	34		
How to... Use these Indoor LED drivers			
as “independent” driver	35		
Thermal design-in	36		
Introduction	36		
Tc point	36		
		How to... Measure Tc at the Tc point	37
		Driver lifetime	37
		Module Temperature Protection (MTP)	37
		Mechanical design-in	39
		Dimension of nipple for track adapters	39
		RF design-in	40
		Introduction	40
		Independent application	40
		Build in application	41
		Controllability	42
		Control characteristics	42
		Trailing edge (TE)	43
		1-10V Dimming	44
		TD dimming: Touch and Dim & DALI	44
		Wireless control and dimming	46
		Non-dimmable	46
		Application guidelines	46
		Configurability	48
		Introduction	48
		Philips MultiOne Interface tool	48
		Philips MultiOne Software	49
		System requirements	49
		Getting Started	49
		Settings	50
		How to... See the programming taking effect	50
		AOC setting	51
		Module Temperature Protection (MTP) behavior setting	51
		Constant Lumen Output setting	52
		DCemDIM setting	53
		Corridor Mode setting	54
		How to... Set the DALI minimum dimming level	55
		Driver diagnostics (TD drivers only)	56
		Quality and Reliability	57
		Switching & cycling lifetime of LED drivers	57
		Electrical failures due to switching Vmains on and off	57
		Mechanical failures due to thermal cycling	57
		Compliance and approval	59
		System Disposal	59
		Disclaimer	60

Introduction to this guide

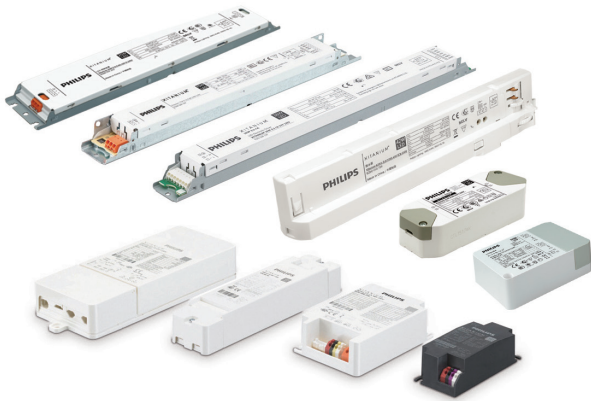

Xitanium Indoor LED drivers

Thank you for choosing Philips Xitanium drivers. In this guide you will find the information needed to integrate these drivers into a LED luminaire or LED system.

This edition describes the Xitanium LED drivers optimized for indoor lighting. We advise you to consult our websites for the latest up-to-date information.

Applications

The Xitanium LED drivers are designed to operate LED solutions for indoor lighting, like office, public buildings, retail, residential and consumer environments. If you use Philips LED drivers in combination with Philips LED modules, specific design-in guides are available from the below mentioned technology websites.

Information and support

Downloads and information

Please consult your local Philips office or visit:

www.philips.com/technology

www.philips.com/multiOne

Design-in support

On request Design-in support from Philips is available. For this service please contact your Philips sales representative.

Determine which documents contain what information. In order to provide information in the best possible way, Philips' philosophy on product documentation is the following.

- Commercial leaflet contains product family information & system combinations
- Datasheet contains the product specific specifications
- Design-in guide describes how the product is to be designed-in

All these documents can be found on the download page of the OEM website www.philips.com/technology. If you require any further information or support please consult your local Philips office.

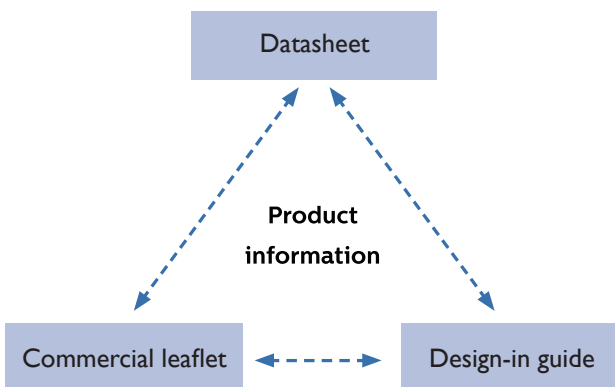

Safety precautions



Warnings:

- Avoid touching live parts!
- Do not use drivers with damaged housing and/or connectors!
- Do not use drivers with damaged wiring!
- Class I luminaires must be connected to protective earth!
- Switchable function to make the open load on the driver output is abnormal condition, it is not an intended application that be allowed.

Safety warnings and installation instructions

To be taken into account during design-in and manufacturing

- Do not use damaged or defective contacts or housings
- Do not use damaged products
- Do not service the driver when the mains voltage is connected; this includes connecting or disconnecting the LED load
- Cap off all unused wires to prevent accidental contact with the luminaire, driver housing or accidental touching
- Do provide an adequate earth connection when applicable
- The luminaire manufacturer is responsible for its own luminaire design and has to comply with all relevant safety standards
- The Xitanium Indoor LED drivers are intended for indoor use and should not be exposed to the elements such as snow, water and ice. It is the luminaire manufacturer's responsibility to prevent exposure
- For the strain relief installation, Crosshead PH-2 Screw is recommended to be used, recommended torque requirement for screw is 0.7~0.9 N.m.
- In case driver being used for the independent application, make sure to keep the driver dry, acidfree, oilfree, fatfree and at least 20mm distance from the body which is not the mounting surface to wall for the sufficient thermal dissipation and do not exceed the maximum ambient temperature (t_a) stated on the device
- For track drivers, due to different track types' size and tolerance, to ensure the connection between driver and track, please move the position on the track if the conductive is not good, track drivers are recommended to hang vertically, and it can withstand 50N force. After turning on the driver, please thumb the on/off wheel to 'on' position
- Lamp control gear relies upon the luminaire enclosure for protection against accidental contact with live parts

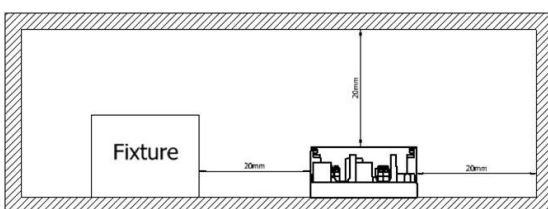

Special remarks about RCM certification:

There are three types of applications in Australia/New Zealand, "IC", "Do not Cover", and "Non IC".

Please refer to product label for details.

IC classification 

An independent controlgear that can be abutted against normally flammable materials, including building insulation, and can be covered in normal use. Building elements, building insulation or debris have restricted access to the heated parts of the controlgear.

Do-not-cover classification 

An independent controlgear that can be used where normally flammable materials, including building insulation, are or may be present, but cannot be abutted against any material and cannot be covered in normal use. The control gear is suitable to abut normally flammable materials and to be covered by insulation inadvertently.

Non IC classification (no mark)

An independent controlgear that cannot be abutted against or covered by normally flammable materials or used in installations where building insulation or debris is, or may be, present in normal use.

Philips Design-in support is available; please contact your Philips sales representative.

Introduction to Xitanium Indoor LED Drivers

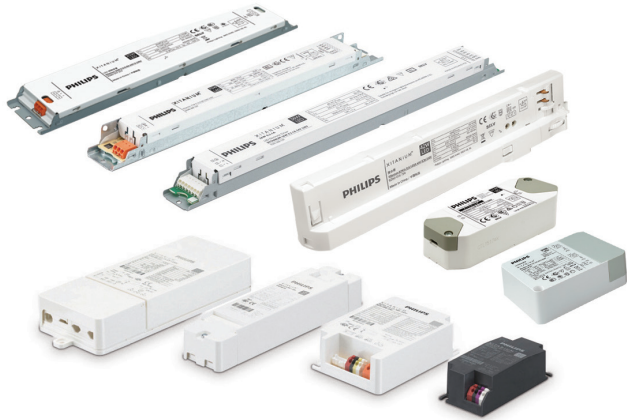

Xitanium Indoor LED drivers

Introduction

Xitanium LED drivers are designed to operate LED solutions for general lighting applications such as lighting in office, downlighting, spot/accent lighting and industry applications. Reliability is underpinned with 5 year warranty, enhanced by specific features that protect the connected LED module, e.g. reduced ripple current (<4%) and thermal de-rating. Most drivers feature central DC operation.

In the coming years LEDs will continue to increase in efficiency, creating generation and complexity challenges for OEMs. With Xitanium LED drivers, flexibility in luminaire design is assured thanks to an adjustable (selectable) output current. Application oriented operating windows offer the flexibility required to provide the stable lumen output and light quality levels that lighting specifiers and architects demand. And the adjustable output current also enables operation of various LED PCB solutions from different manufacturers.

The remarkable energy savings and CO₂ reductions achieved with LED lighting can be further extended with dimming. Xitanium Indoor LED drivers offer a range of dimming options. The 1-10V and TE interface allows for simplified, one-way management, while the DALI interface makes any installation with the Xitanium driver ready for a fully networked control system. Alternatively these Dali drivers also are suitable to interface with Touch and Dim dimming.

Xitanium LED driver versions

The Xitanium LED drivers described in this guide are available in different versions, e.g. both isolated and non-isolated versions, non-dimmable and dimmable (1-10V, trailing edge dimming (TE), Touch and Dim & DALI (TD)) and come in a wide range of power ratings that enable the most popular light output levels for general lighting applications. We recommend you always check our Xitanium LED driver commercial leaflet for the most up-to-date overview of our range. This leaflet can be found on the download section of www.philips.com/technology.

Features

Adjustable Output Current (AOC)

Flexibility in luminaire design is ensured by the adjustable output current (AOC). The adjustable output current enables operation of various LED configurations from different LED manufacturers whilst also ensuring the solution remains “future proof” for new LED generations. The output current can be set with an external resistor (Rset) in case this provision is there in the selected driver. With the TD drivers, the output current setting can also be programmed using the Philips MultiOne programming hardware interface and the matching software “MultiOne driver configurator”. Drivers with SimpleSet® functionality can be configured with the Philips MultiOne Software and the SimpleSet® interface.

More information about AOC and how to set the output current can be found in the chapter “Electrical design-in”. Information about configuring drivers with SimpleSet® can be found in the chapter “Configurability”.

Controllability

The Xitanium Indoor LED drivers are available in 3 different versions:

- Non-dimmable
- 1-10V dimming (available for linear drivers)
- Trailing edge dimming (TE, available for Spot & downlight drivers)
- Touch and Dim & DALI (TD)

Amplitude Modulation (AM) output dimming

Philips Xitanium indoor LED drivers dim the output to the LEDs by means of Amplitude Modulation dimming (AM). This means at no stage of the dimming range Pulse Width Modulation dimming (PWM) at the output to the LEDs is involved. AM dimming guarantees the most smooth and flickerfree operation over the entire dimming range.

The way of controlling is shown in the name of the driver. If no dimming protocol is given in the name, the Xitanium driver can only be used as a nondimmable driver. The output current can be set as described in the Electrical design chapter. More information about the dimming protocols can be found in the Controllability chapter.

Active cooling (available for Spot & downlight drivers)

Selected Xitanium LED drivers feature a 12V output to operate active cooling. Please check the datasheet at www.philips.com/technology to know if the selected driver has this feature.

Thermal de-rating

Thermal de-rating of your LED is possible by integrating an NTC (Negative Thermal Coefficient) component on the LED PCB (Printed Circuit Board) and connecting this NTC to the driver's NTC input.

More details about NTC resistor can be found under chapter "Thermal Management".

Hot wiring

Some of Xitanium Indoor drivers within the statement and performance segments can be serviced, connected or disconnected from the LED load when the mains voltage is connected. Please make sure that all electrical safety regulations are followed when working on a Xitanium driver while powered.

Module Temperature Protection (MTP) – adjustable on TD drivers only

This feature helps to protect the LEDs when operated in a hot ambient environment. The driver helps to regulate LED module temperature by regulating the output current. An NTC (Negative Temperature Coefficient resistor) must be present on the LED module and connected to associated pins on the driver in order to be able to make use this feature. Programmable drivers allow the dimming behavior to be changed.

More information on this feature can be found under chapter "Thermal Management".

Constant Light Output (CLO) – TD drivers only

Traditional light sources suffer from depreciation in light output over time. This applies to LED light sources as well. The CLO feature enables LED solutions to deliver constant lumen output through the life of the light engine. Based on the type of LEDs used, heat management and driver current, it is possible to estimate the depreciation of light output for specific LEDs and this information can be entered into the driver. The driver counts the number of light source working hours and will increase output current based on this input to enable CLO.

Since the CLO curve is not generic, the OEM needs to determine the appropriate CLO curve. This can be used to differentiate on e.g. lumen output or power consumption over lifetime. The CLO feature can be programmed with the Philips MultiOne configurator software.

More information can be found under chapter “Controllability”. More information can be found on www.philips.com/multione.

DC mains operation

It is possible to connect the mains input of the Xitanium driver directly to a DC power net (e.g. central emergency system). This leads the driver to continue normal output when switched to DC mains. On selected TD drivers DCemDIM is available, allowing a pre-defined dim level (%) of the driver’s output when switched to DC. More on DCemDIM in section Controllability.

Check for requirements and default values the driver’s datasheet in the download section on www.philips.com/technology.

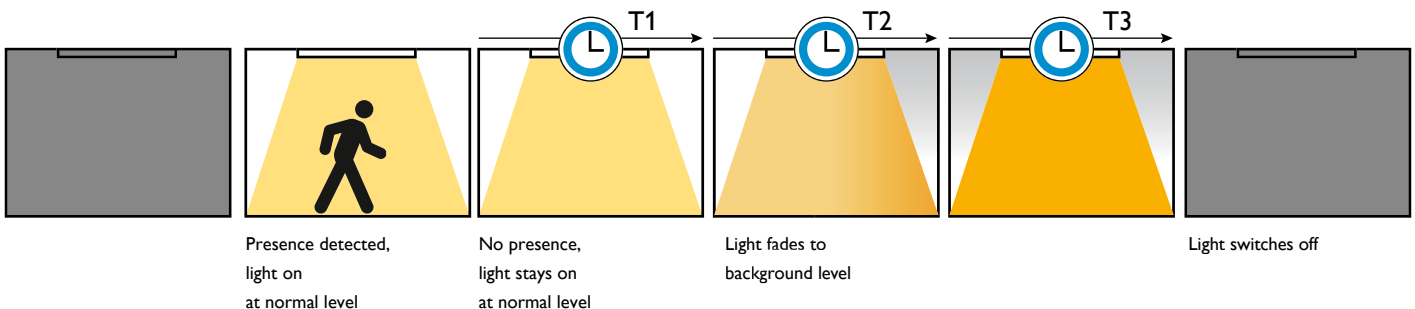

Corridor Mode – TD drivers only

Corridor Mode is typically used in corridors, stairwells, entrance halls, storage rooms, underground car parks, pedestrian underpasses, underground railway stations and lifts. It is a simple function, available with Xitanium indoor TD LED drivers, that controls the light level when presence is detected by a simple on/off mains sensor. It is easy to use and can be activated using default parameters, so no programming via software is required. When the sensor detects presence, the light switches on. When it no longer detects any presence, instead of the light switching off immediately, the TD driver takes over control of the light level and dims it down to a background level. The settings can be customized using the Philips MultiOne configurator software.

How does it work?

A simple on/off mains sensor (e.g. PIR or micro wave) provides the signal and is connected to the Touch and DIM/DALI connection of the TD driver. When the input detects mains power on the DALI connection, it switches on the light to the normal level. When the mains signal of the sensor is switched on for more than 1 minute (default activation time), the TD driver goes into Corridor Mode.

When the on/off sensor no longer detects any movement, it goes into its delay time. After the delay time of the on/off sensor has elapsed, the TD driver no longer receives a mains signal on the DALI input and takes over control of the light level by going into its Corridor Mode sequence:

1. During the delay time the driver maintains the light at the normal level
2. During the fade time the driver dims the light to the background level
3. During the prolong time the driver maintains the light at the background level, after which the light is switched off.

If the on/off sensor detects movement at any point during the Corridor Mode sequence, the light will revert to the normal level.

Newly released Xitanium indoor TD drivers incorporate the Corridor Mode feature. The datasheet states if for the driver you use this feature is present. For the default settings please check the associated datasheet of the driver you use, to be found in the download section on www.philips.com/technology.

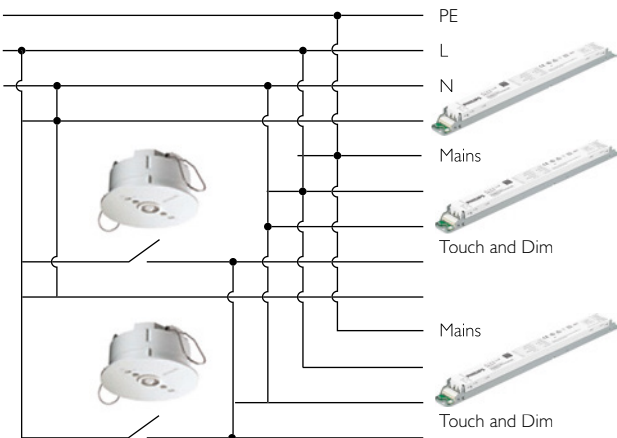

Connecting a sensor to the Dali input to utilize Corridor Mode

The settings can be customized to suit your application using the Philips MultiOne configurator software (see sub section “Programming” under “Controllability”).

Driver diagnostics (actual measurements and logging)

– TD drivers only

On selected TD drivers the diagnostics functionality is available. The purpose of Diagnostics is to gather information and help diagnose the history of the driver and connected LED module. The diagnostics consist mainly of counters which keep track of specific variables like for example the number of startups of the driver; temperature of driver and LED modules, current and voltages etc.

When the driver is shutdown the diagnostics data is stored automatically.

Form factors

Linear housing

The housing of the Xitanium Indoor Linear LED drivers has a form factor compatible with typical fluorescent driver housing design.

The linear housing design (LH)

The linear housing design incorporates three different mounting options:

- Independent
- Screw
- Click mounting.

Screw-mounting and Click-on parts are assembled within the independent housing

The square independent housing design (SH)

The square independent housing is equipped with a 12V power output for active cooling, strain relief possibility for all cables and loop through functionality for the mains wiring.

Small housing design (/s)

The “/s” is the most compact Xitanium form factor within the performance segment. It has a form factor identical to the Philips HID-PrimaVision driver; enabling an easy transformation of your luminaire from HID to LED.

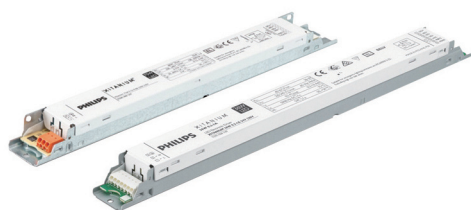
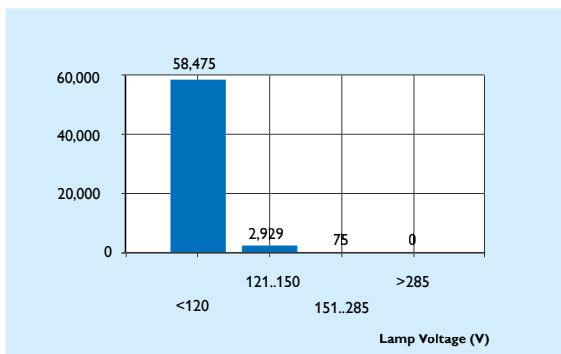

Linear driver Form Factor



LH Form Factor: 3 mounting options
From left to right: Independent, Screw, Click mounting



SH Form Factor



/s Form Factor

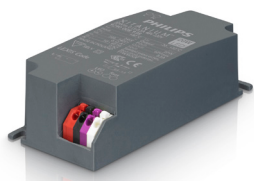

/m size



Strain relief blocks for the /m driver for independent application

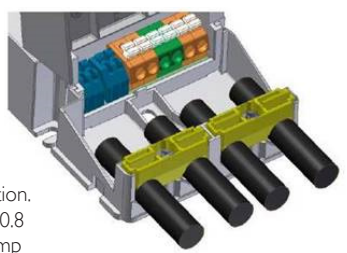

Strain relief blocks for the WH driver for independent application. Screws must be fastened with 0.8 ... 1.2Nm torque. The cable clamp supports cable diameters between 6 ... 10mm.



Potted Independent Form Factor

Mini housing design (/m)

The /m driver has a size which is exactly the same as the Philips HID-PrimaVision Mini driver; thus helping you to easily transform your luminaire from HID to LED. This driver can be adapted for use in independent applications by the use of a strain relief cap that can be ordered separately, as an accessory. This will ensure that the driver is thermally protected and safe to use in ceilings.

Note: This strain relief accessory cannot be used with the 50W/m driver with Rset functionality (Xitanium 50W/m 0.7-1.5A 48V 230V, 12NC: 9290 009 34606) and Simple Set functionality (Xitanium 50W/m 0.7A-1.5A 54V 230V, 12NC: 9290 014 15306). When using the strain relief caps along with the Mini DALI driver (in independent applications), please ensure that the diameter of the DALI cable and the mains cable is the same.

Note: The Mini driver (all /m versions) with strain relief caps in independent application needs to be placed on the ceiling plate such that the bottom of the assembly is completely covered by the supporting surface after installation.

The potted independent housing design

These potted drivers have Form Factor for single output and stand-alone installations.

Explanation of the driver naming

The names of the drivers are defined as shown in the example below.

Example of linear drive

- Xitanium : Brand name for highly efficient and extremely reliable LED drivers
- 75 W : Maximum output power
- 0.12-0.4 A : Output current range
- 215 V : Maximum DC output voltage
- TD : Dimming protocol (Touch and Dim & DALI)
- 230 V : Mains AC input voltage

Example of point driver

Xitanium	: Brand name for highly efficient and extremely reliable LED drivers
17W	: Maximum output power
LH	: Linear Housing
0.3-1A	: Output current range
24V	: Maximum output voltage (minimum being~50% of this value)
TD	: Dimming protocol (Touch & Dali)
/I	: Independent housing design
s	: Small version
230V	: Mains AC input voltage

Naming of the drivers

I	: Independent housing design
TE	: Trailing edge dimming
TD	: Touch & DALI dimming
/s	: Small housing
SH	: Square independent housing
LH	: Linear independent housing
/m	: Mini housing (HID-PrimaVision mini form factor)

Electrical design-in

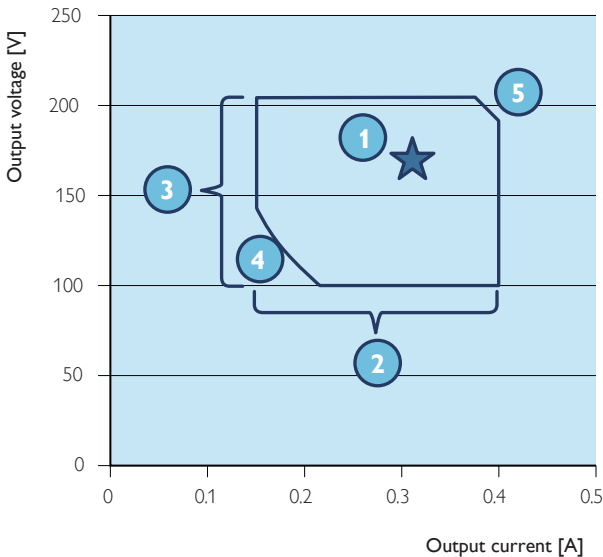

1. Required set point for the LED solution
2. Current can be set to needs within range
3. Driver adapts to required voltage, given it fits range
4. Driver minimum power limit
5. Driver maximum power limit

Example of a Driver Operating Window

Note: by means of dimming it is possible to go below the minimum value of the specified output current.

Xitanium Driver Operating window

LED technology is rapidly evolving. Using more efficient LEDs in a next generation means the same light output can be achieved with less power, hence lower drive currents. At the same time, LEDs can be driven at different currents levels based on the application requirement. Typically, LED drivers are available in discrete current levels e.g. 350 mA, 500 mA or 700 mA. It is often necessary to replace a driver when more efficient LEDs or different LED boards become available.

One of the key features of the Xitanium LED drivers is the adjustable output current (AOC), offering flexibility, differentiation for the OEM and futureproof luminaire design. The Xitanium drivers can operate in a so called "operating window". This power window is defined by the maximum and minimum voltage (V), current (A) and power (W) that the driver can handle. An example of an operating window is shown on the left. The area indicates the possible current /voltage combinations. The current you select will depend on the type and manufacturer of the LEDs, the specific LED configuration of the PCB design and the desired output (lm) per LED. The voltage is the sum of the LEDs used (total Vf string). Both the operating window and default current setting of every driver can be found in the datasheets in the download section on www.philips.com/technology.

The output current of these drivers can be set in two ways.

1. By connecting a specific resistor value to the driver's Rset input.
2. Drivers with SimpleSet® functionality can be configured using the Philips MultiOne software and SimpleSet® interface.
3. TD driver versions can be programmed via the MultiOne interface in order to set the desired current, more information can be obtained at www.philips.com/multiOne.

* Note: when connecting Philips LED Lines to the driver, the type of LED board (LV or HV) determines this requirement. Hybrid LED boards can be used on both type of drivers, indicated in commercial leaflet LED Lines, to be found in the download section of www.philips.com/technology

** Note: for Philips LED Lines standard system configurations, driven at nominal current, are stated in the commercial leaflet LED Lines, to be found in the download section of www.philips.com/technology

Note: for a HV scenario that allows a 2 chain parallel solution, you are likely to find with steps described a lower rated driver power (e.g. 75 W for 1 chain versus 36 W for 2 chain solution)

How to... Select an appropriate driver

Depending on your requirements several drivers can be found as a solution for you. The following steps can help selecting the preferred driver:

For a full overview of available driver models, please refer to the commercial leaflet Xitanium indoor LED drivers, to be found in the download section of www.philips.com/technology, as are the datasheets associated with the drivers you intend to use.

1. Determine your required drive current (I_{drive}) and voltage (V_f)
2. Calculate required power via $P_{drive} = V_f \times I_{drive}$ (W)
3. Determine which type* of driver do you need; Isolated or Non-isolated Collect the associated datasheets from the website.
4. Does required current fit current range of driver?
- $I_{driver\ minimum} \leq I_{drive} \leq I_{driver\ maximum}$
5. Does required voltage fit voltage range of driver?
- $V_{driver\ minimum} \leq V_f \leq V_{driver\ maximum}$
6. Does required power fit power range of driver?
- $P_{driver\ minimum} \leq P_{drive} \leq P_{driver\ maximum}$
7. Choose your type** of dimming (TD/Dali, 1-10V or non-dimmable)

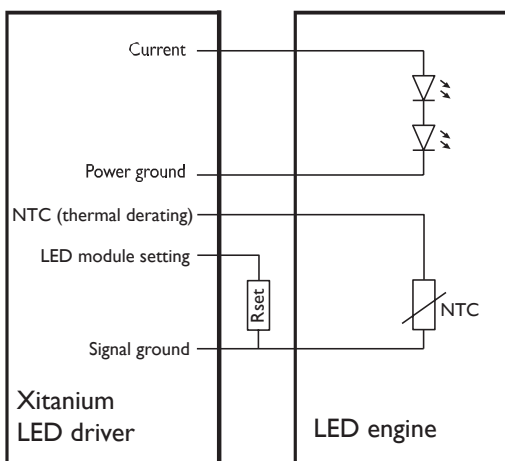

Schematically representation of the driver's output interfaces

Driver wiring and connections

Examples of driver lead wires with corresponding functions can be seen in the figure on the left. Please check the driver's pinning in the associated datasheet on www.philips.com/technology. The function of each wire will be discussed further in detail in the following chapters.

Single channel driver

Currently all the Xitanium Indoor LED drivers are single channel drivers. This means for drivers with a double "+" and "-" output that these outputs are in parallel inside the driver. So you can only set one current.

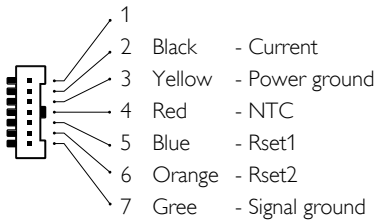

JST connector (driver side) pin layout



JST connector with soldered rse

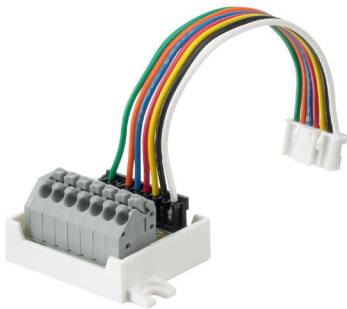

Example of the JST to Push-in adapter



Poke-in Connectors

Connectors

Different connectors are used on the Philips Xitanium Indoor drivers. More info about the type of connector and wiring (diameter, length, etc.) can be found in the datasheet. The datasheets of each driver can be downloaded via www.philips.com/technology.

JST Connectors

Some of the Xitanium LED drivers feature a JST connector that combines the power connection to the LEDs with the Rset or NTC features. The pin layout for this connector is shown on the left. In case a JST connector is to be used to set the current via an Rset, there are 3 options:

1. Use a JST connector with a resistor soldered on to pins 6 and 7 for Rset2 and pins 5 and 7 for Rset1.
2. Use a JST-poke-in adaptor
3. Integrate the resistor into the cable running from the driver to the module (valid for modules that have cables connecting the JST connector of the driver to the module). In this case, the resistor must be integrated into the wire connecting the appropriate pin for Rset 1, Rset 2 or LEDset.

Poke-in Connectors

Some Xitanium LED drivers feature poke-in connectors on the input and output side of the driver for ease and flexibility.

Note: All new drivers and modules are moving away from such connectors towards poke-in options. Please refer to the driver (and module) datasheet at www.philips.com/technology for details on the type of connector available. In case a choice is made to use a driver with a JST connector and a module with poke-in connectors, there are special cables available to allow for this. More information can be seen in the datasheets of the modules or you can contact your Philips representative.

Mains Connectors

Orange push-in connectors are used to connect the drivers to the mains. The connector for PE is colored green (if present). The Xitanium drivers with the SH form factor have 2 connectors for each mains connection to enable loop through functionality.

DALI – Touch Dim Connectors

Blue push-in connectors are used to connect the DALI or Touch Dim connection wires to the Xitanium driver.

Connection details in the case of poke-in connectors

The connections for the mains, 12 V output and the Rset are done using a poke-in connector for selected drivers. Please keep in mind the following while making the connection:

- Make sure to push in the springs before inserting the wires in order to ensure a good connection.
- While connecting the resistor, please refer to the picture shown. The resistor must be inserted such that there is no possibility of a short.

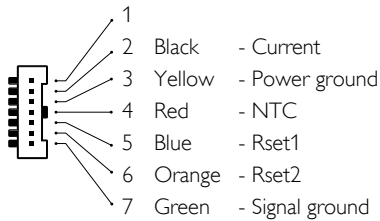
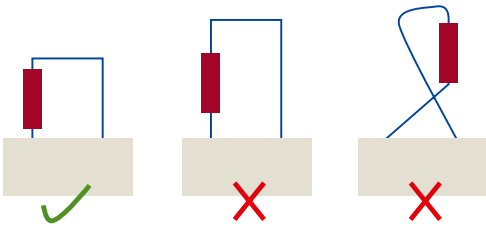

JST connector (driver side) pin layout 75 W & 110 W

Special attention for 75 W and 110 W Xitanium LED drivers

Due to the higher output voltage (>100 V) of these LED drivers more creepage/clearance distance is required for safety reasons. The + terminal of the LED driver output current has therefore been moved from pin 2 to pin 1.



Examples of what solutions could look like for pairing wires

How to... Use wires and cables

In the datasheet of the driver you use it is stated what

- Wire diameters are accepted
- Strip length of the wires are accepted
- Up to what wire length the drivers are tested on EMC

Direct wiring between driver and LED boards

Be informed that no components are allowed between the LED driver and LED boards other than connectors and wiring intended to connect the LED driver to the LED board. For example it is not allowed to install a switch between the driver and LED boards.

2 wires into one connector hole

In some scenarios two wires need to be connected to one connector hole. In this case the pairing has to be done outside the driver, resulting in only one wire going into the driver. Two wires into one connector hole are not supported.



Ferrules

The reliability of twin-wire ferrules (or wire end stop), accepting the wires intended to use, should be checked with the supplier of these ferrules.

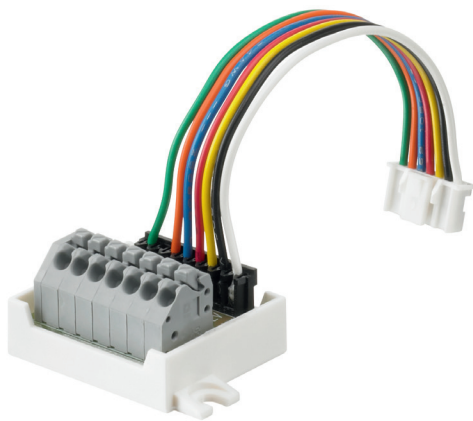

Example of the JST to Push-in adapter

How to... Connect to a driver with JST connector on output

Some Xitanium Indoor LED Drivers carry a JST output connector (non-isolated models only). Until these drivers get updated with a push-in connector be advised to use the JST-to-push-in adapter.

1. Connecting the LED board to the adapter

On the adapter IDC HV (+) and PGND (-) are indicated (pin 1 and 3).

Connect IDC HV (+) to LED board IN+, PGND (-) to LED board IN-.

2. Placing the Rset component into the adapter

- Rset2: place resistor into Rset2 connections (SGND and ISET2, pin 7 and 6).
- Alternatively, when using Rset1: place resistor into Rset1 connections (SGND and ISET1, pin 7 and 5).

3. Wire diameters accepted by the adapter

- AWG 24-16
- 0.2-1.5 mm² solid and stranded
- 0.25-1 mm² with ferrule
- Lead wires of the resistor component

Ordering information can be found in the Commercial Leaflet of the Xitanium indoor LED drivers, located in the download section on www.philips.com/technology.

JST cable developed by OEM

Any luminaire design needs its own approval, organized by the responsible OEM, irrespective of the length of cable used. If you prefer to develop a JST-cable the specification should meet IEC/EN requirements. When selecting wiring, it must be borne in mind that the cable must not emit hazardous gases or catch fire when exposed to high temperatures (e.g. PVC, Halogen).

The following cable/connector specifications can be used, using a JST connector:

- housing JST PAP-07V-S
- contact JST SPHD-001T-P0.5
- diameter of the cable: 24AWG

Pin	Color	Function
1	White	IDC HV (+) (LED +)
2	Black	IDC LV (+) (not used for linear)
3	Yellow	Power Ground (-) (LED -)
4	Red	NTC
5	Blue	Iset1 (Rset1)
6	Orange	Iset2 (Rset2)
7	Green	Signal Ground (for NTC & Rset)

Adjustable Output Current (AOC) – set the driver output current

Output current can be set by placing an external resistor (LEDset and Rset) into the driver's Rset input. Next to that TD driver versions allow also setting of the output current via software configuration.

Note: Rset is used as generic indication for Rset1, Rset2 or LEDset.

Note: LEDset and Rset-interface are not meant to be used as a control or dimming interface (for instance 1...10V). If this is not observed, both performance and safety requirements of the installation may be affected.

Default driver output current

Because of safety requirements Philips decided to structurally implement the minimum output current as default setting for Philips' LED drivers. In addition the LED driver will go into a safe state if the Rset resistor is not functioning well (e.g. broken or disconnected). However, as a result of the LEDset standard the default minimum is not an absolute minimum current anymore. For instance, for linear LED drivers a minimum of 120mA will now become $\leq 120\text{mA}$. Reason for this specification (" \leq " means 'equals or less than') is to allow thermal derating functionality on the LED module, which is part of the new LEDset standard. An 'open' situation (no resistor placed) should therefore be avoided.

In case the LEDset connections are being short circuited, the output of the driver will go to the maximum output power (Pout-max). In this case the required Vf of the LED load defines if at Pout-max also the maximum output current (I-max) is reached. The accuracy in this situation is less than when using a resistor to select and set the output current. An excess in this case are the non-isolated 36W and 75W Fixed Output drivers, potentially reaching up to 133% I-max (530mA).

Strong advice is to always use a well-connected resistor, which will result in a well-defined output current.

		Programming enabled	
		Yes	No
I_{nom} = Programmed value	Rset connected		
	Yes	No	
	I_{nom} = Rset Determined value	I_{nom} = $I_{default}$	
Driver output current I_{nom} should always be			
$I_{driver\ min} \leq I_{nom} \leq I_{driver\ max}$			

Priority selection criteria for Group 1 - 1% minimum dim level

How to... Determine AOC priority with TD drivers

Since the TD drivers allow two methods to set the output current (AOC), it is good to take note of the priority of each method with respect to the other:

Historically there are two groups of TD drivers; those which can dim down to 1% (newer) and those which can dim down to 10% (older).

Group 1: 1% minimum dim level (newer drivers)

AOC programming has priority over Rset. For the priority selection criteria see table on the left.

Group 2: >1% minimum dim level (older drivers, 5% or 10% minimum dim level)

The value that sets the lowest current has priority over the other:

1. $I_{programming} < I_{Rset} ? \Rightarrow$ priority for $I_{programming}$
2. $I_{Rset} < I_{programming} ? \Rightarrow$ priority for I_{Rset}

E.g. programming 200 mA has priority over Rset which would generate 250 mA.

And Rset that generates 200 mA has priority over programming 250 mA.

Note: default current is stated in the driver's datasheet in the download section on www.philips.com/technology.

How to... Set the output current via Rset

Your lumen, your current

1 resistor value generates 1 current only at all window drivers as long as it fits within the driver window.

That is 1 philosophy for all window drivers.

Why a resistor?

- a) Worldwide standardized building block
- b) Worldwide availability and well documented
- c) Freedom for OEM to choose the value and supplier

Resistor placed into driver enables you to

1. Connect different configurations, not just a unique solution
2. Drive different type of LED boards, not restricted to one type
3. Select and tune the current, hence flux or T_c

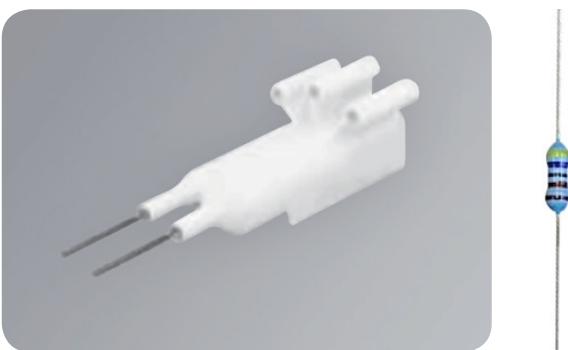

Example of a Set'n'drive resistor featured by BJB, fitted with a leaded resistor inside and allowing both manual or robot placement

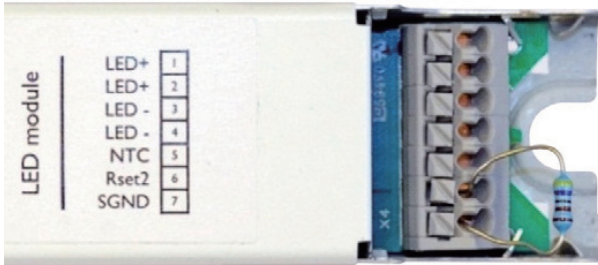

Example of an Rset2 resistor placed into an isolated driver

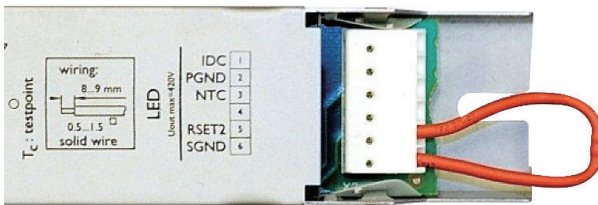

Example of an insulated Rset2 resistor into a non-isolated driver

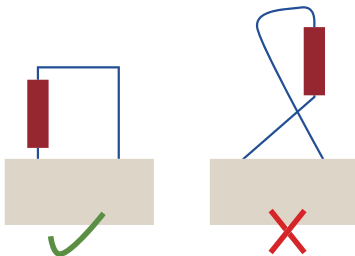

Resistor characteristics

By making use of a resistor component with a determined Ohm value you can set the required current for your LED module. This component can be a leaded standard 1% tolerance resistor of e.g. 0.125 W or 0.25 W, 50 V. Rset will not be part of the electrical chain driving the LEDs, meaning it does not dissipate power. However, make sure it does not come into contact with the driver's housing. For safety reasons with non-isolated drivers the resistor must be insulated. Advice is to always insulate the resistor.

Examples of a resistor placed into the drivers' input is shown on the left.

Different Rset resistors are utilized in the Indoor LED driver portfolio;

- Rset1 (older drivers); allows output current setting up to 700 mA
- Rset2; allows output current setting up to 2000 mA
- LEDset; industry standard, allows current setting up to 8000mA In all documentation.

Rset may refer to Rset1, Rset2, or LEDset depending on the driver type. Please check the driver datasheet for which Rset the driver you use reads.

Note: While inserting the resistor, please refer to the image on the left. The resistor must be inserted such that there is no possibility of a short caused by the leads. Especially when using non-isolated drivers, make sure the leads of the resistor are insulated. This way they cannot generate a potential safety risk, nor can they trip the earth leakage circuit breaker.

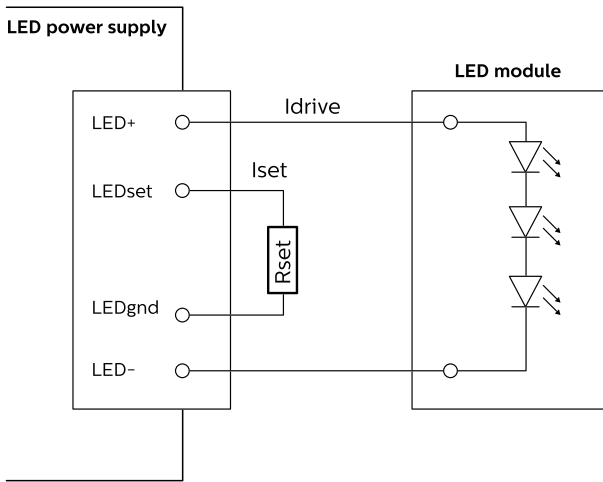

Rset resistor mounted directly onto the driver

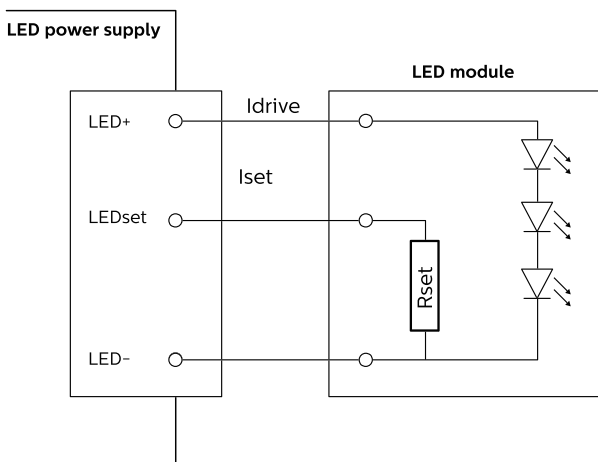

Rset resistor mounted onto the LED module

Rset1 and Rset2 and LEDset use different pins on the driver (and on the JST connector).

The Rset1 and Rset2 and LEDset values with the corresponding drive currents are shown in following tables. It is advised to select the nearest lower resistor value that is available to you, if the exact determined value is not at hand.

How to... Set the output current via LEDset

Rset 1 and Rset 2 have been the traditional ways to set the current in the Xitanium window drivers. Next generation drivers will now be introduced with LEDset. LEDset is introduced by several vendors in the market to provide an industry standardized Rset interface. LEDset is, in essence, like Rset1 and Rset2, where one resistor value leads to one output current value only, differing only in the look-up table. Please find the table for E96 resistor values in the next section.

What does LEDset offer

Like Rset1 and Rset2, LEDset is an analogue interface, allowing basic output current setting. The interface supports the following functions:

- Output current setting of the constant current LED driver to LED modules
- Thermal protection of the LED module(s) via thermal dynamic resistors circuit

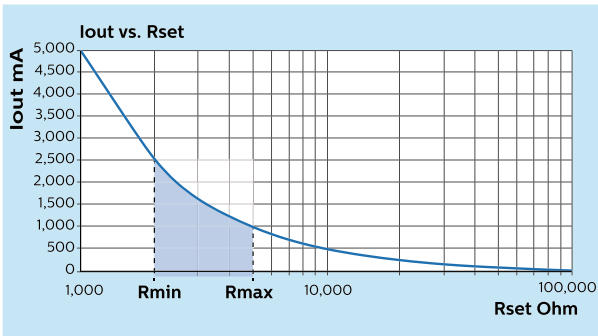

How does LEDset work

LEDset is based on a 3 wire connection between LED driver and one or more LED modules as shown in the figure on the left. Only one additional wire, besides the two LED current supply wires, is used for transferring information from the LED module(s) to the LED driver, provided the Rset is mounted on the LED module.

Alternatively a standard resistor can be put directly into the driver's LEDset input connectors.

The LEDset interface measures the current Iset which flows from a 5V constant voltage source within the LED driver through the setting resistor(s) Rset which is/are located either on the LED modules or directly into the driver's Rset-input.

The current Iset flowing through one setting resistor Rset is determined by the equation:

$$I_{set} [A] = 5 [V] / R_{set} [\Omega]$$

A LED driver with LEDset interface is able to measure Iset and to set the LED driver output current Idrive dependent on the measured value of Iset according to the equation

$$I_{drive} = I_{set} \times 1000 [A]$$

Therefore the overall relationship between the setting resistor and the LED driver output current Idrive is then given by

$$I_{drive} [A] = (5 [V] / R_{set} [\Omega]) \times 1000$$

To calculate the required resistor value for a desired drive current Idrive use:

$$R_{set} [\Omega] = (5 [V] / I_{drive} [A]) \times 1000$$

The LEDset interface is intended to cover a LED driver output current range from 0.05 A to 8 A. The corresponding resistor Rset is therefore within the range 100 kOhm to 625 Ohm.

In addition, it is possible to add an over temperature protection circuit on the LED module which decreases the setting current in case of an over temperature event and thus limits or folds back the LED driver output current.

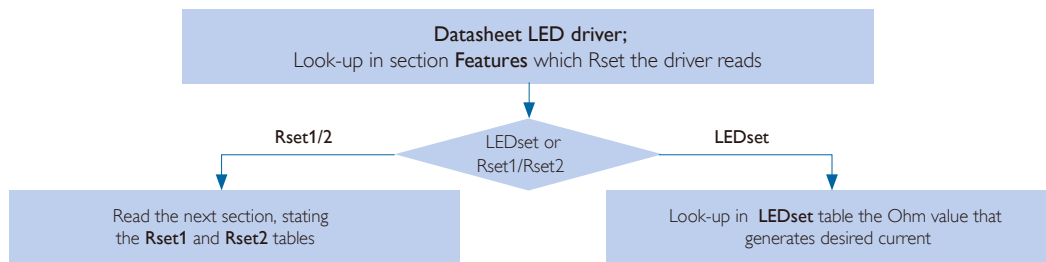

Note on E-series: in electronics, international standard IEC 60063 defines preferred number series for amongst others resistors. It subdivides the interval between subsequent values from 1 to 10 into 6, 12, 24, 48, 96 etc. steps. These subdivisions ensure that when some arbitrary value is replaced with the nearest preferred number, the maximum relative error will be on the order of 20%, 10%, 5%, 1% etc.

LEDset – E96 series: table with E96 resistor values

LEDset [Ω]	Idrive [mA]	LEDset [Ω]	Iset [mA]	LEDset [Ω]	Iset [mA]	LEDset [Ω]	Iset [mA]
open	avoid*	23700	211	11000	455	5110	978
49900	100	23200	216	10700	467	4990	1002
48700	103	22600	221	10500	476	4870	1027
47500	105	22100	226	10200	490	4750	1053
46400	108	22500	233	10000	500	4640	1078
45300	110	21000	238	9760	512	4530	1104
44200	113	20500	244	9530	525	4420	1131
43200	116	20000	250	9310	537	4320	1157
42200	118	19600	255	9090	550	4220	1185
41200	121	19100	262	8870	564	4120	1214
40200	124	18700	267	8660	577	4020	1244
39200	128	18200	275	8450	592	3920	1276
38300	131	17800	281	8250	606	3830	1305
37400	134	17400	287	8060	620	3740	1337
36500	137	16900	296	7870	635	3650	1370
35700	140	16500	303	7680	651	3570	1401
34800	144	16200	309	7500	667	3480	1437
34000	147	15800	316	7320	683	3400	1471
33200	151	15400	325	7150	699	3320	1506
32400	154	15000	333	6980	716	3240	1543
31600	158	14700	340	6810	734	3160	1582
30900	162	14300	350	6650	752	3090	1618
30100	166	14000	357	6490	770	3010	1661
29400	170	13700	365	6340	789	2940	1701
28700	174	13300	376	6190	808	2870	1742
28000	179	13000	385	6040	828	2800	1786
27400	182	12700	394	5900	847	2740	1825
26700	187	12400	403	5760	868	2670	1873
26100	192	12100	413	5620	890	2610	1916
25500	196	11800	424	5490	911	2550	1961
24900	201	11500	435	5360	933	2490	2008
24300	206	11300	442	5230	956	short	avoid**

* driver's default current, however not stable. For details see section on 'Default driver output current'

** driver's maximum current, however not absolute. For details see section on 'Default driver output current'

Datasheet LED driver;
Look-up in section **Features** which Rset the driver reads

If both Rset1 and Rset2 are supported,
Rset2 is advised for future compatibility

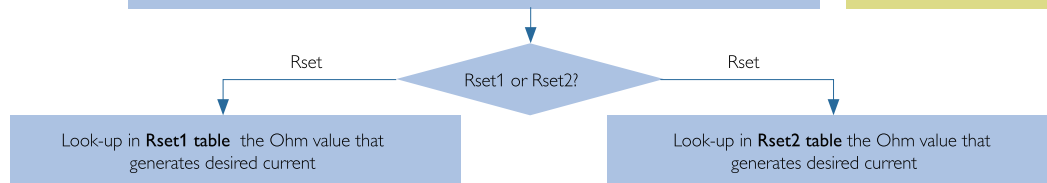

Note on E-series: in electronics, international standard IEC 60063 defines preferred number series for amongst others resistors. It subdivides the interval between subsequent values from 1 to 10 into 6, 12, 24, 48, 96 etc. steps. These subdivisions ensure that when some arbitrary value is replaced with the nearest preferred number, the maximum relative error will be on the order of 20%, 10%, 5%, 1% etc.

Note: next page shows extended Rset2 table: E96 values, stating smaller increments

Rset1 – E24 series

Ret1 [Ω]	Iset [mA]	Ret1 [Ω]	Iset [mA]	Ret1 [Ω]	Iset [mA]	Ret1 [Ω]	Iset [mA]
39	200	510	292	6k8	583	91k	690
43	201	560	300	7k5	591	100k	691
47	202	620	309	8k2	599	110k	692
51	203	680	318	9k1	60	120k	693
56	204	750	327	10k	614	130k	693
62	206	820	336	11k	621	150k	695
68	208	910	347	12k	627	160k	695
75	209	1k	358	13k	632	180k	696
82	210	1k1	369	15k	640	200k	696
91	212	1k2	379	16k	643	220k	697
100	215	1k3	388	18k	649	240k	697
110	217	1k5	406	20k	654	270k	698
120	219	1k6	414	22k	658	300k	698
130	221	1k8	429	24k	661	330k	698
150	226	2k	442	27k	665	360k	699
160	228	2k2	455	30k	669	390k	699
180	232	2k4	466	33k	671	430k	699
200	236	2k7	481	36k	674	470k	699
220	240	3k	494	39k	676	510k	699
240	244	3k3	505	43k	678	560k	700
270	250	3k6	517	47k	680	620k	700
300	256	3k9	525	51k	682	680k	700
330	261	4k3	536	56k	683	750k	700
360	267	4k7	546	62k	685	820k	700
390	272	5k1	555	68k	686	910k	700
430	279	5k6	564	75k	688	1M	700
470	286	6k2	574	82k	689	No Rset	default

Rset2 – E24 series

Ret2 [Ω]	Iset [mA]	Ret2 [Ω]	Iset [mA]	Ret2 [Ω]	Iset [mA]	Ret2 [Ω]	Iset [mA]
short	100	430	245	2k	733	9k1	1558
100	100	470	261	2k2	780	10k	1604
110	106	510	277	2k4	823	11k	1653
120	111	560	297	2k7	884	12k	1694
130	116	620	318	3k	941	13k	1730
150	121	680	340	3k3	993	15k	1793
160	130	750	368	3k6	1042	16k	1817
180	13	820	392	3k9	1086	18k	1864
200	146	910	422	4k3	1143	20k	1902
220	155	1k	452	4k7	1192	22k	1935
240	166	1k1	485	5k1	1238	24k	1965
270	176	1k2	515	5k6	1293	27k	2000
300	190	1k3	545	6k2	1350	No Rset	default
330	204	1k5	602	6k8	1402		
360	215	1k6	632	7k5	1454		
390	228	1k8	684	8k2	1503		

Rset priority behavior for drivers that read both Rset1 and Rset2

Rset1	Rset2	Driver status
Open	Open	Driver's default current (see datasheet)
Rset	Open	Rset1
Open	Rset	Rset2
Rset	Rset	Rset2
Short	Open	Rset1 (driver's minimum current, see datasheet)
Short	Short	Rset2 (driver's minimum current, see datasheet)
Open	Short	Rset2 (driver's minimum current, see datasheet)

Please refer to the datasheet of the driver you use to find which Rset or Rsets the driver actually reads.

Rset2 – E96 series: table with E96 resistor values, stating smaller increments but covering same range as the E24 series on previous page

Rset2 [Ω]	Iset [mA]	Rset2 [Ω]	Iset [mA]	Rset2 [Ω]	Iset [mA]	Rset2 [Ω]	Iset [mA]	Rset2 [Ω]	Iset [mA]	Rset2 [Ω]	Iset [mA]
short	min.	255	171	665	335	1740	669	4530	1171	11800	1686
100	100	261	173	681	341	1780	679	4640	1185	12100	1698
102	101	267	175	698	347	1820	689	4750	1198	12400	1708
105	103	274	178	715	354	1870	701	4870	1212	12700	1719
107	104	280	181	732	361	1910	711	4990	1226	13000	1730
110	105	287	184	750	368	1960	724	5110	1239	13300	1739
113	107	294	187	768	374	2000	733	5230	1253	13700	1752
115	108	301	191	787	381	2050	745	5360	1267	14000	1761
118	110	309	194	806	387	2100	757	5490	1281	14300	1771
121	111	316	197	825	394	2150	768	5620	1295	14700	1783
124	113	324	201	845	400	2210	782	5760	1308	15000	1793
127	115	332	204	866	407	2260	793	5900	1322	15400	1802
130	116	340	207	887	414	2320	806	6040	1335	15800	1812
133	118	348	210	909	422	2370	817	6190	1349	16200	1822
137	119	357	214	931	429	2430	829	6340	1362	16500	1829
140	120	365	217	953	436	2490	841	6490	1375	16900	1838
143	122	374	221	976	444	2550	853	6650	1389	17400	1850
147	123	383	225	1000	452	2610	865	6810	1403	17800	1859
150	125	392	229	1020	459	2670	877	6980	1415	18200	1867
154	127	402	233	1050	469	2740	891	7150	1428	18700	1877
158	129	412	237	1070	475	2800	903	7320	1441	19100	1885
162	131	422	241	1100	485	2870	916	7500	1454	19600	1894
165	132	432	246	1130	494	2940	929	7680	1467	20000	1902
169	134	442	250	1150	500	3010	943	7870	1480	20500	1910
174	136	453	254	1180	509	3090	956	8060	1493	21000	1918
178	137	464	259	1210	518	3160	968	8250	1506	21500	1926
182	139	475	263	1240	527	3240	982	8450	1518	22100	1936
187	141	487	268	1270	536	3320	996	8660	1531	22600	1943
191	143	499	273	1300	545	3400	1009	8870	1544	23200	1952
196	145	511	278	1330	554	3480	1022	9090	1557	23700	1960
200	146	523	282	1370	565	3570	1037	9310	1569	24300	1968
205	148	536	287	1400	574	3650	1049	9530	1580	24900	1975
210	151	549	292	1430	582	3740	1062	9760	1592	25500	1982
215	153	562	297	1470	594	3830	1075	10000	1604	26100	1989
221	155	576	302	1500	602	3920	1088	10200	1614	26700	1996
226	158	590	307	1540	614	4020	1103	10500	1629	27000	2000
232	161	604	313	1580	626	4120	1117	10700	1639	open	default
237	164	619	318	1620	638	4220	1131	11000	1653		
243	167	634	323	1650	645	4320	1145	11300	1666		
249	169	649	329	1690	656	4420	1158	11500	1674		

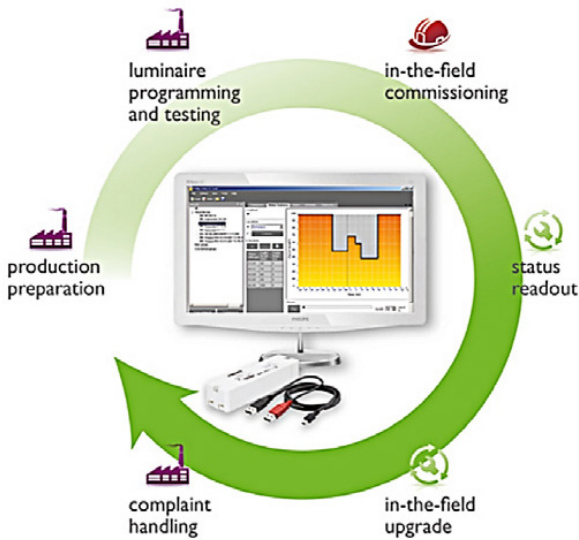

How to... Program the output current

The Xitanium TD drivers offer a full range of controls, enabling customizable luminaire design and performance. It is possible to control light output levels, preset dimming protocols and set system specifications in the factory and even in the complete installations.

This can be done with the Philips MultiOne configurator: The MultiOne configurator is an intuitive tool that unlocks the full potential of all programmable drivers from Philips, ensuring that the driver performance matches the needs of the lighting solution. It offers unprecedented flexibility, before, during and after the product installation.

With the latest selected drivers, SimpleSet[®] functionality is also supported via MultiOne.

Please check the datasheet of the driver on www.philips.com/technology to know if your driver supports SimpleSet[®] or not.

For more information on MultiOne go to the chapter Configurability or visit: www.philips.com/multiOne

This site contains detailed information on how to install the software and how to program the driver.

How to ... Set the output current via DipSwitch

Alongside the programmable TD drivers, there are non-programmable TD drivers with DipSwitch.

Users could toggle the DipSwitch to set the output current. The output current matrix is illustrated on the label.

It's not allowed to adjust output current via DipSwitch when the driver is powered on.

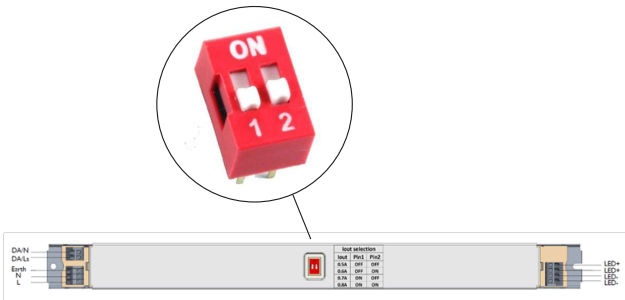

DipSwitch on driver

Mains voltage fluctuations and behavior

The driver is able to withstand high and low mains voltages for limited periods of time. See the associated datasheets for specific values.

Allowable voltage difference between mains input and control input (TD version)

The majority of our LED-drivers do comply with a voltage isolation difference up to 250V between mains and the Touch and Dim control input, as can be caused by a different phase of the power grid in an installation in the field.

Future drivers might have a value higher than 250V by design.

Low mains voltage

A continuous low AC voltage (<202 V) can have an adverse effect on the driver's lifetime. The output power will be limited accordingly. A low voltage will not cause the driver to fail over a maximum period of 48 hours at minimum operating AC voltage and maximum ballast ambient temperature.

High mains voltage

A high mains AC voltage will stress the driver and have an adverse effect on its lifetime (maximum of 264-320 V for a period of 48 hours).

DC, DCemDIM and Emergency operation

Some of the Xitanium Indoor LED drivers are able to operate on DC voltage on the mains input, like when connected to a central DC emergency grid.

Depending on the type, Xitanium LED drivers are released in compliance with lamp control gear standards as stated under "Emergency standards" in section "Quality" at the end of this document. As a result these drivers are suitable for emergency luminaires in compliance with IEC 60598-2-22, excluding high-risk task areas.

Please note the allowed DC voltage range accepted by the driver is stated in the driver's datasheet.

Values outside that range will have an adverse effect of the driver's performance and possibly reliability.

On selected drivers DCemDIM is available, allowing a pre-defined dim level of the driver's output when switched to DC. More on setting parameters of DCemDIM in section Controllability. For specific input requirements, please check the driver's datasheet at the download section on www.philips.com/technology.

Inrush current

'Inrush current' refers to the briefly occurring high input current which flows into the driver during the moment of connection to mains; see the illustration on the left. Typically, the amplitude is much greater than the steady-state input current.

The cumulative inrush current of a given combined number of drivers may cause Mains Circuit Breakers (MCB) to trip. In such a case, either one or a combination of the following measures need to be taken to prevent nuisance tripping:

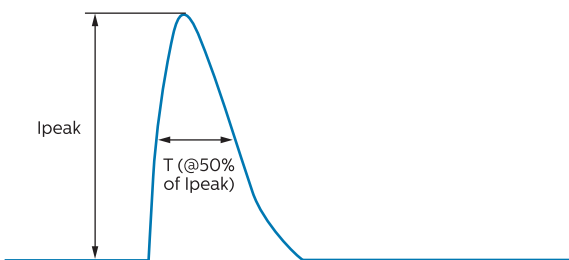

Graphical representation of inrush current

- 1: Replace existing MCB for a less sensitive type (e.g. exchange B type for C type)
- 2: Distribute the group of drivers over multiple MCB groups or phases
- 3: Power up drivers sequentially instead of simultaneously
- 4: Install external inrush-current limiting devices

Inrush parameters are driver-specific and can be found in the driver datasheet at www.philips.com/technology.

MCB type	Rating (A)	Relative number of LED drivers (%)
B4		25
B	6	40
B1	0	63
B1	38	1
B	16	100 (reference)
B2	0	125
B2	5	156
B3	2	200
B4	0	250
C4		42
C	6	63
C1	0	104
C1	3	135
C	16	170
C2	0	208
C2	5	260
C3	2	340
C4	0	415
D4		80
D	6	130
D1	0	210
D1	3	280
D	16	350
D2	0	470
D2	5	550
D3	2	700
D4	0	940
L, I	16	108
L, I	10	65
G, U, II	16	212
G, U, II	10	127
K, III	16	254
K, III	10	154

The max. recommended amount of drivers in the table above is based on inrush current and only serves as guidance. The actual maximum amount in the application may differ; it is dependent on steady-state current, MCB brand/type and inherent MCB tolerances.

How to... Determine the number of drivers on a MCB

The maximum amount of drivers on a 16A type B Miniature Circuit Breaker (MCB) is stated in the driver's datasheet on www.philips.com/technology.

In the conversion table on the left that stated amount is used as reference (100%). The maximum quantity of drivers on different types of MCB can be calculated by the reference (see driver's datasheet) x Relative number (last column).

Example:

If datasheet states: max number on type B, 16 A = 20, then for type C, 13 A the value will be $20 \times 135\% = 27$.

Notes:

1. Data is based on a mains supply with an impedance of 400 mΩ (equal to 15 m of 2.5 mm² cable and another 20 m to the middle of the power distribution) in the worst-case scenario. With an impedance of 800 mΩ the number of drivers can be increased by 10%.
2. Measurements will be verified in real installations; data is therefore subject to change.
3. In some cases the maximum number of drivers is not determined by the MCB but by the maximum electrical load of the installation.
4. Note that the maximum number of drivers is given when these are all switched on at the same time, e.g. by a wall switch.
5. Measurements were carried out on a single-pole MCB. For multiple MCBs it is advisable to reduce the number of drivers by 20%.
6. The maximum number of drivers that can be connected to one 30 mA Residential Current Detector is 30.

Note: DM stands for Differential Mode, CM for Common Mode.

Note: check the driver datasheet of the driver you use for the specific touch current value and conditions

Surge protection

The Xitanium drivers have built-in surge protection up to a certain limit. Depending on the mains connected, additional protection against excessive high surge voltages may be required by adding a Surge Protection Device. The actual limit can differ per driver and can be found in the driver's datasheet in the download section on www.philips.com/technology.

Note for Xtreme indoor drivers (iXt)

Xtreme Indoor LED drivers (iXt) allow a higher maximum surge on the mains input (2 kV DM / 4 kV CM) than on the control input (1 kV DM / 2 kV CM), also stated in the driver's datasheet. As such Touch and Dim operation in environments with surges higher than 1 kV DM / 2 kV CM are not recommended.

Touch current

The Xitanium Indoor LED drivers are designed to meet touch current requirements per IEC 61347-1 standard. The specified maximum values are 0.7 mA peak down to 0.4 mA peak for IEC and 0.75 mA RMS for UL norms. The test is done with the driver alone. In a luminaire, touch current may be higher, since the LED load may introduce additional touch current. As such, precautions may be required on the luminaire level and if multiple drivers are used in a single luminaire.

Electromagnetic compatibility (EMC)

Xitanium Indoor LED drivers meet EMC requirements per CISPR 15 ed 7.2. The test is conducted with a reference setup that includes a driver and an LED load mounted on a metal plate.

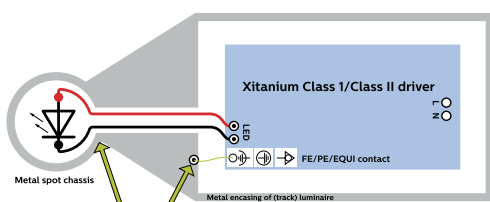
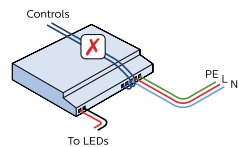
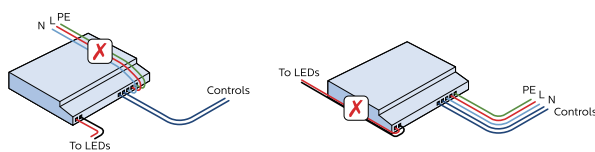
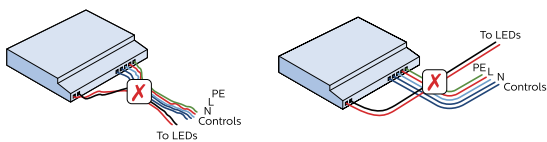
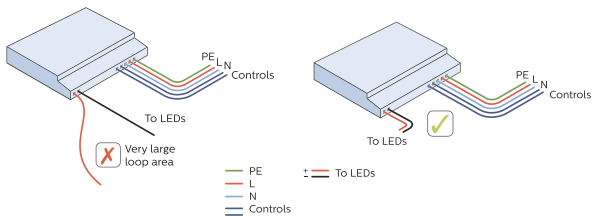

Luminaire housing connected to FE/PE/EQUI contact of driver

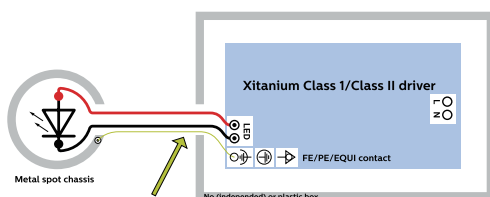

Metal spot chassis of an independent configuration connected to FE of driver

How to... Improve EMI performance

As mentioned before, the total amount of parasitic current needs to be minimized. For that reason, the following practical precautions need to be taken into account in a lighting system to minimize EMI:

- Minimize the Differential Mode loop area of the lamp wires going from the driver to the light source by keeping the wires close together (bundling). This will minimize the magnetic field and reduce the radiated EMI. Long linear light sources are also part of that loop.
- Minimize the Common Mode parasitic capacitance of the output wiring + light source to earth by keeping the length of the wires between driver and light source as short as possible. Also minimize the copper cooling area on the LED PCB and keep the length of the incoming mains wire inside the luminaire as short as possible.
- Keep mains and control wires (DALI, 0-10 V) separated from the output wires (do not bundle).
- Ground the lighting system chassis and other internal metal parts to earth (class I luminaires) and do not let large metal parts "float". Always use the safety or functional earth connector or wire from the lamp driver. Or use equipotential connecting wires for all internal floating metal parts which are inaccessible (class II luminaires). Keep safety and functional earth wires as short as possible to minimize their inductance, use as much as possible large metal areas (chassis, mounting plates, brackets) for earthing purposes instead.
- For Class II it is advised to establish a functional earth connection between all larger conductive, non-accessible luminaire parts and the driver to remedy potential EMC problems.
- Sometimes, radiated EMC compliance cannot be achieved, necessitating the use of a 100 ... 300 Ω axial ferrite bead(s) for either mains or lamp wiring (effective for interference between 30 MHz and 300 MHz), or coupling the wires through ferrite cores within the luminaire may improve the overall EMC performance. However, selection of the type and characteristics of the additional filter depends on what frequency components have to be damped and by how much.

Adhering to these rules will help in EMC compliance. For further questions, please contact your local Philips representative. Alternatively the Philips Lighting OEM Design-In team could be consulted for a possible solution.

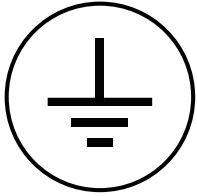

Symbol for Protective Earth (PE)

Electrical isolation and protective earth

One way to split the Xitanium Indoor LED drivers is by isolated and non-isolated driver versions.

Non-isolated drivers

These drivers have no isolation from the primary to the secondary side and basic isolation (single isolation foil) between all the electronic circuits and the chassis, hence the presence of the Protective Earth (PE) symbol (see image on the left) on the driver housing.

Non-isolated drivers can be used in Class I luminaires. Be aware that all output connections of these drivers are not touch-safe when the driver is switched on. An adequate earth connection needs to be made to all electrical conductive parts in the luminaire. The bottom part (unpainted) of the driver housing can be used to create earth contact to the luminaire housing, as the earth connector is internally connected to the driver housing. An intermitting earth contact should be prevented, as this is potentially unsafe and can cause a degraded performance. Most drivers in this group typically can generate output drive voltages higher than 60VDC. Always test the quality of your earth contacts between all relevant conductive parts.

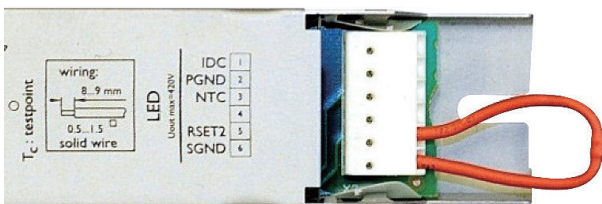

Example of an insulated Rset



Warnings for non-isolated drivers:

- Do not touch any non-insulated live parts, even on the output(secondary) side!
- Any live part on the output (secondary) side should not be touchable during normal operation. This includes the NTC component and Rset component.
- Make sure to insulate the Rset to prevent it from touching the housing.

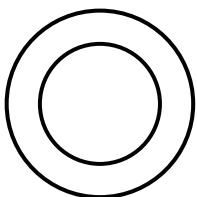

Symbol for Double Isolation. In this case this symbol refers to double isolation between driver mains input and driver housing.

Isolated drivers (SELV output)

Drivers in this group cannot generate output voltages higher than 60VDC. By design these drivers are intended for built-in use, not suited for independent use. The driver must be placed in a suitable adequate enclosure according to the applicable norms and standards. Hence the double circle symbol is to be used, not the double-square symbol (Amendment 2 of safety standard IEC61347-1).

However, these isolated drivers (SELV output) can be used in both Class I and Class II luminaires under the following conditions:

- When used for Class I the protective earth connection should be present (see previous section “Non-isolated drivers”).
- When used for Class II (and SELV), the driver should be incorporated in the luminaire in such a way that
 - a) The driver housing is electrically insulated with respect to electrical conductive materials, such as the housing or reflector and as such not touchable during installation or operation.
 - b) All metal luminaire parts (chassis, heat sink, metallic reflector) connected to the driver housing are not allowed to be accessible by bare hand, or driver housing.
 - c) Any accessible conductive luminaire parts should have basic isolation towards the non-accessible luminaire parts and/or driver housing.

Note: for Class II, EMC requirements should be met without PE connection and particularly also any functional earth connection from driver to accessible fixture/chassis is strictly prohibited, as it will form insufficient (non-single fault-proof) insulation with respect to live parts connected to the driver.

Xitanium Indoor LED drivers meet the IEC 61347-1 safety standard

In accordance to this standard, the following safety requirements are met:

- Basic isolation between the Primary and Secondary side wires:
- Driver output voltage < 1000 VDC
- Insulation test voltage 1500 V (1000+2U)
- Double isolation between all wires and chassis: Insulation test voltage: 3750 V.

How to... Use Indoor LED drivers as “independent” driver (available for linear drivers)

By design the Xitanium Indoor LED drivers are intended for built-in use, not suited for independent use. The driver must be placed in a suitable adequate enclosure according to the applicable norms and standards when used independently.

Thermal design-in

Introduction

This chapter describes two thermal aspects of the Xitanium Indoor LED drivers:

1. The LED driver itself and relationship between case temperature point (T_c) and lifetime of the LED driver
2. Module Temperature Protection (MTP) can be used to help achieve lifetime of LED module or LED PCB.

To facilitate design-in of LED drivers, the critical thermal management points of the LED driver are set out in this section. In Philips' product design phase all possible precautions have been taken to keep the component temperature as low as possible. However, the design of the luminaire and the ability to guide the heat out of the luminaire are of utmost importance. If these thermal points are taken into account this will ensure the optimum performance and lifetime of the system.

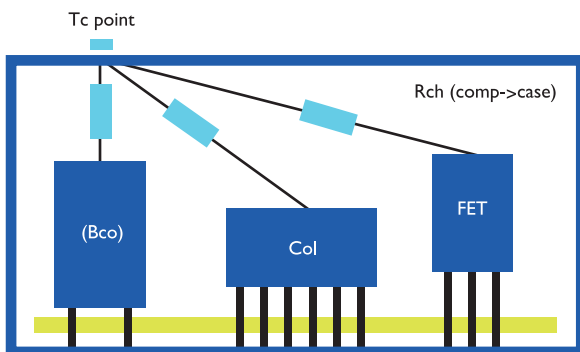

Schematically representation of internal thermal paths to the driver T_c point

Definitions

- Case temperature: temperature measured at the T_c point of the driver
- Ambient temperature (T_{amb}): temperature outside the luminaire

When switched off >2 hours, temperature at T_c point is likely to equal T_{amb}

T_c point

To achieve optimal lifetime and reliability, it is critical that the temperature of the components in the driver remains within its rating.

The T_c test point (case temperature) indicates a reference point for measuring the LED driver's temperature. This can be used during the luminaire design to verify that the temperature remains below the maximum specified temperature for the T_c point.

Since there is a direct relation between the case temperature (T_c) and the driver components inside the driver, it is sufficient to measure the temperature at the T_c point of the LED driver. This T_c point must not exceed the maximum values stated in the associated datasheet in the download section on www.philips.com/technology.

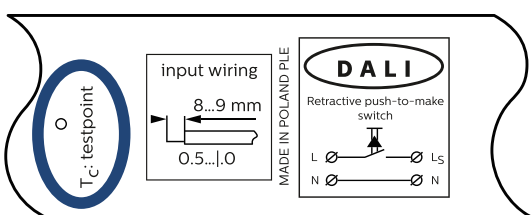

Example of T_c point position on driver housing

How to... Measure Tc at the Tc point

The location of the Tc point is identified on the product label. Tc point is inside the dot (See ellipse in figure on the left). The temperature can be measured using for example a thermocouple that is firmly glued to the driver housing. For a representative measurement the temperature must be stable before any reliable data can be obtained (typically > 0.5 hours).

Relation between Tc and ambient temperature

The Tc increases by approximation with the ambient temperature (Tamb). The temperature offset between Tamb and Tc depends on the thermal design of the luminaire. The Xitanium LED driver has been designed for indoor use. For approved ambient temperature range please check the associated driver datasheet on www.philips.com/technology.

Driver lifetime

Tc, Tc-life and Tc-max

The lifetime of LED drivers depends on the temperature during operation. This means there is a relationship between the Tc point on the LED driver and its lifetime in hours.

- Xitanium Indoor LED drivers typically have a specified minimum lifetime of $\geq 50,000$ hours with a minimum of 90% survivors at the specified Tc-life.
- Xitanium Indoor Xtreme LED drivers typically (iXt) have a specified minimum lifetime of $\geq 100,000$ hours with a minimum of 90% survivors at the specified Tc-life.

Tc-max is the maximum allowed Tc for the driver. Please check the driver's datasheet in the download section on www.philips.com/technology for the lifetime and Tc-life.

Module Temperature Protection (MTP)

NTC and thermal design

This feature helps to protect the LEDs when operated in a hot ambient environment. The thermal design of an LED module/PCB should be designed in such a way that the temperature of the LED board (Tc-life) is not exceeded under normal application conditions. The utilization of a Negative Temperature Coefficient (NTC) component serves the purpose to help achieve the lifetime of the LED module or LED PCB if external thermal influences result in the temperature for lifetime (Tlife) being exceeded. When this occurs the light output will be regulated to remain below the critical temperature by the driver dimming down.

Two NTC part numbers which are supported, while the third option enables correct operation in combination with Philips LED modules.

1. 15 k NTC - Vishay 15 kOhm \pm 2% NTC, B25/85=3700, 2381 615 54153
2. 15 k NTC - Murata 15 k, Part number NCP15XW153E03RC (with a Separate 390 ohms resistor in series with the NTC)
3. On selected Philips LED light engines (currently no LED Lines)

Setting MTP behavior (programmable drivers only)

It is possible to set the temperature at which MTP feature is activated, defined by "MTP warn" and the slope, defined by "MTP max". Using the MultiOne Configurator software the settings can be changed.

Setting the thermal de-rating point via NTC

The LED driver will start reducing the light output when the NTC reaches a value of 2966 Ω . The NTC should be selected such that 2966 Ω represents the desired critical temperature inside your LED module/PCB.

Take for example an LED board with a defined Tc-life of 65 $^{\circ}\text{C}$. Taking the tolerances of the NTC into account results in ± 5 $^{\circ}\text{C}$. This gives a typical value for the NTC of 71 ± 5 $^{\circ}\text{C}$. By choosing this setting of 71 $^{\circ}\text{C}$, we ensure that the driver will not dim the output, due to a too high temperature, before the module reaches 65 $^{\circ}\text{C}$. The following graph shows a typical R vs. T curve of an NTC resistor. To match 2966 Ω at this temperature, the NTC of 15 k Ω \pm 2% has been selected.

NTC resistance as function of temperature

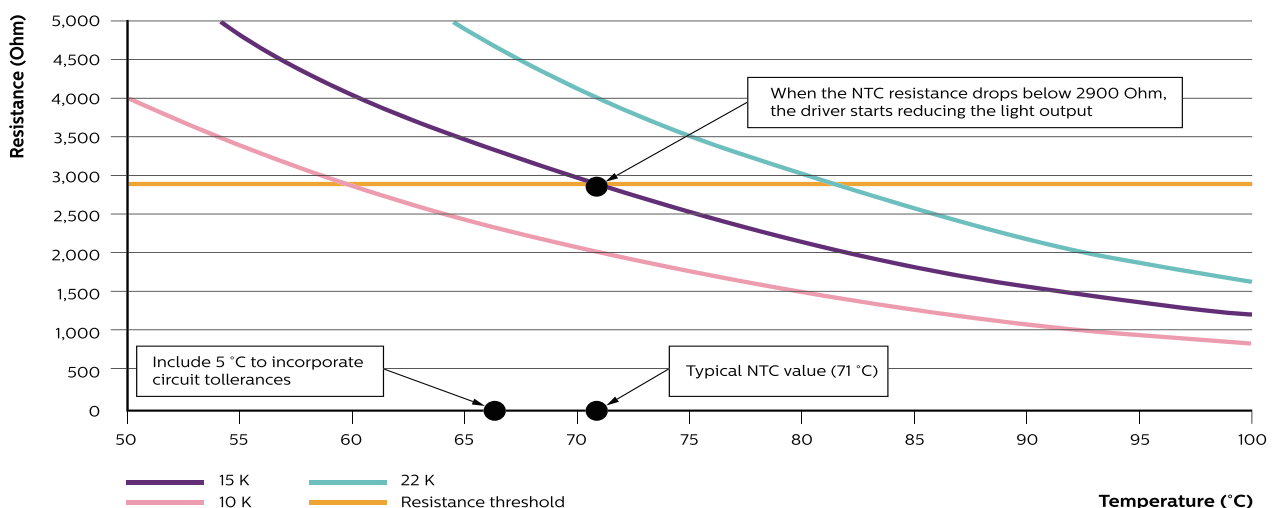

Mechanical design-in

Dimension of nipple for track adapters

For Philips track adapters, the Philips nipple is recommended for all track adapters series.

OEM manufacturers should take responsibility for the reliability if use customized nipples from third party to work with track adapters. The dimensions of customized nipples should strictly follow Philips nipple's mechanical design. Drivers should stay away from acid and alkali. Organic oil is not allowed because it might embrittle the driver's housing.

Dimension of Philips nipple (Unit: mm)

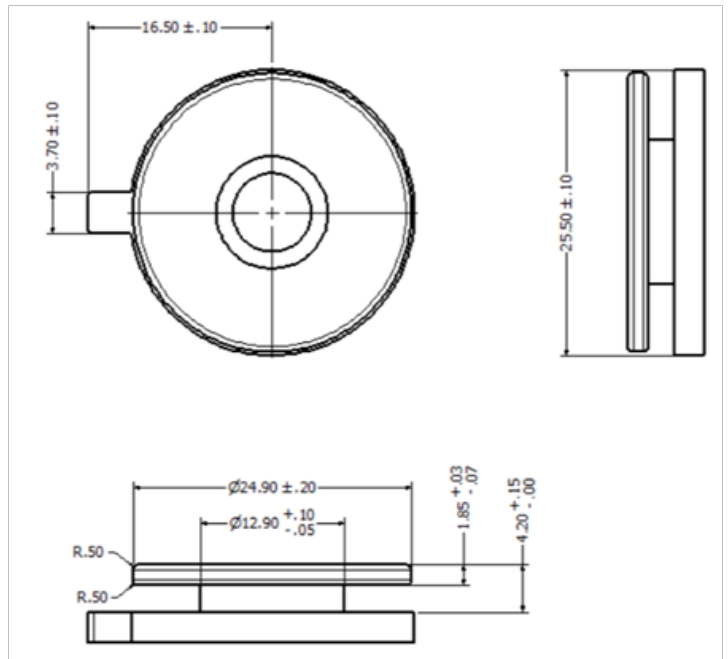

RF design-in

Introduction

This chapter describes the application of RF (radio frequency) aspects of the Xitanium Wireless Indoor LED drivers.

To facilitate design-in of LED drivers, the critical RF application scenarios of the LED driver are set out in this section. In Philips' product design phase all possible precautions have been taken to ensure WiFi, Zigbee or BLE (Bluetooth low energy) signal as good as possible. The driver should be set in an expected position to ensure the optimum performance of the system. Some changes in luminaire housing (especially metal housing) will also be considered to ensure the RF performance.

Independent application

Keep the distance of driver housing edge to luminaire edge $\geq 50\text{mm}$, the facing direction of driver is not a critical concern here.

- Example for downlight luminaires.

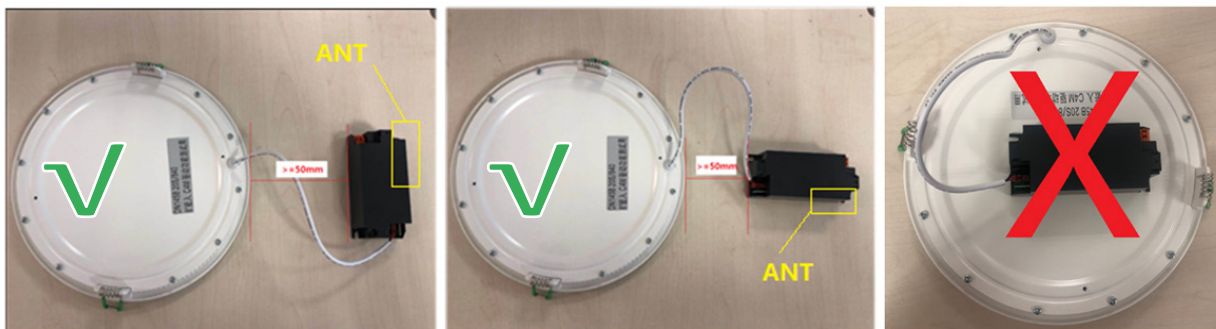

- Example for panel luminaires.

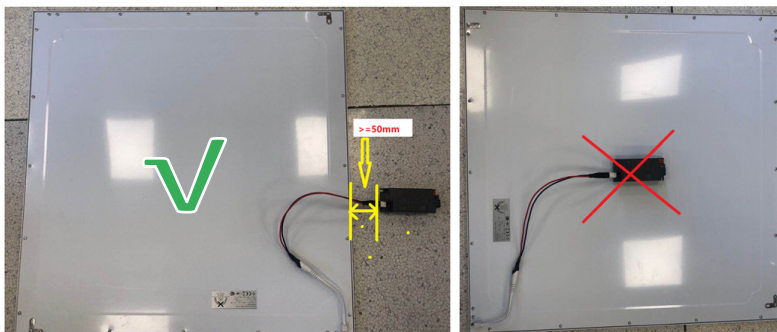

Build in application

Inter-luminaire RF signal should be considered for different housings:

- 1). Plastic housings. There is no impact for RF signal transportation.

For example, the metal gear try has little impact for the waterproof luminaire, the plastic housings are transparent for RF signal.



- 2). Folded sheet metal housings.

Folded sheet metal luminaires could "leak" RF signals and are open at the side of the plastic diffuser.



- 3). Extruded or castled aluminum housings can be critical and need to be evaluated.

For extruded or castled aluminum housings, several strip slots ($\geq 2\text{mm}$) need to be placed closely with driver antenna, each side of housing and LED back plane. 5 slots will be preferable, 3 slots are the minimum requirement to guarantee the RF performance.

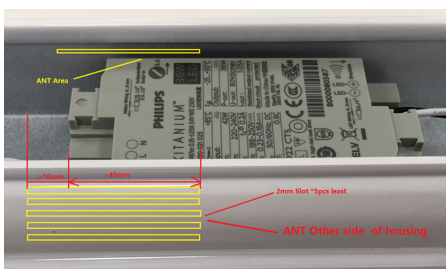
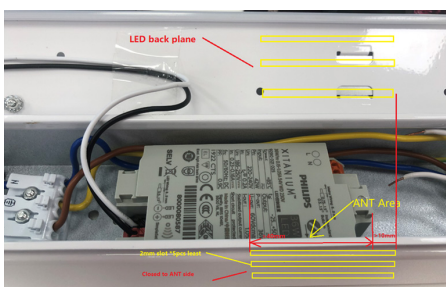

Controllability

Control characteristics

Amplitude Modulation dimming

Philips Xitanium indoor LED drivers dim by means of Amplitude Modulation dimming (AM). This means at no stage of the dimming range Pulse Width Modulation dimming (PWM) is involved. AM dimming guarantees the most smooth and flicker-free operation over the entire dimming range.

Dimming ranges

In the current portfolio there are three different dimming ranges present.

- 100% down to 10%
(e.g. 1-10V non-isolated drivers with introduction date before 2015)
- 100% down to 5%
(e.g. isolated drivers with introduction date before 2014)
- 100% down to 1%
(latest generations dimmable drivers)

The driver's actual dimming range is stated in the associated datasheet on www.philips.com/technology. With future updates of the drivers most likely one dimming range will be present.

Note: for Xtreme Indoor LED drivers (iXt) the allowed dimming range is dependent on ambient temperature (T_{amb}). The influence of the ambient temperature on the minimum allowed dimming levels are stated in the table below. The applicable minimum dimming value should be set via the MultiOne configurator software. The default value is stated in the driver datasheet.

T_{amb} -40..-20 °C	T_{amb} -20..+50 °C	T_{amb} +50..+60 °C
Minimum dimming 10%	Minimum dimming 1%	Minimum dimming 10%

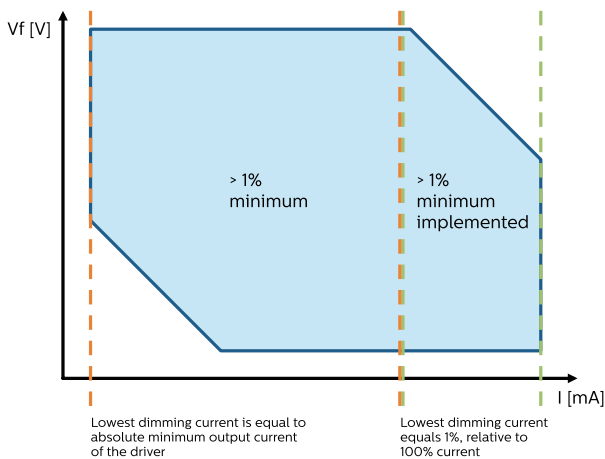

Minimum dimming output current

Maximum selectable output current [mA]	Maximum absolute output current [mA]	Current range allowing for 1% dimming [mA]	Drivers examples
400	3	300..400	Xitanium 75W 0.12-0.4A 215V TD 230V
700	4	400..700	Xitanium 150W 0.2-0.7A 300V TD 230V iXt
2000	14	1400..2000	Xitanium 75W 0.7-2A 54V TD 230V

Minimum dimmed output current

The drivers' min-max current range is by approximation a factor of 140. This means that a 1% minimum dimming current is not feasible for the full operating window. For the lower current part of the operating window the dimming level is limited by an absolute minimum output current of the driver (see drawing). This value differs per LED driver by design. Some examples are provided in the table on the left.

Control input electrical characteristics

The control input is compatible with Philips Lighting control equipment.

Standby power consumption	< 0.5 W
Control input insulation, basic	≥ 1500 Vac

Dynamic resistance of the LED load

The Xitanium drivers are designed to drive and dim LED loads with a specified minimum dynamic resistance of the load, stated in the driver's datasheet. This has been tested and released with the Philips Fortimo LED modules. LED loads which have a dynamic resistance outside the specification of the driver may cause instabilities and should not be used in combination with this driver.

When light instabilities and/or uniformity issues are observed during deep dimming (e.g. down to 1%) it is recommended to increase the minimum dim level by adjusting the DALI minimum dim level to the point the effects are no longer perceived. The required minimum dynamic resistance is stated in the drivers' datasheet.

Trailing edge (TE)

Trailing edge dimmers control the power of the load by varying the duty cycle (ratio on vs. on+off time) of the mains voltage to the driver. Due to the complexity of the combination "TE dimmer + LED driver" and the various qualities of TE dimmers in the market, this way of dimming is not the preferred option. The TE compatible Xitanium LED drivers are tested during the development of the Xitanium LED drivers with below list of recommended TE dimmers.

Drivers			Compatible dimmers
Types	Description	12NC	
Xitanium TE G1	Xitanium 4W 0.1A 40V TE SC 230V	9290 014 20706	Busch-Jaeger, 6513U-102 Jung Licht-Management, 225T DE
	Xitanium 6W 0.15A 40V TE SC 230V	9290 014 20806	
	Xitanium 7W 0.35A 20V TE SC 230V	9290 014 20906	
	Xitanium 8W 0.2A 40V TE SC 230V	9290 014 21006	
	Xitanium 10W 0.5A 20V TE SC 230V	9290 014 21206	
	Xitanium 10W 0.25A 40V TE SC 230V	9290 014 21106	
	Xitanium 14W 0.35A 40V TE SC 230V	9290 014 21306	
	Xitanium 15W 0.75A 20V TE SC 230V	9290 014 21406	
Xitanium TE G2	Xitanium 24W 0.5/0.6A 40V TE 230V	9290 028 04906	SG, LEDDIM 400 Elko, 316 GLED, 315 GLE, 315 GLE 2-pol, 630 GLE Micromatic, UNILED+325 Moeller Eaton, X-confort Type CDAE-01/02 Legrand, ASW3000H Philips, Wireless smart dimmer
	Xitanium 32W 0.7/0.8A 40V TE 230V	9290 028 05006	
	Xitanium 42W 0.9A/1.05A 40V TE 230V	9290 028 05106	

Instructions shall be provided with controlgear that have FELV control terminals that state the following:

WARNING: FELV terminals marked "Risk of electric shock" are not safe to touch.

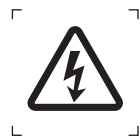

Danger: electricity

WARNING: Circuits connected to any FELV control terminal shall be insulated for the LV supply voltage of the controlgear and terminals connected to the FELV circuit shall be protected against accidental contact.

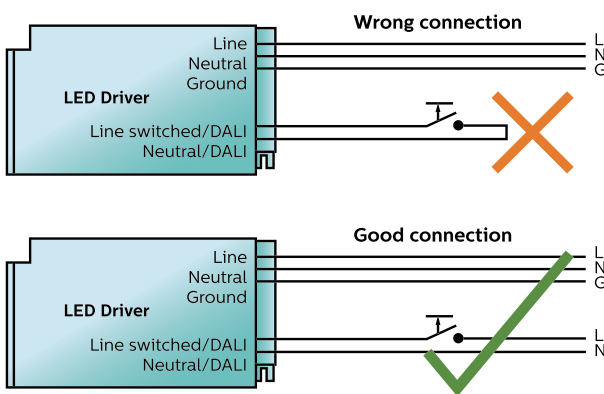

Appropriate connection to the dimmable LED driver using the Touch and Dim protocol

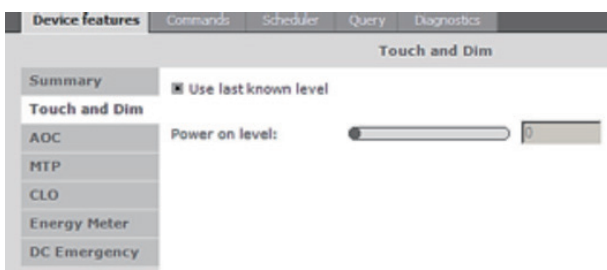

Screenshot from MultiOne - Touch and Dim tab

1-10V Dimming

This is the traditional way of dimming a driver between 100% and 10% based on dimming voltage, in 1% increments. Note that the 100% level is determined by the output current level, set via external Rset (AOC feature). The minimum current that can be supplied by the driver is specified in the datasheet. The lowest possible dim level is defined by the higher of the two values: Minimum output current or 10% dim level. Output current of the 1-10V control input is typical 150 μ A. The 1-10V interface for LED-drivers is the same as for FLUO HFR drivers.

TD dimming: Touch and Dim & DALI

Digital Addressable Lighting Interface, or DALI, is a bi-directional digital communication protocol popular in the lighting industry. It is an IEC standard and there are many control devices from Philips and other manufacturers that communicate using DALI. The voltage across DALI wires is typically 16 V (refer IEC specification for details) and it is not polarity sensitive. The DALI wires can be run alongside input main wires and the maximum current on a DALI line is limited to 250 mA. Philips Xitanium LED drivers feature 12-bit or greater dimming resolution for LED light.

Using DALI, it is possible to send dimming commands (1-254 levels), set fade rates and fade times, query driver or LED status, etc. drivers also respond to LED-specific DALI commands e.g. query if the LED module is short circuit or open circuit; select between logarithmic or dimming curves, etc. Typically up to 64 DALI drivers can be connected to one DALI bus. Note that after a power cycle (not stand-by) the driver by default will come back to its last known light level. This behavior however can be programmed differently into "off" or any dim level between 1..254 DALI level.

For more information on DALI, refer to the IEC specification for DALI protocol.

- IEC 62386: 102 – General requirements – Control gear
- IEC 62386: 207 – Particular requirements for control gear – LED modules.

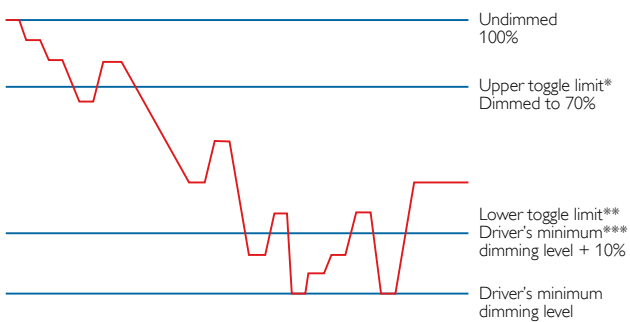

Always dim down above the upper toggle limit
 Always dim up under the lower toggle limit
 Example, a driver with dimming minimum of 10% leads to lower toggle level of 10% + 10% = 20%
 1% leads to lower toggle level of 10% + 1% = 11%'

Touch and Dim function	Contact duration	Driver function
Ignore	< 40 ms	Disregard push
Short push	>=40 ms and <500 ms	Toggle the lamp ON/OFF
Long push	>=500 ms and <10,000 ms	Dim the lamp up or down
Reset push	>10,000 ms	Synchronize drivers
Corridor (if applicable)	>60,000 ms	Switch to Corridor mode

Touch and Dim

For the Xitanium drivers with Touch and Dim function a switched mains is used to dim the light. The switching ON and OFF is also done via this control input. This means that it is no longer necessary to use a power switch to interrupt the mains circuit. The 230V supply voltage is always available at the LED driver (even when switched OFF) and light can be switched or dimmed by momentarily connecting the mains to the dim input. A short push will switch the lighting ON or OFF, depending on the previous situation.

Touch and Dim behavior

If via TD control the driver is switched OFF (short push), the ballast will store the current light level. As soon as the mains power returns (short push via TD will switch the driver ON) the ballast will recall this stored light level. If it was dimmed to 60%, it will come back at 60%.

If the switch is held pushed in, the light will dim up or down, depending on what is opposite from the last dimming direction. The driver will count the number of mains cycles and act on that. If there is a power failure, the ballast will store the current light level. As soon as the mains power returns, the ballast will recall this stored light level. If it was dimmed to 38%, it will come back at 38%. If it was switched off, it will stay switched off. This behavior can be altered via MultiOne configurator software (screenshot on the left).

If the installation has to be extended by one or more light points / drivers, the dimming direction of the newly connected modules may be different from that of those already connected. To solve this problem a synchronization possibility is built into the drivers and can be called upon at any time. If the switch is pressed for at least 10 seconds all drivers will go to 37% light level and the dimming direction will be set to downwards.

Touch and Dim wiring

Special wiring, such as twisted pairs or special cables, is not required to install a Touch and Dim system. All wiring is standard mains wiring and the switch is a standard push-to-make switch. There is no limit to the length of the dim cable or the number of switches connected. The only limitation is the maximum amount of drivers, which is 30 per dimming unit.

Wireless control and dimming

This is the wireless way to control the connected luminaire by wireless technology like Zigbee, WiFi, BLE or other ways. The control interfaces may be website, switch, app...

WiZ (WiFi and BLE)

In order to gain the full control and feature of the controller, it must firstly connect the controller to WiZ system by pairing to WiZ APP. There is a support page in the WiZ APP so that user is able to find what they needed. Also, you may learn more about WiZ from the website:

<http://www.wizconnected.com/en>

<https://www.wizconnected.com/en/pro/get-started/>

MasterConnect (Zigbee and BLE)

All the MasterConnect products can be controlled by MasterConnect APP to enable grouping, scene setting features. The MasterConnect APP can be downloaded from Apple APP store or Google play store.

Non-dimmable

The current of the non-dimmable Xitanium drivers can be set with Rset within the operating window. During normal operation, the set current cannot be changed.

Application guidelines

RC filter for Touch and Dim interface When a Touch and Dim interface is used that works with the mains voltage (Touch and Dim can work with several different voltage levels) and in combination with long cable lengths, high voltage spikes might occur. These voltage spikes can have a negative effect on the performance of the older generation Xitanium Indoor TD LED drivers (listed in table below). To prevent this from happening Philips strongly advises to add a simple RC filter in the system for every Touch and Dim interface that is used, comprising a positive temperature coefficient thermistor. It is advised to install the RC filter directly after the Touch and Dim switch.

TD drivers not listed are not advised to make use of this filter.

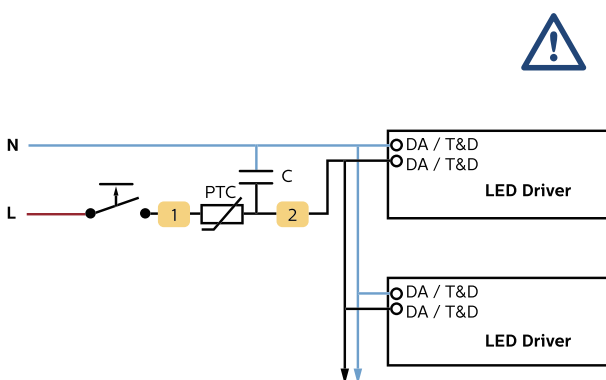

Schematic of Touch and Dim behaviour

The diagram on the left shows a Touch and Dim controlled system with the RC-filter added. The RC filter consists of following components:

- PTC Resistor R = 80-150 Ohm Max Voltage Rating >250V
- Capacitor C = 330 nF Type X2 275 V

Listed drivers are strongly advised to use the RC filter when operated via Touch and Dim

Driver descriptive name	12nc Code
Xitanium 50W 0.3-1A 62V TD/TE 230V	9290 006 61203
Xitanium 50W SH 0.3-1A 62V TD/TE/I 230V	9290 006 17203
Xitanium 50W LH 0.3-1A 62V TD/TE/I 230V	9290 006 17103
Xitanium 25W 0.3-1A 36V TD/Is 230V	9290 004 85803
Xitanium 25W 0.3-1A 36V TD/I 230V	9290 006 00403
Fortimo LED driver 1100-3000TD	9290 004 65003
Fortimo LED driver 1100-3000TD/I	9290 004 65203
Xitanium 17W/0.12-0.4A 54V TD 230V	9290 006 84703
Xitanium 36W 0.12-0.4A 100V TD 230V	9290 006 73703
Xitanium 75W 0.15-0.4A 200V TD 230V	9290 006 70403
Xitanium 75W 0.2-0.4A 200V TD 230V	9290 006 17303
Xitanium 75W 0.7-2A 54V TD 230V	9290 006 92103
Xitanium 75W 2A 54V TD/TE 120-277V	9290 006 36913
Xitanium 75W/160mA 200V TD 230V	9290 008 15903
Xitanium 75W/200mA 200V TD 230V	9290 006 61803
Xitanium 75W/240mA 200V TD 230V	9290 006 61903
Xitanium 75W/280mA 200V TD 230V	9290 006 62003
Xitanium 75W/320mA 200V TD 230V	9290 006 62103
Xitanium 75W/360mA 200V TD 230V	9290 006 62203

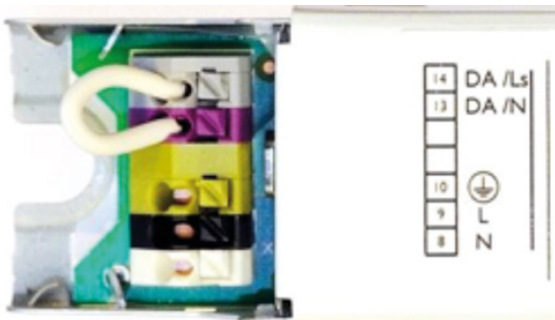

Example of a shorted DALI interface



DALI driver used as fixed output

TD as non-dimmable

When a TD driver is used without any controls connected to the control input, it operates as a non-dimmable driver. However, fluctuations on the power line or other similar interferences might trigger a Touch and Dim lamp OFF command. Due to the fact that no control interface is connected, the system cannot be switched on again. To prevent this, Philips strongly recommends to shortcut the DALI control interface. The DALI interface is also used for connecting the Touch and Dim controls and, by shortcutting this interface, accidental triggering of OFF commands is prevented.

Configurability

Introduction

This chapter describes the way you can configure the drivers with the MultiOne Configurator:

Please check the datasheet of the driver on www.philips.com/technology to know if your driver supports configurability.

The characteristics of the MultiOne configurator are:

- One tool for all Philips configurable drivers: Xitanium LED Indoor and Outdoor drivers; HF-R Indoor fluorescent gear; DynaVision Xtreme HID electronic gear...
- Future proof by design: modular approach, very scalable and backwards compatible
- Provides access to all features built in the driver
- Tool combines configuration with debugging
- Settings of the drivers can be changed any point in the product lifecycle.

This configurator consists of:

1. Philips MultiOne Interface tool
2. USB cable (connection to PC or laptop)
3. Philips MultiOne Software



MultiOne Interface USB2DALI



MultiOne SimpleSet® interface

Philips MultiOne Interface tool

There are 2 versions of MultiOne interface tooling depending on the type of communication:

1. LCN8600/00 MultiOne Interface USB2DALI

The interface that can be used with the MultiOne PC software to commission, configure, diagnose drivers via the DALI interface

2. LCN9600 MultiOne SimpleSet® interface

The interface that can be used with the MultiOne PC software to configure drivers wirelessly using SimpleSet® technology.

Note: The programming of the drivers with SimpleSet must be done while disconnected from mains.

When ordering the MultiOne Interface, the correct USB cable will be supplied with the interface tool. The tool can be ordered via your Philips sales representative or via the Philips OEM webshop, <http://oemwebshop.philips.com>.

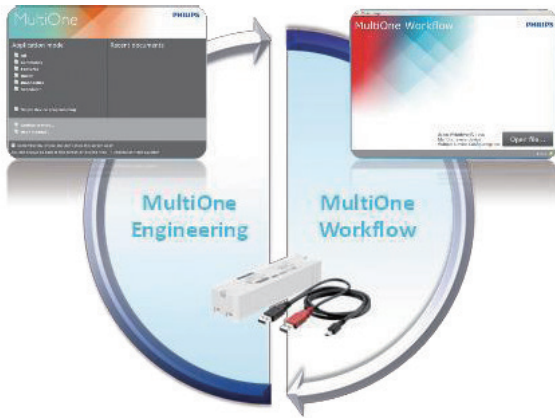

Philips MultiOne Software

There are 2 versions of MultiOne Software depending on functionality and location:

1. MultiOne Engineering

Especially developed to access all functionality of the driver; to configure, diagnose and prepare the configuration file for the production environment. Includes also:

- DALI commands, scheduler.
- SimpleSet®.

2. MultiOne Workflow

Developed to configure all devices or subassemblies in the production environment or field in a simple and quick way.

Get your software (free downloadable) or check if you have the latest version via the website, <http://www.philips.com/multione>.

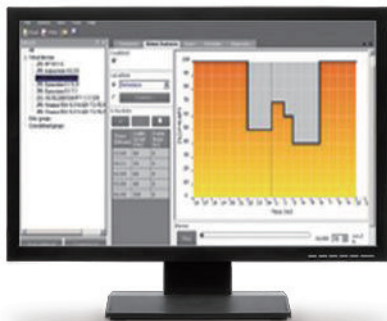

System requirements

The MultiOne configurator must be connected to a system with minimum system requirements:

- Windows PC or Laptop
- Microsoft Windows 8, 8.1, 10, 11
- USB 2.0 ports (preferable two free ports)
- Min 45 MB of free disk space
- Microsoft.NET Framework 4.6.1

Getting Started

Connect the USB cable of the MultiOne Configurator between the PC and the configuration tool.

To install the software, launch the installation file for the latest version and follow the instructions on your screen. The installation wizard will guide through the process of installing the software and will ask where the software needs to be installed, if a shortcut is needed on the desktop and a new program is also created in the Start Menu.

More information on how to program a driver, can be found in getting started and the instruction manual on the website, <http://www.philips.com/multione>.

MultiOne System



Settings

The Xitanium configurable LED drivers have a fixed set of features and factory settings when supplied. The set of features is defined in the datasheet of the driver.

The default settings of the driver can be found in the driver datasheet in the download section on www.philips.com/technology

How to... See the programming taking effect

Programming time

Depending on the selected features to program, the programming time varies between 2 up to about 15 seconds. It is possible to program up to 64 drivers at the same time. In case of group programming there is no individual confirmation (verification) from each driver.

In order to have the programmed values take effect for Xitanium Indoor LED drivers, the mains power needs to be cycled. For newer drivers (1% minimum dim level) On/Off via standby is also sufficient.

Note on Corridor Mode: after a power cycle (e.g. reconnection after luminaire installation) the Corridor Mode needs to be reactivated via the activation pulse. See also upcoming section on Corridor Mode.



Example of a shorted DALI interface

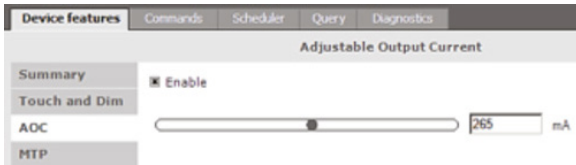

AOC setting

Within the driver's current range, any value can be set via the software, the drivers are programmable in increments of 1mA. For this feature and value changes to be effective, make sure the "Enable" checkbox is ticked.

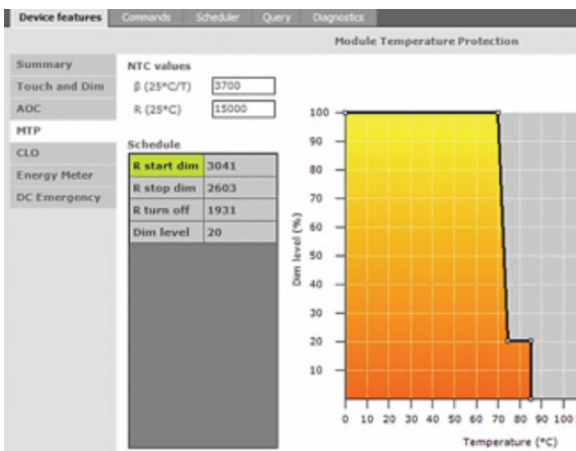

Module Temperature Protection (MTP) behavior setting

It is possible to set the MTP behavior in MultiOne configurator software:

- d) "R start dim" is the temperature at which MTP dim function is activated
- e) "R stop dim" is the temperature at which MTP dimming minimum is defined
- f) "R turn off" is the temperature at which MTP function makes the driver go to its physical minimum dim level (stated in the driver's datasheet)
- g) "Dim level" shows the minimum dim level before switch off

For an extensive explanation of all functionality and allowed values, please refer to the MultiOne configurator software manual, to be found on www.philips.com/multione.

Module Temperature Protection settings in MultiOne

Depending on module temperature, the driver current will follow the line between 100% and "R stop dim" (default 10%). At the rated operating conditions of the luminaire, the LED module temperature should not exceed "R start dim" by design. The MTP feature is helpful in maintaining LED life during occasional/temporary heat spikes like a hot day or loss of air conditioning. The driver responds dynamically to changes in parameters of MTP. There is no need to reset the driver for changes in these parameters to take effect.

Values for R and Beta specify the characteristics of the NTC on the LED modules

	R	Beta
Vishay 15 kΩ	3,700 (default in MultiOne)	15,000 (default in MultiOne)
NTC 10 kΩ	3,850	10,000
Murata 15 kΩ	15,000	3,987
LED light engines	3,700 (default in MultiOne)	15,000 (default in MultiOne)

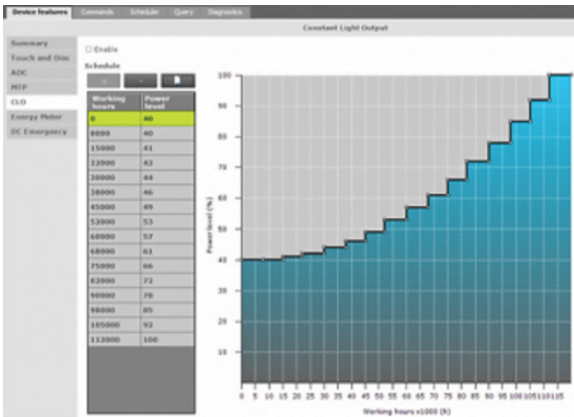

Configure Constant Light Output feature

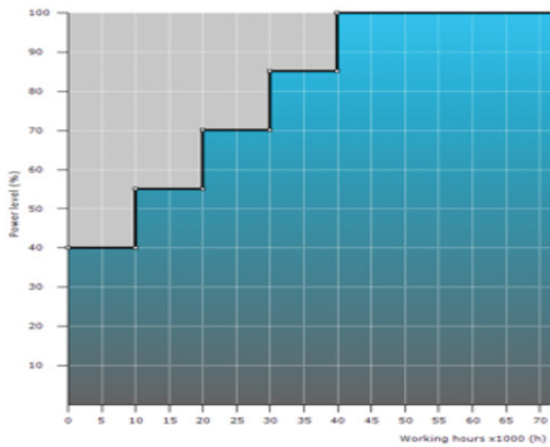

Configure Constant Light Output feature

Constant Lumen Output setting

Traditional light sources like TL and HID typically suffer from depreciation in light output over time. This applies to LED light sources as well. The CLO feature enables LED solutions to deliver constant lumen output through the life of the light engine. Based on the type of LEDs used, heat sinking and driver current, it is possible to estimate the depreciation of light output for specific LEDs and this information can be entered into the driver. The driver counts the number of light source working hours and will increase output current based on this input to enable CLO.

For indoor drivers the CLO percentage can be set to a value between 0-100% with increments of 1%. Value 0% will turn OFF the driver. LED module working hours can be set at any value between (0-120,000 hours) with increments of 1,000 hours. Default the CLO feature is disabled.

Example with CLO

When the CLO feature is enabled (thick the box), the driver nominal output current will be defined by the CLO percentage as shown by the equation below:

$$\text{Driver target nominal output current} = \text{CLO} [\%] \times \text{AOC} [\text{mA}]$$

Assume a driver with a current range of 300-1000 mA. For example, in the CLO profile shown in figure on the left, between 20,000-30,000 working hours, the CLO percentage is set at 70%. Assuming the nominal AOC is set to 800 mA, the driver output current with CLO enabled will be $0.7 \times 800 = 560$ mA from 20 kh to 30 kh.

Please take into account what the AOC (driver current) needs to be when CLO reaches 100%. This value might be higher than the nominal current stated in the datasheet of the LED board. Since the CLO curve is not generic, the OEM needs to determine the appropriate CLO curve for a given luminaire. This can be used to differentiate on e.g. lumen output or power consumption over lifetime.

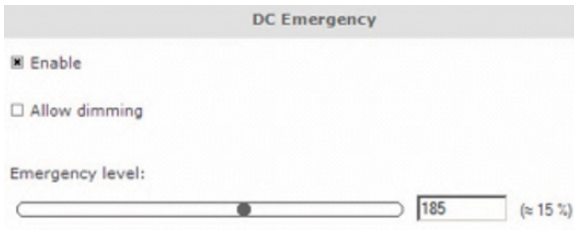

Selectable settings for DCemDIM in MultiOne software

DCemDIM setting

During emergency situations often a 100% light level is not required so power load can be lowered and energy can be saved. DC emergency dimming function is intended to dim the light to a predefined light level as soon as DC mains is applied to the driver's mains input. The MultiOne configurator software can be used to configure the DC emergency dimming feature of the driver:

Parameters are:

- "Enable" DCemDIM when DC is applied to mains input of driver
- While in emergency mode "Allow dimming" overrides driver output when a DALI controller is connected to the driver. Default is Off.
- "Emergency level" can be set between 0..255 (DALI value). The resulting relative dimming value is shown next to the set DALI level. Relative means with respect to the driver's set output current via AOC. When set to 255 the light level is not changed when DC mains is applied.

Example;

AOC set to 200 mA, DCemDIM set to 15% (DALI value 185). Result when mains switched to DC is that the driver outputs $200 \text{ mA} \times 15\% = 30 \text{ mA}$.

For the driver's default settings please check the associated datasheet on www.philips.com/technology.

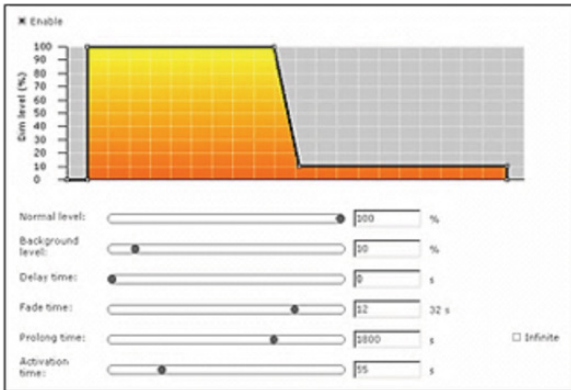

Settings associated with Corridor Mode

Enabled Thick the box to enable this feature

Note: after power cycle option has to be reactivated

Normal level when presence sensor detects activity

Background level when no presence detected and after fade time

Delay time between sensor switch-off and the moment device will start to fade to background level

Fade time used from normal to background level

Prolong time after which device will be switched off

Activation time is time during which mains signal must be detected (pulse), before the device will switch to Corridor Mode

Corridor Mode setting

Newly released Xitanium indoor TD drivers incorporate the Corridor Mode feature. The Corridor Mode adjusts the light to a defined level when a presence sensor detects a person. Corridor Mode can only be activated when the device is in Touch and Dim mode. The settings can be customized to suit your application using the Philips MultiOne configurator software, after which it automatically is in the DALI mode.

Activate Corridor Mode

- Hardware by means of providing mains voltage to the control input for at least the “Activation time” (default 55 s).
- Set via MultiOne configurator software, cycle mains and activate.

If the switch in the application cannot make a pulse that long, via Dali programming the parameter Activation Time in tab Corridor Mode can be adjusted according requirements. For example shortened to 10 s. This value is then stored and will be available after a power cycle.

Reactivate Corridor Mode after a mains power cycle

Please note, when the mains is cycled (e.g. after installation of the luminaire) default the Corridor Mode will be disabled (Touch and Dim will be enabled). This behavior is similar to the conventional Philips fluorescent ballasts. Once powered again the Corridor Mode needs to be reactivated (see previous section).

De-activate Corridor Mode

- Cycling the mains on both control input and mains input of driver
- Set via MultiOne configurator software, cycle mains and activate

The driver enters this mode with default settings as stated in the table on the next page.

Parameter	Value	Default	Remarks
Enabled	0, 1	0	0 = Touch and Dim, 1 = Coridor
Normal level	0 ... 254	254	DALI levels (0 ... 100%)
Background level	0 ... 254	170 (= 10%)	DALI levels (0 ... 100%)w
Delay time driver	0 ... 2550	0	Seconds after "sensor off"
Fade time	0 ... 15	12 (= 32 s)	DALI fade times (0 ... 90 s)
Prolong time	0 ... 2550	1800s (30 mins.)	0 ... 2540 s, 2550 = infinity
Activation time	1 ... 2550	55 s	Seconds to provide mains
LED light engines	3,700 (default in MultiOne)	3,700 (default in MultiOne)	15,000 (default in MultiOne)

Note: if available **Sensor delay time** is set on the sensor itself

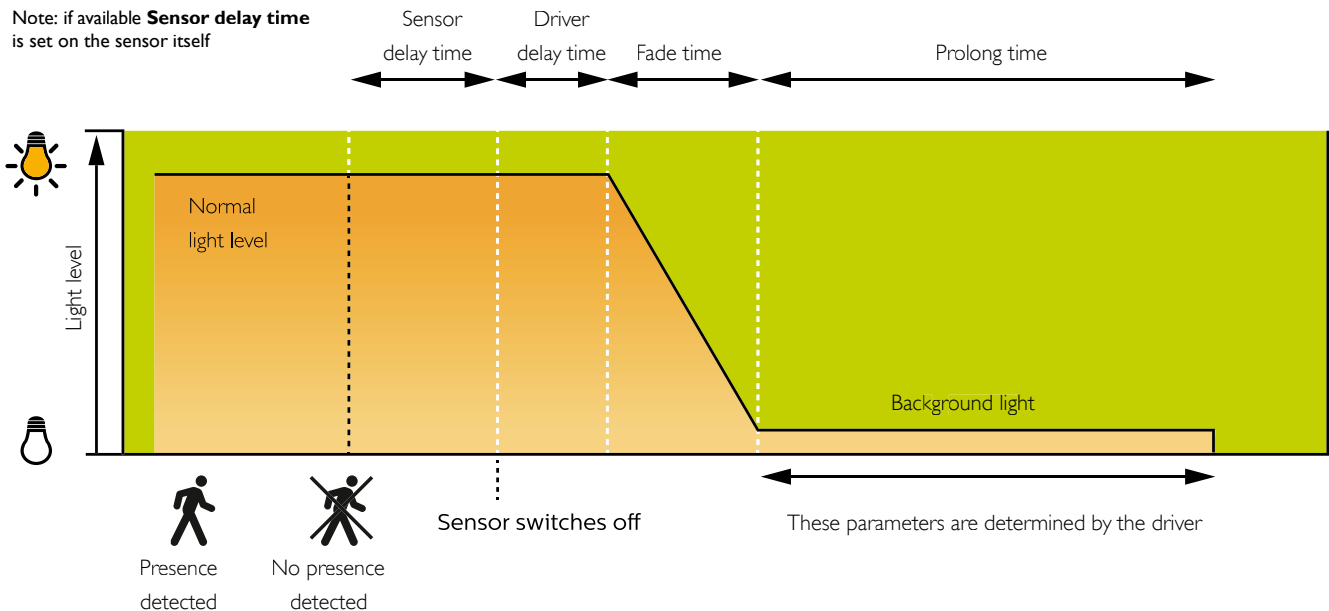

Setting the level in the DALI "command" tab of MultiOne

How to... Set the DALI minimum dimming level

A practical example when to do this; having a 1% dimming driver next to an older 10% dimming driver controlled in the same installation.

Changing the DALI minimum dimming level using the Command tab

You can change the DALI minimum dimming level using MultiOne command form in the "command" tab. The command form uses DALI dim levels. DALI dim level 170 corresponds to 10% dim level.

Steps are:

1. Fill the desired value in the DTR field
2. Select "Set" behind the DTR field
3. Select "DTR -> min level"

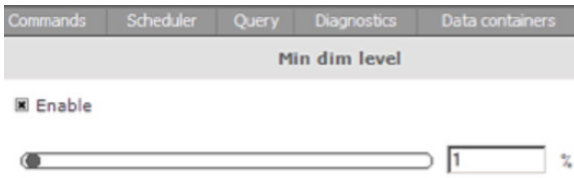

Enable and set the driver's minimum dimming level

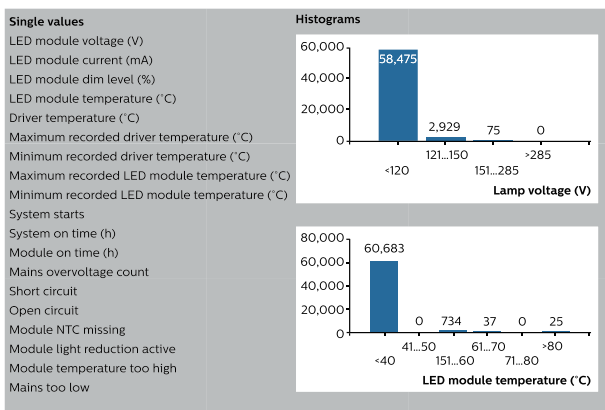

Changing the DALI minimum dimming level using Device Feature tab

Alternatively, on selected drivers (newest) via MultiOne software in the Device Features tab under Min dim level, you can set the minimum dimming level. For this feature to be enabled tick the box.

Driver diagnostics (TD drivers only)

On selected TD drivers (1% dimming range) the diagnostics functionality is available. Please check the datasheet of the driver you use or consider to determine if the functionality is available. To access these diagnostics, select a device in the Network and select the Diagnostics tab. Upon clicking Read on the toolbar, the device's diagnostics information will be read and displayed. Diagnostics for a LED device might look as follows:

A brief explanation of all LED diagnostics is given in the table below.

Table explaining LED diagnostics

Diagnostic	Description
LED module voltage (V)	Represents the output LED module voltage.
LED module current (mA)	Represents the output LED module current.
LED module dim level (%)	Represents the actual dim level set by the LED driver. Takes into account all factors that can influence dimming like Constant Light Output, Module Temperature Protection, all dimming interfaces etc.
LED module temperature (°C)	Represents the LED module temperature. Available only when Module Temperature Protection is selected and an NTC value is selected.
Driver temperature (°C)	Represents the internal driver temperature. It does not represent T _{case} of the driver. Though there is a correlation between T _{case} and internal driver temperature, the difference can vary depending on current setting of driver.
Minimum recorded driver temperature (°C)	Minimum LED driver temperature ever reached during the lifetime of the driver.
Maximum recorded driver temperature (°C)	Maximum LED driver temperature ever reached during the lifetime of the driver.
Minimum recorded LED module temperature (°C)	Minimum LED module temperature ever reached during the lifetime of the driver.
Maximum recorded LED module temperature (°C)	Maximum LED module temperature ever reached during the lifetime of the driver.
System starts	Represents the number of times the LED driver is powered ON.
System on time (h)	Represents the hours the LED driver is ON. (LED module is OFF)
Module on time (h)	Represents the number of hours the LED module is powered ON.
Mains overvoltage count	The numbers of times the mains has exceeded the maximum mains value as listed in the safety range of the product.
Short circuit	This indicates if output LED module is shorted.
Open circuit	This indicates if output LED module is open or not connected to LED driver.
Module NTC missing	This indicates missing NTC on the LED module. Available only when Module Temperature Protection is selected and 10 k NTC is selected. Missing NTC flag will not be activated if 15 k + 390 Ω NTC is selected.
Module light reduction active	This indicates light level reduction due to module temperature being active.
Module temperature too high	This indicates whether the LED module temperature exceeds 90 °C causing module to turn OFF.
Mains too low	This indicates that the LED driver is not operating since input voltage at power ON is too low.

Quality and Reliability

Switching & cycling lifetime of LED drivers

Impact of on and off switching on lifetime of electronic drivers in LED systems

In this section a description is presented of the impact of mains voltage switching on the lifetime of electronic drivers in lighting systems. Because switching on and off the lighting has an impact on different failure modes, a distinction has to be made between switching on and off, and thermal cycling.

Electrical failures due to switching V_{mains} on and off

Before the lighting is switched on in the electronic circuit all capacitors are uncharged. By a simple toggle of the mains voltage all capacitors will be charged, causing peak currents in the circuit. Inductors react to this by creating peak voltages. Occurrence of peak currents & voltages during starting is inevitable. The circuit design and component selection should be of sufficient quality that no components are overstressed during the starting conditions. If the quality is not sufficient, failures will occur at a certain rate over time. The failure rate will be influenced by usage conditions such as temperature and mains voltage. The failure rate will be further enhanced by irregular mains voltage events such as dips, surges or black outs. For a good quality design all conditions and components are carefully checked. In general LED systems and products are designed to withstand >100,000 switches under the specified use conditions.

Mechanical failures due to thermal cycling

A completely different failure mode which is also due to switching on and off the light is the failure of solder joints, due to thermal cycling. Stresses in solder joints are caused by the differences of the thermal expansion coefficients (CTE's) of printed circuit board, solder and component materials.

Due to heating up and cooling down mechanical stresses build up in the solder, which eventually result in cracking and finally failure of the joint. In most cases failure of one solder joint means the end of the product. The solder joint failure mechanism is also referred to as solder joint fatigue. This is a typical wear out failure mechanism with a negligible failure rate for many years, but for which after the typical lifetime has passed, failures come at an accelerated speed.

Electronic Drivers for LED lighting are typically designed to last 50,000 operational hours. The reference for this lifetime is a typical user profile of 10-12 hr usage and up to 3x switching on and off every day. In the worst case this could mean 25,000 switches at a regular rate 2 hrs on, 2 hrs off. For a 100,000 hr specified product, the driver has to survive twice the number of switches. For the electrical stresses during switching there is no problem switching many more times, even up to >100,000 times. However for the solder joints there can be a risk for the lifetime of the product.

Impact of thermal cycles per day on the driver lifetime

As the drivers are typically designed to withstand 3 full thermal cycles every day, lifetime will reduce with an increasing cycling frequency. However this reduction will be limited by the heating time of the product in the application. As the heating time of a driver in real applications varies typically between 60 and 120 minutes, maximum and minimum driver temperature will not be reached when the cycling frequency is faster than 60 minutes. Because the solder-joint damage relates to a higher power of the temperature difference between hot and cold condition, the negative effect on lifetime reduces for the higher cycling frequencies. This is expressed in the above graph.

Because of the large variation and differentiation between drivers and applications, it is an impossible task to specify the above graph for every driver and application specifically. Therefore only the critical conditions are listed for which there could be a risk to the cycling lifetime of the driver:

Critical conditions for the driver lifetime due to thermal cycling are:

- Small driver / system (short heating time) without appropriate heat sinking (high T_{max}).
- Large difference between T_{max} and temperature in off state T_{min} (e.g. $> 50\text{ }^{\circ}\text{C}$). See also next paragraph.
- Application @ temperatures $< -20\text{ }^{\circ}\text{C}$ $T_{ambient}$.

Especially if the above parameters occur in combination with each other there can be a risk for thermal cycling lifetime. To improve cycling lifetime when required, it is most relevant to decrease the T_{max} by appropriate heat sinking of the driver. As a rule of thumb $10\text{ }^{\circ}\text{C}$ diminished ΔT between $T_{case\ on/off}$, will add 30% to cycling performance.

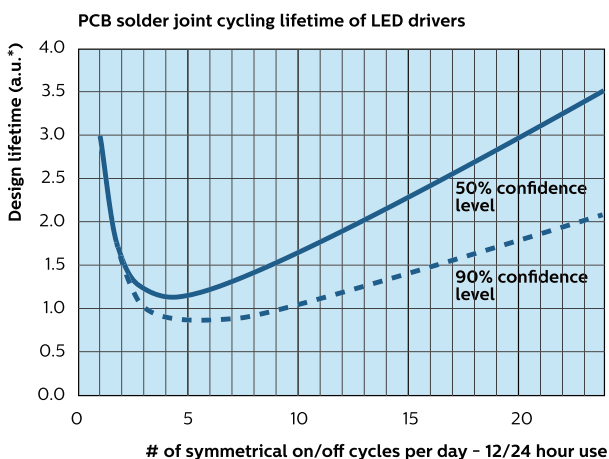

*) arbitrary unit value 1.0 means product design - lifetime will be reached (typical 50,000 h). Longer lifetimes can be limited by other failure modes.

Impact of product ambient temperature on cycling performance

In the first approximation the solder joint lifetime is independent of the ambient temperature. The driving parameter for the solder joint failure fatigue is the temperature difference between T_{max} during the 'on' state and T_{min} during the 'off' state. The way the driver is built in to a luminaire is very important as this can decrease the temperature difference. Appropriate heat sinking of the driver is the most effective way to improve the driver cycling lifetime. As a rule of thumb 10 °C diminished ΔT between $T_{case\ on/off}$, will add 30% to cycling performance.

For potted products additional failure mechanisms can occur at temperatures < -20 °C, which can increase the impact of thermal cycling on the product lifetime.

Compliance and approval

Driver compliances and approvals can be found in the published driver Declarations of Conformity (DoC) and ENEC/CB certificates as published on www.philips.com/oem. For further questions please contact your local Philips sales representative.

System Disposal

Please inform yourself about the local waste disposal, separation and collection system for electrical and electronic products and packaging. Please act according to your local rules and do not dispose of your packaging and old product with your normal household waste. The correct disposal of your product will help prevent potential negative consequences for the environment and human health.

Disclaimer

Philips will perform the testing of the LED systems to high standards of workmanship. The tests are carried out with reference to the EN/IEC standards, if any, which are regarded by Philips as being of major importance for the application of the lamp gear and the lamp within the fixture for horticultural applications.

The design-in guide, regarding the testing and design in of the LED system provided by Philips, is not an official testing certificate, and cannot be regarded as a document for official release of the fixture. The OEM is liable for the official testing by a certified test body and all markings, such as CE and ENEC marks, on the fixture assembly.

The design-in guide is for information purposes only and may contain recommendations for detecting weak points in the design of the system (lamp – lamp gear – fixture), if any.

Specifically mentioned materials and/or tools from third parties are only indicative: other equivalent equipment may be used but it is recommended that you contact Philips for verification.

Philips will not be liable for unforeseen interactions of the proposed solutions when applied in the fixtures or applications using these fixtures. Philips has not investigated whether the recommendations are or will in the future be in conflict with existing patents or any other intellectual property right. Philips does not warrant that its recommendations are technically or commercially the best options.

Since the tests are only performed on one particular fixture provided by the customer, it will be treated as a prototype. This means that there is no statistical evidence regarding later production quality and performance of the lamp – lamp gear – fixture system.

As Philips does not have control over manufacturing of the fixtures, Philips cannot be held liable for the fixture assembly.

Philips will not accept claims for any damage caused by implementing the recommendations.

No warranty whatsoever may be claimed by the OEM with regard to the content and/or quality of the design-in guide or any other advice, or the conclusions and/or recommendations in the design-in guide or any other document, either express or implied, and Philips expressly disclaims any implied warranties of any kind, including without limitation any warranties of satisfactory quality, fitness for a particular purpose or non-infringement and any warranties regarding the design-in guide or any other advice or the use of the results of any activity performed while testing the fixture with respect to its correctness, quality, accuracy, completeness, reliability, performance or otherwise.

The OEM expressly agrees that test design-in guides are provided by Philips on an 'as is' basis and an 'as available' basis at customer's sole risk and expense. Philips shall not be liable for any lost profits or lost savings, indirect, incidental, punitive, special, or consequential damages whether or not such damages are based on tort, warranty, contract, or any other legal theory – even if Philips has been advised, or is aware, of the possibility of such damages.

The OEM must bring any claim for damages within ninety (90) days of the day of the event giving rise to any such claim, and all lawsuits relative to any such claim.



© 2023 Signify Holding, IBRS 10461, 5600VB, NL. All rights reserved.

www.philips.com/Technology

The information provided herein is subject to change, without notice. Signify does not give any representation or warranty as to the accuracy or completeness of the information included herein and shall not be liable for any action in reliance thereon. The information presented in this document is not intended as any commercial offer and does not form part of any quotation or contract, unless otherwise agreed by Signify.

Philips and the Philips Shield Emblem are registered trademarks of Koninklijke Philips N.V. All other trademarks are owned by Signify Holding or their respective owners.

30 May 2023

Data subject to change