



Ophiostomatoid fungi associated with the spruce bark beetle *Ips typographus*, including 11 new species from China

R. Chang¹, T.A. Duong^{1,2}, S.J. Taerum¹, M.J. Wingfield¹, X. Zhou², Z.W. de Beer¹

Key words

11 new taxa
Ophiostomatales
Microascales
vector
Scolytinae

Abstract *Ips typographus* (Coleoptera, Scolytinae) is a spruce-infesting bark beetle that occurs throughout Europe and Asia. The beetle can cause considerable damage, especially when colonized trees are stressed and beetle populations increase. Although some studies have shown that populations of *I. typographus* in Europe, China and Japan are genetically distinct, these populations are biologically similar, including a strong association with ophiostomatoid fungi. To date, only two *Leptographium* spp. have been reported from the beetle in China, while 40 species have been reported from Europe and 13 from Japan. The aims of this study were to identify the ophiostomatoid fungal associates of *I. typographus* in north-eastern China, and to determine whether the fungal assemblages reflect the different geographical populations of the beetle. Field surveys in Jilin and Heilongjiang provinces yielded a total of 1046 fungal isolates from 145 beetles and 178 galleries. Isolates were grouped based on morphology and representatives of each group were identified using DNA sequences of the ribosomal LSU, ITS, β -tubulin, calmodulin and elongation factor 1- α gene regions. A total of 23 species of ophiostomatoid fungi were identified, including 12 previously described species and 11 novel species, all of which are described here. The dominant species were *Ophiostoma bicolor*, *Leptographium taigense* and *Grosmannia piceiperda* D, representing 40.5 %, 27.8 % and 17.8 % of the isolates, respectively. Comparisons of species from China, Europe and Japan are complicated by the fact that some of the European and all the Japanese species were identified based only on morphology. However, assuming that those identifications are correct, five species were shared between Europe, Japan and China, two species were shared between China and Japan, five between Europe and China, and two between Europe and Japan. Consequently, *Ips typographus* populations in these different geographic areas have different fungal assemblages, suggesting that the majority of these beetle-associations are promiscuous. The results also suggested that the symbionts of the bark beetle do not reflect the population structures of the beetle. The use of fungal symbiont assemblages to infer population structures and invasion history of its vectors should thus be interpreted with circumspection.

Article info Received: 18 April 2018; Accepted: 31 July 2018; Published: 22 August 2018.

INTRODUCTION

Symbionts of insects can dramatically impact the ecology, evolution and physiology of their vectors, sometimes with detrimental effects on human health, food security and industry (Klepzig et al. 2009). When molecular data provide ambiguous results regarding the movement history of an insect species, comparisons between symbiont assemblages at various locations can provide clues regarding the movement patterns of the insect. They can also reflect geographical barriers that limit gene flow between populations of the insect (Taerum et al. 2013). For example, when the Formosan subterranean termite (*Coptotermes formosanus*) invaded the United States from China, bacterial symbionts were useful in determining the source population of the insect (Husseneder et al. 2010). However, there are few studies on geographical variation in symbiont assemblages of insects, including those on bark beetles and their associated ophiostomatoid fungi (Jacobs et al. 2003, Taerum et al. 2013). Bark beetles (Coleoptera: Curculionidae: Scolytinae) are a highly diverse group of insects that occur in most forested regions of the world (Raffa et al. 2015). Some species can form large tree-killing outbreaks, which are considered to be major forest

disturbances (Grégoire et al. 2015). Bark beetles are important vectors of microbial and animal symbionts between host trees (Six & Wingfield 2011, Hofstetter et al. 2013). Among the most common associates of these beetles is a group of fungi, commonly referred to as the ophiostomatoid fungi, which includes members of the Ophiostomatales and Microascales (Wingfield et al. 1993, De Beer et al. 2013, 2014). Most of these fungi cause blue stain in the wood of host trees, but a few are important pathogens, such as *Ophiostoma ulmi* and *O. novo-ulmi*, the causal agents of Dutch Elm Disease (Brasier 1988).

In symbioses between bark beetles and microbes, there is frequently evidence for coevolution between the arthropods and microbes. Many species of ophiostomatoid fungi produce long-necked ascomata or conidiophores with sticky ascospores or/and conidia. These characters are thought to be adaptations for dispersal between tree hosts by arthropods (Malloch & Blackwell 1993). In addition, some bark beetle species possess specialised structures, known as mycangia, which facilitate the transport of fungi between trees (Batra 1963). All these adaptations contribute to the maintenance of bark beetle-fungus symbioses.

The patterns of association between fungi and bark beetles is usually not 'one fungus-one insect' (Kirisits 2004). Most bark beetle species are associated with several species of fungi. For example, *Endoconidiophora polonica*, *O. ainoae*, *O. bicolor*, *Grosmannia penicillata* and *G. piceiperda* have all been isolated from *Ips typographus*. Similarly, *O. piceae* is an example of an

¹ Department of Biochemistry, Genetics and Microbiology, Forestry and Agricultural Biotechnology Institute (FABI), University of Pretoria, Pretoria 0002, South Africa; corresponding author e-mail: wilhelm.debeer@fabi.up.ac.za.

² FuturaGene Biotechnology (Shanghai) Co. Ltd, Shanghai 200233, China.

individual fungal species that can be associated with numerous bark beetle species such as *Cryphalus abietis*, *Crypturgus cinereus*, *Crypturgus pusillus*, *Dryocoetes autographus*, *Hylastes cunicularius* as well as other beetle vectors (Kirisits 2004). Due to differences in tolerance to various environmental conditions, including host tree defensive chemistry, and moisture and oxygen requirements, the fungal symbioses can differ over time or vary within and among locations (Solheim 1991, Viiri 1997, Klepzig et al. 2004, Hofstetter et al. 2006, Adams & Six 2007, Six & Bentz 2007, Bleiker & Six 2009a, b).

Associations between fungal symbionts and their bark beetle vectors range from antagonistic to mutualistic (Six & Wingfield 2011). Antagonistic symbionts can affect vector fitness either directly or indirectly. *Beauveria bassiana* is an example of a direct antagonist; this fungus is a pathogen of several bark beetles and other insect species (Wegensteiner et al. 2015). An example of indirect antagonism is the association between the fungus *O. minus* and the southern pine beetle, *Dendroctonus frontalis*. *Ophiostoma minus* is commonly associated with *D. frontalis*, and has negative impacts on the fitness of the beetle, outcompeting the nutritional mutualists of *D. frontalis* within the phloem of host trees (Klepzig 1998). Conversely, mutualistic symbionts can aid their bark beetle vectors in colonizing tree hosts.

Ophiostomatoid fungi have been hypothesized to aid their vectors in overcoming tree defences, thus allowing the beetles to establish colonies in their tree hosts (Lieutier et al. 2009), although this view has been challenged (Six & Wingfield 2011). However, it has been shown that the fungus *G. clavigera*, a symbiont of the mountain pine beetle *Dendroctonus ponderosae*, can detoxify defensive chemicals produced by the host tree (DiGuistini et al. 2011). There are also many examples where fungi associated with bark beetles act as nutritional mutualists, by concentrating nutrients that are essential for brood development (Lee et al. 2005, 2006, Bleiker & Six 2007).

Ips typographus is an aggressive bark beetle species that is native to Eurasia. In Europe, the insect mainly attacks Norway spruce (*Picea abies*), while in Japan where it is known as *I. typographus japonicus*, it mainly attacks Yezo spruce (*P. jezoensis*) and Sachalin spruce (*P. glehnii*) (Yamaoka et al. 1997, Stauffer et al. 2001). Outbreaks of *I. typographus* can result in dramatic host mortality (Krascsenitsova et al. 2013). In China, *I. typographus* is mainly distributed in Heilongjiang, Jilin, Sichuan, Qinghai and Xinjiang provinces, and primarily damages Korean spruce (*P. koraiensis*), Yezo spruce (*P. jezoensis*) and Asian spruce (*P. schrenkiana*). The beetle also incurs costs because it necessitates sanitation felling and the clearing of wind throw areas (Wermelinger 2004). Population genetics studies on *I. typographus* have suggested that the Chinese and Japanese populations are more similar to each other than either population is to the European population (Stauffer et al. 1992, Stauffer et al. 1999, Salle et al. 2007, Bertheau et al. 2013, Mayer et al. 2015).

The ophiostomatoid fungal symbionts of *I. typographus* have been well identified in Europe and Japan. The first fungal associate of *I. typographus* to be recorded was *G. penicillata* in Germany (Grosmann 1930, Solheim 1986). Later, several additional species of ophiostomatoid fungi in the genera *Endoconidiophora* (previously treated as *Ceratocystis*), *Ceratocystiopsis*, *Grosmania*, *Leptographium* and *Ophiostoma* were reported from Japan and Europe (Yamaoka et al. 1997, 1998, Viiri & Lieutier 2004, Jankowiak 2005, Jankowiak & Hilszczanski 2005). *Endoconidiophora polonica*, a highly pathogenic fungal associate of *I. typographus* has been reported from Europe and Japan (Marin et al. 2005). However, research on the association between ophiostomatoid fungi and *I. typographus*, in China is limited, with only *L. curviconidium* and *L. gracile* (as *L. latens*) having been reported as associates of the beetle to date (Paciura et al. 2010, Zhou et al. 2013). In this study, we surveyed the ophiostomatoid fungal associates of *I. typographus* in north-eastern China, and based on published records,

Table 1 Isolates of ophiostomatoid fungi associated with *Ips typographus* in China.

Genus	Species complex	Species	Numbers of isolates		Percentages (%)		Total percentage	
			Heilongjiang	Jilin	Heilongjiang	Jilin		
Ophiostomatales								
<i>Ophiostoma</i> s.lat.	Group A	<i>O. floccosum</i> (Taxon 1)	0	8	0.0	0.8	0.8	
		<i>O. piceae</i>	3	1	0.3	0.1	0.4	
		<i>O. minus</i>	3	0	0.3	0.0	0.3	
		<i>O. clavatum</i>	0	1	0.0	0.1	0.1	
		<i>O. songshui</i> sp. nov. (Taxon 5)	2	0	0.2	0.0	0.2	
		<i>O. ainoae</i> (Taxon 6)	18	2	1.7	0.2	1.9	
		<i>O. brunneolum</i> (Taxon 7)	47	0	4.5	0.0	4.5	
		<i>O. ips</i>	14	1	1.3	0.0	1.3	
			<i>O. bicolor</i> (Taxon 9)	423	0	40.5	0.0	40.5
		Group B	<i>O. jilinense</i> sp. nov. (Taxon 10)	0	2	0.0	0.2	0.2
<i>Leptographium</i> s.lat.	<i>Grosmania galeiformis</i>	<i>L. bachii</i> sp. nov. (Taxon 11)	1	0	0.1	0.0	0.1	
	<i>L. lundbergii</i>	<i>L. shansheni</i> sp. nov. (Taxon 12)	1	0	0.1	0.0	0.1	
	<i>G. piceiperda</i>	<i>L. heilongjiangense</i> sp. nov. (Taxon 13)	2	0	0.2	0.0	0.2	
		<i>G. piceaperda</i> -D (Taxon 14)	158	28	15.1	2.7	17.8	
		<i>L. procerum</i>	4	0	0.4	0.0	0.4	
		<i>G. olivacea</i>	13	0	1.2	0.0	1.2	
			<i>G. olivacea</i> (Taxon 17)	3	0	0.3	0.0	0.3
			<i>L. duchongi</i> sp. nov. (Taxon 18)	1	0	0.1	0.0	0.1
		Group C	<i>L. taigense</i> (Taxon 19)	288	2	27.6	0.2	27.8
			<i>G. fenglinhense</i> sp. nov. (Taxon 20)	1	0	0.1	0.0	0.1
		<i>G. penicillata</i>	<i>G. penicillata</i> (Taxon 21)	4	0	0.4	0.0	0.4
Microascales								
<i>Endoconidiophora</i>		<i>E. polonica</i> (Taxon 22)	7	0	0.7	0.0	0.7	
<i>Graphium</i>		<i>Gr. fimbrisorum</i> (Taxon 23)	6	2	0.6	0.2	0.8	
Total			999	47	95.7	4.5		

Table 2 Isolates of ophiostomatoid fungi obtained from *Ips typographus* in Heilongjiang and Jilin and used in this study.

Taxon	Species	Isolate number ^{1,2}		Host	Locality	GenBank number ³			
		CMW	CBS			ITS/ITS2-LSU	BT	EF	CAL
Ophiostomatales									
1	<i>Ophiostoma floccosum</i>	40505		<i>Picea</i> sp.	Jilin	MH144054	MH124247	MH124332	MH124417
		40518		<i>Picea</i> sp.	Jilin	MH144055	MH124248	MH124333	MH124418
		40519		<i>Picea</i> sp.	Jilin	MH144056	MH124249	MH124334	MH124419
		40525		<i>Picea</i> sp.	Jilin	MH144057	MH124250	MH124335	–
		40526		<i>Picea</i> sp.	Jilin	MH144058	MH124251	MH124336	MH124420
2	<i>O. typographi</i> sp. nov.	44483 ^H	141709	<i>Pinus koraiensis</i>	Heilongjiang	MH144059	MH124252	MH124337	–
		44484	141710	<i>P. koraiensis</i>	Heilongjiang	MH144060	MH124253	MH124338	–
		44586	141711	<i>P. koraiensis</i>	Heilongjiang	–	MH124254	MH124339	–
3	<i>O. wuyingense</i> sp. nov.	44474 ^H	141706	<i>P. koraiensis</i>	Heilongjiang	MH144061	MH124255	MH124340	–
		44475	141753	<i>P. koraiensis</i>	Heilongjiang	MH144062	MH124256	MH124341	–
		44476	141754	<i>P. koraiensis</i>	Heilongjiang	MH144063	MH124257	MH124342	–
4	<i>O. jiamusiensis</i> sp. nov.	40512 ^H	141893	<i>Picea</i> sp.	Jilin	MH144064	MH124258	MH124343	MH124421
5	<i>O. songshui</i> sp. nov.	44473 ^H	141707	<i>P. koraiensis</i>	Heilongjiang	MH144065	MH124259	MH124344	–
		44602	141708	<i>P. koraiensis</i>	Heilongjiang	MH144066	MH124260	MH124345	–
6	<i>O. ainoae</i>	40496		<i>Picea</i> sp.	Jilin	MH144067	MH124261	MH124346	MH124422
		40511		<i>Picea</i> sp.	Jilin	MH144068	MH124262	MH124347	MH124423
		44496		<i>P. koraiensis</i>	Heilongjiang	MH144069	MH124263	MH124348	–
		44497		<i>P. koraiensis</i>	Heilongjiang	MH144070	MH124264	MH124349	–
		44498		<i>P. koraiensis</i>	Heilongjiang	MH144071	MH124265	MH124350	–
		44499		<i>P. koraiensis</i>	Heilongjiang	MH144072	MH124266	MH124351	–
		44500		<i>P. koraiensis</i>	Heilongjiang	MH144073	MH124267	MH124352	–
		44501		<i>P. koraiensis</i>	Heilongjiang	MH144074	MH124268	MH124353	–
		44502		<i>P. koraiensis</i>	Heilongjiang	MH144075	MH124269	MH124354	–
		44503		<i>P. koraiensis</i>	Heilongjiang	MH144076	MH124270	MH124355	–
		44584		<i>P. koraiensis</i>	Heilongjiang	–	MH124271	MH124356	–
7	<i>O. brunneolum</i>	44477		<i>P. koraiensis</i>	Heilongjiang	MH144077	MH124272	MH124357	–
		44478		<i>P. koraiensis</i>	Heilongjiang	MH144078	MH124273	MH124358	–
		44479		<i>P. koraiensis</i>	Heilongjiang	MH144079	MH124274	MH124359	–
		44480		<i>P. koraiensis</i>	Heilongjiang	MH144080	MH124275	MH124360	–
		44481		<i>P. koraiensis</i>	Heilongjiang	MH144081	MH124276	MH124361	–
		44482		<i>P. koraiensis</i>	Heilongjiang	MH144082	MH124277	MH124362	–
8	<i>O. japonicum</i>	44467		<i>P. koraiensis</i>	Heilongjiang	–	MH124278	MH124363	–
		44468		<i>P. koraiensis</i>	Heilongjiang	MH144083	MH124279	–	–
		44469		<i>P. koraiensis</i>	Heilongjiang	MH144084	MH124280	–	–
		44470		<i>P. koraiensis</i>	Heilongjiang	MH144085	MH124281	MH124364	–
		44592		<i>P. koraiensis</i>	Heilongjiang	MH144086	MH124282	MH124365	–
9	<i>O. bicolor</i>	44471		<i>P. koraiensis</i>	Heilongjiang	MH144087	MH124283	MH124366	–
		44472		<i>P. koraiensis</i>	Heilongjiang	MH144088	MH124284	MH124367	–
		44597		<i>P. koraiensis</i>	Heilongjiang	MH144089	MH124285	–	–
		44598		<i>P. koraiensis</i>	Heilongjiang	MH144090	MH124286	–	–
		44599		<i>P. koraiensis</i>	Heilongjiang	MH144091	MH124287	MH124368	–
		44600		<i>P. koraiensis</i>	Heilongjiang	MH144092	MH124288	–	–
		44601		<i>P. koraiensis</i>	Heilongjiang	MH144093	MH124289	MH124369	–
10	<i>O. jilinense</i> sp. nov.	40491 ^H	141894	<i>Picea</i> sp.	Jilin	MH144094	MH124290	MH124370	–
		40492	141716	<i>Picea</i> sp.	Jilin	MH144095	MH124291	MH124371	–
11	<i>Leptographium koraiensis</i> sp. nov.	44461 ^H	141898	<i>P. koraiensis</i>	Heilongjiang	MH144096	MH124292	MH124372	–
12	<i>L. shansheni</i> sp. nov.	44462 ^H	141895	<i>P. koraiensis</i>	Heilongjiang	MH144097	MH124293	MH124373	–
13	<i>L. heilongjiangense</i> sp. nov.	44456 ^H	141702	<i>P. koraiensis</i>	Heilongjiang	MH144098	MH124294	MH124374	–
		45083	141703	<i>P. koraiensis</i>	Heilongjiang	MH144099	MH124295	MH124375	–
14	<i>Grosmannia piceiperda</i>	40498		<i>Picea</i> sp.	Jilin	MH144100	MH124296	MH124376	–
		40499		<i>Picea</i> sp.	Jilin	MH144101	MH124297	MH124377	–
		40501		<i>Picea</i> sp.	Jilin	MH144102	MH124298	MH124378	–
		40506		<i>Picea</i> sp.	Jilin	MH144103	MH124299	MH124379	–
		40507		<i>Picea</i> sp.	Jilin	MH144104	MH124300	MH124380	–
		40510		<i>Picea</i> sp.	Jilin	MH144105	MH124301	MH124381	–
		40524		<i>Picea</i> sp.	Jilin	MH144106	MH124302	MH124382	–
		40529		<i>Picea</i> sp.	Jilin	MH144107	MH124303	MH124383	–
		40532		<i>Picea</i> sp.	Jilin	MH144108	MH124304	MH124384	–
		44457		<i>P. koraiensis</i>	Heilongjiang	MH144109	MH124305	MH124385	–
		44458		<i>P. koraiensis</i>	Heilongjiang	MH144110	MH124306	MH124386	–
		44459		<i>P. koraiensis</i>	Heilongjiang	MH144111	MH124307	MH124387	–
		44460		<i>P. koraiensis</i>	Heilongjiang	MH144112	MH124308	MH124388	–
		44580		<i>P. koraiensis</i>	Heilongjiang	MH144113	MH124309	MH124389	–
15	<i>L. yichunense</i> sp. nov.	44464 ^H	141705	<i>P. koraiensis</i>	Heilongjiang	MH144114	MH124310	MH124390	MH124424
		44465	141752	<i>P. koraiensis</i>	Heilongjiang	MH144115	MH124311	MH124391	MH124425
16	<i>G. cucullata</i>	44485		<i>P. koraiensis</i>	Heilongjiang	MH144116	MH124312	MH124392	–
		44486		<i>P. koraiensis</i>	Heilongjiang	MH144117	MH124313	MH124393	–
		44487		<i>P. koraiensis</i>	Heilongjiang	MH144118	MH124314	MH124394	–
		44578		<i>P. koraiensis</i>	Heilongjiang	MH144119	MH124315	MH124395	–
17	<i>G. olivacea</i>	44488		<i>P. koraiensis</i>	Heilongjiang	MH144120	MH124316	MH124396	–
		44489		<i>P. koraiensis</i>	Heilongjiang	MH144121	MH124317	MH124397	–
18	<i>L. duchongi</i> sp. nov.	44455 ^H	141897	<i>P. koraiensis</i>	Heilongjiang	MH144122	MH124318	MH124398	–
19	<i>L. taigense</i>	40490		<i>Picea</i> sp.	Jilin	MH144123	MH124319	MH124399	–
		40528		<i>Picea</i> sp.	Jilin	MH144124	MH124320	MH124400	–
		44493		<i>P. koraiensis</i>	Heilongjiang	MH144125	MH124321	MH124401	–
		44494		<i>P. koraiensis</i>	Heilongjiang	MH144126	MH124322	MH124402	–
		44495		<i>P. koraiensis</i>	Heilongjiang	MH144127	MH124323	MH124403	–

Table 2 (cont.)

Taxon	Species	Isolate number ^{1,2}		Host	Locality	GenBank number ³			
		CMW	CBS			ITS/ITS2-LSU	BT	EF	CAL
20	<i>G. fenglinhense</i> sp. nov.	44579 ^H	141896	<i>P. koraiensis</i>	Heilongjiang	MH144128	MH124324	MH124404	–
21	<i>G. penicillata</i>	44490		<i>P. koraiensis</i>	Heilongjiang	MH144129	MH124325	MH124405	–
		44491		<i>P. koraiensis</i>	Heilongjiang	MH144130	MH124326	MH124406	–
		44492		<i>P. koraiensis</i>	Heilongjiang	MH144131	MH124327	MH124407	–
		44581		<i>P. koraiensis</i>	Heilongjiang	MH144132	MH124258	MH124369	–
Microascales									
22	<i>Endoconidiophora polonica</i>	43236		<i>P. koraiensis</i>	Heilongjiang	MH144133	MH124328	MH124408	–
		43237		<i>P. koraiensis</i>	Heilongjiang	MH144134	MH124329	MH124409	–
		43238		<i>P. koraiensis</i>	Heilongjiang	MH144135	MH124330	MH124410	–
		43239		<i>P. koraiensis</i>	Heilongjiang	MH144136	MH124331	MH124411	–
23	<i>Graphium fimbriisporum</i>	40517		<i>Picea</i> sp.	Jilin	–	–	–	–
		43240		<i>P. koraiensis</i>	Heilongjiang	MH144137	–	MH124412	–
		43241		<i>P. koraiensis</i>	Heilongjiang	MH144138	–	MH124413	–
		43242		<i>P. koraiensis</i>	Heilongjiang	MH144139	–	MH124414	–
		43243		<i>P. koraiensis</i>	Heilongjiang	MH144140	–	MH124415	–
		44504		<i>P. koraiensis</i>	Heilongjiang	MH144141	–	MH124416	–

¹ The culture collection (CBS) of Westerdijk Fungal Biodiversity Institute, Utrecht, the Netherlands; CMW Culture Collection of the Forestry and Agricultural Biotechnology Institute (FABI), University of Pretoria, Pretoria, South Africa.

² H = ex-holotype isolate.

³ ITS = internal transcribed spacer regions 1 and 2 of the nuclear ribosomal DNA operon, including the 5.8S region; ITS2-LSU = the internal transcribed spacer 2 region and partial large subunit of the nrDNA operon; BT = beta-tubulin; EF = translation elongation factor 1-alpha; CAL = Calmodulin.

compared their diversity with those in Japan and Europe. Based on these comparisons, we considered whether the fungal assemblages reflect the different geographical populations of the beetle.

MATERIALS AND METHODS

Collection of beetles and isolation of fungi

Ips typographus was sampled in June 2010 in Jilin province, and in August 2014 in Heilongjiang province, China. Galleries from trees infested with *I. typographus* adults were collected and stored individually in sealable bags. Adult *I. typographus* were individually placed in Eppendorf tubes. Both adult beetles and galleries were stored at 4 °C until fungal isolations were made.

Beetles were crushed on the surface of 2 % malt extract agar (MEA) that contained 0.05 % streptomycin. In addition, fungal mycelium and/or spore masses from *I. typographus* galleries were transferred to MEA medium. Where no mycelium was visible, galleries were incubated in humid chambers in the dark at 25 °C and inspected every 2 d for fungal structures or mycelial masses. When mycelia and/or spore masses appeared during the incubation period, these were transferred to MEA plates amended with streptomycin. All isolates used in this study were deposited in the Culture Collection (CMW) of the Forestry and Agricultural Biotechnology Institute (FABI), University of Pretoria, Pretoria, Republic of South Africa. Isolates representing types of new species were also deposited in the culture collection (CBS) of Westerdijk Fungal Biodiversity Institute, Utrecht, The Netherlands.

DNA extraction, PCR and sequencing

All the isolates were initially grouped based on morphological characters and only representative isolates of these groups were sequenced. DNA was extracted following the method used by Linnakoski et al. (2010). The internal transcribed spacer (ITS) regions (ITS1 and ITS2, including the 5.8S gene), parts of the β -tubulin (BT) and the elongation factor 1- α (EF) genes were amplified and sequenced for taxa residing in the *Ophiostoma* s.lat. For fungal taxa in *Leptographium* s.lat., the BT, calmodulin (CAL) and EF gene regions were also amplified, as well as ITS2 and part of the ribosomal large subunit 28S (ITS2-LSU).

The primers ITS1-F (Gardes & Bruns 1993) and ITS4 (White et al. 1990) were used to amplify the ITS1-ITS2 region, and Bt2a and Bt2b (Glass & Donaldson 1995) were used for the BT region. T10 (O'Donnell & Cigelnik 1997) was used in place of Bt2a when initial amplification with Bt2a and Bt2b primer combination failed. Primers EF2F (Marincowitz et al. 2015) and EF2R (Jacobs et al. 2004) were used to amplify the EF region, and ITS3 and LR3 (White et al. 1990) were used for the ITS2-LSU region. CL2F and CL2R (Duong et al. 2012) were used for amplifying the CAL.

The PCR reaction mixture consisted of 2.5 μ L 10 \times KAPA Taq Buffer A, 0.5 U KAPA Taq DNA Polymerase, 1.0 μ L dNTP mix (10 mM), 0.5 μ L of each primer (10 mM) and PCR grade water to the final volume of 25 μ L. PCR conditions were as follows: an initial denaturation step at 95 °C for 3 min, followed by 30 cycles of 95 °C for 30 s, 55 °C for 45 s, and 72 °C for 1 min and a final elongation step at 72 °C for 10 min. PCR products were cleaned using EXO-SAP (Exonuclease I - Shrimp Alkaline Phosphatase, Thermo, USA) following the manufacturer's recommendations.

The primers used for the sequencing PCR were the same as those used for PCR. The reaction mixture included 0.5 μ L of BigDye Terminator v. 3.1 ready reaction mixture (Applied Biosystems, Foster City, California, USA), 2 μ L sequencing buffer, 1 μ L of either forward or reverse primer, 1 μ L cleaned PCR product and 5.5 μ L of PCR grade water. The reaction conditions were: 30 cycles at 95 °C for 10 s, 55 °C for 5 s and 4 min at 60 °C. Sequencing products were cleaned using ethanol/salt precipitation. Sequencing products were analysed on the ABI PRISM 3100 Genetic Analyzer (Applied Biosystems, Foster City, California, USA).

Phylogenetic analyses

Geneious Pro v. 7.1.7 (Biomatters, Auckland, New Zealand) with Geneious Alignment was used to construct consensus sequences from forward and reverse reads. Preliminary identification of the isolates was made using the BLAST tool on GenBank (<http://blast.ncbi.nlm.nih.gov>). Data sets were compiled based on the species complex or genera based on BLAST analyses. Sequence alignments were done online with MAFFT v. 7 (Katoh & Standley 2013).

ITS

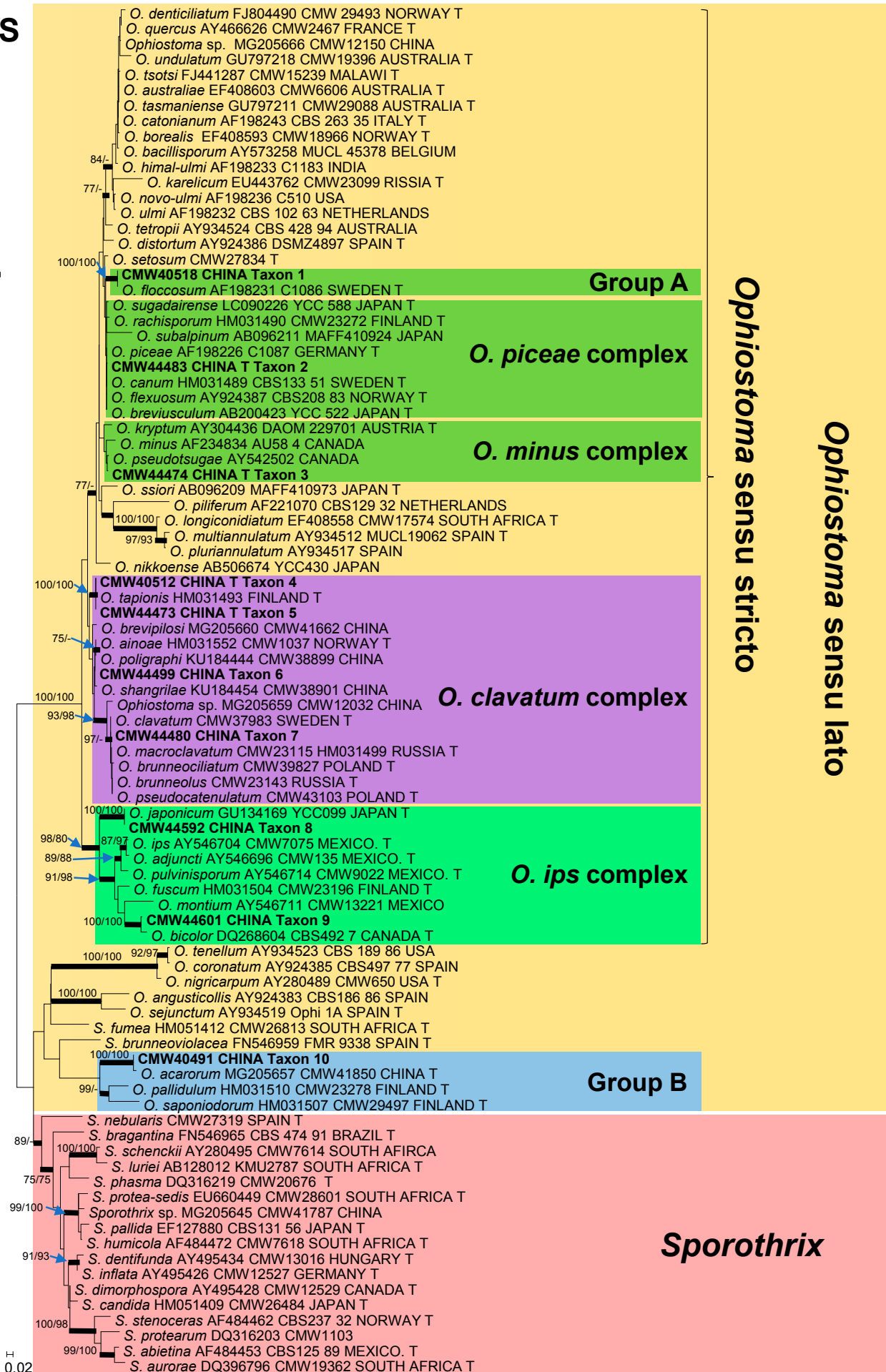

Fig. 1 ML tree of *Ophiostoma* s.l. and *Sporothrix* generated from the ITS DNA sequence data. Sequences generated from this study are printed in bold type. Bold branches indicate posterior probabilities values ≥ 0.9 . Bootstrap values of ML $\geq 75\%$ are recorded at nodes. T = ex-type isolates.

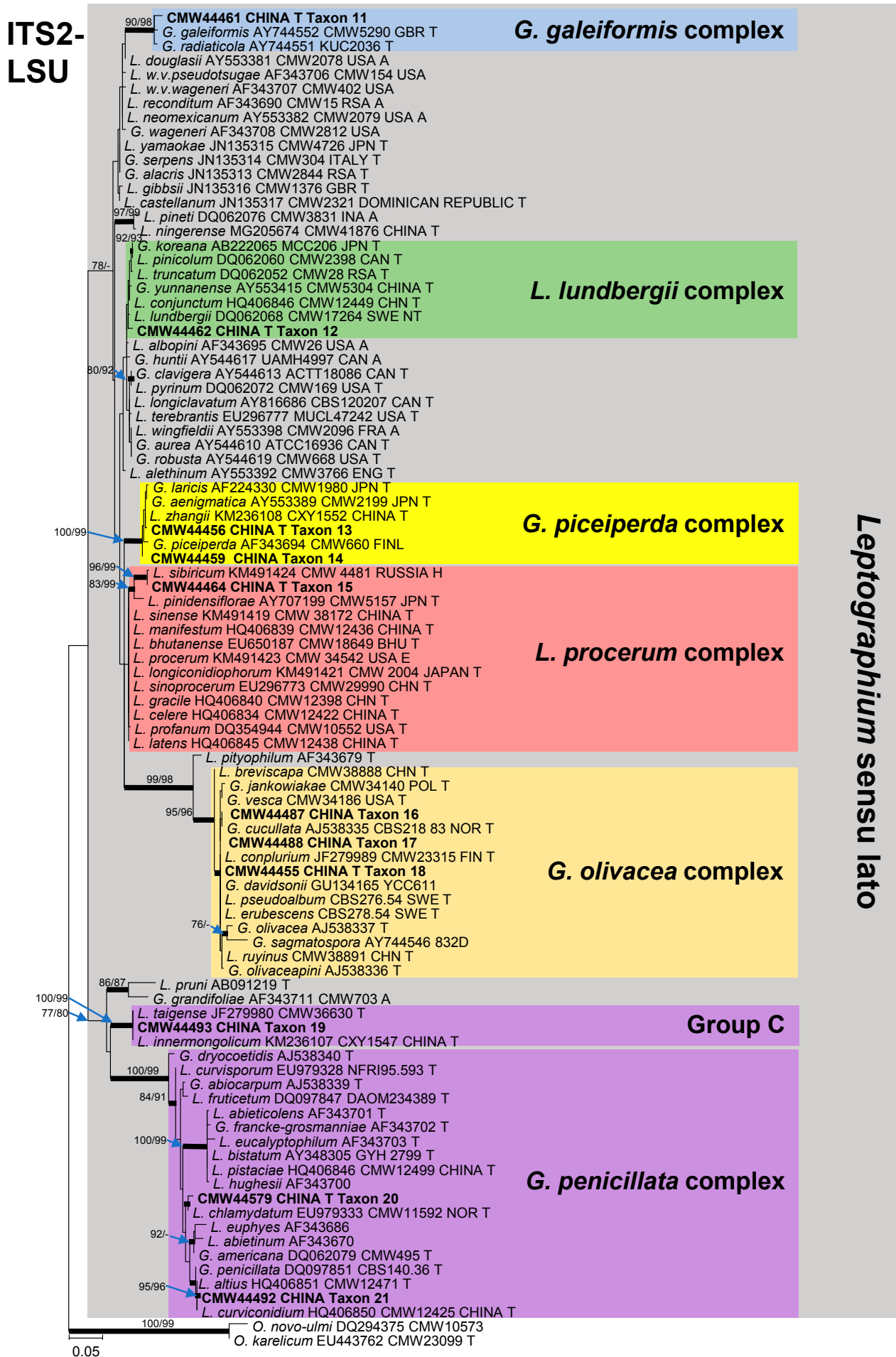

Fig. 2 ML tree of *Leptographium* s.lato generated from the ITS2-LSU DNA sequence data. Sequences generated from this study are printed in **bold** type. **Bold** branches indicate posterior probabilities values ≥ 0.9 . Bootstrap values of ML $\geq 75\%$ are recorded at nodes. T = ex-type isolates.

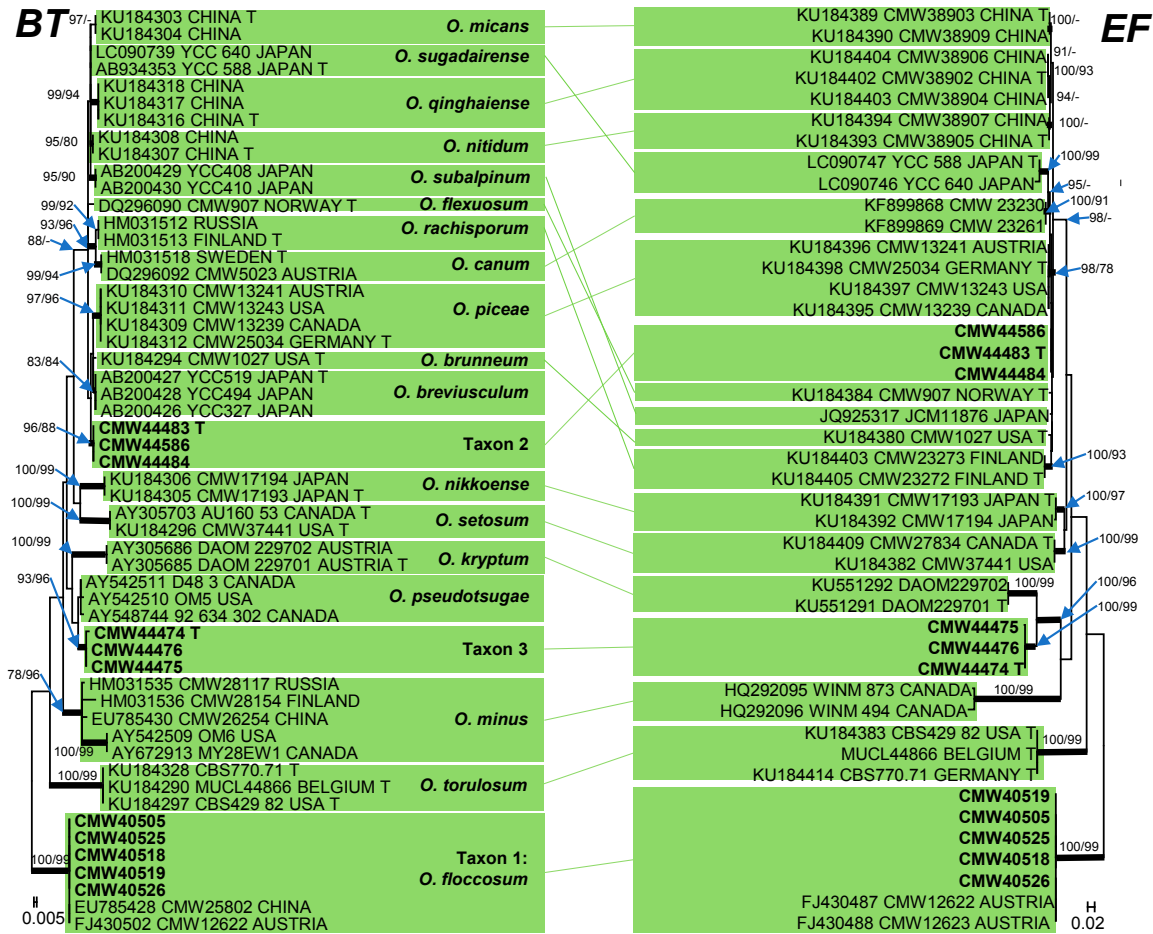

Fig. 3 ML tree of *Ophiostoma piceae*, *O. minus* complex and Group A generated from DNA sequences of *BT* and *EF* regions. Sequences generated from this study are printed in bold type. Bold branches indicate posterior probabilities values ≥ 0.9 . Bootstrap values of ML $\geq 75\%$ are recorded at nodes as ML/MP. T = ex-type isolates.

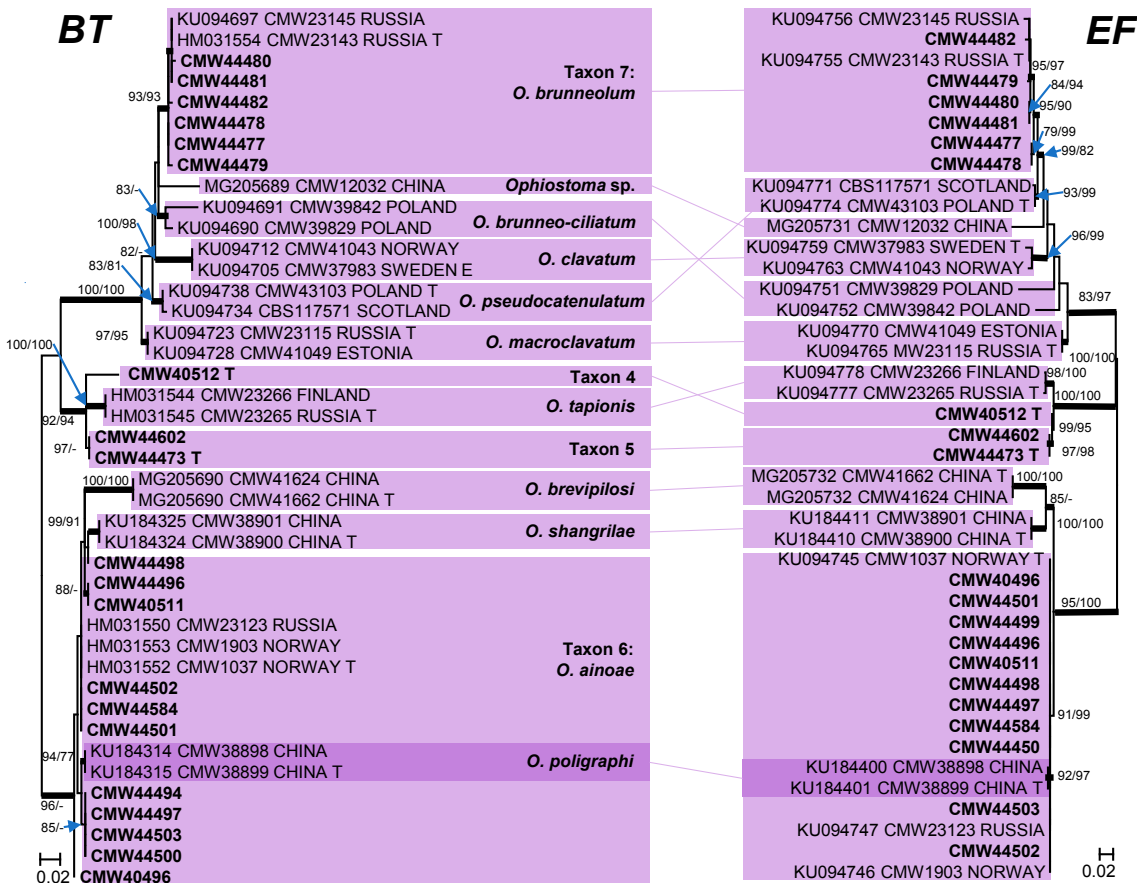

Fig. 4 ML tree of *Ophiostoma clavatum* complex generated from DNA sequences of *BT* and *EF* regions. Sequences generated from this study are printed in bold type. Bold branches indicate posterior probabilities values ≥ 0.9 . Bootstrap values of ML $\geq 75\%$ are recorded at nodes as ML/MP. T = ex-type isolates.

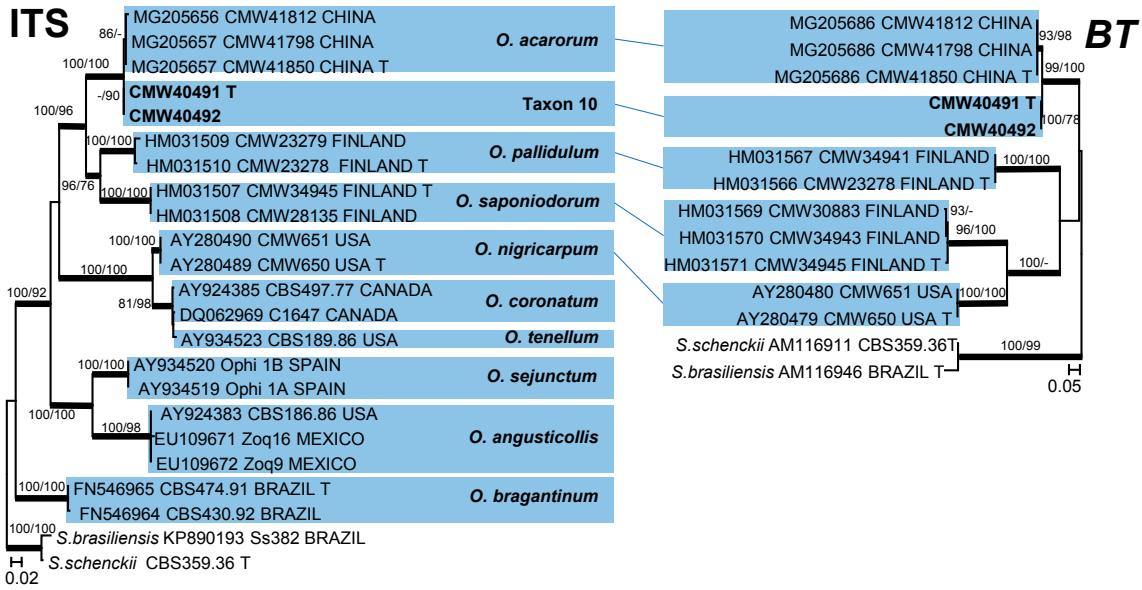

Fig. 5 ML tree of Group B generated from DNA sequences of ITS and BT regions. Sequences generated from this study are printed in bold type. Bold branches indicate posterior probabilities values ≥ 0.9 . Bootstrap values of ML $\geq 75\%$ are recorded at nodes as ML/MP. T = ex-type isolates.

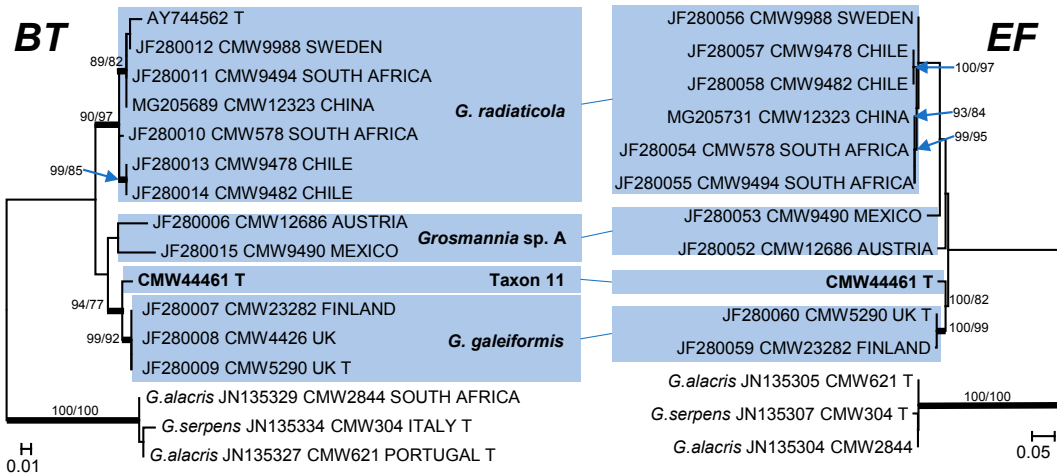

Fig. 6 ML tree of *G. galeiformis* complex generated from DNA sequences of BT and EF regions. Sequences generated from this study are printed in bold type. Bold branches indicate posterior probabilities values ≥ 0.9 . Bootstrap values of ML $\geq 75\%$ are recorded at nodes as ML/MP. T = ex-type isolates.



Fig. 7 ML tree of *L. lundbergii* complex generated from DNA sequences of BT and EF regions. Sequences generated from this study are printed in bold type. Bold branches indicate posterior probabilities values ≥ 0.9 . Bootstrap values of ML $\geq 75\%$ are recorded at nodes as ML/MP. T = ex-type isolates.

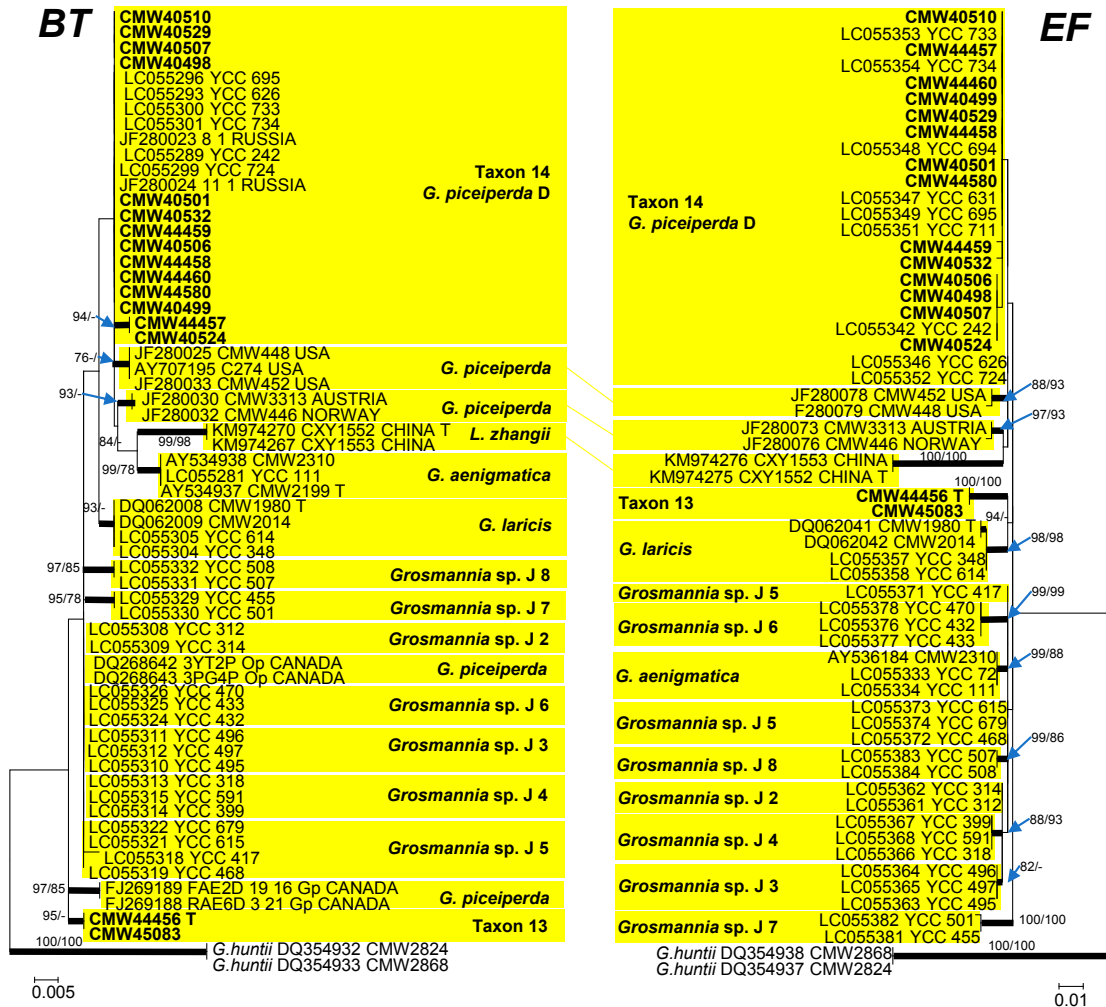

Fig. 8 ML tree of *G. piceiperda* complex generated from DNA sequences of *BT* and *EF* regions. Sequences generated from this study are printed in **bold** type. **Bold** branches indicate posterior probabilities values ≥ 0.9 . Bootstrap values of ML $\geq 75\%$ are recorded at nodes as ML/MP. T = ex-type isolates.

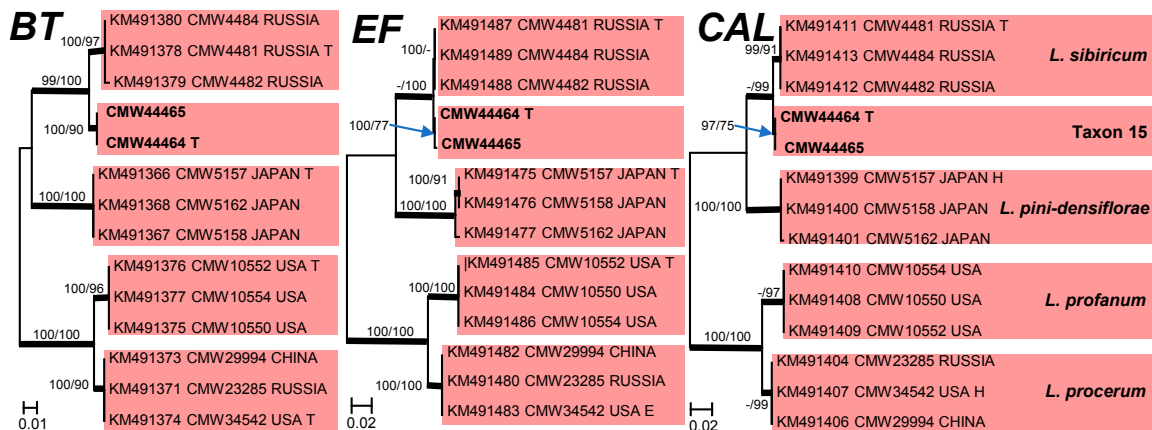

Fig. 9 ML tree of *L. procerum* complex generated from DNA sequences of *BT*, *EF* and *CAL* regions. Sequences generated from this study are printed in **bold** type. **Bold** branches indicate posterior probabilities values ≥ 0.9 . Bootstrap values of ML $\geq 75\%$ are recorded at nodes as ML/MP. T = ex-type isolates.

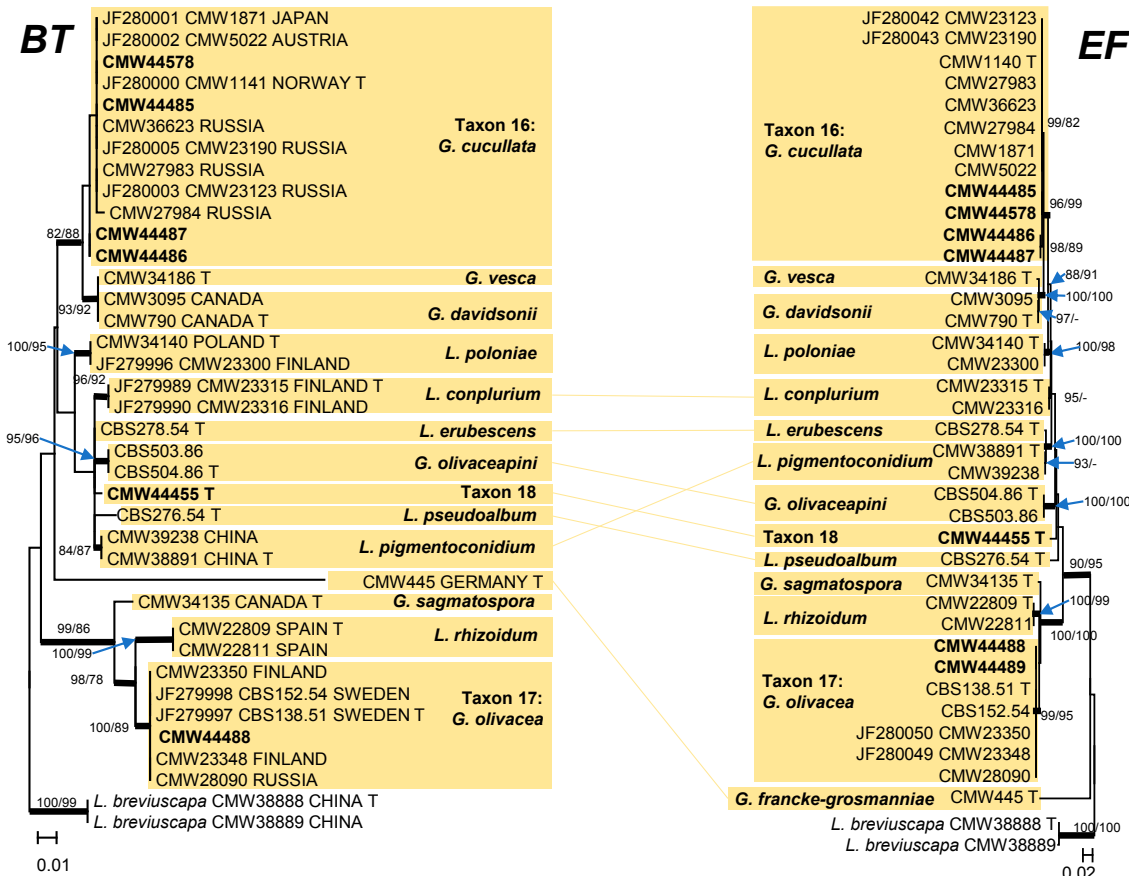

Fig. 10 ML tree of *G. olivacea* complex generated from DNA sequences of BT and EF regions. Sequences generated from this study are printed in bold type. Bold branches indicate posterior probabilities values ≥ 0.9 . Bootstrap values of ML $\geq 75\%$ are recorded at nodes as ML/MP. T = ex-type isolates.

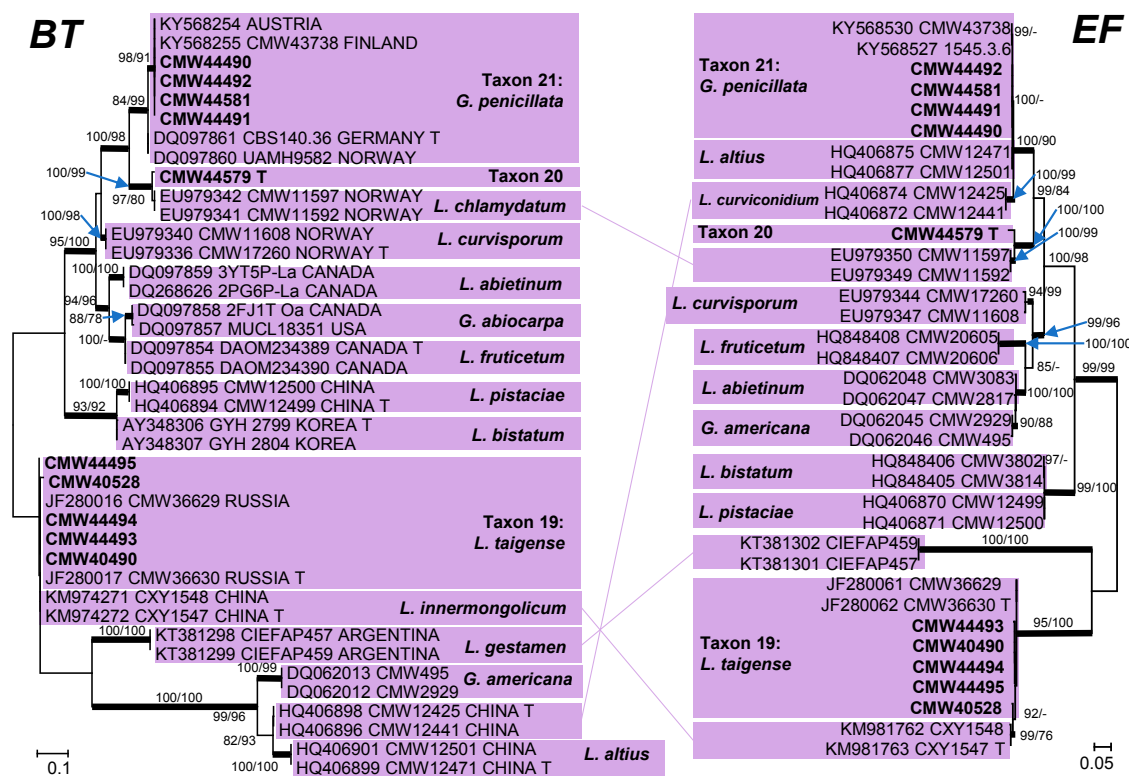

Fig. 11 ML tree of Group C and *G. penicillata* complex generated from DNA sequences of BT and EF regions. Sequences generated from this study are printed in bold type. Bold branches indicate posterior probabilities values ≥ 0.9 . Bootstrap values of ML $\geq 75\%$ are recorded at nodes as ML/MP. T = ex-type isolates.

Phylogenetic analyses were conducted using maximum likelihood (ML), maximum parsimony (MP) and Bayesian inference (BI). ML analyses were conducted using RaxML v. 8.2.4 (Stamatakis 2014) on the CIPRES Science Gateway v. 3.3 (Miller et al. 2010). The best-scoring ML tree searching with GTR substitution matrix and a 1000 rapid bootstrap analysis were conducted. MP analyses were performed using PAUP v. 4.0b10 (Swofford 2002). Gaps were treated as a fifth character. The best substitution models for each data set were determined using jModelTest v. 2.1.6 (Darriba et al. 2012) on the CIPRES Science Gateway v. 3.3. BI analyses were conducted using MrBayes v. 3.2.6 (Ronquist et al. 2012) on the CIPRES Science Gateway v. 3.3. Four MCMC chains were run from a random starting tree for five million generations, trees were sampled every 100 generations. Twenty five percent of trees sampled were discarded as burn-in and the remaining trees were used to construct majority rule consensus trees.

Comparisons of species from China, Europe and Japan

Results from the present study were compared with those from previously published studies from China (Paciura et al. 2010, Zhou et al. 2013), Japan (Yamaoka et al. 1997, Masuya et al. 2013) and Europe (Kirisits 2004, Viiri & Lieutier 2004, Jankowiak 2005, Jankowiak & Hilszczanski 2005, Linnakoski et al. 2010, 2012a, b, 2016b). A summary of these comparisons are presented in Table 3.

RESULTS

Collection of beetles and isolation of fungi

In total, 1046 fungal isolates were obtained from beetles and galleries of *Ips typographus* (Table 1). Of these, 999 isolates were from Heilongjiang province and 47 isolates were from Jilin province.

Phylogenetic analyses

DNA sequence data for 92 isolates, representing all the morphological groups were generated (Table 2). Blast analyses of the ribosomal DNA sequences placed isolates in *Ophiostoma* s.lat., *Leptographium* s.lat., *Endoconidiophora* and *Graphium*. In total, 1031 isolates were species of *Ophiostomatales* and only 15 isolates resided in the *Microascales* (Table 1). Based on phylogenetic analyses of the ITS (Fig. 1), ITS2-LSU (Fig. 2), *BT*, *CAL* and *EF* gene regions (Fig. 3–11, Appendix 1–3), the isolates represented 23 species, which included ten *Ophiostoma* s.lat. (Taxa 1–10), 11 *Leptographium* s.lat. species (Taxa 11–21), and one species each of *Endoconidiophora* (Taxon 22) and *Graphium* (Taxon 23).

Ophiostoma s.lat.

The majority of isolates in *Ophiostoma* s.lat. resided in four species complexes, while two taxa grouped outside any currently recognized species complex (Fig. 1). These are treated in Groups A and B below.

Taxon 1 included eight isolates from Jilin province, five of which were included in the analyses. In the ITS tree, this taxon grouped peripheral to the *O. piceae* complex in Group A (Fig. 1), together with the ex-type isolate of *O. floccosum*. Also in the *BT* and *EF* trees (Fig. 3), these isolates formed a monophyletic clade with authenticated isolates of *O. floccosum*. Taxon 2 grouped in the *O. piceae* complex (Fig. 1). In the *BT* and *EF* trees (Fig. 3), these isolates form a well-supported lineage, distinct from of *O. piceae* and all the other known species in the complex. Taxon 3 grouped in the *O. minus* complex (Fig. 3) and included three isolates forming a well-supported lineage

distinct from *O. minus* and *O. pseudotsugae* in both *BT* and *EF* trees (Fig. 3).

Taxa 4–7 included a total 70 isolates and belonged in the *O. clavatum* complex (Fig. 1; Table 1). Taxon 4 included only one isolate from *Picea* in Jilin, together with Taxon 5 that included two isolates collected from *Pinus koraiensis* in Heilongjiang. These two taxa grouped with the ex-type isolate of *O. tapioinis* based on ITS (Fig. 1). However, both these taxa represented novel species in the phylogenetic analyses based on *BT* and *EF* data (Fig. 4). Taxon 6 included 11 isolates. In the *BT* tree, these isolates separated into several smaller clades and grouped with isolates of both *O. ainoae*, and *O. poligraphi*. However, the *EF* data showed that they formed part of only one monophyletic clade, suggesting that Taxon 6 represented *O. ainoae*. Six of 47 isolates of Taxon 7 were used in the analyses. *BT* and *EF* data confirmed that those isolates all represented *O. brunneolum* (Fig. 4).

There was a total of 438 isolates belonging to the *Ophiostoma ips* complex (Fig. 1; Table 1). These included 15 of *O. japonicum* (Taxon 8), and 423 that were conspecific with *O. bicolor* (Taxon 9). Five of the *O. japonicum* isolates and seven of the *O. bicolor* isolates were included in the analyses. ITS and *BT* data confirmed that those isolates represented *O. japonicum* and *O. bicolor* (Appendix 1).

Two isolates (Taxon 10) formed a lineage with *O. acarorum*, closely related to *O. pallidulum* and *O. saponiodorum*, apart from any currently defined *Ophiostomatales* species complex and labelled here as Group B (Fig. 1). Analyses of ITS and *BT* gene regions confirmed that these isolates from Jilin represented an undescribed species (Fig. 5).

Leptographium s.lat.

Isolates from *I. typographus* belonging to *Leptographium* s.lat. resided in six currently recognized species complexes (Fig. 2). An exception was found for Taxon 19 that grouped outside any defined species complex in a lineage defined here as Group C.

One isolate (Taxon 11) grouped in the *G. galeiformis* complex, distinct from other known species based on *BT* and *EF* data (Fig. 2, 6). Another single isolate resided in the *L. lundbergii* complex (Taxon 12). It grouped close to, but distinct from the ex-type isolate of *L. lundbergii* in the *BT* and *EF* trees (Fig. 7), suggesting that this represented an undescribed species.

Taxon 13 grouped together with Taxon 14 in the *G. piceiperda* complex (Fig. 2; Table 1). The two isolates of Taxon 13 from Heilongjiang formed a well-supported lineage in both *BT* and *EF* trees (Fig. 8) distinct from all other species in the complex. Taxon 14 included 186 isolates from Jilin and Heilongjiang provinces (Table 1) of which 15 were used in the analyses. In both *BT* and *EF* trees (Fig. 8), Taxon 14 grouped with *G. piceiperda* D as defined by Ando et al. (2016).

Two of the four isolates in Taxon 15 were included in the analyses and formed part of the *L. procerum* complex (Fig. 2). These two isolates formed a well-supported clade, closest to but clearly distinct from *L. sibiricum* in the *BT*, *EF* and *CAL* trees (Fig. 9).

Isolates from China collected in the present study grouped in the *Grosmania olivacea* complex and were comprised of three taxa, Taxa 16, 17 and 18 (Fig. 2, 10). Four of 13 isolates (Table 1) representing Taxon 16 were used in the analyses. *BT* and *EF* data confirmed that these isolates grouped with ex-type isolate of *G. cucullata* (Fig. 10). Taxon 17 isolates grouped with ex-type isolate of *G. olivacea* in *BT* and *EF* trees (Fig. 10). One isolate (Taxon 18) grouped closely with *G. olivacea-pini* and *L. album* in the *BT* tree (Fig. 10), but in the *EF* tree, Taxon 18 as well as *G. olivacea-pini* and *L. album* formed separate clades, suggesting that Taxon 18 represented an undescribed species.

Group C (Fig. 2) included 290 isolates (Taxon 19; Table 1), five of which were used in our analyses. In the *BT* tree (Fig. 11), these isolates grouped with *L. taigense* and the newly described species, *L. innermongolicum*, but these could not be separated from each other. In the *EF* tree, our isolates again grouped with *L. taigense*, while the two *L. innermongolicum* sequences formed a well-supported lineage (Fig. 11). We thus treat the Taxon 19 isolates as conspecific with *L. taigense*.

The remaining isolates in *Leptographium* resided in the *G. penicillata* complex (Fig. 2). Taxon 20 was represented by a single isolate that was closest to *L. chlamydatum*, but distinct from this species based on the *BT* and *EF* data (Fig. 11). Four isolates (Taxon 21) formed a clade with *G. penicillata* isolates in both the *BT* and *EF* analyses (Fig. 11). The *BT* sequences for these isolates had 4 bp differences with the ex-type isolate of *G. penicillata*, but the sequences were the same as isolates from Austria and Finland. The *EF* sequences had 3 bp differences with those from Austria and Finland. The *EF* sequence for the ex-type isolate of *G. penicillata* was not available for study and our isolates could thus not be confirmed to be different from *G. penicillata*.

Seven isolates from Heilongjiang grouped in the genus *Endoconidiophora*. Four of these isolates were included in the an-

alyses (Appendix 2). The ITS, *BT* and *EF* sequences confirmed that these isolates were of *E. polonica*.

Eight isolates of which six were from Heilongjiang and two from Jilin, resided in *Graphium*. Analyses of the ITS and *EF* sequences of these six isolates showed that they were identical to those of the ex-type isolate of *Gr. fimbriisporum* (Appendix 3).

At the genus level, most of the isolates from China belonged to *Ophiostoma* s.lat. and *Leptographium* s.lat. and were represented by similar numbers of isolates. The three most frequently isolated taxa were *O. bicolor* (Taxon 9), representing 40.5 % of all isolates, *L. taigense* (Taxon 19), representing 27.8 %, and *G. piceiperda* D (Taxon 14), representing 17.8 % of all isolates. Five of the taxa were collected only once in the study. These include Taxa 4, 11, 12, 18 and 20. Six species were found in both Heilongjiang and Jilin provinces, while 14 species were found in Heilongjiang province only, and three species only in Jilin province (Table 1).

Taxonomy

Eleven of 23 taxa obtained in this study were of undescribed species. These included five *Ophiostoma* spp. and six *Leptographium* spp. They are described as follows:

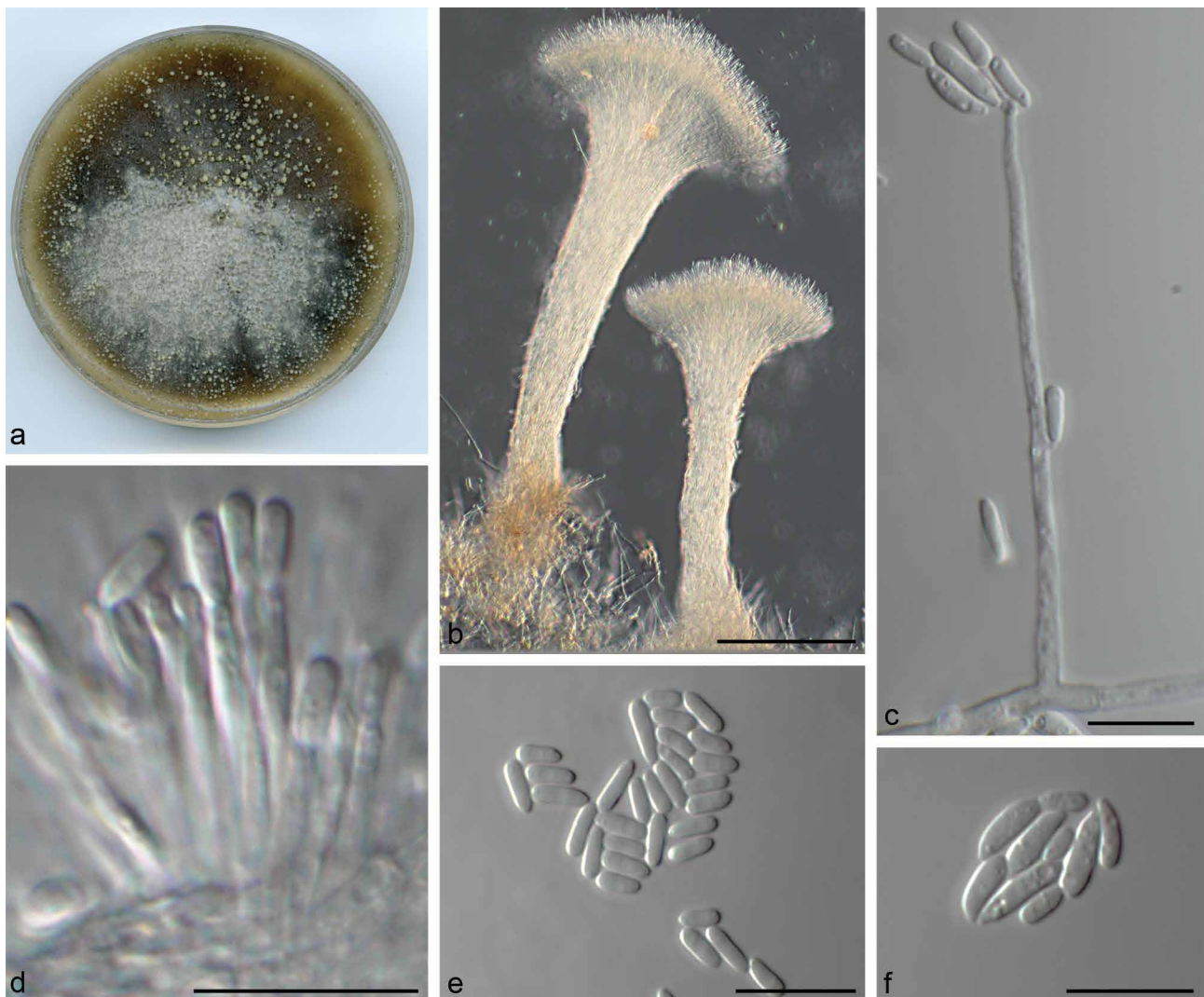

Fig. 12 Morphological characters of asexual structures of *Ophiostoma typographi* sp. nov. (Taxon 2). a. Fourteen-d-old cultures on MEA; b. pesotum-like asexual morph; c. sporothrix-like asexual morph and conidia; d. conidiogenous cells of pesotum-like macronematal asexual morph; e. conidia of pesotum-like asexual morph; f. conidia of sporothrix-like asexual morph. — Scale bars: b = 100 μ m; c–f = 10 μ m.

Taxon 2

Ophiostoma typographi R. Chang, Z.W. de Beer & M.J. Wingf., sp. nov. — MycoBank MB825082; Fig. 12

Etymology. The name refers to the bark beetle vector of this species, *Ips typographus*.

Colonies dark brown. Mycelium superficial on the agar, white. Optimal temperature for growth 25 °C, reaching full plates in 14 d. No growth observed at 5 °C and 35 °C. *Sexual morph* not observed. *Asexual morph* synnematosus, macronematous, erect, (281–)370–848(–1182) × (32–)37–90(–128) µm. *Conidia* hyaline, 1-celled, smooth, oblong, clavate or obovoid (4–)5–8.5(–13) × (1.3–)1.5–1.8(–2) µm.

(3.5–)4–4.5(–5.5) × (1–)1.5(–2) µm. Sporothrix-like asexual morph, erect, arising directly from the mycelium, conidiophore (16–)25–51.5(–69) × (32.5–)37–90(–128.5). *Conidia* hyaline, 1-celled, smooth, oblong, clavate or obovoid (4–)5–8.5(–13) × (1.3–)1.5–1.8(–2) µm.

Specimens examined. CHINA, Heilongjiang province, Yichun city, Wuying district, Wuying National Forest Park, from the gallery of *Ips typographus* on *Pinus koraiensis*, Sept. 2014, R. Chang, holotype PREM 61565 (herbarium specimen of dried culture), CMW 44483 = CBS 141709 (ex-holotype culture); Heilongjiang province, Yichun city, Wuying district, Wuying National Forest Park, from gallery of *Ips typographus* on *Pinus koraiensis*, Sept. 2014, R. Chang, paratype PREM 61566 (herbarium specimen of dried culture), CMW 44484 = CBS 141710 (ex-paratype culture); Heilongjiang province,

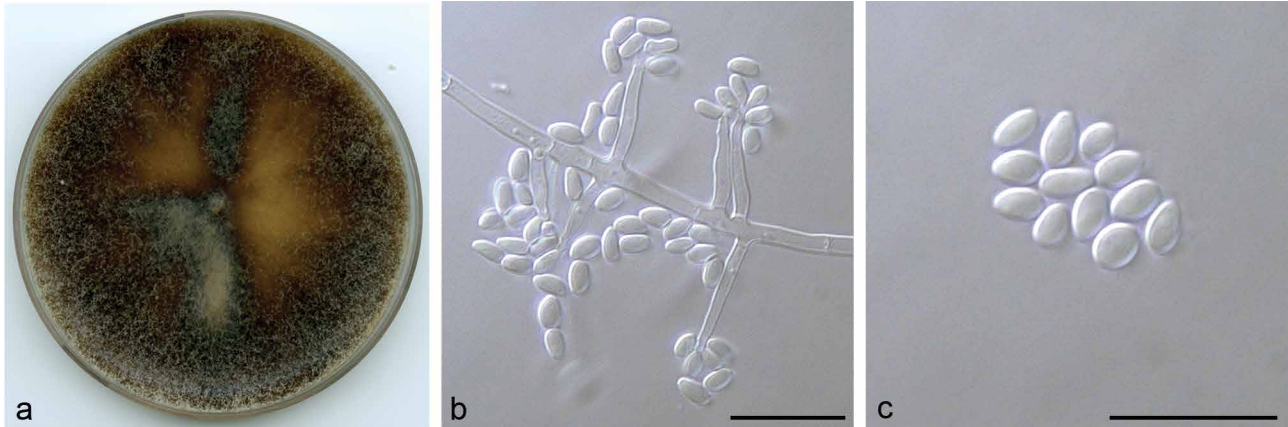

Fig. 13 Morphological characters of asexual structures of *Ophiostoma wuyingense* sp. nov. (Taxon 3). a. Fourteen-d-old cultures on MEA; b–c. hyalorhino-cladiella-like asexual morph and conidia. — Scale bars: b–c = 10 µm.

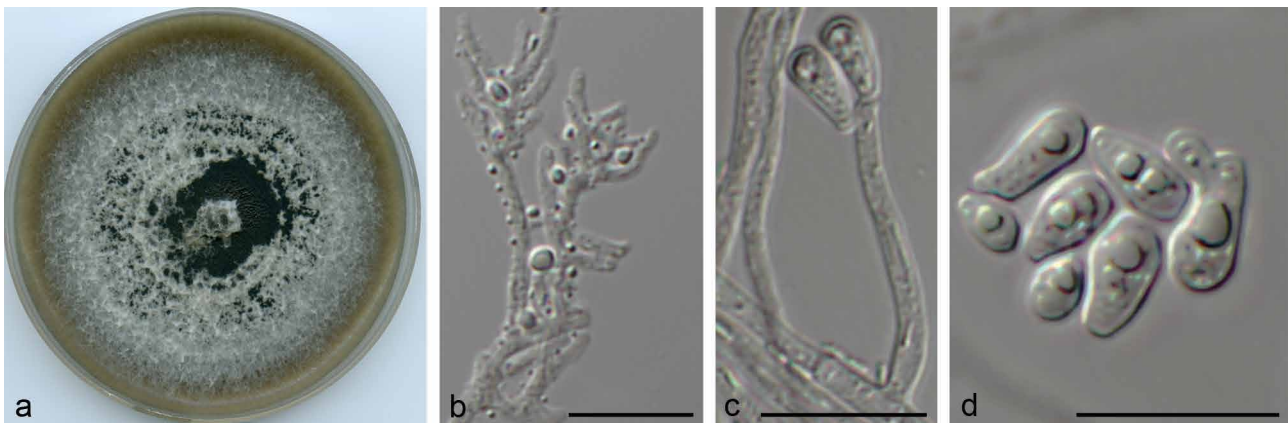

Fig. 14 Morphological characters of asexual structures of *Ophiostoma jiamusiensis* sp. nov. (Taxon 4). a. Thirty-d-old cultures on MEA; b. hyphae; c–d. hyalorhino-cladiella-like asexual morph and conidia. — Scale bars: b–d = 10 µm.

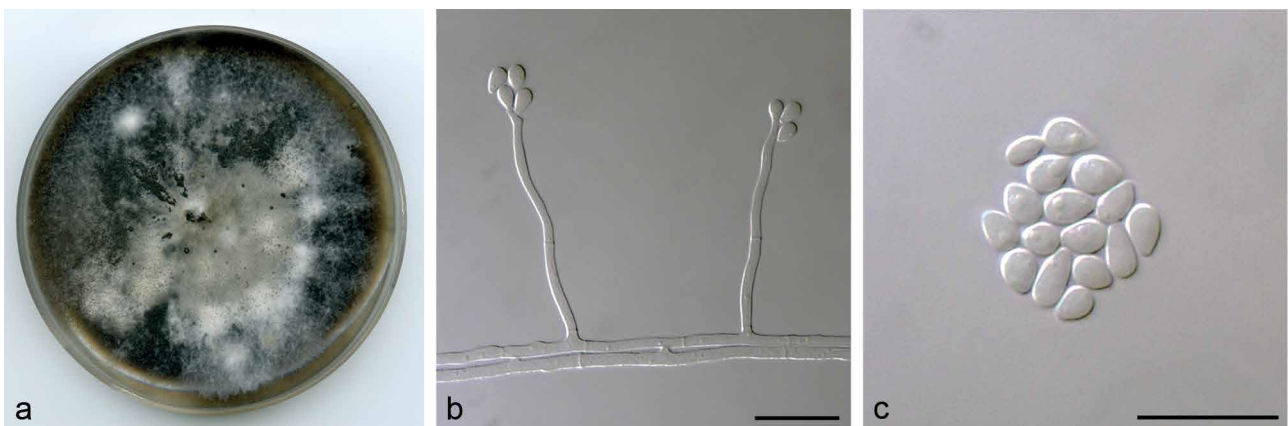

Fig. 15 Morphological characters of asexual structures of *Ophiostoma songshui* sp. nov. (Taxon 5). a. Fourteen-d-old cultures on MEA; b–c. hyalorhino-cladiella-like asexual morph and conidia. — Scale bars: b–c = 10 µm.

Yichun city, Wuying district, Wuying National Forest Park, from gallery of *Ips typographus* on *Pinus koraiensis*, Sept. 2014, R. Chang, paratype PREM 61567 (herbarium specimen of dried culture), CMW 44586 = CBS 141711 (ex-paratype culture).

Notes — Both pesotum-like and sporothrix-like asexual morphs were present. *Ophiostoma typographi* resembles *O. breviusculum* (Chung et al. 2006) that is one of its close relatives. However, the DNA sequences of *BT* and *EF* (Fig. 3) clearly suggested that *O. typographi* is distinct from *O. breviusculum*, *O. piceae* and *O. brunneum*.

Including *O. typographi* there are 10 species now described in the newly defined *O. piceae* complex (Yin et al. 2015), and all of these occur on conifers (Chung et al. 2006, Yin et al. 2016). Species in this complex with sexual morphs are all characterised by unsheathed, allantoid ascospores and most produce pronounced pesotum-like synnemata and sporothrix-like asexual morphs (Yin et al. 2016).

Taxon 3

Ophiostoma wuyingense R. Chang, Z.W. de Beer & M.J. Wingf., *sp. nov.* — MycoBank MB825083; Fig. 13

Etymology. The name refers to Wuying district where this fungus was collected.

Colonies hyaline to dark brown. White aerial mycelium superficial on agar. Colonies flat on 2 % MEA. Optimal temperature for growth 25–30 °C, reaching 90 mm diam in 4 d. No growth observed at 5 °C and 35 °C. *Sexual morph* not observed. *Asexual morph* hyalorhinoconidiella-like, erect, arising directly from mycelium (6–)8.5–14.5(–21) × (1–)1.5(–2) µm. *Conidia* hyaline, 1-celled, smooth, oblong, clavate (2.5–)3–3.5(–4) × (1–)1.5–3(–4) µm.

Specimens examined. CHINA, Heilongjiang province, Yichun city, Wuying district, Wuying National Forest Park, from gallery of *Ips typographus* on *Pinus koraiensis*, Sept. 2014, R. Chang, holotype PREM 61552 (herbarium specimen of dried culture), CMW 44474 = CBS 141706 (ex-holotype culture); Heilongjiang province, Yichun city, Wuying district, Fenglinhe, from gallery of *Ips typographus* on *Pinus koraiensis*, Sept. 2014, R. Chang, paratype PREM 61554 (herbarium specimen of dried culture), CMW 44476 = CBS 141754 (ex-paratype culture); Heilongjiang province, Yichun city, Wuying district, Wuying National Forest Park, from gallery of *Ips typographus* on *Pinus koraiensis*, Sept. 2014, R. Chang, paratype PREM 61553 (herbarium specimen of dried culture), CMW 44475 = CBS 141753 (ex-paratype culture).

Notes — The growth rate of *O. wuyingense* (22.5 mm/d) is more rapid than those of its closest relatives (*O. pseudotsugae*, 7.3 mm/d and *O. kryptum*, 4.3 mm/d) (Gorton & Webber 2000, Jacobs & Kirisits 2003).

Ophiostoma wuyingense, together with *O. kryptum*, *O. minus* and *O. pseudotsugae* reside in the *O. minus* complex, which is close to the *O. piceae* complex. Species in this complex are characterized by ascomata with short necks, elongated ascospores and hyalorhinoconidiella-like asexual morphs (Linnakoski et al. 2010). All the species in the *O. minus* complex are found on conifers (Gorton et al. 2004).

Taxon 4

Ophiostoma jiamusiensis R. Chang, Z.W. de Beer & M.J. Wingf., *sp. nov.* — MycoBank MB825084; Fig. 14

Etymology. Name refers to Jiamusi, the city where the samples were collected.

Colonies hyaline without asexual structures or dark brown when asexual structures form. Mycelium superficial on the agar. Colonies slow growing, reaching 46 mm diam in 10 d at 20 °C. Growth reduced at 5 °C. Growth not observed at 30 °C and 35 °C. Optimal temperature for growth 20 °C. *Sexual morph*

not observed. *Asexual morph*, hyalorhinoconidiella-like erect, arising directly from the mycelium. *Conidia* hyaline, 1-celled, smooth, oblong, clavate or obovoid (3.5–)4.5–6.5(–8) × (1.5–)2–3(–3.5) µm.

Specimens examined. CHINA, Jilin province, Jiamusi, from gallery of *Ips typographus* on *Pinus koraiensis*, June 2010, X.D. Zhou, holotype PREM 61570 (herbarium specimen of dried culture), CMW 40512 = CBS 141893 (ex-holotype culture).

Notes — See comparisons between *O. jiamusiensis*, *O. songshui* and *O. tapionis* below the description of *O. songshui* (Taxon 5).

Taxon 5

Ophiostoma songshui R. Chang, Z.W. de Beer & M.J. Wingf., *sp. nov.* — MycoBank MB825085; Fig. 15

Etymology. Name refers to the Chinese name (songshu) of pine, the tree host from which this fungus was isolated.

Colonies dark brown to black with white aerial mycelium, superficial on agar. No growth observed at 5 °C and 35 °C. Optimal temperature for growth 25 °C, reached 90 mm diam in 14 d. *Sexual morph* not observed. *Asexual morph*, hyalorhinoconidiella-like erect, arising directly from the mycelium (8.5–)9–151(–450) × (1.5–)2.5–3(–4) µm. *Conidia* hyaline, 1-celled, smooth, oblong, clavate or obovoid (3–)4.5(–5.5) × (1.5–)2–2.5(–3) µm.

Specimens examined. CHINA, Heilongjiang province, Yichun city, Wuying district, Fenglinhe, from gallery of *Ips typographus* on *Pinus koraiensis*, Sept. 2014, R. Chang, holotype PREM 61555 (herbarium specimen of dried culture), CMW 44473 = CBS 141707 (ex-holotype culture); Heilongjiang province, Yichun city, Wuying district, Fenglinhe, from gallery of *Ips typographus* on *Pinus koraiensis*, Sept. 2014, R. Chang, PREM 61556 (herbarium specimen of dried culture), CMW 44602 = CBS 141708 (ex-paratype culture).

Notes — The hyalorhinoconidiella-like asexual morph of *O. songshui* resembles those of *O. jiamusiensis* and *O. tapionis* (Linnakoski et al. 2010), its two closest relatives based on phylogeny. These three species are best distinguished from one another using *BT* and *EF* sequences (Fig. 4).

The recently defined *O. clavatum* complex (Linnakoski et al. 2016a) accommodates 13 species, which are all vectored by conifer-infesting bark beetles, most notably of beetles in the genus *Ips* (Linnakoski et al. 2016a, Yin et al. 2016, Chang et al. 2017). Only five species in this complex are known to have sexual morphs. These are characterized by brown, spirally coiled ostiolar hyphae and cylindrical to rectangular ascospores, sometimes covered by a thin sheath (Linnakoski et al. 2016a). The asexual morphs include hyalorhinoconidiella- and in some species also pesotum-like forms. *Ophiostoma songshui* groups closest to *O. jiamusiensis* and *O. tapionis* in a well-supported clade (Fig. 1, 4) in all gene regions.

Taxon 10

Ophiostoma jilinense R. Chang, Z.W. de Beer & M.J. Wingf., *sp. nov.* — MycoBank MB825086; Fig. 16

Etymology. Name refers to Jilin, the province where this species was collected.

Colonies dark brown. White mycelium superficial on agar. Colonies slow growing, reaching 61 mm diam in 10 d at 30 °C. Growth reduced at 5 °C. Growth observed at 35 °C, reaching 54 mm at 10 d. Optimal temperature for growth 30 °C. *Sexual morph* not observed. *Asexual morph*, hyalorhinoconidiella-like erect, arising directly from the mycelium. *Conidia* hyaline, 1-celled, smooth, oblong, clavate or obovoid, (3.5–)4–4.5(–5.5) × (1–)1.5–2(–2.5) µm.

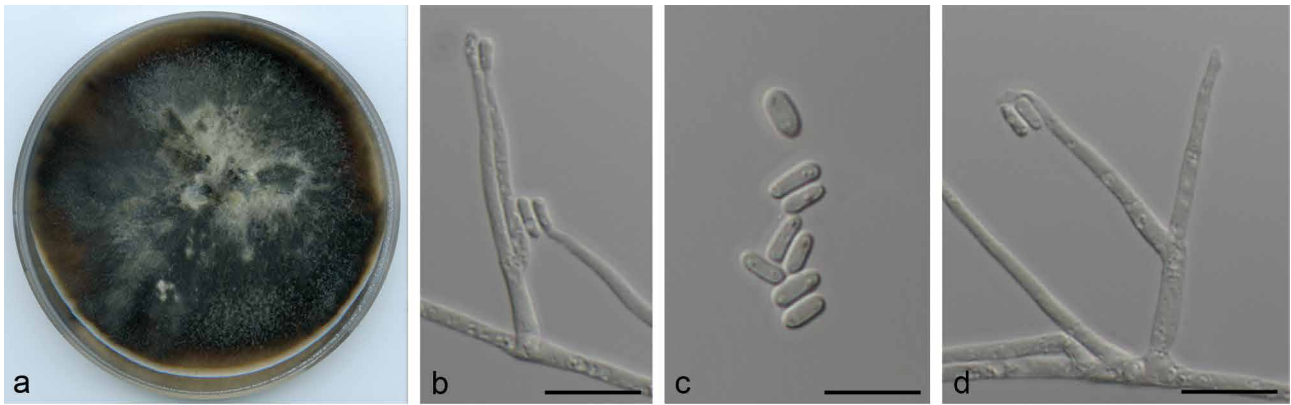

Fig. 16 Morphological characters of asexual structures of *Ophiostoma jilinense* sp. nov. (Taxon 10). a. Fourteen-d-old cultures on MEA; b–d. hyalorhinocladiella-like asexual morph and conidia. — Scale bars: b–d = 10 μ m.



Fig. 17 Morphological characters of asexual structures of *Leptographium koraiensis* sp. nov. (Taxon 11). a. Fourteen-d-old cultures on MEA; b. leptographium-like asexual morph; c–d. conidiogenous cells and conidia. — Scale bars: b–d = 10 μ m.

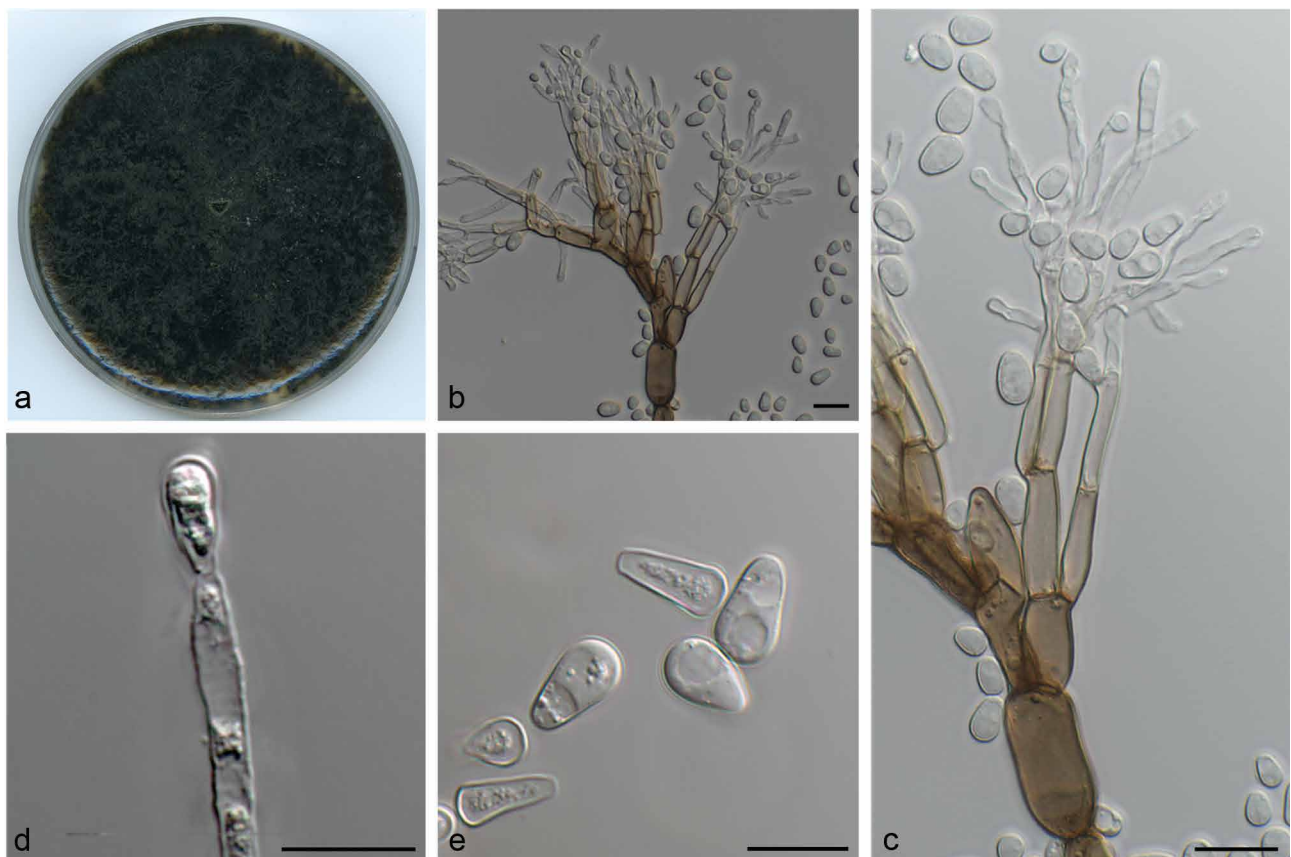

Fig. 18 Morphological characters of asexual structures of *Leptographium shansheni* sp. nov. (Taxon 12). a. Fourteen-d-old cultures on MEA; b–c. leptographium-like asexual morph; d–e. conidiogenous cells and conidia. — Scale bars: b–d = 10 μ m.

Specimens examined. CHINA, Jilin province, Jiamusi, from gallery of *Ips typographus* on *Pinus koraiensis*, June 2010, X.D. Zhou, holotype PREM 61568 (herbarium specimen of dried culture), CMW 40491 = CBS 141894 (ex-holotype culture); Jilin, Jiamusi, from gallery of *Ips typographus* on *Pinus koraiensis*, June 2010, X.D. Zhou, paratype PREM 61569 (herbarium specimen of dried culture), CMW 40492 = CBS 141716 (ex-paratype culture).

Notes — The hyalorhinoclaadiella-like asexual morph of *O. jilinense* resembles that of *O. acarorum*, which is its closest relative based on phylogeny. The other close relatives, *O. pallidulum* and *O. saponiodorum* also have hyalorhinoclaadiella-like asexual morphs (Linnakoski et al. 2010). Both the ITS and *BT* sequences of *O. jilinense* have six bp differences from *O. acarorum* (Fig. 5).

Ophiostoma jilinense grouped in an unsupported clade in *Ophiostoma* s.lat., peripheral to both *Ophiostoma* s.str. and *Sporothrix* based on ITS phylogeny (Fig. 1). Most of the species grouping between these two genera occur on conifer hosts (De Beer et al. 2016). Those that have sexual morphs have unsheathed, allantoid ascospores. Asexual morphs include hyalorhinoclaadiella-like, pesotum-like and sporothrix-like types (Linnakoski et al. 2010).

Taxon 11

Leptographium koraiensis R. Chang, Z.W. de Beer & M.J. Wingf., *sp. nov.* — MycoBank MB825087; Fig. 17

Etymology. Name refers to *Pinus koraiensis*, the tree host from which this species was collected.

Colonies hyaline at first, becoming dark brown in centre with age. Mycelium superficial on the agar. Colonies slow growing, reaching 23 mm diam in 10 d at 20–25 °C. Growth reduced at 5 °C and 30 °C. No growth observed at 35 °C. Optimal temperature for growth 20–25 °C. *Sexual morph* not observed. *Asexual morph* synnematous, macronematous, erect, conidiophores (125–)167–227(–272) µm. *Conidiogenous cells* discrete, cylindrical, tapering slightly at the apex, (11.5–)24–41(–50.5) µm long, (1.5–)2–2.5(–3.5) µm wide. *Conidia* hyaline, aseptate, elliptical, (5.5–)6.5–9(–10.5) × (2.5–)3–4(–4.5) µm.

Specimens examined. CHINA, Heilongjiang province, Yichun city, Wuying district, Wuying National Forest Park, from gallery of *Ips typographus* on *Pinus koraiensis*, Sept. 2014, R. Chang, holotype PREM 61574 (herbarium specimen of dried culture), CMW 44461 = CBS 141898 (ex-holotype culture).

Notes — The synnematous asexual morph of *L. koraiensis* resembles that of *G. galeiformis* (Zhou et al. 2004). For the four taxa in the *G. galeiformis* complex, the sexual morphs of only *G. galeiformis* and *G. radiaticola* are known, and are characterized by ascumal necks lacking ostiolar hyphae and kidney shaped ascospores surrounded by a sheath (Kim et al. 2005). Isolates from Austria and Mexico were labelled (Linnakoski et al. 2012a) as *G. galeiformis* A, and in our analyses these also group distinct from the other species based on the *BT* and *EF* sequences (Fig. 6). Although *L. koraiensis* groups close to *G. galeiformis*, in the *BT* and *EF* sequences it differs from the latter species in 4 bp and 19 bp, respectively.

Apart from *L. koraiensis* from China, the other species in the *G. galeiformis* complex include *G. galeiformis* from Europe, *G. galeiformis* A from Europe and Mexico (although these might represent distinct taxa) and *G. radiaticola* from Europe, China South America and South Africa. All the species in this complex are associated with bark beetles infesting conifers (Kim et al. 2005, Linnakoski et al. 2012a).

Taxon 12

Leptographium shansheni R. Chang, Z.W. de Beer & M.J. Wingf., *sp. nov.* — MycoBank MB825088; Fig. 18

Etymology. Specimens of this fungus were collected in the Lesser Khingan Mountains, where many locals believe in the existence of Shanshen, the 'God of the mountains'.

Colonies hyaline at first, becoming dark brown with age. Mycelium superficial on the agar. Colonies fast growing, reaching 75 mm diam in 4 d at 25 °C. Growth reduced at 5 °C. No growth observed at 35 °C. Optimal temperature for growth 25 °C. *Sexual morph* not observed. *Asexual morph* leptographium-like. *Conidiophores* macronematous, mononematous, erect, arising directly from the mycelium, (36–)59–110(–139) µm in length, rhizoid-like structures absent. *Stipes* light olivaceous, simple, 1-septate, apical cell swollen or not swollen, (9–)12–18(–23) × (3–)4–6(–10) µm. *Conidiogenous apparatus* (33–)46.5–95(–113.5) µm long, excluding the conidial mass, with multiple series of cylindrical branches. *Primary branches* 2–3, light olivaceous, cylindrical, (6.5–)10.5–19(–27.5) × (1.5–)3–5(–7) µm, arrangement of the primary branches on the stipes-type B. *Other branches* hyaline to light olivaceous, (9–)12–19(–23.5) × (2–)2.5–5(–8) µm. *Conidiogenous cells* discrete, cylindrical, tapering slightly at the apex, (9.5–)14.5–24(–31) × (1.5–)2–3(–4) µm. *Conidia* hyaline, aseptate, elliptical, (8–)9–13(–16) × (3.5–)4–5(–6) µm.

Specimens examined. CHINA, Heilongjiang province, Yichun city, Wuying district, Wuying National Forest Park, from gallery of *Ips typographus* on *Pinus koraiensis*, Sept. 2014, R. Chang, holotype PREM 61571 (herbarium specimen of dried culture), CMW 44462 = CBS 141895 (ex-holotype culture).

Notes — The leptographium-like asexual morphs observed both in *L. shansheni* and its closest relative, *L. lundbergii* broadly resemble each other. They do not have rhizoids, which are common in some *Leptographium* spp. (Jacobs et al. 2005). The DNA sequences for the *BT* and *EF* regions confirmed that *L. shansheni* is a novel species (Fig. 7).

Leptographium shansheni grouped in the *L. lundbergii* complex that is defined by *L. lundbergii*, the type species of *Leptographium* known from Europe. All species in this complex are found on conifers (Jacobs et al. 2005, Linnakoski et al. 2012a).

Taxon 13

Leptographium heilongjiangense R. Chang, Z.W. de Beer & M.J. Wingf., *sp. nov.* — MycoBank MB825089; Fig. 19a

Etymology. Name refers to Heilongjiang, the province where this species was collected.

Colonies dark brown. Mycelium superficial on the agar. No spore-forming structures present. Optimal temperature for growth 25 °C, reaching 90 mm in 5 d. No growth observed at 5 °C and 35 °C. No reproductive structures were observed.

Specimens examined. CHINA, Heilongjiang province, Yichun city, Wuying district, Fenglinhe, from gallery of *Ips typographus* on *Pinus koraiensis*, Sept. 2014, R. Chang, holotype PREM 61547 (herbarium specimen of dried culture), CMW 44456 = CBS 141702 (ex-holotype culture); Heilongjiang province, Yichun city, Wuying district, Fenglinhe, from gallery of *Ips typographus* on *Pinus koraiensis*, Sept. 2014, R. Chang, paratype PREM 61548 (herbarium specimen of dried culture), CMW 45083 = CBS 141703 (ex-paratype culture).

Notes — No spore forms were observed for *L. heilongjiangense*. DNA sequences for the *BT* and *EF* gene regions showed that this is a novel species in the *G. piceiperda* complex.

Leptographium heilongjiangense grouped in *G. piceiperda* complex with four other species. All of these species are characterized by cucullate ascospores and typical a leptographium-like asexual morph (De Beer & Wingfield 2013). Ando et al. (2016) identified seven lineages in this complex and considered these

to represent novel species from Japan. Some of our isolates grouped with their '*G. piceiperda* D'.

Taxon 15

Leptographium yichunense R. Chang, Z.W. de Beer & M.J. Wingf., sp. nov. — MycoBank MB825090; Fig. 19b–d

Etymology. Name refers to Yichun, the city where this species was collected.

Colonies dark brown to black. Mycelium superficial on the agar. Optimal temperature for growth 25–30 °C, reaching 90 mm in 7 d. No growth observed at 5 °C and 35 °C. *Sexual morph*

not observed. *Asexual morph* hyalorhinocladiella-like. *Conidiophores* micro- to macronematous, mononematous, erect, arising directly from the mycelium, (8.5–)2.5–83(–228.5) × (1.5–)2(–3) µm. *Conidia* hyaline, aseptate, elliptical, (4–)4.5–7(–9.5) × (1.5–)2–2.5(–3) µm.

Specimens examined. CHINA, Heilongjiang province, Yichun city, Wuying district, Wuying National Forest Park, from gallery of *Ips typographus* on *Pinus koraiensis*, Sept. 2014, R. Chang, holotype PREM 61550 (herbarium specimen of dried culture), CMW 44464 = CBS 141705 (ex-holotype culture); Heilongjiang province, Yichun city, Wuying district, Wuying National Forest Park, from gallery of *Ips typographus* on *Pinus koraiensis*, Sept. 2014, R. Chang, paratype PREM 61551 (herbarium specimen of dried culture), CMW 44465 = CBS 141706 (ex-paratype culture).

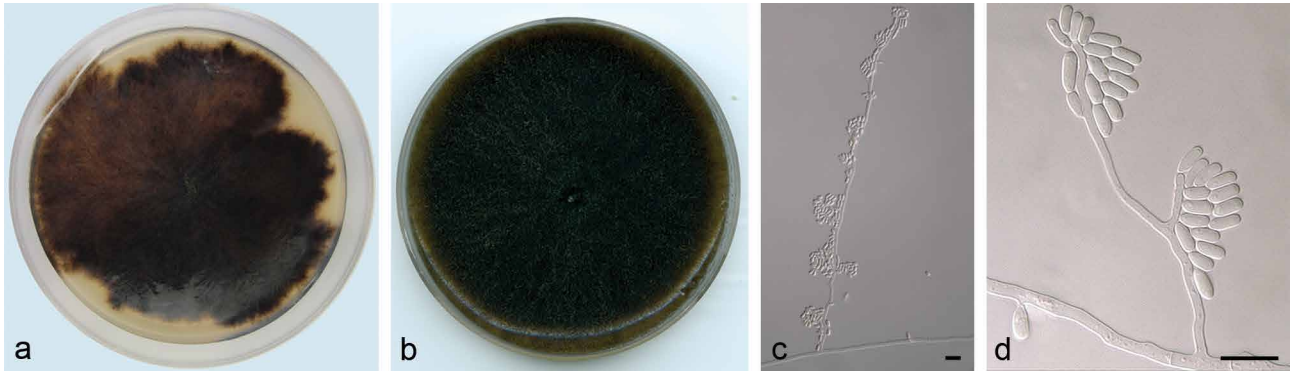

Fig. 19 a–b. Culture characteristics of fourteen-d-old cultures on MEA of a. *Leptographium heilongjiangense* sp. nov. (Taxon 13); b. *Leptographium yichunense* sp. nov. (Taxon 15). c–d. Morphological characters of asexual structures of *L. yichunense* sp. nov. c. Hyalorhinocladiella-like asexual morph; d. conidia. — Scale bars: b–d = 10 µm.

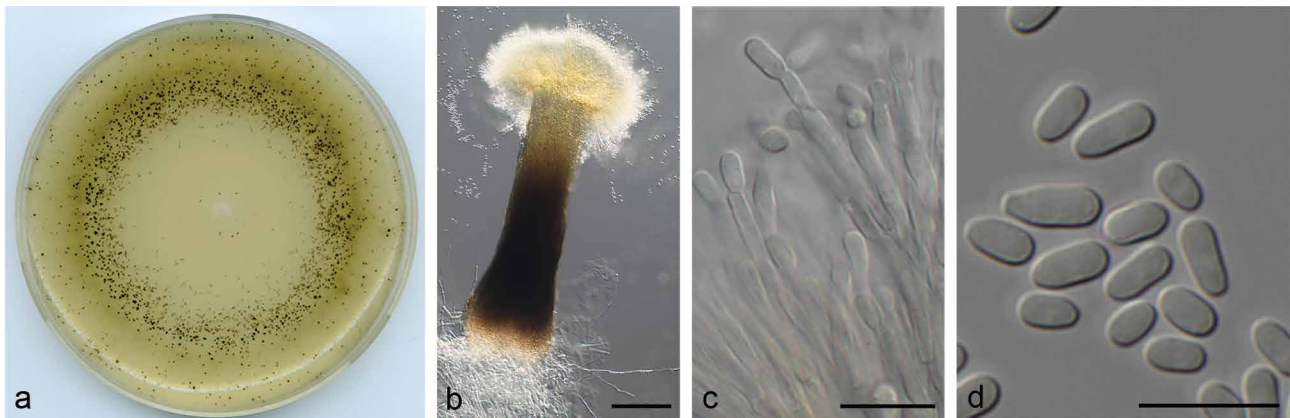

Fig. 20 Morphological characters of asexual structures of *Leptographium duchongi* sp. nov. (Taxon 18). a. Fourteen-d-old cultures on MEA; b. pesotum-like asexual morph; c. conidiogenous cells of pesotum-like macronematous asexual morph; d. conidia. — Scale bars: b = 100 µm; c–d = 10 µm.

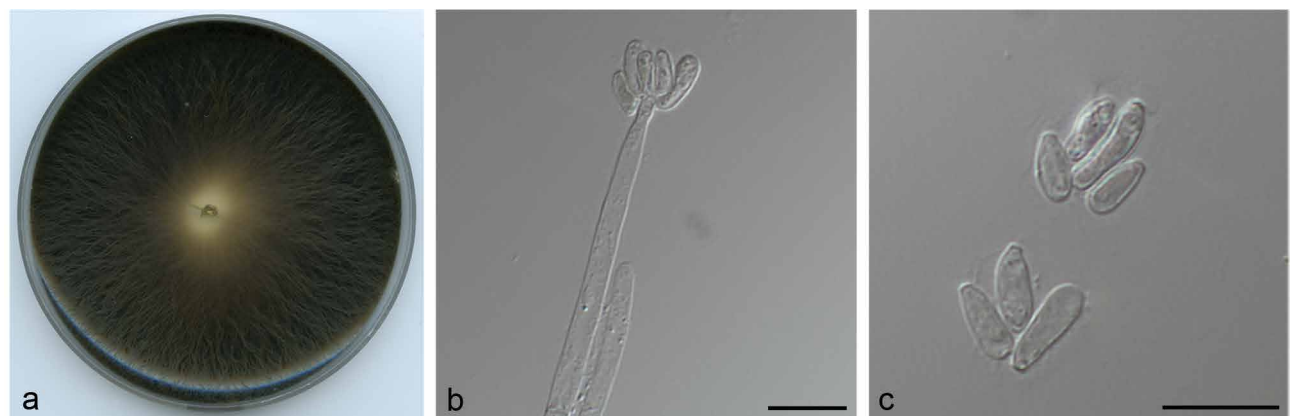

Fig. 21 Morphological characters of asexual structures of *Leptographium fenglinhense* sp. nov. (Taxon 20). a. Fourteen-d-old cultures on MEA; b. sporothrix-like asexual morph; c. conidia. — Scale bars: b–c = 10 µm.

Notes — The hyalorhinocliadiella-like asexual morph (Fig. 19b–d) of *L. yichunense* is different to that of *L. sibiricum* (Jacobs et al. 2000), its closest relative based on phylogeny, that has a leptographium-like asexual morph. The conidia of *L. yichunense* are also larger than those of *L. sibiricum*. The optimal temperature for growth of *L. yichunense* lies between 25 °C and 30 °C, while that for *L. sibiricum* is 25 °C.

Leptographium yichunense resides in the *L. procerum* complex with ten other species, most of which have conifer hosts. The new Chinese taxon was isolated from *I. typographus* infested pines, while *L. sibiricum* came from egg chambers of *Monochamus urussovi* in the phloem of *Abies sibirica* (Jacobs et al. 2000). No sexual morph has been found for any species in this complex even though some have been shown to be genetically heterothallic, and isolates of opposing mating types have been grown together in culture (Duong et al. 2013). Three lineages have been defined in the *L. procerum* complex and these correspond to the geographical origin of the isolates (Yin et al. 2015). *Leptographium yichunense*, *L. pini-densiflorae* and *L. sibiricum* reside in a single lineage and all have been recorded only from Asia.

Taxon 18

Leptographium duchongi R. Chang, Z.W. de Beer & M.J. Wingf., *sp. nov.* — MycoBank MB825091; Fig. 20

Etymology. The name refers to the Chinese word for bark beetles, ‘du-chong’.

Colonies hyaline at first, becoming dark brown with time. Mycelium superficial on agar. Colonies slow growing, reaching 62 mm diam in 10 d at 25 °C. Growth reduced at 5 °C, 30 °C and 35 °C. Optimal temperature for growth 25 °C. *Sexual morph* not observed. *Asexual morph*, macronematous, synnematous, erect, (389.5–)453–608.5(–634.5) × (19–)27.5–106.5(–257.5) µm. *Conidia* hyaline, aseptate, elliptical, (3.5–)4–5.5(–7) × (2–)2.5(–3) µm.

Specimens examined. CHINA, Heilongjiang province, Yichun city, Wuying district, Wuying National Forest Park, from gallery of *Ips typographus* on *Pinus koraiensis*, Sept. 2014, R. Chang, holotype PREM 61573 (herbarium specimen of dried culture), CMW 44455 = CBS 141897 (ex-holotype culture).

Notes — *Leptographium duchongi* has a pesotum-like asexual morph, which is similar to closely related species such as *L. pseudoalbum*, *L. conplurium*, *G. olivaceapini* and *L. pigmentoconidium* (Yin et al. submitted). The conidia of these species are also similar. DNA sequences of the *BT* and *EF* regions supported the distinction between these species (Fig. 10).

Leptographium duchongi resides in the *G. olivacea* complex. All the species in this complex have been collected from *Pinus*, *Picea* and *Pseudotsuga*. Globose ascomata with long necks, terminating in prominent ostiolar hyphae, orange-section shaped ascospores with cucullate gelatinous sheaths are the main characters of species in this complex (Yin et al. submitted).

Taxon 20

Leptographium fenglinhense R. Chang, Z.W. de Beer & M.J. Wingf., *sp. nov.* — MycoBank MB825092; Fig. 21

Etymology. Name Fenglinhe refers to the forest farm, where samples representing this species were collected.

Colonies hyaline at first, becoming dark brown with age. Mycelium superficial on agar. Colonies fast growing, reaching 75 mm diam in 6 d at 25 °C. Growth reduced at 5 °C and 30 °C. No growth observed at 35 °C. Optimal temperature for growth 25 °C. *Sexual morph* not observed. *Asexual morph*, hyalorhinocliadiella-like, micronematous, mononematous, erect, arising directly from the mycelium. *Conidia* hyaline, aseptate, elliptical, (4–)4.5–7(–10.5) × (1.5–)2–3(–4) µm.

Specimens examined. CHINA, Heilongjiang province, Yichun city, Wuying district, Fenglinhe, from gallery of *Ips typographus* on *Pinus koraiensis*, Sept. 2014, R. Chang, holotype PREM 61572 (herbarium specimen of dried culture), CMW 44579 = CBS 141896 (ex-holotype culture).

Notes — Although a leptographium-like asexual morph characterizes all known species in the *G. penicillata* complex, we did not observe this morph in *L. fenglinhense*. However, its closest relative, *L. chlamydatum*, produces a hyalorhinocliadiella-like asexual morph similar to that of *L. fenglinhense*, in addition to its leptographium-like morph (Jacobs et al. 2010). DNA sequences for the *BT* and *EF* regions distinguished *L. fenglinhense* from *L. chlamydatum* and the other species in the complex (Fig. 19).

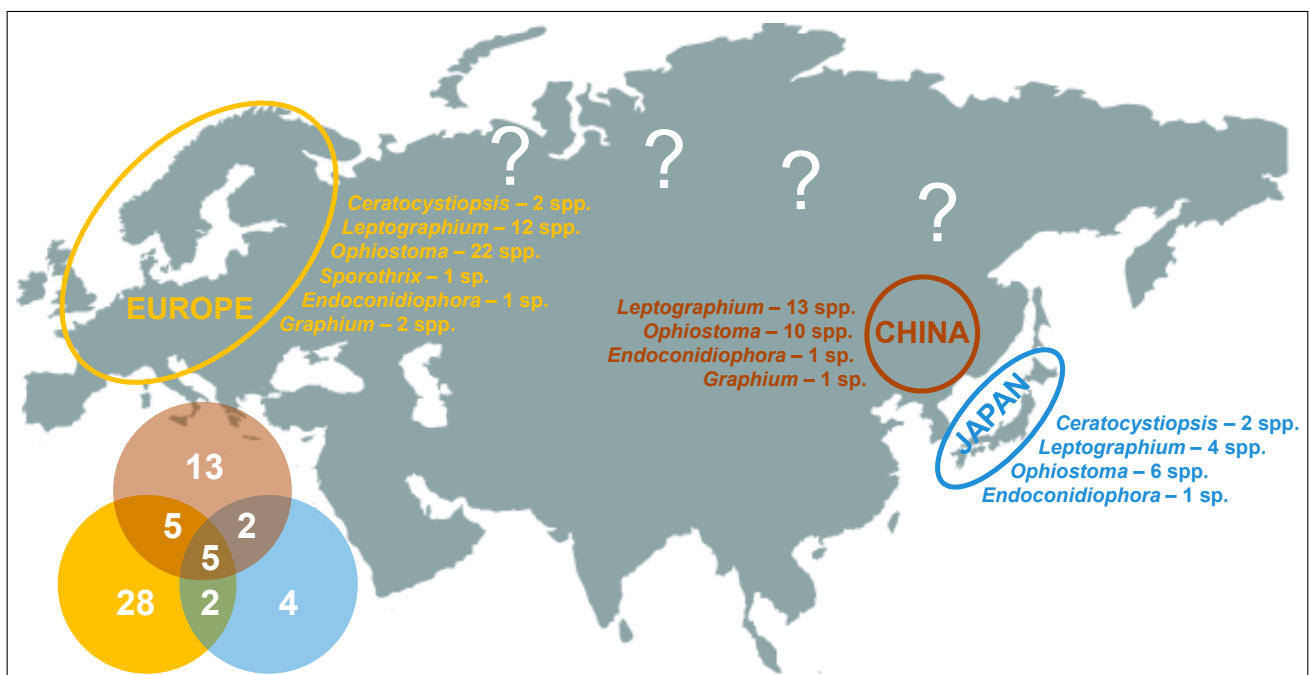

Fig. 22 Comparison of composition of fungal assemblages of *Ips typographus* in Europe, China and Japan. The Venn diagram illustrates the numbers of fungal species overlapping in the different regions. White question marks highlight the absence of data on fungal associates of *Ips typographus* in the boreal forests of Siberia, which forms an ecological corridor for the beetle between Europe and East Asia.

Table 3 Comparison of fungal associates of *Ips typographus* in Europe, Japan and China.

Fungal species	Europe	Japan	China
Ophiostomatales			
<i>Ceratocystiopsis alba</i>	√		
<i>Cop. minuta</i>	√	√	
<i>Cop. minuta-bicolor</i>		√	
<i>Grosmannia aenigmatica</i>		√	
<i>G. cucullata</i> (Taxon 16)	√	√	√
<i>G. europhioides</i>	√		
<i>G. olivacea</i> (Taxon 17)	√		√
<i>G. olivaceapini</i>	√		
<i>G. penicillata</i> (Taxon 21)	√	√	√
<i>G. piceaperda</i>	√		
<i>G. piceaperda-D</i> (Taxon 14)		√	√
<i>G. serpens</i>	√		
<i>Leptographium curviconidium</i>			√
* <i>L. duchongi</i> (Taxon 18)			√
<i>L. euphyes</i>	√		
* <i>L. fenglinhense</i> (Taxon 20)			√
<i>L. gracile</i> (as <i>L. latens</i>)			√
* <i>L. heilongjiangense</i> (Taxon 13)			√
* <i>L. koraiensis</i> (Taxon 11)			√
<i>L. lundbergii</i>	√		
<i>L. obscurum</i>	√		
* <i>L. shansheni</i> (Taxon 12)			√
<i>L. taigense</i> (Taxon 19)	√		√
* <i>L. yichunense</i> (Taxon 15)			√
<i>Leptographium</i> sp.	√		
<i>Ophiostoma ainoae</i> (Taxon 6)	√	√	√
<i>O. albidum</i>		√	
<i>O. araucariae</i>	√		
<i>O. arborea</i>	√		
<i>O. bicolor</i> (Taxon 9)	√	√	√
<i>O. brunneo-ciliatum</i>	√		
<i>O. brunneolum</i> (Taxon 7)	√		√
<i>O. cainii</i>	√		
<i>O. flexuosum</i>	√		
<i>O. floccosum</i> (Taxon 1)	√		√
<i>O. fuscum</i>	√		
* <i>O. japonicum</i> (Taxon 8)		√	√
* <i>O. jiamusiensis</i> (Taxon 4)			√
* <i>O. jilinense</i> (Taxon 10)			√
<i>O. karelicum</i>	√		
<i>O. macroclavatum</i>	√		
<i>O. minus</i>	√		
<i>O. neglectum</i>	√		
<i>O. piceae</i>	√	√	
<i>O. piliferum</i>	√		
<i>O. pluriannulatum</i>	√		
<i>O. saponiodorum</i>	√		
* <i>O. songshui</i> (Taxon 5)			√
<i>O. tetropii</i>	√		
<i>O. tapionis</i>	√		
<i>O. truncicola</i>		√	
* <i>O. typographi</i> (Taxon 2)			√
* <i>O. wuyingense</i> (Taxon 3)			√
<i>Ophiostoma</i> sp.	√		
<i>Ophiostoma</i> (<i>Pesotum</i>) sp.	√		
<i>Sporothrix stenoceras</i>	√		
Microascales			
<i>Endoconidiophora polonica</i> (Taxon 22)	√	√	√
<i>Graphium fimbriisporum</i> (Taxon 23)	√		√
<i>Gr. pseudormiticum</i>	√		
Number of species reported	40	13	25

* Species discovered for the first time from China in the present study.

Species in the *G. penicillata* complex with known sexual morphs are characterised by globose ascumata with medium to long necks and allantoid, sheathed ascospores (Yin et al. submitted). All species have been isolated from spruce or spruce-infesting bark beetles in Europe and East Asia. *Leptographium fenglinhense* is the only species in the group that occurs on *Pinus*.

Comparisons of species from *I. typographus* in China, Europe and Japan

A comparison of the results of the present study with to published studies from Japan and Europe showed that the fungal assemblages of *I. typographus* from China are distinct from those elsewhere in the world (Table 3; Fig. 22). Overall, 58 ophiostomatoid species, including 11 new species resolved in this study, have been found in association with this beetle (Table 3). In terms of species diversity, *I. typographus* from Europe has the largest number of species (i.e., 40). China is second with the 25 species revealed in the present study. Only 13 species are known from *I. typographus* in Japan. Five species, namely *E. polonica*, *G. cucullata*, *G. penicillata*, *O. ainoae* and *O. bicolor*, were shared between all three regions. Two species, namely *Ceratocystiopsis minuta* and *O. piceae*, were shared between Europe and Japan. Five additional species, namely *Graphium fimbriisporum*, *G. olivacea*, *L. taigense*, *O. brunneolum* and *O. floccosum*, were shared between Europe and China. Two species, *O. japonicum* and *G. piceiperda* D were exclusively shared between China and Japan. *Ips typographus* from Europe also had the highest number of unique species (28), followed by China (13) and Japan (3).

DISCUSSION

In this study, 1046 ophiostomatoid fungal cultures representing 23 different taxa, were isolated and identified from *I. typographus* and its galleries in China. Eleven of these taxa represented undescribed species. Most of these isolates resided in the *Ophiostoma* s.lat. and *Leptographium* s.lat. as defined by De Beer & Wingfield (2013). The three species most frequently isolated were *O. bicolor*, *L. taigense* and *G. piceiperda* D. A comparison was made between the species assemblage found in this study with those previously published from Japan (Yamaoka et al. 1997, Masuya et al. 2013) and Europe (Kirisits 2004, Viiri & Lieutier 2004, Jankowiak 2005, Jankowiak & Hilszczanski 2005, Linnakoski et al. 2012a, 2016a, b). These comparisons revealed interesting patterns, most importantly that there are clear differences and some similarities between the fungi associated with *I. typographus* in the three areas considered.

This is the first study focused exclusively on the fungal diversity associated with *I. typographus* in China. Although Paciura et al. (2010) described two new species, *L. curviconidium* and *L. gracile* (as *L. latens*), associated with *I. typographus* in Yunnan and Jilin, the focus of that study was on the taxonomy of *Leptographium* spp. from various hosts and beetles, and included only a small number of randomly sampled isolates from *I. typographus*. Neither of the two species reported by Paciura et al. (2010) were isolated in the present study.

Leptographium taigense (Taxon 19) was the only species found in this study that has previously been recorded in China. This species has previously been described from various conifer-infesting bark beetles in Russia (Linnakoski et al. 2012a), and recently reported from *Ips subelongatus* infesting *Larix gmelinii* in Inner Mongolia in China (Liu et al. 2017). *Ophiostoma floccosum* (Taxon 1), *O. ainoae* (Taxon 6), *O. bicolor* (Taxon 9), *G. cucullata* (Taxon 16), *G. olivacea* (Taxon 17), *G. penicillata* (Taxon 21), *E. polonica* (Taxon 22) and *Gr. fimbriisporum* (Taxon

23) have a wide distribution in Eurasia, where they are not only associated with *I. typographus*, but also with other bark beetles (Yamaoka et al. 1997, Kirisits 2004, Linnakoski et al. 2010). *Ophiostoma brunneolum* (Taxon 7) was recently described from Europe associated with *Ips* spp. on *Picea abies* (Linnakoski et al. 2016a). *Ophiostoma japonicum* (Taxon 8) was previously known only from Japan associated with *I. typographus* (Yamaoka et al. 1997). Similarly, *G. piceiperda* D (Taxon 14) has previously been known only from Japan, where it is associated with several bark beetles (Ando et al. 2016).

Several species found in this study have also been isolated from mites associated with *I. typographus* (Moser et al. 1989, 1997). *Ophiostoma bicolor*, the most commonly encountered species in this study was also the most common species associated with mites phoretic on *I. typographus* in both Sweden and Japan (Moser et al. 1989, 1997). *Endoconidiophora polonica* and *G. penicillata* have also been isolated from mites in Sweden and Japan (Moser et al. 1989, 1997). In the only study of ophiostomatoid fungi vectored by hyperphoretic mites on bark beetles in China, Chang et al. (2017) isolated 19 fungal species from 13 mite species on 17 beetle species in Yunnan, China. However, *I. typographus* was not included in their study. Although mites were not specifically considered in the present study, the fact that *O. bicolor* was the dominant fungus corresponds to its common occurrence on mites in Sweden and Japan. Future studies to consider the fungal diversity of mites phoretic on *I. typographus* in China would be interesting and could for example show whether species such as *O. bicolor* are predominantly a mite-associated fungus, rather than associates of the beetles.

Of all the species found in this study, *E. polonica* is the only fungus known to have a high level of pathogenicity (Christiansen & Solheim 1990). In this regard, it is known to cause serious damage to *P. abies* in Europe and *P. jezoensis* and *P. glehnii* in Japan (Christiansen & Solheim 1990, Visser et al. 1995, Yamaoka et al. 1997). Some authors (Baier 1996, Franceschi et al. 2005, Repe et al. 2015) have suggested that *E. polonica* plays a role in the success of *I. typographus* attacks. However, the role of fungal associates such as *E. polonica* in tree mortality has been questioned (Six & Wingfield 2011). This is for example because the prevalence of this fungus is highly variable between outbreaks and it has been shown that *I. typographus* can kill trees in the absence of *E. polonica* (Solheim 1986, Krokene & Solheim 1996, Viiri 1997, Kirisits 2004, Viiri & Lieutier 2004, Jankowiak 2005, Sallé et al. 2005).

Comparisons of species associated with *I. typographus* occurring in China, Europe and Japan are complicated by the fact that some of the European and all the Japanese species were identified based only on morphology. However, assuming at least the dominant and well-known species were correctly identified, some trends can be inferred. For example, only five species are associated with *I. typographus* in all three regions, while five species were shared exclusively between China and Europe, two species exclusively between Europe and Japan and two species exclusively between China and Japan. Of these three regions, Japan had the lowest while Europe had the highest ophiostomatoid fungus diversity. This could reflect more extensive sampling in Europe than in China and Japan. However, the fact that Japan is made up of geographically isolated islands could restrict horizontal transfer of fungi between beetle species.

It was interesting that the five species of ophiostomatoid fungi shared among China, Japan and Europe (i.e., *E. polonica*, *G. cucullata*, *G. penicillata*, *O. ainoae* and *O. bicolor*) were not necessarily among the most frequently isolated species in these areas. In the present study, *O. bicolor*, *L. taigense* and

G. piceiperda D were the most dominant fungi in north-eastern China where they represented 40.5 %, 27.8 % and 17.8 % of the isolates, respectively. Of these, *O. bicolor* was the only species that was also among the most prevalent species in Japan (Yamaoka et al. 1997), Poland (Jankowiak 2005, Jankowiak & Hilszczanski 2005) and western Russia, but not in Finland (Linnakoski et al. 2010). In Japan, the dominant species are *O. ainoae*, *O. piceae* and *G. penicillata* (Yamaoka et al. 1997), which is consistent with some reports from Europe (Jankowiak 2005, Jankowiak & Hilszczanski 2005). However, Linnakoski et al. (2010) reported that an *O. canum*-like species was most dominant in Finland and *O. brunneolum* (reported as *O. brunneo-ciliatum*) was most common in western Russia. *Ophiostoma ainoae* has never been found in Finland (Linnakoski et al. 2010), while *G. cucullata* was found only in low numbers in that country (Linnakoski et al. 2012a). The differences in composition and dominant fungal species associated with *I. typographus* at the three locations considered, suggests a casual relationship between *I. typographus* and its fungal associates, rather than a specific association with any particular species.

The fact that only few taxa were shared between Europe, Japan and China is consistent with the population genetic data for *I. typographus*. These suggest that the populations from China, Japan and Europe are very distinct (Stauffer et al. 1992, Stauffer et al. 1999, Salle et al. 2007, Bertheau et al. 2013, Mayer et al. 2015). In contrast, only six species of ophiostomatoid fungi were shared between China and Japan when compared with the 10 species shared between China and Europe, and seven between Europe and Japan. This finding is inconsistent with beetle population studies that have suggested a closer genetic relationship between *I. typographus* populations from China and Japan when compared to Europe. Overall, the results of comparisons emerging from the present study showed that the symbionts of bark beetle fail to reflect the population structure of the bark beetle. It is also clear that the use of fungal symbiont assemblages to infer population structures and invasion history of its vectors need to be carefully interpreted. This is especially because factors such as sampling strategy, age of galleries and identification techniques must be taken into consideration.

Acknowledgements We thank members of the Tree Protection and Cooperation Programme (TPCP), the Department of Science and Technology (DST)-National Research Foundations (NRF), Center of Excellence in Tree Health Biotechnology (CTHB) and the University of Pretoria, Pretoria, South Africa for financial support. We are also deeply grateful to Dr Shuaifei Chen for his support during field surveys.

REFERENCES

- Adams AS, Six DL. 2007. Temporal variation in mycophagy and prevalence of fungi associated with developmental stages of *Dendroctonus ponderosae* (Coleoptera: Curculionidae). *Environmental Entomology* 36: 64–72.
- Ando Y, Masuya H, Motohashi K, et al. 2016. Phylogenetic relationship of Japanese isolates belonging to the *Grosmannia piceiperda* complex (Ophiostomatales). *Mycoscience* 57: 123–135.
- Baier P. 1996. Defence reactions of Norway spruce (*Picea abies* Karst) to controlled attacks of *Ips typographus* (L) (Col. Scolytidae) in relation to tree parameters. *Journal of Applied Entomology* 120: 587–593.
- Batra LR. 1963. Ecology of ambrosia fungi and their dissemination by beetles. *Transactions of the Kansas Academy of Science* 66: 213–236.
- Bertheau C, Schuler H, Arthofer W, et al. 2013. Divergent evolutionary histories of two sympatric spruce bark beetle species. *Molecular Ecology* 22: 3318–3332.
- Bleiker KP, Six DL. 2007. Dietary benefits of fungal associates to an eruptive herbivore: potential implications of multiple associates on host population dynamics. *Environmental Entomology* 36: 1384–1396.
- Bleiker KP, Six DL. 2009a. Competition and coexistence in a multi-partner mutualism: interactions between two fungal symbionts of the mountain pine beetle in beetle-attacked trees. *Microbial Ecology* 57: 191–202.

- Bleiker KP, Six DL. 2009b. Effects of water potential and solute on the growth and interactions of two fungal symbionts of the mountain pine beetle. *Mycological Research* 113: 3–15.
- Brasier CM. 1988. *Ophiostoma ulmi*, cause of Dutch Elm Disease. *Advances in Plant Pathology* 6: 207–223.
- Chang R, Duong TA, Taerum SJ, et al. 2017. Ophiostomatoid fungi associated with conifer-infesting beetles and their phoretic mites in Yunnan, China. *MycKeys* 28: 19–64.
- Christiansen E, Solheim H. 1990. The bark beetle-associated blue-stain fungus *Ophiostoma polonicum* can kill various spruces and Douglas fir. *European Journal of Forest Pathology* 20: 436–446.
- Chung WH, Kim JJ, Yamaoka Y, et al. 2006. *Ophiostoma breviusculum* sp. nov. (Ophiostomatales, Ascomycota) is a new species in the *Ophiostoma piceae* complex associated with bark beetles infesting larch in Japan. *Mycologia* 98: 801–814.
- Darriba D, Taboada GL, Doallo R, et al. 2012. jModelTest 2: more models, new heuristics and parallel computing. *Nature Methods* 9: 772.
- De Beer ZW, Duong TA, Barnes I, et al. 2014. Redefining *Ceratocystis* and allied genera. *Studies in Mycology* 79: 187–219.
- De Beer ZW, Duong TA, Wingfield MJ. 2016. The divorce of *Sporothrix* and *Ophiostoma*: solution to a problematic relationship. *Studies in Mycology* 83: 165–191.
- De Beer ZW, Seifert KA, Wingfield MJ. 2013. The ophiostomatoid fungi: their dual position in the Sordariomycetes. In: Seifert KA, De Beer ZW, Wingfield MJ (eds), *The ophiostomatoid fungi: expanding frontiers*: 1–19. CBS, Utrecht, The Netherlands.
- De Beer ZW, Wingfield MJ. 2013. Emerging lineages in the Ophiostomatales. In: Seifert KA, De Beer ZW, Wingfield MJ (eds), *The ophiostomatoid fungi: expanding frontiers*: 21–46. CBS, Utrecht, The Netherlands.
- DiGuistini S, Wang Y, Liao NY, et al. 2011. Genome and transcriptome analyses of the mountain pine beetle-fungal symbiont *Grosmannia clavigera*, a lodgepole pine pathogen. *Proceedings of the National Academy of Sciences* 108: 2504–2509.
- Duong TA, De Beer ZW, Wingfield BD, et al. 2012. Phylogeny and taxonomy of species in the *Grosmannia serpens* complex. *Mycologia* 104: 715–732.
- Duong TA, De Beer ZW, Wingfield BD, et al. 2013. Characterization of the mating-type genes in *Leptographium procerum* and *Leptographium profanum*. *Fungal Biology* 117: 411–421.
- Franceschi VR, Krokene P, Christiansen E, et al. 2005. Anatomical and chemical defenses of conifer bark against bark beetles and other pests. *New Phytologist* 167: 353–376.
- Gardes M, Bruns TD. 1993. ITS primers with enhanced specificity for basidiomycetes-application to the identification of mycorrhizae and rusts. *Molecular Ecology* 2: 113–118.
- Glass NL, Donaldson GC. 1995. Development of primer sets designed for use with the PCR to amplify conserved genes from filamentous Ascomycetes. *Applied and Environmental Microbiology* 61: 1323–1330.
- Gorton C, Kim SH, Henricot B, et al. 2004. Phylogenetic analysis of the bluestain fungus *Ophiostoma minus* based on partial ITS rDNA and β -tubulin gene sequences. *Mycological Research* 108: 759–765.
- Gorton C, Webber JF. 2000. Reevaluation of the status of the bluestain fungus and bark beetle associate *Ophiostoma minus*. *Mycologia* 92: 1071–1079.
- Grégoire JC, Raffa KF, Lindgren BS. 2015. Economics and politics of bark beetles. In: Vega FE, Hofstetter RW (eds), *Bark beetles: biology and ecology of native and invasive species*: 585–613. Academic Press, San Diego, California.
- Grosmann H. 1930. Beiträge zur Kenntnis der Lebensgemeinschaft zwischen Borkenkäfern und Pilzen. *Zeitschrift für Parasitenkunde* 3: 56–102.
- Hofstetter RW, Klepzig KD, Moser JC, et al. 2006. Seasonal dynamics of mites and fungi and their interaction with Southern pine beetle. *Environmental Entomology* 35: 22–30.
- Hofstetter RW, Moser JC, Blomquist S. 2013. Mites associated with bark beetles and their hyperphoretic ophiostomatoid fungi. In: Seifert KA, De Beer ZW, Wingfield MJ (eds), *The ophiostomatoid fungi: expanding frontiers*: 165–176. CBS, Utrecht, The Netherlands.
- Husseneder C, Ho HY, Blackwell M. 2010. Comparison of the bacterial symbiont composition of the formosan subterranean termite from its native and introduced range. *The Open Microbiology Journal* 4: 53–66.
- Jacobs K, Bergdahl DR, Wingfield MJ, et al. 2004. *Leptographium wingfieldii* introduced into North America and found associated with exotic *Tomicus piniperda* and native bark beetles. *Mycological Research* 108: 411–418.
- Jacobs K, Kirisits T. 2003. *Ophiostoma kryptum* sp. nov. from *Larix decidua* and *Picea abies* in Europe, similar to *O. minus*. *Mycological Research* 107: 1231–1242.
- Jacobs K, Krokene P, Solheim H, et al. 2010. Two new species of *Leptographium* from *Dryocetes* autographus and *Hylastes cunicularius* in Norway. *Mycological Progress* 9: 69–78.
- Jacobs K, Seifert KA, Harrison KJ, et al. 2003. Identity and phylogenetic relationships of ophiostomatoid fungi associated with invasive and native *Tetropium* species (Coleoptera: Cerambycidae) in Atlantic Canada. *Canadian Journal of Botany* 81: 316–329.
- Jacobs K, Solheim H, Wingfield BD, et al. 2005. Taxonomic re-evaluation of *Leptographium lundbergii* based on DNA sequence comparisons and morphology. *Mycological Research* 109: 1149–1161.
- Jacobs K, Wingfield MJ, Pashenova NV, et al. 2000. A new *Leptographium* species from Russia. *Mycological Research* 104: 1524–1529.
- Jankowiak R. 2005. Fungi associated with *Ips typographus* on *Picea abies* in southern Poland and their succession into the phloem and sapwood of beetle infested trees and logs. *Forest Pathology* 35: 37–55.
- Jankowiak R, Hilszczanski J. 2005. Ophiostomatoid, fungi associated with *Ips typographus* (L.) on *Picea abies* [(L.) H. Karst.] and *Pinus sylvestris* L. in north-eastern Poland. *Acta Societatis Botanicorum Poloniae* 74: 345–350.
- Katoh K, Standley DM. 2013. MAFFT multiple sequence alignment software version 7: improvements in performance and usability. *Molecular Biology and Evolution* 30: 772–780.
- Kim JJ, Lim YW, Seifert KA, et al. 2005. Taxonomy of *Ophiostoma radiaticola* sp. nov. (Ophiostomatales, Ascomycetes), the teleomorph of *Pesotum pini*, isolated from logs of *Pinus radiata*. *Mycotaxon* 91: 481–496.
- Kirisits T. 2004. Fungal associates of European bark beetles with special emphasis on the ophiostomatoid fungi. In: Lieutier F, Day K, Battisti A, et al. (eds), *Bark and wood boring insects in living trees in Europe, a synthesis*: 181–236. Springer, The Netherlands.
- Klepzig KD. 1998. Competition between a biological control fungus, *Ophiostoma pilliferum*, and symbionts of the southern pine beetle. *Mycologia* 90: 69–75.
- Klepzig KD, Adams AS, Handelsman J, et al. 2009. Symbioses: A key driver of insect physiological processes, ecological interactions, evolutionary diversification, and impacts on humans. *Environmental Entomology* 38: 67–77.
- Klepzig KD, Flores-Otero J, Hofstetter RW, et al. 2004. Effects of available water on growth and competition of southern pine beetle associated fungi. *Mycological Research* 108: 183–188.
- Krascenitsova E, Kozanek M, Ferencik J, et al. 2013. Impact of the Carpathians on the genetic structure of the spruce bark beetle *Ips typographus*. *Journal of Pest Science* 86: 669–676.
- Krokene P, Solheim H. 1996. Fungal associates of five bark beetle species colonizing Norway spruce. *Canadian Journal of Forest Research* 26: 2115–2122.
- Lee S, Kim JJ, Breuil C. 2005. *Leptographium longiclavatum* sp. nov., a new species associated with the mountain pine beetle, *Dendroctonus ponderosae*. *Mycological Research* 109: 1162–1170.
- Lee S, Kim JJ, Breuil C. 2006. Diversity of fungi associated with mountain pine beetle, *Dendroctonus ponderosae*, and infested lodgepole pines in British Columbia. *Fungal Diversity* 22: 91–105.
- Lieutier F, Yart A, Salle A. 2009. Stimulation of tree defenses by Ophiostomatoid fungi can explain attack success of bark beetles on conifers. *Annals of Forest Science* 66: 801–822.
- Linnakoski R, De Beer ZW, Ahtiainen J, et al. 2010. *Ophiostoma* spp. associated with pine- and spruce-infesting bark beetles in Finland and Russia. *Persoonia* 25: 72–93.
- Linnakoski R, De Beer ZW, Duong TA, et al. 2012a. *Grosmannia* and *Leptographium* spp. associated with conifer-infesting bark beetles in Finland and Russia, including *Leptographium taigense* sp. nov. *Antonie van Leeuwenhoek* 102: 375–399.
- Linnakoski R, De Beer ZW, Niemelä P, et al. 2012b. Associations of conifer-infesting bark beetles and fungi in Fennoscandia. *Insects* 3: 200–227.
- Linnakoski R, Jankowiak R, Villari C, et al. 2016a. The *Ophiostoma clavatum* species complex: a newly defined group in the Ophiostomatales including three novel taxa. *Antonie van Leeuwenhoek* 109: 987–1018.
- Linnakoski R, Mahilainen S, Harrington A, et al. 2016b. Seasonal succession of fungi associated with *Ips typographus* beetles and their phoretic mites in an outbreak region of Finland. *PLoS One* 11: e0155622.
- Liu XW, Wang HM, Lu Q, et al. 2017. Taxonomy and pathogenicity of *Leptographium* species associated with *Ips subelongatus* infestations of *Larix* spp. in northern China, including two new species. *Mycological Progress* 16: 1–13.
- Malloch D, Blackwell M. 1993. Dispersal biology of the ophiostomatoid fungi. In: Wingfield MJ, Seifert KA, Webber JF (eds), *Ceratocystis and Ophiostoma: taxonomy, ecology and pathology*: 195–206. APS Press, St. Paul, Minnesota.
- Marin M, Preisig O, Wingfield BD, et al. 2005. Phenotypic and DNA sequence data comparisons reveal three discrete species in the *Ceratocystis polonica* species complex. *Mycological Research* 109: 1137–1148.

- Marincowitz S, Duong TA, De Beer ZW, et al. 2015. *Cornuvesica*: A little known mycophilic genus with a unique biology and unexpected new species. *Fungal Biology* 119: 615–630.
- Masuya H, Yamaoka Y, Wingfield MJ. 2013. Ophiostomatoid fungi and their associations with bark beetles in Japan. In: Seifert KA, De Beer ZW, Wingfield MJ (eds), *The ophiostomatoid fungi: expanding frontiers*: 77–89. CBS, Utrecht, The Netherlands.
- Mayer F, Piel FB, Cassel Lundhagen A, et al. 2015. Comparative multilocus phylogeography of two Palaearctic spruce bark beetles: influence of contrasting ecological strategies on genetic variation. *Molecular Ecology* 24: 1292–1310.
- Miller MA, Pfeiffer W, Schwartz T. 2010. Creating the CIPRES Science Gateway for inference of large phylogenetic trees. In: *Gateway Computing Environments Workshop (GCE)*, Institute of Electrical and Electronics Engineers: 1–8.
- Moser JC, Perry TJ, Furuta K. 1997. Phoretic mites and their hyperphoretic fungi associated with flying *Ips typographus japonicus* Nijima (Col., Scolytidae) in Japan. *Journal of Applied Entomology* 121: 425–428.
- Moser JC, Perry TJ, Solheim H. 1989. Ascospores hyperphoretic on mites associated with *Ips typographus*. *Mycological Research* 93: 513–517.
- O'Donnell K, Cigelnik E. 1997. Two divergent intragenomic rDNA ITS2 types within a monophyletic lineage of the fungus *Fusarium* are nonorthologous. *Molecular Phylogenetics and Evolution* 7: 103–116.
- Paciura D, De Beer ZW, Jacobs K, et al. 2010. Eight new *Leptographium* species associated with tree-infesting bark beetles in China. *Persoonia* 25: 94–108.
- Raffa KF, Grégoire JC, Staffan Lindgren B. 2015. Natural history and ecology of bark beetles. In: Vega FE, Hofstetter RW (eds), *Bark beetles: biology and ecology of native and invasive species*: 1–40. Academic Press, San Diego, California.
- Repe A, Bojović S, Jurc M. 2015. Pathogenicity of ophiostomatoid fungi on *Picea abies* in Slovenia. *Forest Pathology*: 290–297.
- Ronquist F, Teslenko M, Van der Mark P, et al. 2012. MrBayes 3.2: efficient Bayesian phylogenetic inference and model choice across a large model space. *Systematic Biology* 61: 539–542.
- Sallé A, Arthofer W, Lieutier F, et al. 2007. Phylogeography of a host-specific insect: genetic structure of *Ips typographus* in Europe does not reflect past fragmentation of its host. *Biological Journal of the Linnean Society* 90: 239–246.
- Sallé A, Monclus R, Yart A, et al. 2005. Fungal flora associated with *Ips typographus*: frequency, virulence, and ability to stimulate the host defence reaction in relation to insect population levels. *Canadian Journal of Forest Research* 35: 365–373.
- Six DL, Bentz BJ. 2007. Temperature determines symbiont abundance in a multipartite bark beetle-fungus ectosymbiosis. *Microbial Ecology* 54: 112–118.
- Six DL, Wingfield MJ. 2011. The role of phytopathogenicity in bark beetle-fungus symbioses: a challenge to the classic paradigm. *Annual Review of Entomology* 56: 255–272.
- Solheim H. 1986. Species of Ophiostomataceae isolated from *Picea abies* infested by the bark beetle *Ips typographus*. *Nordic Journal of Botany* 6: 199–207.
- Solheim H. 1991. Oxygen deficiency and spruce resin inhibition of growth of blue stain fungi associated with *Ips typographus*. *Mycological Research* 95: 1387–1392.
- Stamatakis A. 2014. RAxML version 8: a tool for phylogenetic analysis and post-analysis of large phylogenies. *Bioinformatics* 30: 1312–1313.
- Stauffer C, Kirisits T, Nussbaumer C, et al. 2001. Phylogenetic relationships between the European and Asian eight spined larch bark beetle populations (Coleoptera, Scolytidae) inferred from DNA sequences and fungal associates. *European Journal of Entomology* 98: 99–105.
- Stauffer C, Lakatos F, Hewitt G. 1999. Phylogeography and postglacial colonization routes of *Ips typographus* L. (Coleoptera, Scolytidae). *Molecular Ecology* 8: 763–773.
- Stauffer C, Leitinger R, Simsek Z, et al. 1992. Allozyme variation among nine Austrian *Ips typographus* L. (Col., Scolytidae) populations. *Journal of Applied Entomology* 114: 17–25.
- Swofford DL. 2002. PAUP*. Phylogenetic analysis using parsimony (*and other methods) 4.0b10. Sinauer Associates, Sunderland, Massachusetts.
- Taerum SJ, Duong TA, De Beer ZW, et al. 2013. Large shift in symbiont assemblage in the invasive red turpentine beetle. *PLoS One* 8: e78126.
- Viiri H. 1997. Fungal associates of the spruce bark beetle *Ips typographus* L. (Col. Scolytidae) in relation to different trapping methods. *Journal of Applied Entomology* 121: 529–533.
- Viiri H, Lieutier F. 2004. Ophiostomatoid fungi associated with the spruce bark beetle, *Ips typographus*, in three areas in France. *Annals of Forest Science* 61: 215–219.
- Visser C, Wingfield MJ, Wingfield BD, et al. 1995. *Ophiostoma polonicum* is a species of *Ceratocystis sensu stricto*. *Systematic and Applied Microbiology* 18: 403–409.
- Wegensteiner R, Wermelinger B, Herrmann M. 2015. Natural enemies of bark beetles: predators, parasitoids, pathogens, and nematodes. In: Vega FE, Hofstetter RW (eds), *Bark beetles: biology and ecology of native and invasive species*: 247–304. Academic Press, San Diego, California.
- Wermelinger B. 2004. Ecology and management of the spruce bark beetle *Ips typographus* – a review of recent research. *Forest Ecology and Management* 202: 67–82.
- White TJ, Bruns T, Lee S, et al. 1990. Amplification and direct sequencing of fungal ribosomal RNA genes for phylogenetics. In: Innis MA, Gelfand DH, Sninsky JJ, et al. (eds), *PCR protocols: a guide to methods and applications*: 315–322. Academic Press, San Diego, California.
- Wingfield MJ, Seifert KA, Webber JF, et al. 1993. *Ceratocystis* and *Ophiostoma*: taxonomy, ecology, and pathogenicity. *American Phytopathological Society, APS Press*, St. Paul, Minnesota.
- Yamaoka Y, Wingfield M, Ohsawa M, et al. 1998. Ophiostomatoid fungi associated with *Ips cembrae* in Japan and their pathogenicity of Japanese larch. *Mycoscience* 39: 367–378.
- Yamaoka Y, Wingfield M, Takahashi I, et al. 1997. Ophiostomatoid fungi associated with the spruce bark beetle *Ips typographus f. japonicus* in Japan. *Mycological Research* 101: 1215–1227.
- Yin ML, Duong TA, Wingfield MJ, et al. 2015. Taxonomy and phylogeny of the *Leptographium procerum* complex, including *Leptographium sinense* sp. nov. and *Leptographium longiconidiophorum* sp. nov. *Antonie van Leeuwenhoek* 107: 1–17.
- Yin ML, Wingfield MJ, Zhou XD, et al. 2016. Multigene phylogenies and morphological characterization of five new *Ophiostoma* spp. associated with spruce-infesting bark beetles in China. *Fungal Biology* 120: 454–470.
- Zhou XD, De Beer ZW, Harrington TC, et al. 2004. Epitypification of *Ophiostoma galeiforme* and phylogeny of species in the *O. galeiforme* complex. *Mycologia* 96: 1306–1315.
- Zhou XD, De Beer ZW, Wingfield MJ. 2013. Ophiostomatoid fungi associated with conifer-infesting bark beetles in China. In: Seifert KA, De Beer ZW, Wingfield MJ (eds), *The ophiostomatoid fungi: expanding frontiers*: 91–98. CBS, Utrecht, The Netherlands.

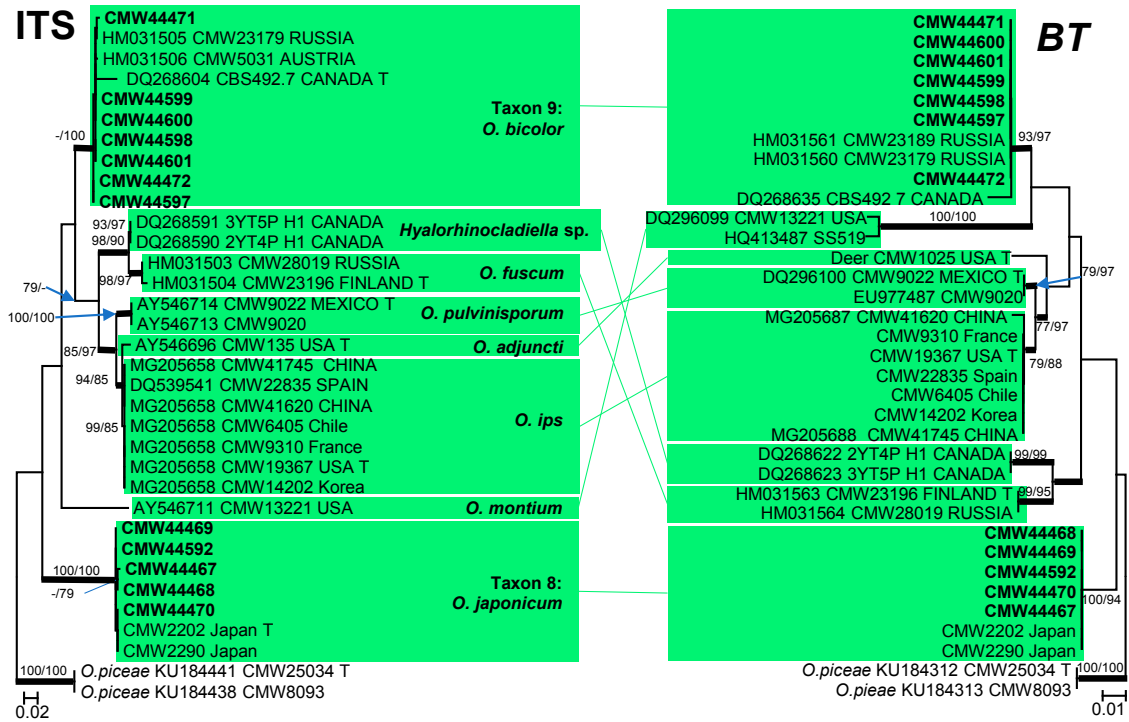

Appendix 1 ML tree of *Ophiostoma ips* complex generated from DNA sequences of ITS and *BT* regions. Sequences generated from this study are printed in **bold** type. **Bold** branches indicate posterior probabilities values ≥ 0.9 . Bootstrap values of $ML \geq 75\%$ are recorded at nodes as ML/MP. T = ex-type isolates.

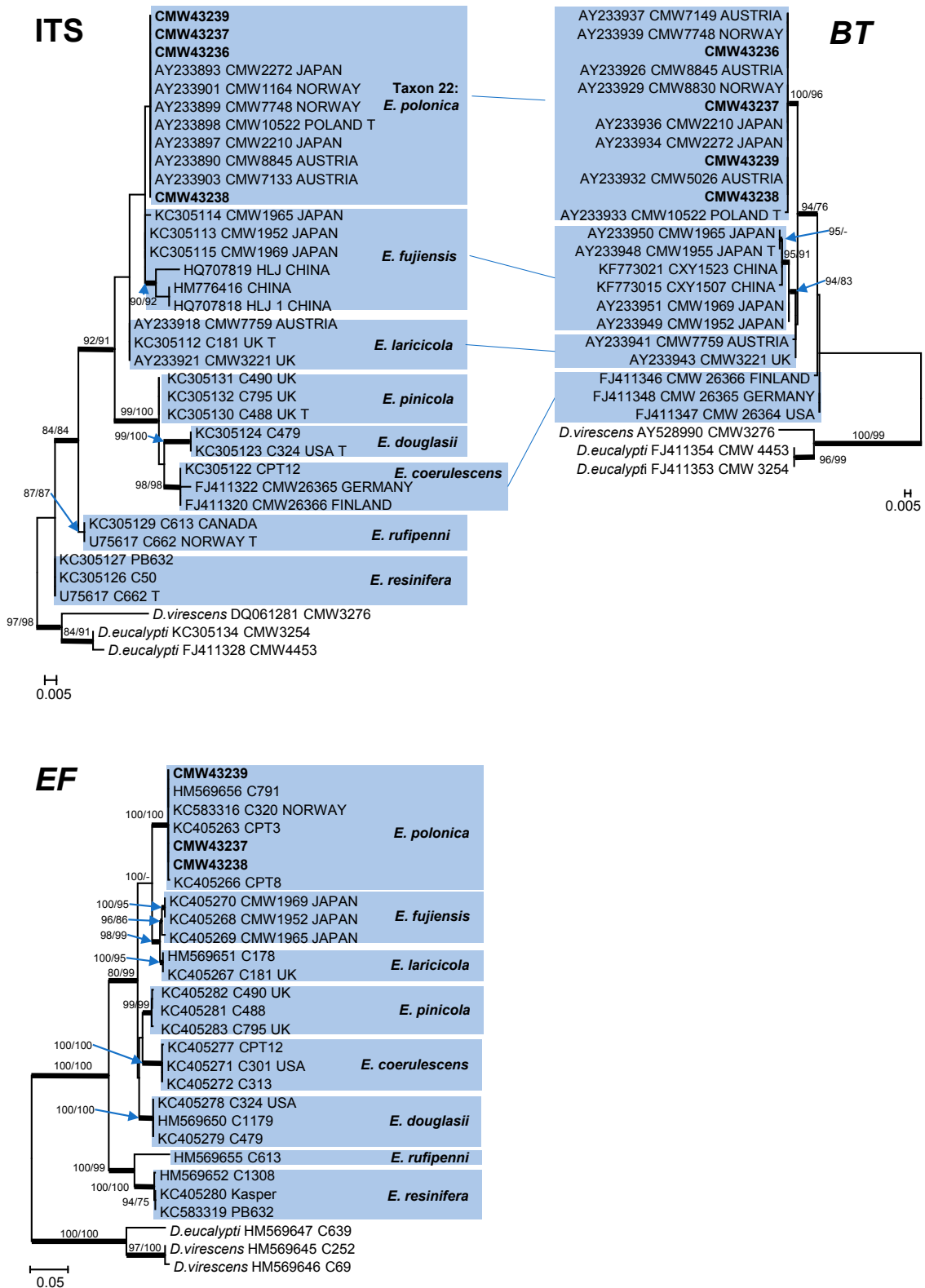

Appendix 2 ML tree of *Endoconidiophora* generated from DNA sequences of ITS, BT and EF regions. Sequences generated from this study are printed in bold type. Bold branches indicate posterior probabilities values ≥ 0.9 . Bootstrap values of ML $\geq 75\%$ are recorded at nodes as ML/MP. T = ex-type isolates.

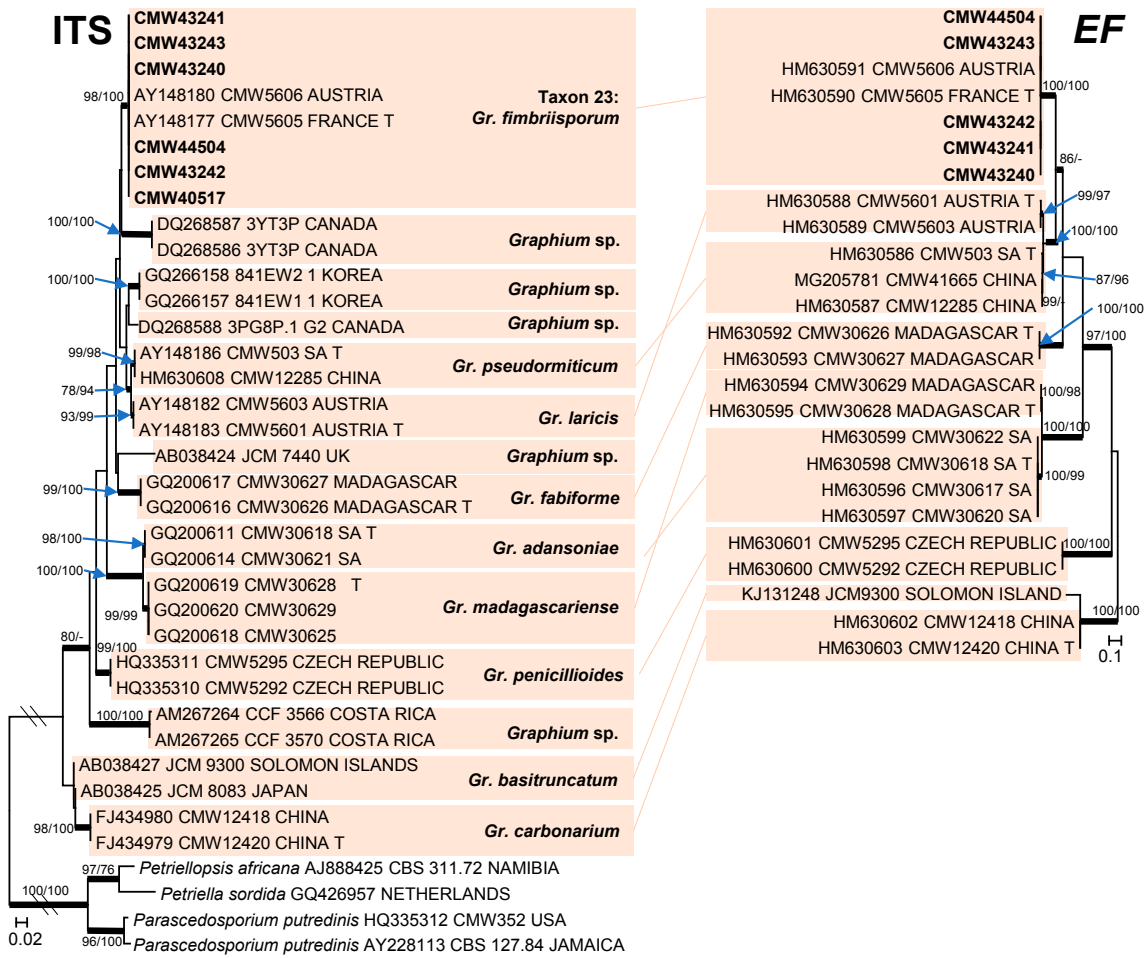

Appendix 3 ML tree of *Graphium* generated from DNA sequences of ITS and EF regions. Sequences generated from this study are printed in bold type. Bold branches indicate posterior probabilities values ≥ 0.9 . Bootstrap values of ML $\geq 75\%$ are recorded at nodes as ML/MP. T = ex-type isolates.