

WIND ACTIONS AND RESPONSES OF STEEL CHIMNEYS



Steven Reid

Steven Reid is the President and owner of Industrial Environmental Systems, Inc. USA. He has thirty years of design and application experience in air pollution control, and steel and fiberglass chimneys. Steven was instrumental in the introduction and implementation of the Hirsch Tuned Mass Damper technology in the United States. Steven has been applying that technology longer than anyone in the United States.

Steven has been a CICIND member since 1990 and is chairman of the GRP Liner Committee. He is also a member of the ASME STS-1 Steel Chimney Committee and the ASCE FRP Chimney Standard Committee. Additionally, Steven is a member of the National Society of Professional Engineers, American Boiler Manufacturer's Association and holds Professional Engineering Licenses in sixteen US states and Puerto Rico.

FOREWARD

The author has been privileged to have heard many CICIND presentations since 1990. Many of those have been by such industry and academic experts such as Vickery, Van Koten, Ruscheweyh, Bottenbroch, Pritchard, Ole Hanson, Hirsch and many others. All these are able to speak about these very complicated concepts and formulae with ease. It is for the rest of us that the author offers this paper.

INTRODUCTION

This paper is intended to introduce or simplify the basic concepts of wind engineering and particularly dynamic responses to wind. It is intended for those not so familiar with the intricacies of wind engineering as it relates to chimney design. Its major purpose is to familiarize the reader with key concepts and terms and to provide an primer for those new to steel chimney design. References are provided so the reader may study each subject in more depth. Most of the references come from the major wind and chimney documents and their appendices and commentaries.

ABSTRACT

Understanding some of the basic wind engineering concepts helps one understand the chimney's response. The circular cross section of the steel chimney characteristically provides aerodynamic lift perpendicular to the wind direction. Knowing how to predict and prevent these adverse responses is of critical importance to steel chimney design.

I. STATIC WIND FORCES

The force exerted by wind varies with the wind speed and its associated turbulence. Turbulence is affected by metrological factors, temperature and terrain. An anemometer is used to measure the wind speed and its direction. Turbulence cannot be so easily measured but its effects must be considered.

ATMOSPHERIC BOUNDARY LAYER

Changes in temperature and pressure near the earth's surface causes air to move across the earth's surface. This movement exerts a horizontal drag force which retards the air flow. It is this force that we consider wind force.

ANEMOMETER DATA

A spinning anemometer magnetically induces a voltage that is proportional to the wind speed.



Anemometer ¹

This voltage is measured and plotted against time to give a history of wind speeds in a chart called an anemogram. This output is the instantaneous wind speed at any given time. The voltage is subject to a conversion factor specific to the anemometer for reporting purposes.

ANEMOGRAMS

An anemogram is a graphic record of the measurements of an anemometer. There are mountains of this data available to engineers. Statistical techniques must be used to analyze or reduce the data into a useable format.

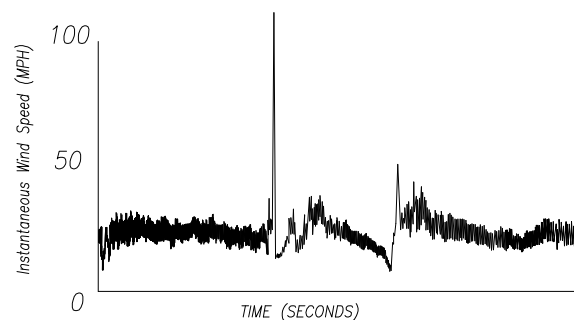

Anemogram Showing a Brief Thunderstorm

Engineers do not use short-term wind events to establish building codes. They use more significant events like the one shown below. Notice how its energy over time is more impressive.

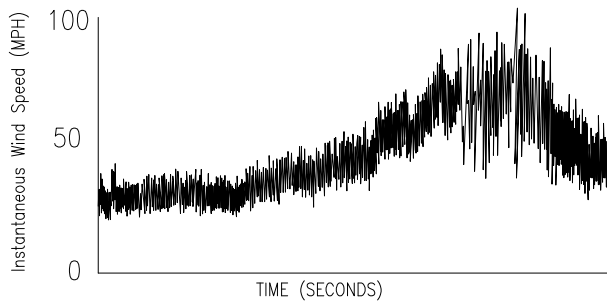

Anemogram Showing Significant Wind Event

Anemometer data is the raw data on which wind loads are based. This data is collected daily by numerous sites around the world. Wind speeds are location specific.

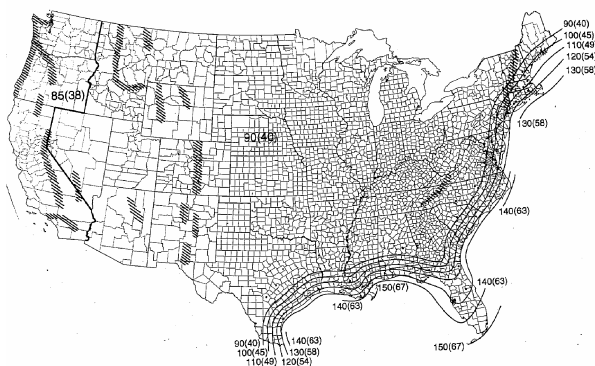

Wind Map for the United States²

RETURN PERIODS

Designers of buildings and other structures often want to optimize their designs based upon the significance of their structures. Wind data can be analyzed to determine the likelihood of a given wind in a given time period. The theoretical return period is the inverse of the probability that an event will be exceeded in any one year. A fifty year wind has a one in fifty (2%) chance of occurring in any given year.

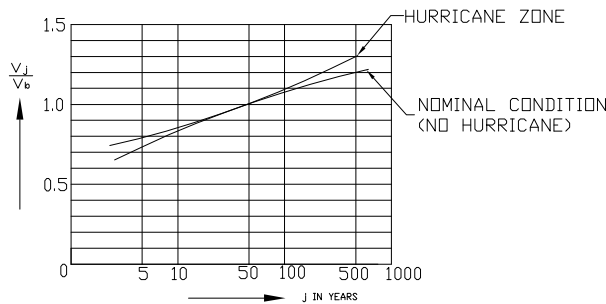

Relationship between Wind Speed and Its Return Period³

AVERAGING TIMES

Because instantaneous data is not as useful to engineers as data collected over a period of time, wind is averaged over a period

of time for analysis and use. Typical averaging times range from three seconds to one hour.

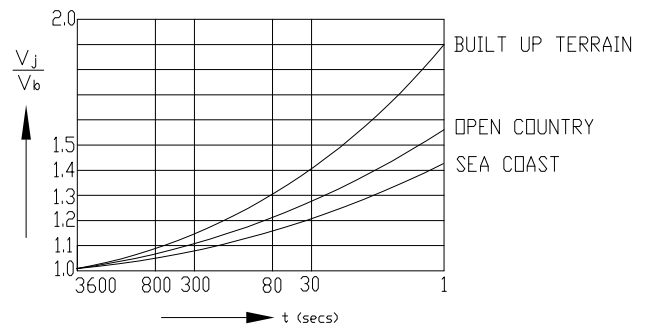

Relationship Between Wind Speed and Averaging Time³

THREE-SECOND GUST WIND SPEED

In 1995 ASCE changed to the 3-second gust averaging time. This averaging time was in use by more and more media outlets that were gathering and reporting their own wind data to the public. Previously the United States had used the fastest mile wind speeds.

TEN TO SIXTY MINUTE AVERAGING TIMES

Europe and the rest of the world have long used longer averaging times to report wind data. CICIND uses mean hourly wind speed. The Euro Norms use ten minute averaging times. When the ASME Steel Chimney Standard performs dynamic analyses, it converts 3-second winds to mean hourly winds.

FASTEST MILE WIND SPEED

For many years, meteorologists and engineers in the United States used the “fastest mile” wind speed. This method averaged the wind data from the largest output from the anemometer over the time it took the fastest mile of wind to pass the measuring station. Fastest-mile wind speed is defined as the average speed for one mile of air passing an anemometer. So for a fastest mile wind speed of 60 miles per hour, one mile of wind passes a given point in one minute. Therefore, the averaging time for a 60 mile per hour fastest mile wind is 60 seconds.

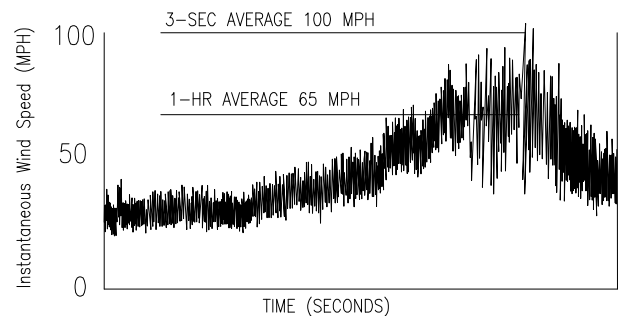

Anemogram Showing Averaging Times

The longer the averaging times the longer the gust factor. This stands to reason since for the major wind events from which wind data is taken.

GUST FACTORS

Once wind speeds have been averaged over the desired time period, it is still desirable to know the extent above the average value that a gust may attain. For this purpose, gust factors are associated with the wind speed. This statistical measure is a dimensionless multiplication factor.

For a maximum instantaneous wind speed, a wind speed averaged for just that instant, the averaged speed and the gust speed are the same. Therefore the gust factor would be 1.0. Similarly, the gust factor for a three second averaging time would have a relatively small gust factor while the gust factor for a one hour averaging time would be much higher.

	<i>Hourly Mean</i>	<i>10-min. Mean</i>	<i>5-sec Gust</i>	<i>3-sec Gust</i>
Hourly Mean	1.0	1.05	1.45	1.5
10-min. Mean	.95	1.0	1.4	1.45
5-sec Gust	.7	.75	1.0	1.05
3- sec Gust	.65	.7	.95	1.0

Relationship between commonly quoted wind speeds at 10m height above grade for “open ground” situations ³

GUST FACTOR

Once wind speeds have been averaged over the desired time period, it is still desirable to know the extent above the average value that a gust may attain. For this purpose, gust factors are associated with the wind speed. This statistical measure is a dimensionless multiplication factor.

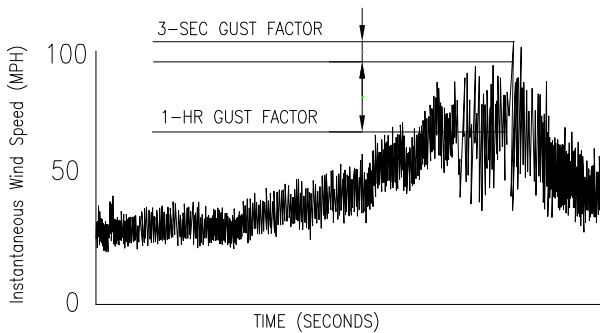

Anemogram Showing Gust Factor

WIND PRESSURE

The kinetic energy available in wind to act as a force per unit area or pressure, as a function of wind speed V, is taken as:

$$KE = \frac{1}{2} \rho V^2$$

Taking the density of air as 0.075 pounds per cubic foot and converting miles per hour to feet per second we have:

$$KE = \frac{1}{2} (0.075 \text{ lbs} / \text{ft}^3) \times \left(\frac{5280^2}{3600^2} \right) \times \frac{1}{32.2}$$

$$KE = 0.00256 V^2 \text{ (psf)}$$

This quantity is used in ASCE as Q_z and Q_p in the Euro Norms. Other factors affecting wind pressures are terrain roughness, shape factors, importance factors, importance factors, altitude and hills.

TERRAIN ROUGHNESS

Wind at ground level is subject to boundary layer effect due to interferences from hills, trees, structures, etc. as well as the friction with the ground. This terrain roughness increases turbulence and decreases resulting wind pressures. Wind data for use in building codes is collected at airports where the terrain roughness is minimized.

The boundary layer effects are not limited to the ground level. The turbulence and compression resulting from terrain roughness extend to higher elevations. Building codes use exposure factors to account for terrain roughness. The most common exposures used in the ASCE-7 Minimum Design Loads for Buildings and Other Structures code are:

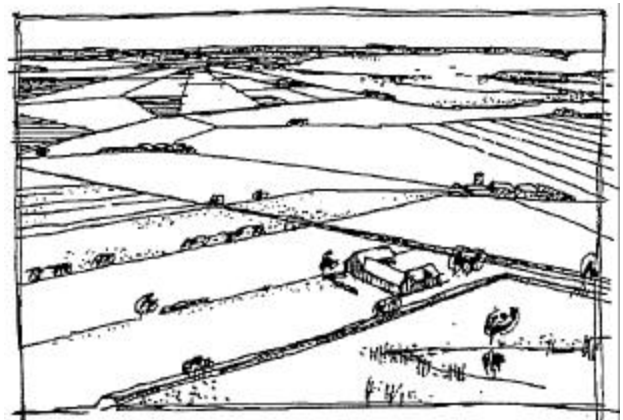

Exposure A – Mostly flat, low-lying area with lakes or negligible vegetation and without obstacles. ⁴

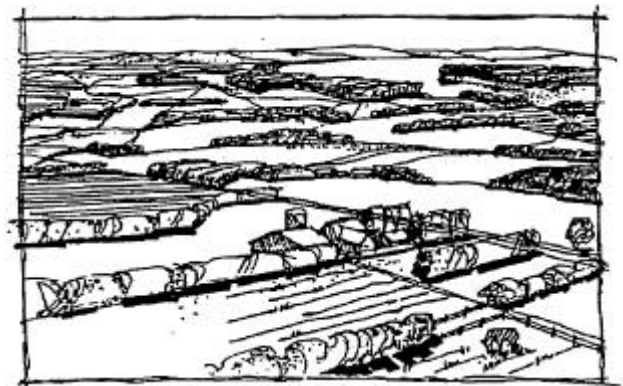

Exposure B – Urban and suburban areas, wooded areas, or other terrain with numerous closely spaced structures having the size of single family dwellings or larger. ⁴



Exposure C – Open terrain with scattered obstructions having heights generally less than 30 feet. This category includes flat, open country and grasslands. ⁴

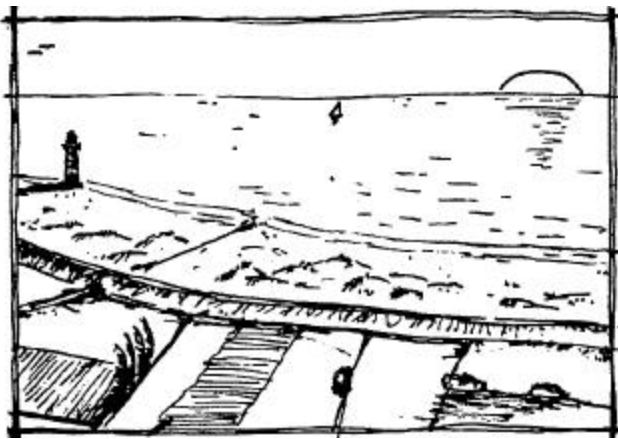

Exposure D – Flat, unobstructed areas exposed to wind flowing over open water for a distance of at least one mile. ⁴

SHAPE FACTORS

The surface roughness of a structure will affect the structures wind load. The smooth, round surface of a steel chimney will deflect a certain portion of the wind's force. By contrast, wind striking the web of an I-beam will collect more wind force. Steel chimneys can be considered composite structures and the designer will apply various shape factors.

Cross-Section	Type of Surface	Cf for h/D Values of:		
		1	7	25
Square (wind normal to face)	All	1.3	1.4	2.0
Square (wind along diagonal)	All	1.0	1.1	1.5
Hexagonal or octagonal	All	1.0	1.2	1.4
Round	Moderately Smooth	0.5	0.6	0.7
	Rough	0.7	0.8	0.9
	Very Rough	0.8	1.0	1.2
	All	0.7	0.8	1.2

Force Coefficients (Shape Factors) for Chimneys ²

IMPORTANCE FACTORS

Most wind codes account for a higher wind load on structures that would be important during an emergency such as central power plants and hospitals compared to farm buildings and temporary structures. These values range from 0.95 to a maximum of 1.25.

Nature of Occupancy	Category	Importance Factor
Buildings and other structures that represent a low hazard to human life in the event of failure. Includes agricultural facilities, certain temporary facilities and minor storage facilities	I	0.87
All building and other structure except those listed in Categories I, II, IV.	II	1.00
Buildings and other structures that represent a substantial hazard to human life in the event of failure. Includes churches, schools, jails and other highly occupied structures.	III	1.15
Buildings and other structures designated as essential facilities. Includes hospitals, emergency facilities, power stations, etc.	IV	1.15

Importance Factors ²

WIND SPEED VARIATION WITH ALTITUDE

Anemometers are generally installed such that they are located ten meters above the ground. This is an international standard for measuring and comparing wind data. Wind speeds increase at higher altitudes due to less interference and turbulence. Wind speeds at higher altitudes are generally related in the following manner. ²

$$V(z) = V \left(\frac{Z}{Z_g} \right)^{\frac{1}{a}}$$

Where **Z** is the elevation in question, **Zg** is the elevation of the observed wind speed and is a constant. This constant is often taken as seven and the calculation to relate the higher altitude wind speed is called the one-seventh power rule. Other values are used in the various codes relating to each exposure category.

WIND INCREASES FOR LOCAL TERRAIN CHANGES

When structures are on or near hills as shown below, certain factors account for increased wind pressures shown in the "speed up" region as shown in this figure.

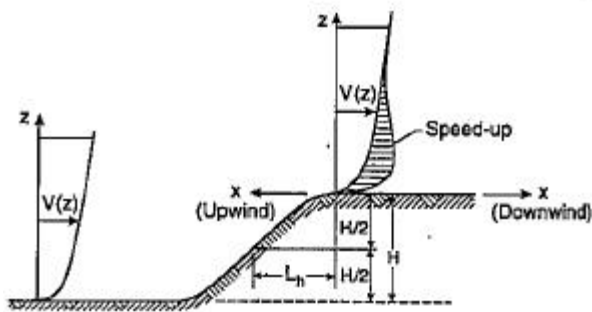

Wind Increases Over Hills And Escarpments²

II. STATIC RESPONSE

The most common concept of wind is that it produces a force in the direction it moves that is proportional to its wind speed. This action is referred to as in-line or downwind force.

$$\text{Force} = \text{Pressure} \times \text{Projected Area}$$

The projected area is the area exposed to the wind flow normal to the wind direction. Wind from all directions must be considered to determine the maximum area and maximum force.

PROJECTED AREA

For the purpose of calculating the total wind load on a structure, the wind pressure is applied to the orthogonal projection of the structure onto a plane perpendicular to wind direction.

WIND SHEAR

Shear is the wind force that would tend to cause a one part of a steel chimney to move past an adjacent part. The sum of these forces is resisted by a support reaction of an equal magnitude and opposite direction. Engineers display these forces and their relative directions in a shear diagram.

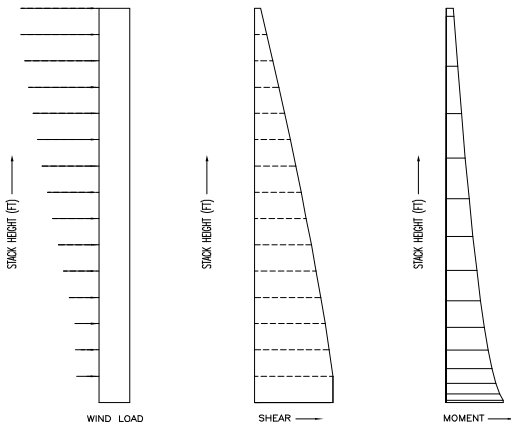

Load Diagram Shear Diagram Moment Diagram

WIND MOMENT

Steel chimneys are typically analyzed as freestanding cantilever beams. As such, the wind moment about the support at the base increases with the distance from the top of the chimney. This gradual increase of moment in the chimney can

be displayed on a moment diagram. Also shown on the moment diagram is the moment resisting capability of the chimney shell for varying shell thicknesses. This capacity is calculated by:

$$M_A = S_A \times s$$

Where M_A is the allowable moment, S_A is the allowable stress, and s is the section modulus of the shell.

$$s = p(r_2^2 - r_1^2)t$$

DEFLECTION

Deflection is a chimney's response or moment due to the static or in-line wind load.

III. DYNAMIC WIND FORCES

The less obvious concept of wind is its ability to produce aerodynamic lift as it flows around a structure. This is the same type of lift force that causes an airplane wing to fly. Because these lifting wind force causes motion of the structure, they are referred to as dynamic.

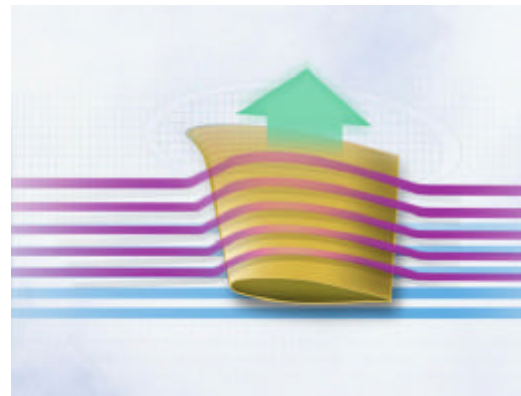

Lift is produced by Airflow over an Airplane Wing⁵

VORTEX SHEDDING

When wind flows around a circular body like a chimney, air compresses as it passes the chimney. Since the air has a certain viscosity, it slows down slightly where it contacts the chimney in passing. This causes a layer of differing wind speeds which engineers call the boundary layer.

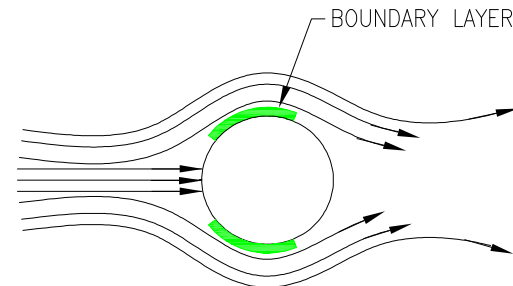

Normal Air flow around a Cylinder

As wind speed increases, this boundary layer can separate from the leeward side of the chimney because of its excessive curvature.

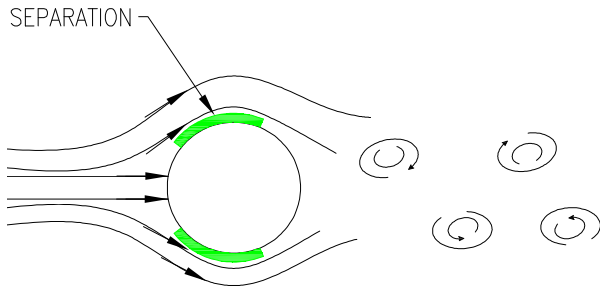

Disturbed Airflow around a Cylinder

This causes a phenomenon called vortex shedding. As this separation occurs, eddies or vortices form on either side of the chimney. These vortices form rhythmically and produce a periodic force on the chimney in a direction perpendicular to the wind direction. These vortices are also referred to as von Karman vortices after Hungarian born engineer Theodore von Karman and as Strouhal vortices after the Czech physicist, Vincenc Strouhal.

As mentioned earlier, the boundary layer separation occurs as wind speed changes. Wind engineers often use important dimensionless parameters to predict occurrence of various phenomenon. One of those parameters is the Reynolds Number.

REYNOLDS NUMBER

The Reynolds number is a measure of whether a given flow is turbulent or laminar. Precisely, the Reynolds number is the ratio of inertial forces to viscous forces.

$$Re = \rho V \left(\frac{d}{\mu} \right)$$

Where ρ is air density and μ is the kinematic viscosity of the air. Since these quantities are constant for ambient conditions, the Reynolds number can be practically computed by:

$$Re = C V d$$

Where C is a constant and is equal to 6.9×10^4 (SI System) and 1.0×10^5 (English System) respectively.

Laminar flow occurs at low Reynolds numbers, where viscous forces are dominant, and is characterized by smooth, constant fluid motion, while turbulent flow, on the other hand, occurs at high Reynolds numbers and is dominated by inertial forces, which tend to produce random eddies, vortices and other flow fluctuations.

At low Reynolds numbers, when separation first occurs, the flow around the body remains steady. At some critical Reynolds Number two thin layers form to the leeward side of the chimney. These unstable layers interact nonlinearly with each other in the chimney’s wake to produce a regular, periodic

array of vortices termed Strouhal vortices.⁶ These vortices are also referred to as Von Karman Vortices.

STROUHAL FREQUENCY

A steel chimney sheds vortices at a predictable frequency which is a function of the wind speed. This frequency is referred to as the Strouhal Frequency (Fs) and can be determined as follows:

$$F_s = S V / D$$

Where S is the Strouhal Number which is generally taken to be 0.20, V is the mean hourly wind velocity and D is the chimney diameter in feet or meters.

IV. DYNAMIC RESPONSE

When a chimney is excited such that it vibrates, it does so at its material frequencies. Each frequency has an associated mode shape. Typical first through fourth mode shapes are shown below.

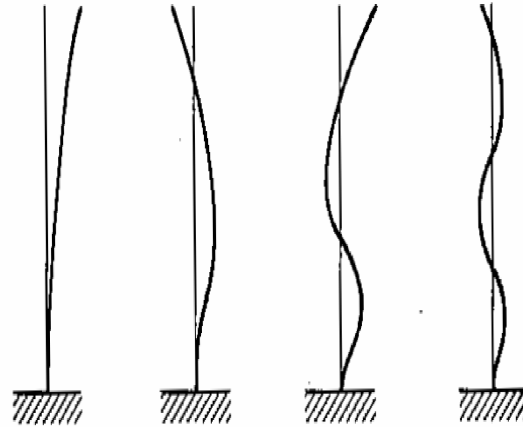

First four normal modes of a cantilever beam.⁶

RESONANCE AND CRITICAL WIND VELOCITY

When the vortex shedding frequency is near a natural frequency of the steel chimney, the wind speed producing this vortex shedding frequency is said to be a critical wind velocity. This is also known as resonance. At this velocity the chimney will oscillate or vibrate at this common frequency. If the wind velocity creating this vibration is relatively short lived, the vibration may dissipate and little ill effects are experienced. As it turns out, the most cost-effective way to control a chimney’s response to vortex shedding is to encourage this vibration dissipation. This gives rise to the concept of damping.

SIMPLIFIED VICKERY – BASU MODEL

The movement of a steel chimney due to vortex shedding can be conservatively estimated by the following formula from Vickery and Basu.⁷ Several factors including turbulence intensity have been included in this formula for simplicity.

$$\frac{a}{D} = \frac{C_1 C_M}{m_r \sqrt{I} \sqrt{b_s - \left(\frac{C_2}{m_r}\right)}}$$

a – root mean square chimney movement

D – Chimney diameter

C_1 - 0.12 for isolated steel chimney

C_2 - 0.6 for un-tapered chimneys

C_M - 2.0 for 1st mode vibration

I - Height to diameter ratio

m_r - A mass ratio

WAKE INTERFERENCES

Chimneys downstream of other chimneys can experience interference effects of wind. The following illustration shows how wind velocity, drag and lift vary in the wake of a chimney. The most common of these wake interferences to chimney design are buffeting and galloping.

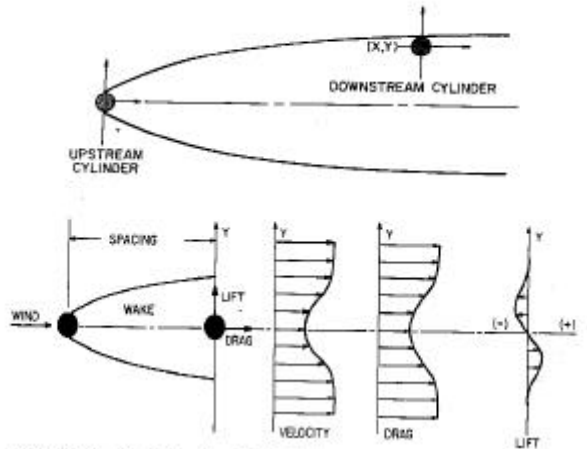

Qualitative sketch of the distributions of mean velocity, drag, and lift on a circular cylinder in the wake of another ⁶

BUFFETING

Buffeting is defined as the unsteady loading of a structure by velocity fluctuations in the incoming flow and not self-induced. Buffeting vibration is the vibration produced by turbulence. ⁶

GALLOPING

Variations in drag and lift forces in the wake of a chimney can lead to oscillations in the downwind chimney referred to as wake galloping. ⁶

SCRUTON NUMBER

The Scruton number is a dimensionless parameter that can help predict a chimney's propensity to vibrating due to vortex shedding. This parameter is a major determining property for dynamic stability. Steel chimneys can be evaluated as to their susceptibility to significant movement due to vortex shedding by evaluating a minimum value of the Scruton number.

The CICIND Model Code for Steel Chimneys gives the Scruton number as follows:

$$Sc = \frac{4pmb}{rD^2}$$

Where m is the mass per unit length of the upper portion of the chimney r is the air density and D is the diameter of the upper portion of the chimney.

The amplitude of the oscillation is inversely proportional to the Scruton number S_c . Increasing the mass and damping of the chimney increases the Scruton number and therefore reduces oscillation amplitudes. Because it involves a chimney's mass, damping and physical dimensions, it is commonly referred to as a mass damping parameter.

LOCK IN (INERTIAL EFFECTS)

As the vortex shedding forces increase, they may "lock in" to the vibrating chimney and amplify greatly.

Many authors have attributed the familiar 1940 failure of the Tacoma Narrows Bridge in Washington to this resonance or self excitation. In fact, this failure introduces an additional effect of vortex shedding – externally initiated forces that "lock on) to the motion of the chimney. ⁸ These lock on forces are associated with the motion of the chimney and becomes more significant with increasing amplitudes. ⁹ See the sections on negative aerodynamic damping and flutter for more discussion of lock on forces.



Collapse of Tacoma Narrows Bridge due to Lock On Effects ¹⁰

NEGATIVE AERODYNAMIC DAMPING

The forces due to vortex shedding are considered in two uncorrelated parts; those which exist on stationary body and those that are motion dependent damping forces which are negative in the vicinity of the critical velocity. These motion dependent forces are known as negative aerodynamic forces which are dependent upon turbulence and decrease in absolute magnitude with the motion of the chimney. ⁹ If this velocity is quite frequent or relatively high, the forces from the vortices and therefore the chimney's response may be quite strong.

DAMPING

It has been demonstrated here that damping plays a very important role in a steel chimney's response to dynamic wind force. Damping is a measure of a structure's ability to dissipate energy after being excited by a forcing function. Steel chimneys have very low inherent damping and are slow to cease movement when put into motion. When the forcing energy ceases, high damping causes the motion to cease rapidly. Damping can be measured by plotting a structure's displacement versus time as shown in the following figure.

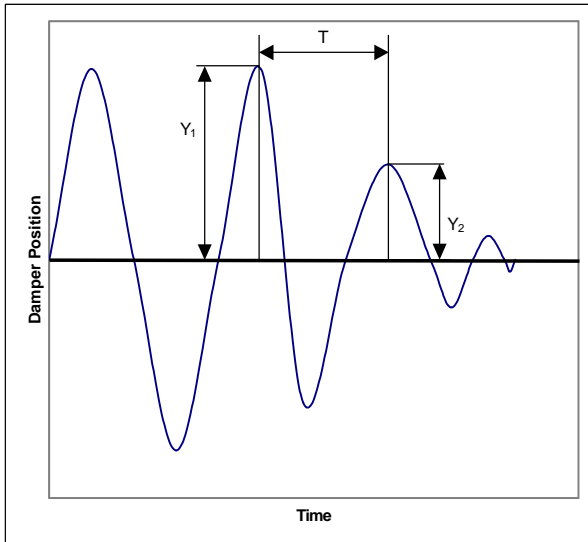

Representative Damping Curve

The frequency of the system is $1/T$. The logarithmic decrement Δ of the system is the natural log of y_1 divided by y_2 .

$$\Delta = \ln\left(\frac{y_1}{y_2}\right)$$

The structural damping is the logarithmic decrement divided by 2 times pi.

$$B_s = \frac{\Delta}{2\pi}$$

Type of Chimney	Damping Ratio
<i>Unlined, uninsulated</i>	0.002
<i>Unlined, externally insulated</i>	0.003
<i>Lined with refractory concrete</i>	0.005
<i>Lined with brickwork</i>	0.015
<i>Chimneys with steel liners:</i>	
<i>I < 26</i>	0.006
<i>I > 28</i>	0.002
<i>Coupled group</i>	0.004
<i>Chimney with tuned mass damper</i>	0.02 min.

Representative Damping Values for Steel Chimneys ¹¹

TUNED MASS DAMPERS

It has become common practice to install tuned mass dampers on steel chimneys. Tuned Mass Dampers can greatly increase the chimney's damping ratio as shown in the above table.



Cutaway Rendering of a Tuned Mass Damper

V. DESIGNING THE CANTILEVERED CYLINDER

A steel chimney is modeled as a cantilevered, thin walled steel cylinder. This is an idealized approximation. Care must be taken in the chimney design to maintain the validity of the assumptions made during the design process.

SECTION PROPERTIES AND STRENGTH

The cylindrical shell is designed to have enough section modulus to resist the static and dynamic wind loads subject to a suitable allowable stress. This allowable stress is determined so as to resist local buckling for the type of steel and design conditions being used.

IDEALIZED NATURAL FREQUENCIES AND MODE SHAPES

Once the size and section properties of the chimney are known, the natural frequencies and their associated mode shapes are determined. Computers are used to determine these quantities and the programming techniques involve finite element solutions identifying the structures mass and stiffness.

DISCONTINUITIES AND IMPERFECT ASSUMPTIONS

Care must be taken to maintain the strength and section modulus of the structure through discontinuities like breeching openings, access openings, field connections and test connections. Failure to maintain the section properties in a

way that validates the idealized assumptions will lead to errant designs. It is important to realize that a given reinforcing scheme could satisfy either the static loads or the dynamic loads, but possibly not both.

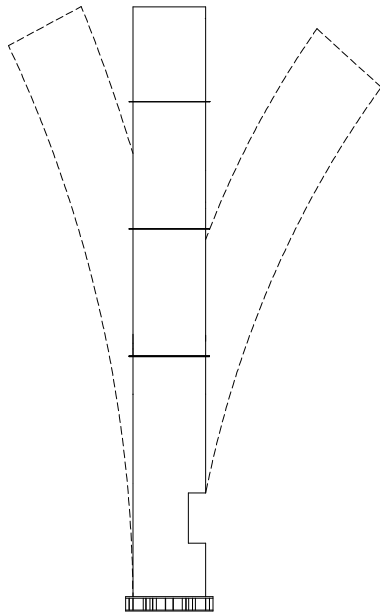

Chimney Vibration May be Greater Than Expected if Weakness in the Structure is Not Accurately Considered

FOUNDATIONS AND SUPPORT CONDITIONS

Classically, a cantilevered beam is idealized to have its base rigidly fixed. In practice the interaction of a chimney’s base, the foundation and the soil can have a great and sometime-unexpected effect on the design of the chimney. In terms of strength, a braced chimney whose foundation is unexpectedly flexible will require more support from the bracing structure. In terms of dynamics, a flexible foundation will lessen a cantilevered structure’s frequency which may cause unexpectedly large vibrations.

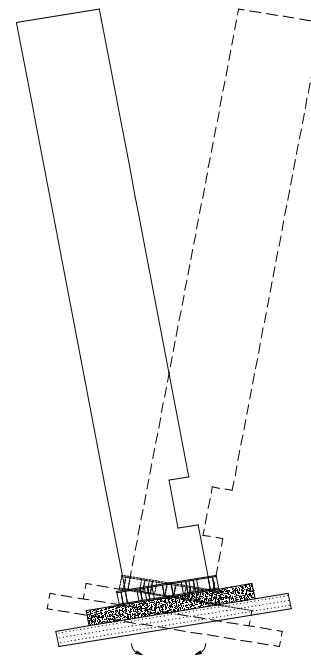

Chimney Vibration May be Greater Than Expected if Weakness in the Structure is Not Accurately Considered

REFERENCES

1. SMG. (1991) MLA Style. Retrieved from www.smg.gov.mo/dm/equiple_ws.htm
2. American Society of Civil Engineers, Minimum Loads for Buildings and Other Structures, ANSI / ASCE 7-95
3. (CICIND Model Code for Steel Chimneys, Commentary 3)
4. “Eurocode 3.2 Design of Steel Chimneys” ENV 1991-1-4: 2005C Annex A: 1995
5. Boeing. (2007). MLA Style. Retrieved 9 April 2008 from www.boeing.com/companyoffices/aboutus/wonder_of_flight/images/airfoil_500.jpg
6. Simiu and Scanlan (1976): “Wind Effects on Structures” Second Edition. John Wiley and Sons, 1986.
7. American Society of Mechanical Engineers , Steel Stack Standard, ASME STS-1, 2006
8. Billah, K. and Scanlan, R. (1991): “Resonance, Tacoma Narrows Bridge Failure, and Undergraduate Physics Textbooks”. Am. J. Physics 59 Vol. 2, American Ass. of Phys. Teachers 1991.
9. Vickery, B.J. and Basu, R.I., The response of reinforced concrete chimneys to vortex shedding, Eng. Struct., 1984, Vol. 6, October, 1984 Butterworth & Co. (Publishers) Ltd.
10. Figure Tacoma Narrows Bridge Collapse-----IMSA (2000). MLA Style. Retrieved 4 April 2008 from www.imsa.edu/.../Chaos/Lorenz/LorenzSummary.html
11. “CICIND Model Code for Steel Chimneys, Revision 1, 1999, Table 7.4