

# Spatial and seasonal changes of brackish peracaridan assemblages and their relation to some environmental variables in two tidal channels of the Ria de Aveiro (NW Portugal)

M. R. Cunha<sup>1,\*</sup>, J. C. Sorbe<sup>2</sup>, M. H. Moreira<sup>1</sup>

<sup>1</sup>Departamento de Biologia, Universidade de Aveiro, 3810 Aveiro, Portugal

<sup>2</sup>Laboratoire d'Océanographie Biologique, UMR 5805 (CNRS-UB1), 2 rue Jolyet, 33120 Arcachon, France

**ABSTRACT:** The shallow-water fauna of 2 main channels in the Ria de Aveiro (Canal de Ovar and Canal de Mira) was sampled between June 1995 and June 1996 using a suprabenthic sled. Samples were collected monthly at 5 stations and every third month at 11 other stations, covering both channels from the lower to the upper reaches. The channels differ in their hydrodynamics, in the distribution of the sediment environments and in the salinity gradient, thus providing an invaluable example for field studies. The results presented herein concern peracaridan crustaceans. Multivariate analysis (MDS, ANOSIM and UPGMA) of the faunal data showed significant differences between the 2 channels. Spatial and seasonal variations within the channels were also significant. The distinctive structural features were the higher number of species and overall dominance of mysids in the Canal de Mira as opposed to the dominance of amphipods and higher densities in the Canal de Ovar. In both channels there was a spatial pattern of high densities in areas with a rich sediment environment (fine sediments, high organic content, more diversified and stable food sources). Specific life cycle features, unfavourable temperature and salinity conditions, and probably also increased predation pressure induced a general impoverishment of the peracaridan assemblage during winter. Amphipods (mainly epibenthic and tube dwellers) and mysids (characteristic suprabenthic) showed defined spatial and seasonal patterns. Amphipods dominated the areas with more stable food sources, while the highly motile mysids succeeded in colonising and dominated in more dynamic and unpredictable environments. Density fluctuations of amphipods and mysids occurred seasonally in non-coincident cycles. On the whole, mysids were dominant during winter and spring and amphipods during summer and autumn.

**KEY WORDS:** Suprabenthos · Crustacea Peracarida · Community structure · Ria de Aveiro

## INTRODUCTION

Research on suprabenthos, also referred to as hyperbenthos, started in the late 1950s when this faunal compartment was first defined by Beyer (1958), but most studies have been carried out over the last 2 decades, reporting mainly on temperate and cold water environments from shallow coastal to deep sea areas (review by Mees & Jones 1997).

Several marine coastal suprabenthic communities of the NE Atlantic have been studied in the North Sea (Buhl-Jensen & Fosså 1991, Hamerlynck & Mees 1991), the English Channel (Dauvin et al. 1994, Wang & Dauvin 1994, Zouhiri & Dauvin 1996), the Bay of Biscay (Sorbe 1982, 1984, 1989, Cornet et al. 1983) and the Portuguese margin (Cunha et al. 1997). However, only a few brackish suprabenthic communities have been investigated: in the Westerschelde, The Netherlands (Mees & Hamerlynck 1992, Cattrijsse et al. 1993, Mees et al. 1993a,b); in the Gironde, France (Sorbe 1981a); in the Rias de Guipuzcoa, north of Spain (San Vicente

\*E-mail: mcunha@bio.ua.pt

1996) and in the tidal channels of the Bay of Cadiz, south of Spain (Drake et al. 1997). Mees et al. (1995) also conducted a comparative study in the Eems-Dollard, the Westerschelde and the Gironde using a standardised methodology.

The faunal assemblage usually referred to as suprabenthos includes not only characteristic suprabenthic species (living close to but not on or in the sediment), but also planktonic and endo- or epibenthic species. The latter may spend only part of their early life history or variable periods of their adult life in the suprabenthos, depending on erratic or regular activity patterns at specific times of the day or year, or at certain life-history stages (Mees & Jones 1997). Still, the suprabenthos may be considered a true community that includes all organisms in the water-sediment interface, i.e. the water layer just above the surface of the sediment, which can only be sampled using a proper collecting apparatus (suprabenthic sled-type sampler). The different terminology and definitions used in the past 3 decades are summarised and discussed by Mees & Jones (1997).

Suprabenthic fauna is difficult to sample and a variety of techniques and sampling devices (Mauchline 1980, Sorbe 1983) has been used for the study of this faunal compartment. The importance of suprabenthic animals has been underestimated in the past because of unrepresentative sampling. Nevertheless, there is growing interest in suprabenthic research related to fisheries, aquaculture, toxicology, pollution and benthopelagic coupling studies (Mees & Jones 1997).

Suprabenthos is a major link in marine and estuarine food webs: it exploits a diversity of food resources, mobilising organic particles and debris or preying on zooplankton (Mauchline 1980, Fulton 1982), and constitutes an important part of the diet of demersal fishes (Sorbe 1981b, 1984, Astthorsson 1985). The role of suprabenthos as a functional compartment is particularly relevant in highly productive coastal systems that act as nursery grounds for commercially important fishes and crustaceans.

The spatial distribution of suprabenthic animals in estuaries results mainly from physiological constraints, hydrodynamic conditions and food availability (Mees et al. 1995). Seasonal patterns of suprabenthic communities are largely dominated by the succession of temporary suprabenthos species (merosuprabenthos: larvae and post-larvae of decapods, larval stages of macrobenthic species and eggs, larvae and early post-larvae of fishes) in the warmer months (Hamerlynck & Mees 1991, Mees et al. 1993b).

The results presented herein concern only the peracaridan crustaceans as permanent members of the suprabenthos (holosuprabenthos). Sampling was carried out along 2 channels of the Ria de Aveiro during a

1 yr period in order to investigate: (1) the differences in the environmental gradients and peracaridan assemblages of the 2 channels; (2) the spatial and seasonal changes in the structure of the community (species composition, number of species, density). The results are discussed in relation to the environmental characteristics of the channels and compared with available data from other brackish water communities. This is the first study on suprabenthic fauna from Portuguese brackish coastal waters and it aims to contribute to the knowledge of the poorly studied estuarine suprabenthos.

## MATERIAL AND METHODS

**Study area.** The Ria de Aveiro is a shallow coastal lagoon on the west coast of Portugal (Fig.1) that can be considered as a bar-built estuary according to the classification of Pritchard (1967). It is a very recent geological feature, developed through marine sediment transport along the coast and by deposition of solids

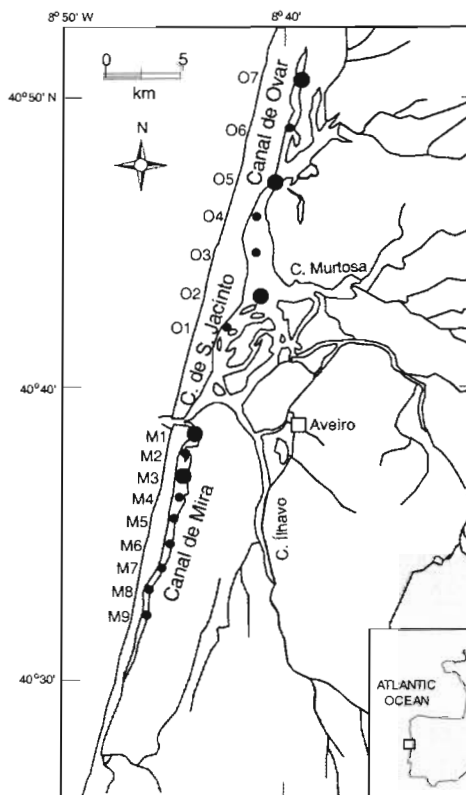

Fig. 1. Map of the Ria de Aveiro and location of the stations sampled with a suprabenthic sled from June 1995 to June 1996. Larger symbols indicate the stations sampled monthly and smaller symbols indicate the stations sampled every third month

carried by rivers. These mechanisms, initiated in the 11th–12th century, have not yet attained an equilibrium and the present trend is to silt up. The mouth of the lagoon was artificially opened in 1808 for maritime, commercial and fishing purposes.

The topography of the Ria de Aveiro is rather complex with 3 main channels that radiate from the mouth with several branches, islands and mudflats. With a length of 45 km and a maximum width of 10 km, the lagoon covers an area of 43 to 47 km<sup>2</sup> at low and high tide, respectively. The hydrological circulation is dominated by marine influence. The volume of water exchanged during a tidal cycle varies from 25 to 70 × 10<sup>6</sup> m<sup>3</sup> for tides with a 1.0 to 2.5 m height range, respectively, whilst the mean total river discharge is only 1.8 × 10<sup>6</sup> m<sup>3</sup>. During flood, about 20% of the tidal prism is diverted to the Canal de Mira, which runs southwards, and another 40% to the Canal de Ovar (named S. Jacinto, near the mouth), which runs northwards (Vicente 1985). The morphodynamics, circulation patterns and environmental gradients in the Canal de Mira have been described by several authors (Teles et al. 1990, Moreira et al. 1993, Cunha & Moreira 1995, Corrochano et al. 1997, Franco 1997), but the Canal de Ovar remains scarcely studied.

In order to make comparisons between the 2 channels, 3 regions were considered in each one: the lower reaches, near the entrance of the channels where marine influence is strong and salinity values are relatively high throughout the year; the upper reaches, a more confined area where the channels are narrower, sometimes with extensive seagrass meadows but with small intertidal areas; the middle reaches, the transition between these opposite regions, which is usually characterised by extensive intertidal areas and subject to a large seasonal and/or tidal variation in salinity.

**Sampling.** Sampling was carried out from June 1995 to June 1996 during the day, at flood, at a total of 16 stations. Five stations were sampled monthly and 11 stations were sampled every third month (Fig. 1) using a small suprabenthic sled (Fig. 2) towed over the bottom from a motor boat. The sled is equipped with 1 net (0.5 mm mesh size) and collects fauna in the 0 to 50 cm water layer above the bottom. An oblique (ca 45°) frontal plate enables sampling of the lowermost centimetres of the water column but prevents the sediment from entering the net. The efficiency of suprabenthic samplers is increased by sampling the few centimetres above the bottom where

suprabenthic fauna may have the highest abundance (Brattegard & Fosså 1991, Mees & Jones 1997). For each haul the sampled area was calculated from the net width (50 cm) and the estimated towed distance (range: 10 to 25 m<sup>2</sup>).

In order to cover the salinity gradient, 7 stations were located in the Canal de Ovar (ca 3 km intervals) and 9 in the Canal de Mira (ca 1.5 km intervals). At the upper reaches of the Canal de Mira the channel is very shallow and narrow, and it was not possible to tow the sled in the area near freshwater. Some difficulties were also experienced in handling the light sled in the strong current area near the entrance of the Canal de Ovar, where it was impossible to prevent the coarse and loose sediment from entering the net. Due to these adverse conditions, the first sampling station in this channel was located at 8 km from the mouth of the Ria. Only 1 haul per station was carried out resulting in a total of 120 samples (Ovar: 59; Mira: 61). Temperature and salinity of the water near the bottom were recorded and a van Veen grab was used to collect sediment for granulometric analysis and determination of organic content. This procedure was repeated at all stations on each sampling occasion.

The collected specimens were fixed with 10% neutral formalin, sorted into various taxa under a dissecting microscope and kept in 70% ethanol. Peracaridan crustaceans were identified and counted, and their density was estimated and expressed as number of individuals per m<sup>2</sup>. Densities could not be reported per volume of water filtered because drifting algae and other debris often interfered with the flowmeter measurements.

The species were allocated to different life-style groups based on their activity and place occupied within the water-sediment column. Four groups were

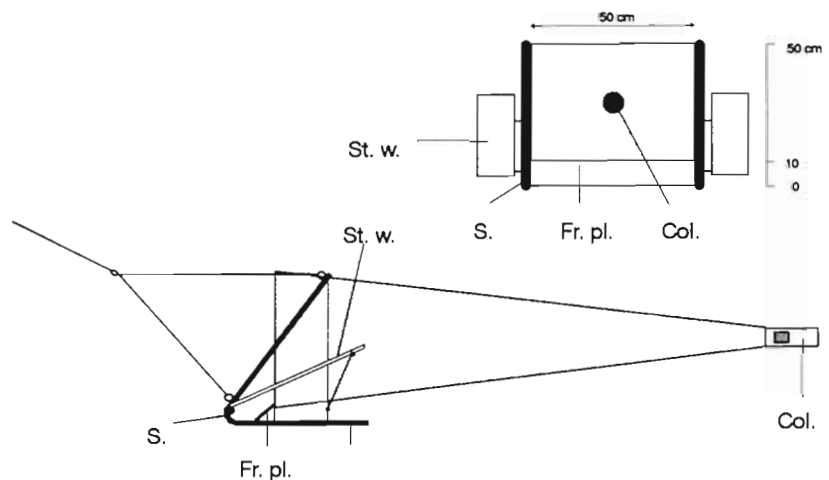

Fig. 2. Suprabenthic sled used in the Ria de Aveiro. St. w.: stability wings; S.: sled; Fr. pl.: frontal plate; Col.: collector. Adapted from Queiroga (1995)

considered: (1) characteristically suprabenthic, strong swimmers, living predominantly in the water column close to the sediment; (2) epibenthic, moderate swimmers, living predominantly on the surface of the sediment, frequently associated with macrophytes; (3) tube dwellers; (4) benthic sand or mud dwellers, living predominantly buried in the sediment.

**Data analysis.** Data analysis was performed using the statistical package PRIMER (Carr et al. 1993). The abundance data were first organised into a sample/species matrix. Non-metric MDS ordination (Kruskal & Wish 1978) was performed using the Bray-Curtis similarity measure (Bray & Curtis 1957) after fourth root transformation of the data. The data were analysed for the 2 channels together and for each channel separately. For the UPGMA classification of the species the data were standardised and taxa with less than 1% of the total abundance in each of all samples were discarded. An analysis of similarities (ANOSIM) by randomisation/permutation tests was performed on the MDS results (Clarke 1993). For the MDS plot of all stations, the ANOSIM tests were directed to assess the significance of spatial differences between and within the channels. A 2-way crossed layout was used with the following groups of stations: Ovar and Mira for 'between channels' differences; lower (Ovar: O1; Mira: M1, M2), middle (Ovar: O2, O3; Mira: M3, M4, M5, M6, M7) and upper reaches (Ovar: O4, O5, O6, O7; Mira: M8, M9) for 'within channels' differences. These 3 regions were defined *a priori* considering the morphodynamics and environmental gradients within each channel (as referred in 'Study area'). For the analysis of the MDS performed separately for Ovar and Mira, 2 factors were considered: the location of the stations along the channel and the time of year at which the samples were taken. For the Canal de Ovar only 2 spatial groups could be considered (upper and middle-lower reaches) because a single station was sampled at the lower reaches and the ANOSIM tests can only be performed with at least 2 samples per group. The *a priori* groups of stations were the lower, middle and upper reaches (as referred to above) for spatial differences, and spring (June 1995, April, May and June 1996), summer (July, August and September 1995), autumn (October, November and December 1995) and winter (January, February and March 1996) for seasonal differences. The samples from the spring of 1995 and 1996 were pooled in the same seasonal group because a previous test had shown that differences between these samples were not significant. A 2-way crossed layout was used to assess the significance of the spatial and seasonal differences in the community structure. This means that tests for differences between 'spatial' groups are averaged across all 'seasonal' groups and vice versa (Clarke

1993). By using the 2-way crossed layout, the effect of seasonal variation can be assessed against a background of changing community structure along the channels. It can be anticipated that the community will change naturally along the salinity gradient and it is important to separate this effect from seasonal changes that might occur.

## RESULTS

### Environmental gradients

Water temperature values measured during this study ranged from 11 (December 1995, February 1996) to 27°C (July 1995, June 1996). Salinity ranged from 1 to 36 in the Canal de Ovar and 5 to 36 in the Canal de Mira. Fig. 3 shows the temperature plotted against salinity in Ovar (Fig. 3A) and Mira (Fig. 3B).

The Canal de Mira displayed characteristic estuarine gradients: increasing temperature and decreasing salinity towards the upper reaches, which was observed during the warmer months. In the colder months (December 1995, March 1996), the salinity gradient remained but the temperature gradient almost disappeared. In this narrow and shallow channel, the renewal of water is almost complete at each tidal cycle and the low freshwater input is sufficient to maintain a permanent salinity gradient.

The upper reaches in the Canal de Ovar form a 'dead end' with an insignificant supply of freshwater, except during the rainy season. Due to these conditions, the salinity gradient was strongly reduced in periods of drought and high values occurred all along the channel (Fig. 3A: June and September 1995). Salinity values slightly higher than those observed at the middle reaches were recorded at the upper reaches during the warmer months due to the higher temperature and evaporation rate. During rainy periods the salinity gradients were similar to those occurring in the Canal de Mira.

The marine influence is strong in both channels and extends further in the wider and deeper Canal de Ovar. However, the tidal variation of salinity is more important in the Canal de Mira. In both channels, seasonal variation of salinity is closely associated with climatic events. After a period of heavy rainfall in June 1996, the observed salinity values were much lower than in June 1995, when dry weather occurred (Fig. 3).

Another important source of environmental variation in the Ria de Aveiro is the sediment grain size and associated organic content. Fig. 4 shows grain size plotted against the organic content of sediment in the Canal de Ovar (Fig. 4A) and the Canal de Mira (Fig. 4B). Differences between the 2 channels are evident.

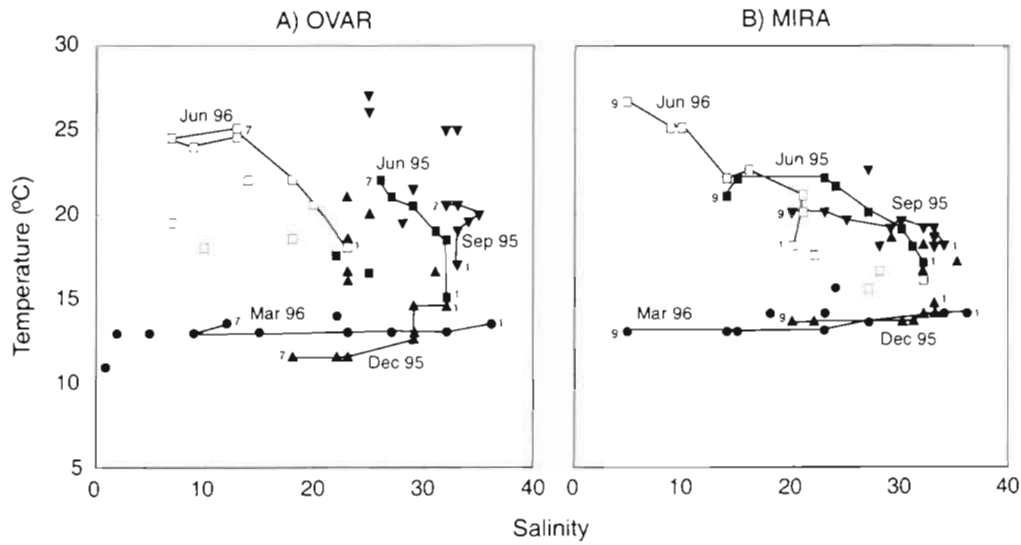

Fig. 3. Salinity-temperature gradients in the Ovar and Mira channels (Ria de Aveiro). Numbers indicate the nearest (1) and the most distant stations (7 in Ovar and 9 in Mira) in relation to the mouth of the Ria. Lines represent the gradients in the months when all the stations were sampled. ■: spring 1995; ▲: summer 1995; ▼: autumn 1995; ●: winter 1996; □: spring 1996

In the Canal de Ovar, a clear spatial pattern is established with finer sediments (mud) and higher organic content at the upper reaches, where calmer hydrodynamic conditions occur, and coarser sediment (medium to coarse sand) with little organic content at the lower reaches. In the Canal de Mira, sediment is more homogeneous. Most samples were classified as medium sand with very low organic content (less than 1% of the total sediment dry weight). Fine sand with higher organic content was found at 2 stations located near the entrance of the channel (M1 and M3). In general,

sediments in Ovar were finer and had higher organic content: a maximum of 11.8% of the sediment dry weight in Ovar against 6.9% in Mira. The observed sediment data from both channels did not show an evident seasonal pattern.

The distribution of sediment environments in the Ria de Aveiro is determined mainly by the morphology of the channels, the hydrodynamic regime and sediment sources. The major input of freshwater and sediment particles of continental origin occurs in the central and northern areas of the Ria. Fine particles may deposit in

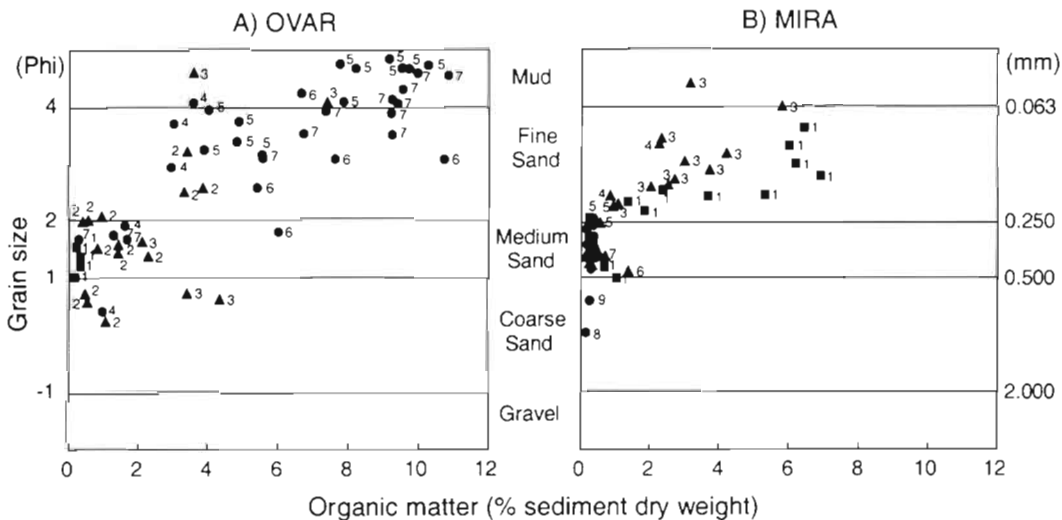

Fig. 4. Distribution of sediment environments in the Ovar and Mira channels (Ria de Aveiro). Numbers indicate the stations (1 to 7 in Ovar and 1 to 9 in Mira). ■: lower reaches; ▲: middle reaches; ●: upper reaches





de Ovar and 53 in the Canal de Mira. A few rare species were only identified to the genus level, but *Schistomysis* sp. and *Jassa* sp. are probably *S. parkeri* and *J. falcata*. Four species of *Gammarus* were found in the 2 channels. These species belong to the *Gammarus locusta* group and their identification to the species level was only possible in large, mature individuals. Due to the overlapping distribution of some species, juveniles and small or immature adults were pooled as *Gammarus* spp.; *Corophium acherusicum* and *C. insidiosum* also occurred in mixed populations. The juveniles of these species could not be readily distinguished and were pooled as *Corophium* spp. (juv.). Both *Gammarus* spp. and *Corophium* spp. (juv.) were excluded from the multivariate analysis.

Half of the species collected are new records for the Ria de Aveiro. In addition, *Diamysis bahirensis* (Cunha et al. in press) and *Zeuxo holdichi* are new records for Portuguese fauna. Eight species were found exclusively in the Canal de Ovar and 20 exclusively in the Canal de Mira. *Diamysis bahirensis* and *Gammarus insensibilis* in the Canal de Ovar and *Zeuxo holdichi* in the Canal de Mira were collected in relatively high numbers at some stations, but the other exclusive species were mostly accidental catches (a few individuals in 1 or 2 samples).

The number of individuals collected per haul ranged from 3 to 13500 and estimated density values ranged from 0.1 (sample M9, December 1995) to 901.8 ind. m<sup>-2</sup> (sample O7, November 1995). The average density of peracaridan crustaceans was 58.4 ind. m<sup>-2</sup> (average from the 16 stations).

The 10 dominant species in each channel (Table 1) represented 89.3 and 90.2% of the individuals in

the communities of Ovar and Mira, respectively. From these species *Mesopodopsis slabberi*, *Paramysis bacescoi*, *Ampithoe valida*, *Melita palmata* and *Lekanesphaera levii* were dominant in both channels. The highest density of a single species was reached by *P. bacescoi* (sample M3, October 1995: 298.9 ind. m<sup>-2</sup>) followed by *A. valida* (sample O5, October 1995: 267.5 ind. m<sup>-2</sup>). *Corophium acherusicum*, *M. palmata*, *Gastrosaccus spinifer* and *Schistomysis spiritus* also reached maximal density values above 100 ind. m<sup>-2</sup>.

Fig. 5 shows spatial and seasonal trends in the number of species and the density of peracaridan assemblages throughout the studied channels. In Ovar there is not an evident trend in the total number of species along the channel, while in Mira there is clearly an impoverishment of the community towards the upper reaches. The seasonal variation is similar in both channels: in general, the highest number of species occurred in September and the lowest in March. Furthermore, the highest densities were recorded in September at the upper reaches of Ovar and middle reaches of Mira. The lowest densities occurred at the upper reaches of Mira and lower reaches of Ovar all year round. In all regions of both channels, the minimal density was recorded in March. In general, density was higher in the Canal de Ovar (average: 91.4 ind. m<sup>-2</sup>) than in the Canal de Mira (average: 32.8 ind. m<sup>-2</sup>).

#### Taxonomic assemblage structure

Amphipods, mysids and isopods were the best represented taxonomic groups in the study area (52, 23 and 14% of the total number of species, and 48, 33

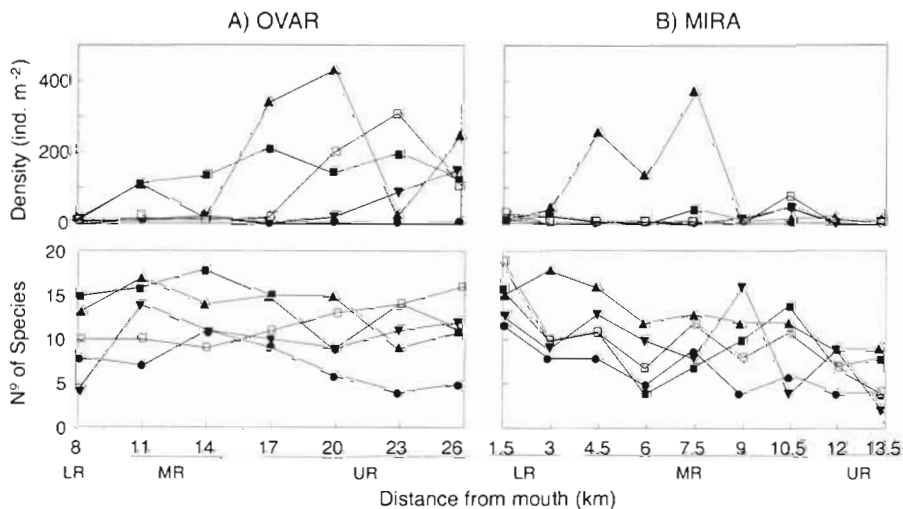

Fig. 5. Number of species and density along Ovar and Mira channels. ■: June 1995; ▲: September 1995; ▼: December 1995; ●: March 1996; □: June 1996. LR: lower reaches; MR: middle reaches; UR: upper reaches

and 17% of the total density, respectively). Cumaceans and tanaids were represented by only a few species in both channels (Table 1), but the latter occurred in relatively high densities in Mira. The annual average densities of the different groups at each sampling station (Table 2) show that amphipods and isopods reached much higher densities in the Canal de Ovar, whereas mysids showed similar densities in both channels.

Data from several sampling occasions at the different stations were grouped into spatial regions and seasons (Fig. 6). The low number of species in the lower reaches of Ovar is partially due to the fact that only 1 station was sampled in this region. Amphipods determined the spatial and seasonal variation of the number of species in both channels while isopods showed little variation. The decrease in mysid species towards the upper reaches of Mira also contributed to the observed spatial pattern in this channel.

The density of peracaridan assemblages in the Ria de Aveiro also showed important spatial and temporal changes. Amphipods dominated the upper reach assemblage in the Canal de Ovar, whereas mysids were dominant in the lower and middle reaches of this channel and all over the Canal de Mira. Isopods made up an important portion of the community in the upper reaches of both channels all year round. Tanaids reached high density values in the middle reaches of Mira, but only in autumn and spring.

In the Ria de Aveiro, amphipods breed almost continuously, but most species exhibited breeding peaks from September to November and their maximal density was recorded in the warmer months. During winter, when amphipods suffered a drastic decrease, dominance by mysids was higher at the lower and middle reaches but not at the upper reaches where low salinity values occurred in both channels. Mysid species showed a reduced regularity in their large scale spatial distribution. Density was highly variable and maximal values were recorded occasionally at different stations, but for most species maximal densities were recorded in June.

#### Structure of assemblages based on life-style groups

The life-style groups assigned to the collected species are given in Table 1: 20 characteristically suprabenthic species, mostly mysids, 19 epibenthic amphipod and isopod species, 9 tube dweller species, mostly Corophiidae amphipods and tanaids and 10 benthic mud or sand dweller species, mostly cumaceans and Haustoriidae amphipods. The most common species (present in more than 50% of the collected samples) were either epibenthic (*Melita palmata*, *Lekanesphaera levii*, *Idotea chelipes*) or suprabenthic (*Mesopodopsis slabberi*, *Paramysis bacescoi*, *Neomysis integer*). Tube dwellers (*Corophium acherusicum*, *C.*

Table 2. Average density (ind. m<sup>-2</sup>) of the main taxonomic groups in the samples collected in Ovar and Mira in June, September and December 1995 and March and June 1996. Numbers in brackets indicate the results from 13 monthly samples.  $\bar{D}$ : average density for the stations in each channel. Mys: Mysidacea; Amp: Amphipoda; Cum: Cumacea; Iso: Isopoda; Tan: Tanaidacea

Stn	Mys	Amp	Cum	Iso	Tan	Total
<b>Ovar</b>						
O1	6.1	0.4	0.0	1.3	0.0	7.8
O2	27.9 (19.8)	23.2 (12.8)	0.0 (<0.1)	1.1 (1.9)	<0.1 (<0.1)	52.2 (34.4)
O3	22.0	15.9	0.0	1.8	0.0	39.7
O4	61.6	40.3	0.0	14.0	0.0	115.9
O5	9.5 (4.5)	105.8 (1996.5)	0.0 (0.0)	44.6 (29.0)	0.0 (0.0)	159.9 (129.9)
O6	3.9	70.2	0.0	50.3	0.0	124.4
O7	37.8 (16.4)	67.8 (142.5)	0.0 (0.0)	23.4 (29.0)	<0.1 (<0.1)	129.0 (187.9)
$\bar{D}$	24.1 (19.3)	46.2 (54.1)	<0.1 (<0.1)	19.5 (18.2)	<0.1 (<0.1)	89.9 (91.4)
<b>Mira</b>						
M1	11.1 (39.8)	3.9 (4.5)	<0.1 (0.2)	0.3 (0.7)	<0.1 (<0.1)	15.3 (45.2)
M2	6.0	6.6	<0.1	5.5	<0.1	18.1
M3	12.8 (29.8)	42.4 (31.3)	0.0 (0.0)	0.7 (1.5)	0.3 (0.3)	56.2 (63.0)
M4	24.6	5.4	0.0	1.3	0.0	31.3
M5	65.1	1.6	0.0	18.9	<0.1	85.5
M6	1.9	4.5	0.0	0.6	<0.1	7.0
M7	6.0	12.4	0.0	2.0	18.3	38.6
M8	3.6	0.5	0.0	0.7	<0.1	4.8
M9	0.8	0.2	0.0	0.4	<0.1	1.4
$\bar{D}$	14.7 (19.7)	8.6 (7.5)	<0.1 (<0.1)	3.4 (3.5)	2.1 (2.1)	28.7 (32.8)



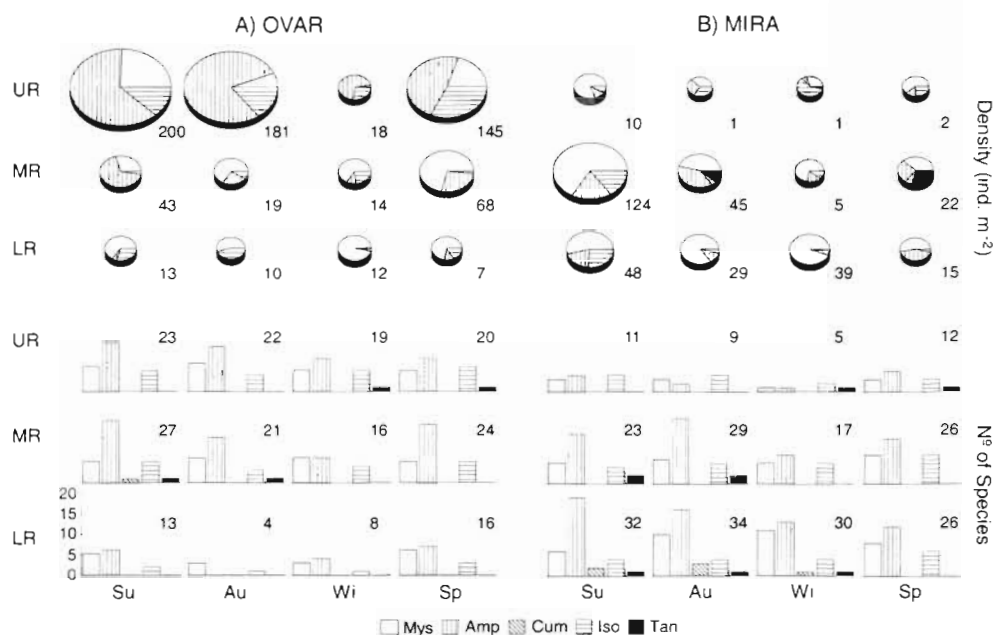

Fig. 6. Spatial and seasonal variation in the number of species and density per taxonomic group. Numbers indicate the pooled number of species (bar charts) and the average density across the stations in each group (pie charts). Mys: Mysidacea; Amp: Amphipoda; Cum: Cumacea; Iso: Isopoda; Tan: Tanaidacea. UR: upper reaches; MR: middle reaches; LR: lower reaches. Su: summer; Au: autumn; Wi: winter; Sp: spring

*insidiosum*) were also common in the Canal de Ovar (Table 1). The annual average density of the different life-style groups at each sampling station (Table 3) show that the peracaridan assemblage is dominated by epibenthic species and tube dwellers in the Canal de Ovar and suprabenthic species in the Canal de Mira.

The decreasing trend in the number of species towards the upper reaches of the Canal de Mira was observed in all life-style groups, while in Ovar spatial variation occurred mainly in the number of epibenthic species and tube dwellers (Fig. 7). The lower number of species in the latter groups recorded during winter also marked the seasonal pattern in both channels.

The highest density of most epibenthic species and tube dwellers was consistently recorded at the end of summer and beginning of autumn at the upper reaches of the Canal de Ovar in areas with *Zostera* and *Potamogeton* meadows. These were also important groups in the middle reaches of both channels. Benthic sand dwellers, mainly Haustoriidae amphipods, were frequently collected in sandy environments and reached their highest densities in the Canal de Mira. The spatial and seasonal changes in density of characteristic suprabenthic species and mysids coincide (compare pie charts in Figs. 6 & 7) because practically all the individuals in this life-style group were mysids.

### Multivariate analysis

Fig 8 and Table 4 show the results of the MDS and ANOSIM for all the samples collected in both channels. The communities from different locations within the channels (lower, middle and upper reaches) occupy defined positions in the plot, but the separation of the samples from the 2 channels is not obvious, except for the upper reaches where divergent environmental conditions occurred. Nevertheless, the ANOSIM tests indicate that both differences 'within channels' and 'between channels' are significant.

Fig. 9 shows the MDS plots for the analysis that was performed separately on each channel. In both channels the spatial groups can be recognised, but a higher definition is achieved in Ovar, where samples from the different regions are clearly segregated (Fig. 9A). In Mira, the summer and autumn samples from the middle reaches are closer to the lower reaches group, and the winter and spring samples are closer to the upper reaches group (Fig. 9B). This pattern reflects the seasonal variation in salinity observed in the Canal de Mira accompanied by the seawards shift of the communities during winter. Seasonal changes in the assemblages of the Canal de Ovar are more apparent with the winter and spring samples positioned in the upper part of the plot, as opposed to the summer and autumn samples. There is a greater distinction be-

Table 3. Average density (ind. m<sup>-2</sup>) of the life-style groups in the samples collected in Ovar and Mira in June, September and December 1995 and March and June 1996. Numbers in brackets indicate the results from 13 monthly samples.  $\bar{D}$ : average density for the stations in each channel. S: characteristic suprabenthic; E: epibenthic; T: tube dwellers; B: benthic sand or mud dwellers; U: unknown

Stn	S	E	T	B	U	Total
<b>Ovar</b>						
O1	6.1	1.4	0.2	0.2	0.0	7.8
O2	27.9 (19.8)	3.7 (3.6)	20.3 (10.8)	0.2 (0.1)	0.1 (0.1)	52.2 (34.4)
O3	22.0	7.6	9.4	0.0	0.7	39.7
O4	61.6	33.3	21.0	0.1	0.1	115.9
O5	9.5 (4.5)	131.1 (110.4)	19.2 (14.8)	0.1 (0.1)	0.0 (<0.1)	159.9 (129.9)
O6	3.9	80.0	40.3	0.2	0.0	124.4
O7	37.8 (16.4)	51.7 (91.3)	39.5 (80.1)	0.1 (<0.1)	0.0 (0.0)	129.0 (187.9)
$\bar{D}$	24.1 (19.2)	44.1 (46.8)	21.4 (25.2)	0.1 (0.1)	0.1 (0.1)	89.9 (91.4)
<b>Mira</b>						
M1	11.1 (40.0)	3.2 (3.6)	0.6 (0.7)	0.2 (0.8)	0.1 (0.1)	15.3 (45.2)
M2	6.0	5.9	0.1	6.2	< 0.1	18.1
M3	12.8 (29.8)	38.0 (29.3)	3.6 (2.0)	1.5 (1.5)	0.3 (0.3)	56.2 (63.0)
M4	24.7	1.5	< 0.1	5.1	0.0	31.3
M5	65.1	19.2	0.3	0.9	< 0.1	85.5
M6	1.9	3.8	1.1	0.2	< 0.1	7.0
M7	6.0	4.6	26.5	1.6	0.0	38.6
M8	3.7	0.3	< 0.1	0.8	0.0	4.8
M9	0.8	0.1	0.2	0.3	0.0	1.4
$\bar{D}$	14.7 (19.8)	8.6 (7.5)	3.6 (3.4)	1.9 (1.9)	<0.1 (<0.1)	28.7 (32.8)

tween the spatial groups during winter and spring when the salinity gradient is well established in the channel.

In the MDS plots, the wider dispersion of the samples within a group may be interpreted as a result of an impoverished faunal assemblage with a low number

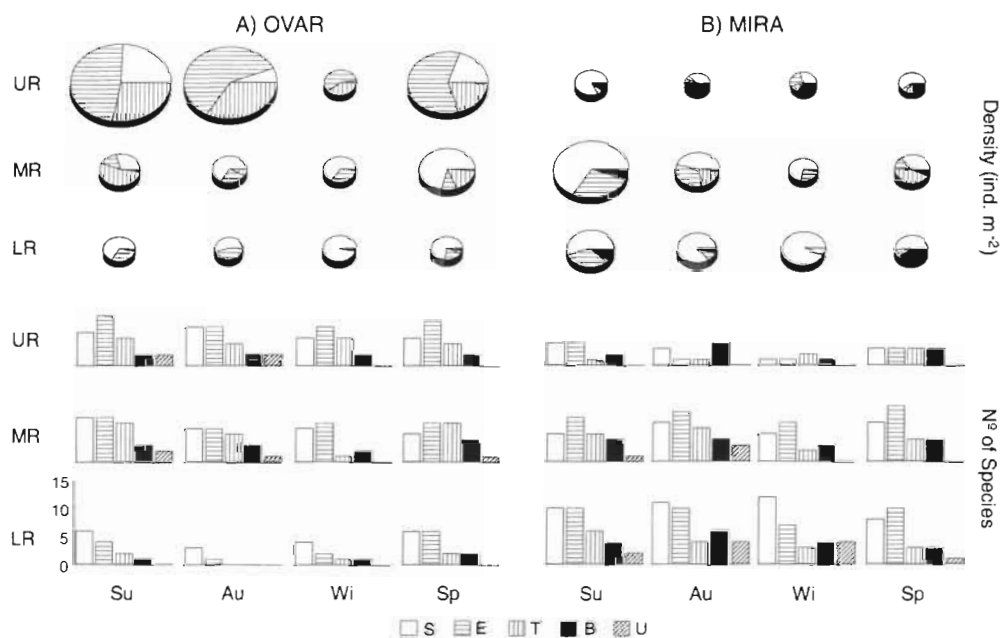

Fig. 7. Spatial and seasonal variation in the number of species and density per life-style group. S: strictly suprabenthic; E: epibenthic; T: tube dwellers; B: benthic sand or mud dwellers; U: unknown or others; UR: upper reaches; MR: middle reaches; LR: lower reaches. Su: summer; Au: autumn; Wi: winter; Sp: spring

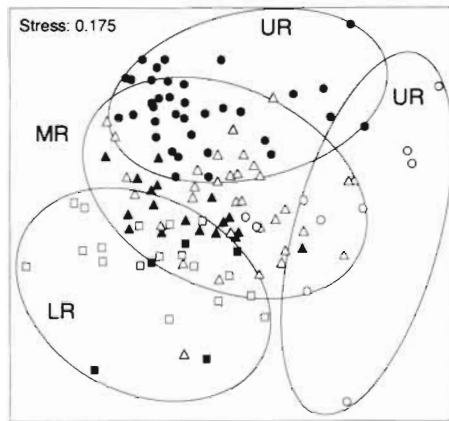

Fig. 8. MDS results of the analysis performed on the faunal data from all samples collected in Ria de Aveiro. Full symbols: samples in the Canal de Óvar; open symbols: samples in Canal de Mira. ■, □: lower reaches; ▲, △: middle reaches; ●, ○: upper reaches

of species and density values. This effect can be observed both in Ovar (Fig. 9A: upper reach winter samples and lower reach group) and Mira (Fig. 9B: upper reach group). The stress values of all MDS plots are rather high, which is not uncommon when the analysis of a large number of highly variable samples is attempted.

The ANOSIM tests (Table 5) assess the significance of spatial and seasonal changes (Figs. 7 & 8). The results show that the faunal assemblages of the spatial groups (lower, middle, and upper reaches) are significantly different in both channels. The global seasonal variation is also significant, but the pairwise tests indicate non-significant differences between 'summer' and 'autumn' assemblages in both channels, and between 'spring' and 'winter' assemblages in Mira.

Fig. 10 shows the dendrograms resulting from the UPGMA classification of the species retained for this analysis (29 in Ovar and 38 in Mira). Several groups of

species are identified which can be associated to groups of samples where they reach maximal density. These species groups reveal the main spatial and seasonal patterns in the 2 channels. The species associated with the lower reach group, mainly the suprabenthic mysids *Gastrosaccus spinifer*, *Schistomysis spiritus* and *Siriella armata* (codes 3S, 10S and 11S), were restricted almost exclusively to the entrance of both channels, which are under the strong influence of marine conditions.

The most common and widespread species, such as *Neomysis integer*, *Praunus flexuosus*, *Ampithoe valida*, *Corophium acherusicum*, *Melita palmata*, *Idotea chelipes*, *Lekanesphaera hookeri*, *L. levii* and *Paragnathia formica* (6S, 8S, 15E, 23T, 38E, 53E, 55E, 56E, 57B), which are mostly epibenthic, reached their maximal density at the upper reaches in the Canal de Ovar and the middle reaches in the Canal de Mira (Fig. 10).

The upper reaches of the Canal de Mira show a very poor peracaridan assemblage with only a few individuals of widespread species. *Saduriella losadai* (58B), an Iberian endemic isopod, is the only species characteristic of this area.

Epibenthic species and tube dwellers (mostly amphipods) are associated with the summer-autumn groups, while suprabenthic mysids and benthic dwellers are associated with the spring-winter groups (Fig. 10). Due to specific life-history features, maxima and minima of amphipods and mysids alternated in non-coincident cycles. Exceptions are *Gastrosaccus spinifer* and *Paramysis bacescoi* (3S, 7S), which reached maximal density during summer and autumn when most mysids were scarce.

Some sub-groups of species can also be related to particular conditions. At the upper reaches of the Canal de Ovar (Fig. 10A) *Ampithoe valida*, *Melita palmata* and *Idotea chelipes* (15E, 38E, 53E) were the dominant species in *Zostera* meadows (Stn O5) whereas *Corophium acherusicum*, *C. insidiosum*, *Siriella clausii*, *Gammarus insensibilis* and *Lekanesphaera*

Table 4. Results of the ANOSIM global and pairwise tests for the MDS performed with all samples. The statistic estimated for each permutation is significant when its value is greater than or equal to the sample statistic. Significance level is calculated as the percentage of significant statistics in the total number of permutations used. LR: lower reaches; MR: middle reaches; UR: upper reaches

	Sample statistic	Permutations used	Significant statistics	Significance level
<b>Global tests</b>				
Between channels	0.422	20000	0	0.0%***
Within channels	0.464	20000	0	0.0%***
<b>Pairwise tests</b>				
(LR, MR)	0.378	20000	0	0.0%***
(LR, UR)	0.743	20000	0	0.0%***
(MR, UR)	0.412	20000	0	0.0%***

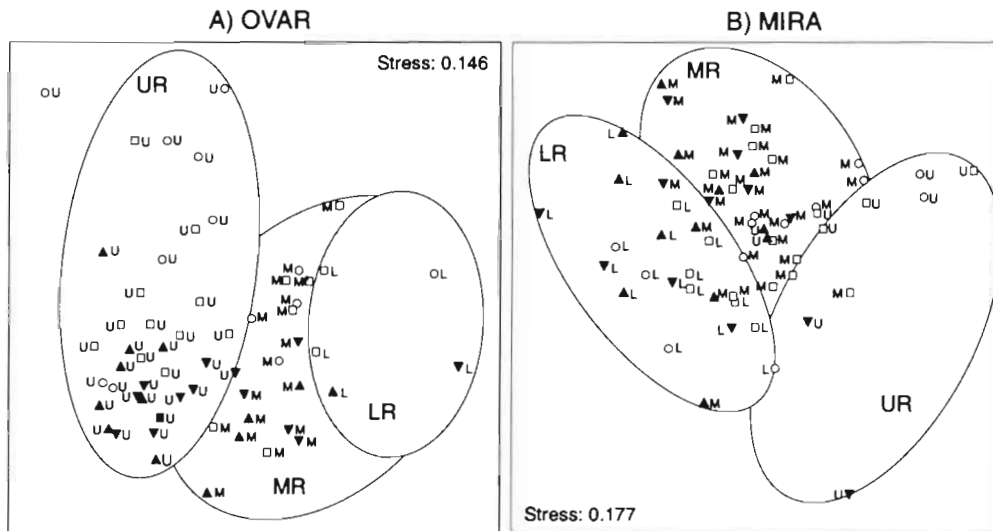

Fig. 9. MDS results of the analysis performed on the faunal data from the samples collected in the Ovar and Mira channels (Ria de Aveiro). LR, L: lower reaches; MR, M: middle reaches; UR, U: upper reaches. ▲: summer; ▼: autumn; ○: winter; □: spring

*hookeri* (23T, 25T, 12S, 31E, 55E) dominated the *Potamogeton* meadows (Stn O7). In the Canal de Mira, where seagrass meadows are not extensive, these epibenthic and tube dwellers were recorded in much lower densities, mostly in the vicinity of intertidal flats at the middle reaches.

In the Canal de Mira, the middle reaches spring group (Fig. 10B) is composed of a rather heterogeneous collection of species. *Mesopodopsis slabberi*, *Bathyporeia sarsi*, *Eurydice pulchra* and *Paragnathia formica* (5S, 19B, 52S, 57B) were recorded frequently at all stations of this region. However, these species

Table 5. Results of the ANOSIM global and pairwise tests for the MDS performed separately for the Canal de Ovar and the Canal de Mira. The statistic estimated for each permutation is significant when its value is greater than or equal to the sample statistic. Significance level is calculated as the percentage of significant statistics in the total number of permutations used. LR: lower reaches; MR: middle reaches; UR: upper reaches; Sp: spring; Su: summer; Au: autumn; Wi: winter

	Sample statistic	Permutations used	Significant statistics	Significance level
<b>OVAR</b>				
<b>Global tests</b>				
Spatial variation	0.624	10000	0	0.0%***
Seasonal variation	0.257	10000	0	0.0%***
<b>Pairwise tests</b>				
(Sp, Su)	0.297	10000	4	0.0%***
(Sp, Au)	0.322	10000	2	0.0%***
(Sp, Wi)	0.274	10000	30	0.3%**
(Su, Au)	0.064	10000	1353	13.5% ns
(Su, Wi)	0.315	10000	24	0.2%**
(Au, Wi)	0.325	10000	12	0.1%**
<b>MIRA</b>				
<b>Global tests</b>				
Spatial variation	0.461	10000	0	0.0%***
Seasonal variation	0.244	10000	0	0.0%***
<b>Pairwise tests</b>				
(LR, MR)	0.376	10000	0	0.0%***
(LR, UR)	0.860	10000	0	0.0%***
(MR, UR)	0.411	10000	5	0.1%**
(Sp, Su)	0.258	10000	40	0.4%**
(Sp, Au)	0.175	10000	278	2.8%**
(Sp, Wi)	0.082	10000	1488	14.9% ns
(Su, Au)	0.115	10000	1200	12.1% ns
(Su, Wi)	0.572	10000	0	0.0%***
(Au, Wi)	0.336	10000	24	0.2%**

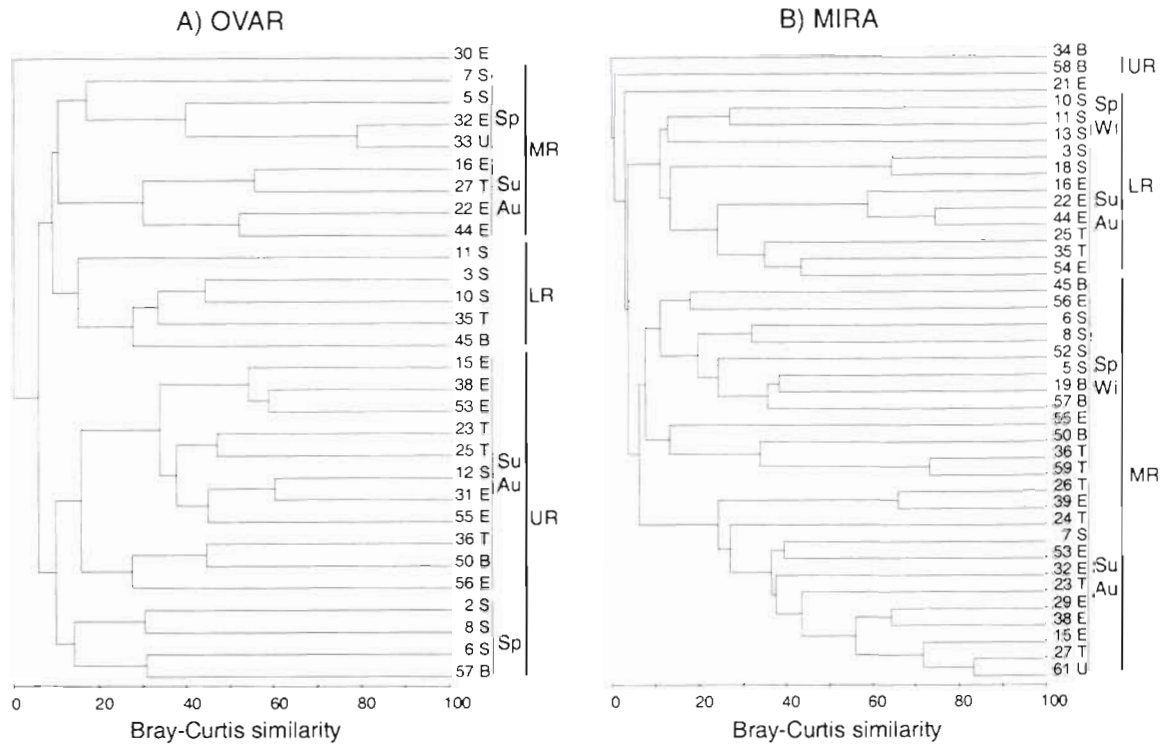

Fig. 10. Cluster analysis (UPGMA) showing the classification of the most important peracarid species from the suprabenthic communities in the Ovar and Mira channels (Ria de Aveiro). The species groups are related to the different regions within each channel (LR: lower reaches; MR: middle reaches; UR: upper reaches). The sub-groups are related to seasons (Su: summer; Au: autumn; Wi: winter; Sp: spring). Species codes are listed in Table 1

can extend their distribution to other regions of the channel and were also collected in considerable numbers in the lower reaches during spring and in the upper reaches during summer and autumn. *Neomysis integer* and *Praunus flexuosus* (6S, 8S) showed a similar behaviour, although they were only occasionally recorded in the upper reaches. On the contrary, the species *Leptocheirus pilosus*, *Cyathura carinata* and *Heterotanais oerstedii* (36T, 50B, 59T) showed a rather restricted distribution. They were very abundant at Stn M7 and rare at the other stations, especially in the lower reaches of the channel.

## DISCUSSION

It is well established that peracaridan crustaceans have diel activity changes determined by specific behavioural patterns (e.g. endogenous rhythms, escape from fish predation) and other factors such as light, currents and food availability (Russell 1925, Champalbert & Macquart-Moulin 1970, Hesthagen 1973, Kaartvedt 1985, 1989, Macquart-Moulin 1985, 1991). Swimming activity of epibenthic and suprabenthic species increases during the night, some species

(mostly mysids) migrate to near-surface water, while some endobenthic species (e.g. amphipods and cumaceans) emerge from the sediment. Only day samples were collected for this study, but it can be expected that a different assemblage would occur in night samples (e.g. higher amphipod densities). These diel activity changes represent a fundamental difficulty in the assignment of individual species to life-style groups. The indications listed in Table 1 were compiled from available information on the behaviour of the collected species and personal observations. In some cases, a species could be assigned to 2 categories. This subjectivity may have produced results different from those of other authors. Furthermore, it has been assumed that species in the Ria de Aveiro behave in the same manner as in other areas. Although the life-style approach is informative, these assumptions need further support from experimental and field data.

Peracaridan crustaceans have been studied in the Ria de Aveiro using only plankton nets, grabs and corer samplers, in general surveys and more specific studies on restricted areas. However, these often mobile animals are not collected efficiently by conventional benthic and pelagic samplers (Mees & Jones

1997). The number of new records for the Ria de Aveiro and the 2 new records for Portuguese fauna reported in the present work demonstrate the value of sled-type samplers in the collection of peracaridan crustaceans. *Diamysis bahirensis*, considered so far as a Mediterranean endemic (Mauchline 1980), was recently reported from the Bay of Cadiz (Drake et al. 1997), but the Ria de Aveiro is now the westernmost limit of its known distribution (Cunha et al. in press). The tanaid *Zeuxo holdichi* was described by Bamber (1990) from Arcachon (French Atlantic coast) and was also recently found in the English Channel (Bamber pers. comm.). Tanaids and cumaceans are frequently overlooked and underestimated in suprabenthic studies because of taxonomic difficulties.

In previous benthic studies (Moreira et al. 1993, unpubl. reports), mysids were poorly represented and only the most common amphipod and isopod species were regularly collected. Nevertheless, the recorded density of benthic fauna in the Ria de Aveiro was usually high. While the maximum density estimated from suprabenthic sampling was 902 ind. m<sup>-2</sup> (present study), macrobenthic densities often exceeded 1000 ind. m<sup>-2</sup> and a maximum of 237 750 ind. m<sup>-2</sup> (only peracaridan crustaceans) was reported from seagrass meadows (Cunha & Moreira 1995). These values were mainly due to dense amphipod populations (e.g. *Corophium* spp.).

The number of species collected in the shallow (21 m depth) coastal area off Aveiro (Cunha et al. 1997) is similar to the number of species recorded at the most marine stations in the Ria de Aveiro (20 to 30 species). However, a maximal density of only 13.6 ind. m<sup>-2</sup> was observed in the shelf suprabenthos (at 125 m depth) against 901.8 ind. m<sup>-2</sup> recorded in the Ria. Mees & Hamerlynck (1992) also reported higher density and biomass of the suprabenthos in the Westerschelde estuary than in adjacent coastal waters. The high productivity of brackish shallow areas certainly contributes to the high density of suprabenthos, but the mobility and feeding habits of suprabenthic species are also competitive advantages in these unpredictable environments (Mees & Jones 1997). Lower net avoidance in turbid conditions (Mees et al. 1995) may also add to higher density estimates in estuaries.

The mysids *Gastrosaccus spinifer*, *Mesopodopsis slabberi* and *Schistomysis spiritus* reported from the shelf suprabenthos (Cunha et al. 1997) were frequently collected inside the Ria, and *M. slabberi* can even migrate to the upper reaches of the channels. These abundant species may have an important role in the energy flow and exchanges between the Ria and the adjacent coastal zone. Migration of *S. spiritus* was observed in coastal European areas, and its importance in production exchanges between infralittoral

and shallower zones in the Bay of Biscay is discussed by San Vicente & Sorbe (1995). *Anchialina agilis*, *Argissa hamatipes*, *Atylus swammerdami*, *Megaluropus agilis*, *Orchomenella nana*, *Pontocrates altamarinus*, *Pontocrates arenarius*, *Iphinoe trispinosa* also occurred both in the Ria and in the adjacent coastal area, but only a few specimens were collected at the lower reaches of the channels.

#### Peracaridan assemblages in the Ria de Aveiro and in other European brackish areas

The suprabenthic communities of brackish environments have been sampled over the last decade in a few European estuaries using different methodologies and sampling devices. The most comprehensively studied areas are the Cadiz tidal channels (7 stations sampled every 15 d over 2 yr using a passive fishing device; Drake et al. 1997) and the Westerschelde estuary (15 stations sampled monthly over 1 yr and on other occasions using a sled-type sampler; Cattrijsse et al. 1993, Mees et al. 1993a,b, 1995). Although the available data (Table 6) suggest a decrease in the number of species with increasing latitude, the lack of standardised methodologies weakens such a conclusion.

In all studied areas, amphipods were the best represented group, usually followed by mysids and then by isopods (Table 6). From the 130 taxa identified to the species level, 55.4% were amphipods. Nevertheless, mysids were the most abundant group in the Eems, Westerschelde and Gironde estuaries (Mees et al. 1995). A similar trend was observed in the Canal de Mira (more amphipod species and higher density of mysids) but not in the Canal de Ovar, where amphipods dominated both in number of species and density. The dominance of mysids may be associated with more dynamic and unpredictable environments. The dominance of either mysids or amphipods associated with some biotic and abiotic factors will be further discussed in relation to the spatial variation of the peracaridan assemblages in the Ria de Aveiro.

The most common and widespread suprabenthic peracarids around the European coast appear to be the mysid species (Table 6). *Gastrosaccus spinifer*, *Mesopodopsis slabberi* and *Neomysis integer* were the only species reported from all the studied areas, and 4 other mysids were very common. The mysid *N. integer* was also the most abundant species in 3 estuaries studied by Mees et al. (1995). The amphipod fauna of the estuarine suprabenthos is much more diversified and the same species was seldom reported from more than 3 of the studied environments (11 species out of 72). However, parallel taxa occur in different areas: common species recorded in 1 or several of these areas



may be replaced by other species of the same genera or close genera in other areas (e.g. *Corophium* spp., *Gammarus* spp., Caprellidae). Nagle (1968) presented several examples of parallelism in epibenthic communities and mentioned that in different studied environments (Cape Cod, Chesapeake Bay, Texas coast and Denmark coast), general trophic-abundance trends were the same although diversity and species composition varied.

Many of the widespread species listed in Table 6 have marine affinities and are also found in shallow coastal areas. Nevertheless, *Neomysis integer*, *Praunus flexuosus*, *Corophium acherusicum*, *C. volutator*, *Gammarus zaddachi*, *Cyathura carinata*, *Idotea chelipes* and *Paragnathia formica*, most of which occur in the Ria de Aveiro, can be regarded as characteristic brackish species.

The peracarid fauna of the Ria de Aveiro presents many similarities both with southern and northern areas. In Cadiz tidal channels, the total number of peracarid species was similar to the value recorded in the

Ria de Aveiro: 65 and 62 species, respectively, of which 24 were common to both areas. The number of species reported from the Westerschelde estuary is lower (40 species, 16 of which were also collected in the Ria de Aveiro).

It is noteworthy that the 2 most abundant species in this study, *Paramysis bacescoi* and *Ampithoe valida*, were not recorded in any of the other studied areas. *A. valida* is known from the Pacific Ocean and north-western Atlantic (Conlan & Bousfield 1982), but it has also been reported from other Portuguese coastal systems (Marques 1989). *P. bacescoi* may be mistaken for other species of the same genus (Labat 1953), but none was reported from the other areas. In fact, although *P. bacescoi* and *P. nouveli* were described from the Atlantic coast of France (Labat 1953), only *P. arenosa* is reported as being quite common in the British Isles (Tattersall & Tattersall 1951) and most *Paramysis* species are endemic to the Mediterranean, Black and Caspian seas (Mauchline 1980).

Table 6. Number of peracaridan species recorded in the suprabenthos of European brackish waters and list of the species present in at least 3 of the 6 studied areas. Numbers in brackets refer to taxa not identified to the species level. Data gathered from Mees et al. (1995) for the Eems, Westerschelde and Gironde estuaries (EE, WE and GE, respectively), Cattrijsse et al. (1993) and Mees et al. (1993a,b) for the Westerschelde, San Vicente (1996) for the 5 Rias of Guipuzcoa (RG), this study for the Ria de Aveiro (RA) and Drake et al. (1997) for the tidal channels of the Bay of Cadiz (CC). The sampling gear and methodology were not standardised in the different areas. \* Complete list of species not available from the published data. ♦: presence of the species; -: not specified

	EE*	WE	GE*	RG	RA	CC	Total
<b>Mysidacea</b>	6	7	5	12	14	10	18 (+4)
<i>Gastrosaccus spinifer</i>	♦	♦	♦	♦	♦	♦	
<i>Mesopodopsis slabberi</i>	♦	♦	♦	♦	♦	♦	
<i>Neomysis integer</i>	♦	♦	♦	♦	♦	♦	
<i>Praunus flexuosus</i>	♦	♦			♦		
<i>Schistomysis kervillei</i>	♦	♦	♦			♦	
<i>Schistomysis spiritus</i>	♦	♦	♦	♦	♦		
<i>Siriella armata</i>				♦	♦	♦	
<b>Amphipoda</b>	8	24	8	20	32	30	72 (+11)
<i>Atylus swammerdami</i>	♦	♦	♦	♦	♦		
<i>Corophium acherusicum</i>		♦			♦	♦	
<i>Corophium volutator</i>	♦	♦	♦				
<i>Gammarus crinicornis</i>	♦	♦	♦	♦			
<i>Gammarus locusta</i>	♦	♦			♦	♦	
<i>Gammarus salinus</i>	♦	♦	♦				
<i>Gammarus zaddachi</i>	♦	♦	♦				
<i>Jassa falcata</i>		♦		♦	♦		
<i>Megaluropus agilis</i>				♦	♦	♦	
<i>Melita palmata</i>		♦	♦	♦	♦	♦	
<i>Pontocrates altamarinus</i>		♦		♦	♦		
<b>Cumacea</b>	-	3	-	6	4	2	11 (+2)
<b>Isopoda</b>	1	6	4	11	9	22	26 (+9)
<i>Cyathura carinata</i>				♦	♦	♦	
<i>Eurydice pulchra</i>		♦	♦		♦	♦	
<i>Idotea chelipes</i>		♦			♦	♦	
<i>Idotea linearis</i>	♦	♦		♦		♦	
<i>Paragnathia formica</i>		♦		♦	♦	♦	
<b>Tanaidacea</b>	-	-	-	1	3	1	3 (+0)
<b>Total</b>	15	40	17	50	62	65	130 (+25)

Density values of suprabenthic communities are available from only a few areas. The highest value has been reported by Mees et al. (1995): 250 ind. m<sup>-2</sup> at the middle reaches of the Westerschelde estuary. In the Gironde and Eems estuaries, maximum values were much lower (50 and 26 ind. m<sup>-2</sup>, respectively) and in the small Rias of Guipuzcoa estimated density values never exceeded 10 ind. m<sup>-2</sup> (Mees et al. 1995, San Vicente 1996). When compared with these northern systems, the Ria de Aveiro appears to be a highly productive system with remarkable suprabenthic density values (maximum density: 902 ind. m<sup>-2</sup>; annual average: 58 ind. m<sup>-2</sup>). Latitudinal differences in temperature are known to be an important factor in the productivity of coastal systems and the growth and reproduction of dominant species is probably favoured by the relatively high temperature observed throughout the year in the Ria de Aveiro.

### Spatial and seasonal variation

The multivariate analysis of faunal data showed that differences within channels dominated over differences between channels. Moreover, it was concluded that spatial patterns also dominated over seasonal patterns. The prevalence of spatial patterns recognised in several estuarine communities (Mees et al. 1993b, 1995, Drake et al. 1997) may be explained by the diversity of environments, the importance of gradients and the physiological constraints of fauna in brackish areas. The variation of environmental factors within an estuary is usually higher than seasonal variation or differences between estuaries. Seasonal patterns may become dominant when merosuprabenthic organisms are considered, especially in more saline areas, as shown by Hamerlynck & Mees (1991) in a shallow coastal area in front of the Dutch Delta.

The distinctive structural features between peracaridan assemblages of the 2 channels were the higher number of species and overall dominance of mysids in Mira as opposed to dominance of amphipods (mainly epibenthic and tube dwellers) and higher densities in Ovar. The 3 regions defined in each channel differed in their peracaridan assemblages, but corresponding regions in the 2 channels also displayed different communities, which is interpreted as a result of the differences in the established environmental gradients.

The most productive areas within the Ria appear to be related to finer sediments (upper reaches of the Canal de Ovar and middle reaches of the Canal de Mira). However, there is little evidence that grain size alone is a determinant for species distribution. Grain size covaries with organic content, pore-water chemistry, microbial abundance and composition, food sup-

ply and trophic interactions, all of which are influenced by near-bottom flow conditions. Animal-sediment relationships must be analysed taking into consideration that all these factors may be important for species distribution patterns (Snelgrove & Butman 1994). In the upper reaches of Ovar and middle reaches of Mira, which have fine sediments and high organic content, food availability must be substantial and determinant of the high density observed.

Extensive seagrass meadows in the upper reaches of Ovar probably contribute to the extremely high abundance recorded in this area. Seagrass meadows provide an additional source of food and shelter (Nagle 1968, Nienhuis & Van Ierland 1978) and harbour a diverse faunal assemblage with very flexible feeding habits, including suspension feeders (caprellids, *Jassa falcata*), algal grazers (*Ampithoe*) and detritus feeders (*Corophium*, *Erichthonius*, *Gammarus*, *Melita*, *Praunus*) (Nagle 1968, Nienhuis & Van Ierland 1978). *Idotea chelipes*, which is particularly associated with *Zostera* meadows in the Ria de Aveiro, plays a peculiar role in this habitat. While feeding on living eelgrass leaves by biting and scraping, this herbivore isopod causes the mechanical breakdown of leaves, which aids the decomposing activities of bacteria. On the other hand, *Idotea* faecal pellets contain numerous undigested pieces of eelgrass, thus accelerating its decomposition and making the smallest particles available for detritus feeders (Nienhuis & Van Ierland 1978). Habitat complexity and stable substrates also contribute to the number of species and density, which are often higher in vegetated sites than in unvegetated adjacent areas (Stoner 1980, Orth 1992).

In more dynamic environments with high flow conditions and coarser sediments, food availability is usually lower (except perhaps for suspension feeders) and food sources unstable. Snelgrove & Butman (1994) summarise the studies on the effect of small-scale topographic variation on the distribution of organic matter and fauna in such environments. Migration of ripples may occur tidally, and the eventual accumulation of detritus in ripple troughs is subject to local flow conditions thus being a temporary and erratic event. The authors mention that organisms may respond actively to the enhanced detritus accumulation that occurs in small depressions and ripple troughs.

In the Canal de Mira, the tidally induced formation of ripples and megaripples characterises extensive subtidal and intertidal areas (Franco 1997). In these areas, mysids were frequently collected in high densities and dominated the faunal assemblage. These suprabenthic organisms have very good swimming capabilities and are known to migrate actively to areas of high primary productivity (Wooldridge 1989). Large aggregations of mysids, probably induced by in-

creased food availability, have also been reported by other authors (Clutter 1967, Fosså 1985, Hargreaves 1985). In highly unpredictable environments, mobility may be a further advantage in searching for food and in anticipating stochastic events (Mees & Jones 1997). Besides mysids, other highly mobile species, such as *Urothoe brevicornis*, *Bathyporeia sarsi* and *Eurydice pulchra*, were recorded in higher densities in the Canal de Mira. These 3 species are mentioned by several authors as occurring preferentially in sandy habitats (Finchan 1971, Naylor 1972, Cattrijsse et al. 1993, review by Snelgrove & Butman 1994).

The well-defined and apparently opposed patterns observed in the spatial distribution of amphipods and mysids in the Ria de Aveiro may be interpreted in terms of their relative mobility. Amphipods, mostly epibenthic and tube dwellers, usually have lower mobility and are probably compelled to colonise areas with more stable food sources. On the other hand, mysids succeed in colonising and become dominant in dynamic and more unpredictable environments. Monospecific swarming (Wittmann 1977) and high mobility may explain the reduced regularity in the spatial distribution of mysids with extremely high values of a single species occasionally recorded at different stations.

Hydrodynamics and sediment transport regime, which are responsible for the distribution of sediment environments, play a major role in structuring the suprabenthic community of the Ria de Aveiro, but another primary determinant for species distribution is salinity. Tidal and seasonal salinity variation is one of the major physiological constraints that brackish fauna must confront (Kinne 1971, Remane 1971, McLusky 1989).

In the Canal de Ovar, the salinity gradient is only established seasonally and the spatial patterns of the suprabenthos are mainly related to the hydrodynamic conditions and associated sediment environments. However, the Canal de Mira has a permanent salinity gradient with important tidal and seasonal variations, which certainly imposes additional constraints to the distribution of organisms. As a result of these conditions, the Canal de Mira presents the characteristic estuarine impoverishment towards the brackish area (McLusky 1989) and the typical sequence of species, with more or less overlapping distributions depending on their capability to endure different ranges of salinity along the channel. Although the changes between communities of the lower, middle and upper reaches were never abrupt, they were more gradual along the Canal de Mira and more discrete in the Canal de Ovar.

Tide, which is responsible for the establishment of salinity gradients, is also a primary component of the hydrodynamics of the Ria de Aveiro. Similarity between channels is higher in the communities of the middle and, especially, the lower reaches due to the

strong tidal influence at the entrance of both channels. However, at the upper reaches the environmental conditions diverge and the impoverished fauna observed in the Canal de Mira contrasts with the prolific community in the Canal de Ovar. While the Canal de Mira is like a small estuary, the Canal de Ovar resembles a semi-enclosed coastal lagoon, with high temperature and salinity values recorded seasonally in the seagrass meadows in the most confined regions. The dominance of mysids, the highest diversity in the marine zone and the impoverishment towards the brackish environment are observed trends in the Canal de Mira that are also reported from other estuarine suprabenthic communities (Mees et al. 1995).

The seasonal patterns of the peracaridan assemblages in the Ria de Aveiro were mainly associated with density fluctuations of the dominant species. The staggered cycles of amphipods and mysids in the Ria de Aveiro induced seasonal changes in the community structure; on the whole, mysids were dominant during winter and spring and amphipods during summer and autumn. Several authors (Boysen 1975, Buhl-Jensen & Fosså 1991, Hamerlynck & Mees 1991, Dauvin et al. 1994) mention that specific life-history features may determine density fluctuations and induce seasonal changes in the community structure.

A decline in the number of species and density occurred in both channels during winter, when salinity and temperature dropped to minimal values. A similar trend was observed in the suprabenthos of the Westerschelde estuary (Mees et al. 1993b). The winter decline was especially evident in the peracaridan assemblage of seagrass meadows (upper reaches of the Canal de Ovar). Abundance fluctuations of epibenthic species in seagrass meadows can range over orders of magnitude and their relation to seasonal patterns of habitat complexity, food availability, reproduction and predation pressure is discussed by Jernakoff et al. (1996).

Predation pressure on the peracaridan assemblages may be assessed by the relative abundance of fishes and waders. 2 density peaks in the ichthyofauna of the Ria de Aveiro were reported by Rebelo (1992): one during summer (July to August) and another during winter (February to April). The minimal density of fishes was recorded from October to November. On the other hand, the waders of the Ria de Aveiro begin to increase their density in October, reaching maximum values in December. Abundant wintering populations remain until the end of February or March (Rufino et al. 1988, Luís 1998). These data on the potential predators of peracarid crustaceans suggest that high predation pressure may act together with specific life-history features and low temperature and salinity values, inducing the observed winter impoverishment of peracaridan assemblages in the Ria de Aveiro.

**Acknowledgements.** Thanks are due to Mr Rui Marques for his assistance with sampling. This research was partially supported by the Centro das Zonas Costeiras e do Mar (CZCM) and by the educational program PRODEP-Formação (C.3/94, No. 16).

#### LITERATURE CITED

- Astthorsson OS (1985) Mysids occurring in the stomachs of cod caught in the Atlantic water South and West of Iceland. *Sarsia* 70:173–178
- Bamber RN (1990) A new species of *Zeuxo* (Crustacea: Tanaidacea) from the French Atlantic coast. *J Nat Hist* 24: 1587–1596
- Beyer F (1958) A new bottom-living Trachymedusa from the Oslofjord. Description of the species and a general discussion of the life conditions and fauna of the fjord deeps. *Nytt Mag Zool (Oslo)* 6:121–143
- Boysen HO (1975) Seasonal variations in abundance of hyperbenthic animals in the Kiel Bight. *Merentutkimuslait Oskan Julk* 239:206–212
- Brattegard T, Fosså JH (1991) Replicability of an epibenthic sampler. *J Mar Biol Assoc UK* 71:153–166
- Bray JR, Curtis JT (1957) An ordination of the upland forest communities of Southern Wisconsin. *Ecol Monogr* 27: 325–349
- Buhl-Jensen L, Fosså JH (1991) Hyperbenthic crustacean fauna of the Gullmarfjord area (western Sweden): species richness, seasonal variation and long-term changes. *Mar Biol* 109:245–258
- Carr MR, Carter RG, Clarke KR (1993) User guide to PRIMER v. 3.1 b (Plymouth Routines In Multivariate Ecological Research). Version prepared for training workshop at Plymouth Marine Laboratory, October 1993
- Catrijse A, Mees J, Hamerlynck O (1993) The hyperbenthic Amphipoda and Isopoda of the Voordelta and the Westerschelde estuary. *Cah Biol Mar* 34:187–200
- Champalbert G, Macquart-Moulin C (1970) Les pécarides de l'hyponeuston nocturne du golfe de Marseille. *Cah Biol Mar* 11:1–29
- Clarke KR (1993) Non-parametric multivariate analyses of changes in community structure. *Aust J Ecol* 18:117–143
- Clutter RI (1967) Zonation of nearshore mysids. *Ecology* 48: 200–208
- Conlan KE, Bousfield EL (1982) The amphipod superfamily Corophioidea in the northeastern Pacific region, Family Ampithoidae: systematics and distributional ecology. *Publ Biol Oceanogr Nat Mus Can* 10:41–75
- Cornet M, Lissalde JP, Bouchet JM, Sorbe JC, Amoureux L (1983) Données qualitatives sur le benthos et le suprabenthos d'un transect du plateau continental sud-Gascogne. *Cah Biol Mar* 24:69–84
- Corrochano A, Galera M, Bernardes CA, Barba P (1997) Características de la llanura intermareal asociada al canal de Mira (dominio interno del complejo isla-barrera de Aveiro, Portugal). *Geogaceta* 22:47–50
- Cunha MR, Moreira MH (1995) Macro-benthos of *Potamogeton* and *Myriophyllum* beds in the upper reaches of Canal de Mira (the Ria de Aveiro, NW Portugal): community structure and environmental factors. *Neth J Aquat Ecol* 29 (3–4):377–390
- Cunha MR, Sorbe JC, Bernardes C (1997) On the structure of the neritic suprabenthic communities from the Portuguese continental margin. *Mar Ecol Prog Ser* 157:119–137
- Cunha MR, Sorbe JC, Moreira MH. (in press) *Diamysis bahirensis* (G.O. Sars, 1877): a mysid species new to the Portuguese fauna and first record from the west European coast. *Crustac Issues*
- Dauvin JC, Iglesias A, Lorgeré JC (1994) Circalittoral suprabenthic coarse sand community from the western English Channel. *J Mar Biol Assoc UK* 74:543–562
- Drake P, Arias AM, Conradi M (1997) Aportación al conocimiento de la macrofauna supra e epibentónica de los caños mareales de la bahía de Cádiz (España). *Publ Espec Inst Esp Oceanogr* 23:133–141
- Finchan AA (1971) Ecology and population studies of some intertidal and sublittoral sand-dwelling amphipods. *J Mar Biol Assoc UK* 51:471–488
- Fosså JH (1985) Near-bottom vertical zonation during day-time of deep-living hyperbenthic mysids (Crustacea: Mysidacea). *Sarsia* 70:297–307
- Franco M (1997) Sedimentologia y morfología del canal mareal de Mira. Dominio interno del sistema isla-barrera de Aveiro, Portugal. PhD thesis, Universidad de Salamanca
- Fulton RS (1982) Preliminary results of an experimental study of the effects of mysid predation on estuarine zooplankton community structure. *Hydrobiologia* 93:79–84
- Hamerlynck O, Mees J (1991) Temporal and spatial structure in the hyperbenthic community of a shallow coastal area and its relation to environmental variables. *Oceanol Acta* 11:205–212
- Hargreaves PM (1985) The distribution of Mysidacea in the open ocean and near-bottom over slope regions in the northern North-east Atlantic Ocean during 1979. *J Plankton Res* 7:241–261
- Hesthagen J (1973) Diurnal and seasonal variations in the near-bottom fauna—the hyperbenthos—in one of the deeper channels of the Kieler Bucht (Western Baltic). *Kiel Meeresforsch* 29:49–85
- Jernakoff P, Brearley A, Nielsen J (1996) Factors affecting grazer-epiphyte interactions in temperate seagrass meadows. *Oceanogr Mar Biol Annu Rev* 34:109–162
- Kaartvedt S (1985) Diel changes in small-scale vertical distribution of hyperbenthic mysids. *Sarsia* 70:287–295
- Kaartvedt S (1989) Nocturnal swimming of gammaridean amphipod and cumacean Crustacea in Masfjorden, Norway. *Sarsia* 74:187–193
- Kinne O (1971) Salinity. In: Kinne O (ed) *Marine ecology*, Vol 1. John Wiley, Chichester, p 683–997
- Kruskal JB, Wish M (1978) *Multidimensional scaling*. Sage Publications, Beverly Hills, CA
- Labat R (1953) *Paramysis noveli* n. sp. et *Paramysis bacescoi* n. sp. Deux espèces de Mysidacés confondues, jusqu'à présent, avec *Paramysis helleri* (GO Sars, 1877). *Bull Inst Océanogr, Monaco* 1034:1–24
- Luis AS (1998) Influência de factores humanos e naturais nas limícolas (Aves, Charadrii) invernaes na Ria de Aveiro, com especial referência ao Pilrito-comum (*Calidris alpina* L.). PhD thesis, Universidade de Aveiro
- Macquart-Moulin C (1985) Le contrôle des phases pélagiques nocturnes chez les crustacés pécarides benthiques. *Tethys* 11 (3–4):275–287
- Macquart-Moulin C (1991) La phase pélagique nocturne des Cumacés. *J Plankton Res* 13:313–337
- Marques JC (1989) Amphipoda (Crustacea) bentónicos da costa portuguesa: estudo taxonómico, ecológico e biogeográfico. PhD thesis, Universidade de Coimbra
- Mauchline J (1980) The biology of mysids and euphausiids. *Adv Mar Biol* 18:1–681
- McLusky DS (1989) *The estuarine ecosystem*. Blackie, Glasgow
- Mees J, Hamerlynck O (1992) Spatial community structure of

- the winter hyperbenthos of the Schelde estuary, The Netherlands, and adjacent coastal waters. *Neth J Sea Res* 29:357-370
- Mees J, Jones MB (1997) The hyperbenthos. *Oceanogr Mar Biol Annu Rev* 35:221-255
- Mees J, Cattrijsse A, Hamerlynck O (1993a) Distribution and abundance of shallow-water hyperbenthic mysids (Crustacea, Mysidacea) and euphausiids (Crustacea, Euphausiacea) in the Voordelta and the Weterschelde, southwest Netherlands. *Cah Biol Mar* 34:165-186
- Mees J, Dewicke A, Hamerlynck O (1993b) Seasonal composition and spatial distribution of hyperbenthic communities along estuarine gradients in the Westerschelde. *Neth J Aquat Ecol* 27(2-4):359-376
- Mees J, Fockedeij N, Hamerlynck O (1995) Comparative study of the hyperbenthos of three European estuaries. In: Heip CHR, Herman PMJ (eds) Major biological processes in European estuaries. *Hydrobiologia* 311:153-174
- Moreira MH, Queiroga H, Machado MM, Cunha MR (1993) Environmental gradients in a southern Europe estuarine system: Ria de Aveiro, Portugal. Implications for soft bottom macrofauna colonisation. *Neth J Aquat Ecol* 27(2-4):465-482
- Nagle JS (1968) Distribution of the epibiota of macroepibenthic plants. *Contrib Mar Sci* 13:105-144
- Naylor E (1972) British marine isopods. Academic Press, London
- Nienhuis PH, Van Ierland ET (1978) Consumption of eelgrass, *Zostera marina*, by birds and invertebrates during the growing season in Lake Grevenlingen (SW Netherlands). *Neth J Sea Res* 12(2):180-194
- Orth RJ (1992) A perspective on plant-animal interactions in seagrasses: physical and biological determinants influencing plant and animal abundance. In: John DH, Hawkins SJ, Price JH (eds) Plant-animal interactions in the marine benthos. Oxford University Press, Oxford, p 147-165
- Pritchard DW (1967) What is an estuary: physical viewpoint. In: Lauff GE (ed) Estuaries. Association for the Advancement of Science, Washington, p 3-5
- Queiroga H (1995) Processos de dispersão e recrutamento das larvas do caranguejo *Carcinus maenas* (L.) na Ria de Aveiro. PhD thesis, Universidade de Aveiro
- Rebello JE (1992) The ichthyofauna and abiotic hydrological environment of the Ria de Aveiro, Portugal. *Estuaries* 15:403-413
- Remane A (1971) Ecology of brackish water. In: Remane A, Schlieper C (eds) Biology of brackish water. Schweizerbart'sche, Stuttgart, p 1-210
- Rufino R, Luís A, Araújo A, Neves R (1988) Waders at Ria de Aveiro. *Wader Study Group Bull* 54:12
- Russell FS (1925) The vertical distribution of marine macroplankton. An observation on diurnal changes. *J Mar Biol Assoc UK* 13:769-809
- San Vicente C (1996) Contribución al conocimiento de las comunidades y poblaciones suprabentónicas en habitats seleccionados del litoral del golfo de Vizcaya y del Mediterraneo noroccidental. PhD thesis, Universidad de Barcelona
- San Vicente C, Sorbe JC (1995) Biology of the suprabenthic mysid *Schistomysis spiritus* (Norman 1860) in the south-eastern part of the Bay of Biscay. *Sci Mar* 59(Suppl 1):71-86
- Snelgrove PVR, Butman CA (1994) Animal-sediment relationships revisited: cause versus effect. *Oceanogr Mar Biol Annu Rev* 32:111-177
- Sorbe JC (1981a) La macrofaune vagile de l'estuaire de la Gironde. Distribution et migration des espèces. Modes de reproduction. Régimes alimentaires. *Oceanis* 6:579-592
- Sorbe JC (1981b) Rôle du benthos dans le régime alimentaire des poissons démersaux du secteur sud-Gascogne. *Kiel Meeresforsch Sonderh* 5:479-489
- Sorbe JC (1982) Observaciones preliminares del suprabentos en un transecto batimétrico de la plataforma continental aquitana (suroeste de Francia). *Oecol Aquat* 6:9-17
- Sorbe JC (1983) Description d'un traineau destiné à l'échantillonnage quantitatif étagé de la faune suprabenthique néritique. *Ann Inst Océanogr Paris* 59(2):117-126
- Sorbe JC (1984) Contribution à la connaissance des peuplements suprabenthiques néritiques sud-Gascogne. Thèse Doctorat d'Etat, Université de Bordeaux I
- Sorbe JC (1989) Structural evolution of two suprabenthic soft-bottom communities of the South Gascogne continental shelf. *Sci Mar* 53(2-3):335-342
- Stoner AW (1980) The role of seagrass biomass in the organization of benthic macrofaunal assemblages. *Bull Mar Sci* 30(3):537-551
- Tattersall WM, Tattersall OS (1951) The British Mysidacea. The Ray Society, London
- Teles M, Negro M, Rodrigues D (1990) Elaboração de um sistema de modelos matemáticos para apoio da sua gestão integrada. In: Borrego C, Ré M, Cruz M, Matos MR, Adrian MC (eds) IV Encontro Nacional de Saneamento Básico; Ria de Aveiro: Que futuro? GRIA/UA, Aveiro, p 99-112
- Vicente CM (1985) Caracterização hidráulica e aluvionar da Ria de Aveiro. Utilização de modelos hidráulicos no estudo de problemas da Ria. In: Gomes CSF (ed) Jornadas da Ria de Aveiro, Vol III. Câmara Municipal de Aveiro, Aveiro, p 41-58
- Wang Z, Dauvin JC (1994) The suprabenthic crustacean fauna of the infralittoral fine sand community from the Bay of Seine (Eastern English Channel): composition, swimming activity and diurnal variation. *Cah Biol Mar* 35:135-155
- Wittmann KJ (1977) Modification of association and swarming in North Adriatic Mysidacea in relation to habitat and interacting species. In: Keegan BK, Cúidigh PO, Boaden PJS (eds) Biology of benthic organisms. Pergamon Press, Oxford, p 605-612
- Wooldridge TH (1989) The spatial and temporal distribution of mysid shrimps and phytoplankton accumulations in a high energy surfzone. *Vie Milieu* 38:127-133
- Zouhiri S, Dauvin JC (1996) Diel change of the benthic boundary layer macrofauna over coarse sand sediment in the western English Channel. *Oceanol Acta* 19(2):141-153