



AQUARIUMS & ACCESSORIES

2022/2023



JUWEL AQUARIUM

Aquariums of the highest quality from Germany





For more than 50 years JUWEL Aquarium has been synonymous with quality and innovation in aquarium manufacturing and thus sets standards in design and technology. Emphasis was placed on a systems concept right from the start.

We therefore developed the technology required for the successful operation of an aquarium from early on and our first brand was able to offer a range of aquariums with components that are all perfectly compatible with each other.

We have remained true to this principle, so that today, JUWEL Aquarium is synonymous with high-quality system aquariums, ultra-modern technology and the highest quality standards.

To this day, an experienced team is constantly working with great enthusiasm to create a beautiful home for your fish. This performance has made us the brand of the century as well as Europe's no. 1 aquarium brand.

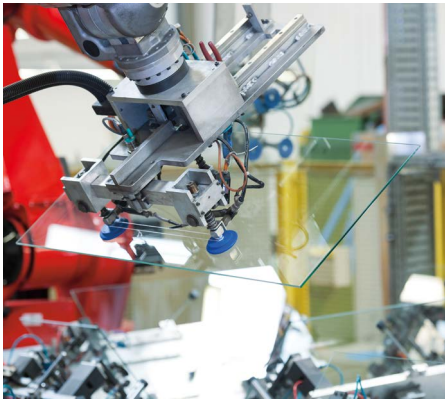

Precision and the latest manufacturing technology in all production steps



**NEW
COLOUR**



Lido 120 LED

NEW COLOUR

Timeless and elegant. Famous aquarium models in a new look.

from winter 2022



Lido 200 LED

Lido 120 LED



Rio 240 LED

Rio 125 LED

Rio 180 LED

AQUARIUMS



Rio 180 LED



RIO 125

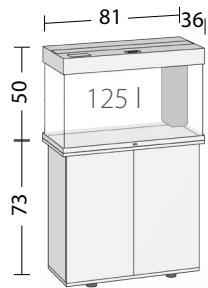

LIGHTING

LED 590 mm

FILTER PERFORMANCE

500 l/h, 5,5 Watt

ADJUSTABLE HEATER

100 Watt

RIO 180

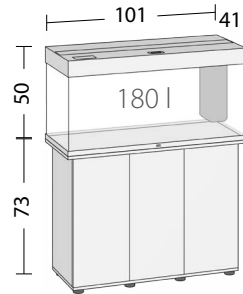

LIGHTING

LED 895 mm

FILTER PERFORMANCE

600 l/h, 7 Watt

ADJUSTABLE HEATER

200 Watt

RIO 240

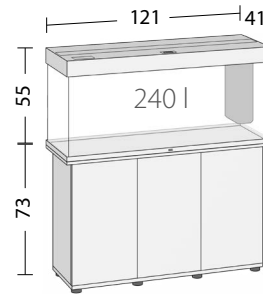

LIGHTING

LED 1047 mm

FILTER PERFORMANCE

600 l/h, 7 Watt

ADJUSTABLE HEATER

200 Watt

DECORS



Black



Grey



White



Light
wood



Dark
wood

QUALITY
made in
Germany



Rio 450 LED

RIO 350

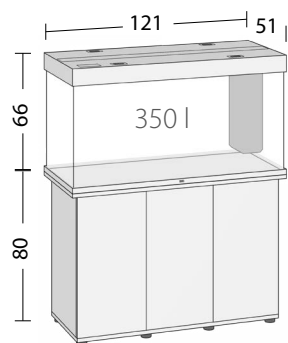

LIGHTING

LED 1047 mm

FILTER PERFORMANCE

1000 l/h, 8 Watt

ADJUSTABLE HEATER

300 Watt

RIO 450

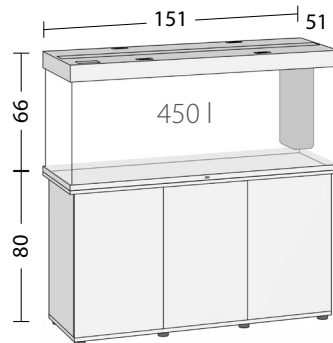

LIGHTING

LED 1200 mm

FILTER PERFORMANCE

1000 l/h, 8 Watt

ADJUSTABLE HEATER

300 Watt

Rio 350 LED



DECORS



Black



White



Light
wood



Dark
wood

QUALITY
made in
Germany



Lido 120 LED

LIDO 120

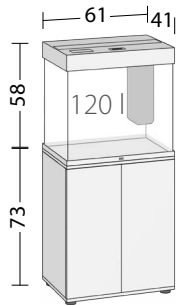

LIGHTING

LED 438 mm

FILTER PERFORMANCE

500 l/h, 5,5 Watt

ADJUSTABLE HEATER

100 Watt

LIDO 200

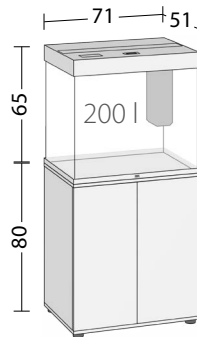

LIGHTING

LED 590 mm

FILTER PERFORMANCE

600 l/h, 7 Watt

ADJUSTABLE HEATER

200 Watt

Lido 200 LED



DECORS



Black



Grey



White



Light
wood

QUALITY
made in
Germany



Vision 180 LED

VISION 180

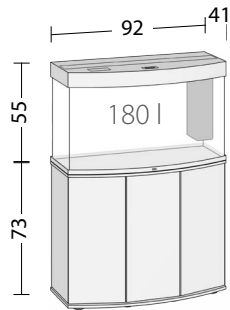

LIGHTING

LED 742 mm

FILTER PERFORMANCE

600 l/h, 7 Watt

ADJUSTABLE HEATER

200 Watt

VISION 260

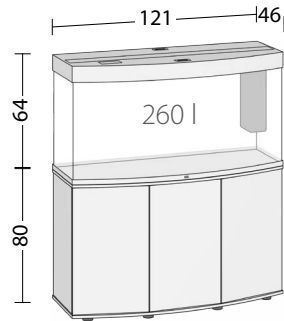

LIGHTING

LED 1047 mm

FILTER PERFORMANCE

1000 l/h, 8 Watt

ADJUSTABLE HEATER

300 Watt

VISION 450

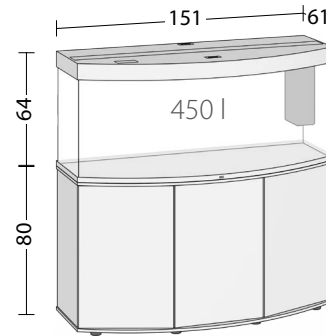

LIGHTING

LED 1200 mm

FILTER PERFORMANCE

1000 l/h, 8 Watt

ADJUSTABLE HEATER

300 Watt

DECORS



Black



White



Light
wood

QUALITY
made in
Germany



Trigon 190 LED

TRIGON 190

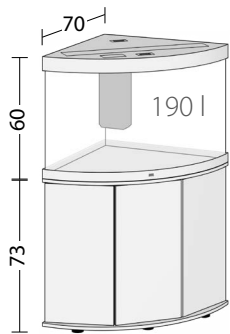

LIGHTING

LED 590 mm

FILTER PERFORMANCE

600 l/h, 7 Watt

ADJUSTABLE HEATER

200 Watt

TRIGON 350

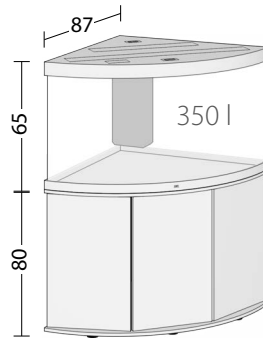

LIGHTING

LED 438 mm + 895 mm

FILTER PERFORMANCE

1000 l/h, 8 Watt

ADJUSTABLE HEATER

300 Watt

Trigon 190 LED



DECORS



Black



White



Light
wood

QUALITY
made in
Germany



Primo 110 LED

PRIMO 70



LIGHTING

NovoLux LED 60, 8 Watt

FILTER PERFORMANCE

300 l/h, 4,4 Watt

ADJUSTABLE HEATER

50 Watt

PRIMO 110



LIGHTING

NovoLux LED 80, 10,5 Watt

FILTER PERFORMANCE

500 l/h, 5,5 Watt

ADJUSTABLE HEATER

100 Watt

ALL INCLUSIVE

LIGHTING

NovoLux LED

Expansion possible with click system.



FILTER SYSTEM

Bioflow Filter

High-performance Bio-internal filter



HEATER

AquaHeat

Continuously adjustable premium heater invisibly integrated into the filter system



DECORS



Black



White

QUALITY

made in
Germany

THE HEART OF A JUWEL AQUARIUM

The Bioflow filtration system

EccoFlow



Circulating pump

Highly-efficient and whisper-quiet flow pump of the new EccoFlow generation with double-mounted impeller axle.

AquaHeat

Adjustable heater

Invisible adjustable heater that is integrated in the water circuit.

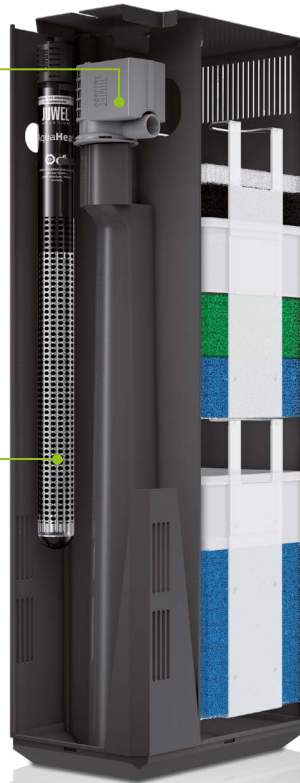

1. Filter phase



High flow velocity

In the top section of the filter system, the increased flow velocity ensures ideal mechanical and chemical filtering of your aquarium.

2. Filter phase



Low flow velocity

The reduced flow velocity in the bottom section of the filter system benefits the development of bacteria in the anaerobic area, which are essential for the biological filtering of an aquarium.

Advantages

Inner filter system proven a million times over



Easy to handle

Particularly easy care and maintenance, thanks to practical filter baskets.



Filter volume

Larger filter volume for particularly intense filtering and long standing times.



2-phase cleaning

Excellent filtering thanks to the dual-flow principle for optimum development of filter bacteria.



Highest safety

No hose connections that lead outwards. The water remains in the aquarium.

Multiple types of filter media included

Perfectly coordinated filter media guarantee optimum filtering.



bioPad

Filter wadding

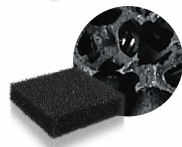

bioCarb

Active charcoal sponge



Nitrox

Nitrate remover



bioPlus coarse

Coarse-pored filter sponge

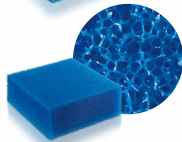

bioPlus fine

Fine-pored filter sponge

OPTIONAL



Amorax

Ammonium remover



Carbox

Highly effective active charcoal



Cirax

Ceramic granules



Phorax

Phosphate remover

The new standard

MultiLux LED

Aquariums with state-of-the-art LED lighting



Replaceable
LED tubes



Optimum light
spectrum for plants
and fish



Energy saving



Including
Lighting media



LED DAY – 9000 K

High-performance LED tubes with
bright, stimulating light for your
MultiLux LED light unit.



LED NATURE – 6500 K

High-performance LED tube with
warm, natural light for your MultiLux
LED light unit.





OPTIONAL



LED COLOUR – 4425 K

High-performance LED tube with warm, reddish light for your MultiLux LED light unit.

* Not compatible with T5 light units

HeliaLux Spectrum

- Specially developed full-spectrum LED light unit with maximum performance
- White, blue, green and red SMD LEDs for maximum brilliance in aquariums



HeliaLux SmartControl

Wi-Fi control for HeliaLux light units

- Colours individually controllable
- For controlling the HeliaLux Spectrum
- Individually programmable daily routines
- Also suitable in combination with the HeliaLux LED Splitter for controlling HeliaLux LEDs
- Individually programmable cloud effects
- With five pre-configured profiles installed



HeliaLux SmartControl

UniversalFit

Universal bracket for HeliaLux LED
compatible with all aquariums

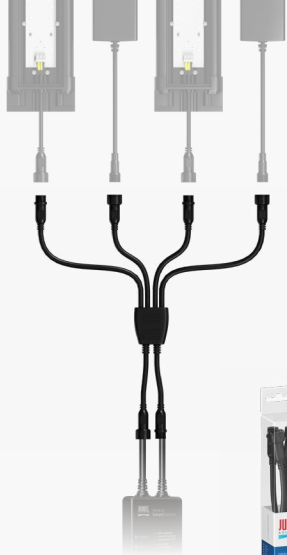

HeliaLux LED Splitter

HeliaLux Spectrum Splitter

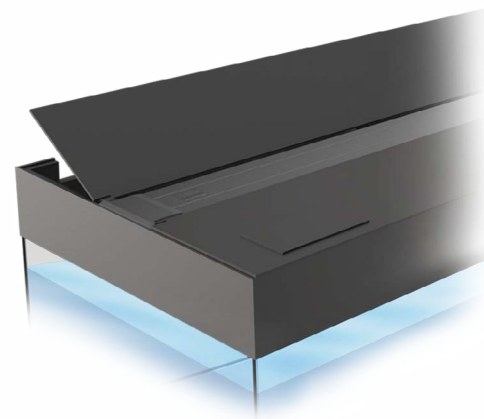
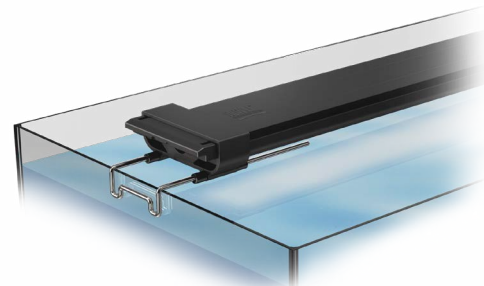

HeliaLux Splitter

Adapter for operating up to two HeliaLux
light units

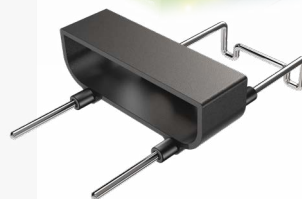



JUWEL DECORATION CONCEPTS

For a greater effect of depth in the aquarium

Cliff

- The Cliff Dark decoration concept impresses with its natural brownish hue.
- The Cliff Light is a naturalistic reproduction of bright, sand-coloured rock.



CLIFF **BACKGROUNDS**



CLIFF **FILTER COVER**

Stone

- The Stone decoration concept is a naturalistic reproduction of a clay- and granite-coloured rock face.



STONE **FILTER COVER**



STONE **BACKGROUNDS**



STR **BACKGROUND**

STR

- Attractive bark structure

Conexo

DECORATION ADHESIVE

- For permanent attachment of Backgrounds



POSTER DECOR

POSTER BACKGROUNDS S, L, XL

- For all aquariums from 60 to 150 cm
- Two attractive motives on each poster



POSTER 1 Front

POSTER 3 Front

black

POSTER 3 Reverse

white



POSTER 4 Front

POSTER 1 Reverse

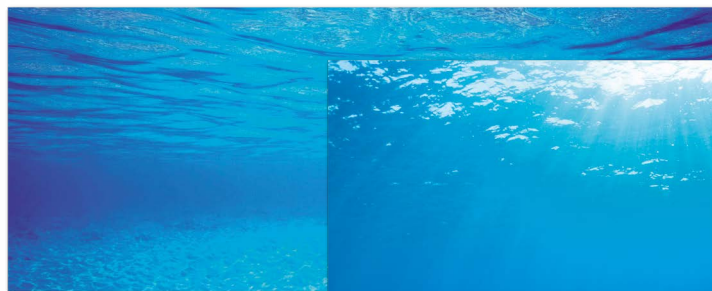

POSTER 2 Front

POSTER 2 Reverse



POSTER 4 Reverse



POSTER FIX

JUWEL PosterFix is an oil that will enhance the three-dimensional effect of your film backgrounds.

- Easy to handle
- Minimises reflection
- Can be removed without a problem
- Improves colour intensity

SmartCam

Underwater camera

The JUWEL SmartCam allows you to comfortably monitor your aquarium from anywhere.



PanoramicView

keep an eye on everything with a 120° camera angle



EasySnap

Integrated photo and video function



SimpleShare

Grant camera authorisations so you can share via the JUWEL app



GlobalAccess

Global access to the camera via the JUWEL app

PERFECT
FIT



Digital Thermometer 3.0

Perfectly integrated digital thermometer with a large display

- Perfectly integrated into the JUWEL design
- Suitable for fresh and salt water
- Precise: +/- 0.5°C
- Also compatible with aquariums from other manufacturers, thanks to the included suction cup

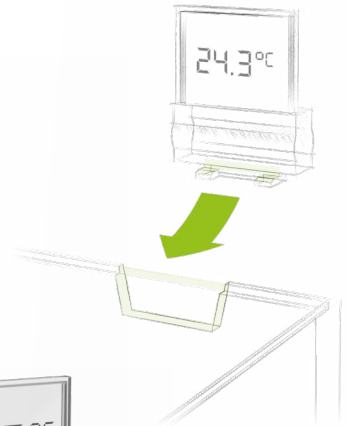



EccoSkim

Surface skimmer

- Conveys surface residues directly to the JUWEL filter
- Removes residue film and organic residues
- Promotes oxygen content
- Suitable for all aquariums thanks to the provided suction attachment



FilterGrid

Fine-mesh intake slot

- Reduces the entry of tiny Shrimp and fish into the JUWEL Bioflow Filter
- Reduces the size of the top and lateral intake slots
- Does not reduce the flow rate
- Works with Bioflow Filters Super, M, L and XL

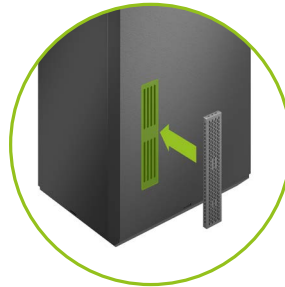
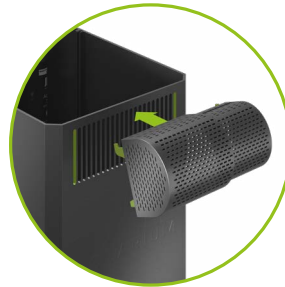

AquaClean 2.0

- Ideal for cleaning JUWEL filters and ground material
- Including an adapter for cleaning the JUWEL internal filter
- Simple, repeated squeezing of the pump activates the water flow immediately



EasyFeed

The automatic feeder to fit all JUWEL aquariums

- Adjustable feed quantity
- Up to two feedings per day may be programmed



SmartFeed 2.0

The comfortable automatic feeder for all JUWEL aquariums

- Up to three feeds per day
- Three feeding intervals can be selected (24/48/72h)
- Feed quantity dispensable in 8 levels
- Exchangeable screw conveyors for granulate and flake feeds
- Including feeding chamber extension
- USB port for continuous power supply



EasyInstall

Step by Step



INSTALLATION EXAMPLES













Be inspired by our set-up examples and simply create your own amazing underwater worlds with the help of our step by step video tutorials.



















www.juwel-aquarium.com/step-by-step



TECHNICAL SPECIFICATIONS

	PRIMO 70 LED	PRIMO 110 LED	LIDO 120 LED	LIDO 200 LED	RIO 125 LED	RIO 180 LED
						
Filter type	Bioflow ONE	Bioflow Super	Bioflow M	Bioflow M	Bioflow M	Bioflow M
Filter volume	0,5 l	1,5 l	3,5 l	3,5 l	3,5 l	3,5 l
Pump	Eccoflow 300	Eccoflow 500	Eccoflow 500	Eccoflow 600	Eccoflow 500	Eccoflow 600
Pump performance	300 l/h	500 l/h	500 l/h	600 l/h	500 l/h	600 l/h
Wattage Pump	4,4 W	5,5 W	5,5 W	7 W	5,5 W	7 W
Lighting	NovoLux LED 60 1 x 8 W	NovoLux LED 80 1 x 10,5 W	MultiLux LED 2 x LED Tube 438 mm	MultiLux LED 2 x LED Tube 590 mm	MultiLux LED 2 x LED Tube 590 mm	MultiLux LED 2 x LED Tube 895 mm
Heater	50 W	100 W	100 W	200 W	100 W	200 W
Decors	 bl w	 bl	 bl g w lw	 bl g w lw	 bl g w lw dw	 bl g w lw dw

RIO 240 LED	RIO 350 LED	RIO 450 LED	VISION 180 LED	VISION 260 LED	VISION 450 LED	TRIGON 190 LED	TRIGON 350 LED
							
Bioflow M	Bioflow L	Bioflow XL	Bioflow M	Bioflow L	Bioflow XL	Bioflow M	Bioflow XL
3,5 l	8 l	11 l	3,5 l	8 l	11 l	3,5 l	11 l
Eccoflow 600	Eccoflow 1000	Eccoflow 1000	Eccoflow 600	Eccoflow 1000	Eccoflow 1000	Eccoflow 600	Eccoflow 1000
600 l/h	1000 l/h	1000 l/h	600 l/h	1000 l/h	1000 l/h	600 l/h	1000 l/h
7 W	8 W	8 W	7 W	8 W	8 W	7 W	8 W
MultiLux LED 2 x LED Tube 1047 mm	MultiLux LED 2 x LED Tube 1047 mm	MultiLux LED 2 x LED Tube 1200 mm	MultiLux LED 2 x LED Tube 742 mm	MultiLux LED 2 x LED Tube 1047 mm	MultiLux LED 2 x LED Tube 1200 mm	MultiLux LED 2 x LED Tube 590 mm	MultiLux LED 2x LED Tube 438 mm 2x LED Tube 895 mm
200 W	300 W	300 W	200 W	300 W	300 W	200 W	300 W
 bl g w lw dw	 bl w lw dw	 bl w lw dw	 bl w lw	 bl w lw	 bl w lw	 bl w lw	 bl w lw



★ ★ ★ ★ ★
EUROPEAN NO 1
AQUARIUM BRAND

For further information about JUWEL Aquarium products and
JUWEL Aquarium dealers in your area, please visit

www.juwel-aquarium.com

JUWEL Aquarium AG & Co. KG

Karl-Göx-Straße 1
D-27356 Rotenburg/Wümme
GERMANY

Service-Hotline +49 (0) 42 61/93 79-32

Service-Fax +49 (0) 42 61/93 79-856

Service-Mail service@juwel-aquarium.de

© JUWEL, Trigon, Vision, Primo, Rio, Lido, PrimoLux, MultiLux, HeliaLux, NovoLux, HiLite, Twin-Lite, Warm-Lite, Colour-Lite, Day-Lite, Bioflow, Eccoflow, SeaSkim, JUWEL Aqua Clean, bioPad, bioCarb, Cirax, Nitrox, Phorax, Carbox, Amorax, HiFlex, UniversalFit, NovoLux DayControl, HeliaLux SmartControl, bioBoost, EccoSkim, SmartFeed, EasyFeed

© JUWEL® Aquarium

© Apple and the Apple logo are trademarks of Apple Inc., registered in the U.S. and other countries.

Design by **R — | — J**
www.redeleitundjunker.de

PRESENTED BY:

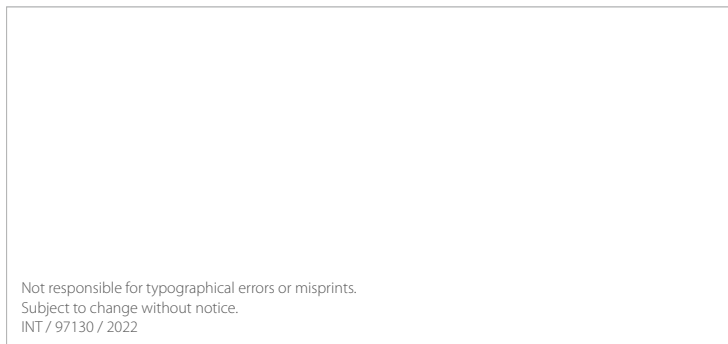

Not responsible for typographical errors or misprints.
Subject to change without notice.
INT / 97130 / 2022

INT