

Important: Read This Booklet First

Noxafil PowderMix (posaconazole)

for delayed-release oral suspension

Instructions for Use

for caregivers and healthcare providers of toddlers and children

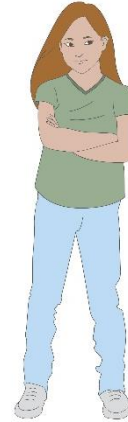

Before You Start

- Before you start, be sure that you read and understand all of these instructions. They may be different than those for medicines that you have used in the past.
- It is important that you make all measurements very carefully.
- Before you give Noxafil PowderMix, check all 3 expiration dates. The expiration date is printed on the box, the Noxafil PowderMix packets, and the mixing liquid.
- Do not open the Noxafil PowderMix packets until you are ready to mix the dose.
- Give Noxafil PowderMix with food.

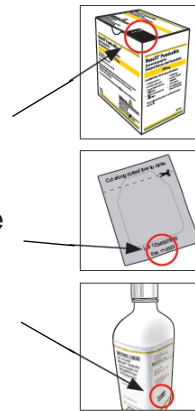

Note: Put your child in a safe place. You will need both hands to prepare Noxafil PowderMix. Wash your hands with soap and water before preparing Noxafil PowderMix.

Before You Start

- The amount of Noxafil PowderMix you give depends on your child's weight. Your healthcare provider will tell you the right dose to give your child. Be sure to keep your healthcare provider's appointments so you get new dosing information as your child grows.
- This booklet tells you how to:
 - Make the Noxafil PowderMix into a liquid form.
 - Measure the right dose using the included notched-tip oral syringe. Only use the notched-tip syringes supplied with the kit. Do not use other oral syringes.
 - Give the Noxafil PowderMix to your child.
 - Clean up.

Note before adding Noxafil PowderMix: Make sure you and your child are ready! If you do not use Noxafil PowderMix within **1 hour**, you will need to throw it away and start over.

Note: If you have any questions, call your healthcare provider.

Kit Contents

- Prescription (on Noxafil PowderMix box)



- Instructions for Use (this booklet)

- Package insert

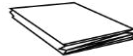

- 4 syringes (shown below)

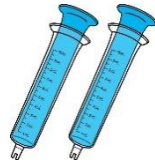

2 blue (10 mL) syringes

- 2 mixing cups

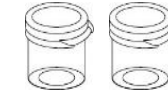

- 8 packets of Noxafil PowderMix



- Bottle adapter



- Bottle of Mixing Liquid for use with Noxafil PowderMix

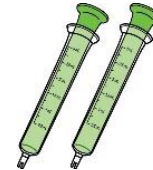

2 green (3 mL) syringes

**The kit has an extra cup and set of syringes in case one is lost or damaged.
Do not use any damaged cups or syringes.**

Get to Know the Oral Syringes

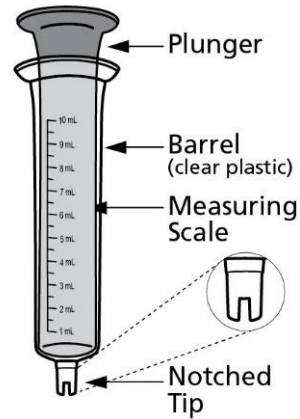

- Before you prepare a dose, review the parts of the syringe and how to use them.
 - If you have any questions about measuring with a syringe, call your healthcare provider.
 - Make sure the plunger is pushed all the way into the barrel before you start to measure the dose.
-
- Look for the number on the measuring scale that matches the amount of mixing liquid or Noxafil PowderMix that you need.
 - Be sure to follow the directions in this booklet to remove air bubbles from the syringe. **Air bubbles can affect the amount of medicine that the child gets.**

Step 1. Get the mixing liquid ready.

Important: Noxafil PowderMix needs to be prepared using the mixing liquid. **Do not** mix Noxafil PowderMix with milk, juice, or water.



When you use the mixing liquid for the first time:

- Open the bottle and remove the safety seal.
- Place the bottle adapter on top of the bottle with the small hole facing up.
- **Push the bottle adapter all the way down.**
- After it is in place, the bottle adapter stays in the bottle.
- Put the cap back on the bottle.

Step 2. Gather all your supplies and put on a clean surface.

Note: Put your child in a safe place. You will need both hands to prepare Noxafil PowderMix. Wash your hands with soap and water before preparing Noxafil PowderMix.



1 mixing cup
(Using the tab on the mixing cup, pull open the lid.)



1 packet of Noxafil PowderMix powder



Mixing liquid

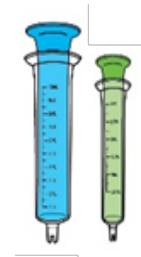

2 syringes
(Have 1 of each size ready, but you may only use 1, depending on the dose.)



Scissors
(not included with kit: use sharp household scissors or kitchen scissors)

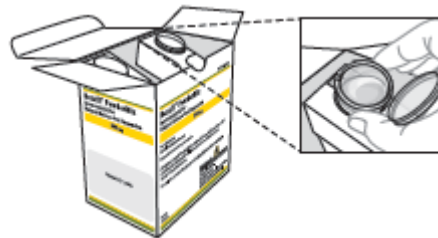

The Noxafil PowderMix box has a mixing cup holder inside to help tilt the cup when you are measuring the dose.

Step 3. Add Noxafil PowderMix to the mixing cup.

Note before adding Noxafil PowderMix:

Make sure you and your child are ready! If you do not use Noxafil PowderMix within **1 hour**, you will need to throw it away and start over.

- Take **1 packet** of Noxafil PowderMix and shake the powder to the bottom of the packet.

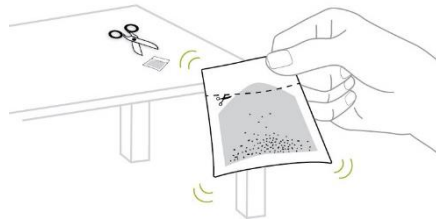

- Cut open the packet of Noxafil PowderMix at the dotted line and add all of the Noxafil PowderMix to the mixing cup. Make sure the packet of Noxafil PowderMix is completely empty.

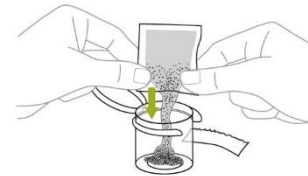

Step 4. Shake the mixing liquid bottle.



- Shake the mixing liquid well before each time you prepare Noxafil PowderMix.

Step 5. Fill the blue syringe with 9 mL of mixing liquid.

- Push the plunger of the **blue** syringe into the syringe barrel as far as it goes.
- Remove the cap from the bottle of mixing liquid.
- Push the notched tip of the syringe into the bottle adapter.
- With the syringe attached to the bottle, turn the bottle and syringe upside down. With your other hand, pull back the plunger to draw the mixing liquid back into the syringe.
- Stop when you get to the 9 mL line.
- Turn the bottle back over and remove the syringe to check your measurement.

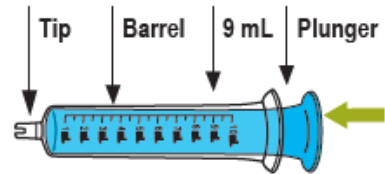

Step 6. Check for air bubbles.

- Hold the syringe with notched tip up. Tap it with your finger to move any air bubbles up.
- Slowly push the plunger to make the air come out.

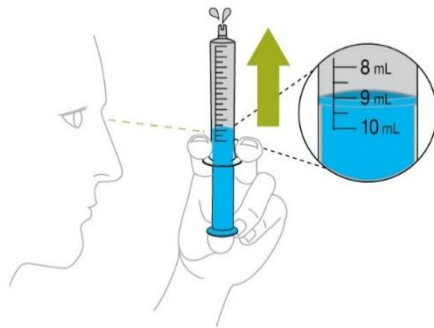
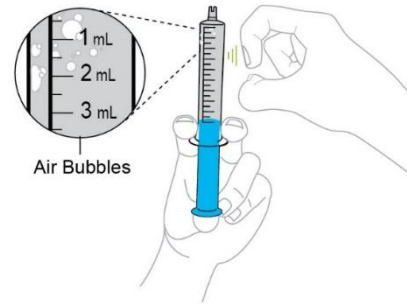

- Re-check the measurement of mixing liquid in the syringe. If it is less than 9 mL, put the notched tip back into the mixing liquid and pull the plunger back until you get to the 9 mL mark.

Step 7. Add the 9 mL of mixing liquid to the Noxafil PowderMix to the Noxafil PowderMix.

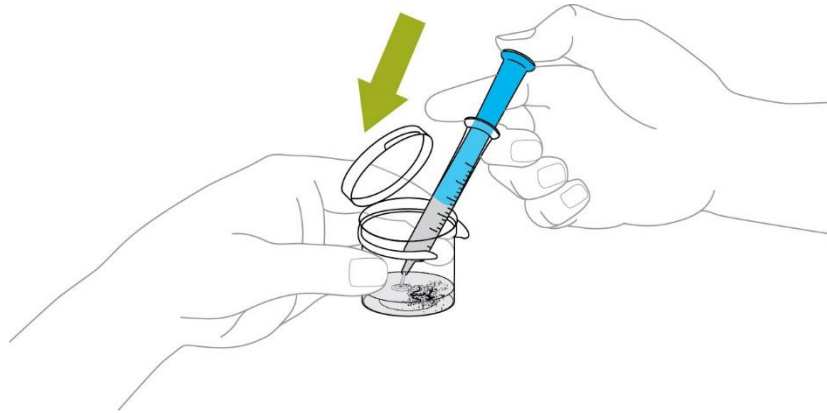

- Add the 9 mL of mixing liquid to the Noxafil PowderMix in the mixing cup by pushing all the way down on the plunger.

Step 8. Mix the Noxafil PowderMix.

- Snap the lid of the mixing cup shut.
- Shake the mixing cup really hard for 45 seconds to mix the Noxafil PowderMix.

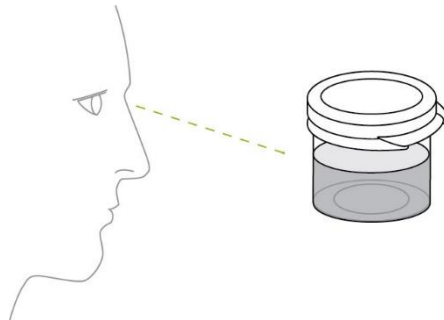
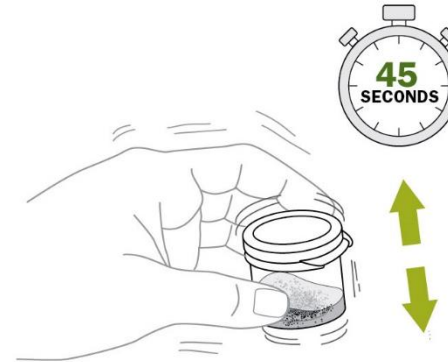

- Check to make sure the Noxafil PowderMix powder is mixed. If it is not mixed, shake the mixing cup some more. Noxafil PowderMix should look cloudy and free of clumps.

Step 9. Check your prescription label.

- Find the dose amount (look for the 'mL' written on the prescription label on the box from your healthcare provider).



Note: The dose may change each time you go to the healthcare provider, so make sure you have all the recent information. Be sure to go to all of your child's healthcare provider appointments so your child gets the right dose.

Step 10. Choose the syringe you need.

Note: Only use the syringes provided in the kit.

Choose the correct syringe for your child's dose:

For 1 mL
to 3 mL
Green

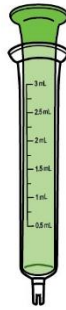

For 3 mL
to 10 mL
Blue

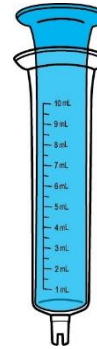

- Then find the mL mark on the syringe that matches your child's dose.

Step 11. Measure the Noxafil PowderMix.

- Push the plunger into the dosing syringe as far as it goes.
- Tilt the cup by hand or use the mixing cup holder inside the Noxafil PowderMix box.
- Put the notched tip of the dosing syringe into the lowest part of the cup with the Noxafil PowderMix and pull back the plunger.
- Stop when you get to the line showing the prescribed dose.

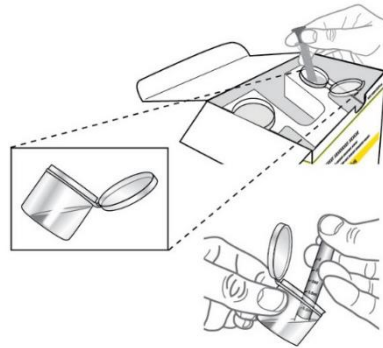

Important: You will not use all of the Noxafil PowderMix. There will be some left over in the mixing cup.

Step 12. Check for air bubbles.

- Be sure to follow the directions to remove air bubbles from the syringe. Air bubbles can affect the amount of medicine that the child gets.
- Hold the syringe with notched tip up. Tap it with your finger to move any air bubbles up. Check for air gaps in the tip of the syringe. Slowly push the plunger to make the air bubbles or air gaps come out.

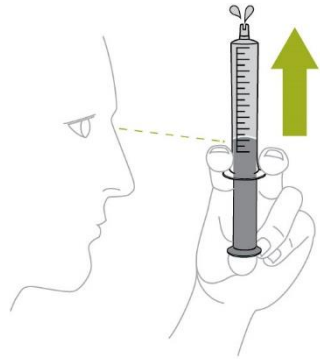
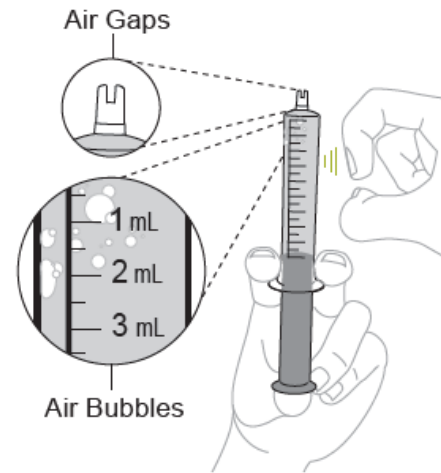

- Re-check the measurement of Noxafil PowderMix in the syringe. If it is less than the prescribed dose, put the notched tip back into the mixing cup with the Noxafil PowderMix and pull the plunger back until you get to the right dose mark.

Step 13. Give the Noxafil PowderMix to your child.

- Gently place the syringe inside your child's mouth so that the notched tip touches one of his or her cheeks.



- Slowly push down on the plunger to give the dose of Noxafil PowderMix. It is important that your child takes all of the dose of Noxafil PowderMix (a little left in the syringe notched tip is ok).

Important:

- If your child does not take the whole dose or spits some of it out, call your healthcare provider to find out what to do.
- Only use the mixing liquid from the kit. Do not mix Noxafil PowderMix with milk, juice, or water.

Step 14. Clean the cup and syringes.

Note: Syringes and mixing cups should be reused. Do not throw away syringes and mixing cups provided until all the Noxafil PowderMix packets are used.

- Pour the leftover Noxafil PowderMix from the mixing cup into the trash.
Do not pour it into the sink.
- Pull the plungers out of any syringes you used.
- Hand wash the syringes, plungers, and mixing cup with warm water and dish soap. **Do not wash in the dishwasher.**
- Rinse with water and air dry.
- Put everything in a clean, dry place.

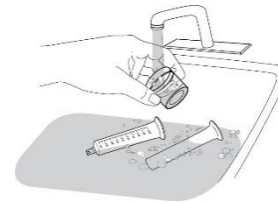
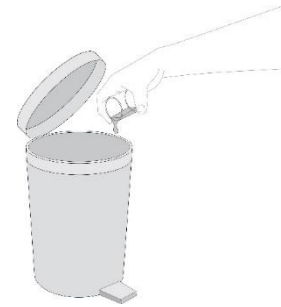

Step 15. After all packets of Noxafil PowderMix have been used.

- After you have used the last Noxafil PowderMix packet in this box, you will have leftover mixing liquid in the bottle. Throw away the leftover mixing liquid and all components of the kit.

How should I store Noxafil PowderMix?

- Store the entire kit at room temperature between 68°F to 77°F (20°C to 25°C) in a clean, dry place.
- Keep the mixing liquid at room temperature.
- Do not open the Noxafil PowderMix packet until you are ready to mix a dose.

This page intentionally left blank.

This page intentionally left blank.

**Keep NOXAFIL PowderMix and all medicines
out of the reach of children.**

For more information go to www.Noxafil.com or call
1-800-622-4477.

Distributed by:
Merck Sharp & Dohme LLC
Rahway, NJ 07065, USA

For patent information: www.msd.com/research/patent

Copyright © 2021-2022 Merck & Co., Inc., Rahway, NJ, USA, and its affiliates.
All rights reserved.

ifu-mk5592-2209r002

This Instructions for Use has been approved by the U.S. Food and
Drug Administration.

Revised: September 2022