

# Drosophila Information Service

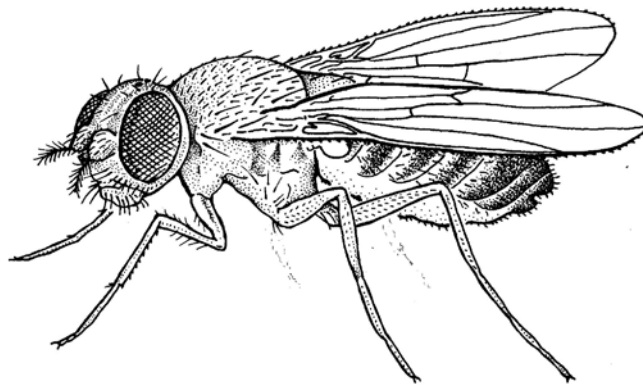

**Number  
98**

December 2015

Prepared at the  
Department of Biology  
University of Oklahoma  
Norman, OK 73019 U.S.A.

## Preface

*Drosophila* Information Service (often called “DIS” by those in the field) was first printed in March, 1934. Material contributed by *Drosophila* workers was arranged by C.B. Bridges and M. Demerec. As noted in its preface, which is reprinted in *Dros. Inf. Serv.* 75 (1994), *Drosophila* Information Service was undertaken because, “An appreciable share of credit for the fine accomplishments in *Drosophila* genetics is due to the broadmindedness of the original *Drosophila* workers who established the policy of a free exchange of material and information among all actively interested in *Drosophila* research. This policy has proved to be a great stimulus for the use of *Drosophila* material in genetic research and is directly responsible for many important contributions.” Since that first issue, DIS has continued to promote open communication.

The production of this volume of DIS could not have been completed without the generous efforts of many people. In particular, Clay Hallman and George Davis have helped maintain key records and assisted our transition to a more completely web-based publication format. Except for the special issues that contained mutant and stock information now provided in detail by FlyBase and similar material in the annual volumes, all issues are now freely-accessible from our web site: [www.ou.edu/journals/dis](http://www.ou.edu/journals/dis).

We continue to encourage all researchers to consider submitting articles that use *Drosophila* for teaching as well as articles that report new techniques, research results, and interesting new mutations. In the interests of honoring the long-standing philosophy of open exchange of ideas, we sometimes accept articles that have unusual or limited perspectives. We thank the many contributors from around the world who sent material for this issue, and we invite your submissions as well as any suggestions you have for maintaining this as a useful *Drosophila* research community resource.

James N. Thompson, jr., Editor  
Department of Biology  
University of Oklahoma, Norman

Jenna J. Hellack, Associate Editor  
Department of Biology, Emeritus  
University of Central Oklahoma, Edmond  
Department of Biology, Adjunct Professor  
University of Oklahoma, Norman

### Contributions, Orders, and Inquiries for the annual DIS issue should be sent to:

James N. Thompson, jr., Department of Biology, University of Oklahoma, Norman, OK 73019;  
Phone: (405) 325-2001, FAX (405) 325-6202, email: [jthompson@ou.edu](mailto:jthompson@ou.edu)

## List of Contributions

### General Announcements

Erratum: Noor and Coyne, 1995, *Dros. Inf. Serv.* 76: 143. 164

### Research Notes

- Alavi, M., and T. Kidd. Genetic suppression of *Netrin* adult behavioral defects by *Notch*<sup>11N-ts1</sup>. 95
- Anjalika, C., N. Paliwal, K. Aditi, A. Raj, and N. Agrawal. A combination of dimethyl sulfoxide (DMSO) and methyl paraben (nipagin) in *Drosophila* food affects survival rate. 16
- Badrinarayanan, S., S. Balasubramanian, and V.D. Parvathi. A modified method to assay the effects of ethanol on the behavior of *Drosophila melanogaster*. 88
- Baker, R., and V.M. Panin. Characterizing muscle contraction strength in *Drosophila* embryos by intensity increase in GFP transgenically expressed in muscles. 76
- Bhattacharyya, D. Further evidences of cannibalism and partial carnivorism in *Drosophila* species larvae. 99
- Bhattacharyya, D. “Pack Hunting” or “Social Digestion” as a possible cause of larval clustering associated with the evolution of cannibalistic behavior in *Drosophila* species larvae. 107
- Castro, I.F.A., C.J. Vercosa, R.D. Coutinho-Silva, G.F. Oliveira, A.C.L. Garcia, and C. Rohde. Richness of drosophilids in a naturally radioactive place in the Caatinga biome, northeast Brazil. 80
- Castro-Vargas, C. Sperm transfer and the enigma of copulation duration in *Drosophila*. 8
- Deepak, D., and M.S. Krishna. *Drosophila* fauna at three different altitudes of Kudremukh (Western Ghats). 56
- Elston, J., and M.J. Simmons. No effect of heterozygous *argonaute3* or *caravaggio* mutations on *P*-element regulation in the germ line of *D. melanogaster* males. 1
- Esteve, C., and F. Mestres. Collection of drosophilids from the Font Grogga site, Barcelona (Spain). 20
- Fernandez-Coosta, J.M., M. Sabater-Arcis, and R. Artero. A description of the adult *Drosophila* miRNome. 51

- Fischer, L.W., D.F. Gomes, W. Cavalcante, and D.C. De Toni. First registry of *Canalineia* group (Diptera, Drosophilidae) at Santa Catarina State, South Brazil. 63
- Goncalves, M.S., M.L. Blauth, A.R. Butnariu, and M.S. Gottschalk. The discrimination of sibling fruit fly species *Drosophila ananassae* and *D. malerkotliana* (Diptera, Drosophilidae) through wing traditional morphometry. 11
- Gonzalez, G., A.L. Mary, and B. Goni. *Drosophila suzukii* (Matsumura) found in Uruguay. 103
- Gredler, J.N., and M.A.F. Noor. Maternally inherited components do not detectably influence recombination rate variation in *Drosophila pseudoobscura*. 6
- Guruprasad, B.R., C. Padmaja, and V. Tangpu. Drosophilidae of Bettadapura hill of Mysuru District (Karnataka, India). 61
- Kitagawa, H. Activity variation in acid phosphatase (ACPH) allozymes of *Drosophila virilis* resulting from two different *AcpH* transcripts. 28
- Manzano-Winkler, B. Suppressed double crossovers in *D. pseudoobscura* inversion heterozygotes. 57
- Medina-Munoz, M.C., X. Lucero, C. Severino, N. Cabrera, D. Olmedo, F. Del Pino, E. Alvarez, C. Jara, and R. Godoy-Herrera. *Drosophila suzukii* arrived in Chile. 75
- Munoz-Moya, A., P. Ramos-Morales, and C. Perez-Amador. Comparison of the genotoxic and antigenotoxic activity of three *Ipomoea* species with medicinal properties in *Drosophila melanogaster*. 111
- Neethu, B.K., and B.P. Harini. Feeding behavior and nutrients act concertedly in determining fecundity and lifespan in *Drosophila nasuta nasuta*. 83
- Orengo, D.J., E. Puerma, and M. Aguade. Interplay between *Drosophila suzukii* and native *Drosophila* species in the Mediterranean area. 37
- Parchami-Araghi, M., E. Gilasian, and A.A. Keyhanian. Spotted Wing Drosophila, *Drosophila suzukii* (Matsumura) (Dip.: Drosophilidae), an invasive fruit pest new to the Middle East and Iran. 59
- Parchami-Araghi, M., E. Gilasian, and A.A. Keyhanian. Olive infestation with *Zaprionus indianus* Gupta (Dip.: Drosophilidae) in northern Iran: a new host record and threat to world olive production. 60
- Poppe, J.L., H.J. Schmitz, and V.L.S. Valente. The diversity of Drosophilidae in the South American pampas: update of the species records in an environment historically neglected. 47

Prestes, J.O., S.A. Beira, L.P.B. Machado, and R.P. Mateus. Microsatellite heterologous amplification in individual samples of <i>Drosophila griseolineata</i> .	35
Raj, A., P. Shah, and N. Agrawal. Silver nanoparticle affects flying ability of fruit flies.	18
Ritz, K.R., and M.A.F. Noor. North American Southwest collection of obscura-group <i>Drosophila</i> in summer 2015.	24
Roque, F., L. Mencarini, and R. Tidon. Revised list of drosophilid species recorded in the Brazilian Savanna.	70
Siagi, F., N. Zsindely, and L. Bodai. Genomic localization of two public gal80ts transgenes.	98
Singh, A.K., S. Kumar, and N. Singh. Electrophoretic variants of esterase in two closely related species of <i>Drosophila</i> : <i>D. bipectinata</i> and <i>D. malerkotliana</i> .	22
Singh, G., and A.K. Singh. Chromosomal translocation at the terminal end of 2L in <i>Drosophila malerkotliana</i> .	43
Srinath, B.S., and N. Shivanna. Fluctuation of <i>D. kikkawai</i> population in Hegdekatta village, Sirsi taluk, India with a preliminary report on its sex comb patterns.	44
Sujaymeendra, D.S.P., H. Arpana, R. Chaithra, A.V. Dilip, G. Rohini, and M. Jayashankar. A rapid diversity survey of drosophilids in selected market places in Bengaluru Urban District.	21
Thorp, M.W., and M.J. Simmons. Impairment of piRNA-mediated regulation of P-element mRNAs in <i>D. melanogaster</i> females heterozygous for a mutant allele of <i>argonaute3</i> or <i>caravaggio</i> .	3
Valadao, H., and R. Tidon. Distribution of drosophilids breeding in <i>Solanum lycocarpum</i> (Solanaceae) fruits.	67
Vilela, C.R. Drosophilidae (Diptera) attracted to fallen fruits of <i>caja-manga</i> ( <i>Spondias dulcis</i> Parkinson; Anacardiaceae) in the western region of the city of Sao Paulo, state of Sao Paulo, Brazil.	78
Weisman, N. Viability and lifespan effect of <i>Drosophila</i> vital gene <i>hsf</i> under elevated temperature conditions.	64
Zanini, R., M. Depra, and V.L.S. Valente. On the geographic distribution of the <i>Drosophila willistoni</i> group (Diptera, Drosophilidae) – updated distribution of <i>alagitans</i> and <i>bocainensis</i> subgroups.	25
Zanini, R., M. Depra, and V.L.S. Valente. On the geographic distribution of the <i>Drosophila willistoni</i> group (Diptera, Drosophilidae) – updated geographic distribution of the Neotropical <i>willistoni</i> subgroup.	39

## Technique Notes

- Aguayo, T., C. Meza, H. Munoz, F. Del Pino, M.C. Medina-Munoz, E. Alvarez, and R. Godoy-Herrera. Safe, fast, cheap, and efficient procedures to collect and deposit in vials large and little numbers of flies in a short time. 149
- Cardoso, E., M.L. Blauth, and M.S. Gottschalk. Technical adaptations to the retention baited trap to *Drosophilidae*. 145
- Gamberi, C. Efficient high-throughput cuticle preparations from fly lines yielding both viable and unviable embryos. 147
- Garcia, J. An efficient, practical, and reliable yeast shaker for *Drosophila melanogaster* culture. 143
- Smrt, R.D., S.A. Lewis, R. Kraft, and L.L. Restifo. Primary culture of *Drosophila* larval neurons with morphological analysis using NeuronMetrics. 125

## Teaching Notes

- Kliethermes, C.L. Two simple jigs for cutting olfactory trap components. 141
- Knackstedt, K.A., H.B. Thorpe, C.R. Santangelo, M.A. Balinski, and R.C. Woodruff. Can selection alter the frequency of recombination of *Drosophila melanogaster*? 153
- Possidente, B., and D. McQuade. A simple lab exercise using inbred *Drosophila* strains for introducing quantitative genetics to undergraduates. 151
- Rampasso, A.S., and C.R. Vilela. Establishment of double mutant strains of *Drosophila melanogaster* (Diptera, Drosophilidae) for teaching purposes. 157
- Strelec, M., and S.S.C. Rund. Real-time visualization software for the TriKinetics Environmental Monitor (DEnM). 142
- Thompson, J.N., jr., D. Tinney, J. Khoussine, G. Cox, J.R. Ogden, G. Audette, S. Bingabr, D. Branesky, A. Gomez, J. Lauderdale, C. Long, J. Mitchell, S. Narula, D. Nguyen, T.-V. Nguyen, D. Pons, C. Steele, G. Sutton, T. Tallman, and B. Safiejko-Mroccka. Using DGRP sequenced genomes to map heterozygous modifier effects on cell death in *Bar* eye of *Drosophila*. 162
- Thorpe, H.B., K.A. Knackstedt, T.M. Birkholz, C.J. Schimmoeller, M.A. Balinski, P.G. Tate, and R.C. Woodruff. The influence of autosomal genetic background on the fitness of a mutant sex-linked gene and linked loci in *Drosophila melanogaster*. 156

- Vercosa, C.J., I.F. de Araujo Castro, A.C.L. Garcia, and C. Rohde. An efficient rearing population cage to expose *Drosophilids* to various environmental agents. 144

### **Mutation Notes**

- Araujo, S.J., R. Romero, and F. Mestres. Displaced genital arch in a *Drosophila melanogaster* male. 165
- Orengo, D.J., E. Puerma, and M. Aguade. A new spontaneous chromosomal inversion in a classical laboratory strain of *Drosophila subobscura*. 166
- Romero, R., and F. Mestres. Abnormal ovipositor in a *Drosophila melanogaster* female. 167

### **Other Reports**

- 56<sup>th</sup> Annual *Drosophila* Research Conference, Chicago, IL 169

### **The North American *Drosophila* Board**





## Research Notes



**No effect of heterozygous *argonaute3* or *caravaggio* mutations on *P*-element regulation in the germ line of *D. melanogaster* males.**

**Elston, Joshua, and Michael J. Simmons.** Department of Genetics, Cell Biology and Development, University of Minnesota, Twin Cities, St. Paul, MN. E-mail: [simmo004@umn.edu](mailto:simmo004@umn.edu)

Many of the transposons in *D. melanogaster* are regulated by small RNAs that associate with the Piwi class of proteins. These Piwi-interacting (or pi) RNAs are generated from transposon sequences inserted in special loci scattered about the genome (Brennecke *et al.*, 2007). One such locus is in the Telomere Associated Sequences (TAS) at the left end of the X chromosome. Transposable *P* elements inserted in this locus produce piRNAs that regulate the entire *P*-element family (Brennecke *et al.*, 2008). These telomeric *P* elements are therefore anchors of the *P* cytotype, the term that Engels (1979) gave to the cellular state that represses *P*-element excision and transposition.

The Piwi-type proteins are encoded by three genes in the *D. melanogaster* genome: *argonaute3* (*ago3*), *aubergine* (*aub*), and *piwi*. In homozygous condition, mutations in these genes are either lethal or sterile. Thus, their possible effects on transposon regulation can only be studied in heterozygous condition. Previously, heterozygous *aub* mutations have been shown to disrupt *P*-element regulation in both males and females (Reiss *et al.*, 2004; Simmons *et al.*, 2007; Simmons *et al.*, 2014), and heterozygous *piwi* mutations have been shown to disrupt *P* element regulation and the related *trans*-silencing effect in females (Josse *et al.*, 2007; Belinco *et al.*, 2009; Simmons *et al.*, 2014); in addition, one heterozygous *piwi* mutation (*piwi*<sup>1</sup>, thought to be the more severe of the two alleles tested) was found to disrupt *P* regulation in males (Simmons *et al.*, 2010). Heterozygous mutations in another vital gene, *Suppressor of variegation 205* [*Su(var)205*], also impair *P* regulation—in females as well as males (Ronsseray *et al.*, 1996; Haley *et al.*, 2005; Simmons *et al.*, 2014). This gene encodes heterochromatin protein 1 (HP1), a protein involved in chromatin organization (Eissenberg *et al.*, 1990). HP1 is found in the centric heterochromatin, at telomeres, and at some euchromatic loci (James *et al.*, 1989). Its presence at telomeres suggests that it plays a role in preventing chromosome entanglements and in maintaining chromosome integrity (Savitsky *et al.*, 2002; Perrini *et al.*, 2004). The HP1/ORC associated protein (HOAP), encoded by the *caravaggio* (*cav*) gene, apparently collaborates with HP1 to stabilize telomere structure (Cenci *et al.*, 2003).

We tested heterozygous *ago3* and *cav* mutations for impairment of *P*-element regulation in males that carried *TP5*, an incomplete *P* element inserted in the TAS of XL (Stuart *et al.*, 2002). The strength of regulation was measured by monitoring the excision of *P* elements inserted in *sn*<sup>w</sup>, a double-*P* insertion mutation of the *singed* bristle gene (Roiha *et al.*, 1988). In hemizygous males, this mutation causes a mild malformation of the bristles. However, when one or the other of the inserted *P* elements is excised from *sn*<sup>w</sup> in a male's germ line, in the next generation the bristles show a different phenotype—either extreme mutant (*sn*<sup>e</sup>) or pseudo-wild type (*sn*<sup>(+)</sup>). Thus, by counting the frequency of *sn*<sup>e</sup> and *sn*<sup>(+)</sup> flies among the progeny of each tested male, we could quantify the strength of *P* regulation in its germ line. A high frequency of *sn*<sup>e</sup> and *sn*<sup>(+)</sup> flies—that is, a high frequency of *P* excisions from *sn*<sup>w</sup>—implies weak regulation whereas a low frequency of these flies implies strong regulation. Excision of the *sn*<sup>w</sup> *P* elements was catalyzed by the *P* transposase produced by *H(hsp/CP)2*, a *hobo* transgene containing a terminally truncated but otherwise complete *P* element (*CP*) that encodes this enzyme (Simmons *et al.*, 2002). *H(hsp/CP)2* is stably located on chromosome II and the *ago3* and *cav* mutations are located on chromosome III; in our experiments these sterile or lethal mutations were balanced over *TM3, Sb Ser*.

To set up the experiments, we crossed *TP5 sn*<sup>w</sup>; *mutation/TM3, Sb Ser* females to *H(hsp/CP)2* males. The mutations tested were *cav* (Cenci *et al.*, 2003) and the *ago3* alleles *t1* and *t3* (Li *et al.*, 2009), all of which behave as nulls. The F<sub>1</sub> *TP5 sn*<sup>w</sup>; *mutation/H(hsp/CP)2* sons were then individually crossed to 3 *C(1)DX, y f*

females. Because of the attached-X chromosomes in these females, the *TP5 sn<sup>w</sup>* chromosome is transmitted patroclinously. Thus, we scored the F<sub>2</sub> males for the singed bristle phenotypes. The cultures were reared at 25°C and scored on days 14 and 17 after the cultures were established. The excision frequency was calculated for each tested male, and then averaged over all the males in a test group; the standard error (SE) associated with this average was calculated empirically.

Table 1. Effect of heterozygous mutant *ago3* and *cav* alleles on the frequency of transposase-catalyzed *P* excisions from the *sn<sup>w</sup>* allele in the male germ line.

<i>TP5</i> present or absent <sup>a</sup>	Mutant allele	No. males tested	No. progeny scored	<i>P</i> excision rate ± SE
absent	none	29	586	0.518 ± 0.018
absent	<i>ago3<sup>t1</sup></i>	31	468	0.457 ± 0.023
absent	<i>ago3<sup>k3</sup></i>	32	827	0.507 ± 0.022
absent	<i>cav</i>	32	890	0.427 ± 0.020
present	none	32	493	0.021 ± 0.008
present	<i>ago3<sup>t1</sup></i>	31	478	0.038 ± 0.018
present	<i>ago3<sup>k3</sup></i>	29	1017	0.044 ± 0.011
present	<i>cav</i>	35	1145	0.031 ± 0.011

<sup>a</sup> The X-linked telomeric element *TP5* anchors the *P* cytotype, which represses *P* excisions from *sn<sup>w</sup>*.

alleles do not impair *TP5*-anchored cytotype regulation in the male germ line. Furthermore, because these mutant alleles were derived from heterozygous mothers of the tested males, they also do not disrupt the maternal component of *TP5*-anchored regulation. In tests for heterozygous effects on repression of *P*-excisions from *sn<sup>w</sup>* in the male germ line, the mutant *ago3* and *cav* alleles therefore behave like mutant *piwi* alleles, not like mutant *aub* or *Su(var)205* alleles (Simmons *et al.*, 2007). Repression of *P*-excisions from *sn<sup>w</sup>* in males is evidently more sensitive to the depletion of *Aub* or *HP1*—achieved by knocking out one copy of the relevant gene—than to the depletion of *Piwi*, *Ago3* or *HOAP*.

**Acknowledgments:** Phillip Zamore kindly provided the *ago3* mutants and Maurizio Gatti kindly provided the *cav* mutant. The Department of Genetics, Cell Biology and Development of the University of Minnesota provided financial support.

**References:** Belinco, C., S.N. DiPrima, R.E. Wolff, M.W. Thorp, J.T. Buschette, and M.J. Simmons 2009, *Genet. Res.* 91: 383-394; Brennecke, J., A.A. Aravin, A. Stark, M. Dus, M. Kellis, R. Sachidanandam, and G.J. Hannon 2007, *Cell* 128: 1089-110; Brennecke, J., C.D. Malone, A.A. Aravin, R. Sachidanandam, A. Stark, and G.J. Hannon 2008, *Science* 322: 1387-1392; Cenci, G., G. Siriaco, G.D. Raffa, R. Kellum, and M. Gatti 2003, *Nature Cell Biology* 5: 82-84; Eissenberg, J.D., T.C. James, D.M. Foster-Hartnett, T. Hartnett, V. Ngan, and S.R.C. Elgin 1990, *Proc. Natl. Acad. Sci. U. S. A.* 87: 9923-9927; Engels, W.R., 1979, *Genet. Res.* 33: 219-236; Haley, K.J., J.R. Stuart, J.D. Raymond, J.B. Niemi, and M.J. Simmons 2005, *Genetics* 171: 583-595; James, T.C., J.C. Eissenberg, C. Craig, V. Dietrich, A. Hobson, and S.R.C. Elgin 1989, *Eur. J. Cell Biol.* 50: 170-180; Josse, T., T.L. Teyssset, A.L. Todeschini, C.M. Sidor, D. Anxolabéhère, and S. Ronsseray 2007, *PLoS Genet.* 3: 1633-1643; Li, C., V.V. Vagin, S. Lee, J. Xu, S. Ma, H. Xi, H. Seitz, M.D. Horwich, M. Strycka, B.M. Honda, E.L.W. Kittler, M.L. Zapp, C. Klattenhoff, N. Schulz, W.E. Theurkauf, Z. Weng, and P.D. Zamore 2004, *Cell* 137: 509-521; Perrini, B., L. Piacentini, L. Fanti, F. Altieri, S. Chichiarelli, M. Berloco, C. Turano, A. Ferraro, and S. Pimpinelli 2004, *Mol. Cell* 15: 467-476; Reiss, D., T. Josse, D. Anxolabéhère, and S. Ronsseray 2004, *Mol. Gen. Genomics* 272: 336-343; Roiha, H., G.M. Rubin, and K. O'Hare 1988, *Genetics* 119: 75-83; Ronsseray, S., M. Lehmann, D. Nouaud, and D. Anxolabéhère 1996, *Genetics* 143: 1663-1674; Savitsky, M., O. Kravchuk, L. Melinkova, and P. Georgiev 2002, *Mol. Cell. Biol.* 22: 3204-3218; Simmons, M.J., K.J. Haley, C.D. Grimes, J.D. Raymond, and J.B. Niemi 2002, *Genetics* 161: 195-204; Simmons, M.J., D-F. Ryzek, C. Lamour, J.W. Goodman, N.E. Kummer, and P.J. Merriman 2007, *Genetics*

The results (Table 1) show that in the absence of the cytotype-anchoring regulatory element *TP5*, the *P* excision rate ranged from 0.427 to 0.518. These values are consistent with other published data from similar experiments in which *H(hsp/CP)2* was the transposase source (Simmons *et al.*, 2002). None of the heterozygous mutant alleles significantly altered the unregulated *P* excision rate. In the presence of *TP5* the *P* excision rate ranged from 0.021 to 0.044—an order of magnitude lower than the unregulated excision rates. The *TP5* element therefore strongly represses transposase-catalyzed *P* excisions from the *sn<sup>w</sup>* allele. The similarity of these excision rates indicates that the heterozygous *ago3* or *cav* mutant

176: 1945-1955; Simmons, M.J., M.W. Thorp, J.T. Buschette, L. Peterson, E.W. Cross, and E.L. Bjorklund 2010, Genet. Res. 92: 261-272; Simmons, M.J., M.W. Meeks, E. Jessen, J.R. Becker, J.T. Buschette, and M.W. Thorp 2014, Genes, Genomes, Genetics 4: 1417-1427; Stuart, J.R., K.J. Haley, D. Swedzinski, S. Lockner, P.E. Kocian, and M.J. Simmons 2002, Genetics 162: 1641-1654.



**Impairment of piRNA-mediated regulation of *P*-element mRNAs in *D. melanogaster* females heterozygous for a mutant allele of *argonaute3* or *caravaggio*.**

**Thorp, Michael W., and Michael J. Simmons.** Department of Genetics, Cell Biology and Development, University of Minnesota, Twin Cities, St. Paul, MN. E-mail: [simmo004@umn.edu](mailto:simmo004@umn.edu)

The proteins encoded by the genes *argonaute3* (*ago3*), *aubergine* (*aub*), and *piwi* are involved in processing small RNAs that regulate transposable elements in the *D. melanogaster* genome. As a group, these proteins are called Piwi-type proteins, and the RNAs associated with them are called Piwi-interacting (or pi) RNAs (Aravin *et al.*, 2007; Brennecke *et al.*, 2007; Li *et al.*, 2009). piRNAs are generated from many different loci, including one in the Telomere Associated Sequences (TAS) at the left end of the X chromosome. This locus has been identified as the source of the piRNAs that regulate the *P* family of transposable elements (Brennecke *et al.*, 2008). *P* elements are mobilized by an enzyme, the *P* transposase, which is encoded by structurally complete members of the *P*-element family (Engels, 1989). *P*-element activity is restricted to the germ line, because the mRNA for the transposase is produced only in that tissue (Laski *et al.*, 1986); in the soma, the last of the introns—the one denoted as the 2-3 intron because it lies between exons 2 and 3—is not removed from *P* transcripts. When translated, these incompletely spliced *P* transcripts produce a polypeptide that is unable to catalyze transposition.

In the germ line, *P* elements are regulated by piRNAs generated from *P*-elements that have fortuitously inserted into the TAS of XL (Ronsseray *et al.*, 1991; Marin *et al.*, 2000; Stuart *et al.*, 2002). These piRNAs can be passed from mother to offspring through the egg cytoplasm (Brennecke *et al.*, 2008). Thus, a female that carries a telomeric *P* element can endow her offspring with the ability to regulate *P*-element activity, even if the offspring do not inherit the telomeric *P* element itself (Simmons *et al.*, 2012). This maternal effect is one of the hallmarks of *P* regulation. Engels (1979) coined the term “*P* cytotype” to encompass all the components of *P* regulation—both chromosomal and cytoplasmic. Recent analyses have revealed that the chromosomal component consists of the *P* elements themselves—especially cytotype-anchoring telomeric *P* elements—and the cytoplasmic component consists of maternally transmitted piRNAs.

At the molecular level, *P* regulation is characterized by a reduction in the amount of germ-line *P* mRNA (Jensen *et al.*, 2008). This reduction could either be due to repression of *P* transcription or to post-transcriptional destruction of *P* transcripts; in either case, the mechanism must be mediated by piRNAs generated from a telomeric *P* element. However, *P*-element regulation might also involve other factors. One candidate is heterochromatin protein 1 (HP1), which is encoded by the *Suppressor of variegation 205* [*Su(var)205*] gene (Eissenberg *et al.*, 1990), and another is the HP1/ORC-associated protein (HOAP), which is encoded by the *caravaggio* (*cav*) gene (Cenci *et al.*, 2003). These two proteins are involved in chromatin organization, notably at telomeres, where they could influence the expression of piRNA-generating *P* elements. The proteins Ago3, Aub, and Piwi are thought to be involved directly in the production of piRNAs from these *P* elements. Depleting any of these chromatin-organizing or piRNA-processing proteins might impair the production of piRNAs, and thereby allow *P*-element mRNAs, especially transposase-encoding mRNAs, to accumulate in the germ line.

To test this hypothesis, we used reverse transcription and the polymerase chain reaction (RT-PCR) to assess the levels of mRNAs from a telomeric *P* element, denoted *TP5*, and a transgenic complete *P* element, denoted *H(hsp/CP)2*, in females that were heterozygous for these elements and a mutant allele of the *ago3* or *cav* gene. Females that are homozygous for the *ago3*<sup>11</sup> or *ago3*<sup>13</sup> alleles are sterile (Li *et al.*, 2009), and flies

that are homozygous for the mutant *cav* allele are lethal (Cenci *et al.*, 2003). All these mutant alleles are functionally null, and in heterozygous condition, they would be expected to deplete the amount of wild-type Ago3 or HOAP protein by 50%, as has been demonstrated with *ago3<sup>ts3</sup>/+* heterozygotes (Li *et al.*, 2009). RNA was isolated from four samples of 20 adult females of each genotype with the Trizol reagent, and then reverse transcribed using the ThermoScript Reverse Transcriptase and an oligo-dT primer. In addition to the samples from the mutant genotypes, we obtained samples from *TP5/+; H(hsp/CP)2/+; +/+* and *+/+; H(hsp/CP)2/+; +/+* control females. The cDNAs from each sample were amplified by PCR with appropriate primers and the products were analyzed by electrophoresis in 1% agarose gels. The procedures for RNA isolation, reverse transcription, and PCR have been described by Jensen *et al.* (2008).

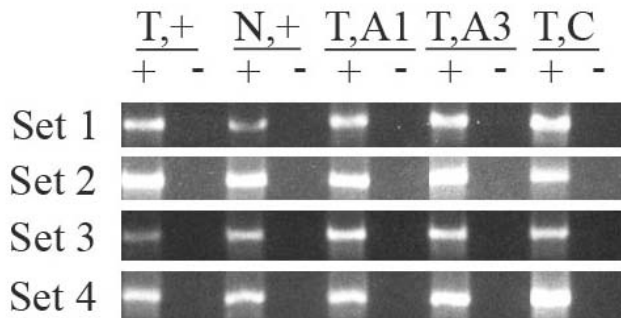

Figure 1. RT-PCR analysis of “somatic” *CP* mRNA in sets of samples from mutant and control female genotypes carrying the *H(hsp/CP)2* transgene (here abbreviated *CP*). Sample T,+ : *TP5/+; CP/+; +/+*. Sample N,+ : *+/+; CP/+; +/+*. Sample T,A1: *TP5/+; CP/+; ago3<sup>ts1</sup>/+*. Sample T,A3: *TP5/+; CP/+; ago3<sup>ts3</sup>/+*. Sample T,C: *TP5/+; CP/+; cav/+*. All the samples came from independent RNA isolates. The 1539 bp RT-PCR products were obtained by amplifying the cDNAs with the primers PΔ0/1-d and P2075-u; see Jensen *et al.*, (2008) for details.

Figure 1 shows the analysis of *CP* mRNAs that retain the 2-3 intron. These mRNAs are produced in somatic cells, where the 2-3 intron cannot be excised from *CP* transcripts; hence, we refer to them as “somatic” mRNAs. However, they may also be produced in germ-line cells if the 2-3 intron is not removed with 100% efficiency. Figure 1 shows no consistent differences in the intensities of the RT-PCR products among the genotypes that were analyzed. Thus, the presence or absence of the cytotype-anchoring *TP5* element or the presence of an *ago3* or *cav* mutation does not seem to affect the abundance of the “somatic” mRNA derived from the *CP* element. These findings fit with the absence of cytotype regulation of *P* elements in somatic cells (Stuart *et al.*, 2002; Simmons *et al.*, 2004). Thus, piRNAs do not operate to diminish *P*-element mRNAs in the soma.

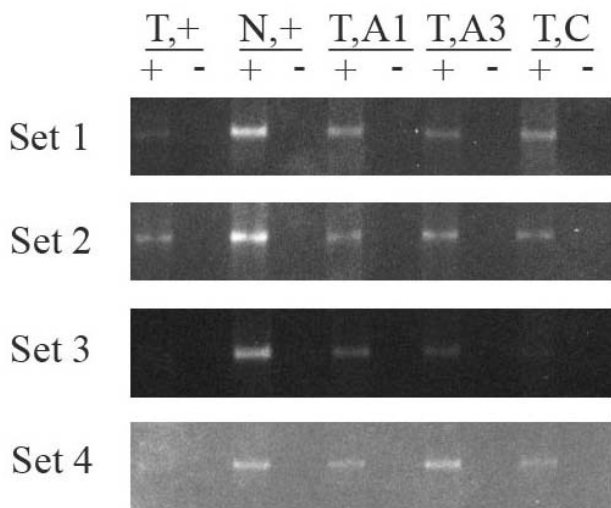

Figure 2. RT-PCR analysis of germ-line *CP* mRNA in sets of samples from mutant and control female genotypes. The genotypes are the same as those in Figure 1. The 1495 bp RT-PCR products were obtained by amplifying the cDNAs with the primers PΔ0/1-d and PΔ2/3-u (Jensen *et al.*, 2008). The latter primer is specific for mRNAs that do not have the 2-3 intron, which is removed from *P* transcripts only in germ-line cells.

Figure 2 shows the analysis of *CP* mRNAs that have lost the 2-3 intron. These mRNAs are produced exclusively in germ-line cells. In each set of samples, the most intense RT-PCR product is the one from the flies that did not carry the *TP5* element (denoted N,+). Without this element, there is no cytotype regulation of the *P*-element family and the abundance of germ-line mRNAs from the *CP* element is undiminished. All the other samples—from flies that carried *TP5* (denoted with a T)—show less intense RT-

PCR products. Thus, in these samples, the abundance of germ-line *CP* mRNA has been reduced. In sets 1, 3, and 4, the reduction is clearly strongest in the samples from flies that did not carry an *ago3* or *cav* mutation (denoted T,+), whereas in set 2, the reduction is about the same for all the *TP5*-bearing genotypes. These observations indicate that the *TP5* element is responsible for reducing the amount of germ-line *CP* mRNA, and that in three of the four sets, the *ago3* mutations (A1 = *ago3*<sup>t1</sup>; A2 = *ago3*<sup>t3</sup>) or the *cav* mutation (C) ameliorate this reduction. Heterozygous *ago3* or *cav* mutant alleles therefore appear to impair the *TP5*-anchored mechanism that prevents *CP* mRNA from accumulating in the female germ line.

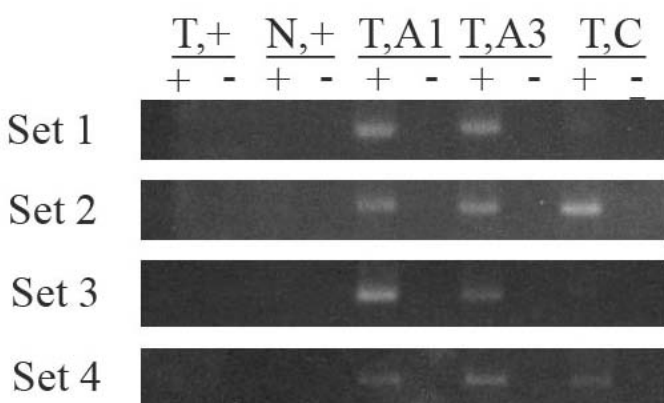

Figure 3. RT-PCR analysis of sets of germ-line *TP5* mRNAs from mutant and control female genotypes. The genotypes are the same as those in Figure 1. The 471 bp RT-PCR products were obtained by amplifying the cDNAs with the primers TP5-d, which is specific for the *TP5* element, and PΔ2/3-u (Jensen *et al.*, 2008).

Figure 3 shows the analysis of germ-line mRNA from the *TP5* element. Of course, the flies that did not carry *TP5* (the sample denoted N,+) could not—and did not—produce this

mRNA. The flies that carried *TP5* but that did not carry a mutant *ago3* or *cav* allele (T,+) also did not produce any germ-line *TP5* mRNA. In these flies, the *TP5* element evidently generates only piRNAs. However, some germ-line *TP5* mRNA does appear when a mutant *ago3* or *cav* allele is present in the genotype (samples denoted T,A1; T,A2 and T,C). Thus, heterozygous mutant alleles of *ago3* or *cav* alter the expression of the *TP5* element. The appearance of *TP5* mRNA in these heterozygous mutant genotypes suggests that expression of the *TP5* element has shifted from generating piRNAs to producing mRNAs, likely diminishing the power of the piRNA mechanism to repress *P*-element activity. This expectation is consistent with the impaired ability of *TP5*-bearing flies that are heterozygous for a mutant *ago3* or *cav* allele to prevent the accumulation of *CP* mRNA in the germ-line (Figure 2). At the molecular level, depleting the Ago3 or HOAP proteins by mutating one copy of the relevant genes therefore seems to weaken the regulatory system that is anchored in the telomeric *TP5* element. However, the accompanying note by Elston and Simmons (2015) indicates that heterozygous *ago3* or *cav* mutations have no effect on repression of *P*-element excisions from an X-linked locus in males. Thus, even a regulatory system weakened by the maternal (and zygotic) effects of heterozygous *ago3* or *cav* mutations is capable of repressing *P* activity in the male germ line.

A similar analysis has been reported for females heterozygous for a mutant allele of the *aub*, *piwi*, or *Su(var)205* genes (Simmons *et al.*, 2010). Heterozygous *aub* alleles and one *piwi* allele (*piwi*<sup>1</sup>) allowed *CP* mRNA to accumulate in the germ line, and they also increased the expression of *TP5* mRNAs. The *piwi*<sup>2</sup> allele, which is thought to be less severe than *piwi*<sup>1</sup> because of the nature of the molecular lesion and the absence of any homozygous effect on male fertility, did not allow *CP* mRNA to accumulate, and it did not increase the expression of *TP5* mRNA. *Su(var)205*<sup>04</sup> also did not allow *CP* mRNA to accumulate, but it did increase the expression of *TP5* mRNAs. When heterozygous, the *aub* alleles, *piwi*<sup>1</sup> and *Su(var)205*<sup>04</sup> disrupted repression of *P*-excisions in the male germ line, whereas *piwi*<sup>2</sup> did not. All these results suggest that *P*-element regulation may involve the collaboration of the Piwi-type proteins Ago3, Aub, and Piwi, the chromatin-organizing proteins HP1 and HOAP, and *P*-specific piRNAs.

**Acknowledgments:** Phillip Zamore kindly provided the *ago3* mutants and Maurizio Gatti kindly provided the *cav* mutant. The Department of Genetics, Cell Biology and Development of the University of Minnesota provided financial support.

**References:** Aravin, A.A., G.J. Hannon, and J. Brennecke 2007, *Science* 318: 761-764; Brennecke, J., A.A. Aravin, A. Stark, M. Dus, M. Kellis, R. Sachidanandam, and G.J. Hannon 2007, *Cell* 128: 1089-110; Brennecke, J., C.D. Malone, A.A. Aravin, R. Sachidanandam, A. Stark, and G.J. Hannon 2008, *Science* 322:

1387-1392; Cenci, G., G. Siriaco, G.D. Raffa, R. Kellum, and M. Gatti 2003, *Nature Cell Biology* 5: 82-84; Eissenberg, J.D., T.C. James, D.M. Foster-Hartnett, T. Hartnett, V. Ngan, and S.R.C. Elgin 1990, *Proc. Natl. Acad. Sci. U. S. A.* 87: 9923-9927; Elston, J., and M.J. Simmons 2015, *Dros. Inf. Serv.* 98: 1-3; Engels, W.R., 1979, *Genet. Res.* 33: 219-236; Engels, W.R., 1989, in *Mobile DNA* (eds. D.E. Berg and M.M. Howe), pp 437-484, Washington, DC: American Society for Microbiology Publications; Jensen, P.A., J.R. Stuart, M.P. Goodpaster, J.W. Goodman, and M.J. Simmons 2008, *Genetics* 179: 1785-1793; Laski, F.A., D.C. Rio, and G.M. Rubin 1986, *Cell* 44: 7-19; Li, C., V. V. Vagin, S. Lee, J. Xu, S. Ma, H. Xi, H. Seitz, M. D. Horwich, M. Syruca, B. M. Honda, E. L. W. Kittler, M. L. Zapp, C. Klattenhoff, N. Schulz, W. E. Theurkauf, Z. Weng and P. D. Zamore. *Cell* 137: 509-521. Marin, L., M. Lehmann, D. Nouaud, H. Izaabel, D. Anxolabéhère, and S. Ronsseray 2000, *Genetics* 155: 1841-1854. Ronsseray, S., M. Lehmann and D. Anxolabéhère 1991, *Genetics* 129: 501-512. Simmons, M. J., J. D. Raymond, J. B. Niemi, J. R. Stuart and P. J. Merriman 2004, *Genetics* 166: 243-254. Simmons, M. J., M. W. Thorp, J. T. Buschette, L. Peterson, E. W. Cross and E. L. Bjorklund 2010, *Genet. Res.* 92: 261-272. Simmons, M. J., L. M. Ragatz, I. R. Sinclair, M. W. Thorp, J. T. Buschette and C. D. Grimes 2012, *Genet. Res.* 94: 339-351. Stuart, J. R., K. J. Haley, D. Swedzinski, S. Lockner, P. E. Kocian and M. J. Simmons 2002, *Genetics* 162: 1641-1654.



### **Maternally inherited components do not detectably influence recombination rate variation in *Drosophila pseudoobscura*.**

**Gredler, Jennifer N., and Mohamed A.F. Noor.** Biology Department, Duke University, Durham, NC 27708 USA; E-mail: jngredler11@gmail.com

#### **Introduction**

Genetic recombination during meiosis is essential for the successful segregation of chromosomes and acts as an important driver of evolutionary change via its roles in the processes of speciation and the maintenance and creation of genetic diversity. Despite its importance, recombination rate is known to respond to a variety of factors, both molecular and environmental, that can ultimately lead to substantial heritable variation in recombination rates amongst individuals, populations, and species (Smukowski and Noor, 2011). Such variation in recombination rates has been documented in a diverse range of taxa that includes humans, mice, *Drosophila*, yeast, and *Arabidopsis* (Comeron *et al.*, 2012; Coop *et al.*, 2008; Drouaud *et al.*, 2006; Dumont and Payseur, 2011; Fledel-Alon *et al.*, 2011; McGaugh *et al.*, 2012; Petes, 2001).

Recently, parent-of-origin effects on gene transcription and expression were suggested to influence the location and formation of double stranded break precursors to recombination, thus potentially influencing patterns of variation in recombination rates across the genome (Adrian and Comeron, 2013). If true, maternal effects may affect recombination landscapes genome-wide and create variation in recombination rates among individuals within species. Maternal effects are known to play pivotal roles in body axis formation during embryogenesis in *Drosophila*; however, studies directly testing the role of maternal effects (*e.g.*, through cytoplasmically inherited factors) on recombination rate variation have yet to be explored. This study aims to step away from the commonly studied influences on recombination rates, including sequence variation, epigenetics, protein binding sites, and plasticity in response to changing environments, to offer further insight about parental influences on recombination in their offspring.

In this study, we use two subspecies of *Drosophila pseudoobscura*, *D. ps. pseudoobscura* and *D. ps. bogotana*, to study how maternal effects impact variation in recombination rates. These two subspecies were chosen since they are genetically divergent (Prakash *et al.*, 1969), allowing more opportunity for potential parent-of-origin effects on recombination, and since they form fully fertile hybrid females. We set up reciprocal inter-subspecies crosses to generate F<sub>1</sub> hybrid females, differing only in maternal effects and organellar genomes, and use over 1400 F<sub>2</sub> progeny from each cross to infer the recombination rates in the F<sub>1</sub> females at two windows located on opposite ends of chromosome 2 (Muller's Element E).

## Materials and Methods

### *Fly Stocks and Crosses:*

Laboratory strains of *Drosophila pseudoobscura pseudoobscura* (genome strain MV2-25) and *Drosophila pseudoobscura bogotana ER white* obtained from the Drosophila Species Stock Center at UCSD in 2012 (stock number 14011-0121.152) were used to set up reciprocal inter-subspecies crosses.

Virgin adult female *D. ps. pseudoobscura* and *D. ps. bogotana* were collected and maintained for 5-6 days to allow for sexual maturity and mating receptivity. After 5-6 days, reciprocal crosses were set up in which four *bogotana* females were crossed with four *pseudoobscura* males, and four *pseudoobscura* (ps) females were crossed with four *bogotana* (bog) males. All parents were allowed to mate for 6-7 days before being removed. A total of 31 mating vials were set up (14 for bog female × ps male, and 15 for ps female × bog male). F<sub>1</sub> females from both crosses were then held for 5-6 days before being backcrossed to ps males. F<sub>1</sub> females and ps males were then confined for 4 days before being removed. From 90 crosses (45 for each reciprocal cross) of four F<sub>1</sub> females with four ps males, a total of 1435 F<sub>2</sub> progeny from the ps female × bog male cross and 1437 F<sub>2</sub> progeny from the bog female × ps male cross were generated and used to infer recombination rates in the F<sub>1</sub> females. A maximum of thirty-two F<sub>2</sub> progeny from each vial were used to avoid results being overly influenced by any single vial.

### *Recombination Rate Assay:*

Recombination rate was measured at two windows located on opposite ends of chromosome 2 using four microsatellite markers (DPS2028, DPS2001, DPS2025, and DPS2003) that produce differentially sized products for the bog and ps alleles at each of the four loci. All primers pairs used can be found in Table 1 and were developed in either Noor *et al.* (2000) or Ortiz-Barrientos *et al.* (2006). The first window examined spanned from base pairs 1,515,714 through 4,807,929 of the assembly (Richards *et al.*, 2005), while the second window spanned from base pairs 22,978,798 through 29,200,493. Base pair positions are based on the November 2004 (Flybase 1.03/dp3) version of the *D. pseudoobscura* genome available on the UCSC genome browser.

Table 1. Primer pairs used to amplify variable microsatellite regions.

Primer Name	Forward	Reverse	Assembly Positions
DPS2028	tcagcctccgcttcgattg	cgctacctcgtacctatacagcat	1515714-1515878
DPS2001	caaagacagagccaaagcct	tgggcattaaagtgcaatca	4807736-4807929
DPS2025	tggcgatgttcaagtgtcaa	attatggaagcgatcgaagcg	22978798-22978990
DPS2003	cattcaagcagaagacgca	cctcgggtattattcggt	29200289-29200493

Genomic DNA from both parents and offspring was extracted using the single fly squish protocol (Gloor and Engels, 1992), and the four markers were amplified by PCR in 10 µl reaction volumes that consisted of 1× buffer, 0.2 mM dNTPs, 1.5 mM MgCl<sub>2</sub>, 0.5 µM forward primer with the M13 tag, 0.5 µM reverse primer, 700 or 800 IRD-labeled M13 tag, and 1U Taq polymerase. The touchdown PCR program consisted of a one minute 95°C denature step, followed by 3 cycles of 95°C, 56°C, and 72°C for 30, 30, and 45 seconds, respectively, 3 cycles of 95°C, 53°C, and 72°C for 30, 30, and 45 seconds, respectively, and 33 cycles of 95°C, 50°C, and 72°C for 30, 30, and 45 seconds, respectively. PCR products were then run on a 5% polyacrylamide gel using a LICOR 4300, and the genotypes were scored manually. Chi-square analyses were used to test for statistically significant differences in recombination rates between the two reciprocal crosses at both the DPS2028-DPS2001 and DPS2025-DPS2003 windows. A power analysis was also performed using a custom Perl script to determine the probability of finding a 4-5% or larger difference in recombination rate at each window given our sample size.

## Results and Discussion

Based on our power analysis, our sample size gave us approximately a 98% chance of detecting a real difference of 5% or larger and approximately a 90% chance of detecting a real difference of 4% or larger in recombination for the DPS2028-DPS2001 window. Likewise, we had approximately a 84% chance of detecting a real difference of 5% or larger and approximately a 65% chance of detecting a 4% or larger difference in recombination for the DPS2025-DPS2003 window. However, we observed only a 1.8% difference in recombination rate for the DPS2028-DPS2001 window and a 0.65% difference in recombination rate for the DPS2025-DPS2003 window between the F1 hybrid females with either the *D. ps. bogotana* or *D. ps. pseudoobscura* cytoplasm (Table 2). Neither of the two differences in recombination rates were statistically significant upon chi-square analysis ( $p < 0.10$  for both windows). Thus, even using crosses between strains from different subspecies, we fail to detect evidence that maternally-inherited cytoplasmic components contribute detectably to variation in recombination rates within *Drosophila pseudoobscura*.

Table 2. Recombination rates observed between the two reciprocal crosses of *D. ps. bogotana* and *D. ps. pseudoobscura*.

cytoplasm	DPS2028-DPS2001 window			DPS2025-DPS2003 window	
	# progeny	# recombinants	Kosambi centiMorgans	# recombinants	Kosambi centiMorgans
<i>bogotana</i>	1437	207	14.82 cM	431	34.65 cM
<i>MV2-25</i>	1435	181	12.89 cM	421	33.64 cM

**Acknowledgments:** We would like to thank B. Manzano-Winkler for comments on and technical assistance with this project, and M. Dubin for comments on the manuscript.

**References:** Adrian, A.B., and J.M. Comeron 2013, BMC Genomics 14: 794; Comeron, J.M., R. Ratnappan, and S. Bailin 2012, PLoS Genet. 8: e1002905; Coop, G., X. Wen, X. Ober, J.K. Pritchard, and M. Przeworski 2008, Science 319: 1395-1398; Drouaud, J., C. Camilleri, P.Y. Bourguignon, A. Canaguier, A. Berard, D. Vezon, S. Giancola, D. Brunel, V. Colot, B. Prum, H. Quesneville, and C. Mezard 2006, Genome Res. 16: 106-114; Dumont, B.L., and B.A. Payseur 2011, PLoS Genet. 7: e1002116; Fledel-Alon, A., E.M. Leffler, Y. Guan, M. Stephens, G. Coop, and M. Przeworski 2011, PLoS One 6: e20321; Gloor, G.B., and W.R. Engels 1992, Dros. Inf. Serv. 71: 148-149; McGaugh, S.E., C.S.S. Heil, B. Manzano-Winkler, L. Loewe, S. Goldstein, T.L. Himmel, and M.A.F. Noor 2012, PLoS Biol. 10(11): e1001422; Noor, M.A.F., M.D. Schug, and C.F. Aquadro 2000, Genet. Res. 75: 25-35; Ortiz-Barrientos, D., A.S. Chang, and M.A.F. Noor 2006, Genet. Res. 87: 25-31; Petes, T.D., 2001, Nat. Rev. Genet. 2: 360-369; Prakash, S., R.C. Lewontin, and J.L. Hubby 1969, Genetics 61: 841-858; Richards, S., Y. Liu, B.R. Bettencourt, P. Hradecky, S. Letovsky, *et al.*, 2005, Genome Res. 15: 1-18; Smukowski, C.S., and M.A.F. Noor 2011, Heredity 107: 496-508.



### Sperm transfer and the enigma of copulation duration in *Drosophila*.

**Castro-Vargas, Cynthia.** Biodiversification Genomics Laboratory, CINVESTAV-LANGEBIO, Guanajuato, Mexico.

*Drosophila* species exhibit tremendous variation in copulation duration (Markow, 1996). In some species, such as *D. arizonae*, a pair is *in copula* for only 1 or 2 minutes, while in others, such as *D. acanthoptera*, copulation lasts for 2 hours. Curiously, the differences among species in copulation duration do



not appear to correlate with any other known traits so that the variation in copulation duration remains a great enigma. Copulations that last longer expose the couple to risks of predation, however, so we assume that there is some important advantage to mating longer that offsets this risk.

Successful copulation involves the transfer of the ejaculate, including seminal fluid and sperm. But the timing of the transfer of the components is not well-known. For example, in *D. melanogaster*, which copulates for 20 minutes, early reports (LeFevre and Johnson, 1962) indicate that sperm transfer does not take place during the first 10 minutes, while some other studies dispute this (Gilchrist and Partridge, 2000). If sperm transfer is not taking place during the entire 20 minutes, and copulation is only a few minutes in other species, the function of longer copulations is enigmatic.

### Stock of flies and their rearing

I used two species, *D. melanogaster*, with a 20 minute copulation duration, and *D. hydei*, with a 2.5 minute copulation duration (Markow 1996) to examine the timing of sperm transfer during copulation. For the experiments with *D. melanogaster*, two strains from different geographic regions were used: SD-5, from San Diego, California, and S13 from Sinaloa, Mexico. For the experiments with *D. hydei*, only one strain was used: GTO 813-5, from Guanajuato. All flies were reared on banana medium with live yeast at  $24 \pm 1^\circ\text{C}$  with a 12 hour photoperiod.

### Timing of sperm transfer during copulation

Virgin females and males were separated and allowed to mature in separate medium vials until used in the experiments. Mature virgin females and males were paired and allowed to mate. At specific time points after copulation began (1, 3, 5, 10 minutes for *D. melanogaster* and 15, 20, 30, 60, 120 seconds for *D. hydei*) the pairs were separated. The female reproductive tract was removed and examined for sperm under the microscope. A minimum of 10 matings per time point were tested in order to reveal whether sperm are transferred continually or whether they are transferred early or late in the copulation.

### Results

Because female *D. melanogaster* had sperm at 10 minutes but not 5 minutes, I performed some additional matings and interrupted them between 5 and 10 minutes (Table 1). Although *D. melanogaster* mates for 20 minutes, sperm transfer clearly does not begin until 7 minutes and all females are not inseminated until 10 minutes have elapsed in both strains. In *D. hydei*, in which copulations last for only a few minutes, sperm transfer does not begin immediately either (Table 1).

Table 1. Sperm present in female reproductive tract after interruption at different time points during copulation.

Sperm present in dissected female?	Minutes after copulation is initiated (Number of females/ 10 sperm)									
	(min)	1	3	5	6	7	8	10	15	20
<i>D. melanogaster</i> SD_5		0/10	0/10	0/10	0/10	7/16	5/10	10/10	10/10	10/10
<i>D. melanogaster</i> S13		0/10	0/10	0/10	2/10	5/10	9/10	10/10	10/10	10/10
	(sec)	15	20	25	30	60	120			
<i>D. hydei</i> GTO 813-5		0/10	2/10	7/10	10/10	10/10	10/10			

### Discussion

Long lasting copulations exhibit costs in terms of time, energy, and predation vulnerability. In some Drosophilid species such as *D. melanogaster*, copulation duration has been reported to be determined by the male (MacBean and Parsons, 1967). Because sperm are not the only thing transferred during copulation, it is

possible that males are initially transferring seminal fluid components (proteins and other molecules) that are necessary for successful fertilization, storage, and use of their sperm. For instance, seminal fluid proteins (SFP) elicit post-mating changes in female physiology and behavior to the male's advantage, reducing female receptivity, increasing ovulation and egg production, or changing feeding behavior (Markow and Ankney, 1988; Ávila *et al.*, 2011; Chapman, 2001); therefore, males increase their offspring number by delaying remating in females. This clearly is not the case for *D. hydei*, because females remate up to four times in a single morning (Markow, 1985).

On the other hand, males could prolong copulation in order to increase their fertilization success by displacing the sperm from former copulations (LeFevre and Johnson, 1962). Given that females copulate with multiple mates, sperm belonging from different males interacts in the female reproductive tract, where sperm competition for predominance occurs (Gromko *et al.*, 1984; Gilchrist and Partridge, 2000; Clark, 2002). Accessory gland proteins (Acp's) present in the seminal fluid have shown to play an important role in this interaction (Harshman and Prout, 1994; Gilchrist and Partridge, 1995; Ram and Wolfner, 2007); however, the mechanisms by which Acp's help mediating sperm competition and sperm displacement remain unknown.

In comparison with *D. melanogaster*, *D. hydei* exhibits a short copulation duration. This represents a big advantage for females, who can increase their genetic variability by remating with different males. Males in many species, however, have developed strategies that offset the female remating. In many *Drosophila* species, a mating plug is formed within the female reproductive tract during or after copulation, which acts as a physical barrier for subsequent sperm or to prevent the loss of sperm (Bairati, 1968). Likewise, in some species of the repleta group, an insemination reaction mass is formed (Patterson, 1946; Markow and Ankney, 1988), and in other species, males transfer nutritional components to females (Markow *et al.*, 1990). Again, this is not the case in *D. hydei* so, if the chances of remating in this short copulation species are high and the males are not transferring any nutritional content in the sperm or forming a mating plug, why does this species exhibits a short copulation duration? It could be argued that given the giant sperm size in *D. hydei* (Pitnick and Markow, 1994a), males only transfer a few sperm to females (Pitnick and Markow, 1994b), therefore reducing the time *in copula*.

My results show no differences among *D. melanogaster* strains. Since copulation duration was recorded for only one strain of *D. hydei*, it would be interesting to analyze and compare another strain from a different location.

While the present study clearly demonstrates that sperm transfer does not begin immediately, the nature of the male-female interactions that take place prior to sperm transfer and the nature of long copulations remain to be studied.

References: Avila, F.W., L.K. Sirot, B.A. La Flamme, C.D. Rubinstein, and M.F. Wolfner 2011, *Annu. Rev. Entomol.* 56: 21–40; Bairati, A., 1968, *Monit. Zool. Ital.* 2: 105–182; Chapman, T., 2001, *Heredity* 87: 511–521; Clark, A.G., 2002, *Heredity* 88: 148–153; Fowler, G.L., 1973, *Adv. Genet.* 17: 293–360; Gilchrist, A.S., and L. Partridge 1995, *J. Insect Physiol.* 41: 1087–92; Gilchrist, A.S., and L. Partridge 2000, *Evolution* 54: 534–542; Gromko, M.H., D.G. Gilbert, and R.C. Richmond 1984, Sperm transfer and use in the multiple mating system of *Drosophila*. In: *Sperm competition and the Evolution of Animal Mating Systems* (Smith, L.R., ed.) Academic Press. 371–426; Lawrence, G., L.G. Harshman, and T. Prout 1994, *Evolution* 48: 758–766; Lefevre, G., and U.B. Jonson 1962, *Genetics* 47: 1719–1736; MacBean, I.T., and P.A. Parsons 1967, *Genetics* 56: 233–239; Markow, T.A., 1985, *Anim. Behav.* 33: 775–781; Markow, T.A., and P. Ankney 1988, *Evolution* 42: 1097–1100; Markow, T.A., P.D. Gallagher, and R.A. Krebs 1990, *Funct. Ecology* 4: 67–73; Markow, T.A., 1996, *Evol. Biol.* 29: 73–106; Patterson, J.T., 1946, *Proc. Natl. Acad. Sci.* 32: 202–208; Pitnick, S., and T.A. Markow 1994a, *Proc. Natl. Acad. Sci. U.S.A.* 91: 9277–9281; Pitnick, S., and T.A. Markow 1994b, *Amer. Nat.* 143: 785–819; Ram, K.R., and M.F. Wolfner 2007, *Integr. Comp. Biol.* 47: 427–445.



## The discrimination of sibling fruit fly species *Drosophila ananassae* and *D. malerkotliana* (Diptera, Drosophilidae) through wing traditional morphometry.

Gonçalves<sup>1</sup>, Michele S., Monica L. Blauth<sup>2</sup>, Alessandra R. Butnariu<sup>1</sup>, and Marco S. Gottschalk<sup>2\*</sup>

<sup>1</sup>Departamento de Ciências Biológicas, Universidade do Estado de Mato Grosso (UNEMAT), Campus de Tangará da Serra, Tangará da Serra, MT, Brasil. <sup>2</sup>Departamento de Ecologia, Zoologia e Genética, Instituto de Biologia, Universidade Federal de Pelotas (UFPel), Pelotas, RS, Brasil. \*Corresponding Author: gotts007@yahoo.com

### Introduction

*Drosophila (Sophophora) ananassae* Doleschall 1858 and *D. (S.) malerkotliana* Parshad and Paika 1964 are widespread Drosophilidae fruit fly species (Bächli, 2014). *Drosophila malerkotliana* has two subspecies, *D. malerkotliana malerkotliana* and *D. malerkotliana pallens*, but the latter has been recorded only in Borneo and the Philippines (Bock and Wheeler, 1972). In Brazil, *D. ananassae* is particularly associated with human habitation (Pavan, 1959), whereas *D. malerkotliana* may be collected in forests (Sene *et al.*, 1980; Tidon and Sene, 1992; Martins, 2001), open vegetation (Tidon, 2006) or disturbed areas (Gottschalk *et al.*, 2007). As suggested by Tidon and Sene (1999), the few records of *D. ananassae* in Brazil may be the result of the difficulty of species identification rather than a low frequency of occurrence. Because the females of these species display very similar abdominal pigmentation patterns, they are indistinguishable by traditional means of external morphological analysis. In contrast, the males are distinguishable by differences in their abdomen color and the morphology and coloration of the sex comb teeth: *D. malerkotliana* males display a black abdomen and black sex comb teeth, as opposed to the yellow abdomen and yellowish and more numerous sex comb teeth of *D. ananassae* males.

The misidentification of sibling species may cause an underestimation of biodiversity or produce erroneous conclusions about species' life history, ecology, and genetics. In this context, morphometric analyses have been an efficient and sensitive method for discriminating between morphologically similar species by detecting small variations in individual morphology (Klaczko and Bitner-Mathé, 1990; Carreira *et al.*, 2006). Among the morphological traits of *Drosophila*, wings are particularly useful structures with a conserved venation pattern that allows the location of many well-defined landmarks and allows more accurate measurements than other body structures (Klingenberg, 2002; Houle *et al.*, 2003; Debat *et al.*, 2008). Although factors such as temperature, larval competition, sex, and karyotype influence wing morphology in Drosophilidae (De Moed *et al.*, 1997; Hatadani and Klackzo, 2008), studies have shown that wings strongly respond to natural selection, providing a good taxonomic marker and, therefore, identifying characteristics for sibling species (Macdonald, 2002; Moraes *et al.*, 2004ab; Franco *et al.*, 2006; Prado *et al.*, 2006; Lyra *et al.*, 2010).

The difficulty of identifying *D. ananassae* and *D. malerkotliana* females in taxonomic surveys motivated the current comparative study, which aimed to verify the use of traditional wing morphometry and of the costal index in the identification of these species and to evidence some aspects of the wings evolution of these species.

### Material and Methods

#### *Collection and establishment of isofemale lines*

Drosophilidae were collected in the Brazilian Cerrado Biome (14°65'20"S; 57°43'37"W) with traps baited with banana and yeast (*Saccharomyces cerevisiae*) following the Tidon and Sene (1988) methodology. The captured flies were anesthetized and screened under a stereomicroscope (Tecnal-ME, SZ). Each *D. ananassae* and *D. malerkotliana* female was individually placed in a culture vial containing 3 mL of culture

medium prepared with 5% rye flour, 10% yeast, 10% sugar, and 1% agar, and maintained at 25°C. Because the identification of the *D. ananassae* and *D. malerkotliana* females is imprecise, the male offspring were used for species determination. The F1 offspring of ten isofemale lines of each species were transferred to 30 mL of culture medium. The F2 individuals were preserved in 70% ethanol prior to their use in the wing morphometry analyses.

#### *Wing landmarks measurements*

Individual wings from ten males and ten females from the F2 generation of each isofemale line were mounted on a microscope slide. Images of the wings were captured with a digital camera (Dino-Eye) connected to an optical microscope (NIKON E200) at 40× magnification. Image-Pro Plus 4.5 software was used to measure the distance between landmarks. Nine measurements were taken between external landmarks (**ab**, **ac**, **ad**, **ae**, **af**, **bc**, **cd**, **de** and **ef**), and four measurements were taken between internal landmarks (**gh**, **hi**, **ij** and **jk**) (Figure 1).

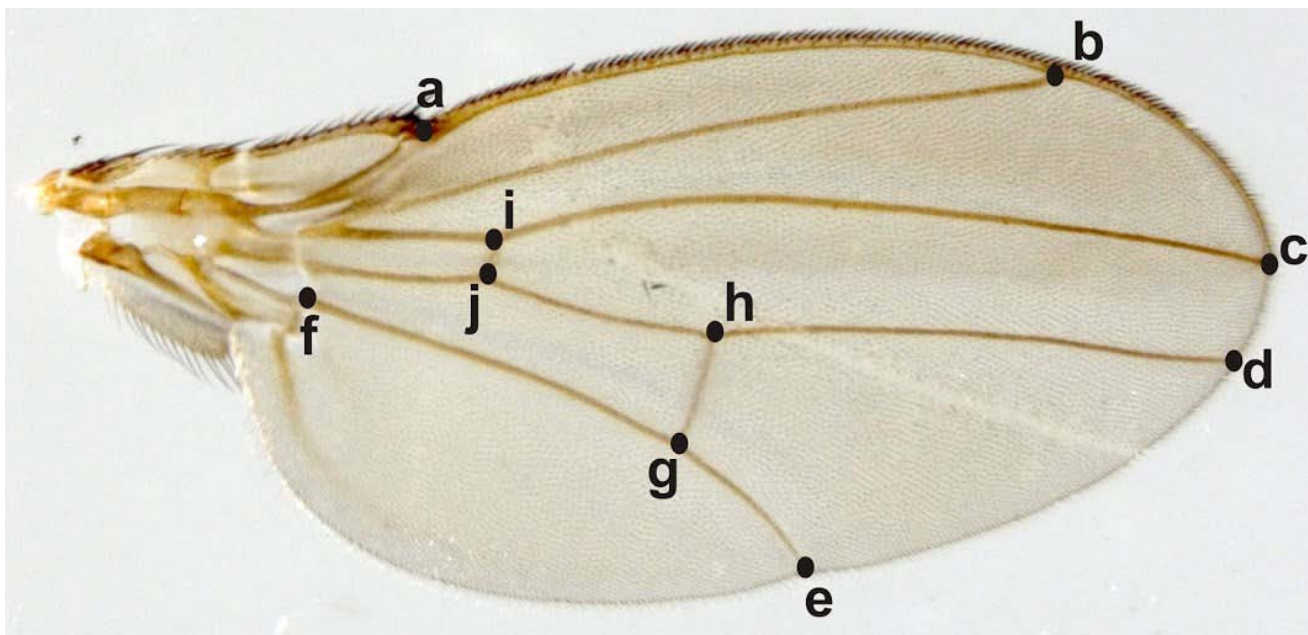

Figure 1. Wing landmarks.

#### *Analysis of the measurements between landmarks*

The wing measurements, after a logarithmic transformation, were analyzed with a principal component analysis (PCA) on the total variance-covariance matrix. To compare the wing size between species and sexes we conducted Mann-Whitney tests to verify the differences of the first PCA component. To detect any influence of the isofemale line heritability, Mann-Whitney tests were carried out using the PC1, PC2, and PC3 scores among the isofemale lines within each species and sex. A discriminant analysis was performed to evaluate the percentage of correct reclassifications of individuals by species and sex using the three first components obtained on the PCA. A Hotelling test was performed to evaluate the differences between the tested groups. The sexual dimorphism ratio (SD) was calculated to the average of each measurement (females/males).

The costal index (the ratio between the second and third section of the costal vein, **ab/bc**) was calculated for each individual, and the results were also compared using a Mann-Whitney tests between species and sex. We conducted a Spearman correlation test to evaluate the relationship of the costal index with PC1 (wing size). The Bonferroni correction was applied for all analyses, and the analyses were performed using PAST 1.82 software (Hammer *et al.*, 2001).

Table 1. Measurements between wing landmarks in mm (mean  $\pm$  standard deviation) and sexual dimorphism ratio (SD) in *D. ananassae* and *D. malerkotliana*.

Landmarks	<i>D. ananassae</i>			<i>D. malerkotliana</i>		
	Male	Female	SD	Male	Female	SD
ab	2.07 $\pm$ 0.11	2.25 $\pm$ 0.12	1.09	1.81 $\pm$ 0.09	2.09 $\pm$ 0.10	1.15
ac	3.20 $\pm$ 0.18	3.51 $\pm$ 0.15	1.10	2.64 $\pm$ 0.12	3.00 $\pm$ 0.11	1.14
ad	3.15 $\pm$ 0.14	3.45 $\pm$ 0.14	1.10	2.58 $\pm$ 0.12	2.91 $\pm$ 0.14	1.13
ae	2.14 $\pm$ 0.10	2.31 $\pm$ 0.08	1.08	1.76 $\pm$ 0.08	1.96 $\pm$ 0.08	1.11
af	0.77 $\pm$ 0.06	0.84 $\pm$ 0.04	1.09	0.61 $\pm$ 0.03	0.69 $\pm$ 0.03	1.13
bc	1.39 $\pm$ 0.06	1.49 $\pm$ 0.06	1.07	1.06 $\pm$ 0.05	1.16 $\pm$ 0.04	1.09
cd	0.46 $\pm$ 0.02	0.48 $\pm$ 0.03	1.04	0.40 $\pm$ 0.02	0.42 $\pm$ 0.03	1.05
de	1.73 $\pm$ 0.09	1.91 $\pm$ 0.09	1.10	1.39 $\pm$ 0.07	1.58 $\pm$ 0.07	1.14
ef	2.08 $\pm$ 0.11	2.26 $\pm$ 0.08	1.09	1.69 $\pm$ 0.08	1.91 $\pm$ 0.08	1.13
gh	0.34 $\pm$ 0.02	0.37 $\pm$ 0.02	1.09	0.27 $\pm$ 0.02	0.30 $\pm$ 0.02	1.11
hi	0.88 $\pm$ 0.04	0.97 $\pm$ 0.04	1.10	0.67 $\pm$ 0.03	0.74 $\pm$ 0.03	1.10
ij	0.20 $\pm$ 0.17	0.19 $\pm$ 0.01	0.95	0.13 $\pm$ 0.01	0.14 $\pm$ 0.01	1.08
jg	0.96 $\pm$ 0.04	1.04 $\pm$ 0.04	1.08	0.72 $\pm$ 0.04	0.81 $\pm$ 0.03	1.13

## Results

The averages of the measurements between the wing landmarks for each sex of *D. malerkotliana* and *D. ananassae* are displayed in Table 1.

The PCA identified three principal axes that explained 89.2% (PC1), 3.6% (PC2) and 1.7% (PC3) of the total variation in the data. The PC1 axis primarily represented the size of the wing and was highly correlated with all of the measurements (see scores for PC1 in Table 2). The PC2 and PC3 were more strongly correlated with the **ij** and **ab** measurements, respectively (Table 2 and Figure 2). Males of *D. malerkotliana* have more differentiated wing shape, while females of *D. malerkotliana* and males and females of *D. ananassae* have more similar PC2 and PC3 values.

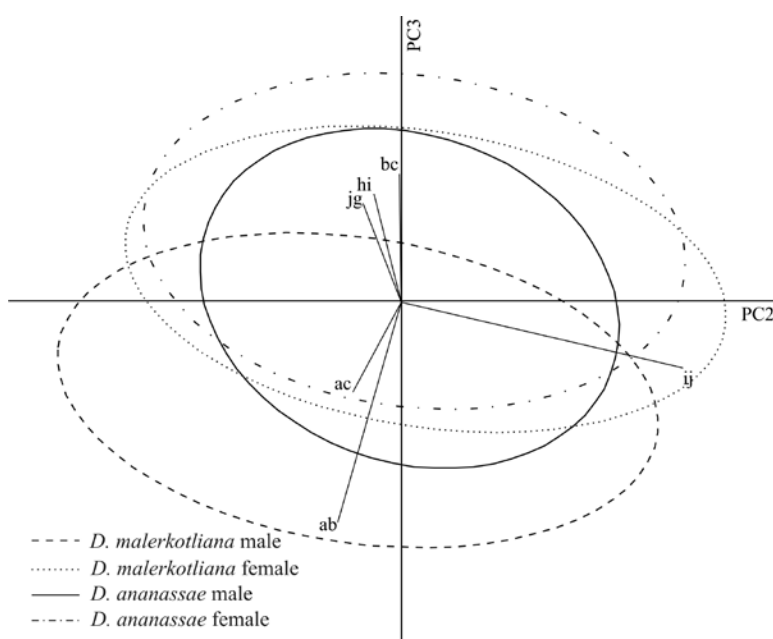

Figure 2.

The Mann-Whitney tests with the PC1 comparing species and sexes showed significant differences between all of the comparisons ( $p < 0.0001$  for all pairwise comparisons), and *D. ananassae* has larger wings than *D. malerkotliana* and females have larger wings than males.

In the discriminant analysis, both species were 100% correctly reclassified ( $p < 0.001$  for both sexes in the Hotelling tests) when the three first principal components were used. When only PC2 and PC3 were used, the success of the discriminant analysis decayed to 64.0% correctly reclassified

Table 2. Scores of the three first components of PCA conducted with the measurements between the wing landmarks.

Distances	PC1	PC2	PC3
ab	-0,18	0,21	-0,65
ac	-0,25	0,16	-0,27
ad	-0,26	0,12	-0,20
ae	-0,25	0,11	-0,10
af	-0,28	0,03	0,09
bc	-0,31	0,01	0,38
cd	-0,19	0,05	-0,01
de	-0,28	0,12	-0,17
ef	-0,26	0,15	-0,10
gh	-0,31	-0,01	0,18
hi	-0,33	0,09	0,32
ij	-0,33	-0,92	-0,20
jg	-0,33	0,13	0,29

Table 3. Costal index (mean  $\pm$  standard deviation) of *D. ananassae* and *D. malerkotliana*.

Costal index	Male	Female
<i>D. ananassae</i>	1.49 $\pm$ 0.07	1.50 $\pm$ 0.07
<i>D. malerkotliana</i>	1.70 $\pm$ 0.08	1.79 $\pm$ 0.09

## Discussion

*Drosophila ananassae* and *D. malerkotliana* females are morphologically very similar, and the distributions of these species in the tropical and equatorial regions overlap (Bächli 2014). The correct identification of these species is important due to their invasive character and because the *D. ananassae* species subgroup has been widely used as a model in population and evolutionary genetics (Matsuda *et al.*, 2009). The present study suggests that traditional wing morphometry could be used in the identification of *D. ananassae* and *D. malerkotliana*; once we noted the difference in wing size and shape, the discriminant analysis using PC1, 2, and 3 reclassified 100% of the flies correctly.

The principal source of wing variation between the sexes and species was size, as demonstrated by the PC1, which explained 89.2% of the variation. Consistent with previous studies, size was the principal variable character for wing sexual dimorphism (Gidaszewski *et al.*, 2009) among species (Morales *et al.*, 2004ab) and even populations or lineages (Bitner-Mathé and Klaczko, 1999, Hatadani and Klaczko, 2008).

In this study, we established ten isofemale lines of each species from recent samples. No differences in wing size and shape were observed between the lines (with one exception in *D. malerkotliana*), suggesting that our results are showing a lower intraspecies rather than interspecies variation. In general, *D. malerkotliana* have higher intraspecies variation, as evidenced by the larger ellipses in the PCA graphic and the lower correlation strengths of the measurements.

As expected, the wings of the females were larger than the wings of the males (Teder and Tammaru, 2005). These authors also verified that the sexual differences in size increased with the species' body size in several insect species; however, a higher wing size dimorphism was observed in *D. malerkotliana*, the smaller studied species. In general, sexual dimorphism in *D. malerkotliana* is more pronounced than in *D. ananassae*,

for males and 78.5% correctly reclassified for females ( $p < 0.001$  for both in Hotelling tests).

Despite the morphometry analysis being quite reliable, we also investigated the possibility of using some measurement identified in the PCA as diagnostic. The measurement **ab** differed between females of *D. ananassae* and *D. malerkotliana*. This measurement comprises the costal index, commonly used as diagnostic character of species of *Drosophila*. The averages and standard deviations of the costal index are shown in Table 3. The costal index was also inversely proportional to the PC1 ( $r_s = -0.63$ ,  $p < 0.0001$ ), showing that the index value was positively correlated with the wing size since all the measures have negative scores on PC1 (Table 2). *Drosophila malerkotliana* had higher values of costal index than *D. ananassae*, and this ratio was higher in the females of both species. The Mann-Whitney tests comparing the values of costal index between species and sexes showed differences between the species in both sexes and between males and females of *D. malerkotliana* ( $p < 0.0001$  for all comparisons). The males and females of *D. ananassae* did not differ significantly ( $p = 0.56$ ). In addition, the sexual dimorphism ratio (SD) in *D. malerkotliana* is higher for all measurements than in *D. ananassae* (Table 1).

The Mann-Whitney tests to assess the variation between isofemale lines in each studied species showed no significant differences in almost all of the comparisons. One isofemale line of *D. malerkotliana* showed significant differences from the other five lineages ( $0.036 > p > 0.001$ ).

especially in the abdominal pigmentation, where males have almost all black tergites while females have yellow tergites.

Wing shape did not differ greatly between *D. ananassae* and *D. malerkotliana*, which supports the idea of canalization or stabilizing selection restricting wing shape divergence (Gilchrist and Partridge, 2001). Our results showed isometric growth of the measurements, even the **ij** and **ab**, the measurements that most correlated with PC2 and PC3. As observed by Hatadani and Klaczko (2008), the displacement of the landmarks **b**, **c**, and **d** is the main factor responsible for the shape variation of *D. mediopunctata* lineage, and our results agree, in part, when **ab** and **bc** are the measurements most related to PC3; however, the **ij** measurement is also important for shape differentiation of *D. malerkotliana* and *D. ananassae* species.

Based on the foregoing, we calculate the costal index (**ab/bc**), a morphological taxonomic trait used in *Drosophila* species identification (Vilela 1983). The costal index differs significantly between *D. ananassae* and *D. malerkotliana*, supporting the use of the index in species identification. We propose costal index values of 1.79 and 1.50 for females of *D. malerkotliana* and *D. ananassae*, respectively, and 1.70 and 1.49 for *D. malerkotliana* and *D. ananassae* males, respectively. Although a previous study did not report differences in the costal index for individuals of both species collected in Kulu and Chandigarh, India (Parshad and Paika 1964), our study suggests that the costal index is relevant. Another important consideration of the present study was to establish the costal index for each gender. Finally, the morphological study of populations is important to aid in species identification, as stated by Parshad and Singh (1971), who reported a costal index of 1.46 for the *D. ananassae* population of the South Andamans, India, in contrast with the value of 1.54 established for the *D. ananassae* populations of Kulu and Chandigarh, India. However, for our proposal of identification of females of sibling species, the costal index and the wing size are informative characteristics for *D. ananassae* and *D. malerkotliana*.

**Acknowledgments:** We thank Prof. Dr. Waldo Troy and Prof. Dr. Anderson Fernandes for their technical support. We also thank Prof. M.Sc. Eduardo Bessa for valuable comments on the study.

#### References:

- Bächli, G., 2014, TaxoDros: The Database on Taxonomy of Drosophilidae. Database 2014/09; Bitner-Mathé, B.C., and L.B. Klaczko 1999, *Genetica* 105: 35-42; Bock, I.R., and M.R. Wheeler 1972, *Texas Univ. Publ.* 7217: 1-102; Carreira, V.P., I.M. Soto, E. Hasson, and J.J. Fanara 2006, *J. Evol. Biol.* 19: 1275-1282; De Moed, G.H., G. de Jong, and W. Scharloo 1997, *Genet. Res.* 70: 35-43; Debat, V., R. Cornette, A.B. Korol, E. Nevo, D. Soulet, and J.R. David 2008, *J. Genet.* 87: 407-419; Franco, F.F., A.L.H. Esguicero, E.C.C. Silva-Bernardi, F.M. Sene, and M.H. Manfrin 2006, *Dros. Inf. Serv.* 89: 7-9; Gilchrist, A.S., and L. Partridge 2001, *Heredity* 86: 144-152; Gidaszewski, N.A., M. Baylac, and C. Klingenberg 2009, *BMC Evol. Biol.* 9: 110; Gottschalk, M.S., D.C. De Toni, V.L.S. Valente, P.R.P. Hofmann 2007, *Neotrop. Entomol.* 36: 848-862; Hammer, O., D.A.T. Harper, and P.D. Ryan 2001, *Palaeontol. Electron.* 4: 9; Hatadani, L.K., and L.B. Klaczko 2008, *Genetica* 133: 335-342; Houle, D., J. Mezey, P. Galpern, and A. Carter 2003, *BMC Evol. Biol.* 3: 25; Klaczko, L.B., and B.C. Bitner-Mathé 1990, *Nature* 346: 321; Klingenberg, C.P. 2002, *Gene* 287: 3-10; Lyra, M.L., L.M. Hatadani, A.M.L. de Azeredo-Espin, and L.B. Klaczko 2010, *Bull. Entomol. Res.* 100: 19-26; Macdonald, S.J., 2002, *Dros. Inf. Serv.* 85: 31-34; Martins, M.B., 2001, *Guilds of Drosophilids on Forest Fragments*, p. 175-186. *In: Lessons from Amazonia. The ecology and conservation of a fragmented forest.* (Bierregaard, R.O., C. Gascon, and T.E. Lovejoy, eds.). Yale, Yale University, xv+478 p.; Matsuda, M., C.S. Ng, M. Doi, A. Kopp, and Y.N. Tobar 2009, *Fly* 3: 157-169; Moraes, E.M., M.H. Manfrin, A.C. Laus, R.S. Rosada, S.C. Bomfim, and F.M. Sene 2004a, *Heredity* 92: 466-473; Moraes, E.M., V.L. Spressola, P.R.R. Prado, L.F. Costa, and F.M. Sene 2004b, *J. Zool. Syst. Evol. Res.* 42: 154-158; Parshad, R., and I.J. Paika 1964, *Res. Bull. Panjab Univ.* 15: 225-255; Parshad, R., and A. Singh 1971, *Res. Bull. Panjab Univ.* 22: 385-399; Pavan, C., 1959, *Bol. Fac. Filos. Cienc. Let., Univ. São Paulo* 221: 1-81; P.R.R., L.F. Costa, E.M. Moraes, M.H. Manfrin, and F.M. Sene 2006, *Braz. J. Morphol. Sci.* 23: 333-342; Sene, F.M., F.C. Val, C.R. Vilela, and M.A.Q.R. Pereira 1980, *Pap. Avulsos de Zoo.* 33: 315-326; Teder, T., and T. Tammaru 2005, *Oikos* 108: 321-334; Tidon, R., and F.M. Sene 1988, *Dros. Inf. Serv.* 67: 89; Tidon, R., and F.M. Sene 1992, *Rev. Bras. Biol.* 52: 311-317; Tidon, R., and F.M. Sene 1999, *Diptera: Drosophila. In: Biodiversidade do Estado de São Paulo, Brasil, Síntese do Conhecimento ao final do século XX: Invertebrados terrestres.* (Brandão, C.R.F., and E.M. Cancellato). São Paulo, FAPESP, 5+279, p. 247-261; Tidon, R., 2006, *Biol. J. Linn. Soc.* 87: 233-247; Vilela, C.R., 1983, *Rev. Bras. Entomol.* 27: 1-114.



## A combination of dimethyl sulfoxide (DMSO) and methyl paraben (nipagin) in *Drosophila* food affects survival rate.

Anjalika, Chongtham, Nidhi Paliwal, Kumari Aditi, Akanksha Raj, and Namita Agrawal\*. Department of Zoology, University of Delhi, Delhi, India-110007;

\*Communicating author

### Introduction

Huntington's disease (HD) is a dominant, late-onset neurodegenerative disease caused by an expansion of a homopolymeric polyglutamine (polyQ) tract within the disease-specific huntingtin (Htt) protein (The Huntington's Disease Collaborative Research Group). HD portrays a clinical condition, which is characterised by the selective and progressive loss of neurons, eventually leading to cognitive, behavioral, and physical defects that can ultimately cause the death of the diseased individual (Beal *et al.*, 2005).

At present, there is no cure or effective therapeutic strategy for HD or other neurodegenerative diseases. Administration of plant-derived compounds or 'phytochemicals' that can target multiple cellular functions and processes are anticipated to achieve better therapeutic efficacy with minimal or no side effects as opposed to mono-targeted agents or synthetic drugs in the treatment of multi-faceted neurodegenerative diseases.

In our attempt to test the efficacy of phytochemicals in alleviating disease symptoms, we performed pilot experiments using a *Drosophila* model of Huntington's disease to investigate if both dimethyl sulfoxide [(CH<sub>3</sub>)<sub>2</sub>S; DMSO] and methyl paraben (HOC<sub>6</sub>H<sub>4</sub>CO<sub>2</sub>CH<sub>3</sub>; nipagin) at intended concentrations can be administered without any undesirable effects. DMSO is an organosulfur, polar, aprotic compound, which is commonly used as a solvent for the dissolution of a wide range of polar and nonpolar molecules (Szmant, 1975). DMSO has the unique capability to penetrate living tissues without causing significant damage. Due to its broad solubilising property, DMSO is used as a solvent for many drug molecules and is also employed as the vehicle control-of-choice for both *in vitro* and *in vivo* studies. The phytochemical we wanted to test was dissolved in DMSO which was thoroughly mixed with regular *Drosophila* food containing nipagin also. Nipagin is one of the member of family of parabens (methyl, ethyl, butyl, heptyl, and benzyl parabens) and is commonly used in *Drosophila* food as an anti-microbial agent. Parabens are particularly active against bacteria, yeast and moulds. Their key mechanisms of action include inhibition of membrane transport and mitochondrial function.

It has been reported that increasing doses of DMSO exhibit toxicity above which survival is reduced (Agrawal *et al.*, 2005). However, we observed that a safe dose of DMSO in combination with nipagin is toxic as revealed by significantly reduced eclosion rate of wild type flies (*Canton S*). Similar results were observed in our experiments in which the control male flies not expressing mHtt (internal control) and female flies expressing the mutant protein also displayed reduced survival.

In order to check the reason for the reduced eclosion, we conducted a series of experiments and found that safe dose of DMSO alone did not affect the survival rate of the flies but if added along with the safe dose of nipagin then it resulted in significant reduction in eclosion rate. Although DMSO is an excellent solvent for a wide variety of drugs employed in biomedical research, caution is required when added with food ingredients of *Drosophila* while designing and interpreting experiments.

### Results

*A non-toxic dose of DMSO in combination with nipagin causes lethality in transgenic flies* Transgenic *Drosophila* models of neurodegenerative diseases, including Huntington's disease mimic most of the major phenotypes associated with the disease, such as reduced eclosion rate, reduced longevity, impaired mobility, and neurodegeneration (Steffan *et al.*, 2001; Richards *et al.*, 2011). During the attempt to test effect of



phytochemical, we found that 0.1 % DMSO (safe dose) in combination with 0.03% nipagin (safe dose to prepare regular *Drosophila* food) displayed only 6% eclosion of flies expressing the first exon of Htt with 93 glutamine residues (Httex1p Q93, mHtt), *i.e.*, diseased flies and 56.67% eclosion of control flies not expressing Htt (Figure 1a). On the contrary, normal eclosion rate of both Httex1p Q93 as well as control flies was observed when transgenic flies were grown in standard food (Figure 1a) or food without nipagin but with DMSO (data not shown).

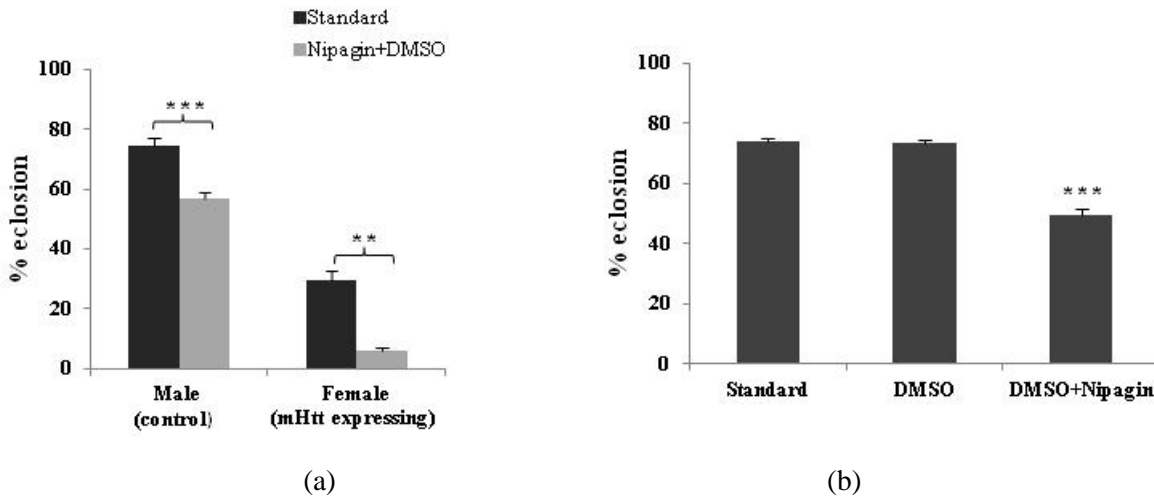

Figure 1. Administration of DMSO in combination with nipagin results in toxicity. (a) DMSO in combination with nipagin significantly reduces viability in control (male) as well as mutant Htt (mHtt) expressing flies (female). (b) The eclosion of wild type flies was affected by DMSO and nipagin in combination, while DMSO alone did not affect their survival. Flies were grown at  $25 \pm 0.5^\circ\text{C}$ . \*\*\*,  $P << 0.001$ ; \*\*,  $P < 0.01$ .

#### *DMSO with nipagin reduces the survival of wild type flies*

Our results clearly indicate that feeding DMSO in combination with nipagin results in detectable toxic effect in control as well as in mHtt (diseased) flies. To further validate our results with the diseased flies, we then investigated if a combination of DMSO (0.1%) and nipagin (0.03%) produces any unwanted toxic effect in wild type flies (Figure 1b). We found similar reduced eclosion of wild type flies reared in food with both DMSO and nipagin. Eclosion remained unaffected when flies were grown in food devoid of nipagin but containing DMSO at 0.1%. Therefore, DMSO by itself at a dose of 0.1% does not cause toxicity and can be safely administered to flies without adding nipagin in the food.

## Materials and Methods

### *Drosophila stocks*

The polyglutamine expressing transgenic line used in the present study was  $w; P\{UAS-Httex1p Q20\}4F1$ . These flies were mated with the pan-neuronal elav driver  $w; P\{w^{+mW.hs}=GawB\}elavC155$ . The wild type line used for the experiments was *Canton S*.

### *Survival assay*

UAS-Httex1p Q93 females were mated with elav-GAL4 males and the eggs were transferred to standard *Drosophila* food containing 0.03 % nipagin (39231, SDFCL), secondly with 0.1 % DMSO ((D5879, Sigma) alone, and third with nipagine and DMSO. The ratio of eclosed adults to eggs of the same genotype (males and females) was taken as a measure of survival. For every condition, at least 6 vials with 100 eggs in each were scored.

### Statistical procedure

Throughout this paper, error bars indicate standard error of the mean (SEM = standard deviation / square root of n). Student's t-test was performed for pair wise comparisons.

References: Agrawal, N., J. Pallos, N. Slepko, B.L. Apostol, L. Bodai, L.W. Chang, A.S. Chiang, L.M. Thompson, and J.L. Marsh 2005, Proc. Natl. Acad. Sci. U S A. 102: 3777–3781; Beal, M.F., A.E. Lang, and A.C. Ludolph 2005, *Neurodegenerative Diseases: Neurobiology, Pathogenesis and Therapeutics*. Cambridge University Press: UK; Richards, P., [C. Didszun](#), [S. Campesan](#), [A. Simpson](#), [B. Horley](#), [K.W. Young](#), [P. Glynn](#), [K. Cain](#), [C.P. Kyriacou](#), [F. Giorgini](#), and [P. Nicotera](#) 2011, Cell Death Differ. 18 (2): 191–200; Steffan, J.S., L. [Bodai](#), J. [Pallos](#), M. [Poelman](#), A. [McCampbell](#), B.L. [Apostol](#), A. [Kazantsev](#), E. [Schmidt](#), Y.Z. [Zhu](#), M. [Greenwald](#), R. [Kurokawa](#), D.E. [Housman](#), G.R. [Jackson](#), J.L. [Marsh](#), L.M. [Thompson](#) 2001, Nature 413 (6857): 739–743; Szmant, H.H., 1975, Ann. N. Y. Acad. Sci. 243: 20–23; The Huntington's Disease Collaborative Research Group, 1993, Cell 72: 971–983.



### Silver nanoparticle affects flying ability of fruit flies.

**Raj, Akanksha<sup>1</sup>, Prasanna Shah<sup>2</sup>, and Namita Agrawal<sup>\*</sup>**. <sup>1</sup>\*Department of Zoology, University of Delhi, Delhi, India-110007; <sup>2</sup>Acropolis Institute of research and technology, Indore, India; <sup>\*</sup>Communicating author.

### Introduction

With the growing knowledge and advancement of nanotechnology, nanoparticles are being ubiquitously utilized in a wide array of applications including consumer goods, construction, food industry, and medicine. The extraordinary feature that makes nanoparticles act differently than bulk counterparts is their relative size in the scale of nanometers, which offers larger surface area for enhanced reactivity (Nam *et al.*, 2008). Silver nanoparticle (SNP) is one of the commonly used nanoparticles that is known for its anti-microbial property (Sharma *et al.*, 2009; Chen *et al.*, 2008). However, several reports using *Drosophila* as a model system suggest that higher dose of SNP compromise behavioral activities such as climbing of *Drosophila* (Key *et al.*, 2011). Flight is the integral behavior found in insects and is vital for performing various activities such as mating, migrating in search of food, and so forth. The influence of SNP on the basic fundamental behavior of *Drosophila*, *i.e.*, flight is largely unknown at this stage. In view of this, the impact of silver nanoparticles on flight of *Drosophila melanogaster* has been successfully monitored by modifying the experimental set up from the existing ones (Sadaf *et al.*, 2012; Sherwood *et al.*, 2004; Wojtas *et al.*, 1997).

### Methodology

The flight assay was performed by placing a set up where an empty vial containing flies was positioned in the center of the beaker (14.5 cm in diameter). The beaker was half filled with water to create a barrier between the vial containing flies and the wall of beaker. The inner side of the beaker was coated with yeast paste in order to attract the flies. The beaker containing the vial was placed in a large enclosure (23 cm in diameter) for 40 minutes. Flight ability was determined by releasing flies from the vial and counting the numbers of flies that flew and crossed the water barrier and sitting on the walls of beaker or enclosure were scored as flyers. However, the flies still wandering in the vial or drowned in the water surrounding the vial were considered as non-flyers. Flies were collected in batches of 30 and starved for 1 hour before conducting this assay (Figure 1).

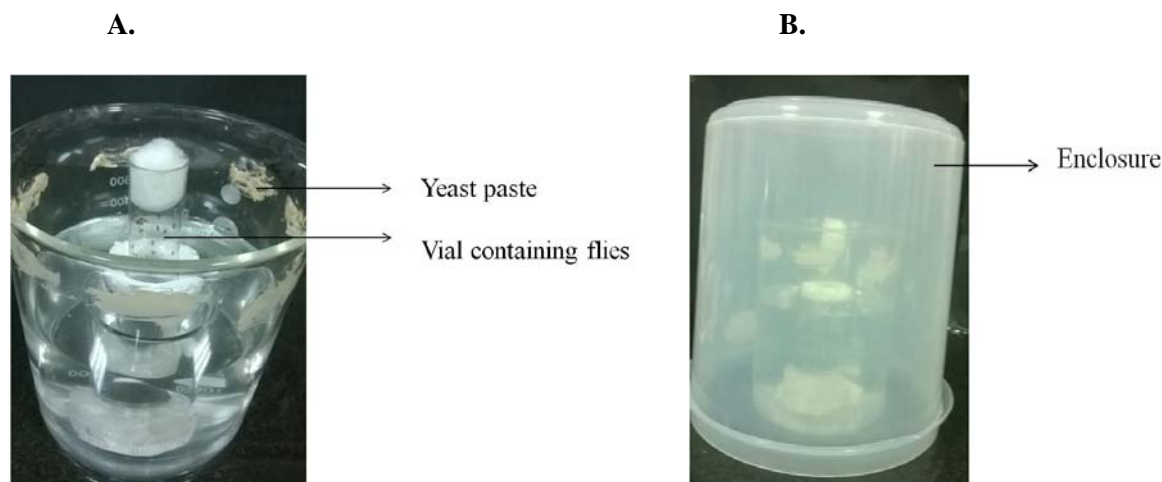

Figure 1. Experimental setup for flight assay. A, without enclosure; B, with enclosure.

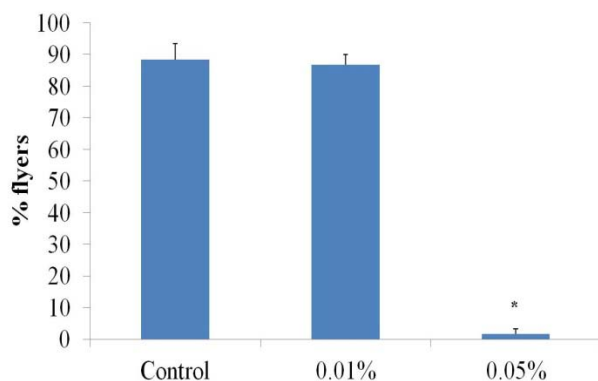

Figure 2. Dose-dependent effect of SNP on flying behavior of flies reared on SNP-supplemented food. \*,  $P < 0.02$ .

## Results

A significant decline in the flying ability was observed in the flies reared on SNP supplemented food (Figure 2). The percentage of flies reared at 0.01% SNP could cross the water barrier like the non-fed ones; however, at a higher concentration of SNP (0.05%), a significant decrease in flying ability was observed when compared with the control flies. At 0.05% SNP, 98% (approximately) of flies got either drowned in the water or they were wandering in the vial.

## Discussion

Flight assay which is being modified by us is a good measure of flying ability of flies. Exposure to higher concentration of SNP throughout the development led to a significant loss in flying ability suggesting that silver nanoparticles might be interfering with the pathway responsible for flight. Flight deficit has been implicated to be caused due to loss of neurons and synaptic activity (Agrawal *et al.*, 2015; Sadaf *et al.*, 2012; Sherwood *et al.*, 2004) or intervention in the functioning of flight muscles (Wojtas *et al.*, 1997). Since nanoparticles may diffuse across the biological membranes (Chen *et al.*, 2008) and thereby opens a new gateway towards detailed understanding of the mechanism through which SNP might disrupt flight.

**Acknowledgment:** We sincerely thank Dr. Punita Nanda for the discussion and technical help. The financial support from the UGC, New Delhi, in the form of Senior Research Fellowship (SRF) to Akanksha Raj is gratefully acknowledged.

**References:** Agrawal, T., G. Hasan 2015, eLife 4:e07046. doi: 10.7554/eLife.07046; Chen, X., and H.J. Schluesener 2008, Toxicol. Lett. 176: 1-12; Key, S.C.S., D. Reaves, F. Turner, and J.J. Bang 2011, Atlas J. Biol. 1: 52-61; Nam, J.Y., and J.R. Lead 2008, Sci. Total Environ. 400: 396-414; Sadaf, S., S. Birman, and G. Hasan 2012, PLoS ONE 7(9): e46405 doi:10.1371/journal.pone.0046405; Sharma, V.K., R.A. Yngard, and Y. Lin 2009, Adv. Colloid Interface Sci. 145: 83-96; Sherwood, N.T., Q. Sun, M. Xue, B. Zhang, and K. Zinn 2004, PLoS Biol. 2(12): e429; Wojtas, K., N. Slepecky, L.V. Kalm, and D. Sullivan 1997, Mol. Biol. Cell 8: 1665-1675.



### Collection of drosophilids from the Font Gropa site, Barcelona (Spain).

**Esteve, C., and F. Mestres\*** Dept. Genètica, Universitat de Barcelona, Barcelona (Spain).  
\*Corresponding author: [fmestres@ub.edu](mailto:fmestres@ub.edu)

Following a series of studies, another collection of drosophilids was obtained from Font Gropa (Barcelona) on 6<sup>th</sup> October 2014. The detailed description of this site can be found in Araúz *et al.* (2009) and samples have been obtained in previous years (Canals *et al.*, 2013; Pineda *et al.*, 2014). A total of 12 baits containing fermenting bananas placed along a trail were used for attracting flies, and they were sampled by nets. Individuals were collected from 4 to 7 pm. In Table 1, the number of individuals of each species and sex is presented.

Table 1. Number and percentage of drosophilids obtained from Font Gropa site (Barcelona, Spain) on 6 October 2014.

Species	Number	Percentage
<i>D. subobscura</i> (♂)	18	6.32
<i>D. subobscura</i> (♀)	69	24.21
<i>D. simulans</i> (♂)	37	12.98
<i>D. menalo/simulans</i> (♀)	74	25.96
<i>D. suzukii</i> (♂)	7	2.46
<i>D. suzukii</i> (♀)	51	17.89
<i>D. immigrans</i> (♀)	19	6.67
<i>D. phalerata</i> (♂)	5	1.75
<i>D. phalerata</i> (♀)	4	1.40
<i>D. cameraria</i> (♂)	1	0.35
Total	285	100

It is worth to compare these data with those from the previous samples of 2012 (Canals *et al.*, 2013) and 2013 (Pineda *et al.*, 2014). In the present collection, the most abundant species is the *melano/simulans* group (38.94%), increasing with regard to last year (25.21%), but far from the percentage of 2012 sample (81.01%). In 2014, *D. subobscura* represents 30.53%, approximately half of the percentage detected in 2013 (62.60%), but clearly higher than that of 2012 (6.85%). The invasive species *D. suzukii* has increased reaching the 20.35%, clearly over the 7.98% (2013) and 9.20% (2012). This species seems to be well adapted to the Font Gropa habitat.

Finally, we have estimated both the  $H'$  (Shannon diversity index) and  $J$  (Shannon uniformity index). The values obtained were 1.36 and 0.76, respectively. They are similar, but higher than those from 2012 and 2013 samples.

**References:** Araúz, P.A., F. Mestres, C. Pegueroles, C. Arenas, G. Tzannidakis, C.B. Krimbas, and L. Serra 2009, J. Zool. Syst. Evol. Res. 47: 25-34; Canals, J., J. Balanyà, and F. Mestres 2013, Dros. Inf. Serv. 96: 185-186; Pineda, L., C. Esteve, M. Pascual, and F. Mestres 2014, Dros. Inf. Serv. 97: 37.



## A rapid diversity survey of drosophilids in selected market places in Bengaluru Urban district.

**Sujaymeendra, D.S. Pranesh\*, H. Arpana, R. Chaithra, A.V. Dilip, G. Rohini, and M. Jayashankar\*\*.**

\*IQ4I Rsearch, Yeshwanthpur, Bengaluru-560 022; 4 Year BS Course, Bangalore University, Jnana Bharathi Campus, Bengaluru- 560 056. \*\*Department of Entomology and Nematology, IIHR, Bengaluru -560 089; \*\*jay81zoology@gmail.com

Drosophilids are common in homes, restaurants, markets and are highly sensitive to environmental variations acting as bio-indicators (Penariol *et al.*, 2013). The present rapid diversity survey was undertaken in market places in Bengaluru Urban district of Karnataka, India, during summer 2014. Traditional bottle trapping method was employed for the collection of flies using banana and apple smash baits in 11 randomly selected market sites *viz.*, Attur (SITE 1/S1), Yelahanka New town (S2), Yelahanka Old town (S3), Vidyaranyapura (S4), M.S. Palya (S5) in Bengaluru North Taluk and Mallathalli (S6), Nagarabhavi (S7), Padmanabhanagar (S8), Chikkalsandra (S9), Kengeri (S10), and Kathriguppe (S11) in Bengaluru South taluk. Two bottles were kept in each site and recovered after 24 hours by carefully plugging the bottle with cotton plugs. The flies in each bottle were identified using the keys (Sturtevant, 1927; Patterson and Stone, 1952; Throckmorton, 1927, 1975; Bock and Wheeler, 1972) and counted to assess the abundance of each species. Eight different *drosophilid* species belonging to two genera were identified. Seven species belonging to genus *drosophila viz.*, *D. rajashkari*, *D. malerkotliana*, *D. melanogaster*, *D. nasuta*, *D. neonasuta*, *D. takahashii*, *D. bipictinata*, and a species under genus *Phorticella (P. striata)* were identified. Attur and Kengeri recorded maximum number of species, *i.e.*, five, and Kathriguppe recorded the lowest with just two species (Table 1). Biodiversity indices were calculated using PAST ver. 3.0 (Hammer *et al.*, 2001). Attur, Yelahanka old town, Nagarabhavi and Kengeri showed higher diversity (Table 2) in comparison to other locations during the study period.

Table 1. Number of individual flies counted from traps in each location.

Sl. no	Species	Sites of collection											Total number of flies
		Bengaluru North taluk					Bengaluru South taluk						
		S1	S2	S3	S4	S5	S6	S7	S8	S9	S10	S11	
1	<i>D. rajashkari</i>	+	-	-	-	+	-	+	+	-	+	-	7
2	<i>D. malerkotliana</i>	+	+	+	-	-	+	+	+	+	-	-	14
3	<i>D. melanogaster</i>	+	+	+	-	+	+	+	+	-	+	+	24
4	<i>D. bipictinata</i>	+	-	-	-	-	+	-	+	-	-	-	3
5	<i>D. nasuta</i>	-	+	+	+	+	-	-	-	-	+	-	5
6	<i>D. takahashii</i>	-	-	-	+	-	-	+	-	+	-	+	14
7	<i>D. neonasuta</i>	-	-	-	-	-	-	-	-	-	+	-	1
8	<i>P. striata</i>	+	-	+	+	-	-	-	-	+	+	-	21

+ = recorded and - = not recorded

The present study is the first of its kind undertaken in Bengaluru city revealed different *Drosophilids* dwelling in market areas with dense human presence and movement. The markets in selected sites are found to be favorable breeding grounds for drosophilids and other scavenger fauna. Movement of market goods between markets, market and residences, and so forth, would enable flies to gain access to different areas facilitating species dispersal and heterogeneous assemblages of populations of different *Drosophila* species.

*D. melanogaster* was recorded in 9 locations followed by *D. malerkotliana* (7) > *D. rajashkari* and *P. striata* (5) > *D. takahashii* (4) > *D. bipectinata* (3) > *D. neonasuta* (1 in Kengeri). Interestingly this is the first record of *P. striata* in the study area and it was found to occur in large proportions followed by *D. melanogaster*. Considering their role in scavenging and as bioindicators, long term research on urban populations of *Drosophilids* needs to be undertaken for better understanding of their spatio-temporal distribution in urban areas, their diversified ecological roles as well to aid in conservatory measures.

Table 2. Diversity indices of heterogenous assemblages of drosophilid species in different areas.

Alpha diversity indices	Sites of collection										
	S1	S2	S3	S4	S5	S6	S7	S8	S9	S10	S11
Taxa_S	5.0	3.0	4.0	3.0	3.0	3.0	4.0	4.0	3.0	5.0	2.0
Individuals	15.0	6.0	4.0	13.0	5.0	4.0	5.0	10.0	4.0	16.0	7.0
Dominance_D	0.3	0.5	0.3	0.4	0.4	0.4	0.3	0.4	0.4	0.3	0.8
Simpson_1-D	0.7	0.5	0.8	0.6	0.6	0.6	0.7	0.6	0.6	0.7	0.2
Shannon_H	1.4	0.9	1.4	0.9	1.0	1.0	1.3	1.2	1.0	1.4	0.4

References Bock, L.R, and M.R. Wheeler 1972, The *Drosophila melanogaster* species Group. University Texas Publication 7103: 273-280; Hammer, *et al.* 2001, PAST ver. 3.0; Patterson, J.T, and W.S. Stone 1952, *Evolution on the Genus Drosophila*. The MacMillan Company; Penariol, LV, Lilian Madi-Ravazzi 2013, Springerplus 2(1): 2013; Sturtevant, A.H., 1927, Phillipine and other oriental Drosophilidae, Phillipine Journal of Science 32: 1-4; Throckmorton, L.H., 1975, *In: Handbook of Genetics* (King, R.C., ed.). Plenum Press, New York, pp. 421-467; TaxoDros 2010, The database on taxonomy of Drosophilidae; Throckmorton, L.M., 1927, The problem of phylogeny in the genus *Drosophila*. University of Texas Publication 6205: 207-374.



### Electrophoretic variants of esterase in two closely related species of *Drosophila*: *D. bipectinata* and *D. malerkotliana*.

**Singh, A.K., S. Kumar, and Neha Singh.** Genetics Laboratory, Department of Zoology, Banaras Hindu University, Varanasi - 221 005, India. Email: aksbhu23@rediffmail.com

Bock and Wheeler (1972) very vividly described the phylogenetic relationships among the four species of *Drosophila bipectinata* species complex. Their explanation on this complex fascinated a number of workers to elucidate the evolutionary relationships among the four species of this complex by employing cytological and molecular investigations. These four closely related and morphologically quite similar species are *D. bipectinata*, *D. parabiptectinata*, *D. malerkotliana*, and *D. pseudoananassae*. This complex is part of the *ananassae* subgroup of the *melanogaster* species group (Bock and Wheeler, 1972). The two species of this complex, *i.e.*, *D. bipectinata* and *D. malerkotliana*, are sympatric over most of their geographic distributions. Under the laboratory conditions, these two species are crossable and produce hybrids whose females are fertile but males are sterile (Gupta *et al.*, 1980).

Studies with regard to electrophoretic variants of enzymes have been one of the interesting aspects for *Drosophila* workers (Ayala and Powell, 1972; Ayala, 1975; Ayala *et al.*, 1974; Prakash, 1977; Mulley *et al.*, 1979; Cavener and Clegg, 1981; Santos *et al.*, 1989; Prout and Barker, 1993; Moraes and Sene, 2002; Kumar and Singh, 2014). Many polymorphic enzyme loci have been depicted from the natural populations of *Drosophila*. Esterase enzyme is known to be represented by more than one locus in a number of species of *Drosophila*. In *D. ananassae*, this enzyme is represented by three distinct polymorphic loci in the natural and

laboratory populations derived from different parts of India (Kumar and Singh, 2012, 2013, 2014; Krishnamoorti and Singh, 2013). Protein polymorphism in *bipectinata* species complex has also been undertaken by some workers (Yang *et al.*, 1972; Hegde and Krishnamurthy, 1976).

In the present note electrophoretic variants of esterase enzyme of the two species of *bipectinata* species complex, *i.e.*, *D. bipectinata* and *D. malerkotliana* and also their hybrids are portrayed. Two laboratory stocks, one containing flies of *D. bipectinata* and the other of *D. malerkotliana* were subjected to allozyme analysis. Reciprocal hybrids derived from the crosses of these two species were also employed for allozyme analysis. For allozyme analysis, a single fly was homogenized in 50  $\mu$ l 20 mM Tris buffer (pH 7.4) and the homogenate was centrifuged at 12000 rpm at 4°C for 10 minutes (Kumar and Singh, 2013). Supernatant was subjected to 8% native polyacrylamide gel electrophoresis in 25mM Tris and 250 mM Glycine electrode buffer (pH 8.2) at 200V for 4 hour at 4°C. In-gel staining for specific enzyme was carried out by adopting the methods proposed by Shaw and Prasad (1970).

A dimeric esterase of *D. bipectinata* and *D. malerkotliana* shows electrophoretically detectable variation in laboratory populations. We could find the expression of three clear cut electrophoretic variants, being expressed in the ratio of 1:2:1 in both the species of this complex. However, a marked difference in the distance covered by variants of both the species was recorded. Three bands observed in a heterozygous individual showed homozygosity for slow and fast bands on either sides, whereas the middle one resulted due to presence of both slow and fast. This arrangement was observed in the heterozygotes of both the species except that the migration pattern differed in them. In a homozygous individual, we could observe either a slow or a fast band only. The variations in the zymogram pattern of the two species clearly indicate genetic variation at this locus, that might have resulted due to amino acid substitution/s. Hybrids obtained from the crosses of both the species did not exactly follow the parental pattern of expression. The bands expressed in the photograph (Figure 1) and in other gel preparations, we observed certain bands to be more intense indicating the expression of common genes of both the species in the hybrids. In hybrids, various genotypic combinations were also seen but in a majority of them, bands matching with both parents were witnessed.

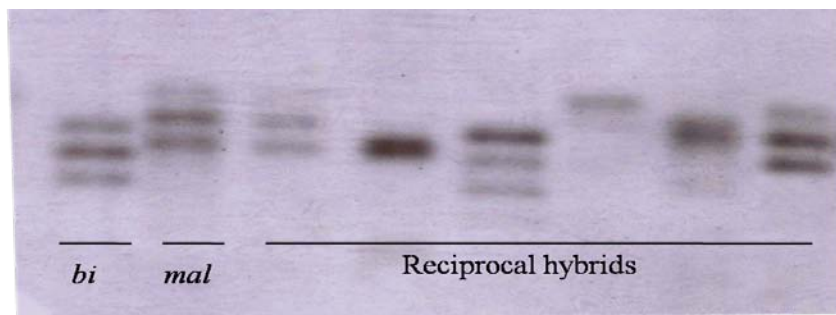

*bi*=*Drosophila bipectinata*; *mal*=*D. malerkotliana*

Figure 1. Photograph showing the electrophoretic variants of *Drosophila bipectinata* and *D. malerkotliana* and their hybrids.

Acknowledgment: We are thankful to UGC (University Grants Commission), New Delhi,

for providing financial support in the form of major research project to AKS and research fellowship to SK.

References: Ayala, F.J., 1975, *Evol. Biol.* 8: 1-78; Ayala, F.J., and J.R. Powell 1972, *Proc. Natl. Acad. Sci. USA* 69: 1094-1096; Ayala, F.J., M.L. Tracey, L.G. Barr, J.F. McDonald, and S. Perez-Salas 1974, *Genetics* 77: 343-384; Bock, I.R., and M.R. Wheeler 1972, *In: The Drosophila melanogaster species group*. Univ. Texas Publ. 7213: 1-102; Cavener, D.R., and M.T. Clegg 1981, *Genetics* 98: 613-623; Gupta, J.P., Y.N. Dwivedi, and B.K. Singh 1980, *Experientia* 36: 290; Krishnamoorti, K., and A.K. Singh 2013, *Dros. Inf. Serv.* 96: 54-55; Kumar, S., and A.K. Singh 2012, *Dros. Inf. Serv.* 95: 18-20; Kumar, S., and A.K. Singh 2013, *Dros. Inf. Serv.* 96: 52-54; Kumar, S., and A.K. Singh 2014, *Genetika* 46: 227-234; Lakovaara, S., and A. Saura 1971, *Genetics* 69: 377-384; Moraes, E.M., and F.M. Sene 2002, *J. Zool. Syst. Evol. Res.* 40: 123-128; Mulley, J.C., J.W. James, and J.S.F. Barker 1979, *Biochemical Genetics* 17: 105-126; Prakash, S., 1977, *Evolution* 31: 14-23; Santos, M., A. Ruiz, and A. Fontdevila 1989, *Amer. Nat.* 133: 183-197; Shaw, C.R., and R. Prasad 1970, *Bioch. Gene.* 4: 297-320; Yang, S.Y., L.L. Wheeler, and I.R. Bock 1972, *Univ. Texas Pub.* 7213: 213-227.



## North American Southwest collection of *obscura*-group *Drosophila* in summer 2015.

**Ritz, Kathryn R.<sup>1</sup> and Mohamed A.F. Noor.** Department of Biology, Duke University, Durham NC 27708; <sup>1</sup>Email: kathryn.ritz@duke.edu

Here we report our 2015 collection data for *obscura*-group *Drosophila* species from Madera Canyon in Arizona and American Fork Canyon in Utah (Ritz). Additionally, we have included previously unreported collection data from 1998 in the same region of Utah (Noor).

2015 collections took place in May/July in Arizona and Utah.

**Madera Canyon, AZ** (31°42'48.9"N, 110°52'22.4"W). Flies were collected from May 23, 2015, to May 26, 2015, in Madera Canyon, a riparian zone in the Santa Rita Mountains in Coronado National Forest, Arizona, USA. (MC 2015).

**American Fork Canyon, AZ** (40°26'38.9"N, 111°42'08.5"W). Flies were collected from July 7, 2015, to July 10, 2015, in American Fork Canyon in Uinta National Forest in American Fork, Utah, USA. (AFC 2015).

1998 collections took place in July in Utah.

**American Fork Canyon, AZ** (40°26'42.7"N, 111°42'44.4"W). Flies were collected from June 29, 1998, to July 2, 1998, in American Fork Canyon in Uinta National Forest in American Fork, Utah, USA. (AFC 1998).

Flies were baited using buckets of fermenting bananas, set up 3 or more hours prior to collection and left at the collection site over the course of collection. Fresh bananas were added daily. Flies were collected for two to three hours after sunrise, and again before sunset. Male flies were identified using sex combs as morphological identifiers (Beckenbach and Prevosti, 1986). *D. subobscura* females and *D. pseudoobscura* females were identified using wing bristles (Beckenbach and Prevosti, 1986). *D. pseudoobscura* females were distinguished from *affinis*-group females by rearing and identifying male offspring using sex combs (2015 collection only).

Table 1. Proportions of *obscura*-group *Drosophila* species collected in 2015, 1998, and 1997.

Site	% pseudoobscura females	% pseudoobscura males	% subobscura females	% subobscura males	% <i>affinis</i> subgroup	Total Count*
MC (2015)	11	34	0	0	55	76
AFC (2015)	7	14	14	60	5	643
AFC (1998)	47**	27	9	17	<1	308
AFC (1997)	8**	16	25	51	<1	253

\*Total count includes only *obscura*-group flies collected.

\*\*Indicates some may have been *affinis* subgroup, not reared to confirm species.

Notably, we observe fluctuations in the relative abundance of *D. subobscura* in AFC despite previous evidence for rapid population expansion. Collections in 1993 found no evidence of *D. subobscura* in AFC; however, by 1997 this species accounted for 75% of the *obscura*-group individuals seen (Noor *et al.*, 1998, these data included in Table 1). With the 2015 collection data, we find that the *D. subobscura* population growth has not displaced other *obscura*-group species such as *D. pseudoobscura*.

Although the sample size of *obscura*-group flies collected from Madera Canyon was low, the overall density of *Drosophila* was quite high. A total of 1736 *Drosophilids* were collected over 4 days, only 76 of which were *obscura*-group individuals.

References: Beckenbach, A.T., and A. Prevosti 1986, Am. Midl. Nat. 115: 10-18; Noor, M.A.F., J.R. Wheatley, K.A. Wetterstrand, and H. Akashi 1998, Dros. Inf. Serv. 81: 136-137.





## On the geographic distribution of the *Drosophila willistoni* group (Diptera, Drosophilidae) – updated distribution of *alagitans* and *bocainensis* subgroups.

**Zanini, Rebeca**<sup>1,2</sup>, **Maríndia Deprá**<sup>1,2</sup>, **Vera Lúcia da Silva Valente**<sup>1,2</sup>. <sup>1</sup>Programa de Pós-Graduação em Biologia Animal, Universidade Federal do Rio Grande do Sul (UFRGS), Avenida Bento Gonçalves, 9500 prédio 43435 CEP 91501-970, Bairro Agronomia, Porto

Alegre, RS, Brazil. <sup>2</sup>Laboratório de *Drosophila*, Departamento de Genética, Instituto de Biociências, Universidade Federal do Rio Grande do Sul (UFRGS), Avenida Bento Gonçalves, 9500 prédio 43323 sala 210 CEP 91501-970, Bairro Agronomia, Porto Alegre, RS, Brazil. Corresponding author: [rebeca.zanini@gmail.com](mailto:rebeca.zanini@gmail.com)

### Introduction

*Drosophila willistoni* group (Diptera, Drosophilidae) is a Neotropical species group and is currently composed of 24 species distributed in three subgroups – *alagitans*, *bocainensis*, and *willistoni* (Bächli, 2015).

The *alagitans* species group was established by Patterson and Mainland (1944), which reunited *D. alagitans* and *D. capnoptera* in a species group belonging to subgenus *Drosophila* (Wheeler and Magalhães, 1962). Later, Hsu (1949) observed that the male genitalia of these species resembled the *willistoni* species group and the *alagitans* group was later transferred to subgenus *Sophophora* (Wheeler, 1949). Wheeler and Magalhães (1962) described two new species for this subgroup – *D. megalagitans* and *D. neoalagitans*.

Carson (1954) observed that three distinct specimens were designated as *D. bocainensis*; one of them was confirmed as *D. bocainensis* and the others redescribed as *D. parabocainensis* and *D. bocainoides*, establishing the *bocainensis* species complex (Carson, 1954). Salzano (1956) also reviewed the status of this species. Wheeler and Magalhães (1962) described some species belonging to this subgroup – *D. changuinolae*, *D. pseudobocainensis*, and *D. parabocainoides*. The later were allocated as *D. subinfumata* synonym (Vilela and Bächli, 1990).

*Drosophila mangabeirai* was inserted in *melanogaster* group (Malogolowkin, 1952); its male genitalia, however, is compatible with those of *D. willistoni* group, to which this species was later transferred (Carson *et al.*, 1957). The *bocainensis* subgroup also encompasses *Drosophila capricorni*, *D. fumipennis*, *D. nebulosa*, and *D. sucinea*.

Later, Vilela and Bächli (1990) redescribed *D. abregolineata*, *D. fumipennis*, and *D. subinfumata*. The authors also described *D. pittieri* (Bächli and Vilela, 2002). Recently, Figuero and Rafael (2013) described *D. neocapnoptera* in Ecuador. Both new reported species belong to *alagitans* subgroup.

Wheeler and Magalhães (1962) provided a distribution map of some *alagitans-bocainensis* species and asserted that the species fall into two clusters: northern distribution (*alagitans*-like forms) and Southern distribution (*bocainensis*-like forms). The geographic range of *D. nebulosa* was discussed in Ehrmann and Powell (1982).

The objective of this study was to update the current distribution map for *alagitans* and part of *bocainensis* subgroup as well as provide distribution maps for the species not included in the previously available map.

### Material and Methods

We gathered all distribution records for each species of *alagitans* and *bocainensis* subgroup in literature and plotted those in maps using QGIS 2.10.1 software. All entries and respective references are available in Taxodros ([taxodros.uzh.ch](http://taxodros.uzh.ch)) (Bächli, 2015).



Figure 1. Geographic distribution of the *alagitans* and *bocainensis* subgroups. A, Subgroup *alagitans* (*D. alagitans*, *D. capnoptera*, *D. megalagitans*, *D. neoalagitans*, *D. neocapnoptera*, and *D. pittieri*). B, Subgroup *bocainensis* (*D. nebulosa* and *D. sucinea*). C, Subgroup *bocainensis* (*D. capricorni* and *D. fumipennis*).

## Results and Discussion

The *alagitans* subgroup distribution is restricted to Northern South America, Central and North America, and Caribbean Islands (Figure 1A). The exception is *D. alagitans*, which is found in some localities in Mexico and in Santa Catarina State, in Southern Brazil. *D. capnoptera* has the broadest distribution in this subgroup, ranging from Mexico through Central America countries. *D. neoalagitans* occurs in Jamaica and Hispaniola islands. The remaining species only have one distribution entry – *D. pittieri* in Rancho Grande, Northern Venezuela, *D. neocapnoptera* in Baeza-Teno, Ecuador, and *D. megalagitans* in Bucaramanga, Colombia.

Regarding *bocainensis* subgroup, *D. nebulosa* seems to have the widest distribution (Figure 1B). The southernmost point of occurrence is in Grutas, Argentina, and the northernmost is in Chatham, Canada. This species is also reported in USA, Mexico, Costa Rica, El Salvador, Panama, Colombia, Venezuela, Peru, Ecuador, Chile, Brazil, Uruguay, Galapagos Islands, Antilles, Hispaniola, Cuba, and Bahamas. *D. sucinea* occurs in Northern South America, Central America, and Mexico (Figure 1B) and lives in sympatry with *D. nebulosa* in Mexico, Panama, Ecuador, and Peru.

*Drosophila fumipennis* distributes from Central America, through Colombia, Venezuela, and Peru to Brazil, from North to South (Figure 1C). *D. capricorni* has a similar distribution, except that it occurs in Mexico and is very uncommon in Northern and Northeast areas of Brazil (Figure 1C).

Some species have a very narrow known distribution – *D. abregolineata* was only found in the type locality, Turrialba (Costa Rica) (Figure 2A); *D. changuinolae* occurs in the type locality Changuinola (Panama), in Leticia (Peru) and in Barreiro Rico (Brazil) (Figure 2B).

*Drosophila mangabeirai* is mostly found in Central America, but also occurs in Salvador, Brazil, and in Antilles (Figure 2A). *D. bocainensis* is also found in South and Southeast Brazil, Colombia, Ecuador, Venezuela, and Honduras (Figure 2A); *D. bocainoides* also lives in South and Southeast Brazil in a more restricted distribution.

*Drosophila subinfumata* presents a very discontinuous distribution, since it inhabits South and Southeast Brazil, Panama, and Costa Rica (Figure 2B). *D.*

*pseudobocainensis* is found in Northern South America (Colombia, Bolivia, and Venezuela) and in Central America (Costa Rica, El Salvador, and Panama) (Figure 2B), whereas *D. parabocainensis* distributes in South and Southern Brazil and Colombia (Figure 2B).

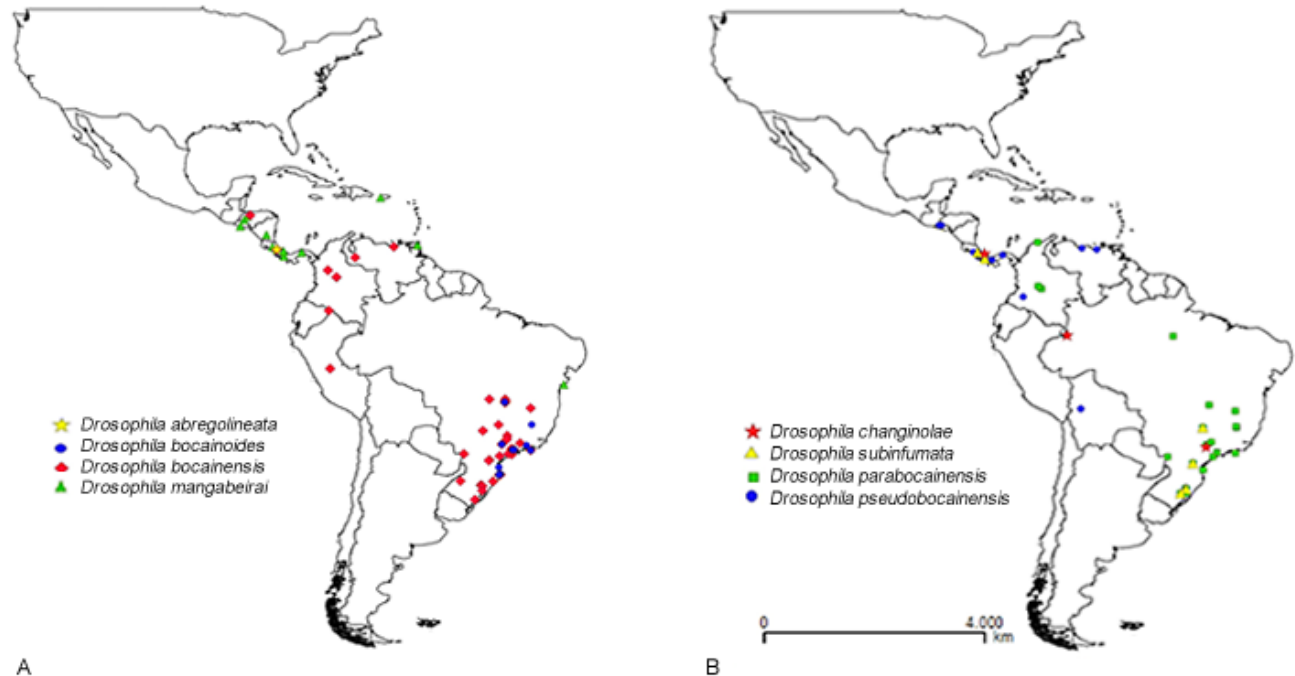

Figure 2. Geographic distribution of the *bocainensis* subgroup. A, *D. abregolineata*, *D. bocainensis*, *D. bocainoides*, and *D. mangabeirai*. B, *D. changinolae*, *D. parabocainensis*, *D. pseudobocainensis*, and *D. subinfumata*.

Central America, Colombia, Venezuela, Ecuador, and Southeast Brazil are the areas where most of the species of *willistoni* group lives in sympatry. The most widespread species are *D. nebulosa*, *D. capricorni*, and *D. fumipennis*. Some species, especially belonging to *alagitans* subgroup, have a few or sometimes a single occurrence, which leads us to wonder if there is a lack of studies, the species are misidentified/unidentified, or these taxa have a very narrow or endemic distribution.

Acknowledgments: We thank CNPq, CAPES and FAPERGS for the scholarships and grants.

References: Bächli, G., 2015, Taxodros - The database on taxonomy of Drosophilidae. [Online]; Bächli, G., and C.R. Vilela 2002, Bulletin de la Société Entomologique Suisse 75: 223-243; Carson, H.L., 1954, Evolution 8: 148-165; Carson, H.L., M.L. Wheeler, and W. B. Heed 1957, Univ. Texas Publ. 5721: 115-122; Ehrmann, L., and J.R. Powell 1982, The *Drosophila willistoni* species group. In: *The Genetics and Biology of Drosophila*, vol. 3b. (Ashburner, M., H.L. Carson, and J.N. Thompson, Jr., eds.). New York: Academic Press Inc, 193-220; Figuero, M.L., and V. Rafael 2013, Iheringia 103: 246-254; Hsu, T.C., 1949, Univ. Texas Publ. :80-142; Malogolowkin, C., 1951, Revis. Bras. Biol. 11 (4): 431-434; Patterson, J.T., and G.B. Mainland 1944, Univ. Texas Publ. 4445: 9-101; Salzano, F.M., 1956, O problema das espécies crípticas: estudos no sub-grupo *bocainensis* (*Drosophila*). PhD thesis. Universidade Federal do Rio Grande do Sul, Porto Alegre, Brazil; Vilela, C.R., and G. Bächli 1990, Bulletin de la Société Entomologique Suisse 63: 1-332; Wheeler, M.R., and L.E. Magalhães 1962, Univ. Texas Publ. 6205: 155-171; Wheeler, M.R., 1949, Univ. Texas Publ. 4920: 157-1920.



## Activity variation in acid phosphatase (ACPH) allozymes of *Drosophila virilis* resulting from two different *AcpH* gene transcripts.

**Kitagawa, Hiroko.** Department of Chemistry, Faculty of Science, Josai University, Keyakidai 1-1, Sakado, Saitama 350-0295, Japan; E-mail: hkita@josai.ac.jp

### Abstract

To reveal the mechanism underlying ACPH allozyme activity variation in *D. virilis*, the acid phosphatase allelic genes *AcpH-1*, *AcpH-2*, and *AcpH-4* and their transcripts were isolated and characterized. Each gene includes six exons. Two major transcripts are formed by alternative splicing of exon 5, with two proteins of differing lengths produced as a consequence. Because exon 6 encodes a transmembrane segment, the long protein was inferred to be the membrane-bound form and the short protein the soluble one. Semi-quantitative and quantitative real-time PCR analyses of these transcripts revealed that the membrane-bound protein had similar expression levels among the three allelic genes. In contrast, the soluble protein showed variable expression: levels of *AcpH-4*, *AcpH-2*, and *AcpH-1* were high, medium, and low, respectively, with their expression ratio (4.6:3.1:1) corresponding approximately to relative enzyme activities observed by gel electrophoresis. Comparative analysis of *AcpH* nucleotide sequences of *D. virilis* and related species revealed that the activity differences are not due to variation in active sites, disulfide bonds, or glycosylation sites.

### Introduction

Acid phosphatase (ACPH; EC 3.1.3.2), a lysosomal enzyme, was first described in the genus *Drosophila* by MacIntyre (1966). Immunological studies in *Drosophila* have shown that ACPH is a rapidly evolving protein (Collier *et al.*, 1990), and *AcpH* has been extensively used as an allozymic marker in evolutionary studies of the genus (Ayala and Tracey, 1974; Kojima *et al.*, 1970; MacIntyre, 1966). Three allelic forms of ACPH specified by the *AcpH* locus have been reported in the Japanese population of *D. virilis* (Ohba, 1977), with *AcpH-2* comprising more than 98% of alleles. The three allelic enzymes (ACPH-1, -2, and -4) show activity differences based on the intensities of the allozyme bands (Narise, 1976). Five electrophoretic variants of ACPH have been found in a natural population of *D. subobscura* but exhibit no activity differences (Loukas *et al.*, 1979). On the basis of cellular localization experiments involving *D. virilis* ACPH, Narise (1985) has suggested that the allozymes are lysosomal enzymes, and that the variation in their activities is caused by differences in their lysosome-anchoring abilities.

Structures of two human ACPH proteins have been deduced from their gene structures. Leucocyte lysosomal acid phosphatase, composed of 11 exons, is a membrane-bound protein (Geier *et al.*, 1989), while prostatic acid phosphatase (Sharief and Li, 1992), which lacks exon 11 encoding the transmembrane segment, is a soluble protein. In *Drosophila*, the *AcpH* gene was first cloned and sequenced in *D. melanogaster* (Chung *et al.*, 1996) and then in three species of the subobscura group (*D. subobscura*, *D. guanche*, and *D. madeirensis*) (Navarro-Sabate *et al.*, 1999). In these species, the *AcpH* gene is organized into five exons interrupted by four short introns, with a single transcriptional start site and an additional intron present in the 5' leader region. I previously characterized the nucleotide sequence of the *AcpH-2* allozyme gene of *D. virilis* and its transcripts (Kitagawa, 2003). The *AcpH* gene was found to possess six exons, as the third exon present in other *Drosophila* species was divided into two exons. In addition, two transcriptional start sites in the 5' region and two spliced forms of exon 5 were identified. As a result of this variable splicing, the *AcpH-2* gene encodes two major transcript forms having differing lengths. Navarro-Sabate *et al.* (1999) have reported that the nucleotide sequence surrounding the last exon encodes the transmembrane region of the enzyme protein. As described above, the ACPH of *D. virilis* is a lysosomal enzyme. The two types of transcripts may, therefore, play different roles, either penetrating or adhering to the lysosomal membrane. On the other hand,

Kim *et al.* (2014) have recently indicated that variable activities of apuric/aprimidinic endonuclease 1 are caused by an amino acid substitution in this enzyme protein.

This study aimed to clarify whether differences in activities of *D. virilis* *AcpH* allozymes were due to an amino acid replacement in active sites of the protein or were instead a consequence of different transcripts resulting from alternative splicing of the *AcpH* gene. To accomplish the study objective, I analyzed *AcpH* allozyme nucleotide sequences of *D. virilis* and related species and the deduced primary structure of ACPH allozyme proteins. I also investigated the expression pattern of the two transcripts arising from alternative splicing.

## Materials and Methods

### *Drosophila* Samples

*Drosophila virilis* and related species were used to survey ACPH protein allelic variation (Table 1). Lines of these species, collected mainly from Japanese populations, were maintained as isofemale lines and supplied by the laboratories listed in Table 1.

Table 1. Allozyme lines of *Drosophila virilis* and related species used in this study.

Species	Electrophoretic allele	Collection location and year	Name
<i>D. virilis</i>	AcpH-1	OMAEZAKI, JAPAN, 1980	ViAc1-OZ <sup>f</sup>
	AcpH-1	HORIOKA, JAPAN, 1999 <sup>c</sup>	ViAc1-HO
	AcpH-1	KYOTO, JAPAN, 2002 <sup>d</sup>	ViAc1-KY
	AcpH-2	OMAEZAKI, JAPAN, 1980 <sup>e</sup>	ViAc2-OZ80 <sup>f</sup>
	AcpH-2	HORIOKA, JAPAN, 1983	ViAc2-HO
	AcpH-2	OMAEZAKI, JAPAN, 1978	ViAc2-OZ78
	AcpH-2	Mexico <sup>a</sup>	ViAc2-ME
	AcpH-4	OMAEZAKI, JAPAN, 1980	ViAc4-OZ80 <sup>f</sup>
	AcpH-4	OMAEZAKI, JAPAN, 1988	ViAc4-OZ88
<i>D. lummei</i>	AcpH-4	SAKATA, JAPAN <sup>b</sup>	Lum-sak
	AcpH-4	KEMI, FINLAND <sup>b</sup>	Lum-kemi
<i>D. novamexicana</i>	AcpH-3	Unknown <sup>b</sup>	Nov
<i>D. ezoana</i>	AcpH-2	JAPAN <sup>a</sup>	Ezo

<sup>a</sup> Obtained from the National *Drosophila* Species Resource Center (stock numbers 15010-1051.48 [*D. virilis*] and 15010-1021.0 [*D. ezoana*]).

<sup>b</sup> Supplied by H. Watabe, Hokkaido University of Education.

<sup>c</sup> Supplied by K. Tsuno, Meikai University.

<sup>d</sup> Supplied by M. Ito, Kyoto Institute of Technology.

<sup>e</sup> Sequenced in a previous study (Kitagawa 2003).

<sup>f</sup> Previously raised in my laboratory and then used as *D. virilis* representative lines.

### Detection of Acid Phosphatase by Gel Electrophoresis

Two days after eclosion, adult flies were homogenized in 10 $\mu$ L distilled water and centrifuged for 5 min at 14,400  $\times$ g. The supernatant was then subjected to polyacrylamide gel electrophoresis on a 7.5% gel at pH 4.3. Phosphatase activity was localized by the diazo coupling method using 0.1 M acetate buffer (pH 5.0) containing 0.5 mg/mL disodium  $\alpha$ -naphthyl phosphate and 0.5 mg/mL Azoic Diazo Component 48 (Narise, 1984).

### DNA Sequencing

Preparation of genomic DNAs from adult flies and genomic library construction were performed as previously described (Tominaga *et al.*, 1992). *AcpH* genes of three *D. virilis* lines (ViAc1-OZ, ViAc4-OZ80, and ViAc4-OZ88) were screened using *AcpH-2* cDNA as a probe. Positive clones were subcloned using a pBluescript SK+ vector (Stratagene, USA). *AcpH* genes of other lines of *D. virilis* and additional species were amplified by genomic PCR. VG-F1 and VG-R1 primers (Table 2) were used to amplify genomic DNA of *D. virilis*, *D. lummei*, and *D. novamexicana*, with VG-F1 and VG-R2 primers (Table 2) used for *D. ezoana*. PCR amplifications were performed in 50- $\mu$ L volumes containing 25  $\mu$ L PrimeSTAR HS reaction mix (Takara, Japan), 10 pmol of each primer, and 1  $\mu$ L genomic DNA. PCR conditions consisted of a denaturation step of 98°C for 30 s, followed by 30 cycles of 98°C for 10 s, 55°C for 5 s, and 72°C for 2 min. The PCR products were cloned into a PCR-script vector (Stratagene) and sequenced using a BigDye Terminator Cycle Sequencing kit (Applied Biosystems, USA) on an ABI PRISM 310 Genetic Analyzer.

Table 2. Oligonucleotide primers used in this study.

Name	Sequence (5' - 3')	Application <sup>a</sup>
VG-F1	GGCTCAGTCTCCCGTTTG	Genomic PCR
VG-R1	GCTCGAAGTCGCGAGCTGAAC	Genomic PCR
VG-R2	AAGGCCTATACTCGTAAATGC	Genomic PCR
VA-RT	P-GTAGATCATCAGGC	5'-RACE
VA-A1	ATAAATGACTTAATGGGCCGACCGCTA	5'-RACE
VA-A2	TCAAAGAGATCTTTGTAACGTGCCCA	5'-RACE
VA-S1	GAGAGCAAGCATAAGAAACAACCTGTGC	5'-RACE
VA-S2	ATACAGCGCACATGATACCACAATTGC	5'-RACE
VA-F	CAACTGTCGCCGGATCGGT	3'-RACE
vT-F1	TGGTCACACTATCTTATCGAC	RT-PCR, qRT-PCR
vT-F2	GTGAGCAACGCGATTGTGCAT	RT-PCR
vT-R1	ATCAGAATGCCTGTTGCTGC	RT-PCR
vT-R2	GTA CTCCCATCTTCGACA	qRT-PCR
nT-F1	TGGTCACACTATTTTATCGAC	RT-PCR
nT-F2	GTGAGCAACGCGTTTGTGCAT	RT-PCR

<sup>a</sup> RACE, rapid amplification of cDNA ends; RT-PCR, semi-quantitative reverse transcription PCR; qRT-PCR, quantitative real-time PCR

### mRNA Isolation

Adult-fly mRNA was isolated using a QuickPrep mRNA Purification kit (GE Healthcare, UK) according to the manufacturer's protocols. After determination of concentration and purity on a UV photometer, mRNA was stored at -80°C.

### Rapid Amplification of cDNA Ends (RACE) Analysis

For 5' RACE, 1  $\mu$ g of mRNA was reverse-transcribed into cDNA using a 5'-Full RACE Core Set (Takara) in the presence of VA-RT primer (Table 2). The reverse transcription was performed under the following conditions: 30°C for 10 min, 50°C for 60 min, and 80°C for 2 min. The resulting cDNA was amplified in two rounds using an LA PCR kit (Takara), with VA-A1 and VA-S1 primers used for the first step followed by VA-A2 and VA-S2 primers in the second step (Table 2). PCR amplifications consisted of 25 cycles of 94°C for 30 s, 65°C for 30 s, and 72°C for 30 s. For 3' RACE, 1  $\mu$ g of mRNA was reverse-transcribed into cDNA using a 3'-Full RACE Core Set (Takara) in the presence of oligo dT-3 site adaptor and

VA-F (Table 2) primers. PCR amplifications consisted of 30 cycles of 94°C for 30 s, 65°C for 30 s, and 72°C for 2 min.

#### *Semi-quantitative reverse transcription PCR (RT-PCR)*

cDNAs were synthesized from 1 µg mRNA by RT-PCR using a PrimeScript RT-PCR kit (Takara) and oligo dT primer. The PCRs were performed with the following primer sets: vT-F1 and vT-R1 (for type A) and vT-F2 and vT-R1 (for type B) for *D. virilis* and *D. lummei* and nT-F1 and vT-R1 (for type A) and nT-F2 and vT-R1 (for type B) for *D. novamexicana* and *D. ezoana* (Table 2). The resulting PCR products were separated on a 0.7 % agarose gel and visualized with a UV transilluminator.

#### *Quantitative Real-time PCR (qRT-PCR)*

Reverse transcription was performed at 37°C for 15 min in 20-µL volumes containing 10 µL of 5× PrimeScript RT master mix (Takara) and 1 µg mRNA. qRT-PCR was performed on a Thermal Cycler Dice Real Time System Lite (Takara). To verify the qRT-PCR results, the *Gapdh* gene was used as an internal control, with *Gapdh* gene-specific primers Gapdh-F (5'-TGGGCTATACCGATGAGGAG-3') and Gapdh-R (5'-CAAGTCAATGACACGGTTGG-3') designed to amplify a 160-bp fragment. The vT-F1 and vT-R2 primer sequences used to amplify *AcpH* transcripts are shown in Table 2. qRT-PCRs were performed in 25-µL volumes containing 12.5 µL 2× SYBR Premix Ex Taq II (Takara), 10 µM of each primer, and 1 µL diluted cDNA. qRT-PCR amplification conditions consisted of a denaturation step of 95°C for 30 s, followed by 40 cycles of 95°C for 5 s and 60°C for 30 s.

#### *Data Analysis*

Clustal W (Thompson *et al.*, 1994) was used to align the nucleotide sequences.

1    2    3    4    5    6



Figure 1. Results of an electrophoretic assay of adult fly extracts. Lanes 1–3 are from representative *Drosophila virilis* lines (1: ACPH-1, 2: ACPH-2, and 3: ACPH-4); lanes 4–6 correspond to related *Drosophila* species (4: Ezo, 5: Nov, and 6: Lum-sak). Details of the different lines are given in Table 1.

## Results and Discussion

As previously reported by Narise (1976), the three allelic enzymes (ACPH-1, ACPH-2, and ACPH-4) of *D. virilis* from natural Japanese populations exhibit dramatically different activities (Figure 1, lanes 1–3 and Table 1). It was first necessary to clarify whether the differences in activity among ACPH allozymes are restricted to Japanese-specific populations or are more widely present in *D. virilis* and related species. Ten newly obtained strains of *D. virilis* and closely related species were, therefore, analyzed according to their electrophoretic mobility and using activity staining. On the basis of mobility and activity, ACPH-1 was identified in two *D. virilis* lines, with three lines characterized by the presence of ACPH-2 and one line possessing ACPH-4 (data not shown). Among related species, ACPHs of *D. ezoana* and *D. lummei* migrated at the same rate as ACPH-2 and ACPH-4 of *D. virilis*, respectively (Table 1). As shown in Figure 1 (lane 5), however, the mobility of the ACPH protein of *D. novamexicana* was halfway between that of ACPH-2 and ACPH-4. I designated this protein, which has not been previously reported, as ACPH-3. In regard to activity in *D. virilis*, the ACPH-4 enzyme showed the highest activity and ACPH-1 the least, with ACPH-2 intermediate (Figure 1, lanes 1–3). Among the three related species, in contrast, the ACPH-4 allozyme exhibited similar levels of activity in spite of differences in mobility (Figure 1, lanes 4–6). Differences in both activity and mobility of ACPH allelic enzymes may thus be specific to the *AcpH* locus of *D. virilis*. Consequently, an analysis of *AcpH* gene nucleotide sequences of eight lines of *D. virilis* and four lines of related species was performed.

*AcpH* genes of eight *D. virilis* lines, two *D. lummei* lines, and one line each of *D. novamexicana* and *D. ezoana* were sequenced in this study (Table 1). A 4.2-Kb region including 0.6 Kb of the 5' region and 1.4 Kb of the 3' region of the *AcpH* gene was sequenced in positive clones of three lines (ViAc1-OZ, ViAc4-OZ80, and ViAc4-OZ88); for the other lines, sequences of a 3.3-Kb PCR fragment including 0.6 Kb of the 5' region and 0.7 Kb of the 3' region were determined. The resulting *AcpH* gene sequences were submitted to GenBank under the following accession numbers: AB271538 (ViAc1-OZ), AB986228 (ViAc1-HO), AB986229 (ViAc1-KY), AB986230 (ViAc2-HO), AB986231 (ViAc2-OZ78), AB986232 (ViAc2-ME), AB986233 (ViAc4-OZ80), AB986234 (ViAc4-OZ88), AB986235 (Lum-sak), AB986236 (Lum-kemi), AB986237 (Nov), and AB986238 (Ezo). The *AcpH* genes of *D. virilis* and related species are organized into six exons. The nucleotide sequence around exon 1 encodes the signal peptide and exon 6 encodes the transmembrane region (Kitagawa, 2003). Nucleotide sequences of the 10 *Drosophila* lines were aligned with 3,479 bp of the ViAc2-OZ80 *AcpH* gene, consisting of a 1,308-bp coding region and a 2,171-bp noncoding region. Only one site of nucleotide substitution, in the 3' region, was identified among the three *AcpH-1* lines. Ten single-nucleotide substitutions and 3 insertions/deletions (indels) were found among the four *AcpH-2* lines, with 23 substitutions and 6 indels, respectively, detected between the two *AcpH-4* lines, and 26 substitutions and 3 indels between the two *D. lummei* lines. No nucleotide substitutions were found among the coding sequences of the three *AcpH-1* lines and among the four *AcpH-2* lines. Four synonymous substitutions were found between the two *AcpH-4* lines and between the two *D. lummei* lines. On the other hand, no amino acid replacements were observed between lines of the same allelic form (data not shown).

The *AcpH* gene encodes a precursor protein of 435 amino acids. Signal peptide (positions 1–29) and transmembrane domain (positions 384–435) regions are subsequently cleaved off to yield the mature protein. The mature protein was found to contain three noncontiguous residues (positions 93, 122, and 298) and two motifs (positions 52–58 and 97–100) for catalytic activity, five cysteine residues (positions 171, 322, 356, 360, and 380) for disulfide binding, and three motifs for glycosylation (positions 219–221, 229–231, and 343–345). All of these characteristics were found to be conserved across the *Drosophila* lines used in this experiment.

Table 3. Amino acid substitutions in deduced ACPH-1 and ACPH-4 sequences of *D. virilis* and related species relative to ACPH-2 of *D. virilis*.

	Position																					
	6	13	14	20	36	39	52	106	140	164	188	199	276	278	305	309	312	332	334	358	363	426
ACPH-2	H	F	F	H	G	A	F	A	N	V	Q	D	T	L	M	L	F	N	R	V	S	N
ACPH-1	.	.	.	.	.	.	.	.	.	.	<b>K</b>	.	.	.	.	.	.	.	.	.	.	.
ACPH-4	.	V	L	D	.	.	.	.	<b>D</b>	I	.	.	.	.	.	.	.	.	<b>S</b>	.	.	.
Lum	.	V	L	D	.	.	.	.	<b>D</b>	I	.	.	.	.	.	.	.	.	<b>S</b>	.	.	.
Nov	.	V	L	D	S	.	Y	.	<b>D</b>	I	.	.	.	.	.	I	.	.	.	.	.	.
Ezo	Y	V	L	D	<b>R</b>	P	.	S	<b>D</b>	I	.	E	N	F	T	.	L	S	.	I	A	K

ACPH-2, ACPH-1, and ACPH-4 refer to allelic forms in *D. virilis*; Lum, Nov, and Evo are *D. lummei*, *D. novamexicana*, and *D. ezoana*, respectively. Dots indicate amino acids that are identical to those of *D. virilis* ACPH-2. Substitutions causing a charge alteration in the mature protein (No. 30-383) are shown in bold. All deduced amino acid sequences of a given allelic form in *D. virilis* were identical to one another.

Table 3 displays amino acid differences between ACPH-1 and ACPH-4 of *D. virilis* and related species compared with ACPH-2 of *D. virilis*. Four nucleotide substitutions were found in *AcpH-1*, one of which was a nonsynonymous substitution leading to a single amino acid replacement (Q → K). This mutation altered the electrophoretic mobility by changing a single charge. Relative to *AcpH-2*, 25 and 27 substitutions were found in ViAc4-OZ80 and ViAc4-OZ88, respectively, of which six changes were nonsynonymous substitutions. Two replacements (N → D and R → S) were responsible for anodic charge differences in ACPH electrophoretic mobility. In the other *Drosophila* species, a charge alteration accompanying the amino acid replacement occurred at two sites (N → D, R → S) in *D. lummei*, at one site (N → D) in *D. novamexicana*, and at two sites (G → R, N → D) in *D. ezoana*. These charge alterations were consistent with the observed differences in electrophoretic mobility. Nevertheless, the amino acid replacements did not occur



at the catalytic residues, glycosylation sites, or disulfide bonds. The amino acid changes thus do not seem to be the main cause of the activity difference.

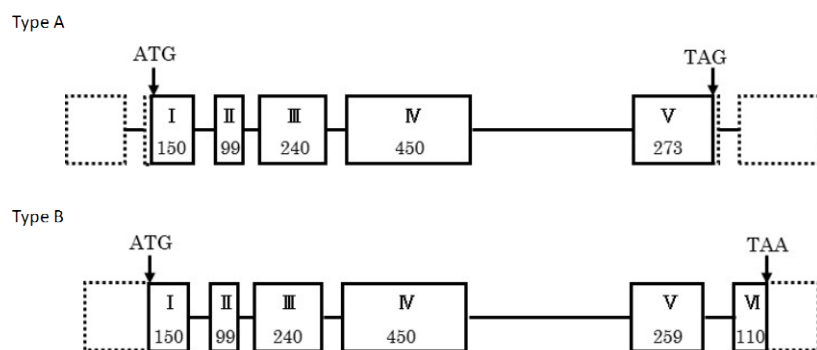

Figure 2. Alternative splicing patterns of *Acph* allozyme genes of *Drosophila virilis*. The dotted and open boxes indicate untranslated and coding regions, respectively. Roman and Arabic numerals in the open boxes are numbers of exons and nucleotides, respectively. Splicing for the type-A transcript begins at -296; the start site of the type-B transcript is at -194 in *Acph-1* and -167 in *Acph-4*.

RACE analysis was carried out using *D. virilis* lines representing *Acph-1* and *Acph-4* allelic forms (Table 1). As shown in Figure 2, two types of transcripts (types A and B) were found in both allelic forms. The coding region of the type-A transcript consisted of five exons, whereas that of type B comprised six exons. Exon 5 of type A was somewhat longer than that of type B and had a stop codon. Because the transmembrane domain, as previously mentioned, is found in exon 6, the type-A transcript yielded a soluble protein, whereas the type-B transcript encoded a membrane-bound form. RACE analyses of *Acph* in *D. lummei* and *D. novamexicana* confirmed the existence of two types of transcripts, similar to *D. virilis Acph*.

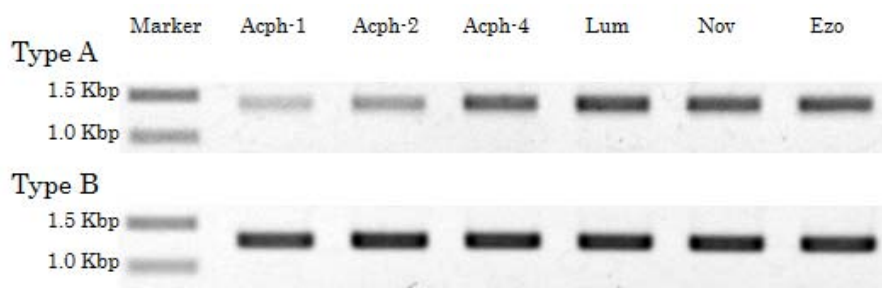
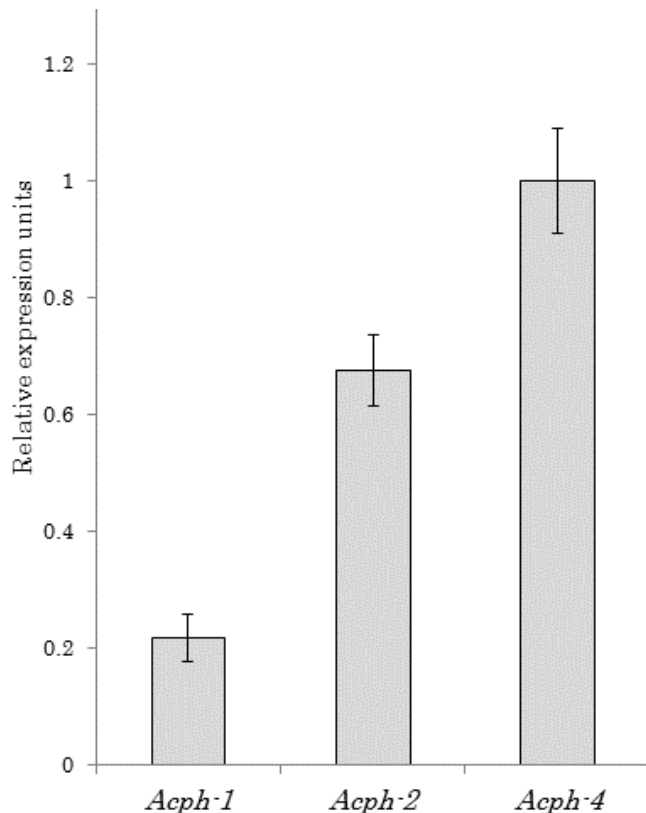

Figure 3. Results of expression analysis of *Acph* transcripts by semi-quantitative reverse transcription PCR. *Acph-1*, *Acph-2*, and *Acph-4* refer to representative *Drosophila virilis* lines harboring those alleles (see Table 1). Lum, Nov, and Ezo are *D. lummei*, *D. novamexicana* and *D. ezoana*, respectively.

Because two transcript types (A and B) were identified in the *Drosophila Acph* gene, their expression levels were examined by semi-quantitative RT-PCR. As revealed in Figure 3, expression levels of type-B transcripts were similar among lines. Type-A expression was variable among *Acph* allelic forms of *D. virilis*, while levels of *D. lummei*, *D. novamexicana*, and *D. ezoana* were similar to those of *D. virilis Acph-4*. Although the electrophoretic mobility of *D. ezoana* was identical to that of ACPH-2 (Figure 1), the expression level of the type-A transcript of *D. ezoana* was similar to that of *Acph-4*. This result indicates that the difference in the activities of *Acph* allozymes is restricted to *D. virilis*.

qRT-PCR was carried out to quantitatively compare type-A expression levels. Expression levels of *Acph-4* and *Acph-2* were, respectively, 4.6 and 3.1 times higher than those of *Acph-1* (Figure 4). These relative expression level differences are consistent with the observed ratio of electrophoretic band staining intensities. In other words, differences in expression levels of the type-A transcript encoding the soluble protein of ACPH were responsible for the activity differences in *Acph* allozyme bands.

ACPH is known to be a lysosomal enzyme in *Drosophila* (MacIntyre, 1966). On the basis of biochemical and morphological studies of developing *Drosophila* larvae, Jones and Bowen (1993) have reported that this enzyme is located in many organelles, with the soluble form appearing during the processes of morphogenesis or cellular degeneration. Narise (1985) has suggested that the variation in enzyme activity



observed on electropherograms is due to differences in the ability of the allozymes to be incorporated into lysosomes.

Figure 4. Results of quantitative real-time PCR analysis of type-A mRNA expression in *Acph* of *Drosophila virilis*. Representative *D. virilis* *Acph-1*, *Acph-2* and *Acph-4* lines were used (see Table 1). Expression was normalized relative to that of the *Gapdh* gene.

My study findings indicate that the *D. virilis* *Acph* gene encodes two types of transcripts—membrane-bound and soluble. The membrane-bound protein is likely located in organelles such as lysosomes, whereas the soluble form may be present in the cytosol of various tissues. The question arises as to why expression levels of transcripts encoding the soluble enzyme differ among *Acph* allozyme genes. One possibility is that this differential expression may be controlled by a regulatory system, such as a system involving enhancers and regulators. Thus far, however, I have been unable to identify any candidate nucleotide sequences in the regulatory region of this gene. Another unresolved question concerns tissue specificity of the different transcripts. In humans, as mentioned in the Introduction, leucocyte lysosomal acid phosphatase is a membrane-bound protein while prostatic acid phosphatase is a soluble protein (Sharief and Li, 1992). In addition, expression of lysosomal acid phosphatase in the testis and brain of mice is not uniform across tissues: high expression has been found to be restricted to spermatocytes in the testis and to neurons in the brain (Geier *et al.*, 1992). Expression of the type-A transcript of the *Acph* gene is thus most likely also differentially regulated in various organs and tissues. Further studies to investigate organ- and tissue-specific expression are required to clarify the mechanism responsible for the differing allozyme activities and to uncover the role of *Acph* in *Drosophila*.

References: Ayala, F.J., and M.L. Tracey 1974, Proc. Natl. Acad. Sci. USA 71: 999-1003; Collier, G., R.J. MacIntyre, and D. Featherston 1990, Ecological and evolutionary genetics of *Drosophila*. (Baker, J.S.F., W.T. Starmer, and R.J. MacIntyre, eds.), pp. 419-446. Plenum Press, New York; Chung, H.J., C. Shaffer, and R.J. MacIntyre 1996, Mol. Gen. Genet. 250: 635-646; Geier, C., K. von Figura, and R. Pohlmann 1989, Eur. J. Biochem. 183: 611-616; Geier, C., J. Kreysing, H. Boettcher, R. Pohlmann, and K. von Figura 1992, J. Histochem. Cytochem. 40: 1275-1282; Jones, H.E., and I.D. Bowen 1993, Cell. Biol. Int. 17: 305-315; Kim, W.C., C. Ma, W-M. Li, M. Chohan, D.M. Wilson III, and C.H. Lee 2014, PLOS ONE 9: e90837; Kitagawa, H., 2003, DNA seq. 14: 135-139; Kojima, K., J. Gillespie, and Y.N. Tobar 1970, Biochem. Genet. 4: 627-637; Loukas, M., C.B. Krimbas, and Y. Vergini 1979, Genetics 93: 497-523; MacIntyre, R.J., 1966, Genetics 53: 461-474; Narise, S., 1976, Jap. J. Genet. 51: 428; Narise, S., 1984, Insect Biochem. 14: 473-480; Narise, S., 1985, Genet. Res. 45: 143-153; Navarro-Sabaté, À., M. Agudé, and C. Segarra 1999, Genetics 153: 871-889; Ohba, S., 1977, UP Biology Series 19, Tokyo Univ. Press, Tokyo, pp. 99-104; Sharief, F.S., and S.S. Li 1992, Biochem. Biophys. Res. Commun. 184: 1468-1476; Thompson, J.D., D.G. Higgins, and T.J. Gibson 1994, Nucleic Acids Res. 22: 4673-4680; Tominaga, H., T. Shiba, and S. Narise 1992, Biochim. Biophys. Acta. 1131: 233-238.



## Microsatellite heterologous amplification in individual samples of *Drosophila griseolineata*.

**Prestes, Jaqueline O., Silvana A. Beira, Luciana P.B. Machado, and Rogério P. Mateus.**

Laboratório de Genética e Evolução, Departamento de Ciências Biológicas, Campus CEDETEG, UNICENTRO – Universidade Estadual do Centro-Oeste, R. Simeão Camargo Varela de Sá, 03, 85040-080, Guarapuava-PR, Brasil; e-mail: [rogeriopmateus@gmail.com](mailto:rogeriopmateus@gmail.com)

### Abstract

In this work we tested the transference of 20 microsatellite loci described for *Drosophila mediopunctata* (*tripunctata* group) in individual samples of *D. griseolineata* (*guaramunu* group). The samples were collected in Caieira da Barra do Sul (27°48'S; 48°33'W), a secondary Atlantic Forest fragment, located south of Florianópolis city, Santa Catarina state, Brazil. According to the literature, among the 20 loci, 18 showed good quality amplification in a pool of individuals of a *D. griseolineata* strain. However, our results showed that only seven (35%) of the 20 analyzed loci presented positive amplification in individual samples from the natural population. This amplification rate was even lower to that obtained in a previous work with *D. maculifrons*, species of the same *guaramunu* group of *D. griseolineata*, and slightly higher to that for *D. ornatifrons* (of the *guarani* group, closely related to *guaramunu* and *tripunctata* groups). These results indicated that the transferability of the microsatellite loci described for *D. mediopunctata* to species of closely related groups is very low in individual samples, which are suitable for populational analyses. Thus, we present here the seven loci, with their respective primer optimal annealing temperatures, which showed to be appropriate for use in future natural population structure analyses of *Drosophila griseolineata*.

### Introduction

The microsatellite molecular marker is a suitable tool to qualify and quantify the genetic variability of natural populations, as well as to determine the possible causes of how this variation is distributed. Microsatellite loci are frequently used in population analyses of *Drosophila* because, among other reasons, most of the times the described primers for one species can be applied in other related species (Machado *et al.*, 2003; Moraes and Sene, 2007; Laborda *et al.*, 2009a; Tractz *et al.*, 2012). The transferability is possible when the flanking regions of the microsatellite loci are conserved among taxa (Peakall *et al.*, 1998). However, in heterologous amplifications a higher frequency of null alleles is expected as a result of mutations in the flanking regions, which prevent primer annealing (Callen *et al.*, 1993; Estoup and Cornuet, 1999; Dakin and Avise, 2004).

Laborda *et al.* (2009b) described more than one hundred microsatellite loci for *Drosophila mediopunctata* (*tripunctata* group) and tested their cross-amplification in species of different groups of *Drosophila* (Laborda *et al.*, 2009a). Tractz *et al.* (2012) analyzed the applicability of 18 microsatellite loci in individual samples from natural populations of *D. maculifrons* and *D. ornatifrons* (*guaramunu* and *guarani* groups, respectively, according to Robe *et al.*, 2010). They observed a transferability rate of only 28% in *D. ornatifrons* and of 50% in *D. maculifrons*, despite of Laborda *et al.* (2009a) have indicated that these loci presented good quality amplification in a pool of individuals from isofemale lines of these species. Silva *et al.* (2015) applied with success the loci suggested by Tractz *et al.* (2012) in estimates of effective population size and gene flow rate in two natural populations of *D. maculifrons* collected in conservation areas of Araucaria forest (Mixed Ombrophilous Forest).

Therefore, due to the conflicted results about the success of transferability using individual DNA samples (Tractz *et al.*, 2012) and pool of individuals from isofemale lines of *Drosophila* (Laborda *et al.*, 2009a), the main goal of this work was to evaluate the applicability in *D. griseolineata* of the microsatellite loci described for *D. mediopunctata*. To those that showed positive amplification in individual samples of *D.*

*griseolineata*, their optimal annealing temperatures were determined in order to achieve a better quality amplification and, consequently, a higher reliability in the population analyses to which these loci could be applied.

## Material and Methods

The *Drosophila griseolineata* samples were supplied by Prof. Daniela C. De Toni, from the Departamento de Biologia Celular, Embriologia e Genética of the Universidade Federal de Santa Catarina – UFSC. Specimens were collected in a secondary Atlantic forest fragment that depicts high stage of forest regeneration, located in Caieira da Barra do Sul (27°48'S; 48°33'W), south of the Florianópolis city, Santa Catarina state, Brazil.

Table 1. Quality, rate of amplification and optimal annealing temperature of microsatellite loci of *Drosophila mediopunctata* in *Drosophila griseolineata* collected in Caieira da Barra do Sul, Florianópolis-SC, Brazil. + = positive and good quality amplification; +/- = positive, but weak amplification; - = absence of amplification.

Loci	Amplification Quality	Annealing Temperature
Dmed <sup>UNICAMP</sup> _ssr034	-	-
Dmed <sup>UNICAMP</sup> _ssr039	-	-
Dmed <sup>UNICAMP</sup> _ssr041	-	-
Dmed <sup>UNICAMP</sup> _ssr053	-	-
Dmed <sup>UNICAMP</sup> _ssr054	+	50°C
Dmed <sup>UNICAMP</sup> _ssr056	-	-
Dmed <sup>UNICAMP</sup> _ssr057	-	-
Dmed <sup>UNICAMP</sup> _ssr065	-	-
Dmed <sup>UNICAMP</sup> _ssr079	±	54°C
Dmed <sup>UNICAMP</sup> _ssr087	+	56°C
Dmed <sup>UNICAMP</sup> _ssr095	-	-
Dmed <sup>UNICAMP</sup> _ssr096	+	54°C
Dmed <sup>UNICAMP</sup> _ssr099	-	-
Dmed <sup>UNICAMP</sup> _ssr102	-	-
Dmed <sup>UNICAMP</sup> _ssr107	+	56°C
Dmed <sup>UNICAMP</sup> _ssr115	-	-
Dmed <sup>UNICAMP</sup> _ssr118	±	50°C
Dmed <sup>UNICAMP</sup> _ssr121	-	-
Dmed <sup>UNICAMP</sup> _ssr126	+	54°C
Dmed <sup>UNICAMP</sup> _ssr133	-	-
Amplification Rate	35%	

The same 18 microsatellite loci analyzed by Tractz *et al.* (2012) in *D. maculifrons* and *D. ornatifrons* were tested in individual samples of *Drosophila griseolineata*, adding two other loci (Dmed<sup>UNICAMP</sup>\_ssr115 and Dmed<sup>UNICAMP</sup>\_ssr121), totaling 20 of the microsatellite loci originally described for *D. mediopunctata* (Laborda *et al.*, 2009b) (Table 1). According to Laborda *et al.* (2009a), 18 loci analyzed in this work showed positive and good quality amplification using DNA sample of a pool of individuals from an isofemale line of *D. griseolineata*. The Dmed<sup>UNICAMP</sup>\_ssr099 and Dmed<sup>UNICAMP</sup>\_ssr107 loci, according to those authors, did not present amplification in *D. griseolineata*.

First, all loci were tested using the same touchdown PCR conditions described by Laborda *et al.* (2009b). Those loci that showed positive amplification were submitted to tests of different temperatures during the annealing stage in order to determine the optimal temperature for each primer, using the following PCR conditions: one denaturation cycle at 94°C for 2 minutes; 25 cycles containing one minute of denaturation at 94°C, 60 seconds in the testing annealing temperature (ranging from 50°C to 60°C, increasing two degrees Celsius in each different reaction) and 72°C for two minutes. For the Dmed<sup>UNICAMP</sup>\_ssr079 and Dmed<sup>UNICAMP</sup>\_ssr118 loci, we also tested the annealing temperatures of 53°C and 55°C. The PCR products were analyzed in 6% PAGE, stained with silver nitrate (Sanguinetti *et al.*, 1994; Machado *et al.*, 2003). The optimal annealing temperature was determined verifying the fragment size according to Laborda *et al.* (2009b) that showed

less unspecific amplifications that could compromise the quality of population studies.

## Results and Discussion

Laborda *et al.* (2009a) tested the amplification of microsatellite loci described for *Drosophila mediopunctata* (Laborda *et al.*, 2009b), of the *tripunctata* group, in DNA samples of a pool of individuals from isofemale lines of different *Drosophila* species. In the present work, the amplification rate of several of these loci in individual DNA samples of *D. griseolineata* specimens (*guaramunu* group, according to Robe *et al.*,

2010) collected from a natural population. Eighteen out of the 20 tested loci had good amplification quality using a pool of individuals of a *D. griseolineata* strain, according to Laborda *et al.* (2009a). However, in the individual DNA samples from freshly collected specimens of this work, only seven (35%) showed amplification. Among these seven loci, two (Dmed<sup>UNICAMP</sup>\_ssr079 and Dmed<sup>UNICAMP</sup>\_ssr118) showed weaker amplification, even when annealing temperature higher (55°C) and lower (53°C) than that applied to obtain the fragment with the expected size were tested. Moreover, these loci were not amplified even using the touchdown PCR condition. The optimal annealing temperature for each primer that showed positive amplification ranged from 50°C to 56°C (Table 1).

The Dmed<sup>UNICAMP</sup>\_ssr107 locus, which showed no amplification for *Drosophila griseolineata* in the work of Laborda *et al.* (2009a), presented positive result in the tests performed in the present work. The proportion of *D. mediopunctata* loci that showed amplification in *D. griseolineata* (35%, Table 1) was lower than that found by Tractz *et al.* (2012) in *D. maculifrons* (50%), despite both belonging to the same group of species. The rate of amplification in *D. griseolineata* was higher when compared with *D. ornatifrons* (28%, Tractz *et al.*, 2012), of the *guarani* group. However, among the loci that showed positive amplification, only three (Dmed<sup>UNICAMP</sup>\_ssr087, Dmed<sup>UNICAMP</sup>\_ssr096, Dmed<sup>UNICAMP</sup>\_ssr118) coincided among *D. griseolineata* and the other two species. On the other hand, five coincident loci were obtained between *D. maculifrons* and *D. ornatifrons* (the same three above, plus Dmed<sup>UNICAMP</sup>\_ssr034 and Dmed<sup>UNICAMP</sup>\_ssr057).

These data indicated that the transferability of the loci described for *Drosophila mediopunctata* to species that belong to closely related groups is reduced in individual samples, which are more adequate for populational analyses. Moreover, despite the higher amplification rate in the *guaramunu* group to be in agreement with the close phylogenetic relationship of this group with the *tripunctata* group, closer than the relationship of the *guarani* group of *Drosophila ornatifrons* with the *tripunctata* group (Kastritsis, 1969; Kastritsis *et al.*, 1970; Hatadani *et al.*, 2009; Robe *et al.*, 2010), the higher number of in common amplified loci between *D. maculifrons* and *D. ornatifrons* than between both species of the *guaramunu* group reinforce the data of Laborda *et al.* (2009a), who postulated that there is no correlation between phylogeny and the results of interspecific amplification.

The microsatellite loci of *Drosophila mediopunctata* that showed good quality amplification in *D. griseolineata* indicated them to be adequate genetic markers to be applied in population studies using this species.

Acknowledgments: We thank D.C. de Toni for collecting and supplying the samples.

References: Callen, D.F., A.D. Thompson, Y. Shen, H.A. Phillips, R.I. Richards, J.C. Mulley, and G.R. Sutherland 1993, *Am. J. Hum. Genet.* 52: 922-927; Dakin, E.E., and J.C. Avise 2004, *Heredity* 93: 504-509; Estoup, A., and J.M. Cornuet 1999, *In: Microsatellites: Evolution and Applications.* (Goldstein, D.B., and C. Schöötter, eds.). Oxford University Press, Oxford, New York, pp. 49-65; Kastritsis, C.D., 1969, *J. Hered.* 60: 51-57; Kastritsis, C.D., G. Pasteur, and J. Quick 1970, *Canad. J. Genet. Cytol.* 12: 952-959; Laborda, P.R., L.B. Klaczko, and A.P. Souza 2009a, *Conserv. Genet. Resour.* 1: 281-296; Laborda, P.R., G.M. Mori, and A.P. Souza 2009b, *Conserv. Genet. Resour.* 1: 297-307; Machado, L.P.B., M.H. Manfrin, W.A. Silva-Junior, and F.M. Sene 2003, *Mol. Ecol. Notes* 3: 159-161; Moraes, E.M., and F.M. Sene 2007, *J. Zoolog. Syst. Evol. Res.* 45: 336-344; Peakall, R., S. Gilmore, W. Keys, M. Morgante, and A. Rafalski 1998, *Mol. Biol. Evol.* 15: 1275-1287; Robe, L.J., V.L.S. Valente, and E.L.S. Loreto 2010, *Genetica* 138: 725-735; Sanguinetti, C., E. Dias Neto, and A.J.G. Simpson 1994, *Biotechniques* 17: 209; Silva, D.C., L.P.B. Machado, and R.P. Mateus 2015, *Braz. J. Biol.* 75: 254-255; Tractz, C.C., G.R. Salomon, S.V. Zorzato, L.P.B. Machado, and R.P. Mateus 2012, *Dros. Inf. Serv.* 95: 76-79.



## Interplay between *Drosophila suzukii* and native *Drosophila* species in the Mediterranean area.

**Orengo, D.J., E. Puerma, and M. Aguadé.** Departament de Genètica, Facultat de Biologia, and Institut de Recerca de la Biodiversitat (IRBio), Universitat de Barcelona, Barcelona,

Spain; dorcasorengo@ub.edu.

*Drosophila suzukii*, an endemic to South East Asia, has become an invasive pest starting by the Mediterranean area and in less than 10 years has colonized almost all of Western Europe (Cini *et al.*, 2012). In Catalonia, the species was first detected in 2008 and near Barcelona in 2009 (Calabria *et al.*, 2012). In fly collections performed near Barcelona at the Font Gropa site—in the northern foothills of the Tibidabo hill at 400 m above sea level—in autumn 2012 and 2013, the species abundance was reported to be 8 to 10% of drosophilid flies (Canals *et al.*, 2013; Pineda *et al.*, 2014), suggesting that it was well established in the Barcelona area.

Here we report the presence of *D. suzukii* in two drosophilid collections performed in autumn 2011 (November 2 and 7) and in autumn 2014 (November 14) at the *Observatori Fabra* fields. This site that is described in Orengo and Prevosti (1996) is located, similarly to Font Gropa near Barcelona, but in this case in the southern foothills of the Tibidabo hill at 413 m above sea level. Flies were captured in the afternoon until dusk, netting over fermenting banana baits placed at regular intervals in the Fabra fields.

Drosophilids had been previously collected multiple times at the Fabra fields in the period extending from 1970 to 2007 (Orengo and Prevosti, 1996, and unpublished results). Records from those collections showed that the most common species in that location were *D. subobscura* and *D. simulans*. Those records also showed that both species experienced a population explosion in autumn, with *D. simulans* reaching its maximum abundance first and *D. subobscura* doing it subsequently (de Frutos and Prevosti, 1984; Orengo, 1994).

Table 1. Number (and %) of flies captured in the Fabra fields in autumn 2011 and 2014.

November 2, 2011				
Species	♀	♂	Total	
<i>D. subobscura</i> <sup>1</sup>	11	9	20	(13.99)
<i>D. simulans</i> <sup>2</sup>	4	4	8	(5.59)
<i>D. buzzatii</i>	4	1	5	(3.50)
<i>D. suzukii</i>	51	58	109	(76.22)
other	1	0	1	(0.70)
Total	71	72	143	(100)
November 7, 2011				
Species	♀	♂	Total	
<i>D. subobscura</i> <sup>1</sup>	21	158	179	(10.09)
<i>D. simulans</i> <sup>2</sup>	493	648	1141	(64.32)
<i>D. buzzatii</i>	11	12	23	(1.30)
<i>D. suzukii</i>	219	208	427	(24.07)
other	1	3	4	(0.23)
Total	745	1029	1774	(100)
November 14, 2014				
Species	♀	♂	Total	
<i>D. subobscura</i> <sup>1</sup>	198	15	213	(77.45)
<i>D. simulans</i> <sup>2</sup>	16	13	29	(10.55)
<i>D. buzzatii</i>	13	11	24	(8.73)
<i>D. suzukii</i>	5	1	6	(2.18)
other	3	0	3	(1.09)
Total	235	40	275	(100)

<sup>1</sup> some *D. ambigua* flies could have been included as *D. subobscura*.

<sup>2</sup> some *D. melanogaster* flies could have been included as *D. simulans*.

period would be successively *D. suzukii*, *D. simulans*, and *D. subobscura*. This observation for the latter two species conforms to those recorded from previous collections in the same area and time period in which the first maximum species abundance in early autumn was that of *D. simulans* followed by that of *D. subobscura* (Orengo, 1994).

When we newly collected drosophilids at the Fabra fields in 2011—*i.e.*, only two years after Calabria *et al.* (2012) reported the presence at low frequency of *D. suzukii* near Barcelona—we found that this species was one of the two most abundant species in this location (Table 1). However, the *Drosophila* species abundance varied greatly between the two samples collected that autumn. Indeed, most flies collected on November 2 were *D. suzukii* individuals (76.22%), being *D. subobscura* the second most abundant species (Table 1). In the much larger sample collected that same year on November 7, the most abundant species was *D. simulans* (64.32%), followed by *D. suzukii* (24.07%) and by *D. subobscura* (10.09%; Table 1). The species abundances also varied greatly between the two samples collected in 2011 and that collected on November 14, 2014. In the latter sample, *D. subobscura* was the prevalent species, and *D. suzukii* was among the least frequent species. Since according to the Observatori Fabra records, climatic conditions at that site along November were very similar in 2011 and 2014, the collection data here reported would indicate that, in autumn, the relatively most abundant species along this

Our drosophilid collection data at Observatori Fabra would support previous observations from collections at Font Gropa indicating that *D. suzukii* is well established in the Barcelona area, even though its frequency was much lower in our last collection in autumn 2014. Its establishment in this area, as well as throughout Europe and North America, raises an important concern given the negative economical consequences of its females ovipositing in commercial fresh fruits and the subsequent damage to the corresponding crops. Moreover, our data would indicate that native species might be affected by the presence of this exotic species that would postpone their autumn population maxima, when they might be subjected to different environmental conditions.

**Acknowledgments:** We thank Alfons Puertas from Observatori Fabra for facilitating our access to the Observatori Fabra fields. We also thank David Salguero, Juan Manuel Calvo, and Unai Cereijo for helping with fly collections.

**References:** Calabria, G., J. Máca, G. Bächli, L. Serra, and M. Pascual 2012, *J. Appl. Entomol.* 136: 139-147; Canals, J., J. Balanyà, and F. Mestres 2013, *Dros. Inf. Serv.* 96: 185-186; Cini, A., C. Ioriatti, and G. Anfora 2012, *Bull. of Insect.* 65: 149-160; de Frutos and Prevosti 1984, *Genetica* 63: 181-187; Orengo, D.J., 1994, *Correlación entre el polimorfismo cromosómico y el tamaño del cuerpo en Drosophila subobscura*. Ph.D. thesis. Universitat de Barcelona, Barcelona. 173 pp; Orengo, D.J., and A. Prevosti 1996, *Evolution* 50: 1346-1350; Pineda, L., C. Esteve, M. Pascual, and F. Mestres 2014, *Dros. Inf. Serv.* 97: 37.



### **On the geographic distribution of the *Drosophila willistoni* group (Diptera, Drosophilidae) – updated geographic distribution of the Neotropical *willistoni* subgroup.**

**Zanini, Rebeca<sup>1,2</sup>, Maríndia Deprá<sup>1,2</sup>, Vera Lúcia da Silva Valente<sup>1,2</sup>.** <sup>1</sup>Programa de Pós-Graduação em Biologia Animal, Universidade Federal do Rio Grande do Sul (UFRGS), Avenida Bento Gonçalves, 9500 prédio 43435 CEP 91501-970, Bairro Agronomia, Porto Alegre, RS, Brazil. <sup>2</sup>Laboratório de *Drosophila*, Universidade Federal do Rio Grande do Sul (UFRGS), Avenida Bento Gonçalves, 9500 prédio 43323 sala 210 CEP 91501-970, Bairro Agronomia, Porto Alegre, RS, Brazil. Corresponding author: [rebeca.zanini@gmail.com](mailto:rebeca.zanini@gmail.com)

### **Introduction**

*Drosophila willistoni* species group comprises 24 Neotropical species, divided into three subgroups – *alagitans*, *bocainensis*, and *willistoni* (Bächli, 2015). The *willistoni* subgroup is composed of six sibling species: *D. willistoni*, *D. equinoxialis*, *D. tropicalis*, *D. insularis*, *D. pavlovskiana*, and *D. paulistorum*. The latter is actually a species complex. *Drosophila willistoni* was described as *Drosophila pallida* (Williston, 1896). Since this nomenclature was already used, Sturtevant (1916) changed it to *D. willistoni*. Dobzhansky and Pavan (1943) found two *willistoni*-like species, one more common and slightly smaller than the other. They believed that the more common species was *D. willistoni* and nominated the larger and less frequent species as *D. paulista*. Later, the authors perceived that, in fact, *D. paulista* was a synonym of the *D. willistoni* and, since then, the smaller species was nominated *D. paulistorum* (Dobzhansky and Pavan in Burla *et al.* 1949).

A few years later, three new siblings were described: *D. equinoxialis* (Dobzhansky, 1946), *D. tropicalis* (Burla and Cunha, 1949 in Burla *et al.*, 1949) and *D. insularis* (Dobzhansky, 1957 in Dobzhansky *et al.*, 1957). Also, Townsend (1954) found that *D. tropicalis* comprises two subspecies, *tropicalis* and *cubana*. *Drosophila tropicalis tropicalis* presents a southern distribution and the northernmost register is in Rio Branco, Brazil; while *D. tropicalis cubana* is a northern form and the southernmost register is in Jamaica (Townsend, 1954).

In 1959, Dobzhansky and Spassky discovered that *D. paulistorum* was not a unique species, but a cluster of six incipient species – Amazonian, Andean-Brazilian, Centroamerican, Guianan, Orinocan and

Transitional. The denominated Guianan was posteriorly elevated to species, *D. pavlovskiana* (Kastritsis and Dobzhansky, 1967) and another incipient species denominated Interior was added to *D. paulistorum* cluster by Pérez-Salas *et al.* (1970).

Similar to *D. tropicalis*, it was discovered that *D. willistoni* and *D. equinoxialis* also represent subspecies. Ayala (1973) observed that populations of *D. willistoni* from Lima, Peru presented incipient reproductive isolation from flies collected in Colombia, Venezuela, Trinidad, and Brazil (*D. willistoni willistoni*) and were assigned as a new subspecies, *D. willistoni quechua*. Populations of *D. equinoxialis* from Hispaniola, Puerto Rico, and Costa Rica exhibited incipient reproductive isolation from flies from Panama and Continental South America. These subspecies were denominated *caribbensis* and *equinoxialis*, respectively.

Concerning the geographic distribution of *D. willistoni* and its siblings, Spassky *et al.* (1971) compiled previously published data and also added new information. This study was updated by Dobzhansky and Powell (1975) and Ehrmann and Powell (1982). Since then, these species have been collected in several new localities. Therefore, the objective of this study was to update the distribution map of *D. willistoni* subgroup, including *D. paulistorum* species complex.

## Material and Methods

We gathered all distribution records in literature for each species and its synonyms of the *willistoni* subgroup. We searched all distribution records compiled in Taxodros and verified the data in the original material. We checked the geographic coordinates using Google Maps and plotted those in maps using QGIS 2.10.1 software. All distribution records, coordinates and respective references are available in Taxodros ([taxodros.uzh.ch](http://taxodros.uzh.ch)) (Bächli, 2015).

## Results and Discussion

The *willistoni* subgroup is almost entirely Neotropical, except for the occurrences in USA and North Mexico.

*Drosophila willistoni* has the broadest distribution of this subgroup, spanning from Florida, Mexico, and Caribbean Islands, in North America, to Argentina and Uruguay, in Southern South America (Figure 1A). This species has been reported in most of South America, except in Paraguay and Chile, while also being found in Galapagos Islands. The northernmost records for *D. willistoni* are in Hawaii and in Crater Lake, Oregon, USA.

*Drosophila tropicalis* occurs in Florida, Mexico, Caribbean Islands, Central America, North and central South America. The southernmost registered locality for this species is São José do Rio Preto, in São Paulo state, Brazil (Figure 1B). *Drosophila equinoxialis* has a geographic distribution very similar to *D. tropicalis*, living in sympatry in the major part of its territory (Figure 1B).

Two species of this subgroups have a very restricted distribution. *Drosophila insularis*, endemic of the Antilles, was found in five localities: Guadeloupe, Monkey Hill, Montserrat, Saint Kitts, and Saint Lucia (Figure 1B). *Drosophila pavlovskiana* occurrence was registered in Apoteri and Georgetown, in Guyana, and in Ocamo, Porto Ayacucho and Rancho Grande, in Venezuela (Figure 1B). *D. pavlovskiana* has not been recently collected.

Regarding *Drosophila paulistorum* cluster, we can observe an interesting aspect. When considering *D. paulistorum* occurrences, not specifying the semispecies (Figure 2A), there are much more registers, and, consequently, the living area seems to be wider than when we indicate the semispecies (Figure 2B). *Drosophila paulistorum* has a highly similar distribution to *D. willistoni*, although not occurring in Uruguay and Argentina (Figure 2A). The southernmost records of *D. paulistorum* are in Porto Alegre, Rio Grande do Sul state, Southern Brazil.

Considering the semispecies of *D. paulistorum*, Andean-Brazilian is the most widespread, occurring in several localities of Brazil, Ecuador, Peru, Colombia, and Venezuela (Figure 2B). This semispecies occurs alone in the largest part of its distribution, although it lives sympatrically with Amazonian, Orinocan or Interior along the Amazon river and the upper Orinoco.



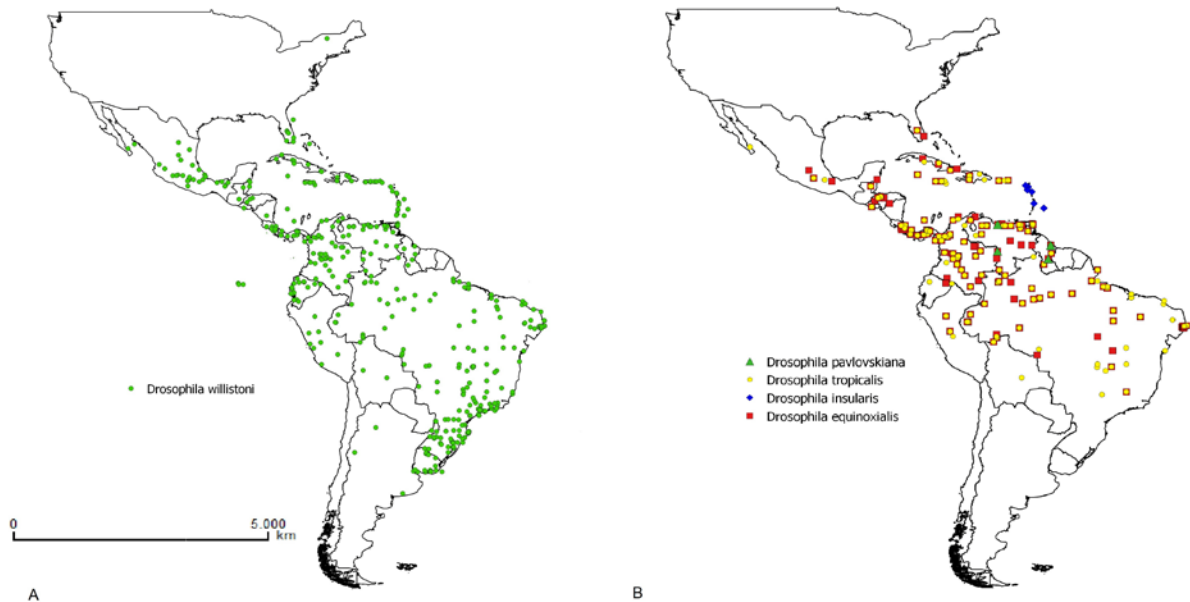

Figure 1. Geographic distribution of the *willistoni* subgroup. A. Distribution of *Drosophila willistoni*. C. Distribution of *Drosophila tropicalis*, *Drosophila equinoxialis*, *Drosophila insularis* and *Drosophila pavlovskiana*.

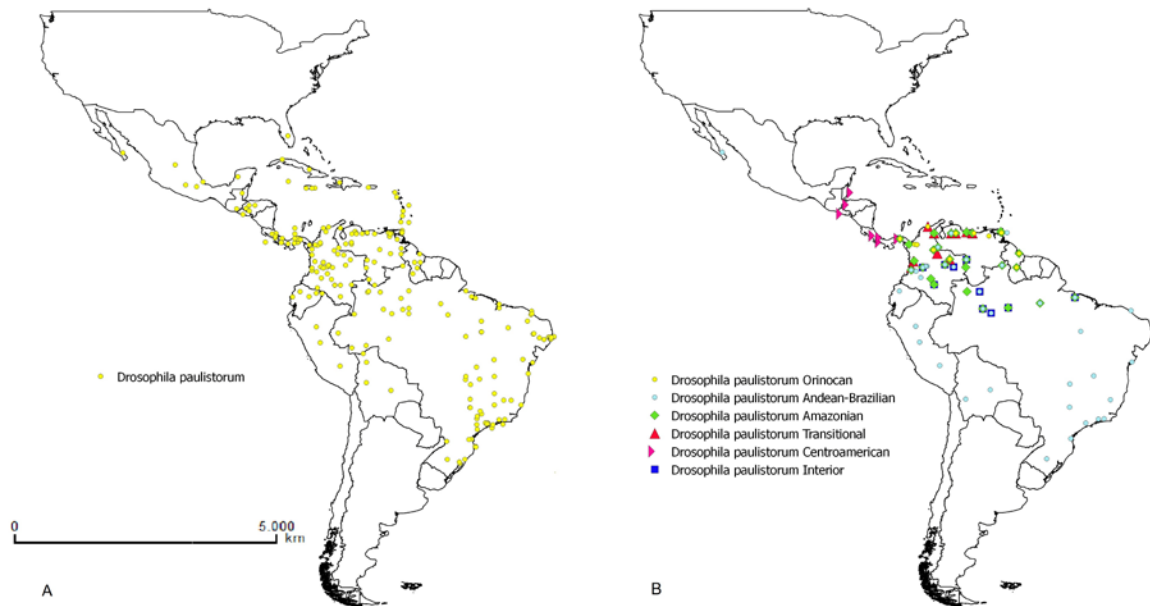

Figure 2. Geographic distribution of the *willistoni* subgroup. A. Distribution of *Drosophila paulistorum*. B. Distribution of *Drosophila paulistorum* semispecies Amazonian, Andean-Brazilian, Centroamerican, Interior, Orinocan, and Transitional.

*Drosophila paulistorum* Centroamerican has been found in Tical (Colombia), Lancetilla (Honduras), San Salvador (El Salvador), Turrialba (Costa Rica) and Boquete, Almirante and the Central area of Panama (Figure 2B). In central Panama, *D. paulistorum* Orinocan occurs together with Amazonian and Orinocan (Figure 2B).

The Transitional semispecies presence was reported in Chocó Condoto, Santa Marta and Valle, in Colombia and in Perija, Vigía, Barinas, Sarare, Rancho Grande and Guatopo, in Venezuela (Figure 2B). It occurs together with Orinocan in Santa Marta and with Andean-Brazilian and Amazonian in Northern Venezuela (Figure 2B).

The Amazonian semispecies spans from Panama and Trinidad to Colombia, Venezuela, Guyana, and Northern Brazil (Figure 2B). It lives in sympatry with Andean-Brazilian, Interior, Orinocan, and Transitional in several localities (Figure 2B).

The Orinocan semispecies occurs in Panama, Trinidad, Colombia, Venezuela, and Guyana, mainly in the Caribbean coast (Figure 2B). The Interior semispecies distributes in Colombia, Venezuela, and Northern Brazil. These semispecies had never been found together (Spassky *et al.*, 1971).

Most of the species of the *willistoni* subgroup live in sympatry in Colombia, Venezuela, Ecuador, Bolivia, and Northern Brazil, while we can observe a large empty patch in central Brazil, Paraguay, and Argentina (Figures 1A-B, 2A-B). This species also has not been reported in Chile, which might be explained by the presence of a great barrier: the Andes chain. This observation raises some questions: Is it possible that none of this species really lives in this area? This could be an artifact because of a lack of studies in these specific areas or the species are not properly identified?

It has been reported that the species identification in this subgroup is difficult, due to the morphological similarity among them. Although many authors have published ecological studies with *D. willistoni* subgroup, only a few studies presented the identification at specific level. Many attempts to identify these species have been made, using different approaches, such as morphological studies, allozymatic assays, crossing tests, and chromosomal analysis (Burla *et al.*, 1949; Malogolowkin, 1952; Spassky, 1957; Dobzhansky and Spassky, 1959; Pasteur, 1970; Ayala *et al.*, 1970; Richmond, 1972; Ayala and Powell, 1972; Garcia *et al.*, 2006, and review of the main results in Ehrmann and Powell, 1982, and in Cordeiro and Winge, 1995). Recently, Zanini *et al.* (2015) has shown that it is possible to identify all species of the *willistoni* subgroup and even *D. paulistorum* incipient species based on morphological characters of the male genitalia, so this study could be helpful in further research.

The most reasonable explanation for those empty spaces is, in fact, a combination of not enough studies encompassing those areas and the misidentification or lack of identification of the *willistoni* subgroup members. Further studies and a more accurate identification of these species are necessary in order to improve its distribution records.

Acknowledgments: We thank to CNPq, CAPES and FAPERGS for the scholarships and grants.

References: Ayala, F.J., 1973, *The Pan Pacific Entomologist* 49(3): 273-280; Ayala, F.J., and J.R. Powell 1972, *Proc. Nat. Acad. Sci.* 69(5): 1094-1096; Ayala, F.J., C.A. Mourão, S. Pérez-Salas, R. Richmond, and Th. Dobzhansky 1970, *Proc. Nat. Acad. Sci.* 67(1): 225-232; Bachli, G., 2015, *Taxodros - The database on taxonomy of Drosophilidae*. [Online]; Burla, H., A.B. DaCunha, A.R. Cordeiro, Th. Dobzhansky, C. Malogolowkin, and C. Pavan 1949, *Evolution* 3: 300-314; Cordeiro, A.R., and H. Winge 1995, Levels of evolutionary divergence of *Drosophila willistoni* sibling species. *In: Genetics of natural populations of Theodosius Dobzhansky*. (Levine, L. ed.). New York: Columbia University Press, 241-261; Dobzhansky, Th., and C. Pavan 1943, *Boletim da Faculdade de Filosofia, Ciências E Letras* 36(4): 10-12; Dobzhansky, Th., and J.R. Powell 1975, The *willistoni* group of sibling species of *Drosophila*. *In: Handbook of Genetics*. (King, R.C., ed.). New York: Plenum Press, 589-622; Dobzhansky, Th., and B. Spassky 1959, *Proceedings of the National Academy of Sciences of United States of America* 45: 419-428; Dobzhansky, Th., 1946, *Ecology* 27(3): 205-211; Dobzhansky, Th., L. Ehrman, and O. Pavlovsky 1957, *University of Texas Publications* 5721: 39-47; Ehrmann, L., and J.R. Powell 1982, The *Drosophila willistoni* species group. *In: The Genetics and Biology of Drosophila*, vol. 3b. (Ashburner, M., H.L. Carson, and J.N. Thompson, Jr., eds.). New York: Academic Press Inc, 193-220; Kastritsis, C.D., and Th. Dobzhansky 1967, *The American Midland Naturalist* 78(1): 244-248; Malogolowkin, C., 1952, *Revista Brasileira de Biologia* 12(1): 79-96; Pasteur, G., 1970, *Evolution* 24: 156-168; Pérez-Salas, S., R.C. Richmond, O.A. Pavlovsky, C.D. Kastritsis, L. Ehrman, and Th. Dobzhansky 1970, *Evolution* 24: 519-527; Richmond, R., 1972, *Genetics* 70: 80-112; Spassky, B., 1957, *University of Texas Publications* 5721: 48-61; Spassky, B., R.C. Richmond, S. Pérez-Salas, O. Pavlovsky, C.A. Mourão, A.S. Hunter, H. Hoentgsberg, Th. Dobzhansky, and F.J. Ayala 1971, *Evolution* 25: 129-143; Sturtevant, A.H., 1916, *Annals of the Entomological Society of America* 9(4): 323-343; Townsend, J.I., 1954,

The American Naturalist 842 (88): 339-351; Williston, S.W., 1896, Transactions of the Entomological Society of London 18(3): 403-417; Zanini, R., M. Deprá, and V.L.S. Valente 2015, Revista Brasileira de Entomologia 59 (4) *in press*.



### Chromosomal translocation at the terminal end of 2L in *Drosophila malerkotliana*.

**Singh, Guruvachan, and A.K. Singh.** Genetics Laboratory, Department of Zoology, Banaras Hindu University, Varanasi-221 005, India. [aksbhu23@rediffmail.com](mailto:aksbhu23@rediffmail.com).

All sorts of structural changes like deletions, duplications, inversions, and translocations in the polytene chromosomes of *Drosophila* can be clearly observed and are reported time to time in its different species. Paracentric inversions are very common in *Drosophila* and occur at a high frequency in a number of species of this genus. However, chromosomal translocations are very rarely reported as they confer deleterious effect. *Drosophila malerkotliana* belongs to the *bipectinata* species complex of the *ananassae* subgroup of the *melanogaster* species group (Bock, 1971). Chromosomal polymorphism in this species has substantially been investigated (Bock, 1971; Jha and Rahman, 1972; Naseerulla and Hegde, 1993). These workers have reported the occurrence of paracentric inversions in the different autosomal chromosomes of this species. As far as we know, any case of translocation has not been reported in *D. malerkotliana* so far.



Fig.1.A

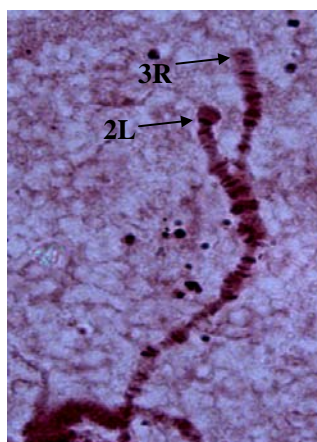

Fig.1. B



Fig.1. C

In this note, we are describing the presence of a chromosomal translocation in the left arm of second chromosome (2L) of *D. malerkotliana* in a isofemale line collected from Bilaspur (Madhya Pradesh, India) in July 2015. Perusal of banding pattern clearly reveals that a part of terminal end of 3R is attached with 2L resulting into the forked appearance of approximately 20% part of terminal end of 2L. Figure 1A shows the normal chromosome arms, whereas Figures 1B and 1C depict the translocation in 2L (translocation heterozygote). In fact, the forked appearance at the tip of 2L is due to pairing between a normal chromosome arm of 2L and a 2L chromosome arm with translocated terminal portion of 3R.

References: Bock, I.R., 1971, Chromosoma 34: 206-209; Jha, A.P., and S.M.Z. Rahman 1972, Chromosoma 37: 445-454; Naseerulla, M.K., and S.N. Hegde 1993, Dros. Inf. Serv. 72: 158-159.

Figure 1. A (top), B and C (bottom).



## Fluctuation of *D. kikkawai* population in Hegdekatta village, Sirsi taluk, India with a preliminary report on its sex comb patterns.

**Srinath, B.S., and N. Shivanna\***. Dept. of Zoology, Karnatak University, Dharwad-580003. \*Corresponding author: drnshivanna@rediffmail.com

### Abstract

*Drosophila* flies were collected from areca plantations of Hegdekatta village, Sirsi taluk, Uttara Kannada District. It revealed a total of 7019 flies comprising of 12 species during 2012 to 2014. *D. kikkawai* Burla 1954, species population fluctuated with respect to areca harvesting period when compared to other species at different seasons. Sex comb teeth and comb pattern variation was observed for the first time in the males of *D. kikkawai* species in either first or second or in both the combs of first and second tarsal segments.

### Introduction

Fluctuation of a species population in a locality/ region may be attributed to many factors such as seasons, temperature, rainfall, humidity, dark – light duration, fruiting plants, and so on (Parsons and Bock, 1979). *Drosophila* flies are constantly used as one of the model organisms in the studies of ecology and biodiversity (Parsons, 1973; Hegde *et al.*, 2001; Markow and O' Grady, 2006). Biodiversity of *Drosophila* till now has revealed a total of 4217 Drosophilids all over the world, which includes 1178 species belonging to genus *Drosophila* (Bachli, 2014). Seasonal studies on *Drosophila* are well documented from different parts of the world (Dobzhansky and Pavan, 1950; Paik, 1957; Wakahama, 1961; Torres and Madi-Ravazzi, 2006), and others. In North India, Parshad and Paika (1964) have studied seasonal variation of *Drosophila* from Punjab. Similarly in South India such studies are well documented from surrounding localities of Mysore (Reddy and Krishnamurthy, 1974; Prakash and Reddy, 1978; Guruprasad and Hegde, 2006; Prakash and Ramachandra, 2008; Guruprasad *et al.*, 2010). In North Karnataka seasonal variation of *Drosophila* is known only from Dharwad District (Srinath and Shivanna, 2014). Variation among particular *Drosophila* species to particular habitat/ locality/ fruiting season is not very well known, though the effects of geographical location, season, species of host plant, and climatic factors on abundance have been studied (Barker *et al.*, 2005). Recently Srinath and Shivanna (2013) studied fluctuation of *Phorticella striata* populations from mango plantations of Dharwad District. *D. kikkawai* is a species belonging to the *kikkawai* species complex of *montium* subgroup categorized under *melanogaster* species group. This species is distributed in parts of Oriental and Neotropical region, females have both dark and light colored abdominal tip in a single population and it is known for color polymorphism (Bock and Wheeler, 1972; Gibert *et al.*, 1999). The variation in male genitalia was also reported (Burla, 1956). The studies on variation of population and other morphological characters were not analysed in this species. In view of this, the present study on above aspects was analysed using *D. kikkawai* in areca plantation.

### Materials and Methods

*Drosophila* flies were collected in areca plantation (*Areca catechu*) of Hegdekatta village, Sirsi taluk during different months from 2012 to 2014 using bottle trapping and net sweeping methods. In bottle trapping method, 250 ml capacity bottles containing about 1 cm of smashed over-ripened banana fruit sprayed with yeast were tied to the twigs of trees near areca plants about 2½ feet above the ground. Bottles were collected after 48 hours by plugging the mouth with cotton. Net sweeping method: the flies were collected directly by sweeping over the areca fruits which were pooled on the ground and were transferred to fresh media bottles containing wheat cream agar medium prepared as per the procedure of Shivanna *et al.* (1996). The bottles were brought to the laboratory, flies were separated according to sex. and species were identified using the

keys as described by Parshad and Paika (1964), Bock and Wheeler (1972), and Markow and O' Grady (2006). For sex comb studies *D. kikkawai* male flies were etherized and forelegs were removed from the bases of the fly and transferred to a transparent glass slide containing a drop of DPX and mounted with a cover glass and observed under microscope. The patterns of teeth arrangement in sex comb were photographed.

## Results and Discussion

A total of 7019 individual flies comprising of 12 species were collected during 2012 to 2014 in areca plantation of Hegdekatta. Figure 1 revealed population fluctuations of 12 species of *Drosophila* in different seasons. *D. n. nasuta*, *D. s. neonasuta*, *D. malerkotliana*, and *D. bipectinata* are dominant species in all the seasons. *D. kikkawai* is not a dominant species in any seasons during 2012 to 2014; it shows dominance only during areca fruiting season. Its dominance is more than the dominant species during other seasons. In 2012 the total number of flies collected is 943 comprising of 7 species, out of which 42% of flies belong to *D. kikkawai*. It amounts to 48% and 43% in 2013 and 2014, respectively. Whereas its percentage in other seasons is 0.05%, 2%; 6%, 3%; and 5%, 2% during summer and monsoon in 2012; 2013 and 2014, respectively. Figure 2 shows the sex combs of *D. kikkawai* collected from areca plantations; it revealed variation in sex comb pattern of male flies in both tarsal segments. These variations were found either in the first or second or in both the sex combs.

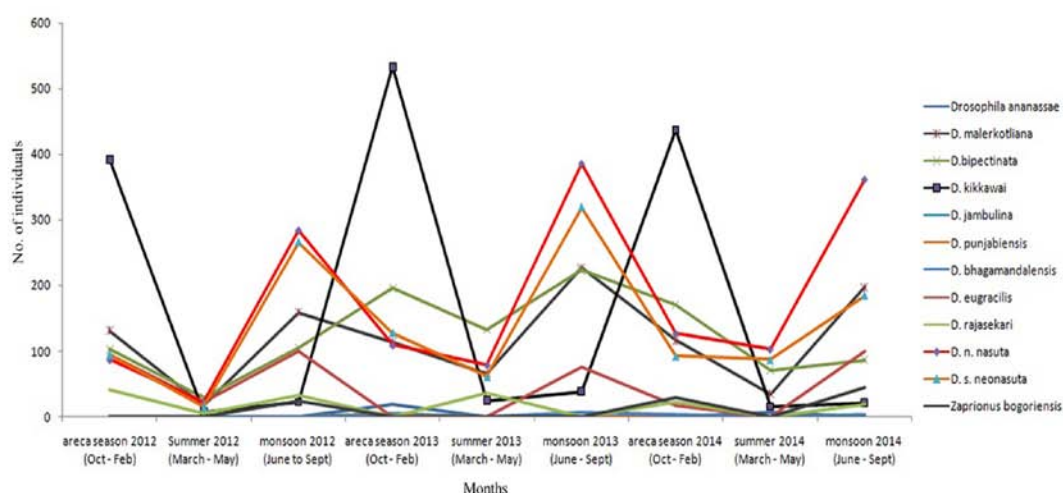

Figure 1. *Drosophila* species and their number of flies collected in different seasons during 2012-14 from Hegdekatta.

*Areca catechu*, which is the major commercial crop in Uttara Kannada district, is grown in an area of approximately 5115 ha (Bhat, 2013). The harvesting season of this crop starts from October to February; during this period maximum yield is obtained. The population of *D. kikkawai* was found maximum in this plantation during the harvesting period of areca fruit compared to other species. Later in summer there is drastic decline in its population and in monsoon other species, such as *D. s. neonasuta*, *D. n. nasuta*, *D. malerkotliana*, and *D. bipectinata*, are found dominant, whereas the population of *D. kikkawai* is negligible. Similar type of result was reported in *D. ananassae*, *D. hypocausta*, and *D. anuda* in a tropical wet climate (Moen Island, Truk, eastern Caroline Islands) due to the presence of fruit-trees (Parsons, 1973); also the range of species is determined by the availability of its host plant range (Barker *et al.*, 2005). In South India, generally it is known that the populations of *Drosophila* are abundant during monsoon season, which usually provides the ideal conditions for populations to thrive (Hegde *et al.*, 2001). The areca harvesting season is categorized under the post-monsoon and winter seasons. Srinath and Shivanna (2013; 2014) studied seasonal variation of *Drosophila* in Dharwad, which is adjacent/ neighbouring district of Sirsi taluk, reported that post-monsoon and winter season has less abundance when compared to monsoon; especially during winter the conditions will be dry, cold, and with a shortage of food source. It was also found that populations of

*Phorticella striata* were abundant during mango harvesting season (May and June), after this season the population declined drastically. The interaction among species and its environment / season shows that fluctuations in number of flies are due to variations in the surrounding microhabitats of the plantations. It could well depend upon the type of particular food on which the species survives and flourishes.

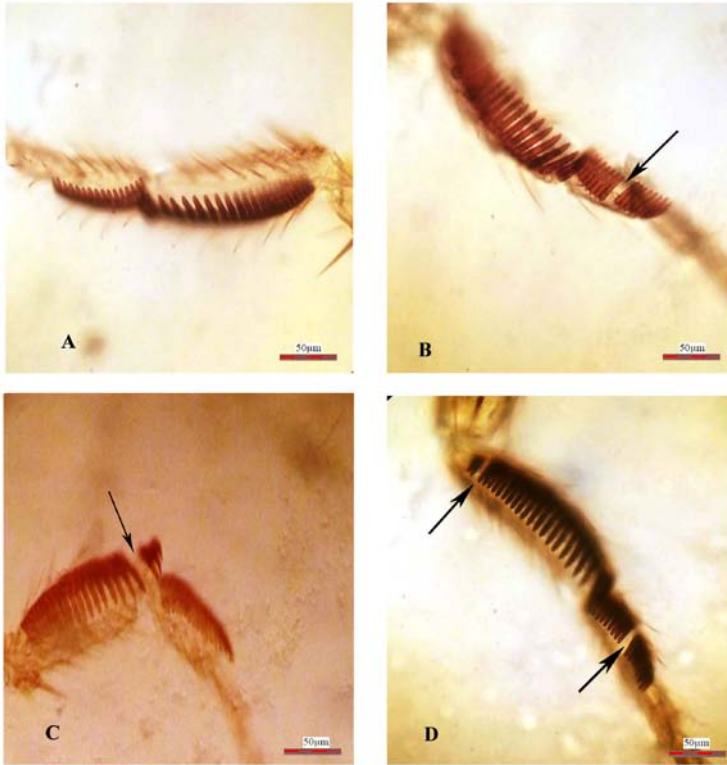

Figure 2. Sex combs of *D. kikkawai*. A, normal; B - D, variants. Arrows indicate gaps in the sex comb at first, second, and both tarsal segments.

The sex comb is one of the traits in identification of species and it is a secondary sexual character which plays an important role in sexual selection. The sex comb is one of the most rapidly evolving male - specific traits in *Drosophila* (Kopp, 2011). The variation among the sex comb in the forelegs was observed in *D. kikkawai*. Variation in number of teeth in combs of first and second tarsal segments as well as gaps was found. Ahuja and Singh (2008) reported similar type of observation in *D. melanogaster*. Sex comb teeth variation and pattern of sex combs in *D. kikkawai* species is the first report from Hegdekatta village of Sirsi. It implies that there is great amount of genetic

variation within population of this species. Further studies in this regard would help in understanding the mechanism of genetic variation and evolution.

**Acknowledgment:** The authors are thankful to the chairperson, Dept. of Zoology, Karnatak University, Dharwad, and also to Mr. Anant Hegde for providing necessary facilities.

**References:** Ahuja, A., and S.R. Singh 2008, *Genetics* 179: 503–509; Bachli, G., 2014, *Taxodros: The database on taxonomy of Drosophilidae*. URL: <http://www.taxodros.unizh.ch> [Date of access: 10-August- 2014]; Barker, J.S.F., R.A. Krebs., and H.I. Davies 2005, *Austral. Ecology* 30: 546–557; Bhat, K., 2013, *Indian J. L. Sci.* 3(1): 117–119; Bock, I.R., and M.R. Wheeler 1972, *Univ. Texas Publ.* 7213: 1–102; Burla, H., 1956, *Archiv d. Julius Klaus-Stiftung*. 290–294; Dobzhansky, Th., and C. Pavan 1950, *J. Anim. Ecol.* 19(1): 1–14; Gibert, P., B. Moreteau, A. Munjal, and J.R. David 1999, *Genetica* 105: 165–176; Guruprasad, B.R., and S.N. Hegde 2006, *Dros. Inf. Serv.* 89: 10–11; Guruprasad, B.R., S.N. Hegde., and M.S. Krishna 2010, *J. Ins. Sci.* 10: 123; Hegde, S.N., V. Vasudev, and M.S. Krishna 2001, *In: Trends in Wildlife Biodiversity Conservation and Management* (Hosetti, B.B., and M. Venkateswarulu, eds.). Daya Publishers, New Delhi, pp. 55–68; Kopp, A., 2011, *Evol. Dev.* 13(6): 504–522; Markow, T.A., and P.M. O' Grady 2006, *Drosophila, A Guide to Species Identification and Use*. Academic Press, London. 247 pp.; Paik, Y.K., 1957, *Dros. Inf. Serv.* 31: 151–153; Parshad, R., and I.J. Paika 1964, *Res. Bull. Punjab Univ.* 15: 225–252; Parsons, P.A., 1973, *Behavioural and Ecological Genetics, A study in Drosophila*. Clarendon Press, Oxford. pp. 221; Parsons, P.A., and I.R. Bock 1979, *Ann. Rev. Ecol. Syst.* 10: 229–245; Prakash, H.S., and G.S. Reddy 1978, *Entomon.* 3(1): 85–90; Prakash, A., and N.B. Ramachandra 2008, *Dros. Inf. Serv.* 91: 82–87; Reddy, G.S., and N.B. Krishnamurthy 1974, *J. Univ. Mysore.* 26(B): 54–64; Shivanna, N., G.S. Siddalingamurthy, and S.R. Ramesh 1996, *Genome* 39: 105–111; Srinath, B.S, and N. Shivanna 2013, *Dros. Inf. Serv.* 96: 61–64; Srinath, B.S, and N. Shivanna 2014, *J. Ento. Zool. Stud.* 2(4): 35–41; Torres, F.R., and L. Madi-Ravazzi 2006, *Iheringia, Sér. Zool. Porto Alegre* 96(4): 437–444; Wakahama, K.I., 1961, *Bull. Shimane Univ. (Natural science)* 10: 90–95.



## The diversity of Drosophilidae in the South American pampas: update of the species records in an environment historically neglected.

**Poppe, Jean Lucas<sup>1,\*</sup>, Hermes José Schmitz<sup>2</sup>, and Vera Lúcia da Silva Valente<sup>1, 3,\*</sup>.**

<sup>1</sup>Programa de Pós-Graduação em Biologia Animal, Universidade Federal do Rio Grande do Sul (UFRGS), Caixa Postal 15.053, 91501-970, Porto Alegre, RS, Brasil; <sup>2</sup>Universidade Federal da Integração Latino-Americana (UNILA). Av. Tancredo Neves, 6731, Bloco 4. Caixa Postal 2044, 85867-970, Foz do Iguaçu, PR, Brasil; <sup>3</sup>Programa de Pós-Graduação em Genética e Biologia Molecular, Universidade Federal do Rio Grande do Sul, Porto Alegre, RS, Brasil; \*Departamento de Genética, Instituto de Biociências, Universidade Federal do Rio Grande do Sul (UFRGS). Caixa Postal 15.053, 91501-970, Porto Alegre, RS, Brasil. E-mail: lucaspoppe@bol.com.br (Corresponding author).

### Introduction

In the last decades many faunal surveys of Drosophilidae have been done in different Neotropical environments in Brazil, such as Atlantic rainforest (De Toni *et al.*, 2007), Cerrado (Mata *et al.*, 2008), mangrove swamps (Schmitz *et al.*, 2007), Caatinga (Tidon-Sklorz and Sene, 1995), Pantanal (Val and Marques, 1996), Amazonian rainforest (Martins, 1987), Araucarian forest (Saavedra *et al.*, 1995; Cvasini *et al.*, 2014), Restinga (Bizzo *et al.*, 2010). However, the Pampas biome, which is the southernmost environment, was neglected by the researchers mainly for being an open grassland environment and apparently lacking breeding and feeding resources to drosophilids.

The pampas covers southernmost Brazil, all of Uruguay, and the central region of eastern Argentina. It is a heterogeneous landscape, with a matrix of natural grasses and small patches of forest. The seasons are well defined, and the annual temperature range is extremely pronounced, ranging from negative values in the winter up to 40°C in the summer. This temperature range has been pointed as determinant to the presence and maintenance of Drosophilidae species in the region (Poppe *et al.*, 2013, 2015).

Only recently Poppe *et al.* (2014) highlighted the high diversity of drosophilids in this environment. The same is noticed in Uruguay (Goñi *et al.*, 1998, 2002, 2012), while in Argentina most of information comes from the studies focused predominantly on genetics and/or autecology (Wheeler and Magalhães, 1962; Hale and Singh, 1991). Thus, it is evident the poor knowledge of the Drosophilidae fauna in the South grasslands of South America.

Poppe *et al.* (2014) mentioned the record of 95 species in the grasslands of Brazil, Uruguay, and Argentina. After that, some studies have been performed in pampas pointing the record of more species, including the new invasion of *D. suzukii*. Thus, the present report is an update of the list of recorded Drosophilidae species in the South American pampas.

### Material and Methods

A comprehensive literature search of species recorded in the pampas of Brazil, Uruguay, and Argentina was performed, including not only taxonomic studies, but also genetic, evolutionary, and ecological ones. Some species records are from unpublished samples performed by us in the Brazilian pampas (28°45'01"S 54°56'55"W; 30°20'44"S 54°19'32"W). These data updated the species list presented by Poppe *et al.* (2014) to that biome.

### Results and Discussion

Thirteen species were included in the pampas species list proposed by Poppe *et al.* (2014): *Drosophila senei* Vilela, *D. suzukii* Matsumura, *D. trapeza* Heed and Wheeler, *Hirtodrosophila levigata* (Burla), *H. mendeli* (Mourão, Gallo and Bicudo), *H. morgani* (Mourão, Gallo and Bicudo), *Mycodrosophila projectans* (Sturtevanti), *Paraliiodrosophila antennata* (Wheeler), *Rhinoleucophenga joaquina* Schmitz,

Gottschalk and Valente, *R. punctuloides* Poppe, Schmitz and Valente, *Zygothrica poeyi* (Sturtevant), *Z. prodispar* Duda, and *Z. dispar* Wiedemann (Table 1). Except for the first two species, the pampas represents the southernmost record region to the other ones.

Table 1. List of Drosophilidae flies recorded in the Pampas. \*: new species added in the list presented by Poppe *et al.* (2014). New record localities, 1: 30°20'44"S 54°19'32"W; 2: 29°11'09"S 54°53'50"W (Robe *et al.*, 2014); 3: 31°48'58"S 52°25'55"W (Robe *et al.*, 2014); 4: 32°32'25"S 52°32'34"W (Robe *et al.*, 2014); 5: 28°45'01"S 54°56'55"W.

Genus	Group	Species
<i>Cladochaeta</i>	<i>bomplandi</i>	<i>C. bomplandi</i> (Malloch)
<i>Drosophila</i>	<i>annulimana</i>	<i>D. annulimana</i> Duda
		<i>D. arassari</i> da Cunha & Frota-Pessoa
		<i>D. schineri</i> Pereira & Vilela
	<i>bromeliae</i>	<i>D. bromelioides</i> Pavan & da Cunha
	<i>busckii</i>	<sup>1</sup> <i>D. busckii</i> Coquillett
	<i>calloptera</i>	<i>D. quadrum</i> (Wiedemann)
	<i>canalinae</i>	<i>D. piratininga</i> Ratcov & Vilela
	<i>cardini</i>	<i>D. cardini</i> Sturtevant
		<i>D. cardinoides</i> Dobzhansky & Pavan
		<i>D. neocardini</i> Streisinger
		<sup>1</sup> <i>D. polymorpha</i> Dobzhansky & Pavan
	<i>coffeata</i>	<i>D. fuscolineata</i> Duda
		<i>D. pagliolii</i> Cordeiro
	<i>dreyfusi</i>	<i>D. briegei</i> Pavan & Breuer
	<i>flavopilosa</i>	<i>D. cestri</i> Brncic
		<i>D. cordeiroi</i> Brncic
		<i>D. flavopilosa</i> Frey
		<i>D. incompta</i> Wheeler & Takada
	<i>guarani</i>	<i>D. alexandrei</i> Cordeiro
		<i>D. griseolineata</i> Duda
		<sup>1</sup> <i>D. maculifrons</i> Duda
		<i>D. ornatifrons</i> Duda
	<i>immigrans</i>	<i>D. immigrans</i> Sturtevant
	<i>melanogaster</i>	<i>D. ananassae</i> Doleschall
		<i>D. kikkawai</i> Burla
		<i>D. malerkotliana</i> Parshad & Paika
		<i>D. melanogaster</i> Meigen
		<sup>1</sup> <i>D. simulans</i> Sturtevant
		<sup>1,5*</sup> <i>D. sukuzii</i> Matsumura
	<i>mesophragmatica</i>	<i>D. gaucha</i> Jaeger & Salzano
	<i>obscura</i>	<i>D. subobscura</i> Collin in Gordon
	<i>pallidipennis</i>	<i>D. pallidipennis</i> Dobzhansky & Pavan
	<i>repleta</i>	<i>D. aldrichi</i> Patterson
		<i>D. antonietae</i> Tidon-Sklorz & Sene
		<i>D. buzzatii</i> Patterson & Wheeler
		<i>D. hydei</i> Sturtevant



		<i>D. koepferae</i> Fontdevila & Wasserman
		<sup>1</sup> <i>D. mercatorum</i> Patterson & Wheeler
		<i>D. meridionalis</i> Wasserman
		<i>D. nigricruria</i> Patterson & Mainland
		<i>D. onca</i> Dobzhansky & Pavan
		<i>D. paranaensis</i> Barros
		<i>D. repleta</i> Wollaston
		<sup>5</sup> <i>D. senei</i> Vilela
		<i>D. serido</i> Vilela & Sene
		<i>D. zottii</i> Vilela
	<i>saltans</i>	<i>D. prosaltans</i> Duda
		<i>D. pulchella</i> Sturtevant
		<i>D. sturtevanti</i> Duda
	<i>sticta</i>	<i>D. sticta</i> Wheeler
	<i>tripunctata</i>	<i>D. angustibucca</i> Pavan
		<i>D. bandeirantium</i> Dobzhansky & Pavan
		<i>D. cuaso</i> Bächli, Vilela & Ratcov
		<i>D. mediopicta</i> Frota-Pessoa
		<sup>1</sup> <i>D. mediopunctata</i> Dobzhansky & Pavan
		<i>D. mediosignata</i> Dobzhansky & Pavan
		<i>D. mediostriata</i> Duda
		<i>D. mediovittata</i> Frota-Pessoa
		<i>D. nappae</i> Vilela, Valente & Basso-da-Silva
		<i>D. neoguaramunu</i> Frydenberg
		<i>D. paraguayensis</i> Duda
		<i>D. paramediostriata</i> Townsend & Wheeler
		<i>D. roehrae</i> Pipkin & Heed
		<sup>5</sup> <i>D. trapeza</i> Heed & Wheeler
		<i>D. trifilum</i> Frota-Pessoa
	<i>virilis</i>	<i>D. virilis</i> Sturtevant
	<i>willistoni</i>	<i>D. bocainensis</i> Pavan & da Cunha
		<i>D. capricorni</i> Dobzhansky & Pavan
		<i>D. fumipennis</i> Duda
		<i>D. nebulosa</i> Sturtevant
		<i>D. parabocainensis</i> Carson
		<i>D. paulistorum</i> Dobzhansky & Pavan
		<i>D. willistoni</i> Sturtevant
	<i>Ungrouped</i>	<i>D. caponei</i> Pavan & da Cunha
		<i>D. denieri</i> Blanchard
		<i>D. flexa</i> Loew
		<i>D. lutzii</i> Sturtevant
		<i>D. serenensis</i> Brncic
<i>Hirtodrosophila</i>	<i>glabrifrons</i>	<sup>3</sup> <i>H. levigata</i> (Burla)
	<i>hirticornis</i>	<sup>2,3</sup> <i>H. mendeli</i> (Mourão, Gallo and Bicudo)

		<sup>3</sup> <i>H. morgani</i> (Mourão, Gallo and Bicudo)
<i>Leucophenga</i>	Ungrouped	<i>L. maculosa</i> Coquillett
<i>Mycodrosophila</i>	Ungrouped	<sup>3,4</sup> <i>M. projectans</i> (Sturtevant)
<i>Paraliiodrosophila</i>	Ungrouped	<sup>2</sup> <i>P. antennata</i> Wheeler
<i>Rhinoleucophenga</i>	Ungrouped	<i>R. gigantea</i> (Thomson)
		<sup>5</sup> <i>R. joaquina</i> Schmitz, Gottschalk & Valente
		<i>R. missionera</i> Poppe <i>et al.</i>
		<i>R. obesa</i> (Loew)
		<i>R. pampeana</i> Poppe <i>et al.</i>
		<i>R. punctulata</i> Duda
		<sup>5</sup> <i>R. punctuloides</i> Poppe, Schmitz & Valente
		<i>R. subradiata</i> Duda
		<i>R. sulina</i> Poppe <i>et al.</i>
<i>Scaptomyza</i>	<i>mesoscaptoomyza</i>	<i>S. striaticeps</i> Wheeler & Takada
	<i>parascaptoomyza</i>	<i>S. nigripalpis</i> Malloch
	<i>scaptoomyza</i> s. str.	<i>S. pallida</i> (Zetterstedt)
	Ungrouped	<i>S. graminum</i> (Fallén)
		<i>S. spinipalpis</i> Seguy
<i>Zaprionus</i>	<i>armatus</i>	<i>Z. indianus</i> Gupta
<i>Zygothrica</i>	<i>atriangula</i>	<sup>3</sup> <i>Z. poeyi</i> (Sturtevant)
	<i>bilineata</i>	<sup>3</sup> <i>Z. bilineata</i> (Williston)
	<i>dispar</i>	<sup>3,5</sup> <i>Z. dispar</i> (Wiedemann)
		<sup>3</sup> <i>Z. prodispar</i> Duda
	<i>hypandriata</i>	<i>Z. hypandriata</i> Burla
	<i>orbitalis</i>	<i>Z. orbitalis</i> (Sturtevant)
	<i>vittimaculosa</i>	<i>Z. vittimaculosa</i> Burla
	Ungrouped	<sup>3</sup> <i>Z. ptilialis</i> Burla

*Rhinoleucophenga* was the genus presenting most new records of species in the pampas, beyond the two species previously mentioned other four species are under description process by J.L. Poppe (data not shown).

Poppe *et al.* (2014) highlighted the presence of 10 exotic species in the pampas. Deprá *et al.* (2014) pointed the first record of *D. suzukii* in the South America continent, after that, the respective species was recorded in many localities in the pampas increasing to 11 the number of exotic species in this environment.

New areas were included as sampled sites to the Brazilian pampas: São Gabriel (30°20'44"S, 54°19'32"W), Santiago (Robe *et al.*, 2014) (29°10'9"S, 54°53'50"W), Pelotas (Robe *et al.*, 2014) (31°48'58"S, 52°25'55"W), and Rio Grande (Robe *et al.*, 2014) (32°32'25"S, 52°32'34"W). A total of 108 Drosophilidae species are now known from the Brazilian, Uruguyan, and Argentinian pampas (Table 1). Twelve of 13 new recorded species were found only in the Brazilian pampas; only *D. suzukii* is widespread by the Brazilian and Uruguayan pampas (B. Goñi, pers. comm.). Despite it is probably still a gross underestimate of pampas diversity, since most of this biome is still not intensively sampled, the presented data indicate the high diversity of Drosophilidae in the South America grasslands, an environment historically neglected by the researchers due its "poor diversity" appearance.

References: Bizzo, L., M.S. Gottschalk, D.C. De Toni, and P.R.P. Hofmann 2010, Iheringia, Ser. Zool. 100: 185-191; Cavasini, R., M.L.T. Buschini, L.P.B. Machado, and R.P. Mateus 2014, Braz. J. Biol. 74:

761-768; Deprá, M., J.L. Poppe, H.J. Schmitz, D.C. De Toni, and V.L.S. Valente 2014, *J. Pest Sci.* 87: 379-383; De Toni, D.C., M.S. Gottschalk, J. Cordeiro, P.R.P. Hofmann, and V.L.S. Valente 2007, *Neotrop. Entomol.* 36: 356-375; Goñi, B., M.E. Martinez, V.L.S. Valente, and C.R. Vilela 1998, *Rev. bras. Entomol.* 42: 131-140; Goñi, B., M.E. Martinez, G. Techera, and P. Fresia 2002, *Dros. Inf. Serv.* 85: 75-80; Goñi, B., M. Remedios, P. Gonzalez-Vainer, M. Martinez, and C.R. Vilela 2012, *Zoologia* 29: 308-317; Hale, L.R., and R.S. Singh 1991, *Genetics* 129: 103-117; Martins, M.B. 1987, *Bol. Mus. Para. Emílio Goeldi* 3: 195-218; Mata, R.A., M. McGeoch, and R. Tidon 2008, *Biodivers. Conserv.* 17: 2899-2916; Poppe, J.L., H.J. Schmitz, S.M. Callegari-Jacques, and V.L.S. Valente 2015, *Neotrop. Entomol.* 44: 140-152; Poppe, J.L., H.J. Schmitz, D. Grimaldi, and V.L.S. Valente 2014, *Zootaxa* 3779: 215-245; Poppe, J.L., H.J. Schmitz, and V.L.S. Valente 2013, *Neotrop. Entomol.* 42: 269-277; Robe, L.J., S. Machado, A.R. Bolzan, J.P.J. Santos, F.B. Valer, A.P. Santos, M.L. Blauth, and M.S. Gottschalk 2014, *Stud. Neotrop. Fauna Environ.* 49: 79-94; Saavedra, C.C.R., S.M. Callegari-Jacques, M. Napp, and V.L.S. Valente 1995, *J. Zool. Syst. Evol. Res.* 33: 62-74; Schmitz, H.J., V.L.S. Valente, and P.R.P. Hofmann 2007, *Neotrop. Entomol.* 36: 53-64; Tidon-Sklorz, R., and F.M. Sene 1995, *Iheringia Ser. Zool.* 78: 85-94; Val, F.C., and M.D. Marques 1996, *Pap. Avul. Zool.* 39: 223-230; Wheeler, M.R., and L.E. Magalhães 1962, *Univ. Texas Publ.* 6205: 155-171.



### A description of the adult *Drosophila* miRNome.

**Fernández-Costa, J.M., M. Sabater-Arcís, and R. Artero.** Incliva Health Research Institute, Valencia, Spain. Avda. Menéndez Pelayo 4 acceso 46010 Valencia. Spain. Departament de Genètica i Estructura de Recerca Interdisciplinària en Biotecnologia i Biomedicina (ERI BIOTECMED), Universitat de València. Dr Moliner 50, 46100 Burjassot, Spain.

Correspondence to: ruben.artero@uv.es

## Introduction

MicroRNAs (miRNAs, miRs) are short (18–24 nucleotides, nt) non-coding RNAs present in all eukaryotes, which play crucial roles during the post-transcriptional gene expression regulation (Ambros, 2004).

According to genomic localization, miRNAs can be classified as intergenic or intragenic. Most of the human miRNAs described up to date (deposited in miRBase) are intergenic (68%). Among the intragenic miRNAs, 12% are located in intronic regions and the others are located in coding exons, repetitive regions, long non-coding RNAs or non-coding regions. miRNA genes are often located near to other miRNA being part of clusters. Clusters of close miRNAs tend to be intergenic and are expressed as polycistronic, co-regulated units that contain their own promoters (Saini, Griffiths-Jones, and Enright, 2007). In contrast, intragenic miRNAs are typically co-expressed with their host gene, although instances of independent transcriptional regulation have also been reported in intronic miRNA. Additionally differences in the expression of polycistronic mRNA located in introns have been associated to regulated alternative splicing (Bell, Buvoli, and Leinwand, 2010).

miRNA biogenesis is a multi-step process requiring several enzymes. In the canonical biogenesis miRNAs are usually transcribed by RNA polymerase II as long primary transcripts (pri-miRNA) (Y. Lee *et al.*, 2004), although, it has also been described pri-miRNA transcription by RNA polymerase III (Babiarz, Ruby, Wang, Bartel, and Blallock, 2008). Pri-miRNA presents 7-methylguanosine cap (m<sup>7</sup>G) in 5' end and they are polyadenylated in 3' end (Cai, Hagedorn, and Cullen, 2004). First, the maturation process begins in the nucleus, where pri-miRNA is folded into a characteristic hairpin structure that is asymmetrically and specifically cut near the stem-loop by RNase III Drosha, generating one or more hairpin structures known as pre-miRNA (approximately 65 nt) (Y. Lee *et al.*, 2003). Drosha needs the binding of RNA protein DGCR8 (Pasha in *Drosophila*) as co-factor, which together form the microprocessor complex (Denli, Tops, Plasterk, Ketting, and Hannon, 2004). Second, pre-miRNAs are then transported to the cytoplasm by exportin 5

(EXP5), and further processed by RNase III Dicer (Dicer-1 in *Drosophila*) to generate a small heteroduplex miRNA (15-21 nt) (Lee *et al.*, 2003). Finally, one strand of the RNA duplex is released by Dicer and the resulting single strand is integrated together with Argonaute proteins into RISC (RNA-induced silencing complex) complex (Gregory, Chendrimada, Cooch, and Shiekhattar, 2005). By guiding the RISC complex to bind to target “seed match” sites within the 3' untranslated region (UTR) of mRNAs, the mature miRNA can silence gene expression by mRNA cleavage, when the sequence is perfectly complementary with the target (Bartel, 2004), or by translation repression or RNA deadenylation, if complementarity is not perfect (Wu, Fan, and Belasco, 2006). Evidence has shown that some miRNAs can also suppress the expression of their target mRNA by binding to the 5'UTR (Lytle, Yario, and Steitz, 2007) or open reading frame (Forman, Legesse-Miller, and Collier, 2008).

Since the first miRNA was discovered in *Caenorhabditis elegans* in 1993 (R.C. Lee, Feinbaum, and Ambros, 1993), miRNAs have been identified in insects, vertebrates, plants, and virus. Computational methods have predicted that miRNAs account for ~1% of all eukaryotic genes, and more than 60% of human genes might be subject to regulation by miRNA (Zhonglin *et al.* 2015). Even though the biological functions of most animal miRNAs are little known, increasing evidence suggests that miRNAs play important roles in diverse physiological processes such as homeostasis, development, proliferation, differentiation, apoptosis, or immune defence (Lu and Liston, 2009). Therefore, dysregulation of gene expression that encode miRNAs can contribute to the development of human diseases including cancer, cardiopathies, metabolic diseases, and neurodegenerative diseases (Abe and Bonini, 2013; Fernández-Hernando *et al.*, 2013; Iorio and Croce, 2012).

New massive sequencing techniques allow us to obtain millions of readings from different sequences of several samples in parallel. Due to its high yield, the results of these platforms can be used for different types of studies. For example, sequencing from small RNA libraries can be used to study miRNA transcriptome (miRNome) profile present in a sample, allowing their identification, characterization, and quantification.

Because of miRNA's crucial role in most biological processes, we decided to use massive sequencing technology to carry out a complete description of which miRNAs are expressed in *Drosophila melanogaster* adult flies, also determining miRNA expression levels. We have found 104 of the 153 miRNA previously identified in *Drosophila melanogaster* obtaining expression levels between 10 and 10<sup>4</sup> reads/million. Our data contribute to the description of miRNAs normal expression levels in adult flies, and provide information to analyse the expression of miRNA altered in many pathologies using *Drosophila melanogaster* as a model.

## Experimental Procedure

### *Small RNA library generation and next-generation sequencing*

In order to describe all miRNAs expressed in *Drosophila melanogaster*, we analysed the expression of wild-type strain *OrR*. Two biological replicates of *OrR* were used, each of which containing 50 *Drosophila* males of the same age (2-day-old). Total RNA was extracted and the small RNA fraction was enriched using the miRVana kit (Ambion). Small RNA was run in 15% acrylamide:bisacrylamide 19:1 gels and the 15–30 nt fraction was sliced out and eluted with 1 M NaCl overnight at 48°C. Purification was carried out using the MEGAclean Kit (Ambion). The quality of purified small RNAs (50 ng) was analysed by capillary electrophoresis (Agilent 2100 Bioanalyzer). Libraries for SOLiD™ 3 sequencing were prepared following the manufacturer's protocol (Small RNA Expression Kit, Applied Biosystems). Briefly, small RNA samples (15 ng) were hybridized and ligated overnight with the adapter mix, reverse transcribed and PCR-amplified (15 cycles). The primers used in this PCR included a unique six-nucleotide barcode for each sample. A single emulsion PCR reaction was used to couple the barcoded libraries to P1-coated beads as per the standard Applied Biosystems protocol. After emulsion PCR, template beads were enriched in a glycerol gradient and deposited onto the surface of glass slides for SOLiD sequencing. Sequencing was performed using 35 bp chemistry on a version 3.0 SOLiD machine (SOLiD™ 3).

### *Bioinformatics analysis*

An average of 29 million readings were obtained from the SOLiD™ 3 sequencing data (Table 1). Low-quality reads were first removed from the data set (at least  $QV \geq 10$  in the first 10 bases). Filtered reads

were then mapped against the *Drosophila melanogaster* genome (version r5.23), using the software Small\_RNA\_Tool\_v0.5.0 (<http://solidsoftwaretools.com/gf/>) and allowing up to two mismatches in the first 8 nt and up to three mismatches in the entire read. A custom pipeline was then used to select reads that mapped uniquely to a point of the *Drosophila* genome, which represented the usable sequence data. mirBase (version 13.0) and custom scripts were applied in order to identify known miRNAs. Contaminations by protein-coding genes or other ncRNAs (rRNAs, tRNAs, snoRNAs, and so forth) were discarded from the final data set. miRNA counts were normalized per million of reads that mapped uniquely, in order to yield the relative transcript abundance in the original sample (Figure 1).

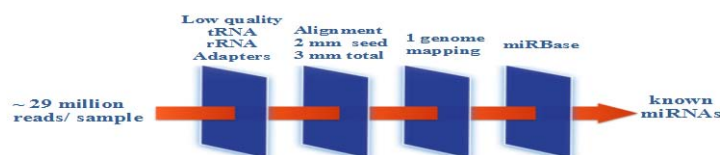

Figure 1. Representative diagram with the steps taken to miRNome characterization of adult flies by massive sequencing of small RNA libraries. mm = mismatch.

## Results and Discussion

Using SOLiD™ 3 sequencing of small-RNA libraries and following bioinformatics analysis described above, we obtained the miRNome profile for two samples of wild-type adult *Drosophila melanogaster* flies (strain *OrR*, samples O\_1 and O\_2). Readings for 104 of the 153 known miRNA up to date of the analysis (mirBase v.13) were detected, so approximately 70% of miRNAs described are expressed in adult flies. In addition, there are large differences in the expression of these miRNA, setting a minimum of 10 reads per million. Therefore, there is a small group of seven miRNAs (*miR-1*, *miR-14*, *miR-277*, *miR-276a*, *miR-279*, *miR-8*, and *Bantam*) with a high expression ( $>10^4$  reads) compared to the others, a group of 29 miRNAs with an intermediate expression ( $>10^3$  reads), and two groups of 33 and 35 miRNAs with a very low expression ( $>10^2$  and  $>10$  reads) (Table 2).

Table 1. Number of reads obtained from massive sequencing and after bioinformatics processing.

Library	Total reads	QV <sup>1</sup>	Mapping into 1 or more sites		Mapping into a single site	
			Filtered reads <sup>2</sup>	Mapping into the genome	Filtered reads <sup>2</sup>	Mapping into the genome
O_1	28691891	21418676	3120769	2066628	2668549	<b>910374</b>
O_2	29572378	21965363	3254335	1719574	3175191	<b>867498</b>

<sup>1</sup>Reads after quality control <sup>2</sup>tRNA, rRNAs, adapters.

The expression differences between all miRNAs analysed suggests that the muscular and nervous tissues contribute the most to adult miRNA expression, considering that *miR-1* (miRNA with the highest expression in adult flies) is involved in myogenesis and cardiogenesis (Kwon, Han, Olson, and Srivastava, 2005), and five members belonging to this high expression group, *bantam*, *miR-8*, *miR-276a*, *miR-277*, and

Table 2. Number of reads per million for miRNAs in *Drosophila melanogaster* adult males.

miRNA	>10 <sup>4</sup> reads			>10 <sup>3</sup> reads			>10 <sup>2</sup> reads			>10 reads		
	average SOLID reads	standard error	miRNA	average SOLID reads	standard error	miRNA	average SOLID reads	standard error	miRNA	average SOLID reads	standard error	miRNA
<i>dme-mir-1</i>	85238.5	387.5	<i>dme-mir-317</i>	9768	3229.0	<i>dme-mir-956</i>	967	661.0	<i>dme-mir-2b-1</i>	82	62.0	
<i>dme-mir-14</i>	56861.5	1936.5	<i>dme-mir-33</i>	9642.5	2543.5	<i>dme-mir-79</i>	870.5	603.5	<i>dme-mir-927</i>	78	25.0	
<i>dme-mir-277</i>	45842.5	6613.5	<i>dme-mir-252</i>	6718.5	2141.5	<i>dme-mir-87</i>	795.5	72.5	<i>dme-mir-1010</i>	77	8.0	
<i>dme-mir-276a</i>	37744.5	7709.5	<i>dme-mir-11</i>	6700	85.0	<i>dme-mir-263b</i>	714.5	432.5	<i>dme-mir-13a</i>	72	2.0	
<i>dme-mir-279</i>	27764.5	7966.5	<i>dme-mir-307</i>	6633	1066.0	<i>dme-mir-92a</i>	668	508.0	<i>dme-mir-965</i>	62.5	14.5	
<i>dme-mir-8</i>	13732	7065.0	<i>dme-mir-263a</i>	6593	1132.0	<i>dme-mir-986</i>	638.5	287.5	<i>dme-mir-4</i>	52.5	52.5	
<i>dme-bantam</i>	12388	3900.0	<i>dme-mir-34</i>	6442.5	1186.5	<i>dme-mir-957</i>	635.5	15.5	<i>dme-mir-2b-2</i>	48.5	34.5	
			<i>dme-mir-12</i>	6080.5	2754.5	<i>dme-mir-274</i>	569.5	244.5	<i>dme-mir-2c</i>	48	4.0	
			<i>dme-mir-210</i>	4767.5	802.5	<i>dme-mir-190</i>	567	218.0	<i>dme-mir-137</i>	46	14.0	
			<i>dme-mir-125</i>	4443	1841.0	<i>dme-mir-lab-4</i>	551.5	310.5	<i>dme-mir-978</i>	44	15.0	
			<i>dme-mir-184</i>	3786	391.0	<i>dme-mir-304</i>	489.5	224.5	<i>dme-mir-318</i>	43	43.0	
			<i>dme-let-7</i>	3749.5	1139.5	<i>dme-mir-960</i>	440.5	24.5	<i>dme-mir-963</i>	37.5	2.5	
			<i>dme-mir-958</i>	2374.5	1256.5	<i>dme-mir-375</i>	393	212.0	<i>dme-mir-1015</i>	35.5	0.5	
			<i>dme-mir-989</i>	2248	2248.0	<i>dme-mir-285</i>	365.5	50.5	<i>dme-mir-984</i>	33	1.0	
			<i>dme-mir-7</i>	2132.5	497.5	<i>dme-mir-2a-2</i>	335.5	39.5	<i>dme-mir-999</i>	32	11.0	
			<i>dme-mir-305</i>	1966.5	869.5	<i>dme-mir-987</i>	295.5	28.5	<i>dme-mir-976</i>	30.5	2.5	
			<i>dme-mir-124</i>	1897	1436.0	<i>dme-mir-995</i>	293	180.0	<i>dme-mir-1004</i>	28	28.0	
			<i>dme-mir-100</i>	1847.5	314.5	<i>dme-mir-932</i>	290	100.0	<i>dme-mir-313</i>	25.5	25.5	
			<i>dme-mir-306</i>	1797.5	417.5	<i>dme-mir-312</i>	288.5	162.5	<i>dme-mir-977</i>	23	2.0	
			<i>dme-mir-284</i>	1781.5	174.5	<i>dme-mir-316</i>	265	5.0	<i>dme-mir-1007</i>	23	5.0	
			<i>dme-mir-1003</i>	1677	239.0	<i>dme-mir-9b</i>	256.5	145.5	<i>dme-mir-985</i>	22	12.0	
			<i>dme-mir-9a</i>	1627.5	447.5	<i>dme-mir-998</i>	248	54.0	<i>dme-mir-929</i>	21.5	1.5	
			<i>dme-mir-10</i>	1476	22.0	<i>dme-mir-193</i>	240	117.0	<i>dme-mir-286</i>	20.5	20.5	
			<i>dme-mir-276b</i>	1377	295.0	<i>dme-mir-133</i>	236	147.0	<i>dme-mir-282</i>	19.5	8.5	
			<i>dme-mir-31a</i>	1298	252.0	<i>dme-mir-1000</i>	231	11.0	<i>dme-mir-982</i>	19	4.0	
			<i>dme-mir-994</i>	1286	1286.0	<i>dme-mir-31b</i>	209	11.0	<i>dme-mir-975</i>	19	0.0	
			<i>dme-mir-988</i>	1173.5	312.5	<i>dme-mir-9c</i>	190	112.0	<i>dme-mir-283</i>	18	18.0	
			<i>dme-mir-993</i>	1090.5	358.5	<i>dme-mir-311</i>	182.5	17.5	<i>dme-mir-962</i>	17.5	5.5	
			<i>dme-mir-970</i>	1035.5	505.5	<i>dme-mir-92b</i>	170.5	72.5	<i>dme-mir-964</i>	16	2.0	
						<i>dme-mir-2a-1</i>	169	38.0	<i>dme-mir-959</i>	16	4.0	
						<i>dme-mir-1012</i>	141.5	27.5	<i>dme-mir-968</i>	13	13.0	
						<i>dme-mir-1017</i>	138	40.0	<i>dme-mir-219</i>	10.5	10.5	
						<i>dme-mir-310</i>	125.5	20.5	<i>dme-mir-1006</i>	10	10.0	
						<i>dme-mir-278</i>	118	29.0				
						<i>dme-mir-996</i>	117	48.0				

*miR-279*, are involved in neural processes (Karres, Hilgers, Carrera, Treisman, and Cohen, 2007; Li *et al.*, 2013; Tan, Poidevin, Li, Chen, and Jin, 2012; Sun, Jee, de Navas, Duan, and Lai, 2015). Furthermore, *miR-14*, the miRNA that completes this group, and *bantam*, were shown to regulate programmed cell death in *Drosophila* (Jovanovic and Hengartner, 2006).

These evidences may be relevant to the study of miRNA involvement in some diseases in which nervous and muscular tissues are most affected using *Drosophila* as a model organism. Neuromuscular diseases caused by repeat expansions like Myotonic Dystrophy type 1 (DM1) are a case in point. Fernandez-Costa *et al.* studying the changes in the muscle miRNome of a *Drosophila* model expressing CTG repeats by SOLiD™ 3 sequencing, demonstrate that the expression of 20 miRNA was affected by expression of CTG repeats in DM1 flies (Fernandez-Costa *et al.*, 2013). The dysregulation of a specific miRNA conserved between *Drosophila* and human, miR-1, had been reported previously in DM1 patients (Rau *et al.*, 2011). Therefore, the information obtained in the present work could be helpful to perform a comparative study of the miRNA expression levels between this DM1 fly model and *OrR* wild-type flies. In addition to comparative studies, the characterization of adult *OrR* miRNome and the expression levels for known miRNAs, could serve to identify new miRNA using prediction algorithms like miRDeep (Friedländer *et al.*, 2008).

In summary, in this study we characterized which miRNAs are expressed in wild-type adult flies, providing information to compare the miRNA expression profile altered in different diseases, such as cancer, cardiopathies, metabolic diseases, or neurodegenerative diseases, or to select miRNA altered in human disease to study the implication of these miRNAs in the pathology using *Drosophila* as a model.

References: Abe, M., and N.M. Bonini 2013, Trends in Cell Biology 23: 30-36; Ambros, V., 2004, Nature 431: 350–5; Babiarz, J.E., J.G. Ruby, Y. Wang, D.P. Bartel, and R. Blelloch 2008, Genes and Development 22: 2773–2785; Bartel, D.P., 2004, Cell 116: 281–97; Bell, M.L., M. Buvoli, and L.A. Leinwand 2010, Molecular and cellular biology 30: 1937–1945; Cai, X., C.H. Hagedorn, and B.R. Cullen 2004, RNA (New York, N.Y.) 10: 1957–1966; Denli, A.M., B.B.J. Tops, R.H. Plasterk, R.F. Ketting, and G.J. Hannon 2004, Nature 432: 231–235; Fernandez-Costa, J.M., A. Garcia-Lopez, S. Zuñiga, V. Fernandez-Pedrosa, A. Felipo-Benavent, M. Mata, O. Jaka, A. Aiausti, B. Aguado, M. Perez-Alonso, J.J. Vilchez, A. Lopez de Munain, and R.D. Artero 2013, Human molecular genetics 22: 704–16; Forman, J.J., A. Legesse-Miller, and H.A. Collier 2008, Proceedings of the National Academy of Sciences of the United States of America 105: 14879–84; Fernández-Hernando, C., C.M. Ramírez, L. Goedeke, and Y. Suárez 2013, Arteriosclerosis, thrombosis, and vascular biology 33: 178-185; Friedländer, M., W. Chen, C. Adamidi, J. Maaskola, R. Einspanier, S. Knispel, and N. Rajewsky 2008, Nature biotechnology 26: 407-415; Gregory, R.I., T.P. Chendrimada, N. Cooch, and R. Shiekhattar 2005, Cell 123: 631–640; Iorio, M.V., and C.M. Croce 2012, Carcinogenesis 33: 1126–33; Jovanovic, M., and M.O. Hengartner 2006, Oncogene 25: 6176–6187; Karres, J.S., V. Hilgers, I. Carrera, J. Treisman, and S.M. Cohen 2007, Cell 131: 136–45; Kwon, C., Z. Han, E.N. Olson, and D. Srivastava 2005, Proceedings of the National Academy of Sciences of the United States of America 102: 18986–18991; Lee, R.C., R.L. Feinbaum, and V. Ambros 1993, Cell 843-54; Lee, Y., C. Ahn, J. Han, H. Choi, J. Kim, J. Yim, J. Lee, P. Provost, O. Rådmark, S. Kim, and V.N. Kim 2003, Nature 425: 415–419; Lee, Y., M. Kim, J. Han, K.-H. Yeom, S. Lee, S.H. Baek, and V.N. Kim 2004, The EMBO journal 23: 4051–4060; Li, W., M. Cressy, H. Qin, T. Fulga, D. Van Vactor, and J. Dubnau 2013, The Journal of neuroscience : the official journal of the Society for Neuroscience 33: 5821–33; Lu, L.-F., and A. Liston 2009, Immunology 127: 291–8; Lytle, J.R., T.A. Yario, and J.A. Steitz 2007, Proceedings of the National Academy of Sciences of the United States of America, 104: 9667–9672; Rau, F., F. Freyermuth, C. Fugier, J.-P. Villemin, M.-C. Fischer, B. Jost, D. Dembele, *et al.* 2011, Nature structural and molecular biology 18: 840–845; Saini, H.K., S. Griffiths-Jones, and A.J. Enright 2007, Proceedings of the National Academy of Sciences of the United States of America 104: 17719–17724; Sun, K., D. Jee, L.F. de Navas, H. Duan, and E.C. Lai 2015, PLoS genetics 11: e1005245; Tan, H., M. Poidevin, H. Li, D. Chen, and P. Jin 2012, PLoS genetics 8: e1002681; Wu, L., J. Fan, and J.G. Belasco 2006, Proceedings of the National Academy of Sciences of the United States of America, 103: 4034–4039; Zhonglin, T., Y. Yalan, W. Zishuai, Z. Shuanping, M. Yulian, and L. Kui 2015, Nature 5: 15544.



### *Drosophila* fauna at three different altitudes of Kudremukh (Western Ghats).

**Deepak, D., and M.S. Krishna\***. *Drosophila* Stock Centre, Department of Studies in Zoology, University of Mysore – Mysore 570006; [fateofacell@gmail.com](mailto:fateofacell@gmail.com), [drosokrish@gmail.com](mailto:drosokrish@gmail.com). \*Corresponding Author

#### Introduction

*Drosophila* is used as a model organism for over a hundred years. It is a successful model organism because of its low cost of maintenance, short life cycle, large number of progenies available in each generation, 70% sequence homology between humans, availability of complete genome sequence, and versatility of several unique genetic tools which makes it unparalleled in its class. There are 3,500 described species in the family Drosophilidae, the majority of which comprises of Genus *Drosophila*. Distribution pattern of *Drosophila* reveals information about micro and macro environmental changes that are associated with abundances of each species. However, such taxonomical studies are poorly concentrated in India. The present study was undertaken to assess the *Drosophila* fauna at different altitudes of Kudremukh.

Kudremukh is located in Chikkamagaluru district in Karnataka, India, which is a part of Western Ghats mountain ranges and is situated 266 km away from Mysore. It consists of tropical wet evergreen and Shola type of forest receiving an average annual rainfall of 7,000mm. Collection was made in the month of December 2014, at three different altitudes using fermented fruits as bait and net sweeping method was employed.

Table 1. Distribution of *Drosophila* at three different altitudes in Kudremukh Wild Life Scantuary, Chikkamagaluru district, Karnataka, India.

S/N	Species	1,400 m	800 m	400 m	Total number
Subgenus: Sophophora					
1	<i>D. malerkotliana</i>	136	125	129	390
2	<i>D. parabipectinata</i>	82	114	84	280
3	<i>D. bipectinata</i>	44	87	72	203
4	<i>D. kikkawai</i>	35	-	13	48
5	<i>D. jambulina</i>	-	8	86	94
6	<i>D. anomelani</i>	64	56	-	120
7	<i>D. takahashii</i>	36	13	-	49
Total		397	403	384	1184
Subgenus: Drosophila					
8	<i>D. nasuta</i>	-	16	23	39
9	<i>D. neonasuta</i>	36	23	88	147
10	<i>D. immigrans</i>	66	41	34	141
Total		102	80	145	327
Subgenus: Scaptodrosophila					
11	<i>D. nigra</i>	-	-	22	22
Total		0	0	22	22
Total no. of flies		499	483	551	1533



A total of 1,533 flies were captured belonging to eleven different species (Table 1), of which seven species belonged to Subgenus *Sophophora*, three species to Subgenus *Drosophila* and one species to Subgenus *Scaptodrosophila*. *D. malerkotliana* was found to be most abundant in all three altitudes suggesting it to be dominant species as previously reported in other regions of Western Ghats (Naseerulla, 1993; Hegde, 1979; Prakash, 1979; Muniyappa, 1981; Hegde, S.N. *et al.*, 2000). Variation in species and their number was seen with respect to altitude, with the highest number of flies in Low altitude (400 m) region. *D. jambulina*, *D. nigra*, and *D. nasuta* preferred lower altitudes, whereas *D. anomelani* and *D. takahashii* seemed to prefer high altitudes.

Lower value of Simpson index (Table 2) in lower altitude 400m shows rich biodiversity, whereas a decrease in diversity at 800 m is seen, followed by increase in diversity at 1,400 m. This result shows that *Drosophila* community is affected by the altitudinal variation as previously reported (Guruprasad *et al.*, 2011; Wakahama, 1962; Kaushik and M.S. Krishna, 2013).

Higher density of *Drosophila* in lower altitudes can be attributed to the type of forest, where fertile top soil is eroded due to heavy rain and deposited in valleys resulting in dense vegetation, providing a suitable environment with thick vegetation at lower altitudes. Diverse species of flowering and fruit bearing flora provide resources for feeding and ovipositioning (Brcic *et al.*, 1985).

Table 2. Diversity index of *Drosophila* population collected at different altitudes in Kudremukh.

Altitude	Simpson index (D)
400 m	0.1512
800 m	0.1784
1,400 m	0.1566

(Simpson Index,  $D = \sum n(n-1) / N(N-1)$ ). Where,  $n$  = the total number of organisms of a particular species and  $N$  = the total number of organisms of all populations).

**Acknowledgment:** The authors extend their gratitude to the Chairman, Department of Studies in Zoology, University of Mysore, Manasagangothri, Mysore, and *Drosophila* Stock Center, University of Mysore, for providing facilities to carry out the above work.

**References:** Brcic, D., M. Budrik., and R. Guines 1985, J. Zoolog. Syst. Evol. Res. 23: 90-100; Guruprasad, B.R., and P. Pankaj 2011, J. Entomol. Nematol, 3(4): 54-57; Hegde, S.N., 1979, Ph.D. Thesis, Univ. of Mysore, Mysore, India; Hegde, S.N., V. Vasudev, V. Shakunthala, and M.S. Krishna 2000, Dros. Inf. Serv. 81: 138; Koushik, P.C.R., and M.S. Krishna 2013, J. Entomol. Nematol. 5(4): 42-44; Muniyappa, N., 1981, Ph. D. Thesis. Univ. of Mysore, Mysore, India; Naseerulla, M.K., 1993, Ph. D. Thesis. Univ. of Mysore, Mysore, India; Prakash, H.S., 1979, Ph.D. Thesis. Univ. of Mysore, Mysore, India; Wakahama, K.L., 1962, Annot. zool. jpn. 35(4): 234-242.



### Suppressed double crossovers in *D. pseudoobscura* inversion heterozygotes.

**Manzano-Winkler, Brenda**<sup>1</sup>. Department of Biology, Duke University, Durham NC 27708;  
<sup>1</sup>Email: [brenda.winkler@duke.edu](mailto:brenda.winkler@duke.edu)

Chromosomal inversions play a large role in speciation by limiting gene flow at loci within inversions through inhibiting meiotic recombination in inversion heterozygotes. In this way, inversions are thought to help maintain hybridizing species that would otherwise homogenize. Gene exchange can still occur between heterokaryotypes through a double crossover event. However, double crossovers in inversion heterozygotes occur at rates far lower than expected based on what is observed in homokaryotypes (*e.g.*, Roberts, 1976; Pergueroles *et al.*, 2010). For example, Stevison *et al.* (2011) observed that double crossovers within the XR inversion occurred at a rate of 1 in 9739 offspring for the interspecies cross between *Drosophila pseudoobscura* and *D. persimilis*. This inhibition of recombination by the inversion may have been greater than normal because it occurred in hybrids of an interspecies cross. A natural extension of this work would be to examine the suppressive power of a comparable inversion within species. Levine (1956) noted strong suppression in *D. pseudoobscura* inversion females heterozygous for the Standard (ST) and Pikes Peak (PP)

inversions, but his marker locations were not known with respect to the inversion breakpoints because of the absence of an assembled genome sequence. I sought to repeat this ST/PP cross using markers that have been mapped to the genome sequence assembly (Richards *et al.*, 2005).

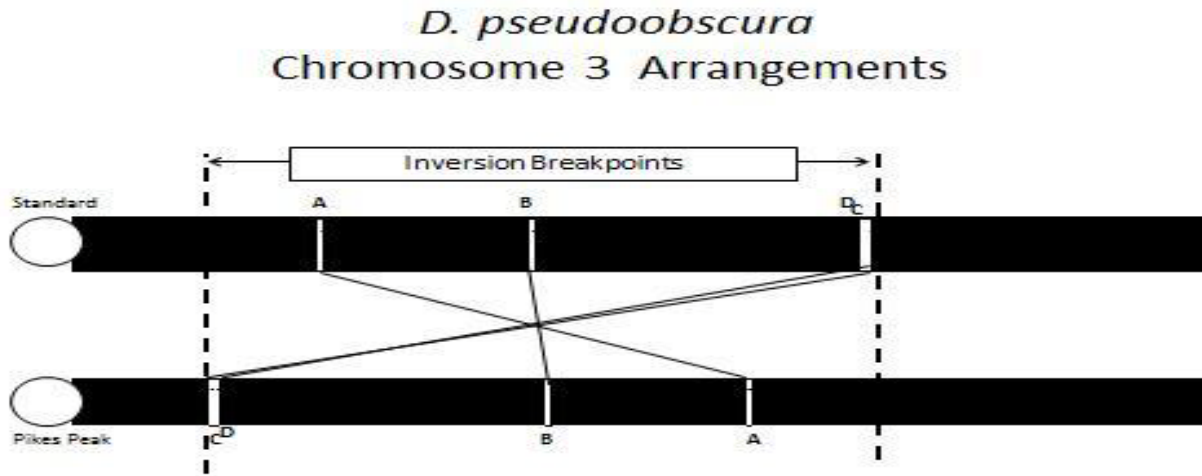

Figure 1.

Table 1. Primer sequences used for markers genotyped.

Marker A:	F: CCTTCTCCAGCGAGCAAT	R: TGTAATATTTTTGGTGCAAATATGA
Marker B:	F: TAATTTAAGCTGTTTCGTCACCGG	R: GTCTCGCTGGACATGTGATCC
Marker C:	F: ATTTCATACCGTTCAG	R: CCGTTGATGCAGCGCTATTTT
Marker D:	F: CTTTCTGCCGCCATTTTG	R: TGGTTCTGTGCGACTGCGAT

I crossed males from a strain of *D. pseudoobscura* with the ST arrangement (Mount Saint Helena, California, strain #177, UC San Diego Stock Ctr. #14011-0121.246) to females from strain with the PP arrangement (San Antonio, New Mexico, strain #1137, UC San Diego Stock Ctr. #14011-0121.199) at 20C. I collected F<sub>1</sub> females and backcrossed them to PP strain males. I then genotyped the progeny (N = 3062) at four microsatellite loci (Table 1) spanning the ~6.5 megabase inversion on chromosome 3 (Figure 1).

Despite the large number of offspring surveyed, I observed no double crossover events in the test cross (0 in 3062 offspring). All offspring had the same genotype across all 4 loci. This result is very consistent with Levine's observation of a double crossover rate of 1 in 6105 offspring for ST/PP inversion heterozygotes and suggests the suppression of recombination observed by Stevison *et al.* (2011) was not unique to hybrids. From these data, I confirm the suppressive power of chromosomal inversions on double crossovers and, therefore, potentially on gene flow within and between species in inversion heterozygotes.

References: Gibbs, R.A., S. Richards, Y. Liu, B.R. Bettencourt, P. Hradecky, S. Letovsky, R. Nielsen, K. Thornton, M.J. Hubisz, R. Chen, R.P. Meisel, O. Couronne, S. Hua, M.A. Smith, P. Zhang, J. Liu, H.J. Bussemaker, M.F. van Batenburg, S.L. Howells, S.E. Scherer, E. Sodergren, B.B. Matthews, M.A. Crosby, A.J. Schroeder, D. Ortiz-Barrientos, C.M. Rives, M.L. Metzker, D.M. Muzny, G. Scott, D. Steffen, D.A. Wheeler, K.C. Worley, P. Havlak, K.J. Durbin, A. Egan, R. Gill, J. Hume, M.B. Morgan, G. Miner, C. Hamilton, Y. Huang, L. Waldron, D. Verduzco, K.P. Clerc-Blankenburg, I. Dubchak, M.A.F. Noor, W. Anderson, K.P. White, A.G. Clark, S.W. Schaeffer, W. Gelbart, and G.M. Weinstock 2005, *Genome Res.* 15: 1-18; Levine, R.P., 1956, *Am. Nat.* 90: 41-45; Noor, M.A.F., L.S. Stevison, and K.B. Hoehn 2011, *Genome Biol. Evol.* 3: 830-841; Pegueroles, C., V. Ordonez, F. Mestres, and M. Pascual 2010, *J. Evol. Biol.* 23: 2709–

2717; Roberts, P.A., 1976, The genetics of chromosome aberration. *In: The Genetics and Biology of Drosophila*, Vol. 1a, (Ashburner, M., and E. Novitski, eds), pp. 67–184. Academic Press, London, UK.



### Spotted Wing Drosophila, *Drosophila suzukii* (Matsumura) (Dip.: Drosophilidae), an invasive fruit pest new to the Middle East and Iran.

**Parchami-Araghi, Mehrdad<sup>1\*</sup>, Ebrahim Gilasian<sup>1</sup>, and Ali Akbar Keyhanian<sup>2</sup>.** <sup>1</sup>Insect

Taxonomy Research Department, Iranian Research Institute of Plant Protection, Agricultural Research, Education and Extension Organization (AREEO), Tehran, 19395-1454, Iran; <sup>2</sup>Research Department of Agricultural Entomology, Iranian Research Institute of Plant Protection, Agricultural Research, Education and Extension Organization (AREEO), Tehran, 19395-1454, Iran. \*Corresponding author: [maraghi20@yahoo.ca](mailto:maraghi20@yahoo.ca)

#### Abstract

In the course of monitoring the olive fruit fly, *Bactrocera oleae* (Gmelin), we spotted the specimens of *Drosophila suzukii* (Matsumura) in our hydrolyzed protein-baited traps placed in the olive groves located on the southern slopes of Elburz Mountains, Iran. This species is a new record for the Iranian insect fauna. The discovery of *D. suzukii* in Iran indicates that this species has already expanded its territory into the Middle East region for the first time.

#### Introduction

The highly polyphagous species *Drosophila suzukii* (Matsumura, 1931), commonly known as spotted wing drosophila (Figures 2, 4), attacks a wide range of fruits such as apple, apricot, blackberry, blueberry, cherry, fig, grape, mulberry, nectarine, peach, pear, persimmon, plum, raspberry, and strawberry (Cabi, 2015). Unlike most of drosophilids, the females of *D. suzukii* are able to attack undamaged fruits and insert their eggs in the fruit tissues with the help of their spectacular saw-like ovipositors (Figures 1, 3). The species has been reported from Europe, New World, Oriental region and southeastern Asia (Cini *et al.*, 2012).

Figures 1-4. *Drosophila suzukii* (Matsumura) from Iran. 1, adult female; 2, adult male; 3, female saw-like ovipositor; 4, male terminali.



1



2



3



4

## Material and Methods

The specimens of *D. suzukii* were accidentally captured in the traps, which were basically set to catch the tephritid olive fruit flies, *Bactrocera oleae* (Gmelin). The locality data are as follows: Iran: Qazvin province, Tarom-sofla, Ghoushchi village, 356m., September 24-October 16, 2015, 49°16'00"N 36°42'08"E, olive groves, hydrolyzed protein-baited traps, leg. A.A. Keyhanian. The specimens are preserved at the Hayk Mirzayans Insect Museum (HMIM), Tehran, Iran.

## A Tale of Two Drosophilid Invasions of Iran

Over a span of seven years, two exotic drosophilid pests have invaded Iran. The first invasion occurred in 2008 when the African fig flies, *Zaprionus indianus* Gupta, were collected in an orange orchard in southern Iran. The introduction was largely blamed on the authorities who mistakenly issued quarantine clearance for the importation of tons of orange fruits unaware of the fact that the exporting country, Egypt, had been announced contaminated by the drosophilid pest (Parchami-Araghi and Mohammadi-Khorramabadi, 2009; Yassin and Abou-Youssef, 2004). Since 2008, *Z. indianus* has been effectively widening its range across the country, seriously threatening the domestic fruit production through attacking various fruits, especially fig. But the second invasion, by *D. suzukii*, is believed to be the result of nonstandard control of the land border with Pakistan, the only country bordering Iran known to be the home of the spotted wing drosophila (Amin Ud Din *et al.*, 2005). There are no existing records of the species *D. suzukii* in other of Iran's neighboring countries. Iran and Pakistan share a porous and long border (ca. 1000 km), which is heavily frequented by traffickers on either side. This area is affected by poverty and high unemployment rate due to prolonged drought and infrastructural deficiencies. By taking advantage of these issues, smugglers trade in various commodities including agricultural products. Therefore, the highest likelihood is that the infested smuggled fruits from Pakistan have been responsible for the introduction of *D. suzukii* to Iran.

## Conclusion

The Iranian fruit farming has been suffering huge economic losses from the polyphagous tephritid *Ceratitis capitata* (Wiedemann), known as Mediterranean fruit fly, for decades. The species *C. capitata*, *D. suzukii*, and *Z. indianus* have overlapping host ranges that might create high level of interspecific competitions among them and with other associated monophagous tephritid fruit pests. Although the females of the species *Z. indianus* are not capable of inserting their eggs under the skin of fruits, they preferably infest fruits at ripening stage (with thin skin) or opportunistically attack the fruits that have been wounded by other pests, including *C. capitata* and *D. suzukii*, enhancing the damage on the harvest. Even though the trapped spotted wing drosophilas have been collected in olive orchards, their possible damages on olive fruits remain uncertain until further detailed studies on the ecology of *D. suzukii* in the region. To date olive fruit has not been recorded as a host for spotted wing drosophila.

References: Amin Ud Din, M., K. Mazhar, S. Haque, and M. Ahmed 2005, Dros. Inf. Serv. 88: 6-7; CABI 2015, Wallingford, UK: CAB International. [www.cabi.org/isc](http://www.cabi.org/isc); Cini, A., C. Ioriatti, and G. Anfora 2012, Bulletin of Insectology 65(1): 149-160; Parchami-Araghi, M., and A. Mohammadi-Khorramabadi 2009, Studia dipterologica 16(1/2): 243-244; Yassin, A.E., and A.Y. Abou-Youssef 2004, Dros. Inf. Serv. 87: 67-68.



## Olive infestation with *Zaprionus indianus* Gupta (Dip.: Drosophilidae) in northern Iran: a new host record and threat to world olive production.

**Parchami-Araghi, Mehrdad<sup>1\*</sup>, Ebrahim Gilasian<sup>1</sup>, and Ali Akbar Keyhanian<sup>2</sup>**. <sup>1</sup>Insect Taxonomy Research Department, Iranian Research Institute of Plant Protection, Agricultural Research, Education and Extension Organization (AREEO), Tehran 19395-1454, Iran;

<sup>2</sup>Research Department of Agricultural Entomology, Iranian Research Institute of Plant Protection, Agricultural

Research, Education and Extension Organization (AREEO), Tehran 19395-1454, Iran. \*Corresponding author: [maraghi20@yahoo.ca](mailto:maraghi20@yahoo.ca)

We here report olive fruit (*Olea europaea*) as a new host record for the polyphagous African fig fly, *Zaprionus indianus* Gupta, from olive plantations on the southern slopes of Elburz Mountains, Iran. The collecting site is located in the province of Qazvin, Tarom-sofla, Ghouschi village, 356 m., 49°16'00"N 036°42'08"E. Olive is one of the most economically important fruits in Iran and many countries including those that are already known to be home of the African fig fly. Although the existing list of host records for *Z. indianus* includes as many as 74 fruits in 31 plant families (van der Linde *et al.*, 2006), olive was never observed to be infested by this drosophilid pest. Olive groves cover an estimated 104,680 hectares (258,670 acres) of Iran's land with an annual production of nearly 102,000 tons of olive fruit (MAJ, 2013). The dominant olive cultivars grown in this region are Zard, Mari, Dezfuli, and Shengeh, which are dual-purpose cultivars preferred for both oil production and eating as table olives. We collected the infested fallen olive fruit from the floor of the orchards and placed in the net-covered jars for the emergence of the adult flies. The emerged flies were later identified as *Z. indianus* and the monophagous tephritid olive fruit fly *Bactrocera oleae* (Gmelin). It is believed that *B. oleae* (primary pest), by causing damage on the skin of olive fruit, encourages the oviposition of the females of the secondary pest, African fig fly. Therefore, the olive groves where contaminated by the both fly species are more likely to be infested by *Z. indianus*. Since its discovery in 2008 (Parchami-Araghi and Mohammadi-Khorramabadi, 2009), the species *Z. indianus* has reportedly attacked a number of fruits including fig, olive, orange, peach, persimmon, and pomegranate in Iran.

References: MAJ 2013, Statistics Newsletter 3: 138pp. <http://maj.ir/portal/File/ShowFile.aspx?ID=648318ef-02ce-4749-9dd2-2fdae1bd699e>; Parchami-Araghi, M., and A. Mohammadi-Khorramabadi 2009, *Studia dipterologica* 16(1/2): 243-244; van der Linde, K., G.J. Steck, K. Hibbard, J.S. Birdsley, L.M. Alonso, and D. Houle 2006, *Florida Entomologist* 89(3): 402-404.



### **Drosophilidae of Bettadapura hill of Mysuru District (Karnataka, India).**

**Guruprasad, B.R\*, C. Padmaja, and V. Tangpu.** Dept of Zoology, Regional College of Education (NCERT), Mysuru-570006, Karnataka state, India; Email: [drguruprasad28@gmail.com](mailto:drguruprasad28@gmail.com) \*Corresponding author.

*Drosophila* has been used as a model organism for research for almost a century and thousands of scientists around the world work on it. It has richly contributed to our understanding of the pattern of eco-distribution, biodiversity (Guru Prasad *et al.*, 2010), and altitudinal variation (Guru Prasad *et al.*, 2006). The *Drosophila* species are observed in any ecosystem, from considerable altitudes to sea level, and in equatorial as well as in temperate zones (Throckmorton, 1975). The Drosophilidae family is composed by 65 genera and more than 3500 described species that occur all over the world (Bachli, 1998). The early studies on *Drosophila* in India were mainly with taxonomy. From 1970 onwards studies in other fields have also been initiated such as biodiversity. Significant progress has been made in the field of taxonomy and biodiversity of family Drosophilidae in South India. However, there are a few areas of south India, especially south Karnataka, which are not explored to analyse the fauna of *Drosophila species*. To fill up this gap at least partially, hence the present study has been undertaken in Bettadapura hill south eastern Karnataka, India, to study *Drosophila* fauna.

In the present study the *Drosophila* fauna was collected from two different altitudes (500 m and 1200 m) of Bettadapura hill (12.29°N, 75.65°E), in August 2015 which is situated in Mysuru district, of south eastern Karnataka, south India, almost near to Western Ghats. Collections were made using regular bottle trapping and banana bait methods. In bottle trapping method regular banana baits in quarter pint 250 ml milk bottles sprayed with yeast were tied to the twigs of trees at two and half feet above the ground in cool shaded

areas covered by scrubs. Next day flies were attracted by the bait and thus the bottles were collected during early morning by plugging with cotton to the mouth of the bottles. In net sweeping methods rotting fruits are spread usually beneath shaded areas of the bushes of plants. The study revealed a total of twelve different *Drosophila* species belongs to three subgenus namely Subgenus Sophophora, *Drosophila*, *Scaptodrosophila* in both higher and lower altitude of the hill being recorded.

Table 1. *Drosophila* fauna of Bettadapura hill of Mysuru district (south eastern Karnataka, India).

Species	Altitudes		Total
	500m	1200m	
Subgenus: Sophophora			
<i>D. anomelani</i>	86	65	151
<i>D. jambulina</i>	66	35	101
<i>D. rajasekari</i>	94	79	173
<i>D. suzukii</i>	91	78	169
<i>D. takahashii</i> *	36	--	36
<i>D. bipectinata</i>	85	31	116
<i>D. malerkotliana</i> **	175	156	331
Total	633	444	1077
Subgenus: <i>Drosophila</i>			
<i>D. nasuta</i> **	180	162	342
<i>D. neonasuta</i>	76	65	141
<i>D. repleta</i>	42	15	57
Total	298	242	540
Subgenus: <i>Scaptodrosophila</i>			
<i>D. brindavani</i>	95	78	173
<i>D. nigra</i> *	23	--	23
Total	118	78	196
Temperature	20 <sup>0</sup> C - 24 <sup>0</sup> C	18 <sup>0</sup> C - 20 <sup>0</sup> C	
Grand total	1049	764	1813

\* indicates the species of least number; \*\* Indicates the species in maximum number.

The results of our *Drosophila* survey are shown in Table 1. According to our results as altitude increases there was a decrease in number of *Drosophila* species. Totally 1,813 flies were encountered during the collection, which belong to three subgenera, namely Sophophora, *Drosophila*, *Scaptodrosophila* with twelve species. The 500 m altitude comprises 1049, and 1200 m (764) of different species of *Drosophila* flies. The Sophophora comprises more number of flies and species compared to other genera. *D. nasuta* and *D. malerkotliana* species are the common and abundant species found in both altitudes. Interestingly species like *D. takahashii* and *D. nigra* were not found in higher altitude (1200 m). The community and biodiversity was big in lower altitude compared to higher altitudes. These results are similar to our own studies of *Drosophila* in Chamundi hill (Guru Prasad *et al.*, 2006). Thus, from the present eco-distributional and population analysis of *Drosophila* in hill, it is clear that the distributional pattern of a species or related group of species is uneven in space. *D. malerkotliana* and *D. nasuta* emerged as champion species, as they are registered in more in number in both altitudes. *D. nigra* and *D. takahashii* are completely absent in the higher altitude. In a nutshell, it can be said that the *Drosophila* community of hill is highly diverse which provides the habitat for flies.

**Acknowledgment:** The authors are extremely grateful to Prof. D.G. Rao Principal, Regional Institute of Education (NCERT), Mysuru for his constant support and encouragement. The authors profusely thank Prof. V.D. Bhat, Dean of Studies and Prof. G.V. Gopal, Head, DESM for their support.

**References:** Guru Prasad, B.R., and S.N. Hegde 2010, *Journal of Insect Science* 10: 123; Guru Prasad, B.R., and S.N. Hegde 2006, *Dros. Inf. Serv.* 89: 10-11; Guru Prasad, B.R., and S.N. Hegde 2006, *Dros. Inf. Serv.* 89: 29-3; Throckmorton, L.H., 1975, *In: Handbook of Genetics* (King, R.C., ed.). Plenum Press, New York, pp. 421-467; Bachli, G., 1998, *Higher Brachteera Science Herald*, Budapest: 1-120.



## First registry of *Canalineia* group (Diptera, Drosophilidae) at Santa Catarina State, South Brazil.

**Fischer, L.W.<sup>1</sup>, D.F. Gomes<sup>1</sup>, W. Cavalcante<sup>1</sup>, and D.C. De Toni<sup>1,2</sup>.** <sup>1</sup>Laboratório de Drosofilídeos, Departamento de Biologia Celular, Embriologia e Genética – Universidade Federal de Santa Catarina; <sup>2</sup>Pós-Graduação em Biologia Celular e do Desenvolvimento, UFSC, Florianópolis, Brasil; e-mail: Leonardo Fischer, leo\_w\_fischer@hotmail.com; **Keywords:** Neotropical species, *Drosophila*, South America, Parque Estadual da Serra do Tabuleiro

### Introduction

The *Canalineia* group includes *D. albomarginata* Duda, *D. annularis*, Sturtevant, *D. annulosa* sp. nov., *D. canalinea* Patterson & Mainland, *D. canalinioides* Wheeler, *D. davidgrimaldii*, sp. nov., *D. hendeli*, sp. nov., *D. melanoptera*, Duda, *D. panamensis* Malloch, *D. parannularis*, sp. nov., and *D. procanalineia*, Wheeler. Its diagnosis includes body color mainly dark brown, mesonotum usually with dark spots at bristles bases and complex pattern of brown and yellow areas, forming diffuse longitudinal stripes, basal scutellars convergent, legs mostly dark, tibiae yellow with 2 brown rings, cross vein clouded, and tergites with broad, brown medially narrowly interrupted marginal bands. The distribution of this group is not well known, especially because it has been widening the colonizing areas in the last ten years in the Brazilian south region.

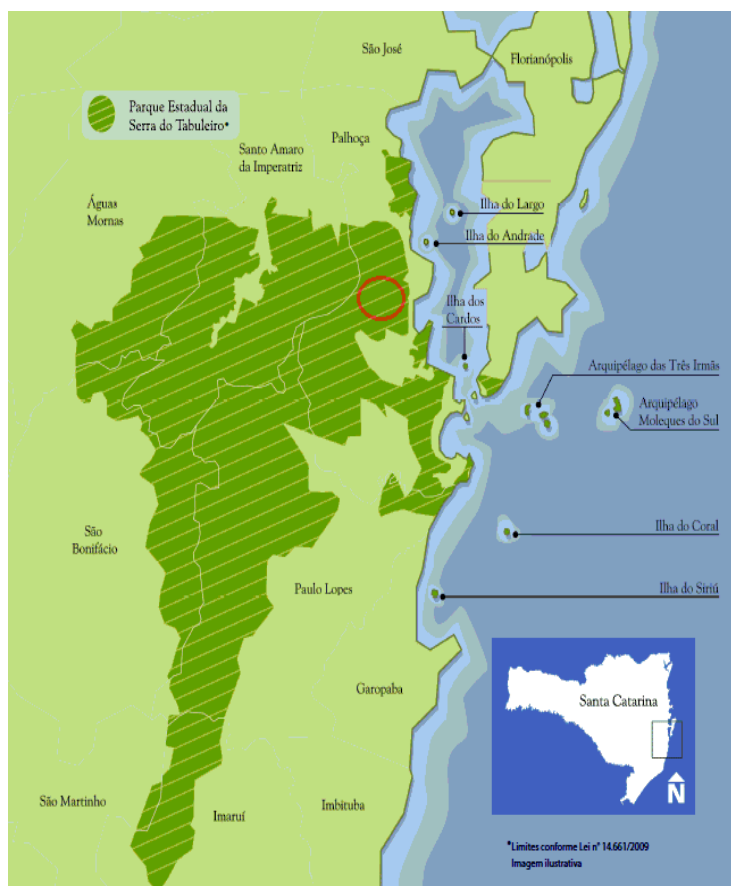
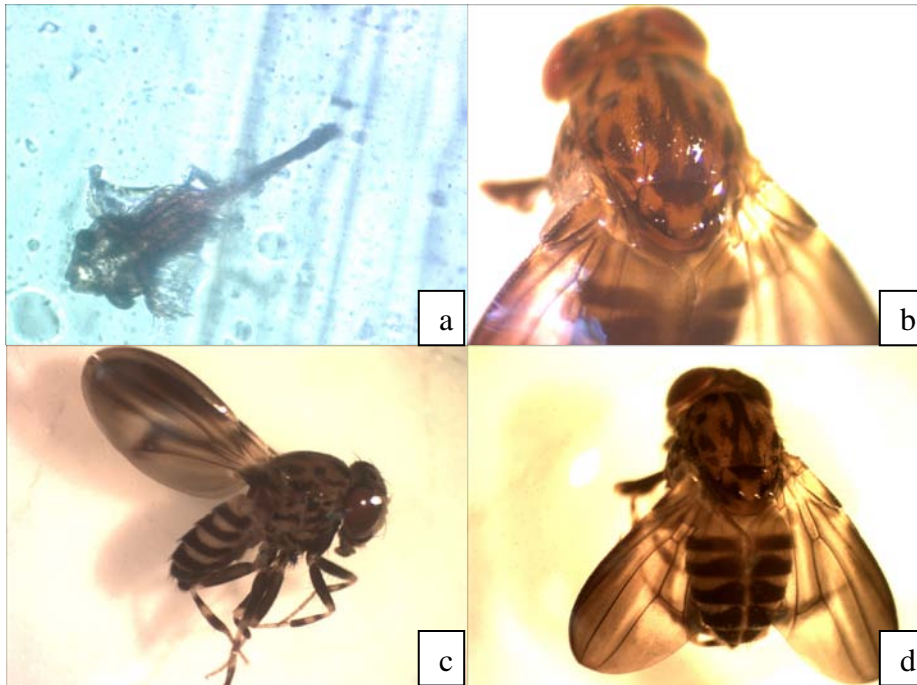

Figure 1. Map - showing the Santa Catarina State, south of Brazil, with the collecting point and a zoom view of the area. Reference: [www.google.com.br/maps/](http://www.google.com.br/maps/)

### Material and Methods

The individuals of *Canalineia* group were collected in September, 2014, with traps containing fermented banana baits (Roque



and Tidon, 2011), in a protected area included at Parque Estadual Serra do Tabuleiro (Figure 1) with geographical coordinates: 27°48'20" S; 48°33'50" W. Adults collected were identified according with external morphology (Freire Maia and Pavan, 1949), after which, the male genitalia dissection technique of was performed (Kaneshiro, 1969).

Figure 2. Pictures of external morphology of *Canalinea* group male terminalia, in a frontal view (a) and parts of the body (b, c, d) in different views.

## Results

Three male individuals of *Canalinea* group were collected in a protected area included at Parque Estadual Serra do Tabuleiro, Santa Catarina State, South of Brazil. The frontal view of the internal male terminalia (Figure 2) shows very similar with *D. canalinea*, but not so angulous. In this three individuals the tip of *aedeagus* is more rounded.

## Conclusions

This is the first record of *Canalinea* group in this area of Santa Catarina State, that spread broadly its distribution, in these last 10 years, since it was collected by Doge, *et al.* (2008) in Joinville, SC. Further studies must be done about the dispersion and ecology, the breeding and feeding sites, of these groups as well as the description of these and 3 other new species of this group founded in the Santa Catarina State (Doge, *et al.*, 2008).

References: Döge, J.S., V.L.S. Valente, and P.R.P. Hofmann 2008, *Revista Brasileira de Entomologia* 52: 615-624; Freire-Maia, N., and C. Pavan 1949, *Cultus* 1: 1-171; Kaneshiro, K.Y., 1969, *University Texas Publication* 6918: 55-70; Ratcov, V., and C.R. Vilela 2007, *Revista Brasileira de Entomologia* 51: 3; Roque, F., S.C.F. de Oliveira, and R. Tidon 2011, *Dros. Inf. Serv.* 94: 140-141; Vilela, C.R., and F.C. Val 2004, *Revista Brasileira de Entomologia*, 48: 1.



## Viability and lifespan effect of *Drosophila* vital gene *hsf* under elevated temperature conditions.

**Weisman, Natalya.** Institute of Cytology and Genetics SB RAS, 630090 Novosibirsk, Russia; [weisman@bionet.nsc.ru](mailto:weisman@bionet.nsc.ru)

There are less studied cases of haplo-advantage described for mutations of some genes influencing longevity and stress resistance, observed in *Drosophila*. Thus, null-allele of *Methuselah* (*mth*) gene displayed



pre-adult lethality in homozygotes. However, *mtl*/<sup>+</sup> heterozygotes of null allele exhibit longevity 30-35% higher than <sup>+/+</sup> wild type flies.

The main goal of this study was to analyze the survival effects of mild heat shock on *hsf*<sup>d</sup>-heterozygous carriers throughout the whole life cycle: (a) pre-adult viability from fertilization to eclosion and (b) from eclosion to death, analyzing the survival dynamics of both sexes. Since HSF protein is present pre-zygotically in eggs (Voellmy, 2004; Fichelson *et al.*, 2010) we analyzed the role of maternal (*hsf*<sup>1/+</sup>) and paternal (<sup>+/</sup>*hsf*<sup>1</sup>) origin of these mutations in survival and lifespan (LS) of F1 progeny.

## Material and Methods

We used the wild-type Canton S (CS) strain and the loss-of-function lethal chemically induced (Jedlicka *et al.*, 1997) *hsf*<sup>1</sup> mutation in balanced condition *hsf*<sup>1</sup>/*Cy* obtained from Bloomington Drosophila Stock Center, USA. Mutation *hsf*<sup>1</sup> in homozygous carriers arrests development at the first or second larval stage.

We conducted the reciprocal crosses between mutant strain and the wild-type strain CS. Animals *Cy*/<sup>+</sup> and <sup>+/</sup>*Cy* with two normal dosages of *hsf* gene were grown under the same genetic and environmental background as flies *hsf*<sup>1/+</sup> and <sup>+/</sup>*hsf*<sup>1</sup>. Therefore, they served as an internal control for mutant heterozygous flies with one normal dosage of the relevant gene. Reciprocal flies *hsf*<sup>1/+</sup> as well as <sup>+/</sup>*hsf*<sup>1</sup> exhibit normal phenotype. Survival rate and LS of F1 progeny were evaluated under normal (25°C) and elevated (29°C) temperature conditions.

For statistical evaluation of significance of differences between experimental and control groups we used Student's criterion. Log-rank test was applied to determine the significance of differences between the survival curves of the tested flies (Bland and Altman, 2004).

## Results

### *Relative viability during embryonic period*

To evaluate pre-adult viability from fertilization to eclosion, the vials with freshly laid eggs were placed into thermostats with either normal (25°C) or elevated (29°C) temperature. The survival changes were measured basing on the statistically significant deviations from the expected segregation of the phenotypes registered in the hatched flies (*Cy* vs wild type).

Under normal temperature conditions (25°C) segregation ratio in the progenies of two reciprocal crosses *hsf*<sup>1</sup>/*Cy* × <sup>+/+</sup> does not deviate from theoretically expected values 1:1. Embryonic survival of two reciprocal classes *hsf*<sup>1/+</sup> and <sup>+/</sup>*hsf*<sup>1</sup> was practically equal. Development under conditions of elevated temperature (29°C) dramatically increased (by 30-39%) the viability of heterozygotes (in comparison with the expected values). In crosses with maternal *hsf*<sup>1</sup> origin the percentage of *hsf*<sup>1/+</sup> females in F1 progeny was 67.1 and males – 68.1%. In reciprocal crosses with paternal *hsf*<sup>1</sup> origin corresponding values were 62.5 and 70.6%.

### *Life span experiments. Average life span analysis*

For measuring of LS, fly cultures were maintained to imago stage at optimal temperature (25°C). Immediately after eclosion virgin females and males of the same age (50 flies per vial) separately were transferred to an incubator with a constant temperature of either 25° or 29°C. Every three days, live flies were counted and transferred to fresh food. In total for an experiment 300 flies of each sex of each genotype were used.

Both classes of reciprocal heterozygotes *hsf*<sup>1/+</sup> and <sup>+/</sup>*hsf*<sup>1</sup> exhibited mean LS advantage in comparison with the control *Cy*/<sup>+</sup> and <sup>+/</sup>*Cy* flies already at the optimal temperature (*hsf*<sup>1/+</sup> : *Cy*/<sup>+</sup> females - 75.9 ± 1.0 : 63.2 ± 0.9 days and males- 80.3 ± 1.0 : 74.6 ± 1.5 days, respectively; <sup>+/</sup>*hsf*<sup>1</sup> : <sup>+/</sup>*Cy* females - 76.2 ± 1.9 : 65.7 ± 1.3 days and males- 77.6 ± 1.5 : 71.7 ± 1.7 days, respectively).

As expected, at 29°C the average LS was drastically reduced up to 40-50% in all genotypes. However, at this temperature mutant heterozygotes preserved their LS advantage in comparison with the control (*hsf*<sup>1/+</sup> : *Cy*/<sup>+</sup> females 38.0 ± 0.3 : 34.4 ± 0.3 days and males 35.5 ± 0.4 : 29.6 ± 0.4 days; <sup>+/</sup>*hsf*<sup>1</sup> : <sup>+/</sup>*Cy* females 35.6

$\pm 0.6$  :  $31.9 \pm 0.6$  days and males  $30.9 \pm 0.2$  :  $31.9 \pm 0.3$  days. The clear-cut maternal effect was manifested under these conditions.

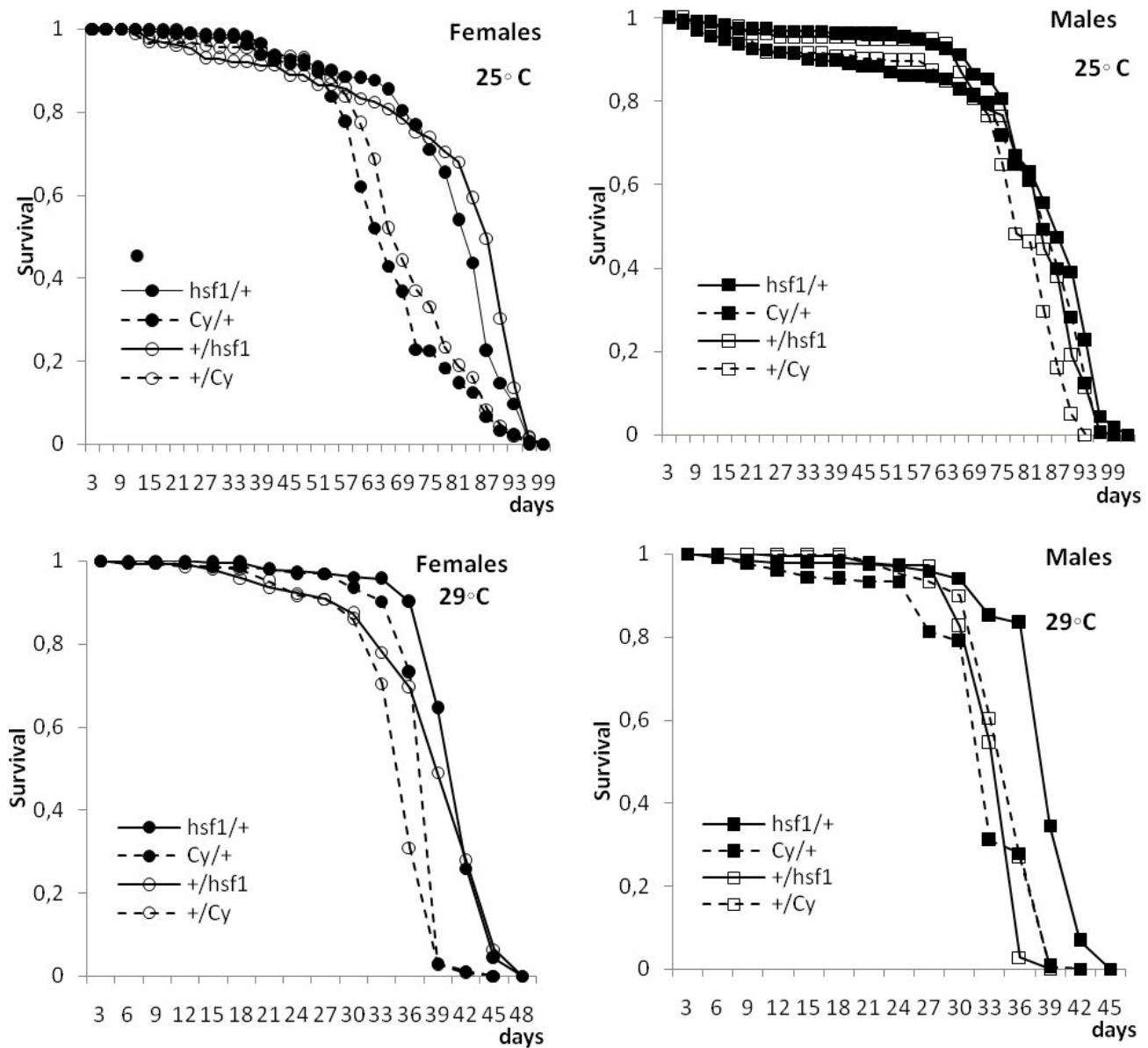

Figure 1. Survival of heterozygous and control females at normal and elevated temperature.

#### Dynamics of aging and mortality

Survival curves of *hsf*<sup>1/+</sup> and *+ / hsf*<sup>1</sup> females differed from those of the control at optimal temperature ( $\chi^2 = 74.9$  and  $\chi^2 = 42.5$  respectively;  $f = 1$ ,  $p = 0.05$ ).

In control females transition from gradual to mass mortality period at LT10 (10% mortality level) occurred approximately by 12 days earlier than in *hsf*<sup>1/+</sup> and by 36 days earlier than in reciprocal *+ / hsf*<sup>1</sup> heterozygotes. The female 50% mortality level (LT50) in the control group also occurred earlier than in heterozygotes. The time interval between LT50 for the control group and LT50 for *hsf*<sup>1/+</sup> and *+ / hsf*<sup>1</sup> genotypes reached 21 days. At the elevated temperature differences between heterozygous females and

control group are less pronounced but still statistically significant ( $\chi^2 = 62.1$  and  $\chi^2 = 38.62$ , correspondingly;  $f = 1$ ,  $p = 0.05$ ).

We also observed clear-cut differences in the survival dynamics between females and males for the above genotypes. Under optimal conditions heterozygous males exhibited survival advantage starting from the beginning of life cycle up to the stage of mass mortality. The LT10 point of *hsf*<sup>1/+</sup> and *+ / hsf*<sup>1</sup> flies occurred 33 and 9 days later than in the control group, correspondingly. However, intervals between LT50 (control) – LT50 (*hsf*<sup>1/+</sup>) and – LT50 (*+ / hsf*<sup>1</sup>) were equal to only 3 and 6 days, respectively. The survival curves of heterozygous males differed from those of the control group not so dramatically ( $\chi^2 = 2.3$  and  $\chi^2 = 14.54$ ;  $f = 1$ ,  $p = 0.05$ ) as in the females.

At 29°C sex specific differences in survival dynamics were also observed in the compared groups. Thus, *hsf*<sup>1/+</sup> males appeared to be less sensitive to the stressful conditions of maintenance. The differences at both T10 and LT50 points increased between *hsf*<sup>1/+</sup> mutants and control. Survival curves of heterozygous males *hsf*<sup>1/+</sup> and *+ / hsf*<sup>1</sup> and control were significantly different ( $\chi^2 = 91.5$  and  $\chi^2 = 7.7$ , correspondingly;  $f = 1$ ,  $p = 0.05$ ).

In general it is possible to conclude that the dynamics of aging and survival of *hsf*- heterozygotes appeared to depend on the direction of cross, stage of life cycle, sex, and response to elevated temperature.

Acknowledgments: The manuscript draft was constructively critiqued by Michael Golubovsky.

References: Jedlicka, P., *et al.*, 1997, EMBO J. 16: 2452–62; Lin, Y.J., *et al.*, 1998, Science 282: 943-46; Voellmy, R., 2004, Cell Stress & Chaperones. 9: 122-33; Fichelson, P., *et al.*, 2010, Development 137: 815-24;



### Distribution of drosophilids breeding in *Solanum lycocarpum* (Solanaceae) fruits.

**Valadão, H., and R. Tidon.** Programa de Pós-Graduação em Ecologia, Universidade de Brasília, Campus Darcy Ribeiro, Brasília, DF 70910-900, Brazil.

One of the main goals of community ecology is to understand species distribution through space and time. Temporal environmental variations, such as temperature and humidity, can substantially change community structure and dynamics (Hone and Clutton-Brock, 2007; Shimadzu *et al.*, 2013), particularly in insects (Wolda, 1988). Seasonal changes can alter developmental rates and adult reproduction, and consequently the survival of the offspring. Because seasonal changes can also alter the availability of resources throughout the year in terms of abundance and quality, the probability of encountering suitable resources also changes over time.

The drosophilids in the Brazilian Savanna are an excellent system in which to study the effects of seasonality, because this biome is characterized by the alternation of dry and rainy seasons. The average annual rainfall is 1,500 mm, but the rains are strongly concentrated in the rainy season (Eiten, 1972), which occurs from November to March. In the wet months, when the richness and abundance of drosophilids are very high (Mata and Tidon, 2013; Mata *et al.*, 2015; Tidon, 2006), many plant species produce fleshy fruits (Oliveira, 1998) that are used as breeding sites. Conversely, drosophilid populations are constricted in the dry season (May to September), when relatively few food resources can be found.

In this study, we examine a local frugivorous drosophilid community exploiting *Solanum lycocarpum* St. Hil. (Solanaceae), a neotropical species with fruits that provide a patchy resource for the feeding and breeding of these flies. The focus of the study is to investigate the effects of temporal variation of fruits on the community of drosophilids.

### Materials and Methods

*Solanum lycocarpum*, an abundant neotropical species of the central regions of South America, is a small tree with fruits of 8-15 cm in diameter and an average weight of 500 g. Due to its size, this fleshy fruit (Figure 1) is an important resource for drosophilids in this region (Leão and Tidon, 2004).



Figure 1. Fruits of *Solanum lycocarpum*.

Collections of *S. lycocarpum* fruits were performed in the Instituto Brasileiro de Geografia e Estatística (IBGE) Ecological Reserve (15 ° 56'S, 47 ° 53'W), located 35 km south of Brasília and protecting approximately 10,000 ha together with two other continuous reserves. We performed a screening in several areas of IBGE, but only one area showed trees with fruits. Fallen fruit from five nearby trees (located up to 5 m from each

other) were monthly collected during the peak months of the rainy season (January, February and March) and the dry season (July, August and September). During the dry season, a period of low availability of fruits, all fruits were collected. On the rainy season, when fruits are abundant, up to 30 fruits were randomly collected each month. Collected fruits were transported to the laboratory in plastic bags, and were individually weighed (wet weight). They were then individually placed in plastic containers with moist vermiculite containing a solution of Nipagin (methyl 4-hydroxybenzoate, Vetec Química Fina LTDA, Rio de Janeiro, RJ, Brazil), an inhibitor of filamentous fungi. After this, each container was covered with a piece of cloth. The adult flies that emerged were removed every two days using an entomological vacuum apparatus and identified to the species level with identification keys (Freire-Maia and Pavan, 1949) and analysis of the male terminalia (Malagolowkin, 1952; Vilela and Bächli, 1990; Vilela and Val, 1985). All the adults collected were deposited in the collection of the Evolutionary Biology Laboratory at the University of Brasília.

## Results

A total of 146 *Solanum lycocarpum* fruits were collected: 85 during the rainy season and 61 during the dry season, and overall these resources supported 12,745 drosophilids of 20 species (Table 1). The mean weight of fruit did not differ between the two seasons (rainy = 494.96 g, dry = 467.46 g,  $t = 0.666$ ,  $df = 144$ ,  $P = 0.507$ ), but the density of flies was significantly higher in the wet season (rainy = 0.321 flies/g, dry = 0.011 flies/g,  $W = 4607.5$ ,  $P < 0.001$ ). Four drosophilid species could be considered for analysis of proportional usage of the fruits, due to sample size in both seasons: *Zaprionus indianus*, *Drosophila simulans*, *D. melanogaster*, and *D. mercatorum*. The proportional usage of the fruits was different between the two seasons for these species individually and for all species combined (Table 2).

## Discussion

The abundance of drosophilids in *Solanum lycocarpum* was 35 times higher in the rainy season than in the dry season, supporting previous findings (Mata and Tidon, 2013; Mata *et al.*, 2015; Tidon, 2006). As in the Brazilian Savanna most fruits are available only in the rainy season (Valadão, unpublished data), the rarity of flies in the dry season could be due a shortage of resources. However, the low density of flies and the high proportion of unexploited fruits, in the dry season, do not support this hypothesis.

Table 1. Dipterans reared from *Solanum lycocarpum* fruits in the peak rainy and dry seasons, in the IBGE Ecological Reserve.

Taxon	Rainy season	Dry season
<i>Scaptodrosophila latifasciaeformis</i> * Duda	5874	0
<i>Drosophila mercatorum</i> Patterson and Wheeler	2925	60
<i>Zaprionus indianus</i> * Gupta	1353	102
<i>D. melanogaster</i> * Meigen	1058	98
<i>D. sturtevantii</i> Duda	691	0
<i>D. hydei</i> * Sturtevant	369	3
<i>D. simulans</i> * Sturtevant	156	53
<i>D. immigrans</i> * Sturtevant	81	0
<i>D. cardini</i> Sturtevant	71	2
<i>D. willistoni</i> Sturtevant	35	0
<i>D. malerkotliana</i> * Parshad and Paika	35	0
<i>D. busckii</i> * Coquillett	24	0
<i>D. mediotriata</i> Duda	18	0
<i>D. cardinoides</i> Dobzhansky and Pavan	15	0
<i>D. nebulosa</i> Sturtevant	9	3
<i>Rhinoleucophenga</i> sp 1	4	7
<i>D. ananassae</i> * Doleschall	10	0
<i>D. trapeza</i> Heed and Wheeler	8	0
<i>D. paramediotriata</i> Townsend and Wheeler	6	0
<i>D. mediopunctata</i> Dobzhansky and Pavan	3	0
Total	12745	406

\* Exotic species in the Neotropical Region

known that lower temperatures and shorter days can promote ovarian diapause and cause an interruption in egg production (Saunders *et al.*, 1989). This strategy could explain the bottlenecks observed in populations of *Drosophila* in the Brazilian Savanna when the mean temperature in the dry season is potentially sufficient to cause 80% of the population to undergo ovarian diapause (Emerson *et al.*, 2009).

Table 2. Proportion of fruits of *Solanum lycocarpum* colonized by drosophilids in the peak rainy and dry seasons, in the IBGE Ecological Reserve.

Species	Rainy season	Dry season	$\chi^2$	P
<i>Z. indianus</i>	0.65	0.16	31.943	0.000
<i>D. simulans</i>	0.24	0.07	6.907	0.009
<i>D. melanogaster</i>	0.49	0.18	13.795	0.000
<i>D. mercatorum</i>	0.75	0.10	58.375	0.000
All species	0.89	0.26	58.148	0.000

In sum, our study has revealed that the rarity of drosophilids in the Brazilian Savanna, often observed in the dry season, is probably not caused by a lack of fruits. We provided alternative explanations for the temporal fluctuations of these flies, which will be tested in future work.

Acknowledgments: We are grateful to M.S. Gottschalk for comments on early drafts of the manuscript, and to A. Brito for his valuable help with the fieldwork. We are also grateful to Universidade de

The precise causes of the seasonal drosophilid bottlenecks in the Brazilian Savanna are not currently known, but some hypotheses can be raised to explain this pattern. In the dry season, for example, the fruits could be not found by females, or they were not suitable as a breeding site. As all the fruits were obtained in a small area, the second option is more reasonable. In that case, even though the fruits are present throughout the year, they are not an available resource for drosophilids when adverse environmental conditions constraint the development of yeasts and bacteria on which these flies feed. These differences in resource availability could change the distribution patterns of the individuals. Additionally, seasonality can also affect drosophilid abundance by modifying individual reproductive parameters. It is well

Brasília and Reserva Ecológica do IBGE for logistical support. This work was funded with grants from Conselho Nacional de Desenvolvimento Científico e Tecnológico (CNPq).

References: Eiten, G., 1972, *Bot. Rev.* 38: 201-341; Emerson, K.J., A.M. Uyemura, K.L. McDaniel, P.S. Schmidt, W.E. Bradshaw, and C.M. Holzapfel 2009, *J. Comp. Physiol., A* 195: 825-9; Freire-Maia, N., and C. Pavan 1949, *Cultus* 1: 1-171; Hone, J., and T.H. Clutton-Brock 2007, *J. Anim. Ecol.* 76: 361-367; Leão, B.F.D., and R. Tidon 2004, *Annales de la Societe Entomologique de France* 40: 285-290; Malagolowkin, C., 1952, *Rev. Bras. Biol.* 12: 79-96; Mata, R.A., and R. Tidon 2013, *Insect Conservation and Diversity* 6: 663-670; Mata, R.A., H. Valadão, and R. Tidon 2015, *Rev. Bras. Entomol.* 59: 52-59; Oliveira, P.E., 1998, *In: Cerrado: ambiente e flora*, (S.M. Sano and S.P. Almeida, eds.) Embrapa-CPAC, Planaltina, pp 169-192; Saunders, D.S., V.C. Henrich, and L.I. Gilbert 1989, *Proc. Natl. Acad. Sci. USA* 86: 3748-3752; Shimadzu, H., M. Dornelas, P.A. Henderson, and A.E. Magurran 2013, *BMC Biol.* 11: 98; Tidon, R., 2006, *Biol. J. Linn. Soc.* 87: 233-247; Vilela, C.R., and G. Bächli 1990, *Mitteilungen der Schweizerischen Entomologischen Gesellschaft* 63: 1-332; Vilela, C.R., and F.C. Val 1985, *Rev. Bras. Entomol.* 29: 503-513; Wolda, H., 1988, *Annu. Rev. Ecol. Syst.* 19: 1-18.



### Revised list of drosophilid species recorded in the Brazilian Savanna.

**Roque, F.<sup>1,2</sup>, L. Mencarini<sup>2</sup>, and R. Tidon<sup>2</sup>.** <sup>1</sup>Instituto Federal de Brasília, Planaltina, DF – BRAZIL; <sup>2</sup>Instituto de Biologia, Universidade de Brasília, Brasília, DF – BRAZIL; Corresponding author: francisco.roque@ifb.edu.br.

### Introduction

The Brazilian Savanna, an environment also known as Cerrado, is found within the interior of Brazil and originally covered an area of about 2 million km<sup>2</sup> in South America (Oliveira and Marquis, 2002). The landscape's typical vegetation consists of savanna and small forests with significantly varying structures (Oliveira-Filho and Ratter, 2002) that contribute to its status as the most biodiverse savanna on Earth. Over the last few decades, large-scale cattle ranching and the emergence of industrial plantations, such as those used for soybeans, *Glycine max* [L.] Merr. have extensively transformed the Brazilian Savanna. Disturbances caused by both the urban, and agricultural expansion have increasingly threatened its rich biodiversity (Klink and Machado, 2005). Currently, this region is considered one of 34 *biodiversity hotspots* around the world because of its high endemism and the extreme threats that it faces (Mittermeier *et al.*, 2005). Accordingly, documenting biodiversity in this area is an important step toward obtaining critical subsidies necessary for its preservation and conservation.

The most recent compilation of drosophilid species recorded in the Brazilian Savanna was provided by Roque and Tidon (2013). This list was based upon unpublished data, along with that available in Chaves and Tidon (2005, 2008), Roque *et al.* (2006), Blauth and Gottschalk (2007), Roque and Tidon (2008), Mata *et al.* (2008), and Valadão *et al.* (2010). They concluded that drosophilid fauna of the Cerrado consisted of 128 species. Subsequent findings by Blauth *et al.* (2013), Paula *et al.* (2014), Junges and Gottschalk (2014), and Vidal and Vilela (2015) eventually added more species to this list.

In this study, we analyzed the current records of drosophilid species proposed by Roque *et al.* (2006), Mata *et al.* (2008), Roque and Tidon (2008, 2013), and Valadão *et al.* (2010). We then updated the existing list of species, adding the information available after 2013. The revised list better organizes the existing knowledge and presents a more realistic checklist of the drosophilids recorded in the Brazilian Savanna.

### Material and Methods

Initially, we analyzed the most current, existing, records of drosophilids for the Cerrado, provided by Roque *et al.* (2006), Mata *et al.* (2008), Roque and Tidon (2008, 2013), and Valadão *et al.* (2010). We went through each of the original species descriptions and verified the specific characteristics for each. Afterwards

Table 1. Drosophilids of the Brazilian Savanna. Detailed informations on the geographic distribution of these insects can be obtained in the following references: Chaves and Tidon (2005; 2008); Roque *et al.* (2006); Blauth and Gottschalk (2007); Mata *et al.* (2008); Roque and Tidon (2008; 2013); Valadão *et al.* (2010); Blauth *et al.* (2013); Junges and Gottschalk (2014); Paula *et al.* (2014); Vidal and Vilela (2015).

Subfamily	Genus	Subgenus	Species
Drosophilinae	<i>Drosophila</i>	<i>Dorsilopha</i>	* <i>D. busckii</i> Coquillett
		<i>Drosophila</i>	<i>D. annulimana</i> Duda
			<i>D. aragua</i> Vilela and Pereira
			<i>D. arapuan</i> da Cunha and Pavan
			<i>D. ararama</i> Pavan and da Cunha
			<i>D. arauana</i> Pavan and Nacur
			<i>D. aureata</i> Wheeler
			<i>D. bromelioides</i> Pavan and da Cunha
			<i>D. atrata</i> Burla and Pavan
			<i>D. calloptera</i> Schiner
			<i>D. quadrum</i> (Wiedemann)
			<i>D. schildi</i> Malloch
			<i>D. annulosa</i> Vilela and Bächli
			<i>D. canalinea</i> Patterson and Mainland
			<i>D. cardini</i> Sturtevant
			<i>D. cardinoides</i> Dobzhansky and Pavan
			<i>D. neocardini</i> Streisinger
			<i>D. neomorpha</i> Heed and Wheeler
			<i>D. polymorpha</i> Dobzhansky and Pavan
			<i>D. coffeata</i> Williston
			<i>D. fuscolineata</i> Duda
			<i>D. paglioli</i> Cordeiro
			<i>D. camargoi</i> Dobzhansky and Pavan
			<i>D. dreyfusi</i> Dobzhansky and Pavan
			<i>D. griseolineata</i> Duda
			<i>D. guaraja</i> King
			<i>D. guaru</i> Dobzhansky and Pavan
			<i>D. maculifrons</i> Duda
			<i>D. ornatifrons</i> Duda
			* <i>D. immigrans</i> Sturtevant
			<i>D. pallidipennis</i> Dobzhansky and Pavan
			<i>D. antonietae</i> Tidon-Sklorz and Sene
			<i>D. borborema</i> Vilela and Sene
			<i>D. buzzatii</i> Patterson and Wheeler
	<i>D. coroica</i> Wasserman		
	<i>D. eleonora</i> Tosi <i>et al.</i>		
	<i>D. gouveai</i> Tidon-Sklorz and Sene		
	<i>D. hydei</i> Sturtevant		
	<i>D. ivai</i> Vilela		
	<i>D. mapiriensis</i> Vilela and Bächli		
	<i>D. mercatorum</i> Patterson and Wheeler		

- D. meridionalis* Wasserman  
*D. moju* Pavan  
*D. neorepleta* Patterson and Wheeler  
*D. nigricruria* Patterson and Mainland  
*D. onca* Dobzhansky and Pavan  
*D. papei* Bächli and Vilela  
*D. paranaensis* Barros  
*D. pseudorepleta* Vilela and Bächli  
*D. querubimae* Vilela  
*D. repleta* Wollaston  
*D. rosinae* Vilela  
*D. serido* Vilela and Sene  
*D. seriema* Tidon-Sklorz and Sene  
*D. zottii* Vilela  
*D. albirostris* Sturtevant  
*D. bandeirantium* Dobzhansky and Pavan  
*D. bifilum* Frota-Pessoa  
*D. cuaso* Bächli, Vilela and Ratcov  
*D. medioimpressa* Frota-Pessoa  
*D. mediopicta* Frota-Pessoa  
*D. mediopunctata* Dobzhansky and Pavan  
*D. mediotriata* Duda  
*D. mesostigma* Frota-Pessoa  
*D. nappae* Vilela *et al.*  
*D. neoguarani* Frydenberg  
*D. paraguayensis* Duda  
*D. paramediotriata* Townsend and Wheeler  
*D. roehrae* Pipkin and Heed  
*D. trapeza* Heed and Wheeler  
*D. unipunctata* Patterson and Mainland  
\* *D. virilis* Sturtevant  
*D. caponei* Pavan and da Cunha  
*D. impudica* Duda  
*Phloridosa* *D. denieri* Blanchard  
*D. lutzii* Sturtevant  
*Sophophora* \* *D. ananassae* Doleschall  
\* *D. kikkawai* Burla  
\* *D. malerkotliana* Parshad and Paika  
\* *D. melanogaster* Meigen  
\* *D. simulans* Sturtevant  
\* *D. suzukii* Matsumura  
*D. austrosaltans* Spassky  
*D. neocordata* Magalhães  
*D. neoelliptica* Pavan and Magalhães  
*D. prosaltans* Duda  
*D. pseudosaltans* Magalhães



			<i>D. sturtevantii</i> Duda
			<i>D. bocainensis</i> Pavan and da Cunha
			<i>D. bocainoides</i> Carson
			<i>D. capricorni</i> Dobzhansky and Pavan
			<i>D. equinoxialis</i> Dobzhansky
			<i>D. fumipennis</i> Duda
			<i>D. nebulosa</i> Sturtevant
			<i>D. parabocainensis</i> Carson
			<i>D. paulistorum</i> Dobzhansky and Pavan
			<i>D. tropicalis</i> Burla and da Cunha
			<i>D. willistoni</i> Sturtevant
		<i>Siphlodora</i>	<i>D. flexa</i> Loew
	<i>Diathoneura</i>		Undetermined species
	<i>Hirtodrosophila</i>		<i>H. morgani</i> (Mourao, Gallo and Bicudo)
			<i>H. pleuralis</i> Williston
			<i>H. subflavohalterata</i> (Burla)
	<i>Mycodrosophila</i>		<i>M. projectans</i> (Sturtevant)
	<i>Neotanygastrella</i>		<i>N. tricoloripes</i> Duda
	<i>Scaptodrosophila</i>		* <i>S. latifasciaeformis</i> (Duda)
	<i>Scaptomyza</i>	<i>Mesoscaptomyza</i>	<i>S. nigripalpis</i> Malloch
	<i>Zaprionus</i>	<i>Zaprionus</i>	* <i>Z. indianus</i> Gupta
	<i>Zygothrica</i>		<i>Z. dispar</i> (Wiedemann)
			<i>Z. microeristes</i> Grimaldi
			<i>Z. prodispar</i> Duda
			<i>Z. poeyi</i> (Sturtevant)
			<i>Z. apopoeyi</i> Burla
<hr/>			
Steganinae	<i>Amiota</i>		Undetermined species
	<i>Leucophenga</i>	<i>Leucophenga</i>	<i>L. bimaculata</i> (Loew)
			<i>L. maculosa</i> Duda
			<i>L. montana</i> Wheeler
			<i>L. ornativentris</i> Kahl
			<i>L. varia</i> (Walker)
	<i>Rhinoleucophenga</i>		<i>R. angustifrons</i> Malogolowkin
			<i>R. lopesi</i> Malogolowkin
			<i>R. matogrossensis</i> Malogolowkin
			<i>R. montensis</i> Junges and Gottschalk
			<i>R. myrmecophaga</i> Vidal and Vilela
			<i>R. nigrescens</i> Malogolowkin
			<i>R. obesa</i> (Loew)
			<i>R. personata</i> Malogolowkin
			<i>R. punctulata</i> Duda
			<i>R. tangaraensis</i> Junges and Gottschalk

---

\*Exotic species

the results of this analysis, along with the records published after 2013, were added to the drosophilid species list presented by Chaves and Tidon (2008). This new compilation provides an updated list of drosophilids recorded in the Brazilian Savanna.

## Results and Discussion

Our analysis revealed that the specimens formerly identified as *Gitona bivisualis* are in fact *Rhinoleucophenga punctulata*, confirming the suspicions of Vidal and Vilela (2015). *R. fluminensis* and *R. brasiliensis* are also *R. punctulata*, a species that demonstrates a certain phenotypic variation in the field. After eliminating these three species and adding the records available after 2013, the new list reveals 129 drosophilid species within the Brazilian Savanna.

The 12 determined genera represent the two subfamilies of drosophilids: Drosophilinae (9) and Steganinae (3). The neotropical species are distributed among the genera *Amiota*, *Drosophila* (predominant genus, with 90 species representing four subgenera), *Diathoneura*, *Hirtodrosophila*, *Leucophenga*, *Mycodrosophila*, *Neotanygastrella*, *Rhinoleucophenga*, *Scaptomyza*, and *Zygothrica* (Table 1). Additionally, eleven species exotic to the Neotropical region are also found here. The exotic species are: *Zaprionus indianus*, *Scaptodrosophila latifasciaeformis*, and nine species of the genus *Drosophila* representing three subgenera: *Dorsilopa* (*D. busckii*), *Drosophila* (*D. immigrans* and *D. virilis*), and *Sophophora* (*D. ananassae*, *D. kikkawai*, *D. malerkotliana*, *D. melanogaster*, *D. simulans*, and the recently introduced *D. suzukii*).

Despite experience and advances in taxonomy, it is difficult to estimate the richness of insect species in a given region. This is mainly because most insects are (1) extremely seasonal, (2) resource specialists, and (3) sometimes misidentified due to uncertain taxonomy. This is the case for many tropical drosophilids, especially those outside the genus *Drosophila*, such as the genera of Steganinae. To combat this, we recommend doing more frequent inventories in this region, preferably using different methods of collection in conjunction with the enhancement of identification keys for neotropical drosophilids. These actions will help provide critical subsidies, improve knowledge of biodiversity in the tropical regions, and help with the development of conservation and management policies.

**Acknowledgments:** We are grateful to J.L. Poppe for the correct diagnosis of the individuals belonging to the genus *Rhinoleucophenga* recorded in Roque and Tidon (2008, 2013) and to the *Universidade de Brasília* for logistical support.

**References:** Blauth, M.L., and M.S. Gottschalk 2007, *Dros. Inf. Serv.* 90: 90-96; Blauth, M.L., D.P. Lima, D.S. de Araújo, J.B. Moysés, and M.S. Gottschalk 2013, *Dros. Inf. Serv.* 96: 58-60; Chaves, N.B., and R. Tidon 2005, *Dros. Inf. Serv.* 88: 25-27; Chaves, N.B., and R. Tidon 2008, *Rev. Bras. Ent.* 52: 340-348; Junges, J., and M.S. Gottschalk 2014, *J. Insect Sci.* 14: 2014; Klink, C.A., and R.B. Machado 2005, *Conserv. Biol.* 19: 707-713; Mata, R.A., F. Roque, and R. Tidon 2008, *Biota Neotrop.* 8: 55-60; Mittermeier, R.A., P.R. Gil, M. Hoffman, J. Pilgrim, T. Brooks, C.G. Mittermeier, J. Lamoreux, and G.A.B. da Fonseca 2005, *Hotspots revisited: earth's biologically richest and most endangered terrestrial ecoregions*, Cemex, WA; Oliveira, P.S., and R.J. Marquis 2002, *The Cerrados of Brazil. Ecology and Natural History of a Neotropical Savanna*. Columbia University press, 424 pp.; Oliveira-Filho, A.T., and J.A. Ratter 2002, *In: The Cerrados of Brazil. Ecology and Natural History of a Neotropical Savanna* (Oliveira, P.S., and R.J. Marquis). Columbia University Press, New York; Paula, M.A., P.H.S. Lopes, and R. Tidon 2014, *Dros. Inf. Serv.* 97: 113-115; Roque, F., R. Figueiredo, and R. Tidon 2006, *Dros. Inf. Serv.* 89: 14-17; Roque, F., and R. Tidon 2008, *Dros. Inf. Serv.* 91: 94-98; Roque, F., and R. Tidon 2013, *Ann. Ent. Soc. Am.* 106: 117-121; Valadão, H.O., J.V. Hay, and R. Tidon 2010, *Int. J. Ecol.* 1: 1-7; Vidal, M.C., and C.R. Vilela 2015, *Ann. Entomol. Soc. Am.* 108(5): 932-940.



### *Drosophila suzukii* arrived in Chile.

**Medina-Muñoz, M.C.<sup>1</sup>, X. Lucero<sup>1</sup>, C. Severino<sup>1</sup>, N. Cabrera<sup>1</sup>, D. Olmedo<sup>1</sup>, F. Del Pino<sup>2</sup>, E. Alvarez<sup>2</sup>, C. Jara, and R. Godoy-Herrera<sup>2</sup>.**

<sup>1</sup>Laboratorio de Ecología, Etología y Genética, Departamento de Biología, Facultad de Ciencias, Universidad de Playa Ancha de Ciencias de la Educación; <sup>2</sup>Laboratorio de Etología, Genética y Evolución de la Conducta,

Programa de Genética Humana, ICBM, Facultad de Medicina, Universidad de Chile.

*Drosophila suzukii* is a major pest that has colonized Japan, India, Europe, and North America (Davis, 2014; Dilip *et al.*, 2014; Rota-Stabelli *et al.*, 2013). In South America it has been found in Brazil (Paula *et al.*, 2014; Bitner-Mathé *et al.*, 2014). *D. suzukii* females deposit the eggs on fresh fruits still hanging from the trees and on native bushes. Here, we report that *D. suzukii* is colonizing Central Valley of Chile 32°3'47"S and 36°49'37"S. More specifically, we report that males and females of the species have been collected in the wild near the principal port Valparaíso 33°3'47"S.

We collect *Drosophila* species by using traps. The traps were set up hanging from Chilean wild bush and shrubs typical of the Central Valley (Table 1). The plants grew in humid, gloomy habitats located in ravines and gullies around Valparaíso. The bushes Lluvia de Oro -Rain Gold- (*Teline monspessulana*), and Tayú (*Dasyphyllum excelsum*) were used to hang traps (Table 1). Some of the traps (N = 8) contained some pieces of banana, the other ones (N = 8) pieces of mature plum (*Prunus domestica*, D'agen variety).

Table 1. List of plants growing in ravines and gullies where *D. suzukii* refuge in the fields around Valparaíso port. The places provide shadow and wind protection to *D. suzukii* adults.

Vernacular name	Scientific name
Palito negro (Black stick)	<i>Adiantum chilensis</i>
Lluvia de oro (Rain gold)	<i>Teline monspessulana</i>
Quila (a type of Bamboo)	<i>Chusquea quila</i>
Eucalipto (Eucalyptus)	<i>Eucalyptus globulus</i>
Tayú (a Chilean endemic bush)	<i>Dasyphyllum excelsum</i>
Zarzamora (wild Blackberry)	<i>Rubus ulmifolius</i>

Most of *D. suzukii* adult flies (97.01 %) were found within the plum traps: 1) plum traps: females = 16; males = 49; 2) Banana traps: females = 0; males = 2 (2.98 %). Other *Drosophila* species were also collected: *Drosophila simulans*, *Drosophila melanogaster*, *Drosophila immigrans*, and *Drosophila busckii*. About 70% of adults of these last four species were in the banana traps, and 30% in the plum traps. *D. suzukii* eggs were not observed in banana traps, but 10 eggs of this species were in the plum traps. The data suggest that females of *D. suzukii* prefer plum to lay the eggs. *D. suzukii* larvae were not detected in the plum

traps. Perhaps, in *D. suzukii* larvae hatched out days after the females deposit eggs. In *D. melanogaster* incubation of eggs takes a few hours, but in *Drosophila pavani* it takes 48 hours (Godoy-Herrera *et al.*, 2005).

Many ships with merchandise arrive in Valparaíso from Asia, particularly Japan, South Korea, and China. These commercial activities could have provided circumstances to some specimens of *D. suzukii* from Asia had arrived in Valparaíso. Like in Chile, in those countries there are plum orchards. The results of our collections suggest that *D. suzukii* adults prefer plum to banana. This last fruit is imported principally from Ecuador. The fly seems to have adapted well to humid, gloomy micro-habitats located nearby Valparaíso. Perhaps, *D. suzukii* is in preparation to invade fruit orchards near the ravines and gullies where it is living at the moment.

References: Bitner-Mathé, B.C., J. Victorino, and F.S. Faria 2014, Dros. Inf. Serv. 97: 136 - 137; Davis, A.J., 2014, Dros. Inf. Serv. 97: 156 - 159; Dilip, A.S., P. Sujaymeendra, R. Alexander, K. Avinash, S. Phalke, and M. Javashankar 2014, Dros. Inf. Serv. 97: 29 - 30; Godoy-Herrera, R., B. Burnet, K. Connolly 2005, Heredity 124: 33 - 40; Paula, M.A., P.H.S. Lopes, R. Tidou 2014, Dros. Inf. Serv. 97: 113 - 115; Rota-Stabelli, O., M. Blaxter, and G. Anfora 2013, Curr. Biol. 23: R8 - R9.



## Characterizing muscle contraction strength in *Drosophila* embryos by intensity increase in GFP transgenically expressed in muscles.

**Baker, Ryan, and Vladislav M. Panin.** Texas A&M University, Biochemistry and Biophysics Department, College Station, TX 77843. Email: [panin@tamu.edu](mailto:panin@tamu.edu).

### Abstract

*Drosophila* embryos provide a good model system for various developmental processes. They develop quickly, hatching with 24 hours post fertilization, thus allowing for high-throughput screens. They are also nearly transparent, and can thus be easily imaged while still alive. As part of the hatching process, embryos go through a series of muscle contractions that progress from either the anterior or posterior to the opposite end. Defects in these contractions have been characterized for a number of mutant and transgenic fly lines. However, the relative strength of these contractions has not been well characterized. Here we use a GFP construct expressed specifically in muscles as an indicator of contraction strength. We find that while individual contractions may increase or decrease in strength over the course of their progression, on average they get weaker as they move from one end to the other in wild type flies. This wild type profile provides a standard against which mutant lines may be compared.

### Introduction

Development of *Drosophila* embryos from fertilization to hatching has been well characterized. Embryonic development has been divided into 17 separate stages. At the end of stage 17, embryos undergo a series of peristaltic contractions of the muscles just prior to hatching (Crisp, Evers *et al.*, 2008). Some *Drosophila* mutants undergo abnormal embryonic contraction patterns. These patterns can lead to defects including failure to hatch, and may be diagnostic of neurological disorders (Suster and Bate, 2002; Song, Onishi *et al.*, 2007). Most often embryonic contractions are measured in terms of frequency and direction. Here we use transgenic flies expressing *Myosin heavy chain-GFP* construct (MHC-GFP) in muscle-specific pattern to estimate the relative strength of contractions as they progress along the body axis in either direction in wild type embryos. Our results indicate that peristaltic contractions decrease in strength on average as they progress, regardless of direction. This information may be used as a point of comparison for relative contraction strengths and patterns in MHC-GFP flies with mutant genetic backgrounds.

### Materials and Methods

A fly stock with MHC-GFP protein trap insertion was obtained from Cynthia Hughes (UC San Diego, CA). Adult flies were allowed to lay eggs on agar plates containing apple juice and yeast paste for three hour increments. After three hours, the flies were moved to a new plate and the first plate was incubated overnight. After incubation, stage 17 embryos with air-filled tracheae (when contractions begin) were collected and placed dorsal-side up on glass slides with a thin coating of petroleum jelly to hold them in place. Embryos were then immersed in PBS and imaged on a Zeiss Examiner D1 microscope using a 10× water immersion objective lens. Fluorescence excitation was produced by a X-Cite BDX LED with emission max at 460 nm, and fluorescence emission was captured by a Hamamatsu camera with an ET 525/50 emission filter. Video was taken for 1 hour after contractions began, and integrated fluorescence intensity over time was analyzed using ImageJ software. Embryonic cross-sections 5 μm thick were analyzed at positions 50 μm, 250 μm, and 450 μm from the posterior tip (designated posterior, middle, and anterior, respectively). GFP intensity over time was plotted for each position in Excel. Baseline GFP intensities were calculated by averaging all intensities between peaks. GFP intensity as a percentage above the baseline was calculated according to the equation  $\% = 100(x-b)/b$  where  $x$  is the total intensity of a given point, and  $b$  is the baseline intensity.

## Results and Discussion

We recorded several MHC-GFP embryos and were able to detect both forward (posterior to anterior) and backward (anterior to posterior) contractions. The GFP specifically expressed in muscles allowed us to visualize longitudinal shortening of individual muscle segments during contraction, as well as a coincident increase in GFP intensity (Figure 1). This intensity increase is due to the fact that as muscles contract, the concentration of GFP within the focal volume increases. Stronger contractions yield greater shortening of muscle segments than weaker ones, which corresponds to a greater increase in GFP concentration in vicinity of the focal position, and thus a greater GFP intensity. In other words, higher GFP intensity corresponds to stronger contractions.

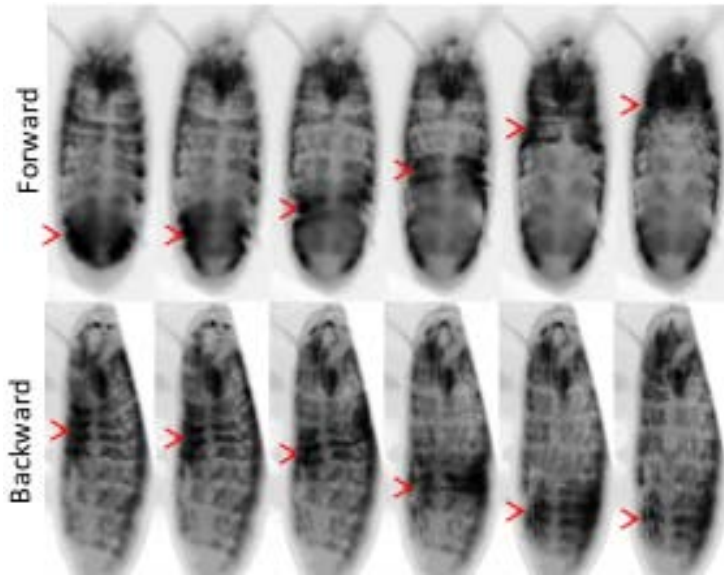

Figure 1. Representative examples of forward (top) and backward (bottom) contraction wave visualization in MHC-GFP embryos in a wild type genetic background. Each image is a single frame from a live video, separated by 2.5 seconds. Images are inverted monochromes, and thus black pixels represent higher GFP intensity. Arrows indicate intensity peak positions for each frame.

backgrounds. Because embryos may not have been placed on slides in a perfectly level manner, it is possible that posterior, middle, and anterior portions did not all lie in exactly the same focal plane. This might lead to artifacts in which one portion of the embryo has a higher GFP baseline intensity than another. Indeed, we found this to be the case in many of the embryos analyzed (not shown). Thus the raw GFP intensities cannot be directly compared. We solved this problem by plotting each graph as percent increase above the baseline, as described. We found several modes of contraction strengths for both backward and forward waves. These included waves in which the GFP intensity decreases as the contraction progresses, waves in which intensity increases throughout the contraction, and waves in which the intensity reaches its peak in the middle of the embryo (Figure 2).

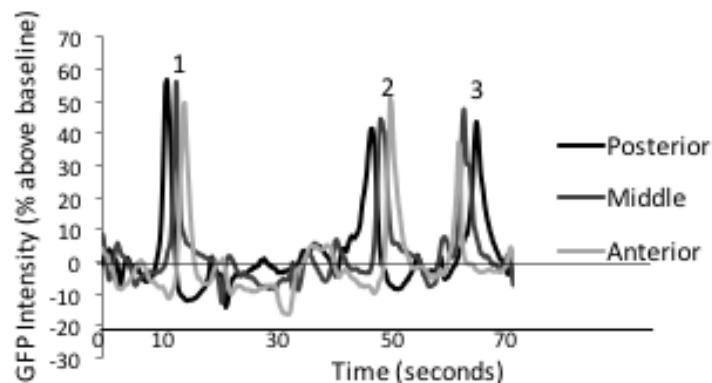

Figure 2. Representative plots of 3 types of contractions. 1) Forward contraction with decreasing intensity from posterior to anterior. 2) Forward contraction with increasing intensity. 3) Backward contraction. Peak intensity is in the middle of the embryo.

The ability to estimate relative contraction strengths at different positions along the embryo also allowed us to generate average contraction strength profiles. We separated backward waves from forward waves in 10 embryos and averaged their peak intensities at each position along the embryo. We found that in wild type embryos, contraction waves decrease in strength on average as they progress. Thus in forward waves the highest intensity is typically at the posterior end, while in backward waves the highest intensity is most frequently at the anterior (Figure 3).

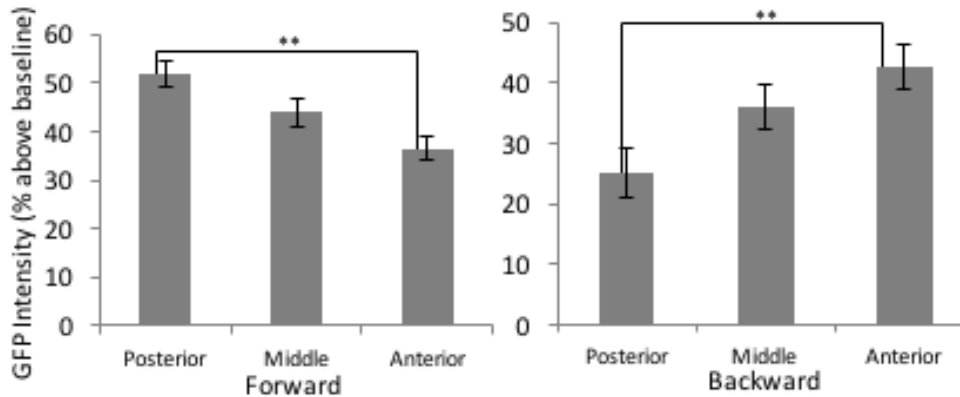

Figure 3. Average GFP intensity at posterior, middle, and anterior positions for forward (left panel) and backward (right panel) waves. In both wave types, contraction is stronger at the point of initiation than at the end point. Ten embryos were analyzed, yielding a total of 50 forward contractions and 24 backward contractions.

Comparison of posterior and anterior intensities by ANOVA analysis yielded p-values of less than 0.01 for both wave types.

Here we have shown that the use of a simple fluorophore transgenically expressed in the muscles of *Drosophila* embryos allows for a quantitative estimate of relative contraction strength within embryos. This technique can be used to examine relative strengths at various points within a given contraction and to generate average contraction profiles. Embryonic contraction waves are an important part of *Drosophila* development and are often affected by mutations, particularly those related to neurological disorders that could disrupt contraction coordination. Therefore the technique described here may be important in characterizing the phenotypes of *Drosophila* mutants by comparing their profiles to that of wild type, and may also help elucidate cellular and molecular mechanisms underlying these phenotypes.

**Acknowledgments:** We are grateful to Cynthia Hughes for MHC-GFP flies. The authors wish to thank Doctors Paul Hardin, Andreas Holzenburg, and Gary Kunkel for their advice, as well as Dr. Naosuke Nakamura for sharing his expertise in embryonic live imaging techniques. This work was funded in part by a grant from the National Institutes of Health, NIH/NS075534 to VMP.

**References:** Crisp, S., J.F. Evers, A. Fiala, and M. Bate 1998, *Development* 22: 3707-3717; Hughes, C.L., and J.B. Thomas 2007, *Mol. Cell. Neurosci.* 35: 383-396; Song, W., N. Onishi, L.Y. Jan, and Y.N. Jan 2007, *Proc. Natl. Acad. Sci. USA* 12: 5199-5204; Suster, M.L., and M. Bate 2002, *Nature* 416: 174-148.



***Drosophilidae* (Diptera) attracted to fallen fruits of *cajá-manga* (*Spondias dulcis* Parkinson; Anacardiaceae) in the western region of the city of São Paulo, state of São Paulo, Brazil.**

**Vilela, C.R.** Departamento de Genética e Biologia Evolutiva, Instituto de Biociências, Universidade de São Paulo, São Paulo - SP, Brazil. [crvilela@ib.usp.br](mailto:crvilela@ib.usp.br)

*Spondias dulcis* Parkinson (The Plant List 2015), vernacularly known as *cajá-manga* or *cajarana* in Brazil and as Polynesian plum, hog plum, ambarella, and many other names in other countries (Pio Corrêa,

1984), is a tropical tree native to the Pacific archipelago of Polynesia (Society Islands) and introduced by human beings in most of the tropical countries around the world. The tree can reach up to 18 m high and is a deciduous plant that loses all its leaves soon after they have turned beautifully golden yellowish (Lorenzi *et al.*, 2006) in the late autumn season (May-June) producing hundreds of edible fruits which ripen during the late winter season (August) of southern hemisphere.

Table 1. Species (alphabetically ordered) richness and abundance of Drosophilidae sampled at the didactic garden of the *Departamento de Botânica* of the IB-USP, *Cidade Universitária "Armando de Salles Oliveira"*, São Paulo, SP, Brazil, by sweeping net over fallen, decaying fruits of *cajá-manga* (*Spondias dulcis* Parkinson; Anacardiaceae); C.R. Vilela coll. 5-6.VIII.2015 (coded M62).

Species	males	females	Total
<i>Drosophila cardinoides</i> Dobzhansky and Pavan, 1943	0	1	1
<i>Drosophila griseolineata</i> Duda, 1927	9	3	12
<i>Drosophila hydei</i> Sturtevant, 1921	2	9	11
<i>Drosophila immigrans</i> Sturtevant, 1921	41	33	74
<i>Drosophila kikkawai</i> Burla, 1954	0	2	2
<i>Drosophila maculifrons</i> Duda, 1927	1	1	2
<i>Drosophila malerkotliana</i> Parshad and Paika, 1965	34	32	66
<i>Drosophila mediopicta</i> Frota-Pessoa, 1954	2	0	2
<i>Drosophila melanogaster</i> Meigen, 1830	1	1	2
<i>Drosophila mercatorum</i> Patterson and Wheeler, 1942	2	0	2
<i>Drosophila nasuta</i> Lamb, 1914	32	44	76
<i>Drosophila nebulosa</i> Sturtevant, 1916	1	1	2
<i>Drosophila neocardini</i> Streisinger, 1946	3	7	10
<i>Drosophila pallidipennis</i> Dobzhansky and Pavan, 1943	0	1	1
<i>Drosophila paramediotriata</i> Townsend and Wheeler, 1955	7	7	14
<i>Drosophila paulistorum</i> Dobzhansky and Pavan in Burla <i>et al.</i> 1949 + <i>D. willistoni</i> Sturtevant, 1916	114	105	219
<i>Drosophila polymorpha</i> Dobzhansky and Pavan, 1943	3	3	6
<i>Drosophila simulans</i> Sturtevant, 1919	82	80	162
<i>Scaptodrosophila latifasciaeformis</i> Duda, 1940	6	2	8
<i>Zaprionus indianus</i> Gupta, 1970	31	18	49
Total	371	350	721

On August 5-6, 2015, while looking for female specimens of *Drosophila kikkawai* aiming to obtain isofemale lines requested by a colleague, I sampled flies by sweeping net over dozens of fallen fruits of *Spondias dulcis*, in different stages of rotting, resting on the ground among low vegetation under two tall adjacent *cajá-manga* trees. The collection site (coded M62)(23°33'54"S, 46°43'52"W; 782 m), was the didactic garden of the *Departamento de Botânica* of the *Instituto de Biociências* (Kraus *et al.*, 1994, p. 10, map I-61), located at the main campus of the *Universidade de São Paulo*, known as *Cidade Universitária "Armando de Salles Oliveira"*, west region of the city of São Paulo, state of São Paulo, Brazil, adjacent to one of the collection sites of Vilela and Goñi (2015) (compost pile coded M60).

The 721 (371 males: 350 females) collected Drosophilidae were identified as belonging to 21 species, 19 of them in the genus *Drosophila*, one in the genus *Scaptodrosophila*, and one in the genus *Zaprionus* (Table 1). Species identifications were based on the papers by Freire-Maia and Pavan (1949), Burla (1954), Frota-Pessoa (1954), Bock and Wheeler (1972), Vilela (1983), Vilela and Bächli (1990), Vilela (1999), Vilela *et al.* (2002), and Vilela and Goñi (2015). No attempts were made to identify other Diptera families. All collected Diptera (coded M62) will be deposited at the *Museu de Zoologia, Universidade de São Paulo*. As expected in

highly urbanized areas, nine (43%) of the 21 species of Drosophilidae and 450 (62%) of the 721 sampled specimens are represented by invasive species. The nine invasive species, in decreasing order of abundance, are as follows: *Drosophila simulans*, *D. nasuta*, *D. immigrans*, *D. malerkotliana*, *Zaprionus indianus*, *D. hydei*, *Scaptodrosophila latifasciaeformis*, *D. kikkawai*, and *D. melanogaster*. The capture of 76 (32 males: 44 females) specimens belonging to *Drosophila nasuta*, an invasive species registered for the first time in the Americas five months earlier, in March 2015 (Vilela and Goñi 2015), is suggestive that it has become established in the surveyed area. It was the second most abundant invader, surpassed only by *D. simulans*, with 162 sampled specimens.

Females of *Drosophila malerkotliana* and *Drosophila ananassae* Doleschall, 1858 are siblings and cannot be reliably separated from each other on morphological grounds. As not even a single male of *D. ananassae* was collected and 34 males of *D. malerkotliana* were sampled among a total of 721 captured drosophilids, it is assumed that the 32 of their females belonged to the latter species. Collections made indoors, mainly in kitchens, in the city of São Paulo (C.R. Vilela, unpublished data) have shown that *D. ananassae* is the second most abundant species only surpassed by *D. melanogaster*, the two species being considered strictly domestic, in the sense they are commonly found indoors, and very, very rarely collected outdoors. Similar condition can be observed in Table 1, regarding the sibling pair *D. simulans/D. melanogaster*, where 162 flies were identified as belonging to the first species and only two to the latter. Vilela and Goñi (2015) collected three males of *D. ananassae* from garbage cans in a place (coded M59) adjacent to the present surveyed area (coded M62), but it should be pointed out that although not stated by those authors the cans were standing in a shed behind the cafeteria, therefore partially indoors.

No attempts were made to individually identify *Drosophila willistoni* and *D. paulistorum*, a pair of sibling species, whose anesthetized males can be told apart by means of the analyses of their terminalia (genital chamber contour and the shape and size of hypandrium lobes), provided the aedeagus is not extruded (refer to Spassky, 1957, Figures. 11 and 13 for details); however, this is a very time-consuming process.

It should be pointed out that given the sampling method (swept nets), it is impossible to say with certainty that all the collected species and specimens were really attracted to the fallen, mostly decaying *cajá-manga* fruits, although it is likely they were. There always is a possibility that some of the sampled flies were just flying around, resting on the surrounding vegetation or other overlooked fermenting substrates.

References: Bock, I.R., and M.R. Wheeler 1972, University of Texas Publications 7213: 1-102; Burla, H., 1954, Revista Brasileira de Biologia 14(1): 41-54; Freire-Maia, N., and C. Pavan 1949, Cultus 5: 3-71; Frota-Pessoa, O., 1954, Arquivos do Museu Paranaense 10(6): 253-304 + XIII plates; Kraus, J.E., R.K. Rechulski, and S. Marchini 1994, Guia para o Jardim do Departamento de Botânica. Instituto de Biociências da Universidade de São Paulo, São Paulo, 57 pp.; Lorenzi, H., L. Bacher, M. Lacerda, and S. Sartori 2006, Frutas brasileiras e exóticas cultivadas (de consumo *in natura*), Instituto Plantarum de Estudo da Flora: São Paulo, 672 pp.; Pio Corrêa, M., 1984, Dicionário das plantas úteis do Brasil e das exóticas cultivadas, v. 1. Ministério da Agricultura, IBDF: Rio de Janeiro, 747 pp.; The Plant List 2015, Version 1.1. Published on the Internet; <http://www.theplantlist.org/> (accessed 24<sup>th</sup>, December); Spassky, B., 1957, University of Texas Publications 5721: 48-61; Vilela, C.R., 1983, Revista Brasileira de Entomologia 27(1): 1-114; Vilela, C.R., and G. Bächli 1990, Mitteilungen der Schweizerischen Entomologischen Gesellschaft 63 (supplement): 1-332; Vilela, C.R., 1999, Dros. Inf. Serv. 82: 37-39; Vilela, C.R., A.F.G. da Silva, F. de M. Sene 2002, Revista Brasileira de Entomologia 46(2): 139-148; Vilela, C.R., and B. Goñi 2015, Revista Brasileira de Entomologia 59(4): 346-350.



### **Richness of drosophilids in a naturally radioactive place in the Caatinga biome, northeast Brazil.**

**Castro, I.F.A., C.J. Verçosa, R.D. Coutinho-Silva, G.F. Oliveira, A.C.L. Garcia, and C. Rohde\***. Laboratório de Genética, Centro Acadêmico de Vitória, Universidade Federal de

Pernambuco, Vitória de Santo Antão, 55608-680, Pernambuco, Brazil. \*E-mail: claudia.rohde@yahoo.com.br



The Caatinga is a semiarid biome exclusive to Brazil. As the country's fourth largest plant physiognomy (Castelletti *et al.*, 2003), the Caatinga covers approximately 70% of the Brazilian northeast region (Bucher, 1982). The biome's climate is characterized by mean annual temperatures between 25°C and 29°C, and considerable oscillations are recorded in annual rainfalls, from 250 mm a year in some sub-regions during the dry season to 1,200 mm between May and August, the rainy period in the biome.

Located in the Caatinga, the urban area of the municipality of Lajes Pintadas (06°08'46,3''S, 36°06'52,5''W, Figure 1) stands out due to the exposure to high Radon radiation levels (Campos *et al.*, 2011; Silva *et al.*, 2014) from natural ionizing elements such as Uranium and Thorium (Silva *et al.*, 2010). These elements and their byproducts are detected in granitic rocks in the Pegmatite Province of Borborema, which stretches across 10,000 km<sup>2</sup> in the Brazilian northeast (Scorza, 1944).

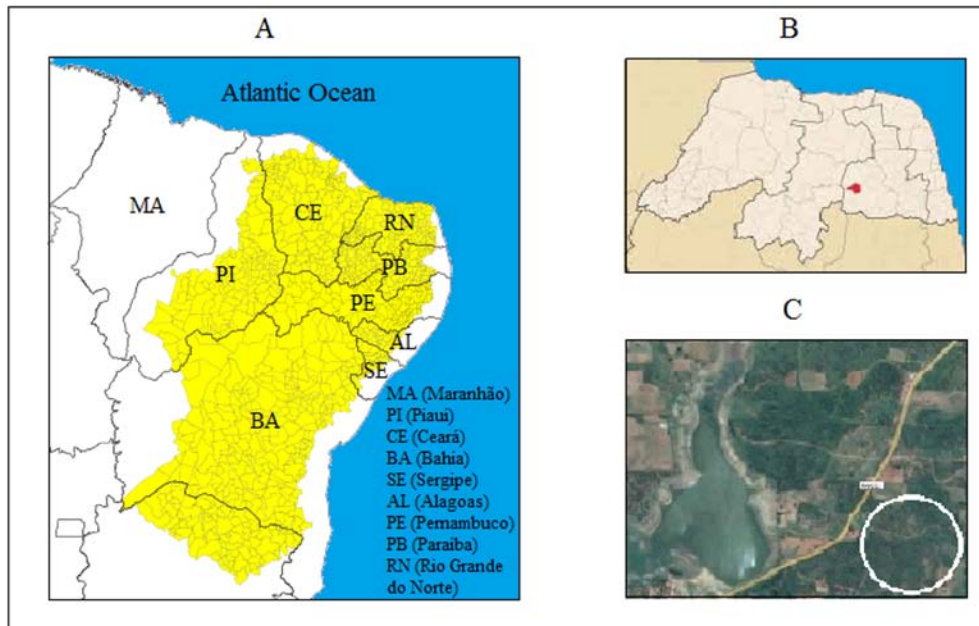

Figure 1. A, Map of the Brazilian northeast region, showing the semiarid zone in yellow. B, Map of the state of Rio Grande do Norte showing the municipality of Lajes Pintadas in red. C, Satellite image showing collection area covered in this study (white circle), near Riacho da Cachoeira, (rc), at 340 m.a.s.l.

As part of an ongoing project to examine the genotoxic effects of radiation on the genome of different drosophilid species in the region, the objective of this study was to investigate the richness and the abundance of drosophilid in Lajes Pintadas. According to Clements (2000) and Mussali-Galante *et al.* (2014), supplementing ecotoxicology data with population data at community and ecosystem levels is essential in any move towards improving robustness of ecological risk assessments. Therefore, here we present preliminary findings about drosophilid richness in this radioactive area of the Caatinga biome, with special emphasis on the abundance of *Zaprionus indianus*, an invader species.

Drosophilids were collected in July 2014 and June 2015 using twenty banana traps (Tidon and Sene, 1988) distributed in an open area distant 1 km from the town's urban area of Lajes Pintadas. The traps remained in place for two days, hanging 1.5 m above the ground and 30 m away from one another. Captured flies were stored in tubes containing ethanol 70% and subsequently identified morphologically. For the analysis of male terminalia of cryptic species, flies were immersed in potassium hydroxide (KOH) 10%, stained in acid fuchsine, and dissected in glycerol (Bächli *et al.*, 2004). The identification of females of cryptic species was carried out considering the proportion of males analyzed.

In total, 7,716 drosophilids of 18 species and five genera were collected (Table 1). *Zaprionus indianus* was the most abundant species (66.7%), followed by *Drosophila malerkotliana* (17.5%), both exotic species of Neotropical region. The other species had relative abundance of 15.8%, 12 of which are native to the Neotropical region: *D. serido*, *D. buzzatii*, *D. borborema*, and *D. mercatorum* (*repleta* group); *D. polymorpha* and *D. cardinoides* (*cardini* group); *D. nebulosa* and *D. willistoni* (*willistoni* group); and *D. sturtevantii* (*saltans* group).

Table 1. Drosophilid species collected listed by abundance during the 2-year collection period in Lajes Pintadas, Caatinga biome, Brazil.

Species	July 2014		July 2015		TOTAL
	N	%	N	%	
<i>Zaprionus indianus</i> *	2,751	62.9	2,397	71.7	5,148
<i>Drosophila malerkotliana</i> *	1,037	23.7	315	9.4	1,352
<i>Drosophila serido</i>	159	3.6	189	5.7	348
<i>Scaptodrosophila latifasciaeformis</i> *	86	2.0	147	4.4	233
<i>Drosophila simulans</i> *	151	3.4	57	1.7	208
<i>Drosophila nebulosa</i>	86	2.0	77	2.3	163
<i>Drosophila buzzatii</i>	10	0.2	79	2.4	89
<i>Drosophila melanogaster</i> *	51	1.2	5	0.2	56
<i>Rhinoleucophenga punctulata</i>	12	0.3	20	0.6	32
<i>Drosophila sturtevantii</i>	10	0.2	14	0.4	24
<i>Rhinoleucophenga trivisualis</i>	3	0.1	13	0.4	16
<i>Drosophila willistoni</i>	8	0.2	5	0.2	13
<i>Drosophila polymorpha</i>	7	0.2	3	0.1	10
<i>Drosophila borborema</i>	-	-	10	0.3	10
<i>Drosophila mercatorum</i>	-	-	10	0.3	10
<i>Rhinoleucophenga</i> sp.	-	-	2	0.1	2
<i>Drosophila cardinoides</i>	-	-	1	0.03	1
<i>Leucophenga</i> sp.	-	-	1	0.03	1
Total	4,371		3,345		7,716
S	13		18		18

\* Exotic species; S, species richness; N, absolute number of specimens; %, relative abundance.

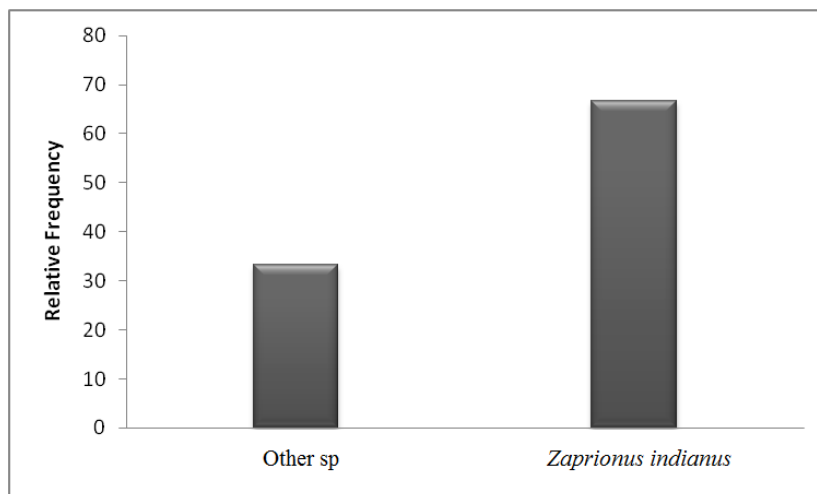

Figure 2. Relative abundance of *Zaprionus indianus* and other species in collections of Lajes Pintadas.

In addition to the considerable local species richness in Lajes Pintadas, the ecological dominance of *Z. indianus* deserves mention. Before a continuous invasion process in America spanning for the past 16 years, the species was first recorded in Brazil in the state of São Paulo in the end of the 1990s (Vilela *et al.*, 1999). Since then it has expanded its distribution area, to the point that it was colonizing the states of Goiás in 1999 (Tidon *et al.*, 2003), Pará in 2000 (Medeiros *et al.*, 2003), and Rio Grande do Sul in 2001 (Castro and Valente, 2001) soon after its arrival to the country, making it a remarkable invader species. In the Brazilian northeast it was found for the first time the Caatinga biome in March 2000, in the municipality of Sobradinho, state of Bahia (Santos *et al.*, 2003). Since then it has

been collected in essentially all environments surveyed in the Brazilian northeast, even in the ocean island of Fernando de Noronha, located 340 km off the coast (Oliveira *et al.*, 2009). However, never before has it been collected in the Brazilian northeast at such high abundance as observed in Lajes Pintadas, even in open environments such as the Caatinga (Santos *et al.*, 2003; Rohde *et al.*, 2010).

The colonization success by *Z. indianus* may be explained in light of a combination of genetic-adaptive traits such as the species' competence in using various food resources (Yassin and David, 2010) and its adaptive plasticity under a set of environmental conditions.

Such combination is typically exhibited by a generalist species with remarkable competitive power (Parkash and Yadav, 1993; Setta and Carareto, 2005; Commar *et al.*, 2012). The present study shows that the species

has adapted well to environment with intense natural radiation, as observed in Lajes Pintadas. Such adaptation may indicate a given degree of radioresistance acquired recently, since the species' arrival in the last years in the region, in what should be more thoroughly investigated in future studies.

Acknowledgments: We are thankful to Municipality of Lajes Pintadas for local support.

References: Bächli G., C.R. Vilela, S.A. Escher, and A. Saura 2004, *Fauna Entomologica Scandinavica* 39: 1-362; Bucher, E.H., 1982, *In: Ecology of Tropical Savanas* (Hunteny, B.J., and B.H. Walther, eds.). pp. 48-79. Springer-Verlag Berlin Heidelberg; Campos, T., R. Petta, and V. Pastura 2011, Abstract, 4th International Conference on Medical Geology, Italy; Castelletti, C.H.M., A.M.M. Santos, M. Tabarelli, and J.M.C. Silva 2003, *In: Ecologia e Conservação da Caatinga* (Leal, I.R., M. Tabarelli, and J.M.C. Silva, eds). pp 719-734. Editora da Universidade Federal de Pernambuco, Recife; Castro, F.L., and V.L.S. Valente 2001, *Dros. Inf. Serv.* 84: 15; Clements, W., 2000, *J. Aquat. Ecosyst. Stress Recovery* 7: 113-116; Commar, L.S., L.G.C. Galego, C.R. Ceron, and C.M.A. Carareto 2012, *Genetics and Molecular Biology* 35: 395-406; Medeiros, H.F., M.B. Martins, and J.R. David 2003. *Dros. Inf. Serv.* 86: 89; Mussali-Galante, P., E. Tovar-Sánchez, M. Valverde, and E. Rojas 2014, *In: Reviews of Environmental Contamination and Toxicology* 227, (Whitacre D.M., ed.). Springer International Publishing, Switzerland; Oliveira, G.F., K.P.S. Melo, A.C.L. Garcia, and C. Rohde 2009, *Dros. Inf. Serv.* 92: 18-20; Parkash, R., and J.P. Yadav 1993, *Hereditas* 119: 161-170; Rohde, C., D.M.I.O. Silva, J.C.L.A. Jucá, M.A. Montes, and A.C.L. Garcia 2010, *Anais da Academia Pernambucana de Ciência Agronômica* 7: 227-240; Santos, J.F., T.T. Rieger, S.R.C. Campos, A.C.C. Nascimento, P.T. Félix, S.V.O. Silva, and F.M.R. Freitas 2003, *Dros. Inf. Serv.* 86: 92; Scorza, E.P., 1944, *Província Pegmatítica da Borborema (Nordeste do Brasil)*. MA, DNPM/ DGM (Boletim 112). Rio de Janeiro 55 pp.; Setta, N., and C.M.A. Carareto 2005, *Iheringia Sér. Zool.* 95: 47-51; Silva, S.M.P., A.P. Crósta, F.J.F. Ferreira, H. Beurlen, A.M. Silva, and L.F. Santos 2010, *Rev. Bras. Geof.* 28: 673-690; Tidon, R., and F.M. Sene 1988, *Dros. Inf. Serv.* 67: 90; Tidon, R., D.F. Leite, and B.F.D. Leão 2003, *Biol. Conserv.* 112: 299-305; Vilela, C.R., 1999, *Dros. Inf. Serv.* 82: 37; Yassin, A., and J.R. David 2010, *Zookeys* 51: 33-72.



### Feeding behavior and nutrients act concertedly in determining fecundity and lifespan in *Drosophila nasuta nasuta*.

Neethu, B.K.<sup>1</sup>, and B.P. Harini<sup>1\*</sup>. <sup>1</sup>Department of Zoology, Bangalore University, Bangalore-560 056, Karnataka, India; e-mail: bpharini@yahoo.co.in

#### Abstract

Feeding behavior is an important element in insects which involves the detection, the initiation of ingestion, and the consumption of food. The larval and adult stages of *Drosophila nasuta nasuta* were fed in combination of restricted glucose with varied concentrations of methionine. These enriched nutrients of restricted glucose and methionine showed greater influence on the fecundity of flies, and subsequently was less affected with respect to lifespan along with control and single concentrations of methionine. The gustatory feeding assay was performed in larval and adult stages with combination of restricted glucose and varied methionine concentrations and single methionine concentrations along with control. It revealed that the former diet has led to increased mortality, while decreased mortality with only methionine fed diet (*i.e.*, 0.03% g/L) in absence of glucose and were significant with control. Thus, the present study indicates that the feeding behavior and nutritional composition act concertedly to determine fecundity and lifespan. In addition, the flies fed *ad libitum* are capable of restricting their feeding behavior in response to their nutritional state.

#### Introduction

Dietary restriction (DR), the reduction of nutrient intake short of malnutrition, appears to improve measures of human health and extends the lifespan of various organisms ranging from yeast to primates (Fontana *et al.*, 2009). Dietary restriction (DR) refers to a moderate reduction of food intake that leads to extension of lifespan beyond that of normal, healthy individuals. Many organisms face a challenge of meeting their optional nutritional requirement for somatic and reproductive growth under natural conditions. Nutrition plays prominent roles in aging, health, metabolism, and disease (Min and Tartar, 2006). Unlike mammals, where the foetus develops in the mother's womb, fertilized eggs of insects develop outside the female body (Starr *et al.*, 2008). All insects go through a larval phase of development that precedes metamorphosis (Aguila *et al.*, 2007). Soon after hatching, larvae forage for nutrients in their vicinity and eventually find a favorable niche that contains an adequate supply of food. This phase of insect development is dedicated to feeding voraciously, and fulfils the much-needed food requirements for the subsequent non-feeding pupal phase. Ingested nutrients are stored as fat bodies (Tian *et al.*, 2010), which serve as potential energy reservoirs for synthesis of macromolecules that are essential for cellular growth during larval and pupal stages (Chapman, 2013).

Carbohydrates are important dietary components for many omnivorous and herbivorous animals, including both humans and livestock. Carbohydrates provide energy for many reactions and processes flowing inside cells. Most organisms can tightly adjust their metabolism according to the availability of dietary components, including carbohydrates. Physiological effects of carbohydrates depend on their type and dosage, as well as on the physiological state of an organism (Wheeler and Pi-Sunyer, 2008). However, the effect of carbohydrate diets, and particularly the type of carbohydrate, as well as the protein-to-carbohydrate ratio on life span and reproduction, are poorly investigated. They are generally studied in comparatively simple organisms like *Drosophila melanogaster*, which is intensively used as a model for nutritional studies. Over the last decade, several studies explored the effect of diet on life span, reproduction, behavior, and adaptation of fruit flies (Vigne and Frelin, 2010). In mammals, this manipulation, which is often called dietary restriction (DR), not only increases lifespan but also imparts a broad-spectrum improvement in health during aging.

Nutrient imbalance, particularly amino-acid imbalance, also received attention with regard to its influence on physiological function and modulation of aging. It was reported that disproportionate levels of amino acids may be associated with the incidence of adverse effects in a rat model. In particular, Met was defined as the most toxic amino acid when used in excess (Harper *et al.*, 1970). Restricted use of amino acids was suggested to be responsible for the lifespan extension caused by protein restriction (Min *et al.*, 2006); on the other hand, Met restriction was reported to be ineffective in extending lifespan of *Drosophila* (Grandison *et al.*, 2009). This sensitivity to methionine may result from impairment of one or more aspects of eukaryotic methionine metabolism. These include the synthesis of polyamines, cysteine and glutathione, and the methylation of DNA, lipid, hormones and enzyme substrates (Finkelstein, 1990). Furthermore, comparing the effects of glucose restriction and methionine restriction might provide insight into generalizable pathways that modify longevity across species. Feeding behavior in many insects involves the detection of food, the initiation of ingestion, and the consumption of discrete meals (Bernays, 1985). The present study was undertaken to ascertain the various concentrations of dietary glucose and methionine content while holding all other nutrients constant so as to determine the effect of dietary methionine and restricted glucose on fecundity and lifespan in *Drosophila nasuta nasuta*.

## Materials and Method

### *Drosophila strain, media, and culture conditions*

*Drosophila nasuta nasuta* stocks were maintained in an uncrowded culture condition at 22±1°C, 70% humidity and 12h: 12h light and dark cycles in standard wheat cream agar medium. From the stock the virgin females and unmated males were collected within 6 hours of eclosion and were aged for 2days. On the third day a single virgin female and an unmated male were transferred to a fresh food media vial (25 × 100 mm) for egg laying. Likewise, three successive changes were made every alternate day. The said experiments were carried out by feeding different concentrations of methionine and restricted glucose concentration 30 g/L, (Bass *et al.*, 2007) along with single concentration of methionine.(0.01 g, 0.02 g, 0.03 g/L) (Pletcher *et al.*, 2002).

### Fecundity assay

Fecundity was assayed by counting number of eggs laid. Flies were successively transferred into fresh vials containing media every alternate day for 6 days. Eggs were allowed to hatch till pupation. Further, the same sets of vials were assessed for the emergence of the adult flies and likewise the fertility was recorded for the total productivity (Harini, 2011).

### Gustatory feeding assay

The method described by Lee *et al.* (2010) was adopted for gustatory assay. Larvae and adult flies were reared in media supplemented with experimental diet. A basal media control was also maintained. To perform a feeding assay, after starving the larvae and flies for 2 h, from each experimental group were transferred into the vials containing the specific diets with bromophenol blue dye (0.05% wt/vol). The absorbance of 100 times diluted supernatant was measured at 595 nm using a spectrophotometer.

### Lifespan assay

Synchronous cultures of 2–3-day-old flies were obtained as described earlier and transferred into vials containing basal medium supplemented with experimental and control. Each group including the control had 10 vials each with 14–20 flies per vial with equal sex ratio. Flies were transferred to fresh media every third day. Dead flies were counted and removed daily throughout the experiment.

### Statistical Analysis

Mean fecundity and lifespan were subjected to one-way ANOVA, Tukey's HSD by using SPSS 20.0.

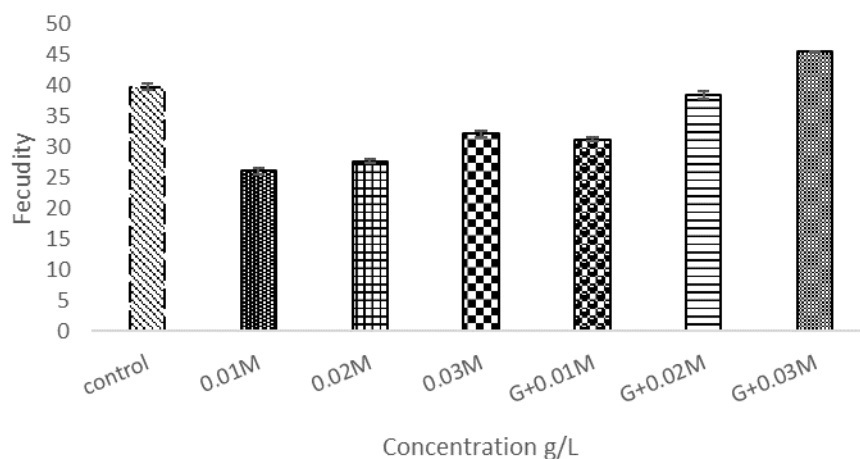

Figure 1. Mean ( $\pm$ SE) fecundity on exposure to single methionine concentrations and restricted glucose (G) with varied concentration of methionine (M) in *Drosophila nasuta nasuta*.

### Results

Nutrients are important factors in determining the reproductive success and life-span of flies. In the present study it is reported that restricted glucose concentrations and methionine (*i.e.*, G+0.03Mg/L) has enhanced the fecundity when compared with all the other concentrations of the fed experimental diet as shown in Figure 1. The analysis of variance for fecundity showed significant values in all the single concentrations of methionine (*i.e.*, 0.01%, 0.02%, 0.03% g/L) and mixed concentrations of glucose and methionine with that of control ( $p < 0.000$ ) as shown in Table 1. The differences were insignificant in single concentration of methionine fed diet, *i.e.*, 0.01% and G+0.01Mg/L concentration ( $p > 0.05$ ). The lifespan of male and female on exposure to restricted glucose with methionine diet concentrations has not extended lifespan, whereas significant changes were observed in single concentrations of methionine ( $p < 0.000$ ) (Figure 2). To ensure this observed change in lifespan of *Drosophila nasuta nasuta*, gustatory feeding assay was performed in both larvae and adult flies for varied dietary concentrations (Figure 3). The mean food intake in larvae decreased as the methionine concentrations increased, *i.e.*, 0.01% to 0.03% (OD 595 nm = 0.80 (0.01 g/L), 0.69 (0.02 g/L), and 0.49 (0.03 g/L), and 30 g/L glucose restriction with varied methionine concentrations was recorded for values of OD 595 nm, *i.e.*, 0.5, 0.3, and 0.05, respectively. In the adult flies, both male and female when fed with different dietary concentrations showed similar results in both single

concentration of methionine and mixed concentration of 30 g/L restricted glucose with methionine diet for male (*i.e.*, OD 595 nm = 0.1 (0.01 g/L), 0.03 (0.02 g/L), 0.03 (0.03 g/L), 0.03, 0.01, and 0.07) and with further reduction in food taken by the adult female (*i.e.*, OD 595 nm = 0.1 (0.01 g/L), 0.03 (0.02 g/L), 0.03 (0.03 g/L), 0.03, 0.01, and 0.06). Thus the data obtained reveal significant increase in the lifespan of females compared to males Table.1.

Table 1. Results of one-way ANOVA of mean fecundity and lifespan of *Drosophila nasuta nasuta* fed with different concentration of experimental diets with control.

concentrations	N	Fecundity	Lifespan(Number of days)	
			Male	Female
Control	30	39.08 ± 0.13a	73.23 ± 0.08a	77.13 ± 0.04a
0.01 Methionine(M) g/L	30	26.10 ± 0.15c	73.23 ± 0.60a	77.26 ± 0.60b
0.02 Methionine(M) g/L	30	27.80 ± 0.12b	73.20 ± 0.06a	82.10 ± 0.02c
0.03 Methionine(M) g/L	30	32.76 ± 0.13d	76.60 ± 0.20b	86.90 ± 0.04d
30% glucose(G) + 0.01 Methionine(M) g/L	30	31.05 ± 0.05b	73.21 ± 0.50a	77.41 ± 0.30a
30% glucose(G) + 0.02 Methionine(M) g/L	30	38.02 ± 0.20a	73.02 ± 0.36a	77.05 ± 0.36a
30% glucose(G) + 0.03 Methionine(M) g/L	30	45.02 ± 0.50c	73.10 ± 0.36a	79.50 ± 0.06b
ANOVA		F = 354.626 d.f = 6,203 P = 0.05	F = 9.830 d.f = 6,203 P < 0.000	F = 61.90 d.f = 6,203 P < 0.000

Note: Mean in each column followed by different alphabetical letter with in the same life stage were significantly different by Tukey's HSD test (P < 0.05) where a, b, c, d represents the significant difference between diets.

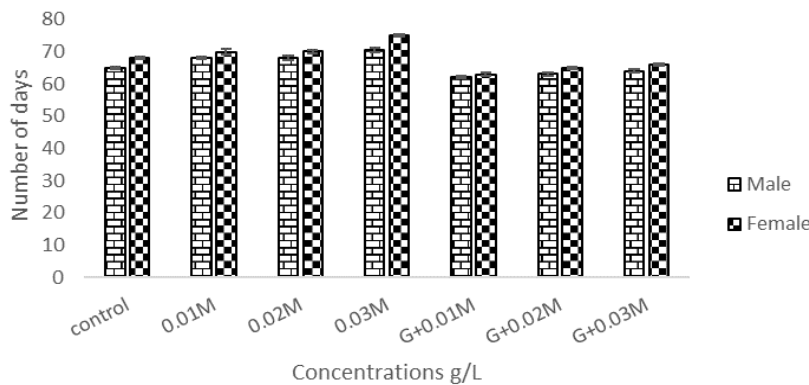

Figure 2. Mean (±SE) lifespan of *Drosophila nasuta nasuta* on exposure to single methionine concentrations and restricted glucose (G) with varied concentration of methionine (M).

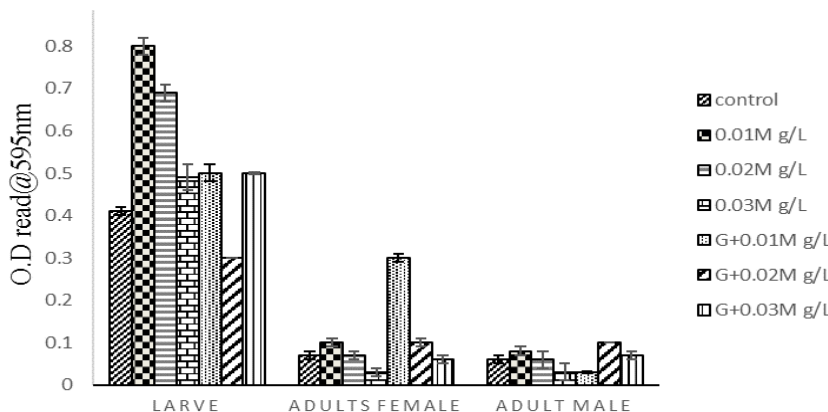

Figure 3. Gustatory feeding assay with single methionine concentrations and restricted glucose (G) with varied concentration of methionine (M) in *Drosophila nasuta nasuta*.

## Discussion

“Dietary restriction”, the experimental restriction of food and nutrient intake compared with *ad libitum* feeding, is a reliable means of extending lifespan in model organisms (Weindruch and Walford, 1988). The repeated observation that dietary restriction retards aging in phylogenetically diverse species ranging from yeast to primates is the cornerstone of a fertile working hypothesis that diet regulates lifespan and aging through a universal mechanism that has been conserved throughout evolution. Commonalities between life-extending mutations in several species suggest a plausible account of how genes and diet might regulate growth and aging by converging on energy and nutrient-responsive pathways. In view of this, the present study has found that the fecundity and lifespan of *Drosophila* can be modified by varying the dietary content of restricted glucose with methionine and single methionine concentrations.

Studies using more tractable insect models have shown that poor nutrition during development generally results in detrimental fitness effects including decreased size, fecundity, and life span (Dmitriew and Rowe, 2011). The most obvious way by which environmental variation may influence body condition and fecundity is via nutritional effects resulting from variability in food type availability. In general terms, diet effect can be classified as either quantitative (*i.e.*, food availability) or qualitative (*i.e.*, food composition). The quantitative effects are evident, since animals obtain energy and other nutritional requirements from food. Thus, under a natural range of conditions there is a positive correlation between food availability and body condition or fecundity. Qualitative effects often are divided into two categories: namely, nutritional deficiencies and inhibitory metabolites. In our study females fed with enriched diet have shown increased fecundity in restricted glucose with methionine diets, *i.e.*, G+0.03M g/L and fecundity decreased in lower methionine (0.01M g/L and 0.02M g/L) with restricted glucose (30 g/L) and single methionine concentrations along with control showing significant ( $P < 0.05$ ) with only the high methionine and restricted glucose. However, of the three methionine concentrations used, the higher concentration of methionine, *i.e.*, 0.03%M g/L was optimal with regard to lifespan and showed significance with the control.

Demographic modelling has suggested that dietary restriction in *Drosophila* acts by lowering age-independent mortality rather than by slowing the accumulation of senescent damage (Partridge *et al.*, 2005). Dietary restriction (DR) - restriction of one or more components of intake (typically macronutrients) with minimal to no reduction in total caloric intake – is another alternative to CR. While research suggests that neither carbohydrate restriction nor lipid restriction extend life (Sanz, 2006), protein restriction increases maximum lifespan by roughly 20% (Pamplona and Barja, 2006). This extension of life may be solely due to the reduction of the amino acid methionine (Caro *et al.*, 2009). In accordance to the above study the flies fed with the high methionine concentration and restricted glucose diets ingested relatively less food in both males and females showed increased fecundity. A low intake of diet supplemented restricted glucose with varied methionine diet did not abrogate the lifespan. We also found that restricting calories merely by limiting glucose intake had only modest benefit for longevity and increase lifespan in single concentration of methionine. Thus the feeding behavior and nutrients have a sole impact on the productivity and longevity.

**Acknowledgment:** The authors thank UGC-RGNF New Delhi, India, for providing financial assistance and also Department of Zoology, Bangalore University, Bangalore, for providing necessary laboratory facility.

**References:** Aguila, J.R., J. Suszko, A.G. Gibbs, and D.K. Hoshizaki 2007, *Journal of Experimental Biology* 210: 956–963; Bass, T.M., R.C. Grandison, R. Wong, P. Martinez, L. Partridge, and M. Piper 2007, *J.A. Gerontol. Biol. Sci. Med. Sci.* 6: 1071-1081; Bernays, E.A., 1985, Regulation of feeding behavior. *In: Comparative Insect Physiology, Biochemistry and Pharmacology*, vol. 4, *Regulation: Digestion, Nutrition, Excretion* (Kerkut, G.A., and L.I. Gilbert, eds.), pp. 1–32. New York: Pergamon Press; Caro, P., J. Gomez, I. Sanchez, R. Garcia, M. Lopez-Torres, A. Naudi, M. Portero-Otin, R. Pamplona, and G. Barja 2009, *Biogerontology* 10: 579-592; Chapman, R.F., 2013, *The Insects: Structure and Function*. 5th ed., 137, Cambridge University Press; Finkelstein, J.D., 1990, *J. Nutr. Biochem.* 1: 228–237; Fontana, L., 2009, *Curr. Opin. Gastroenterol.* 25: 144–150; Grandison, R.C., M.D. Piper, and L. Partridge 2009, *Nature* 462: 1061–1064; Harper, A.E., N.J. Benevenga, and R.M. Wohlhueter 1970, *Physiol. Rev.* 50: 428–558; Harini, B.P., 2011, *The Bioscan.* 6(1): 157-162; Min, K.J., and M. Tatar 2006, *Mech. Ageing Dev.* 127: 643–646; Pamplona, R., and G. Barja 2006, *Biochim. Biophys. Acta.* 1757: 496-508; Partridge, L., M.D.W. Piper, and

W. Mair 2005, Mech. Ageing Dev. 126: 938–950; Pletcher, S.D., S.J. Macdonald, R. Marguerie, U. Certa, S.C. Stearns, D.B. Goldstein, and L. Partridge 2002, Curr. Biol. 12: 712–723; Sanz, A., J. Gomez, P. Caro, and G. Barja 2006, J. Bioenerg. Biomembr. S38: 327-333; Starr, C., R. Taggart, C. Evers, and L. Starr 2008, *Biology: The Unity and Diversity of Life*. Cengage Learning; Tian, L., et al., 2010, Journal of molecular cell biology 2: 255–263; Vigne, P., and C. Frelin 2010, BMC Physiol. 10: 8; Weindruch, R., and R.L. Walford 1988, *The Retardation of Aging and Disease by Dietary Restriction*. Charles C. Thomas, Springfield, IL; Wheeler, M.L., and F.X. Pi-Sunyer 2008, J. Am. Diet. Assoc. 108 (4 suppl 1): S34–S39.



## **A modified method to assay the effects of ethanol on the behavior of *Drosophila melanogaster*.**

**Badrinarayanan, Saishree<sup>1</sup>, Saranya Balasubramanian<sup>2</sup>, and V. Deepa Parvathi<sup>1</sup>.**

<sup>1</sup>Department of Human Genetics, College of Biomedical Sciences, Technology & Research, Sri Ramachandra University, Chennai – 600 116, INDIA; <sup>2</sup>Department of Biotechnology, Sathyabama University, Chennai-600119, INDIA.

### **Abstract**

For over a long period of time, many scientists have frequently studied the fruit fly *Drosophila melanogaster* as a model organism to help elucidate the complex mechanisms that govern development and behavior. Recent advances in scientific research have enabled us to discover that certain strains of *Drosophila* are not only tolerant towards concentrations of alcohol, but also display many ethanol-induced behaviors resembling intoxication (e.g., loss of motor control). Hence, *Drosophila* makes an ideal model to study the effects of alcohol and deduce the neural circuitry involved in producing its intoxicating and rewarding effect. In the present study varying concentrations of ethanol were administered and its effect on the larval locomotion (Larval crawling assay), adult climbing ability (RING assay), and courtship behavior (Courtship and Mating assay) were assessed. It was found that after short term exposure of ethanol, larvae were found to have a decreased locomotor activity at 10% ethanol concentration; adult flies had shown a biphasic reaction towards the effect of ethanol. Mating behavior was affected by ethanol, with a reduction in the Courtship Index for flies that had been exposed to 20% ethanol (loss of postural control and instability in balance was observed). Most of the circuits governing these behaviors involve the inhibition and excitation of certain neurotransmitters, which are conserved between humans and flies. These results indicate that studies using *Drosophila* as a model system may help in understanding how ethanol influences behavior, which is vital to decipher the mechanisms of action of ethanol and alcoholism. **Keywords:** *Drosophila melanogaster*; alcohol; behavior; larva.

### **Introduction**

The human society has resorted to the use of alcohol for a variety of reasons. For more than a thousand years, documentation of its use as a part of food production, medicine, mood changers, and also as an intoxicant has been kept. Along with their uses, the adverse effects of alcohol have also been documented to as far as written records have existed. However the mechanisms responsible for alcohol related behavior and alcohol addiction are still poorly understood.

Complex genetic and environmental factors contribute to a predisposition to drug addiction. The ability to modulate the genetic conditions, which are likely multigenic and heterogeneous make the process of identifying specific genes responsible for addiction a difficult task.

As a model organism *Drosophila* has been instrumental in providing insights into the various molecular (Ulrike, 2000) and neural mechanisms underlying addiction and intoxication (Devineni, 2000).



Along with *Drosophila*, other invertebrate organisms such as *C. elegans* have also been used to understand the mechanisms of action of various drugs (Boris Tabakoff, 2000).

### 1.1 Mesolimbic-dopamine pathway

Various neural circuits are responsible for the “rewarding effect” produced due to alcohol consumption. Among the many neural circuits that are excited (or) suppressed, the mesolimbic dopamine pathway is most widely studied in association with drug addiction in humans (Piercea, 2000). The limbic nuclei which primarily consists of the amygdala, hippocampus, and medial prefrontal cortex sends glutamatergic projections into the nucleus accumbens. The nucleus accumbens is composed of the limbic sub region (or the shell) and the motor sub region (or the core). These have two major outputs that send GABAergic projections into the ventral pallidum and the ventral tegmental area (substantia nigra). The GABAergic efferents are further sent to the medial dorsal thalamus. This stimulates the medial dorsal thalamus to provide glutamatergic projections to the medial prefrontal cortex, thus closing the limbic circuit.

The glutamatergic receptor, also known as the most abundant excitatory receptor in the brain, is present mostly in the hippocampal regions, which is responsible for the formation and storing of memory. Dopamine acts through the limbic component of the basal ganglia. Dopaminergic neurons in the VTA innervate most of the components of the limbic circuit, namely: the nucleus accumbens, amygdala, hippocampus, mPFC, and ventral pallidum. Thus any changes in the transmission of dopamine plays a pivotal role in modulating the information flow through the various parts of the limbic circuit (Steven, 2005).

As discussed earlier, in mammals dopamine is an important regulator of the mesolimbic dopamine pathway. Many of these dopaminergic cells have been shown to illicit much ethanol-related behavior by acting on various brain regions. In *Drosophila*, the function of dopamine in regulating ethanol induced behavior is localized to a pair of dopaminergic neurons (DopR) projecting or expressing neurons, in the ellipsoid body of the central complex. This region is responsible for visual and locomotor behavior, arousal, and memory in the fly. The ellipsoid body also regulates sedation, sensitivity, and tolerance caused due to ethanol. While most of the neurons innervate the ellipsoid body, the others terminate in the mushroom body, a brain structure responsible in olfactory learning and processing. Neurotransmission of the mushroom body neurons is required for the behaviors seen due to ethanol-induced hyperactivity and conditioned ethanol preference. Both of these behaviors are mediated in specific sub regions within the mushroom body by neurons (Kaun, 2012).

The neuranatomical organization of the fly and mammalian brain is quite different. Hence it is not only difficult but also a tedious task to draw parallels between the neural regions and circuits involved in the ethanol induced behaviors in flies and mammals.

In mammals various brain centers such as the VTA, amygdala, ventral pallidum are involved in the mesolimbic pathway; however, it is unclear if structures equivalent to these are found in the fly brain.

As seen earlier the brain structures that are involved in various ethanol induced responses are the ellipsoid body and the mushroom body. The NPY/NPF system, a neuropeptidogenic system, is also found to regulate ethanol responses flies and rodents (Boris Tabakoff, 2000).

To understand further the effect of ethanol on the behavior of *Drosophila melanogaster*, a top down experimental approach was taken. In this study we used various neuro-behavioral assays adapted from (Nichols, 2012). The assays conducted were:

1. Larval crawling assay
2. Rapid Iterative Negative Geotaxis Assay
3. Courtship and Mating Assay.

Here we extended previous approaches utilized to understand the effect of ethanol in *Drosophila melanogaster*.

## Materials and Methods

*Drosophila melanogaster* (wild type) were cultured in standard growth media with a 12 hr light and dark cycle. Flies were transferred into fresh autoclaved vials once in every 3 days. Each vial contained

approximately 35 flies. The neurobehavioral assays performed were adapted from (Nichols, 2012). The assays performed were:

1. Larval crawling assay
2. Rapid Iterative Negative Geotaxis Assay.
3. Courtship and Mating Assay.

For the larval crawling assay, larvae were exposed to 5% and 10% ethanol solution. For the RING assay and Courtship Assay, adult flies were incubated in media containing 15% ethanol and 20% ethanol.

### *2.1 Larval crawling assay:*

3<sup>rd</sup> instar larvae were chosen from a well producing bottle. Before the treatment with ethanol, they were washed to remove off the excess media covering their body wall musculature.

#### *2.1.1 Ethanol treatment for larval crawling assay:*

##### *5% ethanol:*

Individual larvae were placed in a beaker containing 5% ethanol solution and sucrose for 15 minutes. After 15 minutes, it was transferred onto an agarose coated petriplate. The petriplate was placed on a graph sheet of 0.2 cm<sup>2</sup> grid. The number of boxes crossed by the larva in 1 minute, over a period of 5 trials was then tabulated. This was repeated for 4 individual larvae.

##### *10% ethanol:*

For 10% ethanol test group, new larvae were isolated. Individual larva was then subjected to 10% ethanol and sucrose solution treatment for 15 minutes. Once completed it was then transferred onto a new agarose coated petriplate. The number of grid boxes crossed in 1 minute by the larva over a period of 5 trials was then tabulated.

##### *Negative control:*

Prior to being placed on the agarose coated petriplate, the larva was allowed to feed in a solution containing 5% sucrose solution for 15 minutes. After feeding the larva was then transferred onto the petriplate to count the number of grid boxes crossed in 1 minute for over 5 trials.

For each test group, up to 5 larvae were used. The larvae that were not crawling due to possible injury during collection/washing or treatment were disregarded from the assay.

### *2.2 Rapid Iterative Negative Geotaxis Assay:*

For the RING assay, a special apparatus as described in protocol (Nichols, 2012) was constructed. In this assay, the locomotor behavior of the adult fly is tested. As the fruit flies are negatively geotactic by nature, they were made to climb in a scaled tube for a short duration of time.

The concentration of alcohol tested here is 15% and 20% along with the negative control of 0% alcohol. The adult flies were made to feed on the media containing the percentages of alcohol after starving them for a few hours. In the assay, the average height climbed by the group of flies in each separate tube was calculated.

After the flies were placed in the respected falcon tubes, they were allowed to acclimatize to the environment for 10 mins.

- After 10 minutes, the apparatus was tapped 4 times on the surface. At the 4<sup>th</sup> tap a timer for 3 seconds was started.
- At the 3<sup>rd</sup> second, a picture was taken using the camera.
- This was repeated for 20 trials with a rest period of 2 minutes for every 4<sup>th</sup> trial.

The images obtained were then analyzed using ImageJ, and the height climbed by each individual fly in the tube was measured and tabulated.

### *2.3 Courtship and Mating Assay:*

Courtship and mating is a complex behavior that involves the recruitment of fine motor movements coupled with the olfactory, visual, and acoustic processes (sensory processing). Hence it makes for an ideal behavior to assess the effects of alcohol.

The courtship song seen in males is a characteristic combination of movements that involves the following:

1. Orientation [male orients towards female]
2. Tapping [male taps female]
3. Licking [male licks female genitalia]
4. Curling [male curls its abdomen under itself]
5. Copulation attempt [curling activity while attempting to mount female]

### 2.3.1 Calculation of courtship index:

The time at which the behavior occurs is known as 'latency' and the total time engaged in courtship until copulation is calculated as the 'Courtship Index'. Hence the courtship index is calculated as a ratio of:

$$\frac{\text{Time spent in courtship}}{\text{Total time until copulation}}$$

Table 1. Combination of dyads for courtship and mating assay.

Courting wheel no:	Male fly one fly of concentration :	Female fly one fly of concentration:
1	0%	0%
2	15%	0%
3	20%	0%
4	15%	15%
5	20%	15%
6	15%	20%
7	15%	20%

The frequency observed for wild type is usually between 0.6-0.8 as referenced in (Arthur, 2005).

It is important to separate the male flies from the female flies. Once sorted, they were kept in separate vials for 3 days. They were then starved before being fed on media containing the percentages of alcohol (15%, 20%, and 0%). The combination of dyads for courtship and mating assay is given in Table 1.

In each courting wheel, dyads of the different combination were placed. Each dyad was observed for the courtship song. The courtship *index* was then calculated and tabulated. Different courting wheels were used for each dyad.

## Results

### 3.1 Larval crawling assay:

Considering the developmental stage of the larva and its ability to metabolize the concentration of alcohol, it was decided that a lower dose -5% and a moderate dose-10% were to be tested as higher levels of alcohol prove to be toxic to the larva (Malherbe, 2005). Statistical tests such as standard deviation, standard error of mean (SEM), and a One-way ANOVA were performed.

#### 3.1.1 Larvae exposed to 0% alcohol: (n = 5)

Wild type larvae showed normal peristaltic movement. The larvae had a consistent pace of the number of boxes crawled over the 5 trials performed. They showed antics of head lifting, turning, and crawling over the sides of the petri plate.

#### 3.1.2 Larvae exposed to 5% alcohol: (n = 5)

The larvae exposed to 5% alcohol for a brief period of time did not have a consistent pace of crawling. They had a sudden burst of activity during the first 2 minutes (in a few it lasted till the first 3 minutes) with a sudden decrease in their locomotion. Moreover, the number of head lifts and turning were much higher in them. After the experiment, these larvae continued to show peristaltic movement in the PBS solution.

#### 3.1.3 Larvae exposed to 10% alcohol: (n = 7)

Larvae exposed to 10% alcohol did not have much peristaltic movement (maximum boxes crawled = 4). Moreover, 2 showed no movement over the agarose. The larvae that did show movement were, however,

very slow, with continuous turns made by them. The larvae stopped very often in their movement and lay still for a few seconds before resuming peristalsis.

### 3.1.4 Statistical results:

The average or mean of the number of boxes crawled by the larvae exposed to the negative control (0%) was found to be 10.8 boxes, and that of the larvae exposed to 5% alcohol was 7.28 boxes, and 3.58 boxes for the larvae that were exposed to 10% alcohol. The SEM for the groups 0%, 5%, and 10% were found to be: 0.2315, 0.2497, and 0.12806, respectively (Figure 1).

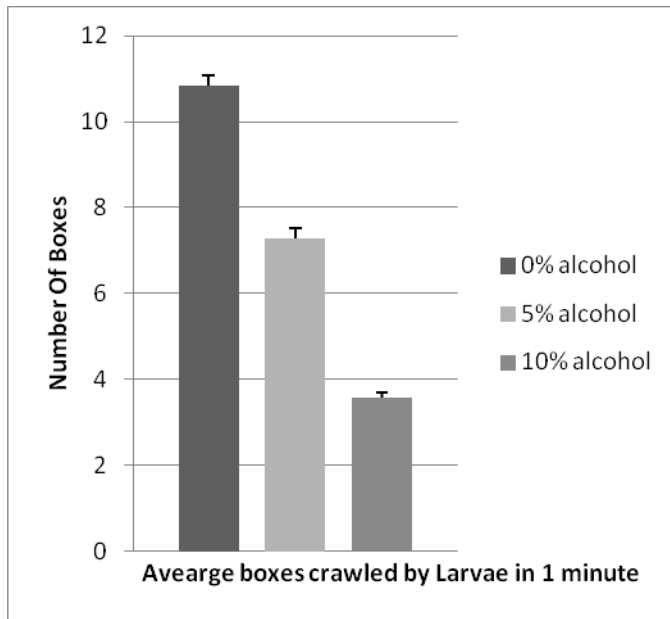

Figure 1. The graph represents the comparisons of the SEM (error bars) and the average of the number of boxes crawled by 5 larvae in each test group. The SEM is statistically significant across the test groups,  $p < 0.0001$  (one-way ANOVA).

### 3.2 Rapid Iterative Negative Geotaxis Assay:

During this assay, apart from the average height climbed by the fly, their ability to regain postural control once knocked was also observed. It has been shown that when given a choice between food containing ethanol – 15% to the normal prepared food, flies showed a preference towards ethanol-containing food (Devineni, 2000).

For each test group, 10 flies were used. A lesser number of flies ensured that the height each fly had climbed was measured. It also

helped in maintaining a consistent sample size during repeated trials. All images were analyzed using ImageJ.

#### 3.2.1 Adult flies exposed to 0% alcohol: ( $n = 10$ )

Young wild type flies had an average climbing height of 4.44 cm<sup>2</sup> in a 3 second time period. The time was set to a 3 second time period to accommodate the maximum height a fly could climb in the given setup. Flies that remained in the bottom were assigned the value of 0. Over the 10 trials, the flies started showing signs of desensitization towards the 9<sup>th</sup> and 10<sup>th</sup> trial.

#### 3.2.2 Adult flies exposed to 15% alcohol: ( $n = 10$ )

Adult flies that were exposed to 15% alcohol had shown a biphasic movement towards alcohol. This was determined by an initial rise in locomotion (determined by climbing height) and a sudden decrease in the ability to climb due to a gradual loss of postural control. After the first 3 trials, the flies increased the height climbed, and then had a sudden decrease in their ability to climb the tubes. Their average height climbed was 4.08 cm<sup>2</sup>.

#### 3.2.3 Adult flies exposed to 20% alcohol: ( $n = 10$ )

Adult flies that were exposed to media containing 20% alcohol climbed an average height of 3.37 cm<sup>2</sup>. Similar to the flies in the test group-15%, the flies in this test group showed an initial increase in their ability to climb at the third trial, after which there was a sudden decrease in their ability to climb. Moreover during their 7<sup>th</sup> and 8<sup>th</sup> trials, the flies did lose postural control leaving most of them at the bottom. Hence these flies were assigned the value of 0.

3.2.4 Statistical Results:

Average heights climbed by the flies of groups 0%, 15%, and 20% were measured as: 4.44 cm<sup>2</sup>, 4.08 cm<sup>2</sup>, and 3.37 cm<sup>2</sup>, respectively. Calculations of standard deviation, standard error of the mean (SEM), and one-way ANOVA were conducted for this assay. The standard deviations for the test groups 0%, 15%, 20% were found to be: 0.6462, 0.3996, and 0.6206, respectively. SEM was calculated and they were calculated as: 0.2043, 0.1263, and 0.1962 for the respective test groups (Figure 2).

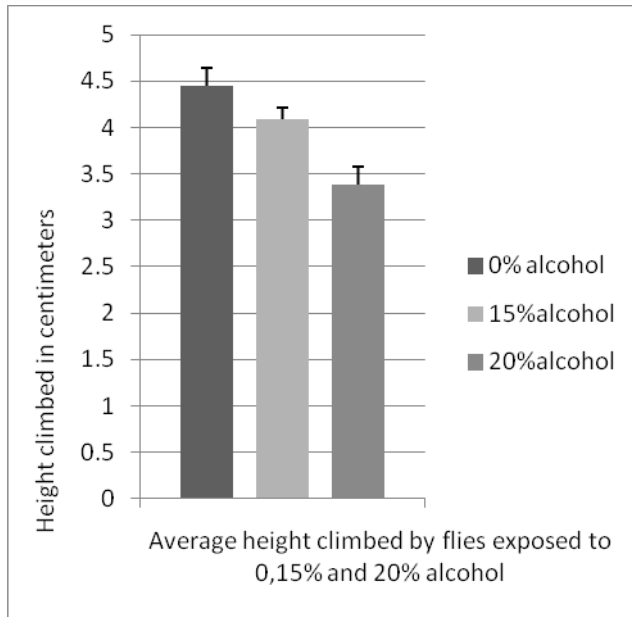

Figure 2. This graph represents the comparisons of the SEM (error bars) and the average height climbed by 10 adult flies in each test group. The SEM is statistically significant across the test groups,  $p < 0.0009$  (one-way ANOVA).

3.3 Courtship and Mating Assay:

Courtship index was calculated for the dyads. The results are tabulated in Table 2.

*Dyad observed: Male-0%, Female-0%:*

Wild type female showed consistent signs of application of her tarsi against her partner; the wild type male would circle around the courting wheel to face the female fly. The male fly then showed signs of orientation, which ultimately led to the courtship song. Successful copulation occurred with a courtship index of 0.78.

*Dyad observed: Male-15%, Female-0%:*

In this dyad, the wild type female made an attempt to orient towards the male. Consistent grooming followed by orientation of the male fly was observed. After many attempts, successful copulation occurred. The courtship index was calculated: 0.66.

*Dyad observed: Male-20%, Female-0%:*

Table 2. Calculation of courtship index.

Dyad observed	Courtship Index
Male - 0%, Female - 0%	0.78
Male - 15%, Female - 0%	0.66
Male - 20%, Female - 0%	Copulation not successful
Male -15%, Female - 15%	0.81
Male - 20%, Female - 15%	0.69
Male - 15%, Female - 20%	0.40
Male - 20%, Female - 20%	Copulation not successful

The male and female were seen to be in close proximity to each other; however, the male found it difficult to stabilize its posture. During the entire courting process it was observed that the male fly lost its stability very often, thus making it quite tedious for it to court the female fly. Male fly eventually made an attempt at courting, but the female fly rejected the male continuously by kicking its tarsi at the male.

*Dyad observed: Male-15%, Female-15%:*

In this dyad, continuous grooming by female was first observed. Rubbing of legs, proboscis extension and abdominal curling are observed in both flies. A brief period of absence in movement by either fly was observed. This was then later followed by tapping and wing extension. The male fly followed the female, until licking took place. Attempts were made at copulation. The courtship index was calculated: 0.81.

*Dyad observed: Male-20%, Female-15%:*

The male made the first attempt by directly tapping the female and then followed it by orientation. Wing extension was prominent in this dyad. The courtship index was calculated: 0.69.

*Dyad observed: Male-15%, Female-20%:*

This dyad has a courtship index of 0.40, indicating that the total time spent in courting was very low when compared to the total time until copulation. Proboscis extension was predominantly seen in this dyad. Towards the end the dyads succeeded in copulation.

*Dyad observed: Male-20%, Female-20%:*

The male had made an attempt at courting; however, due to loss of balance and postural control, both flies were seen to be unstable in their movement. In spite of many attempts, copulation was unsuccessful.

## Discussion and Conclusion

Vertebrates and invertebrates have similar activities such as: searching for food, coordinate activity, reproduce with selective mates, and protect themselves from invaders and death. These behaviors require a synchronized orchestration of sensory inputs and coordination with timely motor outputs.

The results obtained for the three essays demonstrate that with an increase in the concentration of ethanol, a significant decrease in the assessed behavior- locomotion or courtship is seen.

In the larval crawling assay, an initial spike of movement was observed with the administration of 5% ethanol; however, sedating effects were observed gradually with 5% exposure and with the 10% ethanol. Hence we observed a dose-dependent effect of ethanol on the crawling period with higher doses producing a shorter crawling period. Larval motor circuits are highly developed at the third instar stage (Kohsaka, 2012). The decrease in consecutive motor activity is suggestive that ethanol has an impact on the Ventral Nerve Cord of the *Drosophila*. It is also known that various neurotransmitters, such as GABA, glutamergic neurons, and adenosine, play a vital role in the recruitment of sensory and motor feedback to produce a specific motor output (Kohsaka, 2012). Alcohol increases the levels of GABA in the VNC resulting in the characteristic state of sedation and reduced motor output. This mechanism is evident with the test group of 10% in the larval crawling assay. Further, the results obtained are in concordance with previous studies (Seggio, 2012).

Furthermore, the role of alcohol dehydrogenase enzyme and alcohol dehydrogenase (*Adh*) gene is being extensively studied in *Drosophila*, with present data suggesting that the *Adh* gene is known to help in larval tolerance of ethanol. However, the tolerance obtained in an adult fly does not extend to subsequent larvae formed by it (Malherbe, 2005).

To further assess the effect of ethanol on the adult motor and sensory circuits, the flies were subjected to the RING assay. The flies in this assay had shown a consistent biphasic movement. Mushroom bodies and the antennal lobes play an important role in regulating olfaction. These neural structures are highly important in the exhibition of the biphasic movement as the initial increase in locomotion is characterized by the smell of ethanol, and the sudden decrease is because of the effect of ethanol on the VNC (Jefferis, 2002).

The 'biphasic' movement seen in flies is also observed in other animals, such as the rodents (Olivier, 2011), and in humans, where the concentration corresponding to the initial increase in locomotion corresponds to the stage of 'euphoria' in mammals, and the concentration that results in sedation of flies has also shown to cause sedation in humans (Devineni, 2000). However, it is observed that the 20% ethanol exposure does not cause sedation in the flies. Instead it causes instability with reference to the posture of the fly.

The courtship and mating involve interplay of various olfactory, gustatory, and locomotion behaviors. In flies, courtship song and the initiation of mating are exhibited by the male fly. The female fly, in response to the male, can decide to reject or accept the male. It was observed that in addition to the characteristic behaviors displayed by the male, the wild-type female and the exposed female flies had shown extension of the proboscis, abdominal curling, and movement toward the male, previously seen in (Kvitsiani, 2006). Moreover, the male flies when exposed to ethanol, took less time to initiate courtship. Similarly, female flies when exposed to ethanol had shown a lesser rate of rejection.

It is important to note that sexual behavior, satiation after feeding, and the rewarding effects of particular drugs of use have a common pathway - 'the mesolimbic dopamine pathway' (Steven, 2005).

It is noted that various concentrations of ethanol do produce an effect on the VNC of the fruit fly. In addition to this, the various behavioral parameters observed, and their corresponding results, provide an overview of a few mechanisms by which ethanol acts upon the VNC of the fruit fly.

Further studies that can be conducted in addition to the behavioral assessments include estimation of ethanol concentration in whole fly extracts and development of larval to adult fly after ethanol exposure of the larva.

These tests, along with the behavioral assays can help in elucidating the complex mechanisms responsible for ethanol induced behaviors in flies and also validate the use of the fruit fly as effective model to assess behavioral paradigms for future research.

Acknowledgments: The authors thank the Department of Biomedical Sciences for permitting us to use the *Drosophila* facility and other laboratory equipment.

References: Arthur, B.I., and M.S. Magnusson 2005, *Microanalysis of Drosophila Courtship Behavior*. The Hidden Structure of Interaction: From Neurons to Culture Patterns, 8-15; Boris, T.P.D., P.D. Paula, and L. Hoffman 2000, *Alcohol Research & Health* 24: 8-13; Devineni, A.V., and U. Heberlein 2010, *Communicative & Integrative Biology* 4: 3-7; Jefferis, G.S., 2002, *Current Opinion in Neurobiology* 12: 6-10; Kaun, K.R., A.V. Devineni, and U. Heberlein 2012, *Human Genetics* 131: 975-978; Kohsaka, H., 2012, *Development, Growth & Differentiation* 54: 12; Kvitsiani, D., and B.J. Dickson 2006, *Curr. Biol.* 16: 355-56; Malherbe, Y., 2005, *J. Evol. Biol.* 18: 811-19; Nichols, C.D., J. Becnel, and U.B. Pandey 2012, *Journal of Visualized Experiments* 61: 5-13; Olivier, B., 2011, *Curr. Top. Behav. Neurosci.* 8: 15-36; Piercea, R.C., and V. Kumaresana 2006, *Neuroscience and Biobehavioral Reviews* 30: 23-27; Seggio, J.A., B. Possidente, and S.T. Ahmad 2012, *Chronobiology International* 29: 6-12; Steven, E.H.M.D., 2005, *American Journal of Psychiatry* 12: 162-167; Ulrike, H.P., 2000, *Alcohol Research and Health* 24: 3-6.



## Genetic suppression of *Netrin* adult behavioral defects by *Notch*<sup>11N-ts1</sup>.

**Alavi, Marvam, and Thomas Kidd\***, Biology/ms 314, University of Nevada, 1664 N. Virginia St., Reno, NV 89557, USA; \*Corresponding author (email: [tkidd@unr.edu](mailto:tkidd@unr.edu)).

### Abstract

Deletion of both *Netrin* genes (*NetAB*) in adult *Drosophila* leads to behavioral defects that can be suppressed by inhibiting cell death pathways. The *Notch* locus has been shown to play a role in modulating apoptosis, so we tested the ability of a *Notch* temperature sensitive allele (*Notch*<sup>11N-ts1</sup>) to alter *NetAB* phenotypes. Surprisingly, *Notch*<sup>11N-ts1</sup> was able to suppress *NetAB* locomotor and negative geotaxis defects at the permissive temperature. These results suggest that the *Notch*<sup>11N-ts1</sup> allele may have subtly impaired function even at permissive temperatures and that *Notch*<sup>11N-ts1</sup> and *NetAB* mutations display positive epistasis in the adult.

### Introduction

The Netrins are secreted proteins that guide developing axons over short and long distances and are best known for attracting axons to the central nervous system (CNS) midline (reviewed in Lai Wing Sun *et al.*, 2011). In *Drosophila*, the two *Netrin* genes (*NetA* and *NetB*) are largely redundant (Brankatschk and Dickson, 2006), although *NetB* has a neurotrophic activity that *NetA* lacks (Newquist *et al.*, 2013a). An adult viable stock lacking both *Netrin* genes (*NetAB*<sup>ΔGN</sup>) was created by removing a lethal mutation from a *NetAB* chromosome by recombination of the proximal portion of the chromosome. Genetic analysis suggested the existence of a distal mutation near the *white* locus that enhanced viability of the *NetAB* deletion (Newquist *et al.*, 2013b). We wished to test the hypothesis that the *Notch* locus might be the gene responsible for the suppressor effect.

*Notch* encodes a cell surface receptor required for many developmental decisions including cell fate, proliferation, and apoptosis (Hori *et al.*, 2013). *Notch* also plays a role in axon guidance and is required for development of the longitudinal connectives in the embryonic CNS (Kuzina *et al.*, 2011). Longitudinal axon guidance also requires *Netrin* activity (Mitchell *et al.*, 1996; Harris *et al.*, 1996), and *Notch* and *Netrin* enhance defects in longitudinal axon guidance (Kuzina *et al.*, 2011). Apoptotic signaling plays a role in *Netrin* mediated axon guidance (Newquist *et al.*, 2013a), and *Notch* is capable of modulating apoptosis (Ye and Fortini, 1999; Lundell *et al.*, 2003) suggesting that *Notch* could suppress *Netrin* phenotypes in other contexts. We constructed a recombinant chromosome carrying both the temperature sensitive *Notch* allele (*Notch*<sup>11N-ts1</sup>; Shellenbarger and Mohler, 1978) and the adult viable *NetAB* deletion (*NetAB*<sup>AGN</sup>) and tested the stock in adult behavioral assays, predicting that intermediate temperatures between the permissive (18°C) and restrictive (29°C) temperatures for the allele might yield results. Surprisingly, the recombinant chromosome was indistinguishable from wild type at the permissive temperature.

## Materials and Methods

### *Drosophila* stocks and Genetics

The Oregon R and *Notch*<sup>11N-ts1</sup> stocks were obtained from the Bloomington *Drosophila* stock center. The *NetAB*<sup>AGN</sup>/*FM7actin-lacZ* stock is a Kidd laboratory stock (Newquist *et al.*, 2013a). Recombination was carried out at 18°C and candidate recombinant stocks were screened for the *NetAB* phenotypes of uncoordination and wing posture defects, and confirmed by PCR to detect the *NetAB* deletion. The presence of the *Notch*<sup>11N-ts1</sup> allele was detected by raising stocks at the restrictive temperature of 29°C and screening for the absence of hemizygous male progeny.

### Behavioral assays

Negative geotaxis and locomotor activity were assayed by slight modifications of previously published protocols (Newquist *et al.*, 2013b). Negative geotaxis was carried out in graduated cylinders with ten males individually tested three times with a one-minute rest in between. Locomotor assays were carried in vials the day after flies were born between 10 am and noon, and activity during a 45 second interval was recorded. For both assays, the experimenter was blind to genotype, and statistical analysis was performed using a Tukey HSD test within a one-way ANOVA using Statistica software.

## Results and Discussion

We recombined the temperature sensitive *Notch*<sup>11N-ts1</sup> allele onto the viable *NetAB*<sup>AGN</sup> chromosome. The presence of both mutations was confirmed by assaying for temperature sensitive lethality (*Notch*<sup>11N-ts1</sup>) and a lack of coordination and altered wing position (*NetAB*<sup>AGN</sup>) in hemizygous males. We also confirmed the presence of *NetAB* using polymerase chain reaction detection of the deletion. We tested the recombinant stock using flies raised at 18°C, the permissive temperature for the *Notch*<sup>11N-ts1</sup> mutation, comparing the flies to Oregon R and *NetAB* flies as positive and negative controls, respectively. Surprisingly, in both locomotor (Figure 1A) and negative geotaxis (Figure 1B) assays, the *Notch*<sup>11N-ts1</sup> *NetAB* recombinant flies resembled wild type, being statistically different from the *NetAB* control flies. These results suggest that *Notch* can suppress certain *NetAB* phenotypes, while enhancing others such as the longitudinal axon guidance defects (Kuzina *et al.*, 2011), as well as leaving other phenotypes such as altered wing positioning unchanged. *Notch-Netrin* genetic interactions are, therefore, likely to be highly dependent on developmental context, which is not surprising given the pleiotropy of Notch signaling.

The results obtained also suggest that the *Notch*<sup>11N-ts1</sup> allele, although capable of supporting wild type development, is not completely wild type at the permissive temperature. The *Notch*<sup>11N-ts1</sup> mutation is a missense mutation in an extracellular Epidermal Growth Factor repeat that leads to altered Notch protein distribution at the restrictive temperature (Xu *et al.*, 1992; Heitzler *et al.*, 1996). The mutation could possibly alter specific Notch functions at the permissive temperature while retaining overall activity. An alternative explanation for our results is that the *Notch*<sup>11N-ts1</sup> chromosome carries an independent suppressor mutation.



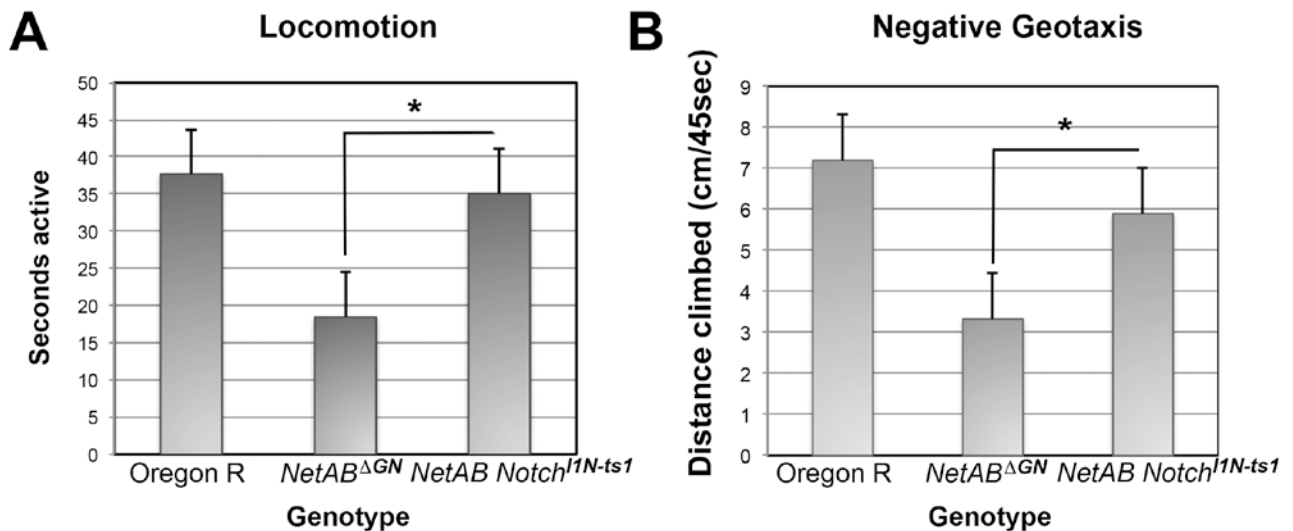

Figure 1. Behavioral assays of *Notch*<sup>1N-ts1</sup> *NetAB* flies. Oregon R was used as a wild type control, and the behavior of *Notch*<sup>1N-ts1</sup> *NetAB* flies was compared to *NetAB* mutants. A, Locomotor activity. Adult males were placed in fly food vials, tapped to the bottom of the vial, and the amount of time spent walking during a 45 second time span recorded. There was a statistically significant difference (\* p = 0.01, Tukey HSD within a one-way ANOVA) between the *Notch*<sup>1N-ts1</sup> *NetAB* and *NetAB* genotypes suggesting that the *Notch*<sup>1N-ts1</sup> mutation rescues the behavioral defects of the *NetAB* deletion. B, Negative geotaxis behavior of *Notch*<sup>1N-ts1</sup> *NetAB* flies. 1-2 day old flies were placed in a graduated cylinder, mechanically pushed to the bottom by a mechanical disturbance and their upward walking distance was recorded after 1 minute, with the flies being pushed back down if it neared the top of the cylinder. Ten male flies were each tested three times with a 1-minute rest between tests. There was a statistically significant difference (\* p = 0.01, Tukey HSD within a one-way ANOVA) between the *Notch*<sup>1N-ts1</sup> *NetAB* and *NetAB* genotypes suggesting that the *Notch*<sup>1N-ts1</sup> mutation rescues the negative geotaxis defects of the *NetAB* deletion.

This mutation would have to be linked to Notch and given the large number of studies using the *Notch*<sup>1N-ts1</sup> allele, it seems unlikely that such a mutation would have gone undetected. Additional temperature sensitive alleles of *Notch* could be tested, although these may be restricted to specific tissues (Shellenbarger and Mohler, 1975). Finally, we believe that the suppression is likely to be developmental in nature, but could reflect the ability of *Notch* alleles to affect behavioral functions acutely after development is complete (Presente *et al.*, 2004). Our data support our original hypothesis that a *Notch* mutation could be the unidentified modifier that promotes the overall viability of the *NetAB*<sup>ΔGN</sup> stock.

**Acknowledgments:** We thank Gunnar Newquist, Adam Bousum, and Kidd laboratory members for advice on genetics and behavioral assays. This project was supported by grants from the National Science Foundation IOS-1052555, National Center for Research Resources (P20RR016464, 5P20RR024210), and the National Institute of General Medical Sciences (8 P20 GM103554) from the National Institutes of Health. Stocks obtained from the Bloomington *Drosophila* Stock Center (NIH P40OD018537) were used in this study.

**References:** Brankatschk, M., and B.J. Dickson 2006, *Nature Neuroscience* 9: 188-294; Harris, R., L.M. Sabatelli, and M.A. Seeger 1996, *Neuron* 17: 217-228; Heitzler, P., M. Bourouis, L. Ruel, C. Carteret, and P. Simpson 1996, *Development* 122: 161-171; Hori, K., A. Sen, and S. Artavanis-Tsakonas 2013, *J. Cell Sci.* 126: 2135-2140; Kuzina, I., J.K. Song, and E. Giniger 2011, 138: 1839-1849; Lai Wing Sun, K., J.P. Correia, and T.E. Kennedy 2011, *Development* 138: 2153-2169; Lundell, M.J., H.K. Lee, E. Perez, and L. Chadwell 2003, *Development* 130: 4109-4121; Mitchell, K.J., J.L. Doyle, T. Serafini, T.E. Kennedy, M.

Tessier-Lavigne, C.S. Goodman, and B.J. Dickson 1996, *Neuron* 17: 203-215; Newquist, G., J.M. Drennan, M. Lamanuzzi, K. Walker, J.C. Clemens, and T. Kidd 2013a, *Cell Reports* 3: 595-606; Newquist, G., J. Hogan, K. Walker, M. Lamanuzzi, M. Bowser, and T. Kidd 2013b, *PLoS ONE* 8: e72524; Presente, A., R.S. Boyles, C.N. Serway, J.S. de Belle, and A.J. Andres 2004, *Proc. Natl. Acad. Sci. USA* 101: 1764-1768; Shellenbarger, D.L., and J.D. Mohler 1978, *Dev. Biol.* 62: 432-446; Shellenbarger, D.L., and J.D. Mohler 1975, *Genetics* 81: 143-162; Xu, T., L.A. Caron, R.G. Fehon, and S. Artavanis-Tsakonas 1992, *Development* 115: 913-922; Ye, Y., and M.E. Fortini 1999, *J. Cell Biol.* 6: 1351-1364.



### Genomic localization of two public gal80ts transgenes.

**Siági, Fruzsina, Nóra Zsindely, and László Bodai\***. Department of Biochemistry and Molecular Biology, University of Szeged, 6726 Szeged, Közép fasor 52., Hungary; \*e-mail: [bodai@bio.u-szeged.hu](mailto:bodai@bio.u-szeged.hu); keywords: gal80<sup>ts</sup>, transposone, genomic position, *Drosophila*

The application of thermo-sensitive *S. cerevisiae* GAL80 protein as an experimental tool was introduced to *Drosophila melanogaster* research more than a decade ago (Davis *et al.*, 2003a). These mutant proteins can be used to regulate GAL4 driven transcription enabling temporal regulation of UAS containing transgenes. The goal of this study was to determine the genomic position of GAL80ts transgenes in the P{tubP-GAL80<sup>ts</sup>}10 and P{tubP-GAL80<sup>ts</sup>}7 lines available from the Bloomington *Drosophila* Stock Center (stock #7108 and #7018, respectively). Both stocks carry a P{tubP-GAL80<sup>ts</sup>} element (Davis *et al.*, 2003b) expressing a temperature-sensitive Scer\GAL80 under the control of the  $\alpha$ Tub84B promoter. To determine the insertion site of the P{tubP-GAL80<sup>ts</sup>} elements we applied inverse PCR followed by capillary sequencing. The 5' end of the P{tubP-GAL80<sup>ts</sup>} construct has a FspBI site (CTAG) 373 bp from the end of the element. We designed inverse PCR primers (forward: TGC ACC TGC AAA AGG TCA GA, reverse: CGA CGG GAC CAC CTT ATG TT) specific for the 5' end of the P element before the FspBI site and used them in PCR reactions to generate amplicons from FspBI digested genomic DNA fragments circularized by ligation. Agarose gel electrophoresis showed single ~500 bp and ~700 bp bands in the lanes of samples prepared from stocks #7108 and #7018, respectively. There was no amplification in the control samples in which DNA ligation was omitted. We determined the sequence of the amplicons by capillary sequencing then identified the positions of the sequences on the r6.08 release of the *D. melanogaster* genome [Dos *et al.*, 2015] by BLAST. The sequence recovered from stock #7108 corresponds to an intergenic genomic region (2R:14884330-14884713, inferred cytogenetic location 51D1) between the *Cyp6a20* and *Cyp6a21* genes. The sequence recovered from stock #7018 contains sequences (3R:29806159-29806760, inferred cytogenetic location 99C2) from the *non-claret disjunctional (ncd)* gene. The transposon is inserted at position 3R:29806760 in the 5' UTR of the *ncd*-RB transcript, 13 bp upstream of the transcriptional start site of the *ncd*-RA transcript variant.

**Acknowledgments:** Stocks obtained from the Bloomington *Drosophila* Stock Center (NIH P40OD018537) were used in this study. This work was supported by the Hungarian Scientific Research Fund (OTKA) grant K-112294 to LB.

**References:** Dos, S.G., A.J. Schroeder, J.L. Goodman, V.B. Strelets, M.A. Crosby, J. Thurmond, D.B. Emmert, W.M. Gelbart, the FlyBase Consortium 2015, *Nucleic Acids Res.* 43(Database issue): D690-D697; Davis, R.L., S.E. McGuire, P.T. Le, A.J. Osborn, and K. Matsumoto 2003a, *Science* 302: 1765-1768; Davis, R.L., S.E. McGuire, P.T. Le, A.J. Osborn, and K. Matsumoto 2003b, *A. Dros. Res. Conf.* 44: 153.

Free access to *Drosophila* Information Service at [www.ou.edu/journals/dis](http://www.ou.edu/journals/dis).



## Further evidences of cannibalism and partial carnivorism in *Drosophila* species larvae.

**Bhattacharyya, Dipita.** Cytogenetics laboratory, P.G. Department of Zoology, Maulana Azad College. 8, Rafi Ahmed Kidwai Road, Kolkata-700013, India.

In our earlier communiqué (Bhattacharyya, 2014), evidences had been provided in the favor of cannibalism and ‘partial carnivorism’ in *D. melanogaster* (Oregon R) larvae and other *Drosophila* species. As a student of 2<sup>nd</sup> year M.S., an attempt was taken to answer more questions before we could conclude on any proper reason for cannibalism in this group of Dipterans being known for decades as the “fruit flies”. Whether it is the resultant of culturing them on an artificial diet and environment for several decades? Or whether such attribute is genetically pre-disposed and has remained to be conserved in the process of evolution?

### Materials and Method

All the wild type *Drosophila* stocks and different mutant strains of *D. melanogaster* were maintained, unless otherwise mentioned, in standard (maize-yeast-agar-jaggery) culture medium at 22+1°C temperature. The wild type species used in the study were *D. melanogaster*, *D. virilis*, and local species collected from three distinctly different demographical regions. While the first one was collected from the Dooars at the Himalayan foothills (Ethelbari Tea Estate; Jalpaiguri), the second one was collected from the north-eastern fringe of this metropolis (Ultadanga, Kolkata), and the third one, from the Gangetic delta region, the Sunderbans (Canning, South 24 Parganas).

Live specimens other than *Drosophila* were either collected personally or purchased, as were the live yeast and the food colors. Each experiment was conducted at least in five vials and repeated for at least three times. Observations were made under a Magnus stereoscopic binocular (model -MS24) using 2× and 4× objectives. Photographs, both still and video, were captured initially by a cell phone (Lumia520), and later by digital cameras (Canon A1100s or Powershot A800 and Sony).

### Experiments

Previous reporters, (Vijendravarma *et al.*, 2013) have emphasized on the artificial culture media with lower content of protein to be the driving cause of cannibalism in this group of Dipterans. Hence, to ascertain, we had to answer the question: Does the depleted quantum of protein in the artificial culture media compel the growing larvae to practice cannibalism and/or carnivorism in order to compensate the deficient nutrition?

To answer this question, three different culture media were prepared by just varying the amount of yeast in the media, (i) a normal media with the prescribed amount of yeast, (ii) media with doubled amount of yeast, and (iii) media completely devoid of yeast.

Yeast being the major source of protein in the culture media- more cannibalism was expected to occur in the media without yeast if it had been due to compensation for deficiency of proteins in the culture media. However, the observations that followed were quite contradictory to this- where cannibalism remained unaltered in all the three, in fact somewhat increased in the vials containing doubled amount of yeast but remained at a basal level only in the vials with culture media devoid of any yeast- that was comparable to (if not exactly) to the control vials (although the development rate in these vials were slower compared to the other two). This observation further supported our previous experiments reported in our previous communiqué enabling us to reach the most possible conclusion that neither supplementation of *excess proteins to an otherwise normal culture medium, nor the relative number of larvae (intraspecific competition) can prevent larval cannibalism.*

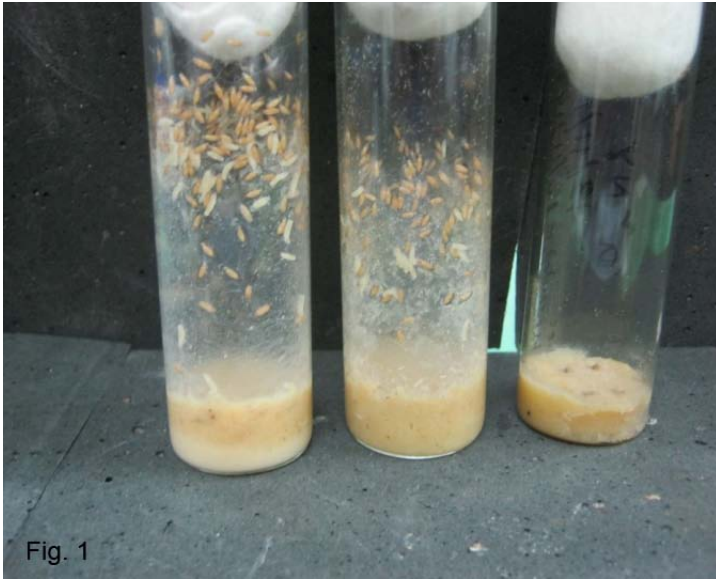

Figure 1. *D. melanogaster* larvae cannibalising on adult bodies irrespective of the gender in a culture vial that had been supplemented with three etherized white ebony males and three wild type females, belonging to the same species.

However, mention must be made that there is a direct correlation between the amount of yeast supplemented in the culture media with the size and developmental rate of the larvae (Figure 1). Especially intriguing were the larvae growing in the yeast deprived media- where the larvae were arrested in a particular developmental stage and did not undergo

moulting into the next stage. However, the addition of exogenous protein into these protein-deprived culture media helps compensate in the delayed/retarded developmental rate. The larvae developing into the adults in the yeast deprived vials, were exclusively cannibals- as the only possible source of the protein metabolised in the process of metamorphosis had to come from the conspecific larvae only, as no other protein source was present in the rearing culture medium. However, an intriguing observation that needs mention about these flies is that the adults emerging from these strictly cannibalistic diet culture media showed an altered sex ratio (from the general 1:1 to a 2:1 ratio for male: female).

The above experiment however, clearly ruled out any direct correlation with the incidences of cannibalism to the quantum of protein (yeast) in the culture media. Nonetheless, the affinity towards an exogenous protein source was also clearly demonstrated. Hence these observations put forth yet another question- as to what is the cue -rather the driving force to this cannibalistic behaviour of these otherwise non-carnivorous flies? What type of cue attracts the larvae to an exogenous protein source, even in a culture media with high protein content?

In our previous communiqué, we provided evidence in which the larvae fed indifferently on flies from the same lineage as well as other members from the same species. Furthermore, the cannibalistic behavior was not only restricted to members of the same genus, but also to the evolutionarily distant species when supplemented to culture media ("partial carnivorism") –which allowed us to logically conclude that even if there is any chemical attractant that acts as the cue, it is not specific for either the species or the genus. Hence the next most potent candidate for being an attractant could be specific to a particular sex of the victim.



Figure 2. Different rates of development in double-yeast medium, normal yeast medium, and yeast deprived medium (from left to right) cultured at the same time.

To find out the validity of such cues in serving as an attractant for cannibalistic larvae towards a potent victim, an experiment was designed in such a manner, such that it was possible to identify the gender of the victimised adult bodies upon which the larvae fed. In fresh cultures containing exclusively larvae in the growing stages, etherized white ebony males (three) and wild type females (three) were

supplemented.

*No gender biasness was noticed* with respect to larval feeding upon the dead adults (Figure 2). Similar observations were recorded in reciprocal event where white ebony females and wild type males were taken in same numbers.

Thus with such diverse victims of the feeding larvae, it was necessary to see is there any preference towards a particular exogenous protein- specifically to a cannibalistic source, when evidences were available on the preference towards a cannibalised conspecific even when the quantum of protein available in the immediate environment was sufficing? Moreover, is there any relation with cannibalism (and/or carnivorism) with the rate of development?

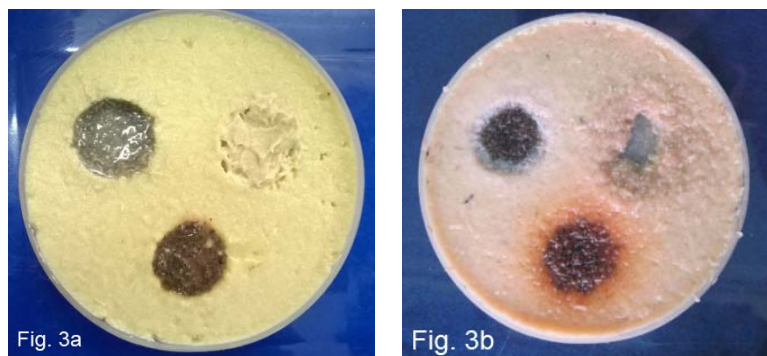

Figure 3. (a) The Three Way Assay (clockwise from bottom: killed adults, injured larvae, and live yeast containing wells). (b) The same after the first day of feeding by the developing first instar larvae in the petridish.

Two separate experiments were conducted to answer the addressed questions. In the first experiment, (*three way assay system*), three wells were produced within the petridish (Figure 3a) which was filled with normal culture medium in which flies were cultured for few days before discarding them. After the emergence of the first instar larvae, three different protein sources were added in the prepared wells- live yeast, freshly killed larvae, and freshly killed adults. The most significant observation from this experiment was that the first instar larvae were initially found to be attracted towards the well containing live yeast (Figure 3b). However, a gradual shift in preference from live yeast towards live protein source, better to say, a cannibalistic source of protein supplement was observed with each successive moult.

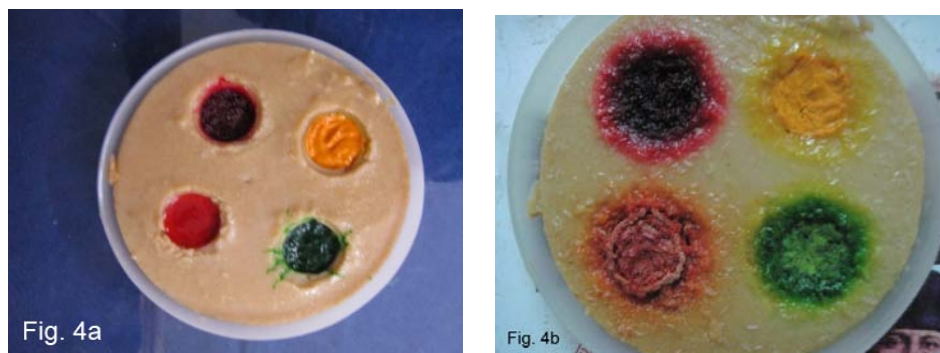

Figure 4. (a) Four Way Assay wells with the supplemented proteins: clockwise from bottom-left: live yeast (orange), freshly killed adults (crimson), amino acids in the form of *Amino-Fit* (yellow) and injured larvae (green)- added after the

appearance of first instar larvae in the surrounding protein deprived media. (b) The same after two days of larval feeding- showing a shift in the affinity to the well containing killed larvae.

For a better resolution of this observed picture of cannibalism, a second experiment was designed based on the same logic, but was slightly modified. In this set of experiment (*four way assay system*), four wells were prepared within the petridish which was filled with a protein deprived, (*i.e.*, completely yeast free) culture medium. After the emergence of the first instar larvae, the four wells were filled with different exogenous source of protein (nearly similar to the previous experiment) along with a synthetic amino acid source (*Amino-Fit*). These different sources of protein were mixed with different food colors (Figures 4-a to

b) in order to determine which particular protein source was preferred by the growing larvae, simply by examining the color of the gut from the otherwise colorless translucent exterior (Figure 5-a to c). Indeed, as expected, it was found that the first and second instar larvae mostly selected live yeast as their most preferred protein source, followed by a shift in the preference to the killed larvae in subsequent stages. Dead adults were found to be mainly preferred by the later instars. However, though in separate experiments- *Amino-Fit*, when added to otherwise protein deprived vials helped resume development in the arrested larvae, the same when added in the wells did not attract a greater number of wandering larvae to it. This observation further helped to emphasize on the specific chemical “cue” offered by the protein from living sources that attracts wandering larvae (arrested in a particular moulting stage). Hence the artificial amino acids in the form of *Amino-Fit*, being devoid of any cue- did not attract.



Figure 5. (a) Developing larva feeding on yeast which is clear from the food color added (orange- to the yeast in the well) being visible from the translucent exterior of the larva. (b) Developing larva feeding on killed conspecific larvae- which is clear from the food color (green- added to the well)- being visible from the translucent exterior of the larva. (c) Matured larva feeding on killed conspecific adults which is clear from the food color (crimson, added to the well) being visible from the translucent exterior of the larva.

Thus, logically, some specific nutritional requirement is being met by a cannibalistic source for the successive moults to occur. Although in separate experiments conducted by us as well as previously by Vijendravarma *et al*, have shown that metamorphosis of the larvae is completed even without cannibalism- hence we cannot conclude on the obligatory pre-requisite in this group of Dipterans. Even though we cannot deny on a possible evolutionary advantage in such modified preference of these fruit flies- the same cannot be considered as plasticity in response to a poor nutritional condition. Hence, our experimental observations logically demand the behavior of cannibalism to be an innate behavioral attribute, pre-disposed genetically- and the *Drosophila sp.* larvae as facultative cannibals.

Now, the question that naturally arise is, why cannibalism?

- Does the incidence of predatory cannibalism result from excessive inbreeding, rearing in relatively crowded conditions on artificial culture medium and environment for several decades?
- Or has this behavioral characteristic evolved even before culturing the flies in the laboratory conditions?

If the former alternative is more probable, then when did this transition, at least partial, from frugivory to predatory cannibalism take place? (Do populations harbour genetic variations for the propensity to cannibalism, allowing it to change with the changing environmental conditions?) Is it restricted to this particular species of fruit fly (*Drosophila melanogaster*), which has been in the cultures for over 90 years? (Lindsley and Grell, 1968).

Comparable experiments were also conducted in ancestral *D. virilis* (Bhattacharyya, 2014). Identical feeding behavior observed in this ancestral species belonging to the same genus suggests its possible existence of cannibalism from the time of evolution of the genus.



Figure 6. A possible cannibalistic aggregation observed in nature- growing on a banana in the wild.

Alternately, depriving both the species from normal diet and environment, as well as space limitation for considerable period (*D. virilis* has also been cultured in the laboratory for some decades from now) might compel them to adapt cannibalistic approach, which thus might have originated as the product of parallel evolution in recent time after speciation. The alternative approach logically demands absence or lower rate of conspecific consumption in larvae living in the wild or introduced very recently in the laboratory. Interestingly, larval cannibalism has been noticed in all culture vials where flies collected from the wild- from three distinct geographical regions were introduced in the lab just a couple of weeks prior to the experimental observations. Moreover, aggregation behavior has also been observed in larvae growing in bananas in nature as well (Figure 6).

Thus it will be wise to speculate that artificial food and environment are not the exclusive cause of predatory cannibalism and such behavior is genetically predisposed in the genome of most, if not all, species of *Drosophila* and might have possibly evolved to compensate inadequate protein required for their metabolism allowing us to conclude on the facultative nature of the cannibalistic behavior.

Acknowledgement: I am grateful to Dr. Debasis Mutsuddi, for his guidance, constant encouragement and valuable suggestions during the preparation of this work. Also, Professor Subir Chandra Dasgupta, Head of the Department of Zoology, and Professor Mamata Roy, Principal in office at Maulana Azad College, Kolkata, for their great help and laboratory facilities provided.

References: Bhattacharyya, D., 2014, *Dros. Inf. Serv.* 97: 67-75; Lindsley, D.L., and E.M. Grell 1968, *Genetic Variations of D. melanogaster*. Carnegie Institute of Washington Publication. No 627; Vijendravarma, R.K., S. Narasimha, and T.J. Kawecki 2013, *Nature Communications* 4: 1789 doi: 10.1038/ncoms 2744; 1-8.



### ***Drosophila suzukii* (Matsumura) found in Uruguay.**

**González, Gisell, Ana Lucia Mary, and Beatriz Goñi\***. Sección Genética Evolutiva, Facultad de Ciencias, Instituto de Biología, Universidad de la República, Iguá 4225, Montevideo 11400, Uruguay; \*Corresponding author: bgoni@fcien.edu.uy

### **Abstract**

*Drosophila* species collected from two southern localities in Uruguay are reported. The spotted wing *Drosophila suzukii* was the most abundant species (96%) of the total *Drosophila* flies (n = 46) emerged from ripened, decayed, or damaged blueberries collected at rural Canelones Department, while it represented 0.50% among the *Drosophila* samples (n = 5007) collected from banana-baited traps in urban Montevideo city. Data suggest that *D. suzukii* has successfully invaded anthropic environments in urban and agrosystem ecosystems in southern localities in Uruguay.

## Introduction

In February 2013, upon returning from an academic exchange program at the *Universidade Federal de Pelotas* (UFPeL) in Brazil, Lic. MSc Maria Victoria Calvo, PhD student at the *Facultad de Agronomia*, UdelAR, alerted that the invasive *Drosophila suzukii* has had already been found in the states of Santa Catarina and Rio Grande do Sul, southern Brazil. A few months later it was confirmed by Prof. Vera L.S. Valente during a visit of one of us (B.G.) to her lab at the *Universidade Federal do Rio Grande do Sul* (UFRGS), whose findings were later reported (Deprá *et al.*, 2014). Soon after, in August 2013, we applied for an undergraduate research project to study the occurrence of *D. suzukii* and its relation to host fruits in Uruguay. Here we report an advance of relevant findings on the occurrence and abundance of *D. suzukii* and other drosophilid species in two southern localities of Uruguay.

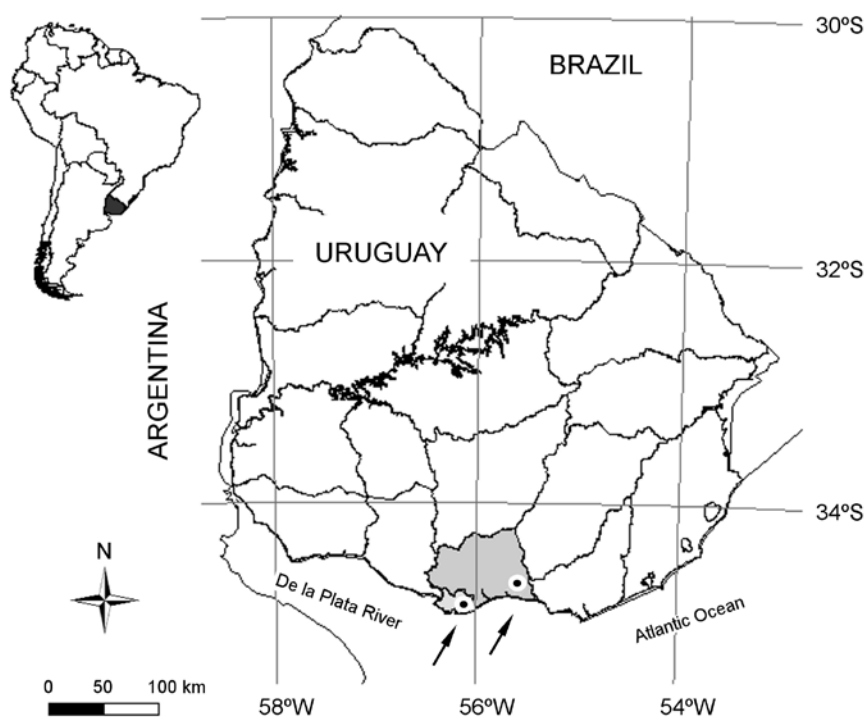

Figure 1. Map showing two Uruguayan localities surveyed: Montevideo city (left arrow) and rural area of Department of Canelones (right arrow).

## Materials and Methods

Uruguayan climate is temperate, with no dry season, and with hot summers (“*Cfa*”, Köppen, 1931). At the southern region, the annual mean temperatures ranges from 16 to 17°C, and in the warmest month the means are between 21 and 23°C; the mean monthly precipitation is between 80 and 110 mm/month, though rainfall variability is the most crucial aspect of the Uruguayan climate

(Caffera, 2010). Our study was carried out in two localities in southern Uruguay during summer 2014 (Figure 1). At Montevideo city, Department of Montevideo (34°52'57.09”S, 56°7'5,35”W, alt. 41 m, Figure 1, left arrow) flies were collected by using banana-baited traps set at the Native Flora Garden of the *Facultad de Ciencias* (Figure 2 a) [i.e., *Butia odorata* (Barb. Rodr.) Nobslick, 1891 (Arecaceae) (“butiá”), *Ficus luschnathiana* (Miq.) Miq. 1868 (Moraceae), *Opuntia arechavaletae* Speg. (Cactaceae), *Phytolacca dioica* L. 1762 (Phytolacaceae) (“ombú”), *Syagrus romanzoffiana* (Cham.) Glassman 1968 (Arecaceae) (“pindó”), *Tipuana tipu* (Benth.) Kuntze, 1868 (Fabaceae) (“tipa”)]. Traps were regularly examined twice a day (mornings and afternoon) during the collecting period. The second locality was a rural area of Canelones Department, known as *Empalme Maldonado* (34°40'16,.69”S, 55°35'57,.88”W, alt. 83 m, Figure 1, right arrow), characterized by small to medium-sized productive forestry units, fruit plantations, or livestock farming. A total of 3.5 kg of over-ripened, decayed or damaged blueberries, *Vaccinium ashei* (Ericaceae) of the “Ochlockonee” cultivar were collected from the ground, at end of the harvest (Figure 2b). “Ochlockonee” cultivar is a late season rabbiteye blueberry, released in 2002 (NeSmith, 2012), that produces medium-large-sized fruits and is planted together with other rabbiteye blueberry varieties for cross pollination. The blueberry farm has an average volume of harvested berries per year of about 1.75 tons per hectare (grown on 4 hectares). Collected berries were taken to the laboratory, weighted and placed in a plastic container with sand at the bottom. Emerged flies were collected at regular intervals (every 4 to 6 days) for one month. Collected





Figures 2. (a) View of the Native Flora Garden of the *Facultad de Ciencias* at Montevideo and banana-baited trap used for collecting flies (left corner). (b) Blueberries of the “Ochlockonee” cultivar at *Empalme Maldonado* farm, Department of Canelones.

drosophilids from both localities were placed under uncrowded conditions in vials with minimal fly medium (agar-sugar-nipagin solution) and kept at 22°C in laboratory conditions until being analyzed. Adults were anesthetized with vapors of triethylamine, counted, classified by sex, and identified to species level using external morphology, and in some cases, by the inspection of male terminalia and preserved in ethanol 70%. The keys and/or illustrations of Freire-Maia and Pavan (1949), Brncic and Santibañez (1957), Spassky (1957), Heed and Russel (1971), Val (1982), Vilela (1983), Vilela and Bächli (1990), Moreteau *et al.* (1995) were used. Samples of male and female specimens used for species identification were labeled and deposited at the collection of Sección Entomología, Departamento de Biología Animal of the Facultad de Ciencias, Universidad de la República, Montevideo (Uruguay). Adult samples of *D. suzukii* from Uruguay were identified by the characteristic sexually dimorphic wing pattern, male foreleg sex combs, male and female terminalia (Bock and Wheeler 1972; Vilela and Mori 2014).

Table 1. Relative abundance of *Drosophila* species emerged from blueberries collected at *Empalme Maldonado*, Department of Canelones, Uruguay, January 11th and 14th, 2014.

Male	Species	Male	Female	Total	%
<i>melanogaster</i>	<i>D. suzukii</i> (Matsumura, 1931)	20	24	44	95.65
<i>willistoni</i>	<i>D. nebulosa</i> Sturtevant, 1916	2	0	2	4.35
Total		22	24	46	100

## Results and Discussion

Table 1 shows the abundance of *Drosophila* species emerged from blackberries (Figure 2b) collected at fruit plantation located 3 km far from the coastal line in the Canelones Department. The thermal amplitude in this region is slighter lower than rest of the Uruguayan territory (Caffera, 2010). The relative low number of *D. suzukii* ( $n = 44$ ) out of a total of 46 *Drosophila* adults that emerged from 3.5 kg of fruits collected at the end of the harvest suggests a low infestation of the spotted-wing fly, not noticed by the farm grower. Most of the blueberries produced in southern region of Uruguay are commercialized in local markets to satisfy the summer demand; however, large commercial producers of blueberries, located in northern regions of

Uruguay, grow early-season berries that are exported to countries of the northern hemisphere. Furthermore, while examining 80 McPhail traps set for monitoring and mass trapping tephritid species [*i.e.*, *Ceratitis capitata* (Wiedemann 1824) and *Anastrepha fraterculus* (Wiedemann 1830)] in several fruit production farms located in southern Uruguay (13 March 2014), Iris Beatriz Scatoni and collaborators (pers. comm.) detected small flies in the attractant liquid that resembled the *Drosophila melanogaster* species but showed a distinct spot at the wing tips, later identified as *Drosophila suzukii* males.

The invasive *Drosophila suzukii* (Matsumura, 1931) (Diptera, Drosophilidae) known as the cherry fly or spotted-wing *Drosophila* (SWD) is a fruit pest that it is expanding rapidly in the Americas and Europe (see Department of Agriculture, Fisheries and Forestry Biosecurity, 2013). This polyphagous species seriously damages commercial and several backyard soft skin fruits including table and wine grapes, loquats, peaches, pears, and plums (Kanzawa 1939), that have been reported to host the new invasive species. The female has a strongly sclerotized oviscapt (Vilela and Mori, 2014) that allows the penetration of the skin of healthy ripening fruits, and larvae cause their collapse in a few days (Sasaki and Sato, 1995). In August 2008, *D. suzukii* was first detected in the continental US, California (Lee *et al.*, 2011), in 2009 in British Columbia, Canada (BCMA, 2014), and in December 2011 in the municipality of *Los Reyes*, Michoacan, Mexico (SENASICA, 2013). Deprá *et al.* (2014) reported the presence of *D. suzukii* for the first time in Brazil, stating it was first collected in the Biological State Reserve Aguaí, Nova Veneza, State of Santa Catarina, on 27.II.2013. They also recorded the relative abundance of this species, ranging from 0.67 to 7.97% in collections made in the states of Rio Grande do Sul and Santa Catarina, in March and April of that year. Two other reports indicate the invasion of *D. suzukii* in natural areas of Brazil. Paula *et al.* (2001) reported a few adults of this species collected April 2014 in gallery forests and savannas in the IBGE Ecological Reserve, Distrito Federal, Brazil, located in the Brazilian Savanna, a tropical biome in the center of South America, locally known as Cerrado biome. Using also banana-baited traps as collecting method, Bitner-Mathé *et al.* (2014) found a few adults of *D. suzukii* on traps set in November 2014 in the *Parque Nacional da Serra dos Órgãos* (PARNASO), Petrópolis, state of Rio de Janeiro, southeastern Brazil, a conserved area of the tropical Atlantic Rainforest.

Table 2. *Drosophila* species, and its relative abundance, attracted to banana-baited traps at the Native Flora Garden of the *Facultad de Ciencias* Faculty of Science, Montevideo city, Uruguay, February 14th to 20th, 2014.

Species group	Species	Male	Female	Total	%
<i>cardini</i>	<i>D. cardini</i> Sturtevant, 1916	1	1	2	0.04
<i>immigrans</i>	<i>D. immigrans</i> Sturtevant, 1921	32	46	78	1.56
<i>mesophragmatica</i>	<i>D. gaucha</i> Jaeger & Salzano, 1953	4	4	8	0.16
<i>repleta</i>	<i>D. hydei</i> Sturtevant, 1921	15	17	32	0.64
	<i>D. mercatorum</i> Patterson & Wheeler, 1942	1	0	1	0.02
<i>melanogaster</i>	<i>D. melanogaster</i> Meigen, 1830	355	308	663	13.24
	<i>D. simulans</i> Sturtevant, 1919	2330	1838	4168	83.24
	<i>D. suzukii</i> (Matsumura, 1931)	21	4	25	0.50
<i>willistoni</i>	<i>D. nebulosa</i> Sturtevant, 1916	6	12	18	0.36
	<i>D. willistoni</i> Sturtevant, 1916	5	5	10	0.20
<i>ungrouped</i>	<i>D. busckii</i> Coquillett, 1901	2	0	2	0.04
Total		2772	2235	5007	100

Concerned with the possible invasion of *D. suzukii* through the national and international fruit trade in the southeastern states of Brazil, Carlos R Vilela and Lyria Mori at the University of São Paulo analyzed commercialized fruits bought in a local market in the city of São Paulo (February 2014). They reported the emergence *D. suzukii* in the blueberries harvested in São Joaquim, state of Santa Catarina (Vilela and Mori, 2014). Santos (2014) recorded the first attack of *D. suzukii* in a strawberry cultivar (variety of San Andreas) in the municipality of Vacaria, Rio Grande do Sul, Brazil (January 2014). The local grower estimated that about 30% of its production was infested. Recently, Geisler *et al.* (2015) reported new host fruits of *D. suzukii* in Brazil: loquats and peaches, collected at the municipalities of Porto Victoria, and União da Victoria, state of Paraná, respectively, from February to December 2014.

Table 2 shows the *Drosophila* species collected at the new campus of *Facultad de Ciencias* (*Malvin Norte* campus, Figure 2a), Montevideo city. Adults of both sexes of *D. suzukii* were attracted to the banana

traps at low, though comparable, frequencies to those calculated for the other *Drosophila* species. Excepting for *D. suzukii* all other *Drosophila* species were previously reported in urban and suburban Montevideo city (Goñi *et al.*, 1997, 1998).

The new data discussed above expand the geographic/climatic range of the invasive *D. suzukii* in the Americas, and place an alert to the Uruguayan and regional agricultural sanitary control authorities about the potential economic effects this propagule on fruit production.

Author contributions: G.G. and A.L.M. equally contributed to this article, and B.G. wrote the article.

Acknowledgments: We are grateful to Ing. Agr. Iris Beatriz Scatoni for sharing unpublished data and encouraging us throughout this study, and to Dr. Carlos R. Vilela (USP, Brazil) for identifying samples of *Drosophila suzukii* from Uruguay and kindly reading the manuscript. We thank Alejandro Gorostidi Mancini and Ana Sofía Pinillos for allowing us to collect blueberries in their farm, and Paulino Alegre and Jeronimo Tucci for participating in the fly collection at Montevideo. We thank Dr. Ruben Mario Caffera for climatic data. Funds were provided by: Programa de Apoyo a la Investigación Estudiantil, Comisión Sectorial de Investigación Científica (PAIE-CSIC, UdelaR); Programa de Desarrollo de las Ciencias Básicas (PEDECIBA).

References: Bitner-Mathé, B.C., J. Victorino, and F.S. Faria 2014, Dros. Inf. Serv. 97: 136-137; BCMA, 2014, Ministry of Agriculture. British Columbia Ministry of Agriculture Plant Diagnostic Laboratory. Available at: <http://www.agf.gov.bc.ca/cropprot/swd.htm>; Bock, I.R., and W.R. Wheeler 1972, Univ. Texas Pubs. 7213: 1–102; Brncic, D., and S. Koref-Santibañez 1957, Evolution 11: 300-310; Caffera, R.M., 2010, In: *Lecturas y Análisis desde la(s) geografía(s)* (F. Pesce coordinator) vol. 2:189-203. Publ. Dep. Geografía, Formación en Educación, ANEP, Uruguay. Available at: <http://www.anpg.org>; Deprá, M., J.L. Poppe, H.J. Schmitz, D.C. Toni, and V.L.S. Valente 2014, J. Pest Sci. 8 7: 379-383; Santos, R.S.S. dos, 2014, Enciclopédia Biosfera 10: 4005–4011; Freire-Maia, N., and C. Pavan 1950, Cultus 1: 1-71; Geisler, F.C.S., J. Santos, D.R. Holdefer, and F.R.M. Garcia 2015, Rev. Ciências Ambientais 9: 125-129; Goñi, B., M.E. Martinez, and P. Daguer 1997, Rev. Bras. Entomol. 41: 89-93; Goñi, B., M. Martinez, V.L.S. Valente, and C.R. Vilela 1998, Rev. Bras. Entomol. 42: 131-140; Heed, W.B., and J.S. Russel 1971, Univ. Texas Pubs. 7103: 91-130; Kanzawa, T., 1939, (Abstr.) Rev. Appl. Entomol. 29: 622; Köppen, W., 1931, In: *Handbuch der Klimatologie* (Köppen, W., and R. Geiger, eds), 1936, vol. 1, pp. 1–44. Berlin, Germany: Gebrüder Bornträger; Lee, J.C., D.J. Bruck, A.J. Dreeves, C. Ioriatti, H. Vogt, and P. Baufeld 2011, Pest Manag. Sci. 67: 1349–1351; Moreteau, B., G. Petavy, P. Gibert, J.P. Morin, A. Munoz, and J.R. David 1995, Annals Soc. ent. Fr. NS 31(3): 249-257; NeSmith, S. 2012, <http://www.smallfruits.org/blueberries/production/newugablueberryvarieties2012.pdf>; Paula, M.A., P.H.S. Lopes, and R. Tidon 2014, Dros. Inf. Serv. 97: 113-115; Sasaki, M., and R. Sato, 1995, Ann. Rep. Soc. Plant Prot. North Jap. 46: 164–172; SENASICA, 2013. *Mosca del vinagre de alas manchadas (Drosophila suzukii Matsumura)*. Dir. Gral. Sanidad Vegetal - Programa de Vigilancia Epidemiológica Fitosanitaria. México, D.F. No. 7. 21 p.; Spassky, B., 1957, Univ. Texas Pubs. 5721: 48-61; Val, F.C., 1982, Pap. Av. Zool. 34: 309-347; Vilela, C.R., 1983, Rev. Bras. Entomol. 27: 1-112; Vilela, C.R., and G. Bächli 1990, Mitt. schweiz. ent. Ges 63 (Suppl.): 1-332; Vilela, C.R., and L. Mori 2014, Rev. Bras. Entomol. 58: 371-375.



**“Pack Hunting” or “Social Digestion” as a possible cause of larval clustering associated with the evolution of cannibalistic behavior in *Drosophila* species larvae.**

**Bhattacharyya, Dipita.** Cytogenetics laboratory, P.G. Department of Zoology, Maulana Azad College, 8, Rafi Ahmed Kidwai Road, Kolkata-700013, India.

The seminal observation of cannibalism in *Drosophila melanogaster* cultured in laboratory culture media for more than nine decades (Lindsley and Grell, 1968) has led us to a few of the major questions - as to

why cannibalism as such - what is the driving force that compels these otherwise non-carnivore species to become cannibals?

Previous reports (Vijendravarma *et al.*, 2013) have emphasized on the propensity to a more cannibalistic diet in the flies grown in protein compromised culture media for successive generations, giving them a direct fitness to combat with the protein deficiency. However, the fact that larvae show a basal level of cannibalism even when grown in optimum (conventional culture media used in the laboratory for generations) nutrient conditions (Bhattacharyya, 2014) and that comparable observations of cannibalistic behavior were made in the ancestral species, *i.e.*, *Drosophila virilis*, hint at the existence of this behavior from the time of evolution of the genus. Moreover, experiments conducted on locally collected species (possibly derived species, as the local species prevalent in this part of the country being *D. ananassae*, *i.e.*, a derived species characterised by a pericentric inversion of the X chromosome) that had been introduced in our laboratory for only 2 weeks just prior to the experimental observations that led to comparable observation, further emphasized on this evolutionary concept. Thus we preferred to consider these Dipterans as Facultative cannibals with the behavior of cannibalism being an innate behavioral character rather than being considered as mere plasticity in response to poor nutrient conditions.



Figure 1. Cannibalistic aggregations in *D. melanogaster* larvae.

This hypothetical view was further supported by the observation of cannibalistic behavior in the wild (nature, in a rotting banana), which would be expected considering cannibalism as an innate behavioral attribute not influenced by the artificial culture medium. Earlier workers have proposed on the aggregational

properties of the larvae (Figure 1) seen even in the wild as a manifestation of the feeding behavior of the larvae and hence have proposed a possible role in the development of cannibalistic behavior in the otherwise non-carnivorous flies (Gregg *et al.*, 1990; and later by Vijendravarma *et al.*, 2013).

Gregg *et al.* (1990) considered “external digestion” as the possible cause of such cannibalistic aggregation. They even applied the term, “social digestion”, to explain such clustering behavior and correlated this attribute to the evolution of exceptionally large size of the larval salivary glands.



Figure 2 (left). ‘Large predator- small victim’ cannibalism observed in a culture of *D. melanogaster* larvae.

Figure 3 (right). ‘Equivalent size predator-prey’ cannibalism in *D. melanogaster* larvae.

Vijendravarma *et al.* (2013), in their communication, highlighted cannibalism in the light of such aggregations where they solely emphasized the advantages of smaller larvae to overpower a large victim in such aggregations, which they termed “pack hunting”, it being a manifestation of cannibalism in the *Drosophila* sp. larvae. They observed, unlike most other cases of cannibalism, ‘size-reversed’ cannibalism (large pre-pupal larvae were cannibalized by younger and smaller ones). Such over-sized victims were found to be attacked by multiple smaller sized larvae. Their observations allowed them to infer that this ‘pack hunting’ presumably helped the attackers to overpower a large victim being attracted by chemical cues to form such aggregations.

We, apart from “size reversed cannibalism”, also observed both ‘large predator- small victim’ (Figure 2) as well as ‘equivalent size predator-prey’ cannibalism (Figure 3). In our experiments “multiple-larvae-single victim” encounters were found to be mostly prevalent in crowded and overcrowded situations, whereas incidences of “one-to-one encounter” between predator and prey were not uncommon (Figure 4), and found mostly in uncrowded, protein deprived and adverse conditions. Our studies so far have shown that apart from conspecific larvae, these cannibalistic larvae also fed on conspecific pupae and dead adults. Comparable observations were reported earlier from *D. hydei*, where larvae were found to consume the puparium (Gregg *et al.*, 1990). As there is no question to overpower the stationary puparium and dead adults, cannibalistic aggressiveness is less likely to be associated with overpowering the large victim, and more likely that “clustering behavior has evolved to facilitate external digestion” (Gregg *et al.*, 1990).



Figure 4. “One-to-one encounter” observed between predator and prey (here a conspecific adult) in a culture vial of *D. melanogaster*.

It has been demonstrated that besides conspecifics, *D. melanogaster* larvae fed on a wide variety of exogenous protein sources when supplemented from outside (Table 1). It includes immediately killed adults, both within and outside the genus, and most surprisingly even on cooked fish (washed thoroughly off any spice or cooked flavor, before being added

to the culture vials) and raw sliced chicken meat. Aggregations in such vials were observed, which again hinted at an evolutionary advantage to the practice of social digestion, rather than pack hunting, where the proponents emphasized completely on the advantage of overpowering an oversized victim.

Hence, from our studies and the earlier evidence and reports, it would be justified enough to conclude that the *feeding behavior, as such, of the Drosophila sp. larvae seems to have originated from “social digestion” rather than “pack hunting”*. Hence the evolution of cannibalism must have originated from the same practice of social digestion. (Figure 5).

Table 1. List of exogenous specimens that were fed on by the *Drosophila melanogaster* larvae.

Common name	Scientific name	Family
Housefly	<i>Musca domestica</i>	Muscidae
Flesh fly	<i>Parasarcophagus ruficornis</i>	Sarcophagidae
Grasshopper	<i>Gesonula punctifrons</i>	Acridae
Honey bee	<i>Apis</i> sp.	Apidae
Black ant	<i>Camponotus compressus</i>	Formicidae
Rohu fish (cooked)	<i>Labeo rohita</i>	Cyprinidae (Class-Actinopterygii)
Chicken (sliced raw meat)	<i>Gallus</i> sp.	Phasianidae (Class-Aves)



Figure 5. Social digestion as a possible manifestation of cannibalistic behavior in *Drosophila* species.

It is noteworthy to mention here that clustering behavior was very prominent in the natural environment of the larvae. Clustering of larvae in a natural culture of banana was also observed in the wild (Figure 6). Such aggregations could be related to a cannibalistic

behavior being at its play, hence emphasizing at the innateness of this attribute, being present even in the natural environment.

However, Gregg *et al.* (1990) as an extension of their work- argued that the unexplained massiveness of both the larval salivary glands and giant chromosomes are the resultant of producing digestive enzymes in huge quantities required for external digestion, relative to the digestive tract enzymes, to counteract the effects of dispersion in the external environment. They even provided strong evidence for the external digestion of amylose, cellulose, and chitin by *Drosophila* larvae. The work of Gregg *et al.* (1990), therefore, contradicted the popular belief (Ashburner and Berendes, 1978) that salivary glands do not produce digestive enzymes.



Figure 6. Aggregation and scraping behavior of larvae observed in the wild on a rotting banana, hinting at a possible presence of cannibalism in nature.

Hence, logically larvae growing in a strictly cannibalistic diet should have massive glands to meet with the nutrient deficiency by socially digesting conspecifics. However, when larvae growing in an otherwise protein deprived culture media, but flourishing entirely by cannibalizing conspecifics, were dissected for the preparation of salivary gland chromosome showed

abnormally small sized glands compared to normal larvae. Moreover, the giant chromosomes prepared from the same, which normally undergo  $2^8$  times endoreplication, were also very thin in appearance, almost comparable to the Malpighian tubules polytene chromosomes in wild type larvae (Figure 7). Hence again, what effect does the cannibalistic diet, or protein deprivation have on the larval development and metamorphosis remains a big question that stands, yet to be answered by further studies.

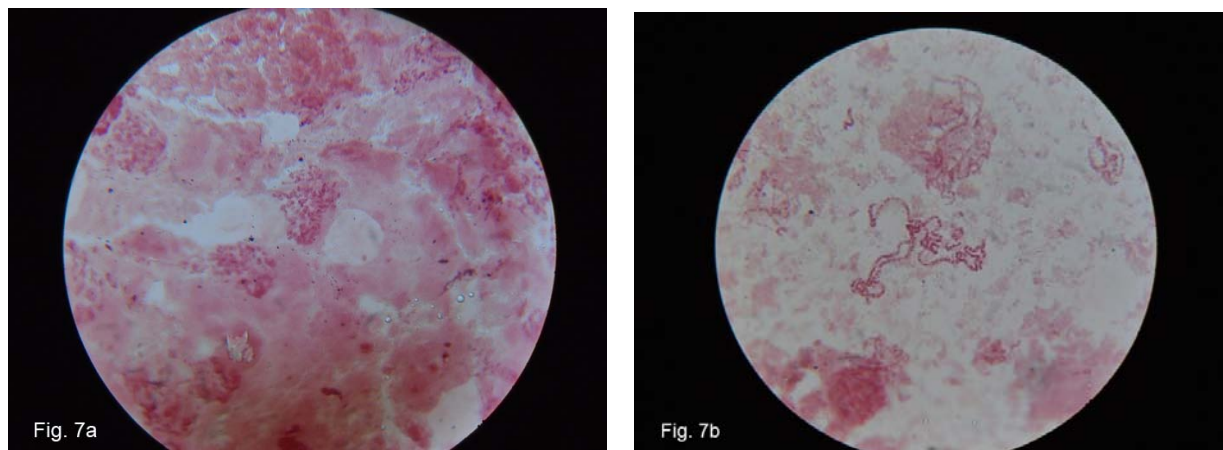

Figure 7. a, Salivary gland chromosome prepared from larvae growing on a strictly cannibalistic diet; b, Salivary gland chromosome prepared from larvae reared in a normal culture medium with only a basal level of cannibalism at play.

Acknowledgment: I am thankful to Dr. Debasis Mutsuddi, for his guidance, constant discussions and encouragement throughout the work. I am also grateful to Professor Subir Chandra Dasgupta, Head of the Department of Zoology, and Professor Mamata Roy, Principal in office at Maulana Azad College, Kolkata, for their great help and laboratory facilities provided

References: Ashburner, M., and H.D. Berendes 1978, Puffing of polytene chromosomes. *In: The Genetics and Biology of Drosophila*, vol. 3a, (Ashburner, M., and T. Wright, eds). Academic Press. New York, 325-421; Bhattacharyya, D., 2014, *Dros. Inf. Serv.* 97: 67-75; Gregg, T.G., A. McCrate, G. Reveal, S. Hall, and A.L. and Rypstra 1990, *Biochemical Genetics* 28(Nos. 3,4): 197-207; Lindsley, D.L., and E.M. Grell 1968, *Genetic Variations of D. melanogaster*. Carnegie Institute of Washington Publication. No 627; Rypstra, A.L., and T.G. Gregg 1982, *Dros. Inf. Serv.* 63: 116; Vijendravarma, R.K., S. Narasimha, and T.J. Kawecki 2013, *Nature Communications* 4: 1789 doi: 10.1038/ncoms 2744: 1-8.



### Comparison of the genotoxic and antigenotoxic activity of three *Ipomoea* species with medicinal properties in *Drosophila melanogaster*.

Muñoz-Moya, Armando<sup>1</sup>, Patricia Ramos-Morales<sup>2</sup>, and Cristina Pérez-Amador<sup>3</sup>. <sup>1</sup>CCH-Sur, UNAM, <sup>2</sup>Laboratorio Genética y Toxicología Ambiental, <sup>3</sup>Laboratorio Química, Facultad

Ciencias, UNAM, 04510, D.F., Mexico.

#### Abstract

Some plants are recognized for their therapeutical properties, which could be associated to the presence of one or more metabolites. The resins from the root from *Ipomoea* species are commonly used for their purgative activity, being *I. purga* the most effective. Nevertheless their low activity as purgative, *I. orizabensis* and *I. jalapa* are used to adulterate the officinal preparation. In spite of the medicinal activity, and the wide use of traditional resources, little is known about collateral effects of plants derivatives. The genotoxicity of three species of the *Ipomoea* (Convolvulaceae) was compared using the Somatic Mutation and Mitotic Recombination Test (SMART) of *Drosophila*. Larvae were chronically exposed to different concentrations of resins from *I. purga*, *I. jalapa*, or *I. orizabensis* before (Pretreatment) or after (Post treatment) acute exposure to sucrose 5% or N-

Nitrosodimethylamine (NDMA). None of the resins showed mutagenic activity. *I. purga* resin [100 ppm] reduces ( $p < 0.05$ ) the frequency of somatic alterations only when it was administered before the NDMA treatment. *I. jalapa*'s resin increased ( $p < 0.05$ ) the frequency of somatic alterations induced by NDMA treatment when it was administered before, but was ineffective after it. Finally, *I. orizabensis* resin reduces ( $p < 0.05$ ) the frequency of alterations when it was administered before (until 93%) or after (83%) the NDMA treatment. The *I. orizabensis* resin could contain a metabolite or metabolites with antimutagenic activity against the NDMA's induced damage. Keywords: Antimutagenesis, Medicinal Plants, *Ipomoea*, *Drosophila*, SMART.

## Introduction

The Jalapa Root constitutes one of the best known traditional resources of Mexico, due its medicinal properties. The Jalapa root was known mainly by its purgative and emetic activities; however, it seems also it has some role as anthelmintic and emmenagogue (Martinez, 1990). For its pharmacological properties it is classified as a drastic cathartic and hydragogue (Bauser, 1937). The use of the root of Jalapa goes back to the Hispanic towns, which took advantage of its properties as laxative resins and purgative (Pereda-Miranda, 1995). In particular, the *Ipomoea* genus, which is member of the Convolvulaceae Family, includes numerous medicinal and economically important species. The sweet potatoes varieties (sweet potato) from *I. batatas* (L) Lam. are appreciated by their nutritious roots; other species are known as ornamental in horticulture; and in agriculture like controllers of growth of grasses in the cane of sugar cultivations (Peterson and Harrison, 1991). It has been reported that the allelopathic principle of *I. tricolor* Cav is the glicoresin from the seeds (Anaya, 1990). The use of hallucinogenic seeds of *I. tricolor* in religious ceremonies of divination and in cure rituals was much appreciated in the prehispanic civilizations in Mexico and Central America (Hernandez-Carlos *et al.*, 1999). In pharmacological studies of extracts from these plants, it has been found activity as antimicrobial, analgesic, spasmogenic, spasmolytic, hypotensive, psychomimetic, and insecticide, among others (Bieber *et al.*, 1986).

The true root of Jalapa is *I. purga*; however, there exist resins obtained from roots of other species that are known as "false Jalapas" and they are also sold as "root of Jalapa" (Pedraza, 1982).

The "Root of Jalapa" complex includes *I. orizabensis* (Pelletan) Ledebour ex Steudel, *I. purga* (Wender) Hayne, and *I. jalapa* (L) Pursh, all herbaceous, tropical plants that prevail in the State of Veracruz (Chiconquiaco and Jalapa), Mex. They are known commonly as Root Escamonea of Mexico", Jalapa of Orizaba or Root of Jalapa". The active principle is the resin that acts as an energetic purgative (Cabrera, 1975), but details about the main derivative still remains unidentified. The resins are a complex mixture of fatty acids of 14C and 16C monohydroxi and dihydroxi moiety join to an oligosaccharide center by glycosidic links (glucose, rannose, quinovose, and fucose), some of them sterificated with volatile organic acids (Bah and Pereda-Miranda, 1997). Commonly, the glicolipids also contains a macro cyclic lactone as part of their molecule (Noda *et al.*, 1987, 1990; Bah and Pereda-Miranda, 1997).

In spite of the medicinal activity, and the wide use of traditional resources, little is known about collateral properties of plant derivatives, as could be the genotoxic and antigenotoxic activities, that means, that one or more substances forming part of the plant, or some metabolite resulting from biotransformation through metabolic activity in the organism could disturb the quality or quantity of genetic material, or inclusive interfere with their genetic regulation (genotoxic activity). Alternatively, some substances can diminish the genetic damage associated to the exposition to chemical, physical or biological agents (antigenotoxic activity).

The genotoxic and antigenotoxic activities from three species of *Ipomoea* (Convolvulaceae) were compared using the Somatic Mutation and Mitotic Recombination Test (SMART) of *Drosophila*.

## Methods

### Chemicals:

N-Nitrosodimethylamine (NDMA) [CAS 62-75-9], Sigma; Tween 80 (polyethylene glycol-sorbitan monooleate) [CAS 9005-65-6], Sigma; Dimethylsulfoxide (DMSO) [CAS 67-68-5], Sucrose [CAS 57-50-1], Baker; Microcrystalline Cellulose, Merck.



*Officinal extraction of resins:*

For the officinal preparation of resins from *I. purga*, *I. jalapa*, and *I. orizabensis*, root was pulverized and placed with ethanol into a Soxhlet for 4 h periods, three times. The ethanolic extracts were vaporized to obtain an extract which was mixed with 4 parts of water. The resins were separated, rinsed with water, and air dry.

*Concentrations:*

The solutions were prepared as described. Resins were dissolved separately with DMSO, stirring continuously until dissolving. The solution was stabilized with Tween 80, to avoid solution precipitation. Water was added slowly by dropping. The final concentrations of DMSO and Tween 80 were 1.5 % and 1 %, respectively. For each resin, the highest concentration dissolved before precipitation of the solution was chosen to be assayed. We adopted this criterion based in the fact that commonly this kind of treatments is used without physician assistant. Another hand, from previous experiments, we fixed in 10% the upper limit of mortality from experimental flies as the maximum mortality accepted for antigenotoxicity determinations. That point is important because otherwise the antimutagenic potential could be confused with cellular or organism death.

For *I. purga*, the highest concentration before precipitation was 500 ppm, three additional dilutions were assayed: 250, 100 and 50 ppm. For *I. jalapa*, it was 5000 ppm, and 2500, 500 and 250 ppm dilutions; the two lowest concentrations were chosen to compare with those from *I. purga*. Finally, for *I. orizabensis* it was 6250 ppm, and 5000, 4375, 3750 and 2500 ppm dilutions; as before, two concentrations were chosen to compare with *I. jalapa* concentrations. None of the resins reduced the viability larvae–imago (data no shown). As positive control and inductor of somatic mutation and mitotic recombination, a 12.5 mM solution of alkylating, promutagen N-Nitrosodimethylamine (NDMA) dissolved in 5 % sucrose was chosen. At this concentration, the viability larvae–imago is affected in less than 10 % and the frequency of somatic mutation is undoubtedly increased, as was preliminarily determined.

*Drosophila strains and matings:*

Two strains with markers on third chromosome were used:

i)  $flr^3/In(3LR)TM3, ri p^p sep bx^{34e} e^s Bd^S$  (brief,  $flr^3/TM3, Bd^S$ ) flies. The recessive marker  $flr^3$  (*flare*, 3-38.8) is lethal in homozygous, and the balancer chromosome *TM3* (Third Multiple) is used for maintaining it. When expressed,  $flr^3$  produces amorphous, chitinous spots in comparison with a single regular trichoma in wild type flies. *TM3*, carrier of the autosomal, dominant, homozygous lethal marker  $Bd^S$  (*Beaded-Serrate*).  $Bd^S/Bd^S$ , is lethal and only  $flr^3/TM3, Bd^S$  flies are recovered.

ii)  $mwh/mwh$  flies. *mwh* (multiple wing hair) (3-0.0) is an autosomal recessive marker which produces multiple trichomes on the wing, instead of only one, as in wild type flies. For a detail description of markers see Garcia Bellido and Dapena (1974); Lindsley and Zimm (1990). 72 h old,  $flr^3/TM3, Bd^S$ , virgin females were mated with 48 h old,  $mwh/mwh$  males. Three days after mating, parents were transferred to fresh bottles during 8 h for egg laying. All the cultures were maintained at  $25 \pm 1^\circ C$  and 60% humidity. The standard food for *Drosophila* was prepared with 1% agar, 10.5% corn meal, 7% sugar, 6% yeast, 0.4% Nipagin (10% dissolved in ethyl alcohol) and 0.4% Propionic Acid.

*Experimental procedure:*

Two types of exposures were chosen to determine possible differences due to the order in which the resins and the NDMA were given (Figure 1).

A. 1 ml of the resin to be assayed was poured into bottles containing larvae of  $24 \pm 4$  h age and distributed homogeneously on the surface. At this age, larvae emerging from the eggs and are coated with the resin solution, or solvents (DMSO + Tween 80). After 48 h, these larvae (now from  $72 \pm 4$  h age) were extracted using a 20% sucrose solution (Nöthiger, 1970) and were put into vials containing a nylon gauze at one side, and a rubber in the other to avoid that larvae escape. The vials were put into 10 ml beaker containing 60 mg of powder cellulose and 0.5 ml of 5% sucrose or 12.5 ml NDMA. After 6 h, larvae were rinsed with tap water and were put into fresh bottles with standard food for *Drosophila*, in which remained until emergence of adult flies. The final exposure was: 24 (larval age)  $\times$  48 (subchronic treatment with resins)  $\times$  6 h (acute treatment with sucrose or NDMA) (E =  $24 \times 48 \times 6$  h).

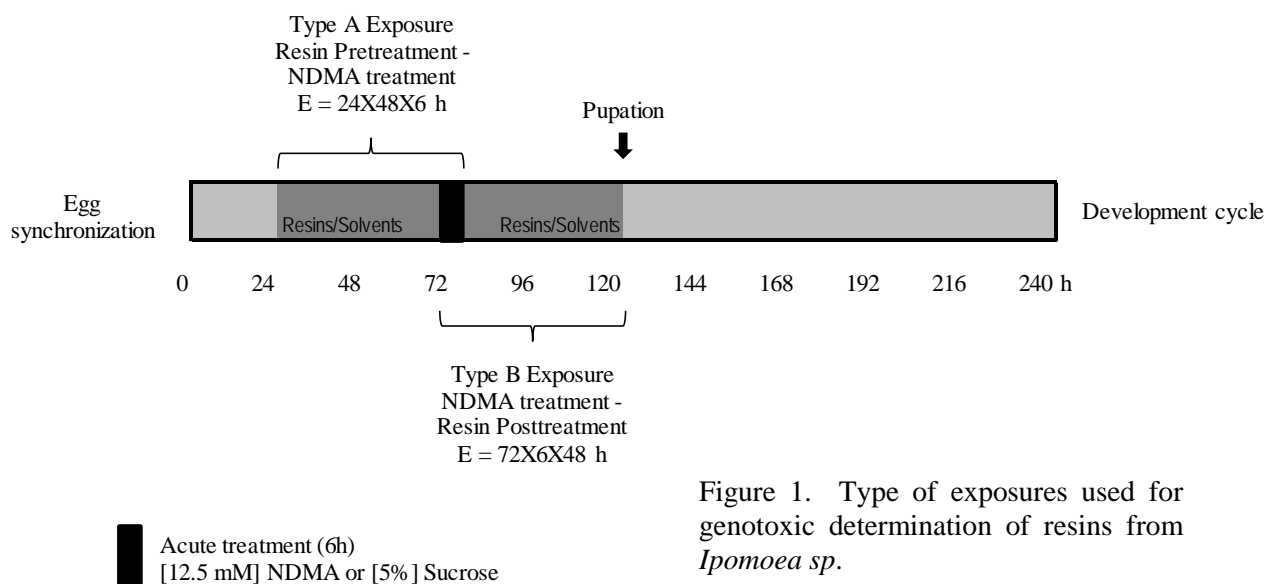

Figure 1. Type of exposures used for genotoxic determination of resins from *Ipomoea sp.*

B. In the other type of exposure, third instar larvae ( $72 \pm 4$  h age) were extracted with a 20% sucrose solution and treated with sucrose or NDMA as described previously. After the acute treatment, larvae were rinsed and put into bottles containing standard medium for *Drosophila* enriched with 1 ml of resin or solvent solution homogeneously distributed on the surface; the larvae remained in these bottles until the adults emerged. The final exposure was: 72 (larval age)  $\times$  6 (acute treatment)  $\times$  48 h (subchronic treatment) (E = 72  $\times$  6  $\times$  48 h). The experiments were done two times.

Adult flies recovered were counted, sexed, over anesthetized, and fixed in 70% ethanol. Wing slides were made putting a couple of wings from 10 females and 10 males using Fauré solution as described Graf *et al.* (1984). For each concentration, 120 wings were reviewed using a microscope at 40 $\times$  magnification. The number, type and size of spots were scored. In addition, the total number of spots per fly was obtained.

#### Criteria for wing scoring:

In the SMART, transheterozygous larvae for two morphological markers affecting the trichome expression in the adult fly are used. The cells from the imaginal discs of the wings are mitotic proliferating but maintain undifferentiated until metamorphosis. In the wild type adult fly, each cell produces a single trichoma on the wing blade. Through larval development, the exposure to endotoxins can produce the loss of heterozygosity, leading to the expression of the recessive markers: *mwh* and *flr*<sup>3</sup>, as described by Graf *et al.* (1984).

The genetic endpoints forming single spots are mainly punctual mutation, deletion, and recombination between markers. The recombination between the proximal marker *flr*<sup>3</sup> and the centromere (which has a role as an additional marker) lead to twins spots, with both markers forming part of a spot. Hence, twins spots indicate recombinogenic activity. Two spots are independent when separated by three or more wild type rows of trichome. Both sides of blade wing (dorsal and ventral) were scored for spots.

The spots were classified by size as small (1-2 trichome) and large (> 3 trichome). The number of trichome (cells) per spot allows us to determine the number of cell cycles occurring after the alteration in the original cell. So, the size of the spots can estimate the time of induction of the cellular clone, in absence of delay or cell death. The qualitative comparison of the distribution of the number of cells per clone also contributes to identify and discard false positives and false negatives diagnostics (Frei and Würigler, 1995).

Another side, the number of spots per fly gives an indication of individual susceptibility. In untreated flies, there are no spots in the flies, but occasionally one spot appears in one of the wings. Flies with two or more spots on the wings are less frequent. This analysis helps us to know whether the increase in the frequency of spots from experimental series has a biological meaning applicable to the population from which derived the treated flies, or it is associated to some particular genetic condition in some rare, exceptional organisms.

*Statistical analysis:*

1. For data processing, the SMART software was used (Frei and Würzler, unpublished). The frequency of small, large, twins and total spots from experimental and control series was compared through the Multiple Decision Procedure (Frei and Würzler, 1988) to determine a positive, negative, inconclusive, and weak positive diagnosis, with  $\alpha/2 = 0.05$  (two tails) as critical region. To determine whether the *Ipomoea*'s resins are genotoxic to *Drosophila*, the frequency of spots from flies treated with resins from each one *Ipomoea* was compared to that from flies only exposed to solvents. To know if the resins modified the frequency of spots induced by NDMA, the frequency of spots from flies exposed to *Ipomoea*'s resin and NDMA, or NDMA and *Ipomoea*'s resins were compared separately to the frequency of spots from flies exposed only to NDMA.

2. The over dispersion in the distribution of the number of spots per fly from experimental and control series was compared with the non-parametric Kruskal-Wallis Test, and the differences between series were confirmed through the Dunn's Multiple Comparison Test (Sheskin, 2004).

**Results***Genotoxicity Assays:*

Type and frequency of spots. Tables 1 and 2 show the frequency and number of spots in transheterozygous *flr<sup>3</sup>/mwh* flies pretreated or post treated with resins from *I. purga*, *I. jalapa*, and *I. orizabensis*, respectively. None of the resins modifies in a significant manner the frequency of small, large and twins spots. Only slight deviations around the corrected control frequency of total spots, to their respective corrected controls were found, as is shown in Figure 2.

Spots per fly distribution. In experimental flies treated separately with each one of the resins, the spots distributed like in those unexposed, being the most of them spots free flies, a minor proportion showed one to three spots on their wings, and flies with 4 or 5 spots were rather rare. However, in treatments with the resin from *I. purga*, we observed a differential toxicity between first and third larval instars. For first instar larvae the treatment did not reduce larval viability, meanwhile for third instar larvae the treatment was toxic and interfered with the viability larvae-adult (data not shown).

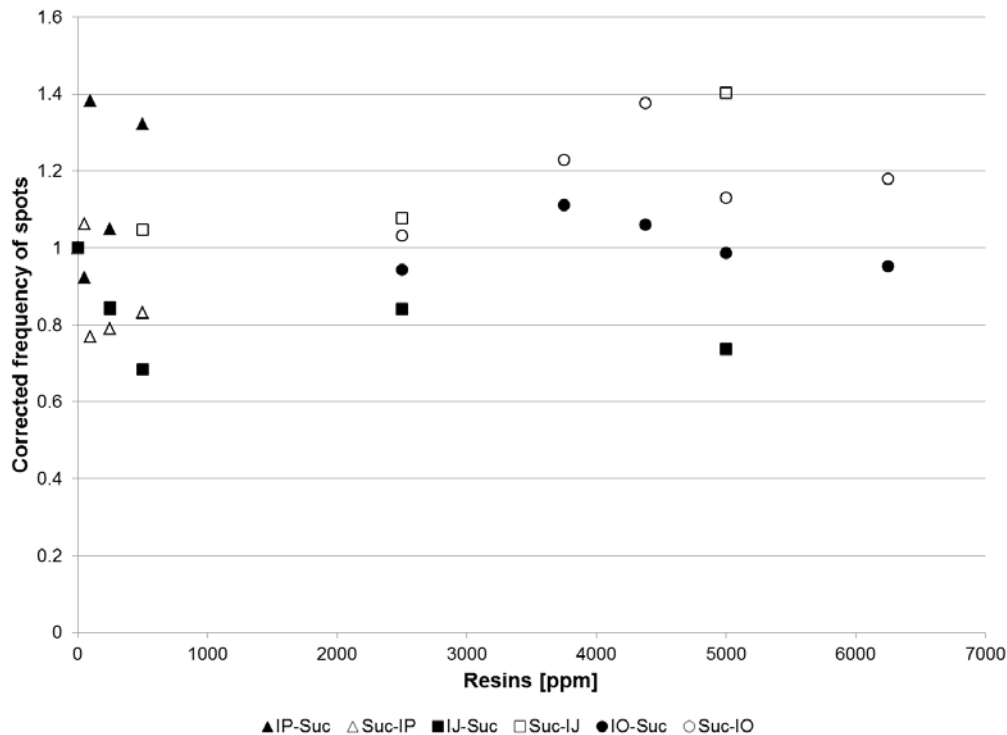

Figure 2. Corrected frequency of spots on the wings from flies exposed to resins from *I. purga*, *I. jalapa*, or *I. orizabensis* during larval development.

Table 1. Frequency and number of spots on the wings from flies pretreated with resins from *I. purga*, *I. jalapa* and *I. orizabensis* and treated with NDMA.

<i>Ipomoea</i> Extract	Number of Wings	Spots per Wing (Number of Spots) Statistical Diagnosis*							
		Small Single (m=2)		Large Single (m=5)		Twin (m=5)		Total (m=2)	
		Fr.	(Number)	Fr.	(Number)	Fr.	(Number)	Fr.	(Number)
[ppm] <i>I. purga</i> + [5%] Sucrose [E: 24X48X6]									
0	118	0.24	( 28 )	0.03	( 4 )	0.00	( 0 )	0.27	( 32 )
50	112	0.16	( 18 )-	0.05	( 6 )-	0.04	( 4 )	0.25	( 28 )-
100	120	0.31	( 37 )i	0.04	( 5 )-	0.03	( 3 )	0.38	( 45 )i
250	116	0.25	( 29 )-	0.01	( 1 )-	0.03	( 3 )	0.28	( 33 )-
500	120	0.28	( 34 )-	0.05	( 6 )-	0.03	( 3 )	0.36	( 43 )-
[ppm] <i>I. purga</i> + [12.5mM] NDMA [E: 24X48X6]									
0	120	0.83	( 100 )	1.09	( 131 )	0.15	( 18 )	2.08	( 249 )
50	118	1.08	( 127 )-	1.86	( 219 )-	0.36	( 43 )	3.30	( 389 )-
100	114	0.46	( 53 )+	0.91	( 104 )-	0.08	( 9 )-	1.46	( 166 )w
250	120	0.56	( 67 )w	1.14	( 137 )-	0.09	( 11 )	1.79	( 215 )-
500	120	0.67	( 80 )-	1.59	( 191 )-	0.20	( 24 )	2.46	( 295 )-
[ppm] <i>I. jalapa</i> + [5%] Sucrose [E: 24X48X6]									
0	120	0.23	( 27 )	0.04	( 5 )	0.05	( 6 )	0.32	( 38 )
250	120	0.23	( 27 )-	0.03	( 4 )-	0.01	( 1 )-	0.27	( 32 )-
500	120	0.17	( 20 )-	0.04	( 5 )-	0.01	( 1 )-	0.22	( 26 )-
2500	120	0.18	( 21 )-	0.07	( 8 )-	0.03	( 3 )-	0.27	( 32 )-
5000	120	0.13	( 16 )-	0.09	( 11 )-	0.01	( 1 )-	0.23	( 28 )-
[ppm] <i>I. jalapa</i> + [12.5mM] NDMA [E: 24X48X6]									
0	108	1.66	( 179 )	3.88	( 419 )	0.78	( 84 )	6.31	( 682 )
250	100	5.68	( 568 )+	6.97	( 697 )w	2.48	( 248 )w	15.13	( 1513 )+
500	120	4.00	( 480 )+	7.64	( 917 )w	2.46	( 295 )w	14.10	( 1692 )+
2500	120	3.43	( 411 )+	6.68	( 801 )w	2.08	( 250 )w	12.18	( 1462 )+
5000	120	1.61	( 193 )-	4.52	( 542 )-	1.08	( 129 )-	7.20	( 864 )-
[ppm] <i>I. orizabensis</i> + [5% Sucrose] [E: 24X48X6]									
0	120	0.10	( 12 )	0.04	( 5 )	0.01	( 1 )	0.15	( 18 )
2500	106	0.06	( 6 )-	0.08	( 8 )-	0.01	( 1 )-	0.14	( 15 )-
3750	120	0.13	( 15 )-	0.03	( 3 )-	0.02	( 2 )-	0.17	( 20 )-
4375	88	0.11	( 10 )-	0.05	( 4 )-	0.00	( 0 )-	0.16	( 14 )-
5000	108	0.14	( 15 )-	0.01	( 1 )-	0.00	( 0 )-	0.15	( 16 )-
6250	56	0.11	( 6 )-	0.02	( 1 )-	0.02	( 1 )-	0.14	( 8 )-

[ppm] *I. orizabensis* + [12.5mM] NDMA [E: 24X48X6]

0	116	1.11	( 129 )	3.08	( 357 )	0.66	( 76 )	4.84	( 562 )
2500	120	0.48	( 57 )+	2.19	( 263 )w	0.29	( 35 )w	2.96	( 355 )+
3750	120	0.43	( 51 )+	1.21	( 145 )w	0.23	( 27 )w	1.86	( 223 )+
4375	120	0.35	( 42 )+	0.63	( 75 )+	0.13	( 15 )+	1.10	( 132 )+
5000	120	0.31	( 37 )+	0.51	( 61 )+	0.08	( 9 )+	0.89	( 107 )+
6250	104	0.15	( 16 )+	0.15	( 16 )+	0.04	( 4 )+	0.35	( 36 )+

\* Statistical Diagnosis according to Frei and Würzler (1992),  $\alpha=\beta=0.05$ ; two side test; -, negative; +, positive; w, weak positive; i, inconclusive; Fr., Frequency.

Table 2. Frequency and number of spots on the wings from flies treated with NDMA and posttreated with resins from *I. purga*, *I. jalapa* and *I. orizabensis*.

<i>Ipomoea</i> Extract	Number of Wings	Spots per Wing (Number of Spots) Statistical Diagnosis*							
		Small Single (m=2)		Large Single (m=5)		Twin (m=5)		Total (m=2)	
		Fr.	(Number)	Fr.	(Number)	Fr.	(Number)	Fr.	(Number)
[5%] Sucrose + [ppm] <i>I. purga</i> [E: 72X6X48]									
0	120	0.30	( 36 )	0.02	( 2 )	0.00	( 0 )	0.32	( 38 )
50	116	0.26	( 30 )-	0.06	( 7 )-	0.02	( 2 )	0.34	( 39 )-
100	78	0.21	( 16 )i	0.04	( 3 )-	0.00	( 0 )	0.24	( 19 )i
250	76	0.17	( 13 )-	0.07	( 5 )-	0.01	( 1 )	0.25	( 19 )-
500	76	0.22	( 17 )-	0.04	( 3 )-	0.00	( 0 )	0.26	( 20 )-
[12.5 mM] NDMA + [ppm] <i>I. purga</i> [E: 72X6X48]									
0	118	1.24	( 146 )	2.68	( 316 )	0.37	( 44 )	4.29	( 506 )
50	112	1.27	( 142 )-	3.33	( 373 )-	0.46	( 51 )-	5.05	( 566 )-
100	96	1.17	( 112 )-	2.88	( 276 )-	0.36	( 35 )-	4.41	( 423 )-
250	108	1.02	( 110 )-	3.86	( 417 )-	0.75	( 81 )-	5.63	( 608 )-
500	118	1.23	( 145 )-	3.01	( 355 )-	0.46	( 54 )-	4.69	( 554 )-
[5%] Sucrose + [ppm] <i>I. jalapa</i> [E: 72X6X48]									
0	118	0.20	( 24 )	0.05	( 6 )	0.01	( 1 )	0.26	( 31 )
250	117	0.17	( 20 )-	0.03	( 4 )-	0.02	( 2 )-	0.22	( 26 )-
500	120	0.24	( 29 )-	0.03	( 4 )-	0.00	( 0 )-	0.28	( 33 )-
2500	120	0.23	( 27 )-	0.04	( 5 )-	0.02	( 2 )-	0.28	( 34 )-
5000	120	0.17	( 20 )-	0.04	( 5 )-	0.03	( 3 )-	0.23	( 28 )-
[12.5 mM] NDMA + [ppm] <i>I. jalapa</i> [E: 72X6X48]									
0	120	1.93	( 231 )	2.56	( 307 )	0.61	( 73 )	5.09	( 611 )
250	120	1.66	( 199 )-	2.53	( 303 )-	0.56	( 67 )-	4.74	( 569 )-

500	120	1.44	( 173 )-	2.75	( 330 )-	0.53	( 64 )-	4.73	( 567 )-
2500	120	1.51	( 181 )-	2.50	( 300 )-	0.49	( 59 )-	4.50	( 540 )-
5000	118	1.49	( 176 )-	2.78	( 328 )-	0.56	( 66 )-	4.83	( 570 )-

[5%] Sucrose + [ppm] *I. orizabensis* [E: 72X6X48]

0	118	0.14	( 16 )	0.03	( 4 )	0.00	( 0 )	0.17	( 20 )
2500	120	0.16	( 19 )-	0.01	( 1 )-	0.01	( 1 )-	0.18	( 21 )-
3750	120	0.17	( 20 )-	0.05	( 6 )-	0.00	( 0 )-	0.22	( 26 )-
4375	120	0.18	( 22 )-	0.03	( 4 )-	0.02	( 2 )-	0.23	( 28 )-
5000	120	0.13	( 15 )-	0.05	( 6 )-	0.02	( 2 )-	0.19	( 23 )-
6250	120	0.16	( 19 )-	0.03	( 4 )-	0.01	( 1 )-	0.20	( 24 )-

[12.5 mM] NDMA + [ppm] *I. orizabensis* [E: 72X6X48]

0	120	2.58	( 310 )	2.88	( 345 )	0.43	( 52 )	5.89	( 707 )
2500	112	0.79	( 88 )+	1.47	( 165 )w	0.38	( 42 )-	2.63	( 295 )+
3750	116	0.93	( 108 )+	0.82	( 95 )w	0.06	( 7 )+	1.81	( 210 )+
4375	120	0.64	( 77 )+	0.72	( 86 )+	0.17	( 20 )w	1.53	( 183 )+
5000	120	0.41	( 49 )+	0.68	( 82 )+	0.10	( 12 )+	1.19	( 143 )+
6250	120	0.16	( 19 )+	0.72	( 86 )+	0.13	( 15 )+	1.00	( 120 )+

\* Statistical Diagnosis according to Frei and Würigler (1992),  $\alpha=\beta=0.05$ ; two side test; -, negative; +, positive; w, weak positive; i, inconclusive; Fr., Frequency.

*Antigenotoxicity assays:*

For those assays, the promutagen NDMA was used and the frequency of spots was compared to that obtained from larvae exposed to NDMA and resins, either before or after the promutagen (Tables 1 and 2). The statistical diagnosis was made to value increasing or reduction in the frequency of spots in relation to that obtained from the positive control.

*I. purga*

Flies initially exposed to 50 ppm of *I. purga* resin and then to the promutagen showed on their wings more spots than flies exposed to the positive control, but not in sufficient number to increase the spots' frequency in a significant form. Treatments with 100 and 250 ppm reduce the frequency of spots, being this significant only at 100 ppm for small and total spots ( $p < 0.05$ ). The higher concentration does not modify the number and type of spots. The post treatment with *I. purga's* resin does not affect the frequency of spots induced by the NDMA acute treatment.

*I. jalapa*

The resin from *I. jalapa* roots induced a different effect, which was associated to NDMA acute exposure and the age of larvae at treatment. For first instar larvae, the pretreatment with this resin increases in a significant manner the frequency of all type of spots ( $p < 0.05$ ), except for the higher concentration assayed, as compared with that from NDMA treatment. For all the concentrations the effect was clearly positive for small and total spots and weak positive for large (except at 5000 ppm), and twins spots. For third instar larvae the response obtained was quite different, because the post treatment with the resin lack of any detectable activity. Here, the type and frequency of spots was similar to that from control positive flies.

*I. orizabensis*

The effect of treatments with this resin, administered before or after NDMA treatment, is to reduce, in a concentration dependent manner, the frequency of all type of spots ( $p < 0.05$ ). For flies pretreated, the frequency of small and total spots was significant lower than that from positive control treatment; for large and twins spots, the reduction was weak positive for 2500 and 3750 ppm, but clearly positive since 4375 to 6250 ppm ( $p < 0.05$ ). A similar effect was observed when post treatments with this resin were given. The frequencies of small and total spots were lower than those from positive control treatments ( $p < 0.05$ ), but for large spots, the first two concentrations gave a weak positive reduction, and higher concentrations were clearly effective ( $p < 0.05$ ). For twins spots, the administration of 2500 ppm of the resin does not reduce in a significant form the frequency of twins spots, but 3750, 5000, and 6250 ppm do reduce ( $p < 0.05$ ); and 4375 ppm treatment only induced a weak positive reduction. Figure 3 show the corrected frequency of total spots from pre and post treatments with *Ipomoea* resins.

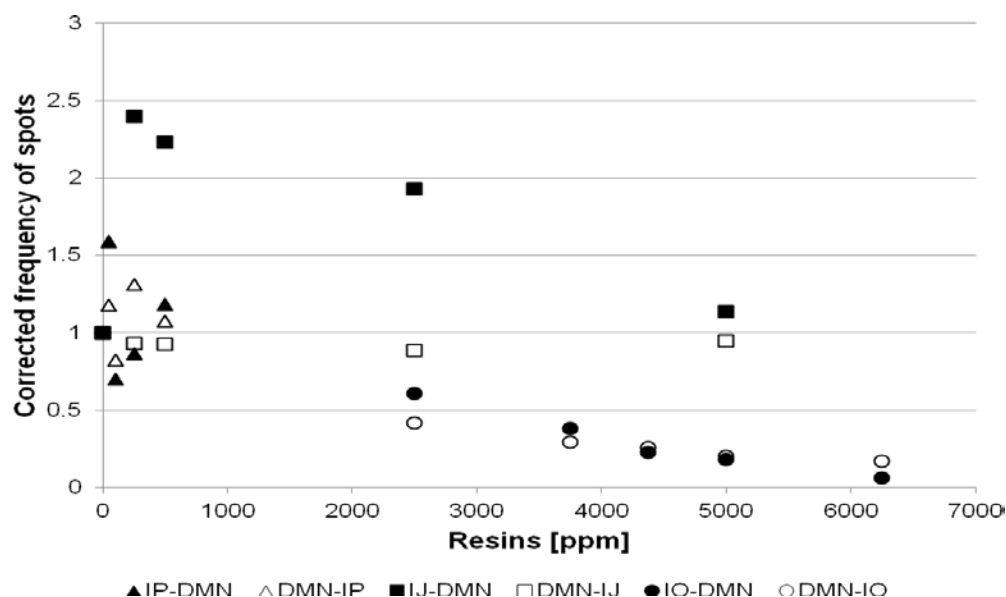

Figure 3. Corrected frequency of spots on the wings from flies exposed to NDMA and resins from *I. purga*, *I. jalapa*, and *I. orizabensis* during larval development.

*Spots per fly distribution*

*I. orizabensis*. This resin was the only one that showed antigenotoxic activity (Figure 4a and 4b). The Kruskal Wallis test found significant differences, which were confirmed through the Dunn's Multiple Comparison Test. The number of spots per fly, from flies exposed initially to *I. orizabensis* resin was different from that from positive control flies since 3750 ppm and higher ( $p < 0.001$ ). Flies pretreated with 2500 ppm showed a different distribution compared with those from 4375 to 6250 ppm ( $p < 0.001$ ). Also differences were detected between flies from 3750 vs. 5000 ( $p < 0.01$ ) and vs. 6250 ppm pretreatments ( $p < 0.001$ ). Finally, the distribution of the number of spots per fly from 4375 ppm pretreatment was different to that from 6250 ppm ( $p < 0.05$ ) (Table 3). Another side, for post treatments, significant differences was detected between flies exposed to NDMA and NDMA + resin at either concentration ( $p < 0.001$ ). Also dispersion was found among distributions from experimental series: 2500 vs. 4375 ( $p < 0.01$ ), 5000 and 6250 ppm ( $p < 0.001$ ), and finally those from 3750 vs. 6250 ppm ( $p < 0.05$ ) (Table 4).

**Discussion**

The unrestricted exposure to plant derivatives for therapeutic use can imply some hazard to humans, because, in despite of the therapeutic effectiveness attributed to the plants, the knowledge about the type and proportion of substances that they contain and the chemical interactions among these substances and their metabolites, are rather scarce. Reports about medicinal properties of plants have been focused mainly on the

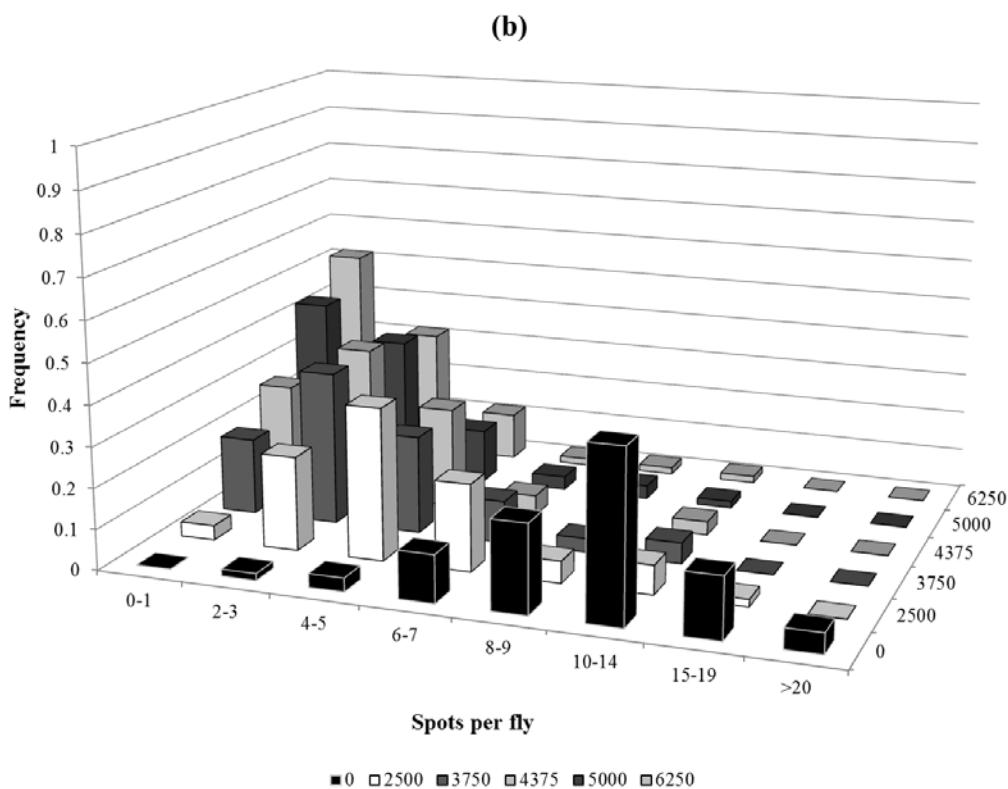
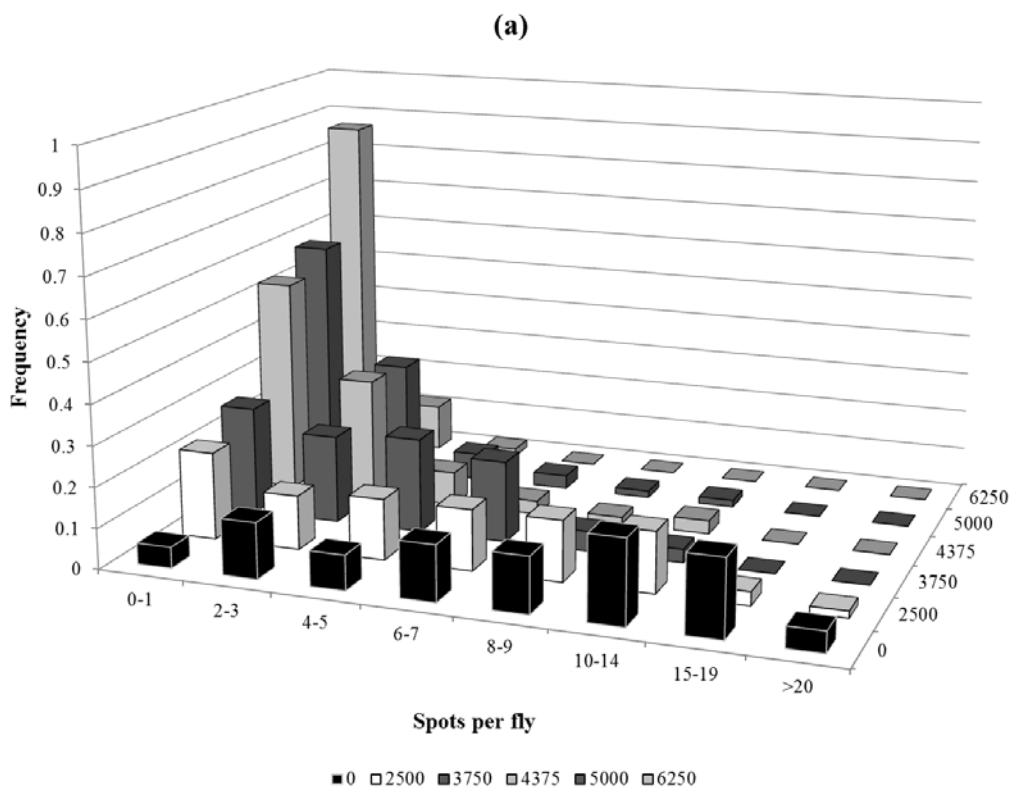

Figure 4. Frequency of spots per fly in flies exposed to *I. orizabensis* resin a) before or b) after an acute treatment with NDMA.



phytochemical composition of the plants, and the possibility of negative collateral effects associated to these kinds of practices have been not explored.

The genotoxic potential of three *Ipomoea* species was determined and compared through the SMART of *Drosophila melanogaster*.

Table 3. Comparison of the dispersion in the distribution of the number of spots per fly, from flies exposed to *I. orizabensis* - NDMA.

[ppm]	0	2500	3750	4375	5000
2500	ns				
3750	***	ns			
4375	***	***	ns		
5000	***	***	**	ns	
6250	***	***	***	*	ns

Statistical diagnosis according to the Kruskal Wallis Test. Differences confirmed through the Dunn Multiple Comparison; \*, p<0.05; \*\*, p<0.01; \*\*\*, p<0.001; ns, non significant.

Table 4. Comparison of the dispersion in the distribution of the number of spots per fly, from flies exposed to NDMA- *I. orizabensis*.

[ppm]	0	2500	3750	4375	5000
2500	***				
3750	***	ns			
4375	***	**	ns		
5000	***	***	ns	ns	
6250	***	***	*	ns	ns

Statistical diagnosis according to the Kruskal Wallis Test. Differences confirmed through the Dunn Multiple Comparison; \*, p<0.05; \*\*, p<0.01; \*\*\*, p<0.001; ns, non significant.

Differences related to the purging potency among the three *Ipomoea* species were reported previously (McDonald *et al.*, 1997; Perez Amador *et al.*, 1980, 1988; Meira *et al.*, 2012). 0.5 ml of a solution containing 0.2 g of the resin were used to instillate male rats, and the time elapsed since resin administration and excretion (diarrheic feces) was scored: *I. purga*, 30 min; *I. jalapa*, 45 min; *I. orizabensis*, 105 min. No feces from control males were recovered in the lapse scored (3 h). In addition, males exposed to *I. jalapa* showed toxicity symptoms like erected hairy, emetic reaction, unbalance, and posterior limbs distended.

#### Antigenotoxicity assays

There exist numerous reports about medicinal plant from *Ipomoea* genera, which in addition to their therapeutic effectiveness to reduce abdominal fever, dysentery, epilepsy, hydrocephalus, and meningitis (Martinez, 1990), some species contain glycosidic resins related to tumor inhibition. The ipolearoside, a glycoside extracted from the ethanolic fraction from whole plant *I. leari* showed a significant activity against the Walker carcinosarcoma 256 in rats (Bhakuni *et al.*, 1969; Sarin *et al.*, 1973); the intraperitoneal application of glycosides from *I. bahiensis* produced tumor growth inhibition against Sarcome 180 in mice (Bieber *et al.*, 1986); in mouse, the methanolic extract from *I. pes-caprae* exhibits antinociceptive activity against pain (De Souza *et al.*, 2000); the subcutaneous injection of the acid extract from *I. orizabensis* produces tumor damage against 37 sarcoma in mice (Bilkin and Fitzgerrald, 1952) and exhibit weak cytotoxicity against oral epidermoid carcinoma in humans (Hernandez-Carlos *et al.*, 1999).

No clear evidence about genotoxic activity was observed in flies treated with each one of the resins, and only random variations around the control frequency of somatic mutation and mitotic recombination were recovered, but wide differences related with toxicity of them were evident, when the concentrations to be assayed were chosen. To select the concentration to be assayed, preliminary tests were run to determine the higher concentration after which 80% or more of the exposed flies survived. This criterion was adopted based in the fact that, in this kind of traditional practice, the supervision of concentration and dosage used is rather inexistent. In addition, we try to choose two concentrations overlapped in order to establish comparisons among the three species. However, the higher concentration was clearly different among the *Ipomea* species, which showed be toxic for *Drosophila* as follow: *I. purga* [500 ppm] > *I. jalapa* [5000 ppm] > *I. orizabensis* [6250 ppm]. For *I. purga*, concentrations upper 500 ppm were toxic for three instar larvae, but not for first instar larvae. That is supported by previous reports showing that metabolism of *Drosophila* larvae varies with age (Fuchs *et al.*, 1993). The *I. orizabensis* resin is not toxic at all.

In this study, the alkylating promutagen NDMA was used to induce somatic mutation and mitotic recombination in the wing version of the SMART, due: 1) this compound increases several times the spontaneous frequency of spots on the wings, making unambiguous the quantification of the antigenotoxic activity; 2) is a promutagen that implied several steps for their activation and posterior elimination and excretion, offering numerous opportunities to establish chemical interactions with compounds assayed for antigenotoxic potential; 3) its toxicity for the *in vivo* system of *Drosophila* is rather low (Ramos-Morales *et al.*, 2001). The effect of the administration of resins at two different ages allows us to distinguish genotoxic activity in two aspects: one related to the age of the larvae at treatment and the other independent of age.

The pretreatment with *I. purga* resin changes slightly the frequency of somatic spots obtained from flies exposed only to NDMA. The lower concentration of the resin seems to induce some spots, although the higher concentration produced a significant reduction in the frequency of spots on the wings, but this protection was less effective as the concentration increased. In contrast, no evident interaction was observed in post treatments.

For *I. jalapa*, we assume that some resin metabolites associated to the incomplete metabolism of first instar larvae enhanced the NDMA activity, because this enhancement does not persist when larvae were third instar at treatment. The metabolism of *Drosophila* is based in an enzymatic system dependent on Cytochrome P450, and the reactions implied in detoxification of genotoxins are quite similar to that from S9 microsomal fraction from mammal liver, and there exist reports about the genetically determined variation in the level and induction of Cytochrome P450 and the effect of NDMA in somatic cells or associated to developmental stages of the fly (Baars, *et al.*, 1980; Clark, 1982; Hällstrom, *et al.*, 1983, 1985).

Nevertheless the enhanced effect of NDMA after the exposure to the *I. jalapa* resin is evidence that this promutagen is efficiently detected and transformed by *Drosophila* larvae when possess a mature metabolism. It is possible that the resin from *I. jalapa* contain some compounds that, in combination with this promutagen, have a synergistic effect in younger larvae, maybe prolonged the half-life of metabolites produced, delayed their detoxification, or retarded the maturation of enzymatic larval system (Fuchs *et al.*, 1993). The absence of this synergistic effect when NDMA is administrated previous to the resin suggest that this response could be associated to initial steps implied in the biotransformation to this promutagen.

In our group, we have observed that the number of spots per fly is a reliable indicator of the metabolic activity in *Drosophila*. As more steps are involved in the biotransformation/detoxification of genotoxins, the number of flies carrying numerous spots increased, too. Third instar larvae of *Drosophila* exposed during 6 h to the alkylant mutagen N-nitrosodiethylamine [1-20 mM] became adults carrying up to 6 spots on their wings. In contrast, larvae treated as quoted to N-nitrosodimethylamine [1-50 mM], became adults showing up to 26 spots on their wings (Ramos-Morales *et al.*, 2001). The dispersion on the distribution of the number of spots per fly can be associated with metabolism genes from the population treated, and make evident the diversity in the individual susceptibility from organisms exposed to the same stimulus.

No more dispersion in the distribution of spots per fly, than that produced by treatment with NDMA, was observed in flies pretreated with the *I. purga* resin, and a weak dispersion was induced when the resin was given after NDMA. In contrast, a strong dispersion, as compared to the distribution of spots per fly induced by NDMA treatment, was recovered from the *I. jalapa* treatments, been higher from pretreatments, but also detected when the resin was administered after NDMA.

For *I. orizabensis*, an effect independent of larval age was observed. In both types of exposures, the resin from *I. orizabensis* reduced in a concentration dependent manner the NDMA genotoxicity, without some kind of toxicity. This similarity in the protection pattern observed suggests, that the components of this resin interfere with the biotransformation of NDMA, probably trapping the intermediary metabolites in a similar way as Vitamin-C does (Shankel *et al.*, 1987). We assume this on the fact that no more steps in metabolism implied in biotransformation/detoxification of NDMA activity were induced, as can be appreciated in Figure 4. The dispersion in the distribution of spots per fly was gradually lower, as the concentration of *I. orizabensis* resin increased, in both types of exposure; that suggests that no different steps in the metabolic pathway involved in the biotransformation of NDMA were implied. So, the frequency of spots recovered in pre- and posttreatments with *I. orizabensis* indicate that only a minor fraction of reactive metabolites escaped to be trapped by *I. orizabensis* resin. In this treatment, the viability larvae-adult was in the range of 80%, compared

to the number of flies recovered in concurrent negative controls, allowing us to discard treatment toxicity as the cause of the reduction in the number of spots.

In sum, the efficient reduction in the frequency of somatic mutation and recombination observed in *I. orizabensis*-NDMA treatments, altogether with the absence of toxicity, the characteristic distribution of the number of cells per spot, and the reduction in the number of spots per fly, without interference in the viability larvae-adult, allow us to propose that *I. orizabensis* resins contain substances with antimutagenic activity that effectively protect to *Drosophila* larvae from NDMA mutagenicity. It is important to know whether the antimutagenic activity detected in the *I. orizabensis* resin is efficient against other promutagens and mutagens from different chemical species. On the other side, more work is required to determine which compound or metabolite, or the interaction of some of them, is associated to the antimutagenic activity found in the *I. orizabensis* resin.

In *I. orizabensis*, the presence of scammonine I and II and orizabins V-VII, which are cytotoxic to some human epidermal carcinomas, and orizabins IX-XXI, which are cytotoxic to human colon cancer, has been reported (Meira *et al.*, 2012)

Although progress has been made in the study of the activity of chemical derivatives of the genus *Ipomoea*, it is necessary to explore other species for which the information is rather scarce as in *I. jalapa*, *I. operculata*, and *I. parasitica*, among others.

Another side, the SMART and the *Drosophila* system, are confirmed as reliable tools to establish the potential mutagenic and antimutagenic of chemicals. Actually, *Drosophila* is one of the few *in vivo*, sensitive systems that provides of valious information about the different composition of complex mixtures, and the individual susceptibility of members from the same population exposed could help to find evidence about the early effect of genotoxins.

Acknowledgments: Workshop Students (93.1- 93.2), UNAM.

References: Anaya, A.L., 1990, *J. of Chem. Ecology* 16: 2145-2152; Baars, A.J., W.G.G. Blijleven, G.R. Mohn, A.T. Natarajan, and D.D. Breimer 1980, *Mutation Research* 72: 257-264; Bah, M., and R. Pereda-Miranda 1997, *Tetrahedron* 53: 9007-9022; Bauser, S.C., 1937, *Torreya* 37: 25-32; Bhakuni, D.S., M.L. Dhar, M.M. Dhar, B.N. Dhawan, and B.N. Mehrotra 1969, *Indian J. Exp. Biol.* 7: 250; Bieber, D.S., A.D.S. Alves, L.R.M.O. Correa, A.C. De Andrade, D.N.S. Carneiro, I.A. De Souza, J.F. De Mello, and H.J. Veith 1986, *Phytochemistry* 25: 1077-1081; Bilkin, M., and D.B. Fitzgerrald 1952, *J. Nat. Cancer. Inst.* 13: 139-149; Cabrera, G.L., 1975, *Yerbario mexicano*. Gómez Gómez Hnos. Eds. México 239 pp; Clark, M., 1982, *Mutation Res.* 2: 89-97; De Souza, M.M., A. Madeira, C. Berti, R. Krogh, R.A. Yunes, and V. Cechinel-Filho 2000, *R. Br., J. of Ethnopharmacology* 69: 85-90; Frei, H., and F.E. Würigler 1995, *Mutation Res.* 334 (1995) 247-258; Frei, H., and F.E. Würigler 1988, *Mutat. Res.* 203: 297-308; Fuchs, S.Y., V.S. Spiegelmen, and G.A. Belitsky 1993, *J. Biochem. Toxicology* 8(2): 83-88; García-Bellido, A., and J. Dapena 1974, *Molec. Genet.* 128: 117-130; Graf, U., E. Würigler, A.J. Katz, H. Frei, H. Juon, C.B. Hall, and P.G. Kale 1984, *Environ. Mutagen.* 6: 153-188; Hällstrom, I., A. Blanck, and S. Atuma 1983, *Chem. Biol. Interact.* 46: 39-54; Hällstron, I., J. Magnusson, and C. Ramel 1985, *Mutat. Res.* 92: 61-168; Hernández-Carlos, B., R. Bye, and R. Pereda-Miranda 1999, *J. Nat. Prod* 62: 1096-1100; Lindsley, D.L., and G. Zimm 1990, *Dros. Inf. Serv.* 68: 382 pp; Martínez, M., 1990, *Las plantas medicinales de México*. Ed Botas. México pp 267-279; McDonald, A., J.S. Flores, J. Morales-Rosas, A.N. Garcia-Argaez 1997, *Convolvulaceae: taxonomía y florística*. Etnobotanica, Universidad Autónoma de Yucatán Merida, Yuc., 157 pp; Meira, M., E. Pereira da Silva, J.M. David, and J.P. David 2012, *Brazilian Journal of Pharmacognosy* 22(3): 682-713; Noda, N., T. Kogetsu, T. Kawasaki, and K. Miyahera 1990, *Phytochemistry* 11: 3565-3569; Noda, N., M. Ono, K. Miyahara, T. Kawasaki, and M. Okabe 1987, *Tetrahedron* 43: 3889-3902; Nöthiger, R., 1970, *Dros. Inf. Serv.* 45: 177; Pedraza, R.A., 1982, *La raíz de jalapa INIREB informa*. Comunicado No 54 sobre recursos bióticos del país. México; Pereda-Miranda, R., 1995, *In: Phytochemistry of Medicinal Plants*, (Arnason, J.T., R. Mata, and J.T. Romeo, eds.). Plenum Press: New York, pp 83-112; Perez-Amador, M.C., A.N. Garcia-Argaez, G. Varala, and F. Garcia-Jimenez 1988, *Phyton* 48: 97-99; Perez-Amador, M.C., E.A. Gonzalez, J. Marquez, J. Bailin, F. Garcia-Jimenez, and O. Collera 1980, *Phyton* 39: 85-94; Peterson, J.K., and H.F. Harrison 1991, *J. of Chem. Ecology* 17: 943-955; Ramos-Morales, P., M.G. Ordaz, A. Dorantes, H. Rivas, P. Campos, M. Martínez, and B. Hernández 2001, *Drosophila is a reliable biomonitor of water pollution*, *In: Biomonitoring and Biomarkers as Indicators of Environmental Change: A Handbook*, Part II, (Butterworth, F.M., A. Gunatilaka,

and M.E. Gonsbatt, eds.), Kluwer Academic/Plenum Publishers, New York, pp. 257-299; Sarin, J.P.S, H.S. Garg, N.M. Khanna, and M.M. Dhar 1973, *Phytochemistry*. 12: 2461-2468; Shankel, D.M., P.E. Hartman, T. Kada, and A. Hollander 1987, *Environmental Mutagenesis* 9: 87-103; Sheskin, D.J., 2004, *Handbook of Parametric and NonParametric Statistical Procedures*, 3rd. ed., Chapman and Hall/CRC, New York, 1184 pp.

## Technique Notes



### Primary culture of *Drosophila* larval neurons with morphological analysis using NeuronMetrics.

**Smrt, Richard D.<sup>1,2,\*</sup>, Sara A. Lewis<sup>1,3</sup>, Robert Kraft<sup>1</sup>, and Linda L. Restifo<sup>1,2,3,4</sup>.**

<sup>1</sup>Department of Neuroscience, <sup>2</sup>Center for Insect Science, <sup>3</sup>Graduate Interdisciplinary Program in Neuroscience, Department of Neurology, University of Arizona, Tucson, AZ, USA. Email: richardsmrt@gmail.com, <sup>4</sup>LLR@email.arizona.edu; \*current: <http://www.psynapticmedia.com/>

Keywords: axon, brain, dendrite, dissociation, image analysis, immunofluorescence, insect, neurite arbor, neurite outgrowth, neurogenetics, software

Primary dissociated cultures of developing CNS neurons provide a powerful experimental system with which to investigate the effects of genetic or chemical manipulations on neuronal differentiation, morphology, and function. A number of methods, based on dissociating CNS tissue from *Drosophila melanogaster* during development, yield cell cultures of primarily neuronal lineage, *i.e.*, neurons and neuroblasts, with few if any glia (Wu *et al.*, 1983; O'Dowd and Aldrich, 1988; Kraft *et al.*, 1998; Küppers-Munther *et al.*, 2004; Sanchez-Soriano *et al.*, 2005; Sicaeros *et al.*, 2007; Moraru *et al.*, 2012). By choosing a specific developmental stage, one can study the neuronal plasticity by which the CNS matures and undergoes remodeling during metamorphosis. By choosing the plating density, one can study individual neurons in isolation or, alternatively, neurons engaged in cell-cell interactions. These approaches are further enhanced by the use of genetic markers that allow neural subtypes to be identified in cell culture (Egger *et al.*, 2013), such as mushroom body neurons (Kraft *et al.*, 1998; Su and O'Dowd, 2003).

One of the great advantages afforded by low-density primary neuronal culture is the ability to reveal **cell-autonomous** characteristics of neurons under physiological and pharmacological conditions. This has been particularly important for identifying intrinsic properties, such as regional specialization of axonal compartments (Katsuki *et al.*, 2009), the localization and transport of ribonucleoprotein particles (Barbee *et al.*, 2006), temperature-dependent membrane excitability (Peng *et al.*, 2007), and spontaneous calcium transients (Jiang *et al.*, 2005) in dissociated neurons differentiating *in vitro*. Similarly, steroid hormone-dependent developmental transitions, such as neurite outgrowth of interneurons undergoing remodeling (Kraft *et al.*, 1998) and segment-specific programmed motor neuronal cell death (Winbush and Weeks, 2011) do not require any cell-cell contact *in vitro*. Neurons with distinctive axonal and dendritic arborization morphologies *in vivo* recapitulate those morphogenetic features when cultured *in vitro* (Kraft *et al.*, 1998, 2006; Sanchez-Soriano *et al.*, 2005). Selective vulnerability to specific neurotoxins and pharmacological rescue thereof can also be demonstrated *in vitro* (Wiemerslage *et al.*, 2013). Furthermore, isolated neurons can reveal mutant phenotypes, such as initial events of neurite outgrowth (Kim and Wu, 1987, 1996; Sánchez-Soriano *et al.*, 2009), neurite-arbor morphology (Kraft *et al.*, 2006; Peng *et al.*, 2007), ion channel physiology (O'Dowd *et al.*, 1989), and toxicology (Suzuki and Wu, 1984; Martin *et al.*, 2000).

When cultured at high density, dissociated *Drosophila* neurons form networks connected by chemical synapses, gap junctions, and neurite fasciculation (Rohrbough *et al.*, 2003; Oh *et al.*, 2008; Saad *et al.*, 2012). Classical physiology and pharmacology approaches along with genetic markers and mutations have been used to characterize excitatory and inhibitory synaptic transmission (Lee *et al.*, 2003; Su and O'Dowd, 2003), as well as synaptic plasticity (Lee and O'Dowd, 2000; Campuzano *et al.*, 2007). Importantly, some aspects of synaptic function, such as action-potential-independent neurotransmitter release mediated by Ca(v)2-type calcium channels, have been revealed by cultured brain neurons but not at the neuromuscular junction (Gu *et al.*, 2009). This is particularly relevant for studying genes whose human orthologs are mutated in developmental brain disorders that cause cognitive and behavioral phenotypes (Inlow and Restifo, 2004; Restifo, 2005; Bolduc and Tully, 2009; Gatto and Broadie, 2011).

One of the most promising applications of primary neuronal culture in the *Drosophila* genetic system is for drug discovery, in particular with the goal of treating disorders of brain development. We have already reported results of a first-of-its-kind small-molecule drug screen using *singed*-mutant cultured neurons as a cell-based assay for fascin function (Kraft *et al.*, 2013). Making use of the dramatic “filagree” neurite-trajectory phenotype (Kraft *et al.*, 2006), we identified chemically diverse blockers and enhancers of the fascin pathway and formulated several structure-activity relationship hypotheses. That same drug screen revealed a striking toxic effect of statin compounds (HMG-CoA reductase inhibitors) on neurite outgrowth, the “beads-on-a-string” morphogenesis defect, that is enhanced by lack of the actin-bundling protein fascin (Kraft *et al.*, 2013). This and other examples of drug-induced morphological neurotoxicity set the stage for use of *Drosophila* neuronal cultures to drive the identification of Gene- $\times$ -Environment interactions that disrupt brain development (Halladay *et al.*, 2009).

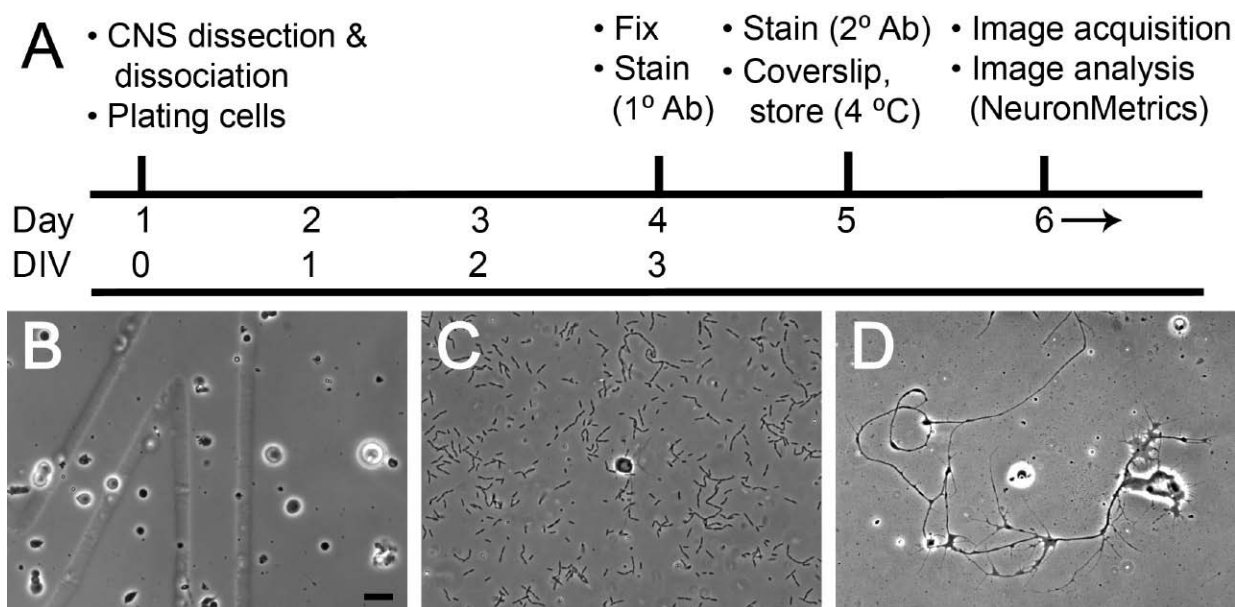

Figure 1. Primary neuronal culture timeline and outcomes. (A) Diagram of a typical experiment. On day 1, the CNS from a w3L is dissected and dissociated, and the cells are plated. The dishes are flooded with culture medium. On day 4, after the neurons have spent 3 div, the cultured cells are chemically fixed and incubated with a primary antibody (*i.e.*, anti-HRP) overnight. On day 5, the neurons are stained with a fluorescent secondary antibody, mounted, coverslipped, and stored at 4°C in the dark. From day 6 onward, neuron images can be acquired using fluorescence microscopy and analyzed quantitatively using NeuronMetrics. (B-D) Phase-contrast images acquired through a 60 $\times$  objective, with same magnification. (B) Dissociated CNS cells immediately after flooding (2 hr after plating), showing the desired density. Part of the alphanumeric grid (top of “4”) is visible under the cells. (C) A 1-div culture, showing yeast contamination, with numerous yeast cells, many in chains, present throughout the field. A single neuron, with a modest neurite arbor, is seen in the center of the field. (D) Wild-type neuron from a 3-div culture, with extensive neurite outgrowth and branching, and growth cones still visible. A long neurite from a nearby cell enters the field from the top.

In this protocol we detail methods for dissociation of enzyme-treated larval CNS tissue by manual mechanical dissociation into individual neurons (Figure 1). The cultured neurons elaborate complex neurite arbors on a laminin-coated substrate over several days. By 3 days *in vitro* (div), differences between wild-type and mutant neurons are often evident by phase-contrast microscopy. For larval cultures prepared with this protocol, neuroblast proliferation is complete and no Repo-positive cells are detected by 3 div (Luedeman,

Chuang, Levine, and Restifo, unpublished observations). Immunofluorescent staining for a neuronal membrane marker, recognized by anti-HRP antisera, generates high-contrast, low-noise images that faithfully reproduce the morphology of living *Drosophila* neurons (Kraft *et al.*, 1998). For quantification of neurite-arbor size and shape, we further demonstrate the use of NeuronMetrics software, a set of plugin modules for ImageJ that carry out semi-automated morphometric analyses of digital 2D images of fluorescently labeled neurons (Narro *et al.*, 2007). NeuronMetrics is available without charge to academic users through Tech Transfer Arizona ([Technology #ua07-056](#)).

## Protocol

### 1) Advance preparations

#### 1.1) Prior to the day of the dissection

1.1.1) Review the overall timeline (Figure 1), recipes (Reagents and Supplies, Table 1), and the dissection protocol detailed below (Section 2). Make sure you have all of the necessary tools, reagents, and that wandering larvae will be available on the day of dissection.

1.1.2) Prepare culture dishes. For homemade dishes, drill 8-mm holes into the centers of 35-mm polystyrene culture dishes. Create a well by securing a glass coverslips (plain or gridded) to the bottom of the dish with a thin layer of Sylgard. Alternatively, pre-made dishes can be purchased from MatTek with 7- or 10-mm wells. Sterilize the dishes by UV exposure for two hours.

1.1.3) Coat the glass-bottom wells with Concanavalin A and laminin (“ConA/laminin”; see Materials, Table 2) to provide a substrate that promotes cell adhesion and neurite outgrowth. Thaw fresh aliquots of ConA (1 mg/ml) and Laminin (1 mg/ml) slowly at 4°C. Add 400 µL ConA to 2 mL sterile water in a small sterile tube. The ConA stock solution is very viscous; flush the pipette tip a few times and mix. Add 4 µL laminin; vortex to mix. Split coating solution into two sterile 1.5-ml tubes and spin in microcentrifuge (16000 × g) at 4°C for 10 minutes. Combine supernatants in a new sterile tube. Use sterile tips to pipette coating solution into wells (100 µL per 8-mm well or 150 µL per 10-mm well) and to spread it carefully to the edges. Do not touch the glass bottom with the pipette tip. Leave dishes in 37°C humidified incubator for 2 hours, then rinse without touching the glass bottom by gently pipetting 6 mL of sterile water onto the well and simultaneously suctioning off the water with a sterile Pasteur pipette attached to a vacuum line. Store coated dishes at room temperature protected from light. For critical experiments, dishes should be used within 2 weeks of coating.

1.1.4) Prepare fresh culture medium by adding FBS, insulin, and NaOH to Schneider’s *Drosophila* Medium (“S10-I” in Materials Table 2). This can be used for up to three weeks when stored at 4°C protected from light.

#### 1.2) On the day of dissection (Day 1)

1.2.1) In the dissection area, clean the entire work surface thoroughly with 70% ethanol. Set aside a test tube rack (rinsed with ethanol) to hold solutions used for dissection. Soak two pairs of forceps (Dumont #5, Figure 2), a sable paintbrush, two applicator-stick-mounted minuten pins, and a 10-well glass dish with 70% ethanol between paper towels.

1.2.2) In the tissue culture hood (ideally, a biosafety cabinet), clean the entire work surface thoroughly with 70% ethanol, preferably wearing gloves sprayed with 70% ethanol. If you are not using gloves, wash your hands with soap and water, then rub your hands with gel alcohol. Use sterile technique and supplies (Pasteur

pipettes, microcentrifuge tubes, volumetric pipettes, and pipette tips). All sterile tubes, solutions, or reagents should be opened only in the hood.

1.2.3) Prepare a working dilution of enzymes (Liberase DH, collagenase with a high concentration of dispase) in Rinaldini's saline (0.21 Wunsch units/ml; see Recipes). For each CNS sample to be dissociated, place 300  $\mu$ l of enzyme solution in a labeled 1.5-ml microcentrifuge tube and place at the dissection station. These enzymes digest the extracellular matrix (ECM) to facilitate mechanical dissociation of the tissue into individual cells.

1.2.4) Assemble in the hood *Drosophila* S10-I culture medium, sterile purified (18-M $\Omega$ ) H<sub>2</sub>O, and sterile screw-top tubes and sterile volumetric pipettes. For each sample, you will need 3 mL of water and 8.25 – 12.25 mL culture medium, as follows: 2.5 mL for dissection, 2 mL for wetting pipettes, 2.75 mL for dissociation, and 1 mL per dish for flooding (each sample will be distributed into 1-6 dishes; see Section 4).

1.2.5) Assemble the following at the dissection area next to the microscope (Figure 2): (a) one autoclaved Pasteur pipette per sample (can be placed in a sterile plastic tube for transport to the dissection area); (b) one multi-well dish for washing and dissecting larvae (e.g., a 10-well glass Boerner slide); (c) one paintbrush (red sable bristles work well); (d) dissection forceps; (e) two dissecting pins for final trimming (e.g., wooden applicator sticks, each with a minutien pin embedded in one end); (f) one sterile 1.5-mL microcentrifuge tube with 300  $\mu$ l of Liberase DH enzyme solution for each sample; (g) one tube containing 3 mL sterile purified H<sub>2</sub>O per dissection (for washing larvae); (h) one tube containing 2.5 mL of culture medium; (i) one tube containing 1 mL of 95% ethanol. These volumes provide sufficient fluids for a single CNS sample; scale up as needed.

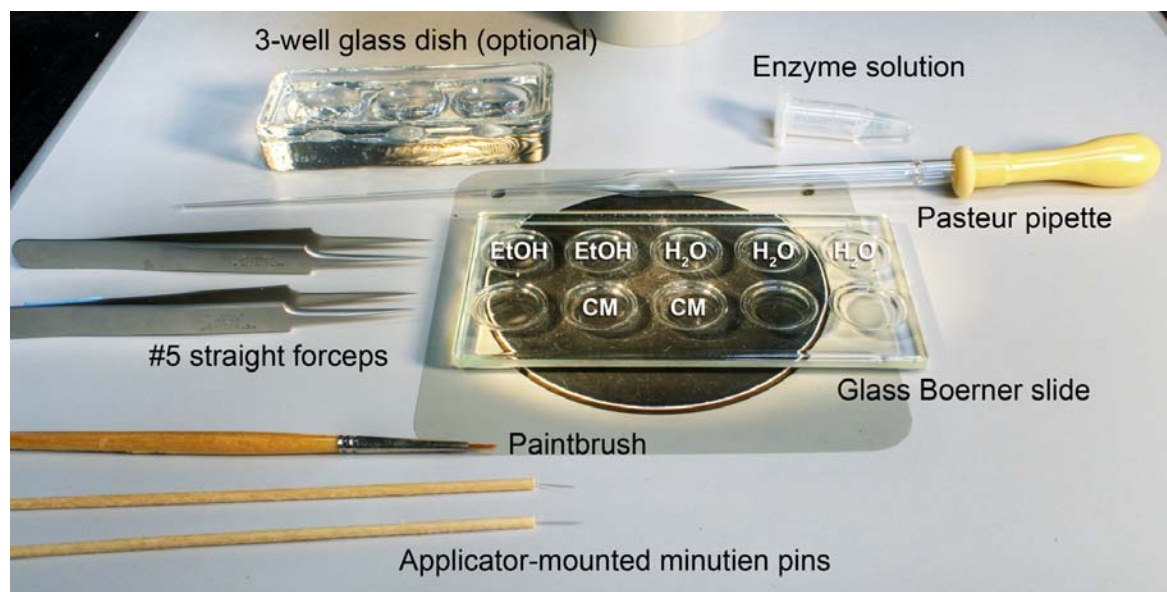

Figure 2. Tools and materials used during the *Drosophila* larval CNS dissection, shown on a stereomicroscope stage. The 3-well glass dish is used for examining larvae and making final selections. The shallow wells of a glass Boerner slide are convenient for cleaning and dissecting the larva. The paintbrush is used to clean and transfer the larva between wells (EtOH, ethanol; H<sub>2</sub>O, water; CM, culture medium). The Dumont #5 forceps are used for microdissection, to expose and explant the CNS. The wooden applicator-mounted minutien pins are used to remove non-neuronal tissue (e.g., imaginal discs and the ring gland) and to trim the peripheral nerves. The CNS can then be transferred into the tube of enzyme solution using a Pasteur pipette.



## 2) CNS dissection

### 2.1) Selection of larvae.

This may be done at a non-sterile lab bench. Use a paintbrush to carefully remove individual wandering third instar larvae (w3L) from the wall of their culture vial, avoiding any undersized, prematurely wandering larvae. Within the wandering stage, fast-moving larvae are younger while older w3L are slower-moving. If comparing multiple conditions or genotypes, match the larvae for developmental stage, sex, culture density, diet (“fly food”), and rearing conditions such as light and temperature. Transfer each selected larva from the paintbrush to a small tube or Petri dish (but do not seal tightly), using separate tubes or dishes for each genotype or condition.

### 2.2) Clean each larva before dissection.

Fill two wells of the 10-well dish with 95% ethanol, starting at the top left (Figure 2). Fill the next three wells with sterile purified H<sub>2</sub>O. Fill two wells in the bottom row with culture medium. Using a brush wetted with water, transfer the larva to an ethanol-containing well and soak for 1 minute. Gently brush the length of the larva to loosen any surface debris. Roll the larva and repeat on the other side. Transfer the larva to purified H<sub>2</sub>O to rinse off the ethanol, using the brush to move the larva to each of the three wells, and for gently brushing if needed. Use forceps to transfer the clean larva to a well containing culture medium for dissection.

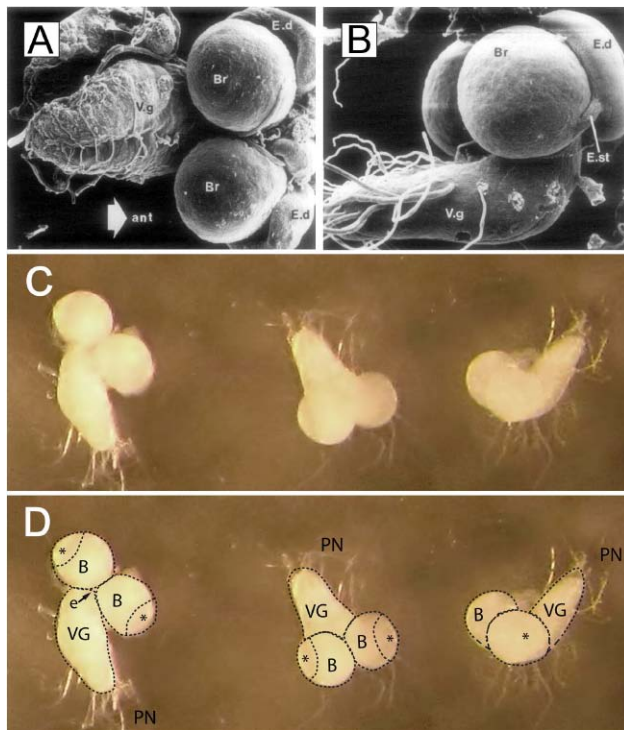

Figure 3. Larval CNS gross anatomy. (A, B) Scanning electron micrographs of larval CNS, with attached eye imaginal discs (E.d), viewed from above (A) and from the side (B); anterior is to the right. Numerous peripheral nerves are seen extending from the ventral (thoracoabdominal) ganglion (V.g). Each eye disc is very closely apposed to the ipsilateral brain lobe (Br), connected by a short stalk (E.st). (Reprinted from *Developmental Biology*, Vol. 65, K. White and D.R. Kankel, Patterns of cell division and cell movement in the formation of the imaginal nervous system in *Drosophila melanogaster*, Pages 296-321, 1978, with permission from Elsevier.) (C) Three freshly microdissected larval CNS in a culture well, each one at a slightly different orientation, viewed through the stereomicroscope. Note that all of the peripheral nerves have been cut short. (D) Same image as in (C), but with an overlay of dotted lines that represent visible anatomical boundaries of interest. Asterisks (\*) indicate the optic lobes. B, brain; VG, ventral ganglion; PN, peripheral nerves; e, approximate location of esophageal canal.

### 2.3) Explant the CNS (Figure 3).

Use two pairs of fine forceps (Dumont #5) to remove the posterior quarter of the larva: clamp with the forceps on the anterior side and pull with the other forceps. Expose the CNS by inverting the anterior portion over the forceps (this is analogous to turning a sock inside out). Explant the CNS by carefully severing the peripheral nerves connecting the CNS to the larval body wall. To avoid damaging the CNS, clamp the peripheral nerves with the forceps adjacent to the CNS and pull with the other forceps, or use one blade of the forceps on the distal side to slice through the nerve. Carefully remove the imaginal discs as well, avoiding damage to the optic lobes when severing the short stalk that connects the eye/antennal disc to the CNS. Use forceps to transfer the CNS to the next well containing fresh culture medium. Use the minutien pins, mounted on wooden applicator sticks, for precision cleanup. Do not leave long pieces of peripheral nerve, which readily stick to

surfaces (see Figure 3 for guidance). Failing to cut them short can result in loss of the sample prior to or during the dissociation process.

#### **2.4) Optional regional dissection** (Figure 3B)

Minutien pins embedded in the ends of wooden applicators can be used for fine dissection to separate CNS regions, *i.e.*, in order to isolate the optic lobes or segmental ganglia (ventral ganglion plus subesophageal ganglion) or the brain, as needed.

#### **2.5) Enzyme treatment of the CNS**

Use a sterile Pasteur pipette that has been pre-wetted with culture medium to transfer the CNS to the microcentrifuge tube containing the enzyme solution. (Pre-wetting is essential to prevent tissue from sticking to the pipette.) Place the tube containing freshly explanted CNS and enzyme to the tissue culture hood. Incubate for 1 hour.

#### **2.6) Repeat the above steps for each larva.**

Dispose of the larval carcass according to the biosafety protocols approved by your institution. Between dissections, clean the multi-well glass dish, the paintbrush, forceps, and minutien pins with ethanol and dry with Kimwipes. Use a new Pasteur pipette for each larva.

**3. CNS dissociation by mechanical trituration** (These steps take place in the hood. Remember to spray your gloves with ethanol each time you begin work in the hood or return to the hood.)

#### **3.1) Verify that the following are available in the hood:**

S10-I culture medium, sterile microcentrifuge tubes, Pasteur pipettes, a micropipettor, and 200- $\mu$ L micropipette tips.

#### **3.2) Wash the tissue to remove the enzyme.**

Use a sterile Pasteur pipette, wetted with culture medium, to transfer the CNS to a microcentrifuge tube containing 200  $\mu$ L of culture medium. The goal is to minimize the transfer of enzyme solution. Soak the tissue for 1-2 minutes before transferring the CNS to a new microcentrifuge tube containing 200  $\mu$ L of fresh culture medium.

#### **3.3) Alternative tissue-washing technique.**

Wash the tissue by adding 1 mL of culture medium to the enzyme-incubation tube, then centrifuging the tissue at  $\sim 1,200 \times g$  for 10 seconds, in a small bench-top mini-microcentrifuge that is kept in the hood. Carefully remove most of the liquid, leaving  $\sim 200 \mu$ l behind to avoid disrupting the pelleted CNS tissue. Repeat the wash once more.

#### **3.4) Dissociate the enzyme-treated tissue by mechanical trituration.**

This can be done using a micropipettor (*e.g.*, Pipetman) and a sterile 200- $\mu$ L tip or a Pasteur pipette that has been flame-polished to smooth the tip and reduce the diameter by about half. In either case, it is imperative to pre-wet the pipette with culture medium. To triturate, hold the pipette tip against the bottom of the tube. Aspirate the fluid into the pipette (tip) and dispense forcefully about 80 times, at which point the tissue should be thoroughly dissociated. Within the first 5-6 cycles, the CNS tissue will be sufficiently disrupted that it is no longer visible to the naked eye. About midway through, close the tube and use a stereomicroscope to confirm that no pieces of tissue are stuck to the pipette tip or wall of the tube. If they are, try to wash them loose with focused pipetting. For best results, minimize foaming or bubbles which decrease recovery. Some evaporation does take place during the trituration, leaving about 180 of the original 200  $\mu$ L. At this point, the tube contains a suspension of cells (mostly neurons) and numerous tiny bits of neuropil debris. The cells will start to settle right away; it will be necessary to resuspend them immediately before distributing the cells into culture dishes.

#### 4) Plating and culturing the neurons

##### 4.1) Assemble in the tissue culture hood:

coated culture dishes, culture medium for flooding, a container to hold the cultures and create a humid chamber (*e.g.*, a 150-mm glass Petri dish containing an open culture dish or bottle cap with sterile water), and strips of Parafilm to seal the dishes. Label both the top and bottom of each culture dish to indicate the genotype, date, and experimental condition (*e.g.*, a numeric code that can be used to reference the experimental details).

##### 4.2) Plate the dissociated cells.

4.2.1) For culture dishes with 8-mm wells, fill each well with 75  $\mu\text{L}$  of culture medium. Then use a pipette tip pre-wetted with culture medium to mix the cell suspension thoroughly by pipetting up and down. Carefully add 25  $\mu\text{L}$  of the cell suspension to the medium in the well of each dish, distributing the fluid as evenly as possible within the well and bringing the total volume to 100  $\mu\text{L}$ . The medium forms a dome-shaped droplet bounded by the edge of the well. Use the pipet tip to ensure that the fluid extends all the way to the edge.

4.2.2) For culture dishes with 10-mm wells, fill each well with 95  $\mu\text{L}$  of culture medium and add 40  $\mu\text{L}$  of cell suspension, for a total volume of 135  $\mu\text{L}$ .

4.2.3) If the dissociation is complete and recovery of cells is good, the suspension from a whole w3L CNS can be distributed into six dishes with 8-mm wells or 4 dishes with 10-mm wells. The resulting density will promote elaboration of complex arbors (at least from wild-type neurons) but still allow individual neurite arbors to be analyzed. If density is too low, neurite outgrowth will be impaired (see below).

##### 4.3) Allow the cells to settle and adhere.

Place covered culture dishes in humid chamber (see Section 4.1). Cover the humid chamber and transfer it to a 25°C incubator (without CO<sub>2</sub>) for 2-3 hours to allow the cells to settle and adhere to the substrate (*i.e.*, the ConA/laminin coating on the glass coverslip).

##### 4.4) Examine the cells.

At the end of this settling period, use a compound microscope with phase-contrast optics and a 40 $\times$  objective to confirm that the cells are present, adherent to the floor of the well, and at an acceptable cell density (Figure 1B). It is particularly important that the cell densities of cultures to be compared to each other are about the same. Adjustments in cell density can be made if some of the cell suspension is kept in reserve. To supplement a low-density well, resuspend the dissociated cells using a new, pre-wetted pipette tip, and carefully add 5-10  $\mu\text{L}$  to the fluid already in the well. Add 2 hours to the settling time after more cells are added. This is a Go/No-Go point: if there are too few cells, it is better to start over than to proceed. The dissociated neurons will generally be spherical, with some having a short neurite that either survived trituration or extended during the settling period. Expect to see numerous tiny fragments of tissue debris, especially near the center of the well.

##### 4.5) Flood the dishes.

Transfer the humid chamber to the tissue culture hood and flood each culture by carefully adding 900  $\mu\text{L}$  of culture medium to each dish using a barrier tip. This is the point at which hormones, drugs, and so forth, are typically added to the culture. Dispense the media at the side of the dish, away from the well, to prevent the cells from detaching from the glass coverslip. Rock the dish gently to ensure the culture medium covers the entire dish. Seal each culture dish by wrapping it with Parafilm to limit evaporation. Return the culture dishes in their humidity chamber to the 25°C incubator (without CO<sub>2</sub>).

##### 4.6) Culture the neurons.

Check the cultures daily using a compound microscope and phase-contrast optics. By the end of 1 div, neurons should have started extending multiple neurites. Signs of trouble are a) lack of neurite outgrowth; b) microbial contamination (yeast is the most common; Figure 1C); c) cell bodies detaching from the substrate.

**4.7) Optional.** If the cells cultured longer than 3 div, replace 500  $\mu$ L of the media with fresh culture medium every four days.

## **5) Immunofluorescent staining of the cultured neurons**

**5.1) Assemble at the bench** (see Materials Table): buffered saline (either PBS or Ikeda Ringer), freshly made 4% formaldehyde in PBS, primary and secondary antibodies, wash buffer (PTN), polyvinyl alcohol (PVA) with DABCO (or similar mounting media with fade retardant).

### **5.2) Fix the neurons.**

Remove all tissue culture medium from each culture dish using a glass pipette, making sure not to touch the well. Carefully rinse each culture dish with 1 mL of saline. Add  $\sim$ 1 mL of 4% formaldehyde in PBS and incubate for 10 minutes at room temperature (RT). Remove the fixative and wash neurons with 1 mL PTN three times for 10 min each at 4  $^{\circ}$ C.

**5.3) Incubate with primary antibody**, goat anti-HRP antiserum at 1:250 to 1:500 dilution (total volume for each dish can be as low as 250  $\mu$ L, if the dishes are in a humid chamber to minimize evaporation). Incubation time can vary from 2-3 hours at RT to 12-16 hours (overnight) at 4 $^{\circ}$ C.

**5.4) Remove the primary antibody** solution from each dish and add 1 mL of PTN. Wash the neurons five times for 5-10 minutes each with 1 mL PTN at RT.

**5.5) Incubate in secondary antibody**, either Alexa Fluor 488- or Alexa Fluor 568-conjugated donkey anti-goat antisera at a dilution of 1:500 in PTN. Note: If the neurons are expressing a GFP-tagged reporter gene, choose the fluorophore that does not overlap with GFP. Incubate at 4 $^{\circ}$ C for 2-3 hours in the dark. A light-tight box or aluminum foil should be used to protect your samples from the light.

**5.6) Remove the secondary antibody** solution from the dishes and add 1 mL of PTN. Wash the dishes five times in 1 mL PTN for 5-10 minutes each at RT in the dark.

### **5.7) Mount the preparations with cover glass.**

Before applying mountant, rinse each dish with 0.1 M Tris-HCl, pH 8.0 and remove all liquid. Apply  $\sim$ 200  $\mu$ L of PVA/DABCO mountant directly to the center of the well without touching the bottom. Avoid creating bubbles; remove any that do occur. Cover with an 18  $\times$  18-mm coverslip. Return the dishes to a light-tight box and allow the mountant to set overnight in the dark at 4 $^{\circ}$ C (make sure the box is on a level surface). If the neurons are not to be examined within a day or two, wrap the dishes with Parafilm to prevent the PVA from drying out. At this point the preparations are quite stable and may be stored (4 $^{\circ}$ C in the dark) for many weeks.

## **6) Acquisition of fluorescent images**

### **6.1) Microscopy and image acquisition.**

Use an inverted compound microscope with fluorescence optics and high-magnification oil-immersion objective (60 $\times$  or 100 $\times$ ). In order to generate high-contrast images for analysis with NeuronMetrics, use exposure times long enough to obtain a signal of sufficient intensity to visualize the entire neurite arbor. This exposure will typically saturate the neuronal cell body.

### **6.2) Sampling of neurons.**

For systematic sampling of fluorescent neurons across the gridded dish, use the “Stair-Step” or “Parallel Track” schemes shown in Figure 4A-B). Phase-contrast microscopy can be used to record the location of each neuron using the alphanumeric codes on the gridded coverslip.

### **6.3) Sample size.**

Images of 50 or more neurons across the dish should be acquired for adequate statistical power.

#### 6.4) For very large neurons

If the neurite arbor extends beyond the image frame, acquire multiple overlapping images and assemble them into a single image using software capable of image stitching. Software options include Panavue ImageAssembler and Adobe Photoshop.

### 7) Neurite-arbor morphology quantification

#### 7.1) Download and install ImageJ and NeuronMetrics.

On [NeuronMetric's Tech Transfer Arizona webpage](#), download the NeuronMetrics User Manual and order the software (registration is required). Download ImageJ version 1.36b for PC from the ImageJ website: <http://rsbweb.nih.gov/ij/>. Download the FeatureJ plugin from the ImageJ website. When you receive an approval notice, download the NeuronMetrics plugins. Carefully follow the installation instructions in the User Manual.

#### 7.2) Rules for image format and file names.

All images must be in 8-bit format. If the images were acquired in a different bit depth, use “batch converter” in ImageJ to convert your images to 8-bit tiff format. Image file names must not end with a letter. To prevent troubleshooting issues with directory names, we STRONGLY advise making a new folder in the root of your C: drive, and giving it a simple name like “images.” This folder should contain the input-images folder for NeuronMetrics (see the video for a demonstration).

#### 7.3) Configure NeuronMetrics in ImageJ (Plugins → NeuronMetrics → 2 Setup).

See the NeuronMetrics User Manual for detailed instructions.

7.3.1) Calibrate the scale. Set “Scale” and “Units in pixels”, a calibration that is obtained from “1 Save Scale”; it is essential for obtaining accurate length units from NeuronMetrics output. Scale calibration is performed only once for each microscope/objective used to acquire images.

7.3.2) Define the “Neuron Folder” that contains all of your image files. The “Destination Folder” will be designated automatically when you define the “Neuron Folder.”

7.3.3) Select “Neuron Signal” – Uniform or Non-uniform.

7.3.4) Select “Optional Features.” Select “Noise ROIs” to eliminate background bright spots. Select “Length Correction” if neurites have regions of self-fasciculation, which NeuronMetrics may interpret as a single neurite. Select “Dominant Neurite” if you want to calculate the Polarity Index, for which you need to determine the primary neurite with the largest total length; if you do not need to calculate Polarity Index, make sure it is not selected. Select “Territory” to calculate the area and perimeter of the neurite-arbor footprint.

7.3.5) Select the “Optional Output Images” you would like to save.

#### 7.4) Run NeuronMetrics.

7.4.1) Open “Neuron and Cell Body” (Plugins → NeuronMetrics → 3 Neuron and Cell Body). As each input image (in the folder defined in Setup) is sequentially opened and you are prompted to circle the region of interest (ROI), click and drag the mouse to circumscribe the entire neuron with all of its neurites. Press the space bar. When prompted to define the cell body, click the center of the neuronal soma. Press the space bar again. The image will automatically close and the next image will appear; this sequence repeats until all images in the folder are done.

7.4.2) Open “Skeletonize and Improve” (Plugins → NeuronMetrics → 4 Skeletonize and Improve). This is an automated process and does not require user input. This module functions to eliminate background noise, fill short gaps, and generate the skeleton. See Narro *et al.* (2007) for information on the algorithms used. If the improved skeleton, when overlaid on the original image, shows that there are errors (*e.g.*, part of a neurite was

not included because there was a large gap in the signal, or a false neurite was created from background noise), it is possible to make changes at this point. Open the skeleton in ImageJ and use the Pencil and Eraser tools to fill the large gap or remove the noise. Delete the improved skeleton and improved skeleton overlay folders. Run Improve Skeleton again.

7.4.3) If desired, open “Length Correction” (Plugins → NeuronMetrics → 5 Length Correction). Draw a free-form curve to indicate the length that should be added to a region of self-fasciculation. To visualize the skeleton, click the “Toggle Skeleton” button in the Length Correction Manager; if needed, use the zoom tool to better visualize the skeleton. To add a neurite, click and drag the mouse to draw it, making sure the neurite drawn makes contact with the original skeleton. Then click the “Add” button and designate the weighting to be used (in the example shown in the video a weight of 1 is used). When you are finished, click the “Finished Image” button. The length correction is used by the “Dominant Neurite” and “Measure Skeleton” Plugins, but not by the “Territory” Plugin.

7.4.4) If you have chosen to compute Polarity Index, open “Dominant Neurite” (Plugins → NeuronMetrics → 6 Dominant Neurite) to indicate the dominant neurite, *i.e.*, the primary neurite with the largest arbor.

7.4.5) Open “Measure Skeleton” (Plugins → NeuronMetrics → 7 Measure Skeleton) to automatically compute all the morphometric parameters. NeuronMetrics creates, in the Destination Folder, a folder with a name ending in “\_dat” which contains a text file (.txt) with the numerical data from all images. Specifically, the data file contains the number of primary neurites, total branch number estimate, total neurite length, Polarity Index (if selected), and Territory perimeter and area (if selected) for each neuron image. Import these tab-separated (a/k/a tab-delimited) data into an MS Excel spreadsheet or other programs for statistical analysis or graphing. The time required to analyze a folder of ~60 neurons will depend on individual user speed, choice of optional features, and computer processing speed.

7.5) If (and only if) you have problems running NeuronMetrics, you may have to download Java 1.5.0-03 (J2SE Development Kit 5.0 Update 3) from: [http://www.oracle.com/technetwork/java/javasebusiness/downloads/java-archive-downloads-javase5-419410.html#jdk-1.5.0\\_03-oth-JPR](http://www.oracle.com/technetwork/java/javasebusiness/downloads/java-archive-downloads-javase5-419410.html#jdk-1.5.0_03-oth-JPR)

## Representative Results

This protocol is most successful when carried out with advanced planning, attention to detail, and practice of the manual techniques (Figures 1A, 2). Microdissection of the *Drosophila* larval CNS (Figure 3C-D) is relatively easy, making it suitable for teaching to novices. The relevant anatomy is well appreciated in scanning electron micrographs of the larval CNS (Figure 3A-B) from a classic study of postembryonic neurogenesis (White and Kankel, 1978). These images reveal two potential dissection-related challenges. First, precision is required to sever the short stalk (labeled E.st), between the eye-antennal imaginal disc and the optic lobe, without tearing the CNS. Second, the peripheral nerves are numerous and, because the cut ends are sticky, must be cut close to the CNS (Figure 3C-D) to prevent the CNS from getting stuck inside pipets. Contaminating microbes will not be evident at this magnification, but note that the larval gut is a potential source of yeast contamination. And, as in all arthropods, the esophagus runs through a narrow canal in the center of the CNS (Figure 3D). Hence, cleanliness of the dissection station (Figure 2) and careful removal of the gut early in the dissection process are important.

When viewed at high-magnification after the dissociated cells have settled and the dish has been flooded, one should see multiple spherical cells per field, with no clumps (Figure 1B). Clumps indicate inadequate dissociation, which could result from reduced activity of old enzymes or insufficient pressure during manual trituration. Some of the cells will not survive or differentiate, and not all are neurons. For example, neuroblasts, neural stem cells whose proliferation during the first 1-2 div can be demonstrated by BrdU incorporation (Luedeman, Levine, and Restifo, unpublished observations). Tiny phase-dark dots represent subcellular debris, most likely bits of neuropil; debris is most common in the center of the well. If

the cell yield is extremely low, the CNS tissue was most likely lost (stuck to a pipet wall) early in the dissociation. The most common errors leading to this result are failing to cut the peripheral nerves short or to pre-wet pipettes with culture medium. If cells are present but the density is low, the problem could be inadequate resuspension of the dissociated cells prior to plating. Reserving some of the cell suspension for density adjustments can help ensure that cultures being compared in a given experiment have similar densities. For this purpose, it is important to check the cell density before flooding, and supplement the dishes as needed.

Neurons cultured from the CNS of *Drosophila* larvae extend neurites within the first few hours. By 1 div, neurite outgrowth should be readily apparent. This is a good time to check for microbial contamination, of which the most common culprit is yeast from the larval gut (Figure 1C). During the next several days the arbors become progressively larger and more complex through neurite extension and branching (Figure 1D). Small neurite arbors may be due to low cell density or problems with the substrate (coating) or culture medium, such as expired or incorrectly handled ingredients. On the other hand, reduced neurite outgrowth can be a *bona fide* mutant phenotype or an indication of neurotoxicity of a chemical added to the culture medium. Hence, good controls are essential for correct interpretation of reduced neurite outgrowth. At 1 div and

thereafter, dead neurons are typically phase-dark spheres with no neurites, or with blebbed neurites that tend to lift off the substrate after a few days. Excessive cell death is generally due to problems with the culture medium, substrate, or exposure to toxins. When testing the effects of drugs or other chemicals, the use of barrier tips during handling of reagents is highly recommended to minimize the risk of cross-contamination.

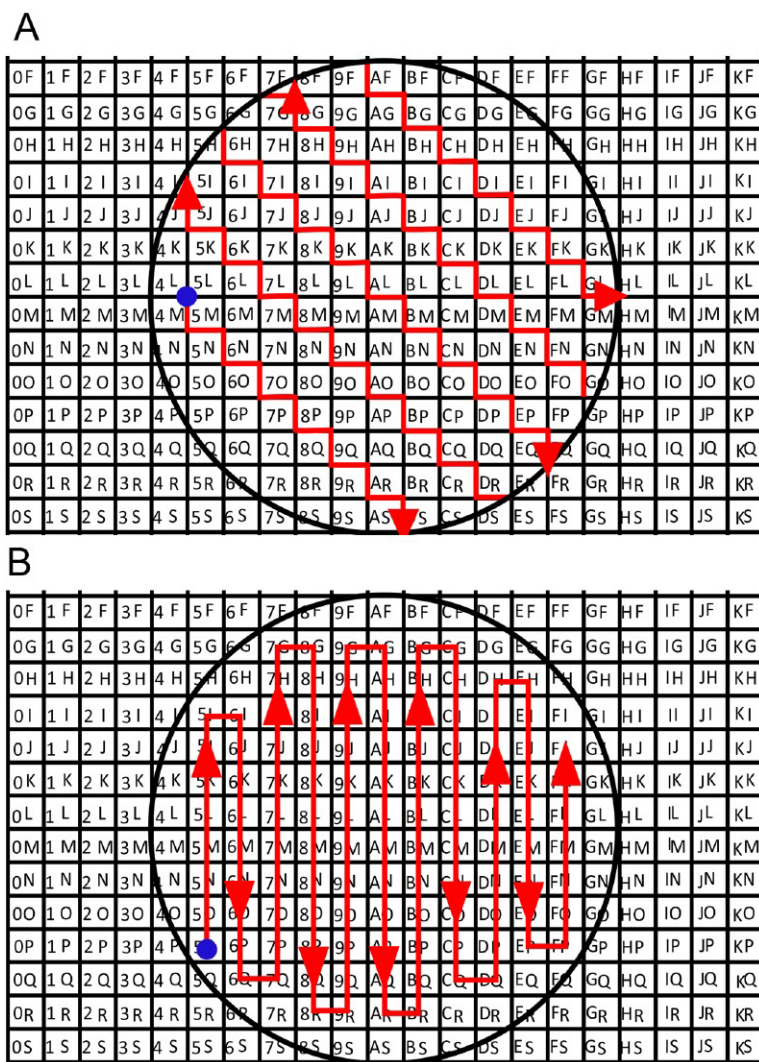

Figure 4. Neuron-sampling strategies using a photoetched grid in the floor of the culture well. Circle, representing the 8-mm culture well, superimposed on a Bellco grid at the same size scale. (A) The “Staircase” sampling method, wherein the experimenter uses the grid to find a standard starting point (blue dot), e.g., at “9 o’clock” in the well, and systematically follows a staircase track (red lines, note directional arrows) during image acquisition. Each diagonal sweep across the dish is two columns away from the adjacent ones, which minimizes the risk of double counting neurons. (B) The “Parallel Track” sampling method whereby, from a standard starting point (blue dot), the experimenter moves up and down each column of the grid.

Optimum cell density will allow for survival and outgrowth of individual neurons whose non-overlapping neurite arbors can be analyzed readily with NeuronMetrics. Two alternative strategies for sampling of neuron images from a single culture dish are diagrammed in Figure 4. The “Staircase” sampling method (Figure 4A) is optimal when the neuron density is high. The “Parallel Track” sampling method

(Figure 4B), which covers a larger fraction of the culture well, is useful when the neurons of interest are in the minority, such as when selection is based on expression of a specific marker. The cell density and neurite-arbor size will determine the specific rules (*e.g.*, all neurons in contact with each stair tread) that are applied to ensure systematic sampling across the dish. In no case should neurons with weak or spotty staining (suggestive of cellular pathology or impending death) be imaged.

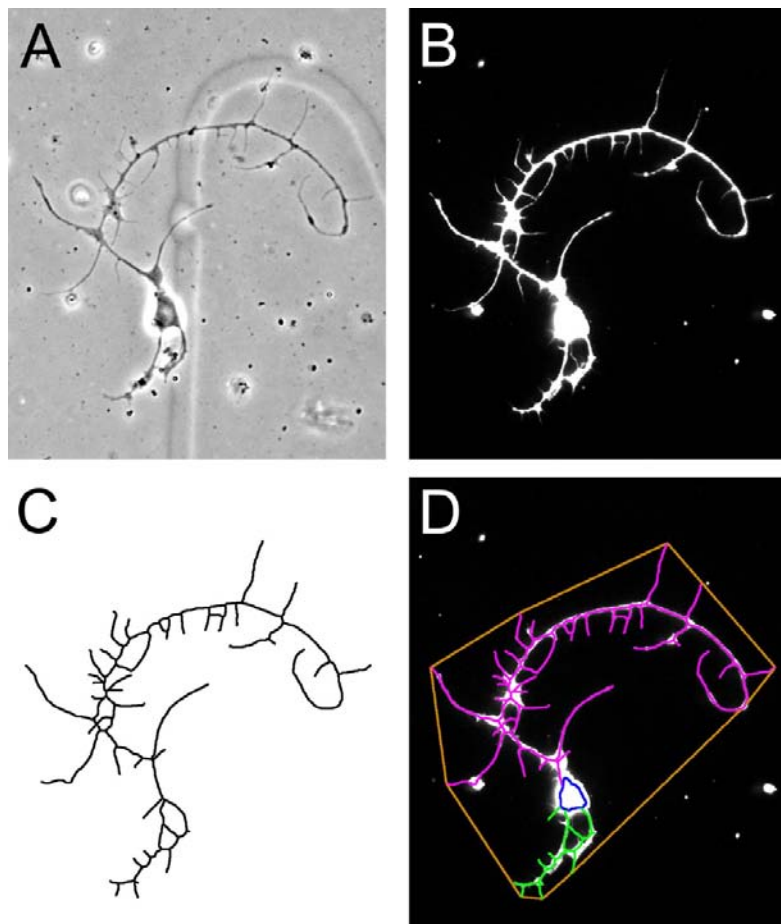

Figure 5. 2D neuron-image analysis with NeuronMetrics. Successive steps in image analysis of a neuron cultured for 3 div. Red asterisks mark the neuronal cell body. (A) Representative phase-contrast image of a live neuron acquired with 60 $\times$  objective (numerical aperture 1.4). Part of the alphanumeric grid is visible underneath the neuron. Scale bar = 20  $\mu$ m. (B) The same neuron after fixation and immunofluorescent labeling with anti-HRP. (C) Computer graphics-assisted drawing (using Adobe Photoshop) of the neurite-arbor skeleton computed by NeuronMetrics; thickening of the NeuronMetrics-generated 1-pixel-wide skeleton aids in visualization. The cell body region has been drawn in for orientation. (D) Final graphic output from NeuronMetrics software, thickened in Photoshop to improve visibility. The neuron territory is represented by the orange polygon (a convex hull) and the neuronal cell body in dark blue. The neurite skeleton is now divided into the dominant, *i.e.*, largest, primary neurite and its branches in magenta, and the other primary neurites in green).

A representative example of an immunostained neuron suitable for NeuronMetrics image analysis is shown in Figure 5. High contrast is essential for automated skeletonization of neurons by NeuronMetrics (Narro *et al.*, 2007). Because the antigen detected by anti-HRP immunostaining is present at high levels throughout the entire neuronal membrane, the fluorescent signal is strong and uniform (Figure 5B), which is optimal for this software. In contrast, neuronal expression of cytoplasmic GFP may not give a strong enough signal unless amplified by anti-GFP labeling. In our experience, transmembrane GFP (*i.e.*, CD8-GFP fusion protein) is problematic in cultured *Drosophila* neurons because it does not yield a smooth membrane signal.

One particularly valuable module within NeuronMetrics' tool set is the assessment of neurite arbor polarity, quantified as Polarity Index (PI). High PI values indicate that the arbor has a major, or dominant, primary process, usually highly branched, with relatively few or no other primary processes. Like cultured pupal gamma mushroom body neurons, the cell shown in Figure 5 has a high PI (Figure 5D). This may reflect distinct axonal and dendritic compartments of the arbor.

## Discussion

One somewhat surprising feature of our neuron culture system is the virtual absence of Repo(+) glial cells after 3 div. Because there are very few glial cells present at the time of plating (data not shown), the



problem is mainly lack of recovery rather than lack of survival. In contrast, CNS glial cells from developing brains of both mammalian and other insect species can be studied in dissociated culture, allowing the investigation of neuron-glia interactions (*e.g.*, Tucker *et al.*, 2004; Jacobs and Doering, 2010). It is possible that the mechanical trituration necessary to release neurons deep in the *Drosophila* CNS is too traumatic for the vast majority of differentiated glia to tolerate, and the small number that do survive the dissociation do not have sufficient access to glial-specific trophic factors to survive. Hence, identifying mechanical and biochemical modifications to the protocol that would permit glial cell recovery and survival remains an important goal.

To our knowledge, there has been no successful mechanical dissociation protocol developed for adult *Drosophila* CNS using trituration of enzyme-treated tissue. A single publication of a vibration-based dissociation technique reported successful isolation of adult CNS neurons for acute electrophysiological studies, but no culture for neurite outgrowth or other features of differentiation was attempted (Wu *et al.*, 2001). The lack of established methods for dissociation and culture of adult neurons limits the ability to study aging, or effects of genes or drugs on adult brain function independent of development. Hence, future efforts to adapt our protocol for studies of brain aging would allow the neuron culture system to take full advantage of *in vivo* aging neuroscience research in *Drosophila* (*e.g.*, Robertson and Keene, 2013).

Future development goals for NeuronMetrics include greater automation, *e.g.*, for cell body identification, which would speed data analysis, and a version for Mac OS. In addition, enhanced signal-detection capabilities, that would allow use of phase-contrast images or low-level fluorescent protein expression without introducing artifacts, would enable time-course data collection and eliminate immunostaining for some single-time-point experiments.

Acknowledgments: Anna Burns, Lynne Oland, Jessica Williams, and Kathy Siwicki provided invaluable assistance. RS was funded through the Center for Insect Science by NIH training grant K12GM000708. Other funding was provided by Autism Speaks to LLR.

References: Barbee, S.A., P.S. Estes, A.M. Cziko, J. Hillebrand, R.A. Luedeman, J.M. Collier, N. Johnson, I.C. Howlett, C. Geng, R. Ueda, A.H. Brand, S.F. Newbury, J.E. Wilhelm, R.B. Levine, A. Nakamura, R. Parker and M. Ramaswami 2006, *Neuron* 52: 997-1009; Bolduc, F.V., and T. Tully 2009, *Fly (Austin)* 3: 91-104; Campusano, J.M., H. Su, S.A. Jiang, B. Sicaeros and D.K. O'Dowd 2007, *Dev. Neurobiol.* 67: 1520-1532; Egger, B., L. van Giesen, M. Moraru, and S.G. Sprecher 2013, *Nat. Protoc.* 8: 958-965; Gatto, C.L., and K. Broadie 2011, *Curr. Opin. Neurobiol.* 21: 834-841; Gu, H., S.A. Jiang, J.M. Campusano, J. Iniguez, H. Su, A.A. Hoang, M. Lavian, X. Sun, and D.K. O'Dowd 2009, *J. Neurophysiol.* 101: 42-53; Halladay, A.K., D. Amaral, M. Aschner, V.J. Bolivar, A. Bowman, E. DiCicco-Bloom, S.L. Hyman, F. Keller, P. Lein, I. Pessah, L. Restifo, and D.W. Threadgill 2009, *Neurotoxicology* 30: 811-821; Inlow, J.K., and L.L. Restifo 2004, *Genetics* 166: 835-881; Jacobs, S., and L.C. Doering 2010, *J. Neurosci.* 30: 4508-4514; Jiang, S.A., J.M. Campusano, H. Su, and D.K. O'Dowd 2005, *J. Neurophysiol.* 94: 491-500; Katsuki, T., D. Ailani, M. Hiramoto, and Y. Hiromi 2009, *Neuron* 64: 188-199; Kim, Y.-T., and C.-F. Wu 1987, *J. Neurosci.* 7: 3245-3255; Kim, Y.T., and C.-F. Wu 1996, *J. Neurosci.* 16: 5593-5602; Kraft, R., M.M. Escobar, M.L. Narro, J.L. Kurtis, A. Efrat, K. Barnard, and L.L. Restifo 2006, *J. Neurosci.* 26: 8734-8747; Kraft, R., A. Kahn, J.L. Medina-Franco, M.L. Orłowski, C. Baynes, F. López-Vallejo, K. Barnard, G.M. Maggiora, and L.L. Restifo 2013, *Disease Models & Mechanisms* 6: 217-235; Kraft, R., R.B. Levine, and L.L. Restifo 1998, *J. Neurosci.* 18: 8886-8899; Küppers-Munther, B., J.J. Letzkus, K. Luer, G. Technau, H. Schmidt, and A. Prokop 2004, *Dev. Biol.* 269: 459-478; Lee, D., and D.K. O'Dowd 2000, *J. Neurosci.* 20: 2104-2111; Lee, D., H. Su, and D.K. O'Dowd 2003, *J. Neurosci.* 23: 4625-4634; Martin, R.L., B. Pittendrigh, J. Liu, R. Reenan, R. French-Constant, and D.A. Hanck 2000, *Insect Biochem. Mol. Biol.* 30: 1051-1059; Moraru, M.M., B. Egger, D.B. Bao, and S.G. Sprecher 2012, *Neural Dev.* 7: 14; Narro, M.L., F. Yang, R. Kraft, C. Wenk, A. Efrat, and L.L. Restifo 2007, *Brain Res.* 1138: 57-75; O'Dowd, D., and R. Aldrich 1988, *J. Neurosci.* 8: 3633-3643; O'Dowd, D.K., S.E. Germeraad, and R.W. Aldrich 1989, *Neuron* 2: 1301-1311; Oh, H.W., J.M. Campusano, L.G. Hilgenberg, X. Sun, M.A. Smith, and D.K. O'Dowd 2008, *Dev. Neurobiol.* 68: 281-294; Peng, I.F., B.A. Berke, Y. Zhu, W.H. Lee, W. Chen, and C.F. Wu 2007, *J. Neurosci.* 27: 12611-12622; Restifo, L.L., 2005, *Ment. Retard. Dev. Disabil. Res. Rev.* 11: 286-294; Robertson, M., and A.C. Keene 2013, *Gerontology* 59: 334-339; Rohrbough, J., D.K. O'Dowd, R.A. Baines, and K. Broadie 2003, *J. Neurobiol.* 54: 254-271; Saad, Y., M. Anabosi, S. Anava, G. Nadav, Y. Yerushalmi, and A. Ayali 2012, *J. Mol. Histol.* 43: 421-430;

Sanchez-Soriano, N., W. Bottenberg, A. Fiala, U. Haessler, A. Kerassoviti, E. Knust, R. Lohr, and A. Prokop 2005, *Dev. Biol.* 288: 126-138; Sanchez-Soriano, N., M. Travis, F. Dajas-Bailador, C. Goncalves-Pimentel, A.J. Whitmarsh and A. Prokop 2009, *J Cell Sci* 122: 2534-2542; Sicaeros, B., J.M. Campusano, and D.K. O'Dowd 2007, *J. Vis. Exp.* 200; Su, H., and D.K. O'Dowd 2003, *J. Neurosci.* 23: 9246-9253; Suzuki, N., and C.F. Wu 1984, *J. Neurogenet.* 1: 225-238; Tucker, E.S., L.A. Oland, and L.P. Tolbert 2004, *J. Comp. Neurol.* 472: 478-495; White, K., and D.R. Kankel 1978, *Dev. Biol.* 65: 296-321; Wiemerslage, L., B.J. Schultz, A. Ganguly, and D. Lee 2013, *J. Neurochem.* 126: 529-540; Winbush, A., and J.C. Weeks 2011, *Neural Dev.* 6: 15; Wu, C.-F., N. Suzuki, and M.-M. Poo 1983, *J. Neurosci.* 3: 1888-1899; Wu, L.J., Y. Lu, and T.L. Xu 2001, *J. Neurosci. Methods* 108: 199-206.

Table 1. Ordering Information for Supplies and Reagents.

Name of Item	Company	Catalog Number	Comments/Description
Antibody, Goat anti-HRP	Cappel	55973	Primary antibody, for detection of abundant <i>Drosophila</i> neuronal membrane antigen
Antibody, Donkey anti-Goat IgG Alexa Fluor 488	Molecular Probes – Life Technologies	A-11055	Secondary antibody, fluorescently tagged; adsorbed against rabbit, rat, mouse, human IgG
Antibody, donkey anti-goat IgG Alexa Fluor 568	Molecular Probes – Life Technologies	A-11057	Secondary antibody, fluorescently tagged; adsorbed against rabbit, rat, mouse, human IgG
Concanavalin A, Type IV	Sigma-Aldrich	C-2010	Dilute to 1 mg/ml in sterile purified H <sub>2</sub> O, aliquot and store at -20 °C.
Coverslips, gridded	Bellco Glass	1916-91818	Photoetched, square, 18 x 18 mm, glass, #2 thickness
Coverslips, plain	Bellco Glass	1943-00012	Round, 12-mm diameter, glass, #1 thickness
DABCO	Sigma-Aldrich	D2522	1,4-Diazabicyclo[2.2.2]octane
Dishes, culture	Corning	430588	35-mm diameter x 10 mm, polystyrene, sterile
Dishes, glass-bottom	MatTek	P35G-1.5-7-C	Pre-made 35-mm culture dish with 7-mm diameter well (also comes with 10- or 14-mm); glass #1.5 thickness
Dishes, glass-bottom with grid	MatTek	P35G-2-14-CGRD	Pre-made 35-mm culture dish with grid-etched 14-mm diameter well; glass #2 thickness. Custom orders for other diameters.
FBS (fetal bovine serum)	Hyclone (sold by Fisher)	SH30071	Characterized, heat-inactivated. This reagent is the most variable from lot to lot. Request aliquots of several lots for screening to find one that supports neuronal survival and outgrowth well.
Filter Sterilization Units	Millipore	SCGPU02RE	0.22-µm, GP Express Plus Membrane
Forceps, Dumont #5	Fine Science Tools	11295-00	Standard tips, 0.1 mm x 0.06 mm, Dumostar
Forceps, fine, Dumont #5	Fine Science Tools	11252-40	Biologie tips, 0.05 mm x 0.02 mm, Titanium
Formaldehyde	Ted Pella	18505	16%, EM-grade, 10-ml glass vials
Insulin, bovine	Sigma-Aldrich	I6634	From bovine, suitable for cell culture. Alternatively, human recombinant insulin (I3536) can be used.

Laminin	VWR	47743-734	Dilute to 1 mg/mL in sterile Tris-buffered saline, pH 7.4. Aliquot and store at -80°C.
Liberase DH Research Grade (replaces Liberase Blendzyme 1)	Roche	5401054001 (2 vials X 5 mg each)	Collagenase I and II, with <b>D</b> ispase at a <b>H</b> igh concentration (hence the term "DH" in the product name). "5 mg" refers to weight of collagenase, and provides 26 Wünsch units of collagenase activity. Dissolve in 1 mL sterile water on ice, aliquot, and store at -20°C.
Minutien pins	Fine Science Tools	26002-15	0.15-mm minutien pins
Paintbrush	Ted Pella	11807	Red Sable, size 3/0 (other sizes available as well)
Parafilm M	VWR	52858-000	4" x 125 ft. roll
PVA	Sigma-Aldrich	P8136	Polyvinyl alcohol
Schneider's Drosophila Medium	GIBCO (Invitrogen Life Technologies)	21720-024	500-ml bottle. Wrap in foil and store at 4°C. Do not use after expiration date or if precipitate has formed.
Slide, Boerner	Thomas Scientific	6690-K10	10-well glass dish for dissection
Sylgard 184	Dow-Corning	4026148	Silicone elastomer kit
Triton X-100	Sigma-Aldrich	T8787	<i>t</i> -Octylphenoxypolyethoxyethanol (CAS 9002-93-1)

Table 2. Solutions.

Solution	Amount	Ingredient (*qs = quantity sufficient)	Final concentration	Instructions (*qs = quantity sufficient)
ConA/Laminin [substrate for culture dishes]	For 2.4 ml: 2 mL 400 µL 4 µL	sterile purified H <sub>2</sub> O Concanavalin A, 1 mg/ml Laminin, 1 mg/ml	167 µg/ml 1.67 µg/ml	<ul style="list-style-type: none"> <li>Use fresh aliquots of ConA and Laminin; thaw slowly at 4°C.</li> </ul> This batch size will coat ~24 8-mm or 16 10-mm wells (100 or 150 µL/well, respectively).
Culture medium ["S10-I"]	For 100 mL: 87.5 mL 10 mL 2.5 mL 200 µL	Schneider's Insect Medium FBS Insulin, 2 mg/mL [see recipe below] 1 N NaOH	10% 50 µg/ml	<ul style="list-style-type: none"> <li>Check pH of ~100 µL on test strip; should be 7.0-7.2. If needed, adjust with 1 N NaOH drop-wise [rarely necessary]. Filter sterilize through 0.22-µm filter under vacuum.</li> <li>Store at 4°C for up to 3 weeks, protected from light.</li> </ul>
Enzyme solution [to digest ECM prior to tissue dissociation]	8 µL 1 mL	Stock solution of Liberase DH (26 Wünsch units/ml) Rinaldini's saline	0.21 Wünsch units/ml	<ul style="list-style-type: none"> <li>See Ordering Info for stock solution instructions and storage.</li> </ul> Make fresh; 300 µL enzyme solution per CNS sample.
Formaldehyde, 4% [fixative]	For 20 mL 5 mL 2 mL	16% Formaldehyde 10X PBS, pH 7.4	4% 10 mM NaPO <sub>4</sub> 137 mM NaC	<ul style="list-style-type: none"> <li>qs* with purified H<sub>2</sub>O to 20 mL</li> <li>store at 4°C for ≤ 1 mo.</li> </ul>

Ikeda Ringer's saline, calcium-free	For 1,000 mL: 7.6 g 0.35 g 0.37 g 0.1 g 0.05 g	NaCl KCl MgCl <sub>2</sub> •6H <sub>2</sub> O KH <sub>2</sub> PO <sub>4</sub> NaHPO <sub>4</sub> qs* with purified H <sub>2</sub> O to 1000 mL	130 mM 4.7 mM 1.8 mM 0.74 mM 0.35 mM	<ul style="list-style-type: none"> <li>• Filter sterilize through 0.22-<math>\mu</math>m filter under vacuum.</li> <li>• Store at 4°C.</li> </ul>
Insulin solution additive for culture medium]	For 2 mg/ml: 100 mg 50 ml	Insulin Water, acidified [freshly made]	2 mg/mL	<ul style="list-style-type: none"> <li>• Aliquot (e.g., 2.5 ml x 20).</li> <li>• Store at -20°C.</li> </ul>
10X PBS (Phosphate-buffered saline) [stock solution]	For 100 mL: 50 mL 8 g	0.2 M Sodium Phosphate, pH 7.4 NaCl qs* with purified H <sub>2</sub> O to 100 mL	For 10X: 100 mM 1.37 M	<ul style="list-style-type: none"> <li>• Autoclave</li> </ul>
PTN [wash buffer]	For 200 mL: 100 mL 2 mL 20 mL	0.2 M Sodium Phosphate, pH 7.4 10% Triton X-100 1% Sodium Azide (NaN <sub>3</sub> ) qs* with purified H <sub>2</sub> O to 200 mL	0.1 M 0.10% 0.10%	<ul style="list-style-type: none"> <li>• Store at 4°C. Note that NaN<sub>3</sub> is a highly toxic compound</li> </ul>
PVA with DABCO [mounting medium with anti-fade agent]	For ~65 mL: 8 g 40 mL 20 mL 1 g	Polyvinyl alcohol 0.2 M Tris-HCl, pH 8.5 Glycerol DABCO	~12% w/v ~125 mM ~30% v/v ~1.5% w/v	<ul style="list-style-type: none"> <li>• Stir PVA in buffer gently overnight to dissolve.</li> <li>• Add glycerol and DABCO, mix. Centrifuge, 1500 x g, 15 min, to pellet any undissolved PVA.</li> <li>• Aliquot supernatant into 1.5-mL tubes. Store at -20°C.</li> </ul>
Rinaldini's saline [to dilute enzymes]	For 100 mL: 800 mg 20 mg 5 mg 100 mg 100 mg	NaCl KCl NaH <sub>2</sub> PO <sub>4</sub> •H <sub>2</sub> O NaHCO <sub>3</sub> D-glucose, anhydrous qs* with purified H <sub>2</sub> O to 100 mL	140 mM 2.7 mM 0.35 mM 12 mM 55 $\mu$ M	<ul style="list-style-type: none"> <li>• Filter sterilize through 0.22-<math>\mu</math>m filter under vacuum. Store at 4°C.</li> </ul>
Sodium Phosphate buffer, 0.2 M, pH 7.4	For 1,000 mL: 5.57 g 41.2 g 900 mL	NaH <sub>2</sub> PO <sub>4</sub> •H <sub>2</sub> O Na <sub>2</sub> HPO <sub>4</sub> purified H <sub>2</sub> O		<ul style="list-style-type: none"> <li>• Adjust pH to 7.4, then qs* with purified H<sub>2</sub>O to 1,000 mL.</li> <li>• Autoclave.</li> </ul>
Tris-buffered saline (TBS), pH 7.4 [to dissolve laminin]	For 1,000 mL: 6.05 g 8.76 g ~800 mL	Tris base NaCl H <sub>2</sub> O, purified	50 mM 150 mM	<ul style="list-style-type: none"> <li>• Adjust pH to 7.4 with 1 M HCl, then qs* with purified H<sub>2</sub>O to 1000 mL.</li> <li>• Autoclave</li> </ul>
Water, acidified [to dissolve insulin]	0.2 mL 99 mL	5 M HCl sterile purified H <sub>2</sub> O	~10 mM HCl	<ul style="list-style-type: none"> <li>• Adjust pH to 2.0 with 5 M HCl dropwise.</li> </ul>



## Two simple jigs for cutting olfactory trap components.

**Kliethermes, Christopher L.** Drake University, Department of Psychology and Neuroscience, Olin Hall 318, 1344 27<sup>th</sup> Street, Des Moines IA 50311; Email: [c.kliethermes@drake.edu](mailto:c.kliethermes@drake.edu)

The olfactory trap is a simple apparatus that can be used to measure innate and learned olfactory preferences (Woodard *et al.*, 1989). Each trap consists of a standard 1.5 mL microcentrifuge tube (the collection vial) with the pointed tip cut off, into which is inserted a cut 200 microliter pipette tip that is in turn wedged into a second tip, forming a double cone-shaped funnel (see Figure 1). During the assembly of many of these traps for use in various projects, we noticed that inconsistencies in the angle and length of the cuts could result in traps that allowed flies to escape the trap.



Figure 1. The olfactory trap apparatus. Flies enter the trap in response to olfactory cues originating from an odorant placed in the cap.

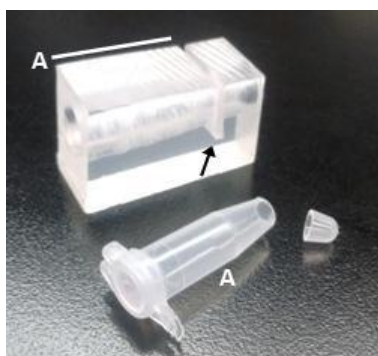

Figure 2. The microcentrifuge tube cutting jig. A 1.5 mL tube is inserted into the hole and cut at the slot indicated by the arrow. Line 'A' indicates the length of the cut.

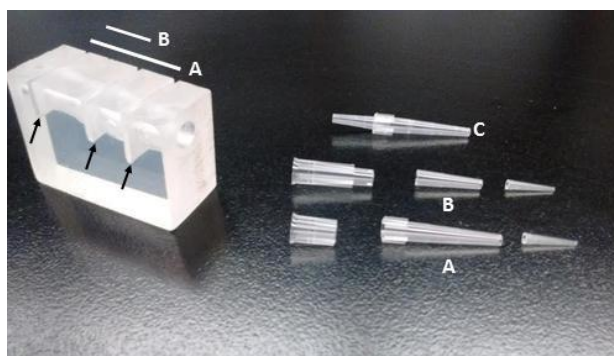

Figure 3. The pipette tip cutting jig. A 200 µL pipette tip is inserted into the hole and cut using two of the three slots (indicated by the black arrows) as guides. Two pipette tips are cut to produce the 'A' and 'B' sections, which are assembled to produce a bidirectional funnel (C). This funnel is inserted into the cut end of the microcentrifuge tube shown in Figure 2 to produce the complete trap shown in Figure 1.

Figures 2 and 3 show two jigs we now use to cut the components of the traps from pipette tips and microcentrifuge tubes accurately and reliably. The microcentrifuge tube cutting jig was made from clear  $\frac{3}{4}$ " acrylic stock. After cutting the stock to length, a tapered hole was bored into the block with a series of bits to accommodate the taper of the microcentrifuge tube, and a small rasp was used to smooth the taper. A single slot was then cut through the diameter of the hole to serve as a guide for cutting the tube with a razor blade (see Figure 2). The pipette tip jig was made similarly to the microcentrifuge tube jig, except that a smaller

diameter tapered hole was drilled to accommodate the smaller diameter of the tips, and two slots were cut to allow for cutting the 200  $\mu$ L pipette tip into the two sizes required to assemble a trap (see Figure 3).

References: Woodard, C., T. Huang, H. Sun, S.L. Helfand, and J. Carlson 1989, *Genetics* 123: 315–326.



## Real-time visualization software for the TriKinetics Environmental Monitor (DEnM).

**Strelec, M.<sup>1</sup>, and S.S.C. Rund<sup>2\*</sup>.** <sup>1</sup>School of Informatics, <sup>2</sup>Centre for Immunity Infection and Evolution, University of Edinburgh, Edinburgh, UK; \*corresponding author (E-mail:

[Samuel.Rund@ed.ac.uk](mailto:Samuel.Rund@ed.ac.uk)).

TriKinetics behavioral analysis equipment is widely used for small-insect (in particular *Drosophila*) experiments where minute by minute insect locomotor behavior can be easily monitored for days or even weeks (Rund *et al.*, 2012; Cavanaugh *et al.*, 2014). In the case of circadian-biology experiments, this involves changing environmental conditions and monitoring the resulting locomotor response in the animal, or monitoring how behavior changes in the absence of any entraining environmental cues (*zeitgebers*) (Dunlap *et al.*, 2004). However, for any behavioral experiment, verifying that no confounding experimental changes occurred is prudent. For this reason, TriKinetics has developed a *Drosophila* Environmental Monitor (DEnM) which continuously monitors light, humidity, and temperature levels and records these data in real-time to a computer spreadsheet in the same format as their behavioral monitors records locomotor activity. This format

is very useful for data processing, is compatible with the popular ClockLab analysis program, but is still cumbersome to get a real-time reading (*e.g.*, What is the temperature *now* inside the incubator?) or daily verification that conditions were held steady or an anticipated environmental change indeed occurred (*e.g.*, Did the one-hour light pulse occur between 3:00 A.M. and 4:00 A.M. as scheduled?) without navigating through a large multi-column spreadsheet.

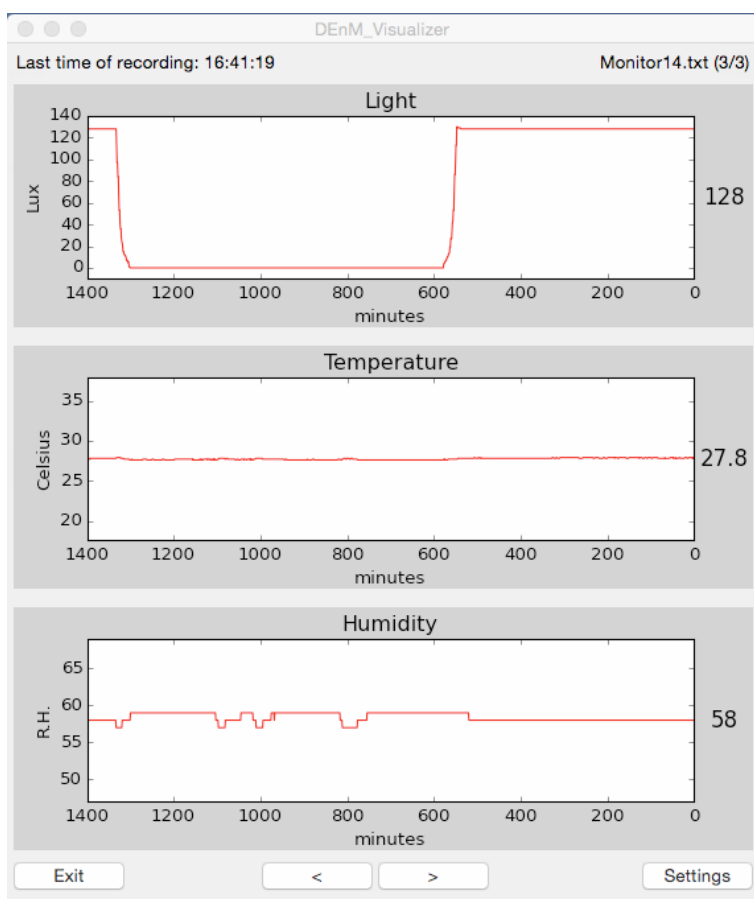
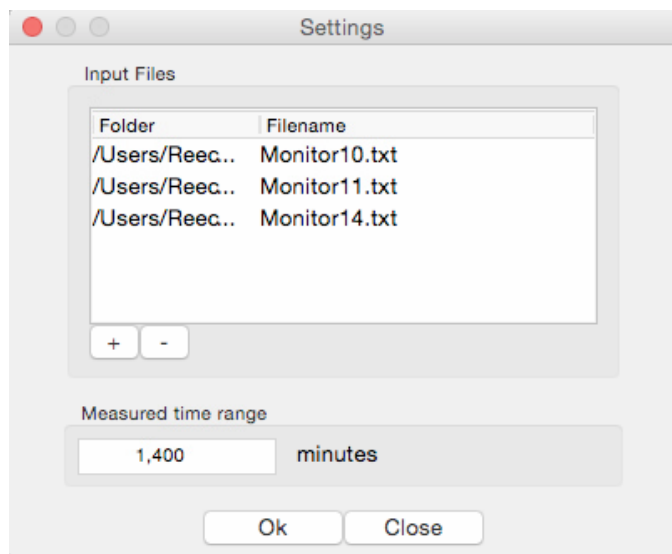

Figure 1. Screenshot of the main window of the DEnM\_Visualizer program displaying the current light level (lux), temperature (Celsius), and humidity (%RH) in the incubator along with the previous 36 hours as recorded with the DEnM system.

For these reasons, we developed a tool we have called DEnM\_Visualizer. DEnM\_Visualizer is installed on the computer collecting data from TriKinetics units and provides real-time temperature, humidity, and light-intensity readings as



measured by one or more connected DEnMs. Additionally, the user may indicate a time-window to view historical sensor information, such as the last 24 hours. In our laboratory we find using these 24 hr readouts to be very useful in verifying new lighting-regime programs were initiated correctly, and there were no unexpected incubator faults that occurred overnight.

Figure 2. Screenshot of the settings window of the DEnM\_Visualizer program demonstrating that the program can display the live data from multiple DEnMs (in this example, from units numbered 10, 11, and 14) and can display historical readings of a user-defined length.

DEnM\_Visualizer is an open-source project and can be downloaded at [https://github.com/samrund/DEnM\\_Visualizer](https://github.com/samrund/DEnM_Visualizer). It is written in Python and has been tested on both Windows and Mac operating systems. The GitHub page has detailed installation instructions.

References: Cavanaugh, D.J., J.D. Geratowski, J.R. Wooltorton, J.M. Spaethling, C.E. Hector, X. Zheng, E.C. Johnson, J.H. Eberwine, and A. Sehgal 2014, *Cell* 157: 689-701; Dunlap, J.C., J.J. Loros, and P.J. Decourcy 2004, *Chronobiology: Biological Timekeeping*, Sinauer Associates, Sunderland Mass.; Rund, S.S.C., S.J. Lee, B.R. Bush, and G.E. Duffield 2012, *J. Insect Physiol.* 58: 1609-1619.



### **An efficient, practical, and reliable yeast shaker for *Drosophila melanogaster* culture.**

**Garcia, Jan.** Biology Department, Skidmore College, Saratoga Springs, NY 12866 USA; email: [jgarcia1@skidmore.edu](mailto:jgarcia1@skidmore.edu).

A few grains of dry yeast is beneficial to the establishment of new fruit fly cultures, but too much can result in the surface of the food being overgrown by the yeast. It is difficult to pour consistently a few grains of dry yeast into multiple new vials from an open container, and adding them by hand is slow. To overcome this problem, I have developed a “yeast shaker.” The yeast shaker is made by using a dissecting needle to perforate the tip of a microcentrifuge tube only one time (Figure 1). This yeast shaker is simple to use. A single shake typically drops two to five grains. This simple method is fast, reliable, consistent, and inexpensive.

Figure 1. Dry yeast shaker (right), dissecting needle used to perforate the microcentrifuge tube (left), and five grains of yeast ejected by a single strong shake.





## An efficient rearing population cage to expose *Drosophilids* to various environmental agents.

**Verçosa, Cícero Jorge, Ícaro Fillipe de Araújo Castro, Ana Cristina Lauer Garcia, and Claudia Rohde.**

Laboratório de Genética, Centro Acadêmico de Vitória, Universidade Federal de Pernambuco, Vitória de Santo Antão, Pernambuco, Brazil. E-mail: cjvercosa@hotmail.com

Despite the growing number of genetic toxicology studies that use the *Drosophila melanogaster* model, the methodologies to assess genetic damage in this organism are essentially laboratory-based (Markow, 2015). This technical note describes a rearing population cage potentially useful to expose drosophilid to various environmental stress agents, including natural radiation and atmospheric pollution, as recently investigated by our research group (Verçosa, 2015; Santana, 2015).

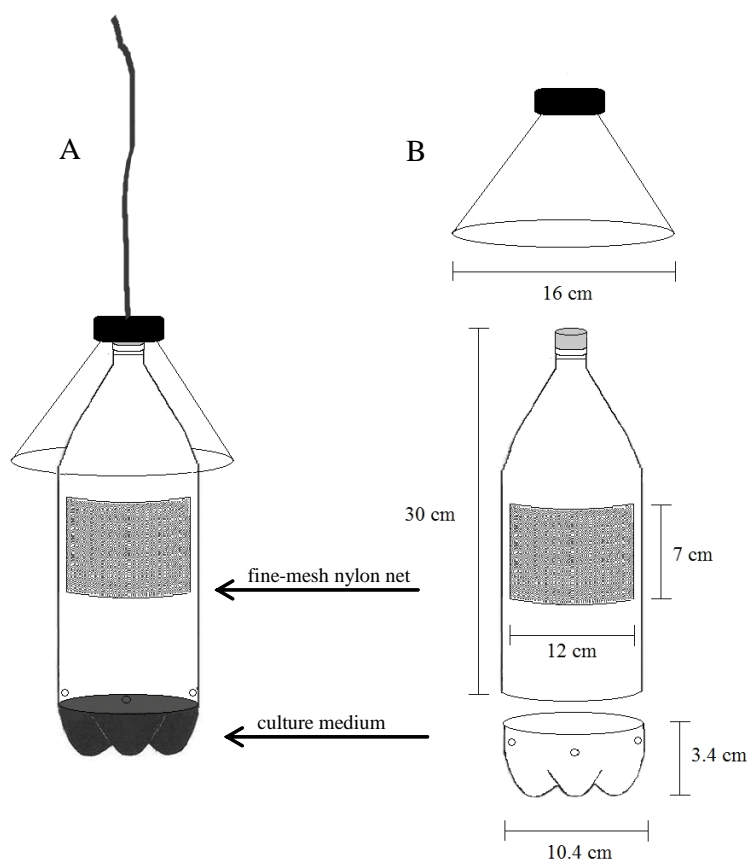

Figure 1. Scheme showing the population cage mounted (A) and dimensions of each part (B).

The population cage model was developed using clear 2-L polyethylene terephthalate (PET) bottles (Figure 1). Two  $12 \times 7$  cm rectangular holes were cut facing each other on the bottle walls and covered with fine-mesh nylon net. This allows atmospheric agents to enter the flask, while preventing the drosophilids tested from leaving. In addition, other organisms are left out. The bottom of the bottle was cut out to serve as a container for approximately 180 mL of culture medium, and fastened back using clear duct tape. This amount of medium should suffice to feed drosophilid adults and larvae exposed for six days in the field given appropriate relative humidity conditions. In dry places, such as in semi-arid regions, for instance, four small holes

cut on the bottom of the bottle body enable to restock the culture medium without opening the flask. Wide duct tape is used to cover these orifices. This maintenance care can be carried out every two days, keeping the appropriate conditions with no stress to drosophilids. The neck of the bottle was covered with a PET umbrella cut out of a larger container. The idea was to stop rainwater from entering the cages through the nylon nets below. A loop was attached to the bottle top to hang cages in shaded areas, 1.50 m above the ground (Figure 2).

Each population cage was able to lodge about 120 adults of *Drosophila melanogaster* for six days in environments with temperatures ranging between 25 and 30°C on average. The environmental mutagenicity and genotoxicity assays carried out in the population cages used 3-day-old males and females. Since emerged larvae reached the third development stage and adults were no more than 10 days old after a 6-day exposure



period in the field, both stages of *Drosophila melanogaster* could be analyzed successfully using the population cage model. The efficiency of the cage described was confirmed in all the 27 experiments we have carried out so far. Another advantage is that drosophilids can be transported to the laboratory in the same cage if vertically shipped in a proper means of transport.



Figure 2. Image of rearing population cage exposed in a humid natural environment of Northeast Brazil.

References: Markow, T.A., 2015, eLife 4:e06793; Santana, S.L., 2015, O Ensaio Cometa em *Drosophila melanogaster* como bioindicador da poluição atmosférica em uma área urbana e rural (in Portuguese), *Trabalho de Conclusão de Curso, Ciências Biológicas*, Universidade Federal de Pernambuco, Brazil; Verçosa, C.J., 2015, Aplicação do Ensaio Cometa em *Drosophila melanogaster* para avaliação da genotoxicidade ambiental (in Portuguese), M.Sc. Thesis (*Biologia Celular e Molecular Aplicada*), Universidade de Pernambuco, Brazil.



### Technical adaptations to the retention baited trap to Drosophilidae.

**Cardoso, Eduardo<sup>1</sup>, Monica L. Blauth<sup>2</sup>, and Marco S. Gottschalk<sup>2\*</sup>.** <sup>1</sup>Centro de Engenharia, Universidade Federal de Pelotas; <sup>2</sup>Departamento de Ecologia, Zoologia e Genética, Instituto de Biologia, Universidade Federal de Pelotas. \*Corresponding author: [marco.gottschalk@yahoo.com](mailto:marco.gottschalk@yahoo.com)

### Introduction

In Brazil, nowadays, one of the most used methods to capture live adults Drosophilidae flies is the use of traps proposed by Tidon and Sene (1988), once it is a simple retention trap, cheap, that use recycled material and had an excellent performance on field. This trap has been successfully used by our research group in several taxonomic survey on different environments (Gottschalk *et al.*, 2006; Blauth and Gottschalk, 2007; Gottschalk *et al.*, 2007; Blauth *et al.*, 2013). Roque *et al.* (2013) suggested two structural adaptations in the trap to avoid the flies getting stuck to the bait, impeding the retention parts of adult flies. In sampling

performed with the trap proposed by Roque *et al.* (2013), we verified a perceptive reduction in the total abundance of adults caught when compared with sampling performed with Tidon and Sene (1988) traps.

We considered the trap proposed by Roque *et al.* (2013) as more practical, viable, and efficient to the capture of drosophilids, reducing flies escape and do not stuck in the bait. The present technical note proposes some changes in order to make it more efficient in regards to attractiveness, increasing the number of individuals captured. Also, we suggest a new practical option to assembling the trap.

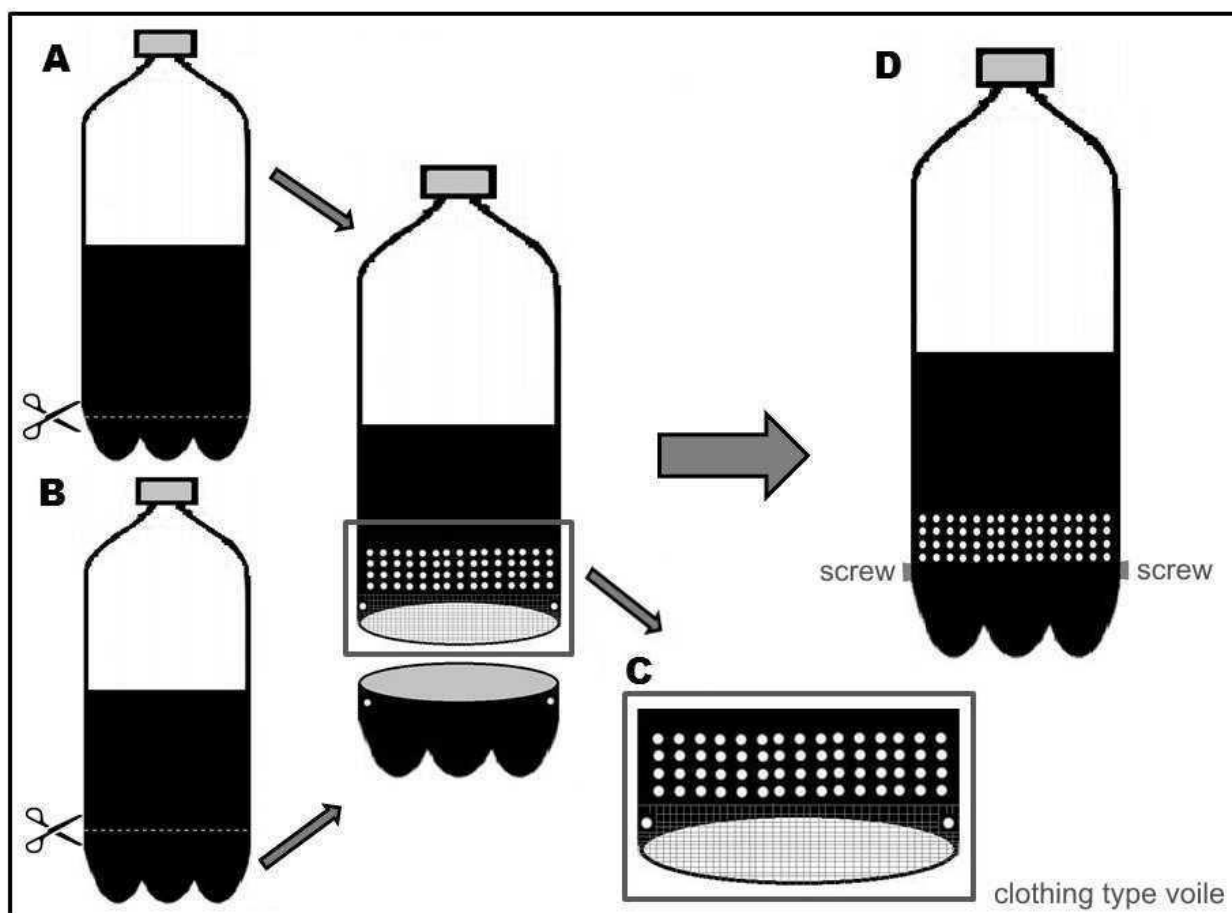

Figure 1. Retention trap of drosophilids. (A) Capture compartment of flies; (B) Bait storage compartment; (C) Capture compartment showing the rows of holes for entrance of flies and the clothing like voile; (D) Trap laid attached by screws.

## Methodology

### Technical adaptations

The trap here proposed is based on the trap described by Roque *et al.* (2013), and all the measurements and proportions were maintained, and its utilization is similar. The trap is made of two 2L PET bottles, where the compartment that captures and retains the flies is made of a bottle that had its bottom removed (Figure 1A), while the compartment that storage the bait is made of other bottle bottom (Figure 1B). Note that it is necessary to use two bottles, because the cutting height is different, being lower for the capture compartment and higher for bait storage compartment to allow a better trap fitting. The bait storage compartment is completely painted black while the retention compartment is painted half black and half kept transparent (Figure 1).

On the retention compartment, holes of 5 mm diameter are made arranged in sets of four parallel series around the bottle on the painted part (Figure 1C), close to the bait compartment. The holes can be done with iron to solder. The holes will be the entrance of flies to the trap and from where the bait smell will spread. Moreover, to optimize the attractiveness, it is suggested to isolate the capture compartment using a clothing like voile affixed with hot glue in the opening of bottom bottle (Figure 1C), replacing the holes in the base of the bottle suggested by Roque *et al.* (2013).

Regarding the assembly of the trap, for the engagement between the capture and bait storage compartments, two opposing holes are made on each compartment, and screws are used to hold the parts together after laying the bait (Figure 1D). Finally, the two compartments are attached with scotch or masking tape to prevent the entry of flies in the bait compartment for possible openings in the slot.

### Trap test

To test the traps, particularly regarding attractiveness, ten pairs of traps suggested by Roque *et al.* (2013) were set on the field and ten pairs of traps as suggested by us. Each pair of traps was spaced 50 m from each other, while each trap in a pair was spaced 5 m. The bait used in each trap was 250g of smashed banana with yeast (*Saccharomyces cerevisiae*). The test was performed in *Restinga* forest area in southern Brazil (31°48'S; 52°43'W).

A paired Wilcoxon test was performed, and the test reliability was calculated through the Monte Carlo test with 100,000 iterations using the Past 2.17c program (Hammer *et al.*, 2001).

## Results

In total, 319 individuals were collected in the trap model proposed by this work and 79 individuals with the model suggested by Roque *et al.* (2013). The abundance was significantly higher in the trap proposed here ( $w = 47$ ,  $df = 9$ ,  $p = 0.0499$ ), suggesting that the adjustments made in the trap provides an increase in the attractiveness for Drosophilidae.

Acknowledgments: We thank the Universidade Federal de Pelotas for research grant.

References: Hammer, Ø., D.A.T. Harper, and P.D. Ryan 2001, *Palaeontologia Electronica*. 4: 9; Roque, F., S.C.F. de Oliveira, and R. Tidon 2011, *Dros. Inf. Serv.* 94: 140-141; Tidon, R., and F.M. Sene 1988, *Dros. Inf. Serv.* 67: 90.



### Efficient high-throughput cuticle preparations from fly lines yielding both viable and unviable embryos.

**Gamberi, Chiara.** Department of Biology, Concordia University, 7141 Sherbrooke Street West, Montréal, Québec Canada H4B 1R6; Chiara.gamberi@concordia.ca

## Introduction

Analysis of *Drosophila* cuticular structures is a classic genetic tool to infer the efficiency of developmental processes via careful morphological evaluation. When performing genetic screens in pursuit of mutations with developmental effects or during mutational scanning to identify functionally important protein domains, high throughput analyses of cuticles from numerous fly lines becomes necessary. To increase throughput ingenious structures of fly containers have been devised such as fly “condominiums”, that allow separate housing of relatively small numbers of flies of different genotypes and parallel embryos collections. The earliest of such devices were artisanal-made by cylindrical chambers the size of fly vials linked into a single structure (Nüsslein-Volhard *et al.*, 1984). Modern commercial versions resemble scaled up microtiter plates with vial-like containers organized in regular arrays lodging onto specialized collection and feeding plates.

To obtain enough embryos for statistically significant analyses, embryos are normally collected on apple or grape plates 1-24 hours, the longer times to accommodate for fewer and/or less fertile flies. Embryos are then incubated 18-36 hours to allow for development and embryos that did not hatch are picked and processed for analyses. While certainly feasible, these procedures can be lengthy and may give rise to accidental sample mixing or confusion when multiple collections are done on the same plate in an attempt to increase throughput. An important additional complication can arise with mutations that produce a distribution of defects that are not all lethal. In such situations, different amounts of viable larvae can develop and can travel around the plate and disturb, eat, or move non-hatched eggs despite a "bait" of yeast paste strategically placed on the collection plate. This may become particularly problematic when long incubation times are required to allow full terminal development of delayed development mutants. Additionally, at collection time such larvae are much bigger than the non-hatched embryos and can hinder collection of the unhatched siblings.

During a recent screen of linker-scanning mutations of a gene of developmental interest I found that the modified protocol described below was particularly easy to follow, practically eliminated the problem of interfering larvae and sample cross-contamination, and did not require any additional equipment to that already used daily in a fly laboratory.

## Methodology

Embryo collections were carried out with regular cornmeal-agar vials, where 10-60 adult flies were placed and collection time was tailored to the number of flies in the vials and embryos laid on its surface. As the viable embryos were hatching into larvae, they could quickly burrow in the cornmeal mixture leaving only the unhatched embryos at the vial's surface. Vials were incubated at the desired temperature and length of time. To harvest the unhatched embryos ~2 ml of diluted bleach (1:4) from a squirt bottle was used to detach embryos from the surface and collect them into small strainers lined with nytex screen. It is important that this step is carried out quickly to prevent larvae buried in the cornmeal agar to float to the surface and pollute the embryo collection. For embryo dechoriation the strainers were then immersed in a shallow container with 50% bleach and incubated for 2 minutes, then washed with PBS 0.04% Triton-X100, PBS, and finally water. Embryos were carefully picked up from the strainer with a paintbrush and placed directly in 1.5 ml conical tubes with 250  $\mu$ l of lactic acid/70% (ethanol 9:1) and incubated 60° C overnight. If needed, embryos could be prior devitellinized with equal volumes of heptane and methanol and vigorous shaking. Skipping vitelline membrane removal was rapid and most appropriate when studying mutations that can damage the cuticle, for example by creating holes that would cause fragmentation upon removal of the vitelline membrane. Processed cuticles were laid on cleaned slides via a P1000 pipette equipped with a cut tip, and gently placed with tweezers. Excess solution was removed either with a Kimwipe tissue or very light suction, then one drop of Hoyer's mounting medium (below) was added, gently mixed with the remnant of lactic acid/ethanol solution on the slide surface, and the coverslip was placed on top avoiding trapping air bubbles beneath. Excess solution extruded from the coverslip was carefully removed with light suction and slides were incubated overnight at 60°C on a leveled slide warmer with 10 g weights on top of the coverslips to ensure proper sample flattening. Incubation could be prolonged to 1-2 days placing 50 g weights onto the coverslip to flatten the preps. Cooled down slides were sealed with nail polish and could be stored for prolonged periods without any loss of quality.

The modified cuticle prep protocol described here is a convenient and expedited way to increase throughput of cuticle analyses without recurring to specialized items such as commercial fly condos and specialty collection plates. Combined with the retaining of the vitelline membrane, this protocol allows the rapid evaluation of all cuticles formed by the embryos, including those remaining incomplete, for example because of mutations causing cuticle holes that could cause disintegration during processing and whose disappearance from the pool could potentially mislead subsequent analyses.

*Hoyer's mounting medium*

Dissolve 30 g of gum arabic in 50 ml distilled water by stirring overnight. Very gradually add 200 g chloral hydrate. Add 20 g glycerol. Clear by centrifugation for at least 3 hours at 12000g. Can be stored for very long times at room temperature without any loss of quality.

References: Nüsslein-Volhard, C., E. Wieschaus, and H. Kluding 1984, Roux's Arch. Dev. Biol. 193: 267-82.



### Safe, fast, cheap, and efficient procedures to collect and deposit in vials large and little numbers of flies in a short time.

Aguayo, T.<sup>1</sup>, C. Meza<sup>1</sup>, H. Muñoz<sup>1</sup>, F. Del Pino<sup>1</sup>, M.C. Medina-Muñoz<sup>2</sup>, E. Alvarez<sup>1</sup>, and R. Godoy-Herrera<sup>1</sup>.

<sup>1</sup>Programa de Genética Humana, ICBM, Facultad de Medicina, Universidad de Chile, Chile. <sup>2</sup>Departamento de Biología, Facultad de Ciencias, Universidad de Playa Ancha, Valparaíso, Chile

In Faculty of Medicine, Universidad de Chile, Santiago, Chile, eight Genetic and Biology Courses each employ *Drosophila* species for several practicals. A similar situation occurs in the Faculty of Pure Sciences in Universidad de Playa Ancha. The mean number of students per course fluctuates between 110 and 55. This means that our laboratories must have ready in an exact day and time 110 – 55 vials. That is, one vial per alumni × course × per eight weeks. Each vial must contain about 10 flies; N = 880 vials. The work is done 5 days a week per two months. To perform this task we have developed efficient procedures to distribute the flies into vials. Our modus operandi saves time taking a few minutes to deposit the flies into vials.

### Handling a large number of flies

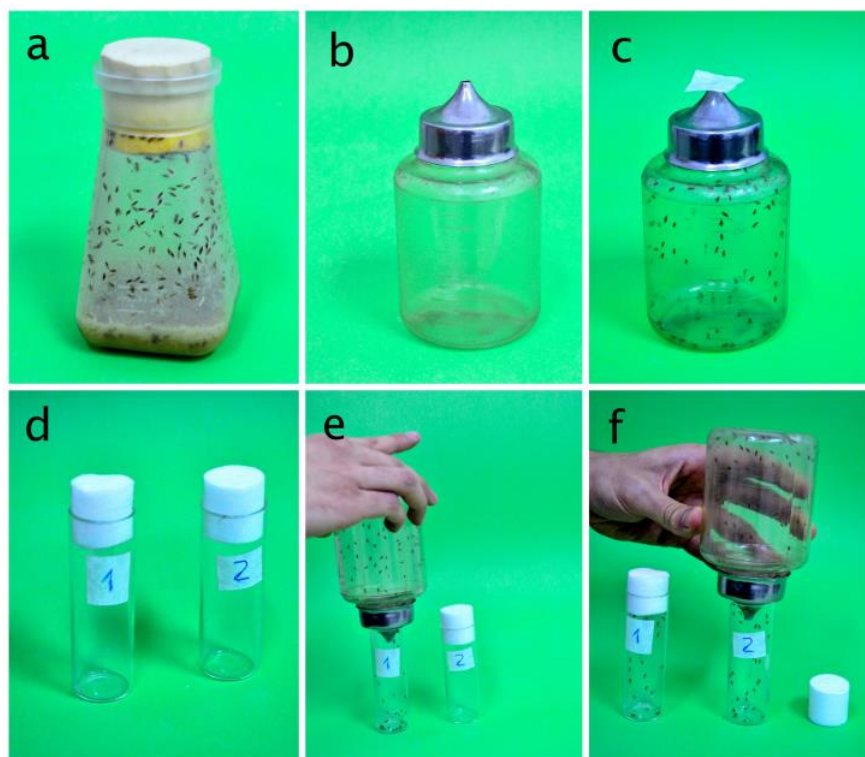

Figure 1. Photographs showing the procedure to handle a large number of flies. 1 a, a rearing bottle; 1 b, a feeding bottle, see text for a description; 1 c, a feeding bottle with adult flies; 1 d, empty vials; 1 e –f, transferring flies.

Figure 1 a- f shows a sequence of photographs describing the procedure to distribute large numbers of flies (Figure 1 a) into a set of 110 vials; each vial must contain 10 flies. For this task, we use plastic feeding bottles of 6 × 12 cm (diameter × height) similar to those employed to give water to mice, hereafter called feeding bottle. Each feeding bottle has a

metal cap (Figure 1 b). Each cap has a hole of 0.4 cm (Figure 1 b). The first step is to take the cap off transferring the adults as usual from the culture bottles (Figure 1 a) to the empty feeding bottles (Figure 1 b, c). A small piece of cotton can be used to close the cap hole of each feeding bottle (Figure 1 c). Once the flies are in the feeding bottle (Figure 1 c), they can be transferred in an appropriate number to empty vials (Figure 1 d - f). The system allows one to count safely the flies transferred to each vial,  $N = 110$ . For this function, the bottles and vials must be arranged as shown in Figure 1 d - f; the task takes no more than 10 min.

### Collecting small number of flies

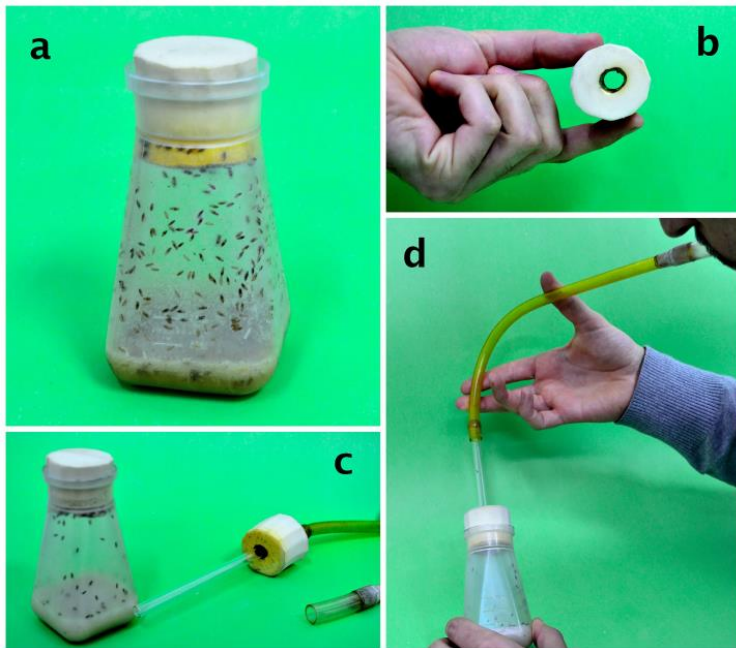

Figure 2. Photograph sequence showing the procedure to safely collect a small number of flies from rearing bottles. 2 a, rearing bottle; 2 b, a rearing bottle plug with a hole; 2 c, a plug with its aspirator; 2 d, sucking flies from a rearing bottle.

To collect groups of about 10 flies from cultures bottles (Figure 2a), we first replace the plastic plug of each bottle by other of the similar material to which a hole of 0.6 cm in diameter was made (Figure 2 a, b). Then, an aspirator is introduced through the hole as shown in Figure 2 c. The procedure allows us easily to collect groups of up to 10 flies preventing the escape of adult flies from the culture bottle (Figure 2 d). Again, the

procedure also has the advantage to count exactly number of adults that are being transferred (Figure 2 d).

The methodologies described are particularly appropriate to train teacher and students that lack experience in managing *Drosophila* adults. Our procedures allow us keep safely separated adults of different strains and species of *Drosophila*. That is, they aid to avoid undesirable mix of flies allowing us to perform safe crosses between individuals of different genotype groups. The feeding bottles described are easily found in supermarkets and similar shops. They are relatively cheap and can be easily transported and handled. In our experience, the bottles are safer than a mouth aspirator. The procedures described are routinely used in our research work being adopted quickly for undergraduate and post-graduate students. Our laboratory is also supporting the work of Biology Teachers at Secondary Schools. We preferably support to those teachers that work in small relatively isolated rural secondary schools of Chile where teaching resources are relatively sparse. Most of these teachers lack experience in managing *Drosophila* species. The procedures above described are quickly and easily adopted by the teachers transferring the experience to their students, arousing interest in learning more about the species of genus *Drosophila*.

## Teaching Notes



### **A simple lab exercise using inbred *Drosophila* strains for introducing quantitative genetics to undergraduates.**

**Possidente, Bernard\*, and Denise McQuade.** Biology Department, Skidmore College, Saratoga Springs, NY USA 12866. \*Corresponding author: [bposside@skidmore.edu](mailto:bposside@skidmore.edu).

### **Abstract**

Students compare mean values between two inbred strains of *Drosophila* for a simple behavioral or anatomical trait. This allows detection of genetic differences between strains affecting the trait, direct partitioning of phenotypic variation into genetic and non-genetic components, and an estimate of heritability. Mean, variance, standard error of the mean, and t-test are introduced and applied to the analysis. The lab is suitable for non-major or major level undergraduate genetics courses as a complement to the more common laboratory exercises for Mendelian genetic analysis. The lab employs simple methods for observing behavioral or morphological traits, uses statistical methods that are simple enough to calculate by hand with pencil and paper to optimize comprehension, and requires no crosses other than maintenance of true-breeding inbred stocks with wild-type phenotypes.

### **Concept**

Labs designed to illustrate Mendelian patterns of heredity are often conducted in genetics courses, frequently using *Drosophila* crosses to illustrate patterns of heredity for one or several discrete traits. More complex traits and patterns of heredity, for instance estimation of heritability for quantitative genetic traits, are rarely analyzed in an undergraduate genetics course, in spite of the prevalence and importance of polygenic quantitative traits in natural populations and in human phenotypes (Mackay and Falconer, 1996; Mackay and Anholt, 2006). Impediments to the incorporation of lab instruction for quantitative genetic traits include the difficulty of experimental designs required to partition genetic variation among relatives, and the complexity of associated statistical analyses (*cf.*, Mackay and Falconer, 1996). Quantitative genetic analysis, however, is simplified by complete inbreeding which creates a uniformly homozygous and isogenic strain (Mackay and Falconer, 1996).

Measuring phenotypic variation among flies from just two inbred strains allows direct and simple estimation of genetic *vs.* non-genetic components of phenotypic variance (Mackay and Falconer, 1996; Hegmann and Possidente, 1981). Since completely inbred strains are isogenic, phenotypic variation among individuals within the same strain estimates only non-genetic effects. Since inbred strains are also homozygous there are no dominance interactions so genetic differences among them estimate only additive genetic effects. Heritability estimates derived from inbred strain comparisons are, therefore, narrow sense heritabilities (Mackay and Falconer, 1996). The only statistical computations required are the mean and variance for a sample of flies from each strain. These, in turn, allow estimation of the heritability for the trait, defined as the proportion of phenotypic variation caused by genetic variation (Mackay and Falconer, 1996) which is otherwise difficult to obtain without comparing relatives across generations. Recently, a large set of inbred lines constituting the *Drosophila melanogaster* Reference Panel (Mackay *et al.*, 2012) has become available from the *Drosophila* stock center in Bloomington, Indiana (USA) (<http://flystocks.bio.indiana.edu/>, *e.g.* inbred line RAL-21, stock number 28122, through inbred line RAL-913, stock number 28265). These inbred lines were derived from wild type flies, and the genome of each line has been sequenced. Any two of

these lines, or other inbred strains, can be used for the basic quantitative genetic analysis described here, and larger sets of strains permit more sophisticated genetic analyses (*cf.*, Mackay and Falconer, 1996; Possidente and Hegmann, 1981) in more advanced courses and in research.

## Methods

Students can breed or be given vials with flies from any two different inbred strains that have common environmental histories. Students are either assigned a trait to assay on a sample of individual flies from each strain, or design their own assay. Designing their own assay affords the opportunity for students to practice observational skills and research design but requires additional lab time. Limiting the subjects to a single sex is optimal to simplify the statistical analysis and minimize within-strain variation. Some simple traits we have assayed range, for example, from body size and sternopleural bristle number, to time required to awake from anesthesia, frequency of grooming, maximum height reached during one minute in a vertical pipette, latency to mating, distance moved per unit time in a horizontal pipette, location in a horizontal pipette after five minutes of acclimation after a sound occurs or an odor is applied to a cotton plug on one end and a blank cotton plug or different odor or sound is presented on the opposite end.

The trait mean, variance, and standard error of the mean are calculated for each strain. We assume a simple additive model where  $V_p = V_g + V_e$ .  $V_p$  represents phenotypic variance,  $V_g$  represents genetic variance, and  $V_e$  represents non-genetic variance.  $V_p$  can be estimated directly as the variance of all the flies from both strains, or as the sum of  $(V_g + V_e)$ , which can be estimated independently (below).  $V_e$  is estimated directly for each strain as the variance among flies within a strain and can be pooled, or averaged for estimates based on the same sample size for a best estimate of  $V_e$ . Once  $V_p$  and  $V_e$  are obtained,  $V_g$  can be estimated by subtraction, or from the difference between the strain mean values (below). Since inbreeding doubles the additive genetic variance relative to an outbred population (*cf.*, Mackay and Falconer, 1996; Hegmann and Possidente, 1981), estimating  $V_g$  by subtraction of  $V_e$  from  $V_p$  estimates  $2V_g$ , so this estimate of  $V_g$  should be halved to obtain the final  $V_g$ .

$V_g$  may also be estimated directly by squaring half the difference between the strain means for the trait and dividing by two (McKay and Falconer, 1996; Hegmann and Possidente, 1981), which estimates  $V_g$  for the special case of two inbred strains. The strain difference between the mean values for a trait estimates twice the average additive genetic effect of allelic differences between the strains ( $2a$ ). Dividing the mean strain difference by two estimates “ $a$ ”, squaring “ $a$ ” estimates twice the additive genetic component of variance, and halving this value estimates  $V_g$ .

Finally, heritability (the proportion of phenotypic variance caused by genetic variance: McKay and Falconer, 1996) can be estimated as  $V_g/V_p$ . We compare the two strain means using Student’s  $t$ -test and assume that a significant difference represents genetic variation caused by genetic differences between the strains.

## Sample Calculation

The set of data below contains anatomical measurements on ten individual flies of the same sex from each of two inbred strains for body size defined as the distance in mm from the posterior tip of the scutellum to the anterior edge of the pronotum (measurement method adapted from Lefranc *et al.*, 2000). The data represent extreme strain values from a set of 65 inbred strains analyzed (unpublished), in order to illustrate the case of two inbred strains with a significant strain difference.

Strain 1 Values from ten flies: (4.4, 4.2, 4.2, 4.2, 4.3, 4.1, 4.5, 4.3, 4.3, 4.3);

Mean<sub>1</sub> = 4.28, Variance<sub>1</sub> =  $V_{e1}$  = 0.013;

Strain 2 Values from 10 flies: (2.3, 2.5, 2.3, 2.5, 2.8, 2.7, 2.6, 2.7, 2.8, 2.7);

Mean<sub>2</sub> = 2.59, Variance<sub>2</sub> =  $V_{e2}$  = 0.034;

$V_e = (V_{e1} + V_{e2}) \times 0.5 = 0.024$ ;

Total Variance =  $V_p = 0.77$ ;



$V_g$  from inbred strain mean difference =  $0.5[((\text{Mean}_1 - \text{Mean}_2)/2)^2] = 0.357$ ;

$V_g$  from  $(V_p - V_e)/2 = 0.373$ ;

Heritability ( $h^2$ ) =  $V_g/V_p$  from estimating  $V_g$  as  $0.5[((\text{Mean}_1 - \text{Mean}_2)/2)^2] = 0.94$ ;

Heritability ( $h^2$ ) =  $V_g/V_p$  from estimating  $V_g$  as  $(V_p - V_e)/2 = 0.94$ .

## Discussion

The lab permits an introduction to the analysis and genetic basis of quantitative traits, with no more investment of time or resources than that required to teach Mendelian genetic lab exercises using *Drosophila*. It is inexpensive, concept-rich and investigative, permits the introduction of parametric statistical methods for genetic analysis, and lends itself to collaborative work within groups, class presentations and formal lab reports. The availability of multiple inbred strains for class use will increase the likelihood that some students will select two strains with different mean values for the assayed trait. The lab can also be made incrementally more complex at the discretion of the instructor with respect to genetic concepts, experimental designs, and statistical methods. Limitations of the methods can also be examined, such as inability to identify specific genetic loci, the absence of dominance effects, the absence of epistasis other than additive by additive interactions (Mackay and Falconer, 1996), the limited number of genotypes represented, and potential for confounding genetic differences with maternal effects or epigenetic mechanisms. We present this exercise to facilitate the inclusion of quantitative genetic analysis in undergraduate courses so that students at this level may acquire a more comprehensive and realistic understanding of genetic concepts and analysis.

References: Falconer, D.S., and T.F.C. Mackay 1996, *Introduction to Quantitative Genetics*, 4<sup>th</sup> ed., Benjamin Cummings, New York; Hegmann, J.P., and B. Possidente 1981, *Behav. Genet.* 11(2): 103-114; Lefranc, A., and J. Bundgaard 2000, *Dros. Inf. Serv.* 83: 171-174; Mackay, T.F.C., and R.R.H. Anholt 2006, *Ann. Rev. Genomics Hum. Genet.* 7: 339-367; Mackay, T.F.C., *et al.*, 2012, *Nature* 482: 173-178.



## Can selection alter the frequency of recombination of *Drosophila melanogaster*?

**Knackstedt, Kathryn A., Henry B. Thorpe, Constance R. Santangelo, Michael A. Balinski, and R.C. Woodruff.** Department of Biological Sciences, Bowling Green State University, Bowling Green, Ohio 43403.

It has been observed that recombination can increase the amount of new multi-gene genetic variation, which in turn can influence adaptive evolution (Muller, 1964; Maynard Smith, 1978, 1988; Michod, 1995). What is not completely understood is how selection influences frequencies of recombination. In *Drosophila melanogaster* there are three reports that recombination is increased for the autosomes in selection experiments for DDT resistance (Flexon and Rodell, 1982), resistance to daily temperature fluctuations (Zuchenko *et al.*, 1985), and geotaxis (Korol and Liliad, 1994). The influence of selection on the frequency of recombination, however, has only been estimated for the sex chromosomes in one *Drosophila melanogaster* experiment (Korol and Liliad, 1994), and no study has combined selection for bristle number with recombination.

To measure the influence of natural selection on the rate of recombination, we selected for increased sternopleural bristle numbers on the thorax of *Drosophila melanogaster* and determined if there was a concomitant change in the frequency of recombination for two X-linked genes (white eyes, *w*, and singed bristles, *sn*<sup>3</sup>). It is our hypothesis that selection will increase the frequency of recombination for X-linked genes.

As a non-selection control, we measured the frequency of recombination between *w* and *sn*<sup>3</sup> in the Canton-S wild-type stock background before selecting for increased bristle numbers by the following crosses.

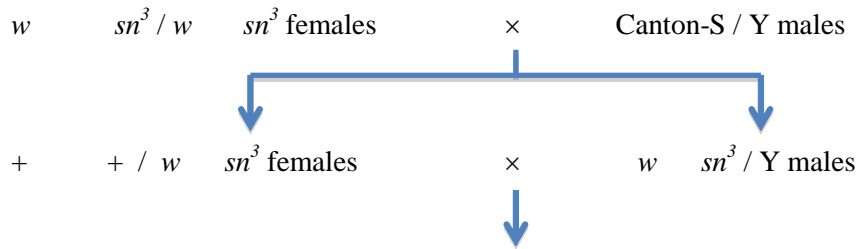

The progeny were screened for the frequency of recombinants:  $w +$  (white-eyed long bristles) and  $+ sn^3$  (red eyes and singed bristle), and non-recombinants:  $++$  (red eyes and long bristles) and  $w sn^3$  (white eyes and singed bristles). The frequency of recombination was then determined as the number of recombinants out of the total. It is reported that the frequency of recombination between the white and singed loci is about 20.5 map units (Lindsley and Zimm, 1992).

Next we selected for increased bristle numbers in females and males of the Canton-S wild-type stock by selecting for five virgin females and five males with the largest number of bristles, among 40 flies (20 females and 20 males), and mated them for the next generation for a total of three generations of selection (Woodruff and Thompson, 2005).

Then we determined if the frequency of recombination between the white and singed genes in the selected line was significantly higher than in the control (unselected) Canton-S stock by use of the chi-square test. We predicted that the frequency of recombination in the selected line would be significantly higher than in the control (unselected) line. This would give support to the hypothesis that natural selection can modify the frequency of recombination on all chromosomes, including the sex chromosomes.

#### *Rate of recombination before selection for increased bristle numbers:*

We measured the frequency of recombination between the white and singed loci by the crosses shown above, and the results for five independent estimations are as follows: KAK (115/803 = 14.3%), HBT (31/230 = 13.5%), CRS (117/872 = 13.4%), MAB (51/323 = 15.8%), and RCW (116/790 = 14.7%) for an average recombination rate of 14.3% (431/3,018), which is significantly lower than the reported rate of 20.3 map units (20.3 % recombination) (Lindsley and Zimm, 1992).

#### *Selection for increased bristle number:*

We next selected for increased bristle numbers as discussed above and the average results for five separate selection experiments are shown in Figure 1. The number of bristles in females and males were increased, but neither increase is significant over time (females  $P = 0.33$  and males  $P = 0.06$ ).

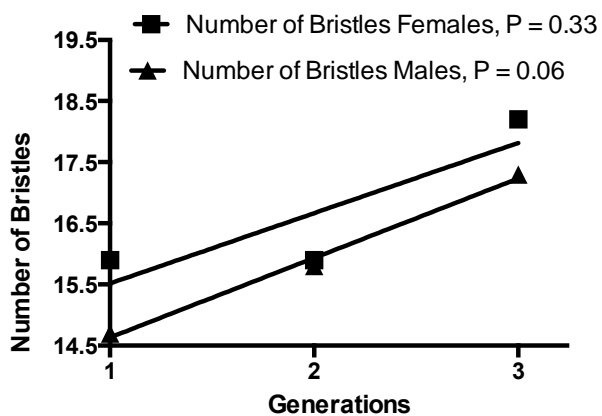

Figure 1. Responses to selection for increased bristle numbers.

The rate of recombination between the white and the singed loci after three generations of selection was: KAK (126/638 = 19.7%), HBT (65/486 = 13.4%), CRS (112/600 = 18.7%), MAB (131/437 = 30.0%), and RCW (123/820 = 15.0%) for an average recombination rate of 18.7% (557/2981), which is significantly different from the recombination rate before selection for increased bristle number ( $P <$

0.001). Comparisons of the rates of recombination between the white locus and the singed locus before and after selection are shown in Table 1 and Figure 2. The chi-square values are for a one-tail test because we predicted that recombination frequencies would go up with selection (using the Prism program).

Table 1. Recombination frequencies before and after selection for increased bristle numbers in five experimental runs and the totals.

	Before Selection	After Selection
KAK	115 / 803 (14.3%) <sup>1</sup>	126 / 638 (19.7%) <sup>1</sup>
HBT	31 / 230 (13.5%) <sup>2</sup>	65 / 486 (13.4%) <sup>2</sup>
CRS	117 / 872 (13.4%) <sup>3</sup>	112 / 600 (18.7%) <sup>3</sup>
MAB	51 / 323 (15.8%) <sup>4</sup>	131 / 437 (30.0%) <sup>4</sup>
RCW	116 / 790 (14.3%) <sup>5</sup>	123 / 820 (15.0%) <sup>5</sup>
Average	431 / 3018 (14.3%) <sup>6</sup>	557 / 2981 (18.7%) <sup>6</sup>

<sup>1</sup>P = 0.003; <sup>2</sup>P = 0.48; <sup>3</sup>P = 0.003; <sup>4</sup>P < 0.0001; <sup>5</sup>P = 0.43; <sup>6</sup>P < 0.0001

decreased in response to selection? There might be times that it is advantageous for closely linked genes to evolve together, as is seen for genes that are found together within inversion heterozygotes (see a discussion of this topic on page 120 in Klug *et al.*, 2013). 2) What are other advantages of recombination? Recombination is important for the removal of deleterious mutations in groups, instead of one at a time in organisms that are asexual (Kondrashov, 1988). Recombination is also essential for the normal segregation of chromosomes during meiosis and for repair of DNA double-strand breaks (Davis and Smith, 2001; Dudas and Chovanec, 2004).

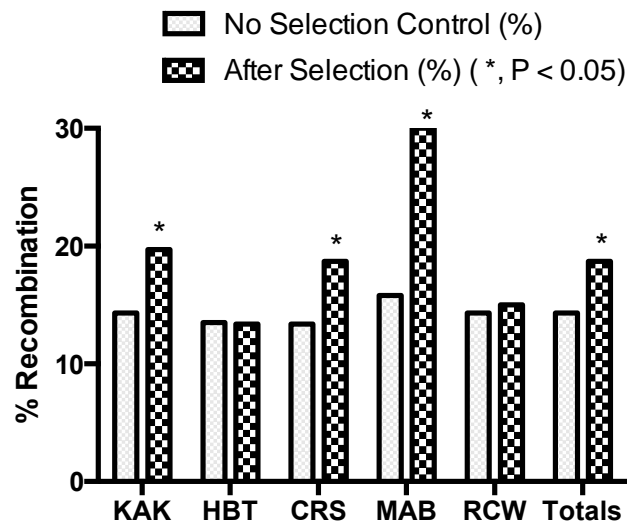

Figure 2. Percent recombination before and after selection for increased bristle numbers.

References: Davis, L., and G.R. Smith 2001, Proc. Natl. Acad. Sci. USA 98: 8395-8402; Dudas, A., and M. Chovanec 2004, Mutat. Res. 566: 131-167; Flexon, P.B., and C.F. Rodell 1982, Nature 298: 672-675; Klug, W.S., M.R. Cummings, C.A. Spencer, and M.A. Palladino 2013, *Essential Genetics*. Pearson, Boston; Kondrashov, A., 1988, Nature 339: 300-301; Korol, A.B., and K.G. Iliad 1994, Heredity 72: 64-68; Lindsley, D.L., and G.G. Zimm 1992, *The Genome of Drosophila melanogaster*. Academic Press, New York;

Maynard Smith, J., 1978, *The Evolution of Sex*. Cambridge University Press. Cambridge; Maynard Smith, J., 1988, The evolution of recombination. Pp. 106-125. In: *The Evolution of Sex*. Eds. R.E. Michod and B.R. Levin. Sinauer Associates Inc., Sunderland, Massachusetts; Michod, R.E., 1995, *Eros and Evolution: A Natural Philosophy of Sex*. Addison-Wesley Publishing Company. New York; Muller, H.J., 1964, Mutation Research 1: 2-9; Woodruff, R.C., and J.N. Thompson, jr. 2005, Dros. Inf. Serv. 88: 139-143; Zhuchenko, A.A., A.B. Korol, and L.P. Kovtyukh 1985, Genetica 67: 73-78.



**The influence of autosomal genetic background on the fitness of a mutant sex-linked gene and linked loci in *Drosophila melanogaster*.**

**Thorpe, Henry B., Kathryn A. Knackstedt, Tyler M. Birkholz, Christopher J. Schimmoeller, Michael A. Balinski, Patrick G. Tate, and R.C. Woodruff.** Department of

Biological Sciences, Bowling Green State University, Bowling Green, Ohio 43403.

“There is an abundance of evidence that the effects of a mutation depend on its genetic background” (Fay, 2011). This fluctuation in gene expression is due to epigenetic interactions of the mutations with other genes. Epistasis has been observed for lethal and visible mutations in *D. melanogaster*, where mutations acting together have a larger effect on fitness than is expected based on multiplicative interactions (Kitagawa, 1967; Mukai, 1969; Temin *et al.*, 1969; Seager *et al.*, 1982; Whitlock and Bourguet, 2000). Similar epistatic interactions occur for some human diseases (Zhang and Liu, 2007). Yet, others have not observed negative synergistic epistasis (for reviews of this topic see Wolf *et al.*, 2000; Sanjuan and Elena, 2006; Azevedo *et al.*, 2006; Arjan *et al.*, 2007). Hence, the presence and role of negative synergistic epistasis in evolution, where the genetic background can influence fitness, is still unclear.

In this study we will measure the influence of the autosomal genetic background on the fitness of the  $w^{1118}$  mutation, and linked genes on the X, in males in comparison to C(1)DX,  $y f / Y$  females, which have two X chromosomes attached to a single centromere, yellow body color ( $y$  mutation), and small bristles ( $f$  mutation) (Lindsley and Zimm, 1992). It is our hypothesis that the genes of the second, third, and fourth chromosomes (the autosomes) from different wild-type stocks will alter the recovery of males with the  $w^{1118}$  mutation and other sex-linked genes.

We first replaced the second, third, and fourth chromosomes of the C(1)DX,  $y f$  stock with autosomes from one of four different wild-type stocks [CS, OBL1&2,  $Per^+(2000)$  and  $Per^+(2013)$ ] by eight generations of backcrossing C(1)DX,  $y f$  females with each of the wild-type stocks as follows (using the CS stock as an example with the CS autosomes marked as  $+^c$  and the C(1)DX,  $y f$  autosomes marked as  $+$ ). By the G3 cross, some autosomes in the C(1)DX,  $y f$  females will be homozygous for the CS autosomes, and by the G8 (eighth generation) females should have all CS autosomes. Also note that the following crosses give matroclinous female offspring that receive their compound-X chromosome from their mothers.

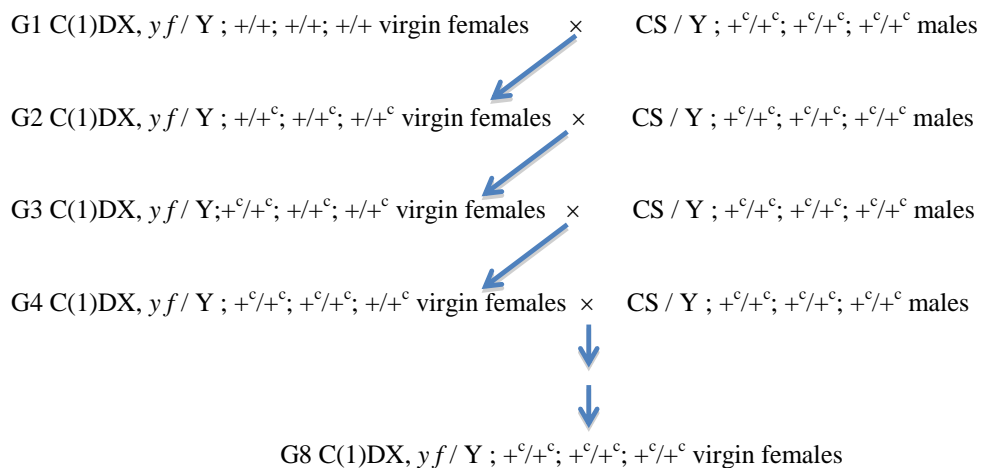

Then single G8 C(1)DX,  $y f / Y$ ;  $+^c/+^c$ ;  $+^c/+^c$ ;  $+^c/+^c$  virgin females were mated to single  $w^{1118}$  males and progeny scored for  $w^{1118}$  males and C(1)DX,  $y f$  females. The same crosses were performed with the other three wild-type stocks and the ratio of males to total progeny was compared among the four autosomal genetic

backgrounds with the results from the stock control. We predict that there will be significant differences in male to total progeny ratios for the five backgrounds.

## Results

A total of 121 crosses were set up, including 24  $w^{1118}$  control crosses (with the  $w^{1118}$  autosomal background) (mean = 0.51; variance = 0.17), 25 crosses with the CS autosomal background (mean = 0.59; variance = 0.13), 21 crosses with the OBL1&2 background (mean = 0.63; variance = 0.24), 31 crosses with the Per+(2000) background (mean = 0.58; variance = 0.13), and 20 crosses with the Per+(2013) background (mean = 0.60; variance = 0.13). The results of these crosses are shown in Figure 1. All four of the crosses with new autosomal genetic backgrounds had significantly higher male/total progeny means compared to the  $w^{1118}$  control (P values were 0.0005 for the CS autosomal background, 0.0004 for OBL1&2, 0.002 for Per+(2000), and 0.0007 for Per+(2013)).

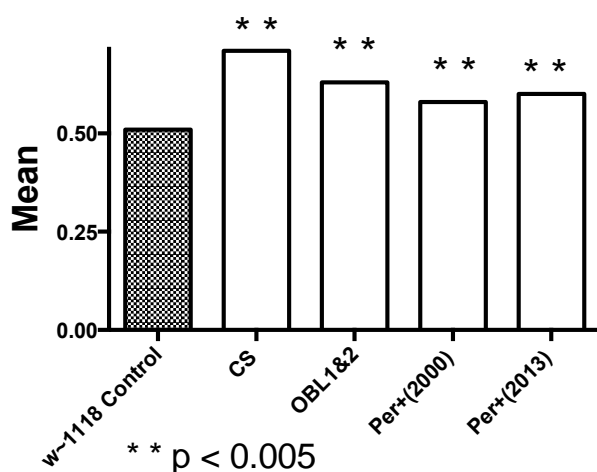

Figure 1. Comparison of the means of male progeny to total progeny in lines with different autosomal genetic backgrounds.

Hence, the effect of the  $w^{1118}$  mutant, and its X-linked genes, on viability (male progeny to total progeny) does depend on epistasis with genes on the autosomal genetic background.

A class discussion of the results of this study might include the role of single genes vs. multiple-genes in the evolution of adaptive traits. An example of an adaptive trait caused by a single gene is coat color in deer mice (Linnen *et al.*, 2009), whereas an

example of a trait associated with selection caused by multiple genes is corn kernel oil content (Laurie *et al.*, 2004).

References: Arjan, J., G.M. de Visser, and S.J. Elena 2007, *Nature Reviews Genetics* 8: 139-149; Azevedo, R.B.R., *et al.*, 2006, *Nature* 440: 87-90; Fay, J.C., 2011, *Cell* 27: 343-349; Kitagawa, O., 1967, *Genetics* 57: 809-820; Laurie, *et al.*, 2004, *Genetics* 168: 2141-2155; Lindsley, D.L., and G.G. Zimm 1992, *The Genome of Drosophila melanogaster*. Academic Press, New York; Linnen, *et al.*, 2009, *Science* 325: 1095-1098; Mukai, T., 1969, *Genetics* 61: 749-761; Seager, R.D., *et al.*, 1982, *Genetics* 102: 485-502; Sanjuan, and Elena 2006, *Proc. Natl. Acad. Sci. USA* 103: 14402-14405; Temin, R.G., *et al.*, 1969, *Genetics* 61: 497-519; Whitlock, M.C., and D. Bourguet 2000, *Evolution* 54: 1654-1660; Wolf, J.R., *et al.*, 2000, *Epistasis and the Evolutionary Process*. Oxford University Press, Oxford; Zhang, Y., and J.S. Liu 2007, *Nature Genetics* 39: 1167-1173.



### Establishment of double mutant strains of *Drosophila melanogaster* (Diptera, Drosophilidae) for teaching purposes.

**Rampasso, Augusto S., and Carlos R. Vilela.** Departamento de Genética e Biologia Evolutiva, Instituto de Biociências, Universidade de São Paulo, Rua do Matão, travessa 14, n. 321, São Paulo - SP, 05508-090, Brazil. Corresponding author: Carlos R. Vilela; E-mail: [crvilela@ib.usp.br](mailto:crvilela@ib.usp.br)

## Abstract

*Drosophila melanogaster* is a valuable model organism that has been used in genetics research since the beginning of the last century, as well as for teaching genetics concepts in the classroom. However, in the latter case, we have noticed the internet can negatively influence the learning process by making experimental outcomes easy to find and students do not need to think over their own observations and results. To overcome such a drawback, the present project aimed to establish six unusual double-mutant strains of *Drosophila melanogaster*, with little to no online information, encouraging students to reach conclusions by their own observations, not only during project's execution but also while collecting data from crosses proposed by the professors. Each double-mutant strain (*yellow brown*, *lozenge singed*, *scute sepia*, *crossveinless eyeless*, *lozenge sepia* and *crossveinless singed*) was established by crossing two single-mutant strains, provided by the Drosophilidae Stock Center of the *Departamento de Genética e Biologia Evolutiva, Instituto de Biociências, Universidade de São Paulo*, with neither the mutant's name/symbol nor its inheritance pattern being revealed. Some of the strains obtained in this project have already been used during basic genetics practical classes for freshmen of Biological Sciences major at the referred university.

Key Words: Basic Genetics, Didactic, Exceptional Flies, Inheritance pattern.

## Introduction

References to the vinegar-fly, not necessarily under the binomen *Drosophila melanogaster* Meigen, 1830, are ancient. It is possible to find 358 citations to these flies prior to 1900 (Drosophila Information Service, 1994). The first documented reference is from 1684, and includes China ink drawings of real-sized flies and one magnified puparium and flies as seen through one of the first microscopes (Mentzel, 1684). Probably the most historically influential person to use this organism for research in the 20th Century was William E. Castle (Allen, 1975), a Harvard University professor who initiated a key-project in 1901, published in 1906, entitled "The Effects of Inbreeding, Cross-breeding, and Selection upon the Fertility and Variability of *Drosophila*". Curiously, its publication year matches the year William Bateson coined the term "Genetics" to name this emergent field of study. Thanks to that article, Thomas H. Morgan, a University of Columbia professor, felt motivated to start using *Drosophila melanogaster* as his research material (Allen, 1975). In 1910, he [or most probably his student Calvin Bridges] found a male that, instead of having typical red eyes, presented white eyes (Sturtevant, 2001). Studies upon this male led to his renowned article "Sex Limited Inheritance in *Drosophila*", published in the same year. Since then, thousands of researchers started studying these flies (Dos Santos *et al.*, 2015), because they are easily bred in laboratories, present a short life-cycle, have conspicuous sexual dimorphism, only four chromosomes pairs, a myriad of described mutations, and produce numerous offspring (Demerec and Kaufmann, 1967; Lindsley and Zimm, 1992).

Due to subsequent inclusion of a Genetics course in Natural History and Medicine majors in universities worldwide, *Drosophila melanogaster* started being largely used for teaching, since all of the advantages of using it for research also make it outstanding material for practical classes. It is worth noting that, in less than two months, it is possible to perform projects that elucidate the concepts of segregation, independent assortment, linkage, recombination, and linkage mapping (Strickberger, 1962; Marconi and Vilela, 2013). On the other hand, access to class-based experimental outcomes has become too simple and immediate, since students can go online to conclude projects without any need of intense intellectual effort, even though they should enjoy the opportunity to learn through introspection and heuristics.

In this project, we established six unusual double mutant strains of *Drosophila melanogaster*, for which online information is not frequently available, challenging the students to reach conclusions on their own.

## Materials and Methods

Our study material is *Drosophila melanogaster*, popularly known as the vinegar-fly, and the most common species indoors all over the world. Approximately one hundred wild and mutant strains belonging to this model organism are currently (2015) being maintained by the Drosophilidae Stock Center of the

*Departamento de Genética e Biologia Evolutiva, Instituto de Biociências, Universidade de São Paulo.* The collection was assembled over a six-decade period by several curators, who received most of the strains from different stock centers, mainly from USA.

The establishment of six double-mutant strains was performed by one of us (ASR), from whom the name/symbol and inheritance pattern of mutations present in single-mutant lineages (parental generation) (Table 1) were unrevealed.

Table 1. Single-mutant strains of *Drosophila melanogaster* used to establish double-mutant lineages. Male adults were collected from an unknown  $\alpha$  strain, and the female pupae, from an unknown  $\beta$  strain.

Cross	Unknown $\alpha$	Unknown $\beta$
1	<i>yellow</i>	<i>brown</i>
2	<i>lozenge</i>	<i>singed</i>
3	<i>scute</i>	<i>sepia</i>
4	<i>crossveinless</i>	<i>eyeless</i>
5	<i>lozenge</i>	<i>sepia</i>
6	<i>singed</i>	<i>crossveinless</i>

After identifying the affected phenotypes, three to nine random couples were crossed in cylindrical vials (height: 7.5 cm, diameter: 2 cm) (Shorrock, 1972) containing a small amount (ca. 5 ml) of banana-agar culture medium with foam plug enclosures (Goldstein and Fyrberg, 1994). Posteriorly, small pieces of fresh bakers' yeast (*Saccharomyces cerevisiae*) were added to feed the couples. For this and subsequent generations, all females were virgins, identified and isolated during pupal stage.

The vials were placed in a chamber at constant temperature ( $25\pm 1^\circ\text{C}$ ), and, eventually, in chambers at lower temperatures ( $22\pm 1^\circ\text{C}$  and  $18\pm 1^\circ\text{C}$ ). Every 3-5 days, flies were transferred to new vials containing culture medium. Larvae remained in previous vials, and more of the same fresh bakers'

yeast was added (Shorrock, 1972) with  $10\times 2$  cm V-shaped strips of filter paper (one per vial) inserted into the culture medium (Freire-Maia and Pavan, 1949). Nine days after larvae hatched from eggs it was possible to find  $F_1$  emerged flies, which were anesthetized by triethylamine fumes (Fuyama, 1977) and analyzed under a stereomicroscope.

## Results and Discussion

The first author (ASR) determined each mutation's inheritance pattern through phenotypic analysis of emerged flies from  $F_1$  and  $F_2$  generations. In all parental crosses, females exhibited one mutation (called **m1**) and males another (called **m2**). Only two inheritance patterns were identified. In one case,  $F_1$  males presented the **m1** mutation, which indicated its allele was located on the X chromosome, since it exhibited crisscross inheritance, meaning the affected character observed in parental females was transmitted to  $F_1$  males. In contrast, all  $F_1$  female flies were phenotypically wild-type. In the  $F_2$  generation, six phenotypic classes were observed: **m1** females, wild-type females, **m1** males, **m2** males, wild-type males and double-mutant males. The absence of both **m2** and double-mutant females in the  $F_2$  generation suggested this mutation (present in parental males) was also X-linked. In order to produce the two last-cited male phenotypes, a crossing over must have occurred between the two genetic markers, once they presented two mutated alleles, or two wild-type alleles, in *cis* position, therefore, located in the same X chromosome. Moreover, one could expect that, in addition to the recombinant males, there would also be heterozygous **m2** females among the phenotypically **m1** female specimens, which would produce recombinant gametes for both genes. In order to detect them, individual test-crosses were performed between  $F_2$  **m1** females and  $F_2$  double-mutant males. In some of those crosses, it was possible to observe that part of their offspring was constituted by double-mutant males and females. To establish the desired strain, recently emerged (less than 4 h) double-mutant females were isolated and then crossed to double-mutant males.

In the other case, all  $F_1$  flies were wild-type. Lack of crisscross inheritance (from parental females to  $F_1$  males) demonstrated the **m1** mutation was autosomal. In the  $F_2$  generation, six phenotypic classes were observed: **m1** females, wild-type females, **m1** males, **m2** males, wild-type males, and double-mutant males. The absence of both **m2** and double-mutant females in the  $F_2$  generation females suggested this mutation was X-linked. It was necessary to perform test-crosses as well, between  $F_2$  **m1** females and  $F_2$  double-mutant males, to verify which females were heterozygous for **m2** mutation. Once identified, as detailed in the preceding paragraph, their double-mutant offspring were intercrossed.

The six established double-mutant strains are listed in Table 2, and are candidates to be used in the basic Genetics course, offered to ca. 120 students enrolled in the Biological Sciences major at *Universidade de São Paulo* per year.

Table 2. Phenotypes of six established double-mutant strains of *Drosophila melanogaster*.

Strain	Phenotypes
1	<i>yellow brown</i>
2	<i>lozenge singed</i>
3	<i>scute sepia</i>
4	<i>crossveinless eyeless</i>
5	<i>lozenge sepia</i>
6	<i>crossveinless singed</i>

As detailed by Marconi and Vilela (2013), the students are organized in groups of mostly four people and must perform a project during part of the four-month (15 week) semester. They are requested to investigate the inheritance pattern of four conspicuous mutations, two being present in the parental male (sampled from an unknown  $\alpha$  *Drosophila melanogaster* strain), crossed to parental female flies (sampled from an unknown  $\beta$  strain), which also bear two different mutations. Combinations vary from year to year. The experiment requires the dedication of 105 min per week, for six weeks. First, each group must isolate twelve male pupae from a strain called unknown  $\alpha$ , and twelve female pupae from an unknown  $\beta$  strain. Sex identification of pupae is based on presence (male)/absence (female) of sexual combs on front legs' first

tarsomeres. Pupae are more easily sexed when they rest over a wet filter paper strip placed on a white stage plate under a stereomicroscope illuminated with white LED ring light, which is not hot and does not kill them by overheating. Upon emergence, five random mating couples must be established and crossed by each group, and kept in vials containing banana-agar culture medium. Next, aiming to identify the genetic markers of both strains, students must analyze a few of the remaining flies (regarding their sexes and the presence/absence of genetic markers), anesthetized with triethylamine fumes (Fuyama, 1977), under a stereomicroscope. Ideally, the female parental strain must exhibit at least one X-linked mutation, and the mutations must always be recessive. Finally, students analyze the next two generations, F<sub>1</sub> (n = 13 randomly sampled flies per student) and F<sub>2</sub> (n = 11 males and 11 females per student). In the F<sub>1</sub> generation, non-crisscross inheritance may be detected. This rare and unusual event is an exciting manner to stimulate students to treasure exceptions, as stressed by Marconi and Vilela (2013). At the end of the project, groups are requested to map the X-linked genes. They should reach by themselves to the conclusion that is more convenient to use only male offspring frequencies of the F<sub>2</sub> generation, without any need of test crossing.

Table 3. Phenotypes of parental and F<sub>1</sub> *Drosophila melanogaster*, and total of F<sub>1</sub> e F<sub>2</sub> flies sampled during the projects made in three consecutive years. F<sub>2</sub> sampled flies belong to 16 different male phenotypes and 4 different female phenotypes. Exceptional flies were intentionally excluded from this table (see Table 4). F<sub>1</sub> flies were analyzed randomly regarding the sexes, whereas F<sub>2</sub> flies, in equal number of males and females.

Year	Sex	Parental generation	F <sub>1</sub> generation	F <sub>2</sub> generation
2012	Male	<i>lozenge singed</i>	615 <i>yellow</i>	1287
	Female	<i>dumpy yellow</i>	983 wild-type	1287
2013	Male	<i>crossveinless forked</i>	690 <i>scute</i>	1243
	Female	<i>scute sepia</i>	868 wild-type	1243
2014	Male	<i>eosin hedgehog</i>	501 <i>crossveinless singed</i>	1265
	Female	<i>crossveinless singed</i>	825 wild-type	1265

As of 2015, three of the six strains established during this project have already been used in the basic Genetics practical classes, ministered by the second author (CRV) and colleagues. In 2012, 128 students crossed *lozenge singed* males (from unknown  $\alpha$  strain) with *dumpy yellow* females (from unknown  $\beta$  strain). In 2013, 125 freshmen performed their project based on *crossveinless forked* males (unknown  $\alpha$  strain) crossed with *scute sepia* females (unknown  $\beta$  strain). A total of 116 students crossed *eosin hedgehog* males (unknown  $\alpha$  strain) with *crossveinless singed* females (unknown  $\beta$  strain) in 2014. The parental generation and the total



of flies sampled by students throughout F<sub>1</sub> and F<sub>2</sub> generations and their respective phenotypes are listed in Table 3.

Table 4. Phenotypes of exceptional *Drosophila melanogaster* observed among F<sub>1</sub> generation in three consecutive years. Students tested and verified that all exceptional males were sterile, whereas females were fertile.

Year	Sex	Phenotype
2012	Male	1 <i>yellow scute</i>
	Female	0
2013	Male	1 <i>crossveinless forked</i>
	Female	1 <i>scute</i>
2014	Male	1 <i>eosin</i>
	Female	1 <i>crossveinless singed</i>

It should be pointed out exceptional flies were found in every of the three cited years (Table 4).

All exceptional flies were investigated in extra class experiments, performed by the groups who detected them. At the end, all enrolled students have access to their results, and are requested to include them in a simulated manuscript, in which they must hypothesize how these organisms could have been produced. It is worth noting one mutation observed among 2013 exceptional flies was not present in the parental generation, providing the students the opportunity to generate additional hypothesis, which could have been tested, if there was enough time for additional experiments.

Results of linkage mapping obtained by freshmen from 2012 to 2014 using double-mutant strains established during this project are represented in Figure 1.

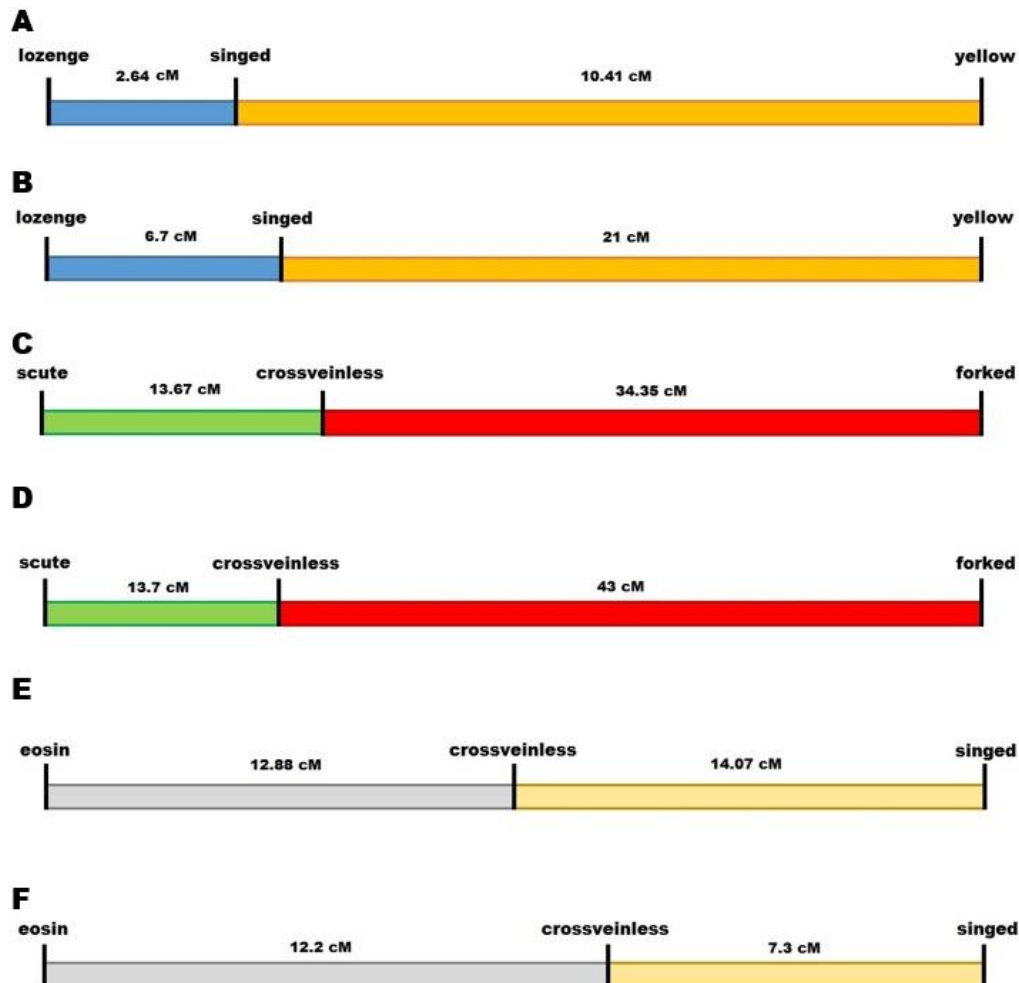

Figure 1. Linkage mapping obtained by freshmen in 2012 (A), 2013 (C), and 2014 (E); compared to respective chromosomal distances detailed in Lindsley and Zimm, 1992 (B, D, F).

## Conclusions

Strains established in this project are highly recommended for developing similar projects. As those combinations are unusual, students will not be able to easily find expected results online, which contributes to the development of their own observation, data collection, and analysis, and awakens their curiosity, which may increase their interest in the challenging scientific activities.

Acknowledgments: We are grateful to the basic Genetics team and enrolled freshmen in 2012, 2013, and 2014, which included 369 Biological Sciences students, four additional Professors (Drs. L. Mori, L.E.S. Netto, D.S. Sheepmaker, and T.T. Torres), monitor students of 2012 (C.R.R. Arantes, B.L.B. Argiona, V.Q. Pretti, and S.C. Vaz), 2013 (J.A. Bachur, C.S. Faria, and P. Perre), and 2014 (C.I.S. Costa, C. Kaid, I.L. Teixeira, and T.I. Yassumoto), two technicians (C.E. Lopes and F. Flauzino) for numerous reasons, Dr. Gerhard Bächli for gently sending us a copy of Mentzel (1684)'s paper, and Dr. Maxi Polihronakis Richmond for kindly reviewing the English version.

References: Allen, G.E., 1975, *Isis* 66: 322-333; Castle, W.E., F.W. Carpenter, A.H. Clark, S.O. Mast, and W.M. Barrows 1906, *Proceedings of the American Academy of Arts and Science* 41: 729-786; Demerec, M., and B.P. Kaufmann 1967, *Drosophila Guide: Introduction to the Genetics and Cytology of Drosophila melanogaster*, Carnegie Institution, Washington; Dos Santos, G., A.J. Schroeder, J.L. Goodman, V.B. Strelets, M.A. Crosby, J. Thurmond, D.B. Emmert and W.M. Gelbart, the FlyBase Consortium, 2015, *FlyBase: introduction of the Drosophila melanogaster Release 6 reference genome assembly and large-scale migration of genome annotations*; *Drosophila* Information Service, 1994, *The Bibliography of Drosophila*, *Dros. Inf. Serv.* 74: 5; Goldstein, L.S.B., and E.A. Fyrberg 1994, *Drosophila melanogaster: Practical Uses in Cell and Molecular Biology*. San Diego, Academic Press; Freire-Maia, N., and C. Pavan 1949, *Introdução ao estudo da drosófila*. *Revista Cultus* 1 (5): 3-61; Fuyama, Y., 1977, *Dros. Inf. Serv* 52: 173; Lindsley, D., and G. Zimm 1992, *The Genome of Drosophila melanogaster*, Academic Press, NY; Marconi, M., and C.R. Vilela 2013, *Dros. Inf. Serv* 96: 233-238; Mentzel, C., 1684, *Miscellanea Curiosa sive ephemeridum medico-physicarum germanicum Academiae Caesareo-Leopoldinae naturae curiosum* 2: 96-98; Morgan, T.H., 1910, *Science* 32: 120-122; Shorrock, B., 1972, *Drosophila*, Ginn and Company, London; Strickberger, M.W., 1962, *Experiments in Genetics with Drosophila*, ED, NY; Sturtevant, A.H., 2001, *A History of Genetics*, Cold Spring Harbor Laboratory, NY.



### Using DGRP sequenced genomes to map heterozygous modifier effects on cell death in *Bar* eye of *Drosophila*.

**Thompson, James N., jr., Daniel Tinney, Jacob Khoussine, Gary Cox, J. Ross Ogden, Grayson Audette, Saba Bingabr, Danielle Branesky, Andres Gomez, Jason Lauderdale, Cassandra Long, Jacob Mitchell, Sonya Narula, Dennis Nguyen, Thuc-Vi Nguyen,**

**Daniel Pons, Cameron Steele, Garrett Sutton, Tyler Tallman, and Barbara Safiejko-Mroccka.**  
Department of Biology, University of Oklahoma, Norman, OK.

The *Drosophila* Genetic Reference Panel (DGRP) lines developed by Trudy MacKay and her colleagues (Mackay *et al.*, 2012) offer a powerful resource for analyzing multi-gene influences on development, behavior, and physiology of *Drosophila melanogaster*. Rather than trying to isolate genes that influence a trait of interest using chromosomal substitutions, recombination mapping, or other approach, mapping of relevant loci begins with known genomes. By correlating specific trait expressions with the extensive database of SNPs for each sequenced line in the DGRP set, regions of the genome that consistently associate with a targeted phenotypic expression can be identified and explored in additional detail. But many of the traits our group is interested in studying require an additional element. We want to know about genes that act as modifiers of a mutation's expression, such as wing vein length mutations like *plexus*, with extra vein fragments, and *veinlet* with wing vein gaps in *Drosophila* (e.g., Thompson, 1974, 1975a, 1975b). A

major mutation exposes a variable range of expression due to secondary modifier loci in the genetic background. These modifier loci must be directly or indirectly relevant to the targeted pathway of the major mutation.

But one cannot introgress a targeted mutation into a sequenced strain without destroying the sequenced background by recombination and segregation. Some experimental designs may benefit from that approach. But drawing upon the exceptional resource offered by the DGRP lines, there is a middle road. In this pilot study, we test a limited set of the more than 200 currently available DGRP sequenced lines to assess their heterozygous modifier effects on mutant expression of *Bar*, a dominant cell death eye mutation (small duplication) with variable expression. Specifically, we are screening for genomic regions that influence cell death by measuring the number of eye facets in *Bar* eyes on different heterozygous sequenced genome backgrounds. If successful, the next phase will be to explore whether the same quantitative modifier loci are involved in phenotypic expression of other cell death-related traits such as mutations that cause notches in *Drosophila* wings.

This pilot experiment used five of the DGRP lines, obtained from the Bloomington *Drosophila* Stock Center (# 25174, 25175, 25177, 25179, and 25180). Virgin females were collected from the *Basc* strain, which carries *Bar*, white-apricot, and scute mutations along with inversions that make it an effective X-chromosome balancer. *Basc* females were mated to males from a DGRP strain yielding F1 males that carried *Bar* and were heterozygous for one of the sequenced genomes. Heads were removed and bisected so the eyes pointed up when mounted on an electron microscope plug. Samples were prepared using the protocol in Thompson *et al.* (2009) and were viewed and photographed with a Zeiss Neon 40EsB electron microscope. The number of successful mounts varied somewhat from one group to another. Future experiments will attempt to standardize the data sample size.

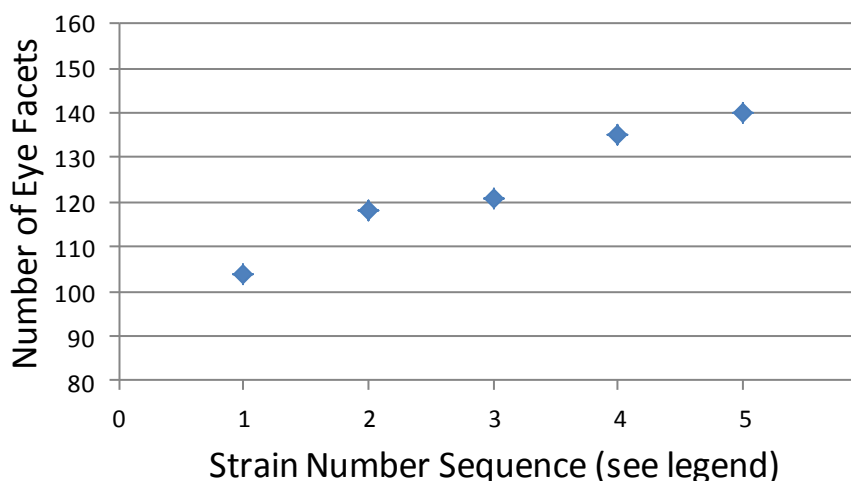

Figure 1. Average facet counts for five representative DGRP strains heterozygous for *Bar* (standard deviations are too small to show). 1, strain 25175; 2, strain 25177; 3, strain 25180; 4, strain 25179; 5, strain 25174.

Perhaps surprisingly (or luckily), even just these five representative sequenced genomes demonstrated significantly different influences on cell death in the *Drosophila* eye (Figure 1). For a sample subset of these data, photographs were scored by up to 15 students, and the replicate variation associated with repeatability among researchers was not significant. Differences were typically only one or two facets in an eye having perhaps 100. Against this “replicate repeatability”, strain effects were easily identifiable (Figure 2; for a comparison of the two extremes in this small sample, mean  $\pm$  sd for strain 25175 is  $105.4 \pm 17.4$ ,  $n = 7$ ; for strain 25174,  $141.0 \pm 7.7$ ,  $n = 15$ , facets per eye). It is clear that even this small sample of DGRP genomes carries cell death modifiers that differ in their effects on *Bar* as heterozygotes.

A future addition to the analysis will be a measure of fluctuating symmetry (FA) when sufficient data are available from both eyes of an individual. FA is a standardized difference between the left and right sides of a trait that is expected to be symmetrical and for which deviations can be interpreted in terms of developmental stress. This will yield an insight into developmental homeostasis influencing cell death expression.

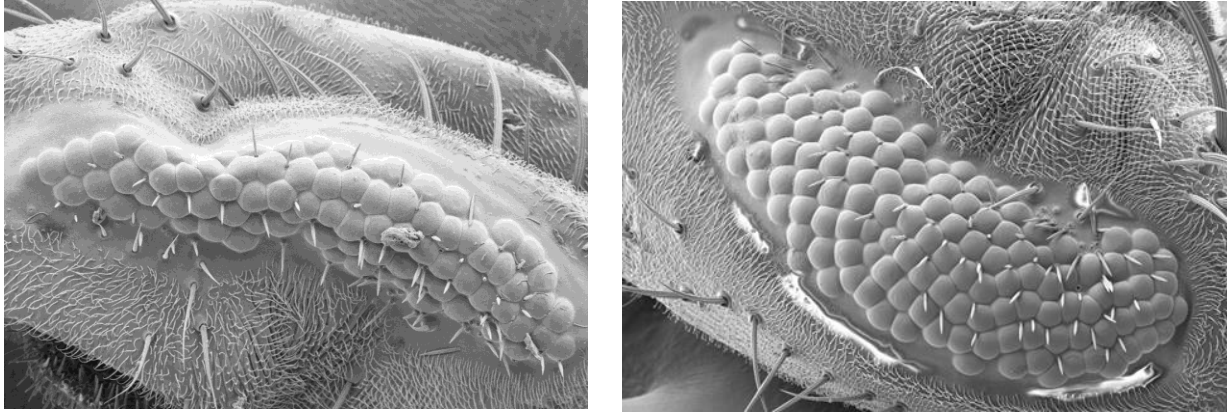

Figure 2. Representative images of *Bar* eyes heterozygous for a sequenced DGRP strain genotype: left, # 25175; right, # 25174.

**Acknowledgments:** This pilot study was done as an experiment designed by students in an advanced Biology lab course and was made possible through the advice and electron microscope supervision of Preston Larson and Gregory Strout, Samuel Roberts Noble Microscopy Laboratory at the University of Oklahoma.

**References:** Mackay, T.F.C., *et al.*, 2012, *Nature* 482: 173-178; Thompson, J.N., jr., 1974, *Heredity* 33: 389-401; Thompson, J.N., jr., 1975a, *Nature* 258: 665-668; Thompson, J.N., jr., 1975b, *Genetics* 81: 387-402; Thompson, J.N., jr., C.N. Hallman, M.A. Anderson, T.R. Bradford, S.J. Lee, K.L. Meyer, S.J. Smith, A.S. Theppote, R.E. Woodson, S.D. Kinzie, and B. Safiejko-Mroczka, 2009, *Dros. Inf. Serv.* 92: 180-184.

## Erratum

### **Erratum: Sterility in *D. pseudoobscura* / *D. p. bogotana* hybrid males. 1995, *Dros. Inf. Serv.* 76: 143.**

Noor and Coyne (1995) reported that hybrid males from a cross between a recently (seven-generations prior) collected strain of *D. p. bogotana* and a stock of *D. pseudoobscura* were sterile. While the conclusion was correct, re-examination of records finds that two pieces were incorrectly described. First, the sample size was five rather than twenty (or no clear record was kept of additional dissections), and second, the hybrid males were tested for fertility 1 day after eclosion rather than 7. I (Noor) apologize for my errors in presentation.

Reference: Noor, M.A., and J.A. Coyne 1995, *Dros. Inf. Serv.* 76: 143.

## Mutation Notes

**Displaced genital arch in a *Drosophila melanogaster* male.**

**Araújo, S.J.<sup>1,2</sup>, R. Romero<sup>1</sup>, and F. Mestres<sup>1,\*</sup>.** <sup>1</sup>Dept. Genètica, Universitat de Barcelona, Barcelona (Spain). <sup>2</sup>Institute for Research in Biomedicine and Institut de Biologia Molecular de Barcelona (CSIC), Parc Científic de Barcelona, Barcelona (Spain). \*Corresponding author:

[fmestres@ub.edu](mailto:fmestres@ub.edu)

*Drosophila melanogaster* mutant *ebony* (*e*) is characterized by its pigmentation defects in the adult cuticle (Bridges and Morgan, 1923); *eyegone* (*eyg*) has been described as having head and eyes much smaller than normal (Ives, 1942); and the *vestigial* (*vg*) locus seems to be only involved in wing development (Bridges and Morgan, 1919). While analyzing the F<sub>1</sub> offspring from the parental cross between the *D. melanogaster* strains *e eyg* and *vg*, a particular fly was observed. It was a male, with no extended wings and normal color (although slightly darker because it was heterozygote for *e*). Interestingly, its genital arch was displaced from its normal position. It was not located in the ventral tip of the abdomen, instead it was displaced almost 90 degrees towards the end of the abdomen (Figures 1 and 2). The abdominal area where the genital arch should be was covered with a thin tegument (Figures 3 and 4). Sex combs were properly located. The animal died by accident nine days after emerging and left no progeny (he was caught in the culture medium).



Figure 1. Abnormal location of the genital arch in the *D. melanogaster* male.



Figure 2. Detail of the genital arch, located at the abdomen.



Figure 3. A thin tegument is located in the original place of the genital arch.



Figure 4. Detail of the ventral aspect of the abdomen.

References: Bridges, C.B., and T.H. Morgan 1919, Carnegie Inst. Washington Pub. 278: 123-304; Bridges, C.B., and T.H. Morgan 1923, Carnegie Inst. Washington Pub. 327: 1-251; Ives, P.T. 1942, Dros. Inf. Serv. 16: 48-49.



### A new spontaneous chromosomal inversion in a classical laboratory strain of *Drosophila subobscura*.

**Orengo, D.J., E. Puerma, and M. Agudé.** Departament de Genètica, Facultat de Biologia, and Institut de Recerca de la Biodiversitat (IRBio), Universitat de Barcelona, Barcelona, Spain; dorcasorengo@ub.edu.

*Drosophila subobscura* stands out for its rich chromosomal polymorphism in natural populations. Krimbas (1992) reviewed up to 66 spontaneous chromosomal inversions that combined into 79 arrangements. Some of these inversions are common in the whole range of the species distribution, but others are only present either at low frequencies across the species distribution area or in a restricted geographical area. In addition, a set of inversions should have been discovered shortly after its appearance in nature. This is the case of inversions E<sub>17</sub>, E<sub>18</sub>, E<sub>21</sub> and O<sub>26</sub> found after the New World colonization by *D. subobscura* (Balanyà *et al.*, 2003), and also that of some inversions recorded only once in populations widely and repeatedly studied, such as E<sub>19</sub>, E<sub>20</sub>, and U<sub>12</sub> in Zürich (Gosteli and Hauschteck-Jungen, 1989) and O<sub>25</sub> in Barcelona (Orengo and Prevosti, 1992).

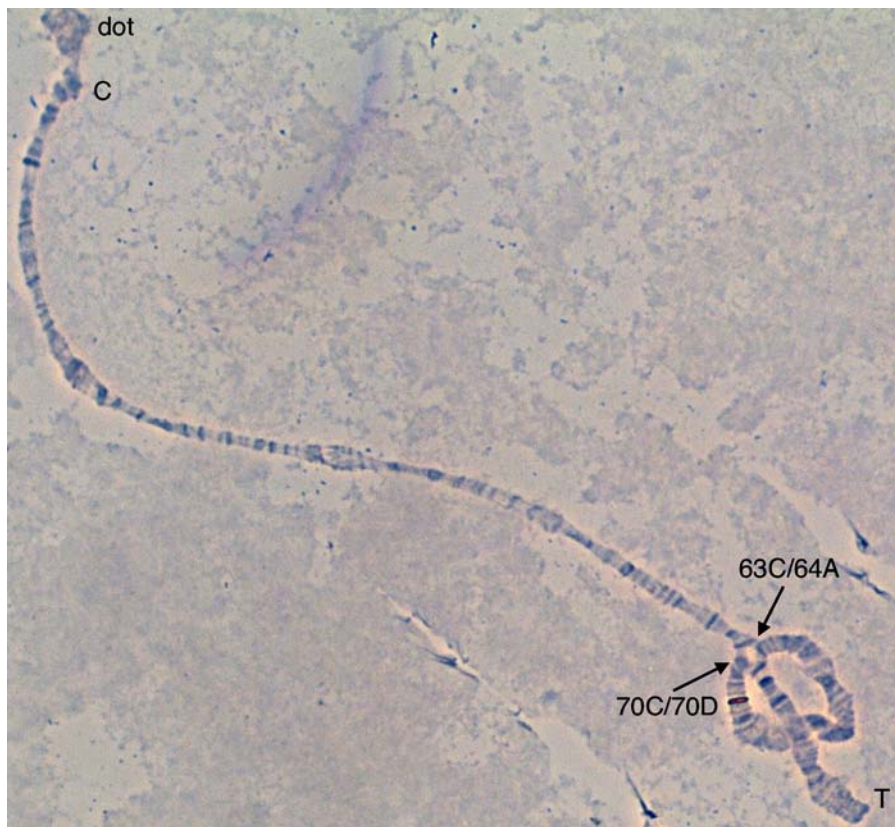

Figure 1. Polytene E chromosomes of an heterokaryotype for chromosomal arrangements E<sub>3t</sub> and E<sub>24</sub> of *Drosophila subobscura*. Arrows indicate the cytological location of both inversion E<sub>24</sub> breakpoints. C: Centromere; T: Telomere; dot: the small chromosome.

Here we report a new spontaneous inversion (Figure 1) that arose in the *ch cu* laboratory strain. This strain that was obtained in the Krimbas' laboratory over 40 years ago (Zouros and Krimbas, 1973) is homo-karyotypic for its five long chromosomes (A<sub>st</sub>, J<sub>st</sub>, U<sub>st</sub>, E<sub>st</sub> and O<sub>3+4</sub>). The *ch cu* strain has been maintained and used in our department for over 35

years to determine the chromosomal polymorphism in natural populations samples by crossing wild males to *ch cu* virgin females and subsequently observing polytene chromosomes from F<sub>1</sub> larvae (*e.g.*, Prevosti *et al.*, 1982; Orengo 1994). In addition, we have commonly used polytene chromosome preparations from this strain to map DNA probes by *in situ* hybridization (*e.g.*, Segarra and Agudé, 1992; Orengo *et al.*, 2015).

Despite the many thousands of *ch cu* chromosomes that we have observed —either in heterokaryotypic  $F_1$  larvae or directly in *ch cu* strain larvae— over the long period elapsed, we had never detected any discordant arrangement in *ch cu* chromosomes.

During one of our *in situ* hybridization experiments, we realized that the pair of E chromosomes from one *ch cu* larva was heterokaryotypic for an inversion (Figure 1). We could readily discard an accidental contamination of the *ch cu* strain from other *D. subobscura* strains of the Barcelona area maintained in our laboratory, since the rest of chromosomes were homokaryotypic for the *ch cu* strain arrangements  $A_{st}$ ,  $J_{st}$ ,  $U_{st}$ , and  $O_{3+4}$ , which are at rather low frequency in the Barcelona area. Moreover, upon closer inspection of the inversion span, we could confirm that this was a new inversion, since its cytological breakpoints correspond to sections 63C/64A and 70C/70D of the Kunze-Mühl and Müller (1958) map, which are not shared by any other spontaneous known inversion. We named this inversion  $E_{24}$ .

The spontaneous origin of a new inversion in a laboratory strain that is normally used to determine the karyotype of wild-caught individuals might raise concerns relative to the identification of inversions newly originated in natural populations. Indeed, if the rate of origin of inversions in laboratory strains were high — which does not seem to be the case for the *ch cu* strain—, some of the inversions newly described as having originated in natural populations might have actually originated in the laboratory strain used to karyotype wild-caught individuals.

References: Balanyà J., L. Serra, G.W. Gilchrist, R.B. Huey, M. Pascual, F. Mestres, and E. Solé 2003, *Evolution* 57(8): 1837–1845; Gosteli, M., and E. Hauschteck-Jungen 1989, *Genetica* 79: 115-120; Krimbas, C.B., 1992, *In: Drosophila Inversion Polymorphism* (Krimbas, C.B., and J.R. Powell, eds.), pp. 127-220. CRC Press, Boca Ratón; Kunze-Mühl, E., and E. Müller 1958, *Chromosoma* 9: 559–570; Orengo, D.J., 1992, *Correlación entre el polimorfismo cromosómico y el tamaño del cuerpo en Drosophila subobscura*. Ph.D. thesis. Universitat de Barcelona, Barcelona. 173 pp; Orengo, D.J., and A. Prevosti 1992, *Dros. Inf. Serv.* 71: 159-160; Orengo, D.J., E. Puerma, M. Papaceit, C. Segarra, and M. Aguadé 2015, *Heredity* 114: 610-618; Prevosti, A., G. Ribó, M.P. García, E. Sagarra, M. Aguadé, L. Serra, and M. Monclús 1982, *Actas V Congr. Latinoam. Genética* p: 189-197; Segarra, C., and M. Aguadé 1992, *Genetics* 130: 513-521; Zouros, E., and C.B. Krimbas 1973, *Genetics* 73: 659-674.



### Abnormal ovipositor in a *Drosophila melanogaster* female.

**Romero, R. and F. Mestres\***. Dept. Genètica, Universitat de Barcelona, Barcelona (Spain).

\*Corresponding author: [fmestres@ub.edu](mailto:fmestres@ub.edu).

While collecting virgin females from a wild stock, we found a female with an abnormal ovipositor (Figures 1, abnormal; Figure 2, normal). The stock was obtained from wild *D. melanogaster* flies collected at the Font Gropa site, near Barcelona, in autumn 2012 (Canals *et al.*, 2013). Unfortunately, it was not possible to cross this female, and we did not have any information on her parents because she appeared in a mass culture.

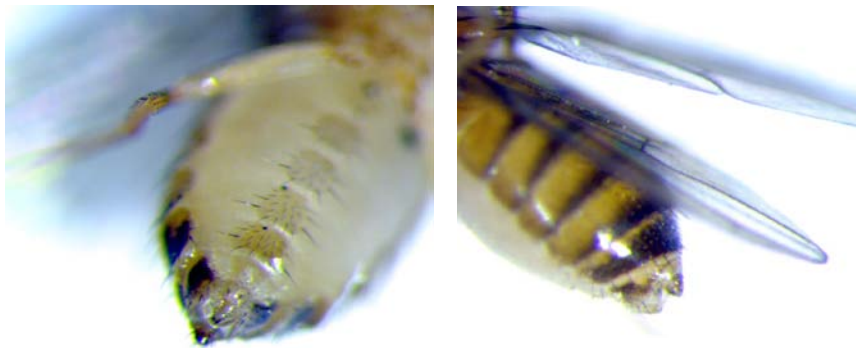

Figure 1. Abnormal ovipositor (ventral and lateral views).

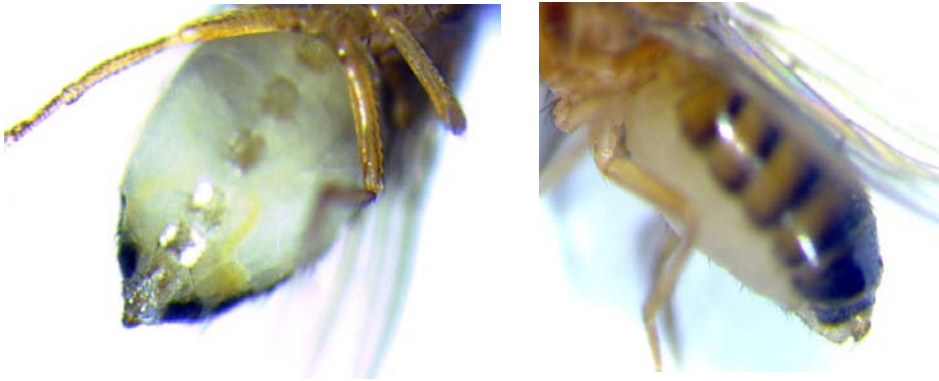

Figure 2. Normal ovipositor (ventral and lateral views).

References: Canals, J., J. Balanyá, and F. Mestres 2013, *Dros. Inf. Serv.* 96: 185-186.