

The Sounds of Spring

Big Bass for your outdoor space

Dayton Audio IO8XTB #310-034
8" Indoor/Outdoor 2-Way Speaker w/ Bass Radiator Black **\$169⁹⁸** EACH

Page 5

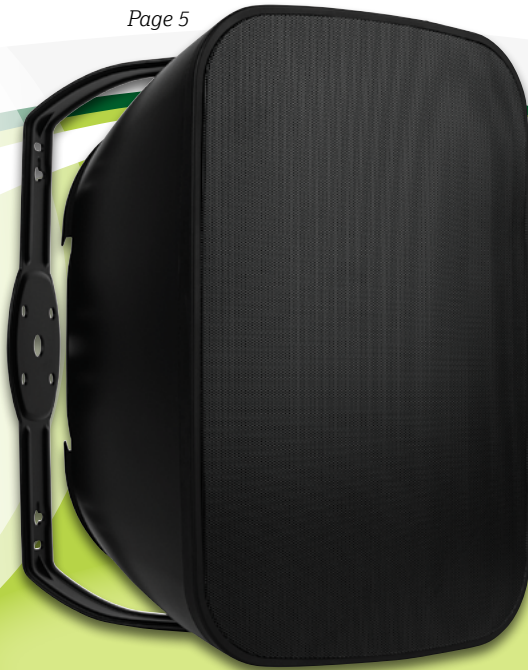

Burial Subwoofer #310-028
See back cover for details



DAYTONAUDIO



NEW

Delivers incredible clarity and detail

Dayton Audio MB1025-8 10" Professional High Power Midbass Driver 8 Ohms

Page 22 **\$59⁹⁸** EACH
#295-637

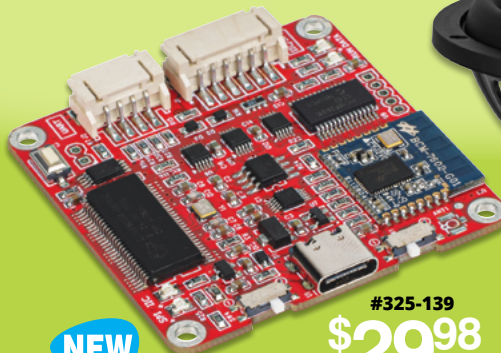

NEW

#325-139
Page 12 **\$29⁹⁸** EACH

Now add custom audio adjustments to your KAB board

Dayton Audio KPX In-Circuit Programmer USB



Max-X Back in stock!

Dayton Audio MX12-22 12" Max-X High Excursion DVC Subwoofer 2 Ohms Per Coil

Page 15 **\$179⁹⁸** EACH
#295-166

Parts Express – Making the world sound better since 1986!



We Accept: **VISA**



Free Economy shipping on domestic orders over \$99.*

Visit parts-express.com for details.

Terms and conditions may change without notice. Parts Express is not responsible for print errors in prices, descriptions, or rates. See our website for the latest information and important customer FAQs.

parts-express.com

Detailed product descriptions, user product reviews, diagrams, and a do-it-yourself resource area are online at parts-express.com – along with over 17,000 products! Orders placed before 4:00 PM ET are shipped the same day.

Commercial Sales

Are you an OEM, installer/integrator, retailer, or in the gaming or amusement park business? We offer personalized service, exclusive discount pricing, outstanding tech support, and more. Go to b2b.parts-express.com or call **1-866-366-4909**.

Customer Support

Call, email, or chat live with our trained and professional Customer Service team for prompt help in processing an order or to obtain price and availability. Contact us at **1-800-338-0531** or sales@parts-express.com or parts-express.com.



Our highly regarded technical support team has hands-on product experience and technical electronics knowledge. For assistance with your audio/video projects call **1-800-338-0531** or email tech@parts-express.com or visit our website to **chat live with our techs**.

Connect With Us:



Parts Express



@Parts_Express



parts_express



Parts Express



Parts Express



parts_express

TECH TALK

CUSTOMER FORUM

VISIT OUR RETAIL STORE

*Save shipping— buy online, pickup in-store!
See products and talk to experts!*

725 Pleasant Valley Drive | Springboro, OH 45066



Industry Affiliates:



NEW Product Arrivals

Deluxe Adjustable Soldering Iron Kit 25W to 60W

- Adjustable temperature from 25W to 60W for multiple applications
- Includes tools for soldering and desoldering
- Case keeps tools organized
- Ground strap protects against static discharge which might damage sensitive electronics



\$22⁹⁸

#374-150List \$39.99 (1-4)
.....**\$21.37** (5-9) **\$20.68** (10-49) **\$19.53** (50-UP)



LaVoce DN10.142
Neodymium
1" Polymer
Compression
Driver 2-Bolt

LAVOCE
ITALIANA

#293-772 Page 22



#300-3805 Page 3

Dayton Audio DTA-100LF Desktop
Subwoofer Amplifier with EQ



Dayton Audio MB1025-8
10" Professional High
Power Midbass Driver

#295-637
Page 22



WARNING: Cancer and Reproductive Harm — www.P65Warnings.ca.gov



Rear View

Dayton Audio APA102BT Class D Stereo 60 WPC Bluetooth Amplifier



- Bluetooth 4.2 with aptX technology for wireless Hi-Fi listening
- Dual stereo RCA line level inputs switch sources automatically
- Convenient signal sensing power on and trigger modes save power when not in use

\$154⁹⁸ (1-3)
 List \$175.99 **\$143.35** (4-UP)

#300-593

Dayton Audio DTA-2.1BT2 100W 2.1 Class D Bluetooth Amplifier with Sub Frequency Adjustment

- Front panel sub crossover frequency adjustment, sub level, tone, and volume controls provide the user with the ability to easily dial in their preferred sonic character



\$89⁹⁸ (1-3)
 List \$129.99 **\$86.38** (4-UP)

#300-3831

Dayton Audio DTA30HP 30W Class D Mini Amplifier with Headphone Output

- Efficient Class D amplification provides crisp, powerful output while retaining a compact form factor perfect for desktops, entertainment centers, and personal listening systems



\$49⁹⁸ (1-7)
 List \$55.99 **\$46.23** (8-UP)

#300-3812

Dayton Audio DA30 2x15W Class D Mini Amplifier

- Class D topology combines efficiency with accuracy
- Auto on/off
- Perfect mini commercial amplifier
- Great for classrooms or conference rooms



\$88⁹⁸ (1-3)
 List \$131.99 **\$82.31** (4-UP)

#300-330

Dayton Audio DTA-1 Class T AC/DC Battery Powered Mini Amplifier 2x15W

- Palm-size Class T 30 watt amplifier
- Great sounding amp—also convenient for travel
- Battery or AC powered—power supply included for perfect portability



ON SALE \$32⁹⁸ EACH
 List \$50.99 Reg. **\$38.98**

#300-380



Dayton Audio APA150 Power Amplifier 150W

- Power stereo speakers or use bridged for mono output
- Selectable 50-150 Hz low pass crossover for use as a subwoofer amplifier
- High current, discrete output transistors that run cool and quiet

\$209⁹⁸ (1-3)
 List \$227.74 **\$194.23** (4-UP)

#300-812

Great for subwoofers or full range systems

Power meets control



Dayton Audio APA1200DSP 1200 Watt Power Amplifier with Integrated Digital Signal Processing

- Dual-channel Class D power amplifier with built-in DSP
- Remotely control from any device with a web browser
- Automatic room correction using included calibration microphone for subwoofers
- Extremely efficient 1200W Class-D amplifier
- Fully adjustable 8-band EQ, filters, phase, limiter, and delay
- Plenty of connectivity with XLR, RCA, and digital coax inputs, and XLR, RCA, and binding post outputs
- Connect multiple APA1200DSP units for unlimited control of multiple zones of speakers, subwoofers or, complete surround sound systems

Control via Smart Device



\$599⁹⁹ EACH
 5 YEAR WARRANTY
 List \$899.99

#300-1000

Powerful enough for large speakers, small enough for small spaces

Dayton Audio DTA-100LF Desktop Subwoofer Amplifier with EQ

- Low-profile design looks good and sounds better
- 70 Watt output at 8 ohms and 100 Watt output at 4 ohms
- Adjustable phase, subsonic filter, low-pass filter, and single band EQ
- RCA line Inputs and outputs



NEW

\$134⁹⁸ (1-3)
 List \$149.99 **\$124.86** (4-UP)

#300-3805

Modern connectivity with vintage flair



Dayton Audio HTA Series Amplifiers

- Tube warmth, class A/B efficiency
- Expanded input options including Bluetooth streaming
- Dedicated subwoofer outputs
- Built-in high quality headphone amplifiers



Utilizing the efficiency of solid-state class A/B amplifier topology and a vacuum tube preamp section, the HTA series of amplifiers authentically reproduce the warmth and character of vintage tube amps with the flexibility and functionality of a modern design. Available in 3 different models for systems of any size!

Part #	Model	Power Output	List Price	Price (1-3)	Price (4-UP)
300-3840	HTA20BT	12 WPC RMS @ 4 ohms	\$189.99	\$146.98	\$135.96
300-3842	HTA100BT	50 WPC RMS @ 4 ohms	279.99	214.98	198.85
300-3844	HTA50BT	25 WPC RMS @ 4 ohm	199.99	149.98 EA	—



5 YEAR WARRANTY



To Learn More Scan Here!
www.daytonaudio.com/topic/DAX88



Demo Matrio™ Control App now!
 Download the app for free from the Apple App Store or Google Play and fully explore Matrio™ in demo mode without a DAX88 unit.



Your home, your music, total control

Dayton Audio DAX88 8-Source 8-Zone Distributed Audio Matrix Amplifier

With a comprehensive and straightforward to use mobile control app, Matrio™, the DAX88 liberates you to listen to your music on your terms, no matter where you are in your house or business.

- 8-source, 8-zone multi-zone amplifier delivers the ultimate customizable whole-house audio experience
- Convenient Matrio™ mobile app gives you total command of all DAX88 features in the palm of your hand
- Wide array of analog and digital inputs including integrated Wi-Fi and AirPlay streaming options
- Six stereo amplified zones and two stereo preamp zones ensure a simplified installation process
- Connect multiple DAX88 units to your network for unlimited system expansion so you never run out of audio options
- Optional keypads, keypad hub, and IR remote increase control accessibility to offer additional whole-home integration



\$1,299⁹⁸ EACH

#300-985 List \$1,689.99

A modern, minimalistic approach to home theater speakers

Dayton Audio 2-Way Micro-Edge Ceiling and In-Wall Speakers

- Optimized 12 dB/octave crossover with exclusive tuning by Dayton Audio
- Kevlar® woofer with butyl rubber surrounds create deep, smooth bass
- Swiveling 1" silk dome tweeters produce natural, never harsh high-end response



Companion in-wall sub for the Micro-Edge series speakers

Dayton Audio ME10S Micro-Edge 10" In-Wall Subwoofer

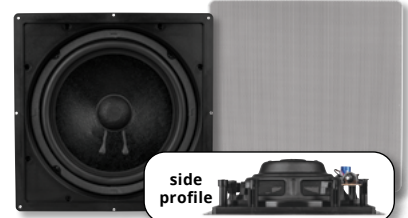

- Slim, stealthy in-wall design mounts into any 3-1/2" deep stud cavity making the sub easy to install
- Robust high-excursion 10" woofer delivers outstanding low-end for home theaters or listening rooms

ON SALE \$69⁹⁸ EACH

#300-421 List \$119.99 Reg. \$89.98



Part #	Model	Style	Woofer Size	Sold As	List Price	Regular Price	Sale Price
300-430	ME650C	LCRS 15 Degree angled ceiling	6-1/2"	Each	\$104.99	\$79.98	\$74.98
300-432	ME620C	2-Way ceiling	6-1/2"	Pair	169.99	109.98	99.98
300-437	ME625W	2-Way In-wall	6-1/2"	Pair	184.99	139.98	124.98
300-442	ME652C	Dual channel ceiling	6-1/2"	Each	114.99	89.98	79.98
300-434	ME820C	2-Way ceiling	8"	Pair	224.99	149.98	134.98
300-439	ME825W	2-Way In-wall	8"	Pair	214.99	164.98	134.96

Dayton Audio ME525MTM 5-1/4" Micro-Edge MTM LCRS In-Wall Speaker



- Versatile all-purpose L/C/R/S speaker for home theater or music
- Contemporary Micro-Edge™ grills with magnetic grill retention
- Dual 5-1/4" woven Kevlar cone woofers and 1" pivoting silk dome tweeter



ON SALE \$69⁹⁸ EACH

#300-435 List \$104.99 Reg. \$79.98

8" Ceiling Speaker with 70V Transformer and White Grill for Background Music, Paging, Alarm Signaling

12 oz. ceramic magnet, 1" aluminum voice coil. Includes pre-installed 70V line-matching transformer and white metal grill.

\$21⁴⁹ (1-11)

#300-022 List \$32.99 \$19.33 (12-47) \$17.06 (48-UP)

Versatile 12 channel amps for zoned audio distribution



- Independent and bus inputs enable unparalleled flexibility
- Bridgeable channel outputs provide additional power when needed
- Independent channel gain controls allow the output of each speaker to be perfectly matched

Dayton Audio MA1240a Multi-Zone 12 Channel Amplifier 40 WPC

\$629⁹⁸ EACH

#300-815 Class AB, 40WPC List \$819.99

Dayton Audio MA1260 Multi-Zone 12 Channel Amplifier 60 WPC

\$734⁹⁸ (1-3)

#300-8150 Class D, 60WPC List \$959.99 \$724.98 (4-UP)





Multi-purpose landscape and outdoor pendant speakers

Dayton Audio IP66 Indoor/Outdoor Pendant Speaker Pairs

- Versatile mounting brackets for pendant mounting, wall mount, or landscape applications
- Integrated 70V/100V transformer with selectable taps and 8 ohm bypass

Sold as single speaker



Dayton Audio 8" IP55 Indoor/Outdoor Pendant Speaker 70V/100V with 8 Ohm Bypass

- 8" woofer with a coaxial 1" tweeter providing a balanced, natural response
- Integrated 70V/100V transformer with selectable taps and 8 ohm bypass
- Suitable for indoor and outdoor installation
- Package includes one speaker, pendant mount end cap, steel cable, gripple connector, and eye bolt



\$194⁹⁸ (1-3)

#310-015 WP8BT, Black

#310-017 WP8WT, White..... List \$254.99 **\$191.98** (4-UP)



Sold in Pairs

Landscape Mount



Wall Mount

Part #	Model	Woofers Size	Tweeter Size	Color	List Price Pair	Price (1-3 PR)	Price (4 PR-UP)
310-018	WP4BT	4"	7/8"	Black	\$214.99	\$161.98	\$158.98
310-020	WP65BT	6-1/2"	1"	Black	289.99	199.98	191.98
310-021	WP65WT	6-1/2"	1"	White	289.99	199.98	191.98

Perfect for patios, pools, gardens, offices, bars, and hotels

Dayton Audio IO8XTB 8" Indoor/Outdoor 2-Way Speaker with Bass Radiator



- Passive radiator produces extended low-end response for deep, tight bass uncharacteristic of outdoor speakers
- Integrated 70V/100V transformer with selectable taps and 8 ohm bypass
- High excursion 8" polypropylene woofer and 1" silk dome tweeter provide a smooth, natural listening experience
- Sealed IP66 ABS enclosure protects the speaker from water damage making the speaker great for outdoor use



Sold as single speaker



Bass radiator delivers an extended low frequency response

Dimensions: 14.9" H x 9.9" W x 9.4" D

\$169⁹⁸ (1-3)

#310-034 IO8XTB, Black

#310-036 IO8XTW, White..... List \$224.99 **\$168.03** (4-UP)

Passive radiator design delivers extended low-end response

All models include the integrated 70V/100V transformer

Dayton Audio IO65XT 6-1/2" IP66 Indoor/Outdoor 2-Way Speaker Pairs with Passive Radiator

- Integrated 70V/100V transformer with selectable taps and 8 ohm bypass
- Sealed IP66 ABS enclosure protects the speaker from water damage
- High excursion polypropylene 6-1/2" woofer with durable rubber surround



Sold in Pairs

Bass radiator delivers an extended low frequency response

Dimensions: 11.25" H x 7.9" W x 7.7" D

\$219⁰⁰ PAIR

#310-023 IO65XTW, White

#310-025 IO65XTB, Black..... List \$324.99 Reg. **\$254.98**

Outdoor audio this good has never been so affordable

Dayton Audio IO Series Indoor/Outdoor Speakers

- Stylish, contemporary appearance suits indoor environments as well as outdoors
- Weather-resistant ABS plastic enclosure and aluminum grills provide years of service



Part #	Model	Color	Woofers Size	Input	List Price Pair	Price (1-3)	Price (4-UP)
310-006	IO525WT	White	5-1/4"	70V, variable	\$194.99	\$149.98 PR	\$146.98 PR
310-008	IO525BT	Black	5-1/4"	70V, variable	194.99	149.98 PR	146.98 PR
310-014	IO655WT	White	6-1/2"	70V, variable	259.99	179.98 PR	172.78 PR
310-016	IO655BT	Black	6-1/2"	70V, variable	259.99	179.98 PR	172.78 PR
310-031	IO800WT	White	8"	70V, variable	189.99	144.98 EA	142.98 EA
310-032	IO800BT	Black	8"	70V, variable	189.99	144.98 EA	142.98 EA

Innovative design maximizes dispersion for ultra-wide coverage



Dayton Audio Quadrant Indoor/Outdoor 70V Speaker Pairs with 4 Ohm Bypass

- Quadrant quarter-arc form factor permits circular arrays
- 70V/100V transformer built-in for distributed applications

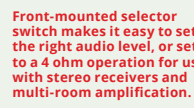

Front-mounted selector switch makes it easy to set the right audio level, or set to a 4 ohm operation for use with stereo receivers and multi-room amplification.

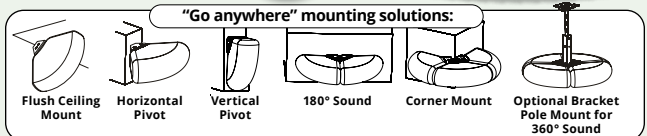

#310-060 Black

#310-063 White..... List \$364.99 Reg. **\$279.98**

ON SALE \$199⁹⁸ EACH

Dayton Audio 4-Way Pole Mount Speaker Bracket for QS204-4 Quadrant Speakers

#310-061 Black

#310-065 White..... List \$69.99 Reg. **\$53.98**

ON SALE \$44⁹⁹ EACH

The classic collection:

Our flagship line of great sounding, affordable speakers



T652

- Industry standard and beloved speakers that truly outperform their budget price tag and provide exceptional value with a listening experience that rivals many higher-priced systems
- Polypropylene cone with a 4-layer voice coil and a 5/8" polycarbonate dome tweeter deliver Dayton Audio's sonic performance with rich, detailed audio fidelity

Part #	Model	Woofer Size	Price (1-3)	Price (4-UP)
BEST SELLER 300-652	B652	6-1/2"	\$44.98 PR	\$43.18 PR
300-452	B452	4-1/2"	39.98 PR	38.38 PR
300-653	T652	6-1/2"	149.98 PR	141.98 PR
300-453	C452	4-1/2"	29.98 EA	28.18 EA



B652

#300-652



B452

#300-452



C452

#300-453



Dayton Audio MK602X 6" 2-Way Bookshelf Speaker Pair



- 6" Glass fiber woofer and 1" silk dome tweeter with built-in crossover
- 4 Ohms impedance compatible with most amplifiers
- Extra low 45Hz bass extension from a compact bookshelf speaker

ON SALE
\$119.98 EACH

#300-469 List \$194.99 Reg. \$149.98

Upgrade to the AIR series!

All the same features as the standard series but equipped with an AMT (Air Motion Transformer) tweeter for sparkling, compelling high frequency extension.

Part #	Model	Woofer Size	Price (1-3)	Price (4-UP)
300-651	B652-AIR	6-1/2"	\$59.98 PR	\$57.58 PR
300-451	B452-AIR	4-1/2"	49.98 PR	47.98 PR
300-654	T652-AIR	6-1/2"	169.98 PR	159.98 PR
300-454	C452-AIR	4-1/2"	39.98 EA	37.58 EA



The MK Series: Performs better than other speakers that cost much more!

- 4" treated-paper woofer extends the low-frequency range to play down to 60 Hz without hindering the critical vocal range for a clean, robust low-end response
- 3/4" tweeter delivers precise vocal and instrumental reproduction that give you a clear and detailed high-frequency performance
- Each MK Series speaker features the same drivers to create a timbre-matched audio system when using multiple models
- Wide speaker dispersion range allows the MK Series to be used in a myriad of audio systems without compromising sound quality
- Textured, black vinyl finish with a removable cloth grill provides an attractive look that doesn't compromise your rooms décor

Part #	Model	Price (1-3)	Price (4-UP)
300-465	MK402X	\$79.98 PR	\$76.78 PR
300-467	MK402BTX	112.98 PR	108.46 PR
300-658	MK442T	219.98 PR	204.85 PR
300-456	MK442	64.98 EA	62.38 EA

Customer Favorites



MK442

#300-456



MK402BTX

#300-467



MK402X

#300-465



MK442T

#300-658



Use two MK442's on their side for a powerful mini-tower setup with extra punch.



Use the MK402X in home theaters as front or rears, or in simple stereo applications to create an impressive soundstage.



Bluetooth!

Use the MK402BTX for easy out of the box operation and convenient Bluetooth. Great for desks, garages, kitchens and more!

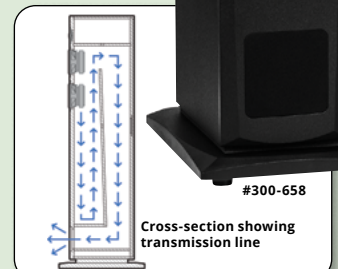

Cross-section showing transmission line

The transmission line construction of the MK402T tower speakers generates deep, articulate bass, perfect for music and movies alike.



Perfect way to add low end to your gaming rig

Dayton Audio GS2.1 Gaming Subwoofer with 2.1 Amplifier and Power Supply

- Powers two speakers and the built-in sub in a compact form factor
- Built-in passive radiator improves bass extension
- Mounting hardware included for out of sight operation
- 5-Way binding posts for absolute compatibility
- Bottom padding virtually eliminates any rattles

★★★★★
RAVE REVIEWS!
"Vocals are balanced (in this instance) and stereo separation is great. Easily handles PC duties and fills the room in the process." -James J.



\$79⁹⁸ (1-3)

#300-4811List \$143.99 **\$78.94** (4-UP)

\$74⁹⁸ (1-3)

Without power supply

#300-481List \$119.99 **\$73.86** (4-UP)



Experience the electrifying low end of a movie theater in your own home

Dayton Audio Powered and Passive Subwoofers

Dayton Audio subwoofers system are capable of delivering realistic, room-shaking home theater bass effects—even in larger rooms.

*300-495 is passive, not powered

For more information, visit parts-express.com

Part #	Woofer Size	Power Output	Frequency Range	List Price	Price Each
300-627	8"	80W	40-140 Hz	\$169.99	\$129.98
300-628	10"	100W	30-140 Hz	209.99	149.98
300-629	12"	120W	25-140 Hz	234.99	169.98
300-634	15"	150W	23-140 Hz	339.99	249.98
300-639	10"	100W	32-140 Hz	234.99	179.98
300-495*	4 x 4"	160W	40-500 Hz	169.99	129.98



#300-628



Low-Profile Subwoofers

#300-639 Low Profile Subwoofer

#300-495



Stream wireless audio between your amps, powered speakers, or powered sub

Dayton Audio Wave-Link WLS System 2.4 GHz Full-Range Wireless Audio Transmitter & Receiver System

- Built-in DAC with USB connection allows you to stream wireless audio to any amplifier or powered subwoofer
- Can be used to stream to powered surround speakers for a completely wireless sound system
- Pair up to three additional receivers to create a wireless distributed audio system



5 YEAR WARRANTY **\$69⁹⁹** (1-3)

#300-594List \$89.00 **\$67.19** (4-UP)

#300-592 Optional add on receiverList \$75.99 **\$49.98** (1-5) **\$46.33** (6-UP)

Impressive low end, subtle design

Dayton Audio IOSUB 10" IP66 Passive Indoor/Outdoor Subwoofer



- Powerful high excursion woofer produces astoundingly deep, clean bass for patio, pools, gardens, and porches
- Rugged IP66 weather-resistant construction protects the sub from environmental conditions providing years of reliable use



#310-026List \$324.99 **ON SALE \$189⁹⁸** EACH **Reg. \$239.98**

Dayton Audio Subwoofer and Bass Shaker Amplifiers

Dayton Audio amplifiers provide clean, solid power for your home theater or music playback system. They are also an ideal partner for high-performance subwoofer speaker systems.



#300-811

#300-813

For more information, visit parts-express.com

SALE

Part #	Model #	Power Output	Regular Price	Sale Price
300-811	SA1000	950 W @ 4 ohm	\$499.98	\$449.98
300-813	SA230	233 W @ 4 ohm	274.95	259.98
300-785	BSA-200	110 W @ 2 ohm	279.98	249.98

Part #	Model #	Power Output	Price (1-3)	Price (4-UP)
300-812	APA150	75 W @ 4 ohm	\$209.98	\$194.23



#300-785

Reverse Side



#300-812

**Dayton Audio Shadow Mount
DTS2260 Desktop TV Stand
22"- 60"**

- Easy-to-follow instructions makes assembly easy
- Supports 22"-60" flat-panel TVs
- Weight capacity: Up to 110 lbs.
- Supports VESA patterns up to 800 x 500

**Supports
110 lbs.** **\$1649**

#182-411 List \$21.99 **\$15.25** (1-3)
..... List \$21.99 **\$15.25** (4-UP)

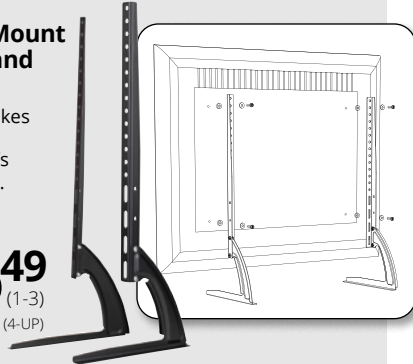

**Dayton Audio Shadow Mount Desktop
Articulating LCD Monitor Mounts 13"-27"**

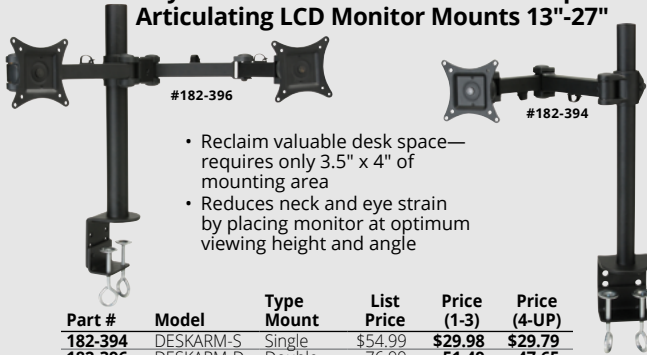

- Reclaim valuable desk space—requires only 3.5" x 4" of mounting area
- Reduces neck and eye strain by placing monitor at optimum viewing height and angle

Part #	Model	Type Mount	List Price	Price (1-3)	Price (4-UP)
182-394	DESKARM-S	Single	\$54.99	\$29.98	\$29.79
182-396	DESKARM-D	Double	76.99	51.49	47.65



The Shadow Mount Difference!

Faster, easier, and more secure with the patented RailClip™ function!

**Dayton Audio
Shadow Mounts
Tilting TV Wall Mounts**

- Easy adjustable ±15° tilt places screen in the optimum viewing position
- Solid steel construction



±15° Tilt  **SALE**

Part #	Model	Fits	Supports	List Price	Regular Price	Sale Price
182-320	LCD37-TM	23" - 37"	100 lb	\$42.99	\$31.49	\$26.49
182-322	LCD60-TM	37" - 60"	175 lb	51.99	39.98	34.98

**Dayton Audio Shadow Mount THIN2337 Super Slim
TV Wall Mount 23"-37"**

- Works great for point-of-purchase displays and portrait display applications
- Holds TVs less than 7/16" off the wall
- Installs in minutes
- Durable cold steel construction

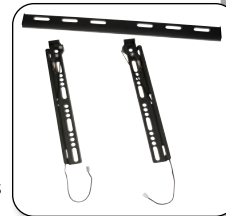

\$1449 (1-3)

Mount shown applied to back of TV

#182-346 List \$21.99 **\$13.40** (4-UP)

**Dayton Audio Shadow Mount
NBS-F Commercial Slim
Fixed TV Wall Mount 32"-80"**

- Safely secures a TV weighing up to 88 lbs. to a wall
- Easily mount TVs with VESA patterns up to 600 x 400 mm
- Sturdy steel construction allows for worry-free use for years to come

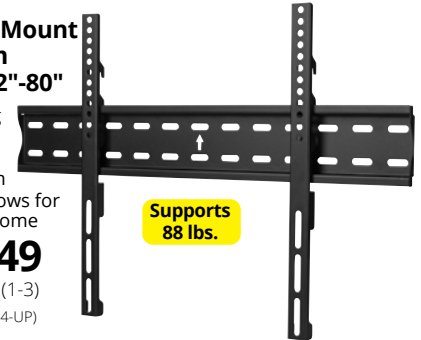

**Supports
88 lbs.**

\$1249 (1-3)

#182-405 List \$16.99 **\$11.55** (4-UP)

Dayton Audio Shadow Mount Fixed TV Wall Mounts



- Slim design places TVs less than 1" off the wall
- Durable steel construction
- Unobtrusive black design shadows most TVs perfectly
- Easy to install, mounting hardware included
- Universal mounting—fits most screens

Part #	Model	Fits	Max Weight Capacity	List Price	Price (1-4)	Price (5-UP)
182-350	LCD2337-FM	23" - 37"	100 lbs.	\$63.99	\$27.98	\$25.88
182-352	LCD3260-FM	32" - 60"	175 lbs.	76.99	32.98	30.50

**Dayton Audio Shadow Mount TM55
Slim TV Wall Mount**



±15° Tilt

- Easy installation and adjustment with innovative mounting hole design
- Tilt detents at 0, 5, 10, 12, and 15°
- When mounted, TV is only 1.4" from the wall

**Supports
175 lbs.**

\$2398 (1-7)

#182-323 List \$28.99 **\$22.20** (8-UP)

**Dayton Audio Shadow
Mount NBS-T Tilting TV
Wall Mount 32"- 80"**

- Safely secures a TV weighing up to 88 lbs. to a wall
- Allows for tilting of ±12°
- Easily mount TVs with VESA patterns up to 600 x 400 mm
- Solid steel construction

**Supports
88 lbs.**

\$1498 (1-3)

#182-407 List \$19.99 **\$13.85** (4-UP)



Outdoor Amplified 4K Ultra HDTV Antenna with 360° Rotor, Remote, and 59" Telescopic Mast

- Included wireless remote prevents multiple trips to the rotor box
- 360° rotor for locations between two or three cities

\$2798 EACH
List \$33.98

#210-546



Outdoor HDTV Digital Bow Tie Antenna with 59" Telescopic Antenna Mast 1" Diameter

- 10 dBi gain for picking up distant stations
- 24" - 59" extendable mast with included hardware great for antennas in attics or outdoors
- 470-860 MHz frequency range for digital TV

\$2549 EACH
List \$32.98

#210-548

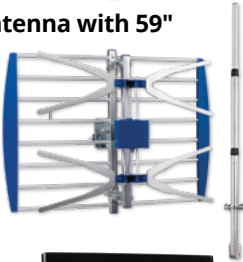

Indoor Multi-Directional Digital Flat HDTV Passive Antenna

- Picks up VHF and UHF signals
- Wall mountable

ON SALE \$1049 EACH
List \$24.99 Reg. \$13.98

#210-544



HDMI 2.0 Premium 4K 60 Hz 3-Input 1-Output HDCP 2.2 Switch with IR Remote

- Manual or remote IR remote switching for total control
- Up to 4K @ 60Hz prevents losing picture quality sent to HDMI 2.0 UHD displays
- Includes IR extender so the small switcher can be placed out of sight



NEW \$2498 (1-3)
List \$39.99 \$23.23 (4-9) \$22.48 (10-UP)

#180-1122

Send your HDMI signal hundreds of feet without running wires

5 GHz 1080p Wireless HDMI Extender Transmitter/Receiver System 100m/328 ft.

- Simple plug and play, no software needed
- Extends HDMI signal up to 328 ft. for convenience
- Compliant with HDCP 1.3

\$22998 (1-2)
\$219.98 (3-UP)

#184-452



Wireless 5 GHz HDMI Extender Optional Receiver

#184-453 List \$113.99 \$109.98 (1-4) \$99.98 (5-UP)

HDMI 2.0 4K 60HZ Extender Over Cat6 Cable 200 ft. Bidirectional IR Control and Daisy Chain Option



- Extends 4K video up to 200 ft. away via Cat6 cable

\$12998 (1-3)
List \$199.99 \$122.50 (4-9) \$118.54 (10-UP)

#184-500

HDMI 2.0 4K 60HZ Extender Over Cat6 Cable 200 ft. Extra Receiver

#184-502 List \$79.99 \$64.98 (1-3) \$60.43 (4-9) \$58.48 (10-UP)

HDMI Audio Extractor with Toslink and L&R Audio

- Pulls the audio signal from HDMI source and converts to analog and digital signals to use with older audio equipment
- Built-in EDID emulator for 2-channel and 5.1-channel audio

\$2898 (1-3)
List \$48.99 \$25.20 (4-UP)

#180-995



Compact A/V to HDMI Converter USB Powered



- Supports PAL, NTSC3.58, NTSC4.43, SECAM, PAL/M, PAL/N, standard TV formats
- No drivers to install for portable, flexible, plug and play

\$1898 (1-9)
List \$29.99 \$17.98 (10-49) \$16.98 (50-99) \$15.98 (100-UP)

#181-379

12 Outlet Surge Power Strip with Circuit Breaker/Switch 6 ft. Cord and Mounting Hardware

- Spaced outlets accommodate over-sized power adapters



450 joules of surge protection!



ON SALE \$1698 EACH
List \$32.99 Reg. \$21.98

#125-421

Commercial Grade 5 Outlet Surge Power Strip with Two USB Charging Ports 6 ft. Cord Circuit Breaker/Switch



- Dual USB-A 5V 3.4A charging ports



ON SALE \$1498 EACH
List \$29.99 Reg. \$16.98

#125-423

RCA AH754A Lightning iPhone USB Charging Sync Cable 4 ft. White Cord

- Apple lightning connector to USB A male
- Certified to work with applicable Apple products

ON SALE \$798 EACH
List \$26.99 Reg. \$14.98

#125-481



RCA 30W USB-C and USB-A Power Delivery (PD) Wall Charger with Foldable Prongs

- USB-C PD (Power Delivery) port is one of the fastest ways to safely charge your smartphone or tablet
- 30W of charging current available for two USB devices

ON SALE \$1498 EACH
List \$24.99 Reg. \$21.98

#125-387



Perfect for bedside charging

15W Ultra Slim Fast Wireless Charging Pad with 3 ft. USB-C to A Cable

- Wireless charging through most cases that aren't metallic
- Includes 3 ft. 10W USB-C cable for convenience



ON SALE \$1098 EACH
List \$19.99 Reg. \$11.98

#125-385



Shown in-use

Audtek HDMI Cable

Larger quantity pricing available!

- All cables are tested to meet requirements for peak 4K @ 60 Hz HDR
- Gold plated connectors ensure maximum signal transfer and longevity



Pro Grade

- Affordable prices make this a great general use HDMI cable



Long Run

- Active circuitry built into the connector maintains signal strength over long distances while keeping the overall cable diameter small



Super Slim

- Perfect for tight spaces, these flexible cables fit where bulky cables can't go



Flat

- Use the Flat series cable for discreet installations under the carpet or along baseboards

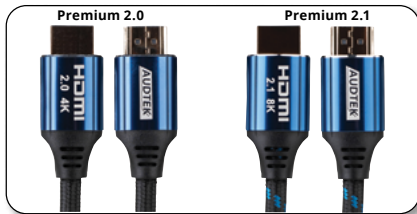

Premium 2.0 and Premium 2.1

- HDMI Premium certified cables undergo additional tests to ensure every length meets the standards set to get true 4K/8K imagery from your TV

Audtek Pro Grade HDMI 2.0

Part #	Model	Length	List Price	Price (1-9)	Price (10-29)	Price (30-49)	Price (50-99)	Price (100-UP)
180-1300	CG1	1 ft.	\$3.99	\$2.49	\$2.24	\$2.12	\$1.99	\$1.87
180-1302	CG3	3 ft.	4.99	3.49	3.25	2.97	2.79	2.62
180-1304	CG6	6 ft.	7.99	3.98	3.58	3.38	3.18	2.99
180-1306	CG12	12 ft.	9.99	7.19	6.69	6.47	6.11	5.39
180-1308	CG25	25 ft.	19.99	13.39	12.05	11.38	10.71	10.04
180-1310	CG35	35 ft.	29.99	20.98	19.51	18.88	17.83	16.78
180-1312	CG50	50 ft.	39.99	34.98	32.53	31.48	29.73	27.98

Audtek Long Run HDMI 2.0

Part #	Model	Length	List Price	Price (1-9)	Price (10-29)	Price (30-49)	Price (50-99)	Price (100-UP)
180-1314	HQ75	75 ft.	\$69.99	\$59.98	\$55.78	\$53.98	\$50.98	\$47.98
180-1316	HQ100	100 ft.	89.99	71.98	66.94	64.78	61.18	57.58

Audtek Super Slim HDMI 2.0

Part #	Model	Length	List Price	Price (1-9)	Price (10-29)	Price (30-49)	Price (50-99)	Price (100-UP)
180-1318	TS1	1 ft.	\$7.99	\$4.98	\$4.63	\$4.48	\$4.23	\$3.98
180-1320	TS6	6 ft.	9.99	8.49	7.90	7.64	7.22	6.79

Audtek Flat HDMI 2.0

Part #	Model	Length	List Price	Price (1-9)	Price (10-29)	Price (30-49)	Price (50-99)	Price (100-UP)
180-1322	HF6	6 ft.	\$9.99	\$4.49	\$4.04	\$3.82	\$3.59	\$3.37
180-1324	HF15	15 ft.	14.99	9.98	8.98	8.48	7.98	7.49
180-1326	HF35	35 ft.	29.99	24.98	22.48	21.23	19.98	18.74

Audtek EMI Premium 4K Certified HDMI 2.0

Part #	Model	Length	List Price	Price (1-9)	Price (10-29)	Price (30-49)	Price (50-99)	Price (100-UP)
180-1328	FC3	3 ft.	\$9.99	\$5.49	\$5.11	\$4.94	\$4.67	\$4.39
180-1330	FC6	6 ft.	12.99	6.49	6.04	5.84	5.52	5.19
180-1332	FC10	10 ft.	17.99	7.79	7.24	7.01	6.62	6.23
180-1334	FC15	15 ft.	20.99	12.49	11.62	11.24	10.62	9.99
180-1336	FC20	20 ft.	24.99	18.49	17.20	16.64	15.72	14.79
180-1337 NEW	FC25	25 ft.	29.99	19.98	18.58	17.98	16.98	15.98

Audtek EMI Premium 8K Certified HDMI 2.1

Part #	Model	Length	List Price	Price (1-9)	Price (10-29)	Price (30-49)	Price (50-99)	Price (100-UP)
180-1338	RF3	3 ft.	\$29.99	\$9.49	\$8.83	\$8.54	\$8.07	\$7.59
180-1340	RF6	6 ft.	39.99	10.98	10.21	9.88	9.33	8.78
180-1342	RF10	10 ft.	49.99	16.98	15.79	14.43	13.58	12.74
180-1344 NEW	RF16	16 ft.	59.99	29.98	27.79	27.09	26.39	25.69

Audtek Premium RCA Audio/Video Cables



- Foil and braid shield prevents outside interference

Part #	Model	Cable Type	Cable Length	List Price (1-9)	Price (10-49)	Price (50-99)	Price (100-UP)
181-950	SMC1.5	Single premium RCA	1.5 ft.	\$2.98	\$2.68	\$2.53	\$2.38
181-951	SMC3	Single premium RCA	3 ft.	3.49	3.14	2.97	2.79
181-952	SMC6	Single premium RCA	6 ft.	3.98	3.58	3.38	3.18
181-953	SMC12	Single premium RCA	12 ft.	4.49	4.04	3.82	3.59
181-954	SMC18	Single premium RCA	18 ft.	5.29	4.76	4.50	4.23
181-955	SMC25	Single premium RCA	25 ft.	6.49	5.84	5.52	5.19
181-960	DMC1.5	Double premium RCA	1.5 ft.	4.49	4.04	3.82	3.59
181-961	DMC3	Double premium RCA	3 ft.	4.98	4.48	4.23	3.98
181-962	DMC6	Double premium RCA	6 ft.	5.49	4.94	4.67	4.39
181-963	DMC12	Double premium RCA	12 ft.	6.49	5.84	5.52	5.19
181-964	DMC18	Double premium RCA	18 ft.	6.98	6.28	5.93	5.58
181-965	DMC25	Double premium RCA	25 ft.	7.98	7.18	6.78	6.38

Audtek Premium Y-Cable Adapters

- Gold-plated connectors and 24 AWG copper conductors for pure signal transfer



Part #	Connector	Length	List Price	Price (1-9)	Price (10-49)	Price (50-99)	Price (100-UP)
181-970	2 RCA M to 1 RCA F	1 ft.	\$6.99	\$3.98	\$3.58	\$3.38	\$3.18
181-971	1 RCA M to 2 RCA F	1 ft.	6.99	3.98	3.58	3.38	3.18
181-972	1 3.5mm F to 2 RCA M	1 ft.	7.99	3.49	3.14	2.97	2.79
181-973	1 3.5mm M to 2 RCA M	3 ft.	8.99	3.59	3.23	3.05	2.87
181-974	1 3.5mm M to 2 RCA M	6 ft.	9.99	3.98	3.58	3.38	3.18
181-975	1 3.5mm M to 2 RCA M	12 ft.	12.99	4.49	4.04	3.82	3.59
181-976	1 3.5mm M to 2 RCA F	1 ft.	6.99	3.49	3.14	2.97	2.79
181-977	1 3.5mm M to 2 3.5mm F	1 ft.	6.99	2.98	2.68	2.53	2.38

Audtek Premium Slim 3.5 mm Stereo Male to Male BC 24 AWG Dual Shield Cables

- Easily fits a smart phone with a protective case installed



Part #	Plugs	Model	Length	List Price	Price (1-9)	Price (10-49)	Price (50-99)	Price (100-UP)
181-920	M/M	35SMC-3	3 ft.	\$4.99	\$2.15	\$1.94	\$1.83	\$1.72
181-921	M/M	35SMC-6	6 ft.	5.99	2.49	2.24	2.12	1.99
181-922	M/M	35SMC-12	12 ft.	6.99	3.29	2.96	2.80	2.63
181-923	M/M	35SMC-25	25 ft.	8.99	4.79	4.23	4.00	3.76
181-924	M/F	35SMFC-6	6 ft.	5.99	2.98	2.68	2.53	2.38
181-925	M/F	35SMFC-12	12 ft.	6.99	3.79	3.41	3.22	3.03
181-926	M/F	35SMFC-25	25 ft.	8.99	4.98	4.48	4.23	3.98

Audtek Premium Toslink Digital Optical Cable with Gold Connectors

- Gold plated metal surrounds the optic connector for durability



Part #	Model	Length	List Price	Price (1-9)	Price (10-49)	Price (50-99)	Price (100-UP)
181-990	ODMC-6	6 ft.	\$9.99	\$5.49	\$4.94	\$4.67	\$4.39
181-991	ODMC-12	12 ft.	12.99	6.98	6.28	5.93	5.58
181-992	ODMC-25	25 ft.	16.99	9.98	8.98	8.48	7.98
181-993	ODMC-50	50 ft.	19.99	15.98	14.38	13.58	12.78

Audtek Electronics In-Wall CL2 Speaker Wire

RAVE REVIEWS!

“ Tremendously happy with this versatile speaker wire.”

— Ryan W.

- Flexible strand cable at an economical price
- Great for use as speaker cable outside of walls

Part #	AWG	Conductors	Length	List Price	Price (1-3)	Price (4-UP)
100-1002	12	2	250 ft.	\$65.99	\$69.98	\$64.98
100-1004	12	2	500 ft.	152.99	132.98	124.98
100-1008	14	2	250 ft.	54.99	51.98	44.98
100-1010	14	2	500 ft.	112.99	97.98	94.98
100-1014	14	4	250 ft.	115.99	99.98	94.98
100-1018	16	2	250 ft.	43.99	39.98	36.98
100-1020	16	2	500 ft.	65.99	79.98	69.98
100-1024	16	4	250 ft.	79.99	59.98	56.98





Sound made POWERFUL!

ICEpower Amplifier Boards

Everything you need for a bass or guitar amplifier, a subwoofer, an active loudspeaker, or a high-end amplifier. In short, get ready to rock 'n' roll.

High wattage amp and power supply all-in-one small board



#326-204

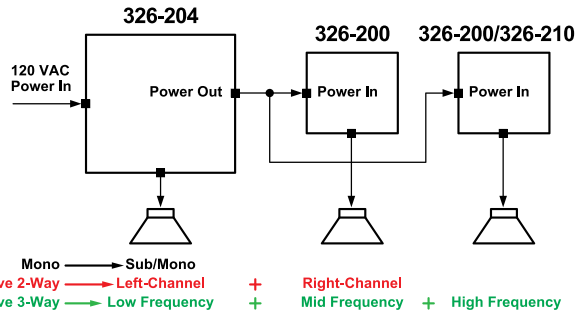

ICEpower ASP and A Series Class D Audio Amplifier Modules



#326-210

High wattage amp and power supply all-in-one small board



#326-206

RAVE REVIEWS!
 "It runs completely cool without a fan."
 -Edward H.

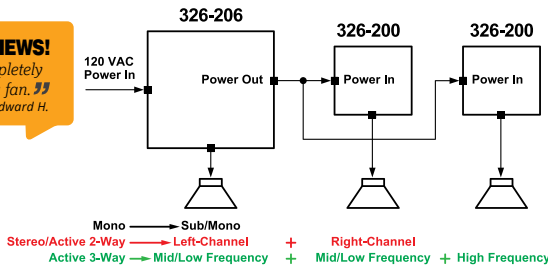

SAVE 10%

#326-200

Part #	Model	Description	Regular Price	Sale Price	
326-204	500ASP	500W built-in power supply	\$319.98	\$287.98	
326-206	1000ASP	1000W built-in power supply	377.60	339.84	
Part #	Model	Description	Price (1-3)	Price (4-9)	Price (10-UP)
326-200	500A	500W	\$101.48	\$96.41	\$92.55

These four modules have rugged 70 g-force construction for professional use!



ICEpower ASC and AC Series Class D Audio Amplifier Modules

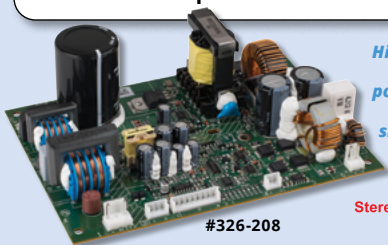

#326-208

High wattage amp and power supply all-in-one small board

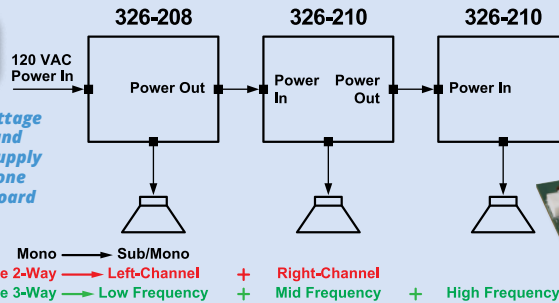

RAVE REVIEWS!
 "Best audio money ever spent."
 -Robert W.



#326-210

Part #	Model	Description	Regular Price	Sale Price
326-208	200ASC	200W built-in power supply	\$134.98	\$121.48
326-210	200AC	200W	70.80	60.18

SAVE UP TO 15%



ICEpower 50ASX2 Series Class D Audio Amplifiers with Power Supply Modules

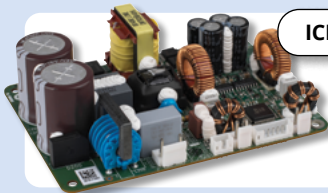

- Fully integrated audio power solution
- Rugged construction
- Thermal and over current protection
- No noisy fan required

Part #	Model	Description
326-212	50ASX2SE	2 x 50W @ 1% THD+N (1 kHz @ 4 ohms)
326-214	50ASX2BTL	1 x 170W @ 1% THD+N (1 kHz @ 4 ohms)

SAVE 10%

ON SALE \$106.20 EACH
 Reg. \$118.00

IEC AC 10A Socket with EMI Filter and Fuse Holder

- EMI filter built-in to help prevent electromagnetic interference

\$7.98 (1-3)

#090-412 List \$14.99 **\$7.18** (4-9) **\$6.78** (10-49) **\$6.38** (50-UP)



IEC Shielded AC Power Cords

- Shielded to prevent outside interference



Part #	Length	Price (1-9)	Price (10-49)	Price (50-UP)
110-312	6 ft.	\$4.98	\$4.79	\$4.29
110-314	12 ft.	7.98	7.49	6.98

External interference-free AC power



Create custom multiple-channel Bluetooth audio projects with integrated DSP

Dayton Audio KABD Series Amplifier Boards with DSP and Bluetooth 5.0 aptX HD

- Wireless Bluetooth 5.0 aptX HD and DSP sound customization in one amp board
- On board antenna for convenience with external antenna jack for metal enclosures
- Plug-n-Play connectors for quick installation

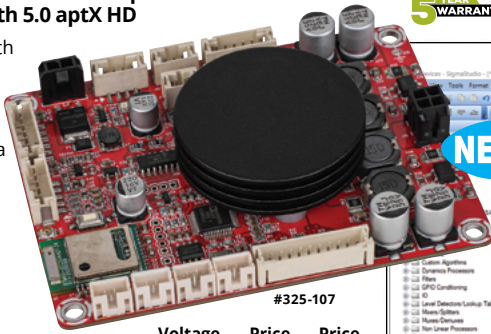

5 YEAR WARRANTY



Programmable with SigmaStudio software
and
Dayton Audio KPX In-Circuit Programmer

Part #	Model	Max Wattage	Voltage Range	Price (1-3)	Price (4-UP)
325-106	KABD-230	2 x 30W @ 8 ohm 24 VDC	12-24 VDC	\$53.98	\$51.28
325-107	KABD-250	2 x 50W @ 4 ohm 24 VDC	12-24 VDC	56.98	54.13
325-430	KABD-430	4 x 30W @ 8 ohm 24 VDC	12-24 VDC	69.98	64.68
325-434	KABD-4100	4 x 100 @ 6 ohm 36 VDC	12-36 VDC	86.98	82.63

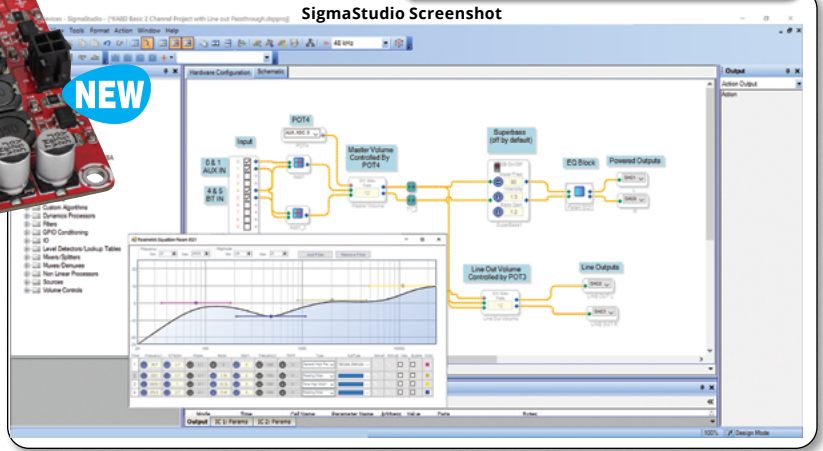

Dayton Audio KABD-SPF Function Cables for KABD-250



- 3.5 mm AUX-in cable with jack provides a way to play music with non-Bluetooth devices
- Four external potentiometers with cables and knobs for sound customization
- Battery cable for true portable projects
- External LEDs for Bluetooth and power status

\$898 (1-3)

#325-117 List \$14.99 **\$8.35** (4-19) **\$8.08** (20-UP)

Dayton Audio KPX In-Circuit Programmer USB

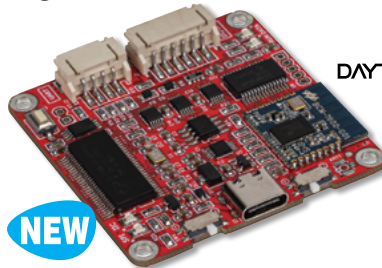

NEW

- Programs with readily available SigmaStudio or KABX computer software
- Connects to your computer using a standard USB-C cable (sold separately)

\$2998 EACH

#325-139 List \$39.99 **\$27.88** (2-19) **\$26.98** (20-UP)

Dayton Audio KAB-FC Function Cables Package for Bluetooth Amplifier Boards



- Conveniently add a 3.5 mm AUX-in cable, external volume control with cable and knob, battery cable, and on/off power cable for optional power switch

\$598 (1-3)

#325-110 List \$6.47 **\$5.15** (4-19) **\$4.85** (20-UP)

Easy-to-use Bluetooth 5.0 and amplification in a single board

Dayton Audio KAB Class D Audio Amplifier Boards with 5.0 Bluetooth

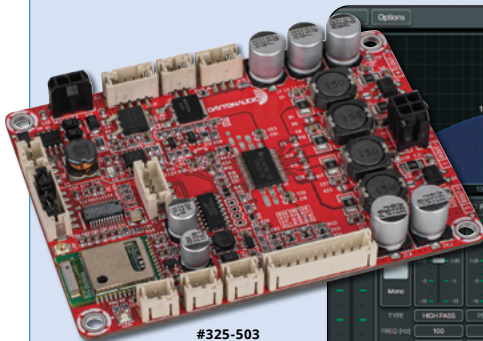

- Bluetooth 5.0 built directly into board — no need for a separate module
- Board includes power and speaker output cables
- Wire harnesses make installation quick and simple with no soldering required



Part #	Model	Max Wattage	Voltage Range	Price (1-3)	Price (4-UP)
325-503	KAB-230v4	2 x 30 @ 8 ohm 19 VDC	12-24 VDC	\$39.98	\$37.18
325-505	KAB-250v4	2 x 50 @ 4 ohm 21 VDC	12-24 VDC	45.98	42.76
325-512	KAB-100M	1 x 100 @ 4 ohm 21 VDC	12-24 VDC	45.98	42.76

Fine-tune your audio project with KABX software
and
Dayton Audio KPX In-Circuit Programmer

Essential KAB accessories

Dayton Audio KAB-AB L-type Aluminum Bracket for Bluetooth Amplifier Boards



- Heavy-duty aluminum bracket will not crack or bend

\$469 (1-3)

#325-114 List \$3.88 **\$4.39** (4-19) **\$4.09** (20-99) **\$3.98** (100-UP)

19.5V DC 3.33A AC Power Supply Adapter with 2.1 x 5.5mm Tip + Plug



- Standard 2.1 x 5.5 mm tip positive plug

\$1698 (1-11)

#120-195 List \$24.99 **\$15.79** (12-23) **\$14.43** (24-49) **\$13.58** (50-UP)



Perfect Start for Large or Small DIY Boom Box

TPA3116 2.1 Bluetooth 2.1 50W x 2 + 100W Amp Board with FM, AUX-In and USB Media Player IR Remote



- Bluetooth, FM radio, media player and 2.1 200W amplifier board all in one matched kit

ON SALE \$54.98 EACH

#320-622 List \$69.99 Reg. \$59.98

Bluetooth 5.0/FM/Media Player 2 x 25W Max Amplifier Board



- Bluetooth, FM radio, media player, and 2 x 25W Max amplifier all built into one space-saving board

\$12.98 (1-3)

#320-642 \$11.98 (4-9) \$10.98 (10-UP)

2 x 100W Bluetooth 5.0 TDA7498 Amplifier Board with Micro SD Card Reader 12 to 30 VDC

- Wide 12 VDC to 30 VDC working voltage (24 VDC for best performance)

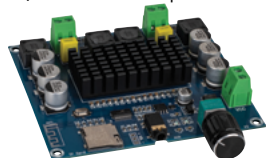

BUYOUT \$19.98 (1-9)

#320-638 Compare to \$25
\$18.86 (10-49) \$18.29 (50-99) \$17.49 (100-UP)

5 VDC Bluetooth 4.2 FM Radio MP3 WAV FLAC Audio Preamp Board with Remote

- Adds Bluetooth and FM radio to non-Bluetooth amp boards



\$24.98 (1-9)

#320-347 List \$34.99
\$23.23 (10-49) \$21.79 (50-99) \$19.98 (100-UP)

12 VDC Bluetooth 4.0 FM Radio MP3 WAV FLAC Audio Preamp Board



- Built-in LED display identifies function mode and FM frequency

ON SALE \$19.98 EACH

#320-348 List \$26.99 Reg. \$21.49

TPS3116D2 Class D 2.1 Amplifier Board 2 x 50W + 100W with Volume Controls



RAVE REVIEWS!
“...it's really great for the price!” -Gabriel S.



- Separate satellite and subwoofer volume controls for the perfect mix

SAVE 20% ON SALE \$15.98 EACH

#320-620 List \$25.99 Reg. \$19.98

TDA7492 Digital Audio Amplifier Board 2x50W

- Class D amplifier produces 2 x 50 watt @ 8 ohms
- Can be wired R+ to L+ for mono mode
- Phoenix connectors for easy speaker hook up

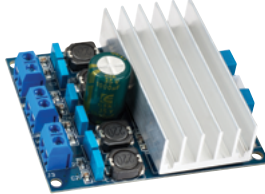

ON SALE \$16.98 EACH

#320-606 List \$26.99 Reg. \$18.98

12V DC 3A AC Adapter Power Supply with 2.1 x 5.5mm Center Positive Tip with Polarized AC Cord



- Versatile 6 ft. DC output cord

BUYOUT \$6.97 (1-9)

#129-1204 Compare to \$15
\$6.49 (10-49) \$5.49 (50-99) \$5.24 (100-UP)

Mean Well 36V 4.44A Grounded DC Power Supply AC Adapter with 2.5 x 5.5mm Center Positive (+) Plug



- Standard 2.5 x 5.5 mm tip positive plug
- 36V 4.44A for power hungry amp boards and mini amplifiers

BUYOUT \$37.97 EACH

#129-225 Compare to \$45

Regulated 3-12 VDC 2A 6-Way Power Supply

- Small size consumes less space on workbench or desk
- Variable voltages 3, 4.5, 6, 7.5, 9, and 12 VDC



ON SALE \$23.98 EACH

#120-536 List \$35.99 Reg. \$25.98

Lavolta 3CL40BK 40-Piece RGB 5050 SMD 3 LED Black Module IP67 Waterproof 19 ft. Light Strip Kit

- Aggressive, 3M wide adhesive strips on each module for quick mounting
- A hole on each side of the module provides a lasting hold with optional screws, part #081-1122

WATERPROOF!



LAVOLTA™



ON SALE \$39.98 EACH

#073-136 List \$56.99 Reg. \$41.98

Lavolta KIT-1 RGB 300 LED 16 ft. Waterproof IP65 Tape Light Strip 12 VDC with Remote



- Impact resistant and weatherproof for outdoor use
- Adhesive backing for quick and easy installation

ON SALE \$35.98 EACH

#073-086 List \$76.99 Reg. \$42.98

Lavolta Home 5050 RGB Wi-Fi Smart 150 LED 16.4 ft. Light Strip Kit with 12 VDC 2A Power Supply

- Uses Magic Home Pro app for easy smartphone control from home or almost anywhere
- Voice control with Alexa or Google Home devices

LAVOLTA™



Control via Smart Device

NEW

\$24.98 (1-9)

#073-087 \$23.98 (10-23) \$22.98 (24-UP)



**Built for the technician,
loved by the hobbyist**
Stahl Tools STSSVT Variable
Temperature Soldering Iron Station

- On/off switch with "power-on" indicator light showing when the iron is hot



ON SALE \$22⁹⁸ EACH
List \$31.99 Reg. \$27.98

#374-100

Stahl Tools TCSS Temp Controlled Soldering Iron Station ESD Safe

- Electronic control of the unit's heat from 300°F to 840°F
- 48 watt ceramic heating element



ON SALE \$61⁹⁸ EACH
List \$89.99 Reg. \$79.98

#374-200

Repair solder joints in less than 40 seconds

Stahl Tools DDSI 30W Digital Display Variable Temperature Soldering Iron Pen Kit



- Lightweight, compact size with temperature display and control buttons built-in the handle

#374-350

ON SALE \$36⁹⁸ EACH
List \$59.99 Reg. \$42.98

Battery Powered Soldering Iron Kit with USB Charging Cable



- Works with three AA alkaline or three AA Ni-MH rechargeable batteries (sold separately)
- Powerful 8-watt/4.5-volt iron heats to working temperature in less than 15 seconds

#374-675

ON SALE \$6⁹⁸ EACH
List \$15.99 Reg. \$8.49

Variable Wattage Soldering Iron 0-50 Watts

- Suitable for many applications
- Continuously variable from 0 to 50 watts



ON SALE \$12⁹⁸ EACH
List \$23.99 Reg. \$22.98

#370-340

Hose Clip/Solder Aid Pliers with Expansion Lock

- Rubber covered 1" x 1" handles provide extra grip and keeps hands cool while soldering



NEW

Excellent for soldering in tight places!

\$21⁹⁸ (1-3)

#360-031 List \$25.99

\$20.98 (4-11) \$19.98 (12-49) \$18.98 (50-UP)

Remove and install components with one soldering station

Stahl Tools DSDS Variable Temperature Digital Solder and Desolder Station



- Soldering iron and desoldering gun operate together or independently to save time and electricity
- Temperature range from 320°F to 896°F for versatility

#374-400

ON SALE \$21⁹⁸ EACH
List \$279.99 Reg. \$229.98

Stahl Tools DDSS Digital Display Soldering Iron Station



- LCD indicates temperature pre-set and actual temperature
- Variable heat setting (normal): 419°F to 572°F
- Variable heat setting (production line): 608°F to 716°F

#374-300

ON SALE \$69⁹⁸ EACH
List \$142.99 Reg. \$84.98

Solder and heat shrink anywhere with one tool



Bonus chisel tip now included

Rechargeable 30W Soldering Iron Kit with Heat Shrink Tip, Heat Shrink Tubing, USB cable, and Case

- Heats up to 30W in less than 30 seconds
- Replaceable and multiple tip options adds more functions

#370-370

ON SALE \$44⁹⁸ EACH
List \$69.99 Reg. \$49.98

Sharp Hot Knife Tip for 370-370 Rechargeable 30W Soldering Iron

#370-375

List \$9.99 \$4.79 (1-9) \$4.45 (10-24) \$4.07 (25-UP)

Variable Wattage Soldering Iron 0-50 Watts

- Suitable for many applications
- Continuously variable from 0 to 50 watts



ON SALE \$12⁹⁸ EACH
List \$23.99 Reg. \$22.98

#370-340

Stahl Tools HH3 LED Magnifying Lamp with Third Helping Hand and Soldering Iron Holder



- Soldering iron stand, alligator clips, solder spool holder, sponge, rosin, and tip cleaning ball

ON SALE \$29⁹⁸ EACH

#374-700 List \$49.99 Reg. \$34.98



Dayton Audio Max-X High Excursion DVC Subwoofers

The Max-X high excursion subwoofers from Dayton Audio are built for incredible low frequency extension and high SPL. These affordable drivers combine durability, efficiency, and displacement into a great looking speaker that will deliver the deepest bass with power and authority.

- High excursion and maximized surface area for excellent displacement capability
- Seamless dish cone is extremely rigid and durable with a sleek and modern look
- Custom tooled surround allows long throw without sacrificing cone area
- Extensive venting cools the voice coil enabling high power handling with low power compression
- Dual spiders maintain linear excursion for lower distortion even when pushed to the limit
- The dual 2 ohm voice coils give you the ability to get the most out of any amplifier

Engineered for max excursion and max SPL, with minimal distortion!

DAYTONAUDIO



Dayton Audio MX10-22 10" Max-X High Excursion DVC Subwoofer 2 Ohms Per Coil

Dayton Audio MX12-22 12" Max-X High Excursion DVC Subwoofer 2 Ohms Per Coil

Dayton Audio MX15-22 15" Max-X High Excursion DVC Subwoofer 2 Ohms Per Coil

Part #	Model	Size	Impedance	Power Handling (Watts RMS)	Frequency Response	Sensitivity (2.83 V/1m)	Fs	XMAX	List Price	Price (1-3)	Price (4-9)	Price (10-UP)
295-164	MX10-22	10"	2 +2 Ohm	400	25-500 Hz	86.1	32.6 Hz	11.6 mm	\$181.99	\$139.98	\$132.98	\$125.98
295-166	MX12-22	12"	2 +2 Ohm	600	23-450 Hz	89.4	28.8 Hz	15.5 mm	233.99	179.98	170.98	161.98
295-168	MX15-22	15"	2 +2 Ohm	800	18-400 Hz	90.2	21.7 Hz	19 mm	298.99	229.98	218.48	206.98

Unexpected low end from 4" drivers

Dayton Audio TCP115 Treated Paper Cone Midbass Woofers

- Aluminum former keeps voice coil cool for high power handling
- Extended pole piece creates symmetrical magnetic field for lower distortion
- Cosmetic low-profile mounting flange looks good without flush mounting

Specifications (4 ohm/8 ohm):

• Power handling: 40 watts RMS/80 watts max • Frequency response: 55-5,000/55-6,000 Hz • SPL: 86.8/81.9 dB 2.83V/1m • Fs: 53.8/59.2 Hz • Vas: 0.11/0.09 ft³ • Qts: 0.35/0.43 • XMAX: 4 mm.

#295-415 TCP115-4, 4 Ohm

#295-416 TCP115-8, 8 Ohm.....List \$18.99 **\$13.77** (4-9) **\$13.04** (10-UP)

DAYTONAUDIO



\$1449 (1-3)

Dayton Audio TD20F-4

3/4" Soft Dome Neodymium Tweeter

- 3/4" silk dome provides articulate yet non-fatiguing high frequency reproduction
- Exceptionally flat and smooth frequency response
- Ferrofluid improves power handling and damping
- Neodymium magnet low-distortion motor system

Specifications: • Power handling: 20 watts RMS/40 watt max • Impedance: 4 ohm • Frequency response: 3,000-20,000 Hz • SPL: 90 dB 2.83V/1m • Fs: 1,696 Hz • Qts: 1.38.

#275-020List \$12.99 **\$9.48** (4-9) **\$8.98** (10-UP)



\$998 (1-3)

Perfect driver for compact 2-way designs

Dayton Audio GF180 6-1/2" Glass Fiber Cone Woofers

- Woven fiberglass cone lowers resonances for smooth response natural sound
- 4-layer voice coil on an aluminum former provides excellent heat dissipation
- Rubber surround helps damp the outside edge of the cone improving high frequency response

Specifications: • Power handling: 40 watts RMS/80 watts max • Impedance: 4 ohm/8 ohm • Frequency response 45-5,000 Hz/50-5,000 Hz • SPL: 90.7/87.9 dB 2.83V/1m • Fs: 49/53 Hz • Vas: 0.58/0.55 ft³ • Qts: 0.42/0.50 • XMAX: 4 mm.

#295-417 GF180-4, 4 Ohm

#295-418 GF180-8, 8 Ohm.....List \$36.99 **\$26.58** (4-9) **\$25.18** (10-UP)



\$2798 (1-3)

Smooth on and off axis response

Dayton Audio TD25F-4 1" Soft Dome Tweeter

- 1" silk dome delivers high efficiency and smooth response
- Low Fs for use with crossovers as low as 2,000 Hz (@12 dB/octave)
- Semi-horn loaded faceplate protects the dome while controlling off-axis response
- Perfect choice for use in budget 2-way designs

Specifications: • Power handling: 20 watts RMS/40 watt max • Impedance: 4 ohm • Frequency response: 2,000-20,000 Hz • SPL: 91 dB 2.83V/1m • Fs: 900 Hz • Qts: 0.94.

#275-022List \$21.99 **ON SALE \$1352** EACH **\$16.90** (10-UP)

DAYTONAUDIO

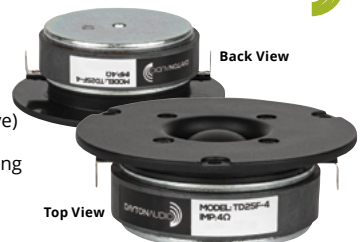

ON SALE \$1352 EACH



Produces remarkably low distortion even when pushed to earth-shaking levels

Dayton Audio Reference Series High Excursion Subwoofers 2+2 ohm

- Designed for maximum excursion and extended low frequency response
- Copper ring and thick aluminum sleeve minimize inductance to deliver ultra-low distortion
- Large 3" diameter voice coil is wound on a spiral cut aluminum former allowing high power handling



Part #	Model	Size Inches	Impedance	Power Handling (Watts RMS)	Frequency Response	Sensitivity (2.83 V/1m)	Fs	XMAX	List Price	Price (1-3)	Price (4-UP)
295-290	RSS265HE-22	10"	2 + 2 Ohm	800	25 - 900 Hz	84.9	30 Hz	25 mm	\$337.99	\$259.98	\$246.98
295-291	RSS315HE-22	12"	2 + 2 Ohm	800	25 - 750 Hz	88.1	32 Hz	25 mm	363.99	279.98	265.98
295-292	RSS390HE-22	15"	2 + 2 Ohm	800	20 - 600 Hz	89.3	29 Hz	27 mm	428.99	329.98	313.48



Reference Series Paper Cone Drivers

- Proprietary cone composition combines kevlar, paper, and glass fiber for an ultra-flat response
- Low-distortion motor produces accurate sonic detail



A size for every application!

Part #	Model	Diameter (Inches)	Impedance (ohms)	Frequency Response (Hz)	Power Handling (Watts RMS)	Sensitivity (2.83V/ 1m)	List Price	Price (1-3)	Price (4-9)	Price (10-UP)
295-369	RS100P-4	4	4	85-13,500	30	88.5	\$48.99	\$36.98	\$35.13	\$33.28
295-359	RS100P-8	4	8	90-12,500	30	86.2	48.99	36.98	35.13	33.28
295-371	RS125P-4	5	4	70-12,000	30	90	54.99	41.98	39.88	37.78
295-361	RS125P-8	5	8	70-10,000	30	87.1	54.99	41.98	39.88	37.78
295-563	RS150P-4A	6	4	45-10,000	40	90.3	68.99	52.98	50.33	47.68
295-573	RS150P-8A	6	8	49-10,000	40	88.7	68.99	52.98	50.33	47.68
295-375	RS180P-4	7	4	35-8,000	60	90.8	81.99	62.98	59.83	56.68
295-365	RS180P-8	7	8	45-8,000	60	89.8	81.99	62.98	59.83	56.68
295-567	RS225P-4A	8	4	35-5,550	80	92.9	103.99	79.98	75.98	71.98
295-577	RS225P-8A	8	8	30-7,000	80	89.1	103.99	79.98	75.98	71.98
295-569	RS270P-4A	10	4	23-6,000	100	90.9	142.99	109.98	104.48	98.98
295-579	RS270P-8A	10	8	23-6,000	100	87.5	142.99	109.98	104.48	98.98



Accurate midrange response with wide dispersion

Dayton Audio 2" Reference Midranges

- Large damped rear chamber for low resonance point

Aluminum or Fabric dome

Specifications 285-020: • Power handling: 60 watts RMS/120 watts max • Impedance: 8 ohm • Frequency response: 500-14,000 Hz • SPL: 89.4 dB 2.83V/1m • Fs: 341 Hz • Vas: 0.005 ft³ • Qts: 0.86 • XMAX: 1 mm.

Specifications 285-022: • Power handling: 60 watts RMS/120 watts max • Impedance: 8 ohm • Frequency response: 500-8,500 Hz • SPL: 90 dB 2.83V/1m • Fs: 394.3 Hz • XMAX: 1 mm.

#285-020 RS52AN-8, Aluminum dome **ON SALE \$3798** EACH
#285-022 RS52FN-8, Fabric dome.....List \$58-99 Reg. **\$44-98**

Dayton Audio 1" NHP High Power Neodymium Tweeters

- Over 94 dB efficiency is perfect for use in higher output designs



#275-108 NHP25F-4, Soft Dome
#275-109 NHP25T-4, Titanium Dome.....List \$30-99 Reg. **\$23-49**

Dayton Audio Cast Aluminum Face Plate for NHP Tweeters

- Rigid cast aluminum construction provides a solid mounting surface



#275-110 FP104, 104 mm diameter
#275-112 FP110, 110 mm diameterList \$11-99 **\$8.53** (4-9) **\$8.08** (10-UP)



WARNING: Cancer and Reproductive Harm — www.P65Warnings.ca.gov

Compact full-range drivers capable of remarkable performance

AURA
C O U N T R Y

**Aurasound Cougar NSW1-205-8A
1" Extended Range Driver**

- NRT radial neodymium motor for extremely low distortion

Specifications: • Power handling: 5 watts RMS/20 watts max • Impedance: 8 ohm
• Frequency response: 220-20,000 Hz
• SPL: 78 dB 1W/1m • Fs: 220 Hz • Vas: 0.01 ft³
• Qts: 0.7 • XMAX: 4.5 mm.



ON SALE \$13.98 EACH

#296-250 List \$23.99 Reg. \$17.98

**Aurasound NSW2-326-8AT Whisper
2" Extended Range Speaker Driver**

- Great for modern audio applications including sound bars and ultra-thin tower speakers

Specifications: • Power handling: 15 watts RMS/60 watts max • Impedance: 8 ohm • Frequency response: 250-15,000 Hz • Fs: 250 Hz • SPL: 84 dB 1W/1m • Vas: 0.01 ft³
• Qts: 0.68 • XMAX: 3 mm.



ON SALE \$17.98 EACH

#296-252 List \$29.99 Reg. \$22.98

Aurasound NS2x3-184-4A 2"x3" Extended Range Driver

- Racetrack shape for maximum surface area in tight spaces

Specifications: • Power handling: 7 watts RMS/15 watts max • Impedance: 4 ohm
• Frequency response: 200-20,000 Hz
• SPL: 84 dB 1W/1m • Fs: 220 Hz
• Vas: 0.01 ft³ • Qts: 1.38.



ON SALE \$8.48 EACH

#296-256 List \$12.99 Reg. \$9.98

Low Fs and smooth response makes this driver a great choice for 3-way designs

HiVi F10 10" Woofer

- Light and extremely rigid cone made from Kevlar/paper composite

Specifications: • Power handling: 100 watts RMS/200 watts max • Impedance: 8 ohm • Frequency response: 28-3,000 Hz
• SPL: 89 dB 2.83V/1m • Fs: 28 Hz
• Vas: 2.78 ft³ • Qts: 0.31
• XMAX: 6 mm.



ON SALE \$99.98 EACH

#297-450 List \$163.99 Reg. \$125.98

HiVi M4N 4" Aluminum/Magnesium Midbass

- Gorgeous magnesium-alloy cone
- Great extension for a small driver

Specifications: • Power handling: 15 watts RMS/30 watts max • Impedance: 8 ohm
• Frequency response: 69-8,000 Hz • SPL: 82 dB 2.83V/1m • Fs: 69 Hz • Vas: 0.16 ft³
• Qts: 1.08 • XMAX: 3 mm.



ON SALE \$11.98 EACH

#297-434 List \$18.99 Reg. \$13.98

HiVi RT2H-A Planar Isodynamic Tweeter

- Nearly weightless Kapton diaphragm for incredible transient response

Specifications: • Power handling: 30 watts RMS/60 watts max • Impedance: 8 ohm
• Frequency response: 1,700-25,000 Hz
• SPL: 94 dB 1W/1m.

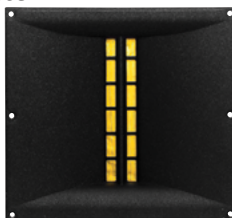

ON SALE \$83.98 EACH

#297-407 List \$136.99 Reg. \$104.98

**Tang Band W5-1138SM
5-1/4" Neodymium Subwoofer**

- Wide roll surround, raised flat spider
- Specifications:** • Power handling: 40 watts RMS/80 watts max • Impedance: 4 ohm • Frequency response: 45-1,500 Hz • SPL: 82 dB 2.83V/1m
• Fs: 45 Hz • Vas: 0.21 ft³
• Qts: 0.48 • XMAX: 9.25 mm.



\$94.98 (1-3)

#264-831 List \$129.99 \$89.98 (4-UP)

Powerful underhung motor allows incredible accuracy and detail

Tang Band W4-1879 4" Full-Range Driver

- Underhung voice coil

Specifications: • Power handling: 25 watts RMS/50 watts max • Impedance: 8 ohm • Frequency response 55-20,000 Hz • SPL: 87 dB 1W/1m • Fs: 55 Hz • Vas: 0.32 ft³ • Qts: 0.43
• XMAX: 5 mm.



\$274.98 (1-3)

#264-903 List \$357.99 \$261.23 (4-9) \$247.48 (10-UP)

Tang Band W2-2243S 2" Aluminum/Magnesium Full-Range Driver

- Full-range design with smooth response up to 20,000 Hz (±3 dB from 250 to 20,000 Hz)

Specifications: • Power handling: 10 watts RMS/20 watts max • Impedance: 4 ohm
• Frequency response 160-20,000 Hz • SPL: 87 dB 1W/1m • Fs: 160 Hz • Vas: 0.008 ft³ • Qts: 0.30 • XMAX: 1 mm.



\$41.98 (1-3)

#264-803 List \$54.99 \$39.88 (4-9) \$37.78 (10-UP)

**Peerless by Tympany SDS-160F25PR01-08
6-1/2" Paper Cone Woofer**

- Premium sculpted stamped steel chassis fits narrow enclosures

Specifications: • Power handling: 60 watts RMS/120 watts max • Impedance: 8 ohm • Frequency response: 35-8,000 Hz • SPL: 87 dB 2.83V/1m • Fs: 42 Hz • Vas: 1.04 ft³ • Qts: 0.49
• XMAX: 6.05 mm.



\$247.00 (1-4)

#264-1146 List \$26.99 \$23.43 (5-49) \$22.18 (50-UP)

Peerless by Tympany 830656 5-1/4" Paper Cone SDS Woofer

- Premium sculpted stamped steel chassis

Specifications: • Power handling: 60 watts RMS/110 watts max • Impedance: 8 ohm
• Frequency response: 50-5,000 Hz • SPL: 84.5 dB 1W/1m • Fs: 57 Hz • Vas: 0.31 ft³ • Qts: 0.59
• XMAX: 3.46 mm.



\$159.30 (1-49)

#264-1078 List \$25.99 \$15.13 (50-UP)

Rising high end response and controlled dispersion is deal for high output line arrays

**Peerless by Tympany TC6FC02-04
2" Neodymium Full-Range Line Array Driver 4 Ohm**

- Patented PentaCut NRSC cone dampens and controls resonances

Specifications: • Power handling: 15 watts RMS/30 watts max
• Impedance: 4 ohm • Frequency response: 150-15,000 Hz • SPL: 86.2 dB 2.83V/1m • Fs: 150 Hz • Vas: 0.011 ft³ • Qts: 0.67 • XMAX: 0.55 mm.



\$980 CLEARANCE EACH Was \$15.86

Renowned for their low distortion and low frequency extension



CSS SDX10 XBL2 10" Subwoofer

- Semi-progressive spider design gives increased linearity

Specifications: • Power handling: 750 watts RMS/1500 watts max • Impedance: 4 ohm
• Frequency response: 16-500 Hz • SPL: 89 dB 2.83V/1m • Fs: 26 Hz
• Vas: 1.87 ft³ • Qts: 0.42
• XMAX: 18.4 mm.

\$237⁹⁸ (1-3)

#290-3004 \$227.42 (4-UP)



CSS SDX12 XBL2 12" Subwoofer

- Dotted non-pressed paper cone with NBR surround

Specifications: • Power handling: 1,000 watts RMS/2,000 watts max • Impedance: 4 ohm
• Frequency response: 16-500 Hz • SPL: 87.2 dB 2.83V/1m • Fs: 21.3 Hz
• Vas: 2.38 ft³ • Qts: 0.37
• XMAX: 28 mm.

\$374⁹⁸ (1-3)

#290-3006 \$355.00 (4-UP)



Incredibly detailed and dynamic sound from a compact package



CSS LD25X 25mm Silk Dome XBL² Tweeter

- XBL² motor uses a split gap to increase strength and excursion for lower distortion

Specifications: • Power handling: 75 watts RMS/150 watts max • Impedance: 8 ohm
• Frequency response: 2,000-22,000 Hz
• SPL: 90 dB 2.83V/1m
• Fs: 865 Hz.

\$164⁹⁸ (1-3)

#290-3007 List \$199.99 \$144.98 (4-UP)

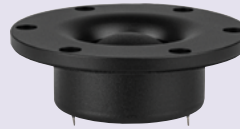

Powerful XBL² motor

CSS LD22F 22mm Soft Dome Neodymium Tweeter

- Rear chamber for low distortion performance

Specifications: • Power handling: 65 watts RMS • Impedance: 4 ohm • Frequency response: 2,000-30,000 Hz
• SPL: 89 dB 2.83V/1m
• Fs: 870 Hz • Qts: 0.77.

\$81⁹⁸ (1-3)

#290-3000 \$78.85 (4-UP)



CSS LDW7 7" Midwoofer



- Symmetrical motor structure for optimal drive force balance

Specifications: • Power handling: 80 watts RMS/200 watts max • Impedance: 8 ohm
• Frequency response: 30-4,500 Hz • SPL: 86 dB 2.83V/1m • Fs: 30 Hz
• Vas: 1.09 ft³ • Qts: 0.37
• XMAX: 5.50 mm.

\$163⁹⁸ (1-3)

#290-3002 List \$164.99 \$158.71 (4-UP)



Morel TiCW 634Nd Titanium Series Hybrid Cu 6" Woofer



- Open Uniflow aluminum diecast chassis for reduced reflections

Specifications: • Power handling: 150 watts RMS/1,000 watts max • Impedance: 4 ohm
• Frequency response: 40-4,500 Hz • SPL: 88 dB 2.83V/1m • Fs: 34 Hz
• Vas: 0.9 ft³ • Qts: 0.29
• XMAX: 5.5 mm.

\$301⁰⁰ EACH

#297-104 List \$451.99



Morel CAW 428 4" Classic Woofer

- Large 2.1" Hexatech™ aluminum voice coil
- Uniflow™ stamped steel chassis

Specifications: • Power handling: 150 watts RMS/800 watts max • Impedance: 8 ohm • Frequency response: 50-6,000 Hz
• SPL: 88 dB 2.83V/1m
• Fs: 74 Hz • Vas: 0.16 ft³
• Qts: 0.38 • XMAX: 4 mm.

\$138⁰⁰ EACH

#297-080 List \$207.99



Morel TM4055-8 2" Midrange and 1-1/8" Tweeter Speaker Plate

- Optimized proximity of tweeter and midrange

2" Midrange Specifications:
• Power handling: 200 watts RMS/1,000 watts max • Impedance: 8 ohm • Frequency response: 365-4,200 Hz • SPL: 86.5 dB 2.83V/1m • Fs: 365 Hz • Vas: 0.03 ft³ • Qts: 0.51 • XMAX: 1 mm.

1-1/8" Tweeter Specifications:
• Power handling: 120 watts RMS/1,000 watts max • Impedance: 8 ohm • Frequency response: 640-20,000 Hz • SPL: 86.5 dB 2.83V/1m • Fs: 640 Hz • Vas: 0.03 ft³ • Qts: 0.70 • XMAX: 1 mm.

\$206⁰⁰ EACH

#287-038 List \$309.99



Combines controlled dispersion with high efficiency for an effortless sound



Wavecor T30mm Semi Horn Loaded Textile Dome Tweeters with Rear Chamber

- Waveguide face plate for controlled dispersion, offering optimized off-axis and power response

Specifications (4 ohm/8 ohm): • Power handling: 45 watts RMS/90 watts max • Impedance: 4/8 ohm • Frequency response: 1,500-25,000 Hz • SPL: 93.5/91 dB 2.83V/1m • Fs: 410/425 Hz • Qts: 0.79/0.90.

#298-1120 TW030WA11, 4 Ohm

#298-1122 TW030WA12, 8 Ohm \$99⁰⁰ EACH



Low distortion motor assembly for dynamic and detailed bass response

Wavecor 8-1/2" Balanced Drive Paper Cone Subwoofers

- Balanced Drive motor structure for optimal drive force symmetry resulting in largely reduced even order harmonic distortion

Specifications (4 ohm/8 ohm): • Power handling: 400 watts RMS/1,500 watts max • Impedance: 4/8 ohm • Frequency response: 33-500/35-500 Hz • SPL: 89/86 dB 2.83V/1m
• Fs: 33/35 Hz • Vas: 0.92 ft³ • Qts: 0.49
• XMAX: 10 mm.

#298-1060 SW215WA01, 4 Ohm

#298-1062 SW215WA02, 8 Ohm \$125⁰⁰ EACH



Wavecor SW182BD03 7" Balanced Drive Black Aluminum Cone Subwoofers

- Very rigid aluminum cone to ensure piston motion at high levels and for better heat transfer at high continuous power levels

Specifications (4 ohm/8 ohm):
• Power handling: 35/250 watts RMS/600/1,100 watts max • Impedance: 4/8 ohm • Frequency response: 35-600/37-600 Hz • SPL: 84/81.5 dB 2.83V/1m • Fs: 35.1/81.5 Hz • Vas: 0.45 ft³
• Qts: 0.44/0.49 • XMAX: 7 mm.

#298-1056 SW182BD03, 4 Ohm

#298-1058 SW182BD04, 8 Ohm \$155⁰⁰ EACH



The easiest way to give your speakers a professional look

Speaker Grill Cloth 70" Wide

- Sold by the linear yard for easy ordering
- Extra wide grill cloth allows for plenty of wiggle room when fitting

RAVE REVIEWS!

“ Outstanding cloth and great value. Stretches easily and sound transparent. ”
-MS



#260-334 White
 #260-335 Black
 #260-337 Dark gray
 #260-339 Brown..... \$8.49 (10-49 YDS) \$7.49 (50 YDS-UP)

\$9.98
(1-9 YDS)

MELLOTONE® division of WENDELL FABRICS CORPORATION

Mellotone Premium Black Speaker Grill Cloth Yard 64" Wide



- Acoustically transparent
- Approximately twice the thickness of our standard grill cloth
- Will pass the ASTM E-84 flame test with a Class A rating
- 64" wide and sold by the linear yard

Guaranteed to be the blackest shade of black!
\$27.98
(1-5)

#260-332
List \$37.99 \$25.39 (6-11) \$21.99 (12-UP)

Speaker Grill Frame Kits

- Tight-fit interlocking assembly
- Rugged construction for even the largest speakers
- Great for large PA or vintage speakers

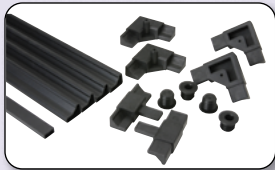

Fabric not included

★★★★★
\$35.98 EACH

#260-346.....\$27.60 (2-3) \$23.99 (4-UP)

Part #	Description	List Price	Price (1-3)	Price (4-UP)
260-348	Additional corners and sockets (4 pr.)	\$14.99	\$11.39	\$10.82
260-349	Additional T-joints (2 pcs.)	6.99	4.89	4.61

Reduce unwanted sound reflections



sonic barrier™ Sound Damping by Dayton Audio

Sonic Barrier™ Acoustic Sound Damping Foam

- Aggressive peel and stick adhesive for the easiest application
- Helps absorb unwanted sound from within speaker cabinets
- Exclusive embossed surface finish helps trap acoustic energy

Part #	Overall Thickness	Composition	List Price	Price (1-3)	Price (4-UP)
260-520	1/2"	1-layer foam	\$14.99	\$10.49	\$9.72
260-525	1"	1-layer foam	20.99	14.49	13.73
260-530	3/4"	1/2" foam - 1/2 lb. barrier - 1/4" foam	30.99	24.84	22.87
260-535	1-1/4"	1" foam - 1 lb. barrier - 1/4" foam	41.99	29.98	27.38

A durable and easy to apply finish that looks great

ExoHyde Pro Grade Textured Protective Speaker Cabinet Coating

- Paint and primer in one for an easy one coat application
- Dries to a hard and resilient finish that withstands scuffs, scratches, and even moisture
- Extremely low volatile organic compounds (VOC), safe to apply indoors
- Create a variety of textures with different application techniques



★★★★★ ExoHyde Quart

#260-2100.....

Quart covers approximately 25 sq. ft.

\$39.98
(1-3)
\$37.98 (4-UP)

ExoHyde Gallon

#260-2102.....

Gallon covers approximately 100 sq. ft.

\$79.98
(1-3)
\$71.98 (4-UP)

foamPRO 9" Foam Roller for Textured Finish

- Creates a textured finish when applying ExoHyde or DuraTex to cabinets and cases

\$7.98
(1-3)

#260-2150.....\$7.60 (4-UP)

foamPRO 4" Textured Roller with Handle

- Compact 4" roller is perfect for smaller projects and tight spots

\$7.39
(1-3)

#260-115.....\$6.35 (4-UP)

foamPRO 4" Textured Roller Refill 2 Pack

- Holds ample paint for a rugged high build coating

\$4.98
(1-3)

#260-117.....List \$5.99 \$4.50 (4-UP)

Add powerful low frequency impact to music, home theater, or gaming system. We have bass shakers to fit any application

Dayton Audio TT25 PUCK Tactile Transducer Mini Bass Shakers

- Quality construction and economically priced
- Add tactile feedback to chairs and couches for the ultimate gaming and movie experience
- Small and easy to install



★★★★★ **ON SALE**
\$13.98 EACH

#300-386 TT25-8, 8 ohm

#300-388 TT25-16, 16 ohm.....List \$22.99 Reg. \$16.98

BUNDLED ITEMS saves you \$\$!

ON SALE
\$39.98 EACH

#300-391 TT25-8, 4 pack, 8 ohm

#300-389 TT25-16, 4 pack, 16 ohm.....List \$79.99 Reg. \$49.98

Our easiest kit. Perfect for beginners!



Dayton Audio BR-1 2-Way Bookshelf Monitor Speaker Kit Pair

- Exceptional value
- Two hour assembly



\$264⁹⁸ PAIR

#300-640

Dayton Audio BR-1 Kit Components

#300-641

\$219⁹⁸ PAIR

\$212.73 (2-UP)

Dayton Audio BR-1CAB BR-1 6-1/2" 2-Way Speaker Cabinet Pair

#300-645

\$99⁹⁸ PAIR

Renowned for detail, accuracy, and bass response

Overnight Sensations MT Speaker Kit Pair

- Top-rated speaker project
- Work great as monitors

Dimensions:
9" H x 6" W x 8-3/8" D

#300-706



\$159⁹⁸ PAIR

List \$209.99

Dual passive radiators for maximum bass from the smallest enclosure

Passive Aggressive Mini Speaker Kit Pair



\$159⁹⁸ PAIR

#300-7148

List \$250.00

Copperhead with Subwoofer 2.1 Channel Powered Desktop Speaker System Kit

Designed specifically for desktop use, the 2.1 channel Copperhead with 6-1/2" powered subwoofer kit delivers audiophile quality sound, pinpoint imaging, and powerful output capability.

The perfect match for computers, gaming, or bedrooms.



#300-7180

#300-7161

\$299⁹⁸ EACH

List \$321.77

#300-7182

Designed specifically for desktop use

Copperhead Desktop Full-Range Speaker Kit Pair

- True full-range point source frequency response from 80 to 20,000 Hz



\$119⁹⁸ PAIR

#300-7180

List \$162.58

The ideal subwoofer to add powerful low end to any compact speaker system

Dayton Audio 6-1/2" Down Firing Active Mini Subwoofer Kit with 2.1 Channel Amplifier



\$199⁹⁸ EACH

#300-7161

List \$249.99

Passive version also available

Dayton Audio 6-1/2" Down Firing Passive Mini Subwoofer Kit

#300-7160

\$119⁹⁸ EACH

List \$150.99

Compact speakers that produce big sound on a budget



C-Sharp Powered 2-Way Speaker Kit Pair

- Built-in LP40PA amplifier makes it easy to add high quality audio almost anywhere

#300-7043

List \$336.87

\$189⁹⁸ PAIR

Build your own powered monitors with convenient Bluetooth input!

C-Note MT Bookshelf Speaker Kit Pair

- Pinpoint imaging with a wide soundstage for an immersive listening experience
- Simple instruction manual makes anybody a speaker builder instantly



#300-7140

List \$224.42

\$149⁹⁸ PAIR

C-Note Center Channel Speaker Kit

- Designed to provide lifelike vocal response with smooth high frequency response
- High output capability to deliver the dynamics necessary for movie sound tracks



#300-7142

List \$213.18

\$134⁹⁸ EACH



A modern sound bar kit that delivers amazing performance with a one-of-a-kind look

AudioBar Powered 1.5-Way 2 Channel Sound Bar Speaker Kit

- Unique low-profile design that is capable of satisfying bass response without the need for a separate subwoofer
- Baltic birch construction with solid walnut baffles combines modern design with a classic look
- 1.5-way design minimizes high frequency lobing to produce a wide soundstage with precise imaging
- 4 x 3" aluminum cone full-range drivers with 4 x 3" passive radiators provide impressive bass response with accurate high frequency reproduction



#300-7146

Dimensions: 4" H x 42" W x 4" D

List \$576.07

\$299⁹⁸ EACH

Premium 2-way bookshelf designs that are perfect for the most discerning audiophiles

Samba MT Bookshelf Speaker Kit with Knock-Down Cabinet

- The Samba speaker kit delivers revealing and accurate response with incredible detail



★★★★★

Part #	Description	List Price	Price Each
300-7121	Speaker kit with enclosures	\$281.31	\$164.98
300-7119	Speaker kit with pre-cut baffle only	216.31	134.98

Morel Ardon Premium 2-Way MT Bookshelf Speaker Kit with Knock-Down Cabinet

- Extremely rigid 3/4" MDF enclosure uses double rabbeted joints and extensive bracing



★★★★★

Audiophile quality speaker that delivers powerful output!

#300-7144

List \$401.58

\$199⁹⁸ EACH

Compact systems that are capable of delivering big sound

AviaTrix-RST Sealed MTM Speaker Kit Pair with Knock-Down Cabinets



- Capable of high output with low distortion, perfect for home theater systems

★★★★★

Part #	Description	List Price	Price Pair
300-7134	AviaTrix with enclosures	\$525.12	\$299.98
300-7041	AviaTrix components only	395.12	249.98

Hitmaker MT Bookshelf Speaker Kit

- Remarkably flat response, ±3 dB from 50-20,000 Hz
- The Hitmaker delivers an incredible level of detail with precise imaging



★★★★★

Part #	Description	List Price	Price Pair
300-7116	Hitmaker with enclosure	\$206.95	\$134.98
300-7114	Hitmaker with pre-cut baffle only	146.95	99.98

Premium Morel drivers produce world class performance

Solstice MLTL Reference Tower Speaker Kit

- Mass Loaded Transmission Line enclosure extends low frequency response to 30 Hz



\$799⁹⁸ EACH

#300-708

True transmission line enclosure for amazing bass response

TriTrix MTM TL Tower Speaker Kit Pair

- This TriTrix kit is an excellent introduction to transmission line speakers

\$399⁹⁸ PAIR

List \$449.99

#300-702

TriTrix MTM TL Components Only

#300-700



\$169⁹⁸ PAIR

List \$274.99

Fully customized low end with DSP software

Powered Dayton Audio 10" with Dual Passive Radiators 500 Watt Subwoofer Kit with Built-In DSP

- Unobtrusive 13" cube enclosure will fit easily into almost any room



★★★★★

\$749⁹⁸ EACH

#300-7152

List \$887.95

Combines high power handling with excellent efficiency to add powerful midbass output to any home, car, or professional sound system

Dayton Audio MB Professional High Power Midbass Drivers



NEW

Dayton Audio MB620-8 6-1/2" Professional High Power Midbass Driver

Specifications: • Power handling: 200 watts RMS/400 watts max • Impedance: 8 ohm • Frequency response 100-7,000 Hz • SPL: 94dB 2.83V/1m • Fs: 104 Hz • Vas: 0.24 ft³ • Qts: 0.55 • XMAX: 2 mm.

\$39⁹⁸ (1-3)

#295-635 List \$53.99 **\$37.98** (4-9) **\$35.98** (10-UP)



NEW

Dayton Audio MB820-8 8" Professional High Power Midbass Driver

Specifications: • Power handling: 200 watts RMS/400 watts max • Impedance: 8 ohm • Frequency response 100-7,500 Hz • SPL: 94dB 2.83V/1m • Fs: 69 Hz • Vas: 0.56 ft³ • Qts: 0.46 • XMAX: 4 mm.

\$44⁹⁸ (1-3)

#295-636 List \$60.99 **\$42.73** (4-9) **\$40.48** (10-UP)



NEW

Dayton Audio MB1025-8 10" Professional High Power Midbass Driver

Specifications: • Power handling: 350 watts RMS/700 watts max • Impedance: 8 ohm • Frequency response 60-5,500 Hz • SPL: 95dB 2.83V/1m • Fs: 45 Hz • Vas: 1.79 ft³ • Qts: 0.34 • XMAX: 3 mm.

\$59⁹⁸ (1-3)

#295-637 List \$79.99 **\$56.98** (4-9) **\$53.98** (10-UP)

Maximum displacement and low Fs for powerful bass at an unbeatable value



21 INCH!

Dayton Audio PSS555-8 21" Pro Subwoofer with 4.5" Voice Coil

• Large 4-1/2" inside/outside wound voice coil to handle 1,000 watts RMS for extended sessions

Specifications: • Power handling: 1,000 watts/2,000 watts max • Impedance: 8 ohm • Frequency response: 27-2,500 Hz • SPL: 96.3 dB 2.83V/1m • Fs: 27.6 Hz • Vas: • 15.68 ft³ • Qts: 0.33 • XMAX: 11 mm.

\$309⁹⁸ (1-3)

#295-050 List \$402.99 **\$294.48** (4-9) **\$278.98** (10-UP)

LaVoce WAN123.01 12" Professional Neodymium Woofer 8 Ohm



• Large 3" voice coil with extensive venting for high power handling and low power compression
• Compact but powerful neodymium motor for minimal weight with maximum efficiency

Specifications: • Power handling: 500 watts/1,000 watts max • Impedance: 8 ohm • Frequency response: 40-2,000 Hz • SPL: 99 dB 2.83V/1m • Fs: 57.3 Hz • Vas: 1.46 ft³ • Qts: 0.24 • XMAX: 6.6 mm.

\$258⁴⁹ EACH

#293-780 List \$309.00

LaVoce WAN153.01 15" Professional Neodymium Woofer 8 Ohm



• Dual aluminum shorting rings for low inductance and minimal distortion
• Waterproof treated paper cone delivers smooth and natural response and resists exposure to weather

Specifications: • Power handling: 600 watts/1,200 watts max • Impedance: 8 ohm • Frequency response: 40-2,000 Hz • SPL: 100 dB 2.83V/1m • Fs: 46.3 Hz • Vas: • 4 ft³ • Qts: 0.29 • XMAX: 6.6 mm.

\$263⁹⁹ EACH

#293-782 List \$326.00



Next generation compression drivers that produces lower distortion and smoother response with minimal power compression

LaVoce 1" Compression Drivers

• FEM optimized motor, diaphragm, and phase plug to produce flat response with low distortion
• Next generation compression driver delivers natural response and high output capability
• Damped polymer diaphragm and surround provides smooth and natural high frequency response
• Easy fit onto many popular horns



LaVoce DF10.101LS 1-3/8" 18 TPI

#293-768 List \$40.99

LaVoce DF10.101 1" Polymer Compression Drivers

• 107 dB efficiency with 20 watt RMS power handling for incredibly dynamic output
• FEM optimized motor, diaphragm, and phase plug to produce flat response with low distortion



LaVoce DF10.101L 2-Bolt

#293-770 List \$42.00

\$31⁹⁹ EACH

\$35¹⁹ EACH

LaVoce DN10.142 Neodymium 1" Polymer Compression Driver 2-Bolt

• 1.4" edgewound CCA voice coil on high temp Kapton former for low mass with maximum motor force

\$71⁴⁹ EACH

#293-772 List \$87.00

LaVoce DF10.172K 1" Polymer Compression Driver 4-Bolt

• 1.7" edgewound CCA voice coil on high temp Kapton former for low mass with maximum motor force

\$87⁹⁹ EACH

#293-774 List \$107.00

LaVoce DN10.172K Neodymium 1" Polymer Compression Driver 4-Bolt

• Damped polyimide diaphragm and surround provides smooth and natural high frequency response

\$109⁹⁹ EACH

#293-776 List \$130.00



Protect your gear without breaking the bank

Talent ABS Rack Cases 19" Depth

- Front and rear panels are secure, easy to open and close
- Impact-resistant ABS construction
- Lightweight aluminum framework
- Molded-in feet, ribbing, and stackable tongue-and-grooves



talent
SOUND & LIGHTING

RAVE REVIEWS!

“Does what it's supposed to, it's light and well constructed.”

- Kevin H



Part #	Model	Rack Spaces	List Price	Price (1-2)	Price (3-UP)
233-300	RC4U19	4	\$194.99	\$149.98	\$143.98
233-302	RC8U19	8	274.99	209.98	201.58
233-304	RC12U19	12	324.99	249.98	242.48

Ultra-efficient Class D power amp with DSP

Crown XLS DriveCore 2 Power Amplifiers



- Feature packed DSP functions including bandpass filters on each channel, high and low pass filters, crossover tuning, loudspeaker matching, and system EQ



Part #	Model	Power Output @ 4 ohms	Price Each
245-507	XLS 1002	350W	\$385.00
245-508	XLS 1502	525W	499.00
245-509	XLS 2002	650W	619.00
245-510	XLS 2502	775W	729.00

RAVE REVIEWS!

“Great value for the money - I'm using two for a bi-amped home stereo system. It is quiet, clean sounding, easy to set up, reliable and flexible to configure.” -Alan B.

QSC GX Series Power Amplifiers



- Power levels matched to the most popular speakers used by entertainers
- Optimized for maximum real-world headroom into 4 ohm and 8 ohm speaker systems
- Inputs: XLR, 1/4" TRS, and phono input connectors for compatibility with any source
- Speakon® combo accepts, 1/4" (TS) plugs or Speakon 2 and 4-pole plugs for connection versatility
- Built-in Subwoofer/ Satellite crossover



Part #	Model	Power Output	List Price	Price Each
245-650	GX3	300 W	\$543.59	\$479.99
245-652	GX5	500 W	645.49	579.99
245-654	GX7	725 W	934.49	799.99
245-6918	GXD8	1200 W	1,128.99	1,039.99



Create a personalized group audio experience



Customer Favorite!



GROUP LISTENING AUDIO SYSTEM
Silent Disco System by Talent

DISCOVER WHAT YOU CAN DO!

Talent RF-309 Silent Disco 3-Channel Headphones

- Combine up to three transmitters to create a 3-channel system that allows for up to three audio sources or performers the audience can select from
- Integrated Chexology NFC sticker for use with iPad app to monitor inventory and unreturned headphones

ON SALE \$39.98 EACH

#233-352 List \$59.99 Reg. \$49.00

Talent TX-50RF Silent Disco 3-Channel Transmitter

- 3-channel UHF/RF transmitter for Talent RF-309 Silent Disco Headphones

ON SALE \$199.98 EACH

#233-354 List \$274.99 Reg. \$228.98

talent
SOUND & LIGHTING

Talent Silent Disco Bundles 3-Channel with Headphones and Transmitters

Bundled to save you more \$\$\$!

- Each transmitter can pair to an unlimited number of headphones which provides flexible expansion options



SALE

Part #	# of Channels	# of Transmitters	# of Headphones	# of Chargers	List Price	Regular Price	Sale Price
233-3521	3	1	5	1	\$649.93	\$479.98	\$449.98
233-3522	3	3	50	3	4,049.40	2,979.98	2,739.99
233-3523	3	3	100	6	7,198.90	5,289.98	4,859.99
233-3524	3	3	20	1	2,099.99	1,549.98	1,429.99

Save stage space and run your audio signals over ethernet cable



Talent XLR Extenders Over CAT5

- Keep your cables tidy and organized by reducing the number of cables used
- Connect up to 4 XLR cables for maximum convenience
- Easily connect an Ethercon CAT5 cable for maximum durability



Part #	Connector Type	Connector	Price (1-3)	Price (4-9)	Price (10-UP)
183-400	Built-In	4 Port 3-Pin XLR Male	\$22.88	\$21.74	\$20.59
183-402	Built-In	4 Port 3-Pin XLR Female	22.88	21.74	20.59
183-404	Built-In	4 Port 5-Pin XLR Male	24.88	23.64	22.39
183-406	Built-In	4 Port 5-Pin XLR Female	24.88	23.64	22.39
183-408	Pigtail	4 Connector 3-Pin XLR Male	25.98	24.68	23.45
183-410	Pigtail	4 Connector 3-Pin XLR Female	25.98	24.68	23.45

Packed with versatile programming options and industry-standard features

Talent DMX-DC16 192 Channel Universal DMX Controller



- 30 banks, 12 scanners, 6 chases, and 8 faders allow for vast programming and recall options
- Dimensions: 19" W x 5.25" D x 2.87" H (rack mountable 3U)

\$6649 (1-3)

#244-521 List \$89.00 **\$63.22** (4-UP)



Professional lighting in a compact size

Talent MP112 RGBW LED Mini Par Stage Light 12 x 1W

- 12 bright 1 watt LEDs (3R, 3G, 3B, 3W) produce a vast color mixing palette
- Dimensions: 4.75" L x 4.75" W x 3.5" D



\$1998 (1-3)

#244-523 List \$44.44 **\$16.72** (4-UP)

Talent PAR910 RGBW 4-in-1 LED Slim Par Stage Light 9 x 10W

- Nine bright 10 watt 4-in-1 RGBW LEDs provide expansive lighting coverage for stages and event spaces



\$6298 (1-3)

#244-522 List \$79.99 **\$62.00** (4-UP)

Vivid lighting at an unbeatable price

Talent SSL2 RGBW LED DMX Mini Moving Head Stage Light 7 x 10W

- Multi-color mixing with RGBW 4-in-1 LEDs provide for a virtually unlimited color palette
- Fully DMX controllable with additional program modes including auto, slave, and sound-activated provides flexible control capabilities
- Tilt, pan, dimming, color mixing, speed, and strobe controls allow for full internally programmed light shows



\$8999 (1-3)



#244-520 List \$129.00 **\$78.70** (4-UP)

Clamps for the touring professional



Talent LCWA Stage Lighting Wrap-Around O Clamp for 1-1/2" to 2" Pipe or Truss Clamp

- Fits horizontal, vertical, and diagonal trusses



\$748 (1-3)

#243-282 List \$12.99 **\$6.87** (4-19) **\$6.30** (20-UP)

Talent TÜV Rheinland Certified Heavy-Duty Lighting Clamps

- Durable, lightweight aluminum construction
- Fits 1-1/2" to 2" pipe or truss
- Large wing nut for fast and easy adjustment



Part #	Model	Description	Rated Load	List Price	Price (1-3)	Price (4-19)	Price (20-99)	Price (100-UP)
243-284	LCNH-C	Narrow Half Coupler	440 lbs.	\$18.99	\$11.48 EA	—	—	—
243-286	LCNC-C	Half Coupler	1,100 lbs.	28.99	14.98	\$13.19	\$12.50	\$11.83
243-288	LCSC-C	Swivel Coupler	1,100 lbs.	45.99	28.98	27.86	27.42	—



WARNING: Cancer and Reproductive Harm — www.P65Warnings.ca.gov

Made with genuine Neutrik etherCON connectors

Talent NECG-30 Cat6A SF/UTP Shielded Grounded Ethercon Cable with Rugged Neutrik Housing

- Durable CAT6A 8mm O.D. cable with a dual rubber jacket that stands up to stage use
- Neutrik metal shells for dependable tight fit
- Double shielded to prevent outside interference
- Grounded to pass through phantom power when using with XLR extenders



Part #	Length	List Price	Price (1-3)	Price (4-11)	Price (12-23)	Price (24-UP)
240-9403	30 ft.	\$109.99	\$59.98	\$53.98	\$47.98	\$41.99
240-9405	50 ft.	139.99	69.98	62.98	55.98	48.99
240-9407	100 ft.	179.99	99.98	89.98	79.98	69.99
240-9409	200 ft.	199.99	149.98	134.98	127.48	119.98
240-9411	300 ft.	299.99	199.98	179.98	169.98	159.98

Talent LS1 8 ft. Heavy-Duty Tripod Lighting Stand

RAVE REVIEWS!

“...Great value! A pair of these stands makes a lighting set-up easy!”
—George P.

- Air cushion suspension keeps lights from free falling during tear-down
- Push-button auto-locking pin system — no pins to lose!



Sturdy 110 lb. capacity!



\$6849 (1-3)

#233-080 List \$129.00 **\$65.22** (4-UP)

3 input channels for mics, instruments, and media



Talent AM150 Active PA Monitor Speaker 150W 3-Channel Mixer with EQ and Echo Effect

- Very versatile 150W powered monitor
- Lightweight but powerful Class-D amp technology

\$17798 (1-2)

#233-210..... List \$273.99 **\$170.51** (3-UP)

Talent AMT Heavy-Duty Tripod Boom Stand for AM150 PA Speaker

- Super stout microphone boom stand
- Locking pin for added stability
- Ideal for use with AM150 powered monitor

\$2449 (1-2)

#233-212..... List \$31.99 **\$21.96** (3-UP)



Talent Single Hand Clutch Microphone Stands

- One hand quick-grip clutch for FAST adjustments
- Heavy duty tripod base for reliable stability

Talent SQMS1 Single Hand Clutch Tripod Microphone Stand

- Height adjustable from 39" to 60"

\$1998 (1-3)

#233-014... List \$26.99 **\$18.66** (4-23) **\$17.72** (24-UP)

Talent SQMS2 Single Hand Clutch Tripod Microphone Stand with Boom

- Height adjustable from 39" - 67"
- 31" boom length

\$2798 (1-3)

#233-016... List \$36.99 **\$26.40** (4-23) **\$25.07** (24-UP)



Talent Microphone Stands



- Steel construction for everyday use
- Quick adjustment features

Part #	Model	Description	Price (1-5)	Price (6-23)	Price (24-UP)
233-003	MS-1	Heavy duty steel base mic stand	\$27.49	\$26.96	\$24.32
233-004	MS-2	Tripod mic stand	14.79	12.99	12.10
233-005	MS-5B	Tripod mic stand w/ tele boom	21.49	19.34	17.05
233-020	MS-3	Low profile tripod mic stand with tele boom	21.49	20.19	19.24
233-030	MS-4	Telescoping boom 20" to 35"	10.98	9.46	8.42

Plug and play microphone bundle for podcasts, streaming, and studio

All-in-One Talent USB Recording Package

- High quality USB mic, isolation booth, shock mount, and pop filter ensure a clean, professional recording
- Attaches easily to any 5/8"-27 TPI microphone stand



#233-090.....

ON SALE \$8498 EACH

List \$199.99 Reg. \$102.98

Talent USB Podcast & Streaming Condenser Microphone with Headphone Output and Volume Control

- Microphone mix control for latency free monitoring
- 24 bit / 96 kHz sampling rate provides great recording quality



CLEARANCE

#233-094

\$3998 EACH

Was \$52.98



Talent DM1 DynaMIC Microphone with Cable and Pouch

- Over 85% off the price of the leading competitor's mic
- Sound quality that rivals, and exceeds, that of "legendary microphones"

\$1598 (1-5)

#233-130... List \$32.99 **\$13.90** (6-23) **\$12.43** (24-UP)



Command your stage with wireless freedom

Talent Wireless UHF Handheld Microphone Systems

- Handheld wireless microphone system with 48 kHz audio sampling rate providing clear, pristine vocal clarity
- Digital ID code helps eliminate RF interference



RAVE REVIEWS!

"The mics have great tone and sensitivity." -John J.

#233-402



Part #	Model	Channels	List Price	Price (1-2)	Price (3-UP)
233-400	TWUH1	Single	\$108.99	\$78.90	\$67.92
233-402	TWUH2	Dual	163.99	109.80	98.36

Talent ProClaw Universal Mic or Music Stand Holder for Tablets

- Multiple rotational joints provide the ultimate flexibility to tilt and rotate your tablet

\$1348 (1-9)

#233-055..... List \$19.99 **\$12.13** (10-UP)



Intuitive software to fine tune your audio experience

Dayton Audio DSP-408 4x8 DSP Digital Signal Processor for Home and Car Audio

- Real-time signal processing for precise tuning
- Complete audio customization for application specific installations
- Easy-to-use Graphical User Interface (GUI)
- 80 bands of completely adjustable parametric EQ
- Optional Bluetooth dongle (for streaming and app control) and wired remote available



Control via Smart Device



ON SALE \$159.98 EACH

#230-500 List \$249.99 Reg. \$177.98

BOSS RIOT Series Car Audio Amplifiers

- Best value in car audio amplification
- Much more dynamic, clear, and powerful than head unit amplification



#265-3987



Part #	Model	RMS @ 4 Ohms <0.01% THD+N	Minimum Impedance	Max Power	List Price	Price Each
265-3980	R1002	38W x 2	2 ohms	200W	\$59.00	\$34.98
265-3987	R1004	38W x 4	2 ohms	400W	75.00	49.98
265-3988	R2504	90W x 4	2 ohms	1000W	159.00	105.49
265-3989	R3004	110W x 4	2 ohms	1200W	189.00	119.99



4 AWG Amplifier Install Wiring Kit with Interconnects



- Powers amps up to 2400 watts peak
- Triple shielded RCA interconnect cable
- Heat resistant jacket

\$2149 (1-9)

#263-698 List \$29.99 **\$20.53** (10-UP)

DS18

#WE LIKE IT LOUD



Small, compact, and powerful — DS18 CANDY is so sweet your ears will tingle



DS18 CANDY Power Amplifiers

- Class-D amplifiers for clear sound
- Small footprint makes it easy to install
- Variety of channel configurations for any audio system

Part #	Model	Output Channels	RMS Power Output per Channel (4 Ohms)	Price Each
294-8144	CANDY-X2B	2	80W	\$129.95
294-8146	CANDY-X4B	4	80W	199.95
294-8148	CANDY-X1B	1	240W	199.95
294-8150	CANDY-XXL1B	1	400W	269.95
294-8152	CANDY-X5B	5	4 x 80W + 1 x 200W	299.95
294-8154	CANDY-6	6	6 x 80W	349.95

Sturdy, sleek, and efficient, GEN-X is a reliable amplifier at a great price

DS18 GEN-X Power Amplifiers

- Class-AB amplifiers for loud and efficient sound
- Sleek case looks great when installed



#294-8166

Part #	Model	Output Channels	RMS Power Output per Channel (4 Ohms)	Price Each
294-8156	GEN-X800.2	2	80W	\$149.95
294-8158	GEN-X2000.2	2	160W	209.95
294-8160	GEN-X900.4	4	80W	187.95
294-8162	GEN-X2000.4	4	120W	284.95
294-8164	GEN-X1200.1	1	130W	179.95
294-8166	GEN-X3000.1D	1	430W	269.95

Powerful waterproof amplifiers for the open road, rough trails, or high seas

DS18 NXL HYDRO Digital Amplifiers

Perfect for ATVs, Jeeps, boats, and everything in between!



#294-8168

#294-8176

Part #	Model	Output Channels	RMS Power Output per Channel (4 Ohms)	Price Each
294-8168	NXL-200.2D	2	100W	\$299.95
294-8170	NXL-800.5D	5	4 x 80W + 1 x 200W	539.95
294-8172	NXL-N4	4	100W	269.95
294-8174	NXL-N2	2	100W	269.95
294-8176	NXL-N1	1	140W	269.95





DS18

#WELIKEITLOUD

These unique speakers hit all frequencies with great style



DS18 GEN-X Coaxial Speaker Series Pairs

- Mylar balanced dome tweeters
- Black paper cones with rubber edges
- Sleek mesh grills with red accents

Part #	Model	Diameter	Speaker Type	Impedance (ohms)	Frequency Response	Power Handling (Watts RMS)	Price Pair
294-8010	GEN-X4	4"	Coaxial pair	4 ohms	120 Hz - 20 kHz	120W	\$37.95
294-8012	GEN-X4.6	4" x 6"	Coaxial pair	4 ohms	105 Hz - 20 kHz	135W	41.95
294-8014	GEN-X5.25	5.25"	Coaxial pair	4 ohms	90 Hz - 20 kHz	135W	41.95
294-8016	GEN-X6.5	6.5"	Coaxial pair	4 ohms	75 Hz - 20 kHz	150W	47.95
294-8018	GEN-X5.7	5" x 7"	Coaxial pair	4 ohms	78 Hz - 20 kHz	150W	47.95
294-8020	GEN-X6.9	6" x 9"	Coaxial pair	4 ohms	65 Hz - 20 kHz	180W	63.95
294-8022	GEN-X6.5C	6.5"	Component set	4 ohms	76 Hz - 20 kHz	150W	94.95

Extremely loud competition grade speakers with excellent sound quality and power handling



DS18 EXL (Extremely Loud) Speakers

- Black glass fiber cones
- Advanced PEI dome tweeters
- 3 ohm strontium-magnets

Part #	Model	Diameter	Speaker Type	Impedance (ohms)	Frequency Response	Power Handling (Watts RMS)	Price Pair
294-8024	EXL-SQ4.0	4"	Coaxial pair	3 ohms	115 Hz - 22 kHz	260W	\$68.95
294-8026	EXL-SQ5.25	5.25"	Coaxial pair	3 ohms	100 Hz - 22 kHz	340W	78.95
294-8028	EXL-SQ6.5	6.5"	Coaxial pair	3 ohms	80 Hz - 22 kHz	400W	99.95
294-8030	EXL-SQ6.9	6" x 9"	Coaxial pair	3 ohms	55 Hz - 22 kHz	560W	129.95
294-8032	EXL-SQ6.5C	6.5"	Component set	4 ohms	45 Hz - 22 kHz	120W	159.95

Rugged yet sleek waterproof design provides amazing sonic fidelity



DS18 NXL Hydro Speakers

- Built-in RGB LED lighting
- Marine grade construction

Perfect for ATVs, Jeeps, boats, and everything in between!

Part #	Model	Diameter	Speaker Type	Impedance (ohms)	Frequency Response	Power Handling (Watts RMS)	Price
294-8094	NXL-6SL/WH	6.5"	Marine speaker	4 ohms	90 Hz - 20kHz	25W	\$57.95 Pair
294-8096	NXL-6SL/BK	6.5"	Marine speaker	4 ohms	90 Hz - 20kHz	25W	\$57.95 Pair
294-8106	NXL-12SUB/BK	12"	Marine subwoofer	4 ohms	30 Hz - 500 Hz	350W	\$339.95 Each

Pyle PLG3.2 3-1/2" Coaxial Speaker Pair



- Yellow color poly injected cone
- \$1848** (1-11 PR)
#267-716..... List \$39.99 **\$17.78** (12 PR-UP)

Pyle PL42BL Blue Label 4" Coaxial Speaker Pair



- Non-fatiguing butyl rubber surround
 - Blue poly injection cone
- \$1998** (1-3 PR)
#267-078..... List \$48.99 **\$19.28** (4 PR-UP)

BOSS Dual Cone Replacement Speakers



- Water-resistant cone
- Ideal for use in a vehicle

BOSS BRS40 4" Dual Cone Replacement Speaker



- Specifications:** • Power handling: 25 watts RMS/50 watts max • Impedance: 4 ohms • Frequency response: 100 Hz - 18 kHz • Mounting depth: 1.7".
- \$898** (1-11)
#265-390..... **\$8.58** (12-UP)

BOSS BRS52 5-1/4" Dual Cone Replacement Speaker



- Specifications:** • Power handling: 30 watts RMS/60 watts max • Impedance: 4 ohms • Frequency response: 100 Hz - 18 kHz • Mounting depth: 1.9".
- \$1098** EACH
#265-382.....

Axxess AX-MLOC-HD1 2-Ch 80W Line Output Converter



- 80W x 2 power handling
 - Converts speaker outputs to line-level output
 - Adjustable step-down ratio
- \$2800** EACH
#265-5815..... List \$42.00

© 2022 Parts Express



KEY CODE

22B

Dayton Audio DB8 8" Outdoor Burial Subwoofer 180W

- 8" woofer with a polypropylene cone and rubber surround handles up to 400 watts ideal for adding massive low end to your outdoor audio system
- Burial form factor keeps the sub discrete easy to hide underground
- Rugged ABS construction ensures reliable performance year after year



★★★★★ **\$199⁹⁸** EACH
List \$354.99

#310-028

Outdoor bass that DIGS DEEP!

Just the right amount of bass for your desk or gaming rig



Dayton Audio GS2.1 Gaming Subwoofer with 2.1 Amplifier and Power Supply



Page 7 **\$79⁹⁸** EACH
#300-4811

Customized low end for subwoofers or bass shakers

Dayton Audio DTA-100LF Desktop Subwoofer Amplifier with EQ



NEW Page 3 **\$134⁹⁸** EACH
#300-3805



Bluetooth 5.0/FM/Media Player 2 x 25W Max Amplifier Board

Easy to add amp with convenient interface

Page 13 **\$12⁹⁸** EACH
#320-642



GET CONNECTED! Text "PARTS" to 33233 to join our e-mail list!