

PENTAX™

Digital Camera

Optio M30

Operating Manual



To ensure the best performance from your camera, please read the Operating Manual before using the camera.

Thank you for purchasing this PENTAX Digital Camera. Please read this manual before using the camera in order to get the most out of all the features and functions. Keep this manual safe, as it can be a valuable tool in helping you to understand all the camera's capabilities.

Regarding copyrights

Images taken using the PENTAX Digital Camera that are for anything other than personal enjoyment cannot be used without permission according to the rights as specified in the Copyright Act. Please take care, as there are even cases where limitations are placed on taking pictures even for personal enjoyment during demonstrations, performances or of items on display. Images taken with the purpose of obtaining copyrights also cannot be used outside the scope of use of the copyright as laid out in the Copyright Act, and care should be taken here also.

Regarding trademarks

- PENTAX and Optio are trademarks of PENTAX Corporation.
-  SD logo and SDHC logo are trademarks.
- QuickTime™ and QuickTime logo are trademarks used under license. The QuickTime logo is registered in U.S. and other countries.
- All other brands or product names are trademarks or registered trademarks of their respective owners.

To users of this camera

- There is a possibility that recorded data may be erased or that the camera may not function correctly when used in surroundings such as installations generating strong electromagnetic radiation or magnetic fields.
- The liquid crystal panel used in the LCD display is manufactured using extremely high precision technology. Although the level of functioning pixels is 99.99% or better, you should be aware that 0.01% or fewer of the pixels may not illuminate or may illuminate when they should not. However, this has no effect on the recorded image.

This product supports PRINT Image Matching III. PRINT Image Matching enabled digital still cameras, printers and software help photographers to produce images more faithful to their intentions. Some functions are not available on printers that are not PRINT Image Matching III compliant.

Copyright 2001 Seiko Epson Corporation. All Right Reserved.

PRINT Image Matching is a trademark of Seiko Epson Corporation. The PRINT Image Matching logo is a trademark of Seiko Epson Corporation.

Regarding PictBridge

PictBridge allows the user to connect the printer and digital camera directly, using the unified standard for the direct printout of images. You can print images directly from the camera through a few simple operations.

- There is a possibility that the illustrations and the display screen of the LCD monitor in this manual are different from the actual product.

Regarding Product Registration

In order to better service you, we request that you complete the product registration, which can be found on the CD-ROM supplied with the camera or the PENTAX website. Thank you for your cooperation.

Refer to the PC Connection Manual (bottom right of the front side) for more information.

Using Your Camera Safely

We have paid close attention to the safety of this product. When using this product, we request your special attention regarding items marked with the following symbols.



Warning

This symbol indicates that violating this item could cause serious personal injury.



Caution

This symbol indicates that violating this item could cause minor or medium personal injury, or material loss.

About the Camera



Warning

- Do not attempt to take the camera apart or remodel the camera. High voltages are present within the camera, and there is therefore a danger of electric shocks if the camera is taken apart.
- If the inside of the camera should become exposed as a result of, for example, the camera being dropped, please do not under any circumstances touch such exposed portions, as there is a danger of receiving an electric shock.
- To avoid the risk of it being swallowed by mistake, keep the SD Memory Card out of the reach of small children. Seek medical attention immediately if a card is accidentally swallowed.
- Wrapping the strap of the camera around your neck is also dangerous. Please take care that small children do not hang the strap around their necks.
- Use an AC adapter that is of the power and voltage specified for exclusive use with this product. The use of an AC adapter other than that specified exclusively for use with this product may cause fire or electric shocks.
- If the camera emits smoke or a strange smell, or in the event of any other irregularity, stop using the camera immediately, remove the battery or unplug the AC adapter, and contact your nearest PENTAX Service Center. Continued use of the camera may result in fire or electric shock.

Caution

- Never try to disassemble or short the battery. Also, do not dispose of the battery in a fire, as it may explode.
- Do not place your finger on the flash when it is discharging as there is a risk of burns.
- Do not discharge the flash while it is touching your clothing as there is a risk of discoloring.
- Some portions of the camera heat up during use, so please take care, as there is a risk of low temperature burns if such portions are held for long periods of time.
- Should the LCD be damaged, be careful of glass fragments. Also, be careful not to allow the liquid crystal to get on your skin or in your eyes or in your mouth.

Precautions for Battery Usage

- Only use specified battery with this camera. Use of other batteries can cause a fire or explosion.
- Keep wires, hairpins, and other metal objects away from the + and – contacts of the battery.
- Do not disassemble the battery. Disassembling the battery can cause explosion or leakage.
- If any of the battery leakage should come in contact with your eyes, do not rub them. Flush your eyes with clean water and get medical attention immediately.
- If any of the battery leakage should come in contact with skin or clothes, wash the affected areas thoroughly with water.
- Remove the battery from the camera immediately if it becomes hot or begins to smoke. Be careful not to burn yourself during removal.

Precautions for Battery Charger Usage

- Only use the battery charger D-BC63 supplied with the camera. Do not use the product at a voltage other than the specified voltage. Use with a power source or voltage other than that designed can cause a fire or electrical shock. The specified voltage is 100 - 240V AC.
- Do not use the battery charger to charge batteries other than rechargeable lithium-ion battery D-LI63. This can cause explosion or a fire or breakdown of the battery charger.

- Do not disassemble or modify the product. This can cause a fire or electrical shock.
- If the generation of smoke or strange odor from the product or other abnormality occurs, immediately discontinue using and consult a PENTAX Service Center. Continued use could cause a fire or electric shock.

About the AC Adapter

Caution



- Do not place heavy objects on the AC plug cord, allow heavy objects to drop onto it or allow the AC plug cord to become damaged due to excessive bending. If the AC plug cord becomes damaged, consult a PENTAX Service Center.
- Do not short or touch the output terminals of the product while it is still plugged in.
- Do not plug in the AC plug cord with wet hands. This can cause an electrical shock.
- Do not subject the product to strong impacts or allow it to drop onto a hard surface. This can cause a malfunction.
- To reduce the risk of hazards, use only CSA/UL Certified power supply cord set, cord is Type SPT-2 or heavier, minimum NO.18 AWG copper, one end with a molded-on male attachment plug cap (with a specified NEMA configuration), and the other is provided with a molded-on female connector body (with a specified IEC nonindustrial type configuration) or the equivalent.

Care to be Taken During Handling



- Take the Worldwide Service Network listing that is included in the package with you when traveling. This will be useful if you experience problems abroad.
- When the camera has not been used for a long time, confirm that it is still working properly, particularly prior to taking important pictures (such as at a wedding or during traveling). Contents of the recording cannot be guaranteed if recording, playback or transferring your data to a computer, etc. is not possible due to a malfunction of your camera or recording media (SD Memory Card), etc.
- The lens on this camera is not interchangeable. The lens is not removable.
- Do not clean the product with organic solvents such as thinner, alcohol or benzene.

- Places of high temperature and humidity should be avoided. Particular care should be taken regarding vehicles, which can become very hot inside.
- Storing the camera where pesticides and chemicals are handled should be avoided. Remove from case and store in a well-ventilated place to prevent the camera from becoming moldy during storage.
- As this camera is not waterproof, do not use the camera where it may come in contact with rain, water or any other liquid.
- Ensure that the camera is not subjected to substantial vibrations, shock, or pressure. Use a cushion to protect the camera when it is subjected to the vibrations of a motorbike, car, ship, etc.
- The temperature range in which the camera can be used is 0°C to 40°C (32°F to 104°F).
- The liquid crystal display will become black at a high temperature but will return to normal when normal temperatures are returned to.
- The response speed of the liquid crystal display becomes slow at low temperatures. This is due to the properties of the liquid crystal and is not a fault.
- Periodic checks are recommended every 1 to 2 years in order to maintain high performance.
- If the camera is subjected to rapid temperature changes, condensation may form on the inside and outside of the camera. Therefore put the camera in a bag or plastic bag, and take the camera out when the difference in temperature has subsided.
- Be careful not to allow dirt, mud, sand, dust, water, toxic gases or salt to enter the camera as this may damage the camera. Wipe away any raindrops or water droplets and allow the camera to dry.
- Refer to “Precautions When Using an SD Memory Card” (p.27) regarding the SD Memory Card.
- Please note that formatting an SD memory card or built-in memory will delete all data; however it may still be possible to recover that data using off-the-shelf data recovery software. Please manage your camera’s memory at your own risk.
- Please do not press forcefully on the LCD monitor. This could cause breakage or malfunction.
- Be careful not to sit down with the camera in your back pocket as this may damage the exterior of the camera or the LCD monitor.
- When using a tripod with the camera, be careful not to overtighten the screw in the tripod socket on the camera.
- The AC plug cord supplied with the camera is for exclusive use with the battery charger D-BC63. Do not use it with any other equipment.

Contents



























Using Your Camera Safely	1
Care to be Taken During Handling	3
Contents	5
Composition of the Operating Manual	11
Camera Features	12
Checking the Contents of the Package	14
Names of Parts	15
Names of Operating Parts	16
Monitor Indications	16
Getting Started	19
<hr/>	
Attaching the Strap	19
Powering the Camera	20
Charging the Battery	20
Installing the Battery	21
Using the AC Adapter with a Household Power Supply	24
Installing the SD Memory Card	25
Recorded Pixels and Quality Level of Still Pictures	28
Recorded Pixels, Quality Level and Frame Rate of Movies	29
Turning the Camera On and Off	31
Turning the Camera On in Playback Mode	32
Initial Settings	33
Setting the Display Language	33
Setting the Date and Time	36
Quick Start	38
<hr/>	
Taking Still Pictures	38
Playing Back Still Pictures	40
Playing Back Images	40
Playing Back the Previous or Next Image	40
Rotating the Displayed Image	41
Common Operations	42
<hr/>	
Understanding the Button Functions	42
 Mode	42
 Mode	44

Setting the Camera Functions	46
Setting with the Menu	46
Menu List	49
Setting the Shooting Mode	51
Calling Up a Specific Menu	55
Setting the Playback Mode	57
Taking Pictures	60
<hr/>	
Taking Pictures	60
Letting the Camera Choose the Optimal Shooting Mode (Auto Picture Mode)	60
Letting the Camera Choose the Optimal Settings (Program Mode)	61
Reducing Camera Shake and Blurring when Taking Pictures (Digital SR Mode)	62
Taking Pictures in the Basic Mode (Green Mode)	63
Taking Pictures of Dark Scenes (Night Scene Mode)	65
Framing Your Pictures (Frame Composite Mode)	66
Taking Pictures of People (Portrait Mode)	68
Taking Pictures of Your Pet (Pet Mode)	70
Using the Self-timer	71
Taking a Series of Pictures	72
Using the Zoom	73
Setting the Exposure (EV Compensation)	75
Displaying Shooting Information	76
Setting the Shooting Functions	78
Selecting the Focus Mode	78
Selecting the Flash Mode	80
Selecting the Recorded Pixels	82
Selecting the Quality Level	84
Adjusting the White Balance	86
Changing the Focusing Area	88
Setting the Sensitivity	89
Setting the Instant Review Time (Instant Review)	91
Setting the Image Sharpness (Sharpness)	92
Setting the Color Saturation (Saturation)	93
Setting the Image Contrast (Contrast)	94
Saving the Settings (Memory)	95

Recording Movies	97
Recording a Movie	97
Selecting the Recorded Pixels for Movies	99
Selecting the Quality Level of Movies	101
Selecting the Frame Rate	102
Recording Movies in Black and White or Sepia Tones (Color Mode)	103
Setting the Movie SR (Movie Anti-Shake) Function	104
Playing Back and Deleting Images	105
<hr/>	
Playing Back Images	105
Switching Between  Mode and  Mode	105
Playing Back Still Pictures	106
Nine-Image Display, Folder Display and Calendar Display	107
Zoom Playback	109
Displaying Shooting Information in Playback Mode	111
Slideshow	112
Playing Back Movies	114
Playing Back a Movie	114
Connecting the Camera to AV Equipment	115
Deleting Images	116
Deleting a Single Image/Sound File	116
Deleting Selected Images and Sound Files (from Nine-Image Display)	118
Deleting All Images and Sound Files	120
Protecting Images and Sound Files from Deletion (Protect)	121
Editing and Printing Images	123
<hr/>	
Editing Images	123
Changing the Image Size and Quality (Resize)	123
Cropping Images	125
Copying Images and Sound Files	126
Using the Digital Filters	128
Using the Brightness Filter	129
Adding a Frame (Frame Composite)	130
Red-eye Compensation	132
Setting the Printing Service (DPOF)	133
Printing Single Images	133
Printing All Images	135

Printing Using PictBridge	136
Connecting the Camera to the Printer	136
Printing Single Images.....	137
Printing All Images.....	139
Printing Using the DPOF Settings	140
Disconnecting the Cable from the Printer.....	140
Recording and Playing Back Sound	141
Recording Sound (Voice Recording Mode).....	141
Playing Back Sound	143
Adding a Voice Memo to Images.....	144
Recording a Voice Memo	144
Playing Back a Voice Memo.....	145
Settings	146
Camera Settings.....	146
Formatting an SD Memory Card or the Built-in Memory	146
Changing the Sound Settings.....	147
Changing the Date and Time.....	149
Setting the World Time	151
Changing the Display Language	153
Changing the Image Folder Name	154
Changing the USB Connection Mode.....	155
Changing the Video Output Format.....	156
Adjusting the Brightness of the LCD Monitor.....	157
Using the Power Saving Function	158
Setting Auto Power Off	159
Setting the Guide Display	160
Resetting to Default Settings (Reset)	161
Changing the Start-up Screen	162
Appendix	163
List of World Time Cities	163
Default Settings.....	165
Functions Available for Each Shooting Mode.....	168
Optional Accessories	169
Messages.....	170
Troubleshooting.....	172
Main Specifications	174
WARRANTY POLICY.....	178
Index.....	183

The meanings of the symbols used in this operating manual are explained below.

	indicates the reference page number for an explanation of the related operation.
	indicates information that is useful to know.
	indicates precautions to be taken when operating the camera.
 mode	This is the mode for capturing still pictures and recording movies and sound files. In this manual, the mode for taking still pictures is referred to as the “Still Picture Capture Mode”, the mode for recording movies is referred to as the “  mode” and the mode for recording sound files is referred to as the “  mode”.
 mode	This is the mode for viewing still pictures and playing back movies and sound files.
 ,  ,  ,  ,  ,  ,  ,  ,  ,  ,  ,  ,  ,  ,  ,  , 	The icons above the title show the shooting modes that can activate the function. Ex.   

Setting the Image Sharpness (Sharpness)

Memo

Composition of the Operating Manual

This operating manual contains the following chapters.

1 Getting Started

This chapter explains what you need to do after purchasing the camera before you start taking pictures. Be sure to read it and follow the instructions.

2 Quick Start

This chapter explains the simplest way to take pictures and play back images. Use it if you want to start taking pictures or playing back images straightaway.

3 Common Operations

This chapter explains common operations such as the functions of the buttons and how to use the menus. For more details, refer to the respective chapters below.

4 Taking Pictures

This chapter explains the various ways of capturing images and how to set the relevant functions.

5 Playing Back and Deleting Images

This chapter explains how to view still pictures and movies on the camera or on a TV and how to delete images from the camera.

6 Editing and Printing Images

This chapter explains the various ways of printing still pictures and how to edit images with the camera. Refer to the PC Connection Manual for instructions on saving images to a computer and installing ACDSee for PENTAX, and refer to ACDSee for PENTAX Help for instructions on editing and printing images with a computer.

7 Recording and Playing Back Sound

This chapter explains how to record sound files or add sound (a voice memo) to an image, and how to play back sound files.

8 Settings

This chapter explains how to set the camera-related functions.

9 Appendix

This section deals with troubleshooting and lists the optional accessories.

1

2

3

4

5

6

7

8

9

Camera Features

In addition to basic picture-taking, the Optio M30 has a variety of shooting modes to suit different situations. This section describes how to make the most of the key features of your camera. Together with the explanations of camera operations, it will enable you to enjoy your camera to the full.

Easy-to-Navigate Capture and Playback Functions!

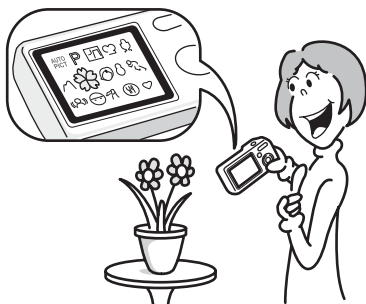

The Optio M30 features an easy-to-see 2.5-inch LCD monitor. In addition, Settings for capture, playback and editing functions are easy to navigate. Simply select icons that appear on the LCD monitor.

If you are unsure of which shooting mode to use, first select **AUTO PICT** (Auto Picture) (p.60). The camera selects the appropriate shooting mode* depending on the scene.

A guide appears when you select an icon, allowing you to check the functions available in each mode and how to use them. (p.59)

* When you select **AUTO PICT** (Auto Picture mode), the shooting mode is selected from ☺ (Standard mode), 🌃 (Night Scene mode), 🏞️ (Landscape mode), and 🗿 (Portrait mode).

- **Let the camera choose the optimal settings.**
- **Use the Green Mode to take pictures easily using standard settings. (p.63)**

Choose a Frame Before Taking the Picture!

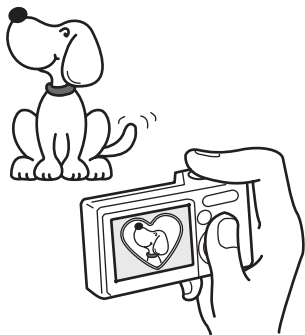

With the Optio M30, you can add a fun frame when taking a picture of a child or your pet, for example. (p.66) You can also add frames to pictures you have taken. Adjust the position of the subject in the picture or reduce or enlarge the picture size to match the frame shape and size. Now you no longer have to worry about the subject not being aligned in the frame.

- For decorating your pictures with a frame.

Easy Printing without Using a Computer!

By connecting the camera to a printer that supports PictBridge using the USB cable, you can print images directly from the camera.

Gone are the days of not being able to print out pictures at home because operating the computer was too difficult!

- Easily print out images without using a computer.

Display Images and Sound Files in Calendar Format!

With the Optio M30, you can display recorded images and sound files by date in calendar format. (p.108) This lets you quickly find the image or sound file you want to play back.

Checking the Contents of the Package



Camera
Optio M30

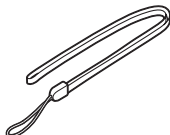

Strap
O-ST51 (*)

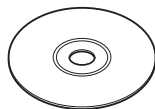

Software (CD-ROM)
S-SW63

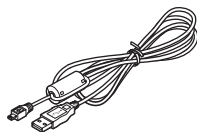

USB cable
I-USB7 (*)

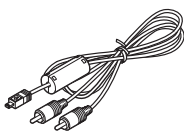

AV cable
I-AVC7 (*)



Rechargeable lithium-ion
battery D-LI63 (*)

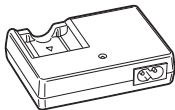

Battery charger
D-BC63 (*)



AC plug cord
D-CO24 (*)

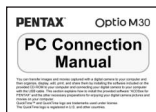

PC Connection Manual



Operating Manual
(this manual)



Quick Guide

Items marked with an asterisk (*) are also available as optional accessories. (The battery charger and AC plug cord are not sold separately and only available together in the battery charger kit K-BC63.)

For other optional accessories, refer to "Optional Accessories" (p.169).

Names of Parts

Front

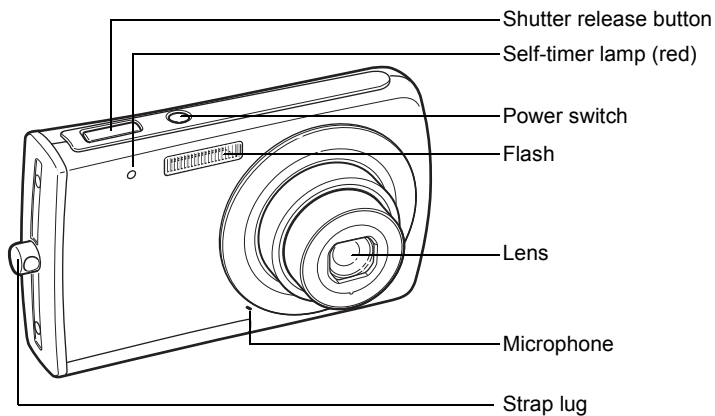

Back

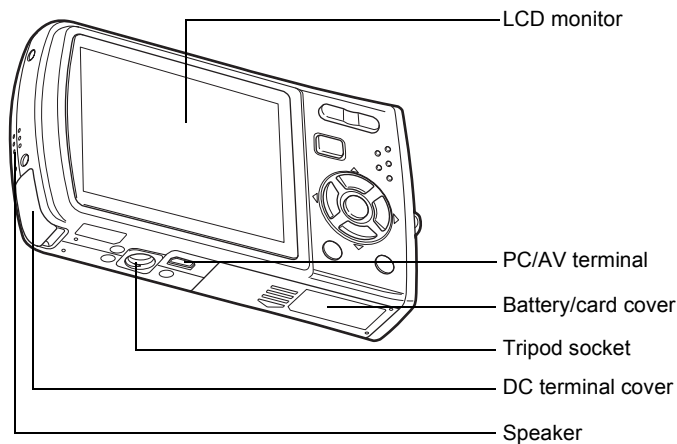

Names of Operating Parts

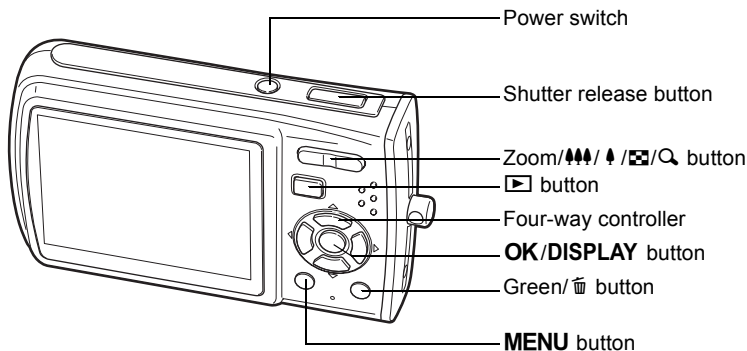

Refer to “Understanding the Button Functions” (p.42 - p.45) for an explanation of the function of each button.

Monitor Indications

Normal Display in Still Picture Capture Mode

The display shows information such as the shooting conditions.



- | | |
|---------------------------------------|------------------------------------|
| 1 Shooting mode (p.51) | 8 Remaining image storage capacity |
| 2 Flash mode (p.80) | 9 Battery indicator (p.23) |
| 3 Drive mode (p.71, p.72) | 10 Focus frame (p.38) |
| 4 Focus mode (p.78) | 11 EV compensation (p.75) |
| 5 Camera shake icon (p.76) | 12 Date and time (p.36) |
| 6 Digital zoom icon (p.73) | 13 World Time (p.151) |
| 7 Memory status (p.31) | No icon : Hometown |
| 📷 : Built-in memory
(without card) | ✈ : Destination |
| 📄 : SD Memory Card | |
| 🔒 : Card is write-protected | |

* 5 only appears when the shutter release button is pressed halfway.

Full Display in Still Picture Capture Mode (All of the indications are displayed here for explanatory purposes.)



- | | |
|--------------------------------|------------------------|
| 1 Bright portion (blinks red) | 6 Quality (p.84) |
| 2 Dark portion (blinks yellow) | 7 White balance (p.86) |
| 3 Shutter speed | 8 Sensitivity (p.89) |
| 4 Aperture | 9 Histogram (p.77) |
| 5 Recorded pixels (p.82) | |

* 3 and 4 only appear when the shutter release button is pressed halfway.

About the Bright and Dark Portions



When there is an area in the frame that is so bright it appears white, the indicated area blinks red as a warning. Similarly, when there is an area that is so dark it appears black, the indicated area blinks yellow as a warning.

Full Display in Still Picture Playback Mode

(All of the indications are displayed here for explanatory purposes.)

The display shows information such as the shooting conditions. A1 to A11 appear when [Normal Display] or [Histogram + Info] is selected. B1 to B9 only appear when [Histogram + Info] is selected. (p.111)



- | | |
|--|---|
| A1 Playback mode (p.57) | A10 Four-way controller guide |
| A2 Folder number (p.154) | A11 Key lock icon (p.64) |
| A3 File number | B1 Bright portion (blinks red) (p.17) |
| A4 Protect icon (p.121) | B2 Recorded pixels (p.82) |
| A5 Voice memo icon (p.145) | B3 Quality (p.84) |
| A6 Battery indicator (p.23) | B4 White balance (p.86) |
| A7 Volume icon (p.145) | B5 Sensitivity (p.89) |
| A8 Memory status (p.31) | B6 Dark portion (blinks yellow) (p.17) |
|  : Built-in memory (without card) | B7 Shutter speed |
|  : SD Memory Card | B8 Aperture |
|  : Card is write-protected | B9 Histogram (p.77) |
| A9 Captured date and time (p.36) | |





In Normal Display, A6 and A9 disappear if no operation is performed in two seconds.

Guide Indications

A guide to available button operations appears on the LCD monitor during operation.

The buttons are indicated as shown below.

Four-way controller (▲)	▲
Four-way controller (▼)	▼
Four-way controller (◀)	◀
Four-way controller (▶)	▶
MENU button	

Zoom button	
OK/DISPLAY button	
Shutter release button	
Green/  button	

Attaching the Strap

Attach the strap (O-ST51) supplied with the camera.

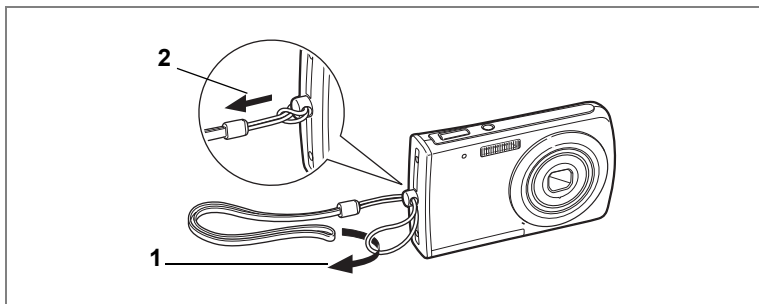

- 1** Pass the narrow end of the strap through the strap lug.
- 2** Pass the other end of the strap through the loop and pull tight.

Powering the Camera

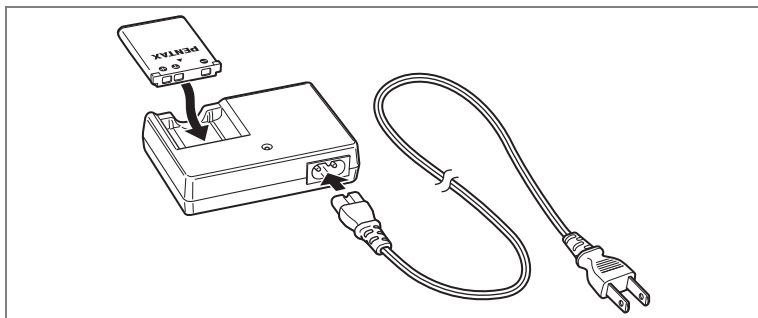

Charging the Battery

Use the battery charger to charge the battery before using it in the camera for the first time or after a long period of non-use, or when the [Battery depleted] message appears.

Note: AC plug cord “Listed, Type SPT-2 or NISPT-2, 18/2 flexible cord, rated 125 V, 7A, minimum 6ft (1.8m)”

- 1** Connect the AC plug cord to the battery charger D-BC63.
- 2** Plug the AC plug cord into the power outlet.
- 3** Place the battery in the charger so that the **PENTAX logo is facing up**.
The charging indicator lights red while the battery is charging and turns off when charging is finished.
- 4** Remove the battery from the battery charger when **charging is finished**.



- The time required to fully charge the battery is about 120 minutes (max.). The appropriate ambient temperature for charging the battery is 0°C to 40°C (32°F to 104°F). (The charging time may vary depending on the ambient temperature and charging conditions.)
- The battery has reached the end of its service life when it starts to run down soon after being charged. Replace with a new battery.



- Do not use the battery charger to charge batteries other than the rechargeable lithium-ion battery D-LI63, as the charger may overheat or be damaged.
- If the battery is inserted correctly but the charging indicator fails to light, the battery may be faulty. Replace with a new battery.

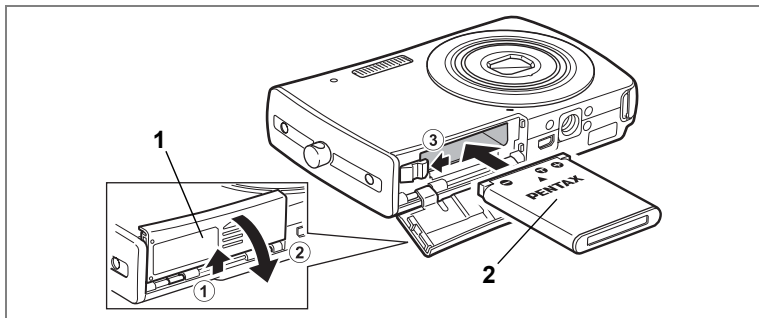

Installing the Battery

Use the battery that is provided with the camera. Charge the battery before using it in the camera for the first time.

1 Open the battery/card cover.

Slide the battery/card cover in the direction of ①. When let go, the cover opens automatically in the direction of ②.

2 Using the side of the battery to press the battery lock lever in the direction of ③, insert the battery with the PENTAX logo pointing toward the lens.

Push the battery in until it is locked in place.

3 Close the battery/card cover and slide it back into place.

Removing the Battery

1 Open the battery/card cover.

2 Release the battery by using your finger to press the battery lock lever in the direction of ③.

The battery will be ejected. Pull the battery out of the camera.



Use the AC adapter kit K-AC64 (optional) if you intend to use the camera for a long time. (p.24)



- This camera uses a rechargeable lithium-ion battery D-LI63. Use of any other type of battery may damage the camera and cause malfunction.
- Insert the battery correctly. If the battery is incorrectly oriented, malfunction may result.
- Do not remove the battery while the camera is turned on.
- If you do not intend to use the camera for a long time, remove the battery.
- If the battery has been removed from the camera for a long time, when it is reinserted and the camera is turned on, the message [Battery depleted] may appear. This can also happen when using the camera for the first time; however this is not a malfunction. Wait a minute and then turn the camera on again to reset the camera. The date and time may also be reset.

• Image Storage Capacity, Movie Recording Time, Sound Recording Time, and Playback Time
(at 23°C with the LCD monitor on and exclusive battery fully charged)

Image Storage Capacity*1	Movie Recording Time*2	Sound Recording Time*2	Playback Time*2
230 pictures	80 min.	250 min.	330 min.

*1: Recording capacity shows approximate number of shots recorded during CIPA-compliant testing (with LCD monitor on, flash used for 50% of the shots, and 23 degrees centigrade). Actual performance may vary according to operating conditions.





*2: According to the result of in-house testing.



- In general, battery performance may temporarily deteriorate as the temperature decreases. Be sure to take spare batteries when using the camera in a cold region and keep the batteries warm by placing them in your pocket or inside your coat. Battery performance that has deteriorated due to cold temperature will return to normal performance when the batteries reach room temperature.
- Be sure to take spare batteries with you when traveling abroad or to a cold region, or if you intend to take a lot of pictures.

- **Battery Level Indicator**

You can check the battery level by the  indicator on the LCD monitor.

Screen Display	Battery Status
 (green)	Adequate power remains.
 (green)	Battery is running low.
 (yellow)	Battery is running very low.
 (red)	Battery is exhausted.
[Battery depleted]	The camera will turn off after this message appears.

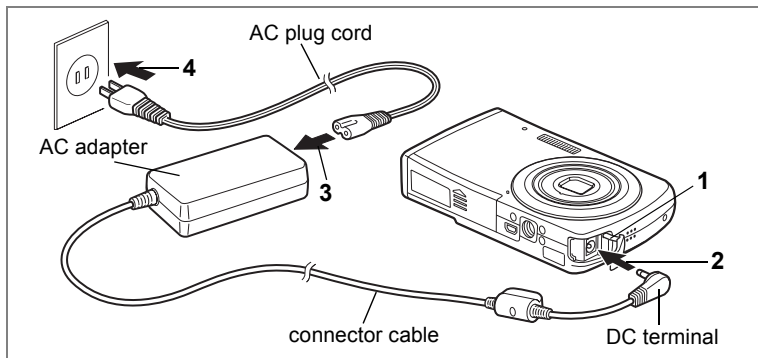

Using the AC Adapter with a Household Power Supply

Use of the AC adapter kit K-AC64 (optional) with a household power supply is recommended if you intend to use the camera for a long time or connect it to a computer.

(The AC adapter kit K-AC64 includes AC adapter D-AC64 and AC plug cord D-CO24.)

- 1** Make sure that the camera is turned off and open the DC terminal cover (DC IN).
- 2** Connect the DC terminal of the AC adapter to the DC input terminal of the camera.
- 3** Connect the AC plug cord to the AC adapter.
- 4** Plug the AC plug cord into the power outlet.



- Make sure that the camera is turned off before connecting or disconnecting the AC adapter.
- Make sure that the AC plug cord and the connector cable are inserted securely. The data may become lost if either cord becomes disconnected while data is being recorded.
- Use the AC adapter with due care to avoid fire or electric shock. Be sure to read "Using Your Camera Safely" (p.1) before using the AC adapter.
- Be sure to read the operation manual accompanying the AC adapter kit K-AC64 before using the adapter.

Installing the SD Memory Card

1

Getting Started

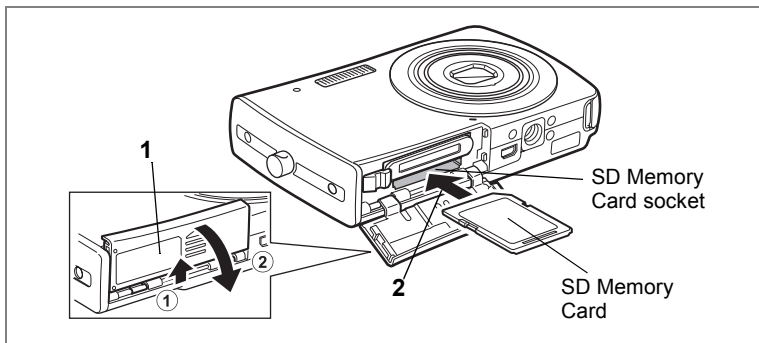

This camera uses an SD Memory Card. Captured images and sound files are saved on the SD Memory Card if a card is inserted in the camera. They are saved in the built-in memory if a card is not inserted. (p.31)



- **Be sure to use this camera to format an SD Memory Card that is unused or has been used on another camera. Refer to “Formatting an SD Memory Card or the Built-in Memory” (p.146) for instructions on formatting.**
- Make sure that the camera is turned off before inserting or removing the SD Memory Card.



The still picture storage capacity varies depending on the capacity of the SD Memory Card and the selected number of recorded pixels and quality level. (p.28)

Backing Up Data

The camera may not be able to access data in the built-in memory in the case of a malfunction. Use a computer or other device to back up important data in another location.

1 Open the battery/card cover.

Slide the battery/card cover in the direction of ①. When let go, the cover opens automatically in the direction of ②.



2 Insert the SD Memory Card into the SD Memory Card socket so that the label is facing toward the lens.

Push the card in until it clicks. Images and sound may not be recorded correctly if the card is not inserted all the way.

3 Close the battery/card cover and slide it back into place.**Removing the SD Memory Card****1 Open the battery/card cover.****2 Push the card into the SD Memory Card socket to eject it.**

Pull the card out.

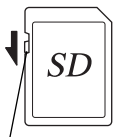
Precautions When Using an SD Memory Card

- The SD Memory Card is equipped with a write-protect switch. Setting the switch to LOCK protects the existing data by prohibiting recording of new data, deletion of existing data or formatting of the card.  Write-protect switch 
- Care should be taken when removing the SD Memory Card immediately after using the camera, as the card may be hot.
- Do not remove the SD Memory Card or turn the camera off while data is being saved to the card, images or sound files are being played back, or the camera is connected to a computer with the USB cable, as this may cause the data to be lost or the card to be damaged.
- Do not bend the SD Memory Card or subject it to violent impact. Keep it away from water and store away from high temperature.
- Do not remove the SD Memory Card during formatting as this may damage the card and render it unusable.
- The data on the SD Memory Card may be deleted in the following circumstances. PENTAX does not accept any liability for data that is deleted
 - (1) when the SD Memory Card is mishandled by the user.
 - (2) when the SD Memory Card is exposed to static electricity or electrical interference.
 - (3) when the card has not been used for a long time.
 - (4) when the card is ejected or the battery is removed while the data on the card is being recorded or accessed.
- The SD Memory Card has a limited service life. If it is not used for a long time, the data on the card may become unreadable. Be sure to regularly make a backup of important data on a computer.
- Avoid using or storing the card where it may be exposed to static electricity or electrical interference.
- Avoid using or storing the card in direct sunlight or where it may be exposed to rapid changes in temperature or to condensation.
- When using an SD Memory Card with a slow recording speed, recording may stop while you are taking movies even when there is adequate space in the memory, or shooting and playback may take a long time.
- For information on compatible SD Memory Cards, visit the PENTAX website or contact your nearest PENTAX Service Center.

Recorded Pixels and Quality Level of Still Pictures

Choose the number of pixels (size) and quality level (data compression rate) of still pictures according to how you intend to use the pictures you have taken.

Higher quality levels and numbers of pixels produce clearer images, but the resulting increase in data volume reduces the total number of pictures that can be taken (stored in the camera's built-in memory or on the SD Memory Card).

The quality of the captured photo or printed picture also depends on the quality level, exposure compensation, resolution of the printer and a variety of other factors, so you do not need to select more than the required number of pixels. As a rough guide, [2M] (1600×1200) is adequate for making postcard-size prints. Refer to the table below for the appropriate settings according to use.

● Appropriate Number of Recorded Pixels According to Use

Recorded Pixels	Use	
[7M] 3072×2304	↑ Clearer	For printing high quality photos or A4-size pictures, or editing images on a PC.
[5M] 2592×1944		
[4M] 2304×1728		For making postcard-size prints.
[3M] 2048×1536		
[2M] 1600×1200		
[1024] 1024× 768		For posting on a website or attaching to e-mail.
[640] 640× 480		

The default setting is [7M] (3072×2304).

● Appropriate Quality Level According to Use

★★★	Best	Lowest compression rate. Suitable for photo prints.
★★	Better	Standard compression rate. Suitable for viewing the image on a computer screen.
★	Good	Highest compression rate. Suitable for posting on a website or attaching to e-mail.

The default setting is ★★ (Better).

Choose the appropriate number of recorded pixels and quality level for still pictures on the [📷 Rec. Mode] menu.

Selecting the Recorded Pixels 📄p.82

Selecting the Quality Level 📄p.84

● Recorded Pixels, Quality Level and Image Storage Capacity (Approximate numbers of pictures)

	★★★ (Best)		★★ (Better)		★ (Good)	
	Built-in Memory	128MB	Built-in Memory	128MB	Built-in Memory	128MB
7M 3072×2304	6 pictures	35 pictures	12 pictures	69 pictures	18 pictures	103 pictures
5M 2592×1944	7 pictures	44 pictures	15 pictures	88 pictures	24 pictures	137 pictures
4M 2304×1728	11 pictures	62 pictures	22 pictures	124 pictures	31 pictures	177 pictures
3M 2048×1536	13 pictures	77 pictures	27 pictures	153 pictures	40 pictures	223 pictures
2M 1600×1200	22 pictures	124 pictures	36 pictures	206 pictures	54 pictures	301 pictures
1024 1024× 768	43 pictures	244 pictures	73 pictures	412 pictures	93 pictures	522 pictures
640 640× 480	87 pictures	489 pictures	127 pictures	711 pictures	175 pictures	978 pictures

- The above figures may vary depending on the subject, shooting conditions, shooting mode and SD Memory Card, etc.

Recorded Pixels, Quality Level and Frame Rate of Movies

Choose the recorded pixels, quality level and frame rate (number of frames per second) according to how you intend to use the movies you have taken.

The higher the number of recorded pixels and the quality level, the clearer the details, but the bigger the file size.

The more frames per second, the better the quality of the movie, but the bigger the file size.

Choose the appropriate number of recorded pixels, quality level and frame rate in [Movie] on the [📷 Rec. Mode] menu.

Selecting the Recorded Pixels for Movies p.99

Selecting the Quality Level of Movies p.101

Selecting the Frame Rate p.102

● Appropriate Number of Recorded Pixels According to Use

640 (640×480)	Suitable for viewing on a TV or computer screen.
320 (320×240)	Suitable for posting on a website or attaching to e-mail.

The default setting is **640** (640×480).

● Appropriate Quality Level According to Use

★★★	Best	↑	Images will be clearer but file size will be larger.
★★	Better		
★	Good		

The default setting is ★★★ (Best).

● Appropriate Frame Rate According to Use

30fps	Produces high quality movies, but reduces the total recording time.
15fps	Increases the total recording time because the file size is smaller.

The default setting is 30fps (frames per second).

● Recorded Pixels, Quality Level, Frame Rate and Recording Time (Approximate recording time)

		30fps		15fps		Sound	
		Built-in Memory	128MB	Built-in Memory	128MB	Built-in Memory	128MB
640 (640×480)	★★★	20 sec.	1 min. 56 sec.	41 sec.	3 min. 50 sec.	17 min. 22 sec.	1 hr. 36 min. 57 sec.
	★★	28 sec.	2 min. 36 sec.	53 sec.	5 min. 1 sec.		
	★	42 sec.	3 min. 57 sec.	1 min. 22 sec.	7 min. 40 sec.		
320 (320×240)	★★★	33 sec.	3 min. 6 sec.	1 min. 3 sec.	5 min. 55 sec.		
	★★	45 sec.	4 min. 12 sec.	1 min. 27 sec.	8 min. 9 sec.		
	★	1 min. 3 sec.	5 min. 55 sec.	2 min. 7 sec.	11 min. 51 sec.		

- The above figures are based on PENTAX standard shooting conditions and may vary depending on the subject, shooting conditions and type of SD Memory Card used.

Turning the Camera On and Off

1

Getting Started

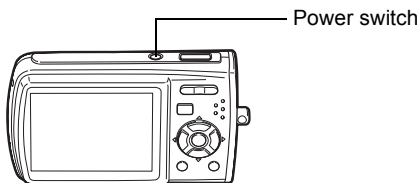

1 Press the power switch.

The camera turns on and the LCD monitor turns on. When you turn the camera on, the lens cover opens and the lens extends. If the Language Selection screen or Date Adjust screen appears when you turn the camera on, follow the procedure on p.33 to set the display language and/or current date and time.

2 Press the power switch again.

The LCD monitor turns off, the lens closes, and the camera turns off.

Taking Pictures p.60

Checking the Memory Card

The memory card is checked automatically when the camera turns on. appears on the LCD monitor when there is no SD Memory Card inserted in the camera. In this case, images and sound files will be saved in the built-in memory. appears instead of when the write-protect switch on the SD Memory Card is in the locked position. Images and sound cannot be recorded when the write-protect switch is locked.

Memory status



If the battery has been removed from the camera for a long time, when it is reinserted and the camera is turned on, the message [Battery depleted] may appear. This can also happen when using the camera for the first time; however this is not a malfunction. Wait a minute and then turn the camera on again to reset the camera. The date and time and other settings may also be reset. Follow the procedure on p.36 to set these settings again.

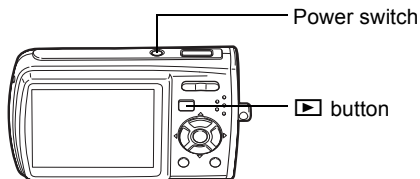

Turning the Camera On in Playback Mode

You can start Optio M30 in playback mode with the lens closed. Use this mode when you want to play back an image or sound file straightaway without taking any more pictures.

1 Press the power switch while holding down the ▶ button.

The LCD monitor turns on while the lens is closed and the camera turns on in Playback Mode.



To switch from Playback Mode to  mode, press the ▶ button or press the shutter release button halfway.

Playing Back Still Pictures  p.40

Initial Settings

Set the language, time, and date after purchasing the camera before you start taking pictures.

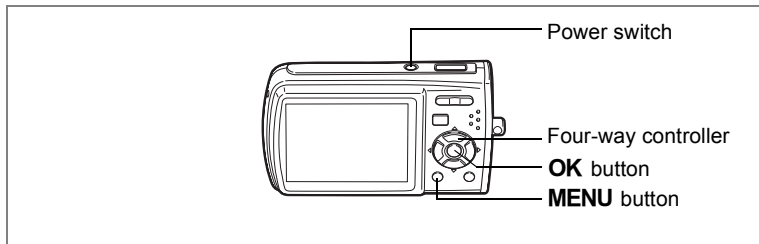

The Language/言語 screen appears when the camera is turned on for the first time. Perform the operations in “Setting the Display Language” below to set the language, and in “Setting the Date and Time” (p.36) to set the current date and time.

Go to “Setting the Date and Time” (p.36) when the Date Adjust screen appears.

Language, Date, and Time can be changed. Refer to the pages below for instructions.

- To change the language, follow the steps in “Changing the Display Language” (p.153).
- To change the date and time, follow the steps in “Changing the Date and Time” (p.149).

Setting the Display Language

- 1 Use the four-way controller (▲▼◀▶) to choose the display language.



2 Press the OK button.

The Initial Setting screen appears in the selected language. If the desired settings for [Hometown] and daylight saving time appear, press the **OK** button again to display the [Date Adjust] screen. Go to "Setting the Date and Time" (p.36 and p.37). Go to Step 3 in "Setting Hometown and DST" if the desired settings do not appear.

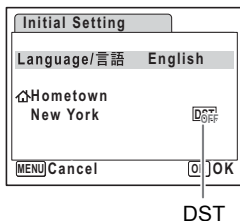

DST

If you accidentally select another language and go to the next procedure, perform the following operation to set the language back.

● When Another Language Has Been Inadvertently Selected

- 1 Press the four-way controller (▶).
- 2 Use the four-way controller (▲▼◀▶) to select the language and press the **OK** button.

● When the Screen After Step 2 Appears in Another Language

- 1 Press the **OK** button.
- 2 Press the **MENU** button.
- 3 Press the four-way controller (▶).
- 4 Use the four-way controller (▼▲) to select [Language/ 言語].
- 5 Press the four-way controller (▶).
The Language/言語 screen appears.
- 6 Use the four-way controller (▲▼◀▶) to select the language.
- 7 Press the **OK** button.
The [X Setting] menu appears in the selected language.

The language is now switched to your desired language. To reset Hometown and the Date and Time, refer to the pages below for instructions.

- To change Hometown, follow the steps in "Setting the World Time" (p.151).
- To change the Date and Time, follow the steps in "Changing the Date and Time" (p.149).

Setting Hometown and DST

- 3 Press the four-way controller (▼).**
The frame moves to [Hometown].
- 4 Press the four-way controller (▶).**
The Hometown screen appears.
- 5 Use the four-way controller (◀▶) to choose the city.**
- 6 Press the four-way controller (▼).**
The frame moves to [DST] (Daylight Saving Time).
- 7 Use the four-way controller (◀▶) to select (Off).**
- 8 Press the OK button.**
The Initial Setting screen appears.
- 9 Press the OK button.**
The [Date Adjust] screen appears. Next, set the date and time.

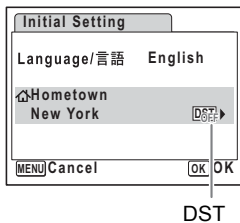

Setting the Date and Time

Set the current date and time and the display style.

- 1 Press the four-way controller (▶).**

The frame moves to [mm/dd/yy].

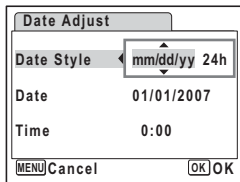

- 2 Use the four-way controller (▲▼) to choose the date and time display style.**

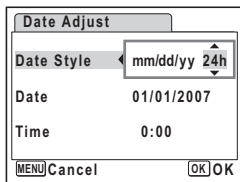

- 3 Press the four-way controller (▶).**

The frame moves to [24h].

- 4 Use the four-way controller (▲▼) to select [24h] (24-hour display) or [12h] (12-hour display).**

- 5 Press the four-way controller (▶).**

The frame returns to [Date Style].

- 6 Press the four-way controller (▼).**

The frame moves to [Date].

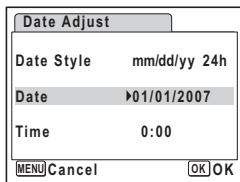

- 7 Press the four-way controller (▶).**

The frame moves to the month.

- 8 Use the four-way controller (▲▼) to change the month.**

Change the day and year in the same manner. Next, change the time.

If you selected [12h] in Step 4, the setting switches between am and pm corresponding to the time.

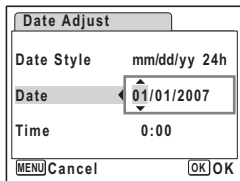

9 Press the **OK** button.

The camera returns to capture status.

Language, Date, Time, Hometown, and DST can be changed. Refer to the pages below for instructions.

- To change the language, follow the steps in “Changing the Display Language” (☞p.153).
- To change the date and time, follow the steps in “Changing the Date and Time” (☞p.149).
- To change the city or turn DST on and off, follow the steps in “Setting the World Time” (☞p.151).



- When the **MENU** button is pressed in the Language/言語 screen, the selected language is canceled and the Date Adjustment screen is displayed in the default language (English). To set to another language, follow the steps on p.34.
- When the **MENU** button is pressed in the Date Adjustment screen, the camera enters Shooting mode without setting the date. Restart the camera to set the date. The Date Adjust screen reappears. Alternatively, you can display the Date Adjustment screen from the [X] Setting] menu. (☞p.149)



If you press the **OK** button in Step 9, the camera clock is reset to 00 seconds. To set the exact time, press the **OK** button when the time signal (on the TV, radio, etc.) reaches 00 seconds.

The video output format (NTSC/PAL) is automatically set according to the City set for [Hometown] in initial settings. Refer to the pages below for the video output settings and instructions on how to change the video output setting after initial settings.

- To see the video output format set in initial settings, refer to “List of World Time Cities” (p.163).
- To change the video output format after initial settings, refer to “Changing the Video Output Format” (p.156).

Taking Still Pictures

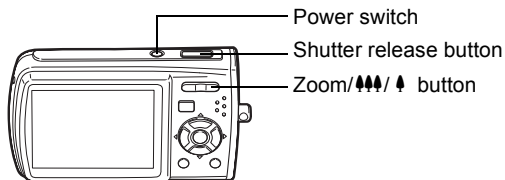

The standard procedure for taking still pictures is described below. The flash fires automatically depending on the light conditions.

1 Press the power switch.

The camera turns on and is ready to take still pictures. In this manual, this is called Still Picture Capture Mode.

2 Confirm the subject and shooting information on the LCD monitor.

The focus frame in the middle of the LCD monitor indicates the zone of automatic focusing.



Focus frame

You can change the captured area by pressing the Zoom/AAA/A button to the left or right.

▲ : enlarges the subject

AAA : widens the area that is captured by the camera

3 Press the shutter release button halfway.

The focus frame on the LCD monitor turns green if the subject is in focus.

4 Press the shutter release button fully.

The picture is taken.

The image appears on the LCD monitor for one second (Instant Review) and is saved to the SD Memory Card or built-in memory. (p.25)



- The shooting mode is set to **AUTO PICT** (Auto Picture mode) in the default settings. (p.60) Turn the power on to enable taking still pictures in **AUTO PICT** mode.
- Press the Green button to switch to the Green Mode and let the camera set all the shooting functions automatically. (p.63)

Using the Shutter Release Button

The shutter release button works in a two-step action as follows.

Press halfway

The focus and exposure are locked when the shutter release button is pressed halfway. The green focus frame lights on the LCD monitor when the shutter release button is pressed halfway and the subject is in focus. If the subject is out of focus, the frame will light red.

Press fully

Press the shutter release button all the way down to take the picture.

[Poor focusing conditions]

The camera may not be able to focus under the following conditions. In these cases, lock the focus on an object the same distance away as the subject (by pressing the shutter release button halfway), then aim the camera at your subject and press the shutter release button fully.

- Objects that lack contrast such as a blue sky or white wall
- Dark places or objects, or conditions that prevent light being reflected back
- Horizontal lines or intricate patterns
- Fast moving objects
- When there is an object in the foreground and an object in the background in the same picture
- Strongly reflected light or strong backlighting (bright background)

Instant Review

The image appears on the LCD monitor for one second (Instant Review) immediately after it is captured. You can change the Instant Review time. (p.91)



You can delete the image during Instant Review by pressing the button.

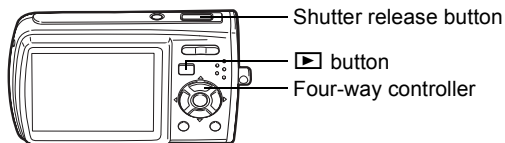

Playing Back Still Pictures



Playing Back Images

- 1 Press the  button after taking a picture.

The image appears on the LCD monitor. In this manual, this is called  mode (Playback mode). Displaying one image in full in  mode ( mode default setting) is called single-image display.

Press the  button again in  mode or press the shutter release button halfway to switch to  mode.



Playing Back the Previous or Next Image

- 1 Press the  button after taking a picture.







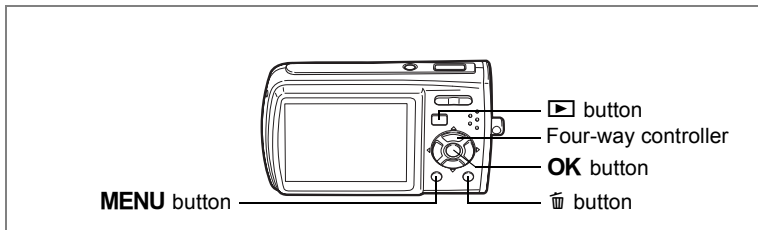



The image appears on the LCD monitor.

- 2 Press the four-way controller ( ).

The previous or next image appears.



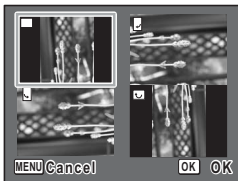

Rotating the Displayed Image

- 1 Press the  button after taking a picture.**
The image appears on the LCD monitor.
- 2 Press the four-way controller ().**
The Playback Mode Palette appears.
- 3 Use the four-way controller (, , , ) to select  (Image Rotation).**
The rotation selection screen (0°, Right 90°, Left 90°, or 180°) appears.
- 4 Use the four-way controller (, , , ) to choose the rotation direction and press the **OK** button.**
The rotated image appears.



- Movies cannot be rotated.
- Protected images can be rotated, but they cannot be saved in a rotated state.

Deleting the Displayed Image

Press the  button while the image is displayed to display the Delete screen. Use the four-way controller () to select [Delete] and press the **OK** button. (p.116)



Understanding the Button Functions

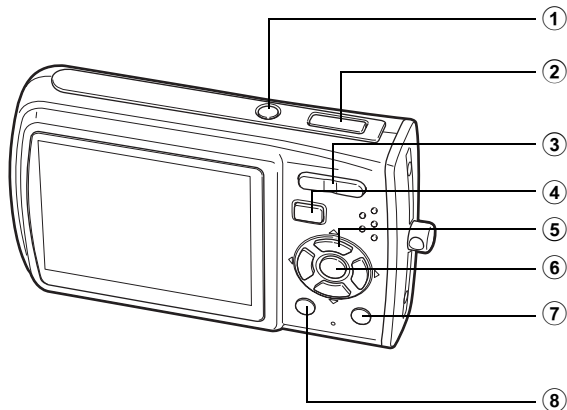

Mode

- ① **Power switch**
Turns the camera off. (p.31)
- ② **Shutter release button**
Focuses the camera on the subject when pressed halfway in Still Picture Capture Mode. (Except in **▲**, **PF** and **MF** modes) (p.39)
Takes the still picture when pressed down fully. (p.38)
Starts and stops movie recording in **📹** mode. (p.97)
Starts and stops sound file recording in **🎤** mode. (p.141)
- ③ **Zoom/▲▲▲/▲/📺/🔍 button**
Changes the captured area. (p.73)
- ④ **▶ button**
Switches to the **▶** mode. (p.105)

⑤ **Four-way controller**

(▲) : Changes the drive mode. (p.71, p.72)

(▼) : Displays the Capture Mode Palette. (p.51)

(◀) : Changes the flash mode. (p.80)

(▶) : Changes the focus mode. (p.78)

(▲▼) : Adjusts **MF** in **MF** mode. (p.79)

⑥ **OK/DISPLAY button**

Changes the information displayed on the LCD monitor. (p.76)

⑦ **Green button**

Switches to the Green Mode. (p.63)







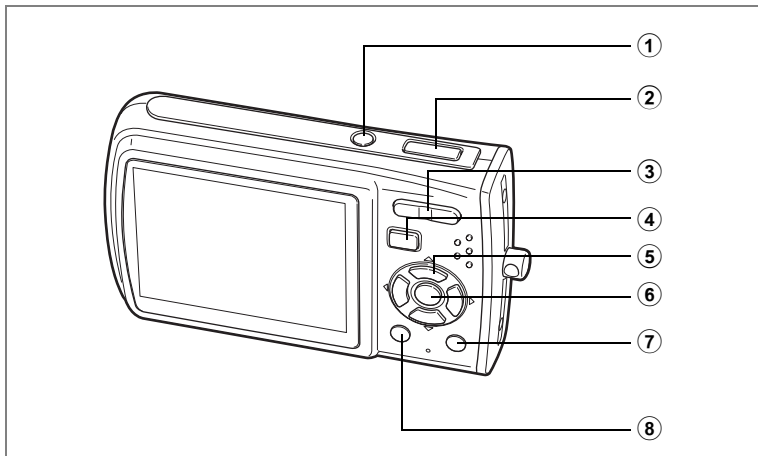





Calls up the assigned menu. (p.55)

⑧ **MENU button**

Displays the [ Rec. Mode] menu. (p.46)



▶ Mode

- ① **Power switch**
Turns the camera off. (p.31)
- ② **Shutter release button**
Switches to  mode when pressed halfway. (p.105)
- ③ **Zoom// button**
Press  during single-image display to change to nine-image display. Returns to the previous display when  is pressed. (p.107)
Enlarges the image when  is pressed during single-image display. Returns to the previous display when  is pressed. (p.109)
Press  during nine-image display to change to folder or calendar display. (p.108)
Press  during folder display to change to nine-image display of the selected folder. (p.108)
Press  during calendar display to change to nine-image display for the selected date. (p.108)
Can be used to adjust the volume during playback of movies or sound files. (p.114, p.143)
- ④ ** button**
Switches to  mode. (p.105)

⑤ Four-way controller

- (▲) : Plays back and pauses a movie or sound file. (p.114, p.143)
- (▼) : Displays the Playback Mode Palette. (p.58)
Stops a movie or sound file during playback. (p.114, p.143)
- (◀▶) : Displays the previous or next image and sound file during single-image display. (p.40)
Frame forwards, frame reverses and reverses a movie during playback. (p.114)
Fast forwards, reverses, and moves to the index in sound file playback. (p.143)
- (▲▼◀▶) : Moves the display area during zoom display. (p.109)
Selects an image in nine-image display, a folder in folder display, and a date in calendar display. (p.107, p.108)
Moves the image when using the Frame Composite function. (p.130)

⑥ OK/DISPLAY button

- Changes the information displayed on the LCD monitor. (p.111)
- Returns zoom display or nine-image display to single-image display. (p.107, p.109)
- Changes to nine-image display of the selected folder during folder display. (p.108)
- Changes to single-image display of the selected date during calendar display. (p.108)

⑦ Green/ button

- Switches from single-image display to the Delete screen. (p.116)
- Switches from nine-image display to the Select & Delete screen. (p.118)
- Switches from folder display to the calendar display screen. (p.108).
- Switches from calendar display to the folder display screen. (p.108)

⑧ MENU button

- Displays the [X Setting] menu during single-image display. (p.46)
- Returns to single-image display during Playback Mode Palette display. (p.57)
- Returns zoom display or nine-image display to single-image display. (p.107, p.109)
- Changes to nine-image display of the selected folder during folder display. (p.108)
- Changes to nine-image display of the selected date during calendar display. (p.108)

Setting the Camera Functions

To change the camera settings, press the **MENU** button to display the [📷 Rec. Mode] menu or [⏏ Setting] menu. Menus for playing back and editing images and sound files are displayed from the Playback Mode Palette.

Setting with the Menus

Pressing the **MENU** button in 📷 mode displays the [📷 Rec. Mode] menu. Pressing the **MENU** button in ▶ mode displays the [⏏ Setting] menu.

During recording

During playback



MENU

MENU

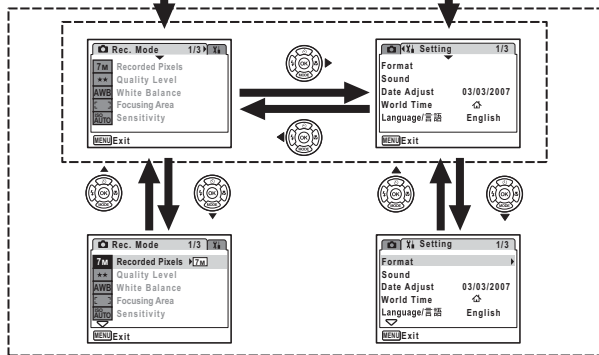

SHUTTER

MENU, OK or ▶

Press halfway



The setting is complete and the camera returns to 📷 mode

The setting is complete and the camera returns to ▶ mode



A guide to available button operations appears on the LCD monitor during menu operation.

Ex.) To set the [Quality Level] on the [Rec. Mode] menu

1 Press the MENU button in camera mode.

The [Rec. Mode] menu appears.

2 Press the four-way controller (▼).

The frame moves to [Recorded Pixels].

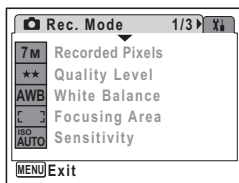

3 Press the four-way controller (▼).

The frame moves to [Quality Level].

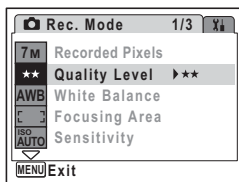

4 Press the four-way controller (▶).

A pull-down menu appears with the items that can be selected.

The pull-down menu displays only those items that can be selected with the current camera settings.

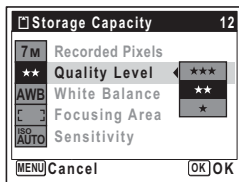

5 Use the four-way controller (▲▼) to change the setting.

The quality level changes each time the four-way controller (▲▼) is pressed.

Refer to the following page for instructions on saving settings and canceling changes.

Saving the Setting and Start Taking Pictures

6 Press the shutter release button halfway.

The setting is saved and the camera returns to capture status.
When the shutter release button is pressed fully, the picture is taken.

Saving the Setting and Begin Playback of Images

6 Press the button.

The setting is saved and the camera returns to playback status.

Saving the Setting and Continue with Menu Operations

6 Press the OK button or the four-way controller (◀).

The setting is saved and the screen returns to Step 3.

Canceling the Changes and Continue with Menu Operations

6 Press the MENU button.

The changes are canceled and the screen returns to Step 3.

The **MENU** button function differs depending on the screen. Refer to the guide indications.

 Exit : Exits the menu and returns to the original screen.

  : Returns to Step 3 with the current setting.

 Cancel : Cancels the current selection, exits the menu and returns to Step 3.

Menu List

This displays the items that can be set with the menus and provides descriptions of each item. See the list of default settings in the Appendix “Default Settings” (p.165) to decide whether you want the settings saved when the camera is turned off and whether you want the settings returned to the defaults when the camera is reset.

[📷 Rec. Mode] Menu



This menu shows the functions related to taking still pictures and recording movies.

Item	Description	Page	
Recorded Pixels	For choosing the number of recorded pixels of still pictures	p.82	
Quality Level	For choosing the quality level of still pictures	p.84	
White Balance	For adjusting the color balance according to the light conditions	p.86	
Focusing Area	For changing the area of the autofocus	p.88	
Sensitivity	For setting the sensitivity	p.89	
EV Compensation	For adjusting the overall brightness of the picture	p.75	
Movie	Recorded Pixels	For choosing the number of recorded pixels of movies	p.99
	Quality Level	For choosing the quality level of movies	p.101
	Frame Rate	For setting the frame rate (number of frames per second)	p.102
	Color Mode	For choosing a color mode for movies	p.103
	Movie SR	For choosing whether to use the movie anti-shake function	p.104
Digital Zoom	For choosing whether to use the digital zoom function	p.74	
Instant Review	For setting the Instant Review time	p.91	
Memory	For choosing whether to save the set values of the shooting function or return to the defaults when the camera is turned off	p.95	
Sharpness	For choosing sharp or soft outlines	p.92	
Saturation	For setting the color saturation	p.93	
Contrast	For setting the image contrast level	p.94	



- Use the Green Mode to enjoy easy picture-taking using standard settings, regardless of the settings in the [📷 Rec. Mode] menu. (p.63)
- You can save time by assigning frequently used menus to the Green button. (p.55)

[X] Setting] Menu

Item	Description	Page
Format	For formatting the SD Memory Card or built-in memory	p.146
Sound	For adjusting the playback volume and setting the start-up sound, shutter sound, key operation sound and self-timer sound	p.147
Date Adjust	For adjusting the date, time, and date and time styles	p.149
World Time	For setting the world time	p.151
Language/言語	For setting the language in which menus and messages appear	p.153
Folder Name	For choosing how names are assigned to folders for storing images and sound files	p.154
USB Connection	For setting the USB cable connection (to PC or printer)	p.155
Video Out	For setting the output format to the AV equipment	p.156
Brightness Level	For setting the brightness of the LCD monitor	p.157
Power Saving	For setting the time until power saving mode is activated	p.158
Auto Power Off	For setting the time until the camera turns off automatically	p.159
Quick Zoom	For displaying an image at maximum magnification by pressing  on the Zoom/  /  button during still picture playback	p.110
Green Button	For assigning a function to the Green button in Capture mode	p.55
Guide Display	For setting to display guides when an icon is selected in Capture Mode Palette and Playback Mode Palette	p.160
Reset	For returning settings other than the date and time, language, and video out to their defaults	p.161

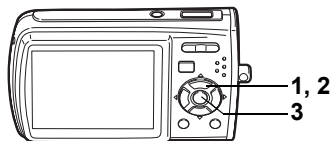

Setting the Shooting Mode

The Optio M30 has a variety of shooting modes that let you take pictures or record movies and sound in different situations simply by choosing the right mode for the particular situation from the Capture Mode Palette.

1 Press the four-way controller (▼) in mode.

The Capture Mode Palette appears.

2 Use the four-way controller (▲▼◀▶) to choose a shooting mode.

A guide of the selected shooting mode appears after approximately two seconds when a shooting mode is selected. (p.59)
You can also set to hide the guides. Refer to “Setting the Guide Display” (p.160) for instructions.



3 Press the OK button.

The shooting mode is selected and the camera returns to capture status.





- In shooting modes other than **P**, **M**, **A**, **S**, **MF** and **LV**, the flash, focus mode, saturation, contrast, sharpness, white balance, etc. are automatically set to the optimal settings for each mode.
- Some functions may not be available or may not function fully depending on the shooting mode. For details, refer to “Functions Available for Each Shooting Mode” (p.168).
- The Capture Mode Palette does not appear even if you press the four-way controller (▼) when Focus Mode is set to **MF** and focus position is being adjusted (p.79).

3

There are 15 available shooting modes.

① **AUTO PICT** **Auto Picture**

Selects the best capture mode. (p.60)

② **P** **Program**

The basic picture-taking mode. You can let the camera set the functions or choose various functions yourself. (p.61)

③ **Night Scene**

Ideal for taking night views. It is best to use a tripod in this mode. Use the flash if including people in your picture. (p.65)



④ **Movie**

Use this mode for taking movies. Sound is recorded at the same time. (p.97)

⑤ **Voice Recording**

Use this mode to record sound files. Be careful not to cover the microphone with your hand. (p.141)

⑥ **Landscape**

Use this mode for taking landscape views. The depth of field encompasses a wide area.



7  **Flower**

Use this mode for taking bright, colorful pictures of flowers with soft outlines.

**8**  **Portrait**

Use this mode for taking pictures of people. Gives your subject a bright, healthy look.

**9**  **Surf & Snow**

For capturing images with dazzling backgrounds, such as beaches or snowy mountains.

**10**  **Sport**

Ideal for taking fast-moving action shots. The camera keeps the moving subject in focus until the shutter release button is pressed.

**11**  **Digital SR (Blur reduction)**

Uses higher sensitivity to reduce blur when taking pictures. (p.62)

12  **Kids**

Ideal for taking pictures of children who are moving around. Gives your subject a bright, healthy look.



13 🐾 **Pet**

Ideal for taking pictures of pets. The camera keeps the moving pet in focus until the shutter release button is pressed. You can select settings according to the color of your pet's coat. (p.70)

**14** 🍴 **Food**

Use this mode for taking pictures of food. The increased saturation gives pictures a bright, vivid finish.

**15** ❤️ **Frame Composite**

Use this mode to take pictures with a frame. Recorded pixels is fixed at **3M** and Quality level is fixed at ★★. (p.66)



Calling Up a Specific Menu

Assign menu items to the Green Button and recall these quickly by simply pressing the Green Button. This is useful for going straight to the setting screens of frequently used functions such as EV Compensation, Sensitivity and White Balance.



- The following functions can be assigned to the Green button: Green Mode, Recorded Pixels, Quality Level, White Balance, Focusing Area, Sensitivity, EV Compensation, Sharpness, Saturation and Contrast.
- The default setting is Green Mode.
- The Green Button setting can be returned to the default setting by selecting [Reset] on the [X Setting] menu.
- The functions assigned to the Green button can also be used in the usual manner on the original menus ([Rec.Mode] and [X Setting]).
- You cannot save different settings for the same function on the Green button and on the original menu.

Assigning a Function to the Green Button

- 1 Select [Green Button] on the [X Setting] menu.**
- 2 Press the four-way controller (▶).**
The Green Button screen appears.
- 3 Use the four-way controller (▲ ▼) to choose the function you want to set and press the OK button.**

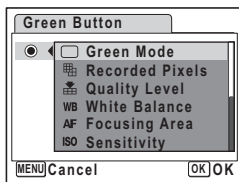

- 4 Press the MENU button.**

The camera returns to capture status with the current setting.

Using the Green Button

1 Press the Green button in mode.

The function assigned to [Green Button] on the [M Setting] menu is called up.

The function assigned to Green button



3

Common Operations

2 Use the four-way controller (◀▶) to change the settings and press the OK button.

The camera returns to capture status.



- If the Green Mode has been assigned to the Green button, the camera enters the Green Mode (p.63) 1.5 seconds after the Green button is pressed.
- If a function other than the Green Mode has been assigned to the Green button, the camera returns to the original screen if no operation is performed for five seconds after the Green button is pressed.







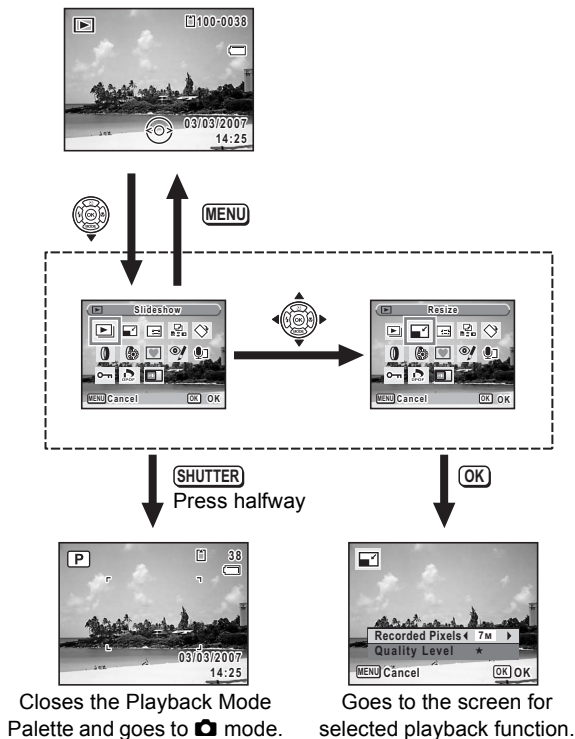





Setting the Playback Mode

Press the four-way controller (▼) in Playback mode to display the Playback Mode Palette.

You can display the playback function you want to use simply by using the four-way controller (▲▼◀▶) to choose an icon and pressing the **OK** button.



Playback Mode Palette

Item		Description	Page
	Slideshow	For playing back recorded images one after another	p.112
	Resize	For changing the recorded pixels and quality of images	p.123
	Cropping	For deleting the unneeded part of a picture	p.125
	Image/Sound Copy	For copying images and sound files from the built-in memory to the SD Memory Card and vice versa	p.126
	Image Rotation	For rotating still pictures	p.41
	Digital Filter	For changing the color of still pictures	p.128
	Brightness Filter	For changing the brightness of still pictures	p.129
	Frame Composite	For adding a decorative frame to a still picture	p.130
	Red-eye Compensation	For correcting still pictures where the flash has caused the subject to appear with red eyes	p.132
	Voice Memo	For adding a voice memo to still pictures	p.144
	Protect	For protecting images and sound files from accidental deletion	p.121
	DPOF	For setting the DPOF print order data for still pictures	p.133
	Start-up Screen	For setting the start-up screen	p.162

Viewing a Guide of the Shooting and Playback Modes

When Guide Display (p.160) is set to (On), a guide of the mode selected in the Capture Mode Palette or Playback Mode Palette appears.

1 Press the four-way controller (▼) in mode.

The Capture Mode Palette appears.

Press the four-way controller (▼) in  mode to display the Playback Mode Palette.

2 Use the four-way controller (▲▼◀▶) to choose a shooting mode.

Choose a Playback Mode if the camera is in  mode.

A guide of the selected mode appears after approximately two seconds when a mode is selected.

3 Press the OK button.

The camera returns to capture status with the selected shooting mode.

The setting screen for the selected Playback Mode is displayed if the camera is in  mode.

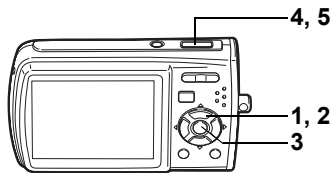

Taking Pictures

AUTO
PICT

Letting the Camera Choose the Optimal Shooting Mode (Auto Picture Mode)

In **AUTO PICT** (Auto Picture mode), when you press the shutter release button, the camera selects the most appropriate mode from four capture modes: ☺ (Normal mode), 🌃 (Night Scene mode), 🏞️ (Landscape mode), and 🗿 (Portrait mode).

1 Press the four-way controller (▼) in 📷 mode.

The Mode Palette appears.

2 Use the four-way controller (▲▼◀▶) to select **AUTO PICT** (Auto Picture).

3 Press the OK button.

The shooting mode is selected and the camera returns to capture status.

4 Press the shutter release button halfway.

The focus frame on the LCD monitor will light green when the camera is in focus, and the selected mode icon will appear on the top left of the LCD monitor.



5 Press the shutter release button fully.



- In **AUTO PICT** mode, the exposure is fixed to ± 0.0 . (p.75)
- In **AUTO PICT** mode, [Focusing Area] is set to Multiple. (p.88)
- The continuous shooting function is not available in **AUTO PICT** mode.
- The shooting mode is set to **AUTO PICT** mode in the default settings.

Taking Still Pictures p.38

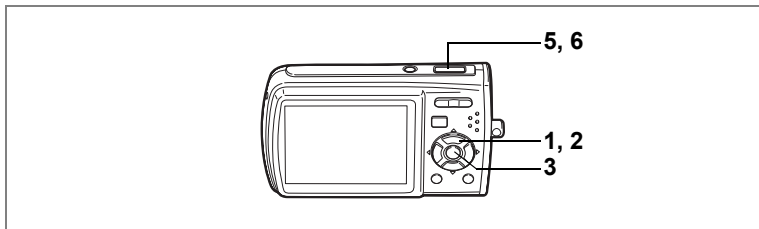

P

Letting the Camera Choose the Optimal Settings (Program Mode)

In **P** (Program mode), the camera automatically sets the shutter speed and aperture for taking still pictures. However, you can select other functions such as the flash mode and recorded pixels.

1 Press the four-way controller (▼) in **☞** mode.

The Capture Mode Palette appears.

2 Use the four-way controller (▲▼◀▶) to select **P** (Program).

3 Press the OK button.

The shooting mode is selected and the camera returns to capture status.

4 Set the functions you want to use.

Refer to “Setting the Shooting Functions” (p.78 - p.94) for details of how to set the functions.

5 Press the shutter release button halfway.

The focus frame on the LCD monitor turns green if the subject is in focus.

6 Press the shutter release button fully.

The picture is taken.



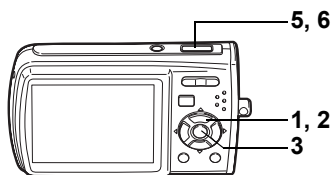

Reducing Camera Shake and Blurring when Taking Pictures (Digital SR Mode)

In  (Digital SR mode), the camera automatically raises the sensitivity to reduce camera shake and blurring when taking pictures. The camera also sets the shutter speed (set to remain faster than 1/15 sec) and aperture automatically. However, you can select other functions such as the flash mode and recorded pixels.

1 Press the four-way controller (▼) in mode.

The Capture Mode Palette appears.

2 Use the four-way controller (▲▼◀▶) to select (Digital SR).

3 Press the OK button.

The shooting mode is selected and the camera returns to capture status.

4 Set the functions you want to use.

Refer to “Setting the Shooting Functions” (p.78 - p.94) for details of how to set the functions.

5 Press the shutter release button halfway.

The focus frame on the LCD monitor turns green if the subject is in focus.

6 Press the shutter release button fully.

The picture is taken.



When shooting mode is set to , the sensitivity is automatically adjusted to between ISO 64 and 3200. (p.90)

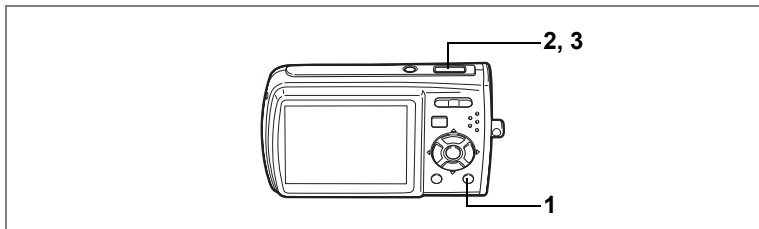

Taking Pictures in the Basic Mode (Green Mode)

In the Green Mode, you can enjoy easy picture-taking using standard settings*, regardless of the settings in the [📷 Rec. Mode] menu.

1 Press the Green button in 📷 mode.

The camera switches to the Green Mode. Press the Green button again to return to the status before the Green Mode was selected.



2 Press the shutter release button halfway.

The focus frame on the LCD monitor turns green if the subject is in focus.

3 Press the shutter release button fully.

The picture is taken.



- If any other functions have been assigned to the Green button, the camera does not switch to Green Mode. The assigned function is displayed. (p.55)
- In Green Mode, you cannot change the information displayed on the LCD monitor by pressing the **OK/DISPLAY** button.
- You cannot use the [📷 Rec. Mode] menu or Capture Mode Palette in Green Mode. If you try to display the [📷 Rec. Mode] menu or Capture Mode Palette, 🔒 (key lock icon) and a message appear.
- If you switched to [▶] mode from Green Mode, you cannot display the [⏏ Setting] menu by pressing the **MENU** button. If you try to display the [⏏ Setting] menu, 🔒 (key lock icon) and a message appear.
- When the camera is turned off in the Green Mode, it turns on in the Green Mode next time the power switch is pressed.



- * The Green Mode settings are as shown below.

Flash Mode	🔆 (Auto)* ¹
Drive Mode	□ (Standard)* ²
Focus Mode	AF (Standard)* ³
Information Display	Standard
Recorded Pixels	[7M]
Quality Level	★★ (Better)
White Balance	AWB (Auto)
Focusing Area	[] (Multiple)
Sensitivity	Auto
EV Compensation	±0.0
Digital Zoom	☑ (On)
Instant Review	1 sec
Sharpness	—■■— (Standard)
Saturation	—■■— (Standard)
Contrast	—■■— (Standard)

*1 Can be set to 🚫 (Flash Off)

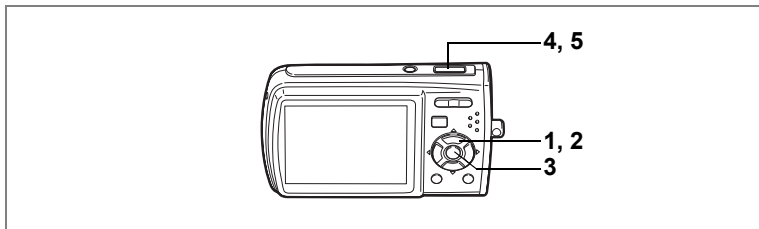

*2 Can be set to ⌚ (10 sec. Self-timer) or ⌚ (2 sec. Self-timer). (The setting in a shooting mode other than Green Mode is available.)

*3 Can be set to 🌿 (Macro), 🌿 (super macro) and **PF** (Pan Focus)



Taking Pictures of Dark Scenes (Night Scene Mode)

In  (Night Scene mode), you can choose settings appropriate for taking pictures of dark scenes, such as nightscapes.

- 1 Press the four-way controller (▼) in  mode.**
The Capture Mode Palette appears.
- 2 Use the four-way controller (▲▼◀▶) to select  (Night Scene).**
- 3 Press the OK button.**
The shooting mode is selected and the camera returns to capture status.
- 4 Press the shutter release button halfway.**
The focus frame on the LCD monitor turns green if the subject is in focus.
- 5 Press the shutter release button fully.**
The picture is taken.



- The shutter speed is slower when taking pictures of dark scenes.
- The continuous shooting function is not available in  mode.
- To prevent camera shake, use a tripod and the self-timer function.
(p.71)

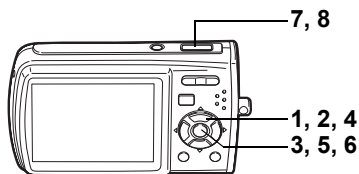

Framing Your Pictures (Frame Composite Mode)

In  (Frame Composite mode), you can take pictures using the frames stored in the camera.

- 1 Press the four-way controller (▼) in  mode.**

The Capture Mode Palette appears.

- 2 Use the four-way controller (▲▼◀▶) to select  (Frame Composite).**

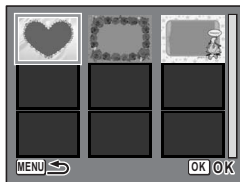



- 3 Press the OK button.**

A 9-frame display of the frame selection screen appears.

- 4 Use the four-way controller (▲▼◀▶) to choose the frame you want to use.**

- 5 Press the OK button.**

The selected frame appears in single-image display. You can choose another frame using either of the following operations.

- Use the four-way controller (◀▶) to choose a different frame.
- Press the **MENU** button or  on the Zoom//Quick button to return to the 9-frame display of the frame selection screen, and then perform Step 4 to choose a different frame.



- 6 Press the OK button.**

The frame appears on the screen.

7 Press the shutter release button halfway.

The focus frame on the LCD monitor turns green if the subject is in focus.

8 Press the shutter release button fully.

The picture is taken.



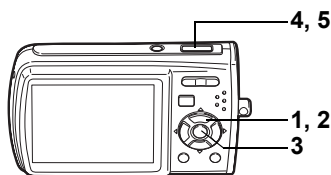

- The number of recorded pixels is fixed at **3M** and the quality level at **★★**.
- The continuous shooting function is not available in **♥** mode.



Taking Pictures of People (Portrait Mode)

In  (Portrait mode), Face Recognition AF and Face Recognition AE are activated. Simply point the camera toward your subject's face and the camera automatically recognizes the location of the subject's face, adjusts the focus (using Face Recognition AF) and the exposure (using Face Recognition AE) and allows you to take a picture.

- 1 Press the four-way controller (▼) in  mode.**
The Capture Mode Palette appears.
- 2 Use the four-way controller (▲▼◀▶) to select  (Portrait).**
- 3 Press the OK button.**

The shooting mode is selected and the camera returns to capture status. When the location of the subject's face is recognized, a yellow focus frame appears on the LCD monitor at the location of the face. As the subject moves, the size and location of the focus frame change to match the location of the subject's face.

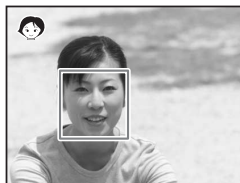

- 4 Press the shutter release button halfway.**
The focus frame on the LCD monitor turns green if the subject is in focus.
- 5 Press the shutter release button fully.**
The picture is taken.





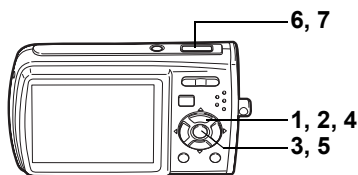





- If the camera cannot recognize the location of the subject's face, the camera focuses using the normal Focusing Area (Multiple).
- The digital zoom function cannot be used in mode.
- Continuous Shooting cannot be used in mode.
- In mode, only and the focus frame appear on the LCD monitor. No other shooting information is displayed. In addition, you cannot change the information displayed on the LCD monitor by pressing the **OK/DISPLAY** button.
- Face Recognition AF and Face Recognition AE may not work if the subject is wearing sunglasses or has part of the face covered or if the subject is not looking toward the camera.



Taking Pictures of Your Pet (Pet Mode)

In  (Pet mode), your moving pet is kept in focus while you take the picture, allowing you to capture the color of your pet's coat. Choose the appropriate icon depending on what color your pet is (closer to black or white or in between).

- 1 Press the four-way controller (▼) in  mode.**
The Capture Mode Palette appears.
- 2 Use the four-way controller (▲▼◀▶) to select  (Pet).**
- 3 Press the OK button.**
The Pet mode selection screen appears.
- 4 Use the four-way controller (▲▼) to select , , , ,  or .**
There are two types of icons: a cat and dog icon. (Choosing either the cat or dog icon does not affect the resulting picture. Choose whichever you prefer.) Choose an icon (white, gray or black) whose tone best matches your pet's coat or fur.
- 5 Press the OK button.**
The Pet mode is selected and the camera returns to capture status.
- 6 Press the shutter release button halfway.**
The focus frame on the LCD monitor turns green if the subject is in focus. The focus frame follows the pet while the shutter release button is pressed halfway.
- 7 Press the shutter release button fully.**
The picture is taken.



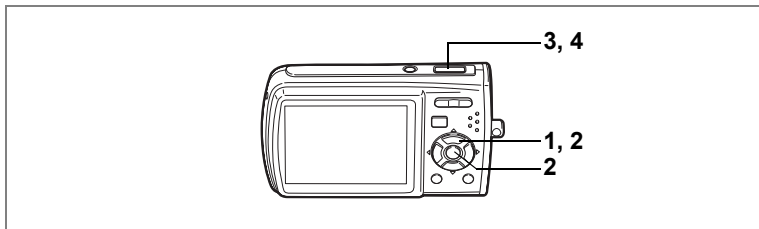

Using the Self-timer

In Self-timer mode, the picture is taken ten seconds or two seconds after the shutter release button is pressed.

Stabilize the camera with a tripod when taking a picture with the self-timer.

	<p>Use this mode when you want to be included in a group picture. The picture is taken approximately ten seconds after the shutter release button is pressed.</p>
	<p>Use this mode to avoid camera shake. The picture is taken approximately two seconds after the shutter release button is pressed.</p>

1 Press the four-way controller (▲) in mode.

2 Use the four-way controller (◀▶▼) to select or and press the OK button.

The camera is ready to take the picture using the self-timer.

3 Press the shutter release button halfway.

The focus frame on the LCD monitor turns green if the subject is in focus.

4 Press the shutter release button fully.

The picture is taken ten seconds or two seconds later.



Focusing may be compromised if you move the camera while the self-timer lamp is blinking when taking still pictures.



- In mode, recording will start after ten seconds (or two seconds).
- Press the shutter release button halfway while the self-timer is engaged to stop the countdown and press fully to restart the countdown.
- cannot be selected while mode is in default setting. Select in another shooting mode and then switch the shooting mode to mode.

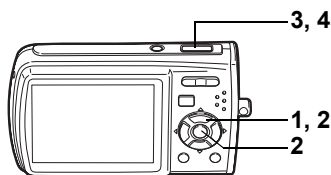

Taking a Series of Pictures

In this mode, pictures are taken continuously for as long as the shutter release button is pressed.



Continuous Shooting

Each time a picture is taken, the image is saved in the memory before the next image is taken. The higher the image quality, the longer the interval between shots.

1 Press the four-way controller (▲) in  mode.

2 Use the four-way controller (◀▶) to select  (Continuous Shooting) and press the OK button.

The camera is ready to take a series of pictures.







3 Press the shutter release button halfway.

The focus frame on the LCD monitor turns green if the subject is in focus.

4 Press the shutter release button fully.

Pictures are taken continuously for as long as you keep the shutter release button pressed.



- The flash will not discharge in Continuous Shooting mode.
- The continuous shooting function is not available in , , , , ,  or  mode.



- You can continue shooting until the memory capacity of the SD Memory Card or built-in memory is full.
- The interval of continuous shooting will vary according to the Recorded Pixels and Quality Level settings.
- The focus, exposure and white balance are locked with the first image.

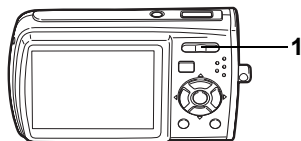

Using the Zoom

You can use the zoom to change the captured area.

1 Press the Zoom/🌲/🌲/🌲/🌲 button in mode.

🌲 Tele : enlarges the subject

🌲🌲 Wide : widens the area that is captured by the camera

The zoom bar indicates the current level of magnification.

When the digital zoom function is set to (Off), you can take pictures at up to three times magnification using the optical zoom. When the digital zoom function is set to (On), you can combine it with the optical zoom to enlarge the subject to a maximum magnification equivalent to 12 times.



Zoom bar



Optical zoom range Digital zoom range



- You are recommended to use a tripod to prevent camera shake when taking pictures at a high magnification rate.
- Pictures taken in the digital zoom range appear grainier than pictures taken in the optical zoom range.
- The digital zoom function cannot be used in  mode.

Setting the Digital Zoom

The digital zoom is set to (On) in the default settings. To take pictures using only the optical zoom, set the digital zoom to (Off).

1 Press the MENU button in  mode.

The [ Rec. Mode] menu appears.

2 Use the four-way controller (▲▼) to select [Digital Zoom].

3 Use the four-way controller (◀▶) to select (On) or (Off).

The selected setting is saved.

4 Press the MENU button.

The setting is complete and the camera returns to capture status.

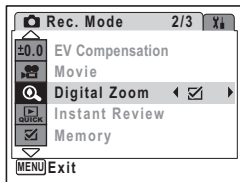

Saving the Digital Zoom Function Setting  p.95



Setting the Exposure (EV Compensation)

You can adjust the overall brightness of the picture. Use this function to take pictures that are intentionally overexposed or underexposed.

1 Press the MENU button in mode.

The [Rec. Mode] menu appears.

2 Use the four-way controller (▲▼) to select [EV Compensation].

3 Use the four-way controller (◀▶) to select the EV value.

The selected EV value is saved.

To brighten, select a positive (+) value. To darken, select a negative (-) value.

You can choose the EV setting in the range of -2.0 EV to +2.0 EV in 1/3 EV steps.

4 Press the MENU button.

The setting is complete and the camera returns to capture status.

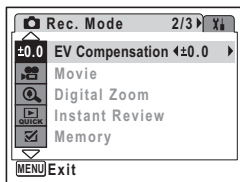

- If you use the EV compensation function frequently, you can save time by assigning it to the Green button. (p.55)
- When the histogram is displayed, bright portions and dark portions are indicated on the LCD monitor, enabling you to check the exposure. (p.77)
- In and modes, the EV compensation is fixed to ±0.0.

Saving the EV Compensation Value p.95

Displaying Shooting Information

The LCD monitor display changes in the following sequence each time you press the **OK/DISPLAY** button: Normal Display, Histogram + Info, No Info.

For details of each display mode, refer to “Monitor Indications” (p.16).



- appears if the shutter release button is pressed halfway when camera shake is likely to occur. To prevent camera shake, use a tripod and the self-timer function. (p.71)
- Only and the focus frame are displayed on the LCD monitor in mode. Other shooting information is not displayed. You cannot change the information displayed on the LCD monitor by pressing the **OK/DISPLAY** button.

4

Normal Display



Histogram + Info



No Info



Using the Histogram

A histogram shows the brightness distribution of an image. The horizontal axis represents brightness (dark at the left and bright at the right) and the vertical axis represents the number of pixels.

The shape of the histogram before and after shooting tells you whether the brightness and contrast are correct or not, and lets you decide if you need to use EV compensation and take the picture again.

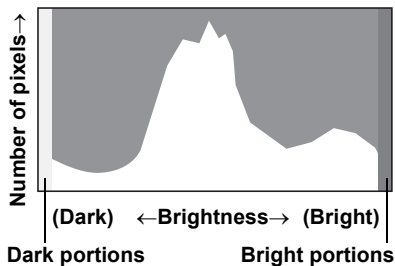

Setting the Exposure (EV Compensation)  p.75

Understanding Brightness

If the brightness is correct, the graph peaks in the middle. If the image is too dark, the peak is on the left side, and if it is too bright, the peak is on the right side.

Dark image

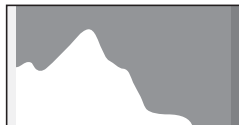

Correct image

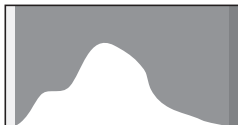

Bright image

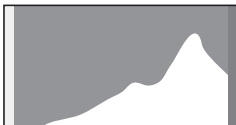

When the image is too dark, the part to the left is cut off (dark portions) and when the image is too bright, the part to the right is cut off (bright portions).

Bright portions blink red on the LCD monitor and dark portions blink yellow.

Displaying Shooting Information  p.76

Displaying Shooting Information in Playback Mode  p.111

Understanding Contrast



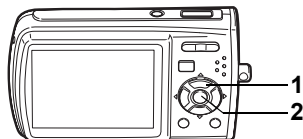

The graph peaks gradually for images in which contrast is balanced. The graph peaks on both sides but sinks in the middle for images with a large difference in contrast and low amounts of mid-level brightness.

Setting the Shooting Functions



4 Selecting the Focus Mode

Focus Mode

AF	Standard	This mode is used when the distance to the subject is 40 cm (15.7 in.) or more (60 cm or 23.6 in. for Tele). The camera is focused on the subject in the autofocus area when the shutter release button is pressed halfway.
	Macro	This mode is used when the distance to the subject is approx. 10 cm to 1 m (3.9 in. to 39.4 in.). The camera is focused on the subject in the autofocus area when the shutter release button is pressed halfway.
	Super Macro	This mode is used when the distance to the subject is approx. 5 cm to 40 cm (1.9 in. to 15.7 in.). The camera is focused on the subject in the autofocus area when the shutter release button is pressed halfway. Only digital zoom is available for zoom.
	Infinity	This mode is used for taking distant objects. The flash is set to  (Flash Off).
PF	Pan Focus	This mode is used when you ask someone to take pictures for you, or when taking pictures of the scenery through the window of a car or train. The entire picture, from the front to the back, is focused sharply.
MF	Manual Focus	This mode lets you adjust the focus manually.

1 Press the four-way controller (▶) in mode.

The focus mode changes each time the button is pressed. You can also change the setting using the four-way controller (▲▼).

2 Press the OK button.

The Focus Mode setting is saved and the camera returns to capture status.

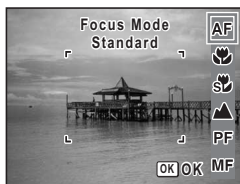



- In mode, you can only select **AF**, , and **PF**.
- If you select **AF**///**MF** in mode, you can only focus before shooting.

Manual Focus Below
 Saving the Focus Mode p.95

Manual Focus

The procedure for setting the focus manually (**MF**) is described below.

1 Press the four-way controller (▶) in mode.

2 Use the four-way controller (▶) to select MF and press the OK button.

The central portion of the image is magnified to fill the screen of the LCD monitor when focusing.

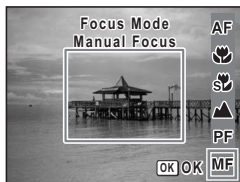

3 Press the four-way controller (▲▼).

The **MF** indicator appears on the LCD monitor to indicate the approximate distance to the subject. Use the four-way controller (▲▼) to adjust the focus using the indicator as a guide.

- ▲ : for distant focus
- ▼ : for closer focus

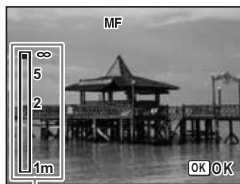

MF indicator

4 Press the OK button.

The focus is fixed and the camera returns to capture status. The focus position is fixed five seconds after you remove your finger from the four-way controller.

After the focus is fixed, you can press the four-way controller (▶) again to display the **MF** indicator and readjust the focus using the four-way controller (▲▼).



Shooting mode and drive mode cannot be changed while adjusting **MF**.



To switch from **MF** to another focus mode, press the four-way controller (▶) while the **MF** indicator is displayed.

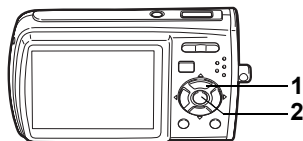

Selecting the Flash Mode

Flash Modes

4		Auto	The flash discharges automatically depending on the light conditions.
		Flash Off	The flash will not discharge, regardless of the brightness. Use this mode to take pictures where flash photography is prohibited.
		Flash On	The flash discharges regardless of the brightness.
		Auto + Red-eye	This mode reduces the phenomenon of red eyes caused by the light from the flash being reflected in the subject's eyes. The flash discharges automatically.
		Flash On + Red-eye	This mode reduces the phenomenon of red eyes caused by the light from the flash being reflected in the subject's eyes. The flash will discharge regardless of the light conditions.
		Soft Flash	This mode reduces the intensity of the flash so that the flash is not too bright even when fired at close range. The flash will discharge regardless of the light conditions.



- The flash will not discharge (Flash Off) in mode or when the drive mode is set to , or the focus mode is set to .
- A pre-flash discharges when using the red-eye reduction function.
- In mode, you can only select or .

1 Press the four-way controller (◀) in  mode.



The flash mode changes each time the button is pressed. You can also change the setting using the four-way controller (▲▼).

2 Press the OK button.

The camera returns to capture status with the selected flash mode.



[About the red-eye phenomenon]_____

Taking pictures using the flash may cause the subject's eyes to appear red in the resulting picture. This phenomenon occurs when the light from the flash is reflected in the subject's eyes. It can be reduced by illuminating the area around the subject or moving closer to the subject and zooming out to a wider angle. Setting the flash mode to  (Auto + Red-eye) or  (Flash On + Red-eye) is also an effective way of reducing red eyes.

Saving the Flash Mode  p.95



Selecting the Recorded Pixels

You can choose from seven recorded pixels settings for still pictures. The larger your recorded pixels, the clearer the details will appear when you print your picture. As the quality of the printed picture also depends on the image quality, exposure control, resolution of the printer and other factors, you do not need to select more than the required number of recorded pixels. **[2M]** (1600×1200) is adequate for making postcard-size prints. The more pixels there are, the larger the picture and the bigger the file size. The data volume also varies depending on the quality level setting (p.84).

Recorded Pixels

Recorded Pixels	Use
[7M] 3072×2304	↑ Clearer For printing high quality photos or A4-size pictures, or editing images on a PC.
[5M] 2592×1944	
[4M] 2304×1728	For making postcard-size prints.
[3M] 2048×1536	
[2M] 1600×1200	For posting on a website or attaching to e-mail.
[1024] 1024× 768	
[640] 640× 480	

1 Press the **MENU** button in **📷** mode.

The [**📷** Rec. Mode] menu appears.

2 Use the four-way controller (**▲ ▼**) to select [**Recorded Pixels**].

3 Press the four-way controller (▶).

A pull-down menu appears.

4 Use the four-way controller (▲▼) to change the number of recorded pixels.

Storage capacity for the selected recorded pixels is displayed when the Recorded Pixels setting is changed.

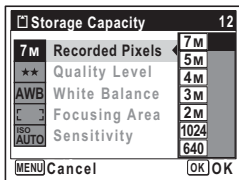



5 Press the OK button.

The Recorded Pixels setting is saved.

6 Press the MENU button.

The camera returns to capture status with the current setting.



- When shooting mode is set to , Recorded pixels is fixed at **3M**.
- When shooting mode is set to , the number of recorded pixels set in [Movie] on the recording mode menu is set. (p.99)
- If you use the [Recorded Pixels] function frequently, you can save time by assigning it to the Green button. (p.55)

Recorded Pixels and Quality Level of Still Pictures  p.28

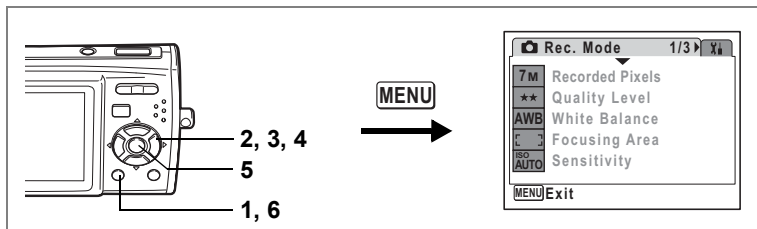







Selecting the Quality Level

You can select the quality (compression rate) of still pictures. The more stars, the lower the compression rate and the clearer the picture, but the file size becomes larger. The recorded pixels setting also affects the file size (p.82).



Quality Level

★★★	Best	Lowest compression rate. Suitable for photo prints.
★★	Better	Standard compression rate. Suitable for viewing the image on a computer screen.
★	Good	Highest compression rate. Suitable for posting on a website or attaching to e-mail.

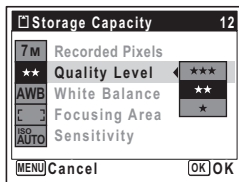
- 1 Press the MENU button in  mode.**
The [ Rec. Mode] menu appears.
- 2 Use the four-way controller ( ) to select [Quality Level].**
- 3 Press the four-way controller ().**
A pull-down menu appears.
- 4 Use the four-way controller ( ) to change the quality level.**
Storage capacity for the selected quality level is displayed when the Quality Level setting is changed.
- 5 Press the OK button.**
The Quality Level setting is saved.
- 6 Press the MENU button.**
The camera returns to capture status with the current setting.





- When shooting mode is set to , Quality level is fixed at ★★.
- When shooting mode is set to , the quality level set in [Movie] on the recording mode menu is set. (p.101)
- If you use the [Quality Level] function frequently, you can save time by assigning it to the Green button. (p.55)

Recorded Pixels and Quality Level of Still Pictures  p.28



Adjusting the White Balance

You can take pictures in natural colors by adjusting the white balance according to the light conditions at the time of shooting.

White Balance

AWB	Auto	The camera adjusts the white balance automatically.
	Daylight	Use this mode when taking pictures outside in sunlight.
	Shade	Use this mode when taking pictures outside in the shade.
	Tungsten Light	Use this mode when taking pictures under electric or other tungsten light.
	Fluores. Light	Use this mode when taking pictures under fluorescent light.
	Manual	Use this mode when adjusting the white balance manually.

- 1 Press the MENU button in mode.**
The [Rec. Mode] menu appears.
- 2 Use the four-way controller () to select [White Balance].**
- 3 Press the four-way controller ().**
The White Balance screen appears.
- 4 Use the four-way controller () to change the setting.**
- 5 Press the OK button.**
The White Balance setting is saved.
- 6 Press the MENU button.**
The camera returns to capture status with the current setting.
Refer to “Manual Setting” (p.87) for instructions on adjusting the white balance manually.





If you use the [White Balance] function frequently, you can save time by assigning it to the Green button. (p.55)

Saving the White Balance p.95

Manual Setting

Have a blank sheet of white paper or similar material for White balance adjustment ready beforehand.

- 1 In the White balance screen, use the four-way controller (▲▼) to select (Manual).**
- 2 Point the camera at the blank sheet of white paper or similar material for White balance adjustment so that it fits the frame at the center of the LCD monitor.**
- 3 Press the shutter release button fully.**

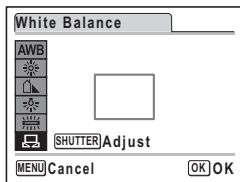

The white balance is automatically adjusted.

- 4 Press the OK button.**

The setting is saved and the screen returns to the [📷 Rec. Mode] menu.

- 5 Press the MENU button.**

The camera returns to capture status.

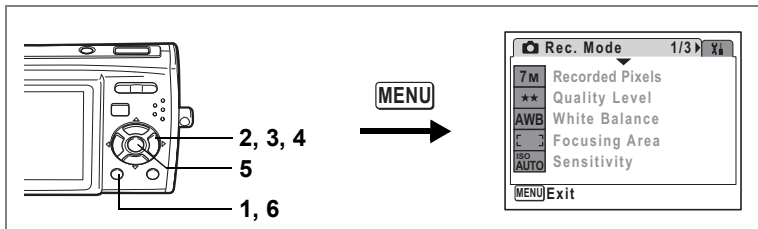

Changing the Focusing Area

You can change the autofocus area (Focusing Area).

4

Taking Pictures

Focusing Area

[]	Multiple	Normal range
[]	Spot	The autofocus range becomes smaller.
[]	Automatic Tracking AF	Keeps moving subjects in focus.

- 1 Press the **MENU** button in **📷** mode.
The [📷 Rec. Mode] menu appears.
- 2 Use the four-way controller (▲ ▼) to select **[Focusing Area]**.
- 3 Press the four-way controller (▶).
A pull-down menu appears.
- 4 Use the four-way controller (▲ ▼) to change the setting.
- 5 Press the **OK** button.
The Focusing Area setting is saved.
- 6 Press the **MENU** button.
The camera returns to capture status with the current setting.

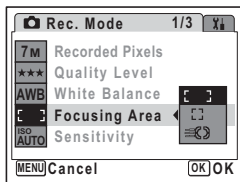

- In 📷 and ❤️ modes, [Focusing Area] can only be set to [] (Multiple) or [] (Spot).
- In **AUTO PICT** and 📷 modes, [Focusing Area] is set to [] (Multiple).
- If you use the [Focusing Area] function frequently, you can save time by assigning it to the Green button. (p.55)

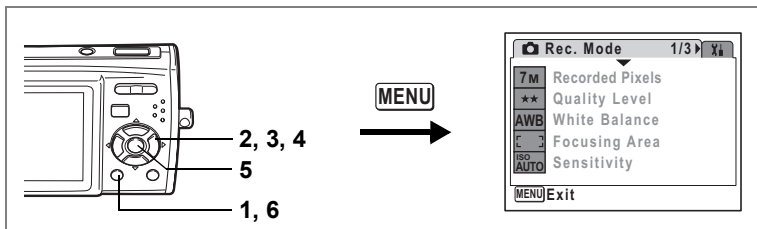

Setting the Sensitivity

You can select the sensitivity to suit the brightness of the surroundings.

Sensitivity

Auto	Sensitivity is automatically adjusted to between ISO 64 and 400.
64	<ul style="list-style-type: none"> The lower the sensitivity, the less noise that affects the image. The shutter speed will be slower in low light conditions. Higher sensitivity settings use faster shutter speeds in low light conditions to reduce camera shake, but the image may be affected by noise.
100	
200	
400	
800	
1600	
3200	

- Press the MENU button in mode.**
The [Rec. Mode] menu appears.
- Use the four-way controller () to select [Sensitivity].**
- Press the four-way controller ().**
A pull-down menu appears.
- Use the four-way controller () to change the sensitivity.**
- Press the OK button.**
The Sensitivity setting is saved.
- Press the MENU button.**
The camera returns to capture status with the current setting.

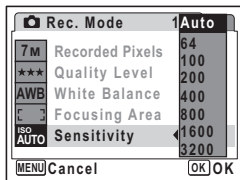



- When shooting mode is set to ((P)), the sensitivity is automatically adjusted to between ISO 64 and 3200.
- If you use the [Sensitivity] function frequently, you can save time by assigning it to the Green button. (p.55)

Saving the Sensitivity  p.95

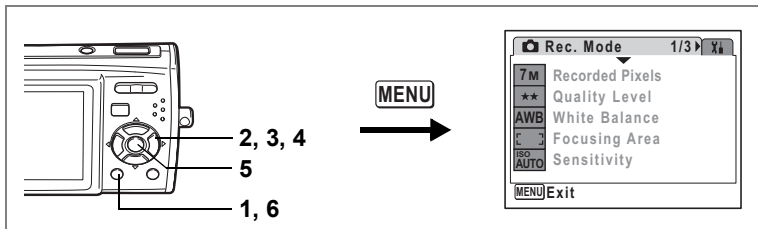

Setting the Instant Review Time (Instant Review)

You can choose the Instant Review time (the length of time the image is displayed immediately after capture) from 0.5sec, 1sec, 2sec, 3sec, 5sec and Off (no display).

1 Press the **MENU** button in **📷** mode.

The [📷 Rec. Mode] menu appears.

2 Use the four-way controller (▲▼) to select [Instant Review].

3 Press the four-way controller (▶).

A pull-down menu appears.

4 Use the four-way controller (▲▼) to change the display time.

5 Press the **OK** button.

The Instant Review setting is saved.

6 Press the **MENU** button.

The camera returns to capture status with the current setting.

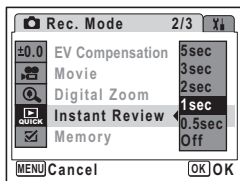

Instant Review p.39



Setting the Image Sharpness (Sharpness)

You can give the image sharp or soft outlines.

- 1 Press the MENU button in mode.**
The [Rec. Mode] menu appears.
- 2 Use the four-way controller () to select [Sharpness].**
- 3 Use the four-way controller () to change the sharpness level.**

The following setting is saved.

- (Soft)
- (Normal)
- (Hard)

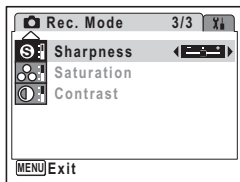

- 4 Press the MENU button.**

The Sharpness setting is saved and the camera returns to capture status.



If you use the [Sharpness] function frequently, you can save time by assigning it to the Green button. (p.55)



Setting the Color Saturation (Saturation)

You can set the color saturation.

- 1 Press the MENU button in mode.**
The [Rec. Mode] menu appears.
- 2 Use the four-way controller () to select [Saturation].**
- 3 Use the four-way controller () to change the saturation level.**

The following setting is saved.

- (Low)
- (Normal)
- (High)

- 4 Press the MENU button.**

The Saturation setting is saved and the camera returns to capture status.

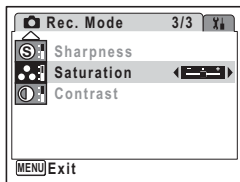

If you use the [Saturation] function frequently, you can save time by assigning it to the Green button. (p.55)



Setting the Image Contrast (Contrast)

You can set the image contrast level.

- 1 Press the MENU button in mode.**
The [Rec. Mode] menu appears.
- 2 Use the four-way controller () to select [Contrast].**
- 3 Use the four-way controller () to change the contrast level.**

The following setting is saved.

- (Low)
- (Normal)
- (High)

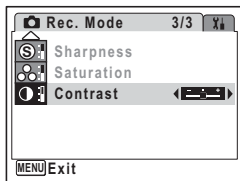

- 4 Press the MENU button.**

The Contrast setting is saved and the camera returns to capture status.



If you use the [Contrast] function frequently, you can save time by assigning it to the Green button. (p.55)

Saving the Settings (Memory)

The Memory function is for saving the current camera settings even when the camera is turned off.

For some camera settings, the Memory function is always set to (On) (the settings are saved when the camera is turned off), while for others you can choose on or off (to choose whether the settings are saved or not when the camera is turned off). The items which can be set to (On) or (Off) in the Memory function are shown in the table below. (Items not listed here will be saved in the selected settings when the camera is turned off.) If you select (On), the settings will be saved in the status they were in immediately before the camera was turned off. If you select (Off), the settings will be reset to the defaults when the camera is turned off. The table below also shows whether the Memory default setting for each item is on or off.

Item	Description	Default Setting
Flash Mode	The flash mode set with the four-way controller (◀) (p.80)	<input checked="" type="checkbox"/>
Drive Mode	The drive mode set with the four-way controller (▲) (p.71, p.72)	<input type="checkbox"/>
Focus Mode	The focus mode set with the four-way controller (▶) (p.78)	<input type="checkbox"/>
Zoom Position	The zoom position set with the Zoom/⏏/⏏ button (p.73)	<input type="checkbox"/>
MF Position	The manual focus position set with the four-way controller (▲▼) (p.79)	<input type="checkbox"/>
White Balance	The [White Balance] setting on the [📷 Rec. Mode] menu (p.86)	<input type="checkbox"/>
Sensitivity	The [Sensitivity] setting on the [📷 Rec. Mode] menu (p.89)	<input type="checkbox"/>
EV Compensation	The [EV Compensation] setting on the [📷 Rec. Mode] menu (p.75)	<input type="checkbox"/>
Digital Zoom	The [Digital Zoom] setting on the [📷 Rec. Mode] menu (p.74)	<input checked="" type="checkbox"/>
DISPLAY	The LCD monitor information display mode set with the OK/DISPLAY button (p.76, p.111)	<input type="checkbox"/>
File No.	If a new SD Memory Card is inserted when On has been selected, file numbers are assigned sequentially.	<input checked="" type="checkbox"/>

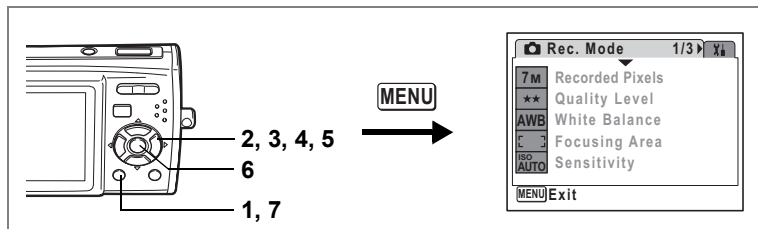

- 1 Press the MENU button in mode.**
The [Rec. Mode] menu appears.
- 2 Press the four-way controller () to select [Memory].**
- 3 Press the four-way controller ().**
The Memory screen appears.
- 4 Use the four-way controller () to choose an item.**
- 5 Use the four-way controller () to select (On) or (Off).**
- 6 Press the OK button.**
The Memory setting is saved.
- 7 Press the MENU button.**
The camera returns to capture status with the current setting.

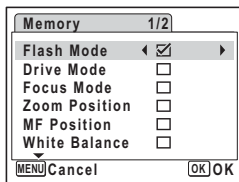

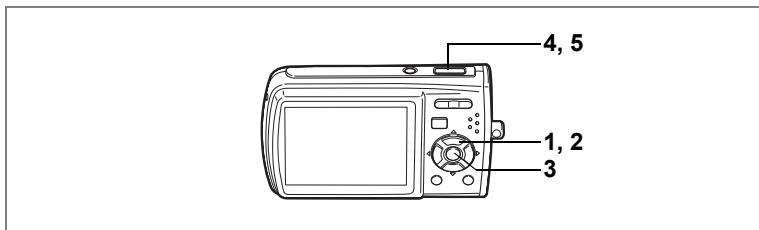

Recording Movies



Recording a Movie

This mode enables you to record movies. Sound is recorded at the same time.

- 1 Press the four-way controller (▼) in  mode.**
The Capture Mode Palette appears.
- 2 Use the four-way controller (▲▼◀▶) to select  (Movie).**



3 Press the OK button.

Movie mode is selected and the camera returns to capture status. The following information appears on the LCD monitor.

- 1 Movie mode icon
- 2 Focus mode icon
- 3 Recording indicator (appears when recording begins in step 4 and blinks during recording)
- 4 Recording time
- 5 Movie anti-shake icon (appears when Movie SR is set to On. p.104)
- 6 Date and time display
- 7 Focus frame (does not appear during recording)

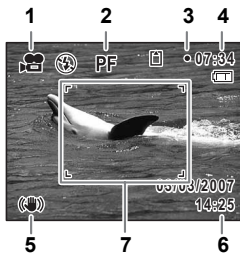

You can change the captured area by pressing the Zoom/**AAA**/**A** button to the left or right.

A : enlarges the subject

AAA : widens the area that is captured by the camera

4 Press the shutter release button fully.

Recording starts. You can record movie consecutively until the built-in memory/SD Memory Card is full, or up to 4 GB.



- The flash will not discharge in **Movie** mode.
- You can use the optical zoom and digital zoom before starting to record, and the digital zoom while recording.
- When you select **AF**/**A**/**s**/**MF**, you can press the shutter release button halfway before starting to record to focus.
- Changing the LCD monitor display mode by pressing the **OK/DISPLAY** button while recording a movie will not display the histogram.

5 Press the shutter release button fully.

Recording stops.

Playing Back Movies **▶** p.114

Keeping the Shutter Release Button Pressed

If you keep the shutter release button pressed for more than one second, recording will continue for as long as you keep the button pressed. Shooting stops when you take your finger off the shutter release button.



Selecting the Recorded Pixels for Movies

You can choose from two recorded pixels settings for movies:
 [640] 640×480] and [320] 320×240].

The more pixels there are, the bigger the file size. The data volume also varies depending on the quality level and frame rate settings. (p.29)

Recorded Pixels for Movies

[640] (640×480)	Suitable for viewing on a TV or computer screen.
[320] (320×240)	Suitable for posting on a website or attaching to e-mail.

- 1 Press the MENU button in mode.**
The [Rec. Mode] menu appears.
- 2 Use the four-way controller (▲ ▼) to select [Movie].**
- 3 Press the four-way controller (▶).**
The Movie screen appears.
- 4 Use the four-way controller (▲ ▼) to select [Recorded Pixels].**
- 5 Press the four-way controller (▶).**
A pull-down menu appears.

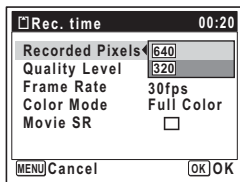

6 Use the four-way controller (▲ ▼) to change the number of recorded pixels.

Recording time for the selected recorded pixels is displayed when the Recorded Pixels setting is changed.

7 Press the OK button.

The Recorded Pixels setting is saved.

8 Press the MENU button twice.

The camera returns to capture status with the current setting.

Recorded Pixels, Quality Level and Frame Rate of Movies  p.29
--



Selecting the Quality Level of Movies

You can set the quality level of movies. The higher the quality level, the clearer the details and the bigger the file size.

Quality level of movies

★★★	Best	↑ ↓	Images will be clearer but file size will be larger.
★★	Better		
★	Good		Images will be grainier but file size will be smaller.

- Press the **MENU** button in mode.
The [Rec.Mode] menu appears.
- Use the four-way controller (▲▼) to select [Movie].
- Press the four-way controller (▶).
The Movie screen appears.
- Use the four-way controller (▲▼) to select [Quality Level].
- Press the four-way controller (▶).
A pull-down menu appears.
- Use the four-way controller (▲▼) to change the quality level.
Recording time for the selected quality level is displayed when the Quality Level setting is changed.
- Press the **OK** button.
The Quality Level setting is saved.
- Press the **MENU** button twice.
The camera returns to capture status with the current setting.

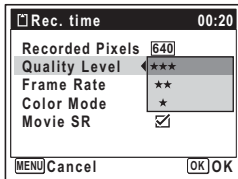

Recorded Pixels, Quality Level and Frame Rate of Movies p.29



Selecting the Frame Rate

You can choose from two frame rates (number of frames per second) for movies: [30fps] and [15fps]. The more frames per second, the better the quality of the movie, but the file size becomes larger.

- 1 Press the MENU button in mode.**
The [Rec. Mode] menu appears.
- 2 Use the four-way controller () to select [Movie].**
- 3 Press the four-way controller ().**
The Movie screen appears.
- 4 Use the four-way controller () to select [Frame Rate].**
- 5 Press the four-way controller ().**
A pull-down menu appears.
- 6 Use the four-way controller () to select [30fps] or [15fps].**
Recording time for the selected frame rate is displayed when the Frame Rate setting is changed.
- 7 Press the OK button.**
The Frame Rate setting is saved.
- 8 Press the MENU button twice.**
The camera returns to capture status with the current setting.

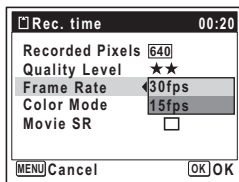



Recorded Pixels, Quality Level and Frame Rate of Movies p.29



Recording Movies in Black and White or Sepia Tones (Color Mode)

In  (Movie mode), you can set the color mode to Black and White or Sepia, as well as Full Color, when recording a movie.

- 1 Press the MENU button in  mode.**
The [ Rec. Mode] menu appears.
- 2 Use the four-way controller (▲ ▼) to select [Movie].**
- 3 Press the four-way controller (▶).**
The Movie screen appears.
- 4 Use the four-way controller (▲ ▼) to select [Color Mode].**
- 5 Press the four-way controller (▶).**
A pull-down menu appears.
- 6 Use the four-way controller (▲ ▼) to choose a color.**
- 7 Press the OK button.**
The Color Mode setting is saved.
- 8 Press the MENU button twice.**
The camera returns to capture status with the current setting.

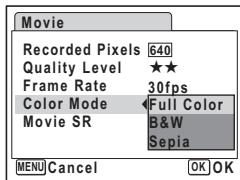

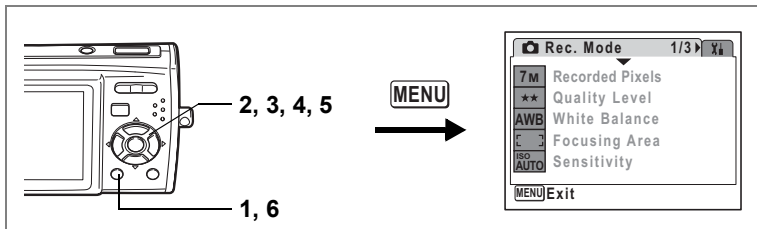

The color mode setting cannot be changed after a movie is recorded.



Setting the Movie SR (Movie Anti-Shake) Function

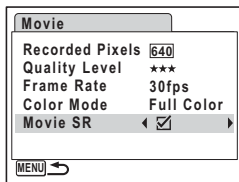

In  (Movie mode), you can use the Movie SR (movie anti-shake) function to correct camera shake.

- 1 Press the MENU button in  mode.**
The [ Rec.Mode] menu appears.
- 2 Use the four-way controller (▲ ▼) to select [Movie].**
- 3 Press the four-way controller (▶).**
The Movie screen appears.
- 4 Use the four-way controller (▲ ▼) to select [Movie SR].**
- 5 Use the four-way controller (◀ ▶) to select (On) or (Off).**
The Movie SR (movie anti-shake) setting is saved.
- 6 Press the MENU button twice.**
The camera returns to capture status with the current setting.



Playing Back Images



Switching Between Mode and Mode

In this manual, the capture mode, such as for taking still pictures, is referred to as “ mode”. The playback mode, such as for displaying captured images on the LCD monitor, is referred to as “ mode”. In  mode, you can perform simple editing operations on the images that are played back.

Follow the procedure below to switch between  mode and  mode.

Switching from Mode to Mode

1 Press the button.

- Press the  button to switch to the Playback mode and view pictures while the lens is extended.
- Hold down the  button for approximately one second to activate the Playback mode with the lens retracted.
- Hold down the  button for approximately two seconds to display the pictures stored in the built-in memory with the SD Memory Card inserted. (Browse built-in memory)



When an SD Memory Card is inserted, images, movies and sound files saved in the SD Memory Card are displayed.

Browse Built-in Memory

- You can play back still pictures (including magnify) (p.40, 109), movies (p.114), and sound (p.143), or display images in divided nine-image display, Folder display or Calendar display (p.107).
- You cannot delete data, Select & Delete, or display the Playback Mode Palette or menu. Remove the SD Memory Card to perform these operations on images, movies and sound files saved in the built-in memory.

Switching from Mode to Mode

1 Press the button or shutter release button halfway.

The camera switches to  mode.

Playing Back Still Pictures

Refer to “Playing Back Images” (p.40) for instructions.

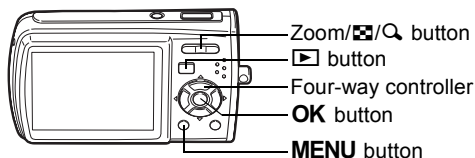

Nine-Image Display, Folder Display and Calendar Display

Nine-Image Display

You can display nine captured images on the LCD monitor at a time.

1 In **▶** mode, press **Matrix/Quick** on the Zoom/Matrix/Quick button.

A page consisting of nine thumbnail images appears. The displayed images change nine at a time page by page.

Use the four-way controller (**▲▼◀▶**) to move the frame. When 10 or more images have been saved, if you choose image ① and press the four-way controller (**▲◀**), the previous page appears. Similarly, if you choose image ② and press the four-way controller (**▼▶**), the next page appears.

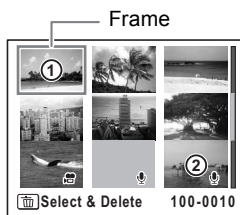



The icons that appear on the images indicate the following:

- No icon : Still picture without sound
- 🔊 (with image) : Still picture with sound
- 🎬 : Movie (first frame appears)
- 🔊 (without image) : Sound file only

Press the **OK** button, **MENU** button or **Q** on the Zoom/Matrix/Quick button to switch to single-image display of the selected image.

Press the **▶** button to switch to **📷** mode.

Switching to Folder Display or Calendar Display

In nine-image display, press  on the Zoom//Q button to switch to folder display or calendar display. Press the Green button to switch between folder display and calendar display.

1 In mode, press on the Zoom//Q button.





The screen changes to nine-image display.



2 Press on the Zoom//Q button.

The screen changes to folder display or calendar display.

Folder display

The list of folders with recorded images and sound files appears.

Use the four-way controller (   ) to move the selection frame.

Select a folder and press  or **OK** of the zoom//Q button to switch to nine-image display with the first image in the folder selected.

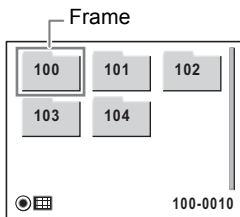





Calendar display

Recorded images and sound files are displayed by date in calendar format.

The first image recorded on a date is displayed for that date on the calendar.

 appears for dates on which a sound file was first recorded.



Use the four-way controller (   ) to move the selection frame.

Select a date and press  of the zoom//

Q button to switch to nine-image display with the first image from that date selected.

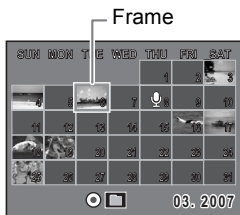
Select a date and press the **OK** button to switch to single-image display of the first image recorded on that date.





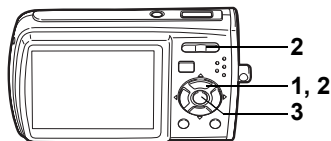



- Press the **MENU** button in folder display or calendar display to switch to normal nine-image display.
- Press the  button or half-press the shutter release button in folder display or calendar display to switch to  mode.





Zoom Playback

You can magnify an image up to eight times. A guide showing the center of the magnified portion of the image appears on the LCD monitor during zoom playback.

- 1 Enter the  mode and use the four-way controller ( ) to choose the image you want to magnify.**
- 2 Press  on the Zoom// button.**

The image is magnified ($\times 1.1$ to $\times 8$).











Holding down  on the Zoom// button changes the magnification continuously.

You can use the guide at the bottom left of the screen to check which portion of the image is magnified.



Guide

The following operations can be performed while the magnified image is displayed.

- | | |
|---|--|
| Four-way controller (   ) | Moves the position to be magnified |
| Zoom/  /  button () | Makes the image bigger (max. $\times 8$) |
| Zoom/  /  button () | Makes the image smaller (min. $\times 1.1$) |

- 3 Press the OK button.**

The image returns to single-image display.



- Movies cannot be magnified.
- The guide does not appear if the LCD monitor display mode is set to "No Info".

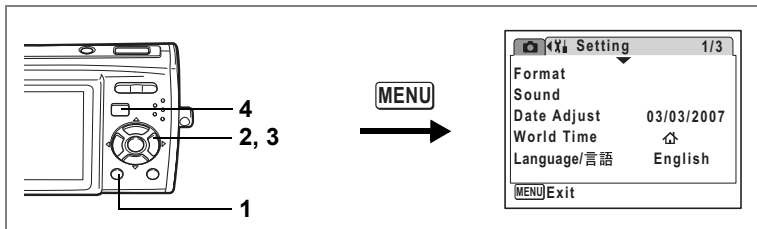

Setting the Quick Zoom Function

When the Quick Zoom function is enabled, you can display an image at maximum magnification ($\times 8$) simply by pressing \mathcal{Q} on the Zoom/ \mathcal{Q} / \mathcal{Q} button once.

1 Press the MENU button in \mathcal{P} mode.

The [\mathcal{X} Setting] menu appears.

2 Use the four-way controller (\blacktriangle \blacktriangledown) to select [Quick Zoom].

3 Use the four-way controller (\blacktriangleleft \blacktriangleright) to select (On) or (Off).

- : Jumps to $\times 8$ magnification
- : Pressing \mathcal{Q} on the Zoom/ \mathcal{Q} / \mathcal{Q} button once magnifies the image in stages from $\times 1.1$ to $\times 8.0$

4 Press the MENU button.

The camera returns to \mathcal{P} mode.

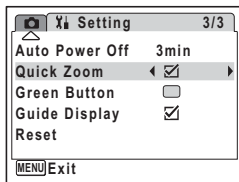

Displaying Shooting Information in Playback Mode

Shooting information can be displayed on the LCD monitor in  mode. Pressing the **OK/DISPLAY** button changes the display mode. Refer to p.18 for details of each display mode.

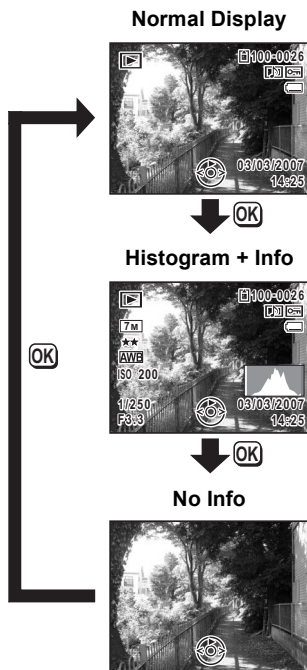



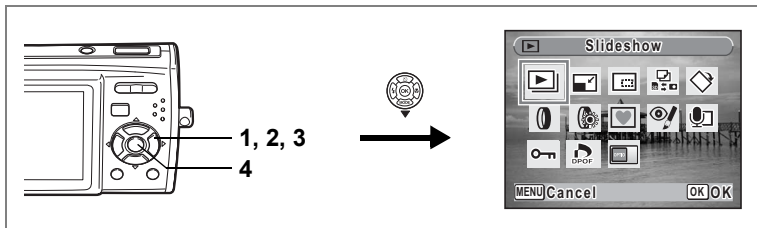





Displaying Shooting Information  p.76



Slideshow

You can play back recorded images one after another.







- 1 Enter the  mode and use the four-way controller ( ) to choose an image to start the slideshow with.**
- 2 Press the four-way controller ().**
The Playback Mode Palette appears.
- 3 Use the four-way controller (   ) to select  (Slideshow).**
- 4 Press the OK button twice.**
The slideshow starts.
Pressing the **OK** button during the slideshow pauses the slideshow. To resume the slideshow, press the **OK** button while the slideshow is paused.
- 5 Press any button other than the OK button or the power switch.**
The slideshow stops.



If you press the four-way controller () while playing back a movie or picture with sound, the next image is displayed without ending the slideshow.

Setting the Slideshow Conditions

You can set the playback interval and also a screen effect and sound effect for when one image changes to the next.

- 1 Press the four-way controller () in  mode.**
The Playback Mode Palette appears.
- 2 Use the four-way controller (   ) to select  (Slideshow).**

3 Press the OK button.

The screen for setting the slideshow conditions appears.

4 Use the four-way controller (▲▼) to select [Interval].**5 Press the four-way controller (▶).**

A pull-down menu appears.

6 Use the four-way controller (▲▼) to change the interval and press the OK button.

You can choose from 3sec, 5sec, 10sec, 20sec, and 30sec.

7 Use the four-way controller (▲▼) to select [Screen Effect].

After selecting [Screen Effect], press the four-way controller (▶).

A pull-down menu appears with the following items that can be selected. Use the four-way controller (▲▼) to select an item and press the **OK** button.

Off	No effect
Wipe	The next image slides over the previous one from left to right
Checker	The next image appears in small square mosaic blocks
Fade	The current image gradually fades out and the next image fades in

8 Use the four-way controller (▲▼) to select [Sound Effect].**9 Use the four-way controller (◀▶) to select (On) or (Off).**

Except when the screen effect is set to Off, you can choose (On) or (Off) for the sound that is played when one image changes to the next.

10 Press the OK button.

The slideshow starts using the selected interval and effect.



- The slideshow will continue until you press any button other than the **OK** button or the power switch.
- Movies or pictures with sound will normally be played through to the end before the next picture is played back, regardless of the interval setting. However, pressing the four-way controller (▶) while playing back a movie or a picture with sound skips to the next image.
- Sound files made in Voice Recording mode are not played back in the slideshow.

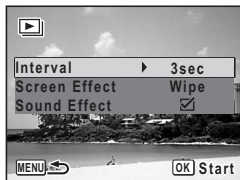

Playing Back Movies

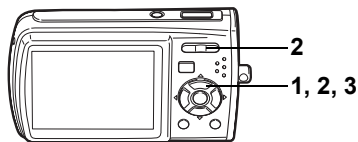

Playing Back a Movie

You can play back the movies you have taken. Sound is played back at the same time.

5

Playing Back and Deleting Images

1 Enter the  mode and use the four-way controller (◀▶) to choose the movie you want to play back.

2 Press the four-way controller (▲).

Playback starts.



The following operations can be performed during playback.

Four-way controller (◀) Reverse playback

Four-way controller (▲) Pause

Zoom/▬▬▬/▲ button (▲) Increases the volume

Zoom/▬▬▬/▲ button (▬▬▬) Reduces the volume

The following operations can be performed while playback is paused.

Four-way controller (◀) Frame reverse

Four-way controller (▶) Frame forward

Four-way controller (▲) Releases the Pause function (Play)

3 Press the four-way controller (▼).

Playback stops.

Connecting the Camera to AV Equipment

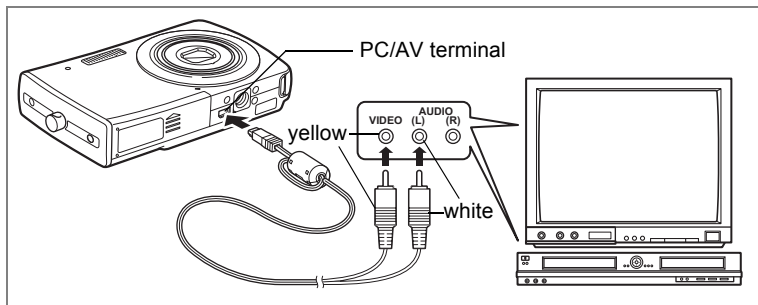

By using the AV cable, you can take pictures and play back captured images on equipment with a video IN jack, such as a TV. Make sure the camera and TV are turned off before connecting the camera to the TV.

- 1 Connect the AV cable to the PC/AV terminal.**
- 2 Connect the other ends of the AV cable (yellow: video, white: audio) to the AV device's video input terminal and audio input terminal.**

When using stereo sound equipment, insert the sound terminal into the L (white) terminal.

- 3 Turn the AV device on.**

When the device that the camera is connected to and the device that plays back images are different, turn both devices on.

When viewing images on AV equipment with multiple video input terminals (such as a TV), refer to the operation manual of the device and select the video input terminal to which the camera is connected.

- 4 Turn the camera on.**



- You are recommended to use the AC adapter kit K-AC64 (optional) if you intend to use the camera for a long time.
- Depending on the country or region, images and sound files may fail to be played back if the video output format is set different from the one in use there. If this happens, change the video output format setting. (p.156)
- The camera LCD monitor turns off while the camera is connected to AV equipment.
- Volume cannot be adjusted with the zoom button while the camera is connected to AV equipment.

Deleting Images

Delete images and sounds with mistakes or that are unnecessary.

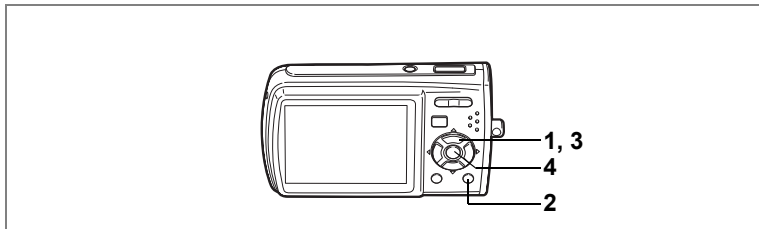

Deleting a Single Image/Sound File







You can delete a single image and sound file.

5

Playing Back and Deleting Images



Protected images and sound files cannot be deleted. (p.121)



- 1 Enter the  mode and use the four-way controller ( ) to choose the image/sound file you want to delete.**
- 2 Press the  button.**
The confirmation screen appears.
- 3 Use the four-way controller ( ) to select [Delete].**
- 4 Press the OK button.**
The image or sound file is deleted.



If you press the  button during Instant Review, the screen in Step 2 appears, enabling you to delete the image you have just taken. (p.41)

Deleting a Sound File

If sound has been recorded with an image (p.144), you can delete the sound without deleting the image.

- 1 Enter the  mode and use the four-way controller (◀▶) to choose an image with sound.**
- 2 Press the  button.**
The confirmation screen appears.
- 3 Use the four-way controller (▲▼) to select [Delete Sound].**
- 4 Press the OK button.**
The sound file is deleted.

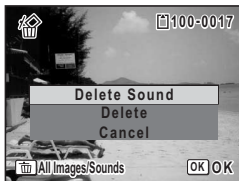

Select [Delete] in Step 3 above to delete both the image and sound file.

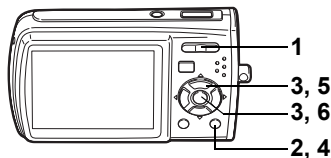

Deleting Selected Images and Sound Files (from Nine-Image Display)

You can delete several images/sound files selected from the nine-image display at once.



Protected images and sound files cannot be deleted.

5

- 1** In mode, press on the Zoom//Q button.

Nine thumbnail images appear.

- 2** Press the button.

appears on the images and sound files.



- 3** Use the four-way controller () to choose the images and sound files that you want to delete and press the OK button.

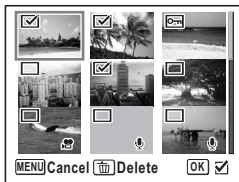

appears on the selected images and sound files.



If you select an image and press Q on the Zoom//Q button, the selected image appears in single-image display for as long as the button is pressed, enabling you to check whether you really want to delete it or not. (The display returns to the nine-image display when you release the button.) However, protected images cannot be displayed in single-image display.

4 Press the  button.

A confirmation dialog appears.

5 Use the four-way controller ( ) to select [Select & Delete].

6 Press the **OK button.**

The selected images and sound files are deleted.



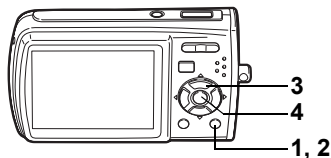





Deleting All Images and Sound Files

You can delete all the images and sound files at once.



Protected images and sound files cannot be deleted. (p.121)

- 1 Press the  button in  mode.**
A confirmation dialog appears.
- 2 Press the  button.**
A confirmation dialog appears.
- 3 Use the four-way controller ( ) to select [Delete All].**
- 4 Press the OK button.**
All the images and sound files are deleted.

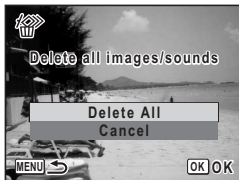

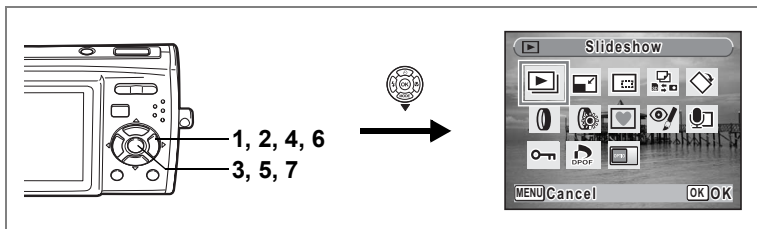

Protecting Images and Sound Files from Deletion (Protect)

You can protect stored images and sound files from being accidentally deleted.

- 1 Press the four-way controller (▼) in [▶] mode.**
The Playback Mode Palette appears.
- 2 Use the four-way controller (▲▼◀▶) to select [Protect].**
- 3 Press the OK button.**
The screen for selecting [Select image/sound] or [All Images/Sounds] appears.
- 4 Use the four-way controller (▲▼) to select [Select image/sound].**
- 5 Press the OK button.**
The message [Protect this image/sound] appears. To protect another image or sound file, use the four-way controller (◀▶) to select another image or sound file.
- 6 Use the four-way controller (▲▼) to select [Protect].**
- 7 Press the OK button.**
The selected image or sound file is protected.



- To cancel the Protect setting, select [Unprotect] in Step 6.
- [] appears below the file number on protected images and sound files during playback.

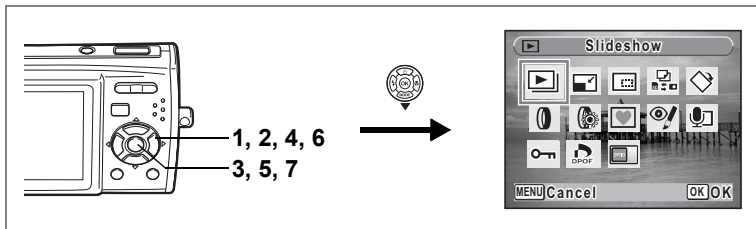

Protecting All Images and Sound Files

- 1 **Press the four-way controller (▼) in [▶] mode.**
The Playback Mode Palette appears.
- 2 **Use the four-way controller (▲▼◀▶) to select [Protect].**
- 3 **Press the OK button.**
The screen for selecting [Select image/sound] or [All Images/Sounds] appears.
- 4 **Use the four-way controller (▲▼) to select [All Images/Sounds].**
- 5 **Press the OK button.**
The screen for selecting [Protect] or [Unprotect] appears.
- 6 **Use the four-way controller (▲▼) to select [Protect].**
- 7 **Press the OK button.**

All the images and sound files are protected.



Protected images and sound files will be deleted when the SD Memory Card or built-in memory is formatted.



To cancel the Protect setting on all your images and sound files, select [Unprotect] in Step 6.

Editing Images

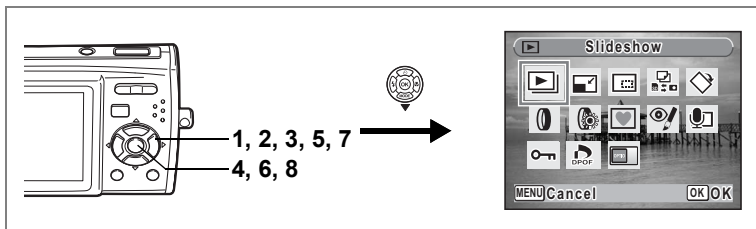

Changing the Image Size and Quality (Resize)

By changing the size and quality of a selected image, you can make the file size smaller than the original. You can use this function to continue taking pictures when the SD Memory Card or built-in memory is full, by making the images smaller and overwriting the original images to make more space available.



- Movies cannot be resized.
- You cannot select a larger resolution or higher quality than that of the original image.
- You can select the available Recorded Pixels (p.28), **6M** (2816×2112), or **320** (320×240) for [Recorded Pixels].

- 1 Enter the mode and use the four-way controller (◀▶) to choose the image you want to resize.**
- 2 Press the four-way controller (▼).**
The Playback Mode Palette appears.
- 3 Use the four-way controller (▲▼◀▶) to select (Resize).**
- 4 Press the OK button.**

The screen for choosing the size and quality appears.



5 Select [Recorded Pixels] and [Quality Level].

Use the four-way controller (◀▶) to choose the size and quality.

Use the four-way controller (▲▼) to switch between [Recorded Pixels] and [Quality Level].

6 Press the OK button.

A confirmation dialog for overwriting the image appears.

If the image is protected, a confirmation screen does not appear. The image is automatically saved with a new file name.

7 Use the four-way controller (▲▼) to select [Overwrite] or [Save as].

8 Press the OK button.





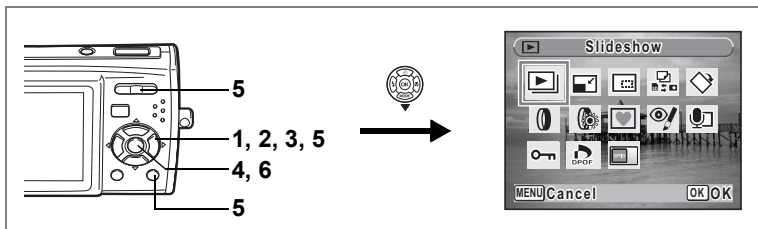



The resized image is saved.









Cropping Images

You can delete the unwanted part of a picture and save the cropped image as a separate image.

- 1 Enter the  mode and use the four-way controller ( ) to choose the image you want to crop.**
- 2 Press the four-way controller (.**
The Playback Mode Palette appears.
- 3 Use the four-way controller (   ) to select  (Cropping).**
- 4 Press the OK button.**
The Cropping screen appears.
- 5 Choose the cropping conditions.**

Zoom//Q button

Changes the size of the cropped section

Four-way controller (   )

Moves the cropping position up, down, left and right

Green button Rotates the cropping frame

- 6 Press the OK button.**

The cropped image is saved with a new file name.

The cropped image is saved in the same quality as the original image. The number of recorded pixels is selected automatically according to the size of the cropped section.

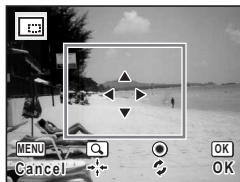

Movies cannot be cropped.

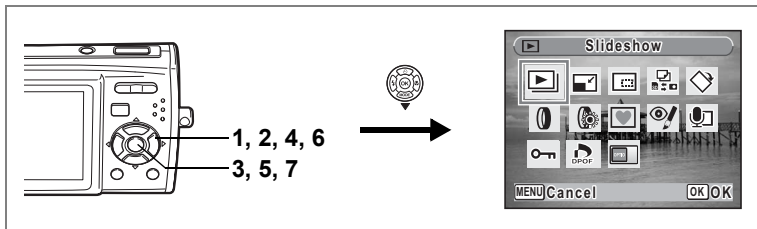

Copying Images and Sound Files

You can copy images and sound files from the built-in memory to the SD Memory Card and vice versa. This function can only be selected when an SD Memory Card has been inserted in the camera.



Make sure that the camera is turned off before inserting or removing the SD Memory Card.

- 1 Press the four-way controller (▼) in mode.**
The Playback Mode Palette appears.
- 2 Use the four-way controller (▲▼◀▶) to select (Image/Sound Copy).**
- 3 Press the OK button.**
The copying method selection screen appears.

Copying Files from the Built-in Memory to the SD Memory Card

All the images and sound files in the built-in memory are copied to the SD Memory Card at once. Before copying the images, make sure that there is enough space in the SD Memory Card.

- 4 Use the four-way controller (▲▼) to select [→ SD].**
- 5 Press the OK button.**
All the images and sound files are copied.



Copying Files from the SD Memory Card to the Built-in Memory

Selected images and sound files from the SD Memory Card are copied to the built-in memory one at a time.

- 4 Use the four-way controller (▲▼) to select [SD] → [●].
- 5 Press the OK button.
- 6 Use the four-way controller (◀▶) to select the file you want to copy.
- 7 Press the OK button.



The selected image/sound file is copied.





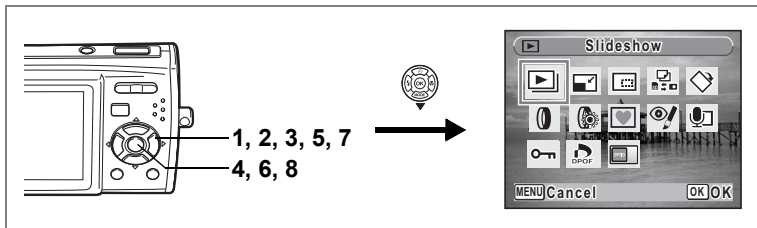











- If you press the four-way controller (▲) in step 6, playback of movies, sound or picture with sound begins. Press the four-way controller (▼) during playback to stop. You cannot adjust the volume, fast forward, rewind, etc.
- If sound has been recorded with the image, the sound file is copied with the image.
- When a file is copied from the SD Memory Card to the built-in memory, it is assigned a new file name.



Using the Digital Filters

This function lets you edit selected images with digital filters to change the color, etc.

You can choose from 10 digital filters: B&W, Sepia, Red, Pink, Purple, Blue, Green, Yellow, Color extract (B&W with Red, B&W with Green, B&W with Blue), and SOFT.

- 1 Enter the  mode and use the four-way controller ( ) to choose the image you want to edit.**
- 2 Press the four-way controller ().**
The Playback Mode Palette appears.
- 3 Use the four-way controller (   ) to select  (Digital Filter).**
- 4 Press the OK button.**
The digital filter selection screen appears.
- 5 Use the four-way controller ( ) to choose a digital filter.**
If you choose a Color extract filter, use the four-way controller ( ) to select the color to extract.
You can preview the results of the filter effect.
- 6 Press the OK button.**
A confirmation dialog for overwriting the image appears.
- 7 Use the four-way controller ( ) to select [Overwrite] or [Save as].**
If the image is protected, a confirmation screen does not appear. The image is automatically saved with a new file name.
- 8 Press the OK button.**
The edited image is saved with the same number of recorded pixels and quality level as the original.

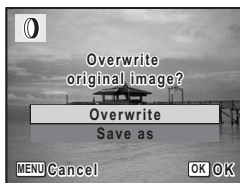

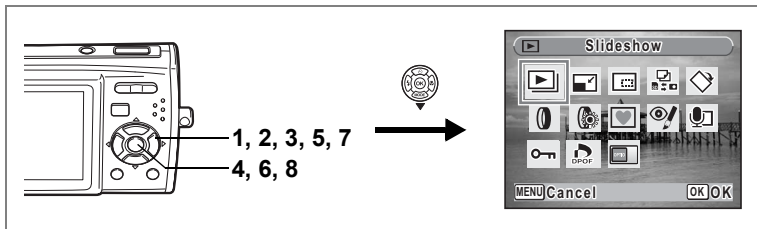

Using the Brightness Filter

This function lets you adjust the brightness of the selected image.

- 1** Enter the mode and use the four-way controller () to choose the image you want to edit.
- 2** Press the four-way controller ().
The Playback Mode Palette appears.
- 3** Use the four-way controller () to select (Brightness Filter).
- 4** Press the **OK** button.
The brightness adjustment screen appears.
- 5** Use the four-way controller () to adjust the brightness.
You can preview the results of the brightness adjustment.
- 6** Press the **OK** button.
A confirmation dialog for overwriting the image appears.
- 7** Use the four-way controller () to select **[Overwrite]** or **[Save as]**.
If the image is protected, a confirmation screen does not appear. The image is automatically saved with a new file name.
- 8** Press the **OK** button.
The edited image is saved with the same number of recorded pixels and quality level as the original.



Movies or images taken with another camera cannot be edited using [Digital Filter] or [Brightness Filter]. An error message appears if you choose this function from the Playback Mode Palette and press the **OK** button.

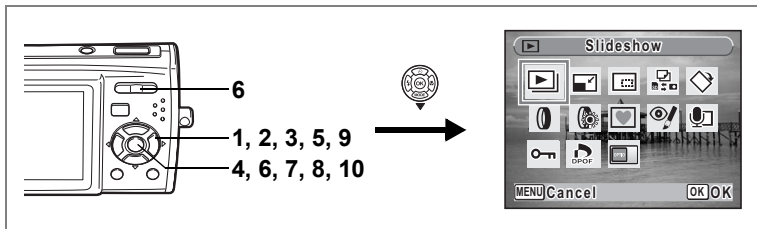

Adding a Frame (Frame Composite)

This function lets you add a decorative frame to still pictures. There are three frames already stored in the camera.

- 1 Enter the mode and use the four-way controller () to choose the image to which you want to add a frame.
- 2 Press the four-way controller ().
The Playback Mode Palette appears.
- 3 Use the four-way controller () to select (Frame Composite).
- 4 Press the OK button.
A 9-frame display of the frame selection screen appears.
- 5 Use the four-way controller () to choose a frame.
- 6 Press the OK button or on the Zoom// button.

The selected frame appears in single-image display.

You can choose another frame using either of the following operations.

- Use the four-way controller () to choose a different frame.
- Press the **MENU** button or on the Zoom// button to return to the 9-frame display of the frame selection screen, and then perform Step 5 to choose a different frame.

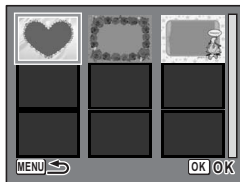

7 Press the OK button.

The frame position and size adjustment screen appears. Use the four-way controller (▲▼◀▶) to adjust the position of the image, and use the Zoom/☒/Q button to make the image larger or smaller.

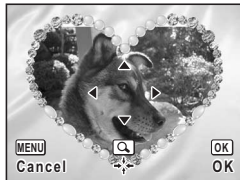

8 Press the OK button.

A confirmation dialog for overwriting the image appears.

9 Use the four-way controller (▲▼) to select [Overwrite] or [Save as].

If the image is protected, a confirmation screen does not appear. The image is automatically saved with a new file name.

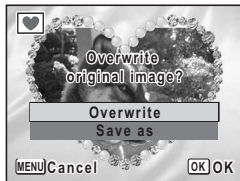

10 Press the OK button.

The edited image is saved with the recorded pixels of **3M**.



The Frame Composite function cannot be used on movies or images of size **2M** and smaller. An error message appears in Step 4.

6

Using a New Frame

Frames downloaded from a website or other source can be used when taking pictures. To display the frames available in the built-in memory or the SD Memory Card, in Step 3, select **♥** (Frame Composite) and press the **OK** button.



- The three frames stored in the internal memory cannot be deleted.
- Up to 96 downloaded frames can be displayed. Including the three frames already stored in the internal memory, you can choose from up to 99 frames.

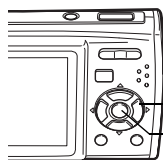











1, 2, 3, 5
4, 6



Red-eye Compensation

You can correct images where the flash has caused the subject to appear with red eyes.

- 1 Enter the  mode and use the four-way controller ( ) to choose the image you want to correct.**
- 2 Press the four-way controller (.**
The Playback Mode Palette appears.
- 3 Use the four-way controller (   ) to select  (Red-eye Compensation).**
- 4 Press the OK button.**
A confirmation dialog for overwriting the image appears.
- 5 Use the four-way controller ( ) to select [Overwrite] or [Save as].**
If the image is protected, a confirmation screen does not appear. The image is automatically saved with a new file name.
- 6 Press the OK button.**



- The red-eye compensation function cannot be used on movies or on images where red eyes cannot be detected on the camera. An error message appears in Step 4.
- The red-eye compensation function can only be used with still pictures taken with this camera.

Setting the Printing Service (DPOF)

DPOF (Digital Print Order Format) is the format for storing print order data on still pictures captured with a digital camera. Once the print order data has been stored, the pictures can be printed according to the DPOF settings using a DPOF-compatible printer or photo processing lab. You cannot store print order data for movies or sound-only files.

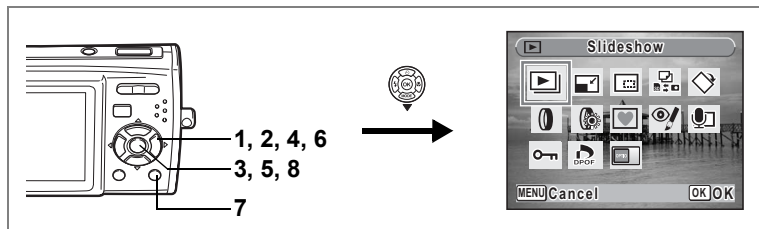

Printing Single Images

Set the following items for each image.

Copies	Choose the number of copies up to 99.
Date	Specify whether you want the date inserted on the print or not.

- 1 Press the four-way controller (▼) in [▶] mode.**
The Playback Mode Palette appears.
- 2 Use the four-way controller (▲▼◀▶) to select [DPOF].**
- 3 Press the OK button.**
The screen for selecting [Single Image] or [All Images] appears.
- 4 Use the four-way controller (▲▼) to select [Single Image].**



5 Press the OK button.

The message [DPOF setting for this image] appears. To make DPOF settings for another image, use the four-way controller (◀▶) to select another image.

If DPOF settings have already been made for an image, the previous number of copies and date setting (☑ or ☐) will be displayed.

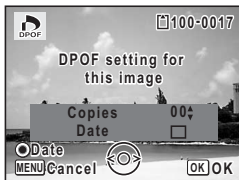

6 Use the four-way controller (▲▼) to choose the number of copies.

7 Use the Green button to choose whether to insert the date or not.

☑ (On) : The date will be imprinted.

☐ (Off) : The date will not be imprinted.

To continue setting DPOF print order data, use the four-way controller (◀▶) to choose another image and repeat Steps 6 and 7.



8 Press the OK button.

The DPOF settings are saved and the screen returns to the DPOF menu.



Depending on the printer or printing equipment at the photo processing lab, the date may not be imprinted on the pictures even if ☑ (On) was selected in the DPOF settings.



To cancel DPOF settings, set the number of copies to [00] in Step 6 and press the **OK** button.

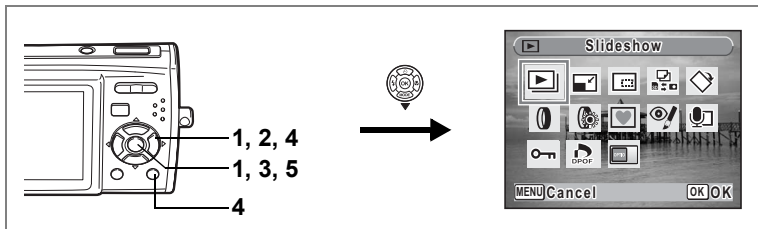

Printing All Images

When you choose the number of copies and whether or not to insert the date, the settings are applied to all the images stored in the camera.

- 1 Display the screen for DPOF settings in mode.**
Refer to Steps 1 to 3 on p.133.
- 2 Use the four-way controller () to select [All Images].**
- 3 Press the OK button.**

The message [DPOF setting for all images] appears.

- 4 Choose the number of copies and whether to insert the date or not.**

Refer to Steps 6 and 7 in “Printing Single Images” (p.134) for details of how to make the settings.

- 5 Press the OK button.**

The DPOF settings for all the images are saved and the camera returns to the DPOF setting screen.

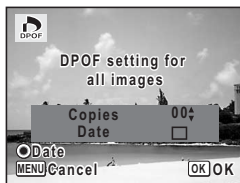

The number of copies specified in the DPOF settings applies to all the images. Before printing, check that the number is correct.



Settings for single images are canceled when settings are made for all images.

Printing Using PictBridge

By connecting the camera to a printer that supports PictBridge using the USB cable (I-USB7) provided, you can print images directly from the camera without using a PC. Connect the camera to the printer and select the images you want to print and the number of copies on the camera.



- You are recommended to use the AC adapter kit K-AC64 when the camera is connected to the printer. The printer may not work properly or the image data may be lost if the battery runs out of power while the camera is connected to the printer.
- Do not disconnect the USB cable during data transfer.
- Depending on the type of printer, not all the settings made on the camera (such as print settings and DPOF settings) may be valid.
- A printing error may occur if the selected number of copies exceeds 500.
- Printing the index of the images (printing multiple images on a single sheet) cannot be performed directly from the camera. Make the settings on a printer supporting index printing function or use a PC.

6

Connecting the Camera to the Printer

- 1 Select [PictBridge] for the [USB Connection] mode on the [X] Setting] menu.**

Refer to “Changing the USB Connection Mode” (p.155).

- 2 Turn off the camera.**
- 3 Connect the camera to the printer using the USB cable provided.**
- 4 Turn the printer on.**
- 5 When the printer is ready to print, turn the camera on.**

The printing mode selection screen appears.

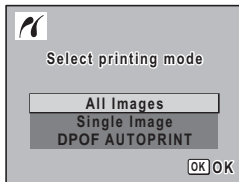

Printing Single Images

- 1 In the printing mode selection screen, use the four-way controller (▲▼) to select [Single Image].**
- 2 Press the OK button.**
The setting screen appears.
- 3 Use the four-way controller (◀▶) to choose an image to print.**
- 4 Use the four-way controller (▲▼) to choose the number of copies.**
You can print up to 99 copies.
- 5 Use the Green button to choose whether to insert the date or not.**
 - (On) : The date will be imprinted.
 - (Off) : The date will not be imprinted.
- 6 Press the OK button.**
A confirmation dialog appears.
To print the pictures according to the print settings on the printer, press the **OK** button.
To change the print settings, go to Step 7.
- 7 Press the Green button.**
The screen for changing the print settings appears.
- 8 Select [Paper Size] and press the four-way controller (▶).**

The Paper Size screen appears.

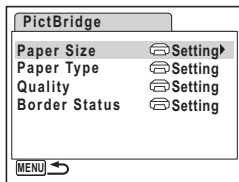
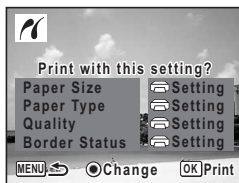
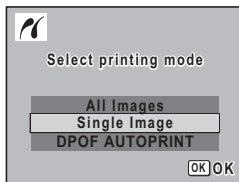

9 Use the four-way controller (▲▼◀▶) to choose the paper size.

You can only choose a size that is supported by your printer.

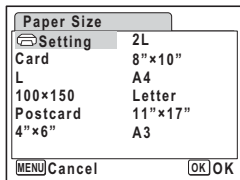

10 Press the OK button.

The Paper Size setting is saved, and the screen returns to the print settings screen.

11 Use the four-way controller (▲▼) to select [Paper Type] and press the four-way controller (▶).

A pull-down menu appears.

12 Use the four-way controller (▲▼) to select the paper type and press the OK button.

The Paper Type setting is saved, and the screen returns to the print settings screen. Set [Quality] and [Border Status] in the same way as in Steps 11 and 12.

If you select [⊞ Setting] for each print setting, images are printed according to the settings made on the printer.

Paper Type with more ★ supports higher quality paper.

Quality with more ★ indicates higher print quality.

The print settings screen appears after each item has been set.

13 Press the MENU button.

The screen returns to the confirmation dialog.

14 Press the OK button.

The image is printed according to the settings.

Press the **MENU** button to cancel printing.



- The self-timer lamp lights while the camera is communicating with the printer, and blinks while the card is being accessed and during printing. Do not disconnect the USB cable while the self-timer lamp is blinking.
- The [Paper Size], [Paper Type], [Quality] and [Border Status] settings are reset to the defaults when the camera is turned off.

Disconnecting the Cable from the Printer  p.140

Printing All Images

- 1 In the printing mode selection screen, use the four-way controller (▲▼) to select [All Images].**

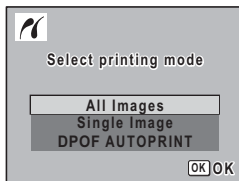

- 2 Press the OK button.**

The setting screen appears.

- 3 Choose the number of copies and whether to insert the date or not.**

The number of copies and date setting that you choose apply to all the images.

Refer to Steps 4 and 5 in "Printing Single Images" (p.137) for details of how to make the settings.

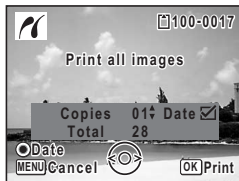

- 4 Press the OK button.**

A confirmation dialog appears.

Refer to Steps 7 to 11 of "Printing Single Images" (p.137 and p.138) for details of changing print settings.

- 5 Press the OK button on the print settings confirmation screen.**

All the images are printed according to the settings.

Press the **MENU** button to cancel printing.

Printing Using the DPOF Settings

1 In the printing mode selection screen, use the four-way controller (▲▼) to select [DPOF AUTOPRINT].

2 Press the OK button.

The DPOF settings you have made appear. Use the four-way controller (◀▶) to check the number of copies for each picture, whether to insert the date or not, and the total number of copies. Refer to p.133 for instructions on how to make the DPOF settings.

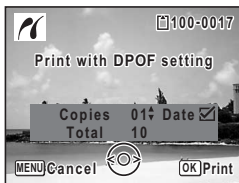

3 Press the OK button.

A confirmation dialog appears.

Refer to Steps 7 to 11 of “Printing Single Images” (p.137 and p.138) for details of changing print settings.

4 Press the OK button on the print settings confirmation screen.

The images are printed according to the settings.

Press the **MENU** button to cancel printing.

6

Disconnecting the Cable from the Printer

Disconnect the USB cable from the camera and printer when you have finished printing.

1 Turn off the camera.

2 Disconnect the USB cable from the camera and printer.

Recording Sound (Voice Recording Mode)

You can record sound with the camera. The microphone is located below and to the left of the lens on the camera. When recording sound, aim the camera to obtain the best conditions.

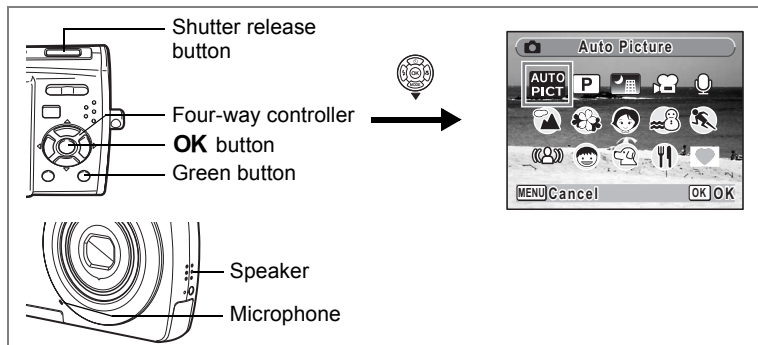

- 1 Press the four-way controller (▼) in mode.**
The Capture Mode Palette appears.
- 2 Use the four-way controller (▲▼◀▶) to select (Voice Recording).**
- 3 Press the OK button.**
The remaining recordable time and the recording time of the current file appear on the LCD monitor.
1 Recording time
2 Remaining recordable time

- 4 Press the shutter release button fully.**
Recording starts. The self-timer lamp blinks during recording. You can record sound until the built-in memory/SD Memory Card is full, or up to 24 hours consecutively. When the Green button is pressed during recording, an index can be added to the current sound file.



5 Press the shutter release button fully.

Recording stops.





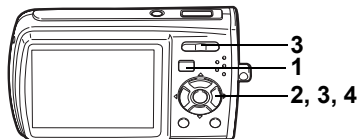

- If you press and hold down the shutter release button for more than one second in Step 4, recording continues until you take your finger off the button.
- Sound is saved in WAVE monaural files.

Playing Back Sound

You can play back the sound files you made in  mode.







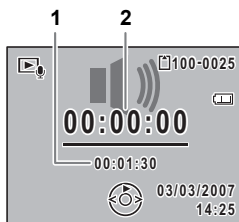

- 1** Press the  button.
- 2** Use the four-way controller ( ) to choose a sound file to play back.
- 3** Press the four-way controller () .

The sound file is played back.



- 1 Total file recording time
- 2 Playback time





The following operations can be performed during playback.

- Four-way controller () Pauses playback
- Zoom//  button () Increases the volume
- Zoom//  button () Reduces the volume



If there are no recorded indexes:

- Four-way controller () Reverses playback
- Four-way controller () Fast forwards playback

If there are recorded indexes:

- Four-way controller () Plays back starting from the previous index
- Four-way controller () Plays back starting from the next index

The following operations can be performed while playback is paused.

- Four-way controller () Resumes playback
- Four-way controller () Rewinds approx. 5 seconds
- Four-way controller () Advances approx. 5 seconds

- 4** Press the four-way controller () .

Playback stops.





If an SD Memory Card is inserted and you press and hold the  button for more than one second in step 1, sound recorded in the built-in memory is played back. (p.105)

Adding a Voice Memo to Images

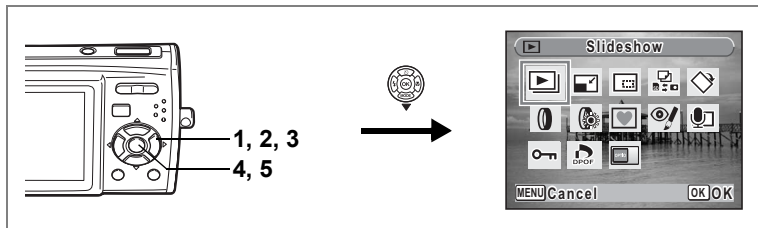
You can add a voice memo to your still pictures.







Recording a Voice Memo

1 Enter the  mode and use the four-way controller ( ) to choose the still picture to which you want to add a voice memo.

2 Press the four-way controller ().

The Playback Mode Palette appears.

3 Use the four-way controller (   ) to select  (Voice Memo).

4 Press the **OK** button.

Recording starts. You can record a voice memo until the built-in memory/SD Memory Card is full, or up to 24 hours consecutively.

5 Press the **OK** button.

Recording stops.



- A voice memo cannot be added to an image that already has a voice memo. Delete the old voice memo and record a new one. (p.117)
- A voice memo cannot be added to protected () images (p.121).

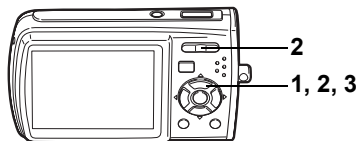

Playing Back a Voice Memo

- 1 Enter the  mode and use the four-way controller (◀▶) to choose the still picture with the voice memo that you want to play back.**

 appears on images with voice memos in single-image display.



- 2 Press the four-way controller (▲).**

Playback starts.

The following operations can be performed during playback.

Zoom/▲▲▲/▲ button (▲) Increases the volume

Zoom/▲▲▲/▲ button (▲▲▲) Reduces the volume

- 3 Press the four-way controller (▼).**

Playback stops.

Deleting a Sound File  p.117

Camera Settings

How to display the [Setting] menu



Four-way controller

OK button

MENU button

MENU

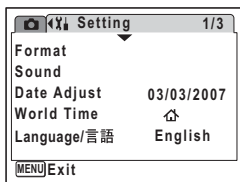

Formatting an SD Memory Card or the Built-in Memory

Formatting will delete all the data on the SD Memory Card.

All the data in the built-in memory will be deleted if no SD Memory Card is inserted in the camera.

Caution

- Do not remove the SD Memory Card during formatting as this may damage the card and render it unusable.
- Formatting will delete protected images and any data recorded on the card with a camera other than this camera.
- SD Memory Cards formatted on a PC or device other than the camera cannot be used. Be sure to format the card with the camera.

8

Settings

1 Use the four-way controller (▲▼) to select [Format] on the [Setting] menu.

2 Press the four-way controller (▶).

The Format screen appears.

3 Use the four-way controller (▲▼) to select [Format].

4 Press the OK button.

Formatting starts. When formatting is completed, the camera returns to Capture mode or Playback mode.

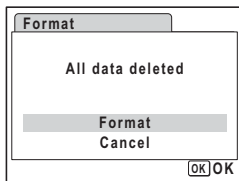

How to display the [MENU Setting] menu

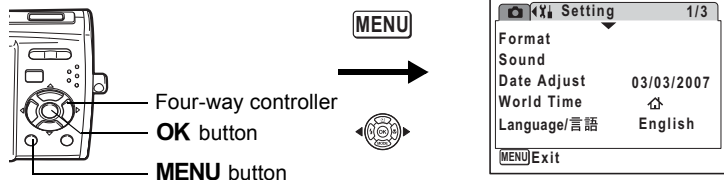

Changing the Sound Settings

You can adjust the volume of operation sounds and change the type of sound.

- 1 Use the four-way controller (▲▼) to select [Sound] on the [MENU Setting] menu.**
- 2 Press the four-way controller (▶).**
The Sound screen appears.

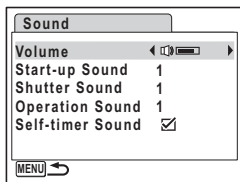

Changing the Operation Volume

- 3 Use the four-way controller (▲▼) to select [Volume].**
- 4 Use the four-way controller (◀▶) to adjust the volume.**
The selected volume is saved.
Set the volume to 0 to mute the start-up sound, shutter sound, operation sound, and self-timer sound.

Changing the Sound Type

- 5 Use the four-way controller (▲▼) to select [Start-up Sound].**
- 6 Press the four-way controller (▶).**
A pull-down menu appears.

- 7 Use the four-way controller (▲ ▼) to select [1], [2], [3] or [Off] and press OK button.**

The selected sound type is saved.

- 8 Set [Shutter Sound] and [Operation Sound] in the same way as in Steps 5 to 7.**

Use the four-way controller (◀ ▶) to select (On) or (Off) for the self-timer sound.

- 9 Press the MENU button.**

The screen returns to the [⏏ Setting] menu with the changed setting.

How to display the [Setting] menu

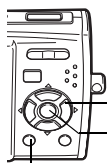

Four-way controller

OK button

MENU button

MENU

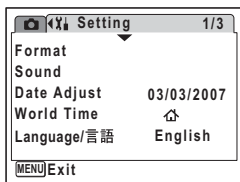

Changing the Date and Time

You can change the initial date and time settings. You can also set the style in which the date appears on the camera.

- 1 Use the four-way controller (▲▼) to select [Date Adjust] on the [Setting] menu.**
- 2 Press the four-way controller (▶).**
The Date Adjust screen appears.

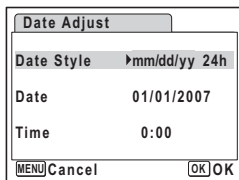

- 3 Press the four-way controller (▶).**
The frame moves to [mm/dd/yy].
Depending on the initial setting or previous setting, [dd/mm/yy] or [yy/mm/dd] may be displayed.

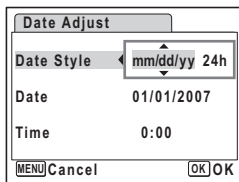

- 4 Use the four-way controller (▲▼) to choose the date display style.**
Choose [mm/dd/yy], [dd/mm/yy] or [yy/mm/dd].
- 5 Press the four-way controller (▶).**
The frame moves to [24h].
- 6 Use the four-way controller (▲▼) to select [24h] (24-hour display) or [12h] (12-hour display).**

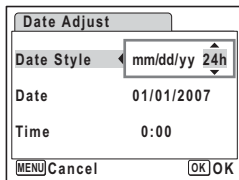

7 Press the four-way controller (▶).

The frame returns to [Date Style].

8 Press the four-way controller (▼).

The frame moves to [Date].

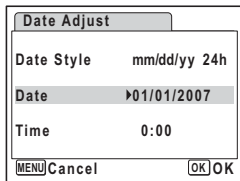

9 Press the four-way controller (▶).

The frame moves to one of the following items depending on the date style set in Step 4.

For [mm/dd/yy] month (Example: [01])

For [dd/mm/yy] day (Example: [01])

For [yy/mm/dd] year (Example: [2007])

The following operations and screens use [mm/dd/yy] as an example. The operations are the same even if another date style has been selected.

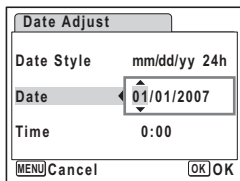

10 Use the four-way controller (▲ ▼) to change the month.

11 Press the four-way controller (▶).

The frame moves to the day field. Use the four-way controller (▲ ▼) to change the day. After changing the day, change the year in the same manner.

8

12 Change the time in the same way as in Steps 7 to 10.

If you selected [12h] in Step 6, the setting switches between am and pm corresponding to the time.

13 Press the OK button.

The date and time settings are saved.



When you finish the settings and press the **OK** button, the camera clock is reset to 00 seconds. To set the exact time, press the **OK** button when the time signal (on the TV, radio, etc.) reaches 00 seconds.

How to display the [X Setting] menu

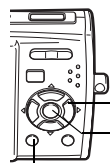



Four-way controller
OK button
MENU button

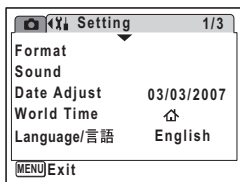











MENU



Setting the World Time

The date and time selected in “Setting the Date and Time” (p.36) and “Changing the Date and Time” (p.149) serve as the  (Hometown) date and time. By using the world time function, you can display the time in a city other than the Hometown ( Destination). This is useful when taking pictures in a different time zone.

Setting the Destination

- 1 Use the four-way controller ( ) to select [World Time] on the [X Setting] menu.**
- 2 Press the four-way controller ().**
The World Time screen appears.
- 3 Use the four-way controller ( ) to select  (Destination).**
- 4 Press the four-way controller ().**
The Destination screen appears. The city that is currently selected blinks on the map.
- 5 Use the four-way controller ( ) to change the Destination city.**
The current time, location and time difference of the selected city appear.
- 6 Use the four-way controller ( ) to select [DST] (Daylight Saving Time).**
- 7 Use the four-way controller ( ) to select (On) or (Off).**
Select (On) if the Destination city uses daylight saving time.

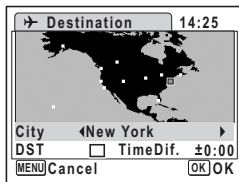
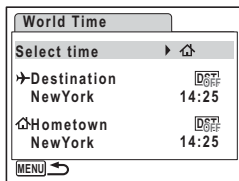

8 Press the OK button.

The World Time setting is saved.

9 Press the MENU button twice.

The camera returns to capture status with the current setting.



Select (Hometown) in Step 3 of p.151 to set the city and DST setting for the Hometown city.

Displaying the Time of the Destination on the LCD Monitor (Select Time)

1 Use the four-way controller (▲ ▼) to select [World Time] on the [X↓ Setting] menu.

2 Press the four-way controller (▶).

The World Time screen appears.

3 Use the four-way controller (▲ ▼) to select [Select time].



4 Press the four-way controller (▶).

A pull-down menu appears.

5 Use the four-way controller (▲ ▼) to select (Destination) or (Hometown).

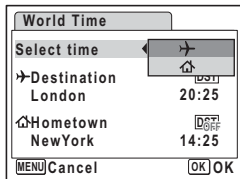

: Displays the time in the city selected as the Destination city

: Displays the time in the city selected as the Hometown city

6 Press the OK button.

The Select time setting is saved.

7 Press the MENU button twice.

The camera returns to mode or mode.

(Destination) appears on the LCD monitor when the camera returns to mode and World Time is selected.



How to display the [MENU Setting] menu

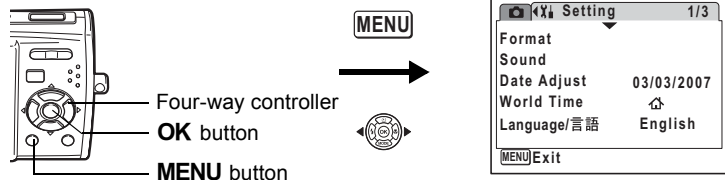

Changing the Display Language

You can change the language in which the menus, error messages, etc. are displayed.

You can choose from English, French, German, Spanish, Portuguese, Italian, Dutch, Danish, Swedish, Finnish, Polish, Czech, Hungarian, Turkish, Russian, Thai, Korean, Chinese (traditional and simplified) and Japanese.

- 1 Use the four-way controller (▲▼) to select [Language/言語] on the [MENU Setting] menu.**
- 2 Press the four-way controller (▶).**
The Language/言語 screen appears.
- 3 Use the four-way controller (▲▼◀▶) to select the language.**
- 4 Press the OK button.**
The selected language is set to be displayed.



How to display the [MENU Setting] menu

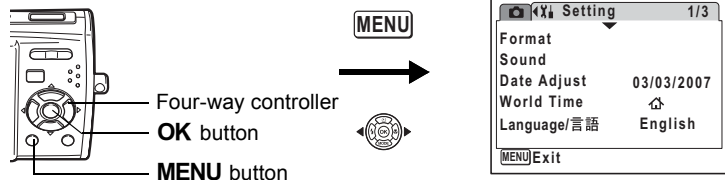

Changing the Image Folder Name

You can change the image folder name from the standard name to the date that pictures were taken. When the name is changed to the date, pictures are saved in separate folders by the date they were taken.

Folder Name

Standard	XXXPENTX (where XXX is the 3-digit folder number)
Date	XXX_mmdd (3-digit folder number_month day) * xxx_ddmm (3-digit folder number_day month) when the date style is set to [dd/mm/yy].

Picture taken with standard folder name
(Example: March 25)

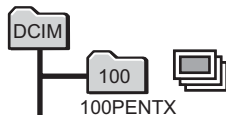

Folder name changed to date setting
(Example: March 25)

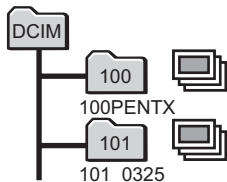

Next time a picture is taken
(Example: April 1)

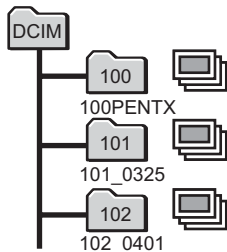

- 1 Use the four-way controller (▲▼) to select [Folder Name] on the [MENU Setting] menu.**
- 2 Press the four-way controller (▶).**
A pull-down menu appears.
- 3 Use the four-way controller (▲▼) to select [Standard] or [Date].**
- 4 Press the OK button.**
The Folder Name setting is saved.

How to display the [X Setting] menu

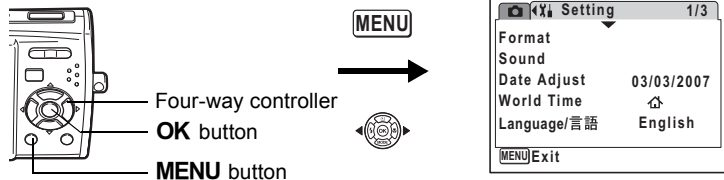

Changing the USB Connection Mode

Choose the appropriate USB connection mode depending on whether you are going to connect the USB cable to a PC or a PictBridge-compatible printer.



Refer to the PC Connection Manual for instructions on connecting the camera to a computer.

- 1 Use the four-way controller (▲▼) to select [USB Connection] on the [X Setting] menu.**
- 2 Press the four-way controller (▶).**
A pull-down menu appears.
- 3 Use the four-way controller (▲▼) to select [PC] or [PictBridge].**

[PC] : Select this option when transferring image data to a computer

[PictBridge] : Select this option when connecting the camera to a PictBridge-compatible printer

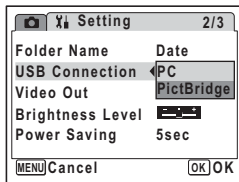

- 4 Press the OK button.**

The USB Connection setting is saved.



Do not connect the camera to your PC while [PictBridge] is selected for the USB Connection mode. And do not connect the camera to your printer while [PC] is selected.

How to display the [Setting] menu

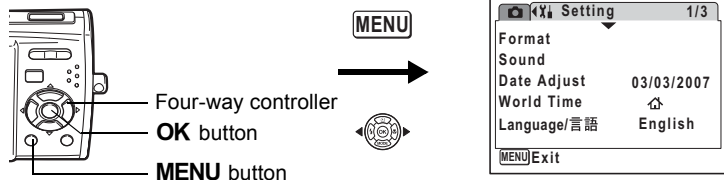

Changing the Video Output Format

When you connect the camera to AV equipment, choose the appropriate video output format (NTSC or PAL) for taking and playing back images.

1 Use the four-way controller (▲▼) to select [Video Out] on the [Setting] menu.

2 Press the four-way controller (▶).

A pull-down menu appears.

3 Use the four-way controller (▲▼) to select [NTSC] or [PAL].

Choose the video output format to match the output format of the AV equipment.

4 Press the OK button.

The Video Out setting is saved.

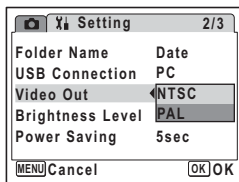

8

Settings



Depending on the country or region, images and sound files may fail to be played back if the video output format is set different from the one in use there. If this happens, change the video output format setting.

Connecting the Camera to AV Equipment p.115

List of World Time Cities p.163

How to display the [Setting] menu

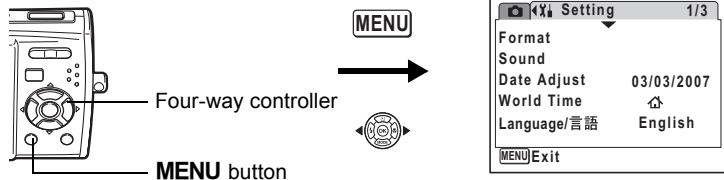

Adjusting the Brightness of the LCD Monitor

You can adjust the brightness of the LCD monitor.

- 1 Use the four-way controller (▲▼) to select [Brightness Level] on the [Setting] menu.
- 2 Use the four-way controller (◀▶) to adjust the brightness.

The following setting is saved.

- — + (Dark)
- — + (Normal)
- — + (Bright)

- 3 Press the **MENU** button.

The camera returns to Capture mode or Playback mode.

The LCD monitor is displayed with the set brightness. To change the brightness setting, perform the above steps again.

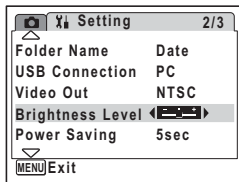

How to display the [X Setting] menu

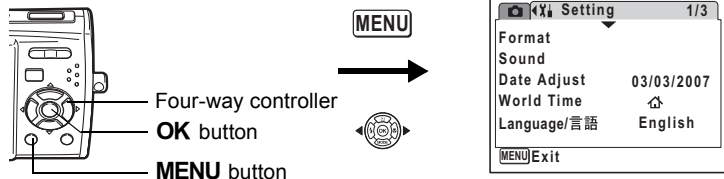

Using the Power Saving Function

You can save battery power by setting the LCD monitor to turn off automatically when no operation is performed for a fixed time. After the power saving function has been activated, you can turn the LCD monitor on again by pressing any of the buttons.

- 1 Use the four-way controller (▲▼) to select [Power Saving] on the [X Setting] menu.**
- 2 Press the four-way controller (▶).**
A pull-down menu appears.
- 3 Use the four-way controller (▲▼) to select [2min], [1min], [30sec], [15sec], [5sec] or [Off].**
- 4 Press the OK button.**

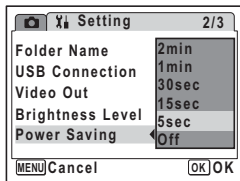

The Power Saving setting is saved.

8



Power Saving does not function in the following situations:

- in Playback mode
- while the camera is connected to a PC or printer
- when using the AC adapter
- while recording a movie
- while the menu is being displayed

How to display the [X Setting] menu

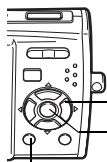

Four-way controller

OK button

MENU button

MENU

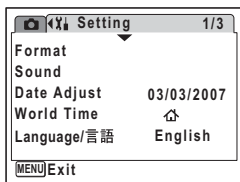

Setting Auto Power Off

You can set the camera to turn off automatically when no operation is performed for a fixed time.

- 1 Use the four-way controller (▲▼) to select [Auto Power Off] on the [X Setting] menu.**
- 2 Press the four-way controller (▶).**
A pull-down menu appears.
- 3 Use the four-way controller (▲▼) to select [5min], [3min] or [Off].**
- 4 Press the OK button.**
The Auto Power Off setting is saved.

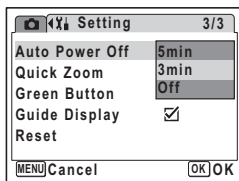

Auto Power Off does not function in the following situations:

- during a slideshow and movie or sound playback
- while the camera is connected to a PC or printer

How to display the [X Setting] menu

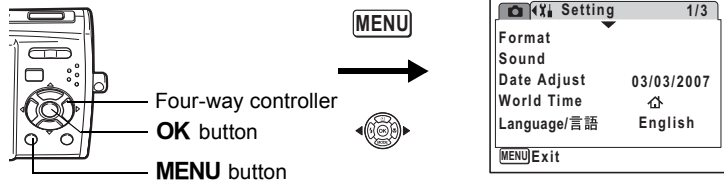

Setting the Guide Display

You can set to display or hide guides when the mode is selected in Capture Mode Palette (p.51) and Playback Mode Palette (p.57).

- 1 Use the four-way controller (▲▼) to select [Guide Display] on the [X Setting] menu.**
- 2 Use the four-way controller (◀▶) to select (On) or (Off).**

The following setting is saved.

On : Display

Off : Hide

- 3 Press the MENU button.**

The camera returns to Capture mode or Playback mode.

To change the setting, perform the above steps again.

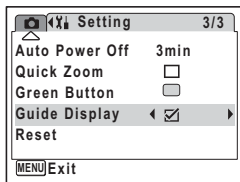

How to display the [Setting] menu

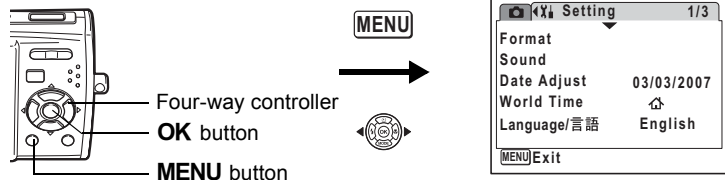

Resetting to Default Settings (Reset)

You can reset the camera settings to their defaults. Refer to “Default Settings” (p.165) for the reset settings.

- 1 Use the four-way controller (▲▼) to select [Reset] on the [Setting] menu.**
- 2 Press the four-way controller (▶).**
The Reset screen appears.
- 3 Use the four-way controller (▲▼) to select [Reset].**
- 4 Press the OK button.**
The settings return to the defaults.

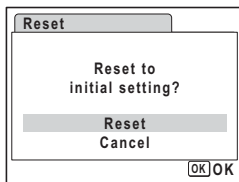





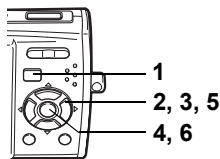





The following settings are not affected by resetting:
Date Adjust, Language/言語 and Video Out.

How to display the Playback Mode Palette



Changing the Start-up Screen

You can choose an image to be displayed as the start-up screen when the camera is turned on.

- 1 Press the  button.**
The camera enters  mode.
- 2 Press the four-way controller ()**.
The Playback Mode Palette appears.
- 3 Use the four-way controller (   ) to select .**
(Start-up Screen).
- 4 Press the OK button.**
The image selection screen appears.
- 5 Use the four-way controller ( ) to choose an image for the start-up screen.**
- 6 Press the OK button.**
The Start-up Screen setting is saved.



- Once the start-up screen has been set, it will not be deleted even if the original image is deleted or the SD Memory Card or built-in memory is formatted.
- Select [Off] to hide the start-up screen.

List of World Time Cities

The following are cities that can be set for [Hometown] and [Destination] in World Time.

Region	City	Video output	Region	City	Video output
North America	Honolulu	NTSC	Africa/ West Asia	Dakar	PAL
	Anchorage	NTSC		Algiers	PAL
	Vancouver	NTSC		Johannesburg	PAL
	San Francisco	NTSC		Istanbul	PAL
	Los Angeles	NTSC		Cairo	PAL
	Calgary	NTSC		Jerusalem	PAL
	Denver	NTSC		Nairobi	PAL
	Chicago	NTSC		Jeddah	PAL
	Miami	NTSC		Tehran	PAL
	Toronto	NTSC		Dubai	PAL
	New York	NTSC		Karachi	PAL
	Halifax	NTSC		Kabul	PAL
Central and South America	Mexico City	NTSC		Male	PAL
	Lima	NTSC	Delhi	PAL	
	Santiago	NTSC	Colombo	PAL	
	Caracas	NTSC	Kathmandu	PAL	
	Buenos Aires	PAL	Dacca	PAL	
	Sao Paulo	PAL	East Asia	Yangon	NTSC
Rio de Janeiro	PAL	Bangkok		PAL	
Europe	Lisbon	PAL		Kuala Lumpur	PAL
	Madrid	PAL		Vientiane	PAL
	London	PAL		Singapore	PAL
	Paris	PAL		Phnom Penh	PAL
	Amsterdam	PAL		Ho Chi Minh	PAL
	Milan	PAL		Jakarta	PAL
	Rome	PAL		Hong Kong	PAL
	Copenhagen	PAL		Beijing	PAL
	Berlin	PAL		Shanghai	PAL
	Prague	PAL		Manila	NTSC
	Stockholm	PAL		Taipei	NTSC
	Budapest	PAL	Seoul	NTSC	
	Warsaw	PAL	Tokyo	NTSC	
	Athens	PAL	Guam	NTSC	
	Helsinki	PAL			
Moscow	PAL				

Region	City	Video output
Oceania	Perth	PAL
	Adelaide	PAL
	Sydney	PAL
	Noumea	PAL
	Wellington	PAL
	Auckland	PAL
	Pago Pago	NTSC



- The video output mode shown in the Video output column in the table on the left is selected when Hometown is selected in Initial Setting (p.33).
- Change the video output mode manually when Hometown in [World Time] of the [X↓ Settings] is changed.

Default Settings

The table below lists the factory default settings.

The meaning of the indications for menu items with a default setting is explained below.

Last Memory Setting

Yes : The current setting (last memory) is saved when the camera is turned off.

No : The setting returns to the default setting when the camera is turned off.

* : The setting depends on the [Memory] setting (p.95).

Reset Setting

Yes : The setting returns to the default setting with the Reset function (p.161).

No : The setting is saved even after reset.

● [📷 Rec. Mode] Menu Items

Item		Default Setting	Last Memory Setting	Reset Setting	Page
Recorded Pixels		[7M] (3072×2304)	Yes	Yes	p.82
Quality Level		★★ (Better)	Yes	Yes	p.84
White Balance		AWB (Auto)	*	Yes	p.86
Focusing Area		[] (Multiple)	Yes	Yes	p.88
Sensitivity		Auto	*	Yes	p.89
EV Compensation		±0.0	*	Yes	p.75
Movie	Recorded Pixels	[640] (640×480)	Yes	Yes	p.99
	Quality Level	★★★ (Best)	Yes	Yes	p.101
	Frame Rate	30fps	Yes	Yes	p.102
	Color Mode	Full Color	Yes	Yes	p.103
	Movie SR	On	Yes	Yes	p.104
Digital Zoom		On	*	Yes	p.74
Instant Review		1 sec	Yes	Yes	p.91
Memory	Flash Mode	On	—	Yes	p.80
	Drive Mode	Off	—	Yes	p.71, p.72
	Focus Mode	Off	—	Yes	p.78
	Zoom Position	Off	—	Yes	p.73

Item		Default Setting	Last Memory Setting	Reset Setting	Page
Memory	MF Position	Off	—	Yes	p.79
	White Balance	Off	—	Yes	p.86
	Sensitivity	Off	—	Yes	p.89
	EV Compensation	Off	—	Yes	p.75
	Digital Zoom	On	—	Yes	p.74
	DISPLAY	Off	—	Yes	p.76, p.111
	File No.	On	—	Yes	—
Sharpness		Normal	Yes	Yes	p.92
Saturation		Normal	Yes	Yes	p.93
Contrast		Normal	Yes	Yes	p.94

● [M Setting] Menu Items















Item		Default Setting	Last Memory Setting	Reset Setting	Page
Sound	Volume	3	Yes	Yes	p.147
	Start-up Sound	1	Yes	Yes	
	Shutter Sound	1	Yes	Yes	
	Operation Sound	1	Yes	Yes	
	Self-timer Sound	On	Yes	Yes	
Date Adjust	Date Style (date)	According to initial setting	Yes	No	p.36
	Date Style (time)	According to initial setting	Yes	No	
	Date	According to initial setting	Yes	No	
	Time	According to initial setting	Yes	No	
World Time	World Time Setting	Hometown	Yes	Yes	p.151
	Destination (City)	Same as Hometown	Yes	No	
	Destination (DST)	Same as Hometown	Yes	No	
	Hometown (City)	According to initial setting	Yes	No	
	Hometown (DST)	According to initial setting	Yes	No	
Language/言語		According to initial setting	Yes	No	p.33
Folder Name		Date	Yes	Yes	p.154
USB Connection		PC	Yes	Yes	p.155
Video Out		According to initial setting	Yes	No	p.156
Brightness Level		Standard	Yes	Yes	p.157
Power Saving		5 sec	Yes	Yes	p.158

Item	Default Setting	Last Memory Setting	Reset Setting	Page
Auto Power Off	3 min	Yes	Yes	p.159
Quick Zoom	Off	Yes	Yes	p.110
Green Button	Green Mode	Yes	Yes	p.55
Guide Display	On	Yes	Yes	p.160

● Playback Mode Palette Items

Item	Default Setting	Last Memory Setting	Reset Setting	Page
Slideshow	Interval	3 sec	Yes	p.112
	Screen Effect	Wipe	Yes	
	Sound Effect	On	Yes	
Start-up Screen	Optio Logo screen 1	Yes	Yes	p.162

● Key Operation

Item	Function	Default Setting	Last Memory Setting	Reset Setting	Page	
 button	Operation Mode	 mode	—	—	—	
Zoom/    button	Zoom Position	Wide	*	Yes	p.73	
Four-way controller		Drive Mode	 (Normal)	*	Yes	p.71, p.72
		Shooting Mode	 (Auto Picture)	Yes	Yes	p.51
		Flash Mode	 (Auto)	*	Yes	p.80
		Focus Mode	AF (Standard)	*	Yes	p.78
MENU button	Menu Display	Capture mode: [ Rec. Mode] menu Playback mode: [ Setting] menu	—	—	p.46	
OK/DISPLAY button	Information Display	Normal	*	Yes	p.76, p.111	

Functions Available for Each Shooting Mode

Yes: Can be set and function is available.

- : Fixed setting. Cannot be changed.

: Can be set but function is not available.

No : Cannot be set.

(Auto)	Yes	Yes	Yes	No	No	No	Yes	Yes	Yes	Yes	Yes
(Flash Off)	Yes	Yes	Yes	Yes	-	No	Yes	Yes	Yes	Yes	Yes
(Flash On)	No	Yes	Yes	Yes	No	No	Yes	Yes	Yes	Yes	Yes
(Auto + Red-eye)	No	Yes	Yes	No	No	No	Yes	Yes	Yes	Yes	Yes
(Flash On + Red-eye)	No	Yes	Yes	Yes	No	No	Yes	Yes	Yes	Yes	Yes
(Soft Flash)	No	Yes	Yes	Yes	No	No	Yes	Yes	Yes	Yes	Yes
(Self-timer)	Yes ¹	Yes	Yes	Yes	Yes	No	Yes	Yes	Yes	Yes	Yes
(2 sec. Self-timer)	Yes ¹	Yes	Yes	Yes	Yes	No	Yes	Yes	Yes	Yes	Yes
(Continuous Shooting)	No	No	Yes	No	No	No	Yes	No	Yes	No	Yes
AF (Standard)	Yes	Yes	Yes	Yes	Yes	No	Yes	Yes	Yes	Yes	Yes
(Macro)	Yes	Yes	Yes	Yes	Yes	No	Yes	Yes	Yes	Yes	Yes
(Super Macro)	Yes	Yes	Yes	Yes	Yes	No	Yes	Yes	Yes	No	Yes
(Infinity)	No	Yes	Yes	Yes	Yes	No	Yes	Yes	Yes	Yes	Yes
PF (Pan Focus)	Yes	Yes	Yes	Yes	Yes	No	Yes	Yes	Yes	Yes	Yes
MF (Manual Focus)	No	Yes	Yes	Yes	Yes	No	Yes	Yes	Yes	Yes	Yes
Recorded Pixels	-	Yes	Yes	Yes	Yes ²	#	Yes	-	Yes	Yes	Yes
Quality Level	-	Yes	Yes	Yes	Yes ²	#	Yes	-	Yes	Yes	Yes
White Balance	-	-	Yes	Yes	Yes	#	Yes	Yes	-	-	-
Focusing Area	-	-	Yes	Yes	Yes ³	#	Yes	Yes ³	Yes	- ⁶	Yes
Sensitivity	-	Yes	Yes	Yes	-	#	- ⁵	Yes	Yes	Yes	Yes
EV Compensation	No	No	Yes	Yes	Yes ⁴	#	Yes	Yes	Yes	Yes	Yes
Movie	No	#	#	#	Yes	#	#	#	#	#	#
Digital Zoom	-	Yes	Yes	Yes	Yes	#	Yes	Yes	Yes	No	Yes
Instant Review	-	Yes	Yes	Yes	#	#	Yes	Yes	Yes	Yes	Yes
Memory	No	Yes	Yes	Yes	Yes	Yes	Yes	Yes	Yes	Yes	Yes
Sharpness	No	No	Yes	Yes	Yes	#	Yes	Yes	No	No	No
Saturation	No	No	Yes	Yes	Yes	#	Yes	Yes	No	No	No
Contrast	No	No	Yes	Yes	Yes	#	Yes	Yes	No	No	No

*1 The setting in a shooting mode other than Green Mode is available.

*2 Follows setting for [Movie]

*3 (Automatic Tracking AF) is not available

*4 Not available during recording

*5 Fixed at an automatic high sensitivity setting

*6 Fixed at [] (Multiple) because Face Recognition AF is set

Optional Accessories

A number of dedicated accessories are available for this camera. Products marked with an asterisk (*) are the same as those supplied with the camera.

- **Battery**

- **Rechargeable lithium-ion battery D-LI63 (*)**

- **Battery charger kit K-BC63 (*)**

- (including Battery charger D-BC63 and AC plug cord D-CO24)

- **AC adapter kit K-AC64**

- (including AC adapter D-AC64 and AC plug cord D-CO24)

The battery charger and AC adapter are only available in the set. The ending of the AC plug cord name differs depending on the country.

- **Cables**

- **USB cable I-USB7 (*)**

- **AV cable I-AVC7 (*)**

- **Strap**

- **O-ST51 (*)**

- **O-ST24** Genuine leather strap

- **O-ST8** Silver chain strap

- **O-ST30** Vinyl-coated strap

- **Camera case**

- **O-CC64**

Messages

Messages such as the following may appear on the LCD monitor during camera operation.

Battery depleted	The battery is exhausted. Charge the battery with the charger. (p.23)
Built-in memory full	The built-in memory/SD Memory Card is full and no more images can be saved.
Memory card full	Insert a new SD Memory Card or delete unwanted images. (p.25, p.116) Change the quality level or recorded pixels of recorded images and try again. (p.123)
Memory card error	Shooting and playback are impossible due to a problem with the SD Memory Card. You may be able to display or copy the images on the card using a PC.
Card not formatted	The SD Memory Card you have inserted is unformatted or has been formatted on a computer or other device and is not compatible with this camera. (p.146)
Card locked	The SD Memory Card is write-protected. (p.27)
Compression error	This message appears when compression of images has failed. Change the quality level/size and record or save again.
No image/sound	There are no image/sound files on the SD Memory Card.
Movie recording stopped	This message appears when the internal temperature of the camera has exceeded normal operating limits while recording a movie.
Deleting	This message appears when deleting an image or sound file.
Camera cannot play this image and sound	You are trying to play back an image or sound in a format not supported by this camera. You may be able to play it back on another brand of camera or your computer.
Image folder could not be created	The largest file number (9999) has been assigned to an image in the largest folder number (999) and no more images can be saved. Insert a new SD Memory Card or format the card. (p.146)
Protected	The image or sound file you are trying to delete is protected.
Data being recorded	This message appears when you try to switch to  mode while an image is still being recorded, or when the protect setting or DPOF setting is being changed. It disappears after the image is recorded or the setting is changed.





Data being processed	This message appears when the camera takes more than five seconds to display an image due to image processing, or when the SD Memory Card or built-in memory is being formatted.
Green mode must be canceled to use this function.	This function is not available in Green Mode. Press the Green button to cancel Green Mode. (p.63)
No image to be processed	This message appears when no image/sound file is present.
This image/sound cannot be processed	This message appears when you attempt to edit a file that cannot be processed.
No card in the camera	This message appears when an SD Memory Card is not inserted and [Image/Sound Copy] is selected.
The card memory is not enough to copy images/sounds	This message appears when there is not enough memory to copy to the SD Memory Card/built-in memory. Insert a new SD Memory Card or delete unwanted images. (p.25, p.116)
The built-in memory is not enough to copy images/sounds	
Cannot process correctly	This message appears when Red-eye Compensation cannot be performed correctly.

Messages such as the following may appear on the LCD monitor when using the PictBridge function.

Low paper level in the printer	The paper is running low in the printer.
Low ink level in the printer	The ink is running low in the printer.
No paper in the printer	There is no paper in the printer.
No ink in the printer	There is no ink in the printer.
Printer error	An error message has been sent from the printer.
Data error	A data error message has been sent from the printer.
Paper stuck in the printer	The paper is stuck in the printer.
Connection error Check printer	PictBridge connection failed. Check the connection and try again. (p.136)
No image to be processed	This message appears when there are no images that can be printed.
Wrong DPOF setting	This message appears when DPOF printing is not available.

Troubleshooting

Problem	Cause	Remedy
Camera will not turn on	Battery is not installed	Check if the battery is installed. If not, install the battery.
	Battery is installed incorrectly	Check orientation of the battery. Reinsert the battery according to the ⊕ ⊖ symbols on the battery compartment. (p.21)
	Battery power is low	Charge the battery.
No image on LCD monitor	Camera is connected to a PC	LCD monitor is off when camera is connected to a computer.
	Camera is connected to the AV equipment	LCD monitor is off when camera is connected to the AV equipment.
	Image is displayed but is hard to see	Image on LCD monitor may be hard to see when taking pictures outside in sunlight.
Shutter will not release	Flash is charging	Pictures cannot be taken while the flash is charging. Wait until charging is finished.
	No available space on SD Memory Card or in the built-in memory	Insert SD Memory Card with available space or delete unwanted images. (p.25, p.116)
	Recording	Wait until recording is finished.
Picture is dark	Subject is too far away in a dark environment, such as a night scene	Picture becomes dark if subject is too far away. Take picture within range of flash.

Problem	Cause	Remedy
Subject is not in focus	Subject is difficult to focus on with autofocus	Lock focus on another object located at same distance (press shutter release button halfway), then aim at target and press shutter release button fully (p.39), or use Manual Focus mode. (p.79)
	Subject is not in focusing area	Position subject in focus frame in middle of LCD monitor. If the subject is outside the focusing area, aim the camera at the subject and lock the focus (press shutter release button halfway), then compose picture and press the shutter release button fully.
Flash does not discharge	Flash mode is set to  (Flash Off)	Set to Auto or  (Flash On). (p.80)
	Drive mode is set to  Focus mode is set to  Shooting mode is set to 	Flash will not discharge in these modes.
USB connection with computer does not work properly	USB connection mode is set to [PictBridge]	Change the USB connection mode to [PC]. (p.155)
USB connection with printer does not work properly	USB connection mode is set to [PC]	Change the USB connection mode to [PictBridge]. (p.136)

Static electricity may occasionally prevent the camera from operating correctly. If this should occur, try removing and then reloading the battery. If the camera turns on and operates properly, this indicates that there is no malfunction. You can use the camera as usual.

Main Specifications

Type	Fully automatic compact digital still camera with built-in zoom lens	
Effective Pixels	7.1 megapixels	
Sensor	7.38 megapixels (total pixels) 1/2.5 inch interline transfer CCD with a primary color filter	
Recorded Pixels	Still Picture	7M (3072×2304 pixels), 5M (2592×1944 pixels) 4M (2304×1728 pixels), 3M (2048×1536 pixels) 2M (1600×1200 pixels), 1024 (1024×768 pixels) 640 (640×480 pixels) * Fixed at 3M (2048×1536) for Frame Composite
	Movie	640 (640×480 pixels), 320 (320×240 pixels)
Sensitivity	Auto, manual (ISO 64/100/200/400/800/1600/3200) * Automatically adjusted between ISO 64 - 400 in ISO Auto. * When Digital SR (blur reduction) mode is selected, automatically adjusted until ISO 3200 for ISO Auto.	
File Format	Still Picture	JPEG (Exif 2.2), DCF, DPOF, PictBridge, PRINT Image Matching III
	Movie	MOV (QuickTime Motion JPEG), streaming video, approx. 30fps/15fps, PCM system with monaural sound, full color/sepia/black and white, Movie anti-shake function
	Sound	Voice memo, voice recording: WAVE (PCM) system, monaural
Quality Level	Still Picture	★★★ "Best", ★★ "Better", ★ "Good"
	Movie	★★★ "Best", ★★ "Better", ★ "Good"
Storage Medium	Built-in memory (approx. 21.9 MB), SD Memory Card, SDHC Memory Card	



Approximate Image Storage Capacity and Recording Time

Still Picture

	★★★ (Best)		★★ (Better)		★ (Good)	
	Built-in Memory	128MB	Built-in Memory	128MB	Built-in Memory	128MB
7M 3072×2304	6 pictures	35 pictures	12 pictures	69 pictures	18 pictures	103 pictures
5M 2592×1944	7 pictures	44 pictures	15 pictures	88 pictures	24 pictures	137 pictures
4M 2304×1728	11 pictures	62 pictures	22 pictures	124 pictures	31 pictures	177 pictures
3M 2048×1536	13 pictures	77 pictures	27 pictures	153 pictures	40 pictures	223 pictures
2M 1600×1200	22 pictures	124 pictures	36 pictures	206 pictures	54 pictures	301 pictures
1024 1024× 768	43 pictures	244 pictures	73 pictures	412 pictures	93 pictures	522 pictures
640 640× 480	87 pictures	489 pictures	127 pictures	711 pictures	175 pictures	978 pictures

The image storage capacity is for reference only. The actual image storage capacity may vary depending on the SD memory card and the subject.

Movie/Sound

		30fps		15fps		Sound	
		Built-in Memory	128MB	Built-in Memory	128MB	Built-in Memory	128MB
 640×480	★★★	20 sec.	1 min. 56 sec.	41 sec.	3 min. 50 sec.	17 min. 22 sec.	1 hr. 36 min. 57 sec.
	★★	28 sec.	2 min. 36 sec.	53 sec.	5 min. 1 sec.		
	★	42 sec.	3 min. 57 sec.	1 min. 22 sec.	7 min. 40 sec.		
 320×240	★★★	33 sec.	3 min. 6 sec.	1 min. 3 sec.	5 min. 55 sec.		
	★★	45 sec.	4 min. 12 sec.	1 min. 27 sec.	8 min. 9 sec.		
	★	1 min. 3 sec.	5 min. 55 sec.	2 min. 7 sec.	11 min. 51 sec.		

The recording time is for reference only. The actual recording time may vary depending on the SD memory card and the subject.

White Balance	Auto, Daylight, Shade, Tungsten Light, Fluorescent Light, Manual	
Lens	Focal Length	6.3 mm - 18.9 mm (equivalent to 38 mm - 114 mm in 35 mm format)
	Aperture	f/3.1 - f/5.9
	Lens Composition	6 elements in 5 groups (four aspherical elements)
	Zoom Type	Electrically driven
	Picture Range	Approx. 44 mm × 33 mm (screen is filled) (Super Macro mode)
	Lens Cover	Electrically driven
Digital Zoom	Capture Mode	Max. 4× (combines with 3× optical zoom to give zoom magnification equivalent to 12×)
LCD Monitor	2.5-inch TFT color LCD monitor (with backlight) with brightness adjustment function, approx. 115,000 pixels	
Playback Functions	Single-frame, 9-frame index, enlargement (max. 8×, scroll), folder display, calendar display, rotating, sound playback, voice memo playback, slideshow, movie playback, histogram display, bright/dark portion display, Select & Delete, image/sound copying, digital filter (B&W, Sepia, Red, Pink, Purple, Blue, Green, Yellow, Color extract (B&W with Red, B&W with Green, B&W with Blue), Soft), brightness filter, cropping, resizing, framing, red-eye compensation, protect, DPOF	

Focus Modes	Autofocus, Macro, Super Macro, Infinity, Pan Focus, Manual Focus	
	Type	TTL contrast detection system by sensor 9-point autofocus (multiple/spot/automatic tracking AF changeable)
Focus Range (from lens front)	Normal	: Approx. 0.4 m - ∞ (full zoom range; 0.6 m to ∞ during tele)
	Macro	: Approx. 0.1 m - 1.0 m (Wide)
	Super Macro	: Approx. 0.05 m - 0.4 m
	Landscape	: ∞ (full zoom range)
	Pan focus	: (Still Picture) Approx. 1.4 m - ∞ (Wide), approx. 5.8 m - ∞ (Tele) (Movie) Approx. 0.5 m - ∞ (Wide), approx. 2.0 m - ∞ (Tele)
	Manual focus:	Approx. 0.1 m - ∞ (Wide), approx. 0.6 m - ∞ (Tele)
	* Face Recognition AF is available only when [Portrait] is selected in picture mode.	
	Focus Lock	By half-pressing shutter release button
Exposure Mechanism	AE metering	TTL metering by sensor (multi-segment metering)
	EV Compensation	±2 EV (can be set in 1/3 EV steps)
Shooting Modes	Green, Auto Picture, Program, Night Scene, Movie, Voice Recording, Landscape, Flower, Portrait, Surf & Snow, Sport, Digital SR (Blur reduction), Kids, Pet, Food, Frame Composite	
Movie	Continuous Recording Time	Approx. 1 second - until built-in memory or SD Memory Card is full (or up to 4 GB)
Digital Filter	B&W, Sepia, Red, Pink, Purple, Blue, Green, Yellow, Color extract (B&W with Red, B&W with Green, B&W with Blue), Soft, Brightness	
Shutter	Type	Electronic/mechanical shutter
	Speed	Approx. 1/2000 sec. - 4 sec.
Flash	Type	Auto flash with red-eye reduction function
	Flash Modes	Auto (at low illumination), Flash Off, Flash On, Auto + Red-eye, Flash On + Red-eye (Slow synchronization is possible only in Night Scene mode)
	Effective Range	Wide: Approx. 0.4 m to 5.5 m (in ISO Auto condition), approx. 0.4 m to 15.5 m (in Digital SR mode) Tele : Approx. 0.6 m to 2.8 m (in ISO Auto condition), approx. 0.6 m to 8.1 m (in Digital SR mode)

Drive Modes	Single-frame, Self-timer (approx. 10 sec., approx. 2 sec.), Continuous	
Self-timer	Electronic control type, control time: Approx. 10 sec., 2 sec.	
Power Supply	Rechargeable lithium-ion battery D-LI63, AC adapter kit (optional)	
Battery Life	Number of Recordable Images 230 pictures	* Recording capacity shows approximate number of shots recorded during CIPA-compliant testing. Actual performance may vary according to operating conditions. (with LCD monitor on, flash used for 50% of the shots, and 23 centigrade)
	Playback Time 330 min.	* According to the result of in-house testing.
	Movie Recording Time 80 min.	
	Sound Recording Time 250 min.	
Maximum charging time	Approx. 120 min.	
In/Out Port	PC/AV terminal, DC input terminal	
Video Output Format	NTSC/PAL (monaural)	
PictBridge	Printer	PictBridge-compatible printer
	Print Modes	Print One, Print All, DPOF AUTOPRINT
	Paper Size	Card, L, 2L, Postcard, 100 mm×150 mm, 4"×6", 8"×10", Letter, 11"×17", A4, A3, printer setting
	Paper Type	★★★, ★★, ★, printer setting
	Quality	★★★, ★★, ★, printer setting
	Border Status	With/without, printer setting
Size	97 (W) × 57 (H) × 18 (D) mm (excluding operating or protruding parts)	
Weight	120 g (excluding the battery and SD Memory Card)	
Weight When Shooting	135 g (including the battery and SD Memory Card)	
Accessories	Exclusive battery, battery charger, AC cord, USB cable, AV cable, software (CD-ROM), strap, operating manual, Quick Guide	

WARRANTY POLICY

All PENTAX cameras purchased through authorized bona fide photographic distribution channels are guaranteed against defects of material or workmanship for a period of twelve months from date of purchase. Service will be rendered, and defective parts will be replaced without cost to you within that period, provided the equipment does not show evidence of impact, sand or liquid damage, mishandling, tampering, battery or chemical corrosion, operation contrary to operating instructions, or modification by an unauthorized repair shop. The manufacturer or its authorized representatives shall not be liable for any repair or alterations except those made with its written consent and shall not be liable for damages from delay or loss of use or from other indirect or consequential damages of any kind, whether caused by defective material or workmanship or otherwise; and it is expressly agreed that the liability of the manufacturer or its representatives under all guarantees or warranties, whether expressed or implied, is strictly limited to the replacement of parts as hereinbefore provided. No refunds will be made on repairs by non-authorized PENTAX service facilities.

Procedure During 12-month Warranty Period

Any PENTAX which proves defective during the 12-month warranty period should be returned to the dealer from whom you purchased the equipment or to the manufacturer. If there is no representative of the manufacturer in your country, send the equipment to the manufacturer, with postage prepaid. In this case, it will take a considerable length of time before the equipment can be returned to you owing to the complicated customs procedures required. If the equipment is covered by warranty, repairs will be made and parts replaced free of charge, and the equipment will be returned to you upon completion of servicing. If the equipment is not covered by warranty, regular charges of the manufacturer or of its representatives will apply. Shipping charges are to be borne by the owner. If your PENTAX was purchased outside of the country where you wish to have it serviced during the warranty period, regular handling and servicing fees may be charged by the manufacturer's representatives in that country. Notwithstanding this, your PENTAX returned to the manufacturer will be serviced free of charge according to this procedure and warranty policy. In any case, however, shipping charges and customs clearance fees to be borne by the sender. To prove the date of your purchase when required, please keep the receipt or bills covering the purchase of your equipment for at least a year. Before sending your equipment for servicing, please make sure that you are sending it to the manufacturer's authorized representatives or their approved repair shops, unless you are sending it directly to the manufacturer. Always obtain a quotation for the service charge, and only after you accept the quoted service charge, instruct the service station to proceed with the servicing.

- This warranty policy does not affect the customer's statutory rights.
- The local warranty policies available from PENTAX distributors in some countries can supersede this warranty policy. Therefore, we recommend that you review the warranty card supplied with your product at the time of purchase, or contact the PENTAX distributor in your country for more information and to receive a copy of the warranty policy.



The CE Mark is a Directive conformity mark of the European Union.

For customers in USA

STATEMENT OF FCC COMPLIANCE

This device complies with Part 15 of the FCC Rules. Operation is subject to the following two conditions: (1) This device may not cause harmful interference, and (2) this device must accept any interference received, including interference that may cause undesired operation.

Changes or modifications not approved by the party responsible for compliance could void the user's authority to operate the equipment.

This equipment has been tested and found to comply with the limits for a Class B digital device, pursuant to part 15 of the FCC Rules.

These limits are designed to provide reasonable protection against harmful interference in a residential installation. This equipment generates, uses and can radiate frequency energy and, if not installed and used in accordance with the instructions, may cause harmful interference to radio communications. However, there is no guarantee that interference will not occur in a particular installation.

If this equipment does cause harmful interference to radio or television reception, which can be determined by turning the equipment off and on, the user is encouraged to try to correct the interference by one or more of the following measures:

- Reorient or relocate the receiving antenna.
 - Increase the separation between the equipment and receiver.
 - Connect the equipment into an outlet on a circuit different from that to which the receiver is connected.
- * Consult the dealer or an experienced radio/TV technician for help.

For customers in Canada

This Class B digital apparatus complies with Canadian ICES-003.

Pour les utilisateurs au Canada

Cet appareil numérique de la classe B est conforme à la norme NMB-003 du Canada.

Declaration of Conformity
According to 47CFR, Parts 2 and 15 for
Class B Personal Computers and Peripherals

We: PENTAX Imaging Company
A Division of PENTAX of America, Inc.

Located at: 600 12th Street, Suite 300
Golden, Colorado 80401 U.S.A.
Phone: 303-799-8000 FAX: 303-790-1131

Declare under sole responsibility that the product identified herein complies with 47CFR Parts 2 and 15 of the FCC rules as a Class B digital device. Each product marketed is identical to the representative unit tested and found to be compliant with the standards. Records maintained continue to reflect the equipment being produced can be expected to be within the variation accepted, due to quantity production and testing on the statistical basis as required by 47CFR §2.909. Operation is subject to the following two conditions: (1) This device may not cause harmful interference, and (2) This device must accept any interference received, including interference that may cause undesired operation. The above named party is responsible for ensuring that the equipment complies with the standards of 47CFR §15.101 to §15.109.

Product Name: PENTAX Digital Still Camera

Model Number: Optio M30

Contact person: Customer Service Manager

Date and Place: February, 2007, Colorado

Information on disposal for users



1. In the European Union

If your product is marked with this symbol, it means that used electrical/electronic products should not be mixed with general household waste. There exists a separate collection system for these products.

Used electric/electronic equipment must be treated separately and in accordance with legislation that requires proper treatment, recovery and recycling of these products. Following the implementation by member states, private households within the EU states may return their used electrical/electronic equipments to designated collection facilities free of charge*. In some countries your local retailer may also take back your old product free of charge if you purchase a similar new one.

*Please contact your local authority for further details.

By disposing of this product correctly you will help ensure that the waste undergoes the necessary treatment, recovery and recycling and thus prevent potential negative effects on the environment and human health which could otherwise arise due to inappropriate waste handling.

2. In other countries outside the EU

If you wish to discard this product, please contact your local authorities and ask for the correct method of disposal.

For Switzerland: Used electrical/electronic equipment can be returned free of charge to the dealer, even when you don't purchase a new product. Further collection facilities are listed on the home page of www.swico.ch or www.sens.ch.

Symbols

[Rec. Mode] menu	49
mode	9, 105
button	42, 44
mode	9, 105
[Setting] menu	50
Green Mode	63
Green Button	43, 45, 55
Delete	41, 116
Tele	73
Wide	73
Magnify	109
Nine-image display	107
Self-timer	71
Auto Picture	52, 60
Program	52, 61
Night Scene	52, 65
Movie	52
Voice Recording	52, 141
Landscape	52
Flower	53
Portrait	53, 68
Surf & Snow	53
Sport	53
Digital SR (Blur reduction)	53, 62
Kids	53
Pet	54, 70
Food	54
Frame Composite	54, 66

A

AC adapter	24
Adding sound (Voice Memo)	144
Auto 	80
Auto AWB	86

Auto Power Off	159
Autofocus	88
AV equipment	115

B











B&W	103, 128
Basic mode	63
Battery	21
Battery level indicator ..	23
Bright portions	17
Brightness Filter	129
Brightness level	157
Browse Built-in Memory ...	105







C

Calling up menus	55
Camera shake	73, 76
Capture Mode Palette	51
Changing volume	143, 147
Checking the memory card	31
Color extract filter	128
Color Mode	103
Computer	155
Connecting to a printer	136
Continuous shooting 	72
Contrast	94
Copy	126
Cropping	125

D

Dark portions	17
Date and time	36, 149
Daylight 	86
Default setting	33
Delete 	41, 116
Deleting sounds	117
Digital Filter	128

Digital SR	53, 62	Memory	95
Digital Zoom	74	Movie SR	104
DPOF printing	140	N	
DPOF settings	133	Nine-image display 	107
F		NTSC	156
File No.	95	Number of pixels	82
Flash	80	Number of recordable images	29
Flash Off 	80	O	
Flash On 	80	OK/DISPLAY button	43, 45
Fluorescent Light 	86	Optional accessory	169
Focus Mode	78	P	
Focusing	78	PAL	156
Focusing Area	88	Pan Focus PF	78
Folder display	108	Photo processing lab	133
Format	146	PictBridge	136
Four-way controller	43, 45	Playback	40, 105, 114, 143, 145
Frame Composite	130	Playback Mode	32
Frame Rate	29, 102	Playback Mode Palette	57
G		Playing back movies	114
Green Button 	43, 45, 55	Playing back sounds	143
Green Mode 	63	Power Saving	158
Guide Display	59, 160	Power supply	20, 31
H		Power switch	31, 42, 44
Histogram	77	Press fully (shutter release button)	39
I		Press halfway (shutter release button)	39
Infinity 	78	Printing	136
Installing battery	21	Protect 	121
Instant Review	39, 91	Q	
L		Quality Level	28, 84, 101
Language	33, 153	Quick Zoom	110
M			
MENU button	43, 45		
Macro 	78		
Magnify 	109		
Manual Focus MF	78		
Manual 	86		

R	
Recorded Pixels	28, 29, 82, 99
Recording movies	97
Recording sounds	141
Red-eye Compensation	132
Red-eye reduction	
	80, 81
Resetting settings	161
Resize	123
Rotating	41
S	
Saturation	93
Saving by date	154
Saving settings	95
SD Memory Card	25
Select time	152
Self-timer 	71
Sensitivity	89
Sepia	103, 128
Setting the exposure	75
Shade 	86
Sharpness	92
Shooting information	76, 111
Shooting mode	51
Shutter release	
button	39, 42, 44
Slideshow	112
Soft 	80
Soft (digital filter)	128
Sound settings	147
Sound types	147
Standard AF	78
Start-up screen	162
Strap	19
Super Macro 	78
T	
Tungsten Light 	86
TV	115
U	
USB connection mode	155
V	
Video output format	156
Viewing a guide	59
Voice Memo	144
W	
White Balance	86
World Time	151
Z	
Zoom 	73
Zoom button	42, 44

- PENTAX Corporation** 2-36-9, Maeno-cho, Itabashi-ku, Tokyo 174-8639, JAPAN
(<http://www.pentax.co.jp/>)
- PENTAX Europe GmbH
(European Headquarters)** Julius-Vosseler-Strasse, 104, 22527 Hamburg, GERMANY
(HQ - <http://www.pentaxeurope.com>)
(Germany - <http://www.pentax.de>)
- PENTAX U.K. Limited** PENTAX House, Heron Drive, Langley, Slough, Berks
SL3 8PN, U.K.
(<http://www.pentax.co.uk>)
- PENTAX France S.A.S.** 112 Quai de Bezons, B.P. 204, 95106 Argenteuil
Cedex, FRANCE
(<http://www.pentax.fr>)
- PENTAX (Schweiz) AG** Widenholzstrasse 1, 8304 Wallisellen, Postfach 367
8305 Dietlikon, SWITZERLAND
(<http://www.pentax.ch>)
- PENTAX Scandinavia AB** P.O. Box 650, 75127 Uppsala, SWEDEN
(<http://www.pentax.se>)
- PENTAX Imaging Company**
A Division of PENTAX of America, Inc.
(Headquarters)
600 12th Street, Suite 300 Golden, Colorado 80401, U.S.A.
(PENTAX Service Department)
12000 Zuni Street, Suite 100B Westminster, Colorado
80234, U.S.A. (<http://www.pentaximaging.com>)
- PENTAX Canada Inc.** 1770 Argentia Road Mississauga, Ontario L5N 3S7, CANADA
(<http://www.pentax.ca>)



for your
precious moments

<http://www.pentax.co.jp/english>

- Printed on recycled paper
- Specifications and external dimensions are subject to change without notice.