

PENTAX Corporation 2-36-9, Maeno-cho, Itabashi-ku, Tokyo 174-8639, JAPAN
(<http://www.pentax.co.jp/>)

PENTAX Europe GmbH (European Headquarters)
Julius-Vosseler-Strasse, 104, 22527 Hamburg, GERMANY
(HQ - <http://www.pentaxeuropa.com>)
(Germany - <http://www.pentax.de>)

PENTAX U.K. Limited
PENTAX House, Heron Drive, Langley, Slough, Berks
SL3 8PN, U.K.
(<http://www.pentax.co.uk>)

PENTAX France S.A.S. 12/14, rue Jean Poulmarch, 95106 Argenteuil Cedex, FRANCE

PENTAX Benelux B.V. (for Netherlands)
Spinveld 25, 4815 HR Breda, NETHERLANDS
(<http://www.pentax.nl>)
(for Belgium & Luxembourg)
Weiveldlaan 3-5, 1930 Zaventem, BELGIUM
(<http://www.pentax.be>)

PENTAX (Schweiz) AG Widenholzstrasse 1 Postfach 367 8305 Dietlikon, SWITZERLAND
(<http://www.pentax.ch>)

PENTAX Scandinavia AB P.O. Box 650, 75127 Uppsala, SWEDEN
(<http://www.pentax.se>)

PENTAX Imaging Company
A Division of PENTAX of America, Inc.
(Headquarters)
600 12th Street, Suite 300
Golden, Colorado 80401, U.S.A.
(Distribution & Service Center)
16163 West 45th Drive, Unit H Golden, Colorado
80403, U.S.A.
(<http://www.pentaximaging.com>)

PENTAX Canada Inc. 1770 Argentia Road Mississauga, Ontario L5N 3S7,
CANADA
(<http://www.pentax.ca>)



for your
precious moments

<http://www.pentax.co.jp/english>

• Specifications and external dimensions are subject to change without notice.

57565

Copyright © PENTAX Corporation 2005
01-200510 Printed in Philippines

PENTAX™

Optio
S6

Digital Camera

Optio S6

Operating Manual

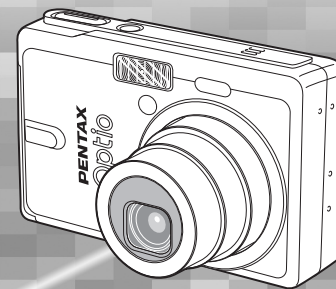

To ensure the best performance from
your camera, please read the Operating
Manual before using the camera.

Thank you for buying the PENTAX Digital Camera.

Please read this manual before using the camera in order to get the most out of all the features and functions. Keep this manual safe, as it can be a valuable tool in helping you to understand all the camera's capabilities.

Regarding copyrights

Images taken using the PENTAX Digital Camera that are for anything other than personal enjoyment cannot be used without permission according to the rights as specified in the Copyright Act. Please take care, as there are even cases where limitations are placed on taking pictures even for personal enjoyment during demonstrations, performance or of items on display. Images taken with the purpose of obtaining copyrights also cannot be used outside the scope of use of the copyright as laid out in the Copyright Act, and care should be taken here also.

To users of this camera

- There is a possibility that recorded data may be erased or that the camera may not function correctly when used in surroundings such as installations generating strong electromagnetic radiation or magnetic fields.
- The liquid crystal panel used in the LCD display is manufactured using extremely high precision technology. Although the level of functioning pixels is 99.99% or better, you should be aware that 0.01% or fewer of the pixels may not illuminate or may illuminate when they should not. However, this has no effect on the recorded image.

Regarding trademarks

- PENTAX, Optio and smc PENTAX are trademarks of PENTAX Corporation.
- The SD logo  is a trademark.
- "Beau-Reflective®" is a registered trade mark of Sony Corporation.
- All other brands or product names are trademarks or registered trademarks of their respective owners.

This product supports PRINT Image Matching III.

PRINT Image Matching enabled digital still cameras, printers and software help photographers to produce images more faithful to their intentions. Some functions are not available on printers that are not PRINT Image Matching III compliant.

Copyright 2001 Seiko Epson Corporation. All Rights Reserved.

PRINT Image Matching is a trademark of Seiko Epson Corporation. The PRINT Image Matching logo is a trademark of Seiko Epson Corporation.

Regarding PictBridge

PictBridge allows the user to connect the printer and digital camera directly, using the unified standard for the direct printout of images. You can print images directly from the camera through a few simple operations.

- There is a possibility that the illustrations and the display screen of the LCD monitor in this manual are different from the actual product.

FOR SAFE USE OF YOUR CAMERA

Sufficient attention has been paid to the safety of this product but please pay particular attention to the warnings indicated by the following symbols during use.



Warning

These symbols indicate that it is possible that the user may experience serious difficulties if the warnings are not heeded.



Caution

These symbols indicate that it is possible that the user may experience minor or middling difficulties or physical difficulties if the warnings are not heeded.

About the Camera



Warning

- Do not attempt to take the camera apart or remodel the camera. High voltages are present within the camera, and there is therefore a danger of electric shocks if the camera is taken apart.
- If the inside of the camera should become exposed as a result of, for example, the camera being dropped, please do not under any circumstances touch such exposed portions, as there is a danger of receiving an electric shock.
- Wrapping the strap of the camera around your neck is also dangerous. Please take care that small children do not hang the strap around their necks.
- To avoid the risk of it being swallowed by mistake, keep the SD Memory Card out of the reach of small children. Seek medical attention immediately if a memory card is accidentally swallowed.
- Use an AC adapter that is of the power and voltage specified for exclusive use with this product. The use of an AC adapter other than that specified exclusively for use with this product may cause fire or electric shocks.
- If the camera emits smoke or a strange smell, or in the event of any other irregularity, stop using the camera immediately, remove the battery or disconnect the AC adapter and contact your nearest PENTAX service center. Continued use of the camera may result in fire or electric shock.

Caution

- Never try to disassemble or short the battery. Also, do not dispose of the battery in fire, as it may explode.
- Do not charge any batteries other than rechargeable lithium-ion battery D-LI8. The battery could explode or catch fire.
- Do not place your finger on the flash when it is discharging as there is a risk of burns.
- Do not discharge the flash while it is touching your clothing as there is a risk of discoloring.
- If any of the battery leakage should come in contact with your eyes, do not rub them. Flush your eyes with clean water and get medical attention immediately.
- If any of the battery leakage should come in contact with skin or clothes, wash the affected areas thoroughly with water.
- Remove the battery from the camera immediately if it becomes hot or begins to smoke. Be careful not to burn yourself during removal.
- Some portions of the camera heat up during use, so please take care, as there is a risk of low temperature burns if such portions are held for long periods of time.
- Should the LCD be damaged, be careful of glass fragments. Also, be careful not to allow the liquid crystal to get on your skin or in your eyes or mouth.

About the Battery Charger and the AC Adapter

Warning

- Do not use the product at a voltage other than the specified voltage. Use with a power source or voltage other than that designed can cause a fire or electrical shock. The specified voltage is 100-240 V AC.
- Do not disassemble or modify the product. This can cause a fire or electrical shock.
- If the generation of smoke or strange odor from the product or other abnormality occurs, immediately discontinue using and consult a PENTAX Service Center. Continuing to use the product can cause a fire or electrical shock.
- If water should happen to get inside the product, consult a PENTAX Service Center. Continuing to use the product can cause a fire or electrical shock.

- If lightning should be present during use of the battery charger or AC adapter, unplug the power cord and discontinue use. Continuing to use the product can cause damage to the equipment, fire or electrical shock.
- Wipe off the plug of the power cord if it should become covered with dust. This can cause a fire.

 **Caution**

- Do not place heavy objects on the AC plug cord, allow heavy objects to drop onto it or allow the AC plug cord to become damaged due to excessive bending. If the AC plug cord becomes damaged, consult a PENTAX Service Center.
- Do not short or touch the output terminals of the product while it is still plugged in.
- Remove the battery and unplug the AC plug cord when not using the battery charger.
- Do not plug in the AC plug cord with wet hands. This can cause an electrical shock.
- Do not subject the product to strong impacts or allow it to drop onto a hard surface. This can cause a malfunction.
- To reduce the risk of hazards, use only CSA/UL Certified power supply cord set, cord is Type SPT-2 or heavier, minimum NO.18 AWG copper, one end with a molded-on male attachment plug cap (with a specified NEMA configuration), and the other is provided with a molded-on female connector body (with a specified IEC nonindustrial type configuration) or the equivalent.
- Do not use the battery charger to charge batteries other than the ones specified. This can cause overheating or malfunctions.

Care to be Taken During Handling

- Take the international warranty card with you when you travel abroad. Also take the Worldwide Service Network that is included in the package. This will be useful if you experience problems abroad.
- When the camera has not been used for a long time, confirm that it is still working properly, particularly prior to taking important pictures (such as at a wedding or during travelling). Contents of a recording such as images and sounds cannot be guaranteed if recording, playback or data transfer from your camera to a computer, etc. is not possible due to a malfunction of your camera or recording medium (SD Memory Card), etc.
- The lens on this camera is not exchangeable. The lens is not removable.
- Do not clean the product with organic solvents such as thinner, alcohol or benzene.
- Places of high temperature and humidity should be avoided. Particular care should be taken regarding vehicles, which can become very hot inside.
- Storing the camera where pesticides and chemicals are handled should be avoided. Remove from case and store in a well-ventilated place to prevent the camera from becoming moldy during storage.
- Do not use the camera where it may come in contact with rain, water or any other liquid, because the camera is not weather, water, or liquid resistant.
- Ensure that the camera is not subjected to substantial vibrations, shocks or pressure. Place the camera on a cushion for protection when the camera is subjected to the vibrations of a motorbike, car, or ship, etc.
- The temperature range in which the camera can be used is 0°C to 40°C (32°F to 104°F).
- The liquid crystal display will become black at high temperature but will return to normal when normal temperatures are returned to.
- The response speed of the liquid crystal display becomes slow at low temperatures. This is due to the properties of the liquid crystal and is not a fault.
- Periodic checks are recommended every 1 to 2 years in order to maintain high-performance.

- If the camera is subjected to rapid temperature changes, condensation may form on the inside and outside of the camera.
Therefore put the camera in a bag or plastic bag, and take the camera out when the difference in temperature has subsided.
- Avoid contact with garbage, dirt, sand, dust, water, toxic gases, salt, etc. as this may cause damage to the camera. If rain or drops of water get onto the camera, please wipe dry.
- Refer to “Precautions When Using an SD Memory Card” (p.24) regarding the SD Memory Card.
- The AC plug cord supplied with the camera is for exclusive use with the Battery charger D-BC8. Do not use it with any other equipment.
- Please do not press forcefully on the LCD monitor. This could cause breakage or malfunction.
- Be careful not to sit down with the camera in your back pocket as this may damage the exterior of the camera or the LCD monitor.
- When using a tripod with the camera, be careful not to overtighten the screw in the tripod socket on the camera.

LED Safety Standard

This device is a digital still camera that conforms to the safety standard (IEC60825-1) for a Class 1 LED product.

Regarding Product Registration

To serve you better, we request that you complete the product registration, which can be found on the CD-ROM supplied with the camera or the PENTAX website.

Thank you for your cooperation.

Refer to the PC Connection Manual (bottom right of reverse side) for more information.

Contents

FOR SAFE USE OF YOUR CAMERA	1
Care to be Taken During Handling	4
Contents of the Operating Manual	9
Checking the Contents of the Package	10
Names of Parts	11
Names of Operating Parts	12
Getting Started	13
Attaching the Strap	13
Powering the Camera	14
Installing the Battery	14
Removing the Battery	14
Charging the Battery	16
Charging the Battery Abroad	19
Using the AC Adapter (optional).....	21
Installing the SD Memory Card	23
Image Size and Quality of Still Pictures.....	25
Size and Quality of Movies	26
Initial Settings (Setting the Display Language and the Date and Time).....	28
Setting the Display Language	28
Setting the Date and Time.....	29
Quick Start	32
Taking Still Pictures	32
Playing Back Still Pictures	34
Playing Back an Image.....	34
Playing Back the Previous or Next Image	34
Common Operations	36
Turning the Camera On and Off	36
Using the My Album Function	36
Turning the Camera On in Playback Mode	38
Turning the Camera On in Voice Recording Mode.....	38
Using the Button Functions	39
Capture Mode.....	39
Playback Mode	40
Voice Recording Mode	42
Setting the Menus	43
How to Set the Menus	43
Menu List.....	46
Operating the Mode Palette	48
How to operate the Mode Palette	48
Taking Pictures	51
Taking Pictures	51
Changing the Mode	51
Selecting the Capture Mode.....	51
Displaying Shooting Information in Capture Mode	51

Setting the Functions (Program Mode).....	54
Selecting the Picture Mode According to the Shooting Scene (Picture Mode).....	55
Taking Pictures of Dark Scenes (Night Scene Mode)	58
Taking Movies (Movie Mode)	59
Taking Panorama Pictures (Panorama Assist Mode).....	61
Taking Pictures in Frame Composite mode	63
Using the Self-timer	65
Continuous Shooting (Continuous Shooting Mode).....	67
Using the Remote Control Unit (optional).....	69
Using the Zoom to Change the Subject Size	71
Setting the Shooting Functions	73
Selecting the Focus Mode.....	73
Selecting the Flash Mode.....	76
Selecting the Recorded Pixels of Still Pictures.....	78
Selecting the Quality Level of Still Pictures	80
Adjusting the White Balance	82
Selecting the Autofocus Settings.....	84
Setting the Light Metering Mode to Determine the Exposure.....	87
Setting the Sensitivity	88
Setting the Exposure (EV Compensation).....	89
Selecting the Settings for Taking Movies	90
Setting the Instant Review Time.....	93
Setting the Green Button	94
Setting the Image Sharpness	97
Setting the Color Saturation	98
Setting the Image Contrast.....	99
Saving the Settings	100
Saving the Menu Items (Memory)	100
Returning the Shooting Functions to the Default Settings	102
Recording and Playback of Sound	103
<hr/>	
Recording Sound (Voice Recording Mode)	103
Playing Back Sound.....	105
Adding a Voice Memo	106
Recording a Voice Memo	106
Playing Back a Voice Memo.....	107
Playback/Deleting/Editing	108
<hr/>	
Playing Back Images	108
Playing Back Still Pictures	108
Zoom Display	108
Playing Back Movies	110
Displaying Shooting Information in Playback Mode	111
Nine-Image Display	112
Slideshow	113
Deleting Images, Movies and Sounds	115
Deleting a Single Image, Movie or Sound	115
Deleting All Images	117

Deleting Selected Images and Sound Files (from Nine-Image Display)	118
Protecting Images, Movies and Sounds from Deletion (Protect)	120
Viewing Images on AV Equipment	122
Playing Back an Image Using the Remote Control Unit (optional)	123
Setting the Printing Service (DPOF)	124
Printing Single Images	124
Printing All Images	126
Direct Printing Using PictBridge	127
Connecting the Camera to the Printer	127
Printing Single Images	128
Printing All Images	129
Printing Using the DPOF Settings	130
Disconnecting the Camera from the Printer	130
Editing Images	131
Changing the Image Size and Quality	131
Trimming Images	133
Rotating the Displayed Image	134
Editing Pictures with Color Filters	135
Editing Pictures with the Digital Filter	137
Editing Pictures with Brightness Filter	139
Editing Movies	141
Red-eye Compensation	144
Copying Files	145
Settings	147
<hr/>	
Camera Settings	147
Setting Up the Start-up Screen	147
Formatting an SD Memory Card or the Built-in Memory	148
Changing the Sound Settings	149
Changing the Date and Time	152
Setting the World Time	154
Changing the Display Language	156
Changing the USB Connection Mode	157
Changing the Video Output Format	157
Adjusting the Brightness of the LCD Monitor	158
Setting Power Saving	159
Setting Auto Power Off	160
Setting the Guide Display	160
Resetting to Default Settings	161
Appendix	162
<hr/>	
List of City	162
Default Settings	163
Optional Accessories	169
Messages	170
Troubleshooting	172
Main Specifications	174
WARRANTY POLICY	177
Index	182

Contents of the Operating Manual

This operating manual contains the following chapters.

1 Getting Started

This chapter explains what you need to do after purchasing the camera before you start taking pictures. Be sure to read it and follow the instructions.

2 Quick Start

This chapter explains the simplest way to take pictures and play back images. Use it if you want to start taking pictures straightaway.

3 Common Operations

This chapter explains common operations such as the functions of the buttons and how to use the menus. For more details, refer to the respective "Taking Pictures", "Recording and Playback of Sound", "Playback/Deleting/Editing" and "Settings" chapters.

4 Taking Pictures

This chapter explains the various way of capturing images and how to set the relevant functions, including how to use the Capture Mode screen to select the capture mode best suited to the situation.

5 Recording and Playback of Sound

This chapter explains how to record sound only or add a voice memo to an image, and how to play back voice memos.

6 Playback/Deleting/Editing

This chapter explains how to play back images on the camera or on a TV, how to delete, resize and trim images, and how to print images directly to the printer.



7 Settings

This chapter explains how to set the camera-related functions.

8 Appendix

This tells you about the messages displayed on the LCD monitor and what to do in the event of trouble.

The meanings of the symbols used in this operating manual are explained below.

	indicates the reference page number for an explanation of the related operation.
	indicates information that is useful to know.
	indicates precautions to be taken when operating the camera.

1

2

3

4

5

6

7

8

Checking the Contents of the Package



Camera
Optio S6

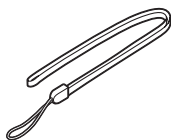

Strap
O-ST20 (*)

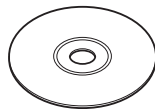

Software (CD-ROM)
S-SW39

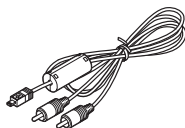

AV cable
I-AVC7 (*)

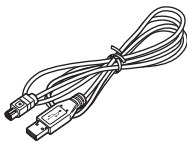

USB cable
I-USB17 (*)



Rechargeable
lithium-ion battery
D-LI8 (*)

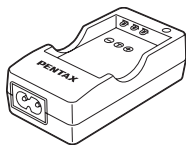

Battery charger
D-BC8 (*)



AC plug cord (*)

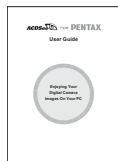

ACDSee for PENTAX
User Guide

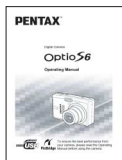

Operating Manual
(this manual)

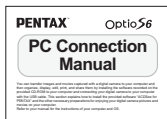

Operating Manual
(PC Connection Manual)

Items marked with an asterisk (*) are also available as optional accessories. For other optional accessories, refer to "Optional Accessories" (p.169).

Type of AC plug cord

D-CO2A Australia/D-CO2E Europe/D-CO2H Hong Kong, United Kingdom/
D-CO2J Japan/D-CO2K Korea/D-CO2U North America, Canada

Names of Parts

Front

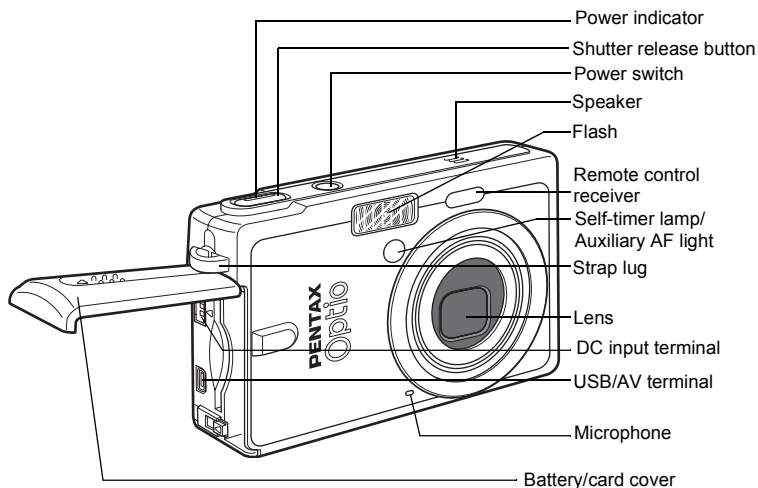

Back

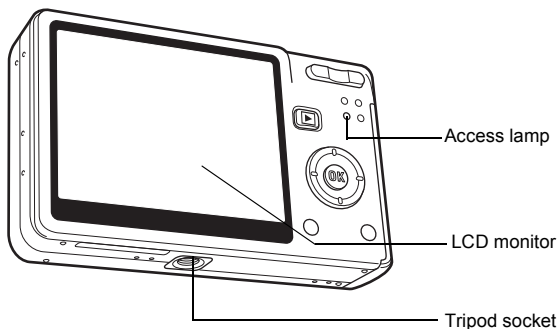

Names of Operating Parts

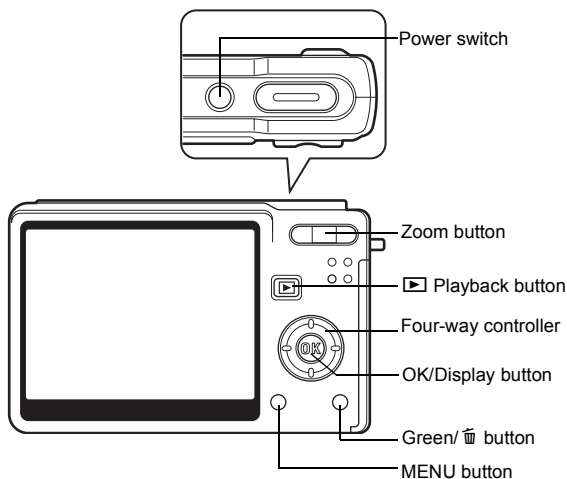

Four-way controller

In this operating manual, the four-way controller is described as shown below.

Guide Indications

A guide to available button operations appears on the LCD monitor during operation.

The buttons are indicated as shown below.

Four-way controller (▲)	▲
Four-way controller (▼)	▼
Four-way controller (◀)	◀
Four-way controller (▶)	▶
MENU button	
Shutter release button	
OK button	

Zoom button	
for digital zoom	
for trimming	
Green/Trash button	
for operating as the Green button	
for deleting an image	

Attaching the Strap

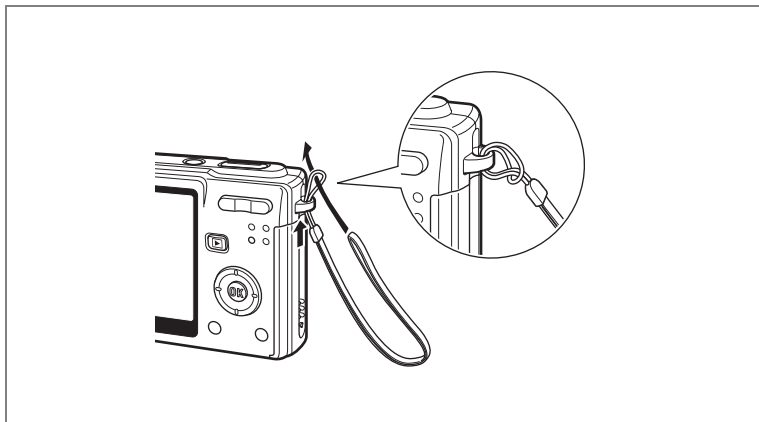

Pass the narrow end of the strap through the strap lug and pass the other end through the loop.

Powering the Camera

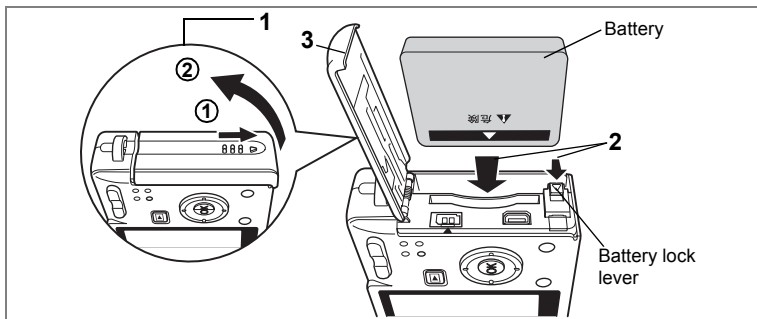

Installing the Battery

Install the battery provided with the camera.

- 1 Open the battery/card cover.**
Slide the battery/card cover in the direction indicated by the arrow ① and flip the cover open ②.
- 2 Insert the battery with the ▲ symbol facing toward the LCD monitor while using the side of the battery to press the battery lock lever in the direction indicated by the arrow.**
- 3 Close the battery/card cover.**

Removing the Battery

- 1 Open the battery/card cover.**
- 2 Release the battery by using your finger to press the battery lock lever in the same direction as when you inserted the battery.**

Pull the battery out.



If you intend to use the camera continuously for a long period, use of the AC adapter D-AC8 (optional) is recommended. (p.21)



- Insert the battery correctly. If the battery is incorrectly oriented, it may cause a malfunction.
- Do not remove the battery when the camera is turned on.
- If you do not intend to use the camera for a long time, remove the battery.
- If the camera is left without the battery for a long time, the date will be reset.

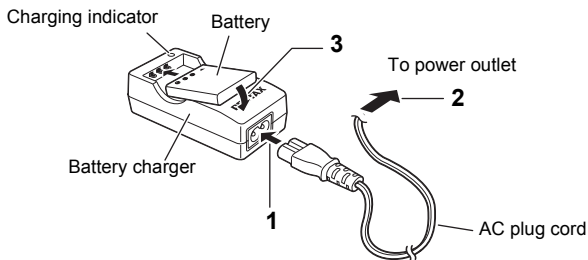

Charging the Battery

Use the battery charger D-BC8 supplied with the camera to charge the battery before using the camera for the first time or when the [Battery depleted] message appears.

- 1 Connect the AC plug cord to the battery charger.**
- 2 Plug the AC plug cord into the power outlet.**
- 3 Place the battery in the battery charger so that the PENTAX name is visible.**

The charging indicator on the charger lights red while the battery is being charged and changes to green when charging is completed.

- 4 Remove the battery from the battery charger when charging is completed.**



- The time required for full charge is about 100 minutes. The appropriate ambient temperature range for charging the battery is 0°C – 40°C (32°F to 104°F).
- The charging time may vary depending on the ambient temperature and charging conditions.
- When the battery reaches the end of its service life, the time that the camera can be operated becomes shorter even when the battery is fully charged. In this event, replace the battery.



- Always charge the battery before using the camera for the first time or when the battery has not been used for a long time.
- Do not use the battery charger D-BC8 to charge batteries other than D-LI8 rechargeable lithium-ion batteries, as the charger may overheat or be damaged as a result.
- If the battery is inserted correctly but the charging indicator blinks, the battery may be faulty. Replace with a new battery.

• Approximate Operating Time (when the D-LI8 battery is fully charged)

Number of recordable images: Approx. 130 (at 23°C with the LCD monitor on and the flash used for 50% of shots)

Playback time: Approx. 90 min.

Movie recording time: Approx. 50 min.

Sound recording time: Approx. 130 min.

- The number of recordable images are based on CIPA standard measurement and may vary depending on capture mode and shooting conditions.



- In general, battery performance temporarily deteriorates as the temperature decreases. When using the camera in a cold environment, keep it warm by putting it in your pocket or inside your coat. Battery performance that has deteriorated due to low temperature will be restored when the battery is returned to room temperature.
- Be sure to take a spare battery with you when traveling abroad or to a cold region, or if you intend to take a lot of pictures.

• Battery Level Indicator

You can check the battery level by the  symbol on the LCD monitor.

 (lit green) : Adequate power remains.



 (lit green) : Battery is running low.



 (lit red) : Battery is exhausted.



[Battery depleted] : The camera will turn off after the message appears.

• Recycling Batteries



This symbol indicates that the battery is recyclable. Cover the terminals with insulating tape and take the battery to a store displaying this symbol.

Li-ion

Charging the Battery Abroad

The battery charger supplied with the camera is designed to switch automatically to the voltage (100-240V) and frequency (50Hz, 60Hz) of the electricity supply in the country or region where used.

However, electrical socket shapes differ depending on the country or region. Before traveling abroad, you are advised to check the socket shape in your destination (see “Main Socket Types in the Major Countries and Regions of the World” (p.20)) and take an appropriately shaped off-the-shelf adapter plug with you. (Electrical socket shapes may vary depending on every region in the country. Check the socket shape used in the region.)

The socket shape does not affect the charging method.

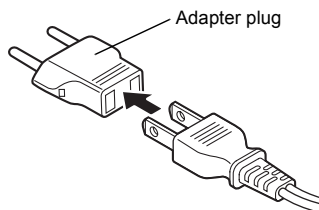

- Use of an off-the-shelf transformer may lead to defective operation.
- Unplug the adapter plug from the power outlet when the battery charger is not in use.

Type	A	B	BF	C	S
Shape					
Adapter plug					

Main Socket Types in the Major Countries and Regions of the World

1

Getting Started

		A	B	BF	C	S
North America	U.S.A., Canada	✓				
Europe, Former Soviet Union	Iceland, Ireland, Italy, Ukraine, Austria, Netherlands, Kazakhstan, Greece, Sweden, Denmark, Germany, Norway, Hungary, Finland, France, Belarus, Belgium, Rumania, Russia				✓	
	U.K.		✓	✓		
	Spain	✓			✓	
	Switzerland, Poland, Portugal		✓		✓	
Asia	Taiwan, Japan	✓				
	Sri Lanka, Maldives		✓			
	Nepal, Bangladesh, Mongolia				✓	
	Vietnam	✓			✓	
	India, Indonesia, Pakistan, Macau		✓		✓	
	Thailand	✓		✓	✓	
	Korea	✓	✓		✓	
	Philippines	✓			✓	✓
	Singapore, Hong Kong		✓	✓		
	China	✓	✓	✓	✓	✓
Malaysia		✓	✓	✓		
Oceania	Australia, Tonga, New Zealand, Fiji					✓
	Guam	✓				
	Tahiti				✓	
Central and South America	Colombia, Jamaica, Haiti, Panama, Bahamas, Puerto Rico, Venezuela, Mexico	✓				
	Brazil, Peru	✓			✓	
	Chile		✓		✓	
	Argentina			✓	✓	✓
Middle East	Israel, Iran				✓	
	Kuwait		✓		✓	
	Jordan		✓	✓		
Africa	Canary Islands, Guinea, Mozambique, Morocco				✓	
	Kenya, South Africa		✓		✓	
	Algeria	✓	✓	✓		
	Egypt		✓	✓	✓	
	Zambia, Tanzania		✓	✓		

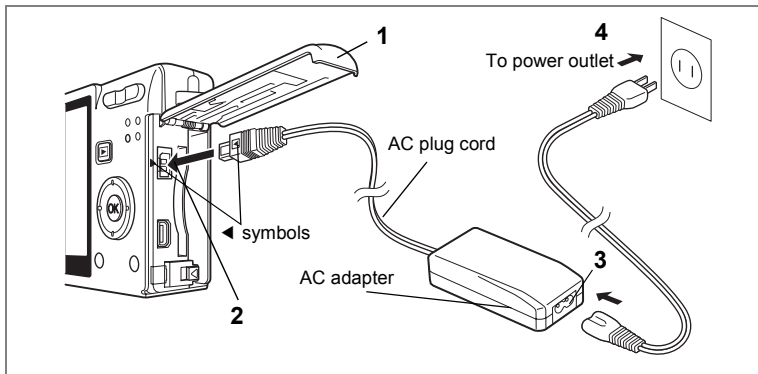

Using the AC Adapter (optional)

If you intend to use the LCD monitor for a long time or connect the camera to a PC, use of the AC adapter D-AC8 (optional) is recommended.

- 1** Make sure that the camera is turned off and open the battery/card cover.
- 2** Connect the DC terminal on the AC adapter to the DC input terminal on the camera, being sure to match the ◀ symbols.
- 3** Connect the AC plug cord to the AC adapter.
- 4** Plug the AC plug cord into the power outlet.

Caution

- Make sure that the camera is turned off when connecting or disconnecting the AC adapter.
- Make sure that the AC plug cord and connecting cable are inserted securely. The data may be lost if the cable becomes disconnected while you are taking pictures.
- Be sure to read the operating manual accompanying the AC adapter before using the adapter.
- Be sure to match the ◀ symbols when connecting the DC terminals. Inserting the plugs with too much force may damage them.

Precautions When Using the Battery Charger or AC Adapter

To avoid the risk of fire or electric shock when using the battery charger or AC adapter, be sure to read the section on “FOR SAFE USE OF YOUR CAMERA” on page 1. Refer to page 176 for the specifications of the battery charger and AC adapter.

Installing the SD Memory Card

1

Getting Started

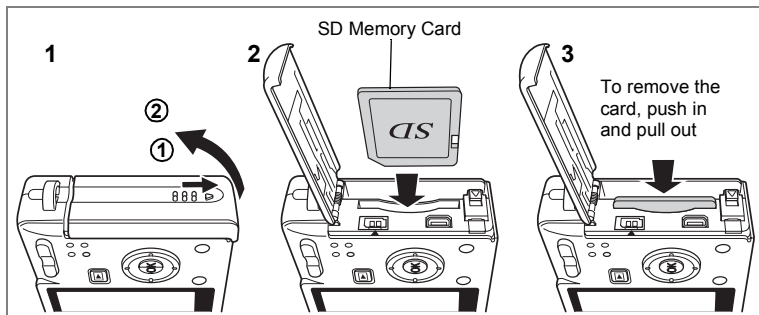

An SD Memory Card can be used with this camera. Captured images are recorded on the SD Memory Card if a card is inserted or in the built-in memory if no card is inserted.



- Make sure that the camera is turned off before inserting or removing the SD Memory Card.
- Be sure to format unused cards or cards that have been used on another camera. Refer to “Formatting an SD Memory Card or the Built-in Memory” (p.148) for instructions on formatting.

1 Open the battery/card cover.

Slide the battery/card cover in the direction indicated by the arrow ① and flip the cover open ②.

2 Insert an SD Memory Card so the label (the side with the ▲ symbol) is facing toward the LCD monitor and push the card in until it clicks.

3 Close the battery/card cover.

To remove the card, eject the card by pressing it in the direction indicated by the arrow and pull it out.



The number of recordable images varies depending on the capacity of the SD Memory Card or built-in memory and the selected image size and quality. (p.25)

Data Backup

Very occasionally, data stored in the built-in memory becomes unreadable. As a backup measure, we recommend that you download important data to a PC or store the data in a medium other than the built-in memory.

Precautions When Using an SD Memory Card

- Make sure that the camera is turned off before opening the battery/card cover.
- The SD Memory Card is equipped with a write-protect switch. Setting the switch to [LOCK] protects the existing data by prohibiting recording of new data, deletion of existing data or formatting of the card. Write-protect switch
- Care should be taken if you remove the SD Memory Card immediately after using the camera, as the card may be hot.
- Do not remove the SD Memory Card or turn the camera off while data is being recorded on the card, images or sound are being played back, or the camera is connected to a PC with the USB cable as this may cause the data to be lost or the card to be damaged.
- Do not bend the SD Memory Card or subject it to violent impact. Keep it away from water and store away from high temperature.
- Be sure to format unused cards or cards that have been used on another camera. Refer to "Formatting an SD Memory Card or the Built-in Memory" (p.148) for instructions on formatting.
- Do not remove the SD Memory Card during formatting as this may damage the card and render it unusable.
- The data on the SD Memory Card may be deleted in the following circumstances. PENTAX does not accept any liability for data that is deleted
 - (1) when the SD Memory Card is mishandled by the user.
 - (2) when the SD Memory Card is exposed to static electricity or electrical interference.
 - (3) when the card has not been used for a long time.
 - (4) when the card is ejected, the AC adapter is disconnected or the battery is removed while the data on the card is being recorded or accessed.
- The SD Memory Card has a limited service life. If it is not used for a long time, the data on the card may become unreadable. Be sure to regularly make a backup of important data on a PC.
- Avoid using or storing the card where it may be exposed to static electricity or electrical interference.
- Avoid using or storing the card in direct sunlight or where it may be exposed to rapid changes in temperature or to condensation.
- When using an SD Memory Card with a slow recording speed, recording may stop while you are taking movies even when there is adequate space in the memory, or shooting and playback may take a long time.
- When you purchase the SD Memory Card, access the PENTAX website and confirm beforehand if they have compatibility with your camera. Inquiries on the card compatibility can also be answered by your nearest PENTAX service center.

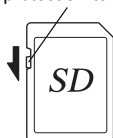



Image Size and Quality of Still Pictures

Choose the image size and quality best suited to your purpose. Higher quality levels and numbers of recorded pixels produce clearer images for printing, but the resulting increase in data volume reduces the total number of pictures that can be taken.

When you choose high image quality as well as a large image size, it may take ten seconds or more for the camera to finish recording after shooting.

Choose the appropriate number of recorded pixels and quality level on the [ Rec. Mode] menu.

How to Set the Menu  p.43

Selecting the Recorded Pixels of Still Pictures  p.78

Selecting the Quality Level of Still Pictures  p.80

● Appropriate Sizes According to Use

6M (2816×2112)	↑ Clear, Fine	Printing images with high-resolution settings in your printer, Printing at A4 size or larger, Editing and processing images
5M (2592×1944)		
4M (2304×1728)		Printing at postcard size For use as images on websites, For attaching images to e-mail
3M (2048×1536)		
2M (1600×1200)		
1024 (1024×768)		
640 (640×480)		

The default setting is **6M (2816×2112)**.

● Appropriate Quality According to Use

★★★	Best	Lowest compression ratio. Suitable for large A4-size photo prints.
★★	Better	Standard compression ratio. Suitable for photo prints or viewing images on a computer screen.
★	Good	Highest compression ratio. Suitable for attaching to e-mails or creating websites.

The default setting is **★★**.

● Approximate Number of Recordable Images by Size and Quality

Quality Level Recorded Pixels	Best ★★★	Better ★★	Good ★	Sound
6M (2816×2112)	53	80	121	2 hr. 13 min. 21 sec.
5M (2592×1944)	67	101	151	
4M (2304×1728)	81	122	183	
3M (2048×1536)	96	144	216	
2M (1600×1200)	134	202	303	
1024 (1024×768)	245	367	551	
640 (640×480)	449	674	1011	

- The above table indicates the approximate number of images and recording time when using a 128MB SD Memory Card.
- The above table is based on standard shooting conditions specified by PENTAX and may vary depending on the subject, shooting conditions, capture mode, SD Memory Card, etc.

Size and Quality of Movies

Choose the size and quality best suited to your purpose.

The larger size and the higher quality level ★ are chosen, the clearer moving images are produced, but the file size is increased, so that shorter recording time can be stored on a given card.

Choose the appropriate size and quality on the [📷 Rec. Mode] menu.

Selecting the Recorded Pixels of Movies 📷p.90

Selecting the Quality Level of Movies 📷p.91

● Appropriate Sizes (Recorded Pixels) According to Use

640 (640×480)	Viewing high-quality movies at VGA size. The recordable time is shorter.
320 (320×240)	Smaller data volume allows a longer time recording.

The default setting is **640 (640×480)**.

● Approximate Recordable Time by Size (Recorded Pixels) and Quality

Quality Level Recorded Pixels	★★★ S.Fine	★★ Fine	★ Economy
640 (640×480)	5 min. 11 sec.	6 min. 14 sec.	7 min. 13 sec.
320 (320×240)	14 min. 3 sec.	15 min. 51 sec.	17 min. 20 sec.

The default setting is ★★★.

- The above table indicates the approximate recording times when using a 128 MB SD Memory Card.
- The above table is based on standard shooting conditions specified by PENTAX and may vary depending on the subject, shooting conditions, capture mode, SD Memory Card, etc.

Initial Settings (Setting the Display Language and the Date and Time)

1

Getting Started

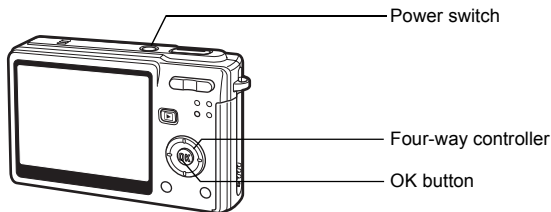

If the Initial Setting screen or Date Adjust screen appears when you turn the camera on, follow the procedure below to set the display language and/or current date and time.

If the Initial Setting screen appears:

☞ p.28 - 29 “Setting the Display Language”, “Setting the Date and Time”

If the Date Adjust screen appears:

☞ p.29 - 30 “Setting the Date and Time”

If you want to change the initial settings, refer to “Changing the Date and Time” (p.152) and “Changing the Display Language” (p.156).

Setting the Display Language

You can choose the language in which the menus, error messages, etc. are displayed from the following: English, French, German, Spanish, Portuguese, Italian, Swedish, Dutch, Russian, Korean, Chinese (traditional and simplified) and Japanese.

1 Press the four-way controller (►).

The Language/言語 screen appears.

2 Use the four-way controller (▲▼◀▶) to choose a language.

The default setting is English.

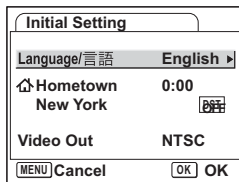

- 3 Press the OK button.**
- 4 Press the four-way controller (▼).**
The frame moves to [↕].
- 5 Use the four-way controller (◀▶) to choose the desired city (Hometown).**
- 6 Press the four-way controller (▼).**
The frame moves to [DST] (Daylight Saving Time).
- 7 Use the four-way controller (◀▶) to select (On) or (Off).**
- 8 Press the OK button.**
The Date Adjust screen appears.

Setting the Date and Time

Set the current date and time and the display style.

- 1 Press the four-way controller (▶).**
The frame moves to [mm/dd/yy].
- 2 Use the four-way controller (▲▼) to choose the date and time display style.**
- 3 Press the four-way controller (▶).**
The frame moves to [24h].
- 4 Use the four-way controller (▲▼) to select [24h] (24-hour display) or [12h] (12-hour display).**
- 5 Press the four-way controller (▶).**
The frame returns to [Date Style].

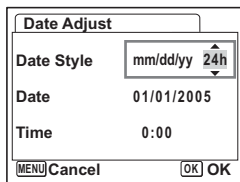
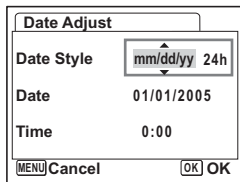

6 Press the four-way controller (▼).

The frame moves to [Date].

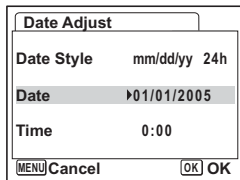
**7 Press the four-way controller (▶).**

The frame moves to the month.

8 Use the four-way controller (▲▼) to change the month.

Change the day and year in the same manner.

Next, change the time.

If you selected [12h] in Step 4, the setting switches between am and pm corresponding to the time.

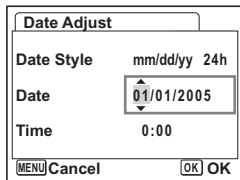

- When you finish the settings and press the OK button, the camera clock is reset to 00 seconds.
- To set the exact time, press the OK button when the time signal (on the TV, radio, etc.) reaches 00 seconds.



- When the Initial Settings screen is displayed, you can cancel the setting operation and switch to Capture mode by pressing the MENU button. In this case, the Initial Settings or Date Adjust screen will appear next time you turn the camera on.
- You can change the settings on the menu. Refer to the pages below for details.

Language: "Changing the Display Language" (p.156)

City, World Time: "Setting the World Time" (p.154)

Date and Time: "Changing the Date and Time" (p.152)

- The video output format is automatically set in conjunction with the language you have chosen as listed below. If the output format is different from the one used in your country or region, change the format following the steps in "Changing the Video Output Format" (p.157).

Language	Video Output Format
English (English)	NTSC
French (Français)	PAL
German (Deutsch)	PAL
Spanish (Español)	PAL
Portuguese (Português)	PAL
Italian (Italiano)	PAL
Sweden (Svenska)	PAL
Netherlands (Nederlands)	PAL
Russian (Русский)	PAL
Korean (한국어)	NTSC
Chinese (traditional) (中文繁體)	PAL
Chinese (simplified) (中文简体)	PAL
Japanese	NTSC

Taking Still Pictures

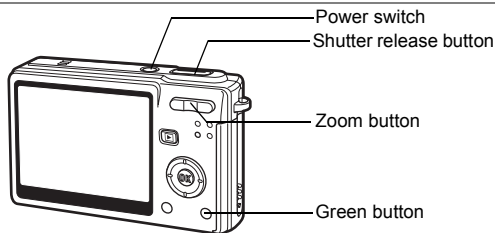

The simplest procedure for taking still pictures is described below. The flash fires automatically depending on the light conditions.

1 Press the power switch.

The camera turns on.

2 Confirm the subject and shooting information on the LCD monitor.

The focus frame in the middle of the LCD monitor indicates the zone of automatic focusing. You can change the size of the subject by pressing the zoom button.

▲ : makes the subject bigger.

◆◆ : makes the subject smaller.

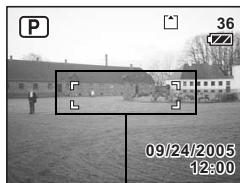

Focus frame

3 Press the shutter release button halfway.

The focus frame on the LCD monitor will light green when the camera is in focus.

4 Press the shutter release button fully.

The image appears on the LCD monitor for one second (Instant Review) and is recorded on the SD Memory Card or in the built-in memory.

Using the Shutter Release Button

The shutter release button works in a two-step action as follows.

Press halfway

The focus and exposure are locked when the shutter release button is pressed lightly (halfway). The shutter speed and aperture settings only appear on the LCD monitor when the shutter release button is pressed halfway. The focus frame on the LCD monitor will light green when the subject is in focus while the shutter release button is pressed halfway. The frame does not appear if the subject is out of focus.

Press down fully

Press the shutter release button all the way down (fully) to take a picture.

[Poor focusing conditions]

The camera may not be able to focus under the following conditions. In this case, lock the focus on an object the same distance away as the subject (by pressing the shutter release button halfway), then aim the camera at your subject and press the shutter release button fully.

- Objects that lack contrast such as a blue sky or white wall
- Dark places or objects, or conditions that prevent light being reflected back
- Finely patterned object
- Fast moving objects
- When there is an object in the foreground and an object in the background in the same picture
- Strongly reflected light or strong backlighting (bright background)

Instant Review

The Instant Review default setting is one second. During this time, you can delete the image by pressing the Green button, selecting [Delete] when the [Delete] menu appears and pressing the OK button. (p.115) You can also record a voice memo by pressing the OK button during Instant Review. (p.106)

Setting the Instant Review Time p.93

Playing Back Still Pictures

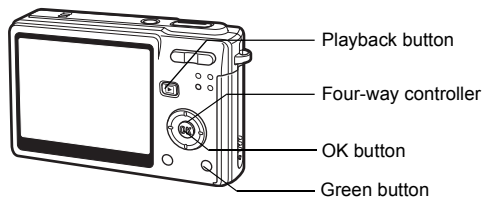

Playing Back an Image

You can display the still picture you have just taken.

- 1 Press the  Playback button after taking a picture.**

The image appears on the LCD monitor.



Zoom Display  p.108

Playing Back the Previous or Next Image

Still pictures can be played back one at a time, proceeding either forward or backward.

- 1 Press the  Playback button after taking a picture.**

The image appears on the LCD monitor.

- 2 Press the four-way controller ( ).**



displays the previous image.



displays the next image.

Deleting the Displayed Image

You can delete the image displayed on the LCD monitor by pressing the Green button, using the four-way controller (▲) to select [Delete] and pressing the OK button.

Press the  Playback button again or press the shutter release button halfway to return to the Capture mode.



- The last picture taken appears on the LCD monitor when you switch to the Playback mode.
- You can enlarge the image (except a rotated image) displayed on the LCD monitor by pressing the zoom button.
- If there are no images stored, the [No image/sound] message appears.

Zoom Display  p.108

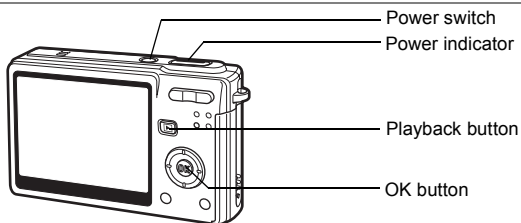

Deleting a Single Image, Movie or Sound  p.115

Turning the Camera On and Off

**1 Press the power switch.**

The power indicator is illuminated by a green light. The lens extends and the camera turns on in the Capture mode.

The camera is ready to take pictures by pressing the shutter release button.

- Press the  Playback button to switch to the Playback mode and view pictures while the lens is extended.
- Hold down the  Playback button for two seconds to activate the Playback mode with the lens retracted.
- Hold down the  Playback button for more than four seconds to display the contents of the pictures stored in the built-in memory with the SD Memory Card inserted.

2 Press the power switch again.

The camera turns off.

Switching between Capture Mode and Playback Mode
 p.51

Using the My Album Function

This camera has a built-in memory, but the built-in memory becomes hidden when an SD Memory Card is inserted. You can activate the built-in memory using the following procedure. You can save your favorite pictures, movies, and sounds in the built-in memory and use the built-in memory as a private album.

- 1 Confirm the SD Memory Card is set in the camera.**
- 2 Hold down the  Playback button for more than four seconds in Capture Mode.**

The lens retracts two seconds after you start holding down the  Playback button, and the contents of the built-in memory are displayed two seconds later.





- When you turn the power off and on or switch from Playback Mode to Capture Mode, the My Album function is canceled and the SD Memory Card becomes activated.
- While using the My Album function, you cannot access the SD Memory Card, so you cannot copy files between the built-in memory and the SD Memory Card. Cancel the My Album function to copy the files.
- While using the My Album function, you cannot perform formatting.

To Copy Files from the SD Memory Card to the Built-in Memory  p.146

Turning the Camera On in Playback Mode

1 Press the power switch while pressing the Playback button.

The power indicator lights green and the camera turns on in the Playback mode with the lens retracted.

- Press the  Playback button to extend the lens and switch to the Capture mode.
- Hold down the  Playback button for more than two seconds in the Capture mode or press the  Playback button in the Voice Recording mode to switch to the Playback mode with the lens retracted.



The power may be turned off when the power switch is held for a while.

Playing Back Still Pictures  p.34

Turning the Camera On in Voice Recording Mode

You can use the camera as a voice recorder.

1 Press the power switch while pressing the OK button.

The power indicator lights green and the camera turns on in the Voice Recording mode.

- Press the  Playback button to switch to the Playback mode.



- You can also select the Voice Recording mode from the Capture Mode Palette. ( p.103)
- The power may be turned off when the power switch is held for a while.

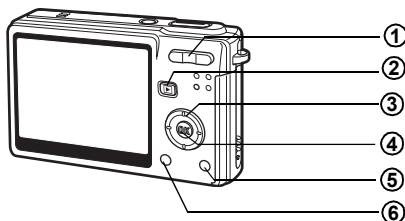

Capture Mode

- ① **⏏/⏏ Zoom button**
Changes the size of the subject. (☞p.32)
- ② **▶ Playback button**
Switches to the Playback mode. When pressed again, returns to Capture mode. (☞p.34)
- ③ **Four-way controller (◀▶▶)**
(⏏▶▶) Changes the focus mode. (☞p.73)
(☺▶▶) Changes the drive mode. (☞p.65 to p.70)
(▼) Displays the Capture Mode Palette. (☞p.48)
(⚡▶) Changes the flash mode. (☞p.76)
- ④ **OK/Display button**
Changes the information displayed on the LCD monitor. (☞p.51)
- ⑤ **Green/🗑️ button**
Initializes the shooting function settings. (☞p.102)
You can assign a different function to the Green button by selecting [Green Button] on the [📷 Rec.Mode] menu. (☞p.94)
- ⑥ **MENU button**
Displays the [📷 Rec.Mode] menus. (☞p.43)

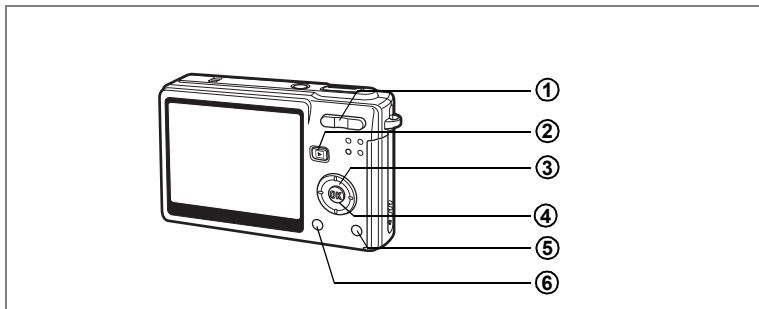

Playback Mode

① **Zoom button**

Press **▲▲▲/▲** in single-image display to switch to nine-image display. Press **▲/Q** to return to the previous display. (☞p.112)

Press **▲/Q** to enlarge the image in single-image display. Press **▲▲▲/☒** to return to the previous display. (☞p.108)

② **▶ Playback button**

Switches to Capture mode. When switched to the Playback mode by pressing the **▶** Playback button in Voice Recording mode, pressing the **▶** Playback button again switches to the Voice Recording mode.

③ **Four-way controller**

For playing back still images

(◀▶) : Displays the previous or next image in single-image display. (☞p.34)

When rotating the displayed image, the image is rotated 90° degrees clockwise each time you press the **▶**, and 90° degrees counter clockwise each time you press the **◀**. (☞p.134)

(▼) : Displays the Playback Mode Palette. (☞p.50)

(▲▼◀▶) : Moves the display area of the enlarged image. (☞p.108)
Selects an image in nine-image display. (☞p.112)

For playing back movies

(▲) : Plays back and pauses a movie. (☞p.110)

(◀▶) : Frame forwards, frame reverses, fast forwards and reverses a movie during playback. (☞p.110)

(▼) : Stops a movie during playback. (☞p.110)

For playing back voice recording files

(▲) : Starts playback. When pressed again, pauses playback.

(◀▶) : Selects a recorded file before playback. Performs the following operations during playback.

If there are no recorded indexes:

When (◀) is pressed during playback, rewinds five seconds.

When (▶) is pressed during playback, advances five seconds.

If there are recorded indexes:

When (◀) is pressed during playback, plays back starting from the previous index.

When (▶) is pressed during playback, plays back starting from the next index.

④ **OK/Display button**

Changes the information displayed on the LCD monitor. (☞p.111)

Returns to a single-image display in nine-image display. (☞p.112)

⑤ **Green/🗑️ button**

Deletes the image displayed on the LCD monitor. (☞p.115)

⑥ **MENU button**

Displays the [📷 Rec.Mode] menus. (☞p.43)

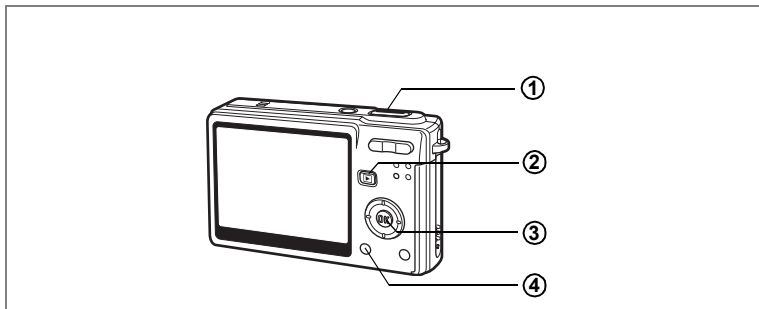

Voice Recording Mode

- ① **Shutter release button**
When pressed, starts recording, and when pressed again, stops recording.
When pressed for more than one second, recording continues for as long as the button is held down and stops when the button is released.
- ② **▶ Playback button**
Switches to Playback mode. (☞p.38) When pressed again, returns to Voice Recording mode.
- ③ **OK/Display button**
Turns the LCD monitor on and off.
- ④ **MENU button**
When pressed during recording, an index can be added.
When pressed during standby or before playback, displays the [📷 Rec.Mode] menu. (☞p.43)

Setting the Menu

When you press the MENU button, the menus appear on the LCD monitor. You can set functions, save the settings and change the camera settings on these menus.

How to Set the Menu

When you are making settings from a menu, a guide to operation appears on the LCD monitor.

- 1 Press the MENU button.**
The [📷 Rec.Mode] menu appears.
The selected area is highlighted.
- 2 Press the four-way controller (◀▶).**
Changes the menu screen.
- 3 Use the four-way controller (▲▼) to choose an item.**
Moves the highlight up or down.
- 4 Press the four-way controller (▶).**
A pull-down menu or setting screen appears.
The pull-down menu displays only those items that can be selected with the current camera settings.
- 5 Use the four-way controller (▲▼) to change the setting.**
The setting changes each time the four-way controller (▲▼) is pressed.

To Save the Setting and Start Taking Pictures

- 6 Press the shutter release button halfway.**
The setting is saved and the camera is ready to take pictures.
When the shutter release button is pressed fully, the picture is taken.

To Save the Setting and Begin Playback of Images

6 Press the Playback button.

The setting is saved and the camera returns to playback status.

To Save the Setting and Continue with Menu Operations

6 Press the OK button or the four-way controller (◀).

The setting is saved and the screen returns to Step 3.

To Cancel the Changes and Continue with Menu Operations

6 Press the MENU button.

The changes are canceled and the screen returns to Step 3.

The MENU button functions differ depending on the screen. Refer to the guide indications.

 Exit : Saves the current setting, exit the operation and return to the original screen (Capture or Playback mode).

  : Saves the current setting and return to Step 1.

 Cancel: Cancels the current selection, exit the operation and return to Step 3.



- If you press the MENU button with the pull-down menu displayed, the setting is canceled.
- If you press the OK button, the MENU button or the four-way controller (◀) with the pull-down menu displayed, the menu returns to the screen used for selecting an item.
- The menu is exited automatically one minute after the last operation.

Example of Menu Operation

1 MENU button

[📷 Rec.Mode] Menu

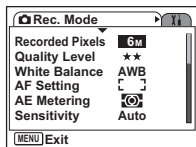

2

[⚙️ Set-up] Menu

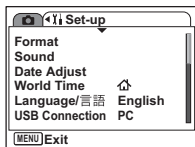

3

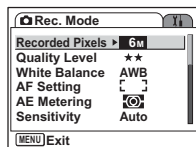

3

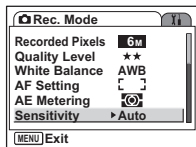

3

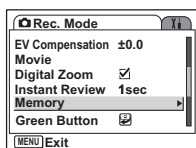

3

To the next screen

4

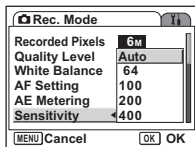

4'

Select Screen

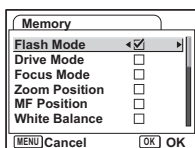

Menu List

[Rec.Mode] Menu

Item		Description	Page
Recorded Pixels		For selecting the number of pixels	p.78
Quality Level		For selecting the image compression ratio	p.80
White Balance		For adjusting the color balance according to lighting	p.82
AF Setting	Focusing Area	For changing the area of the autofocus	p.84
	Focus Limiter	For limiting the moving range of the lens in accordance with the shooting conditions	p.85
	Aux. AF light	For focusing with auxiliary AF light when the subject is dim and the autofocus is hard to function properly	p.86
AE Metering		For setting the metering method to determine the exposure	p.87
Sensitivity		For setting the sensitivity	p.88
EV Compensation		For adjusting the exposure between -2.0 and +2.0	p.89
Movie	Recorded Pixels	For selecting the recorded pixels of the movie	p.90
	Quality Level	For selecting the quality level of the movie	p.91
	Time-lapse Movie	For setting the time-lapse setting of the movie	p.92
	Movie anti-shake	For compensating for camera shake of the movie automatically	p.92
Digital Zoom		For taking digital zoom pictures	p.71
Instant Review		For setting the Instant Review time	p.93
Memory		For saving the shooting function settings when the camera is turned off	p.100
Green Button		For registering a function on the Green button	p.94
Sharpness		For setting the sharpness	p.97
Saturation		For setting the saturation	p.98
Contrast		For setting the contrast	p.99

[Set-up] Menu

Item	Description	Page
Format	For formatting the SD Memory Card or built-in memory	p.148
Sound	For adjusting the operation volume and the playback volume and setting the type and volume of start-up sound, shutter sound, key operation sound, self-timer sound.	p.149
Date Adjust	For adjusting the date, time, and display style	p.152
World Time	For setting the world time	p.154
Language/言語	For changing the language in which menus and messages appear	p.156
USB Connection	For changing the USB connection mode	p.157
Video Out	For setting the video output format	p.157
Brightness Level	For changing the brightness of the LCD monitor	p.158
Power Saving	For setting the Power Saving function	p.159
Quick Zoom	For displaying the image at specified magnification by pressing the zoom button once	p.109
Quick Delete	For displaying the Delete screen with [Delete] highlighted when On is selected	p.116
Auto Power Off	For turning off the power automatically	p.160
Guide Display	For showing the mode selected on the screen in Capture mode, the status of the four-way controller, and assignment of the Green button.	p.160
Reset	For returning the camera settings to defaults	p.161

Operating the Mode Palette

Once you press the four-way controller (▼), the Mode Palette appears on the LCD monitor. You can edit an image or change the settings of the camera.

How to operate the Mode Palette

The guide display is indicated while using the Mode Palette.

1 Press the four-way controller (▼).

In Capture mode, the Capture Mode Palette appears and in Playback mode, the Playback Mode Palette appears.

2 Use the four-way controller (▲▼◀▶) to choose an item.

3 Press the OK button.

The screen for each mode appears.

Mode Palette List

Capture Mode Palette

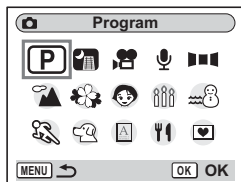

Icon	Item	Description	Page
	Program mode	The basic picture-taking mode.	p.54
	Night Scene mode	Lets you take dark scenes such as night views.	p.58
	Movie mode	Lets you take movies and sounds.	p.59
	Voice Recording Mode	Records audio, such as voices.	p.103
	Panorama Assist mode	Lets you take a number of images to be joined into a panorama picture using the software supplied with the camera.	p.61

Icon	Item	Description	Page
	Landscape mode	Lets you capture the natural colors of landscape views.	p.55
	Flower mode	Lets you take brightly colored flower pictures.	
	Portrait mode	Lets you take portraits with spatial effect, by emphasizing the person.	
	Candlelight mode	Ideal for capturing a candlelit atmosphere.	
	Surf & Snow mode	Lets you take photos against dazzling backgrounds like beaches or snow-covered mountains.	
	Sport mode	Lets you take clear pictures of moving subjects with a high shutter speed to prevent motion blur.	
	Pet mode	Lets you take clear pictures of pets to fit the hair color.	
	Text mode	Lets you take clear pictures of text or writing. Also lets you turn colored text black/white or reverse color.	
	Food mode	Lets you take appetizing pictures of prepared food.	
	Frame Composite mode	Lets you take pictures with a decorative frame.	p.63

Playback Mode Palette

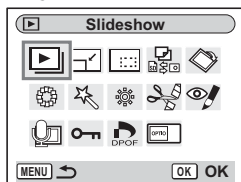



Icon	Item	Description	Page
	Slideshow	For playing recorded images successively	p.113
	Resize	For changing the size and quality level of images	p.131
	Trimming	For trimming images and saving them as separate images	p.133
	Image/ Sound Copy	For copying files from the built-in memory to the SD Memory Card and vice versa	p.145
	Image Rotation	For displaying rotated still pictures	p.134
	Color Filter	For processing images using the color filter	p.135
	Digital Filter	For applying special effects such as the illustration effect or the slim effect to still pictures according to your taste	p.137
	Brightness Filter	For adjusting the brightness of images using a filter	p.139
	Movie Edit	For editing movies	p.141
	Red-eye Compensation	For retouching red-eyes, a phenomenon that can happen when shooting with a flash	p.144
	Voice Memo	For adding a voice memo to an image	p.106
	Protect	For protecting images and sounds to avoid accidental erasure	p.120
	DPOF	For printing images from a DPOF compatible printer or at a printing service	p.124
	Start-up screen	For setting the Start-up screen	p.147

Changing the Mode

Capture mode is for taking pictures and Playback mode is for playing back or deleting images.

Switching between Capture Mode and Playback Mode

- To change from Capture mode to Playback mode, press the  Playback button.
- To change from Playback mode to Capture mode, press the  Playback button or press the shutter release button halfway.

Selecting the Capture Mode

Select the Capture Mode from the Mode Palette. (p.48)

Displaying Shooting Information in Capture Mode

You can display shooting information on the LCD monitor when taking pictures. The display mode can be changed by pressing the OK/Display button.

Normal Display

Shooting information is displayed when the power is turned on.

- | | |
|---|-----------------------|
| 1 Capture mode | 2 Flash mode |
| 3 Drive mode | 4 Focus mode |
| 5 Focus frame | 6 Zoom |
| 7 Card/Built-in memory | 8 Battery indicator |
| 9 Remaining number of recordable images | 10 Date and time |
| 10 Date and time | 11 World Time setting |
| 12 Anti-shake warning | 13 Aperture |
| 14 Shutter speed | |

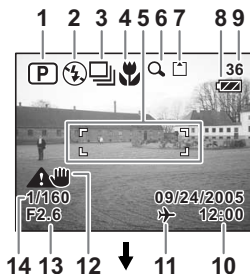

Histogram Display

The brightness distribution of the image is displayed. The horizontal axis shows the brightness (darkest at the left end and brightest at the right end) and the vertical axis shows the number of pixels.

- | | |
|-------------------|-----------------|
| 1 Recorded Pixels | 2 Quality Level |
| 3 White Balance | 4 AE Metering |
| 5 Sensitivity | 6 Histogram |

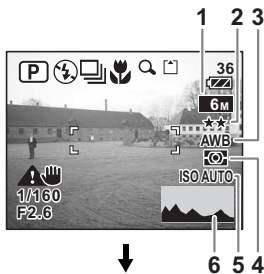

Guide Display

The grids divided into three parts are displayed. These grids will help you to improve composition.

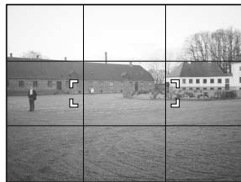

No icons

No shooting information is displayed.

- The focus frame appears in Autofocus mode.
- If any of the modes are changed, the mode you have changed appears for a few seconds.



Backlight Off

The LCD monitor is turned off.

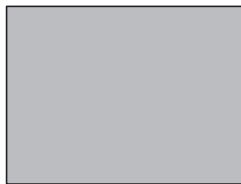

Saving the Display Mode p.100



- Under shooting conditions where camera shake is likely to occur, (Anti-shake warning) will be displayed. Take pictures with the camera secured on a tripod or other stable surface.
- All the camera buttons function as normal even when the backlight is off. Press the shutter release button to take pictures as normal.

Using Histogram

A histogram is a graph showing the brightness of an image on the horizontal axis and the number of pixels on the vertical axis (distribution chart of the brightness). The histogram will help you detect the brightness of the image you have taken. For instance, the graph peak tends to appear on the left side for a darker image, and the graph peak tends to appear on the right side for a brighter image. In general, when the exposure meter of your image is well-balanced, the graph peaks tend to appear in the middle. On the contrary, when the exposure meter gets imbalanced tending dark and bright without showing a neutral brightness, the peaks appear not in the middle but on both sides.

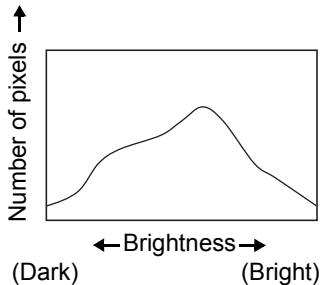

Dark

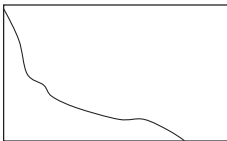

Neutral

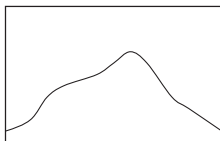

Bright



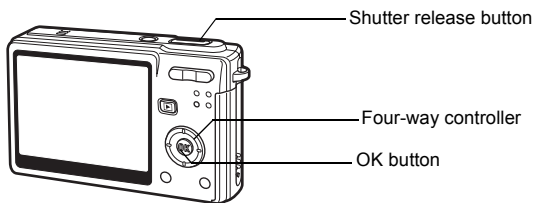

Setting the Functions (Program Mode)

In **P** (Program mode), the camera automatically sets the shutter speed and aperture for taking still pictures. However, you can select other functions such as the Flash Mode or Continuous Shooting mode.

1 Press the four-way controller (▼) in Capture mode.

The Mode Palette appears.

2 Use the four-way controller (▲▼◀▶) to select **P** (Program mode).

3 Press the OK button.

4 Set the functions you want to use.

Refer to “Setting the Shooting Functions” (p.73 - 99) for details of how to set the functions.

5 Press the shutter release button halfway.

The focus frame on the LCD monitor will light green when the camera is in focus.

6 Press the shutter release button fully.

The picture is taken.

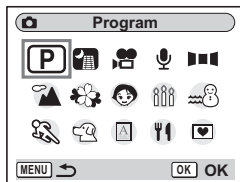

Taking Still Pictures p.32

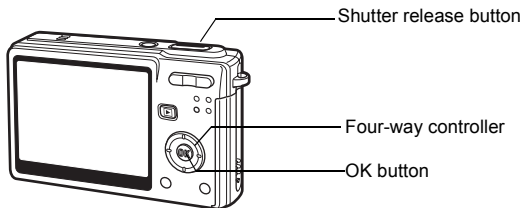

Selecting the Picture Mode According to the Shooting Scene (Picture Mode)

You can select the Picture mode according to the shooting scene. There are nine available modes in Picture mode.

	Landscape	Lets you capture the natural colors of landscape views.
	Flower	Lets you take brightly colored flower pictures.
	Portrait	Lets you take portraits with spatial effect, by emphasizing the person.
	Candlelight	Ideal for capturing a candlelit atmosphere.
	Surf & Snow	Lets you take photos against dazzling backgrounds like beaches or snow-covered mountains.
	Sport	Lets you take clear pictures of moving subjects with a high shutter speed.
	Pet	Lets you take clear pictures of pets to fit the hair color.
	Text	Lets you take clear pictures of text or writing. Also lets you turn colored text black/white or reverse color.
	Food	Lets you take appetizing pictures of prepared food.

- 1 Press the four-way controller (▼) in Capture mode.**
The Mode Palette appears.
- 2 Use the four-way controller (▲▼◀▶) to choose the desired mode.**
For example, select (Landscape mode).
- 3 Press the OK button.**
- 4 Press the shutter release button halfway.**
The focus frame on the LCD monitor will light green when the camera is in focus.
- 5 Press the shutter release button fully.**
The picture is taken.

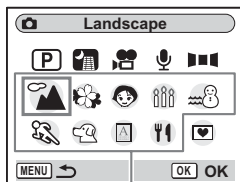
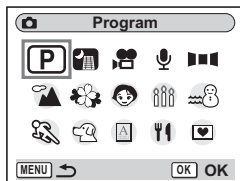

Picture mode



- When the (Sport) or (Pet) mode is selected, the automatic tracking AF function operates and the camera continues to adjust the focus on the moving subject even after the shutter release button is pressed halfway.
- In Picture mode, Saturation, Contrast, Sharpness and White Balance are automatically set to their default settings. You cannot change the settings.

Taking Pictures of Your Pet (Pet Mode)

In Pet mode, you can take pictures that shows natural hair color of your pet. Choose the appropriate icon depending on what color your pet is (closer to black or white or in between).

1 Press the four-way controller (▼) in Capture mode.

The Mode Palette appears.

2 Use the four-way controller (▲▼◀▶) to select .

3 Press the OK button.

The screen for selecting the pet mode appears.

4 Use the four-way controller (▲▼) to select , , , , or .

There are two icons of a cat and a dog. (Choosing either the cat or dog icon does not affect the resulting picture. Choose whichever you prefer.)



5 Press the OK button.

The Pet mode is selected and the camera is ready to take the picture.

6 Press the shutter release button halfway.

The focus frame turns green when the subject is in focus.



7 Press the shutter release button fully.

The picture is taken.



When the (Pet) mode is selected, the automatic tracking AF function operates and the camera continues to adjust the focus on the moving subject even after the shutter release button is pressed halfway.

Taking Pictures of Text (Text Mode)

This mode allows you to take clear pictures of written text. This is convenient for capturing a digital copy of an important document or enhancing legibility of small print.

1 Press the four-way controller (▼) in Capture mode.

The Mode Palette appears.



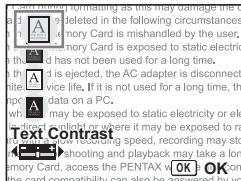

2 Use the four-way controller (▲▼◀▶) to select .

3 Press the OK button.

The screen for selecting the Text mode appears.



4 Use the four-way controller (▲▼) to select , , , or .

	Color	Maintains original colored text.
	Neg. Color	Reverses colored text.
	B&W	Turns colored text black/white.
	Neg. B&W	Reverses black/white text.

Press the four-way controller (◀▶) to adjust the contrast.

5 Press the OK button.

The text mode is selected and the camera is ready to take the picture.

6 Press the shutter release button halfway.

The focus frame turns green when the subject is in focus.

7 Press the shutter release button fully.

The picture is taken.

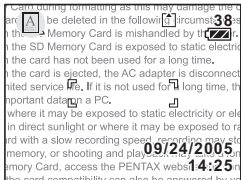

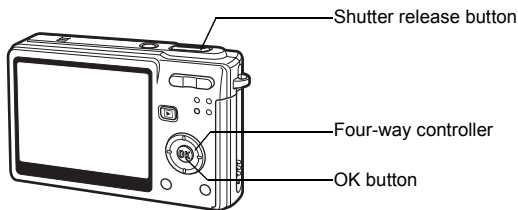

Taking Pictures of Dark Scenes (Night Scene Mode)

You can take pictures of dark scenes, such as nightscapes, with the appropriate settings.

1 Press the four-way controller (▼) in Capture mode.

The Mode Palette appears.

2 Use the four-way controller (▲▼◀▶) to select (Night-Scene mode).

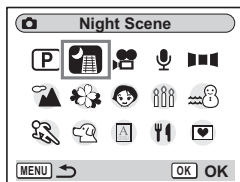

3 Press the OK button.

4 Press the shutter release button halfway.

The focus frame on the LCD monitor will light green when the camera is in focus.

5 Press the shutter release button fully.

The picture is taken.



Total recording time will be longer when the picture is taken at slower shutter speed (approximately 1/4 second or slower), because the noise reduction activates to reduce noise.



The shutter speed is slower when taking pictures of dark scenes. To prevent camera shake, secure the camera on a tripod or other stable surface.

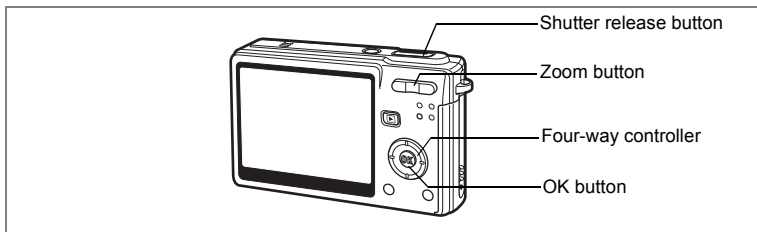

Taking Movies (Movie Mode)

This mode enables you to take movies and sounds.

- 1 Press the four-way controller (▼) in Capture mode.**

The Mode Palette appears.

- 2 Use the four-way controller (▲▼◀▶) to select  (Movie mode).**

- 3 Press the OK button.**

The following shooting information appears on the LCD monitor and the camera is ready to take movies.

- | | |
|-------------------------|-------------------|
| 1 Movie mode icon | 2 Flash Off icon |
| 3 Card/Built-in memory | 4 Recordable time |
| 5 Movie anti-shake (On) | |

- 4 Press the shutter release button.**

Shooting starts. You can change the size of the image using the zoom button.

▲ : makes the subject bigger.

▶▶▶ : makes the subject smaller.

- 5 Press the shutter release button.**

Shooting ends.

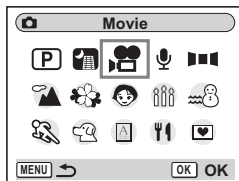
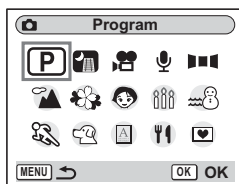

Keeping the Shutter Release Button Pressed

If you keep the shutter release button pressed for more than one second, the movie will be taken for as long as you keep the button pressed. Shooting stops when you take your finger off the shutter release button.



- The flash will not discharge in Movie mode.
- Continuous shooting is not possible in Movie mode.
- You cannot use the remote control unit in Movie mode.
- Sound cannot be recorded when [Time-lapse Movie] is set to On.
- Set the Movie anti-shake to Off to use the digital zoom in Movie mode.
- The optical zoom cannot be used while taking movies in Movie mode.
- The Focusing Area is fixed to Spot, and the Focus Limiter and the auxiliary AF light are set to Off in Movie mode. When Focus Mode is set to Autofocus or Macro, the AF operation is performed once right before starting taking a movie.

Taking Time-lapse Movies p.92

Playing Back Movies p.110



When you register [Movie] on the Green Button, press the Green Button in Capture mode to switch to Movie mode. (p.94).

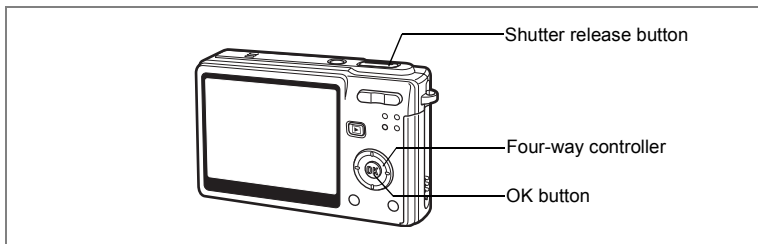

Taking Panorama Pictures (Panorama Assist Mode)

You can take a number of images and join them together to form a panorama picture. The software supplied with the camera (ACDSee for PENTAX) and a computer are necessary for joining the images. The Panorama Assist mode enables you to overlap the edges of the images so that they are easier to join together later into a panorama picture.

1 Press the four-way controller (▼) in Capture mode.

The Mode Palette appears.

2 Use the four-way controller (▲▼◀▶) to select (Panorama Assist mode).

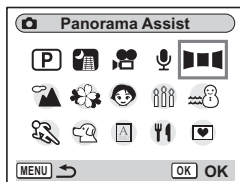

3 Press the OK button.

4 Use the four-way controller to choose the direction in which the images will be joined.

- ◀ Joins the images at the left.
- ▶ Joins the images at the right.
- ▲ Joins the images at the top.
- ▼ Joins the images at the bottom.

The example shows the images when ▶ is selected.



5 Take the first image.

Press the shutter release button to take the first image. The right edge of the image appears in half-transparent form on the left of the LCD monitor.



6 Move the camera to the right and take the second image.

Move the camera until the half-transparent image and the actual view overlap and press the shutter release button. Repeat Steps 5 and 6 to take the third and subsequent images.

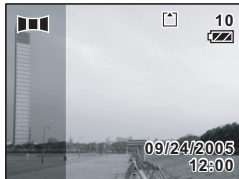

To cancel Panorama Assist mode, change to another mode.



- The camera cannot join the images. Use the panorama software supplied with the camera (ACDSee for PENTAX, ACD photostitcher). Refer to “ACDSee for PENTAX Users Guide” for instructions on creating panorama pictures.
- Continuous shooting is not possible in Panorama Assist mode.

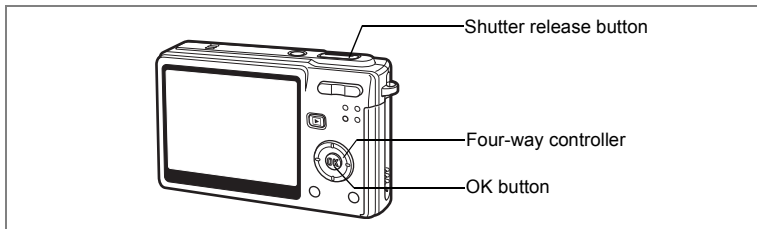

Taking Pictures in Frame Composite mode

You can take pictures with a decorative frame added using the Frame Composite function. There are three frames already stored in the camera.

- 1 Press the four-way controller (▼) in Capture mode.**

The Mode Palette appears.

- 2 Use the four-way controller (▲▼◀▶) to select ♥ (Frame Composite).**

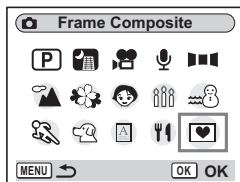

- 3 Press the OK button.**

The frame selection screen appears.

- 4 Use the four-way controller (◀▶) to choose a frame.**

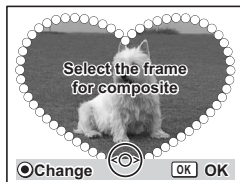

- 5 Press the OK button.**

The subject appears in the selected frame.

- 6 Press the shutter release button halfway.**

The focus frame on the LCD monitor will light green when the camera is in focus.

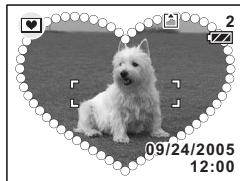

7 Press the shutter release button fully.

The picture is taken.



- The Recorded Pixels is fixed to 3M, and cannot be changed to any other size.
- Continuous Shooting is not possible in Frame Composite mode.

To Register a New Frame

To switch to the screen for registering a frame, press the Green button in Step 3. You can register frames which you have downloaded from the internet, etc. When you register a new frame, it replaces one of the existing frames in the built-in memory. Before you can register a new frame, copy it first to the SD Memory Card.

4



When a new frame on the SD Memory Card is registered in the built-in memory, it replaces one of the existing frames in the built-in memory. The replaced frame is deleted from the built-in memory.

1 In the frame selection screen, choose the frame you want to remove and press the Green button.

A message appears and the frames on the SD Memory Card that you can register in the built-in memory appear.

2 Use the four-way controller (◀▶) to choose the frame you want to register and press the OK button.

The frame is registered in the built-in memory instead of the frame selected in Step 1.

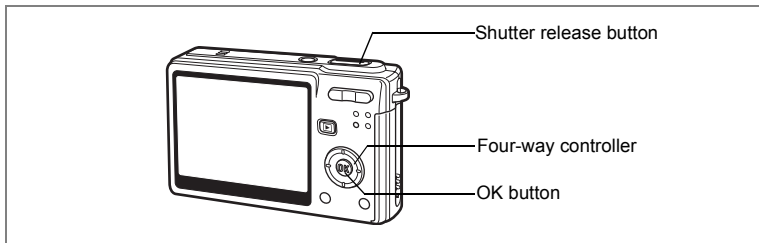

Using the Self-timer

In self-timer mode, the picture is taken ten seconds or two seconds after the shutter release button is pressed.

- 1 Press the four-way controller (▲) in Capture mode.**
- 2 Press the four-way controller (◀▶) to select 10s or 2s.**
- 3 Press the OK button.**

The camera is ready to take pictures using the Self-timer.

- 4 Press the shutter release button halfway.**

The focus frame on the LCD monitor will light green when the camera is in focus.

- 5 Press the shutter release button fully.**

- ☺ The self-timer is engaged and the self-timer lamp lights for about seven seconds. The picture is taken approximately three seconds after the self-timer lamp starts to blink.
- 2s The self-timer is engaged and the picture is taken approximately two seconds after the self-timer lamp starts to blink.



Focusing may be compromised if you move the camera while the self-timer is running.



- The countdown is displayed on the LCD monitor when you press the shutter release button.
- If you press the shutter release button halfway while the camera is counting down, it stops counting down. And if you press the shutter release button fully, it starts counting down again from the beginning.

Troubleshooting "Subject is not in focus" p.173

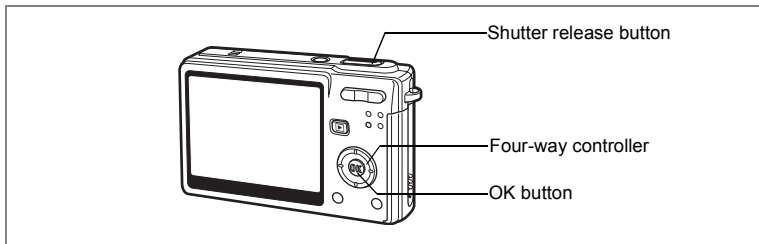

Continuous Shooting (Continuous Shooting Mode)

You can switch the Drive mode to Continuous Shooting mode. Pictures are taken continuously while the shutter release button is pressed.

- 1 Press the four-way controller (▲) in Capture mode.**
- 2 Press the four-way controller (◀▶) to select .**
- 3 Press the OK button.**

The camera is ready to take pictures continuously.

- 4 Press the shutter release button halfway.**

The focus frame on the LCD monitor will light green when the camera is in focus.

- 5 Press the shutter release button fully.**

Pictures are taken continuously while the shutter release is pressed.

Shooting stops when you take your finger off the shutter release button.



- You can continue shooting until the SD Memory Card or the built-in memory is full.
- The interval will vary according to the [Recorded Pixels] and [Quality Level] settings.

 Caution

- The flash will not discharge in Continuous Shooting mode.
- Continuous shooting is not available for Movie, Panorama Assist or Frame Composite mode.
- The focus, exposure and white balance are locked with the first image.

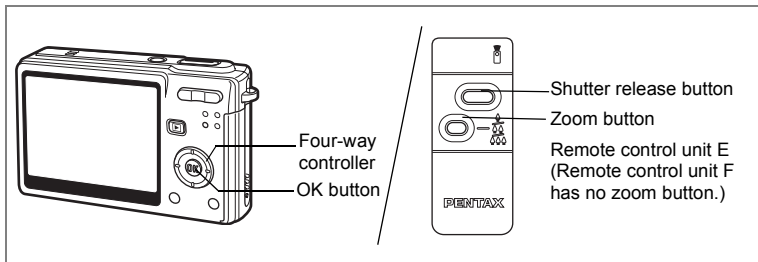

Using the Remote Control Unit (optional)

You can switch the Drive mode to Remote Control mode and take pictures using the remote control unit E or F (optional).

Taking Pictures Using the Remote Control

- 1 Press the four-way controller (▲) in Capture mode.
- 2 Press the four-way controller (◀▶) to select or .
- 3 Press the OK button.
The self-timer lamp blinks slowly and the camera is ready to take the picture.
- 4 Press the shutter release button on the remote control unit.





- The self-timer lamp blinks quickly and the picture is taken after approximately three seconds.
- The picture is taken immediately.



- Focusing may be compromised if you move the camera while the self-timer lamp is blinking.
- You cannot use the remote control unit in Movie mode.

Changing the Magnification Using the Remote Control Unit

You can not only change the zoom magnification with the zoom button, but also shoot images with the shutter button using the remote control unit E (optional).

- 1 Press the four-way controller (▲) in Capture mode.**
- 2 Press the four-way controller (◀▶) to select  or .**
- 3 Press the zoom button on the remote control unit.**

The function is same either in  or .

Each time you press the zoom button, the zoom position will change among tele, middle, and wide.



The zoom position will not change in Macro mode, even if you press the zoom button. If the camera is in the optical zoom range, the zoom magnification is cancelled when you press the zoom button.



- The buttons on the camera can be used in the normal way.
- Ensure that the remote control unit is no more than about four meters away from the front of the camera.
- You cannot change the digital zoom range with the remote control unit; you can change only the optical zoom range.

Life of the Battery for the Remote Control Unit

A signal can be sent from the remote control unit to the camera approximately 30,000 times. Contact your nearest PENTAX customer service center if the battery needs changing. (A charge is made for changing the battery.)

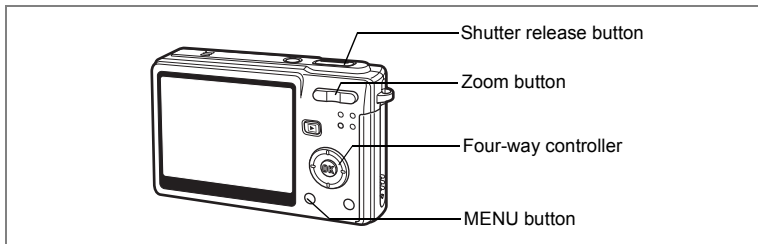

Using the Zoom to Change the Subject Size

You can use the zoom to change the size of the subject and take pictures in Tele or Wide mode.

1 Press the zoom button in Capture mode.

- ▲ Tele: makes the subject bigger.
- ▲▲▲ Wide: makes the subject smaller.

When the digital zoom function is disabled, you can take pictures at up to three times magnification using the optical zoom. When the digital zoom function is enabled, you can further enlarge the subject to a maximum magnification equivalent to 12 times.

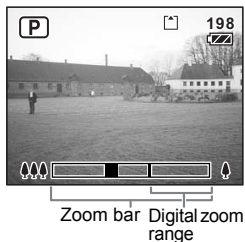

When digital zoom is enabled

Saving the Zoom Position p.100



You cannot use the optical zoom when taking movies.

Setting the Digital Zoom

The digital zoom is set to (On) in the default settings. To take pictures using only the optical zoom, set the digital zoom to (Off).

1 Press the MENU button in Capture mode.

The [📷 Rec.Mode] menu appears.

2 Use the four-way controller (▲▼) to select [Digital Zoom].

3 Use the four-way controller (◀▶) to select (On)/ (Off).

4 Press the shutter release button halfway.

The camera is ready to take pictures.

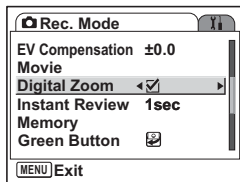

Saving the Digital Zoom Function Setting p.100



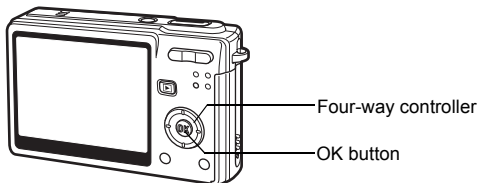

Set the Movie anti-shake to Off to use the digital zoom in Movie mode.

Setting the Shooting Functions



Selecting the Focus Mode

Focus mode

AF	Autofocus mode	The camera focuses on the object in the autofocus area when the shutter release button is pressed halfway. Use this mode when the distance to the subject is more than 40 cm (16 in.).
	Macro mode	This mode is used when the distance to the subject is approx. 15 cm – 50 cm (5.9 in. – 19.7 in.). The camera focuses on the object in the autofocus area when the shutter release button is pressed halfway.
PF	Pan Focus mode	This mode is used when shooting close and distant subjects together or the subject is hard to focus on. You can adjust the focus on a subject in the following ranges. When taking still pictures: approx. 1.1 m (3.6 ft.) to ∞ (wide end), approx. 4.5 m (15 ft.) to ∞ (tele end) When taking movies: approx. 0.6 m (1.97 ft.) to ∞ (wide end), approx. 2.5 m (8.2 ft.) to ∞ (tele end)
	Infinity-Landscape mode	This mode is used for taking distant objects.
MF	Manual Focus mode	Adjust the focus manually with the four-way controller.

Saving the Focus Mode  p.100

- 1 Press the four-way controller (▶) in Capture mode.
- 2 Press the four-way controller (▲▼) to select the focus mode.
- 3 Press the OK button.

The camera is ready to take pictures in the selected focus mode.

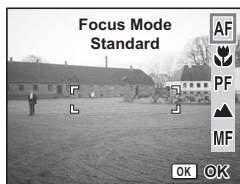

Auxiliary AF light

- The auxiliary AF light may be activated under low lighting in Autofocus mode.
- The auxiliary AF light of this camera conforms to the safety standard (IEC60825-1) for Class 1 LED product. Looking at the light directly will not create safety hazard. However, do not look into the emitter from a very short distance since you may feel dazzled.



- The default setting is Autofocus mode.
- When Focus Mode is set to Autofocus or Macro in Movie mode, the AF operation is performed once just right before starting taking a movie.

Manual Focus

When the mode is set to **MF** (Manual Focus), press the OK button to make the central portion of the picture enlarged to full screen on the LCD monitor for focus adjustment. Use the four-way controller (▲▼) to adjust the focus while watching the indicator on the LCD monitor.



For distant focus



For closer focus



Indicator

After the focus is set, press the OK button to determine the focus position and return to the normal capture screen.

Press the OK button again to change the previously determined focus position.

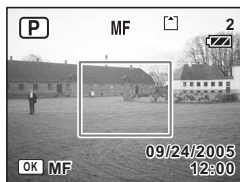

- When focusing, hold down the four-way controller (▲ ▼) to focus quickly.
- When you use Manual Focus in Movie mode, adjust the focus right before starting taking a movie. You cannot adjust the focus while taking the movie.

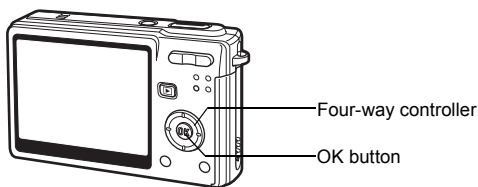

Selecting the Flash Mode

Flash Modes

⚡A	Auto	The flash discharges automatically depending on the light conditions.
⚡	Flash Off	The flash will not discharge, regardless of the brightness. Use this mode to take pictures at dusk or in museums etc. where flash photography is prohibited.
⚡	Flash On	The flash discharges regardless of the brightness.
⚡A	Auto + Red-eye	This mode reduces the phenomenon of red eyes caused by the light from the flash being reflected in the subject's eyes. The flash discharges automatically.
⚡	Flash On + red-eye	This mode reduces the phenomenon of red eyes caused by the light from the flash being reflected in the subject's eyes. The flash will discharge regardless of lighting conditions.
SOFT ⚡	Soft Flash	This mode reduces the intensity of the flash so that the flash is not too bright even when fired at close range. The flash will discharge regardless of the light conditions.



- The flash is off when the Capture mode is set to (Movie mode), Continuous Shooting, or Infinity-Landscape.
- The flash discharges a total of three times, two pre-flashes (It may look like one flash to your eye) and the third time to take the pictures. (In the red-eye reduction modes, the interval between the pre-flashes and the last flash is longer.)

- 1 Press the four-way controller (◀) in Capture mode.
- 2 Use the four-way controller (▲▼) to select the flash mode.

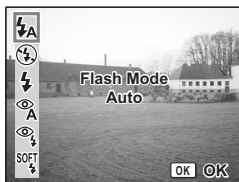

3 Press the OK button.

The camera is ready to take pictures in the selected flash mode.

Saving the Flash Mode  p.100



- Using the flash in Macro mode may cause the image to be overexposed.
- The shutter speed is slower when taking pictures of dark scenes using a flash in Night Scene mode. To prevent camera shake, secure the camera on a tripod or other stable surface.

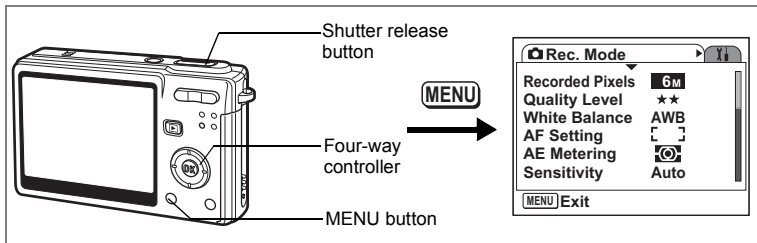

Selecting the Recorded Pixels of Still Pictures

You can choose the number of recorded pixels from [6M], [5M], [4M], [3M], [2M], [1024] and [640].

The more pixels there are, the larger the picture and the bigger the file size. The data volume also varies depending on the quality level setting (p.80).

Number of Recorded Pixels

6M (2816×2112)	↑ Clear, Fine	Printing images with high-resolution settings in your printer, Printing at A4 size or larger, Editing and processing images
5M (2592×1944)		
4M (2304×1728)		
3M (2048×1536)		
2M (1600×1200)		
1024 (1024×768)		
640 (640×480)	Printing at postcard size	
		For use as images on websites, For attaching images to e-mail

1 Press the MENU button in Capture mode.

The [Rec.Mode] menu appears.

2 Use the four-way controller (▲▼) to select [Recorded Pixels].

3 Press the four-way controller (▶).

The pull-down menu appears.

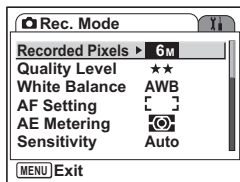

- 4 Use the four-way controller (▲▼) to change the recording pixels.
- 5 Press the shutter release button halfway.

The camera is ready to take the picture.

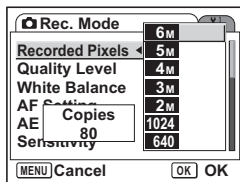

- Selecting a large size produces a clear picture when it is printed out.
- The Recorded Pixels setting is saved when the camera is turned off.

Image Size and Quality of Still Pictures p.25

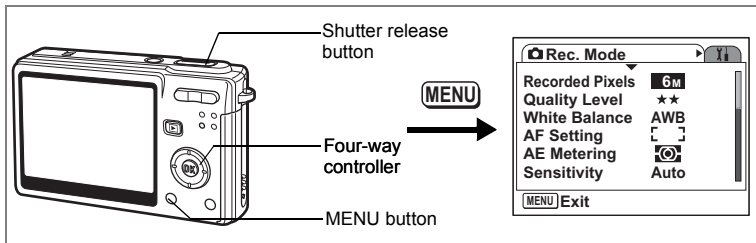

Selecting the Quality Level of Still Pictures

You can choose the image compression ratio.

The more stars, the clearer the quality and the larger the volume. The Recorded Pixels setting also changes the picture volume (p.78).

Quality Levels

★★★	Best	Lowest compression ratio. Suitable for photo prints.
★★	Better	Standard compression ratio. Suitable for viewing the image on a computer screen.
★	Good	Highest compression ratio. Suitable for attaching to e-mails or creating websites.

1 Press the MENU button in Capture mode.

The [Rec.Mode] menu appears.

2 Use the four-way controller (▲▼) to select [Quality Level].

3 Press the four-way controller (▶).

The pull-down menu appears.

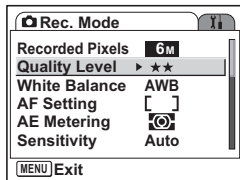

- 4 Use the four-way controller (▲▼) to change the quality level.
- 5 Press the shutter release button halfway.

The camera is ready to take the picture.

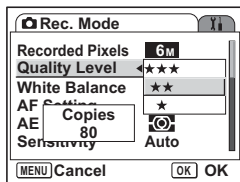

The Quality Level setting is saved when the camera is turned off.

Image Size and Quality of Still Pictures ESP p.25

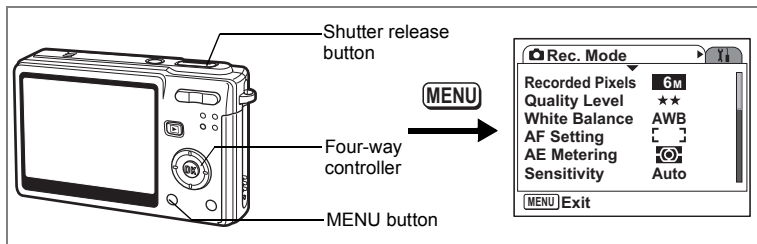

Adjusting the White Balance

You can select a white balance function best suited to the light conditions at the time of shooting. The Auto adjusts a white balance automatically and reproduces natural colors. The Manual allows you to decide a white balance based on the subject you want to make appear white. You can also choose other white balance functions to reproduce colors more accurately depending on the weather or a type of light source.

White Balance

AWB	Auto	The camera adjusts the white balance automatically.
	Daylight	Use this mode when taking pictures outside in sunlight.
	Shade	Use this mode when taking pictures outside in the shade.
	Tungsten Light	Use this mode when taking pictures under electric or other tungsten light.
	Fluorescent Light	Use this mode when taking pictures under fluorescent light.
	Manual	Use this mode when taking pictures by adjusting the white balance manually.

- 1 Press the MENU button in Capture mode.**
The [📷 Rec.Mode] menu appears.
- 2 Use the four-way controller (▲▼) to select [White Balance].**

3 Press the four-way controller (▶).

The White Balance screen appears.

4 Use the four-way controller (▲▼◀▶) to change the setting.

5 Press the shutter release button halfway.

The camera is ready to take the picture.

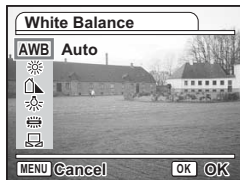

Saving the White Balance p.100

Manual Setting

Place a white material such as a piece of white paper in front of your camera to adjust white balance.

1 Select [] (Manual) on the White Balance screen.

2 Point the camera at the white material so that it fills the screen.

3 Press the Green button.

The white balance is automatically adjusted. [Complete] appears on the LCD monitor.

4 Press the OK button.

The setting now adjusted is saved and the screen returns to the [Rec.Mode] menu.

5 Press the shutter release button halfway.

The camera is ready to take the picture.

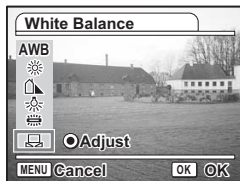

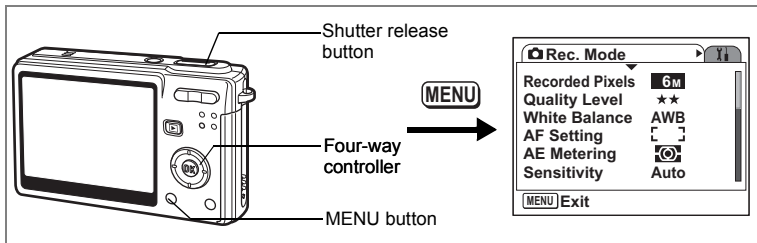

Selecting the Autofocus Settings

You can set the autofocus area and focusing method.

- 1 Press the MENU button in Capture mode.**
The [📷 Rec. Mode] menu appears.
- 2 Use the four-way controller (▲▼) to select [AF Setting].**
- 3 Press the four-way controller (▶).**
The AF Setting screen appears.

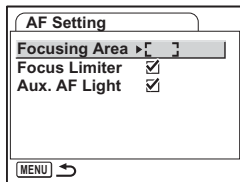

Changing the Focusing Area

You can change the autofocus area (Focusing Area).

Focusing Area

[]	Multiple	The camera measures a wide range in the center of the monitor (within the focusing area) and focuses on the nearest subject.
[]	Spot	The camera measures a narrow range in the center of the monitor (the spot focusing area) making easier for you to focus on a specific subject.
	Automatic tracking AF	The camera always continues to focus on a specified subject while the LCD monitor is on.

4 Press the four-way controller (▶).

The pull-down menu appears.

5 Use the four-way controller (▲▼) to change the Focusing Area.

6 Press the shutter release button halfway.

The camera is ready to take the picture.

Saving the Focusing Area Setting  p.100

Setting the Focus Limiter

You can limit the moving range of the lens in accordance with the shooting conditions. When you set the Focus Limiter to On, the moving range of the lens is limited to the long range side for normal shooting, and to the close-up side for macro shooting. You can adjust the focus on the subject quickly.

4 Use the four-way controller (▲▼) to select [Focus Limiter].

5 Use the four-way controller (◀▶) to select (On)/ (Off).

6 Press the shutter release button halfway.

The camera is ready to take the picture.

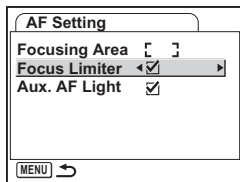

Setting the Auxiliary AF Light

The auxiliary AF light is convenient when you shoot a dark subject. The function helps you to focus on the subject under the conditions that the auto focus does not work properly.

- 4 Use the four-way controller (▲▼) to select [Aux. AF Light].
- 5 Use the four-way controller (◀▶) to select (On)/ (Off).
- 6 Press the shutter release button halfway.

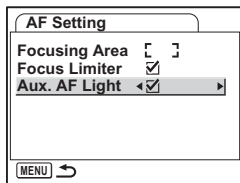

The camera is ready to take the picture.

4



The auxiliary AF light of this camera conforms to the safety standard (IEC60825-1) for Class 1 LED product. Looking at the light directly will not create safety hazard. However, do not look into the emitter from a very short distance since you may feel dazzled.



The camera does not emit the auxiliary AF light under the following condition: the recording mode is set to (Movie), (Landscape) or (Candlelight), or the focus mode is set to pan focus, infinity-landscape mode, or manual focus.

In the (Landscape) and (Candlelight) mode, however, you can let the camera emit the auxiliary AF light by setting [Aux. AF Light] to On.

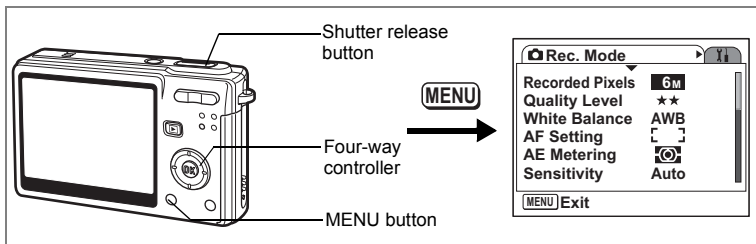

Setting the Light Metering Mode to Determine the Exposure

You can choose which part of the screen to use to measure the brightness and determine the exposure.

AE Metering Modes

	Multi-segment	The exposure is determined by the entire screen.
	Center-weighted	The exposure is determined mainly by the center of the screen.
	Spot	The exposure is determined by the small area in the center of the screen only.

1 Press the MENU button in Capture mode.

The [Rec.Mode] menu appears.

2 Use the four-way controller (▲▼) to select [AE Metering].

3 Press the four-way controller (▶).

The pull-down menu appears.

4 Use the four-way controller (▲▼) to change the AE metering mode.

5 Press the shutter release button halfway.

The camera is ready to take the picture.

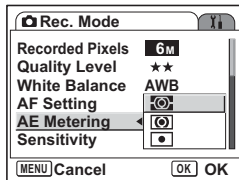
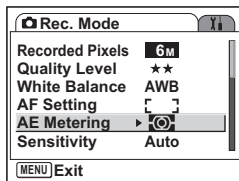

Saving the AE Metering Mode p.100

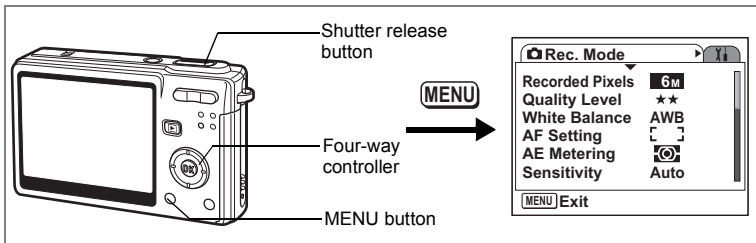

Setting the Sensitivity

You can select the sensitivity to suit the brightness of the surroundings.

Sensitivity

Auto	The sensitivity is automatically set in the range from 64 to 200.
64	<ul style="list-style-type: none"> The lower the sensitivity (the lower values), the sharper the image and the less noise. The shutter speed will be slower in low light conditions. The higher the sensitivity (the higher values), the faster the shutter speed in low light conditions to reduce camera shake, but the image may be affected by noise.
100	
200	
400	

1 Press the MENU button in Capture mode.

The [Rec.Mode] menu appears.

2 Use the four-way controller (▲▼) to select [Sensitivity].

3 Press the four-way controller (▶).

The pull-down menu appears.

4 Use the four-way controller (▲▼) to change the sensitivity.

5 Press the shutter release button halfway.

The camera is ready to take the picture.

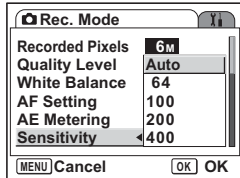
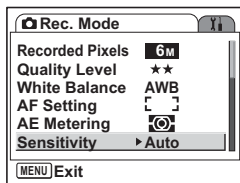

Saving the Sensitivity esp. p. 100



You can select 800 for Sensitivity in Candlelight mode.

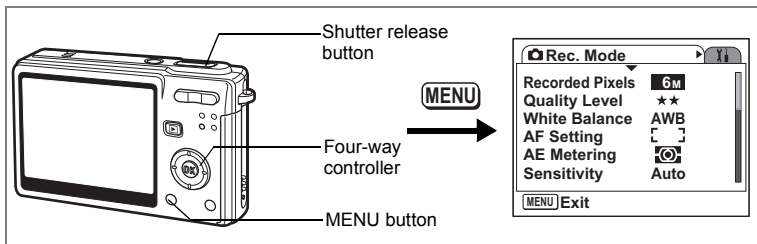

Setting the Exposure (EV Compensation)

You can adjust the overall brightness of the picture.

Use this function to take pictures that are intentionally overexposed or underexposed.

1 Press the MENU button in Capture mode.

The [📷 Rec.Mode] menu appears.

2 Use the four-way controller (▲▼) to select [EV Compensation].

3 Use the four-way controller (◀▶) to change the EV setting.

To brighten, set a positive (+) value. To darken, set a negative (-) value.

You can choose the EV setting in the range of -2.0 EV to +2.0 EV in 1/3 EV steps.

4 Press the shutter release button halfway.

The camera is ready to take the picture.

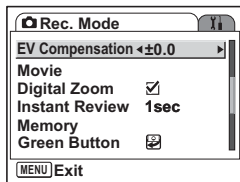

Saving the EV Compensation Value p.100

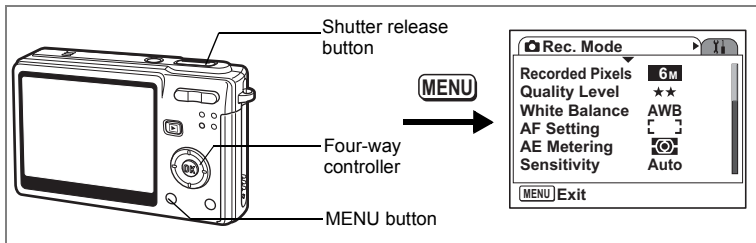

Selecting the Settings for Taking Movies

You can select the recorded pixels and quality level for taking movies.

1 Press the MENU button in Capture mode.

The [📷 Rec. Mode] menu appears.

2 Use the four-way controller (▲▼) to select [Movie].

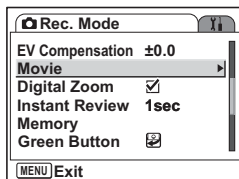

3 Press the four-way controller (▶).

The Movie setting menu appears.

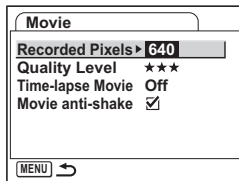

Selecting the Recorded Pixels of Movies

You can choose the number of recorded pixels from 640 (640×480) and 320 (320×240). The more pixels are selected, the larger the file size. The data volume also varies depending on the quality level setting.

Recorded Pixels

640 (640×480)	You can view high-quality movies at VGA size. The recordable time is shorter.
320 (320×240)	The file size is small and the recordable time is longer.

4 Press the four-way controller (▶).

The pull-down menu appears.

5 Use the four-way controller (▲▼) to select [Recorded Pixels].

The recordable time for the selected Recorded Pixels appears.

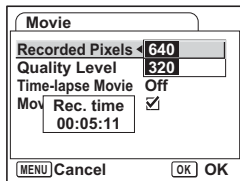

6 Press the shutter release button halfway.

The camera is ready to take the picture.

Size and Quality of Movies p.26

Selecting the Quality Level of Movies

You can choose the quality level from ★★★, ★★ and ★. The more ★, the clearer the movie appears and the larger the data volume.

4 Use the four-way controller (▲▼) to select [Quality Level].

5 Press the four-way controller (▶).

The pull-down menu appears.

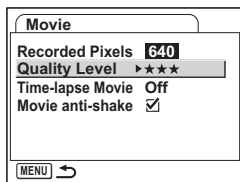

6 Use the four-way controller (▲▼) to select Quality Level.

The recordable time for the selected quality level appears.

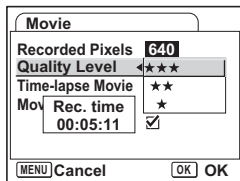

7 Press the shutter release button halfway.

The camera is ready to take the picture.

Size and Quality of Movies p.26

Taking Time-lapse Movies

This mode lets you take movies at a delayed frame rate so that when you play the movie back, the action appears speeded up.

4 Use the four-way controller (▲▼) to select [Time-lapse Movie].

5 Press the four-way controller (▶).

A pull-down menu appears.

6 Use the four-way controller (▲▼) to change the time-lapse setting.

You can choose from [Off], [×2], [×5], [×10], [×15] and [×30].

7 Press the shutter release button halfway.

The camera is ready to record a time-lapse movie.

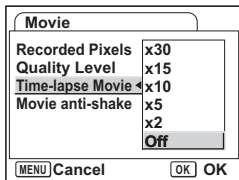
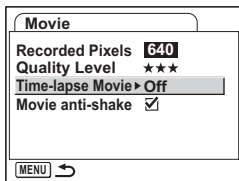

- Off (×1) is the normal setting for movies (approximately 30 frames per second). When ×2 or ×5 is selected, the number of frames taken per second is reduced to 1/2 or 1/5.
- As movies are normally played back at the rate of approximately 30 frames per second, movies taken at ×2 appear to be played back at twice the normal speed and movies taken at ×5 appear to be played back at five times the normal speed.
- Sound cannot be recorded.

Compensating for Camera Shake

When you set Movie anti-shake to On, you can compensate for camera shake, which is more likely to occur while taking movies.

4 Use the four-way controller (▲▼) to select [Movie anti-shake].

5 Use the four-way controller (◀▶) to select (On)/ (Off).

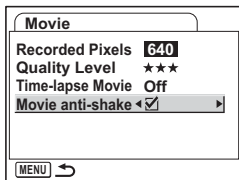

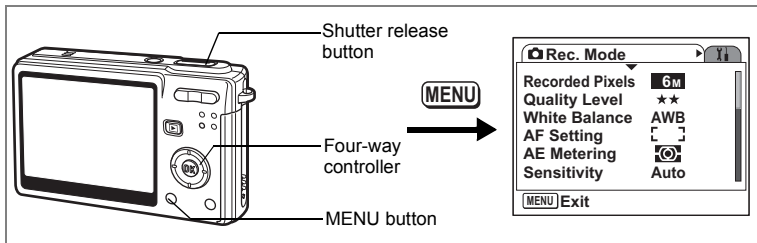

Setting the Instant Review Time

You can choose the Instant Review time from Off (no display), 1 sec., 2 sec., 3 sec., 4 sec., and 5 sec.

1 Press the MENU button in Capture mode.

The [Rec.Mode] menu appears.

2 Use the four-way controller (▲▼) to select [Instant Review].

3 Press the four-way controller (▶). The pull-down menu appears.

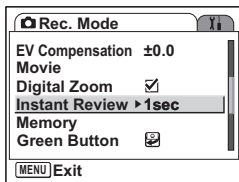

4 Use the four-way controller (▲▼) to change the display time.

5 Press the shutter release button halfway.

The camera is ready to take the picture.

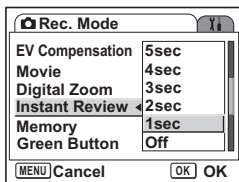

The Instant Review setting is saved when the camera is turned off.

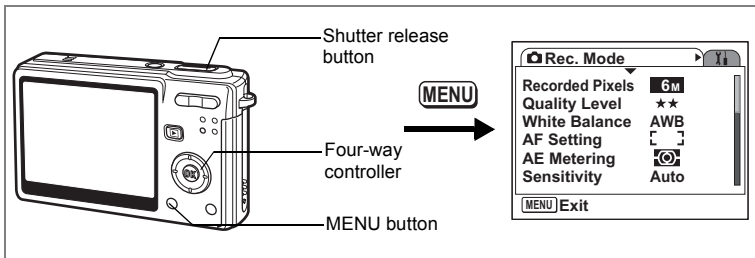

Setting the Green Button

You can register one of the three functions: Initialize Rec. Mode (p.102), Movie (p.59) or Fn Setting (p.95) on the Green button. The function can be activated simply by pressing the Green button.

4

Taking Pictures

Registering a Function (Initialize Rec. Mode) · (Movie)

1 Press the MENU button in Capture mode.

The [📷 Rec.Mode] menu appears.

2 Press the four-way controller (▲▼) to select [Green Button].

3 Press the four-way controller (▶).

The Green button setting screen appears.

4 Use the four-way controller (▲▼) to select the function you want to register.

5 Press the shutter release button halfway.

The camera is ready to take the picture.

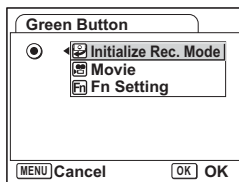
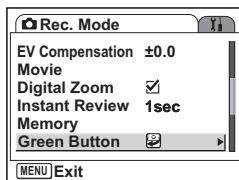

As the initial setting, the Initialize Rec. Mode function is registered.

Registering Frequently Used Functions (Fn Setting)

You can register frequently used functions on the four-way controller. Using this function, you can directly set the functions by pressing the four-way controller without displaying the menu in Capture mode. In Fn Setting, still picture mode and Movie mode have different settings. To execute Fn Setting for Movie mode, press MENU button in Movie mode in Step 1 on page 94.

4 Use the four-way controller (▲▼) to select [Fn Setting].

5 Press the OK button.

The Fn Setting screen appears.

6 Use the four-way controller (▲▼) to select a key you want to assign a function to.

7 Press the four-way controller (▶).

The pull-down menu appears.

8 Use the four-way controller (▲▼) to select a function you want to assign.

9 Press the OK button.

10 Press the shutter release button halfway.

The camera is ready to take the picture.

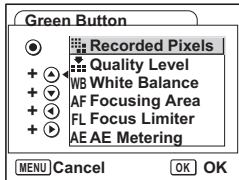
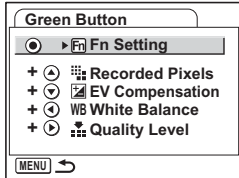
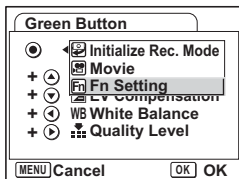

This function is activated only when assigning the Fn Setting to the Green button.



You can assign only one function to each key.

The initial settings for Fn Setting

	still picture mode	Movie mode
Initial settings	(▲) Recorded Pixels	(▲) Recorded Pixels
	(▼) EV Compensation	(▼) EV Compensation
	(◀) White Balance	(◀) Quality Level
	(▶) Quality Level	(▶) Time-lapse Movie

Functions that can be registered on Fn Setting

	still picture mode	Movie mode
Setting items	Recorded Pixels	Recorded Pixels
	Quality Level	Quality Level
	White Balance	Time-lapse Movie
	Focusing Area	Movie anti-shake
	Focus Limiter	White Balance
	AE Metering	EV Compensation
	Sensitivity	Sharpness
	EV Compensation	Saturation
	Sharpness	Contrast
	Saturation	Off
	Contrast	
	Off	

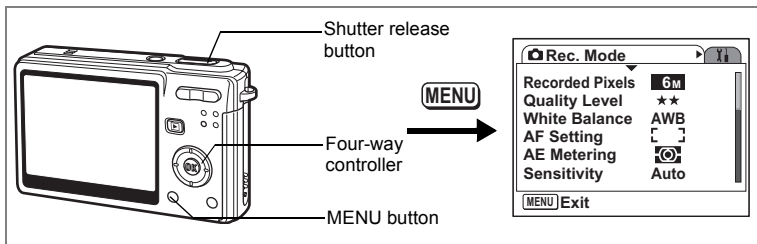

Setting the Image Sharpness

You can choose whether you want the image to have sharp or soft outlines.

1 Press the MENU button in Capture mode.

The [📷 Rec.Mode] menu appears.

2 Use the four-way controller (▲▼) to select [Sharpness].

3 Use the four-way controller (◀▶) to adjust sharpness.

To soften the contours, choose (–) and to sharpen the contours, choose (+).

4 Press the shutter release button halfway.

The camera is ready to take the picture.

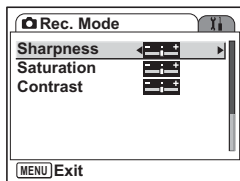

The Sharpness setting is saved when the camera is turned off.

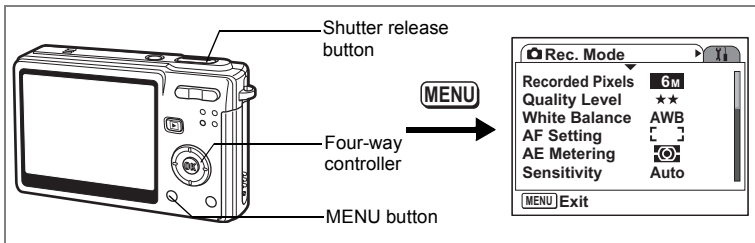

Setting the Color Saturation

You can set the color saturation.

1 Press the MENU button in Capture mode.

The [📷 Rec.Mode] menu appears.

2 Use the four-way controller (▲▼) to select [Saturation].

3 Use the four-way controller (◀▶) to adjust saturation.

To reduce the saturation, choose (-) and to increase the saturation, choose (+).

4 Press the shutter release button halfway.

The camera is ready to take the picture.

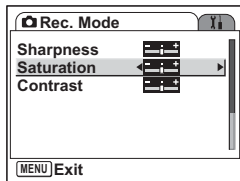

The Saturation setting is saved when the camera is turned off.

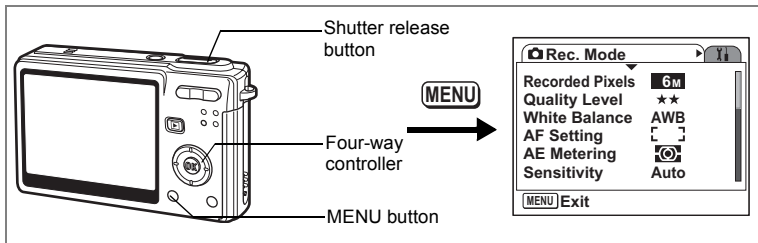

Setting the Image Contrast

You can set the image contrast.

1 Press the MENU button in Capture mode.

The [📷 Rec.Mode] menu appears.

2 Use the four-way controller (▲▼) to select [Contrast].

3 Use the four-way controller (◀▶) to adjust contrast.

To reduce the contrast, choose (–) and to increase the contrast, choose (+).

4 Press the shutter release button halfway.

The camera is ready to take the picture.

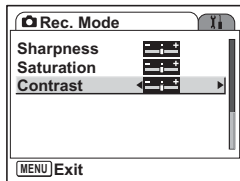









The Contrast setting is saved when the camera is turned off.

Saving the Settings

Saving the Menu Items (Memory)

You can choose whether you want the set values to be saved when the camera is turned off. If you select (On), the settings will be saved in the status they were in immediately before the camera was turned off. If you select (Off), the settings will be reset to the defaults when the camera is turned off.

Item	Description	Default Setting
Flash Mode	The flash mode setting on the  button is saved.	<input checked="" type="checkbox"/>
Drive Mode	The drive mode setting ( , etc.) selected using the four-way controller () is saved.	<input type="checkbox"/>
Focus Mode	The focus mode setting on the  button is saved.	<input type="checkbox"/>
Zoom Position	The optical zoom position setting on the zoom button is saved.	<input type="checkbox"/>
MF Position	The manual focus position is saved.	<input type="checkbox"/>
White Balance	The [White Balance] setting on the [ Rec.Mode] menu is saved.	<input type="checkbox"/>
AE Metering	The [AE Metering] setting on the [ Rec.Mode] menu is saved.	<input type="checkbox"/>
Sensitivity	The [Sensitivity] setting on the [ Rec.Mode] menu is saved.	<input type="checkbox"/>
EV Compensation	The [EV Compensation] setting on the [ Rec.Mode] menu is saved.	<input type="checkbox"/>
Digital Zoom	The [Digital Zoom] setting (On/Off) on the [ Rec.Mode] menu is saved.	<input checked="" type="checkbox"/>
DISPLAY	The LCD monitor display mode is saved.	<input type="checkbox"/>
File #	The file number is saved. If a new SD Memory Card is inserted, file numbers are assigned sequentially.	<input checked="" type="checkbox"/>



- Menu items not included in [Memory] will also be saved in the settings selected on the menus for each function when the camera is turned off.
- The zoom position setting in the digital zoom range will not be saved even if [Zoom Position] is set to (On) in [Memory].

1 Press the MENU button in Capture mode.

The [📷 Rec.Mode] menu appears.

2 Use the four-way controller (▲▼) to select [Memory].

3 Press the four-way controller (▶).

The [Memory] menu appears.

4 Use the four-way controller (▲▼) to choose an item.

5 Use the four-way controller (◀▶) to select (On) or (Off).

6 Press the shutter release button halfway.

The camera is ready to take the picture.

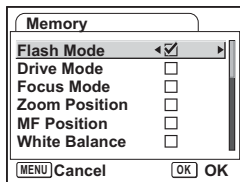
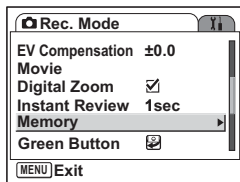

Returning the Shooting Functions to the Default Settings

This function lets you return all the shooting function settings to the defaults.

All the items on the [📷 Rec.Mode] menu and the settings for the capture mode, flash, drive, focus, and displayed information are reset.

For details on Rec. Mode menu, refer to “Menu List” (p.46).

1 Press the Green button in Capture mode.

The [Initialize Rec. Mode?] message appears.

2 Use the four-way controller (▲▼) to select [Initialize].

3 Press the OK button.

All the shooting function settings return to the defaults and the camera returns to Capture mode.

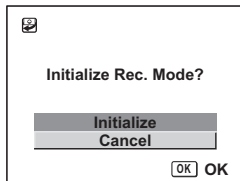

This function cannot be used when assigning a function other than Initialize Rec. Mode to the Green button. (p.94)

Recording Sound (Voice Recording Mode)

You can record sound. The recordable time appears on the LCD monitor according to how much space is available on the SD Memory Card.

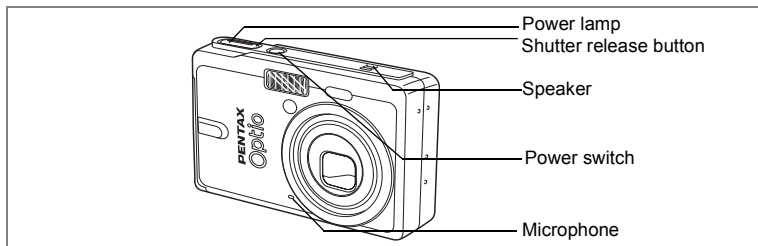

1 Press the four-way controller (▼) in Capture mode.

The Mode Palette appears.

2 Use the four-way controller (▲▼◀▶) to select .



3 Press the OK button.

The recordable time appears on the LCD monitor.

1 Remaining recordable time

2 Recording time

4 Press the shutter release button.

Recording starts. The access lamp lights during recording.

When the shutter release button is pressed for more than one second, recording continues for as long as the button is held down and stops when the button is released.



5 Press the shutter release button.

Recording stops. The remaining recordable time appears.

6 Press the four-way controller (▼) to display Mode Palette and change to another mode.

You can exit the Voice Recording mode.



- Sound is saved in WAVE monaural files.
- The microphone is located on the front of the camera. Aim the camera to obtain the best sound.
- An index can be added by pressing the MENU button during recording.

Playing Back Sound

You can play back the recording you made in Voice Recording mode.

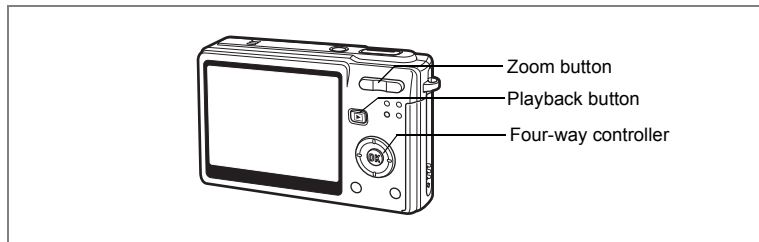

1 Press the  Playback button in the Voice Recording mode.

2 Use the four-way controller ( ) to choose the recording to play back.

3 Press the four-way controller ().
Playback starts.



• **The following operations can be performed during playback.**

Four-way controller () Pauses playback
Press again to resume playback

If there are no recorded indexes:

Four-way controller () Rewinds about five seconds

Four-way controller () Advances about five seconds

If there are recorded indexes:

Four-way controller () Plays back starting from the previous index

Four-way controller () Plays back starting from the next index

Zoom button () Increases the volume

Zoom button () Reduces the volume

4 Press the four-way controller ().
Playback stops.

Adding a Voice Memo

You can add a voice memo to a captured image.

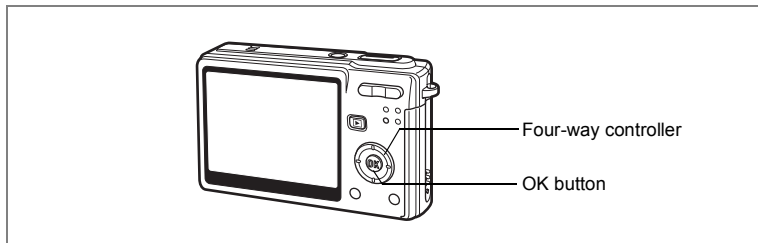

Recording a Voice Memo

1 Enter the Playback mode and use the four-way controller (◀▶) to choose the image to which you want to add a voice memo.

2 Press the four-way controller (▼).
The Mode Palette appears.

3 Use the four-way controller (▲▼◀▶) to select  (Voice Memo).

4 Press the OK button.
Recording starts. You can record for up to 30 seconds.

5 Press the OK button.
Recording stops.

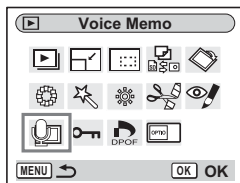

-  appears on the screen when a voice memo is added.
- A voice memo cannot be added to an image which already has a voice memo. Delete the old voice memo and record a new one. (p.116)



A voice memo cannot be added to protected () images.

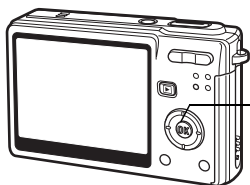

Four-way controller

Playing Back a Voice Memo

- 1 Enter the Playback mode and use the four-way controller (◀▶) to choose the still picture with the voice memo that you want to play back.**

If  appears on the displayed image, a voice memo has been recorded.



- 2 Press the four-way controller (▲).**
Playback starts.

The following operations can be performed during playback.

Zoom button (▲) Increases the volume

Zoom button (▲▲▲) Reduces the volume

- 3 Press the four-way controller (▼).**
Playback stops.

Deleting Voice Memos Only  p.116

Playing Back Images

You can play back images recorded on the SD Memory Card when a card is inserted in the camera, or in the built-in memory when no card is inserted.

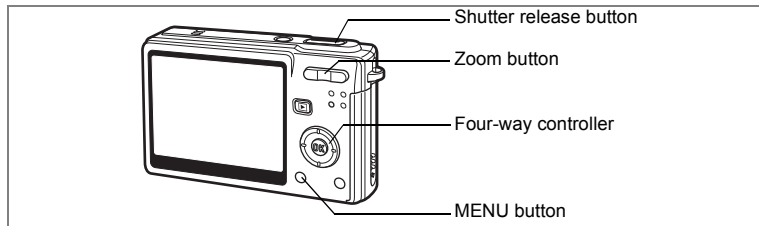

Playing Back Still Pictures

Press the  Playback button.

Refer to “Playing Back an Image” (p.34), or “Playing Back the Previous or Next Image” (p.34) for instructions on playing back images.

Zoom Display

You can display images magnified up to eight times.

1 Enter the Playback mode and use the four-way controller (◀▶) to choose the image to magnify.

2 Press ▲/Q on the zoom button.

Each time you press the button, the zoom scaling changes as follows: 1.3×, 2.0×, 2.6×, 4.0×, 5.3×, 8.0×.

• **The following operations can be performed while the magnified image is displayed.**

Four-way controller (▲▼◀▶) Moves the position to be magnified

Zoom button (▲) Makes the image bigger

Zoom button (◆◆◆) Makes the image smaller



3 Press the MENU button.

Zoom playback ends.

Setting the Quick Zoom Function

You can display the image at maximum magnification simply by pressing \blacktriangle/Q on the zoom button once during zoom playback.

1 Press the MENU button.

The [📷 Rec.Mode] menu appears.

2 Press the four-way controller (▶).

3 Use the four-way controller (▲ ▼) to select [Quick Zoom].

4 Use the four-way controller (◀ ▶) to select (On)/ (Off).

5 Press the shutter release button halfway.

The camera is ready to take the picture.

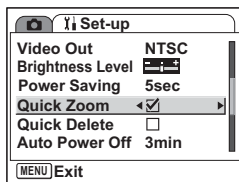

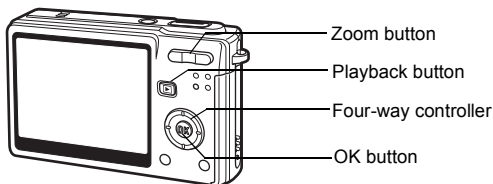

Playing Back Movies

You can play back movies. A guide to operation appears on the LCD monitor during playback. Operations include playback, frame by frame playback (forward or reverse), pause and volume adjustment.

1 Enter the Playback mode and use the four-way controller (◀▶) to choose the movie to play back.

2 Press the four-way controller (▲).

Playback starts.

- **The following operations can be performed during playback.**

Four-way controller (◀) Fast-rewind playback

Four-way controller (▶) Fast-forward playback

Four-way controller (▲) Pause

OK button Changes the display mode (p.111)

Zoom button ▲▲▲/▲ Adjusts the volume



- **The following operations can be performed while pause is engaged.**

Four-way controller (◀) Frame reverse

Four-way controller (▶) Frame forward

Four-way controller (▲) Releases the pause function

OK button Changes the display mode (p.111)

3 Press the four-way controller (▼).

Playback stops and the screen returns to the first frame.

4 Press the ▶ Playback button.

The camera returns to Capture mode.



No sound is output during fast-rewind and fast-forward playback.

Displaying Shooting Information in Playback Mode

Shooting information can be displayed on the LCD monitor in Playback mode. Pressing the OK button changes the display mode. The Histogram is not displayed while playing back movies.

Normal Display

Shooting information is displayed.

- 1 Voice Memo icon
- 2 Card/Built-in memory icon
- 3 Folder name
- 4 File name
- 5 Protect icon
- 6 Battery indicator
- 7 Shooting date and time
- 8 Four-way controller operation guide

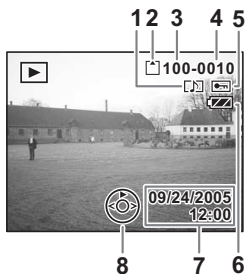

Histogram Display

The brightness distribution of the image is displayed. The horizontal axis shows the brightness (darkest at the left end and brightest at the right end) and the vertical axis shows the number of pixels.

- 1 Recorded pixels
- 2 Quality level
- 3 White balance
- 4 AE metering
- 5 Sensitivity
- 6 Histogram
- 7 Aperture
- 8 Shutter speed

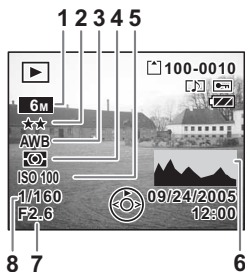

No icons

No shooting information is displayed.



Normal Display

Saving the Display Mode p.100

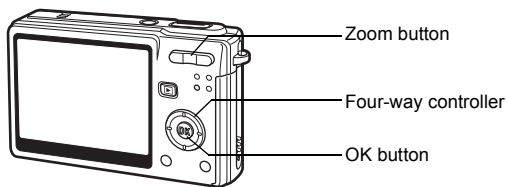

Nine-Image Display

You can display nine images at the same time.

- 1 Enter the Playback mode and use the four-way controller (◀▶) to choose an image.**
- 2 Press ▲▲▲/📷 on the zoom button.**

A page consisting of nine thumbnail images appears. The displayed images change nine at a time page by page.

Use the four-way controller (▲▼◀▶) to move the frame. When ten or more images have been saved, if you choose an upper-left image and press the four-way controller (◀), the previous page appears. Similarly, if you choose a lower-right image and press the four-way controller (▶), the next page appears.



Selected image

The icons that appear on the images indicate the following:

- No icon : Still picture without voice memo
- 🎤 (with image) : Still picture with voice memo
- 🎬 : Movie (first frame appears)
- 🎤 (without image) : Sound file only
- ❓ : Undisplayable image

- 3 Press the OK button.**

The screen returns to full screen display of the selected image.



Pressing the MENU button, OK button or ▲/🔍 on the zoom button returns the screen to full screen display of the selected image.

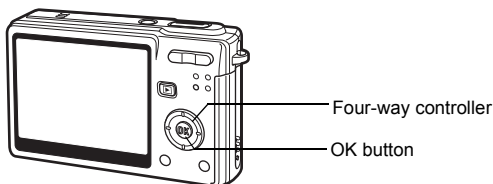

Slideshow

You can play back all the images on the SD Memory Card or in the built-in memory continuously.

- 1 Enter the Playback mode and use the four-way controller (◀▶) to choose the image with which to start the slideshow.**
- 2 Press the four-way controller (▼).**
The Mode Palette appears.
- 3 Use the four-way controller (▲▼◀▶) to select  (Slideshow).**
- 4 Press the OK button.**
- 5 Use the four-way controller (◀▶) to change the playback interval.**
Choose from the following: [3 sec], [5 sec], [10 sec], [20 sec], [30 sec].
- 6 Use the four-way controller (▼) to select [Screen Effect].**

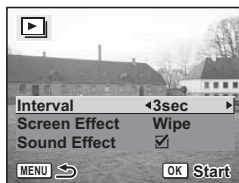
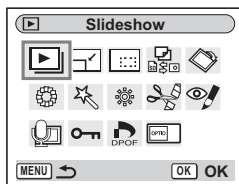

7 Use the four-way controller (◀▶) to select the effect.

Wipe	The effect is like a slide show that slides the displayed images one by one to the left.
Fade	The current image gradually disappears and the next image appears under it.
Shrink	The current image shrinks towards the center.
Off	No screen effect.

8 Use the four-way controller (▼) to select [Sound Effect].

9 Use the four-way controller (◀▶) to select (On)/ (Off).

10 Press the OK button.

[Start] appears on the LCD monitor and playback starts at the set interval. If you press the OK button while playing back the slideshow, the slide show is paused. Press the OK button during playback pause to resume the slideshow.

Press any button other than the OK button to stop the slideshow.

[Stop] appears on the LCD monitor.



- The slideshow will continue until you press any button.
- Movies and pictures with a voice memo will be played through to the end before the next picture is played back, regardless of the set playback interval.
- Recordings made in Voice Recording mode are not played back.

Deleting Images, Movies and Sounds

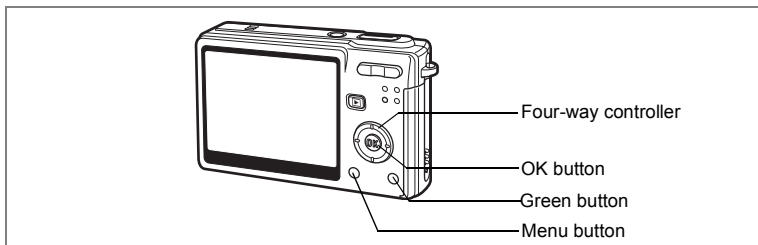

Deleting a Single Image, Movie or Sound

You can delete a single image, movie or sound.



Once deleted, images, movies or sounds cannot be restored.

- 1 Enter the Playback mode and use the four-way controller (◀▶) to choose the image, movie or sound to delete.**
- 2 Press the Green button.**
The Delete screen appears.
- 3 Use the four-way controller (▲) to select [Delete].**
- 4 Press the OK button.**
The image, movie or sound is deleted.



- You can also delete images from Instant Review. (p.93)
- You cannot delete protected (Ⓞ) images, movies or sounds. (p.120)
- If [Quick Delete] is set to On in the [Y Set-up] menu, Step 3 can be omitted. (p.116)

Deleting a Voice Memo only

If an image has a voice memo, you can delete the voice memo without deleting the image.

- 1 Enter the Playback mode and use the four-way controller (◀▶) to choose an image with a voice memo to delete.**
- 2 Press the Green button.**
The Delete screen appears.
- 3 Use the four-way controller (▲) to select [Delete sound].**
- 4 Press the OK button.**
The voice memo is deleted.

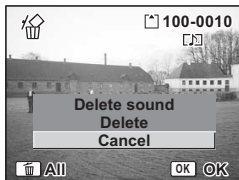

Select [Delete] in Step 3 above to delete both the image and the voice memo.

6 Setting the Quick Delete Function

When the Quick Delete function is set to On, the Delete screen appears with [Delete] already selected.

- 1 Press the MENU button in Playback mode.**
The [M] Set-up] menu appears.
- 2 Press the four-way controller (▶).**
- 3 Use the four-way controller (▲▼) to select [Quick Delete].**
- 4 Use the four-way controller (◀▶) to select (On)/ (Off).**
- 5 Press the shutter release button halfway.**
The camera is ready to take pictures.

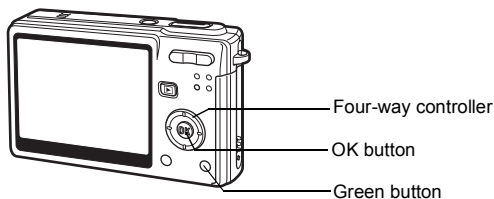

Deleting All Images

You can delete all the images, movies and sounds at once.



Once deleted, images, movies or sounds cannot be restored.

- 1 Enter the Playback mode and press the Green button twice.**
The Delete All screen appears.
- 2 Use the four-way controller (▲) to select [Delete all].**
- 3 Press the OK button.**

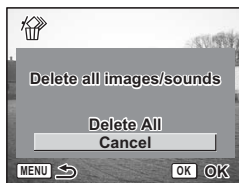

All the images and sounds will be deleted.



You cannot delete protected (🔒) images, movies or sounds.
(p.120)

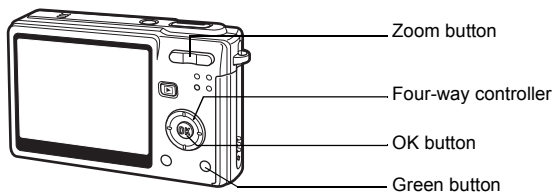

Deleting Selected Images and Sound Files (from Nine-Image Display)

You can delete several images/sound files selected from the nine-image display at once.

- 1 Enter the Playback mode and press $\blacktriangle\blacktriangledown\blacktriangleleft\blacktriangleright$ on the Zoom button.**

Nine thumbnail images appear.

- 2 Press the Green button.**

appears on the images and sound files.

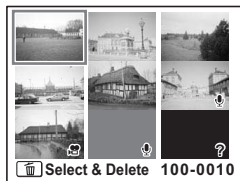

- 3 Use the four-way controller ($\blacktriangle\blacktriangledown\blacktriangleleft\blacktriangleright$) to choose the images and sound files that you want to delete and press the OK button.**

appears on the selected images and sound files.

If you select an image and press \blacktriangle / Q on the Zoom button, the selected image appears in single-image display for two seconds, enabling you to check whether you really want to delete it or not. However, protected images cannot be displayed in single-image display.

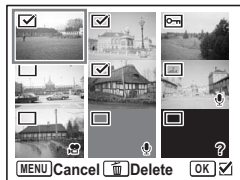

4 Press the Green button.

A confirmation dialog appears.

5 Use the four-way controller (▲▼) to select [Select & Delete].

6 Press the OK button.

The selected images and sound files are deleted.



Protected (🔒) images and sound files cannot be deleted.

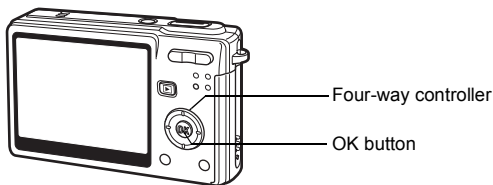

Protecting Images, Movies and Sounds from Deletion (Protect)

You can protect images, movies and sounds from being accidentally deleted.

- 1** Enter the Playback mode and use the four-way controller (◀▶) to choose the image, movie or sound to protect.
- 2** Press the four-way controller (▼).
The Mode Palette appears.
- 3** Use the four-way controller (▲▼◀▶) to select  (Protect).
- 4** Press the OK button.
The Protect screen appears.

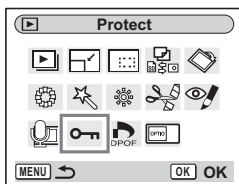

Protecting Images, Movies and Sounds

- 5** Use the four-way controller (▲▼) to select [Select image/sound].
- 6** Press the OK button.

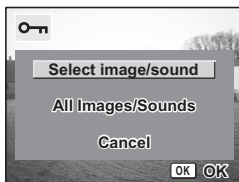

- 7 Use the four-way controller (▲▼) to select [Protect].
- 8 Press the OK button.

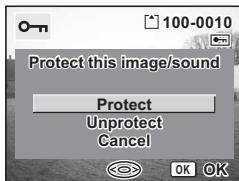

- Select [Unprotect] in Step 7 to cancel the Protect setting.
- If the image is protected, the key icon appears when the image, movie or sound is played back.

Protecting All Images, Movies and Sounds

You can protect all the images, movies and sounds.

- 5 Use the four-way controller (▲▼) to select [All Images/Sounds].
- 6 Press the OK button.
The [Protect all images/sounds] message appears.
- 7 Use the four-way controller (▲▼) to select [Protect].
- 8 Press the OK button.

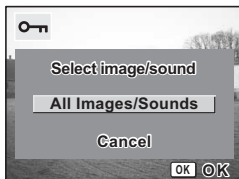

Select [Unprotect] in Step 7 to cancel the Protect setting on all the images, movies and sounds.



Even protected images, movies and sounds will be deleted by formatting the SD Memory Card or built-in memory.

Viewing Images on AV Equipment

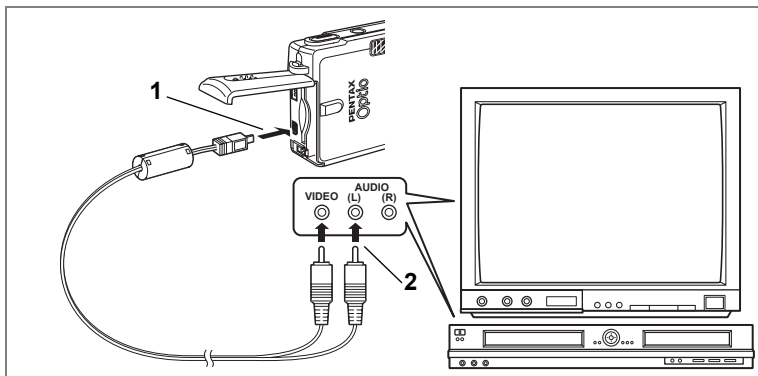

By using the AV cable, you can capture, play back and dub images on a TV or other equipment with a video IN jack. Make sure that both the AV equipment and the camera are turned off before connecting the cable.

6

Playback/Deleting/Editing

- 1 Open the battery/card cover and connect the AV cable supplied with the AV terminal.**
- 2 Connect the other end of the AV cable to the AV equipment.**
Yellow (video) → video input terminal
White (audio) → sound input terminal
When using stereo sound equipment, insert the sound jack into the L (white) terminal.
- 3 Turn the AV equipment on.**
When the AV equipment connected to the camera and the AV equipment used to view images are separate, turn both pieces of equipment on.
To view images on a TV with several video inputs, switch the video inputs to the one connected to the camera, referring to the operating manual for the TV.
- 4 Turn the camera on.**

Changing the Video Output Format  p.157



- If you intend to use the camera for a long time, use of the AC adapter D-AC8 (optional) is recommended. Refer to the operating manual for the TV or equipment to which the camera is connected.
- Images may not be displayed properly depending on the countries or areas when the Video Out setting is the default. In this situation, change the Video Out setting.
- While the camera is connected to the TV, the LCD monitor of the camera will be turned off.

Playing Back an Image Using the Remote Control Unit (optional)

When the AV cable is connected to the camera, the image can be displayed using the remote control unit E or F (optional).

- 1 Press the  Playback button.**
- 2 Press the Shutter button or the zoom button of the remote control unit.**

Shutter button: displays the next image.

Zoom button: displays the previous image.



- As there is no zoom button on the remote control unit F, only an operation using the shutter button (displaying the next image) is available.
- You cannot play back movies, images with a voice memo, and voice files recorded in Voice Recording mode, using the remote control unit.

Setting the Printing Service (DPOF)

You can print the images on the SD Memory Card using a DPOF (Digital Print Order Format) compatible printer or at a printing service.

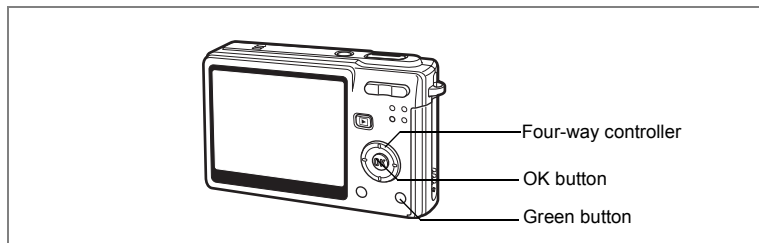

Printing Single Images

Set the following items for each image.

Copies: Choose the number of copies up to a maximum of 99.

Date: Specify whether you want the date imprinted on the print or not.

- 1 Enter the Playback mode and use the four-way controller (◀▶) to choose the image to print.**
- 2 Press the four-way controller (▼).**
The Mode Palette appears.
- 3 Use the four-way controller (▲▼◀▶) to select  (DPOF).**
- 4 Press the OK button.**
The DPOF screen appears.
- 5 Press the OK button.**

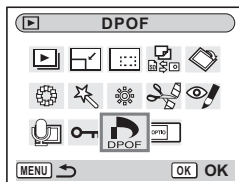

- 6 Use the four-way controller (▲▼) to choose the number of copies.**



- 7 Use the Green button to select (On)/ (Off) of [Date].**

- (On): The date will be imprinted.
- (Off): The date will not be imprinted.

- 8 Press the OK button.**

Prints can be made according to the settings.



- If DPOF settings have already been made for an image, the previous number of copies and date setting will be displayed.
- To cancel DPOF settings, set the number of copies to 0 and press the OK button.



- You cannot set the printing service for movies or sound-only files.
- Depending on the printer or printing equipment at the photo processing lab., the date may not be imprinted on the pictures even if the DPOF settings were made.

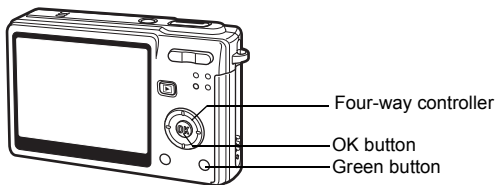

Printing All Images

- 1 Enter the Playback mode and press the four-way controller (▼).**

The Mode Palette appears.

- 2 Use the four-way controller (▲▼◀▶) to select  (DPOF).**

- 3 Press the OK button.**

- 4 Use the four-way controller (▼) to select [All Images].**

- 5 Press the OK button.**

- 6 Use the four-way controller (▲▼) to choose the number of copies.**

You can print up to 99 copies.

- 7 Use the Green button to choose whether to insert the date or not.**

(On): The date will be imprinted.

(Off): The date will not be imprinted.

- 8 Press the OK button.**

Prints can be made according to the settings.



The number of copies specified in the DPOF settings applies to all the images. Before printing, check that the number is correct.



- Settings for single images are cancelled when settings are made for all images.
- DPOF settings are not possible for movies.

Direct Printing Using PictBridge

By connecting the camera to a printer that supports PictBridge using the USB cable (I-USB17) supplied with the camera, you can print images directly from the camera without using a PC. Select the images you want to print and the number of copies on the camera after it has been connected to the printer.



- You are recommended to use the AC adapter D-AC8 (optional) while the camera is connected to the printer. The printer may not work properly or the image data may be damaged if the battery runs out of power while the camera is connected to the printer.
- The access lamp blinks slowly while data is being transferred from the camera to the printer.
- Do not disconnect the USB cable during data transfer.
- Depending on the type of printer, not all the settings made on the camera (such as DPOF settings) may be valid.

Connecting the Camera to the Printer

1 Select **[PictBridge]** for **[USB Connection]** on the **[Set-up]** menu.

"Changing the USB Connection Mode" (p.157)

2 Connect the camera to the printer using the USB cable supplied with the camera.

The PictBridge menu appears.

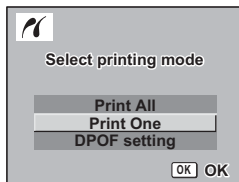

Printing Single Images

1 Use the four-way controller (▲▼) to select [Print One].

2 Press the OK button.

The Print this image screen appears.

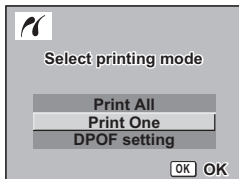

3 Use the four-way controller (◀▶) to choose the image to print.

4 Use the four-way controller (▲▼) to choose the number of copies.

You can print up to 99 copies.



5 Use the Green button to choose whether to insert the date or not.

(On): The date will be imprinted.

(Off): The date will not be imprinted.

6 Press the OK button.

The print settings confirmation screen appears.

To print the image according to the print settings, press the OK button.

To change the print settings, go to Step 7.



7 Press the Green button.

The Change setting screen appears.

8 Select [Paper Size] and press the four-way controller (▶).

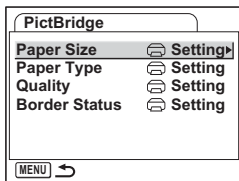

9 Use the four-way controller (▲▼◀▶) to choose the paper size.

You can select only the print sizes available with the printer you are using.

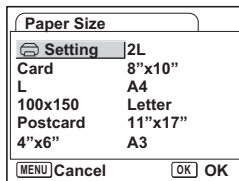

10 Press the OK button.

11 Repeat Step 8 to 10 to set [Paper Type] [Quality] and [Border Status].

When the Paper Size is set to [Setting], images are printed according to the printer settings.

Paper Type with more ★ support higher quality paper.

Quality with more ★ indicate higher print quality.

12 Press the OK button twice.

The image is printed according to the settings.

Press the MENU button to cancel printing.

Printing All Images

1 Use the four-way controller (▲▼) to select [Print All].

2 Press the OK button.

The Print All screen appears.

Use the four-way controller (◀▶) to check the images and make sure you want to print them all.

3 Set the number of copies, the setting of the date imprint, and confirm the print setting.

To set these items, refer to Steps 4 to 11 on “Printing Single Images” (pages 128 to 129).

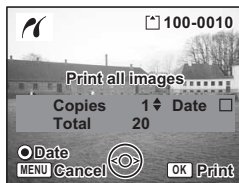

Printing Using the DPOF Settings

1 Use the four-way controller (▲▼) to select [DPOF setting].

2 Press the OK button.

The DPOF setting screen appears.

Use the four-way controller (◀▶) to check the images and the print settings.

3 Set the number of copies, the setting of the date imprint, and confirm the print setting.

To set these items, refer to Steps 4 to 11 on “Printing Single Images” (pages 128 to 129).

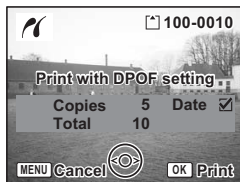

Disconnecting the Camera from the Printer

Disconnect the camera from the printer when you have finished printing.

1 Turn the camera off.

2 Disconnect the USB cable from the camera.

3 Disconnect the USB cable from the printer.



When you disconnect the USB cable from the camera before you turn the camera off, the camera returns to Playback mode.

Editing Images

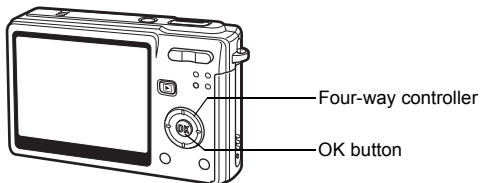

Changing the Image Size and Quality

By changing the size and quality of a selected image, you can make the file smaller than the original. You can use this function to continue taking pictures when the card or memory is full, by making the images smaller and overwriting the original images to make more space available in the memory.

Resizing Single Images

After changing the size and quality, the image can be saved as a new image or written over the original image.

- 1 Use the four-way controller (◀▶) in Playback mode to select an image to resize.**
- 2 Press the four-way controller (▼).**
The Mode Palette appears.
- 3 Use the four-way controller (▲▼◀▶) to select  (Resize).**
- 4 Press the OK button.**
The Resize screen appears.

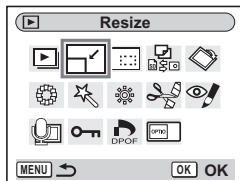

- 5 Use the four-way controller (◀▶) to change the size.
- 6 Press the four-way controller (▼).
The frame moves to [Quality Level].
- 7 Use the four-way controller (◀▶) to change the quality.
- 8 Press the OK button.
- 9 Use the four-way controller (▲▼) to select [Overwrite] or [Save as].
- 10 Press the OK button.
The resized image is saved.

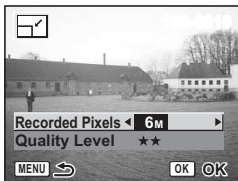

- Movies cannot be resized.
- You cannot select a larger size than that of the original image.
- Protected (🔒) images cannot be overwritten.
- You can resize only still pictures taken with this camera.

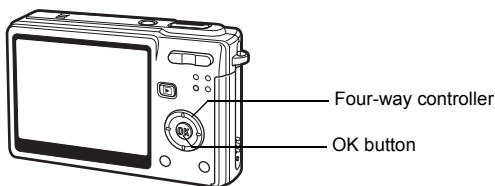

Trimming Images

You can trim a part of a picture and save it as a separate image.

- 1 Use the four-way controller (◀▶) in Playback mode to select an image to trim.**
- 2 Press the four-way controller (▼).**
The Mode Palette appears.
- 3 Use the four-way controller (▲▼◀▶) to select  (Trimming).**

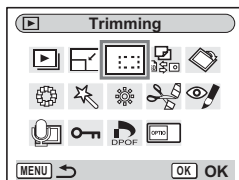

- 4 Press the OK button.**
The Trimming screen appears.
- 5 Trim the image.**
 - Operations that can be performed on the Trimming screen

Zoom button: Changes the size of the trimming

Four-way controller (▲▼◀▶):

Moves the trimming position up, down, left and right

MENU button: Returns to the Mode Palette.

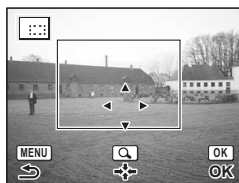

- 6 Press the OK button.**

The trimmed image is saved as a separate image.



- Movies cannot be trimmed.
- The image size is changed and saved.
- You can trim only still pictures taken with this camera.

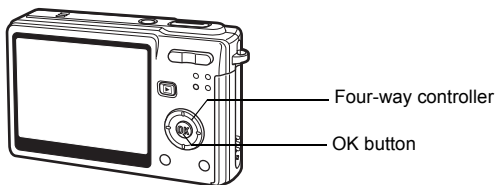

Rotating the Displayed Image

You can rotate a displayed image on the LCD monitor.

- 1 In Playback mode, use the four-way controller (◀▶) to select the image to be rotated.**
- 2 Press the four-way controller (▼) in Playback mode.**

The Mode Palette appears.

- 3 Use the four-way controller (▲▼◀▶) to select  (Image Rotation).**

- 4 Press the OK button.**

The Image Rotation screen appears.

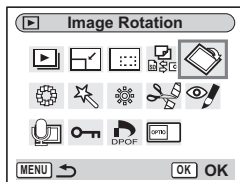

- 5 Press the four-way controller (▶) or the four-way controller (◀).**

The image is rotated 90° clockwise each time you press the four-way controller (▶), and the image is rotated 90° counter clockwise each time you press the four-way controller (◀).

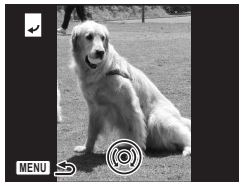

- 6 Press the  button.**

The camera saves the rotated image and returns to Playback mode.



- You can rotate protected () images, but the rotated image will not be saved.
- You cannot rotate movies.

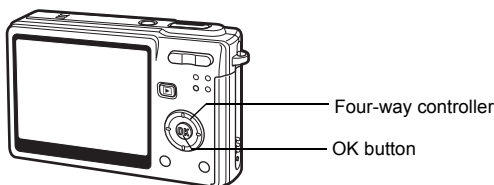

Editing Pictures with Color Filters

This function enables you to edit still pictures with color filters. You can choose from thirteen filters: B&W, Sepia, Eight different colors, B&W + Red, B&W + Green, and B&W + Blue.

1 Use the four-way controller (◀▶) in Playback mode to select an image to edit.

2 Press the the four-way controller (▼).

The Mode Palette appears.

3 Use the four-way controller (▲▼◀▶) to select  (Color Filter).

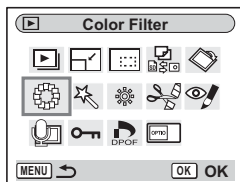

4 Press the OK button.

The color filter screen appears.

5 Use the four-way controller (▲▼) to choose a desired filter.

6 Press the OK button.

The overwrite confirmation screen appears.

7 Use the four-way controller (▲▼) to select [Overwrite] or [Save as].

8 Press the OK button.

The edited image is saved with the same number of recorded pixels and quality level as the original.



Selecting the Color Filter (Eight Colors)

- 5 Use the four-way controller (▲▼) to select the color filter (eight colors).**

The color bar appears.

- 6 Use the four-way controller (◀▶) to select a desired color.**

- 7 Press the OK button.**

The Overwrite confirmation screen appears.

- 8 Use the four-way controller (▲▼) to select [Overwrite] or [Save as].**

- 9 Press the OK button.**

The edited image is saved with the same number of recorded pixels and quality level as the original.

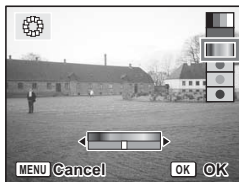

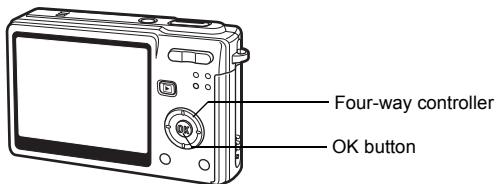

Editing Pictures with the Digital Filter

This function enables you to apply special effects to still pictures with the digital filter. You can choose from five filters: Soft, Illustration, Special Effect 1, Special Effect 2 and Slim.

- 1 Use the four-way controller (◀▶) in Playback mode to choose an image to edit.**
- 2 Press the the four-way controller (▼).**
The Mode Palette appears.
- 3 Use the four-way controller (▲▼◀▶) to select  (Digital Filter).**
- 4 Press the OK button.**
The Digital Filter screen appears.
- 5 Press the four-way controller (▲▼) to select a desired filter.**
- 6 Press the OK button.**
The overwrite confirmation screen appears.

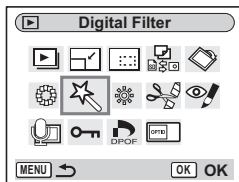

7 Use the four-way controller (▲▼) to select [Overwrite] or [Save as].

8 Press the OK button.

The edited image is saved with the same number of recorded pixels and quality level as the original.

Selecting the Slim Filter

5 Press the four-way controller (▲▼) to select the slim filter.

6 Press the four-way controller (◀▶) to adjust the strength of the slim effect.

7 Press the OK button.

The overwrite confirmation screen appears.

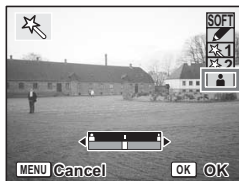

8 Use the four-way controller (▲▼) to select [Overwrite] or [Save as].

9 Press the OK button.

The edited image is saved with the same number of recorded pixels and quality level as the original.

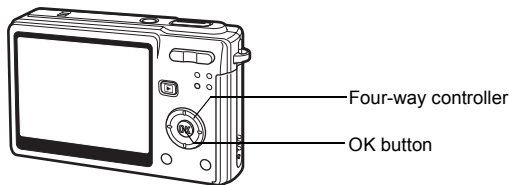

Editing Pictures with Brightness Filter

This function enables you to adjust the brightness of still pictures with the brightness filter.

- 1 Use the four-way controller (◀▶) in Playback mode to choose an image to edit.**
- 2 Press the four-way controller (▼).**
The Mode Palette appears.
- 3 Use the four-way controller (▲▼◀▶) to select * (Brightness Filter).**

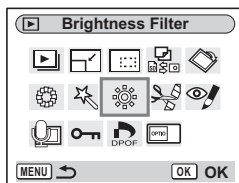

- 4 Press the OK button.**
The brightness filter screen appears.
- 5 Use the four-way controller (◀▶) to adjust the brightness.**

Each time you press the four-way controller (▶), the image becomes brighter step by step and each time you press the four-way controller (◀), the image becomes darker step by step. The brightness is selected between -2.0EV and +2.0EV by 1/3EV step.

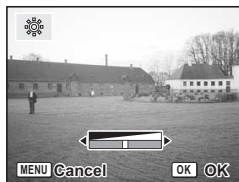

6 Press the OK button.

The overwrite confirmation screen appears.

7 Use the four-way controller (▲▼) to select [Overwrite] or [Save as].

8 Press the OK button.

The edited image is saved with the same number of recorded pixels and quality level as the original.

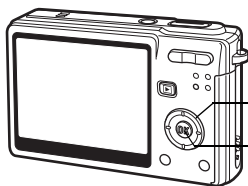

Four-way controller

OK button

Editing Movies

You can select a frame from a recorded movie to save as a still picture or divide a movie into two.

- 1 Use the four-way controller (◀▶) in Playback mode to select a movie to edit.**
- 2 Press the four-way controller (▼).**
The Mode Palette appears.
- 3 Use the four-way controller (▲▼◀▶) to select  (Movie Edit).**
- 4 Press the OK button.**

The Movie Edit screen appears. Choose the editing function that you want to use.

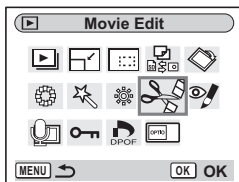

Saving a Frame from a Movie as a Still Picture

- 5 Use the four-way controller (▲▼) to select [Save as Still Image].**
- 6 Press the OK button.**
The screen for choosing a frame appears.



7 Use the four-way controller (◀▶) to choose the frame you want to save.

8 Press the OK button.

The selected frame is saved as a still picture.



Dividing a Movie

5 Select [Divide Movies] on the Movie Edit screen.

6 Press the OK button.

The screen for choosing the dividing position appears.

7 Use the four-way controller (▲▼◀▶) to determine the dividing position.

▲ : Plays the movie

▼ : Stops the movie

◀ : Reverses the movie frame by frame
(available only during pause)

▶ : Advances the movie frame by frame
(available only during pause)



8 Press the OK button.

The confirmation screen appears.

9 Use the four-way controller (▲▼) to select [Divide].

10 Press the OK button.

The movie is divided at the specified position and the two portions are saved as separate files.

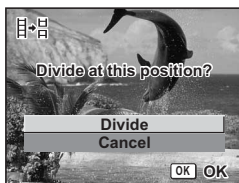

Extracting Movies

5 Select [Extract] on the Movie Edit screen.

6 Press the OK button.

The Extract screen appears.

7 Press the four-way controller (▲) to play back the movie and press it again to select the desired start point.

The movie is paused. During pause, you can move forwards or backwards a frame by pressing the four-way controller (◀▶).

8 Press the OK button.

9 Press the four-way controller (▲) to play back the movie and press it again to select the desired end point.

The movie is paused. During pause, you can move forwards or backwards a frame by pressing the four-way controller (◀▶).

10 Press the OK button.

The extracted movie is saved.

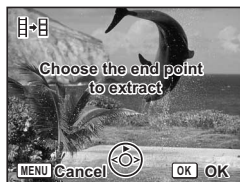
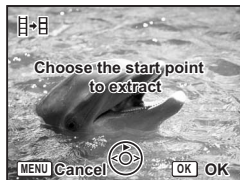

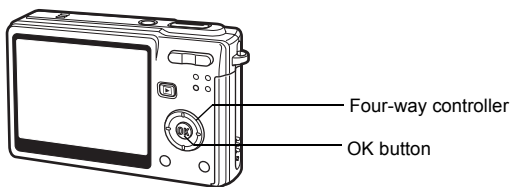

Red-eye Compensation

You can correct images where the flash has caused the subject to appear with red eyes.

1 Enter the Playback mode and press the four-way controller (◀▶) to choose the image you want to correct.

2 Press the four-way controller (▼).

The Mode Palette appears.

3 Use the four-way controller (▲▼◀▶) to select  (Red-eye Compensation).

4 Press the OK button.

A confirmation dialog for overwriting the image appears.

5 Use the four-way controller (▲▼) to select [Overwrite] or [Save as].

When the image is protected, [Save as] will be selected automatically.

6 Press the OK button.

The edited image is saved with the same number of recorded pixels and quality level as the original.

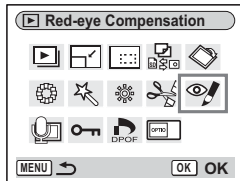

Caution:

- The red-eye compensation function cannot be used on movies or on images where red eyes cannot be detected by the camera. An error message appears in Step 4.
- The red-eye compensation function can only be used with still pictures taken with this camera.

Copying Files

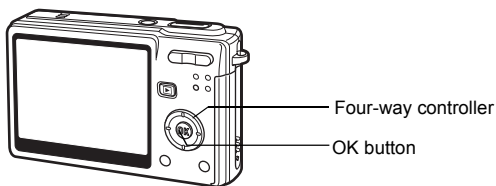

You can copy image and sound files from the built-in memory to the SD Memory Card and vice versa. This function can only be selected when a card has been inserted in the camera.

When files are copied from the built-in memory to the SD Memory Card, all the files are copied at once. When files are copied from the SD Memory Card to the built-in memory, the files are copied one at a time.

1 Press the the four-way controller (▼) in Playback mode.

The Mode Palette appears.

2 Use the four-way controller (▲▼◀▶) to select (Image/Sound Copy).

The Image/Sound Copy screen appears. Choose the copying method you want to use.

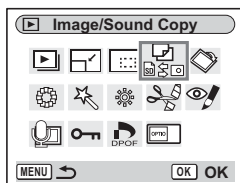

3 Press the OK button.



Be sure to turn the camera off before inserting or removing the SD Memory Card.

To Copy Files from the Built-in Memory to the SD Memory Card

- 4 Use the four-way controller (▲▼) to select [📁 → SD] and press the OK button.

All the files are copied to the SD Memory Card.



To Copy Files from the SD Memory Card to the Built-in Memory

- 4 Use the four-way controller (▲▼) to select [SD → 📁] and press the OK button.
- 5 Use the four-way controller (◀▶) to select the file to copy.
- 6 Press the OK button.

The selected file is copied to the built-in memory.

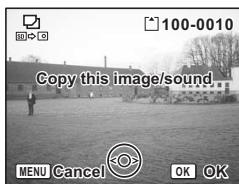

6



- If the image has a voice memo, the sound file will be copied at the same time as the image.
- When a file is copied from the SD Memory Card to the built-in memory, it is assigned a new file name.

Camera Settings

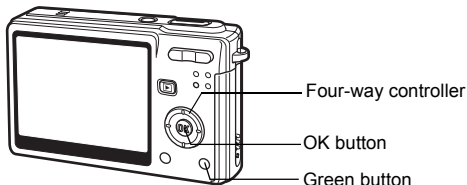

Setting Up the Start-up Screen

You can display an image recorded with the camera as the start-up screen when the camera is turned on.

- 1 Press the four-way controller (▼) in Playback mode.**
The Mode Palette appears.
- 2 Press the four-way controller (▲▼◀▶) to choose [USER] (Start-up Screen).**
- 3 Press the OK button.**
The screen for setting start-up screen appears. You can choose from five different types of start-up screens, including USER and off.

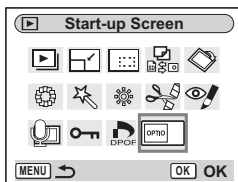

Setting Up the Start-up Screen Using a Captured Image (Go to Step 5 to select a start-up screen other than USER)

- 4 Press the Green button, while displaying [USER] in the upper-right corner of the screen, and use the four-way controller (◀▶) to choose an image for the start-up screen.**
- 5 Press the OK button.**
The camera is ready to play back images.



Once the start-up screen has been set, it will not be deleted even if the original image is deleted or the SD Memory Card or built-in memory is formatted. To delete the start-up screen, display the Image select screen. While the image you have selected as a start-up screen is on the screen ([USER] is indicated on the upper-right corner of the screen.), press the Green button.

How to recall the [Y/Menu] Set-up] menu

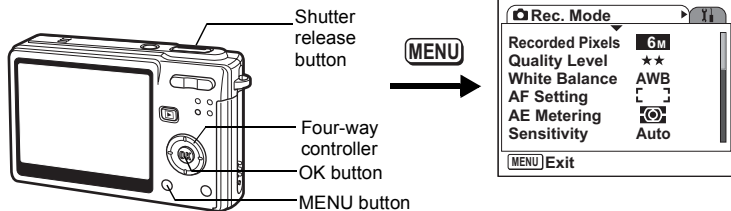

Formatting an SD Memory Card or the Built-in Memory

Formatting will delete all the data on the SD Memory Card if you are using a card, and all the data in the built-in memory if there is no SD Memory Card inserted.



- Do not remove the SD Memory Card while the card is being formatted as this may damage the card and render it unusable.
- SD Memory Cards formatted on a PC or device other than the camera cannot be used. Be sure to format the card with the camera.
- Formatting will delete protected data too. Be careful.

7

Settings

1 Select [Format] on the [Y/Menu] Set-up] menu.

2 Press the four-way controller (▶).

The Format screen appears.

3 Use the four-way controller (▲) to select [Format].

4 Press the OK button.

Formatting starts. When formatting is completed, the camera is ready to take pictures.

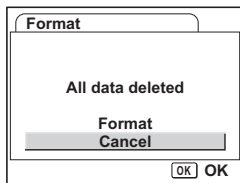

If formatting was performed in Playback mode, the camera returns to Playback mode after it was completed, then the [No image/sound] message appears.

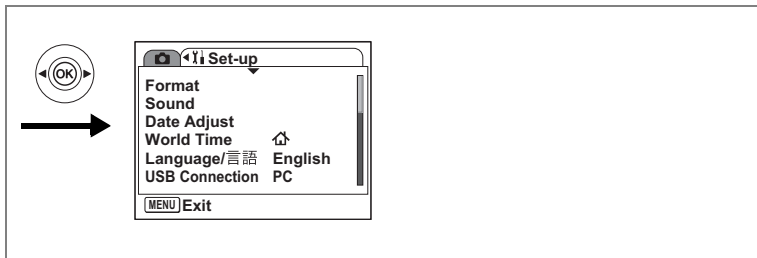

Changing the Sound Settings

You can adjust the playback volume and the volume of operation sounds, such as the start-up sound, shutter sound and operation sound. You can also change the operation sounds.

- 1 Select [Sound] on the [Set-up] menu.**
- 2 Press the four-way controller (▶).**

The Sound screen appears.

Changing the Volume

- 3 Use the four-way controller (◀▶) to change the operation volume.**
- 4 Use the four-way controller (▼) to select [Playback Volume].**
- 5 Use the four-way controller (◀▶) to change the volume of playback sounds.**
- 6 Press the shutter release button halfway.**

The camera is ready to take pictures.

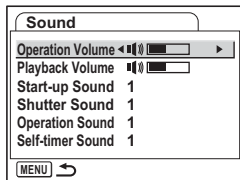

How to recall the [Y/Menu] Set-up] menu

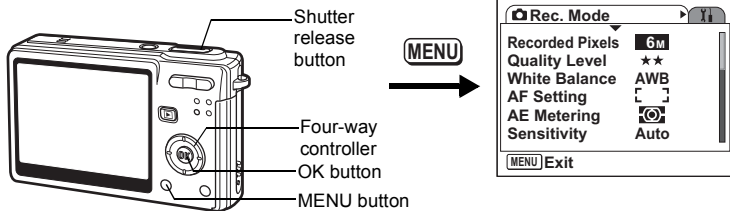

Changing the Sound

- Use the four-way controller (▲▼) to select [Start-up Sound].
- Press the four-way controller (▶).
The pull-down menu appears.
- Use the four-way controller (▲▼) to select [1], [2], [3], [Off] or [USER].
- Change the [Shutter Sound], [Operation Sound], and [Self-timer Sound] in the same way.
- Press the shutter release button halfway.
The camera is ready to take pictures.

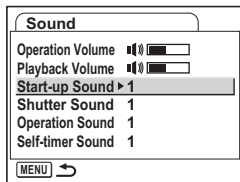

The Sound settings are saved when the camera is turned off.

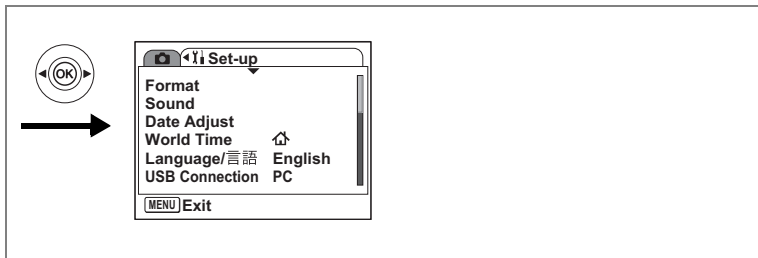

Setting the User Sound

You can set the first two seconds of your favorite recorded sound as the user sound and then use this as the start-up sound or shutter sound. The sound to be used is recorded with the camera. (p.101)

1 Select [USER] in Step 5 on page 150.

2 Press the OK button.

The Playback screen appears if a sound that can be used as the user sound has been saved in the camera. [USER] appears for the sound set as the user sound.

3 Use the four-way controller (◀▶) to choose a sound file.

Four-way controller (▲) Plays back the first two seconds of the sound file
 Four-way controller (▼) Stops playback

4 Press the OK button.

The selected sound is set as the user sound for the start-up sound or shutter sound.



How to recall the [Y] Set-up] menu

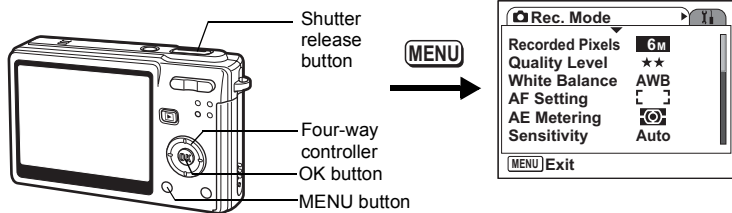

Changing the Date and Time

You can change the initial date and time settings. You can also set the style in which the date appears on the camera. Choose [mm/dd/yy], [dd/mm/yy] or [yy/mm/dd].

1 Select [Date Adjust] on the [Y] Set-up] menu.

2 Press the four-way controller (▶).

The Date Adjust screen appears.

3 Press the four-way controller (▶).

The frame moves to [mm/dd/yy].

4 Use the four-way controller (▲▼) to choose the date and time display style.

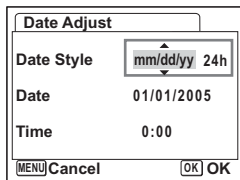

5 Press the four-way controller (▶).

The frame moves to [24h].

6 Use the four-way controller (▲▼) to select [24h] (24-hour display) or [12h] (12-hour display).

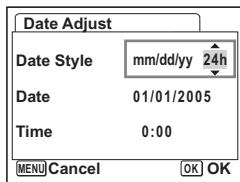

7 Press the four-way controller (▶).

The frame moves to [Date Style].

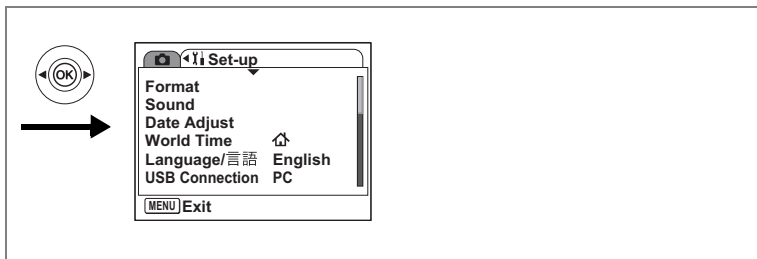

8 Press the four-way controller (▼).

The frame moves to [Date].

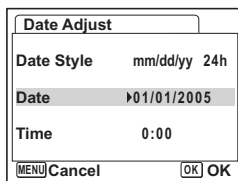

9 Press the four-way controller (▶).

The frame moves to month.

10 Use the four-way controller (▲▼) to change the month.

Change the day and year in the same manner.

Next, change the time.

If you select [12h] in Step 6, the setting switches between am and pm corresponding to the time.

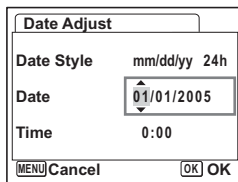

11 Press the OK button.

The settings are confirmed.

12 Press the shutter release button halfway.

The camera is ready to take pictures.

How to recall the [Y] Set-up] menu

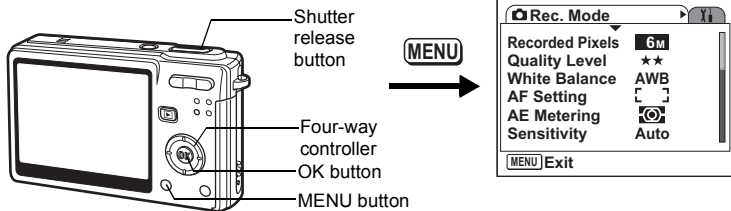

Setting the World Time

The date and time selected in “Initial Settings (Setting the Display Language and the Date and Time)” (p.28) serve as the Home Time setting.

You can display the time in a city other than the Home Time city (World Time). This is useful when taking pictures abroad.

1 Select [World Time] on the [Y] Set-up] menu.

2 Press the four-way controller (▶).

The World Time screen appears.

3 Use the four-way controller (◀▶) to select ↗ (Destination) or ↖ (Hometown).

↗ : Displays the time in the city selected as the Destination city

↖ : Displays the time in the city selected as the Hometown city

4 Press the four-way controller (▼) to select ↗ (Destination).

5 Press the four-way controller (▶).

The Destination screen appears. The city that is currently selected blinks on the map.

6 Use the four-way controller (◀▶) to change the Destination city.

The current time and location of the selected city appear.



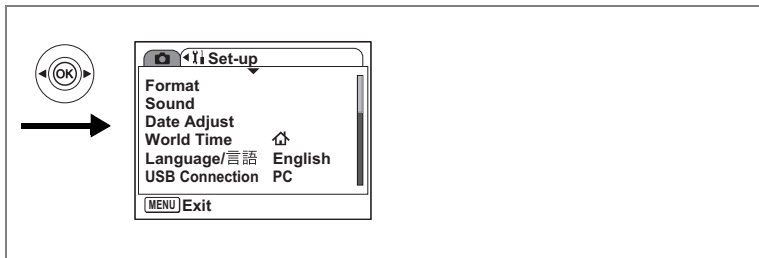

- 7 Use the four-way controller (▼) to select [DST].**
- 8 Use the four-way controller (◀▶) to select (On) or (Off).**

Select (On) if the Destination city uses daylight saving time.
- 9 Press the OK button.**
- 10 Press the four-way controller (▼) to select  (Hometown).**

Set the location and the current time in the same manner as Steps 5 to 9.
- 11 Press the shutter release button halfway.**

The camera is ready to take pictures.

How to recall the [Y] Set-up] menu

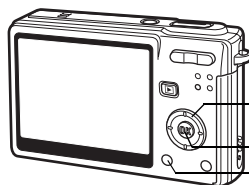

Four-way controller
OK button
MENU button

MENU

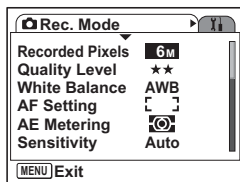

Changing the Display Language

You can change the language in which the menus, error messages, etc. are displayed.

You can choose from English, French, German, Spanish, Portuguese, Italian, Swedish, Dutch, Russian, Korean, Chinese (traditional and simplified), and Japanese.

- 1** Select [Language/言語] on the [Y] Set-up] menu.
- 2** Press the four-way controller (▶).
- 3** Use the four-way controller (▲▼◀▶) to choose the language.
- 4** Press the OK button.
- 5** Press the MENU button.

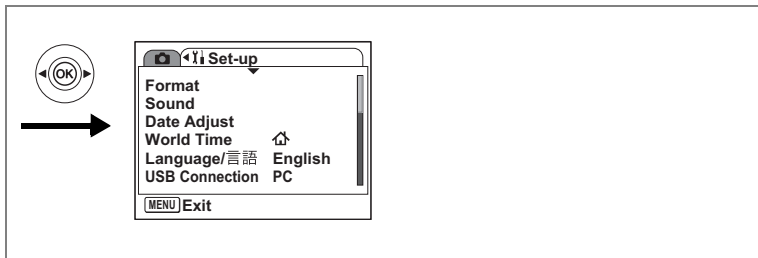

Changing the USB Connection Mode

You can change the USB Connection mode depending on whether the USB cable is to be connected to a printer (PictBridge) or a computer.

- 1 Select [USB Connection] on the [Set-up] menu.**
- 2 Press the four-way controller (▶).**
The pull-down menu appears.
- 3 Use the four-way controller (▲▼) to select [PC] or [PictBridge].**
- 4 Press the [▶] Playback button.**
The camera is ready to play back images.

Changing the Video Output Format

You can select the output format (NTSC or PAL) for taking or playing back images on a TV.

- 1 Select [Video Out] on the [Set-up] menu.**
- 2 Press the four-way controller (▶).**
The pull-down menu appears.
- 3 Use the four-way controller (▲▼) to select [NTSC] or [PAL].**
Choose the video output format to match the output format of the TV.
- 4 Press the [▶] Playback button.**
The camera is ready to play back images.

How to recall the [Y] Set-up] menu

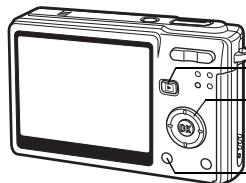

Playback
button

Four-way
controller

MENU

MENU button

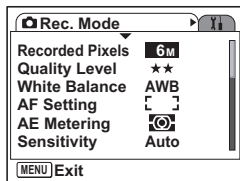

Adjusting the Brightness of the LCD Monitor

You can adjust the brightness of the LCD monitor by seven levels.

- 1 Select [Brightness Level] on the [Y] Set-up] menu.**
- 2 Use the four-way controller (◀▶) to adjust the brightness.**

Moving the slider leftwards makes the LCD monitor darker and moving rightwards makes it brighter.

- 3 Press the ▶ Playback button.**

The camera is ready to play back images.

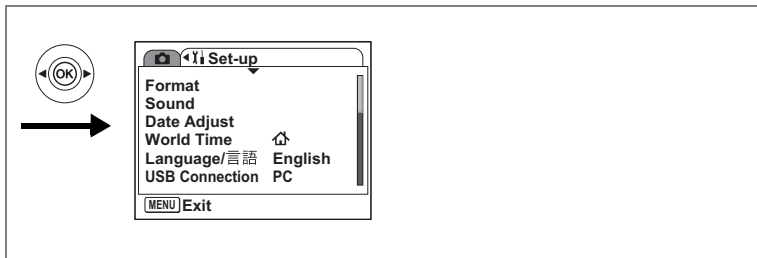

Setting Power Saving

By setting the LCD monitor to dim automatically when you leave the camera without performing any operations for a certain period, you can lessen battery depletion. When Power Saving takes effect and the LCD monitor dims, press any button to return to the ordinary brightness.

- 1 Select [Power Saving] on the [χ i Set-up] menu.**
- 2 Press the four-way controller (▶).**
The pull-down menu appears.
- 3 Use the four-way controller (▲ ▼) to select [2 min], [1 min], [30 sec], [15 sec], [5 sec] or [Off].**
- 4 Press the  Playback button.**
The camera is ready to play back images.



The Power Saving function will not work in the following conditions.

- In Playback mode
- When the USB cable is connected
- While taking movies

How to recall the [Y/| Set-up] menu

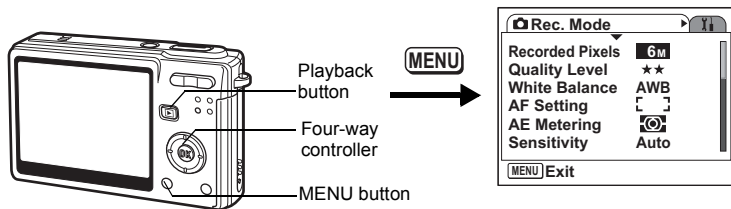

Setting Auto Power Off

You can set the camera to turn off automatically when no operation is performed for a fixed time.

- 1 Select [Auto Power Off] on the [Y/| Set-up] menu.**
- 2 Press the four-way controller (▶).**
The pull-down menu appears.
- 3 Use the four-way controller (▲ ▼) to select [5 min], [3 min] or [Off].**
- 4 Press the [▶] Playback button.**
The camera is ready to play back images.



The Auto Power Off function will not work when the USB cable is connected.

Setting the Guide Display

You can display the information on the mode you are currently using and the functions that are assigned to the Green button, etc., right after starting up the camera in Capture mode or switching to the Capture mode from other modes.

- 1 Select [Guide Display] on the [Y/| Set-up] menu.**
- 2 Use the four-way controller (◀ ▶) to select (On)/ (Off).**
- 3 Press the [▶] Playback button.**
The camera is ready to play back images.

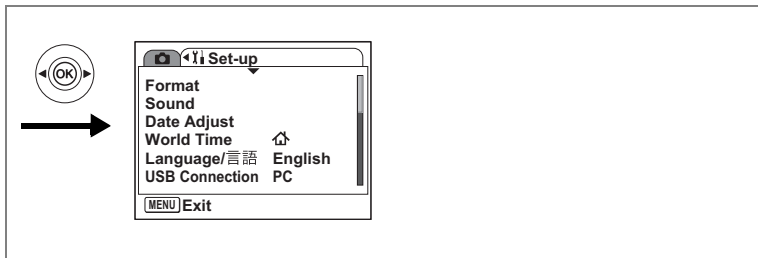

Resetting to Default Settings

You can return all the settings other than the date and time, world time, **language/言語**, and video out to the default settings.

- 1 Select [Reset] on the [Y] Set-up] menu.**
- 2 Press the four-way controller (▶).**
The Reset screen appears.
- 3 Use the four-way controller (▲) to select [Reset].**
- 4 Press the OK button.**

The settings return to the defaults and the camera is ready to take or play back images.

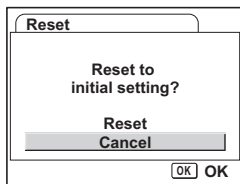

List of City

This is a list of cities which you can choose for the World Time.

Region	City	Region	City	
North America	Honolulu	Africa/West Asia	Nairobi	
	Anchorage		Jeddah	
	Vancouver		Tehran	
	San Francisco		Dubai	
	Los Angeles		Karachi	
	Calgary		Kabul	
	Denver		Male	
	Chicago		Delhi	
	Miami		Colombo	
	Toronto		Kathmandu	
	New York		Dacca	
	Halifax	East Asia	Yangon	
Central and South America	Mexico City		Bangkok	
	Lima		Kuala Lumpur	
	Santiago		Vientiane	
	Caracas		Singapore	
	Buenos Aires		Phnom Penh	
	Sao Paulo		Ho chi Minh	
	Rio de Janeiro		Jakarta	
Europe	Lisbon		Hong Kong	
	Madrid		Beijing	
	London		Shanghai	
	Paris	Manila		
	Amsterdam	Taipei		
	Milan	Seoul		
	Rome	Tokyo		
	Berlin	Guam		
	Stockholm	Oceania	Perth	
	Athens		Adelaide	
	Helsinki		Sydney	
	Moscow		Noumea	
	Africa/West Asia		Dakar	Wellington
Algiers			Auckland	
Johannesburg			Pago Pago	
Istanbul				
Cairo				
	Jerusalem			

Default Settings

The table below lists the factory default settings.

Last Memory Setting

- Yes : The current setting (last memory) is saved when the camera is turned off.
- No : The setting returns to the default setting when the camera is turned off.
- * : The setting depends on the Memory setting (p.100).

Reset Setting

- Yes : The setting returns to the default setting with the Reset function (p.161).
- No : The setting is saved even after reset.

● [Rec. Mode] Menu Items

Item	Default Setting	Last Memory Setting	Reset Setting	Page	
Recorded Pixels	6M	Yes	Yes	p.78	
Quality Level	★★ (Better)	Yes	Yes	p.80	
White Balance	AWB (Auto)	*	Yes	p.82	
AF Setting	Focusing Area	[] (Multiple)	Yes	Yes	p.84
	Focus Limiter	On	Yes	Yes	p.85
	Aux. AF Light	On	Yes	Yes	p.86
AE Metering	 (Multi-segment)	*	Yes	p.87	
Sensitivity	Auto	*	Yes	p.88	
EV Compensation	±0.0	*	Yes	p.89	
Movie	Recorded Pixels	640 (640x480)	Yes	Yes	p.90
	Quality Level	★★★ (S. Fine)	Yes	Yes	p.91
	Time-lapse Movie	Off	Yes	Yes	p.92
	Movie anti-shake	On	Yes	Yes	p.92
Digital Zoom	On	*	Yes	p.72	
Instant Review	1 sec	Yes	Yes	p.93	















Item		Default Setting	Last Memory Setting	Reset Setting	Page
Memory	Flash Mode	On	-	Yes	p.76
	Drive Mode	Off	-	Yes	p.65 to p.70
	Focus Mode	Off	-	Yes	p.73
	Zoom Position	Off	-	Yes	p.71
	MF Position	Off	-	Yes	p.74
	White Balance	Off	-	Yes	p.82
	AE Metering	Off	-	Yes	p.87
	Sensitivity	Off	-	Yes	p.88
	EV Compensation	Off	-	Yes	p.89
	Digital Zoom	On	-	Yes	p.72
	DISPLAY	Off	-	Yes	p.51
File #	On	-	Yes	-	
Green Button		Initialize Rec. Mode	Yes	Yes	p.94
Sharpness		Normal	Yes	Yes	p.97
Saturation		Normal	Yes	Yes	p.98
Contrast		Normal	Yes	Yes	p.99

● [M] Set-up] Menu

Item		Default Setting	Last Memory Setting	Reset Setting	Page
Sound	Operation Volume	3	Yes	Yes	p.149
	Playback Volume	3	Yes	Yes	
	Start-up Sound	1	Yes	Yes	
	Shutter Sound	1	Yes	Yes	
	Operation Sound	1	Yes	Yes	
	Self-timer Sound	1	Yes	Yes	
Date Adjust	Date Style (date)	According to initial setting	Yes	No	p.152
World Time	Select time	Hometown	Yes	No	p.154
	Destination (City)	Same as Hometown	Yes	No	
	Destination (DST)	Same as Hometown	Yes	No	
	Hometown (City)	According to initial setting	Yes	No	
	Hometown (DST)	According to initial setting	Yes	No	

















Item	Default Setting	Last Memory Setting	Reset Setting	Page
Language/ 言語	According to initial setting	Yes	No	p.28
USB Connection	PC	Yes	Yes	p.157
Video Out	According to initial setting	Yes	No	p.157
Brightness Level	4	Yes	Yes	p.158
Power Saving	5 sec	Yes	Yes	p.159
Quick Zoom	Off	Yes	Yes	p.109
Quick Delete	Off	Yes	Yes	p.116
Auto Power Off	3 min	Yes	Yes	p.160
Guide Display	On	Yes	Yes	p.160
Reset	Cancel	No	Yes	p.161

● Playback Mode Palette Items

Item		Default Setting	Last Memory Setting	Reset Setting	Page
	Slideshow	Interval	3 sec	Yes	p.113
		Screen Effect	Wipe	Yes	
		Sound Effect	On	Yes	
	Resize	According to the taken picture	No	-	p.131
	Trimming	-	No	-	p.133
	Image/Sound Copy	Cancel	No	-	p.145
	Image Rotation	Normal	No	No	p.134
	Color Filter	B&W	No	-	p.135
	Digital Filter	SOFT	No	-	p.137
	Brightness Filter	0	No	-	p.139
	Movie Edit	Save as Still Image	No	-	p.141
	Red-eye Compensation	-	-	-	p.144
	Voice Memo	-	-	-	p.106
	Protect	Select image/sound	Yes	No	p.120
	DPOF	Select image	Yes	No	p.124
	Start-up Screen	According to the taken picture	Yes	Yes	p.147

● Capture Mode and Functions

Yes: Available No: Not available

		Flash	Manual Focus Landscape, Macro, Pan Focus,	Self-timer	Continuous Shooting	Remote Control	Digital Zoom	LCD Off
Capture Mode	 Program	Yes	Yes	Yes	Yes	Yes	Yes	Yes
	 Night Scene							
	 Landscape							
	 Flower							
	 Portrait							
	 Candlelight							
	 Surf & Snow							
	 Sport							
	 Pet							
	 Text							
	 Food							
	 Panorama Assist (First Shot)	Yes	Yes	Yes	No	Yes	Yes	No
	 Panorama Assist (Second Shot and later)	Yes (*1)	Yes(*1)	Yes(*1)	No	Yes(*1)	Yes (*1)	No
 Frame Composite (*2)	Yes	Yes	Yes	No	Yes	Yes	No	
 Movie	No (*3)	Yes	Yes	No	No	No (*4)	Yes	
 Voice Recording	-	-	-	-	-	-	Yes	

		Flash	Manual Focus Landscape, Macro, Pan Focus,	Self-timer	Continuous Shooting	Remote Control	Digital Zoom	LCD Off
Others		Digital Zoom	Yes	Yes	Yes	Yes	Yes	No (*5)
		Macro Mode	Yes	-	Yes	Yes	Yes	Yes
		Landscape Mode	No (*3)	-	Yes	Yes	Yes	Yes
		Manual Focus	Yes	-	Yes	Yes	Yes	No
		Continuous Shooting	No (*3)	Yes	-	-	-	Yes

*1: Available but the setting is the same as that of the first shot

*2: If you enter this mode when LCD is set to Off, the LCD monitor returns to normal display.



*3: Flash is fixed to off.

*4: Available only when Movie anti-shake is set to Off.

*5: The digital zoom is canceled when the LCD monitor is set to Off.

● Capture Mode and Default Setting of Each Function

		Flash Mode	Recorded Pixels	White Balance	Focusing Area	Focus Limiter	Aux. AF light	AE Metering	Sensitivity	Sharpness	Saturation	Contrast
	Program											
	Night Scene											
	Movie	①			⑤	⑦	⑦	⑨	⑩			
	Panorama Assist											
	Voice Recording											
	Landscape			④			⑧			⑪	⑪	⑪
	Flower			④		⑧				⑪	⑪	⑪
	Portrait			④						⑪	⑪	⑪
	Candlelight	②	③	④						⑪	⑪	⑪
	Surf & Snow			④						⑪	⑪	⑪
	Sport	②		④	⑥	⑧				⑪	⑪	⑪
	Pet	②		④	⑥	⑧				⑪	⑪	⑪

		Flash Mode	Recorded Pixels	White Balance	Focusing Area	Focus Limiter	Aux. AF light	AE Metering	Sensitivity	Sharpness	Saturation	Contrast
	Text			④		⑧				⑩	⑩	⑩
	Food			④		⑧				⑩	⑩	⑩
	Frame Composite		③									

* Blank means no changes of settings.

- ①: Fixed to Flash Off
- ②: Set to Flash Off (Setting can be changed)
- ③: Fixed to 3M (2048x1536)
- ④: Fixed to AWB
- ⑤: Fixed to Spot
- ⑥: Set to the automatic tracking AF
- ⑦: Fixed to Off
- ⑧: Set to Off (Setting can be changed)
- ⑨: Fixed to center-weighted
- ⑩: Fixed to Auto
- ⑪: Fixed to normal

Optional Accessories

A number of dedicated accessories are available for this camera.

AC adapter D-AC8

USB cable I-USB17 (*)

AV cable I-AVC7 (*)

Camera case O-CC35

Strap O-ST8

Strap O-ST20 (*)

Leather Strap O-ST24

Sports Strap O-ST30

Remote control unit E (zoom function)

Remote control unit F

Rechargeable lithium-ion battery D-LI8 (*)

Battery charger D-BC8 (*)

AC plug cord D-CO2 (*)

D-CO2A Australia

D-CO2E Europe

D-CO2H Hong Kong, United Kingdom

D-CO2J Japan

D-CO2K Korea

D-CO2U North America, Canada

Products marked with an asterisk (*) are the same as those supplied with the camera.

Messages

Messages such as the following may appear on the LCD monitor during camera operation.

Compression error	Compression of the image you captured has failed. Change the quality/size and try again.
No image/sound	There are no images/sounds on the SD Memory Card or in the built-in memory.
Memory card full	The SD Memory Card or the built-in memory is full and no more images can be saved.
Built-in memory full	Insert a new SD Memory Card or delete unwanted images. (p.23, 115) Change the quality/size and try again. (p.131)
Image/sound cannot be created	You can only record up to 5000 files due to the specifications of the camera, even when using a large volume SD Memory Card. Delete unwanted files to continue recording.
Memory card error	Shooting and playback are impossible due to a problem with the SD Memory Card. You may be able to play back an image or sound on a PC.
Card not formatted	The SD Memory Card you have inserted is unformatted or has been formatted on a PC or other device and is not compatible with this camera. (p.148)
Card locked	The SD Memory Card is write-protected. Only menu operation and mode change are possible.
Data being recorded	This is displayed when you switch to Playback mode while the image is being saved or protect setting or DPOF settings are being saved. The message disappears when saving of an image or setting is completed.
Data being processed	The image is being recorded on the SD Memory Card or in the built-in memory.
	The protect setting or DPOF settings is being changed.
	The movie is being recorded.
	The image is being processed with digital filter.
	The movie is being edited.
Deleting	The SD Memory Card or built-in memory is being formatted.
	The image or voice is being deleted.
Camera cannot play this image and sound	You are trying to play back an image or sound in a format not supported by this camera. You may be able to play it back on another brand of camera or PC.
Battery depleted	The battery is exhausted. Recharge the battery or replace with charged battery. (p.14)











Image folder could not be created	The largest folder number has been used and the largest file number has been assigned to an image and no more images can be saved. Insert a new SD Memory Card or format the SD Memory Card or built-in memory. (p. 23, 148)
Protected	The image or sound you are trying to delete is protected.
This image/sound cannot be processed	You are trying to resize, trim, protect an image, or you are trying to set an image for DPOF, or you are trying to edit an image with a digital filter or edit a movie while the image or movie cannot be processed with these functions.
No image to be processed	There is no file that can be processed with the Playback Mode Palette.

Messages such as the following may appear on the LCD monitor when using the PictBridge function.

No paper in the printer	There is no paper in the printer.
No ink in the printer	There is no ink in the printer.
Printer error	An error message has been sent from the printer.
Data error	A data error message has been sent from the printer.
Paper stuck in the printer	The paper in the printer has jammed.

Troubleshooting

Problem	Cause	Remedy
Camera will not turn on	Battery is not installed	Check battery is installed. If not, install battery.
	Battery is installed incorrectly	Check orientation of battery. Reinsert battery, making sure that the battery matches the label inside the battery compartment. (p.14)
	Battery power is low	Insert a charged battery or use the AC adapter.
No image on the LCD monitor	LCD monitor is set to Off	Press OK/Display button to turn LCD monitor on.
	Image is displayed but is hard to see	Image on LCD monitor may be hard to see when taking pictures outside in sunlight.
Shutter will not release	Flash is charging	When flash icon blinks red on the LCD monitor, flash is charging and no pictures can be taken. Flash icon lights red when charging is completed.
	No available space on SD Memory Card or in built-in memory	Insert SD Memory Card with available space or delete unwanted images. (p.23, 115)
	Recording	Wait until recording is finished.
	The number of image, movie, and voice files recorded on the SD Memory Card has reached 5000.	Change SD Memory Cards or delete unwanted files.
Picture is dark	Subject is too far away in a dark environment, such as a night scene	Picture becomes dark if subject is too far away. Take picture within range of flash.
	Background is dark	When taking a picture of a person against a dark background, such as a night scene, the background may appear dark if the flash does not reach it, even with the correct exposure. Set to  mode to ensure both person and background are clear. (p.51, 58)

Problem	Cause	Remedy
Subject is not in focus	Subject difficult to focus on	Subjects difficult to focus on using autofocus: objects with little contrast (blue sky, white walls, etc.), dark objects, finely patterned objects, fast-moving objects, scenery through window or net, etc. Lock focus on another object located at same distance (press shutter release button halfway), then aim at target and press shutter release button fully, or use Manual Focus mode.
	Subject is not in focusing area	Position subject in focus frame (focusing area) in middle of LCD monitor. If the subject is outside the focusing area, aim the camera at the subject and lock the focus (press shutter release button halfway), then compose picture and press the shutter release button fully.
	Subject is too close	Set focus mode on  (Macro). (p.73)
	Focus mode is set on  (Macro)	Normal pictures will be out of focus if taken with focus mode set on  (Macro).
Flash does not discharge	Flash mode is set to Off	Set to Auto or  . (p.76)
	The Capture mode is set to  (Movie) mode, Continuous Shooting, Infinity-Landscape,  (Sport) mode,  (Pet) mode or  (Candlelight) mode.	Flash will not discharge in these modes. You can cancel the non-flash setting for  (Sport) mode,  (Pet) mode and  (Candlelight) mode.
The USB Connection with a personal computer does not function properly.	The USB Connection setting of the camera is set to PictBridge.	Set the USB Connection setting to PC. (p.157)
The USB Connection with a printer does not function properly.	The USB Connection setting of the camera is set to PC.	Set the USB Connection setting to PictBridge. (p.157)

Very occasionally, static electricity may cause malfunction of the camera. In this case, remove the battery and install it again. If the camera works properly, the camera is in its normal condition and you can continue to use it.

Main Specifications

Camera

Type	Fully automatic compact digital still camera with built-in zoom lens		
Effective Pixels	6.0 megapixels		
Sensor	6.36 megapixels (total pixels), 1/2.5-inch interline transfer CCD with a primary color filter		
Recorded Pixels	Still Picture	6M (2816×2112), 5M (2592×1944), 4M (2304×1728), 3M (2048×1536), 2M (1600×1200), 1024 (1024×768), 640 (640×480)	
	Movie	640 (640×480), 320 (320×240)	
Sensitivity	Auto, manual (64/100/200/400: Standard Output Sensitivity)		
File Format	Still Picture	JPEG (Exif2.2), DCF, DPOF, PRINT Image Matching III	
	Movie	AVI (MPEG-4 DivX), approx. 30 fps with sound, Movie anti-shake	
	Sound	WAV (PCM system), monaural, max. recording time approx. 2 hours 13 min. 21 sec. (when using a 128 MB SD Memory Card)	
Quality Level	"Best", "Better", "Good"		
Storage Medium	Built-in memory (approx. 23 MB), SD Memory Card		

Image Storage Capacity and Recording Time (When using a 128MB SD Memory Card)

Quality Level \ Recorded Pixels	Best ★★★	Better★★	Good★	Sound
6M	53	80	121	2 hr. 13 min. 21 sec.
5M	67	101	151	
4M	81	122	183	
3M	96	144	216	
2M	134	202	303	
1024	245	367	551	
640	449	674	1011	

Movie

Quality Level \ Recorded Pixels	★★★ S.Fine	★★ Fine	★ Economy
640 (640×480)	5 min. 11 sec.	6 min. 14 sec.	7 min. 13 sec.
320 (320×240)	14 min. 3 sec.	15 min. 51 sec.	17 min. 20 sec.

* The above table indicates the approximate number of images and recording time. The number of images and recording time may vary depending on a SD Memory Card and subject.

White Balance	Auto, Daylight, Shade, Tungsten Light, Fluorescent Light, Manual	
Lens	Focal Length	6.2 mm - 18.6 mm (equivalent to 37.5 mm - 112.5 mm in 35 mm format)
	Maximum Aperture	$f/2.7 - f/5.2$
	Lens Composition	6 elements in 5 groups (two aspherical elements)
	Zoom Type	Electrically driven
	Picture Range	Approx. 148 mm × 111 mm (screen is filled) (Macro mode)
	Lens Cover	Electrically driven
Digital Zoom	Capture/Playback Mode	Max 4× (combines with 3× optical zoom to give zoom magnification equivalent to 12×)
LCD Monitor	2.5-inch TFT color LCD with approx. 232 kilopixels monitor (with backlight), Beau-Reflective® type, frame coverage approx. 100%	
Playback Functions	Single-frame, 9 frame index, enlargement (max. 8×, scrollable), movie playback, sound playback, histogram display, Select & Delete Playback Mode Palette (Slideshow, Resize, Trimming, Image/Sound Copy, Image Rotation display, Color Filter, Digital Filter, Brightness Filter, Movie Edit, Red-eye Compensation, Voice Memo, Protect, DPOF, Start-up Screen)	
Color filter	B&W, Sepia, Color filter (Bar display, Eight colors), B&W + Red, B&W + Green and B&W + Blue.	
Digital filter	Soft, Illustration, Special Effect 1, Special Effect 2, Slim	
Brightness filter	Brightness filter	
Focusing System	Type	TTL contrast detection system by sensor, 5-point multiple/spot selection, auxiliary AF light, Focus Lock (by half-pressing shutter release button), Automatic tracking AF is possible
	Still Picture Focusing Range (from lens front)	Normal: Approx. 0.4 m - ∞ (full zoom range) Macro: Approx. 0.15 m - Approx. 0.5 m (wide end only) Landscape: ∞ (full zoom range) Pan focus: Approx. 1.1 m - ∞ (wide end), Approx. 4.5 m - ∞ (tele end) Manual Focus: Approx. 0.15 m - ∞ (wide end), Approx. 0.4 m - ∞ (except wide end)
	Movie Focusing Rang (from lens front)	Normal: Approx. 0.15 m - ∞ (wide end), Approx. 0.4 m - ∞ (except wide end) Macro: Approx. 0.15 m - 0.5 m (wide end only) Landscape: ∞ (full zoom range) Pan focus: Approx. 0.6 m - ∞ (wide end), Approx. 2.5 m - ∞ (tele end) Manual Focus: Approx. 0.15 m - ∞ (wide end), Approx. 0.4 m - ∞ (except wide end)
	Exposure Mechanism	AE Metering
	Capture Modes	Mode Palette (Program, Night Scene, Movie, Voice Recording, Panorama Assist, Landscape, Flower, Portrait, Sport, Surf & Snow, Candlelight, Food, Pet, Text, Frame Composite)
	EV Compensation	±2 EV (can be set in 1/3 EV steps)
	Movie	Recording time approx. 1 sec. until memory card is full
Shutter	Type	Electronic/mechanical shutter
	Speed	Approx. 1/2000 sec. - 4 sec.

Flash	Type	Auto flash with red-eye reduction function
	Flash Modes	Auto, Flash Off, Flash On, Auto + Red-eye , Flash On + Red-eye (low-speed synchro in Night Scene mode), Soft Flash
	Effective Range	Wide: Approx. 0.15 m - Approx. 5.1 m (at the standard output sensitivity of Auto) Tele: Approx. 0.4 m - Approx. 2.7 m (at the standard output sensitivity of Auto)
Drive Modes	Single-frame, Continuous, 10-sec. Self-timer. 2-sec. Self-timer, 3-sec. Remote Control, Instant Remote Control	
Self-timer	Electronic control type, delay time: approx. 10 sec., 2 sec.	
Time Function	World Time setting for 71 cities (28 time zones)	
Power Supply	Rechargeable lithium-ion battery D-LI8, AC adapter (optional)	
Battery Life	Approx. 130 images	(at 23°C with LCD monitor on, flash fired for 50% of shots and using a rechargeable lithium ion battery D-LI8) * The battery life is based on the CIPA standard measurement, but it may vary with the conditions under which the camera is used.
In/Out Port	USB/AV terminal (PC communication type USB 2.0, high-speed-compatible), external power supply terminal	
Video Output Format	NTSC, PAL	
Size	85.5 (W) × 53.5 (H) × 19 (D) mm (excluding operating members and projections)	
Weight	100 g (excluding battery and SD Memory Card)	
Weight When Shooting	120 g (including battery and SD Memory Card)	
Accessories	Rechargeable lithium-ion battery, battery charger, AC plug cord, USB cable, software (CD-ROM), AV cable, strap, operating manual	

Power Supply

	Battery Charger D-BC8	AC Adapter D-AC8 (optional)
Rated input	AC100-240V (50Hz/60Hz)	AC100-240V (50Hz/60Hz)
Rated output	DC 4.2 V / 630 mA	DC 4.5 V/2 A
External dimensions	88 × 46 × 26.5 (mm)	90 × 43.5 × 26.5 (mm)
Weight	61 g	122 g

WARRANTY POLICY

All PENTAX cameras purchased through authorized bona fide photographic distribution channels are guaranteed against defects of material or workmanship for a period of twelve months from date of purchase. Service will be rendered, and defective parts will be replaced without cost to you within that period, provided the equipment does not show evidence of impact, sand or liquid damage, mishandling, tampering, battery or chemical corrosion, operation contrary to operating instructions, or modification by an unauthorized repair shop. The manufacturer or its authorized representatives shall not be liable for any repair or alterations except those made with its written consent and shall not be liable for damages from delay or loss of use or from other indirect or consequential damages of any kind, whether caused by defective material or workmanship or otherwise; and it is expressly agreed that the liability of the manufacturer or its representatives under all guarantees or warranties, whether expressed or implied, is strictly limited to the replacement of parts as hereinbefore provided. No refunds will be made on repairs by non-authorized PENTAX service facilities.

Procedure During 12-month Warranty Period

Any PENTAX which proves defective during the 12-month warranty period should be returned to the dealer from whom you purchased the equipment or to the manufacturer. If there is no representative of the manufacturer in your country, send the equipment to the manufacturer, with postage prepaid. In this case, it will take a considerable length of time before the equipment can be returned to you owing to the complicated customs procedures required. If the equipment is covered by warranty, repairs will be made and parts replaced free of charge, and the equipment will be returned to you upon completion of servicing. If the equipment is not covered by warranty, regular charges of the manufacturer or of its representatives will apply. Shipping charges are to be borne by the owner. If your PENTAX was purchased outside of the country where you wish to have it serviced during the warranty period, regular handling and servicing fees may be charged by the manufacturer's representatives in that country. Notwithstanding this, your PENTAX returned to the manufacturer will be serviced free of charge according to this procedure and warranty policy. In any case, however, shipping charges and customs clearance fees to be borne by the sender. To prove the date of your purchase when required, please keep the receipt or bills covering the purchase of your equipment for at least a year. Before sending your equipment for servicing, please make sure that you are sending it to the manufacturer's authorized representatives or their approved repair shops, unless you are sending it directly to the manufacturer. Always obtain a quotation for the service charge, and only after you accept the quoted service charge, instruct the service station to proceed with the servicing.

- This warranty policy does not affect the customer's statutory rights.
- The local warranty policies available from PENTAX distributors in some countries can supersede this warranty policy. Therefore, we recommend that you review the warranty card supplied with your product at the time of purchase, or contact the PENTAX distributor in your country for more information and to receive a copy of the warranty policy.



The CE Mark is a Directive conformity mark of the European Union.

For customers in USA

STATEMENT OF FCC COMPLIANCE

This device complies with Part 15 of the FCC Rules. Operation is subject to the following two conditions: (1) This device may not cause harmful interference, and (2) this device must accept any interference received, including interference that may cause undesired operation.

Changes or modifications not approved by the party responsible for compliance could void the user's authority to operate the equipment.

This equipment has been tested and found to comply with the limits for a Class B digital device, pursuant to part 15 of the FCC Rules.

These limits are designed to provide reasonable protection against harmful interference in a residential installation. This equipment generates, uses and can radiate frequency energy and, if not installed and used in accordance with the instructions, may cause harmful interference to radio communications. However, there is no guarantee that interference will not occur in a particular installation.

If this equipment does cause harmful interference to radio or television reception, which can be determined by turning the equipment off and on, the user is encouraged to try to correct the interference by one or more of the following measures:

- Reorient or relocate the receiving antenna.
 - Increase the separation between the equipment and receiver.
 - Connect the equipment into an outlet on a circuit different from that to which the receiver is connected.
- * Consult the dealer or an experienced radio/TV technician for help.

For customers in Canada

This Class B digital apparatus meets all requirements of the Canadian Interference - Causing Equipment Regulations.

Pour les utilisateurs au Canada

Cet appareil numérique de la classe B respecte toutes les exigences du Règlement sur le matériel brouilleur du Canada.

Declaration of Conformity
According to 47CFR, Parts 2 and 15 for
Class B Personal Computers and Peripherals

We: PENTAX IMAGING COMPANY
A Division of PENTAX of America, Inc.

Located at: 600 12th Street, Suite 300
Golden, Colorado 80401 U.S.A.
Phone: 303-799-8000 FAX: 303-790-1131

Declare under sole responsibility that the product identified herein, complies with 47CFR Parts 2 and 15 of the FCC rules as a Class B digital device. Each product marketed is identical to the representative unit tested and found to be compliant with the standards. Records maintained continue to reflect the equipment being produced can be expected to be within the variation accepted, due to quantity production and testing on the statistical basis as required by 47CFR §2.909. Operation is subject to the following two conditions: (1) This device may not cause harmful interference, and (2) This device must accept any interference received, including interference that may cause undesired operation. The above named party is responsible for ensuring that the equipment complies with the standards of 47CFR §15.101 to §15.109.

Product Name: PENTAX Digital Still Camera

Model Number: Optio S6

Contact person: Customer Service Manager

Date and Place: October, 2005, Colorado

Information on disposal for users



1. In the European Union

If your product is marked with this symbol, it means that used electrical/electronic products should not be mixed with general household waste. There exists a separate collection system for these products.

Used electric/electronic equipment must be treated separately and in accordance with legislation that requires proper treatment, recovery and recycling of these products. Following the implementation by member states, private households within the EU states may return their used electrical/electronic equipments to designated collection facilities free of charge*. In some countries your local retailer may also take back your old product free of charge if you purchase a similar new one.

* Please contact your local authority for further details.

By disposing of this product correctly you will help ensure that the waste undergoes the necessary treatment, recovery and recycling and thus prevent potential negative effects on the environment and human health which could otherwise arise due to inappropriate waste handling.

2. In other countries outside the EU

If you wish to discard this product, please contact your local authorities and ask for the correct method of disposal.

For Switzerland: Used electrical/electronic equipment can be returned free of charge to the dealer, even when you don't purchase a new product. Further collection facilities are listed on the home page of www.swico.ch or www.sens.ch.

- A**
- AC Adapter 21
 - Access lamp 11
 - Auto Power Off 160
 - Autofocus mode 73
 - Autofocus Settings 84
 - Auxiliary AF light 86
- B**
- Battery 14
 - Battery Level Indicator 18
 - Battery/card cover 14
 - Best 25
 - Better 25
 - Brightness Filter 139
- C**
- Capture Mode 39
 - Capture Mode Palette 48
 - Color Filters 135
 - Color Saturation 98
 - Continuous Shooting 67
- D**
- Date and Time 152
 - DC input terminal 11
 - Delete All Images 117
 - Delete Images 115
 - Digital Filter 137
 - Display Language 156
 - DPOF 124
- E**
- Exposure 89
- F**
- Flash 11
 - Flash Mode 76
 - Focus Limiter 85
 - Focus Mode 73
 - Focusing Area 84
 - Format 148
 - Four-way controller 12, 39, 40
 - Frame Composite 63
- G**
- Good 25
 - Green button 12, 39, 41
 - Guide Display 160
- H**
- Home Time 154
- I**
- Image Contrast 99
 - Image quality of movies 26
 - Image quality of still pictures 25
 - Image Sharpness 97
 - Image Size of movies 90
 - Image Size of still pictures 25
 - Infinity-Landscape mode 73
 - Initial Settings 28
 - Instant Review 33, 93
- L**
- LCD monitor 11
 - Lens 11
 - Light Metering mode 87
- M**
- Macro mode 73
 - Manual Focus mode 73
 - Memory 100
 - MENU button 12, 39, 41
 - Menu List 46
 - Messages 170
 - Microphone 11
 - Movie anti-shake 92
 - Movie Edit 141
 - My Album 36
- N**
- Night Scene Mode 58
 - Nine-Image Display 112

Number of recordable images . . .	18	Set Up the Screen	147
O		Set-up Menu	47
OK button	12, 39	Shutter release button	11, 32
Operating Time	18	Shutter Sound	150
Optional Accessories	169	Slideshow	113
P		Sound Settings	149
Pan Focus mode	73	Start-up Sound	150
Panorama Assist Mode	61	Strap	13
PictBridge	127	Strap lug	11
Picture Mode	55	Symbols	9
Play back Movies	110	T	
Play back Sound	105	Take Movies	59
Play back Still Pictures	34	Take Still Pictures	32
Play back the Previous or Next Image	34	Tele	71
Playback button	12, 39, 40	Text	57
Playback Mode	40	Trimming	133
Playback Mode Palette	50	Tripod socket	11
Power switch	11	TV	122
Press down fully	33	U	
Press halfway	33	USB Connection	157
Printer	127	USB/AV terminal	11
Program Mode	54	V	
Protect	120	Video Output Format	157
Q		Voice Memo	106
Quick Delete	116	Voice Recording Mode	42, 103
Quick Zoom	109	W	
R		White Balance	82
Rec. Mode Menu	46	Wide	71
Recording Sound	103	World Time	154
Red-eye Compensation	144	Write-protect switch	24
Remote Control	69, 123	Z	
Reset	161	Zoom	71
Resize images	131	Zoom button	12, 39, 40
S		Zoom Display	108
SD Memory Card	23, 24		
Self-timer	65		
Self-timer lamp	11		
Sensitivity	88		
Set the Menus	43		

Memo

Memo