

soulful lighting
utua®



welcome to our world

utu - soulful lighting is the response to an urge to create lighting solutions that enrich spaces with individuality and meaning.

The experience of spaces and the feeling created has the huge contribute of lighting, as it contributes to its atmosphere and appearance.

Born from the creative hub mambo unlimited ideas, that comprises design talents in a team dedicated to develop new products and ideas, utu soulful lighting is the new brand specifically dedicated to lighting, where this dimension of design is tirelessly explored and developed.

Presenting a wide lighting collection with different concepts and functional solutions which includes suspension, table, floor and wall lamps in a wide range of possible finishings, utu launches as a very versatile and complete brand.

Already mature as being heir of the experience and knowhow acquired while under the mambo unlimited ideas label, utu soulful lighting follows the market call. It builds an individual space in the company scope for the continued growth of the lighting collection, with the same base values but with a soul of its own!

So we welcome you to our world! A world where innovation, creativity, quality and reliability are the guidelines. We produce original top quality products - our work is developed towards global business, with international inspiration, while rooted in our local knowledge and crafts expertise.

The growing presence we conquer in the international market reflects our approach and our reputation: we offer original quality products and a professional team ready to collaborate with professionals worldwide.

utu - soulful lighting, light devices with soul in a wide range of finishings: endless possible combinations.





lighting collection

INDEX

magnolia	4
jules	18
comb	32
carousel	40
star	46
up	60
circus	68
spider	82
extrude	94
revolution	102
expand	104
cage	106
new spider	110



H10 Duque de Loulé

At H10 Duque de Loulé Hotel in Lisbon, the cosy feeling gets a touch of sophistication with Magnolia lamps.

With three different structural elements which colors can be customized, this lamp can transform itself when it appears in different color combinations, suiting every project specific needs.

H10 Duque de Loulé

Contemporain Studio project

Portugal

*design by Cláudia Melo



01



02



03



04

magnolia

suspension lamp
 ø: 26 in
 h: 27 in
 lacquered metal and optional metal/brass/copper ring (cup only in lacquered metal)
 ● energy saving bulbs E27 / 1x23W

candeeiro de suspensão
 ø: 65 cm
 a: 68 cm
 metal lacado e aro opcional em metal/latão/cobre (copo apenas em metal lacado)
 ● lâmpada económica E27 / 1x23W



Sushita cafe
 Madrid in Love project
 Spain

*design by Cláudia Melo



01

magnolia

09



magnolia I

suspension lamp
 ø: 26 in
 h: 19 in
 lacquered metal and optional metal/brass/copper
 ring (cup only in lacquered metal)
 ● energy saving bulbs E27 / 1x23W

candeeiro de suspensão
 ø: 65 cm
 a: 47 cm
 metal lacado e aro opcional em metal/latão/
 cobre (copo apenas em metal lacado)
 ● lâmpada económica E27 / 1x23W



Maison du Peuple cafe
 Sacré Sacré project
 Belgium

*design by Cláudia Melo



01



02



03



04



05

magnolia II

suspension lamp
 ø: 11 in
 h: 23 in
 cup and structure lacquered metal/brass/copper,
 optional ring metal/brass/copper and cotton shade
 ● energy saving bulbs E27 / 1x23W

candeeiro de suspensão
 ø: 27 cm
 a: 59 cm
 copo e estrutura metal lacado/latão/cobre, aro
 opcional metal/ latão/cobre e abajur de algodão
 ● lâmpada económica E27 / 1x23W



Crustó cafe
 Madrid in Love project
 Spain

*design by Cláudia Melo



01



02

03

04

05

magnolia III

suspension lamp
 ø: 12 in
 h: 17 in
 cup and structure lacquered metal/brass/copper,
 optional ring metal/brass/copper and cotton shade
 ● energy saving bulbs E27 / 1x20W

candeeiro de suspensão
 ø: 31 cm
 a: 42 cm
 copo e estrutura metal lacado/latão/cobre, aro
 opcional metal/ latão/cobre e abajur de algodão
 ● lâmpada económica E27 / 1x20W

*design by Cláudia Melo



01

magnolia table

table lamp
ø: 13 in
h: 25 in

cup and structure lacquered metal/brass/copper
and cotton shade
● energy saving bulbs E27 / 1x15W

candeeiro de mesa
ø: 32 cm
a: 63 cm

copo e estrutura metal lacado/latão/cobre
e abajur de algodão
● lâmpada económica E27 / 1x15W



02



03



04



05



*design by Cláudia Melo



01



02

03

04

05

magnolia floor

floor lamp
 ø: 15 in
 h: 67 in
 cup and structure lacquered metal/brass/copper
 and cotton shade
 ● energy saving bulbs E27 / 2x23W

candeeiro de chão
 ø: 37 cm
 a: 170 cm
 copo e estrutura metal lacado/latão/cobre
 e abajur de algodão
 ● lâmpada económica E27 / 2x23W



*design by Cláudia Melo



01



02



03



04



05

magnolia wall

wall lamp
w: 12 in
d: 5 in
h: 22 in
cup and structure lacquered metal/brass/copper
and cotton shade
● energy saving bulbs E14 / 1x20W

aplique
l: 30 cm
p: 13 cm
a: 56 cm
copo e estrutura metal lacado/latão/cobre
e abajur de algodão
● lâmpada económica E14 / 1x20W



*design by Cláudia Melo



01



02



03



04

jules

suspension lamp
ø: 25 in
h: 28 in
lacquered metal, brass or copper and
cotton shade
● energy saving bulbs E27 / 1x23W

candeeiro de suspensão
ø: 63 cm
a: 72 cm
metal lacado, latão ou cobre e abajur
de algodão
● lâmpada económica E27 / 1x23W



*design by Cláudia Melo



01



02

03

04

04

jules I

suspension lamp
 ø: 25 in
 h: 22 in
 lacquered metal, brass or copper and
 cotton shade
 energy saving bulbs E27 / 1x23W

candeeiro de suspensão
 ø: 63 cm
 a: 57 cm
 metal lacado, latão ou cobre e abajur
 de algodão
 lâmpada económica E27 / 1x23W



Refahn Hotel
Turkey

*design by Cláudia Melo



01

jules
025

jules II

suspension lamp
ø: 12 in
h: 25 in
lacquered metal, brass or copper and
cotton shade
● energy saving bulbs E27 / 1x23W

candeeiro de suspensão
ø: 30 cm
a: 64 cm
metal lacado, latão ou cobre e abajur
de algodão
● lâmpada económica E27 / 1x23W





*design by Cláudia Melo



01

jules
027



02



03



04

jules III

suspension lamp
 ø: 15 in
 h: 17 in
 lacquered metal, brass or copper and
 cotton shade
 ● energy saving bulbs E27 / 1x23W

candeeiro de suspensão
 ø: 38 cm
 a: 44 cm
 metal lacado, latão ou cobre e abajur
 de algodão
 ● lâmpada económica E27 / 1x23W



*design by Cláudia Melo



01



02

03

04

05

jules table

table lamp
 ø: 12 in
 h: 25 in
 lacquered metal, brass or copper and
 cotton shade
 ● energy saving bulbs E27 / 1x23W

candeeiro de mesa
 ø: 30 cm
 a: 63 cm
 metal lacado, latão ou cobre e abajur
 de algodão
 ● lâmpada económica E27 / 1x23W



*design by Cláudia Melo



01



02



03



05

jules floor

floor lamp
ø: 15 in
h: 70 in
lacquered metal, brass or copper and
cotton shade
● energy saving bulbs E27 / 1x23W

candeeiro de chão
ø: 38 cm
a: 177 cm
metal lacado, latão ou cobre e abajur
de algodão
● lâmpada económica E27 / 1x23W

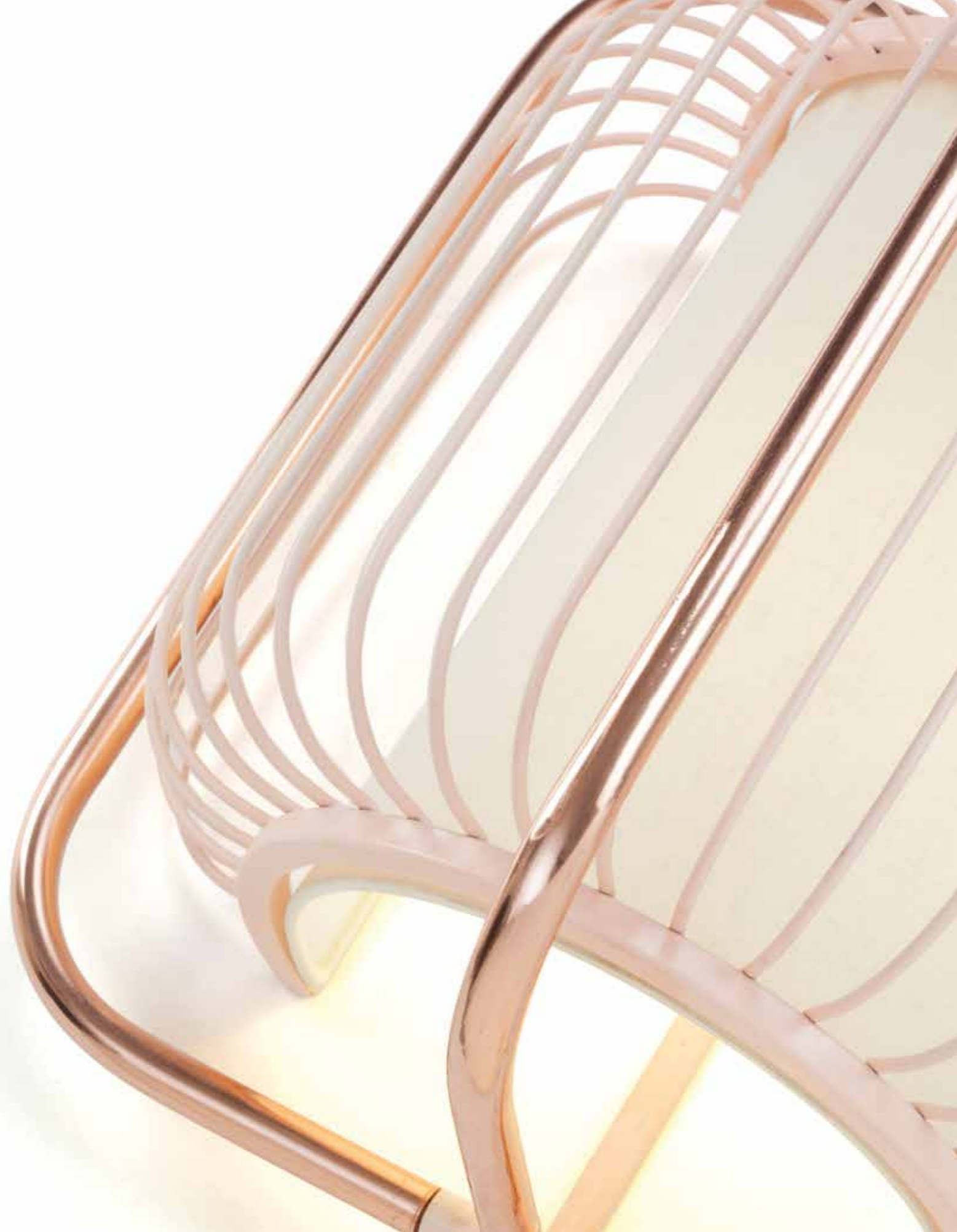

*design by Cláudia Melo



01

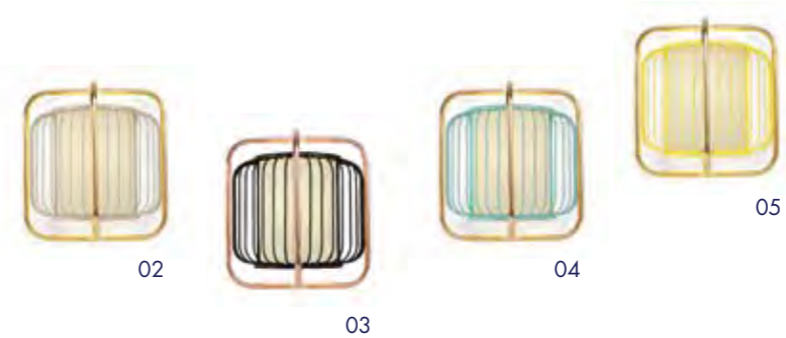

jules wall

wall lamp
w: 16 in
d: 9 in
h: 16 in
lacquered metal, brass or copper and
cotton shade
● energy saving bulbs E14 / 1x20W

aplique
l: 40 cm
p: 23 cm
a: 40 cm
metal lacado, latão ou cobre e abajur
de algodão
● lâmpada económica E14 / 1x20W

**casa
mono**



Casa Mono cafe

Spain

Comb lamps are elegant in their balanced shapes, glances of light are visible between the carefully shaped geometric plates. The different combinations made possible by the interchangeable finishings are endless.

*design by Cláudia Melo



01

comb
035

comb

suspension lamp
ø: 29 in
h: 24 in

lacquered metal and optional metal, brass or copper rings and cotton shade
● energy saving bulbs E27 / 1x23W

candeeiro de suspensão
ø: 74 cm
a: 60 cm

metal lacado e aros em metal, latão ou cobre opcionais
● lâmpada económica E27 / 1x23W



02



03



04



05



Chapeau Noir restaurant
France

*design by Cláudia Melo



01

037 comb

comb I

suspension lamp
ø: 30 in
h: 14 in

lacquered metal and optional metal, brass or copper rings and cotton shade
● energy saving bulbs E27 / 1x23W



02



03



04

candeeiro de suspensão
ø: 75 cm
a: 35 cm
metal lacado e aros em metal, latão ou cobre opcionais
● lâmpada económica E27 / 1x23W

H10 Duque de Loulé



Floor lamp Comb results as a suspended light jewel, standing on its discreet base, drawing delicate light and shade shapes. Comb floor lamp appears at the banquet room at H10 Duque de Loulé Hotel, bringing a touch of modernity and design to this otherwise classical room.

H10 Duque de Loulé

Contemporain Studio project

Portugal

*design by Cláudia Melo



01



02



03



04



05

comb floor

floor lamp
 ø: 21 in
 h: 69 in
 lacquered metal and optional metal, brass or
 copper rings and cotton shade
 ● energy saving bulbs E27 / 1x23W

candeeiro de chão
 ø: 54 cm
 a: 175 cm
 metal lacado e aros em metal, latão ou cobre
 opcionais
 ● lâmpada económica E27 / 1x23W



*design by Cláudia Melo

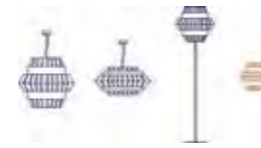

01



02



03



04

comb wall

wall lamp
w: 15 in
d: 7 in
h: 13 in

lacquered metal and optional metal, brass or copper rings and cotton shade
● energy saving bulbs E14 / 1x15W

applique
l: 37 cm
p: 19 cm
a: 34 cm

metal lacado e aros em metal, latão ou cobre opcionais
● lâmpada económica E14 / 1x15W



Pryanosti & Radosti Restaurant
MEGRE INTERIORS project
Russia

*design by Cláudia Melo

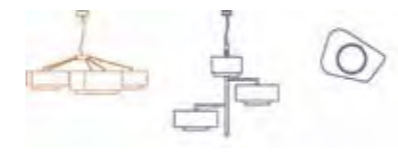

01

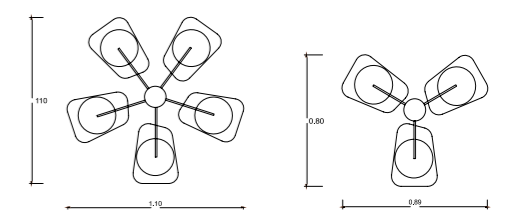

carousel

suspension lamp
ø: 43 or 35 in
h: 16 in

lacquered metal and 5/3 cotton shades
energy saving bulbs E27 / 5 or 3x23W



03



02



04

candeeiro de suspensão
ø: 110 or 89 cm
a: 40 cm

metal lacado e 5/3 abajures de algodão
lâmpada económica E27 / 5 ou 3x23W

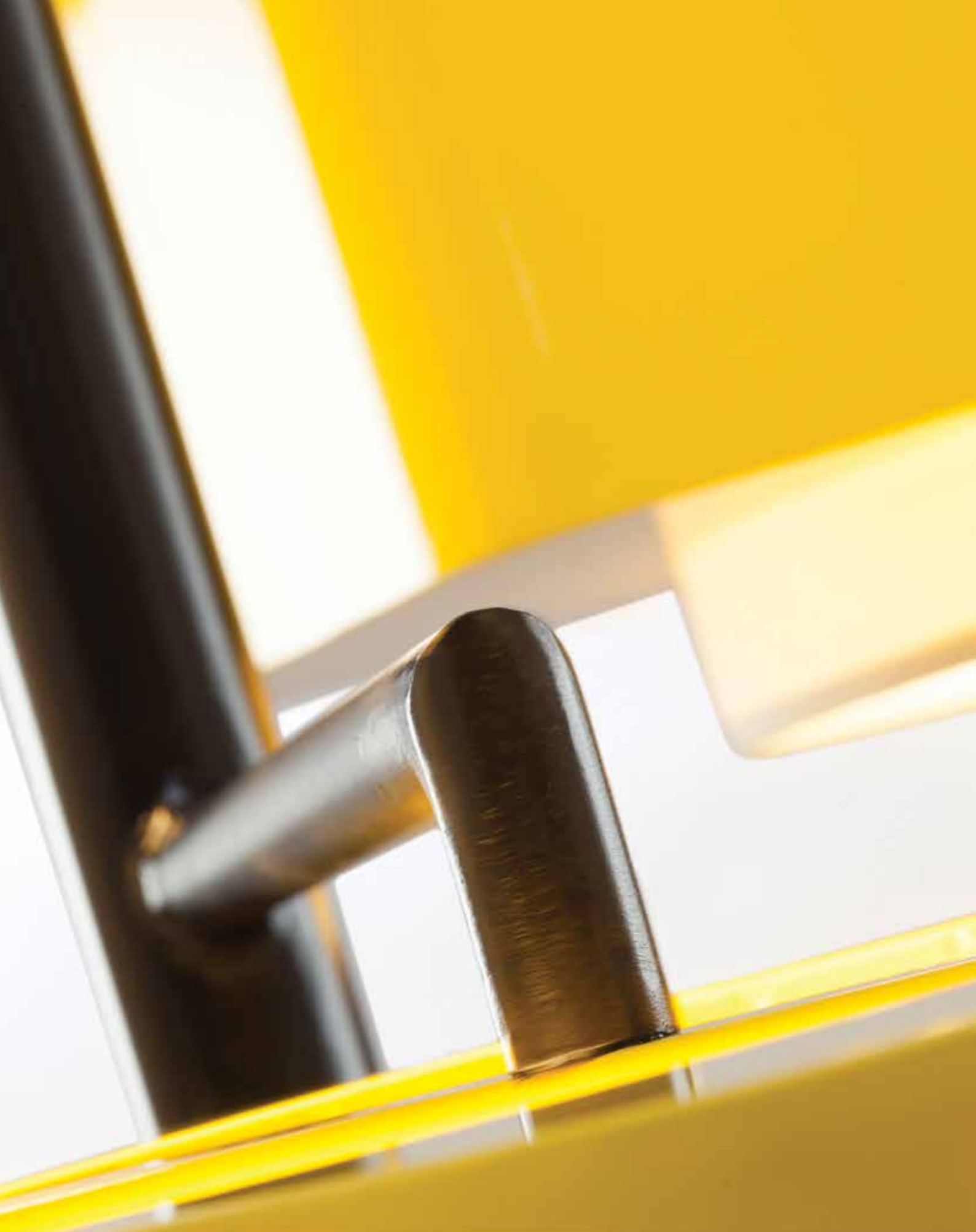

*design by Cláudia Melo



01



02



03



04

carousel I

suspension lamp
ø: 38 in
h: 34 in
lacquered metal and 3 cotton shades
● energy saving bulbs E27 / 3x23W

candeeiro de suspensão
ø: 97 cm
a: 86 cm
metal lacado e 3 abajures de algodão
● lâmpada económica E27 / 3x23W



Love Ceramic Tiles
 Von Hoff Architecture & Design and
 Rita Glória project
 Portugal

*design by Cláudia Melo

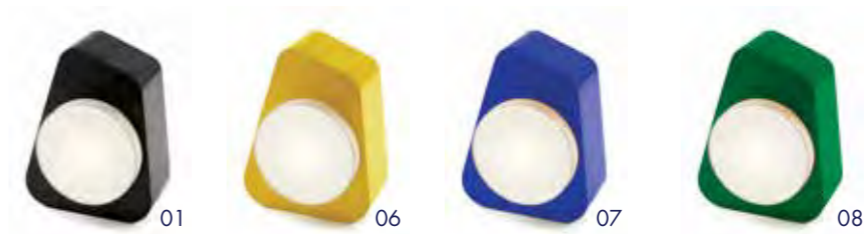
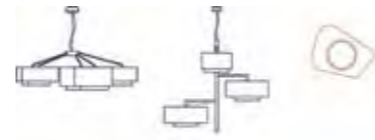

carousel wall

wall lamp
 w: 16 in
 d: 7 in
 h: 12 in
 lacquered metal or brass/copper and
 cotton shade
 ● energy saving bulbs E27 / 1x20W

applique
 l: 40 cm
 p: 18 cm
 a: 30 cm
 metal lacado ou latão/cobre e abajur
 de algodão
 ● lâmpada económica E27 / 1x20W

*design by Cláudia Melo



Junqueira Residence

Star is a lampshade collection made of polished brass. Our goal was to create a lamp filled with personality that could fit in a wide range of environments. Seducing, this asymmetrical floating structure, with its rich linen lampshade, is a sculptural piece that brings a touch of poetry to spaces. The unpredictable geometry gives the Star lamp many different facets, from each perspective that it is observed.

Junqueira Residence

Roof Design Studio project

Portugal

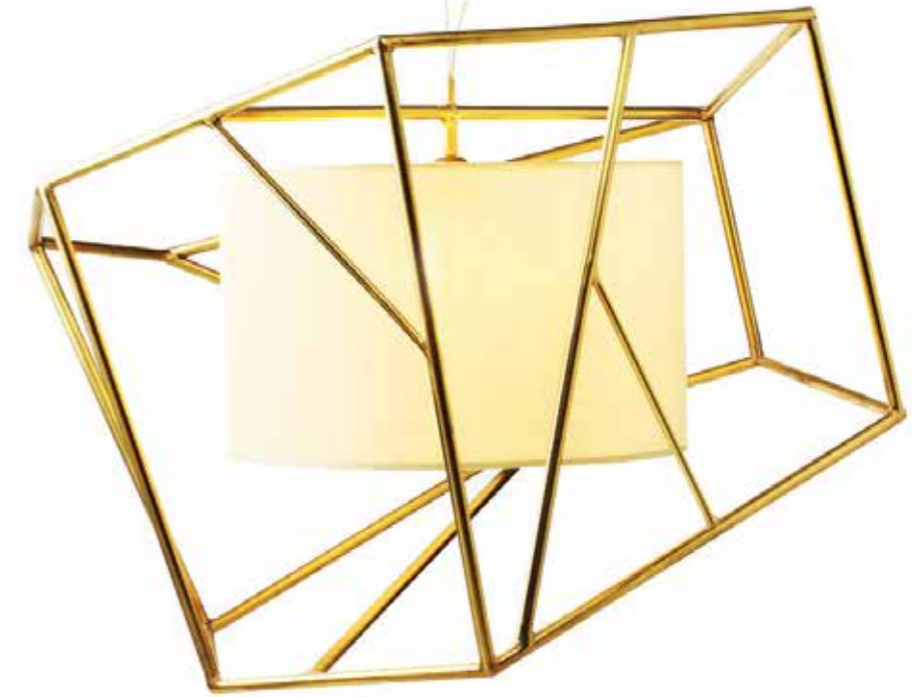

01

star
049

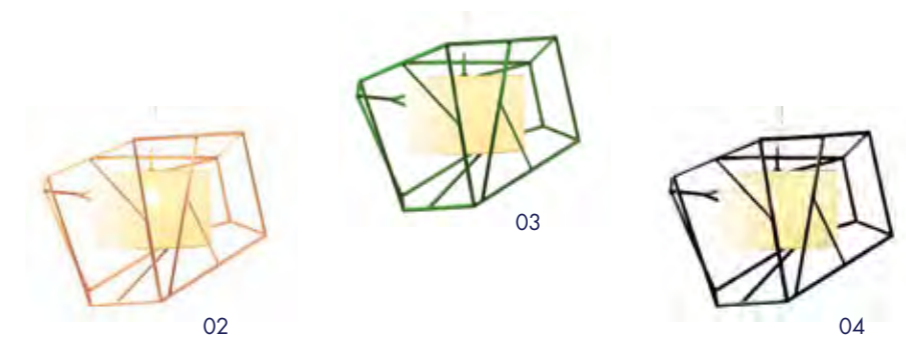

star

suspension lamp
max w: 32 in
max h: 28 in
lacquered metal, brass or copper and
linen shade
● energy saving bulbs E27 / 1x23W

candeeiro de suspensão
l max: 80 cm
a max: 70 cm
metal lacado, latão ou cobre e abajur
de linho
● lâmpada económica E27 / 1x23W



*design by Cláudia Melo



01



02



03



04

star I

suspension lamp
max w: 24 in
max h: 20 in
lacquered metal, brass or copper and
linen shade
● energy saving bulbs E27 / 1x23W

candeeiro de suspensão
l max: 60 cm
a max: 50 cm
metal lacado, latão ou cobre e abajur
de linho
● lâmpada económica E27 / 1x23W



*design by Cláudia Melo



01

star
053

star II

suspension lamp
max w: 18 in
max h: 28 in
lacquered metal, brass or copper and
linen shade
● energy saving bulbs E27 / 1x23W

candeeiro de suspensão
l max: 45 cm
a max: 72 cm
metal lacado, latão ou cobre e abajur
de linho
● lâmpada económica E27 / 1x23W



02



03



04



05



Boca restaurant

Viterbo Interior Design project

Singapore

*design by Cláudia Melo



01

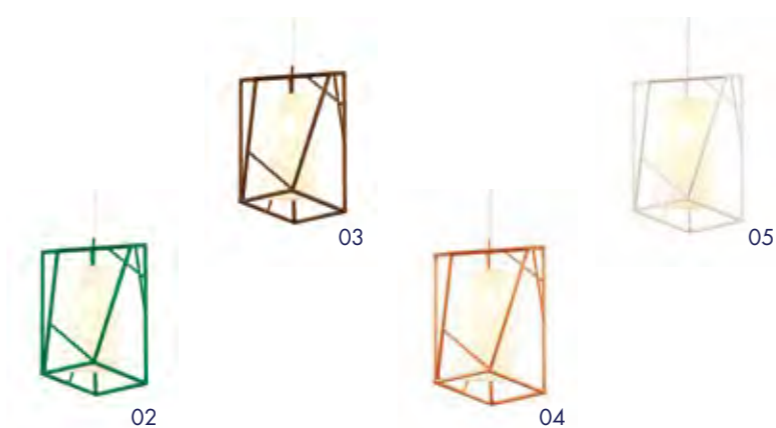

star III

suspension lamp
 max w: 14 in
 max h: 21 in
 lacquered metal, brass or copper and
 linen shade
 ● energy saving bulbs E27 / 1x23W

candeeiro de suspensão
 l max: 35 cm
 a max: 53 cm
 metal lacado, latão ou cobre e abajur
 de linho
 ● lâmpada económica E27 / 1x23W



Star collection

Light as made of pure lines. With no standard base, Star table lamp seems light as a feather. While one travels through space and sees it in different perspectives, its shape changes. It never looks the same. It's the perfect balance between elegance and irreverence.

*design by Cláudia Melo



01



02



03



04



05

star table

table lamp
max w: 13 in
max h: 29 in
lacquered metal, brass or copper and
linen shade
● energy saving bulbs E27 / 1x15W

candeeiro de mesa
l max: 33 cm
a max: 72 cm
metal lacado, latão ou cobre e abajur
de linho
● lâmpada económica E27 / 1x15W



Private house
 Roof Design Studio project
 Portugal

*design by Cláudia Melo



01



03



04



05

star floor

floor lamp
 max w: 18 in
 max h: 67 in
 lacquered metal, brass or copper and
 linen shade
 ● energy saving bulbs E27 / 1x23W

candeeiro de chão
 l max: 45 cm
 a max: 170 cm
 metal lacado, latão ou cobre e abajur de
 linho
 ● lâmpada económica E27 / 1x23W



Groenendael Hotel
Coralie Michiels project
Holland

Groenendael Hôtel



Featured at Groenendael Hôtel, Star wall lamps are the perfect fit for this modern and sleek space. With its faceted golden jewel look, balanced with its purity of lines, Star wall lamps enrich the space.

*design by Cláudia Melo

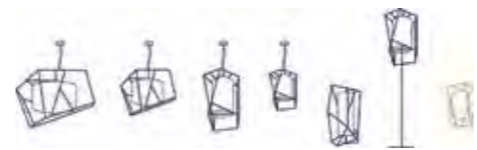

01



02



03



04

star wall

wall lamp
max w: 11 in
max d: 8 in
max h: 20 in
lacquered metal, brass or copper and
linen shade
● energy saving bulbs E14 / 1x20W

applique
l max: 28 cm
p max: 20 cm
a max: 51 cm
metal lacado, latão ou cobre e abajur de
linho
● lâmpada económica E14 / 1x20W



iSight Partners offices
Roof Design Studio project
Holland

**iSight
Partners**

Up lamps combine classic with original style. A rhythmic lacquered metal mesh makes these pieces surface textured and the light results soft and comfortable filtered by the cotton lampshade. At iSight Partners office in Amsterdam, a space with a cosy irreverent feeling is accomplished with these lamps.

*design by Cláudia Melo

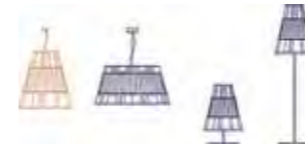

01



02



03



04



05

up
063

up

suspension lamp
ø: 22 in
h: 28 in

lacquered metal and optional metal,
brass or copper ring and cotton shade
● energy saving bulbs E27 / 1x23W

candeeiro de suspensão
ø: 55 cm
a: 72 cm

metal lacado e aro em metal, latão ou
cobre opcional e abajur de algodão
● lâmpada económica E27 / 1x23W



*design by Cláudia Melo



01



02



04



03



05

up I

suspension lamp

ø: 27 in

h: 15 in

lacquered metal and optional metal,
brass or copper ring and cotton shade

● energy saving bulbs E27 / 1x23W

candeeiro de suspensão

ø: 68 cm

a: 39 cm

metal lacado e aro em metal, latão ou
cobre opcional e abajur de algodão

● lâmpada económica E27 / 1x23W

up
065



Private house
Roof Design Studio project
Portugal

*design by Cláudia Melo



01

up table

table lamp

ø: 17 in

h: 28 in

lacquered metal and optional metal,
brass or copper ring and cotton shade

● energy saving bulbs E27 / 1x15W

candeeiro de mesa

ø: 44 cm

α: 72 cm

metal lacado e aro em metal, latão, ou
cobre opcional e abajur de algodão

● lâmpada económica E27 / 1x15W



02



03



04



Private house
Roof Design Studio project
Portugal

*design by Cláudia Melo

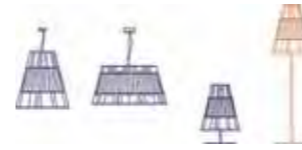

01



02



03



04

up floor

floor lamp
ø: 19 in
h: 67 in
lacquered metal and optional metal,
brass or copper ring and cotton shade
● energy saving bulbs E27 / 1x23W

candeeiro de chão
ø: 47 cm
a: 170 cm
metal lacado e aro em metal, latão ou
cobre opcional e abajur de algodão
● lâmpada económica E27 / 1x23W



Le Belmont restaurant
France

*design by Cláudia Melo

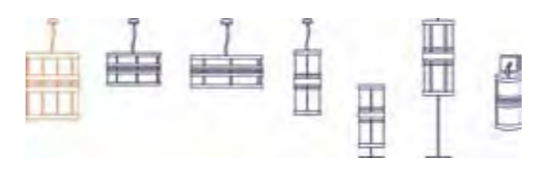

01

circus
071



circus

suspension lamp
 ø: 22 in
 h: 29 in
 lacquered metal, copper or brass and
 5 cotton shades
 ● energy saving bulbs E27 / 5x23W

candeeiro de suspensão
 ø: 56 cm
 a: 73 cm
 metal lacado, cobre ou latão e 5 abajures
 de algodão
 ● lâmpada económica E27 / 5x23W



OYSHO stores
 Contemporain Studio project
 Spain/ Portugal

*design by Cláudia Melo



01



02



03



04

circus I

suspension lamp
 ø: 22 in
 h: 15 in
 lacquered metal, copper or brass and
 5 cotton shades
 energy saving bulbs E27 / 5x23W

candeeiro de suspensão
 ø: 56 cm
 a: 38 cm
 metal lacado, cobre ou latão e 5 abajures
 de algodão
 lâmpada económica E27 / 5x23W



Le Berry

Circus lamps round and linear design result in powerful and elegant pieces. Extremely balanced and handmade with extreme care, Circus lamps have a strong classy feeling. Seen here at Le Berry restaurant, they are a plus on lighting and sophistication.



Le Berry
France

*design by Cláudia Melo



01

circus
075

circus II

suspension lamp
 ø: 26 in
 h: 13 in
 lacquered metal, copper or brass and
 5 cotton shades
 ● energy saving bulbs E27 / 5x23W



02



03



04

candeeiro de suspensão
 ø: 65 cm
 a: 34 cm
 metal lacado, cobre ou latão e 5 abajures
 de algodão
 ● lâmpada económica E27 / 5x23W

*design by Cláudia Melo



01



02



03



04

circus III

suspension lamp
ø: 12 in
h: 26 in
lacquered metal, copper or brass and
cotton shade
● energy saving bulbs E27 / 1x20W

candeeiro de suspensão
ø: 30 cm
a: 66 cm
metal lacado, cobre ou latão e abajur de
algodão
● lâmpada económica E27 / 1x20W



Private house
Roof Design Studio project
Portugal

*design by Cláudia Melo

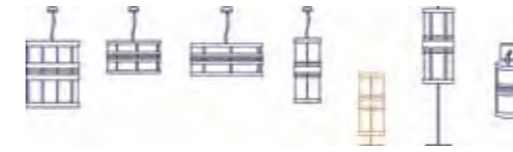

01



circus table

table lamp
ø: 12 in
h: 30 in
lacquered metal, copper or brass and
cotton shade
● energy saving bulbs E27 / 1x15W

candeeiro de mesa
ø: 30 cm
a: 76 cm
metal lacado, cobre ou latão e abajur
de algodão
● lâmpada económica E27 / 1x15W

London Home

Circus floor lamp is an uncommon lamp, as it is a column of light with its wide illuminated area. It distributes light in a large area, providing soft, comfortable lighting that spreads throughout the space. At this modern and art filled London home, it shines with its elegant presence.



Private house
Lewis and Company project
United Kingdom

*design by Cláudia Melo



01



02



03



04



05

circus floor

floor lamp
ø: 14 in
h: 67 in
lacquered metal, copper or brass and
6 cotton shades
● energy saving bulbs E27 / 6x15W

candeeiro de chão
ø: 35 cm
a: 170 cm
metal lacado, cobre ou latão e 6 abajures
de algodão
● lâmpada económica E27 / 6x15W



Love Ceramic Tiles
 Von Hoff Architecture & Design and
 Rita Glória project
 Lisboa, Portugal

*design by Cláudia Melo

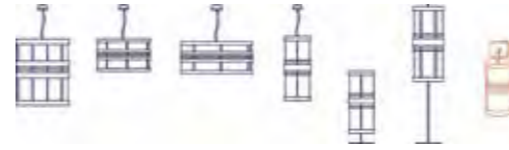

01

circus
083

circus wall



02



03



04

wall lamp
 ø: 11 in
 d: 12 in
 h: 24 in
 lacquered metal, copper or brass and
 cotton shade
 ● energy saving bulbs E14 / 1x20W

applique
 ø: 27 cm
 p: 30 cm
 a: 62 cm
 metal lacado, cobre ou latão e abajur
 de algodão
 ● lâmpada económica E14 / 1x20W



Antemare hotel
 Patricia Galdón Studio project
 Spain

*design by Cláudia Melo



01

spider
085



spider

suspension lamp
 ø: 28 in
 h: 14 in
 lacquered metal

● energy saving bulbs E27 / 1x23W

candeeiro de suspensão
 ø: 70 cm
 a: 35 cm
 metal lacado

● lâmpada económica E27 / 1x23W

*design by Cláudia Melo



01

Spider collection

Spider collection is a complete lighting range, from suspension to wall lamps, which design plays with shape and transparency. The different suspension sizes available result in very different pieces, not only regarding sizes but also formats. The wall, floor and table lamps are surprising, shapes inspired in a section of the suspension lamp, adding a complete new concept to this collection.



spider I

suspension lamp
ø: 20 in
h: 28 in
lacquered metal

● energy saving bulbs E27 / 1x23W

candeeiro de suspensão
ø: 52 cm
a: 70 cm
metal lacado

● lâmpada económica E27 / 1x23W

*design by Cláudia Melo



01



spider II

suspension lamp
ø: 28 in
h: 39 in
lacquered metal

● energy saving bulbs E27 / 1x23W

candeeiro de suspensão
ø: 70 cm
a: 100 cm
metal lacado

● lâmpada económica E27 / 1x23W



Roof Design Studio
Portugal

*design by Cláudia Melo



01



spider table

table lamp
 ø: 9 in
 h: 20 in
 lacquered metal and cotton shade
 ● energy saving bulbs E27 / 1x15W

candeeiro de mesa
 ø: 24 cm
 a: 60 cm
 metal lacado e abajur de algodão
 ● lâmpada económica E27 / 1x15W



Private house
 Roof Design Studio project
 Portugal

*design by Cláudia Melo



01

spider
093

spider floor

floor lamp
 ø: 9 in
 h: 55 in
 lacquered metal and cotton shade
 energy saving bulbs E27 / 2x23W

candeeiro de chão
 ø: 24 cm
 a: 140 cm
 metal lacado e abajur de algodão
 lâmpada económica E27 / 2x23W



02



03



04



05



Maulu hotel
Russia

*design by Cláudia Melo



01

spider
095

spider wall

wall lamp
w: 10 in
d: 6 in
h: 20 in
lacquered metal and/or brass and cotton shade
● energy saving bulbs E14 / 1x15W

applique
l: 25 cm
p: 15 cm
a: 50 cm
metal lacado e/ou latão e abajur de algodão
● lâmpada económica E14 / 1x15W



02



03



04



05



*design by Cláudia Melo

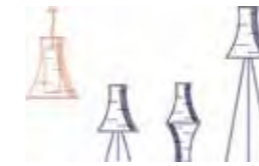

01



02



03



04



05

extrude

suspension lamp
ø: 24 in
h: 28 in
lacquered metal and cotton shade
● energy saving bulbs E27 / 1x23W

candeeiro de suspensão
ø: 60 cm
a: 70 cm
metal lacado e abajur de algodão
● lâmpada económica E27 / 1x23W

*design by Cláudia Melo



01



02



03



04

extrude table

table lamp
ø: 14 in
h: 28 in
lacquered metal
● energy saving bulbs E27 / 1x15W

candeeiro de mesa
ø: 35 cm
a: 70 cm
metal lacado
● lâmpada económica E27 / 1x15W



Roof Design Studio
Portugal

*design by Cláudia Melo



01



02



03



04



05

extrude table I

table lamp
ø: 13 in
h: 30 in
lacquered metal

● energy saving bulbs E27 / 1x15W

candeeiro de mesa
ø: 34 cm
a: 75 cm
metal lacado

● lâmpada económica E27 / 1x15W

Junqueira Residence

*design by Cláudia Melo

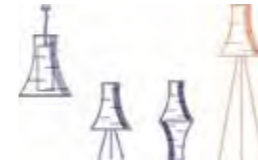

01

Extrude lamps are joyful and irreverent, with their uncommon shapes and bases. Here featured at a Lisbon residence, the Extrude floor shows its tripod base, which makes this lamp streamlined and original.

Private house
Roof Design Studio project
Portugal



02



03



04



05

extrude floor

floor lamp
ø: 20 in
h: 69 in
lacquered metal
● energy saving bulbs E27 / 1x23W

candeeiro de chão
ø: 50 cm
a: 175 cm
metal lacado
● lâmpada económica E27 / 1x23W



Antemare hotel
 Patricia Galdón Studio project
 Spain

*design by Cláudia Melo



01



revolution

suspension lamp
 ø: 22 in
 h: 28 in
 lacquered metal
 ● energy saving bulbs E27 / 1x23W

candeeiro de suspensão
 ø: 55 cm
 a: 70 cm
 metal lacado
 ● lâmpada económica E27 / 1x23W



Antemare hotel
 Patricia Galdón Studio project
 Spain

*design by Cláudia Melo



01



02



03



04

expand

suspension lamp
 ø: 20 in
 h: 28 in
 lacquered metal
 ● energy saving bulbs E27 / 1x23W

candeeiro de suspensão
 ø: 50 cm
 a: 70 cm
 metal lacado
 ● lâmpada económica E27 / 1x23W

*design by Cláudia Melo



01



02



03



04

cage

suspension lamp
ø: 28 in
h: 28 in
lacquered metal, brass or copper and cotton shade
● energy saving bulbs E27 / 1x23W

candeeiro de suspensão
ø: 70 cm
a: 70 cm
metal lacado, latão ou cobre e abajur de algodão
● lâmpada económica E27 / 1x23W



iSight Partners offices
 Roof Design Studio project
 Holland

*design by Cláudia Melo

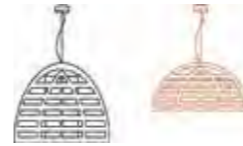

01

cage



cage I

suspension lamp
 ø: 28 in
 h: 14 in
 lacquered metal, brass or copper and
 cotton shade
 ● energy saving bulbs E27 / 1x23W

candeeiro de suspensão
 ø: 70 cm
 a: 35 cm
 metal lacado, latão ou cobre e abajur de
 algodão
 ● lâmpada económica E27 / 1x23W



02



03



04



Coriander Leaf restaurant
 URBNarc project
 Singapore

*design by Cláudia Melo



01

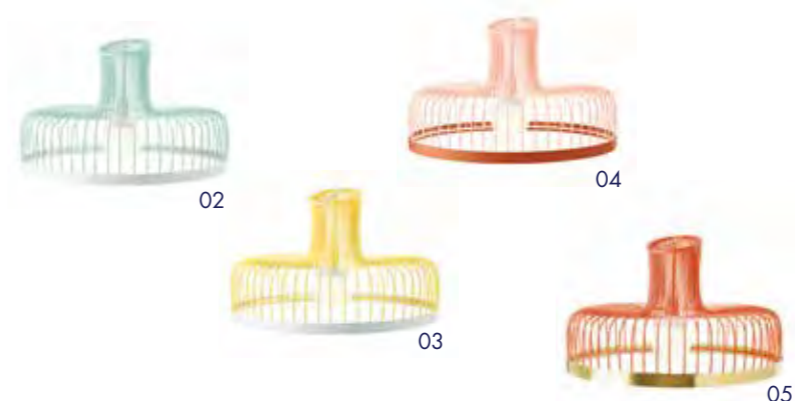

02

03

04

05

new spider

suspension lamp
 ø: 28 in
 h: 14 in
 lacquered metal and brass, copper or metal ring
 ● energy saving bulbs E27 / 1x23W

candeeiro de suspensão
 ø: 70 cm
 a: 35 cm
 metal lacado e aro em latão, cobre ou metal
 ● lâmpada económica E27 / 1x23W

*design by Cláudia Melo



01

Antemare Hotel

Born form the Spider collection, New Spider is enriched with a lacquered metal, brass or copper detail at its base. The resulting combination of different colors and materials transforms these lamps in pieces with their own personality. Here they are featured at the entrance of Antemare Hotel in Sitges.

Antemare hotel

Patricia Galdón Studio project

Spain



02



03



04



05

new spider I

suspension lamp
ø: 20 in
h: 28 in
lacquered metal and brass, copper or metal ring
● energy saving bulbs E27 / 1x23W

candeeiro de suspensão
ø: 52 cm
a: 70 cm
metal lacado e aro em latão, cobre ou metal
● lâmpada económica E27 / 1x23W



Coriander Leaf

New Spider are unique lamps that bring light movements into spaces. The light projects through the revolving structural elements, in a dance between light and shade. Scenographic, they bring character to spaces, as seen here at restaurant Coriander Leaf in Singapore.

Coriander Leaf restaurant

URBNarc project

Singapore

*design by Cláudia Melo



01

new spider

suspension lamp
 ø: 28 in
 h: 39 in

lacquered metal and brass, copper or metal ring
 ● energy saving bulbs E27 / 1x23W

candeeiro de suspensão
 ø: 70 cm
 α: 100 cm

metal lacado e aro em latão, cobre ou metal
 ● lâmpada económica E27 / 1x23W



02



03



04

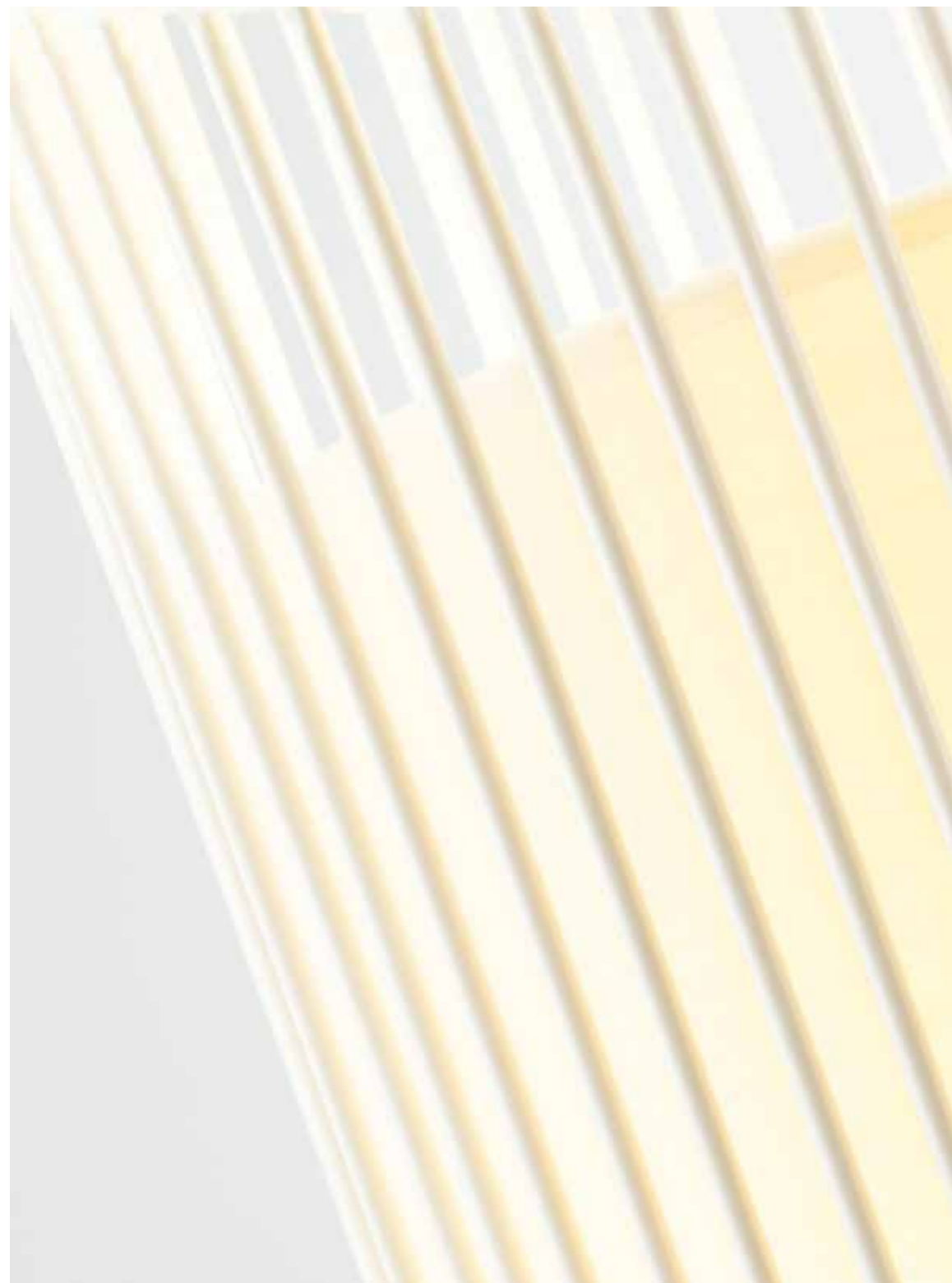

*design by Cláudia Melo



01



new spider table

table lamp
 ø: 28 in
 h: 14 in
 lacquered metal and brass, copper or metal
 ring and cotton shade
 ● energy saving bulbs E27 / 1x15W

candeeiro de mesa
 ø: 70 cm
 a: 35 cm
 metal lacado e aro em latão, cobre ou metal
 e abajur de algodão
 ● lâmpada económica E27 / 1x15W

Meet our
Lighting Collection

suspension

magnolia	 metal custom colors ø65 x 68 cm	magnolia I	 metal custom colors ø65 x 47 cm	magnolia II	 metal custom colors ø27 x 59 cm	magnolia III	 metal custom colors ø31 x 42 cm	jules	 metal custom colors ø63 x 72 cm	jules I	 metal custom colors ø63 x 57 cm
jules II	 metal custom colors ø30 x 64 cm	jules II	 metal custom colors ø38 x 44 cm	comb	 metal custom colors ø74 x 60 cm	comb I	 metal custom colors ø75 x 35 cm	carousel	 metal custom colors ø105 x 40 cm	carousel I	 metal custom colors ø97 x 86 cm
star	 metal custom colors ø80 x 70 cm	star I	 metal custom colors ø60 x 50 cm	star II	 metal custom colors ø45 x 72 cm	star III	 metal custom colors ø35 x 53 cm	up	 metal custom colors ø55 x 72 cm	up I	 metal custom colors ø68 x 39 cm
circus	 metal custom colors ø56 x 73 cm	circus I	 metal custom colors ø56 x 38 cm	circus II	 metal custom colors ø65 x 34 cm	circus III	 metal custom colors ø30 x 66 cm	spider	 metal custom colors ø70 x 35 cm	spider I	 metal custom colors ø52 x 70 cm
spider II	 metal custom colors ø70 x 100 cm	extrude	 metal custom colors ø60 x 70 cm	revolution	 metal custom colors ø55 x 70 cm	expand	 metal custom colors ø50 x 70 cm	cage	 metal custom colors ø70 x 70 cm	cage I	 metal custom colors ø70 x 35 cm
new spider	 metal custom colors ø70 x 35 cm	new spider I	 metal custom colors ø52 x 70 cm	new spider II	 metal custom colors ø70 x 100 cm						

table

magnolia table	 metal custom colors ø32 x 63 cm	jules table	 metal custom colors ø30 x 63 cm	star table	 metal custom colors ø33 x 72 cm	up table	 metal custom colors ø44 x 72 cm	circus table	 metal custom colors ø30 x 76 cm	spider table	 metal custom colors ø24 x 60 cm
extrude table	 metal custom colors ø35 x 70 cm	extrude I table	 metal custom colors ø34 x 75 cm	new spider table	 metal custom colors ø24 x 60 cm						

floor

magnolia floor	 metal custom colors ø37 x 170 cm	jules floor	 metal custom colors ø38 x 177 cm	comb floor	 metal custom colors ø54 x 175 cm	star floor	 metal custom colors ø45 x 170 cm	up floor	 metal custom colors ø47 x 170 cm	circus floor	 metal custom colors ø35 x 170 cm
extrude floor	 metal custom colors ø50 x 175 cm	spider floor	 metal custom colors ø24 x 140 cm								

wall

magnolia wall	 metal custom colors 30 x 13 x 56 cm	jules wall	 metal custom colors 40 x 23 x 40 cm	comb wall	 metal custom colors 37 x 13 x 34 cm	carousel wall	 metal custom colors 30 x 18 x 40 cm	star wall	 metal custom colors 28 x 20 x 51 cm	circus wall	 metal custom colors 27 x 30 x 62 cm
spider wall	 metal custom colors 25 x 15 x 50 cm										

magnolia



27" / 68 cm

26" / 65 cm

230V / 50Hz
 ● E27/1x23W CFL 19 lb | 9 kg
 30x30x30 in
 120V / 60Hz
 ● E26/1x18W CFL 75x75x75 cm
 0,42 m³
 Cable
 59" / 1,5m



magnolia I



19" / 47 cm

26" / 65 cm

230V / 50Hz
 ● E27/1x23W CFL 19 lb | 9 kg
 25x25x20 in
 120V / 60Hz
 ● E26/1x18W CFL 65x65x50 cm
 0,21 m³
 Cable
 59" / 1,5m



magnolia II



23" / 59 cm

11" / 27 cm

230V / 50Hz
 ● E27/1x23W CFL 13 lb | 6 kg
 13x13x30 in
 120V / 60Hz
 ● E26/1x18W CFL 34x34x80 cm
 0,09 m³
 Cable
 59" / 1,5m



magnolia III



17" / 42 cm

12" / 31 cm

230V / 50Hz
 ● E27/1x20W CFL 11 lb | 5 kg
 13x13x18 in
 120V / 60Hz
 ● E26/1x15W CFL 34x34x45 cm
 0,05 m³
 Cable
 59" / 1,5m



magnolia table

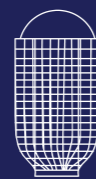

25" / 63 cm

13" / 32 cm

230V / 50Hz
 ● E27/1x15W CFL 17 lb | 8 kg
 13x13x30 in
 120V / 60Hz
 ● E26/1x13W CFL 34x34x80 cm
 0,09 m³



magnolia floor



67" / 170 cm

15" / 37 cm

230V / 50Hz
 ● E27/2x23W CFL 26 lb | 12 kg
 18x18x71 in
 120V / 60Hz
 ● E26/2x18W CFL 46x46x180 cm
 0,38 m³



jules III



17" / 44 cm

15" / 38 cm

230V / 50Hz
 ● E27/1x23W CFL 11 lb | 5 kg
 13x13x18 in
 120V / 60Hz
 ● E26/1x18W CFL 34x34x45 cm
 0,05 m³
 Cable
 59" / 1,5m



jules table



25" / 63 cm

12" / 30 cm

230V / 50Hz
 ● E27/1x15W CFL 17 lb | 8 kg
 13x13x30 in
 120V / 60Hz
 ● E26/1x13W CFL 34x34x80 cm
 0,09 m³



jules floor



38" / 177 cm

15" / 38 cm

230V / 50Hz
 ● E27/1x23W CFL 26 lb | 12 kg
 18x18x71 in
 120V / 60Hz
 ● E26/1x18W CFL 46x46x180 cm
 0,38 m³



magnolia wall



22" / 56 cm

5" / 13cm

12" / 30 cm

230V / 50Hz
 ● E14/1x20W CFL 8 lb | 4 kg
 14x10x22 in
 120V / 60Hz
 ● E12/1x15W CFL 35x25x56 cm
 0,05 m³



jules

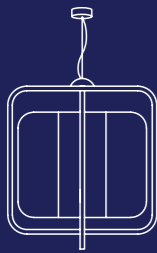

28" / 72 cm

25" / 63 cm

230V / 50Hz
 ● E27/1x23W CFL 19 lb | 9 kg
 30x30x30 in
 120V / 60Hz
 ● E26/1x18W CFL 75x75x75 cm
 0,42 m³
 Cable
 59" / 1,5m



jules I



22" / 57 cm

25" / 63 cm

230V / 50Hz
 ● E27/1x23W CFL 19 lb | 9 kg
 25x25x20 in
 120V / 60Hz
 ● E26/1x18W CFL 65x65x50 cm
 0,21 m³
 Cable
 59" / 1,5m



jules II



25" / 64 cm

12" / 30 cm

230V / 50Hz
 ● E27/1x23W CFL 13 lb | 6 kg
 13x13x30 in
 120V / 60Hz
 ● E26/1x18W CFL 34x34x80 cm
 0,09 m³
 Cable
 59" / 1,5m



comb



24" / 60 cm

29" / 74 cm

230V / 50Hz
 ● E27/1x23W CFL 35 lb | 16 kg
 30x30x30 in
 120V / 60Hz
 ● E26/1x18W CFL 75x75x75 cm
 0,42 m³
 Cable
 59" / 1,5m



comb I

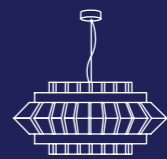

14" / 35 cm

30" / 75 cm

230V / 50Hz
 ● E27/1x23W CFL 35 lb | 16 kg
 30x30x16 in
 120V / 60Hz
 ● E26/1x18W CFL 75x75x40 cm
 0,23 m³
 Cable
 59" / 1,5m



comb II



69" / 175 cm

21" / 54 cm

230V / 50Hz
 ● E27/1x23W CFL 30 lb | 14 kg
 24x24x71 in
 120V / 60Hz
 ● E26/1x18W CFL 60x60x180 cm
 0,65 m³



comb III



13" / 34 cm

5" / 13cm

15" / 37 cm

230V / 50Hz
 ● E14/1x20W CFL 11 lb | 5 kg
 14x10x22 in
 120V / 60Hz
 ● E12/1x15W CFL 35x25x56 cm
 0,05 m³



carousel

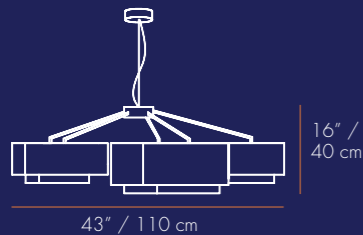

230V / 50Hz 44 lb | 20 kg
 E27/3/5 x23W CFL 43x43x18 in
 120V / 60Hz 110x110x45 cm
 E26/3/5x18W CFL 0,55 m³
 Cable 59" / 1,5m

carousel I

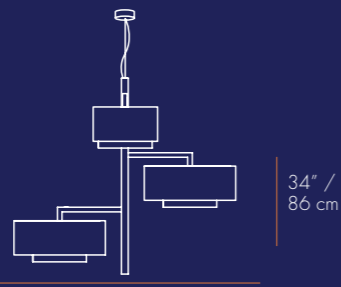

230V / 50Hz 44 lb | 20 kg
 E27/3x23W CFL 43x43x18 in
 120V / 60Hz 110x110x45 cm
 E26/3x18W CFL 0,55 m³
 Cable 59" / 1,5m

carousel wall

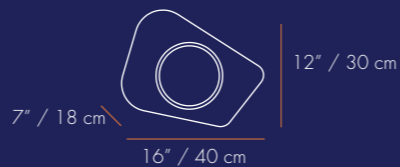

230V / 50Hz 11 lb | 5 kg
 E27/1x20W CFL 14x10x22 in
 120V / 60Hz 35x25x56 cm
 E26/1x15W CFL 0,05 m³
 Cable 59" / 1,5m

up

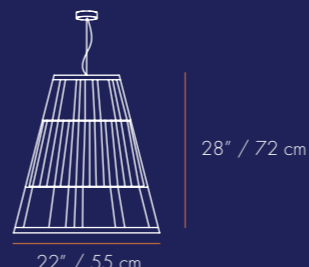

230V / 50Hz 19 lb | 9 kg
 E27/1x23W CFL 30x30x30 in
 120V / 60Hz 75x75x75 cm
 E26/1x18W CFL 0,42 m³
 Cable 59" / 1,5m

up I

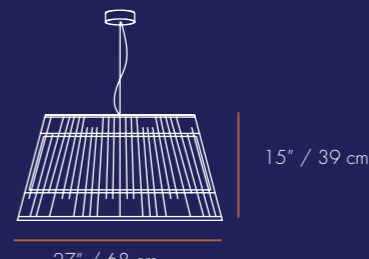

230V / 50Hz 34 lb | 15 kg
 E27/1x23W CFL 30x30x17 in
 120V / 60Hz 75x75x45 cm
 E26/1x18W CFL 0,25 m³
 Cable 59" / 1,5m

up table

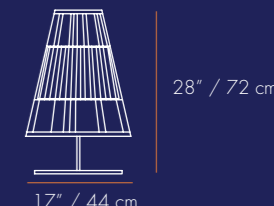

230V / 50Hz 19 lb | 9 kg
 E27/1x15W CFL 18x18x32 in
 120V / 60Hz 46x46x80 cm
 E26/1x13W CFL 0,16 m³
 Cable 59" / 1,5m

star

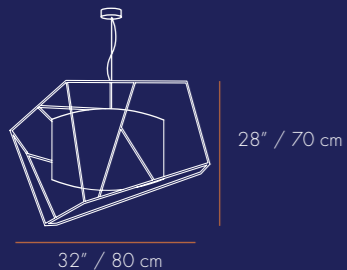

230V / 50Hz 13 lb | 6 kg
 E27/1x23W CFL 30x30x30 in
 120V / 60Hz 75x75x75 cm
 E26/1x18W CFL 0,42 m³
 Cable 59" / 1,5m

star I

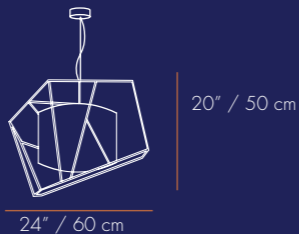

230V / 50Hz 13 lb | 6 kg
 E27/1x23W CFL 25x25x25 in
 120V / 60Hz 65x65x65 cm
 E26/1x18W CFL 0,28 m³
 Cable 59" / 1,5m

star II

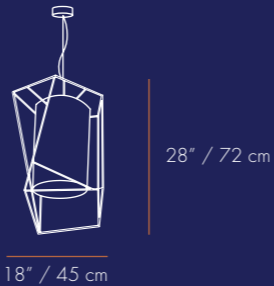

230V / 50Hz 11 lb | 5 kg
 E27/1x23W CFL 18x18x31 in
 120V / 60Hz 46x46x80 cm
 E26/1x18W CFL 0,17 m³
 Cable 59" / 1,5m

up floor

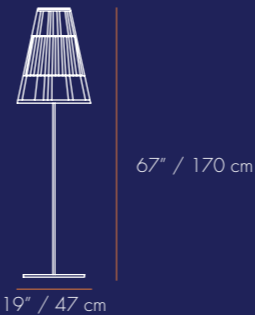

230V / 50Hz 27 lb | 12 kg
 E27/1x23W CFL 20x20x70 in
 120V / 60Hz 52x52x180 cm
 E26/1x18W CFL 0,49 m³
 Cable 59" / 1,5m

star III

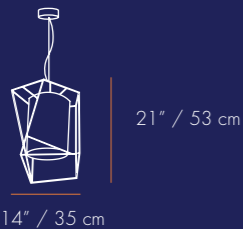

230V / 50Hz 8 lb | 4 kg
 E27/1x20W CFL 18x18x22 in
 120V / 60Hz 46x46x55 cm
 E26/1x15W CFL 0,18 m³
 Cable 59" / 1,5m

star table

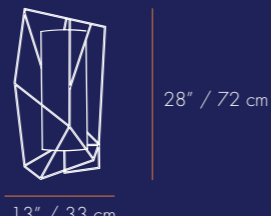

230V / 50Hz 9 lb | 4 kg
 E27/1x15W CFL 18x18x30 in
 120V / 60Hz 46x46x75 cm
 E26/1x13W CFL 0,16 m³
 Cable 59" / 1,5m

star floor

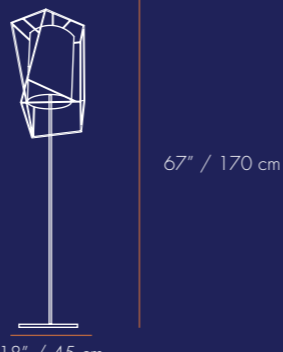

230V / 50Hz 19 lb | 9 kg
 E27/1x23W CFL 18x18x71 in
 120V / 60Hz 46x46x180 cm
 E26/1x18W CFL 0,38 m³
 Cable 59" / 1,5m

circus

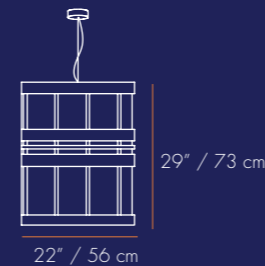

230V / 50Hz 35 lb | 14 kg
 E27/5x23W CFL 30x30x30 in
 120V / 60Hz 75x75x75 cm
 E26/5x18W CFL 0,42 m³
 Cable 59" / 1,5m

circus I

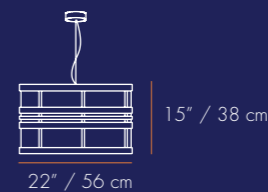

230V / 50Hz 28 lb | 13 kg
 E27/5x23W CFL 30x30x17 in
 120V / 60Hz 75x75x45 cm
 E26/5x18W CFL 0,25 m³
 Cable 59" / 1,5m

circus II

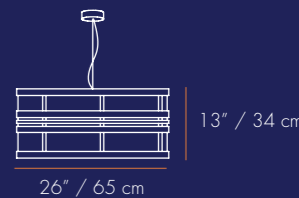

230V / 50Hz 30 lb | 14 kg
 E27/5x23W CFL 30x30x16 in
 120V / 60Hz 75x75x40 cm
 E26/5x18W CFL 0,23 m³
 Cable 59" / 1,5m

star wall



230V / 50Hz 6 lb | 3 kg
 E14/1x20W CFL 14x10x22 in
 120V / 60Hz 35x25x56 cm
 E12/1x15W CFL 0,05 m³
 Cable 59" / 1,5m

circus III

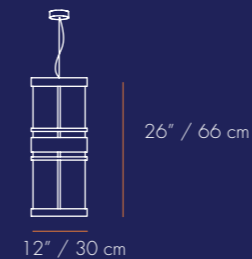

230V / 50Hz 17 lb | 8 kg
 E27/1x20W CFL 13x13x30 in
 120V / 60Hz 34x34x80 cm
 E26/1x18W CFL 0,09 m³
 Cable 59" / 1,5m

circus table

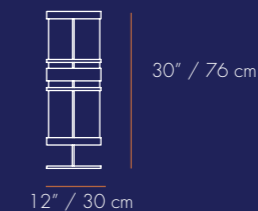

230V / 50Hz 17 lb | 8 kg
 E27/1x15W CFL 13x13x30 in
 120V / 60Hz 34x34x80 cm
 E26/1x13W CFL 0,09 m³
 Cable 59" / 1,5m

circus floor

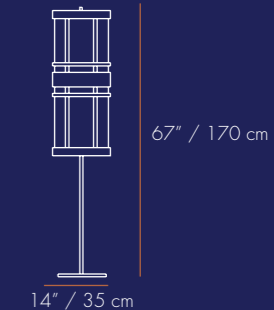

230V / 50Hz 37 lb | 17 kg
 E27/6x15W CFL 18x18x71 in
 120V / 60Hz 46x46x180 cm
 E26/6x13W CFL 0,38 m³
 Cable 59" / 1,5m

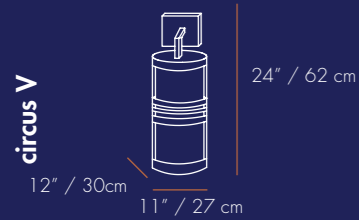

circus V

12" / 30cm
11" / 27 cm
24" / 62 cm

230V / 50Hz 17 lb | 8 kg
E27/1x20W CFL 13x13x30 in
120V / 60Hz 34x34x80 cm
E26/1x18W CFL 0,09 m³

CE

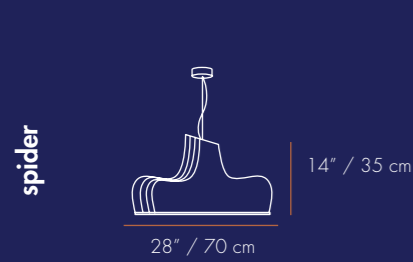

spider

28" / 70 cm
14" / 35 cm

230V / 50Hz 17 lb | 8 kg
E27/1x23W CFL 30x30x16 in
120V / 60Hz 75x75x40 cm
E26/1x18W CFL 0,26 m³

Cable 59" / 1,5m

CE

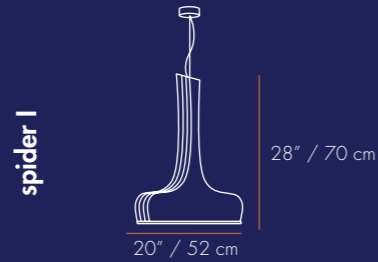

spider I

28" / 70 cm
20" / 52 cm

230V / 50Hz 19 lb | 9 kg
E27/1x23W CFL 30x30x30 in
120V / 60Hz 75x75x75 cm
E26/1x18W CFL 0,42 m³

Cable 59" / 1,5m

CE

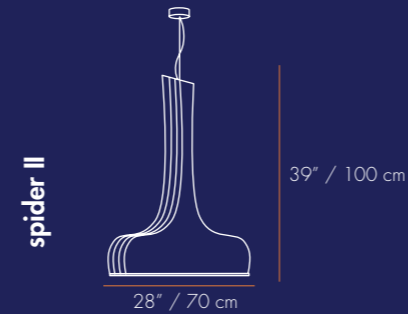

spider II

39" / 100 cm
28" / 70 cm

230V / 50Hz 26 lb | 12 kg
E27/1x23W CFL 30x30x41 in
120V / 60Hz 75x75x105 cm
E26/1x18W CFL 0,59 m³

Cable 59" / 1,5m

CE

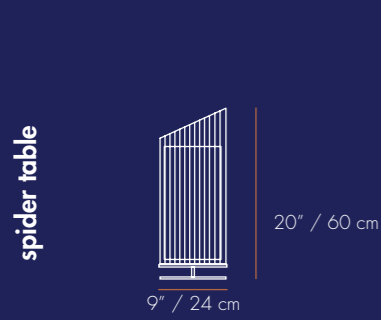

spider table

20" / 60 cm
9" / 24 cm

230V / 50Hz 15 lb | 7 kg
E27/1x15W CFL 14x10x22 in
120V / 60Hz 34x34x80 cm
E26/1x13W CFL 0,09 m³

CE

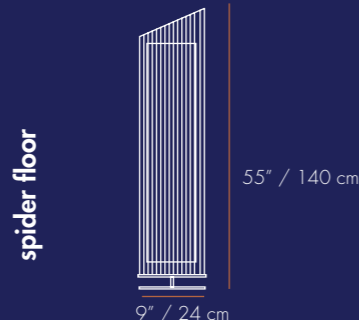

spider floor

55" / 140 cm
9" / 24 cm

230V / 50Hz 26 lb | 12 kg
E27/2x23W CFL 18x18x59 in
120V / 60Hz 46x46x150 cm
E26/2x18W CFL 0,38 m³

CE

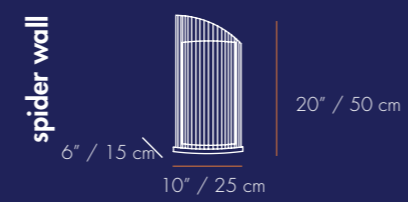

spider wall

20" / 50 cm
6" / 15 cm
10" / 25 cm

230V / 50Hz 11 lb | 5 kg
E14/1x20W CFL 14x10x22 in
120V / 60Hz 35x25x57 cm
E12/1x15W CFL 0,05 m³

CE

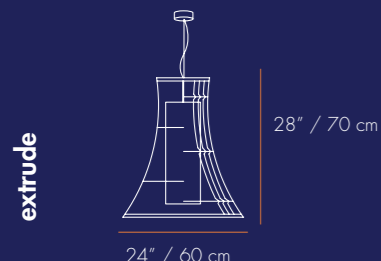

extrude

28" / 70 cm
24" / 60 cm

230V / 50Hz 19 lb | 9 kg
E27/1x23W CFL 30x30x30 in
120V / 60Hz 75x75x75 cm
E26/1x18W CFL 0,42 m³

Cable 59" / 1,5m

CE

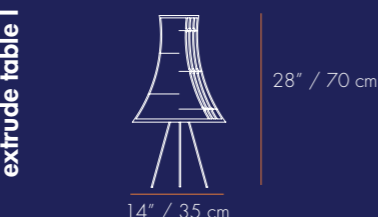

extrude table I

28" / 70 cm
14" / 35 cm

230V / 50Hz 13 lb | 6 kg
E27/1x15W CFL 13x13x30 in
120V / 60Hz 34x34x80 cm
E26/1x13W CFL 0,09 m³

CE



extrude table II

30" / 75 cm
13" / 34 cm

230V / 50Hz 15 lb | 7 kg
E27/1x15W CFL 13x13x30 in
120V / 60Hz 34x34x80 cm
E26/1x13W CFL 0,09 m³

CE

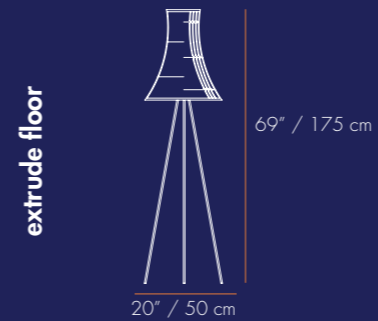

extrude floor

69" / 175 cm
20" / 50 cm

230V / 50Hz 26 lb | 12 kg
E27/1x23W CFL 20x20x70 in
120V / 60Hz 56x56x180 cm
E26/1x18W CFL 0,57 m³

CE

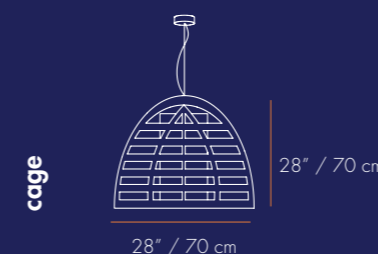

cage

28" / 70 cm
28" / 70 cm

230V / 50Hz 50 lb | 22 kg
E27/1x23W CFL 30x30x30 in
120V / 60Hz 75x75x75 cm
E26/1x18W CFL 0,42 m³

Cable 59" / 1,5m

CE

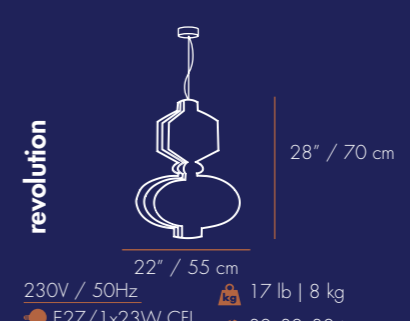

revolution

28" / 70 cm
22" / 55 cm

230V / 50Hz 17 lb | 8 kg
E27/1x23W CFL 30x30x30 in
120V / 60Hz 75x75x75 cm
E26/1x18W CFL 0,42 m³

Cable 59" / 1,5m

CE



cage I

14" / 35 cm
28" / 70 cm

230V / 50Hz 26 lb | 12 kg
E27/1x23 W CFL 30x30x16 in
120V / 60Hz 75x75x40 cm
E26/1x18W CFL 0,23 m³

Cable 59" / 1,5m

CE

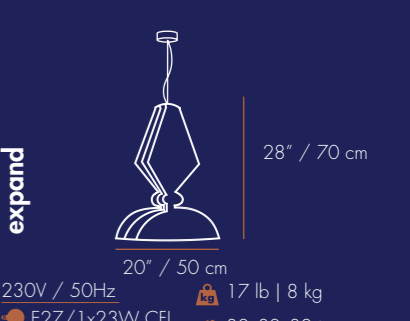

expand

28" / 70 cm
20" / 50 cm

230V / 50Hz 17 lb | 8 kg
E27/1x23W CFL 30x30x30 in
120V / 60Hz 75x75x75 cm
E26/1x18W CFL 0,42 m³

Cable 59" / 1,5m

CE



new spider I

28" / 70 cm
20" / 52 cm

230V / 50Hz 19 lb | 9 kg
E27/1x23W CFL 30x30x30 in
120V / 60Hz 75x75x75 cm
E26/1x18W CFL 0,42 m³

Cable 59" / 1,5m

CE

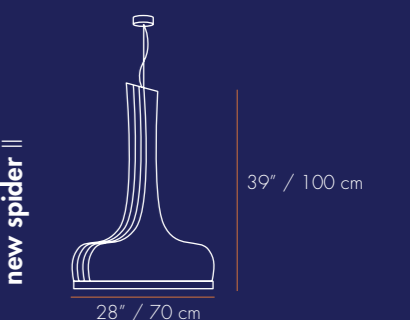

new spider II

39" / 100 cm
28" / 70 cm

230V / 50Hz 26 lb | 12 kg
E27/1x23W CFL 30x30x41 in
120V / 60Hz 75x75x105 cm
E26/1x18W CFL 0,59 m³

Cable 59" / 1,5m

CE



new spider table

20" / 60 cm
9" / 24 cm

230V / 50Hz 15 lb | 7 kg
E27/1x15W CFL 14x10x22 in
120V / 60Hz 34x34x80 cm
E26/1x13W CFL 0,09 m³

CE

cup

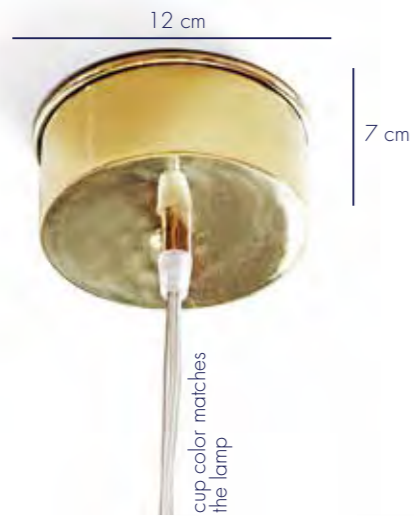

CORDS

black textile cord

brown textile cord

red and blue textile cord*

black and white textile cord*

yellow textile cord*

transparent rubber cord

*on extra charge

lamp shades



linen lamp shade



cotton lamp shade

more colors and shapes available on extra charge

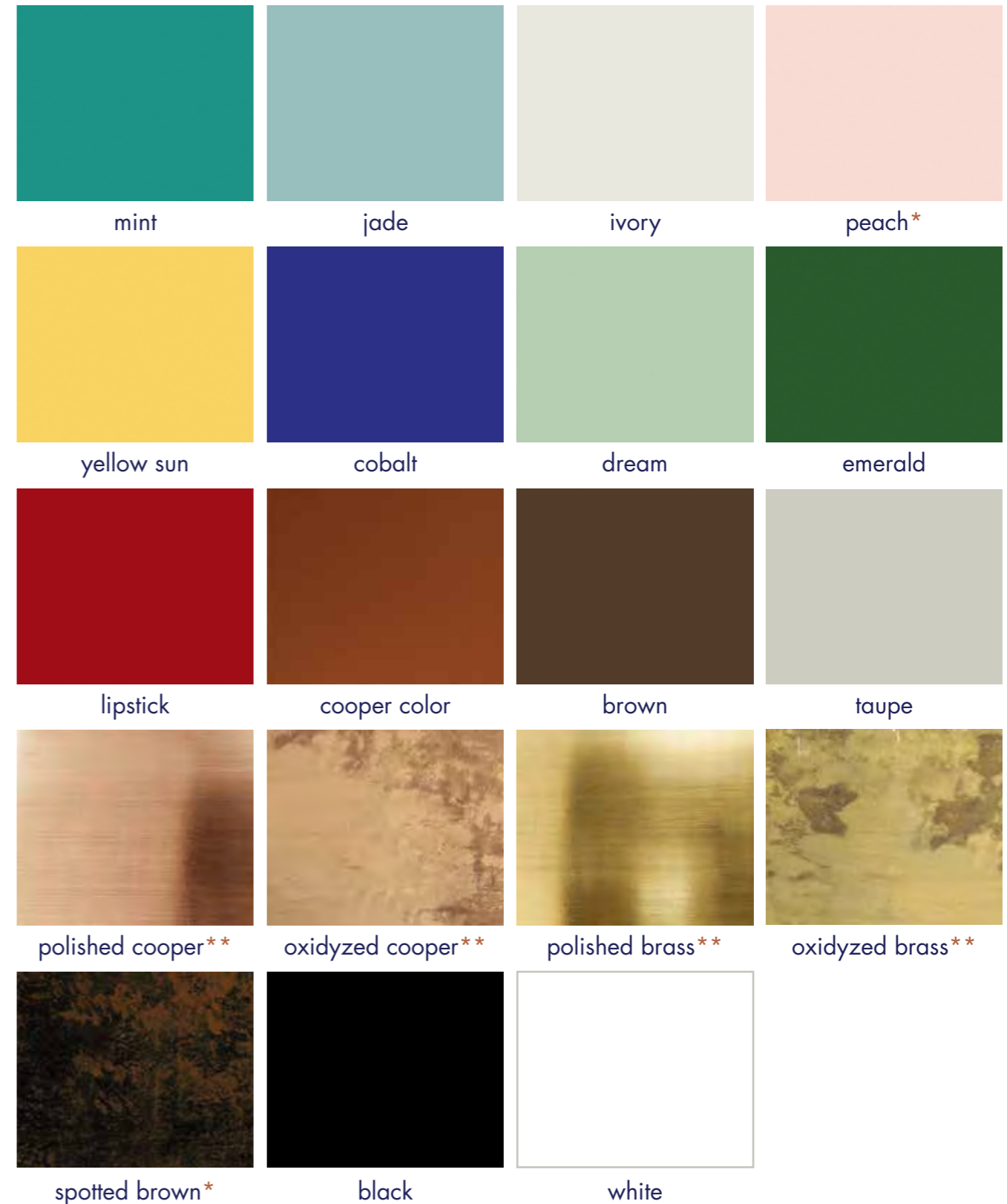

*painted colors, not lacquered
** this product is handmade. any small stain or roughness is a feature of the product, not a flaw.
material not available for all models

finishing



by



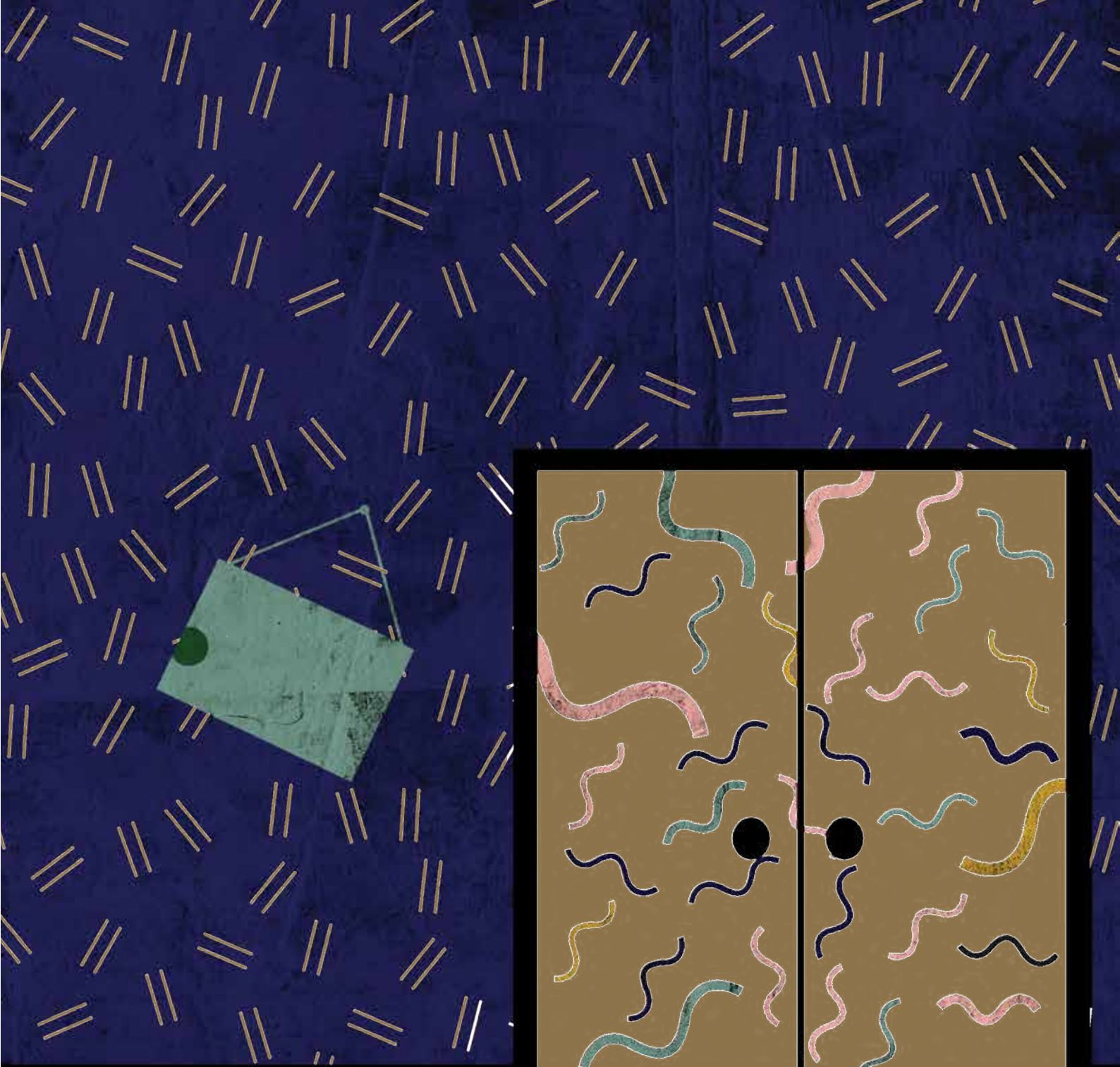

Light

mambo
unlimited ideas



Tienda, Proyectos y Distribución



Lighting Shop

www.Select-Light.com



(+34) 931 145 863

select *Light*