



POWER

3300.1D / 5500.1D / 8800.1D

CONTEÚDO DA EMBALAGEM // PACKAGE CONTENTS

1 Amplificador POWER	1 POWER Amplifier
1 Manual do Proprietário	1 Owner's Manual
1 Chave Allen 2,5mm	1 Allen Wrench 2.5mm
1 Chave Allen 4mm	1 Allen Wrench 4mm
1 Adesivo Promocional	1 Promotional Sticker



www.soundigital.com.br
www.soundigitalusa.com



+ 55 51 3042-9001
+ 1 786-600-1056



/SounDigitalBrasil
/SounDigitalUSA



@soundigital
@soundigitalUSA

Dear Customer,

Congratulations on acquiring your **SoundDigital!** You've just purchased a product of high quality and technology. The **SoundDigital** products are developed to assure maximum efficiency and reliability to your sound system.

State of Art

The POWER Line is the state of art in audio reproduction. Deep bass, precise midranges and nice highs are guaranteed by the high technology implemented in this line.

Amazing Bass

The innovative Twin Source 2.0 system guarantees much more stability in the audio reproduction, with the use of two twin power supplies.

Live Show

With the NST (Noise Suppression Technology) system in the RCA inputs, you will have a much cleaner sound, totally noise free. We implement a new input topology, with more efficient filters and isolators, that not only suppress any noise, but also guarantees a very clean signal.

Feel the Power

Real power is what you will find in the POWER Line. Amplifiers that range from 400W RMS to 35000W RMS make this line the most powerful in the world.

Thermal Efficiency

New aluminum heatsink with more mass and forced venting systems makes the POWER Line even more efficient and robust. You will have an efficient system with low distortion for a much longer period.

Efficiency

The POWER Line uses Class D topology, together with high thermal efficiency, which result in a very high efficiency overall (>70%). You will have less battery consumption, which means more power for a much longer period.

Low EMI Interference

We made the impossible, possible! Even our 35000.1D POWER has a very low EMI interference. This means they can be easily clamped in measuring tools such as TermLab*.

*TermLab is a trade mark by Harris, Wayne - Carson City-NV

IMPORTANT INFO

Read this manual and follow its instructions carefully. It contains extremely important information to have your amplifier working properly. If you feel the need to contact our Tech Support, you can reach our technicians through the e-mail info@sounddigitalusa.com.

We recommend the use of **SoundDigital** original accessories for a better performance. The crossovers, power supplies and voltmeters offered by **SoundDigital** follow the same quality standards as our amplifiers, assuring an excellent quality a high power sound system to our customers.

To know our complete line of amplifiers and accessories, visit www.sounddigitalusa.com.



Warning!

This "Warning" sign alerts the user of important info. Not following this instructions may cause injuries to the user or damage to the equipment.

ADDITIONAL INFORMATION

PACKAGE CONTENTS

- 1 POWER Amplifier
- 1 Owner's Manual
- 1 Allen Wrench 2.5mm
- 1 Allen Wrench 4mm
- 1 Promotional Sticker

CONTACT CHANNEL

Customer Service

+1 786-600-1056
info@sounddigitalusa.com

Tech Support

info@sounddigitalusa.com

Website

sounddigitalusa.com

Social Media

facebook.com/sounddigitalusa



3300.1D/5500.1D/8800.1D POWER

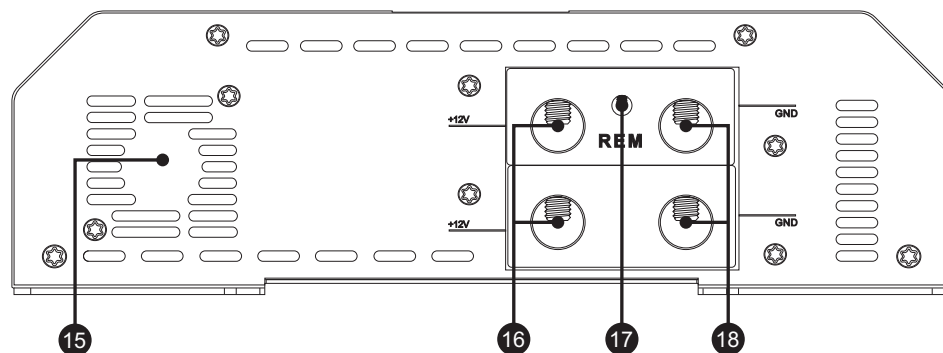
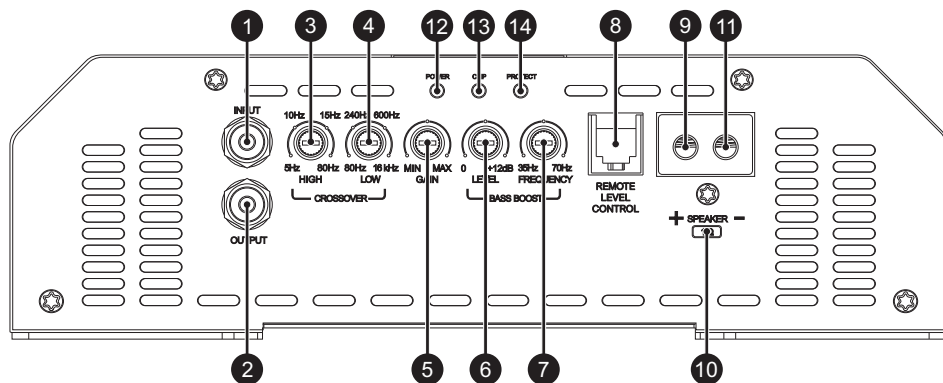

- ❶ Audio input RCA connector;
- ❷ Audio output RCA connector;
- ❸ Variable high pass filter control (5Hz ~ 80Hz);
- ❹ Variable low pass filter control (80Hz ~ 16kHz);
- ❺ Variable signal gain control;
- ❻ Variable bass boost control (0dB ~ +12dB);
- ❼ Variable bass boost frequency control (35Hz ~ 70Hz);
- ❽ Remote level control connector;
- ❾ Positive speaker connector (+);
- ❿ Minimum speaker load allowed (impedance);
- ⓫ Negative speaker connector (-);
- ⓬ "Power On" LED indicator (Blue);
- ⓭ "CLIP" LED indicator (Yellow);
- ⓮ "Protection" LED indicator (Red);
- ⓯ Electric fan (Not in 3300.1D POWER);
- ⓰ Positive power supply connector (+12V);
- ⓱ Remote power supply connector (REM) ;
- ⓲ Negative power supply connector (GND).

Safety Instructions

- ▶ To prevent injuries to the user or damage to the amplifier, read all the safety instructions written on this manual;
- ▶ If you're insecure about the installation of this equipment, get in touch with our tech support or with a professional specialized in car audio installation;
- ▶ Before proceeding with the installation of any electric equipment on your vehicle, unplug the negative (-) terminal of the battery to avoid fires, injuries or damages;
- ▶ Use your sound system safely. The continuous exposure to sound pressures over 85dB may cause irreversible hearing damage;
- ▶ This equipment is for use in automotive DC voltage batteries, between 12.6 and 14.4 volts. Before installing the equipment, check the voltage of the batteries;
- ▶ Do not install the amplifier in places exposed to water, dirt or humidity;
- ▶ Choose a ventilated place to install the amplifier and avoid blocking the side ventilation windows;
- ▶ Fix the amplifier in a steady and proper way. Avoid fixing it in metallic parts of the vehicle, because it may cause ground looping (noise);
- ▶ When passing cables through metallic walls, use rubber O-rings to avoid cable cutting and short-circuits. Make sure the place chosen for the installation of the amplifier will not interfere with the proper working of the vehicle;
- ▶ Make sure the location chosen for the amplifier installation does not affect the operation of the vehicle;
- ▶ Clean the amplifier periodically with a brush or dry cloth to assure the thermal efficiency of the heatsink;
- ▶ This product may reach temperatures over 60°C/140°F. Make sure it is cold before touching it;
- ▶ Be careful when making holes in the vehicle. Make sure you're not making holes in the fuel tank, brake lines or electrical cables of the vehicle;
- ▶ Make sure the cables are properly fixed throughout the installation;
- ▶ Wear gloves, safety glasses and all necessary PPE during the installation of **SoundDigital** amplifiers.

Electrical Dimensioning

For proper operation of your **SoundDigital** amplifier, you need the proper sizing of the electrical system and the cables used.

Table 1 shows the appropriate section of grounding and power cables according to the power generated by the amplifier, and the distance that it will be installed from the battery.

*To achieve the capacity of protection needed, more than one fuse/circuit breaker can be linked for the battery connections to the amplifier and ground, use good quality copper cables. **CCA cables should not be used.**



Warning!

Unplug the negative (-) terminal of the battery before proceeding with any electrical installation in the vehicle to avoid fire starts, wounds or damage to the amplifier.

- ▶ The ground cable should be the shortest possible and should be connected to the chassis of the vehicle. The surface should be sanded at the contact point to create a clean, metal-to-metal connection between the chassis and the termination of the ground wire;

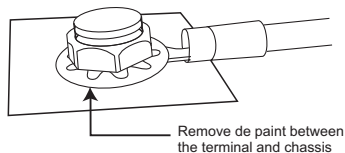

Speaker Association

For a smooth operation of your **SoundDigital** amplifier, it is important that the minimum working impedance is respected.

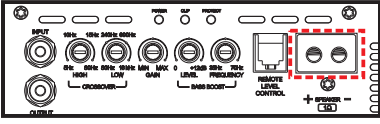

Warning! Never connect the speakers with a lower impedance than the amplifier nominal impedance, otherwise it will be damaged.

Speaker Connections and Associations

Double Coil subwoofers:

A Subwoofer with Parallel Coils:

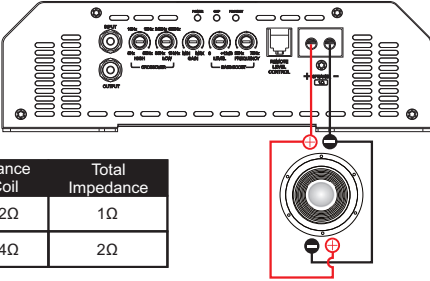

A Subwoofer with Serial Coils:

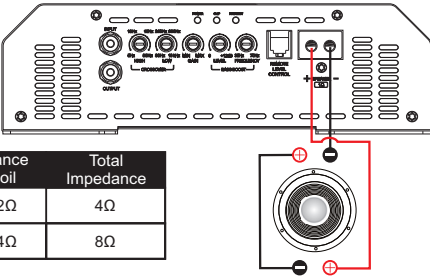

Two Subwoofers with Parallel Coils:

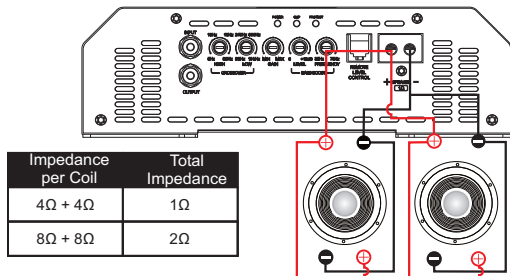

Two Subwoofers with Parallel/Serial Coils:

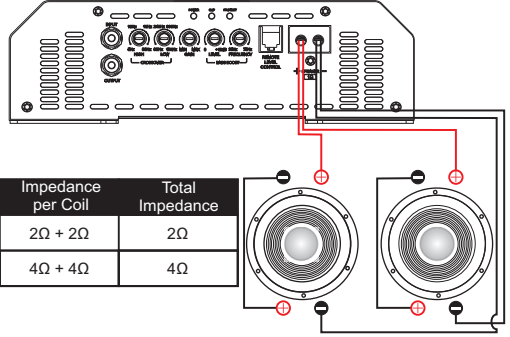

Input Connections

Keep the RCA cables together, but away from the power or the audio output cables and away from electric equipment such as electronic fuel injection centrals, electric engines, etc.



Warning! You should never connect or disconnect RCA cables with the amplifier turned on, because it may damage the head unit or the amplifier.

Example of one RCA cable connection only.

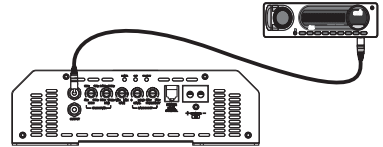

Example of two RCA cables connection.

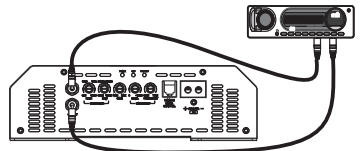

Example of one RCA cable connection only and using the RCA output to connect another amplifier.

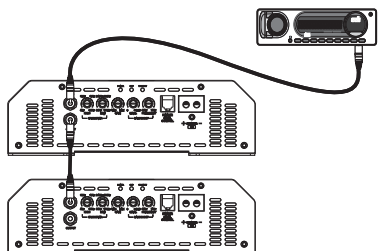

Power Connections

Simplified Wiring Diagram (Power).

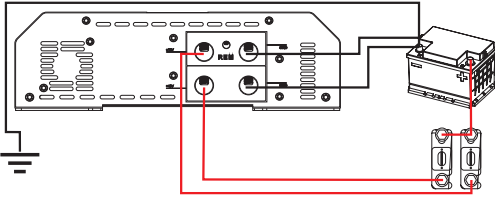

Remote Input Connections

Connection via Main Unit's Remote.

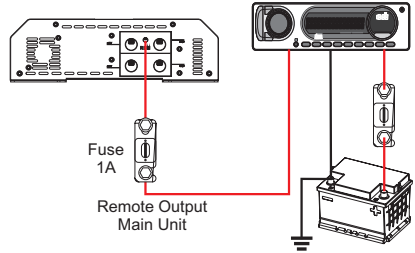

Multiple Battery Connections

For connection of multiple batteries, the use of copper busbars is recommended. These must have equidistant holes and a balanced distribution of the battery connections and the amplifiers, in order to avoid uneven heating of the bar.

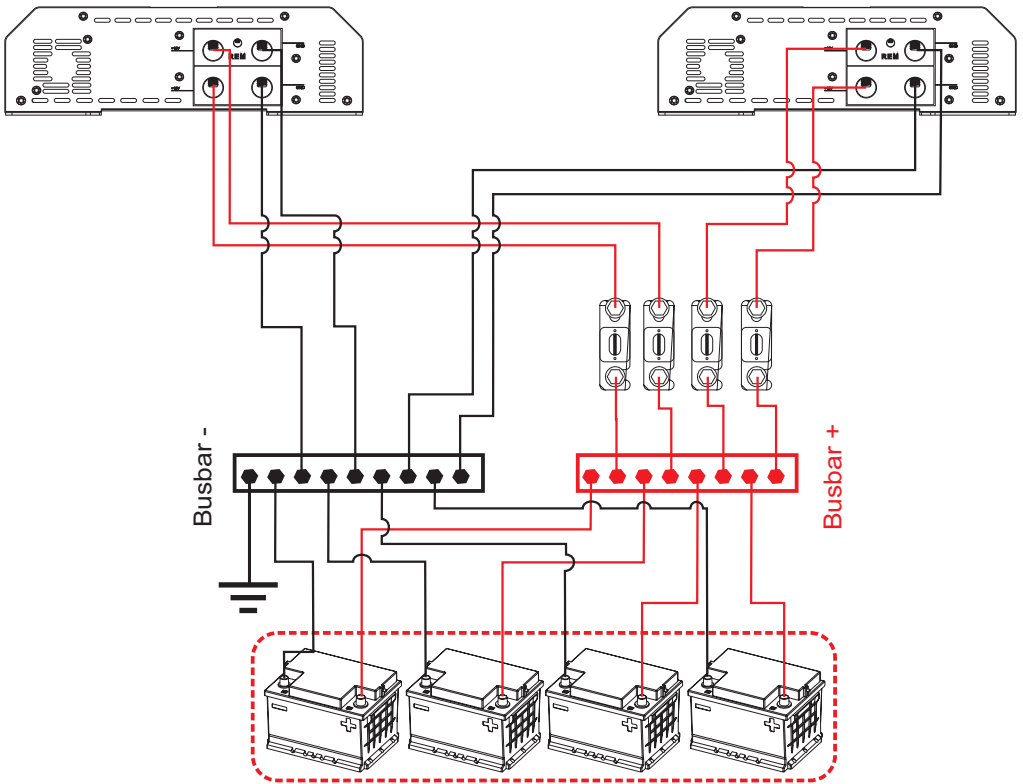

Installation Sequence

- ▶ Before proceeding with the installation, unplug the negative from all of the batteries;
- ▶ Affix the amplifier in such a way you have access to the connectors;
- ▶ Install the power cables on the vehicle in a proper way. From the battery to the busbar, fuse holder or circuit breaker. Chose the appropriate section for the cable (see Table 1). Make all of the connections to the busbars fuse holders or circuit breakers, with no fuses in the holder and with the circuit breakers in the "Off" position;



Warning

The max. distance for the installation of the fuse/circuit breaker is one foot away from the battery.

- ▶ Connect the power cables in to the amplifier, observing the polarity. Connect all the positive cables from the fuse holder or circuit breaker to the positive connector of the amplifier and all the negative power cables from the busbar or from the batteries, to the negative connector of the amplifier;
- ▶ Install the signal input cables in a proper way, distant from the power cables;
- ▶ Connect the RCA and Link cables to the head unit and amplifiers;
- ▶ Install the audio output cables with the appropriate section (see table 2), distant from the power and audio input cables;
- ▶ Connect the audio output cables to the amplifiers and the acoustic boxes, observing the positive (+) and negative (-) polarities;
- ▶ Install the remote cable with the power cables, using a section of 1.5mm² or thicker;
- ▶ Connect the remote cable to the two REM terminals on the amplifier and to a 12V power supply activated by a switch key or to the remote power output of the head unit;
- ▶ Before powering the system, verify all the connections and make sure there are no mistakes or short-circuits on the power and ground cables;
- ▶ Reconnect the ground of the batteries;
- ▶ Check if the remote key is in the "Off" position and if the head unit is turned off, then place the fuses in the fuse holders or switch the circuit breakers on.

Procedures for Setting the Gain

To set the gain of your amplifier properly, follow the steps below:

- ▶ Disconnect the output cables from the amplifier outputs;

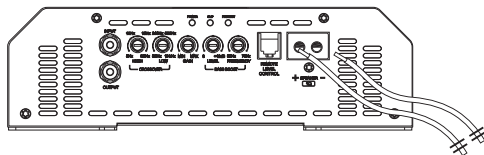

- ▶ With the gain set to minimum, turn on the head unit and the remote switch to power on the amplifier. Wait until only the power LED is on;
- ▶ Reproduce a 60Hz sine wave signal through the head unit;
- ▶ Set the volume of the head unit to about 70% of its capacity;

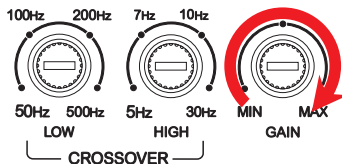

- ▶ Turn up the gain clockwise slowly until the "CLIP" LED starts blinking;



- ▶ Return the gain to the limit where the "CLIP" LED stops blinking and remains off;
- ▶ Some head units with higher tension RCA outputs, may reach max power even with the gain set close to minimum. In such cases, limit the volume of the head unit in such a way the "CLIP" LED will not blink.

Crossover Adjustment

SounDigital POWER amplifiers feature high-precision adjustable crossovers that increase audio quality and speaker performance. The choice of frequency depends on the system design, if you have any questions about which crossover frequency to use refer. If you have any questions about which frequency cut filter to use, refer to the speaker technical manual, to which the amplifier will be connected.

3300/ 5500/ 8800.1D POWER

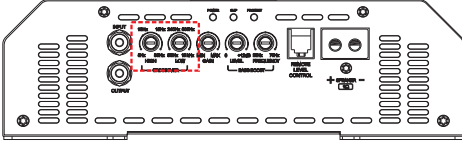

- ▶ "Full Range" Use – (all frequencies playback) - For all frequencies playback, the "HIGH" variable control shall be set to 5Hz, and the "LOW" variable control to 16kHz;

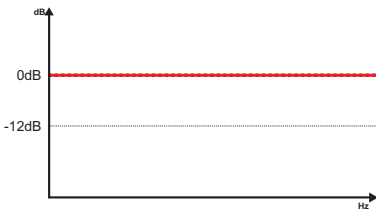

- ▶ Use in "High Pass" cut filter (HIGH) 12dB/oct – Set in the "LOW" variable control to 16kHz and in the "HIGH" variable control, set "A" frequency between 5Hz and 80Hz, where you want to perform the high pass cut filter;

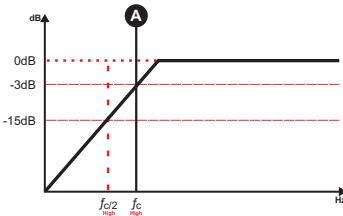

- ▶ Use in "Low Pass" cut filter (LOW) 12dB/oct – Set in the "HIGH" variable control to 5Hz and in the "LOW" variable control, set "B" frequency between 80Hz and 16kHz, where you want to perform the low pass cut filter;

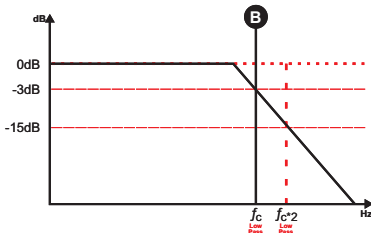

- ▶ Use in "Band Pass" cut filter – Set in the "HIGH" variable control the "A" frequency between 5Hz and 80Hz, where you want to perform the high pass cut filter and set the "LOW" variable control to "B" frequency between 80Hz and 16kHz, where you want to perform low pass cut filter.

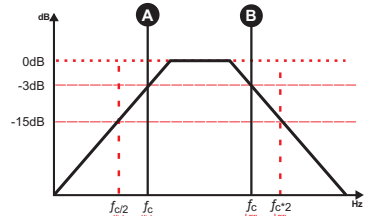

Using Bass Boost

The Amplifier Bass Boost setting enables the user to boost the sound intensity at low frequencies of the sound system, where boost intensity can be adjusted, as well as the frequency of the region to be boosted, as indicated in the chart below by the letter "C".

This is a semi-parametric equalizer type circuit with "Q" value for the fixed filter, with an intensity boost adjustment from 0 to +12dB (16 times), and a central frequency adjustment of the filter between 35 and 70Hz, making it versatile for several types of sound systems.

Bass Boost Chart

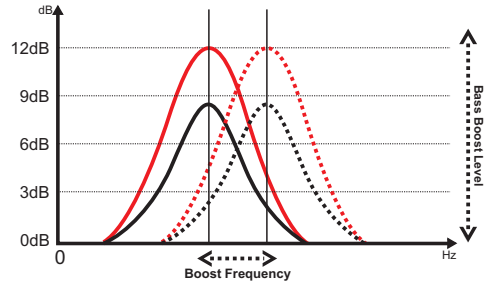

How to Adjust Bass Boost

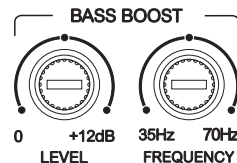

Set the variable control Frequency to the frequency you want boost between 35Hz and 70Hz. Set boost intensity between 0dB and +12dB at the variable control Level.

Table 1 - Power Cables - Recommendation

Potência em Watts RMS	40.000W	A	A	2 x A*	2 x A*	4 x A*	4 x A*	6 x A*
	35.000W	A	A	A	2 x A*	4 x A*	4 x A*	6 x A*
	30.000W	B	A	A	A	2 x A*	4 x A*	4 x A*
	25.000W	B	B	A	A	A	4 x A*	4 x A*
	20.000W	B	B	B	A	A	2 x A*	4 x A*
	15.000W	B	B	B	A	A	2 x A*	4 x A*
	12.000W	B	B	B	A	A	2 x A*	2 x A*
	8.000W	B	B	B	B	A	A	2 x A*
	6.500W	C	B	B	B	B	A	2 x A*
	5.000W	C	B	B	B	B	B	A
	4.000W	C	C	B	B	B	B	B
	3.000W	D	C	C	C	C	C	B
	2.500W	D	D	C	C	C	C	C
	2.000W	E	E	E	D	D	D	C
1.600W	F	F	E	E	E	D	D	
1.200W	G	G	F	F	E	E	E	
	0 - 1	1 - 2	2 - 3	3 - 4	4 - 5	5 - 6	6 - 7	
Comprimento do cabo (em metros)								

*All cables shall be doubled with the aid of an adapter or busbar.

Section

REF.	AWG	mm ²
A	00	67.4
B	1/0	53.5
C	2	33.6
D	3	26.6
E	4	21.2
F	5	16.8
G	6	13.3

Table 2 - Speaker Cables - Recommendation

Power in Watts RMS	40.000W	F	F	F	F	F	F	F
	35.000W	F	F	F	F	F	F	F
	30.000W	G	G	F	F	F	F	F
	25.000W	G	G	F	F	F	F	F
	20.000W	G	G	G	F	F	F	F
	15.000W	G	G	G	G	F	F	F
	12.000W	H	G	G	G	G	G	F
	8.000W	H	H	H	G	G	G	G
	6.500W	H	H	H	H	G	G	G
	5.000W	H	H	H	H	H	G	G
	4.000W	I	H	H	H	H	H	H
	3.000W	I	I	I	H	H	H	H
	2.500W	I	I	I	I	H	H	H
	2.000W	J	I	I	I	I	I	H
1.600W	J	J	J	I	I	I	I	
1.200W	J	J	J	J	J	J	J	
	0 - 1	1 - 2	2 - 3	3 - 4	4 - 5	5 - 6	6 - 7	
Comprimento do Cabo (em metros)								

Section

REF.	AWG	mm ²
F	5	16,8
G	6	13,3
H	8	8,3
I	10	5,2
J	14	2,0

Table 3 - Recommended Fuse/Circuit Breakers

Model	Efficiency	Max Current Draw	Recommended Circuit Breaker*
3300.1D POWER	78%	294A	150A
5500.1D POWER	83%	490A	250A
8800.1D POWER	83%	737A	500A**

* The recommended fuse is sized for music use. For "SPL" or "Hair Trick" cars it may be necessary the use of a fuse / circuit breaker that supports larger current, but the fuse rating must not exceed the maximum current draw of the amplifier.

** To achieve the current rating of the recommended fuse / circuit breaker, more than one fuse (or circuit breaker) may be associated (in parallel circuit).

RMS Power - CTA 2006 @ 40Hz

3300.1D POWER 1Ω

Impedance	1Ω	2Ω	4Ω
Power Nominal @ 14.4V	3300W	1815W	998W

Input Signal and Filters

Input Sensitivity 0.5V ~ 8V

Power Supply

Operating Voltage	9VDC ~ 16VDC
Max Current Draw	294A
Total Efficiency (Source+Output)	78%

Audio Specs

SNR (LPF 15kHz / Nominal Power)	84dB
THD + N (Nominal Impedance/100Hz/LPF 15kHz/10% of Nominal Power)	0.094%
Frequency Response (-3dB)	5Hz ~ 16kHz
Damping Factor (Nominal Impedance @100Hz)	>1000

Graphics

THD X Input Amplitude

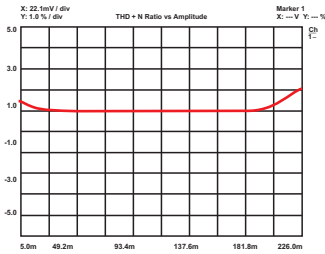

Frequency Response 5Hz ~ 30kHz

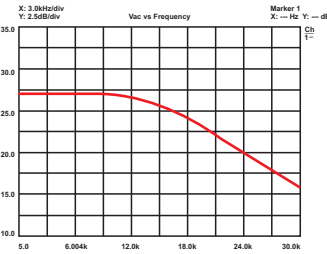

THD + N X Power

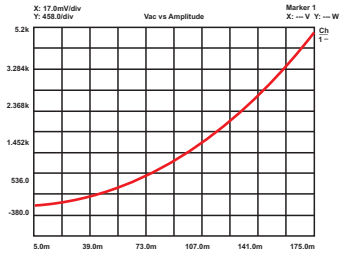

Dimensions

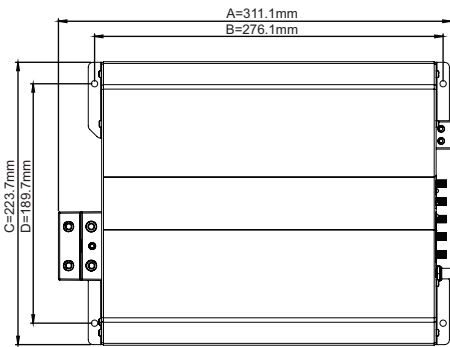

A	311.1mm
B	276.1mm
C	223.7mm
D	189.7mm
E	68.1mm
8.2lbs (3.7kg)	

RMS Power - CTA 2006 @ 40Hz		5500.1D POWER 1Ω		
Impedance		1Ω	2Ω	4Ω
Power Nominal @ 14.4V		5500W	3025W	1664W

Input Signal and Filters	
Input Sensitivity	0.5V ~ 8V

Power Supply	
Operating Voltage	9VDC ~ 16VDC
Max Current Draw	460A
Total Efficiency (Source+Output)	83%

Audio Specs	
SNR (LPF 15kHz / Nominal Power)	75dB
THD + N (Nominal Impedance / 100Hz / LPF 15kHz / 10% of Nominal Power)	0.062%
Frequency Response (-3dB)	5Hz ~ 16kHz
Damping Factor (Nominal Impedance @100Hz)	>1000

Graphics

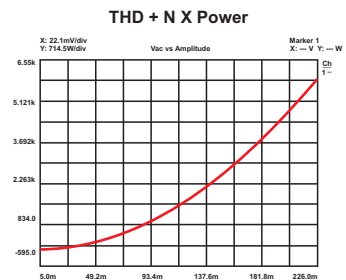
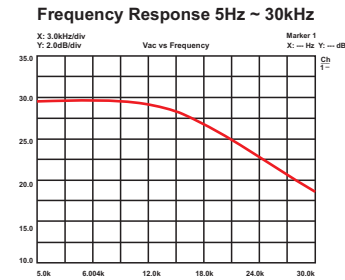
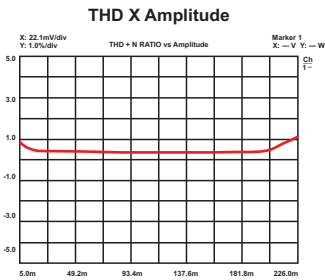

Dimensions

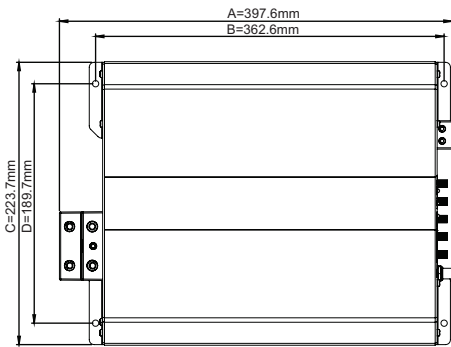

A	397.6mm
B	362.6mm
C	223.7mm
D	189.7mm
E	68.1mm
11.1lbs (5.0kg)	

RMS Power - CTA 2006 @ 40Hz

8800.1D POWER 1Ω

Impedance	1Ω	2Ω	4Ω
Power Nominal @ 14.4V	8800W	4840W	2662W

Input Signal and Filters

Input Sensitivity 0.5V ~ 8V

Power Supply

Operating Voltage	9VDC ~ 16VDC
Max Current Draw	737A
Total Efficiency (Source+Output)	83%

Audio Specs

SNR (LPF 15kHz / Nominal Power)	73dB
THD + N (Nominal Impedance/100Hz/LPF 15kHz/10% of Nominal Power)	0.015%
Frequency Response (-3dB)	5Hz ~ 16kHz
Damping Factor (Nominal Impedance @100Hz)	>1000

Graphics

TH+N X Amplitude

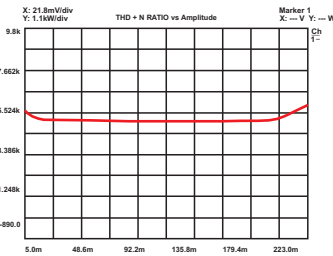

Frequency Response 5Hz ~ 30kHz

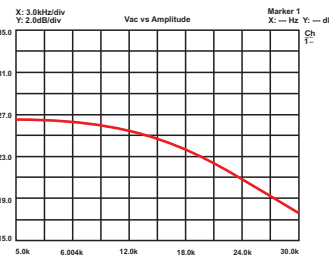

THD + N X Power

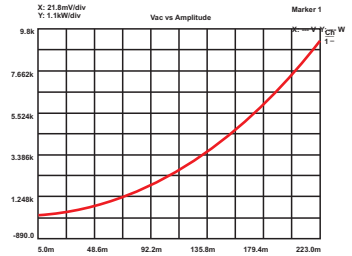

Dimensions

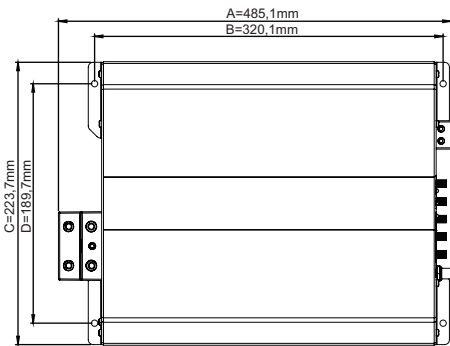

A	485.1mm
B	320.1mm
C	223.7mm
D	189.7mm
E	68.1mm
15.2lbs (6.9kg)	

LIMITED WARRANTY

SoundDigital warrants the original purchaser that this product shall be free of defects in materials and workmanship for a period of twelve (12) months from the original date of purchase. Some countries have extended warranty in case the product is installed by an authorized dealer. This warranty is not transferable and applies only to the original customer from an authorized **SoundDigital** dealer.

Warranty is void when:

- Defect or problem caused by misuse of the product;
- Incorrect installation or non-conformity with the Manual;
- Maintenance made by unauthorized personnel;
- Alteration or removal of the seal/serial number;
- Exposure to adverse conditions (weather, humidity, etc);
- Damage caused by fall, impact or natural depreciation, caused by transport and/or handling, risks, or smashings;
- Products was purchased more than 12 months ago.

Warranty covers:

- Component or material with manufacturing defects;
- Workmanship/service needed to repair the equipment;
- If you need service on your **SoundDigital** amplifier, send it (freight-prepaid) to **SoundDigital's** Amplifier Repair Center through an authorized **SoundDigital** dealer (must be accompanied by proof of purchase);
- Any extra information you can get by contacting us at the e-mail address: info@sounddigitalusa.com;
- In case of manufacturing defect or bad quality of raw material, the max compensation will be the replacement of the product, not allowing any kind of compensation payment;
- New modifications/iterations on a product don't obligate the manufacturer to modify products formerly produced.





www.soundigital.com.br
www.soundigitalusa.com



+ 55 51 3042-9001
+ 1 786-600-1056



/SounDigitalBrasil
/SounDigitalUSA



@soundigital
@soundigitalUSA