

Appendices for The Determination of Minimum Flows for the Lower Myakka River

Report of the
Southwest Florida Water Management District

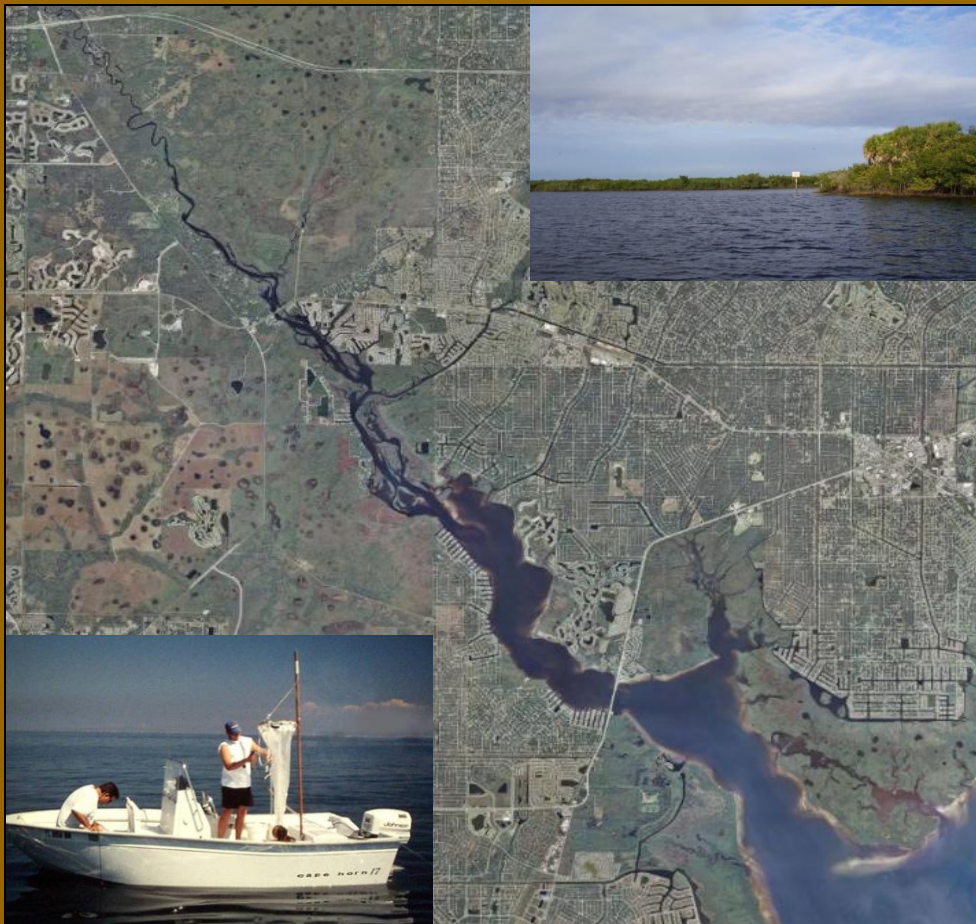

APPENDICES

for

**THE DETERMINATION OF MINIMUM FLOWS FOR THE
LOWER MYAKKA RIVER**

December 16, 2011

**Southwest Florida Water Management District
Brooksville, Florida**

LIST OF APPENDICES

- Appendix 1A – Report of the Scientific Review Panel for the August 2010 draft District report – The Determination of Minimum Flows for the Lower Myakka River.
- Appendix 2A - Comments received from the Charlotte Harbor National Estuary Program concerning the draft 2010 District report - The Determination of Minimum Flows for the Lower Myakka River.
- Appendix 3A - Comments received from the Florida Department of Environmental Protection concerning the draft 2010 District report - The Determination of Minimum Flows for the Lower Myakka River.
- Appendix 2A - Statistical outputs for regression of flow at Big Slough Canal near Myakka City and estimated flow at Water Control Structure 101 prepared by HSW Engineering, Inc.
- Appendix 2A - Statistical outputs for regression of flow at Big Slough Canal near Myakka City and estimated flow at Water Control Structure 101.
- Appendix 2B - Methods and statistical outputs for prediction of gaged flow in Big Slough Canal at Tropicaire Blvd. as a function of gaged flow at Big Slough Canal near Myakka City.
- Appendix 2C - Time series plots of median monthly flows at the Myakka River near Sarasota gage for 1937-2005
- Appendix 2D - Time series plots of moving average values for mean, minimum and maximum flows for 3, 10, 30, 60, 90 and 190-day periods within each year at the Myakka River near Sarasota gage for 1937-2005
- Appendix 2E - Time series plots of median monthly flows at the Big Slough Canal near Myakka City gage for 1981-2005
- Appendix 2F - Time series plots of yearly values of the 10th, 25th, 50th, 75th and 90th percent exceedance flows for the Big Slough Canal near Myakka City for 1981-2005
- Appendix 2G - Time series plots of moving average values for mean, minimum and maximum flows for 3, 10, 30, 60, 90 and 190-day periods within each year at the Big Slough Canal near Myakka City for 1981-2005
- Appendix 4A - Salinity Data Sources
- Appendix 4B - Development of Empirical Salinity Models
- Appendix 4C - Isohaline Regression Results, Statistics, and Verifications
- Appendix 4D - Fixed Station Regression Results, Statistics, and Verifications
- Appendix 4E - Regression Analysis of Dissolved Oxygen

- Appendix 4F - Water Quality as a Function of Time, Season, Salinity, Temperature, and Flow
- Appendix 5A - Hydrodynamic Simulations of the Upper Charlotte Harbor - Lower Peace River – Lower Myakka River System in Support of Determining Minimum Flows for the Lower Peace and Lower Myakka Rivers
- Appendix 6A - Lists of emergent and submerged aquatic plant species on the Lower Myakka River
- Appendix 6B - GIS and related field methods for the mapping and characterization of river shorelines, vegetation, and land use
- Appendix 6C - Annotated bibliography of additional literature on the effects of salinity on oligohaline and tidal freshwater marsh species and communities
- Appendix 6D - Benthic macroinvertebrate species list for the Myakka River. Dominant species from the middle section (RK 16 - RK 32) are in bold.
- Appendix 6E - Benthic Fauna Community Parameter Statistics. June, 2004.
- Appendix 6F - Distribution of benthic macroinvertebrate species in the Lower Myakka River arranged from first appearance extending from the river mouth, June, 2004.
- Appendix 8A - Yearly time series plots of flow at the Myakka River near Sarasota gage and flows at that location predicted by MIKE SHE for the existing watershed conditions for 1995-2005
- Appendix 8B - Yearly time series plots of flow at the Myakka River near Sarasota gage and total excess flows at that location predicted by MIKE SHE for 1995-2005
- Appendix 8C - Yearly time series plots of flow at the Myakka River near Sarasota gage and total excess flows at that location predicted by MIKE SHE that are capped at 130 cfs for 1995-2005
- Appendix 8D - Yearly time series plots of total excess flows at the location of the Myakka River near Sarasota gage predicted by MIKE SHE adjusted by Method 1 (direct from model) and Method 2 (based on percentage of gaged flow). Both values are capped at 130 cfs
- Appendix 8E - Yearly time series plots of total excess flows at the location of the Myakka River near Sarasota gage predicted by MIKE SHE and adjusted by Method 1 and by Method 1 with total excess flow never exceeding gaged flow for 1995-2005. Both values capped at 130 cfs.
- Appendix 8F - Yearly time series plots of flow at the location of the Myakka River near Sarasota gage reported by the USGS and adjusted flows at that location predicted by MIKE SHE and adjusted by Method 1 (with 130 cfs cap and excess flows never exceed gaged flows) for 1995-2005

- Appendix 8G - Plots of the bottom area of water with salinity < 2, < 5, < 12, and < 17 versus preceding 5-day flow at the Myakka River near Sarasota gage for seasonal blocks 1, 2, and 3.
- Appendix 8H - Plots of the volume of water with salinity < 2, < 5, < 14, and 3 to 14 psu versus preceding 5-day flow at the flow at the Myakka River near Sarasota gage for seasonal blocks 1, 2, and 3.
- Appendix 8I - Cumulative distribution function plots of the bottom area of water with salinity < 2, < 5, < 11, < 17, 2 to 12, and 11 to 17 for baseline flows and seven flow reduction scenarios and bar charts of the percent reduction from baseline for these same scenarios.
- Appendix 8J - Cumulative distribution function plots of the volume of water with salinity < 2, < 5, < 14, and 3 to 14 for baseline flows and seven flow reduction scenarios and bar charts of the percent reduction from baseline for these same scenarios.
- Appendix 8K - Cumulative distribution function plots of the bottom area of water with salinity < 2, < 5, < 11, < 17, 2 to 12, and 11 to 17 for baseline flows and seven flow reduction scenarios for the three seasonal blocks.
- Appendix 8L - Bar charts of the percent of bottom area of water with salinity < 2, < 5, < 11, < 17, 2 to 12, and 11 to 17 relative to baseline flows for seven flow reduction scenarios for three seasonal blocks.
- Appendix 8M - Cumulative distribution function plots of water volume with salinity < 2, < 5, < 14, and 3 to 14 for baseline flows and seven flow reduction scenarios for the three seasonal blocks.
- Appendix 8N - Bar charts of the percent of water volume with salinity < 2, < 5, < 14, and 3 to 14 relative to baseline flows for seven flow reduction scenarios for three seasonal blocks.
- Appendix 8O - Percent reductions in mean values for the bottom area and water volume of selected salinity zones for the period 1999-2002
- Appendix 8P - Percent reductions in daily values of bottom area with salinity <2, <5, <17, and 2 to 12 vs. preceding 5-day mean flow at the Myakka River near Sarasota gage for four flow reduction scenarios.
- Appendix 8Q - Percent reductions in daily values of water volumes with salinity <2, <5, <14, and 3 to 14 vs. preceding 5-day mean flow at the Myakka River near Sarasota gage for four flow reduction scenarios.
- Appendix 8R - Time series plots of percent reductions in daily values of bottom areas with salinity <2, <5, 17, and 2 to 12 psu for four flow reduction scenarios.

- Appendix 8S - Time series plots of percent reductions in daily values of water volumes with salinity <2, <5, <14, and 3 to 14 psu for four flow reduction scenarios.
- Appendix 8T - Box and whisker plots of percent reductions in daily abundance for selected indicator taxa for seven flow reduction scenarios for three seasonal blocks.
- Appendix 8U - Median values for percent reductions in daily abundance for selected indicator taxa for seven flow reduction scenarios for three seasonal blocks.
- Appendix 8V - Cumulative distribution function plots of daily abundances of selected indicator taxa for seven flow reduction scenarios for three seasonal blocks.
- Appendix 8W - Percent reductions in daily abundances for selected indicator taxa for seven flow reduction scenarios for three seasonal blocks measured as differences in the normalized areas under cumulative distribution function curves
- Appendix 8X - Percent reductions in mean daily abundances for selected indicator taxa for seven flow reduction scenarios for three seasonal blocks.
- Appendix 8Y - Percent reductions in median daily abundances for selected indicator taxa for seven flow reduction scenarios for three seasonal blocks.

***SCIENTIFIC REVIEW OF THE DETERMINATION OF MINIMUM FLOWS
FOR THE LOWER MYAKKA RIVER***

Scientific Peer Review Report prepared for the

Southwest Florida Water Management District
2379 Broad Street
Brooksville, Florida 34609-6899

Merryl Alber, Ph.D. (Panel Chair)
Professor
Dept. Marine Sciences
University of Georgia
Athens, GA 30602
malber@uga.edu

Gary L. Powell, President
Aquatic Science Associates
8308 Elander Drive
Austin, TX 78750
garypowell@austin.rr.com

Billy H. Johnson, Ph.D., P.E., D.WRE
Computational Hydraulics and Transport LLC
300 Front Street
P.O. Box 569
Edwards, MS 39066
cht@canufly.net

December 10, 2010

Summary and Recommendations

The Southwest Florida Water Management District (the District) is mandated by Florida statutes to establish minimum flows and levels (MFLs) for state surface waters and aquifers within its boundaries for the purpose of protecting the water resources and the ecology of the area from “significant harm” (Florida Statutes, 1972 as amended, Chapter 373, §373.042). The District implements the statute directives by annually updating a list of priority water bodies for which MFLs are to be established and identifying which of these will undergo a voluntarily independent scientific review.

This document represents an independent scientific review of the District’s proposed MFL for the Lower Myakka River. An MFL is already in place for the Upper Myakka River, which flows approximately 34 miles until it reaches Lake Myakka, after which the Lower Myakka River continues downstream approximately 32 miles (52 km) to its mouth in the upper bay and estuary of Charlotte Harbor. The watershed of the entire Myakka River, which measures some 602 square miles (1,559 km²), is ecologically valuable because of the abundance, diversity and quality of its living ecosystem. It contains more freshwater wetlands than any other area in Charlotte Harbor region and it also includes extensive tidal wetlands. The central portion of the watershed features a large complex of public conservation lands. As a result, much of the Myakka River watershed has been given special protective designations as a State of Florida Wild and Scenic River, an Outstanding Florida Waterway and a State of Florida Aquatic Preserve. The watershed even has large expanses of dry prairie that are considered a globally imperiled habitat. The remainder of the watershed contains ecologically characteristic depressional marshes interspersed with pine flatwoods and hammocks.

The Lower Myakka is tidally affected over much of its length. The wetland plant community along the river includes hardwood forest upstream and then grades through tidal freshwater, oligohaline, and salt marshes (mixed with mangroves) towards the mouth. The area is home to diverse and abundant fish and zooplankton that support the resources of the river (e.g. wading birds), and serves as a prime nursery for several economically important fisheries in the Charlotte Harbor region, including mullet, snook, red drum, tarpon, spotted seatrout, pink shrimp and blue crab. The Charlotte Harbor Estuary, an Outstanding Florida Water, is one of Florida’s most pristine estuarine ecosystems, containing extensive seagrass meadows, mangrove swamps and intertidal salt marshes, which provide food and shelter to the Florida subspecies (*Trichechus manatus latirostris*) of the endangered West Indian manatee, and serve as nurseries for shrimp, crabs, and estuarine-dependent marine fishes. Further, the Southwest Florida Water Management District’s (the District’s) Surface Water Improvement and Management (SWIM) program lists the area as a priority waterbody for restoration and protection.

Freshwater inflow to the Lower Myakka has been highly modified due to changes in the watershed, primarily because of increased discharge from irrigated agriculture. The District’s MFL Report describes the conversion of agricultural lands since about 1972 into croplands that require substantially more irrigation, and how the resulting agricultural return flows bring large quantities of groundwater to the upper Myakka River creating a situation of excess flows. The District has developed a Myakka River Watershed Initiative to create management plans for reducing/removing excess flows in the upper river reaches. At the same time, water has been diverted from the Lower Myakka through the Cow Pen

Slough and Blackburn Canals, although these diversions are only important during periods of above normal flows. There is currently one permitted withdrawal on the Lower River: the City of North Port withdraws water from the Myakkahatchee Creek.

The District's approach for setting the MFL for the Lower Myakka River was to determine inflows to the system without the excess flows from the upper portion of the watershed, and to compare this with current conditions (which were taken as baseline). Excess flows were estimated using a water budget model of the watershed (the MIKE SHE modeling platform). Three hydrodynamic / salinity / temperature models were used in determining the MFL for the Lower Myakka River. A three dimensional (3D) model of the entire Charlotte Harbor and a portion of the Gulf of Mexico (45 km off shore) that was developed by the University of Florida was used to provide boundary conditions to a combined 3D (LESS3D) and laterally averaged (LAMFE) 2D model of the UCH-LMR-LPR system. The University of Florida (UF) 3D model utilizes a boundary fitted grid in the horizontal plane and a sigma stretched grid in the vertical plane. This model was run for the same simulation periods that were run in the combined 3D / 2D model of the UCH-LMR-LMP system. Also, to aid in estimating ungaged flows for input into the UCH-LMR-LPR 3D/2D model, a HSPF watershed model of the lower basin was employed.

Baseline flows, as well as various inflow reduction scenarios (removing excess flow and then removing additional water beyond this amount), were evaluated, as was the effect of the City of North Port's withdrawal. These observations were used in association with a hydrodynamic model to predict estuarine salinity. The model was used to evaluate changes in river bottom area and water volume in various salinity zones for the different scenarios. Regressions were used to predict the location of the 2 psu isohaline in response to changes in inflow as a way to evaluate effects on oligohaline tidal freshwater wetlands in terms of both shoreline length and area; additional inflow regressions were used to evaluate the abundance and center of distribution of selected fish and invertebrate species in the river.

The District's management goal for the Lower Myakka River is to maintain ecosystem integrity and, thereby, protect ecological health and productivity. As a result, the District's MFL was developed to limit potential changes in aquatic and wetland habitat availability associated with reductions in freshwater inflows (SWFWMD 2010). When biologically meaningful thresholds or breakpoints were not found in the more or less continuous physical, chemical and biological responses, as is often the case in field studies, a criterion of no more than a 15% loss of habitat or other resources, as compared to the estuary's baseline condition, was used as the limit for "significant harm."

The District's analysis showed that the maximum permitted withdrawals from the City of North Port made little difference to the Lower River. However, removal of excess flows, without any further withdrawals, caused some parameters to show more than a 15% decrease as compared to the baseline condition (in terms of shoreline length and area of wetlands as well as abundance of some fish and invertebrates), particularly during the driest part of the year (Block 1). The centers of distribution of the organisms also moved upstream as flows decreased. During other parts of the year, when flows are higher, the predicted changes caused by the removal of excess flows was generally less than 15%.

The proposed MFL for the Lower Myakka River is to allow no more than the removal of excess agricultural flows (up to 130 cfs) until gauged streamflows at the Myakka River near Sarasota exceed 400 cfs. Above 400 cfs, the District proposes the allowance of 10% of the daily flow at the Sarasota gage, determining that this will not cause significant harm to the lower river and its living resources. The City of North Port withdrawals will be allowed to remain in place.

The major conclusions and recommendations of the Panel are as follows:

1. Because of the generally good ecological health of the lower Myakka river in its current condition, the Panel agrees with the District's choice of the existing flow regime of the river as the baseline for assessing the effects of future withdrawals. However, it would be useful to compare the scenario in which excess agricultural flow is removed from the current conditions, which were simulated for this report, with the historic condition (e.g. before these diversions were in place and before excess flow augmented runoff in the upper watershed).
2. Several models were used in this analysis. The MIKE SHE model was used to estimate runoff to the river. A distributed hydrological model like the MIKE SHE model can potentially provide a more accurate prediction of daily stream flow and water table depth under varying climatic conditions, and the Panel agrees with the model evaluation and selection based on the Myakka River Watershed Initiative criteria. The Panel further concludes that the UCH-LMR-LPR numerical hydrodynamic / salinity / temperature model is an appropriate model to be used to predict salinity in the estuary.
3. The HSPF model was used to compute ungauged flows, and these predictions had to be reduced by approximately 50% to arrive at a good calibration of the UCH-LMR-LPR hydrodynamic model. When one has to adjust boundary conditions to match model results with recorded data in the interior, it is always a reason for concern. Despite its drawbacks, the Panel does acknowledge that the HSPF model was an appropriate model to be applied in an attempt to estimate the ungauged flows in the LMR and LPR sub basins, and that the District employed the best available data. Although there is substantial room for error in the absolute inflow values, as long as the inflow estimates are used consistently, as they were, then the relative numerical differences between one modeled scenario run and the next will be the same across all hydrologies.
4. The Panel accepts the District's plan to remove excess flows in the upper watershed as established policy. However, the amount of excess flow that is being removed will be substantial (predicted average flow during Block 1 would be reduced by almost 20% during the minimum flow study period, from 122 to a predicted 98 cfs). Moreover, the District's analyses show that removal of excess flows, without any further withdrawals, will cause most parameters in the Lower Myakka to show more than a 15% decrease as compared to the baseline condition during low flow conditions. The District has argued that this is acceptable because the River will be restored to its condition before flow augmentation began. However, it is difficult to accept that a substantially lower flow will protect the ecological health and productivity of this tidally affected river and the receiving bay and estuary system. Given these results, the Panel has several recommendations:

- a. The District should estimate a conservative threshold to determine what flow levels during Block 1 will constrain the reductions in habitat to 15% or less.
- b. The District should consider monitoring the removal of excess flow under the MFL, so that they will be in a position to know when this removal is approaching the flows that will result in changes in resources greater than 15%. The Panel understands that estuaries like the Lower Myakka River are highly non-linear, which means that impacts will be magnified during low flow periods, both seasonally and interannually.
- c. The District should choose a sensitive indicator such as OTF distribution or one of the more sensitive fish and continue to monitor the system for the purpose of determining whether the reduced flows have the effects predicted in the MFL analysis.
- d. If removing excess flows does cause a substantial change in resources, the District should consider options to at least partially replace lost excess flows during low flow periods, especially in the springtime when estuarine nursery habitat usage is highest.

5. The large amount of water scheduled to be removed in the upper watershed, coupled with the level of uncertainty in the statistical and mechanistic models used in the MFL analysis, makes it difficult to support the estimated allowable 10% flow reduction at high flows. Moreover, it is unclear why 400 cfs was chosen as the threshold above which 10% withdrawals would be allowed. The hogchoker, for example, would be better protected if the threshold were > 700 cfs (see Fig. 8-46C). The panel recommends this high flow threshold be revisited.

6. Given the scope of this MFL, the District's focus on the Lower Myakka, as opposed to determining the inflow needs of the entire bay and estuary system at once, means that it was appropriate to focus on freshwater and resident brackish water taxa to evaluate the effect of inflow changes. Presumably this means that the District will have to add up the MFL's for the various riverine parts in order to obtain the freshwater needs for the total coastal system, an eventual goal of most freshwater inflow analyses. If the sum of the parts does not comport well with the needs of the entire coastal bay and estuary system, and their living resources of ecological and economic importance, then some revisions in the MFL's may be in order.

7. The report provides several suggestions for ongoing analysis and additional data collection that the Panel supports, as these are good opportunities to improve the hydrology and the other important statistical and numerical models, not the least of which is to continue to collect more and better data so that a revised MFL can be determined in the future. These include:

- a. Continued seine and trawl sampling would potentially strengthen the inflow relationships observed between nekton abundance and distribution in the lower Myakka River. In particular, additional data collection during dry years would be helpful in learning more about the response of the fish community to steep salinity gradients with much compressed salinity habitats in the Myakka River. However, the Panel does not feel that the Myakkahatchee Creek is as important

here, since the natural channel was destroyed long ago and water control structures provide barriers to mobile species.

b. Continued monitoring for the purpose of verifying that the MFL is having its intended effect of maintaining ecological health and productivity of the Myakka River System, especially if the minimum flows are at unreasonable variance with current conditions that seem to be maintaining the lower river and the braided reach of nursery habitats above the confluence with Salt Creek. The verification monitoring should include streamflows, tidal flows, basic water quality (including temperature, salinity, pH, DO and chlorophyll), benthos and nekton, particularly during the dry season, which coincides with the beginning of peak utilization of nursery habitats by the young of estuarine-dependent fish and shellfish species.

c. Finally, the panel thinks it is very important to keep the new gages in place, to be able to accurately assess freshwater inflow to the lower portion of the River. In particular the gage below Blackburn Canal should be maintained so that it will be possible to estimate how much water is diverted. Flows in Myakkahatchee Creek are also an important contribution. When sufficient data exist additional model simulations should be made, which will likely yield more accurate computations and improve the results of the 2D/3D model and the MFL as well.

8. The Panel recognizes that setting this MFL is one piece in a larger context that is affected by activities in the Upper Myakka River and watershed, the adjacent Rivers, and Charlotte Harbor itself. We also understand that MFLs are set using the best available data. In the case of the Lower Myakka River, the Panel strongly encourages the District to take an adaptive management approach in this system and to evaluate the options for offsetting ecological changes the lower river might experience as the result of removing excess flows in dry periods. We also encourage the District to re-evaluate this MFL once additional data are available.

9. Editorially, this report is not as clear and readable as desired. It is repetitive and several of the chapters are poorly organized (particularly Chapters 4 and 6, see specific suggestions in Section 3). There is also a tendency to present information in several ways (e.g. showing regressions developed for one vs. several gages; evaluating things for all flows and then just the domain of the regression, etc). Although these additional analyses can provide additional information, it made the report confusing in places and more like a data exploration (plus, it makes for a very unwieldy report). On a related note, the document presents data for a lot of different time intervals. In the final analysis the 10 year period of the SHE modeling and the 4 year period of the hydrodynamic modeling were used. The Panel agrees that showing both a wet and a dry period can be instructive (and we understand the constraints imposed by the modeling period), but all of the different intervals were confusing. In order to improve the readability of the report, it seems like it would be better to only present the analyses that were actually used in the MFL or otherwise considered the most important or the most conservative in the main document, and put the rest of the analyses in appendices. Likewise, the Panel suggests that the District consider picking two time periods to present in the main body of the report, with additional information included in appendices.

Review

The District's MFL report provides information on the physical and hydrological characteristics of the watershed of the Myakka River and the changes that have occurred over time. It describes the current characteristics of the estuary, including its bathymetry, shoreline features, salinity, water quality, and flora and fauna. The review below is divided into three sections: Section 1 is an evaluation of the modeling aspect of the project; Section 2 presents comments on the other aspects of the report and reviews the setting of the MFL; Section 3 provides detailed comments and questions on a chapter-by-chapter basis; Section 4 presents the Panel's response to the recommendations of the Charlotte Harbor National Estuary Program. At the end of the document (Appendix A) is a list of errata and minor editorial comments. **The Panel's conclusions are written in bold**, and our suggestions for further study or questions for the District are underlined.

Section 1. Modeling

Three hydrodynamic / salinity / temperature models were used in determining the MFL for the Lower Myakka River. A) A MIKE SHE model of the upper Myakka River watershed was used to estimate flows into the lower Myakka River. B) A HSPF watershed model of the lower basin was employed for estimating ungaged flows. Both were used as inputs into the Upper Charlotte Harbor - Lower Myakka River – Lower Peace River (UCH-LMR-LPR) 3D/2D model. C) A three dimensional (3D) model of the entire Charlotte Harbor and a portion of the Gulf of Mexico (45 km off shore) that was developed by the University of Florida was used to provide boundary conditions to a combined 3D (LESS3D) and laterally averaged (LAMFE) 2D model of the UCH-LMR-LPR system.

Each of these models is reviewed individually below, but an overall suggestion is that the District should consider conducting quantitative uncertainty analyses on the models it uses for flow recommendations. Along these lines, the U.S. Army Corps of Engineers has instructed all its Districts to consider uncertainty in their projects, particularly those related to flood alleviation and ecosystem restoration. Determining the level of uncertainty in a model, or a cascade of models, is a normal procedure in some scientific disciplines, but it is only just beginning to be applied to water resources projects.

1A. MIKE SHE

The MIKE SHE model was used to determine the excess flows into the lower Myakka due to increased runoff from agricultural irrigation in the upper Myakka basin. The MIKE SHE model (Interflow 2008) is an integrated surface and ground water simulator that tries to account for all the major land-based processes of the hydrologic cycle from rainfall to river flow via various physical pathways such as overland flow, infiltration into soils, evapotranspiration from vegetation, groundwater flow in both saturated and unsaturated strata, and surface/ground water interactions. This model was used during the MFL analysis for the Upper Myakka River and hence has already been reviewed as part of that process. However, a few comments are provided here.

Sensitivity of the MIKE SHE model to structural parameters such as grid size and time step, and to the functional parameters, including hydraulic resistance coefficient, surface and subsurface hydraulic properties, has been investigated previously (Xevi et al. 1997). The results indicated that peak overland flow and the total overland flow were very sensitive to the flow resistance parameters and to the vertical hydraulic conductivity of the surface soil, while the peak aquifer discharge and the total aquifer discharge were sensitive to the horizontal hydraulic conductivity in the saturated zone. The model output variables considered were not affected to a significant extent by the vegetation parameters or by the specific storage coefficient.

Problems with such distributed models include over-parameterization and uncertainties in model predictions due to variability in the large number of input parameters. In many cases, the model parameter values are simply not available, which makes it difficult to properly set up the model. As a result, model use requires a great deal of technical expertise and the learning curve is steep for new users. Because of the high uncertainties, distributed models may perform poorly even if they are calibrated well using data from another time period, and similar problems can occur when models are tested against data from different study sites (Dai et al. 2010). As a result of the model's complexity and data requirements, some investigators have reported difficulties in using this commercial modeling package to produce reliable simulations of flow. Other investigators have concluded that a simple lumped parameter model could perform equally well at the monthly temporal scale for modeling stream flow under average climatic conditions. However, **the Panel agrees with the model evaluation and selection of MIKE SHE** based on the Myakka River Watershed Initiative criteria.

The application of the MIKE SHE model to the Myakka used a grid cell resolution (125 m) for both the groundwater and surface water models, which appears to be reasonable. The NEXRAD rainfall adjustment factors, using measured rain gage data, conforms to standard engineering practices and the soils and land use discretization are reasonable. For the purpose of computing water balance, the two-layer groundwater model is adequate and the general order of magnitude of the various water budget components appears to be reasonable. The model calibration and verification are fairly good. However, based on the Double-Mass analysis of the Myakka River State Park NWS gage, additional investigation should be conducted to determine why there is a gage discrepancy compared to surrounding gages. If the gage was moved during the period of record, the rainfall records should be adjusted to reflect the amounts being measured at the current location.

Bridges and culverts at road crossings were not simulated because their effects were assumed to be localized and significant only during flood events. Given the detail that the modelers used in the other areas, in addition to modeling continuous period of records with computational time steps on the order of seconds and minutes, in future applications modeling bridges and culverts at road crossings should be considered. The mild slopes of this area could cause back water effects to propagate further than the localized area. In addition, water storage in the floodplain due to back water caused by these obstructions could cause changes in flow timing.

1B. HSPF

HSPF is a well known watershed model that has been used in many studies of rainfall runoff over the United States. HSPF simulates hydrologic and associated water quality processes on pervious and impervious land surfaces and in streams and well-mixed impoundments. The HSPF model in this effort was primarily constructed to provide estimates of the ungaged flows in the Lower Myakka and Lower Peace River sub basins for input to the numerical hydrodynamic and salinity model discussed in the next section. (About 16% of the Lower Peace River sub-basin and 50% of the Lower Myakka River sub basins are ungaged.)

The reviewers agree that the HSPF model is well known and tested, often producing more precise estimates than a simple drainage-area ratio or similar shorthand techniques for estimating runoff, but it too is filled with input parameters that must be specified accurately. Unfortunately, assessments of model performance indicated the ungaged flow values predicted by the HSPF model might be too high, as the estuarine model tended to under-predict salinity. The District adjusted the daily ungaged flows produced by the HSPF model by a constant coefficient (0.507) derived by comparing mean HSPF modeled flows to mean flow values from unit area runoff estimates for rural versus urban areas made by SDI consultants. This 50.7% reduction in the estimated ungaged flows improved performance of the estuarine hydrodynamic (circulation and salinity) model; however, the District reports that application of the estuarine model to different gauged inflow scenarios in the MFL determination for the years 1999-2002 only used ungaged flow values computed by SDI consultants.

The Panel notes that the HSPF model was calibrated using three gages, only one of which (Deer Prairie Slough at Power Line near North Port Charlotte) is shown in Table 2-2 of the report. The other two gages used for model calibration were Big Slough at North Port Charlotte and Gator Slough in southern Charlotte Harbor, the latter of which doesn't contribute to Myakka River inflows. The Panel suggests that existing records from the other inputs to the lower River (Deer Prairie Slough, Warm Mineral Springs/Salt Creek, and Big Slough/ Myakkahatchee Creek), although short-term, would still be valuable for checking the output from the rainfall runoff model (i.e., the HSPF model) from these important sub-basins. Another approach would be to use the hydrodynamic models of the receiving bay and estuary as another estimate of how much freshwater is mixing with sea water to produce the observed salinity gradient. In this case, the UCH-LMR-LPR model could probably have been applied in a sensitivity sense to arrive at the ungaged flows that gave a good calibration, negating the need for the HSPF model.

The fact that the HSPF flows had to be reduced so much leads one to question the model results. However, **the Panel does acknowledge that the HSPF model was an appropriate model to be applied in an attempt to estimate the ungaged flows in the LMR and LPR sub basins and employed the best available data.**

1C. UPPER CHARLOTTE HARBOR – LOWER MYAKKA – LOWER PEACE HYDRODYNAMIC MODEL

In order to develop a hydrodynamic model of the Lower Myakka River (LMR), one must also consider the interaction of the LMR, the Lower Peace River (LPR) and the upper part of Charlotte Harbor (UCH). The

Lower Myakka and Peace Rivers provide freshwater flows into Upper Charlotte Harbor, and the hydrodynamics and salinity conditions in the Harbor impact the circulation and salinity conditions in the Rivers. Thus, it is important to develop a numerical model that includes all three segments in order to model the LMR.

The flow pattern in the UCH is generally three dimensional (3D), so a 3D hydrodynamic model (including salinity and perhaps temperature) is required for this area. However, as one moves up into the LMR and the LPR the flow pattern is more two dimensional (2D), with the dimensions being along the river and over the depth. Thus, a 2D laterally averaged hydrodynamic model can be employed in the upper portions of these rivers. The hydrodynamic modeling was performed using the District's LESS code that dynamically links a laterally-averaged 2-D model (LAMFE) to a 3-D hydrodynamic model (LESS3D).

Assuming that the elevation of the river bed does not rise above mean sea level, the 3D model could be extended up to cover the LMR and the LPR. The report states that the bed elevation in the LMR doesn't intercept the mean sea level until above river km 40. However, additional resolution would be required in the 3D model in the upper reaches of the LMR and the LPR. Thus, modeling those portions of the rivers with the 2D model is appropriate.

The discussion below answers the following questions: (i) was the appropriate model employed, (ii) was there sufficient geometric / bathymetric data available to generate a numerical grid, (iii) does the numerical grid have sufficient resolution to address issues the modeling is expected to resolve, (iv) are there sufficient data to set boundary conditions, and (v) was the model sufficiently calibrated / validated.

1Ci. Was the appropriate model employed?

The LESS3D and LAMFE models constitute the two models that make up the UCH-LMR-LPR model (LESS). The LESS3D model is a hydrostatic 3D model that computes a 2D water surface field and 3D fields of velocity, salinity, and temperature. The LAMFE model is a 2D laterally averaged hydrostatic model that makes computations for a one dimensional (1D) water surface field along the river and 2D fields of velocity, salinity, and temperature along the river and over the depth. Both LESS3D and LAMFE are well developed models. They both employ a finite difference solution scheme to solve the governing equations of motion. Both models are quite efficient due to employing a semi-implicit solution scheme that removes the very restrictive speed of a free surface gravity wave from the allowable computational time step. Thus, the basic restriction on the magnitude of the time step is determined by the speed of a water particle and the size of the spatial steps in the numerical grid.

Both the LESS3D and LAMFE models utilize a Cartesian coordinate system in both the longitudinal and vertical direction. In 2D vertically averaged and 3D models, some finite difference models (e.g. the 3D UF model) utilize a transformed boundary fitted coordinate system in the horizontal dimensions and a type of vertical boundary fitted coordinate system often referred to as a sigma grid. With a vertical sigma coordinate system, a coordinate line always follows the free surface and a line always follows the bottom topography. Interior lines and the line following the water surface then move in time with the

rise and fall of the water surface. Such a grid system is able to model the bottom topography quite well. However, the problem with a sigma vertical coordinate system is that water column stratification cannot be maintained very well near significant slopes in the bottom topography unless the grid resolution is quite fine. This problem is not encountered in models that utilize a Cartesian vertical grid since derivatives of the horizontal pressure gradient terms in the momentum equations are evaluated along levels of constant pressure. Thus, a grid system that utilizes a Cartesian vertical grid but still models the bottom topography accurately would seem to be the best of both worlds. The LESS3D and LAMFE models do this through representing the bottom topography in a piece wise linear fashion while still utilizing a Cartesian system over the remainder of the water depth. This procedure does present some rather complicated control volumes along the bottom of the water body, but once the computer coding is accomplished presents no particular complication in the computations.

A special feature of the UCH-LMR-LPR model is the manner in which the 3D LESS3D and 2D LAMFE models are coupled. Computations for the water surface elevations at the boundary of the two models are performed in such a way that they are computed simultaneously. Final velocities at the new time step are calculated after the final water surface elevations in both the 3D and 2D domains are computed. The new velocities are then employed in the transport equations for the salinity and temperature. Thus, the computations are fully coupled such that there is a two way feedback between the 3D and 2D domains.

The Panel concludes that the UCH-LMR-LPR numerical hydrodynamic / salinity / temperature model is an appropriate model to be used to aid in setting the MFL for the LMR.

1Cii. Was there sufficient geometric / bathymetric data available to generate a numerical grid?

The report does not explicitly state the source(s) for the bathymetry data employed in the creation of the numerical grid. However, based on the fact that other rivers in the SWFWMD have good bathymetry data, **the Panel feels that the best available bathymetry data were employed.** The District should state in the report the source(s) for the bathymetry data used in the UCH-LMR-LPR numerical model. If changes are suspected from tropical storms, hurricanes, or human activities, then the District should consider updating the bathymetry before the next round of modeling.

1Ciii. Does the numerical grid have sufficient resolution to address issues the modeling is expected to resolve?

The numerical grid is a rectilinear or Cartesian grid that allows for a variable cell size. Thus, in the 3D grid there are many grid cells that are land cells. However, as the water level rises some land grid cells can become water cells and are treated as active computational cells at the new time step.

The 3D grid covers the UCH, 13.8 km of the LMR, 15.5 km of the LPR, and 1.74 km of the lower Shell Creek. There are 108 cells in the E/W direction, 81 cells in the N/S direction, and 13 vertical layers. The size of the cells vary from 100 m to 500 m in the horizontal plane and 0.3 m to 1.0 m in the vertical.

The 2D grid covers the LMR up to river kilometer 13.8, the LPR to 38.4 km, the LPR from 15.5 km to Arcadia, the Shell Creek from 1.74 km to the dam, 4.16 km of the Myakkahatchee Creek, and various other branches of the LPR. The upper limit of the LMR did not extend to the upper limit of the lower river at about 51 km since there was little data and a reduced likelihood of significant harm. All of the 2D grid segments consist of a total of 356 longitudinal cells and 17 vertical layers. The 13 layers of the 3D grid correspond exactly to the same 13 layers of the 2D grid. There appears to be some confusion in Table 2 of Appendix 5. Are the headers for the 3D and 2D grids interchanged?

The Panel agrees that the coupled 3D / 2D grids of the UCH-LMR-LPR model have adequate resolution to resolve the hydrodynamics / salinity / temperature computations of the modeled system.

1Civ. Are there sufficient data to set boundary conditions?

Data required to specify boundary conditions for the UCH-LMR-LMP numerical model consist of freshwater inflows; water surface elevations, salinity and temperature at the UCH grid open boundary; winds over the numerical grid domain; and meteorological data at the water surface over the modeled domain. Freshwater inflow data consisted of both gaged and ungaged flows.

The simulation period for the calibration / validation of the numerical model was from 6/13/2003 to 7/12/2004. For this period gaged daily flows for input to the UCH-LMR-LPR were available. These were prescribed at the upstream boundaries of the LMR (38.4 km), LPR (Arcadia), the Myallahatchee (4.16 km) and Shell Creek (dam) of the 2D domain of the modeled system. Regression equations were used to estimate the exchange of flow between the LMR and Dona / Roberts Bay through Blackburn Canal. Two sets of equations were developed. One related canal flow to measured flow at the Sarasota gage on the Myakka River while the other related canal flow to the measured water depth at the Sarasota gage. It appears these regressions give good results on estimating the flow in the Blackburn Canal.

As previously noted, about 16% of the LPR basin and about 50% of the LMR basin are ungaged, which represents a significant part of the total freshwater flow. The HSPF model of the modeled system provided estimates of the ungaged flows that were generally much too high and had to be adjusted downward. **When one has to adjust boundary conditions to match model results with recorded data in the interior, it is always a reason for concern. However, it appears there was no choice in this effort.**

The 3D UF hydrodynamic model of the Charlotte Harbor also included the LMR and LMP along with a portion of the gulf extending out for about 45 km off shore. It is difficult to ascertain the grid resolution in the UF model from Figure 18 in Appendix 5 of the report. Rather than developing the 3D / 2D UCH-LMR-LPR model, one might question why the UF model wasn't used to aid in establishing the LMR MFL. Other than the argument about modeling the river better with a 2D laterally averaged model, were there other reasons for not using the UF model to assess the impact of flow reductions on bottom area, water volume, and shoreline lengths for different salinity zones.

The UF model was run for the same 13 month period of 6/13/2003 to 7/12/2004. Water surface elevations, salinities, and temperatures from the UF model were saved at the southern boundary of the UCH-LMR-LPR grid and employed as boundary conditions. Unlike the coupling of the 3D and 2D models

of the UCH-LMR-LPR at the boundaries where the computational domain transitioned from a 3D domain to a 2D domain, there is no feedback between the UF model and the UCH-LMR-LPR model. The District should discuss whether they feel this is important.

Wind data were taken from the UF station in Upper Charlotte Harbor and used to compute shear stress on the water surface. These shear stresses were considered spatially constant.

Meteorological data such as solar radiation, air temperature, etc. were collected at the UF station and at a station near the Peace River Manasota Regional Water Supply Authority. These data were used to compute the surface heat exchange at the water surface that is needed in the temperature computations.

The Panel feels that the data available for setting boundary conditions during the calibration / validation simulation as well as for the four year production simulation are adequate.

1Cv. Was the model sufficiently calibrated / validated?

There were eight interior stations where water surface elevations, salinity, and temperature data were available to aid in the calibration of the model. There were three stations in the LMR (El Jobean, North Port, and Snook Haven), three stations in the LPR (Punta Gorda, Harbor Heights, and Peace River Heights), one station on Shell Creek, and the UF station in UCH. In addition, water velocity data were available at several vertical locations at the UF station.

There is very little stratification in salinity except at the lower stations, e.g. El Jobean, Punta Gorda, and the UF station. Except during an extremely dry period in June 2004, no salinity appears at the upper stations of Snook Haven on the LMR and Peace River Heights on the LPR.

Data collected during the period of 12 Dec 2003 to 9 Apr 2004 were employed in the calibration of the model, with data from 13 Jun 2003 to 9 Jan 2004 and 19 Apr 2004 to 11 Jul 2004 used to verify or validate the model. In the simulations, the first 30 days of the simulation were used to spin up the computations. Thus, there was no attempt to try to accurately specify the initial salinity field. Model parameters such as bottom roughness, background eddy viscosities and diffusivities were varied during the calibration phase with no variation during the verification phase. This two step procedure of calibration and verification is the accepted procedure when conducting numerical modeling studies.

Model results were compared with water surface elevation, velocity, and salinity data at the stations listed above. Temperature results were also compared, but these computations had very little impact on the salinity and hydrodynamics. Generally the computed water surface elevations matched well except at the upstream ends of the LMR and LPR. This is likely due to inaccurate bathymetry data for the floodplains.

Velocity data were available at the UF UCH station. Given that measured velocity data are at a point and that the grid resolution near the UF station is relatively coarse, the agreement is relatively good.

A visual comparison of the computed salinities with the measured data reveals that at times the agreement is good but not as good as at other times. However, the extent of salinity intrusion is computed well. Considering the uncertainty in the ungaged freshwater flows, boundary conditions obtained from the UF 3D model, etc, the agreement is considered acceptable. This is especially true since differences in model simulations are used in setting the LMR MFL rather than absolute values. Generally the match between model results for the calibration phase is a little better than for the verification phase. This is to be expected.

Visual comparisons of model results and field data are subjective and only provide a qualitative assessment of how well the model matches the field data. The District also computed several statistics to quantify how well the model matches field data. These statistics included a skill parameter using an equation developed by Wilmont (1981), mean errors, mean absolute errors and R^2 values. These statistics are listed in Tables 3-5 of Appendix 5. The Wilmont skill parameter varies between 0 and 1, with 1 being a perfect match. The average value for the skill parameter over all stations was 0.91 for the water surface elevations, 0.84 for the one velocity station, and 0.87 for the salinity. These are actually fairly good given the uncertainties mentioned above.

The Panel accepts that the calibrated UHC-LMR-LPR numerical hydrodynamic and salinity model is based on the best available data and can be used in setting the LMR MFL. As more of the system becomes gaged for freshwater flow, additional simulations should be made and will likely yield more accurate computations.

Section 2. Chemical and Biological Analyses, MFL Evaluation

The section below presents some of the Panel's comments on the chemical and biological analyses, and the MFL evaluation. Additional feedback on these areas are provided on a chapter-by-chapter basis in Section 3.

2.1. Dissolved Oxygen

The District reports that if flows increased gradually, then salinity in the lower Myakka River was depressed and the resulting plume from additional higher flows had insufficient relative buoyancy to result in stratification. On the other hand, if the wet season begins abruptly while the lower river is still relatively saline, then a moderate increase in flow can result in a buoyant plume of fresh water, stratification, and subsequent hypoxia that threatens most fish and shellfish species. This creates potential violations of Florida's state water quality standards, which contain DO criteria for Class III marine waters such as these that call for an instantaneous minimum of 4 ppm and a daily average of not less than 5 ppm (4 and 5 mg/L DO concentration, respectively). This standard may be practical and scientifically appropriate for inland freshwaters, but it is problematic in warm shallow estuaries with high biological productivity. For example, with 100% saturation of 25°C (77°F) freshwater (0 psu) at sea level atmospheric pressure (760 mm), the DO concentration is 8.4 mg/L, declining to 6.2 mg/L when both salinity and temperatures are high (35 psu at 30°C or 86°F), and this is for sterile water with no biological or chemical oxygen demand. If the coastal waters are alive with biota and contain any pollutant runoff, then there is no way to consistently maintain DO concentrations above 4 mg/L at night when plants switch from O₂ production (i.e., sunlight-driven photosynthesis) to O₂ consumption (i.e., plant respiration).

The District concludes that flow reductions are unlikely to impact the occurrence of hypoxic conditions in the low salinity habitats upriver if these are the product of the addition of DO depressed water from adjacent flood plain storage (unless reduction techniques include shallow groundwater withdrawals). Downstream below river kilometer 5, hypoxic events could be reduced by flow reductions if withdrawals modify the establishment of stratification. In addition, the District suggests that hypoxic events would likely be reduced if withdrawals either reduced the total flow (perhaps below 400 cfs) or if the rapid increase in flow at the onset of the rainy season is attenuated such that stratification does not form as rapidly. **Based on the data presented, it is apparent that summertime hypoxic conditions in the primary bay, Charlotte Harbor, are also associated with large freshwater inflow events.**

2.2 Chlorophyll

It is interesting to note that the District reports chlorophyll *a* maxima greater than 20 µg/l in any portion of the river were typically limited to when flows were less than ~600 cfs. **This suggests that chlorophyll *a* maxima may be expected to increase and move upriver under any significant reduction in flows,** although the degree of change is uncertain because it cannot be quantified from the present information, according to the District. Overall, chlorophyll *a* values in the Lower Myakka seldom exceed

20 µg/l, and the median value for the lower river (5 µg/l) is less than the median chlorophyll *a* value (8.5 µg/l) for Florida estuaries, **which suggests that the augmented flows and nutrients from upstream agricultural activities have not had a significant deleterious effect on water quality in the Lower Myakka River.**

2.3 Fish

While the MFL determination seems to depend more on the sensitive freshwater and resident estuarine organisms in the brackish waters of the lower river, it is really the marine species that are the object of most coastal fisheries management. Without food, cover, and physiologically advantageous water quality conditions in their inshore nursery habitats, the coast becomes a poor producer of many of these economically important fishery species (shrimp, crabs and marine fishes). Oysters and clams, like several of the resident estuarine fishery species, are adapted to variable salinity conditions, rather than the stable conditions most often required for freshwater and marine habitats. Indeed, the variation in daily flows protects them and others from biological “over dominance” wherein a winner in the competition for salinity habitats continues to outcompete others to the detriment of the desired ecosystem’s ecological health and productivity. Salinity variation also protects against an overwhelming invasion/infestation of marine predators, parasites and disease organisms into the estuarine nursery areas. **Nevertheless, the District’s use of freshwater and resident brackish water taxa was appropriate given their goal of determining the MFL of the lower river only, as opposed to determining the inflow needs of the entire bay and estuary system at once. Because the Lower Myakka River is highly non-linear, any impacts will be magnified, particularly on these low (< 2 psu) salinity species, and especially during low flow periods.**

2.4 Fish, macroinvertebrates and plankton

Fishes and macroinvertebrates were collected from the Lower Myakka River and Myakkahatchee Creek during 2003 and 2004, an unusually wet period that compressed some salinity habitats and in general moved isohalines substantially downstream (Peebles et al. 2006). Additional planktonic samples were taken during a prolonged dry period with low flows from February through June 2008 (Peebles 2008). Bay anchovy (*Anchoa mitchilli*) larvae and juveniles were both the most abundant fish species and most frequently collected. Hogchoker (*Trinectes maculatus*) was the second most abundant species.

Fish eggs were more abundant near the river’s mouth and declined upriver. Peebles et al. (2006) found percomorph eggs, probably from sciaenid fishes (i.e., drums, croakers and seatrouts), to be the most abundant of the planktonic fish life stages in the lower Myakka River. They had a center of abundance at river kilometer 8.6 and a weighted mean salinity of 22.6. Further, the planktonic stages of all fish and invertebrate taxa collected exhibited a spring maxima in the month of April. Larval densities were also high during the spring. Juveniles, on the other hand, were most abundant in the winter months. The numbers of taxa present in both the ichthyoplankton and the invertebrate zooplankton generally

increased from a winter low to a spring maximum, followed by a decline through the late summer to the fall.

Peebles et al. (2006) and Peebles (2008) also presented regressions to predict the abundance of different life stages of various fish and invertebrates species in the river as a function of freshwater inflow. A number of regressions (i.e., 9 from the plankton sampling and 4 from the seine and trawl sampling) relating the abundance of taxa with river flow were selected for use in the District's minimum flows analysis. Interestingly, the District concluded that the regressions for the plankton samples were more robust because they covered a greater range of flows and, thus, they were given greater emphasis in the minimum flows analysis than the predictions developed from the seine and trawl samples.

In addition, the distribution of fish and invertebrate taxa collected in the plankton samples was quantified as Km_u , or the density weighted center of catch per unit effort, expressed in river kilometers. This parameter does not describe the variability of a population about its mean value, but it can provide useful information about where in the river the population is distributed under specific inflow conditions. Regressions were then developed to predict Km_u as a function of freshwater inflow. The District reports that as flows increased these organisms were displaced downstream. Conversely, when flows declined, populations of these taxa migrated upstream through a variety of transport mechanisms. Shifts in Km_u resulting from reductions in freshwater inflow could result in a loss of recruitment or abundance if a population shifted away from what are the most desirable habitats for that species. In most regions of the lower river, the area and volume of riverine habitats decrease progressively upstream and, therefore, the upstream movement of a population due to large flow reductions can compress that population into smaller regions of the tidal river with less habitat area and volume. As a result, shifts in Km_u were used as an ecological indicator in the determination of the MFL for the lower Myakka River.

The Florida Fish and Wildlife Conservation Commission's Fish and Wildlife Research Institute (FWRI) collected fish and macroinvertebrates using both seines and trawls. The organisms sampled by seine are considered more indicative of shallow-water and shoreline habitats, while a trawl typically samples the deeper water habitats along the middle of the river channel. Species selected for detailed analysis included the pink shrimp (*Farfantepenaeus duorarum*), blue crab (*Callinectes sapidus*), bay anchovy (*Anchoa mitchilli*), sand seatrout (*Cynoscion arenarius*), spotted seatrout (*Cynoscion nebulosus*), and southern kingfish (*Menticirrhus americanus*). Many of these species have peak utilization of estuarine nursery habitats in the springtime and grow out through the summer and fall. For example, the sand seatrout spawns near bay passes or inlets in the Gulf of Mexico between March and August with a spawning peak during spring. Similar to the previous analysis of the planktonic life stages, linear regression of Km_u against freshwater inflow were performed on the taxa collected by seine or trawl, of which over half exhibited significant distributional responses with freshwater inflow.

Unfortunately, the short (20 month) duration of the sampling and the limited variation in inflows made this expensive nekton sampling effort less useful. The District remarks that unlike the additional plankton sampling under low flow conditions in 2008, the seine and trawl sampling was not reinstated due to cost constraints. As a result, the predictive ability of the seine and trawl regressions is limited to higher flow conditions that were not particularly useful for the minimum flows analysis. **The Panel**

agrees that continued seine and trawl sampling would have strengthened the inflow relationships observed between nekton abundance and distribution in the lower Myakka River.

2.5 MFL Evaluation

2.5.1 Baseline conditions

The District chose to use the existing flow regime of the Lower Myakka River as the baseline for assessing the effects of potential flow reductions on natural resources of the lower river. This means that the baseline condition includes the historical alterations to the Cowpen Slough and the Blackburn Canal. These alterations resulted in a decrease of freshwater from the River. **The Panel agrees that these two diversions are generally more important during high flow times, which would make them less important under the low flow conditions that are the focus of the MFL.** However, the fact that all of the supplementary flows will be removed with the diversions in place means that the lower portion of the river could potentially experience a situation that is worse than historic conditions. It would therefore be useful to compare the scenario in which excess agricultural flow is removed from the current conditions, as simulated for this report, with the historic condition (e.g. before these diversions were in place and before excess flow was delivered from the watershed). In addition to the fact that the two diversions are removing fresh water from the Lower Myakka, there is also the possibility that dredging of Charlotte Harbor and sea level rise may have also served to increase the inflow of saltier water from the ocean. Will removing excess flow from the watershed, as is currently planned, result in the River being saltier than it was under historic conditions? If that is the case, it would then be a useful exercise to estimate how much water would be necessary to bring the system to the historic salinity conditions. There is some language in the document about potentially mitigating for the effect of the removal of the excess flows by storing water and it would be helpful to understand what might be necessary to do this in this context.

2.5.2 Determination of Blocks

It has been a long-standing practice of the District to define the dry season as Block 1 (April 20 to June 20), the intermediate flow season as Block 2 (October 28 to April 19), and the high flow season as Block 3 (June 21 to October 27). However, the seasonal blocks were altered in this analysis such that Block 1 now begins on March 1 (and still runs through June 20). **The Panel supports the District's decision to include inflow in March in Block 1 in order to protect early spring spawners.** The rationale for this adjustment is that in the warm subtropical waters of the Gulf of Mexico, early spring spawners, including a number of important sciaenid fishes (many drums, croakers, and seatrouts) and penaeid shrimp (e.g., brown, white and pink), are present immediately after the winter (January-February), and continue through the spring (March-May).

However, the implications of this adjustment for the other indicators need to be evaluated. Including March flows results in lower salinities for this period, which will affect the predicted reductions in habitat due to withdrawals. This adjustment may be problematic for the OTF analysis, as described

below. There is also some confusion in the report where the old Block 1 interval was used in some analyses and the new Block 1 was used in others (and in some cases it's not clear which were used).

2.5.3 Evaluation of the impact of flow reductions on bottom area and water volume.

The UCH-LMR-LPR numerical hydrodynamic and salinity model was used to predict the impact of various flow reductions at the Sarasota gage in terms of the amount of areal (i.e., river bottom), and volumetric (i.e., water volume) habitats within various salinity ranges. The impact of these salinity changes could then be related to impacts on natural resources in the Lower Myakka River.

For this analysis, the calibrated UCH-LMR-LPR model was employed for a four calendar year simulation from 1999 to 2002. Changes in salinity were evaluated for the entire simulation and for three seasonal blocks within the modeled period. These were: Block 1 (March 1 – June 20), Block 2 (June 21 – October 27), and Block 3 (October 28 – end of February). The 1999-2002 period was generally drier than the complete baseline period of 1995-2005 used for other analyses (see below), so it can be considered as a conservative flow period with a built-in safety margin. The same boundary condition data previously discussed were also required in the four year production simulations.

Application of the UCH-LMR-LPR numerical hydrodynamic and salinity model involved modeling the four year period for the existing flow regime and four flow reduction scenarios:

1. Model existing flow regime but remove the maximum withdrawal of freshwater allowed in the City of North Port water use permit. These can range from 3.2 to 9.3 cfs. Model results indicate these withdrawals have virtually no impact on the resources within the LMR.
2. Remove the excess daily flows predicted by the MIKE SHE model from the flows at the Sarasota gage. However, the excess flows to be subtracted were capped at 130 cfs.
3. Remove City of North Port withdrawals and the excess flows predicted by the MIKE SHE model from the Sarasota gage.
4. Model scenario 3 with flow reductions of 10, 20, and 30 percent from the Sarasota gage flows.

Model results from scenario 4 were then compared to model results for the existing flow regime during the same time period.

The District's accepted definition of significant harm to a resource is a 15% decrease in the resource. The salinity regimes for which changes in bottom area and water volume were computed are presented in Table 8-10 of the report. These are based on documented relations between salinity and fish and invertebrate communities in southwest Florida estuaries. When viewed for the entire modeling period, the only flow reduction scenario that resulted in a 15% or greater reduction in bottom area was for the < 2 ppt zone that involved removing the North Port withdrawals, the excess flows, and 30% of the remaining flows at the Sarasota gage. Reductions in water volume produced very similar results since there is little stratification in the LMR. Looking at the bottom area and volume reductions for the seasonal blocks produced different results among the blocks--in Block 1, the 15% criterion was exceeded

for most of the salinity regimes for most scenarios, in Block 2 the only violations occurred for a 30% flow reduction for the <2 and <5 % salinity regimes, and in Block 3, no violations of the 15% criterion occurred.

The Panel finds that the District appropriately applied the UCH-LMR-LPR numerical hydrodynamic and salinity model to aid in evaluating bottom area and volume. The fact that removing excess flows and the City of Northport (scenario 3, above) resulted in such large changes in predicted bottom area and water volume during Block 1 (e.g. bottom area in the 2-12 psu zone decreased by 25% as compared to baseline and water volume in the 3-14 psu decreased by 24%) suggests that **there will be a potentially large reduction in the low salinity habitat available to fish and benthic invertebrates if all of the excess flow (up to 130 cfs) is removed.** The District should consider strategies to ameliorate these large reductions, particularly during the dry season, if they are found unexpectedly harmful to the abundance and distribution of ecologically characteristic and economically important nekton species.

2.5.3 Evaluation of the impact of flow reductions on shoreline length.

The District used the isohaline regression equations developed by Mote Marine Lab to predict isohaline locations for the entire baseline period (calendar years 1995-2004) as well as for the more limited, dryer period used to assess changes in bottom area and water volume (1999-2002). Predicted locations of isohalines were used to assess changes in the location and shoreline length of tidal wetlands for the same flow reduction scenarios described above.

These analyses found that the median position of the 2 psu isohaline would shift upstream to varying degrees under the different flow scenarios, resulting in fairly large changes in shoreline length and area of OTF. Under Scenario 3 (removal of excess flow and North Port Withdrawals), there is a 40% reduction in shoreline length and a 42% decrease in area during Block 1, when evaluated for the entire period (1995-2004). These reductions are lower for the shorter, dryer interval, largely because the isohalines have already moved upstream during the dry period and so the starting area is smaller. These are potentially large changes in a key habitat zone, and it is not clear that there is room for these marshes to shift upstream.

As mentioned above, the adjustment in Block 1 may be problematic for the OTF analysis, as the adjusted Block 1 tends to have higher flows, which means that salinities averaged over the period will generally be lower. Given that on page 7-18 it is stated that “movement of the 2 ppt isohaline during block 1 would be the best indicator for potential changes to the OTF marsh community” the Panel recommends evaluating the difference between using the old block 1 and the new block 1 for the location of the 2 ppt isohaline under the different flow scenarios. It is also unclear which blocks were used in the analyses presented on p. 6-23.

2.5.3 Evaluation of the impact of flow reductions on fish, macroinvertebrates and plankton

The District used the fish, macroinvertebrate and plankton surveys described above to calculate percent reductions in the daily abundance of selected indicator taxa. Values for plankton taxa are percent

change in total abundance in the river, while values for seine and trawl taxa are for percent change in catch-per unit-effort. Similarly, the District also calculated percent reductions measured as differences in the normalized areas under cumulative distribution function curves. Percent changes in the abundance of taxa, calculated as the difference in the areas under the cumulative distribution function curves for the baseline versus the flow reduction scenarios during 1995-2004, began to exceed 15% during Block 1 dry season flow conditions using the total adjusted flow minus the North Port permit. Additional flow reductions of 10%, 15% and 20% widely exceeded the 15% loss limit in these living resources. Percent changes in the abundance of taxa, calculated as the difference in the areas under the cumulative distribution function curves for the baseline versus the flow reduction scenarios, began to exceed a 15% loss when the total adjusted flow minus the North Port permit was reduced by an additional 10% in Block 3 and an additional 15% in Block 2.

2.5.4 Proposed MFL

Based on the above analyses, the District has set the MFL for the Lower Myakka River as follows. Flow reductions should not exceed the excess flows (capped at 130 cfs) computed by the MIKE SHE model until flows exceed 400 cfs at the Sarasota gage. Above a flow rate of 400 cfs at the Sarasota gage, 10% of the remaining flow above the excess flows can be removed. **This MFL is most applicable to the reach of the river from the river mouth to just upstream of the confluence of the Blackburn Canal at river kilometer 32.** Only under extreme low flow conditions can any brackish (~ 1 psu) waters be found at the upper end of this reach. From there to river kilometer 51, the river is completely fresh; therefore, the MFL presumably will be protective of this segment of the lower Myakka River as well. Further, the proposed minimum flows are very close to the flows the river received before the flow augmentations in the upper river began in the 1970s. In this regard, it should be noted that excess flow after the 1970s has increased the abundance of a number of species such as mysid shrimp (*Americamysis almyra*) and hogchokers (*Trinectes maculatus*.)

The proposed MFL will result in upstream shifts of some ecological communities and reduced abundances of some fish and invertebrate species in the lower Myakka River. The District justifies this as being necessary and appropriate to return the river to a more historical condition. However, the Panel recommends that the District consider implementing adaptive management strategies that include at least partially replacing lost excess flows during low flow periods, especially in the dry springtime when estuarine nursery habitat usage is highest.

Section 3. Detailed comments

Executive Summary

- p. xxxix This makes the case that the river is currently in good shape, and that the excess agricultural flows have been balanced to a degree by the loss of freshwater through existing modifications. These other modifications actually exacerbate the situation downstream. Although the Panel accepts that the Diversions are considered part of the existing situation (there are no current plans to change that) so that it makes sense to evaluate the potential effects of flow removal with the Diversions in place, it must be recognized that removal of all of the excess flows will potentially result in a situation that is worse than historic conditions.
- p. xl The first paragraph, which describes the meat of the MFL, is difficult to follow. Also, as mentioned in the main recommendations, **the cutoff of 400 cfs may need to be revisited.**

Chapter 2

- Most of Chapter 2 describes other methods, such as regression analyses, that were used by various investigators to estimate flows from the small sub-basins, while only the last few pages of the chapter are devoted to describing the large HSPF modeling effort and the unit area runoff estimates for rural versus urban areas made by SDI consultants, which were the ones actually used as the important hydrologic inputs to the hydrodynamic and conservative mass transport models that form the basis for evaluating change scenarios in the final MFL analysis. It is unclear why the District did not use any of the other estimates or produce new ones for the MFL, but if that is the case then **this chapter should focus primarily on HSPF and SDI consultant estimates of ungaged rainfall runoff**, and only mention the other efforts briefly.
- p. 2-5 Is more recent land use information available? How much has changed since 1999? (has there been an increase in urban land cover?) Is this what the watershed runoff model is using?
- p. 2-8 It would be useful to have a complete map showing all the various gages and places mentioned in the text. Here are some things mentioned in the text: Curry Creek, Cowpen Slough, Laurel, Myakkahatchee Creek, Cocoplum Waterway, Myakka River State Park, county lines and names, North Port.
- p. 2-14 5th para, line 5: Reporting that the average flow of the Myakka River near Sarasota is 256 cfs, equivalent to 15.2 inches of runoff per year, is fine as a hydrological observation, but it is not very biologically meaningful. A better measure of central tendency is a median based on the frequency of flow rather than its total volume. In this case, the median flow is only 80 cfs, a factor of 3 smaller than the mean, which indicates the system is dominated by high flow events. It is the median that appears about right for a river of this size as a long-term flow minimum flow need. **Dewatering the river below this central tendency flow, even under the emergency condition that we call drought, needs to proceed with caution.**
- p. 2-15 Again, can all of these gages please be laid out on one map? Although several of the 15 streamgages shown in Table 2-2 have records with as little as 5-10 years of data, they are or at least should have been useful for calibrating and verifying rainfall

- runoff flows from the ungaged watersheds of the lower Myakka River. Since only one was used, perhaps this is why the uncertainty of the ungaged hydrology is large.
- p. 2-26 How might the regressions of fish and invertebrates be affected if flows in Blackburn Canal were included? Is it that the flows from the Sarasota gage haven't been adjusted for the potential loss of water through the Blackburn Canal? If so, wouldn't this mean that a given density of fish corresponds to slightly less actual inflow than is assumed in the relationships. Is that correct? The District should consider using flows from the Blackburn Canal and other missing waterways in the MFL analyses next time (5-10 years) when they revisit the MFL determination of the lower Myakka River.
- p. 2-29 Would be nice to have new info. on flow from Warm Mineral Springs. What evidence is there that this might be "significant"?
- p. 2-30 If the interval for the blocks was adjusted, why is this section using the old intervals? This contrasts with p. 7-13, where the information is repeated but done with different blocks.
- p. 2-31 Why not present rainfall analysis to coincide with interval analyzed for Big Slough (1980-2005) to facilitate comparison? (vs. pp. 2-53, 2-58)
- p. 2-34 Here again, if the dates of the blocks are changed for this analysis then it's confusing to see the hydrological analyses using the other intervals. On the other hand, this might be a good place to compare the flows in the old vs. adjusted Block 1 (to show the difference), which could be referred back to if the OTF calculation is re-done. Also, intervals on p. 2-41 are slightly different (June 20 vs 24).
- p. 2-35 Last para. refers to a consistent increase in May, but the slope is not very high for this month. Is something missing or have the increases been that incremental?
- p. 2-37 Can stats be run on a shorter time period (1987-present) to back up the information in the 2nd para.?
- p. 2-47 Does the fact that the excess flows are similar for ag (last para, 7-15 cfs) and total (2nd para) mean that all excess flows in the dry season are due to ag? Should say so.
- p. 2-50 There appears to be a discrepancy between the upper river report and the MIKE SHE model, which implies that excess flows may not have increased in the wet season—did the other report show an increase in flow during these months? Seems better to trust empirical evidence than a model. If there is a trend over time towards increased flow, that says they are likely now higher than historic flows as opposed to the condition here that shows times when existing flows are lower than historic. Have there been changes in rainfall?
- p.2-53 Talks about how a change to urban land would increase runoff rates, which is true in terms of rapidity but it wouldn't mean an actual increase in water. Would need a new source.
- p. 2-57 last para: why not do the same time period at the Sarasota gage to try to tease these apart/separate these effects? It seems like it could be driven by rainfall. Did wet flow at the Sarasota gage increase over the last 25 y?
- p. 2-61 2nd para: is it rate of delivery or absolute amount that has increased. Wouldn't change in land use to urban mean the water would get there eventually through GW?

Chapter 4

This chapter was poorly organized and difficult to follow. The outline doesn't make sense (look at the table of contents); parts of the chapter switches to past tense (e.g. section 4.5.4); some of the sections are repetitive. We suggest a thorough re-organization, and separating the material from Temperature on (section 4.4) into a separate chapter. Some suggestions for reorganizing the first 62 pages are to set things up as follows: 1) salinity data, 2) interpolated isohalines, 3) regression methods 3a) factors considered 3b) data sources 3c) approach 3d) results 3e) evaluation of results 4) predictions. Some of the detail here about the regression models could just be in the appendices.

Section 4.5.4 should precede 4.5.3, and they don't seem like they need to be stand-alone sections. Is section 4.5.4 really about straight description of isohaline position without any regressions? If so, the section title is misleading, and we would suggest a new section head on p. 4-39. However, p. 4-39 starts with what the regression found before setting up what went into the regression. It was difficult to understand what was actually done. It seems that once the isohaline positions were interpolated (based on data), regressions were applied to relate their location to flow. Is this the case? If so, it needs to be clearer. Also, the 1st para: on p. 4-39 is about preliminary regressions. Once things were learned from the preliminary investigations, were the models refined?

- p. 4-1 2nd para: this seems like it would be better after the description of the regressions.
3rd para: also seems out of place.
- p. 4-11 3rd para: were the MIKE SHE predictions used in the regressions?
- p. 4-16 Fig. 4-10 caption: are the differences between the periods due to the differences in gages used?
- p. 4-28 1st para, last sentence: does this sentence refer to the mean, or to the daily variation in salinity?
Last para, last sentence: does this mean that the variability within a day is similar to the variability observed when comparing the daily mean values of several days?
- p. 4-39 1st para: this is about preliminary regressions. Once things were learned from the preliminary investigations, were the models refined?
2nd para: 1st sentence repeats info. from above.
- p. 4-41 These all look log-linear. Are there differences in the model form?
- p. 4-42 The first paragraph repeats information and is out of place. If stratification is not included in regressions, were vertically averaged positions used? Or were separate regressions done for surface and bottom? Were they evaluated independently? After p. 4-42 is where the information on 4-39 and how the regressions performed. Or perhaps that comes in the following section? It's hard to know whether some data were pulled out for verification, or if it should be included in the section beginning on 4.44. Once regressions are explained (section 4.2.4), can follow with section 4.5.5 (verification).
- p. 4-44 A lot of the info is redundant: use of mean tide and weather, differences in flow periods. State one time clearly.
- p. 4-47 Seems to start a new section on application at the top of the page.
Info. on fixed station regressions being limited seems out of order.
Does it make sense to use separate variables in the regressions for each isohaline? Are there data on the performance of each one?

- p. 4-53 Where are observations from? Which data were modeled?
- p 4-54 1st para. seems like another new step. Once data are presented and used to determine the most appropriate model form and break points, then the actual regression/prediction relationships can be applied. And then section 4.5.7 is the application
- p. 4-55 This table is difficult to understand. What are the differences between the top and bottom half of the table? What is the reader supposed to be looking at?
- p. 4-57 It would be useful to see a scatter plot comparing modeled vs. observed salinity.
- p. 4-62 1st para: Where did salinity increase?; what reference gage site?; change in salinity from 0-15 at what station?
2nd para, last sentence: If temperature increased (and was it significant? Right now it just says “appear”), what does that mean/ is it important?
- p. 4-66 There is no water quality data in the report—it is all in the Appendix. Seems like one could cut back on a number of figures in the first half of the chapter and include at least a few representative figures here.
- p. 4-68 last sentence: The water temperature data aren’t shown, but isn’t the fact that there’s no pattern of DO vs. water temperature in part due to the fact that this is only during warm months (July – Sept).
- p. 4-69 last sentence: this does not seem correct: Figure 4-68 shows depressed DO at all stratification levels.
- p. 4-70 Is the top figure surface or bottom water, or combined?
- p. 4-73 Again, it would be nice to see info. on organic and inorganic N forms. Could that be added to Figures?
- p. 4-78 Using the weight:weight ratio of N:P is o.k., although this is usually expressed on a molar basis
- p. 4-81 4th para: alternatively, could seasonality in flow lead to downstream shift in chlorophyll during higher flow, rather than a fundamental difference in response between the upper and lower portions of the river?
- p. 4-88 The DAYS function is not an approximation of residence time because the basin is being filled with freshwater, which ignores tidal flushing and the presence of saltwater. This means that the approximation would get worse downstream where there is increased flushing and increased salinity. One way to estimate this is to use the freshwater volume rather than the total volume. As it stands, please delete the last phrase in paragraph 1 about this representing tau.

Chapter 6

The description of the wetland community was confusing and often redundant. This could be reorganized and cut way back. Some suggestions: No need to show figures like 6-7 and 6-8. This information could all be in a table.

Section 6.2.4 is out of place, and it is not actually about flow change scenarios. This whole section could be condensed and combined with the information presented on p. 6-13. Section 6.2.5 is also repetitive/reaches the same conclusions already presented on 6-13. The statement about the location of the OTF marshes is repeated again on p. 6-22.

Table 6-2 is redundant with 6-1. And how does it compare to the species listed in Table 6-3?

Section 6.2.6 could be a place for some of the information currently on p. 6-17.

The section on p. 6-26 is extremely rough, with awkward sentences and fragments. There is also no section number.

p. 6-10 3rd para: Why would freezes affect upstream mangroves only? Doesn't make sense unless the buffering effect of the near Gulf provides the difference noted.

p. 6-23 Which blocks were used in this analysis? The original or modified Block 1?

p. 6-28 last para: shouldn't it say that a given species would have a wider salinity tolerance in a system with a **greater** rate of change?

p. 6-36 1st para: Why was this species comparison done? What is the point of Table 6-7?

Last para: It is difficult to discern three faunal clusters—is this supposed to be in the figure?

p. 6-39 This figure is confusing. What is the x-axis/how should this be interpreted?

p. 6-67 1st para: Is the positive response considered a stock response?

2nd para: the word “conversely” implies the remaining 7 (23-16). Is that correct? This is confusing, as the paragraph is set up as a discussion of positive responses. Or are these the other 28 species? (51-23). Please clarify.

3rd para: is this a recruitment or a stock response?

p. 6-74 2nd para describes 82 pseudo-species, but p. 6-76 talks about 98. Was there a different number in the two analyses?

p. 6-76 1st para: were the rest of the responses positive?

Chapter 7

p. 7-1 last para: makes the point that the river can affect the Harbor, but what about the Harbor affecting the River? This shouldn't be discounted. This point was also made in the discussion about using the UF 3D hydrodynamic model to provide boundary conditions for the 3D/2D model.

p. 7-5 The report states that during May (a low flow month), there is no loss of water to the Blackburn Canal. However, additional water is entering the estuary due to excess flows in the watershed (43% of the gaged flow). Are there estimates for the proportion of excess flow during other months?

p. 7-12 It might be worth pointing out that the District has used 15% loss threshold in establishing the MFLs of other estuaries.

p. 7-14 The information in the 3rd and 4th paragraphs is out of place—it is part of the set up and not the goal. This should be moved to an earlier chapter. Also, why introduce salinity schemes that are not used?

Chapter 8

p. 8-4 The numbers in Table 8-1 don't seem quite right: 3rd para says that it's 276 cfs, but $329 - 56 = 273$. Similarly, in Table 3 Group 1, Block 3, USGS – total excess ($620 - 116$) = 504 and not 510 (as written). Was the excess readjusted for the location of the gage? Minor errors like that occur throughout the table.

p. 8-6 2nd para. Could Method 2 results be added to Table 8-1?

- p. 8-8 2nd para. Would be useful to add a third limit (3) flows were added to gaged flows when model predicted that historic flows were greater than flows under current conditions. Is that a realistic scenario given general trends in development?
- p. 8-24 1st para: This could probably use a new section head.
- p. 8-28 2nd para: This paragraph is confusing. If water runs off quicker now than it did historically (due to changes in watershed storage), there will be less slow release following wet periods than there was historically. Is that the explanation for reduced flows now in comparison with historic conditions? (i.e. are we talking about several days after a rain?) What was simulated for the MFL analysis, and why does it say that the amount that might be removed as part of the management option is greater than these excess flows? Is something backwards?
- p. 8-34 This formula is probably unnecessary. It's just the proportion of area in the new scenario as compared to the baseline.
- p. 8-38 Fig. 8-27 is unnecessary—it doesn't add info. vs. the table.
- p. 8-48 how would these results change with a diff. Block 1 date?
- p. 8-50 last sentence: Please explain what this means/how lateral extent of the OTF affects the proportionate change.
- p. 8-53 2nd para: The distinction between what can be learned from the median location vs. the CDF/NAUC method is confusing. The fact that there are similarities among scenarios does not explain why the two methods were similar (1st sentence). The 2nd to last sentence again discerns among scenarios, not differences between median and CDF method. Just saying that median and CDF provide the same results. Possible rewording: "methods were **closer**, since"; "< 2 psu **was affected by** flow scenarios" [vs. median location?]
- p. 8-55 Why was 5-day flow used in these analyses?
- p. 8-64 1st para: does this mean that if a species was outside the regression for any scenario, it was not evaluated at all (values set to 0). If that is correct, does it mean that this analysis was done for less than half the species?
4th para: So plots in Figures generated using only the common set of dates?
- p. 8-67 Were these analyses done on all flows or just those within the range of the regressions?
- p. 8-69 1st para: were unusual in that changes...were **greater**. Is this backwards?
4th para: It would be useful to see the Tables that are now in 8-U. Taking out some of the redundancies in this chapter would provide room to include them here.
- p. 8-70 last para: It's not the CDF method that shows greater reductions—this would be true for any method.
- p. 8-72 2nd para: Which taxa were calculated using both methods?
3rd para: The info. in this para. needs to be in a table—it's very difficult to evaluate as presented.
- p. 8-77 2nd para: shouldn't it be 9 to **17** percent?
- p. 8-79 These figures seem like they could be in the appendices—they don't add very much. Seems like the info. is all summarized in tables.
- p. 8-80 1st para: This is confusing. If a regression on log-transformed data is linear, then the relationship to non-transformed flow is **not** linear but rather exponential. The sentence referencing Flannery et al. is just the definition of slope. I also do not follow the next sentence: Negative (not positive) slopes closer to 0 don't necessarily indicate a response to low flows.

p. 8-82 2nd para: which of the relationships in Table 8-21 was used and why? Does the relationship include flow from both gages?

p. 8-90 2nd para: Did Anchoa have a significant inflow regression?

p. 8-91 Can the info. in Table 8-3 be converted to % so that it can be color coded/compared with 15% cut-off?

Section 4. Response to Charlotte Harbor National Estuary Program

Lisa Beever, Director of the Charlotte Harbor National Estuary Program (CHNEP), submitted comments on the proposed MFL for the Lower Myakka River in a memo dated Nov. 22, 2010. The Panel's responses to the four recommendations included in the memo are as follows:

- a. Evaluate hydrologic restoration within the last 5-7 years – The CHNEP makes the point that some of the agricultural excess flows have already been reduced due to improvements made after 2003. This would not affect the coupled modeling analyses of bottom area and water volume, which were confined to the 1999-2002 period. However, it does mean that the conditions evaluated for the larger baseline period (1995-2004) could include up to 2 years of data where the Mike SHE model may have over-estimated excess flow. Although these estimates could possibly be refined, **the Panel agrees that this is a moving target and that the District used the best available data.** Moreover, this would not change the overall management strategy of removing excess flow but rather just show that this removal has begun. As described above, the Panel recommends that the District keep track of the excess flow removal in order to be able to evaluate the response of the River.
- b. Reduce proposed Block 1 allowable withdrawals to the 15% habitat reduction threshold – The CHNEP urges the District to use the 15% threshold as a cut-off. The District has argued that changes beyond 15% are allowable in this case because they are restoring the watershed to natural conditions, even if that means larger reductions. The Panel feels that this is a case where adaptive management is important. As described above, we recommend that the District calculate what flow would be necessary to keep the reductions at 15% or below during Block 1, track the removal of excess flow, and monitor the upper reach to see how it is responding to the change in flow. The District has suggested that these dry season flows could potentially be augmented by flow reductions through other diversions (see below) and this may be necessary.
- c. Account for watershed diversions which counteract “excess flow” – The CHNEP suggests that flow reductions through the Blackburn Canal and Cowpen Slough have not been taken into account, and that these historic modifications served to decrease flow. Although the data suggest that these flow diversions are not important during the critical low-flow times of year, **the Panel agrees that the District should evaluate the historic flows** to determine whether the targeted removal of the agricultural flows will end up reducing the freshwater inflow to the Lower Myakka to lower than historic conditions. If this is the case, the District may again need to consider augmenting these flows or re-evaluating the MFL to account for these circumstances.
- d. Establish a link between removal of excess flows and management options for the Lower River – The District suggests management options of Blackburn Canal, Cowpen Slough, or Tatum Sawgrass marsh as a way to partially offset potential reductions in flow, but did not make the MFL contingent on this, and the CHNEP recommends that these be more specifically incorporated. The Panel agrees that these options need to be studied but feels that the decision as to whether it should be formally included in the MFL is a policy decision that should be left to the District. However, the Panel does endorse the call for adaptive management in this system.

REFERENCES

- Chen, X. 2010. Hydrodynamic simulations of the Lower Peace River-Lower Myakka River-Upper Charlotte Harbor System in support of determining minimum flows and levels for the Lower Peace and Lower Myakka Rivers. Southwest Florida Water Management District, Brooksville, FL. 104 pp.
- Dai, Z., C. Li, C. Trettin, G. Sun, D. Amatya and H. Li. 2010. Bi-criteria evaluation of the MIKE SHE model for a forested watershed on the South Carolina coastal plain. *Hydrol. Earth Syst. Sci.* 14: 1033-1046.
- Interflow Engineering, LLC. 2008. Myakka River Watershed Initiative. Task 2.2.8 – Historical and Future Conditions Modeling Technical Memorandum. Technical memorandum dated May 16, 2008, submitted to the Southwest Florida Water Management District, Brooksville, FL.
- Peebles, E.B. 2008. Revised analyses of regressions between freshwater inflow and the abundance and center of distribution (Km_u) for selected fish and invertebrate taxa in the Lower Myakka River to include data collected during 2008. Written correspondence from the University of South Florida, College of Marine Science, to the Southwest Florida Water Management District, Brooksville, FL. 36 pp.
- Peebles, E.B., and M.F.D. Greenwood. 2009. Spatial Abundance Quantiles as a Tool for Assessing Habitat Compression in Motile Estuarine Organisms. *Florida Scientist* 72 (4): 277-288.
- Peebles, E. B., T.C. MacDonald, M.F.D. Greenwood, R.E. Matheson, S.E. Burgarht, R. H. McMichael. 2006. Freshwater inflow effects on fishes and invertebrates in the Myakka River and Myakkahatchee Creek estuaries. Report of the University South Florida, College of Marine Science, and the Florida Fish and Wildlife Conservation Commission to the Southwest Florida Water Management District. Brooksville, FL. 320 pp.
- Ross, M.A., A. Said, K. Trout and J. Zhang. 2005. Hydrologic modeling of stream flow from ungauged areas in upper Charlotte Harbor Basin – Phase 2. Report by USF Department of Civil and Environmental Engineering Center for Modeling Hydrologic and Aquatic Systems to the Southwest Florida Water Management District, Brooksville, FL.
- SWFWMD. 2010. The Determination of Minimum Flows for the Lower Myakka River (Peer Review Draft). Southwest Florida Water Management District, Brooksville, FL. 431 pp. + 638 pp. appendices.
- Xevi, E., K. Christiaens, A. Espino, W. Sewnandan, D. Mallants, H. Sørensen and J. Feyen. 1997. Calibration, validation and sensitivity analysis of the MIKE-SHE model using the Neuenkirchen Catchment as case study. *Water Resources Management* 11(3): 219-242.

Appendix A. Errata and minor editorial comments

- p. xxxvi line 27: RK stands for “river” kilometer, not “fire” kilometer
- p. xxxix Please use the names of the “dominant fish species” and “crustacean”
- p. 2-4 The organization of this section is confusing. We suggest moving the information in the first paragraph that describes the layers to the end of the section.
- p. 2-5 If the sum of uplands and wetlands is what is important, it’s distracting to show them separately because that’s what jumps out. Looks like 1972 definitions of wetlands were different than in later years.
1st para, line 3: Change “1972 and 1999” to “1972, 1990 and 1999.”
- p. 2-13 2nd para, line 10: Remove repeated words “relationship of.”
- p. 2-19 1st para: change “greater of the smaller” to “greater **at** the smaller”
- p. 2-20 This says flow at Big Slough drains 208 km², whereas Table 2-2 says it’s 210 km²
Last para: Insert “**that**” before “was gaged for flow”
- p. 2-22 Last para: insert “**of**” before “predicted flows”
- p. 2-24 Last para: Insert “**is**” after “Blackburn Canal”
- p. 2-25 1st para: change “no operable” to “**not** operable”
- p. 2-28 2nd vs. 3rd para: miles or km between gages?
- p. 2-29 1st para: change “near” to “**nearly**”
2nd para: insert “**in**” after “included”
3rd para: delete “during”; insert “**a**” before “catchment”
- p. 2-30 2nd para: change “initialed” to “**initially**”
- p. 2-32 1st para; change “which to “that”; delete “However”
- p. 2-33 2nd para: insert “**the**” after “with”
3rd para: delete “is” before “uses” Change last sentence to “**As seen in the following section**, the Kendall test **on annual data** was influenced **by**” Why is this the case? (that is, why does an increase in flows affect the Kendall results?)
- p. 2-35 1st para: should be in the same paragraph as 2-34.
1st para: last sentence: do you mean “average” or “mean”?
2nd para: are these mean flows for block 1 or 2?
- 4th para: p<0.05; change to “observed for November though June”; “graphs” instead of “graphics”
- p. 2-37 1st para line 2: Replace “that” with “there” has been an increase.
3rd para: change “years in” to “years”
last para: change “that” to “than”; last sentence should read: “flow trends **that** can affect estuarine resources, **as** many physico....have been **integrated** over preceding...”
- p. 2-41 4th para, line 5: Replace “that” with “there” has been an increase.
- p. 2-43 1st para: insert “on **the** river”; “of **the** upper river”
3rd para, line 4: Fix “19994”
4th para: delete “**watershed** of watershed” insert “in **the** upper-river”
- p. 2-44 3rd para: delete “excess flows **are** described”

- p. 2-45 1st para: insert “in **the** upper river”; change “difference” to “differences” insert “and **the** historic scenario”
- p. 2-46 3rd para: change “an” to “**and** relative”
- p. 2-53 last para: insert “because **the** period” and “at **the** longest-term gage”
- p. 2-54 1st para: insert “**the** Myakka River”
2nd para: delete “on record **were** occurred”
- p. 2-55 last para: delete “**on yearly**”; change “plot to **plots**”
- p. 2-58 last para: delete “**by** is presented”
- p. 4-1 1st para: data were generally incorporated into what?
- p. 4-28 2nd para: last sentence shouldn’t be in past tense.
- p. 4-35 1st para last sentence: change to “flow percentiles **moved downstream with flow**, as expected.”
Change whole page to past tense
Fig. 4-33: please include the salinity values in the caption.
- p. 4-45 Figure caption for 4-41 needs to explain the red line and the dotted line. Are the “observed” isohalines interpolated? Which equations were used for modeling?
- p. 4-46 Are there stats for these fits?
- p. 4-47 1st sentence should be present tense.
- p. 4-56 3rd para: insert “Due **to** the larger”; change “regressions which” to “regressions **that**”
- p. 4-63 Figure 4-58 is extremely confusing. Please clarify the legend/consider separating the information into more than one plot.
- p. 4-73 1st para: what does “PCU” mean?; change sentence to “but increased **flow**”
- p. 4-74 The legend is very hard to see.
- p. 4-75 Figure 4-74 caption needs more detail: Are these surface or bottom samples? What is the source of the data?
- p. 4-80 How are weighted flows calculated?
- p. 4-81 1st para: how were chlorophyll values corrected?
- p. 4-83 Fig. 4-81. Is this averaged over a year?
- p. 4-84 last sentence: are these data shown somewhere?
- p. 4-86 Why are these figures on a log scale?
- p. 4-87 Is there information on organic N as well?
- p. 4-88 last para: which equation was used to predict chlorophyll?
- p. 4-89 The fit on Fig. 4-85 left looks off. Wouldn’t a power function or an exponential decrease work better?
Also, is the fit on 4-85 right significant?
- p. 5-4 1st sentence: change “later” to “**latter**”
- p. 6-2 Would it be possible to add river kilometers to this figure?
- p. 6-3 3rd para, 1st sentence is awkward.
4th para: add “dominated **by** black”
- p. 6-5 1st para. Where is Park located (RK?)
- p. 6-10 1st para: adding river kilometers to this would help: e.g. location of Counties and Tippecanoe Bay
- p. 6-13 2nd para: “further upstream” is transposed
4th para: this is a standard definition of glycophytes (not just Clewell)

- p. 6-32 4th para: Isn't it between km -3 and **18** (rather than 20?); what km is the US 41 bridge?
- p. 6-34 Fig. 6-19 does not provide any real information: a table would be much better
2nd para: The fact that insects are mostly in the upper portion of the river should be qualified
"particularly in June"
- p. 6-36 1st para: change to "invertebrates"
- p. 6-40 2nd para: do you mean Table 6-8?
- p. 6-43 Table numbers again off.
- p. 6-44 "**abundant**"
- p. 6-45 what was the core size?
- p. 6-50 3rd para: is the reference to Montagna 2008 correct?; the last sentence is awkward
- p. 6-52 What are the thick lines for? The legend seems wrong (>0-11)
- p. 6-53 Since all species listed were present in the Myakka, why denote them with an asterisk? (Table 6-12 could say: All species, with the exception of Hobsonia, were present)
- p. 6-56 2nd para: delete "primarily **of** biological"
last sentence: "**fishes**"
- p. 6-57 1st sentence: delete "**have**" add comma "zones, which"
- p. 6-58 1st sentence: delete "**on**"
- p. 6-59 2nd para: minutes' is plural; delete "**was** filtered"
- p. 6-61 3rd para: "fish fauna that **were** collected"
- p. 6-62 Table caption: "postflexion"
- p. 6-63 1st para: "through"; change to "species **would** not be"
- p. 6-64 1st para: "appears"; "to **a** variety"
last paragraph: "plankton **tows**"
- p. 6-66 2nd para: "tide stage **and** at"
- p. 6-67 3rd para: "taxa that **have** positive"
- p. 6-69-70 Would it be possible to add common names to these lists?
- p. 6-70 3rd para: Replace "Menticirrus" with "Menticirrus," which is spelled correctly in the first paragraph on the same page.
last para: The figure shows the highest catch in Myakkahatchee Creek; also, need to refer to 6-35 here. Insert "in" after "common" in estuaries.
- p. 6-76 2nd para: "had maximum abundance" is repeated
- p. 7-2 last para: "just upstream **of** the confluence **with** the Blackburn" "developed for **the** river"
- p. 7-3 2nd para: "**the** City of North Port"
- p. 7-4 1st para: "gages **will** allow"
2nd para: "scheduled"
Last para: "that **the** amount"
- p. 7-5 1st para: Figure 2-14
last para: "1980s to **the present**"
- p. 7-8 2nd para "was **used** for the minimum"
- p. 7-9 last para: repeated on p. 7-11 (3rd para)
- p. 7-12 2nd para: "to determine **whether**"
last para: "and the abundance **of** resources"

- p. 7-13 1st para: “have affected **the** flow regime”; “last sentence is awkward.”
 3rd para: “and **that** if protection”
 Last para: “was to **use** indentify”
- p. 7-14 last para: “surveys **that** were conducted”
- p. 7-15 2nd para: zones of **at** < 11 psu”
 last para: “analysis **for** it can” large number **of**”; “all but one **of**”
- p. 7-16 1st para: “was run was”; “and **the** curve”
 3rd para: “possibly **by** more”; “geomorphology **of**”
- p. 7-17 2nd para: “would not **differ**”
 last para: “from **a** large”
- p. 7-18 4th para: “for **the** entire”
 last para: spotted seatrout repeated
- p. 7-19 1st para: are these the correct figures?; what km has less habitat?
 3rd para: “stages **of** various” “fish and invertebrates”
 Last para: “and **for which** the”
- p. 8-3 “occurred **over** due”
- p. 8-4 3rd para, last line: “This does **not** necessarily mean”
- p. 8-5 Table – seems redundant to have flows from all scenarios in all groups – just separate the different estimates of excess and what that means for USGS-excess.
 Last para: “value for **the** adjusted”
- p. 8-6 4th para: “Since **the** Method 1”; “Excess flows calculated by **the** Method 2... **to model output the gaged record**” is confusing.
- p. 8-7 last para: this info. is repeated
- p. 8-8 1st para: “in **an** increases”;
 2nd para: “removal **of** the”
- p. 8-10 1st para: “for **the** entire modeling period”
 last para: “for **the** most part”; “was **a** very dry year”
- p. 8-13 last para: “plans **that** are being”
- p. 8-16 Table 8-5 Please change title of 4th column to “gaged flows during study period”
- p. 8-18 Table title “Three conditions”
- p. 8-19 2nd para: “not **as** consistent”; “indicating **that**”; “water **is stored** in wetlands”
- p. 8-23 2nd para: “93% **if** the ten-year values”
- p. 8-24 1st para: Is it page 2-22? Also, which regressions are being referred to, HSW or Janicki?
- p. 8-25 last para: “along **with** withdrawals”
- p. 8-27 1st para: Where is Flatford Swamp?
 2nd para: “**other** otherwise remediate”
- p. 8-30 section 8.6.3 “area **for** as a”
- p. 8-31 “below and elevation”; “than a **given** salinity” “**at flows**”
- p. 8-32 1st para: “Means daily”
- p. 8-33 figure caption “less than <” Would be useful to point out scale change.
- p. 8-34 last para: Replace formula in text with correct one.
- p. 8-35 Reference should be to page 8-29; “overall”

- p. 8-41 1st line “2 and 3 **because** the other”
- p. 8-42 1st para: “zones reported”
last para: “to **evaluate** the percent”
- p. 8-46 2nd para: “This is due”
3rd para is quite rough—please review and correct all of the English. Also the references to Figures are off throughout.
4th para: “could **be** potentially”
- p. 8-47 1st para: Section 7.11.3
2nd para “the **locations of the**”; “isohalines, as they”
Figure caption: what are dotted and solid lines?
- p. 8-48 1st para: Do you mean 12 psu isohaline in Block 1?
2nd para: Figure 6-17; Block 1 (21.6 km); Section 7.11.13; “isohalines **during** Block 1”
3rd para “affected **by** long-term”; “with the **with**”
- p. 8-49 Figure caption: What do bars represent?
- p. 8-50 last para: “1999-2002” “area **were** much lower” “marshes **do not**”
Table 8-17: too many significant digits (Table 8-18 as well)
- p. 8-51 Table 8-18 is 4 psu—headers need changing
- p. 8-54 last para: “rates **during which** these marshes”; “if its corresponding”
- p. 8-61 2nd para “and **both mean** and median values of predicted daily abundance” “in **the** following”
3rd para: “to the range of flows”
- p. 8-63 Table: “**only**”
2nd para: “holbrooki **was** because”
3rd para: Fig. 8-8?
last para: “that **fall** within”
- p. 8-64 2nd para: “relying on a single”
3rd para “for **the** 1999-2002”; “**as examples**”; which appendices?
Section head: “relative **to** baseline”
4th para: “abundance calculated”; “**The** steps”
- p. 8-67 1st para: “changes **in** the”; last sentence needs fixing
2nd para: “all flows predictions”
Last para: “and **how** the” “**affected changes in the medians**”
Table legend: The first number represents the % based on the flow...and the 2nd ...”
- p. 8-69 There are numerous typos and missing words, etc. on this page.
- p. 8-70 1st full para: Last sentence is sloppy
2nd para: “Examples CDF”
4th para: “were **lower** in Blocks” “until **with** the”
- p. 8-73 last para: “two timer periods”
- p. 8-74 Which flow domain was used for column B? Also, NP should be written out.
- p. 8-78 3rd para: “abundances **in** were observed for **the** total”
- p. 8-82 1st para: “gage **to** reductions”; last line: what does “increase the number of high abundance reduction values” mean?
2nd para: “which **15%** reduction”

- 3rd para: "below **at** 15%"
- p. 8-83 If this figure is kept in, it would be useful to include the regression info. in the legend.
- p. 8-87 1st para: What was the "corresponding mean flow term" in number of days; "days **in** that"
2nd para "there **was** a large"
- p. 8-88 1st para: "are probably **some** further"
- p. 8-90 2nd para: 1st 2 sentences awkward
- p. 8-91 "three species **is** slightly"
- p. 8-92 numbers all seem off: 1st para: isn't it 0.1 to 0.7 km?
2nd para: "2.1 to **3** km; "2.6 to 4 km"; "2.9 **to** 4.6 km"; "not considered appropriate"
- p. 8-94 4th para: "in addition **to** the"
- p. 8-95 1st para: 2nd sentence is awkward
- p. 8-96 All figure numbers seem off (e.g. 8-27B is actually 8-28B, etc.) on this and the following page.
- p. 8-97 2nd para: "Compared **with** flows"
4th para: "based on **the** sum"
- p. 8-98 2nd para: "for **the** City's"
- p. 8-99 2nd para: "for **the** 1994-"; "on **a** real time"
3rd para: "assess **the** proportion"
- p. 8-100 3rd para: "changes **in** the"
- p. 8-101 "in **the** near term"
- p. 9-15 3rd para: Replace "Riv," with "River," before "Florida."



CHARLOTTE HARBOR NATIONAL ESTUARY PROGRAM

1926 Victoria Avenue, Fort Myers, Florida 33901
239/338-2556, Fax 239/338-2560, www.chnep.org

November 22, 2010

Michael S. (Sid) Flannery
Chief Environmental Scientist
Southwest Florida Water Management District
Brooksville, FL 34609-6899
Via email: sid.flannery@swfwmd.state.fl.us

Re: Draft Minimum Flows and Levels for the Lower Myakka River

Dear Mr. Flannery:

Thank you for presenting the August 24, 2010 Peer Review Draft of *The Determination of Minimum Flows for the Lower Myakka River* to the Charlotte Harbor National Estuary Program (CHNEP) Management Conference committees. On September 7, 2010, we received the report and appendices. We compliment you and the other authors on this very thorough and technically interesting minimum flow and level analysis. We appreciate your efforts to improve each Minimum Flow and Level (MFL) document. Though we are eager to read the comments from the peer review, we wanted to provide you with some initial comments.

As you know, the CHNEP is guided by our *Comprehensive Conservation and Management Plan* (CCMP), pursuant to Section 320 of the Clean Water Act. Our CCMP calls for:

- **HA-1:** By 2015, identify, establish and maintain a more natural seasonal variation (annual hydrograph) in freshwater flows for [...] Myakka River...
 - **HA-A:** Develop a historic and current estuarine mixing model, focusing on salinity and indicator species that are sensitive to salinity changes, and better evaluate proposed capital and operations projects.
 - **HA-E:** Establish minimum flows and levels (MFLs).
- **HA-2:** By 2020, restore, enhance and improve where practical historic watershed boundaries and natural hydrology for watersheds within the CHNEP study area, with special attention to Outstanding Florida Waters and Class I water bodies.
 - **HA-G:** Reestablish hydrologic watersheds to contribute flows to their historic receiving water bodies.

The act of developing an MFL for the Lower Myakka River before 2015 helps to implement our CCMP. We endorse the development of the historic and current estuarine mixing model, focusing on salinity and indicator species that are sensitive to salinity changes. We are also interested in restoring the historic basin boundaries of the Myakka River watershed, with special reference to Cowpen Slough and the Blackburn Canal. In addition, development of an appropriate Lower Myakka River MFL could help compliment the Lower Peace River/Shell Creek MFLs, resulting in more comprehensive water resource management within the CHNEP, supporting the long term sustainability of both Charlotte Harbor and Dona/Roberts Bays.

We are providing the recommendations below, using our CHNEP “Advocacy and Review Procedures” which aim:

- To implement the quantitative objectives and priority actions of the adopted *Comprehensive Conservation and Management Plan (CCMP)*,
- To provide policy-makers with a source of review and comment from an organization which represents considered opinions of diverse interests from throughout the CHNEP study area, and
- To provide a voice for the natural systems within the study area watersheds based on the best scientific information available.

Based on our understanding of the technical information provided, the CHNEP recommends that the following conditions be incorporated into the *Proposed MFLs for the Lower Myakka River*:

- Evaluate hydrologic restoration evident within the last 5-7 years of flow data and the availability of “excess flows.”
- Reduce Proposed Block 1 Allowable Withdrawals to the 15% habitat reduction threshold.
- Account for watershed diversions which counteract “excess flows.”
- Incorporate management strategies within the proposed rule.

Evaluate hydrologic restoration evident within the last 5-7 years of flow data.

We understand that a document such as *The Determination of Minimum Flows for the Lower Myakka River* requires a great deal of time to complete. Because of this most of the data sets used for evaluation concluded in 2006, out of necessity. Phase 1 of the Falkner Farms and Pacific Tomato Growers (PTG) surface water exchange projects was operational by early 2003 and phase II was operational by 2008. The conclusion that the Lower Myakka has “excess flows” is a basic assumption throughout the MFL document, based on 1999-2006 analysis and needs to be re-evaluated in light of restoration and apparent reduced flows after 2003. This is especially true in context of reduced watershed size associated with Cow Pen Slough modification and Blackburn Canal construction.

Reduce Proposed Block 1 Allowable Withdrawals to the 15% habitat reduction threshold.

The District has used 15% habitat reduction as the threshold to define “significant harm.” Tables 8-12, 8-17, 8-19, 8-20, 8-24 and 8-27 all demonstrate habitat reductions greater than 15% for the block 1 period, typically for withdrawals beyond those permitted by the City of North Port. Delivery of water to the estuary during the low flow period is critical for the productivity of fish and invertebrates, as demonstrated in Table 8-27.

Account for Watershed Diversions which counteract “Excess Flow.”

As reported in the document, the construction of the Blackburn Canal and the modification of Cowpen Slough drainage basin diverted approximately ten percent of the historic watershed of the Lower Myakka River toward Dona and Roberts Bays. The District used the low flow regime of the reduced watershed as the baseline to measure the effects of withdrawals, which was an excellent approach. However, the supplementation of flows in the upper river sub-basin and these historic modifications in the lower river sub-basin has counteracted each other to some extent. Though the excess flows have been featured prominently in the proposed MFL, estimates of the historic fluctuations and reductions needs to be incorporated, as well as a minimum flow threshold necessary to support aquatic life in the river, as well as Charlotte Harbor. These additions would create an elegant relationship between water supply and reestablishing hydrologic watersheds to contribute flows to their historic receiving water bodies and assure natural variability and minimum flows are maintained.

Establish a Link between Removal of Excess Flows and Management Options for the Lower River

By accounting for watershed diversions within the MFL calculations, restoration of these historic flows could similarly be part of the calculation. Currently, the document proposes no benefit for water supply when management strategies are implemented nor would “the removal of the excess flows and compliance with the minimum flow rule for the lower river would not be contingent upon the implementation of such management plans.” Providing specific mechanisms to allow incorporation of the effects of hydrologic restoration projects into the Lower Myakka River MFL implementation and calculations would assure that "adaptive management" is achieved.

Summary and Conclusions

The District’s work toward setting MFLs for the Lower Myakka River helps to implement our CCMP and compliments sustainable management of the CHNEP estuaries. Furthermore, this is the most technically complete (and interesting) MFL document to date. Clearly, the technical work supporting MFL continually improves. We are pleased with the use of an integrated surface water/groundwater hydrologic model coupled with a hydrodynamic model. The District’s success in hydrologic restoration (reviewing data post the model validation period of 1999-2006) suggested that excess flow may not be available from the Myakka River. We would appreciate an evaluation of 2006-2010 data which may show depressed flows, probably resulting from drainage projects of the past. We would also appreciate Block 1 allowable withdrawals to be lowered so that the 15% habitat loss threshold is maintained by rule. We would also like the calculation of “excess flows” to take into account historic watershed diversions. This would, in effect, create a water supply incentive to reestablish hydrologic watersheds to contribute flows to their historic receiving water bodies. Finally, we would like to see specific mechanisms included in the MFL to require adaptive management to assure maintenance of natural variability in flow and a minimum threshold of water in the river and delivered to Charlotte Harbor.

Thank you for the opportunity to comment, your responsiveness, and the efforts of your staff to develop MFLs which are reasonable and science-based.

If you have any questions or need additional information, please do not hesitate to contact me.

Sincerely,



Lisa B. Beever, PhD, AICP
Director

DEP Comments

Lower Myakka River MFL (August 24, 2010 Draft)

We appreciate the opportunity to comment on the draft MFL for the Lower Myakka River. DEP's TMDL Section, Florida Geological Survey, Springs Coordinator, and Office of Water Policy reviewed this report. Overall, we compliment the District on its comprehensive analysis and clear presentation of a large amount of data. Conducting many analyses on large data sets can be a daunting task and the District has done a commendable job.

In our comments, we first summarize our major concerns, and then provide more details in the General Comments section. This latter section also identifies areas where expanded discussions could help readers better understand the District's decision-making process. Following this section, we include some minor questions and edits.

Major Concerns

1. Water Quality Data – The report states that the water quality of the lower river is generally good. In contrast, DEP has found that many segments of the lower river are impaired for nutrients and dissolved oxygen, and are included on the State of Florida's 303(d) list of impaired waters. The report should discuss this incongruity.
2. Interpretation of Significant Harm – The District's management plan for the upper river is to remove agricultural excess flows. Much of the data presented in the report indicates removal of the agricultural excess flows upriver will cause more than a 15% change in important ecological indicators in the lower river. See comment 15 below. The report should expand the discussion of significant harm to address these issues.
3. Baseline vs. Target Flows – Similarly, the District accepts today's flows in the lower river as the baseline, but does not use this baseline to set the minimum flows. Instead, the District appears to be applying alternate target flows in its conclusions. The report needs to more clearly explain the development and use of these alternate target flows. See comment 15 below.
4. Reducing Existing Withdrawals in the Lower River – Are there existing withdrawals that affect flows in the lower river that could be reduced to help maintain current flow levels? We recommend exploring this option and including the findings in the report.
5. Compliance – The proposed MFL for the river is descriptive. The MFL should be expressed as a hydrologic statistic, and the report should explain in detail how determinations of compliance will be made.

General Comments

6. In Section 2.2.4 (pages 2-5 ff), land use information is summarized for the years 1972, 1990, and 1999. The report indicates that of all the major land use categories, the amount of land

converted to urban uses has shown the single greatest increase, with most of this increase occurring in the southern part of the watershed. Land use coverages are available for more recent years. Presentation of the most recent land use information would better represent land use changes due to the likelihood of additional urbanization in the lower part of the watershed since 1999.

7. Section 2.4 (pages 2-13 ff) discusses changes to the river's base flow in a qualitative way, as significant increases in groundwater pumping have occurred for irrigation of agricultural lands in the watershed. The report would benefit by presenting information on base flow quantities at the Myakka River near Sarasota USGS gage for different time periods, i.e., before and after significant groundwater pumping for irrigation in the watershed.
8. On pages 3-9 and 3-10, the date of the shoreline study should be included in the text and caption. We're not sure when the shoreline study was completed, but the northernmost extent of mangroves in the river currently seems to lie a few miles northward of the locations depicted in Figures 3-8 and 3-9.
9. In Section 4.5 (pages 4-66 ff), the report indicates that the lower river has generally good water quality and that chlorophyll a values are relatively low compared to other rivers in the region. However, based on DEP's surface water assessment and following the Impaired Waters Rule methodology, many of the water segments in the Lower Myakka River are impaired for nutrients and dissolved oxygen, and are included on the State of Florida's 303(d) list of impaired waters. Three of the four Myakka River estuarine segments are impaired for nutrients, due to elevated annual average chlorophyll a values. Furthermore, the annual average values in this area have been exhibiting an increasing trend since the mid to late 1990s.

The report should discuss these water quality impairments in the Lower Myakka River. The State of Florida's verified lists of impaired waters for the Sarasota Bay-Peace River-Myakka River Group 3 Basin include this information and are available at DEP's web site:

<http://www.dep.state.fl.us/water/watersheds/assessment/index.htm>. In addition, it would be helpful to know if removing the agricultural excess upriver is expected to improve water quality (by removing nutrients) or diminish it (by concentrating existing nutrients).

Also, in this section, most figures simply have the label "...the Myakka River." It is unclear if these figures and the corresponding text refer to the entire river or just the lower segment where the MFL is being proposed (that is, unless the river kilometer is shown). Additionally, in some places, it is unclear if the reference "upriver and downriver sections" differs from "upper and lower river" (for example, see page 4-81, paragraph 4).

10. Segments of the Lower Myakka currently are designated as an Outstanding Florida Water. In general, DEP's rules do not allow water quality degradation in Outstanding Florida Waters. What does the District anticipate will happen to water quality in these designated areas when agricultural flows are removed and the lower river changes?

11. Section 7.7 (page 7-9) states that a low-flow threshold is not warranted, partly because there are no water quality problems in the Lower Myakka that are exacerbated at low flows (apart from high salinity). This statement conflicts with the information provided in comment 10 above, and needs resolution within the report.
12. In Chapter 8, both the data in the tables and the corresponding text should be double-checked for accuracy. It's not clear if the data in the tables are incorrect, or are being misread, as illustrated in the following two examples:
- When referring to Table 8-26 (page 8-68), the text (page 8-69, paragraph 2) says: "Reductions in *Trinectes* juveniles exceeded 15% at... the total adjustment – NP – 10% in Block 3." Our reading of Table 8-26, for both gages, indicates that the reduction in *Trinectes* juveniles exceeds 15% starting with the removal of the North Port (NP) quantity alone, a 16% reduction. Removing an additional 10% from this reduced quantity results in a 21 – 22% reduction. While it is true that 21 – 22% exceeds 15%, this fact misses the point that the >15% reduction begins with removal of the North Port quantity.
- Moreover, the findings at the single gage (Myakka River near Sarasota) need further examination and explanation. At this gage, removal of the agricultural quantities alone results in significant harm for *Trinectes* juveniles and other plankton species during Blocks 1 and 3. The effects of removing the agricultural quantities on plankton populations upstream of inflow from Big Slough Canal (aka Myakkahatchee Creek) should be discussed in the report.
- When referring to Table 8U-1, the text (page 8-70, paragraph 1) says "Reductions in median values for *Americamysis* and *Cyathura* increased slightly in Block 1 for the shorter period, with the Total adjust – North Port – 10% causing 15% change in abundance for these taxa." Our reading of Table 8U-1, for both gages, indicates a 25 – 45% reduction in these two species at the Total adjust – North Port – 10% quantity; the >15% reduction starts with removal of the agricultural quantity alone. For the single gage, removal of these quantities results in even greater reductions.
- In fact, Table 8U-1 indicates significant harm for nearly all species occurs with just the agricultural adjustment. Indeed, several other tables in this chapter (for example, Tables 8-17 – 8-20, 8-27, 8W-4, 8X-4, and 8Y-4) show a 15% change with just the agricultural adjustment for Block 1 during the drier period. The report should discuss how the MFL will protect these species during dry times.
13. For Figures 8-42 – 8-46 (pages 8-79 ff), the meaning of the red line needs to be defined in the caption (or in the text).
14. On page 8-80, paragraph 3, the text says "...the flow rates above which reductions in abundance are less than 15% are observed for *Trinectes* is near a 34-day flow rate of 500

cfs...” when referring to Figure 8-42 (page 8-79). Yet, it appears the first time the red line crosses the 15% reduction reference line on this graph is at about 300 cfs. The report needs to explain why the first crossing of the 15% reference line is not considered. Preferably, this description would explain the meaning of crossing the reference line twice and how this finding is used in the MFL development. Note that this dip in the line near 300 cfs also shows up in Figures 8-44 (page 8-81) and 8-46 (page 8-84).

Furthermore, Figures 8-44B and 8-46B appear to be identical, yet the corresponding text interprets these two figures differently:

- For Figure 8-44B, the text (page 8-80, last sentence) says “...with the smoothed line crossing the 15% reduction reference line at about 400 cfs...” citing the second time the red line crosses the 15% reference line.
- For Figure 8-46B, the text (page 8-82, paragraph 3) says “...[f]lows at which the smoothed line went below 15% reductions were: 280 cfs for the total excess flows scenario...” citing the first time the red line crosses the 15% line.

These two descriptions do not comport, and the document needs to resolve these differences.

15. On page 8-82, the first sentence of the last paragraph begins “Using *Trinectes maculatus* as the most sensitive resource indicator, and accepting the rationale that the total excess flow scenario is allowable...” (*emphasis added*). The report does not present a convincing argument that removing the total excess flow is allowable, mostly because the District’s use of the significant harm criteria for the Lower Myakka River differs from previous applications for other rivers, and this switch in the application is unexplained. We recommend expanding the discussion of significant harm and addressing the following issues:

- The report clearly states that the management plan for the upper river is to remove the agricultural excess flows. Much of the data presented in the Lower Myakka report indicates removal of the agricultural excess flows in the upper river will exceed the District’s established 15% significant harm level, during Block 1, to the identified resources of concern: the oligohaline/tidal freshwater wetland communities, and the mysid shrimp and hogchoker fish populations. The District used 15% change as a threshold in previous MFL analyses. The report attempts to convey that changes greater than 15% are acceptable, but does not identify where the new threshold for significant harm lays, whether or not this threshold was established prior to the MFL analysis, how the threshold was applied during the analysis, or the details of why this threshold change is necessary.
- The report does not discuss prevention strategies. Evidently, because of decision that significant harm will not occur, the District has deemed a prevention strategy unnecessary. However, without knowing what the specific threshold for significant

harm is, it is difficult for the reader to understand how the District evaluated the need for a prevention strategy. Based on the District's application of significant harm criteria in previous MFL evaluations, it would appear that the management plan for the upper river will necessitate a prevention strategy for the lower river. The report's explanation of significant harm should discuss the concept of prevention strategies, relate this concept to the analysis, and make it clear whether or not such a strategy is warranted.

- The report accepts today's flows in the lower river as the baseline. The District's analysis indicates removal of the agricultural excess flows upriver will cause flows to fall below present-day flows (i.e., the baseline) to some alternate target flows that are acceptable to the District. The report does not identify what these alternate target flows are, but it is clear that they fall below the identified baseline. Thus, the "baseline flows" don't seem to be baseline. The report needs to more specifically explain what these alternate target flows are, how and when they were determined, how they were used in the analysis, and why they are acceptable to the District.
- The report periodically refers to the lower river's "present healthy condition" (pages 6-40, 7-5, and 8-95), and states that the Lower Myakka, in its current state, is one of the most "highly valued natural resources" in the region (pages xxxviii, 7-5 and 8-95). The land use map provided (page 2-6) indicates most of the land surrounding the saltwater marsh and oligohaline/tidal freshwater wetland communities is in a natural state.

In few and very brief references, the report mentions that removing the excess flows upriver will allow the lower river to return to the "more natural condition" (i.e., lower flows) of the pre-1970s. Yet, because the lower river currently is healthy and thriving, it is apparent that the lower river system already has adapted to the increased flows over the past 40+ years. The river's present, healthy condition seems to belie the need for returning it to any previous natural condition.

The report needs to explain why the District desires to change this currently healthy, ecologically important river into a different natural state (the pre-development condition), and how, in particular, allowing this change is consistent with the statutory charge to prevent significant harm.

16. We concur with the District's proposals (page 8-93) to develop minimum flows for Myakkahatchee Creek, and to begin periodic flow measurements from Warm Mineral Springs. Although Warm Mineral Springs and its run, Salt Creek, are not major contributors of flow to the lower river, the spring and run provide important water refugia for the West Indian Manatee.
17. The expression of the MFL should be presented more clearly in both the Executive Summary and in Chapter 8. The report describes the MFL only in text format, and

this description differs on different pages. It would be helpful to have the MFL presented in a table format, separating the two different conditions, and explaining when the cap applies.

In addition, the expressions of the MFL need to match each other. Two descriptions used in the report are:

- “...the proposed minimum flows for the Lower Myakka River are that flow reductions should not exceed water quantities that are hydrologically equivalent to the excess flows that were simulated for this minimum flows report, until daily flows at the Myakka River near Sarasota gage exceed a flow rate of 400 cfs. The removal of excess flows should be capped at 130 cfs at all rates of river flow” (Executive Summary, page xl, paragraph 1).
- “...the recommended minimum flows for the Lower Myakka River are that flow reductions be limited to the flows that are hydrologically equivalent to the adjusted excess flows identified in this minimum flows report (including the 130 cfs cap), unless flows at the Myakka River near Sarasota gage are in excess of 400 cfs” (Section 8.9.1, page 8-94, paragraph 2),

The placement of the parenthetical expression in Section 8.9.1 means the 130 cfs cap does not apply to flows over 400 cfs. The cap should apply to all flows, and the text should be changed to express this.

18. The last section of the report (Section 8.9.6, pages 8-100 and 8-101) is replete with the phrase “could be.” This section can be interpreted as showing perfunctory planning and a lack of commitment towards protecting the lower river. If these interpretations are not the District’s intention, we recommend fleshing out this section.

Minor Comments

19. It would be very helpful to have all appendices bookmarked, in addition to the bookmarking of Appendices 8T and 8V.
20. Section 2.2.3 (page 2-4) discusses aquifers in the different counties. It would be helpful to have a map showing where these counties are located.
21. On page 2-19, was the gage near Laurel used in the analysis? This information is clearly stated for each of the other gages in Section 2.4.1.1, but not for the Laurel gage.
22. Figure 4-59 (page 4-63) and the corresponding text should identify if the temperatures presented are for air or water, as well as the location of these measurements.
23. In Table 6-7 (pages 6-37 – 6-38), it would be helpful to arrange the page breaks so that all species within a group appear on the same page. For example, place all of the bivalves on the same page instead of having the list start on page 6-38 and then continue back on page

- 6-37. (This same comment applies to the list of crustaceans.) In addition, it may help some readers to include the phylum names for the classes shown.
24. In the last paragraph on page 6-43, it would help the reader to have a brief explanation of why the discussion suddenly switches to mollusk species only.
25. The references throughout the document should be double-checked for errors. For example, Section 8.6.9, paragraph 2 (page 8-46) indicates that Figure 8-19 (page 8-27) is a plot of areas similar in format to Figure 8-20 (page 8-31), and it is not; similarly, page 8-47, paragraph one references a section that does not appear in the report.
26. Page 8-70, last sentence of paragraph 1, "...largely because the flows between the 1999-2002 and the 1999-2002 were fairly similar during Block 3..." has problems with missing words and referenced dates.
27. Figure 8-42 (page 8-79) should identify the gages used.
28. On page 8-96, paragraph 4, there is no Figure 8-27C.
29. The keys for the following figures need revision:
- Figure 4-60 (page 4-64), define the colors
 - Figure 4-66 (page 4-68), identify the meaning of B vs. S
 - Figure 4-71 (page 4-74), define the colors and improve readability
 - Figure 8-31 (page 8-47), identify the meaning of dotted vs. solid lines
30. We noticed the following typos:
- Page 2-13, paragraph 2, "The City uses a relationship of ~~relationship~~ of water..."
 - Page 2-14, paragraph 3, "...flows from 14 15 gaged sites..."
 - Page 2-28, subheading, "~~Deep~~Deer Prairie Slough"
 - Page 2-30, paragraph 2, "...presented in Figure ~~2-8~~ 2-9 (page 2-18)..."
 - Page 2-46, paragraph 2, "...in the seasonality and relative..."
 - Page 2-55, last paragraph, "Trend tests on yearly ~~on yearly~~ percent..."
 - Page 2-58, paragraph 1, "Approximately 39% ~~percent~~ of..."
 - Page 4-39, last line, "...could not be included in the isohaline..."
 - Page 6-26, last line, "...salinity ~~plant~~ on the distribution..."
 - Page 6-44, 6 lines from the bottom, "...predators. *Tagelus*, was abundant in..."
 - Page 6-51, end of paragraph 2, "...expected to shift..."

- Page 6-76, paragraph 2, “Several estuarine species had maximum abundance ~~had maximum abundance~~ at intermediate...”
- Page 7-16, paragraph 3, “...salinity waters, which is driven by the input of...”
- Page 7-18, last paragraph, “...spotted seatrout, pink shrimp, ~~spotted seatrout~~ and...”
- Table 8-18 (page 8-51), bolded column headings, “...**position of the 2-4 psu surface...**”
- Page 8-80, paragraph 4, “~~At As~~ will be discussed...”

Appendix 2A

Statistical outputs for regression of flow at Big Slough Canal near Myakka City and estimated flow at Water Control Structure 101 prepared by HSW Engineering, Inc.

Appendix 2A

Presented on the following pages are three SPSS output files of regression models of associations between discharge at the USGS gage (# USGS 02299410 BIG SLOUGH CANAL NEAR MYAKKA CITY FL) and the water control structure on the Myakkahatchee Creek (WCS 101) that are reported by the City of North Port. The three output files are for piecewise linear associations for 2003, 2004, and combined 2003 and 2004 data sets. Piecewise regression solutions were found after examining scatter plots and selecting appropriate coefficients (slope and inflection) for initial estimates. Inflection points are defined by knots (e.g., knot1) in the SPSS software.

Results are as follows:

Year	BA0	BA1	BA2	BA3	Knot1	knot2	R-Square
2003	2.68	3.44	-1.09	-0.92	0.54	172.60	0.94
2004	3.02	17.95	-14.91	-1.99	0.59	46.0	0.86
2003 and 2004	7.83	3.73	-1.05	-1.18	0.57	45.0	0.91

Prediction equations are of the form

Predicted DO =

$$BA0 + BA1 \cdot \text{Flow} \quad \text{for Flow} < \text{knot1 and}$$

$$BA0 + BA1 \cdot \text{Flow} + BA2 \cdot (\text{Flow} - \text{knot1}) \quad \text{for Flow} > \text{knot1 and}$$

$$BA0 + BA1 \cdot \text{Flow} + BA2 \cdot (\text{Flow} - \text{knot1}) + BA3 \cdot (\text{Flow} - \text{knot2}) \quad \text{for Flow} > \text{knot2}$$

Model constraints: $BA0 > 0$, $BA1 > 0$, $BA2 < 0$, $BA3 < 0$, $\text{knot1} > 0$, and $\text{knot2} > \text{knot1}$.

The model is very insensitive to combinations of BA0 and BA1, which is the linear association at very low flows (flow < knot1). Care was taken to ensure reasonableness of the results but modelers can expect slightly different results unless the exact initial estimates, constraints, solution algorithm and error tolerances are specified. The output files include various plots of residuals, observed, and predicted values. There is some bias noted, which can be attributed to missing and/or the wrong form of explanation variables.

Constrained Nonlinear Regression 2003 Data

All the derivatives will be calculated numerically.

The following new variables are being created:

Name	Label
PREDEX1	Predicted Values
RESIDEX1	Residuals

—

Iteration	Residual	SS	BA0 KNOT1	BA1 KNOT2	BA2 Lin Con 1	BA3
0.5	2723711.600	8.00000000	4.00000000	-1.00000000	-1.00000000	
		2.00000000	45.00000000	43.00000000		
1.5	1342284.517	7.99999973	3.99999986	-1.2243403	-1.2093190	
		1.99999993	44.9999985	42.9999985		
2.2	1339913.610	7.99993501	4.15396799	-1.2243304	-1.3757851	
		1.99998375	45.0150822	43.0150984		
3.1	1243658.907	6.22822632	3.44893175	-.95318358	-1.0710963	
		1.55705658	138.972145	137.415089		
4.2	1229561.016	5.32647985	3.10329343	-.81517801	-.91601891	
		1.33161996	179.300794	177.969174		
5.4	1222025.645	3.69221947	2.93302203	-.56506665	-.99874972	
		.923054868	185.355865	184.432810		
6.3	1221936.126	3.68573146	3.07849881	-.71120302	-.99743683	
		.978576180	185.087299	184.108723		
7.5	1214236.588	1.77906012	3.87161451	-1.5191356	-.92878130	
		.472347449	171.852820	171.380473		
8.5	1214120.253	2.92846847	3.48988946	-1.1407534	-.92313479	
		.354696437	171.512447	171.157751		
9.2	1214117.410	2.60010128	3.37850448	-1.0282384	-.92467268	
		.587104430	171.727133	171.140029		
10.1	1214112.324	2.48335486	3.87188264	-1.5218235	-.92265425	
		.457035725	171.592883	171.135848		
11.1	1214108.947	2.56033459	3.59072136	-1.2412677	-.92289805	
		.540692365	172.048113	171.507420		
12.1	1214107.372	2.64993994	3.44670764	-1.0987459	-.92175209	
		.549553484	172.401940	171.852386		
13.1	1214106.950	2.67755762	3.41682905	-1.0697607	-.92082218	
		.551842462	172.605931	172.054088		
14.1	1214106.918	2.68785448	3.43574344	-1.0888808	-.92053193	
		.539859105	172.610976	172.071117		
15.1	1214106.917	2.68260788	3.44048620	-1.0936233	-.92051571	
		.540909857	172.604051	172.063141		
16.1	1214106.917	2.68265860	3.43964242	-1.0927775	-.92051881	
		.541091239	172.603639	172.062547		

Run stopped after 16 major iterations.
Optimal solution found.

Nonlinear Regression Summary Statistics Dependent Variable Y

Source	DF	Sum of Squares	Mean Square
Regression	6	22959719.3033	3826619.88389
Residual	186	1214106.91667	6527.45654
Uncorrected Total	192	24173826.2200	
(Corrected Total)	191	19493261.1531	

R squared = 1 - Residual SS / Corrected SS = .93772

Parameter	Estimate	Asymptotic Std. Error	Asymptotic 95 % Confidence Interval	
			Lower	Upper
BA0	2.682658602	2522738.8568	-4976856.822	4976862.1870
BA1	3.439642423	2940416.1780	-5800849.932	5800856.8109
BA2	-1.092777512	2940416.1769	-5800854.462	5800852.2762
BA3	-.920518809	.169322902	-1.254559050	-.586478568
KNOT1	.541091239	1410758.9854	-2783144.946	2783146.0282
KNOT2	172.60363857	39.958532130	93.773441830	251.43383531

Asymptotic Correlation Matrix of the Parameter Estimates

	BA0	BA1	BA2	BA3	KNOT1	KNOT2
BA0	1.0000	-.8121	.8121	-.1526	-.7983	.2248
BA1	-.8121	1.0000	-1.0000	.1261	.2968	-.0669
BA2	.8121	-1.0000	1.0000	-.1261	-.2968	.0669
BA3	-.1526	.1261	-.1261	1.0000	.1195	.3860
KNOT1	-.7983	.2968	-.2968	.1195	1.0000	-.2988
KNOT2	.2248	-.0669	.0669	.3860	-.2988	1.0000

Plot

Plot of RESIDEX1 with PREDEX1

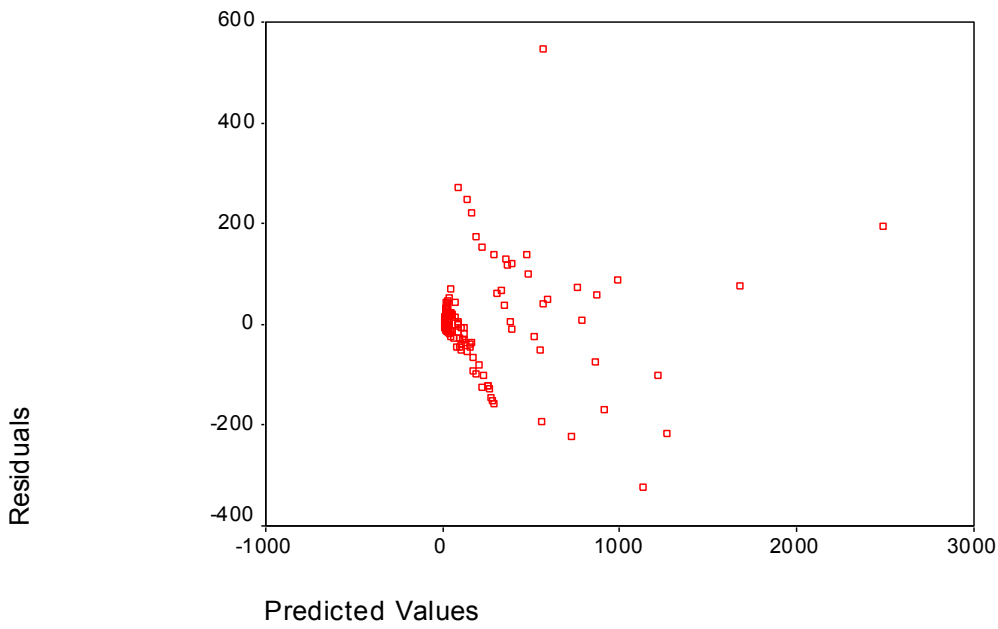

Plot of Y with PREDEX1

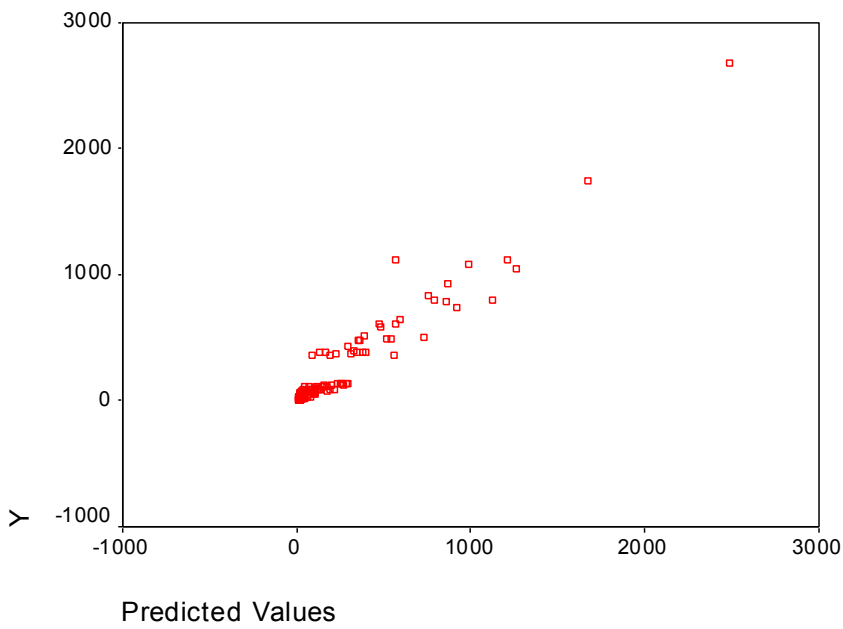

Plot of PREDEX1 with XA

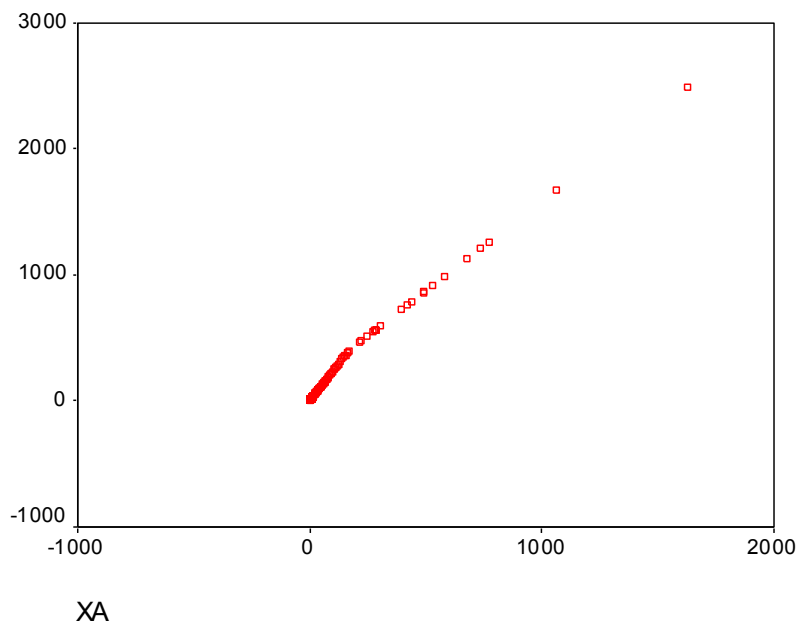

Plot of Y with XA

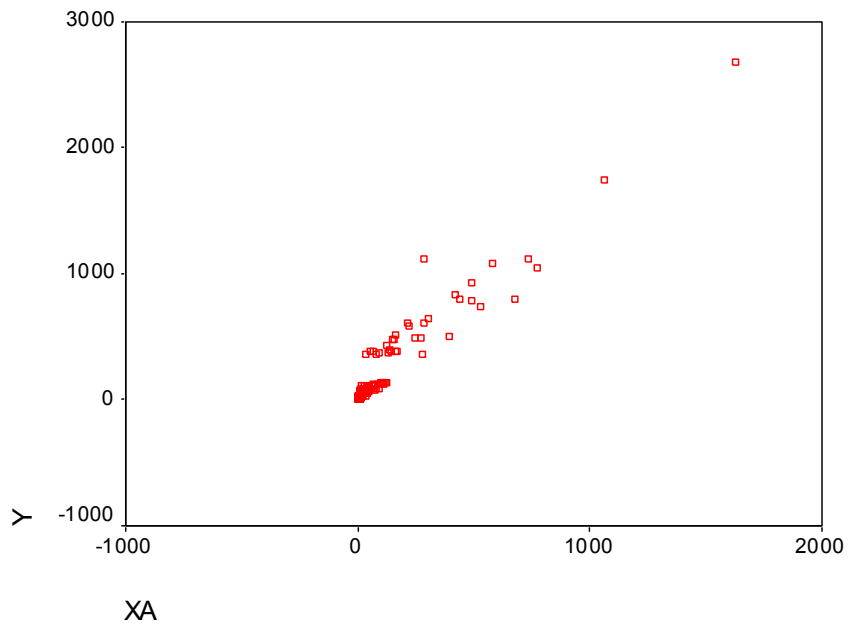

Graph

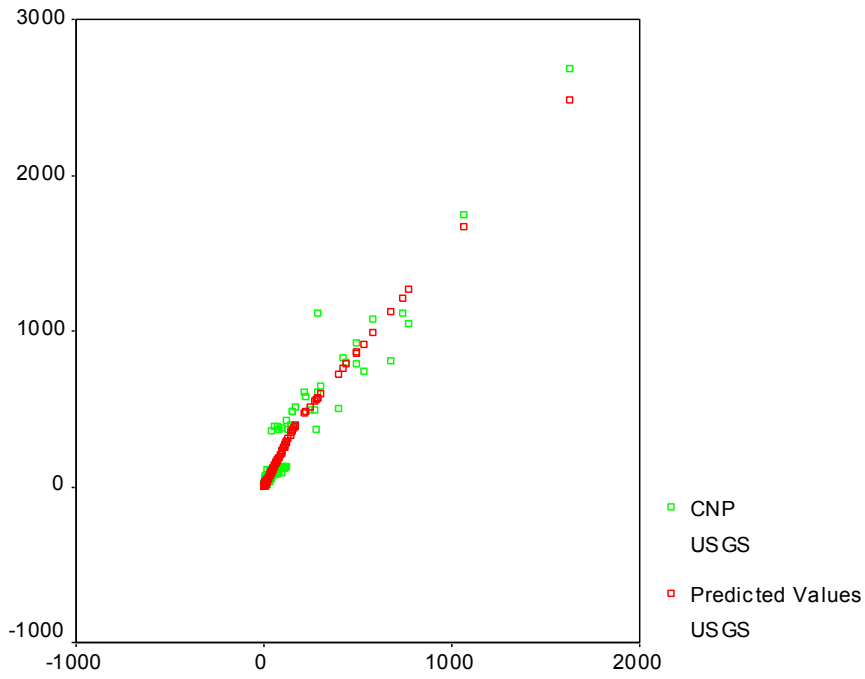

Graph

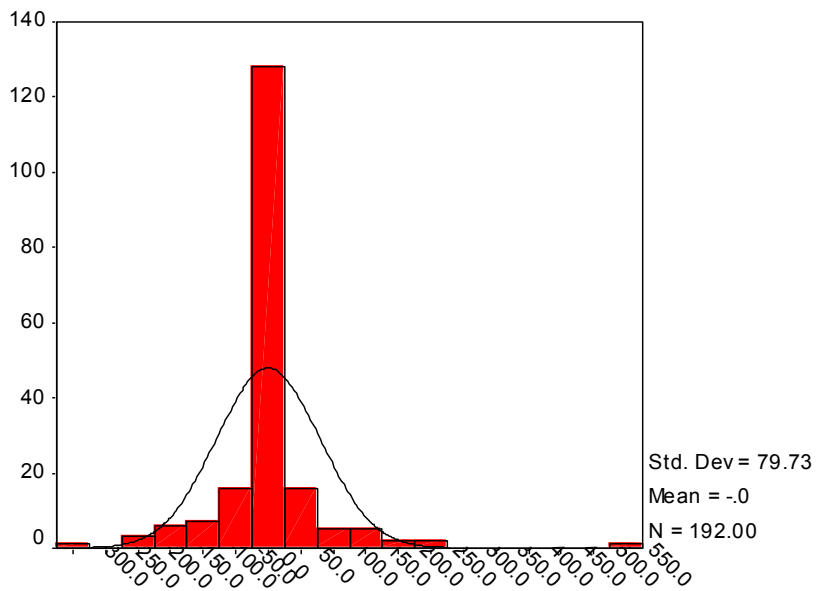

Residuals

PPlot

MODEL: MOD_1.

Expected Normal quantiles calculated using Blom's proportional estimation formula and assigning the mean to ties.

—

For variable RESIDEX1...

Normal distribution parameters estimated: location=0 scale=1



Detrended Normal P-P Plot of Residuals

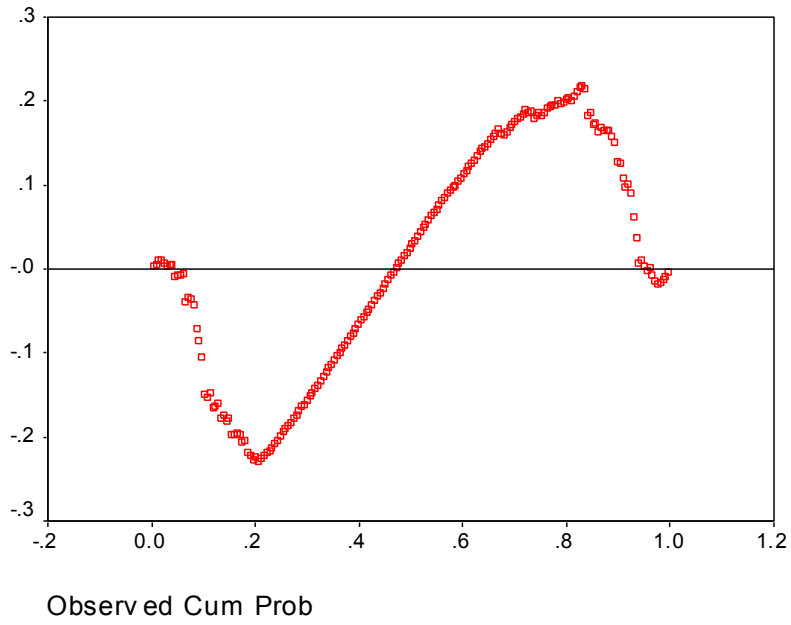

Constrained Nonlinear Regression 2004 Data

All the derivatives will be calculated numerically.

The following new variables are being created:

Name	Label
PREDEX_1	Predicted Values
RESIDE_1	Residuals

—

Iteration	Residual	SS	BA0 KNOT1	BA1 KNOT2	BA2 Lin Con 1	BA3
0.5	1924710.743	8.00000000	4.00000000	-1.00000000	-1.00000000	
		2.00000000	45.00000000	43.00000000		
1.6	678418.1335	7.99999895	3.99999947	-1.4417145	-1.3640733	
		1.99999974	44.9999941	42.9999943		
2.5	648513.6580	8.03127208	4.53759902	-1.4417009	-2.0437525	
		2.03301224	45.0326023	42.9995901		
3.6	648051.0585	7.98547457	4.51644428	-1.4334798	-2.0320982	
		2.02141920	45.8945792	43.8731600		
4.4	647966.8018	8.28966979	4.49876454	-1.4260378	-2.0215485	
		2.01092488	45.9985020	43.9875771		
5.1	647965.9421	8.28763271	4.50144755	-1.4288421	-2.0214294	
		2.01043072	46.0002384	43.9898077		
6.2	647933.0726	6.91867426	6.16399150	-3.1415774	-1.9672923	
		1.67834601	45.9996521	44.3213061		
7.3	647913.0510	6.84967498	6.32839826	-3.3090151	-1.9644476	
		1.54874210	45.9996068	44.4508647		
8.2	647834.3677	7.74169836	5.73859016	-2.7044068	-1.9847495	
		1.52133801	45.9995316	44.4781936		
9.1	647821.9188	7.49299041	6.19850832	-3.1666492	-1.9841204	
		1.38173219	45.9997576	44.6180255		
10.1	647772.0769	7.35072509	6.41878612	-3.3705424	-2.0016714	
		1.20129729	46.0006573	44.7993600		
11.1	647718.8889	7.41136113	6.66204700	-3.5976857	-2.0170639	
		.988844736	45.9998419	45.0109972		
12.1	647707.7733	7.46178191	6.61015825	-3.5453524	-2.0167364	
		1.03490172	46.0003447	44.9654429		
13.1	647648.7083	7.17167483	7.41174154	-4.3624003	-1.9983345	
		.982883248	46.0017876	45.0189043		
14.1	647580.1231	6.41415640	8.91429637	-5.8787887	-1.9840465	
		.918727973	46.0029163	45.0841883		
15.1	647546.3783	5.88532167	10.1380940	-7.1025288	-1.9846671	
		.805246175	46.0035733	45.1983272		
16.1	647476.4033	5.19662307	11.7298304	-8.6892647	-1.9913070	
		.757102090	46.0012463	45.2441442		
17.1	647455.8888	4.44065978	13.7496183	-10.705432	-1.9951207	
		.653735426	45.9982339	45.3444984		
18.1	647412.4499	4.06156805	15.0122733	-11.965791	-1.9967242	

		.654154902	45.9937648	45.3396099	
19.1	647397.6987	3.68689071	16.1803940	-13.133435	-1.9971975
		.611256518	45.9924347	45.3811782	
20.1	647393.6105	3.49215643	16.6159610	-13.574074	-1.9919748
		.616090705	45.9928244	45.3767337	
21.1	647392.5658	3.37548990	16.8638890	-13.823457	-1.9904612
		.618274318	45.9935388	45.3752645	
22.1	647391.7532	3.28027696	17.0943726	-14.054218	-1.9902049
		.616127747	45.9947093	45.3785816	
23.1	647388.7824	3.02275393	17.7742849	-14.734057	-1.9904121
		.605977961	45.9997792	45.3938012	

—

Iteration	Residual SS	BA0 KNOT1	BA1 KNOT2	BA2 Lin Con 1	BA3
24.1	647388.6590	3.01105082	17.8069838	-14.766739	-1.9904339
		.605385840	46.0000274	45.3946416	
25.1	647388.0342	2.97128879	17.9665850	-14.925181	-1.9916331
		.598339956	45.9998991	45.4015592	
26.1	647387.6842	2.98318011	18.0454760	-15.002633	-1.9931282
		.591825970	46.0000053	45.4081794	
27.1	647387.6823	2.99185186	18.0274150	-14.984629	-1.9930614
		.592145387	45.9999801	45.4078347	
28.1	647387.6623	3.01360726	17.9773998	-14.935009	-1.9926109
		.593407587	45.9999936	45.4065860	
29.1	647387.6577	3.01508481	17.9741115	-14.931781	-1.9925395
		.593446524	46.0000006	45.4065541	
30.1	647387.6573	3.01271067	17.9792817	-14.936958	-1.9925266
		.593190359	45.9999968	45.4068064	
31.1	647387.6553	3.01694936	17.9676188	-14.925246	-1.9925805
		.593312680	45.9999986	45.4066859	
32.1	647387.6547	3.02034676	17.9578118	-14.915422	-1.9925999
		.593443978	46.0000009	45.4065569	
33.1	647387.6542	3.02159291	17.9538982	-14.911515	-1.9925937
		.593539882	45.9999998	45.4064599	
34.1	647387.6542	3.02159294	17.9538981	-14.911515	-1.9925937
		.593539884	45.9999998	45.4064599	
35.1	647387.6542	3.02159294	17.9538981	-14.911515	-1.9925937
		.593539884	45.9999998	45.4064599	
36.1	647387.6542	3.02159294	17.9538981	-14.911515	-1.9925937
		.593539883	45.9999998	45.4064599	

Run stopped after 37 major iterations.
Cannot improve on the current point.

Nonlinear Regression Summary Statistics Dependent Variable Y

Source	DF	Sum of Squares	Mean Square
Regression	6	6246874.45580	1041145.74263
Residual	324	647387.65420	1998.11004
Uncorrected Total	330	6894262.11000	

(Corrected Total) 329 4699890.23724

R squared = 1 - Residual SS / Corrected SS = .86225

-

Parameter	Estimate	Asymptotic Std. Error	Asymptotic 95 % Confidence Interval	
			Lower	Upper
BA0	3.021592940	15.247075961	-26.97417433	33.017360210
BA1	17.953898116	41.628194895	-63.94178136	99.849577595
BA2	-14.91151520	41.629147635	-96.80906902	66.986038618
BA3	-1.992593688	.287256098	-2.557716278	-1.427471099
KNOT1	.593539883	.805705266	-.991534377	2.178614143
KNOT2	45.999999778	6.734219080	32.751684575	59.248314981

Asymptotic Correlation Matrix of the Parameter Estimates

	BA0	BA1	BA2	BA3	KNOT1	KNOT2
BA0	1.0000	-.9605	.9605	.0000	.7062	.0000
BA1	-.9605	1.0000	-1.0000	.0000	-.8376	.0000
BA2	.9605	-1.0000	1.0000	-.0066	.8356	-.0047
BA3	.0000	.0000	-.0066	1.0000	.2831	.5802
KNOT1	.7062	-.8376	.8356	.2831	1.0000	.1209
KNOT2	.0000	.0000	-.0047	.5802	.1209	1.0000

Plot

Plot of Y with XA

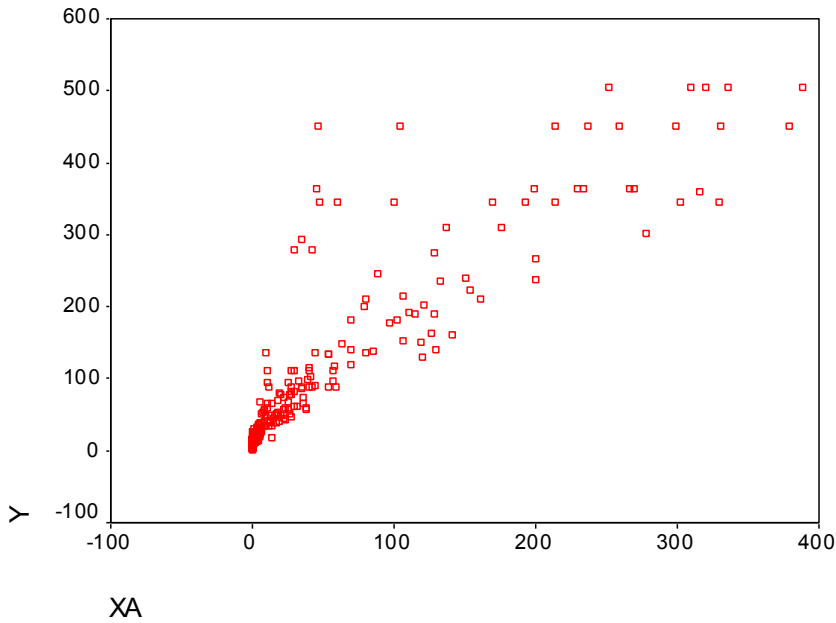

Graph

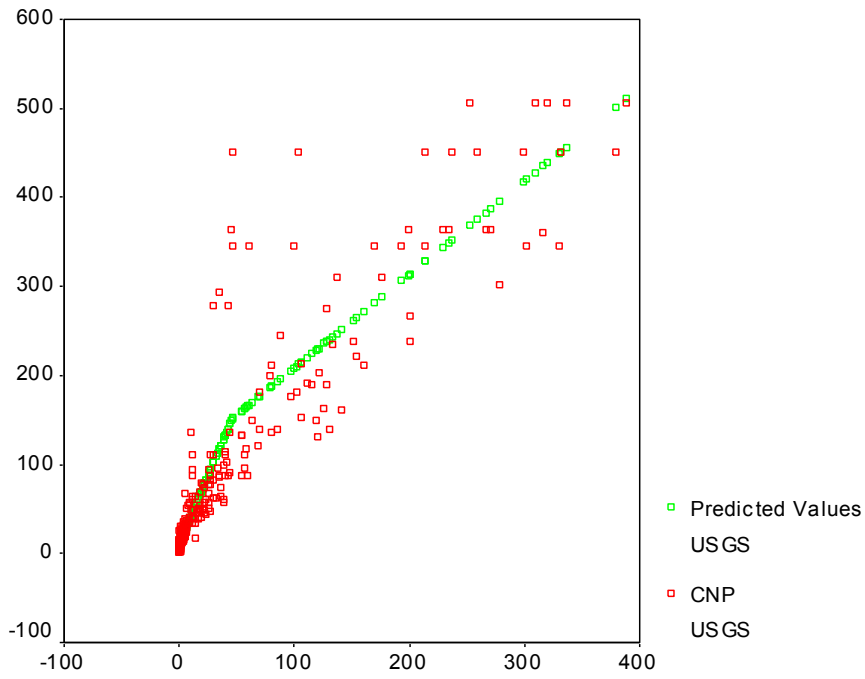

Graph

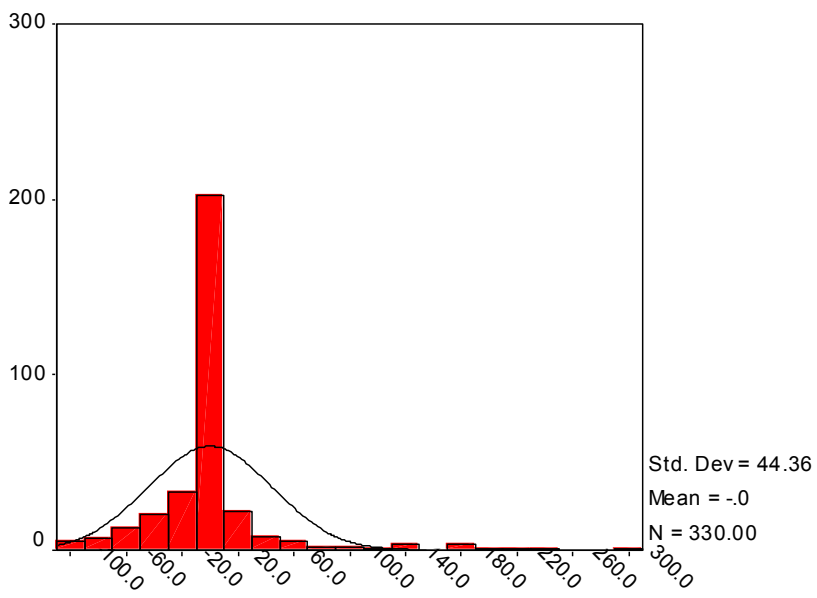

Residuals

PPlot

MODEL: MOD_2.

Expected Normal quantiles calculated using Blom's proportional estimation formula and assigning the mean to ties.

—

For variable RESIDE_1...

Normal distribution parameters estimated: location=0 scale=1

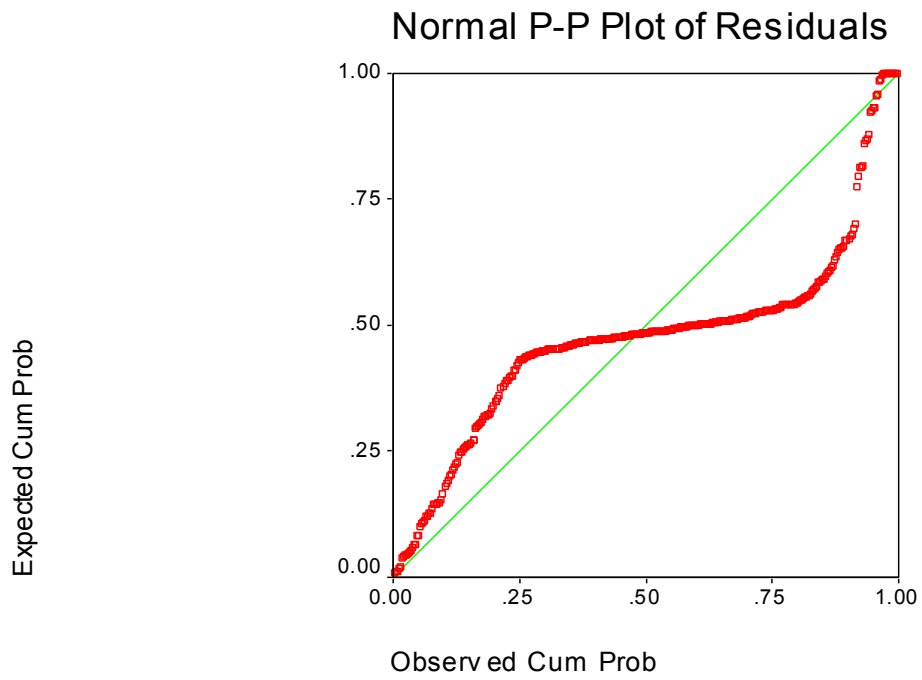

Detrended Normal P-P Plot of Residuals

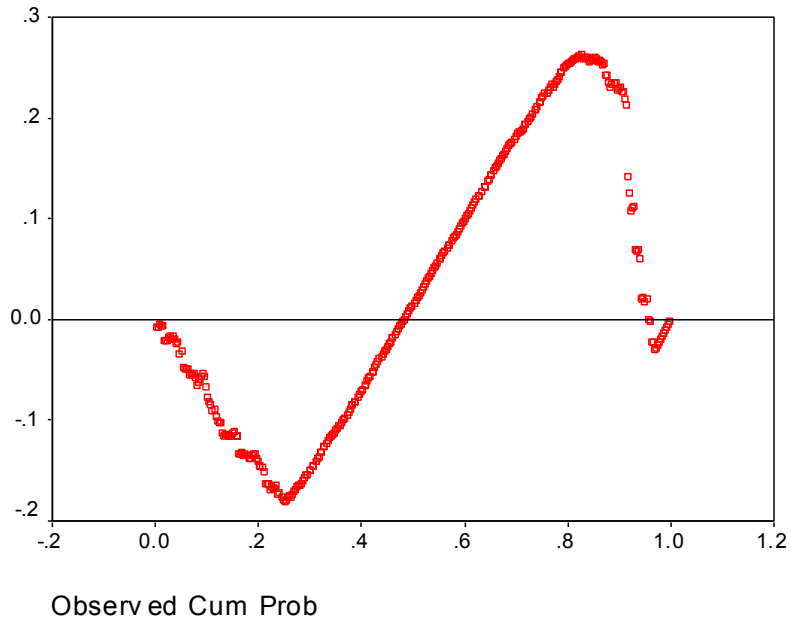

Constrained Nonlinear Regression 2003 and 2004 Data

All the derivatives will be calculated numerically.

The following new variables are being created:

Name	Label
PREDEX_3	Predicted Values
RESIDE_3	Residuals

—

Iteration	Residual	SS	BA0 KNOT1	BA1 KNOT2	BA2 Lin Con 1	BA3
0.5	4648422.343		8.00000000	4.00000000	-1.0000000	-1.0000000
			2.00000000	45.0000000	43.0000000	
1.3	2233740.307		7.99999978	3.99999989	-1.2693140	-1.2413788
			1.99999995	44.9999988	42.9999988	
2.4	2231409.641		7.61263211	3.89094217	-1.2078526	-1.1812700
			1.90315803	42.8210556	40.9178976	
3.2	2230599.654		7.49345196	3.85044595	-1.1889430	-1.1627766
			1.87336299	45.2814987	43.4081358	
4.3	2230494.454		7.25685819	3.82976519	-1.1514040	-1.1796170
			1.81421455	44.8882511	43.0740365	
5.2	2230134.159		8.51757269	3.37431631	-.71255630	-1.1602659
			1.12274231	44.9969744	43.8742321	
6.2	2230021.727		7.98105938	3.32928745	-.66767309	-1.1592640
			1.05202190	45.3397651	44.2877431	
7.2	2229977.689		7.95408873	3.28507899	-.60720424	-1.1771995
			.956743896	45.3940803	44.4373364	
8.1	2229921.461		7.65859697	3.74646401	-1.0674867	-1.1793166
			.615760181	45.2604945	44.6447343	
9.2	2229920.266		7.72282621	3.73034288	-1.0518789	-1.1785693
			.555982199	45.2787810	44.7227988	
10.1	2229898.245		7.87647390	3.63425028	-.95324501	-1.1808269
			.580680470	45.1802297	44.5995493	
11.1	2229877.304		7.83267115	3.72507477	-1.0399680	-1.1851039
			.573671621	45.0159603	44.4422887	
12.1	2229875.397		7.82660524	3.73357959	-1.0481293	-1.1854417
			.574039892	45.0000014	44.4259615	
13.1	2229875.397		7.82660473	3.73358030	-1.0481300	-1.1854417
			.574039916	45.0000000	44.4259601	
14.1	2229875.397		7.82660472	3.73358032	-1.0481300	-1.1854417
			.574039916	45.0000000	44.4259601	

Run stopped after 15 major iterations.
Cannot improve on the current point.

—

Nonlinear Regression Summary Statistics Dependent Variable Y

Source	DF	Sum of Squares	Mean Square
Regression	6	28838212.9328	4806368.82214
Residual	516	2229875.39719	4321.46395
Uncorrected Total	522	31068088.3300	

(Corrected Total) 521 24868451.5268

R squared = 1 - Residual SS / Corrected SS = .91033

Parameter	Estimate	Asymptotic Std. Error	Asymptotic 95 % Confidence Interval	
			Lower	Upper
BA0	7.826604723	23.246746982	-37.84330416	53.496513603
BA1	3.733580319	64.392222537	-122.7695789	130.23673958
BA2	-1.048130028	64.393111566	-127.5530359	125.45677580
BA3	-1.185441723	.339515371	-1.852444124	-.518439321
KNOT1	.574039916	16.036190969	-30.93021231	32.078292140
KNOT2	45.000000000	11.779110627	21.859088738	68.140911262

Asymptotic Correlation Matrix of the Parameter Estimates

	BA0	BA1	BA2	BA3	KNOT1	KNOT2
BA0	1.0000	-.9626	.9626	.0000	.7339	.0000
BA1	-.9626	1.0000	-1.0000	.0000	-.8678	.0000
BA2	.9626	-1.0000	1.0000	-.0052	.8666	-.0042
BA3	.0000	.0000	-.0052	1.0000	.2328	.7650
KNOT1	.7339	-.8678	.8666	.2328	1.0000	.1231
KNOT2	.0000	.0000	-.0042	.7650	.1231	1.0000

Plot

Plot of RESIDEX1 with PREDEX1

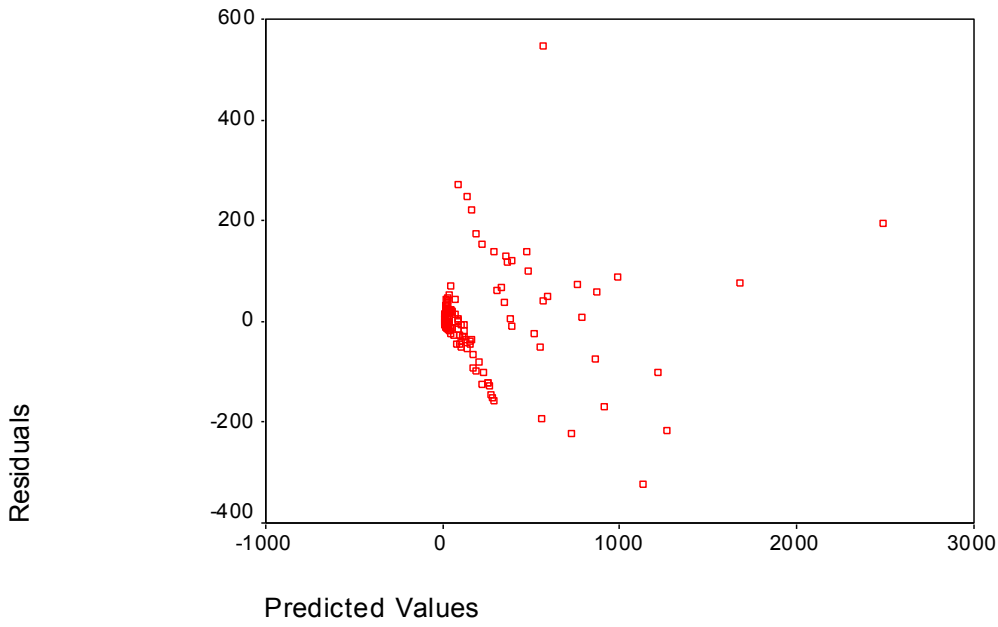

Plot of Y with PREDEX1

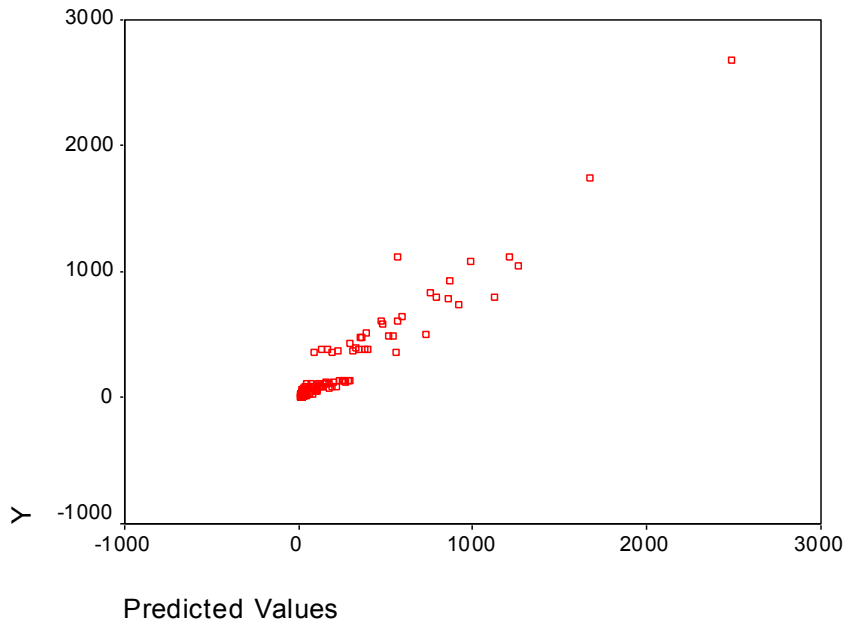

Plot of PREDEX1 with XA

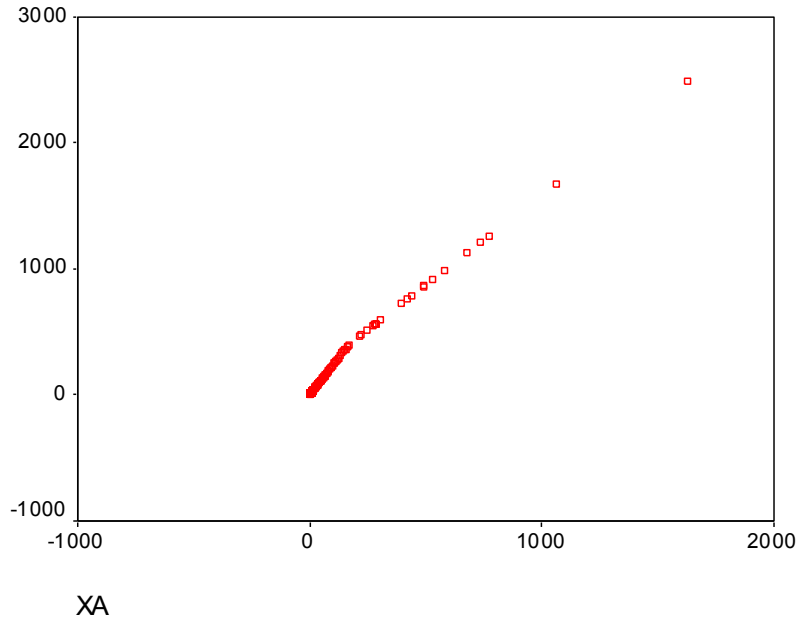

Plot of Y with XA

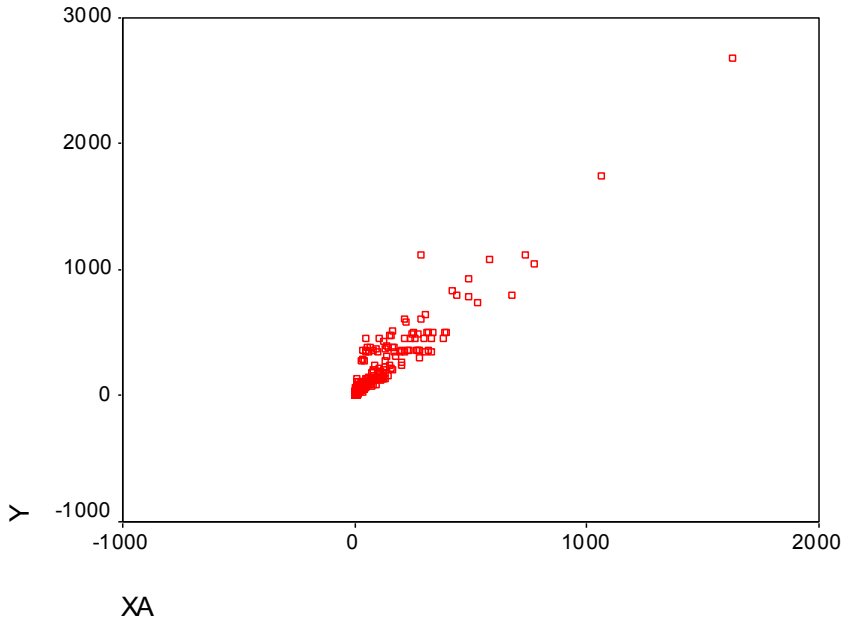

Graph

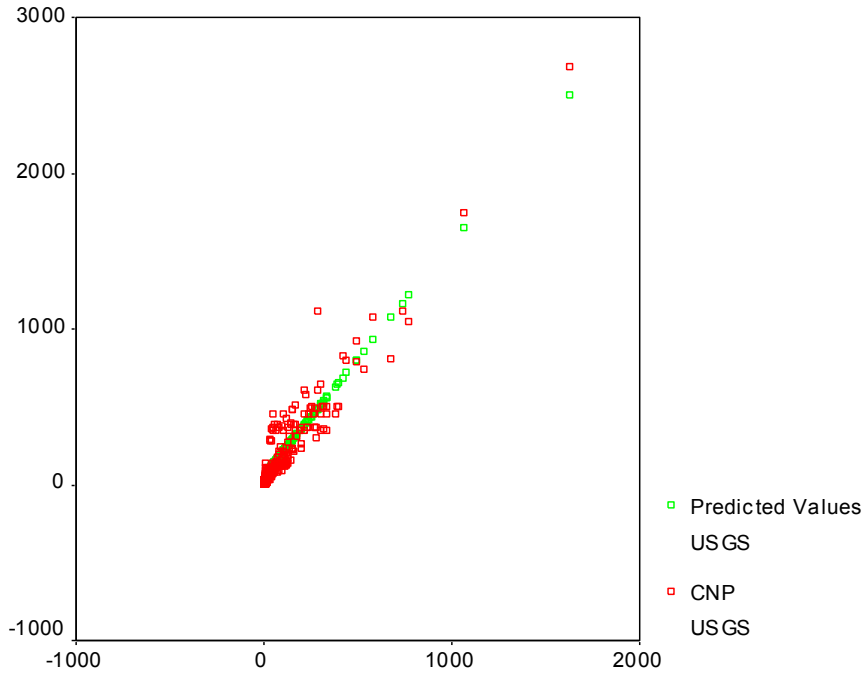

Graph

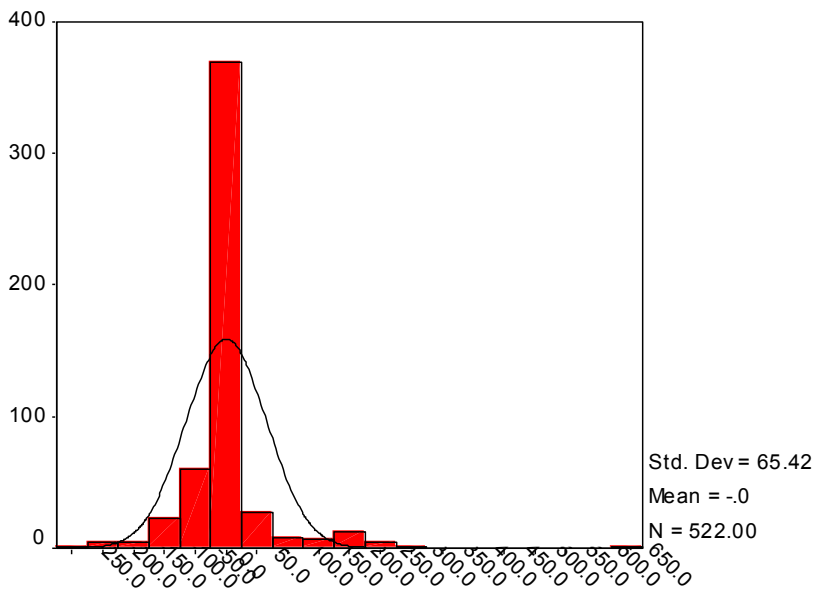

Residuals

PPlot

MODEL: MOD_3.

Expected Normal quantiles calculated using Blom's proportional estimation formula and assigning the mean to ties.

—

For variable RESIDE_3...

Normal distribution parameters estimated: location=0 scale=1

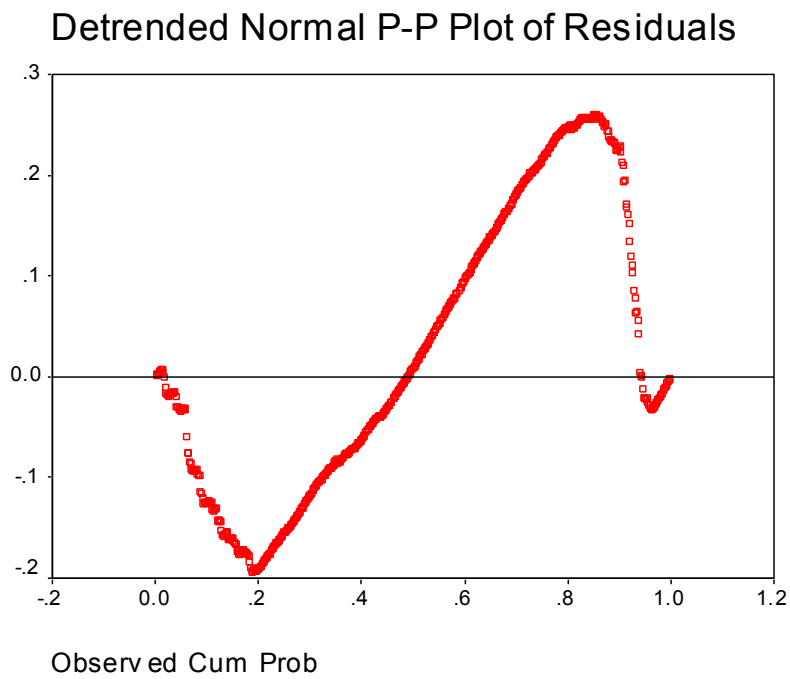
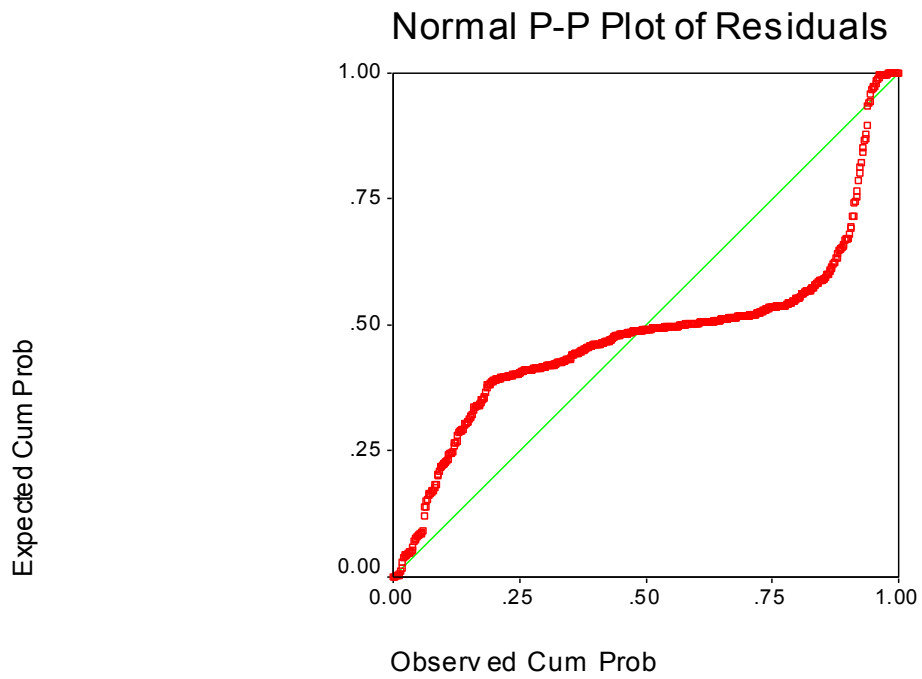

Appendix 2B

Methods and statistical outputs for prediction of gaged flow in Big Slough Canal at Tropicaire Blvd. as a function of gaged flow at Big Slough Canal near Myakka City prepared by Janicki Environmental, Inc.

Appendix 2B

Prediction of Flow in Big Slough Canal at Tropicaire Blvd. as a function of USGS gaged flow at Big Slough Canal near Myakka City

Methods

A regression analysis was used to calculate predicted flow at the USGS gage Big Slough Canal at Tropicaire using flow at the Big Slough Canal at Myakka City. Categorical variables with values of 0 or 1 representing monthly seasonal effects were included. Use of categorical variables along with the numeric flow variable required the use of a general linear model (GLM) regression technique. The slope coefficients on the individual monthly categorical variables represent the seasonal effect relative to the December observations. No categorical variable was created for December to allow for sufficient degrees of freedom for the model, so that the regression would not be over-parameterized.

A log base-10 transformation was used for modeling and plotting to improve the distributional properties of the data. A value of 1 was added to all flow observations so there would be no zero flows prior to calculation of the log transformation.

Results

A plot of Big Slough flow and Myakka City Flow over-laid on the same plot by date show a close correlation of flows in time and magnitude at the two monitoring gages (Figure 1). A plot of flow of Big Slough at Tropicaire vs. flow at Myakka City also shows a close 1 to 1 correspondence in the magnitude of flows (Figure 2).

The analysis of variance table produced by the GLM is shown in the SAS printout below. Estimates of the slope coefficients of monthly seasonal categorical variables ranged from -0.158 for April, the driest month, to 0.233 for August, the wettest month in terms of rainfall. The slope coefficient for the Myakka City flow is 0.903 (Table 2). Nine of the monthly categorical seasonality variables were significant; January and February were insignificant.

A plot of the regression residuals vs. date shows very little seasonality remains unaccounted for in the regression equation (Figure 3). A plot of the regression residuals vs. the independent variable, log₁₀ Myakka City flow, shows a very random pattern, with slightly higher variance in the relationship below 10 cfs (Figure 4). A plot of the regression residuals vs. the back-transformed independent variable, Myakka City flow, shows a similar relationship (Figure 5). The x-axis for Figure 5 was limited in magnitude to 3000 cfs, to show greater resolution in the portion of the plot with the greatest number of points. However all observations were included in the regression analysis.

A plot of the log base-10 transformed predicted flow values of Big Slough at Tropicaire vs. the observed logged flow at Myakka City show most of the values closely clustered around a line with a slope of 1 (Figure 6). The plot shows a very good prediction. The same observations back-transformed to the original flow scale are shown in Figure 7.

The statistics of the regression analysis show a very significant relationship (Table 1), with overall model significance measured by a p-value of < 0.0001, an F-test value equal to 11,101.3, and a model R-squared coefficient of determination equal to 0.944.

Table 1. Analysis of Variance, Type III Sums of Squares

The SAS System
The GLM Procedure

Dependent Variable: TropQ_log

Source	DF	Sum of Squares	Mean Square	F Value	Pr > F
Model	13	5053.720068	388.747698	11101.3	<.0001
Error	2273	79.596498	0.035018		
Uncorrected Total	2286	5133.316566			

R-Square Coeff Var Root MSE TropQ_log Mean
0.943840 14.67733 0.187132 1.274971

Source	DF	Type III SS	Mean Square	F Value	Pr > F
Intercept	1	16.0195518	16.0195518	457.46	<.0001
MyaCiQ_log	1	672.0087727	672.0087727	19190.2	<.0001
Jan	1	0.0025141	0.0025141	0.07	0.7888
Feb	1	0.0032688	0.0032688	0.09	0.7600
Mar	1	0.6927091	0.6927091	19.78	<.0001
Apr	1	2.2459752	2.2459752	64.14	<.0001
May	1	1.8168600	1.8168600	51.88	<.0001
Jun	1	1.5100940	1.5100940	43.12	<.0001
Jul	1	1.3990821	1.3990821	39.95	<.0001
Aug	1	4.8738708	4.8738708	139.18	<.0001
Sep	1	2.4771947	2.4771947	70.74	<.0001
Oct	1	1.6736529	1.6736529	47.79	<.0001
Nov	1	0.1812042	0.1812042	5.17	0.0230

Table 2. Parameter Estimates of the regression slope coefficients.

The SAS System
The GLM Procedure

Dependent Variable: TropQ_log

Parameter	Parameter Estimate	Standard Error	t Value	Pr > t
Intercept	0.3137523111	0.01466929	21.39	<.0001
MyaCiQ_log	0.9032453940	0.00652027	138.53	<.0001
Jan	0.0051997237	0.01940583	0.27	0.7888
Feb	-.0060826357	0.01990880	-0.31	0.7600
Mar	-.0863172159	0.01940748	-4.45	<.0001
Apr	-.1583243203	0.01976935	-8.01	<.0001
May	-.1411242517	0.01959242	-7.20	<.0001
Jun	-.1285537181	0.01957627	-6.57	<.0001
Jul	0.1244564975	0.01968989	6.32	<.0001
Aug	0.2332976212	0.01977519	11.80	<.0001
Sep	0.1651301380	0.01963331	8.41	<.0001
Oct	0.1346356938	0.01947488	6.91	<.0001
Nov	0.0445544951	0.01958640	2.27	0.0230

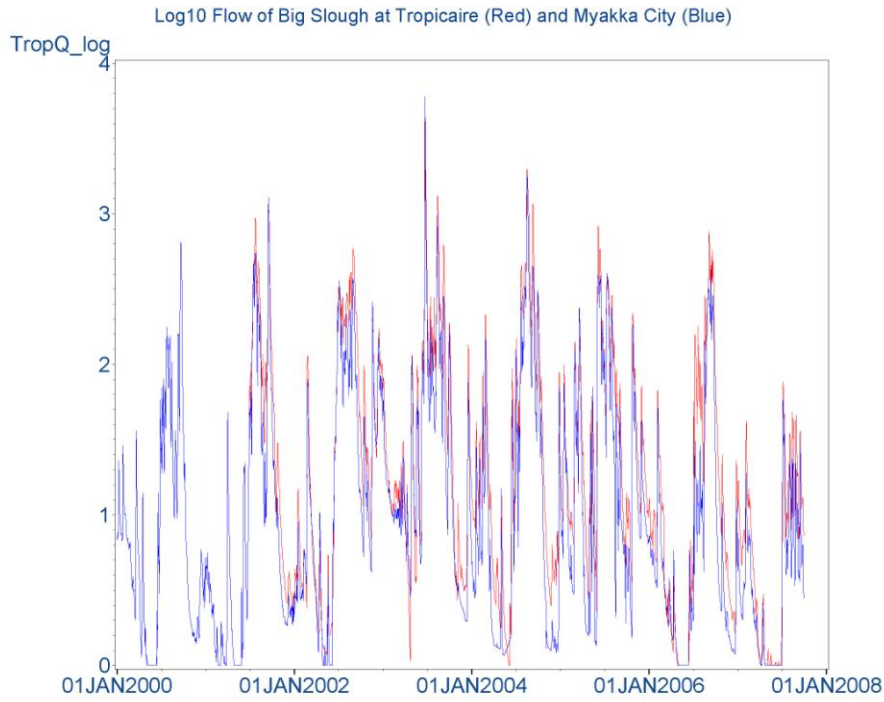

Figure 1. Time series of log transformed Big Slough and Myakka City Flow observations.

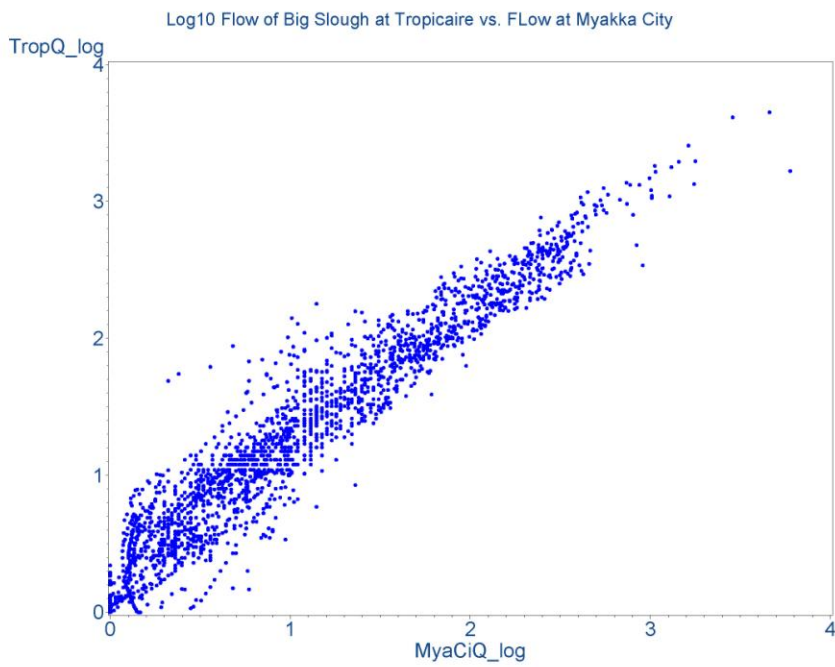

Figure 2. Log transformed Big Slough flow observations vs. Myakka City Flow observations.

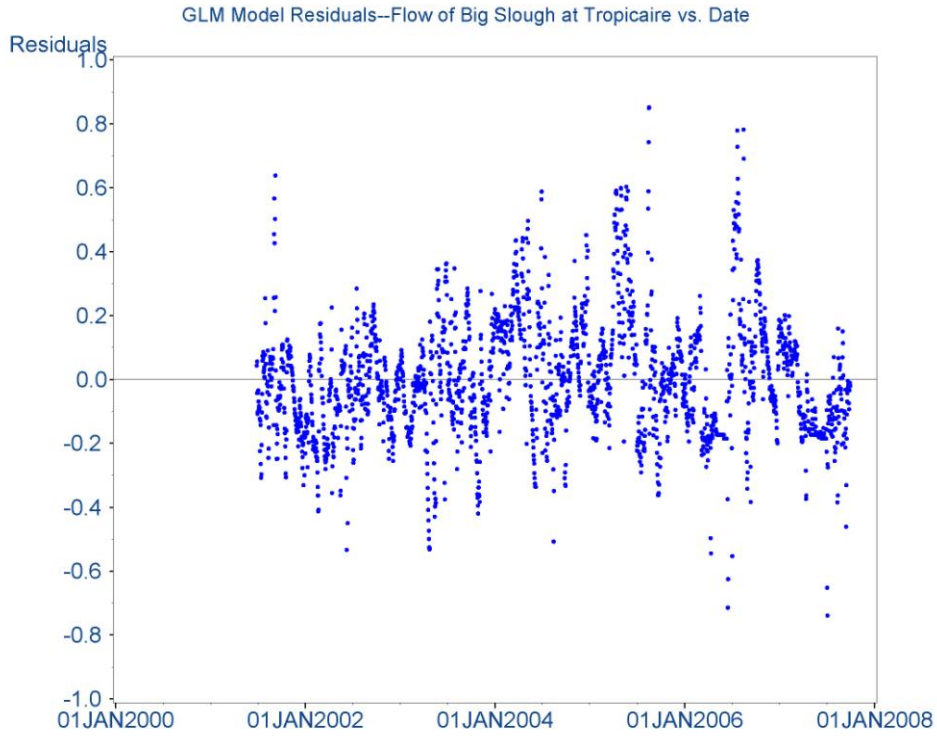

Figure 3. Regression model residuals of equation predicting flows at Big Slough vs. date.

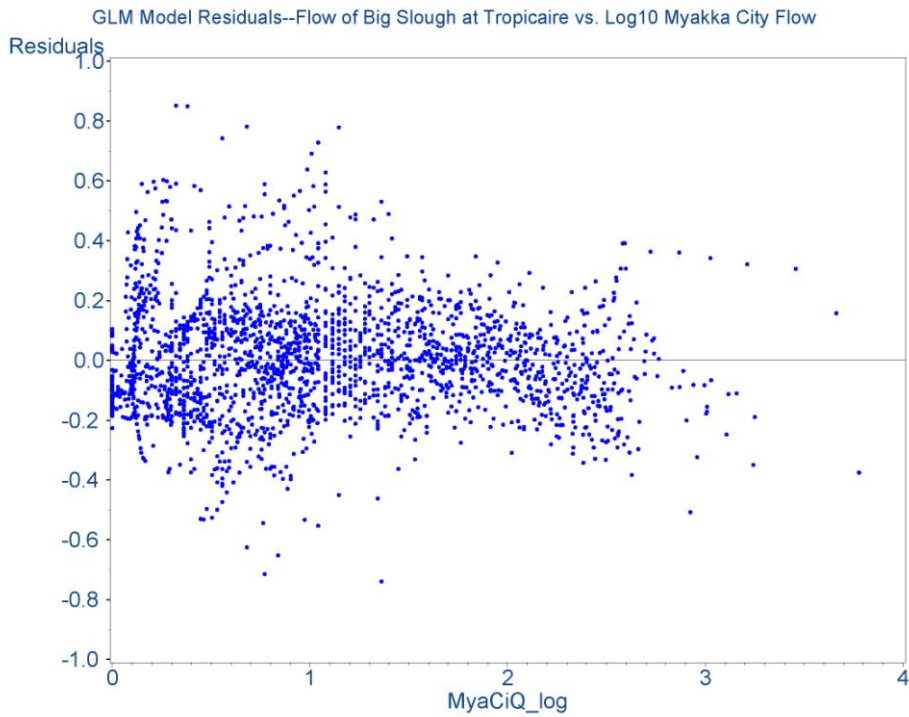

Figure 4. Regression model residuals of equation predicting flows at Big Slough vs. log transformed Myakka City flows.

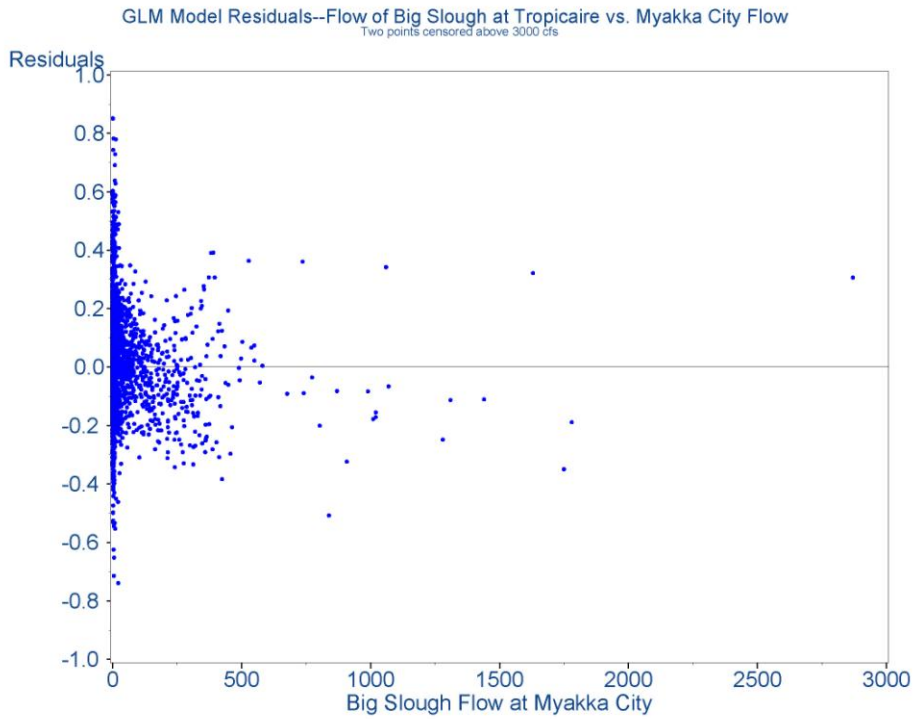

Figure 5. Regression model residuals of equation predicting flows at Big Slough vs. log transformed Myakka City flows.

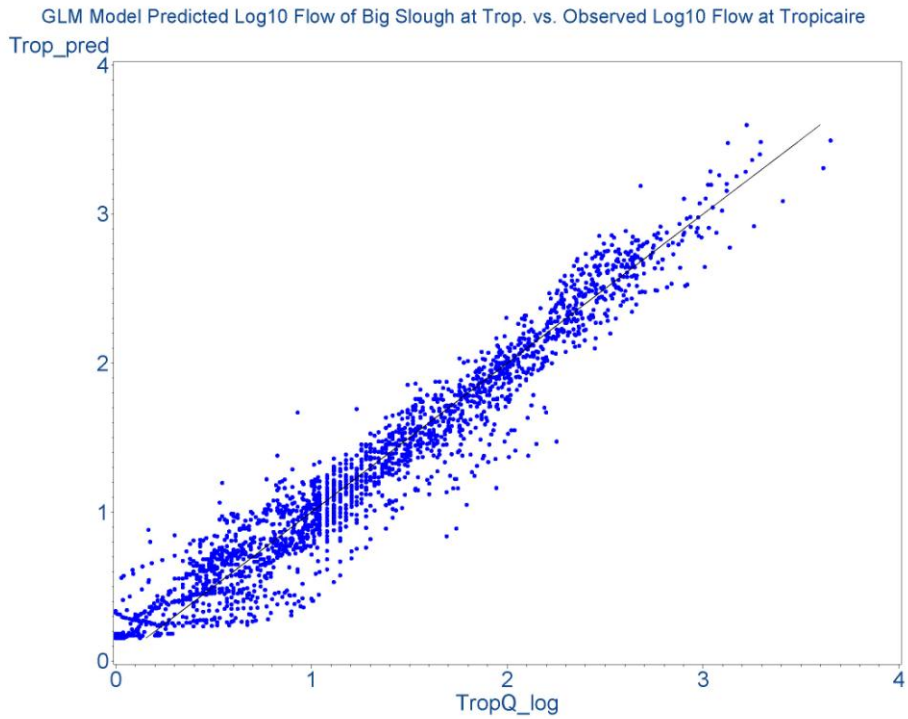

Figure 6. Predicted flow in Big Slough at Tropicaire (log transformed) vs. Observed flow.

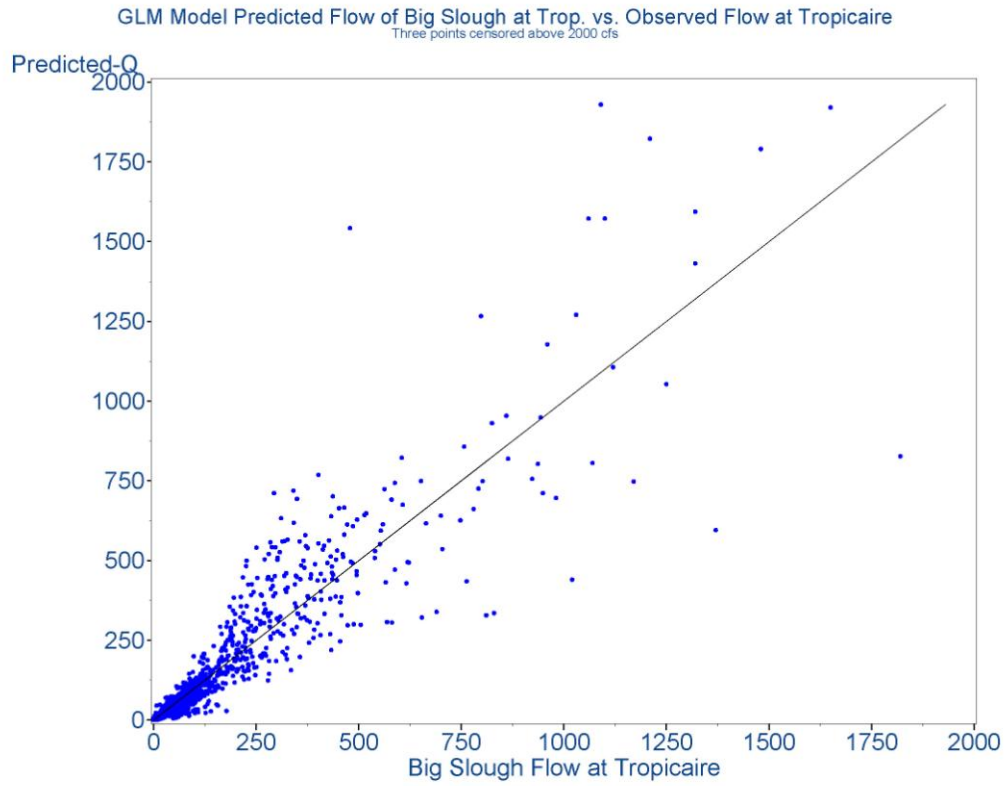
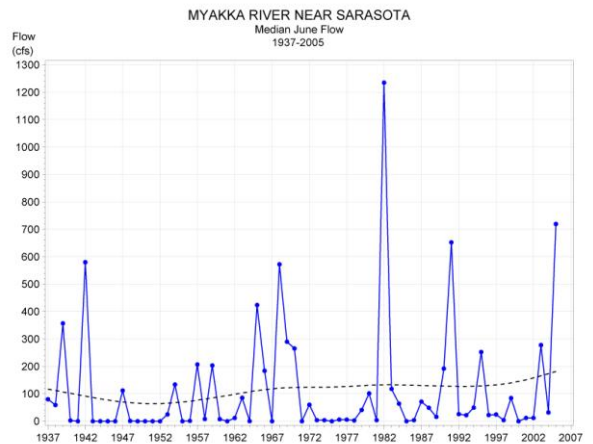
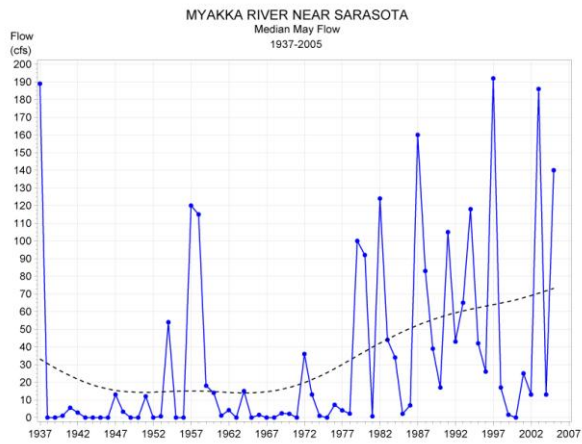
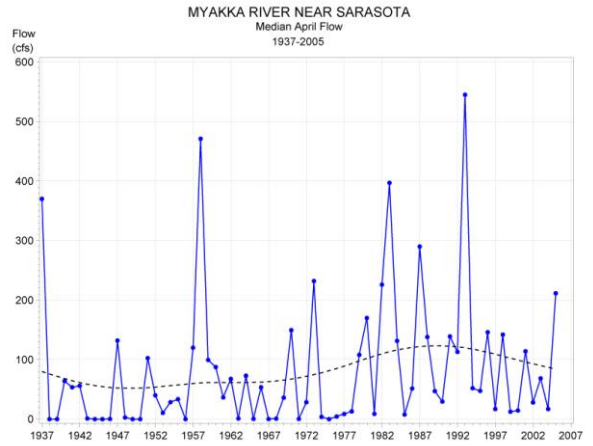
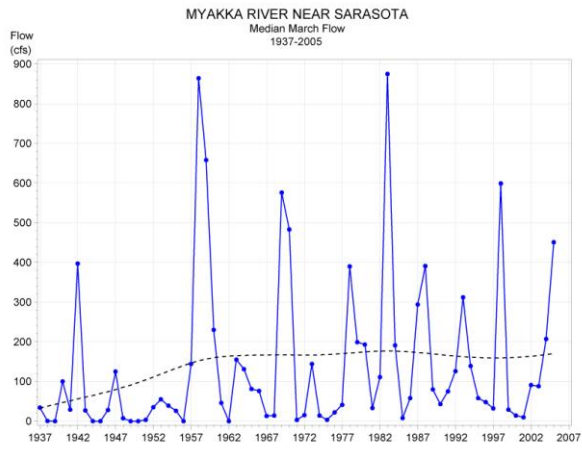
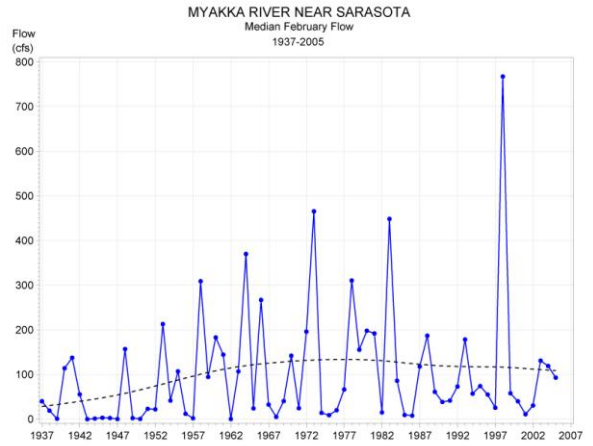
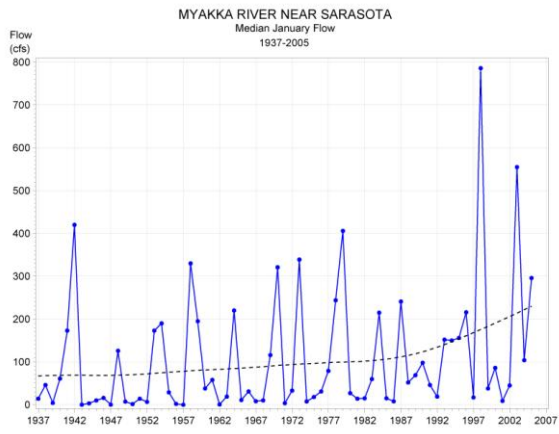
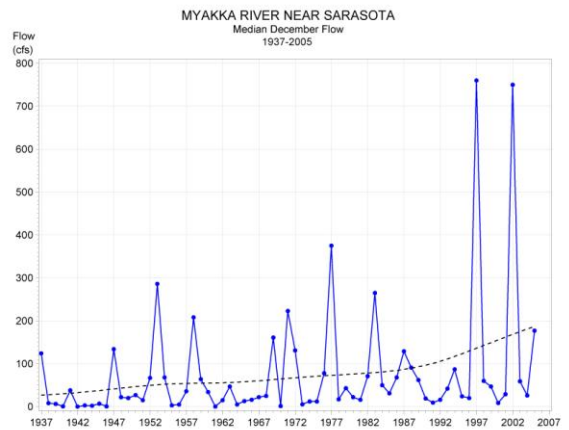
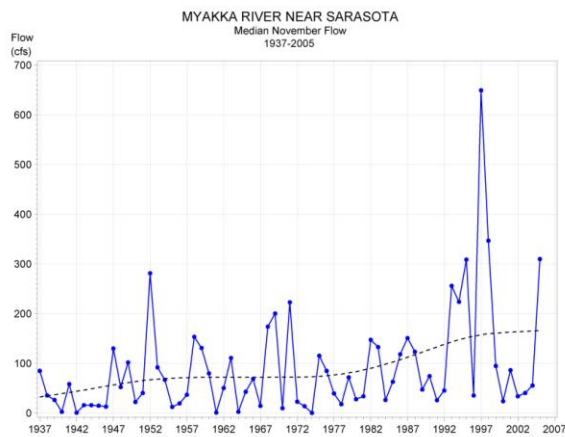
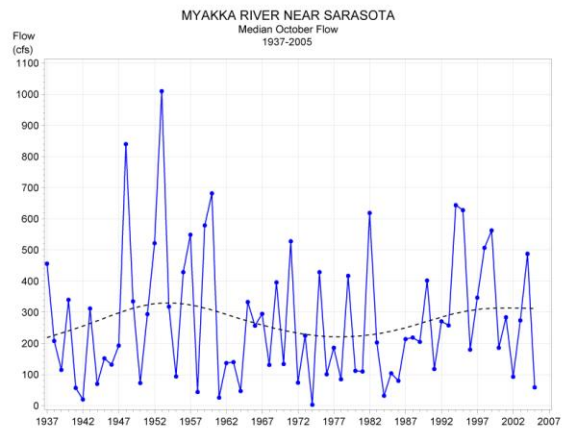
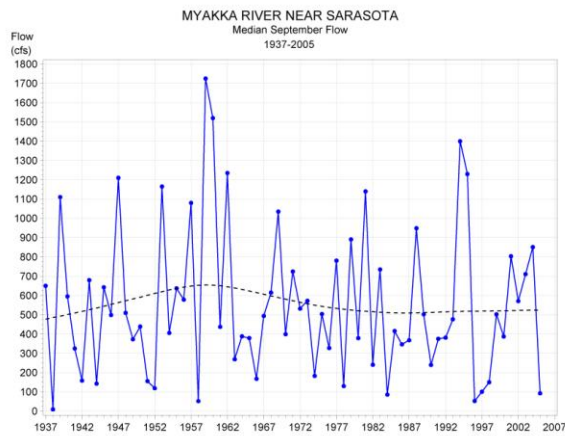
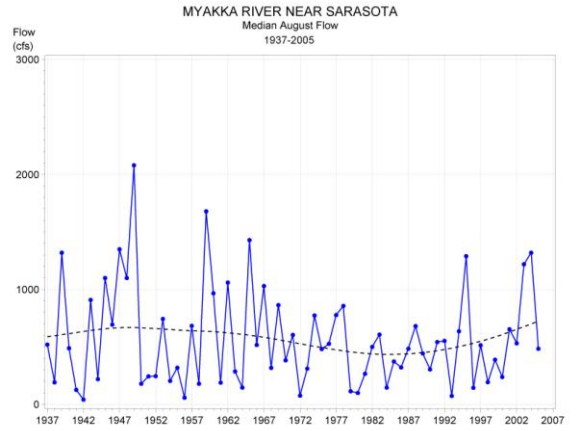
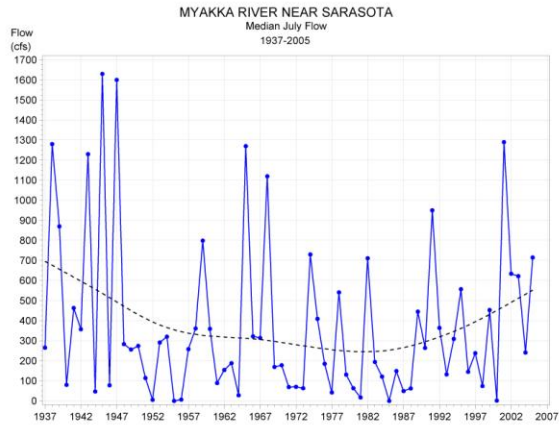

Figure 7. Predicted flow in Big Slough at Tropicaire vs. Observed flow, back-transformed.

Appendix 2C

Time series plots of median monthly flows at the Myakka River near
Sarasota gage for 1937-2005





Appendix 2D

Time series plots of moving average values for mean, minimum and maximum flows for 3, 10, 30, 60, 90 and 190-day periods within each year at the Myakka River near Sarasota gage for 1937-2005

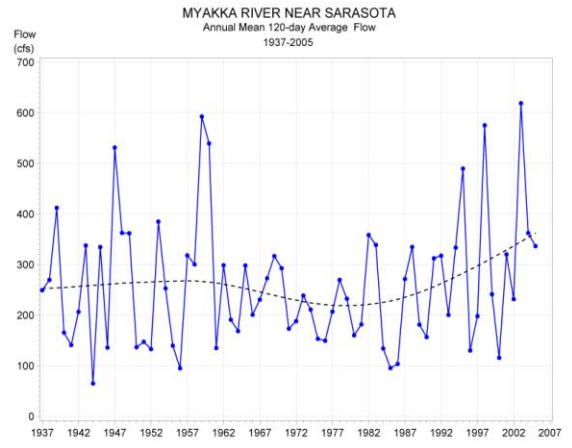
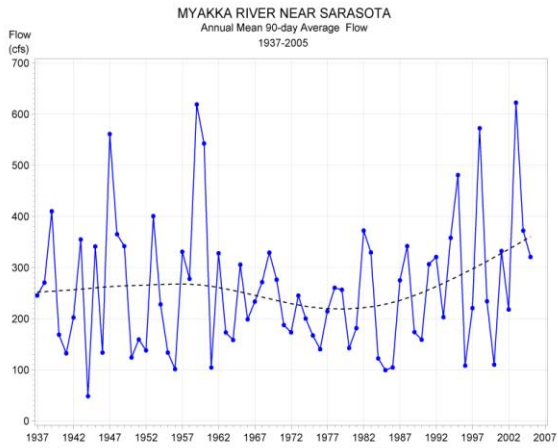
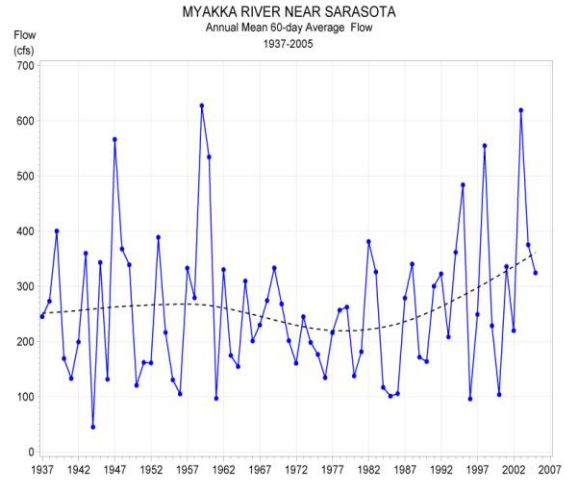
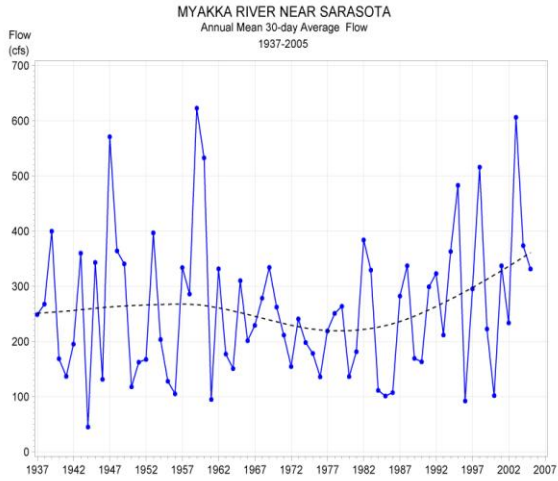
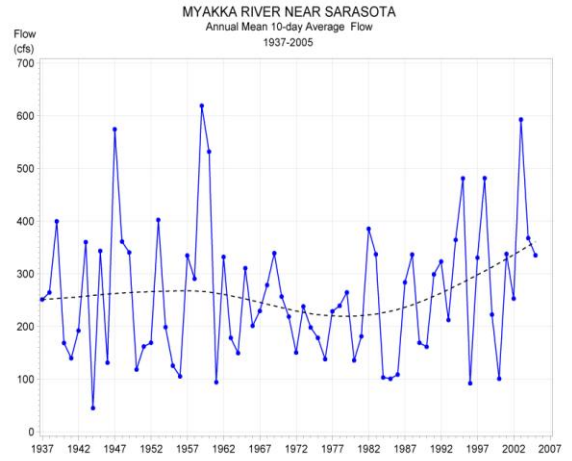
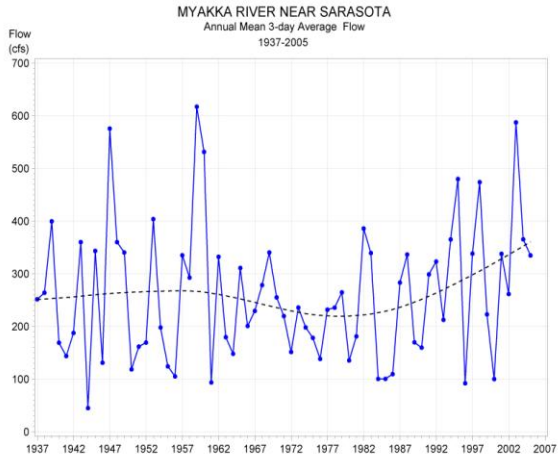

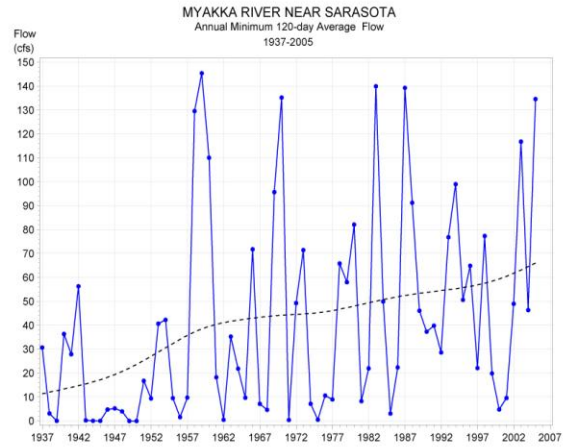
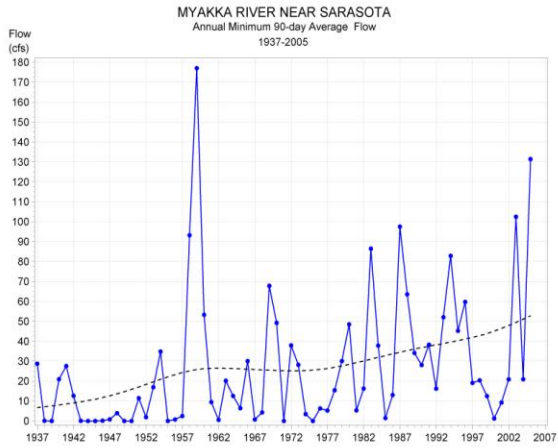
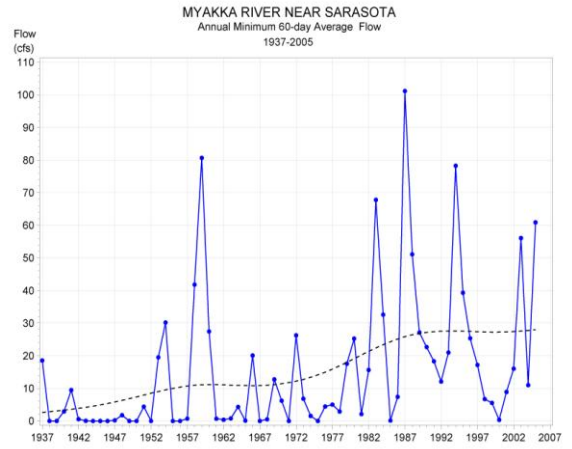
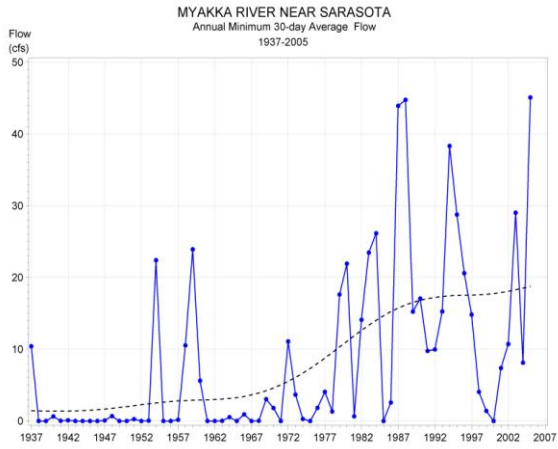
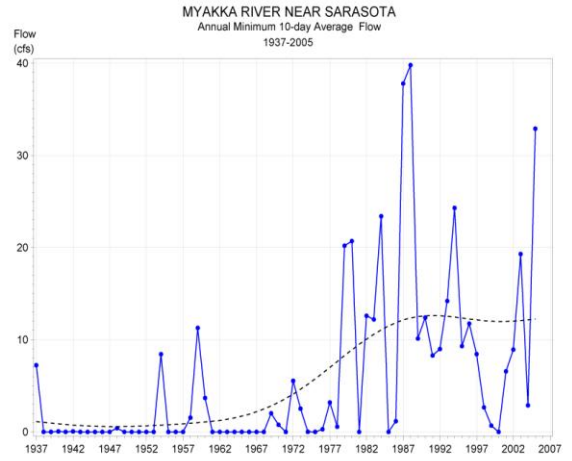
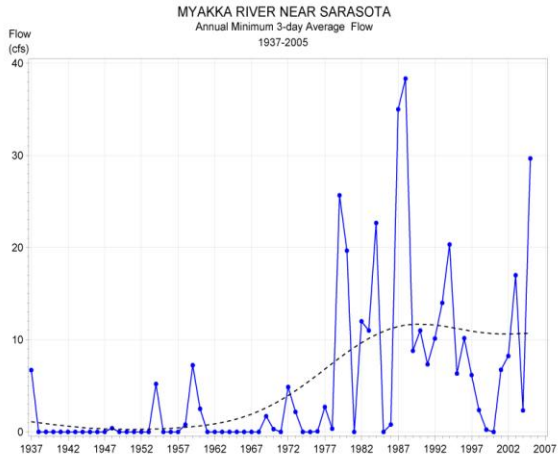

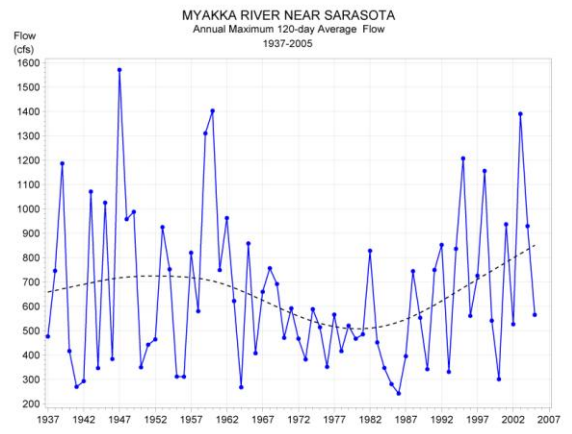
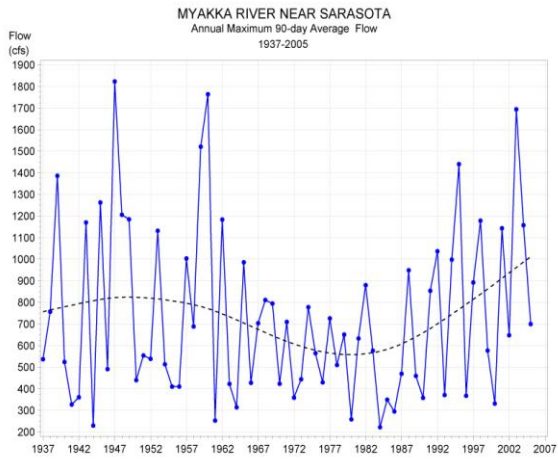
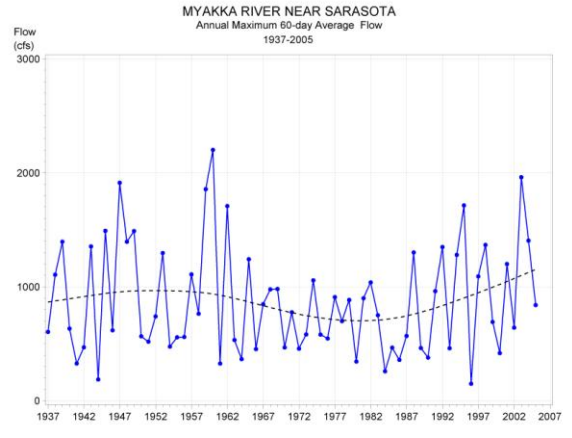
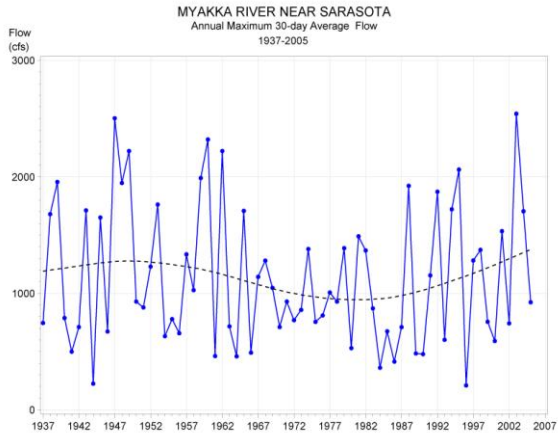
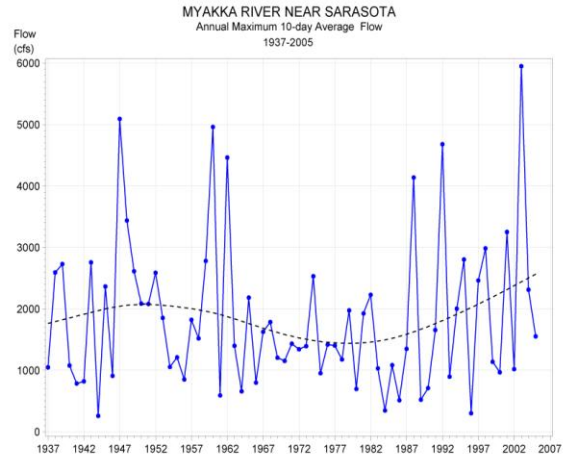
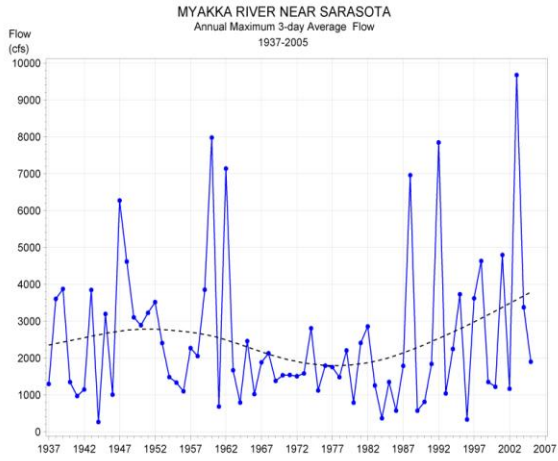

Appendix 2E

Time series plots of median monthly flows at the Big Slough Canal near
Myakka City gage for 1981-2005

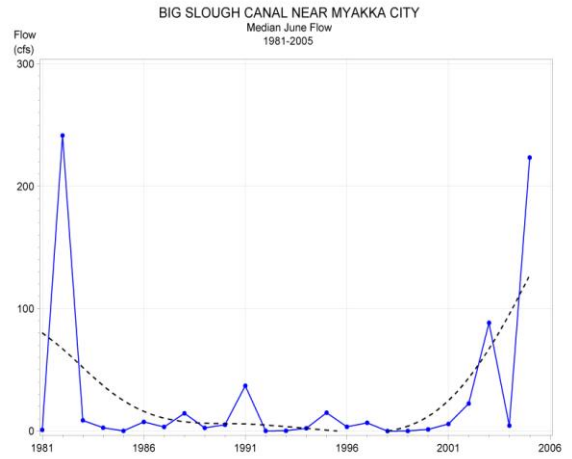
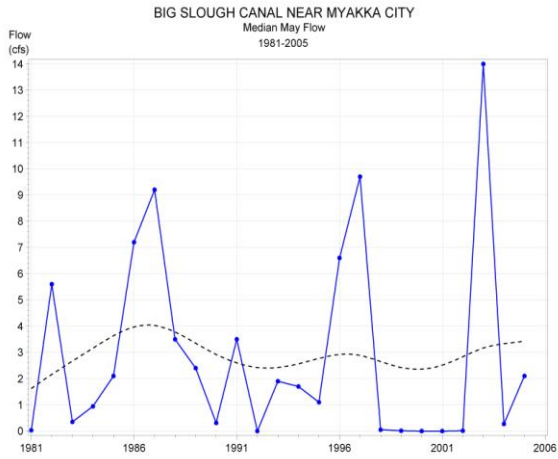
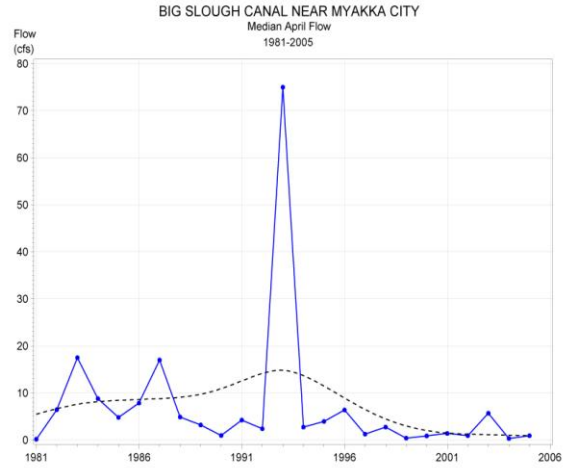
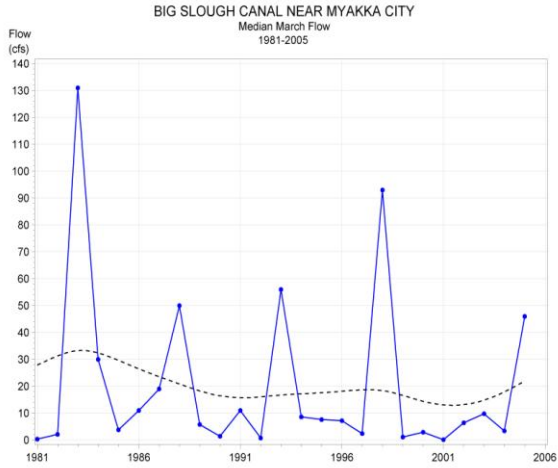
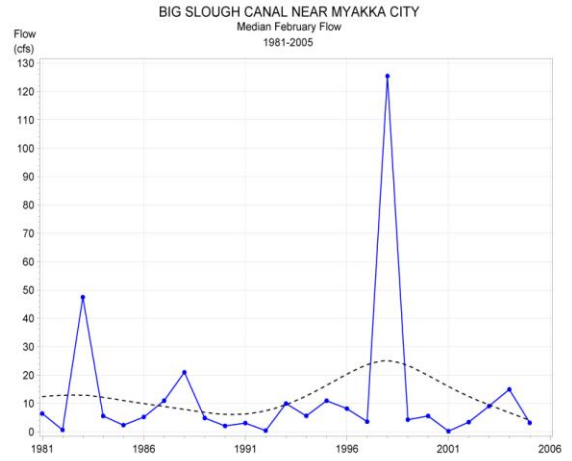
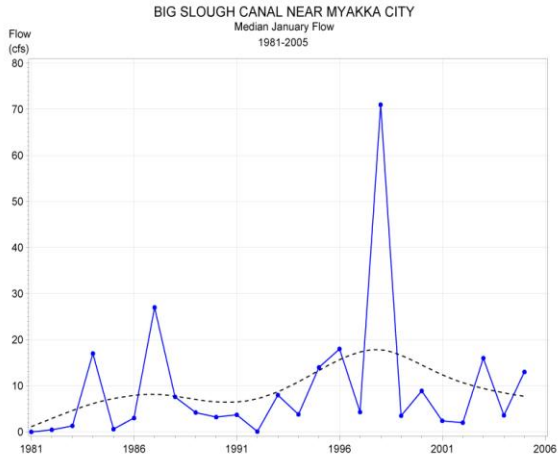

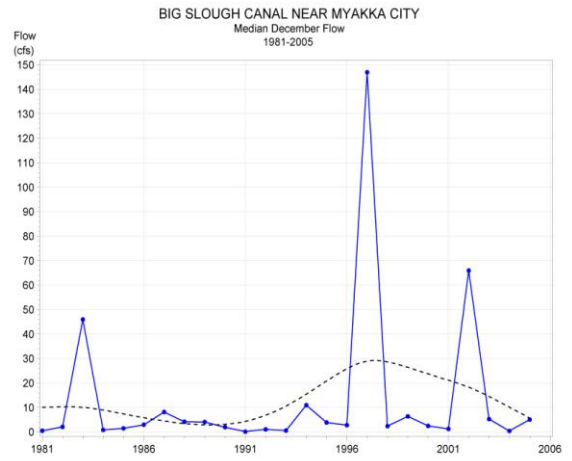
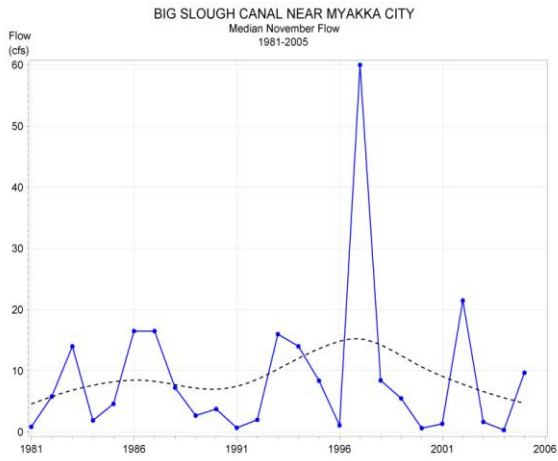
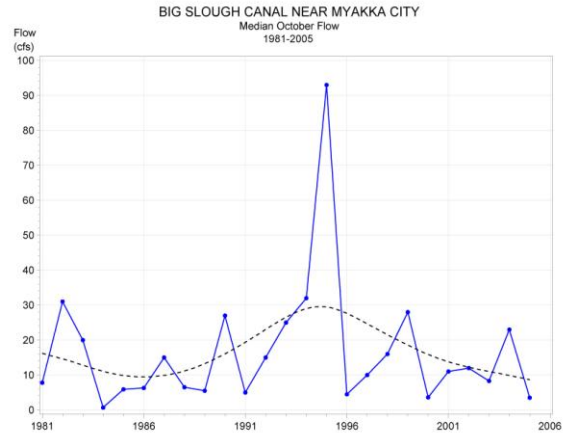
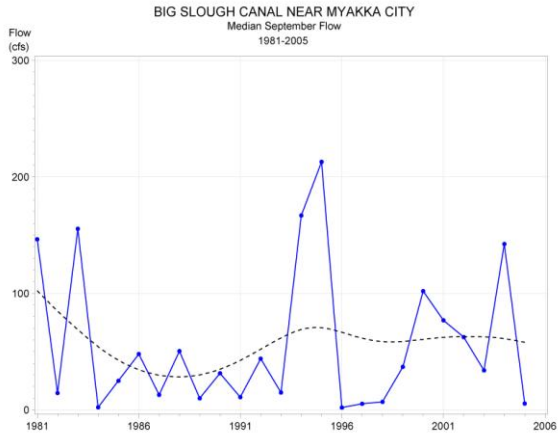
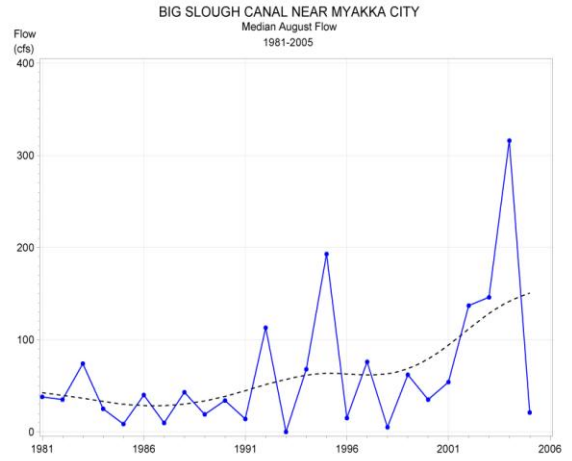
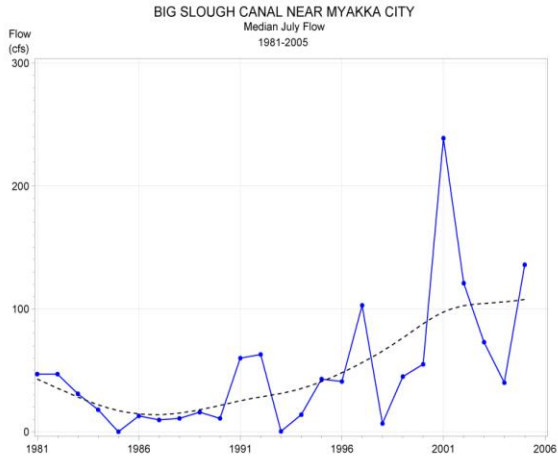

Appendix 2F

Time series plots of yearly values of the 10th , 25th , 50th , 75th and 90th percent exceedance flows for the Big Slough Canal near Myakka City for 1981-2005

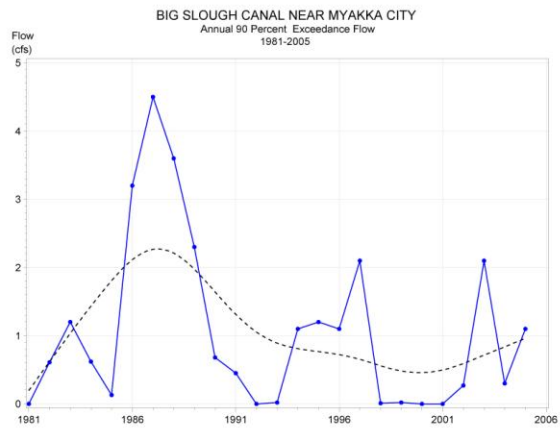
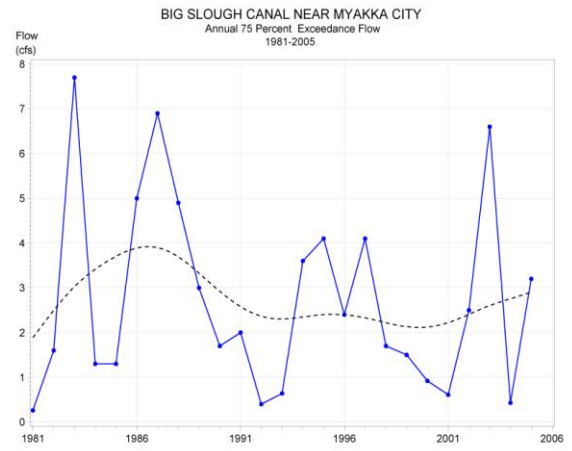
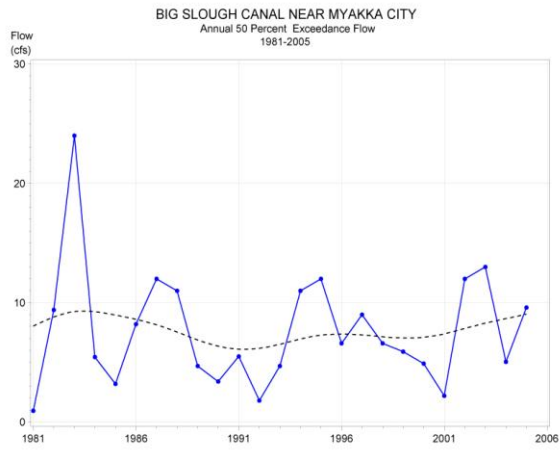
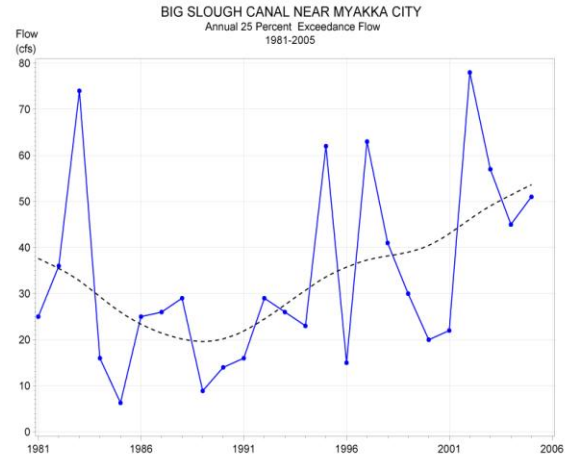
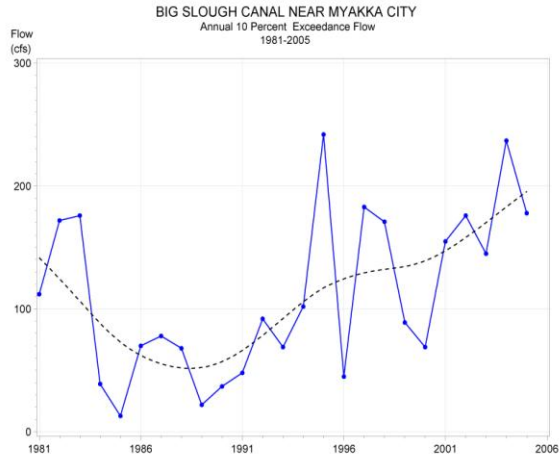

Appendix 2G

Time series plots of moving average values for mean, minimum and maximum flows for 3, 10, 30, 60, 90 and 190-day periods within each year at the Big Slough Canal near Myakka City for 1981-2005

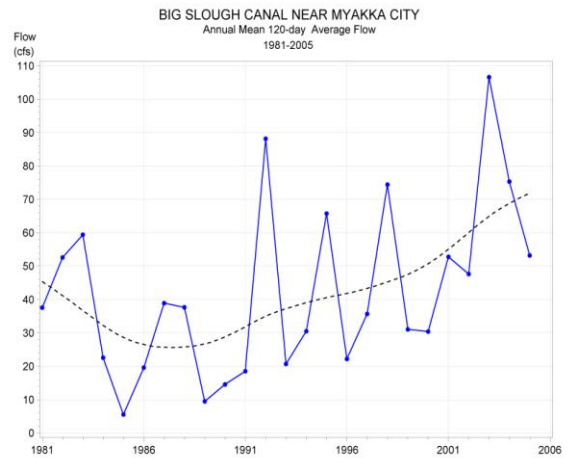
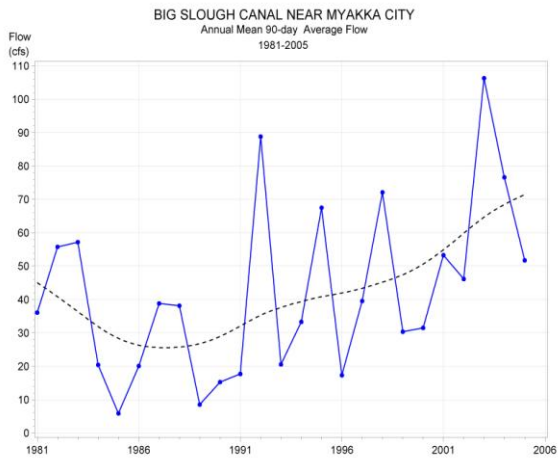
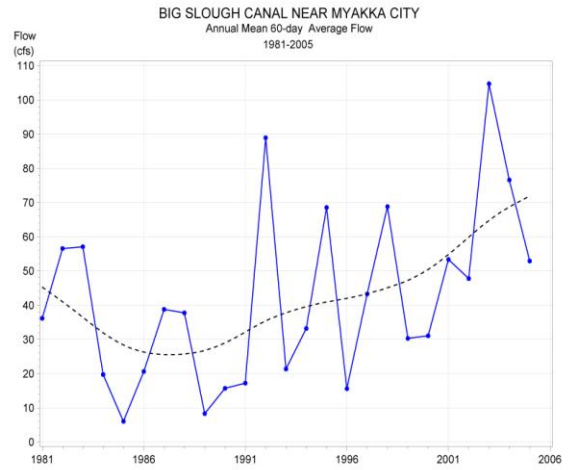
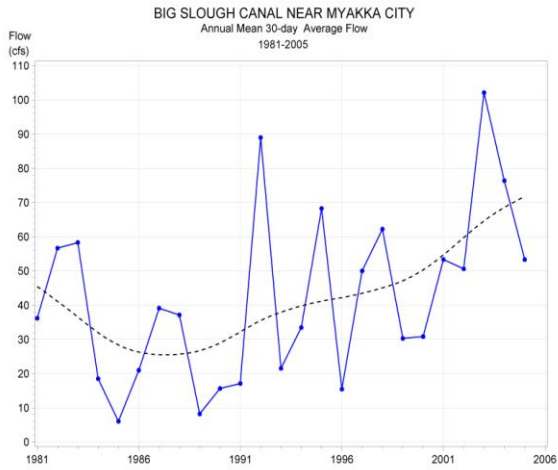
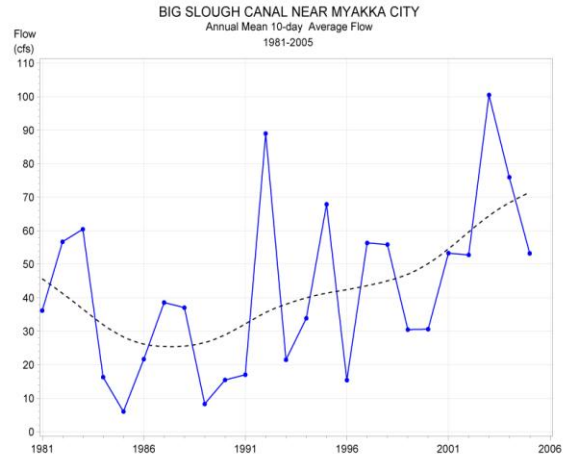
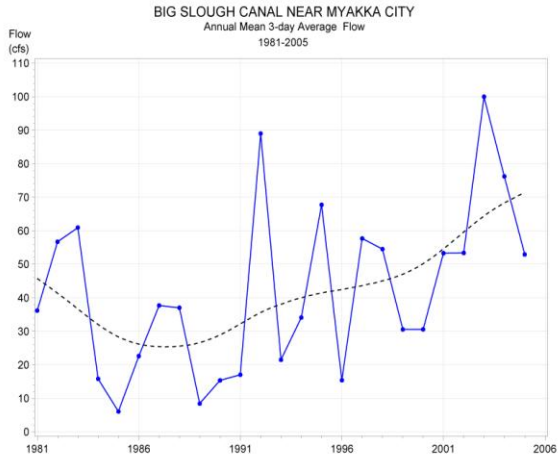

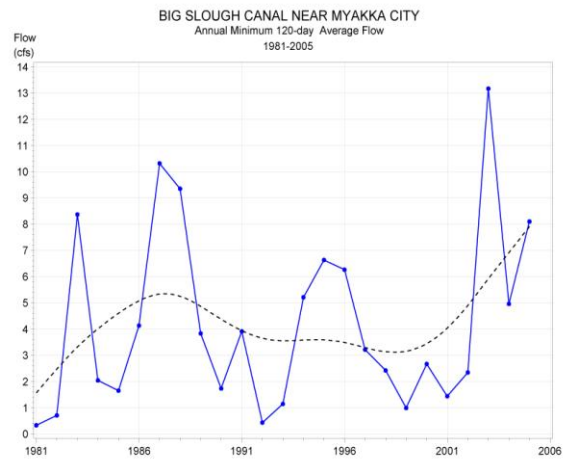
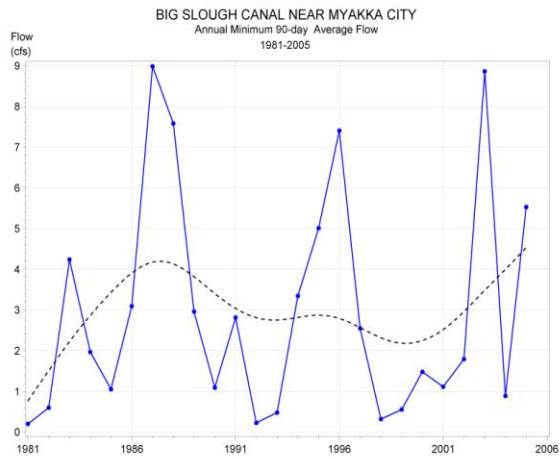
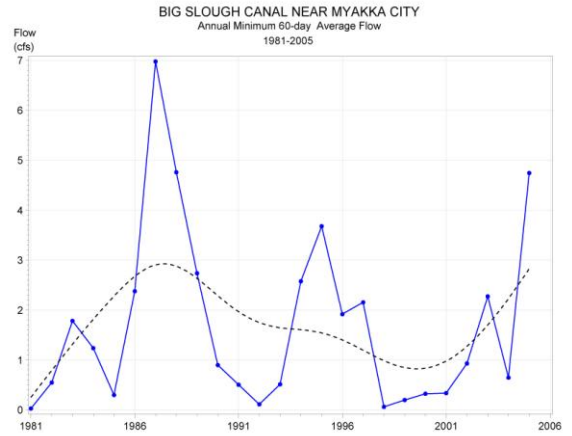
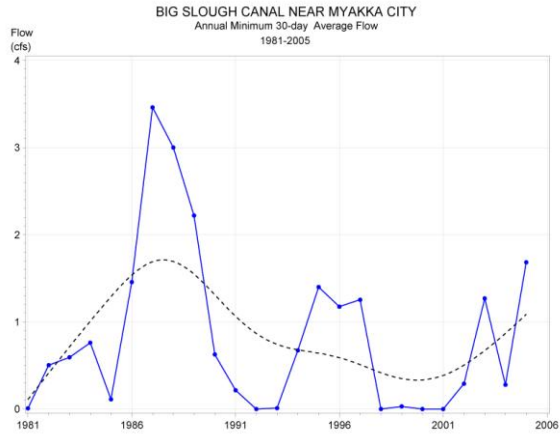
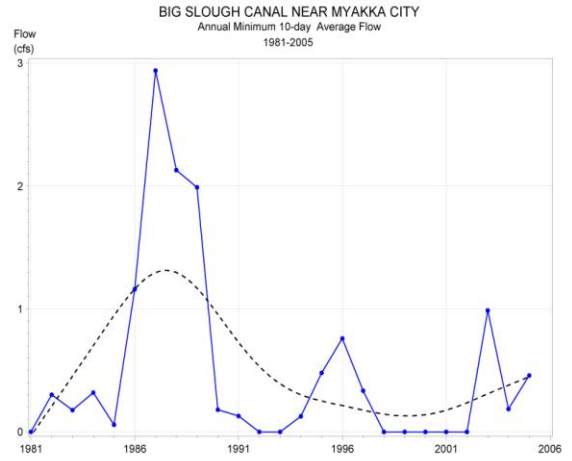
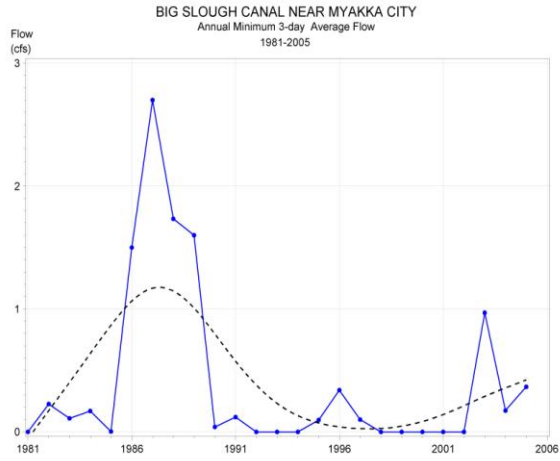

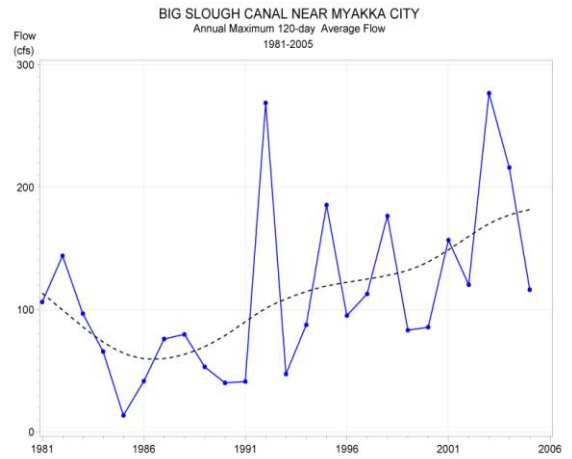
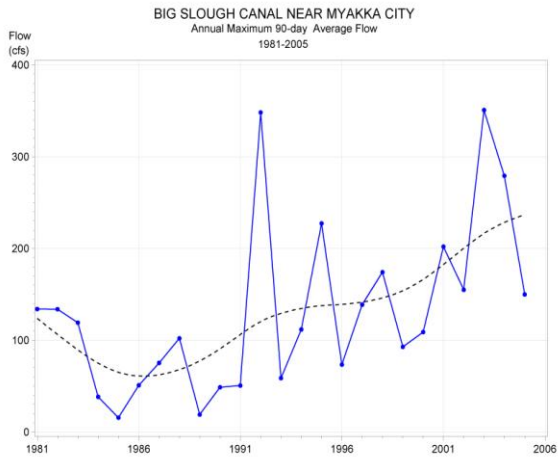
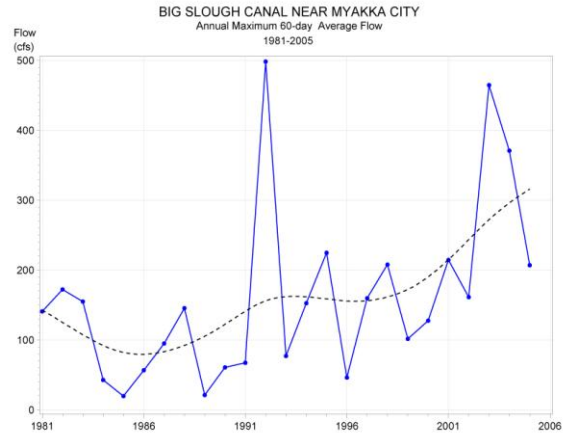
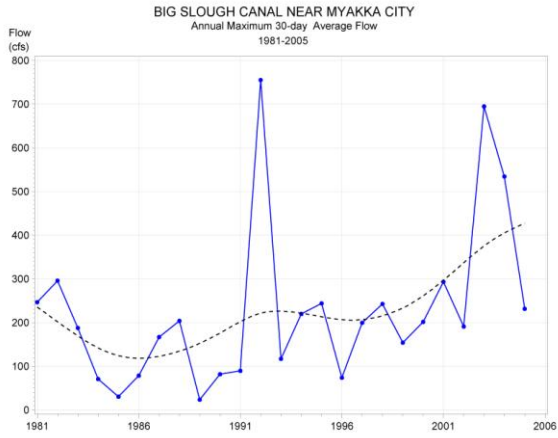
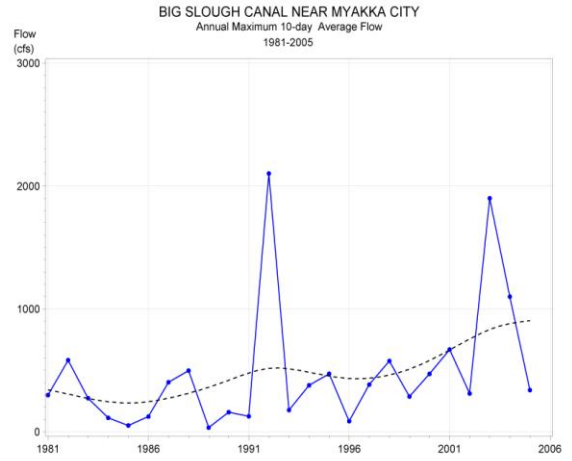
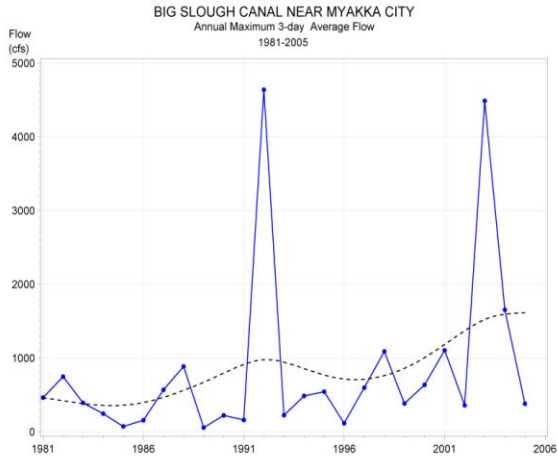

Appendices 4A – 4F

for

Chapter 4

Salinity, Empirical Model Development and Water Quality



Submitted to:

**Michael S. Flannery
Southwest Florida Water Management District
2379 Broad Street
Brooksville, FL 34604-6899
352-796-7211 ext. 4277**

Submitted by:

**L. K. Dixon
Mote Marine Laboratory
1600 Ken Thompson Parkway
Sarasota, FL 34236
941-388-4441 ext. 341**

Mote Technical Report No. 1170

04/25/07

Appendix 4A
Salinity Data Sources

Table 4A-1. Data used for regression analyses of salinity in the Myakka River.

Ref #	Agency	Period of Record	Spatial Coverage	Frequency	Data Storage	Description
3	MML	5/72-5/73	U.S. 41	Weekly N=52	Paper, graphs, annotated	Part of a multi-estuary effort on red tide. Surface salinity, temperature, nutrients, chlorophyll, others. Times are unavailable.
4	MML	5/72-5/75	El Jobean	Weekly, N=156	Paper, graphs, annotated	Part of a multi-estuary effort on red tide. Surface salinity, temperature, nutrients, chlorophyll, others. Times are unavailable.
5	FDEP	73-90's	Lower Myakka, U.S. 41, Border Road,	Erratic, Quarterly to monthly	Digital	Conductivity and other parameters, some periods have monthly data, some profiles
6	FDEP	73-03	Snook Haven	Quarterly, monthly since 1998	Digital	Conductivity, nutrients, and other parameters. Most are near surface samples
7	EQL	6/75-2/90	El Jobean	Monthly, N=207	Digital	Depth profiles of physical parameters (Salinity, DO, temperature, etc.) biweekly until 8/77, monthly thereafter. Chemical data (nutrients, chlorophyll, turbidity, etc.) on varying schedule. Times are unavailable.
8	ESE	6/76-6/77	El Jobean to U.S. 41	Monthly, N=10	Paper	Conductance, nutrients, light related parameters, and pesticides from 3 stations, including Big Slough.
9	EQL	9/76-12/94	Below El Jobean	Monthly, N=204	Digital	Surface and bottom physical data. Times are unavailable.
11	MML	8/85-10/85	Below Cattle Dock Point to Ramblers Rest	Irregular, N=7, on 4 dates	Paper	High-tide and low-tide runs for salinity and other parameters at up to 16 stations or 0.0 ppt.
12	MML	4/86	Below Cattle Dock Point to Blackburn Canal	N=2, on 1 date	Paper	High-tide and low-tide runs for salinity and other parameters at up to 25 stations or 0.0 ppt.
13	USGS	12/82-10/85	Cattle Dock Point to County Line	N=18	Digital	Depth profiles at 4 stations as part of a larger Harbor-wide effort. Physical parameters, nutrients, chlorophyll, light related parameters, others.

14	USGS	1982, 1984-87	Cattle Dock Point to above Blackburn Canal (Some)	N=19	Digital (1985) , Paper (1986)	High and low tide profiles at up to 12 stations or 0.0 ppt. Salinity transition zone not always determined.
16	MML	1/86-12/87	Cattle Dock Point to Snook Haven	Monthly, N=27	Paper	Slack low tide runs for ichthyoplankton, salinity, temperature and dissolved oxygen at 9 stations.
17	Sarasota County	1/89-8/90	Below Cattle Dock Point to Ramblers Rest	Irregular, N=17, 15 in 1989, 2 in 1990	Partial Paper	Rising tide runs at 8 fixed stations and 2 movable stations for salinity and dissolved nutrients, TSS, turbidity, particulate C,N,P.
19	FDEP	8/90-6/98	Below Cattle Dock Point to U.S.41 and tributaries	Monthly, N=113	Digital	26 stations in region of interest, including tributaries and canals. Salinity and other parameters. Surface and bottom readings at some stations.
21	MML	9/95-8/97	Below Cattle Dock Point to El Jobean	Irregular, wet season, N=11	Digital	2 stations sampled for physical parameters, during onset and duration of hypoxia. Depth profiles or surface and bottom measurements.
22	Sarasota County	1/95-1/98	Charlotte County line to near Snook Haven	Monthly, N=37	Digital	Mixed-tide runs at 10 stations for meter profiles plus dissolved nutrients, chlorophyll, BOD, etc. Collected by CCI for Sarasota County.
23	SWFWMD	1/96-12/00	Below Cattle Dock Point to the County Line	Monthly, N=92	Digital	3 stations sampled as part of Harbor-wide effort for physical profiles, nutrients, and chlorophyll
25	CHEVWQMN	11/96-4/00, 2/04-12/04	Near El Jobean	Monthly, N=51	Digital	Surface sampling of salinity, temperature, and dissolved oxygen, nutrients since 8/98
27	Sarasota County	2/98-8/04	Charlotte County Line to Near Snook Haven	Monthly, N=66	Digital	Mixed-tide runs at 10 monthly randomized stations for meter profiles plus dissolved nutrients, chlorophyll, BOD, etc. Collected by MML for Sarasota County. Collected over 2 days since July 2003.
28	MML	2/01-9/04	Below and near Cattle Dock Point	Wet season and summer, N=25	Digital	Surface and bottom or profiles of physical data only. Sampled as part of a several programs addressing hypoxia in the main harbor. Mixed tides.

29	Multi-Agency	3/01-present	Below Cattle Dock Point to the County Line	Monthly, N>84	Digital	5 of 33 stratified random stations sampled monthly as part of a Harbor-wide effort for physical profiles, nutrients, and chlorophyll.
30	SWFWMD	7/03-8/04	Cattle Dock Point to above Blackburn Canal	Monthly, N=14	Digital	Mixed-tide runs at 25 fixed stations for meter profiles plus dissolved nutrients, chlorophyll, BOD, etc. Collected concurrently with Sarasota County AMP. Collected over 2 days.
31	Sarasota County	11/04-12/05	Charlotte County Line to near Blackburn Canal	Monthly, N=14	Digital	Mixed-tide runs at 5 monthly randomized stations for meter profiles plus near surface samples for nutrients, chlorophyll, BOD, etc.
33	FWC-FWRI	1/96-12/04	Below Cattle Dock Point to U.S. 41	Monthly, N=108	Digital	Randomized stations, salinity collected with fisheries data

Appendix 4B

Development of Empirical Salinity Models

Development of Empirical Salinity Models

Independent Variables for Regression Analysis

Independent terms investigated in regression modeling included a wide variety of flow and weighted flow terms, predicted tidal variables, and weather variables (wind speed and direction). Initial investigations employed all variables listed in the following sections, while final regressions (Appendices 4C and 4D) were developed using a reduced subset of the most commonly related variables.

Weather

The most comprehensive hourly weather data were available from VENF1, located approximately 10 kilometers to the west of the Myakka River (27.07Deg N, 82.45 Deg W). The station is owned and operated by the National Data Buoy Center and wind speed and direction data of greater than 99% completeness and barometric data of greater than 98% completeness were retrieved from http://www.ndbc.noaa.gov/station_history.php?station=venf1 for May 1986 through November 2005. Weather data incorporated into the data set were the hourly values closest to the time of sampling or interpolated times calculated with isohalines.

Using these weather data as potential explanatory variables was designed to capture the larger scale weather events, the strong winds and departures of water levels from predicted tides that were associated with frontal passages. The difference between observed and predicted tides was plotted as a function of wind direction during low flow periods to determine that positive residuals (higher than predicted tide) were maximized when wind direction was from 230 ° M, and minimized when wind direction was from 50 ° M. The exact relationship is undoubtedly much more complex, involving set up of water levels along the coast and in Charlotte Harbor, as well as within the Myakka, but for regression purposes, wind direction data (as degrees) were transformed as follows when the cosine function is based on a radian units and wind direction is in degrees.

$$\text{COS_WD} = -1 * \text{Cos}((\text{Wind Direction} - 50) * 2 \text{ Pi}/360)$$

The result was a parameter with a value of -1.0 when the wind direction was 50 ° M and a value of +1.0 when the wind was from 230 ° M. If significant in regressions, this parameter should have a direct relationship with salinity or isohaline position (i.e. positive regression coefficients). Wind stress was approximated by multiplying the transformed wind direction by the wind speed squared. In addition to the hourly values, the averages of the prior three and six hours of barometric pressure, wind direction, and wind stress were also considered (Table 4B-1). Inclusion of weather data as an independent variable in a linear regression typically reduced the available data due to the somewhat shorter period of record relative to flow data and to the number of stations without a specified sampling time.

Table 4B-1. Weather variables investigated during regression analyses.

BAR	Barometric pressure, millibars or hectopascals
COS_WD	Cosine of wind direction, (see text for transformation)
COS_WDS2	Wind stress: COS_WD *(wind speed in m/sec) ²
BAR3	Mean barometric pressure of last 3 hours
BAR6	Mean barometric pressure of last 6 hours
COS_WD3	Mean cosine transformed wind direction of last 3 hours
COS_WD6	Mean cosine transformed wind direction of last 6 hours
COS_WDS23	Mean wind stress of last 3 hours
COS_WDS26	Mean wind stress of last 6 hours

Tide

The use of predicted tidal variables in regression modeling was preferable to observed tides to permit synthesis of tides for the entire period of record and to separate the effects of tides and stage elevations due to increased flows. Predicted tidal heights were developed from continuous stage recorders operated by the US Geological Survey at El Jobean (02299496 Myakka River at El Jobean, FL., 26.9578 ° N, 82.2128 ° W). A 30 day period of hourly data recorded during the lowest flow period available (5/31/1985 – 6/30/1985) was selected. Flow ranged between 0.1 and 0.0 cfs and averaged less than 0.007 cfs. Seasonal variation in sea level was removed based on linear interpolations of monthly values of the sea level variations recorded at the NOAA/NOS CO-OPS site at Fort Myers (8725520, <http://tidesandcurrents.noaa.gov/sltrends/seasonal.shtml?stnid=8725520&name=Fort+Myers&state=Florida>). Tidal harmonics were abstracted (Boon and Kiley, 1978), predictions of hourly stage were generated for 1972-2005, seasonal variations in sea level were returned to the predicted record, and the data were converted to meters.

Correspondence between observed and predicted timing and tidal elevation during the 1985 low flow period was excellent, with an average RMS error of less than 0.15 feet (Figure 4B-1). The 1985 harmonics were demonstrated to be faithful through time as predicted tides during the second lowest flow period available (April 23, 05:00 to June 9, 2004, 05:00, Figure 4B-2) retained excellent high and low tide correspondence of timing with observed tides. Amplitudes of predicted tides, as RMS error between observed and predicted, were somewhat larger than in the 1985 initiating data period (0.34 ft), and may include some effects of the non-zero flow during the 2004 period illustrated.

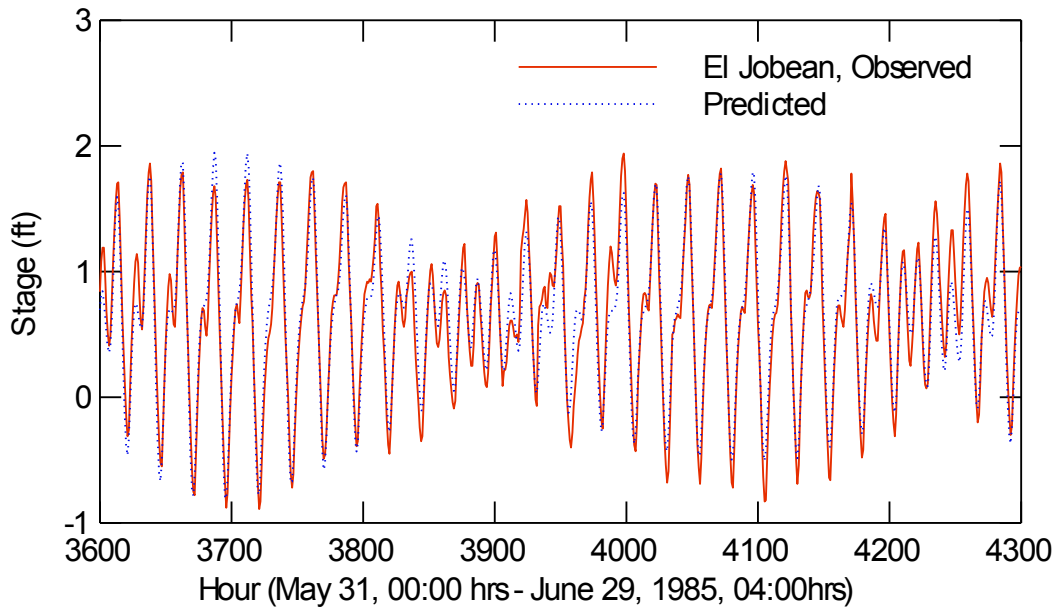

Figure 4B-1. Correspondence of observed and modeled tide heights at El Jobean during the period of the initiating data.

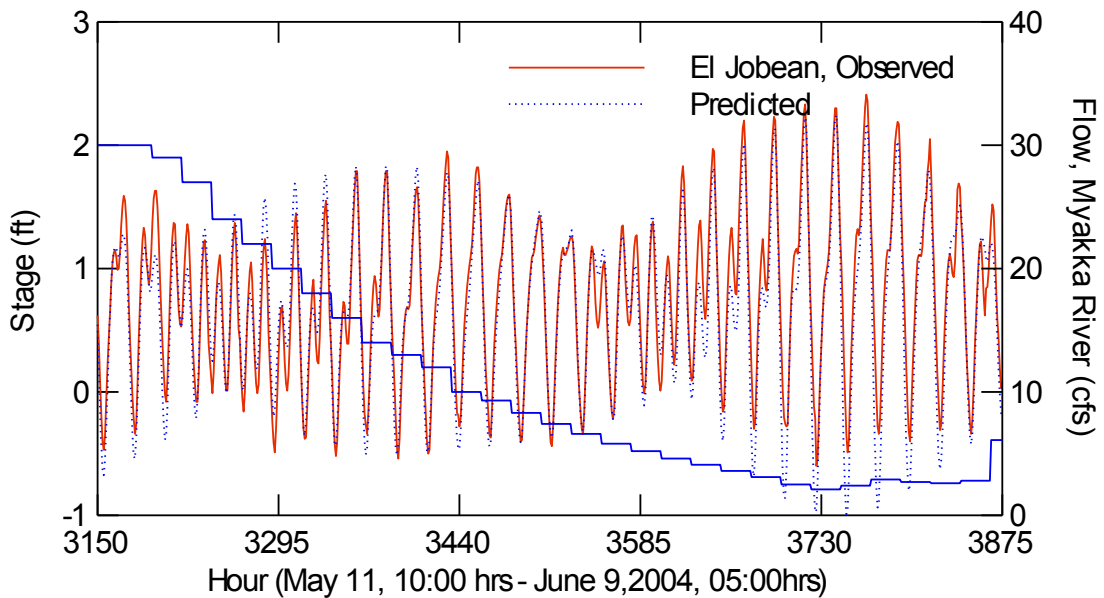

Figure 4B-2. Correspondence of observed and predicted tide heights during a low flow period other than during the 1985 initiating data.

Residuals of tide height (observed minus predicted) for 2004 as a whole were shown to be significantly related to wind direction, wind stress, barometric pressure, flow, time of day, month, and stage, with the combination of parameters accounting for over 66% of the variation in residuals. Signs of coefficients were appropriate and indicated that predicted tide heights, computed from harmonics derived in 1985 and applied to the entire period of record, were an appropriate independent variable to consider for salinity regression modeling.

Predicted tidal variables considered as potential independent variables appear in Table 4B-2 and include variables computed relative to the precise time of each data point or calculated isohaline location (data from the nearest hour). Lag times investigated are based on the range of lags in stage timing reported (Hammett, 1992) for various locations in the river relative to El Jobean. Data without sampling times did not have the time-specific variables. Other tidal variables are day-specific (based on 0-2300 hrs GMT) and were available for all data.

Table 4B-2. Predicted tidal variables at El Jobean investigated during linear regression analyses. Heights are in meters.

Time specific variables

PRED_M_SEA	Predicted stage in m, with seasonal sea level added back in, based on 1985 harmonics
DELTA_M	Change in stage per hour, over last hour
TIDE_M1	Stage 1 hour earlier
TIDE_M2	Stage 2 hours earlier
TIDE_M3	Stage 3 hours earlier
TIDE_P1	Stage 1 hour later
TIDE_3M	Mean stage of last 3 hours
RATE_3M	Mean rate of change (DELTA_M) of last 3 hours
MAXRATE_3	Maximum rate of change of last 3 hours
MAXTIDE_3	Maximum stage of last 3 hours
MINTIDE_3	Minimum stage of last 3 hours
TIDE_6M	Mean stage of last 6 hours
RATE_6M	Mean rate of change of last 6 hours
MAXRATE_6	Maximum rate of change of last 6 hours
MAXTIDE_6	Maximum stage of last 6 hours
MINTIDE_6	Minimum stage of last 6 hours

Table 4B-2. Predicted tidal variables at El Jobean investigated during linear regression analyses. Heights are in meters. (Continued.)

Day specific variables

MIN_TIDE	Minimum stage of the day
MAX_TIDE	Maximum stage of the day
RANGE_TIDE	Range of stage for the day
TIDE_MEAND	Mean tide for the day
TIDE_MEANL	Mean tide during typical sampling hours (1000-1600 hours UTC inclusive)
MIN_RATE	Minimum rate of change for the day
MAX_RATE	Maximum rate of change for the day
RANGE_RATE	Range of rate of change for the day
RATE_MEAND	Mean rate of change for the day
RATE_MEANL	Mean rate of change for typical sampling hours (1000-1600 hours UTC, inclusive)

Flows

The reference flow station used for discharge from the Myakka River was the U.S.G.S. Station 02298830, Myakka River near Sarasota, FL (27.2403 ° N, 82.3139 ° W) with a drainage area of 593 km² (229 mi²). Period of record available for the site was much greater than for the salinity record available, extending from September 1, 1936 and completed with data available through December 31, 2005 for this project.

(http://waterdata.usgs.gov/fl/nwis/dv/?site_no=02298830&agency_cd=USGS&app=referred_module=sw). References in this report to flows in the Myakka River refer to this site exclusively unless specified otherwise.

Ungaged flows to the Myakka River were developed by Ross, *et al.* (2005) using the HSPF rainfall/runoff model for an additional 746 km² (288 mi²) of watershed and down to river kilometer 0.0. Data were simulated for January 1989 through September 2004 and incorporated gaged flows as well from Deer Prairie Slough and Myakkahatchee Creek. These data were originally scheduled for analysis as a potential independent variable. Differences in timing of peak flows between adjacent reaches, and an extended record of flows available from Myakkahatchee Creek, however, resulted in the use of Myakkahatchee flows as a potential variable instead. Ungaged flows were not included in regression analyses.

Myakkahatchee flows were developed from a variety of sources to provide a record from October 1, 1980 through December 31, 2004. Flows were reported from WCS 101 (U.S.G.S. Station 02299484, 27.0467 ° N 82.2381 ° W) by the City of Northport for 2003 and 2004 on the majority of days using methods reported by Boyle Engineering (2003). Some unreasonable values were

discarded. A piecewise regression was developed by HSW Engineering, Inc., between WCS 101 flows and the U.S.G.S. gage immediately upstream (Station 02299410, Big Slough Canal near Myakka City, FL, 27.1931 Deg N 82.1444 Deg W). The regression was used to provide flow estimates at WCS 101 for the 1980 to 2002 period. For the period May 1, 2002 through December 31, 2004, flow estimates at WCS 101 included values reported by the City of North Port and values predicted by the regression on dates where the City's values were missing. Data from June 23-24, 2003 were not included in regression variables as they were outside the rating curve of the Big Slough Canal site and were excessive relative to other flows in the Myakkahatchee and adjacent basins.

As an indicator of end member conditions affecting the lower Myakka River (i.e. salinity in Charlotte Harbor), flows from the Peace River at Arcadia (U.S. G.S. Station 02296750, 27.2219 Deg N 82.8761 Deg W) were also examined as a potential independent variable. The site captures approximately 3,541 km² (1,367 mi²) or roughly 60% of the total gaged flow of the Peace River watershed with average flows slightly over three times that of the Myakka River. Data retrieved were matched to the period of record used for the Myakka River, (http://waterdata.usgs.gov/nwis/dv?referred_module=sw&site_no=02296750) 1936 through 2005,.

Exponential Flow Weighting

A variety of flow weighting and transformations were applied to flow data to generate potential independent variables. In addition to the daily flow values of the three gages, lagged flows of the Myakka River of 1, 2, 3, 5, 7, and 10 days were considered. Exponentially weighted flow terms over the prior 3, 5, and 7 days were also computed from the Myakka and Peace Rivers and the Myakkahatchee Creek records. Exponential weighting was calculated after Berthouex, et al. (1978) as:

$$EXWTQ = \sum_{n=1}^D (1 - WT)^n * (WT)^n * Q_n$$

where
EXWTQ = exponentially weighted flow
D = number of days of weighting, 3, 5, or 7 days
WT = weighting factor; 0.26 for 3-day, 0.6 for 5-day, and 0.79 for 7-day
Q_n = daily flow value on the nth day

Variable Flow Weighting

A mechanistically-based variable weighting technique was also developed and applied to the Myakka River, Myakkahatchee Creek, and Peace River flows. The number of days over which flow weightings were performed was varied daily as a function of both the daily flow value and the computed river kilometer of isohaline or the kilometer of the fixed station.

To develop the number of days of flow weighting, the volume of the river at mean tide level was computed from the volume:kilometer file developed by the District based on bathymetric data collected relative to NGVD 29 by the University of South Florida Department of Geology (Wang, 2004). Mean tide level was estimated to be 0.183 m (NGVD 29) based on elevation information for PID AG1725 VM 17163 at El Jobean

(http://tidesandcurrents.noaa.gov/data_menu.shtml?stn=8725769%20El%20Jobean,%20Myakka%20River,%20FL&type=Bench%20Mark%20Data%20Sheets and http://www.ngs.noaa.gov/cgi-bin/ngs_opsd.prl). The horizontal layer consisting of the river volume between 0.134 and 0.434 m was linearly interpolated to 0.183 and added to deeper layers to obtain the volume of the river (in 1000 m³) at mean tide upstream of the specified kilometer interval. The volume of the last segment was extrapolated to river kilometer 51.0 (The approximate southern boundary of Lower Lake Myakka) and included in the total riverine volume. An empirical relationship (Figure 4B-3) of riverine volume as a function of kilometer position (KM) was developed for the portion of the river above and below 13.0 km. Volume was in units of 1000 m³ and equations were as follows:

0.0 to <13.0 km	$Vol = 74.405 * KM^2 - 3109.8 * KM + 30342$
13.0 to 40.0 km	$Vol = 10837 e^{-0.1107 * KM}$

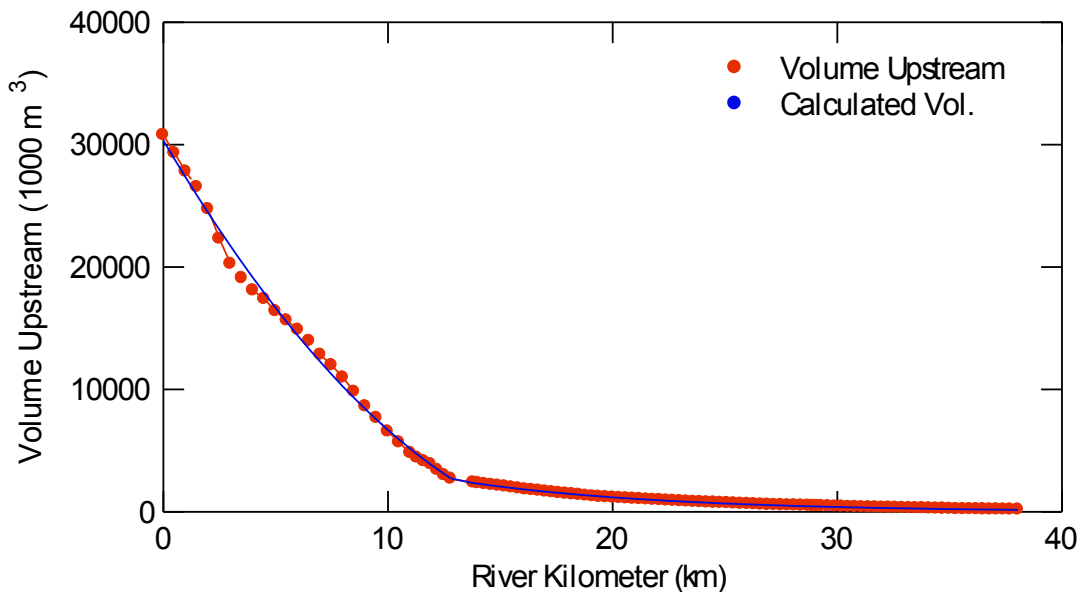

Figure 4B-3. Cumulative volume of the Myakka River upstream of specified kilometers and the empirical function used for description (see text). Volumes are estimated for mean tide level and extrapolated to approximately 51.0 km.

Using the river kilometer (km x) of an individual isohaline location or salinity observation, the volume of the river upstream of the position (Vol) was calculated using one of the two formulae above. The Myakka flow on that same day (Q_n) was used to compute the number of days (DAYS) that it would require to fill the river between 51.0 km and km x if the flow remained constant. With appropriate unit conversions:

$$\text{DAYS} = \text{Vol} / Q_n$$

The quantity DAYS is then the period over which flow weighting was conducted. On a given date, the DAYS quantity was smaller for upriver locations than for positions downstream due to the differences in river volume upstream of the respective locations. The variable weighting method results in a more immediate response to flow change in the upper river than in the lower river. The quantity DAYS (the effective flow history) is also smaller for high flow conditions than for low flow days. The DAYS parameter was also used for Peace River flow weighting, while for Myakkahatchee Creek, creek volume and days to fill (BSDAYS) was computed as a sum of the estimated Creek volume between the U.S. 41 bridge and the Myakka River and 0.26 times the Myakka River volume between the isohaline position and the mouth of Myakkahatchee Creek. (Flows of Myakkahatchee Creek average about 0.26 the Myakka River flows.) Influence of the Myakkahatchee Creek upstream of the confluence with the Myakka River (at near 15 km) was limited to river kilometer 20.3.

Once the DAYS parameter was computed, a flow weighting was performed over the minimum of either the calculated DAYS or BSDAYS quantity or 45 days (i.e. the maximum period over which flow weighting was performed was 45 days). A new DAYS or BSDAYS value was calculated for each day and for each isohaline position. An example of the variable flow weighting, VWT45, appears in Figure 4B-4. Weightings were performed both as a declining linear function (VWT45) and an exponential weighting (VEXWT45). The variable flow weighting was mechanistic in that it captured a long history of flow influence at low flow conditions with higher weights for more recent flows, while high flow conditions were primarily a function of the last few days. Variable flow weightings were also calculated using 30 and 15 days as a maximum period as well as the 45 day maximum described above. Again using the DAYS parameter, lagged flows of one, one-half, and one-quarter of the DAYS parameter were also used as an independent variables.

Rate of change in flow was also used as an independent variable to capture any difference in salinity:flow relationships between the ascending or descending limb of a hydrograph. Change in flow rates for the Myakka and Peace Rivers were calculated by two methods over either a three or five day period. Changes in flow rates were calculated as either the mean change of prior days relative to the day in question (FLORATE3) or as mean of change in flow rates between each successive day (FLORATE3B). The three day calculations are illustrated below,

Figure 4B-4. Example of variable flow weighting calculation.

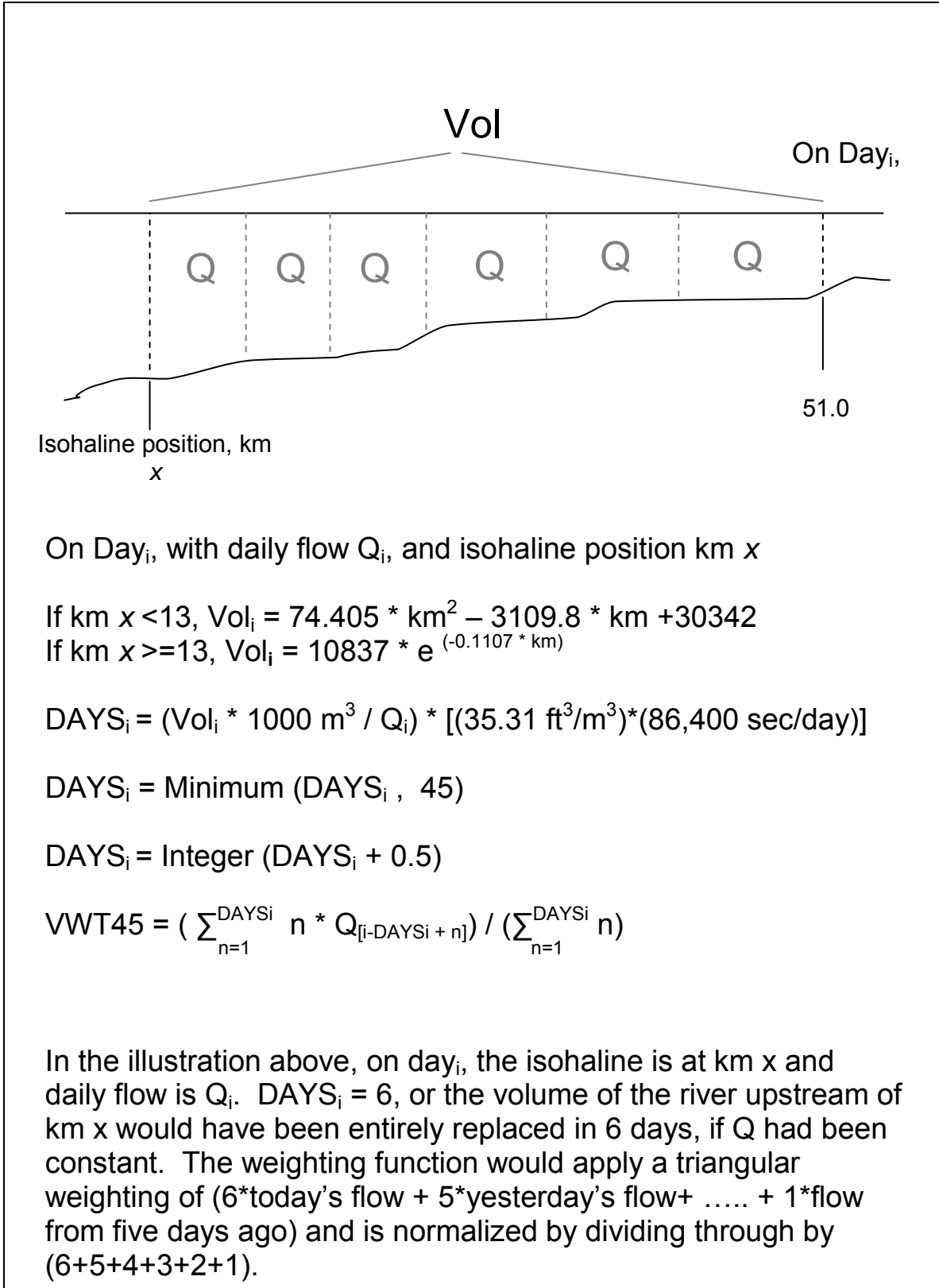

where Q_0 is the flow on the day for which weighted flows are desired and Q_3 is flow three days prior

$$\text{FLORATE3} = ((Q_0 - Q_3) + (Q_0 - Q_2) + (Q_0 - Q_1)) / 3$$

$$\text{FLORATE3B} = ((Q_0 - Q_1) + (Q_1 - Q_2) + (Q_2 - Q_3)) / 3$$

Flow terms were natural log transformed after the addition of 10 cfs. Table 4B-3 lists the flow terms examined during regression analyses. (Initial investigations also included squared and cubed terms of some of the dominant flow terms but these were subsequently discarded as modeled salinities often decreased in response to decreased flows.)

Table 4B-3. Flow variables considered as independent variables in regression analyses.

FLOW	Daily flow, Myakka River.
DAYS	Days required to fill river volume between 51.0 and isohaline km at the daily flow.
VWT45	Variable weighted flow over maximum of either DAYS or 45 days
VWT30	Variable weighted flow over maximum of either DAYS or 30 days
VWT15	Variable weighted flow over maximum of either DAYS or 15 days
VEXWT	Variable exponentially weighted flow over maximum of either DAYS or 45 days
EXWT3	Exponentially weighted flow over the prior 3 days
EXWT5	Exponentially weighted flow over the prior 5 days
EXWT7	Exponentially weighted flow over the prior 7 days
LNFLOW	Natural log transformation of (FLOW+10)
LNVT45	Natural log transformation of (VWT45+10)
LNVT30	Natural log transformation of (VWT30+10)
LNVT15	Natural log transformation of (VWT15+10)
LNEXWT	Natural log transformation of (VEXWT+10)
LNEXWT3	Natural log transformation of (EXWT3+10)
LNEXWT5	Natural log transformation of (EXWT5+10)
LNEXWT7	Natural log transformation of (EXWT7+10)
FLORATE3	Change in flow rate, method 1, 3 days prior
FLORATE3B	Change in flow rate, method 2, 3 days prior
FLORATE5	Change in flow rate, method 1, 5 days prior
FLORATE5B	Change in flow rate, method 2, 5 days prior
LAGDAYS	Daily flow, DAYS (see above) prior
LAG_5DAYS	Daily flow, DAYS/2 prior
LAG_25DAYS	Daily flow, DAYS/4 prior

Table 4B-3. Flow variables considered as independent variables in regression analyses. (Continued.)

LAG_1	Daily flow, Myakka River, 1 day prior
LAG_2	Daily flow, Myakka River, 2 days prior
LAG_3	Daily flow, Myakka River, 3 days prior
LAG_5	Daily flow, Myakka River, 5 days prior
LAG_7	Daily flow, Myakka River, 7 days prior
LAG_10	Daily flow, Myakka River, 10 days prior
PFLOW	Daily flow, Peace River at Arcadia
PVWT45	Variable weighted flow over maximum of either DAYS or 45 days
PVWT30	Variable weighted flow over maximum of either DAYS or 30 days
PVWT15	Variable weighted flow over maximum of either DAYS or 15 days
PVEXWT	Variable exponentially weighted flow over maximum of either DAYS or 45 days
PEXWT3	Exponentially weighted flow over the prior 3 days
PEXWT5	Exponentially weighted flow over the prior 5 days
PEXWT7	Exponentially weighted flow over the prior 7 days
LNPFLOW	Natural log transformation of (PFLOW+10)
LNPVWT45	Natural log transformation of (PVWT45+10)
LNPVWT30	Natural log transformation of (PVWT30+10)
LNPVWT15	Natural log transformation of (PVWT15+10)
LNPEXWT	Natural log transformation of (PVEXWT+10)
LNPEXWT3	Natural log transformation of (PEXWT3+10)
LNPEXWT5	Natural log transformation of (PEXWT5+10)
LNPEXWT7	Natural log transformation of (PEXWT7+10)
BSFLOW	Daily flow, Myakkahatchee Creek
BSDAYS	Number of days required to fill Creek and a portion of the river volume (see text).
BVWT45	Variable weighted flow over maximum of either BSDAYS or 45 days
BVWT30	Variable weighted flow over maximum of either BSDAYS or 30 days
BVWT15	Variable weighted flow over maximum of either BSDAYS or 15 days
BVEXWT	Variable exponentially weighted flow over maximum of BSDAYS or 45 days
BEXWT3	Exponentially weighted flow over the prior 3 days
BEXWT5	Exponentially weighted flow over the prior 5 days
BEXWT7	Exponentially weighted flow over the prior 7 days
LNBSFLOW	Natural log transformation of (BSFLOW+10)
LNBVWT45	Natural log transformation of (BSVWT45+10)
LNBVWT30	Natural log transformation of (BSVWT30+10)
LNBVWT15	Natural log transformation of (BSVWT15+10)
LNBVEXWT	Natural log transformation of (BSVEXWT+10)
LNBEXWT3	Natural log transformation of (BSEXWT3+10)
LNBEXWT5	Natural log transformation of (BSEXWT5+10)
LNBEXWT7	Natural log transformation of (BSEXWT7+10)

Regression Techniques

Data were segregated by depth (surface or bottom) and either isohaline value or station category before regression analysis and limited to the 99th percentile (2115 cfs) and below of variably weighted Myakka flow. For isohaline regressions, input data were further restricted to positions computed from sampling data separated by no more than 6 km and 7 PSU and to isohalines computed not to exceed 1000m from the river centerline. Data were also limited to isohaline positions at or above river kilometer 0.0 to emphasize low flow conditions. Lastly data were limited to a single value per month-year to reduce serial correlation. Data which passed all of the former criteria but were not used as the one value per month-year were reserved for regression model verification.

For fixed station regression modeling, data similarly limited to variable weighted Myakka River flows less than or equal to 2115 cfs. Data were further restricted from use based on available depth data to prevent bias from sampling off channel rather than in-channel locations. Data designated as surface were not used if depths of observations were greater than 1.0 m. Data designated as bottom were not used if overall depths were less than 1.0 m, or if observations were not within 0.2 m of the overall depth, if available.

Models of both isohaline position and of salinity at fixed station locations were developed as forward interactive regressions, using $p \leq 0.05$ as criteria for inclusion and maintenance in the model and including a constant term. Once a flow term from a river or creek was included, no other flow term of the same river was included. Weather and tide variables were generally included subsequent to flow terms and limited to one parameter of each category. The sign of the individual regression coefficients and constancy of sign with the inclusion of additional variables was examined before and after inclusion to prevent spurious correlations. Due to the inclusion of wind and tide terms the constant term is not necessarily synonymous with isohaline position at zero flow.

All regression models were subjected to both residuals analysis and verification. Residuals analysis (Figure 4B-5) included graphic analysis of residuals as a function of both the dependent variable (A), the predicted dependent variable (regression estimates, B), and of the overall dominant independent flow term (C). Residuals were graphically examined for normality (D) and for trend over time (E). The distribution of both the estimated and observed dependent variables (isohaline position or salinity) was also illustrated as a function of the dominant flow term (F). Lastly, the regression estimates and the associated 95% confidence intervals were illustrated as a function of observed salinity (G), with inclusion of the 1:1 slope within the confidence interval indicating the best agreement of modeled with observed data. Outliers to the regression relationship (H) were examined for reasonableness, but generally not removed from consideration as data often represented an end-member condition (highest flow of one of the secondary flow variables, highest tide conditions, etc.). One

Figure 4B-5. Example of residuals analysis performed for each regression model. This example is for the 2.0 PSU, surface isohaline.

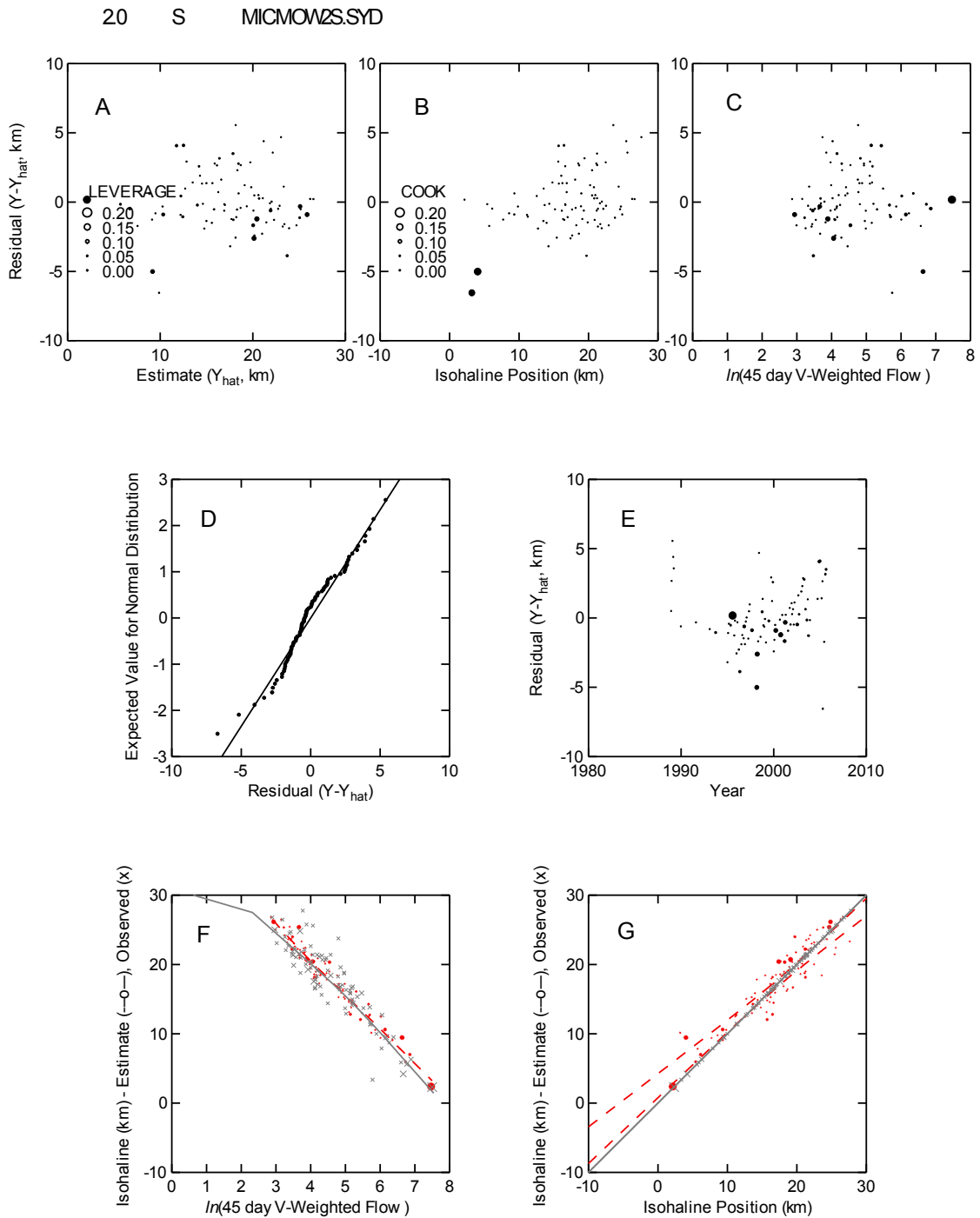

exception was that data from July 19, 2000 were consistently an outlier for many isohalines, with no noteworthy flow conditions to explain the reduced salinities measured on this date. As these data were outliers and also exerted high leverage on regressions coefficients, these data were not included in isohaline regressions.

Regression verification was also performed for each regression model (Figure 4B-6). Data not used in the development of the regression model were used with the regression coefficients to compute an alternate group of the estimated dependent variable. The verification estimates and the regression estimates were both plotted as a function of the observed dependent variable. The 95% confidence intervals of the regression and verification estimates were then examined for overlap to indicate robustness of regression coefficients and any deviation from a 1:1 relationship.

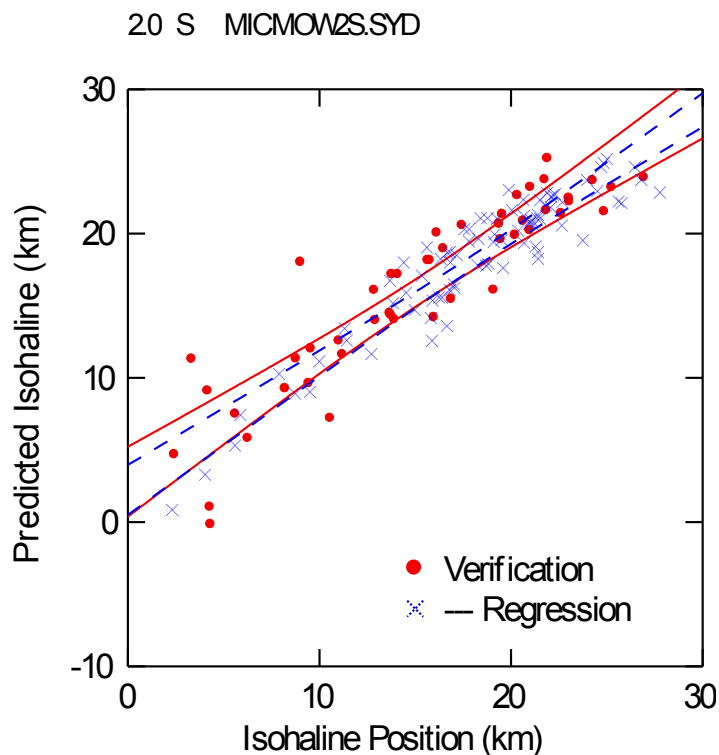

Figure 4B-6. Verification of regression model in which estimates of the dependent variable are calculated with the regression coefficients and independent variables from data not used in developing the regression. Correspondence of the 95% confidence intervals indicate the regression is robust to varying independent variables.

Regression Application

Weather data were not available for the entire period for which flow data existed. In order to calculate isohaline positions over an extended period, the various weather variables were set to constant values for all simulations. The constant weather values used were the mean conditions observed in the initiating data for all isohalines. This approach provided weather-neutral simulations of isohalines and allowed for comparisons between the positions of different isohalines whose raw observations may well have been collected on different days and under different weather conditions. A similar approach was followed for the predicted tidal variables, replacing any significant tidal terms with fixed values. Inclusion of the weather and tide variables in the original regressions almost always enhanced regression significance, resulting in greater confidence that all major variables affecting isohaline position or salinity had been represented. As weather and tides will not be management issues, however, fixing weather and tide variables allows regression results between baseline and altered flow scenarios to concentrate on salinity alterations that may result from altered flows alone.

For isohaline simulations, position (river kilometer) was generally a function of variably weighted flows (either of the Myakka or Peace River). Variably weighted flows, however, depend on river kilometer to determine the number of days over which to flow weight. To simulate daily isohaline positions, therefore, an iterative process was used, beginning with the isohaline position from the day prior. The DAYS parameter was calculated as described above, using the prior isohaline position, and then a new isohaline position was calculated. Recalculation of DAYS and isohaline position was repeated iteratively until the difference between successive isohaline positions was less than 0.1 km, there was no change in the DAYS parameter, or until iterations had reached 15. Convergence within specifications was generally achieved within two to three iterations. For fixed station modeling, river kilometer positions were fixed and no iterative process was required.

Based on distribution of input data, modeling results were limited to the following conditions for isohaline results (Table 4B-4), with similar limitations for fixed station modeling (Table 4B-5).

Table 4B-4. Maximum flows for isohaline regression models.

<u>Flow Term</u>	<u>Maximum cfs</u>
Variably weighted flow, Myakka River, 45 day maximum	2,115
Change in flow rate, Myakka River (FLORATE5B)	+/- 200
Variably weighted flow, Peace River, 45 day maximum	8,000
Variably weighted flow, Myakkahatchee Creek, 45 day maximum	600

Table 4B-5. Maximum flows for fixed station salinity regression models.

Flow Term	Maximum cfs
Myakka River	2,115
Change in Myakka Flow (FLORATE3)	+/- 500
Peace River	8,000
Myakkahatchee Creek	600

Application of regression models to reduced flow scenarios provided some results that were not immediately intuitive. Some reductions in flow resulted in a temporary downstream migration of an isohaline position or a reduction in salinity at a given station. These results are a product of the definition and method of calculation of weighted flow parameter and an example appears in Figure 4B-7.

Baseline and adjusted flows appear in (A). The weighted flow parameter used the flow on a single given day to compute the number of days that would be needed for the river flow to completely fill the volume of the river between river kilometer 51 and the isohaline position. Under reduced flows this DAYS parameter (B) would be larger (i.e. longer period needed to fill the river). With a longer DAYS parameter, the flow weighting period would be extended into the past, and the longer history has a possibility of encountering a higher flow, thus increasing the value of the weighted flow parameter (C) and resulting in less saline or more downstream positions (D). The effect was not universal, and occurred only when extreme dry periods followed immediately after very wet periods with a rapid transition in flows between the two conditions. These results, while somewhat counterintuitive, were accepted as regressions were developed using parameters calculated in this fashion.

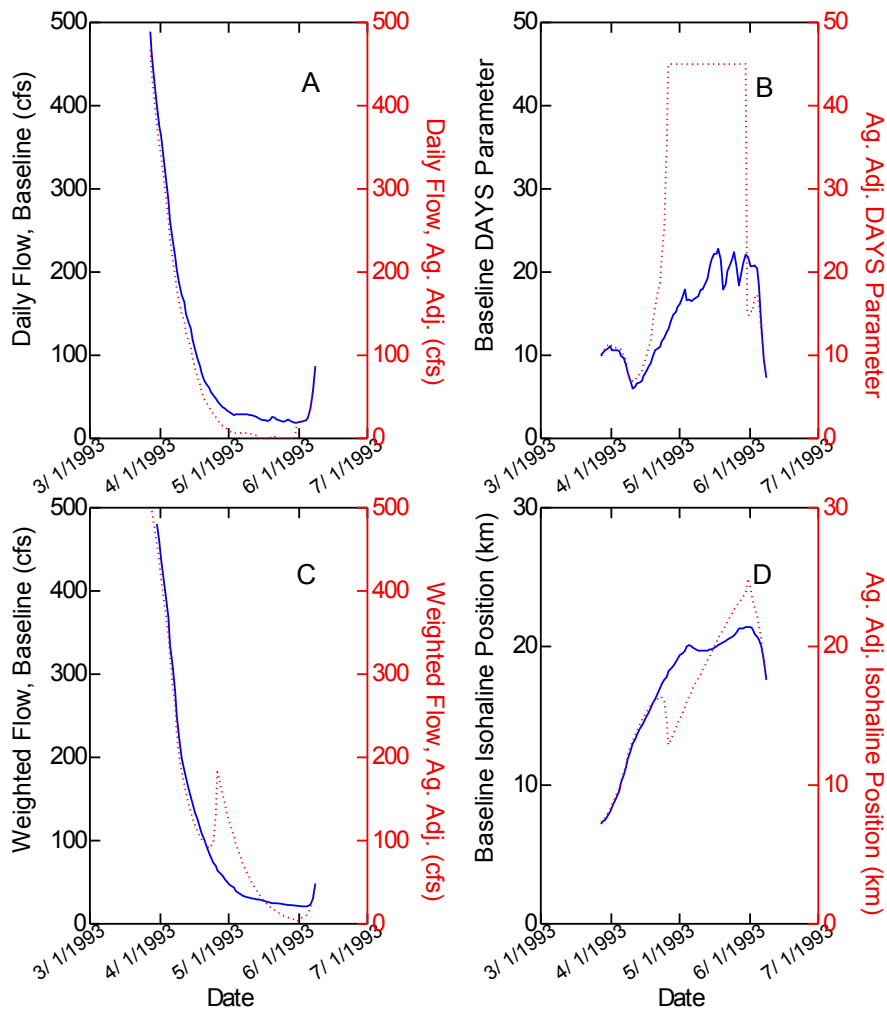

Figure 4B-7. Illustration of an instance where decreased flows result in downriver displacement of isohaline locations. Example is for the 4.0 PSU surface isohaline.

References

Berthouex, P.M., W.G. Hunter, and L. Pallesen. 1978. Monitoring sewage treatment plants: some quality control aspects, *Journal of Quality Technology*, Vol. 10 pp.139-49.

Boon, J.D., and K.P. Kiley. 1978. Harmonic analysis and tidal prediction by the method of least squares. Virginia Institute of Marine Science Special Report on Applied Marine Science and Ocean Engineering, #186. 49 pp.

Boyle Engineering Corporation. 2003. Development of flow rating curves and flow records for Myakkahatchee Creek at WCS 101 and Cocoplum Waterway at WCS 106. Report prepared for the City of North Port. North Port, FL.

Hammett, K.M. 1992. Physical processes, salinity characteristics, and potential salinity changes due to fresh water withdrawals in the tidal Myakka River, Florida. U.S. Geological Survey Water Resources Investigations Report 90-4054. Tallahassee, FL.

Ross, M. A., A. Said, K. Trout, and J. Zhang. 2005. Hydrologic modeling of streamflow from ungaged areas in the Upper Charlotte Harbor Basin - Phase 2. Report prepared by the University of South Florida Department of Civil and Environmental Engineering Center for Modeling Hydrologic and Aquatic Systems for the Southwest Florida Water Management District. Brooksville, Florida.

Wang, P. 2004. Bathymetric Survey in the Charlotte Harbor Area. Parts 1 and 2. Report prepared by the University of South Florida Department of Geology for the Southwest Florida Water Management District. Brooksville, FL.

Appendix 4-C

Isohaline Regression Results, Statistics, and Verifications

Equations for isohaline position (km) as a funtion of weather, tide, and flow variables

Isohaline	Depth	Estimated Isohaline Kilometer	Regression			Wind Variable			Tide Variable			Myakka R. Flow		Peace R. Flow		Myakkahatchee Crk. Flow Variable		Change in Myakka R. Flow Variable	
			Constant	Coefficient		Coefficient		Coefficient		Coefficient		Coefficient		Coefficient		Coefficient		Coefficient	
1	S	El_KM	=	42.1945	+	1.3810	COS_WD6	+	-3.8683	LNWWT45	+	-0.8514	LNPVWT45	+					
1	B	El_KM	=	40.4826	+	1.5266	COS_WD6	+	-3.6121	LNWWT45	+	-0.6855	LNPVWT45	+					
2	S	El_KM	=	42.8151	+	1.1954	COS_WD6	+	-3.8328	LNWWT45	+	-1.2053	LNPVWT45	+					
2	B	El_KM	=	41.2314	+	1.4475	COS_WD6	+	-3.8143	LNWWT45	+	-0.8713	LNPVWT45	+					
4	S	El_KM	=	43.6365	+	0.0464	COS_WDS26	+	-3.6421	LNWWT45	+	-1.8097	LNPVWT45	+					
4	B	El_KM	=	41.8206	+	0.0574	COS_WDS26	+	-3.3763	LNWWT45	+	-1.6075	LNPVWT45	+					
8	S	El_KM	=	40.3415	+	0.0354	COS_WDS26	+	-2.8869	LNWWT45	+	-1.2644	LNPVWT45	+	-1.5795	LNBSVEXWT	+	0.0668	FLORATE5B
8	B	El_KM	=	39.8595	+	0.0600	COS_WDS23	+	-3.0653	LNWWT45	+	-1.9060	LNPVWT45	+			+	0.0484	FLORATE5B
12	S	El_KM	=	36.0018	+	0.0571	COS_WDS23	+	-1.8819	LNWWT45	+	-2.8512	LNPVWT45	+			+	0.0586	FLORATE5B
12	B	El_KM	=	38.6973	+			+	-2.6496	LNWWT45	+	-2.4364	LNPVWT45	+			+	0.0279	FLORATE5B
16	S	El_KM	=	33.2649	+	1.6142	COS_WD	+			+	-4.3717	LNPVWT45	+					
16	B	El_KM	=	33.8809	+			+			+	-4.2137	LNPVWT45	+					
20	S	El_KM	=	26.9635	+			+	-47.4744	MIN_RATE	+	-4.5559	LNPVWT45	+					
20	B	El_KM	=	29.8442	+			+	18.6299	MAXRATE_3	+	-4.2412	LNPVWT45	+					
24	S	El_KM	=	33.8189	+			+	12.0335	PRED_M_SEA	+	-6.1181	LNPVWT45	+					
24	B	El_KM	=	23.0913	+			+			+	-3.4985	LNPVWT45	+					

Equations for isohaline position (km) under mean weather conditions. Weather and tide coefficients and mean values are now included in the combine regression constant

Isohaline	Depth	Estimated Isohaline Kilometer	Combined Regression			Myakka R. Flow		Peace R. Flow		Myakkahatchee Crk.		Change in Myakka R. Flow	
			Constant	Coefficient		Coefficient		Coefficient		Coefficient		Coefficient	
1	S	El_KM	=	41.9107	+	-3.8683	LNWWT45	+	-0.8514	LNPVWT45	+		
1	B	El_KM	=	40.1362	+	-3.6121	LNWWT45	+	-0.6855	LNPVWT45	+		
2	S	El_KM	=	42.7143	+	-3.8328	LNWWT45	+	-1.2053	LNPVWT45	+		
2	B	El_KM	=	40.9954	+	-3.8143	LNWWT45	+	-0.8713	LNPVWT45	+		
4	S	El_KM	=	43.5694	+	-3.6421	LNWWT45	+	-1.8097	LNPVWT45	+		
4	B	El_KM	=	41.7297	+	-3.3763	LNWWT45	+	-1.6075	LNPVWT45	+		
8	S	El_KM	=	40.3573	+	-2.8869	LNWWT45	+	-1.2644	LNPVWT45	+	-1.5795	LNBSVEXWT
8	B	El_KM	=	39.8524	+	-3.0653	LNWWT45	+	-1.9060	LNPVWT45	+	0.0668	FLORATE5B
12	S	El_KM	=	36.9435	+	-1.8819	LNWWT45	+	-2.8512	LNPVWT45	+	0.0484	FLORATE5B
12	B	El_KM	=	38.6426	+	-2.6496	LNWWT45	+	-2.4364	LNPVWT45	+	0.0586	FLORATE5B
16	S	El_KM	=	33.8305	+			+	-4.3717	LNPVWT45	+	0.0279	FLORATE5B
16	B	El_KM	=	33.8809	+			+	-4.2137	LNPVWT45	+		
20	S	El_KM	=	31.7727	+			+	-4.5559	LNPVWT45	+		
20	B	El_KM	=	30.5372	+			+	-4.2412	LNPVWT45	+		
24	S	El_KM	=	35.5698	+			+	-6.1181	LNPVWT45	+		
24	B	El_KM	=	23.0913	+			+	-3.4985	LNPVWT45	+		

Data for the following results were selected according to:
 (best=>VAL('1')) and (depth_c2\$='S') and (iso=VAL('1.0')) AND VWT45<=VAL('2115')
 AND DISTANCE<1000 AND I_KM>=0 AND ONE_A_MO=1) AND DYEAR<>2000.545
 51 case(s) deleted due to missing data.

Eigenvalues of unit scaled X'X

	1	2	3	4
	3.1790	0.7922	0.0212	0.0076

Condition indices

	1	2	3	4
	1.0000	2.0032	12.2366	20.4808

Variance proportions

	1	2	3	4
CONSTANT	0.0026	0.0011	0.7680	0.2284
COS_WD6	0.0232	0.9746	0.0022	0.0001
LNVWT45	0.0017	0.0006	0.3043	0.6934
LNPVWT45	0.0011	0.0004	0.0160	0.9824

Dep Var: I_KM N: 96 Multiple R: 0.8980 Squared multiple R: 0.8063

Adjusted squared multiple R: 0.8000 Standard error of estimate: 2.2829

Effect	Coefficient	Std Error	Std Coef	Tolerance	t	P(2 Tail)
CONSTANT	42.1945	1.4163	0.0000	.	29.7913	0.0000
COS_WD6	1.3810	0.4172	0.1525	0.9913	3.3102	0.0013
LNVWT45	-3.8683	0.3704	-0.7321	0.4283	-10.4433	0.0000
LNPVWT45	-0.8514	0.3431	-0.1737	0.4293	-2.4812	0.0149

Effect	Coefficient	Lower 95%	Upper 95%
CONSTANT	42.1945	39.3816	45.0075
COS_WD6	1.3810	0.5524	2.2096
LNVWT45	-3.8683	-4.6040	-3.1327
LNPVWT45	-0.8514	-1.5328	-0.1699

Correlation matrix of regression coefficients

	CONSTANT	COS_WD6	LNVWT45	LNPVWT45
CONSTANT	1.0000			
COS_WD6	-0.0125	1.0000		
LNVWT45	-0.0826	0.0512	1.0000	
LNPVWT45	-0.5822	0.0125	-0.7537	1.0000

Analysis of Variance

Source	Sum-of-Squares	df	Mean-Square	F-ratio	P
Regression	1996.4990	3	665.4997	127.6913	0.0000
Residual	479.4844	92	5.2118		

*** WARNING ***

Case 396 is an outlier (Studentized Residual = -3.5767)

Durbin-Watson D Statistic 1.6575
 First Order Autocorrelation 0.1702

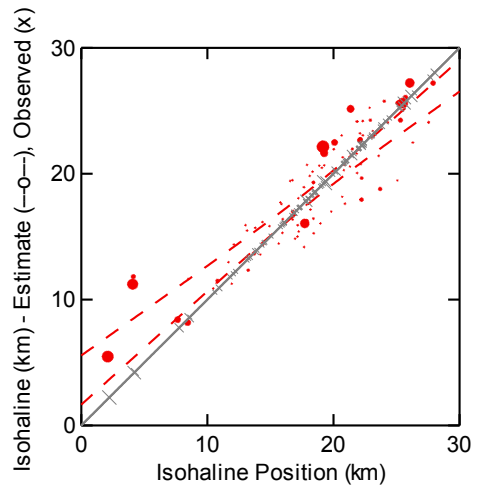
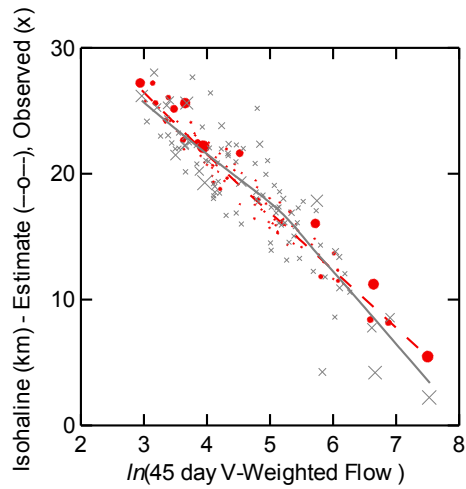
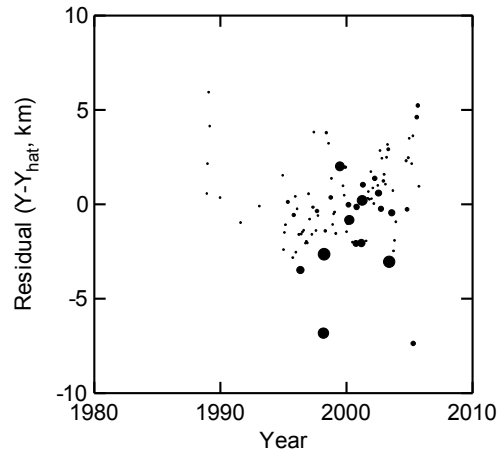
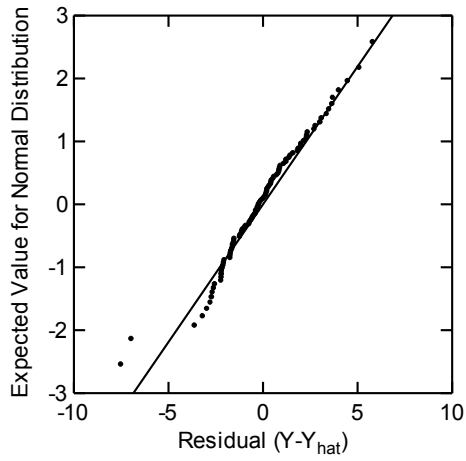
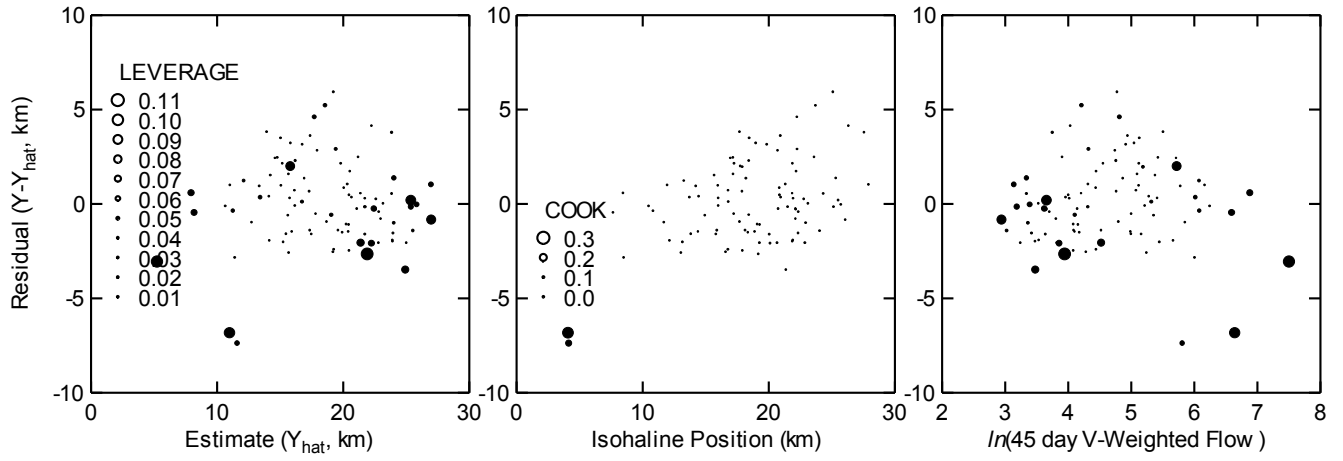

1.0 S MICMOW1S.SYD

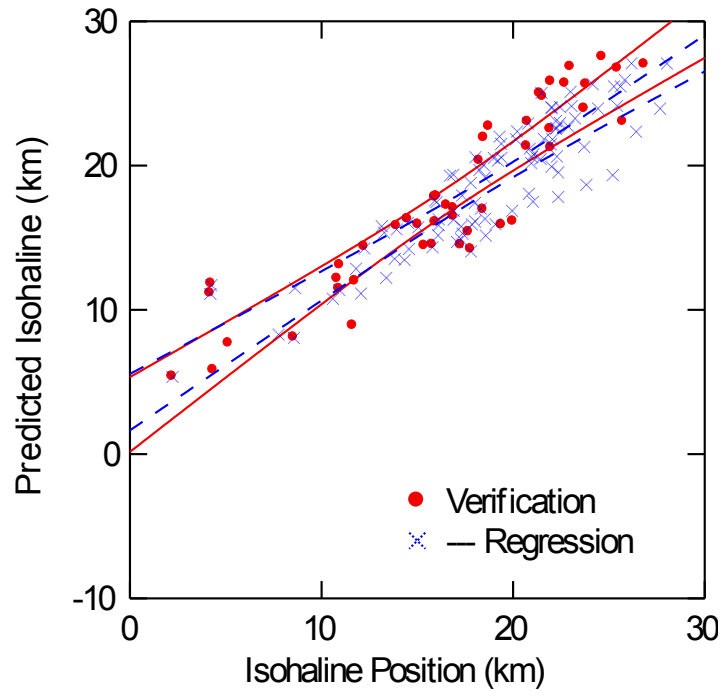

Data for the following results were selected according to:
 (best=>VAL('1')) and (depth_c2\$='B') and (iso=VAL('1.0')) AND VWT45<=VAL('2115')
 AND DISTANCE<1000 AND I_KM>=0 AND ONE_A_MO=1) AND DYEAR<>2000.545
 45 case(s) deleted due to missing data.

Eigenvalues of unit scaled X'X

	1	2	3	4	5
	3.2175	1.0061	0.7469	0.0224	0.0071

Condition indices

	1	2	3	4	5
	1.0000	1.7883	2.0755	11.9911	21.2733

Variance proportions

	1	2	3	4	5
CONSTANT	0.0026	0.0002	0.0013	0.7419	0.2540
COS_WD6	0.0244	0.0285	0.9208	0.0221	0.0041
RATE_MEANL	0.0009	0.9252	0.0618	0.0011	0.0111
LNVWT45	0.0016	0.0001	0.0005	0.2827	0.7151
LNPVWT45	0.0010	0.0000	0.0004	0.0145	0.9840

Dep Var: I_KM N: 97 Multiple R: 0.9184 Squared multiple R: 0.8435

Adjusted squared multiple R: 0.8367 Standard error of estimate: 2.0004

Effect	Coefficient	Std Error	Std Coef	Tolerance	t	P(2 Tail)
CONSTANT	40.4826	1.2184	0.0000	.	33.2262	0.0000
COS_WD6	1.5266	0.3633	0.1775	0.9529	4.2014	0.0001
RATE_MEANL	10.5493	4.8789	0.0900	0.9820	2.1622	0.0332
LNVWT45	-3.6121	0.3255	-0.7370	0.3857	-11.0971	0.0000
LNPVWT45	-0.6855	0.3072	-0.1471	0.3912	-2.2310	0.0281

Effect	Coefficient	Lower 95%	Upper 95%
CONSTANT	40.4826	38.0627	42.9024
COS_WD6	1.5266	0.8049	2.2482
RATE_MEANL	10.5493	0.8593	20.2392
LNVWT45	-3.6121	-4.2586	-2.9657
LNPVWT45	-0.6855	-1.2957	-0.0753

Correlation matrix of regression coefficients

	CONSTANT	COS_WD6	RATE_MEANL	LNVWT45	LNPVWT45
CONSTANT	1.0000				
COS_WD6	-0.0669	1.0000			
RATE_MEANL	-0.0794	-0.0734	1.0000		
LNVWT45	-0.0289	0.1504	-0.0701	1.0000	
LNPVWT45	-0.6012	-0.0293	0.1082	-0.7730	1.0000

Analysis of Variance

Source	Sum-of-Squares	df	Mean-Square	F-ratio	P
Regression	1984.5261	4	496.1315	123.9809	0.0000
Residual	368.1543	92	4.0017		

Durbin-Watson D Statistic 1.3996
 First Order Autocorrelation 0.2964

1.0 B MICMOWIB.SYD

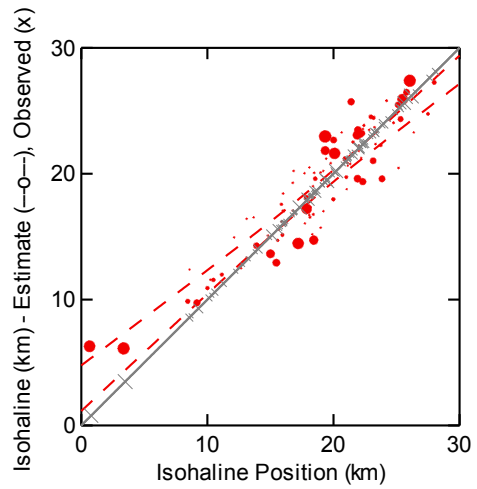
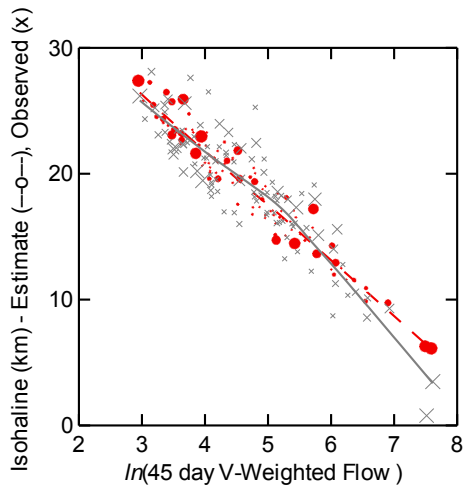
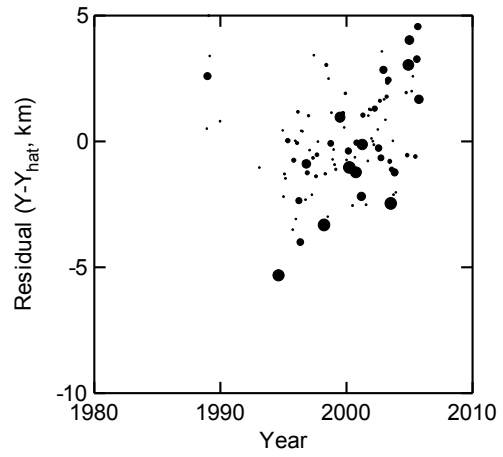
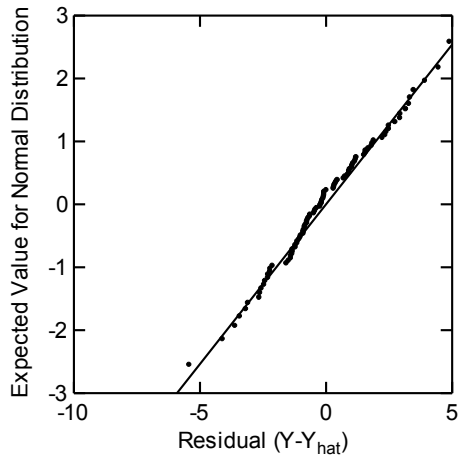
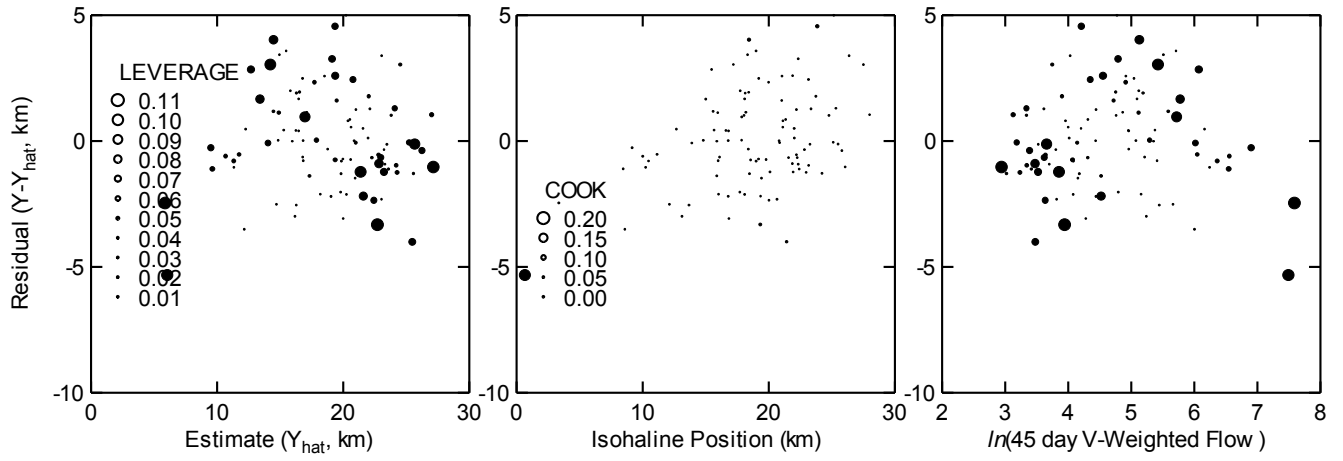

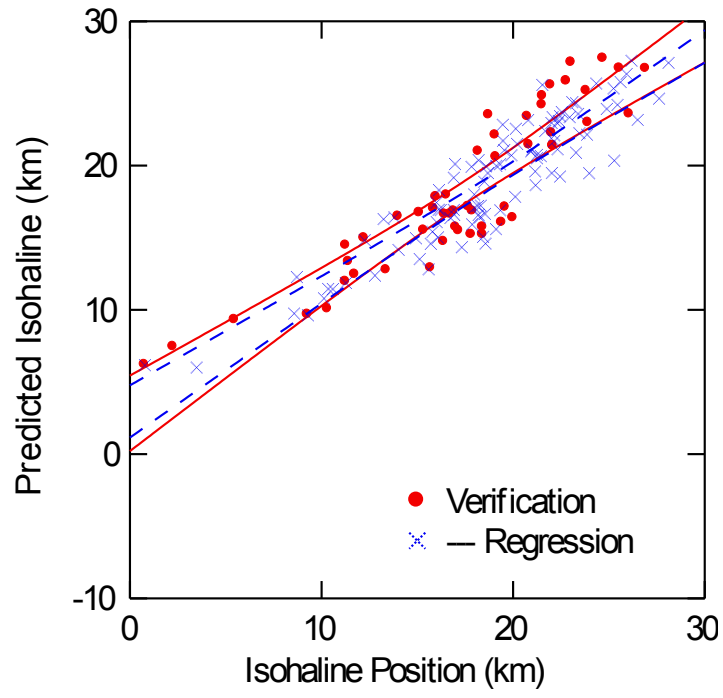

Data for the following results were selected according to:
 (best=>VAL('1')) and (depth_c2\$='S') and (iso=VAL('2.0')) AND VWT45<=VAL('2115')
 AND DISTANCE<1000 AND I_KM>=0 AND ONE_A_MO=1) AND DYEAR<>2000.545
 58 case(s) deleted due to missing data.

Eigenvalues of unit scaled X'X

	1	2	3	4	5
	3.2585	1.0317	0.6789	0.0235	0.0074

Condition indices

	1	2	3	4	5
	1.0000	1.7772	2.1908	11.7829	21.0199

Variance proportions

	1	2	3	4	5
CONSTANT	0.0027	0.0000	0.0017	0.8064	0.1891
COS_WD6	0.0224	0.1886	0.7827	0.0042	0.0021
RATE_3M	0.0060	0.6688	0.3000	0.0088	0.0164
LNVWT45	0.0015	0.0000	0.0009	0.2397	0.7579
LNPVWT45	0.0011	0.0000	0.0006	0.0216	0.9767

Dep Var: I_KM N: 88 Multiple R: 0.9263 Squared multiple R: 0.8580

Adjusted squared multiple R: 0.8512 Standard error of estimate: 2.1456

Effect	Coefficient	Std Error	Std Coef Tolerance	t	P(2 Tail)
CONSTANT	42.8151	1.3106	0.0000	32.6691	0.0000
COS_WD6	1.1954	0.4153	0.1213	2.8782	0.0051
RATE_3M	8.8296	4.2383	0.0880	2.0833	0.0403
LNVWT45	-3.8328	0.3751	-0.6929	-10.2185	0.0000
LNPVWT45	-1.2053	0.3432	-0.2361	-3.5123	0.0007

Effect	Coefficient	Lower 95%	Upper 95%
CONSTANT	42.8151	40.2084	45.4218
COS_WD6	1.1954	0.3693	2.0215
RATE_3M	8.8296	0.3999	17.2594
LNVWT45	-3.8328	-4.5788	-3.0868
LNPVWT45	-1.2053	-1.8878	-0.5227

Correlation matrix of regression coefficients

	CONSTANT	COS_WD6	RATE_3M	LNVWT45	LNPVWT45
CONSTANT	1.0000				
COS_WD6	-0.0073	1.0000			
RATE_3M	-0.0436	-0.1290	1.0000		
LNVWT45	-0.0578	0.0925	0.1436	1.0000	
LNPVWT45	-0.5590	-0.0178	-0.1224	-0.7864	1.0000

Analysis of Variance

Source	Sum-of-Squares	df	Mean-Square	F-ratio	P
Regression	2308.7776	4	577.1944	125.3758	0.0000
Residual	382.1084	83	4.6037		

*** WARNING ***

Case 430 is an outlier (Studentized Residual = -3.3952)

Durbin-Watson D Statistic 1.1444
 First Order Autocorrelation 0.4123

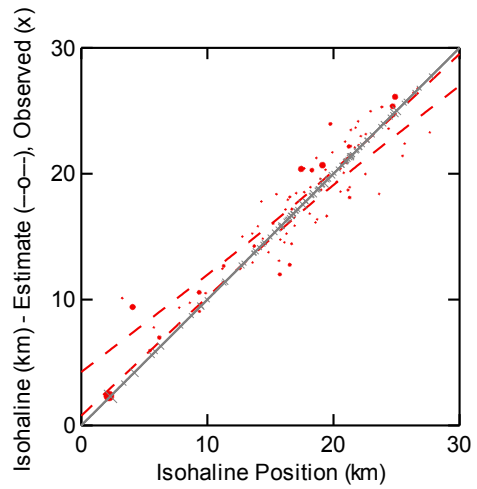
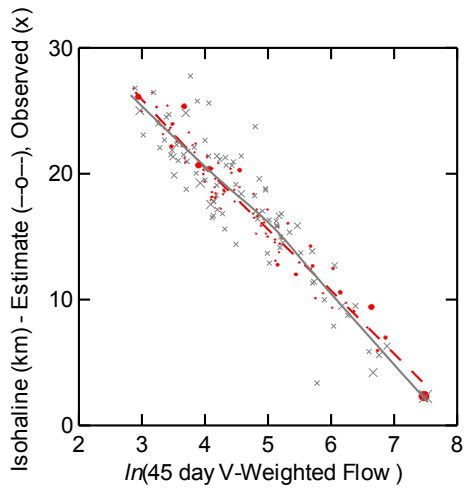
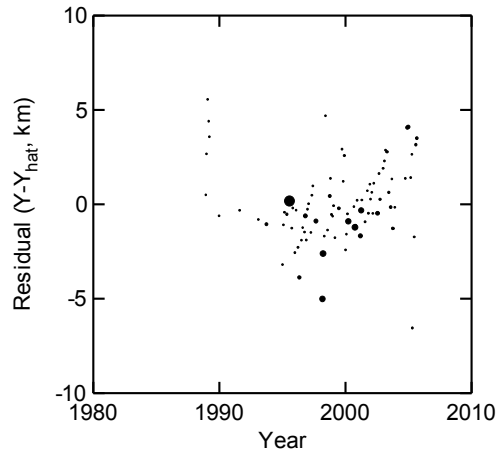
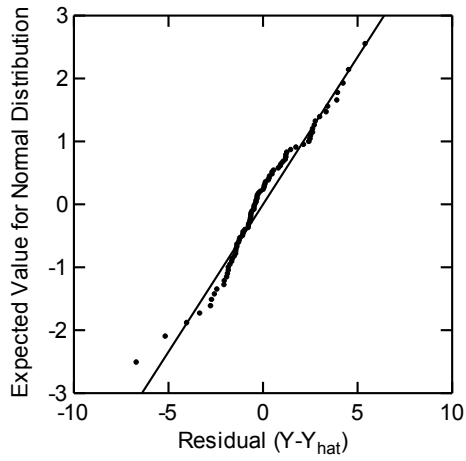
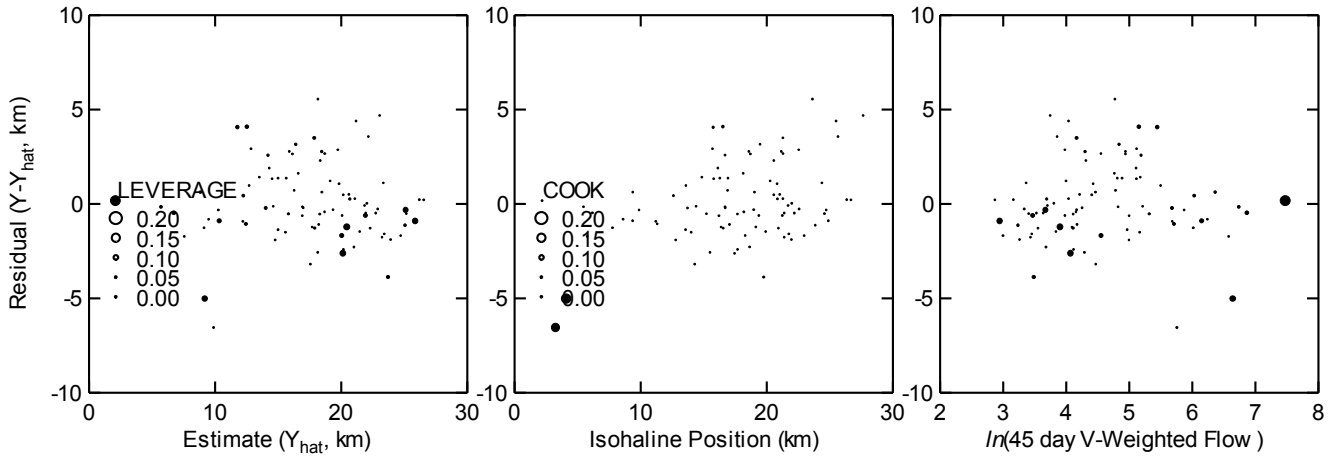

20 S MICMOW2S.SYD

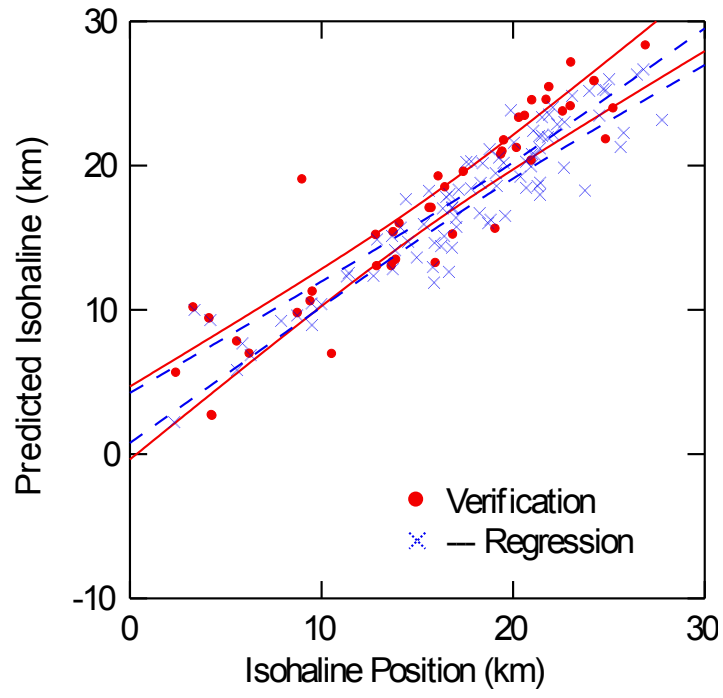

Data for the following results were selected according to:
 (best=>VAL('1')) and (depth_c2\$='B') and (iso=VAL('2.0')) AND VWT45<=VAL('2115')
 AND DISTANCE<1000 AND I_KM>=0 AND ONE_A_MO=1) AND DYEAR<>2000.545
 49 case(s) deleted due to missing data.

Eigenvalues of unit scaled X'X

	1	2	3	4	5
	3.2670	1.0192	0.6827	0.0239	0.0072

Condition indices

	1	2	3	4	5
	1.0000	1.7904	2.1876	11.6979	21.2647

Variance proportions

	1	2	3	4	5
CONSTANT	0.0027	0.0000	0.0023	0.7877	0.2073
COS_WD6	0.0248	0.0706	0.8489	0.0414	0.0142
RATE_6M	0.0016	0.8594	0.1336	0.0054	0.0000
LNVT45	0.0015	0.0000	0.0007	0.2388	0.7591
LNPVT45	0.0010	0.0000	0.0006	0.0212	0.9772

Dep Var: I_KM N: 89 Multiple R: 0.9382 Squared multiple R: 0.8802

Adjusted squared multiple R: 0.8745 Standard error of estimate: 1.8954

Effect	Coefficient	Std Error	Std Coef	Tolerance	t	P(2 Tail)
CONSTANT	41.2314	1.1443	0.0000	.	36.0335	0.0000
COS_WD6	1.4475	0.3761	0.1521	0.9136	3.8486	0.0002
RATE_6M	10.2361	4.5824	0.0851	0.9833	2.2338	0.0282
LNVT45	-3.8143	0.3300	-0.7385	0.3493	-11.5587	0.0000
LNPVT45	-0.8713	0.3034	-0.1794	0.3655	-2.8722	0.0052

Effect	Coefficient	Lower 95%	Upper 95%
CONSTANT	41.2314	38.9559	43.5068
COS_WD6	1.4475	0.6996	2.1954
RATE_6M	10.2361	1.1234	19.3488
LNVT45	-3.8143	-4.4705	-3.1581
LNPVT45	-0.8713	-1.4746	-0.2680

Correlation matrix of regression coefficients

	CONSTANT	COS_WD6	RATE_6M	LNVT45	LNPVT45
CONSTANT	1.0000				
COS_WD6	-0.0898	1.0000			
RATE_6M	0.0526	-0.1119	1.0000		
LNVT45	-0.0338	0.2216	-0.0429	1.0000	
LNPVT45	-0.5762	-0.0693	-0.0150	-0.7883	1.0000

Analysis of Variance

Source	Sum-of-Squares	df	Mean-Square	F-ratio	P
Regression	2217.5510	4	554.3878	154.3179	0.0000
Residual	301.7703	84	3.5925		

Durbin-Watson D Statistic 1.0871
 First Order Autocorrelation 0.4561

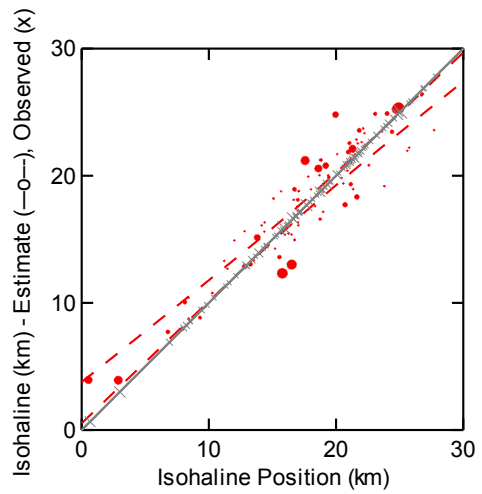
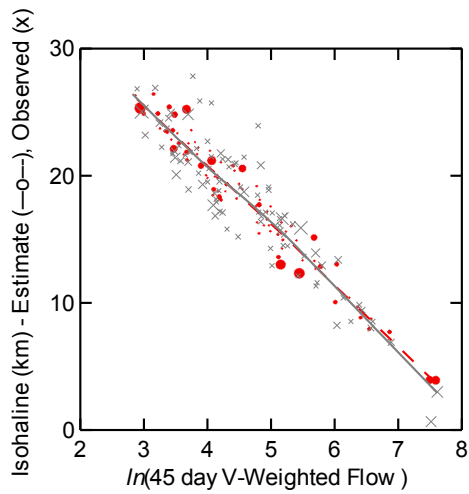
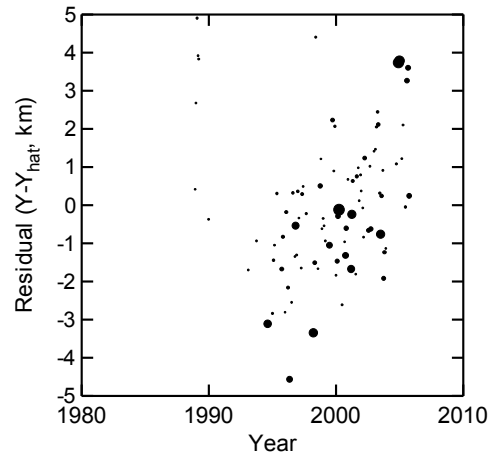
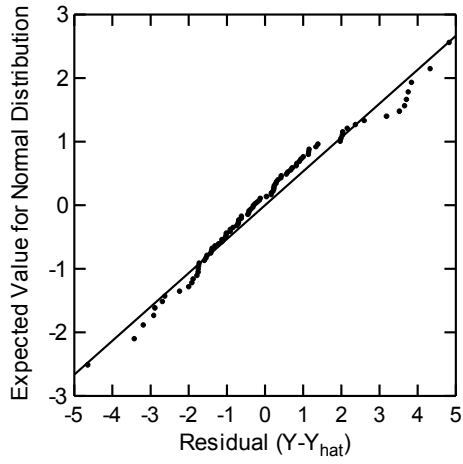
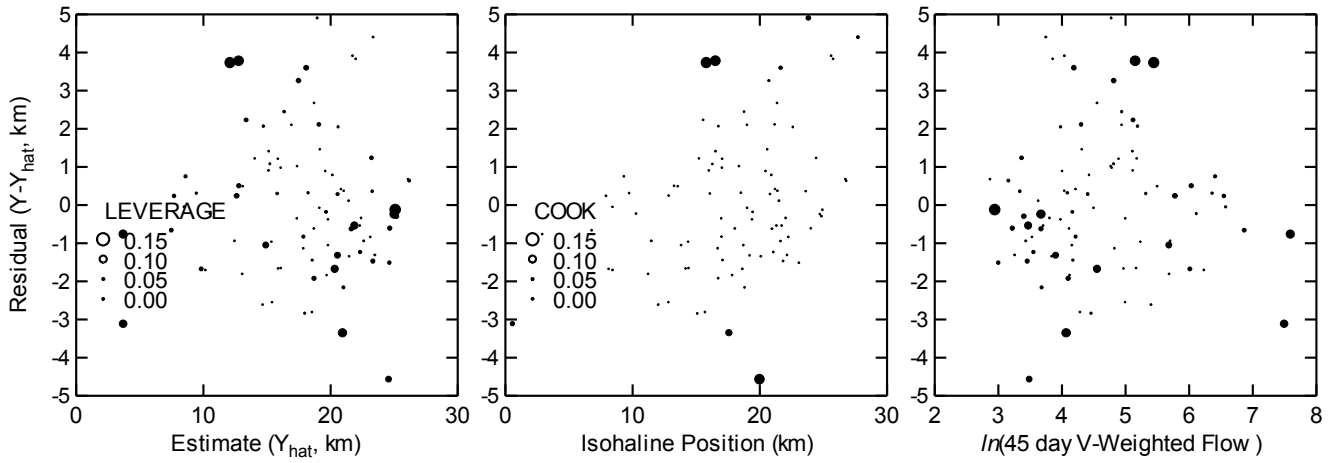

20 B MICMOW2B.SYD

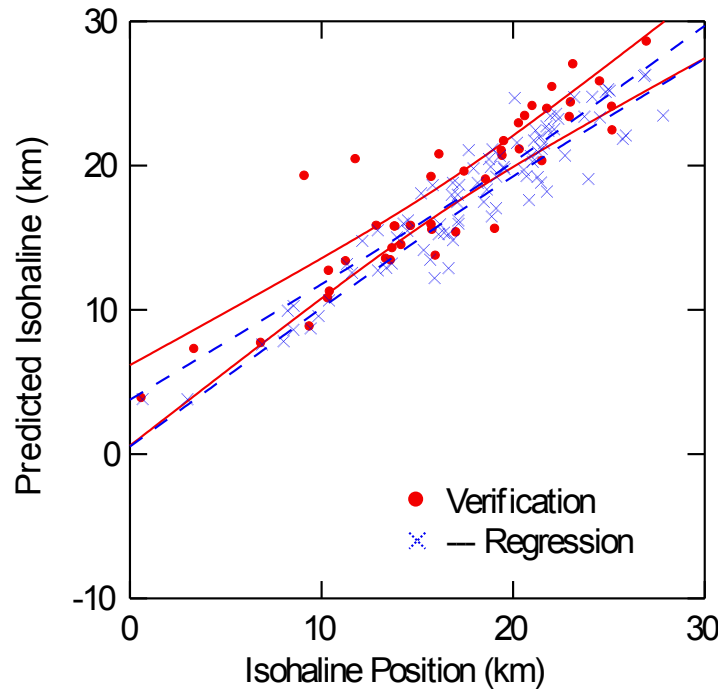

Data for the following results were selected according to:
 (best=>VAL('1')) and (depth_c2\$='S') and (iso=VAL('4.0')) AND VWT45<=VAL('2115')
 AND DISTANCE<1000 AND I_KM>=0 AND ONE_A_MO=1) AND DYEAR<>2000.545
 57 case(s) deleted due to missing data.

Eigenvalues of unit scaled X'X

	1	2	3	4	5
	3.1239	1.0443	0.8010	0.0238	0.0069

Condition indices

	1	2	3	4	5
	1.0000	1.7295	1.9749	11.4616	21.2126

Variance proportions

	1	2	3	4	5
CONSTANT	0.0031	0.0001	0.0010	0.8455	0.1503
COS_WDS26	0.0164	0.2074	0.7389	0.0249	0.0124
RATE_6M	0.0024	0.6914	0.2985	0.0035	0.0043
LNVT45	0.0015	0.0000	0.0003	0.1980	0.8002
LNPVWT45	0.0011	0.0000	0.0003	0.0281	0.9705

Dep Var: I_KM N: 84 Multiple R: 0.9333 Squared multiple R: 0.8710

Adjusted squared multiple R: 0.8645 Standard error of estimate: 2.2325

Effect	Coefficient	Std Error	Std Coef	Tolerance	t	P(2 Tail)
CONSTANT	43.6365	1.3655	0.0000	.	31.9568	0.0000
COS_WDS26	0.0464	0.0174	0.1110	0.9420	2.6664	0.0093
RATE_6M	13.1442	5.5768	0.0960	0.9849	2.3569	0.0209
LNVT45	-3.6421	0.4210	-0.6032	0.3358	-8.6506	0.0000
LNPVWT45	-1.8097	0.3746	-0.3326	0.3442	-4.8306	0.0000

Effect	Coefficient	Lower 95%	Upper 95%
CONSTANT	43.6365	40.9186	46.3544
COS_WDS26	0.0464	0.0118	0.0811
RATE_6M	13.1442	2.0439	24.2445
LNVT45	-3.6421	-4.4801	-2.8040
LNPVWT45	-1.8097	-2.5554	-1.0640

Correlation matrix of regression coefficients

	CONSTANT	COS_WDS26	RATE_6M	LNVT45	LNPVWT45
CONSTANT	1.0000				
COS_WDS26	-0.0784	1.0000			
RATE_6M	-0.0876	-0.0952	1.0000		
LNVT45	-0.0595	0.1812	-0.0387	1.0000	
LNPVWT45	-0.5336	-0.0710	0.0682	-0.8050	1.0000

Analysis of Variance

Source	Sum-of-Squares	df	Mean-Square	F-ratio	P
Regression	2659.5747	4	664.8937	133.4080	0.0000
Residual	393.7291	79	4.9839		

Durbin-Watson D Statistic 1.0758
 First Order Autocorrelation 0.4609

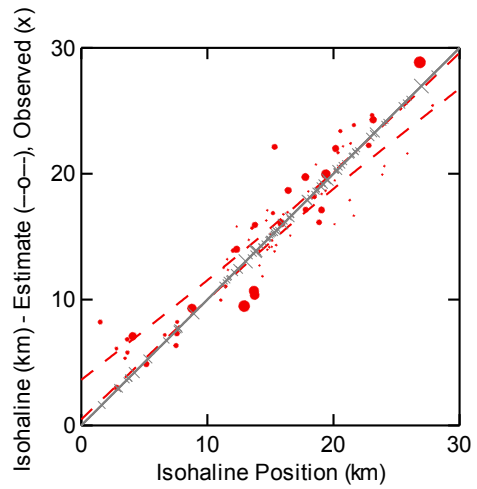
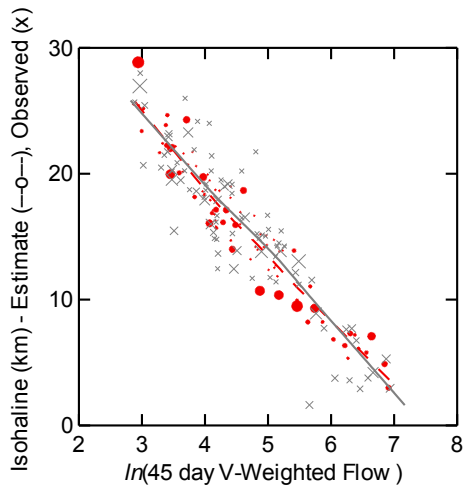
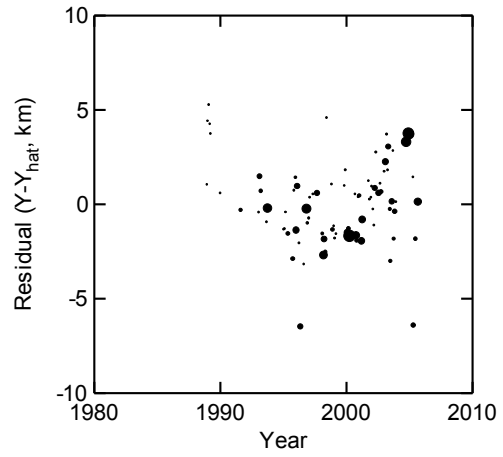
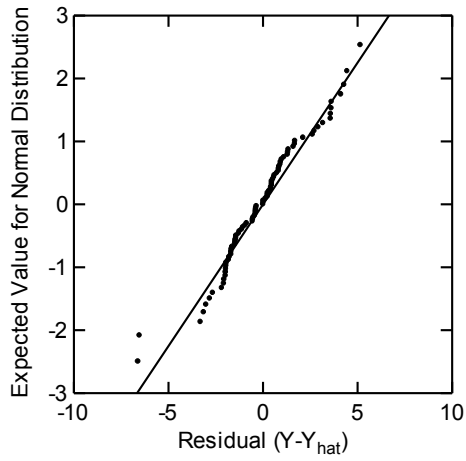
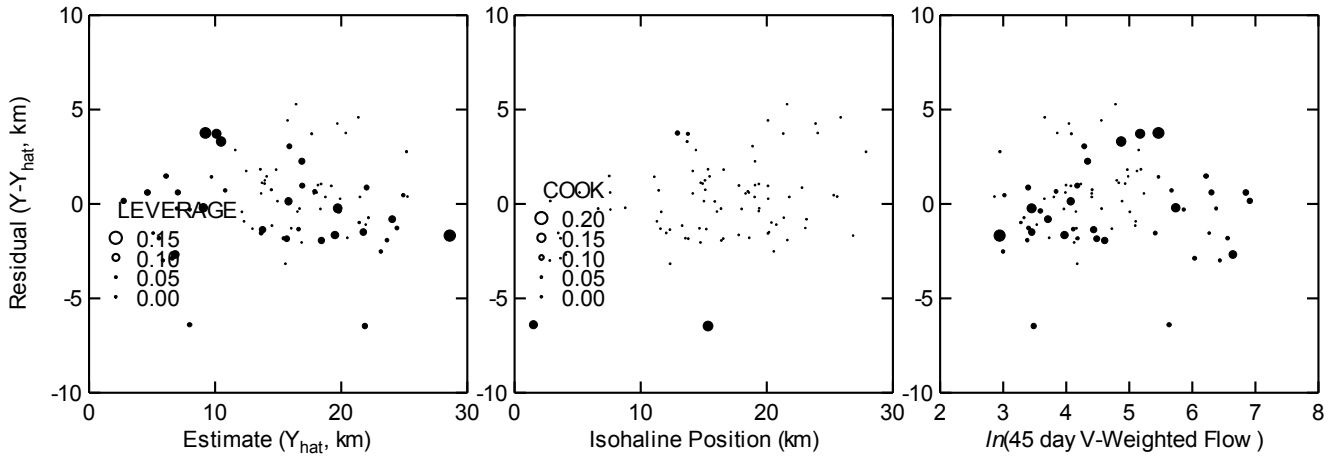

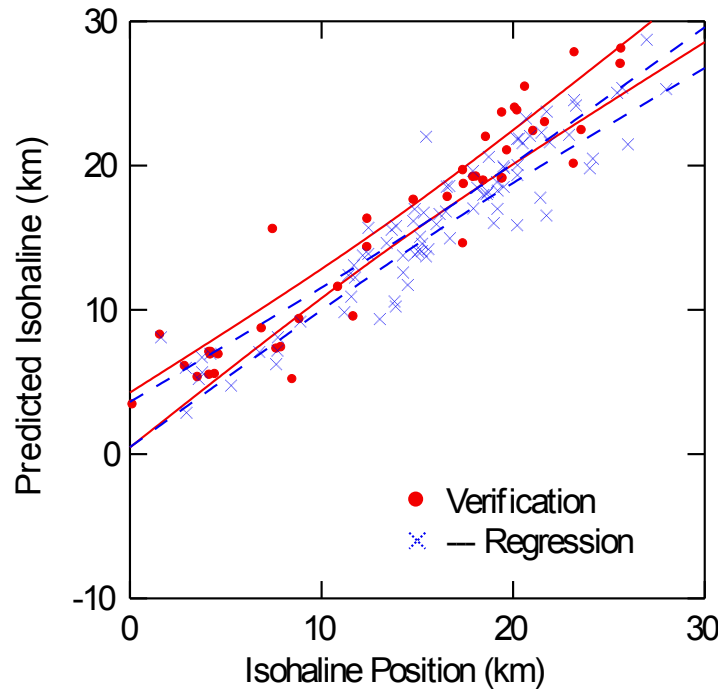

Data for the following results were selected according to:
 (best=>VAL('1')) and (depth_c2\$='B') and (iso=VAL('4.0')) AND VWT45<=VAL('2115')
 AND DISTANCE<1000 AND I_KM>=0 AND ONE_A_MO=1) AND DYEAR<>2000.545
 49 case(s) deleted due to missing data.

Eigenvalues of unit scaled X'X

	1	2	3	4	5
	3.1267	1.0407	0.8011	0.0244	0.0071

Condition indices

	1	2	3	4	5
	1.0000	1.7333	1.9756	11.3232	20.9205

Variance proportions

	1	2	3	4	5
CONSTANT	0.0032	0.0000	0.0011	0.8421	0.1536
COS_WDS26	0.0135	0.3018	0.6392	0.0284	0.0171
RATE_6M	0.0061	0.5844	0.4078	0.0016	0.0001
LNVWT45	0.0016	0.0000	0.0004	0.2005	0.7976
LNPVWT45	0.0011	0.0000	0.0003	0.0276	0.9709

Dep Var: I_KM N: 81 Multiple R: 0.9337 Squared multiple R: 0.8718

Adjusted squared multiple R: 0.8650 Standard error of estimate: 2.0772

Effect	Coefficient	Std Error	Std Coef Tolerance	t	P(2 Tail)
CONSTANT	41.8206	1.2794	0.0000	32.6877	0.0000
COS_WDS26	0.0574	0.0168	0.1451	3.4155	0.0010
RATE_6M	14.9564	5.2846	0.1168	2.8302	0.0059
LNVWT45	-3.3763	0.3957	-0.6046	-8.5328	0.0000
LNPVWT45	-1.6075	0.3521	-0.3180	-4.5651	0.0000

Effect	Coefficient	Lower 95%	Upper 95%
CONSTANT	41.8206	39.2724	44.3687
COS_WDS26	0.0574	0.0239	0.0909
RATE_6M	14.9564	4.4313	25.4815
LNVWT45	-3.3763	-4.1644	-2.5882
LNPVWT45	-1.6075	-2.3088	-0.9062

Correlation matrix of regression coefficients

	CONSTANT	COS_WDS26	RATE_6M	LNVWT45	LNPVWT45
CONSTANT	1.0000				
COS_WDS26	-0.0808	1.0000			
RATE_6M	-0.0541	-0.0943	1.0000		
LNVWT45	-0.0580	0.2024	-0.0017	1.0000	
LNPVWT45	-0.5360	-0.0894	0.0098	-0.8040	1.0000

Analysis of Variance

Source	Sum-of-Squares	df	Mean-Square	F-ratio	P
Regression	2229.4515	4	557.3629	129.1767	0.0000
Residual	327.9197	76	4.3147		

*** WARNING ***

Case 111 is an outlier (Studentized Residual = -3.3927)

Durbin-Watson D Statistic 1.2799
 First Order Autocorrelation 0.3596

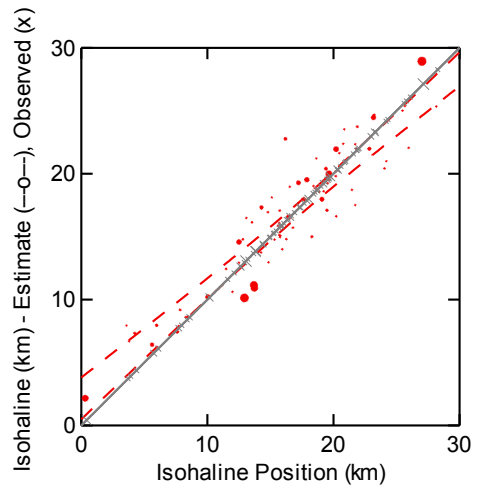
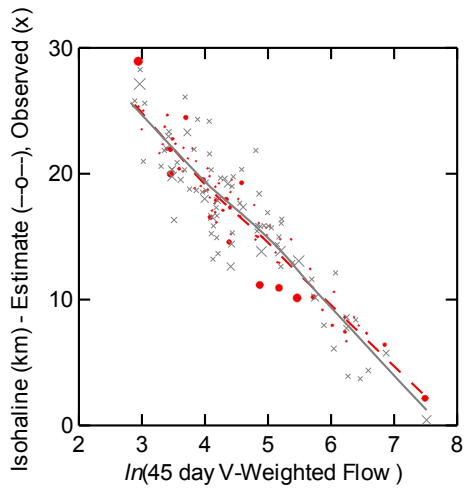
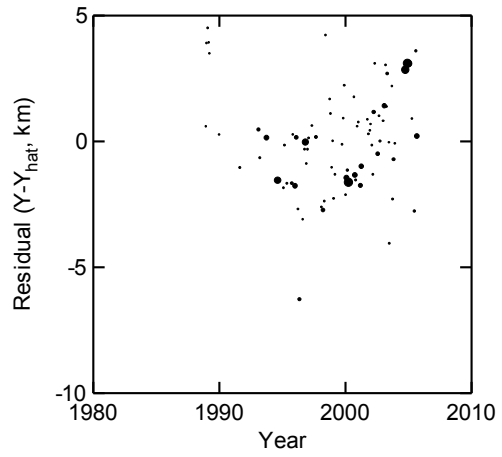
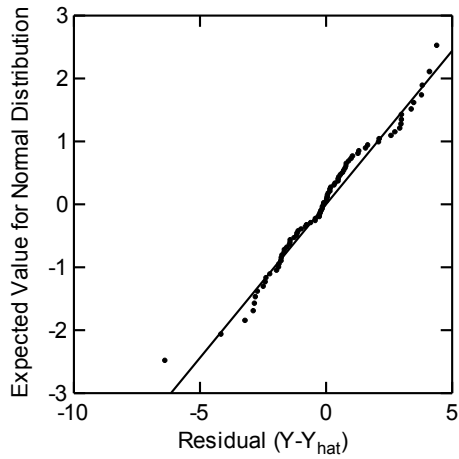
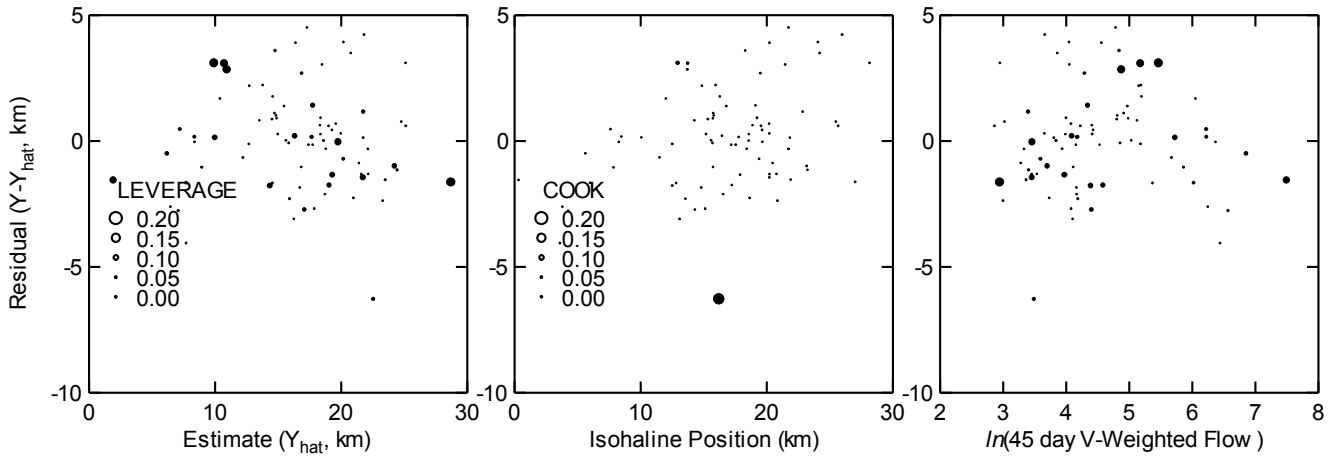

4.0 B MICMOW4B.SYD

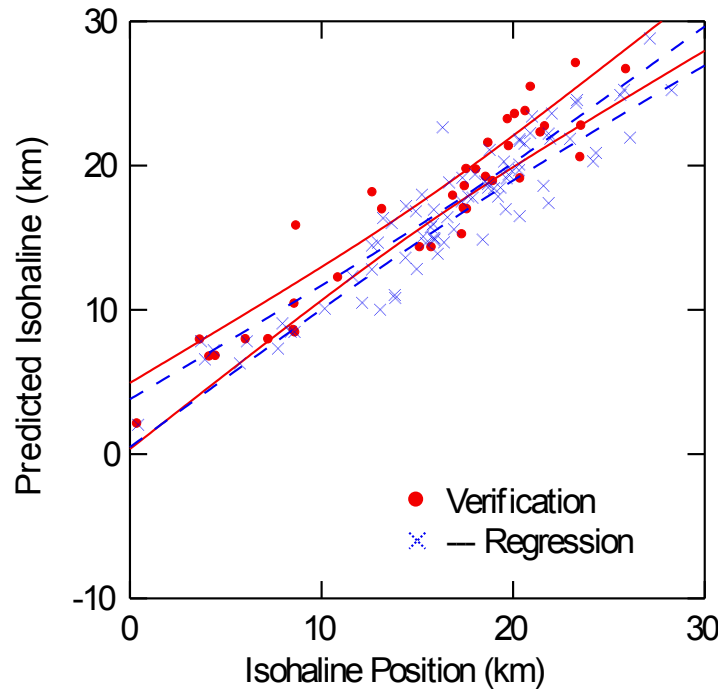

Data for the following results were selected according to:
 (best=>VAL('1')) and (depth_c2\$='S') and (iso=VAL('8.0')) AND VWT45<=VAL('2115')
 AND DISTANCE<1000 AND I_KM>=0 AND ONE_A_MO=1) AND DYEAR<>2000.545
 51 case(s) deleted due to missing data.

Eigenvalues of unit scaled X'X

	1	2	3	4	5
	4.1019	1.0796	0.9487	0.8233	0.0284
	6	7			
	0.0128	0.0053			

Condition indices

	1	2	3	4	5
	1.0000	1.9492	2.0794	2.2322	12.010
	6	7			
	17.9089	27.9180			

Variance proportions

	1	2	3	4	5
CONSTANT	0.0019	0.0000	0.0001	0.0006	0.8172
COS_WDS26	0.0023	0.2638	0.5253	0.1771	0.0123
RATE_6M	0.0074	0.1654	0.0163	0.7296	0.0156
LNVWT45	0.0007	0.0000	0.0000	0.0001	0.0846
LNPVWT45	0.0005	0.0000	0.0000	0.0001	0.0100
LNBSVEXWT	0.0010	0.0000	0.0000	0.0002	0.0237
FLORATE5B	0.0000	0.3617	0.3858	0.0713	0.0234
	6	7			
CONSTANT	0.0294	0.1509			
COS_WDS26	0.0005	0.0188			
RATE_6M	0.0344	0.0313			
LNVWT45	0.1734	0.7412			
LNPVWT45	0.0503	0.9391			
LNBSVEXWT	0.9635	0.0116			
FLORATE5B	0.1477	0.0100			

Dep Var: I_KM N: 84 Multiple R: 0.9344 Squared multiple R: 0.8731

Adjusted squared multiple R: 0.8632 Standard error of estimate: 2.2126

Effect	Coefficient	Std Error	Std Coef	Tolerance	t	P(2 Tail)
CONSTANT	40.3415	1.3355	0.0000	.	30.2060	0.0000
COS_WDS26	0.0354	0.0160	0.0919	0.9598	2.2171	0.0296
RATE_6M	21.1965	6.2849	0.1444	0.8990	3.3726	0.0012
LNVWT45	-2.8869	0.4723	-0.5312	0.2182	-6.1121	0.0000
LNPVWT45	-1.2644	0.4436	-0.2481	0.2174	-2.8502	0.0056
LNBSVEXWT	-1.5795	0.4815	-0.2256	0.3485	-3.2807	0.0016
FLORATE5B	0.0668	0.0130	0.2299	0.8209	5.1306	0.0000

Effect	Coefficient	Lower 95%	Upper 95%
CONSTANT	40.3415	37.6821	43.0009
COS_WDS26	0.0354	0.0036	0.0673
RATE_6M	21.1965	8.6817	33.7113
LNVWT45	-2.8869	-3.8275	-1.9464
LNPVWT45	-1.2644	-2.1477	-0.3810
LNBSVEXWT	-1.5795	-2.5383	-0.6208
FLORATE5B	0.0668	0.0408	0.0927

Correlation matrix of regression coefficients

	CONSTANT	COS_WDS26	RATE_6M	LNVWT45	LNPVWT45
CONSTANT	1.0000				
COS_WDS26	-0.0318	1.0000			
RATE_6M	0.0579	-0.0963	1.0000		
LNVWT45	0.1443	0.1624	-0.1188	1.0000	
LNPVWT45	-0.4272	-0.1125	0.1921	-0.7112	1.0000
LNBSVEXWT	-0.2640	0.0158	-0.2282	-0.2704	-0.3081
FLORATE5B	0.2401	-0.0235	0.0094	0.2015	-0.0251

	LNBSVEXWT	FLORATE5B
LNBSVEXWT	1.0000	
FLORATE5B	-0.3834	1.0000

Analysis of Variance

Source	Sum-of-Squares	df	Mean-Square	F-ratio	P
Regression	2593.6047	6	432.2674	88.2978	0.0000
Residual	376.9582	77	4.8956		

*** WARNING ***

Case	355 has large leverage	(Leverage =	0.5539)
Case	369 has large leverage	(Leverage =	0.2676)

Durbin-Watson D Statistic	1.3083
First Order Autocorrelation	0.3363

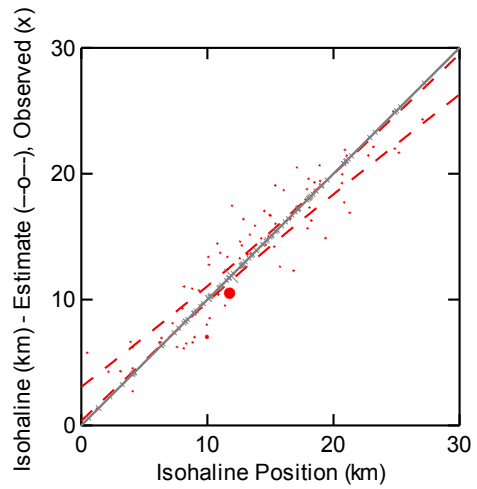
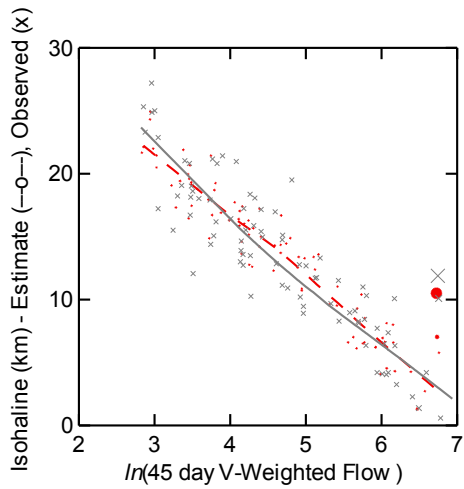
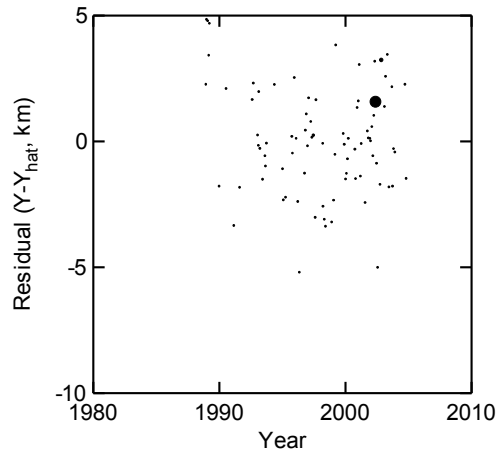
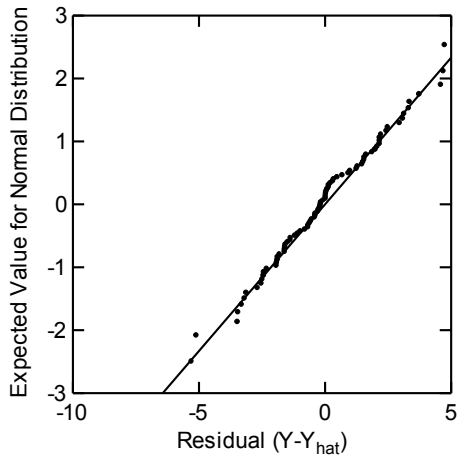
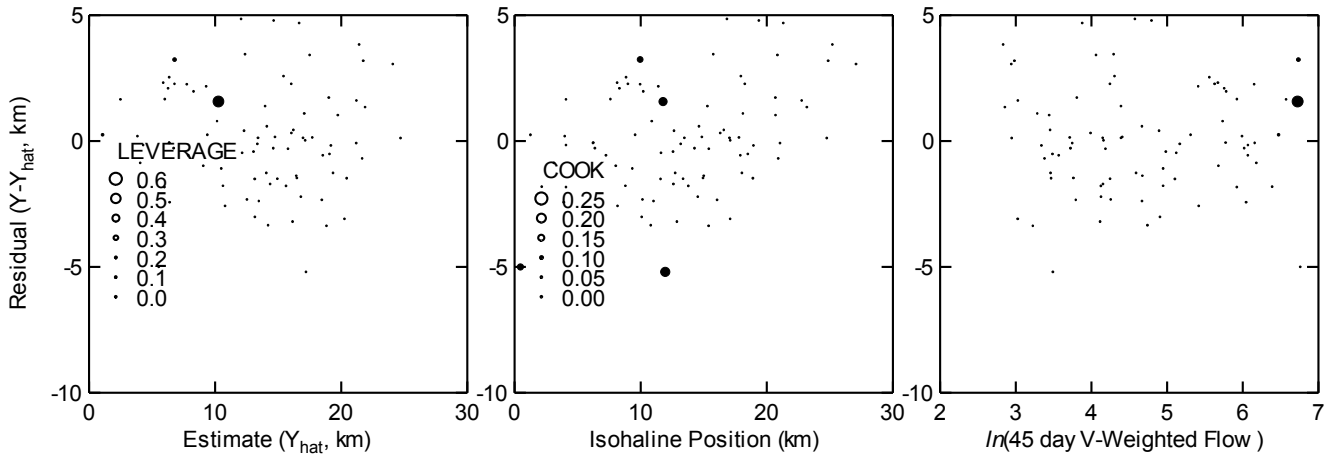

8.0 S MICMOW&S.SYD

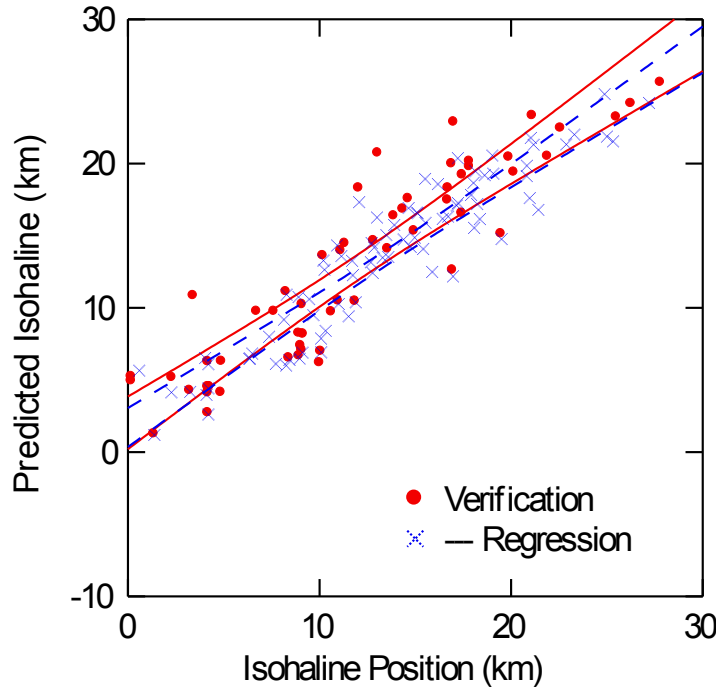

Data for the following results were selected according to:
 (best=>VAL('1')) and (depth_c2\$='B') and (iso=VAL('8.0')) AND VWT45<=VAL('2115')
 AND DISTANCE<1000 AND I_KM>=0 AND ONE_A_MO=1) AND DYEAR<>2000.545
 39 case(s) deleted due to missing data.

Eigenvalues of unit scaled X'X

	1	2	3	4	5
	2.9753	1.0129	0.9794	0.0271	0.0053

Condition indices

	1	2	3	4	5
	1.0000	1.7139	1.7429	10.4790	23.6519

Variance proportions

	1	2	3	4	5
CONSTANT	0.0039	0.0001	0.0000	0.8464	0.1496
COS_WDS23	0.0000	0.6053	0.3218	0.0556	0.0173
LNVWT45	0.0013	0.0000	0.0000	0.1237	0.8749
LNPVWT45	0.0010	0.0000	0.0000	0.0238	0.9752
FLORATE5B	0.0016	0.3273	0.6586	0.0064	0.0062

Dep Var: I_KM N: 73 Multiple R: 0.9327 Squared multiple R: 0.8699

Adjusted squared multiple R: 0.8622 Standard error of estimate: 2.2473

Effect	Coefficient	Std Error	Std Coef Tolerance	t	P(2 Tail)
CONSTANT	39.8595	1.3961	0.0000	28.5509	0.0000
COS_WDS23	0.0600	0.0169	0.1613	3.5569	0.0007
LNVWT45	-3.0653	0.5131	-0.5442	-5.9740	0.0000
LNPVWT45	-1.9060	0.4696	-0.3645	-4.0586	0.0001
FLORATE5B	0.0484	0.0142	0.1499	3.4093	0.0011

Effect	Coefficient	Lower 95%	Upper 95%
CONSTANT	39.8595	37.0736	42.6453
COS_WDS23	0.0600	0.0264	0.0937
LNVWT45	-3.0653	-4.0892	-2.0414
LNPVWT45	-1.9060	-2.8431	-0.9689
FLORATE5B	0.0484	0.0201	0.0767

Correlation matrix of regression coefficients

	CONSTANT	COS_WDS23	LNVWT45	LNPVWT45	FLORATE5B
CONSTANT	1.0000				
COS_WDS23	-0.1598	1.0000			
LNVWT45	0.0405	0.2034	1.0000		
LNPVWT45	-0.5220	-0.0937	-0.8682	1.0000	
FLORATE5B	0.1067	-0.0236	0.0487	-0.0867	1.0000

Analysis of Variance

Source	Sum-of-Squares	df	Mean-Square	F-ratio	P
Regression	2295.8218	4	573.9554	113.6440	0.0000
Residual	343.4320	68	5.0505		

*** WARNING ***

Case 233 has large leverage (Leverage = 0.7672)

Durbin-Watson D Statistic 1.6546
 First Order Autocorrelation 0.1564

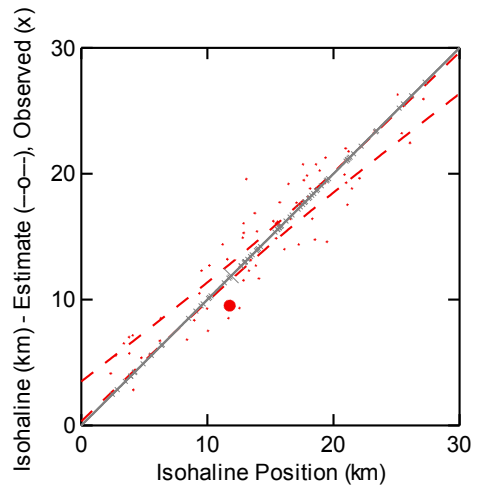
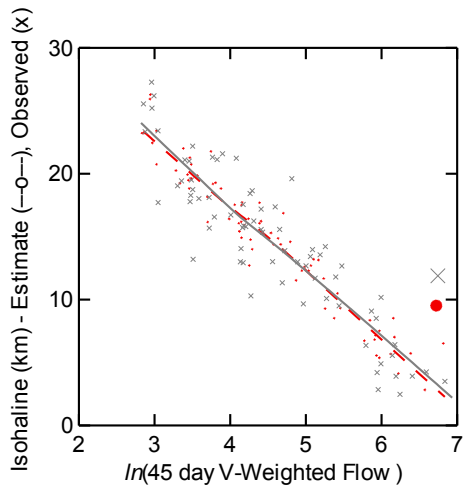
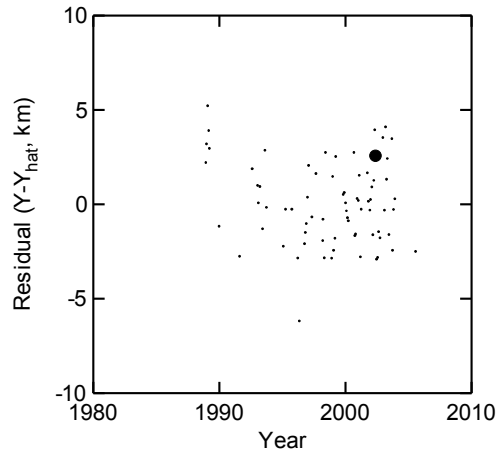
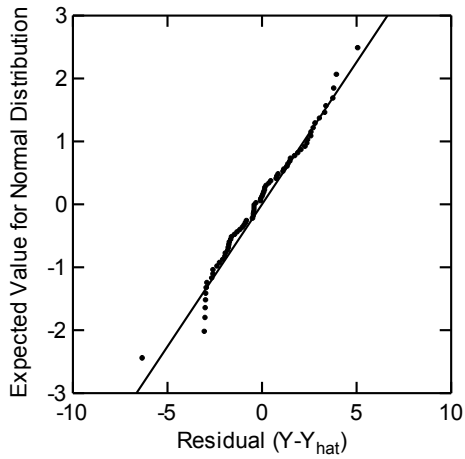
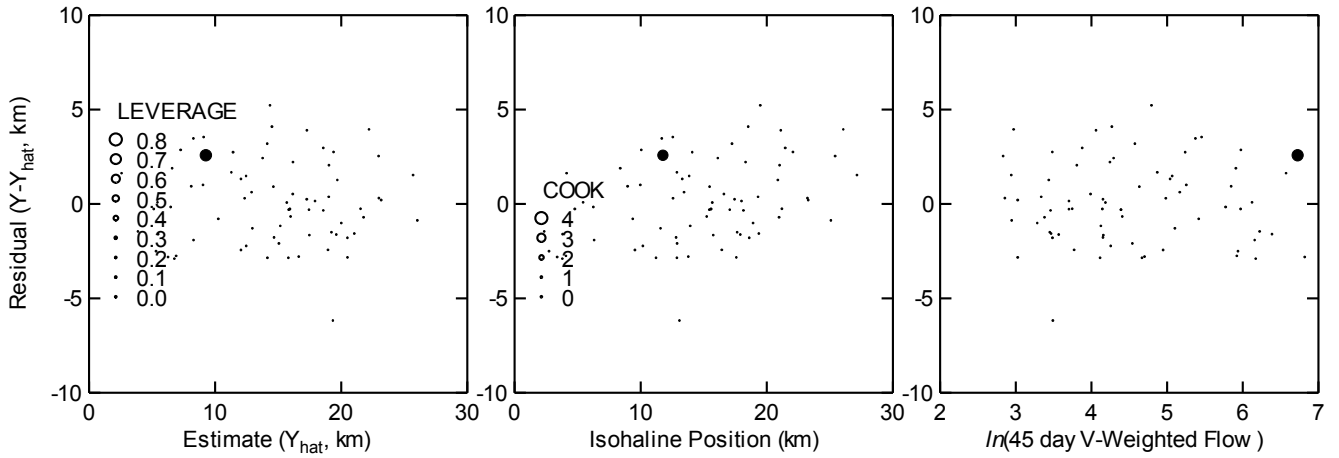

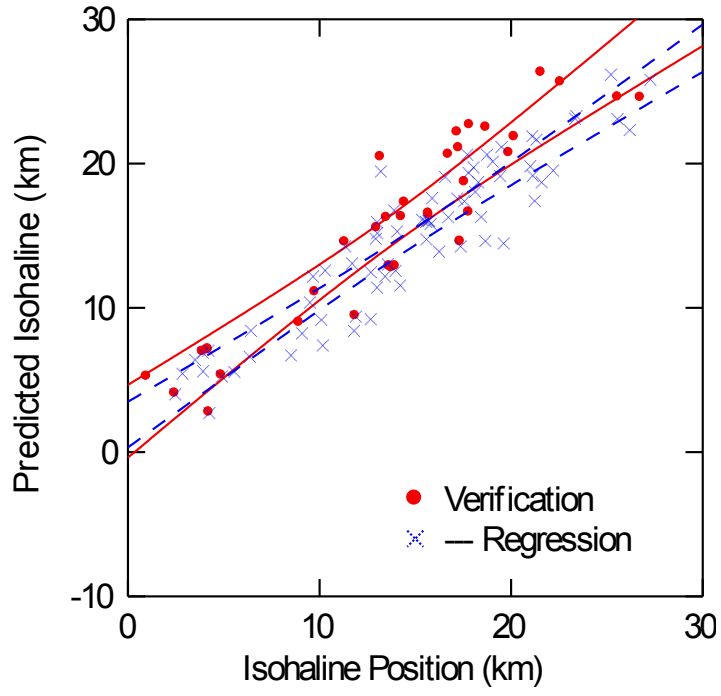

Data for the following results were selected according to:
 (best=>VAL('1')) and (depth_c2\$='S') and (iso=VAL('12.0')) AND
 VWT45<=VAL('2115') AND DISTANCE<1000 AND I_KM>=0 AND ONE_A_MO=1) AND DYEAR<>2000.545
 53 case(s) deleted due to missing data.

Eigenvalues of unit scaled X'X

1	2	3	4	5
3.7137	1.0263	0.9647	0.2634	0.0269
6				
0.0050				

Condition indices

1	2	3	4	5
1.0000	1.9022	1.9621	3.7546	11.7555
6				
27.2715				

Variance proportions

	1	2	3	4	5
CONSTANT	0.0023	0.0000	0.0000	0.0043	0.8097
COS_WDS23	0.0008	0.4273	0.5332	0.0072	0.0108
MAXRATE_6	0.0171	0.0017	0.0001	0.8793	0.0795
LNVWT45_	0.0008	0.0000	0.0000	0.0040	0.1133
LNPVWT45	0.0006	0.0000	0.0000	0.0030	0.0168
FLORATE5B	0.0003	0.4970	0.4568	0.0031	0.0037
6					
CONSTANT	0.1837				
COS_WDS23	0.0207				
MAXRATE_6	0.0223				
LNVWT45_	0.8818				
LNPVWT45	0.9796				
FLORATE5B	0.0390				

Dep Var: I_KM N: 83 Multiple R: 0.9077 Squared multiple R: 0.8239

Adjusted squared multiple R: 0.8125 Standard error of estimate: 2.6934

Effect	Coefficient	Std Error	Std Coef	Tolerance	t	P(2 Tail)
CONSTANT	36.0018	1.6449	0.0000	.	21.8876	0.0000
COS_WDS23	0.0571	0.0150	0.1853	0.9635	3.8030	0.0003
MAXRATE_6	17.0581	7.9249	0.1042	0.9760	2.1525	0.0345
LNVWT45_	-1.8819	0.5875	-0.3283	0.2178	-3.2033	0.0020
LNPVWT45	-2.8512	0.5385	-0.5434	0.2172	-5.2949	0.0000
FLORATE5B	0.0586	0.0154	0.1864	0.9566	3.8131	0.0003

Effect	Coefficient	Lower 95%	Upper 95%
CONSTANT	36.0018	32.7265	39.2771
COS_WDS23	0.0571	0.0272	0.0870
MAXRATE_6	17.0581	1.2777	32.8386
LNVWT45_	-1.8819	-3.0518	-0.7121
LNPVWT45	-2.8512	-3.9234	-1.7789
FLORATE5B	0.0586	0.0280	0.0892

Correlation matrix of regression coefficients

	CONSTANT	COS_WDS23	MAXRATE_6	LNVWT45	LNPVWT45
CONSTANT	1.0000				
COS_WDS23	-0.0216	1.0000			
MAXRATE_6	-0.3730	-0.0417	1.0000		
LNVWT45_	0.1051	0.1746	-0.1012	1.0000	
LNPVWT45	-0.5359	-0.1233	0.1361	-0.8817	1.0000
FLORATE5B	0.1424	-0.0053	-0.0796	0.1686	-0.1989

FLORATE5B FLORATE5B
FLORATE5B 1.0000

Analysis of Variance						
Source	Sum-of-Squares	df	Mean-Square	F-ratio	P	
Regression	2613.1200	5	522.6240	72.0443	0.0000	
Residual	558.5739	77	7.2542			

*** WARNING ***

Case	389 has large leverage	(Leverage =	0.6213)
Case	399 has large leverage	(Leverage =	0.3024)

Durbin-Watson D Statistic	1.2446
First Order Autocorrelation	0.3759

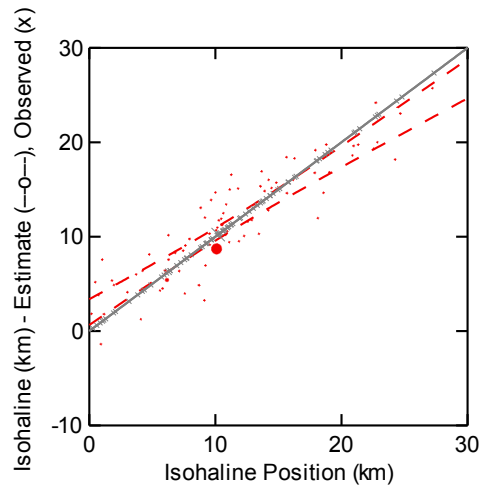
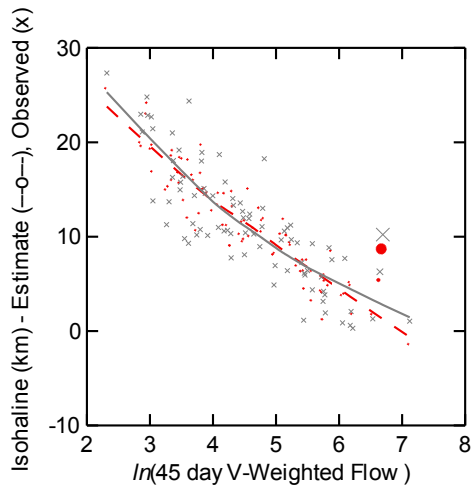
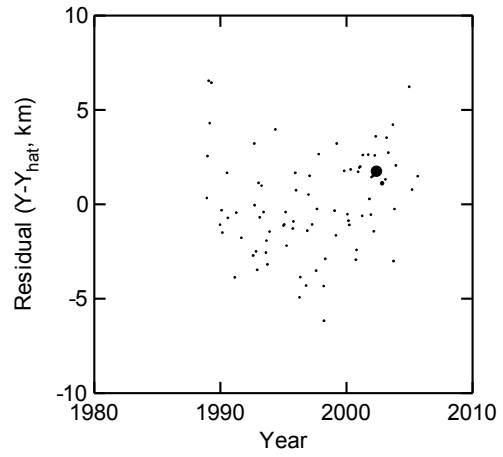
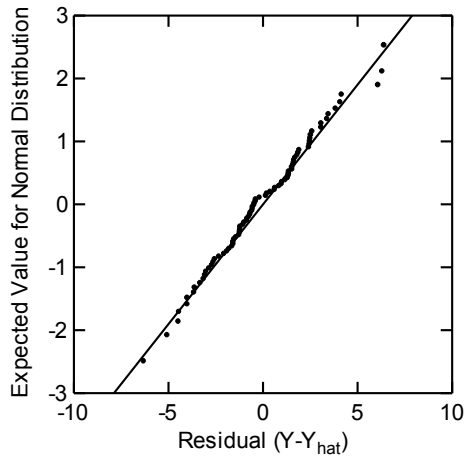
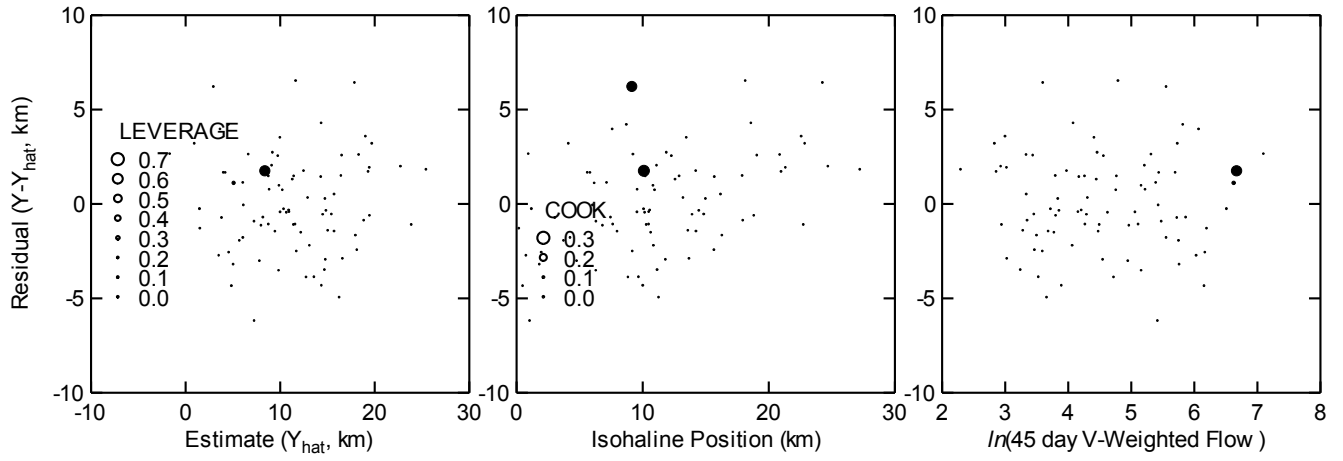

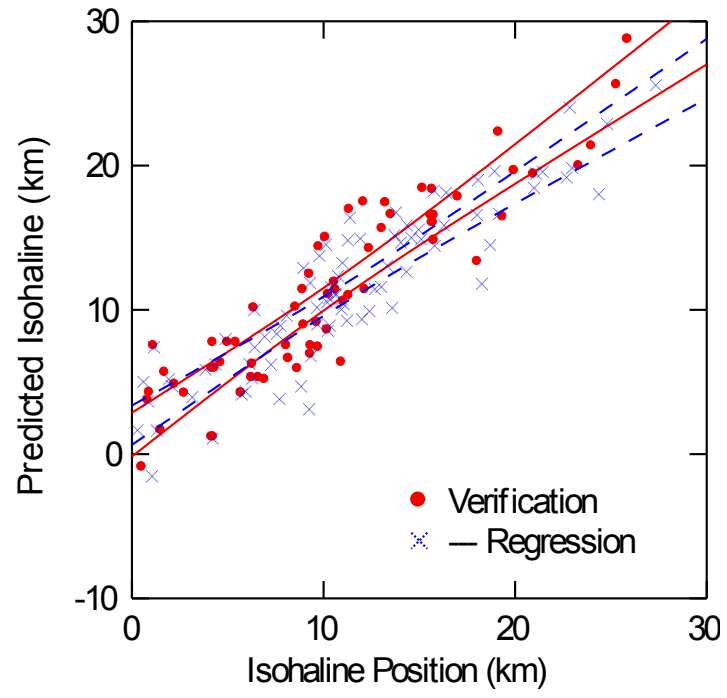

Data for the following results were selected according to:
 (best=>VAL('1')) and (depth_c2\$='B') and (iso=VAL('12.0')) AND
 VWT45<=VAL('2115') AND DISTANCE<1000 AND I_KM>=0 AND ONE_A_MO=1) AND DYEAR<>2000.545

Eigenvalues of unit scaled X'X

	1	2	3	4	5
Condition indices	2.9809	1.0024	0.9818	0.0291	0.0059

	1	2	3	4	5
Variance proportions	1.0000	1.7245	1.7425	10.1179	22.4792

	1	2	3	4	5
CONSTANT	0.0037	0.0000	0.0001	0.7174	0.2788
RATE_MEANL	0.0027	0.1070	0.8830	0.0043	0.0031
LNVWT45	0.0016	0.0000	0.0000	0.1735	0.8248
LNPVWT45	0.0010	0.0000	0.0000	0.0131	0.9859
FLORATE5B	0.0000	0.8715	0.1106	0.0026	0.0153

Dep Var: I_KM N: 116 Multiple R: 0.8873 Squared multiple R: 0.7873

Adjusted squared multiple R: 0.7796 Standard error of estimate: 3.0144

Effect	Coefficient	Std Error	Std Coef	Tolerance	t	P(2 Tail)
CONSTANT	38.6973	1.5239	0.0000	.	25.3936	0.0000
RATE_MEANL	17.6508	6.1993	0.1252	0.9908	2.8472	0.0053
LNVWT45	-2.6496	0.4773	-0.4668	0.2710	-5.5515	0.0000
LNPVWT45	-2.4364	0.4723	-0.4365	0.2677	-5.1589	0.0000
FLORATE5B	0.0279	0.0134	0.0918	0.9824	2.0793	0.0399

Effect	Coefficient	Lower 95%	Upper 95%
CONSTANT	38.6973	35.6775	41.7170
RATE_MEANL	17.6508	5.3665	29.9352
LNVWT45	-2.6496	-3.5953	-1.7038
LNPVWT45	-2.4364	-3.3723	-1.5006
FLORATE5B	0.0279	0.0013	0.0545

Correlation matrix of regression coefficients

	CONSTANT	RATE_MEANL	LNVWT45	LNPVWT45	FLORATE5B
CONSTANT	1.0000				
RATE_MEANL	-0.0764	1.0000			
LNVWT45	0.1293	-0.0193	1.0000		
LNPVWT45	-0.6190	0.0653	-0.8528	1.0000	
FLORATE5B	0.1062	-0.0032	0.0908	-0.1278	1.0000

Analysis of Variance

Source	Sum-of-Squares	df	Mean-Square	F-ratio	P
Regression	3733.0687	4	933.2672	102.7086	0.0000
Residual	1008.6077	111	9.0866		

*** WARNING ***

Case 9	has large leverage	(Leverage = 0.1947)
Case 32	is an outlier	(Studentized Residual = -3.8157)
Case 240	has large leverage	(Leverage = 0.3844)
Case 247	has large leverage	(Leverage = 0.1922)

Durbin-Watson D Statistic 1.2091
 First Order Autocorrelation 0.3906

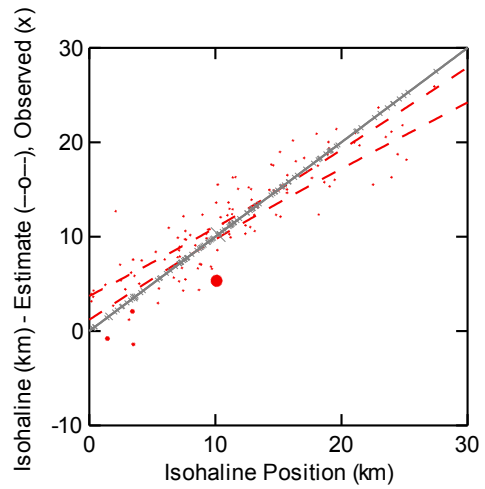
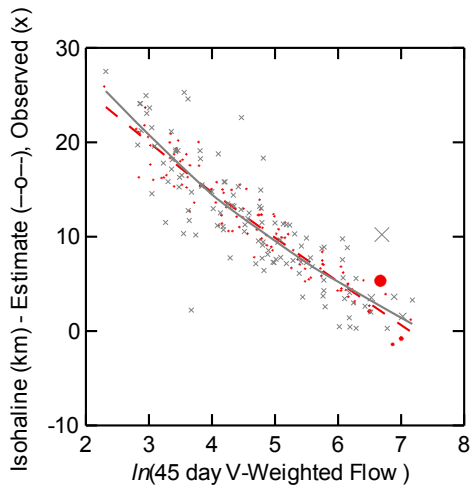
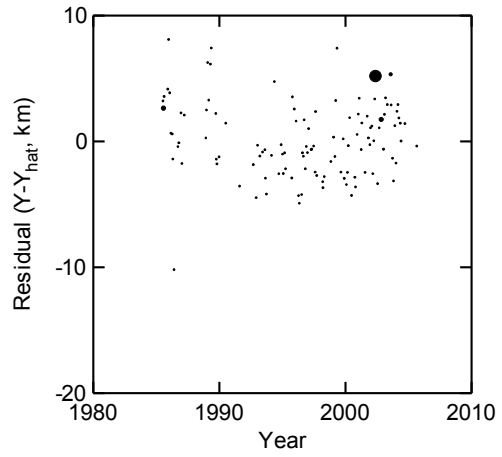
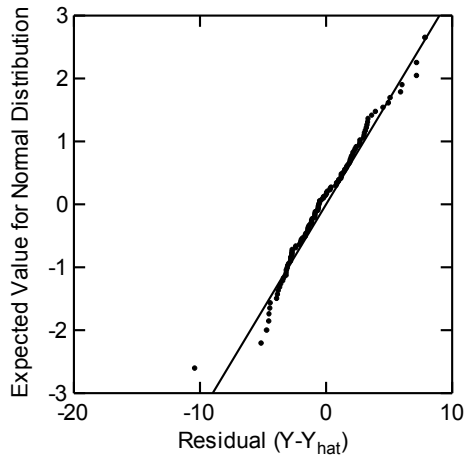
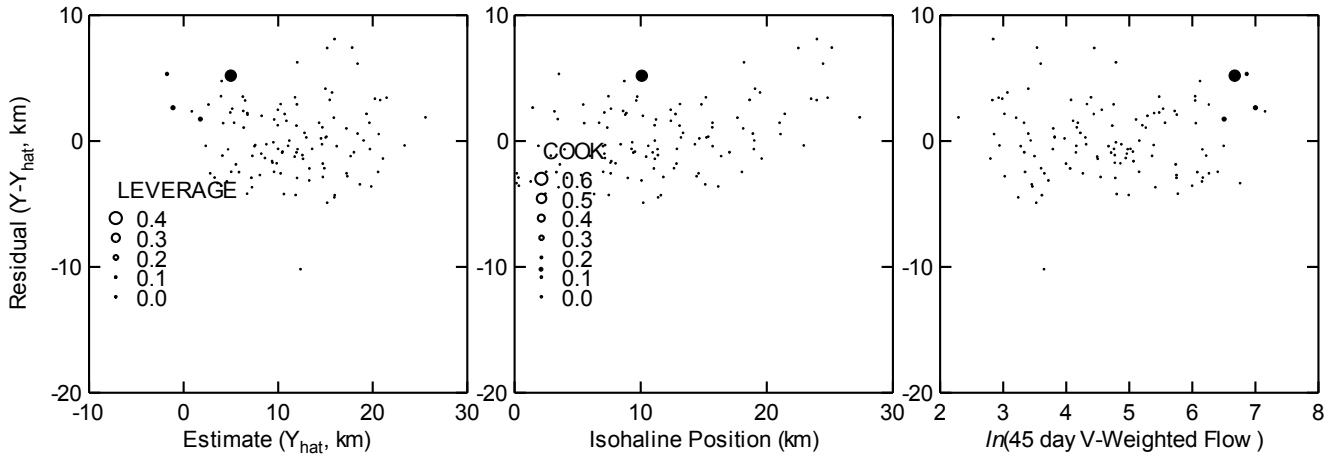

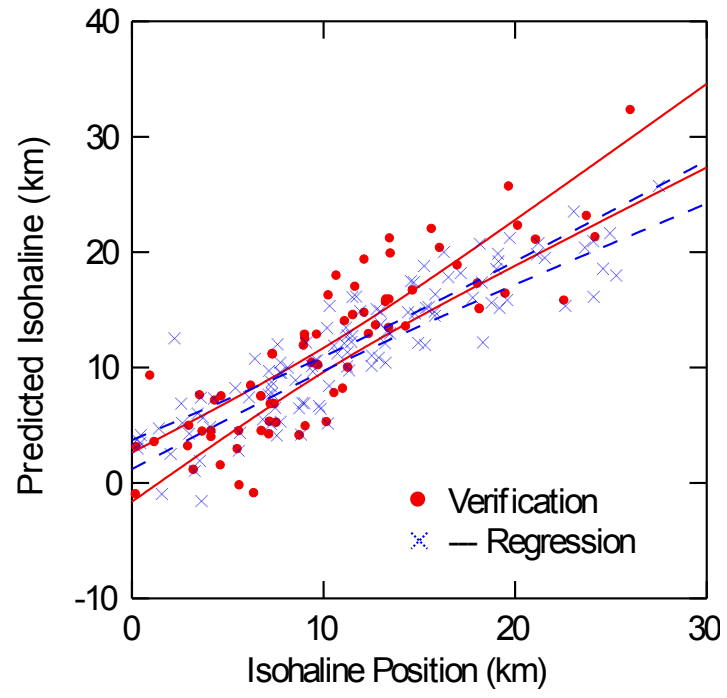

Data for the following results were selected according to:
 (best=>VAL('1')) and (depth_c2\$='S') and (iso=VAL('16.0')) AND
 VWT45<=VAL('2115') AND DISTANCE<1000 AND I_KM>=0 AND ONE_A_MO=1) AND DYEAR<>2000.545
 57 case(s) deleted due to missing data.

Eigenvalues of unit scaled X'X

1	2	3	4
2.1992	0.9482	0.8388	0.0137

Condition indices

1	2	3	4
1.0000	1.5229	1.6192	12.6734

Variance proportions

	1	2	3	4
CONSTANT	0.0052	0.0000	0.0019	0.9929
COS_WD	0.0256	0.6451	0.2591	0.0702
RATE_3M	0.0362	0.2735	0.5981	0.0922
LNPVWT45	0.0052	0.0000	0.0033	0.9914

Dep Var: I_KM N: 71 Multiple R: 0.8690 Squared multiple R: 0.7552

Adjusted squared multiple R: 0.7442 Standard error of estimate: 3.0788

Effect	Coefficient	Std Error	Std Coef	Tolerance	t	P(2 Tail)
CONSTANT	33.2649	2.2411	0.0000	.	14.8429	0.0000
COS_WD	1.6142	0.5511	0.1825	0.9414	2.9292	0.0046
RATE_3M	23.5049	8.2051	0.1801	0.9242	2.8647	0.0056
LNPVWT45	-4.3717	0.3779	-0.7469	0.8767	-11.5694	0.0000

Effect	Coefficient	Lower 95%	Upper 95%
CONSTANT	33.2649	28.7916	37.7382
COS_WD	1.6142	0.5143	2.7142
RATE_3M	23.5049	7.1274	39.8824
LNPVWT45	-4.3717	-5.1259	-3.6175

Correlation matrix of regression coefficients

	CONSTANT	COS_WD	RATE_3M	LNPVWT45
CONSTANT	1.0000			
COS_WD	-0.2779	1.0000		
RATE_3M	-0.3201	0.0845	1.0000	
LNPVWT45	-0.9844	0.2413	0.2746	1.0000

Analysis of Variance

Source	Sum-of-Squares	df	Mean-Square	F-ratio	P
Regression	1958.9890	3	652.9963	68.8899	0.0000
Residual	635.0820	67	9.4788		

Durbin-Watson D Statistic 1.6704
 First Order Autocorrelation 0.1641

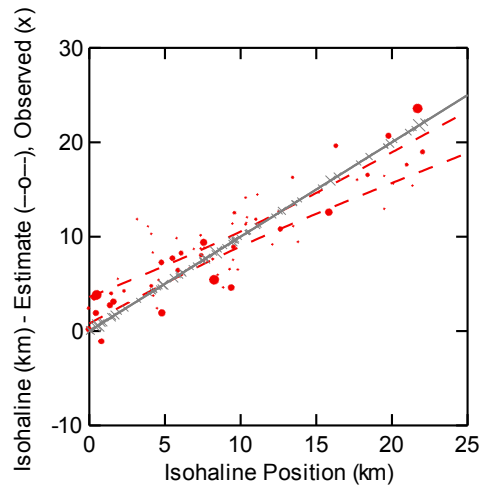
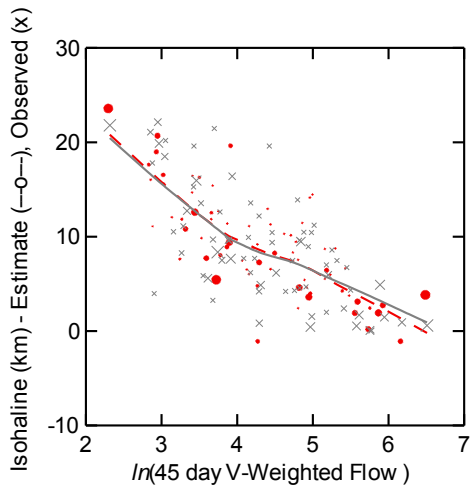
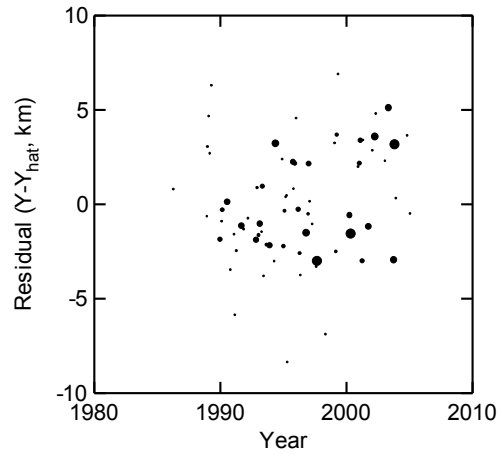
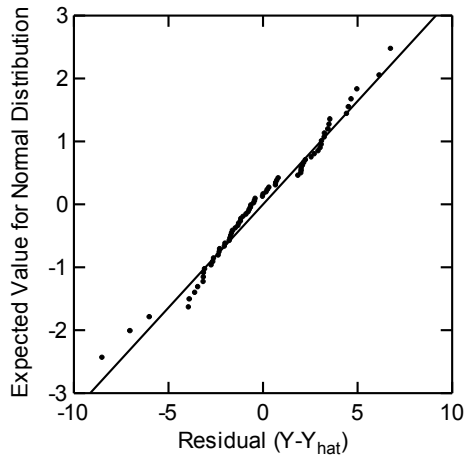
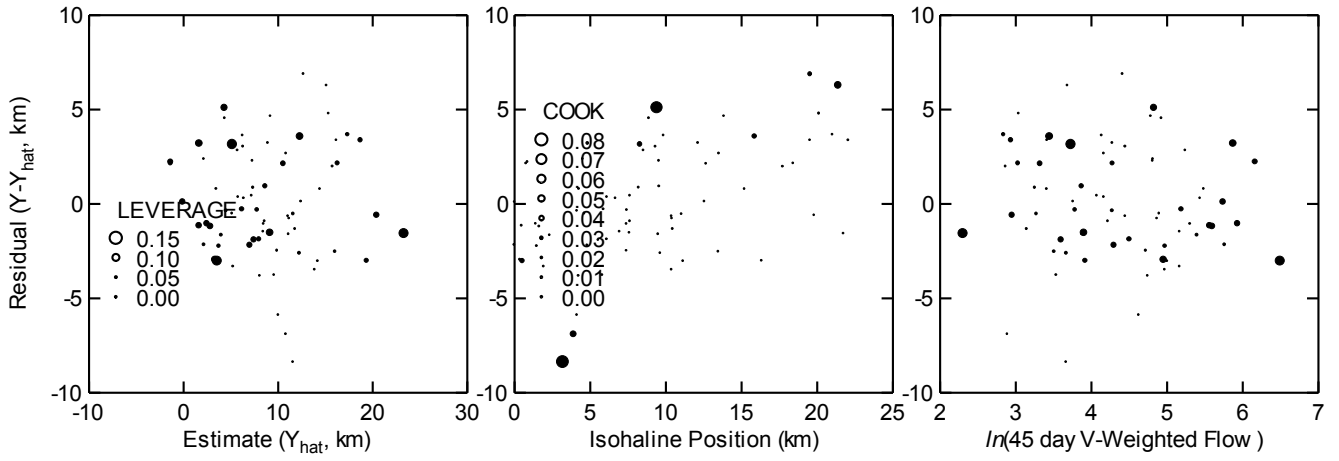

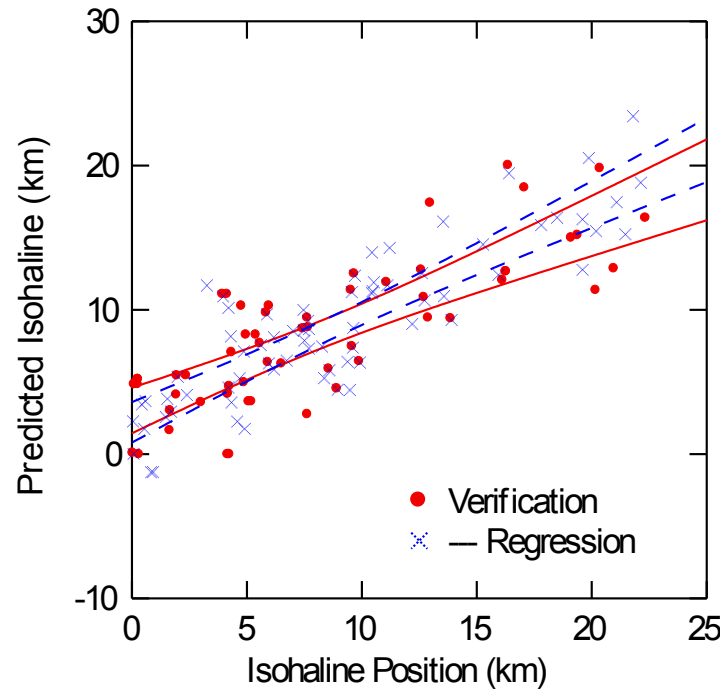

Data for the following results were selected according to:
 (best=>VAL('1')) and (depth_c2\$='B') and (iso=VAL('16.0')) AND
 VWT45<=VAL('2115') AND DISTANCE<1000 AND I_KM>=0 AND ONE_A_MO=1) AND DYEAR<>2000.545

Eigenvalues of unit scaled X'X

	1	2
	1.9854	0.0146

Condition indices

	1	2
	1.0000	11.6420

Variance proportions

	1	2
CONSTANT	0.0073	0.9927
LNPVWT45	0.0073	0.9927

Dep Var: I_KM N: 118 Multiple R: 0.8004 Squared multiple R: 0.6406
 Adjusted squared multiple R: 0.6375 Standard error of estimate: 3.2578

Effect	Coefficient	Std Error	Std Coef	Tolerance	t	P(2 Tail)
CONSTANT	33.8809	1.7586	0.0000	.	19.2654	0.0000
LNPVWT45	-4.2137	0.2930	-0.8004	1.0000	-14.3798	0.0000

Effect	Coefficient	Lower 95%	Upper 95%
CONSTANT	33.8809	30.3977	37.3641
LNPVWT45	-4.2137	-4.7940	-3.6333

Correlation matrix of regression coefficients

	CONSTANT	LNPVWT45
CONSTANT	1.0000	
LNPVWT45	-0.9854	1.0000

Analysis of Variance

Source	Sum-of-Squares	df	Mean-Square	F-ratio	P
Regression	2194.6308	1	2194.6308	206.7789	0.0000
Residual	1231.1563	116	10.6134		

Durbin-Watson D Statistic 1.3220
 First Order Autocorrelation 0.3218

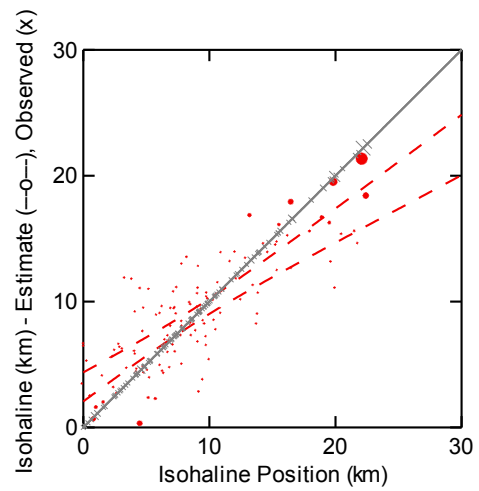
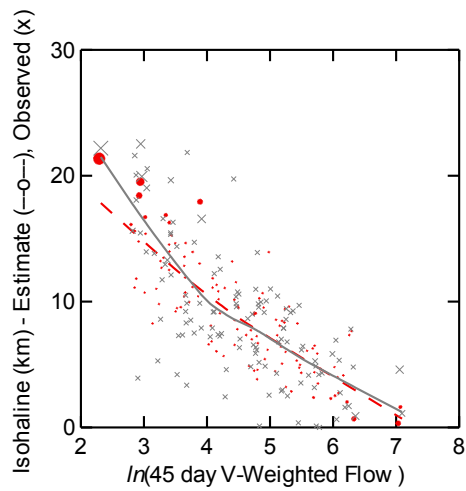
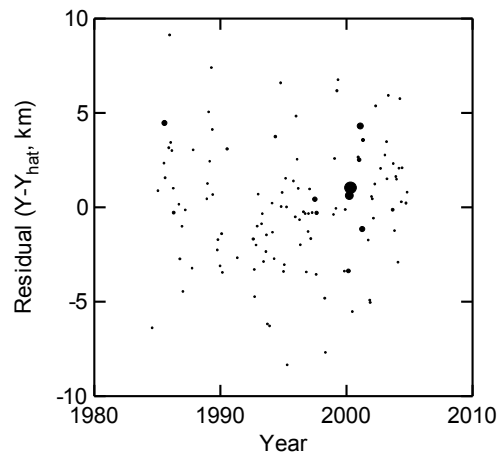
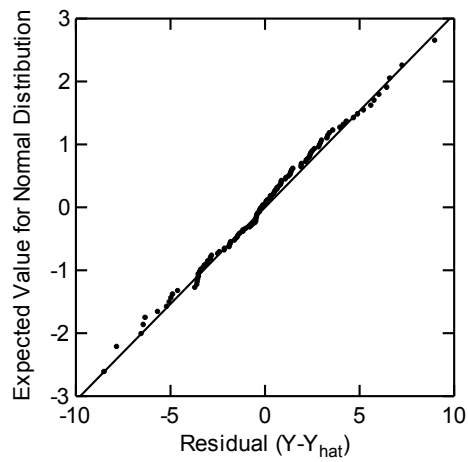
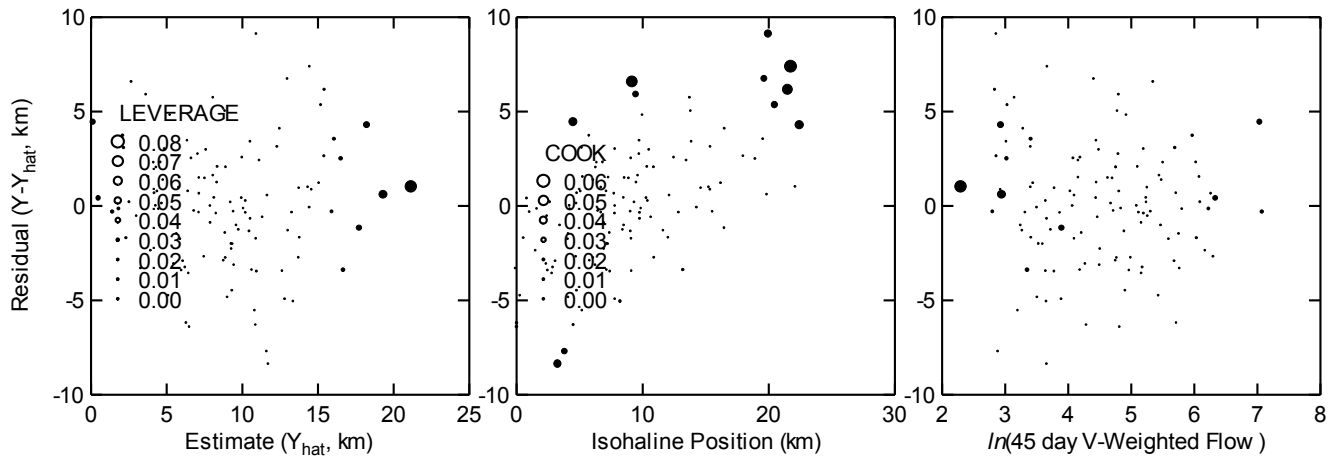

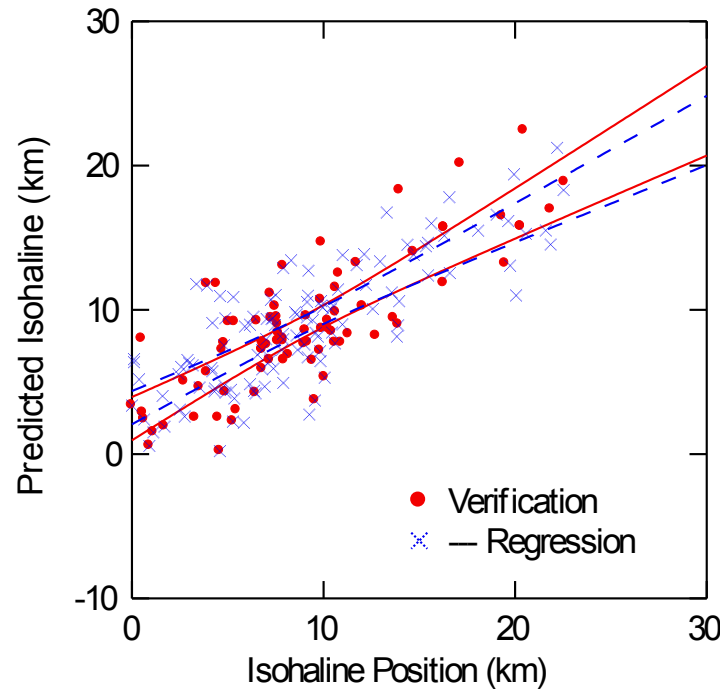

Data for the following results were selected according to:
 (best=>VAL('1')) and (depth_c2\$='S') and (iso=VAL('20.0')) AND
 VWT45<=VAL('2115') AND DISTANCE<1000 AND I_KM>=0 AND ONE_A_MO=1) AND DYEAR<>2000.545

Eigenvalues of unit scaled X'X

	1	2	3
	2.9441	0.0451	0.0108

Condition indices

	1	2	3
	1.0000	8.0752	16.5373

Variance proportions

	1	2	3
CONSTANT	0.0020	0.0250	0.9730
MIN_RATE	0.0066	0.8397	0.1537
LNPVWT45	0.0027	0.1574	0.8398

Dep Var: I_KM N: 84 Multiple R: 0.8168 Squared multiple R: 0.6672

Adjusted squared multiple R: 0.6590 Standard error of estimate: 2.9486

Effect	Coefficient	Std Error	Std Coef	Tolerance	t	P(2 Tail)
CONSTANT	26.9635	2.4329	0.0000	.	11.0828	0.0000
MIN_RATE	-47.4744	12.9919	-0.2342	1.0000	-3.6542	0.0005
LNPVWT45	-4.5559	0.3732	-0.7826	1.0000	-12.2092	0.0000

Effect	Coefficient	Lower 95%	Upper 95%
CONSTANT	26.9635	22.1227	31.8042
MIN_RATE	-47.4744	-73.3241	-21.6247
LNPVWT45	-4.5559	-5.2983	-3.8134

Correlation matrix of regression coefficients

	CONSTANT	MIN_RATE	LNPVWT45
CONSTANT	1.0000		
MIN_RATE	0.5279	1.0000	
LNPVWT45	-0.8389	0.0001	1.0000

Analysis of Variance

Source	Sum-of-Squares	df	Mean-Square	F-ratio	P
Regression	1411.9873	2	705.9937	81.2028	0.0000
Residual	704.2306	81	8.6942		

Durbin-Watson D Statistic 1.6083
 First Order Autocorrelation 0.1924

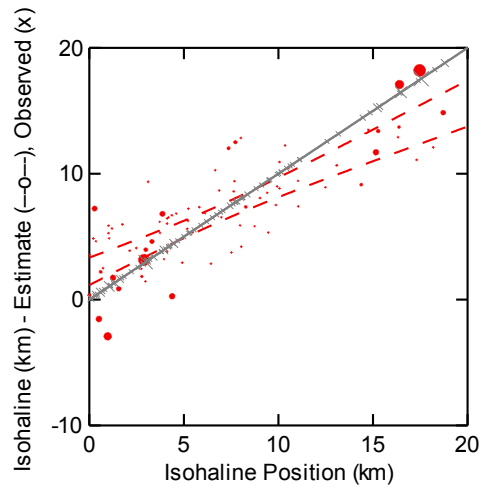
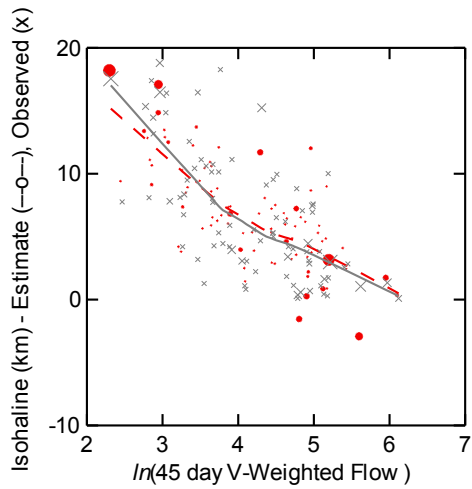
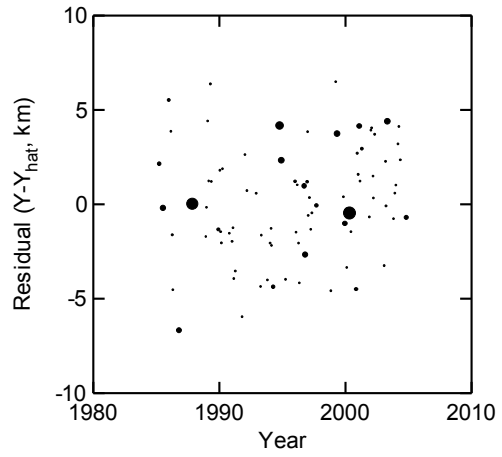
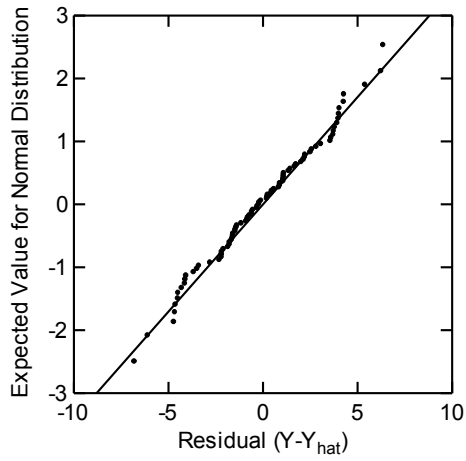
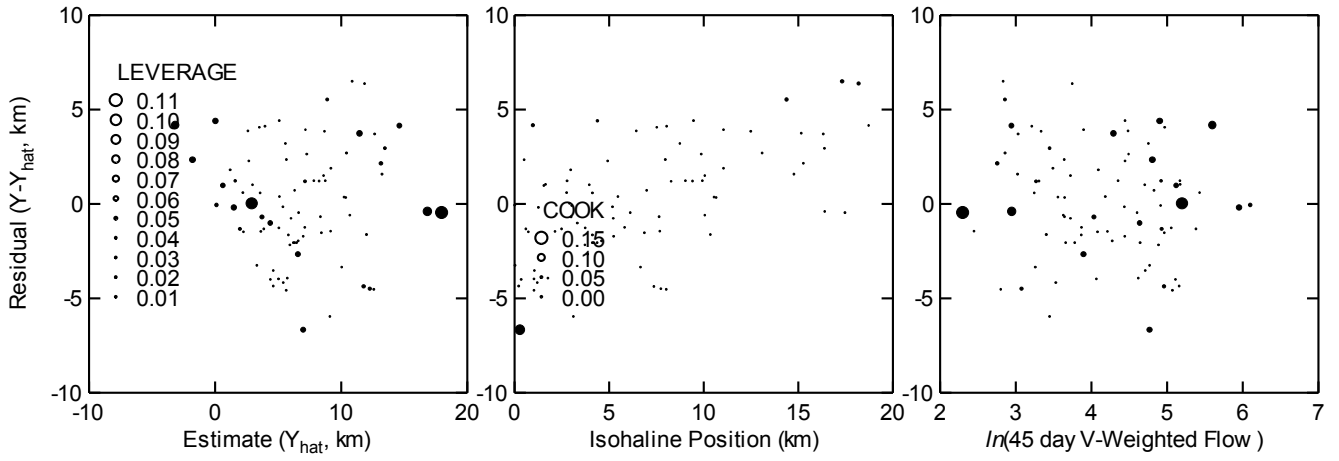

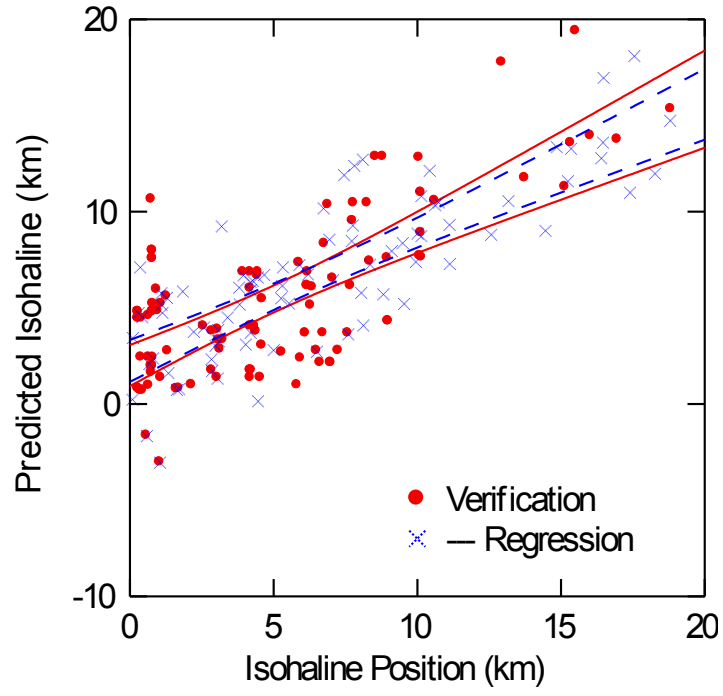

Data for the following results were selected according to:
 (best=>VAL('1')) and (depth_c2\$='B') and (iso=VAL('20.0')) AND
 VWT45<=VAL('2115') AND DISTANCE<1000 AND I_KM>=0 AND ONE_A_MO=1) AND DYEAR<>2000.545
 22 case(s) deleted due to missing data.

Eigenvalues of unit scaled X'X

	1	2	3
	2.5268	0.4593	0.0140

Condition indices

	1	2	3
	1.0000	2.3456	13.4437

Variance proportions

	1	2	3
CONSTANT	0.0040	0.0066	0.9894
MAXRATE 3	0.0581	0.8999	0.0420
LNPVWT45	0.0041	0.0093	0.9866

Dep Var: I_KM N: 68 Multiple R: 0.8022 Squared multiple R: 0.6435

Adjusted squared multiple R: 0.6325 Standard error of estimate: 3.2668

Effect	Coefficient	Std Error	Std Coef Tolerance	t	P(2 Tail)
CONSTANT	29.8442	2.4159	0.0000	12.3534	0.0000
MAXRATE 3	18.6299	8.8009	0.1581	2.1168	0.0381
LNPVWT45	-4.2412	0.4132	-0.7665	-10.2643	0.0000

Effect	Coefficient	Lower 95%	Upper 95%
CONSTANT	29.8442	25.0194	34.6690
MAXRATE 3	18.6299	1.0532	36.2065
LNPVWT45	-4.2412	-5.0664	-3.4160

Correlation matrix of regression coefficients

	CONSTANT	MAXRATE_3	LNPVWT45
CONSTANT	1.0000		
MAXRATE_3	-0.2661	1.0000	
LNPVWT45	-0.9761	0.1278	1.0000

Analysis of Variance

Source	Sum-of-Squares	df	Mean-Square	F-ratio	P
Regression	1251.9244	2	625.9622	58.6534	0.0000
Residual	693.6944	65	10.6722		

Durbin-Watson D Statistic 1.3946
 First Order Autocorrelation 0.2868

20.0 B MICMOW20B.SYD

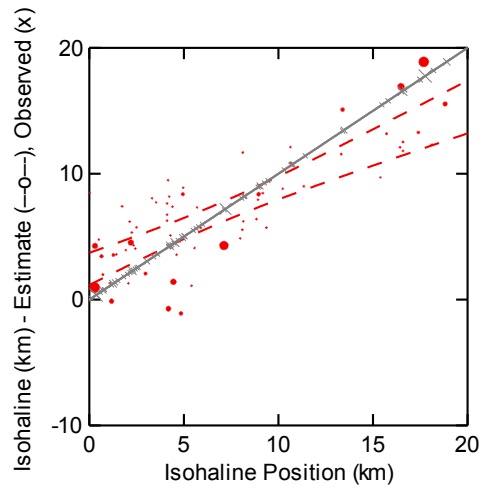
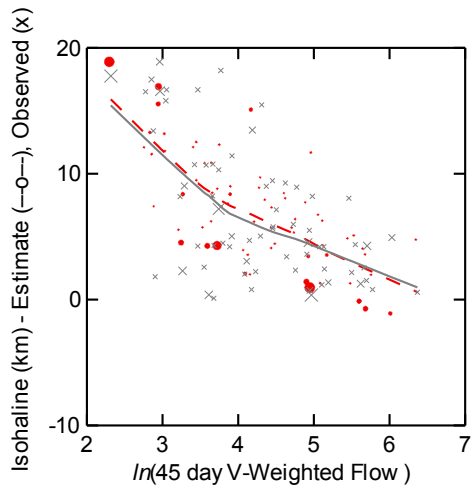
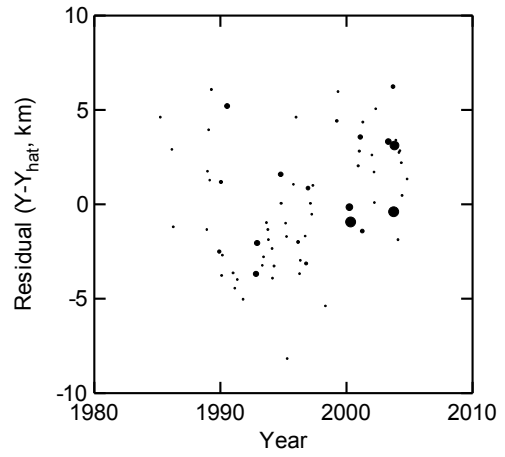
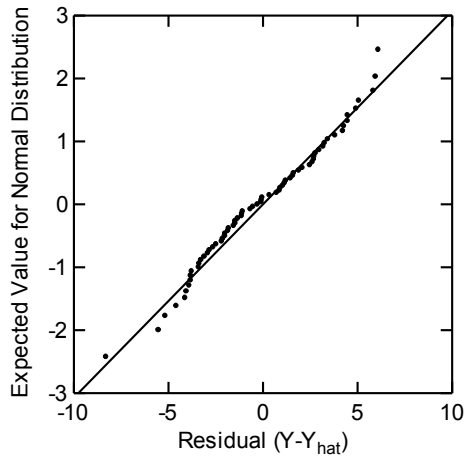
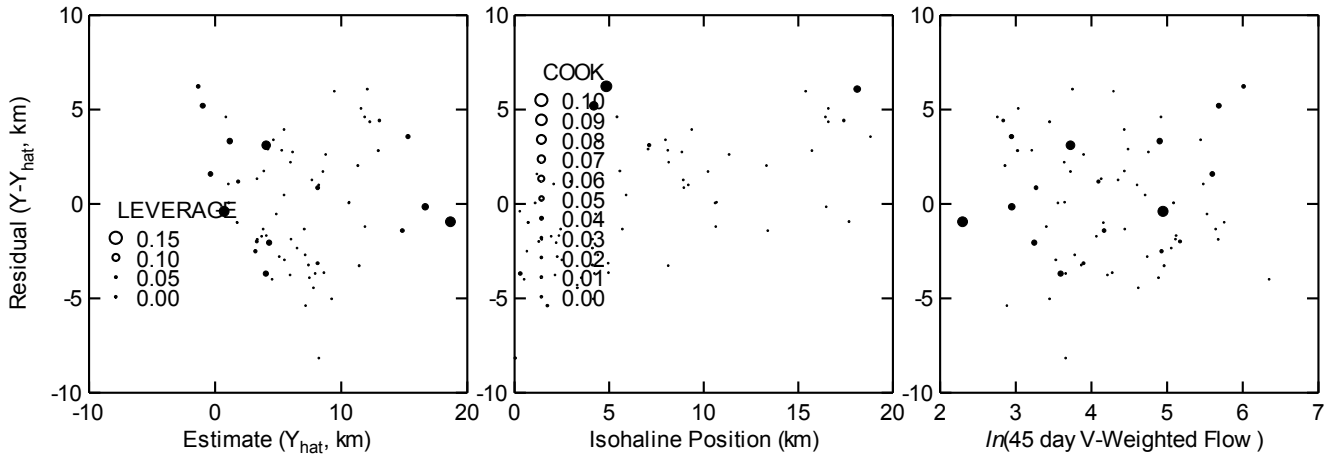

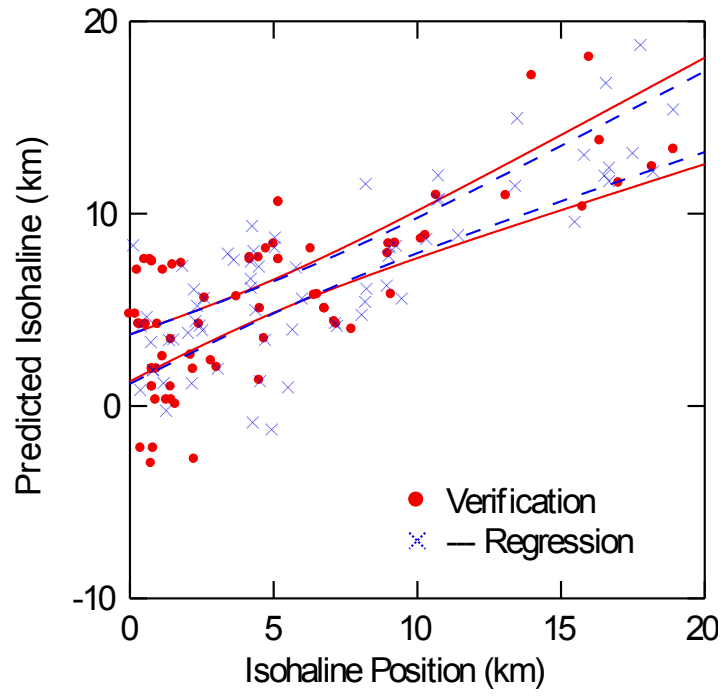

Data for the following results were selected according to:
 (best=>VAL('1')) and (depth_c2\$='S') and (iso=VAL('24.0')) AND
 VWT45<=VAL('2115') AND DISTANCE<1000 AND I_KM>=0 AND ONE_A_MO=1) AND DYEAR<>2000.545
 8 case(s) deleted due to missing data.

Eigenvalues of unit scaled X'X

	1	2	3
	2.6468	0.3481	0.0051

Condition indices

	1	2	3
	1.0000	2.7573	22.7594

Variance proportions

	1	2	3
CONSTANT	0.0014	0.0050	0.9935
PRED_M_SEA	0.0437	0.8371	0.1191
LNPVWT45	0.0013	0.0034	0.9953

Dep Var: I_KM N: 30 Multiple R: 0.7224 Squared multiple R: 0.5219

Adjusted squared multiple R: 0.4865 Standard error of estimate: 3.2155

Effect	Coefficient	Std Error	Std Coef Tolerance	t	P(2 Tail)
CONSTANT	33.8189	5.7034	0.0000	5.9296	0.0000
PRED_M_SEA	12.0335	3.6532	0.4760	3.2940	0.0028
LNPVWT45	-6.1181	1.1635	-0.7598	-5.2585	0.0000

Effect	Coefficient	Lower 95%	Upper 95%
CONSTANT	33.8189	22.1166	45.5213
PRED_M_SEA	12.0335	4.5378	19.5292
LNPVWT45	-6.1181	-8.5054	-3.7308

Correlation matrix of regression coefficients

	CONSTANT	PRED_M_SEA	LNPVWT45
CONSTANT	1.0000		
PRED_M_SEA	0.2869	1.0000	
LNPVWT45	-0.9889	-0.3898	1.0000

Analysis of Variance

Source	Sum-of-Squares	df	Mean-Square	F-ratio	P
Regression	304.7817	2	152.3908	14.7387	0.0000
Residual	279.1673	27	10.3395		

*** WARNING ***

Case 8 is an outlier (Studentized Residual = 3.0658)

Durbin-Watson D Statistic 1.8355
 First Order Autocorrelation 0.0767

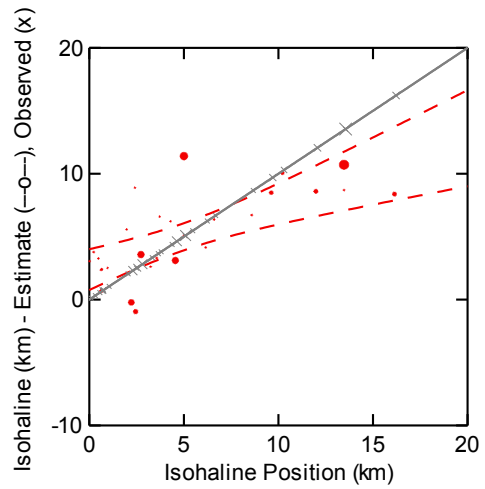
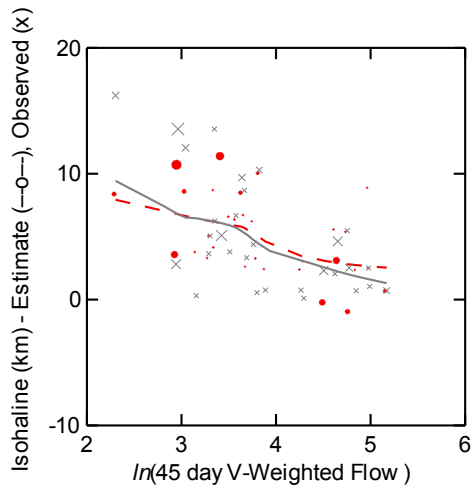
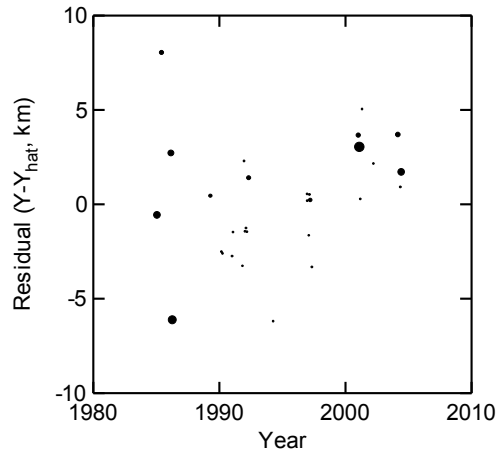
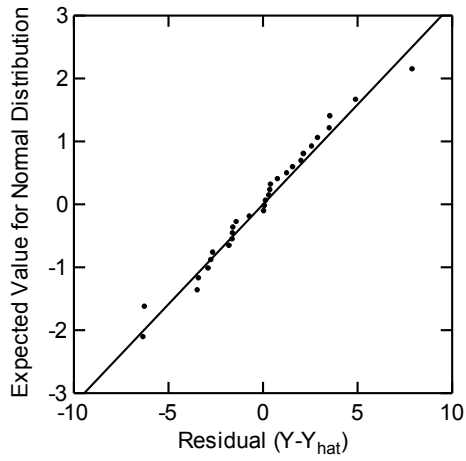
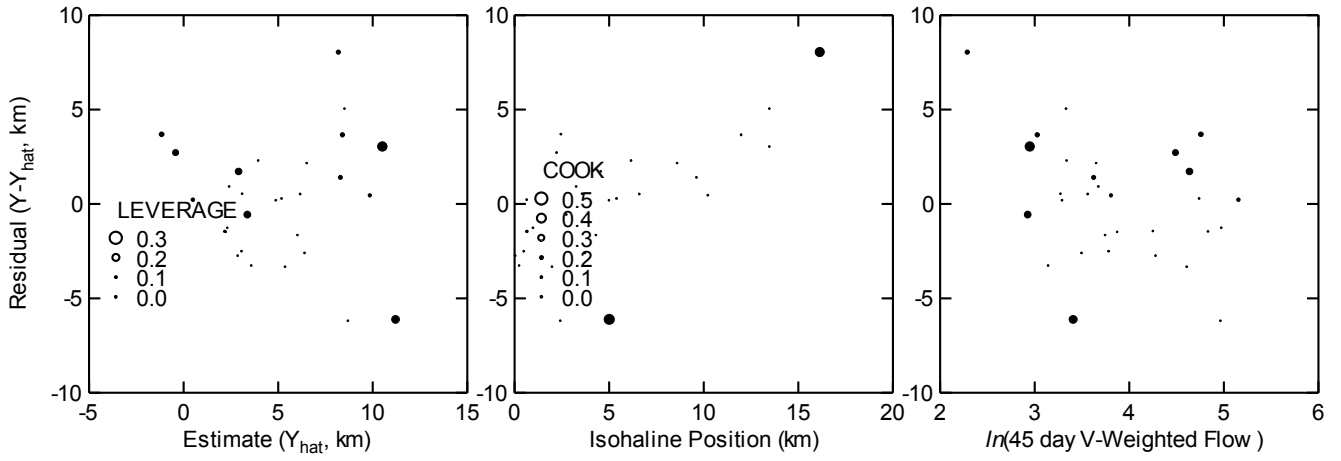

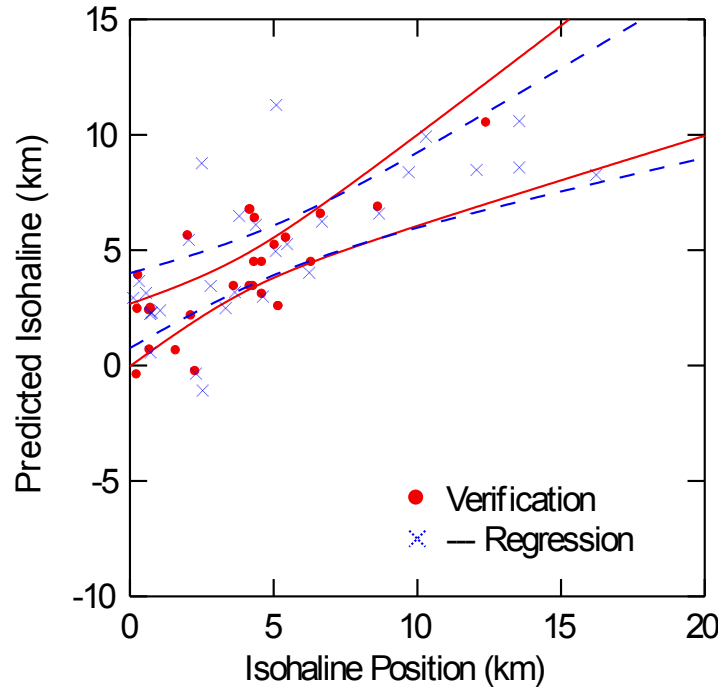

Data for the following results were selected according to:
 (best=>VAL('1')) and (depth_c2\$='B') and (iso=VAL('24.0')) AND
 VWT45<=VAL('2115') AND DISTANCE<1000 AND I_KM>=0 AND ONE_A_MO=1) AND DYEAR<>2000.545

Eigenvalues of unit scaled X'X

	1	2
	1.9896	0.0104

Condition indices

	1	2
	1.0000	13.8646

Variance proportions

	1	2
CONSTANT	0.0052	0.9948
LNPVWT45	0.0052	0.9948

Dep Var: I_KM N: 39 Multiple R: 0.5955 Squared multiple R: 0.3547

Adjusted squared multiple R: 0.3372 Standard error of estimate: 3.5121

Effect	Coefficient	Std Error	Std Coef	Tolerance	t	P(2 Tail)
CONSTANT	23.0913	3.9189	0.0000	.	5.8923	0.0000
LNPVWT45	-3.4985	0.7758	-0.5955	1.0000	-4.5094	0.0001

Effect	Coefficient	Lower 95%	Upper 95%
CONSTANT	23.0913	15.1509	31.0318
LNPVWT45	-3.4985	-5.0705	-1.9265

Correlation matrix of regression coefficients

	CONSTANT	LNPVWT45
CONSTANT	1.0000	
LNPVWT45	-0.9896	1.0000

Analysis of Variance

Source	Sum-of-Squares	df	Mean-Square	F-ratio	P
Regression	250.8166	1	250.8166	20.3344	0.0001
Residual	456.3800	37	12.3346		

*** WARNING ***
 Case 6 is an outlier (Studentized Residual = 3.8250)

Durbin-Watson D Statistic 1.4785
 First Order Autocorrelation 0.2387

24.0 B MICMOW24B.SYD

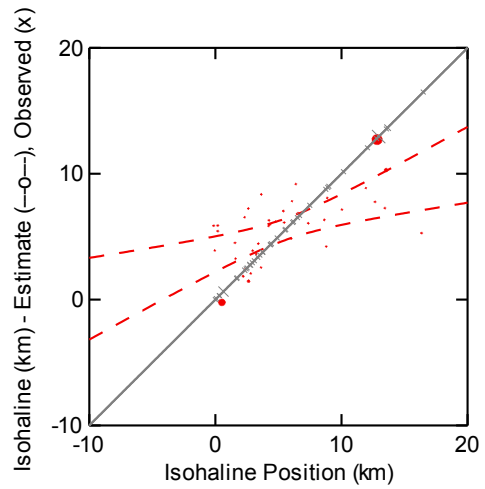
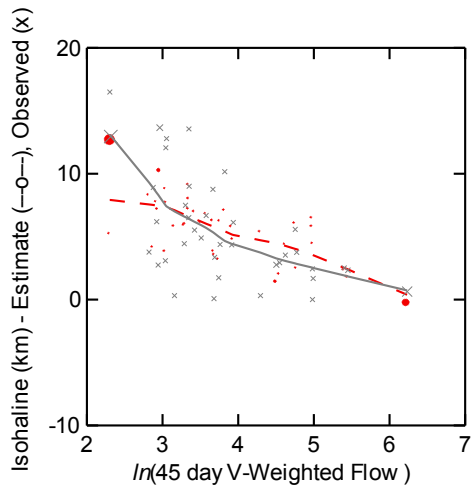
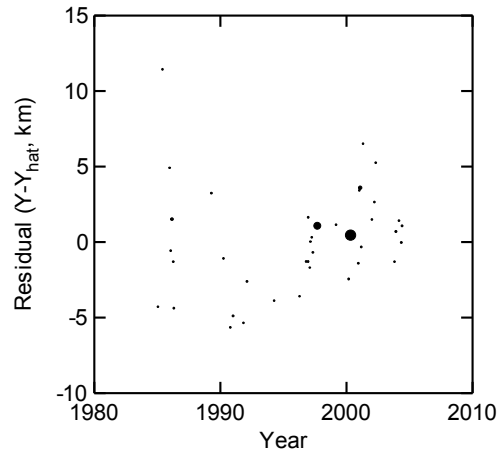
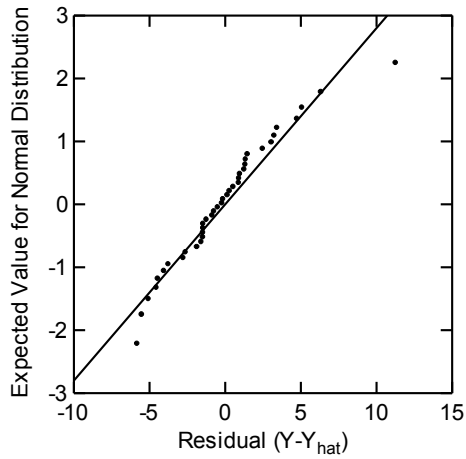
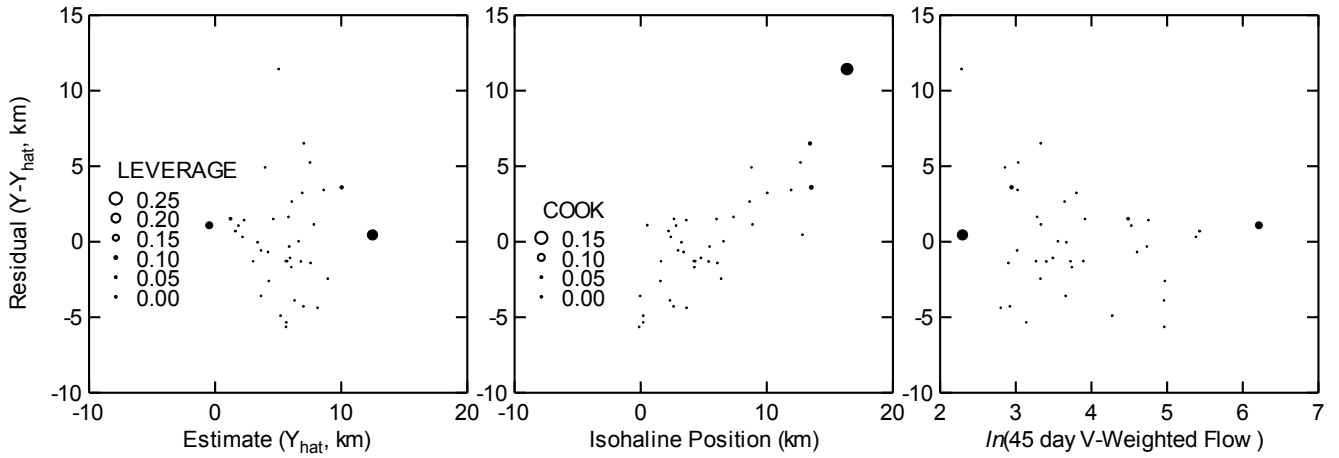

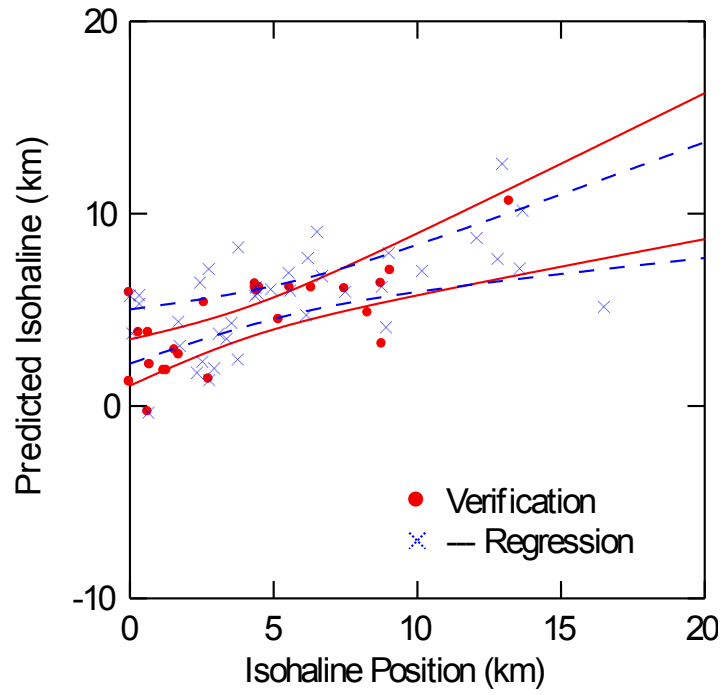

Appendix 4-D

Fixed Station Regression Results, Statistics, and Verifications

Equations for salinity (PSU) at specific stations as a function of weather, tide, and flow variables. Note log transformation for most.

Segment Kilometer	Depth	Applicable Flow Range	Estimated Salinity	Regression Constant	Coefficient	Wind Variable	Coefficient	Tide Variable	Coefficient	Myakka R. Flow Variable	Coefficient	Peace R. Flow Variable	Coefficient	Myakka/hatchee Crk. Flow Variable	Coefficient	Change in Myakka R. Flow Variable
4 (Cat. 7)	S	0-2115	SAL_PSU2 =	43.0143	+		33.3333	RATE_6M	+							
4 (Cat. 7)	B	0-2115	SAL_PSU2 =	39.2048	+		28.7997	RATE_6M	+	-2.0239	LNVEEXWT	+	-1.4066	LNPEXWT7	+	
12 (Cat. 11)	S	0-2115	LNSAL =	6.5621	+	0.2056		COS_WD	+	-1.7524	TIDE_MEANL	+			LNBSVWT45	+
12 (Cat. 11)	B	0-2115	LNSAL =	6.3930	+			10.3402	+	-0.6573	LNEXWT7	+			LNBSVEXWT	+
18 (Cat. 15)	S	0-400	LNSAL =	6.5556	+	0.0200		COS_WDS26	+	-0.5830	LNEXWT7	+			LNBSVWT30	+
18 (Cat. 15)	S	400-2115	LNSAL =	6.5556	+	0.0200		COS_WDS26	+	-0.5830	LNEXWT7	+			LNBSVWT30	+
18 (Cat. 15)	B	0-2115	LNSAL =	6.0204	+	0.0207		COS_WDS2	+	-1.2937	TIDE_MEANL	+	-0.6618	LNVEEXWT	+	
22 (Cat. 17)	S	0-120	LNSAL =	3.9057	+	0.5978		COS_WD	+	11.7329	MAXRATE_6	+	-1.1617	LNVEEXWT	+	
22 (Cat. 17)	S	120-2115	LNSAL =	-0.1932	+				+					LNVEEXWT	+	
22 (Cat. 17)	B	0-120	LNSAL =	4.5137	+	0.0376		COS_WDS23	+	9.9247	MAXRATE_6	+	-0.7934	LNVEEXWT	+	
22 (Cat. 17)	B	120-2115	LNSAL =	-0.2414	+				+					LNVEEXWT	+	
28 (Cat. 20)	S	50-2115	LNSAL =	0.6847	+				+	3.4376	MAXRATE_3	+	-0.3529	LNVEEXWT	+	
28 (Cat. 20)	S	0-50	LNSAL =	4.1034	+				+	-1.6404	RANGE_TIDE	+	-1.1833	LNVEEXWT	+	
28 (Cat. 20)	B	0-50	LNSAL =	3.5856	+	0.0205		COS_WDS26	+					LNVEEXWT	+	
28 (Cat. 20)	B	50-2115	LNSAL =	0.6898	+				+	1.3341	MAXTIDE_6	+		LNVEEXWT	+	0.0591 FLORATE3

Equations for salinity (PSU) at specific stations under mean weather conditions. Weather and tide coefficients and mean values are now included in the combine regression constant. Note log transformations.

Segment Kilometer	Depth	Applicable Flow Range	Estimated Salinity	Combined Regression Constant	Coefficient	Myakka R. Flow Variable	Coefficient	Peace R. Flow Variable	Coefficient	Myakka/hatchee Crk. Flow Variable	Coefficient	Change in Myakka R. Flow Variable
4 (Cat. 7)	S	0-2115	SAL_PSU2 =	42.9210	+		-2.9330	LNVEEXWT	+	-2.6983	LNBSVWT45	+
4 (Cat. 7)	B	0-2115	SAL_PSU2 =	39.1242	+	-2.0239	LNVEEXWT	+	-1.4066	LNPEXWT7	+	
12 (Cat. 11)	S	0-2115	LNSAL =	6.3384	+	-0.6573	LNEXWT7	+			LNBSVEXWT	+
12 (Cat. 11)	B	0-2115	LNSAL =	6.8893	+	-0.5850	LNEXWT7	+			LNBSVEXWT	+
18 (Cat. 15)	S	0-2115	LNSAL =	5.8345	+	-1.2182	LNVEEXWT	+			LNBSVWT30	+
18 (Cat. 15)	S	0-400	LNSAL =	6.4898	+	-1.4206	LNEXWT7	+			LNBSVWT30	+
18 (Cat. 15)	S	400-2115	LNSAL =	0.1476	+						LNBSVWT30	+
18 (Cat. 15)	B	0-2115	LNSAL =	5.8916	+	-0.6618	LNVEEXWT	+	-0.4169	LNPEXWT7	+	
22 (Cat. 17)	S	0-120	LNSAL =	4.5407	+	-1.1617	LNVEEXWT	+			LNVEEXWT	+
22 (Cat. 17)	S	120-2115	LNSAL =	-0.1932	+						LNVEEXWT	+
22 (Cat. 17)	B	0-120	LNSAL =	4.9863	+	-0.7934	LNVEEXWT	+	-0.3758	LNPEXWT7	+	
22 (Cat. 17)	B	120-2115	LNSAL =	-0.2414	+						LNPEXWT7	+
28 (Cat. 20)	S	50-2115	LNSAL =	0.7627	+						LNPEXWT7	+
28 (Cat. 20)	S	0-50	LNSAL =	3.1977	+						LNPEXWT7	+
28 (Cat. 20)	B	0-50	LNSAL =	3.5856	+	-1.1833	LNVEEXWT	+			LNPEXWT7	+
28 (Cat. 20)	B	50-2115	LNSAL =	1.0321	+						LNPEXWT7	+
28 (Cat. 20)	B	50-2115	LNSAL =	1.0321	+						LNPEXWT7	+

Data for the following results were selected according to:
 (depth_c4\$='S') and (sta_cat=VAL('7')) AND (VWT45<=VAL('2115')) AND (TOOWIDE=1)
 AND (distance<=1000) AND (ONE_A_MO=1) AND (DEPTH_MN<>-99)
 183 case(s) deleted due to missing data.

Eigenvalues of unit scaled X'X

	1	2	3	4
	2.9776	0.9806	0.0314	0.0104

Condition indices

	1	2	3	4
	1.0000	1.7426	9.7307	16.8885

Variance proportions

	1	2	3	4
CONSTANT	0.0047	0.0002	0.8696	0.1255
RATE_6M	0.0032	0.9772	0.0040	0.0156
LNPVEXWT	0.0025	0.0001	0.2148	0.7826
LNBSVWT45	0.0019	0.0000	0.0323	0.9658

Dep Var: SAL_PSU2 N: 147 Multiple R: 0.9059 Squared multiple R: 0.8207

Adjusted squared multiple R: 0.8170 Standard error of estimate: 3.0272

Effect	Coefficient	Std Error	Std Coef Tolerance	t	P(2 Tail)
CONSTANT	43.0143	1.2053	0.0000	35.6864	0.0000
RATE_6M	33.3333	5.3253	0.2241	6.2595	0.0000
LNPVEXWT	-2.9330	0.2914	-0.5746	-10.0646	0.0000
LNBSVWT45	-2.6983	0.4681	-0.3313	-5.7641	0.0000

Effect	Coefficient	Lower 95%	Upper 95%
CONSTANT	43.0143	40.6317	45.3969
RATE_6M	33.3333	22.8069	43.8597
LNPVEXWT	-2.9330	-3.5091	-2.3570
LNBSVWT45	-2.6983	-3.6236	-1.7730

Correlation matrix of regression coefficients

	CONSTANT	RATE_6M	LNPVEXWT	LNBSVWT45
CONSTANT	1.0000			
RATE_6M	-0.0927	1.0000		
LNPVEXWT	-0.1153	-0.0753	1.0000	
LNBSVWT45	-0.5128	0.1374	-0.7838	1.0000

Analysis of Variance

Source	Sum-of-Squares	df	Mean-Square	F-ratio	P
Regression	5999.4108	3	1999.8036	218.2301	0.0000
Residual	1310.4146	143	9.1637		

*** WARNING ***

Case 4101 has large leverage (Leverage = 0.1351)

Durbin-Watson D Statistic 1.7674

First Order Autocorrelation 0.1140

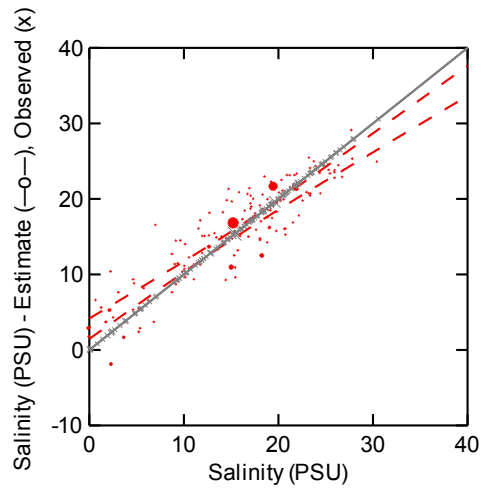
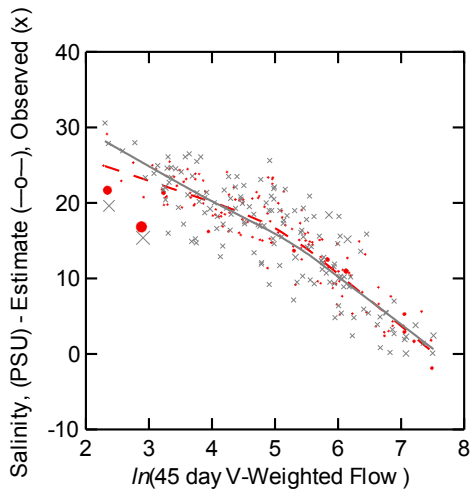
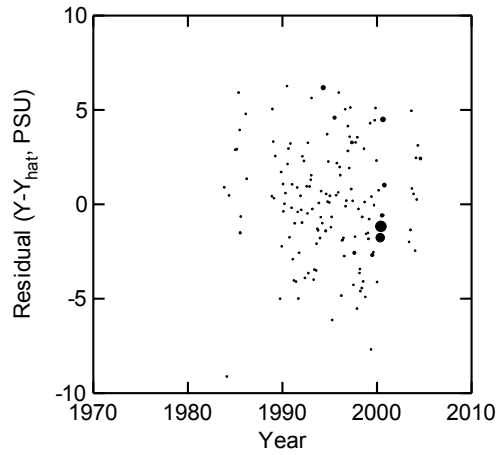
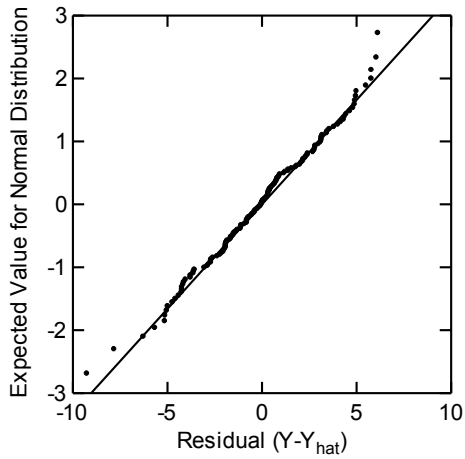
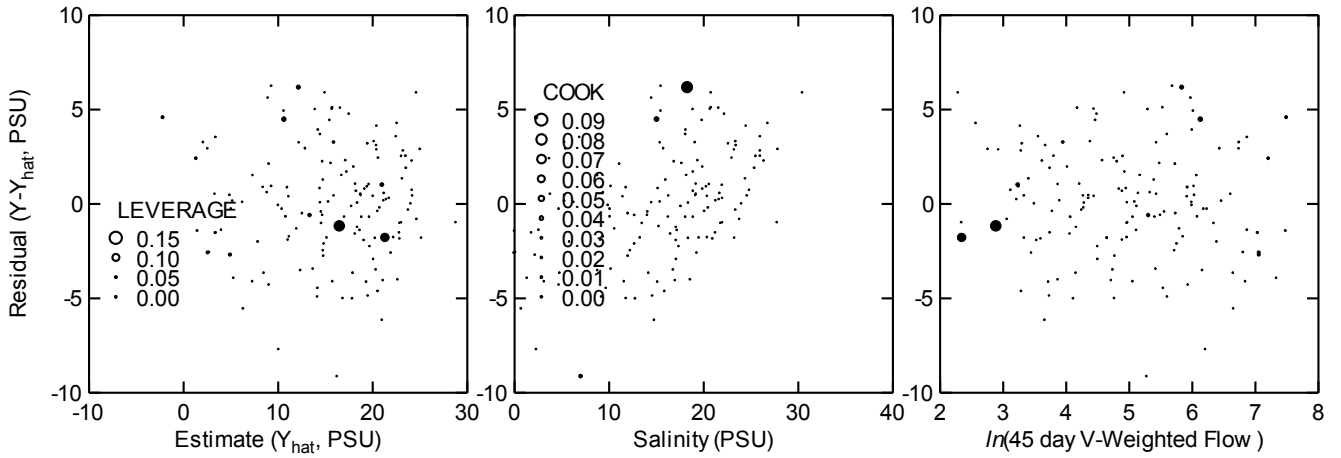

CAT7 S MSCMOW7S.SYD

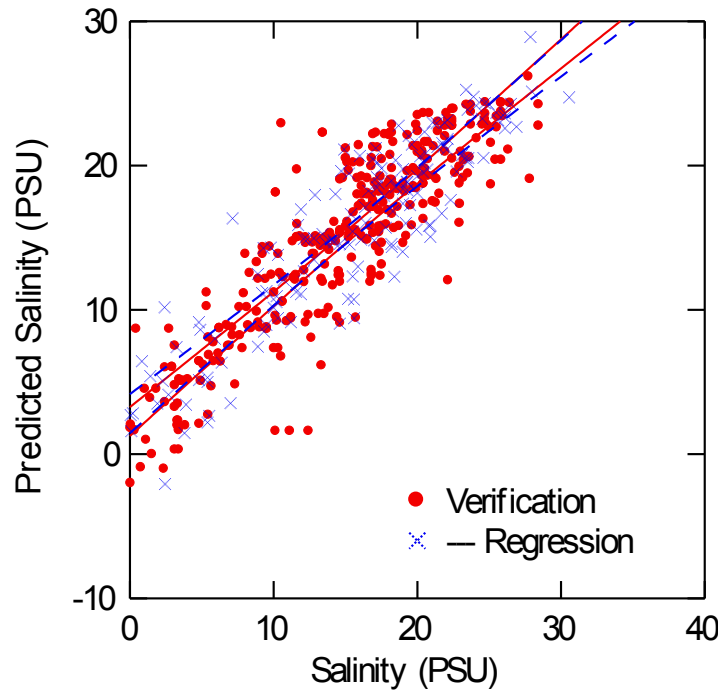

Data for the following results were selected according to:
 (depth_c4\$='B') and (sta_cat=VAL('7')) AND (VWT45<=VAL('2115')) AND (TOOWIDE=1)
 AND (distance<=1000) AND (ONE_A_MO=1) AND (DEPTH_MN<>-99)
 154 case(s) deleted due to missing data.

Eigenvalues of unit scaled X'X

	1	2	3	4	5
	3.9778	0.9481	0.0426	0.0210	0.0104

Condition indices

	1	2	3	4	5
	1.0000	2.0483	9.6580	13.7522	19.5396

Variance proportions

	1	2	3	4	5
CONSTANT	0.0021	0.0004	0.4849	0.0037	0.5089
RATE_6M	0.0041	0.9572	0.0386	0.0002	0.0000
LNVE_XWT	0.0016	0.0001	0.2097	0.2572	0.5314
LNPE_XWT7	0.0009	0.0001	0.0011	0.0770	0.9208
LNBSVEXWT	0.0018	0.0001	0.0431	0.9497	0.0053

Dep Var: SAL_PSU2 N: 111 Multiple R: 0.8668 Squared multiple R: 0.7514

Adjusted squared multiple R: 0.7420 Standard error of estimate: 3.2775

Effect	Coefficient	Std Error	Std Coef Tolerance	t	P(2 Tail)
CONSTANT	39.2048	1.6666	0.0000	23.5239	0.0000
RATE_6M	28.7997	6.5859	0.2170	4.3730	0.0000
LNVE_XWT	-2.0239	0.4212	-0.4117	-4.8047	0.0000
LNPE_XWT7	-1.4066	0.4346	-0.2509	-3.2368	0.0016
LNBSVEXWT	-1.4632	0.4931	-0.2122	-2.9673	0.0037

Effect	Coefficient	Lower 95%	Upper 95%
CONSTANT	39.2048	35.9006	42.5090
RATE_6M	28.7997	15.7426	41.8568
LNVE_XWT	-2.0239	-2.8591	-1.1888
LNPE_XWT7	-1.4066	-2.2682	-0.5451
LNBSVEXWT	-1.4632	-2.4408	-0.4855

Correlation matrix of regression coefficients

	CONSTANT	RATE_6M	LNVE_XWT	LNPE_XWT7	LNBSVEXWT
CONSTANT	1.0000				
RATE_6M	-0.1211	1.0000			
LNVE_XWT	0.2340	0.0889	1.0000		
LNPE_XWT7	-0.6426	-0.0045	-0.5729	1.0000	
LNBSVEXWT	-0.2537	0.0594	-0.4504	-0.2062	1.0000

Analysis of Variance

Source	Sum-of-Squares	df	Mean-Square	F-ratio	P
Regression	3440.9305	4	860.2326	80.0834	0.0000
Residual	1138.6215	106	10.7417		

*** WARNING ***

Case 3154 has large leverage (Leverage = 0.1877)

Durbin-Watson D Statistic 1.4691
 First Order Autocorrelation 0.2633

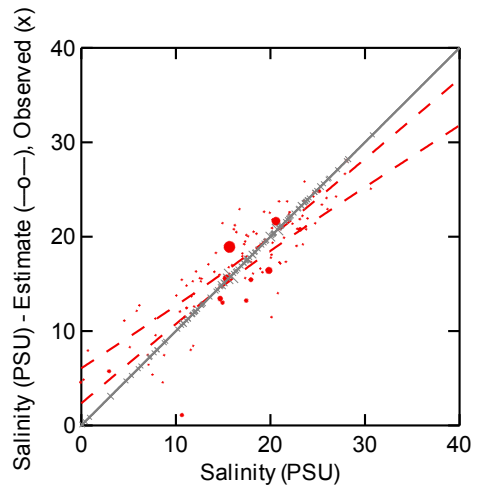
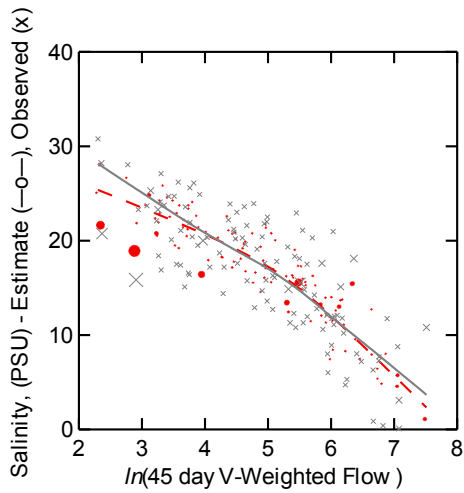
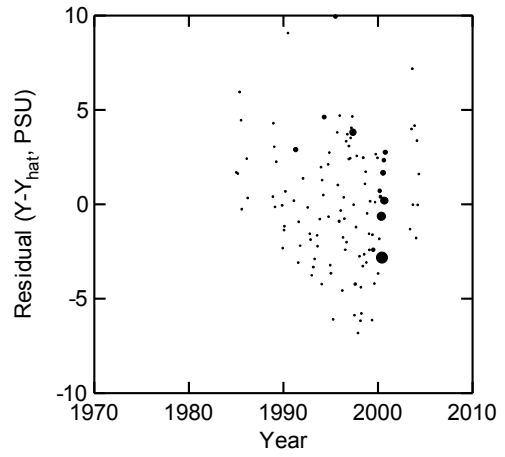
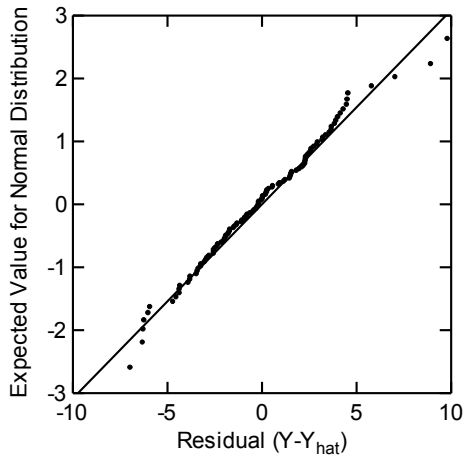
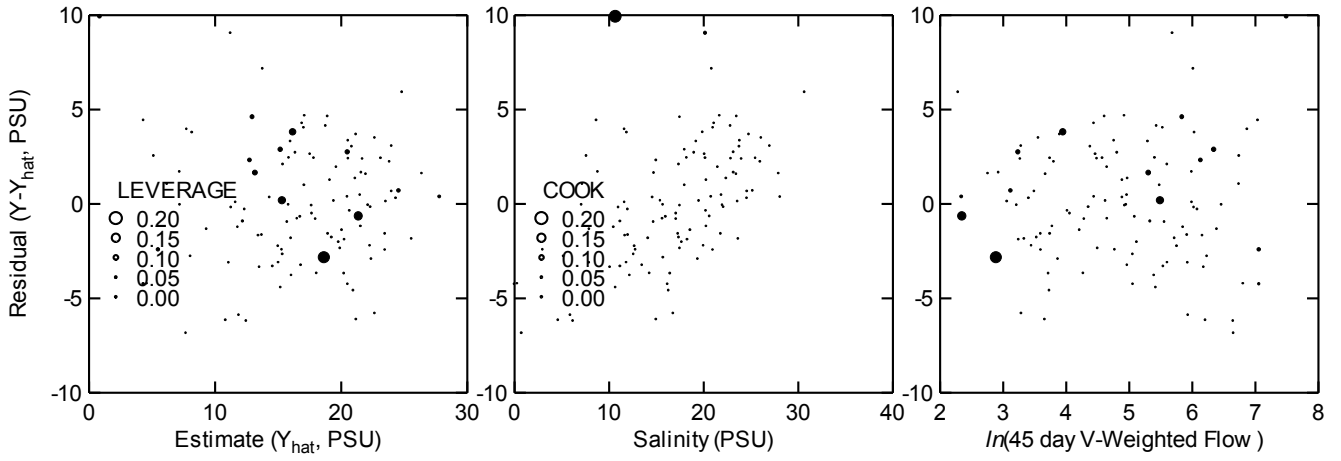

CAT 7 B MSCMOW7B.SYD

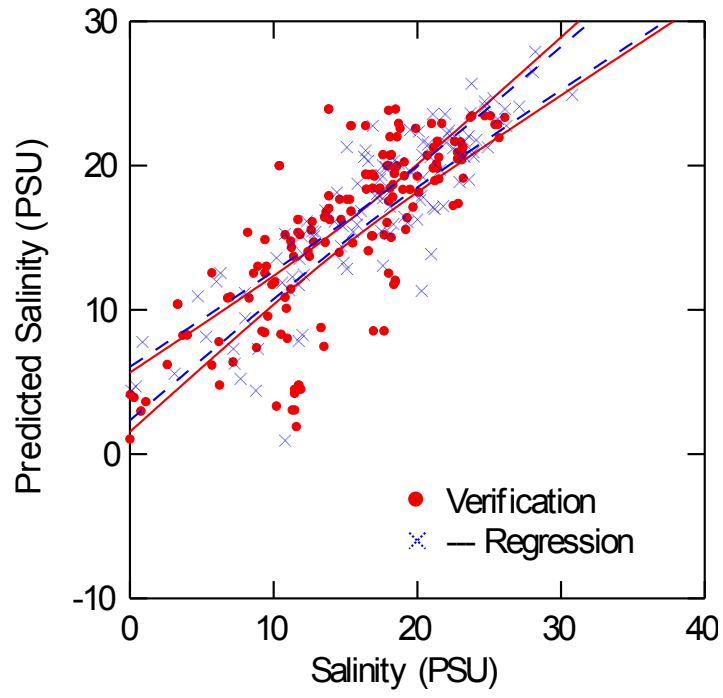

Data for the following results were selected according to:
 (depth_c4\$='S') and (sta_cat=VAL('11')) AND (VWT45<=VAL('2115')) AND
 (TOOWIDE=1) AND (distance<=1000) AND (ONE_A_MO=1) AND (DEPTH_MN<>-99)
 40 case(s) deleted due to missing data.

Eigenvalues of unit scaled X'X

	1	2	3	4	5
	3.6100	1.0116	0.3290	0.0349	0.0145

Condition indices

	1	2	3	4	5
	1.0000	1.8891	3.3126	10.1676	15.7784

Variance proportions

	1	2	3	4	5
CONSTANT	0.0035	0.0001	0.0127	0.8272	0.1565
COS WD	0.0013	0.8795	0.1000	0.0176	0.0017
TIDE_MEANL	0.0219	0.0158	0.9332	0.0238	0.0053
LNEXWT7	0.0023	0.0000	0.0055	0.3087	0.6835
LNBSEXWT7	0.0017	0.0000	0.0038	0.0284	0.9661

Dep Var: LNSAL N: 120 Multiple R: 0.9043 Squared multiple R: 0.8178

Adjusted squared multiple R: 0.8114 Standard error of estimate: 0.6225

Effect	Coefficient	Std Error	Std Coef Tolerance	t	P(2 Tail)
CONSTANT	6.5621	0.2593	0.0000	25.3061	0.0000
COS WD	0.2056	0.0875	0.0960	2.3489	0.0205
TIDE_MEANL	-1.7524	0.4175	-0.1802	-4.1970	0.0001
LNEXWT7	-0.6573	0.0693	-0.5666	-9.4787	0.0000
LNBSEXWT7	-0.4929	0.1010	-0.2924	-4.8799	0.0000

Effect	Coefficient	Lower 95%	Upper 95%
CONSTANT	6.5621	6.0485	7.0758
COS WD	0.2056	0.0322	0.3789
TIDE_MEANL	-1.7524	-2.5795	-0.9254
LNEXWT7	-0.6573	-0.7946	-0.5199
LNBSEXWT7	-0.4929	-0.6930	-0.2928

Correlation matrix of regression coefficients

	CONSTANT	COS_WD	TIDE_MEANL	LNEXWT7	LNBSEXWT7
CONSTANT	1.0000				
COS_WD	-0.1300	1.0000			
TIDE_MEANL	0.0677	0.1755	1.0000		
LNEXWT7	-0.1671	0.0843	-0.0899	1.0000	
LNBSEXWT7	-0.5328	-0.0352	-0.1514	-0.7124	1.0000

Analysis of Variance

Source	Sum-of-Squares	df	Mean-Square	F-ratio	P
Regression	199.9653	4	49.9913	129.0020	0.0000
Residual	44.5652	115	0.3875		

*** WARNING ***

Case 5949 is an outlier (Studentized Residual = -4.5489)

Durbin-Watson D Statistic 1.9463
 First Order Autocorrelation 0.0225

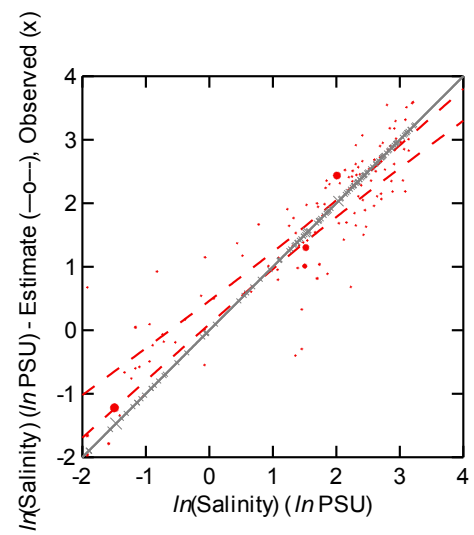
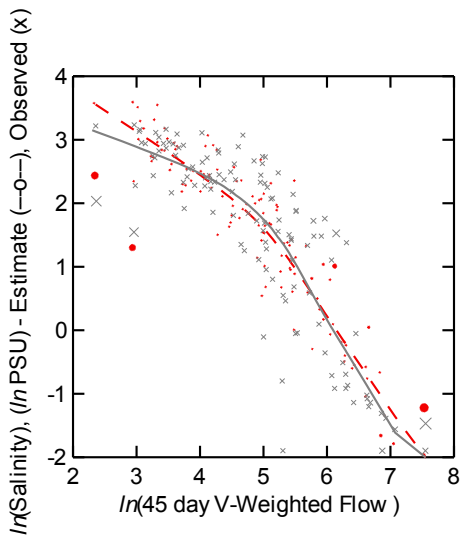
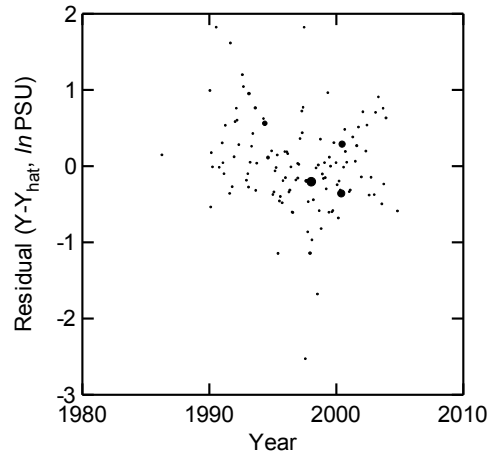
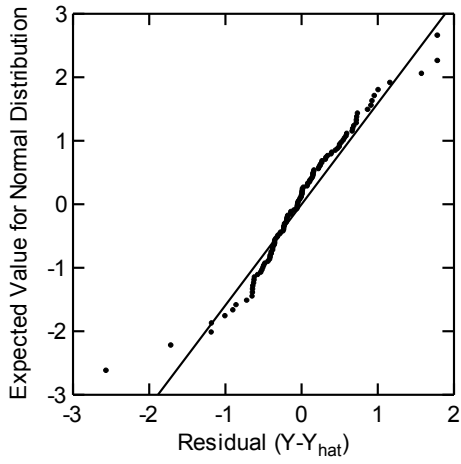
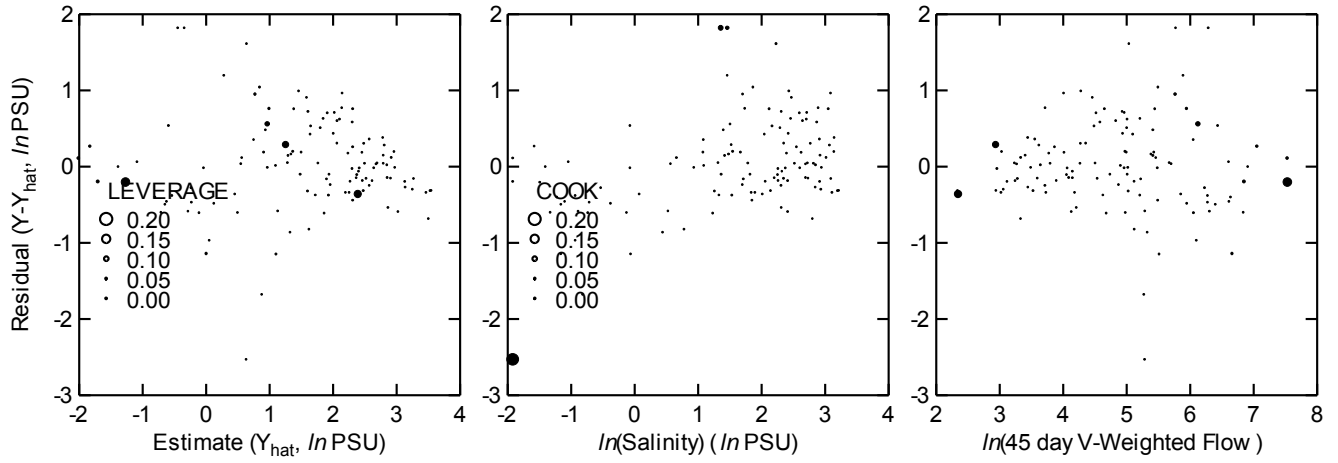

CAT 11 S MSCMOW11SLSYD

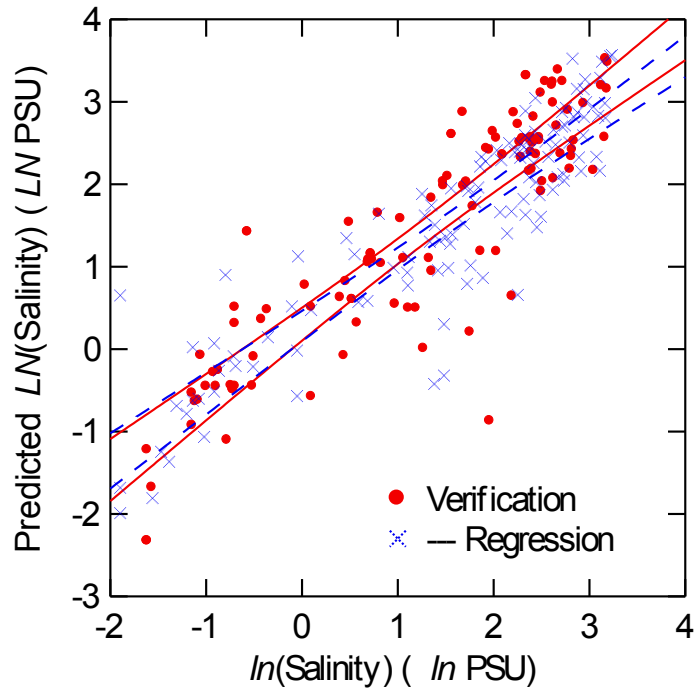

CAT 11 S MSCMOW11SLSYD

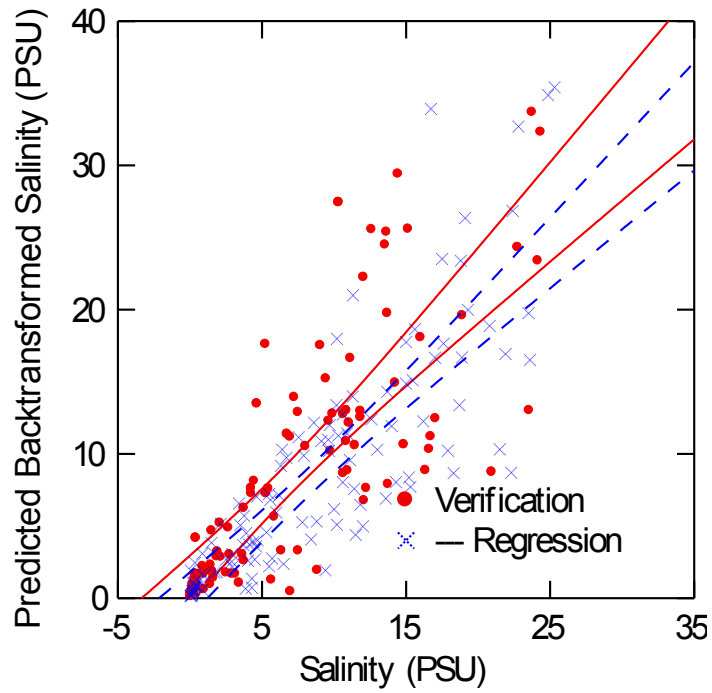

Data for the following results were selected according to:
 (depth_c4\$='B') and (sta_cat=VAL('11')) AND (VWT45<=VAL('2115')) AND
 (TOOWIDE=1) AND (distance<=1000) AND (ONE_A_MO=1) AND (DEPTH_MN<>-99)
 3 case(s) deleted due to missing data.

Eigenvalues of unit scaled X'X

	1	2	3	4
	3.6988	0.2596	0.0295	0.0121

Condition indices

	1	2	3	4
	1.0000	3.7749	11.1943	17.5026

Variance proportions

	1	2	3	4
CONSTANT	0.0025	0.0033	0.7587	0.2354
MAXRATE_6	0.0164	0.8315	0.1508	0.0013
LNEXWT7	0.0020	0.0134	0.3290	0.6557
LNBSVWT30	0.0013	0.0062	0.0066	0.9859

Dep Var: LNSAL N: 69 Multiple R: 0.9275 Squared multiple R: 0.8602

Adjusted squared multiple R: 0.8537 Standard error of estimate: 0.5470

Effect	Coefficient	Std Error	Std Coef Tolerance	t	P(2 Tail)
CONSTANT	6.3950	0.3498	0.0000	18.2793	0.0000
MAXRATE_6	10.3402	1.8508	0.2617	5.5868	0.0000
LNEXWT7	-0.5850	0.0825	-0.4991	-7.0867	0.0000
LNBSVWT30	-0.7277	0.1230	-0.4147	-5.9143	0.0000

Effect	Coefficient	Lower 95%	Upper 95%
CONSTANT	6.3950	5.6963	7.0937
MAXRATE_6	10.3402	6.6438	14.0365
LNEXWT7	-0.5850	-0.7498	-0.4201
LNBSVWT30	-0.7277	-0.9735	-0.4820

Correlation matrix of regression coefficients

	CONSTANT	MAXRATE_6	LNEXWT7	LNBSVWT30
CONSTANT	1.0000			
MAXRATE_6	-0.4017	1.0000		
LNEXWT7	-0.0978	0.0940	1.0000	
LNBSVWT30	-0.5463	0.0004	-0.7466	1.0000

Analysis of Variance

Source	Sum-of-Squares	df	Mean-Square	F-ratio	P
Regression	119.6606	3	39.8869	133.3125	0.0000
Residual	19.4479	65	0.2992		

Durbin-Watson D Statistic 1.8719
 First Order Autocorrelation 0.0594

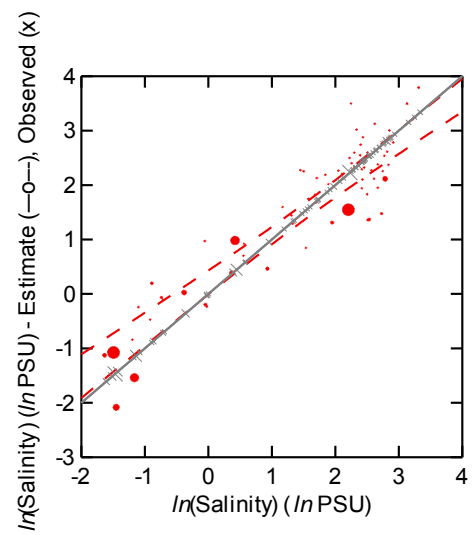
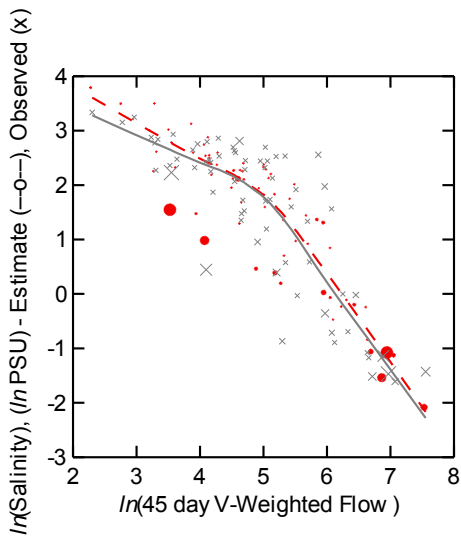
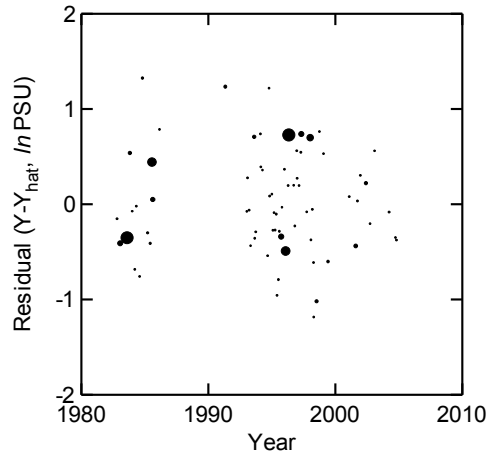
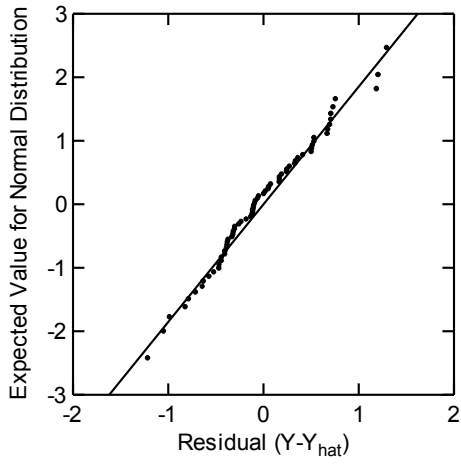
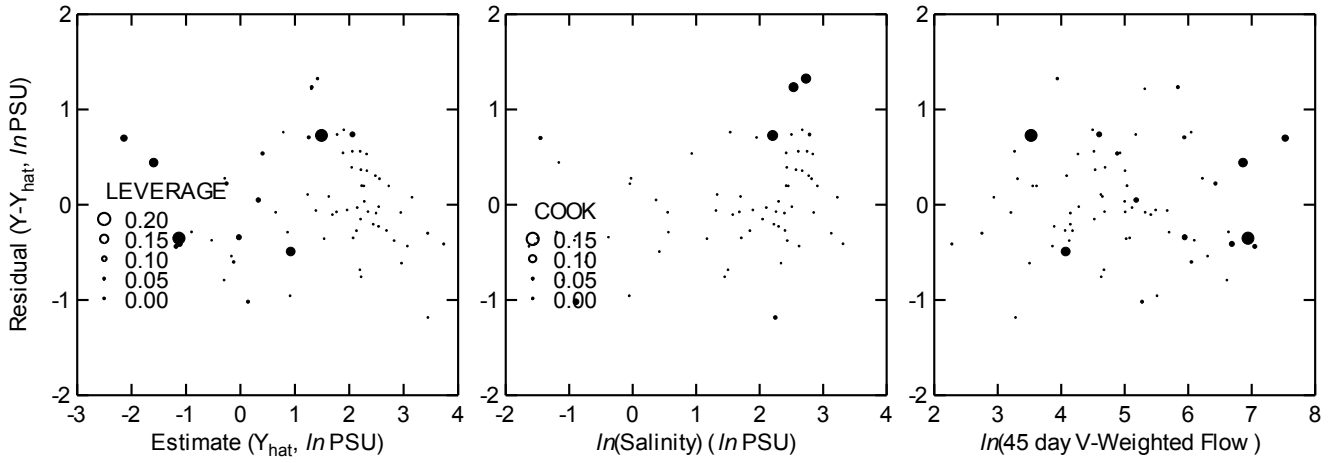

CAT 11 B MSCMOW1BLSYD

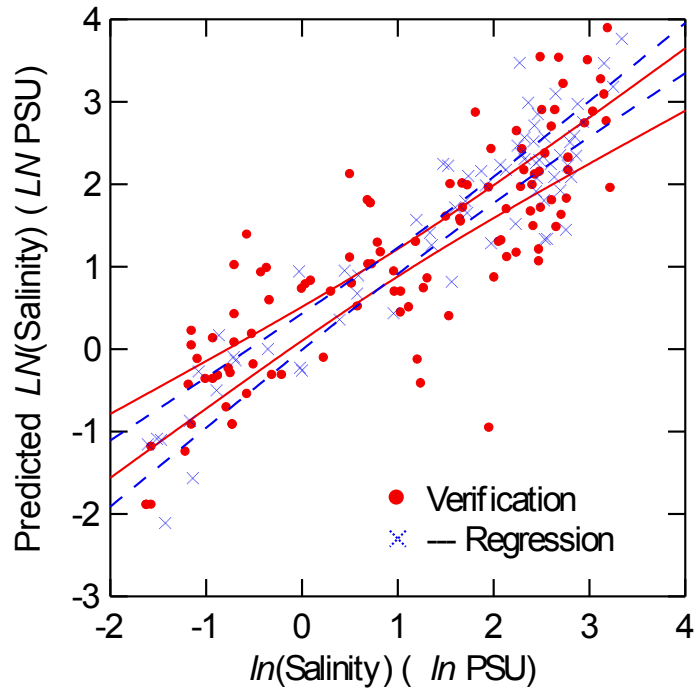

CAT 11 B MSCMOW1BLSYD

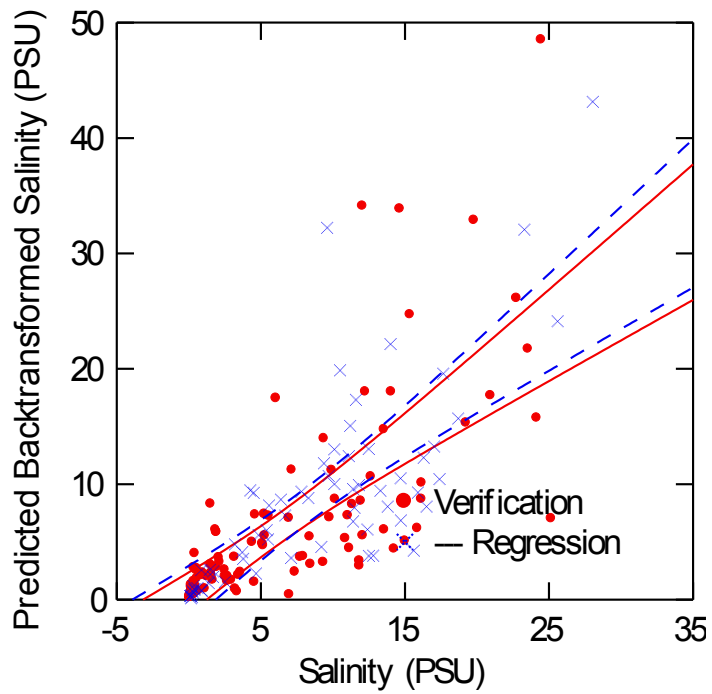

Data for the following results were selected according to:
 (depth_c4\$='S') and (sta_cat=VAL('15')) AND (vwt45>=VAL('0')) and
 (VWT45<VAL('400')) AND (TOOWIDE=1) AND (distance<=1000) AND (ONE_A_MO=1) AND
 (DEPTH MN<>-99)
 77 case(s) deleted due to missing data.

Eigenvalues of unit scaled X'X

	1	2	3	4
	2.1613	1.0560	0.7646	0.0181

Condition indices

	1	2	3	4
	1.0000	1.4306	1.6813	10.9340

Variance proportions

	1	2	3	4
CONSTANT	0.0070	0.0025	0.0002	0.9903
COS_WDS26	0.0252	0.4695	0.5050	0.0004
RATE_MEANL	0.0426	0.2737	0.6837	0.0000
LNEXWT7	0.0070	0.0026	0.0002	0.9902

Dep Var: LNSAL N: 82 Multiple R: 0.7974 Squared multiple R: 0.6358

Adjusted squared multiple R: 0.6218 Standard error of estimate: 0.9766

Effect	Coefficient	Std Error	Std Coef	Tolerance	t	P(2 Tail)
CONSTANT	6.5556	0.5702	0.0000	.	11.4967	0.0000
COS_WDS26	0.0200	0.0080	0.1740	0.9614	2.4964	0.0147
RATE_MEANL	6.6648	2.6626	0.1745	0.9613	2.5031	0.0144
LNEXWT7	-1.4206	0.1296	-0.7489	0.9997	-10.9585	0.0000

Effect	Coefficient	Lower 95%	Upper 95%
CONSTANT	6.5556	5.4204	7.6908
COS_WDS26	0.0200	0.0041	0.0360
RATE_MEANL	6.6648	1.3640	11.9656
LNEXWT7	-1.4206	-1.6787	-1.1626

Correlation matrix of regression coefficients

	CONSTANT	COS_WDS26	RATE_MEANL	LNEXWT7
CONSTANT	1.0000			
COS_WDS26	0.0298	1.0000		
RATE_MEANL	0.0275	-0.1963	1.0000	
LNEXWT7	-0.9805	-0.0078	0.0152	1.0000

Analysis of Variance

Source	Sum-of-Squares	df	Mean-Square	F-ratio	P
Regression	129.8878	3	43.2959	45.3924	0.0000
Residual	74.3975	78	0.9538		

*** WARNING ***

Case 7791 is an outlier (Studentized Residual = -3.6969)

Durbin-Watson D Statistic 1.7995
 First Order Autocorrelation 0.0897

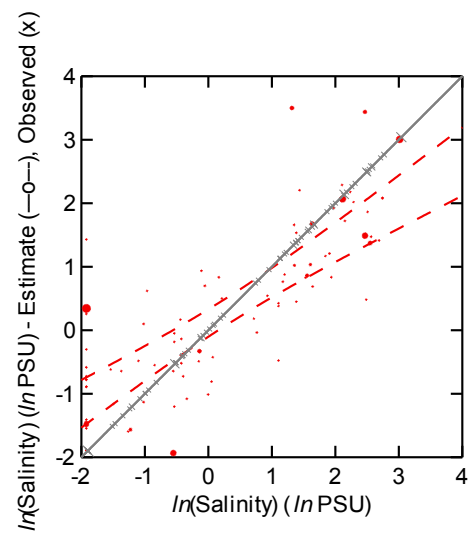
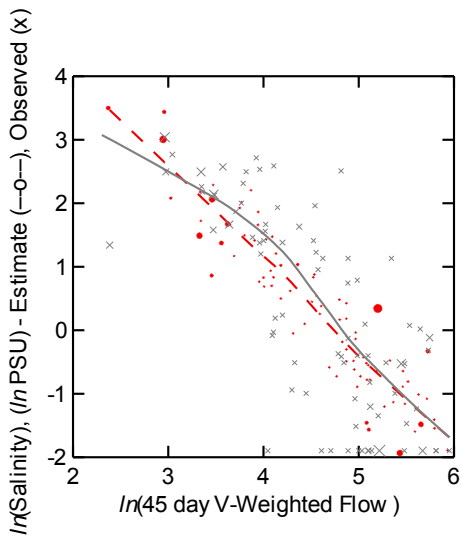
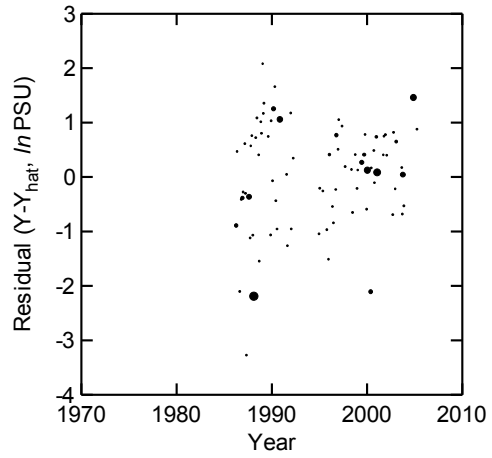
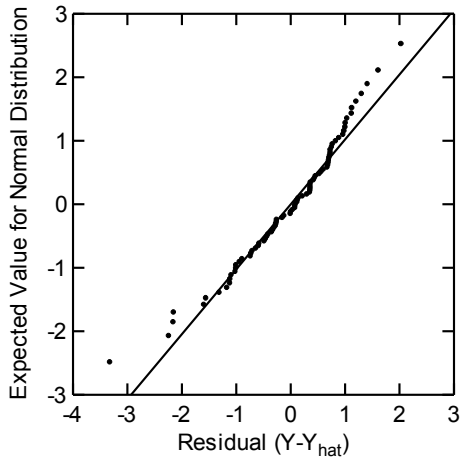
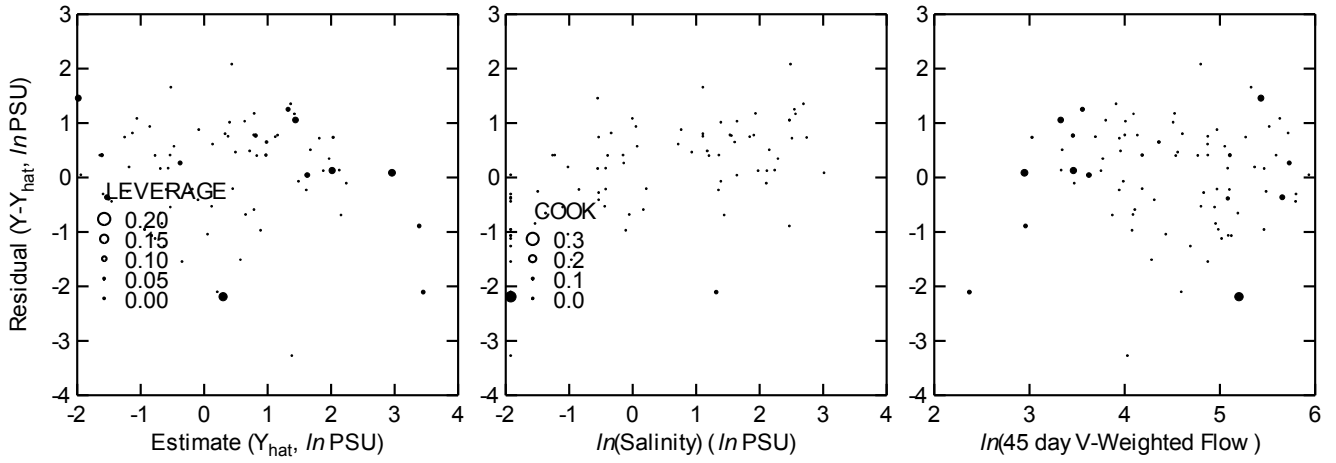

CAT 15 S MSCMOW15SL1.SYD

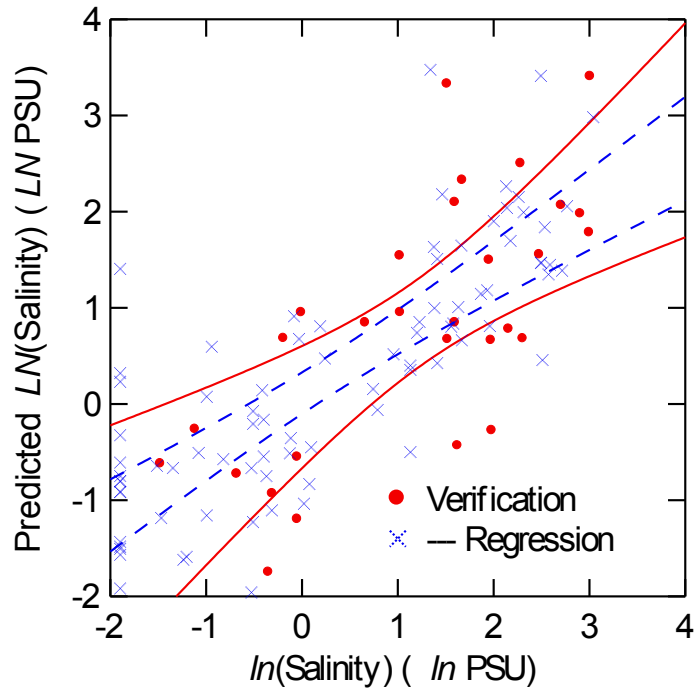

CAT 15 S MSCMOW15SL1.SYD

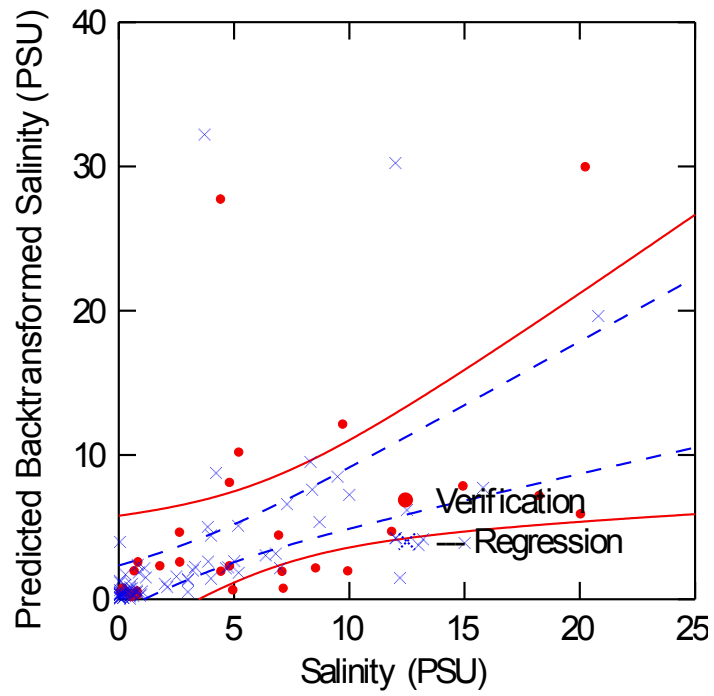

Data for the following results were selected according to:
 (depth_c4\$='S') and (sta_cat=VAL('15')) AND (vwt45>=VAL('400')) and
 (VWT45<VAL('2115')) AND (TOOWIDE=1) AND (distance<=1000) AND (ONE_A_MO=1) AND
 (DEPTH MN<>-99)
 17 case(s) deleted due to missing data.

Eigenvalues of unit scaled X'X

	1	2	3
	2.0106	0.9805	0.0089

Condition indices

	1	2	3
	1.0000	1.4320	15.0446

Variance proportions

	1	2	3
CONSTANT	0.0043	0.0001	0.9955
COS_WD6	0.0093	0.9818	0.0089
LNBSVWT30	0.0043	0.0002	0.9955

Dep Var: LNSAL N: 18 Multiple R: 0.6509 Squared multiple R: 0.4237

Adjusted squared multiple R: 0.3469 Standard error of estimate: 0.3884

Effect	Coefficient	Std Error	Std Coef Tolerance	t	P(2 Tail)
CONSTANT	0.2527	0.6888	0.0000	.03668	0.7189
COS_WD6	0.5549	0.2510	0.4349	0.9925 2.2103	0.0430
LNBSVWT30	-0.3643	0.1369	-0.5234	0.9925 -2.6604	0.0178

Effect	Coefficient	Lower 95%	Upper 95%
CONSTANT	0.2527	-1.2154	1.7207
COS_WD6	0.5549	0.0198	1.0900
LNBSVWT30	-0.3643	-0.6562	-0.0724

Correlation matrix of regression coefficients

	CONSTANT	COS_WD6	LNBSVWT30
CONSTANT	1.0000		
COS_WD6	0.0998	1.0000	
LNBSVWT30	-0.9910	-0.0865	1.0000

Analysis of Variance

Source	Sum-of-Squares	df	Mean-Square	F-ratio	P
Regression	1.6636	2	0.8318	5.5140	0.0160
Residual	2.2628	15	0.1509		

*** WARNING ***

Case 7820 is an outlier (Studentized Residual = 4.6944)

Durbin-Watson D Statistic 2.5544
 First Order Autocorrelation -0.3095

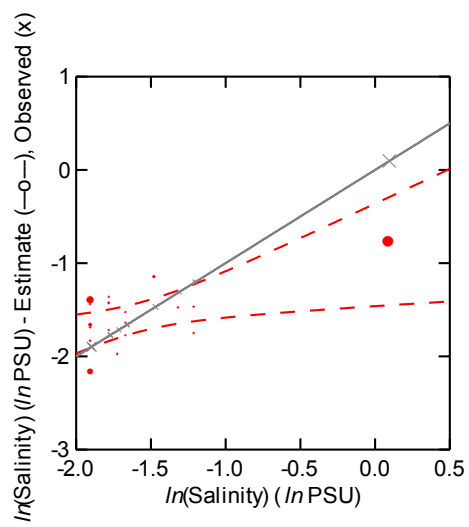
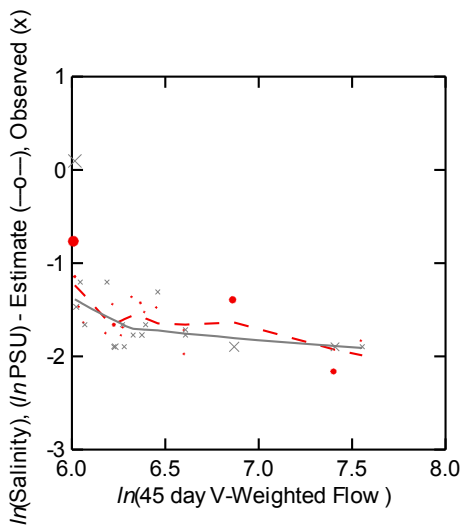
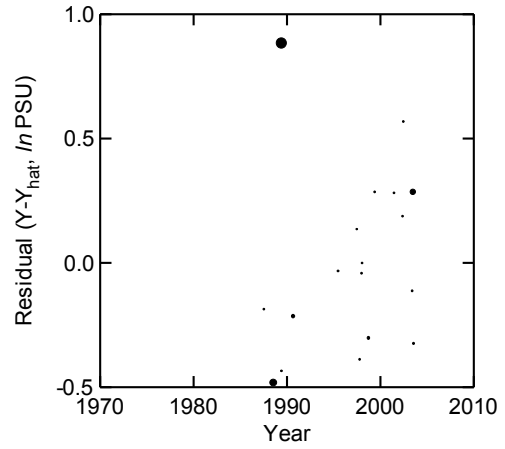
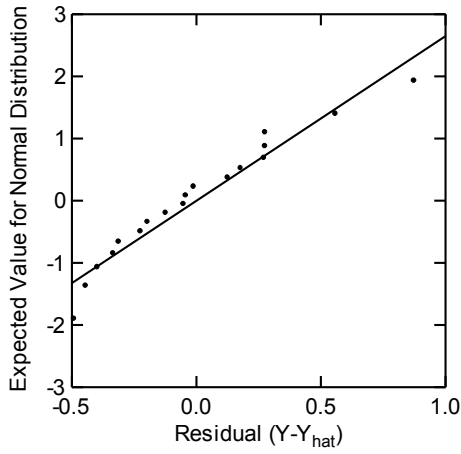
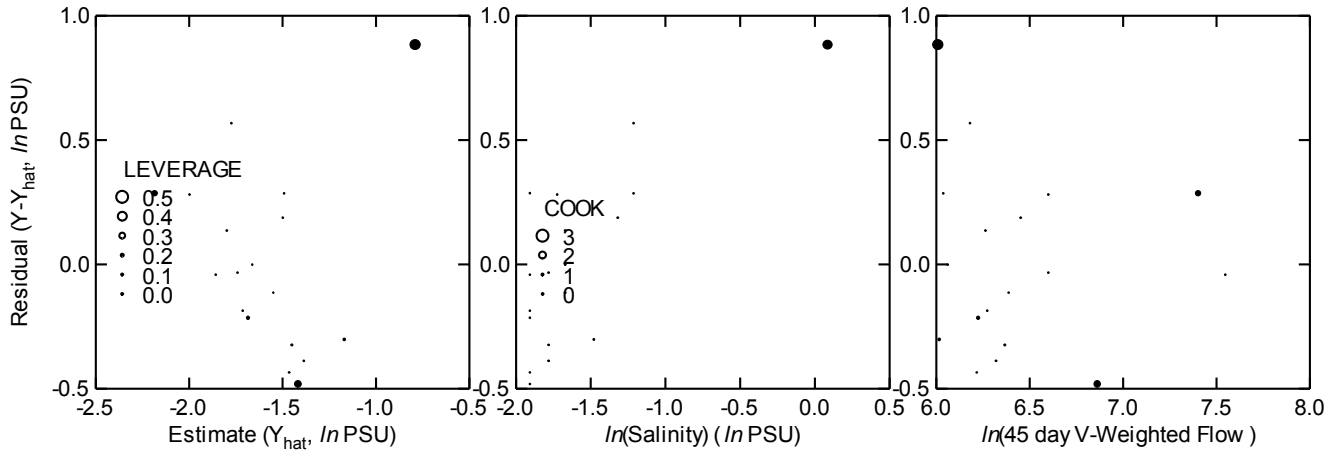

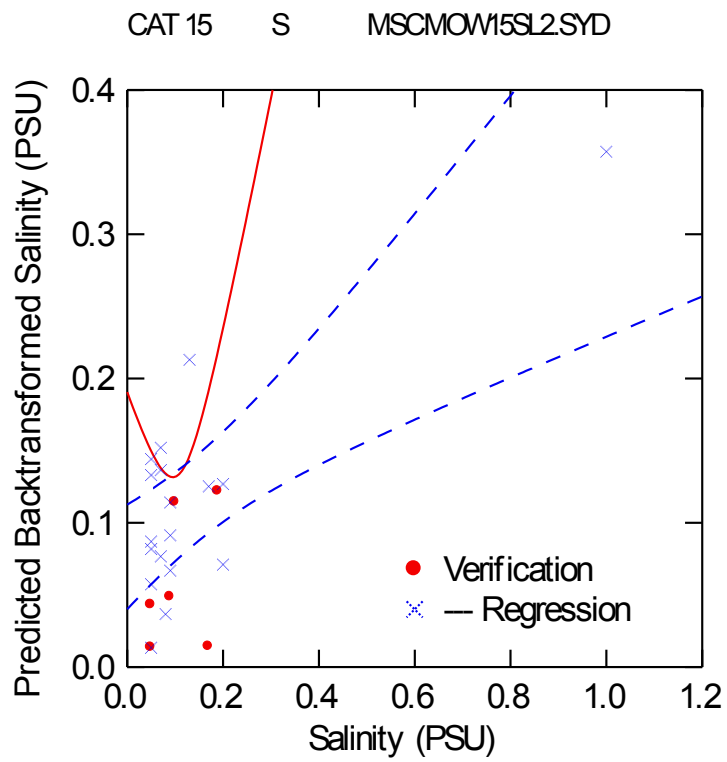
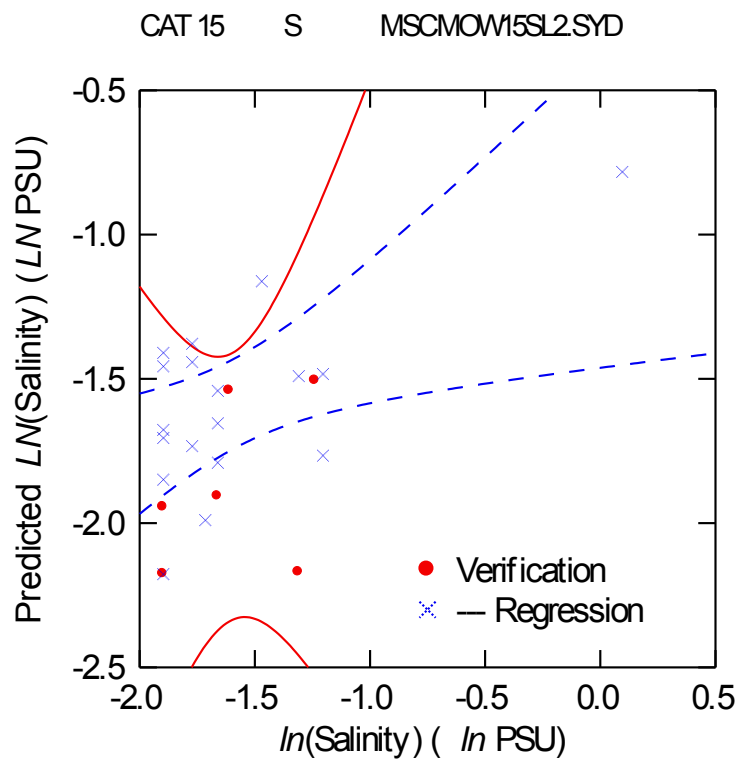

Data for the following results were selected according to:
 (depth_c4\$='B') and (sta_cat=VAL('15')) AND (VWT45<=VAL('2115')) AND
 (TOOWIDE=1) AND (distance<=1000) AND (ONE_A_MO=1) AND (DEPTH_MN<>-99)
 22 case(s) deleted due to missing data.

Eigenvalues of unit scaled X'X

	1	2	3	4	5
	3.5218	0.9507	0.4927	0.0306	0.0042

Condition indices

	1	2	3	4	5
	1.0000	1.9247	2.6735	10.7217	29.0661

Variance proportions

	1	2	3	4	5
CONSTANT	0.0029	0.0001	0.0076	0.7885	0.2009
COS_WDS2	0.0058	0.9635	0.0253	0.0017	0.0037
TIDE_MEANL	0.0244	0.0151	0.8514	0.0961	0.0131
LNVE_XWT	0.0008	0.0000	0.0009	0.0941	0.9043
LNPE_XWT7	0.0005	0.0000	0.0006	0.0186	0.9802

Dep Var: LNSAL N: 57 Multiple R: 0.9094 Squared multiple R: 0.8270

Adjusted squared multiple R: 0.8137 Standard error of estimate: 0.6730

Effect	Coefficient	Std Error	Std Coef	Tolerance	t	P(2 Tail)
CONSTANT	6.0204	0.4503	0.0000	.	13.3691	0.0000
COS_WDS2	0.0207	0.0056	0.2164	0.9909	3.7345	0.0005
TIDE_MEANL	-1.2957	0.5852	-0.1404	0.8275	-2.2143	0.0312
LNVE_XWT	-0.6618	0.1849	-0.5091	0.1644	-3.5794	0.0008
LNPE_XWT7	-0.4169	0.1789	-0.3361	0.1599	-2.3304	0.0237

Effect	Coefficient	Lower 95%	Upper 95%
CONSTANT	6.0204	5.1168	6.9241
COS_WDS2	0.0207	0.0096	0.0319
TIDE_MEANL	-1.2957	-2.4699	-0.1215
LNVE_XWT	-0.6618	-1.0328	-0.2908
LNPE_XWT7	-0.4169	-0.7759	-0.0579

Correlation matrix of regression coefficients

	CONSTANT	COS_WDS2	TIDE_MEANL	LNVE_XWT	LNPE_XWT7
CONSTANT	1.0000				
COS_WDS2	-0.0102	1.0000			
TIDE_MEANL	0.2559	0.0437	1.0000		
LNVE_XWT	0.1579	-0.0778	-0.0083	1.0000	
LNPE_XWT7	-0.5615	0.0481	-0.1749	-0.8982	1.0000

Analysis of Variance

Source	Sum-of-Squares	df	Mean-Square	F-ratio	P
Regression	112.6020	4	28.1505	62.1607	0.0000
Residual	23.5491	52	0.4529		

Durbin-Watson D Statistic 1.5268
 First Order Autocorrelation 0.2330

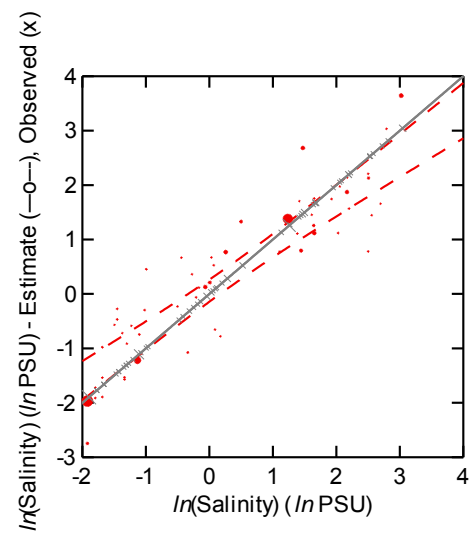
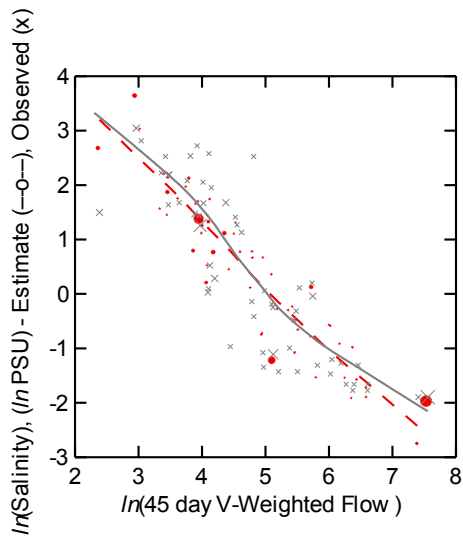
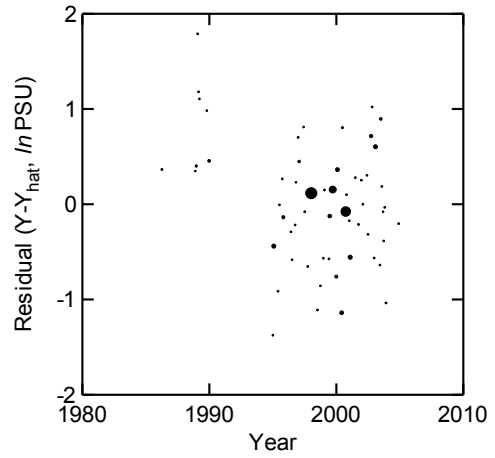
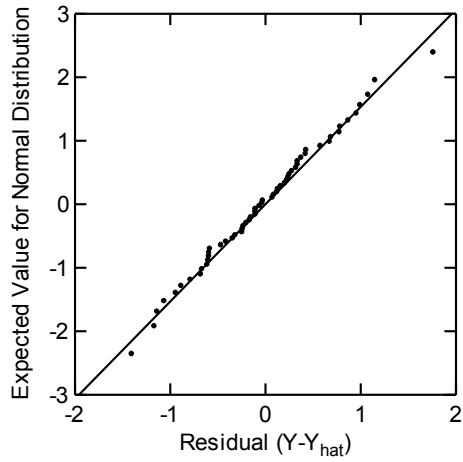
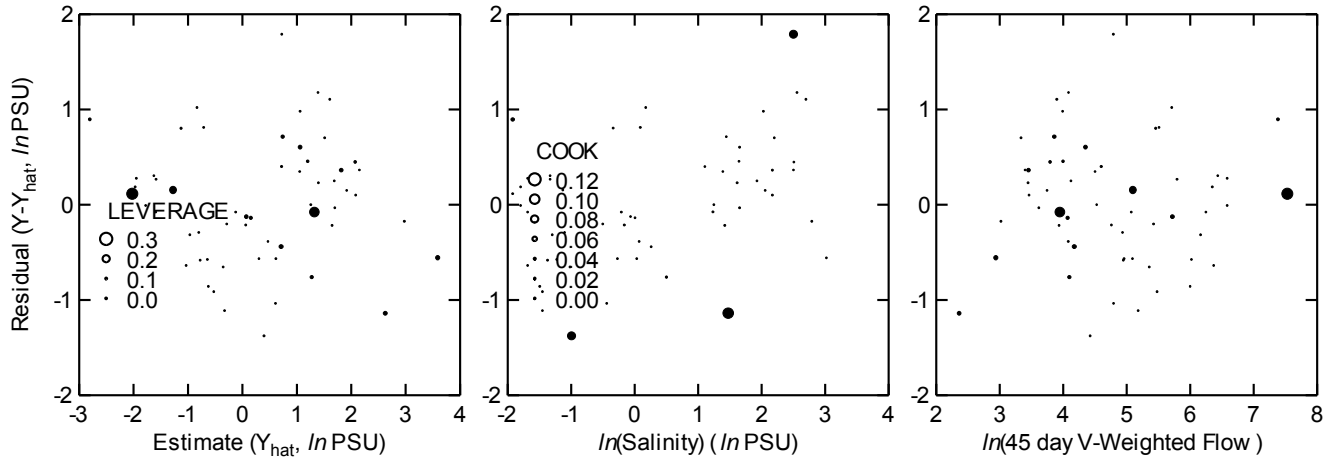

CAT 15 B MSCMOW15BLSYD

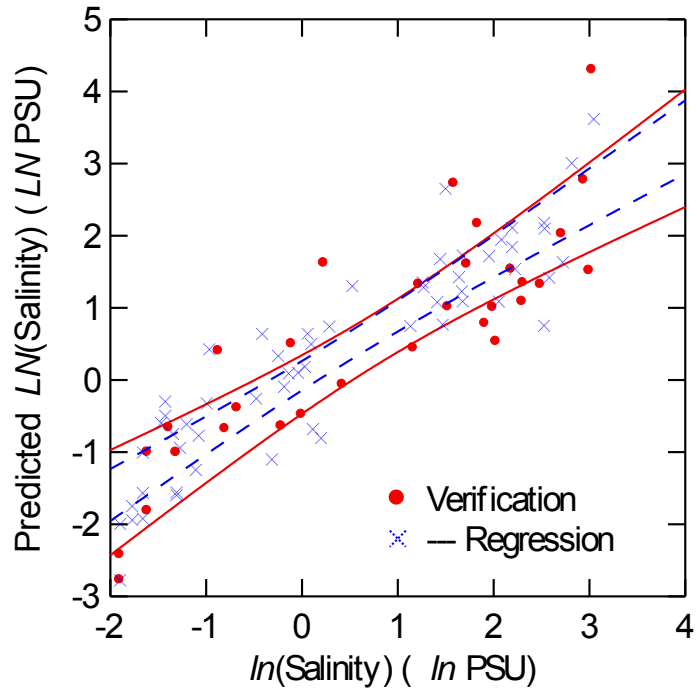

CAT 15 B MSCMOW15BLSYD

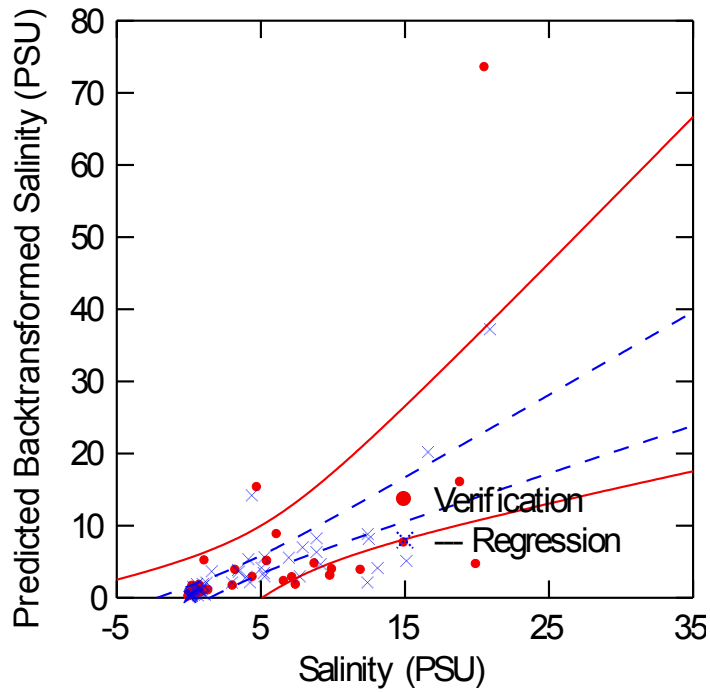

Data for the following results were selected according to:
(depth_c4\$='S') and (sta_cat=VAL('17')) AND (vwt45>=0) and (VWT45<VAL('120'))
AND (TOOWIDE=1) AND (distance<=1000) AND (ONE_A_MO=1) AND (DEPTH_MN<>-99)
9 case(s) deleted due to missing data.

Eigenvalues of unit scaled X'X

	1	2	3	4
	2.7887	0.9435	0.2574	0.0103

Condition indices

	1	2	3	4
	1.0000	1.7192	3.2915	16.4167

Variance proportions

	1	2	3	4
CONSTANT	0.0024	0.0004	0.0094	0.9878
COS_WD	0.0113	0.9090	0.0397	0.0400
MAXRATE_6	0.0358	0.0001	0.9334	0.0307
LNVWT45	0.0025	0.0006	0.0132	0.9837

Dep Var: LNSAL N: 47 Multiple R: 0.7466 Squared multiple R: 0.5574

Adjusted squared multiple R: 0.5266 Standard error of estimate: 0.9430

Effect	Coefficient	Std Error	Std Coef Tolerance	t	P(2 Tail)
CONSTANT	3.9057	0.9805	0.0000	3.9835	0.0003
COS_WD	0.5978	0.2301	0.2727	2.5973	0.0128
MAXRATE_6	11.7329	3.6557	0.3309	3.2095	0.0025
LNVWT45	-1.1617	0.2418	-0.5004	-4.8037	0.0000

Effect	Coefficient	Lower 95%	Upper 95%
CONSTANT	3.9057	1.9284	5.8831
COS_WD	0.5978	0.1336	1.0619
MAXRATE_6	11.7329	4.3605	19.1053
LNVWT45	-1.1617	-1.6493	-0.6740

Correlation matrix of regression coefficients

	CONSTANT	COS_WD	MAXRATE_6	LNVWT45
CONSTANT	1.0000			
COS_WD	-0.1927	1.0000		
MAXRATE_6	-0.2587	-0.1447	1.0000	
LNVWT45	-0.9716	0.2023	0.0727	1.0000

Analysis of Variance

Source	Sum-of-Squares	df	Mean-Square	F-ratio	P
Regression	48.1661	3	16.0554	18.0541	0.0000
Residual	38.2396	43	0.8893		

*** WARNING ***

Case 4736 has large leverage (Leverage = 0.3109)

Durbin-Watson D Statistic 1.4678
First Order Autocorrelation 0.2322

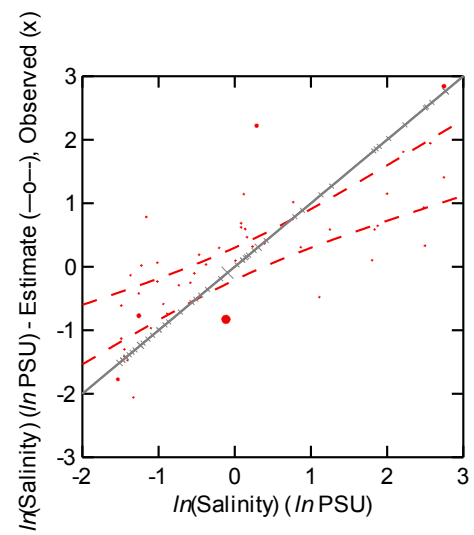
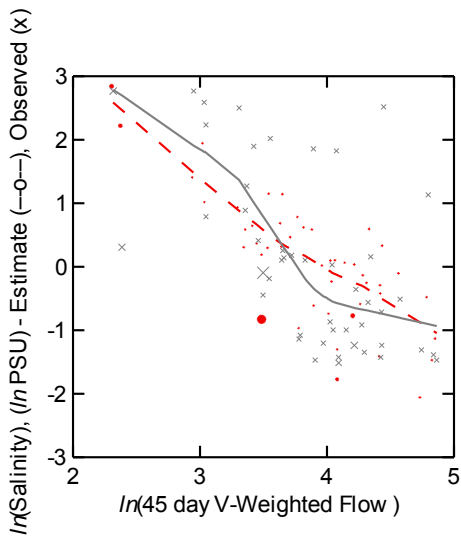
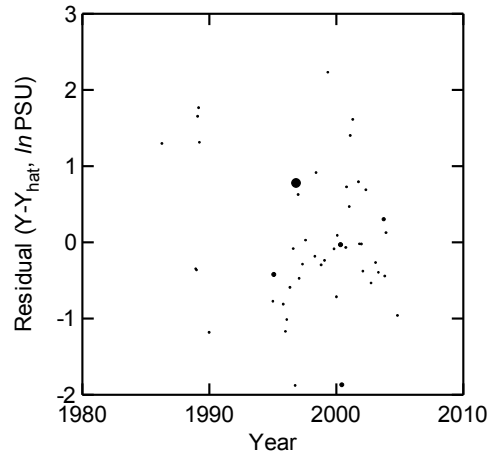
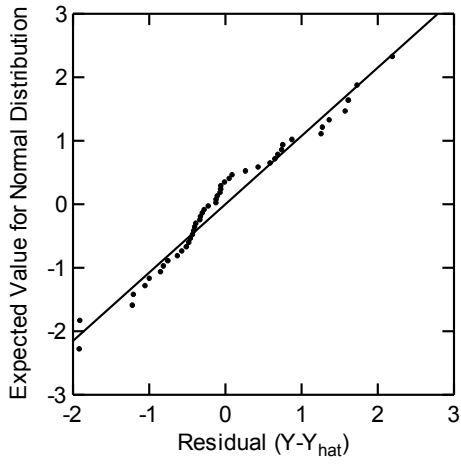
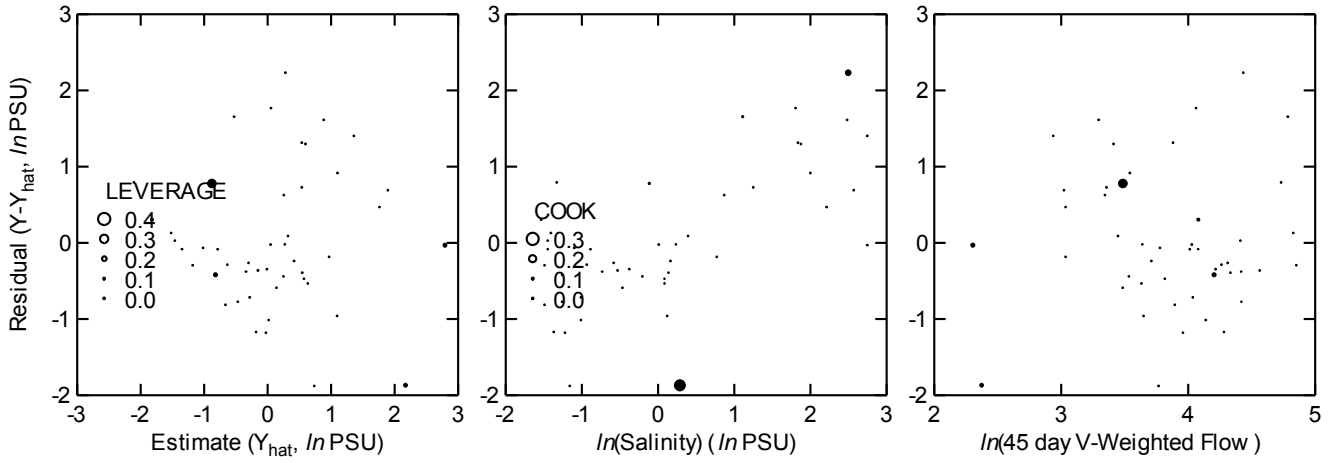

CAT 17 S MSCMOW17SL1.SYD

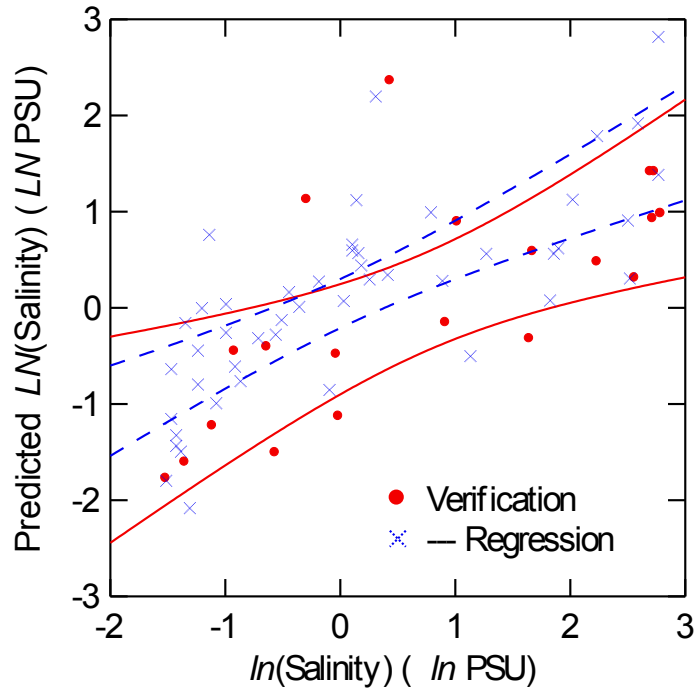

CAT 17 S MSCMOW17SL1.SYD

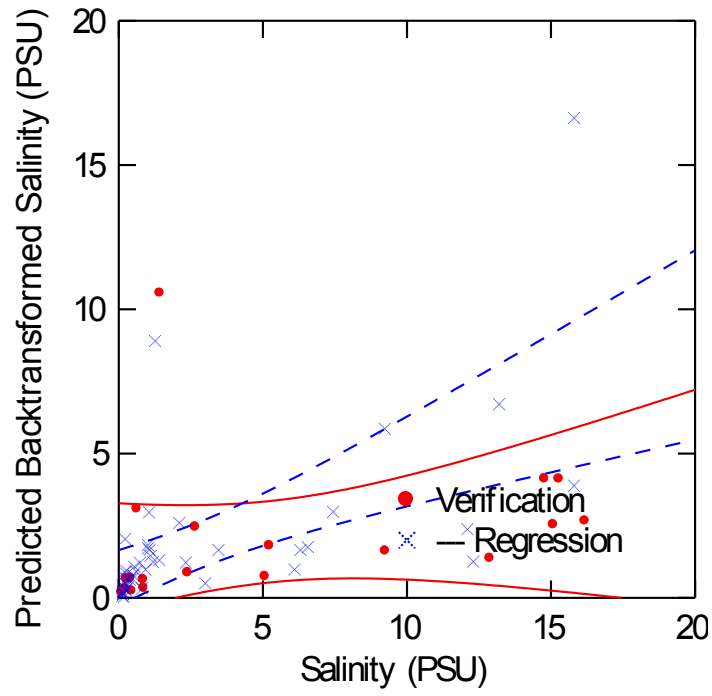

Data for the following results were selected according to:
 (depth_c4\$='S') and (sta_cat=VAL('17')) AND (vwt45>=VAL('120')) and
 (VWT45<VAL('2115')) AND (TOOWIDE=1) AND (distance<=1000) AND (ONE_A_MO=1) AND
 (DEPTH_MN<>-99)

Eigenvalues of unit scaled X'X

1	2
1.9928	0.0072

Condition indices

1	2
1.0000	16.5907

Variance proportions

	1	2
CONSTANT	0.0036	0.9964
LNPEXWT7	0.0036	0.9964

Dep Var: LNSAL N: 45 Multiple R: 0.6309 Squared multiple R: 0.3981

Adjusted squared multiple R: 0.3841 Standard error of estimate: 0.2040

Effect	Coefficient	Std Error	Std Coef	Tolerance	t	P(2 Tail)
CONSTANT	-0.1932	0.2532	0.0000	.	-0.7628	0.4498
LNPEXWT7	-0.1953	0.0366	-0.6309	1.0000	-5.3327	0.0000

Effect	Coefficient	Lower 95%	Upper 95%
CONSTANT	-0.1932	-0.7038	0.3175
LNPEXWT7	-0.1953	-0.2692	-0.1215

Correlation matrix of regression coefficients

	CONSTANT	LNPEXWT7
CONSTANT	1.0000	
LNPEXWT7	-0.9928	1.0000

Analysis of Variance

Source	Sum-of-Squares	df	Mean-Square	F-ratio	P
Regression	1.1839	1	1.1839	28.4381	0.0000
Residual	1.7901	43	0.0416		

*** WARNING ***

Case 9303 is an outlier (Studentized Residual = 3.2927)

Durbin-Watson D Statistic 1.5675
 First Order Autocorrelation 0.1799

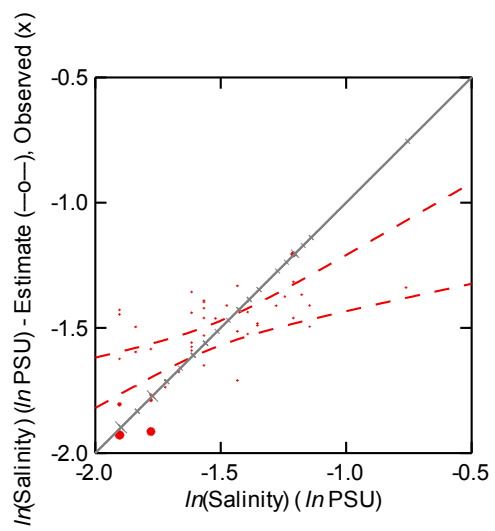
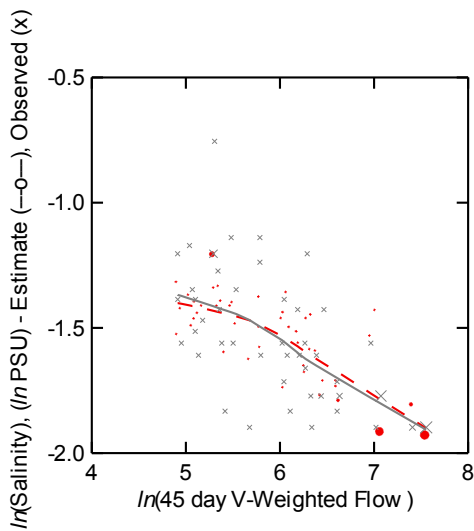
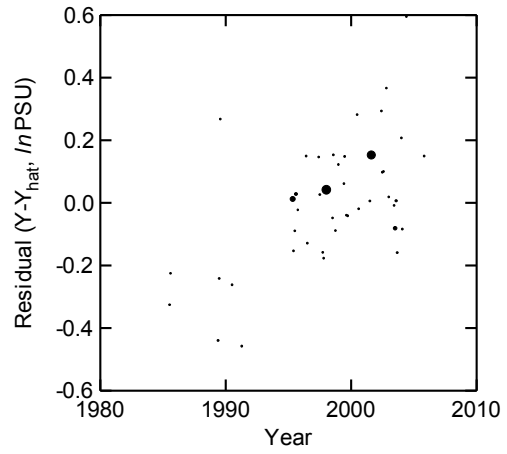
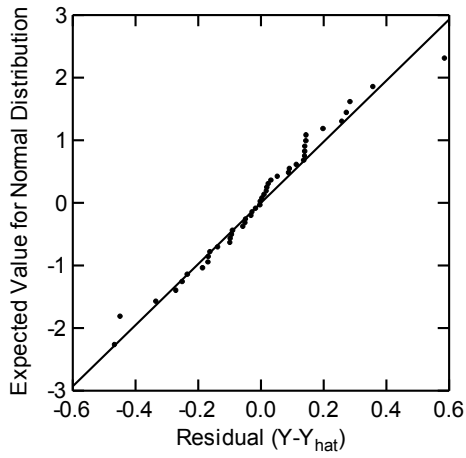
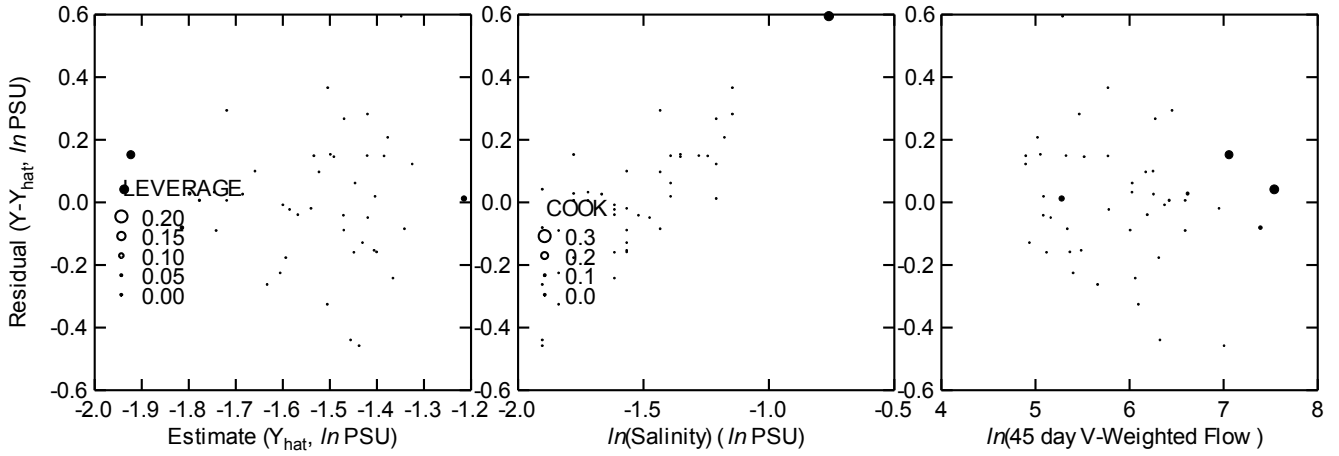

CAT 17 S MSCMOW17SL2SYD

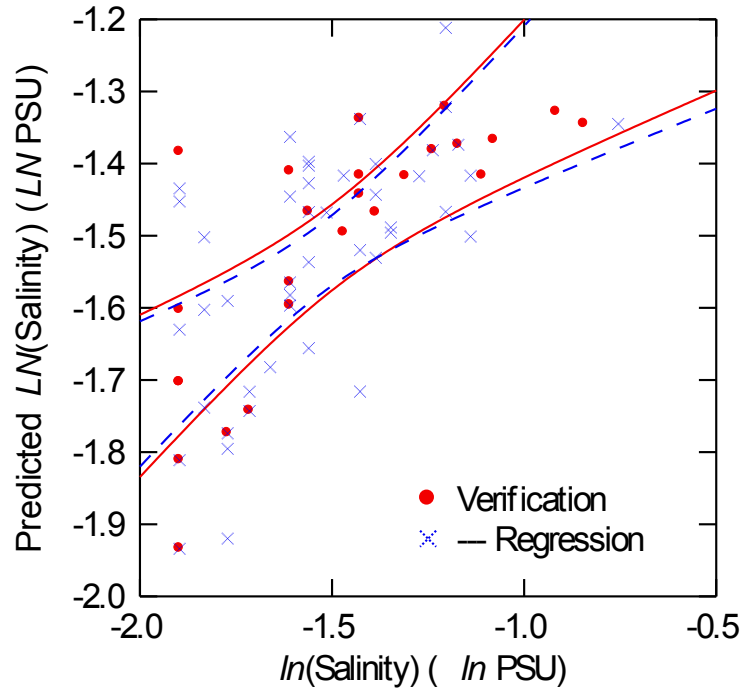

CAT 17 S MSCMOW17SL2SYD

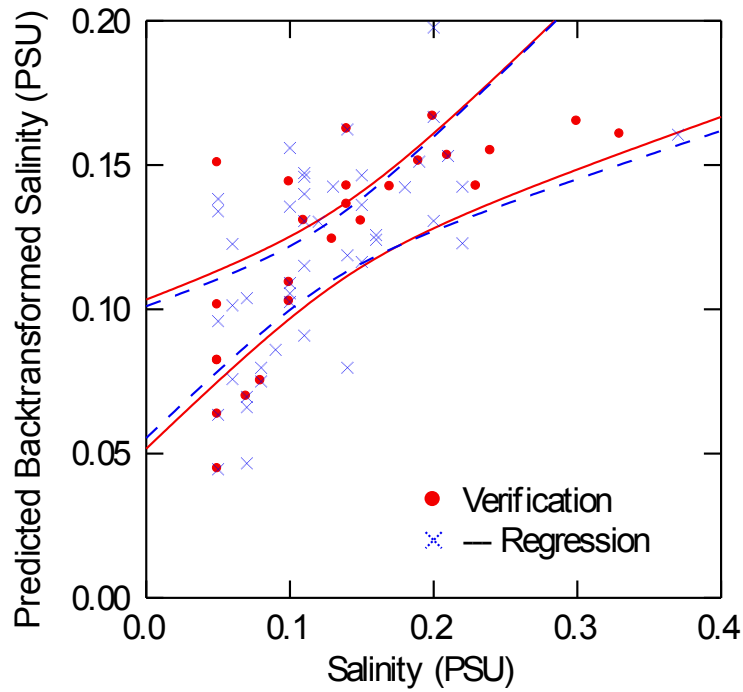

Data for the following results were selected according to:
 (depth_c4\$='B') and (sta_cat=VAL('17')) AND (vwt45>=VAL('0')) and
 (VWT45<VAL('120')) AND (TOOWIDE=1) AND (distance<=1000) AND (ONE_A_MO=1) AND
 (DEPTH_MN<>-99)
 11 case(s) deleted due to missing data.

Eigenvalues of unit scaled X'X

	1	2	3	4	5
	3.7000	1.0033	0.2688	0.0210	0.0070

Condition indices

	1	2	3	4	5
	1.0000	1.9204	3.7099	13.2845	23.0660

Variance proportions

	1	2	3	4	5
CONSTANT	0.0012	0.0001	0.0020	0.3434	0.6533
COS_WDS23	0.0009	0.9071	0.0599	0.0093	0.0227
MAXRATE_6	0.0167	0.0023	0.8353	0.1070	0.0387
LNVWT45	0.0008	0.0001	0.0030	0.0115	0.9847
LNPVEXWT	0.0018	0.0001	0.0098	0.6507	0.3376

Dep Var: LNSAL N: 35 Multiple R: 0.8413 Squared multiple R: 0.7078

Adjusted squared multiple R: 0.6688 Standard error of estimate: 0.7752

Effect	Coefficient	Std Error	Std Coef Tolerance	t	P(2 Tail)
CONSTANT	4.5137	1.0118	0.0000	4.4613	0.0001
COS_WDS23	0.0376	0.0102	0.3746	3.6682	0.0009
MAXRATE_6	9.9247	3.8383	0.2663	2.5857	0.0148
LNVWT45	-0.7934	0.3197	-0.3347	-2.4816	0.0189
LNPVEXWT	-0.3758	0.1553	-0.3222	-2.4195	0.0218

Effect	Coefficient	Lower 95%	Upper 95%
CONSTANT	4.5137	2.4475	6.5800
COS_WDS23	0.0376	0.0167	0.0585
MAXRATE_6	9.9247	2.0858	17.7636
LNVWT45	-0.7934	-1.4464	-0.1405
LNPVEXWT	-0.3758	-0.6929	-0.0586

Correlation matrix of regression coefficients

	CONSTANT	COS_WDS23	MAXRATE_6	LNVWT45	LNPVEXWT
CONSTANT	1.0000				
COS_WDS23	-0.0606	1.0000			
MAXRATE_6	-0.3877	-0.1757	1.0000		
LNVWT45	-0.7357	0.1663	0.1133	1.0000	
LNPVEXWT	0.0029	-0.1487	0.0640	-0.6566	1.0000

Analysis of Variance

Source	Sum-of-Squares	df	Mean-Square	F-ratio	P
Regression	43.6652	4	10.9163	18.1671	0.0000
Residual	18.0265	30	0.6009		

Durbin-Watson D Statistic 1.4991
 First Order Autocorrelation 0.2483

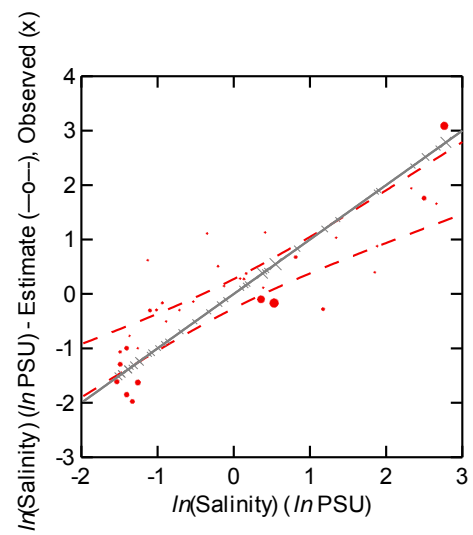
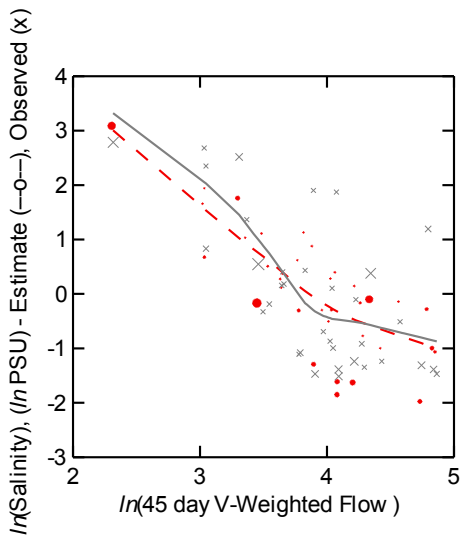
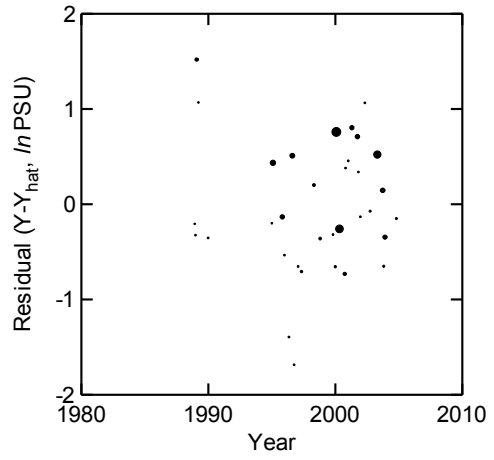
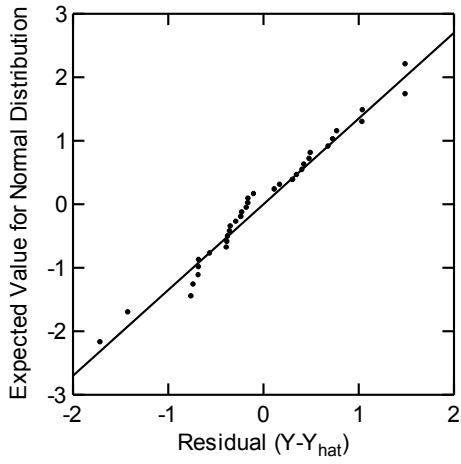
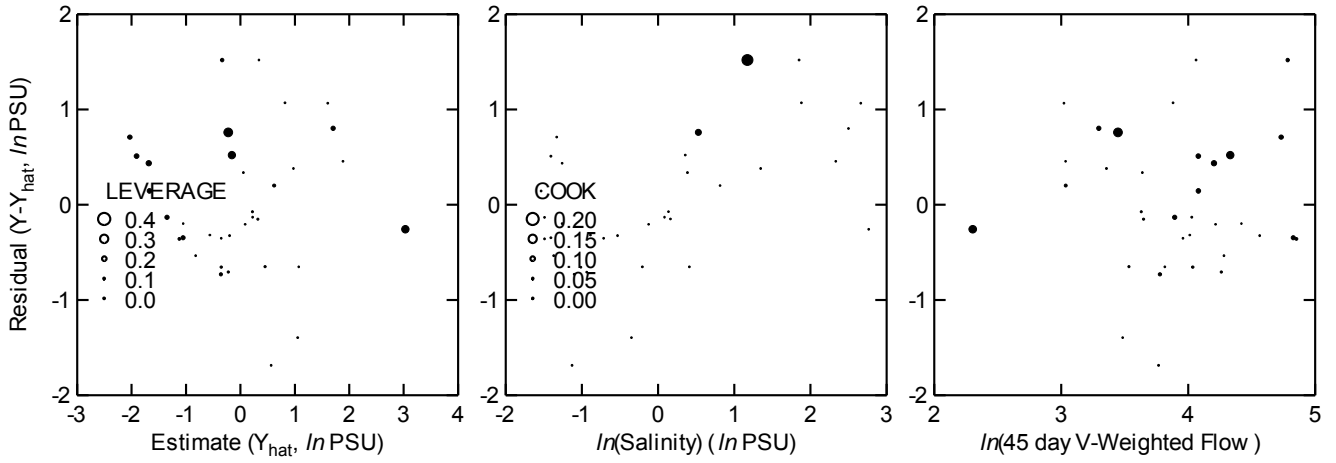

CAT 17 B MSCMOW17BL1.SYD

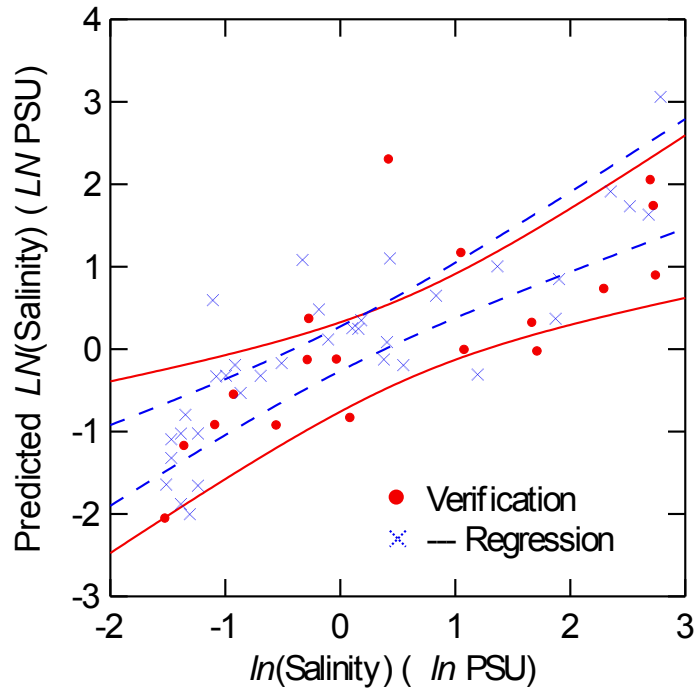

CAT 17 B MSCMOW17BL1.SYD

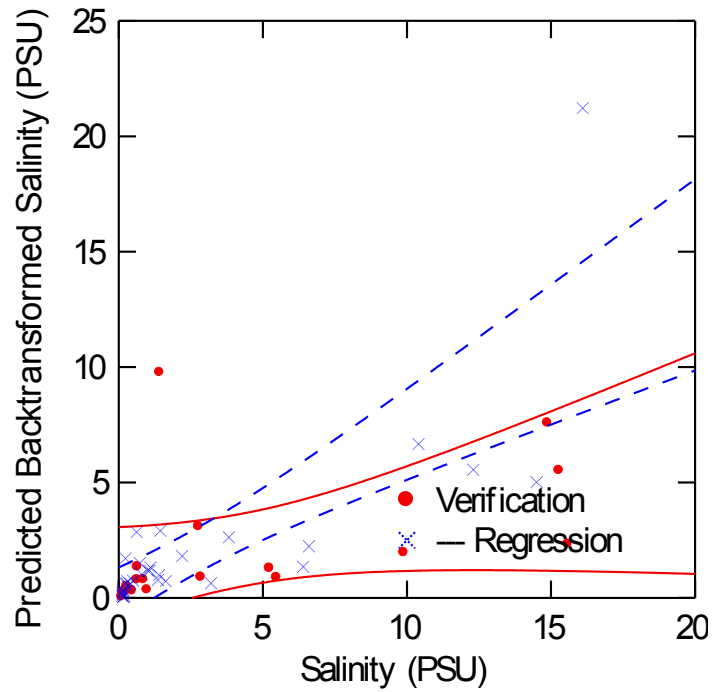

Data for the following results were selected according to:
 (depth_c4\$='B') and (sta_cat=VAL('17')) AND (vwt45>=VAL('120')) and
 (VWT45<VAL('2115')) AND (TOOWIDE=1) AND (distance<=1000) AND (ONE_A_MO=1) AND
 (DEPTH_MN<>-99)

Eigenvalues of unit scaled X'X

	1	2
	1.9908	0.0092

Condition indices

	1	2
	1.0000	14.7008

Variance proportions

	1	2
CONSTANT	0.0046	0.9954
LNEXWT7	0.0046	0.9954

Dep Var: LNSAL N: 38 Multiple R: 0.6684 Squared multiple R: 0.4468

Adjusted squared multiple R: 0.4314 Standard error of estimate: 0.1982

Effect	Coefficient	Std Error	Std Coef Tolerance	t	P(2 Tail)
CONSTANT	-0.2414	0.2375	0.0000	-1.0166	0.3161
LNEXWT7	-0.2203	0.0409	-0.6684	-5.3918	0.0000

Effect	Coefficient	Lower 95%	Upper 95%
CONSTANT	-0.2414	-0.7230	0.2402
LNEXWT7	-0.2203	-0.3032	-0.1374

Correlation matrix of regression coefficients

	CONSTANT	LNEXWT7
CONSTANT	1.0000	
LNEXWT7	-0.9908	1.0000

Analysis of Variance

Source	Sum-of-Squares	df	Mean-Square	F-ratio	P
Regression	1.1424	1	1.1424	29.0712	0.0000
Residual	1.4147	36	0.0393		

*** WARNING ***
 Case 9304 is an outlier (Studentized Residual = 3.0586)

Durbin-Watson D Statistic 2.1156
 First Order Autocorrelation -0.0684

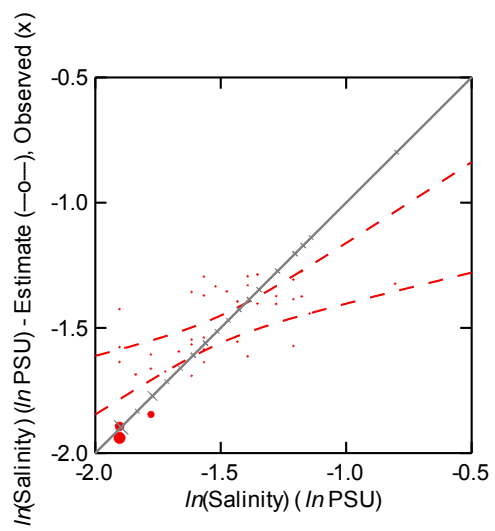
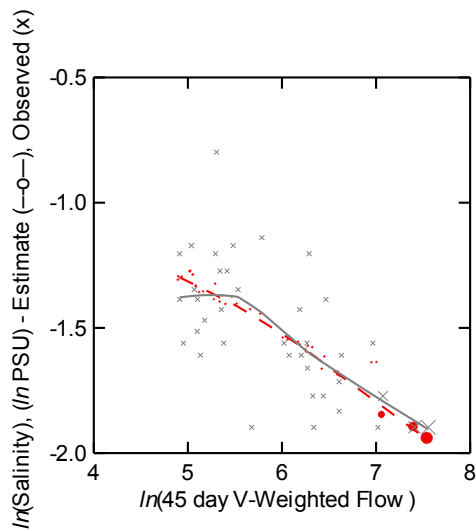
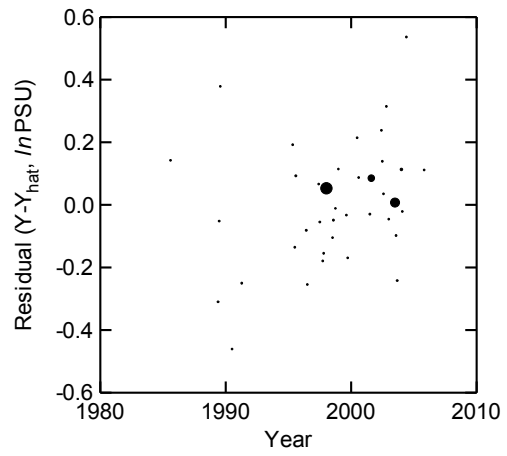
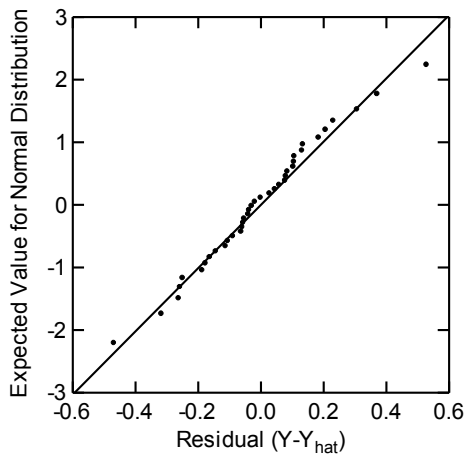
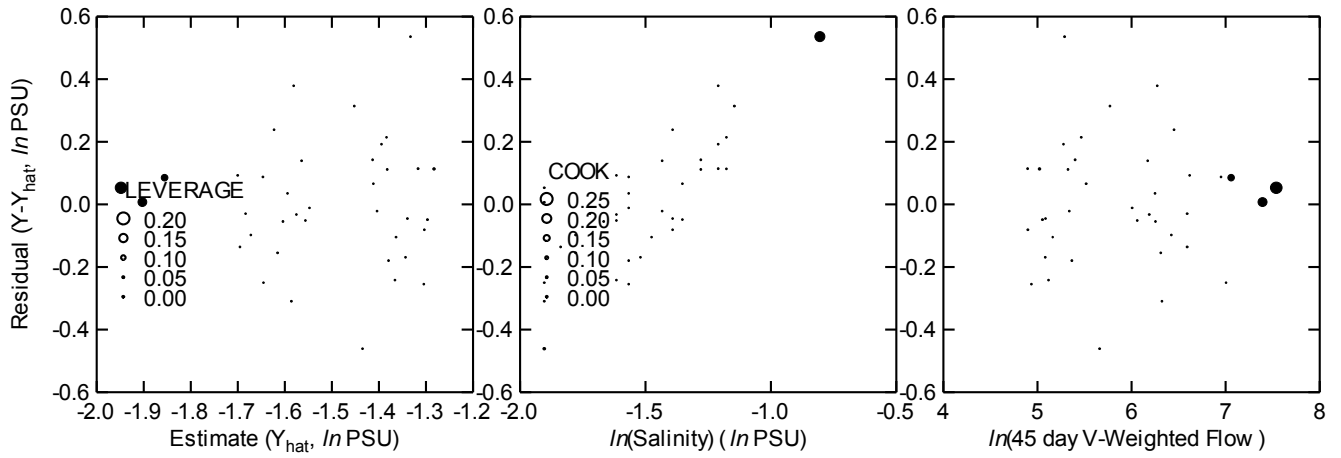

CAT 17 B MSCMOW17BL2SYD

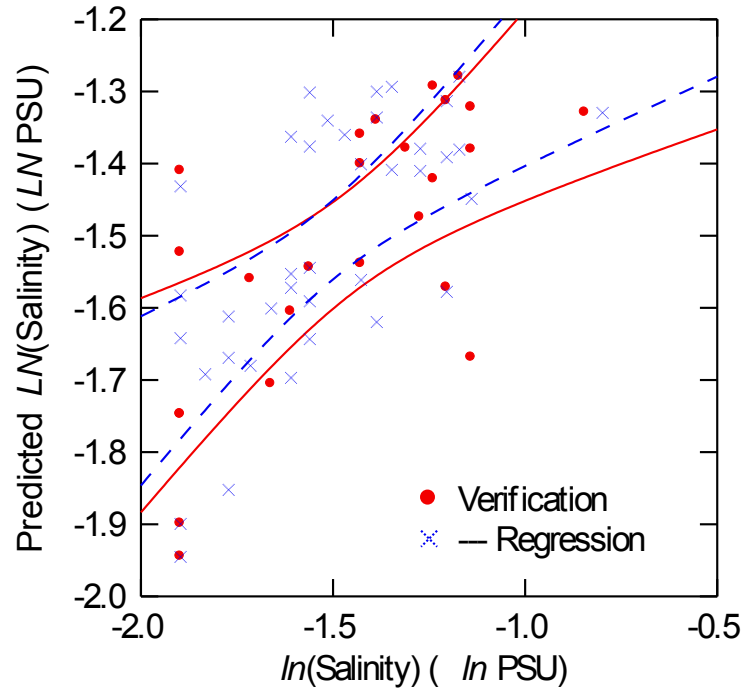

CAT 17 B MSCMOW17BL2SYD

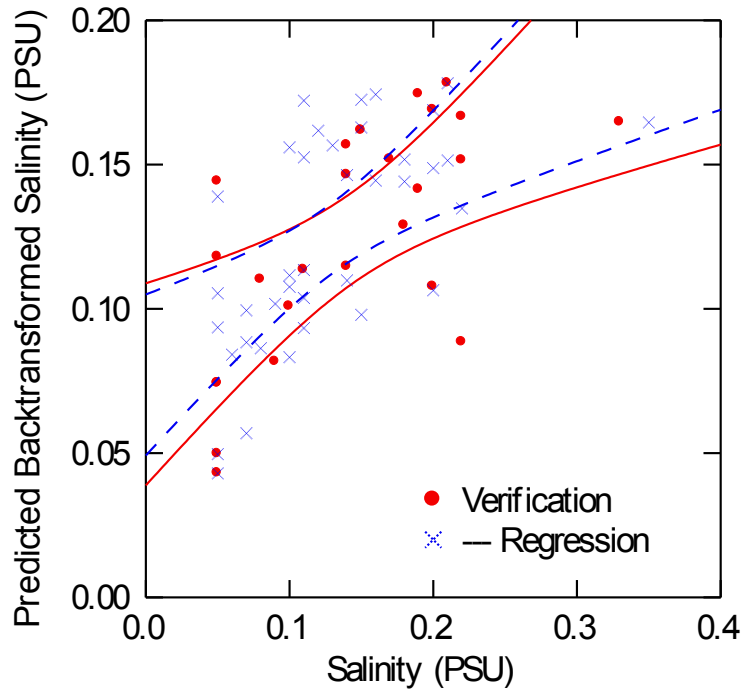

Data for the following results were selected according to:
 (depth_c4\$='S') and (sta_cat=VAL('20')) AND (vwt45>=VAL('0')) and
 (VWT45<VAL('50')) AND (TOOWIDE=1) AND (distance<=1000) AND (ONE_A_MO=1) AND
 (DEPTH_MN<>-99)
 22 case(s) deleted due to missing data.

Eigenvalues of unit scaled X'X

	1	2	3	4
	2.9780	0.9755	0.0402	0.0063

Condition indices

	1	2	3	4
	1.0000	1.7472	8.6073	21.8105

Variance proportions

	1	2	3	4
CONSTANT	0.0012	0.0000	0.0261	0.9727
COS_WDS26	0.0041	0.9555	0.0303	0.0101
RANGE_TIDE	0.0060	0.0005	0.8927	0.1008
LNVWT45	0.0015	0.0000	0.0830	0.9155

Dep Var: LNSAL N: 49 Multiple R: 0.6754 Squared multiple R: 0.4562

Adjusted squared multiple R: 0.4199 Standard error of estimate: 0.7323

Effect	Coefficient	Std Error	Std Coef Tolerance	t	P(2 Tail)
CONSTANT	4.1034	1.0092	0.0000	4.0659	0.0002
COS_WDS26	0.0205	0.0066	0.3457	3.0860	0.0035
RANGE_TIDE	-1.6404	0.7950	-0.2287	-2.0635	0.0449
LNVWT45	-1.1833	0.2575	-0.5116	-4.5952	0.0000

Effect	Coefficient	Lower 95%	Upper 95%
CONSTANT	4.1034	2.0707	6.1361
COS_WDS26	0.0205	0.0071	0.0339
RANGE_TIDE	-1.6404	-3.2415	-0.0392
LNVWT45	-1.1833	-1.7020	-0.6647

Correlation matrix of regression coefficients

	CONSTANT	COS_WDS26	RANGE_TIDE	LNVWT45
CONSTANT	1.0000			
COS_WDS26	-0.0671	1.0000		
RANGE_TIDE	-0.4629	-0.1158	1.0000	
LNVWT45	-0.8957	0.1489	0.0347	1.0000

Analysis of Variance

Source	Sum-of-Squares	df	Mean-Square	F-ratio	P
Regression	20.2442	3	6.7481	12.5837	0.0000
Residual	24.1314	45	0.5363		

Durbin-Watson D Statistic 2.1333
 First Order Autocorrelation -0.0727

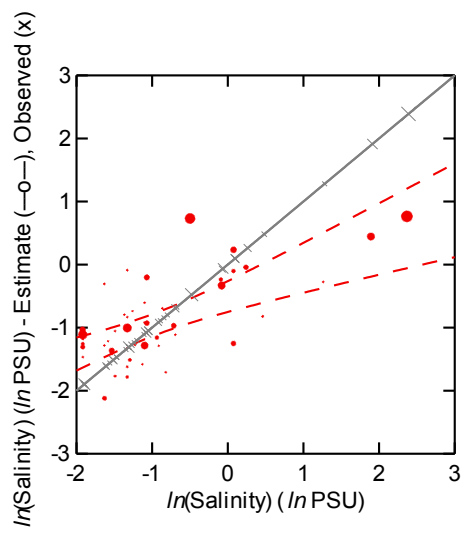
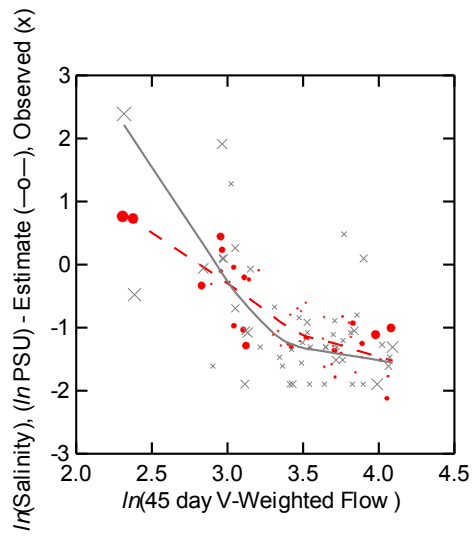
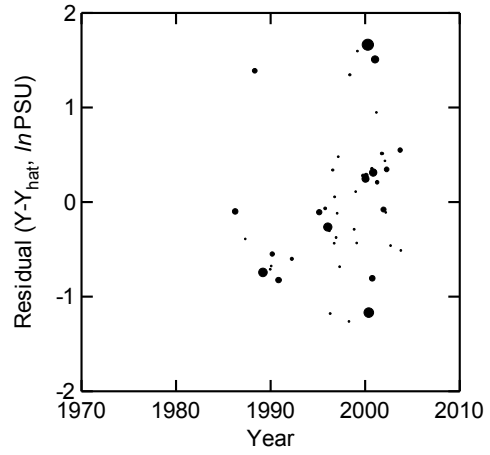
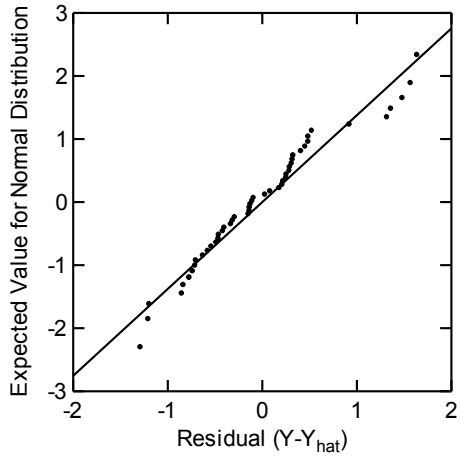
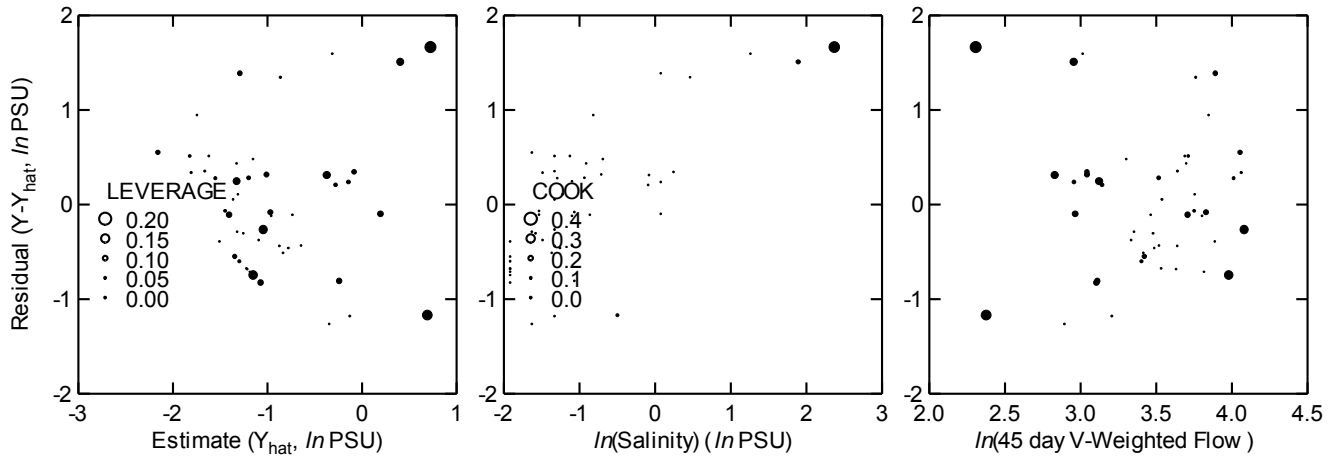

CAT 20 S MSCMOW20SL1.SYD

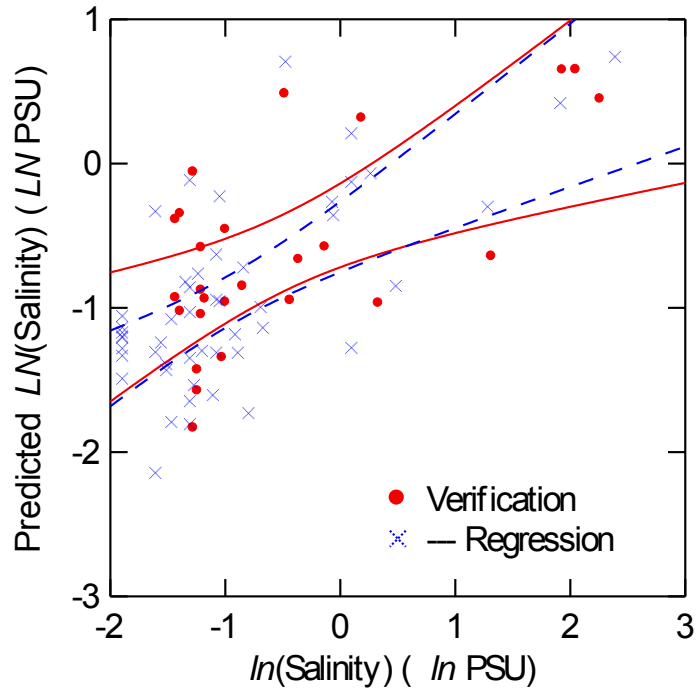

CAT 20 S MSCMOW20SL1.SYD

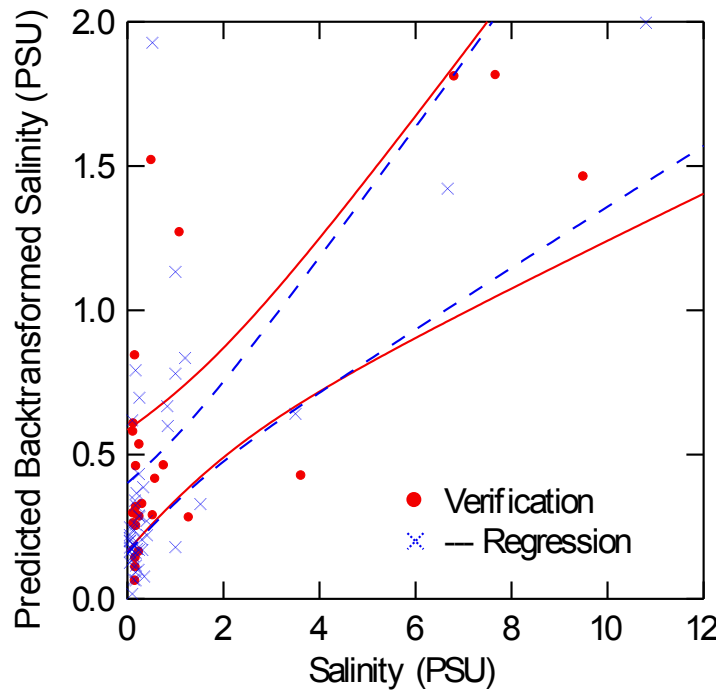

Data for the following results were selected according to:
 (depth_c4\$='S') and (sta_cat=VAL('20')) AND (VWT45<=VAL('2115')) AND
 (TOOWIDE=1) AND (distance<=1000) AND (ONE_A_MO=1) AND (DEPTH_MN<>-99)

Eigenvalues of unit scaled X'X

	1	2	3
	2.1150	0.8654	0.0197

Condition indices

	1	2	3
	1.0000	1.5633	10.3695

Variance proportions

	1	2	3
CONSTANT	0.0082	0.0026	0.9891
MAXRATE_3	0.0468	0.9456	0.0077
LNPVEXWT	0.0082	0.0022	0.9896

Dep Var: LNSAL N: 205 Multiple R: 0.5285 Squared multiple R: 0.2793

Adjusted squared multiple R: 0.2722 Standard error of estimate: 0.7210

Effect	Coefficient	Std Error	Std Coef	Tolerance	t	P(2 Tail)
CONSTANT	0.6847	0.2546	0.0000	.	2.6891	0.0078
MAXRATE_3	3.4376	0.8984	0.2300	0.9871	3.8263	0.0002
LNPVEXWT	-0.3529	0.0422	-0.5026	0.9871	-8.3599	0.0000

Effect	Coefficient	Lower 95%	Upper 95%
CONSTANT	0.6847	0.1827	1.1868
MAXRATE_3	3.4376	1.6661	5.2091
LNPVEXWT	-0.3529	-0.4362	-0.2697

Correlation matrix of regression coefficients

	CONSTANT	MAXRATE_3	LNPVEXWT
CONSTANT	1.0000		
MAXRATE_3	0.0568	1.0000	
LNPVEXWT	-0.9787	-0.1134	1.0000

Analysis of Variance

Source	Sum-of-Squares	df	Mean-Square	F-ratio	P
Regression	40.6951	2	20.3475	39.1401	0.0000
Residual	105.0125	202	0.5199		

*** WARNING ***

Case	624 is an outlier	(Studentized Residual =	3.7259)
Case	1918 is an outlier	(Studentized Residual =	4.1535)

Durbin-Watson D Statistic	1.7737
First Order Autocorrelation	0.0998

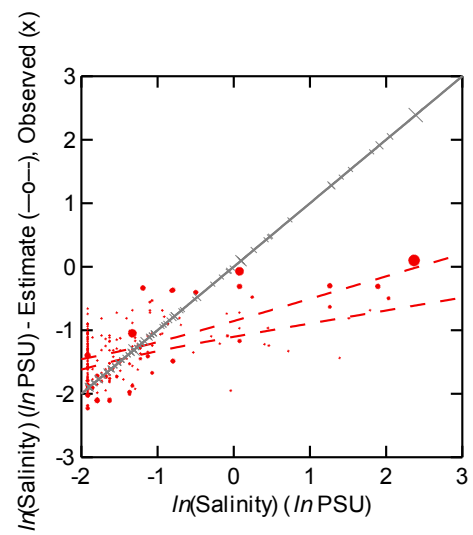
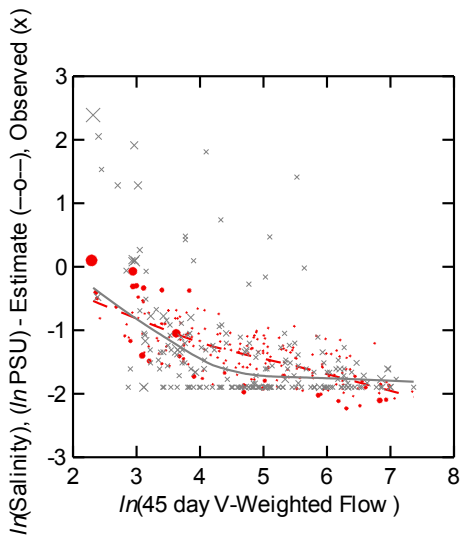
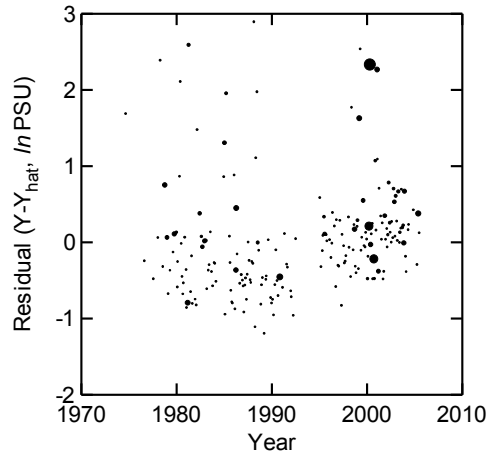
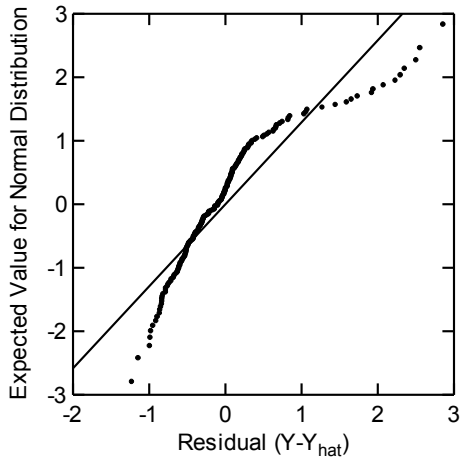
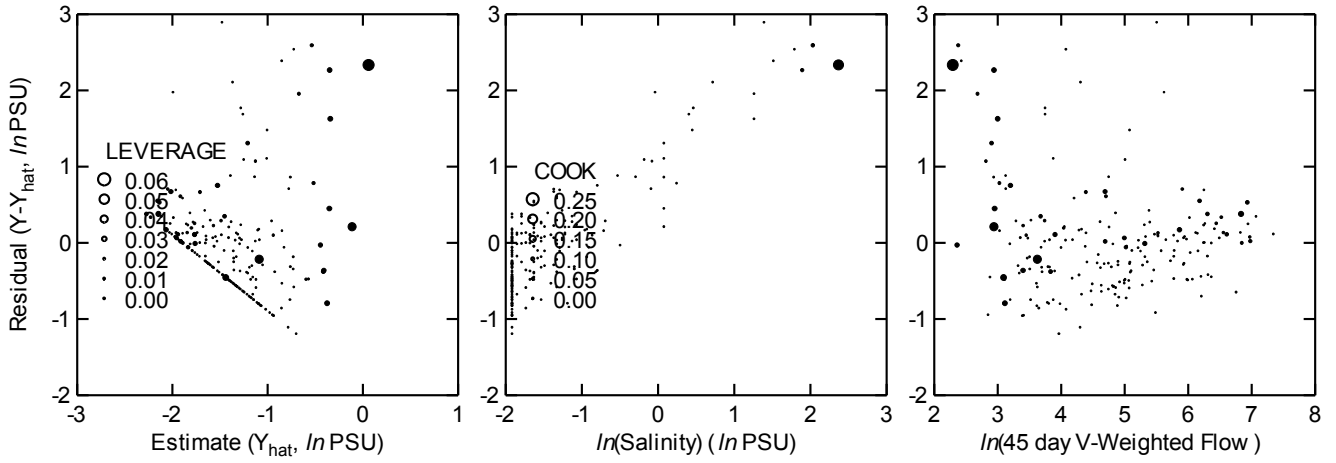

CAT 20 S MSCMOM20SLSYD

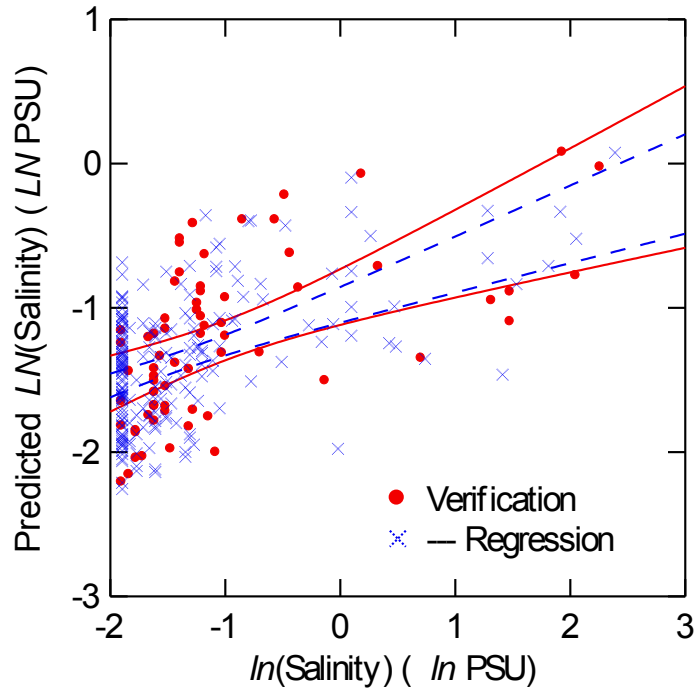

CAT 20 S MSCMOM20SLSYD

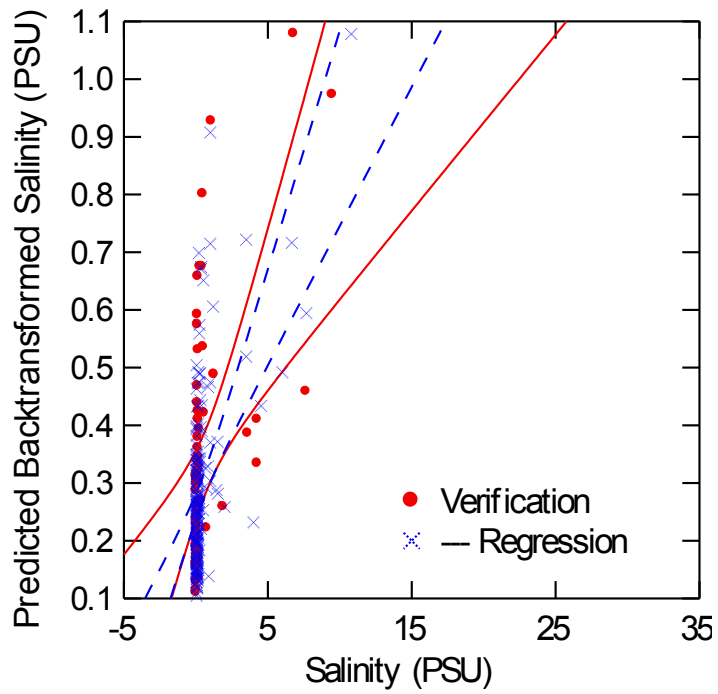

Data for the following results were selected according to:
 (depth_c4\$='B') and (sta_cat=VAL('20')) AND (vwt45>=VAL('0')) and
 (VWT45<VAL('50')) AND (TOOWIDE=1) AND (distance<=1000) AND (ONE_A_MO=1) AND
 (DEPTH_MN<>-99)

Eigenvalues of unit scaled X'X

1	2	3
1.9939	0.9958	0.0103

Condition indices

1	2	3
1.0000	1.4150	13.9222

Variance proportions

	1	2	3
CONSTANT	0.0051	0.0000	0.9948
LNVWT45	0.0051	0.0000	0.9948
FLORATE3	0.0021	0.9979	0.0000

Dep Var: LNSAL N: 22 Multiple R: 0.6958 Squared multiple R: 0.4841

Adjusted squared multiple R: 0.4298 Standard error of estimate: 0.8472

Effect	Coefficient	Std Error	Std Coef	Tolerance	t	P(2 Tail)
CONSTANT	3.5856	1.2625	0.0000	.	2.8402	0.0105
LNVWT45	-1.2893	0.3624	-0.5861	1.0000	-3.5571	0.0021
FLORATE3	0.0591	0.0257	0.3788	1.0000	2.2990	0.0330

Effect	Coefficient	Lower 95%	Upper 95%
CONSTANT	3.5856	0.9433	6.2280
LNVWT45	-1.2893	-2.0479	-0.5307
FLORATE3	0.0591	0.0053	0.1129

Correlation matrix of regression coefficients

	CONSTANT	LNVWT45	FLORATE3
CONSTANT	1.0000		
LNVWT45	-0.9897	1.0000	
FLORATE3	0.0002	-0.0067	1.0000

Analysis of Variance

Source	Sum-of-Squares	df	Mean-Square	F-ratio	P
Regression	12.7963	2	6.3981	8.9149	0.0019
Residual	13.6361	19	0.7177		

*** WARNING ***

Case	5909 has large leverage	(Leverage =	0.9518)
Case	6952 is an outlier	(Studentized Residual =	2.9951)
Case	7345 is an outlier	(Studentized Residual =	2.9773)

Durbin-Watson D Statistic	2.5986
First Order Autocorrelation	-0.3084

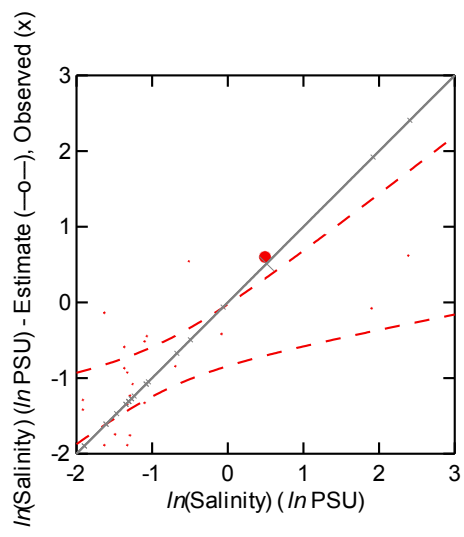
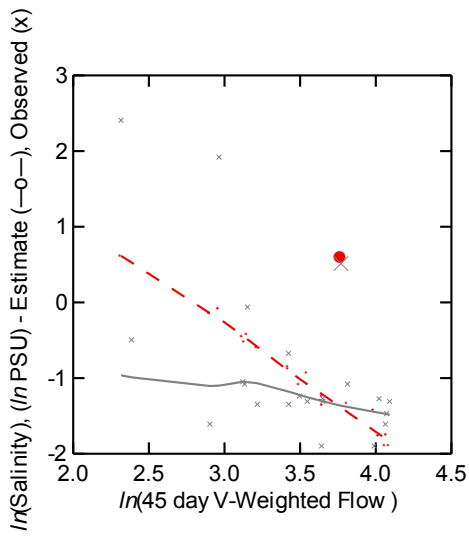
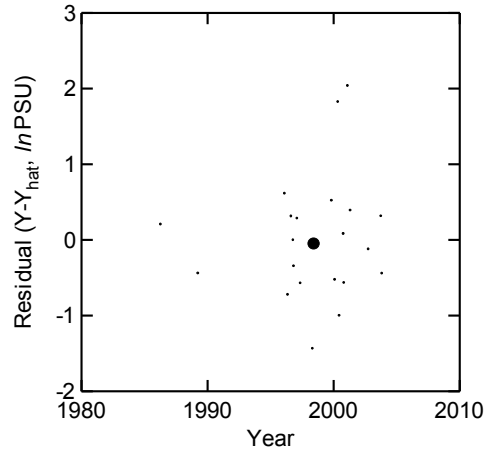
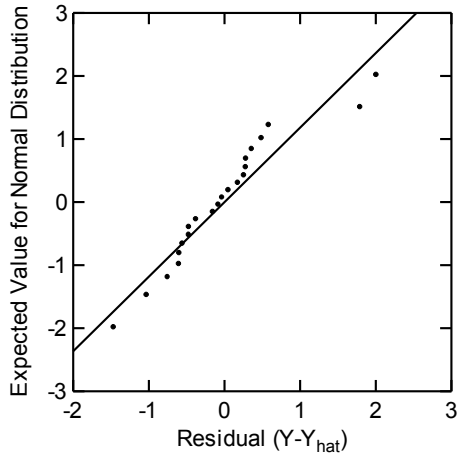
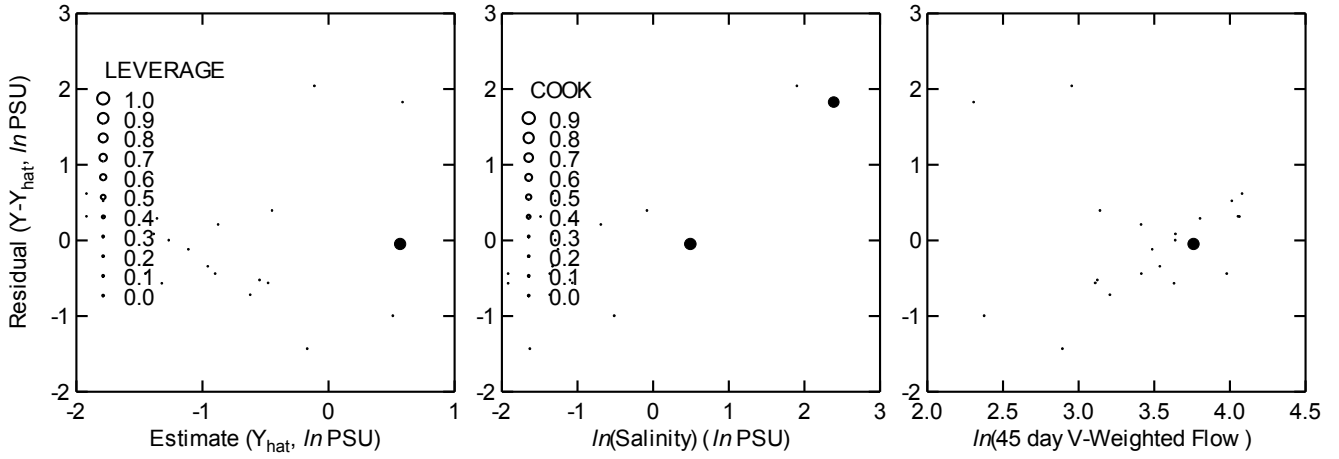

CAT 20 B MSCMOW20BL1.SYD

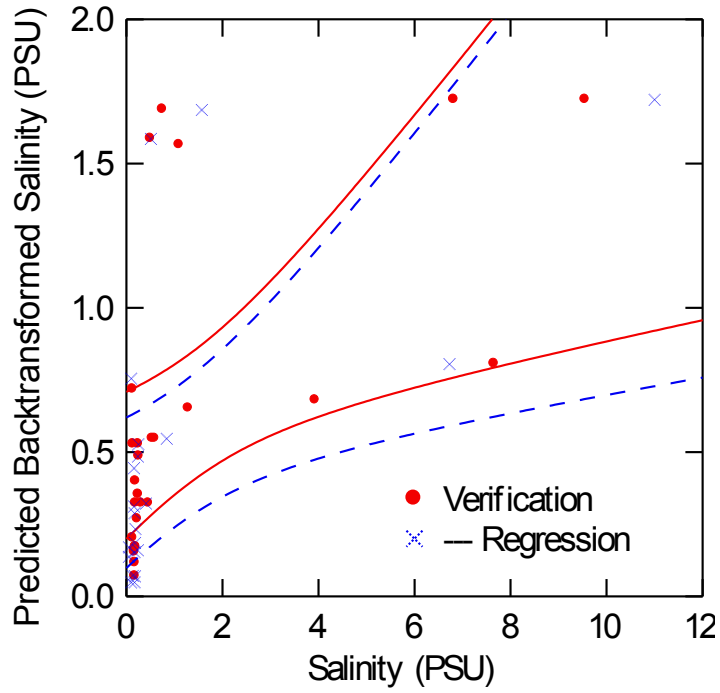

CAT 20 B MSCMOW20BL1.SYD

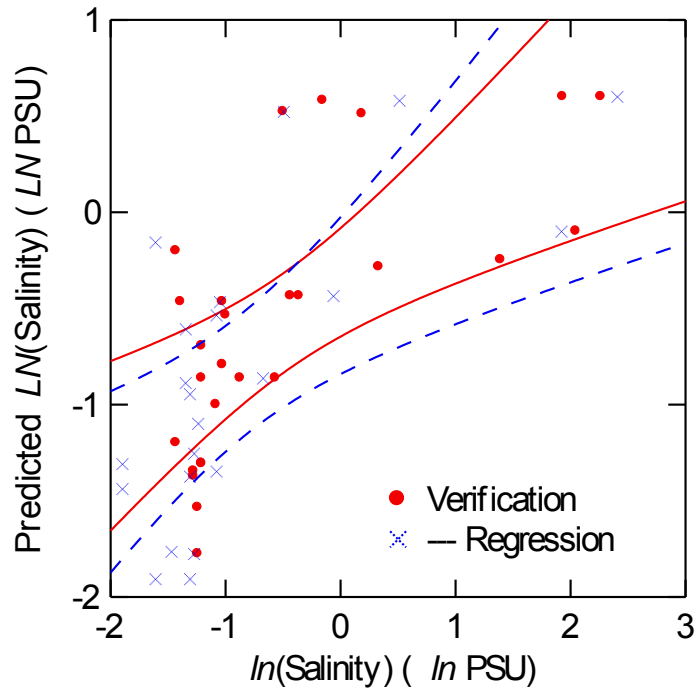

Data for the following results were selected according to:
(depth_c4\$='B') and (sta_cat=VAL('20')) AND (vwt45>=VAL('50')) and
(VWT45<VAL('2115')) AND (TOOWIDE=1) AND (distance<=1000) AND (ONE_A_MO=1) AND
(DEPTH_MN<>-99)

Eigenvalues of unit scaled X'X

	1	2	3
	2.8446	0.1460	0.0094

Condition indices

	1	2	3
	1.0000	4.4139	17.4226

Variance proportions

	1	2	3
CONSTANT	0.0024	0.0301	0.9675
MAXTIDE_6	0.0204	0.8502	0.1294
LNPVWT45	0.0020	0.0124	0.9855

Dep Var: LNSAL N: 32 Multiple R: 0.5731 Squared multiple R: 0.3284

Adjusted squared multiple R: 0.2821 Standard error of estimate: 0.5024

Effect	Coefficient	Std Error	Std Coef Tolerance	t	P(2 Tail)
CONSTANT	0.6898	0.6224	0.0000	1.1083	0.2769
MAXTIDE_6	1.3341	0.6338	0.3594	2.1048	0.0441
LNPVWT45	-0.3760	0.1006	-0.6381	-3.7374	0.0008

Effect	Coefficient	Lower 95%	Upper 95%
CONSTANT	0.6898	-0.5832	1.9629
MAXTIDE_6	1.3341	0.0377	2.6304
LNPVWT45	-0.3760	-0.5818	-0.1703

Correlation matrix of regression coefficients

	CONSTANT	MAXTIDE_6	LNPVWT45
CONSTANT	1.0000		
MAXTIDE_6	0.2010	1.0000	
LNPVWT45	-0.9549	-0.4535	1.0000

Analysis of Variance

Source	Sum-of-Squares	df	Mean-Square	F-ratio	P
Regression	3.5791	2	1.7895	7.0900	0.0031
Residual	7.3197	29	0.2524		

*** WARNING ***

Case 2064 is an outlier (Studentized Residual = 10.0682)

Durbin-Watson D Statistic 2.0570
First Order Autocorrelation -0.0700

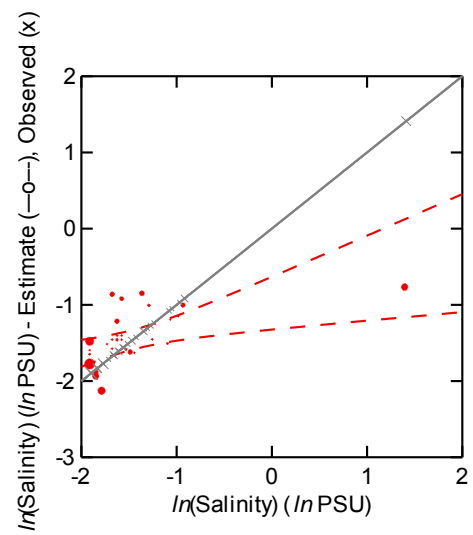
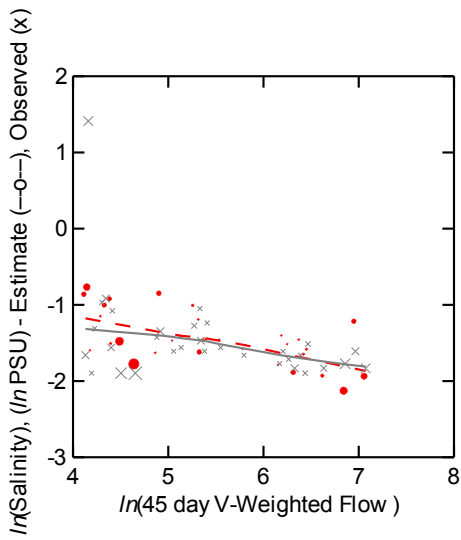
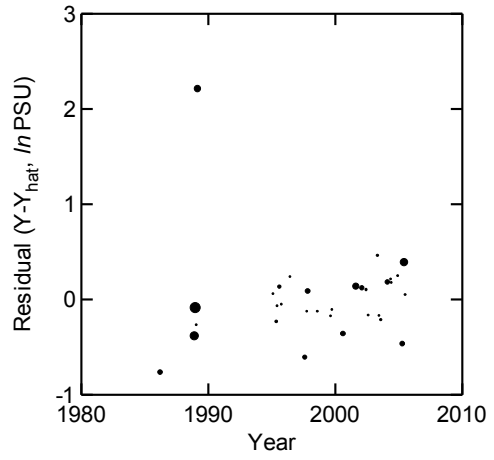
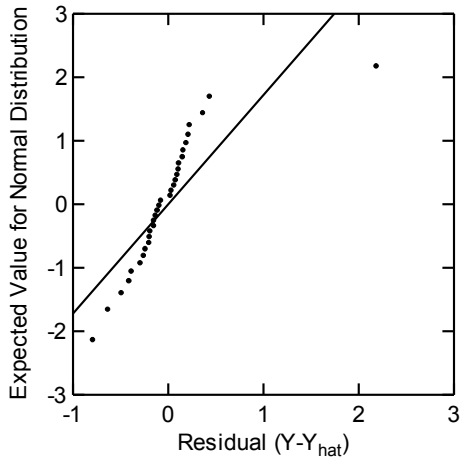
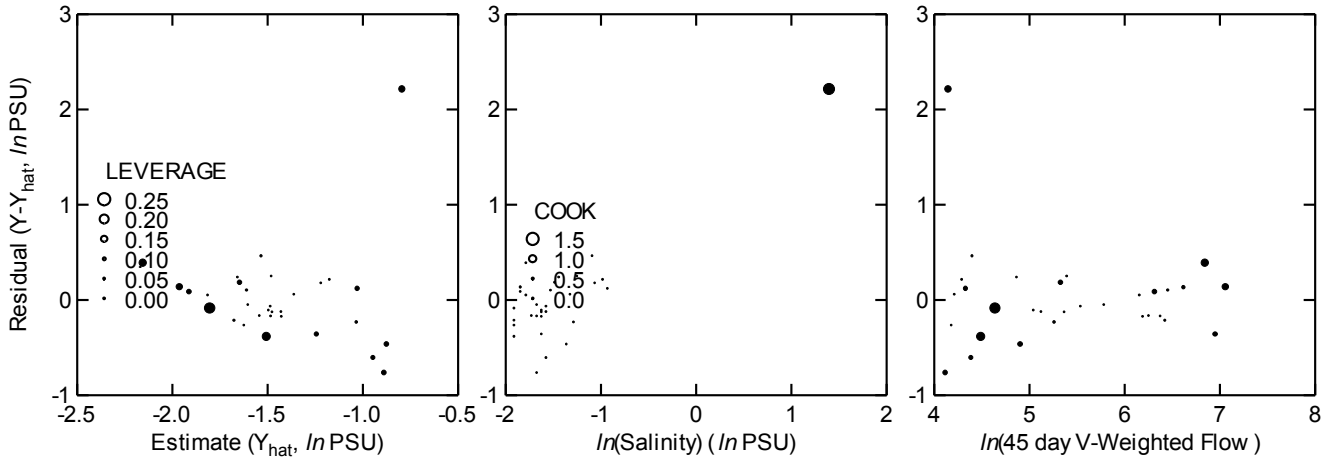

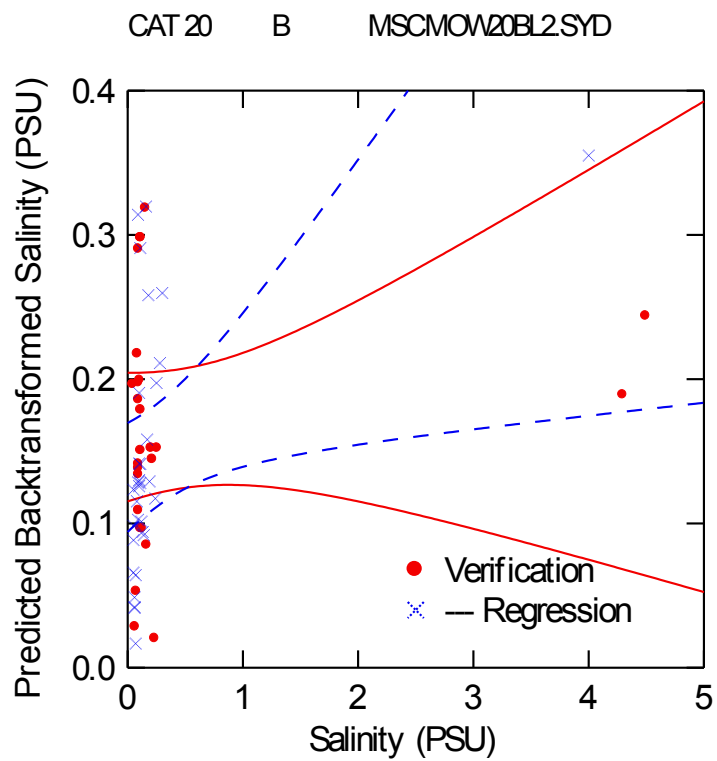
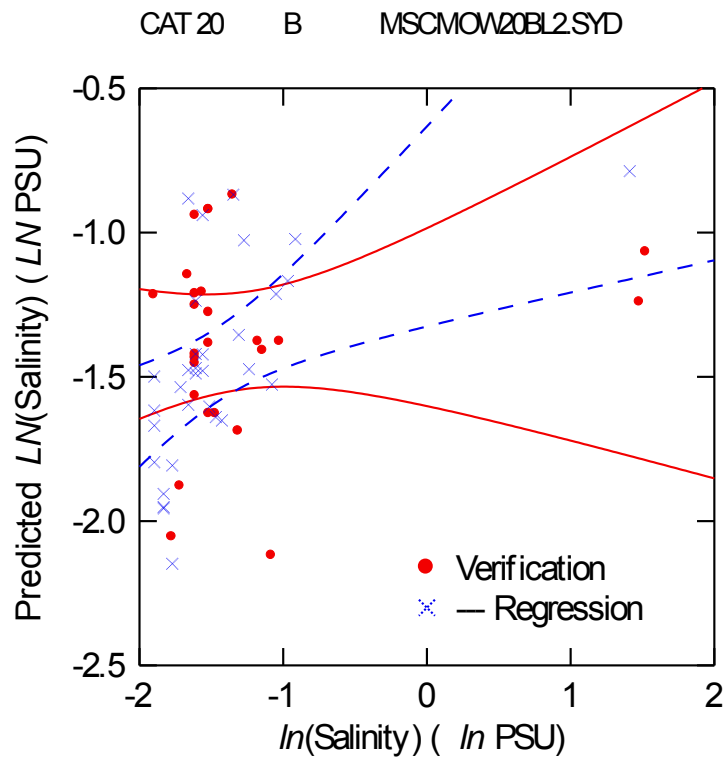

Appendix 4-E

Regression Analysis of Dissolved Oxygen

Data for the following results were selected according to:
 depth_c2\$='S'
 7229 case(s) deleted due to missing data.

Eigenvalues of unit scaled X'X

	1	2	3	4	5
	5.2467	0.9391	0.7143	0.5870	0.3158
	6	7	8		
	0.1466	0.0389	0.0116		

Condition indices

	1	2	3	4	5
	1.0000	2.3636	2.7102	2.9897	4.0762
	6	7	8		
	5.9833	11.6071	21.2986		

Variance proportions

	1	2	3	4	5
CONSTANT	0.0006	0.0005	0.0002	0.0004	0.0012
KM	0.0054	0.1182	0.2391	0.0197	0.0911
DTIMEGMT	0.0084	0.0010	0.0033	0.0499	0.7104
TEMP_C	0.0009	0.0005	0.0001	0.0003	0.0008
COLOR_A	0.0035	0.0157	0.0032	0.0005	0.0001
SAL_PSU2	0.0017	0.0372	0.0031	0.0063	0.0235
VWT45	0.0067	0.0430	0.2493	0.0309	0.1111
CHL_BOTH	0.0097	0.0262	0.0336	0.7473	0.0488
	6	7	8		
CONSTANT	0.0009	0.0373	0.9590		
KM	0.2877	0.0905	0.1482		
DTIMEGMT	0.1378	0.0752	0.0140		
TEMP_C	0.0060	0.3044	0.6869		
COLOR_A	0.4654	0.4922	0.0194		
SAL_PSU2	0.0083	0.6439	0.2761		
VWT45	0.5059	0.0244	0.0287		
CHL_BOTH	0.1181	0.0119	0.0044		

Dep Var: DO_MG N: 513 Multiple R: 0.6819 Squared multiple R: 0.4650

Adjusted squared multiple R: 0.4576 Standard error of estimate: 1.1187

Effect	Coefficient	Std Error	Std Coef	Tolerance	t	P(2 Tail)
CONSTANT	12.2358	0.3796	0.0000	.	32.2296	0.0000
KM	-0.0729	0.0079	-0.3943	0.5731	-9.1713	0.0000
DTIMEGMT	0.0498	0.0066	0.2638	0.8711	7.5660	0.0000
TEMP_C	-0.1787	0.0119	-0.5345	0.8342	-14.9980	0.0000
COLOR_A	-0.0044	0.0012	-0.2092	0.3381	-3.7372	0.0002
SAL_PSU2	-0.0474	0.0107	-0.2666	0.2929	-4.4338	0.0000
VWT45	-0.0006	0.0002	-0.1476	0.5944	-3.4973	0.0005
CHL_BOTH	0.0297	0.0044	0.2303	0.9111	6.7550	0.0000

Effect	Coefficient	Lower 95%	Upper 95%
CONSTANT	12.2358	11.4900	12.9817
KM	-0.0729	-0.0885	-0.0573
DTIMEGMT	0.0498	0.0369	0.0628
TEMP_C	-0.1787	-0.2021	-0.1553
COLOR_A	-0.0044	-0.0068	-0.0021
SAL_PSU2	-0.0474	-0.0683	-0.0264
VWT45	-0.0006	-0.0009	-0.0002
CHL_BOTH	0.0297	0.0211	0.0384

Correlation matrix of regression coefficients

	CONSTANT	KM	DTIMEGMT	TEMP_C	COLOR_A
CONSTANT	1.0000				
KM	-0.4421	1.0000			
DTIMEGMT	-0.2016	0.0872	1.0000		
TEMP_C	-0.7001	0.1166	-0.0995	1.0000	
COLOR_A	-0.2545	-0.0810	-0.0354	-0.2211	1.0000
SAL_PSU2	-0.6594	0.4915	0.2052	-0.0024	0.5458

VWT45	-0.2128	0.4029	0.0707	0.0045	-0.3004
CHL_BOTH	0.0129	0.1083	0.1360	-0.1588	-0.1489

	SAL_PSU2	VWT45	CHL_BOTH
SAL_PSU2	1.0000		
VWT45	0.2798	1.0000	
CHL_BOTH	0.0067	0.0906	1.0000

Analysis of Variance

Source	Sum-of-Squares	df	Mean-Square	F-ratio	P
Regression	549.3790	7	78.4827	62.7074	0.0000
Residual	632.0432	505	1.2516		

 *** WARNING ***

Case	3609	has large leverage	(Leverage =	0.0663)	
Case	4085	has large leverage	(Leverage =	0.1839)	
Case	7254	is an outlier	(Studentized Residual =		5.3632)
Case	7257	has large leverage	(Leverage =	0.0827)	
Case	7275	is an outlier	(Studentized Residual =		5.1122)
Case	9011	has large leverage	(Leverage =	0.1156)	
Case	9351	has large leverage	(Leverage =	0.1442)	
Case	11566	has large leverage	(Leverage =	0.1224)	
Case	11629	has large leverage	(Leverage =	0.1664)	

Durbin-Watson D Statistic	1.5751
First Order Autocorrelation	0.2073

Data for the following results were selected according to:
depth_c2\$='B'
5199 case(s) deleted due to missing data.

Eigenvalues of unit scaled X'X

	1	2	3	4	5
	3.9361	0.9195	0.7046	0.3896	0.0358
	6				
	0.0144				

Condition indices

	1	2	3	4	5
	1.0000	2.0690	2.3635	3.1784	10.4818
	6				
	16.5426				

Variance proportions

	1	2	3	4	5
CONSTANT	0.0013	0.0001	0.0006	0.0028	0.0130
KM	0.0129	0.0779	0.1416	0.4410	0.2194
DEPTH_M	0.0028	0.0017	0.0005	0.0186	0.6887
TEMP_C	0.0020	0.0001	0.0005	0.0038	0.4201
STRAT	0.0164	0.2157	0.2284	0.5268	0.0057
CHL_BOTH	0.0124	0.4067	0.5226	0.0096	0.0487
	6				
CONSTANT	0.9822				
KM	0.1071				
DEPTH_M	0.2877				
TEMP_C	0.5735				
STRAT	0.0070				
CHL_BOTH	0.0000				

Dep Var: DO_MG N: 270 Multiple R: 0.8008 Squared multiple R: 0.6412

Adjusted squared multiple R: 0.6345 Standard error of estimate: 1.0912

Effect	Coefficient	Std Error	Std Coef Tolerance	t	P(2 Tail)
CONSTANT	12.9916	0.4551	0.0000	28.5456	0.0000
KM	-0.0340	0.0159	-0.0940	-2.1429	0.0330
DEPTH_M	-0.3747	0.1023	-0.1605	-3.6633	0.0003
TEMP_C	-0.2180	0.0147	-0.5653	-14.8671	0.0000
STRAT	0.3111	0.0277	0.4358	11.2371	0.0000
CHL_BOTH	0.0344	0.0082	0.1603	4.2044	0.0000

Effect	Coefficient	Lower 95%	Upper 95%
CONSTANT	12.9916	12.0955	13.8877
KM	-0.0340	-0.0653	-0.0028
DEPTH_M	-0.3747	-0.5761	-0.1733
TEMP_C	-0.2180	-0.2469	-0.1891
STRAT	0.3111	0.2566	0.3656
CHL_BOTH	0.0344	0.0183	0.0506

Correlation matrix of regression coefficients

	CONSTANT	KM	DEPTH_M	TEMP_C	STRAT
CONSTANT	1.0000				
KM	-0.4023	1.0000			
DEPTH_M	-0.6164	0.4762	1.0000		
TEMP_C	-0.6710	-0.0863	-0.1201	1.0000	
STRAT	-0.0335	-0.1951	0.0656	0.1565	1.0000
CHL_BOTH	-0.0355	-0.0442	0.1591	-0.1563	-0.0094

CHL_BOTH
CHL_BOTH
1.0000

Analysis of Variance					
Source	Sum-of-Squares	df	Mean-Square	F-ratio	P
Regression	561.9301	5	112.3860	94.3767	0.0000
Residual	314.3776	264	1.1908		

*** WARNING ***

Case	141	is an outlier	(Studentized Residual =	3.8665)
Case	3414	has large leverage	(Leverage =	0.1062)
Case	6542	has large leverage	(Leverage =	0.1372)
Case	6546	has large leverage	(Leverage =	0.1024)
Case	7249	has large leverage	(Leverage =	0.1292)
Case	7259	has large leverage	(Leverage =	0.1005)
Case	7283	has large leverage	(Leverage =	0.3983)

Durbin-Watson D Statistic	1.8342
First Order Autocorrelation	0.0806

Appendix 4-F

Water Quality as a Function of Time, Season, Salinity, Temperature, and Flow

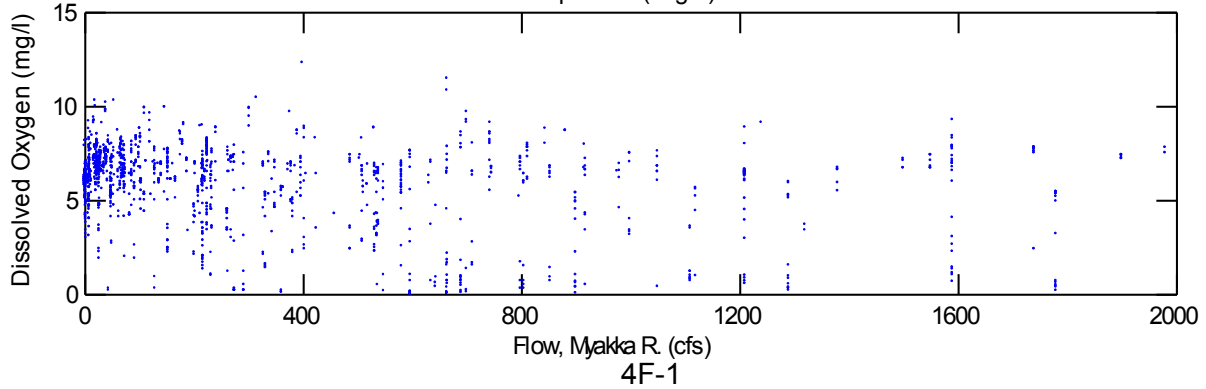
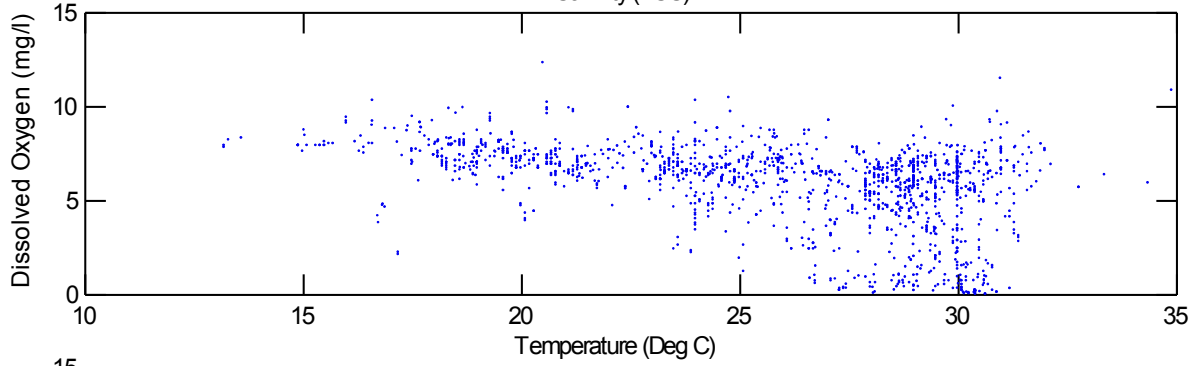
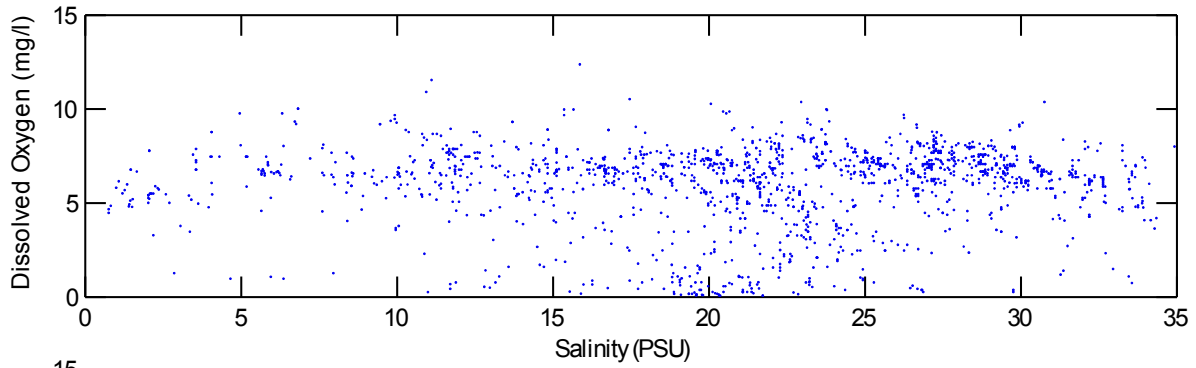
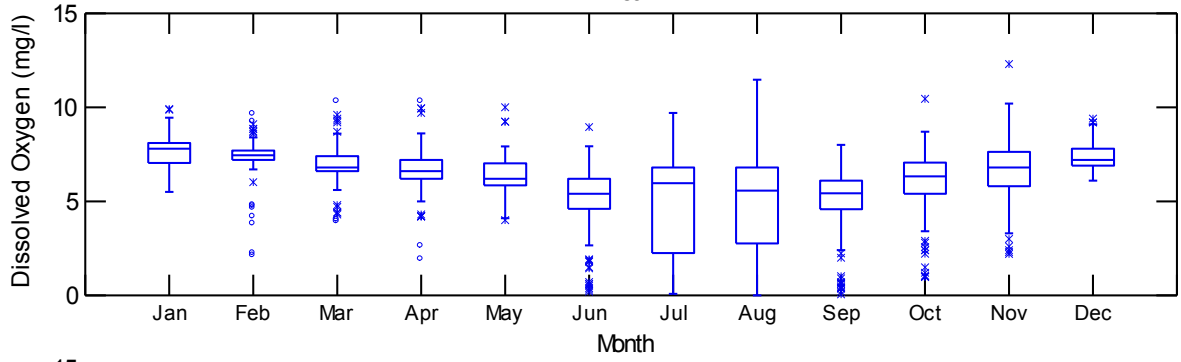
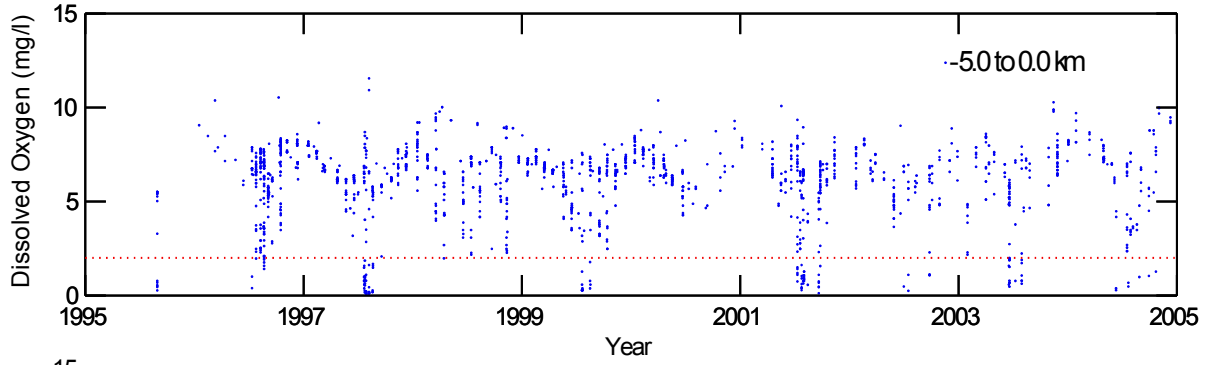

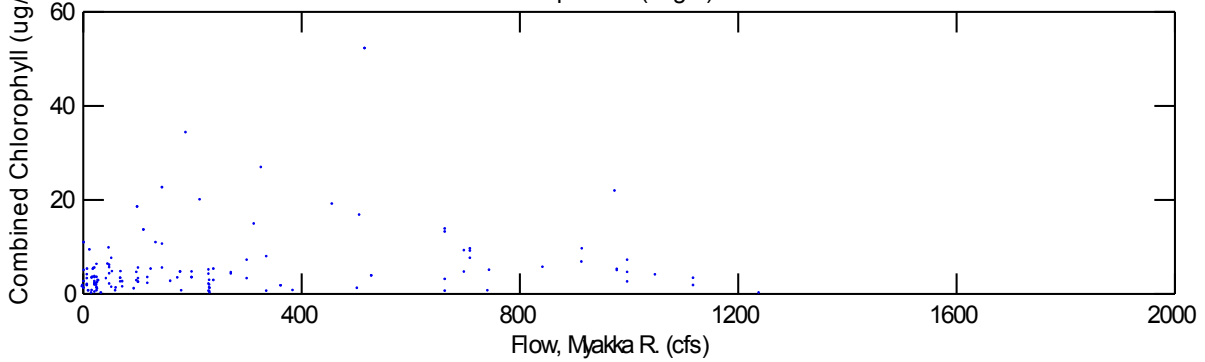
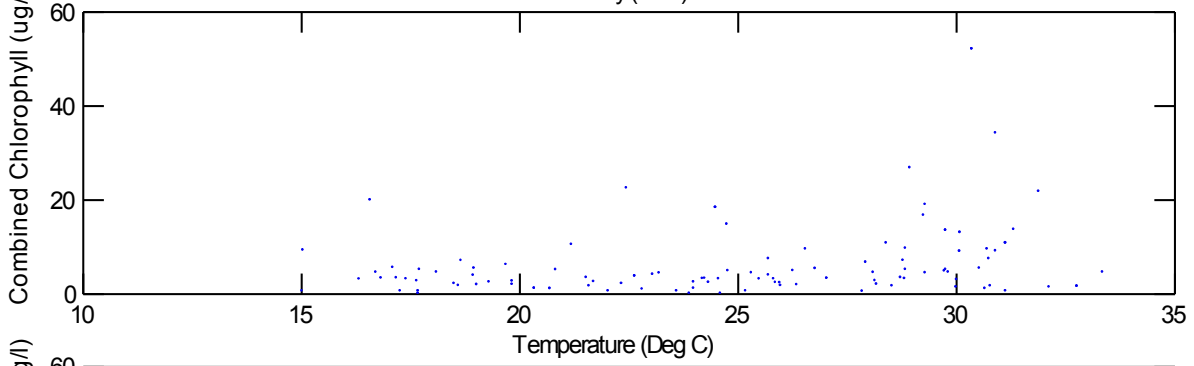
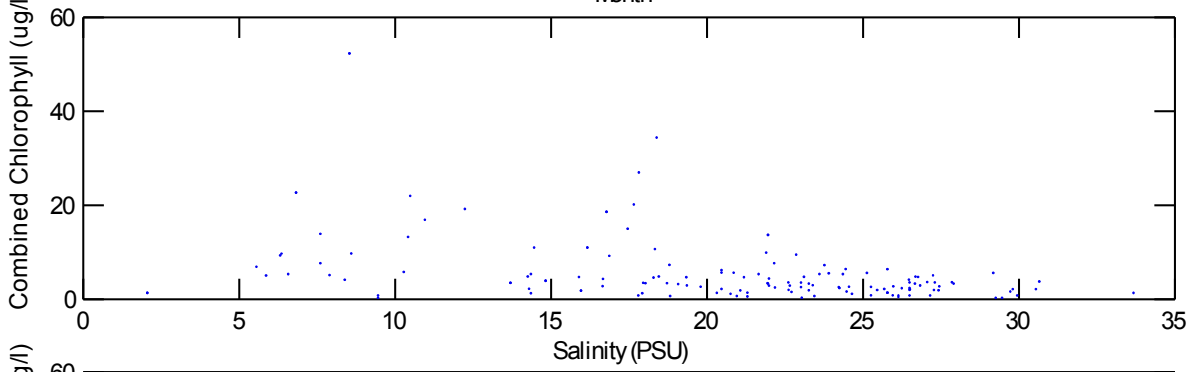
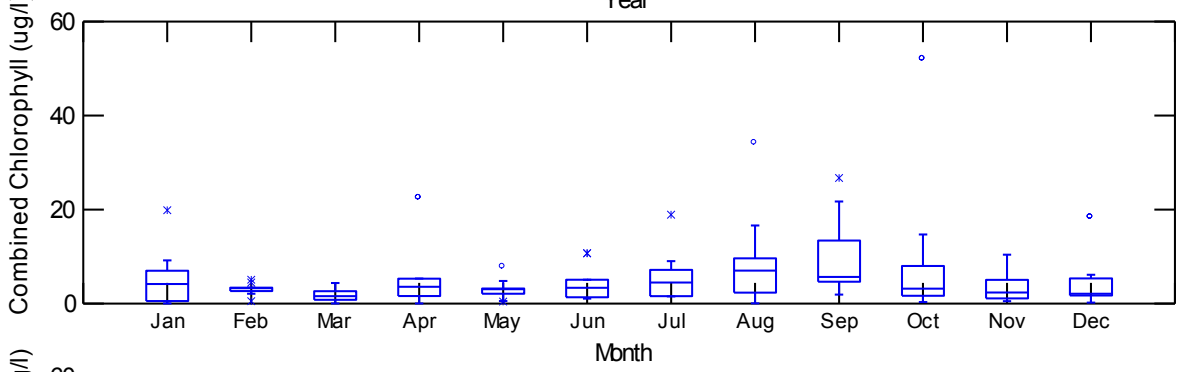
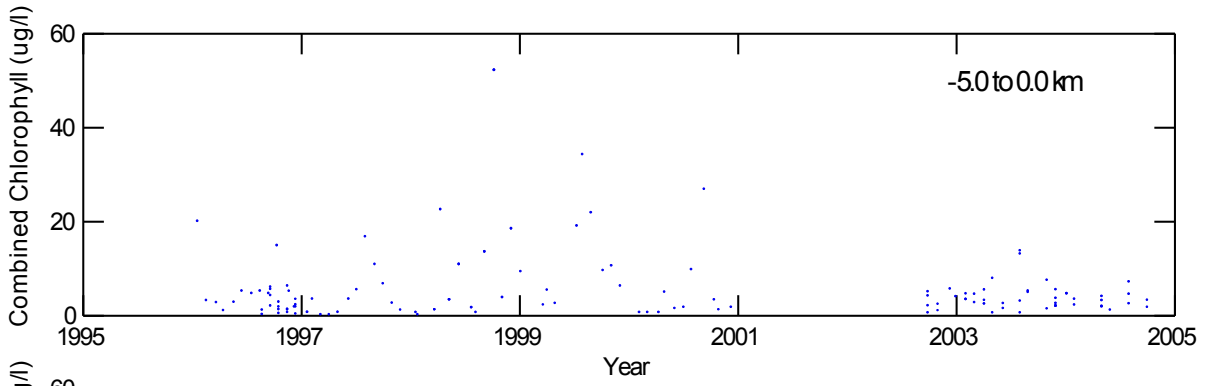

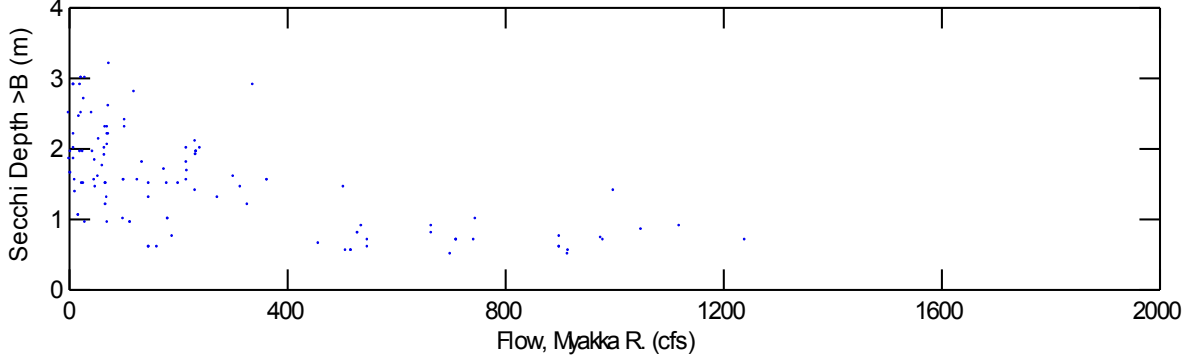
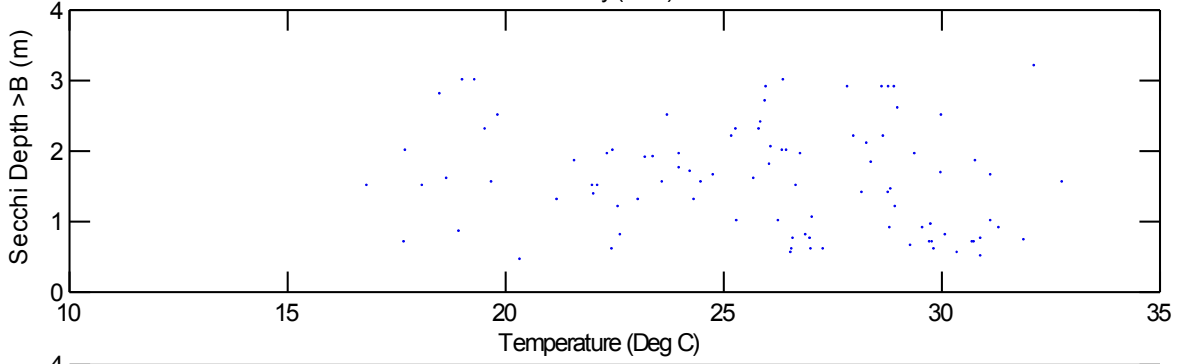
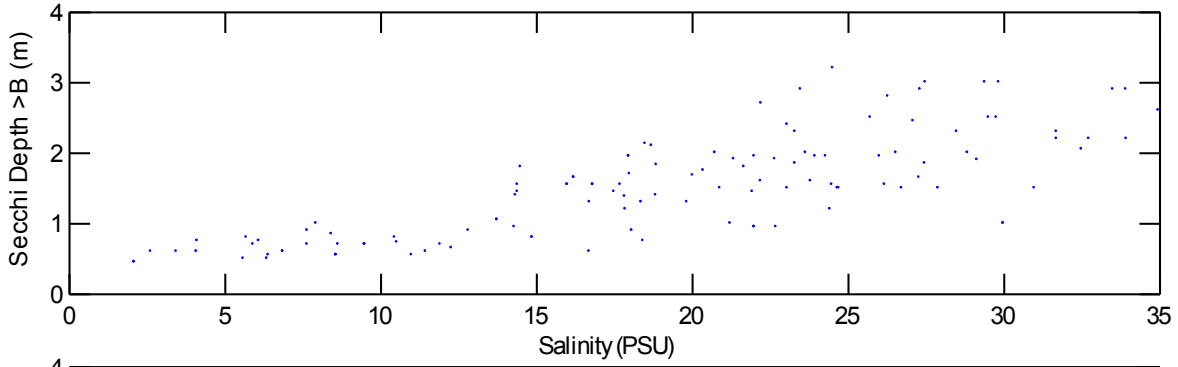
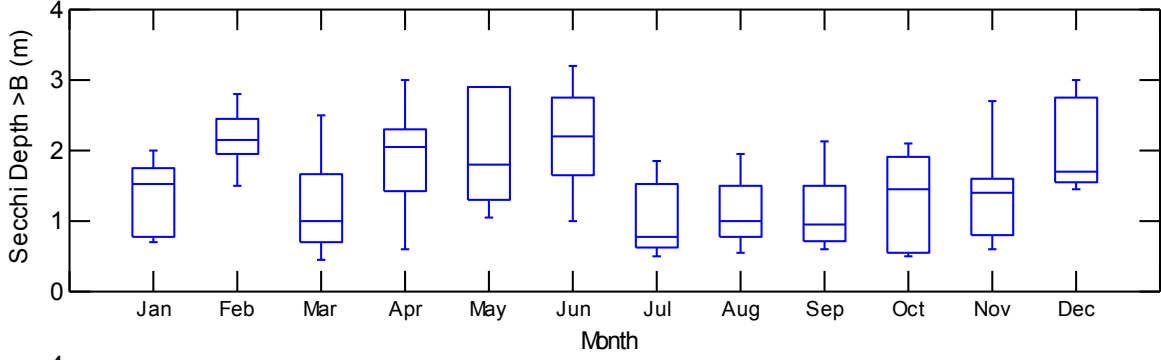
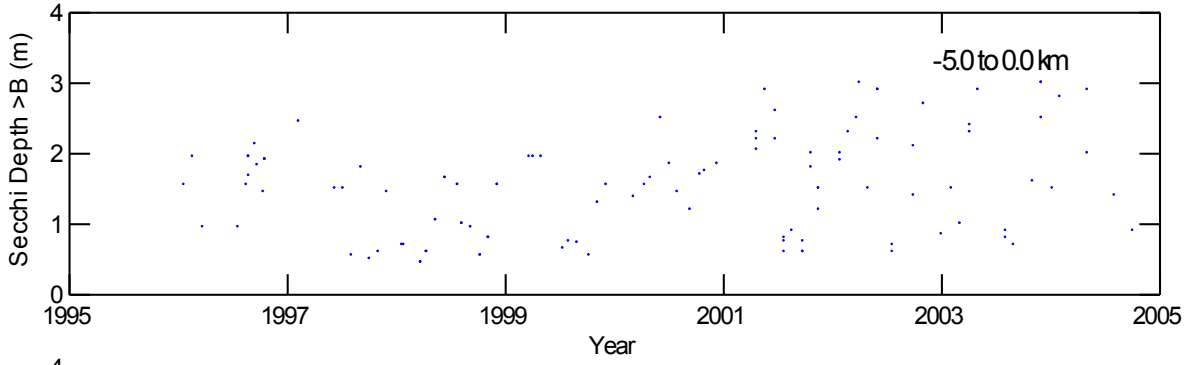

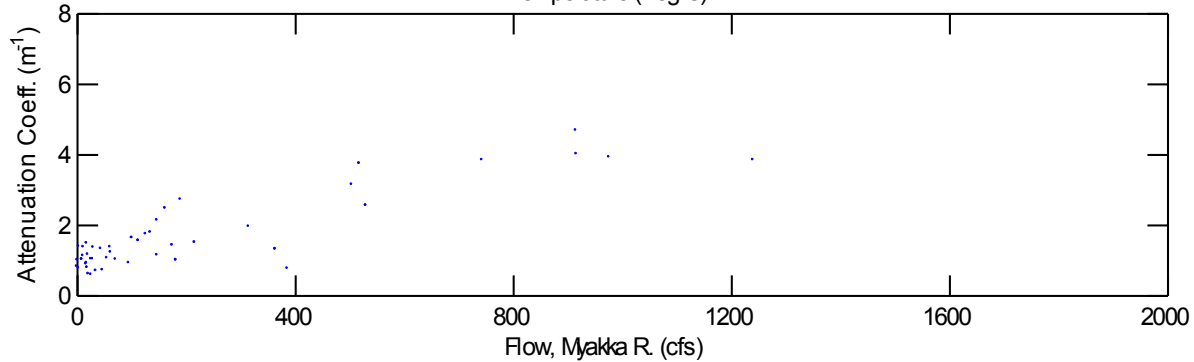
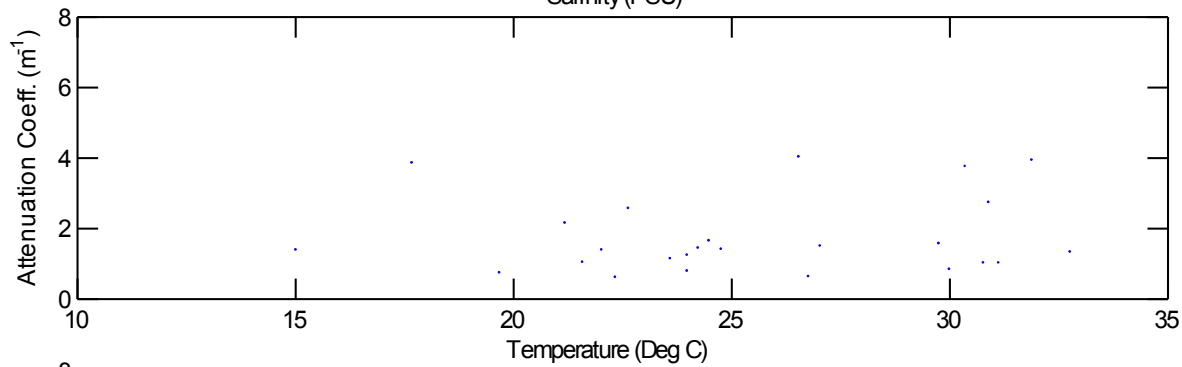
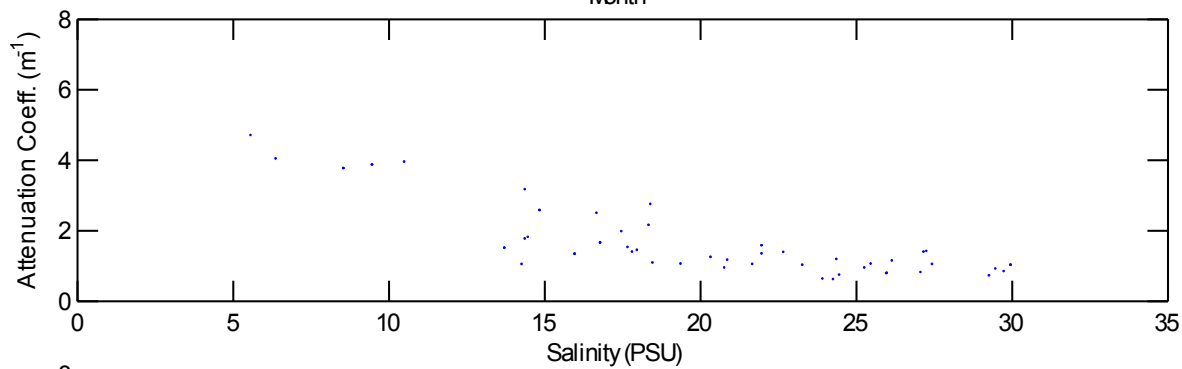
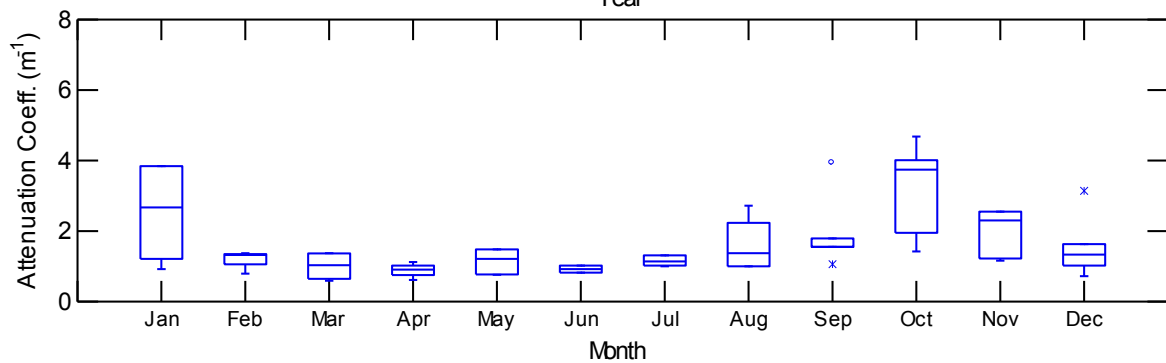
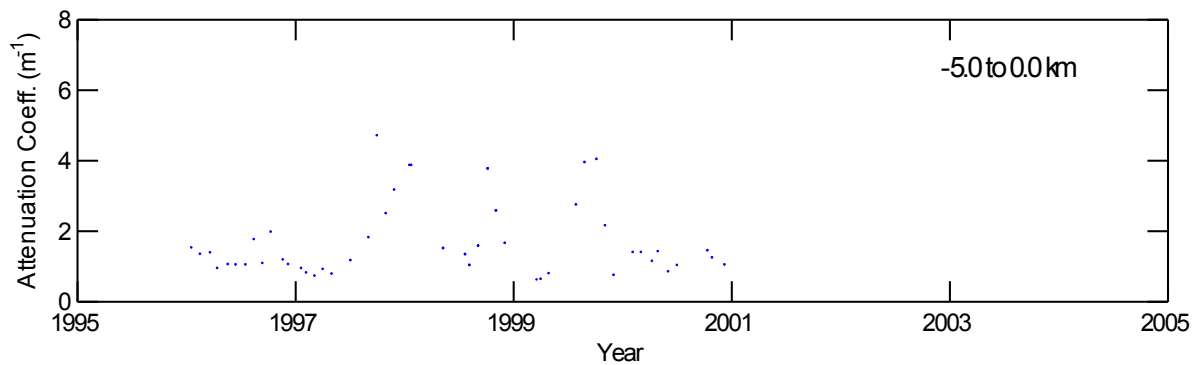

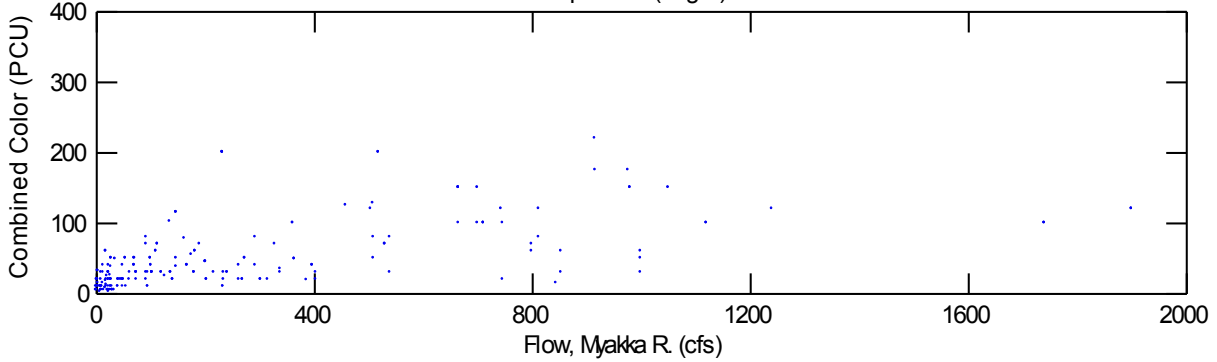
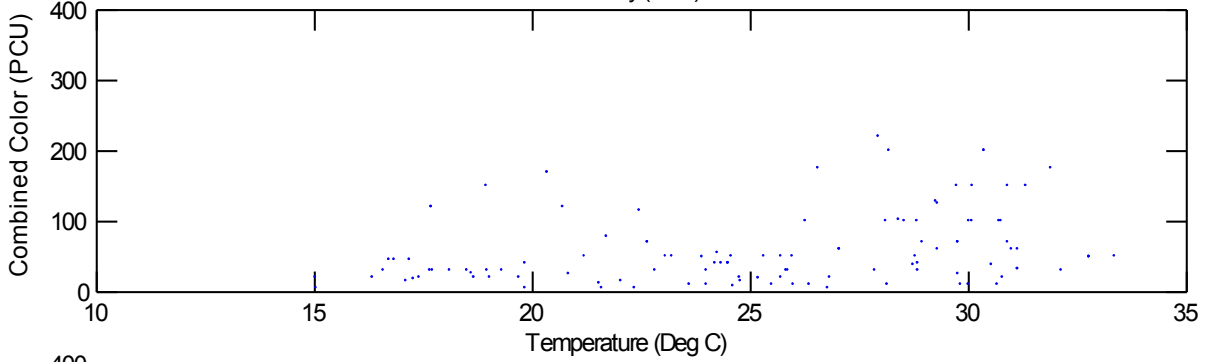
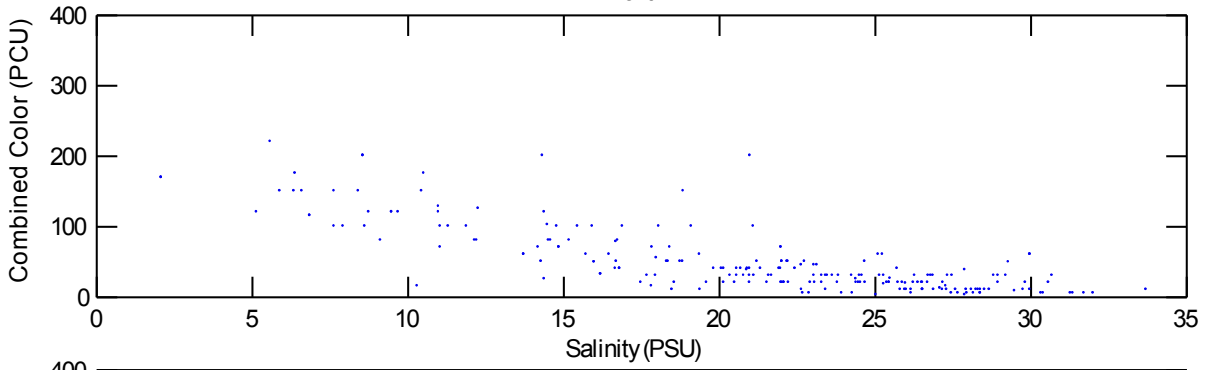
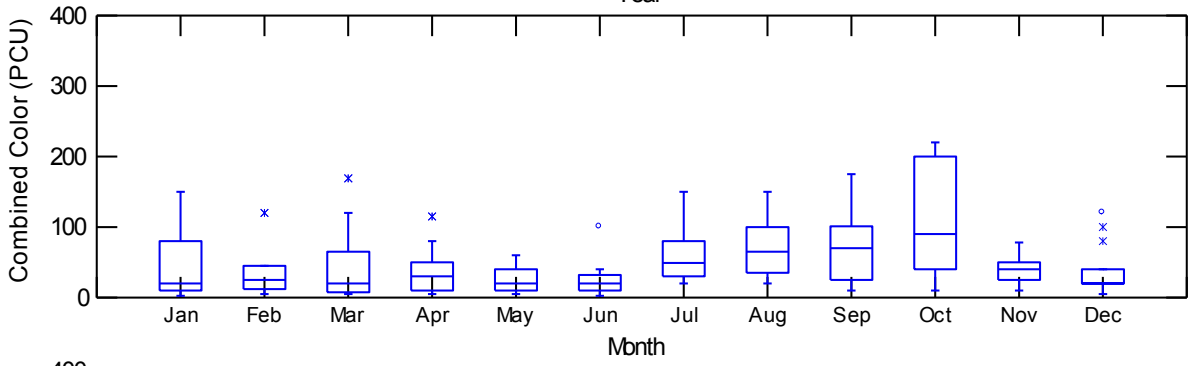
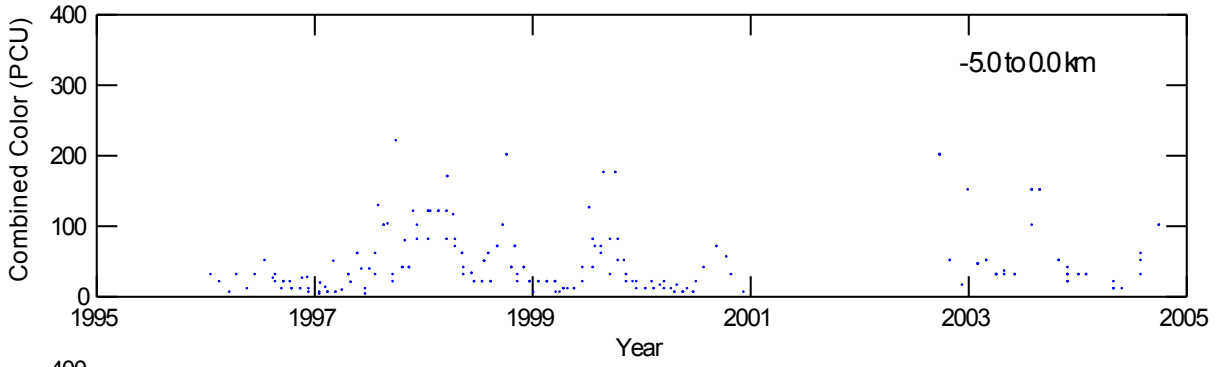

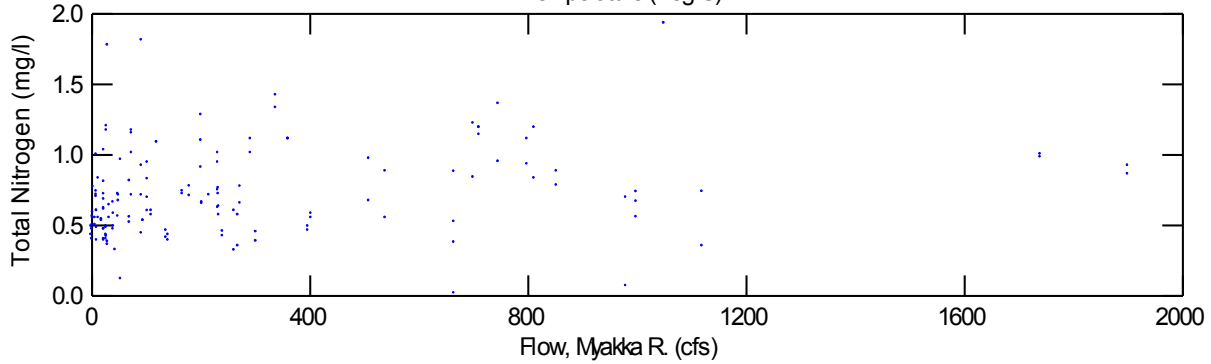
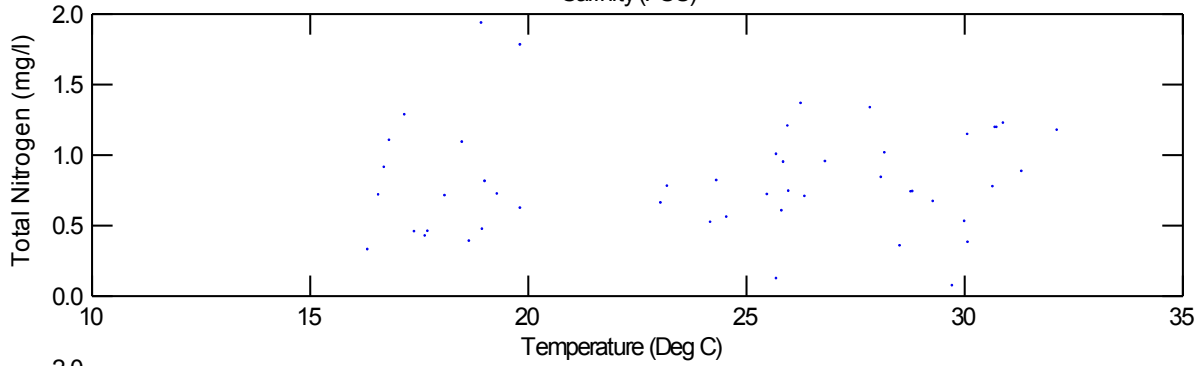
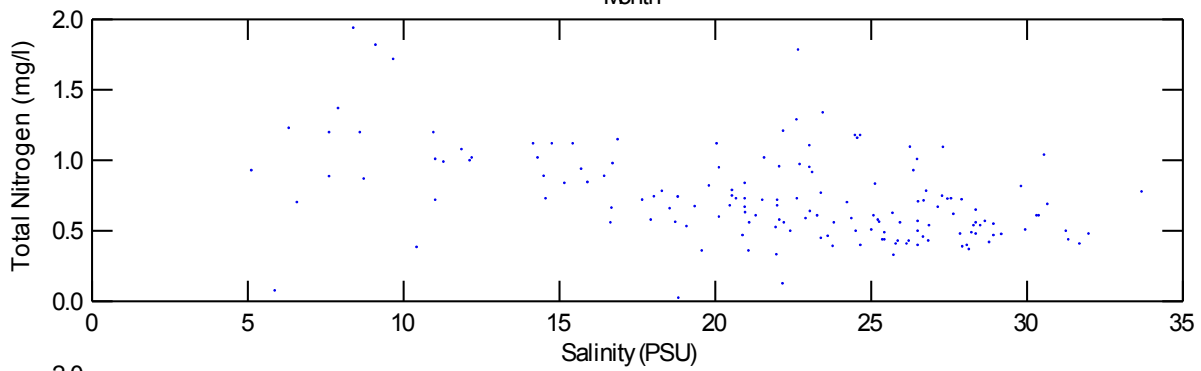
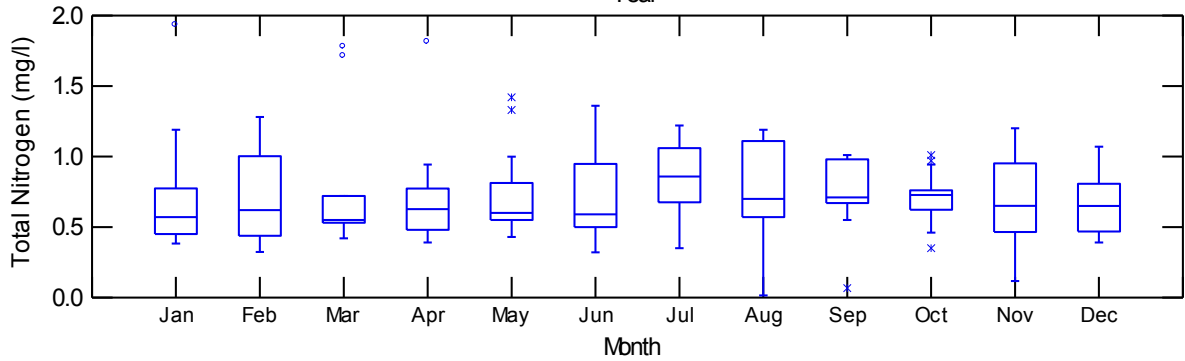
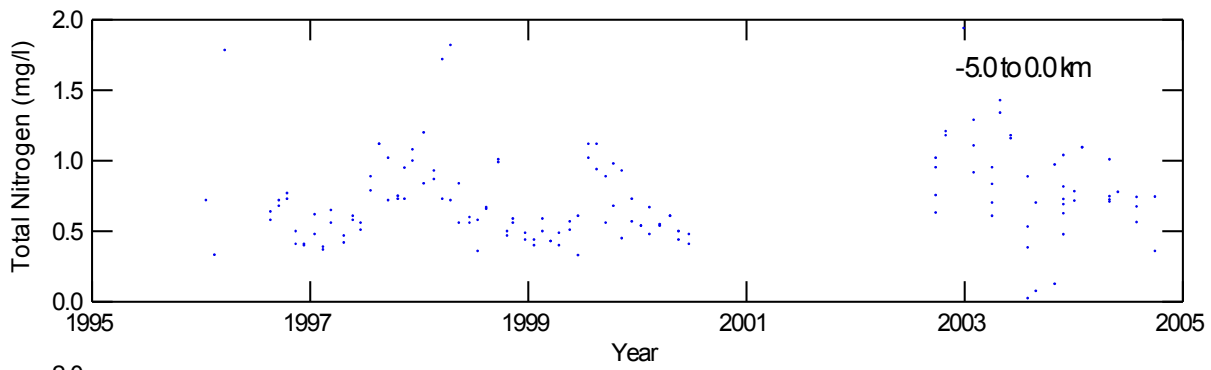

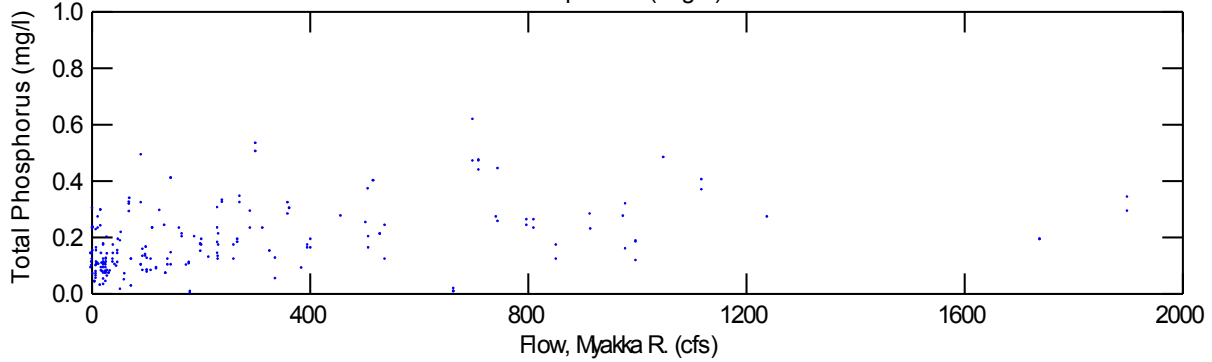
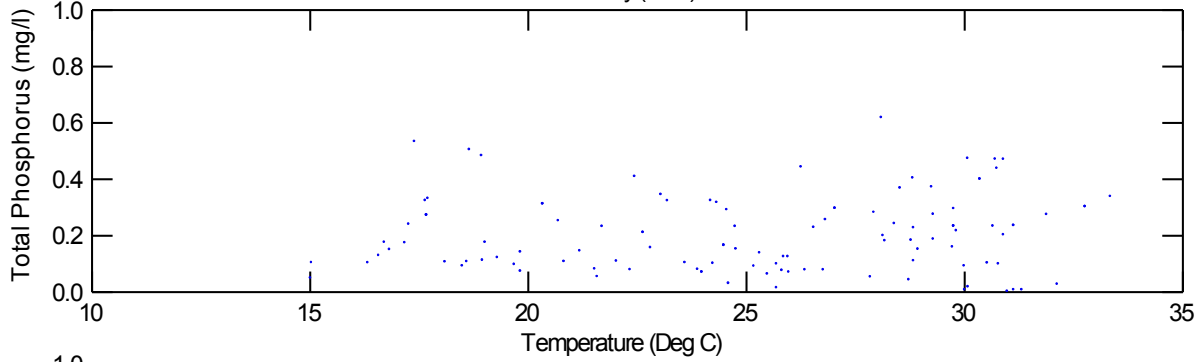
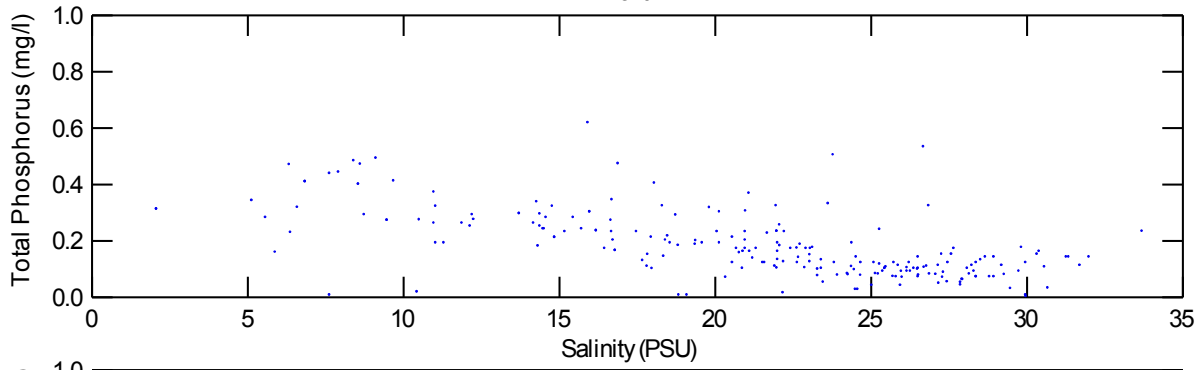
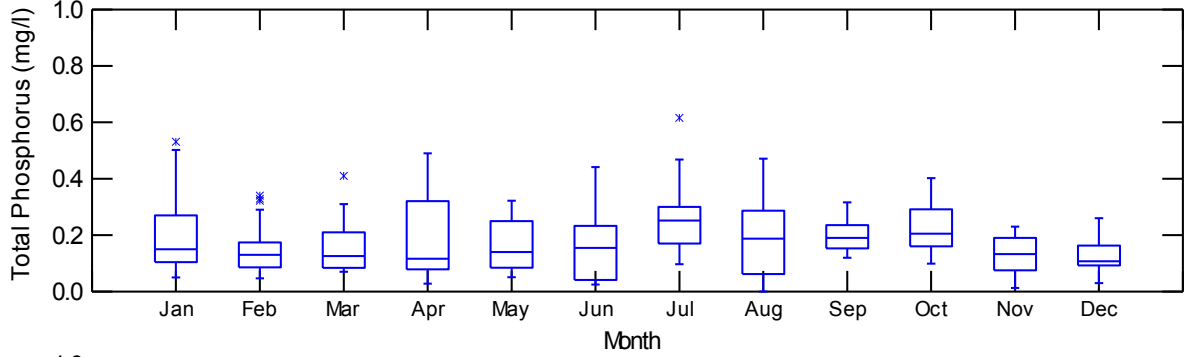
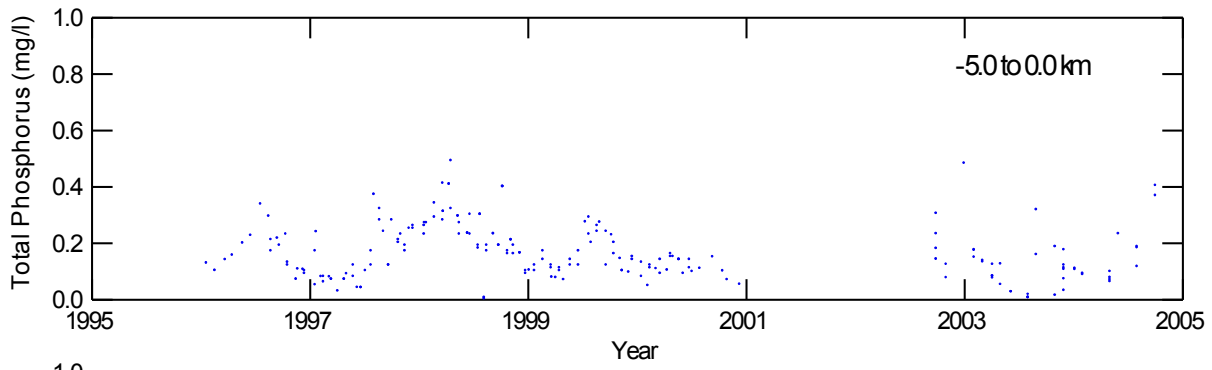

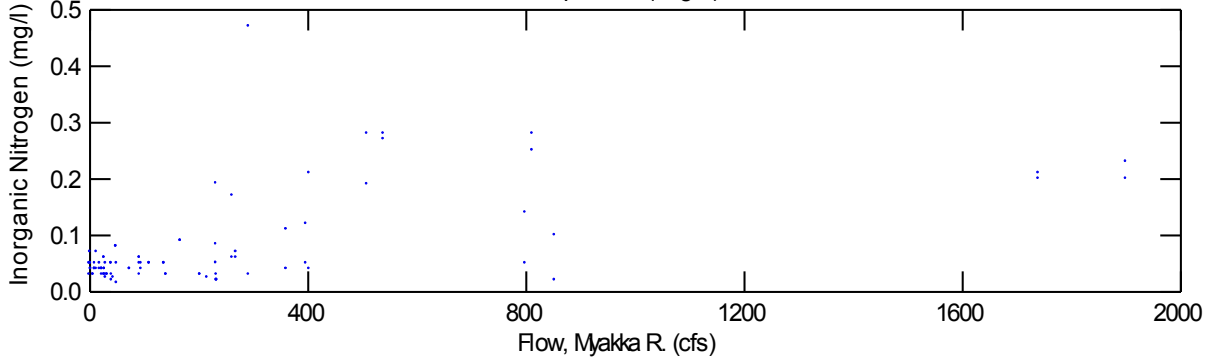
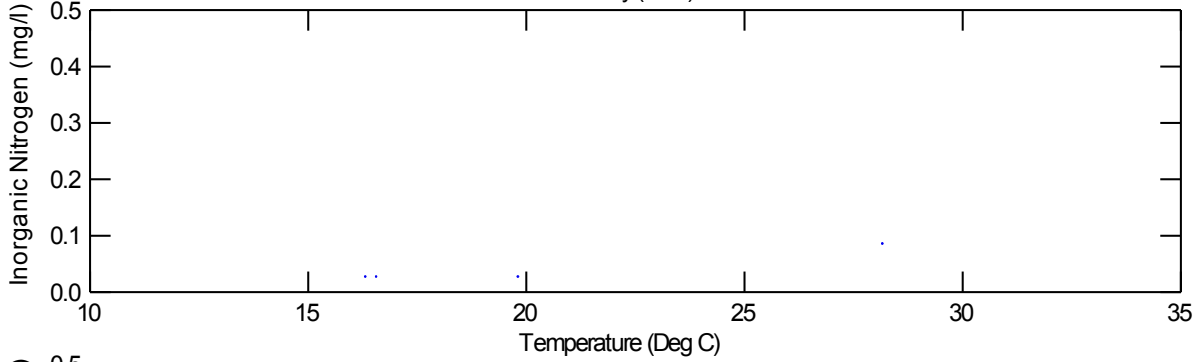
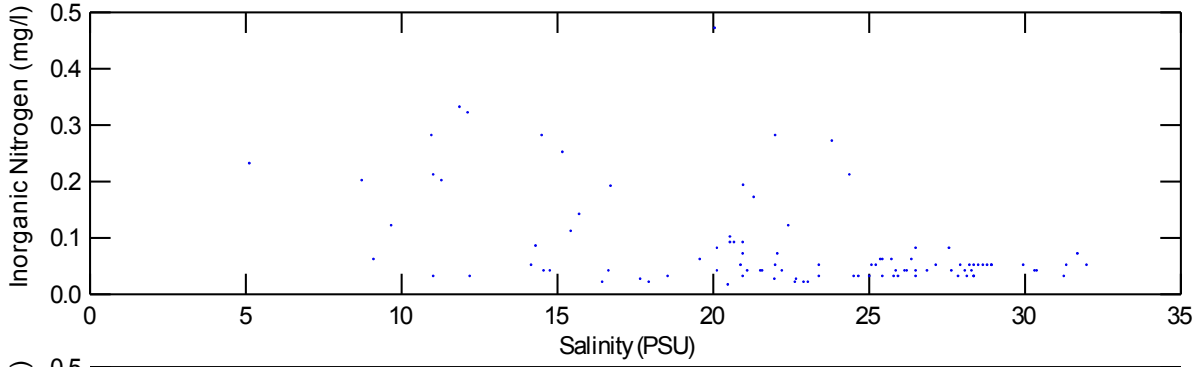
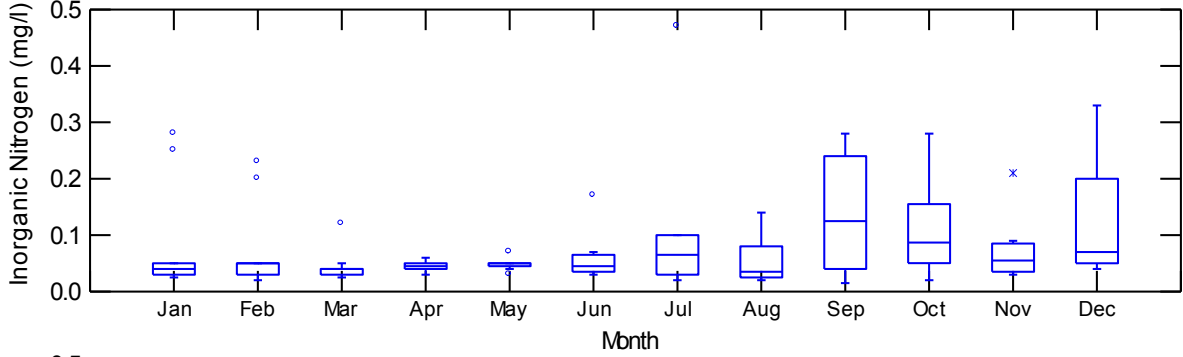
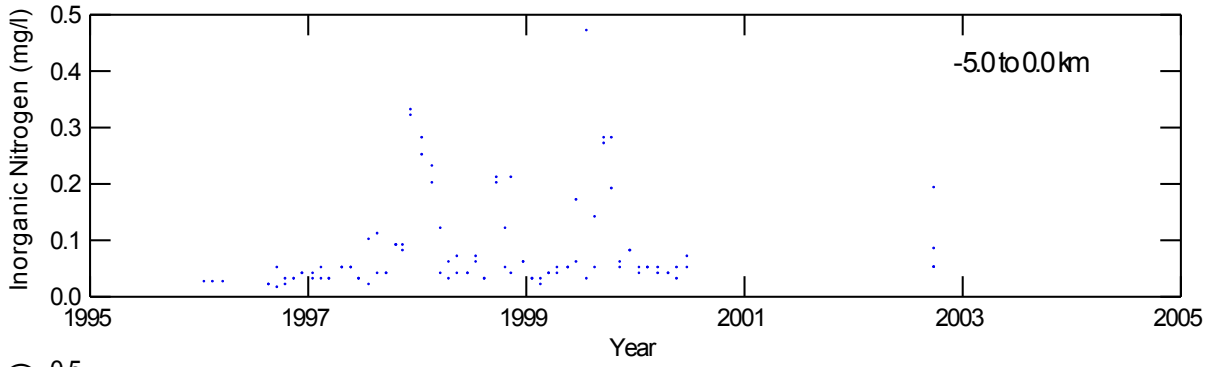

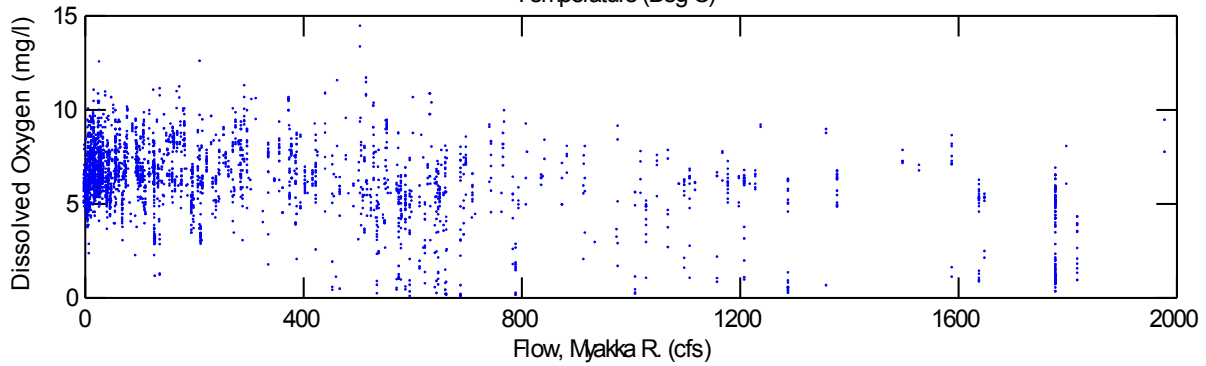
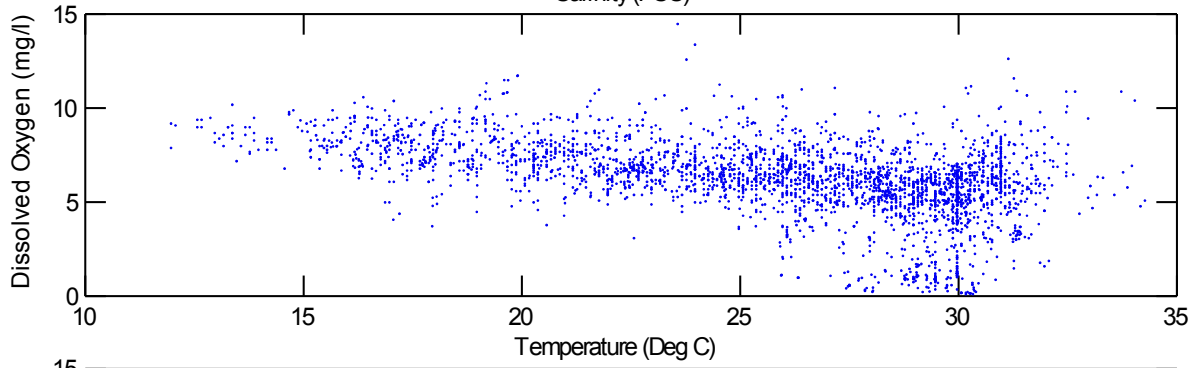
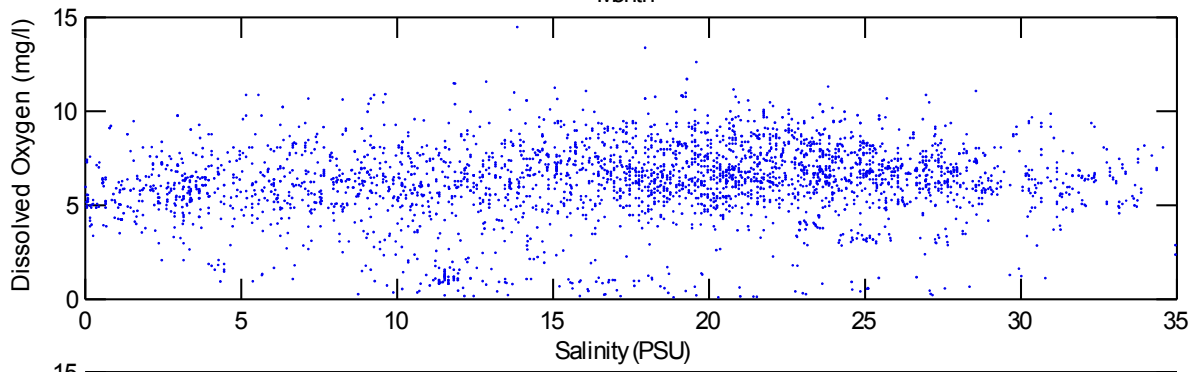
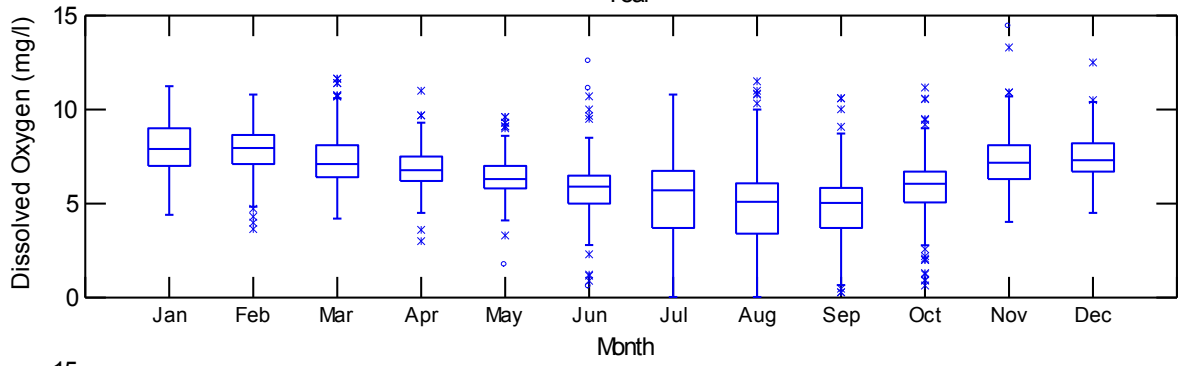
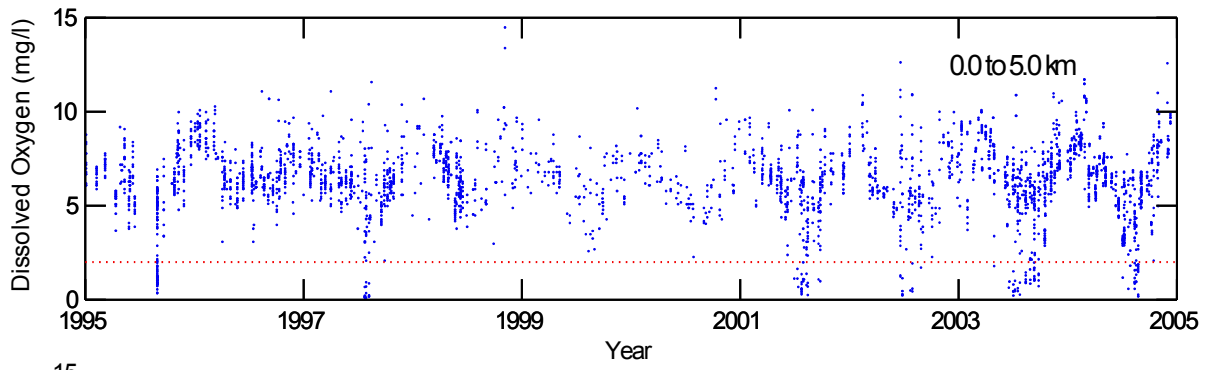

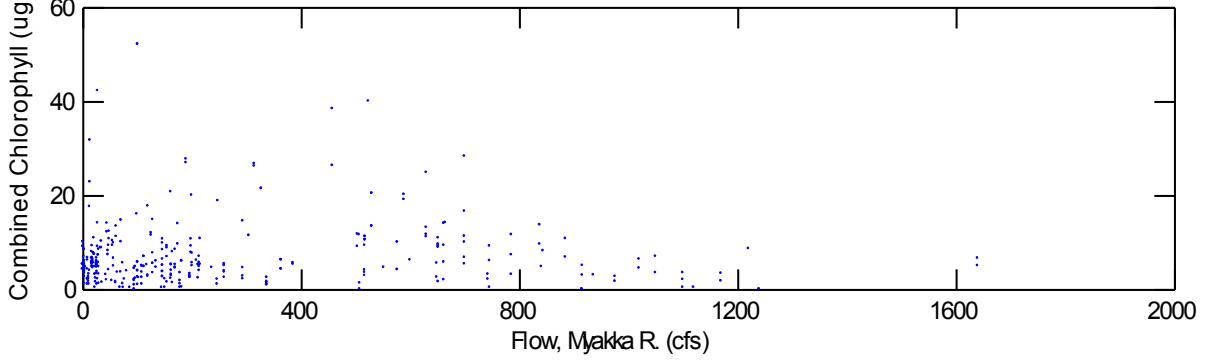
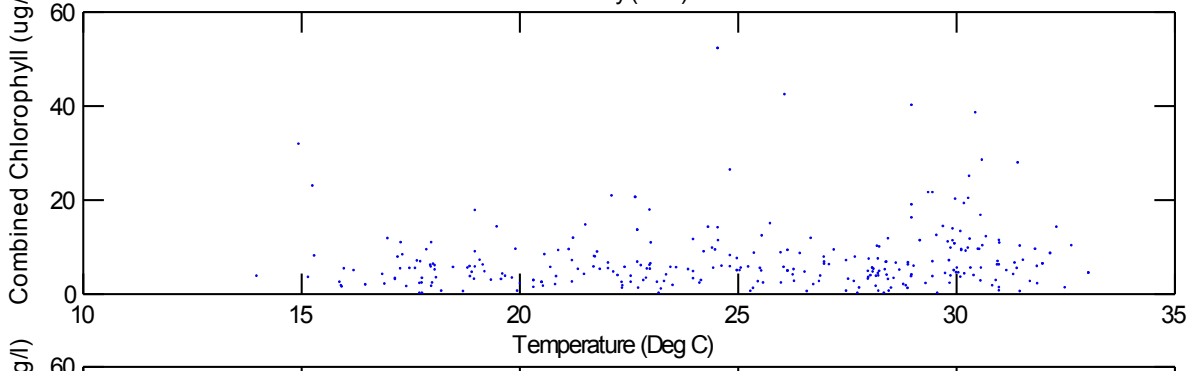
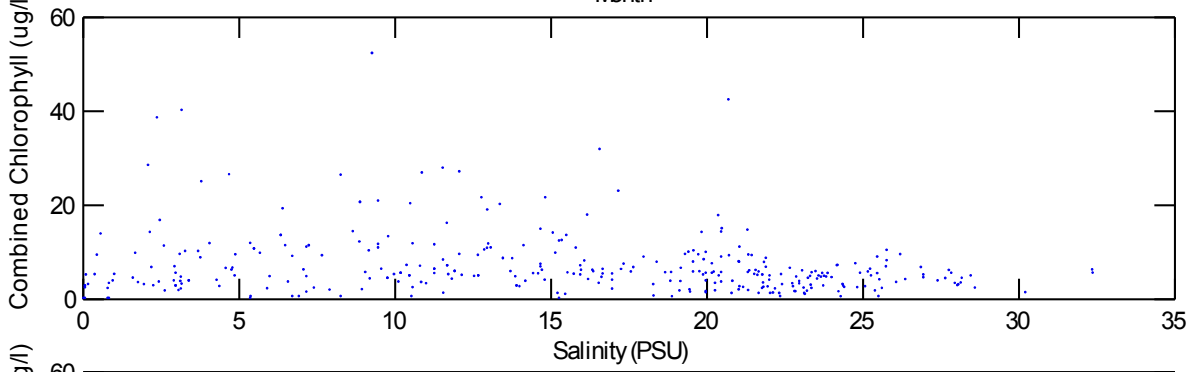
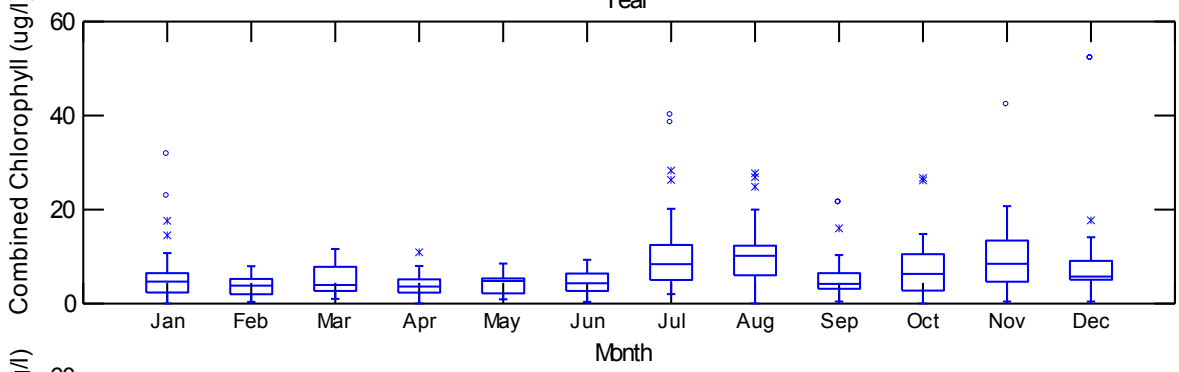
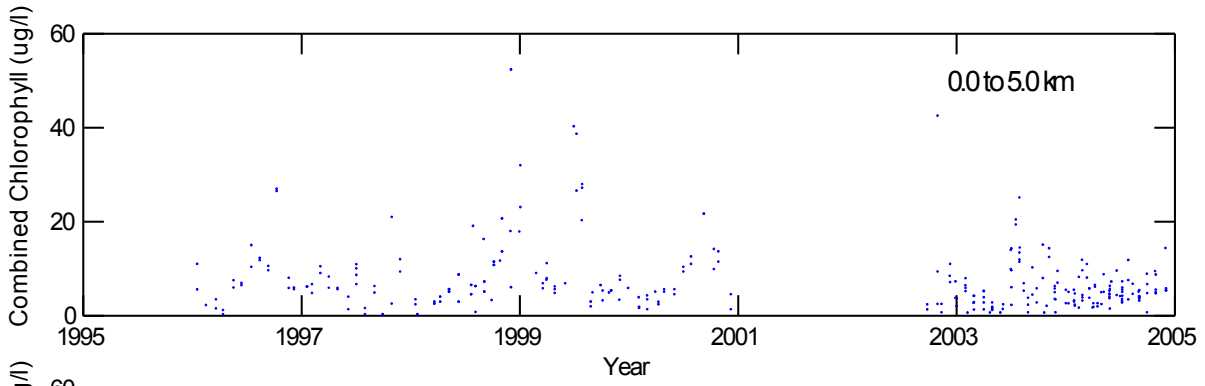

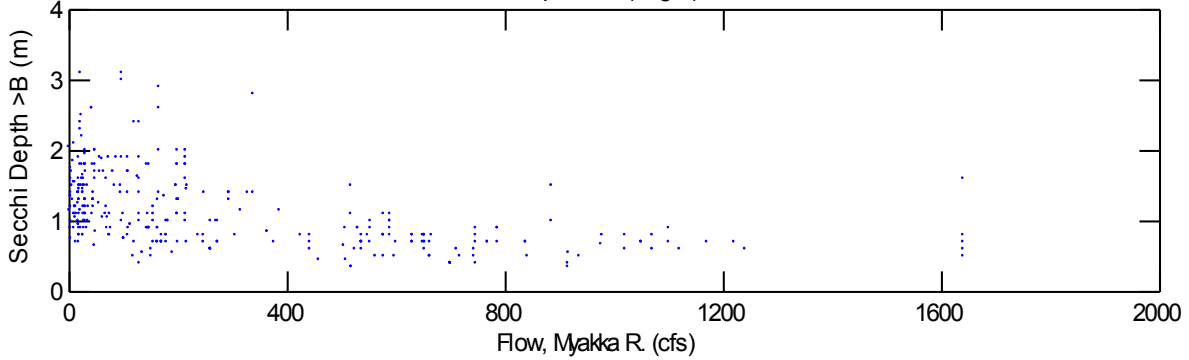
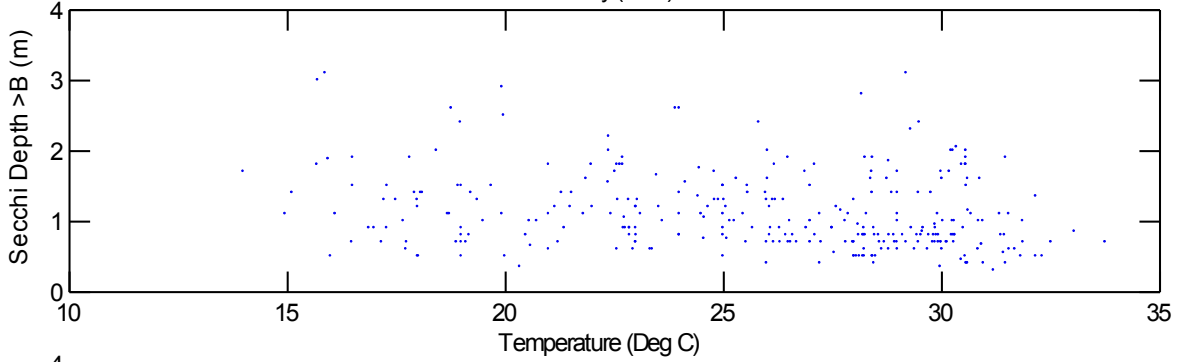
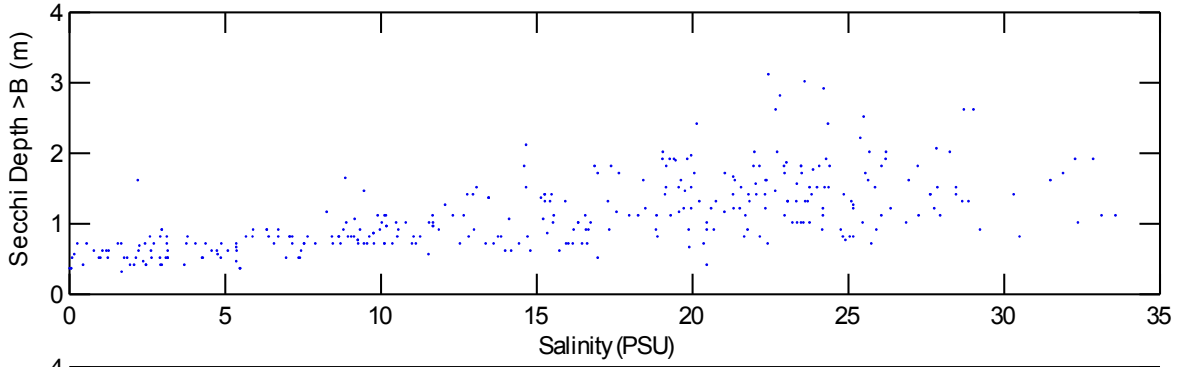
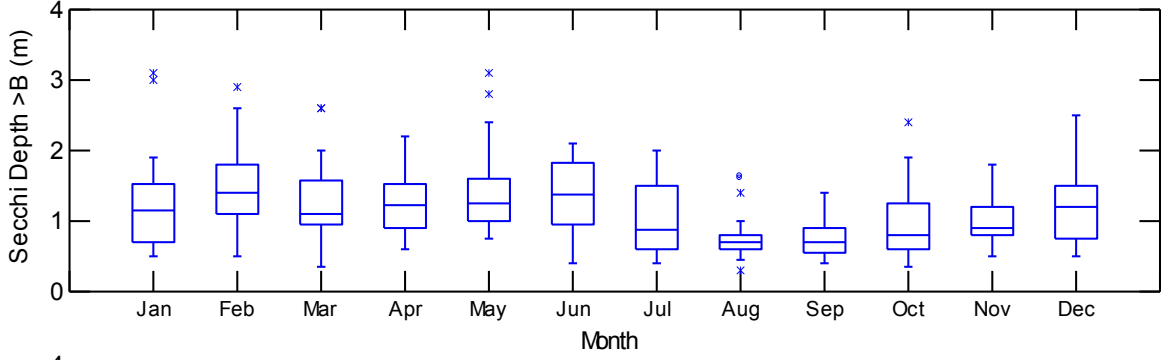
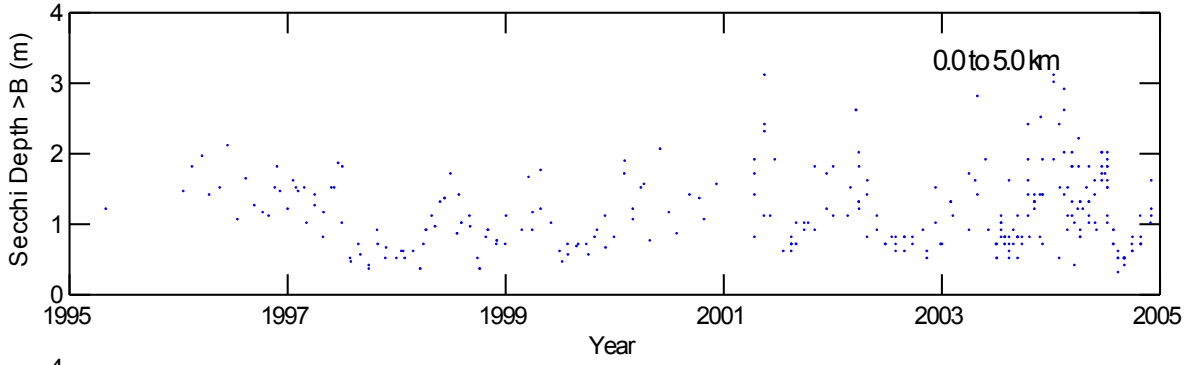

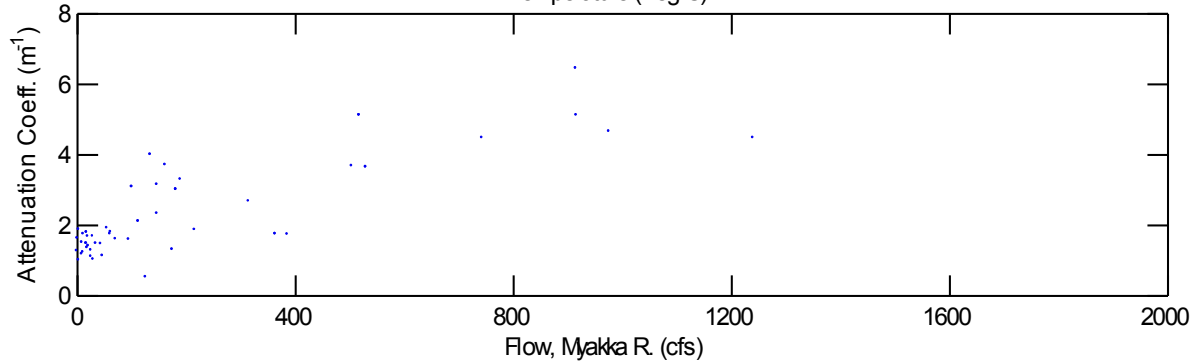
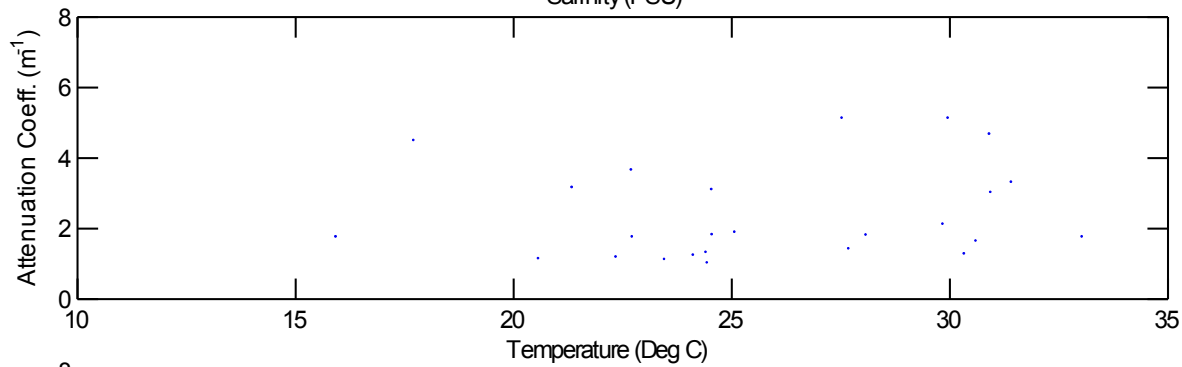
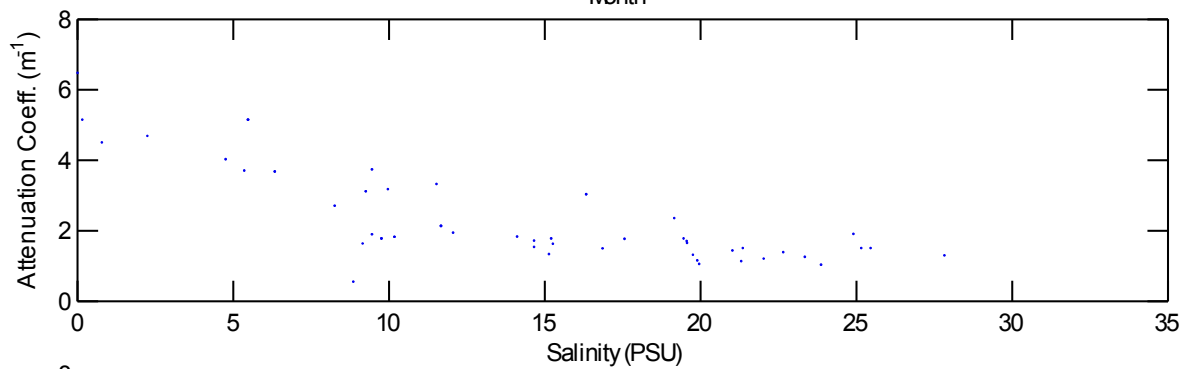
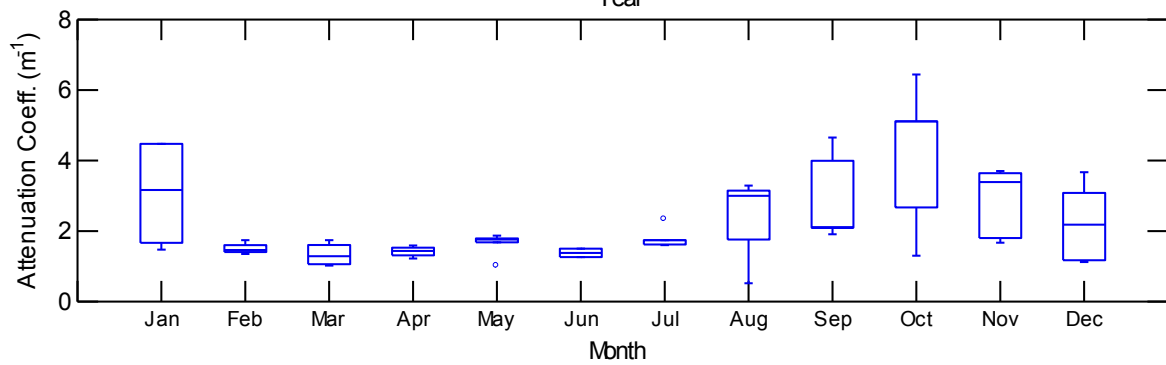
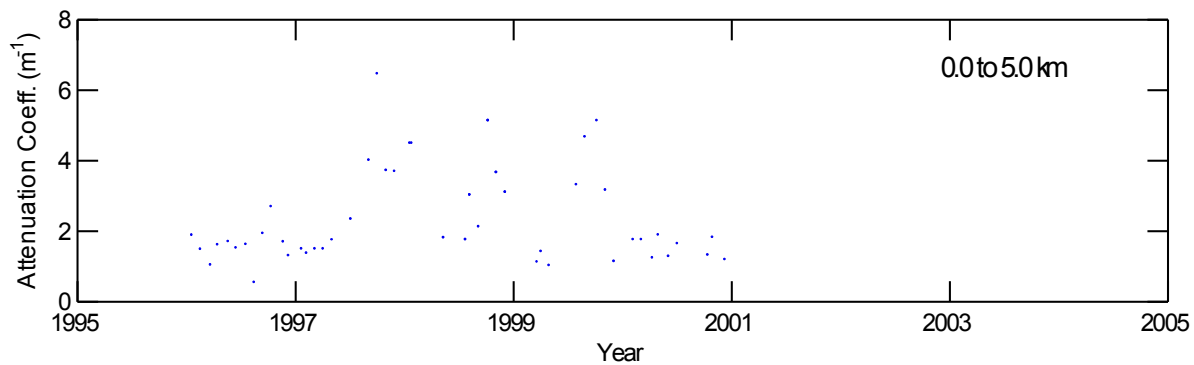

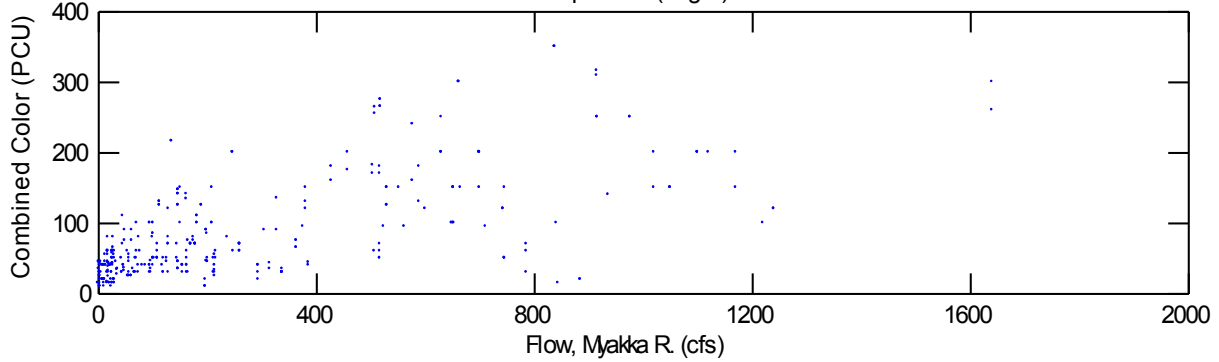
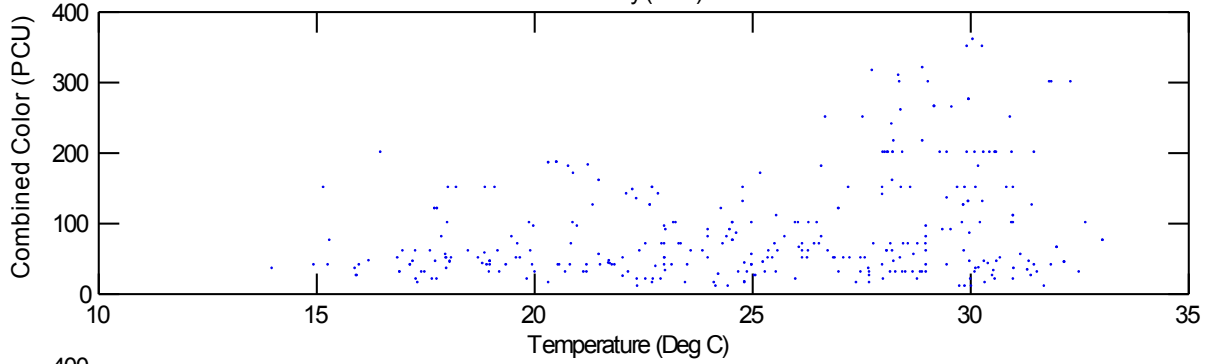
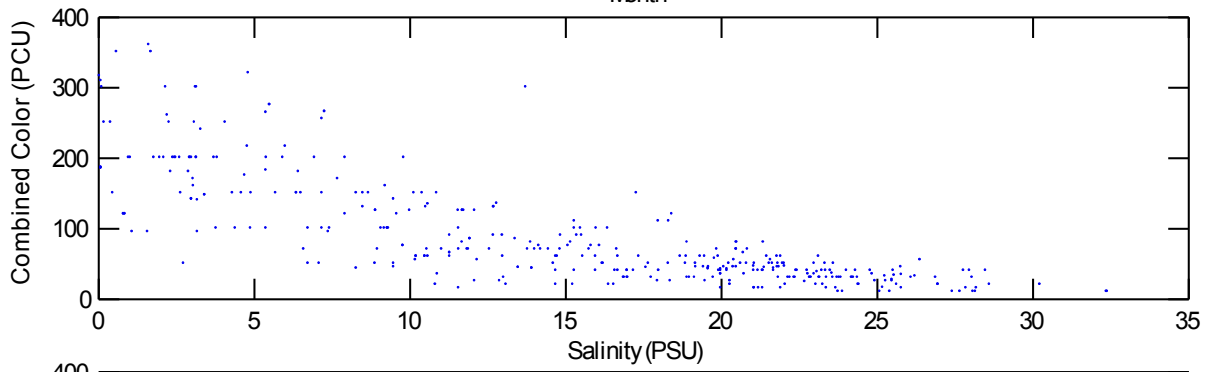
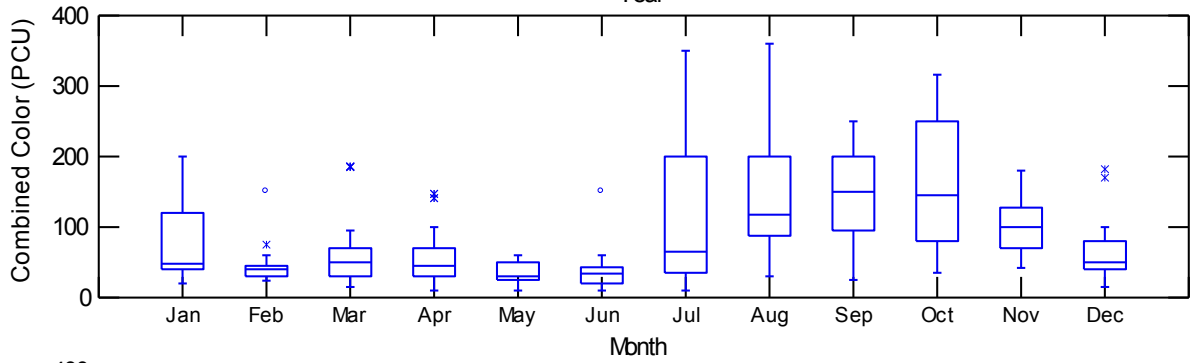
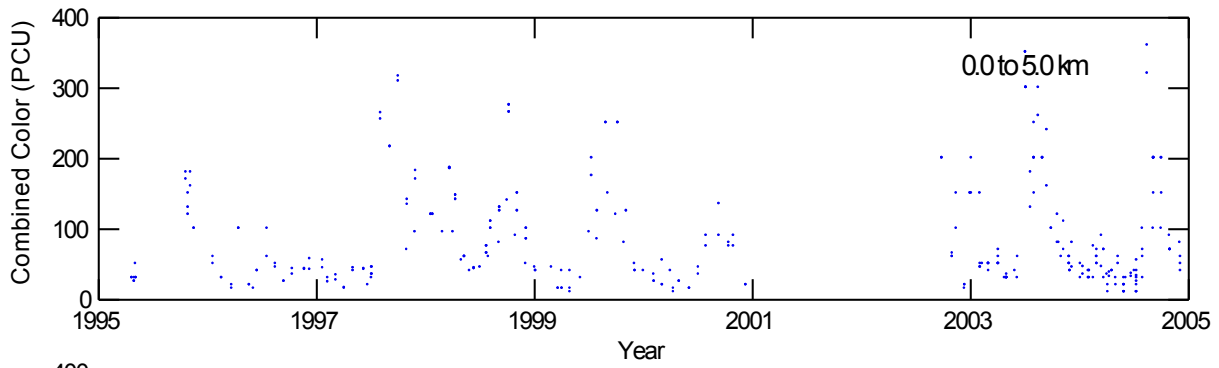

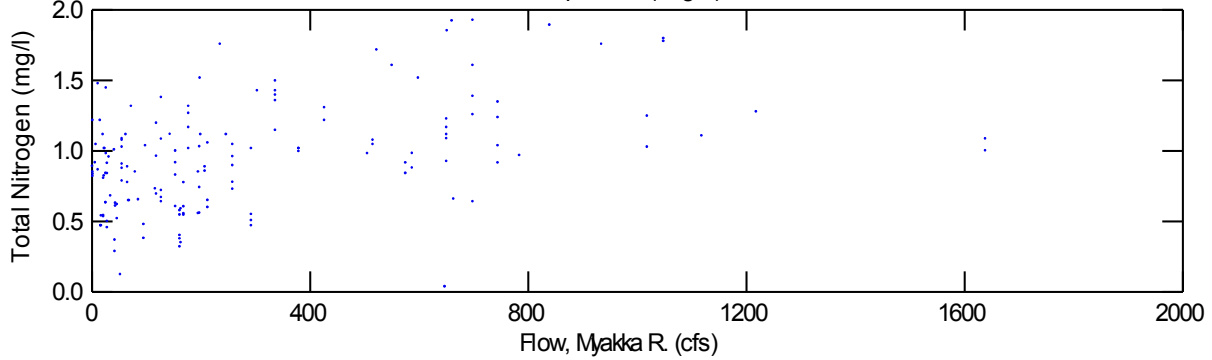
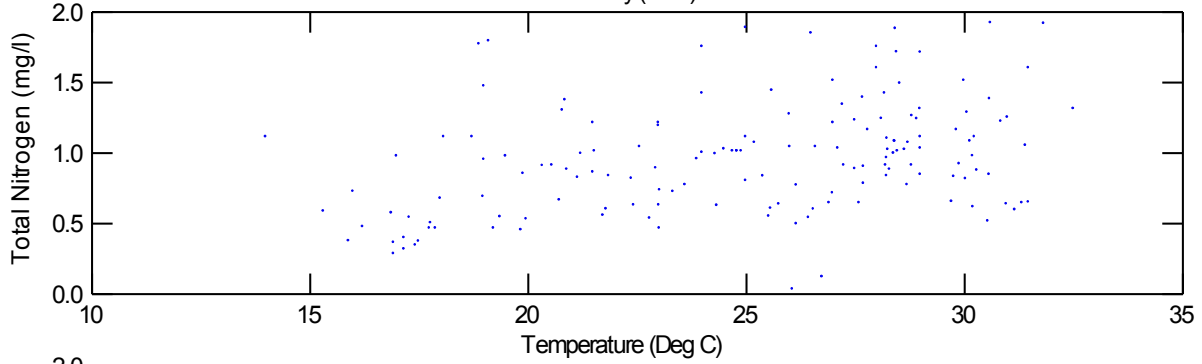
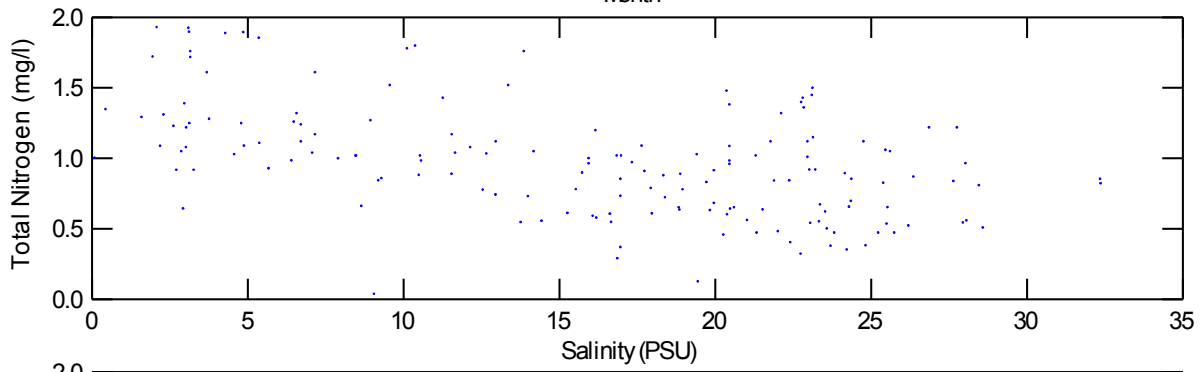
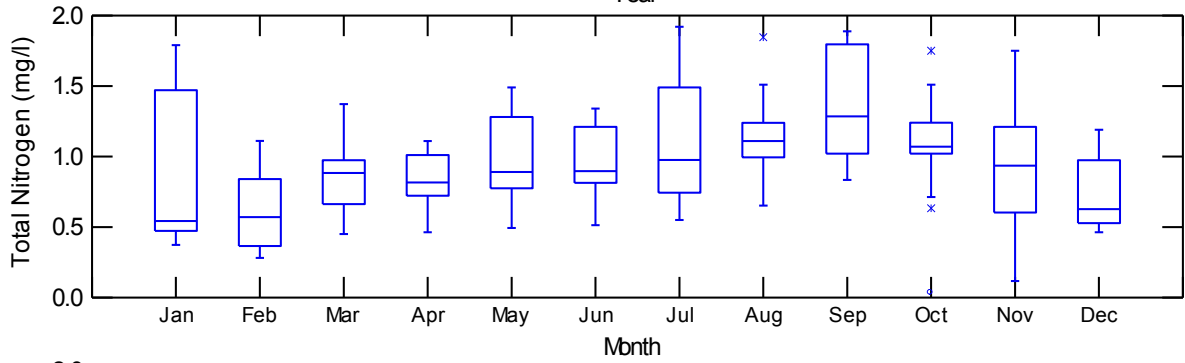
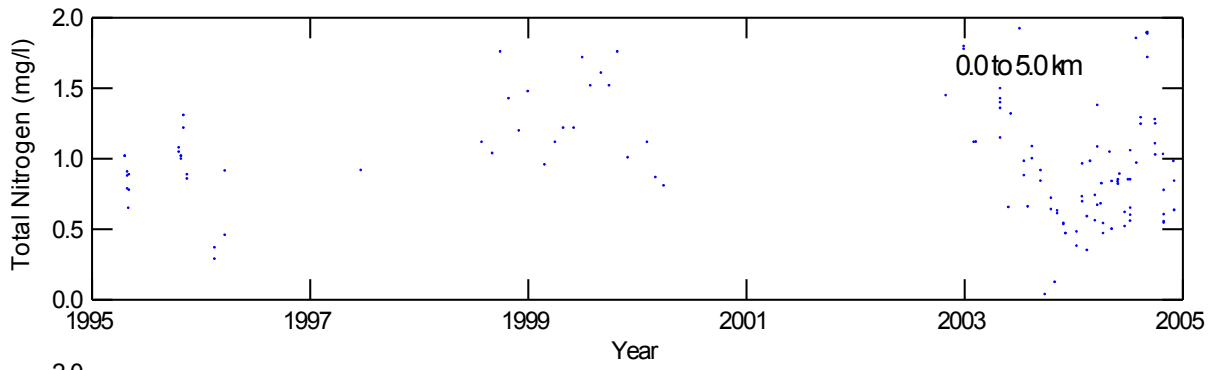

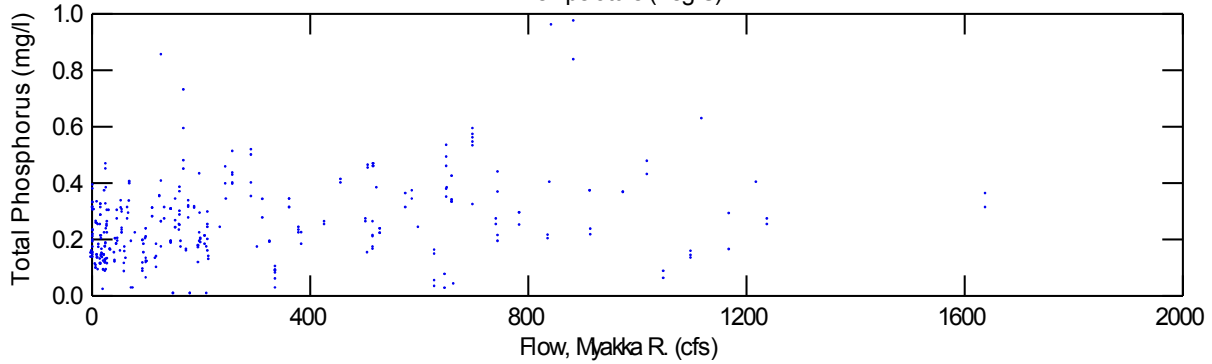
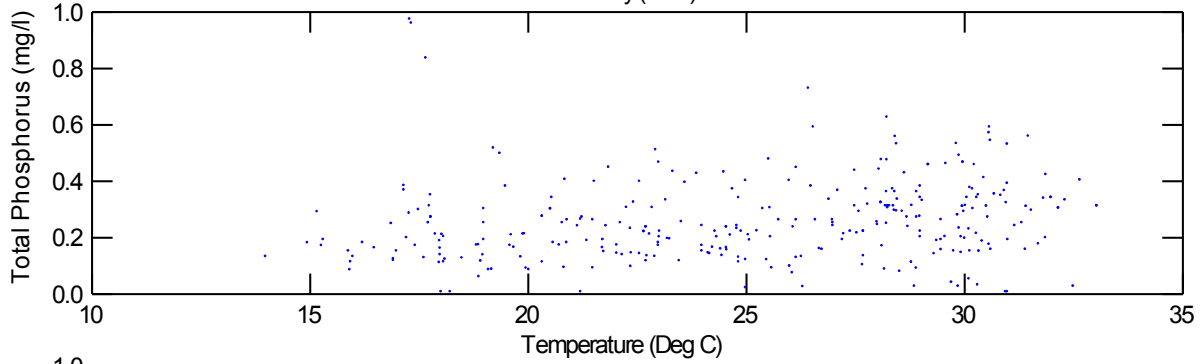
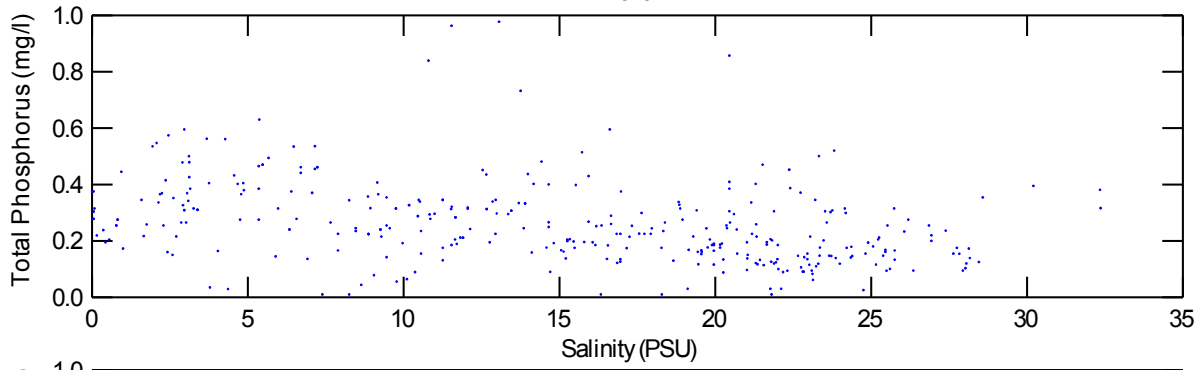
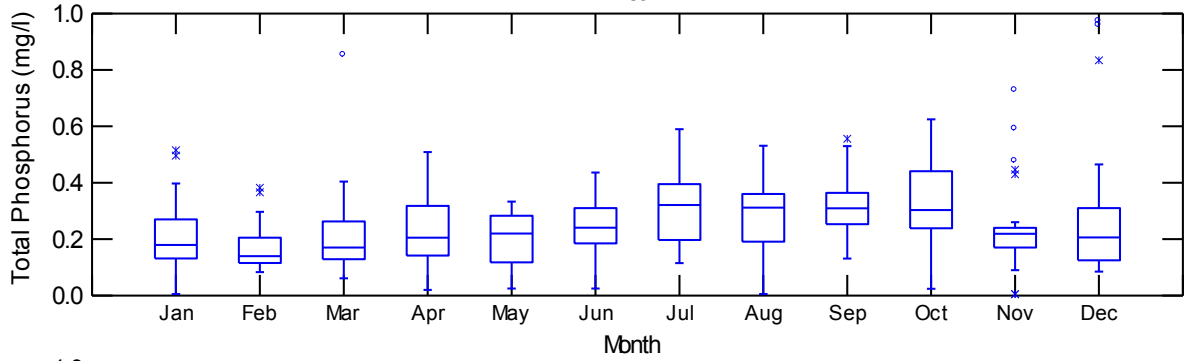
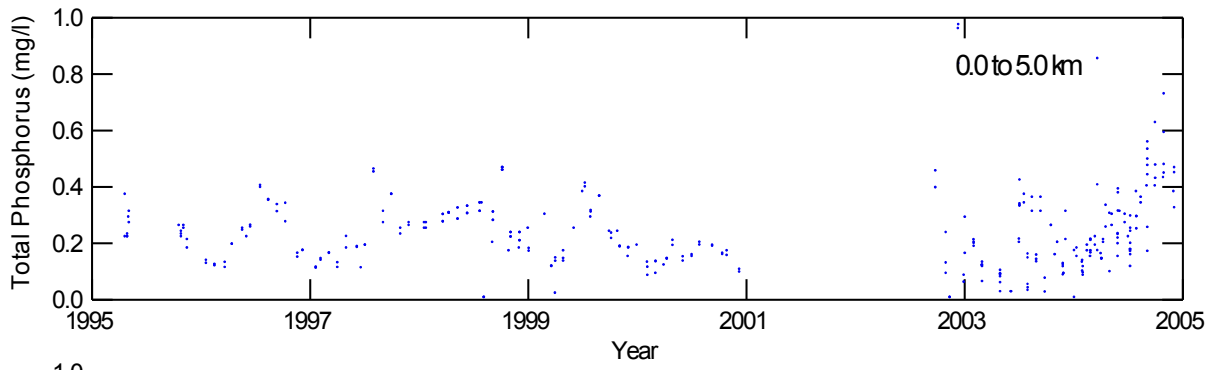

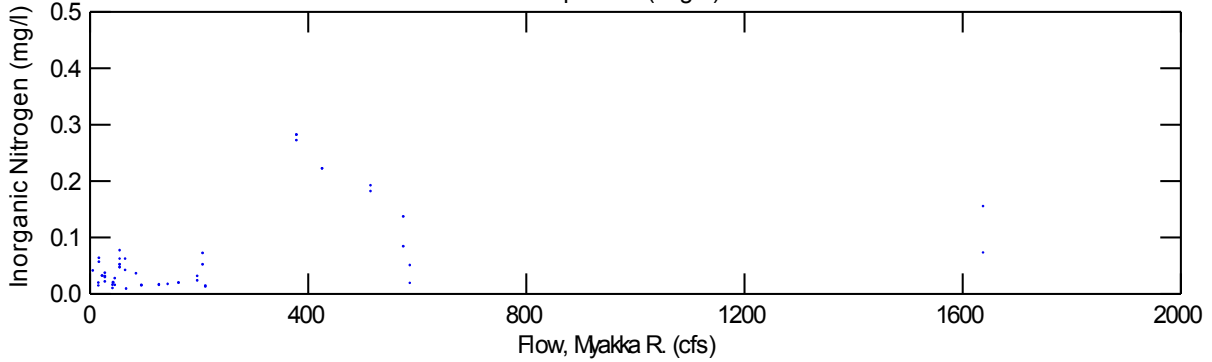
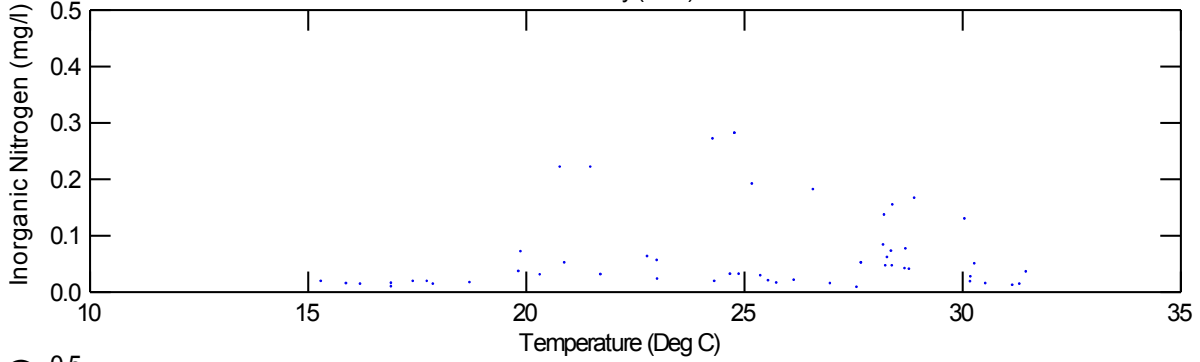
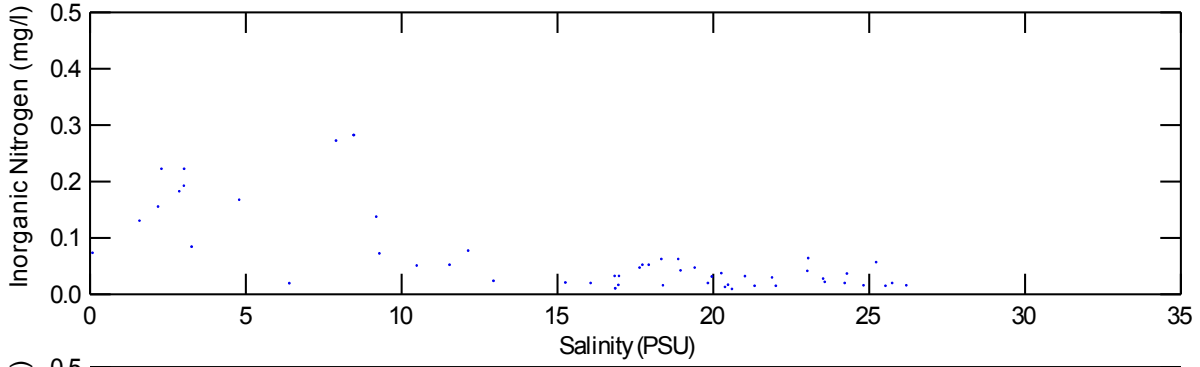
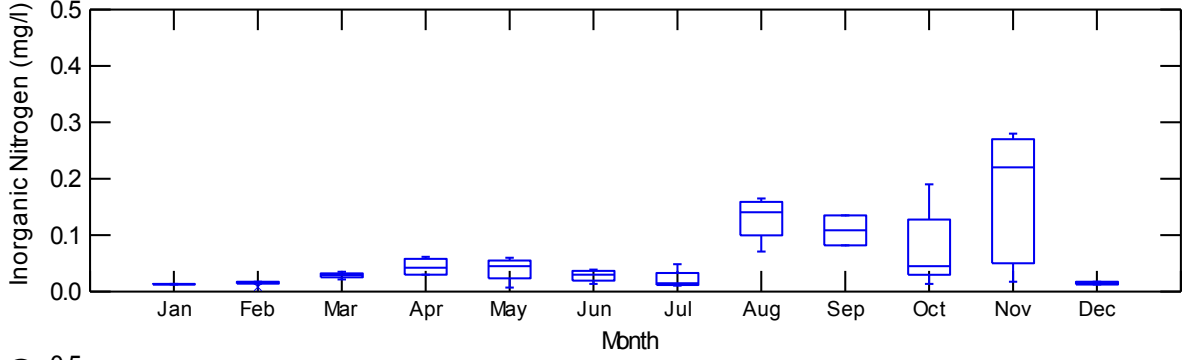
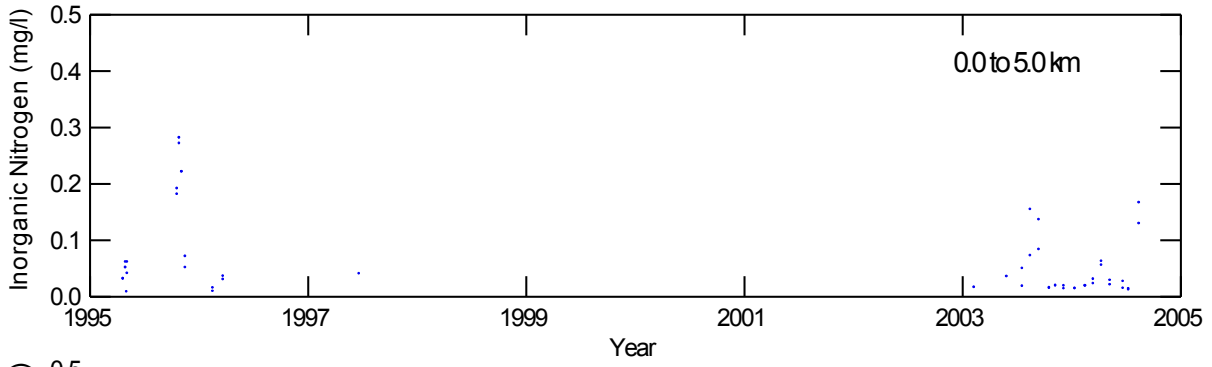

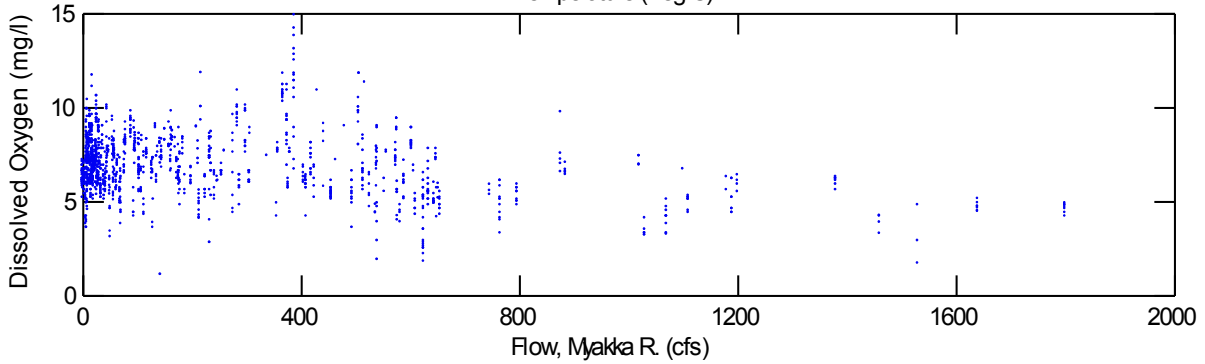
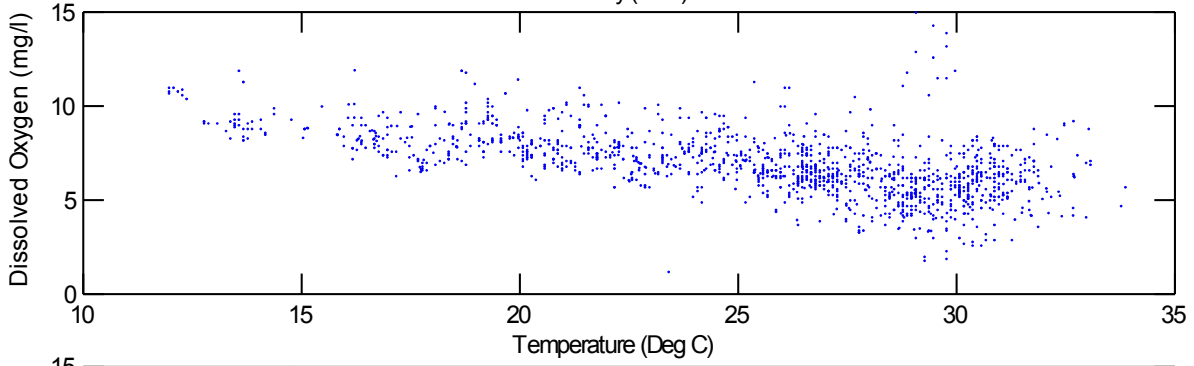
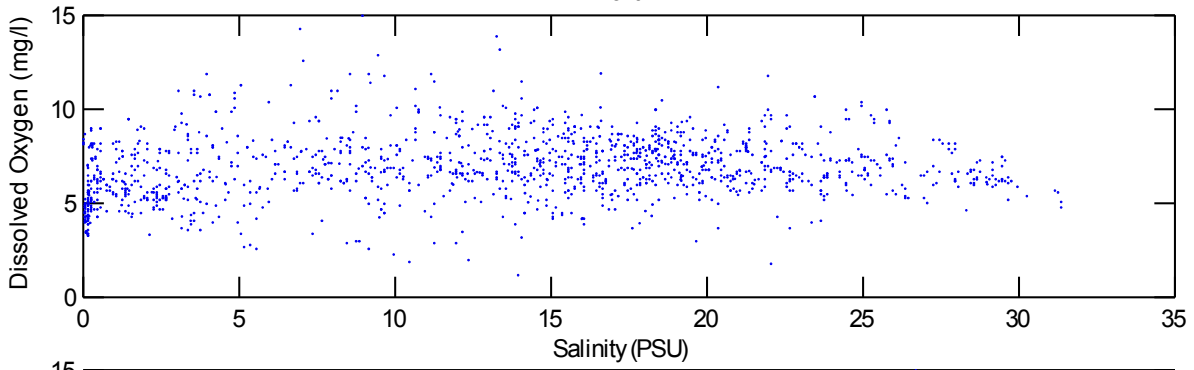
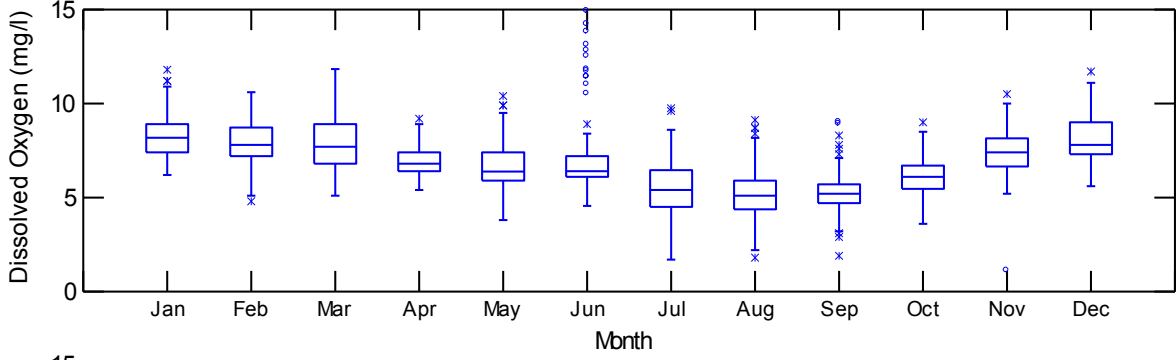
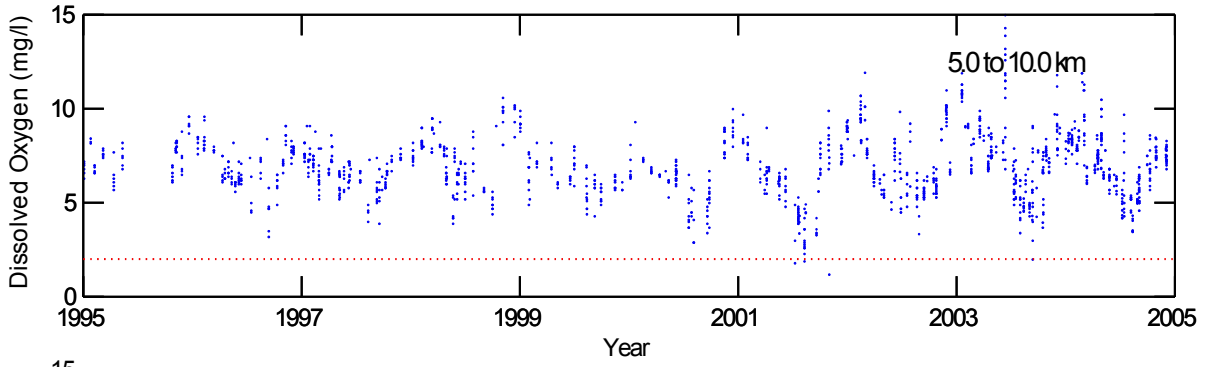

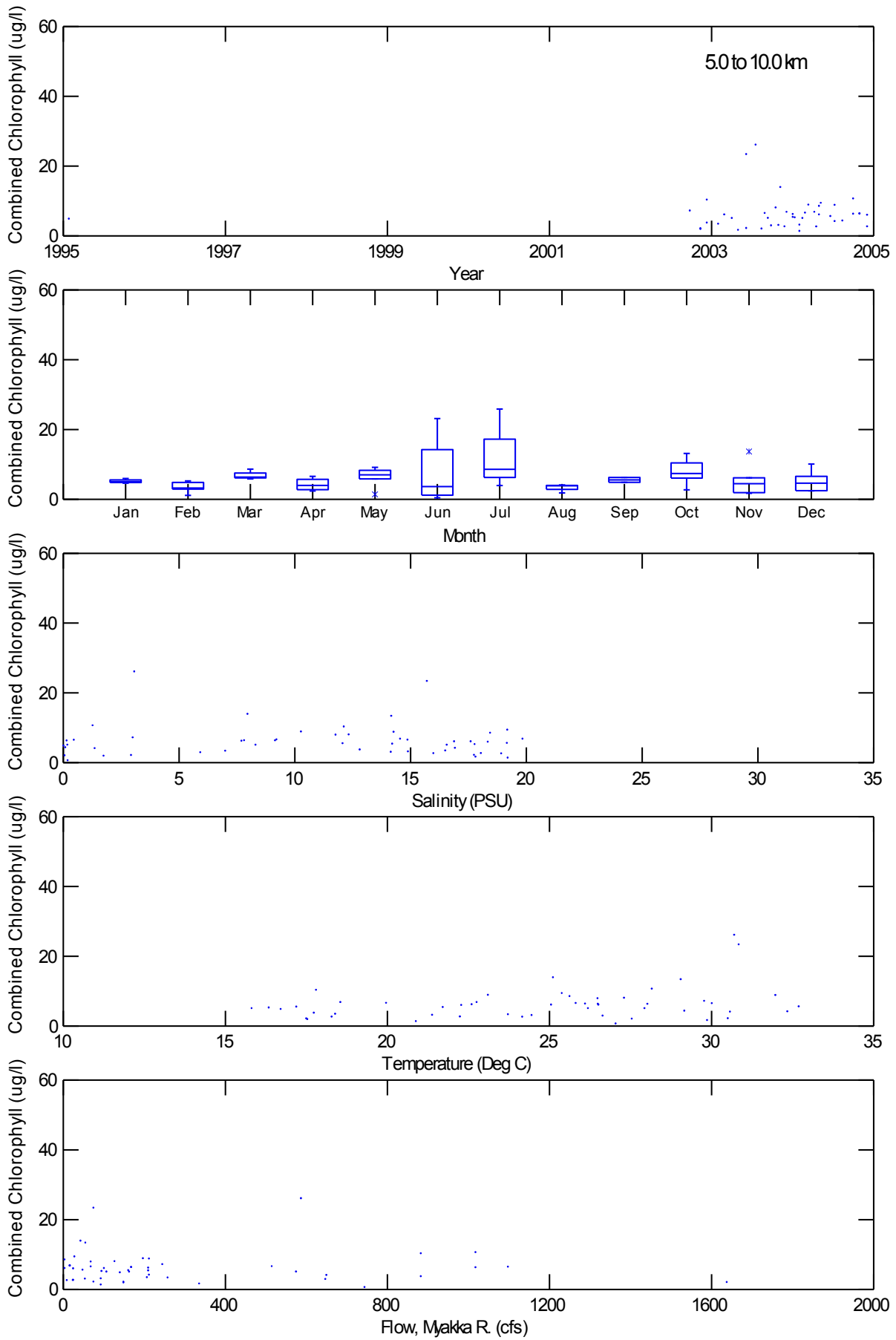

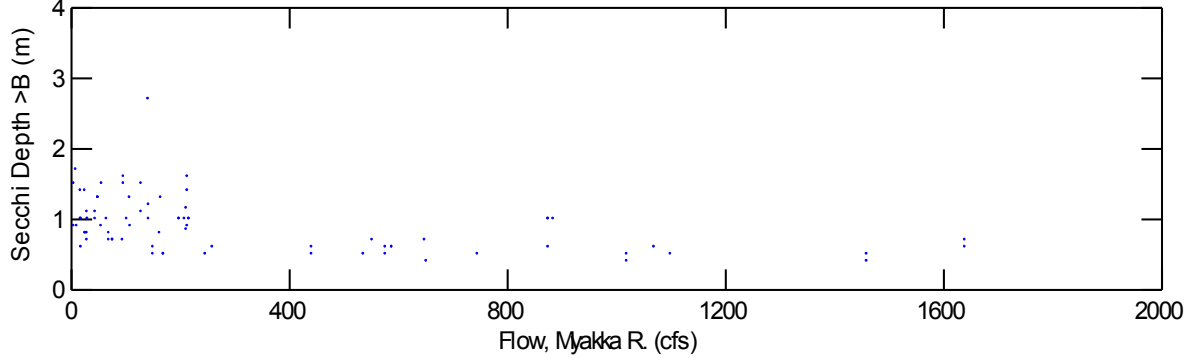
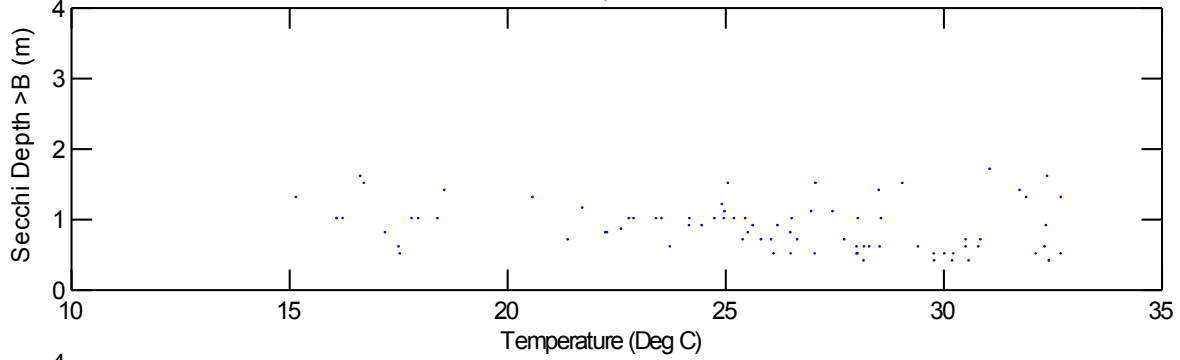
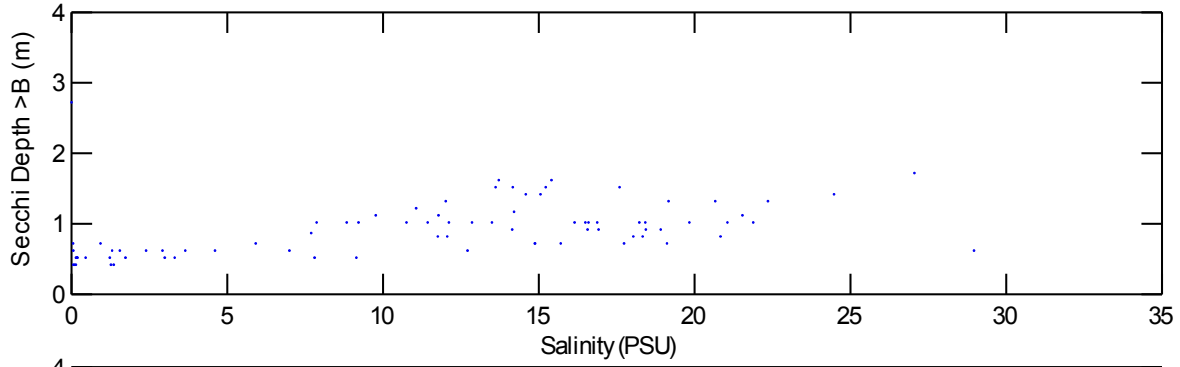
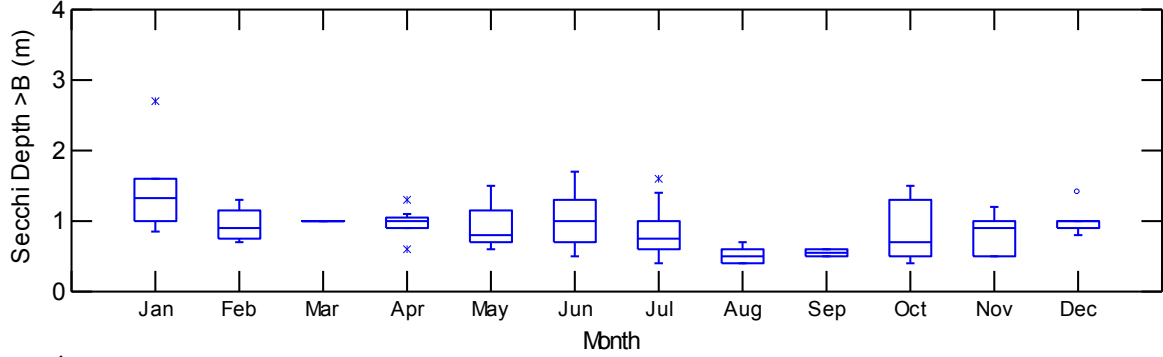
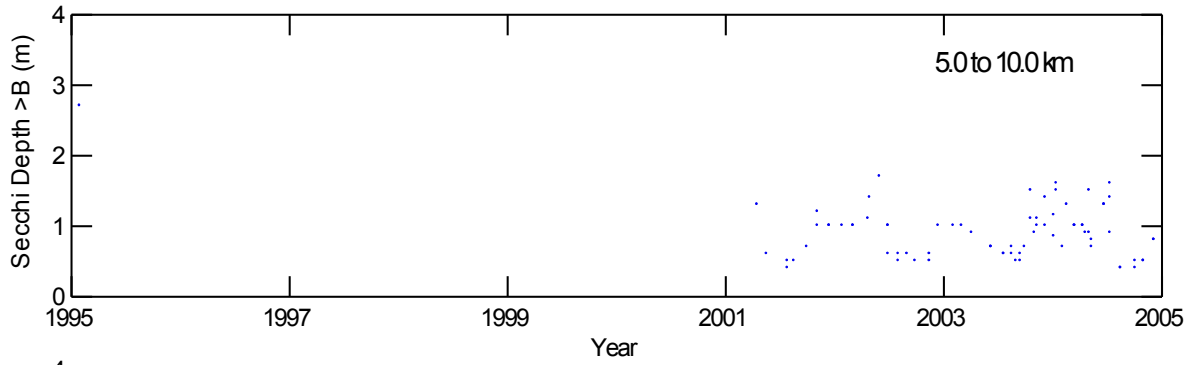

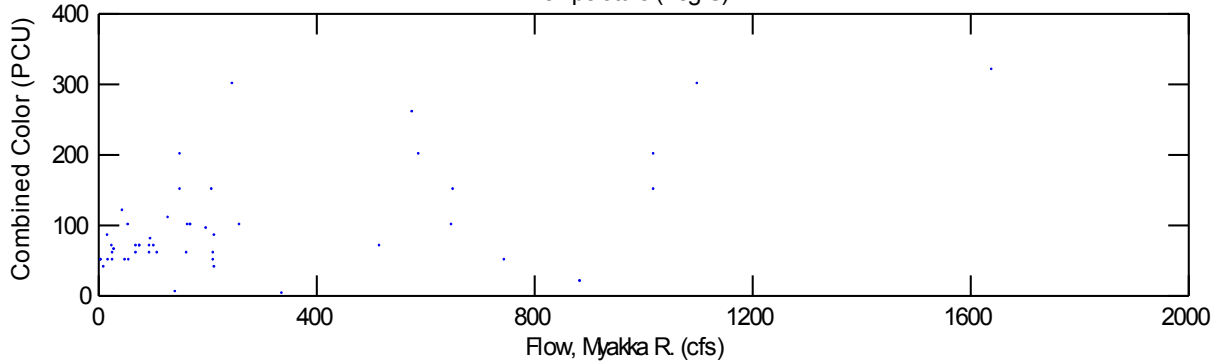
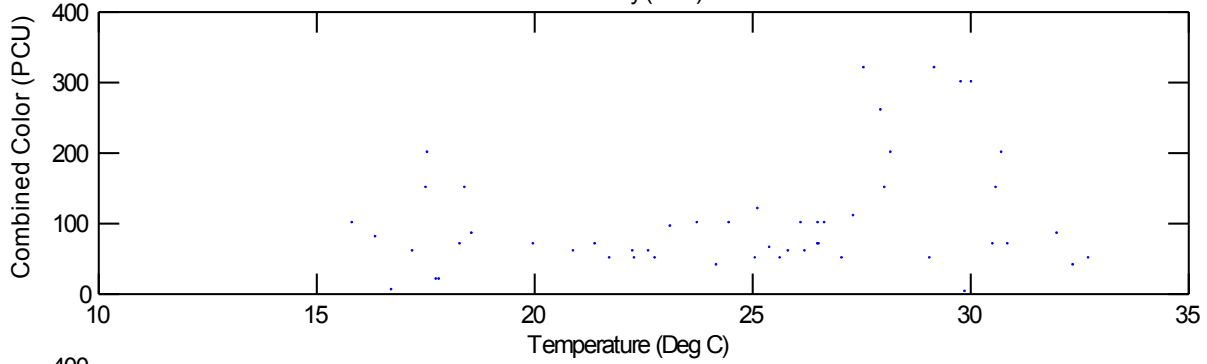
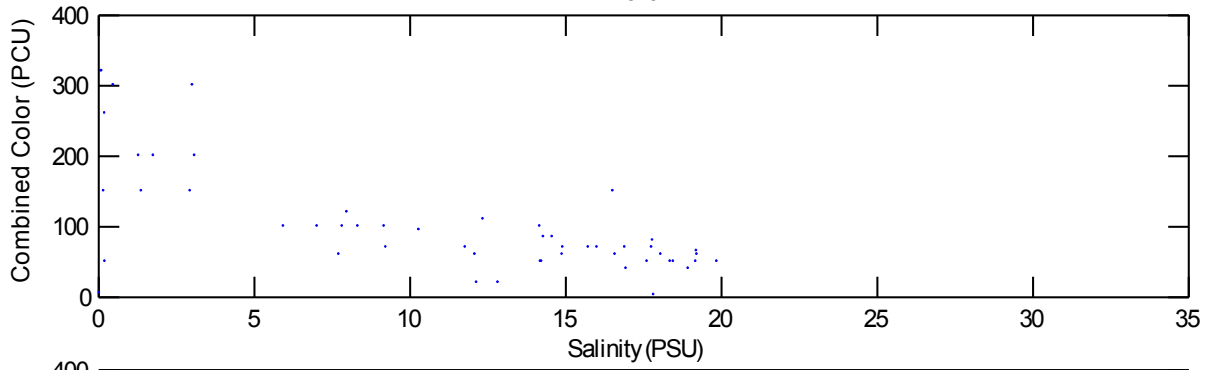
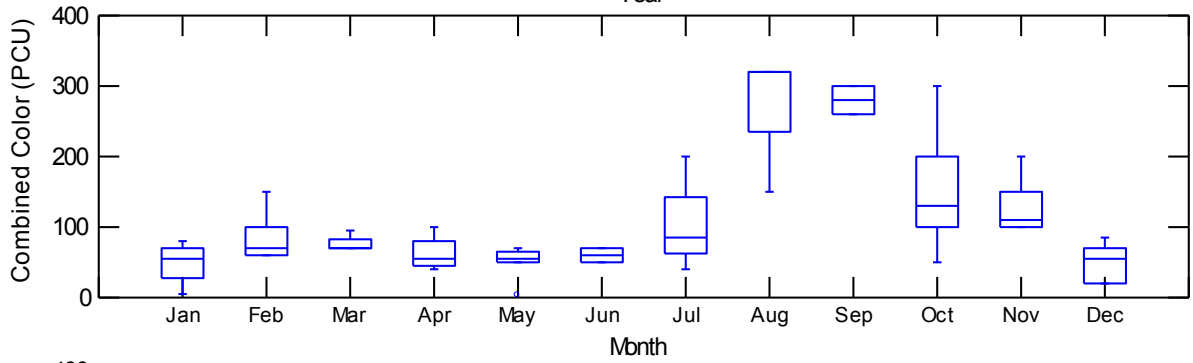
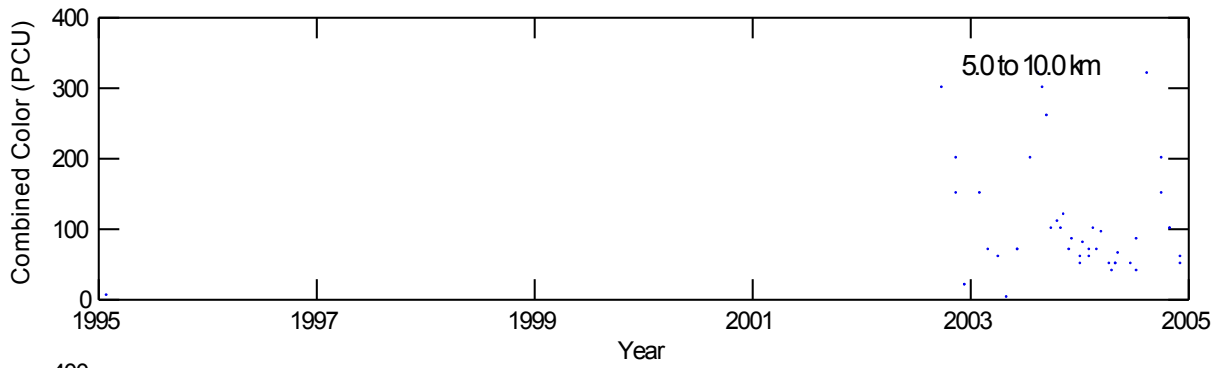

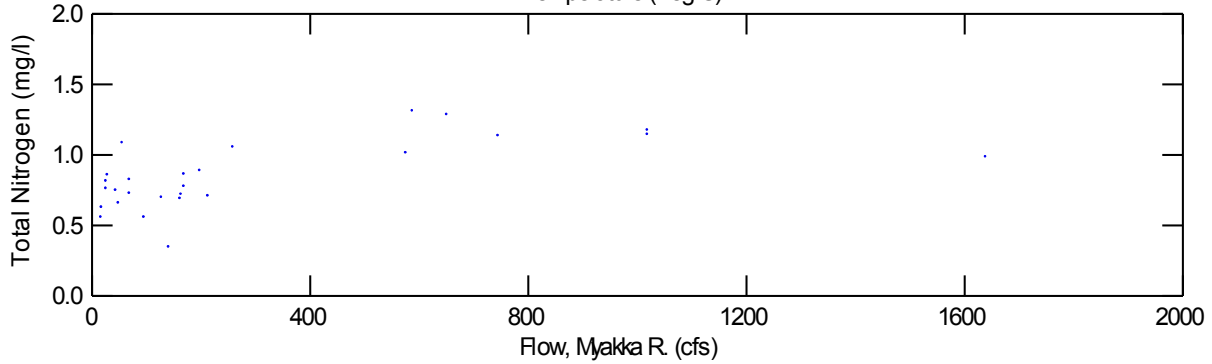
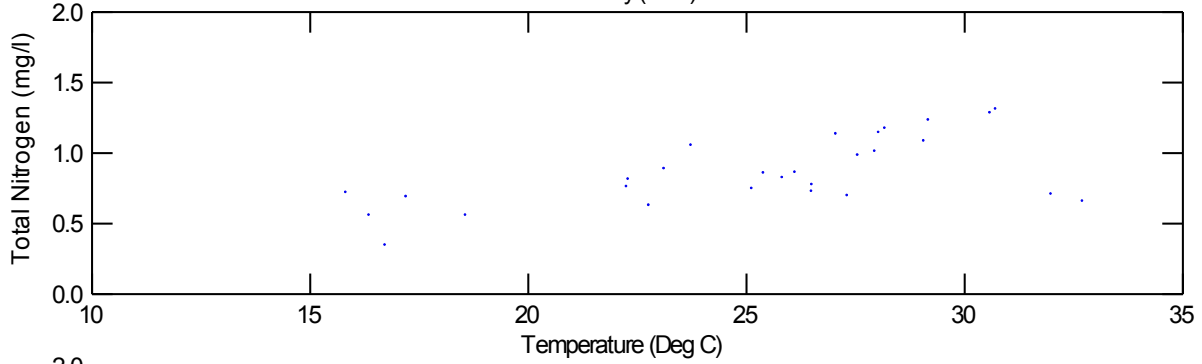
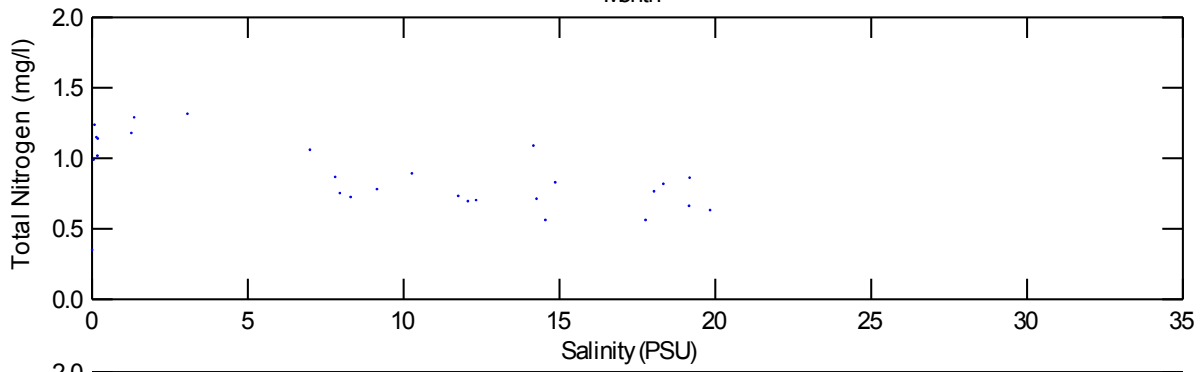
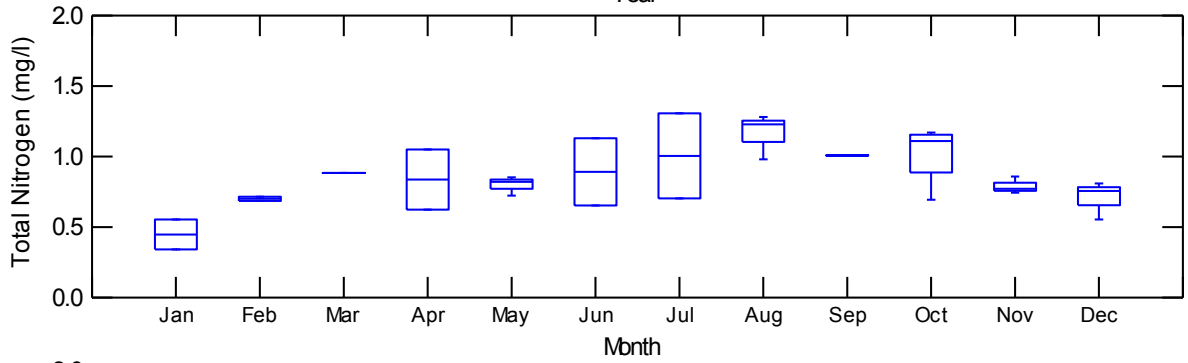
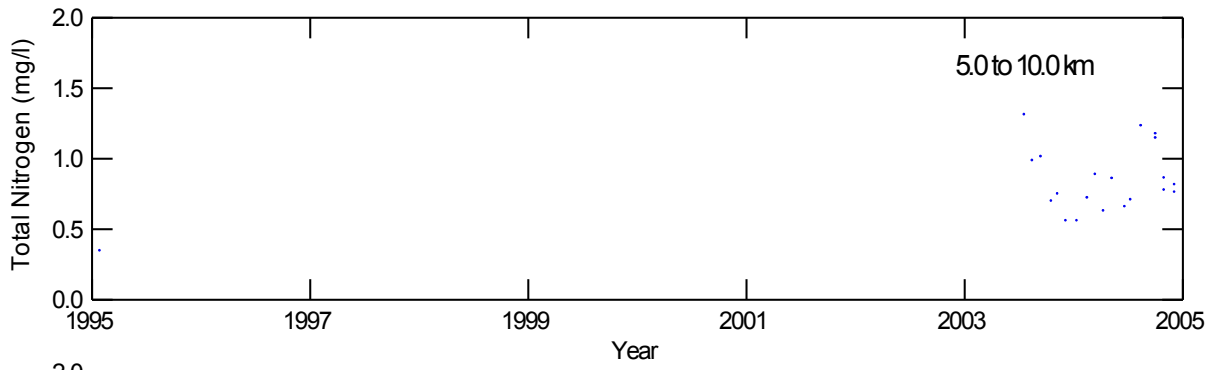

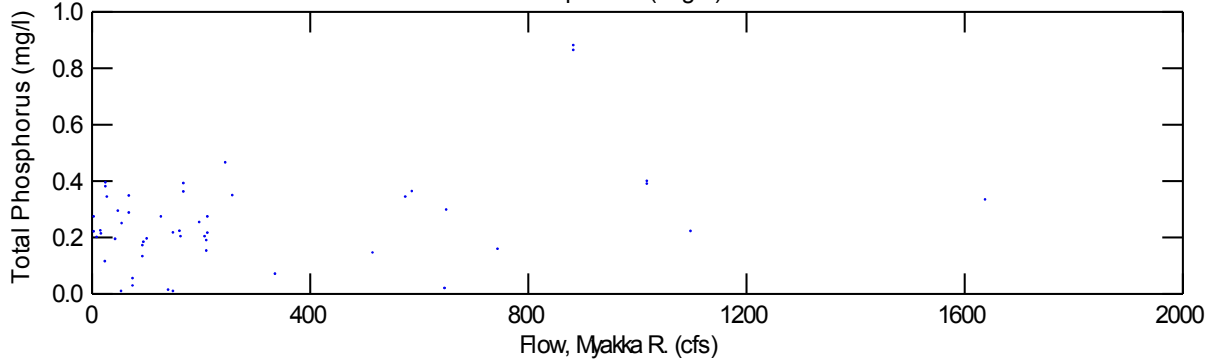
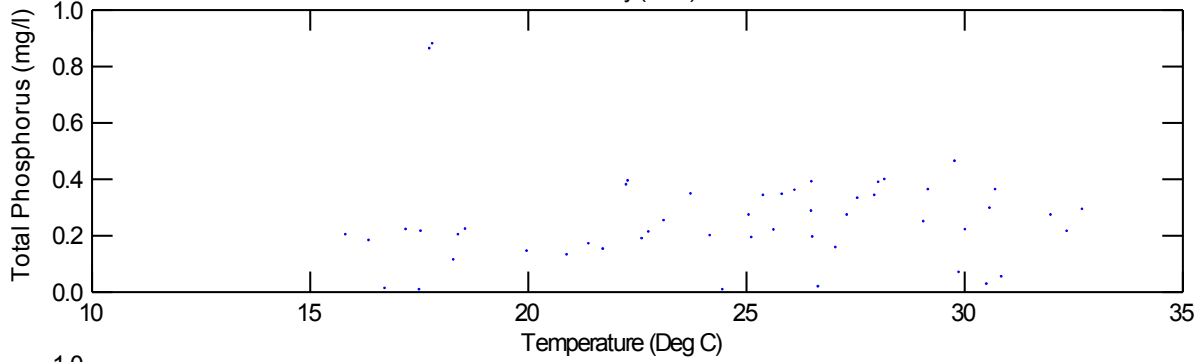
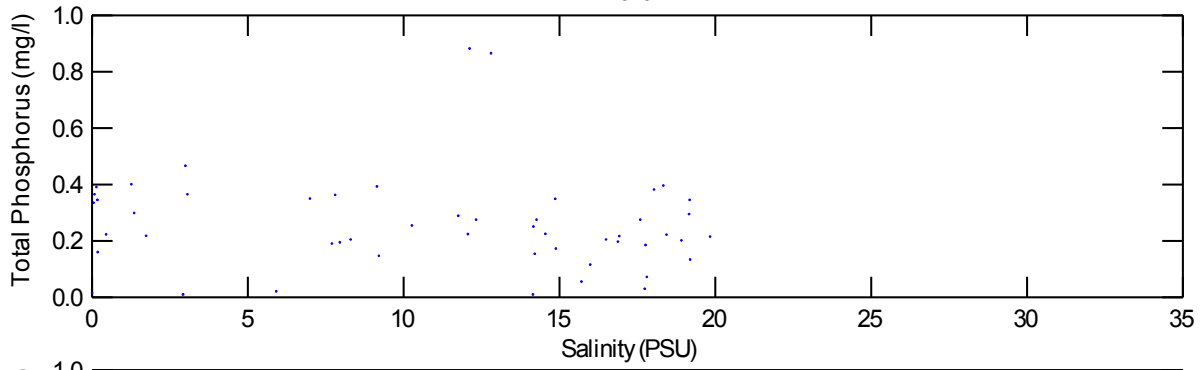
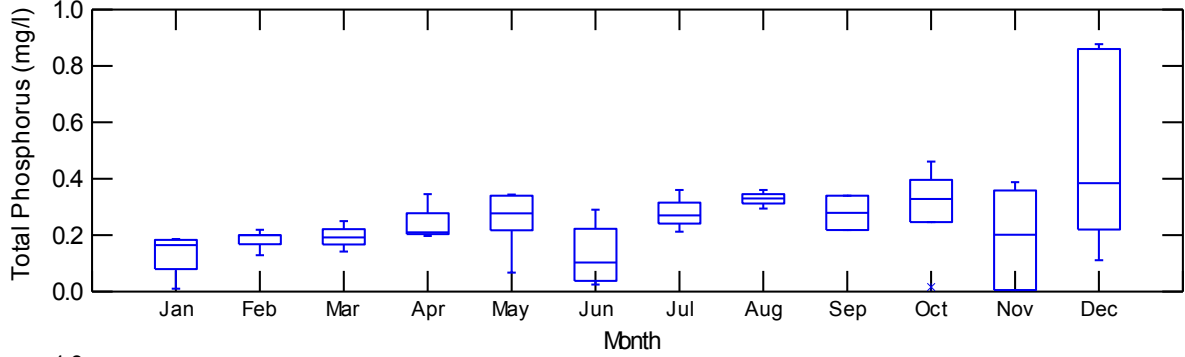
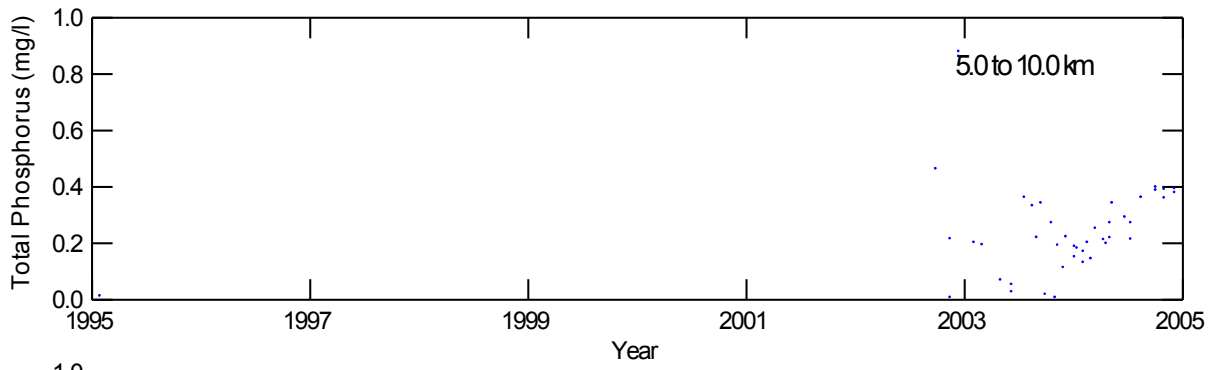

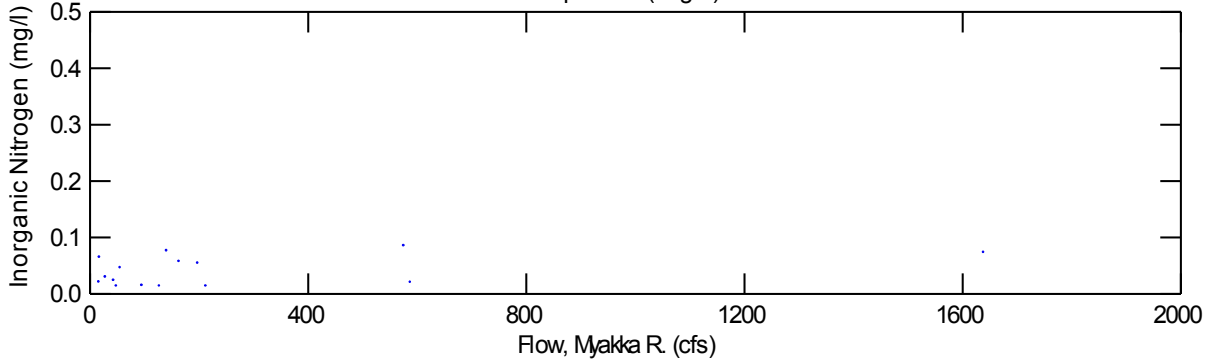
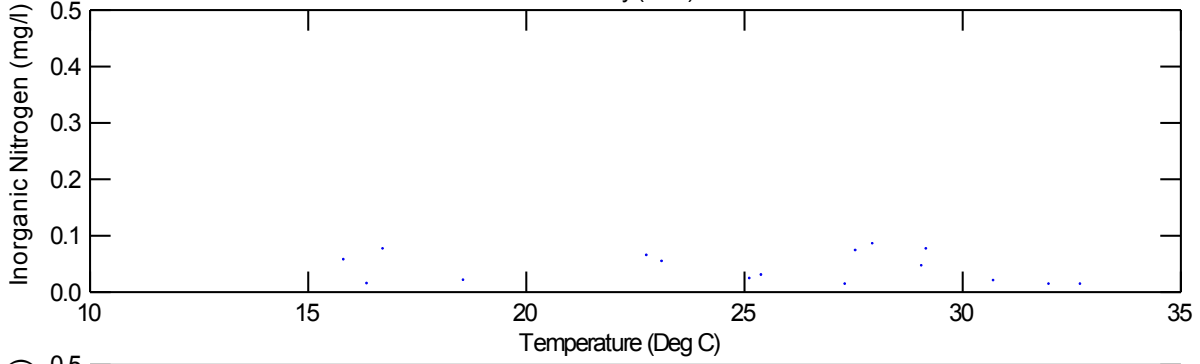
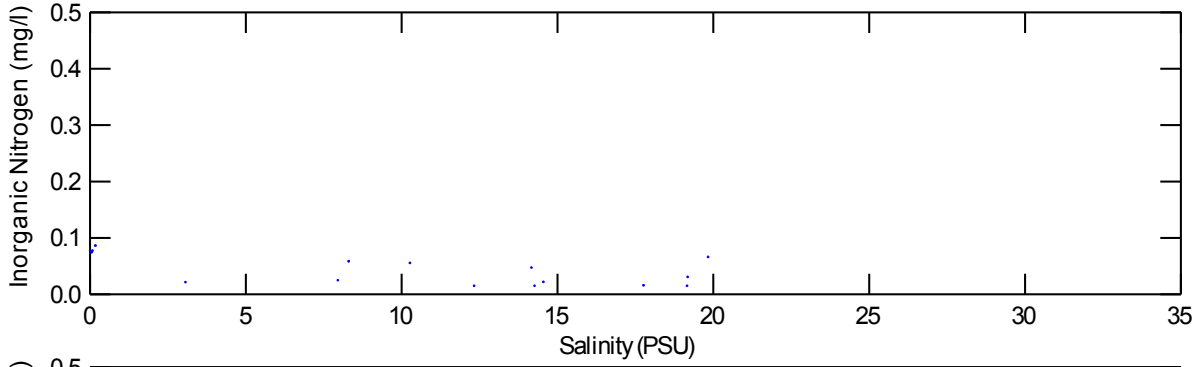
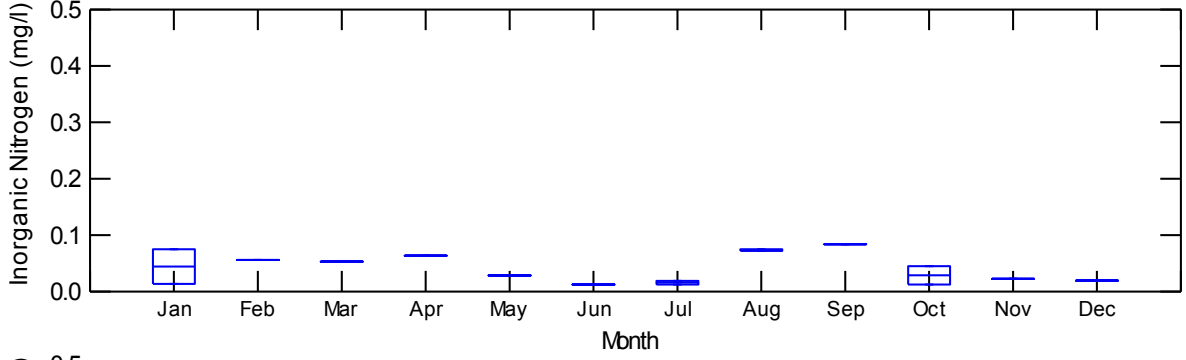
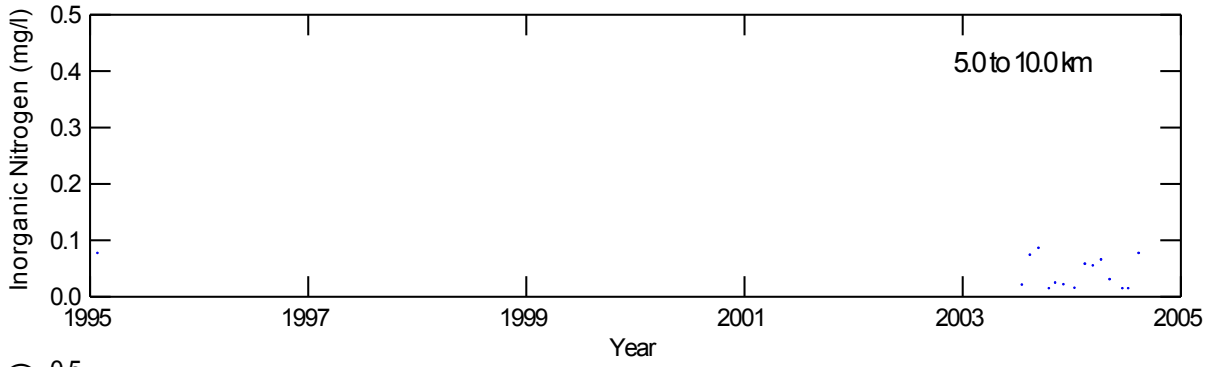

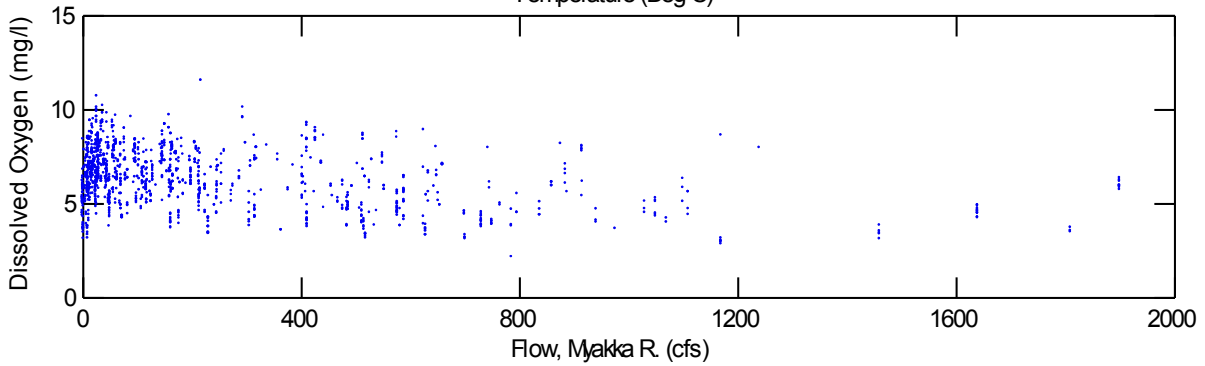
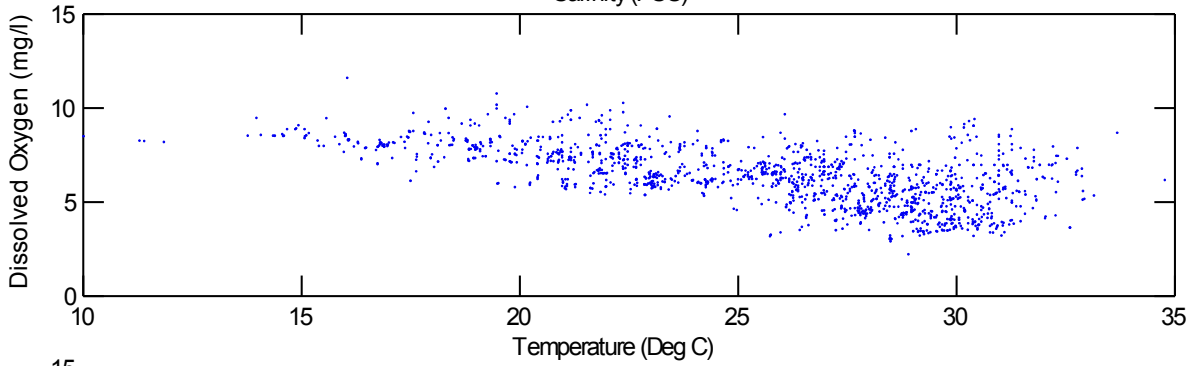
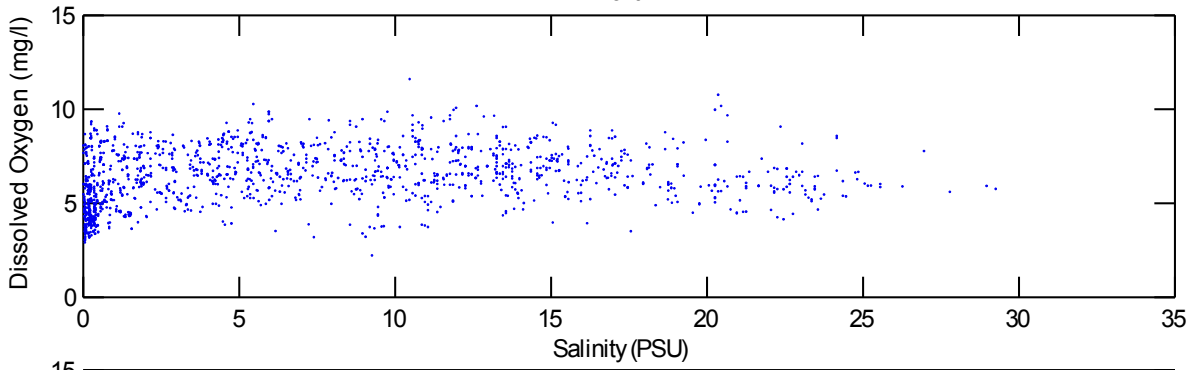
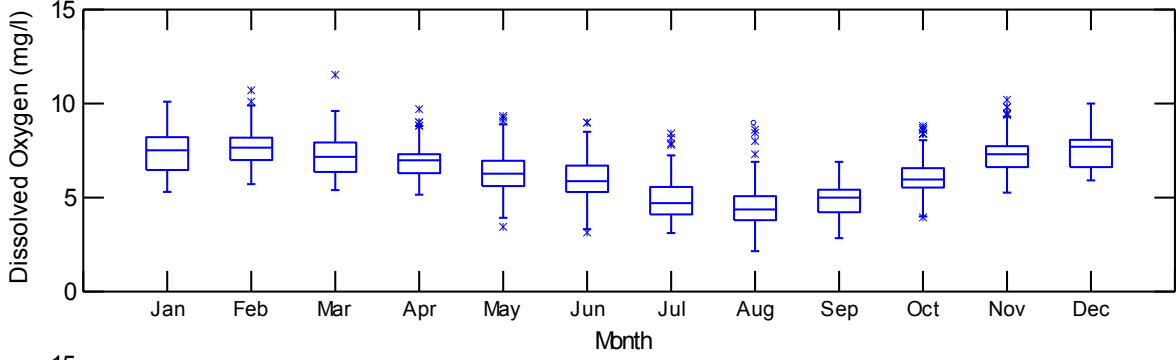
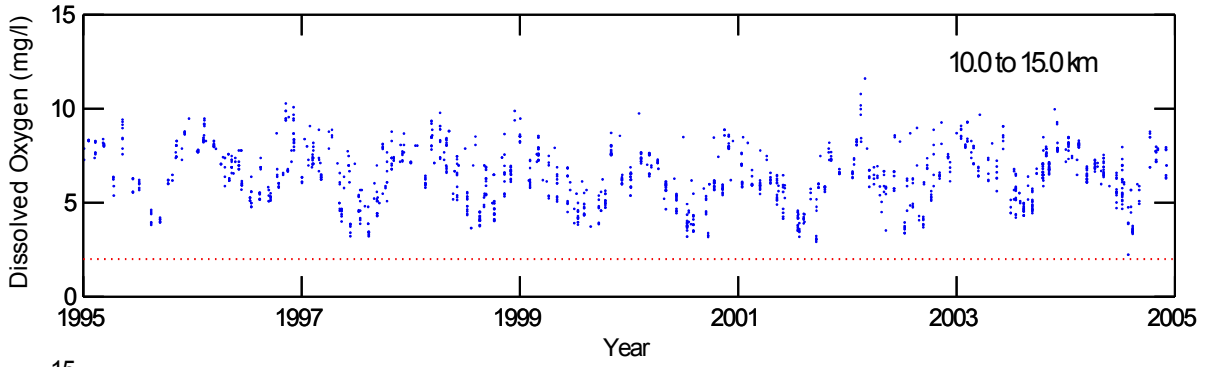

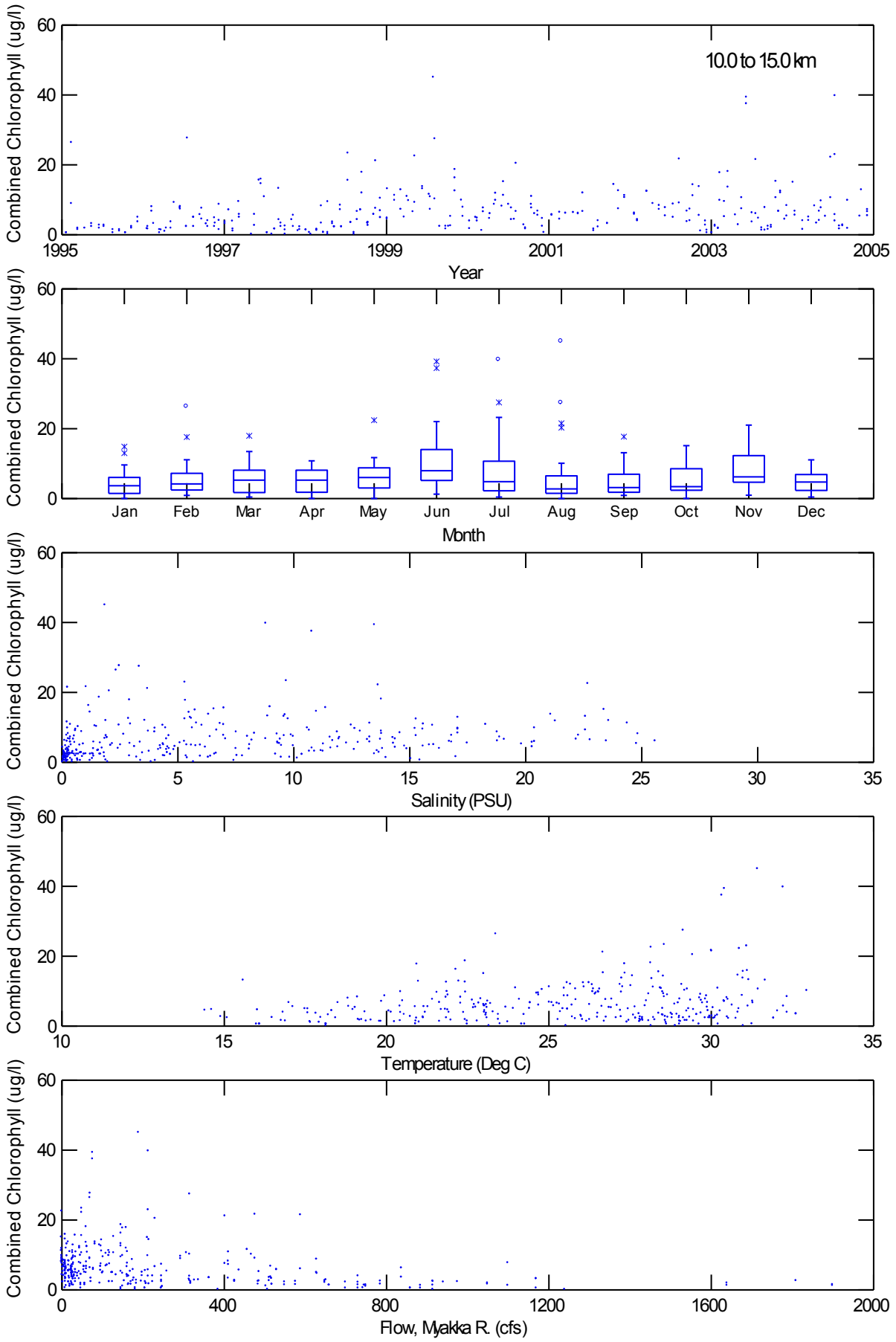

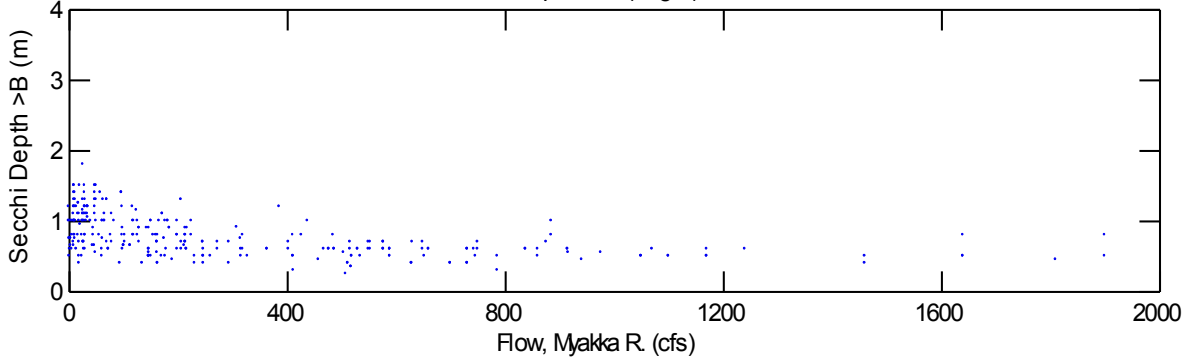
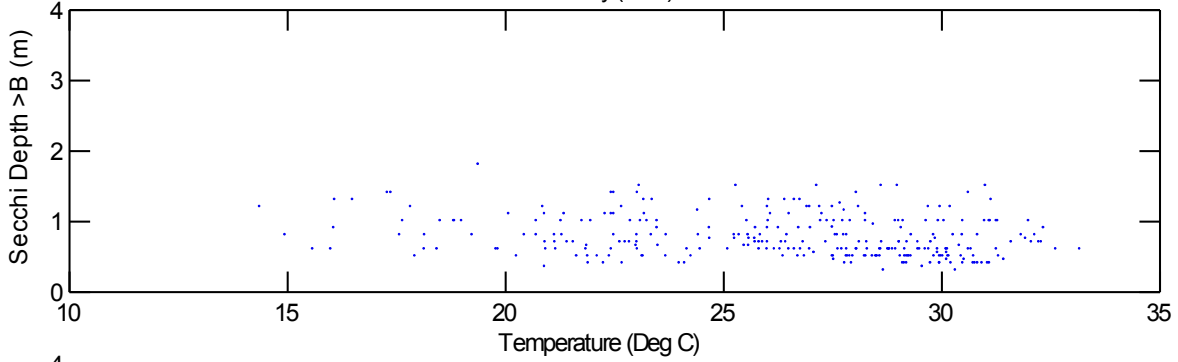
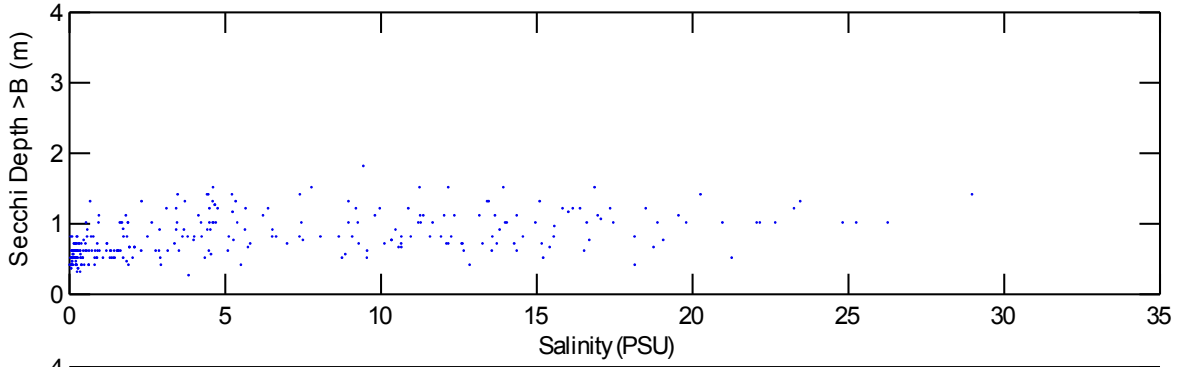
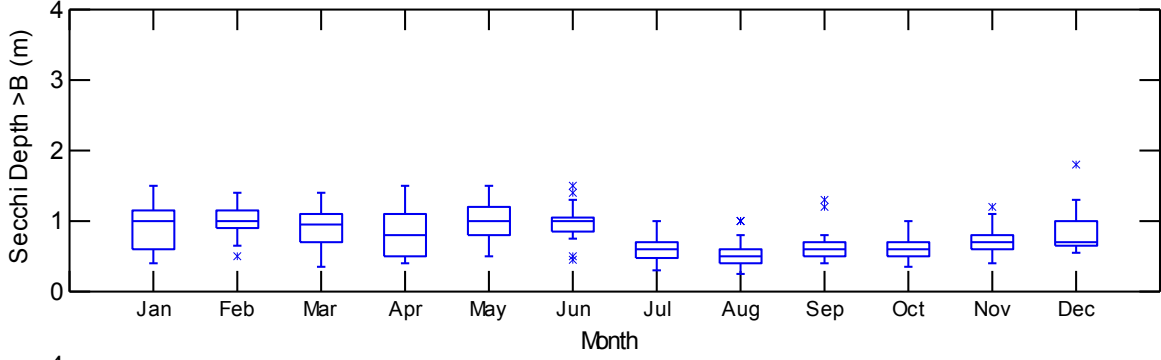
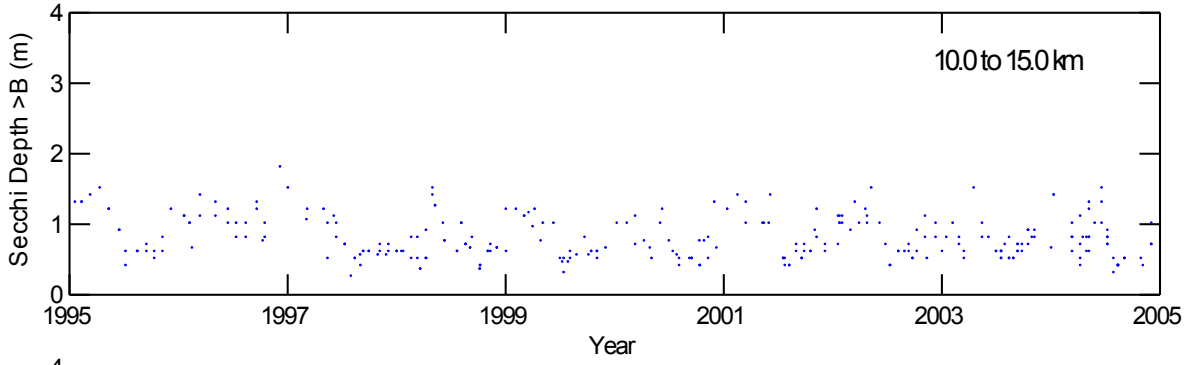

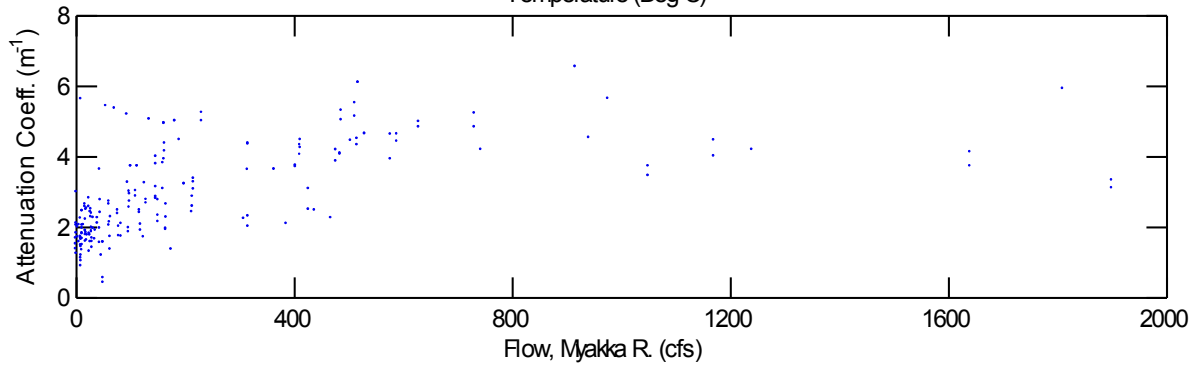
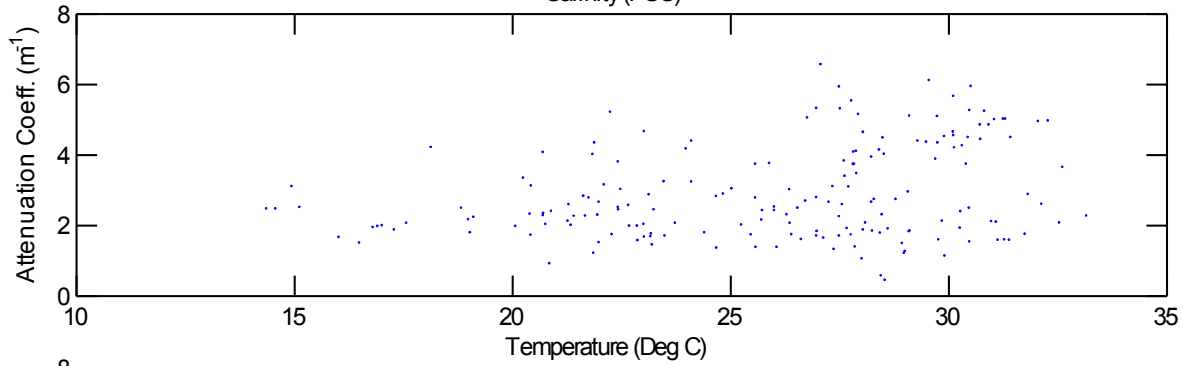
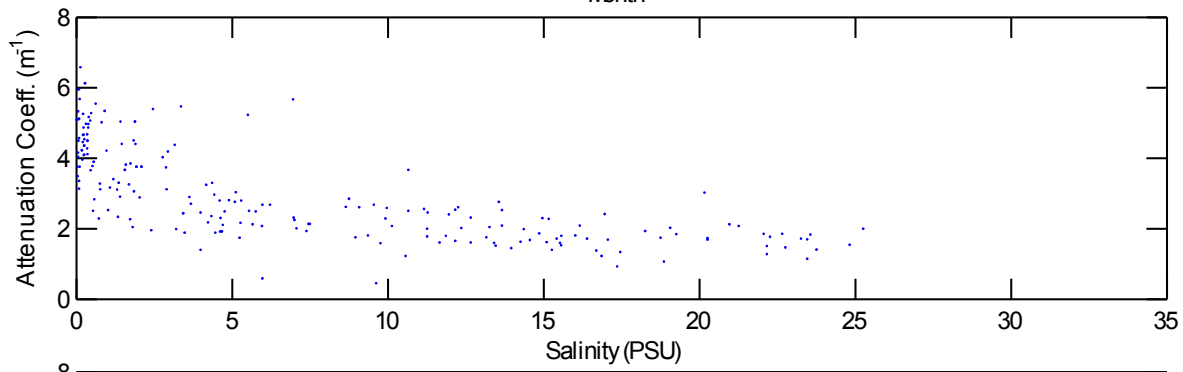
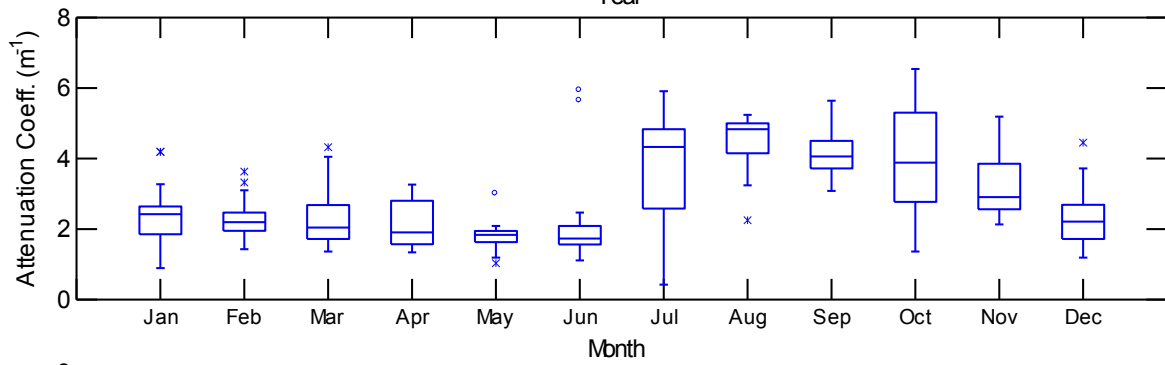
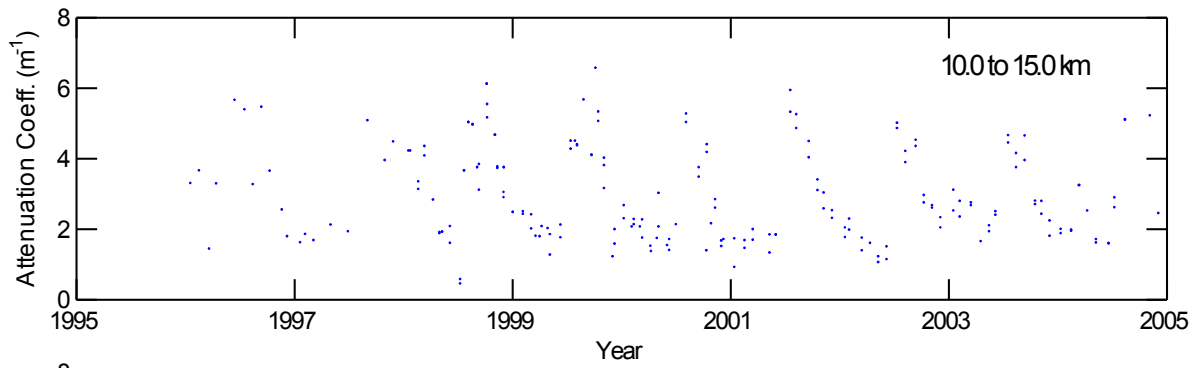

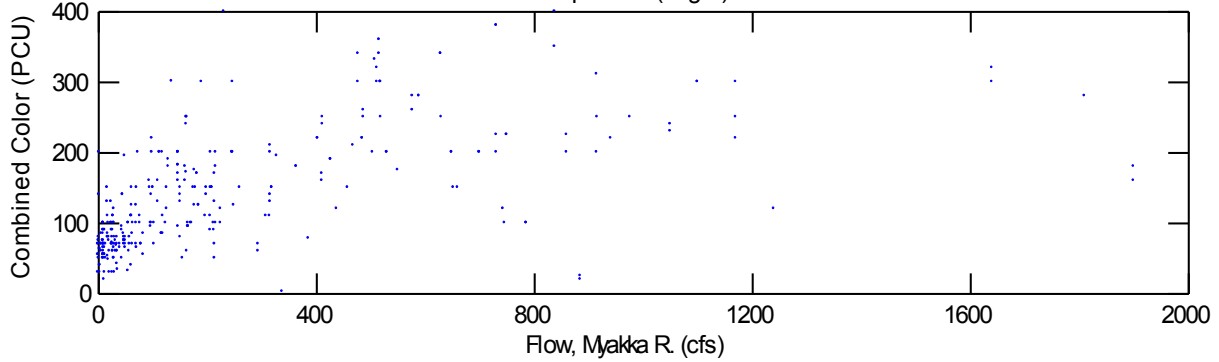
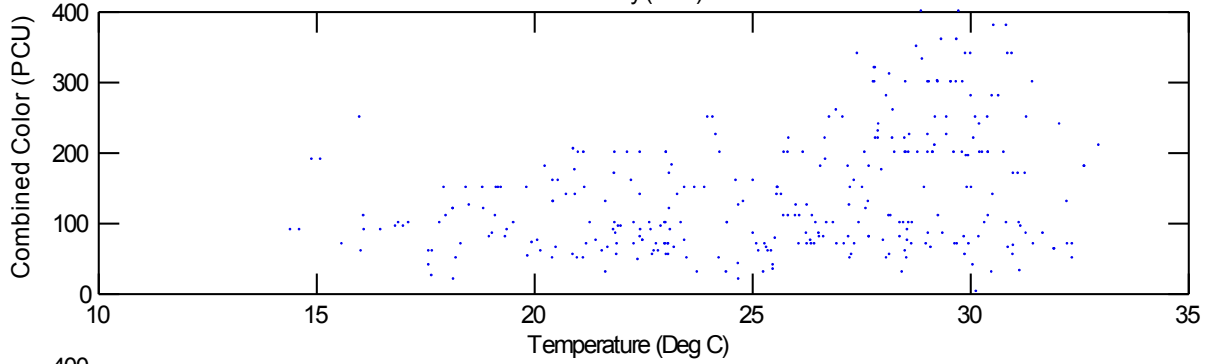
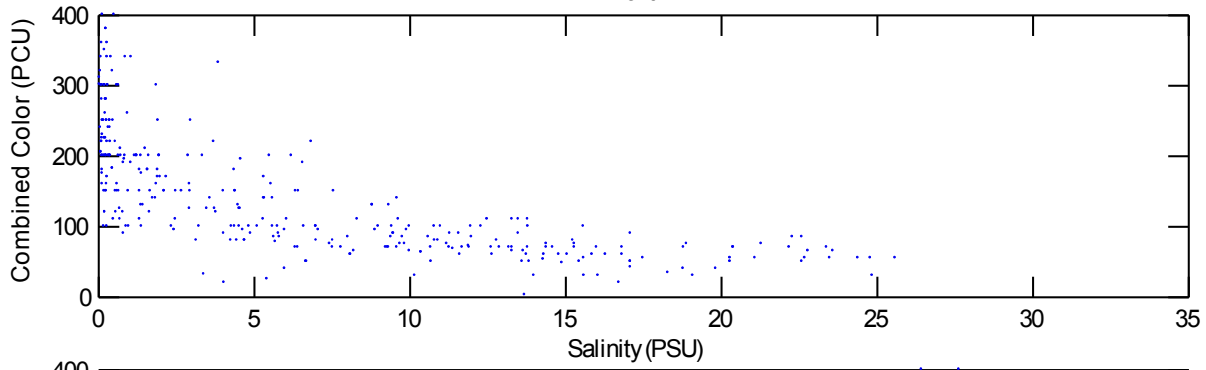
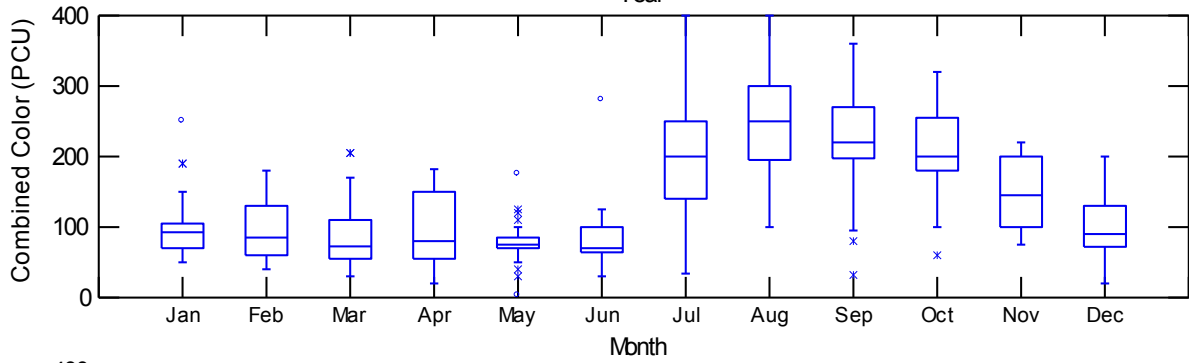
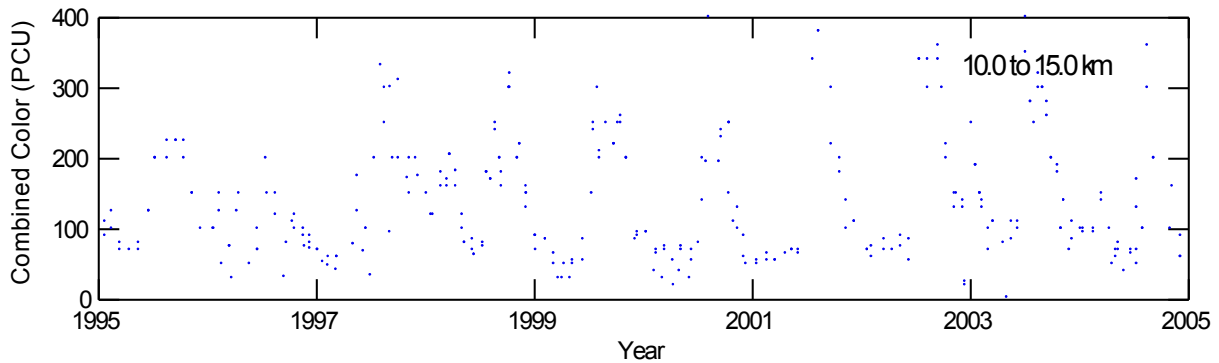

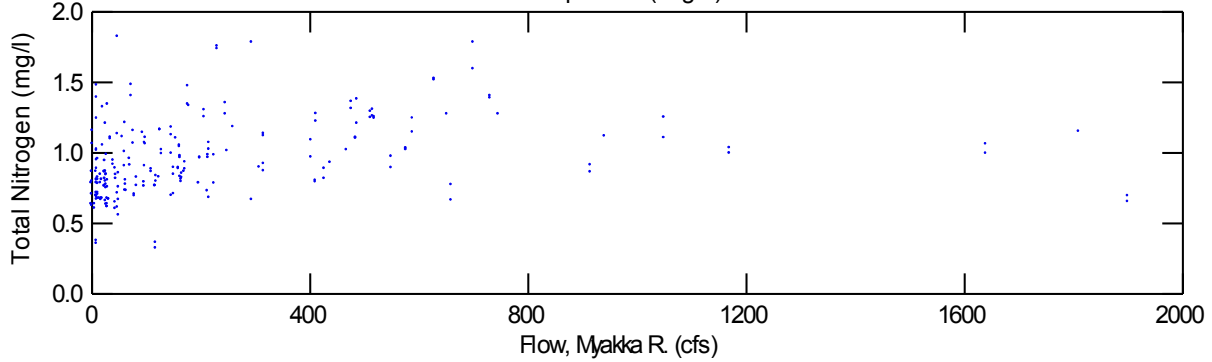
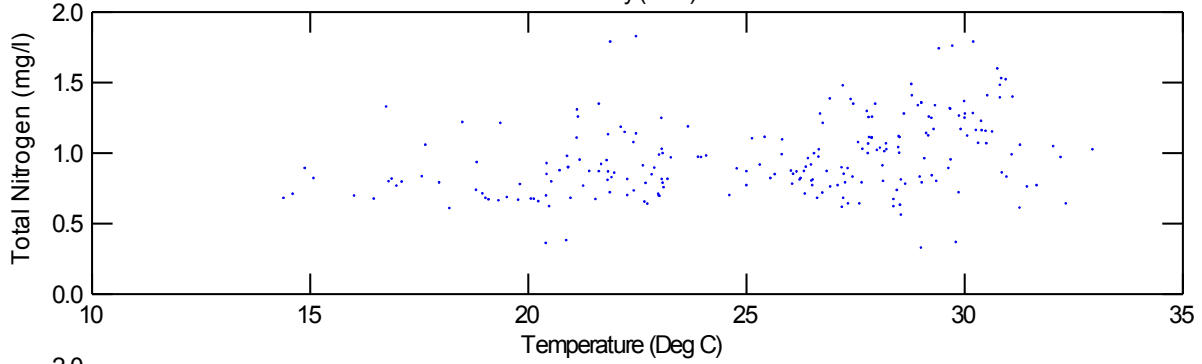
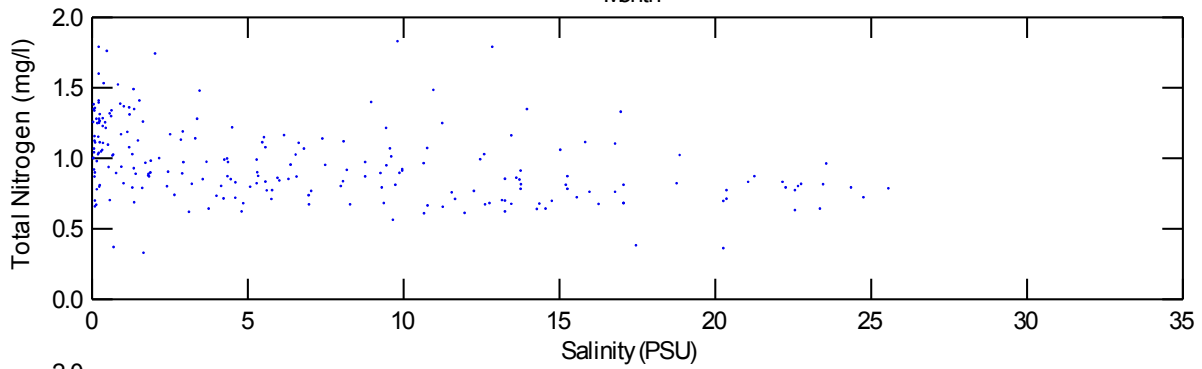
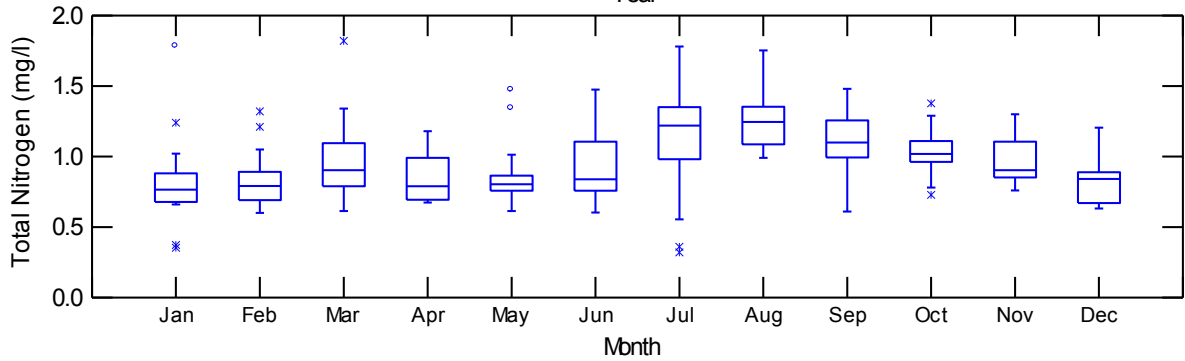
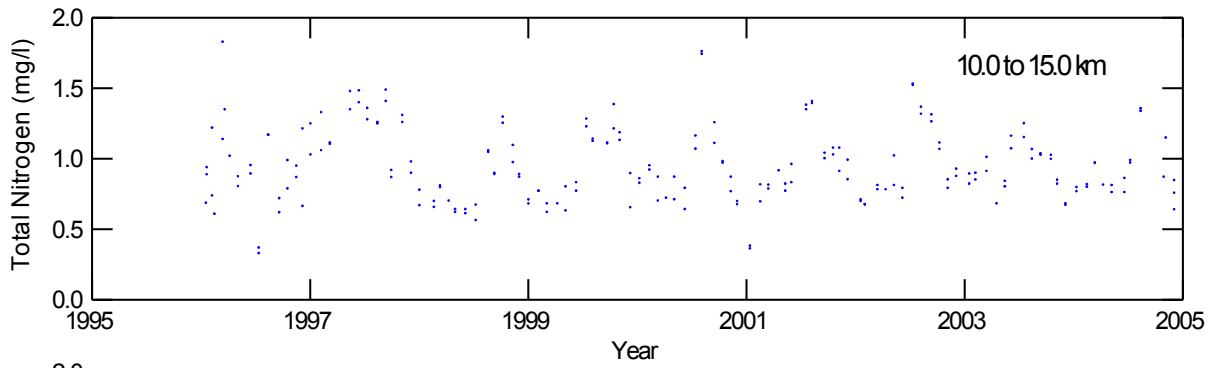

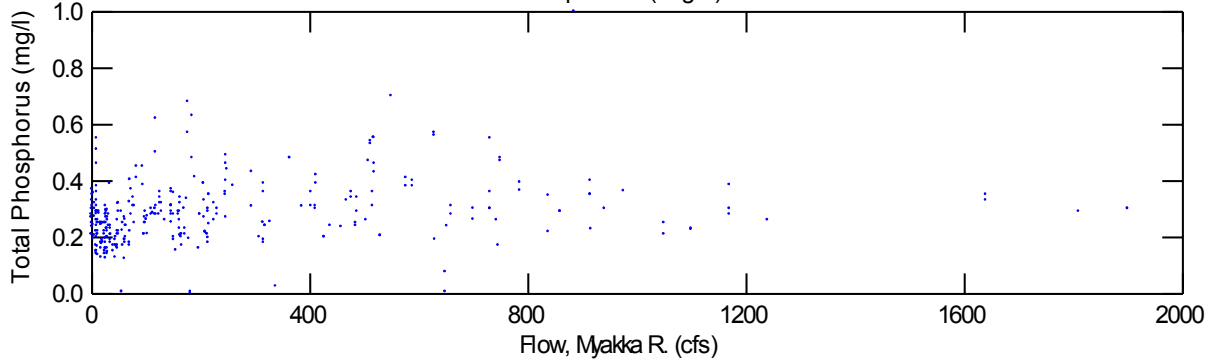
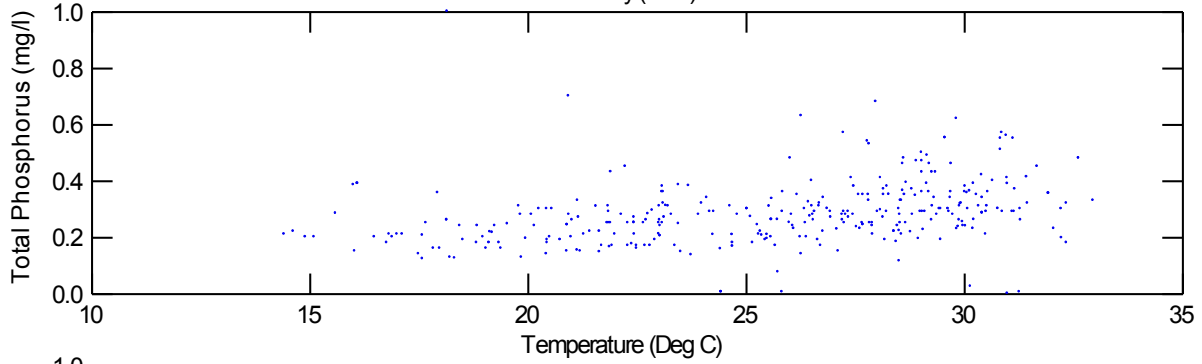
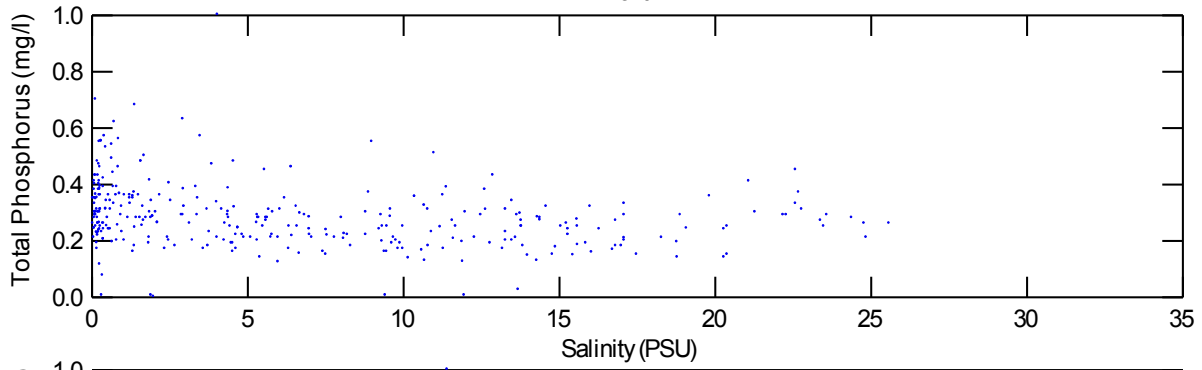
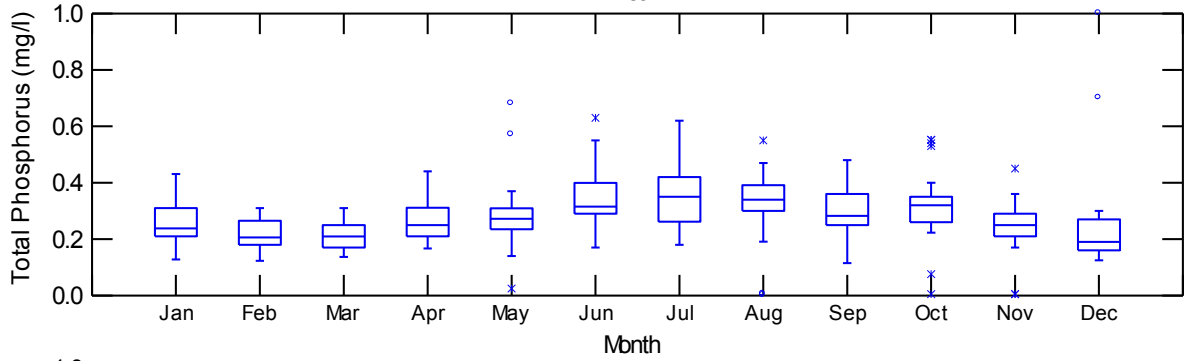
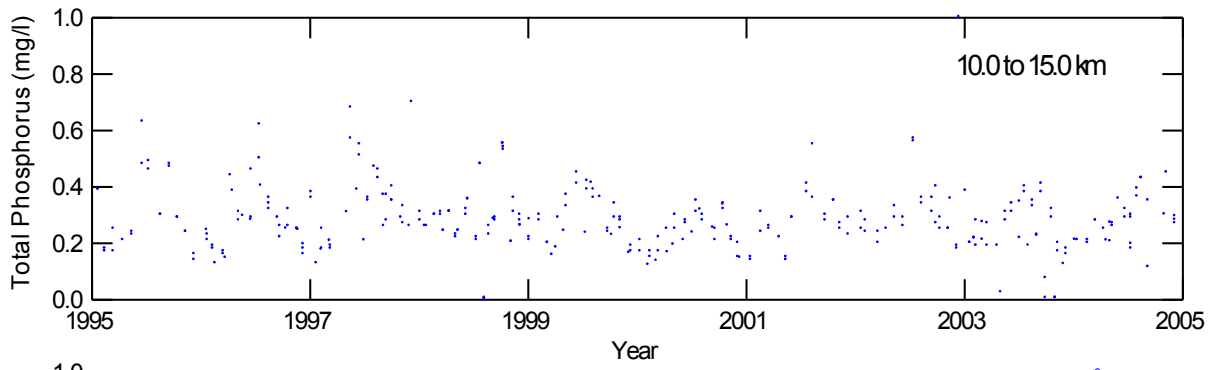

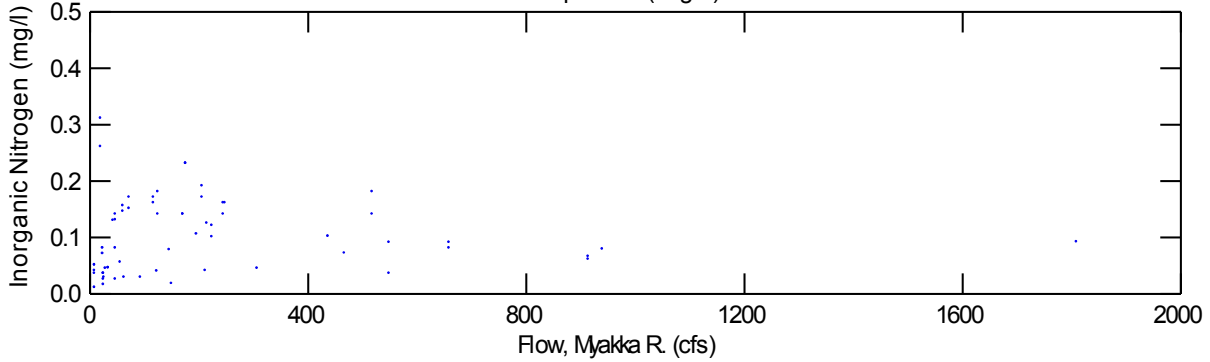
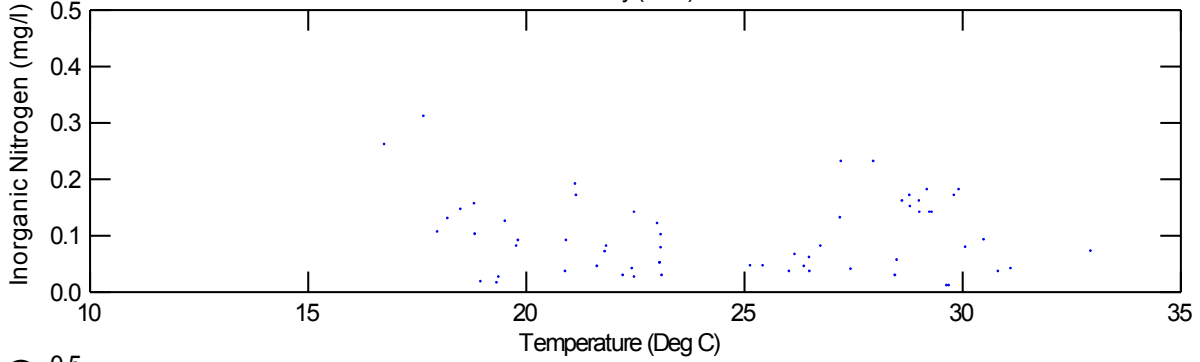
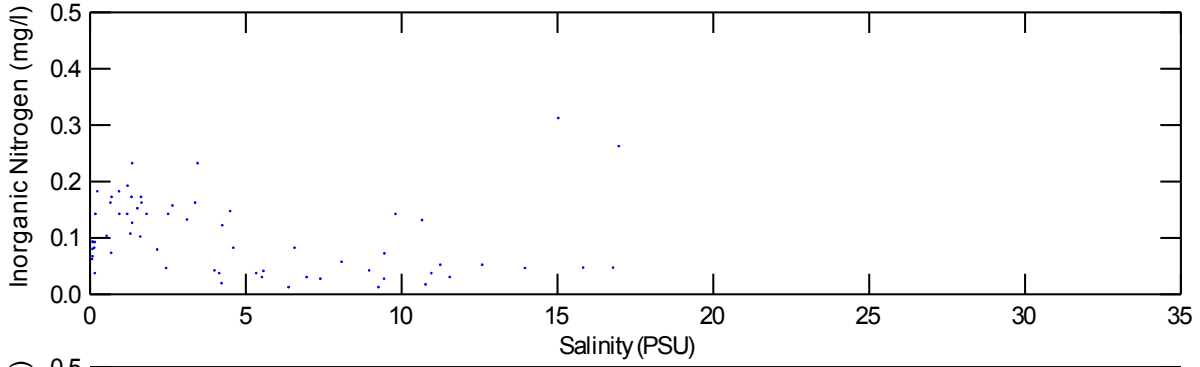
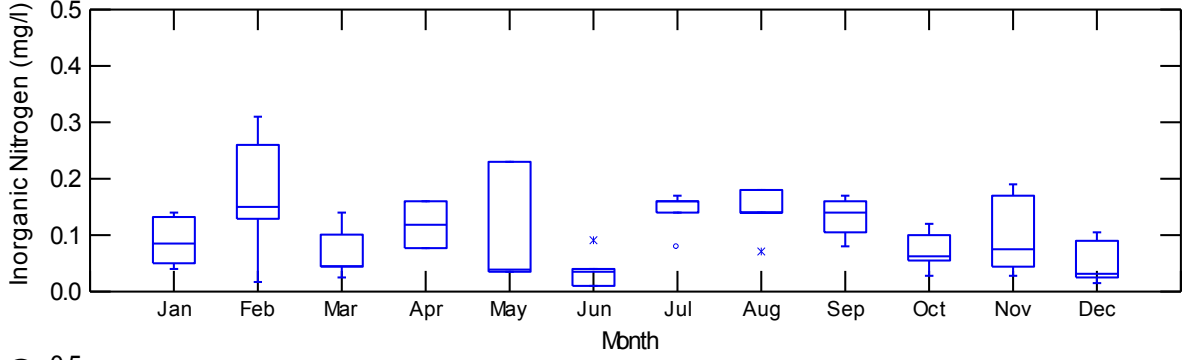
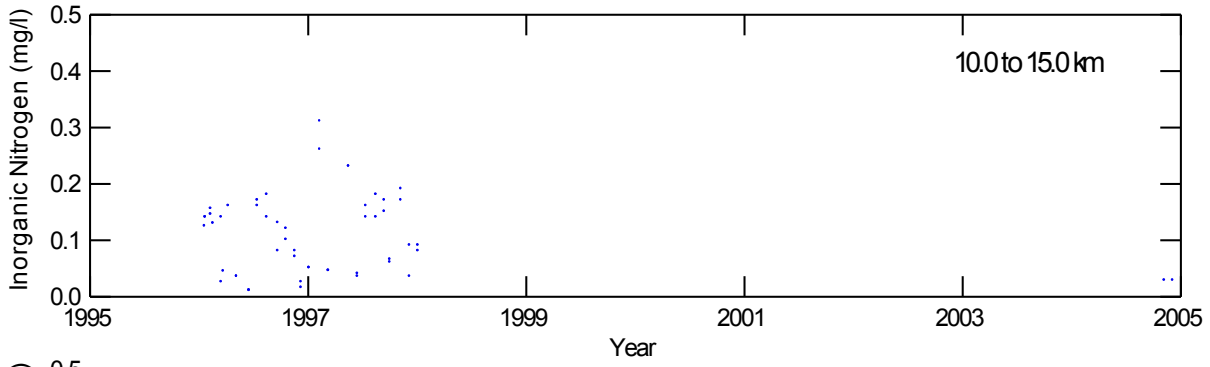

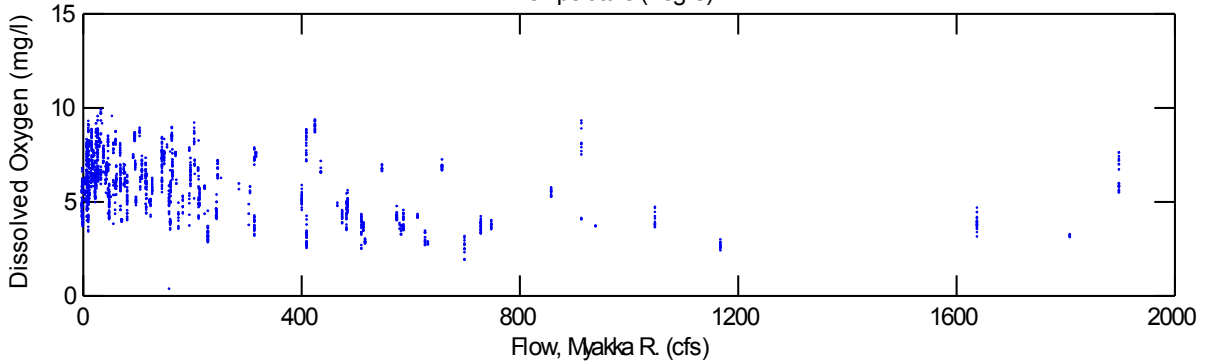
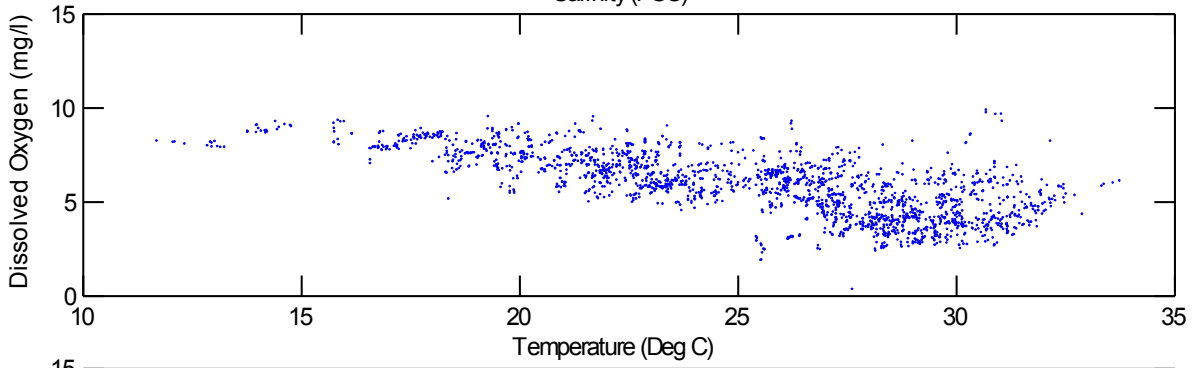
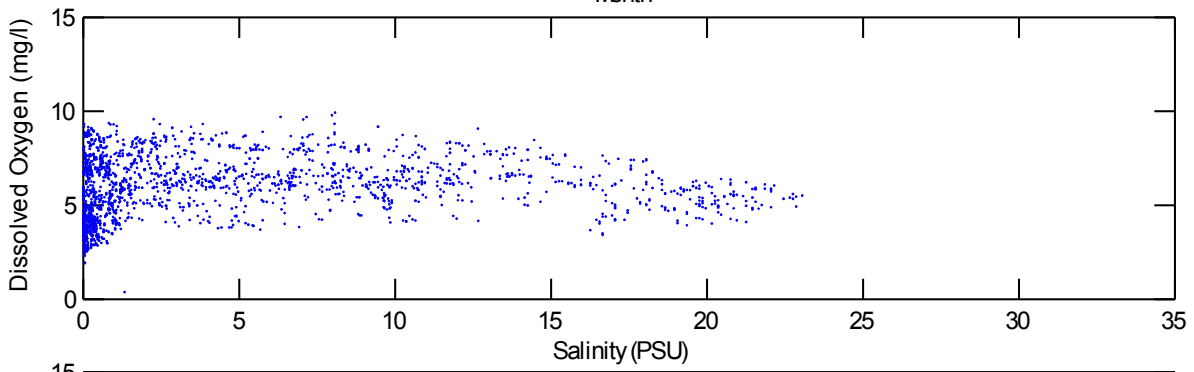
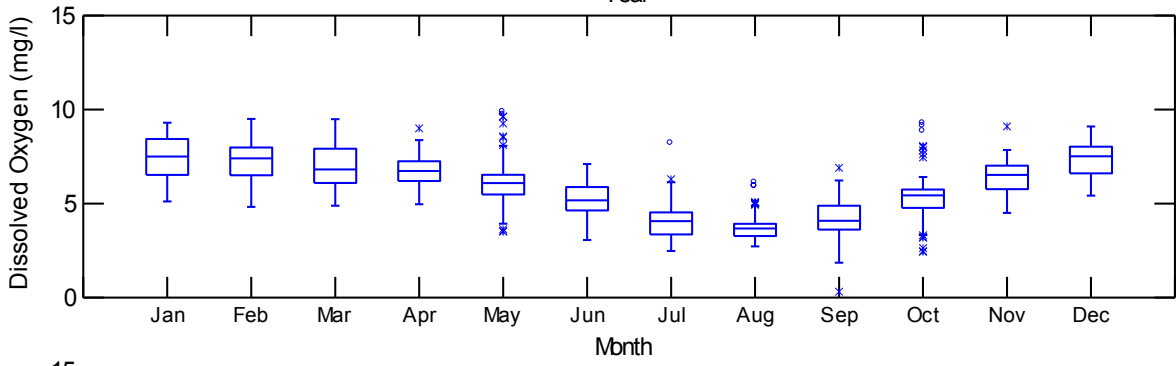
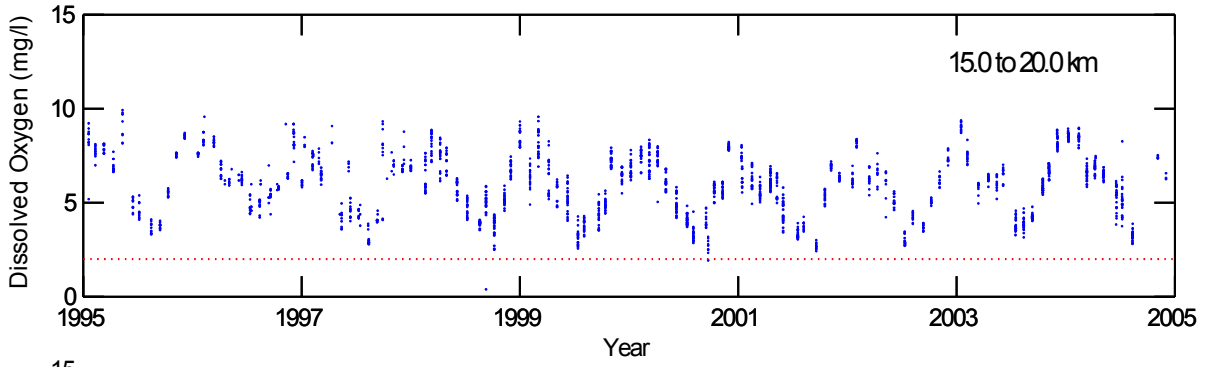

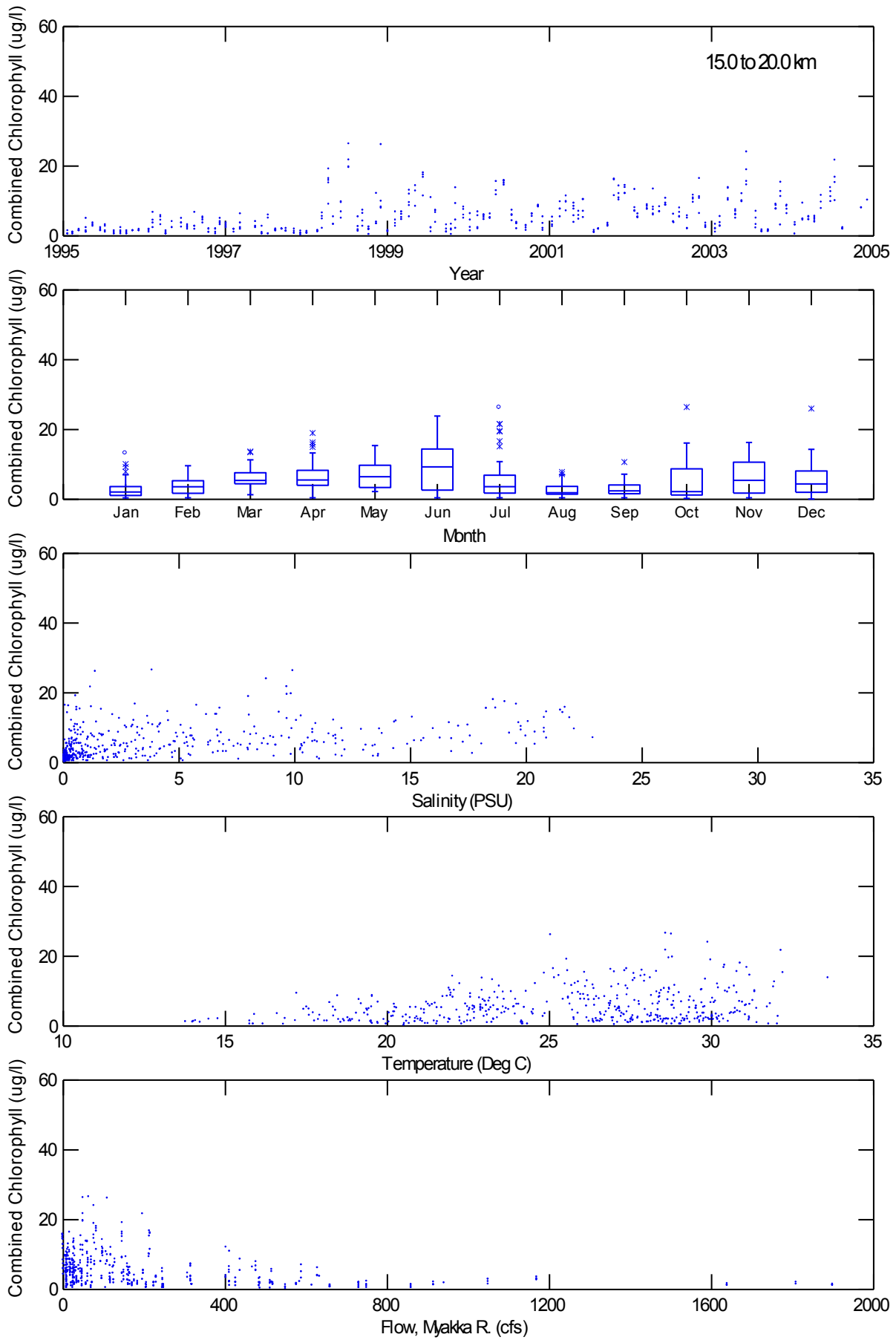

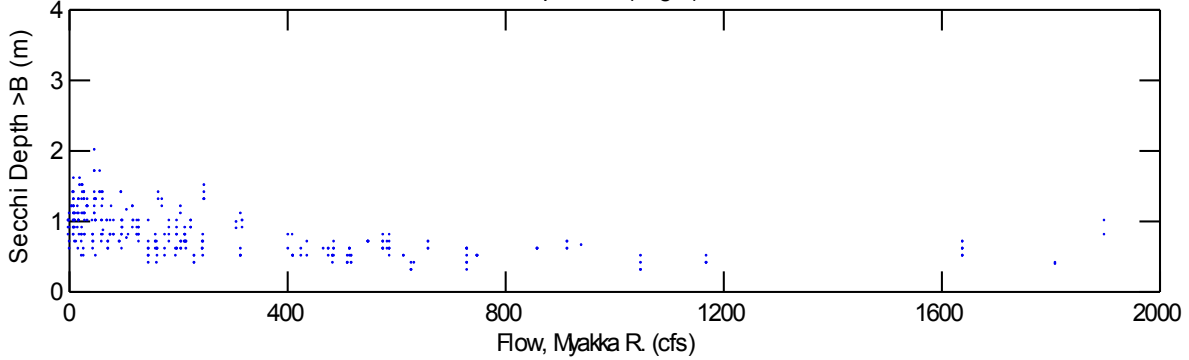
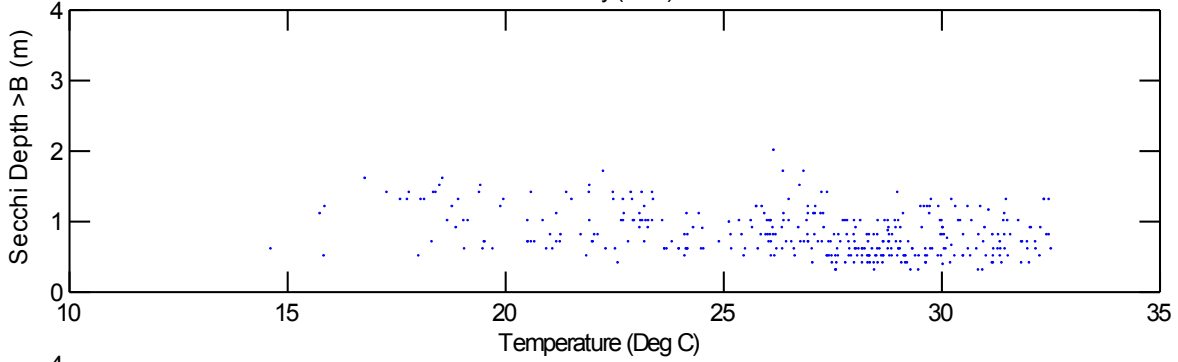
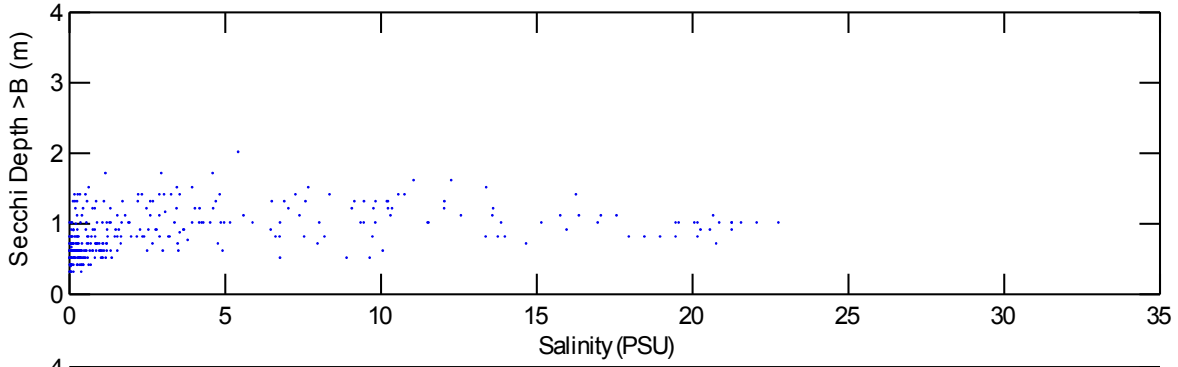
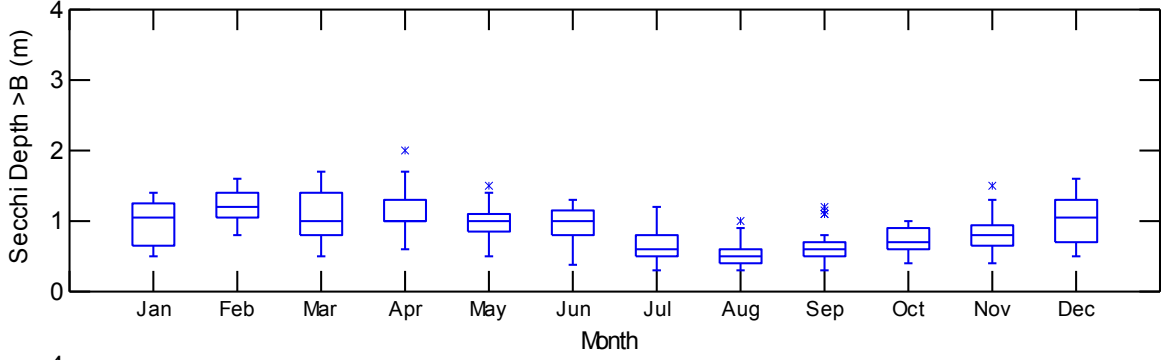
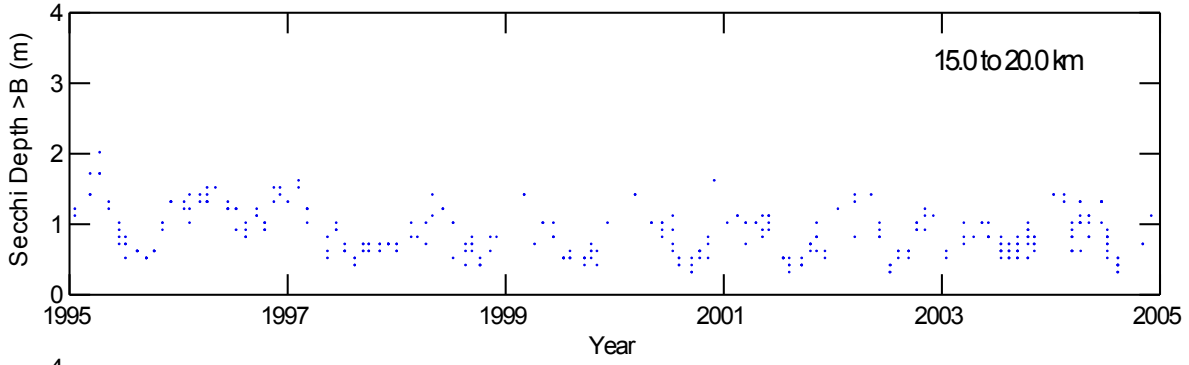

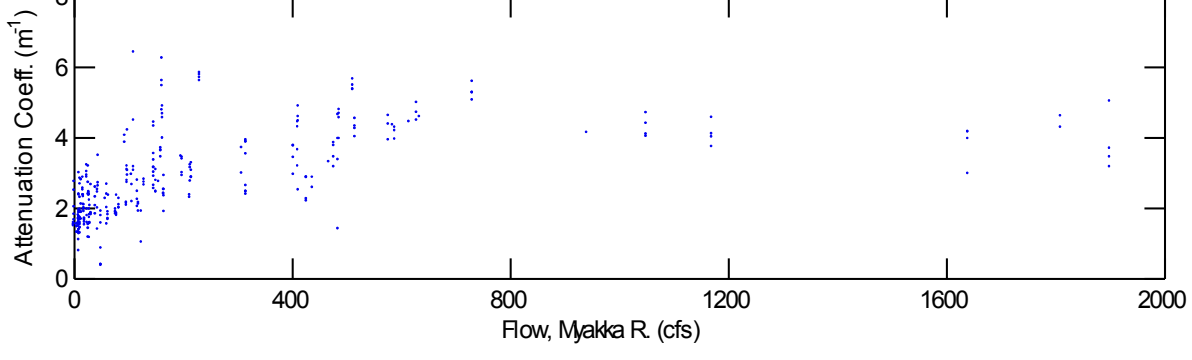
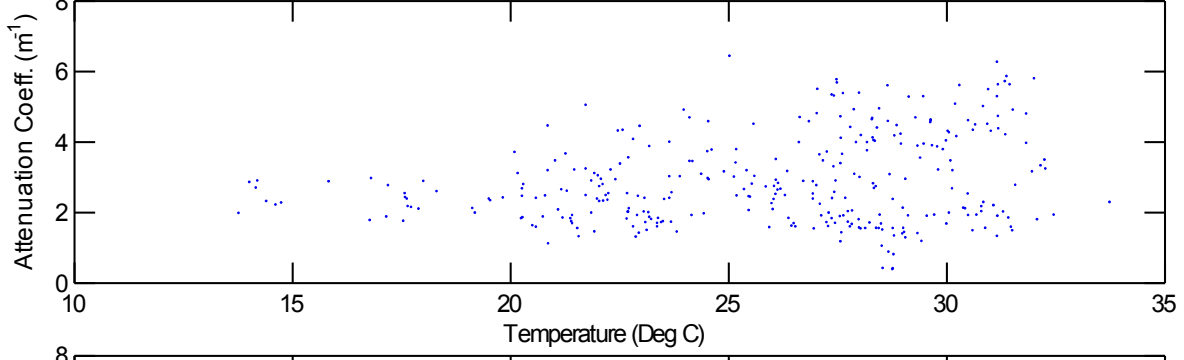
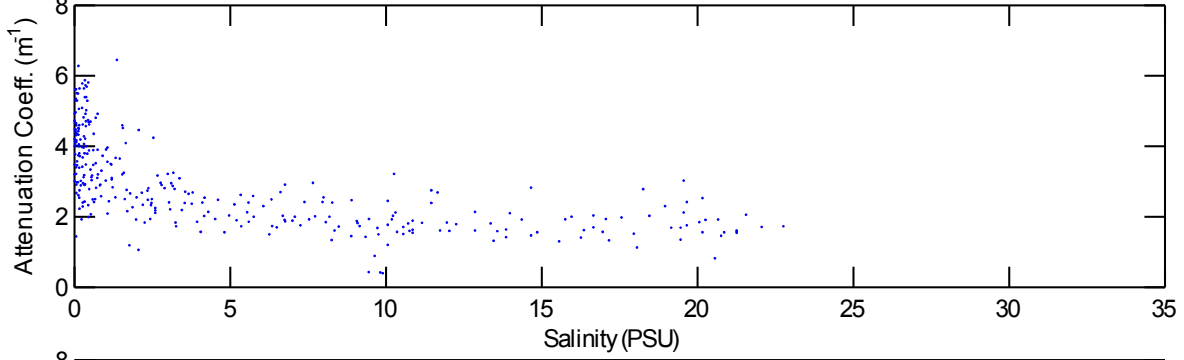
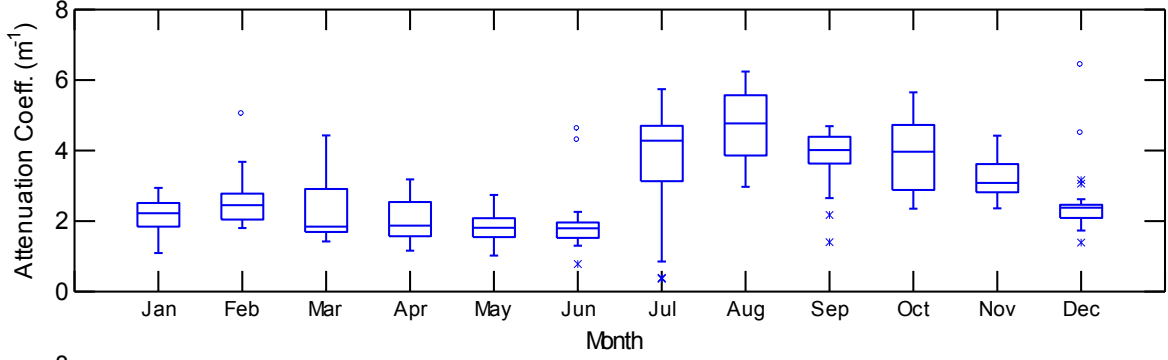
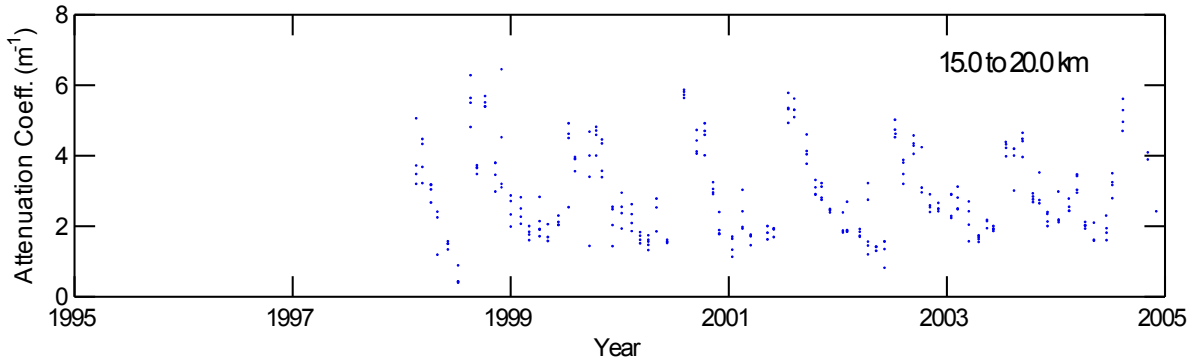

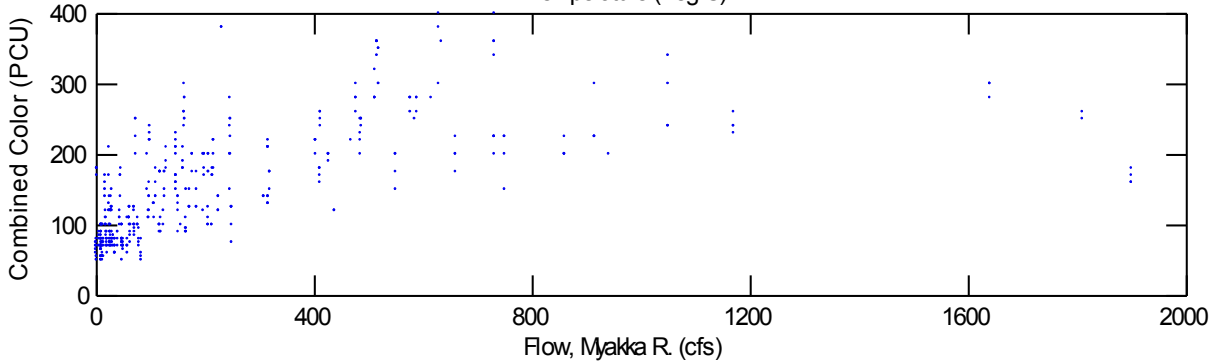
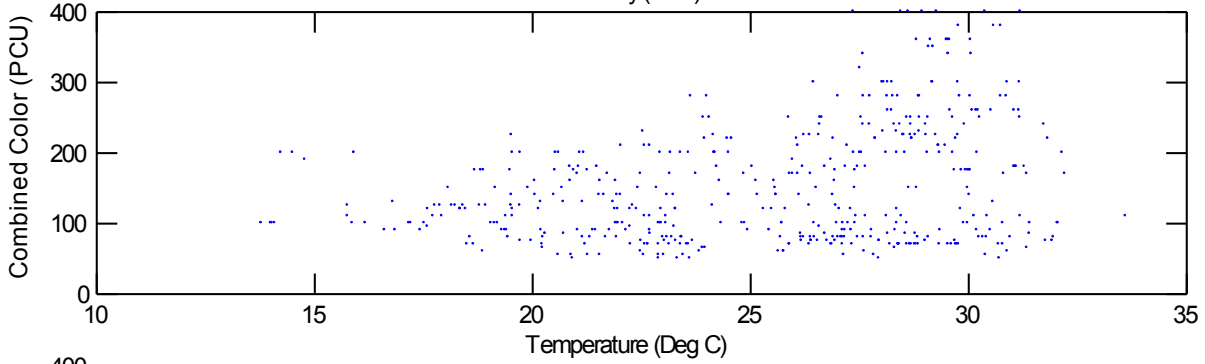
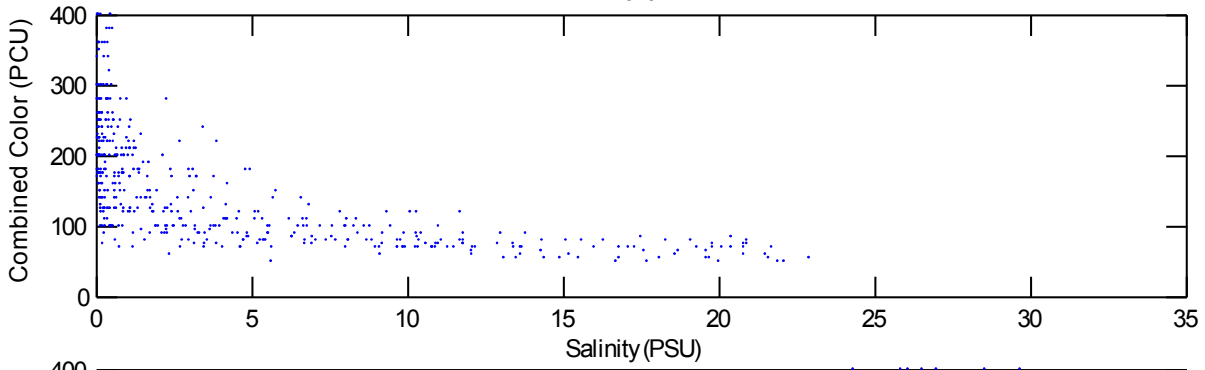
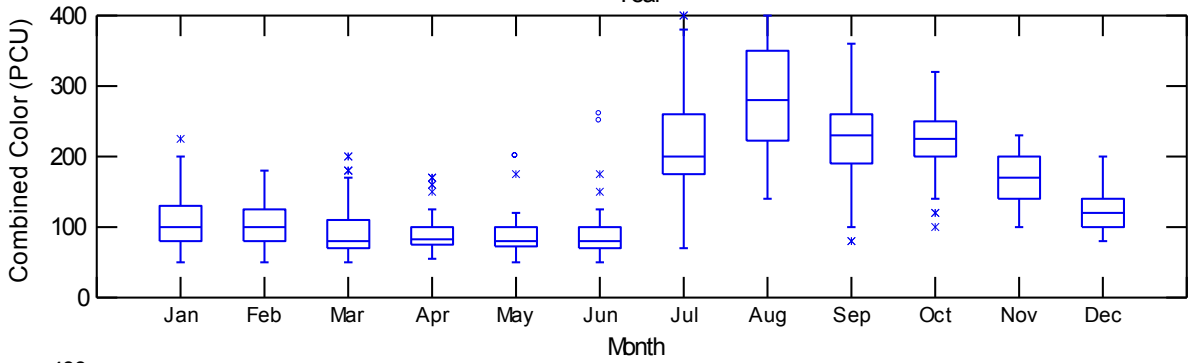
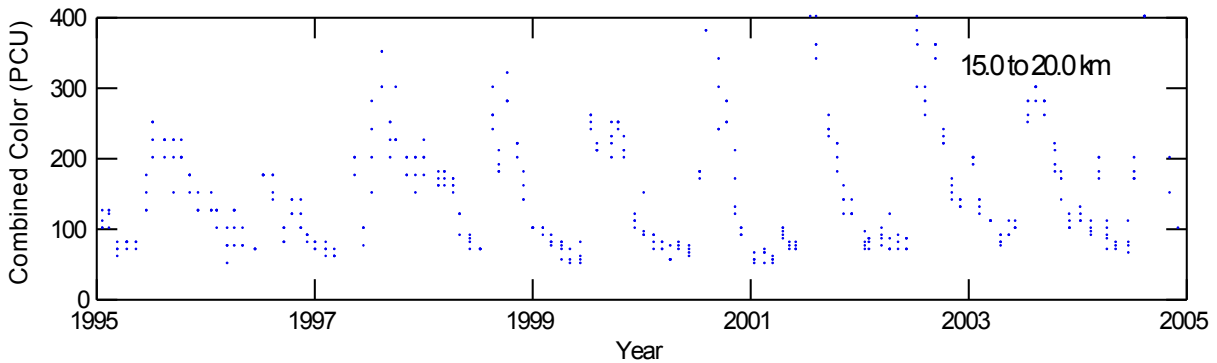

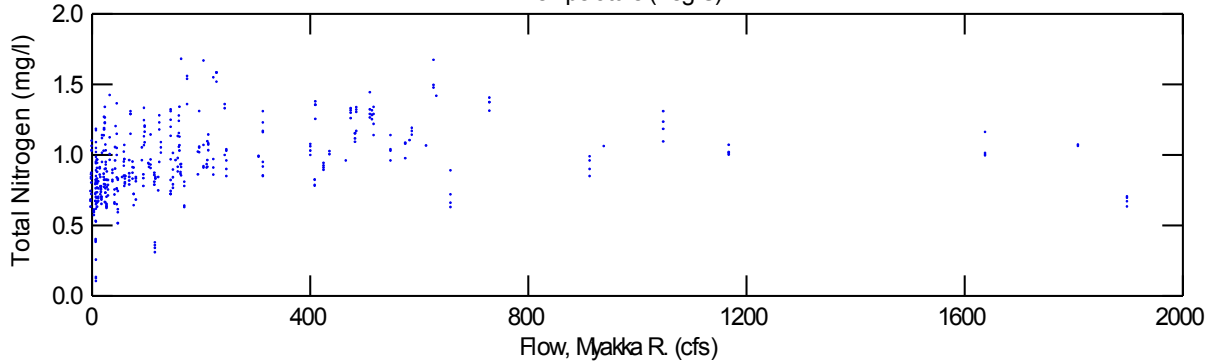
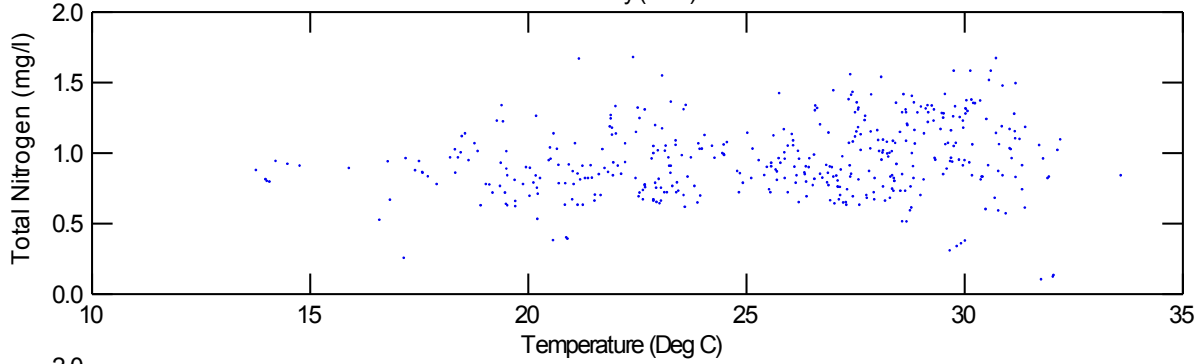
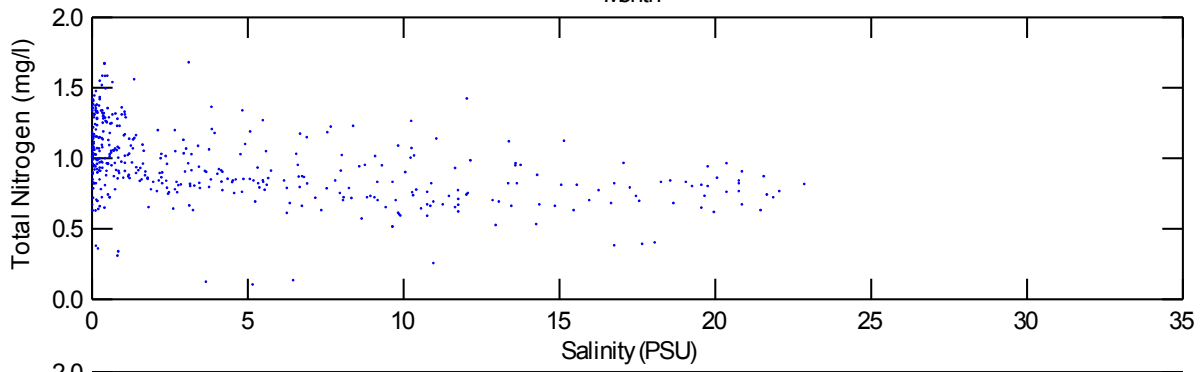
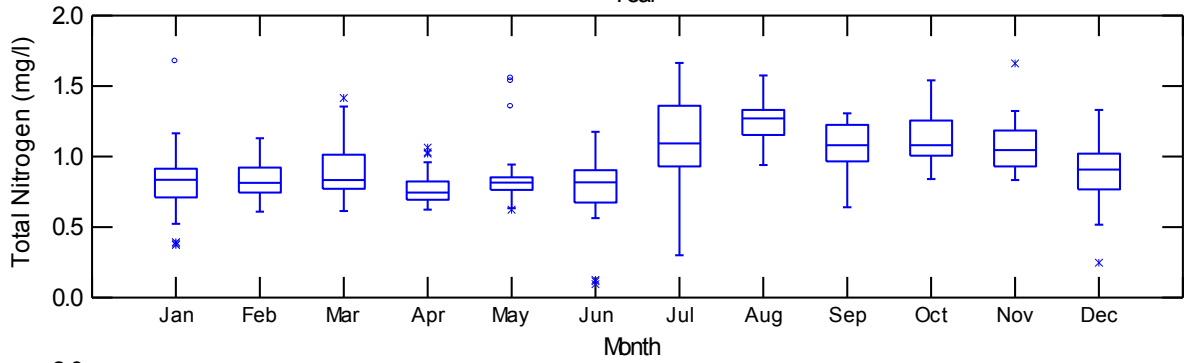
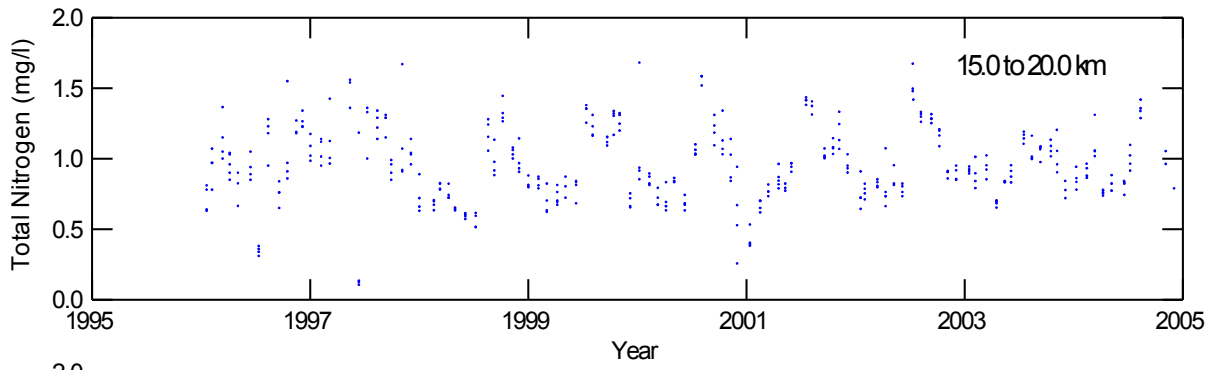

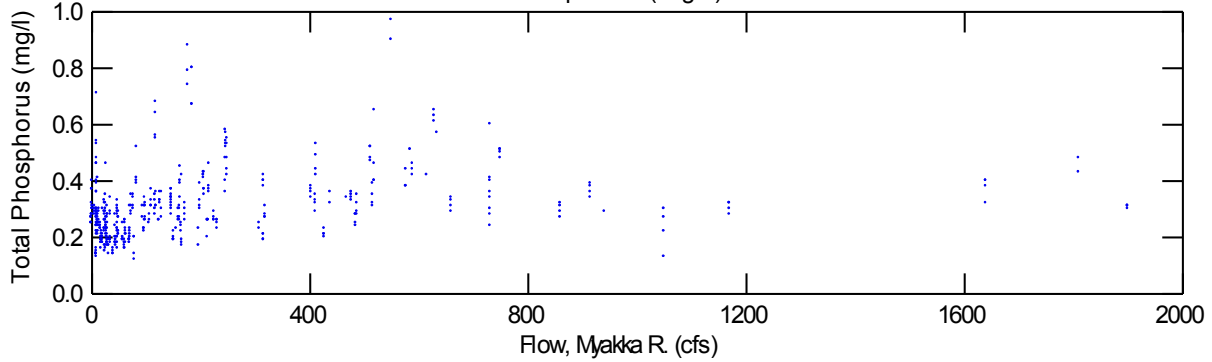
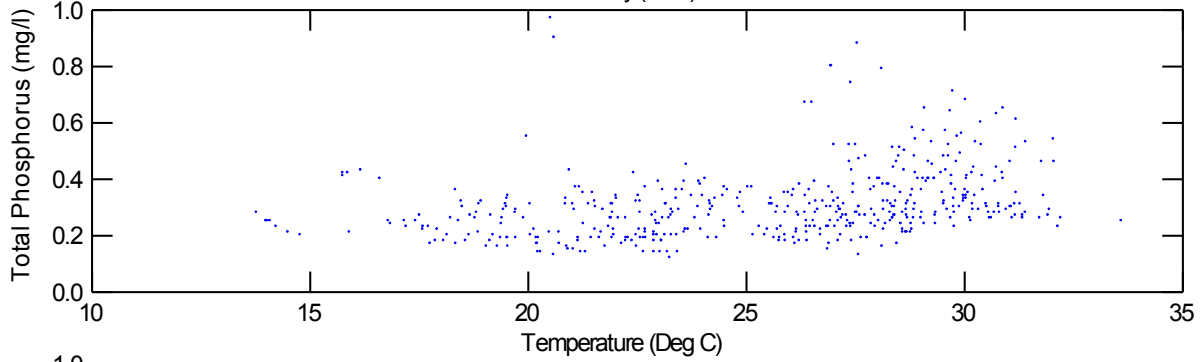
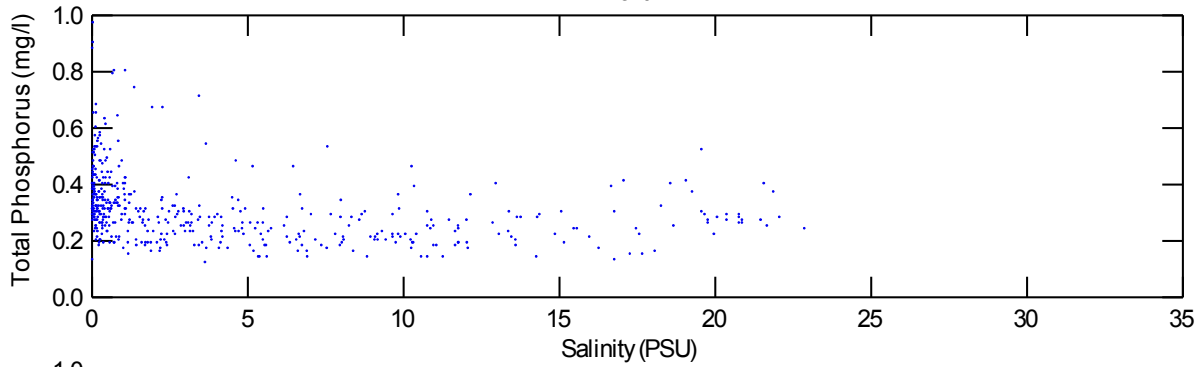
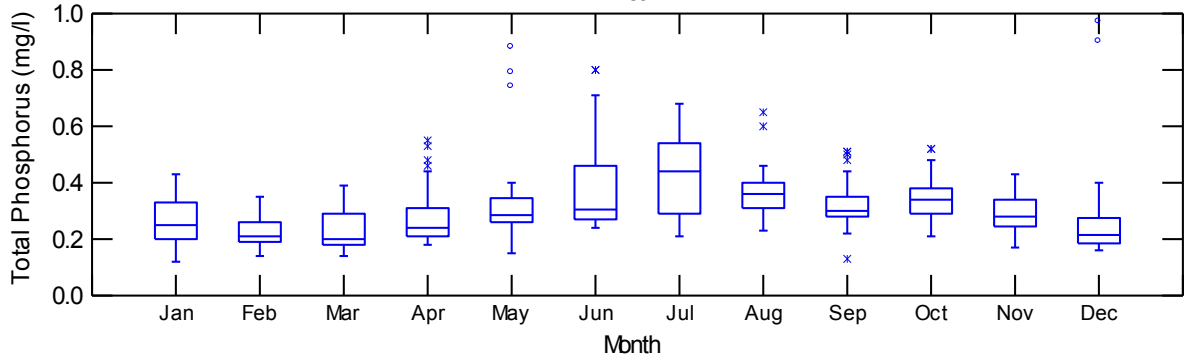
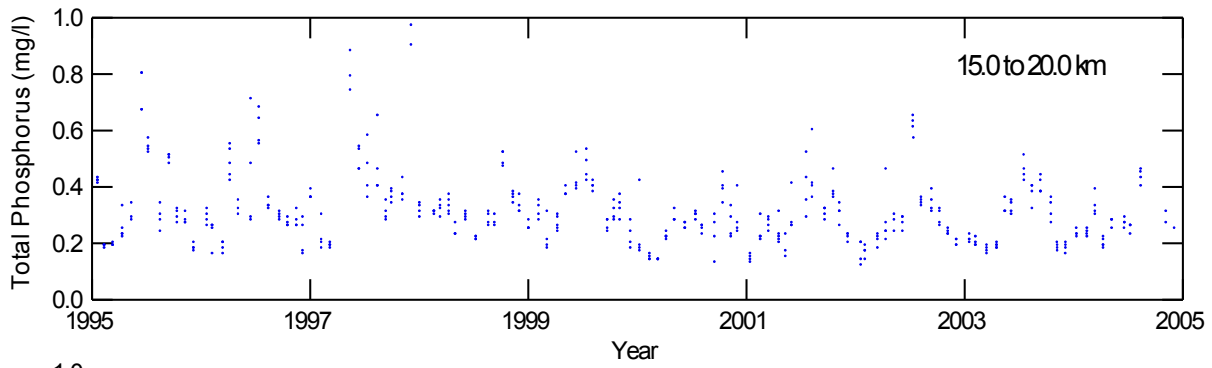

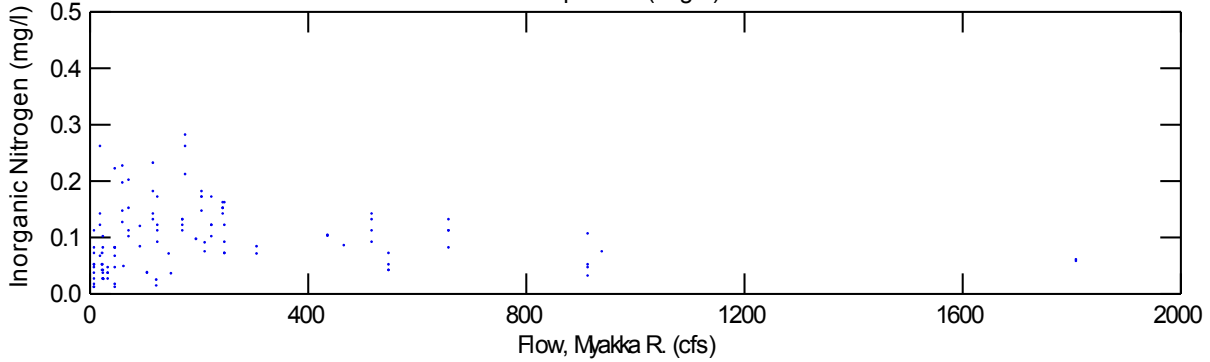
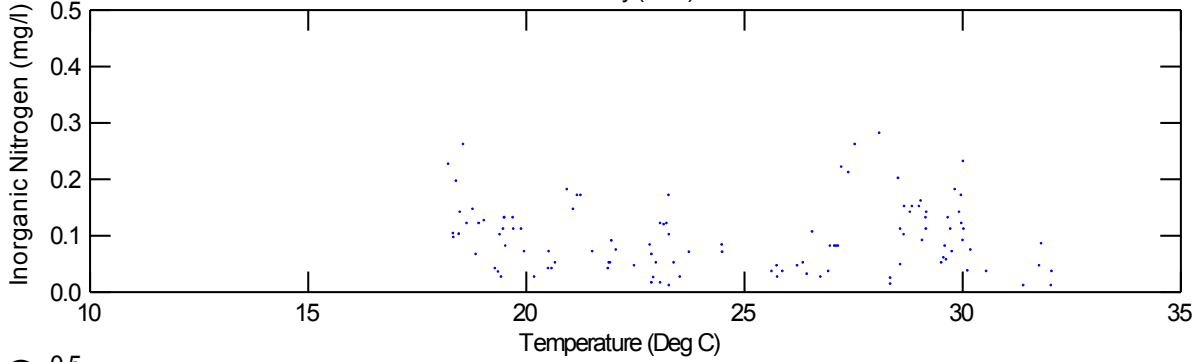
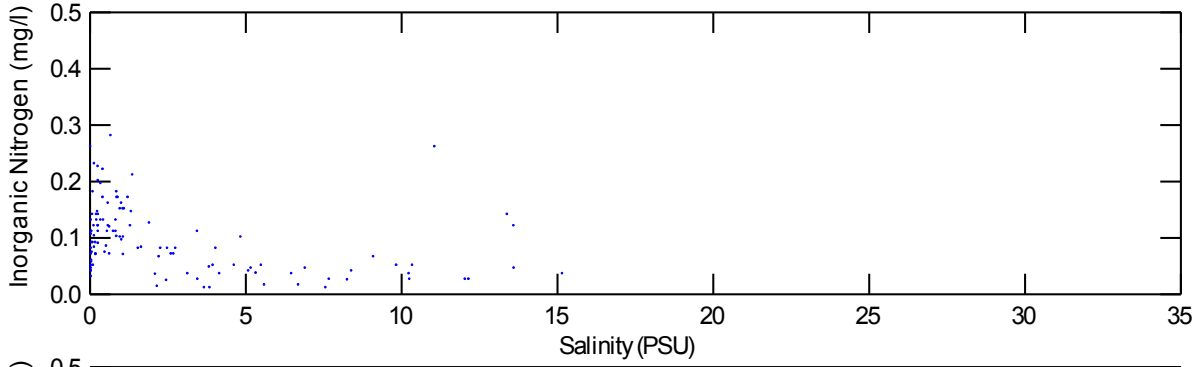
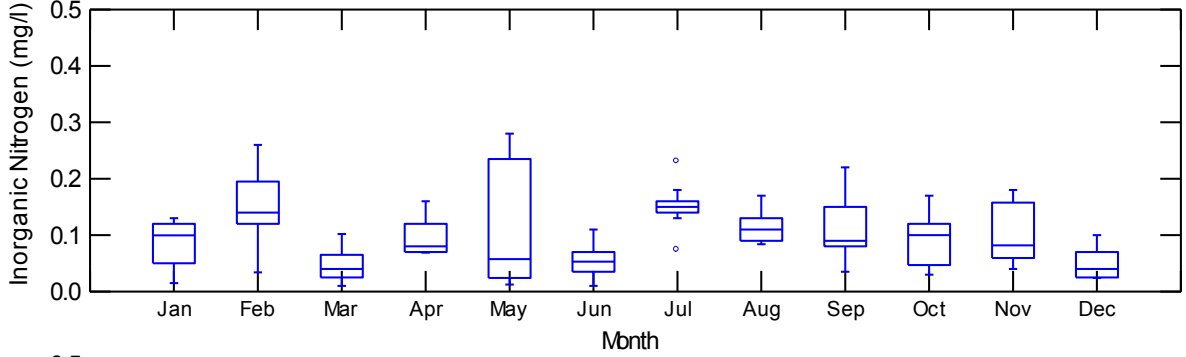
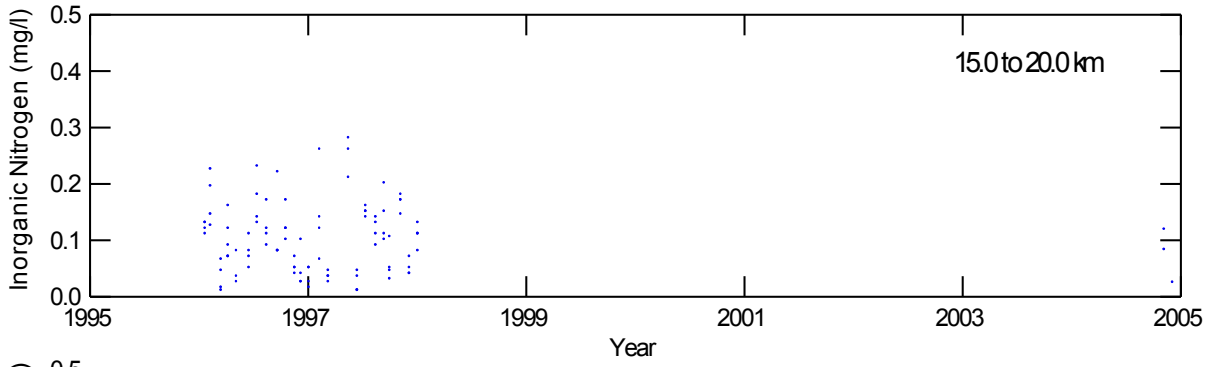

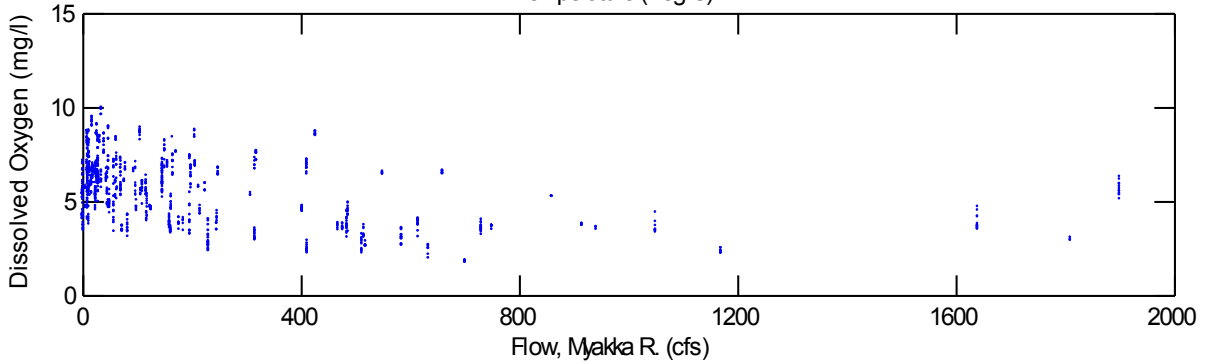
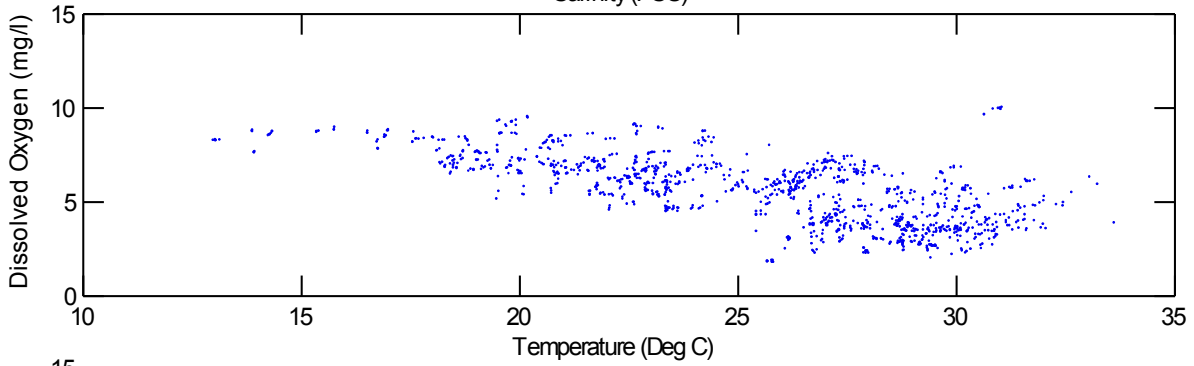
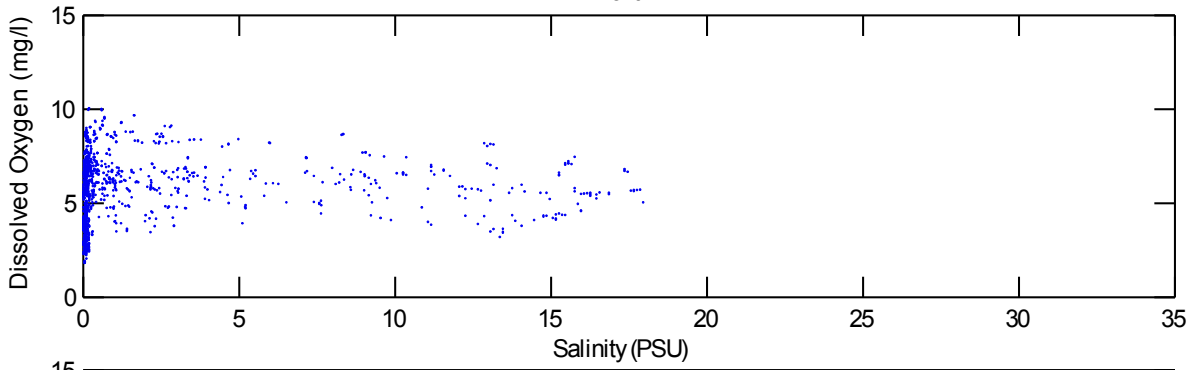
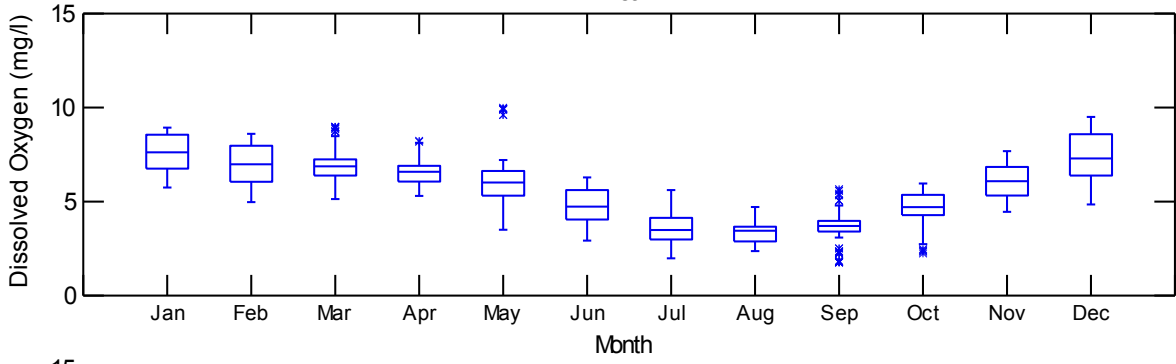
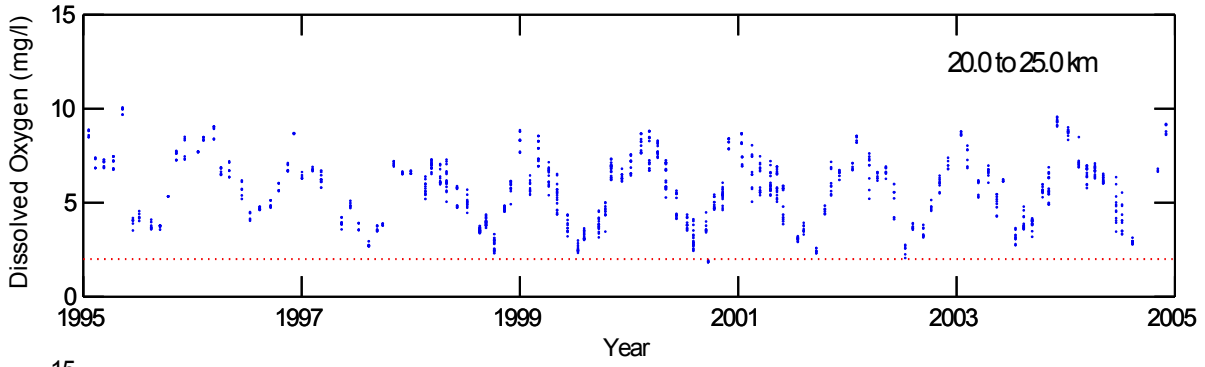

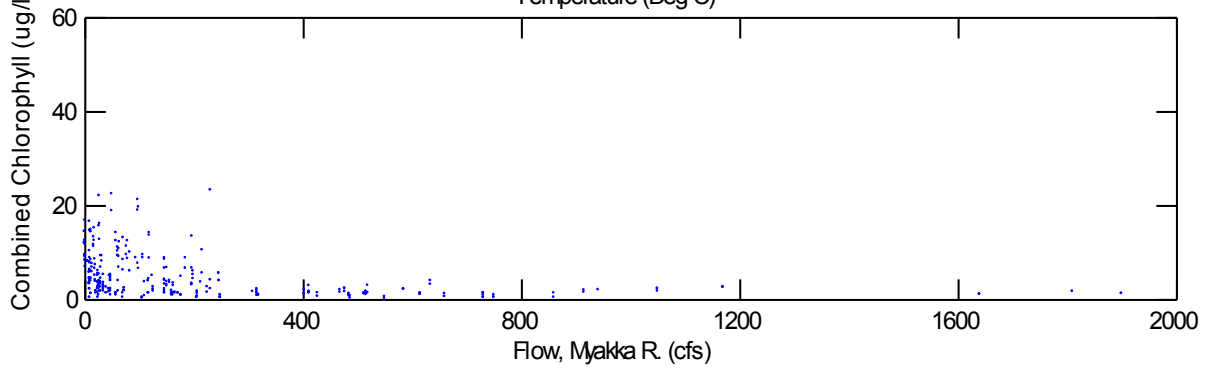
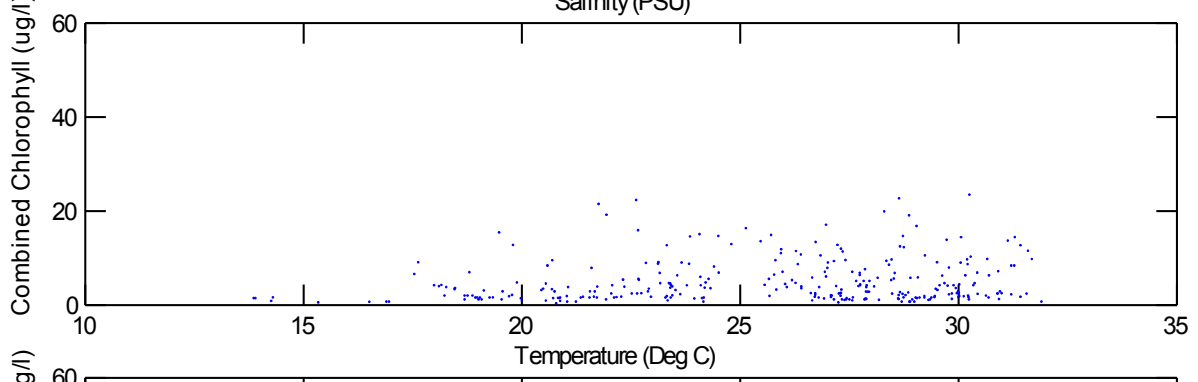
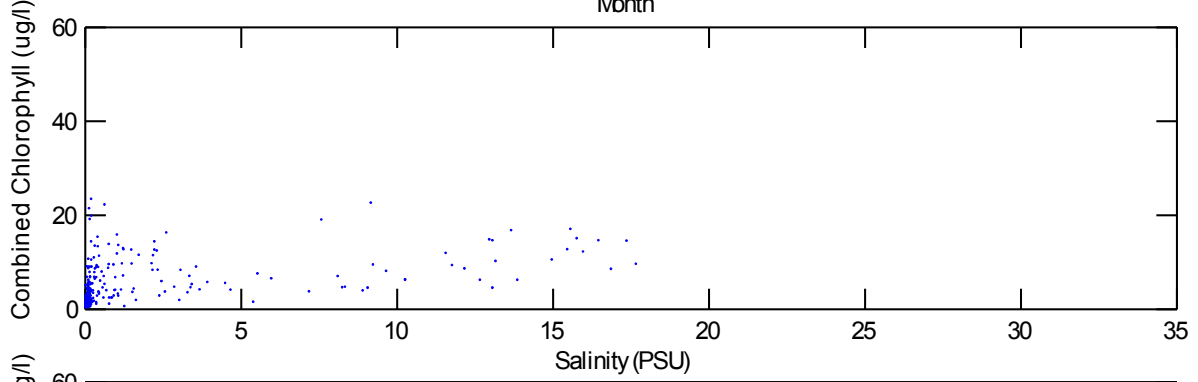
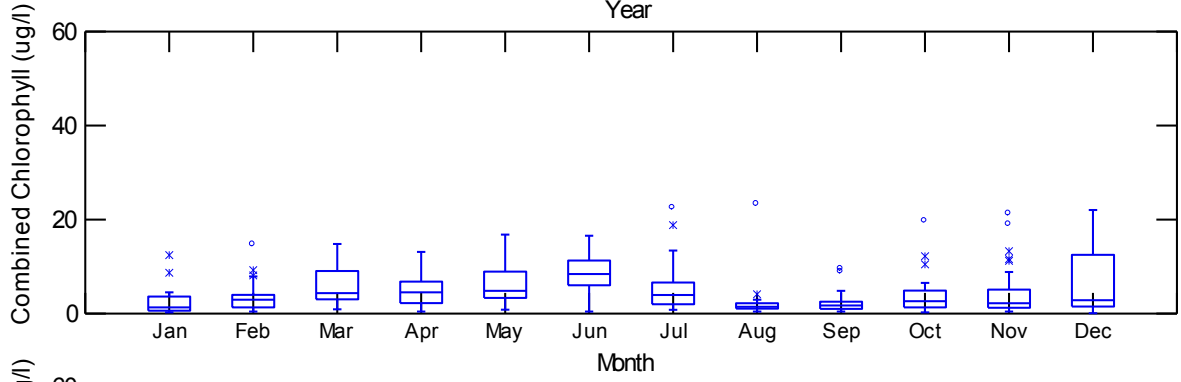
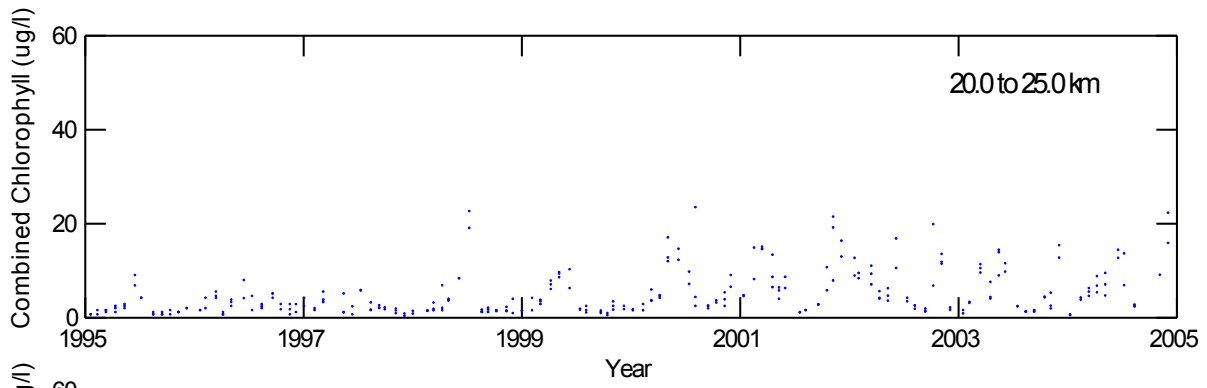

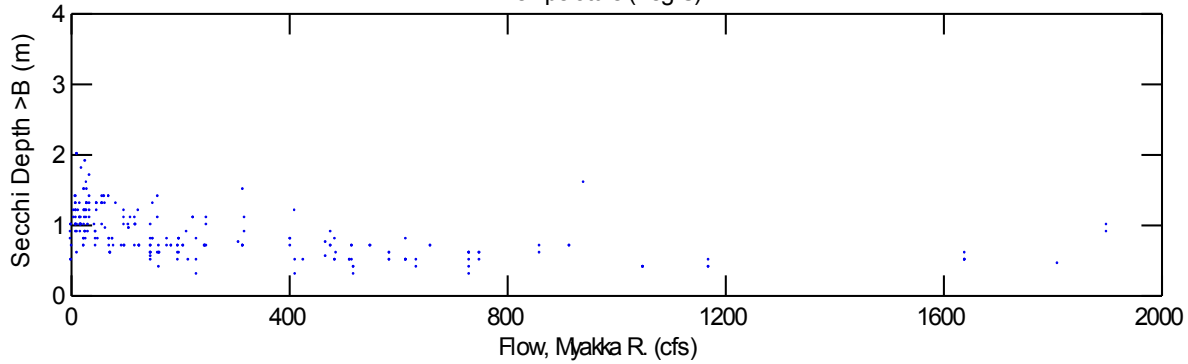
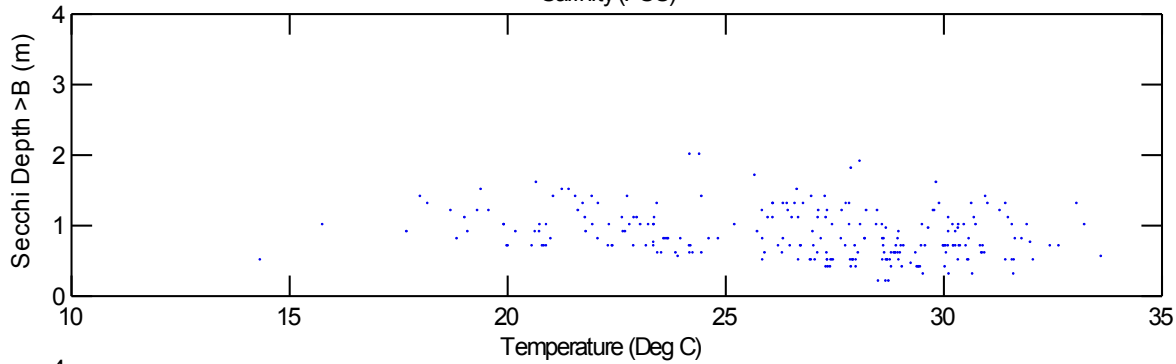
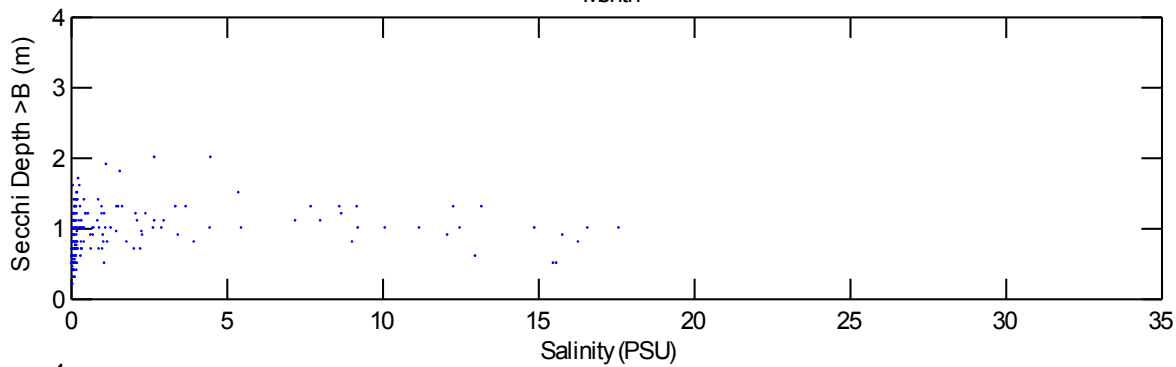
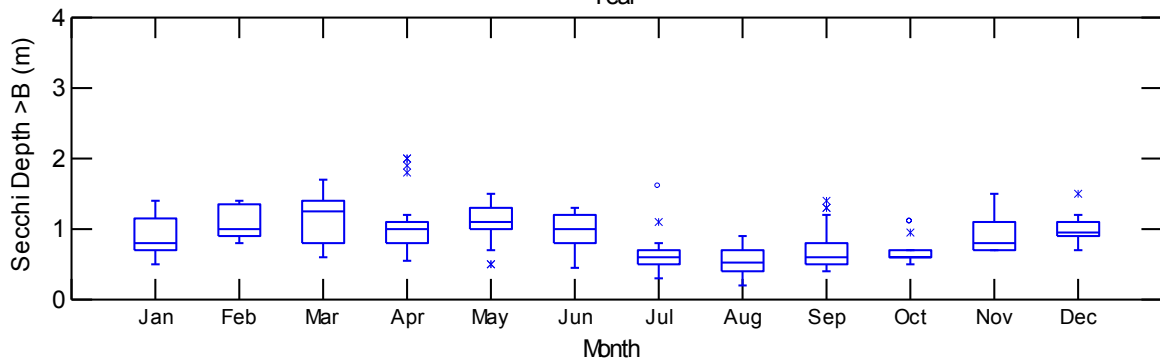
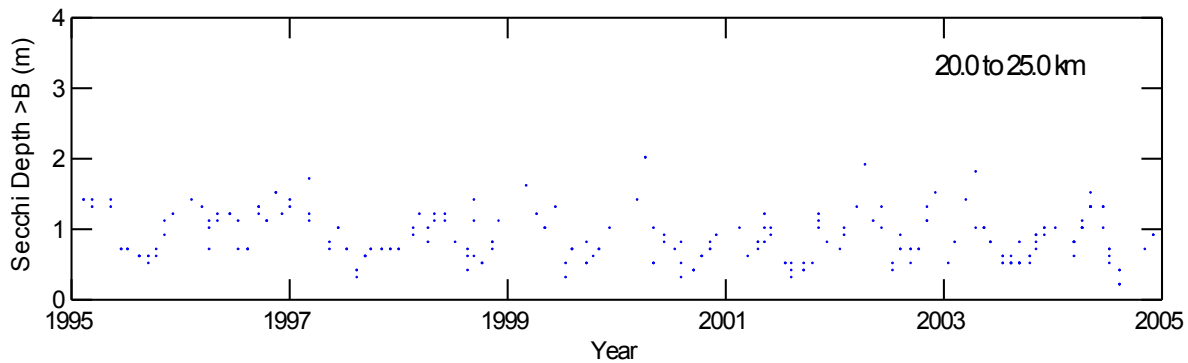

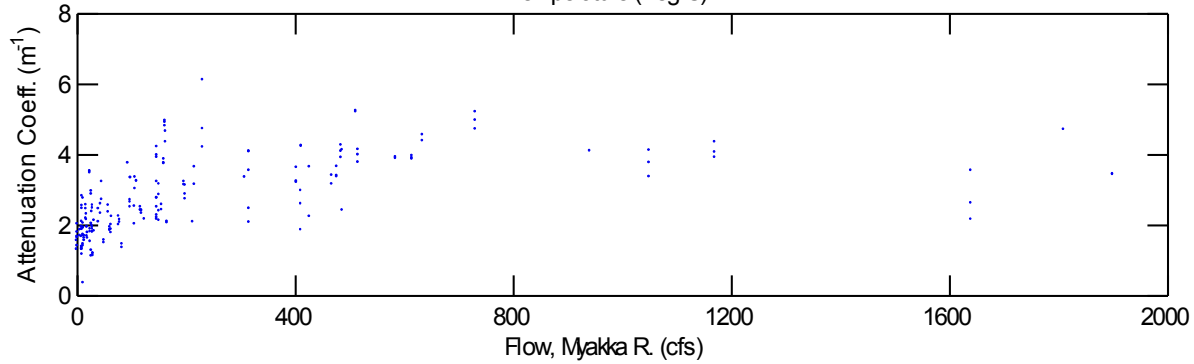
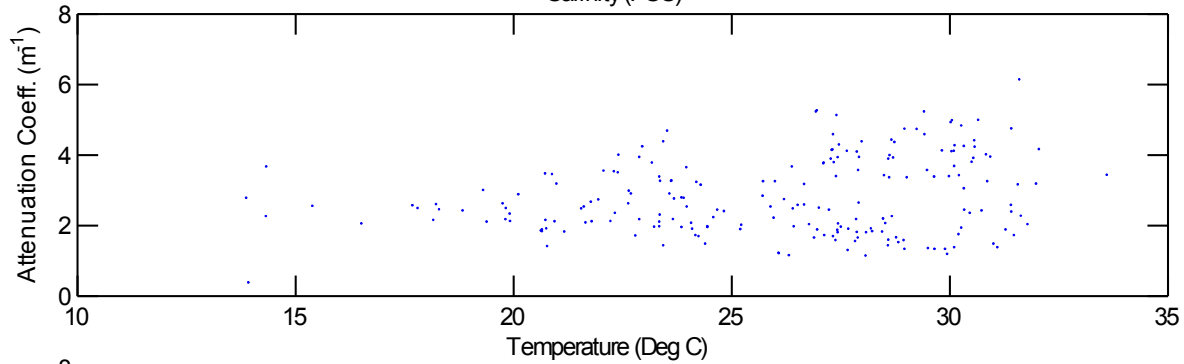
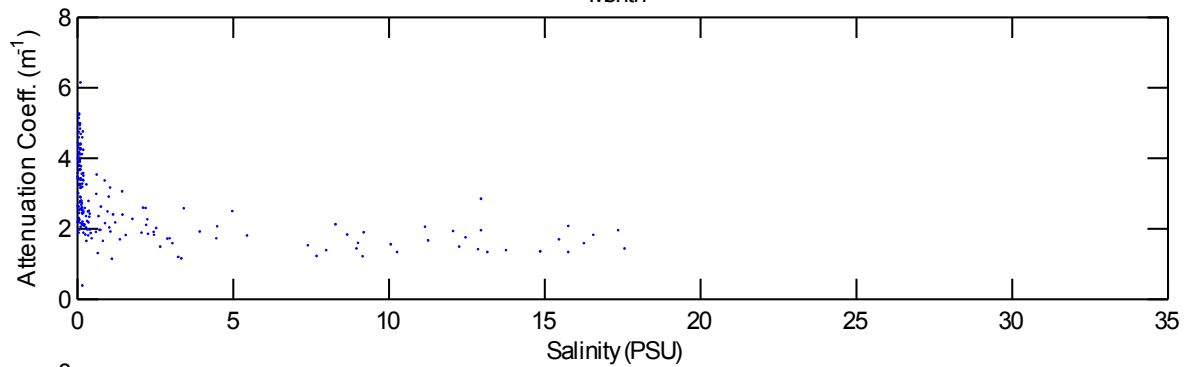
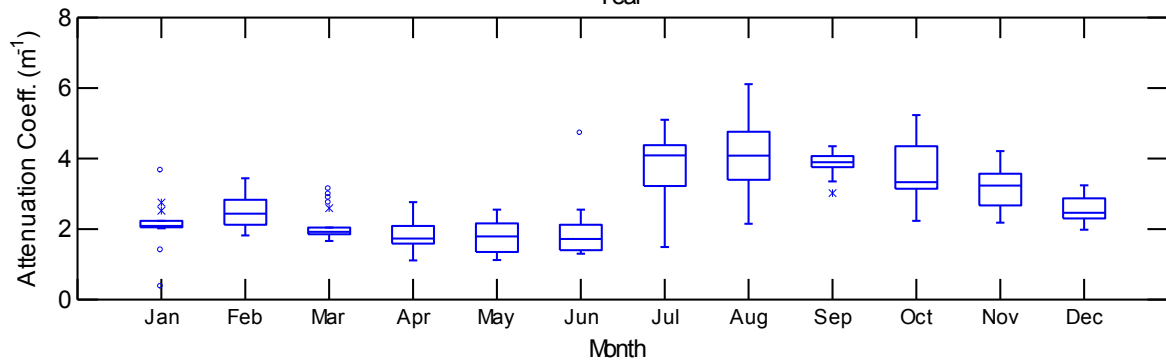
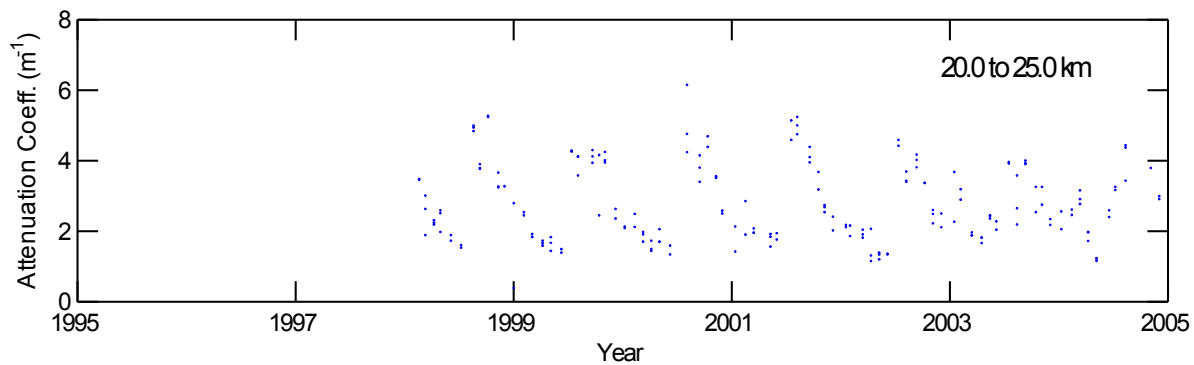

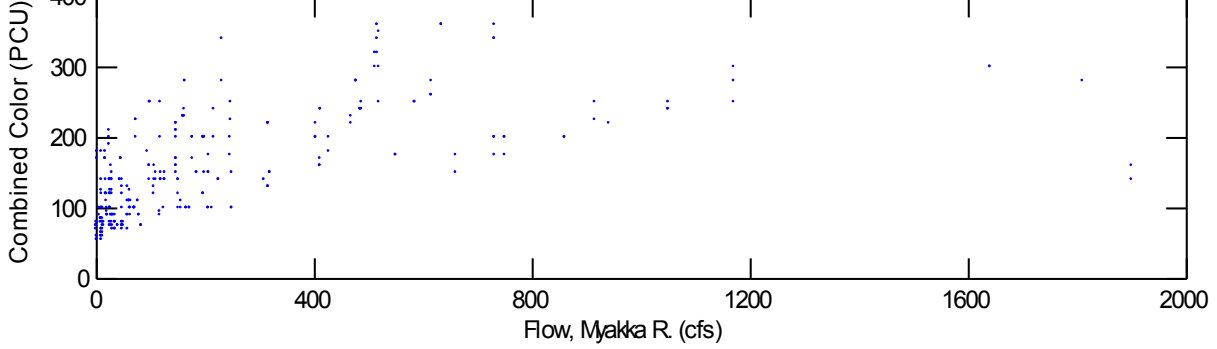
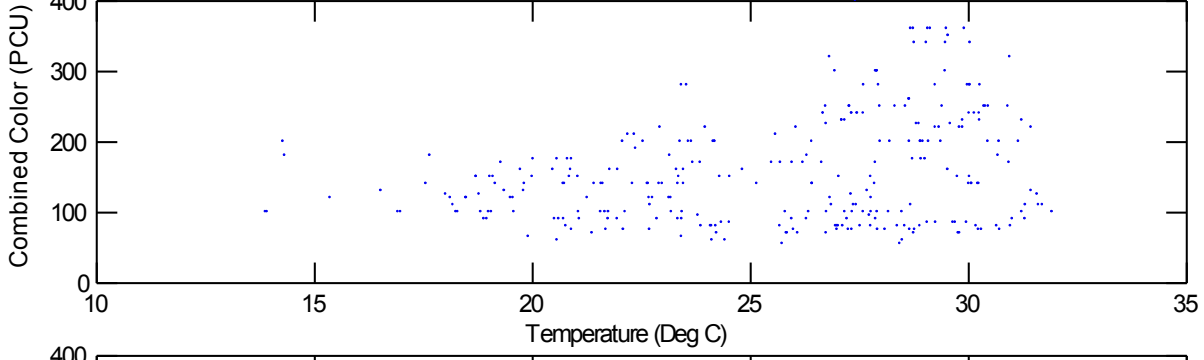
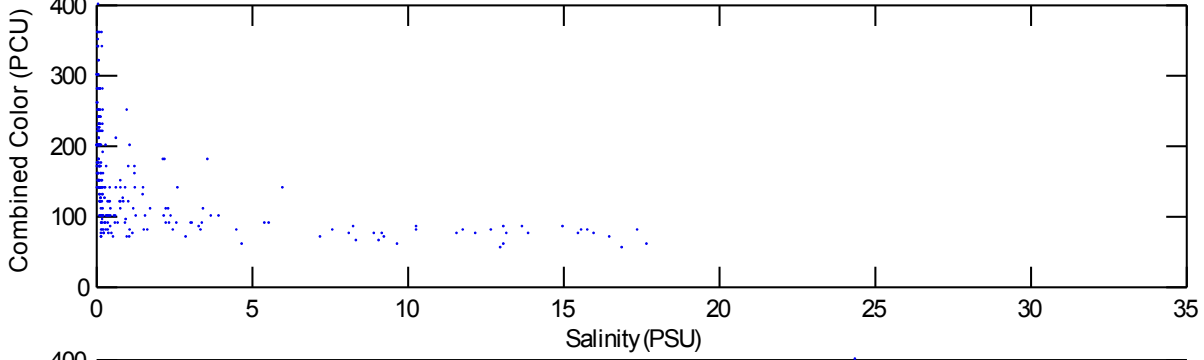
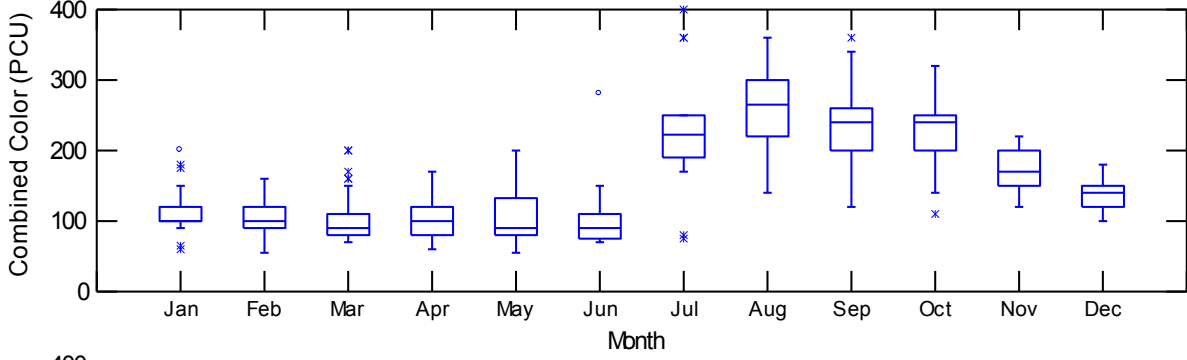
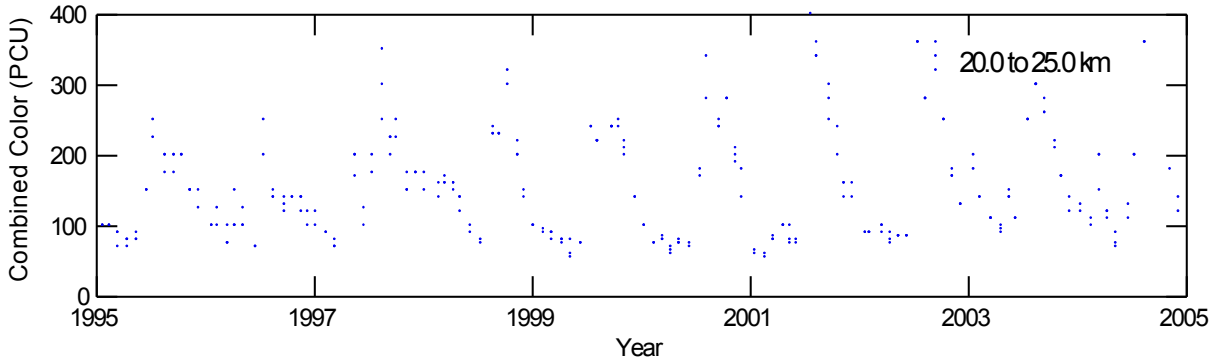

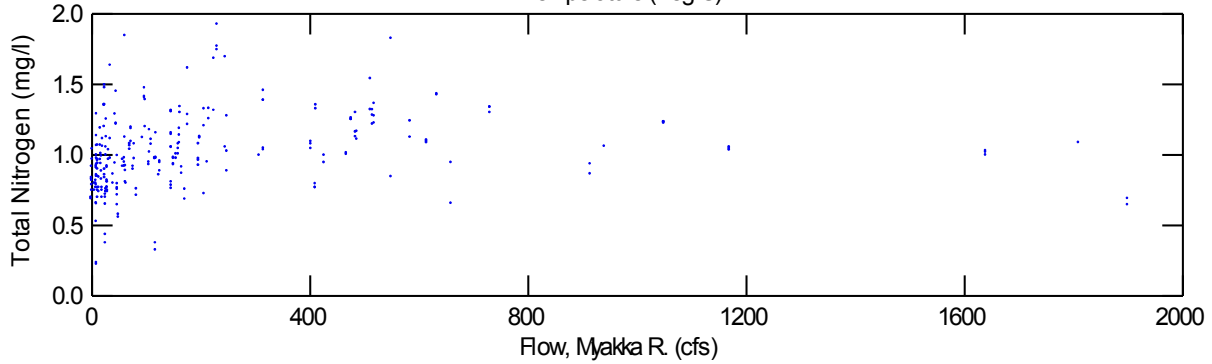
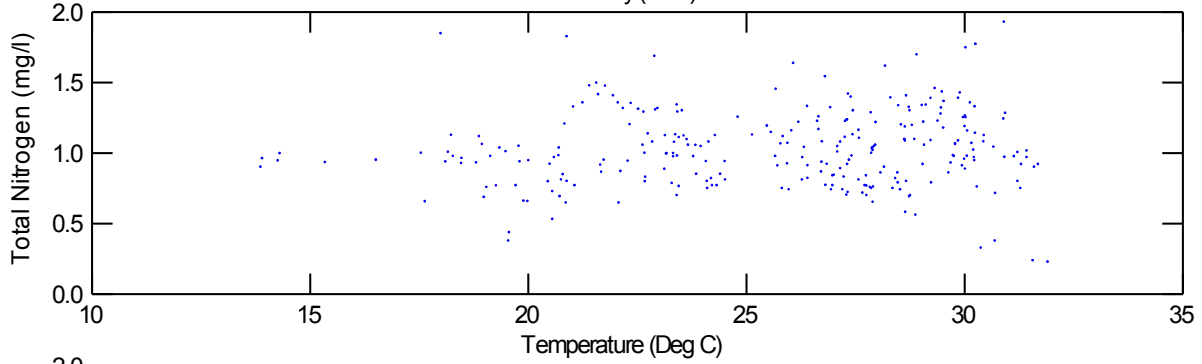
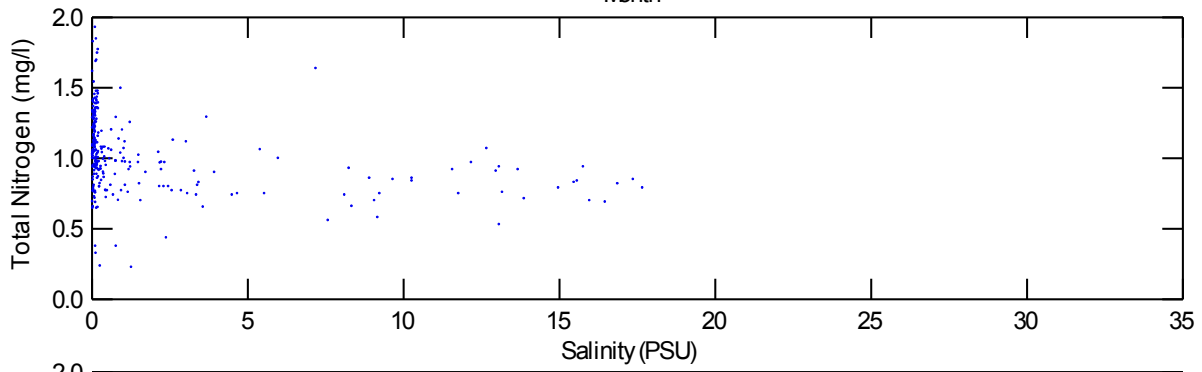
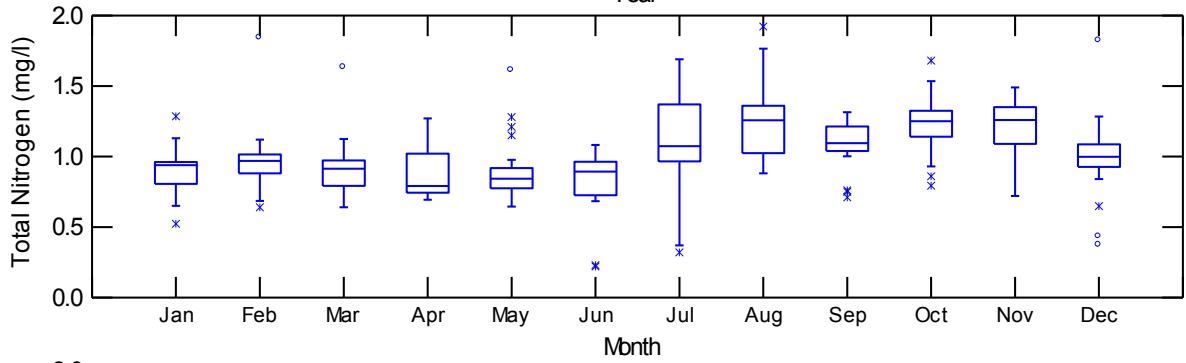
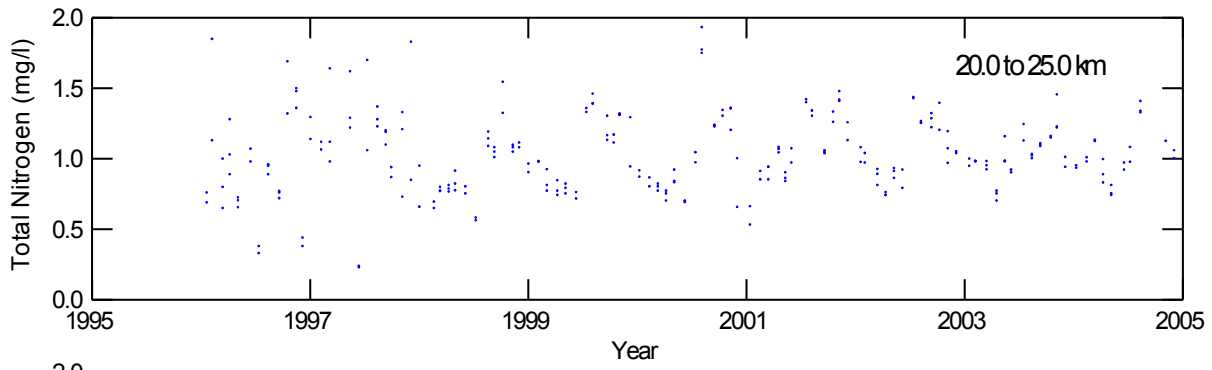

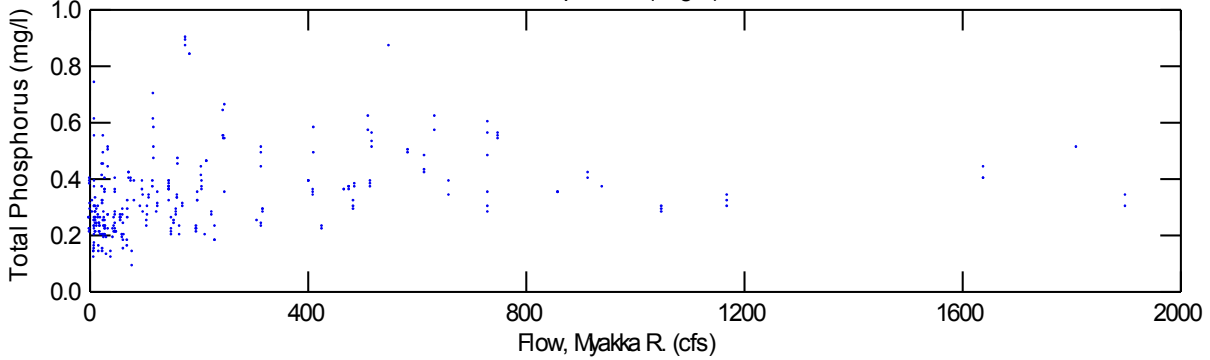
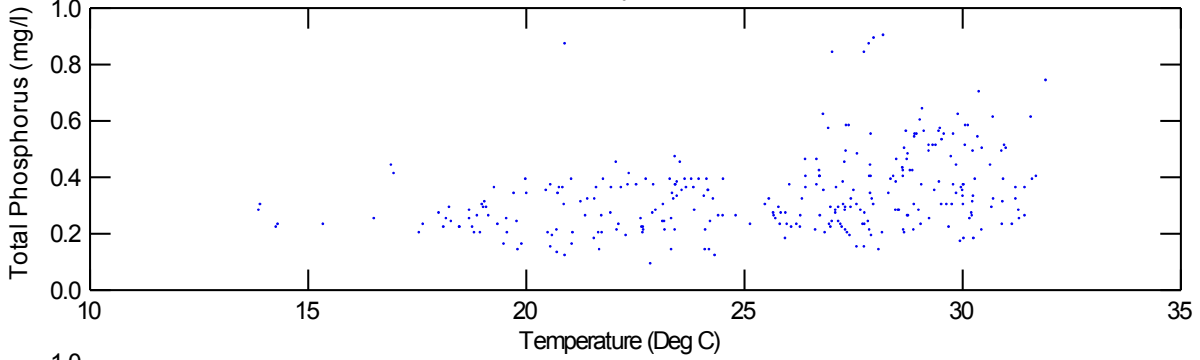
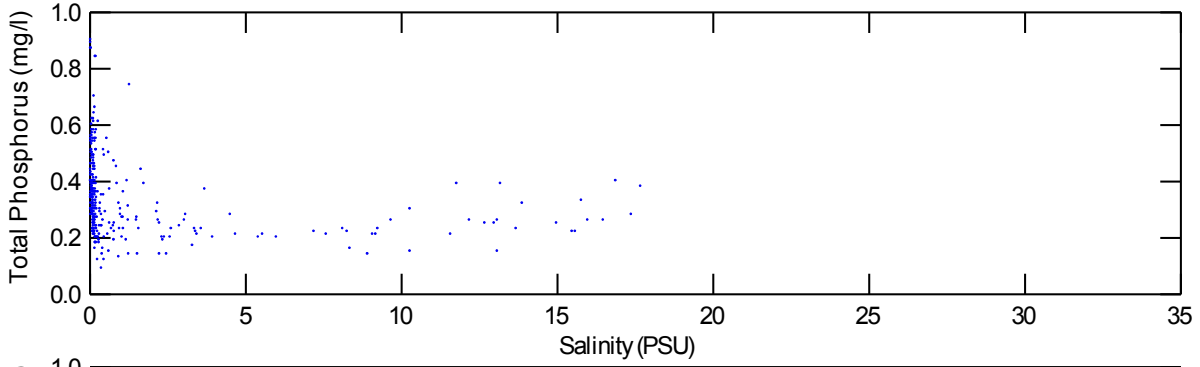
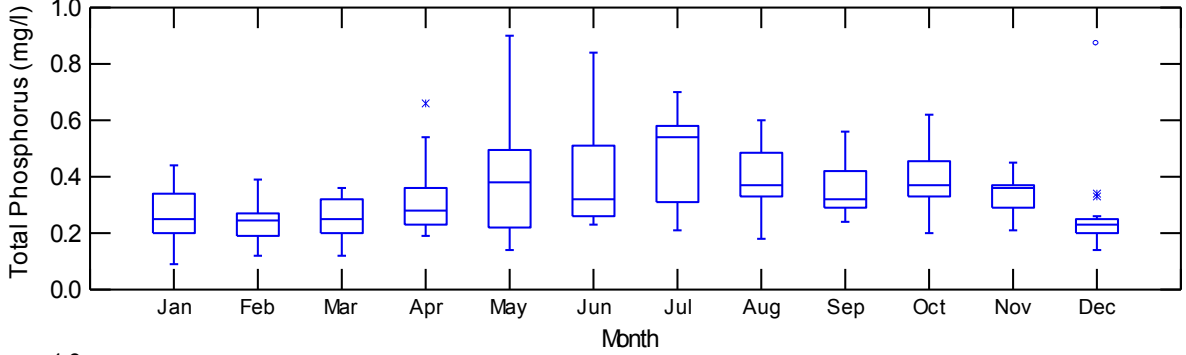
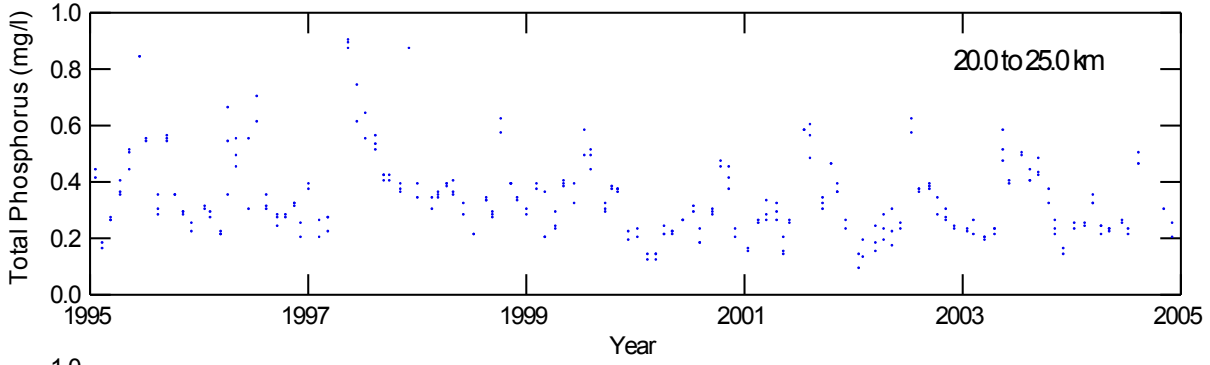

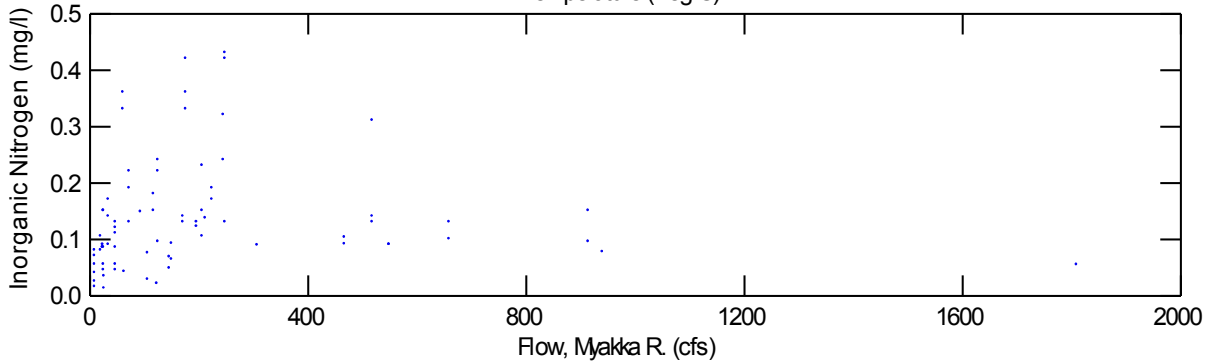
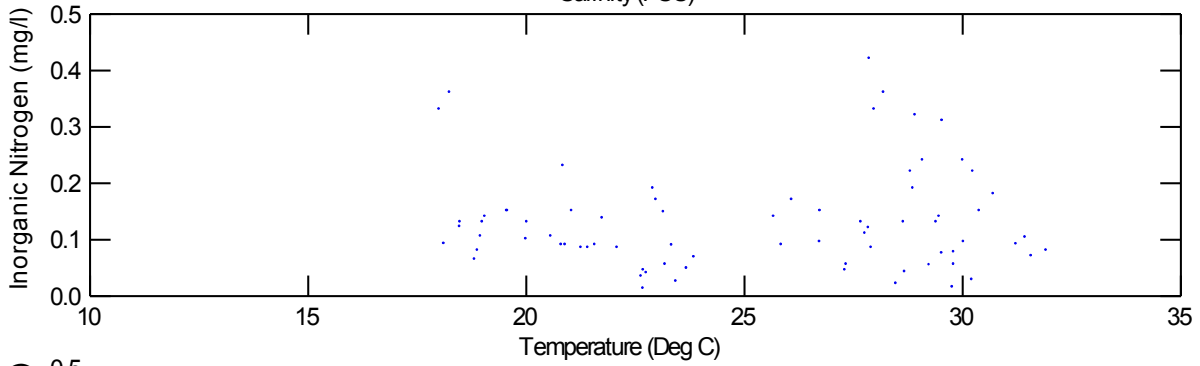
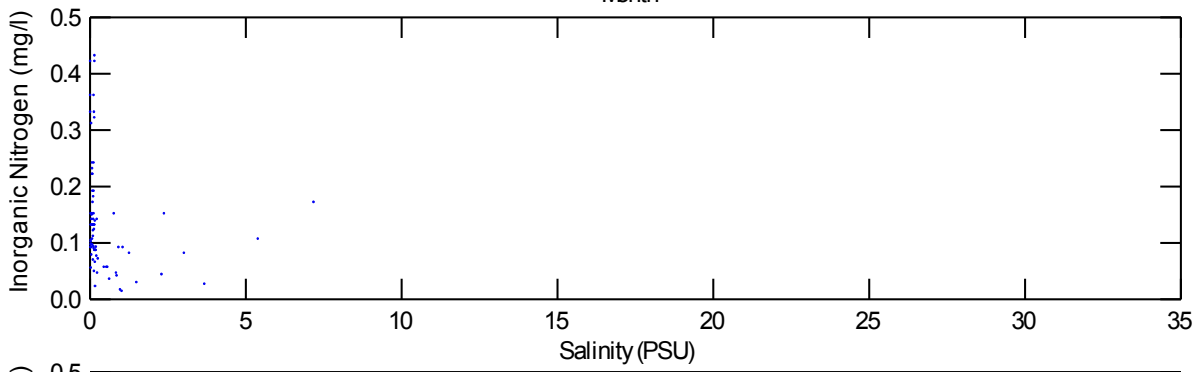
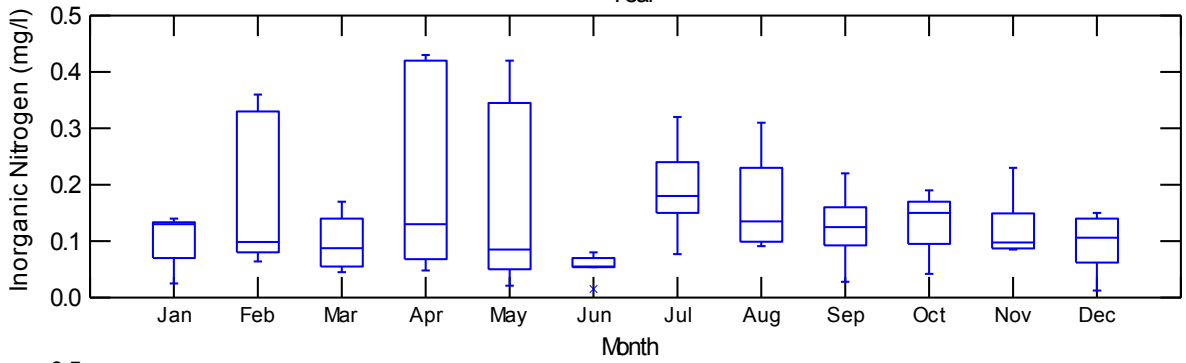
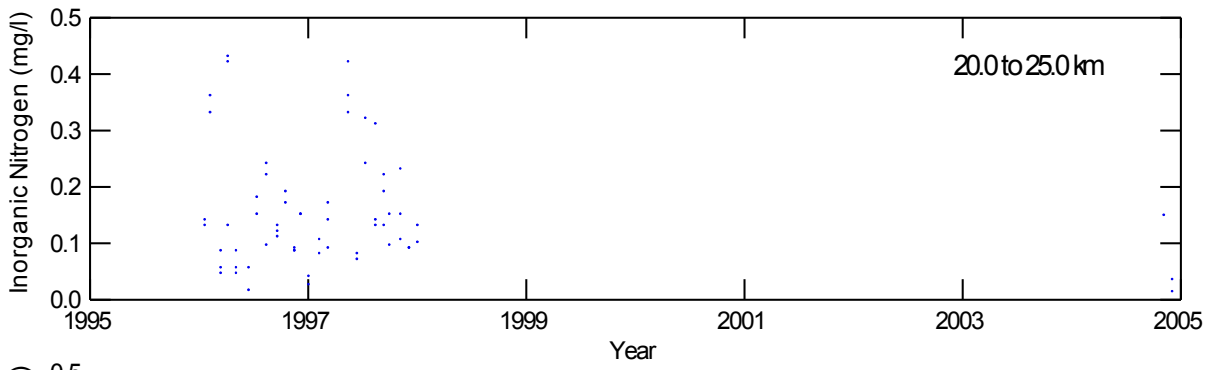

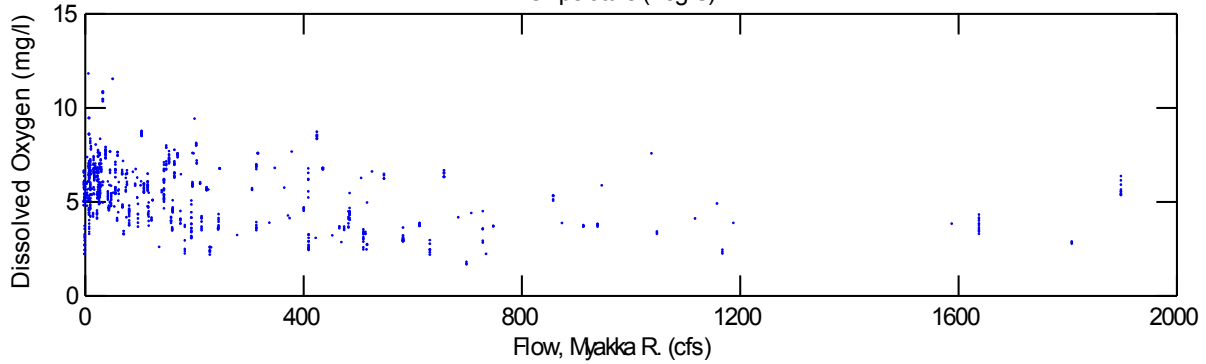
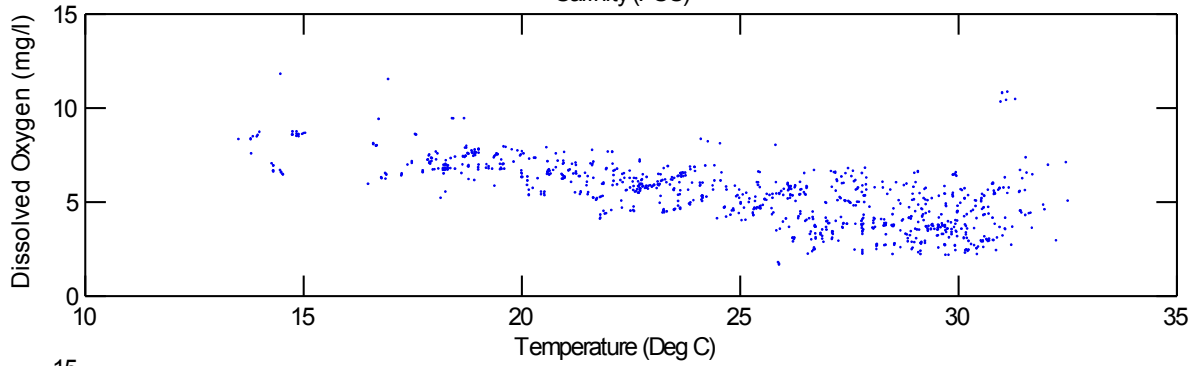
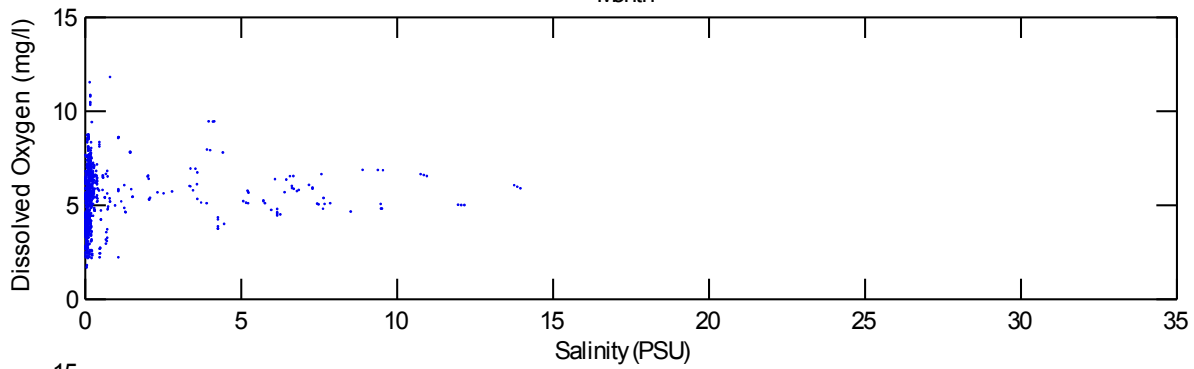
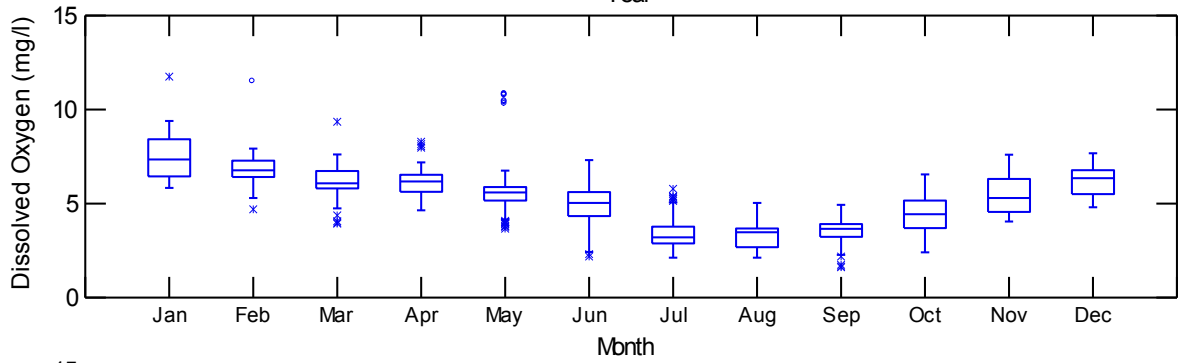
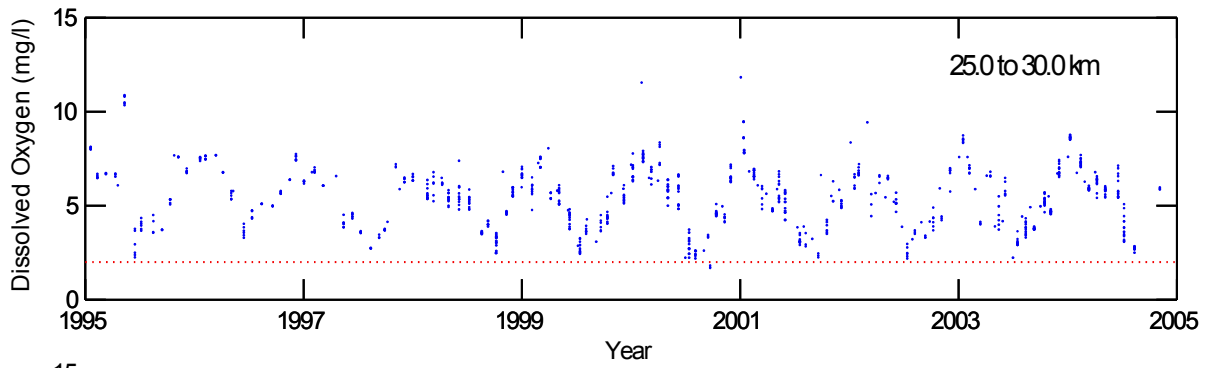

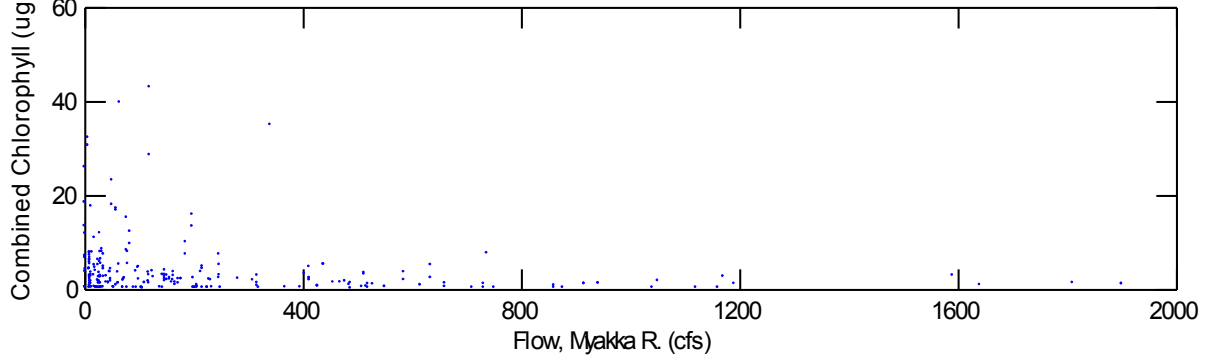
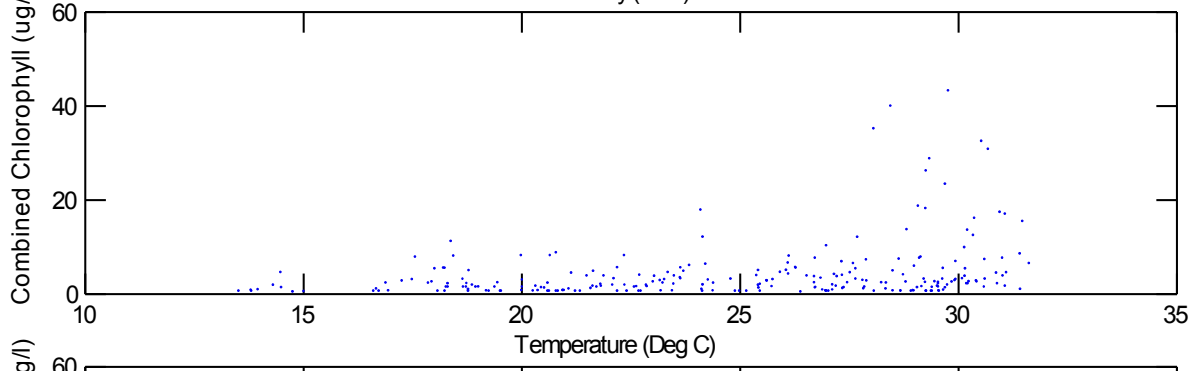
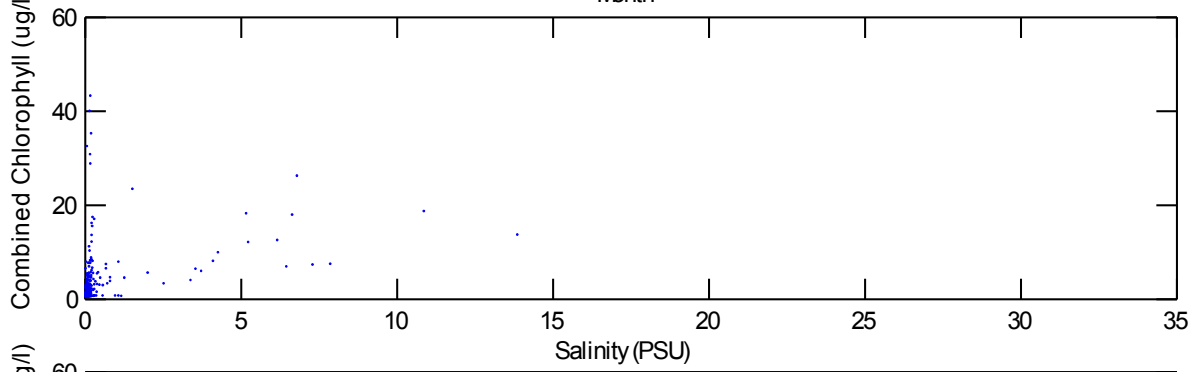
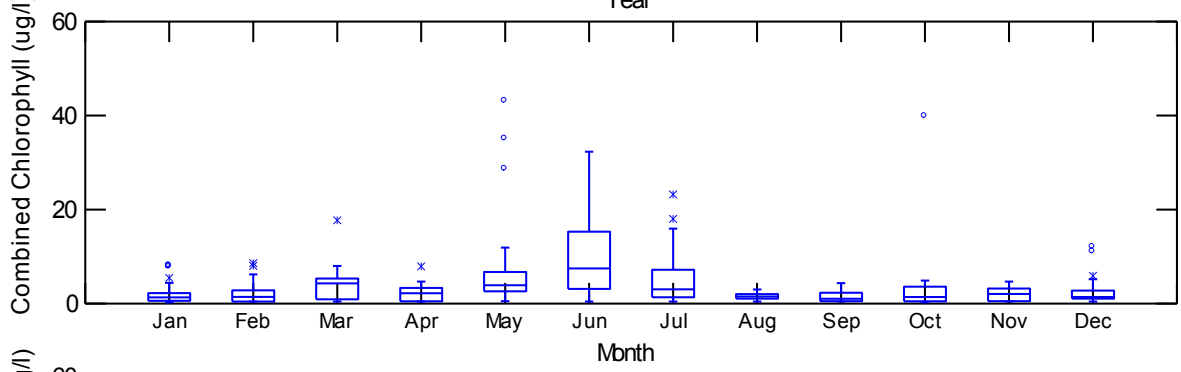
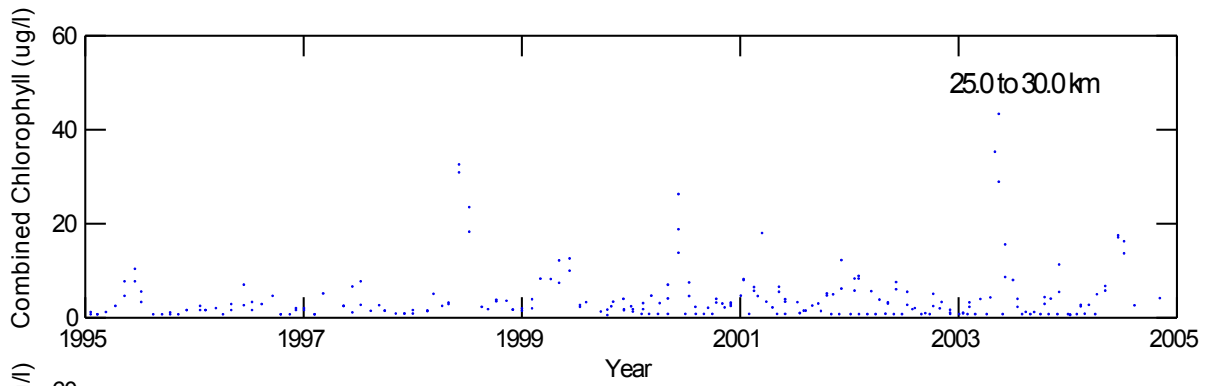

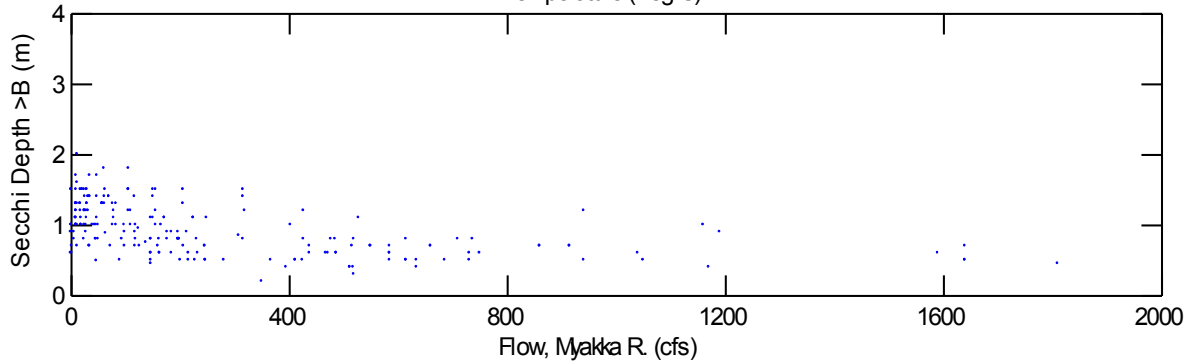
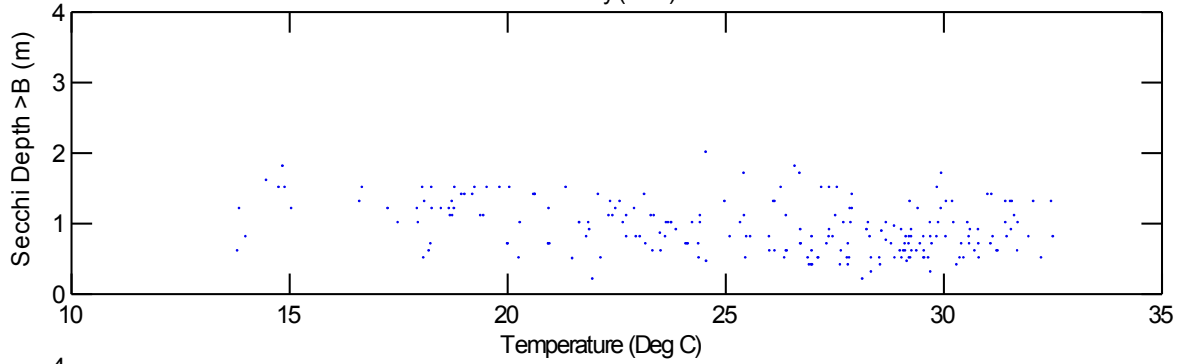
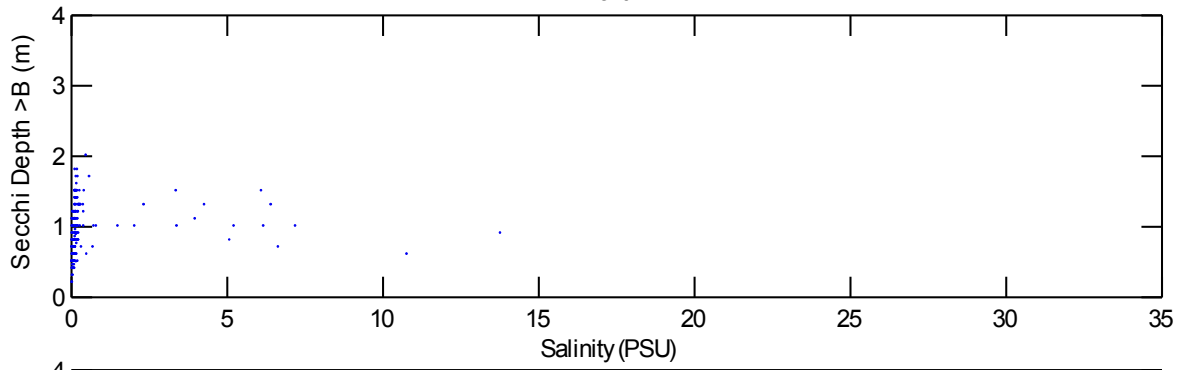
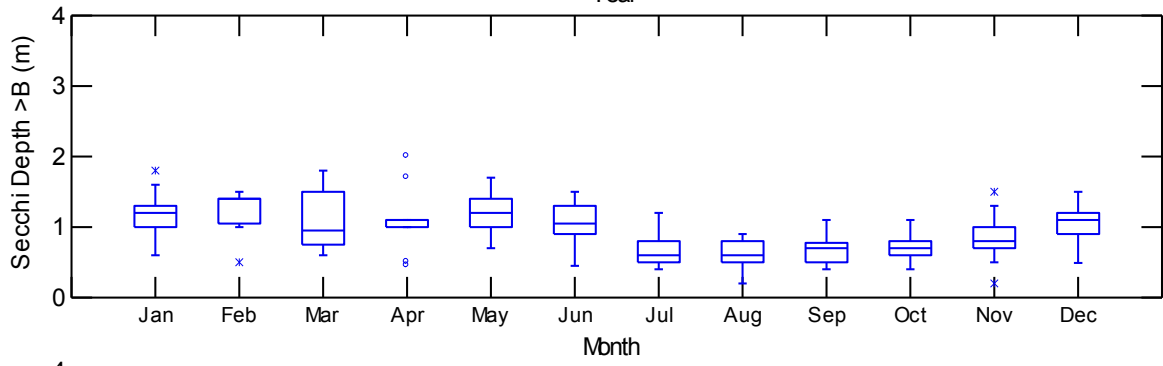
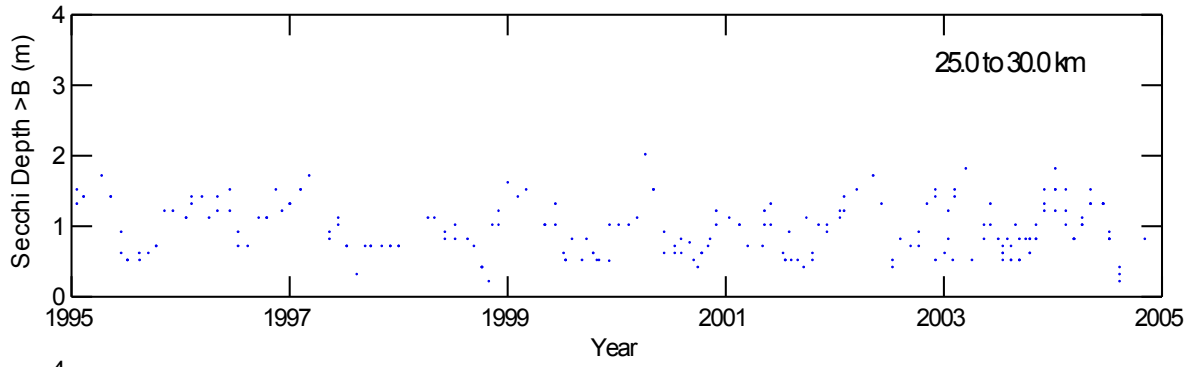

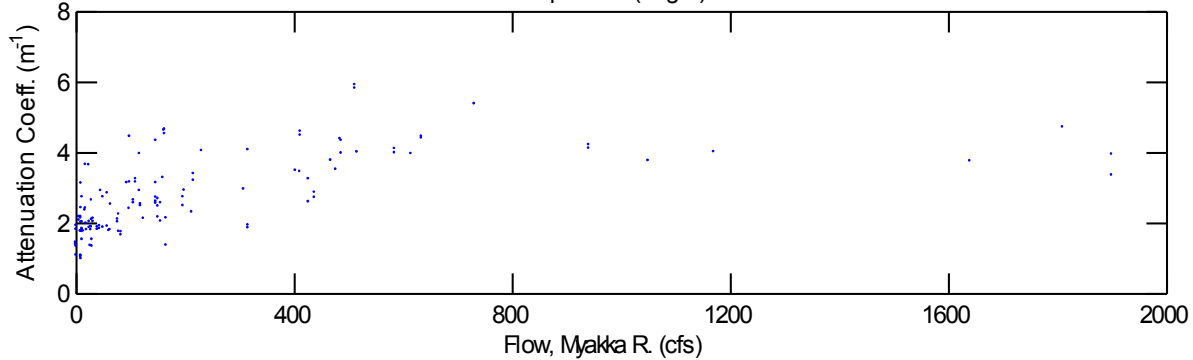
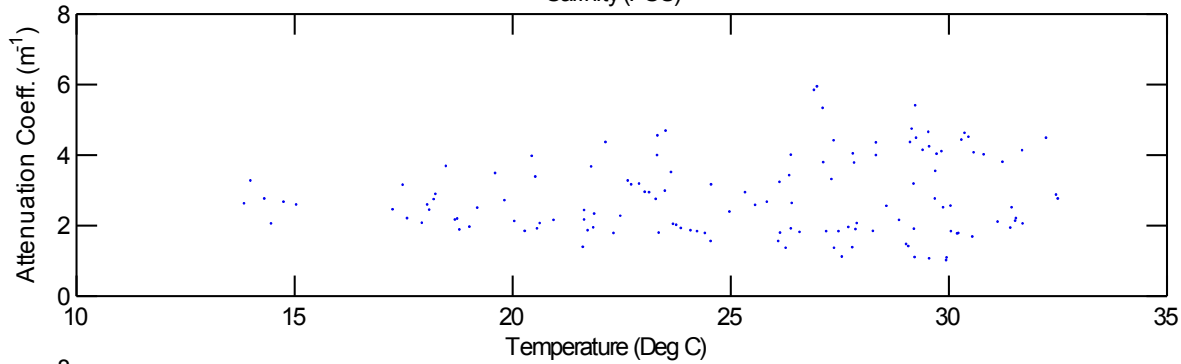
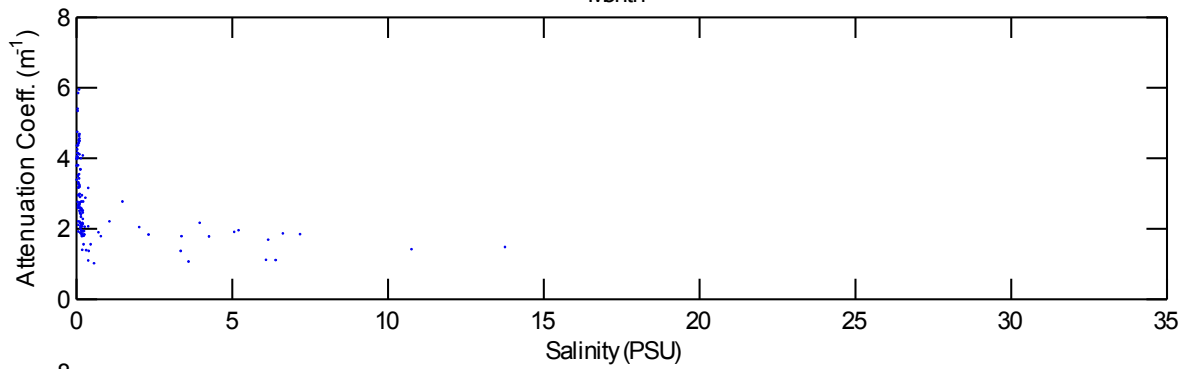
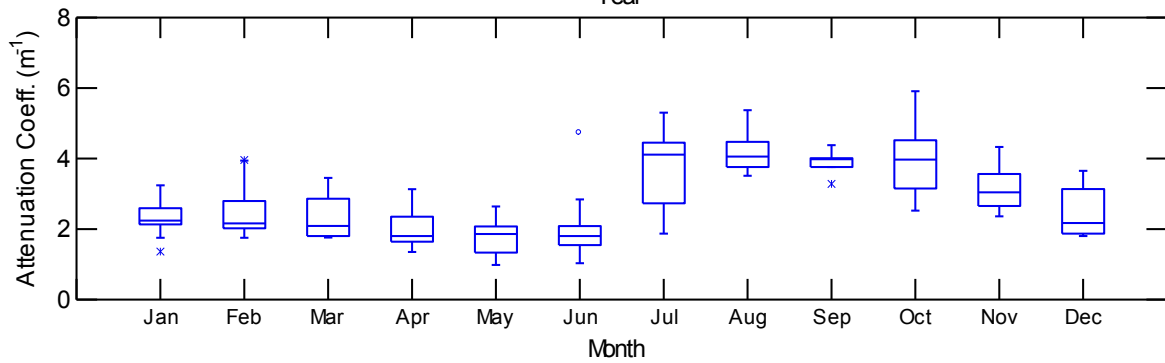
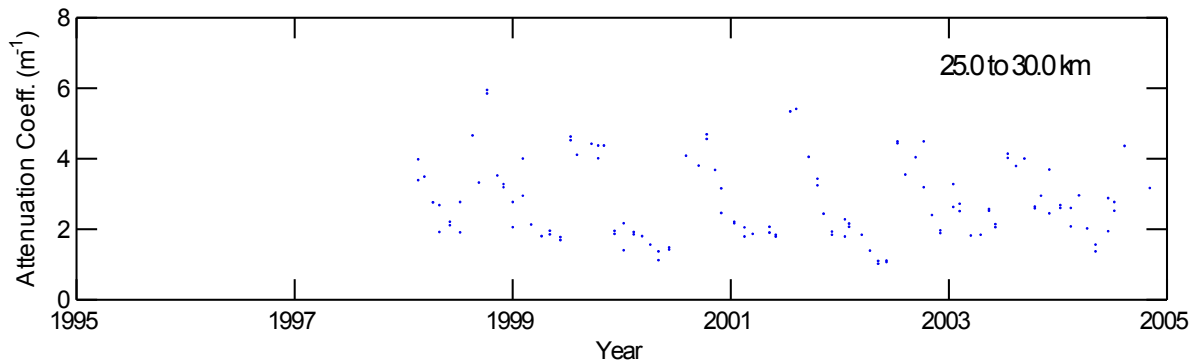

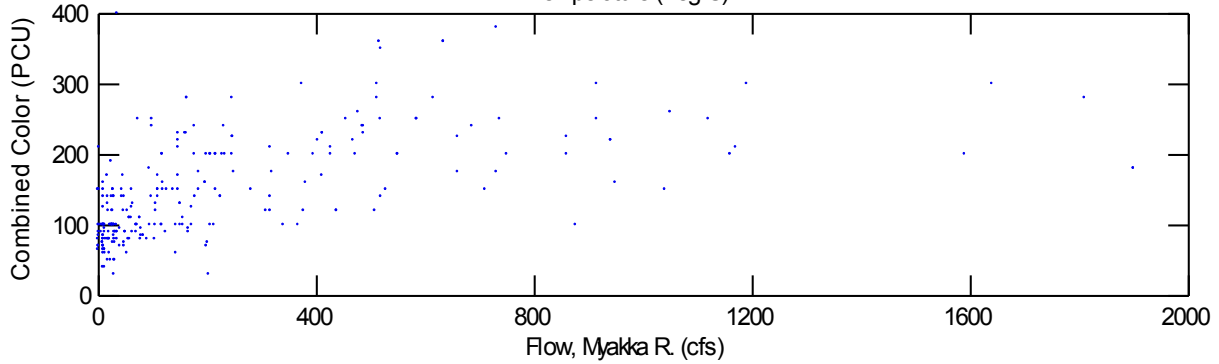
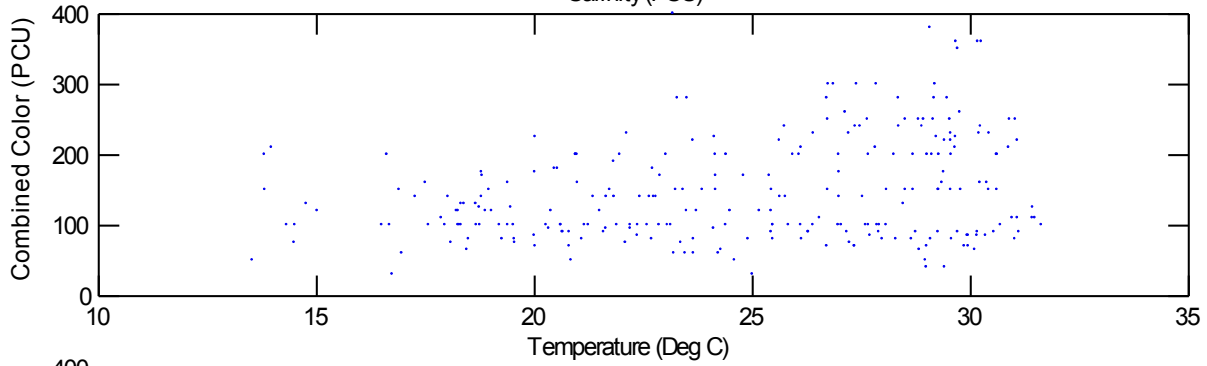
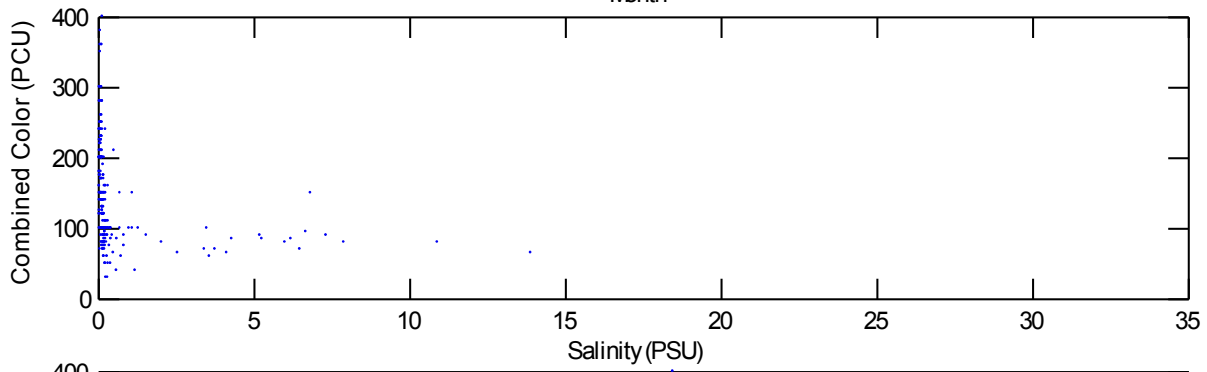
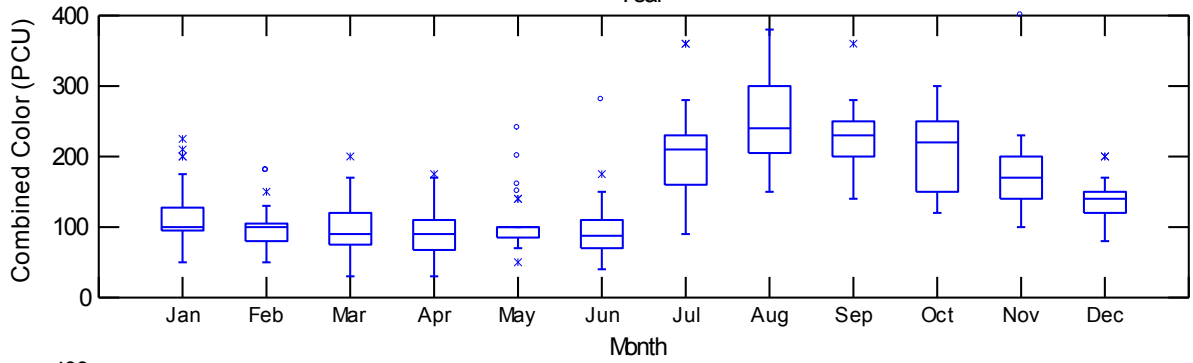
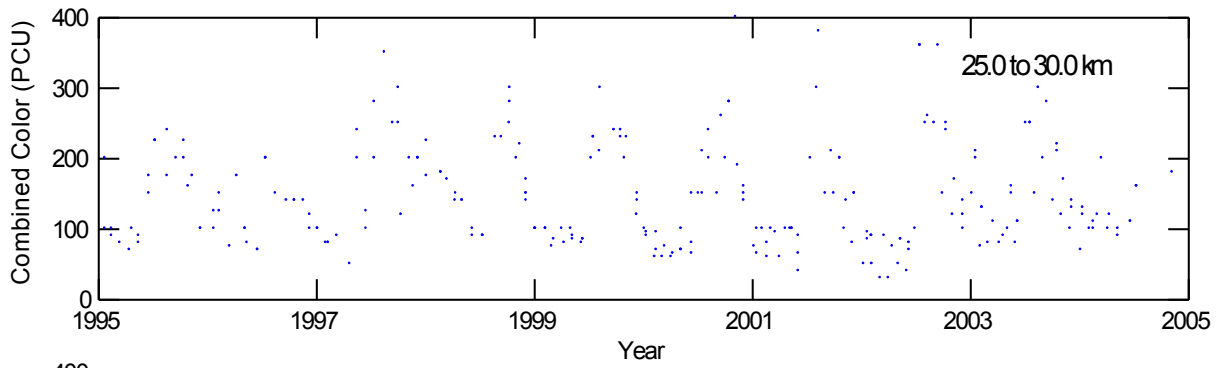

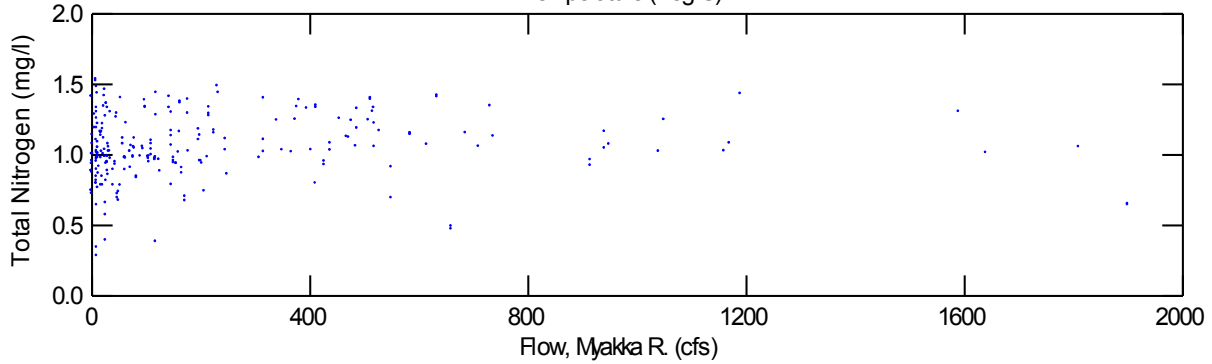
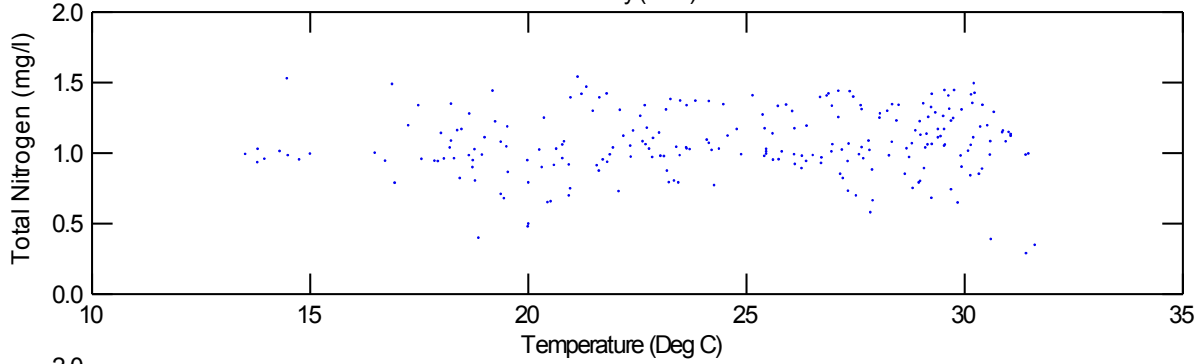
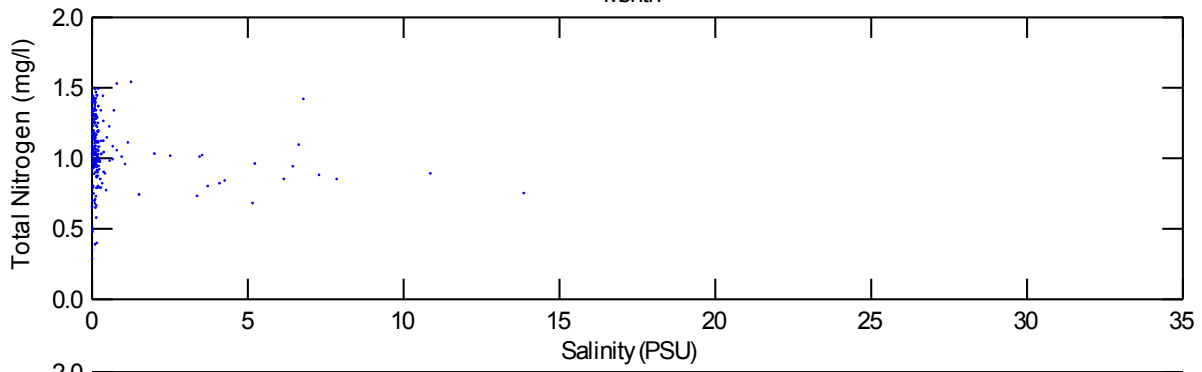
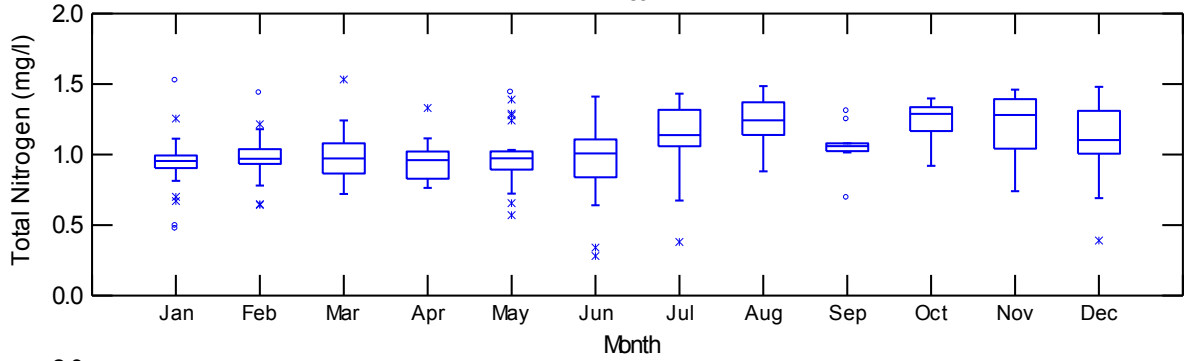
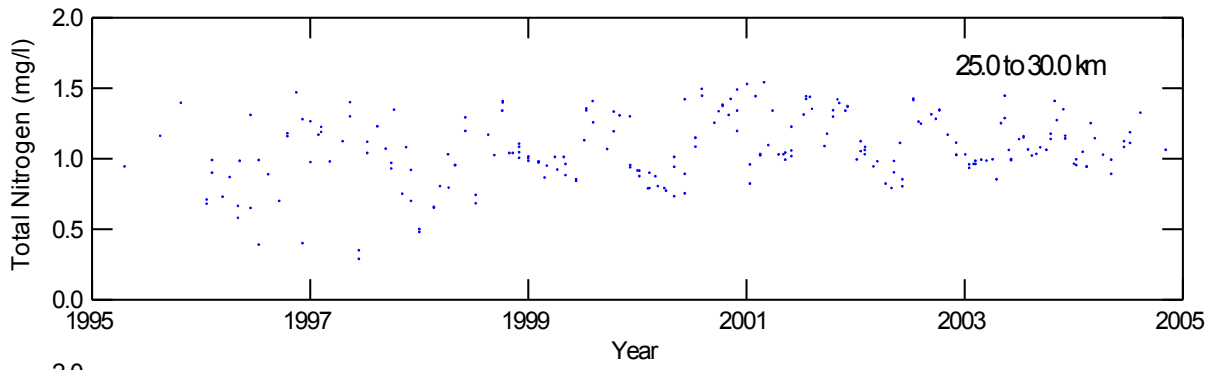

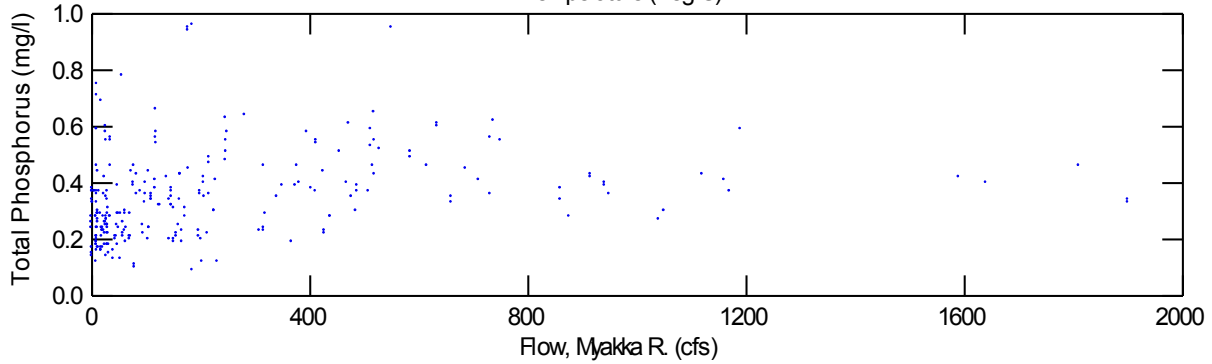
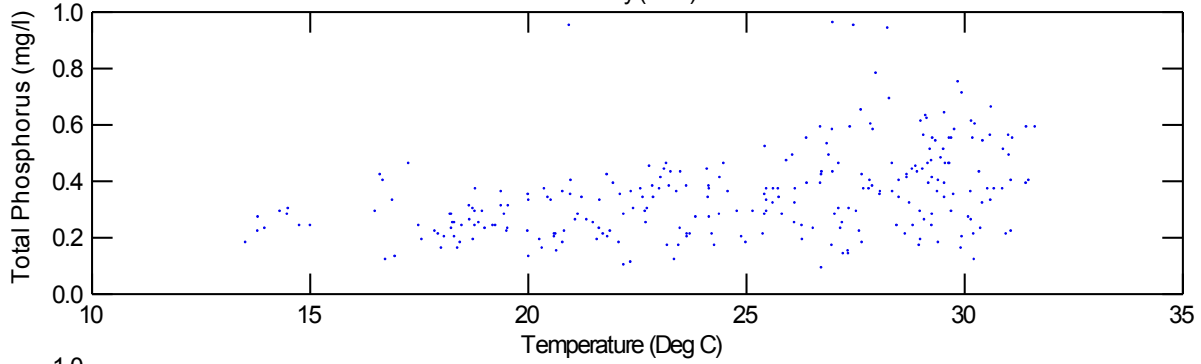
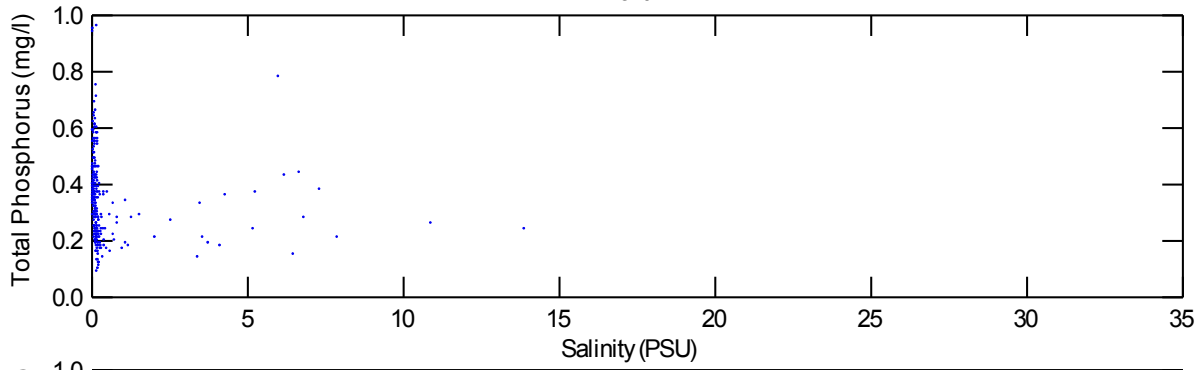
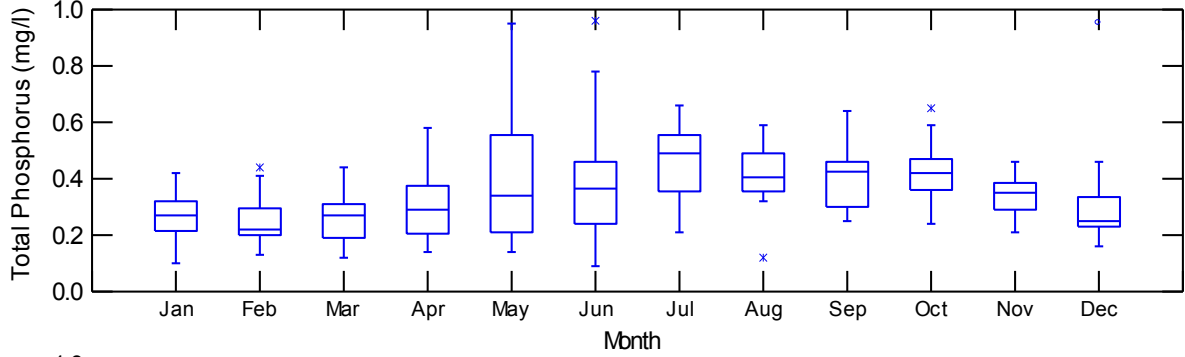
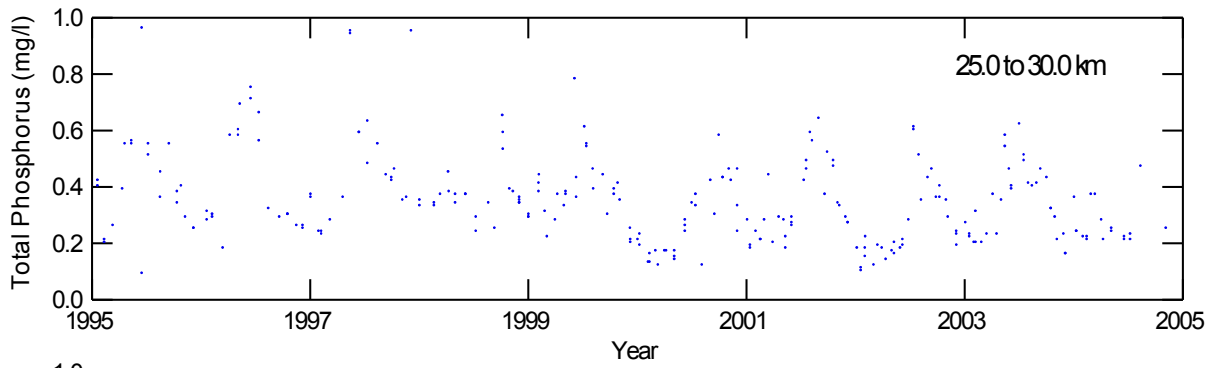

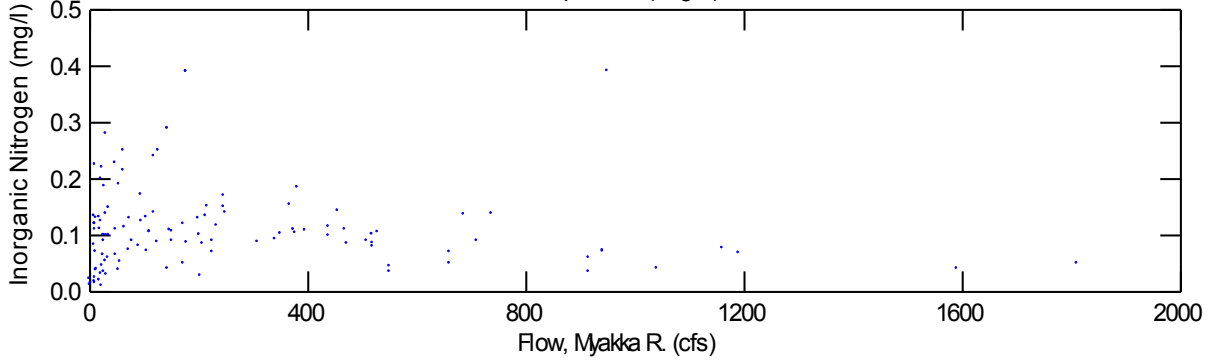
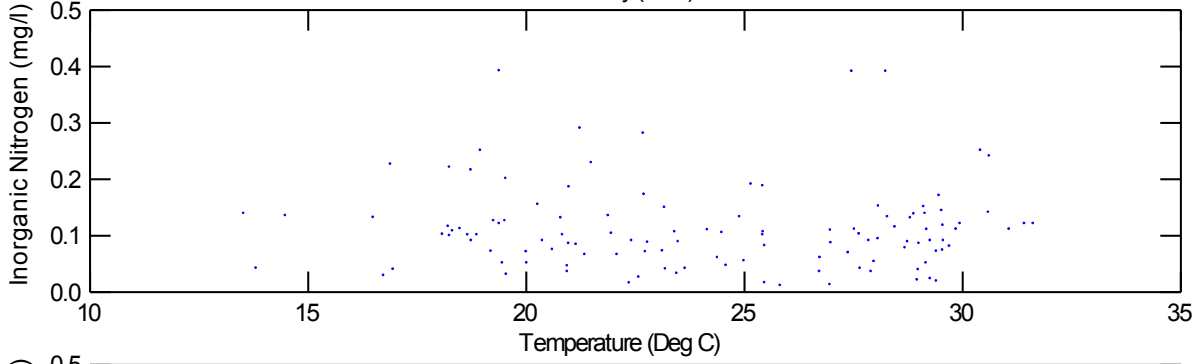
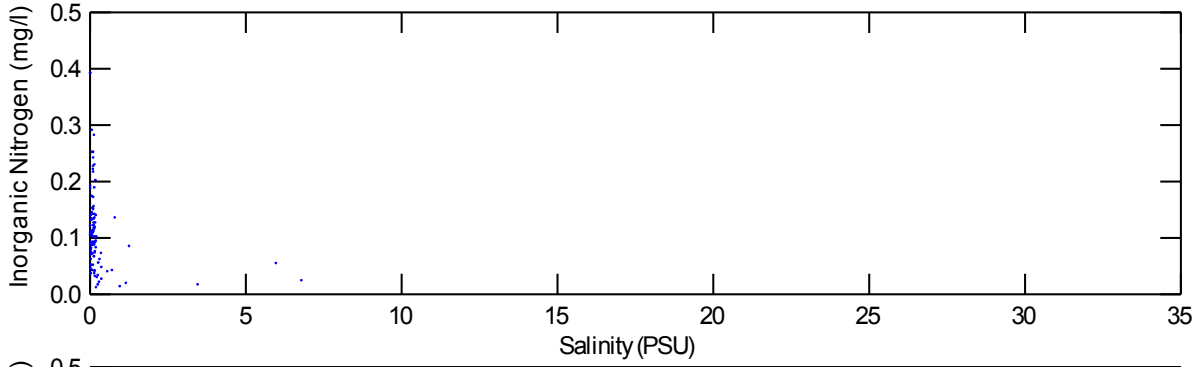
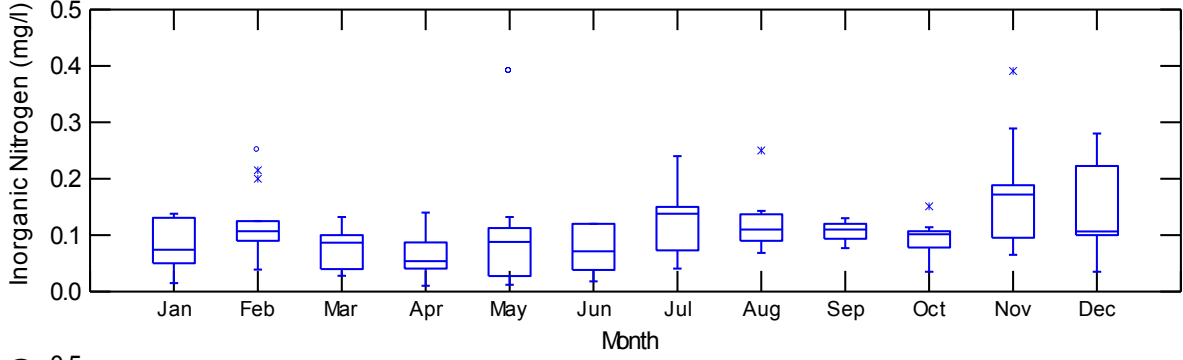
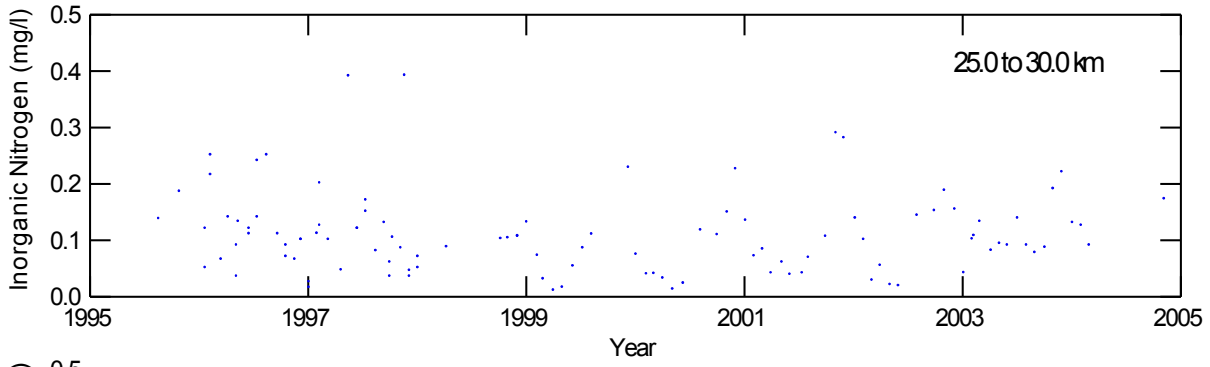

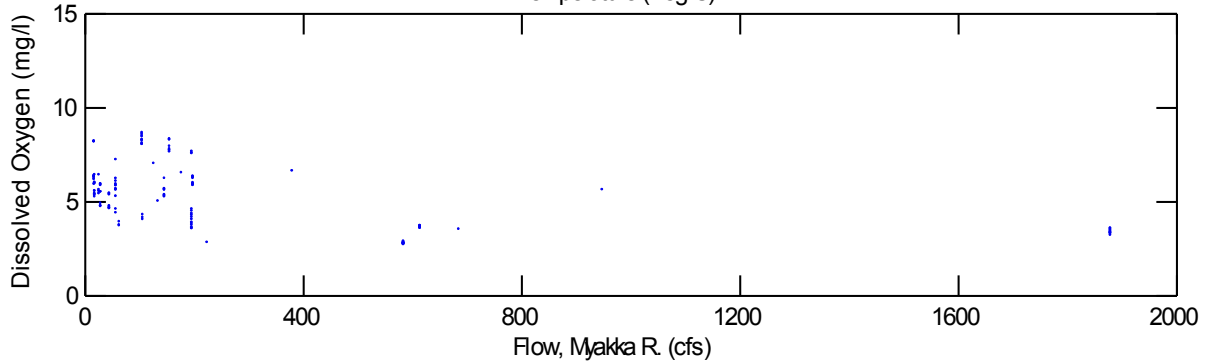
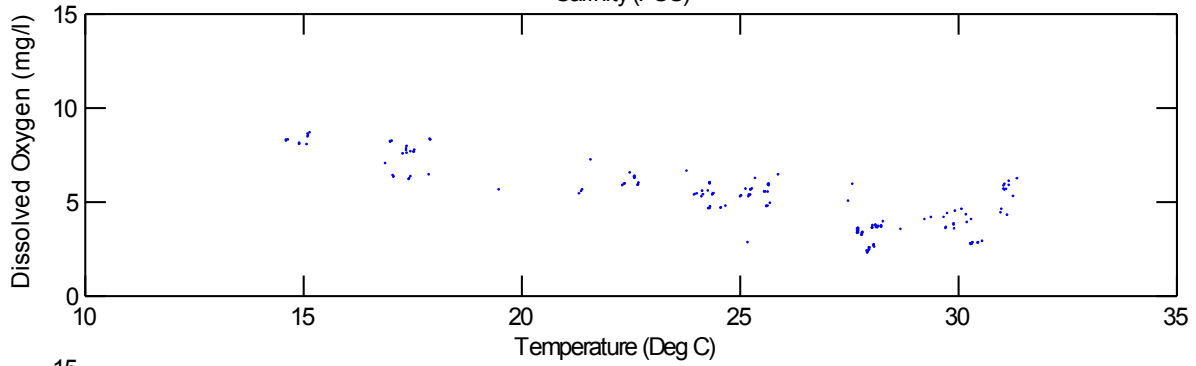
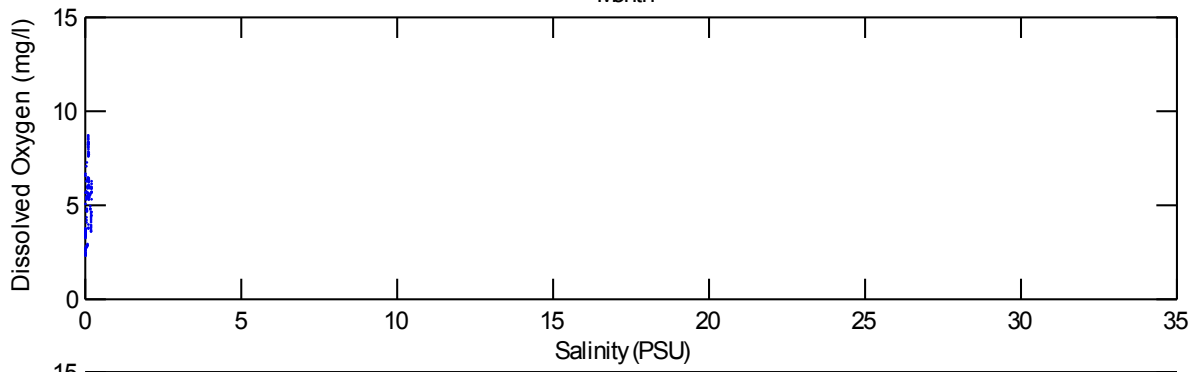
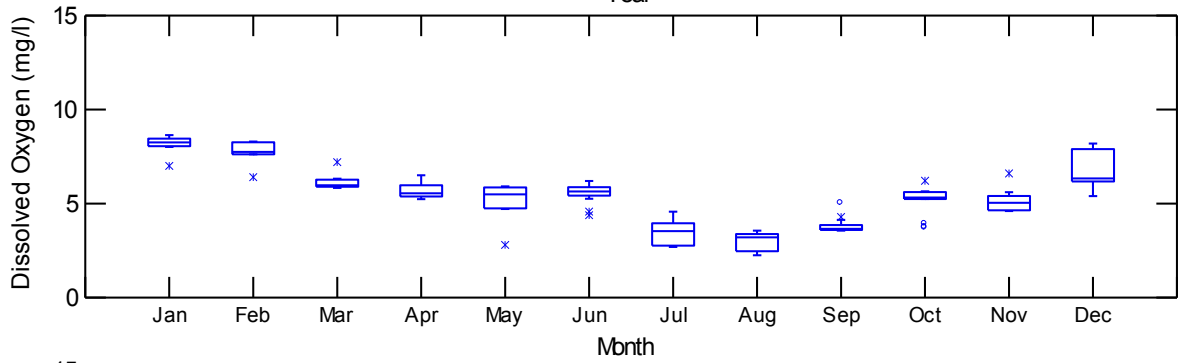
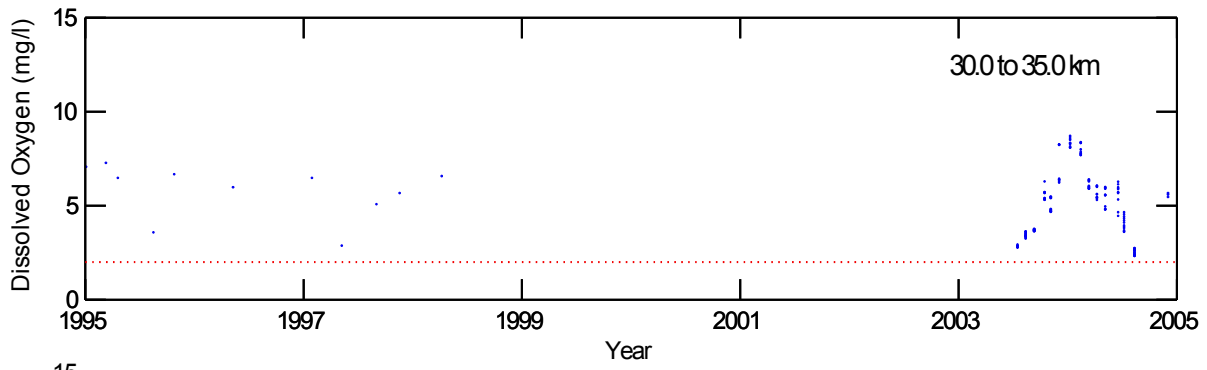

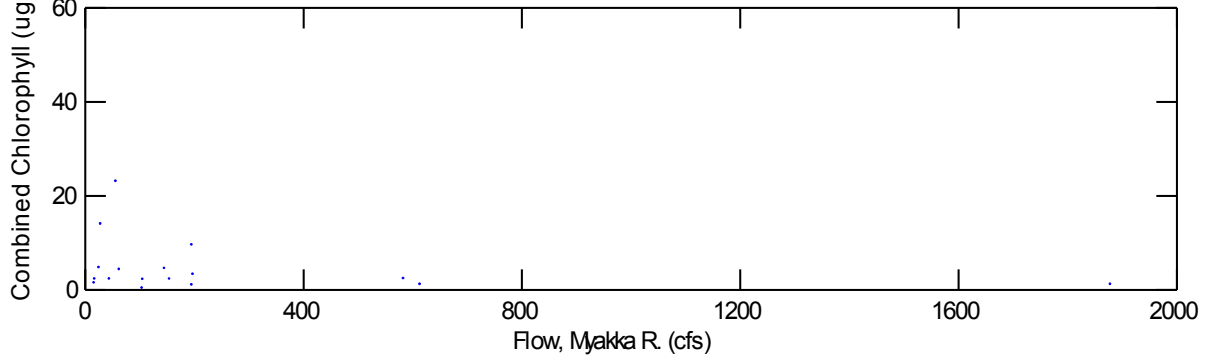
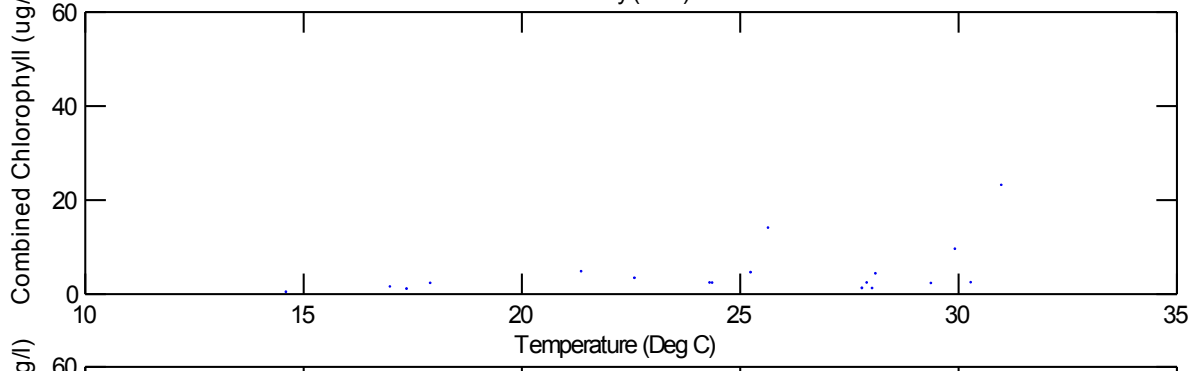
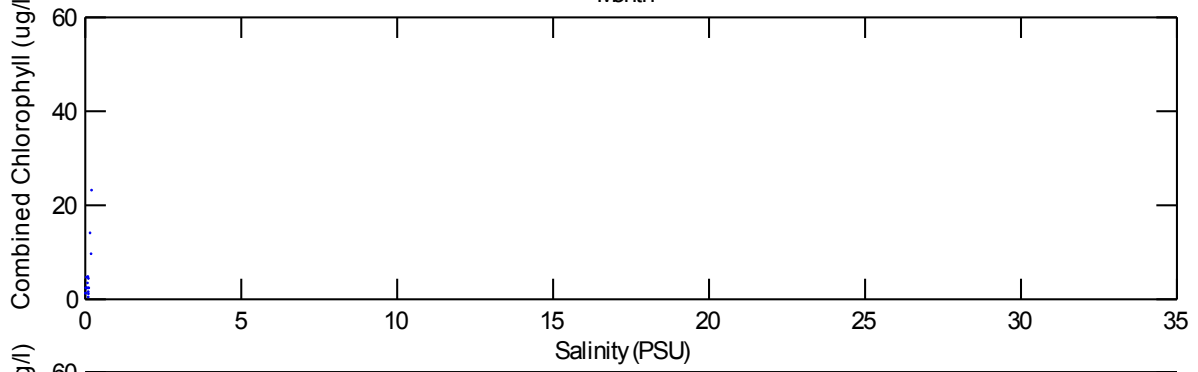
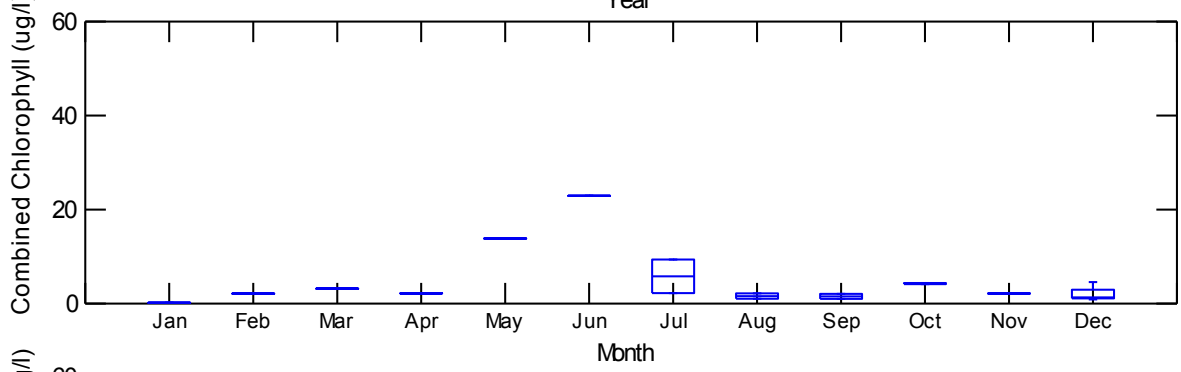
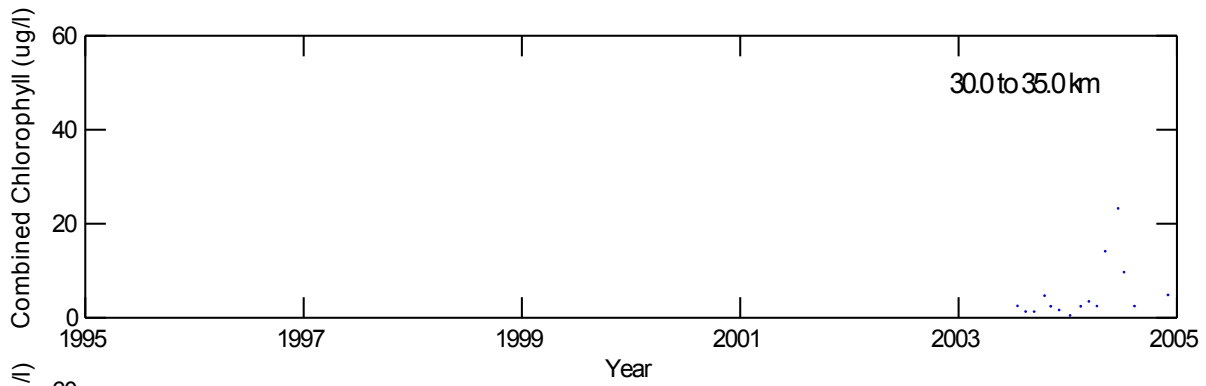

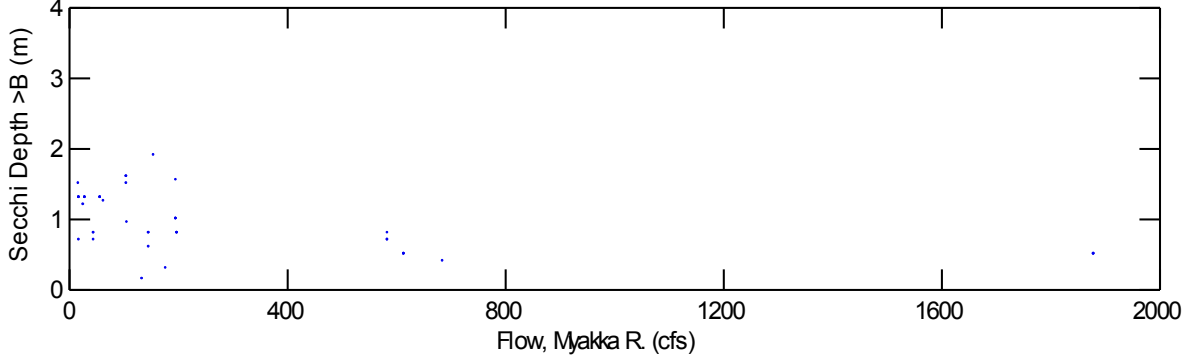
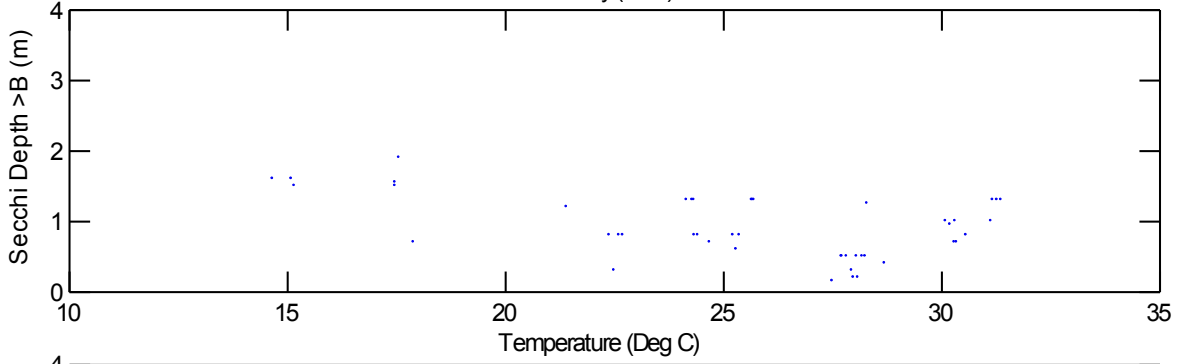
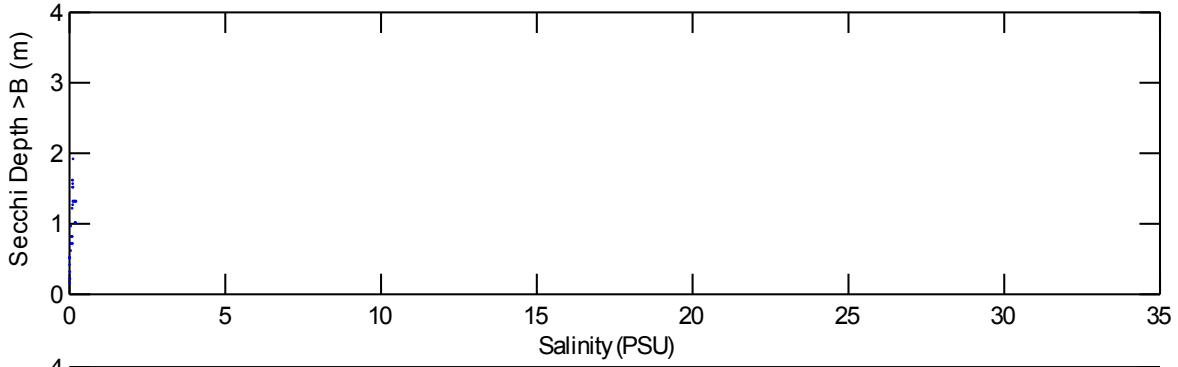
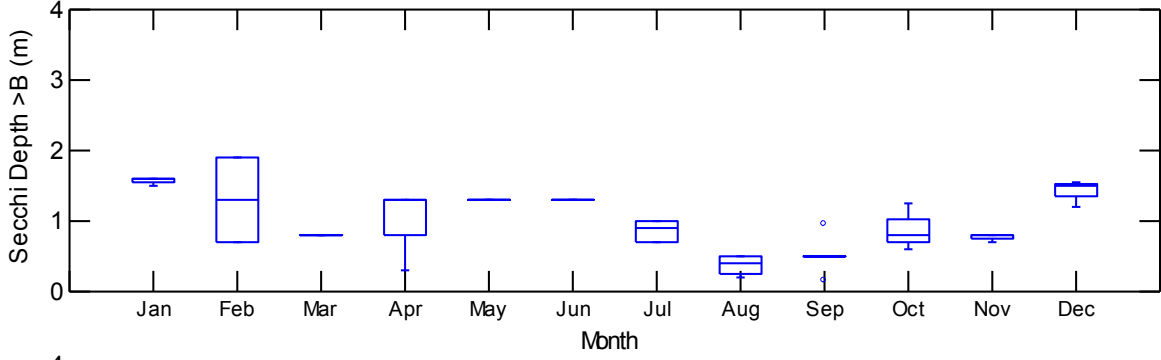
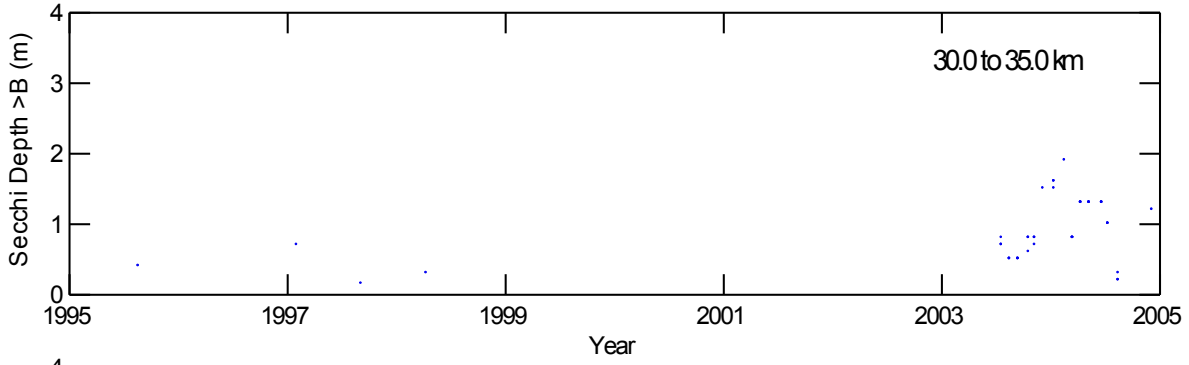

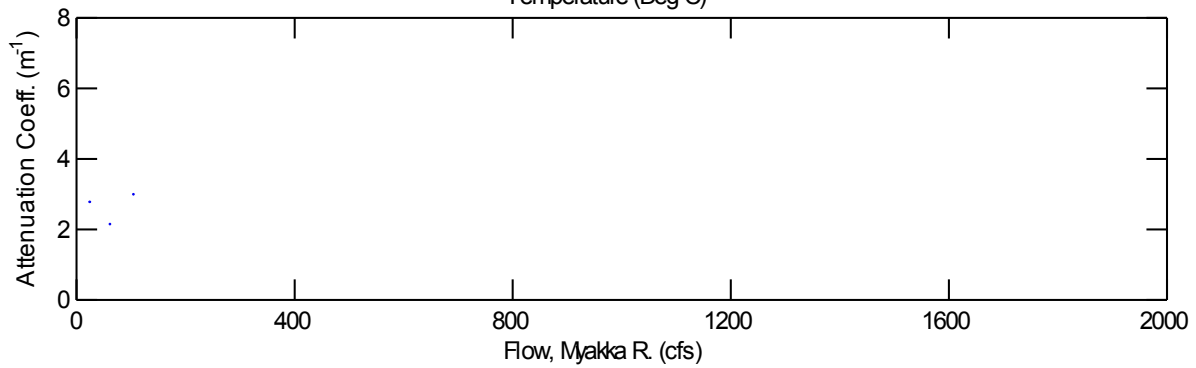
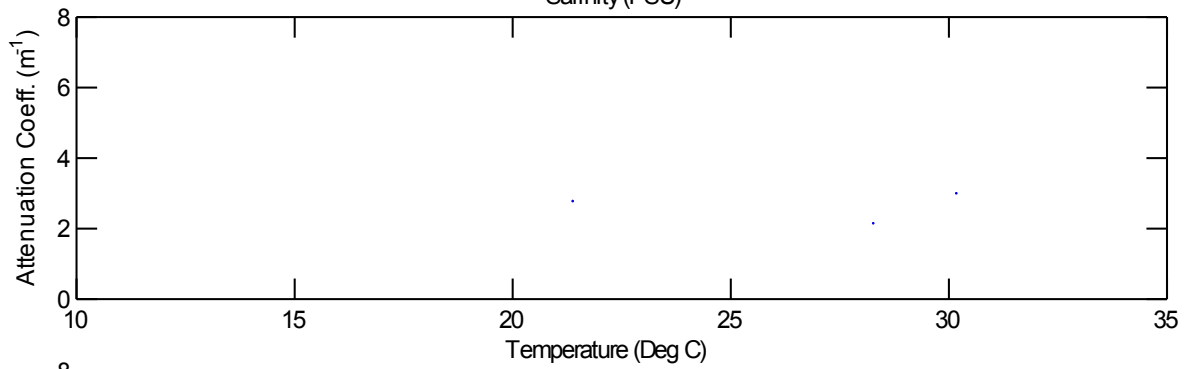
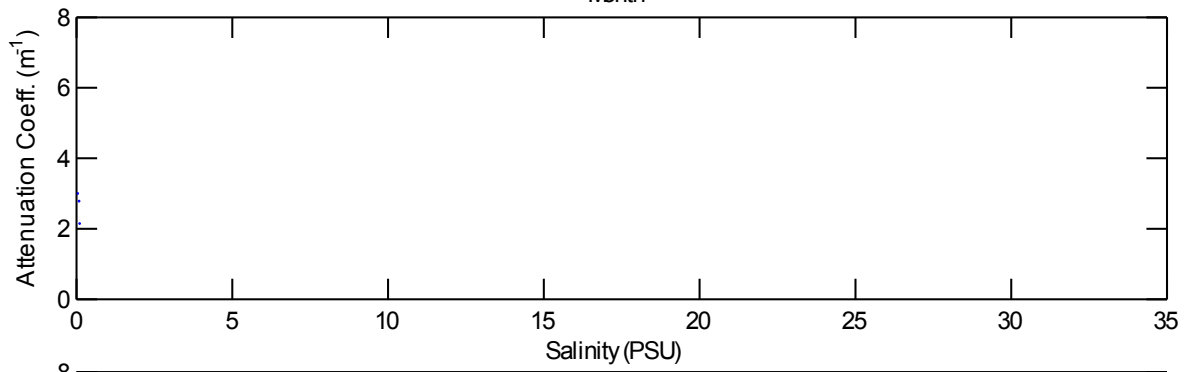
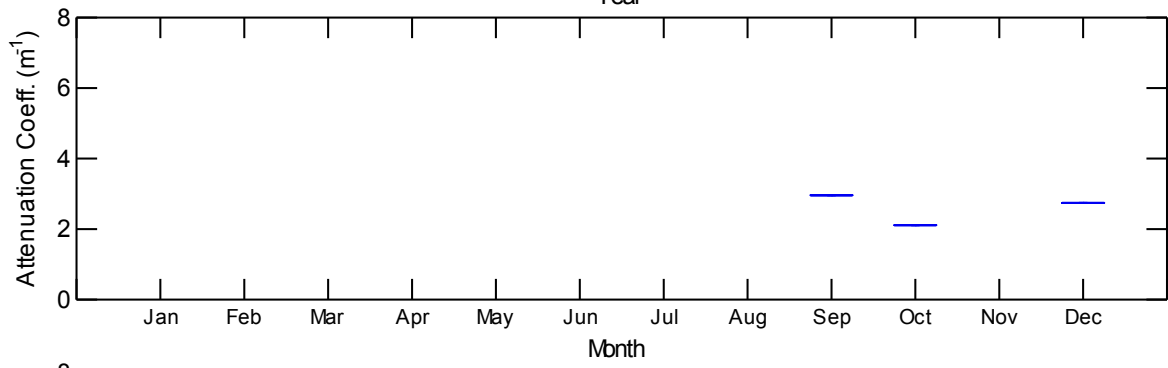
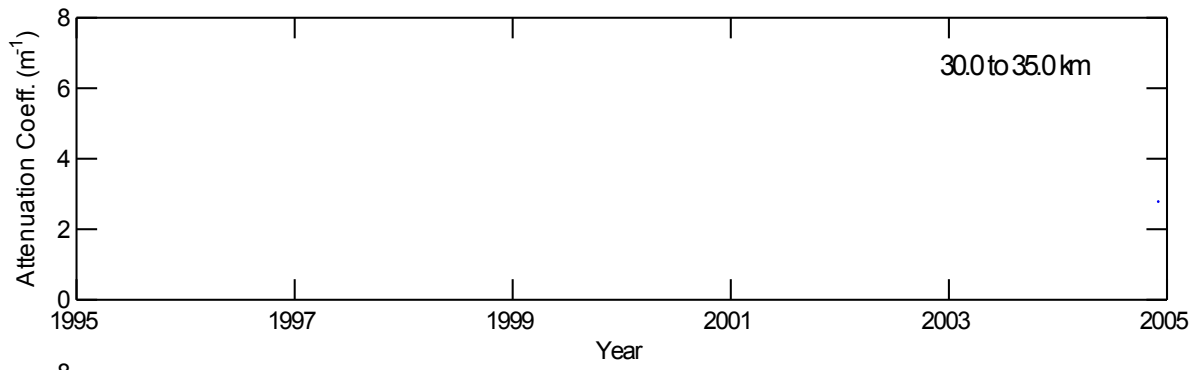

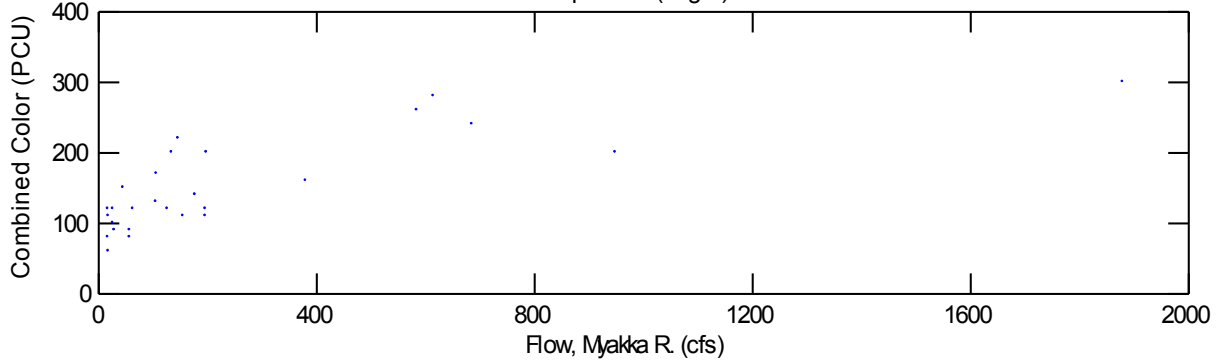
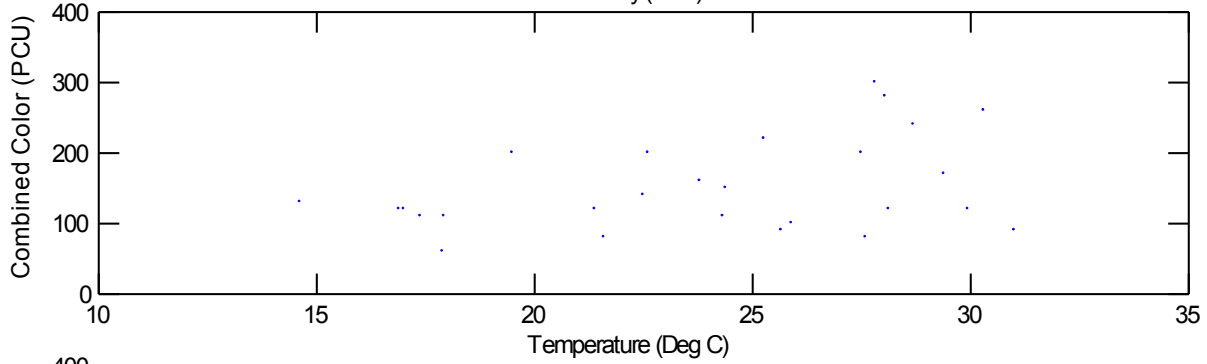
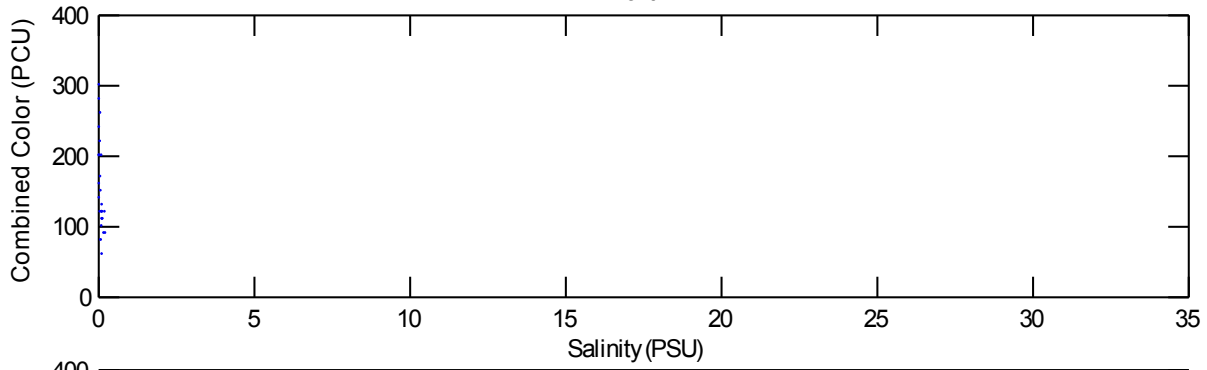
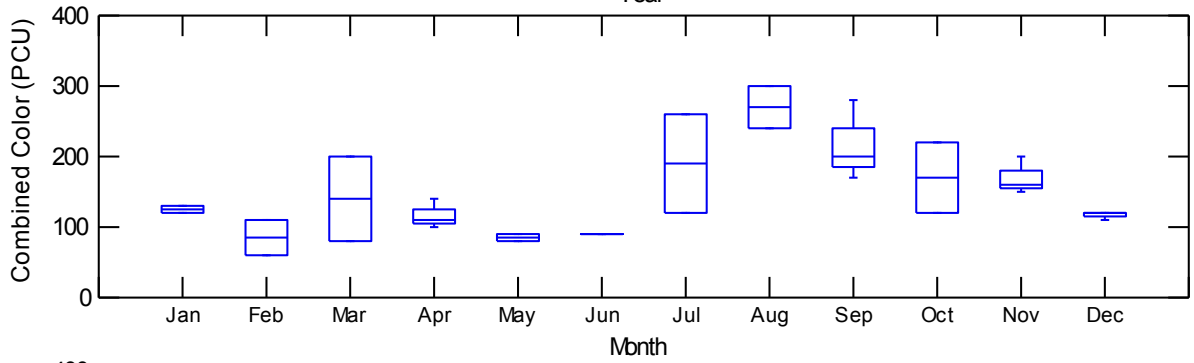
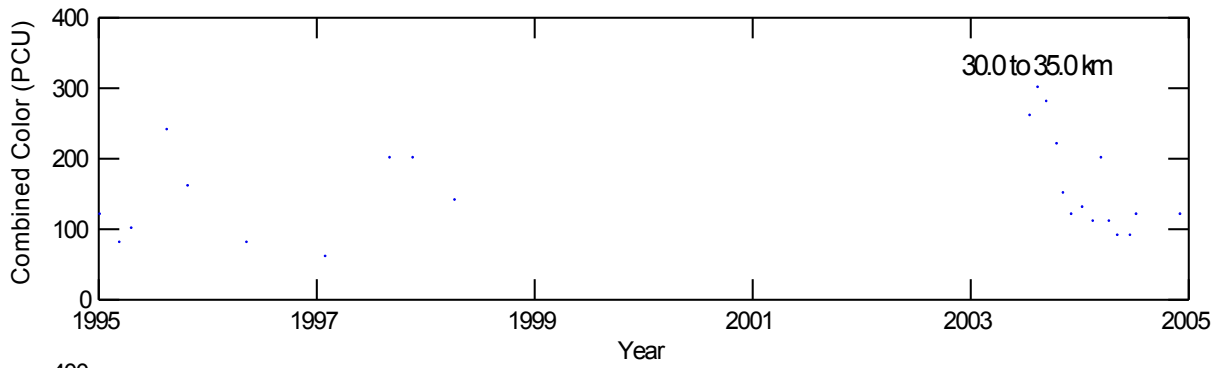

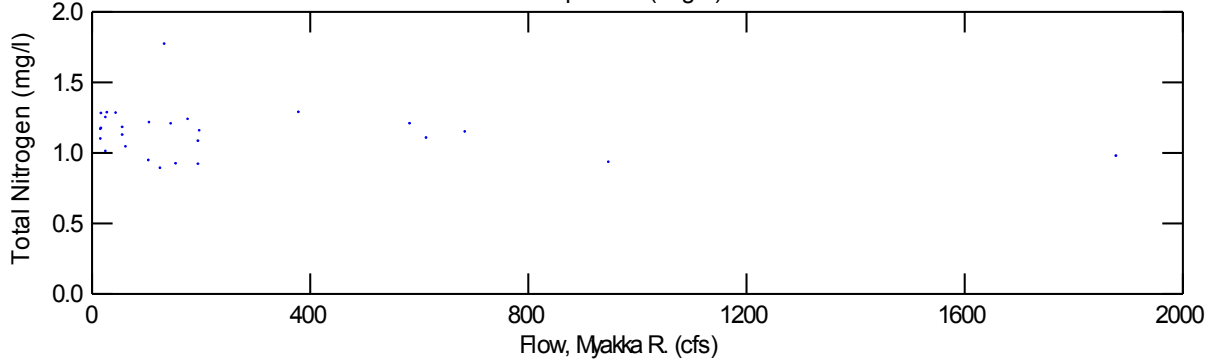
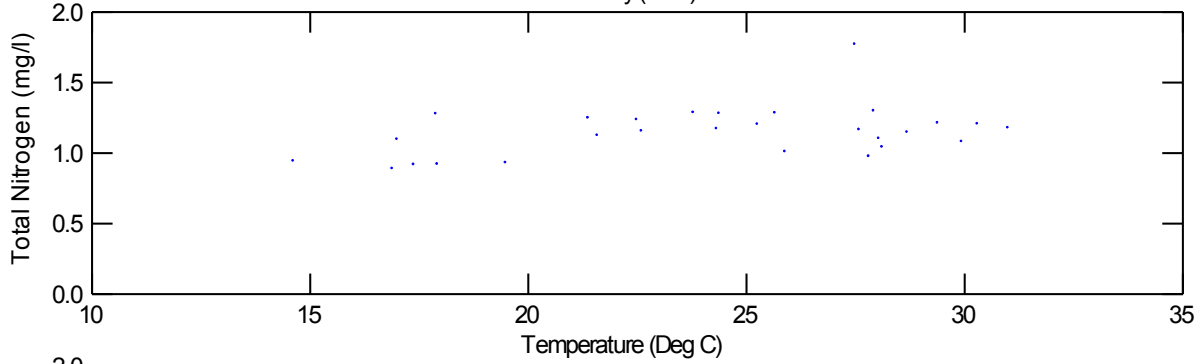
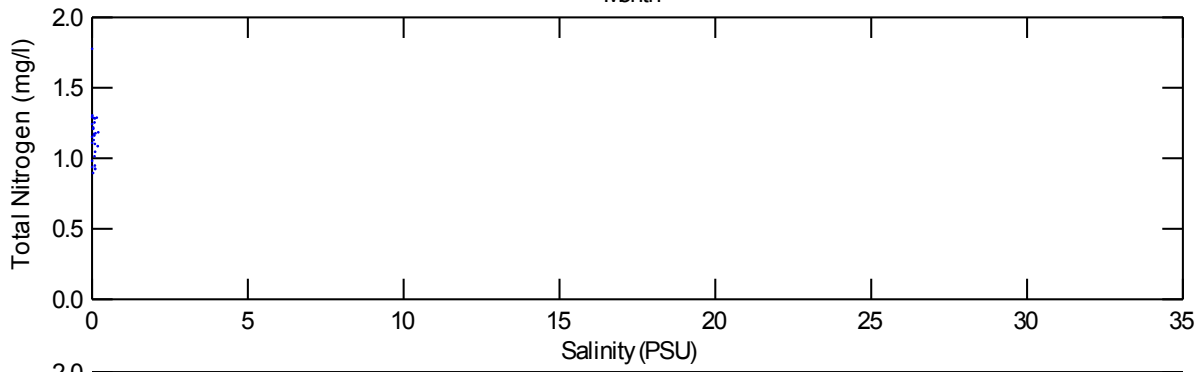
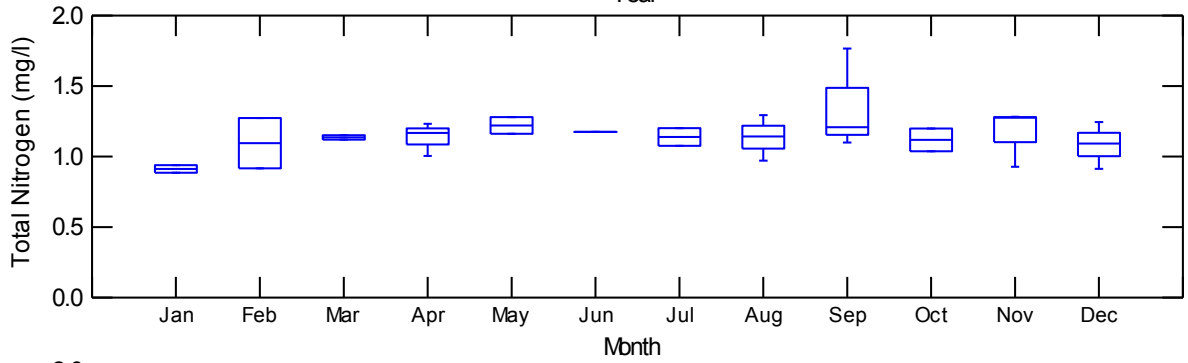
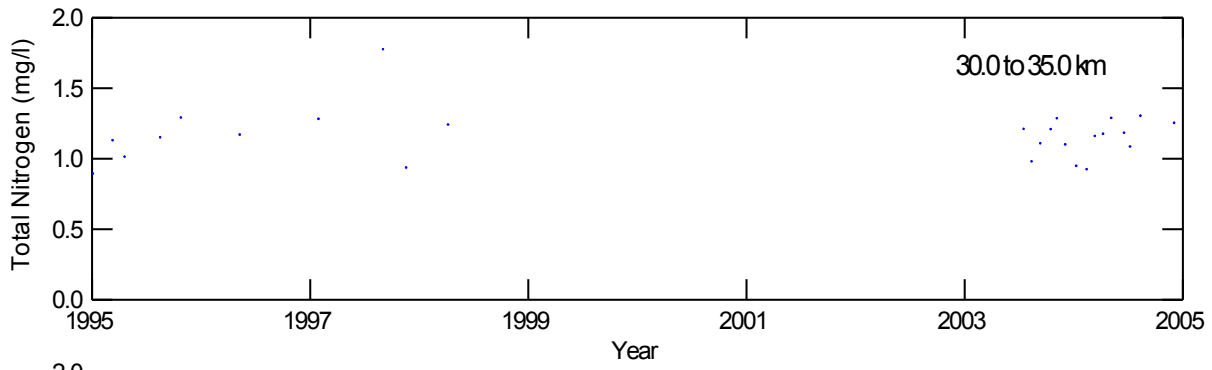

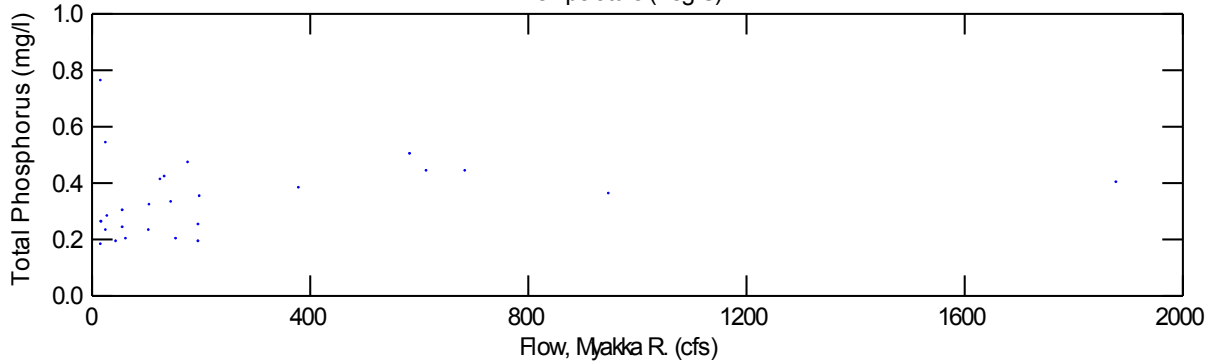
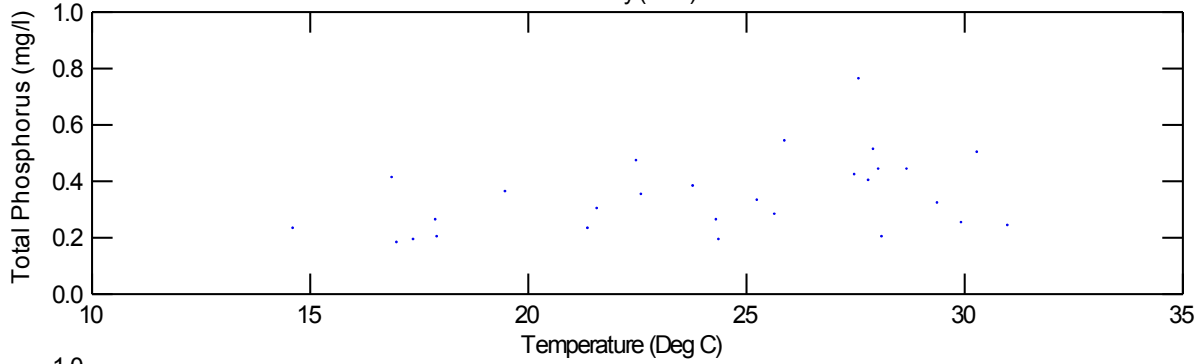
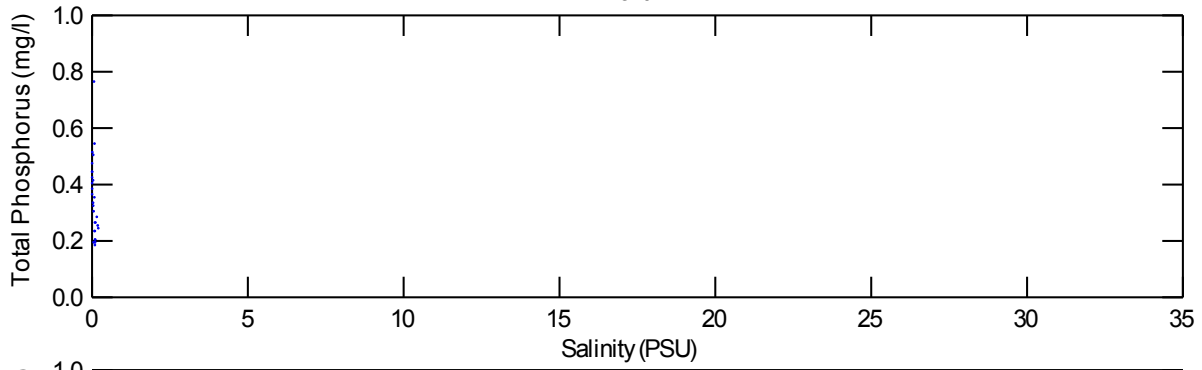
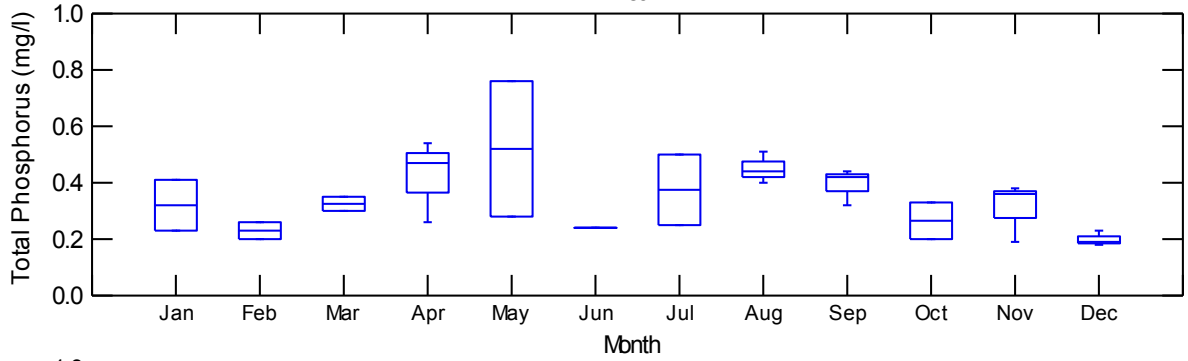
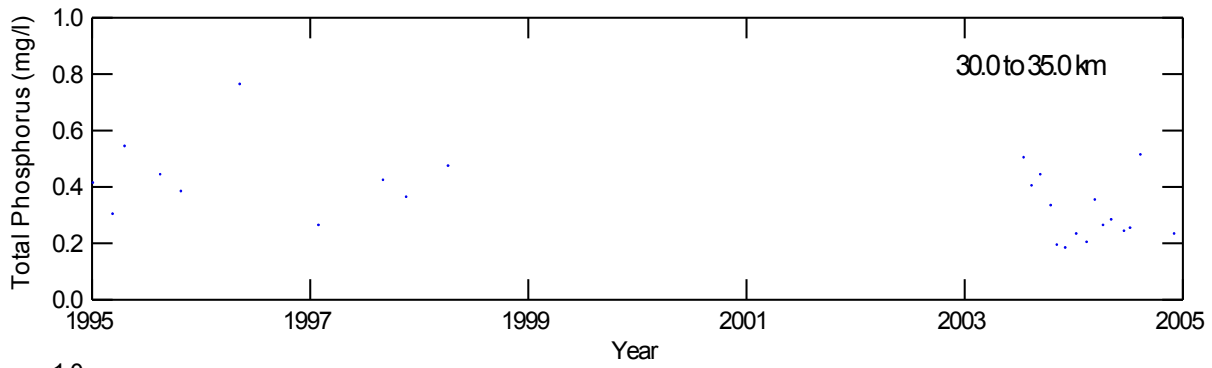

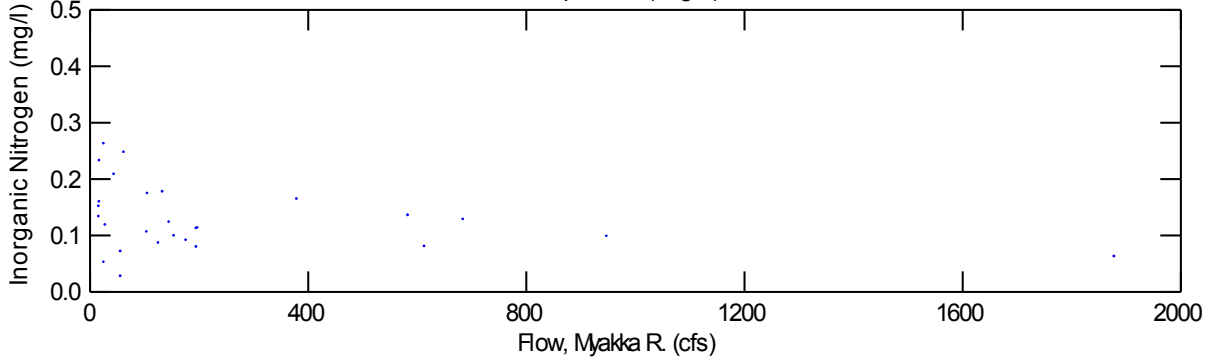
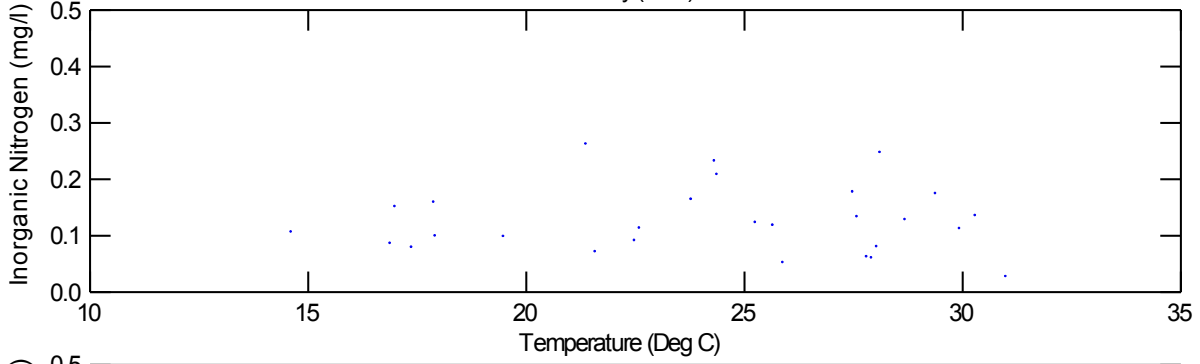
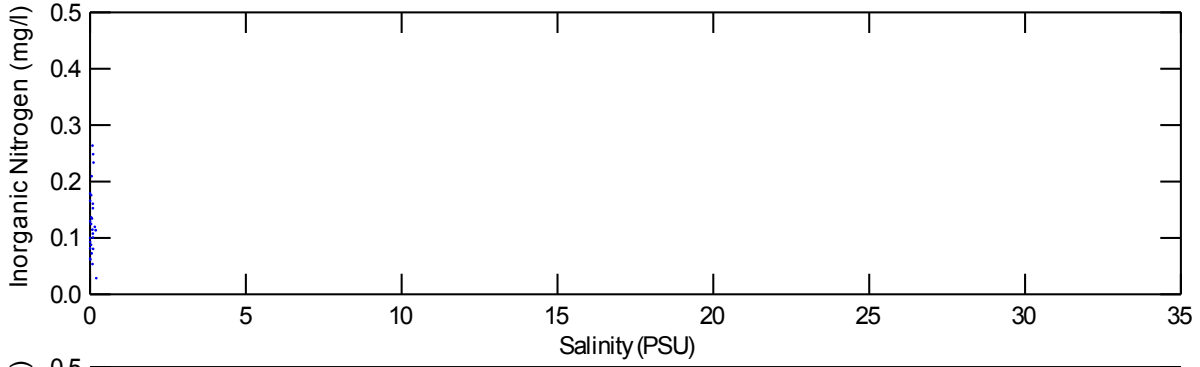
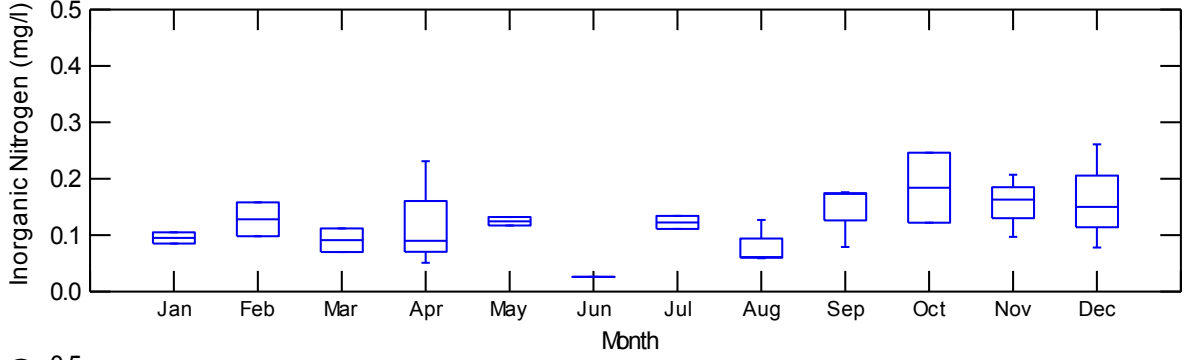
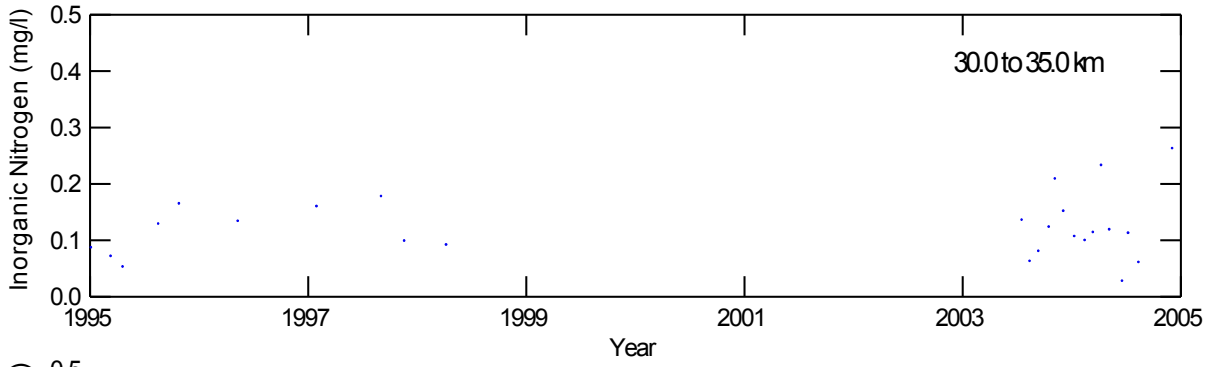

Appendix 5A

Hydrodynamic Simulations of the Upper Charlotte Harbor - Lower Peace River – Lower Myakka River System in Support of Determining Minimum Flows for the Lower Peace and Lower Myakka Rivers

XinJian Chen, Ph.D., P.E.

Ecological Evaluation Section
Resource Projects Department



June 2010

Summary

In an effort to determine the regulatory minimum freshwater inflows to the Lower Peace River (LPR) and the Lower Myakka River (LMR), a sophisticated hydrodynamic model has been developed that simulates circulations, salt transport processes, and thermal dynamics in a simulation domain that comprises not only the LPR and LMR, but also the upper portion of the Charlotte Harbor (UCH) and Shell Creek. The numerical model developed for this complex LPR - LMR - UCH system is a coupled 3D – 2DV model named LESS that dynamically links a laterally averaged two-dimensional hydrodynamic model (LAMFE) with a three-dimensional hydrodynamic model (LESS3D).

Model simulations were conducted for a 13-month period from June 13, 2003 to July 11, 2004, during which the first 30 days of the simulation (June 13 – July 12, 2003) were used for model spin-up. Data used to drive the model included measured freshwater inflows at upstream boundaries, wind speed near the mouth of the Myakka River in UCH, meteorological data (rain, solar radiation, air temperature, air humidity) at an SWFWMD SCADA station near the Peace River/Manasota Regional Water Supply Authority, estimated ungaged flows, and the downstream boundary conditions of tides, salinity, and temperature which were simulated results of another model simulation effort (Sheng et al., 2006) that included the entire Charlotte Harbor and a coastal area extending almost 45 km off-shore for the same 13-month period.

The LESS model was calibrated and verified against measured real-time data at a total of eight stations inside the simulation domain, including a University of Florida (UF) station in UCH, a USGS station in Shell Creek, three USGS stations in the LPR, and three USGS stations in the LMR. Model calibration was conducted for a 3-month period between January 10 and April 9, 2004, while the verification of the model was done for a 6-month period between July 13, 2003 and January 9, 2004 and a 3-month period between April 10 and July 11, 2004.

After the model was calibrated and verified, it was used to evaluate estuarine residence times for 16 flow scenarios for the LPR. It was found that the estuarine residence time (ERT) in the LPR is related to the sum of gauged USGS flows (Q) in the Joshua Creek, the Horse Creek, and in the Peace River at the Arcadia station through a power function, with its coefficient and exponent depending on what percentage (L) of remaining conservative mass is used in defining the ERT. An analysis of the estuarine residence times using different L values in the 16 flow scenario runs demonstrated that ERT in the LPR can be expressed as a function of Q and L in the following form: $ERT = [1747.3 - 375.53 \ln(L)]Q^{-(0.54+0.00088L)}$.

The calibrated model was then used to evaluate minimum flows for both the LPR and LMR, in conjunction with the minimum flow evaluation of the Shell Creek. For the minimum flow analyses, the model was used to predict the river bottom area, water volume, and shoreline length (LPR only) within various salinity ranges in each river. Baseline flows and various flow reduction scenarios were simulated for a 4-year period from January 1999 to December 2002 for the determination of the minimum flows for the LPR and the LMR.

1. Introduction

The Peace and Myakka Rivers (Figure 1) are major tributaries to Charlotte Harbor, one of the largest estuaries in Florida and identified by the US Environmental Protection Agency as an estuary with national significance. The Peace River is approximately 120 km long and runs southwestward into the northeast portion of the Charlotte Harbor, while the Myakka River is about 106 km long and flows first southwestward and then southeastward into the northwest portion of the Charlotte Harbor. The entire Peace River watershed is about 6213 km². The most downstream segment of the Peace River, from Arcadia to the mouth, is the Lower Peace River (LPR) and is about 58 km long. About 84% of the Peace River watershed is gauged by the United States Geological Survey (USGS) at the Peace River at Arcadia station and in two tributaries downstream of Arcadia: Joshua and Horse Creeks (SWFWMD, 2001). The remaining 11% of the Peace River watershed is ungauged with unknown freshwater contribution to the Charlotte Harbor. The Lower Peace River is generally narrow and meandering, except for areas near the mouth where the river becomes wider with islands. The majority of the 58 km long Lower Peace River is tidally influenced, and the tidal limit extends to roughly 50 km upstream from the mouth.

The Lower Myakka River (LMR) is about 52 km long and begins at the downstream side of Lower Myakka Lake (Downs' Dam) in the Myakka River State Park. The Myakka River watershed is approximately 1560 km². Although two recent gages have been established that slightly increase the gaged area of Myakka River watershed (Myakka River at Laurel and Cocoplum Waterway), the ungauged area of the watershed at the time of the model development was about 52 percent (SWFWMD 2010). Similar to the Peace River, the Myakka River is also narrow and meandering except for its very downstream portion where the river is wider and has several islands. The majority of Lower Myakka River is tidal water level fluctuations extend to Downs' Dam, a poorly constructed low rock dam near kilometer XXX.

Although they are often treated as three individual water bodies, the LPR, LMR, and the UCH are interconnected with different degrees of interactions among them. On one hand, the LPR and LMR provide the UCH freshwater inflows that are ecologically critical for the health of the harbor. On the other hand, hydrodynamics and salinity in the UCH play a very important role in keeping the ecosystems of the LPR and LMR in balance as both rivers are tidally influenced. Tides and salinity transport in the downstream estuary directly affect habitat distributions in both rivers. To manage the water resources and protect the ecosystems of the LPR and LMR, it is important to understand the hydraulic interactions among the LPR, the LMR, and the UCH. As such, it is necessary to develop a numerical model that can provide detailed information of circulations and salinity and temperature distributions in all three segments of the LPR - LMR - UCH system with a similar degree of accuracy.

Because the flow pattern in Charlotte Harbor is generally three-dimensional, a 3D hydrodynamic model is needed to accurately simulate hydrodynamics in the estuary. To include the Lower Peace River and the Lower Myakka River in the simulation, one can extend the 3D model domain upstream to cover the entire reach of the LPR and LMR. However, this way of including the tributary in the simulation is not very efficient. In addition, it is also difficult to correctly represent the cross section of the LPR and LMR in a 3D model because only limited number of grids (usually five or less grids, sometimes just one grid) are used to discretize the width of the river (e.g., Johnson et al, 1991; Sucsy et al, 1997; Mendelsohn et al, 1997). For

example, it is impossible to accurately resolve the cross section shown in Figure 2 with just three grids in the latitudinal direction of the tributary (perpendicular to the tributary).

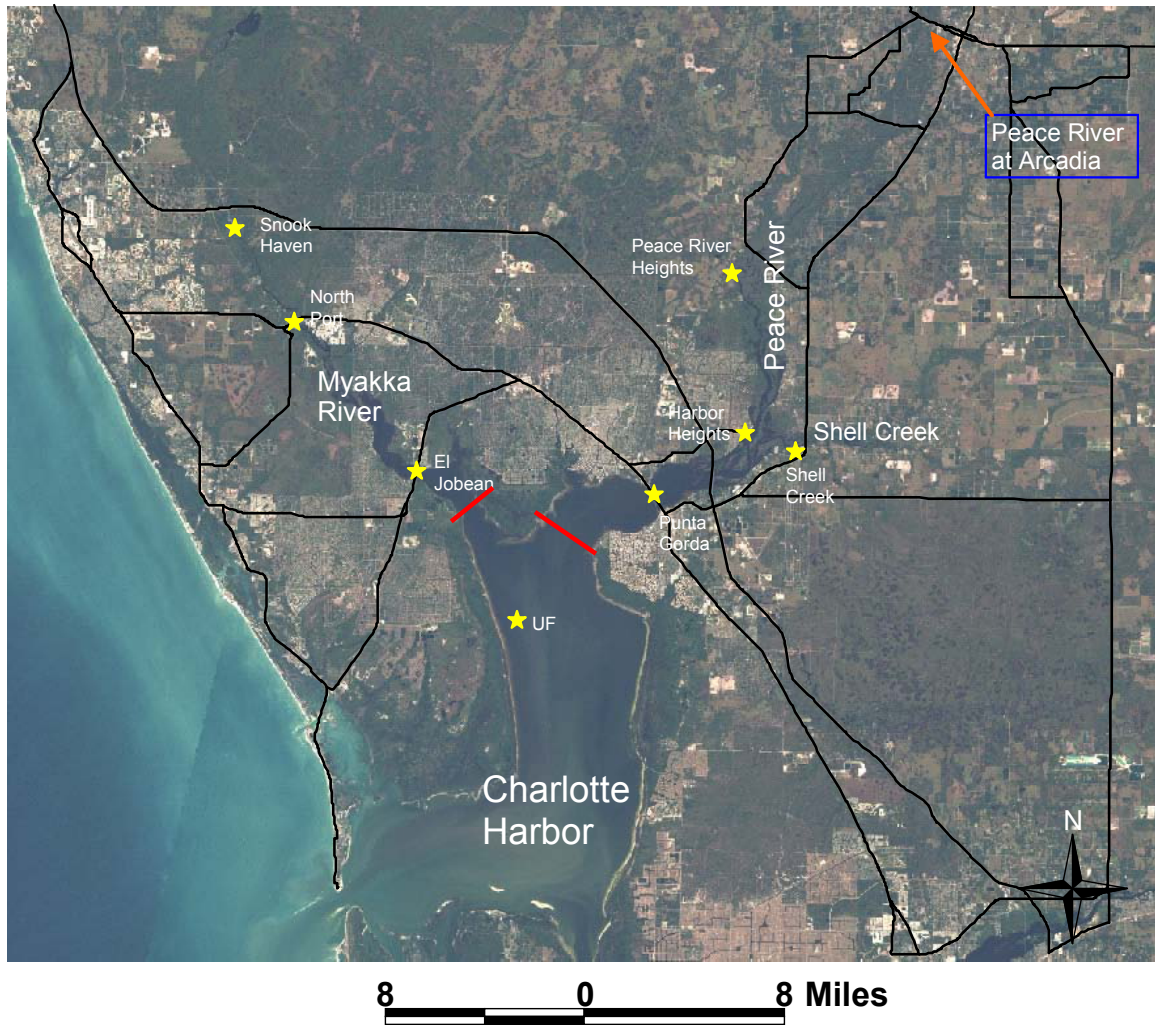

Figure 1 An aerial photo of the LPR - LMR - UCH system. Yellow stars denote real-time data collection sites. The two red bars are the locations of the starting points (River Kilometer 0) for the Peace and Myakka River estuaries.

Although the flow pattern in upper Charlotte Harbor is three-dimensional, the flow pattern is generally vertically two-dimensional in most segments of the LPR and LMR because the rivers are narrow. It is much more efficient to use a laterally averaged 2D (2DV) model for the narrow and meandering portions of the LPR and LMR than to use a 3D model. With enough number of vertical layers (generally eight or more), a 2DV model resolves the bathymetry of a tributary better than a 3D model that has only a limited number of grids in the latitudinal direction. Also, a 2DV model automatically handles the wetting/drying phenomenon in the tributary, while a 3D model require more computational effort to deal with the temporal

shoreline change in the narrow and meandering tributary. The cross section shown in Figure 2 is quite typical in the narrow portions of the LPR and LMR. As can be seen from the figure, the cross section is comprised of a main channel and two floodplains on both sides of the river. While the main channel can be very narrow, on the order of 10 – 30 m in some upstream reaches, the floodplain can be a few kilometers wide. When flow is low, water only exists in the main channel. However, during a major storm event, the floodplains will be submerged and used for flood conveyance. For a better understanding of the river system, it is critical to accurately simulate emerging/submerging floodplain features. In this circumstance, one needs information about the total flow rate and water elevation, not the detailed velocity distribution in the narrow portions of the LPR and LMR. It is much harder for a 3D model to handle these river areas. The emerging/submerging feature of the cross section can be automatically simulated in a laterally averaged 2D model without any special treatment often required in a 3D model simply because the river width is included in the governing equations for the 2DV model (see Section 3).

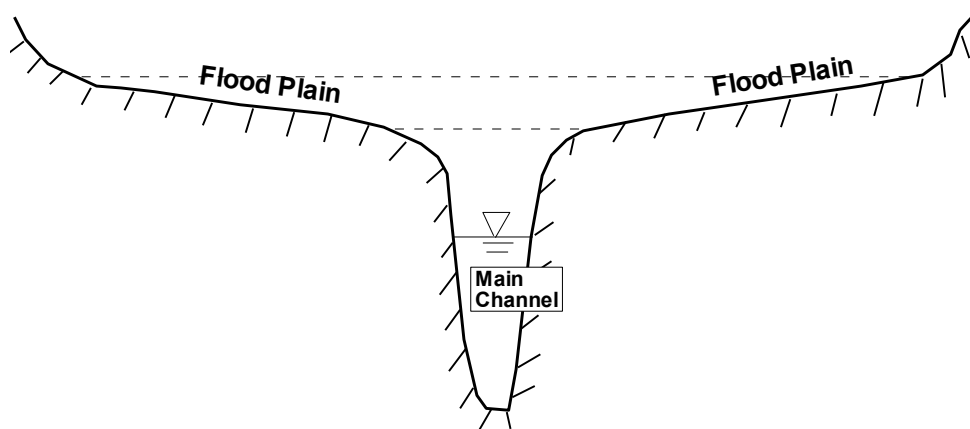

Figure 2. A typical cross section of the narrow part of the Peace (or Myakka) River. It is comprised of a main channel and floodplains on both sides. Most of the time, flow is restricted to the main channel. During a major storm event, the floodplains can be submerged to convey the flood.

The most effective way to simulate the interactions among the upper Charlotte Harbor and the Lower Peace and Myakka Rivers is to use a coupled 3D-2DV model. For this purpose, this study developed and used a dynamically coupled 3D-2DV model to simulate hydrodynamics in the Lower Peace River – Lower Myakka River - Upper Charlotte Harbor system. In the following sections, a dynamically coupled 3D-2DV hydrodynamic model developed for the LPR – LMR - UCH system is briefly presented, followed by a description of available field data used by the model as boundary conditions and for model calibration/ verification. The use of the coupled model to simulate hydrodynamics in the LPR – LMR – UCH system is then described. Model results are presented and discussed before conclusions are drawn.

2. A Dynamically Coupled 3D-2DV Model

The coupled 3D-2DV model (Chen, 2003c, 2005a, 2007) involves a dynamic, two-way coupling of the laterally averaged 2D hydrodynamic model LAMFE (Chen and Flannery, 1997; Chen et al., 2000; Chen, 2003a and 2004a) and the 3D hydrodynamic model LESS3D (Chen, 1999, 2003b, 2004b). In the LAMFE model, the following governing equations are solved:

$$\frac{\partial ub}{\partial x} + \frac{\partial wb}{\partial z} = v \quad (1)$$

$$\begin{aligned} \frac{\partial u}{\partial t} + u \frac{\partial u}{\partial x} + w \frac{\partial u}{\partial z} = & -\frac{\tau_{wx}}{\rho_o b} - g \frac{\partial \eta}{\partial x} - \frac{g}{\rho_o} \int_z^{\eta} \frac{\partial \rho}{\partial x} d\zeta + \frac{1}{b} \frac{\partial}{\partial x} (bA_h \frac{\partial u}{\partial x}) \\ & + \frac{1}{b} \frac{\partial}{\partial z} (bA_v \frac{\partial u}{\partial z}) \end{aligned} \quad (2)$$

$$b \frac{\partial c}{\partial t} + \frac{\partial ubc}{\partial x} + \frac{\partial wbc}{\partial z} = \frac{\partial}{\partial x} (bB_h \frac{\partial c}{\partial x}) + \frac{\partial}{\partial z} (bB_v \frac{\partial c}{\partial z}) + vc_t + S_s \quad (3)$$

where t is time; x is the horizontal coordinate along the river/estuary, z is the vertical coordinate, u and w denote velocity components in x - and z -directions, respectively; v is the lateral velocity from lateral inputs (sheet flow of direct runoff, tributary, etc.); b , p , g , and η denote the width, pressure, gravity acceleration, and the free surface elevation, respectively; ρ_o is the reference density; τ_{wx} represents the shear stress due to the friction acting on the side wall ($= \rho C_w u [u^2 + w^2]^{1/2}$, where C_w is a non-dimensional frictional coefficient for side walls); A_h and A_v are eddy viscosities in the x - and z -directions, respectively; c is concentration (can be temperature, salinity, suspended sediment concentrations, nutrient concentrations, etc.); c_t is concentration in lateral inputs; B_h and B_v are eddy diffusivities in the x - and z -directions, respectively; S_s denotes source/sink terms; and ρ is density which is a function of salinity and temperature (UNESCO, 1983). In the above transport equation, if the material simulated involves settling, w in the advective term includes the settling velocity of the material.

In the LESS3D model, the governing equations are

$$\frac{\partial u}{\partial x} + \frac{\partial v}{\partial y} + \frac{\partial w}{\partial z} = 0 \quad (4)$$

$$\begin{aligned} \frac{\partial u}{\partial t} + \frac{\partial uu}{\partial x} + \frac{\partial vu}{\partial y} + \frac{\partial wu}{\partial z} = & fv - \frac{1}{\rho_o} \frac{\partial p}{\partial x} + \frac{\partial}{\partial x} (A_h \frac{\partial u}{\partial x}) + \frac{\partial}{\partial y} (A_h \frac{\partial u}{\partial y}) + \frac{\partial}{\partial z} (A_v \frac{\partial u}{\partial z}) \\ \frac{\partial v}{\partial t} + \frac{\partial uv}{\partial x} + \frac{\partial vv}{\partial y} + \frac{\partial wv}{\partial z} = & -fu - \frac{1}{\rho_o} \frac{\partial p}{\partial y} + \frac{\partial}{\partial x} (A_h \frac{\partial v}{\partial x}) + \frac{\partial}{\partial y} (A_h \frac{\partial v}{\partial y}) + \frac{\partial}{\partial z} (A_v \frac{\partial v}{\partial z}) \end{aligned} \quad (5)$$

$$p = g \int_z^{\eta} \rho d\zeta \quad (6)$$

$$\frac{\partial c}{\partial t} + \frac{\partial uc}{\partial x} + \frac{\partial vc}{\partial y} + \frac{\partial wc}{\partial z} = \frac{\partial}{\partial x} (B_h \frac{\partial c}{\partial x}) + \frac{\partial}{\partial y} (B_h \frac{\partial c}{\partial y}) + \frac{\partial}{\partial z} (B_v \frac{\partial c}{\partial z}) + S_s \quad (7)$$

where x , y , and z are Cartesian coordinates (x is from west to east, y is from south to north, and z

3. Field Data

This section presents field data used in modeling hydrodynamics and salinity and thermal transport processes in the LPR – LMR - UCH system. As will be described in the next section, the simulation period is a 13-month period from the middle of June 2003 to the middle of July 2004. As such, the focus of the section is only on measured field data during this 13-month period.

Flow Data

Freshwater inflows are critical to the health of an estuary, as they directly affect salinity distributions in the estuary. The purpose of the hydrodynamic simulation of the LPR – LMR - UCH system is to use a hydrodynamic model to find the relationship between freshwater inflows and salinity distributions in the system, so that minimum freshwater inflows for the LPR and LMR can be determined to prevent the two riverine estuaries from significant harms. Therefore, flow data are the most important piece of information needed in every step of the process of determining minimum flows, including the hydrodynamic modeling.

The USGS has been gauging flow rates at several stations in the Peace and Myakka River watersheds for a number of years, with varying lengths of records at the gages. These USGS stations include (1) Peace River at Arcadia (02296750), (2) Joshua Creek at Nocatee (02297100), (3) Horse Creek near Arcadia (02297310), (4) Shell Creek near Punta Gorda (02298202), (5) Big Slough Canal at Tropicaire (02299450), (6) Myakka River near Sarasota (02298830), (7) Deer Prairie Slough near Myakka City (02299060), and (8) Blackburn Canal near Venice (02299692). The gauged USGS flow data were used, either directly or indirectly, as freshwater inputs to the hydrodynamic model described in the next section. In addition to gauged USGS flows, there are also ungauged flows that contribute a significant portion of the total freshwater budget to the upper Charlotte Harbor. As mentioned before, for the Peace River watershed, the ungauged area is about 11% of the total watershed, while for the Myakka River, about one half of the watershed is ungauged. In this study, freshwater flows from the ungauged sub-basins of the watershed were first estimated by Ross et al (2005) using the Hydrological Simulation Program - FORTRAN (HSPF) (Bicknell, 1997) and then adjusted based on another study (see Section 4 for more details). Some of the USGS gauge stations are located at the boundary of the simulation domain of the HSPF model, and gauged flow rates at these stations were used as boundary fluxes in the HSPF model.

Figure 3 shows flow data gauged during the 13-month period from June 2003 to July 2004 at four locations on the Peace River side of the watershed, including Peace River at Arcadia (black solid line), Horse Creek (green solid line), Joshua Creek (red solid line), and Shell Creek (blue solid line). Also shown in the figure is the withdrawal (black dashed line) from the Peace River by the Peace River/Manasota Regional Water Supply Authority. The withdrawal point of the regional water supply authority is located roughly 3.5 km upstream of USGS Peace River Heights station (Figure 1). Withdrawal by the City of Punta Gorda from the upstream of the Shell Creek dam is included in the Shell Creek flow shown in the figure. Figure 4 shows gauged flow rates at the USGS Myakka River near Sarasota station (black solid line) and the USGS Myakkahatchee (Big Slough Canal) at North Port station (blue solid line). The black dashed line

shown in Figure 4 is the flow in the Blackburn Canal that connects the Donna/Roberts Bay on the Florida Gulf Coast to the Myakka River at about 3.8 km upstream of the USGS Myakka River at Snook Haven station. The period of available gauged flow data for the Blackburn Canal at the time of this modeling study was a 209-day period from March 6, 2004 to September 30, 2004. It was found that water in the Blackburn Canal can flow either to or away from the Myakka River, depending on the water levels in the Myakka River and in the Dona/Roberts Bay. Although it drains the Myakka River most of the time, the Blackburn Canal occasionally flows to Myakka River. Figure 5 is a plot of the flow leaving Myakka River through the Blackburn Canal versus the Myakka River flow gauged at the USGS Myakka River near Sarasota station during March 6 – September 30, 2004. From the figure, it can be seen that the two flow rates are fairly correlated. Therefore, water leaving the Myakka River through Blackburn Canal can be roughly estimated using the following equations:

$$\begin{aligned} Q_b &= 0.057Q_m, & Q_m &\leq 457 \\ Q_b &= 0.169Q_m - 51.184, & Q_m &> 457 \end{aligned} \quad (16)$$

where Q_b (in cfs) is the flow rate that drains Myakka River through the Blackburn Canal, and Q_m (in cfs) is the Myakka River flow at the USGS station near Sarasota. The units in the above equation are cubic feet per second. It should be noted that the above equation only estimates flow leaving the Myakka River, as Q_b calculated from in the equation is always positive. From the available Blackburn Canal flow data shown in Figure 5, the negative flow rate is generally very small in magnitude (≤ 2.2 cfs) and occurs only infrequently. Recently, as more data became available, Intera, Inc. (personnel communication) related Blackburn Canal flow with water stage data collected at the USGS Myakka River near Sarasota station when working on Dona/Roberts Bay. With 491 days of Blackburn Canal data (5/6/2004 – 2/4/2006), they found that the rate of water leaving the Myakka River through Blackburn Canal can be expressed as

$$\begin{aligned} Q_b &= 3.981089h_m - 4.58861, & h_m &< 6.5 \\ Q_b &= 129.7358h_m - 846.14, & h_m &\geq 6.5 \end{aligned} \quad (17)$$

where h_m is measured water level (in ft, NGVD 29) measured at the Myakka River near Sarasota station.

Equations (16) and (17) provide two methods for estimating the Blackburn Canal flow. Although both equations only use measured data at the Myakka River near Sarasota station, not the head difference between Myakka River and Dona/Roberts Bay, to estimate flow, they both work well except for peak values during major storm events. Heyl (2008, personnel communication) used both equations to predict Blackburn Canal flow. It was found that comparing to available data during the 491-day period between May 6, 2004 and February 4, 2006, both equations generated similar flow rates. However, during several major storm events prior to 5/6/2004, Equation (17) yields much smaller peak flows than Equation (16). Because there are no measured Blackburn Canal flows available during these major events, it can not be determined if Equation (17) under-predicts the flow or Equation (16) over-predicts the flow. Intuitively, Equation (17) is expected to give a smaller peak value because it gives a linear relationship between flow and stage, which is not true for most natural streams.

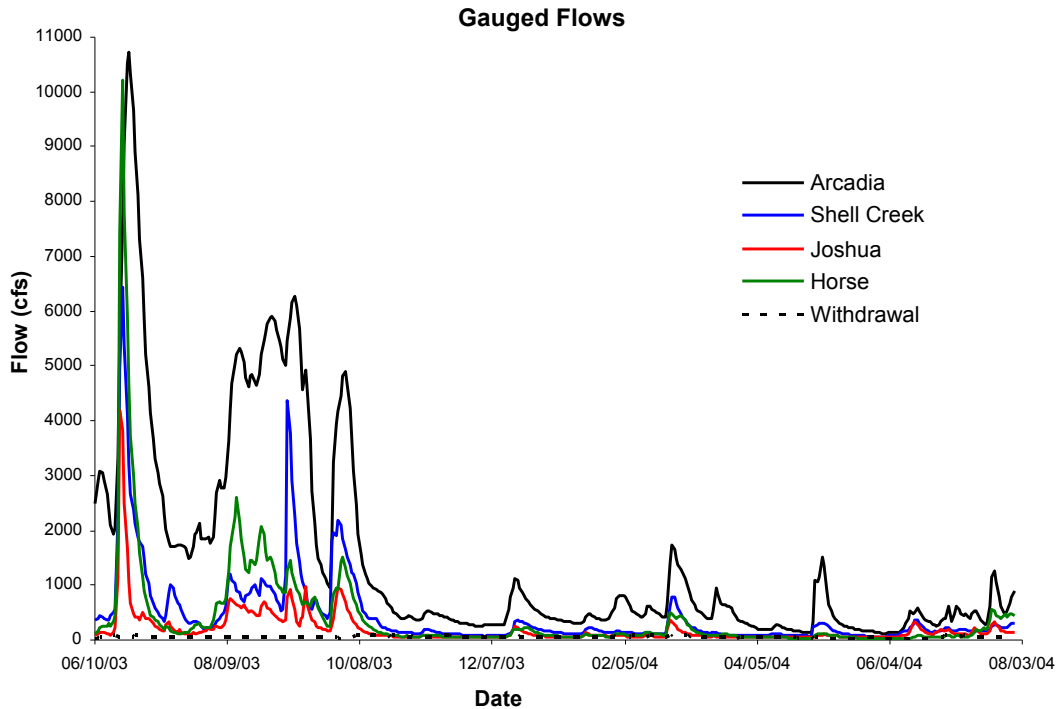

Figure 3. Gauged flow rates on the Peace River side, including USGS gauges at Arcadia, Joshua, Horse, and Shell Creek. The withdrawal by the Peace River/Manasota Regional Water Supply Authority is also shown.

From Figures 3 and 4, several things can be quickly discerned. First, during the 13-month period, the LPR – LMR - UCH received the majority of its freshwater inflows during a 100-day period from June 20, 2003 to the end of September 2003. Second, all gauged flows have their highest peaks around June 24, 2003, with Arcadia, Horse and Myakka flows having similar peak values larger than 10,000 cfs. Rainfall data collected at a SWFWMD rain station close to the Peace River/Manasota Regional Water Supply Authority (Figure 6) indicated that a major storm event passed through the region and delivered about 10 inches of rain during a 3-day period on June 20 - 22, 2003. It is interesting to note that although the Horse Creek and the Myakka River near Sarasota stations gauge much smaller areas than that of the Peace River Arcadia station, they had almost the same peak discharge as the Arcadia station. This might be caused by a relatively low surface water yield in the upstream portion of the Peace River watershed after a long dry period. A closer examination of the flow data measured at these stations revealed that the time of concentration for the Arcadia station is much longer than those at the Horse Creek and the Myakka River near Sarasota stations.

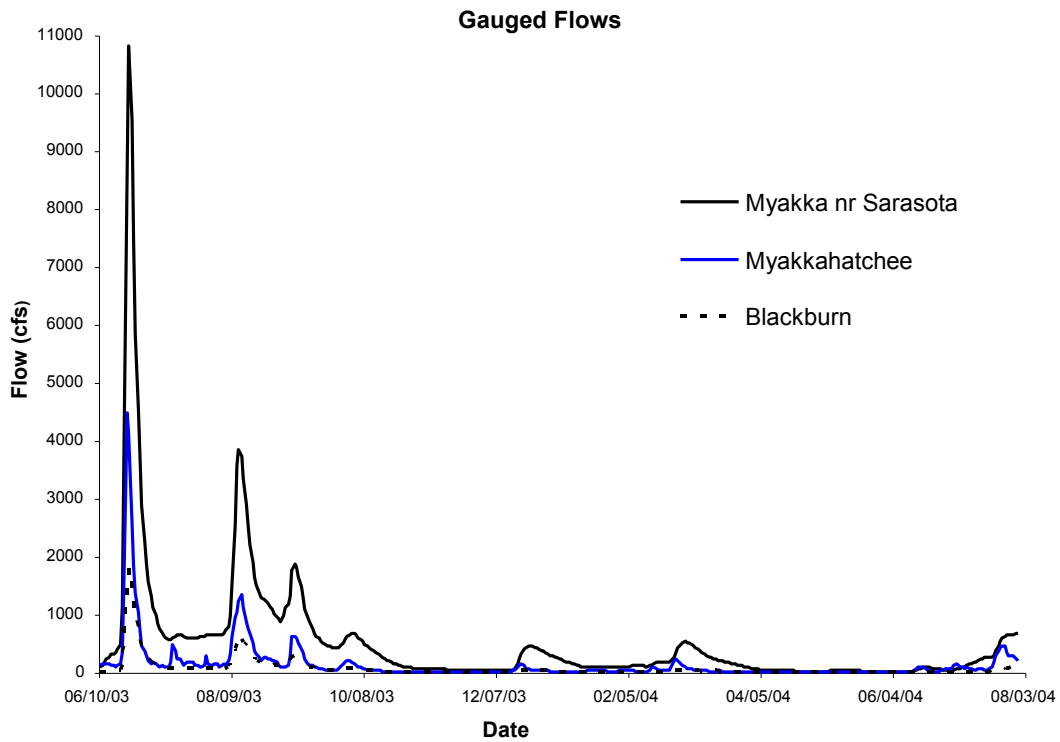

Figure 4. Gauged flow rates on the Myakka River watershed by the USGS, including the Myakka River near Sarasota station, the Myakkahatchee at North Port station, and Blackburn Canal station near Venice.

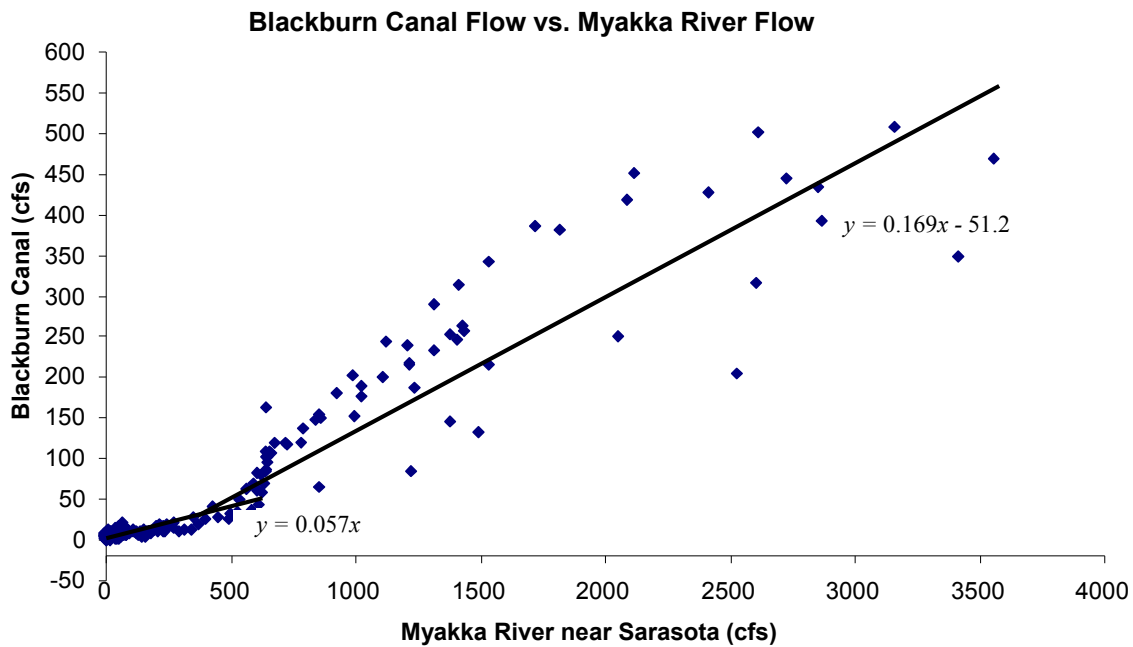

Figure 5. Blackburn Canal flow versus Myakka River flow gauged at the USGS station near Sarasota. Positive Blackburn Canal flow leaves the Myakka River.

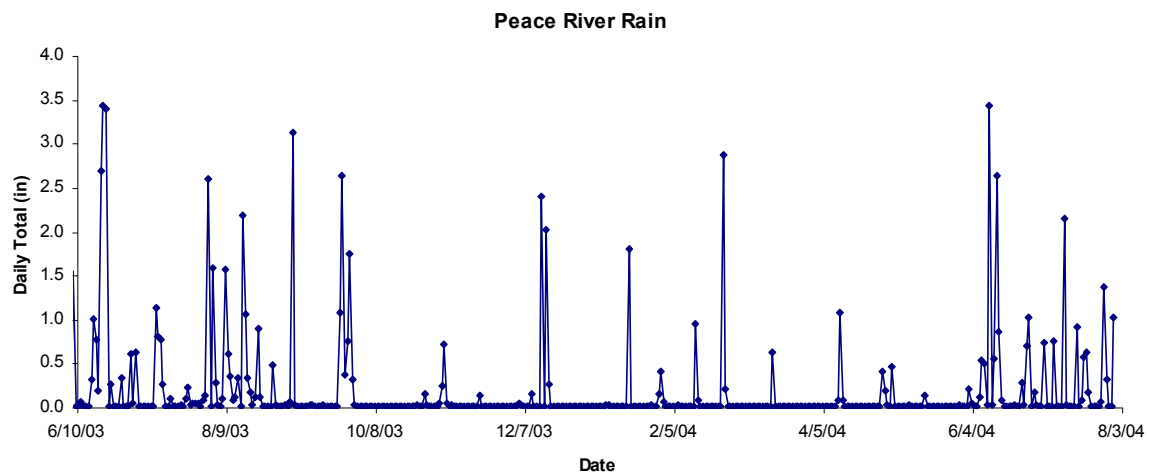

Figure 6. Daily rainfall total measured at a location close to the Peace River/Manasota Regional Water Supply Authority

Water Level, Salinity, Temperature, and Velocity

Real-time data of water level, specific conductance, and temperature were collected by the University of Florida (UF) and the USGS at the several fixed stations noted with stars in Figure 1. These stations included (1) UF station in the upper Charlotte Harbor near the mouth of

the Myakka River, (2) USGS Peace River at Punta Gorda (02298300), (3) USGS Peace River at Harbor Heights (02297460), (4) USGS Peace River at Peace River Heights, (5) USGS Myakka River at El Jobean (02299496), (6) USGS Myakka River at North Port (02299230), (7) USGS Myakka River at Snook Haven (02298955), and (8) USGS Shell Creek Tidal near Punta Gorda (02298208). The USGS real-time data were collected using a 15 minute time interval, while the UF data had a 30 minute time interval. For salinity and temperature, data were collected at three water depths at the UF station, but only at two depths at the USGS stations. Table 1 lists elevations of the salinity and temperature sensors at all eight stations.

Real-Time Measurement Stations	Sensors	Elevations (ft, NGVD29)
UF in the UCH	Top	-1.31
	Middle	-4.14
	Bottom	-7.4
Punta Gorda	Top	-1.1
	Bottom	-8.0
Harbor Height	Top	-1.0
	Bottom	-3.0
Peace River Heights	Top	-1.0
	Bottom	-3.0
El Jobean	Top	-2.0
	Bottom	-8.0
North Port	Top	-2.5
	Bottom	-10.0
Snook Haven	Top	-0.85
	Bottom	-6.0
Shell Creek	Top	-1.0
	Bottom	-3.0

Table 1. Elevations of specific conductance/temperature sensors at eight stations in the LPR - LMR - UCH system. Units in the table are ft, NGVD29.

Figure 7 shows measured water levels during a 14-month period from June 2003 to July 2004 at the Punta Gorda, Harbor Heights, Peace River Heights, Shell Creek Tidal (for simplicity, this station is also called Shell Creek hereafter), El Jobean, North Port, Snook Haven, and UF stations. Water levels at all eight stations have strong tidal signals that are mainly semi-diurnal tides with a range of 50 – 60 cm. Unlike downstream stations, upstream stations in both the LPR (Peace River Heights and Harbor Heights) and the LMR (Snook Haven and North Port) recorded considerable water level increases caused by major storm events occurred in 2003 as the tributaries are narrow in these areas. For the downstream stations, including Punta Gorda, El Jobean, and UF stations, although measured water level data do not contain distinctive storm signals, it does appear that average water levels were higher in the wet season than in the dry season. Of course, this kind of seasonal variation in water level is not only caused by storm events, but also caused by other factors, such as the general wind pattern, loop current in the Gulf of Mexico, and the seasonal water temperature variation.

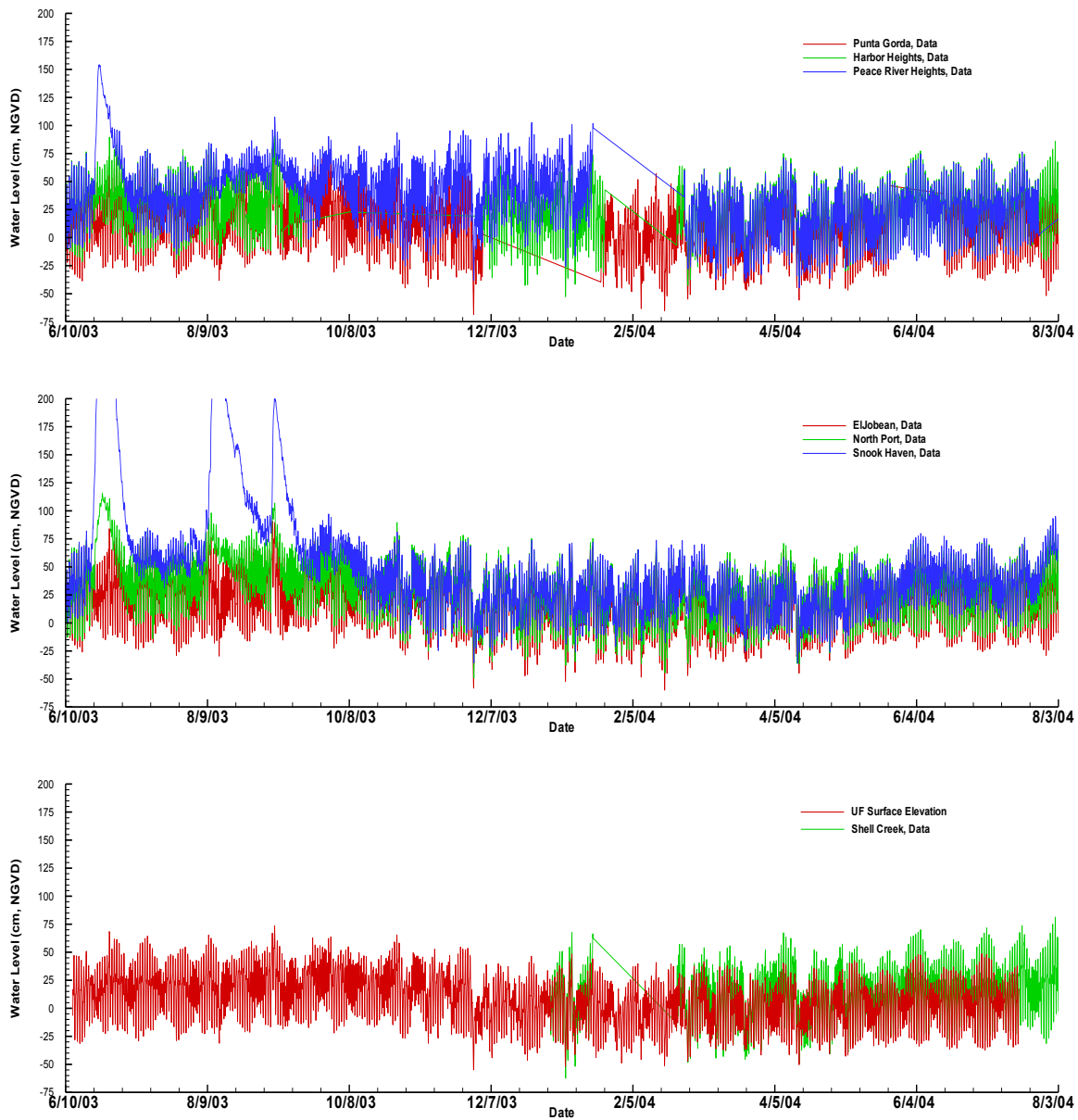

Figure 7. Measured water levels during June 2003 through July 2004 at three Lower Peace River stations (top graph), three Lower Myakka River stations (middle graph), one Shell Creek station (bottom graph), and one Upper Charlotte Harbor station (bottom graph).

The specific conductance data were converted to salinity values. Figure 8 shows top- and bottom-layer salinity time series measured at the three LPR stations, while Figure 9 presents top- and bottom-layer salinity time series measured at the three LMR stations. Measured salinity time series in Shell Creek and the UF station in the Upper Charlotte Harbor are plotted in Figure 10. Generally speaking, the vertical salinity stratification is not very strong for upstream narrow channels in the LPR – LMR - UCH system. Measured top- and bottom layer salinities were

almost the same for Peace River Heights, Harbor Heights, Shell Creek, North Port, and Snook Haven. The three downstream stations (UF, El Jobean, and Punta Gorda) did show some vertical salinity stratification, especially during time periods when there were major storm events. The horizontal salinity gradients along the LPR and LMR are quite evident with the salt wedge located between the Punta Gorda and Harbor Heights stations in the LPR and between the El Jobean and North Port stations in the LMR during the wet season. The salt wedge migrated upstream during the dry season and passed the Harbor Heights and North Port stations in the LPR and LMR, respectively. During the driest time period of the year 2004, the salt edge moved past the Peace River Heights station in the LPR and the Snook Haven station in the LMR.

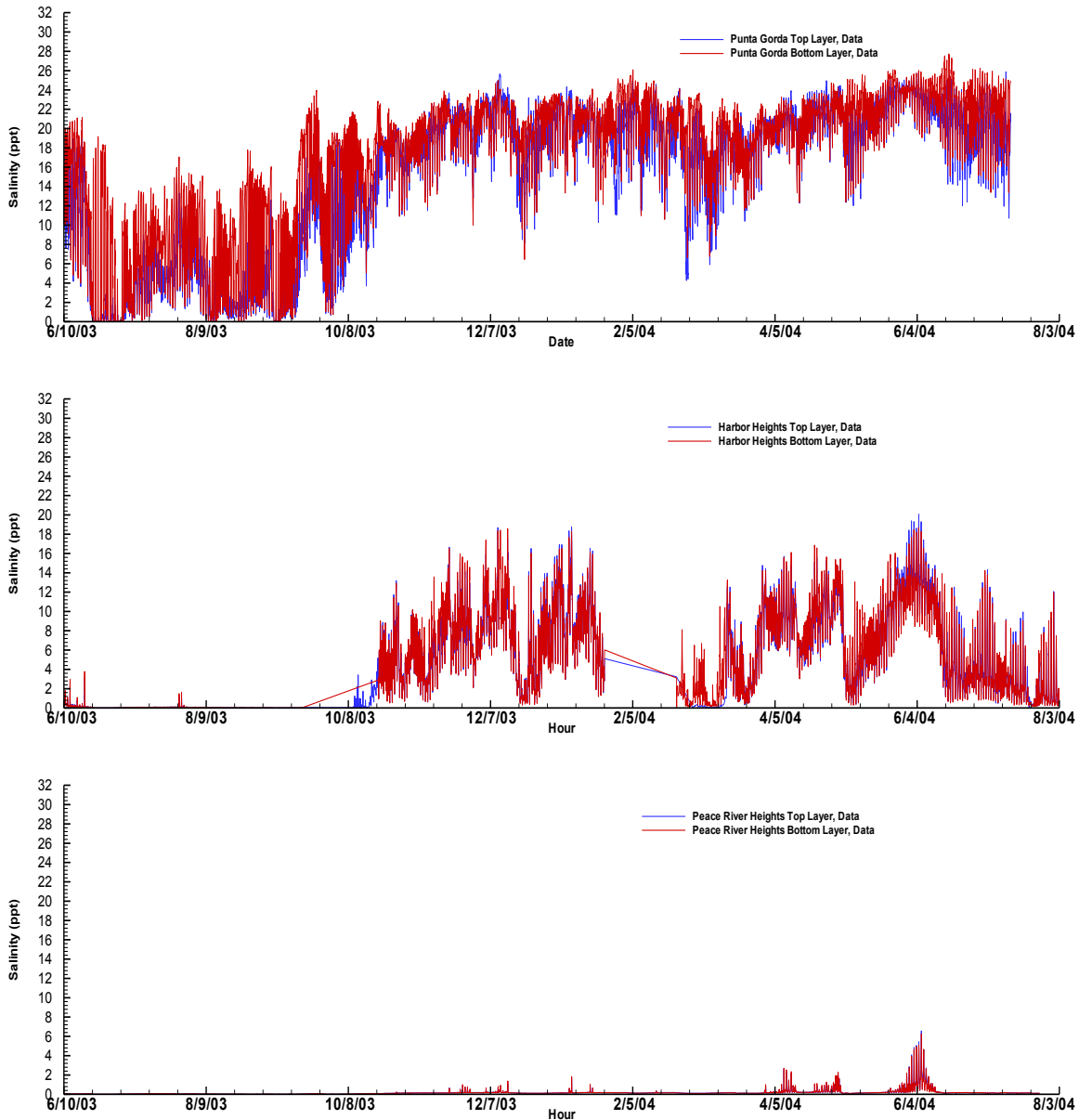

Figure 8. Measured salinity time series at three Lower Peace River stations during June 2003 – July 2004.

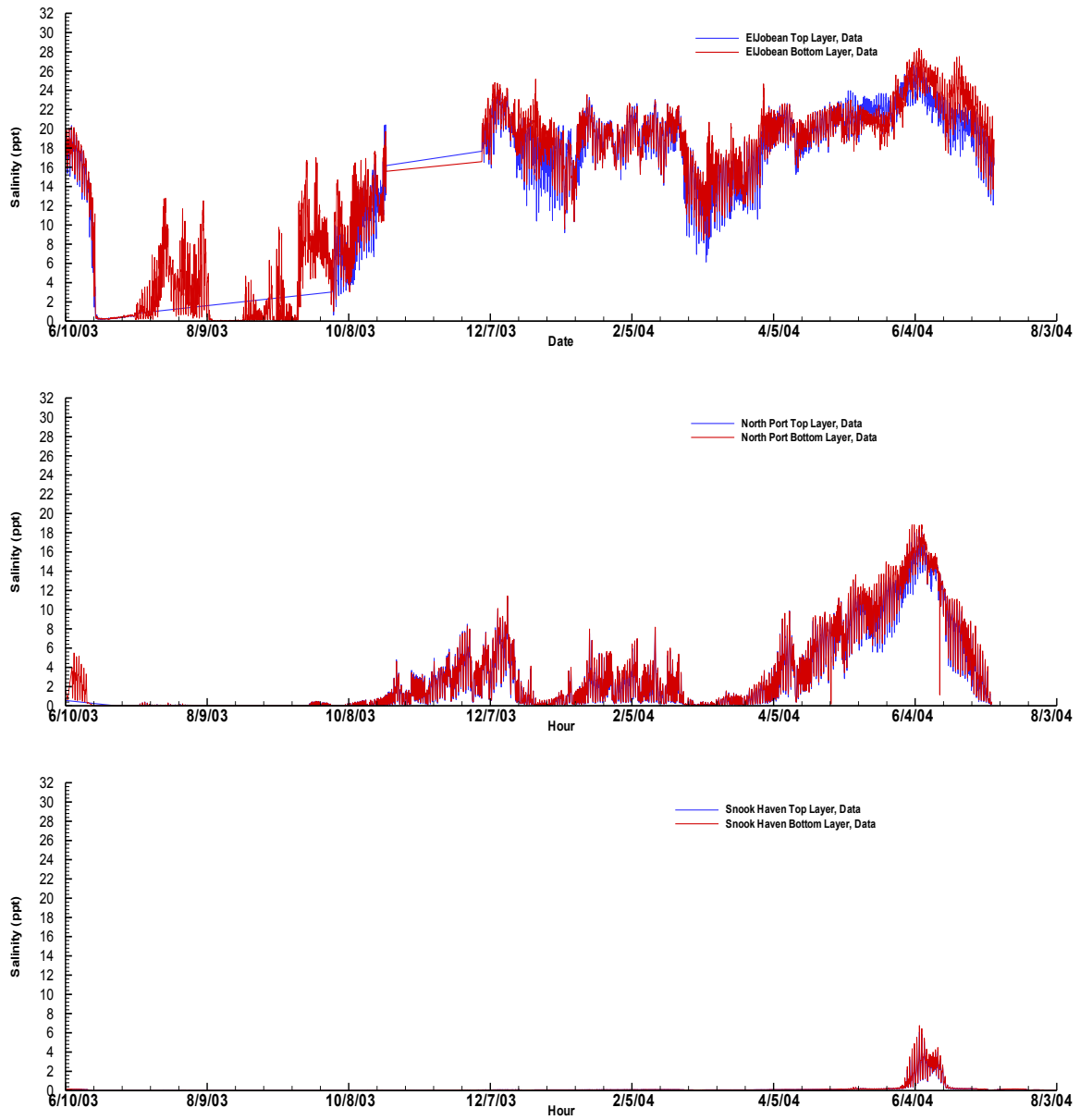

Figure 9. Measured salinity time series at three Lower Myakka River stations during June 2003 – July 2004.

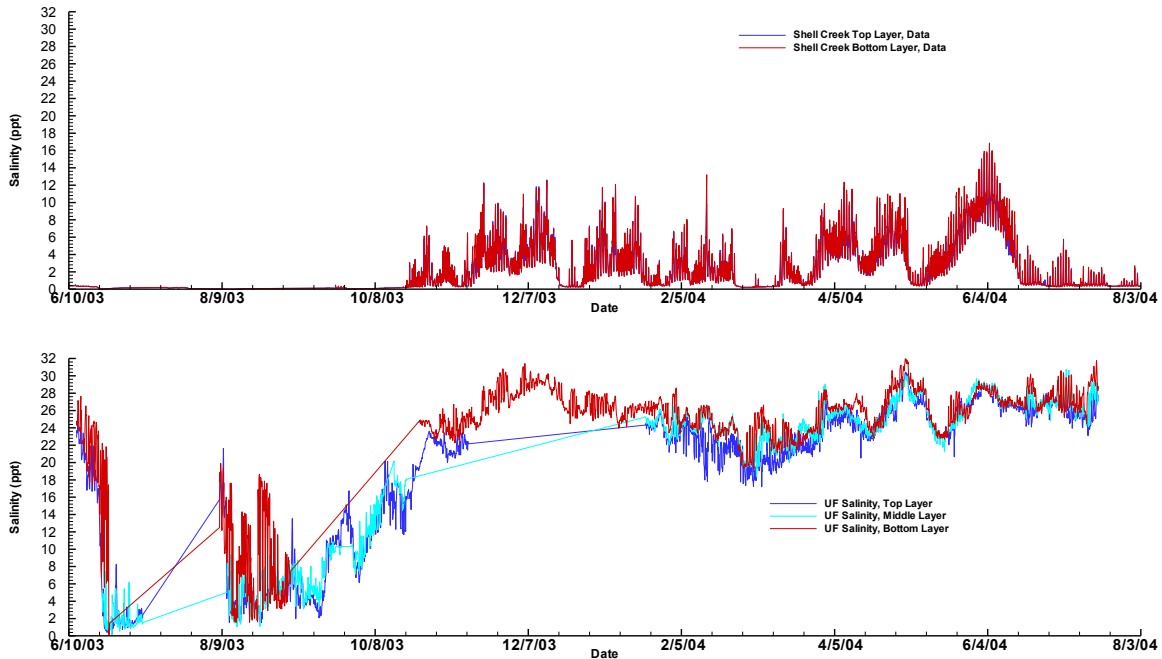

Figure 10. Measured salinity time series in Shell Creek (top graph) and Upper Charlotte Harbor (UF station, bottom graph) during June 2003 – July 2004.

Figures 11 – 13 are measured water temperature time series at the eight measurement stations in the LPR – LMR - UCH system presented in the same order as those of Figures 8 – 10. Figures 11 – 13 clearly show that water temperature does not exhibit much stratification in the LPR – LMR - UCH system. Except for the UF station in the UCH, all other seven stations exhibited only slight temperature differences between the top and bottom layers. It is speculated that the abnormality observed in top-layer temperature at the Peace River Heights station might be due to an equipment failure. The only measurement station that has shown temperature stratification is the UF station. However, the quality of the UF temperature data is questionable. One obvious problem is that the top-layer temperature was consistently higher than the middle- and bottom-layer temperatures during February – June 2004, while the middle-layer temperature was consistently lower than the bottom-layer temperature during the same period. Therefore, it is not certain whether the temperature stratification shown in UF data is real or not.

Overall, the quality of the available real-time water level, salinity, and temperature data measured at the eight stations was judged average. Several stations had many missing data periods. Some of the salinity and temperature data do not make sense. Besides the apparent problems with the UF temperature data, salinity data collected by the USGS in April and May 2004 at the Punta Gorda and El Jobean stations, respectively, appear problematic. The daily high of the top-layer salinity was always greater than that of the bottom-layer salinity in April 2004 at the Punta Gorda station, and in May 2004 at the El Jobean station. Obviously, salinity sensors malfunctioned at the two stations in April – May 2004. At the Peace River Heights station, the stage data appeared to have a datum problem before the missing data period around 2/5/04. For the Shell Creek station, although there are only about six months of data available, there are a

number of problematic readings. For example, the stage data at the Shell Creek station appeared to have not only a datum problem, but also an increasing trend between 4/5/04 and 8/3/04.

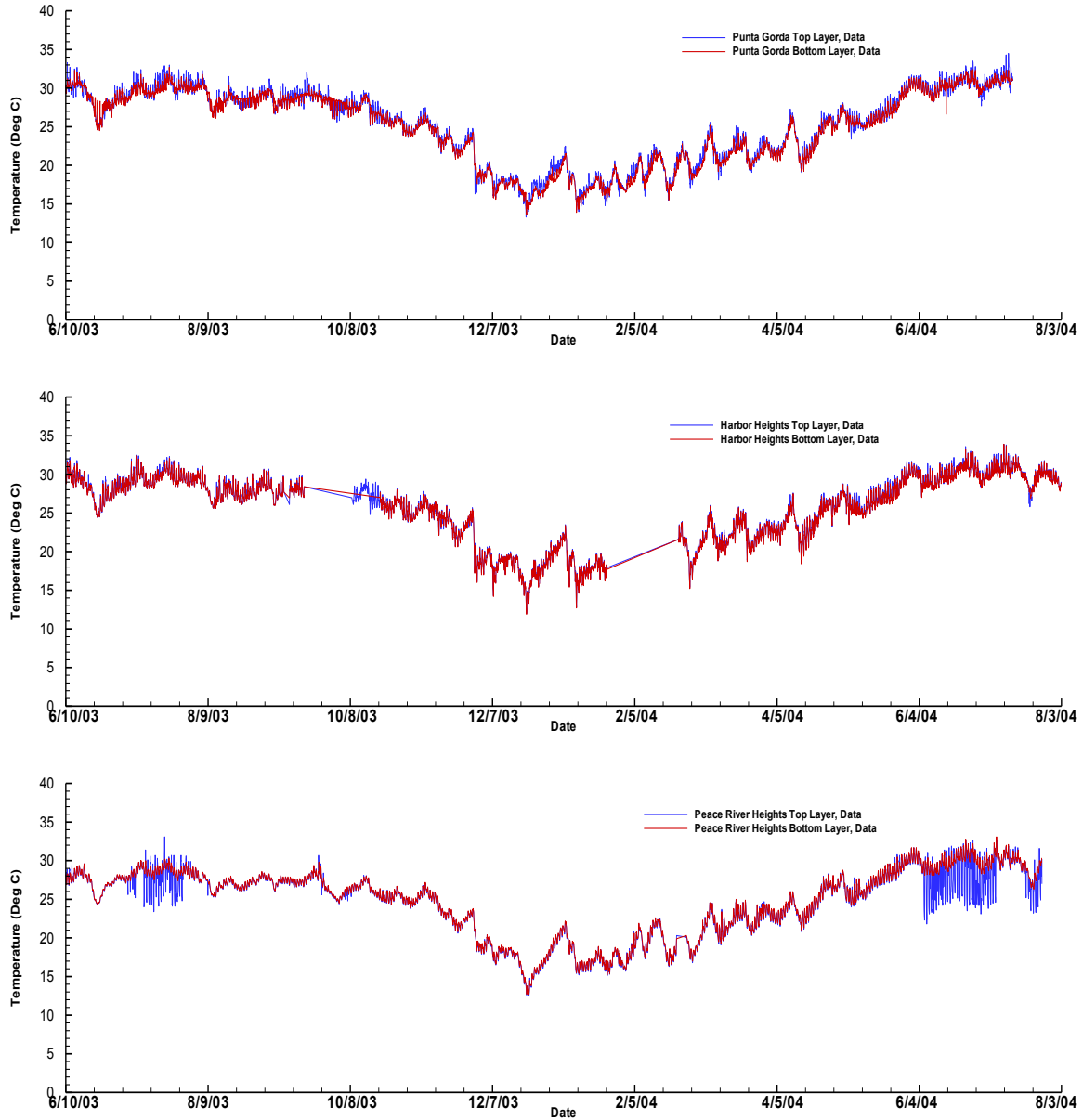

Figure 11. Temperature time series at three Lower Peace River stations during June 2003 – July 2004.

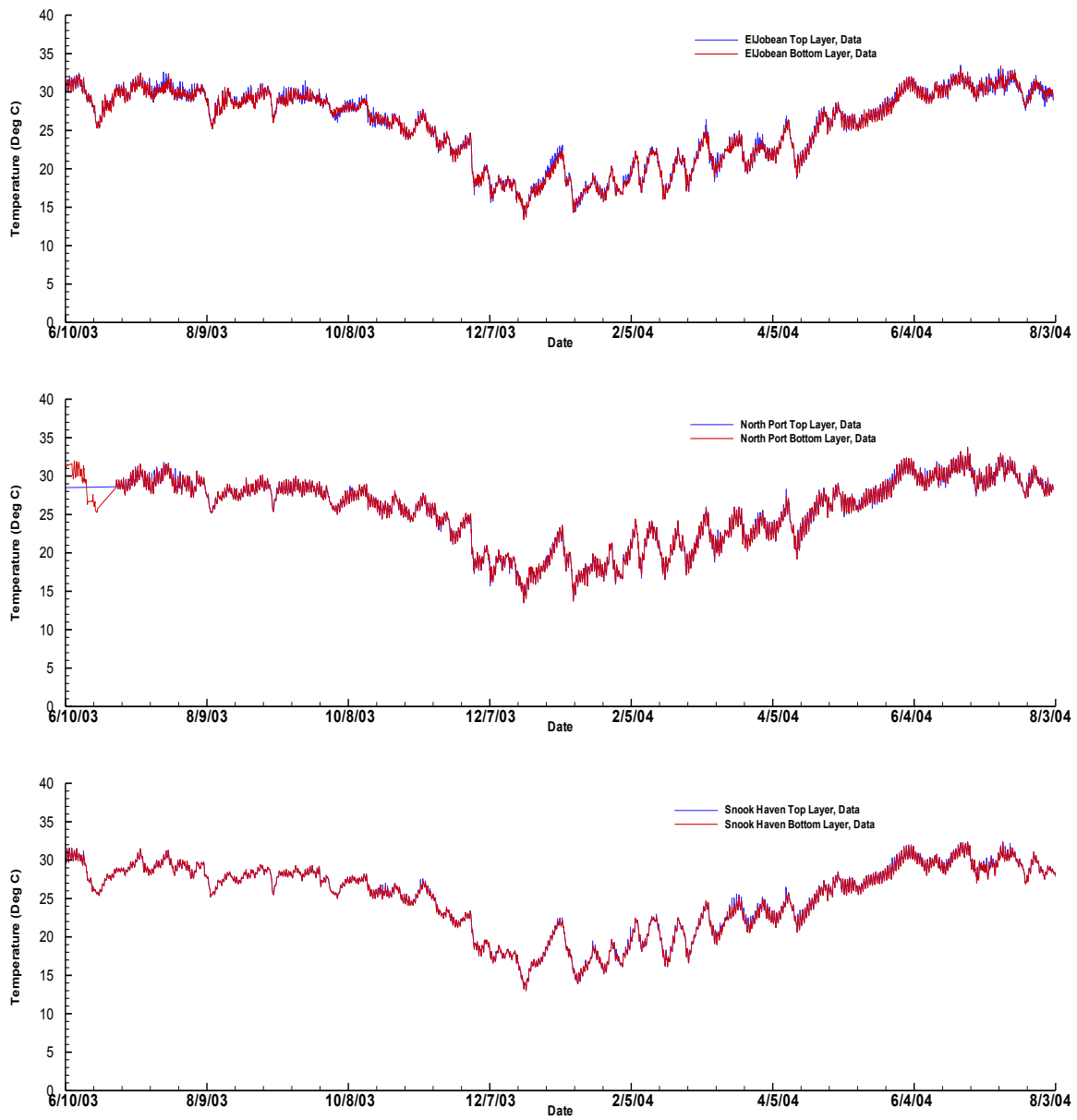

Figure 12. Temperature time series at three Lower Myakka River stations during June 2003 – July 2004.

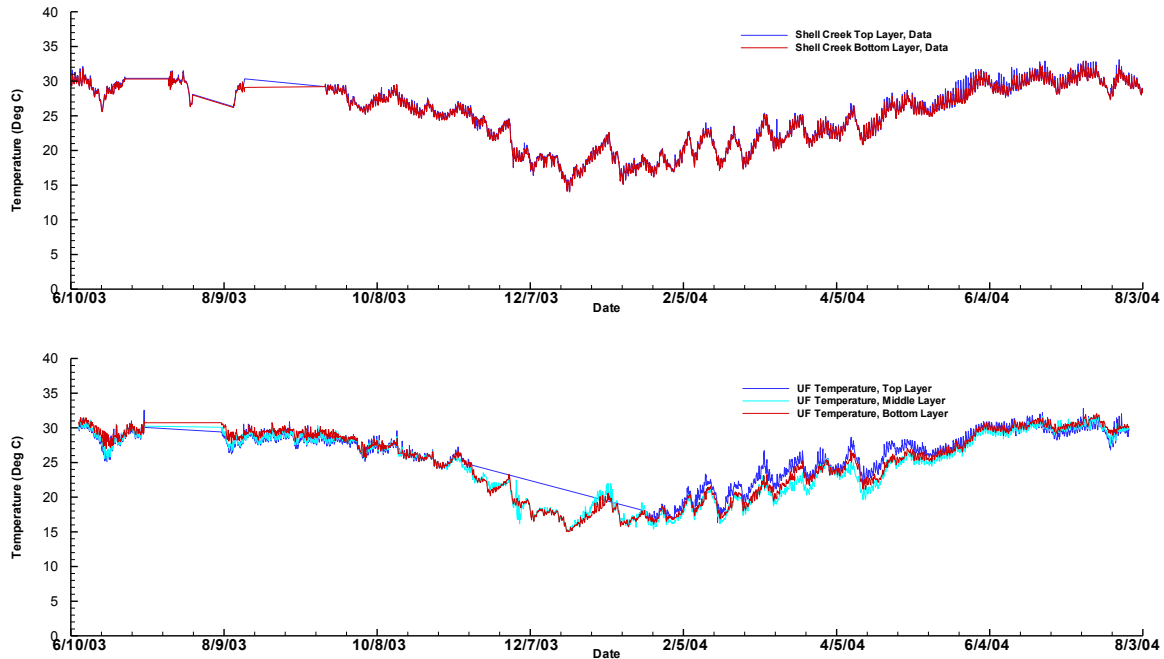

Figure 13. Temperature time series in Shell Creek (top graph) and Upper Charlotte Harbor (UF station, bottom graph) during June 2003 – July 2004.

Real-time water velocity data were measured only at the UF station in Charlotte Harbor (Figure 1). An Acoustic Doppler Current Profiler (ADCP) was deployed to measure velocities at six vertical layers. Unfortunately, current data at the top two layers are not useful because the water level often dropped below these two layers (Sheng et al., 2007). Figure 14 shows measured velocities at the four depths that were always below the water surface. The u -velocity is the water velocity component in the x -direction that runs from west to east (a positive u -velocity means that water particle moves eastward), while the v -velocity is the water velocity component in the y -direction that points from south to north (a positive v -velocity means that water particle moves northward). Because of the physical configuration of Charlotte Harbor, the magnitude of the v -component of the current is generally much larger than that of the u -component at the UF station. During the dry season when the current was predominantly tidally driven, the magnitude of the v -component was about twice of that of the u -component. However, during the wet season, the magnitude of the v -velocity was as much as three times greater than that of the u -component because fresh water coming from the Peace and Myakka Rivers turns south when it exits the Upper Charlotte Harbor. Due to the Coriolis effect and the way the Peace River flows into UCH, fresh water exits the harbor mainly near the west bank, resulting in a negative, long-term averaged v -velocity of 4 - 5 cm s^{-1} during the wet season and only about 1 cm s^{-1} during the dry season. On the other hand, although the long-term average of the u -velocity component is generally very small (about 0.75 cm s^{-1} in the wet season and about 0.4 cm s^{-1} in the dry season), it is always positive due to the proximity of the UF station to the mouth of the Myakka River.

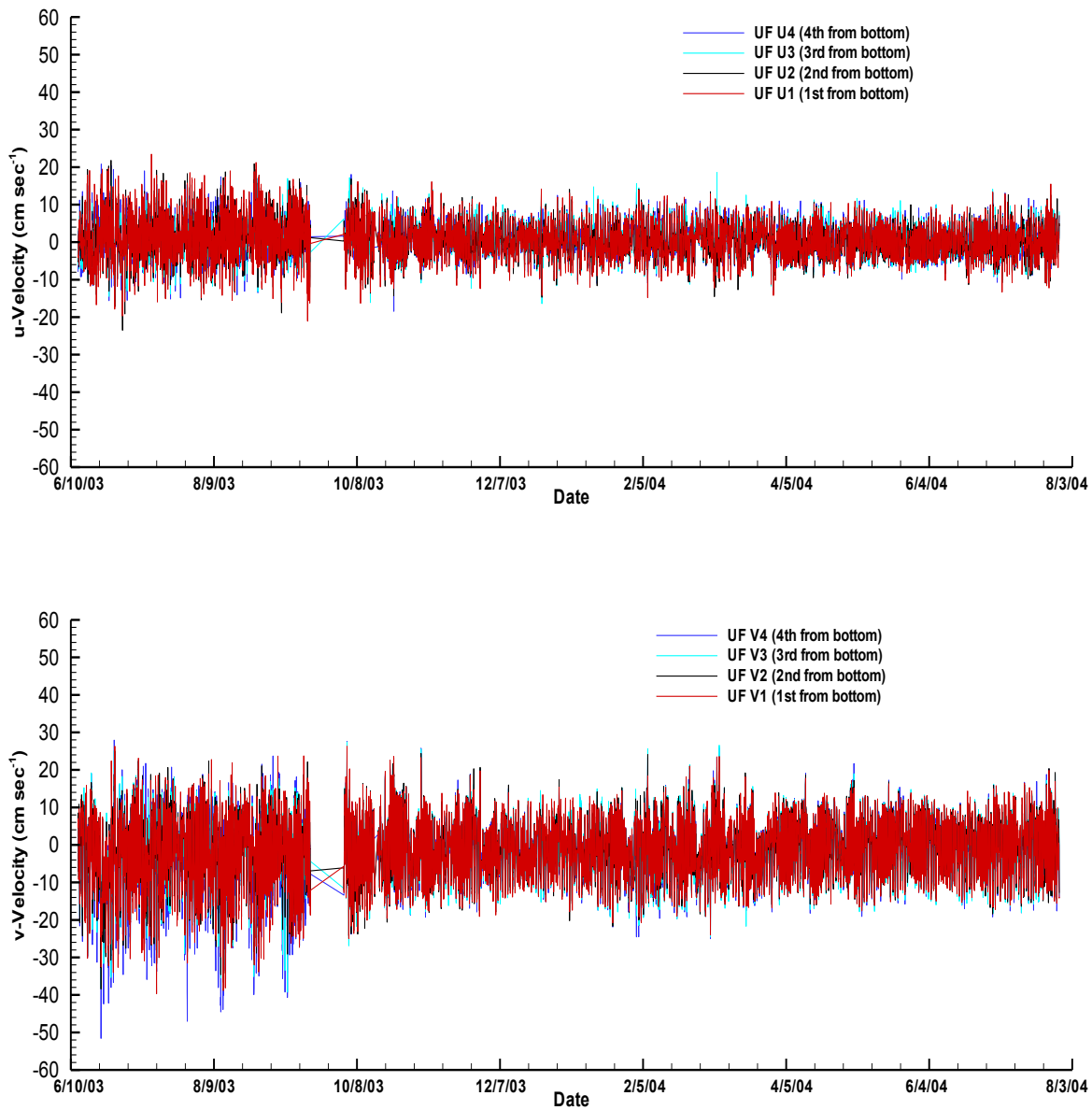

Figure 14. Measured u- (top graph) and v-velocities (bottom graph) in four depths at the UF station in the Upper Charlotte Harbor during June 2003 – July 2004.

Other Field Data

Other field data used in this modeling study included wind data measured at the UF station, air temperature, solar radiation, and air humidity data collected at a SWFWMD station near the Peace River/Manasota Regional Water Supply Authority.

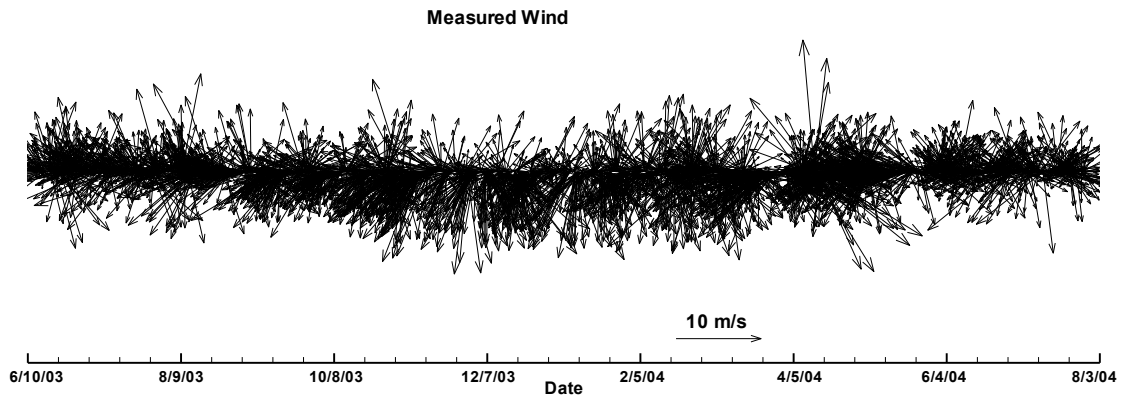

Figure 15. Measured wind at the UF station in Upper Charlotte Harbor during June 2003 – July 2004.

Figure 15 shows vector plots of measured wind at the UF station in the UCH. The figure shows a quite dynamic wind pattern blowing over the UCH during the period from June 2003 to July 2004. It appears that there is not a dominant direction in which the wind consistently blows; however, it does appear that the harbor often experienced either a northwest or a northeast wind during the 14 month period.

Measured solar radiation, relative air humidity, and air temperature collected at a SWFWMD station near the Peace River/Manasota Regional Water Supply Authority are plotted in Figure 16: the top graph is measured solar radiation in kilowatts per square meter (kw m^{-2}), the middle graph is the relative air humidity in percentage, and the bottom graph is the air temperature in degrees Celsius. All these meteorological parameters follow their general patterns for the southwest part of Florida, i.e.: summer is hotter and more humid with stronger solar radiation than winter.

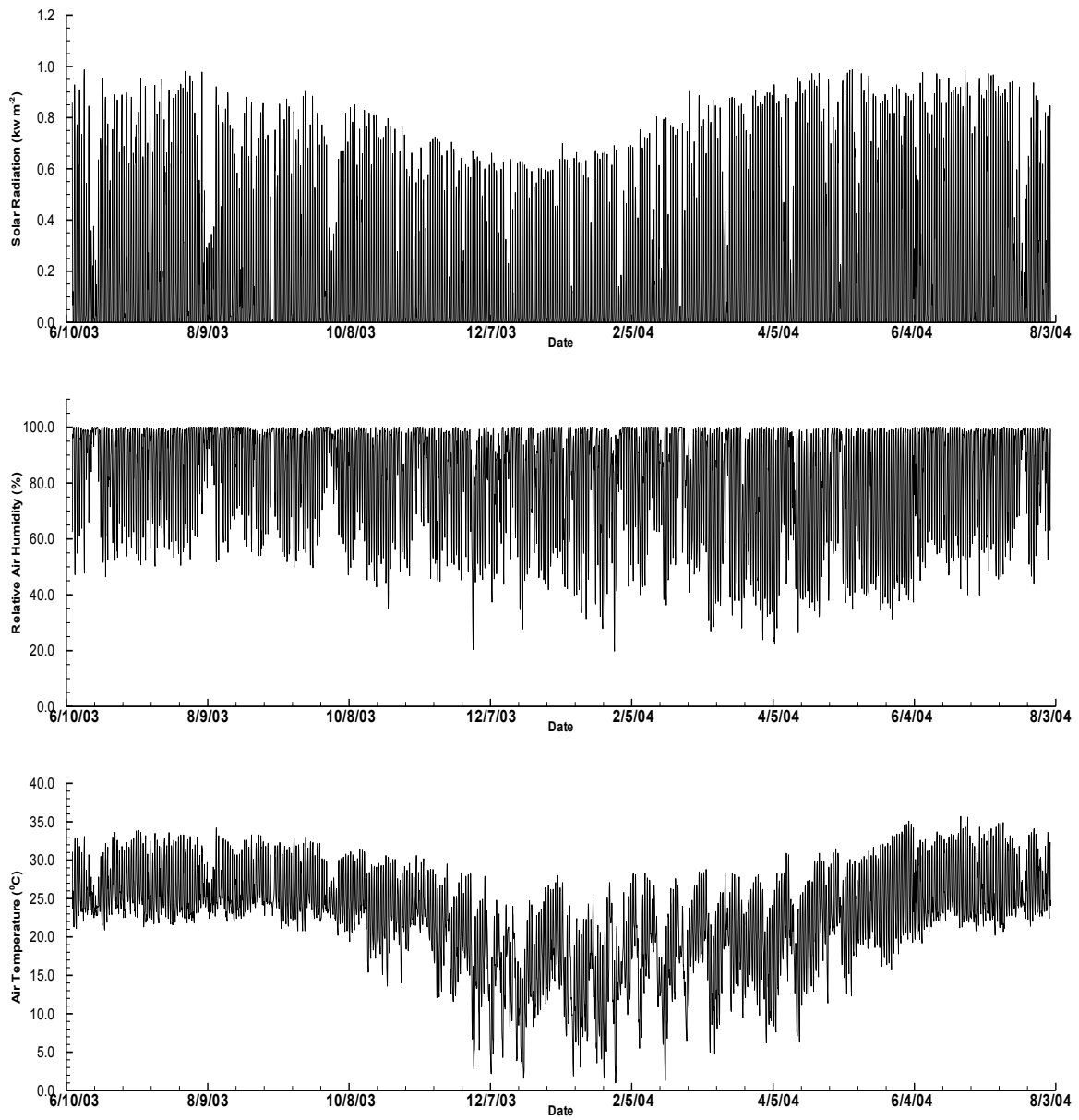

Figure 16. Measured solar radiation, relative air humidity, and air temperature at a SWFWMD station near the Peace River/Manasota Regional Water Supply Authority.

4. Model Applications to the LPR - LMR - UCH System

The dynamically coupled model LESS was applied to simulate hydrodynamics in the LPR - LMR - UCH system in support of the determination of the regulatory minimum freshwater inflow rates for the LPR and the LMR. The 3D domain includes the entire upper Charlotte Harbor, the downstream 15.5 kilometers of the lower Peace River, the downstream 13.8 kilometers of the lower Myakka River, and the most downstream 1.74 km portion of the Shell Creek. A Rectilinear grid system was used to discretize the 3D simulation domain with 108 grids in the x -direction, 81 grids in the y -direction, and 13 layers in the z -direction. The grid size in the 3D domain varies from 100m to 500m in both the x - and y -directions, while the spacing varied between 0.3m and 1.0m in the vertical direction. The 2DV domain includes three main sub-domains: (1) the LPR from river-km 15.5 to Arcadia, (2) the LMR from river-km 13.8 to river-km 38.4, and (3) and the Shell Creek from river-km 1.74 to the dam. Also included in the 2DV domain were the downstream 4.16km of the Myakkahatchee Creek and major branches of the LPR and the Shell Creek. The 2DV domain was discretized with 356 longitudinal grids and 17 vertical layers. The longitudinal length for 2DV grids varied between 200 m and 400 m. To make the 3D-2DV coupling simple, the first 13 layers for the 2DV domain is set to be the same as the 13 layers used for the 3D domain. Table 2 lists the vertical spacing in both the 3D and 2DV domains. The layer number is counted from the bottom upward, with the first layer being the lowest layer. Also included in Table 2 are the elevations of the layer centers. The bottom of the first layer is located at the elevation of -6.766 m. NGVD29. Basically, the first 10 layers discretize the water column below the NGVD29 datum, while Layers 11 and above discretize the water column above the NGVD29 datum. Because the vertical layers are fixed in space, many grid cells may not contain water at all the times. Although these cells are included in the model, they are excluded in the computation.

Layer No.	DZ for 3D Domain (m)	DZ for 2DV Domain (m)	Layer Center Elevation (m, NGVD29)
17	0.8		3.434
16	0.8		3.034
15	0.7		2.284
14	0.6		1.634
13	0.5	0.5	1.084
12	0.4	0.4	0.634
11	0.3	0.3	0.284
10	0.3	0.3	-0.016
9	0.4	0.4	-0.366
8	0.6	0.6	-0.866
7	0.6	0.6	-1.466
6	0.8	0.8	-2.166
5	0.8	0.8	-2.966
4	0.8	0.8	-3.766
3	0.8	0.8	-4.566
2	0.8	0.8	-5.366
1	1.0	1.0	-6.266

Table 2. Layer thicknesses and layer center elevations for the 3D and 2DV domains.

The reason for having four extra layers for the 2DV domain is to allow the model to simulate major storm events when very high flows cause water surface in the narrow channel areas of the 2DV domain to rise significantly. Also the riverbed near the USGS Peace River at Arcadia station which is about 8 km upstream of the tidal limit is more than 1m above the NGVD 29 datum. Figure 17 is the mesh of the LPR - LMR - UCH model, including model grids for both the 3D and 2DV domains. The red portion of the mesh represents land grids in the 3D domain, while the black portion represents water grids. Only water grids are included in the computation at each time step. Land grids are kept inactive and not included in the computation. As the water level rises, the shoreline also changes. As a result, some land grids may become water grids and will be treated as active grids in the computation at the new time step.

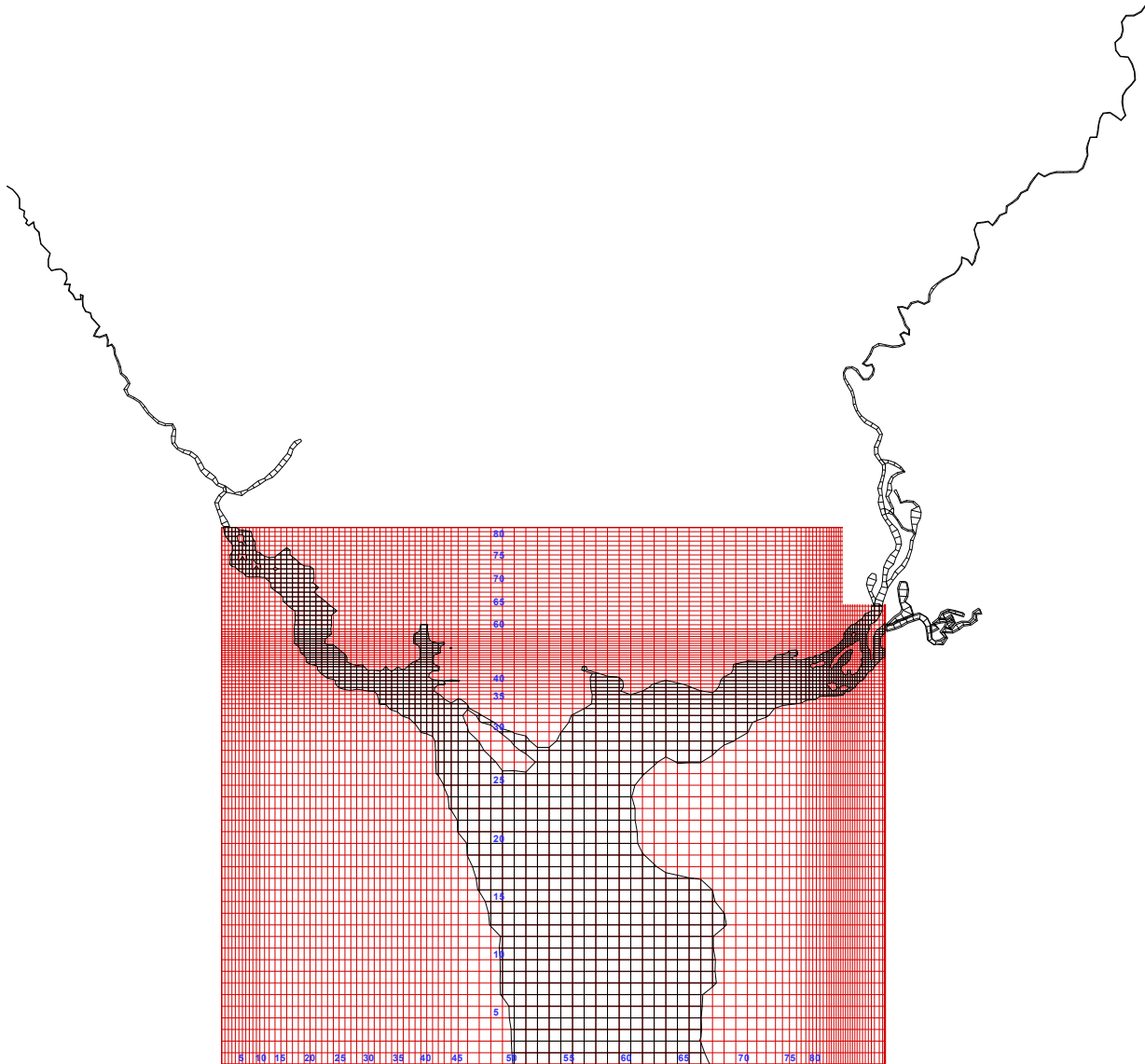

Figure 17. Model grids used in the LPR - LMR - UCH model. The red portion of the mesh represents land grids that are inactive in the computation in the 3D domain.

Hydrodynamic simulations in the complex LPR - LMR - UCH system were conducted for a period of 395 days from June 13, 2003 through July 12, 2004, with a variable time step between 90 and 180 seconds. The dynamically coupled 3D-2DV model was driven by boundary conditions specified at free surface (wind shear stresses and heat fluxes), at the open boundary at the southern side of the 3D domain, and at the upstream boundaries of the LPR, the LMR, and the Myakkahatchee and Shell Creeks of the 2DV domain. At the upstream boundaries of the 2DV domain, measured daily flow rates were uniformly distributed over the cross sections with zero salinity and zero temperature gradient in the longitudinal direction. At the open boundary on the southern side of the 3D domain, the boundary conditions were given using simulated results of water elevation, salinity and temperature by another hydrodynamic model (Sheng, et al.,

2007) that covered the entire Charlotte Harbor and a coastal area almost 45 km offshore into the Gulf of Mexico (Figure 18). Wind data measured at the UF station were used to calculate shear stresses at the free surface. The heat exchange with the atmosphere at the free surface was calculated based on measured solar radiation, wind, and air temperature data at the UF station and the SWFWMD station near the Peace River/Manasota Regional Water Supply Authority.

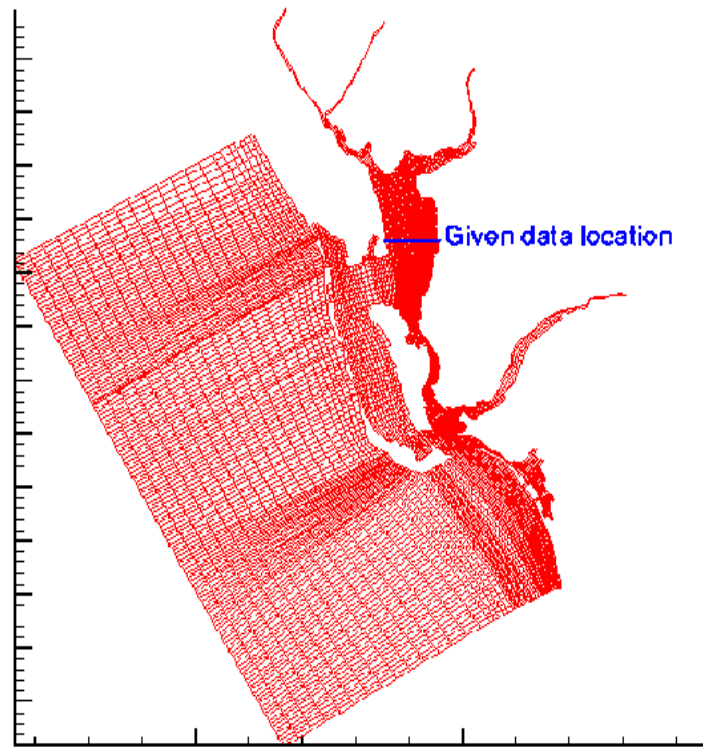

Figure 18. The boundary conditions at the southern boundary of the LPR - LMR - UCH model were provided by another hydrodynamic model by Sheng et al. (2007). The blue bar represents the southern boundary of the LPR - LMR - UCH model.

As mentioned above, because about 16% of the Peace River sub-basin and almost 50% of the Myakka River sub-basin are ungauged, freshwater inflows from these ungauged areas comprise a great deal of the total freshwater budget to the Charlotte Harbor and have significant effects on salinity distributions in the LPR – LMR - UCH system. However, it is very challenging to obtain reasonable estimates of ungauged flows from a very complex system such as the Peace - Myakka River watershed. Although the HSPF model (Bicknell et al., 1997) is a popular model that has been used in many areas of the country, including Florida, it cannot guarantee good model results, especially when it is used as an extrapolation tool for an area that is quite different from the gauged areas in terms of land-use and hydro-geological properties. Moreover, due to the unavailability of freshwater flow data to the tidal reaches, it is impossible to determine the severity of the errors and the confidence interval of the simulated ungauged flows. The unknown errors in the estimated ungauged flow will inevitably cause errors in model results of the coupled

3D-2DV model. Unfortunately, without a better way to estimate ungaged flows, simulated results using the HSPF model by Ross et al. (2005) appeared to be the only choice available for a rough estimate of the freshwater contribution from the ungaged areas of the watershed. During the calibration process of the model, it was found that the model under-predicted salinity during the wet months of the simulation period (see below), suggesting that ungaged flows by Ross et al. (2005) could be over-estimated. As such, this study compared the HSPF results to those estimated by Janicki Environmental using a simple method developed by SDI Environmental Services (SWFWMD, 2010). The estimated ungaged flows using the SDI method are generally 50 – 60% lower than the HSPF results, except for the few peak flows in the first couple of months of the simulation period which are much higher than HSPF peak flows. Based on this comparison, the daily ungaged flow values generated by the HSPF model were multiplied by constant factors (0.39 for the Peace, and 0.51 for the Myakka) to produce the final adjusted ungaged flow values that were input to the coupled model.

For the Blackburn Canal flow, Equation (16) was used to estimate how much flow is exchanged between Myakka River and Dona/Roberts Bay during the model calibration and verification periods mentioned below. It was also used in the scenario runs for the LPR MFL simulations. Lately (early 2008), Equation (17) was tested to see how much difference it would make in terms of simulated water levels and salinities at eight measurement stations during the calibration and verification periods. The model results are the same, except for the Snook Haven and North Port stations in the LMR where the difference is very insignificant. To be consistent with the Dona/Roberts Bay study, Equation (17) was used in the LMR MFL scenario runs.

Model Calibration and Verification

During the 13-month simulation period from June 13, 2003 to July 11, 2004, the first 30 days, from June 13 to July 12, were used for spinning up the LESS model because initial conditions on June 13, 2003 were not available. Considering the quality of available data and errors associated with the estimation of ungaged flows during extreme conditions, a three-month period from January 10, 2004 to April 9, 2004 was chosen for model calibration. During the model calibration process, key model parameters (e.g., bottom roughness, background vertical eddy viscosity and diffusivity, various advection schemes, etc.) were adjusted to obtain the best fit between model results and measured data at the eight stations in the LPR - LMR - UCH system. Because the initial conditions for the calibration period were also unknown, a 30-day spin-up period was included in the model calibration. Therefore, the calibration run was actually performed for a four-month period from December 12, 2003 to April 9, 2004, with the model results during the first 30 days being excluded in model calibration. After the model was calibrated, it was verified against field data measured at the eight stations during a six-month period before the calibration period (July 12, 2003 – January 9, 2004) and a three-month period after the calibration period (April 19 – July 11, 2004).

Figures 19 and 20 are comparisons of simulated water levels with measured field data during the 91-day calibration period from January 10, 2004 to April 9, 2004. While Figure 19 compares at the four stations in the 3D domain (UF, Punta Gorda, El Jobean, and Harbor Heights), Figure 20 compares at the four stations in the 2DV domain (Peace River Heights, Shell Creek, North Port, and Snook Haven). Comparisons of simulated water levels to measured field

data at all eight stations during the two verification periods are shown in Figures A-1 through A-6 in Appendix A. As can be seen from these figures, simulated water levels match the data very well, with the exception that the model under-predicts flooding at the Peace River Heights and the Snook Haven stations during extremely high flow events. The under-prediction of the water levels at these two stations is mainly due to the inaccurate bathymetric data for the floodplains of the upstream portions of the LPR and LMR. For the Peace River Heights station, it is also partially due to the datum problem mentioned in Section 2.

Figures 21 and 22 compare simulated u- and v-velocities with measured data at the UF station during the 91-day calibration period. Simulated u- and v-velocities during the two verification periods were plotted and compared with measured data in Figures B-1 through B-6 in Appendix B. For simplicity, comparisons were made only at three depths (second to fourth from the bottom), instead of all four depths, in the figures. The reason for this is that the spatial resolution ($500\text{m} \times 500\text{m}$) used near the UF station was quite coarse and the actual bottom elevation at the UF station can not be accurately represented in the model. Therefore, in Figures 21-22, "Near Bottom", "Middle Depth", and "Near Surface" are respectively the second, third, and fourth layers from the bottom in Figure 14. From Figures 21 – 22, as well as those shown in Appendix B, it is evident the model worked well in simulating currents in the harbor (at least near the UF station). Both the short-term (semi-diurnal) and long-term variations of the current in the x- and y-directions have been successfully simulated by the model.

Simulated salinities during the calibration period at all eight measurement station are also plotted against measured real-time data for comparison. Figures 23 – 26 are plots of simulated and measured salinities at UF, Punta Gorda, El Jobean, and Harbor Heights, respectively, while Figure 27 - 30 are those of simulated and measured salinities at Peace River Heights, Shell Creek, North Port, and Snook Haven, respectively. These plots suggest that the dynamically coupled model has been successfully calibrated against measured real-time salinities in the LPR - LMR - UCH system, except for the North Port station, where the model under-predicted salinities at both the top and bottom layers during the calibration period. There are many factors that could cause the under-prediction of salinity at the North Port station, including the ungaged flow from the Myakka River watershed, the Myakka River bathymetry data used in the model, flow estimated for Blackburn Canal, etc. A careful comparison of the bathymetric data used in the model with those surveyed in the Myakka River showed that many deep areas in the river were not correctly represented in the model because of the use of model grids ranging from a $200\text{m} \times 100\text{m}$ resolution to a $200\text{m} \times 200\text{m}$ resolution in the Myakka River portion of the 3D sub-domain. Adjusting the bathymetry data in these areas by lowering the bottom elevations a bit, the simulated salinity results at the North Port station did show some degree of improvement. Although one can continue to adjust the bathymetry data to further improve simulated salinity results at North Port, this should be done with caution. We chose to adjust the bathymetry data in the downstream portions of the Peace and Myakka Rivers only slightly to ensure that downstream water volumes of the two rivers have no obvious increases and important physical characteristics in the regions are preserved (e.g., islands are not noticeably shrunk or eliminated).

Comparisons of model results and measured salinities at the eight stations for the two verification periods are presented in Figures C-1 through C-23 in Appendix C. From these figures, it is apparent that the coupled model can reproduce both the long-term and short-term trends of salinity variations at all eight stations during the two verification periods. Nonetheless, it under-predicts salinities in the wet season before the calibration period and slightly over-

predicts salinities in the driest months after the calibration period. The best agreement between simulated and measured salinities occurred in last couple weeks of the second verification period when simulated salinities in all eight stations match the data very well. Obviously, the agreement between simulated and measured salinities at all eight stations in the LPR - LMR - UCH system for the verification periods is not as good as that for the calibration period; however, it was judged satisfactory considering the many uncertainties inherent with the input data that drive the model, including the bathymetry data read to the model, ungaged flow estimates, the boundary conditions provided by another model (Sheng et al., 2007), etc.

Figure 31 – 35 are time series of simulated and measured temperatures during the calibration period at the UF, Punta Groda, El Jobean, Peace River Heights, and Snook Haven stations. Because the purpose of this modeling effort is to evaluate the effects of freshwater inflows on salinity distributions in the LPR and LMR in support of the establishments of the minimum freshwater flows for the two riverine estuaries, emphasis was placed on calibrating/verifying model results against measured salinity data instead of measured temperature data. Although no special effort was made to calibrate the model for temperature, Figures 31 - 35 illustrate that the agreement between simulated and measured temperatures in the LPR - LMR - UCH system is still good. For simplicity, only five stations during the calibration are included in this report. Comparisons of simulated and measured temperatures during the two verification periods and at the remaining three stations during the calibration period are omitted. As mentioned before, although measured temperature data in the simulation domain show large temporal variations, they exhibit only very small spatial variations. As a result, temperature has only minor effects on circulations and salt transport processes in the LPR - LMR - UCH system. Model runs confirmed that simulated water level, velocity, and salinity results are almost the same with or without including temperature in the simulations.

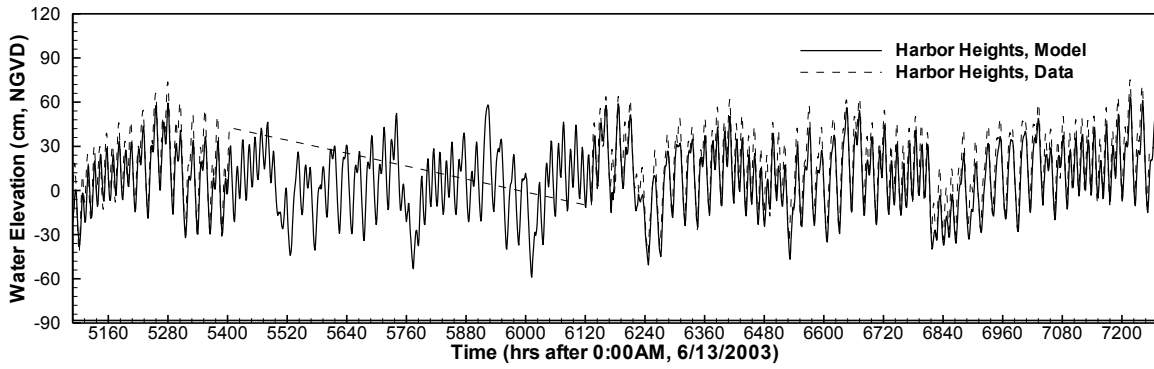
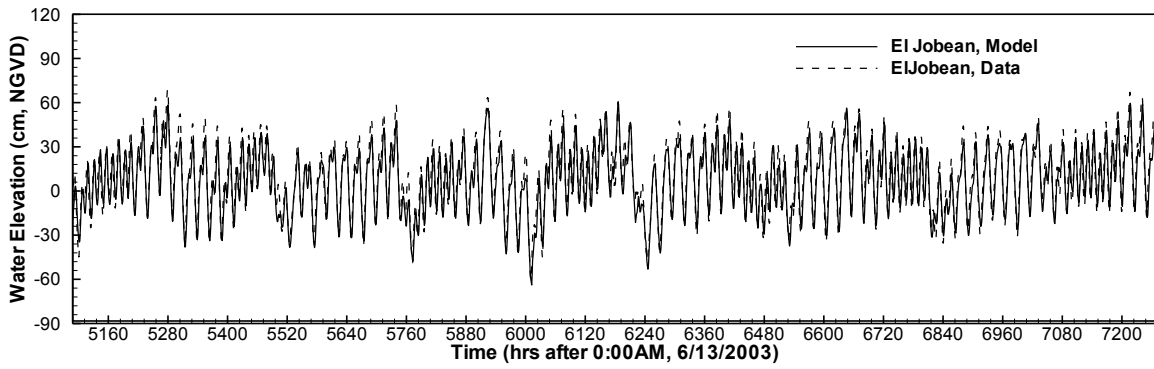
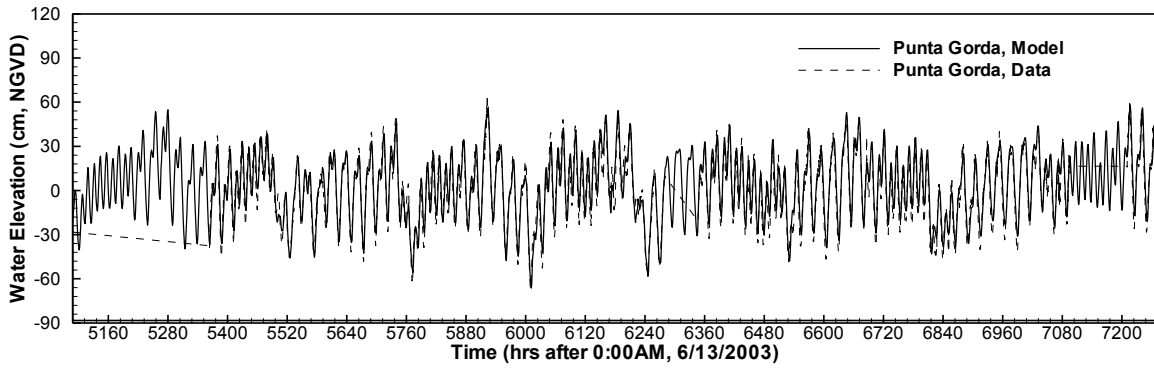
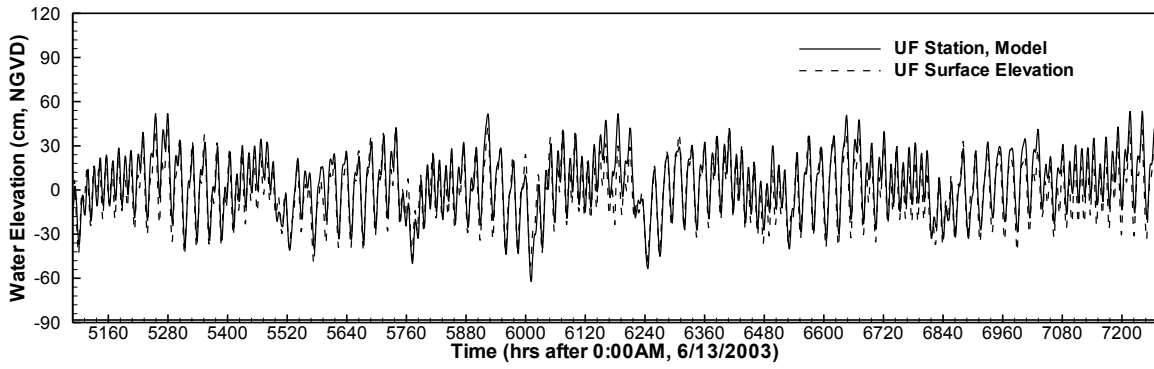

Figure 19. Comparisons of simulated and measured water elevations at UF, Punta Gorda, El Jobean, and Harbor Heights during January 10 – April 9, 2004.

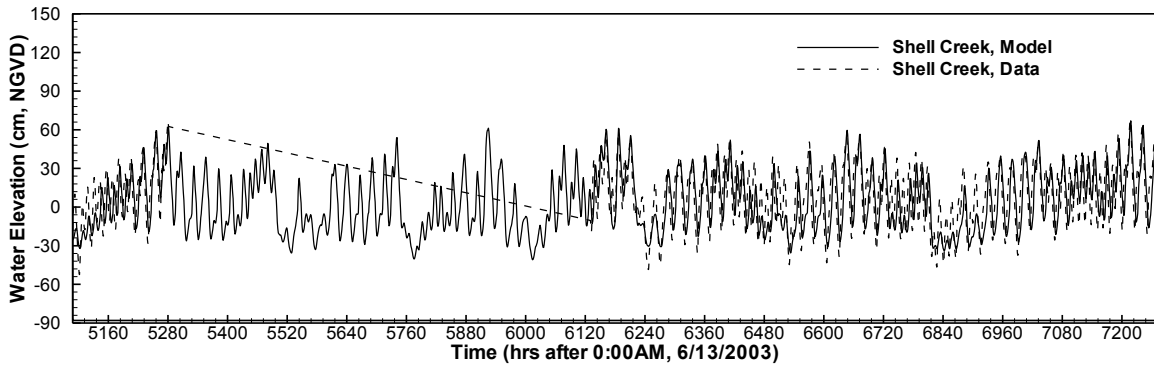
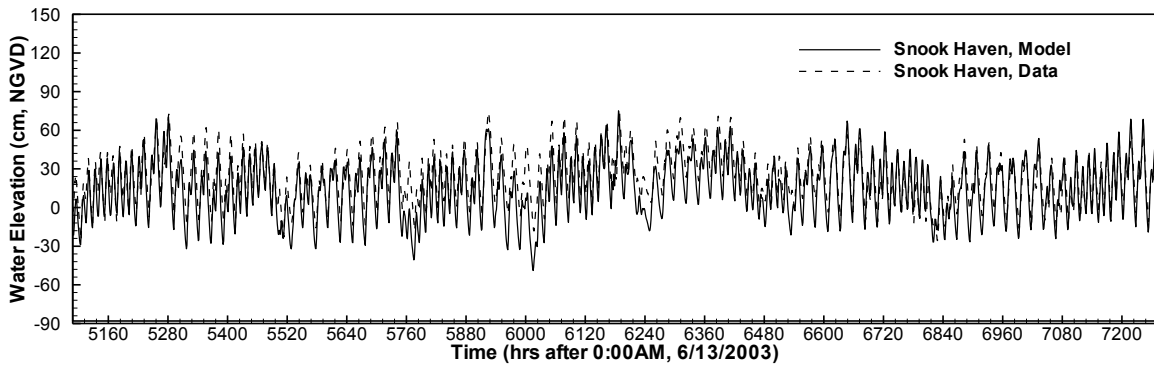
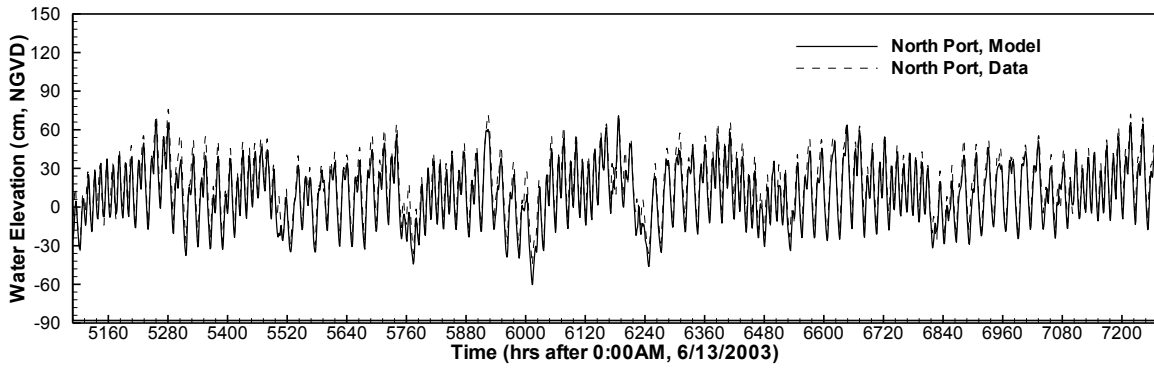
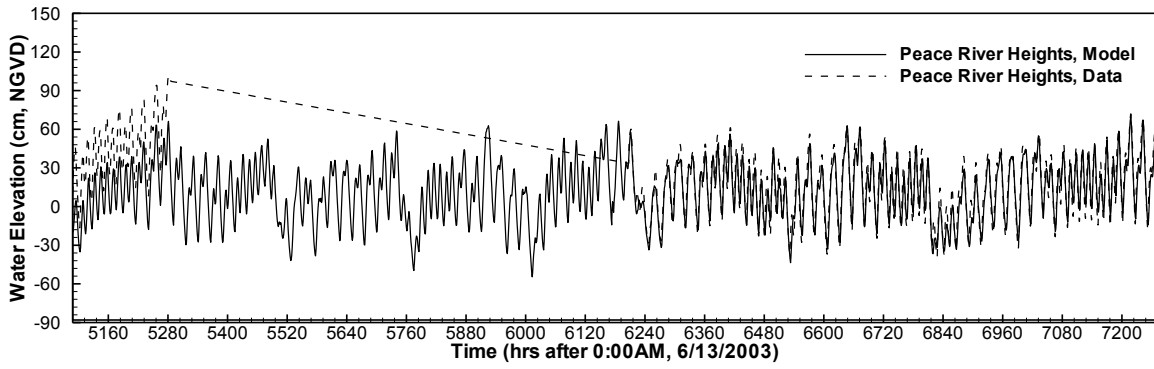

Figure 20. Comparisons of simulated and measured water elevations at Peace River Heights, North Port, Snook Haven, and Shell Creek during January 10 – April 9, 2004.

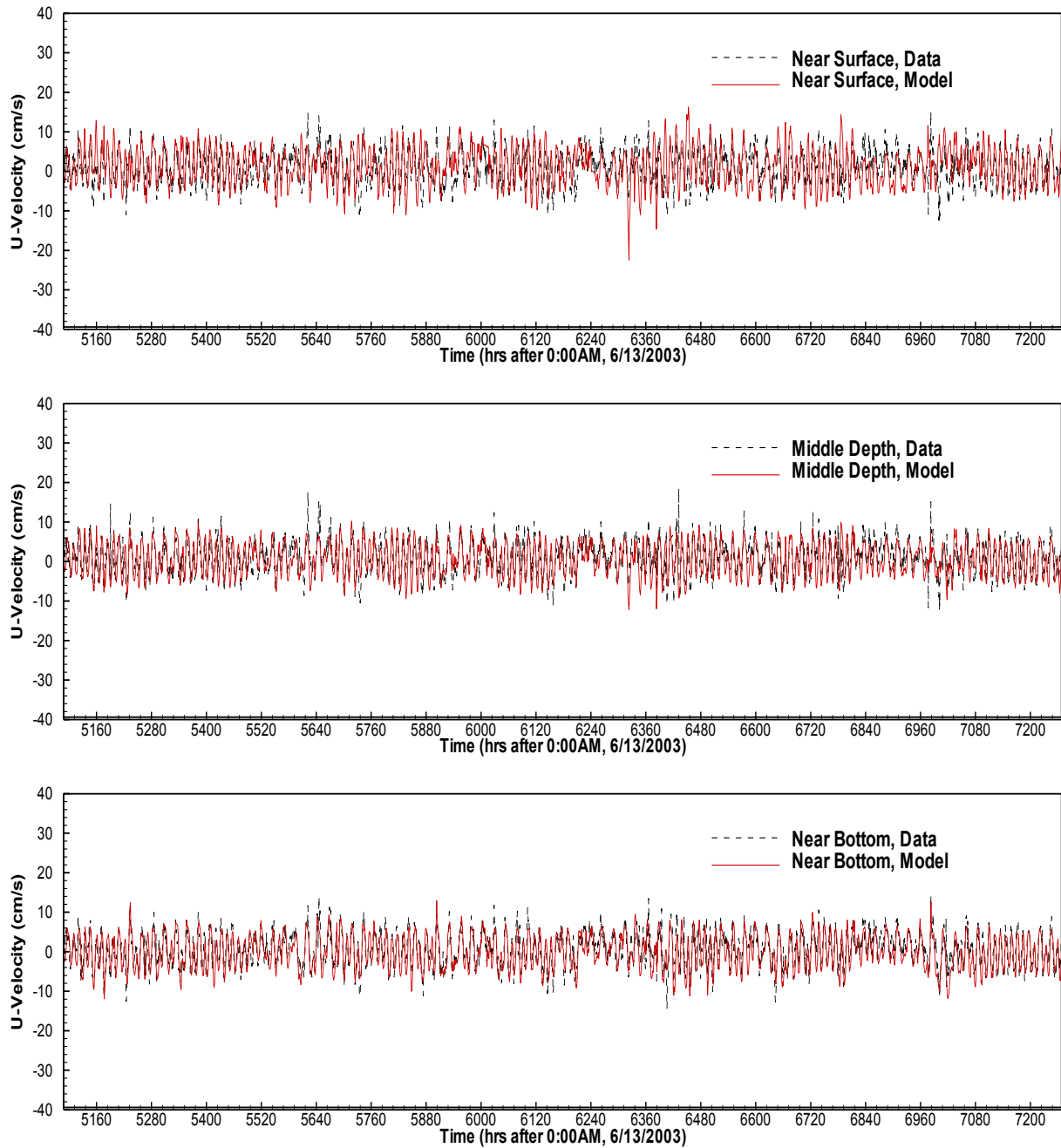

Figure 21. Comparisons of simulated and measured u-velocities at three depths at the UF station during January 10 – April 9, 2004.

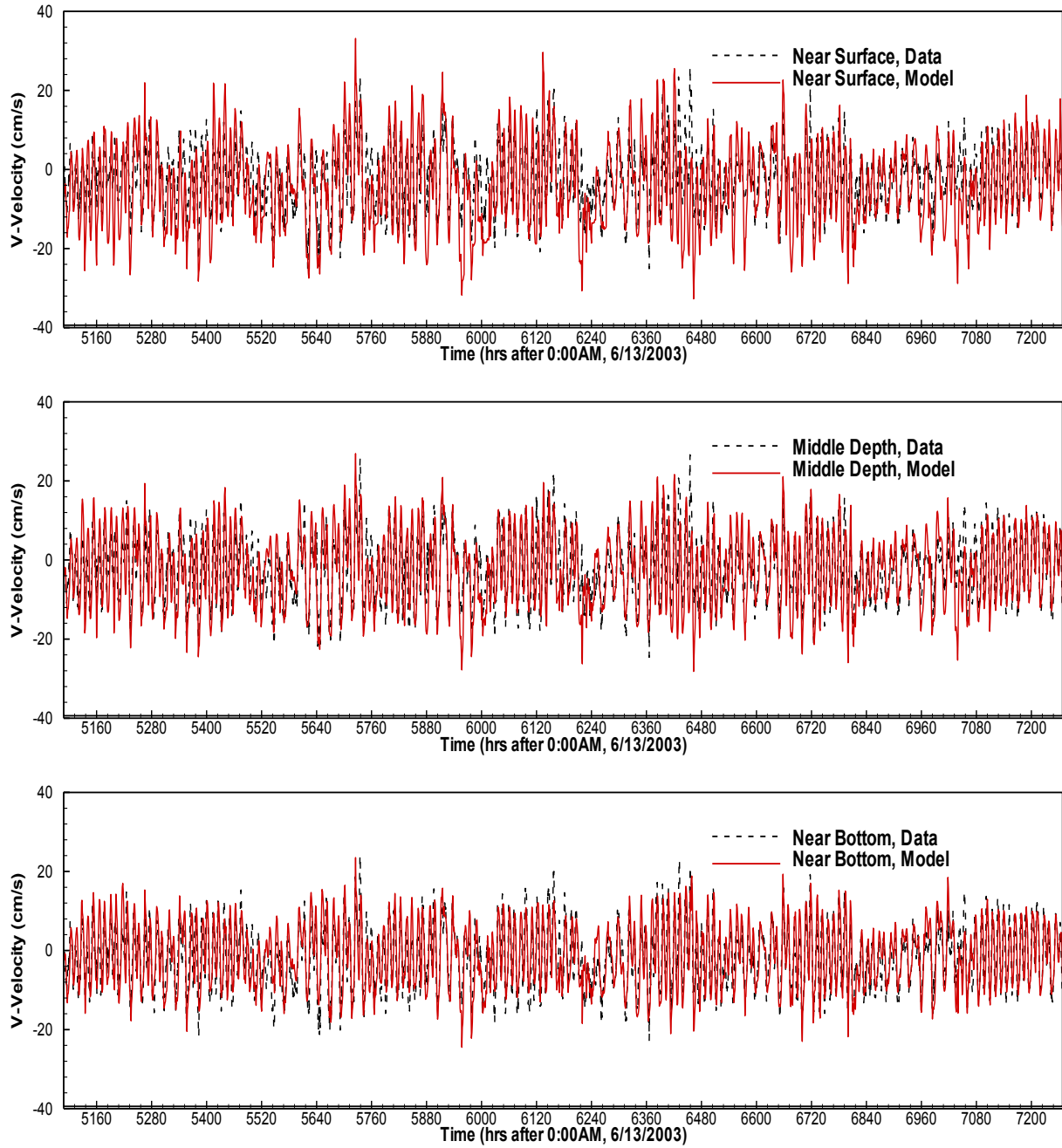

Figure 22. Comparisons of simulated and measured v-velocities at three depths at the UF station during January 10 – April 9, 2004.

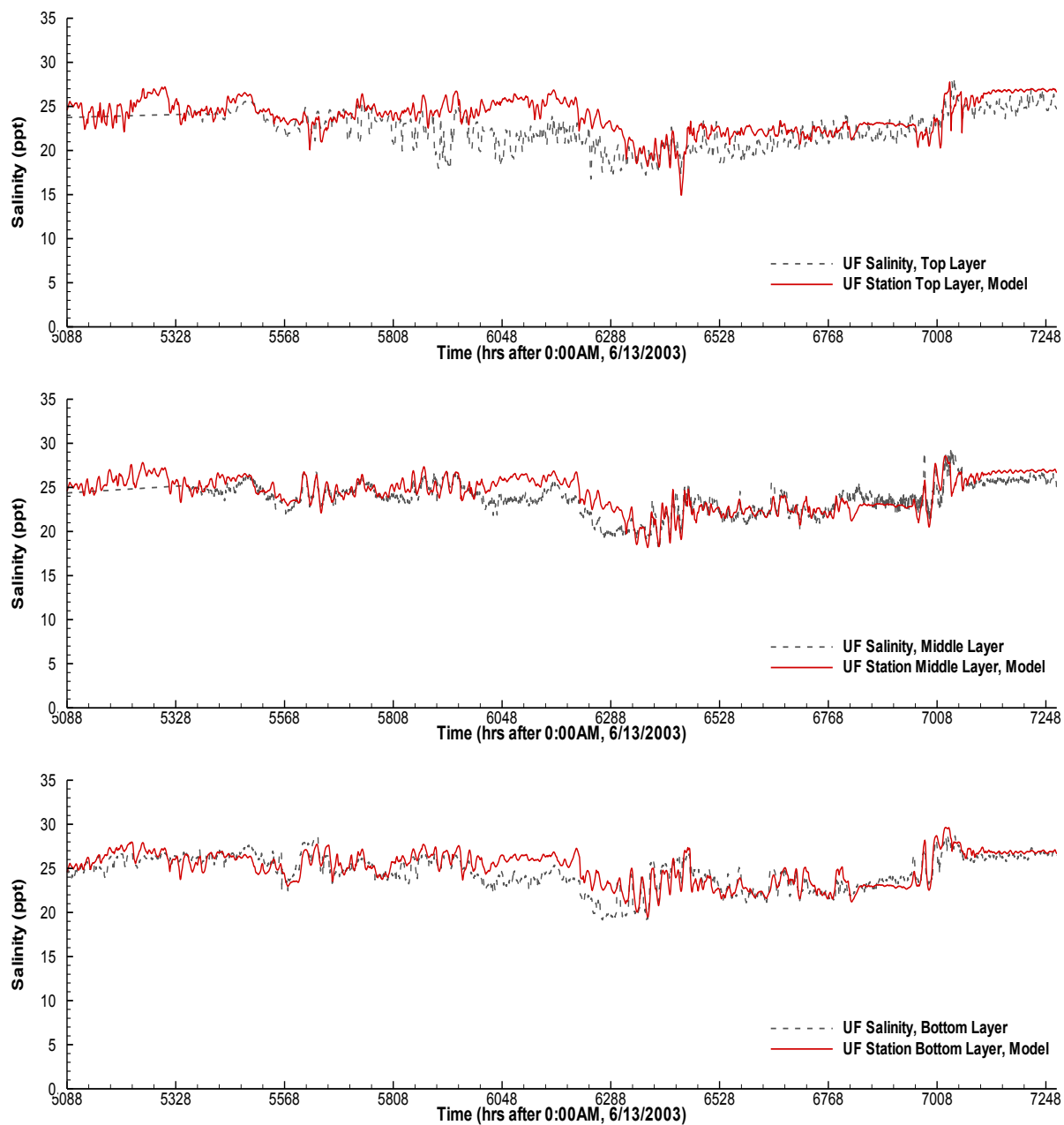

Figure 23. Comparisons of simulated and measured salinities at three depths at the UF station during January 10 – April 9, 2004.

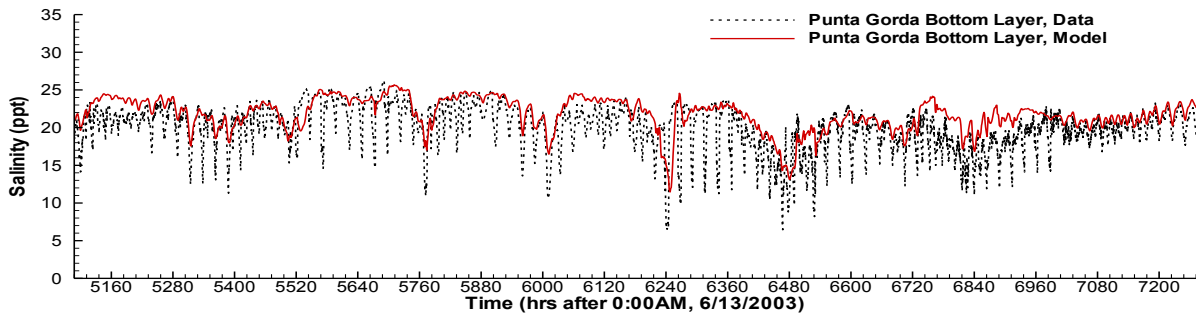
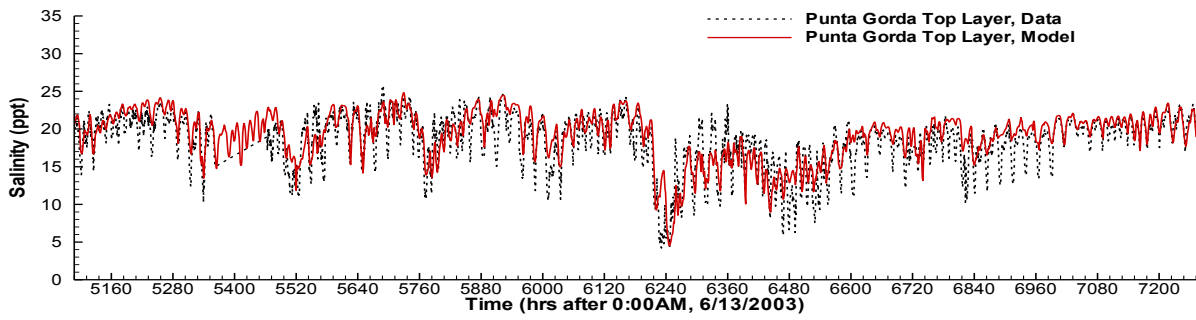

Figure 24. Comparisons of simulated and measured salinities at two depths at the Punta Gorda station during January 10 – April 9, 2004.

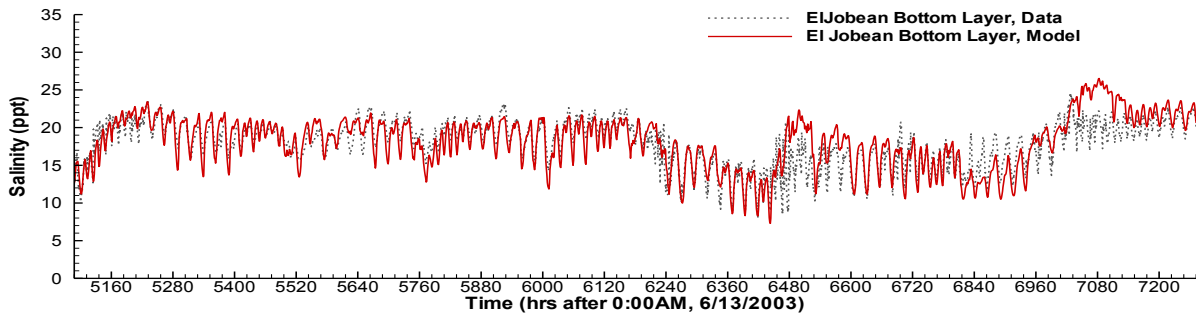
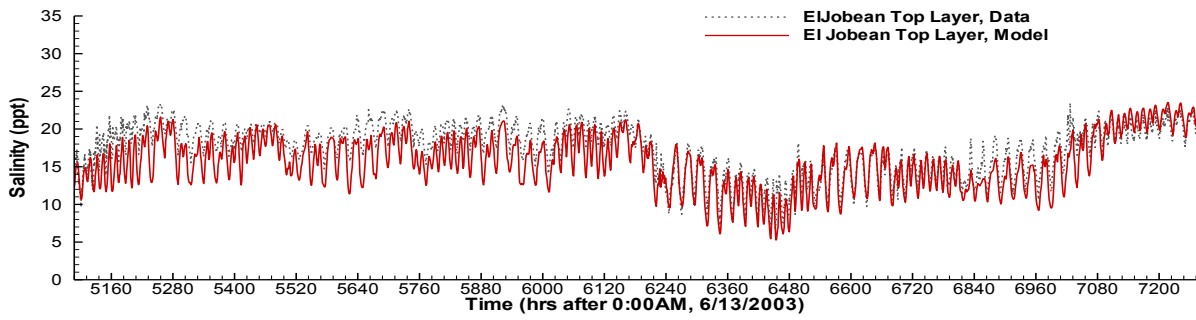

Figure 25. Comparisons of simulated and measured salinities at two depths at the El Jobean station during January 10 – April 9, 2004.

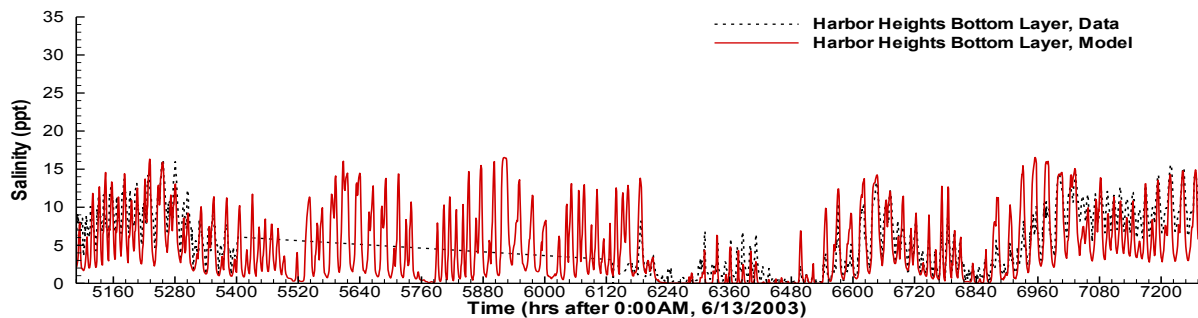
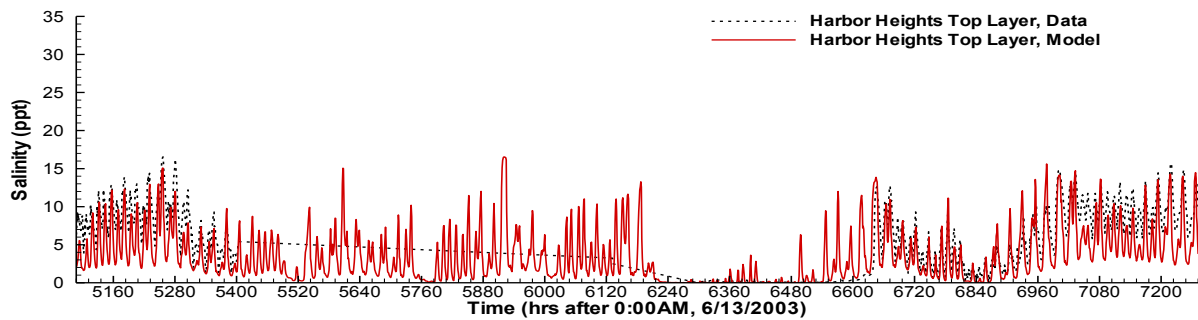

Figure 26. Comparisons of simulated and measured salinities at two depths at the Harbor Heights station during January 10 – April 9, 2004.

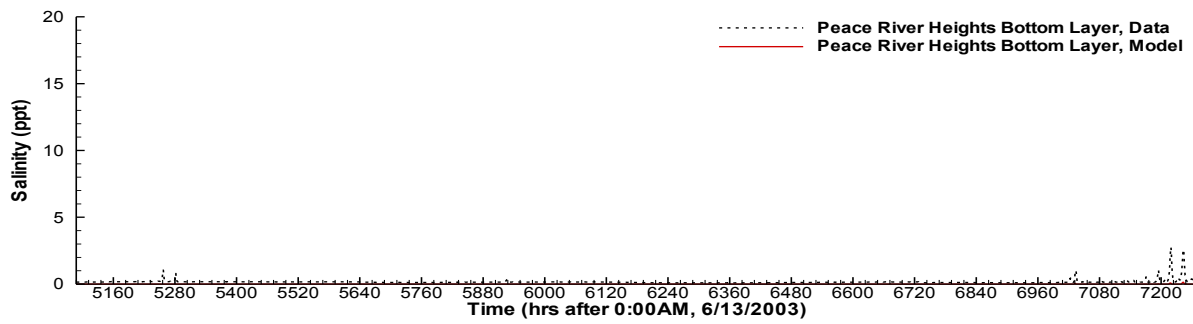
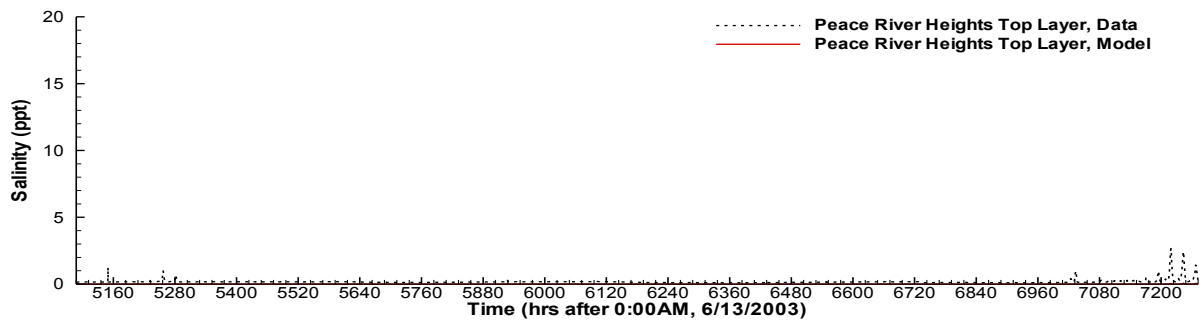

Figure 27. Comparisons of simulated and measured salinities at two depths at the Peace River Heights station during January 10 – April 9, 2004.

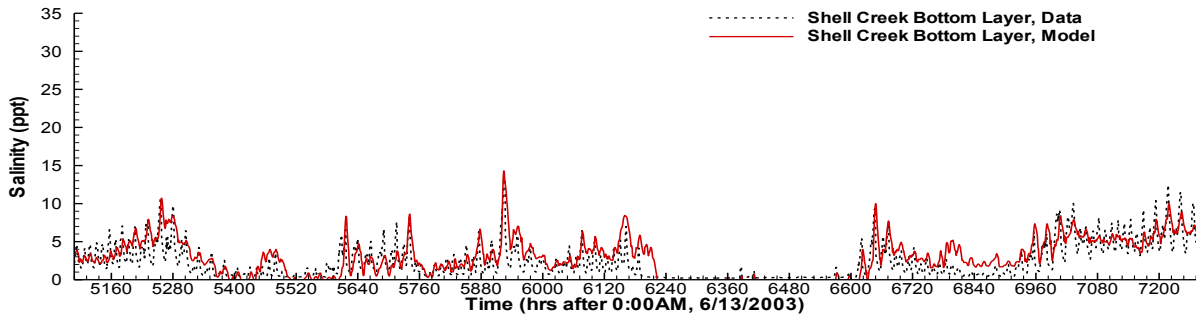
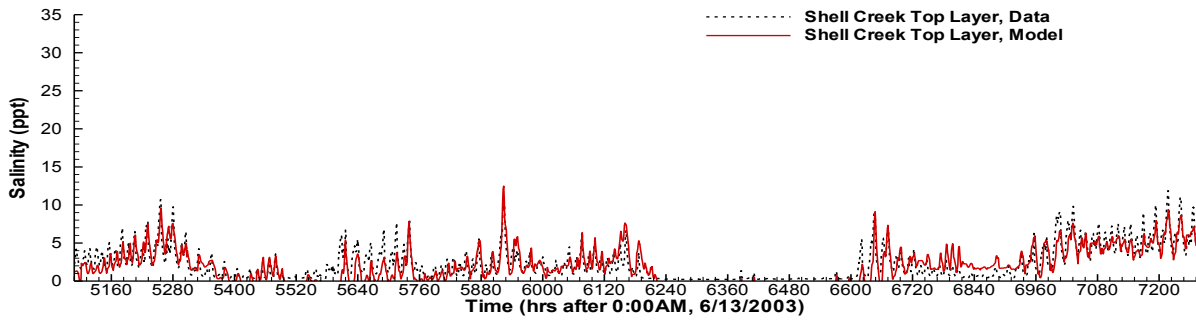

Figure 28. Comparisons of simulated and measured salinities at two depths at the Shell Creek station during January 10 – April 9, 2004.

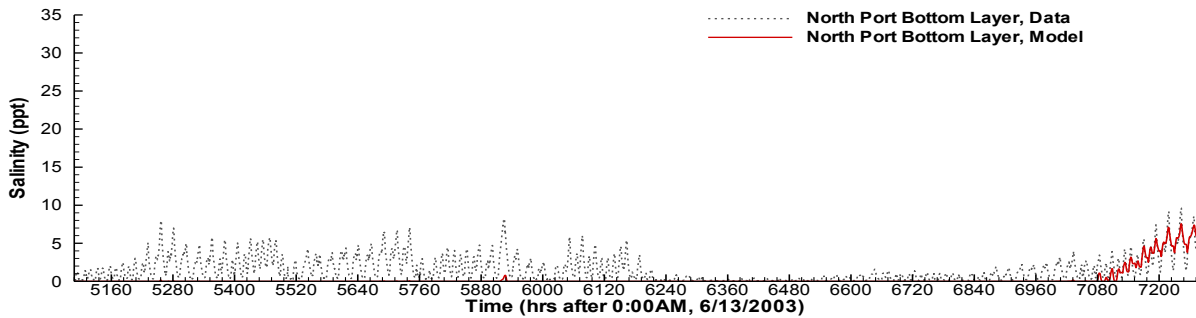
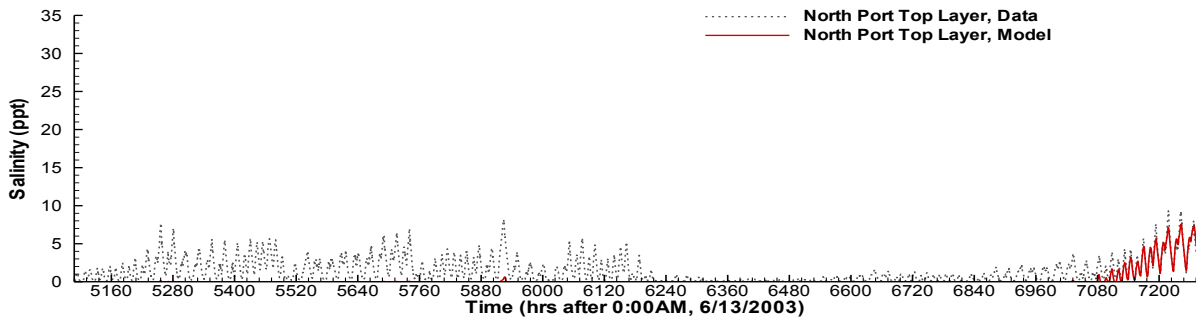

Figure 29. Comparisons of simulated and measured salinities at two depths at the North Port station during January 10 – April 9, 2004.

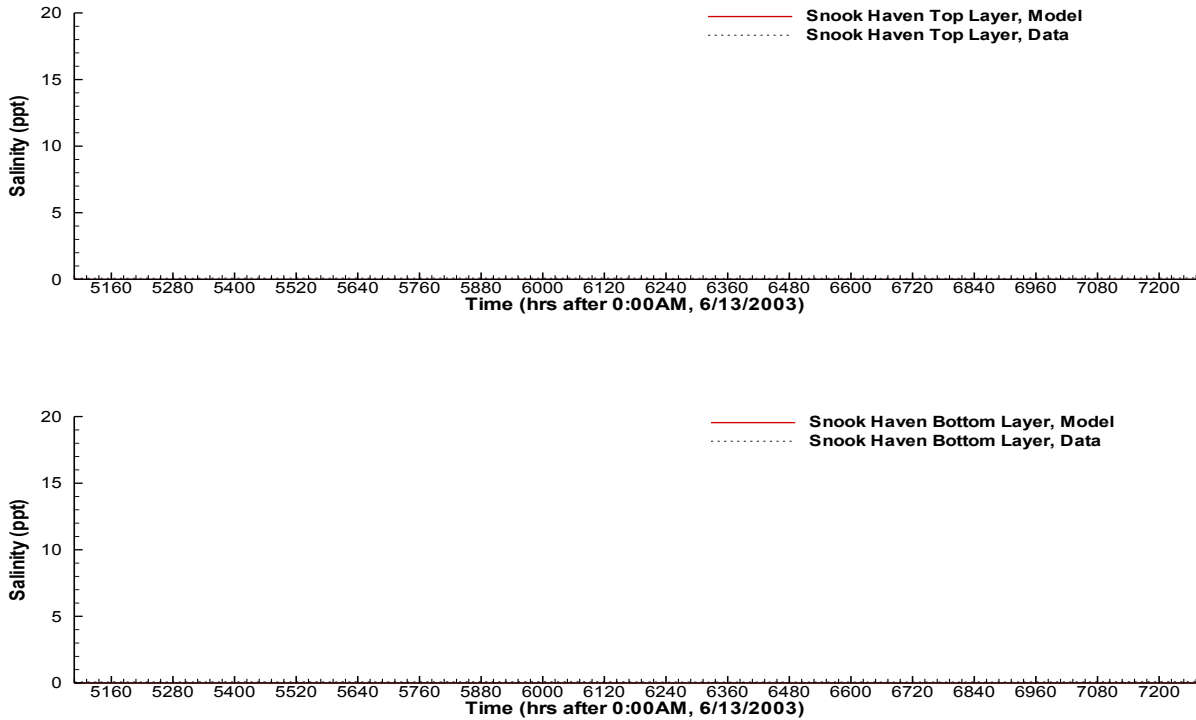

Figure 30. Comparisons of simulated and measured salinities at two depths at the Snook Haven station during January 10 – April 9, 2004.

Quantitative Assessments of the Model Performance – Skill Assessment

Comparisons shown in Figures 19 – 35 only give qualitative assessment of the performance of the model. To gain a quantitative assessment of the model performance, a skill assessment parameter introduced by Wilmott (1981) was used to judge the agreement between model results and measured data. This skill assessment parameter was used by Warner et al. (2005) to assess the performance of an estuary hydrodynamic model for the Hudson River estuary. It also was used by Chen (2005b) to examine the performance of a laterally averaged model named LAMFE for the Lower Alafia River in Florida. This skill assessment parameter takes the following form

$$\text{Skill} = 1 - \frac{\sum (y^M - y^D)^2}{\sum (|y^M - \overline{y^D}| + |y^D - \overline{y^M}|)^2} \quad (18)$$

where y^M and y^D are simulated and measured variables (surface elevation or salinity) and $\overline{y^D}$ and $\overline{y^M}$ are means of y_i^D and y_i^M , respectively. Skill in Equation (18) varies between 0 and 1: a perfect agreement between simulated results and measured data yields a skill of one and a complete disagreement yields a skill of zero.

In addition to the skill parameter, several other statistical parameters such as the R^2 value, the mean error (ME), and the mean absolute error (MAE) were also calculated to analyze the error of the model. Tables 3 - 6 list values of skill, R^2 , ME, and MAE for different simulated parameters (water level, velocity, temperature, and salinity) at the eight measurement stations for both the calibration and verification periods are listed. These tables show that the coupled 3d-2DV model performs well for the LPR – LMR - UCH system.

From Table 3, one can see that skills for stage are generally greater than 0.9, except for the most upstream stations for the LPR (the Peace River Heights station) and LMR (the Snook Haven station), where the errors mainly occur during high flow conditions in the wet season when the floodplains are filled with water. Because detailed bathymetry data for floodplains are not available for all the cross sections, the 2DV portion of the coupled model simply extrapolates the river widths based on the available widths in river channel for those sections which have no floodplain bathymetry data. This practice inevitably introduces (sometimes large) errors, which could result in relatively higher deviations simulated water levels from measured data at the most upstream stations in the LPR and LMR. Similar to skill, R^2 for stage is generally greater than 0.85 except for the Peace River Heights station in LPR and the Snook Haven station in LMR. Averaged among all eight stations, the overall skill is 0.91 and the overall R^2 is 0.82 for stage. The mean errors and the mean absolute errors of simulated water levels are small in comparison to the water level variations in the LPR – LMR - UCH system, except for the two upstream stations. The average ME and MAE for all eight stations are -5.07 cm and 11.33 cm, respectively.

Site_Name	Parameter	ME	MAE	R^2	Skill
UF	Stage (cm)	7.56	8.89	0.88	0.94
El Jobean	Stage (cm)	-3.25	6.98	0.88	0.96
Punta Gorda	Stage (cm)	5.72	8.09	0.89	0.96
North Port	Stage (cm)	-10.29	10.82	0.88	0.93
Snook Haven	Stage (cm)	-21.81	23.21	0.61	0.76
Harbor Heights	Stage (cm)	-6.47	9.89	0.80	0.92
Peace R Heights	Stage (cm)	-13.77	14.80	0.74	0.87
Shell Creek	Stage (cm)	1.78	7.97	0.85	0.95
Average	Stage (cm)	-5.07	11.33	0.82	0.91

Table 3. Values of skill, R^2 , the mean error, and the mean absolute error of simulated water levels at the eight measurement stations during both the calibration and verification periods.

For simulated velocity components at the UF site, Table 4 shows that their skills are mostly 0.8 or better, except for the u-velocity near the surface which has a skill of 0.72 (Table 4). The mean error of the u-velocity is between -0.63 and -0.29 cm/s, while the mean error of the v-velocity varies between -0.62 and 1.55 cm/s. The mean absolute error ranges between 2.48 and 3.49 cm/s for the u-velocity and between 4.14 and 5.43 cm/s for the v-velocity. Although the model was able to simulate both the long-term and short-term velocity variations (see Figs. 21 and 22 and those in Appendix B) at the UF site, R^2 values for simulated velocities are relatively low, ranging between 0.27 and 0.58 for the u-velocity and between 0.57 and 0.63 for the v-velocity. There are several reasons for these low R^2 values. First of all, measured velocities

represent localized water movement at the UF site, while simulated velocities represent overall water movement within an area with a length scale of the grid size (500 m × 500 m near the UF site). Some localized features (e.g., bathymetric variation, wind) cannot be resolved by relatively coarse grids used at and around the UF site. A close inspection of measured and simulated velocities reveals that the field data have many high frequency fluctuations which do not exist in model results. Also, because the UF site is close to the west bank of the Upper Charlotte Harbor, the sub-grid variation of velocity could be large. Another reason for the low R^2 values of modeled velocities appears to be related to a phase shift of roughly one hour between simulated and measured velocities during some summer months. This could be due to an error in recording the correct time during the daylight saving time. Other reasons include some sporadic peaks which cannot be simulated by the coupled model because they might be caused by some localized forces such as the boat movement, interference of the measurement platform on the velocity field, etc. As shown in Table 4, average values of ME, MAE, R^2 , and skill for all eight velocity sensors at the UF site are -0.04 cm/s, 3.69 cm/s, 0.53, and 0.84, respectively.

Site_Name	Parameter	ME	MAE	R^2	Skill
UF	1st_u (cm/s)	-0.63	2.48	0.58	0.86
UF	2nd_u (cm/s)	-0.53	2.49	0.54	0.85
UF	3rd_u (cm/s)	-0.29	2.73	0.42	0.80
UF	4th_u (cm/s)	-0.29	3.49	0.27	0.72
UF	1st_v (cm/s)	1.55	4.15	0.58	0.85
UF	2nd_v (cm/s)	0.61	4.14	0.63	0.89
UF	3rd_v (cm/s)	-0.13	4.61	0.63	0.88
UF	4th_v (cm/s)	-0.62	5.43	0.57	0.85
Average	Velocity (cm/s)	-0.04	3.69	0.53	0.84

Table 4. Values of skill, R^2 , the mean error, and the mean absolute error of simulated u- and v-velocities at the UF measurement station during both the calibration and verification periods.

Site_Name	Parameter	ME	MAE	R^2	Skill
UF	Top_Sal (ppt)	0.26	1.76	0.94	0.98
UF	Mid_Sal (ppt)	0.42	1.56	0.95	0.99
UF	Bot_Sal (ppt)	-0.05	1.90	0.83	0.95
El Jobean	Top_Sal (ppt)	-1.88	2.22	0.88	0.92
El Jobean	Bot_Sal (ppt)	-1.03	1.84	0.92	0.97
Punta Gorda	Top_Sal (ppt)	0.13	1.99	0.90	0.97
Punta Gorda	Bot_Sal (ppt)	1.10	2.59	0.77	0.93
North Port	Top_Sal (ppt)	-1.07	1.21	0.88	0.93
North Port	Bot_Sal (ppt)	-1.17	1.34	0.86	0.92
Snook Haven	Top_Sal (ppt)	0.03	0.13	0.81	0.94
Snook Haven	Bot_Sal (ppt)	0.02	0.13	0.80	0.94
Harbor Heights	Top_Sal (ppt)	1.62	2.13	0.75	0.90
Harbor Heights	Bot_Sal (ppt)	1.98	2.28	0.76	0.89

Peace R Heights	Top_Sal (ppt)	0.71	0.78	0.39	0.40
Peace R Heights	Bot_Sal (ppt)	0.74	0.80	0.39	0.38
Shell Creek	Top_Sal (ppt)	0.96	1.40	0.77	0.91
Shell Creek	Bot_Sal (ppt)	1.13	1.54	0.77	0.90
Average	Salinity (ppt)	0.23	1.51	0.79	0.87

Table 5. Values of skill, R^2 , the mean error, and the mean absolute error of simulated salinities at the eight measurement stations during both the calibration and verification periods.

From Table 5, it can be seen that the R^2 and skill values for salinity are good at most stations. Seven of the eight stations have an R^2 of 0.75 or better and a skill of 0.89 or better. The only exception is the Peace River Heights station where water is fresh most of the year. Although the mean errors and the mean absolute errors are low at this station, R^2 values for the top and bottom layers of this station are only 0.39, and salinity skills for the top and bottom layers are only 0.40 and 0.38, respectively. There were several reasons for the low salinity skills at the Peace River Heights station. First, the ungaged flow estimates used in this study did not include any base flows, causing the model to over-predict salinity at Peace River Heights during dry seasons. Second, measured salinity was never zero (in the range of 0.01 - 0.5 ppt), even during major storm events in 2003 and 2004 when water at Peace River Heights was supposed to be fresh with zero salinity. This indicates that either the salinity sensors at this station were not correctly calibrated or runoff from the watershed might contain a certain amount of minerals. On the other hand, because we assumed that all freshwater loadings from both upstream boundaries and ungaged areas have a salinity of 0 ppt, the couple model correctly predicted zero salinity at Peace River Heights when it is fresh there. Although an error in the range of 0.01 – 0.5 ppt is small, it lessens the R^2 and skill values, because the Peace River Heights station is fresh most of the time and this small error also occurs most of the time.

Site_Name	Parameter	ME	MAE	R^2	Skill
UF	Top_Temp (C ^o)	-1.18	1.52	0.93	0.94
UF	Mid_Temp (C ^o)	-0.73	0.99	0.98	0.98
UF	Bot_Temp (C ^o)	-1.13	1.24	0.98	0.98
El Jobean	Top_Temp (C ^o)	-1.05	1.19	0.99	0.98
El Jobean	Bot_Temp (C ^o)	-1.04	1.21	0.98	0.98
Punta Gorda	Top_Temp (C ^o)	-0.74	1.08	0.97	0.98
Punta Gorda	Bot_Temp (C ^o)	-0.47	0.96	0.98	0.99
North Port	Top_Temp (C ^o)	-2.01	2.22	0.93	0.93
North Port	Bot_Temp (C ^o)	-2.05	2.25	0.92	0.93
Snook Haven	Top_Temp (C ^o)	-1.80	2.12	0.90	0.93
Snook Haven	Bot_Temp (C ^o)	-1.81	2.13	0.89	0.93
Harbor Heights	Top_Temp (C ^o)	-1.05	1.76	0.82	0.93
Harbor Heights	Bot_Temp (C ^o)	-1.02	1.69	0.82	0.93
Peace R Heights	Top_Temp (C ^o)	-0.97	2.22	0.69	0.88
Peace R Heights	Bot_Temp (C ^o)	-1.37	2.21	0.71	0.89
Shell Creek	Top_Temp (C ^o)	-1.31	1.35	0.98	0.97

Shell Creek	Bot_Temp (C°)	-1.22	1.28	0.98	0.97
Average	Temperature (C°)	-1.23	1.61	0.91	0.95

Table 6. Values of skill, R^2 , the mean error, and the mean absolute error of simulated temperatures at the eight measurement stations during both the calibration and verification periods.

Table 6 shows that temperature MEs and MAEs are generally small except for the upstream stations in both LPR and LMR (Peace River Heights, Snook Haven, and North Port). The R^2 and skill values are generally high: the lowest R^2 and skill are 0.69 and 0.88, respectively, and both occur at the top layer of the Peace River Heights station. The main reason for the relatively large errors and relatively low R^2 and skill values at these upstream stations is that tree shading is not properly considered in the model. As the Peace and Myakka rivers become narrow, tree shading can significantly affect the net heat flux at the water surface. Another cause for the relatively large errors and relatively low R^2 and skill values at these upstream stations is the lack of measured temperature for freshwater inflows, both gauged and ungauged flows. In this study, the model used the Neumann-type temperature boundary conditions with a zero gradient for freshwater loadings, i.e.: temperature in the freshwater loading is the same as that in the grid cell where the freshwater is added to. Because temperature is not a controlling factor in determining minimum flows for the LPR, LMR, or Shell Creek, not much effort was made to calibrate the model with temperature data. Model results of temperature are considered to be good enough in this MFL modeling study.

Comparisons with Salinity Profile Data

In addition to the UF and USGS real-time data, a salinity profile data set was provided by the Mote Marine Laboratory, using the data base assembled for the Lower Myakka River minimum flows project – see Chapter 4 in SWFWMD (2010). These salinity profile data were collected by several government agencies and private entities, with a majority of them being collected by Mote Marine Laboratory. The salinity profile data for the Lower Peace River were collected as part of the Hydrological Monitoring Program for the Lower Peace River that is conducted by the Peace River Manasota Regional Water Supply Authority (PBS&J 2008). There were 13 salinity profile stations in the LPR, and 10 in the LMR. Locations where the salinity profiles were measured in the LPR and LMR are listed in Table 7. River KM in the table is positive in the upstream direction. Locations for River KM 0 for the LPR and LMR are denoted with red bars in Figure 1.

Salinity Profile Data Locations	Peace River	Myakka River
	River KM	River KM
1	-2.4	1.2
2	6.6	7.2
3	10.5	9.0
4	12.7	11.3
5	12.8	13.9

6	15.5	15.8
7	17.5	17.1
8	21.1	18.2
9	21.9	26.5
10	23.6	31.2
11	24.7	
12	29.5	
13	30.4	

Table 7. Locations (expressed in River Kilometers) where salinity profile data were collected in the LPR and LMR.

The profile data was normally collected monthly by driving a boat to the pre-determined stations. Although measurements were to be taken at the exact same location every time profile data were collected, errors did occur, especially at downstream stations where the Peace and Myakka Rivers are relatively wide and measurement locations for the same station could be different by as much as a few hundreds of meters for different trips. Unlike UF or USGS real-time data which represent averages of hundreds (even thousands, depending on the reading frequency) of readings during the measurement time interval (30 minutes in UF's data, and 15 minutes in USGS data), a salinity profile reading is an instantaneous reading of salinity at the moment of the measurement. As such, profile data could contain more noise than the real-time data. Also, for the same salinity profile, salinity readings for different water depths were not collected simultaneously. From the time the top layer was measured to the time the bottom layer was measured, it usually took several minutes to complete a salinity profile. Considering all these factors, one may not expect simulated salinities to match profile data very well.

Comparisons of simulated salinities at 13 stations in the LPR and 10 stations in the LMR are shown in Figures 31 and 32, respectively. In both figures, simulated results (x-axes) were plotted against measured profile data (y-axes). Comparisons were made for depth less than 1 m (top layer), greater or equal 1 m (bottom layer), and for all depths. The top left graphs in Figures 31 and 32 are comparisons for all depths (all data points), while the top right and bottom graphs are comparisons for depth < 1 m and depth \geq 1 m, respectively. Also plotted in the figures are the linear regression lines (solid) and the 1-to-1 lines (dashed). Contrary to what might be expected, comparisons of model results with salinity profiles data in both the LPR and LMR are good. As shown in Figures 31 and 32, R^2 values are 0.89 – 0.91 for the LPR and 0.92 - 0.96 for the LMR. Mean errors, mean absolute errors, and skills were also calculated and listed in Table 8. It can be seen that the errors are small and the skills are quite high.

	Depth	ME	MAE	R^2	Skill
Peace River	All Depths	-0.06	1.69	0.89	0.99
	< 1m	0.28	1.51	0.91	0.98
	\geq 1m	-0.23	1.79	0.89	0.97
Myakka River	All Depths	-0.97	1.36	0.94	0.98
	< 1m	-0.95	1.50	0.92	0.97

	$\geq 1\text{m}$	-0.99	1.26	0.96	0.98
--	------------------	-------	------	------	------

Table 8. Mean errors, mean absolute errors, q^2 -values, and skills of simulated salinities in comparison with salinity profile data compiled by Mote Marine Laboratory during model calibration and verification periods in the LPR and LMR.

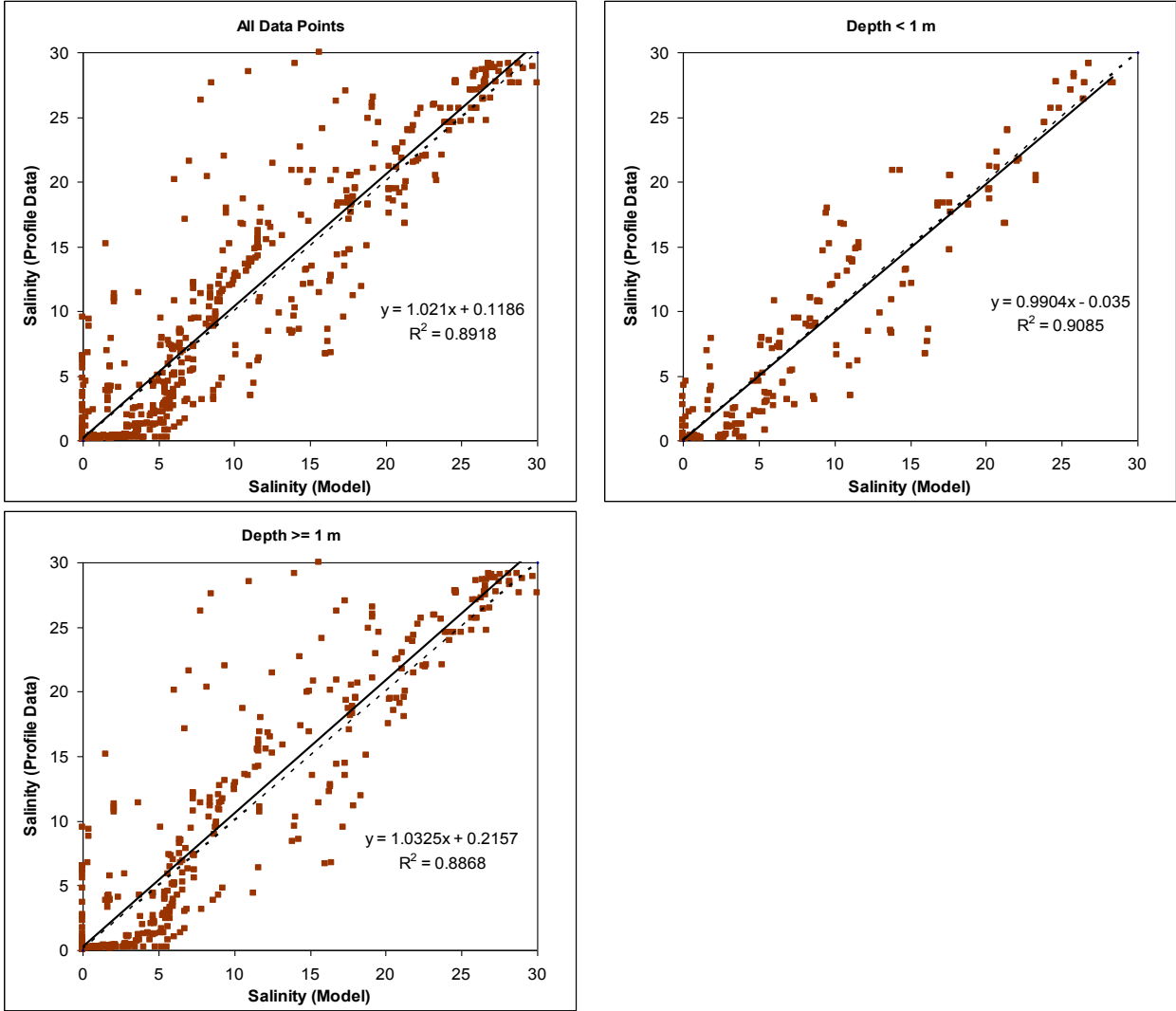

Figure 31. Comparisons of model results with salinity profile data measured at 13 stations in the Lower Peace River. The top left graph is for all data points, while the top right and bottom graphs are for depth < 1 m and depth ≥ 1 m, respectively.

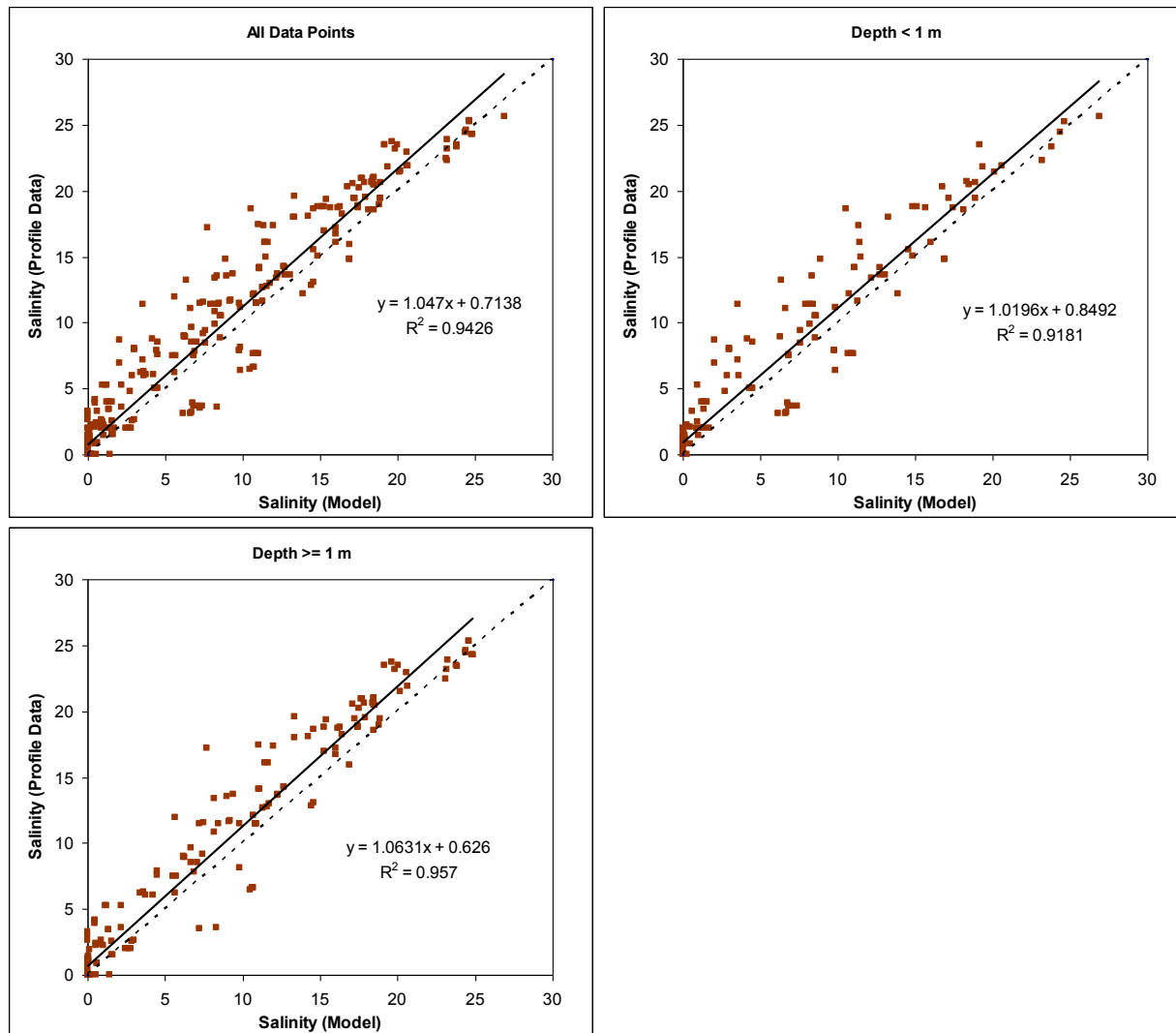

Figure 32. Comparisons of model results with salinity profile data measured at 10 stations in the Lower Myakka River. The top left graph is for all data points, while the top right and bottom graphs are for depth < 1 m and depth \geq 1 m, respectively.

Estuarine Residence Time the LPR

During this modeling study of the LPR – LMR – UCH system, the dynamically coupled model LESS was also used to estimate the estuarine residence time (ERT) in the LPR system, even though the results of ERT for LPR was not used (also not needed) in the determination of the LPR MFL. By assuming an evenly distributed conservative tracer concentration of 10 mg L⁻¹ in the main stem of the LPR only, from Arcadia to its mouth, at time = 0, the model was run for 16 combined Arcadia – Joshua - Horse flow scenarios. Table 3 lists the 16 flow rates (Q) used in the ERT simulations, and they are sums of gauged USGS flows in the Joshua Creek, the Horse Creek, and the Peace River at the Arcadia station. These flow rates were partitioned among

Arcadia, Joshua, and Horse according to their long-term averages. Their corresponding ungaged flows for each ungaged sub-basins used in the ERT runs were obtained using ratios of long-term averages of ungaged flow estimates to that of the Arcadia flow. During the 16 model runs, the total mass of the conservative tracer remained in the LPR was calculated and book-kept at each time step. Time series of the remaining conservative tracer mass were analyzed. Figures D-1 through D-16 in Appendix D are plots of these time series. Time series of the percentage of the remaining conservative mass in the LPR are also shown in Figures D-1 through D-16. It is evident that strong tidal signals are contained in these time series. To filter out the tidal signals, trend lines in the form of exponential decay can be drawn to approximate the curves:

$$L = a \exp(-Kt) \quad (19)$$

where L is the percentage of the remaining conservative mass, a is a coefficient, K is the rate of the exponential decay in hour^{-1} , and t is time in hour. Parameters a and K for trend lines of the percentage remaining curves are listed in Table 3. As shown in the figures in Appendix D, all trend lines fit the percentage remaining curves well, with R^2 values being larger than 0.9. Some of the R^2 values are larger than 0.97.

No.	Q (cfs)	a	K
1	55	94.291	0.00119
2	106	95.316	0.00127
3	154	95.316	0.00136
4	199	86.390	0.00117
5	240	87.266	0.00256
6	281	71.633	0.00265
7	332	71.783	0.00247
8	391	83.899	0.00293
9	455	77.685	0.00301
10	544	108.858	0.00352
11	644	93.268	0.00379
12	939	78.729	0.00396
13	1443	95.558	0.00463
14	2256	63.996	0.00559
15	4036	66.788	0.00977
16	9340	100.238	0.01727

Table 3. Flow rates and values of a and K in Equation (17) for the 16 LPR ERT runs.

Equation (17) can be used to calculate the ERT for each of the flow scenarios with a given L :

$$t = -\frac{1}{K} \ln\left(\frac{L}{a}\right) \quad (20)$$

One may define ERT using different L values. For example, if the ERT is defined as the time when 95% of the conservative mass is flushed out of the system, then $L = 5$. Therefore, for different L values, one can obtain different ERTs for the same flow scenario. In the table below,

ERT values (in days) were calculated for 16 flow rates using $L = 1, 2, 5, 10, 15, 20, 25, 30, 35,$ and 36.79 .

Q (cfs)	% Remaining L									
	1	2	5	10	15	20	25	30	35	36.79
55	159.32	135.03	102.92	78.63	64.42	54.34	46.52	40.13	34.73	32.98
106	149.75	126.97	96.86	74.09	60.76	51.31	43.98	37.99	32.92	31.28
154	139.93	118.65	90.51	69.23	56.78	47.94	41.09	35.49	30.76	29.23
199	158.25	133.65	101.13	76.53	62.14	51.93	44.01	37.54	32.07	30.30
240	72.62	61.36	46.47	35.20	28.62	23.94	20.31	17.35	14.85	14.04
281	67.21	56.31	41.89	30.98	24.60	20.08	16.56	13.70	11.27	10.48
332	72.24	60.52	45.03	33.32	26.46	21.60	17.83	14.75	12.14	11.30
391	63.04	53.17	40.13	30.27	24.50	20.40	17.23	14.63	12.44	11.73
455	60.35	50.74	38.04	28.43	22.80	18.81	15.72	13.19	11.06	10.36
544	55.60	47.38	36.52	28.30	23.49	20.08	17.44	15.28	13.45	12.86
644	49.84	42.22	32.15	24.54	20.08	16.92	14.47	12.46	10.77	10.22
939	45.96	38.66	29.02	21.72	17.45	14.43	12.08	10.16	8.53	8.01
1443	41.05	34.81	26.56	20.32	16.67	14.08	12.07	10.43	9.04	8.59
2256	30.99	25.82	19.00	13.83	10.81	8.67	7.00	5.65	4.50	4.12
4036	17.92	14.96	11.05	8.10	6.37	5.14	4.19	3.41	2.76	2.54
9340	11.11	9.44	7.23	5.56	4.58	3.89	3.35	2.91	2.54	2.42

Table 4. ERT values in days for 16 flow rates using 10 different L values ranging from 1 to 36.79.

From Table 4, one can find the relationship between ERT and Q for each L . These ERT- Q relationships are illustrated in Figures 31 – 33. For any L value, the ERT – Q relationship can be fitted to a power function:

$$ERT = bQ^n \quad (21)$$

where b is a coefficient and n is the exponent. The above equation has an R^2 value varying between 0.91 and 0.94. Furthermore, the coefficient b and the exponent n in the above equation are related to L , the percentage of remaining conservative mass, with the following functions (see Figure 34):

$$b = 17473 - 37553 \ln(L) \quad (22)$$

$$n = -0.00088L - 0.54 \quad (23)$$

As can be seen from the R^2 values shown in Figure 34, the logarithm function in Equation (20) is a perfect fit to the b - L relationship with a R^2 of 1, while the linear relationship in Equation (21) also fit the n – L relationship very well with a R^2 of 0.987.

Replacing b and n in Equation (19) with the right hand sides of Equations (20) – (21), the final relationship among ERT, Q , and L is expressed as follows

$$ERT = [1747.3 - 375.53 \ln(L)]Q^{-(0.54+0.00088L)} \quad (24)$$

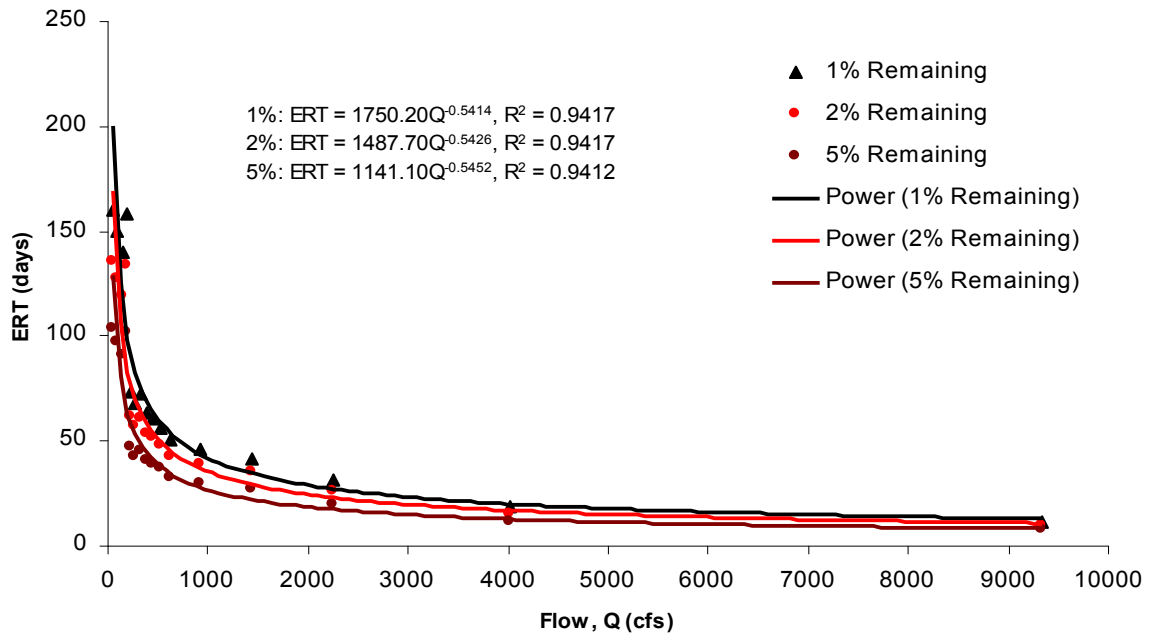

Figure 33. Relationships between ERT and Q for 1%, 2%, and 5% remaining of conservative mass in the LPR.

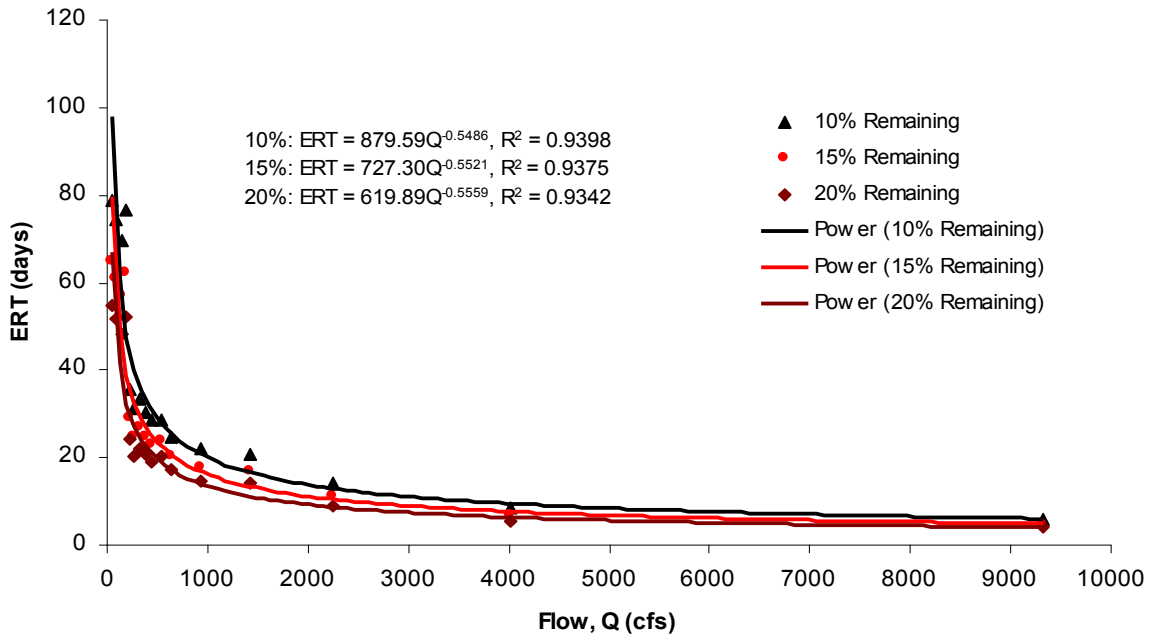

Figure 34. Relationships between ERT and Q for 10%, 15%, and 20% remaining of conservative

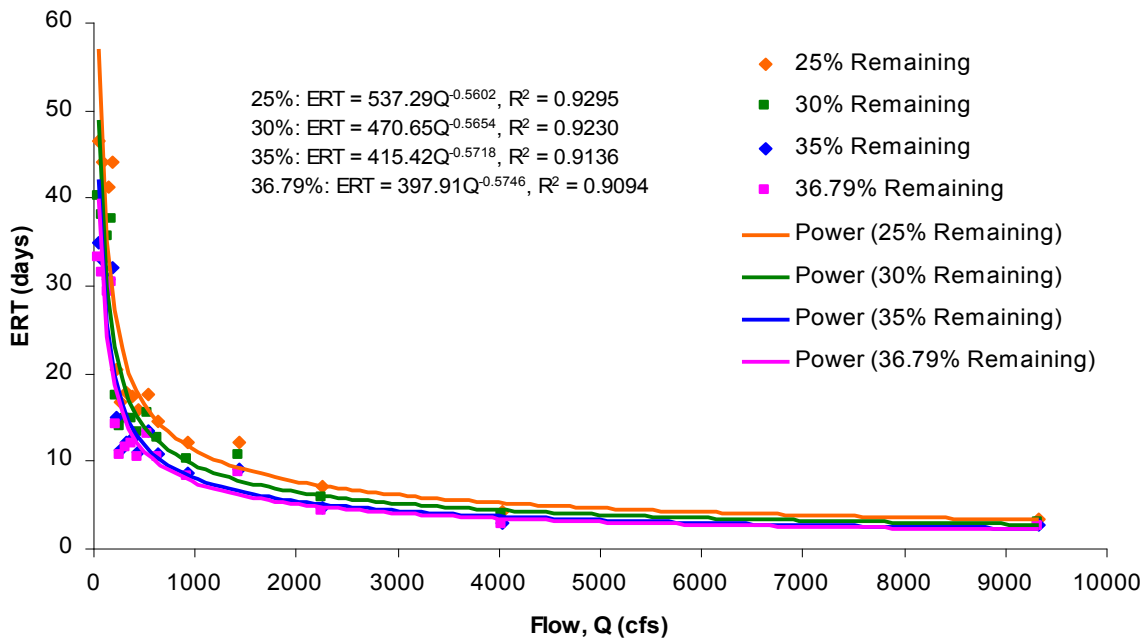

Figure 35. Relationships between ERT and Q for 25%, 30%, 35%, and 36.79% remaining of conservative mass in the LPR.

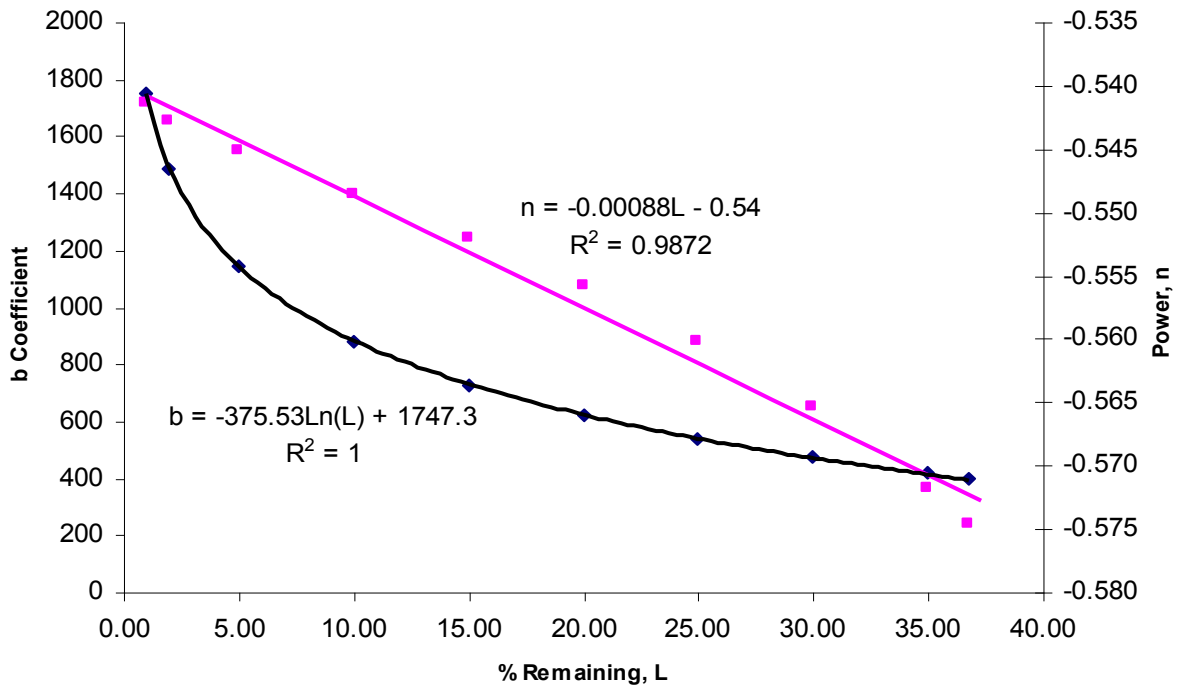

Figure 36. Relationship between b and L and relationship between n and L .

5. Conclusions

The purpose of this modeling study is to support the determinations of minimum freshwater inflows to the LPR and LMR to prevent the two riverine estuaries from significant harms. Because of the interactions among the LPR, the LMR, and the UCH, it is logical to develop a hydrodynamic model that includes all three water bodies. To efficiently deal with the complex geometry of the LPR – LMR - UCH system, this study developed a dynamically coupled 3D-2DV model by coupling a 3D model (LESS3D) with a 2DV model (LAMFE), so that both the large downstream water body and the narrow upstream tributaries can be simulated with the same degree of resolution. The dynamically coupling of the two models is facilitated with a free-surface correction (FSC) method that is unconditionally stable with respect to gravity waves, wind and bottom shear stresses, and vertical eddy viscosity terms. The use of the FSC method allows a simultaneous solution of the free-surface elevation in both the 3D sub-domain and the 2DV sub-domain, and thus avoids any problems associated with the internal boundary. The coupled model solves laterally averaged RANS equations for the narrow open channel. For the larger water body, it solves 3D RANS equations. This kind of a coupled model is especially desirable when the narrow open channel has a large floodplain that can be submerged during a major storm event.

To apply the coupled model to the LPR - LMR - UCH system, various field data were obtained, analyzed, and graphed to evaluate their quality and availabilities and to obtain a preliminary assessment of the physical characteristics of LPR - LMR - UCH system, including freshwater inflows, rainfall, tides, salinity and temperature distributions, wind patterns, etc. Overall, the quality and availabilities of field data in the LPR - LMR - UCH system are found to be marginal with many missing data periods. One important missing piece of data is ungaged flows, which were first estimated with the HSPF model and then adjusted based on a comparison to results generated by Janicki Environment, Inc. using the SDI method (SWFWMD, 2010).

The dynamically coupled 3D-2DV model was applied to the LPR - LMR - UCH system to simulate hydrodynamics and salinity and temperature transport processes in the three interconnected water bodies. The 3D domain includes the upper Charlotte Harbor, the downstream 1.74km of the Shell Creek, the downstream 15.5km of the LPR, and the downstream 13.8km of the LMR. The 2DV domain includes the LPR from river-km 15.5 to Arcadia, the LMR from river-km 13.8 to river-km 38.4, the Shell Creek from river-km 1.74 to the dam, and the downstream 4.16km of Myakkahatchee Creek. Model simulations were conducted for a 13-month period from June 13, 2003 to July 11, 2004, of which the first 30 days (June 13 – July 11, 2003) were used for the model spin-up run. The model was calibrated against measured water levels, currents, salinities, and temperatures at a total of eight stations in the LPR - LMR - UCH system (current data are only available at one station) during a 3-month period of January 10 – April 9, 2004. It was then verified against field data measured at the same eight stations during a 6-month period before the calibration period and a 3-month period after the calibration period. Gauged freshwater flows were used for upstream boundary conditions, while adjusted ungaged flow estimates were added to the top cells of the model at their corresponding locations. The downstream boundary conditions on the southern border of the 3D domain were specified with simulation results of another hydrodynamic model (Sheng, et al., 2007).

Although there are many uncertainties in the input data used to drive the LESS model, including measured data, ungauged flows, boundary conditions provided by another hydrodynamic model (Sheng et al., 2007), the dynamically coupled model was successfully calibrated to measured real-time data of water levels, currents, salinities, and temperatures at eight stations during January 10 – April 9, 2004, except for salinity at the North Port station. During the two verification periods before and after the calibration period, the model generally works well in predicting water levels, velocities, and temperatures, but under-predicts salinities in wet months and slightly over-predicts salinities in the driest months. The performance of the model was assessed by calculating mean errors, mean absolute errors, coefficients of determination (R^2 values), and skills of simulated parameters in comparison with field data at eight real-time stations in the system. Overall, the performance of the coupled model is good, especially for the lower portion of the simulation domain, including the downstream segments of the LPR and LMR and the UCH. For upper portion of the simulation domain, including the upstream segments of the LPR and LMR, it didn't have as good a performance as it did in the lower portion of the simulation domain. This should not be a surprise, as there are many uncertainties in the input data (bathymetry, freshwater flows, etc.) to which the upstream segments of the LPR and LMR are more sensitive than the lower portion of the simulation domain is.

Compared to many 3D hydrodynamic simulations found in the literature with a similar complexity as that of the LPR – LMR – UCH system, the coupled model used for LPR and LMR MFL studies has been calibrated and verified against a very large data set. In most 3D hydrodynamic models found in literature, model calibration and verification were only done against limited real-time data for short time periods (days, weeks, or a couple of months). In this study, the coupled model was calibrated and verified against 13 months of real-time data collected at eight stations across the simulation domain and salinity profile data collected during a 12-month period at 23 stations. Considering the many challenges involved in calibrating and verifying a coupled 3D-2DV model in a complicated system like the LPR – LMR – UCH system, this modeling study is considered successful.

After the dynamically coupled model LESS was successfully calibrated and verified, it was used to evaluate estuarine residence times for 16 flow scenarios for the LPR. It was found that the estuarine residence time in the LPR is related to the combined flow of Arcadia, Joshua, and Horse through a power function. Based on an analysis of estimated ERT values for a total of 16 flow scenarios, the power function was found to take the form of $ERT = [1747.3 - 375.53 \ln(L)] Q^{-(0.54 + 0.00088L)}$, where L is the percentage of conservative mass remains in the estuary after ERT days and Q is the sum of gauged USGS flows in the Joshua and Horse Creeks and in the Peace River at the Arcadia station. If the ERT is defined as the time when 95% of conservative mass is flushed out of the estuary, then $L = 5$ and $ERT = 1142.91 Q^{-0.5444}$. It should be pointed out that the ERT calculations for the LPR are simply a by-product of this modeling effort. As a result, calculated ERT values were not used in the LPR MFL determination.

6. References

- Bicknell, B.R., Imhoff, J.C., Kittle, J.L. Jr., Donigian, A.S. Jr. and Johanson R.C., 1997. *Hydrological Simulation Program-FORTRAN, User's Manual for Version 11*. EPA/600/SR-97/080. U.S. Environmental Protection Agency, National Exposure Research Laboratory, Research Triangle Park, NC 27711.
- Chen, X. and M.S. Flannery. 1997. Use of a Hydrodynamic Model for Establishing a Minimum Freshwater Flow to the Lower Hillsborough River. In (M. L. Spaulding and A. F. Blumberg, eds.) *Estuarine and Coastal Modeling (V)*, Proceedings of the 5th International Conference, ASCE, pp. 663-678.
- Chen, X. 1999. Three-Dimensional, Hydrostatic and Non-Hydrostatic Modeling of Seiching in a Rectangular Basin. In (M. L. Spaulding and H. L. Butler, eds.) *Estuarine and Coastal Modeling (VI)*, Proceedings of the 6th International Conference, ASCE, pp. 148-161.
- Chen, X., M.S. Flannery, and D.L. Moore. 2000. Salinity Response to the Change of the Upstream Freshwater Flow in the Lower Hillsborough River, Florida. *Estuaries*, 23: 735-742.
- Chen, X. 2003a. An efficient finite difference scheme for simulating hydrodynamics in narrow rivers and estuaries. *International Journal for Numerical Methods in Fluids*. 42: 233-247.
- Chen, X. 2003b. A Free-Surface Correction Method for Simulating Shallow Water Flows. *Journal of Computational Physics*, 189:557-578.
- Chen, X. 2003c, Coupling a 3D model with a 2DV model using a free-surface correction method, In (M. L. Spaulding, ed.) *Estuarine and Coastal Modeling (IIX)*, Proceedings of the 8th International Conference, ASCE, pp. 769 - 783.
- Chen, X. 2004a. Using a piecewise linear bottom to fit the bed variation in a laterally averaged, z-co-ordinate hydrodynamic model. *International Journal for Numerical Methods in Fluids*. 44: 1185-1205.
- Chen, X. 2004b. A Cartesian method for fitting the bathymetry and tracking the dynamic position of the shoreline in a three-dimensional, hydrodynamic model. *Journal of Computational Physics*, 200: 749 - 768.
- Chen, X. 2005a. Using a Dynamically Coupled 3D-2DV Model to Simulate Hydrodynamics in the Lower Peace River – Upper Charlotte harbor System in Southwest Florida, In (M.L. Spaulding, ed.) *Estuarine and Coastal Modeling (V)*, Proceedings of the 9th International Conference, ASCE, pp. 72 - 87.
- Chen, X. 2005b. *Simulating Hydrodynamics in the Lower Alafia River Estuary*. Technical Report, Southwest Florida Water Management District, Tampa, Fla.

- Chen, X. 2007. Dynamic coupling of a three-dimensional hydrodynamic model with a laterally averaged, two-dimensional hydrodynamic model. *Journal of Geophys. Research.* 112, C07022, doi:10.1029/2006JC003805.
- Sucsy P.V., F.W. Morris, M.J. Bergman, and L.J. Donnangelo. 1997. A 3-D Model of Florida's Sebastian River Estuary, In (M. L. Spaulding and A. F. Blumberg, eds.) *Estuarine and Coastal Modeling (V)*, Proceedings of the 5th International Conference, ASCE, pp. 59 - 74.
- Johnson, B.H. K.W. Kim, R. Heath, B. Hsieh, and L. Butler. 1991. Validation of a Three-Dimensional Hydrodynamic Model of Chesapeake Bay, *Journal of Hydraulic Engineering*, 117 (1): 2 – 20.
- Mendelsohn, D.L., S. Peene, E. Yassuda, and S. Davie, 1999. A Hydrodynamic Model Calibration Study of the Savannah River Estuary with an Examination of Factors Affecting Salinity Intrusion, In (M. L. Spaulding and L. Butler, eds.) *Estuarine and Coastal Modeling (VI)*, Proceedings of the 6th International Conference, ASCE, pp. 663-685.
- Ross, M.A., A. Said, K. Trout, and J. Zhang, 2005. *Hydrologic Modeling of Streamflow from Ungaged Areas in the Upper Charlotte Harbor Basin – Phase 2*, Prepared for the Southwest Florida Water Management District. Department of Civil and Environmental Engineering, University of South Florida, Tampa, Florida.
- Sheng, Y.P., T. Kim, and S. Schofield, 2007. *Hydrodynamic Modeling of Charlotte Harbor in Support of the Determination of Minimum Flows for the Lower Peace and Myakka Rivers*. Prepared for the Southwest Florida Water Management District. Civil & Coastal Engineering Department, University of Florida, Gainesville, Florida.
- SWFWMD, 2001. *Peace River Comprehensive Management Plan, Volume I (Draft)*, Southwest Florida Water Management District Brooksville, Fla.
- SWFWMD, 2010. *The determination of minimum flows for the Lower Myakka River*. Report of the Southwest Florida Water Management District, Brooksville, Fla.
- Van der Vorst, H.A.. 1992. Bi-CGSTAB: A fast and smoothly converging variant of Bi-CG for solution of non-symmetric linear systems, *SIAM J. Sci. Statist. Comput.* 13: 631-644.
- UNESCO (1983), *Algorithms for computation of fundamental properties of seawater*, UNESCO Technical Papers in Marine Science, Number 44, 53 pp., Paris.
- Warner, J.C., W.R. Geyer, and J.A. Lerczak., 2005. Numerical modeling of an estuary: A comprehensive skill assessment. *Journal of Geophys. Research*, 110, C05001, doi:10.1029/2004JC002691.

Wilmott, C.J., 1981. On the validation of models, *Phys. Geogr.*, 2, 184 – 194.

Appendix A

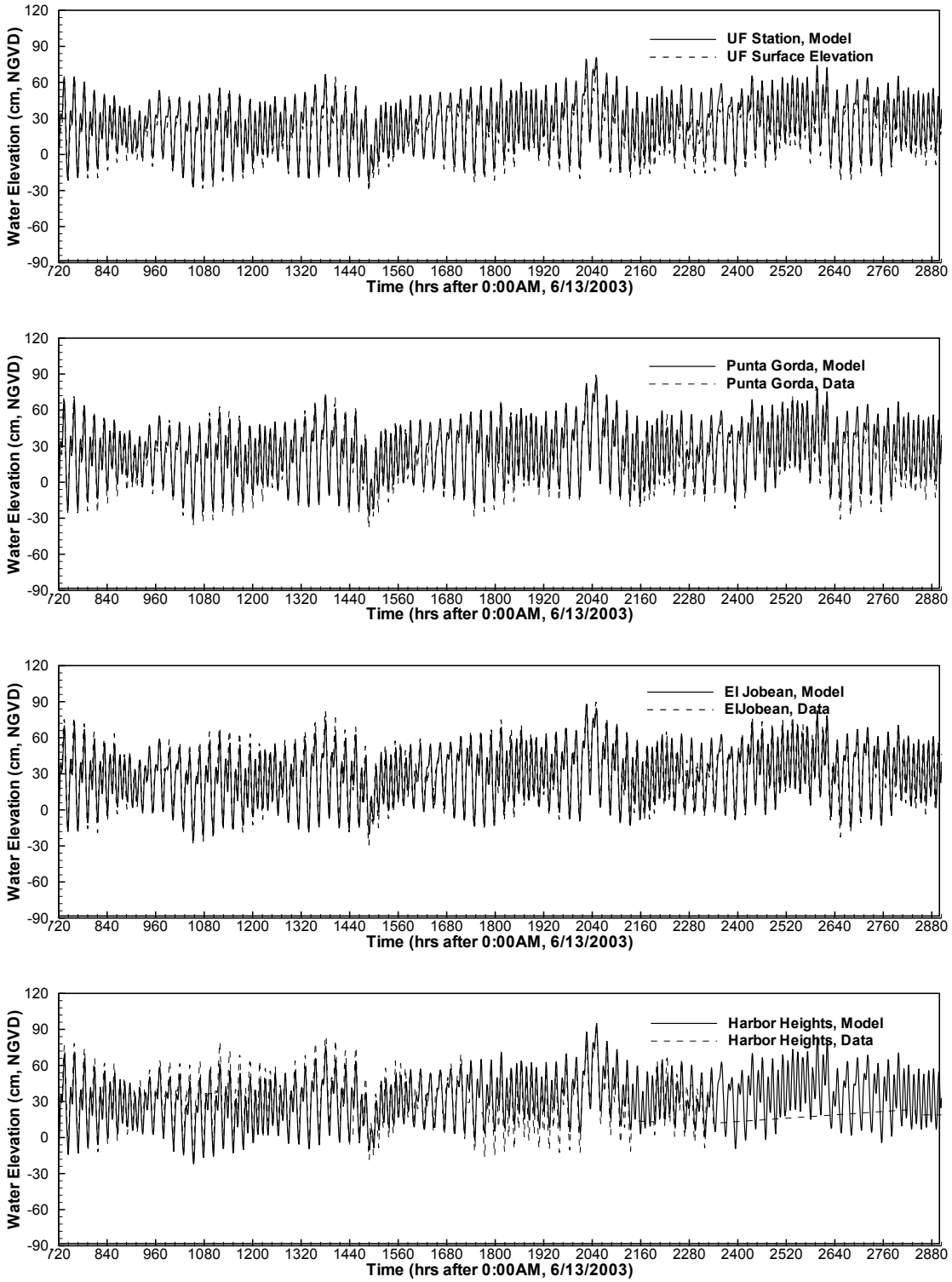

Figure A- 1. Comparisons of simulated and measured water elevations at UF, Punta Gorda, El Jobean, and Harbor Heights during July 12 – October 10, 2003.

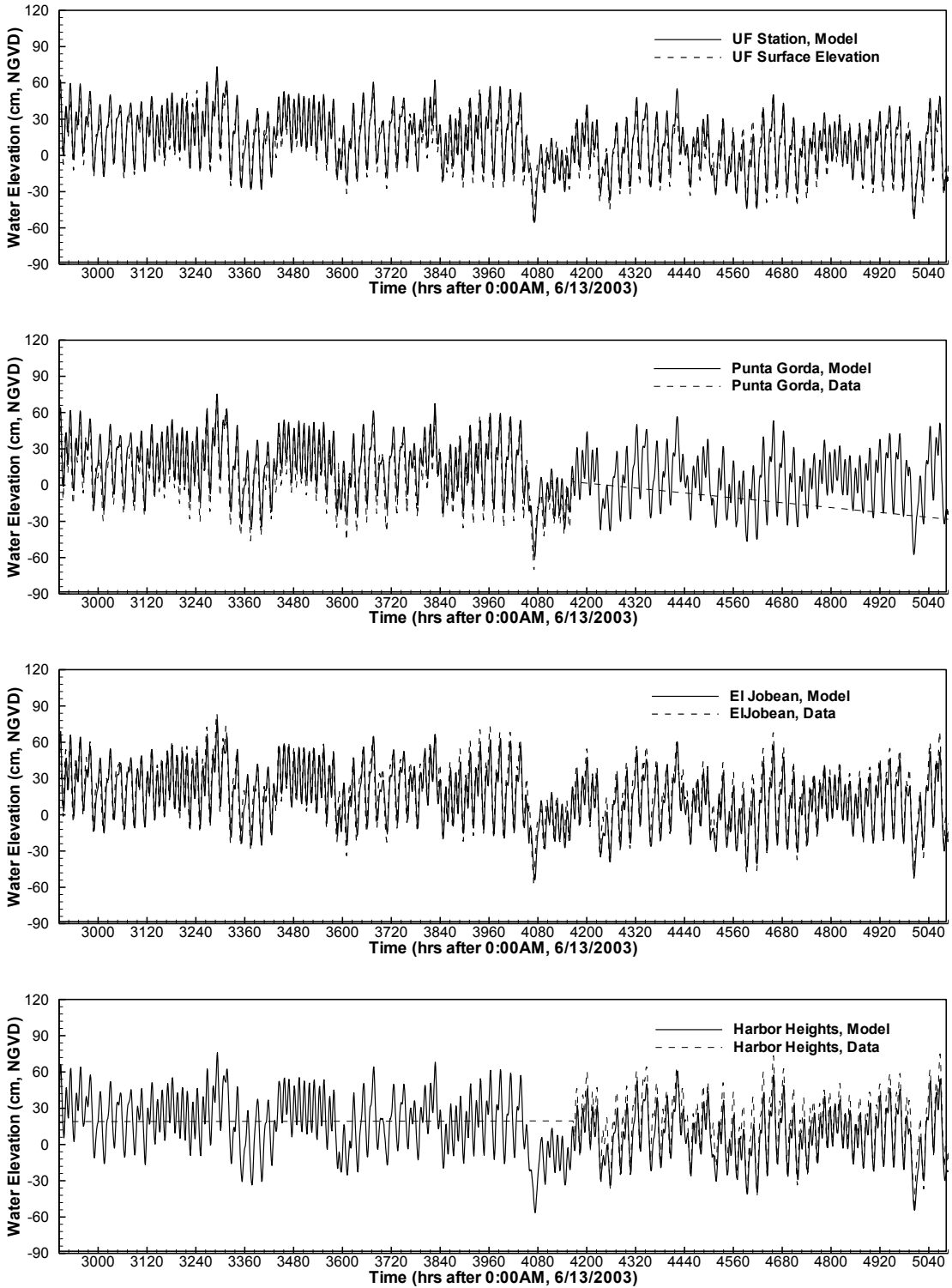

Figure A- 2. Comparisons of simulated and measured water elevations at UF, Punta Gorda, El Jobean, and Harbor Heights during October 11, 2003 – January 9, 2004.

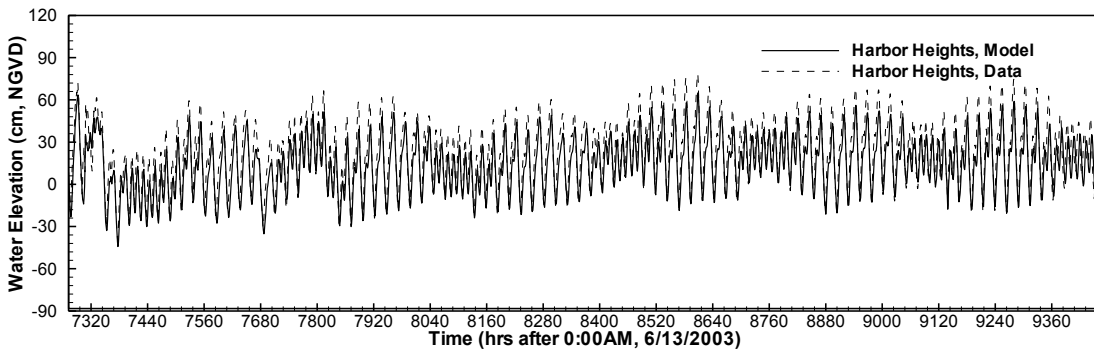
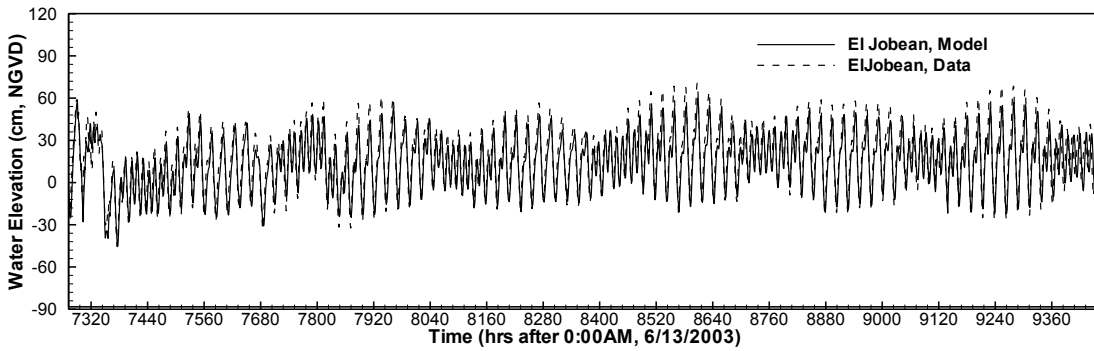
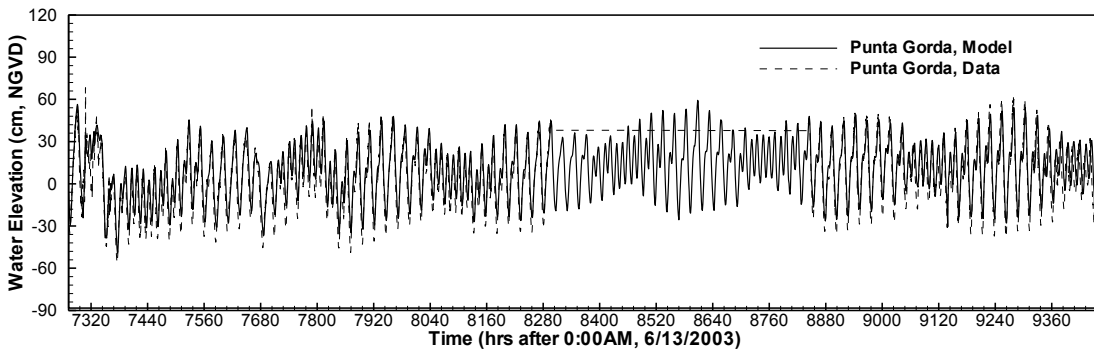
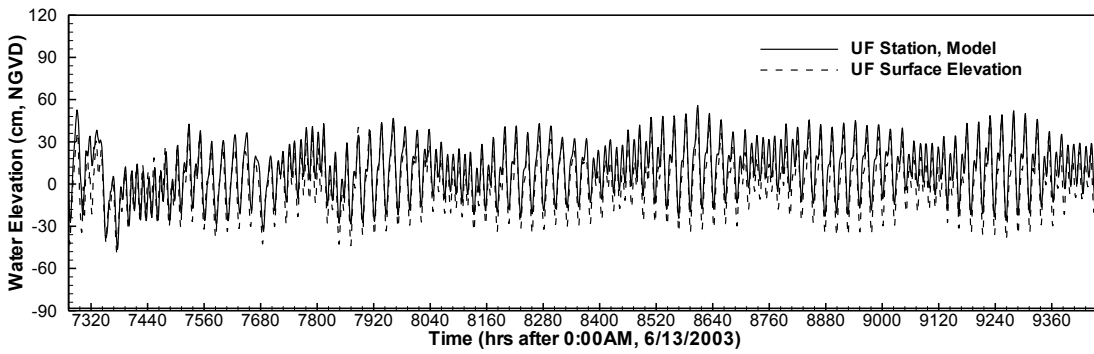

Figure A- 3. Comparisons of simulated and measured water elevations at UF, Punta Gorda, El Jobean, and Harbor Heights during April 10 – July 11, 2004.

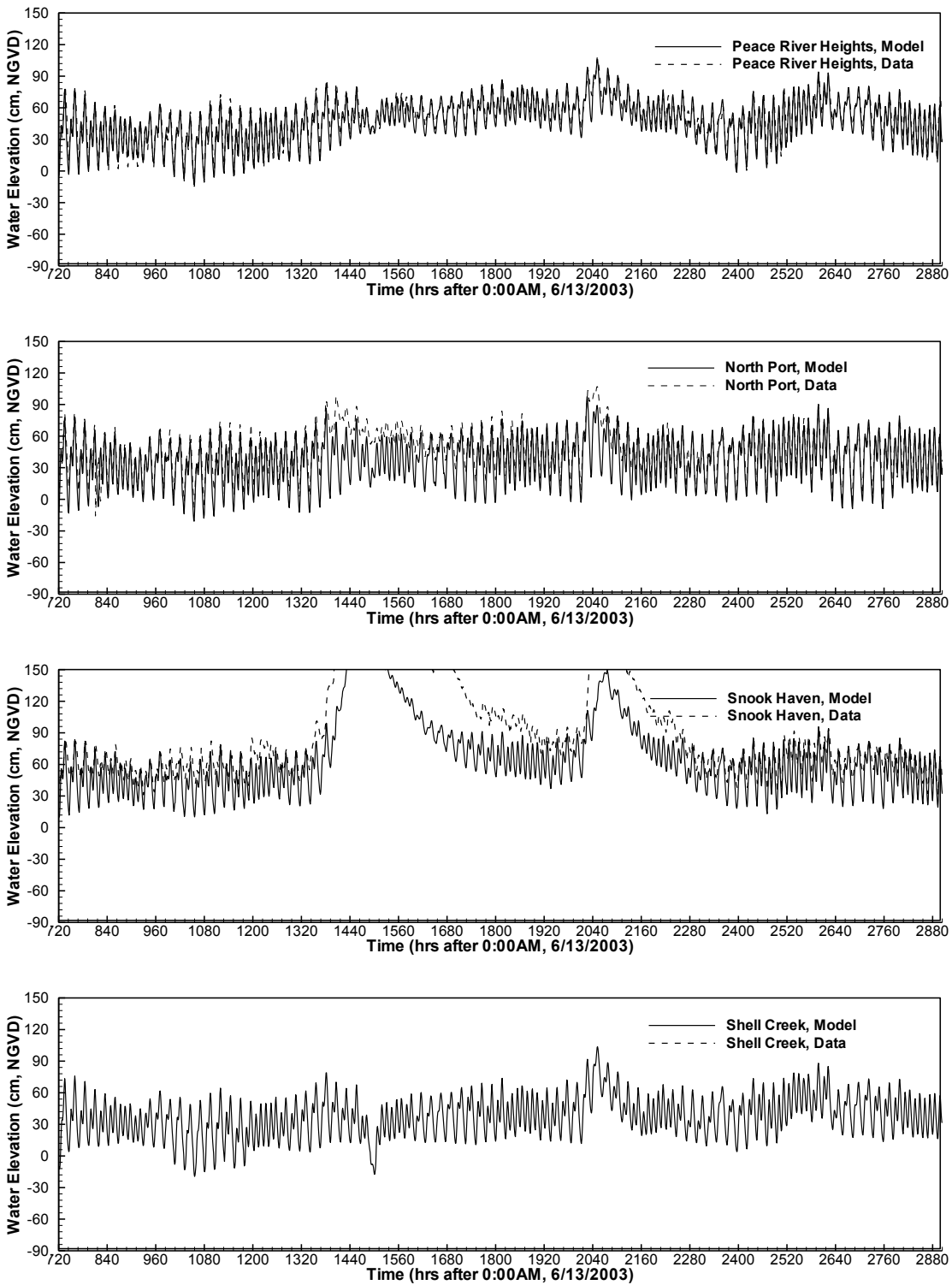

Figure A- 4. Comparisons of simulated and measured water elevations at Peace River Heights, North Port, Snook Haven, and Shell Creek during July 12 – October 10, 2003.

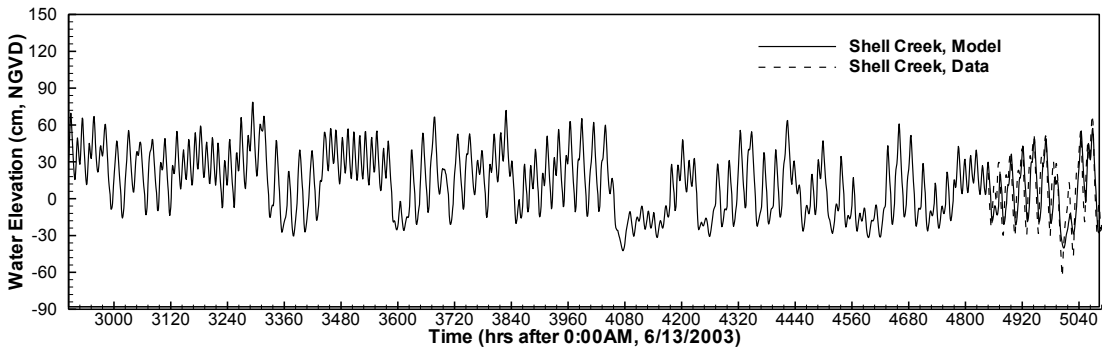
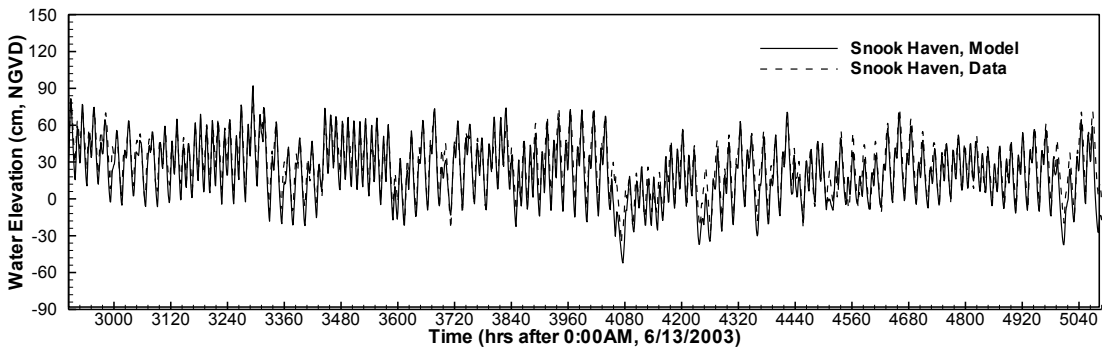
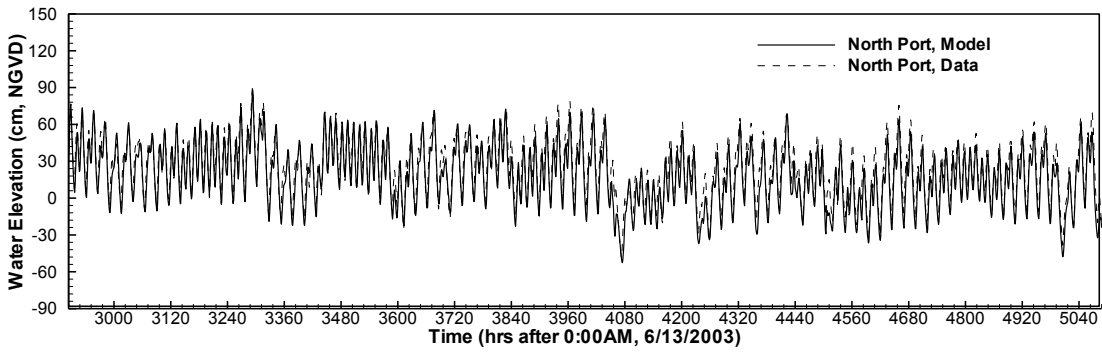
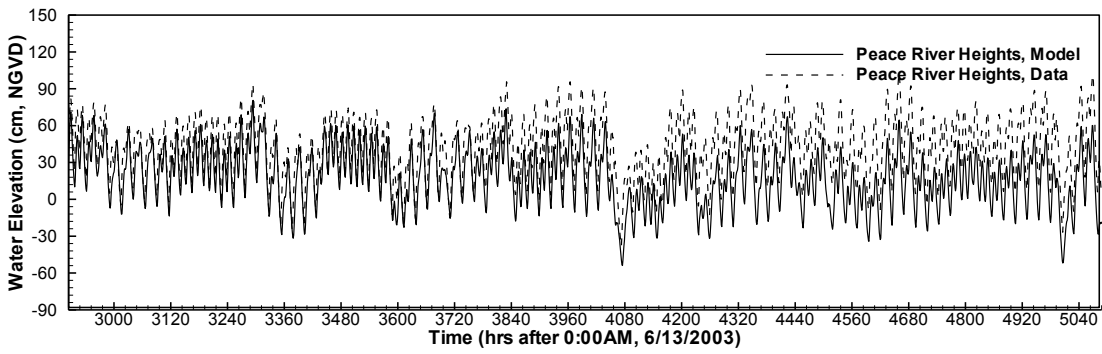

Figure A- 5. Comparisons of simulated and measured water elevations at Peace River Heights, North Port, Snook Haven, and Shell Creek during October 11, 2003 – January 9, 2004.

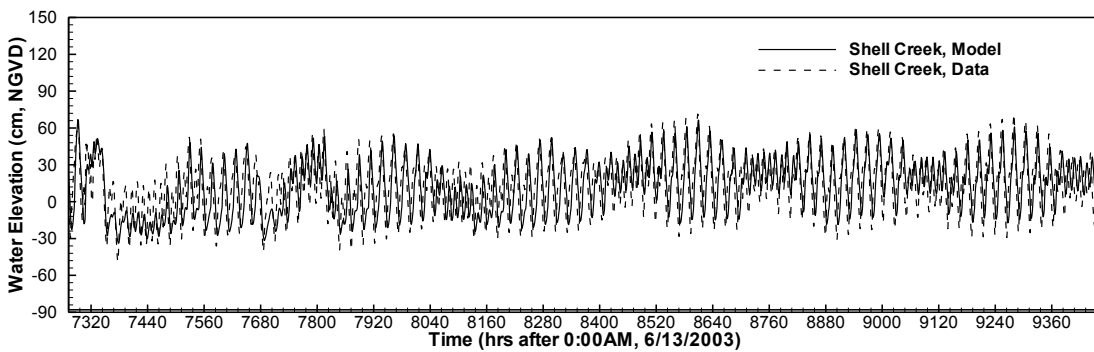
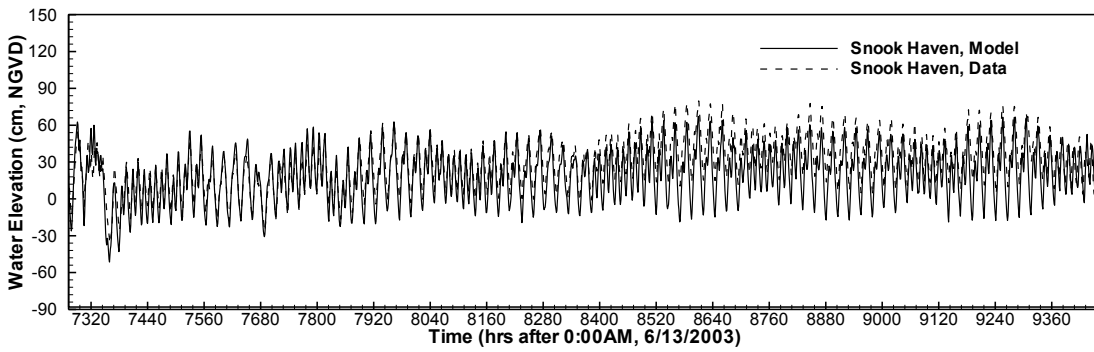
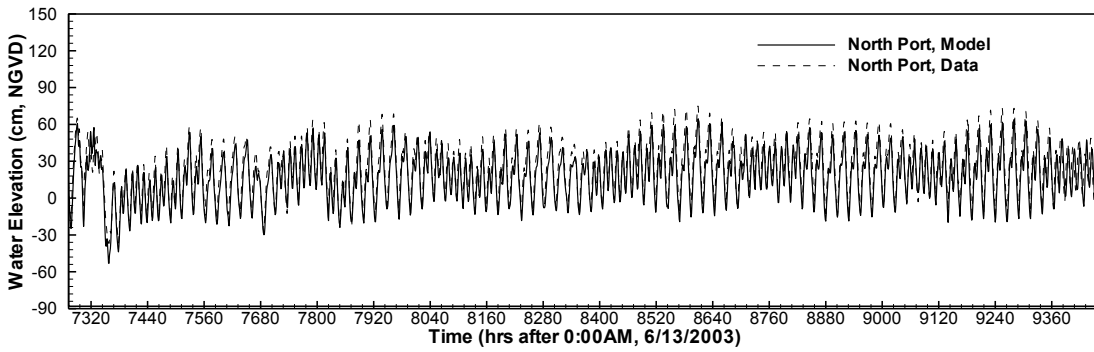
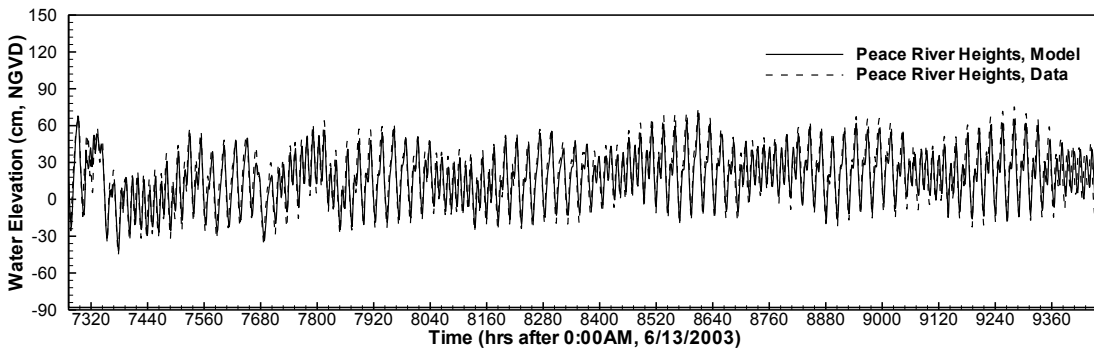

Figure A- 6. Comparisons of simulated and measured water elevations at Peace River Heights, North Port, Snook Haven, and Shell Creek during April 10 – July 11, 2004.

Appendix B

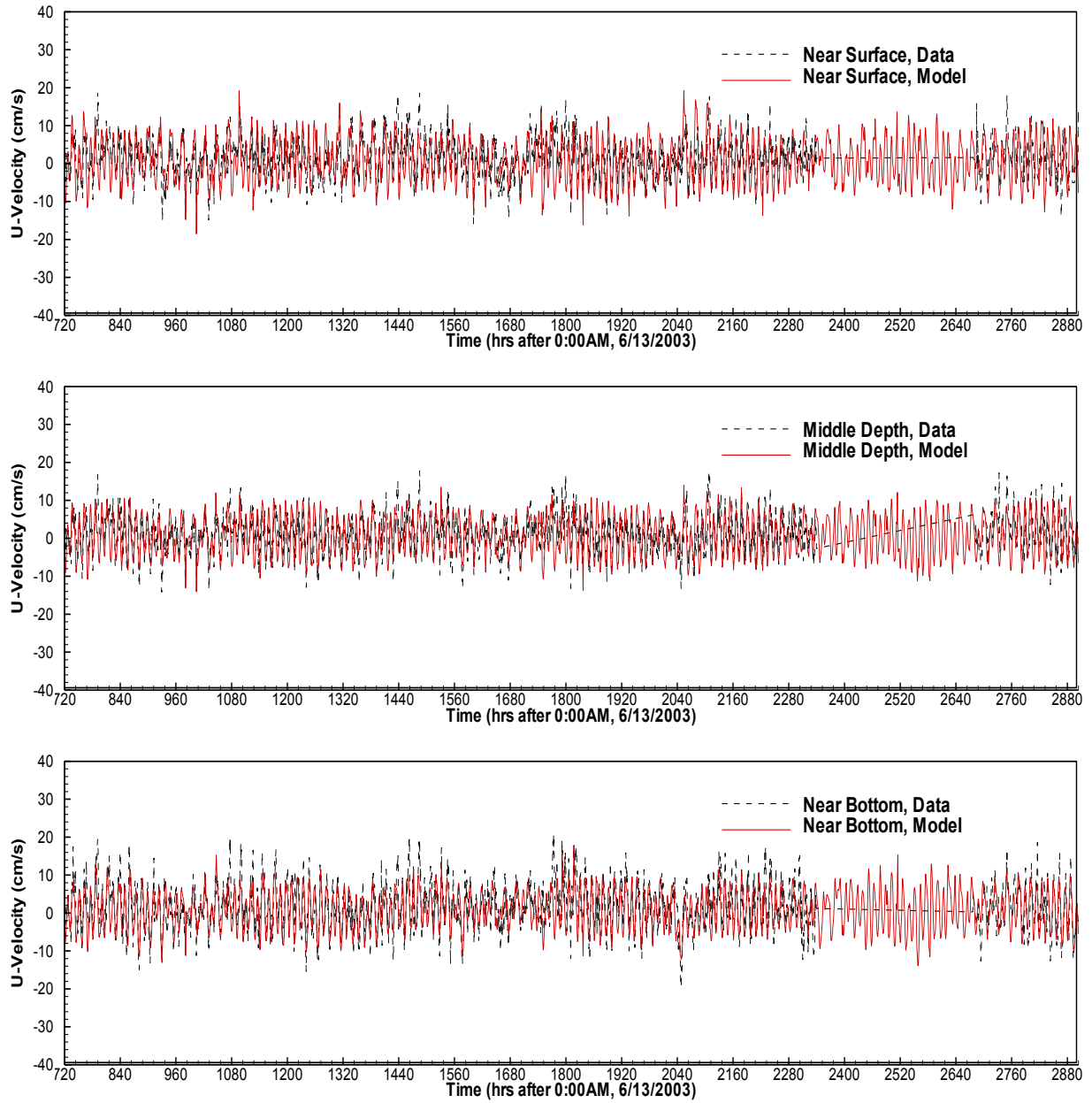

Figure B- 1. Comparisons of simulated and measured u-velocities at three depths at the UF station during July 12 – October 10, 2003.

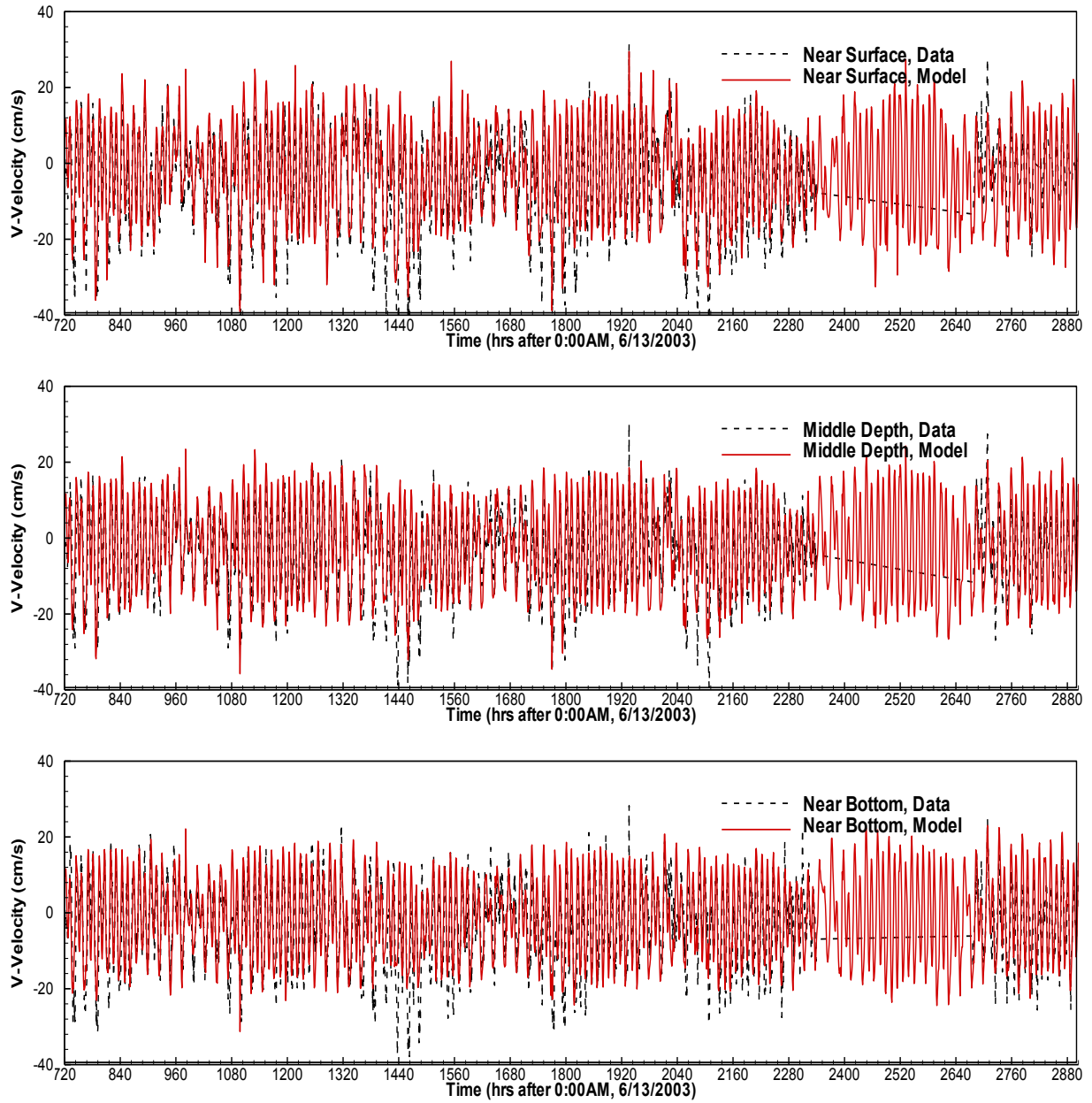

Figure B- 2. Comparisons of simulated and measured v-velocities at three depths at the UF station during July 12 – October 10, 2003.

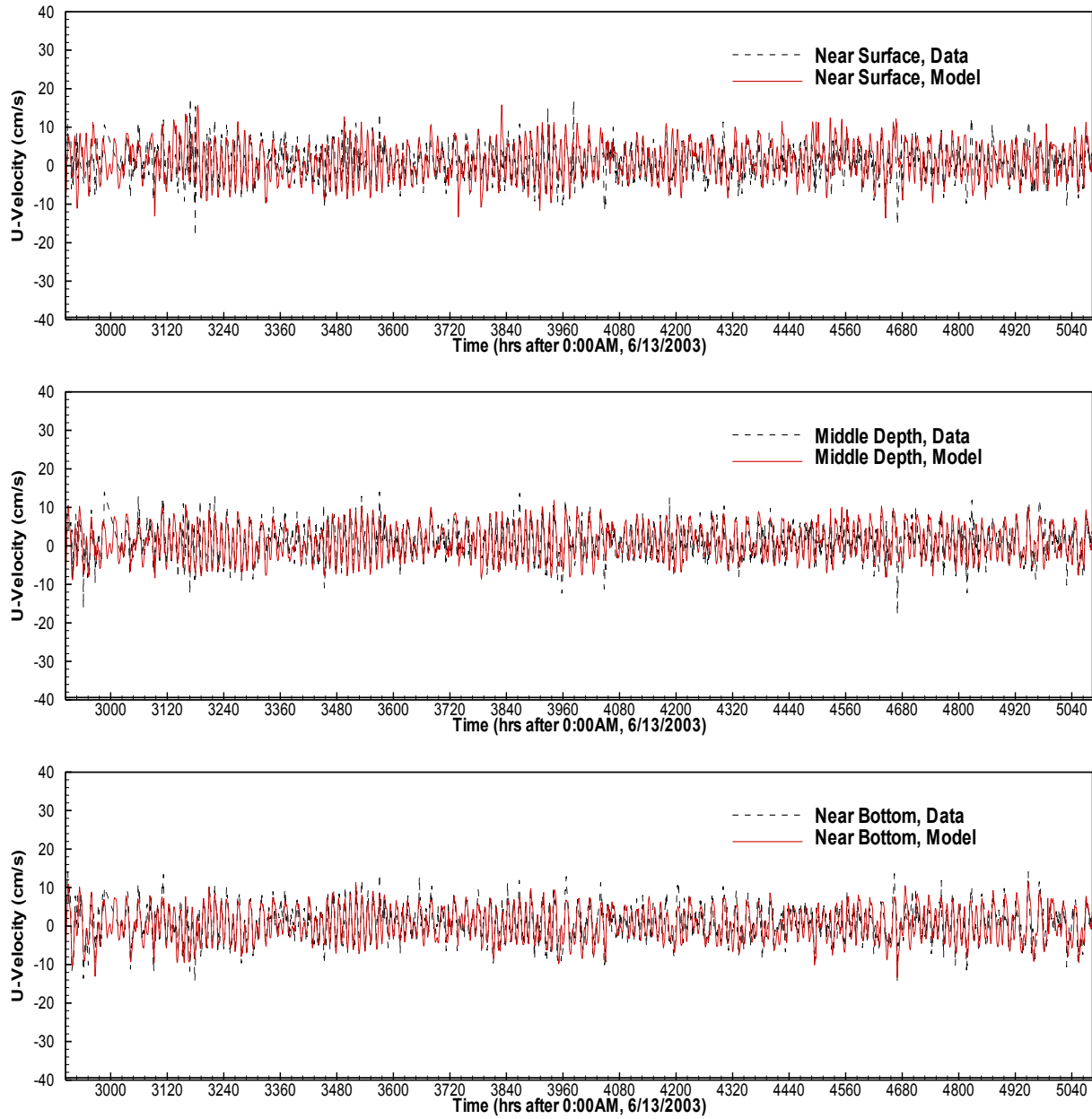

Figure B- 3. Comparisons of simulated and measured u-velocities at three depths at the UF station during October 11, 2003 – January 9, 2004.

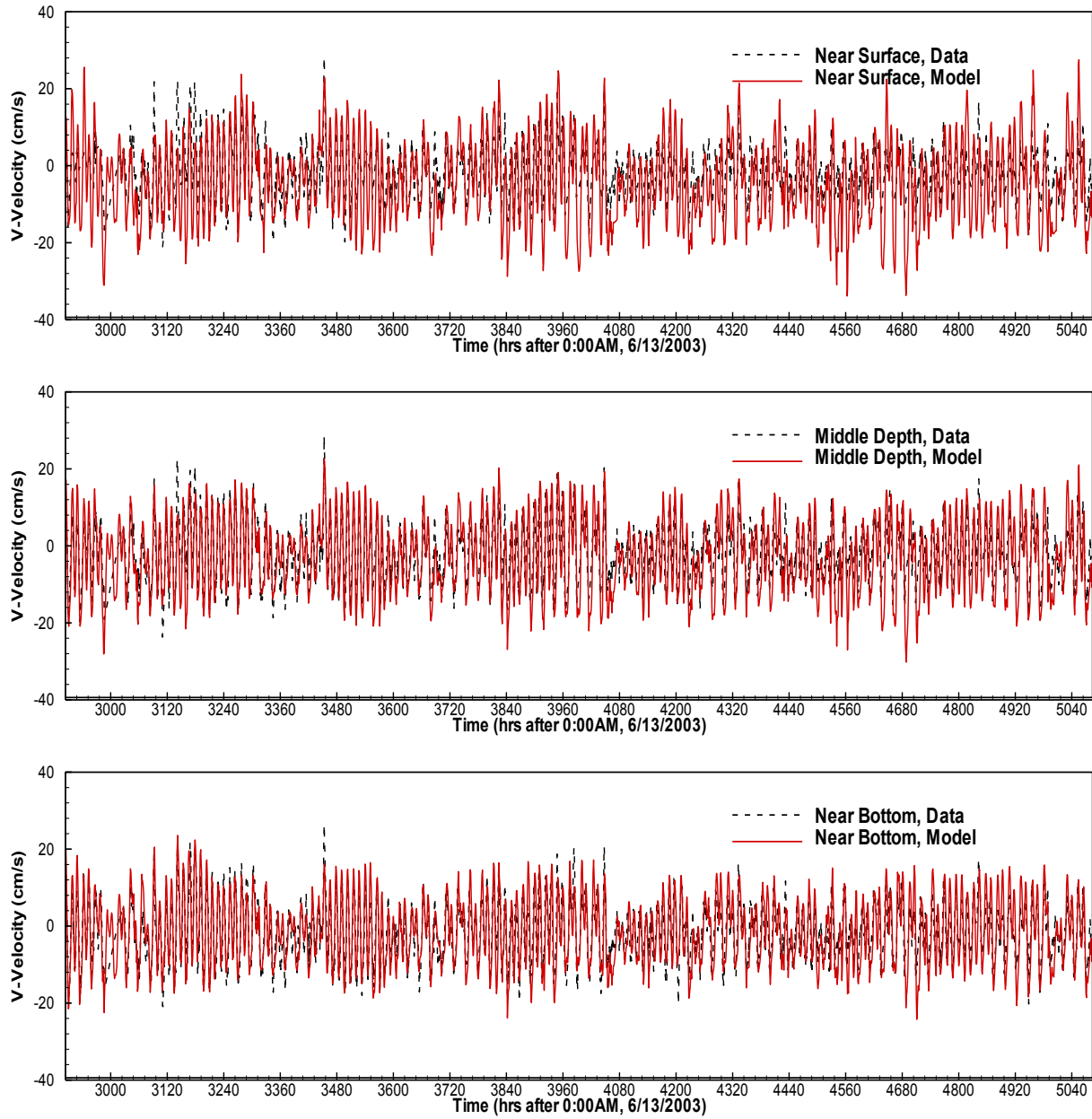

Figure B- 4. Comparisons of simulated and measured v-velocities at three depths at the UF station during October 11, 2003 – January 9, 2004.

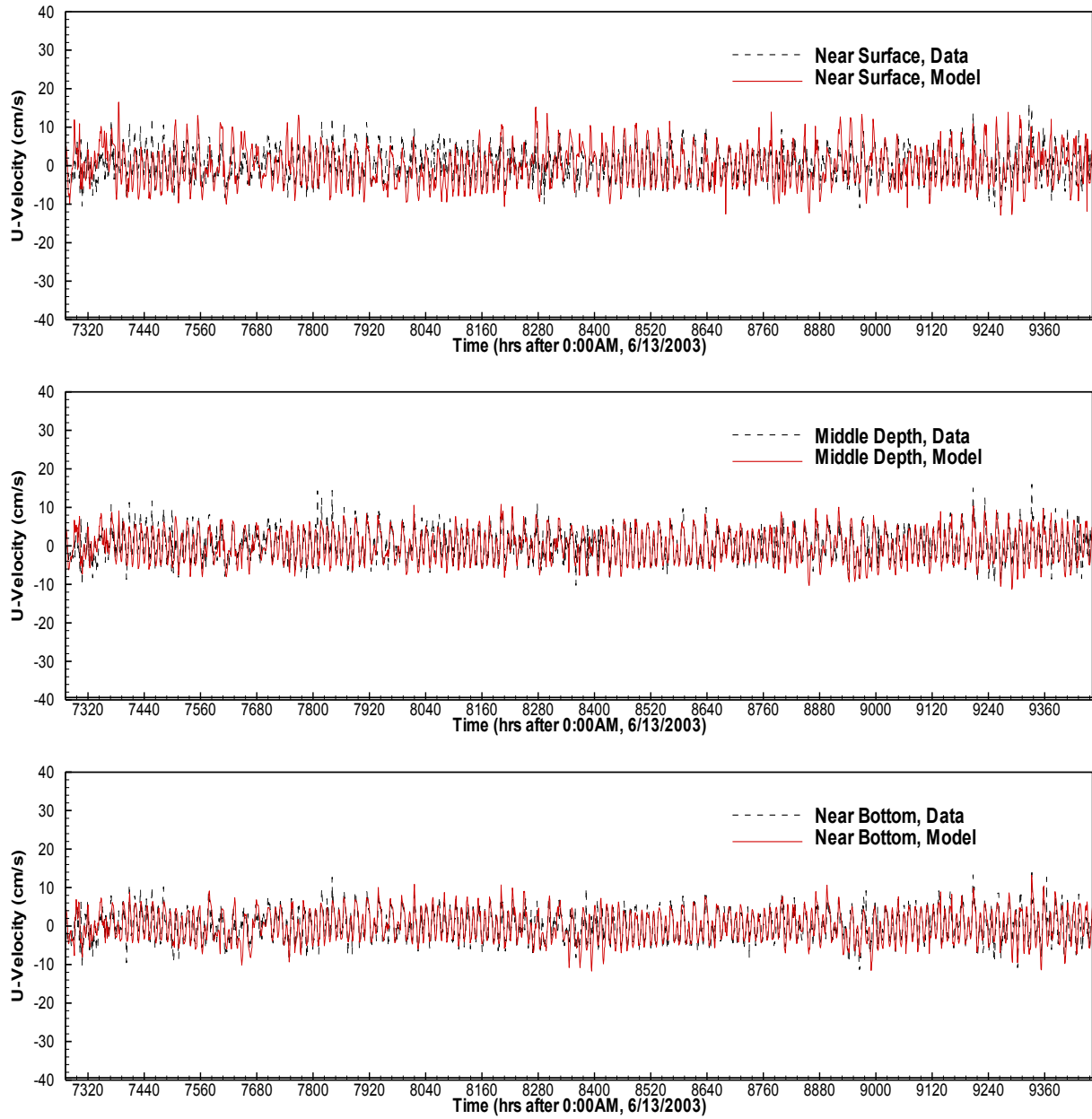

Figure B- 5. Comparisons of simulated and measured u-velocities at three depths at the UF station during April 10 – July 11, 2004.

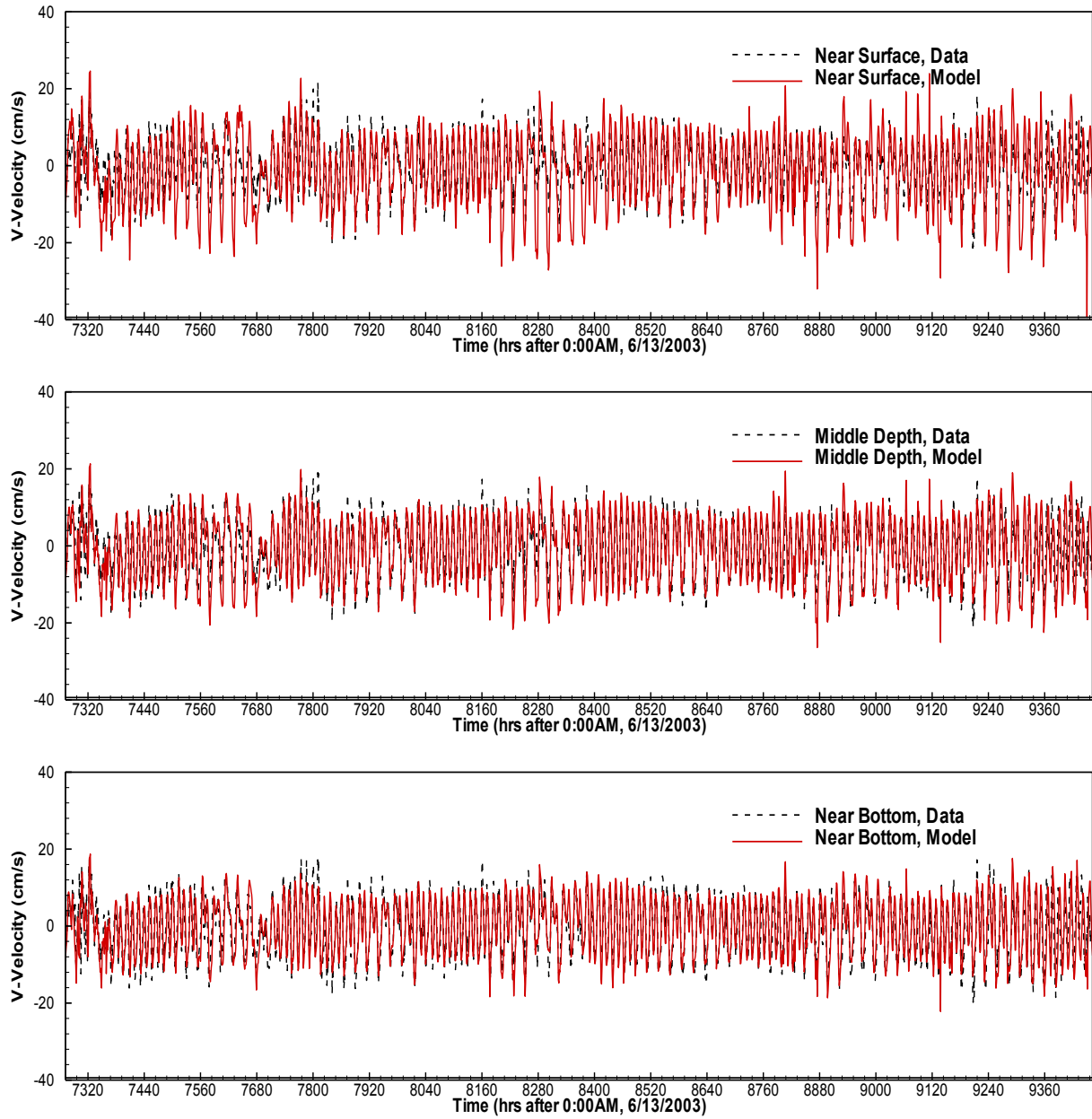

Figure B- 6. Comparisons of simulated and measured v-velocities at three depths at the UF station during April 10 – July 11, 2004.

Appendix C

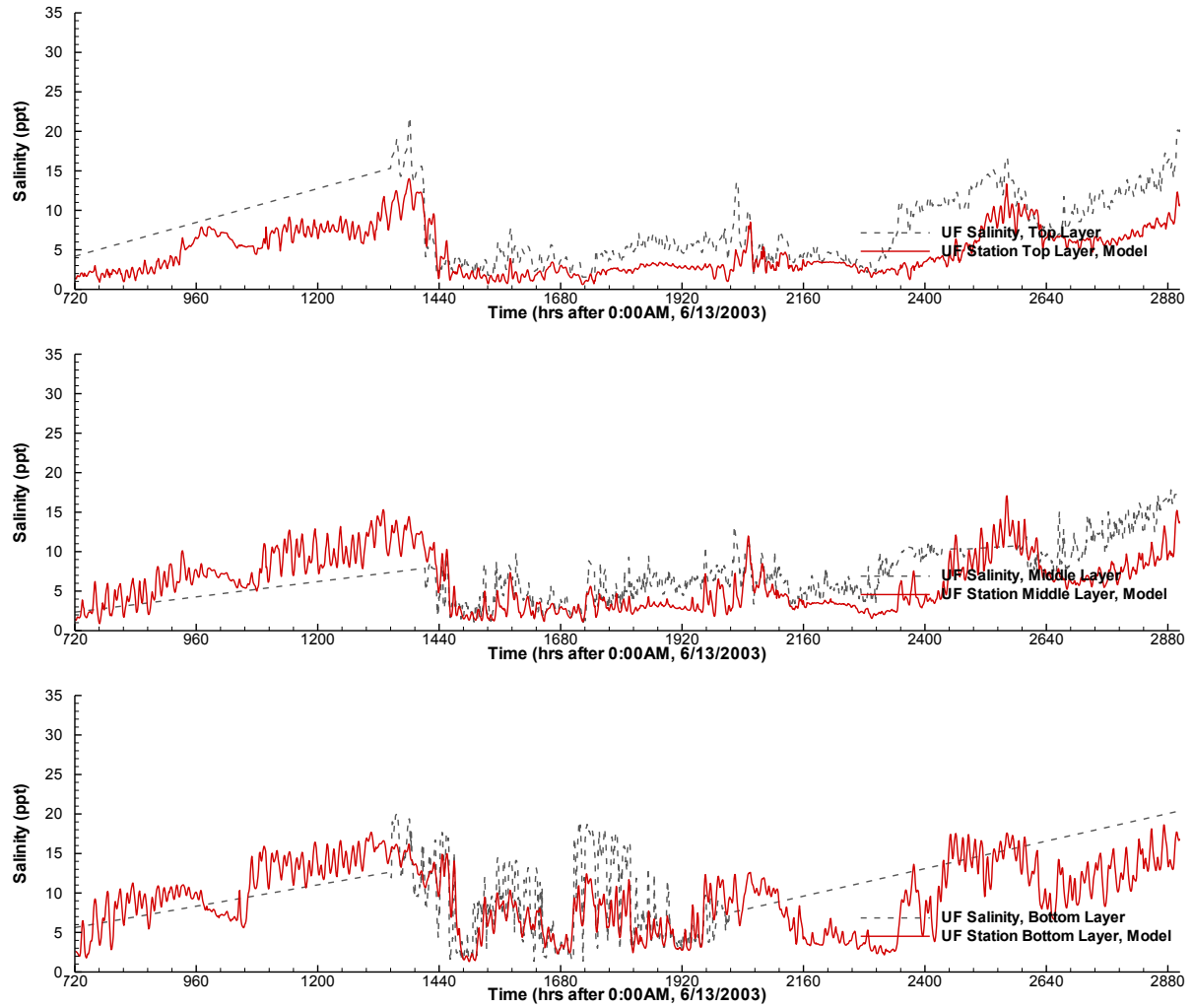

Figure C- 1. Comparisons of simulated and measured salinities at three depths at the UF station during July 12 – October 10, 2003.

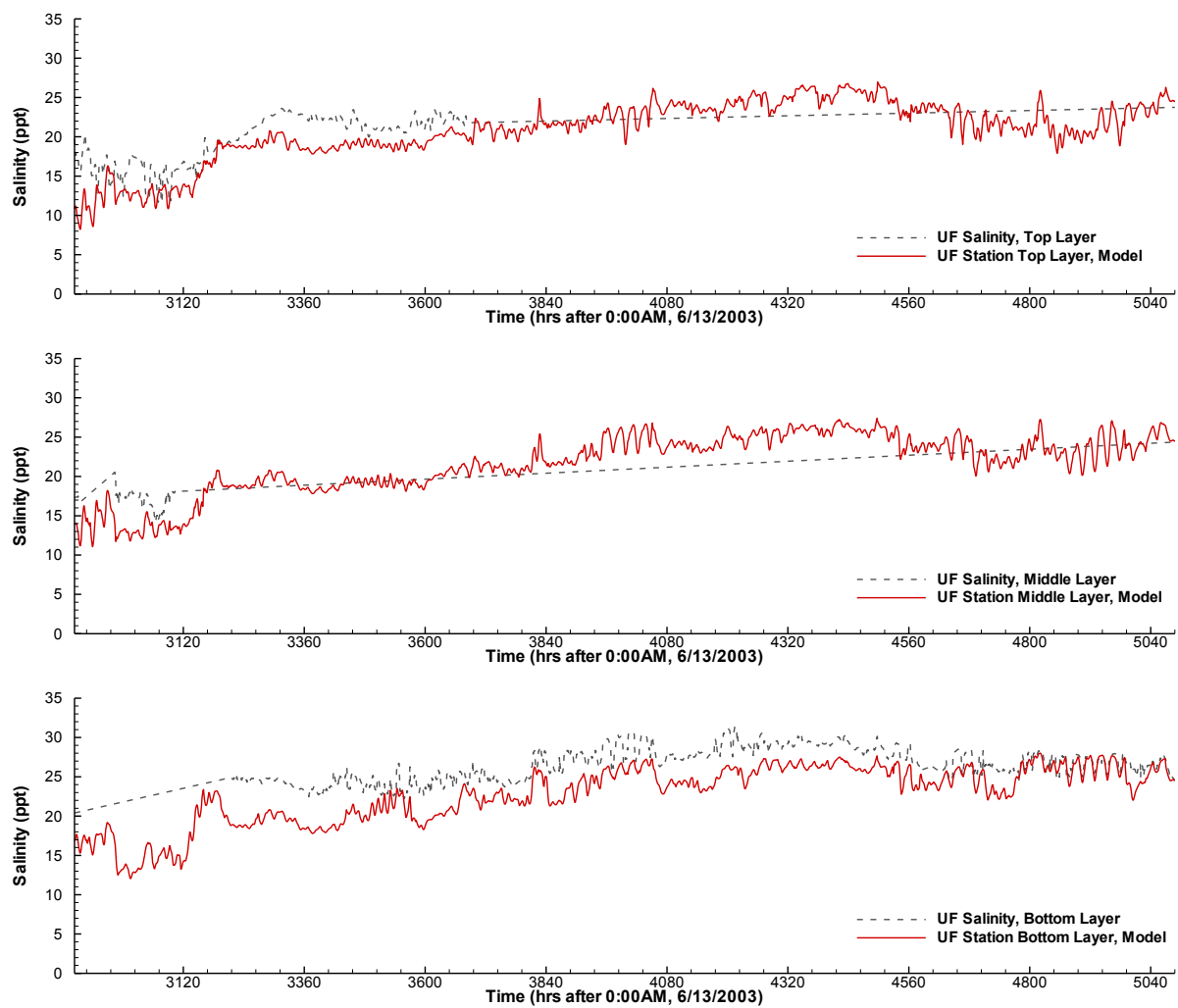

Figure C- 2. Comparisons of simulated and measured salinities at three depths at the UF station during October 11, 2003 – January 9, 2004.

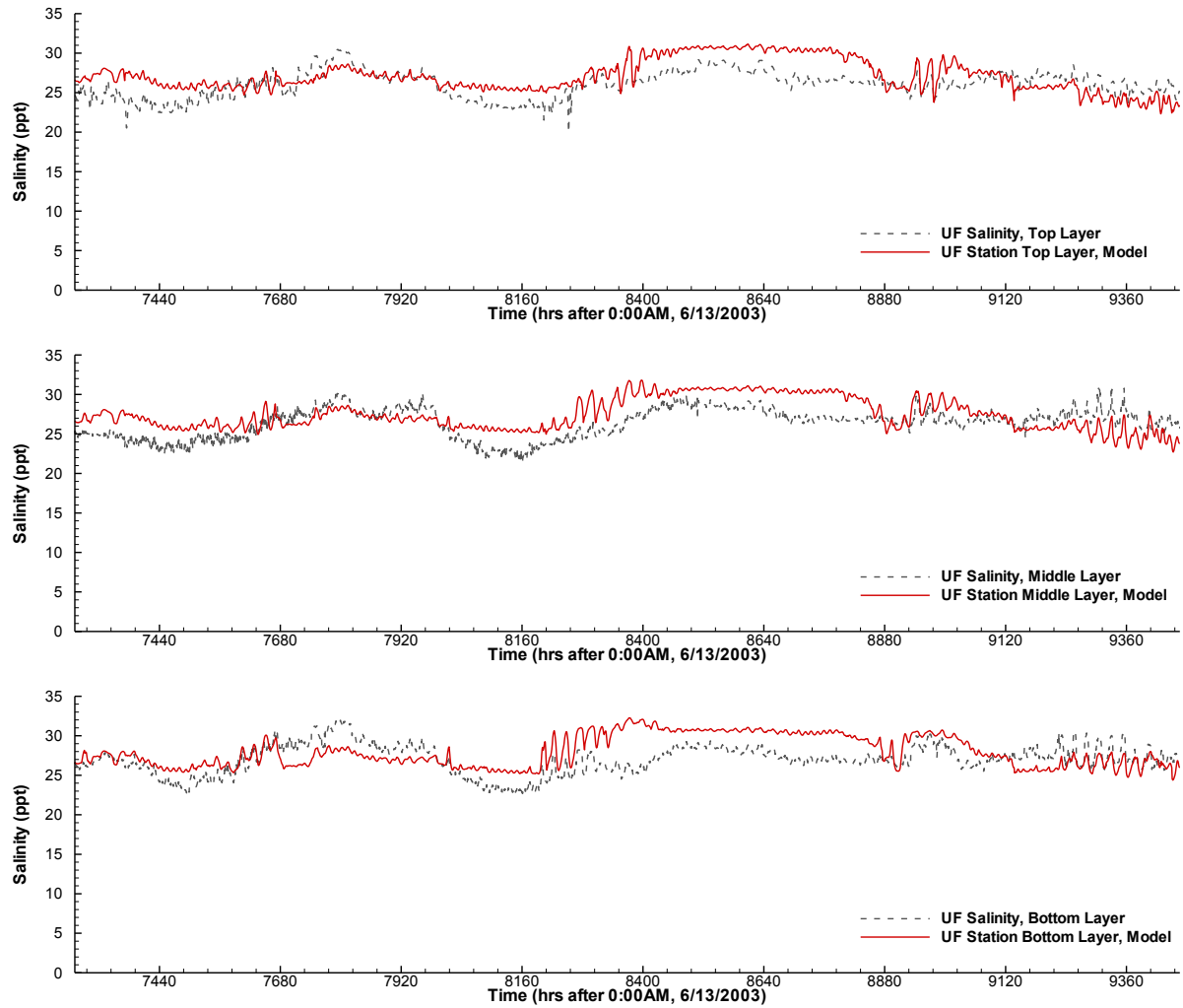

Figure C- 3. Comparisons of simulated and measured salinities at three depths at the UF station during April 10 – July 11, 2004.

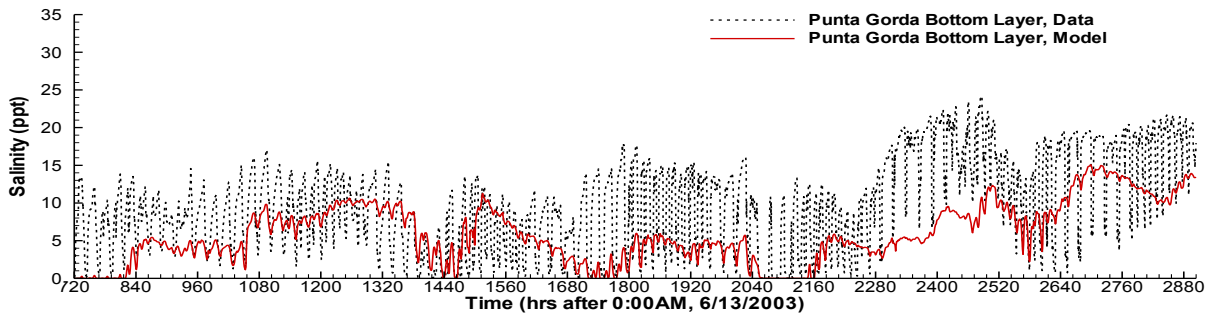
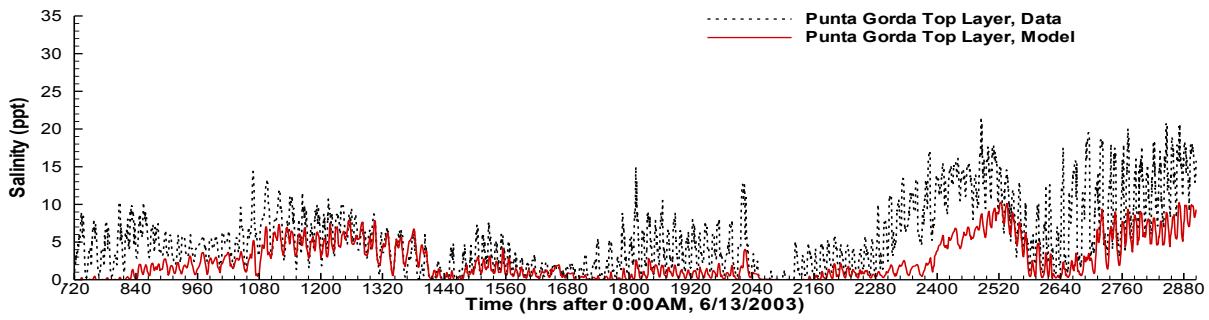

Figure C- 4. Comparisons of simulated and measured salinities at two depths at the Punta Gorda station during July 12 – October 10, 2003.

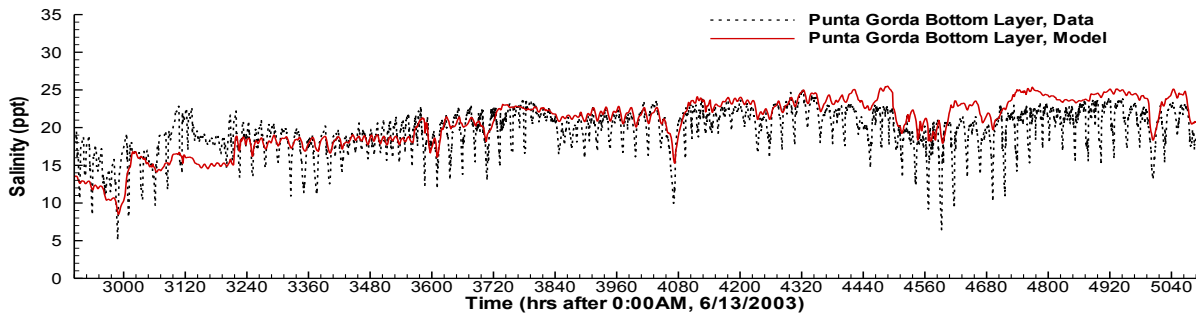
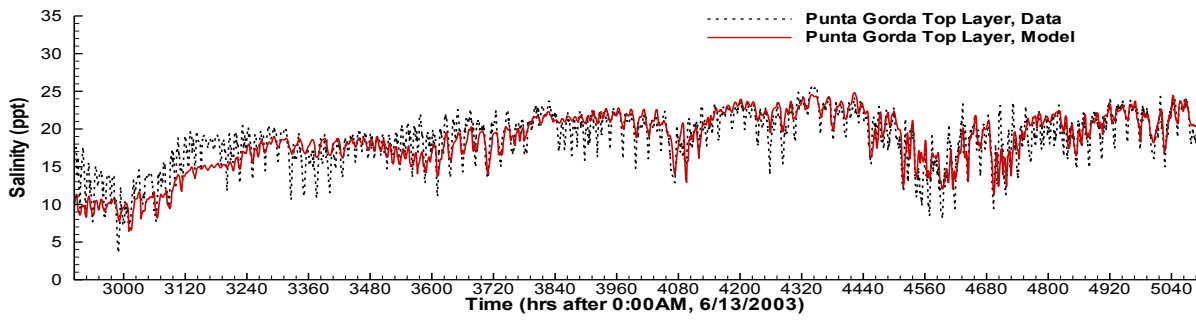

Figure C- 5. Comparisons of simulated and measured salinities at two depths at the Punta Gorda station during October 11, 2003 – January 9, 2004.

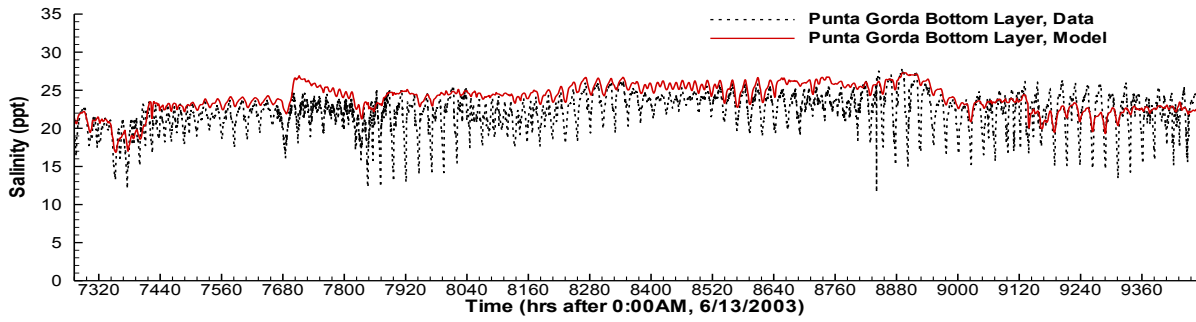
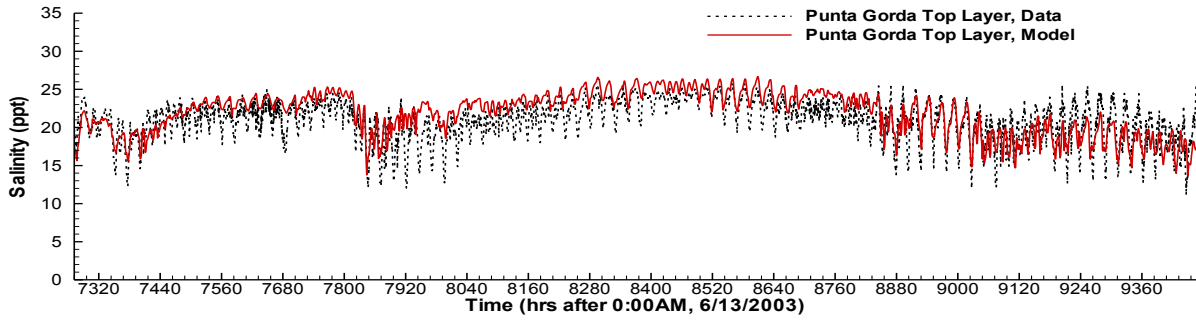

Figure C- 6. Comparisons of simulated and measured v-velocities at two depths at the Punta Gorda station during April 10 – July 11, 2004.

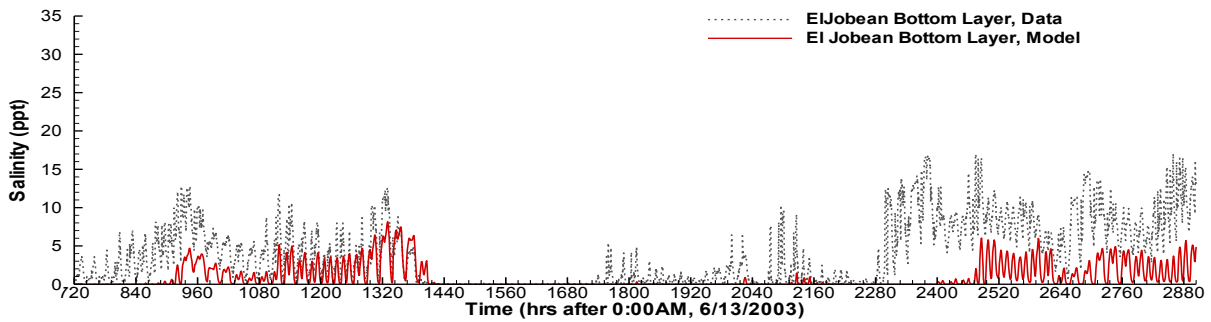
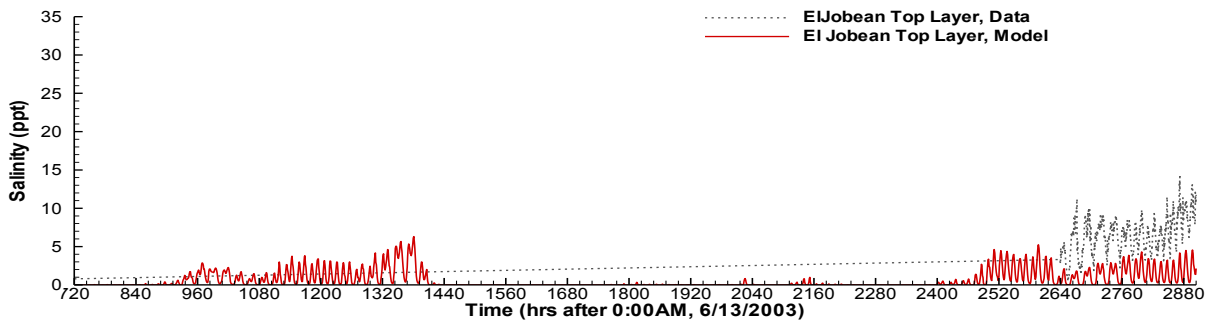

Figure C- 7. Comparisons of simulated and measured salinities at two depths at the El Jobean station during Julv 12 – October 10, 2003.

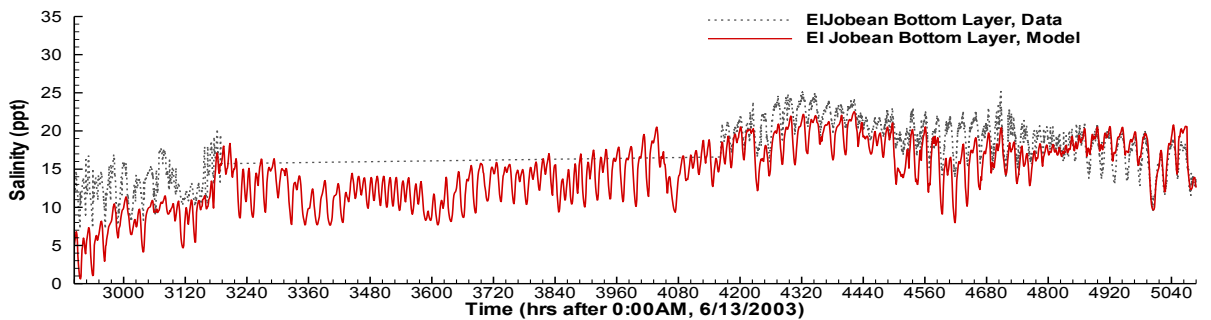
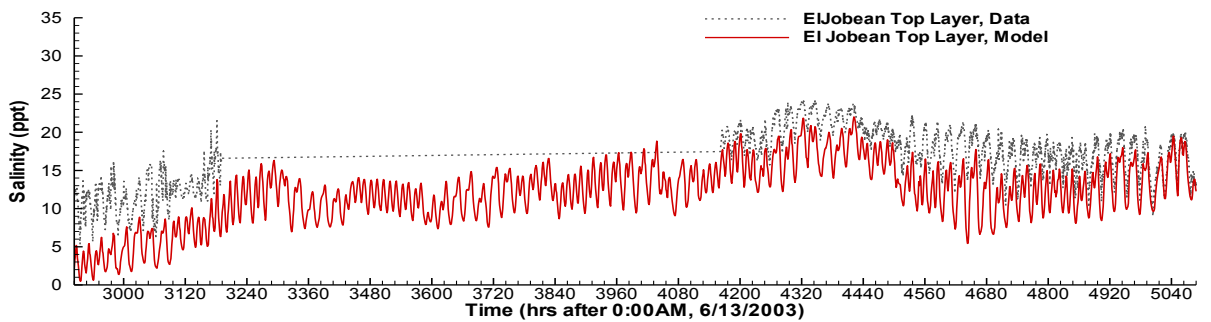

Figure C- 8. Comparisons of simulated and measured salinities at two depths at the El Jobean station during October 11, 2003 – January 9, 2004.

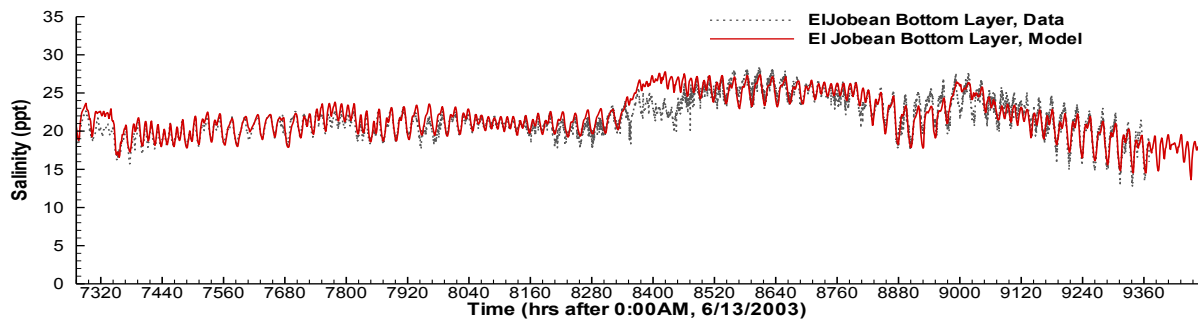
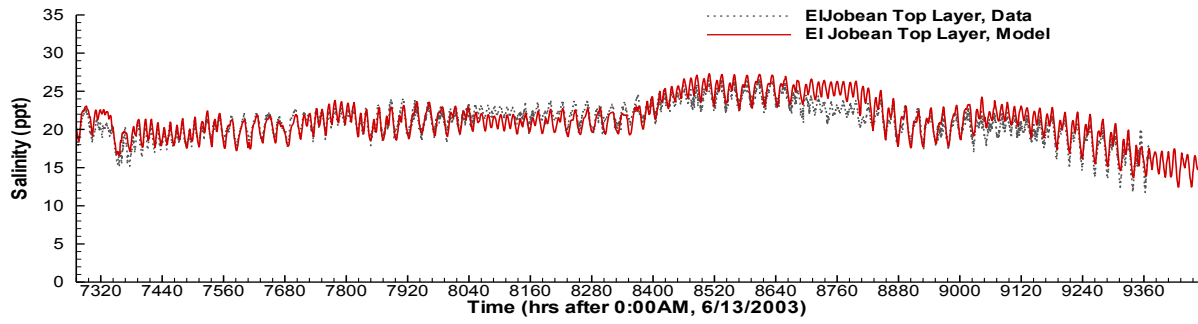

Figure C- 9. Comparisons of simulated and measured salinities at two depths at the El Jobean station during April 10 – July 11, 2004.

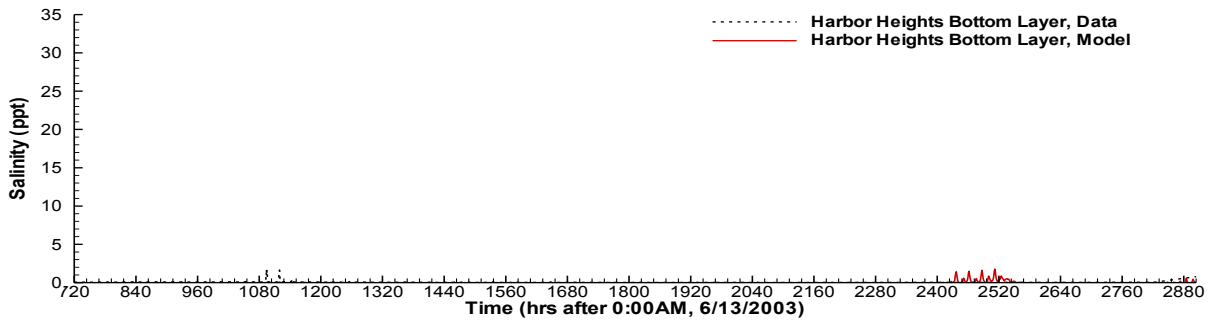
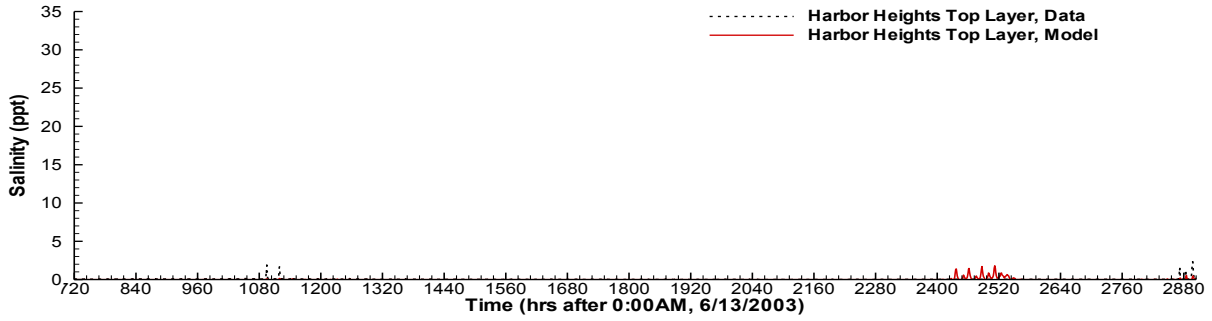

Figure C- 10. Comparisons of simulated and measured salinities at two depths at the Harbor Heights station during July 12 – October 10, 2003.

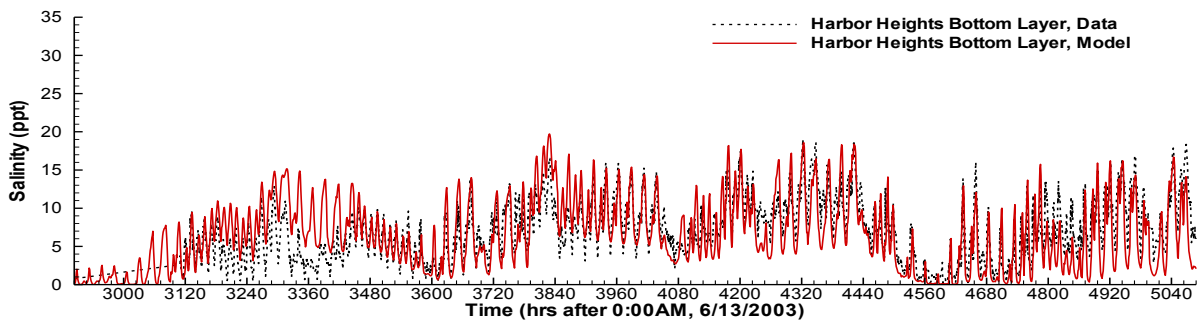
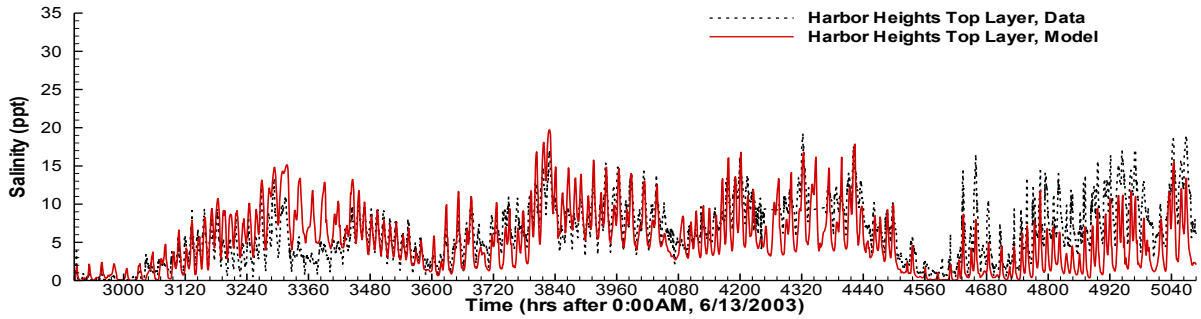

Figure C- 11. Comparisons of simulated and measured salinities at two depths at the Harbor Heights station during October 11, 2003 – January 9, 2004.

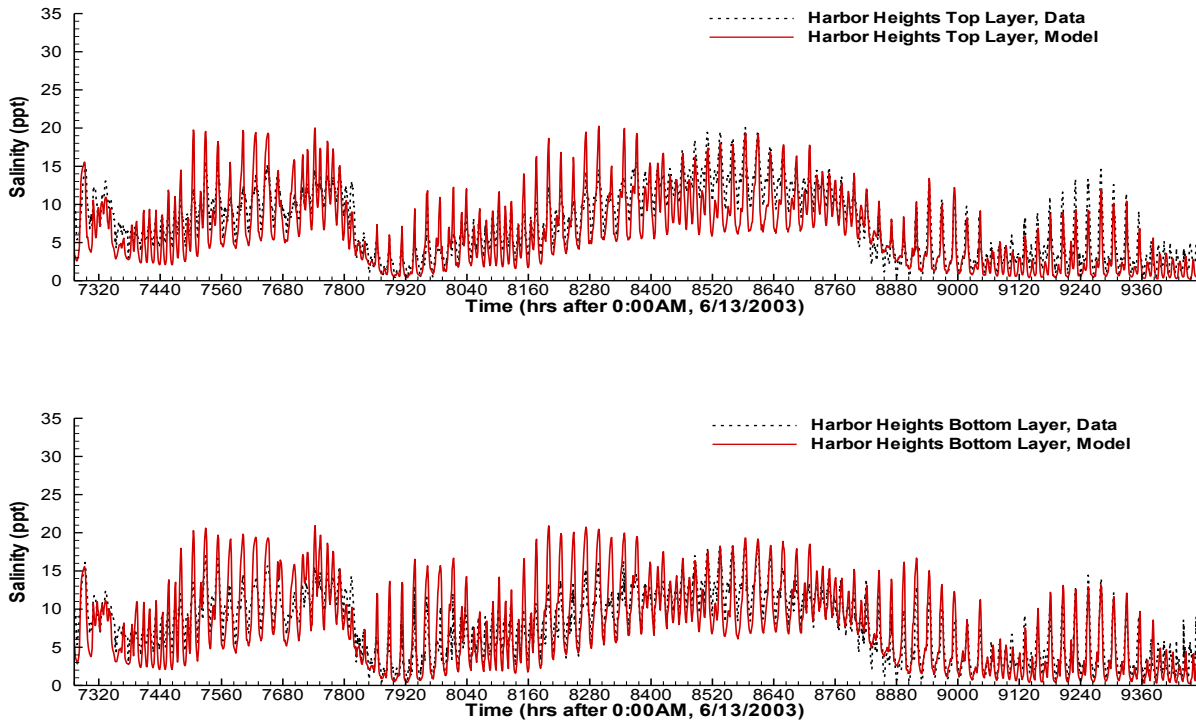

Figure C- 12. Comparisons of simulated and measured salinities at two depths at the Harbor Heights station during April 10 - July 11, 2004.

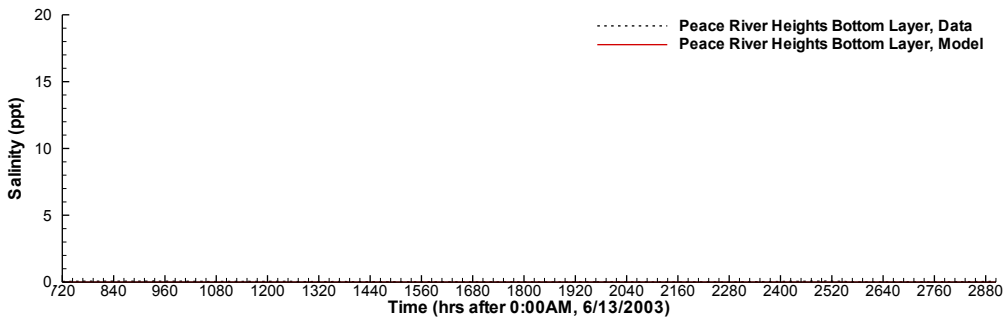
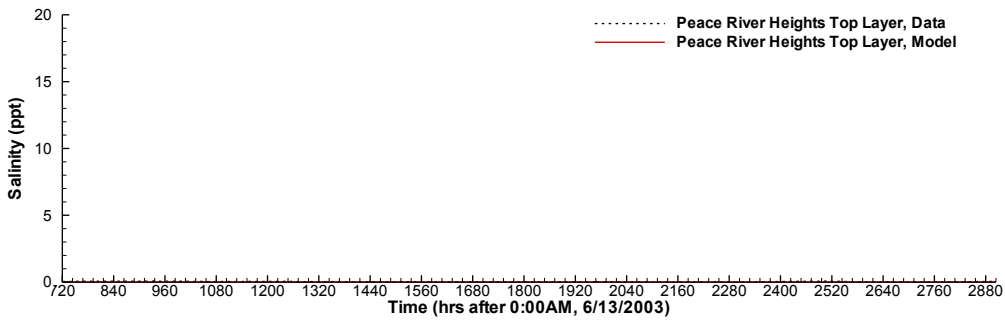

Figure C- 13. Comparisons of simulated and measured salinities at two depths at the Peace River Heights station during July 12 – October 10, 2003.

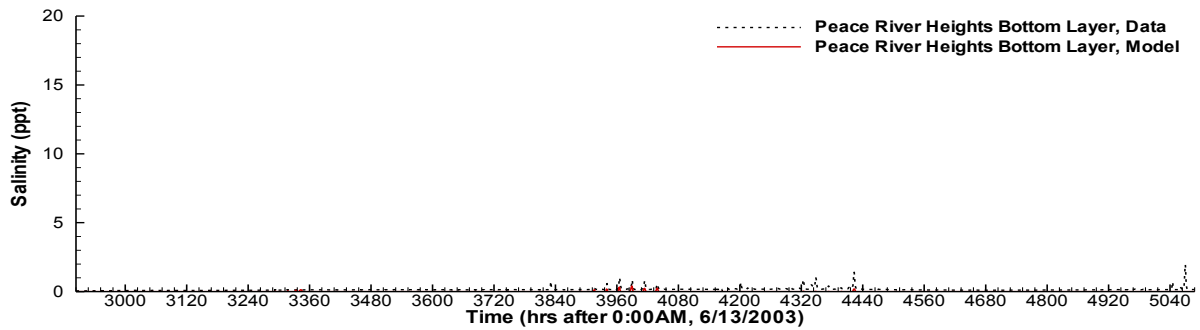
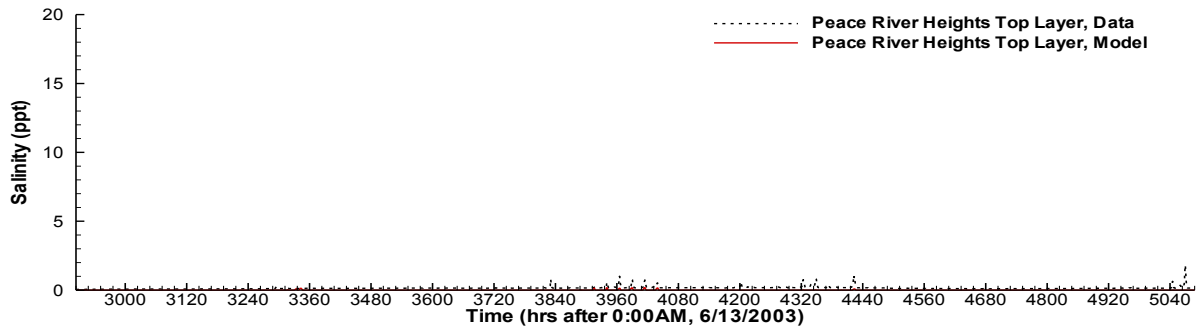

Figure C- 14. Comparisons of simulated and measured salinities at two depths at the Peace River Heights station during October 11, 2003 – January 9, 2004.

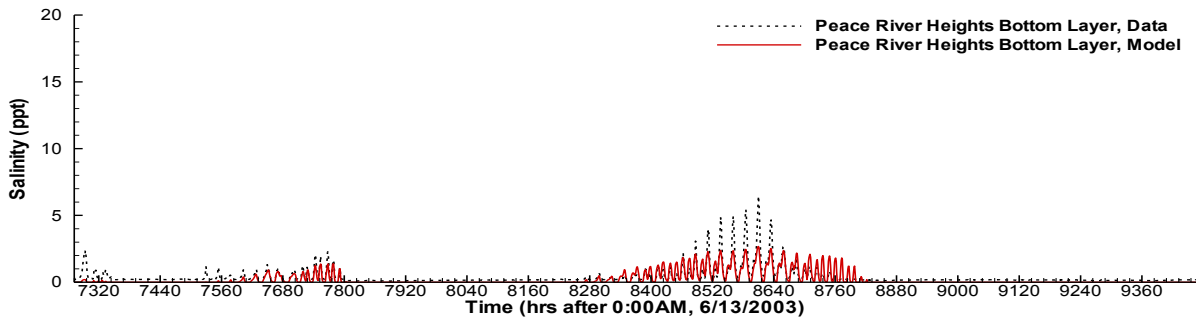
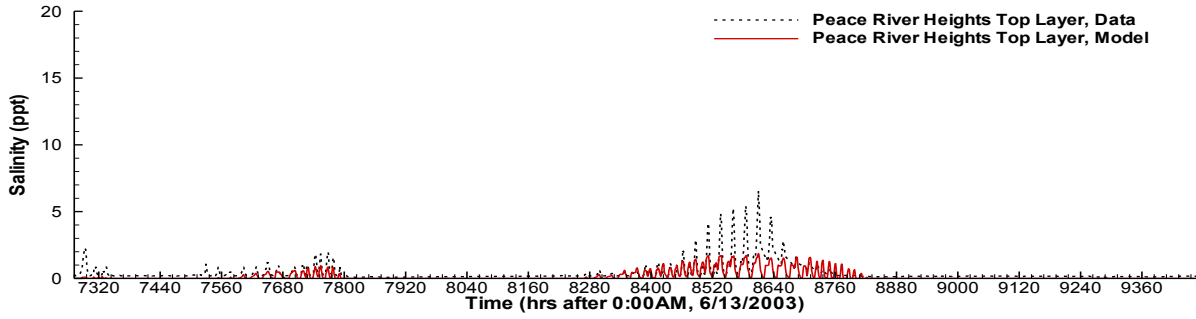

Figure C- 15. Comparisons of simulated and measured salinities at two depths at the Peace River Heights station during April 10 – July 11, 2004.

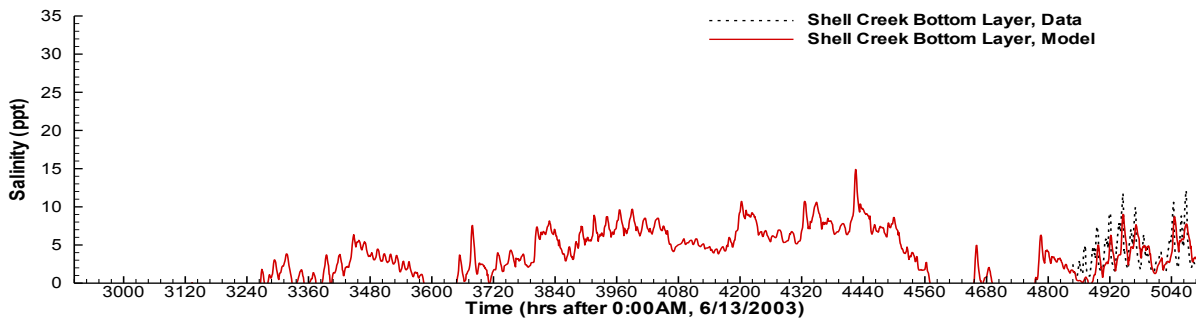
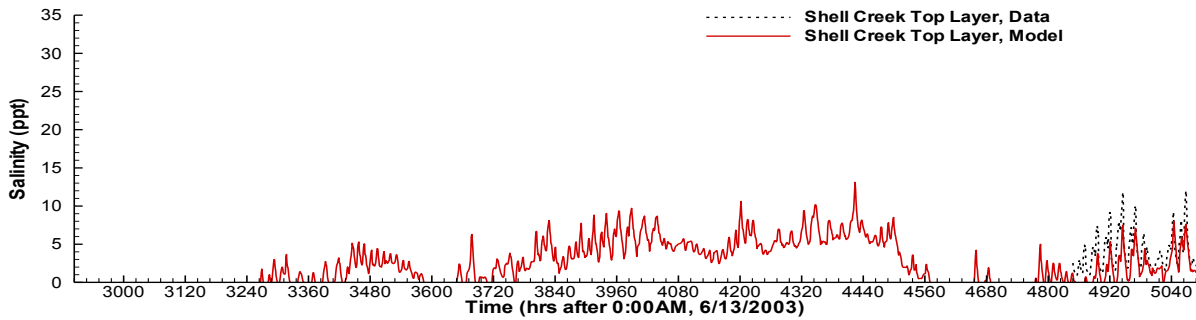

Figure C- 16. Comparisons of simulated and measured salinities at two depths at the Shell Creek station during October 11, 2003 – January 9, 2004.

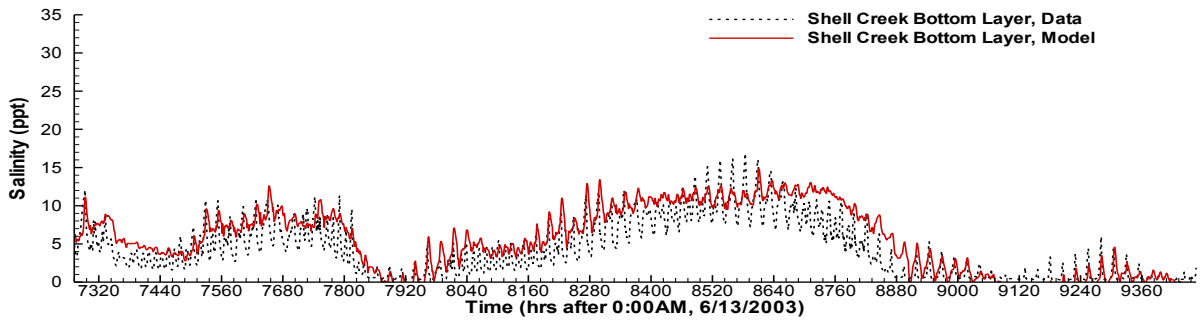
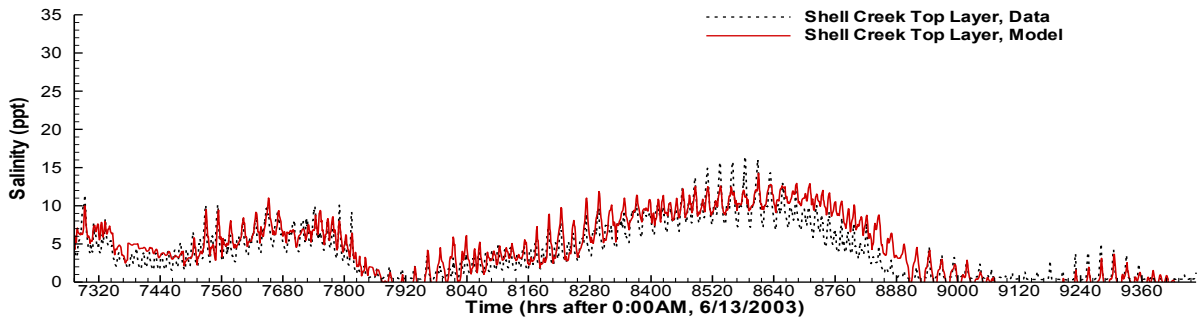

Figure C- 17. Comparisons of simulated and measured salinities at two depths at the Shell Creek station during April 10 - July 11, 2004.

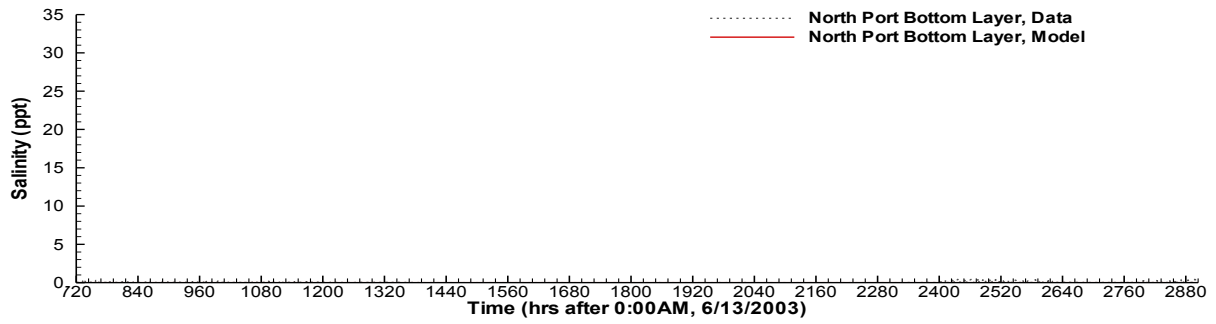

Figure C- 18. Comparisons of simulated and measured salinities at two depths at the North Port station during July 12 – October 10, 2003.

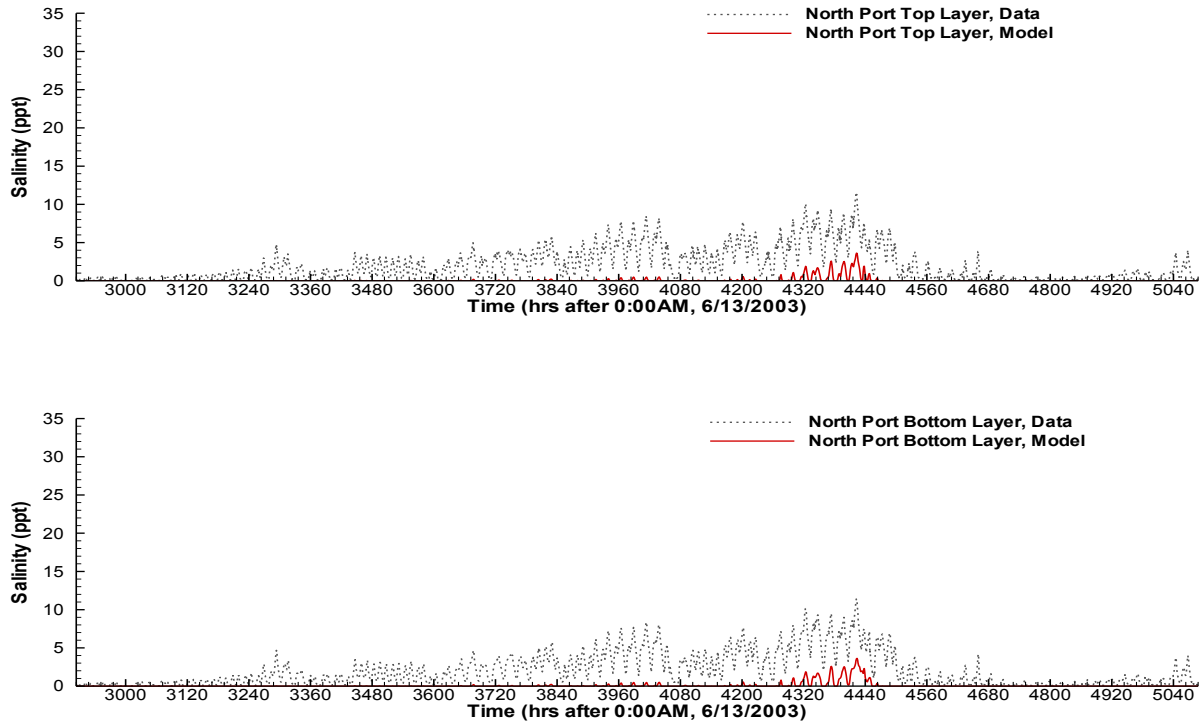

Figure C- 19. Comparisons of simulated and measured salinities at two depths at the North Port station during October 11, 2003 – January 9, 2004.

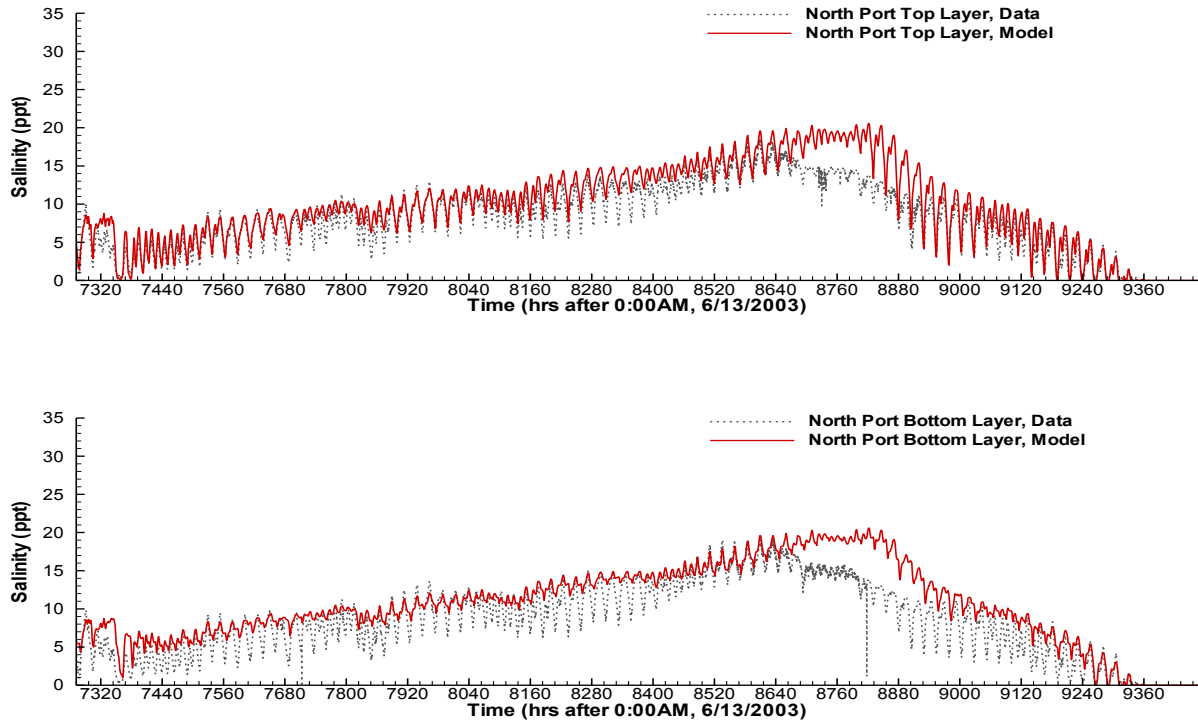

Figure C- 20. Comparisons of simulated and measured salinities at two depths at the North Port station during April 10 – July 11, 2004.

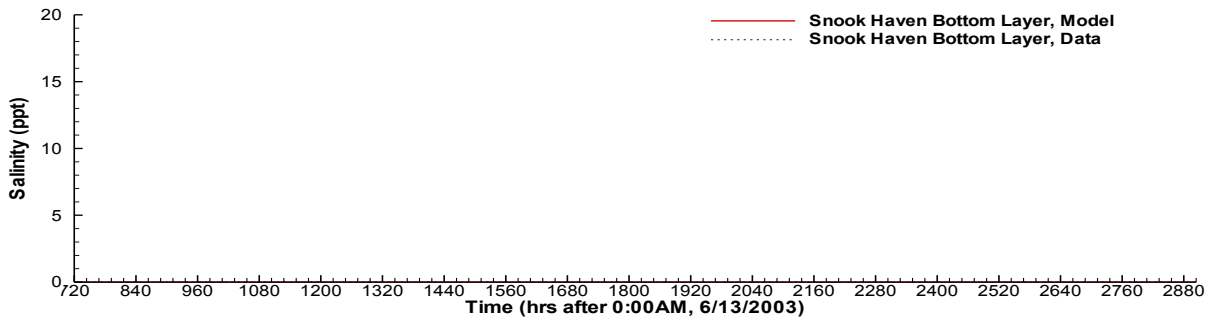

Figure C- 21. Comparisons of simulated and measured salinities at two depths at the Snook Haven station during July 12 – October 10, 2003.

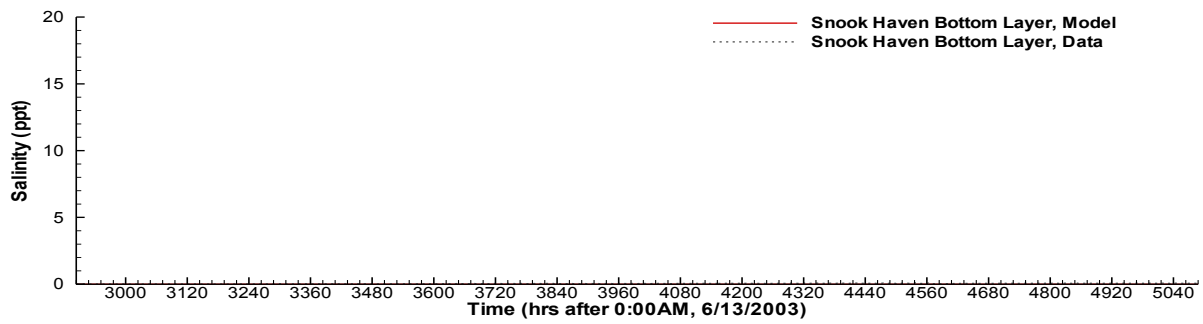
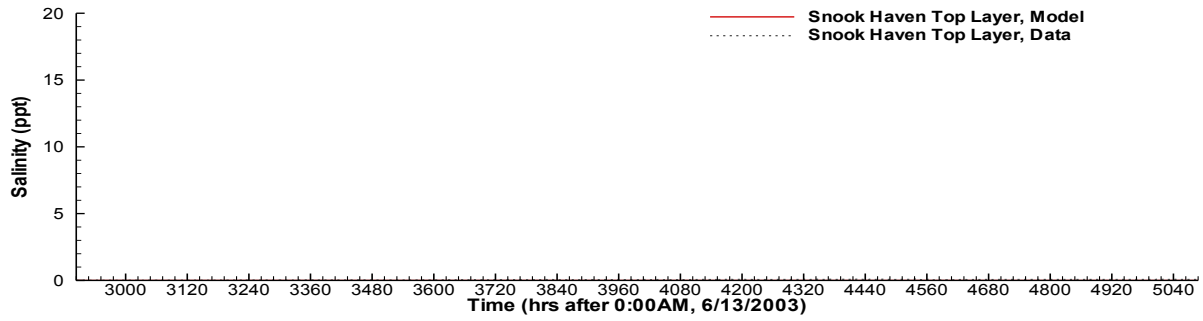

Figure C- 22. Comparisons of simulated and measured salinities at two depths at the Snook Haven station during October 11, 2003 – January 9, 2004.

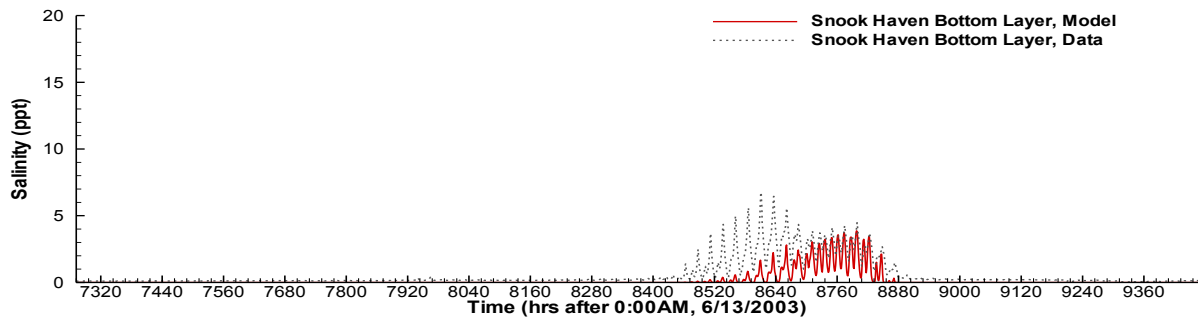
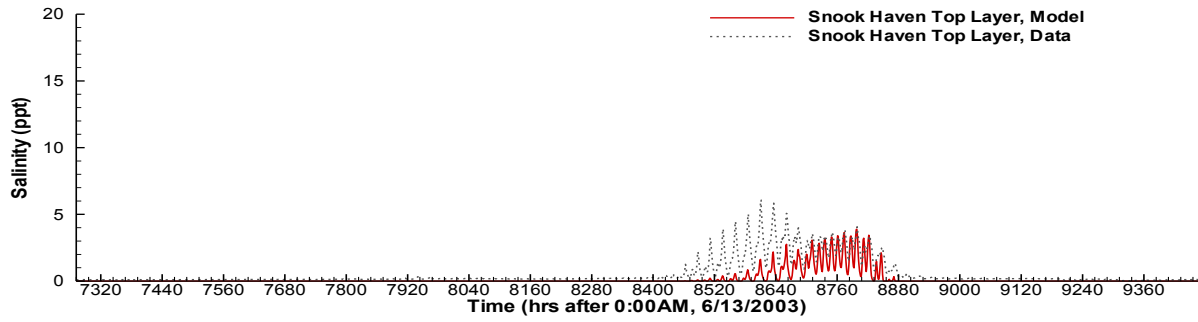

Figure C- 23. Comparisons of simulated and measured salinities at two depths at the Snook Haven station during April 10 – July 11, 2004.

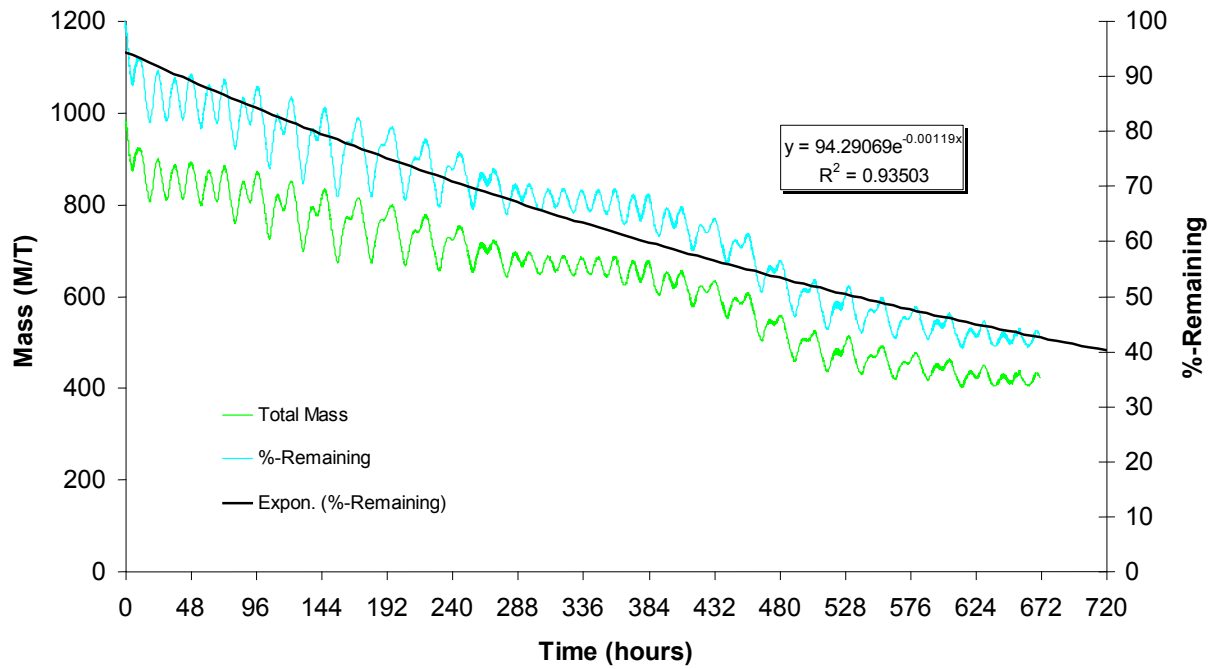

Figure D - 1. Time series of remaining conservative tracer mass in the main stem of the LPR for a combined Arcadia – Joshua - Horse flow rate of 55 cfs.

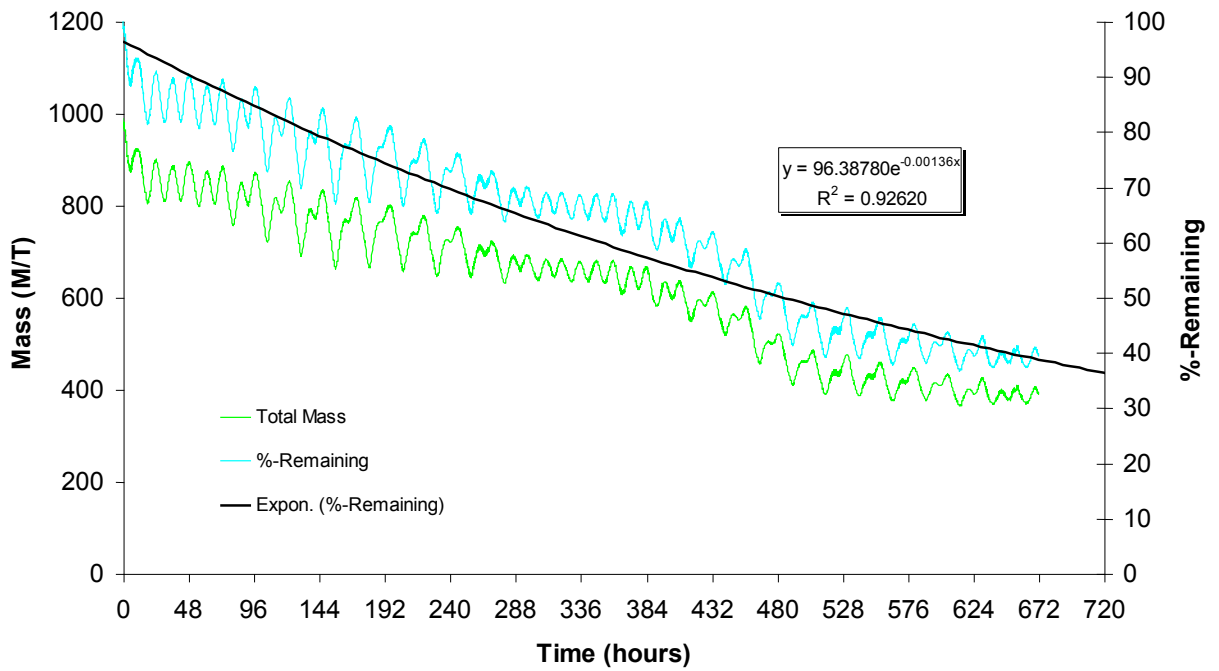
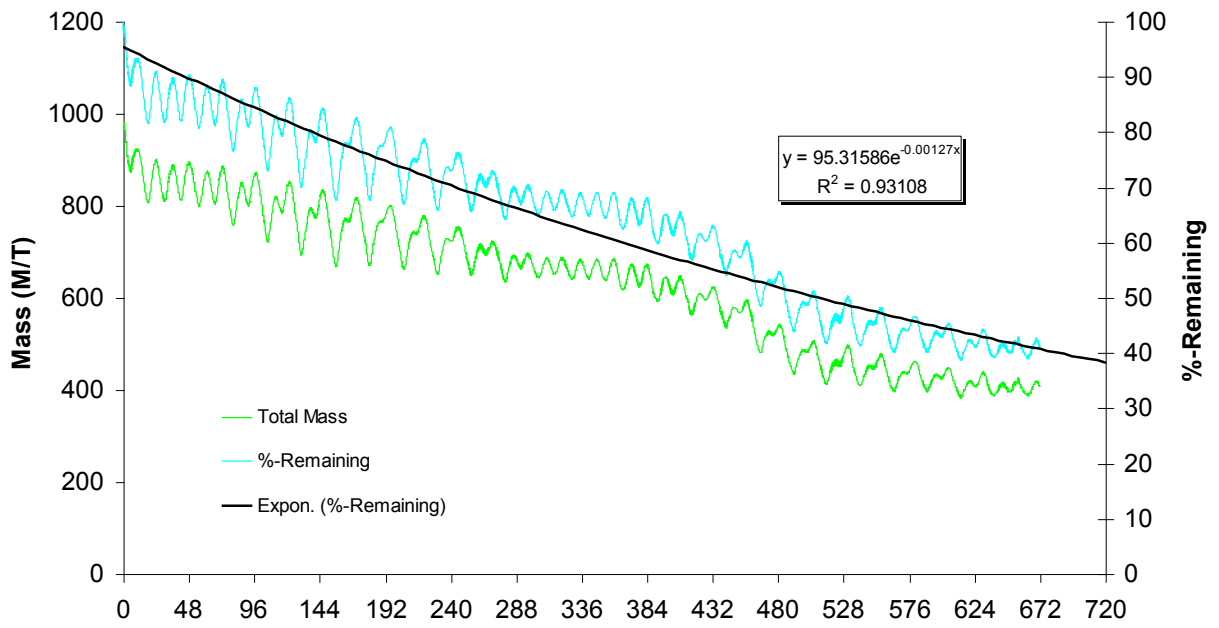

Figure D - 3. Time series of remaining conservative tracer mass in the main stem of the LPR for a combined Arcadia – Joshua - Horse flow rate of 154 cfs.

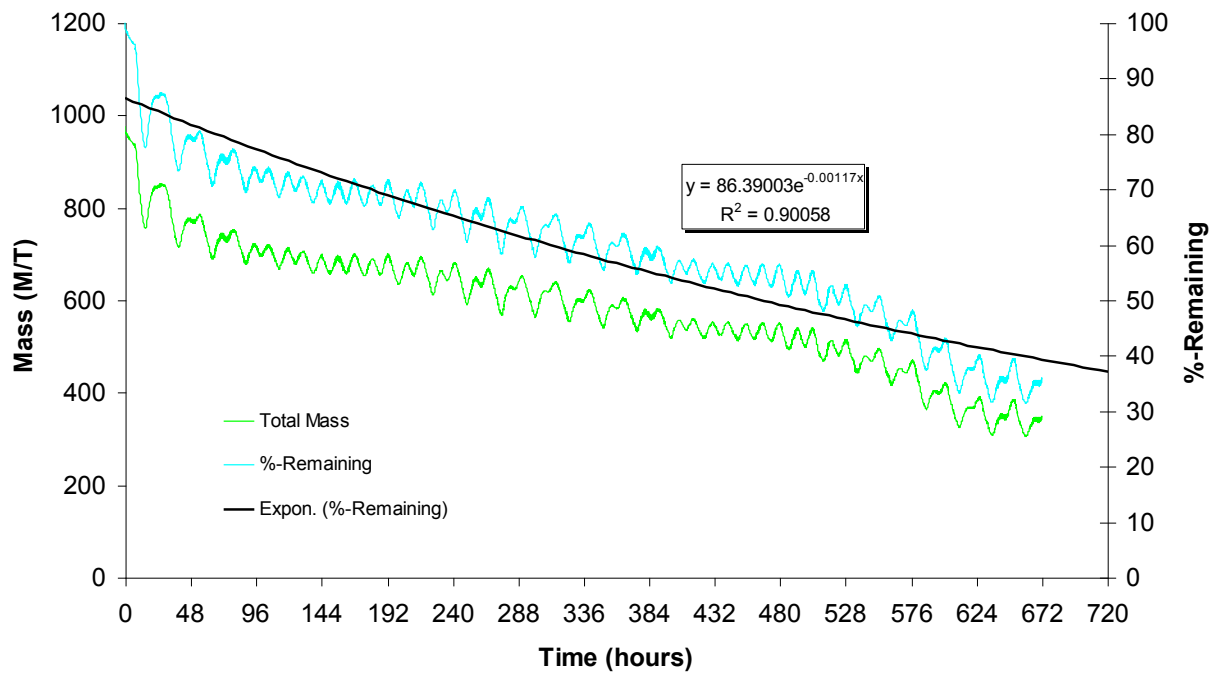

Figure D - 4. Time series of remaining conservative tracer mass in the main stem of the LPR for a combined Arcadia – Joshua - Horse flow rate of 199 cfs.

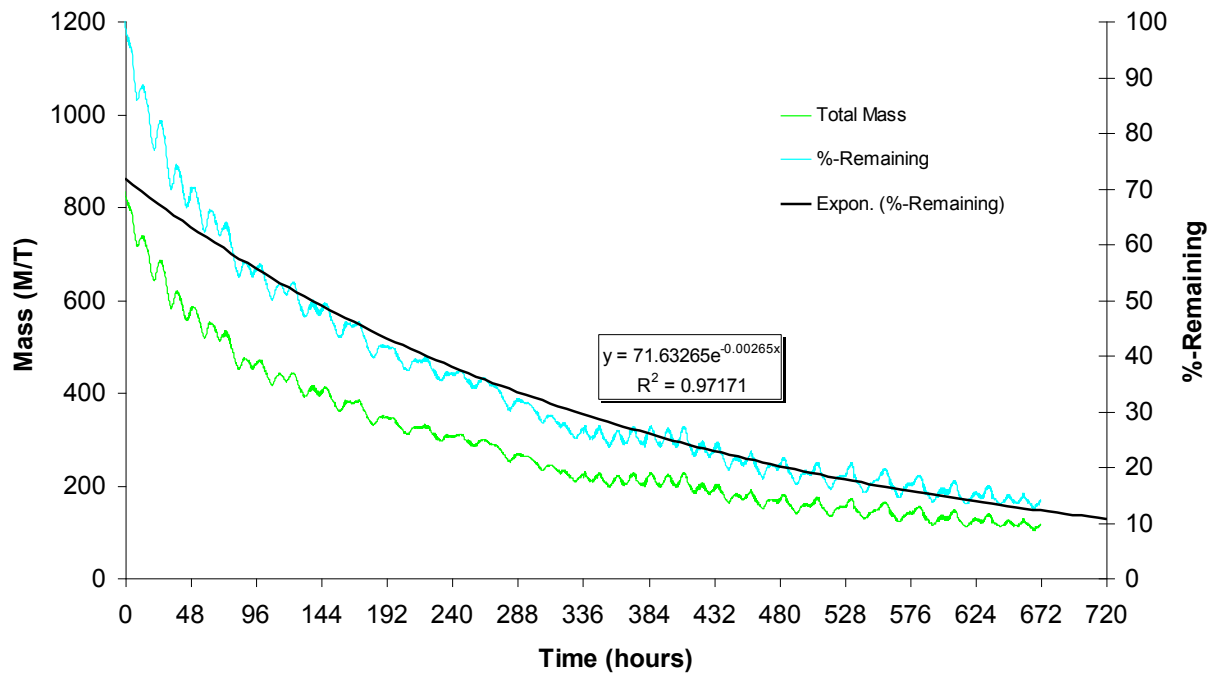
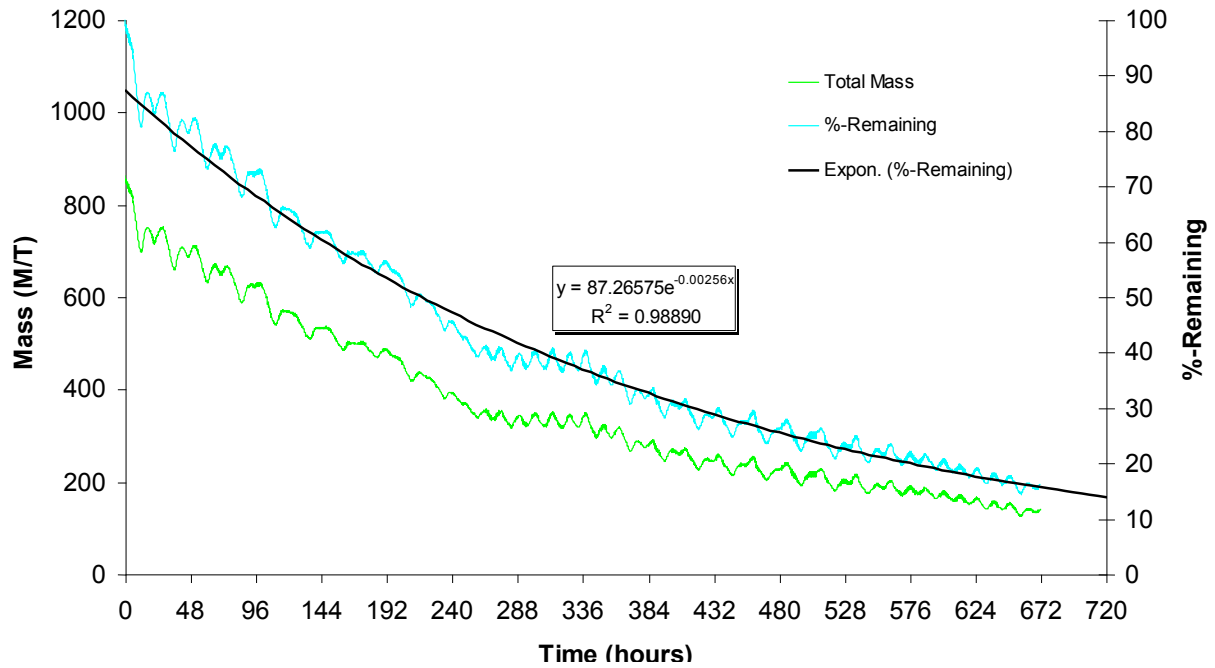

Figure D - 6. Time series of remaining conservative tracer mass in the main stem of the LPR for a combined Arcadia – Joshua - Horse flow rate of 281 cfs.

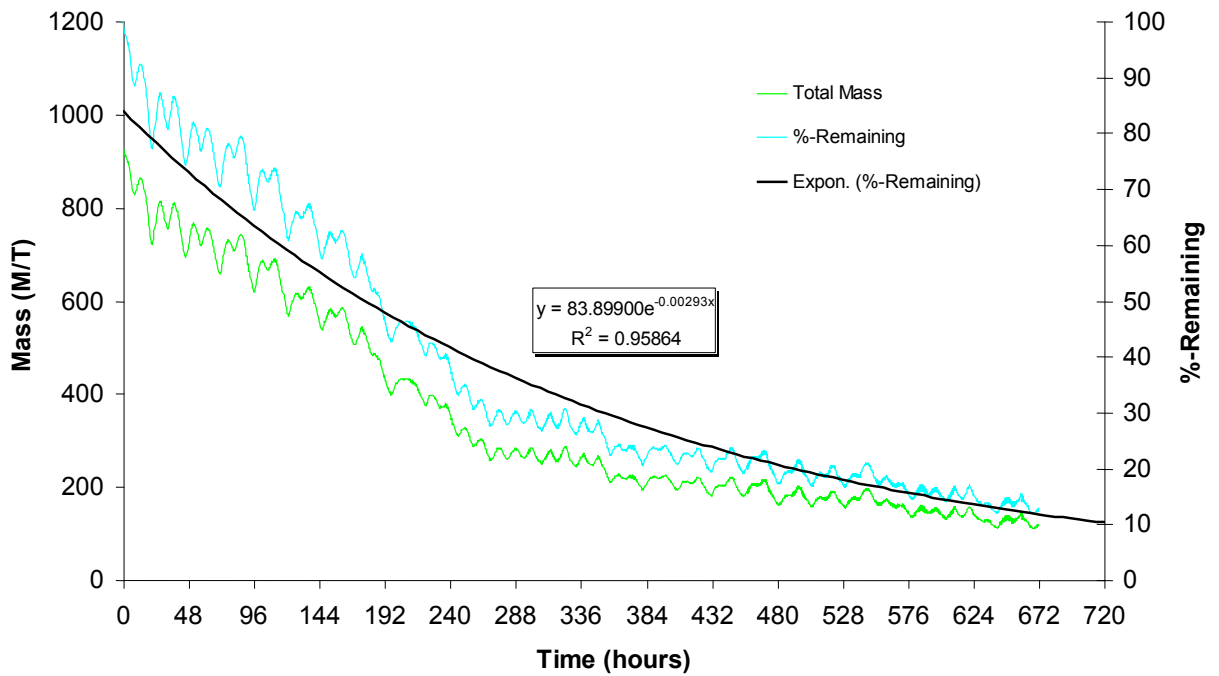
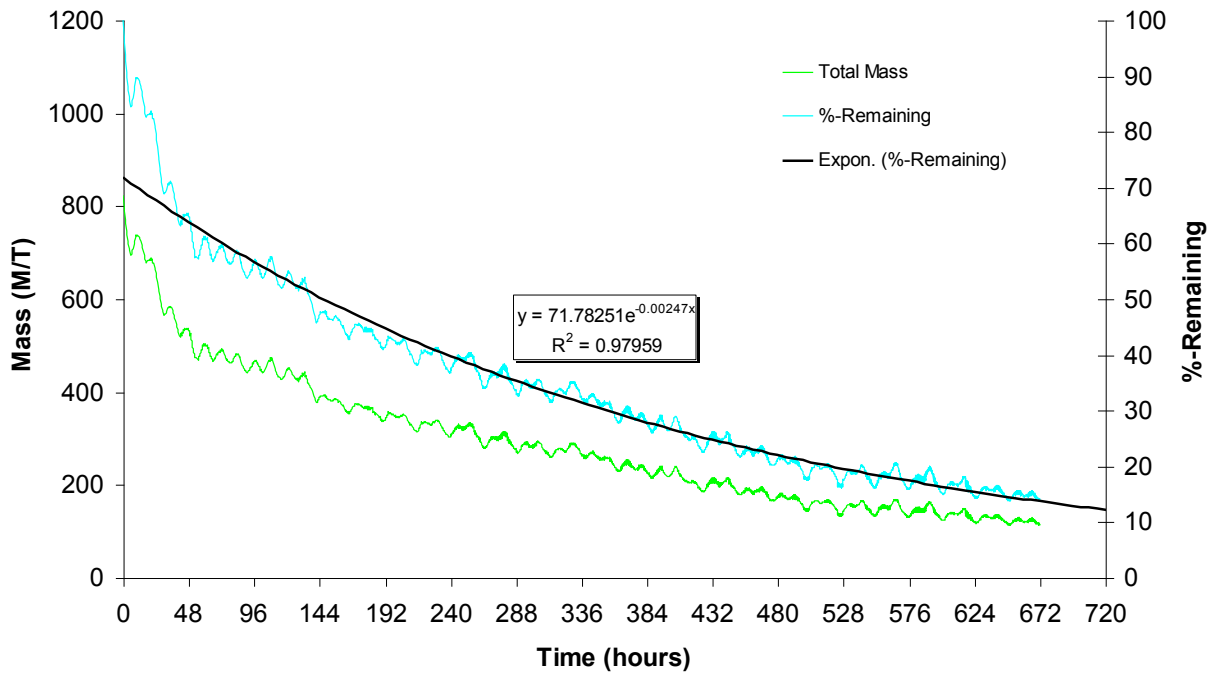

Figure D - 8. Time series of remaining conservative tracer mass in the main stem of the LPR for a combined Arcadia – Joshua - Horse flow rate of 391 cfs.

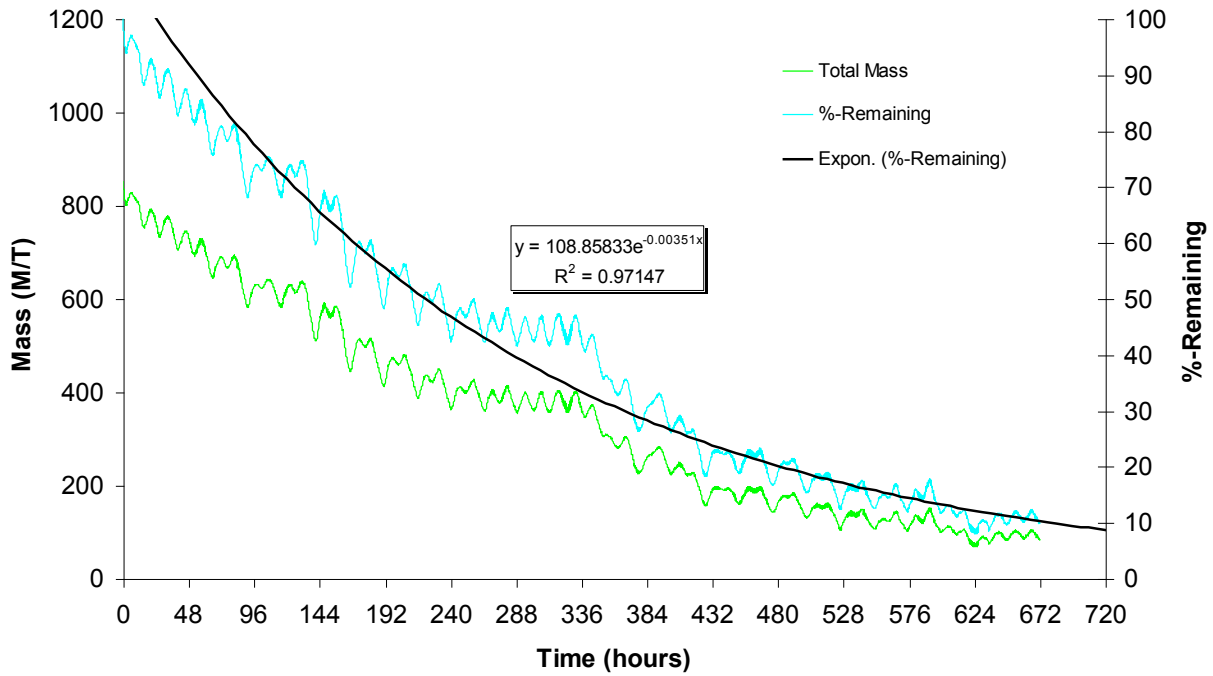
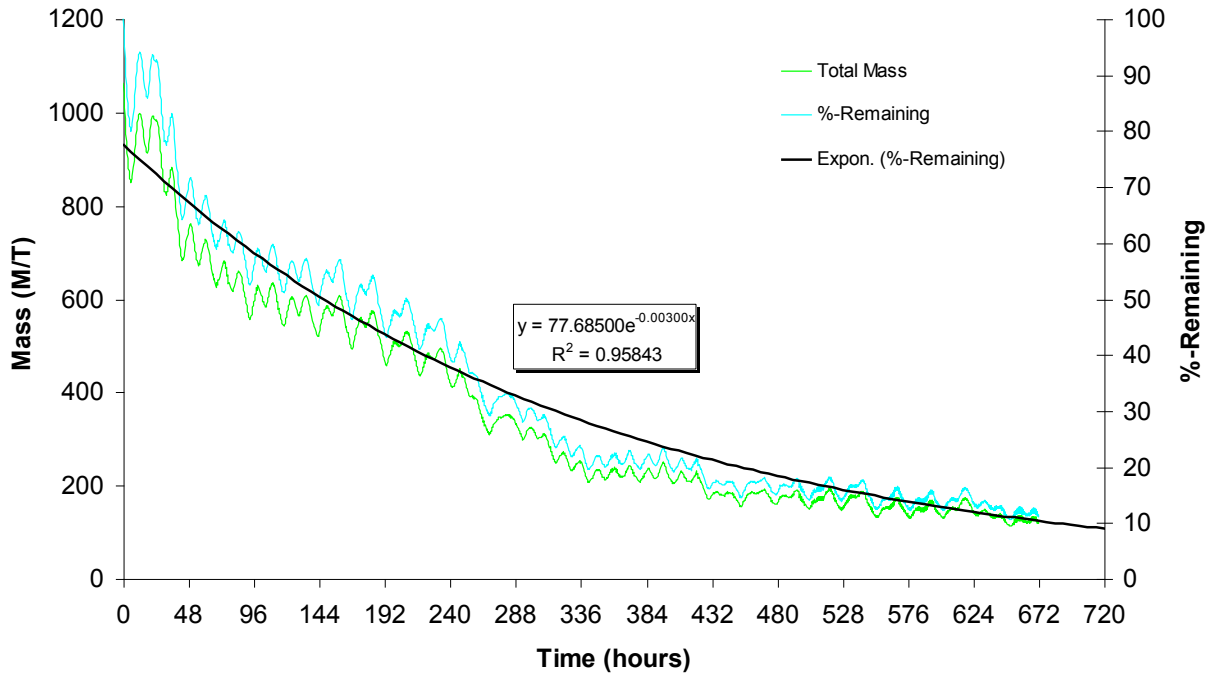

Figure D - 10. Time series of remaining conservative tracer mass in the main stem of the LPR for a combined Arcadia – Joshua - Horse flow rate of 544 cfs.

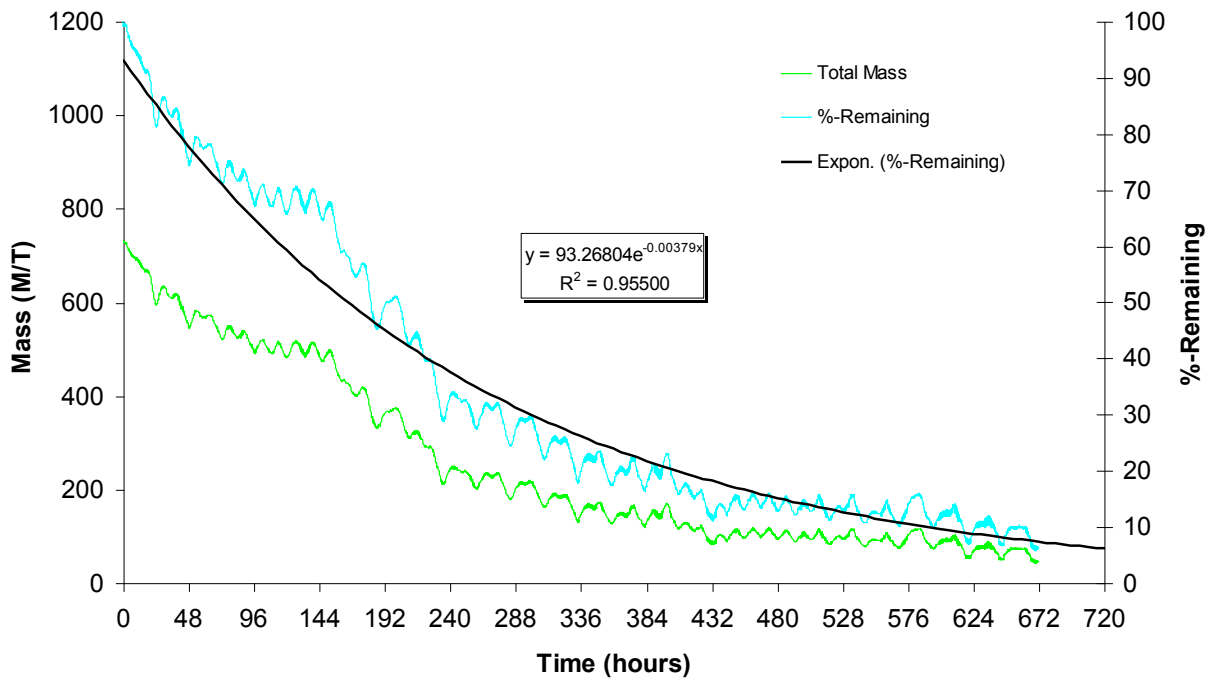

Figure D - 11. Time series of remaining conservative tracer mass in the main stem of the LPR for a combined Arcadia – Joshua - Horse flow rate of 644 cfs.

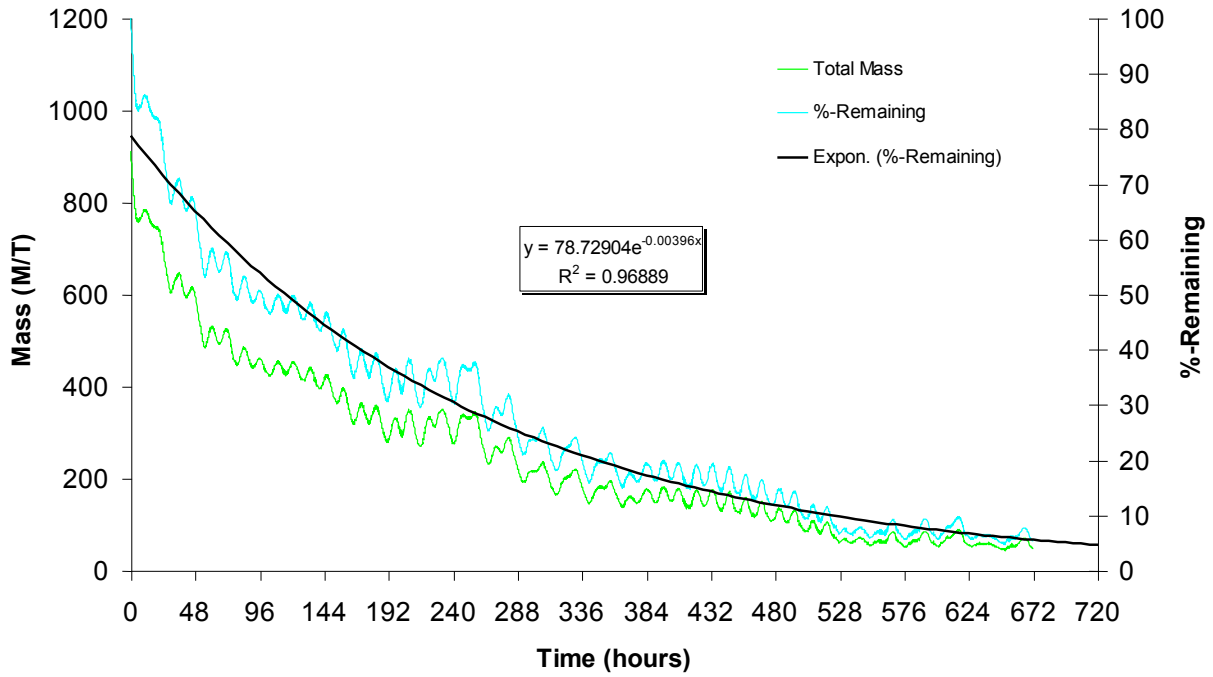

Figure D - 12. Time series of remaining conservative tracer mass in the main stem of the LPR for a combined Arcadia – Joshua - Horse flow rate of 939 cfs.

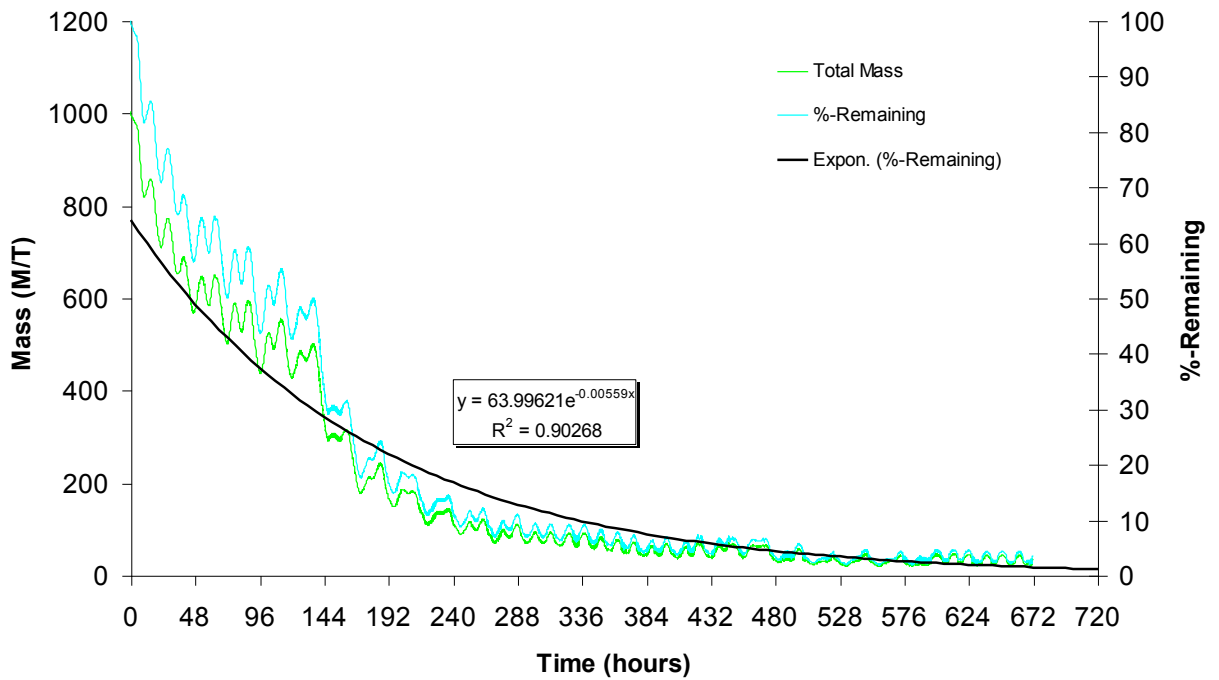
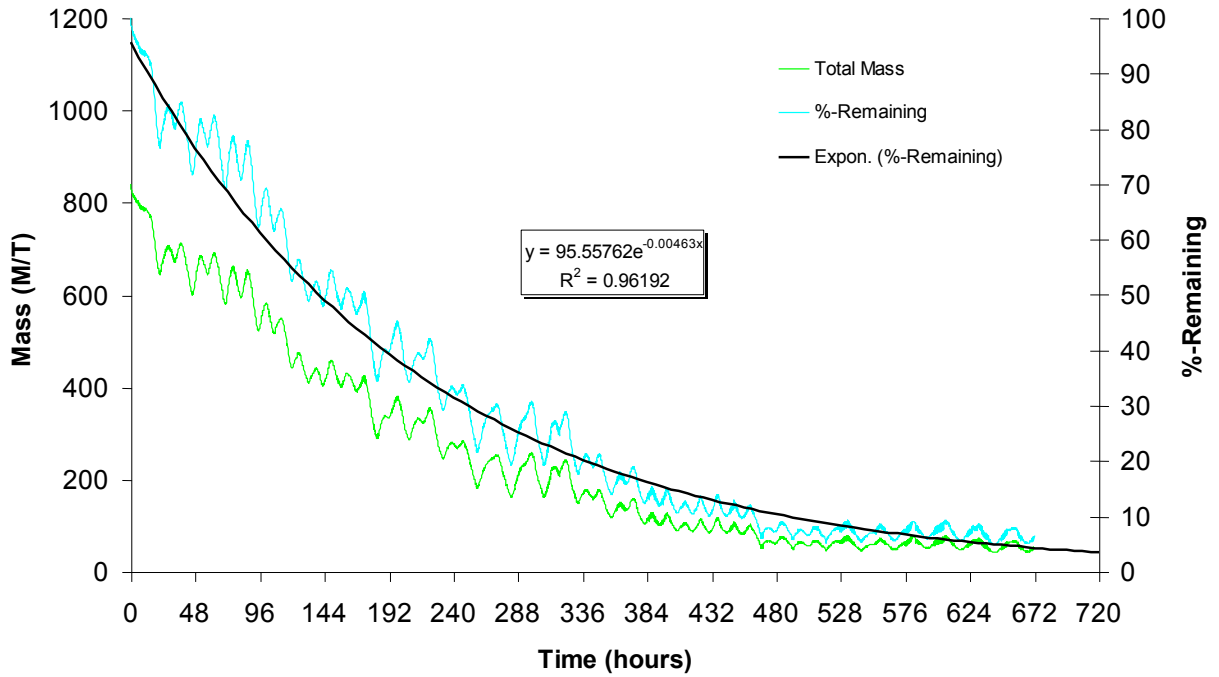

Figure D - 14. Time series of remaining conservative tracer mass in the main stem of the LPR for a combined Arcadia – Joshua - Horse flow rate of 2256 cfs.

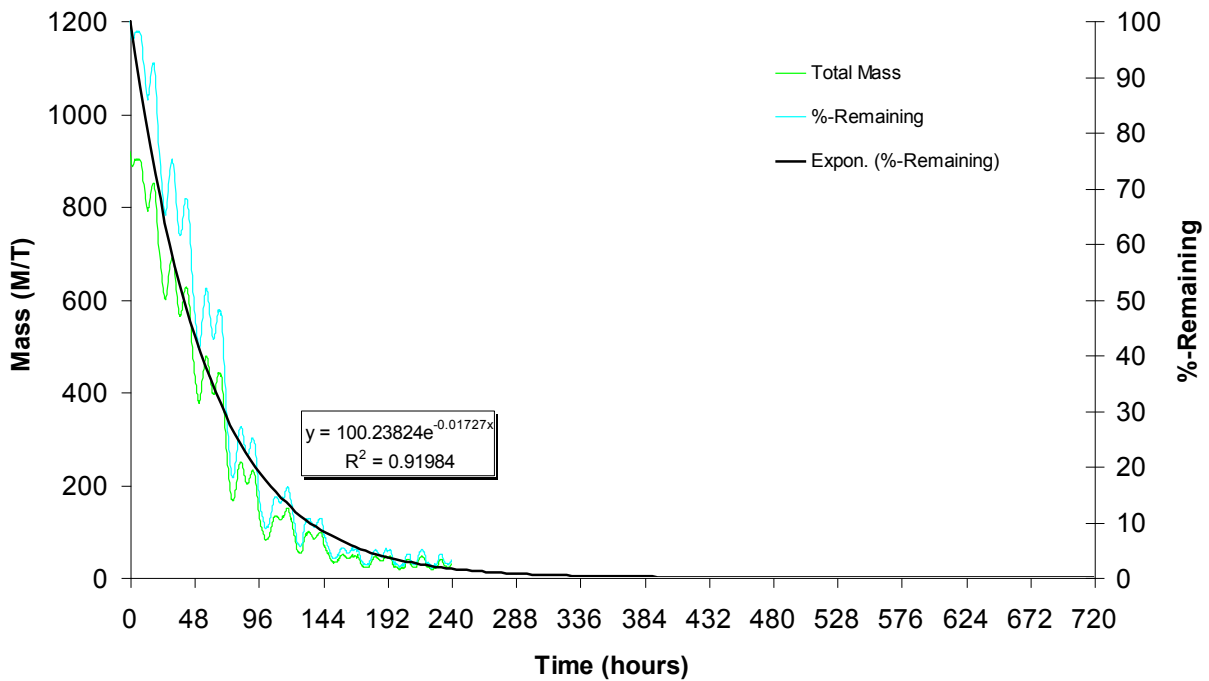
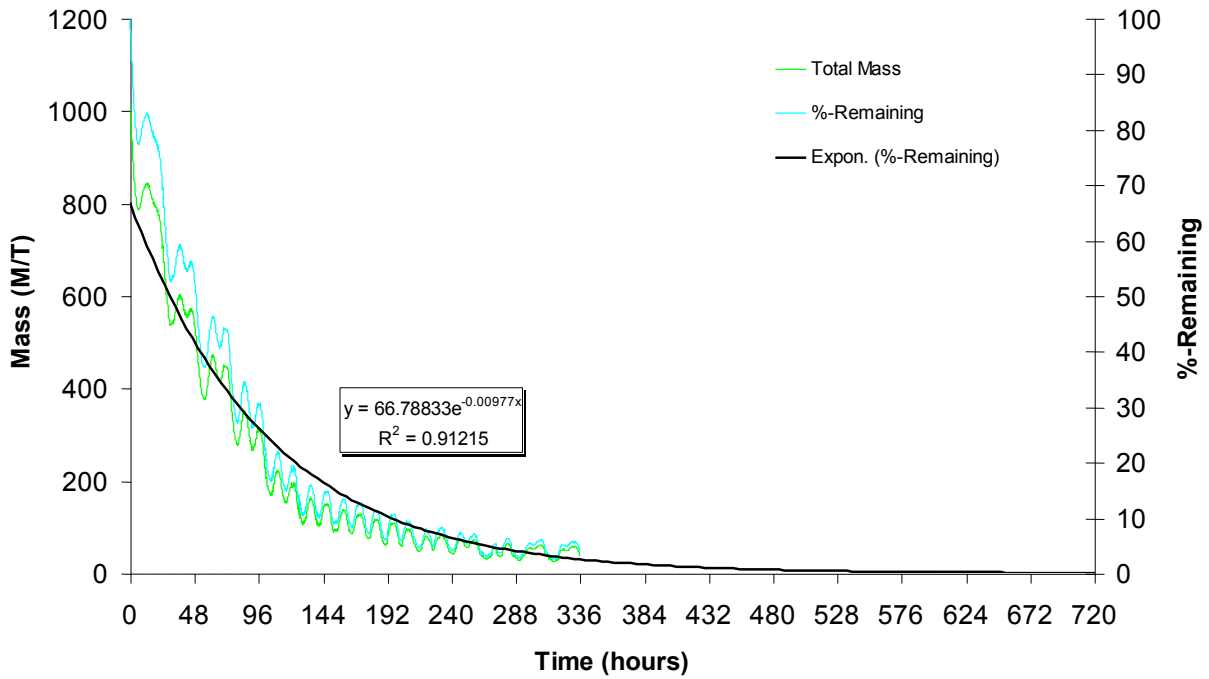

Figure D - 16. Time series of remaining conservative tracer mass in the main stem of the LPR for a combined Arcadia – Joshua - Horse flow rate of 9340 cfs.

Appendix 6A

- LIST 1. Taxonomic list of shoreline species from the tidal Myakka River from (Hussey, 1985).
- LIST 2. Wetland plant species and species with wetland affinities in the tidal Myakka River from (Estevez et al. 1990).
- LIST 3. Master wetland and shoreline plant species list in the tidal Myakka River from Clewell et al. (2002).
- LIST 4. Submerged Aquatic Vegetation in the Tidal Myakka River, adapted from Hussey (1986) and Estevez et al. (1990).
- LIST 5. Combined Species List of Wetland and Shoreline Plant Species in the Tidal Myakka River.

LIST 1. Taxonomic list of shoreline species from the tidal Myakka River from (Hussey, 1985).

Acrostichum danaeifolium
Ampelopsis arborea
Andropogon perangustatus
Andropogon glomeratus
Avicennia germinans
Baccharis glomeruliflora
Baccharis halimifolia
Batis maritima
Borrchia frutescens
Caesalpinia crista
Callicarpa americana
Chloris glauca
Cicuta mexicana
Cladium jamaicense
Coccoloba uvifera
Conocarpus erectus
Crinum americanum
Distichlis spicata
Erythrina herbacea
Eugenia axillaris
Eupatorium sp.
Fimbristylis castanea
Fraxinus caroliniana
Galactia macreei
Heterotheca subaxillaris
Hypericum h. hypericoides
Ilex sp.
Ipomea sagittaria
Iva frutescens
Juncus roemerianus
Juniperus silicicola
Laguncularia racemosa
Limonium carolinianum
Lycium carolinianum
Lythrum lineare
Melanthera nivea
Myrica cerifera
Parthenocissus quinquefolia
Phlebodium aureum

Pinus elliottii
Pluchea purpurascens
Polypodium polypodioides
Pterocaulon pycnostachyum
Quercus v. virginiana
Quercus laurifolia
Rhizophora mangle
Rumex vertiallatus
Sabal palmetto
Salix caroliniana
Scaevola plumieri
Schrankia microphylla
Scirpus validus
Serenoa repens
Sesuvium portulacastrum
Solidago sempervirens
Solidago fistulosa
Spartina patens
Spartina alterniflora
Spartina bakeri
Stenataphrum secundum
Toxicodendron r. radicans
Typha domingensis
Vittaria lineata
Yucca aloifolia
Zamia floridana

LIST 2. Wetland plant species and species with wetland affinities in the tidal Myakka River from (Estevez et al. 1990).

Acrostichum aureum
Acrostichum danaeifolium
Alternanthera philoxeroides
Amaranthus floridanus
Aster caroliniensis
Avicennia germinans
Baccharis halimifolia
Bacopa caroliniana
Bacopa monnieri
Ceratophyllum demersum
Ceratopteris pteridoides
Chara sp.
Cladium jamaicensis
Conocarpus erectus
Coreopsis sp.
Crinum americanum
Dichromena sp.
Distichlis spicata
Eleocharis baldwinii
Eleocharis cellulosa
Hydrilla verticillata
Hydrocotyle umbellata
Hygrophila polysperma?
Hypericum fasciculatum
Iris sp.
Iva frutescens
Juncus effusus
Juncus roemerianus
Laguncularia racemosa
Ludwigia repens
Ludwigia peruviana
Micranthemum glomeratum
Mikania scandens
Osmunda regalis
Panicum spp.
Panicum hemitomon
Paspalum sp.
Polygonum punctatum
Pontederia lanceolata
Proserpinaca pectinata
Rhizophora mangle
Rhyncospora tracyi

Ruppia maritima
Sagittaria graminea
Sagittaria lancifolia
Sagittaria latifolia
Sagittaria subulata
Samolus ebracteatus
Scirpus validus
Spartina alterniflora
Spartina bakeri
Spartina patens
Typha latifolia
Utricularia sp.
Vallisneria neotropicalis
Vigna luteola

LIST 3. Master wetland and shoreline plant species list in the tidal Myakka River from Clewell et al. (2002).

Acrostichum aureum
Acrostichum danaeifolium
Alternanthera philoxeroides
Ampelopsis arborea
Aster carolinianus
Avicennia germinans
Bacopa monnieri
Blutaparon vermiculare
Borrichia frutescens
Carex lupulina
Cephalanthus occidentalis
Cicuta maculata
Cladium jamaicense
Conocarpus erectus
Crinum americanum
Diodia virginiana
Distichlis spicata
Eleocharis flavescens
Ficus aurea
Gratiola virginiana
Hydrocotyle umbellata
Hypericum mutilum
Iris hexagona
Isoetes flaccida
Iva frutescens
Juncus megacephalus
Juncus roemerianus
Laguncularia racemosa
Lobelia feayana
Ludwigia repens
Lythrum alatum
Mikania scandens
Panicum rigidulum
Pluchea odorata
Polygonum hydropiperoides
Pontederia cordata
Rhizophora mangle
Rhynchospora colorata
Rumex verticillatus
Sabal palmetto
Sabatia calycina
Sagittaria subulata

Sagittaria lancifolia
Salix caroliniana
Samolus valerandi
Schinus terebinthifolius
Scirpus californicus
Scirpus tabernaemontani
Senecio glabellus
Sesuvium portulacastrum
Solidago stricta
Spartina bakeri
Spartina patens
Spartina alterniflora
Teucrium canadense
Typha domingensis
Urochloa mutica

LIST 4. Submerged Aquatic Vegetation in the Tidal Myakka River, adapted from Hussey (1986) and Estevez et al. (1990).

Ceratophyllum demersum
Eleocharis geniculata
Eleocharis baldwinii
Halodule wrightii
Nitella sp.
Ruppia maritima
Sagittaria subulata
Vallisneria americana

LIST 5. Combined Species List of Wetland and Shoreline Plant Species in the Tidal Myakka River.

Acrostichum danaeifolium
Acrostichum aureum
Alternanthera philoxeroides
Amaranthus floridanus
Ampelopsis arborea
Andropogon perangustatus
Andropogon glomeratus
Aster caroliniensis
Avicennia germinans
Baccharis glomeruliflora
Baccharis halimifolia
Bacopa monnieri
Bacopa caroliniana
Batis maritima
Blutaparon vermiculare
Borrchia frutescens
Caesalpinia crista
Callicarpa americana
Carex lupulina
Cephalanthus occidentalis
Ceratophyllum demersum
Ceratopteris pteridoides
Chara sp.
Chloris glauca
Cicuta maculata
Cladium jamaicensis
Coccoloba uvifera
Conocarpus erectus
Coreopsis sp.

Crinum americanum
Dichromena sp.
Diodia virginiana
Distichlis spicata
Eleocharis baldwinii
Eleocharis cellulosa
Eleocharis flavescens
Erythrina herbacea
Eugenia axillaris
Eupatorium sp.
Ficus aurea
Fimbristylis castanea
Fraxinus caroliniana
Galactia macreei
Gratiola virginiana
Halodule wrightii
Heterotheca subaxillaris
Hydrilla verticillata
Hydrocotyle umbellata
Hygrophila polysperma
Hypericum fasciculatum
Hypericum mutilum
Hypericum h. hypericoides
Ilex sp.
Ipomea sagittaria
Iris sp.
Iris hexagona
Isoetes flaccida
Iva frutescens
Juncus effusus
Juncus megacephalus
Juncus roemerianus
Juniperus silicicola
Laguncularia racemosa
Limonium carolinianum
Lobelia feayana
Ludwigia peruviana
Ludwigia repens
Lycium carolinianum
Lythrum alatum
Lythrum lineare
Melanthera nivea
Micranthemum glomeratum
Mikania scandens

Myrica cerifera
Nitella sp.
Osmunda regalis
Panicum hemitomom
Panicum rigidulum
Parthenocissus quinquefolia
Paspalum sp.
Phlebodium aureum
Pinus elliotii
Pluchea odorata
Pluchea purpurascens
Polygonum hydropiperoides
Polygonum punctatum
Polypodium polypodioides
Pontederia cordata
Pontederia lanceolata
Proserpinaca pectinata
Pterocaulon pycnostachyum
Quercus v. virginiana
Quercus laurifolia
Rhizophora mangle
Rhynchospora colorata
Rhynchospora tracyi
Rumex verticillatus
Ruppia maritima
Sabal palmetto
Sabatia calycina
Sagittaria graminea
Sagittaria lancifolia
Sagittaria latifolia
Sagittaria subulata
Salix caroliniana
Samolus ebracteatus
Samolus valerandi
Scaevola plumieri
Schinus terebinthifolius
Schrankia microphylla
Scirpus californicus
Scirpus tabernaemontani
Scirpus validus
Senecio glabellus
Serenoa repens
Sesuvium portulacastrum
Solidago fistulosa

Solidago sempervirens
Solidago stricta
Spartina alterniflora
Spartina bakeri
Spartina patens
Stenotaphrum secundatum
Teucrium canadense
Toxicodendron r. radicans
Typha domingensis
Typha latifolia
Urochloa mutica
Utricularia sp.
Vallisneria americana
Vigna luteola
Vittaria lineata
Yucca aloifolia
Zamia floridana

Appendix 6B

GIS and related field methods for the mapping and characterization of river shorelines, vegetation, and land use

GIS and related field methods for the mapping and characterization of river shorelines, vegetation and land use

A Myakka River GIS was developed within ArcGIS Version 9.1 using data representing the river's bathymetry and associated landuse from a variety of sources. After acquisition, data with a shapefile native format were converted horizontally using the projected coordinate system NAD1983 UTM Zone 17N as necessary. Data in other formats (e.g. relational database) were imported into the GIS and then exported as shapefiles using the same projection criteria. New *in situ* data collected during a "windshield" survey (see below) are also included in the GIS. All manipulations of the data were conducted using tools (e.g. Spatial Analyst) available in the ArcGIS Toolbox.

Landuse data represented either as raster (grid) or vector ArcGIS shapefiles were found for each of seven years. Each landuse shapefile was assessed for completeness and accuracy by comparing individual layers with modern aerial photographs (2004 DOQQ). Because the 1999 landuse cover supercedes all those that precede it (1967, 1994, and 1995) we found that it best represented the Myakka River as it is today. The 2002 landuse classification was not chosen because it represents a prediction of what landuse in 2002 might be based on probable changes, and the 2003 landuse cover was not adequately documented to be usable. In addition, we located and acquired a variety of wetlands studies that could be used to better describe the Myakka River's wetlands. These data were used for the most part to increase our understanding of individual wetland communities and their constituent species at a level of resolution greater than the scope of this study.

To ensure compatibility between shapefile layers, we extracted the river's shorelines from the 1999 landuse shapefile. The river was split into 41 segments defined by river kilometer (RK) using data provided by the District. Kilometer polygon segments were produced using the river centerline and 100m points provided by the district. At each half-kilometer point, a line was digitized that ran perpendicular to the centerline segment directly downstream of it, using the heads-up digitizing capabilities of ArcGIS. This line was extended from shoreline to shoreline. A polygon was then derived from these perpendicular lines and the river shoreline. It should be noted that in some regions of the river, segments do not include both shorelines due to curvature of the river. Note that river kilometer polygons are not of equal size because of the sinuosity of the river. The shoreline of each segment was classified by FLUCCS category (Levels 1 through 4) by extracting the appropriate classification from the 1999 Landuse shapefile with modifications made as needed based on a review of other landuse shapefile and natural color aerial photographs. Differences in the proportion of shoreline by river kilometer and shoreline position were computed. A database was created that includes RK, FLUCCS categories, segment endpoint positions, segment lengths, etc.

A dominant feature along the shorelines of the middle reach of the river (RK21 through RK30) is the presence of low-lying natural levees. These serve to separate and entrain the contiguous wetlands from the river proper. A secondary feature of the levee system is breaks, which we hypothesized was essential in linking levee-entrained wetlands to the river. Subsequently we conducted a “windshield” survey of the river from RK21 (lower extent of the levee system) to the I-75 Bridge (RK30), which marks the upper extent of the levee system. The survey was conducted from a small boat moving slowly along the river taking care to note each potential levee break. These were investigated and if proven to be an actual break were spatially registered using a WAAS-enabled GPS, both at their upstream and downstream points. Each was also digitally photographed. All shorelines associated with the main channel of the river including bayou shorelines were included in the survey. These data were imported into MRGIS and converted to a shapefile for use in assigning wetland areas to the appropriate river kilometer.

Several levee breaks were found within the area we surveyed. In some cases, the levee breaks found were small (~1m wide) and probably serve only to drain the associated wetland following a flood event. Other observed levee breaks were large (1 to many meters wide) that while dry during low tides probably represent less ephemeral connections to entrained wetlands. Still other breaks are “wet” in that even at low tide they maintain a connection with their associated wetland.

Although too small to be detected reliably from aerial photographs, and too small to be defined at a FLUCCS level 4, many marshes are present along the river’s shorelines either as small isolated marshes, larger pocket marshes, or fringing marshes either separating upland forests from the river or found on points fronted by intertidal sand/mudflats.

As noted in Figure 5-14 wetlands were distributed both linearly and areally across the study area (RK0 through RK41). Of this the most common (in terms of areal extent) wetland type seen was saltwater marsh followed by mangrove swamps, upland forests (coniferous then hardwoods), and freshwater marshes. Upland coniferous forests were most commonly distributed across the study area with this category being found at 19 km. Saltmarsh has similar distribution (18 km) followed by upland hardwoods (12 km), mangrove swamps (11 km), and freshwater marshes (4 km).

Although mangrove swamps were seemingly restricted to the lower reaches of the river (RK0 through RK14) mangroves were seen above RK15. Specifically, we found a red mangrove sapling at RK22.

Appendix 6C

Annotated bibliography of additional literature on the effects of salinity on oligohaline and tidal freshwater marsh species and communities

Annotated bibliography of additional literature on the effects of salinity on oligohaline and tidal freshwater marsh species and communities

Baldwin, A.H., K.L. McKee, and I.A. Mendelssohn. 1996. The influence of vegetation, salinity, and inundation on seed beds of oligohaline coastal marshes. *American Journal of Botany* 83(4): 470-479.

Seed bed experiments from three types of oligohaline marshes demonstrated that flooding and salinity are important determinants of germination and plant community structure. Effects were greatest under conditions of concurrent increases in flooding and salinity, inhibiting seedling emergence in most of the seed banks studied. For salinity effects alone, short-term salinity pre-treatments simulating storm events had little effect compared to increased germination salinities. Few species germinated at salinities greater than 4 ppt. Results indicate that oligohaline marshes can recover from episodic salinity increases but are affected by elevated germination salinities. Several authors have noted the inhibitory effects of increased salinity (Baldwin et al., 1996).

Brewer, J.S. and J.B. Grace. 1990. Plant community structure in an oligohaline tidal marsh. *Plant Ecology* 90:93-107.

In explaining the spatial structure of an oligohaline tidal marsh system at Lake Pontchartrain, Brewer and Grace (1990) found that the most salt tolerant species, *Spartina patens*, was closest to the lake, followed by *Sagittaria lancifolia* and finally *Cladium jamaicense*. Although *Cladium* had the least salt tolerance of the 3 species, gradients in low ambient soil salinities (<5 ppt) across the area could not be related to species distributions. Distance from the lake, elevation, and soil organic content were better correlated with species ranges, leading to the hypothesis that species distributions are regulated by irregular storm-generated salt pulses that generate strong, short-lived salinity gradients related to distance from the lake.

Crain, C.M., B.R. Silliman, S.L. Bertness and M.D. Bertness. 2004. Physical and biotic drivers of plant distribution across estuarine salinity gradients. *Ecology* 85: 2539-2549.

When freshwater marsh plants were transplanted into salt marshes, they did poorly and generally died with or without neighboring salt marsh plants nearby. When saltmarsh plants were transplanted into freshwater marshes, they thrived in the absence of freshwater marsh neighbors and grew better than they did in their original salt marshes. However, when freshwater marsh neighbors were present, the transplanted saltwater plants were strongly suppressed. These results indicate that competitively superior freshwater marsh plants displace salt-tolerant plants to physically harsh saltmarsh environments, but that freshwater marsh plants are limited from living in salt marshes by high salinities (Crain et al., 2004).

Howard, R.J. and I.A. Mendelssohn. 1999. Salinity as a constraint on growth of oligohaline marsh macrophytes. I. Species variation in stress tolerance. *American Journal of Botany* 86(6): 785-794.

Increased salinity can affect marsh plant growth by imposing water stress and/or accumulating ions or plant toxins in the soil or plant tissues. Greenhouse experiments with four oligohaline marsh species investigated the effects of the rate of salinity increase compared to the final salinity reached, in terms of plant decline and mortality. *Sagittaria lancifolia* was the first species to show early stress signs but *Panicum hemitomon* had the highest aboveground tissue mortality rate with prolonged exposure. For all species, the final salinity affected all species to a greater degree than the rate of salinity increase. Although no aboveground mortality occurred at 6 ppt, growth suppression was evident at that salinity and the effect increased with duration of exposure. For all response variables, species ranked from least to most salt tolerant were *Panicum* < *Sagittaria* < *Eleocharis palustris* < *Scirpus americanus* (Howard and Mendelssohn, 1999).

Latham, P.J., L.G. Pearlstine and W.M. Kitchens. 1991. Spatial distributions of the softstem bulrush, *Scirpus validus*, across a salinity gradient. *Estuaries* 14(2): 192-198.

Spatial patterns of bulrushes may reflect the number and kind of factors regulating their presence and abundance. In the Savannah River, mean soils salinities of < 2 ppt are regarded tidal freshwater; 2-3 ppt is mildly oligohaline; 5 ppt is strongly oligohaline, and 10 ppt is mesohaline. Marshes associated with these salinity ranges also vary, with means of 18 species in tidal freshwaters (many annuals), compared to 7 in mildly and only 4 species in strongly oligohaline reaches. Patchiness of *Scirpus* in these marshes also varies greatly, indicating that multiple factors influence the dispersion of bulrushes. When tidal freshwater systems experience increased salinity *Scirpus* becomes dominant, but if salinity continues to increase *Scirpus* is replaced by *Spartina alterniflora* (Latham et al., 1991).

Odum, W.E. 1988. Comparative ecology of tidal freshwater and salt marshes. *Annual Review Ecology and Systematics* 19:147-76.

Tidal freshwater marshes occur by definition where the mean annual salinity is less than or equal to 0.5 ppt. Oligohaline waters have mean annual salinity ranges of 0.5-5.0 ppt and mesohaline waters range from 5.0 to 18.0 ppt. Compared to salt marshes, distinguishing features of tidal freshwater marshes include high species diversity, low species dominance, zonation present but not pronounced, much species overlap, seasonal sequencing of species dominance, and reproduction by sexual as well as asexual means. Tidal freshwater marshes are principally methane releasers whereas salt marshes are mostly emitters of sulfide gases. Compared to salt marshes, tidal freshwater marshes support higher diversities of amphibians, reptiles, and fur-bearing mammals (Odum, 1988).

Pearlstine, L.G., W.M. Kitchens, P.J. Latham, and R.D. Bartleson. 1993. Tide gate influences on a tidal marsh. *Water Resources Bulletin* 29(6): 1009-1020.

Construction of a tide gate at the mouth of the north channel of the Savannah River in Georgia has caused significant changes in salinities influencing marsh community changes. The tide gate is directly responsible for a 2 to 6 mile upstream displacement of salt water in the river. In the marsh, soil salinities ranged from 0 ppt at upstream sites to 12 ppt at downstream sites when the tide gate was in operation. Within two months with the tide gate out of operation, interstitial salinities at the downstream site dropped to 4 ppt. Influences of the tide gate on marsh vegetation were modeled in a geographic information system. With the tide gate out of operation the model predicts that freshwater marsh would increase in area by 340 percent.

Perry, J.E. and R.B. Atkinson. 1997. Plant diversity along a salinity gradient of four marshes on the York and Pamunkey Rivers in Virginia. *Castanea* 62(2): 112-118.

The York River maintains a salinity gradient extending from fresh water to 22 ppt. Four marshes corresponding to polyhaline, mesohaline, oligohaline, and tidal freshwater salinities were divided into three floristic divisions: halophytic (obligate and facultative halophytes), brackish (facultative halophytes), and freshwater (glycophytes). Species diversity was highest and species importance values (a measure of dominance) were lowest in the tidal freshwater marsh where salinities ranged from 0.0-5.0 ppt. Species diversity in the oligohaline reach, where salinities ranged from 0.5-8.0 ppt, was 84 percent lower than tidal freshwater diversity, and species importance values were higher, signifying a threshold salinity range of 5.0-8.0 (Perry and Atkinson, 1997).

Webb, E.C. and I.A. Mendelssohn. 1996. Factors affecting vegetation dieback of an oligohaline marsh in coastal Louisiana: field manipulation of salinity and submergence. *American Journal of Botany* 83(11): 1429-1434.

Increasing interstitial salinity from freshwater to 4.6 ppt did not directly cause major mortality in a *Sagittaria lancifolia*-dominated oligohaline marsh community. However, increased inundation in the presence of marine waters caused a great decline in marsh growth because the sulfate in seawater is reduced to sulfide in reduced soils, and sulfide reduces freshwater plant growth by inhibiting NH₄-N uptake (Webb and Mendelssohn, 1996).

Wetzel, P.R., W.M. Kitchens, J.M. Brush and M.L. Dusek. 2004. Use of a reciprocal transplant study to measure the rate of plant community change in a tidal marsh along a salinity gradient. *Wetlands* 24(4): 879-890.

Transplant experiments involving reciprocal plantings across salinity gradients have shown that plant community structure and composition are significantly changed within 6 to 18 months of a salinity change; that 6 to 30 months were required for transplants to resemble surrounding marshes, and that other transplants never acclimated. The most rapid changes occurred when fresh or oligohaline transplants were moved into more saline areas (Wetzel et al., 2004).

Appendix 6D

Benthic species list for the Myakka River.

Dominant species from the middle section (RK 16 - RK 32) are in bold.

Benthic species list for the Myakka River.

Dominant species from the middle section (RK 16 - RK 32) are in bold.

PHYLUM NEMERTEA

Nemertea sp. F

Prostoma rubrum

CLASS POLYCHAETA

Sthenelais sp. A

Eteone heteropoda

Eumida sanguinea

Phyllodoce arenae

Podarkeopsis levifuscina

Ancistrosyllis jonesi

Sigambra tentaculata

Sigambra bassi

Exogone dispar

Neanthes succinea

Laeonereis culveri

Nephtys sp.

Glycera sp.

Glycera americana

Glycinde solitaria

Diopatra cuprea

Lumbrineris verrilli

Leitoscoloplos sp.

Aricidea philbinae

Aricidea taylori

Polydora sp.

Polydora ligni

Prionospio pygmaea

Paraprionospio pinnata

Streblospio gynobranchiata

Scolelepis texana

Carazziella hobsonae

Boccardiella sp.

Poecilochaetus johnsoni

Spiochaetopterus costarum

Capitella capitata

Heteromastus filiformis

Mediomastus ambiseta

Amphicteis gunneri

Pectinaria gouldii

Asychis elongata

CLASS OLIGOCHAETA

Eclipidrilus palustris

Tubificidae w/o cap. setae

Tubificidae w cap. setae

Limnodrilus hoffmeisteri

Aulodrilus pigueti

Tubificoides brownae

Haber speciosus

Slavina appendiculata

Pristina aequiseta

Pristina leidyi

Pristina synclites

Pristina unidentata

Dero flabelliger

Dero trifida

Dero digitata

Dero vaga

Dero lodeni

Nais communis

Nais elinguis

Nais cf. *pardalis*

Nais pardalis

Nais pseudobtusa

Allonais paraguayensis

Nais aequiseta

Stephensoniana trivandrana

Bratislavia unidentata

Piquetiella michiganensis

Crustipellis tribranchiata

Lumbriculus variegatus

PHYLUM MOLLUSCA

CLASS GASTROPODA

Batracobdella phalera
Helobdella sp.
Helobdella elongata
Helobdella stagnalis
Helobdella triserialis
Mooreobdella microstoma
Littoridinops monroensis
Assiminea succinea
Vitrinella helicoidea
Cyclostremiscus sp.
Caecum pulchellum
Melanoides tuberculata
Elimia sp.
Elimia sp. B
Diastoma varium
Bittium varium
Epitonium rupicola
Epitonium lamellosum
Crepidula sp.
Crepidula plana
Natica marochiensis
Polinices duplicatus
Astyris lunata
Mitrella lunata
Nassarius vibex
Eulimastoma sp.
Odostomia sp.
Odostomia seminuda
Turbonilla sp.
Turbonilla interrupta
Turbonilla conradi
Turbonilla dalli
Laevapex fuscus
Hebetancylus excentricus

Gyraulus parvus
Promenetus exacuus
Menetus sampsoni
Amphigyra cf. *alabamensis*
Biomphalaria glabrata
Planorbella duryi
Physella sp.
Anadara sp.

CLASS BIVALVIA

Amygdalum papyrium
Geukensia demissa
Ischadium recurvum
Crassostrea virginica
Elliptio buckleyi
Mysella planulata
Laevicardium mortoni
Mulinia lateralis
Rangia cuneata
Macra fragilis
Ensis minor
Macoma tenta
Macoma constricta
Tellina sp.
Tellina versicolor
Tellina alternata
Tellina texana
Tellina sp. A
Tagelus plebeius
Abra aequalis
Mytilopsis leucophaeata
Polymesoda caroliniana
Corbicula fluminea
Boonea impressa
Odostomia cf. *gibbosa*
Rictaxis punctostriatus
Acteocina canaliculata

PHYLUM CHELICERATA

Limulus polyphemus

PHYLUM CRUSTACEA

Podocopa sp. B

Podocopa sp. C

Mysidopsis almyra

Mysidopsis furca

Bowmaniella sp.

Bowmaniella floridana

Taphromysis louisianae

Taphromysis bowmani

Oxyurostylis smithi

Almyracuma sp.

Almyracuma nr. *proximoculae*

Cyclaspis pustulata

Cyclaspis varians

Cyclaspis sp. A

Hargeria rapax

Xenanthura brevitelson

Mesanthura floridensis

Mesanthura pulchra

Mesanthura paucidens

Amakusanthura magnifica

Exosphaeroma diminuta

Sphaeroma sp.

Sphaeroma terebrans

Erichsonella sp.

Erichsonella filiformis

Erichsonella crenulata

Edotea montosa

Edotea triloba

Haminoea succinea

Pisidium sp.

Sphaerium partumeium

Asthenothaerus hemphilli

Cymadusa compta

Acuminodeutopus naglei

Rudilemboides naglei

Batea cf. *catharinensis*

***Corophium* sp.**

Apocorophium lacustre

Apocorophium louisianum

Corophium ellisi

Erichthonius brasiliensis

Grandidierella bonnieroides

Bemlos sp.

Gammarus sp.

Gammarus tigrinus

Gammarus palustris

Gammarus mucronatus

Melita sp.

Dulichchiella appendiculata

Hyaella azteca

Listriella cf. *barnardi*

Lysianopsis alba

Podocerus cf. *brasiliensis*

Penaeus sp.

Penaeus duorarum

Leptocheila sp.

Palaemonetes sp.

Palaemonetes pugio

Alpheus heterochaelis

Alpheus normanni

Ambidexter symmetricus

Pagurus longicarpus

Munna reynoldsi

Ampelisca sp.

Ampelisca abdita

Ampelisca holmesi

Ampelisca sp. C

Ampelisca sp. B

Gitanopsis laguna

Hourstonius laguna

Pinnixa sp.

Pinnixa cf. *lunzi*

Pinnixa pearsei

Pagurus carolinensis

Euceramus praelongus

PHYLUM CRUSTACEA (CONT)

Upogebia affinis
Persephona mediterranea
Libinia dubia
Callinectes sapidus
Portunus gibbesii
Rhithropanopeus harrisii

PHYLUM UNIRAMIA

CLASS PTERYGOTA

Stenonema sp.
Stenonema exiguum
Stenacron interpunctatum
Procloeon viridocularis
Pseudocloeon sp.
Callibaetis floridanus
Choroterpes hubbelli
Tricorythodes albilineatus
Brachycercus sp.
Brachycercus maculatus
Caenis sp.
Caenis hilaris
Dromogomphus nr. *spinosus*
Macromia sp.
Ischnura sp.
Enallagma sp.
Nehalennia sp.
Argia tibialis

HETEROPTERA-HEMIPTERA

Peltodytes sp.
Brychius sp.
Hydrovatus sp.
Dineutus sp.

PHYLUM UNIRAMIA

CLASS PTERYGOTA

Stenonema sp.
Stenonema exiguum
Oecetis sp.
Oecetis sp. E
Oecetis inconspicua complex sp. A
Oecetis sp. A

Nectopsyche sp.
Polycentropus sp.
Neureclipsis sp.
Neureclipsis crepuscularis
Nyctiophylax sp.
Tetragoneura sp.
Chaoborus punctipennis
Atrichopogon sp.
Dasyhelea sp.
Bezzia/Palmpomyia spp.
Clinotanypus sp.
Clinotanypus pinguis
Coelotanypus sp.
Coelotanypus cf. *concinus*
Coelotanypus concinns
Coelotanypus tricolor
Ablabesmyia (Karelia) sp.
Ablabesmyia sp.
Ablabesmyia mallochi
Ablabesmyia parajanta
Labrundinia johannseni
Labrundinia neopilosella
Labrundinia pilosella
Larsia sp.
Berosus sp.
Stenelmis sp.
Dubiraphia sp.
Dubiraphia vittata

ORDER TRICHOPTERA

Cheumatopsyche sp.
Hydropsyche simulans
Hydroptila sp.
Oxyethira sp.
Orthotrichia sp.
Setodes sp.
Parakeifferiella sp.
Thienemanniella sp.
Pedionomus beackae

Axarus sp.
Chironomus sp.
Cladopelma sp.
Cryptochironomus sp.
Cryptochironomus fulvus
Cryptotendipes sp.
Demicryptochironomus sp.
Dicrotendipes sp.
Dicrotendipes neomodestus
Dicrotendipes tritonus
Einfeldia sp.
Glyptotendipes sp. B
Harnischia sp.
Lauterborniella agrayloides
Microtendipes sp.
Microtendipes pedellus gp.
Nilothauma sp.
Parachironomus sp.
Parachironomus alatus
Parachironomus arcuatus gp.
Parachironomus abortius/hirtatus
Paracladopelma camptolabis
Paralauterborniella nigrohalterale
Phaenopsectra flavipes
Polypedilum sp.
Polypedilum convictum
Polypedilum halterale
Polypedilum illinoense
Polypedilum scalaenum gp.
Stenochironomus sp.
Stictochironomus sp.
Monopelopia boliekae
Pentaneura sp.
Zavreliomyia sp.
Djalmabatista pulchra variant
Procladius sp.
Procladius nr. *adumbratus*
Procladius (Holotanypus) sp.
Tribelos jucundum
Chironomini Genus B
Chironomini (pupae)
Chironomini Genus A

Pseudochironomus sp.
Tanypus sp.
Corynoneura taris
Cricotopus sp.
Nanocladius minimus
Pseudochironomus sp. A
Cladotanytarsus sp.
Cladotanytarsus cf. *davies*
Cladotanytarsus vanderwulpi gp.
Micropsectra sp.
Nimbocera pinderi
Paratanytarsus sp.
Rheotanytarsus sp.
Stempellina sp.
Tanytarsus sp.
Tanytarsus (pupae) sp.
Tanytarsus cf. sp. Q
Tanytarsus sp. O
Tanytarsus sp. K
Notophilinae sp.
PHYLUM BRACHIOPODA
Glottidia pyramidata

Appendix 6E

Benthic Fauna Community Parameter Statistics. June, 2004.

Benthic Fauna Community Parameter Statistics. June, 2004.

River Km	Sample Type	Depth	Total Taxa	Total Ind	Ind/m ²	Shannon-Weiner Index H'			Pielou's Index	Margalef's Index	Simpson's Index	Gini's Index
						logE	log10	log2				
0	Core	Sub	26	183	44,033	2.55	1.11	3.68	0.78	4.80	0.11	0.89
0	Sweep	Sub	16	67	-	2.39	1.04	3.44	0.86	3.57	0.11	0.89
0	Core	Int	14	41	9,865	2.28	0.99	3.29	0.87	3.50	0.11	0.89
0	Sweep	Int	9	552	-	0.59	0.26	0.85	0.27	1.27	0.71	0.29
2	Core	Sub	14	38	9,143	2.26	0.98	3.26	0.86	3.57	0.13	0.87
2	Sweep	Sub	15	88	-	2.34	1.02	3.37	0.86	3.13	0.11	0.89
2	Core	Int	11	37	8,903	1.89	0.82	2.73	0.79	2.77	0.21	0.79
2	Sweep	Int	23	163	-	2.57	1.11	3.70	0.82	4.32	0.11	0.89
4	Core	Sub	11	61	14,678	1.69	0.74	2.44	0.71	2.43	0.24	0.76
4	Sweep	Sub	21	267	-	1.82	0.79	2.63	0.60	3.58	0.28	0.72
4	Core	Int	17	46	11,068	2.53	1.10	3.66	0.89	4.18	0.08	0.92
4	Sweep	Int	29	160	-	2.96	1.29	4.27	0.88	5.52	0.06	0.94
6	Core	Sub	9	30	7,218	1.52	0.66	2.19	0.69	2.35	0.33	0.67
6	Sweep	Sub	17	92	-	2.15	0.93	3.10	0.76	3.54	0.16	0.84
6	Core	Int	9	21	5,053	1.93	0.84	2.79	0.88	2.63	0.14	0.86
6	Sweep	Int	22	212	-	2.12	0.92	3.05	0.68	3.92	0.22	0.78
8	Core	Sub	15	140	33,686	0.92	0.40	1.33	0.34	2.83	0.66	0.34
8	Sweep	Sub	18	78	-	2.52	1.09	3.64	0.87	3.90	0.10	0.90
8	Core	Int	8	18	4,331	1.77	0.77	2.55	0.85	2.42	0.18	0.82
8	Sweep	Int	18	231	-	2.07	0.90	2.99	0.72	3.12	0.21	0.79
10	Core	Sub	10	56	13,474	1.50	0.65	2.16	0.65	2.24	0.36	0.64
10	Sweep	Sub	21	251	-	2.17	0.94	3.13	0.71	3.62	0.17	0.83
10	Core	Int	16	141	33,927	1.90	0.83	2.75	0.69	3.03	0.26	0.74
10	Sweep	Int	19	191	-	2.32	1.01	3.34	0.79	3.43	0.13	0.87

12	Core	Sub	7	30	7,218	1.29	0.56	1.86	0.66	1.76	0.38	0.62
12	Sweep	Sub	16	118	-	2.31	1.00	3.33	0.83	3.14	0.12	0.88
River Km	Sample Type	Depth	Total Taxa	Total Ind	Ind/m ²	Shannon-Weiner Index H'			Pielou's Index	Margalef's Index	Simpson's Index	Gini's Index
						logE	log10	log2				
12	Core	Int	14	55	13,234	2.35	1.02	3.40	0.89	3.24	0.10	0.90
12	Sweep	Int	21	291	-	2.56	1.11	3.70	0.84	3.53	0.10	0.90
14	Core	Sub	7	20	4,812	1.34	0.58	1.93	0.69	2.00	0.36	0.64
14	Sweep	Sub	18	96	-	2.46	1.07	3.55	0.85	3.72	0.10	0.90
14	Core	Int	9	23	5,534	1.98	0.86	2.86	0.90	2.55	0.12	0.88
14	Sweep	Int	23	714	-	1.32	0.57	1.91	0.42	3.35	0.47	0.53
16	Core	Sub	13	90	21,655	1.80	0.78	2.60	0.70	2.67	0.25	0.75
16	Sweep	Sub	9	96	-	1.67	0.73	2.41	0.76	1.75	0.22	0.78
16	Core	Int	18	142	34,167	1.99	0.87	2.88	0.69	3.43	0.19	0.81
16	Sweep	Int	9	484	-	0.81	0.35	1.16	0.37	1.29	0.57	0.43
18	Core	Sub	10	31	7,459	1.72	0.75	2.48	0.75	2.62	0.27	0.73
18	Sweep	Sub	12	62	-	1.92	0.83	2.77	0.77	2.67	0.22	0.78
18	Core	Int	9	33	7,940	1.70	0.74	2.45	0.77	2.29	0.24	0.76
18	Sweep	Int	17	526	-	0.94	0.41	1.36	0.33	2.55	0.64	0.36
20	Core	Int	6	17	4,090	1.60	0.69	2.31	0.89	1.76	0.18	0.82
20	Sweep	Int	12	574	-	0.69	0.30	1.00	0.28	1.73	0.70	0.30
22	Core	Sub	9	136	32,724	1.48	0.64	2.14	0.68	1.63	0.29	0.71
22	Sweep	Sub	13	68	-	1.83	0.79	2.64	0.71	2.84	0.24	0.76
22	Core	Int	7	16	3,850	1.60	0.69	2.31	0.82	2.16	0.21	0.79
22	Sweep	Int	7	206	-	1.05	0.46	1.51	0.54	1.13	0.50	0.50
24	Core	Sub	8	73	17,565	1.40	0.61	2.01	0.67	1.63	0.32	0.68
24	Sweep	Sub	7	44	-	1.39	0.60	2.00	0.71	1.59	0.32	0.68
24	Core	Int	10	78	18,768	1.50	0.65	2.16	0.65	2.07	0.30	0.70
24	Sweep	Int	5	14	-	1.30	0.56	1.87	0.81	1.52	0.27	0.73
26	Core	Sub	5	81	19,490	1.25	0.54	1.80	0.77	0.91	0.32	0.68

26	Sweep	Sub	9	55	-	1.78	0.77	2.57	0.81	2.00	0.20	0.80
26	Core	Int	8	91	21,896	1.22	0.53	1.76	0.59	1.55	0.44	0.56
26	Sweep	Int	6	32	-	1.43	0.62	2.06	0.80	1.44	0.28	0.72
28	Core	Sub	9	147	35,371	1.18	0.51	1.70	0.54	1.60	0.41	0.59

River Km	Sample Type	Depth	Total Taxa	Total Ind	Ind/m ²	Shannon-Weiner Index H'			Pielou's Index	Margalef's Index	Simpson's Index	Gini's Index
						logE	log10	log2				
28	Core	Int	4	38	9,143	0.96	0.42	1.39	0.69	0.82	0.42	0.58
28	Sweep	Int	3	23	-	0.47	0.20	0.68	0.43	0.64	0.75	0.25
30	Sweep	Sub	7	33	-	1.38	0.60	1.99	0.71	1.72	0.31	0.69
30	Core	Int	8	42	10,106	1.66	0.72	2.39	0.80	1.87	0.26	0.74
30	Sweep	Int	4	14	-	1.28	0.55	1.84	0.92	1.14	0.25	0.75
32	Core	Sub	5	49	11,790	0.59	0.26	0.85	0.37	1.03	0.74	0.26
32	Sweep	Sub	8	11	-	1.97	0.86	2.85	0.95	2.92	0.07	0.93
32	Core	Int	5	19	4,572	1.17	0.51	1.68	0.72	1.36	0.35	0.65
32	Sweep	Int	12	36	-	2.05	0.89	2.95	0.82	3.07	0.16	0.84
34	Core	Sub	2	8	1,925	0.66	0.29	0.95	0.95	0.48	0.46	0.54
34	Sweep	Sub	10	51	-	1.49	0.65	2.15	0.65	2.29	0.30	0.70
34	Core	Int	5	30	7,218	0.84	0.37	1.21	0.52	1.18	0.59	0.41
34	Sweep	Int	18	28	-	2.73	1.19	3.94	0.94	5.10	0.04	0.96
36	Core	Sub	11	29	6,978	1.90	0.83	2.74	0.79	2.97	0.20	0.80
36	Sweep	Sub	22	62	-	2.69	1.17	3.88	0.87	5.09	0.08	0.92
36	Core	Int	9	77	18,527	1.10	0.48	1.58	0.50	1.84	0.51	0.49
36	Sweep	Int	7	23	-	1.63	0.71	2.35	0.84	1.91	0.22	0.78
38	Core	Sub	6	36	8,662	1.23	0.54	1.78	0.69	1.40	0.36	0.64
38	Sweep	Sub	6	8	-	1.67	0.72	2.41	0.93	2.40	0.11	0.89
38	Core	Int	2	26	6,256	0.16	0.07	0.24	0.24	0.31	0.92	0.08
38	Sweep	Int	9	19	-	1.82	0.79	2.63	0.83	2.72	0.19	0.81
40	Core	Int	6	24	5,775	1.47	0.64	2.11	0.82	1.57	0.25	0.75

40	Sweep	Int	6	59	-	1.49	0.65	2.14	0.83	1.23	0.23	0.77
42	Core	Sub	5	17	4,090	1.09	0.47	1.57	0.68	1.41	0.43	0.57
42	Sweep	Sub	16	104	-	1.95	0.85	2.81	0.70	3.23	0.22	0.78
42	Core	Int	9	40	9,625	1.65	0.72	2.39	0.75	2.17	0.27	0.73

River Km	Sample Type	Depth	Total Taxa	Total Ind	Ind/m ²	Shannon-Weiner Index H'			Pielou's Index	Margalef's Index	Simpson's Index	Gini's Index
						logE	log10	log2				
42	Sweep	Int	12	57	-	1.84	0.80	2.66	0.74	2.72	0.24	0.76
44	Core	Sub	15	65	15,640	2.26	0.98	3.26	0.84	3.35	0.12	0.88
44	Sweep	Sub	14	174	-	1.02	0.44	1.47	0.39	2.52	0.60	0.40
44	Core	Int	5	25	6,015	1.41	0.61	2.03	0.88	1.24	0.24	0.76
44	Sweep	Int	14	234	-	2.05	0.89	2.96	0.78	2.38	0.16	0.84
All River Statistics		Mean	11	105	13,628	1.66	0.72	2.40	0.72	2.46	0.29	0.71
		S.D.	6	134	10,410	0.58	0.25	0.83	0.17	1.09	0.18	0.18
		Med	9	57	962	1.66	0.72	2.40	0.75	2.39	0.24	0.76
		Min	2	8	1,925	0.16	0.07	0.24	0.24	0.31	0.04	0.08
		Max	29	714	44,033	2.96	1.29	4.27	0.95	5.52	0.92	0.96

Appendix 6F

Distribution of benthic macroinvertebrate species in the Lower Myakka River arranged from first appearance extending from the river mouth, June, 2004.

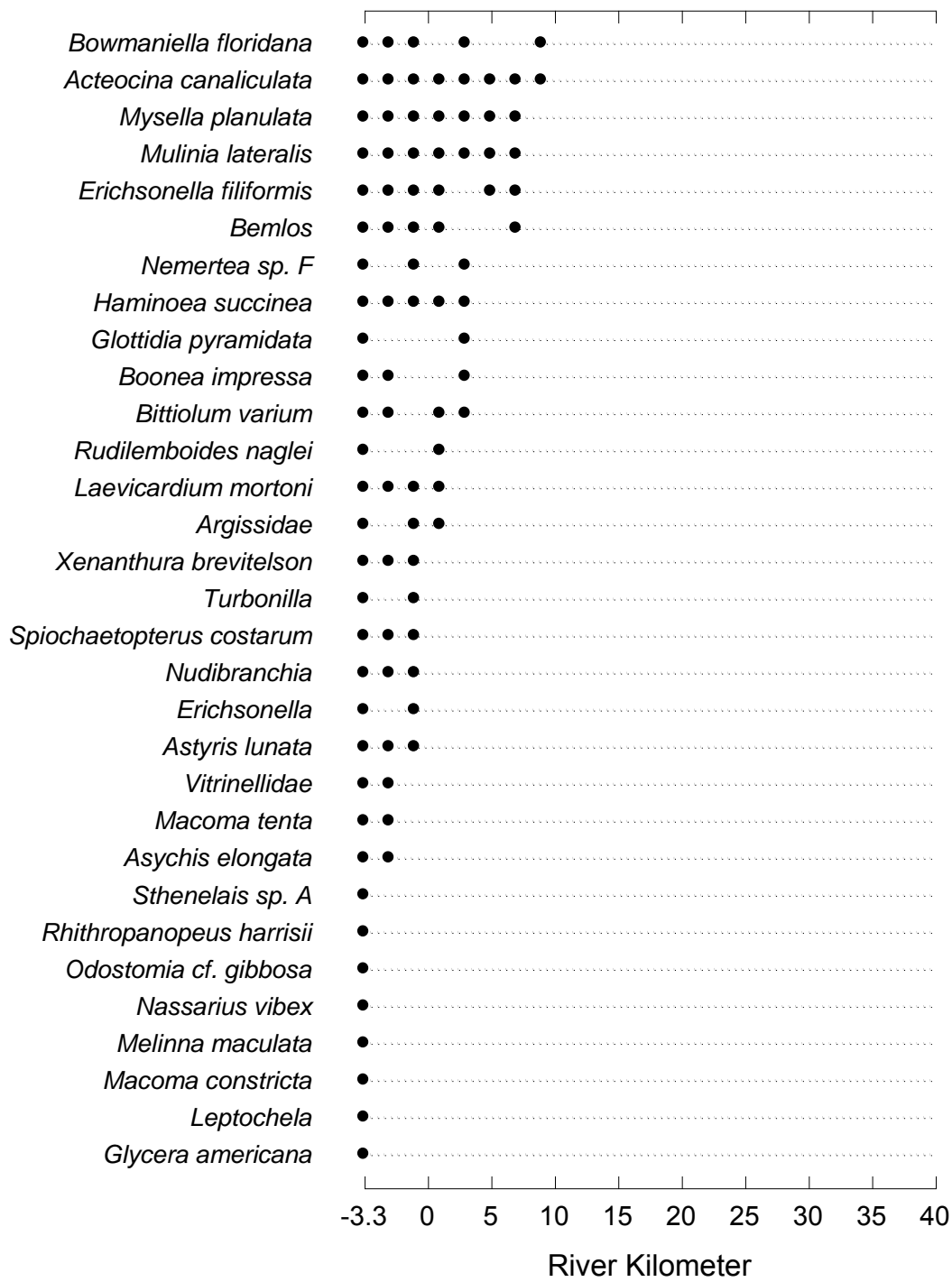

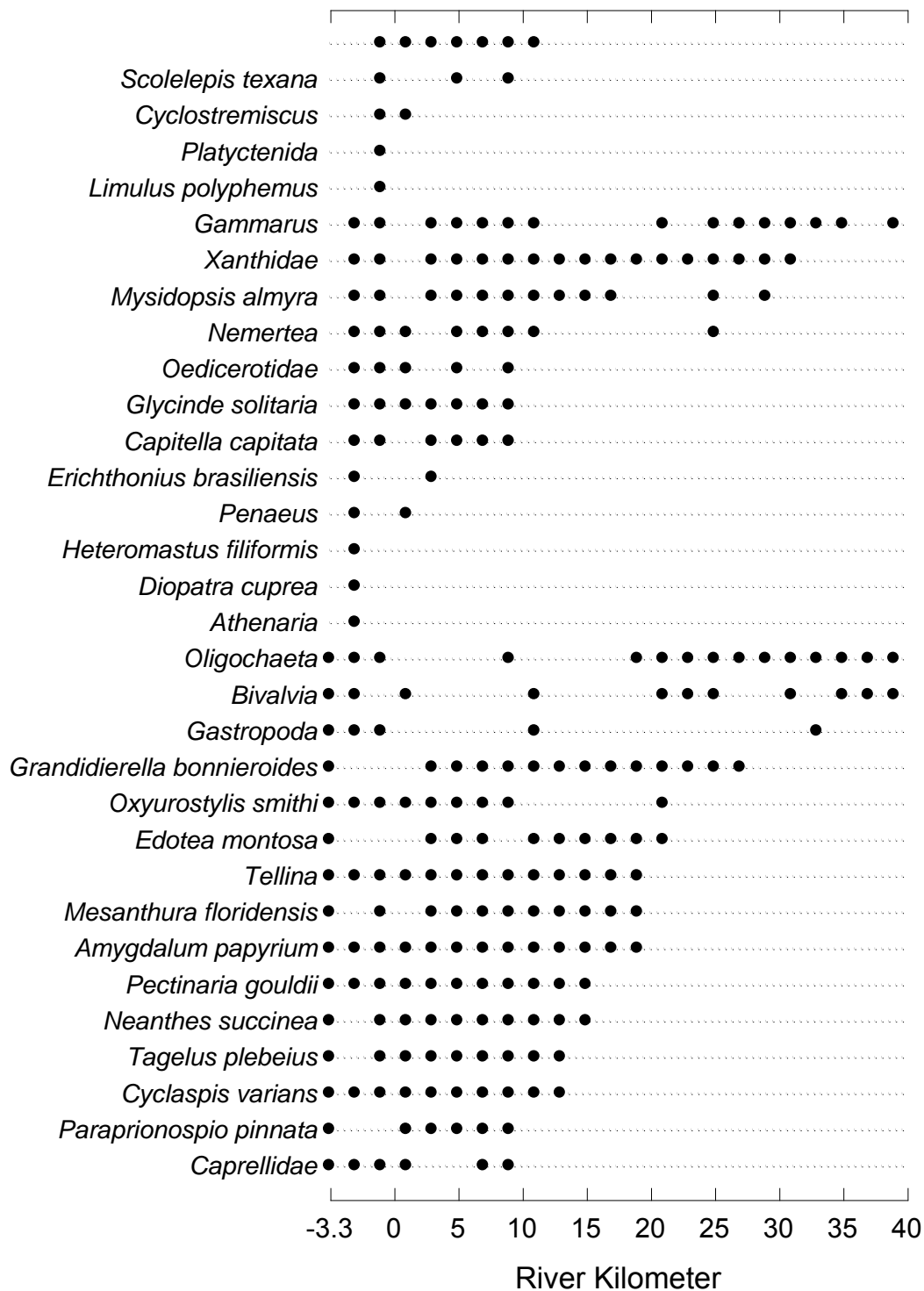

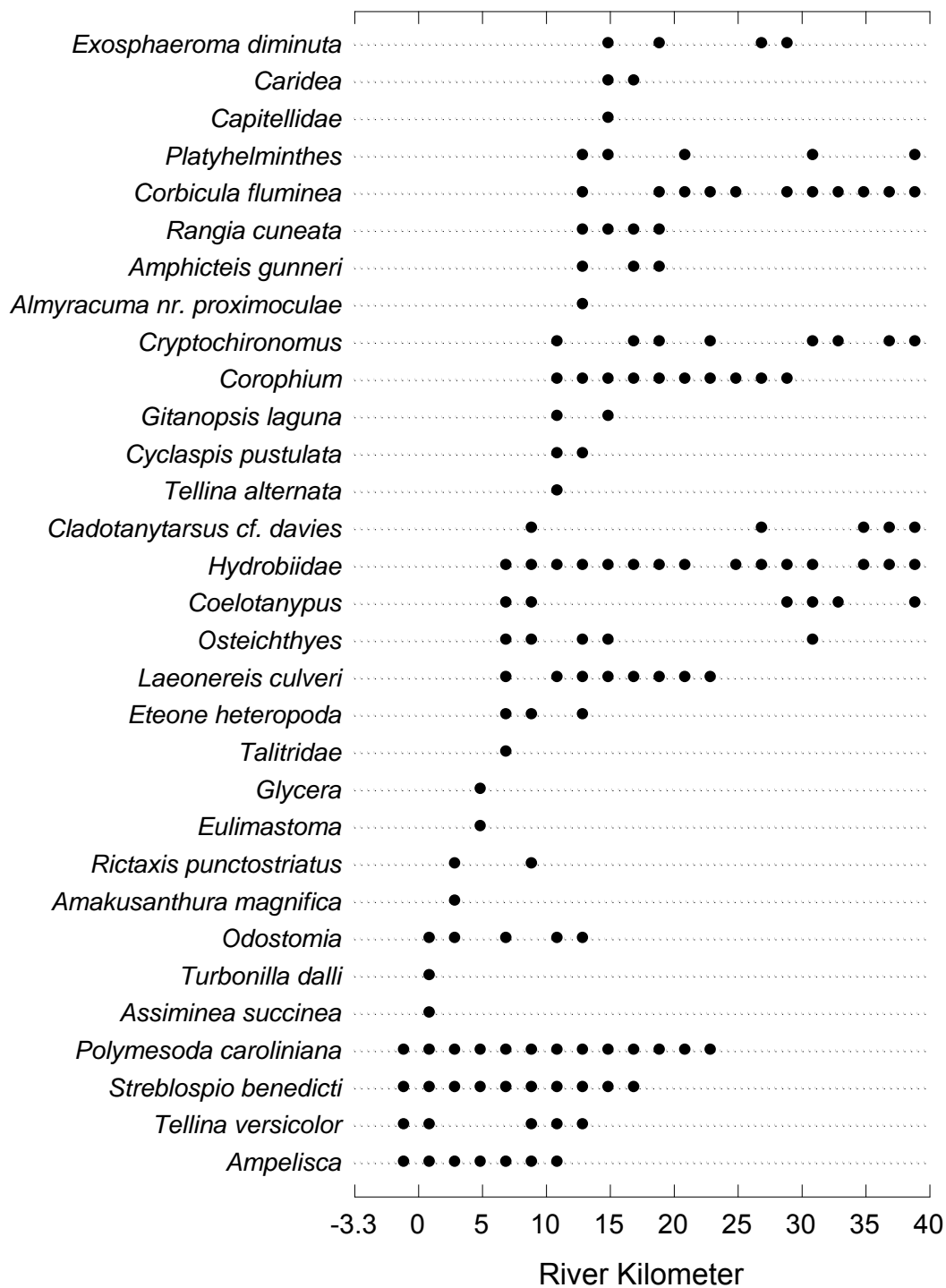

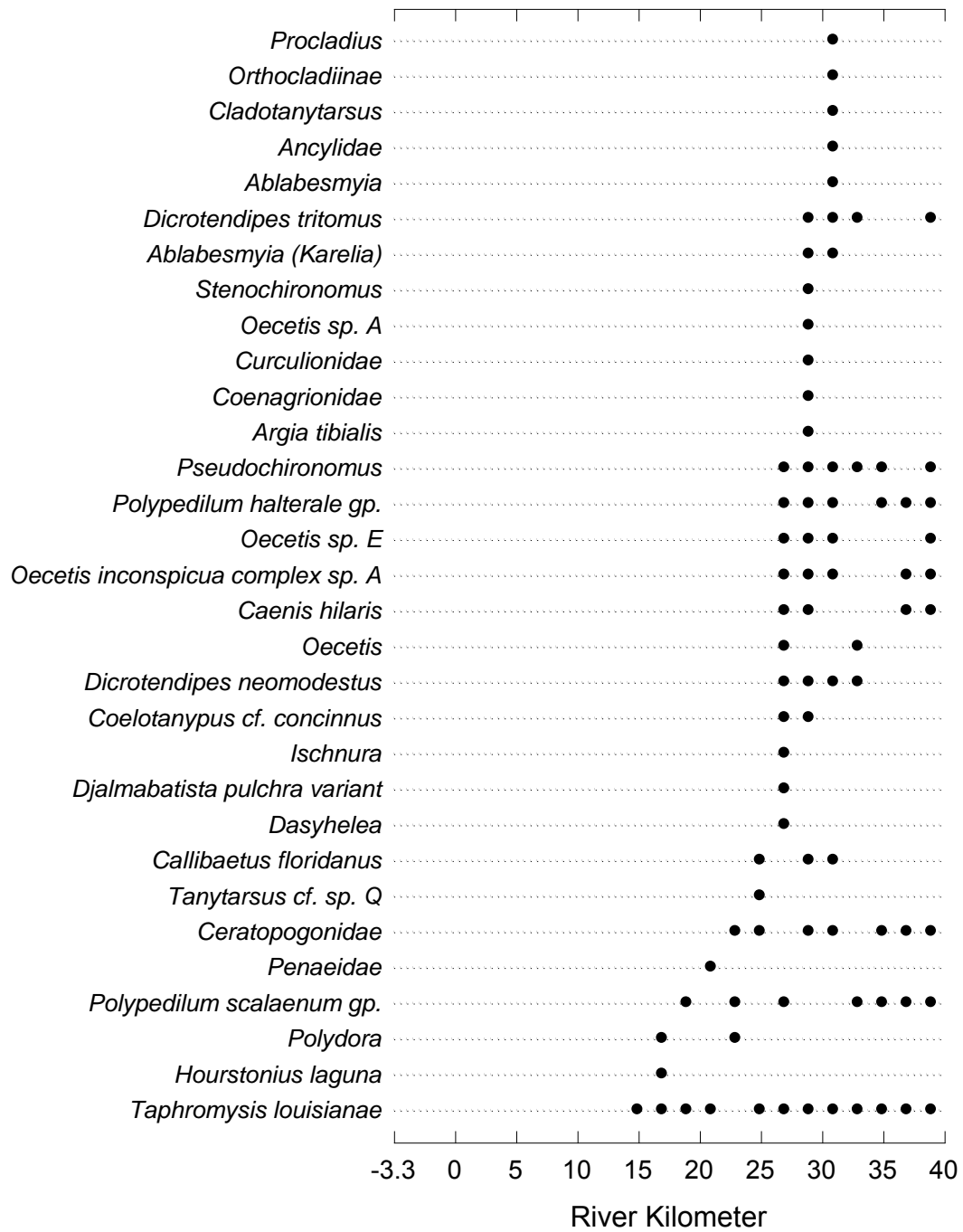

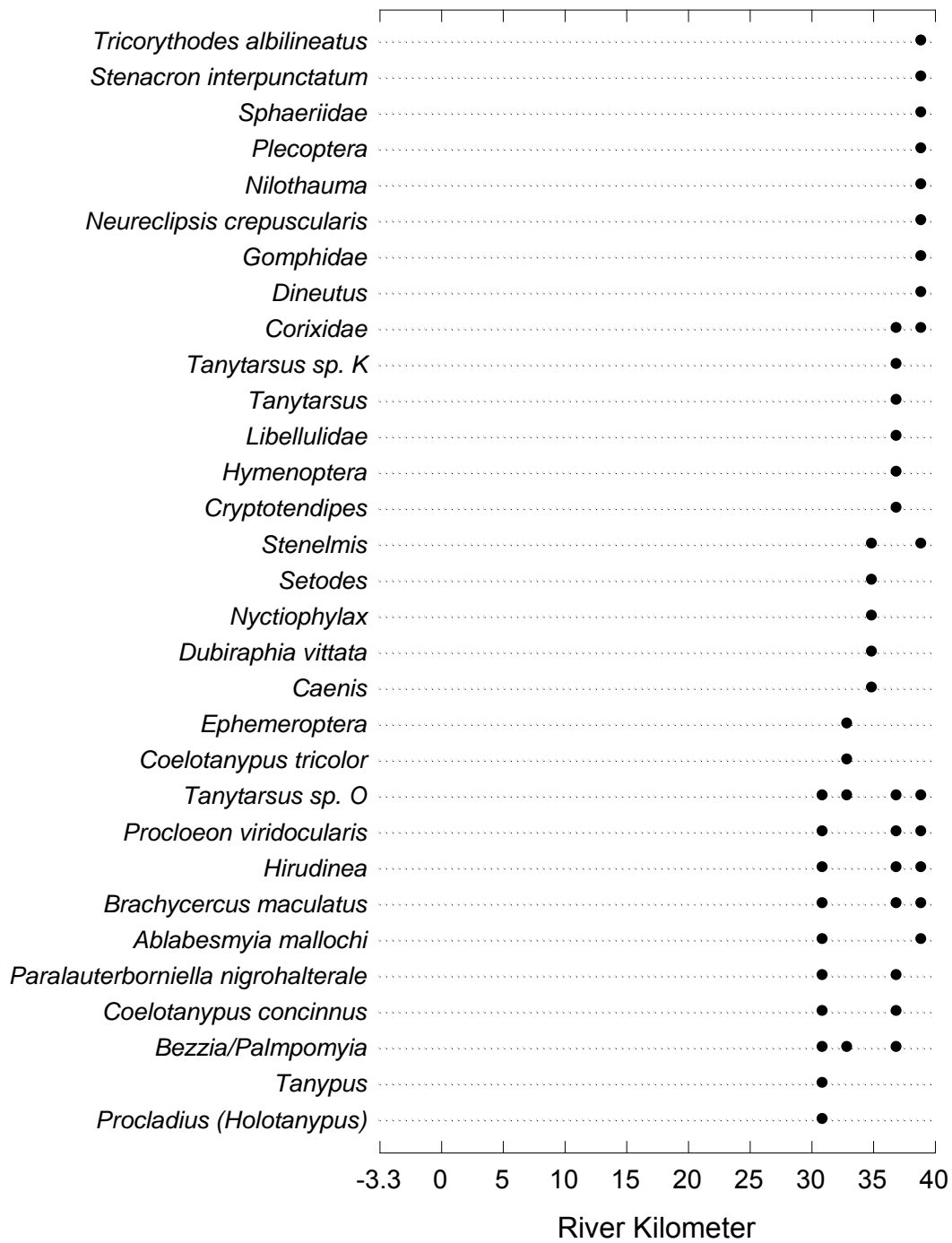

Appendix 8A

Yearly time series plots of flow at the Myakka River near Sarasota gage
and flows at that location predicted by MIKE SHE for the existing
watershed conditions for 1995-2005

year=1995

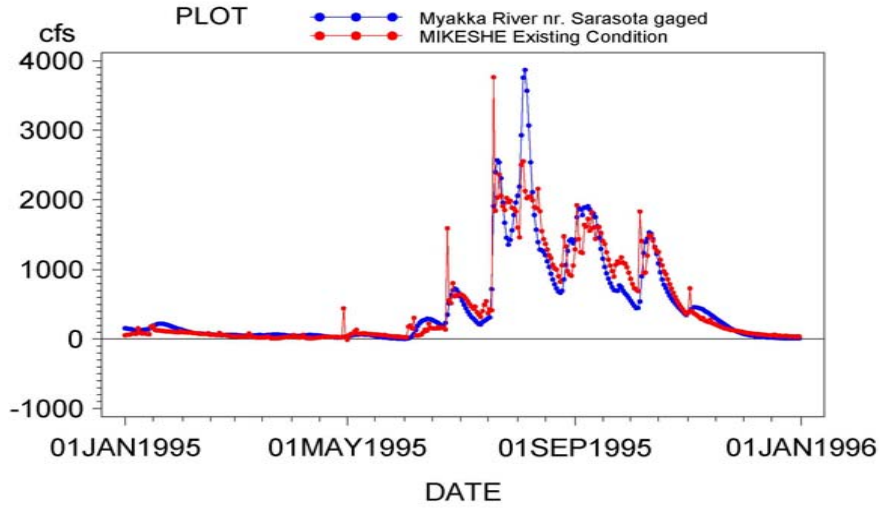

year=1996

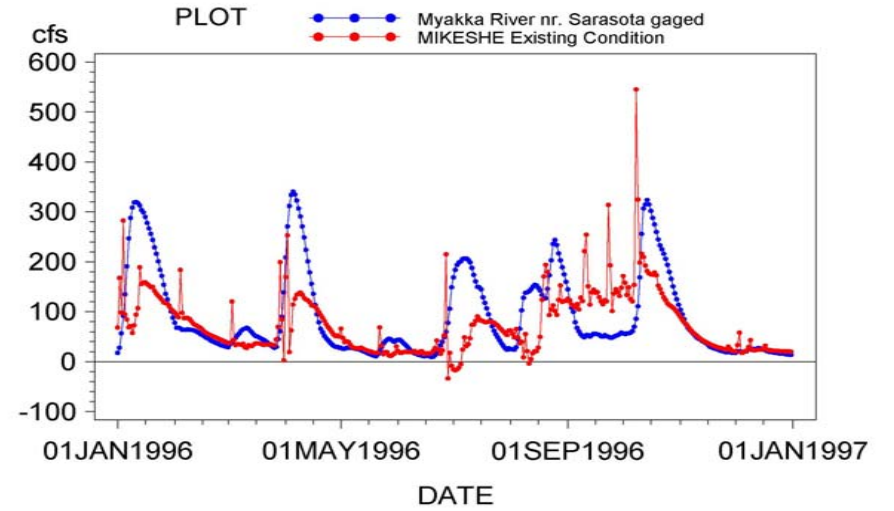

year=1997

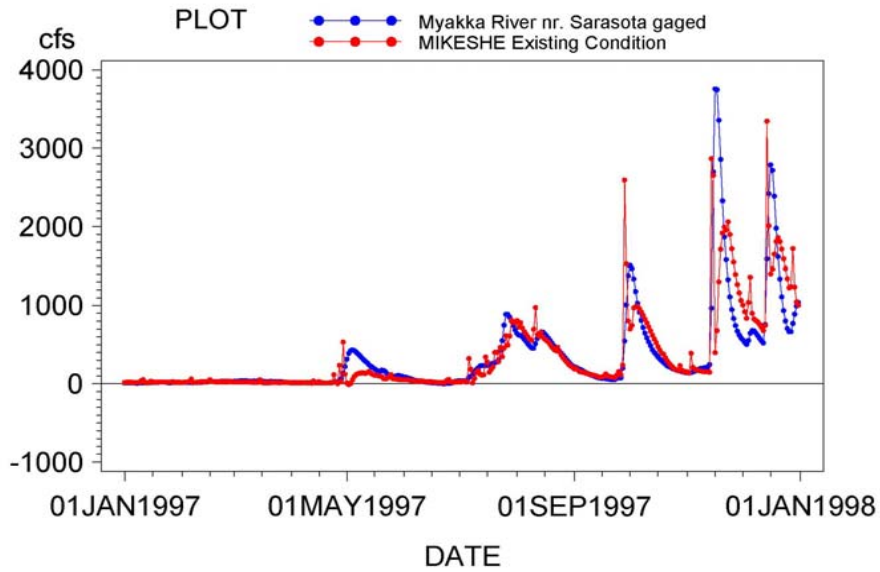

year=1998

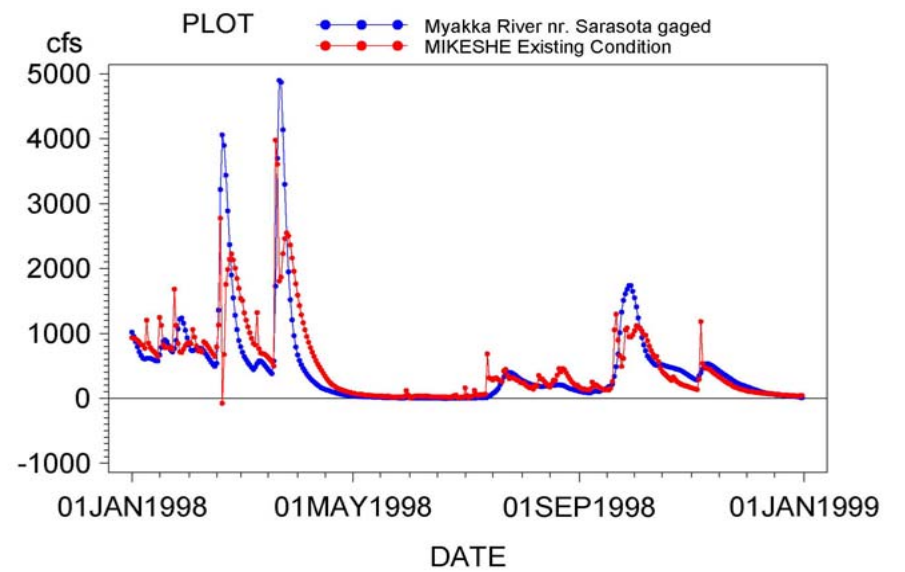

year=1999

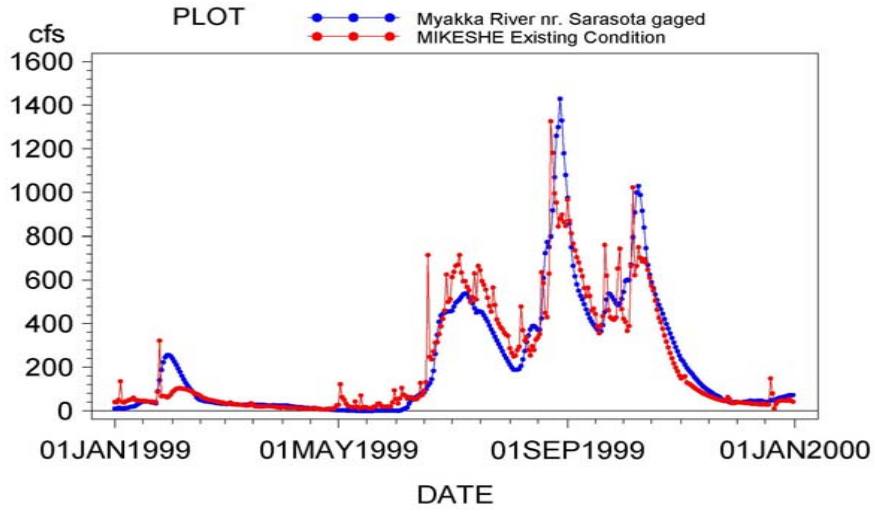

year=2000

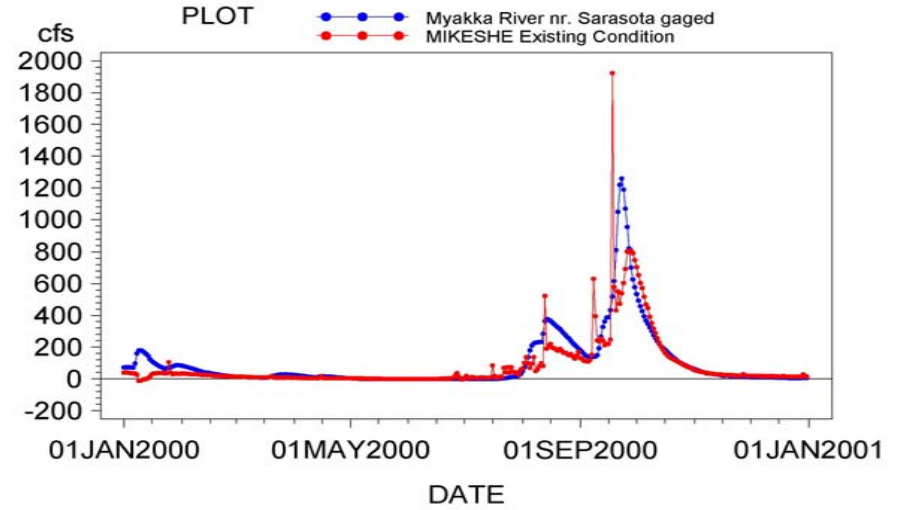

year=2001

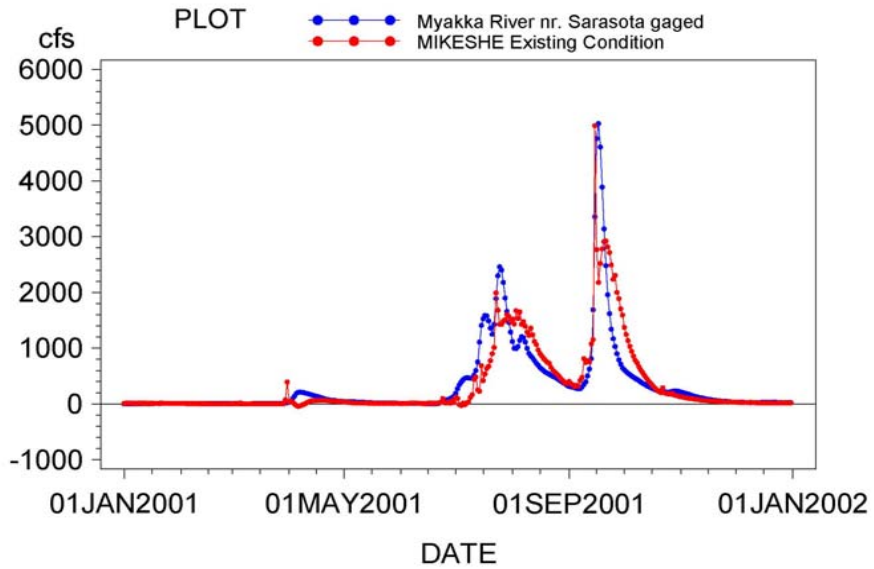

year=2002

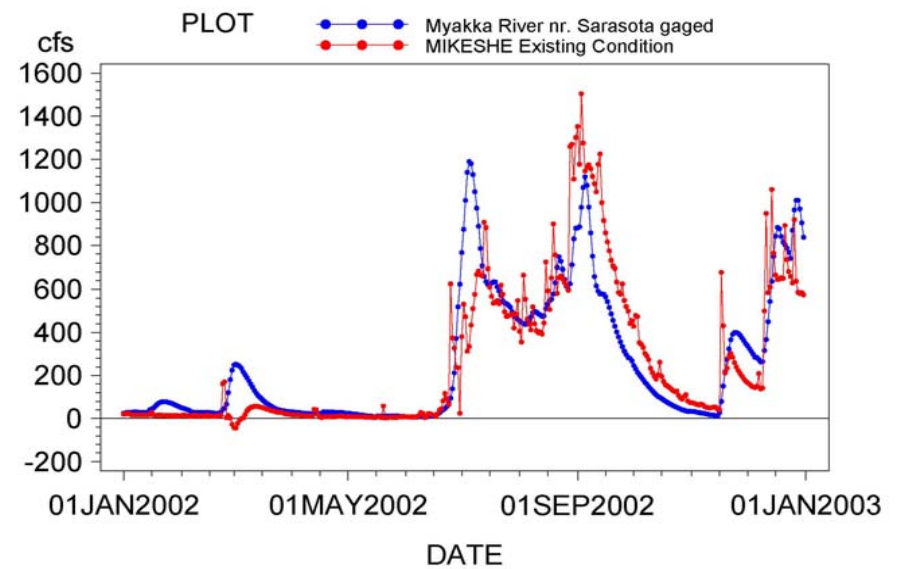

year=2003

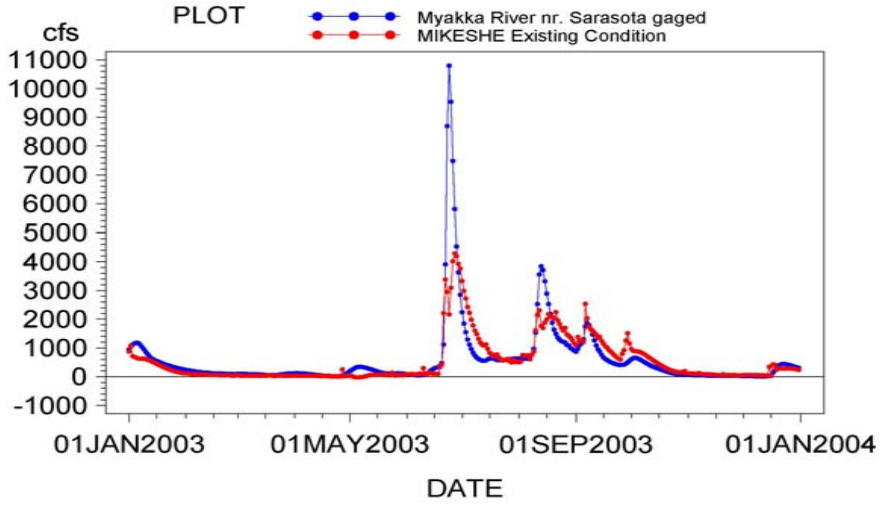

year=2004

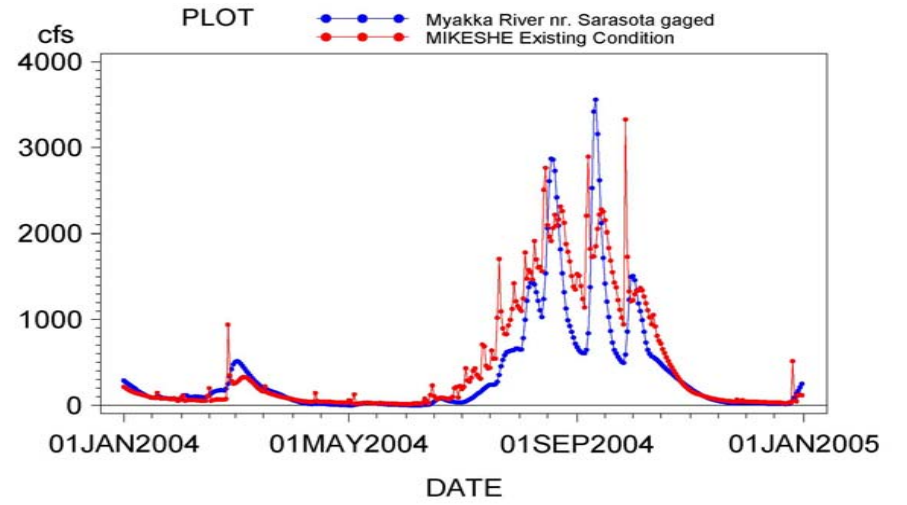

year=2005

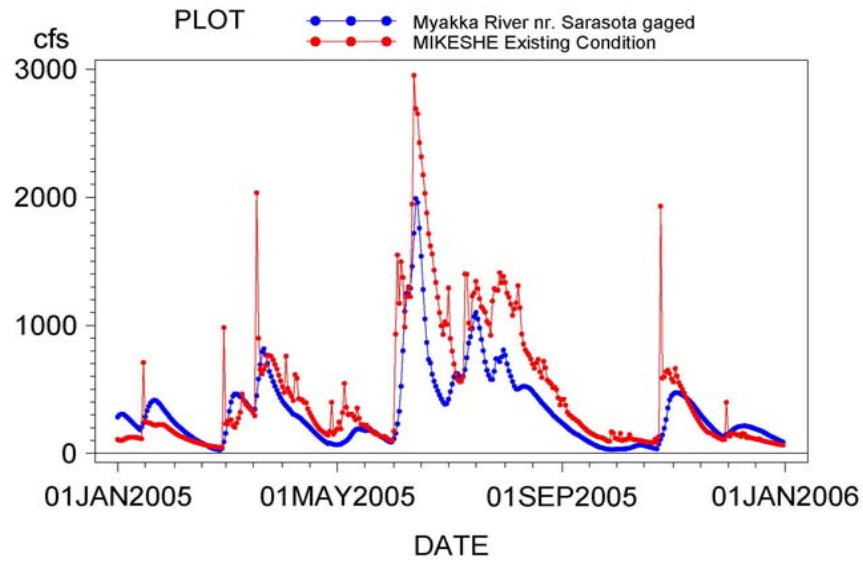

Appendix 8B

Yearly time series plots of flow at the Myakka River near Sarasota gage and total excess flows at that location predicted by MIKE SHE for 1995-2005

year=1995

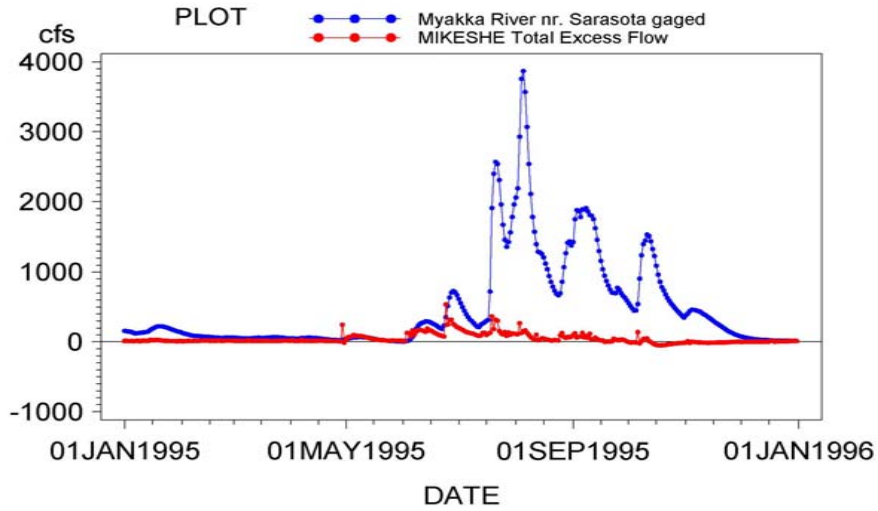

year=1996

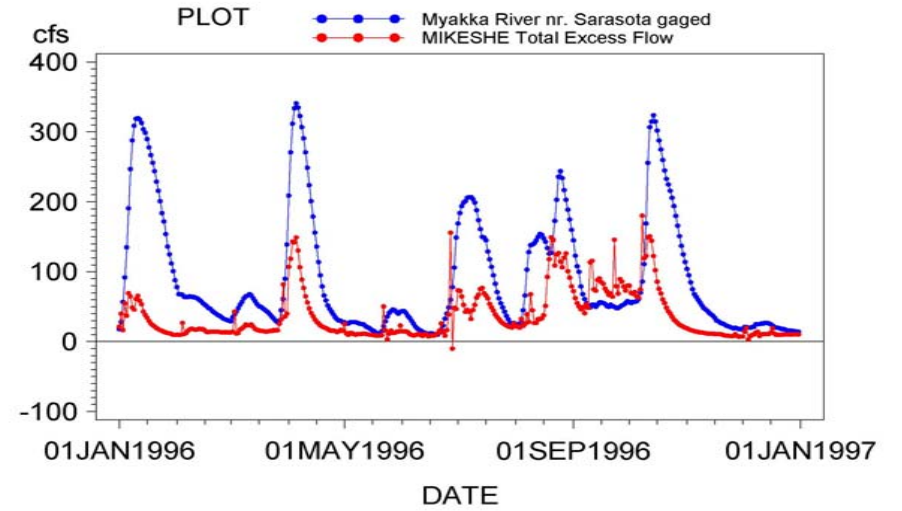

year=1997

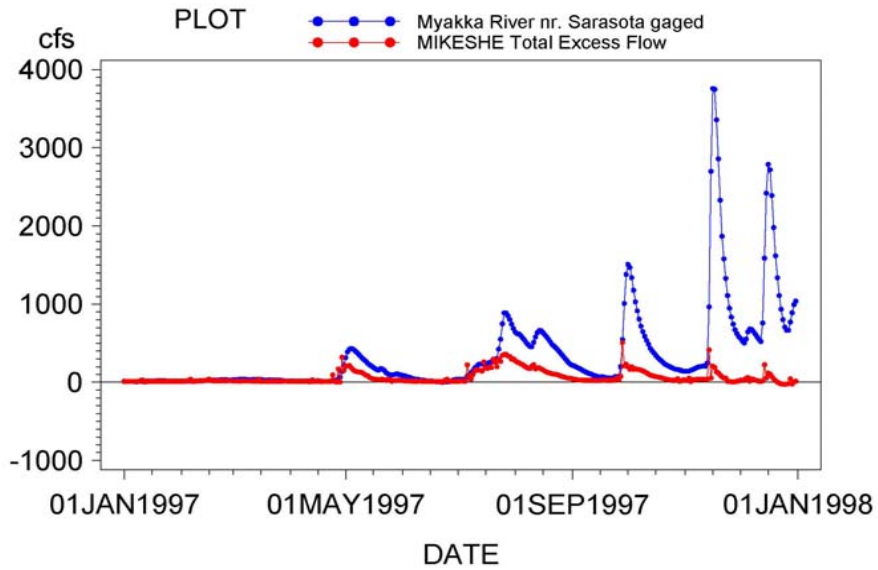

year=1998

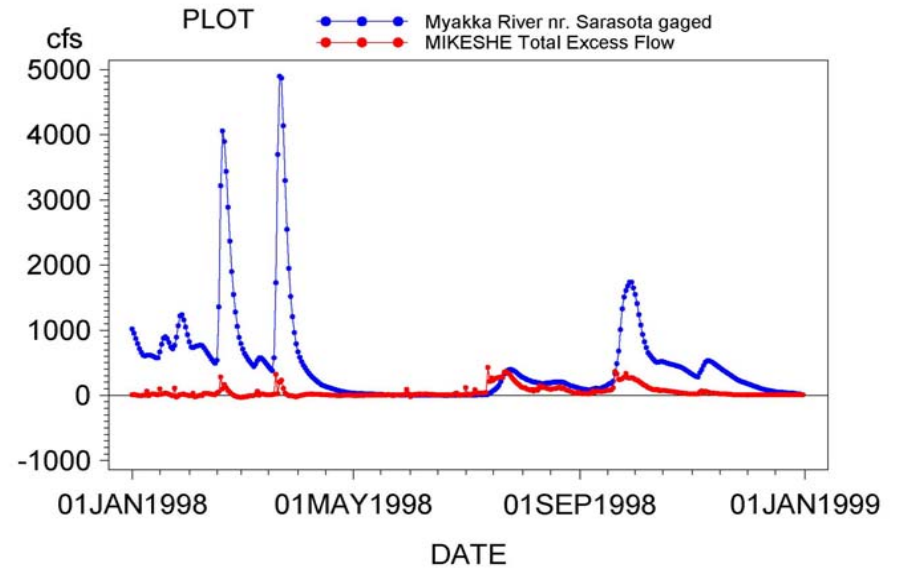

year=1999

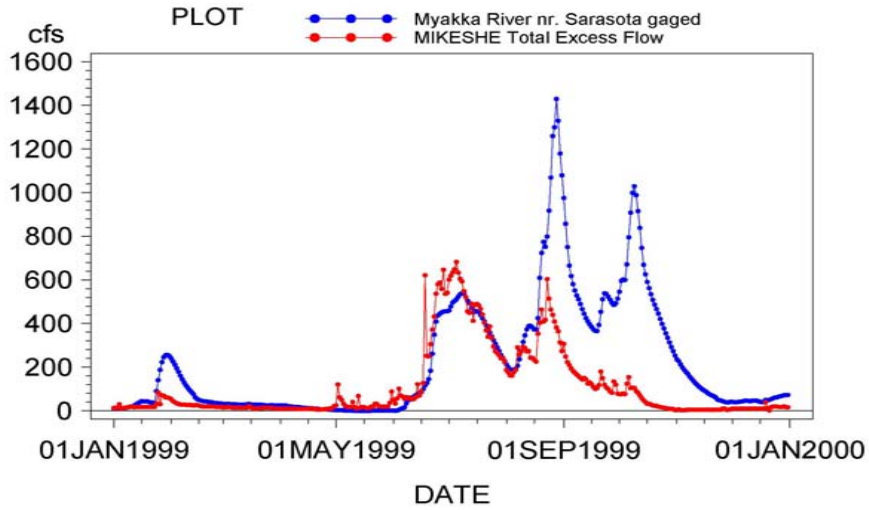

year=2000

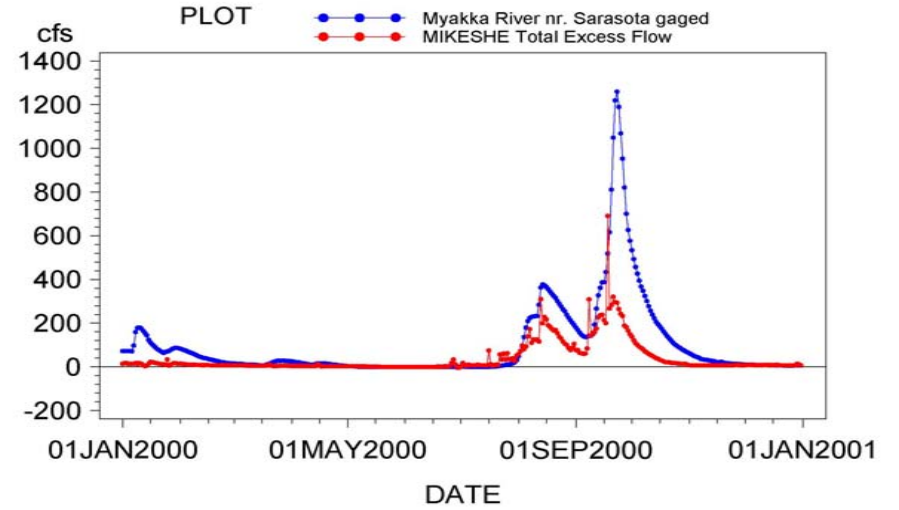

year=2001

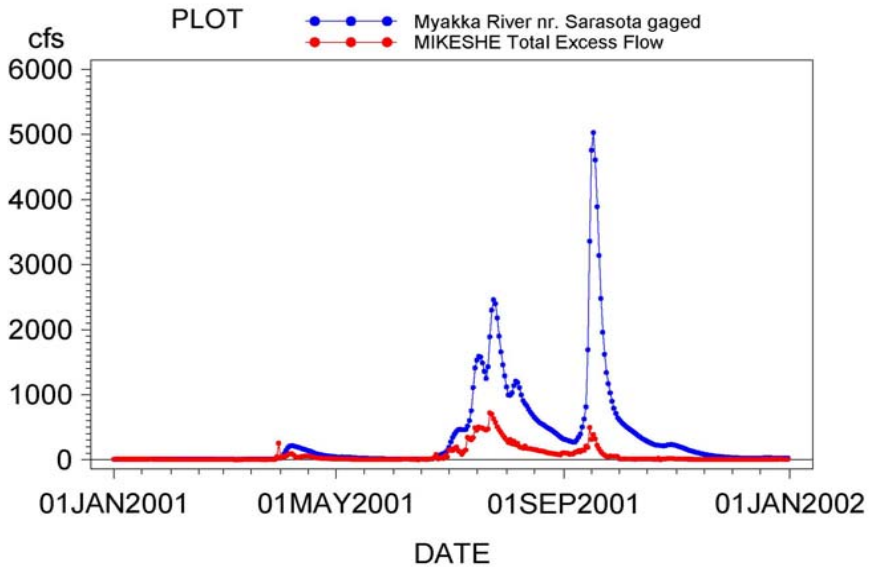

year=2002

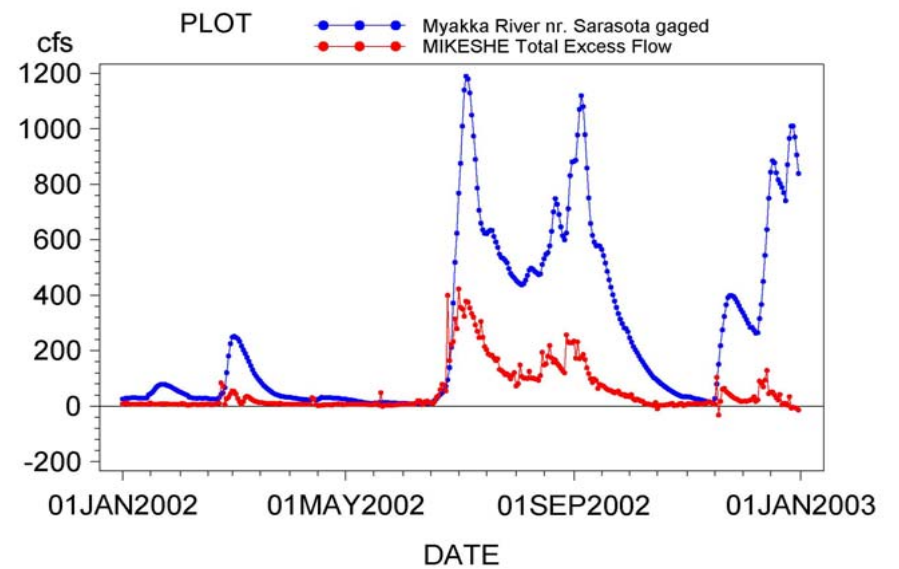

year=2003

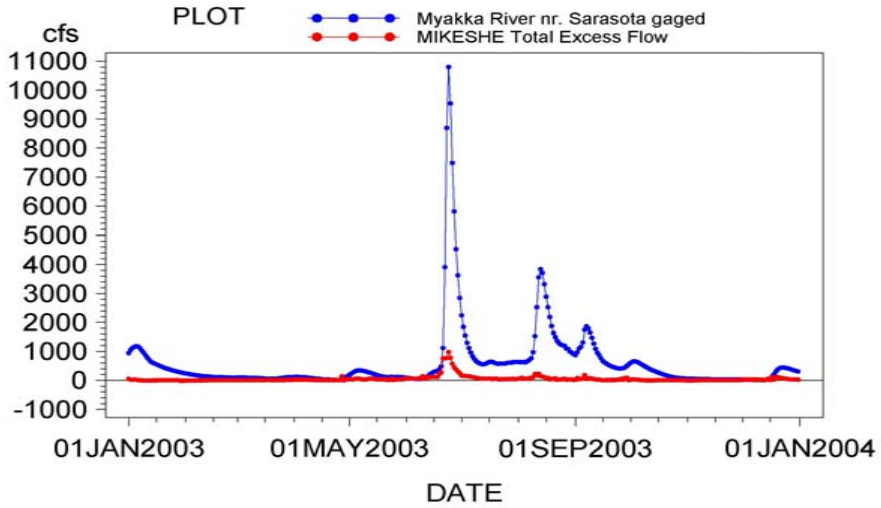

year=2004

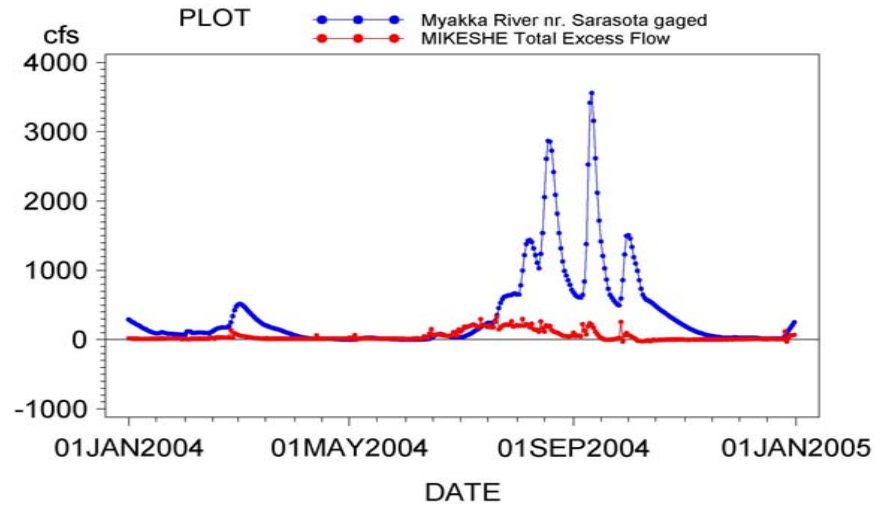

year=2005

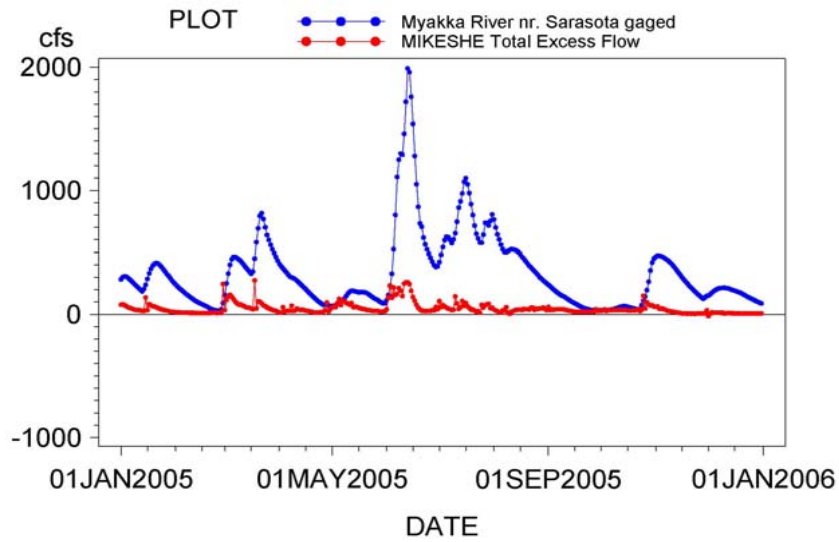

Appendix 8C

Yearly time series plots of flow at the Myakka River near Sarasota gage and total excess flows at that location predicted by MIKE SHE that are capped at 130 cfs for 1995-2005

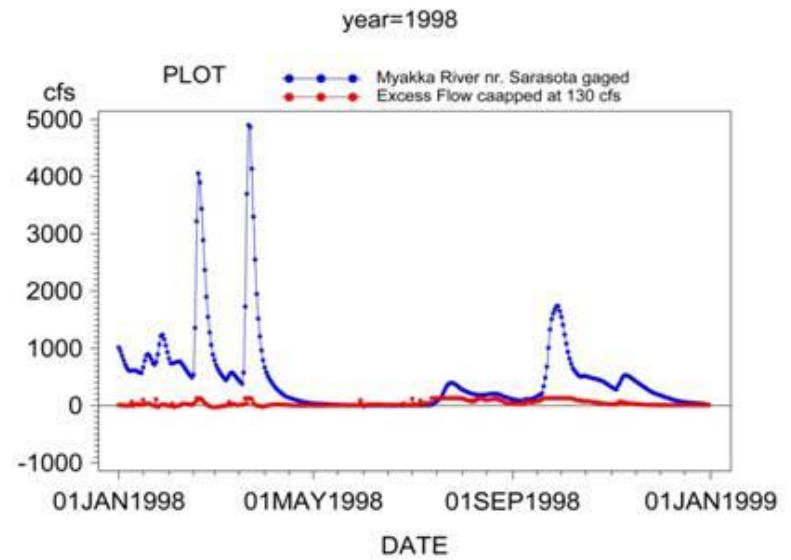
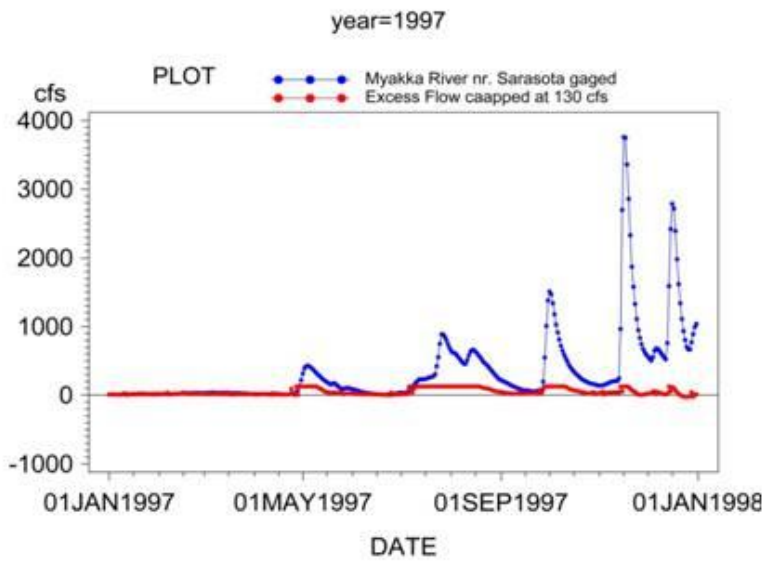
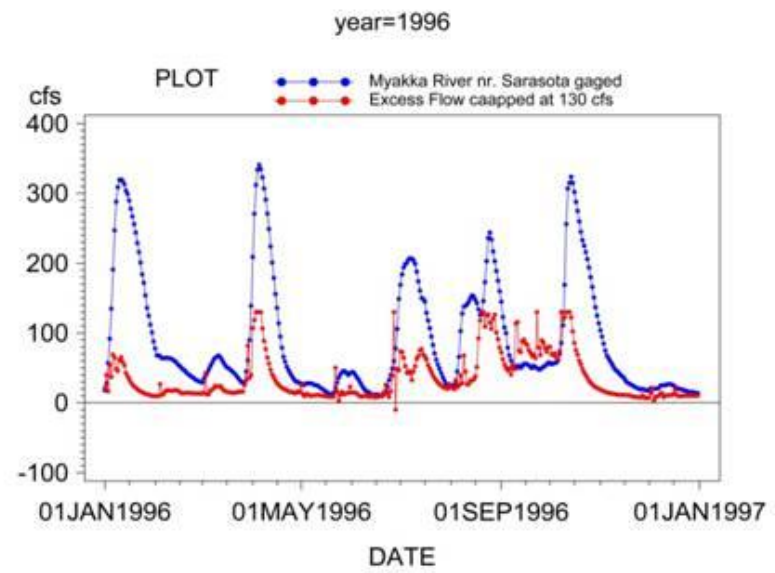
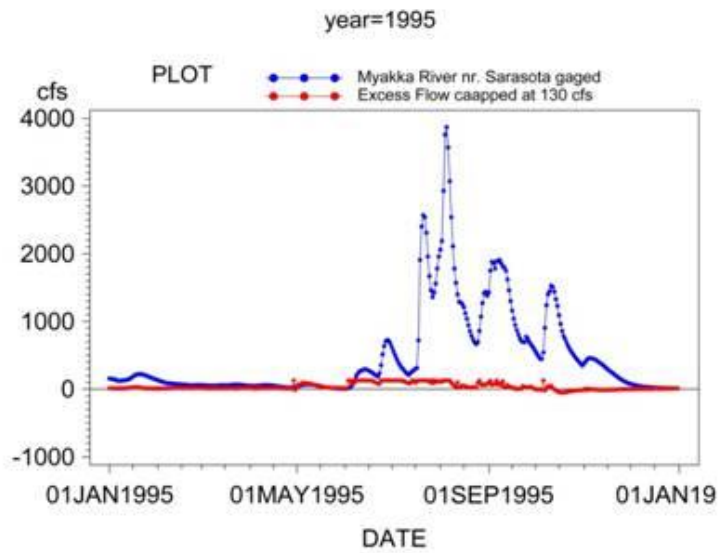

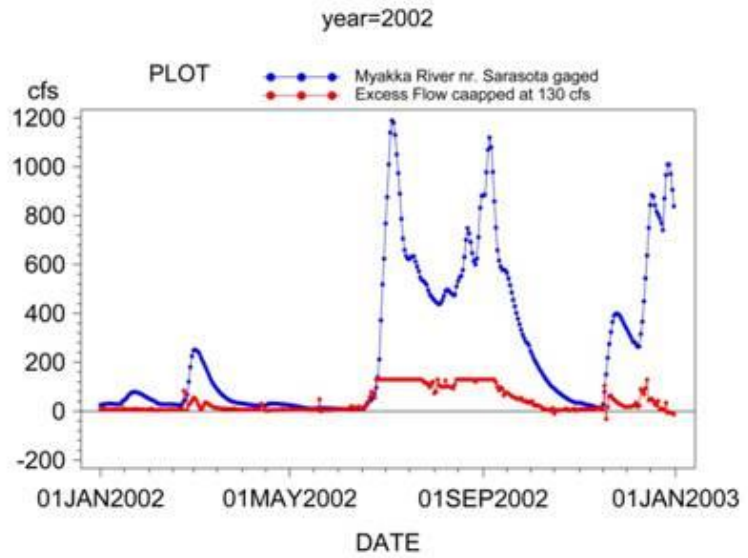
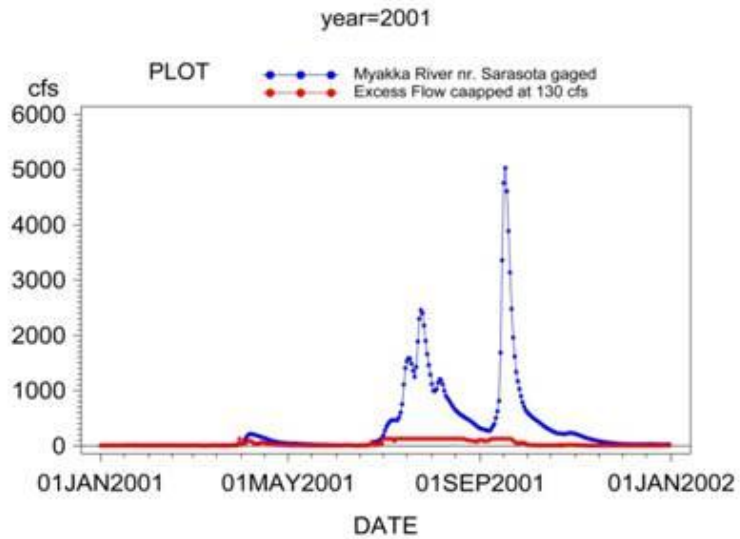
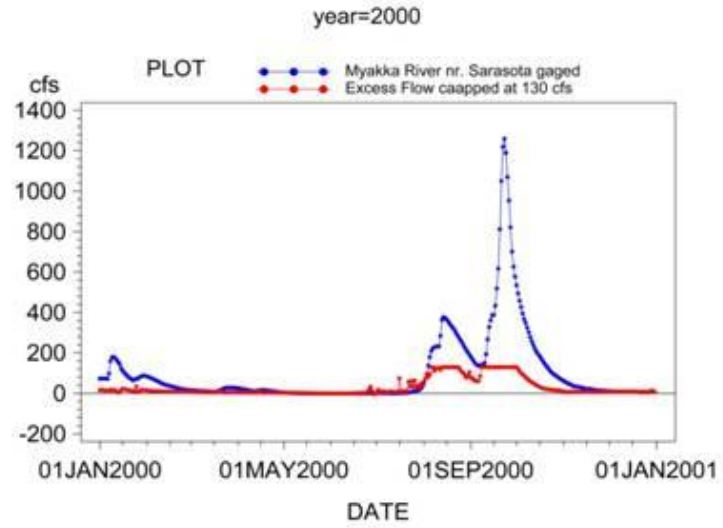
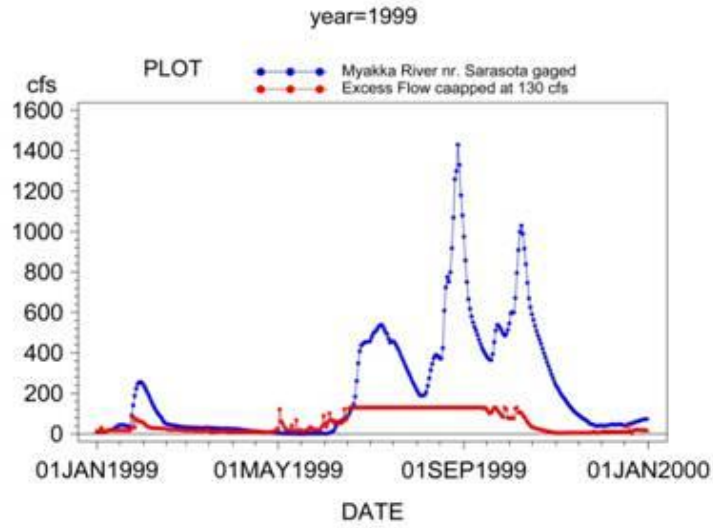

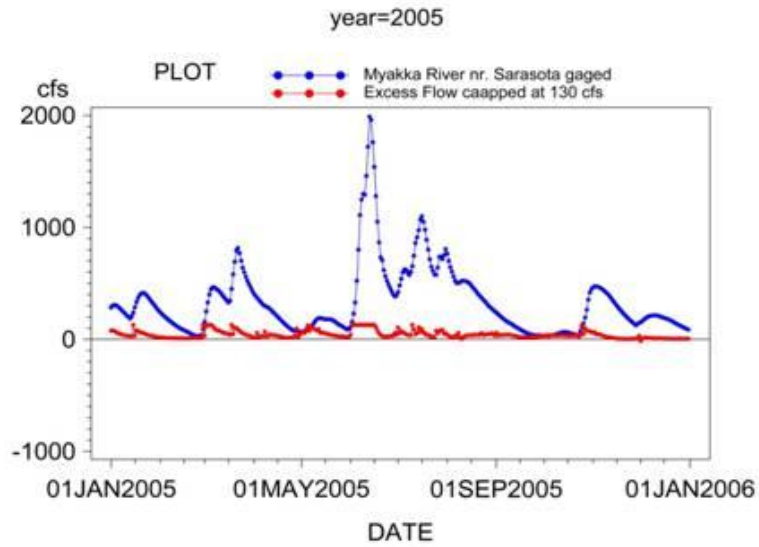
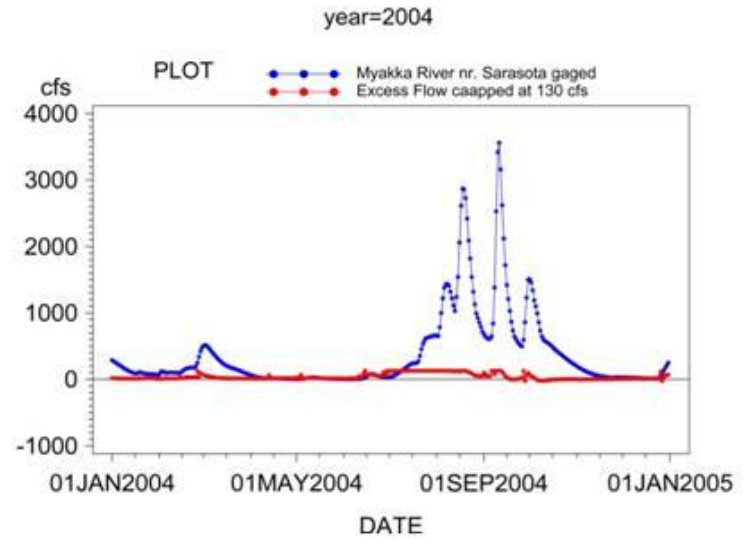
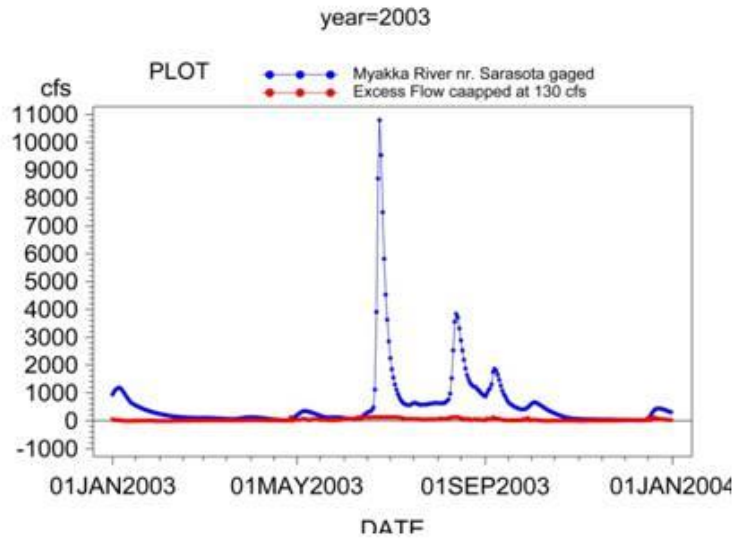

Appendix 8D

Yearly time series plots of total excess flows at the location of the Myakka River near Sarasota gage predicted by MIKE SHE adjusted by Method 1 (direct from model) and Method 2 (based on percentage of gaged flow). Both values are capped at 130 cfs

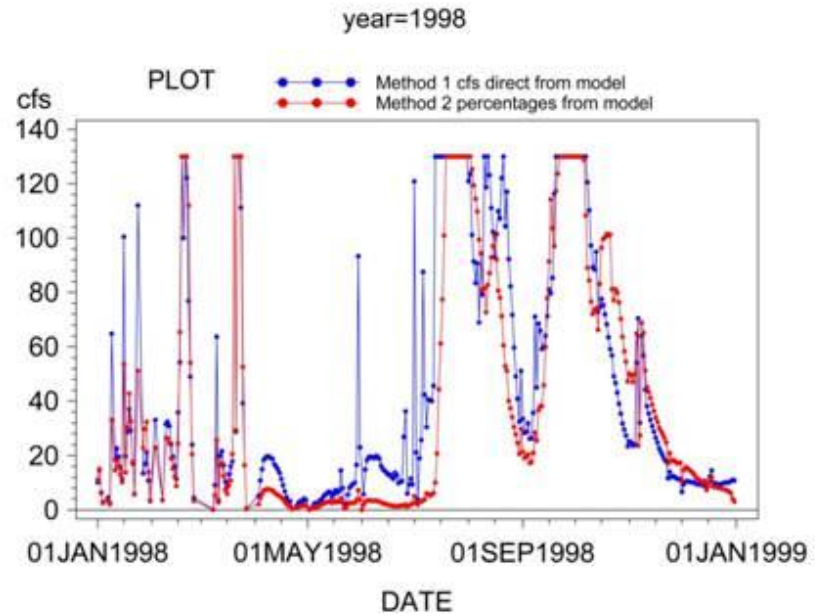
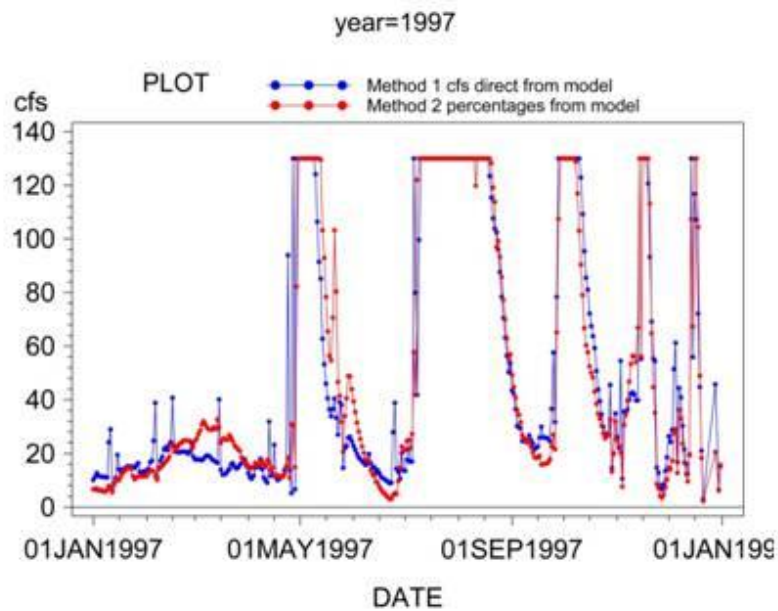
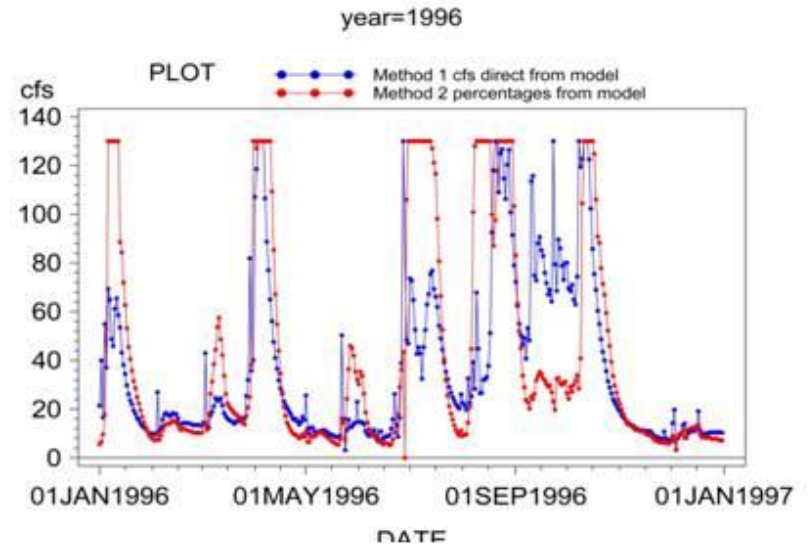
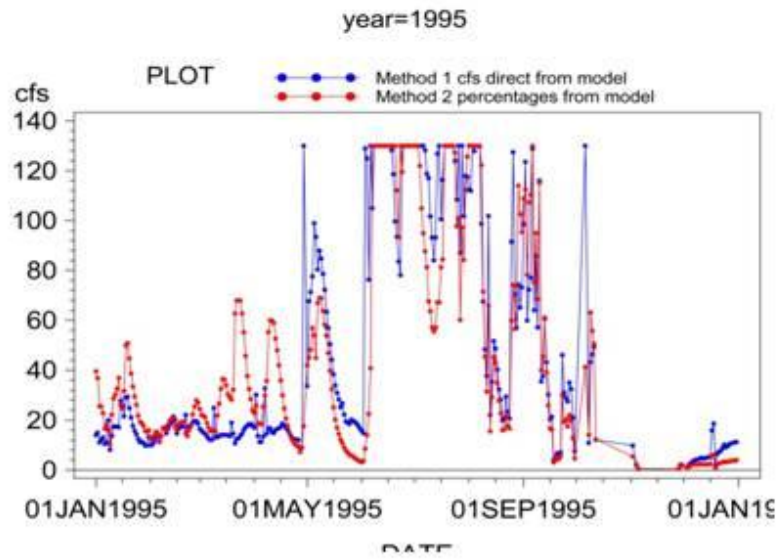

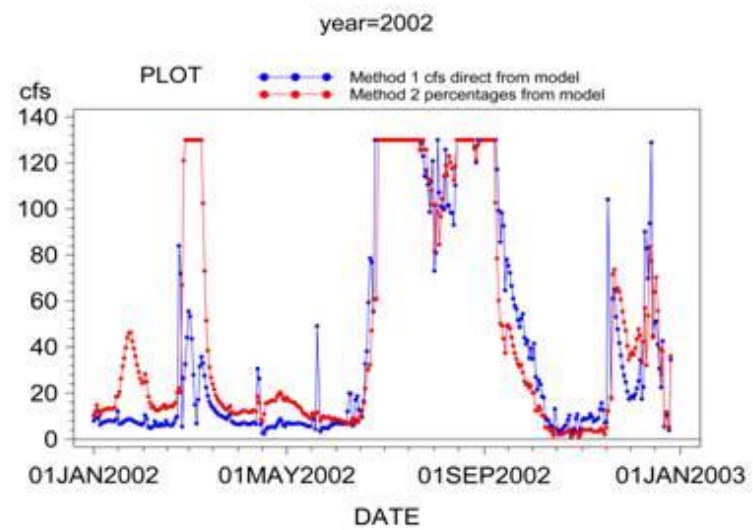
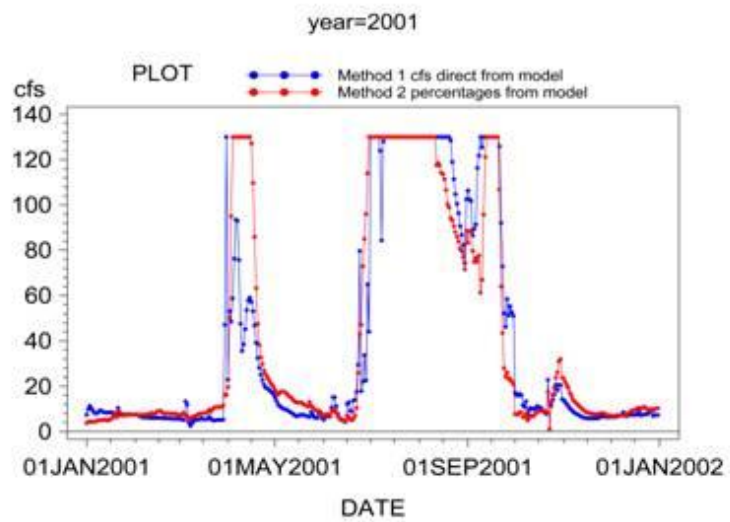
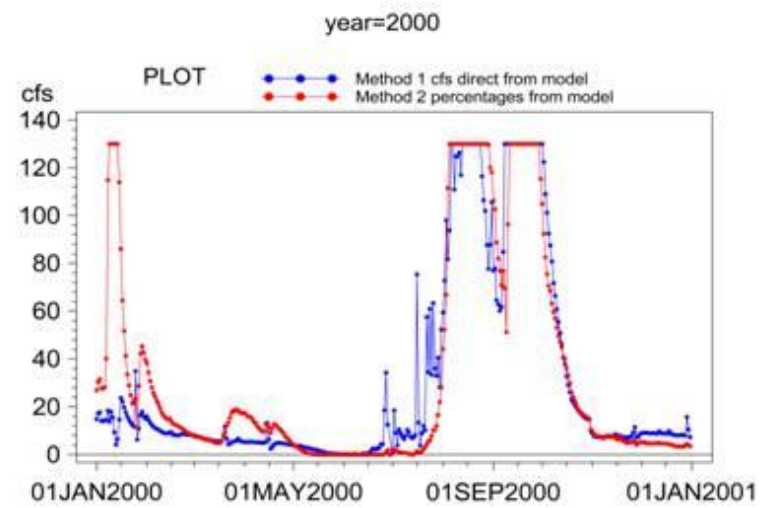
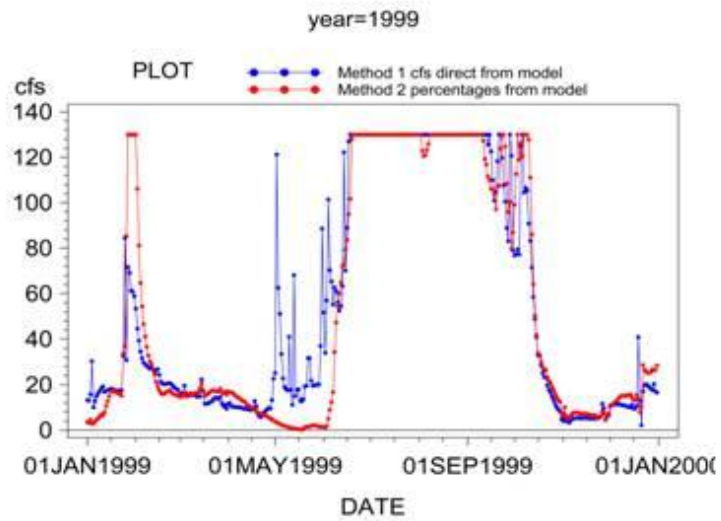

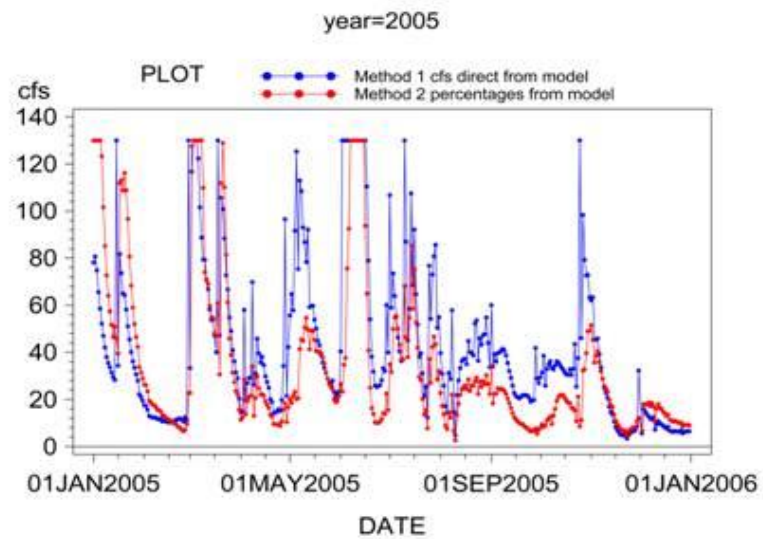
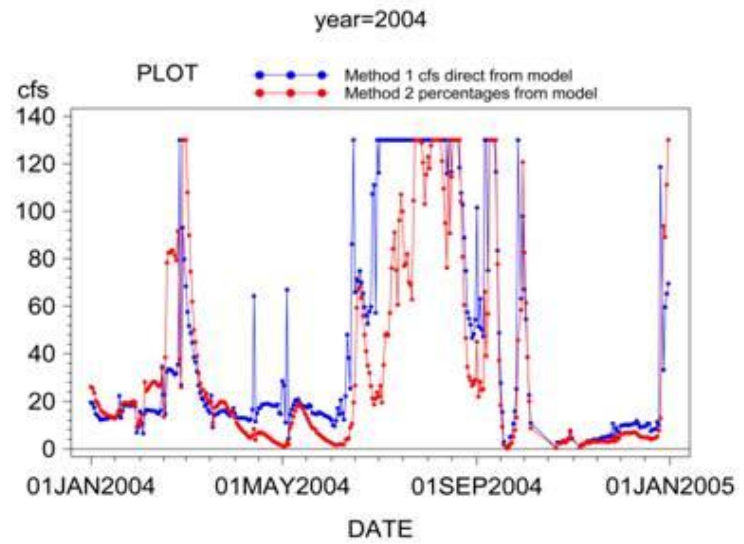
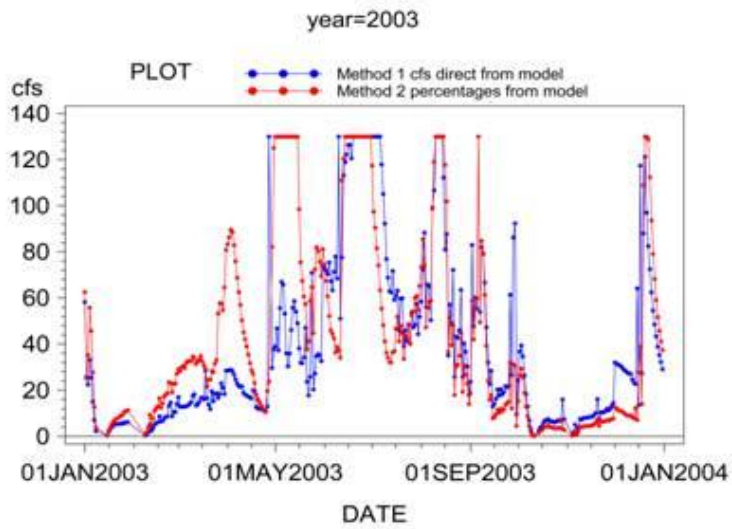

Appendix 8E

Yearly time series plots of total excess flows at the location of the Myakka River near Sarasota gage predicted by MIKE SHE and adjusted by Method 1 and by Method 1 with total excess flow never exceeding gaged flow for 1995-2005.

Both values capped at 130 cfs.

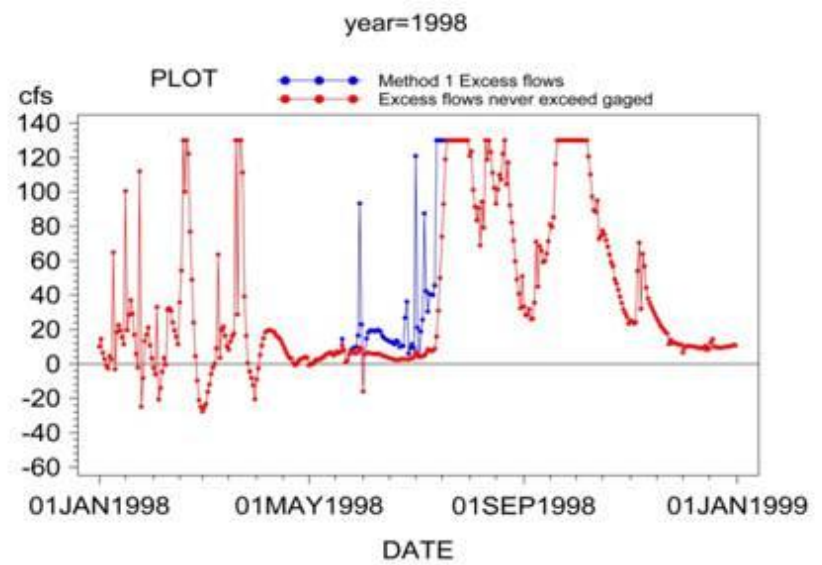
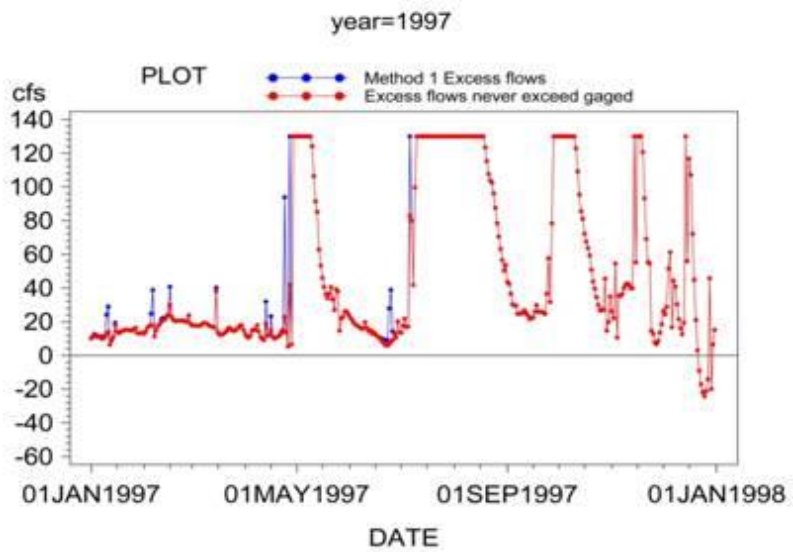
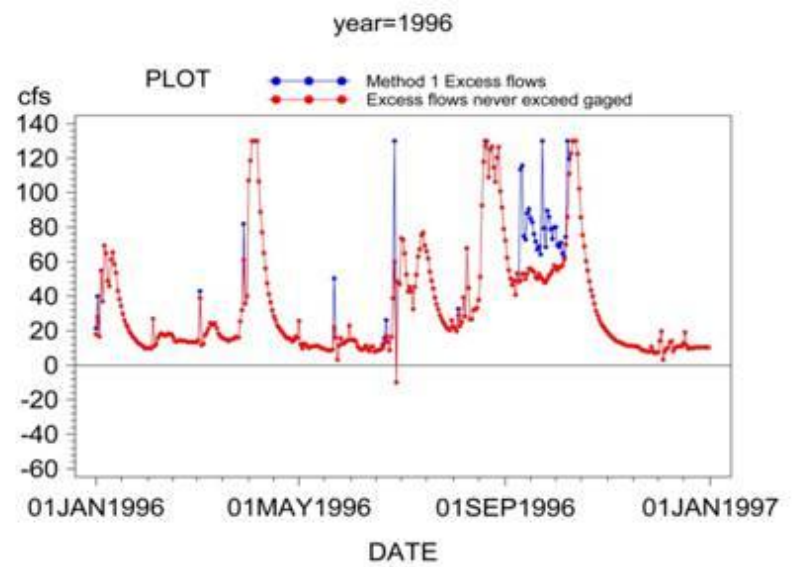
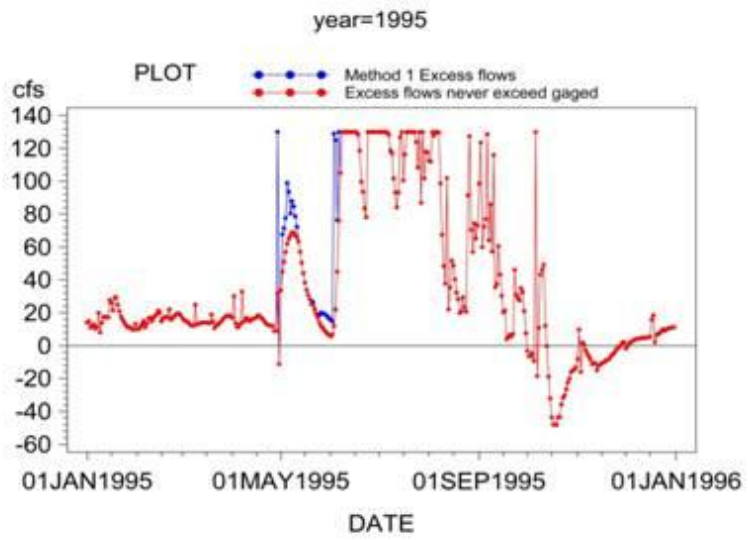

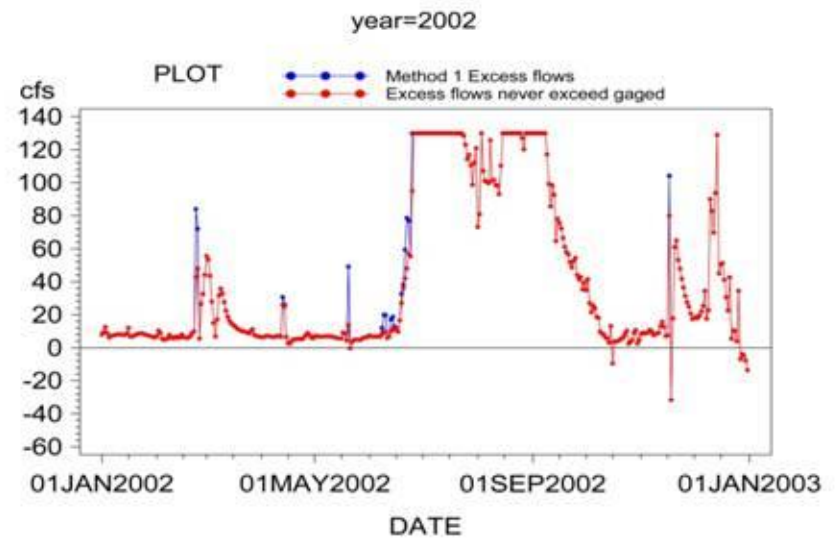
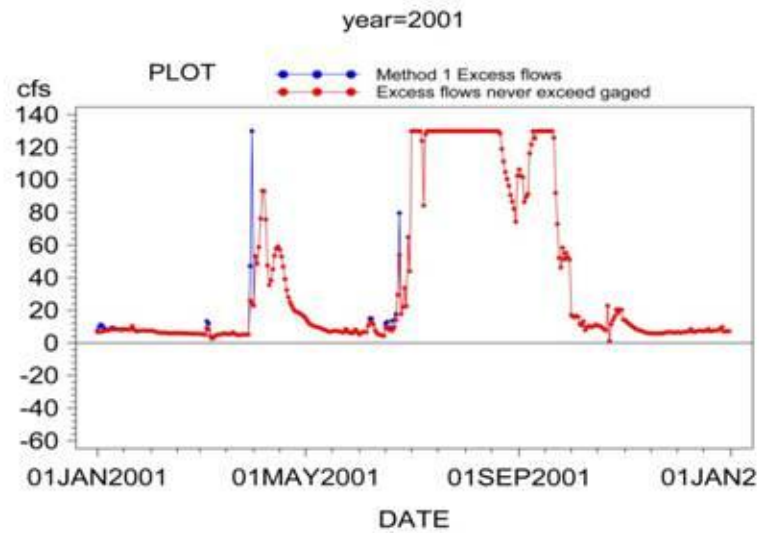
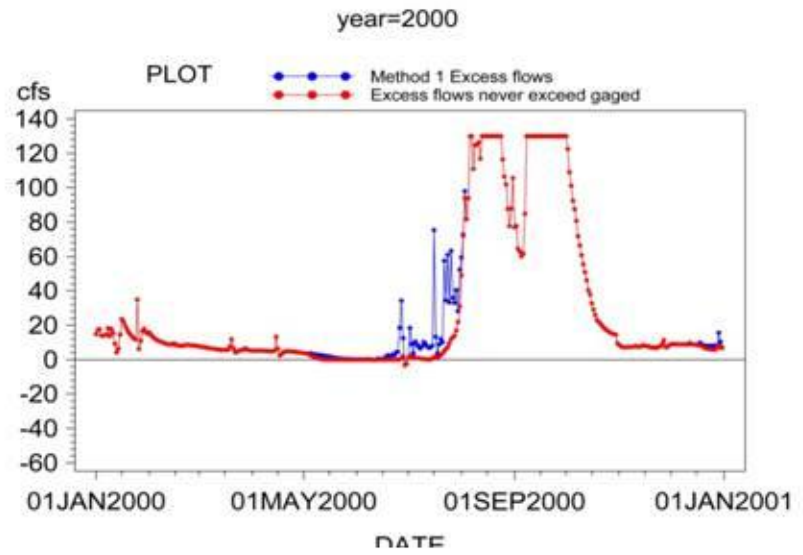
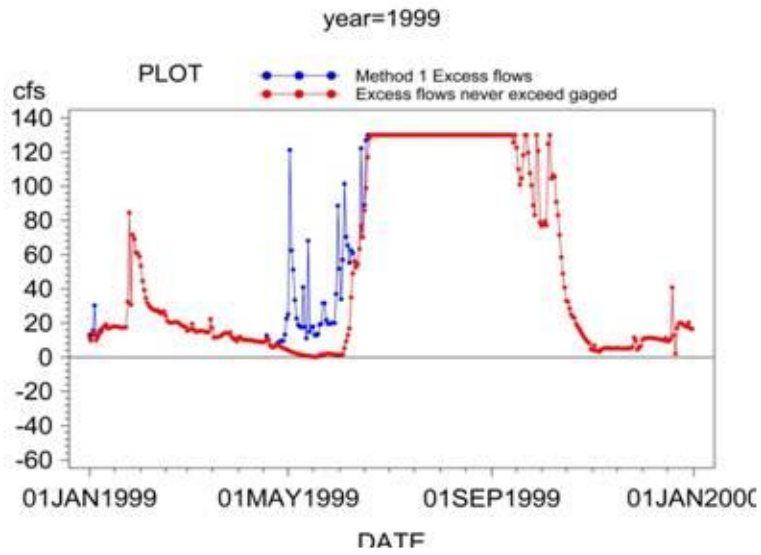

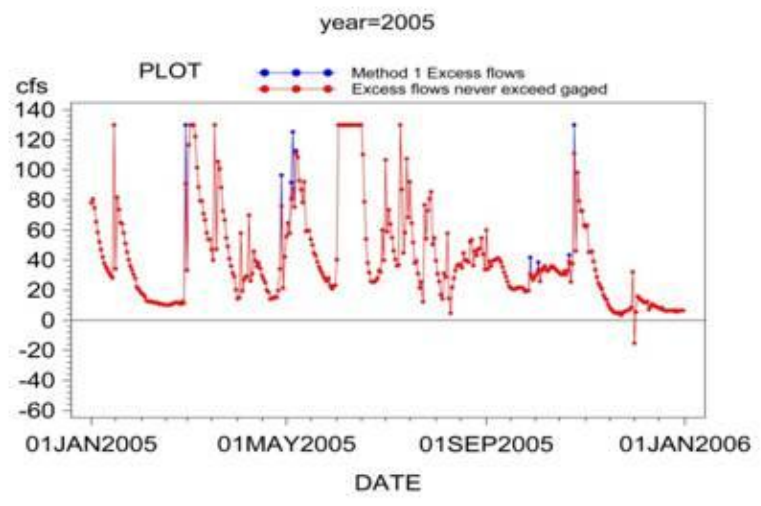
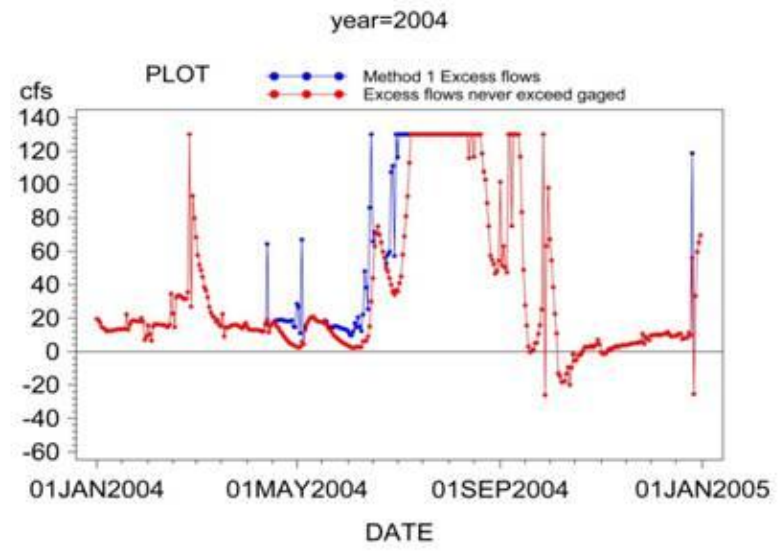
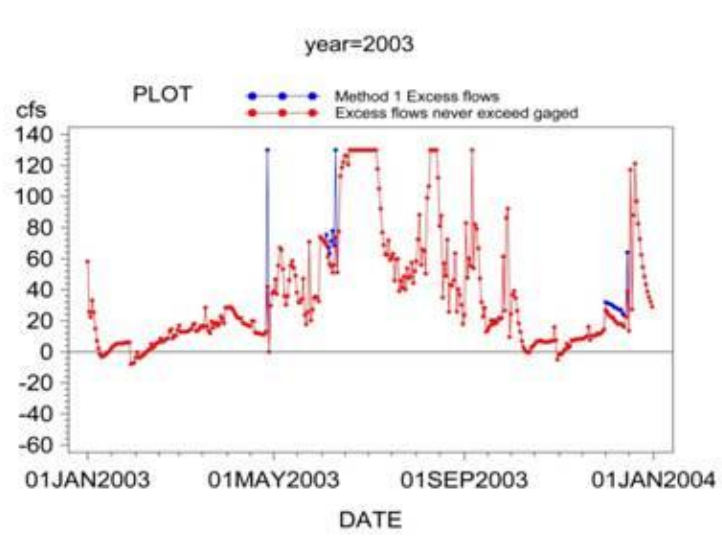

Appendix 8F

Yearly time series plots of flow at the location of the Myakka River near Sarasota gage reported by the USGS and adjusted flows at that location predicted by MIKE SHE and adjusted by Method 1 (with 130 cfs cap and excess flows never exceed gaged flows) for 1995-2005

year=1995

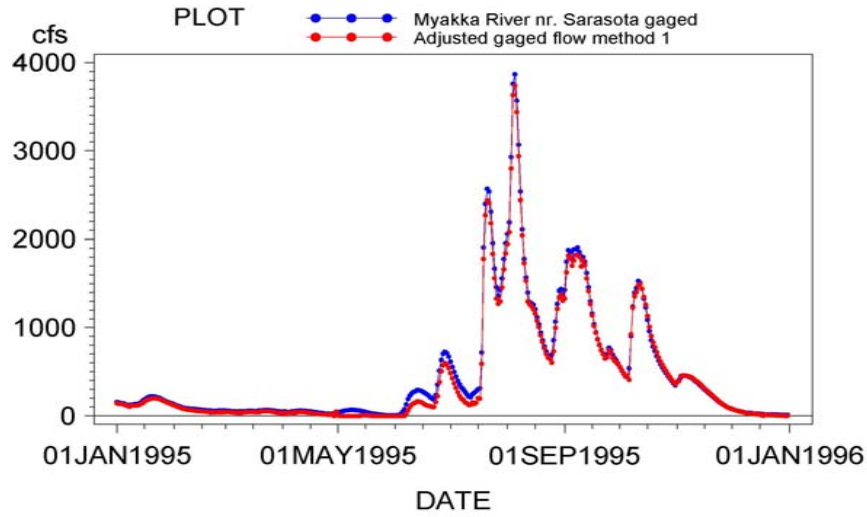

year=1996

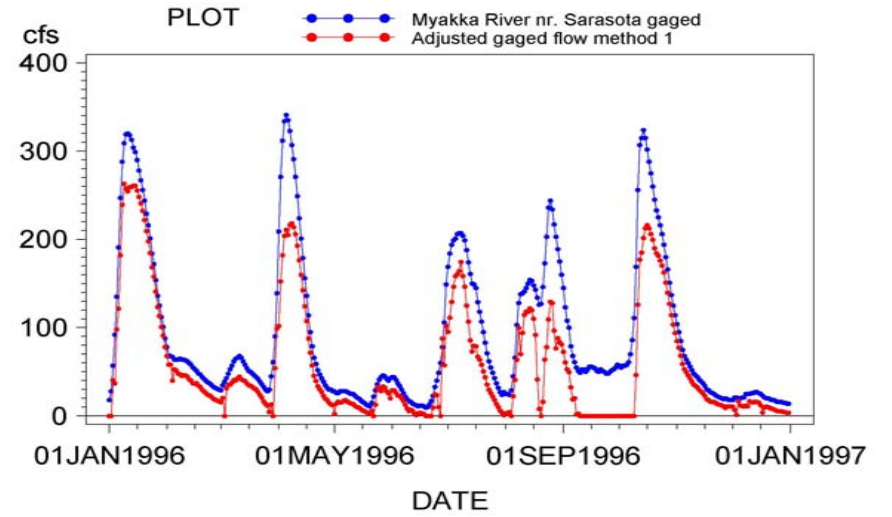

year=1997

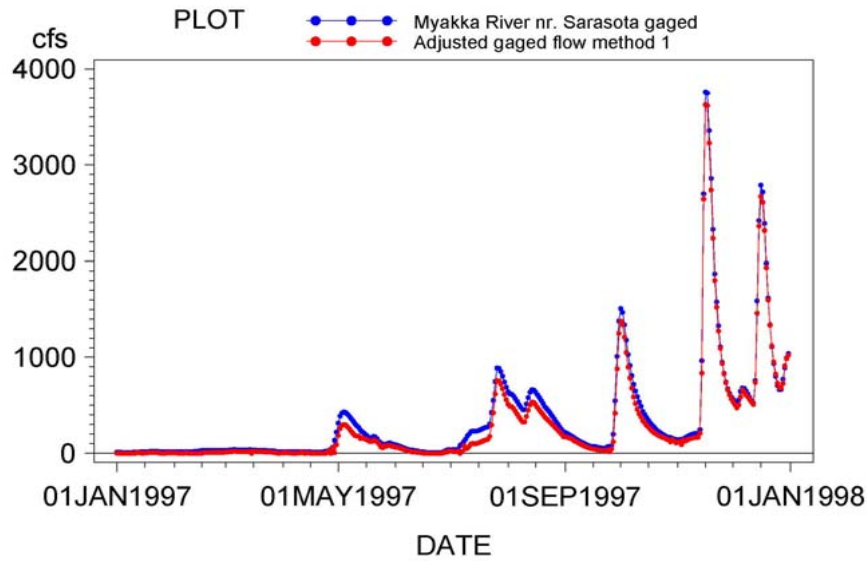

year=1998

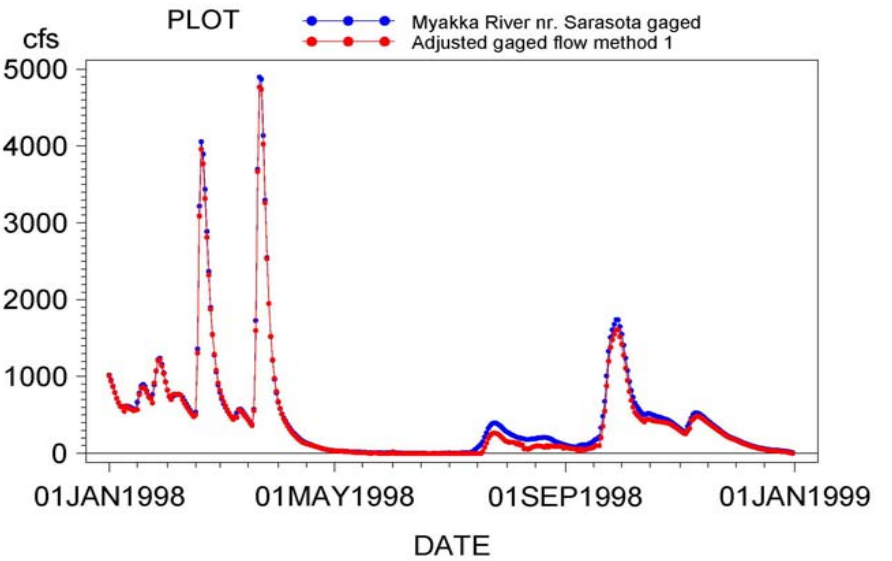

year=1999

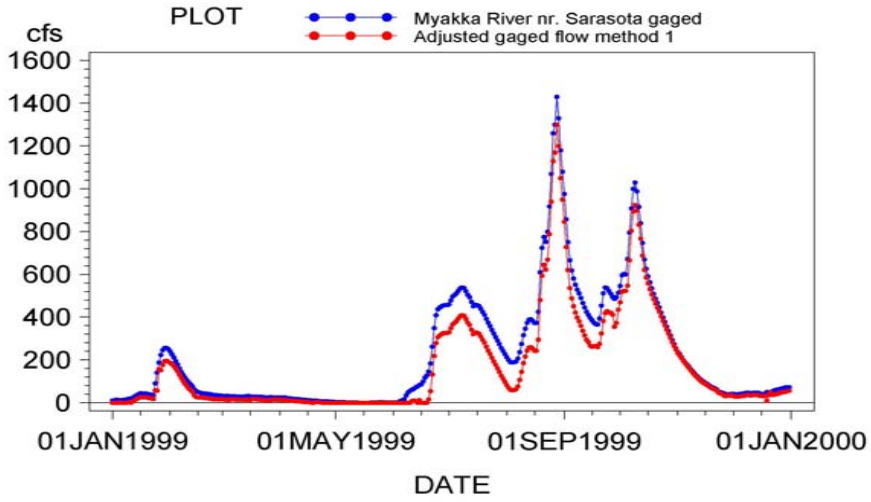

year=2000

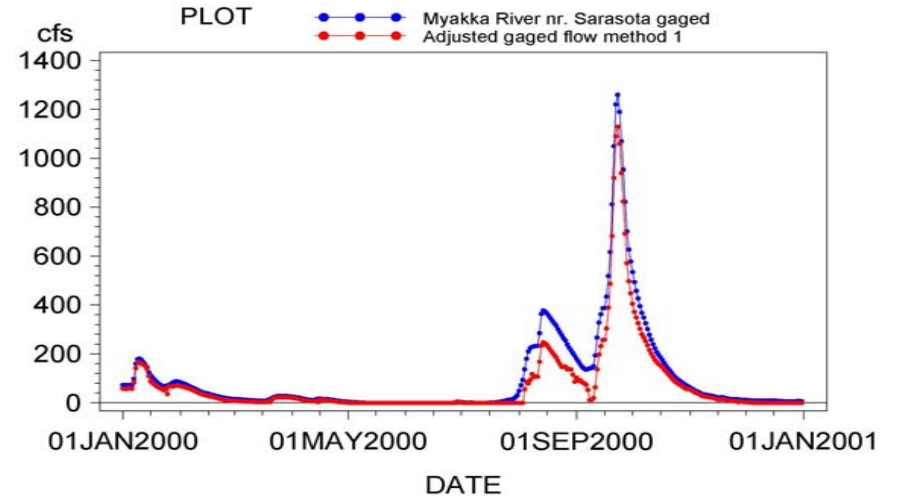

year=2001

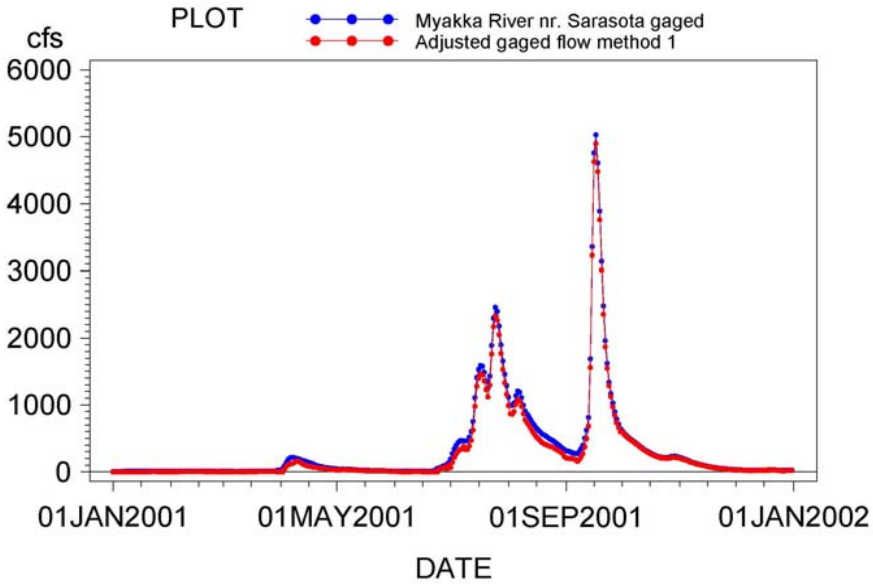

year=2002

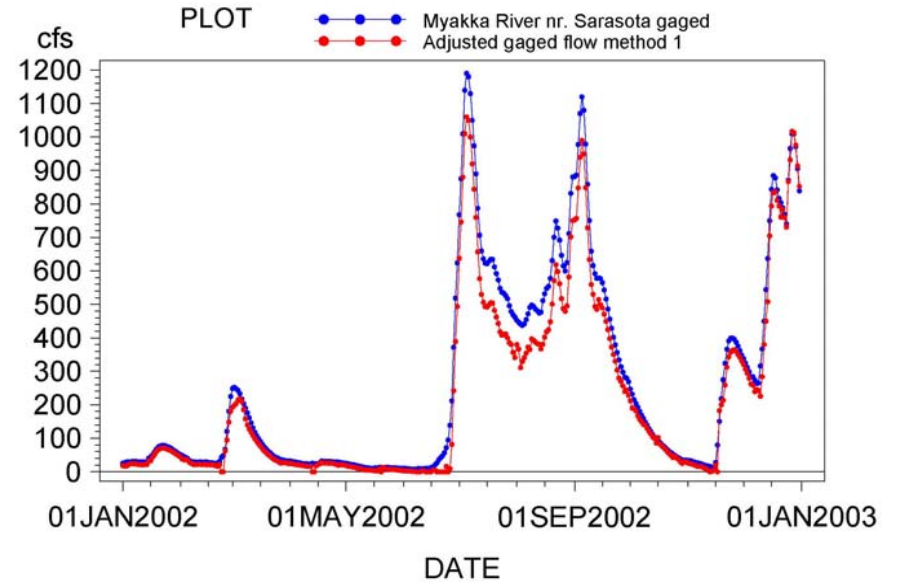

year=2003

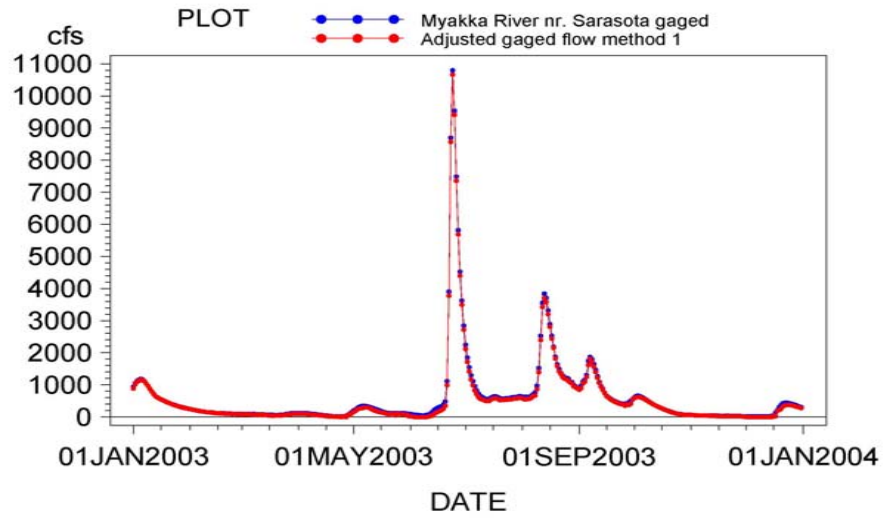

year=2004

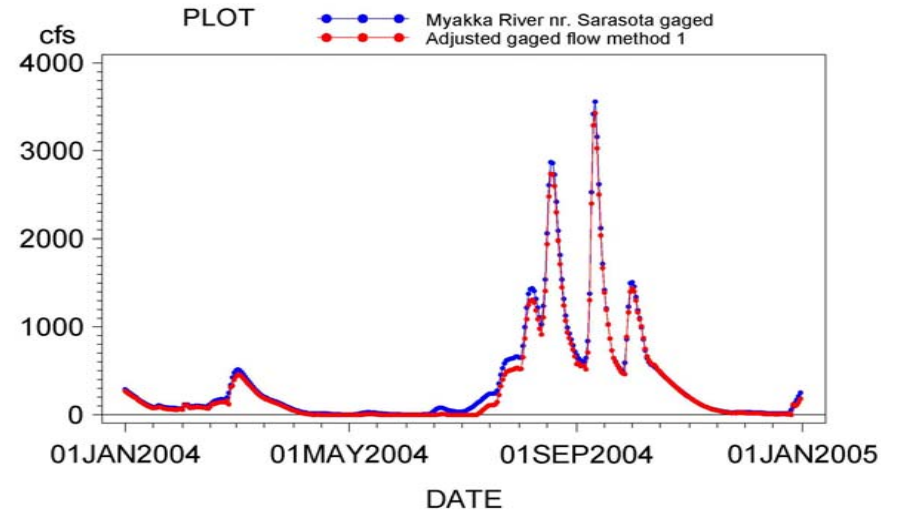

Appendix 8G

Plots of the bottom area of water with salinity < 2 , < 5 , < 12 , and < 17 versus preceding 5-day flow at the Myakka River near Sarasota gage for seasonal blocks 1, 2, and 3.

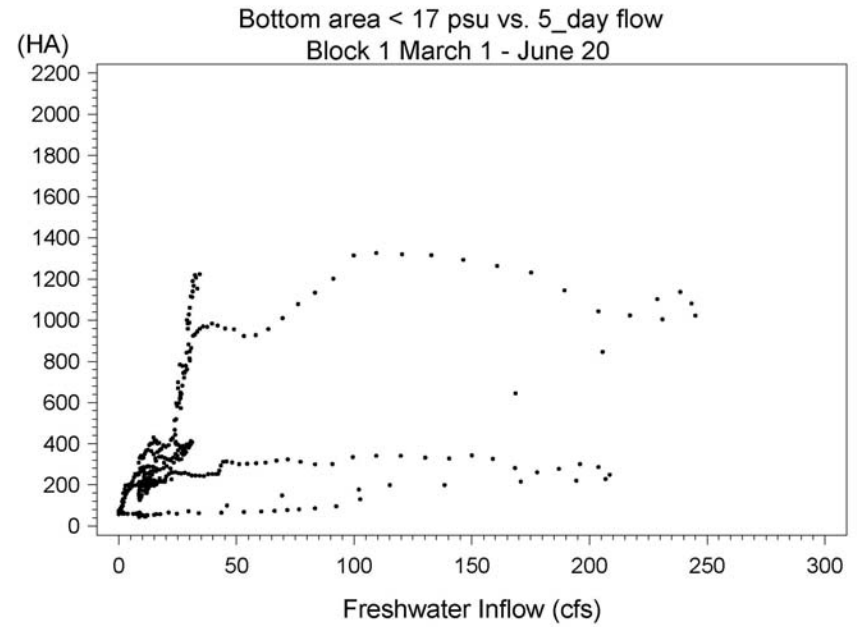
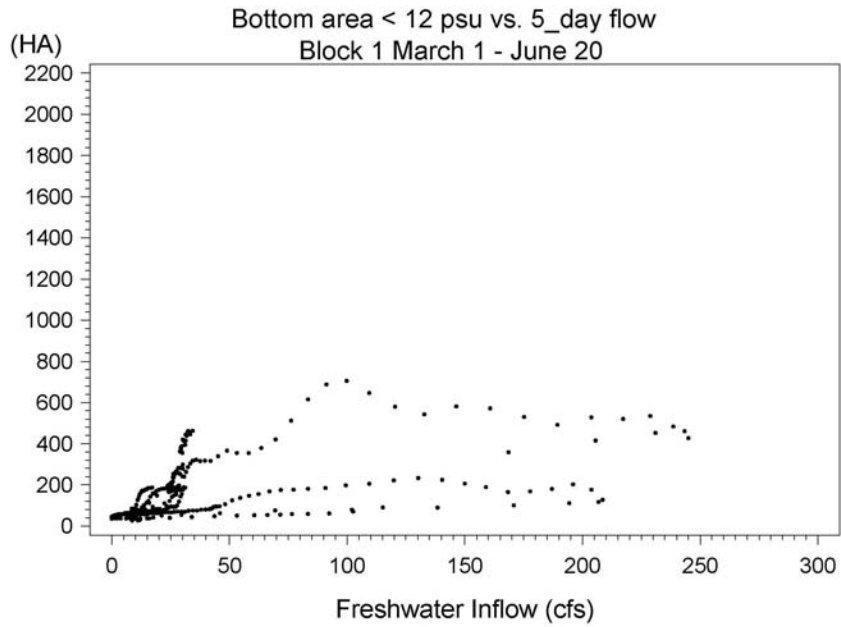
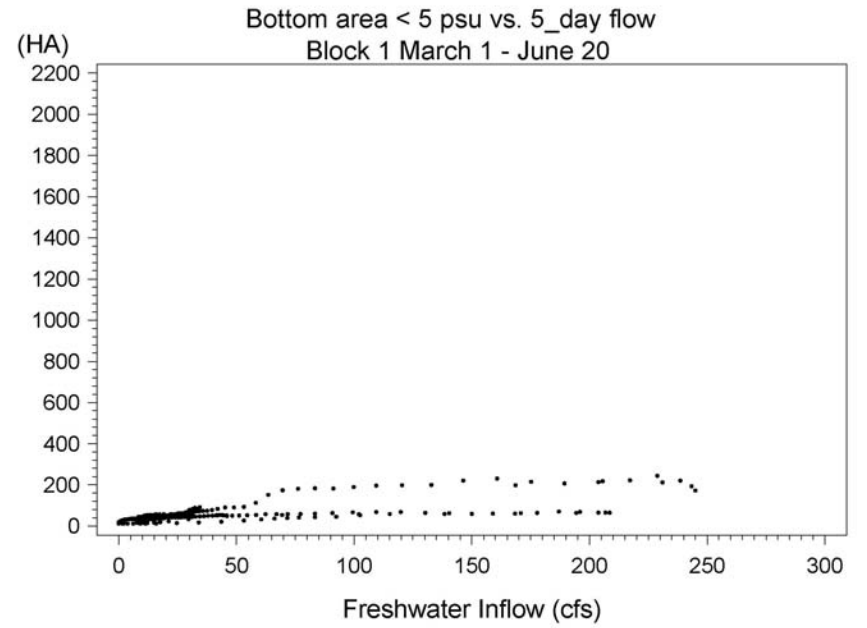
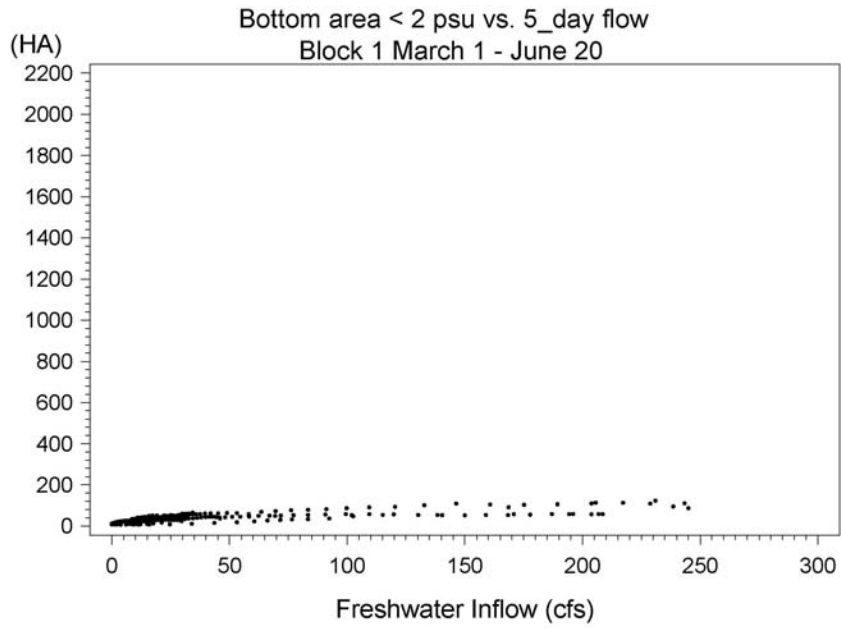

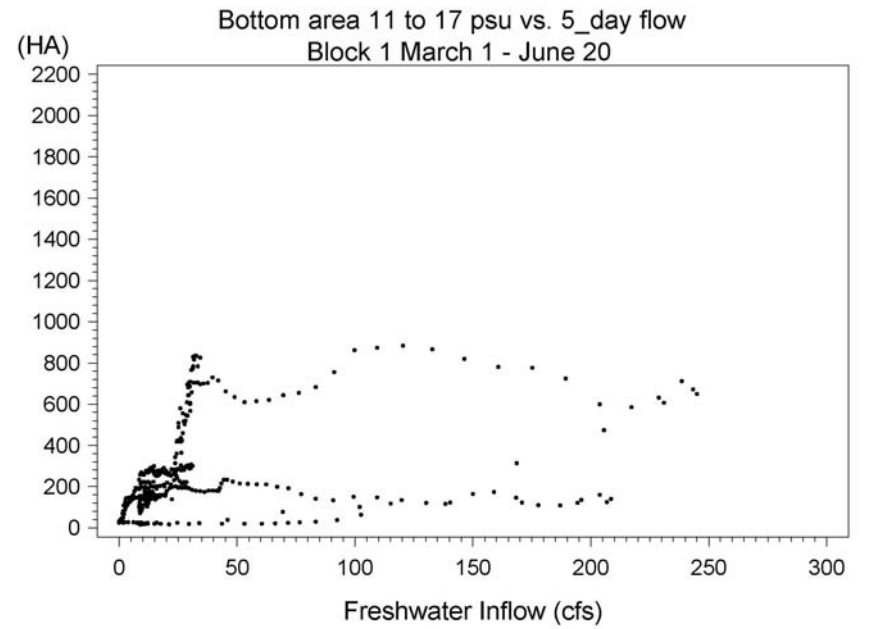
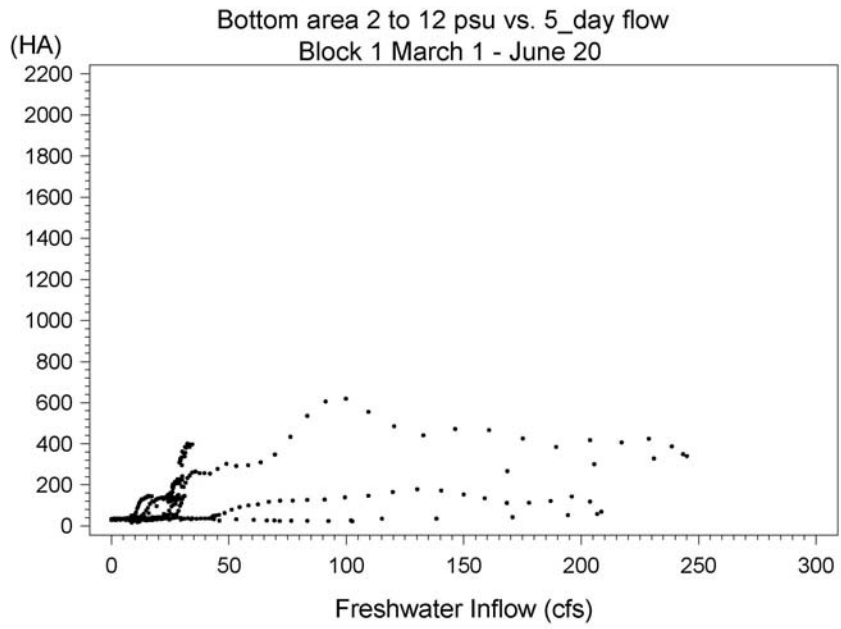

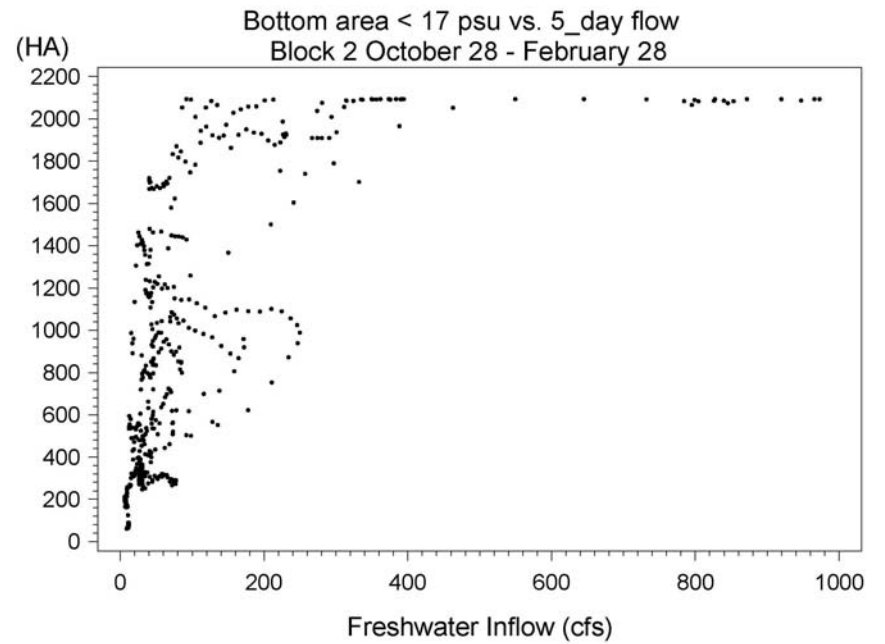
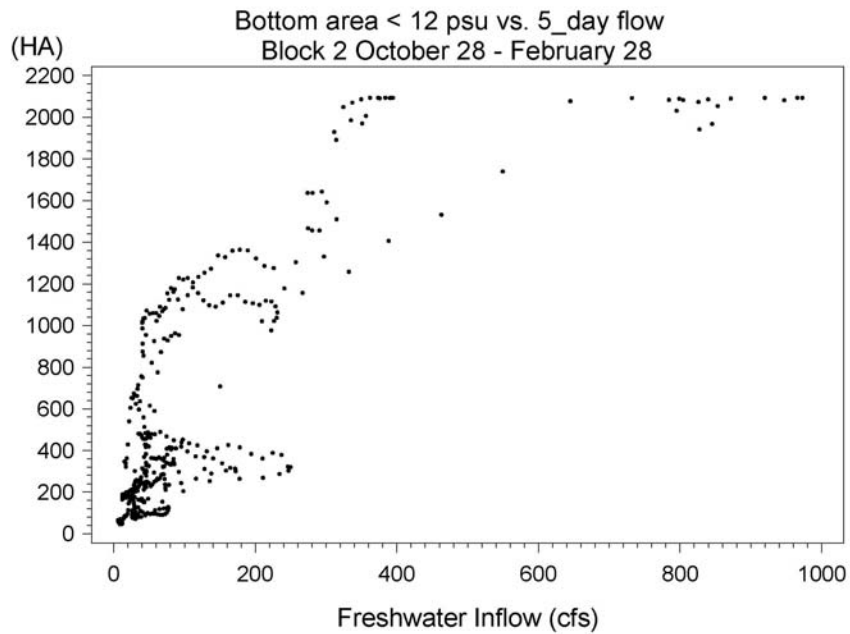
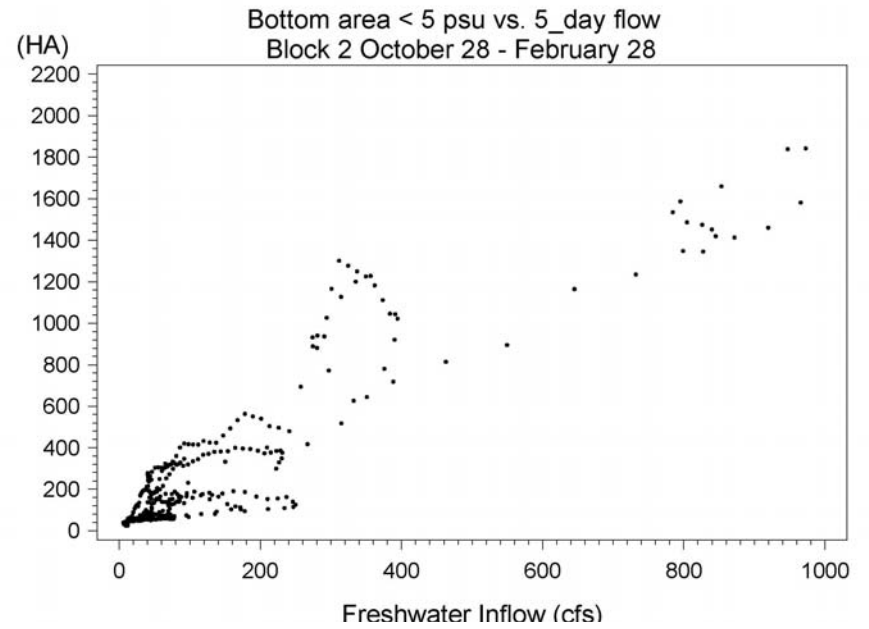
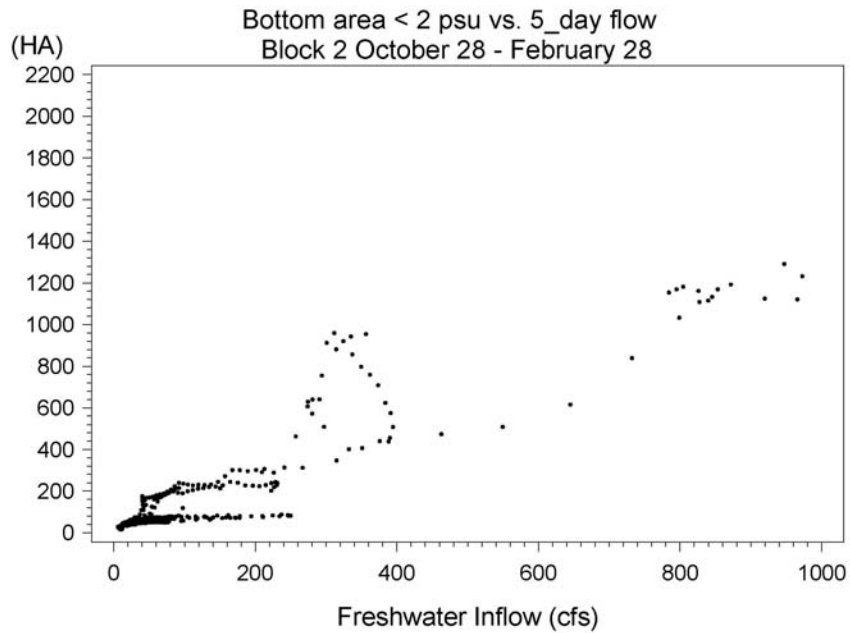

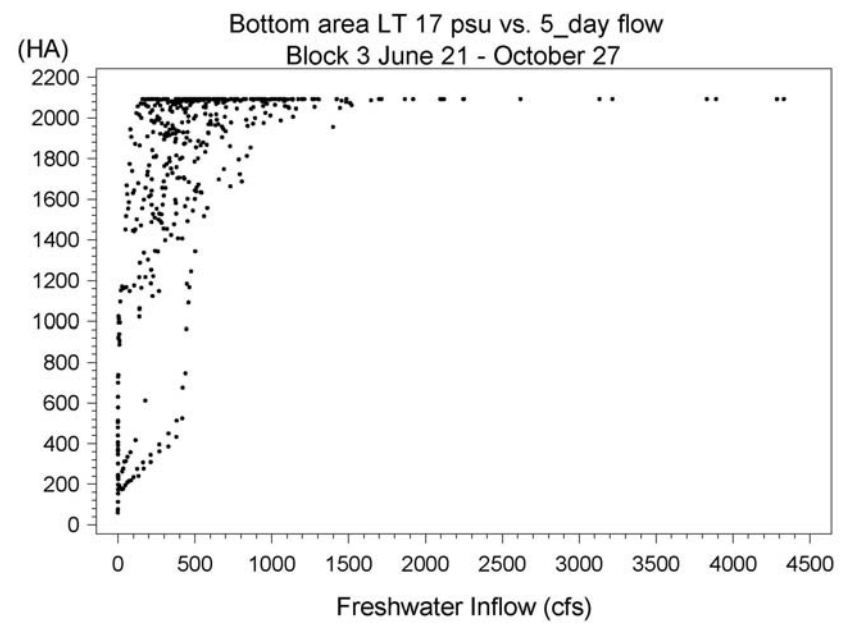
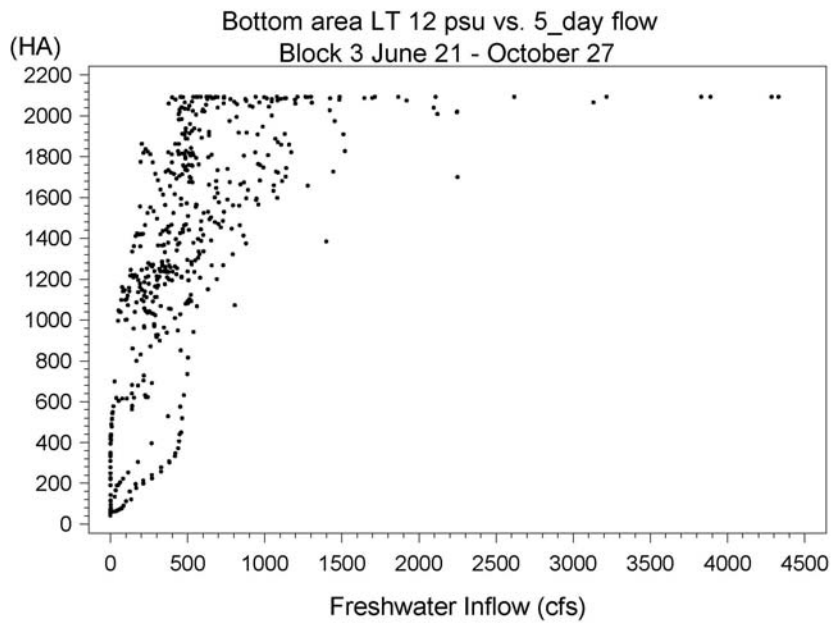
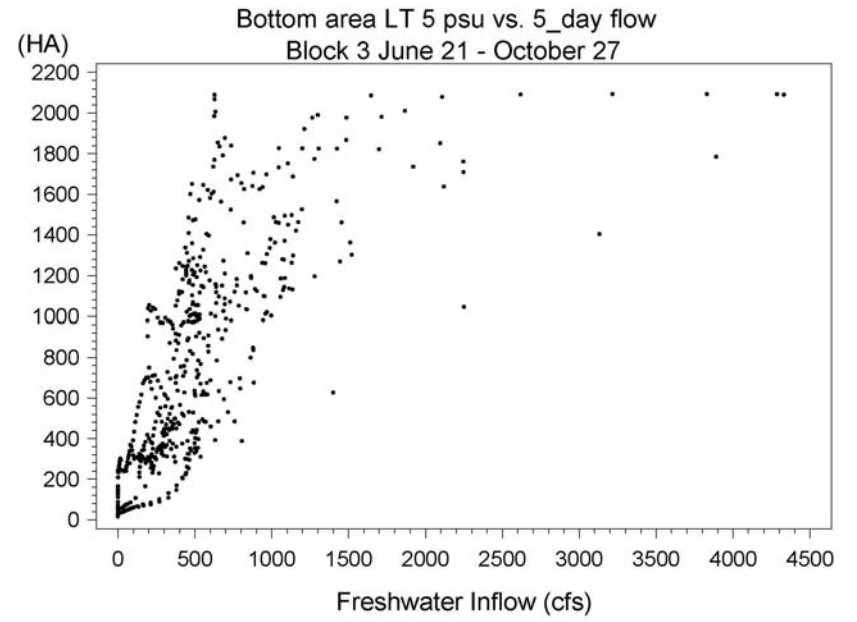
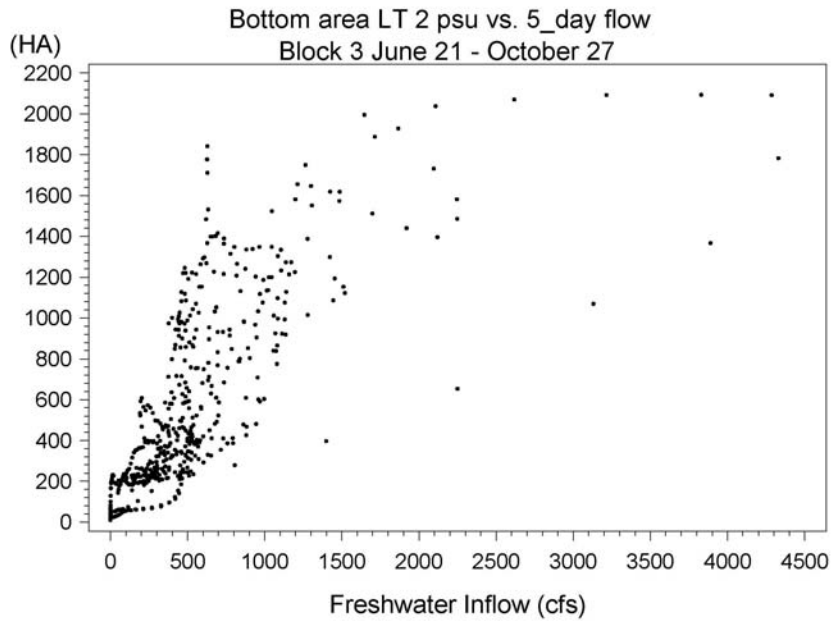

Appendix 8H

Plots of the volume of water with salinity < 2 , < 5 , < 14 , and 3 to 14 psu versus preceding 5-day flow at the flow at the Myakka River near Sarasota gage for seasonal blocks 1, 2, and 3.

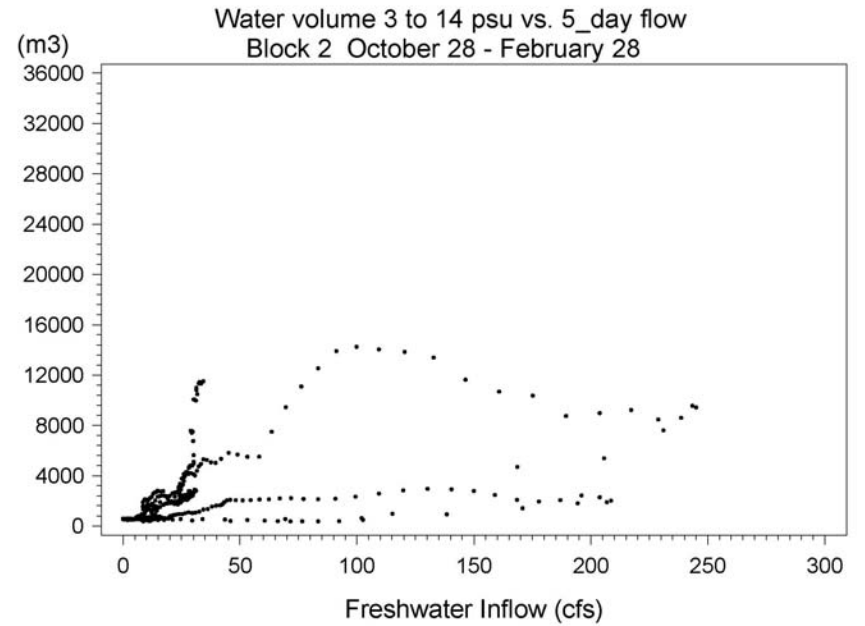
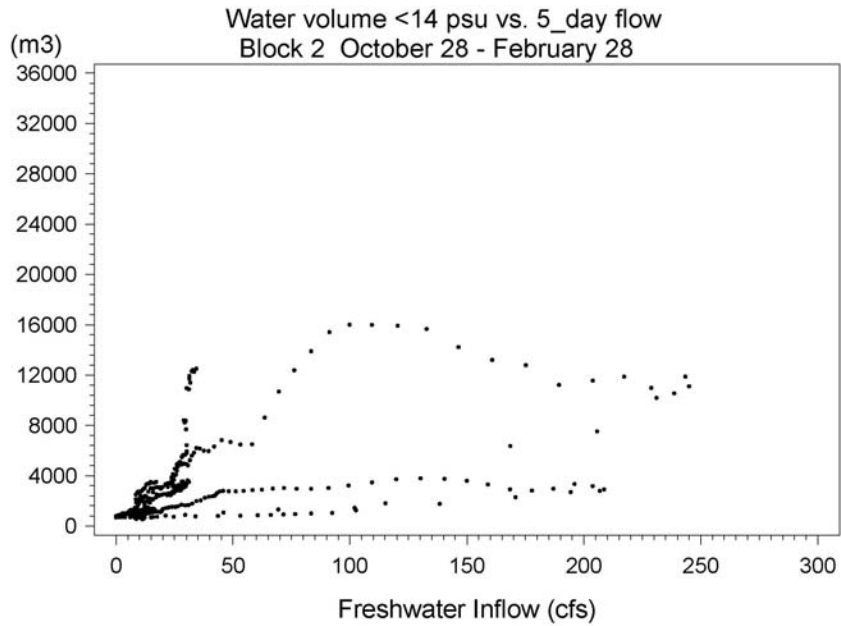
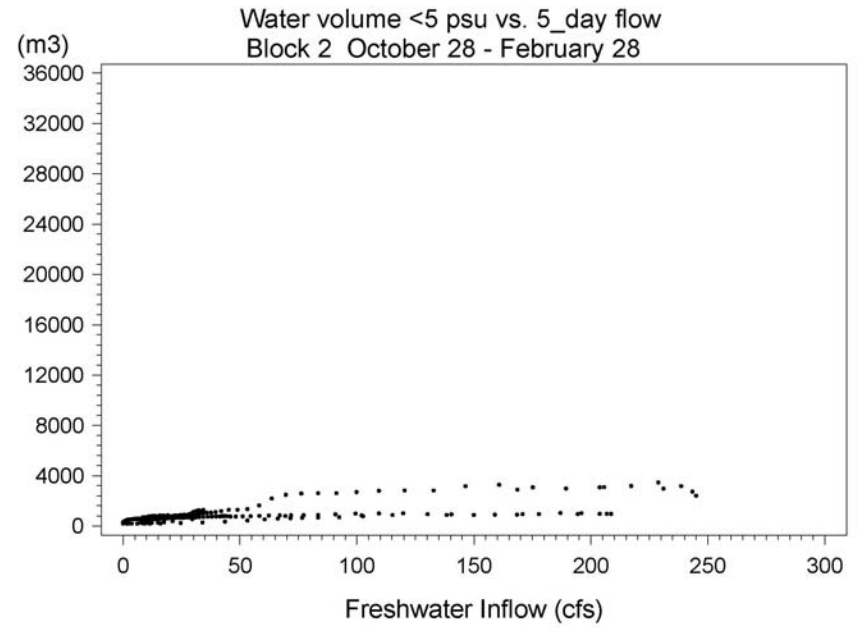
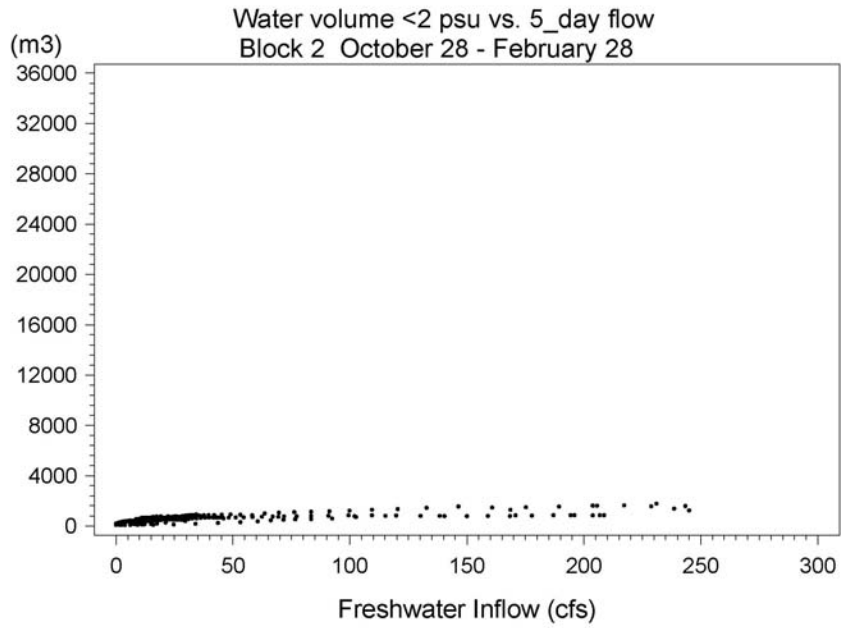

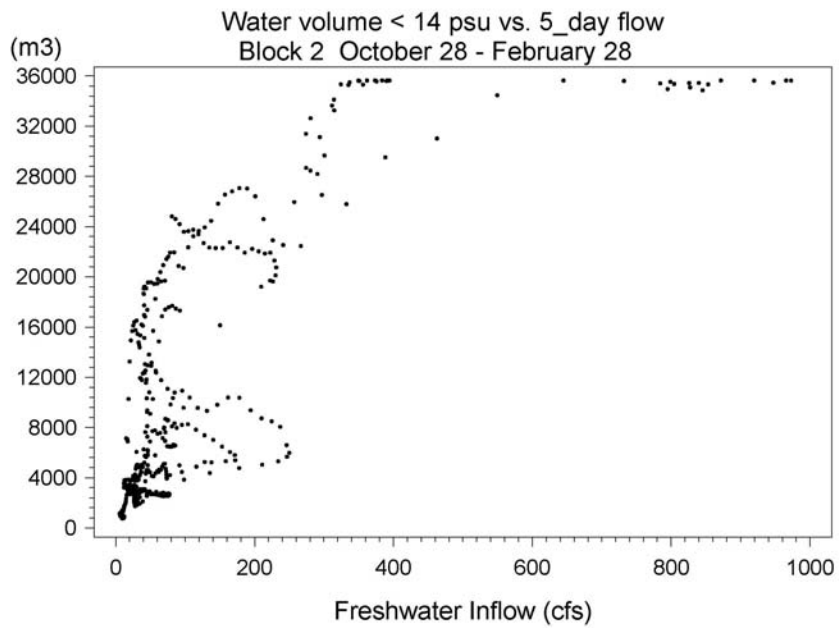
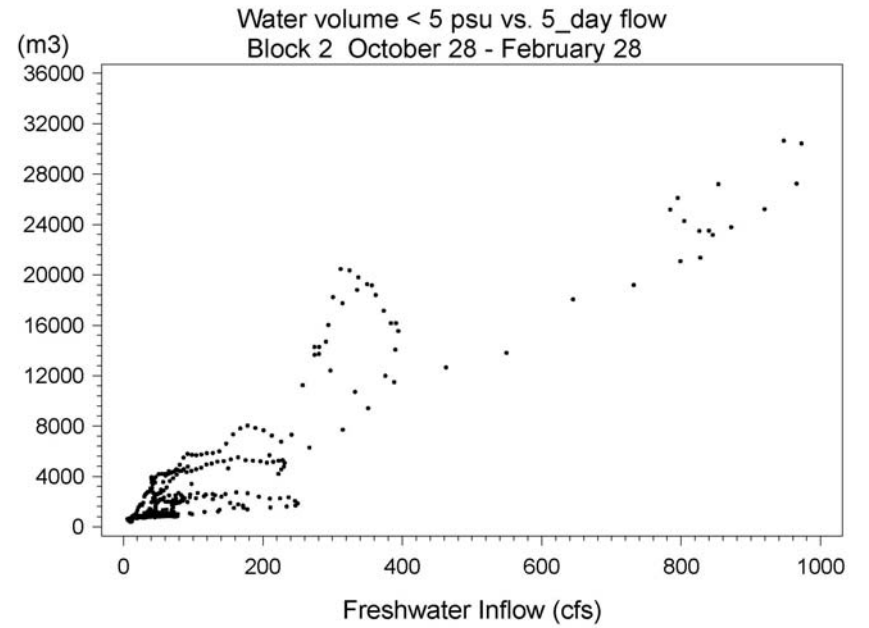
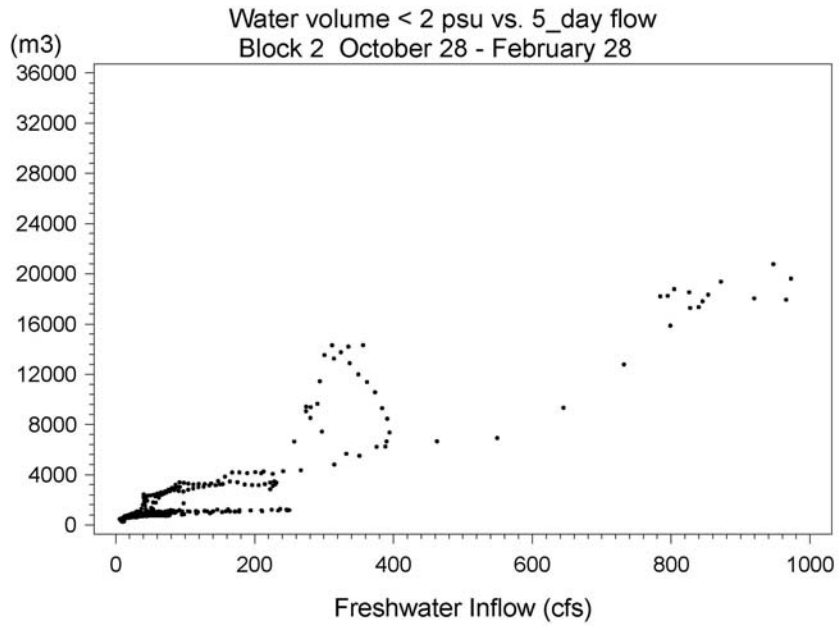

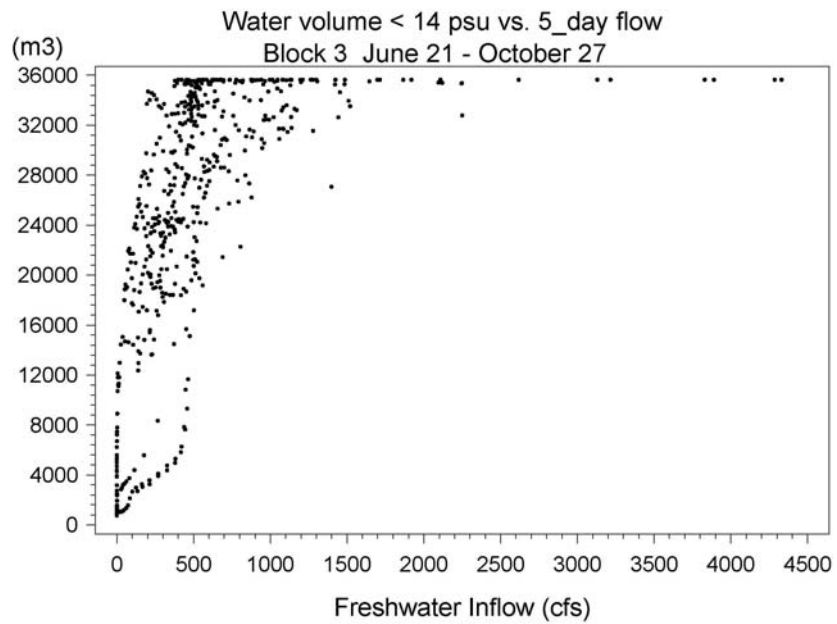
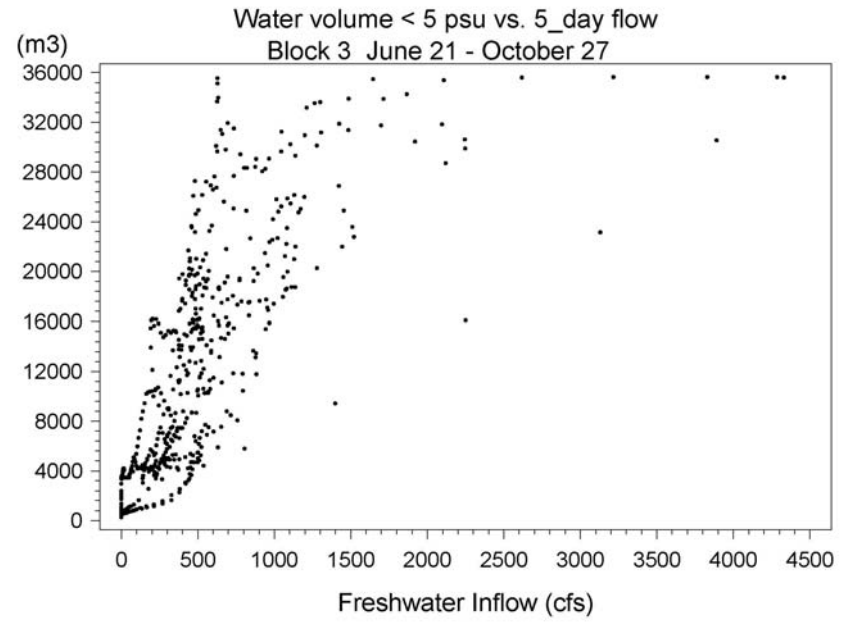
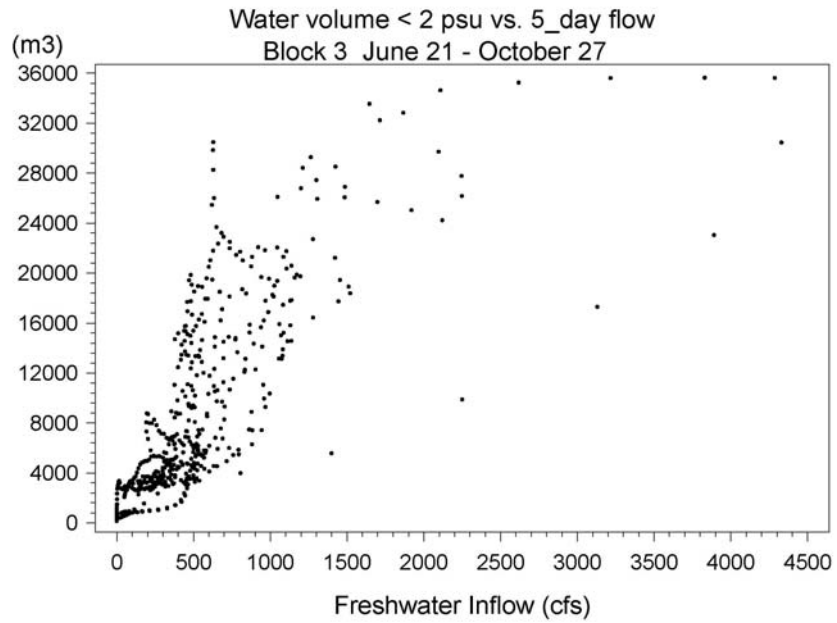

Appendix 8I

Cumulative distribution function plots of the bottom area of water with salinity < 2, < 5, < 11, < 17, 2 to 12, and 11 to 17 for baseline flows and seven flow reduction scenarios and bar charts of the percent reduction from baseline for these same scenarios.

Myakka River
 Hydrodynamic Model Predictions - 1999-2002
 Bottom area below 2 ppt (ha)
 Comparison of Scenarios

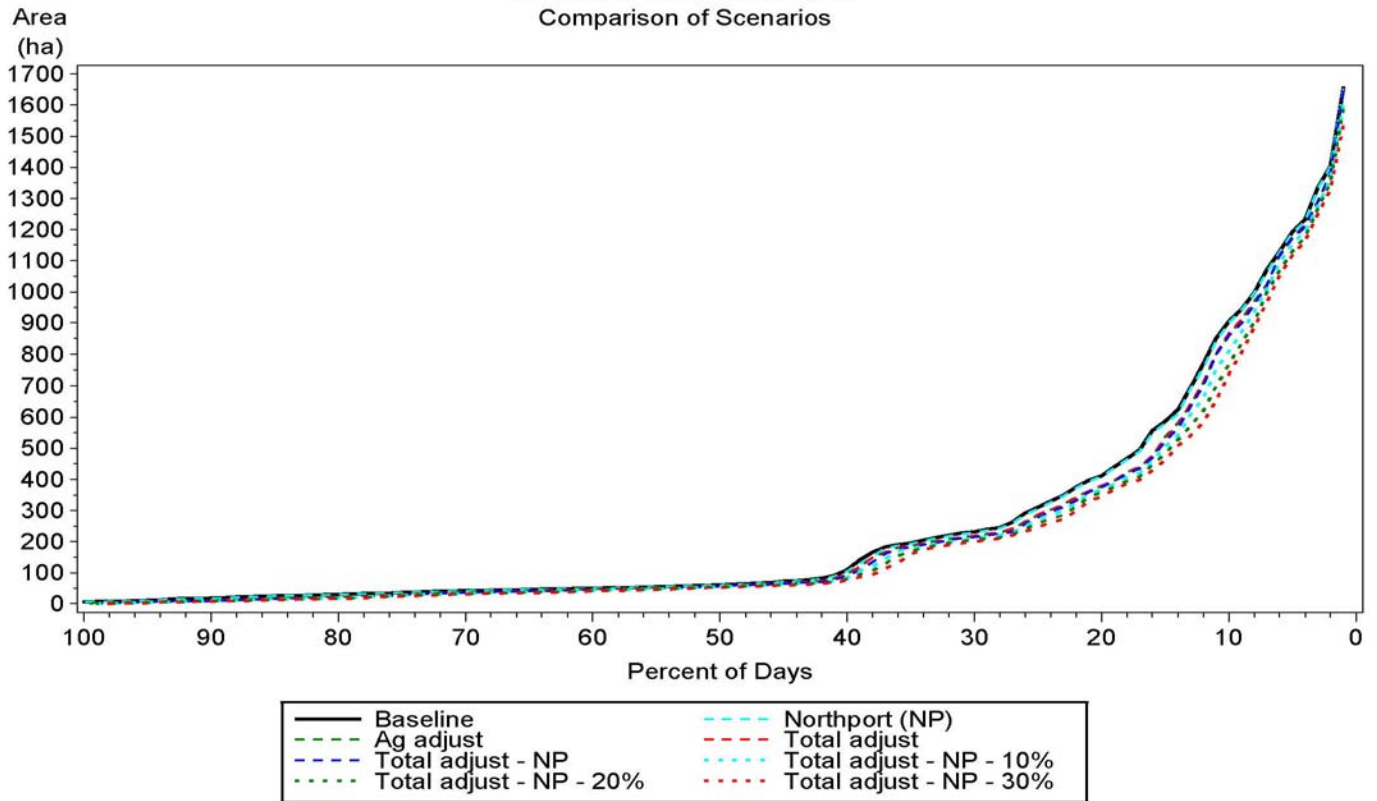

Myakka River
 Hydrodynamic Model Predictions - 1999-2002
 Normalized Area Under Curve from CDF of area below 2 ppt
 Comparison of Scenarios

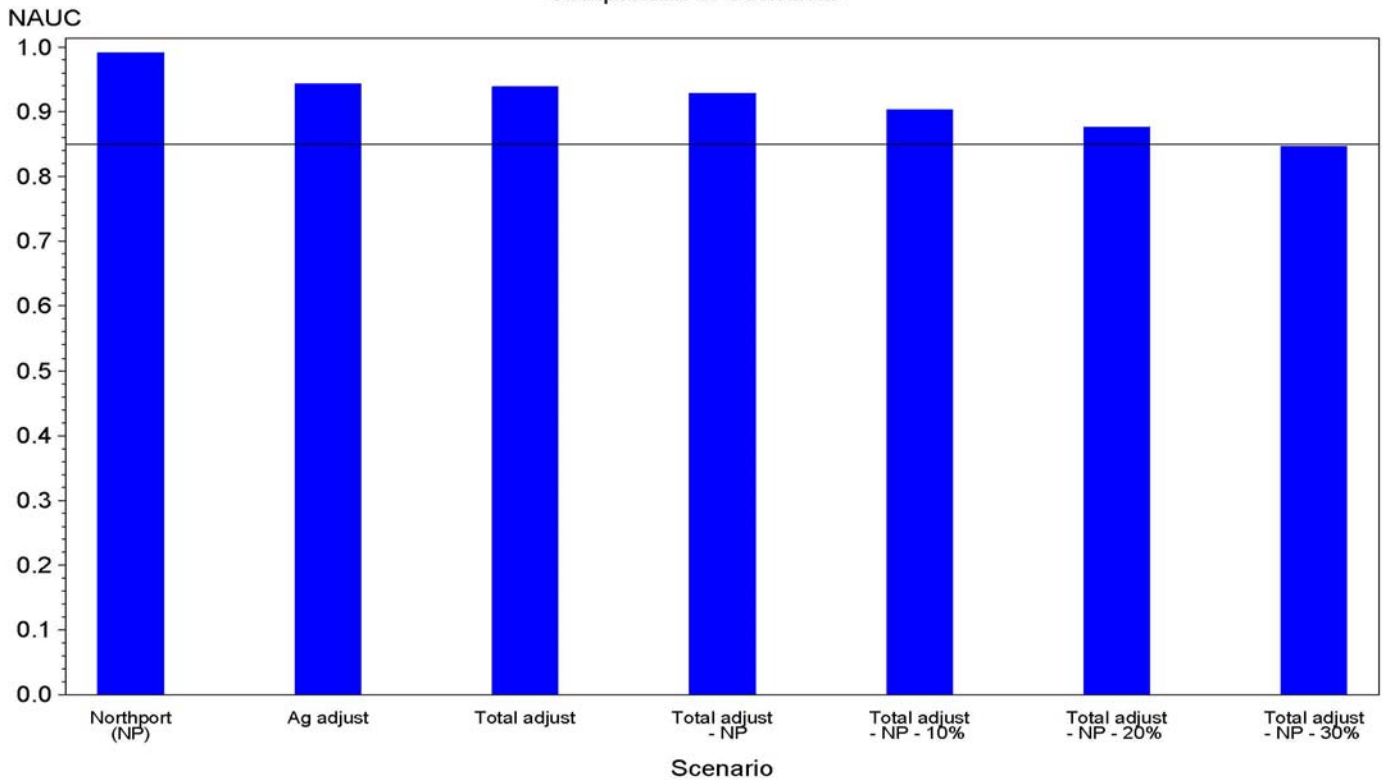

Myakka River
Hydrodynamic Model Predictions - 1999-2002
Bottom area below 5 ppt (ha)
Comparison of Scenarios

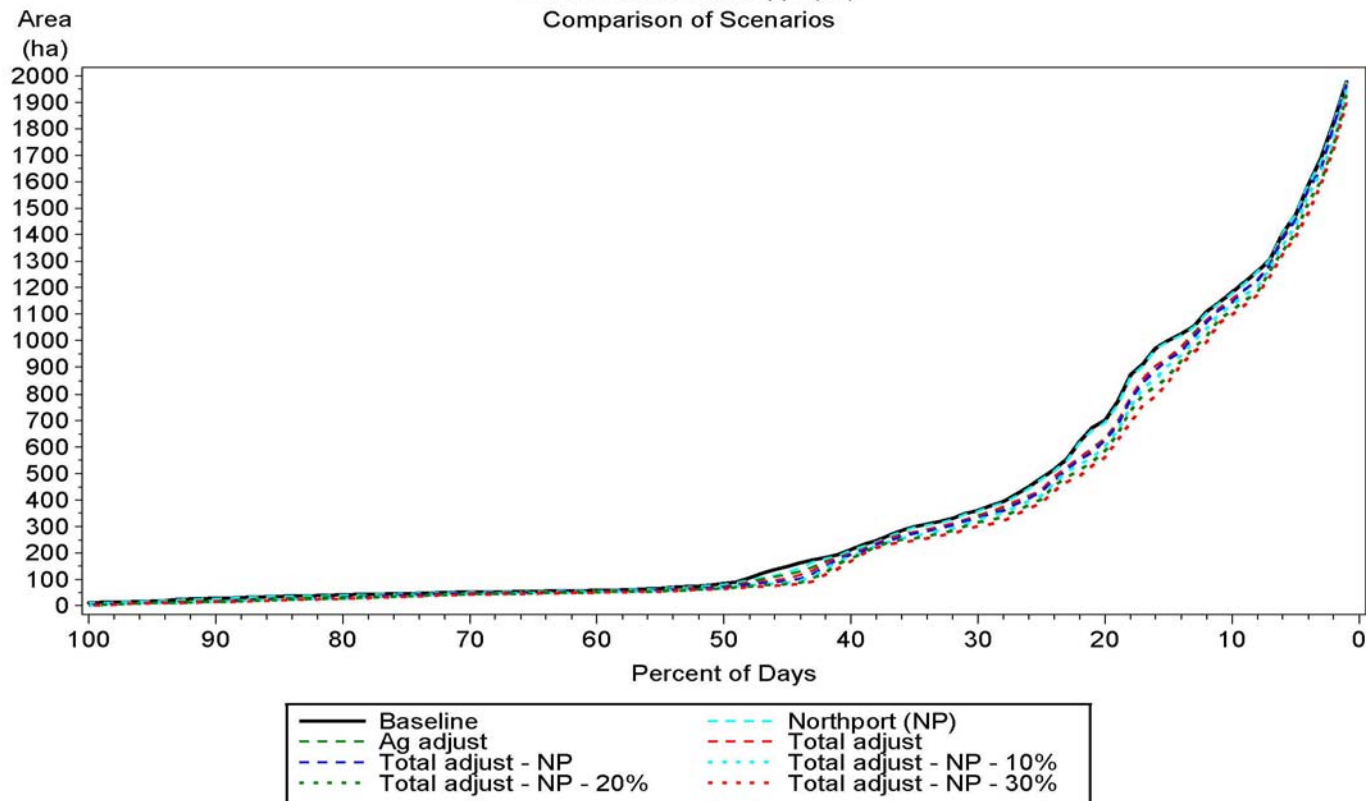

Myakka River
Hydrodynamic Model Predictions - 1999-2002
Normalized Area Under Curve from CDF of area below 5 ppt
Comparison of Scenarios

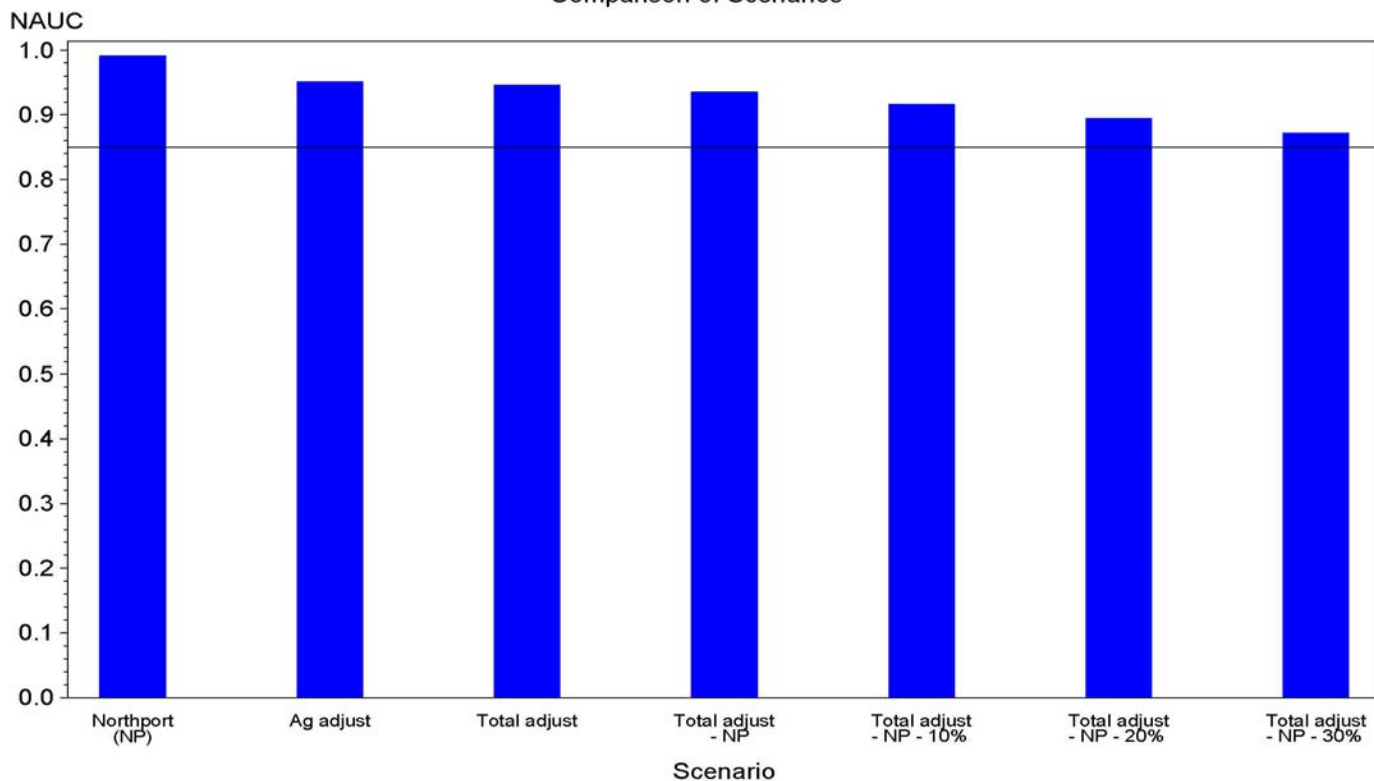

Myakka River
Hydrodynamic Model Predictions - 1999-2002
Bottom area below 12 ppt (ha)
Comparison of Scenarios

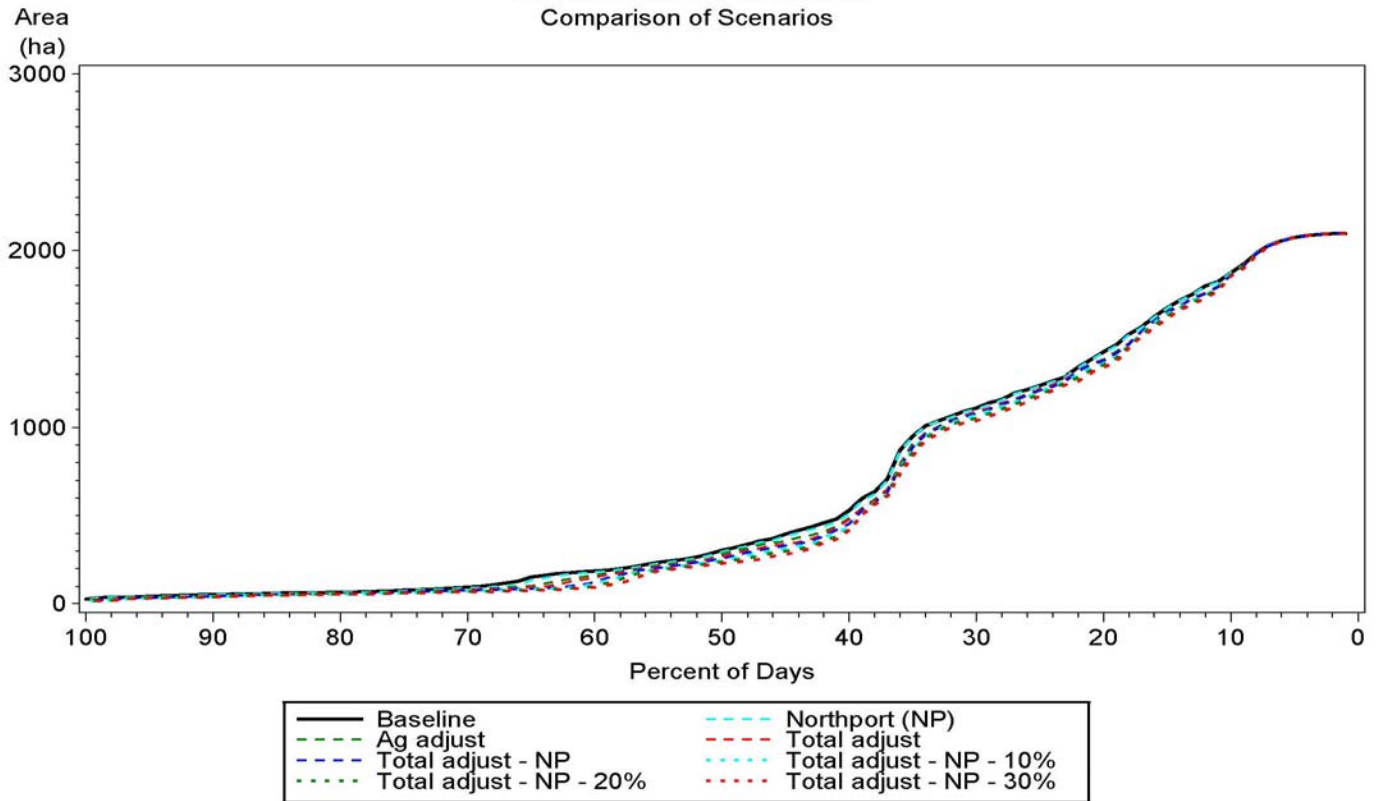

Myakka River
Hydrodynamic Model Predictions - 1999-2002
Normalized Area Under Curve from CDF of area below 12 ppt
Comparison of Scenarios

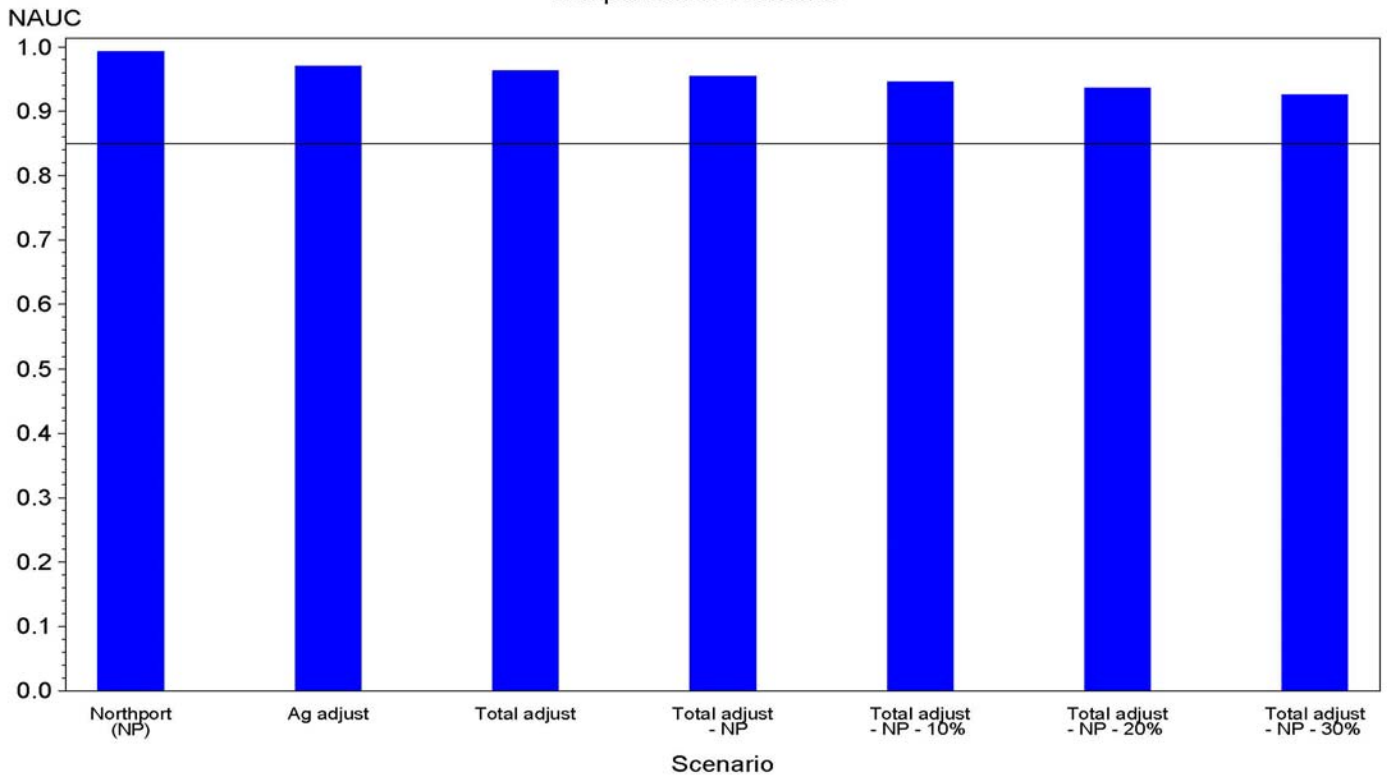

Myakka River
Hydrodynamic Model Predictions - 1999-2002
Bottom area below 17 ppt (ha)
Comparison of Scenarios

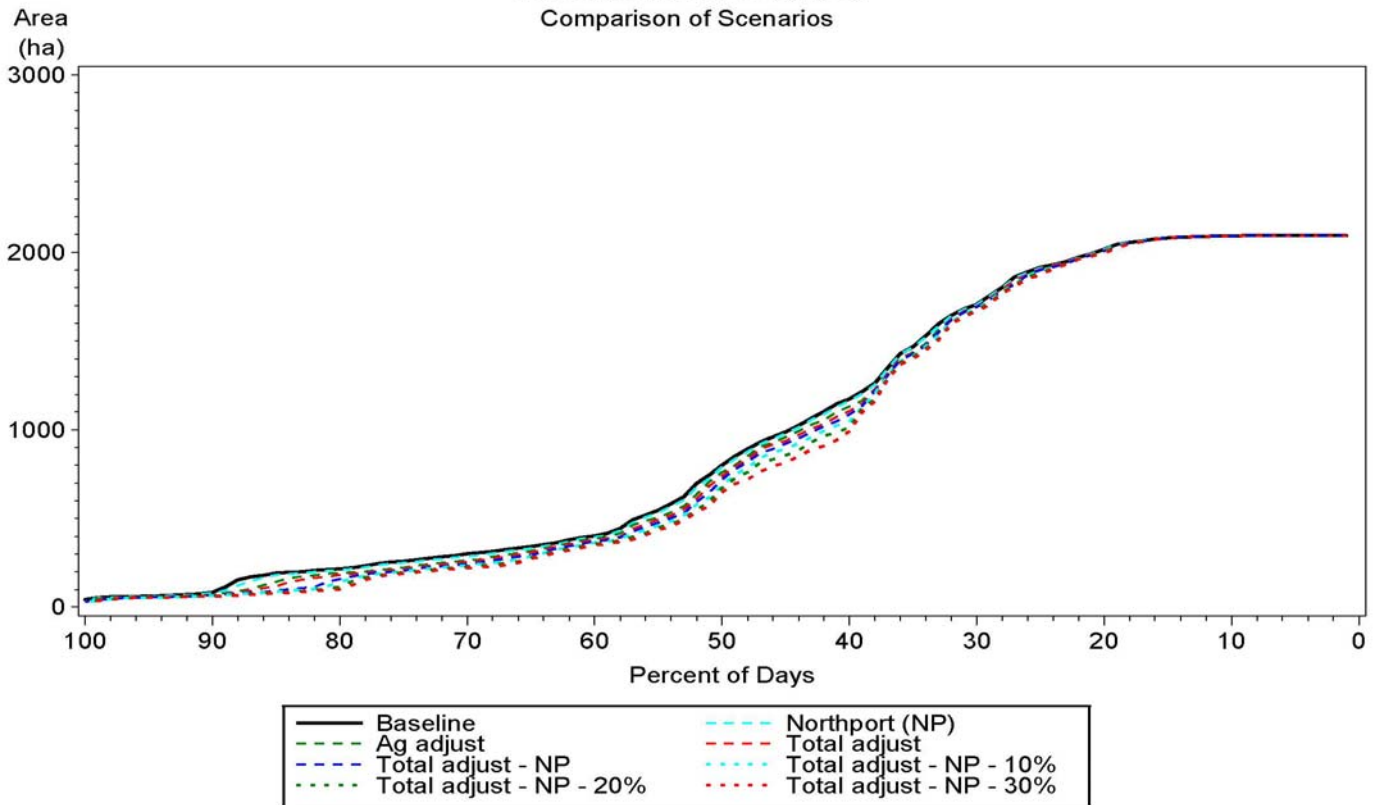

Myakka River
Hydrodynamic Model Predictions - 1999-2002
Normalized Area Under Curve from CDF of area below 17 ppt
Comparison of Scenarios

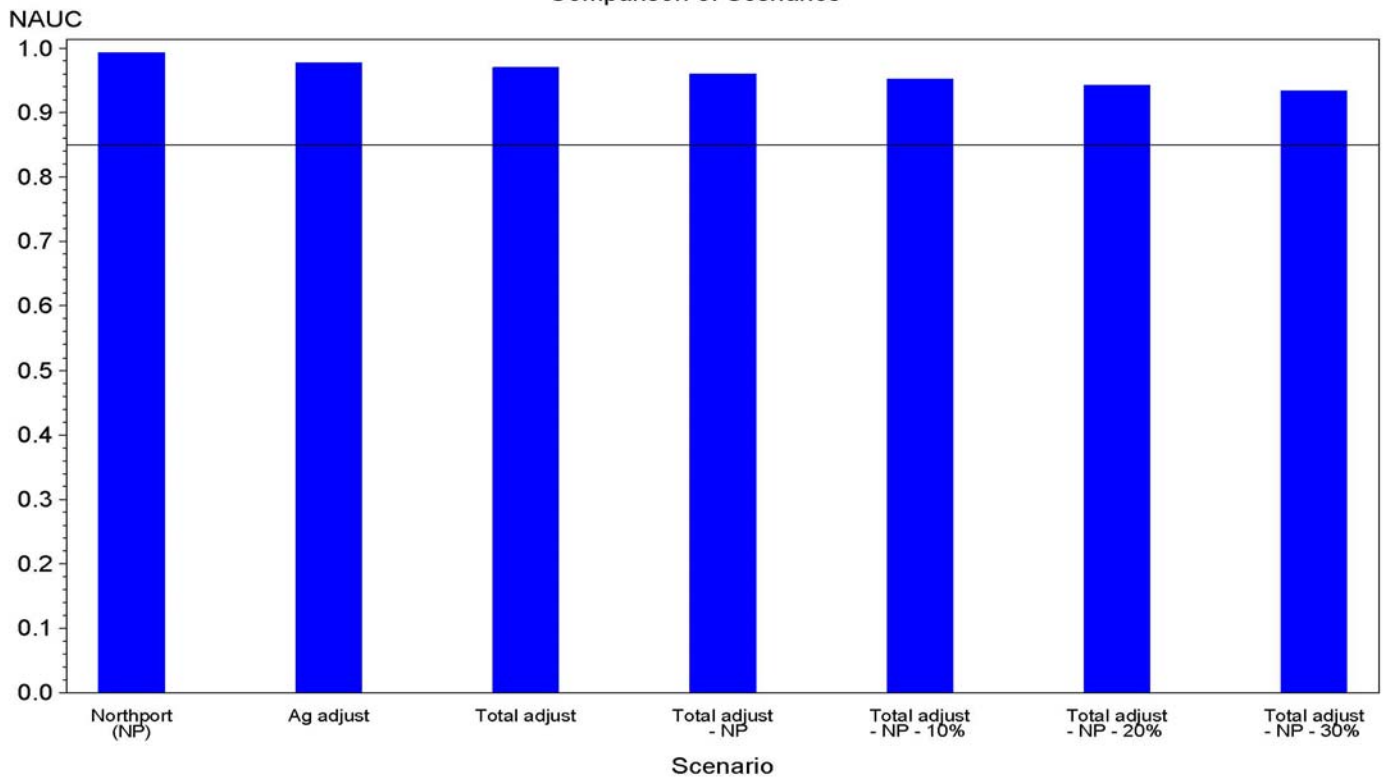

Myakka River
Hydrodynamic Model Predictions - 1999-2002
Bottom area between 11 & 17 ppt (ha)
Comparison of Scenarios

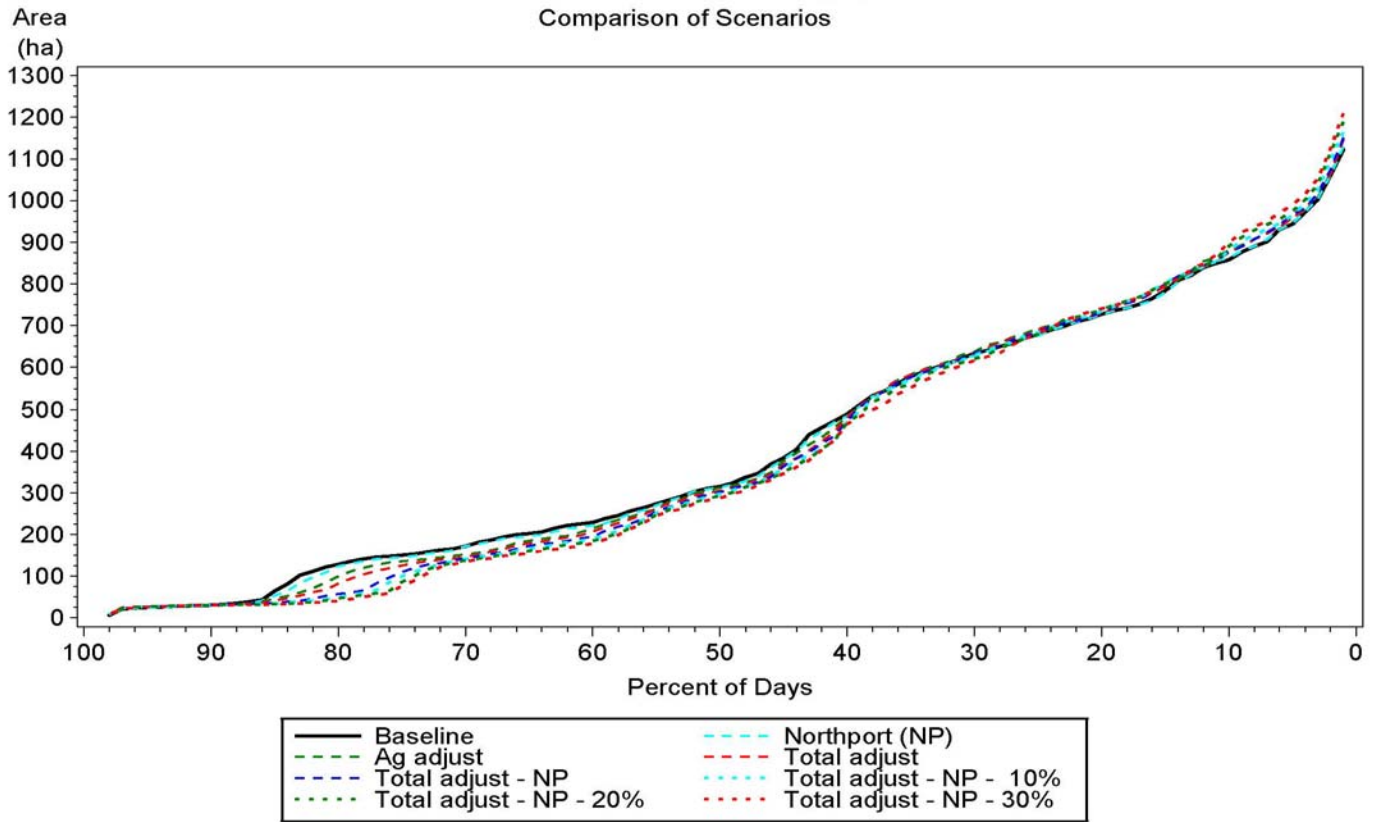

Myakka River
Hydrodynamic Model Predictions - 1999-2002
Normalized Area Under Curve from CDF of area 11 to 17 ppt
Comparison of Scenarios

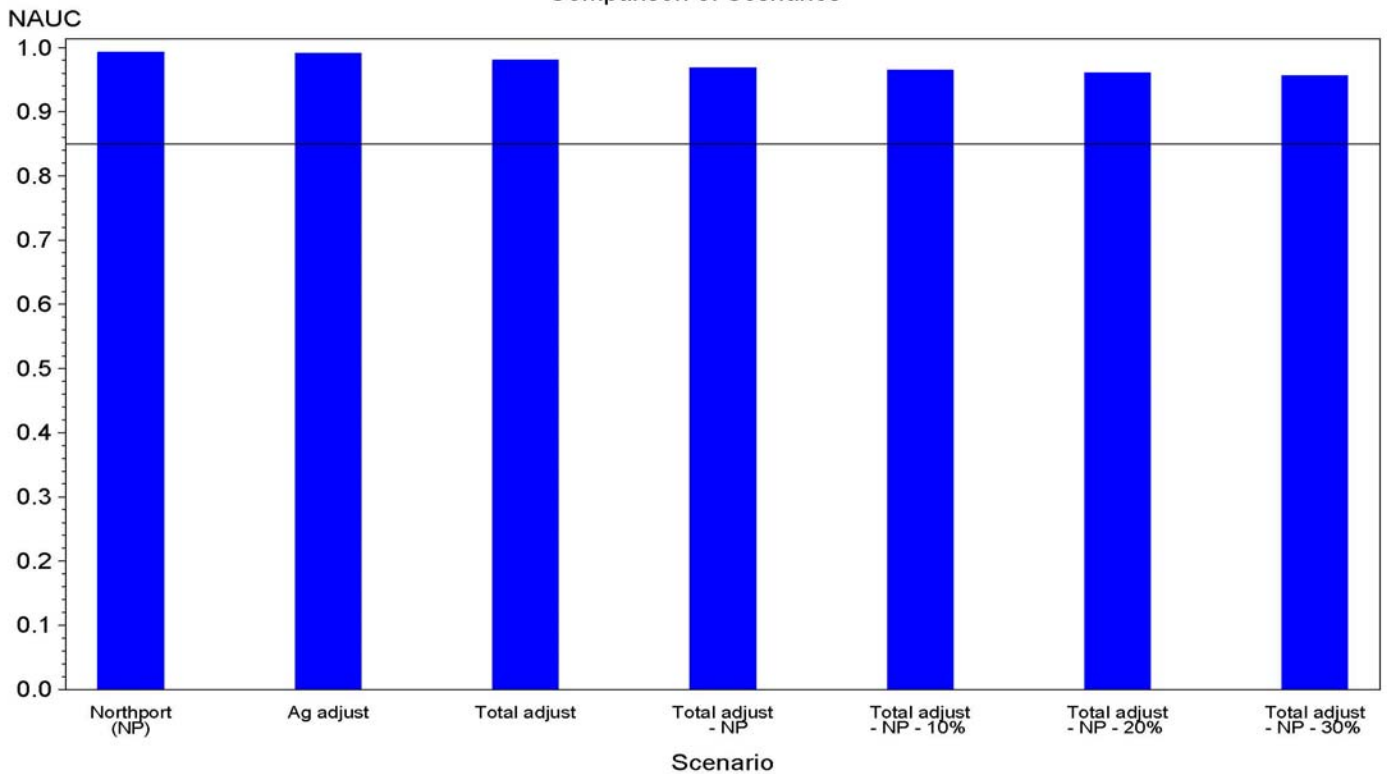

Myakka River
Hydrodynamic Model Predictions - 1999-2002
Bottom area between 2 & 12 ppt (ha)
Comparison of Scenarios

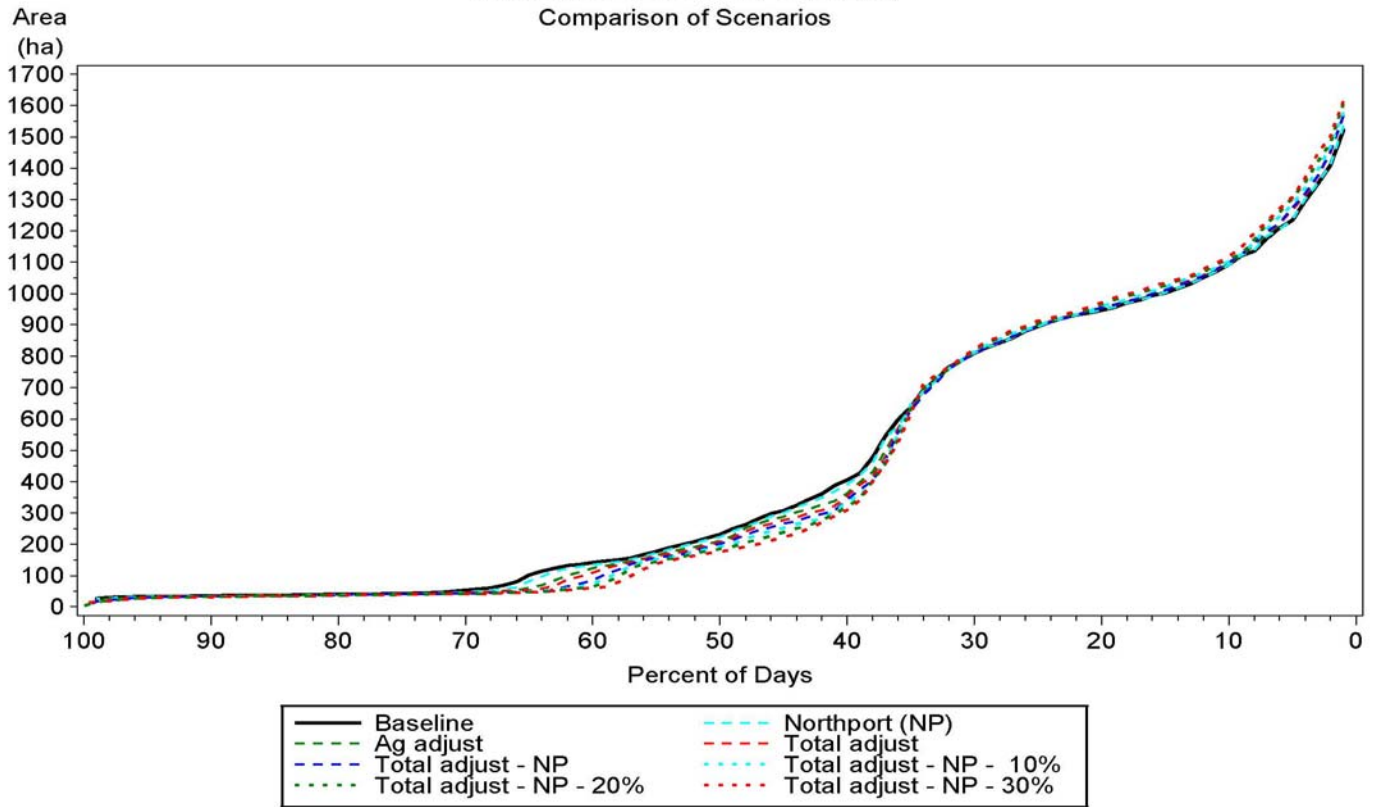

Myakka River
Hydrodynamic Model Predictions - 1999-2002
Normalized Area Under Curve from CDF of area 2 to 12 ppt
Comparison of Scenarios

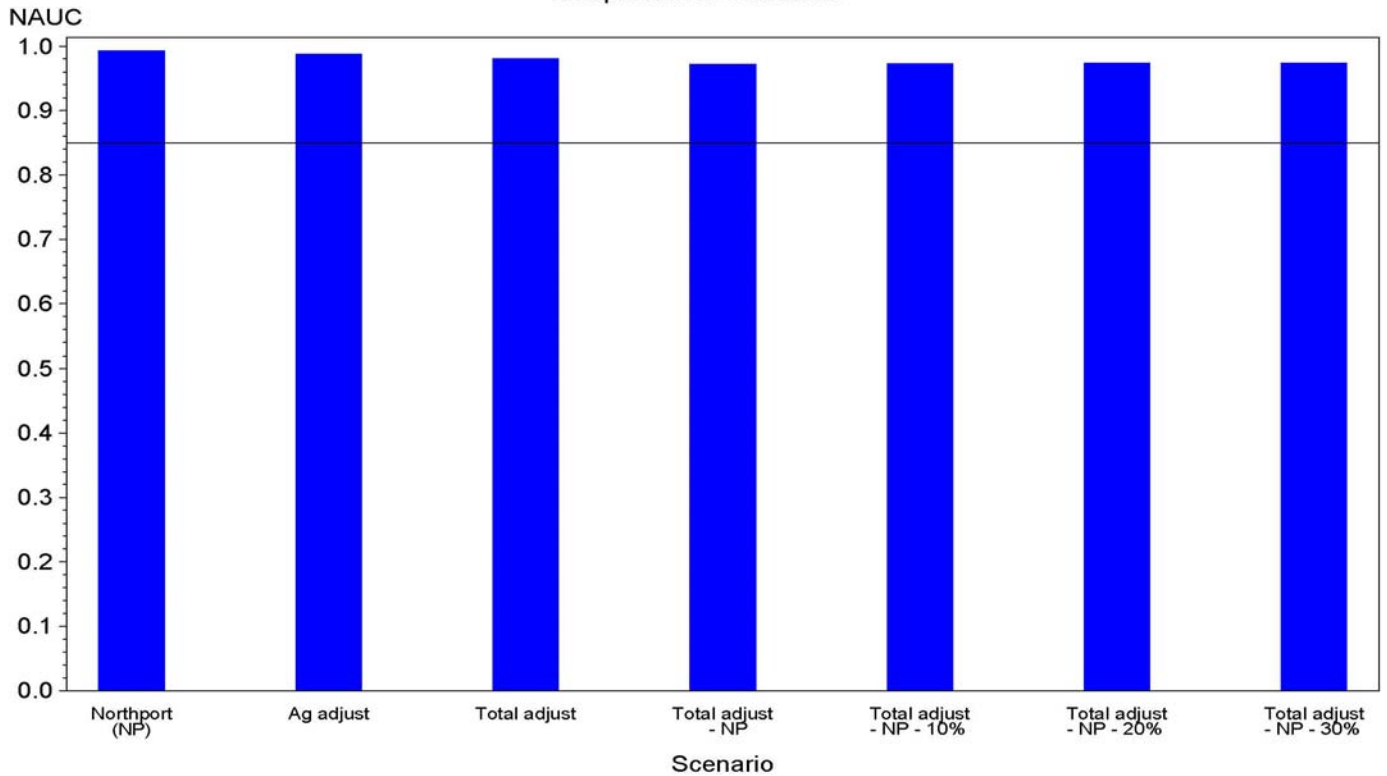

Appendix 8J

Cumulative distribution function plots of the volume of water with salinity < 2, < 5, < 14, and 3 to 14 for baseline flows and seven flow reduction scenarios and bar charts of the percent reduction from baseline for these same scenarios.

Myakka River
Hydrodynamic Model Predictions - 1999-2002
Volume below 2 ppt (10**6 m3)
Comparison of Scenarios

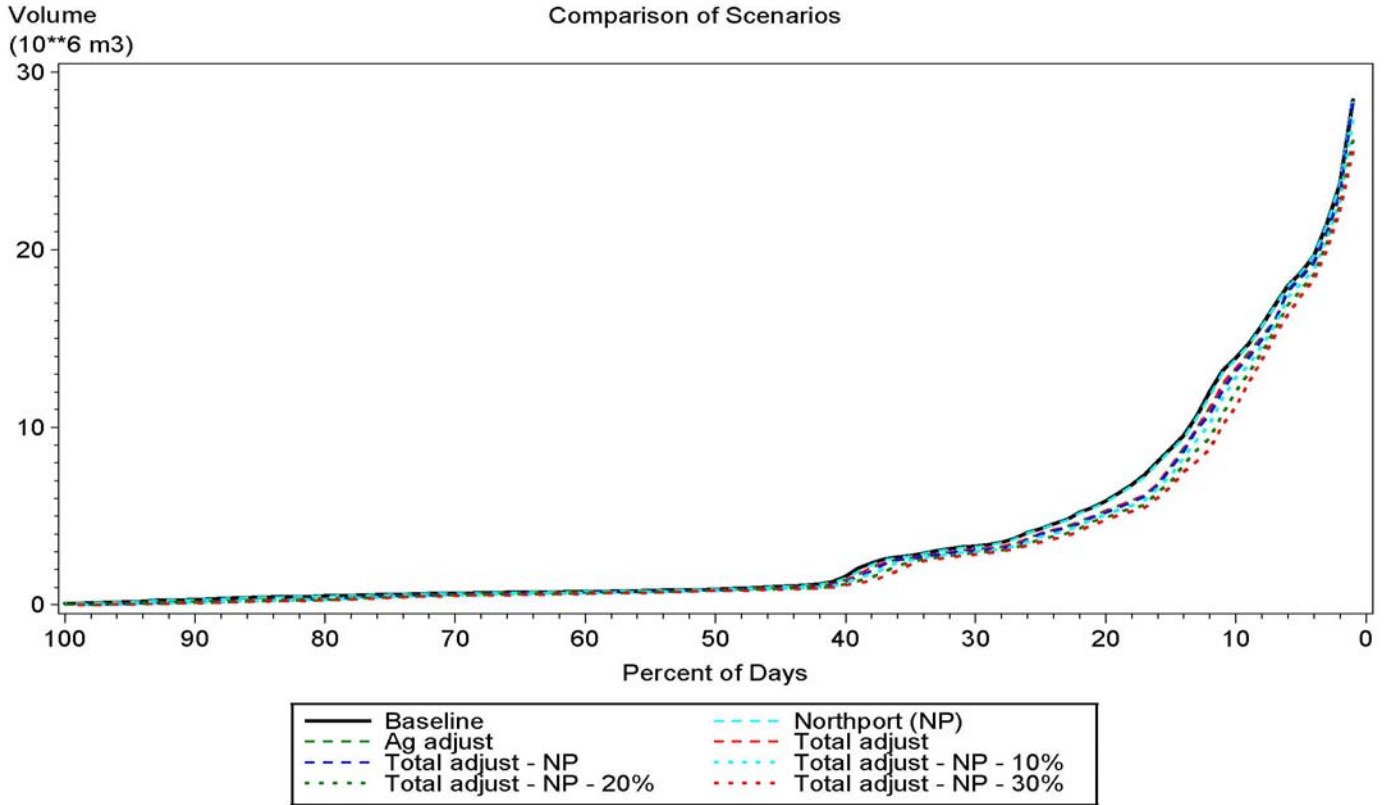

Myakka River
Hydrodynamic Model Predictions - 1999-2002
Normalized Area Under Curve from CDF of volume below 2 ppt
Comparison of Scenarios

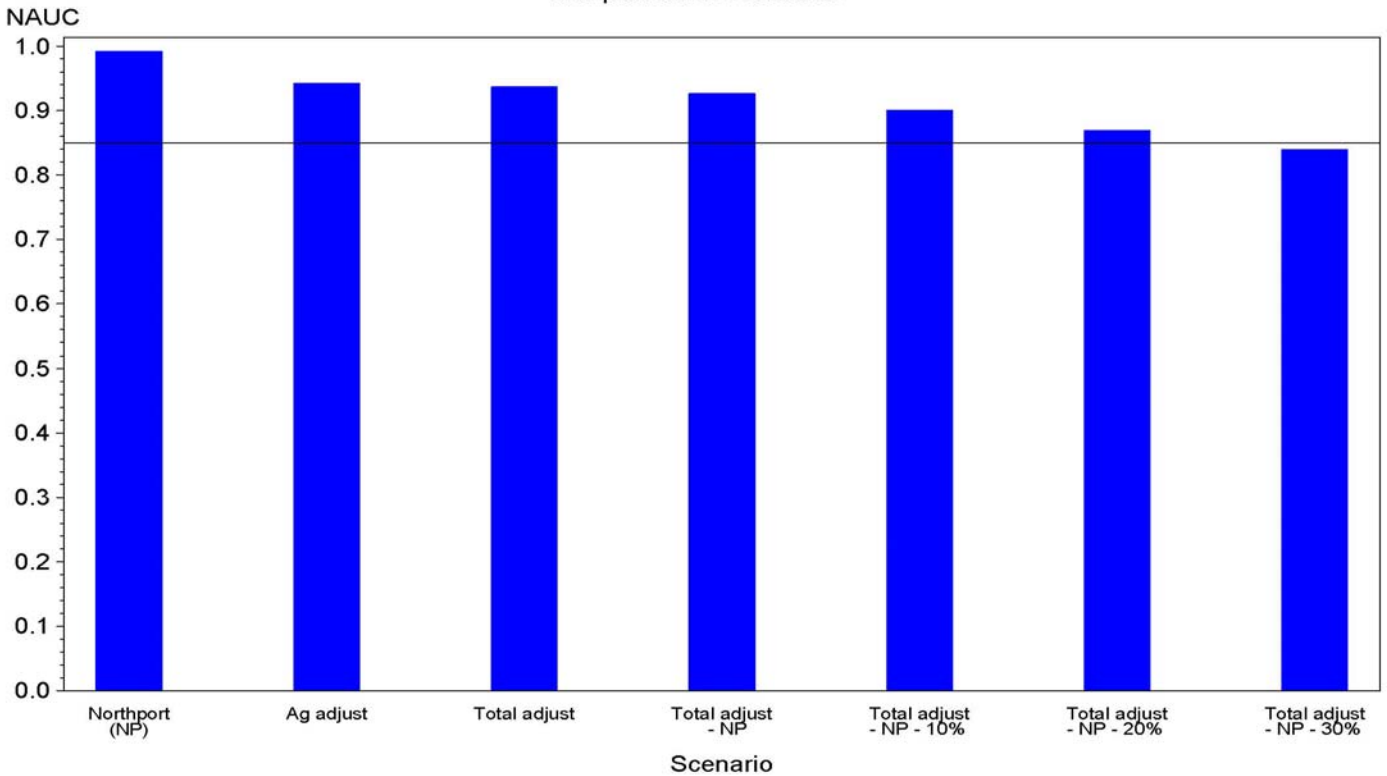

Myakka River
Hydrodynamic Model Predictions - 1999-2002
Volume below 5 ppt (10**6 m3)
Comparison of Scenarios

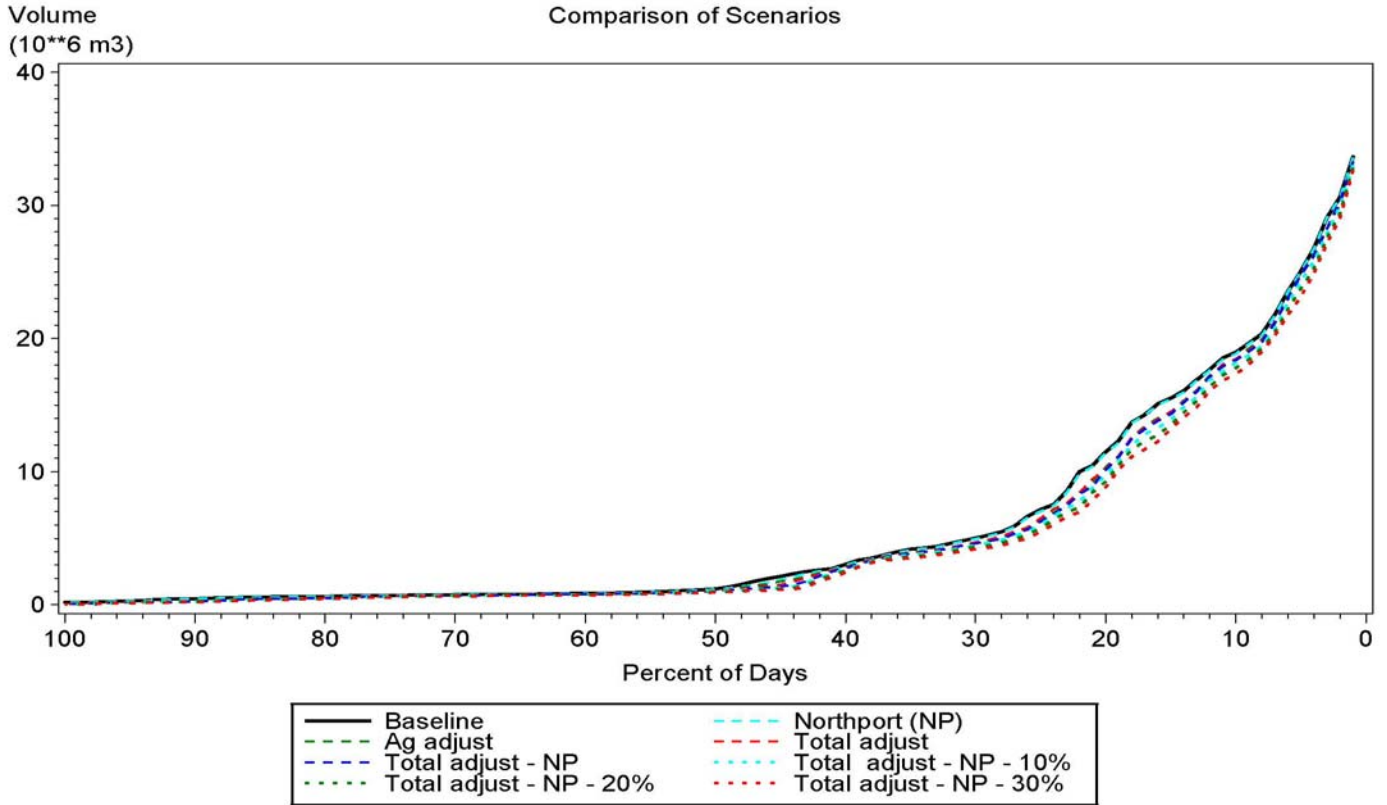

Myakka River
Hydrodynamic Model Predictions - 1999-2002
Normalized Area Under Curve from CDF of volume below 5 ppt
Comparison of Scenarios

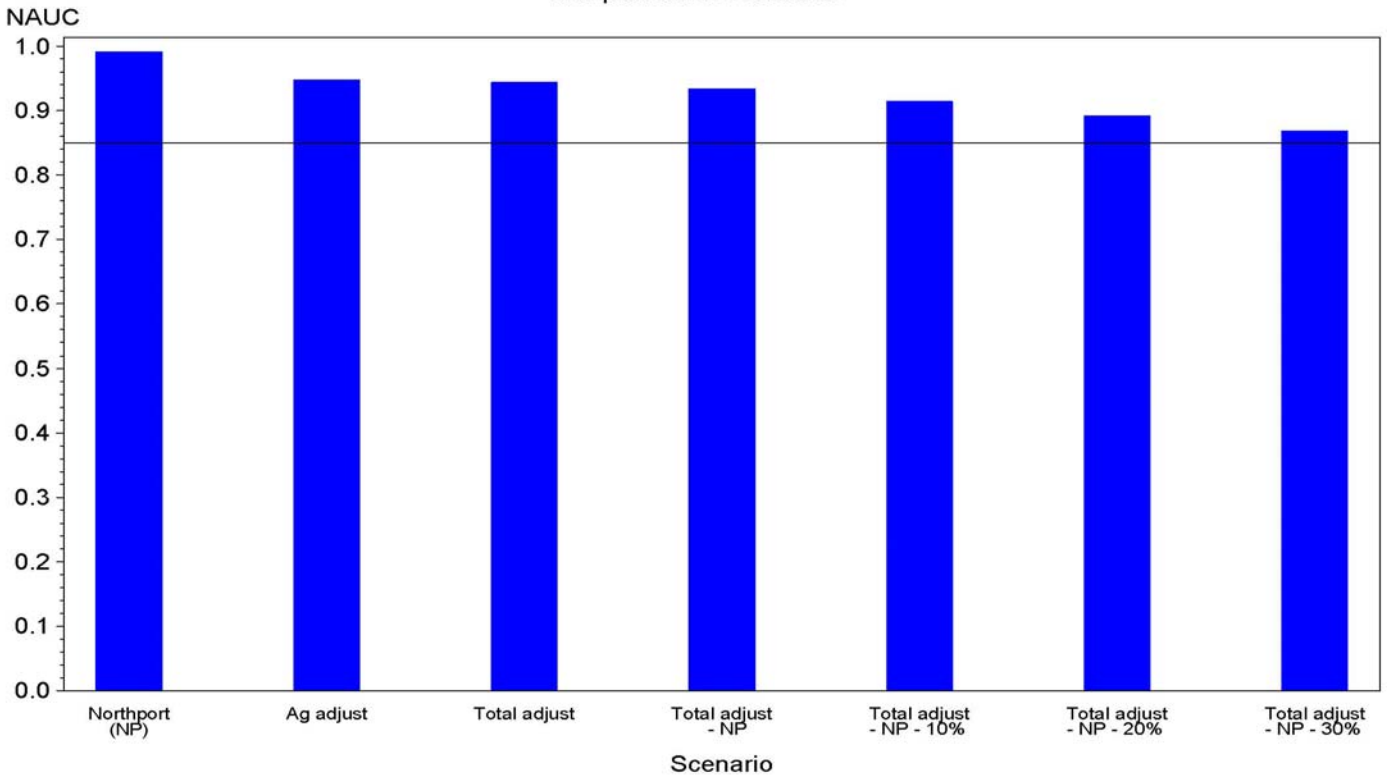

Myakka River
Hydrodynamic Model Predictions - 1999-2002
Volume below 14 ppt (10**6 m3)
Comparison of Scenarios

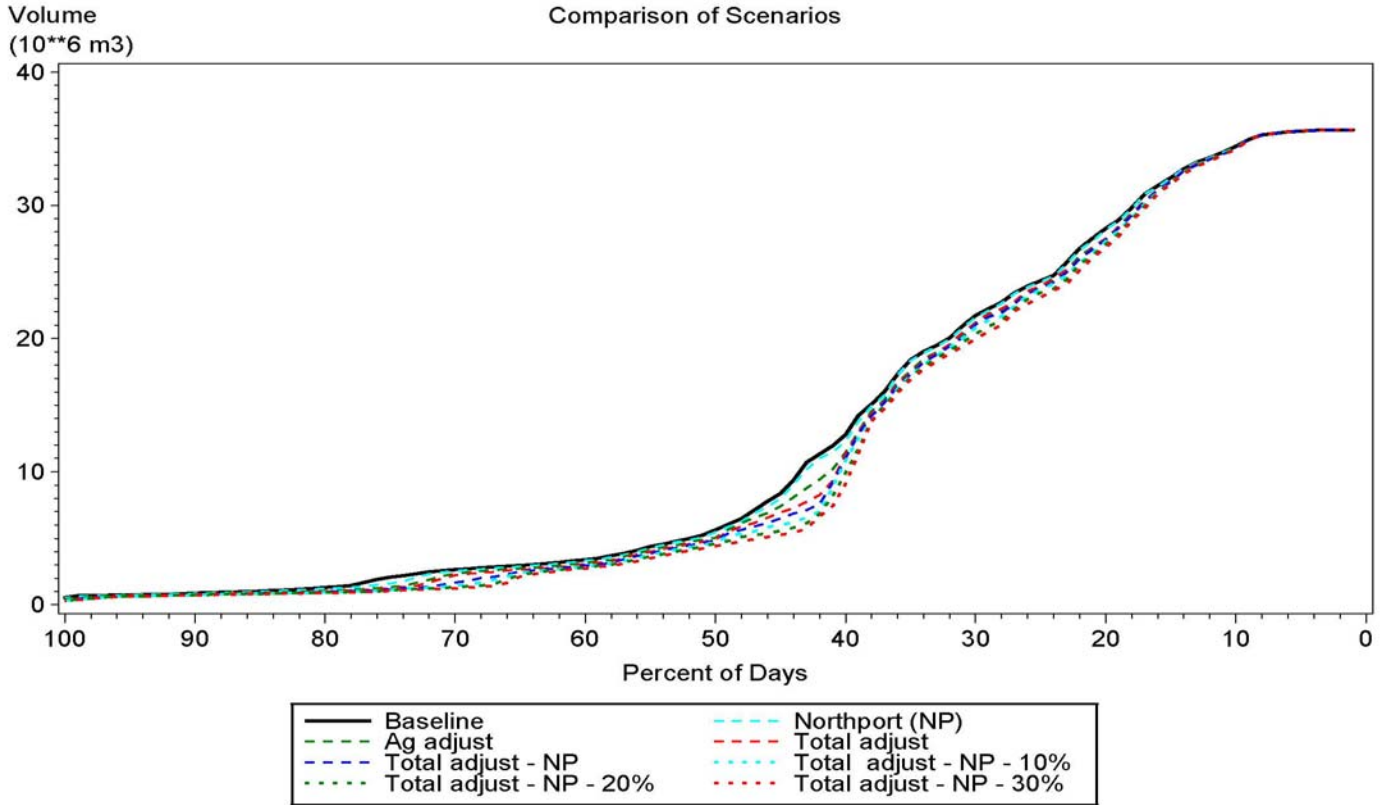

Myakka River
Hydrodynamic Model Predictions - 1999-2002
Normalized Area Under Curve from CDF of volume below 14 ppt
Comparison of Scenarios

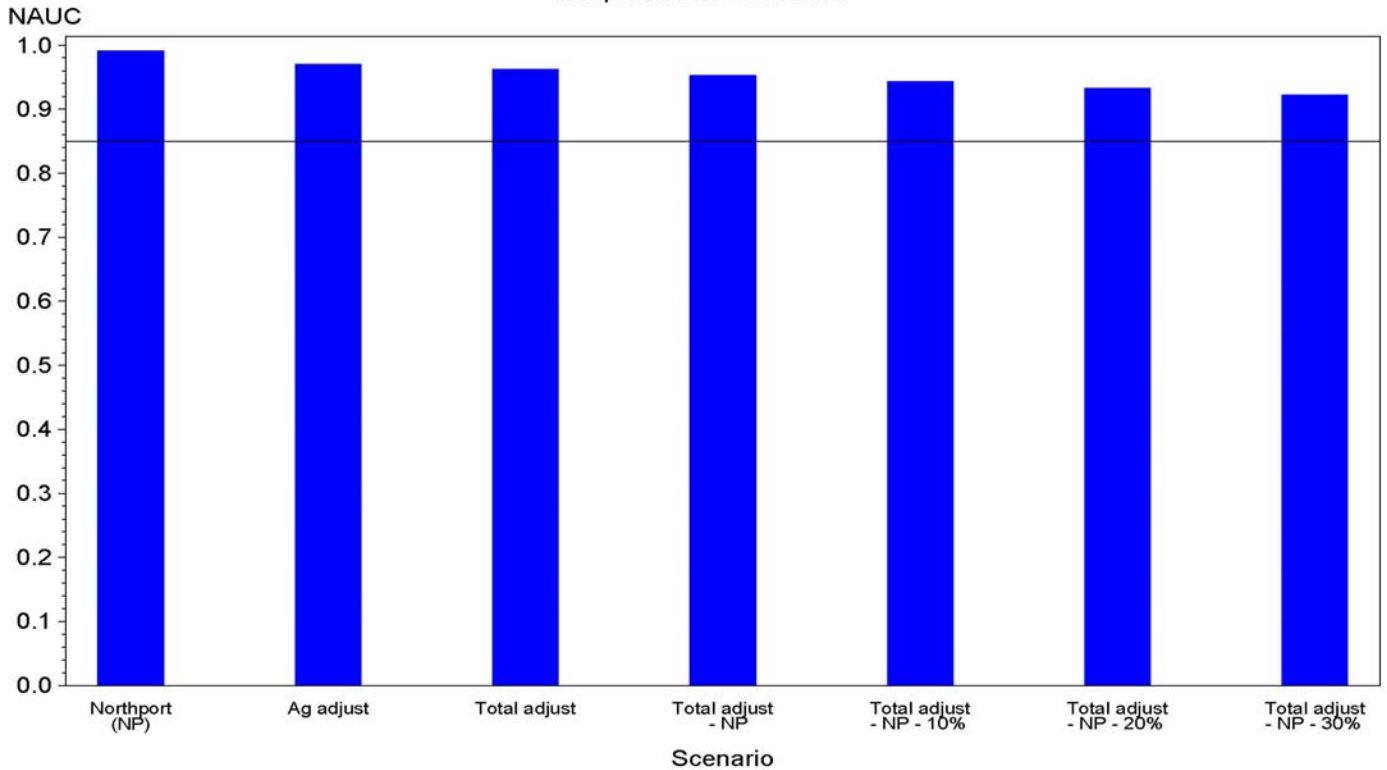

Myakka River
Hydrodynamic Model Predictions - 1999-2002
Volume between 3-14 ppt (10**6 m3)
Comparison of Scenarios

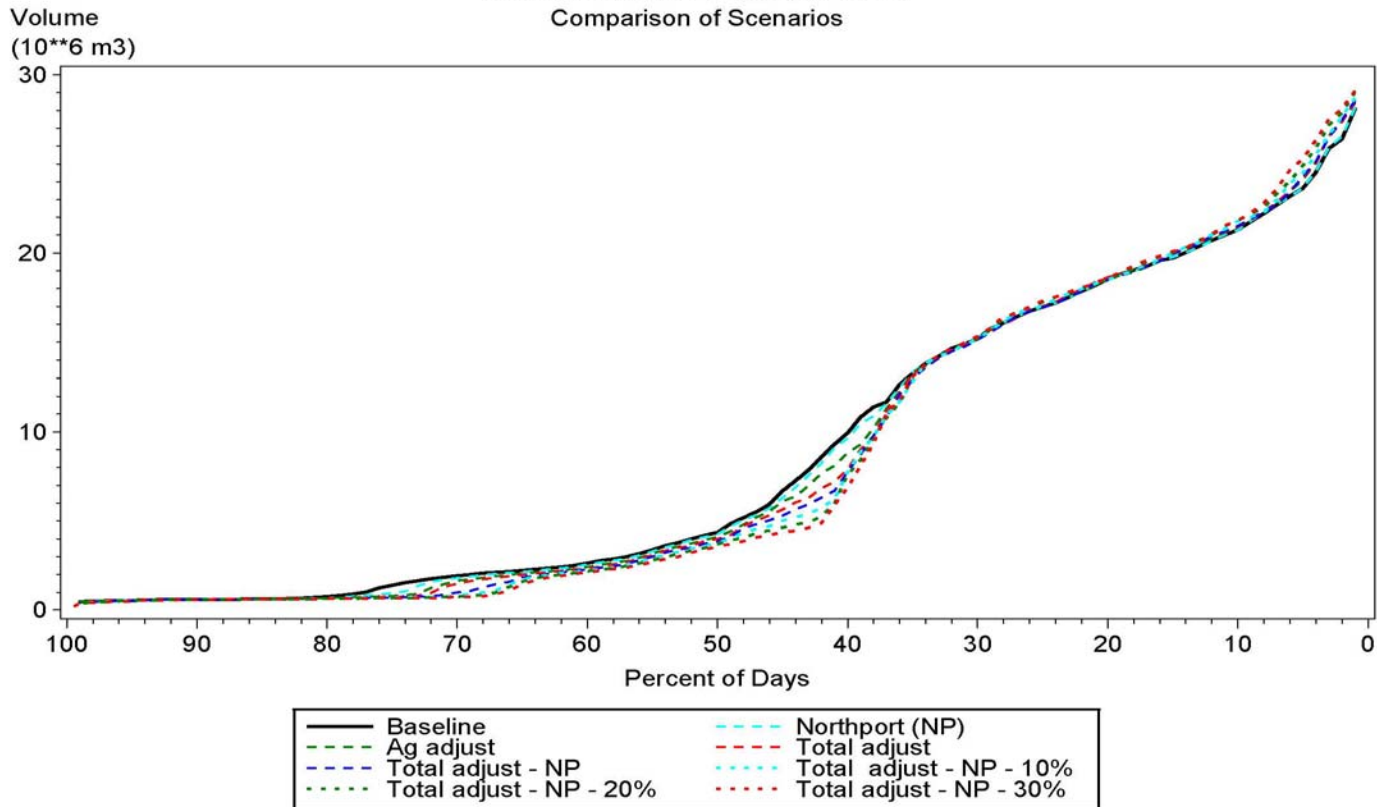

Myakka River
Hydrodynamic Model Predictions - 1999-2002
Normalized Area Under Curve from CDF of volume 3-14 ppt
Comparison of Scenarios

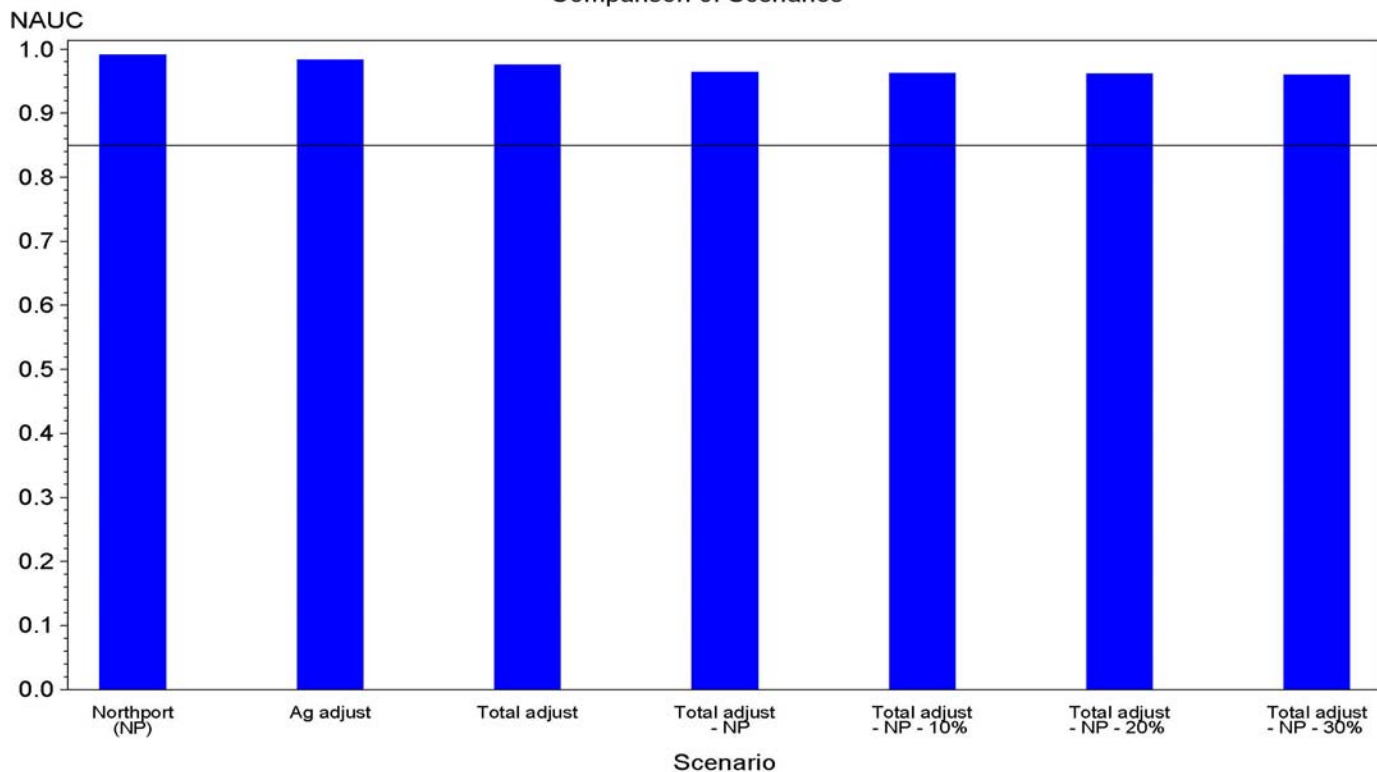

Appendix 8K

Cumulative distribution function plots of the bottom area of water with salinity < 2, < 5, < 11, < 17, 2 to 12, and 11 to 17 for baseline flows and seven flow reduction scenarios for the three seasonal blocks.

Myakka River
Hydrodynamic Model Predictions - 1999-2002
Bottom area below 2 ppt (ha)
Comparison of Scenarios
Block 1 (March 1 to June 20)

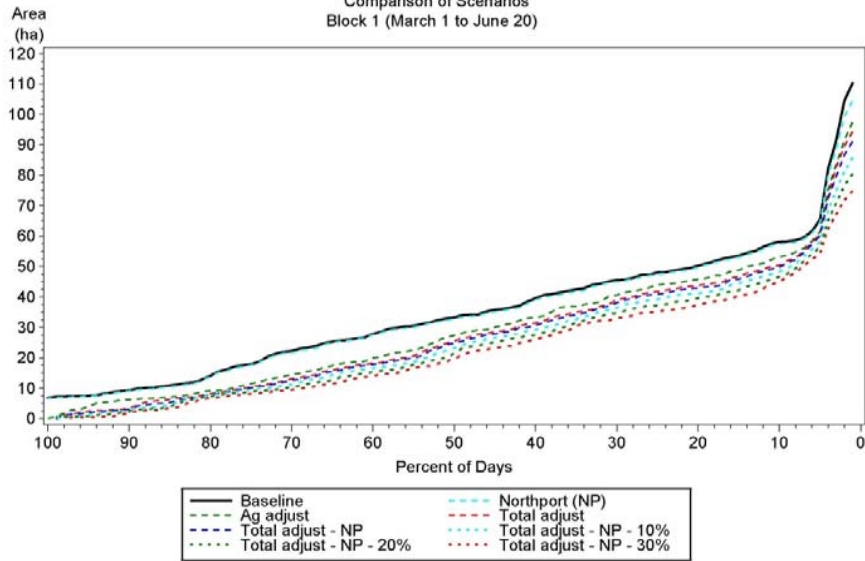

Myakka River
Hydrodynamic Model Predictions - 1999-2002
Bottom area below 2 ppt (ha)
Comparison of Scenarios
Block 2 (October 28 to February 28)

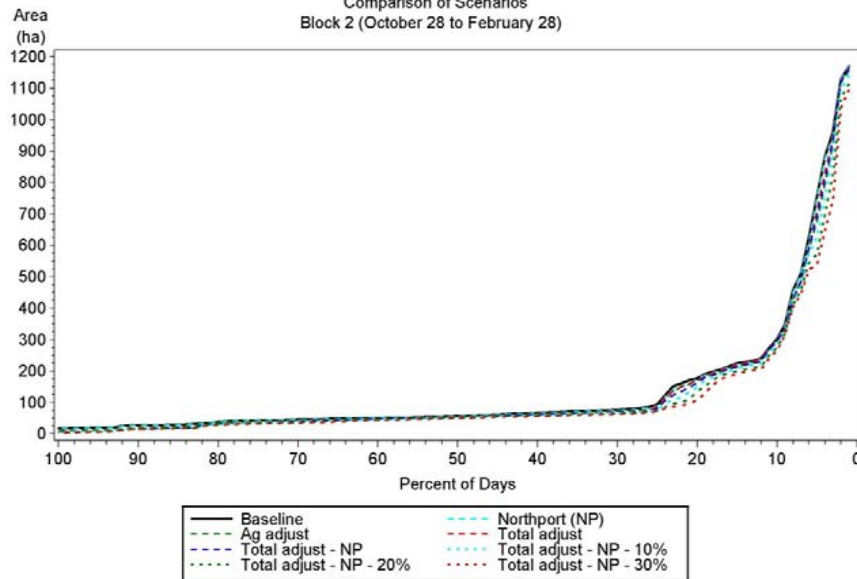

Myakka River
Hydrodynamic Model Predictions - 1999-2002
Bottom area below 2 ppt (ha)
Comparison of Scenarios
Block 3 (June 21 to October 27)

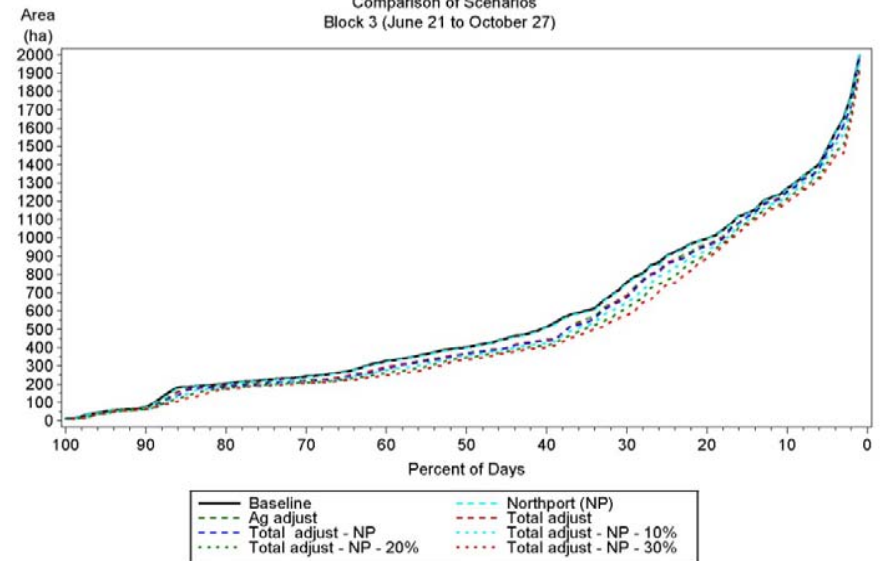

Myakka River
 Hydrodynamic Model Predictions - 1999-2002
 Bottom area below 5 ppt (ha)
 Comparison of Scenarios
 Block 1 (March 1 to June 20)

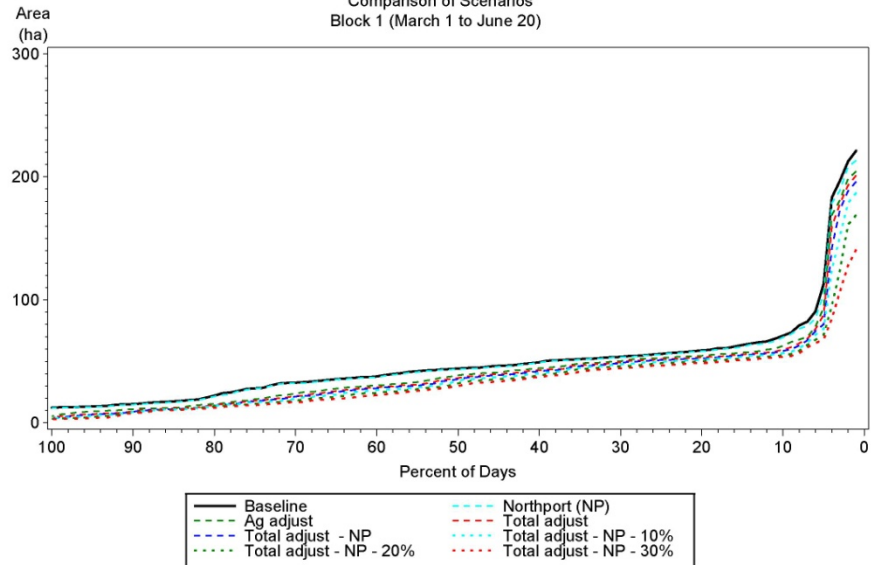

Myakka River
 Hydrodynamic Model Predictions - 1999-2002
 Bottom area below 5 ppt (ha)
 Comparison of Scenarios
 Block 2 (October 28 to February 28)

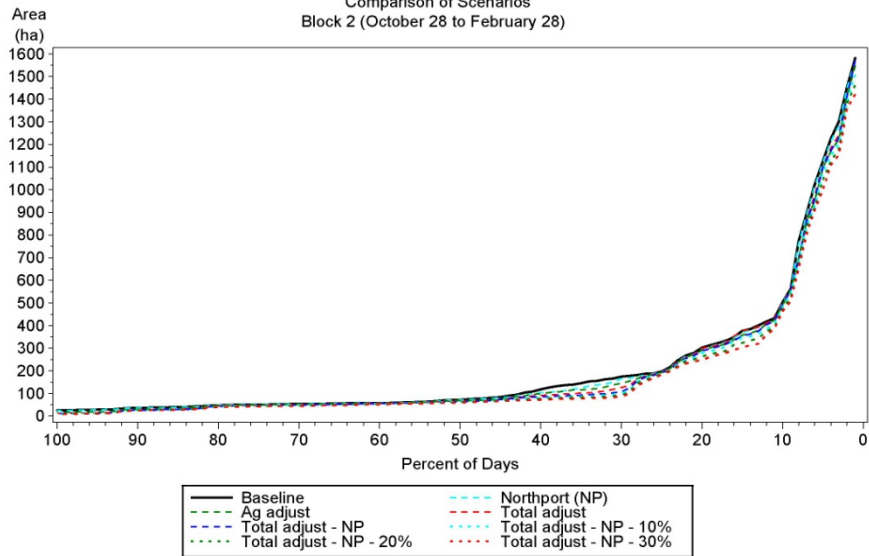

Myakka River
 Hydrodynamic Model Predictions - 1999-2002
 Bottom area below 5 ppt (ha)
 Comparison of Scenarios
 Block 3 (June 21 to October 27)

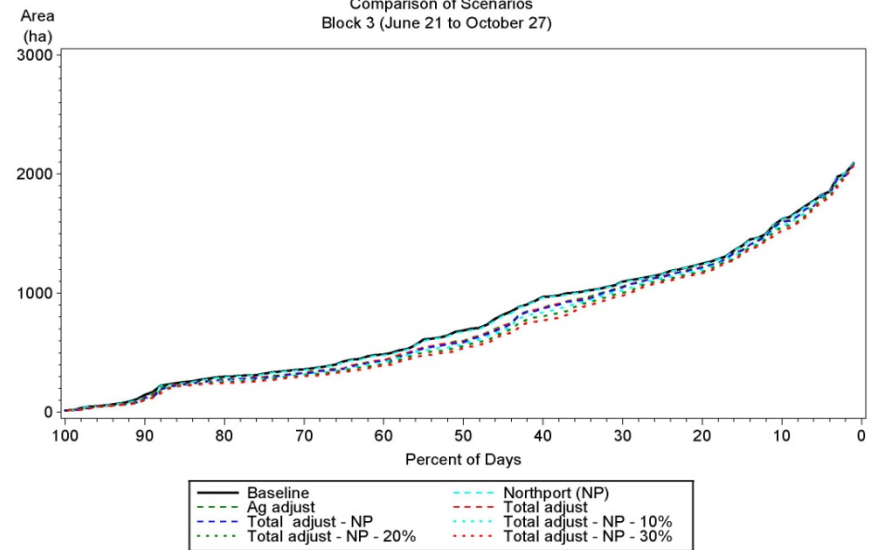

Myakka River
 Hydrodynamic Model Predictions - 1999-2002
 Bottom area below 12 ppt (ha)
 Comparison of Scenarios
 Block 1 (March 1 to June 20)

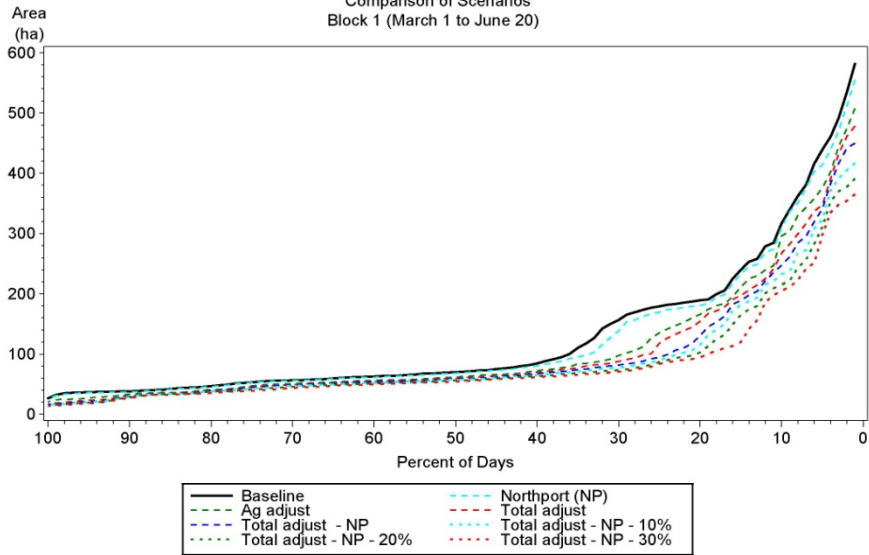

Myakka River
 Hydrodynamic Model Predictions - 1999-2002
 Bottom area below 12 ppt (ha)
 Comparison of Scenarios
 Block 2 (October 28 to February 28)

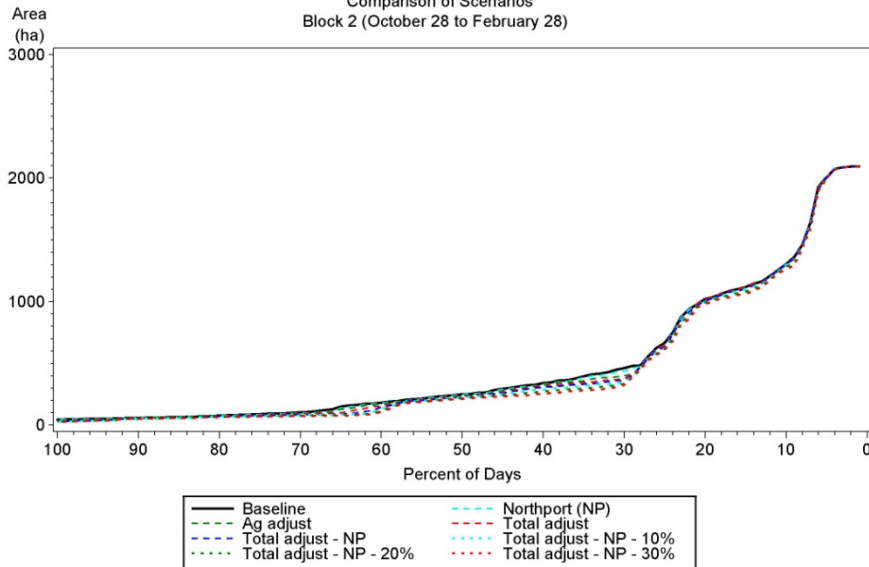

Myakka River
 Hydrodynamic Model Predictions - 1999-2002
 Bottom area below 12 ppt (ha)
 Comparison of Scenarios
 Block 3 (June 21 to October 27)

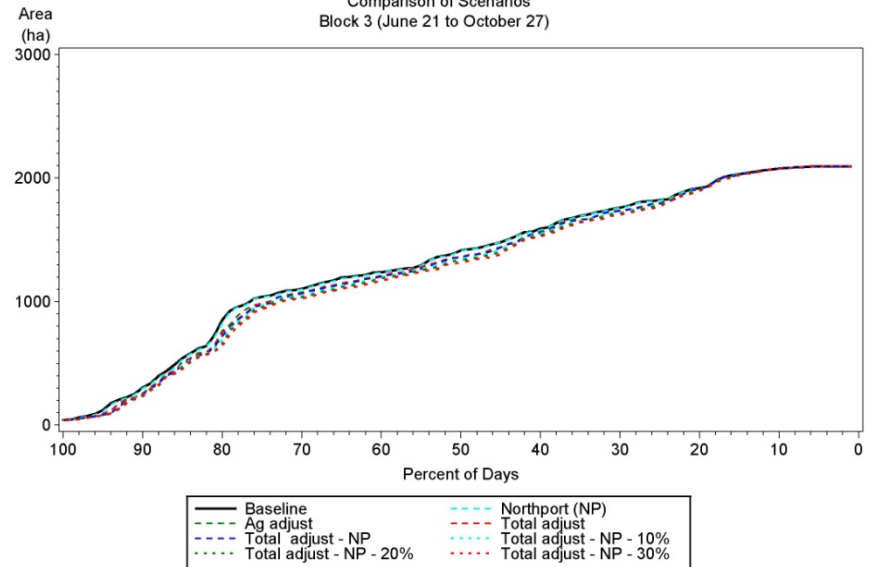

Myakka River
Hydrodynamic Model Predictions - 1999-2002
Bottom area below 17 ppt (ha)
Comparison of Scenarios
Block 1 (March 1 to June 20)

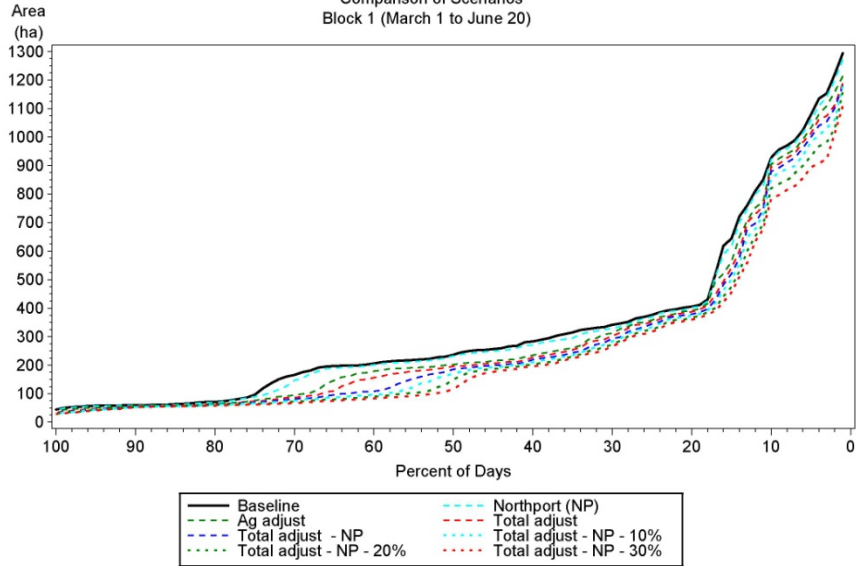

Myakka River
Hydrodynamic Model Predictions - 1999-2002
Bottom area below 17 ppt (ha)
Comparison of Scenarios
Block 3 (June 21 to October 27)

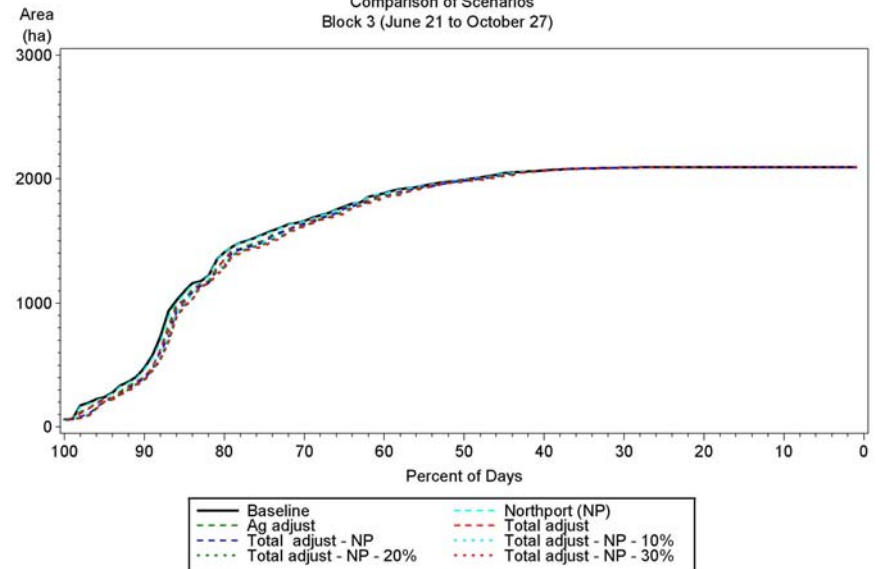

Myakka River
Hydrodynamic Model Predictions - 1999-2002
Bottom area below 17 ppt (ha)
Comparison of Scenarios
Block 2 (October 28 to February 28)

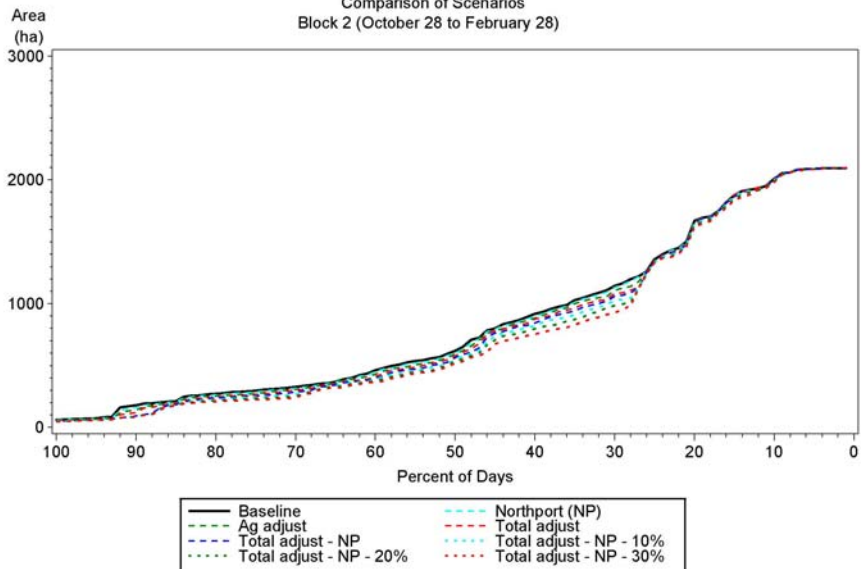

Myakka River
Hydrodynamic Model Predictions - 1999-2002
Bottom area between 11 & 17 ppt (ha)
Comparison of Scenarios
Block 1 (March 1 to June 20)

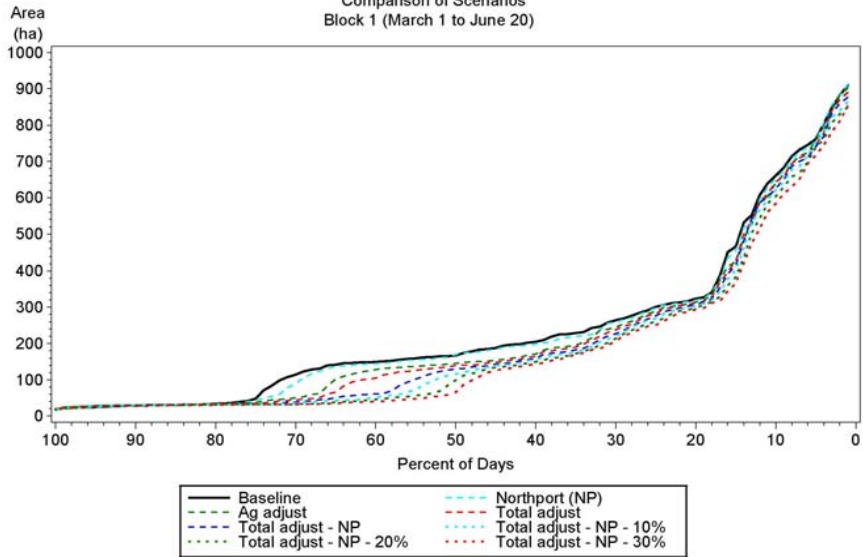

Myakka River
Hydrodynamic Model Predictions - 1999-2002
Bottom area between 11 & 17 ppt (ha)
Comparison of Scenarios
Block 2 (October 28 to February 28)

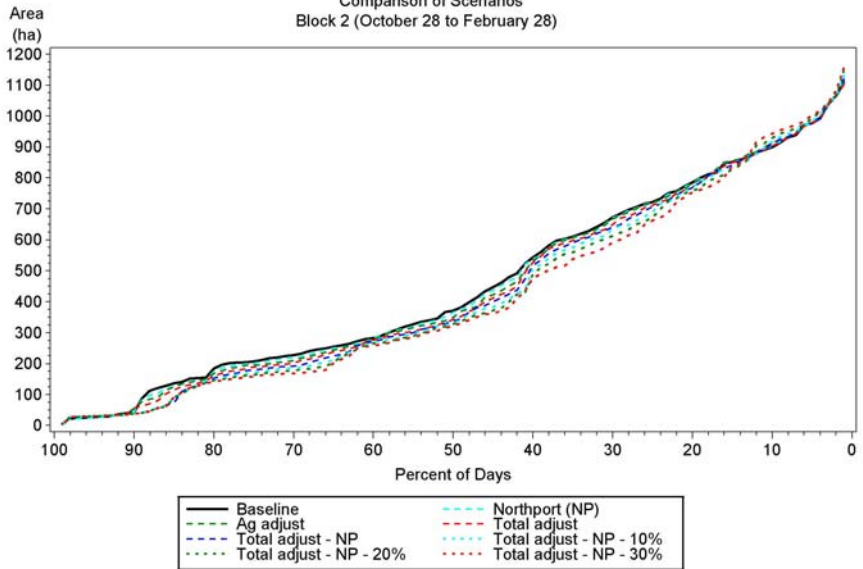

Myakka River
Hydrodynamic Model Predictions - 1999-2002
Bottom area between 11 & 17 ppt (ha)
Comparison of Scenarios
Block 3 (June 21 to October 27)

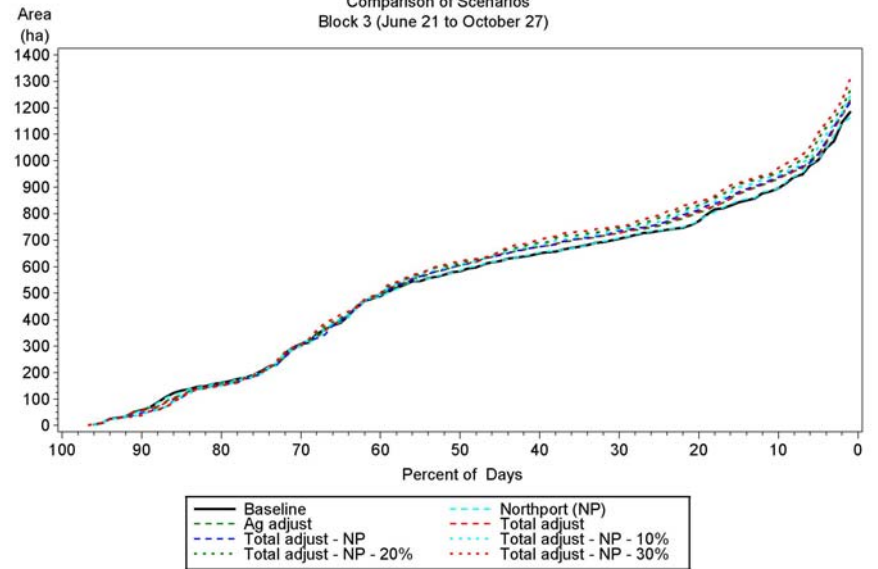

Myakka River
 Hydrodynamic Model Predictions - 1999-2002
 Bottom area between 2 & 12 ppt (ha)
 Comparison of Scenarios
 Block 1 (March 1 to June 20)

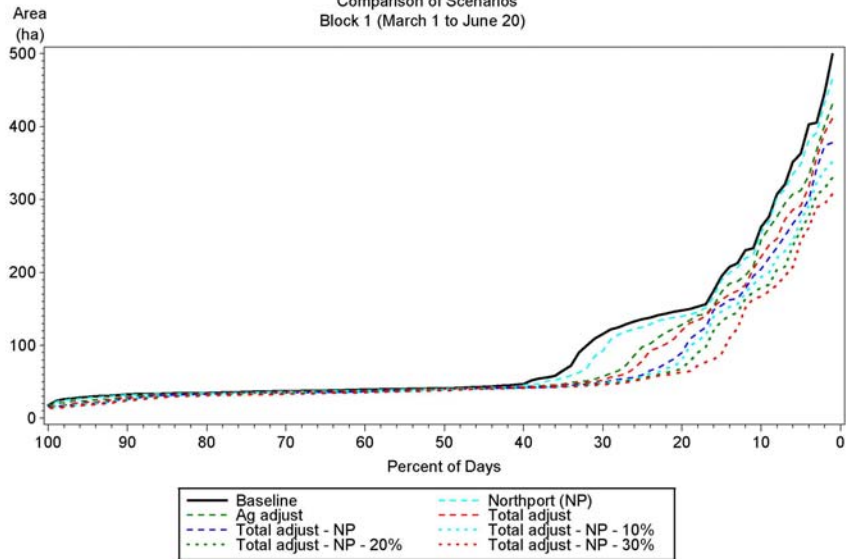

Myakka River
 Hydrodynamic Model Predictions - 1999-2002
 Bottom area between 2 & 12 ppt (ha)
 Comparison of Scenarios
 Block 2 (October 28 to February 28)

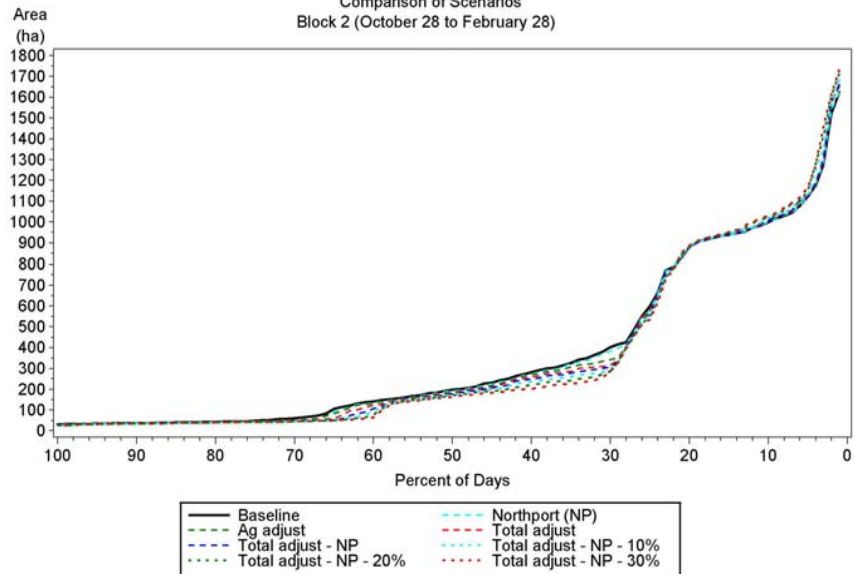

Myakka River
 Hydrodynamic Model Predictions - 1999-2002
 Bottom area between 2 & 12 ppt (ha)
 Comparison of Scenarios
 Block 3 (June 21 to October 27)

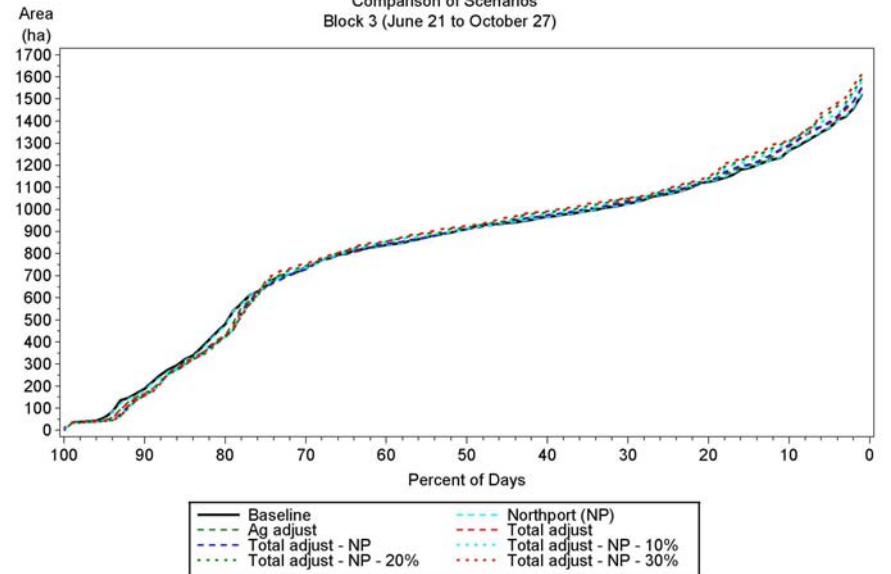

Appendix 8L

Bar charts of the percent of bottom area of water with salinity < 2, < 5, < 11, < 17, 2 to 12, and 11 to 17 relative to baseline flows for seven flow reduction scenarios for three seasonal blocks.

Myakka River
 Hydrodynamic Model Predictions - 1999-2002
 Normalized Area Under Curve from CDF of area below 2 ppt
 Comparison of Scenarios
 Block 1 (March 1 to June 20)

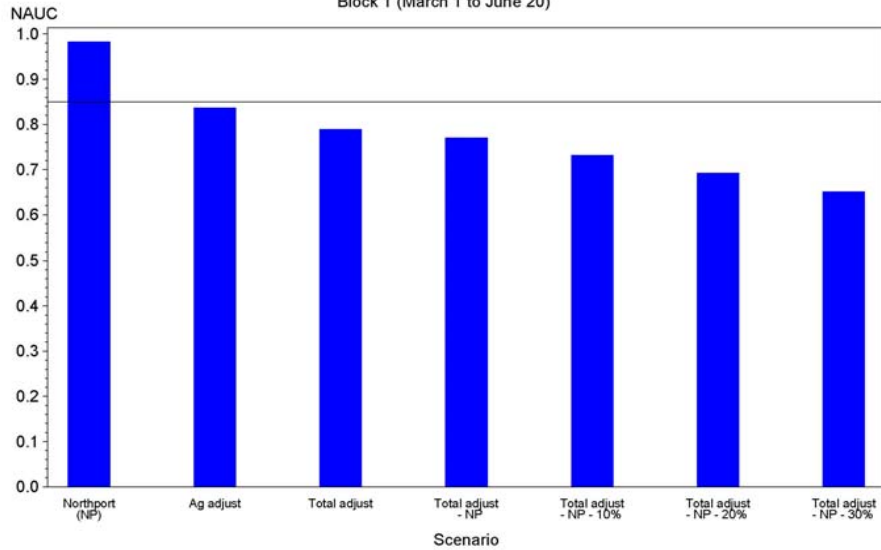

Myakka River
 Hydrodynamic Model Predictions - 1999-2002
 Normalized Area Under Curve from CDF of area below 2 ppt
 Comparison of Scenarios
 Block 2 (October 28 to February 28)

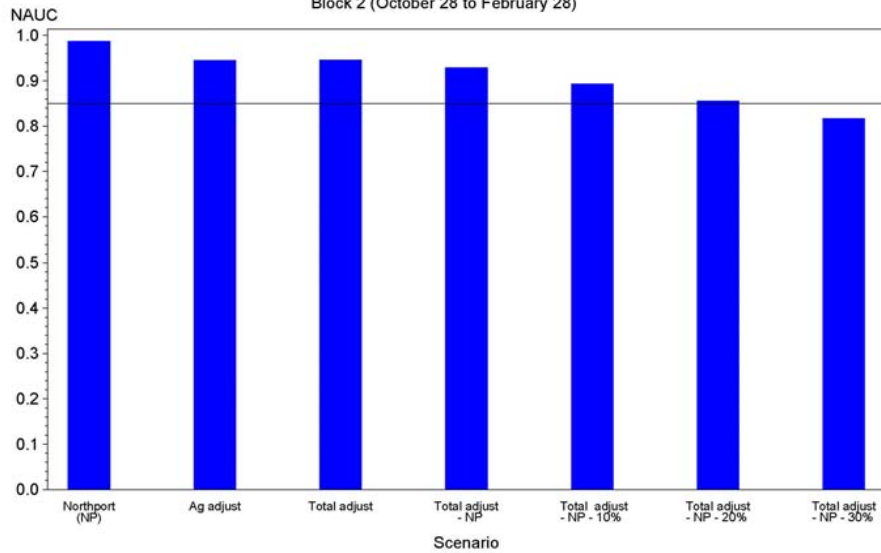

Myakka River
 Hydrodynamic Model Predictions - 1999-2002
 Normalized Area Under Curve from CDF of area below 2 ppt
 Comparison of Scenarios
 Block 3 (June 21 to October 27)

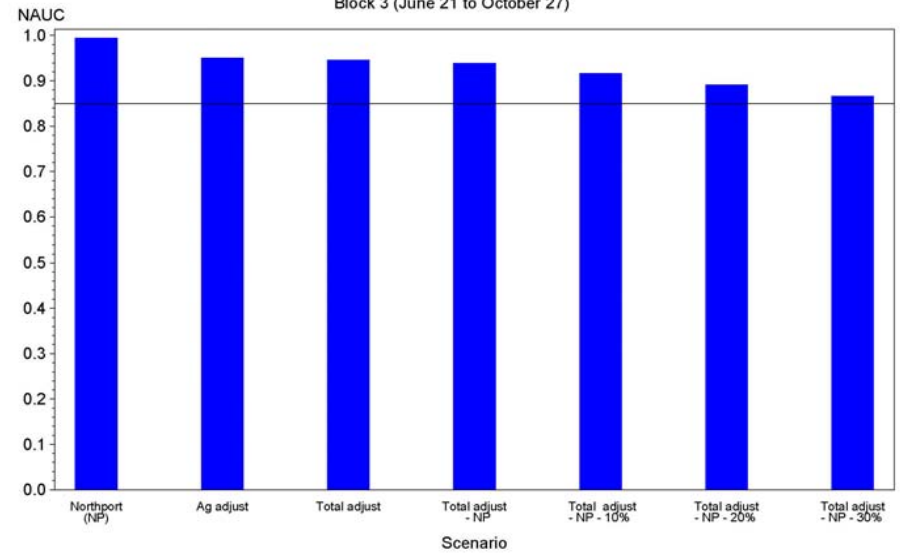

Myakka River
 Hydrodynamic Model Predictions - 1999-2002
 Normalized Area Under Curve from CDF of area below 5 ppt
 Comparison of Scenarios
 Block 1 (March 1 to June 20)

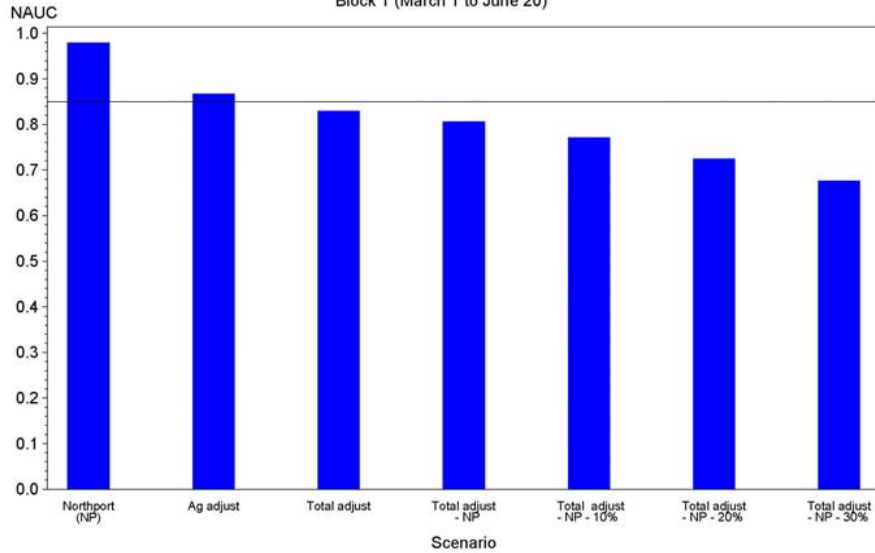

Myakka River
 Hydrodynamic Model Predictions - 1999-2002
 Normalized Area Under Curve from CDF of area below 5 ppt
 Comparison of Scenarios
 Block 2 (October 28 to February 28)

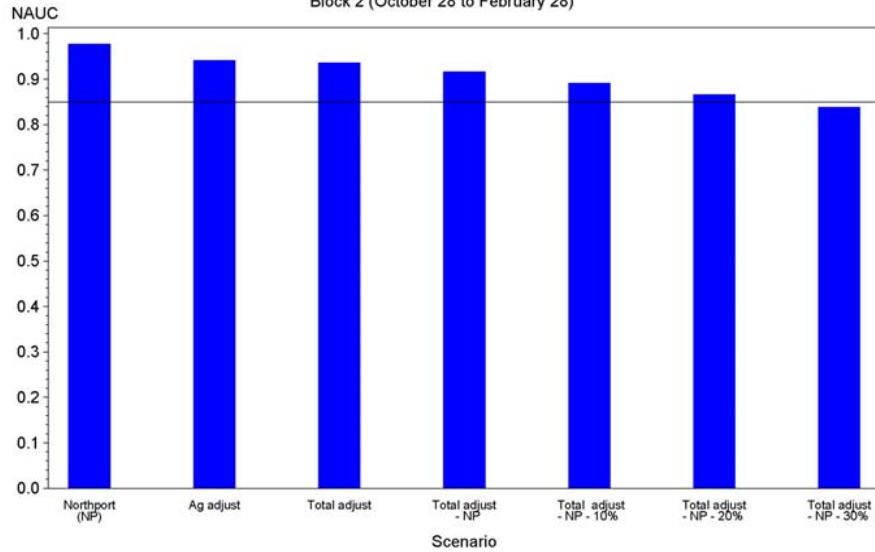

Myakka River
 Hydrodynamic Model Predictions - 1999-2002
 Normalized Area Under Curve from CDF of area below 5 ppt
 Comparison of Scenarios
 Block 3 (June 21 to October 27)

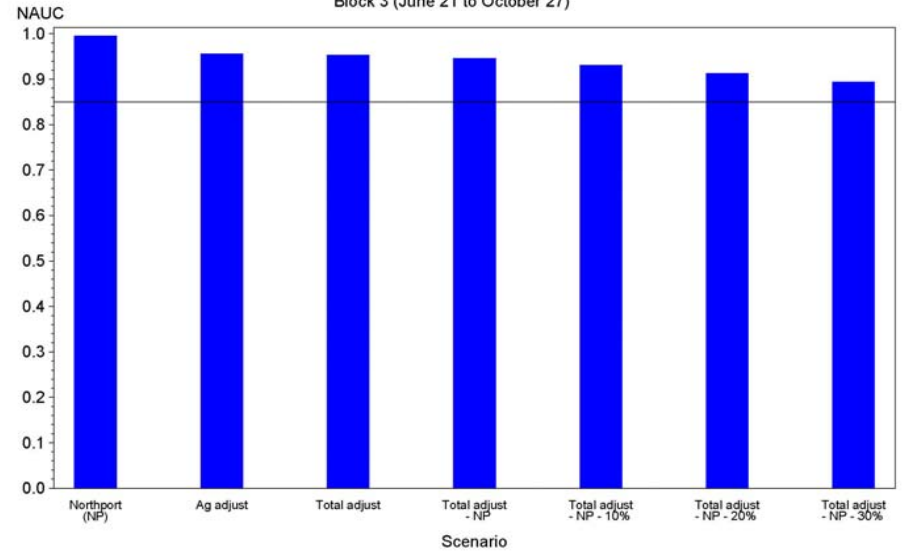

Myakka River
 Hydrodynamic Model Predictions - 1999-2002
 Normalized Area Under Curve from CDF of area below 12 ppt
 Comparison of Scenarios
 Block 1 (March 1 to June 20)

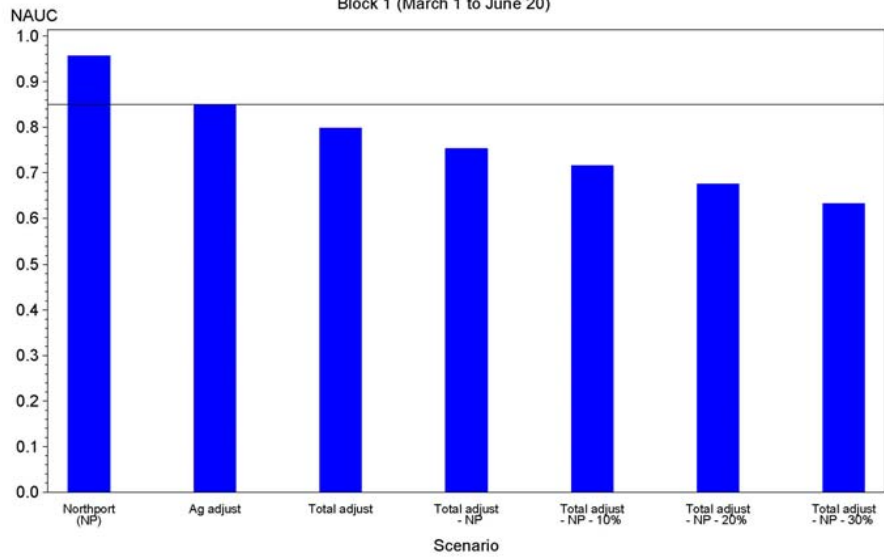

Myakka River
 Hydrodynamic Model Predictions - 1999-2002
 Normalized Area Under Curve from CDF of area below 12 ppt
 Comparison of Scenarios
 Block 2 (October 28 to February 28)

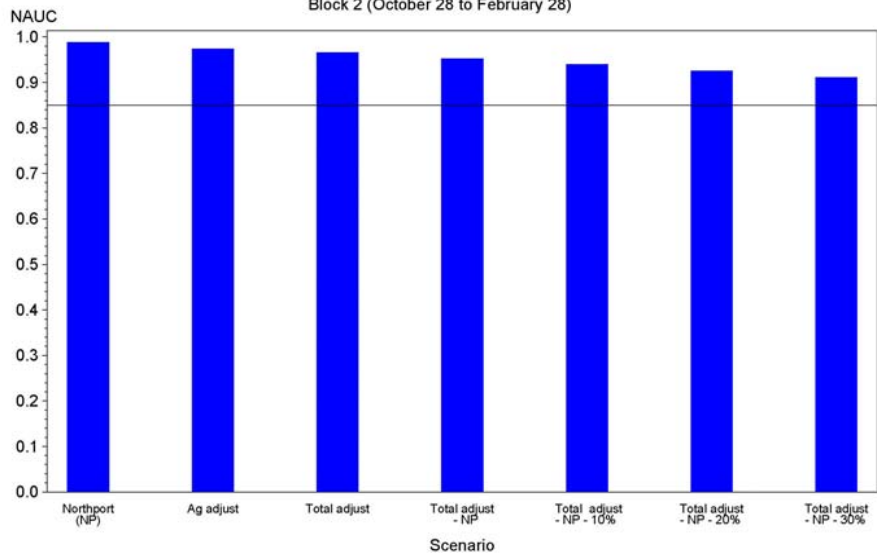

Myakka River
 Hydrodynamic Model Predictions - 1999-2002
 Normalized Area Under Curve from CDF of area below 12 ppt
 Comparison of Scenarios
 Block 3 (June 21 to October 27)

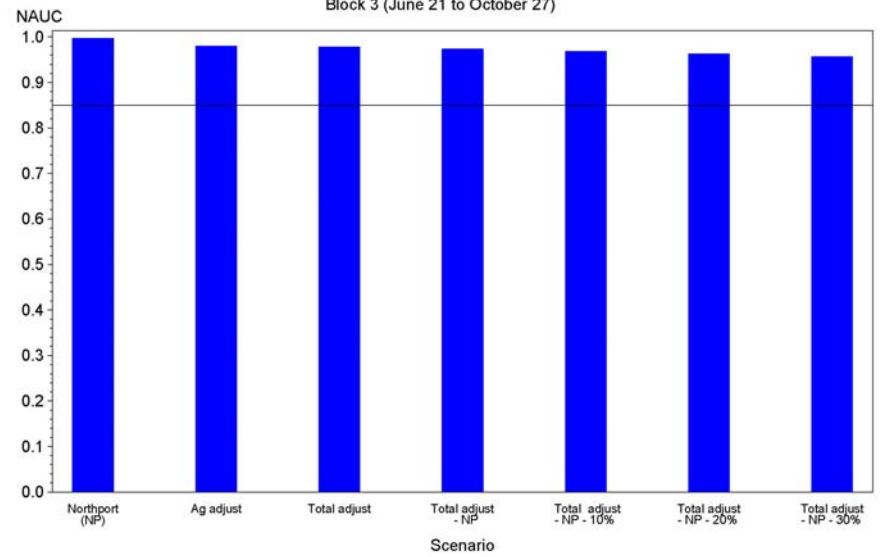

Myakka River
 Hydrodynamic Model Predictions - 1999-2002
 Normalized Area Under Curve from CDF of area below 17 ppt
 Comparison of Scenarios
 Block 1 (March 1 to June 20)

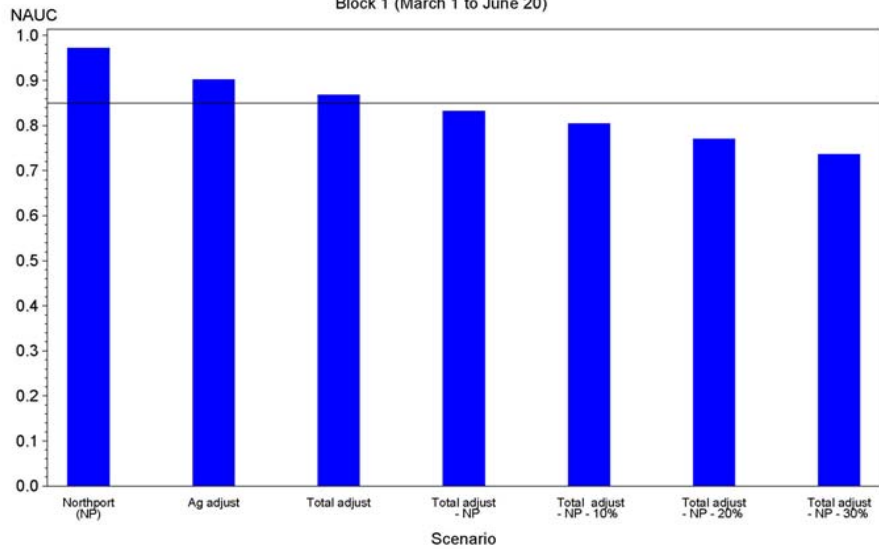

Myakka River
 Hydrodynamic Model Predictions - 1999-2002
 Normalized Area Under Curve from CDF of area below 17 ppt
 Comparison of Scenarios
 Block 2 (October 28 to February 28)

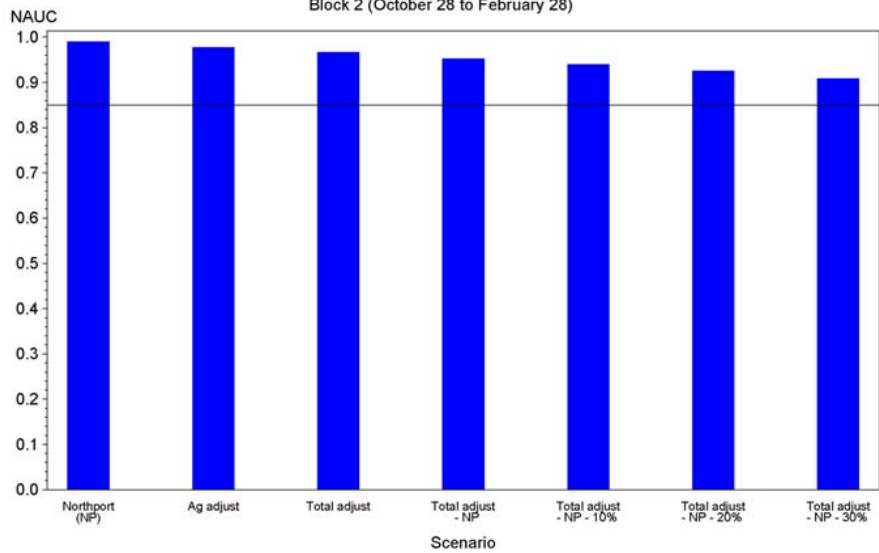

Myakka River
 Hydrodynamic Model Predictions - 1999-2002
 Normalized Area Under Curve from CDF of area below 17 ppt
 Comparison of Scenarios
 Block 3 (June 21 to October 27)

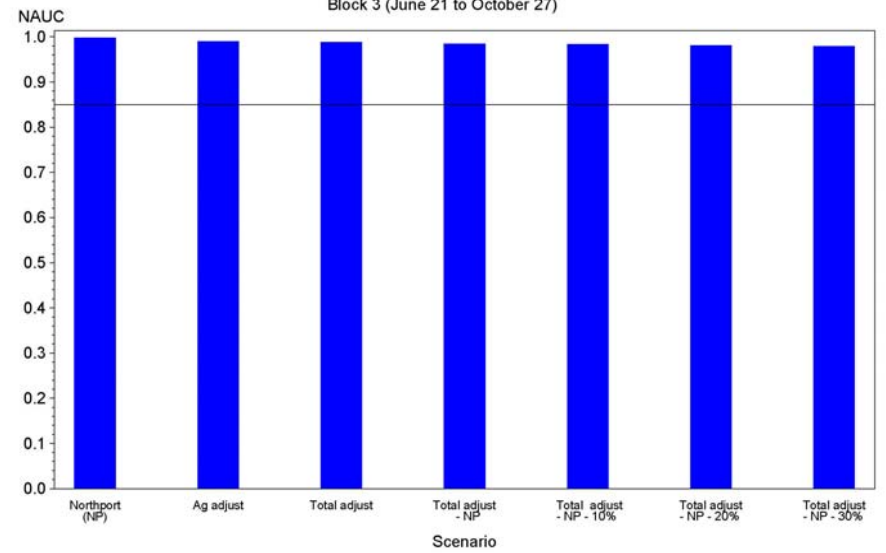

Myakka River
 Hydrodynamic Model Predictions - 1999-2002
 Normalized Area Under Curve from CDF of area 11 to 17 ppt
 Comparison of Scenarios
 Block 1 (March 1 to June 20)

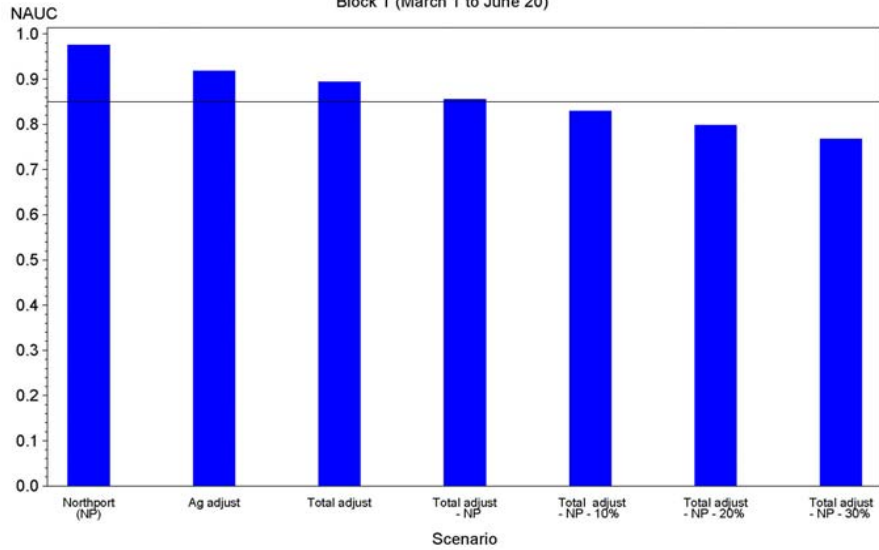

Myakka River
 Hydrodynamic Model Predictions - 1999-2002
 Normalized Area Under Curve from CDF of area 11 to 17 ppt
 Comparison of Scenarios
 Block 2 (October 28 to February 28)

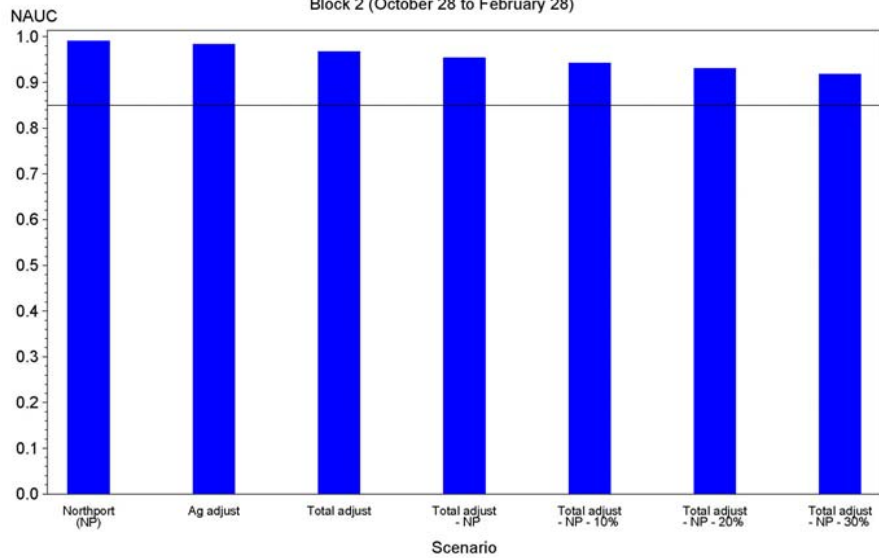

Myakka River
 Hydrodynamic Model Predictions - 1999-2002
 Normalized Area Under Curve from CDF of area 11 to 17 ppt
 Comparison of Scenarios
 Block 3 (June 21 to October 27)

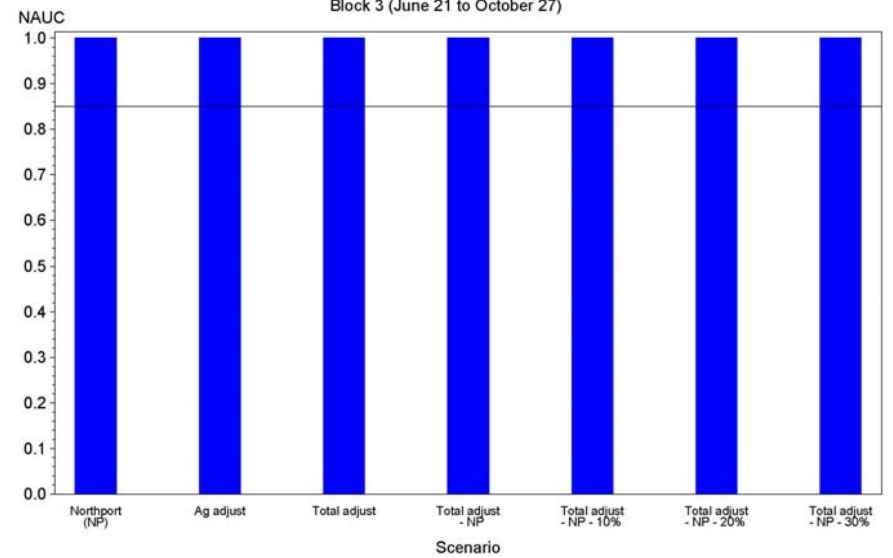

Myakka River
 Hydrodynamic Model Predictions - 1999-2002
 Normalized Area Under Curve from CDF of area 2 to 12 ppt
 Comparison of Scenarios
 Block 1 (March 1 to June 20)

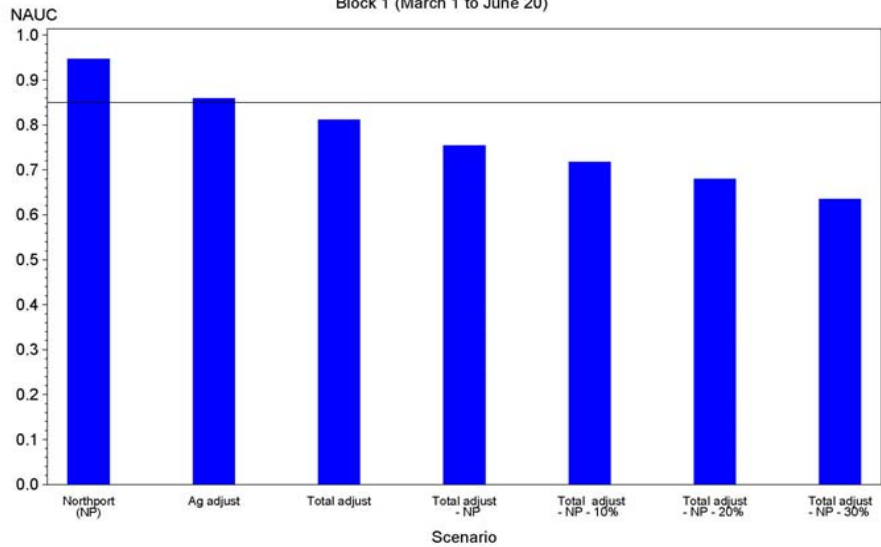

Myakka River
 Hydrodynamic Model Predictions - 1999-2002
 Normalized Area Under Curve from CDF of area 2 to 12 ppt
 Comparison of Scenarios
 Block 2 (October 28 to February 28)

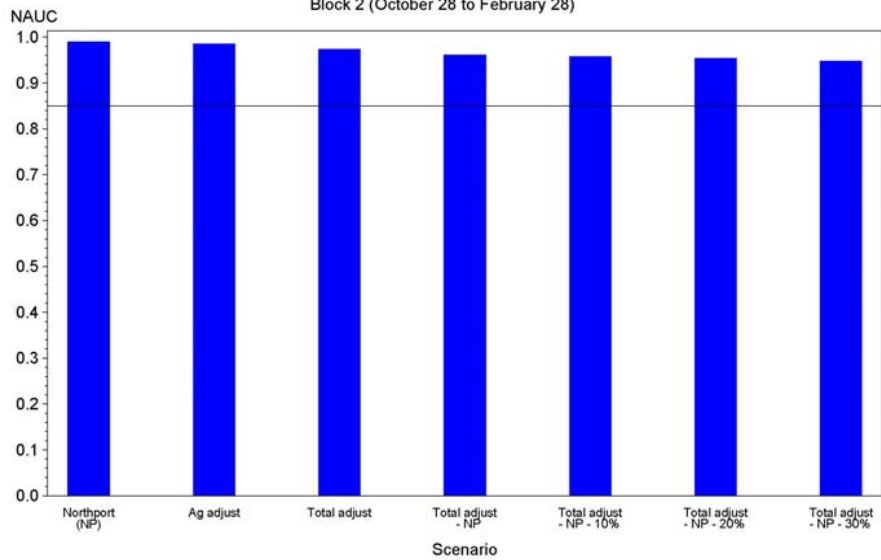

Myakka River
 Hydrodynamic Model Predictions - 1999-2002
 Normalized Area Under Curve from CDF of area 2 to 12 ppt
 Comparison of Scenarios
 Block 3 (June 21 to October 27)

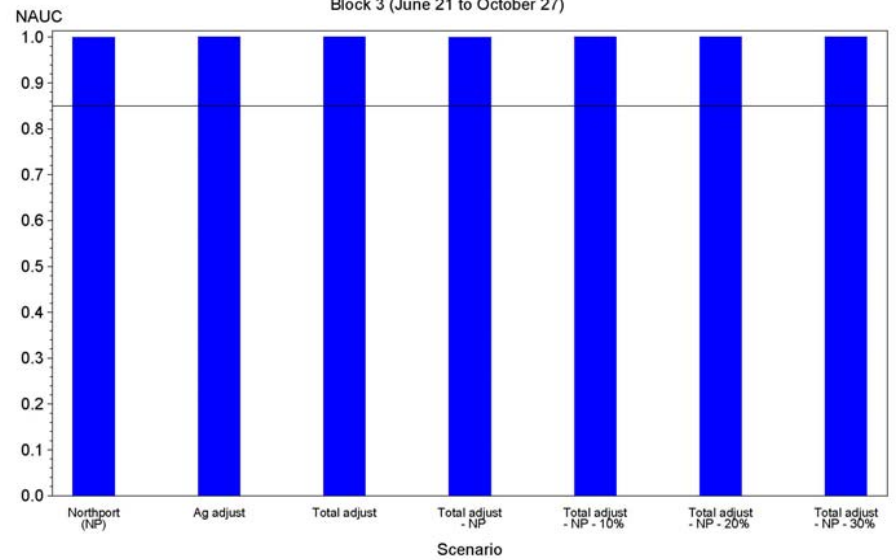

Appendix 8M

Cumulative distribution function plots of water volume with salinity < 2, < 5, < 14, and 3 to 14 for baseline flows and seven flow reduction scenarios for the three seasonal blocks.

Myakka River
Hydrodynamic Model Predictions - 1999-2002
Volume below 2 ppt (10**6 m3)
Comparison of Scenarios
Block 1 (March 1 to June 20)

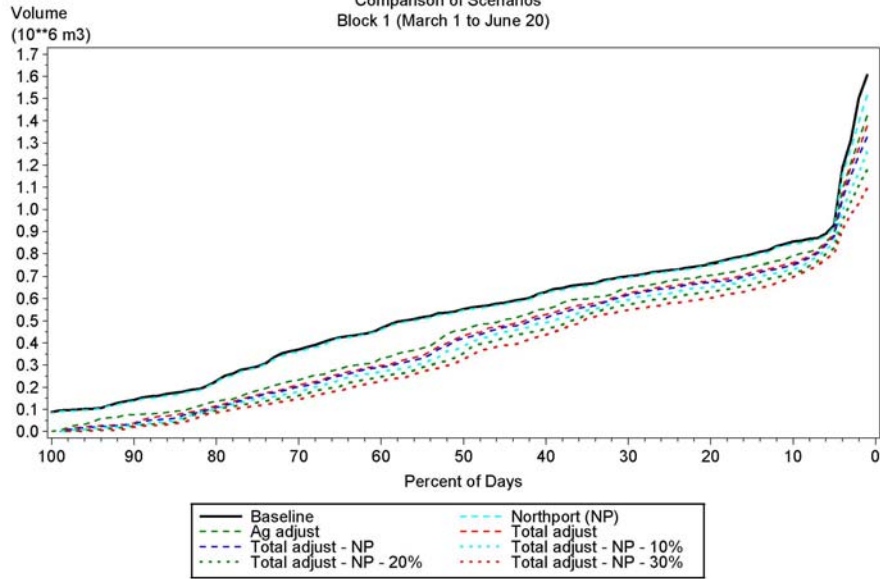

Myakka River
Hydrodynamic Model Predictions - 1999-2002
Volume below 2 ppt (10**6 m3)
Comparison of Scenarios
Block 2 (October 28 to February 28)

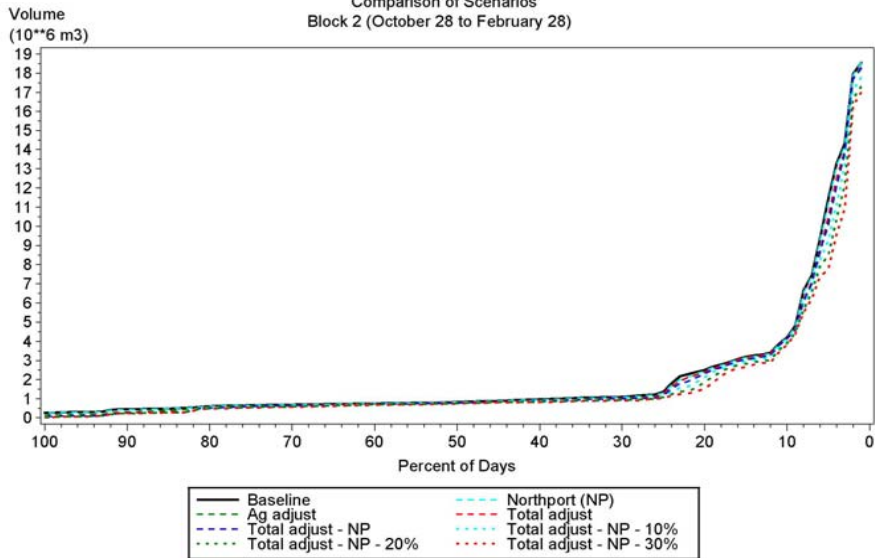

Myakka River
Hydrodynamic Model Predictions - 1999-2002
Volume below 2 ppt (10**6 m3)
Comparison of Scenarios
Block 3 (June 21 to October 27)

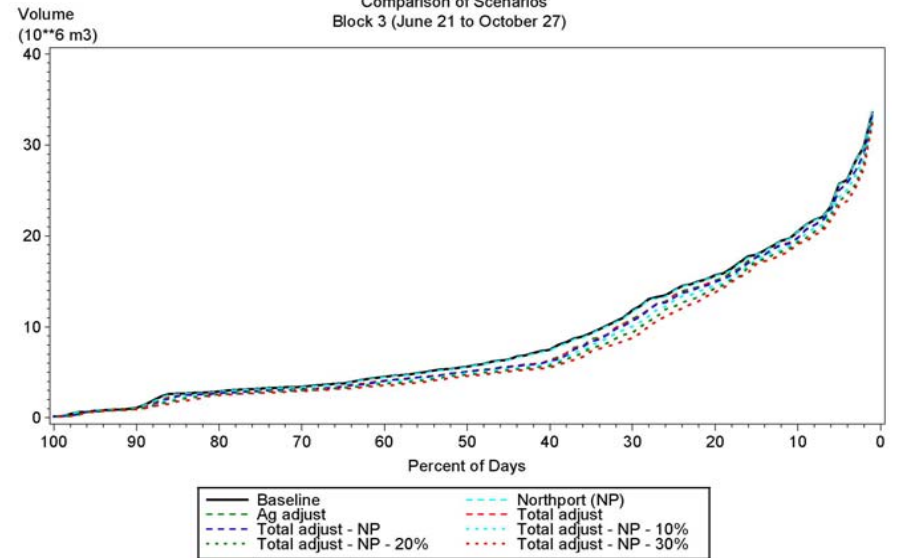

Myakka River
Hydrodynamic Model Predictions - 1999-2002
Volume below 5 ppt (10**6 m3)
Comparison of Scenarios
Block 1 (March 1 to June 20)

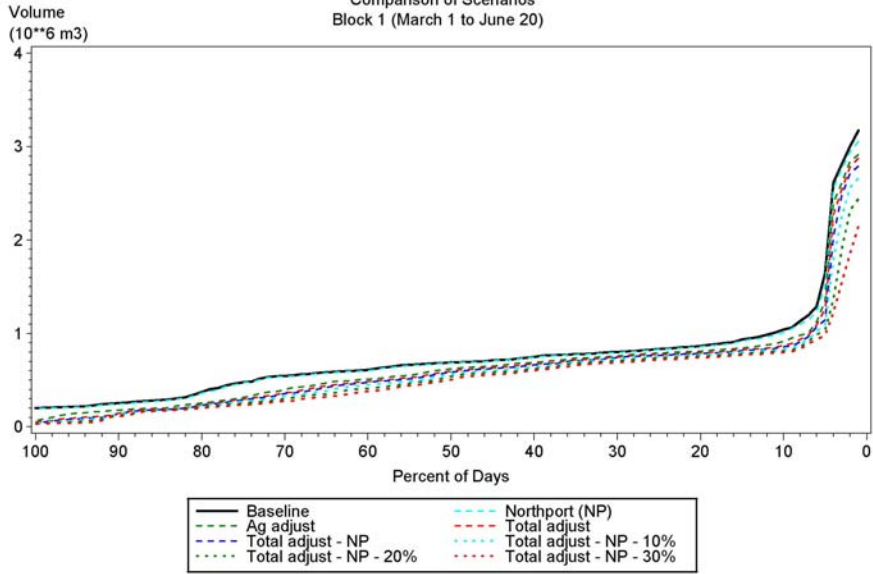

Myakka River
Hydrodynamic Model Predictions - 1999-2002
Volume below 5 ppt (10**6 m3)
Comparison of Scenarios
Block 3 (June 21 to October 27)

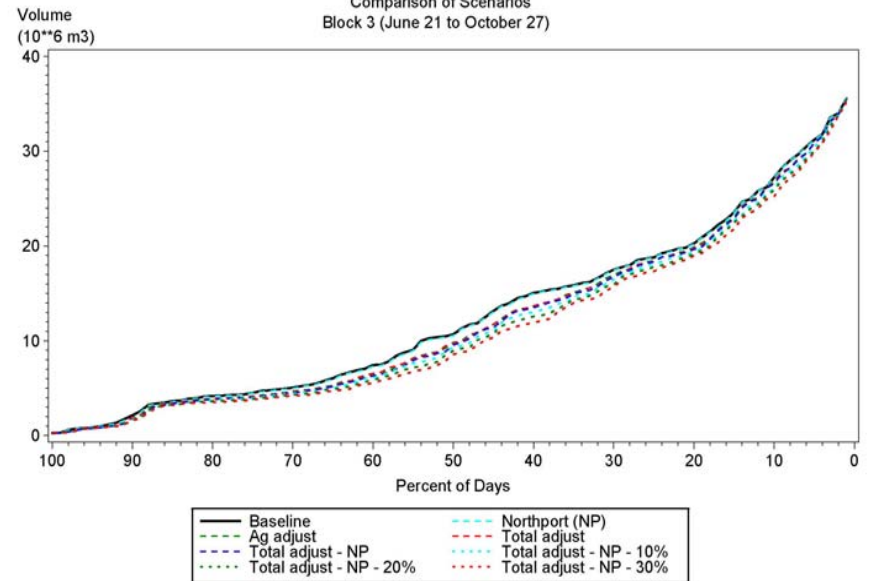

Myakka River
Hydrodynamic Model Predictions - 1999-2002
Volume below 5 ppt (10**6 m3)
Comparison of Scenarios
Block 2 (October 28 to February 28)

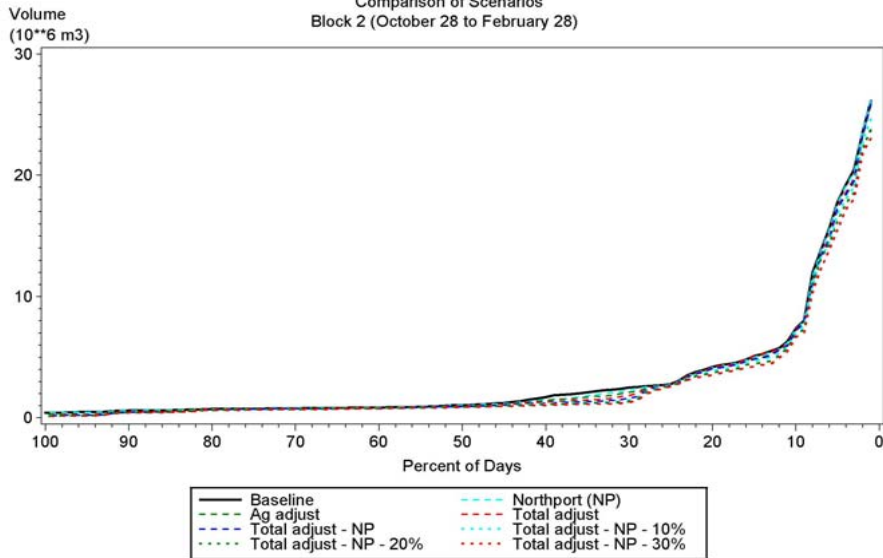

Myakka River
 Hydrodynamic Model Predictions - 1999-2002
 Volume below 14 ppt (10**6 m3)
 Comparison of Scenarios
 Block 1 (March 1 to June 20)

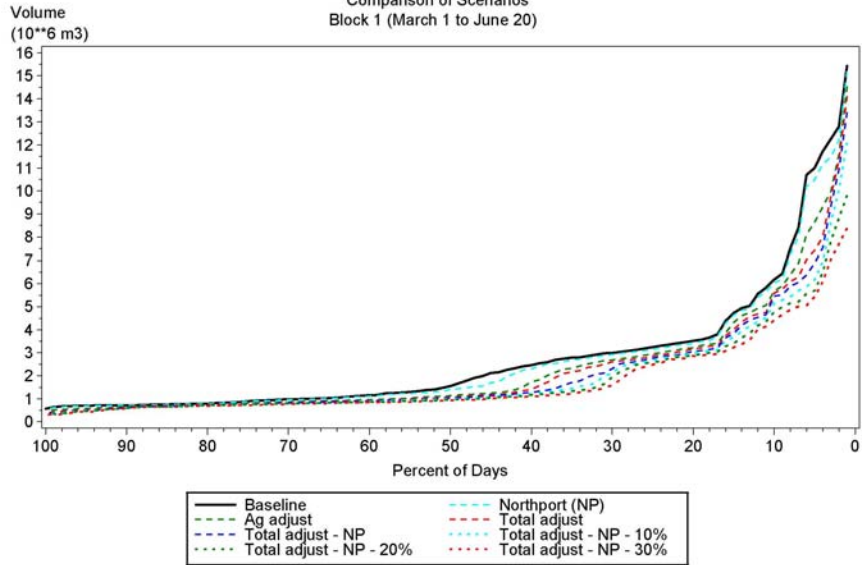

Myakka River
 Hydrodynamic Model Predictions - 1999-2002
 Volume below 14 ppt (10**6 m3)
 Comparison of Scenarios
 Block 2 (October 28 to February 28)

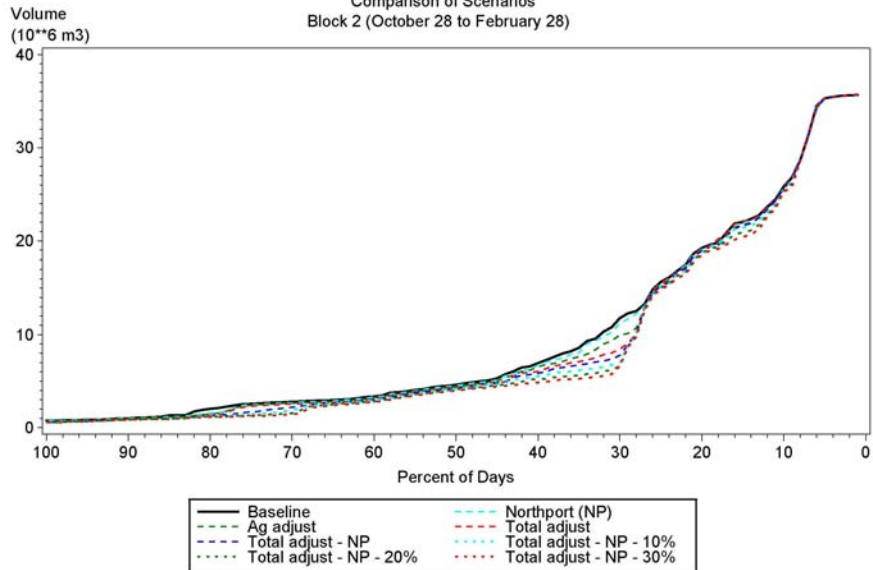

Myakka River
 Hydrodynamic Model Predictions - 1999-2002
 Volume below 14 ppt (10**6 m3)
 Comparison of Scenarios
 Block 3 (June 21 to October 27)

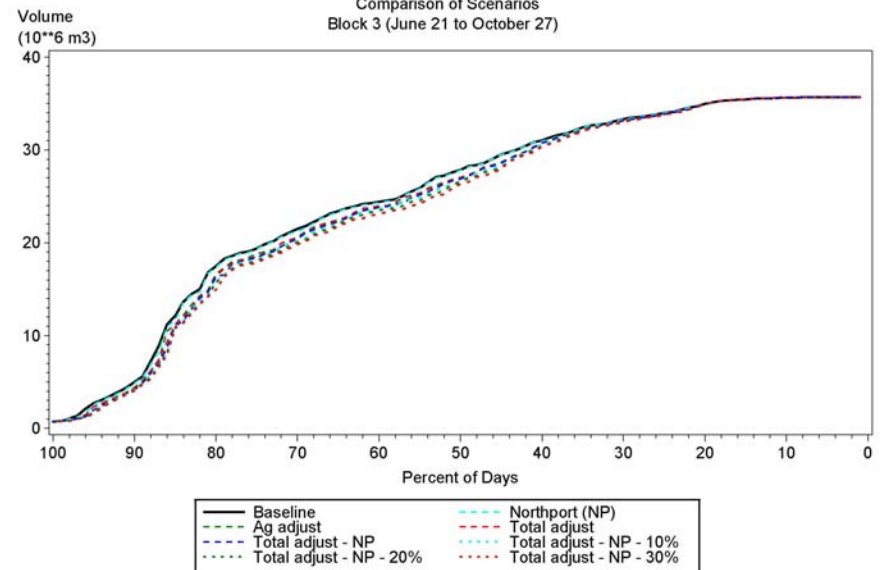

Myakka River
 Hydrodynamic Model Predictions - 1999-2002
 Volume between 3-14 ppt (10^6 m³)
 Comparison of Scenarios
 Block 1 (March 1 to June 20)

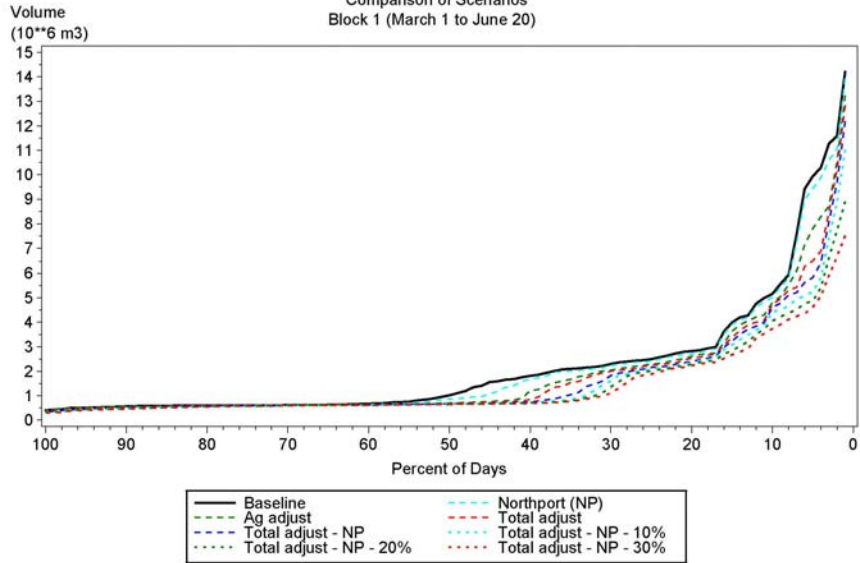

Myakka River
 Hydrodynamic Model Predictions - 1999-2002
 Volume between 3-14 ppt (10^6 m³)
 Comparison of Scenarios
 Block 2 (October 28 to February 28)

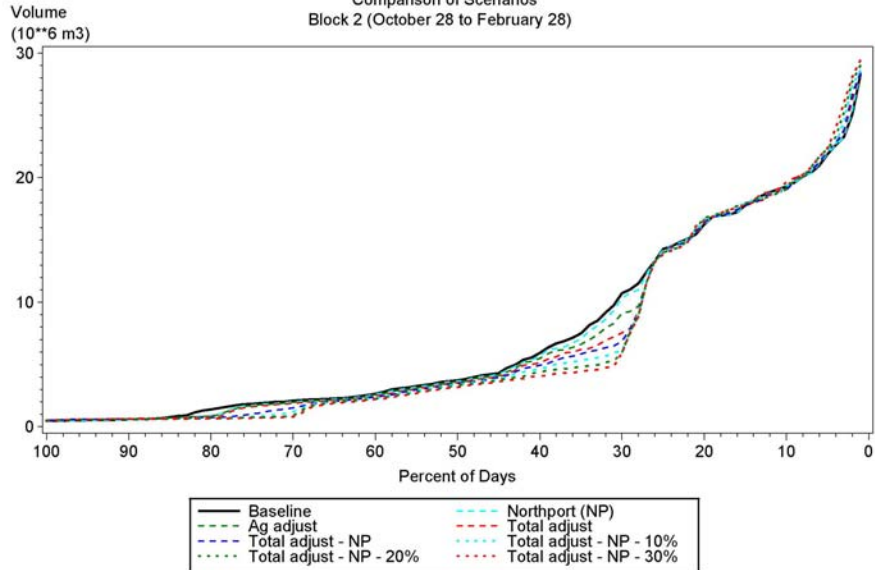

Myakka River
 Hydrodynamic Model Predictions - 1999-2002
 Volume between 3-14 ppt (10^6 m³)
 Comparison of Scenarios
 Block 3 (June 21 to October 27)

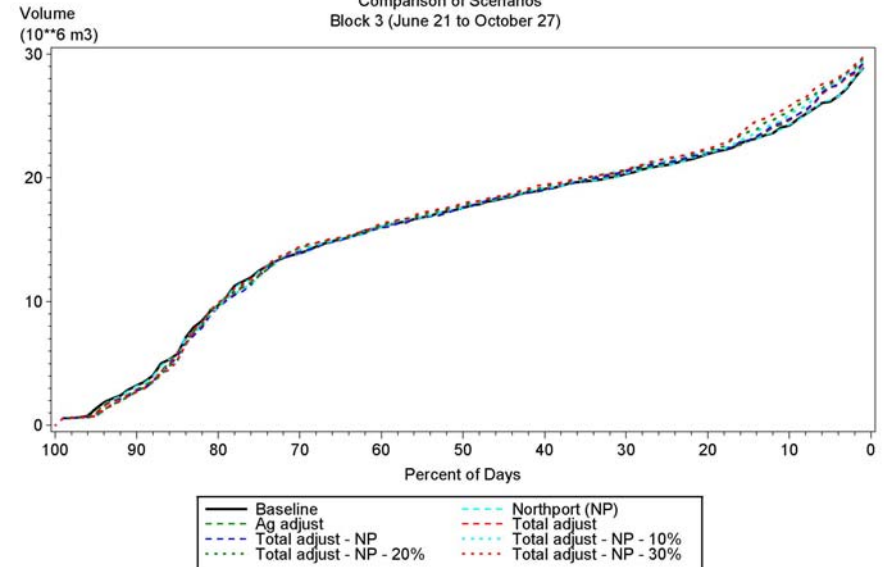

Appendix 8N

Bar charts of the percent of water volume with salinity < 2, < 5, < 14, and 3 to 14 relative to baseline flows for seven flow reduction scenarios for three seasonal blocks.

Myakka River
 Hydrodynamic Model Predictions - 1999-2002
 Normalized Area Under Curve from CDF of volume below 2 ppt
 Comparison of Scenarios
 Block 1 (March 1 to June 20)

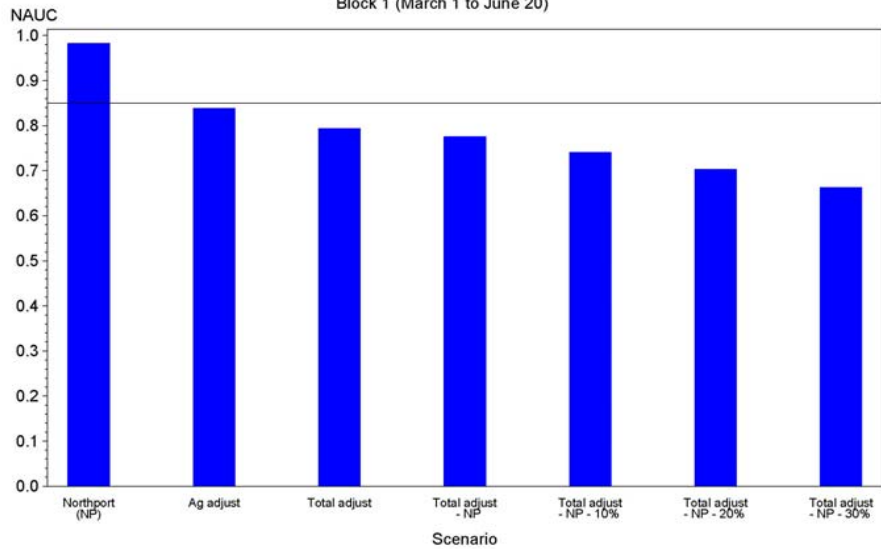

Myakka River
 Hydrodynamic Model Predictions - 1999-2002
 Normalized Area Under Curve from CDF of volume below 2 ppt
 Comparison of Scenarios
 Block 2 (October 28 to February 28)

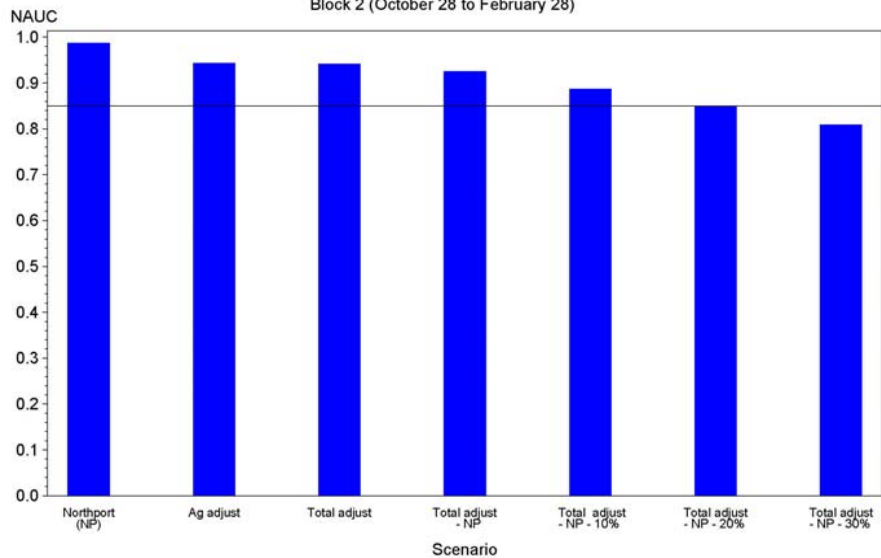

Myakka River
 Hydrodynamic Model Predictions - 1999-2002
 Normalized Area Under Curve from CDF of volume below 2 ppt
 Comparison of Scenarios
 Block 3 (June 21 to October 27)

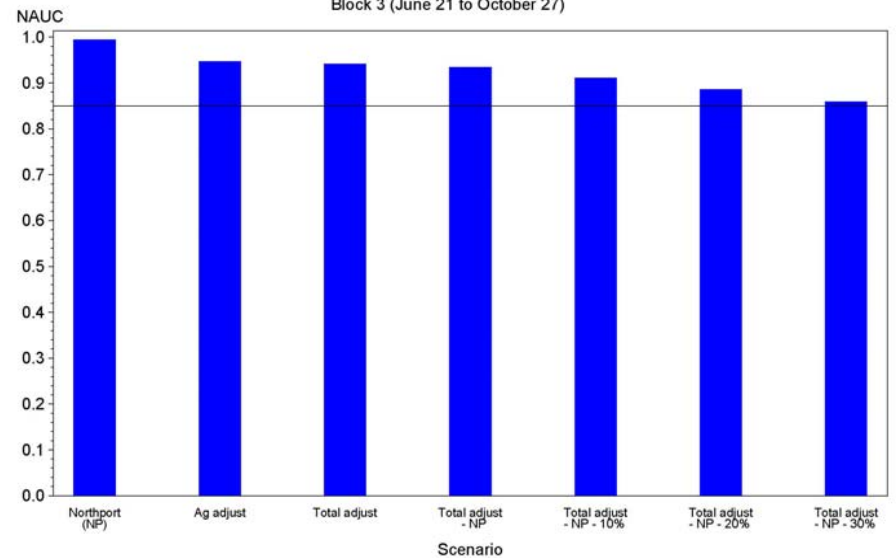

Myakka River
 Hydrodynamic Model Predictions - 1999-2002
 Normalized Area Under Curve from CDF of volume below 5 ppt
 Comparison of Scenarios
 Block 1 (March 1 to June 20)

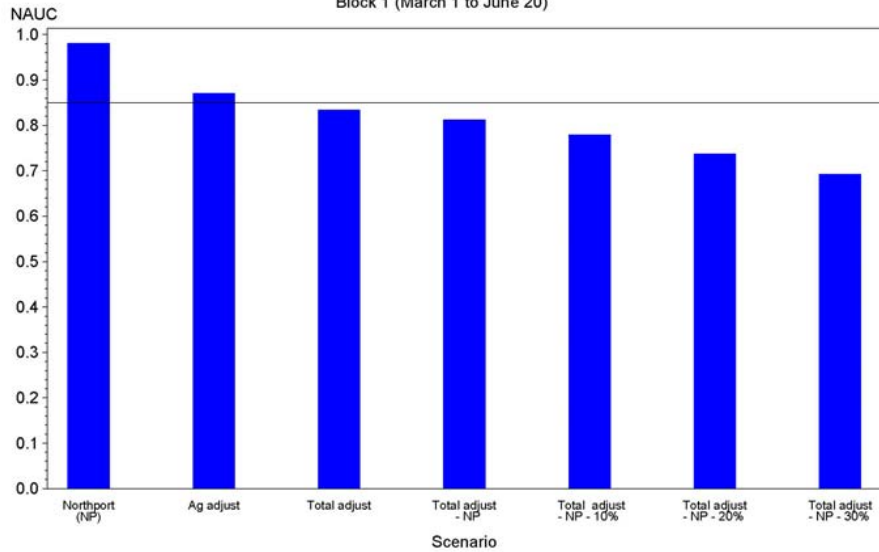

Myakka River
 Hydrodynamic Model Predictions - 1999-2002
 Normalized Area Under Curve from CDF of volume below 5 ppt
 Comparison of Scenarios
 Block 2 (October 28 to February 28)

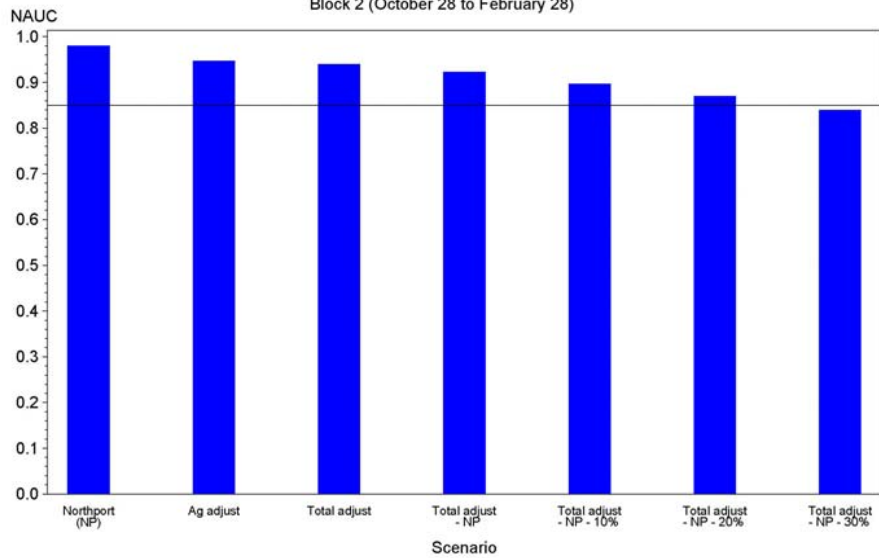

Myakka River
 Hydrodynamic Model Predictions - 1999-2002
 Normalized Area Under Curve from CDF of volume below 5 ppt
 Comparison of Scenarios
 Block 3 (June 21 to October 27)

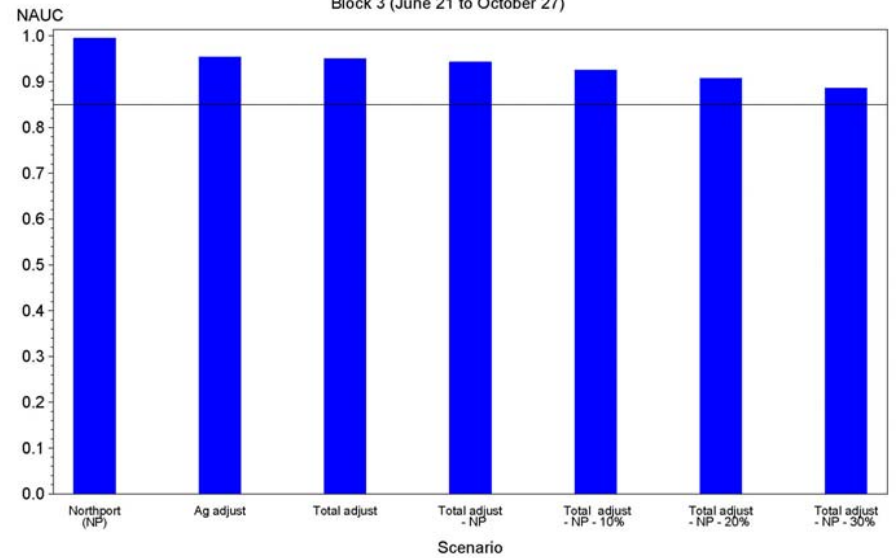

Myakka River
 Hydrodynamic Model Predictions - 1999-2002
 Normalized Area Under Curve from CDF of volume below 14 ppt
 Comparison of Scenarios
 Block 1 (March 1 to June 20)

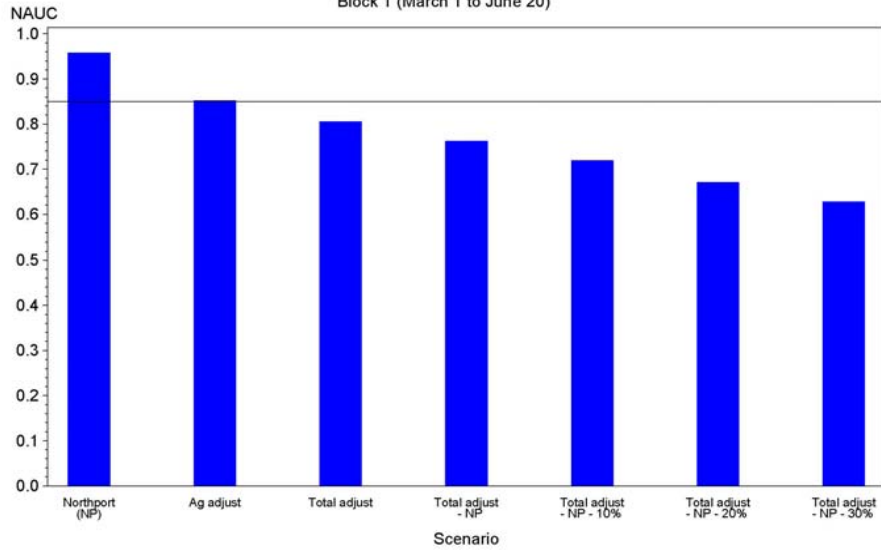

Myakka River
 Hydrodynamic Model Predictions - 1999-2002
 Normalized Area Under Curve from CDF of volume below 14 ppt
 Comparison of Scenarios
 Block 2 (October 28 to February 28)

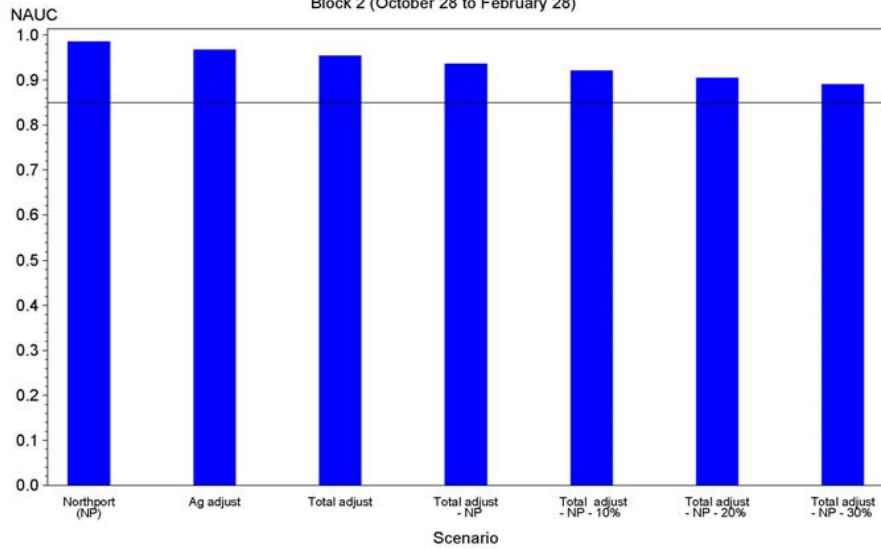

Myakka River
 Hydrodynamic Model Predictions - 1999-2002
 Normalized Area Under Curve from CDF of volume below 14 ppt
 Comparison of Scenarios
 Block 3 (June 21 to October 27)

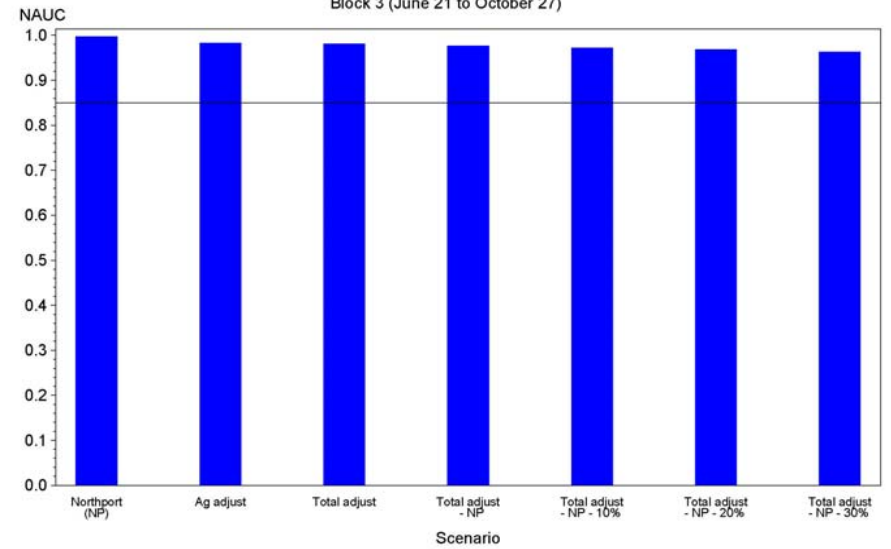

Myakka River
 Hydrodynamic Model Predictions - 1999-2002
 Normalized Area Under Curve from CDF of volume 3-14 ppt
 Comparison of Scenarios
 Block 1 (March 1 to June 20)

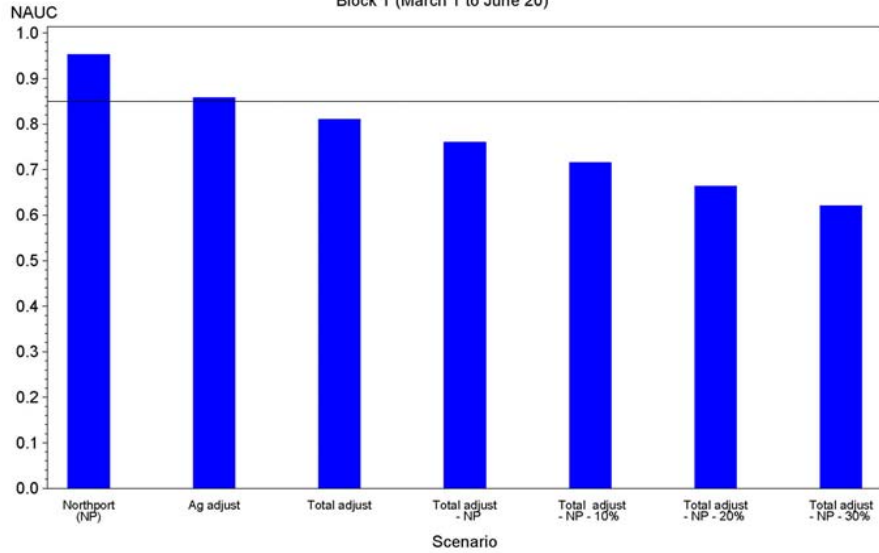

Myakka River
 Hydrodynamic Model Predictions - 1999-2002
 Normalized Area Under Curve from CDF of volume 3-14 ppt
 Comparison of Scenarios
 Block 2 (October 28 to February 28)

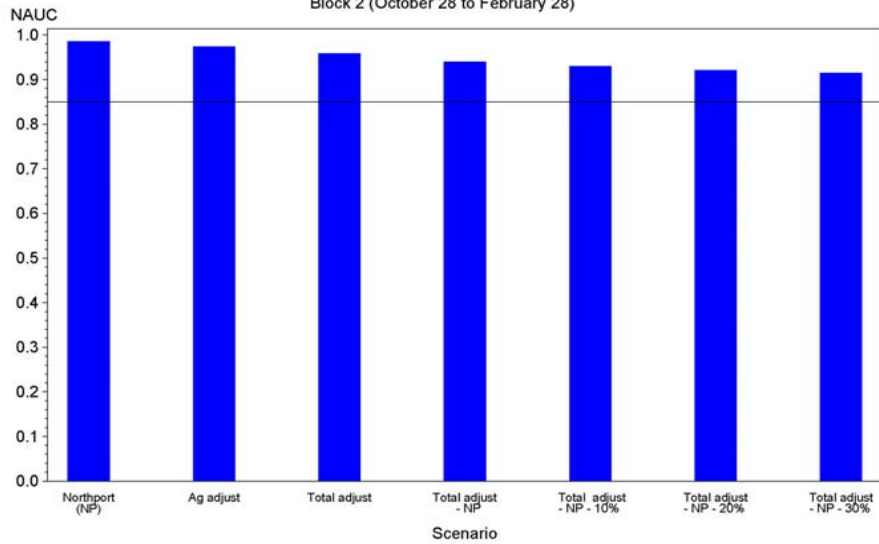

Myakka River
 Hydrodynamic Model Predictions - 1999-2002
 Normalized Area Under Curve from CDF of volume 3-14 ppt
 Comparison of Scenarios
 Block 3 (June 21 to October 27)

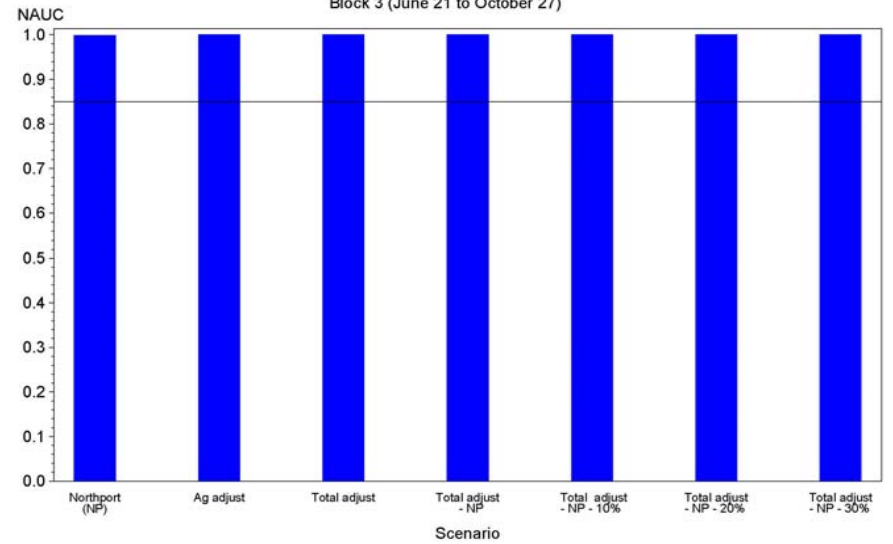

Appendix 80

Percent reductions in mean values for the bottom area and water volume of selected salinity zones for the period 1999-2002

Table 8O-1. Percent reductions in mean values for the bottom area and water volume of selected salinity zones in the Lower Myakka River for flow reduction scenarios relative to baseline flows for the years 1999-2002. Percent reductions greater than or equal to 15% are highlighted in yellow. All values rounded to nearest interger. NA is listed for zones that moved past the downstream end of the study area for substantial amounts of time.

Bottom Area	Salinity Zone					
	<2 psu	< 5 psu	<12 psu	<17 psu	2 to 12 psu	11 to 17 psu
North Port Permitted	1%	1%	NA	NA	NA	NA
Agricultural adjustment	6%	5%	NA	NA	NA	NA
Total adjustment	6%	5%	NA	NA	NA	NA
Total adjustment - North Port	7%	6%	NA	NA	NA	NA
Total adjustment - North Port - 10%	10%	8%	NA	NA	NA	NA
Total adjustment - North Port - 20%	12%	10%	NA	NA	NA	NA
Total adjustment - North Port - 30%	15%	13%	NA	NA	NA	NA

Water Volume	Salinity Zone			
	<2 psu	< 5 psu	< 14 psu	3 to 14 psu
North Port Permitted	1%	1%	NA	NA
Agricultural adjustment	6%	5%	NA	NA
Total adjustment	6%	6%	NA	NA
Total adjustment - North Port	7%	7%	NA	NA
Total adjustment - North Port - 10%	10%	8%	NA	NA
Total adjustment - North Port - 20%	13%	11%	NA	NA
Total adjustment - North Port - 30%	16%	13%	NA	NA

Table 8O-2. Percent reductions in mean values for the bottom area and water volume of selected salinity zones in the Lower Myakka River for flow reduction scenarios relative to baseline flows for **BLOCK 1** during the years 1999-2002. Percent reductions greater than or equal to 15% are highlighted in yellow; reductions greater than 25% are highlighted in gray. All values rounded to nearest interger.

Bottom Area Block 1 (March 1 - June 20)	Salinity Zone					
	<2 psu	< 5 psu	<12 psu	<17 psu	2 to 12 psu	11 to 17 psu
North Port Permitted	2%	2%	8%	3%	6%	2%
Agricultural adjustment	16%	13%	16%	10%	15%	7%
Total adjustment	21%	17%	21%	13%	20%	10%
Total adjustment - North Port	23%	21%	25%	17%	26%	13%
Total adjustment - North Port - 10%	27%	23%	29%	20%	30%	16%
Total adjustment - North Port - 20%	31%	28%	33%	23%	34%	19%
Total adjustment - North Port - 30%	35%	32%	37%	27%	38%	22%

Water Volume Block 1 (March 1 - June 20)	Salinity Zone			
	<2 psu	< 5 psu	< 14 psu	3 to 14 psu
North Port Permitted	2%	2%	4%	5%
Agricultural adjustment	16%	13%	15%	14%
Total adjustment	21%	17%	19%	19%
Total adjustment - North Port	23%	19%	24%	24%
Total adjustment - North Port - 10%	26%	22%	28%	28%
Total adjustment - North Port - 20%	30%	26%	33%	33%
Total adjustment - North Port - 30%	34%	31%	37%	38%

Table 80-3. Percent reductions in the bottom area and water volume of selected salinity zones in the Lower Myakka River for flow reduction scenarios relative to baseline flows for BLOCK 2 during the years 1999-2002. Percent reductions greater than or equal to 15% are highlighted in yellow. NA is listed for zones that moved past the downstream end of the study area for substantial amounts of time during Block 2.

Bottom Area Block 2 (Oct. 28 - Feb. 28)	Salinity Zone					
	<2 psu	< 5 psu	<12 psu	<17 psu	2 to 12 psu	11 to 17 psu
North Port Permitted	1%	2%	NA	NA	NA	NA
Agricultural adjustment	5%	5%	NA	NA	NA	NA
Total adjustment	5%	6%	NA	NA	NA	NA
Total adjustment - North Port	7%	8%	NA	NA	NA	NA
Total adjustment - North Port - 10%	10%	10%	NA	NA	NA	NA
Total adjustment - North Port - 20%	14%	13%	NA	NA	NA	NA
Total adjustment - North Port - 30%	18%	15%	NA	NA	NA	NA

Water Volume Block 2 (Oct. 28 - Feb. 28)	Salinity Zone			
	<2 psu	< 5 psu	< 14 psu	3 to 14 psu
North Port Permitted	1%	2%	NA	NA
Agricultural adjustment	6%	5%	NA	NA
Total adjustment	6%	6%	NA	NA
Total adjustment - North Port	7%	7%	NA	NA
Total adjustment - North Port - 10%	11%	10%	NA	NA
Total adjustment - North Port - 20%	15%	13%	NA	NA
Total adjustment - North Port - 30%	19%	16%	NA	NA

Table 80-4. Percent reductions in mean values for the bottom area and water volume of selected salinity zones in the Lower Myakka River for flow reduction scenarios relative to baseline flows for BLOCK 3 during the years 1999-2002. Percent reductions greater than or equal to 15% are highlighted in yellow. NA is listed for zones that moved past the downstream end of the study area for substantial amounts of time during Block 3.

Bottom Area Block 3 (June 21 - Oct. 27)	Salinity Zone					
	<2 psu	< 5 psu	<12 psu	<17 psu	2 to 12 psu	11 to 17 psu
North Port Permitted	1%	1%	NA	NA	NA	NA
Agricultural adjustment	5%	4%	NA	NA	NA	NA
Total adjustment	6%	5%	NA	NA	NA	NA
Total adjustment - North Port	6%	5%	NA	NA	NA	NA
Total adjustment - North Port - 10%	8%	7%	NA	NA	NA	NA
Total adjustment - North Port - 20%	11%	9%	NA	NA	NA	NA
Total adjustment - North Port - 30%	13%	11%	NA	NA	NA	NA

Water Volume Block 3 (June 21 - Oct 27)	Salinity Zone			
	<2 psu	< 5 psu	< 14 psu	3 to 14 psu
North Port Permitted	1%	1%	NA	NA
Agricultural adjustment	5%	5%	NA	NA
Total adjustment	6%	5%	NA	NA
Total adjustment - North Port	7%	6%	NA	NA
Total adjustment - North Port - 10%	9%	7%	NA	NA
Total adjustment - North Port - 20%	11%	9%	NA	NA
Total adjustment - North Port - 30%	14%	11%	NA	NA

Appendix 8P

Percent reductions in daily values of bottom area with salinity <2, <5, <17, and 2 to 12 vs. preceding 5-day mean flow at the Myakka River near Sarasota gage for four flow reduction scenarios.

Reduction in Percent Bottom Area < 2 PSU vs. 5_day flow
Flow Reduction Scenario = North Port Permitted

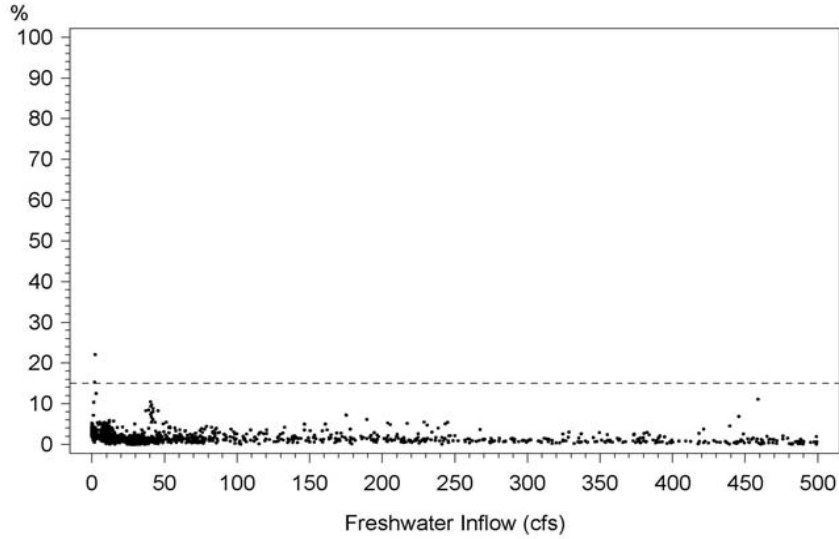

Reduction in Percent Bottom Area < 5 PSU vs. 5_day flow
Flow Reduction Scenario = North Port Permitted

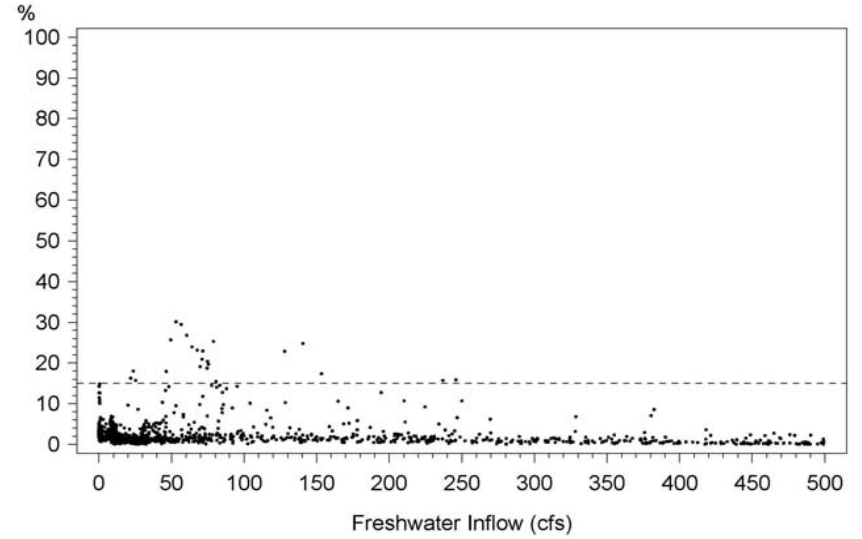

Reduction in Percent Bottom Area < 17 PSU vs. 5_day flow
Flow Reduction Scenario = North Port Permitted

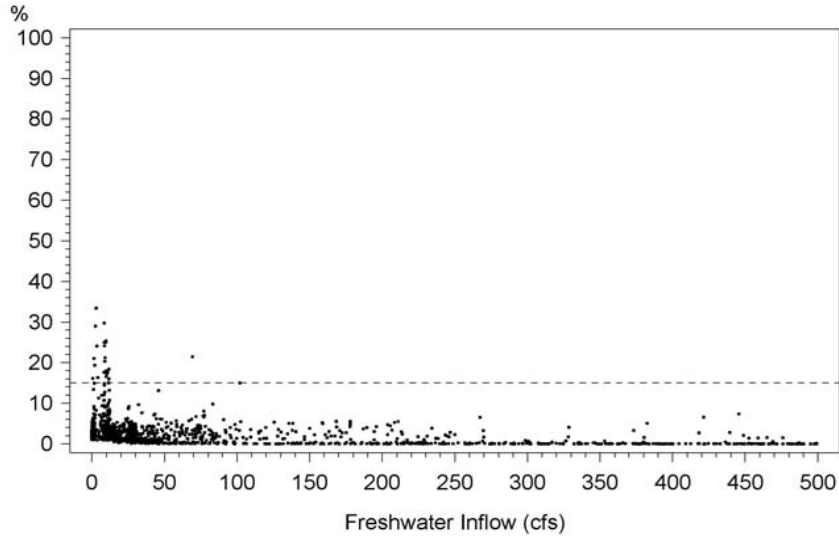

Reduction in Percent Bottom Area 2 to 12 psu vs. 5_day flow
Flow Reduction Scenario = North Port Permitted

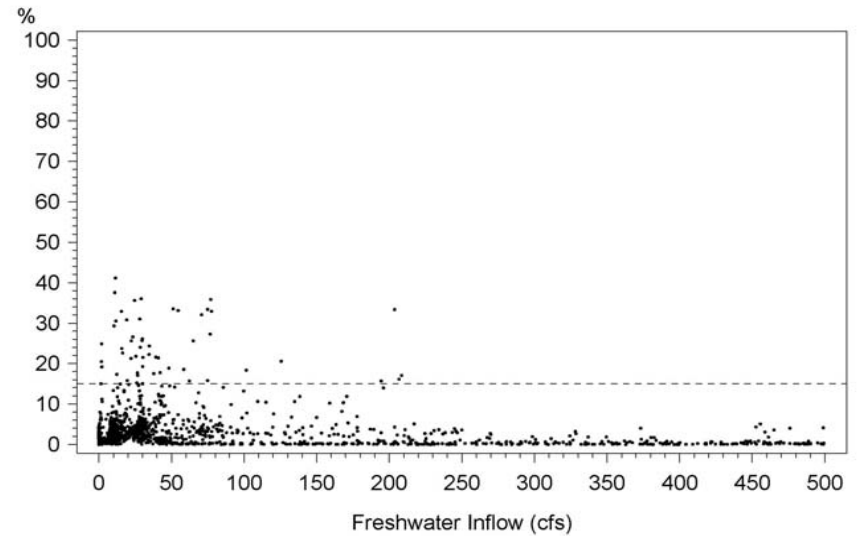

Reduction in Percent Bottom Area < 2 psu vs. 5_day flow
Flow Reduction Scenario = Total Excess Flows

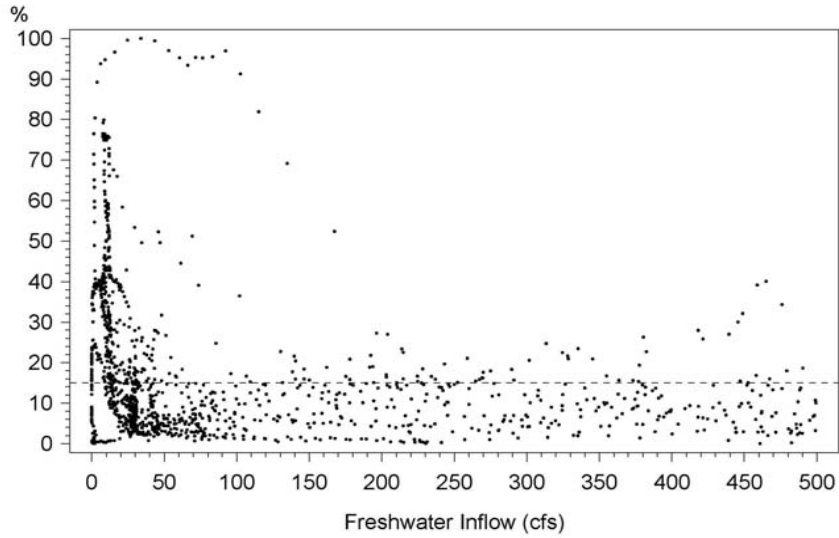

Reduction in Percent Bottom Area < 5 psu vs. 5_day flow
Flow Reduction Scenario = Total Excess Flows

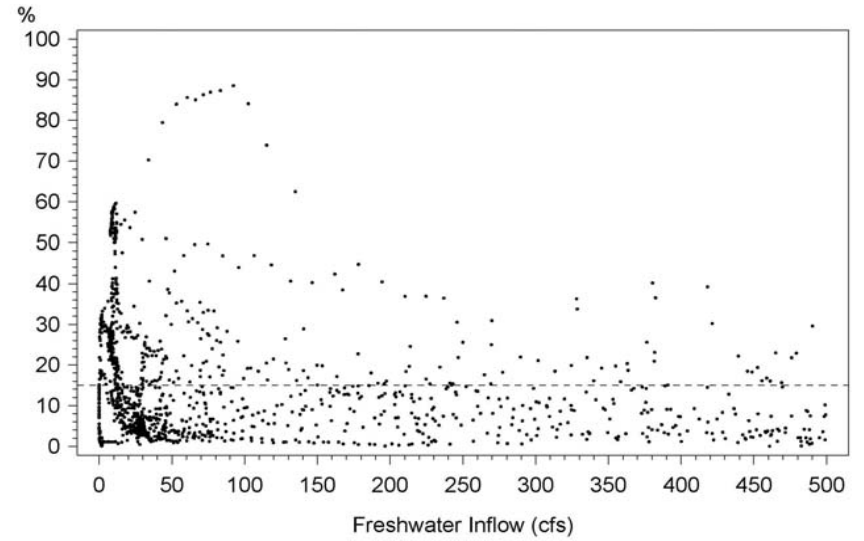

Reduction in Percent Bottom Area < 17 psu vs. 5_day flow
Flow Reduction Scenario = Total Excess Flows

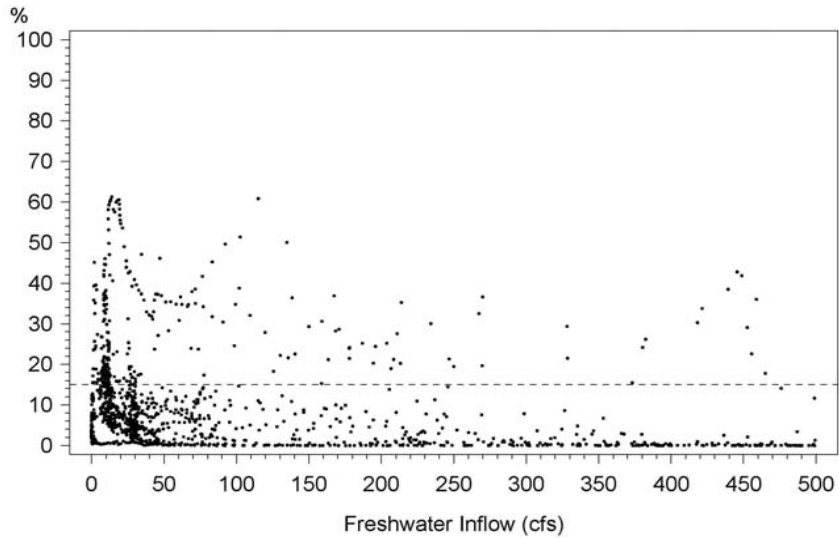

Reduction in Percent Bottom Area 2 to 12 psu vs. 5_day flow
Flow Reduction Scenario = Total Excess Flows

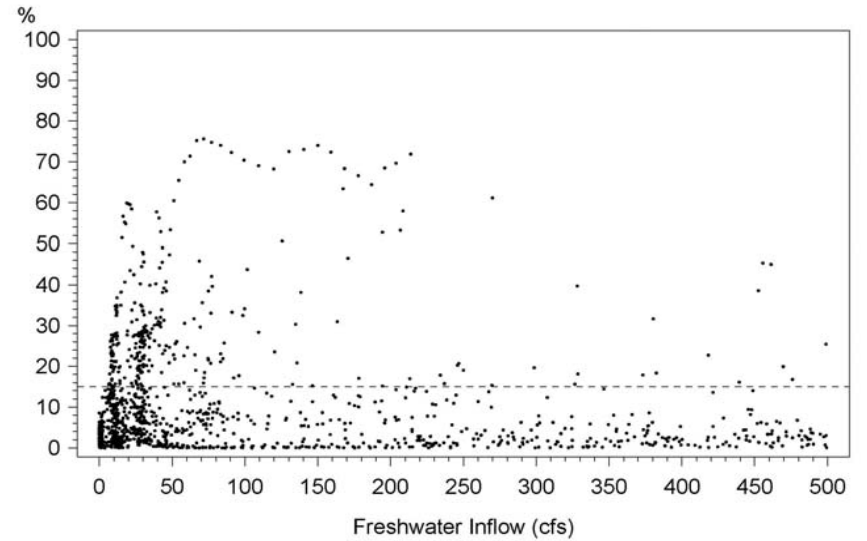

Reduction in Percent Bottom Area < 2 PSU vs. 5_day flow
Flow Reduction Scenario = Total Excess Flow - North Port - 10%

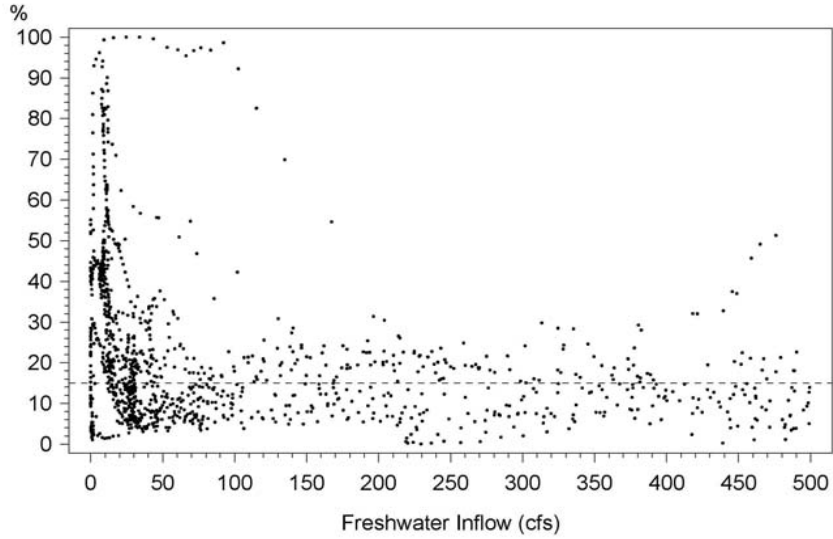

Reduction in Percent Bottom Area < 5 PSU vs. 5_day flow
Flow Reduction Scenario = Total Excess Flow - North Port - 10%

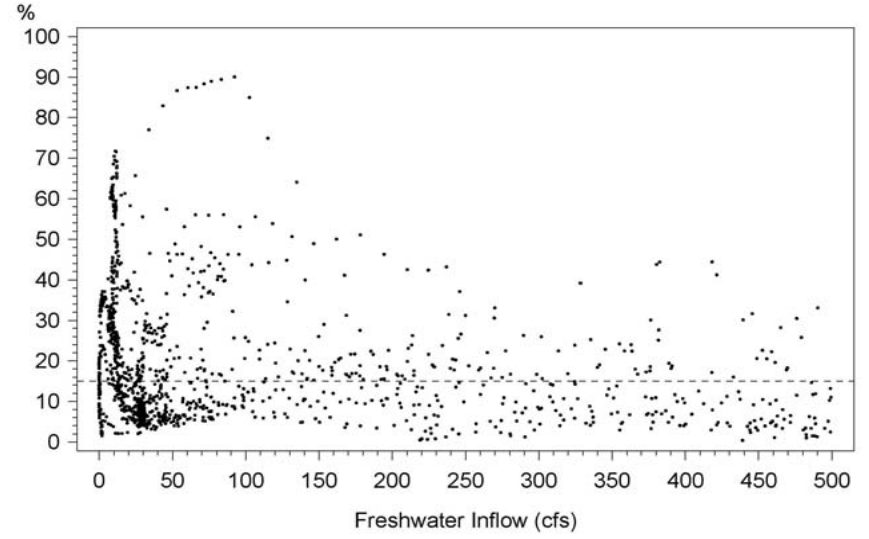

Reduction in Percent Bottom Area < 17 PSU vs. 5_day flow
Flow Reduction Scenario = Total Excess Flow - North Port - 10%

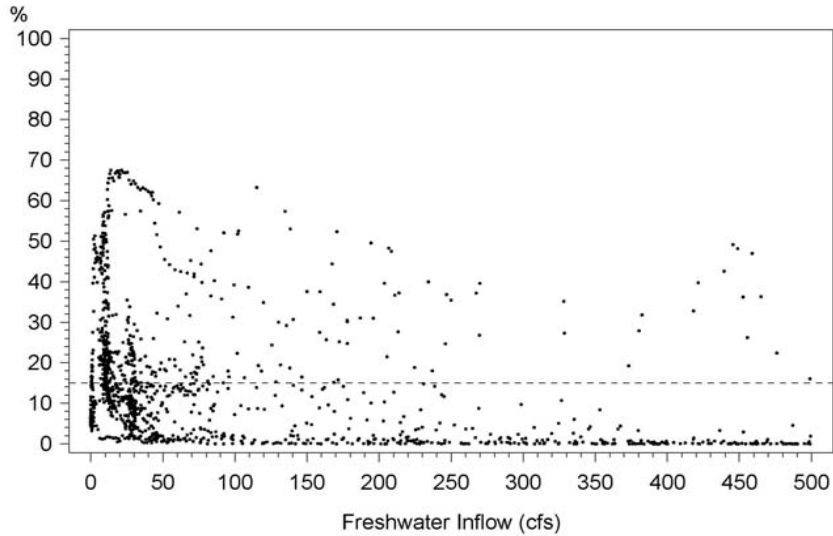

Reduction in Percent Bottom Area 2 to 12 PSU vs. 5_day flow
Flow Reduction Scenario = Total Excess Flow - North Port - 10%

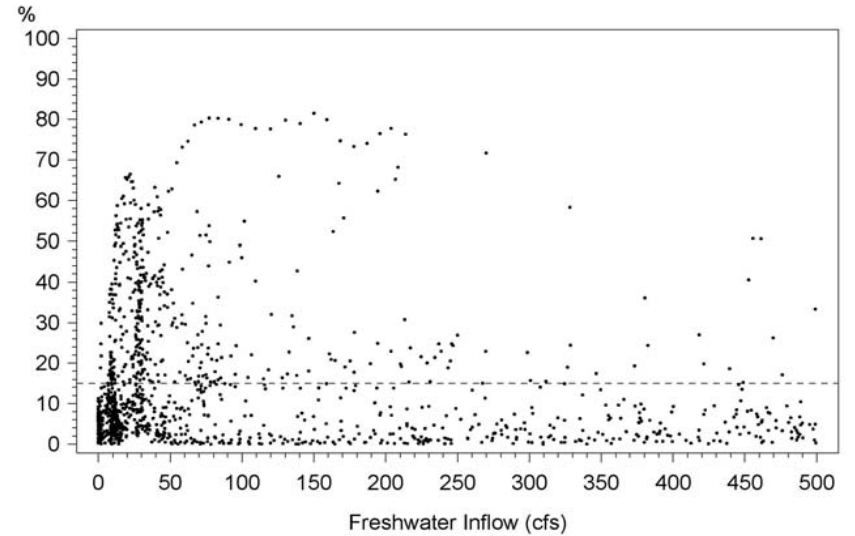

Reduction in Percent Bottom Area < 2 PSU vs. 5_day flow
Flow Reduction Scenario = Total Excess Flow - North Port - 30%

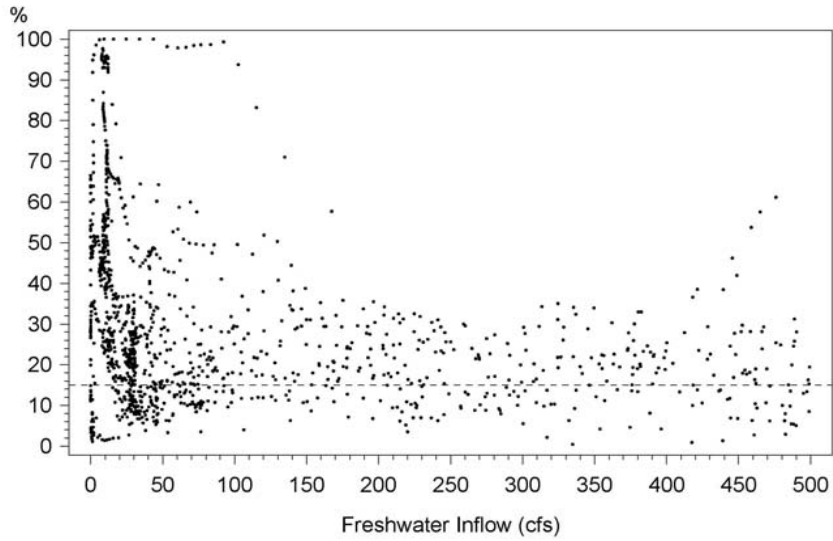

Reduction in Percent Bottom Area < 5 PSU vs. 5_day flow
Flow Reduction Scenario = Total Excess Flow - North Port - 30%

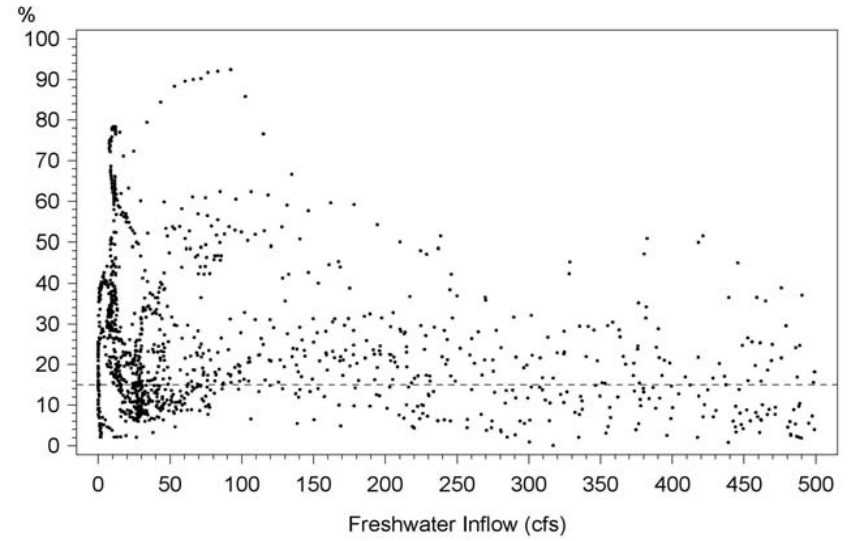

Reduction in Percent Bottom Area < 17 PSU vs. 5_day flow
Flow Reduction Scenario = Total Excess Flow - North Port - 30%

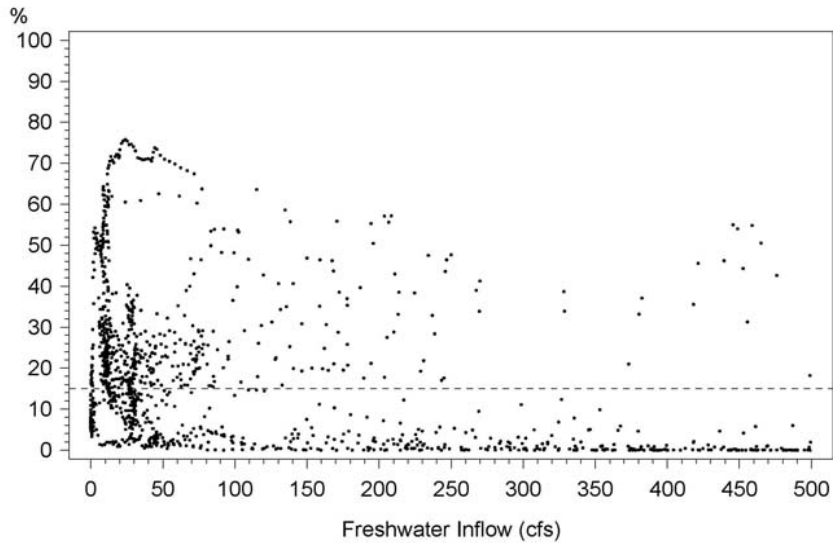

Reduction in Percent Bottom Area 2 to 12 PSU vs. 5_day flow
Flow Reduction Scenario = Total Excess Flow - North Port - 30%

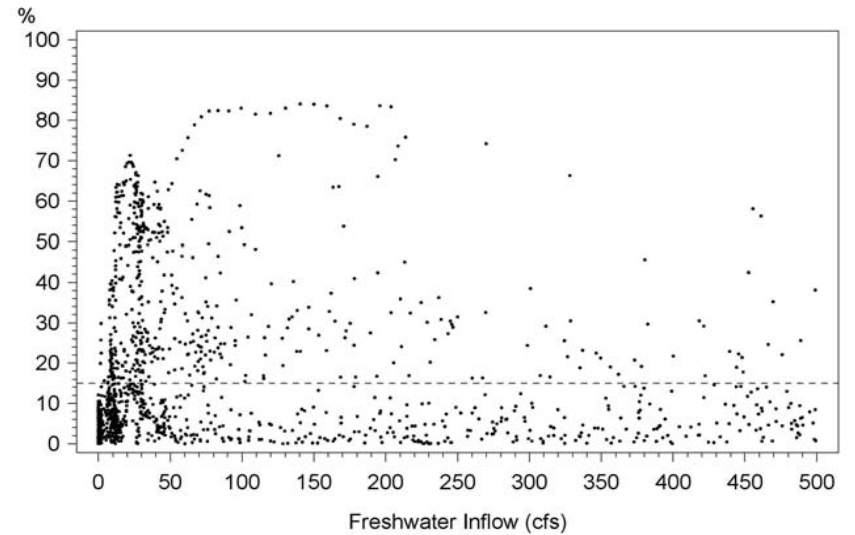

Appendix 8Q

Percent reductions in daily values of water volumes with salinity <2, <5, <14, and 3 to 14 vs. preceding 5-day mean flow at the Myakka River near Sarasota gage for four flow reduction scenarios.

Reduction in Water Volume < 2 PSU vs. 5_day flow
Flow Reduction Scenario = North Port Permitted

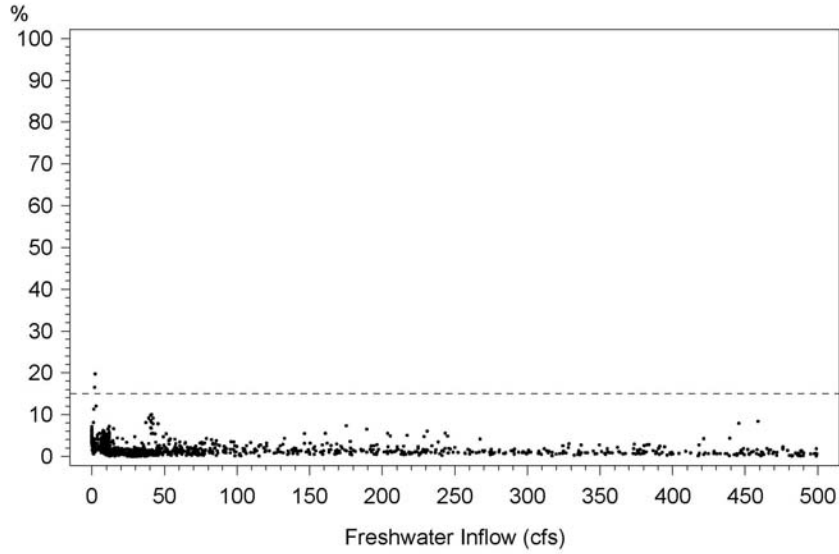

Reduction in Water Volume < 5 PSU vs. 5_day flow
Flow Reduction Scenario = North Port Permitted

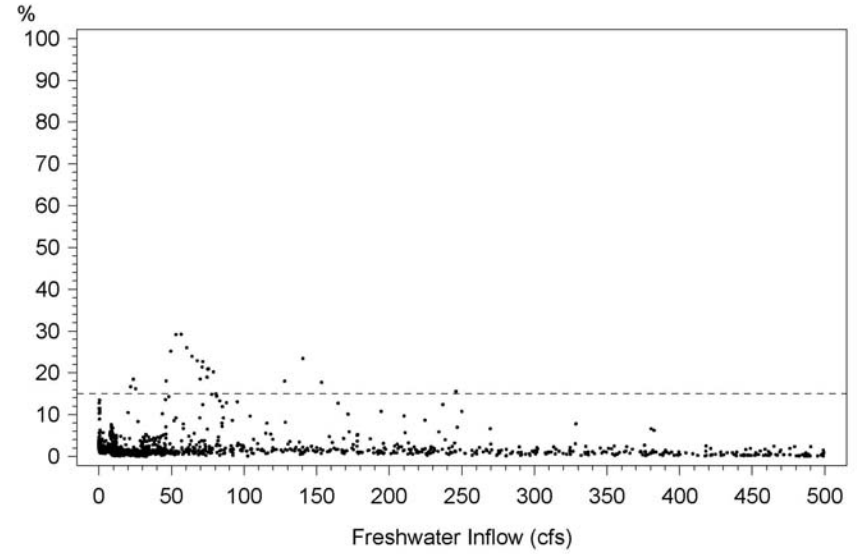

Reduction in Water Volume < 14 PSU vs. 5_day flow
Flow Reduction Scenario = North Port Permitted

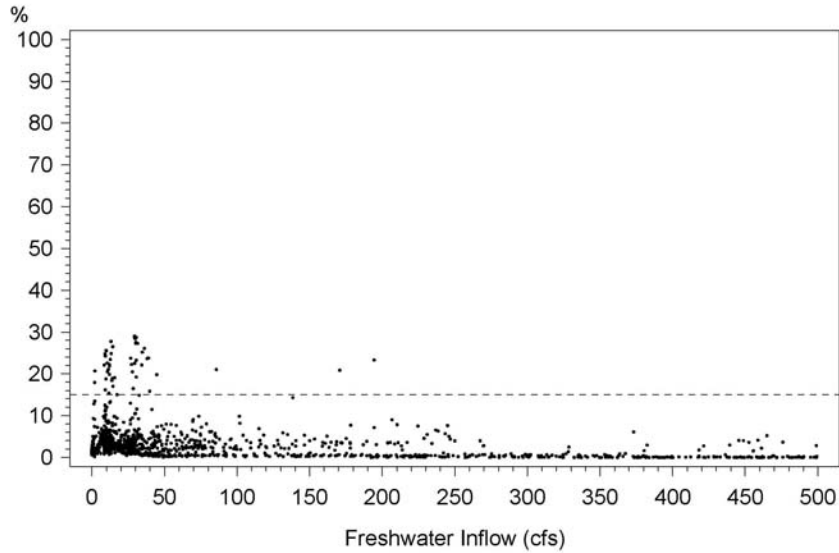

Reduction in Water Volume 3 to 14 PSU vs. 5_day flow
Flow Reduction Scenario = North Port Permitted

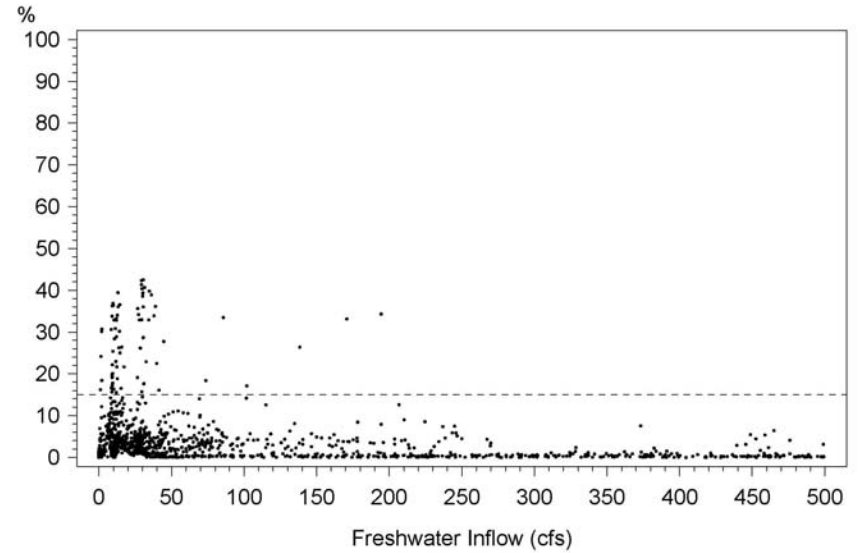

Reduction in Water Volume < 2 PSU vs. 5_day flow
Flow Reduction Scenario = Total Excess Flow

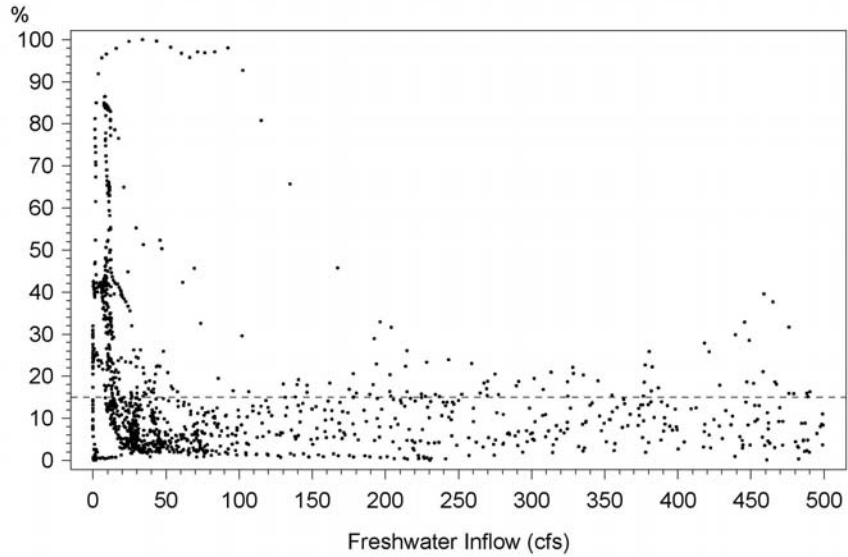

Reduction in Water Volume < 14 PSU vs. 5_day flow
Flow Reduction Scenario = Total Excess Flow

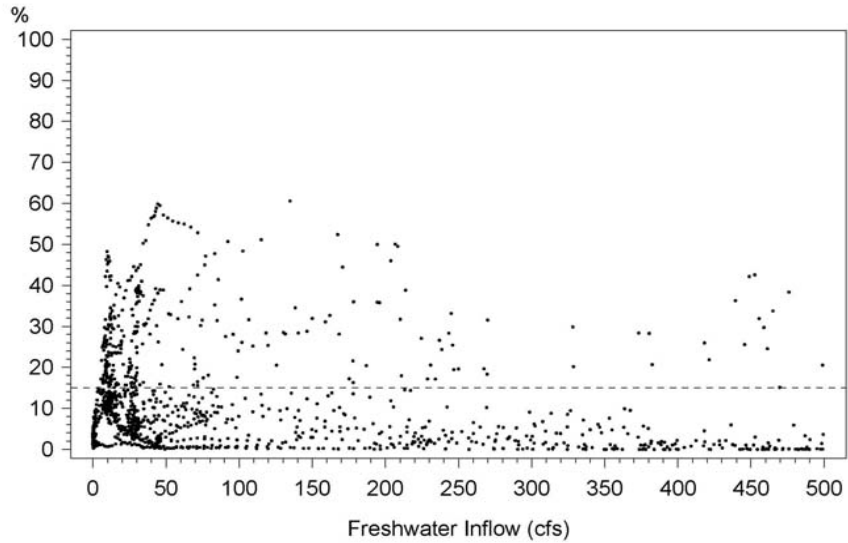

Reduction in Water Volume 3 to 14 PSU vs. 5_day flow
Flow Reduction Scenario = Total Excess Flow

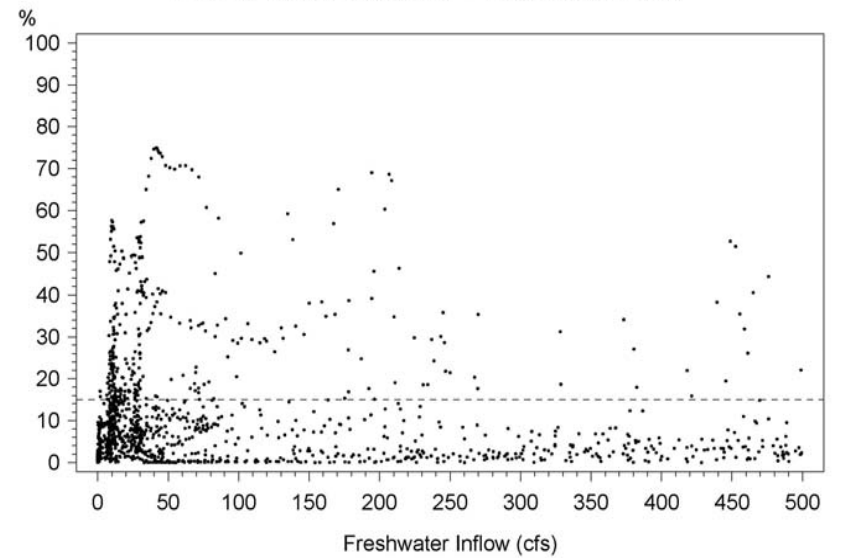

Reduction in Water Volume < 2 PSU vs. 5_day flow
Flow Reduction Scenario = Total Excess Flow - North Port - 10%

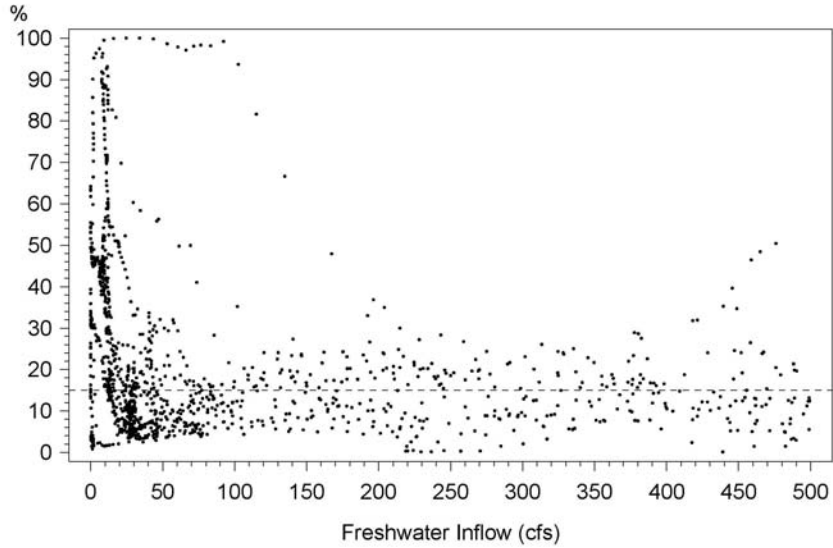

Reduction in Water Volume < 5 PSU vs. 5_day flow
Flow Reduction Scenario = Total Excess Flow - North Port - 10%

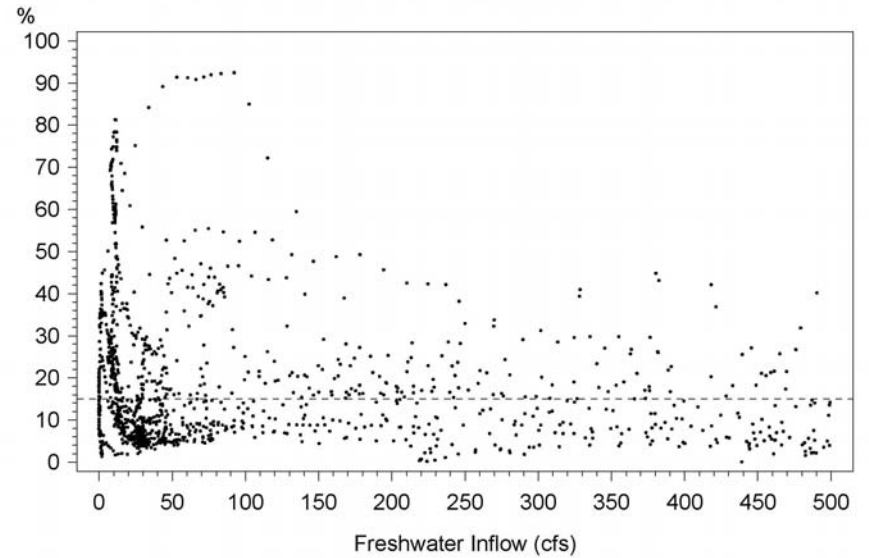

Reduction in Water Volume < 14 PSU vs. 5_day flow
Flow Reduction Scenario = Total Excess Flow - North Port - 10%

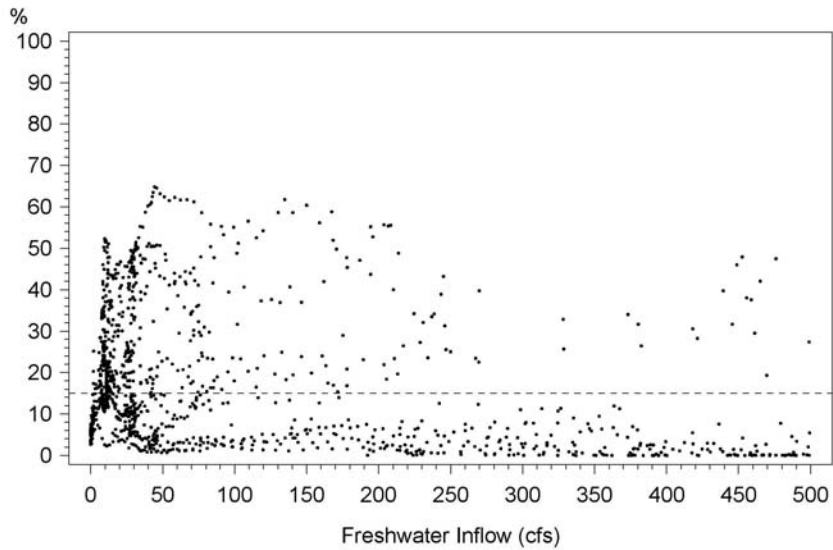

Reduction in Water Volume 3 to 14 PSU vs. 5_day flow
Flow Reduction Scenario = Total Excess Flow - North Port - 10%

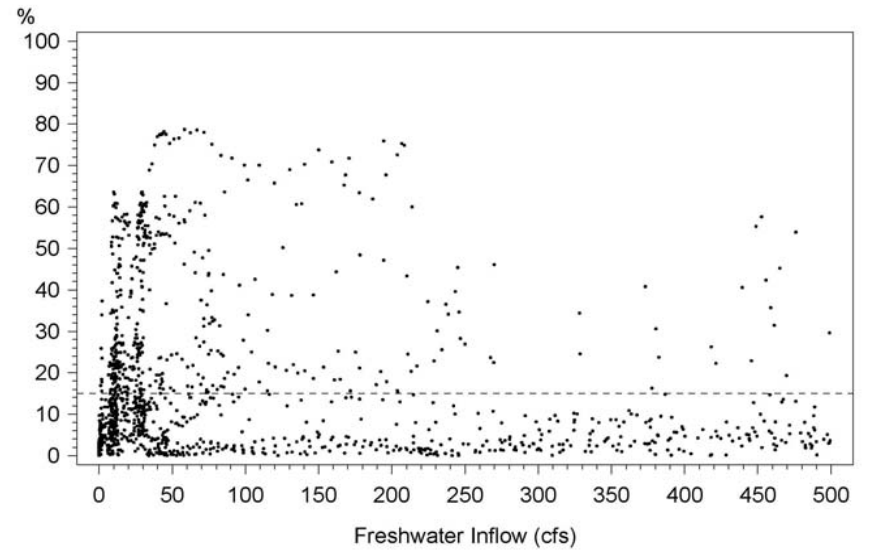

Reduction in Water Volume < 2 PSU vs. 5_day flow
Flow Reduction Scenario = Total Excess Flow - North Port - 30%

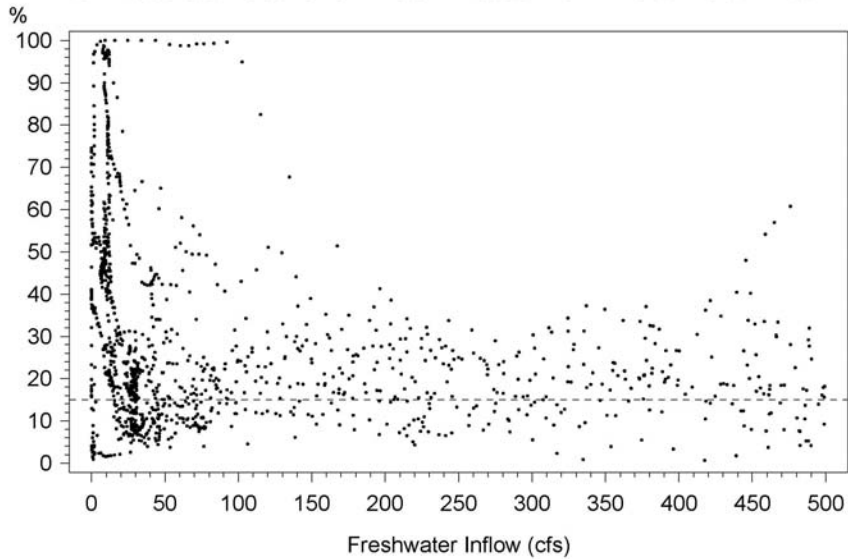

Reduction in Water Volume < 5 PSU vs. 5_day flow
Flow Reduction Scenario = Total Excess Flow - North Port - 30%

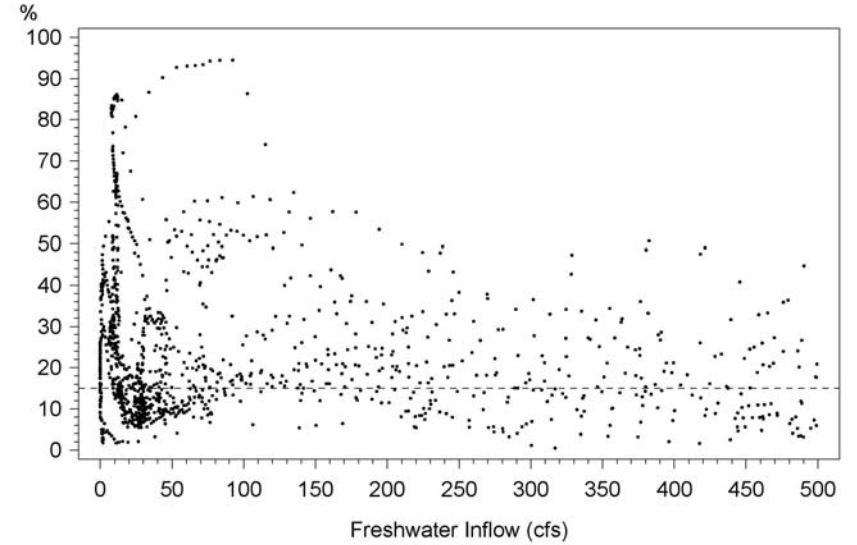

Reduction in Water Volume < 14 PSU vs. 5_day flow
Flow Reduction Scenario = Total Excess Flow - North Port - 30%

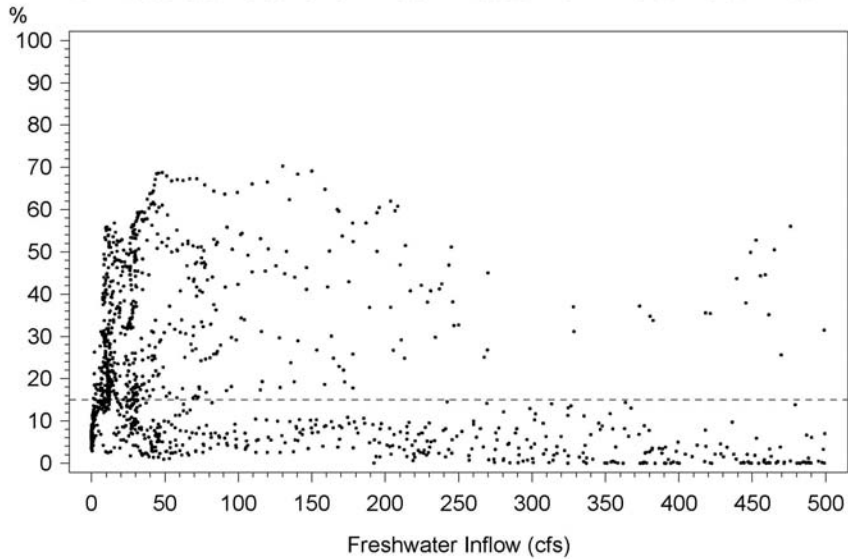

Reduction in Water Volume 3 to 14 PSU vs. 5_day flow
Flow Reduction Scenario = Total Excess Flow - North Port - 30%

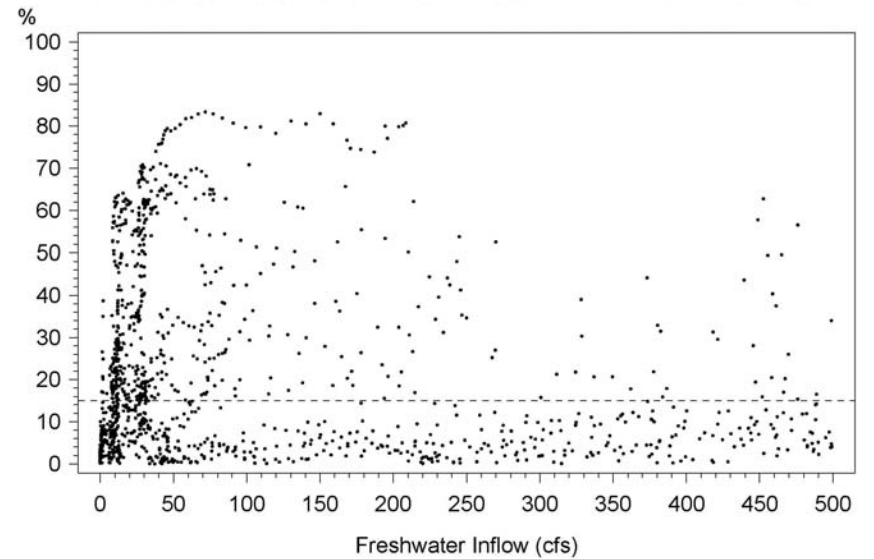

Appendix 8R

Time series plots of percent reductions in daily values of bottom areas with salinity <2, <5, 17, and 2 to 12 psu for four flow reduction scenarios.

Percent Reduction in Bottom Area < 2 PSU
Flow Reduction = North Port Permitted

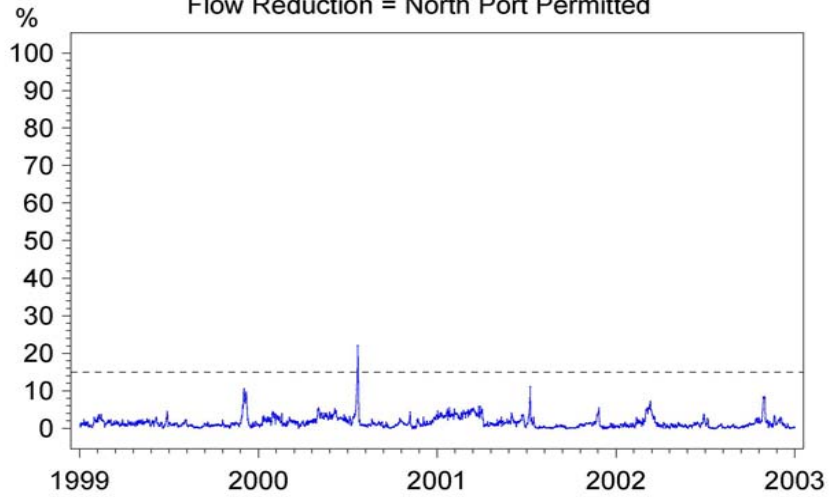

Percent Reduction in Bottom Area < 5 PSU
Flow Reduction = North Port Permitted

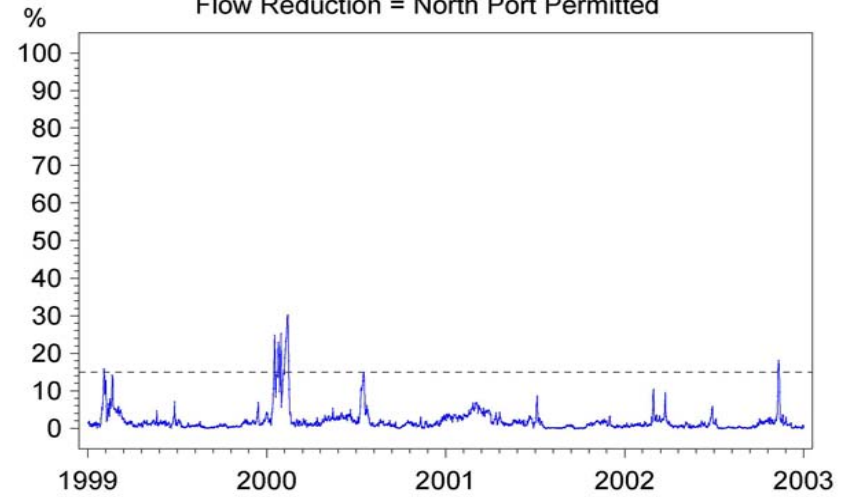

Percent Reduction in Bottom Area < 17 PSU
Flow Reduction = North Port Permitted

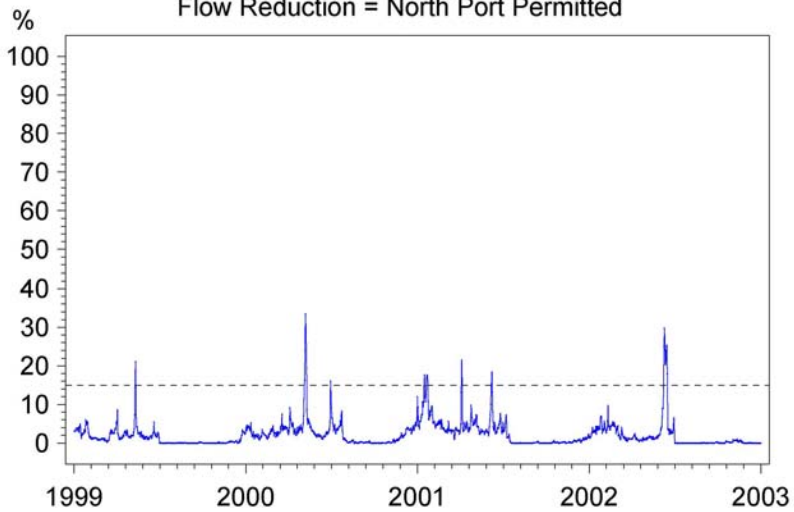

Percent Reduction in Bottom Area - 2 to 12 PSU
Flow Reduction = North Port Permitted

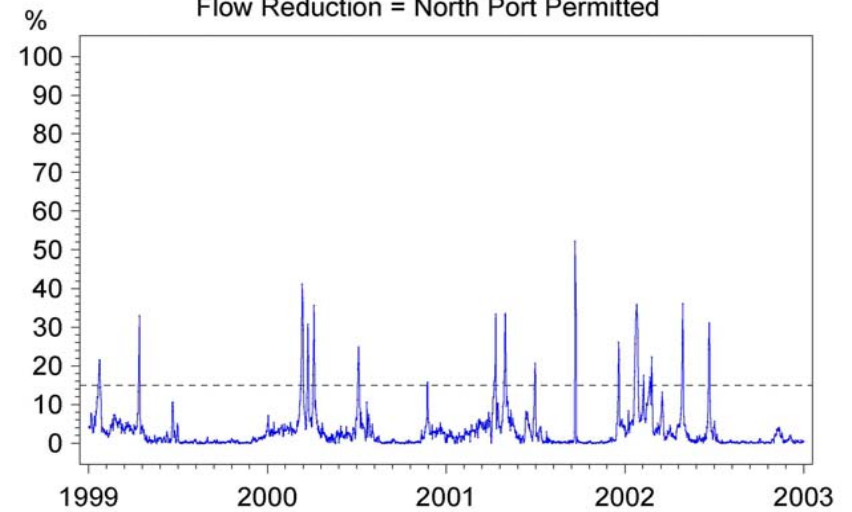

Percent Reduction in Bottom Area < 2 PSU
Flow Reduction = Total Excess Flow

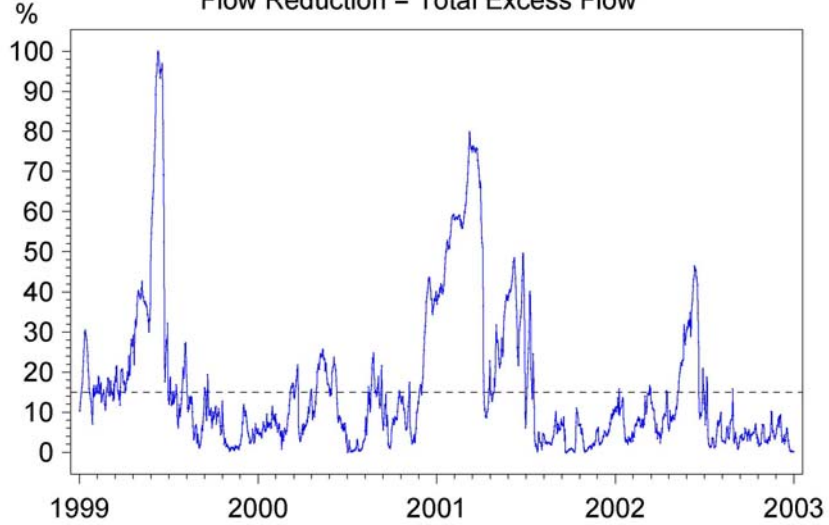

Percent Reduction in Bottom Area < 5 PSU
Flow Reduction = Total Excess Flow

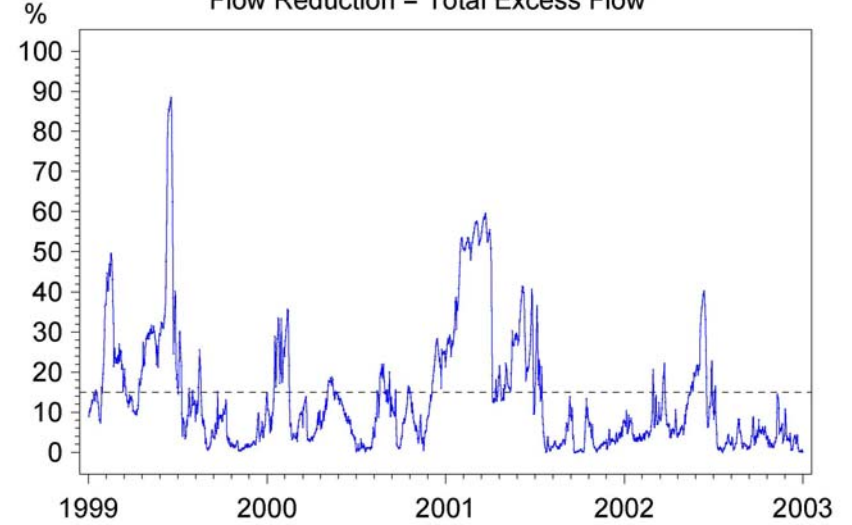

Percent Reduction in Bottom Area < 17 PSU
Flow Reduction = Total Excess Flow

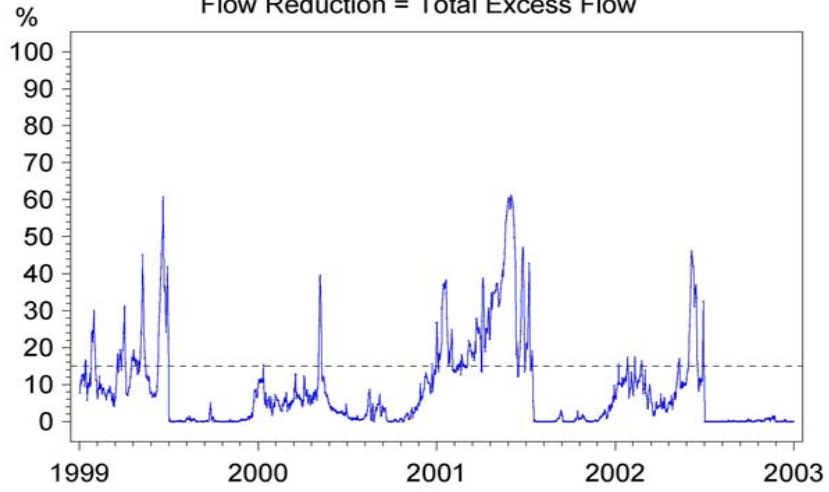

Percent Reduction in Bottom Area - 2 to 12 PSU
Flow Reduction = Total Excess Flow

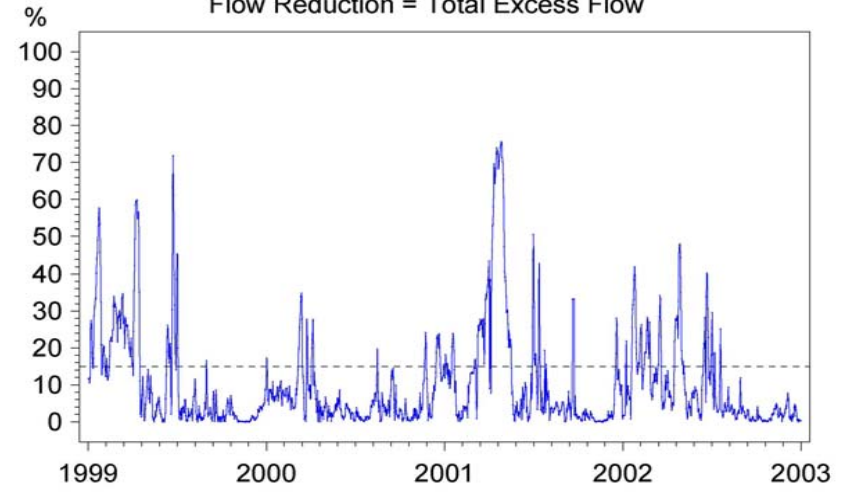

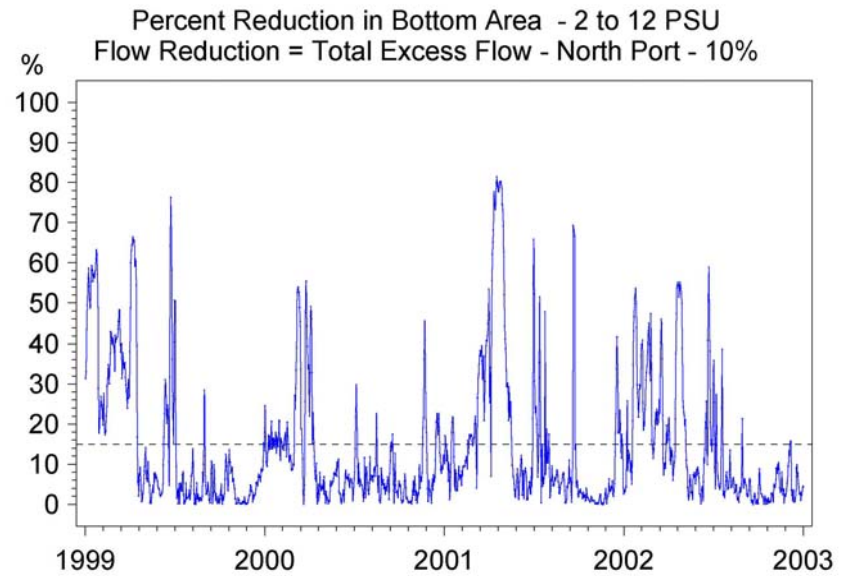
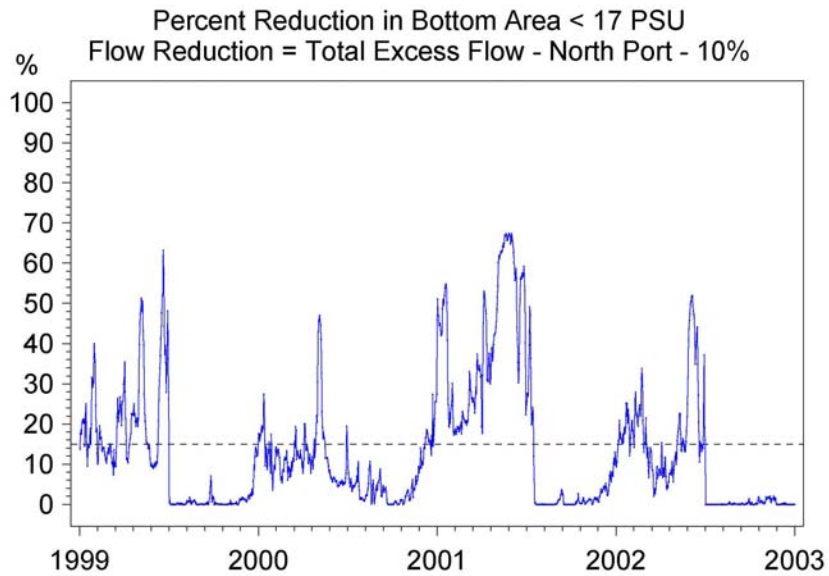
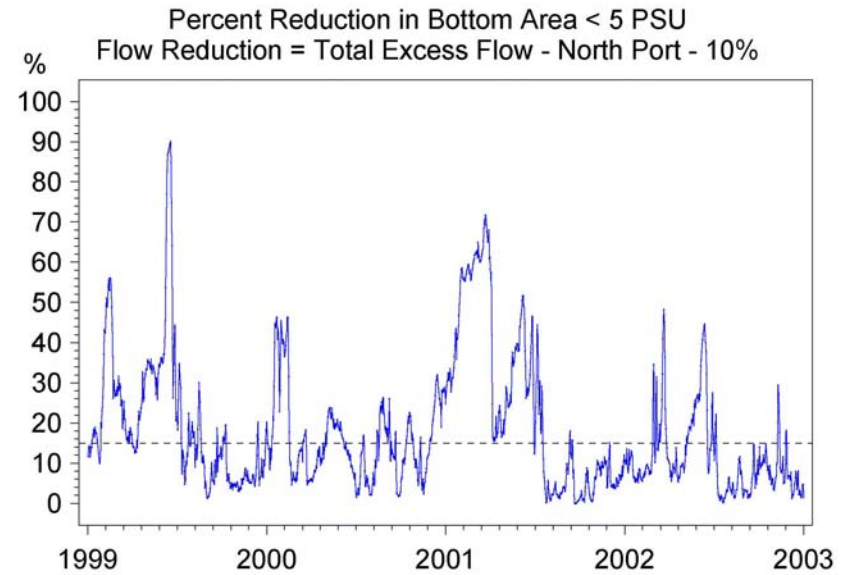
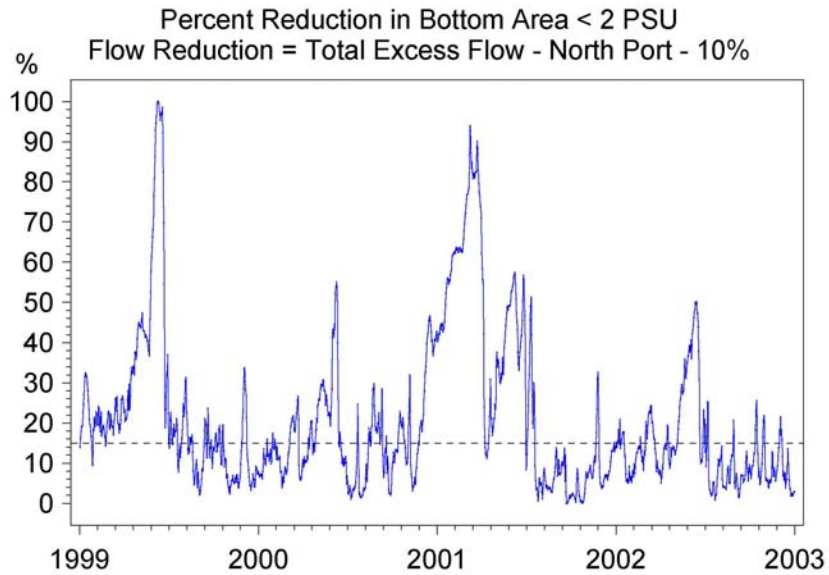

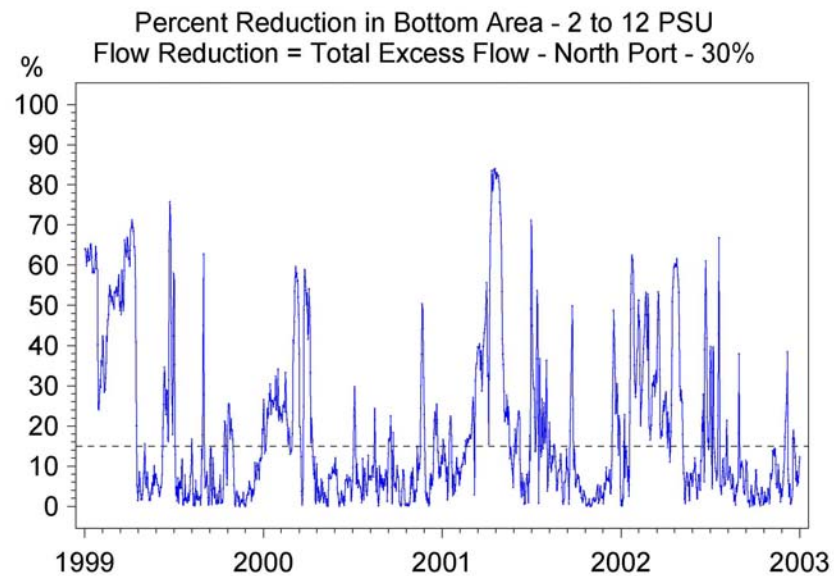
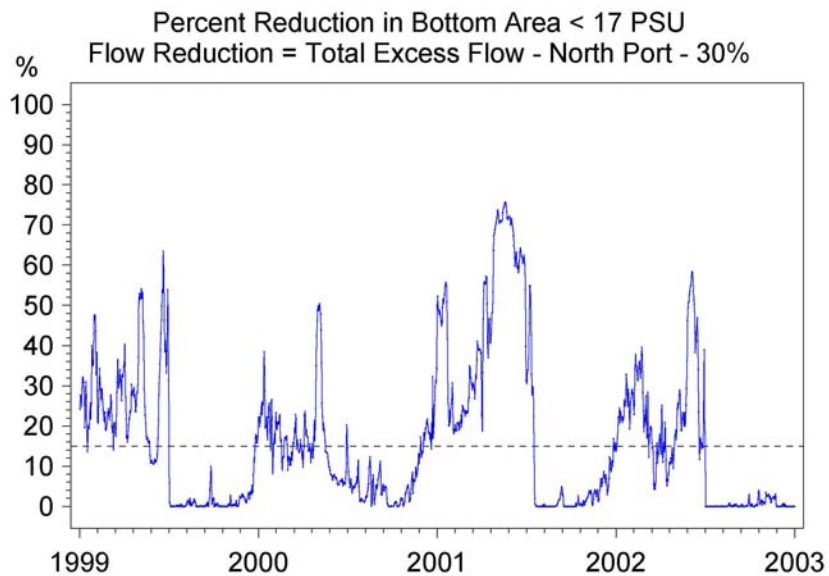
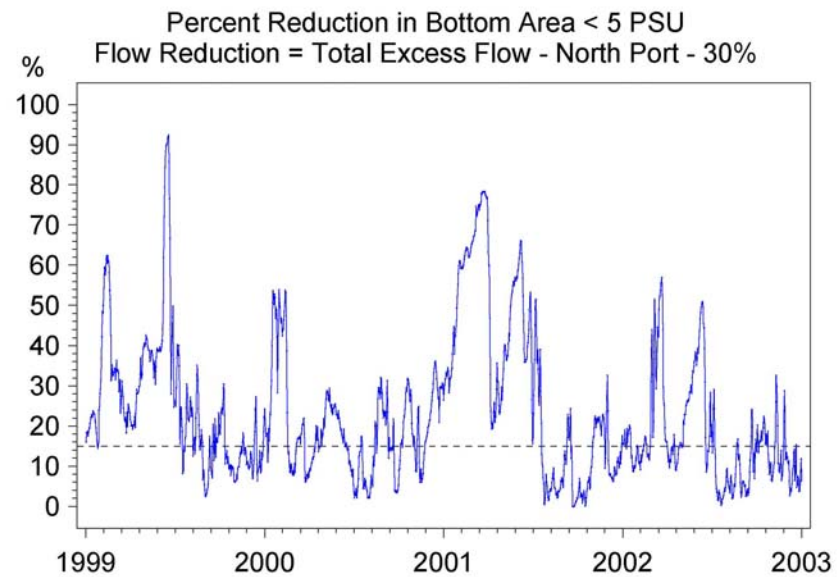
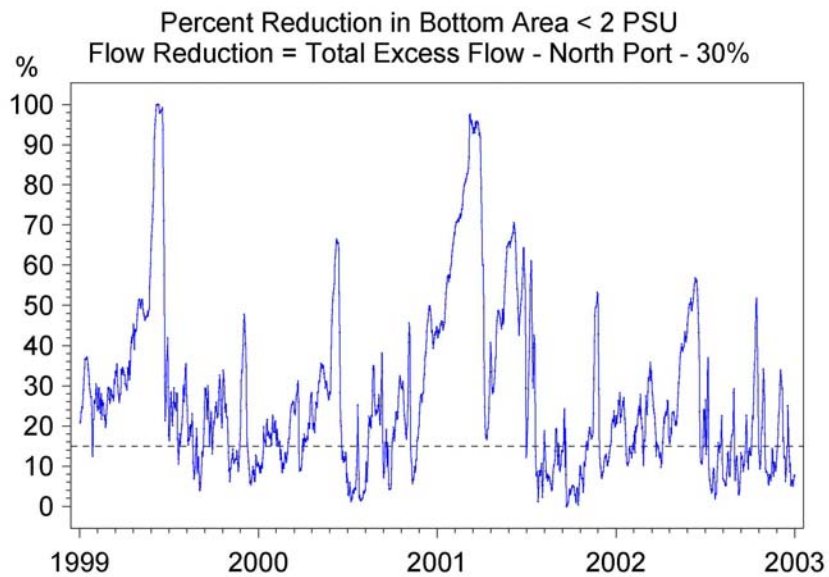

Appendix 8S

Time series plots of percent reductions in daily values of water volumes with salinity <2, <5, <14, and 3 to 14 psu for four flow reduction scenarios.

Percent Reduction in Water Volume < 2 PSU
Flow Reduction = North Port Permitted

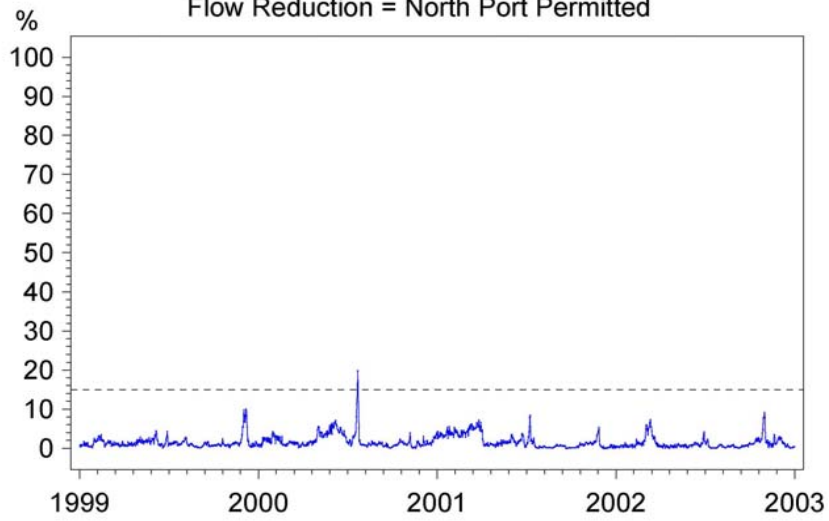

Percent Reduction in Water Volume < 5 PSU
Flow Reduction = North Port Permitted

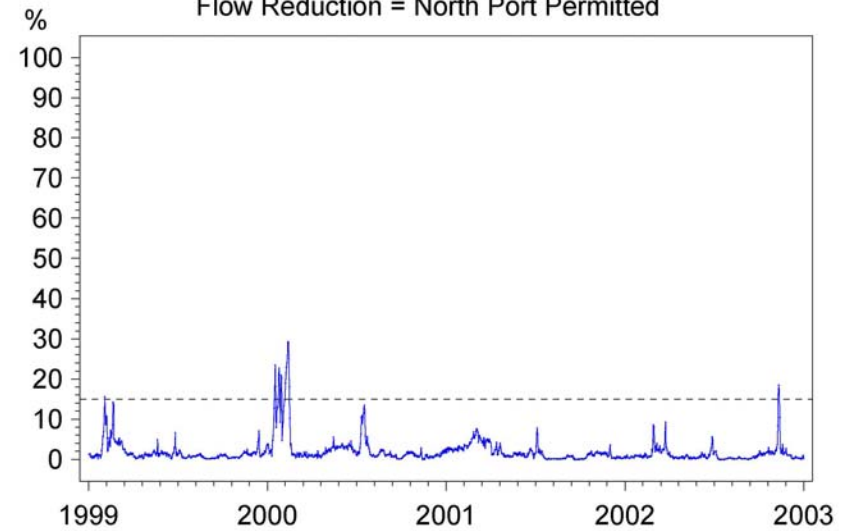

Percent Reduction in Water Volume < 14 PSU
Flow Reduction = North Port Permitted

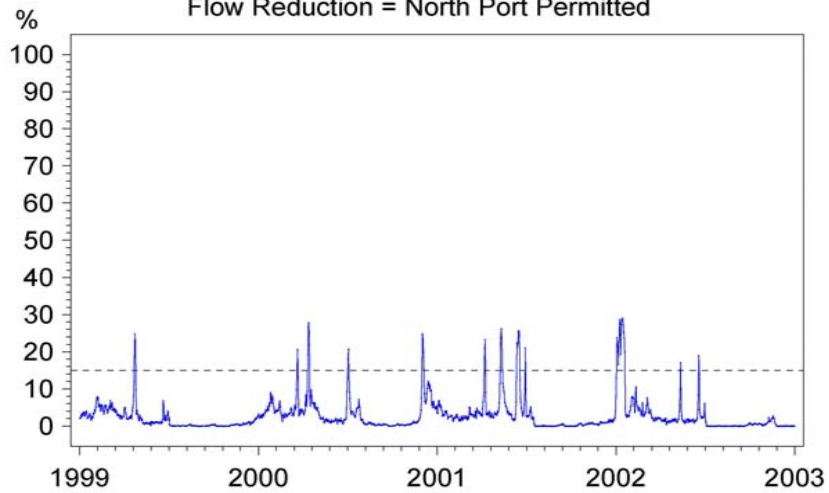

Percent Reduction in Water Volume 3 to 14 PSU
Flow Reduction = North Port Permitted

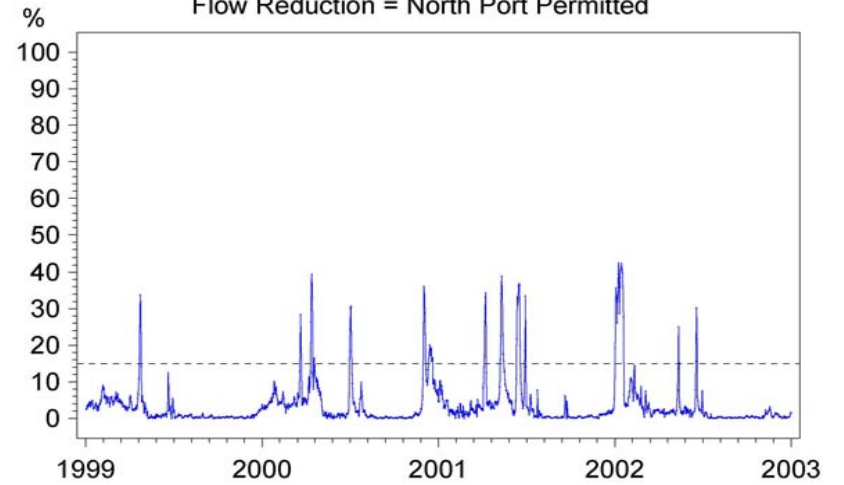

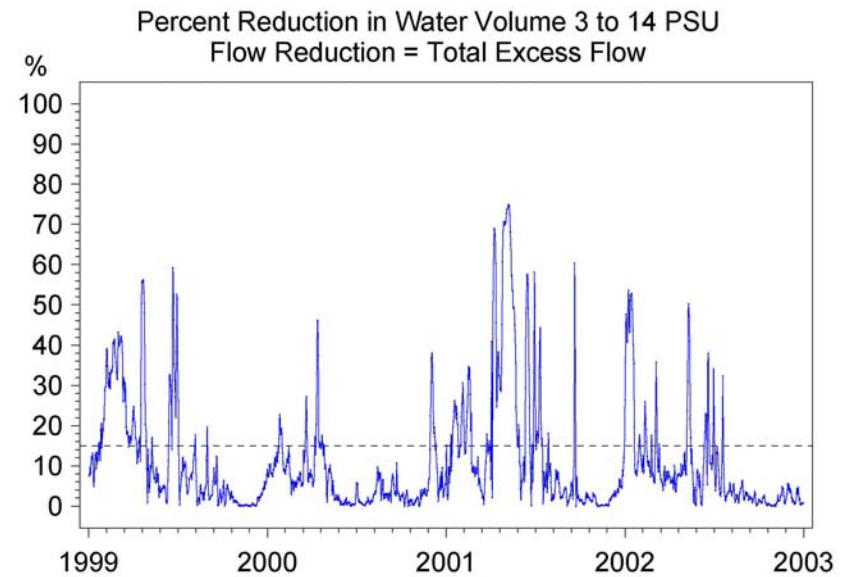
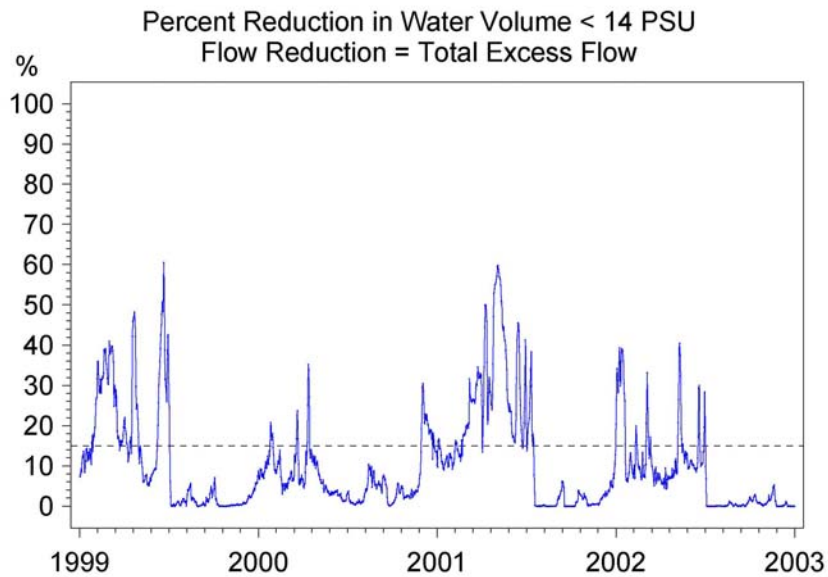
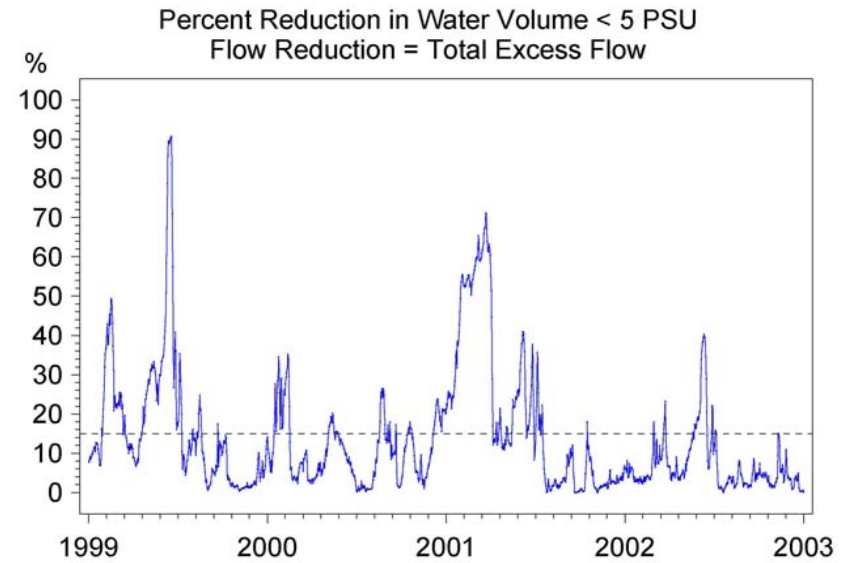
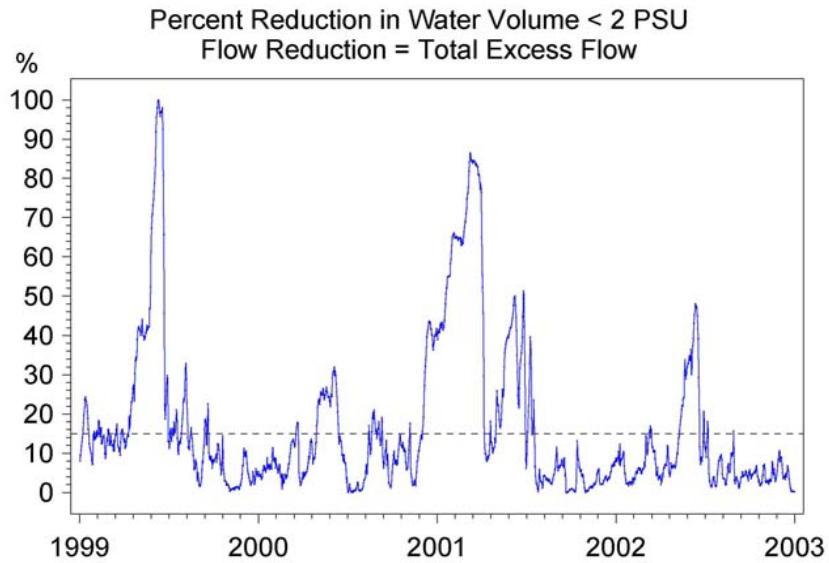

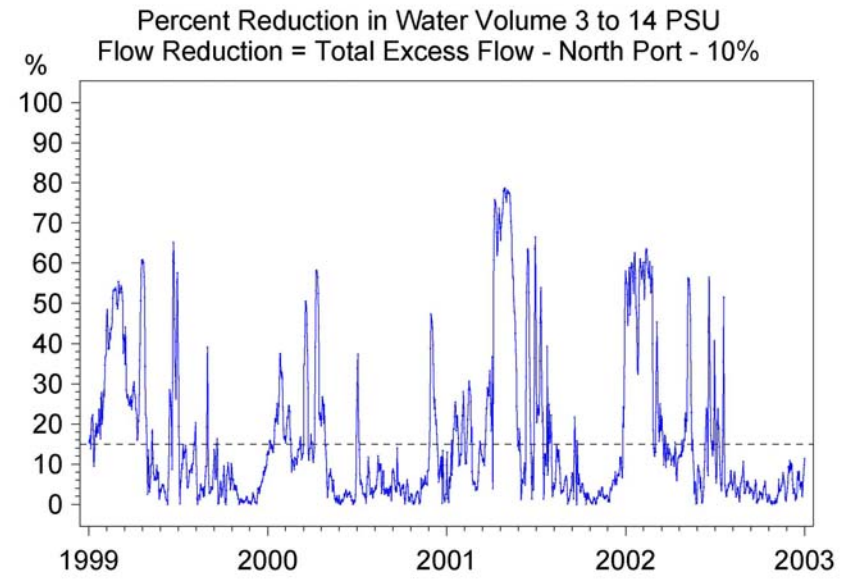
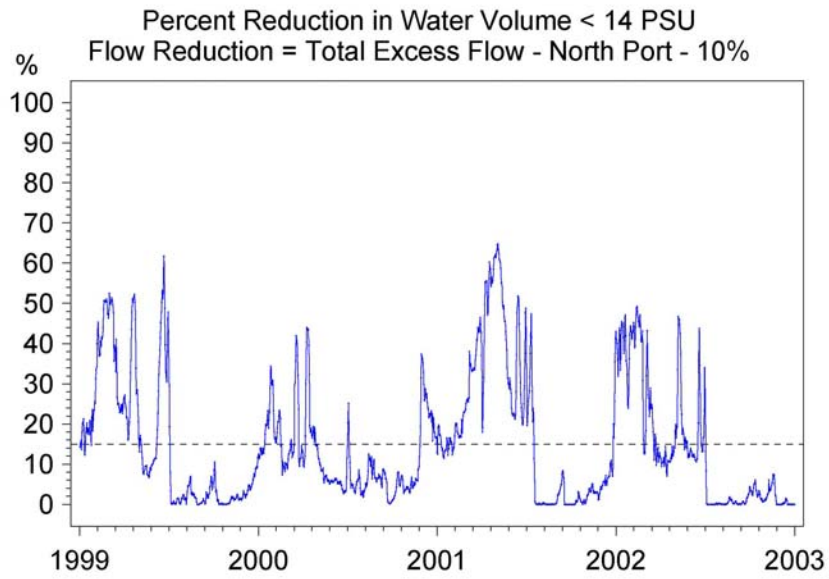
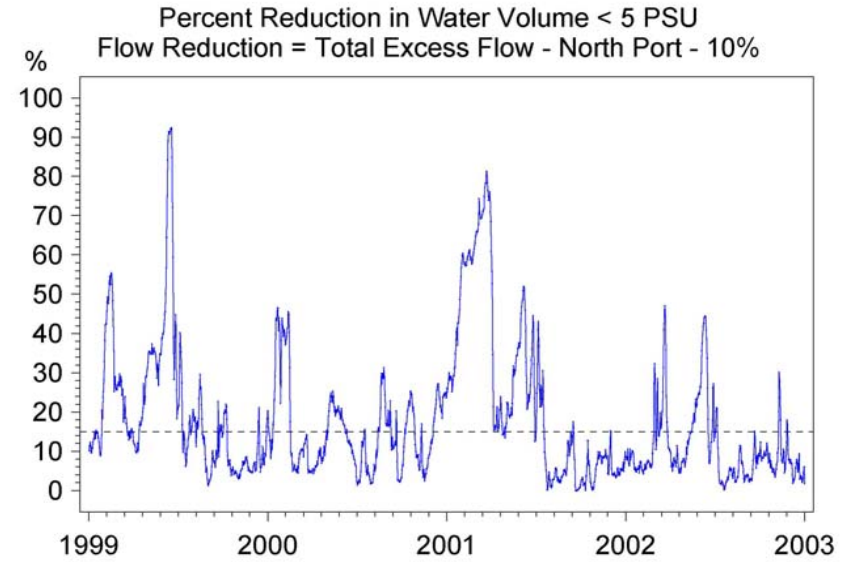
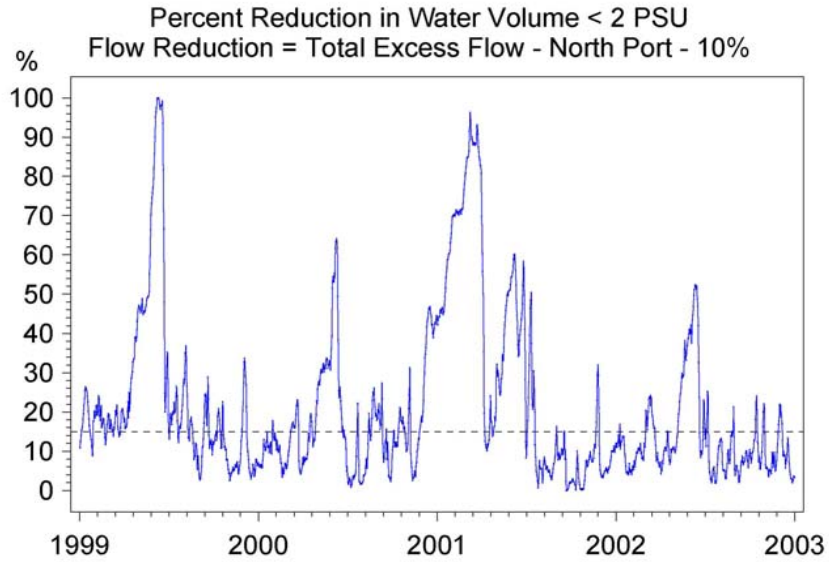

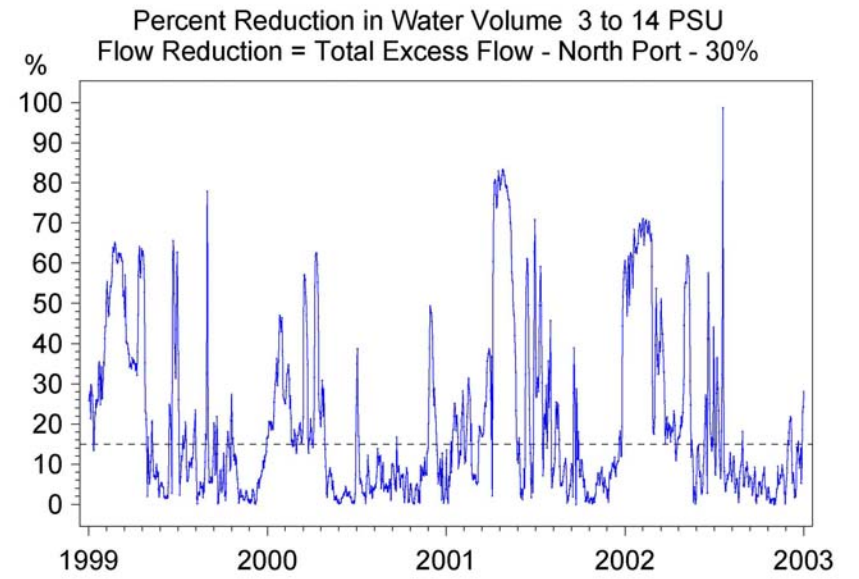
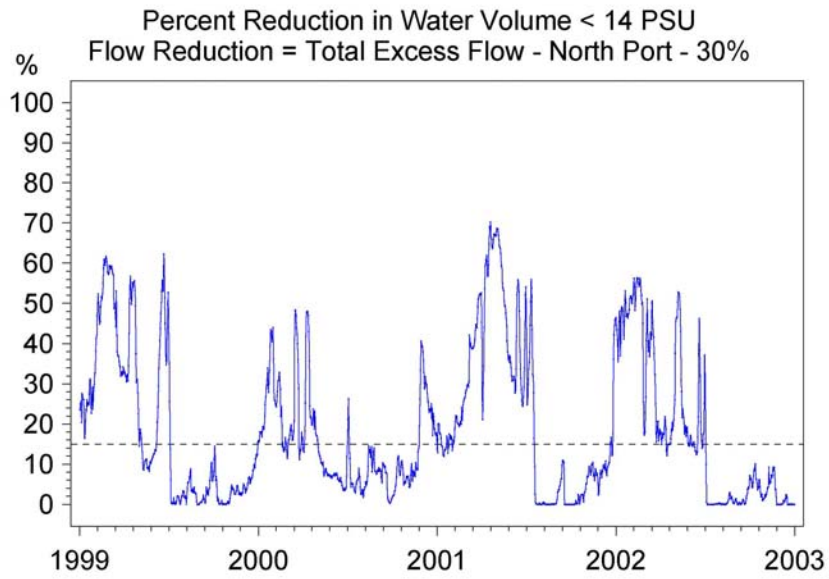
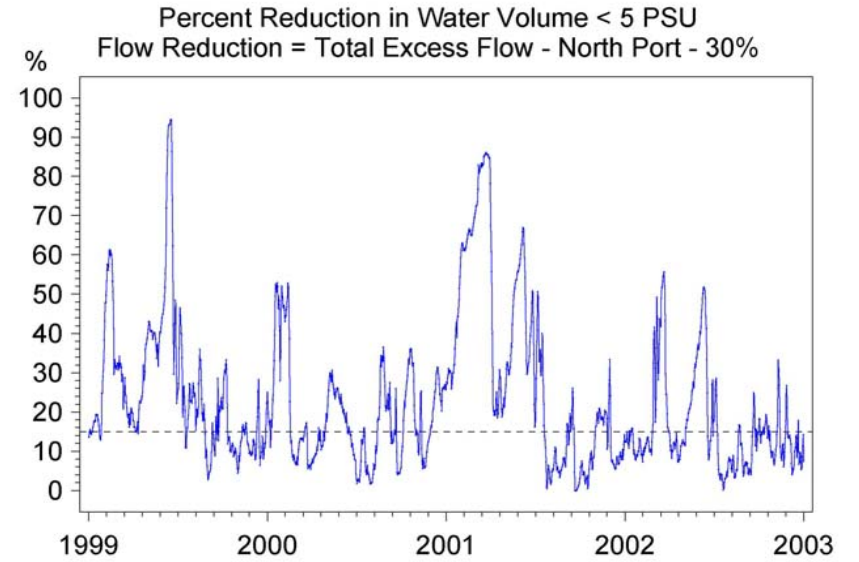
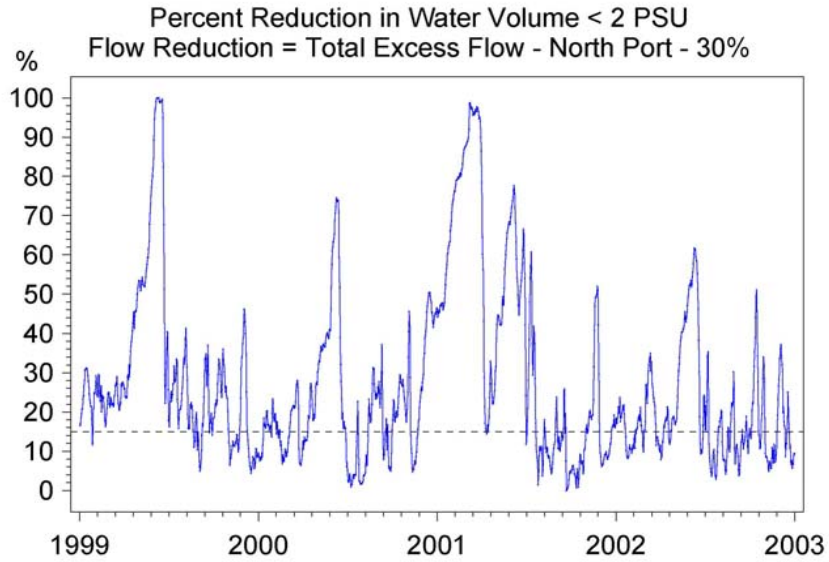

Appendix 8T

Box and whisker plots of percent reductions in daily abundance for selected indicator taxa for seven flow reduction scenarios for three seasonal blocks. Values for plankton taxa are percent change in total abundance in the river, while values for seine and trawl taxa are for percent change in catch-per-unit-effort.

Period of Record: 1995-2004
Distribution of % Change in Abundance by Block
Species=*Americamysis almyra* Scenario=Northport (NP)

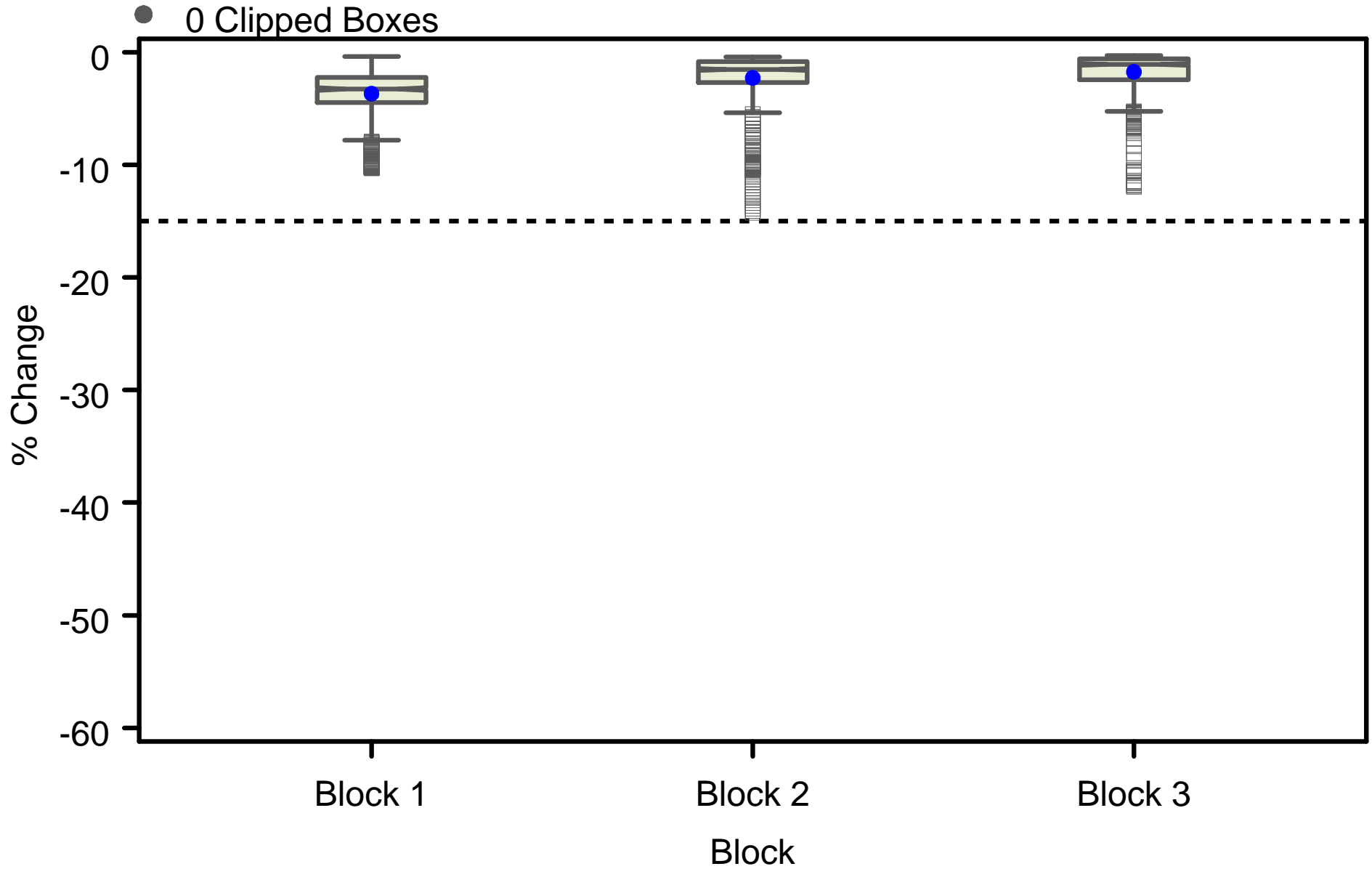

Period of Record: 1995-2004
Distribution of % Change in Abundance by Block
Species=*Americamysis almyra* Scenario=Ag adjust

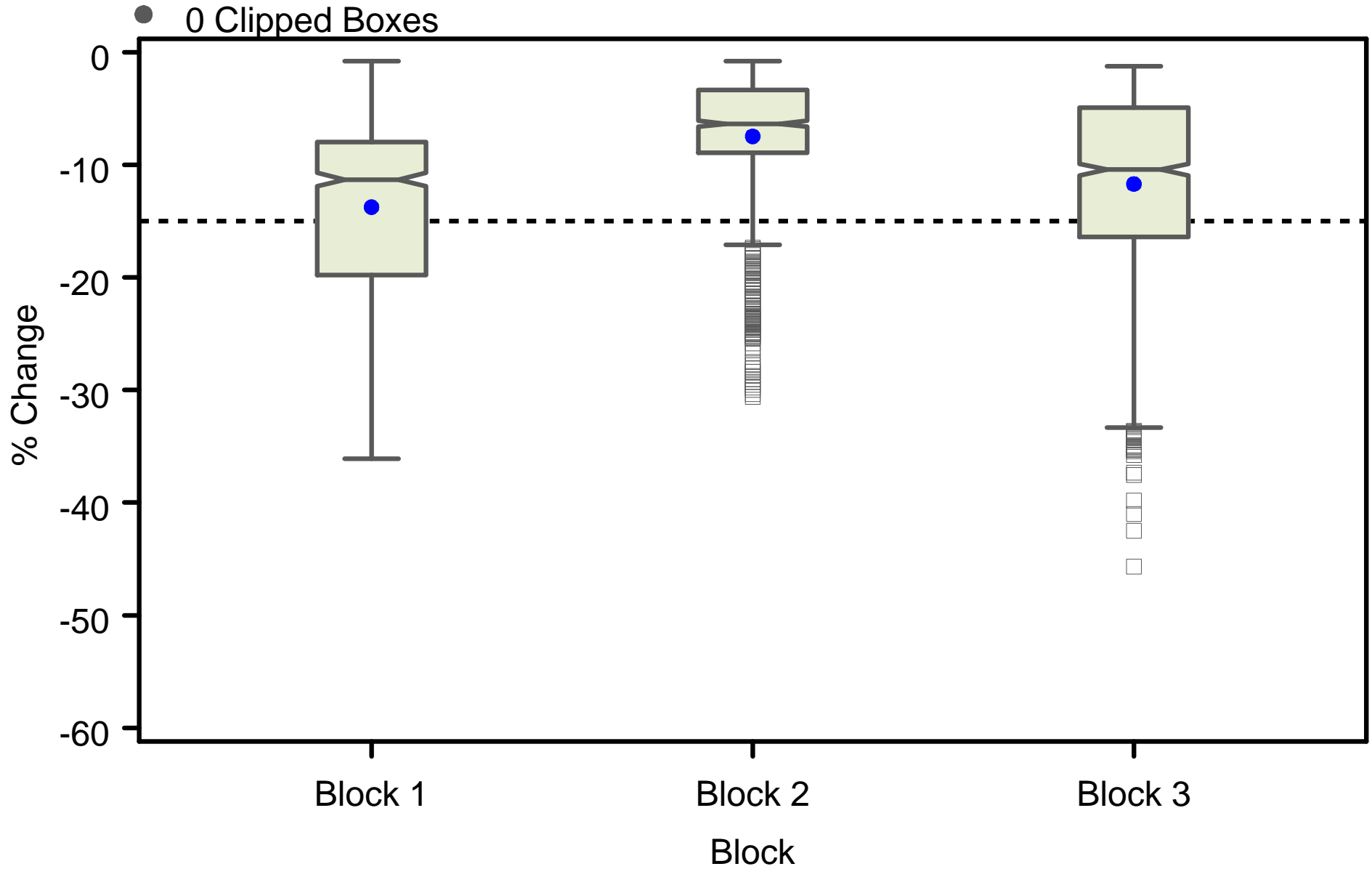

Period of Record: 1995-2004
Distribution of % Change in Abundance by Block
Species=*Americamysis almyra* Scenario=Total adjust

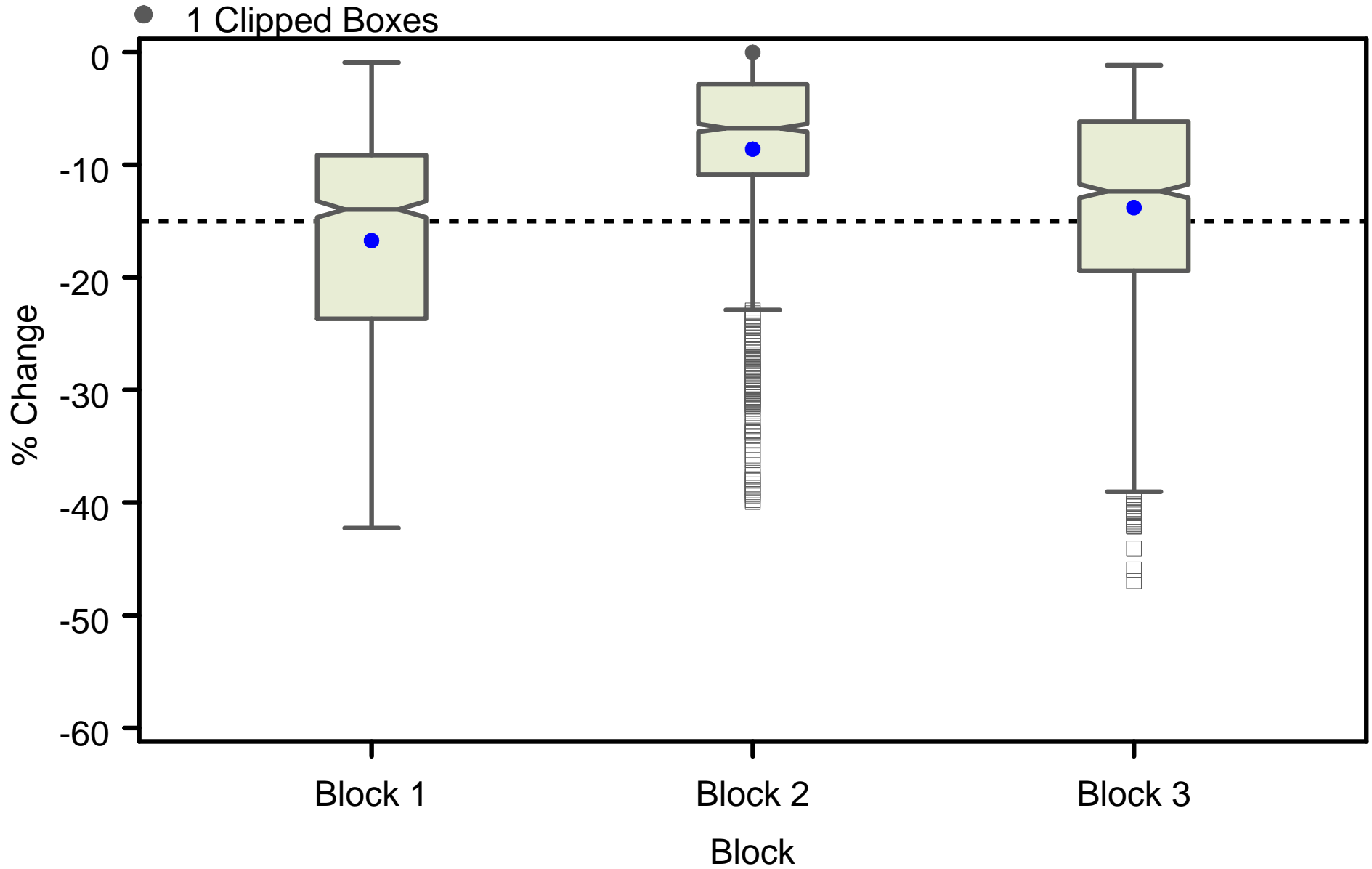

Period of Record: 1995-2004
Distribution of % Change in Abundance by Block
Species=*Americamysis almyra* Scenario=Total adjust - NP

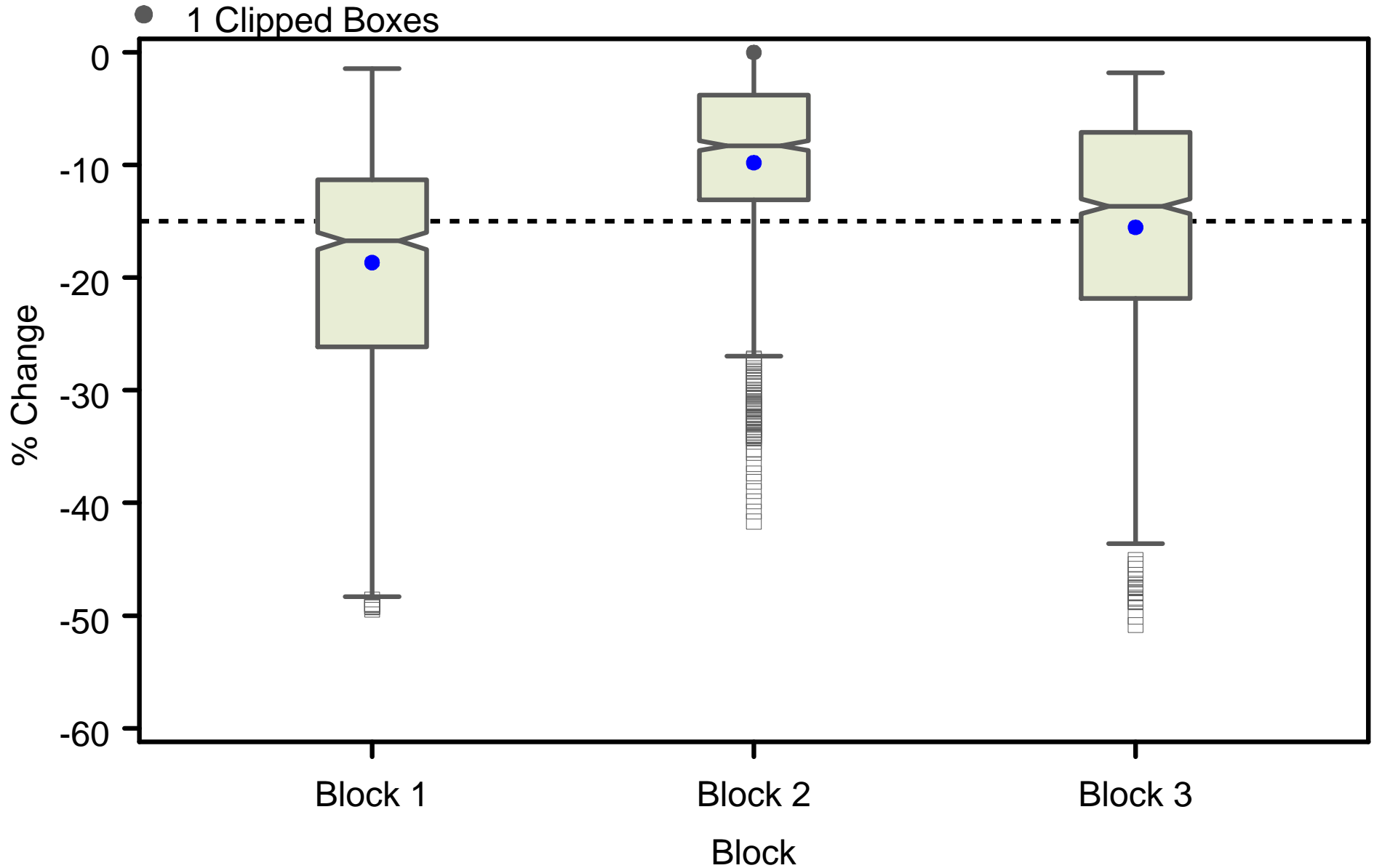

Period of Record: 1995-2004
Distribution of % Change in Abundance by Block
Species=*Americamysis almyra* Scenario=Total adjust - NP - 10%

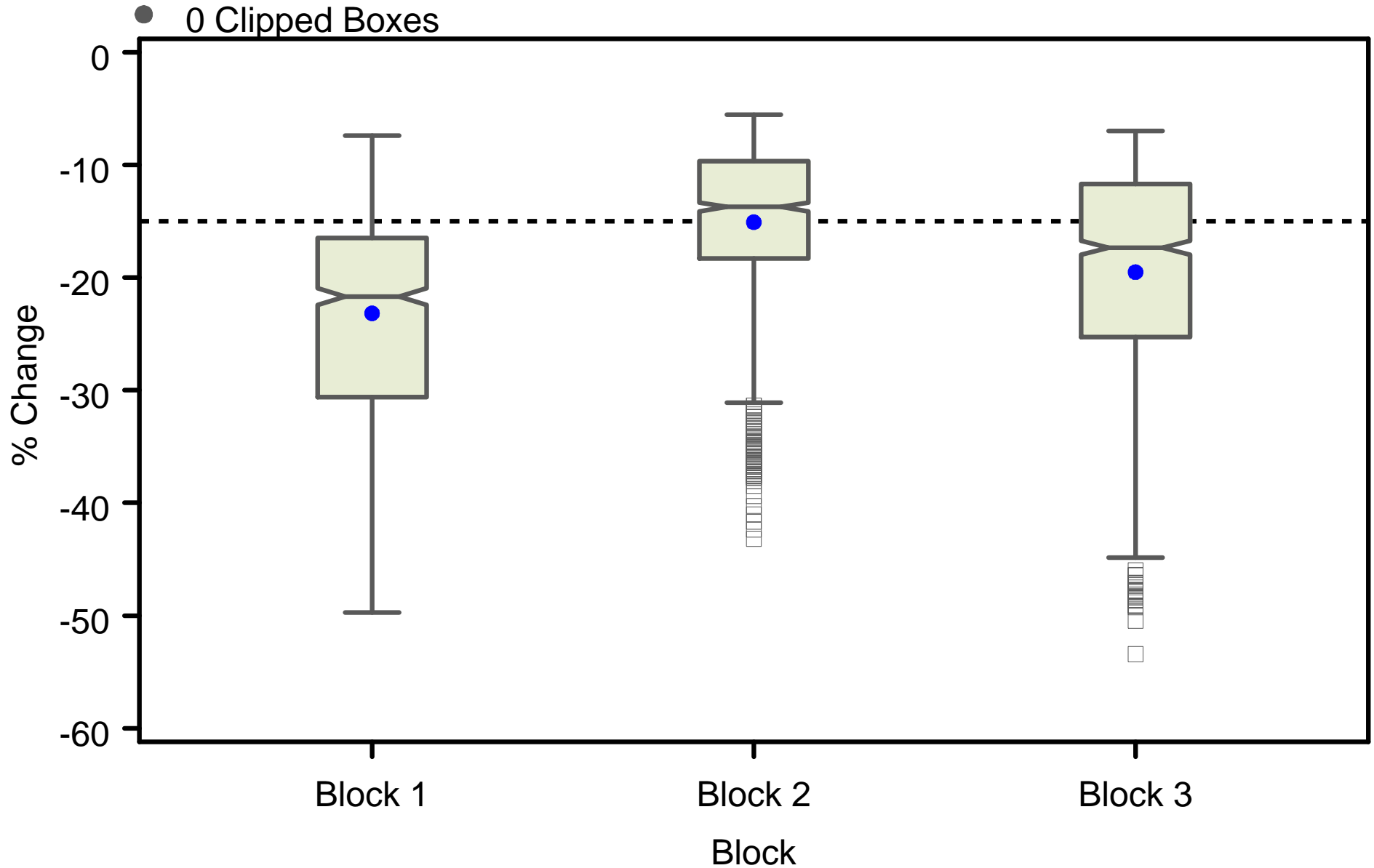

Period of Record: 1995-2004
Distribution of % Change in Abundance by Block
Species=*Americamysis almyra* Scenario=Total adjust - NP - 15%

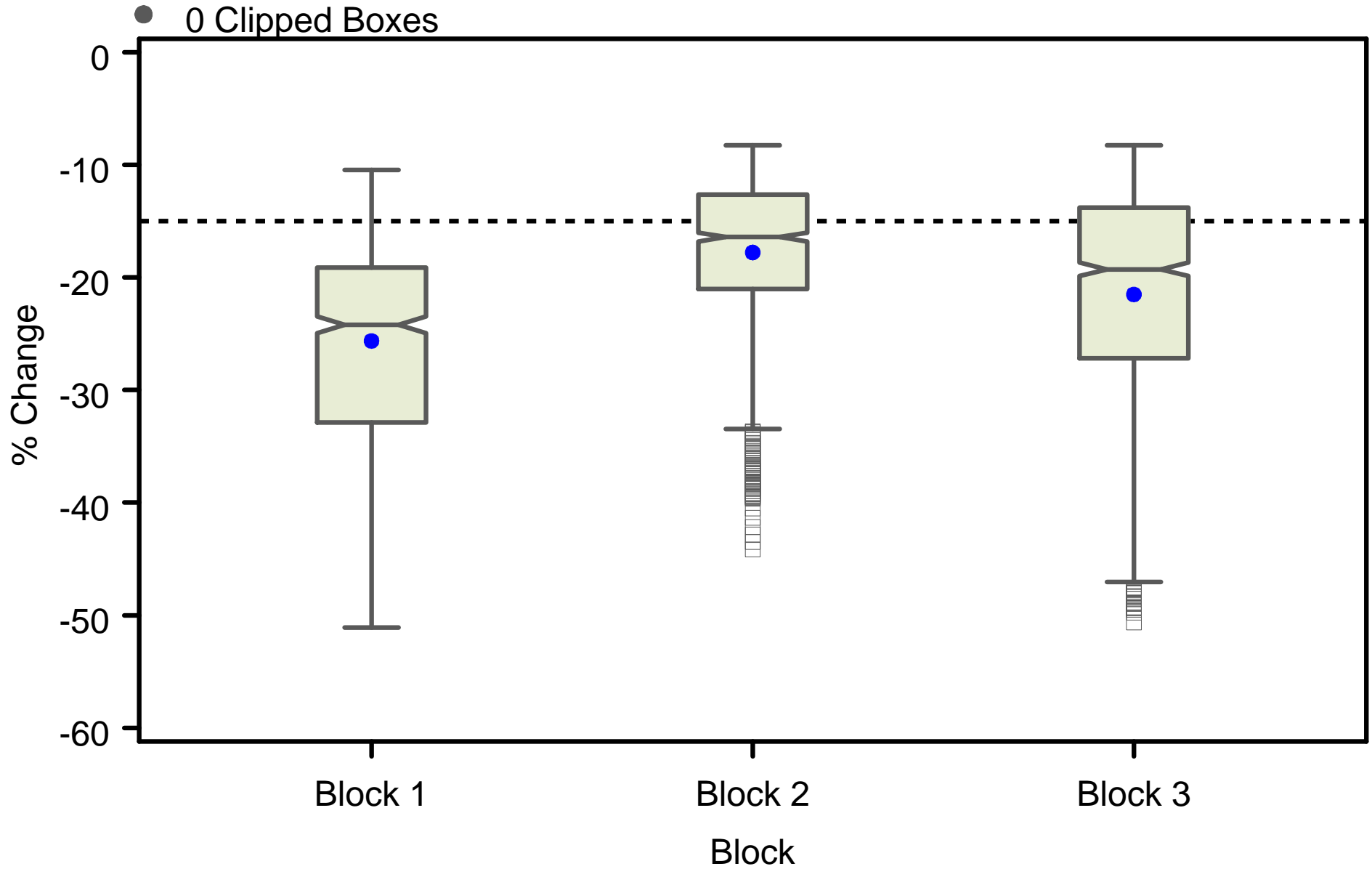

Period of Record: 1995-2004
Distribution of % Change in Abundance by Block
Species=*Americamysis almyra* Scenario=Total adjust - NP - 20%

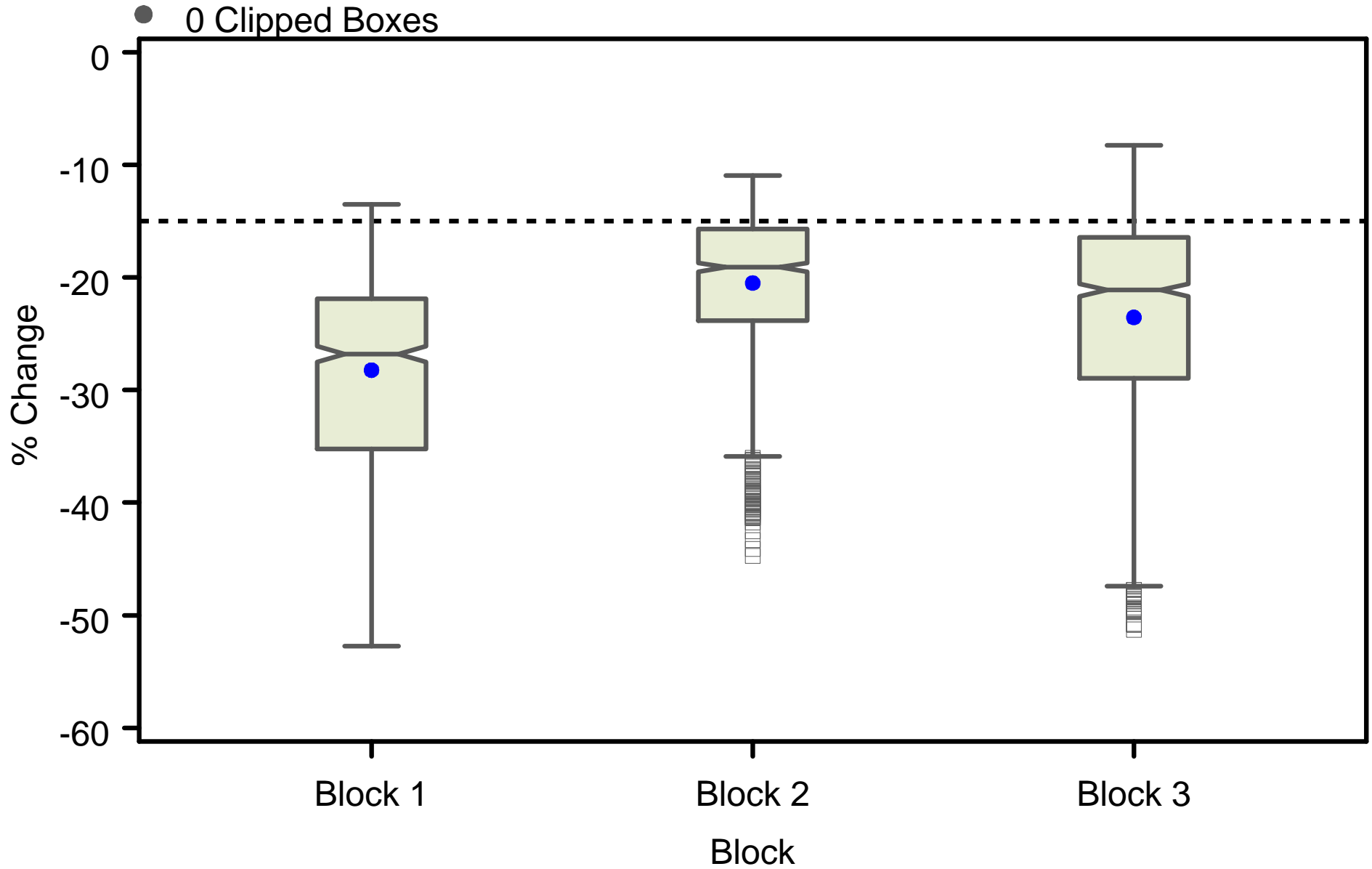

Period of Record: 1995-2004
Distribution of % Change in Abundance by Block
Species=*Americamysis almyra*2 Scenario=Northport (NP)

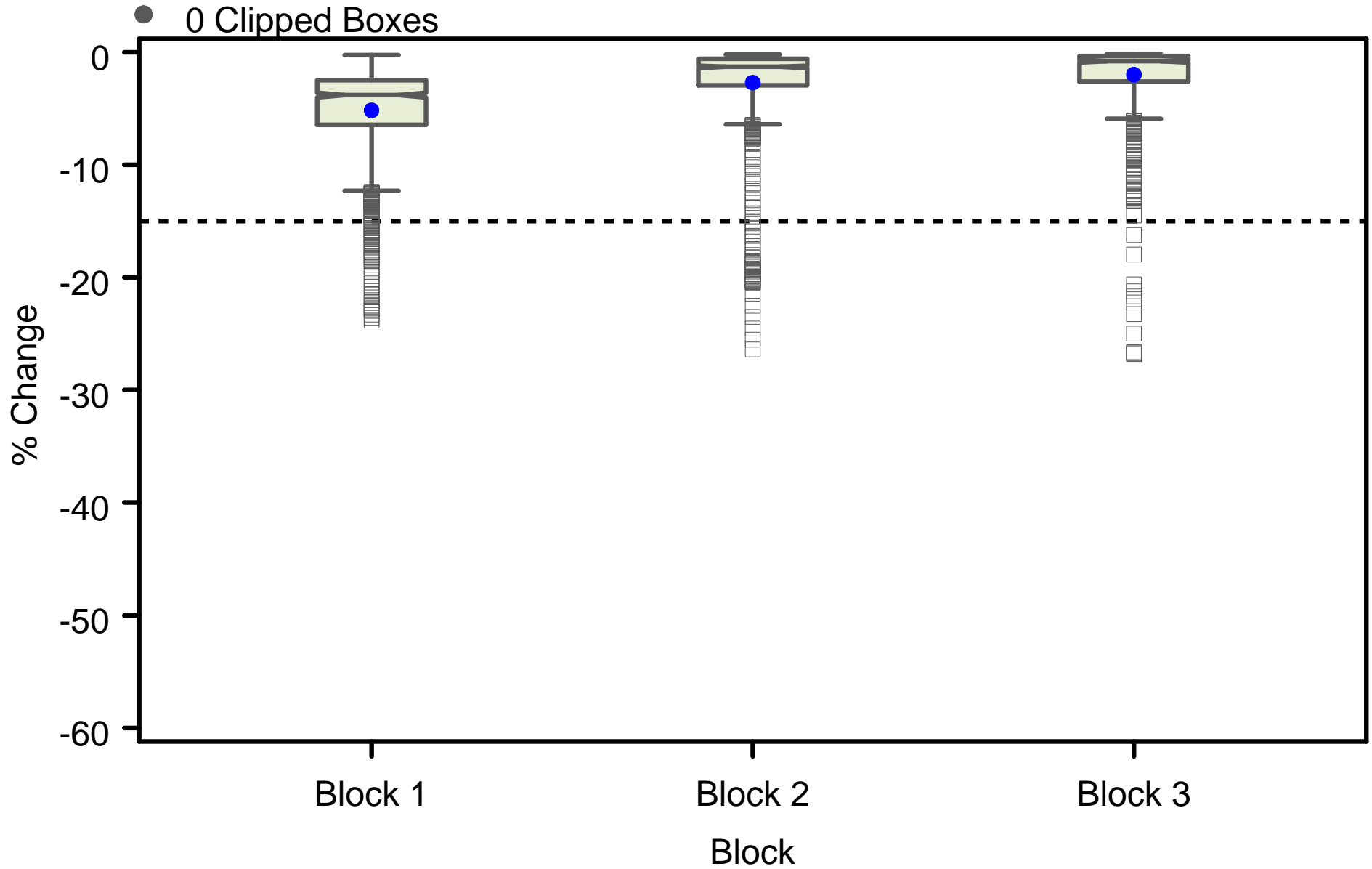

Period of Record: 1995-2004
Distribution of % Change in Abundance by Block
Species=*Americamysis almyra*2 Scenario=Ag adjust

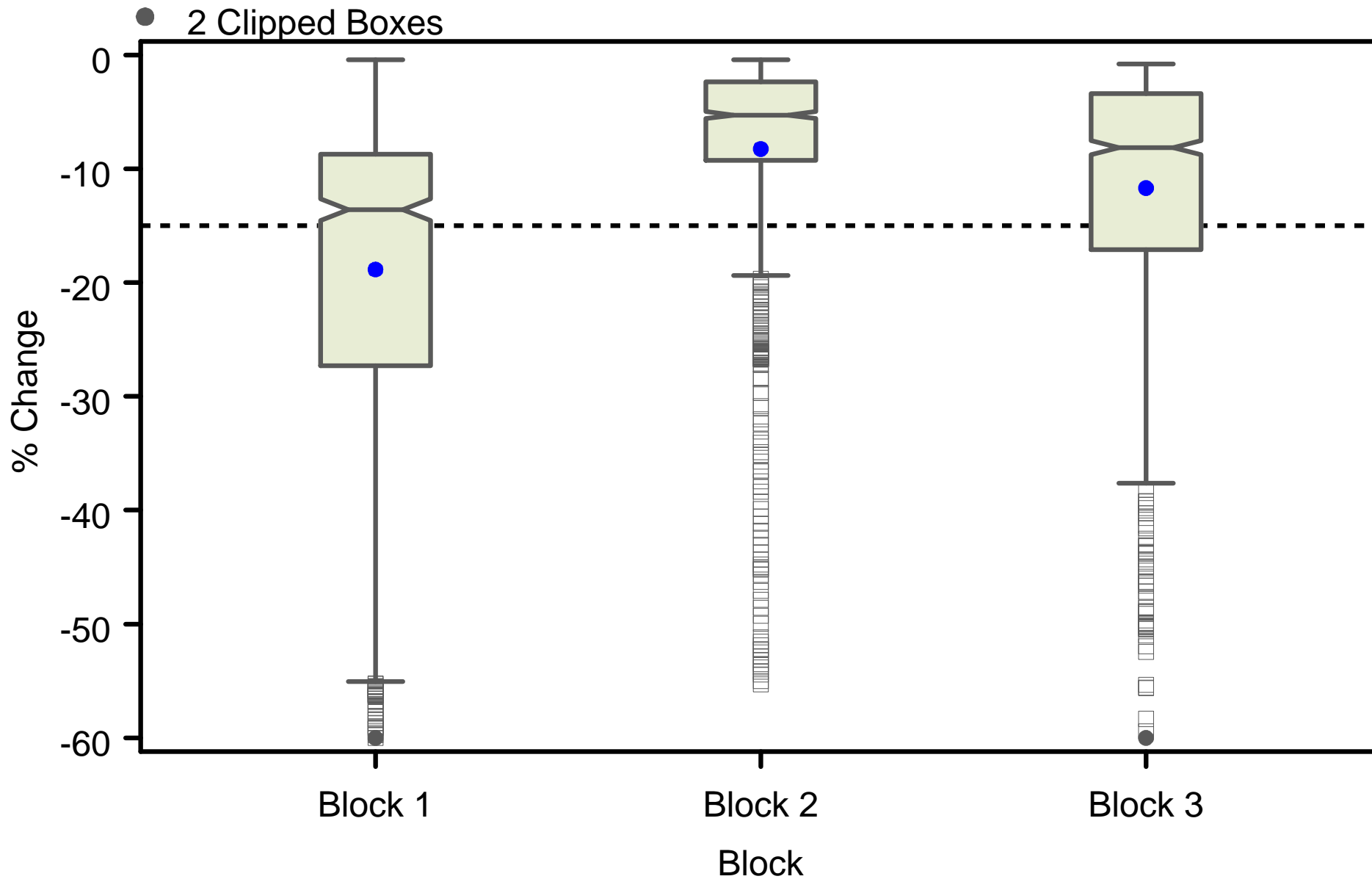

Period of Record: 1995-2004
Distribution of % Change in Abundance by Block
Species=*Americamysis almyra*2 Scenario=Total adjust

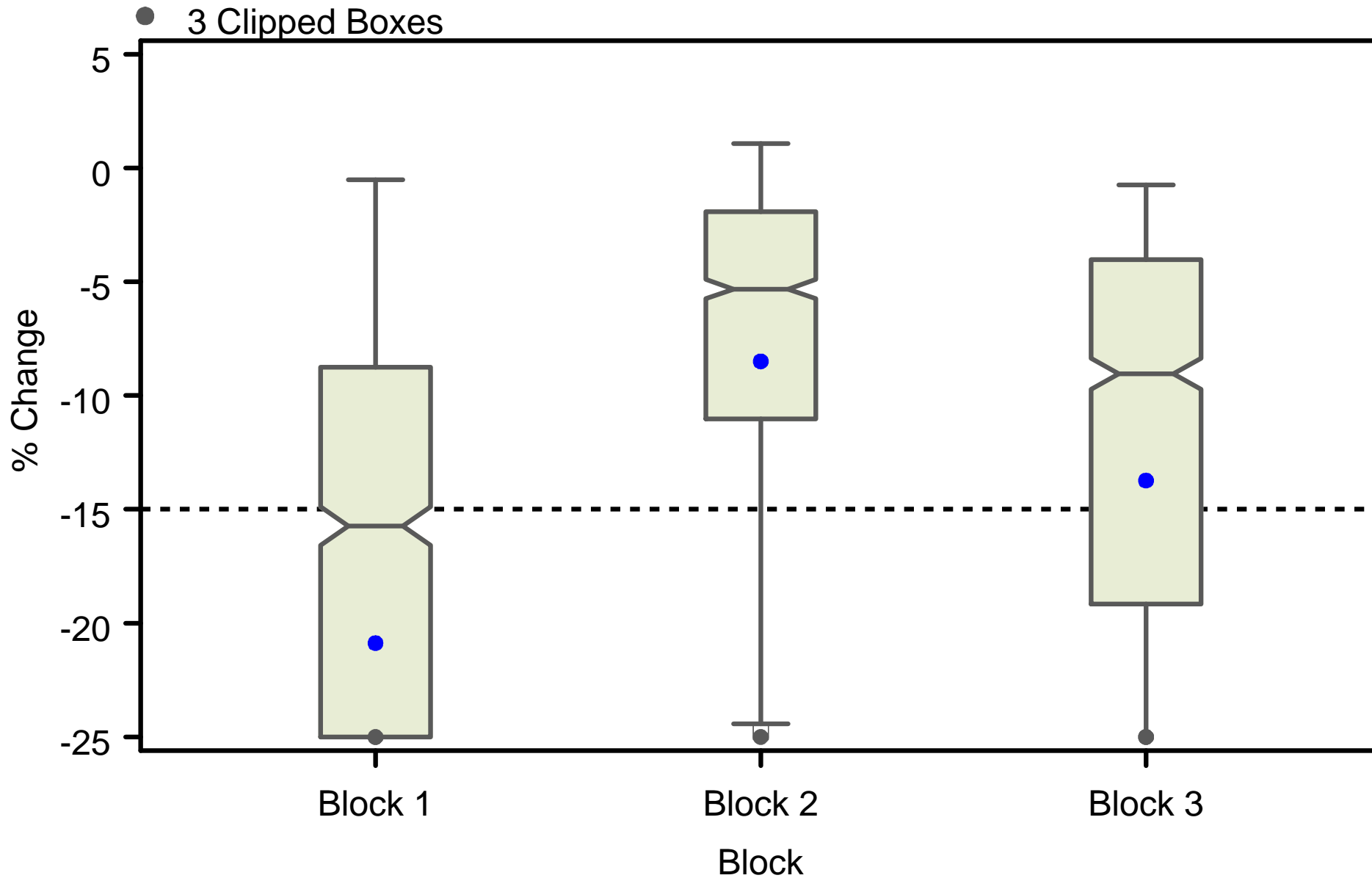

Period of Record: 1995-2004
Distribution of % Change in Abundance by Block
Species=*Americamysis almyra*2 Scenario=Total adjust - NP

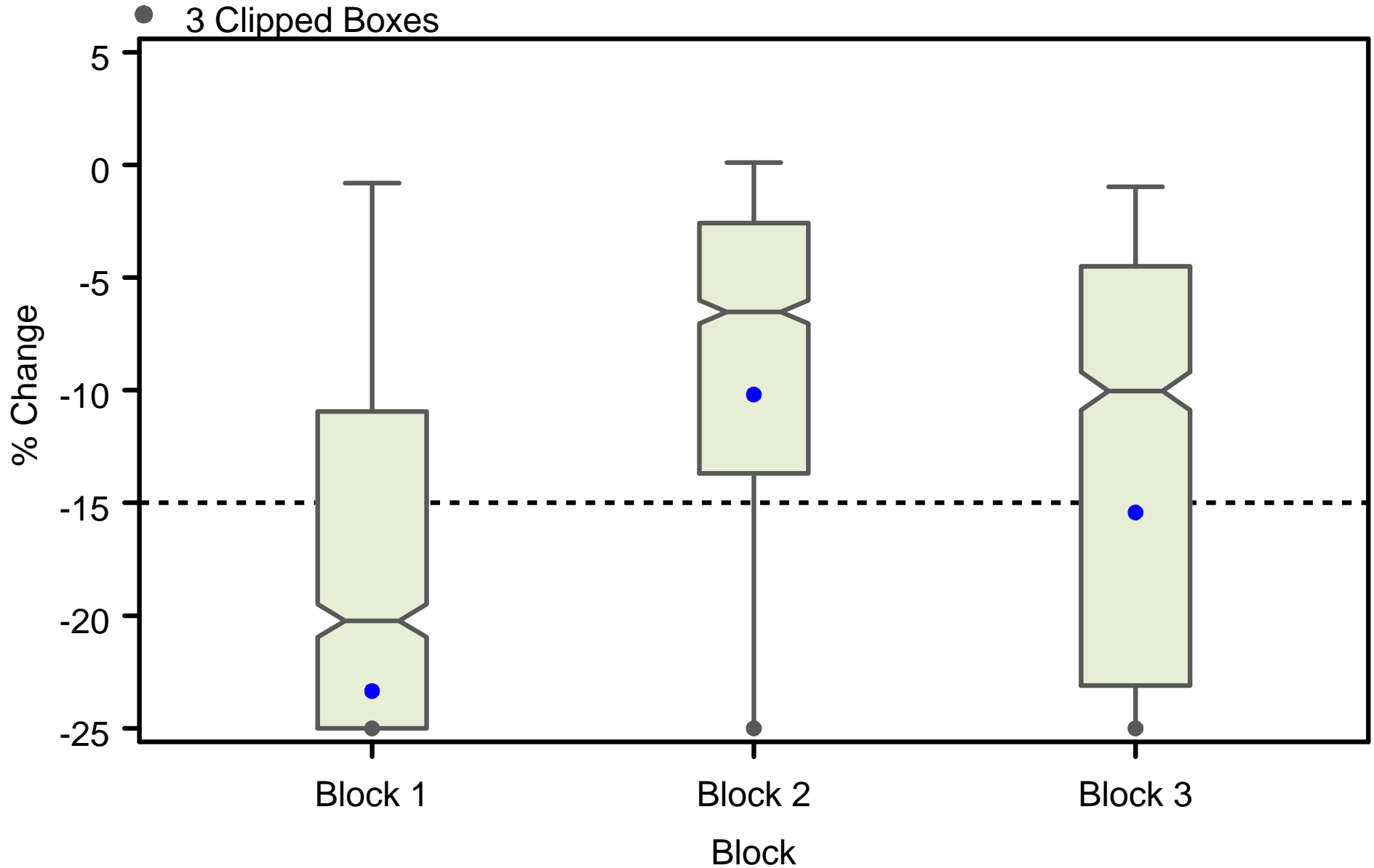

Period of Record: 1995-2004
Distribution of % Change in Abundance by Block
Species=*Americamysis almyra*2 Scenario=Total adjust - NP - 10%

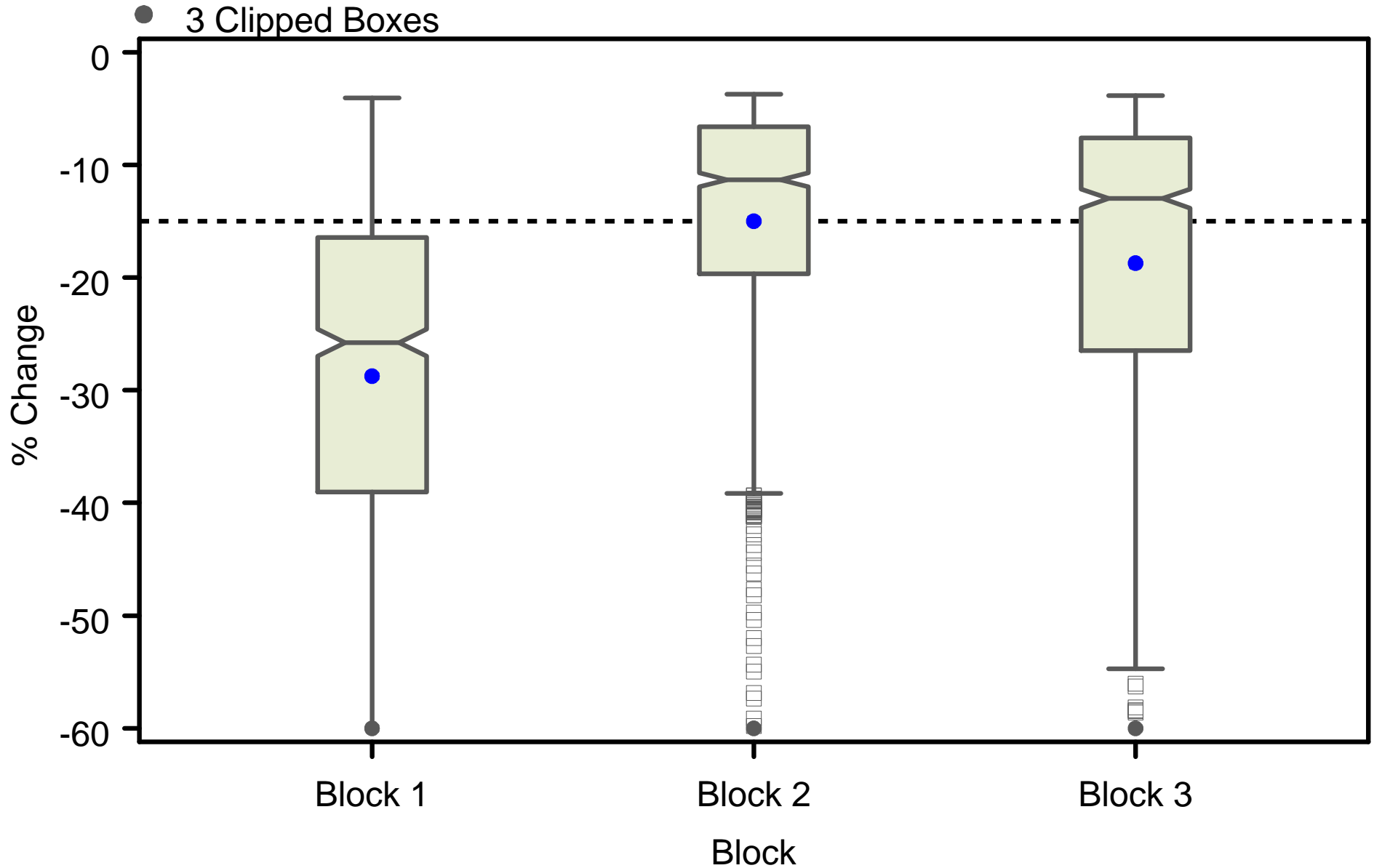

Period of Record: 1995-2004
Distribution of % Change in Abundance by Block
Species=*Americamysis almyra*2 Scenario=Total adjust - NP - 15%

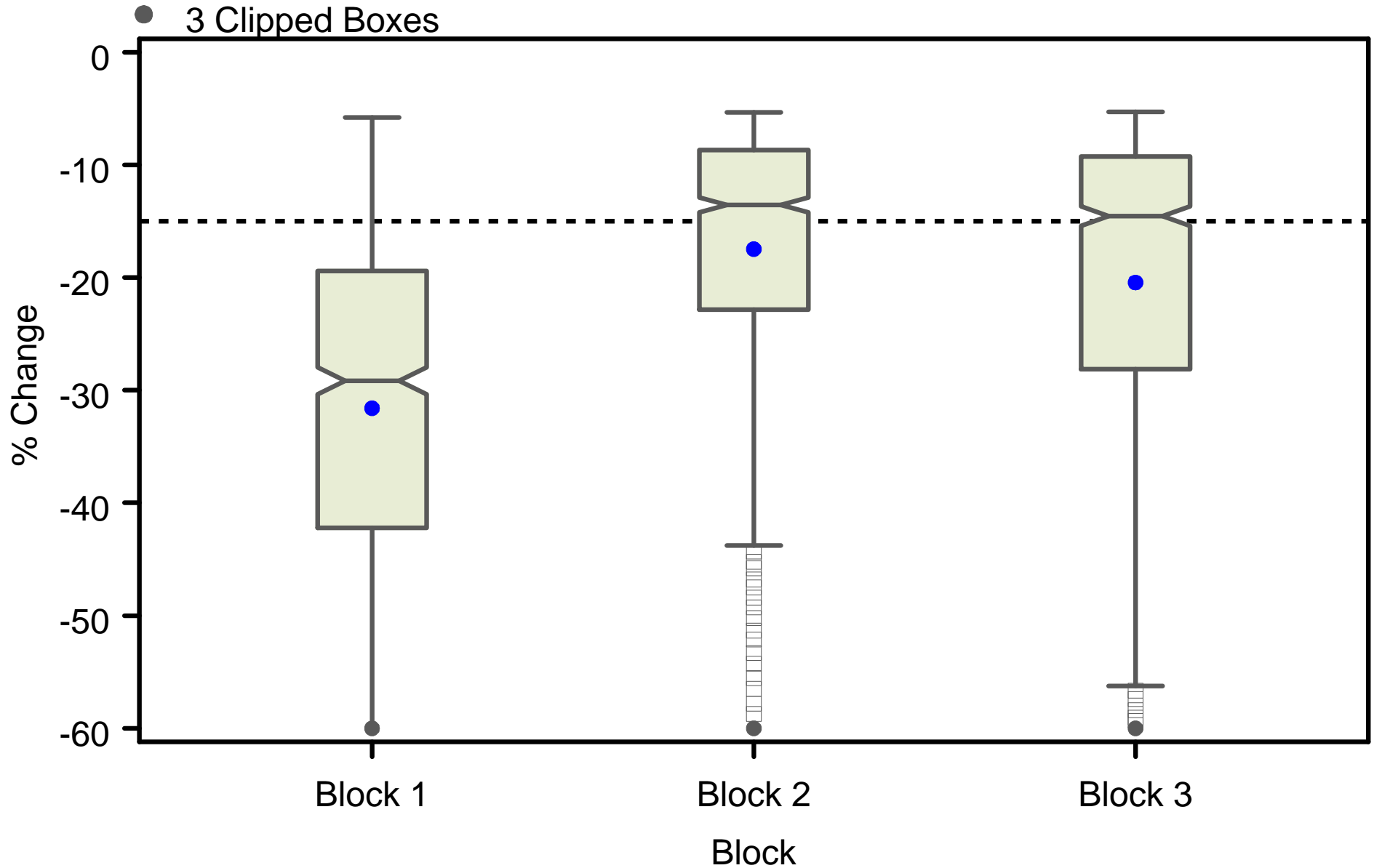

Period of Record: 1995-2004
Distribution of % Change in Abundance by Block
Species=*Americamysis almyra*2 Scenario=Total adjust - NP - 20%

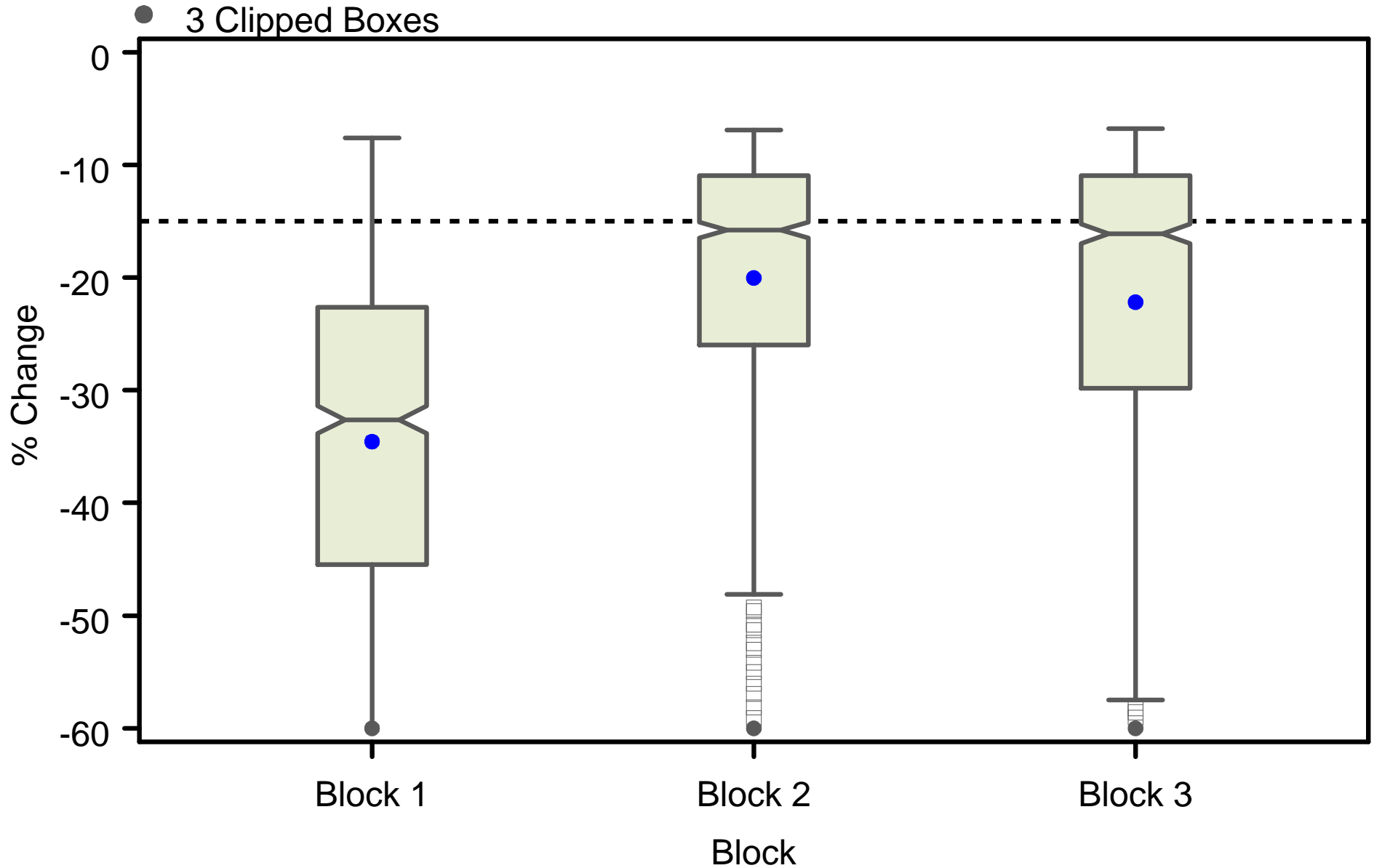

Period of Record: 1995-2004
Distribution of % Change in Abundance by Block
Species=*Anchoa mitchilli* adults Scenario=Northport (NP)

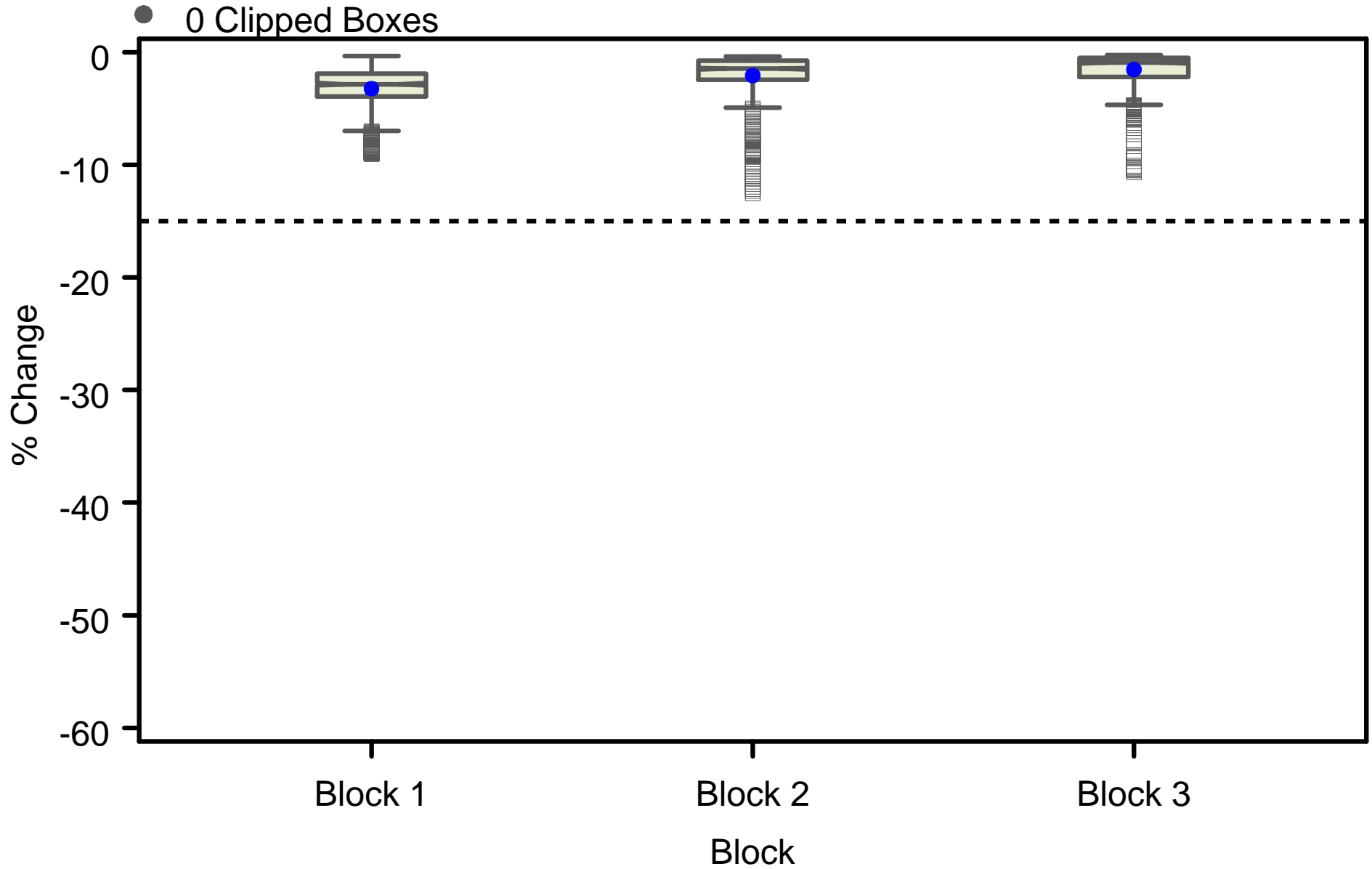

Period of Record: 1995-2004
Distribution of % Change in Abundance by Block
Species=Anchoa mitchilli adults Scenario=Ag adjust

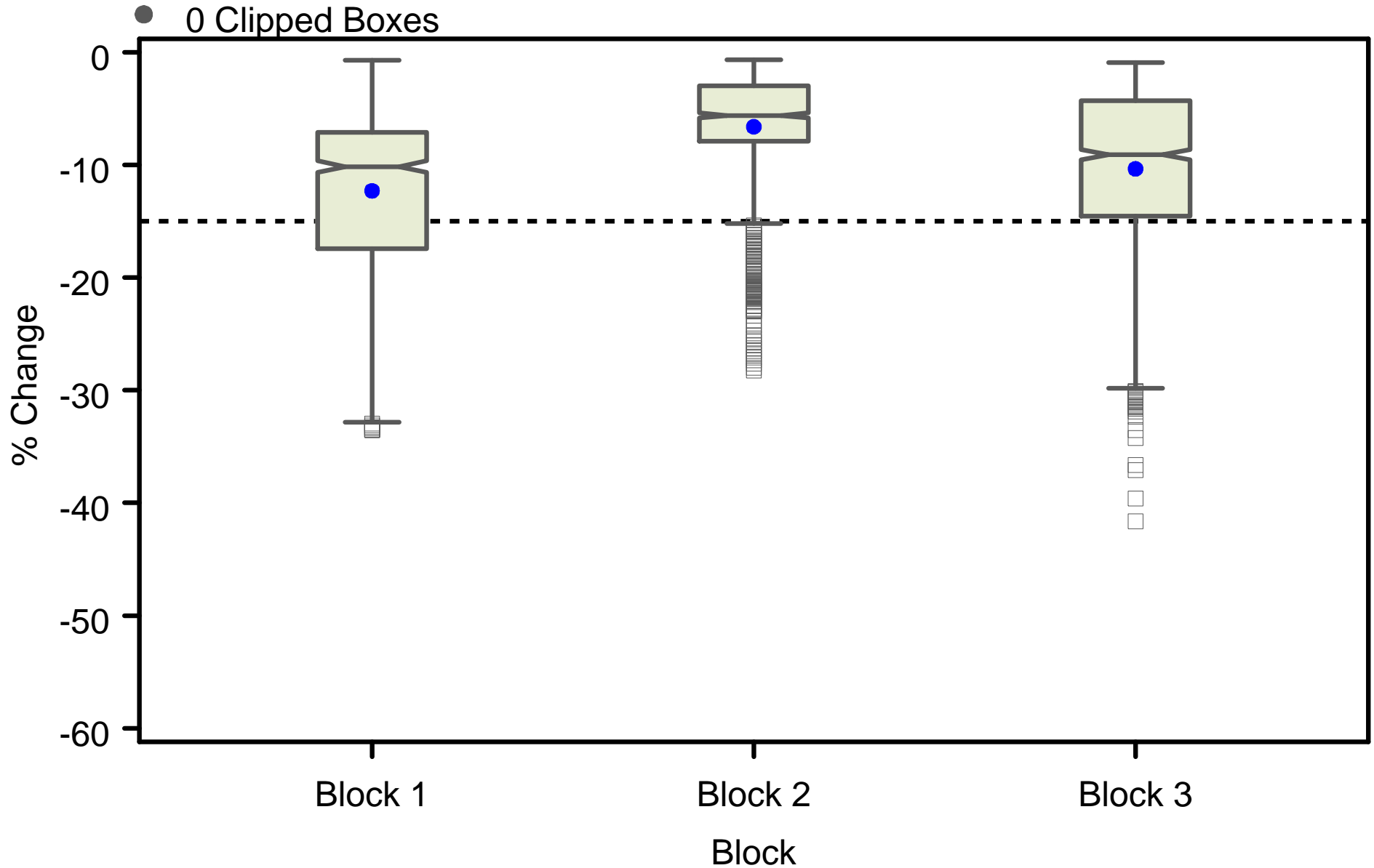

Period of Record: 1995-2004
Distribution of % Change in Abundance by Block
Species=Anchoa mitchilli adults Scenario=Total adjust

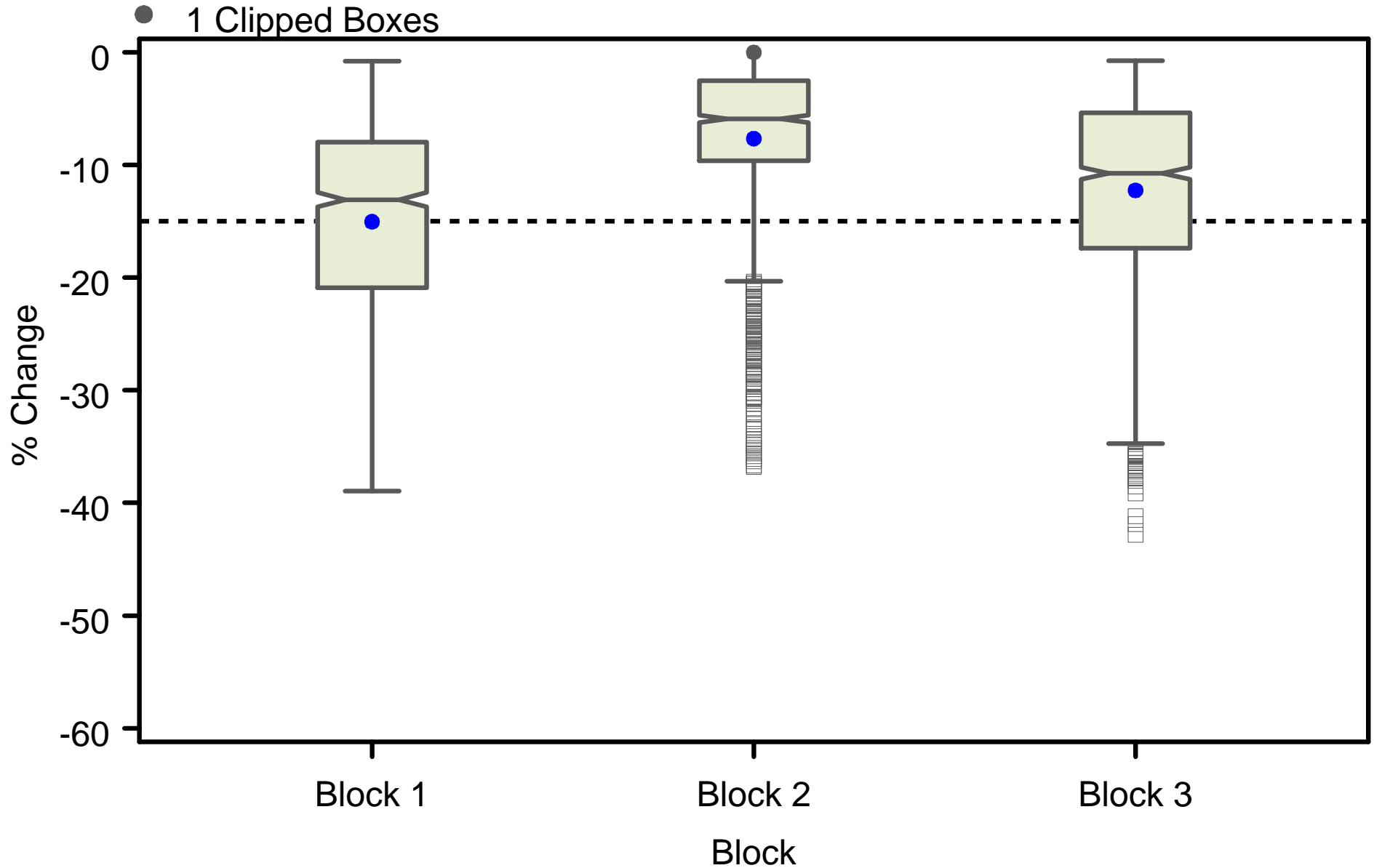

Period of Record: 1995-2004
Distribution of % Change in Abundance by Block
Species=*Anchoa mitchilli* adults Scenario=Total adjust - NP

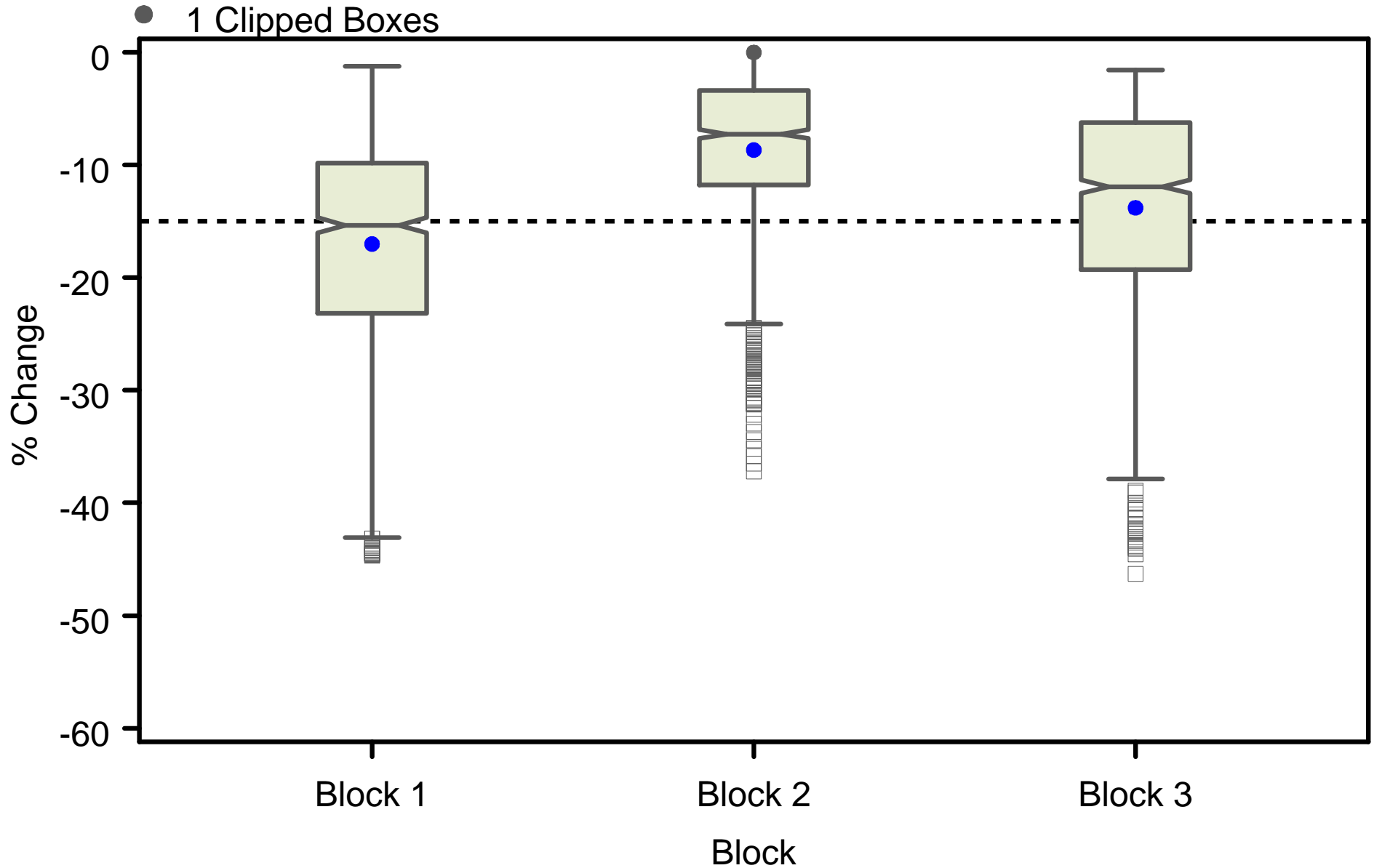

Period of Record: 1995-2004
Distribution of % Change in Abundance by Block
Species=Anchoa mitchilli adults Scenario=Total adjust - NP - 10%

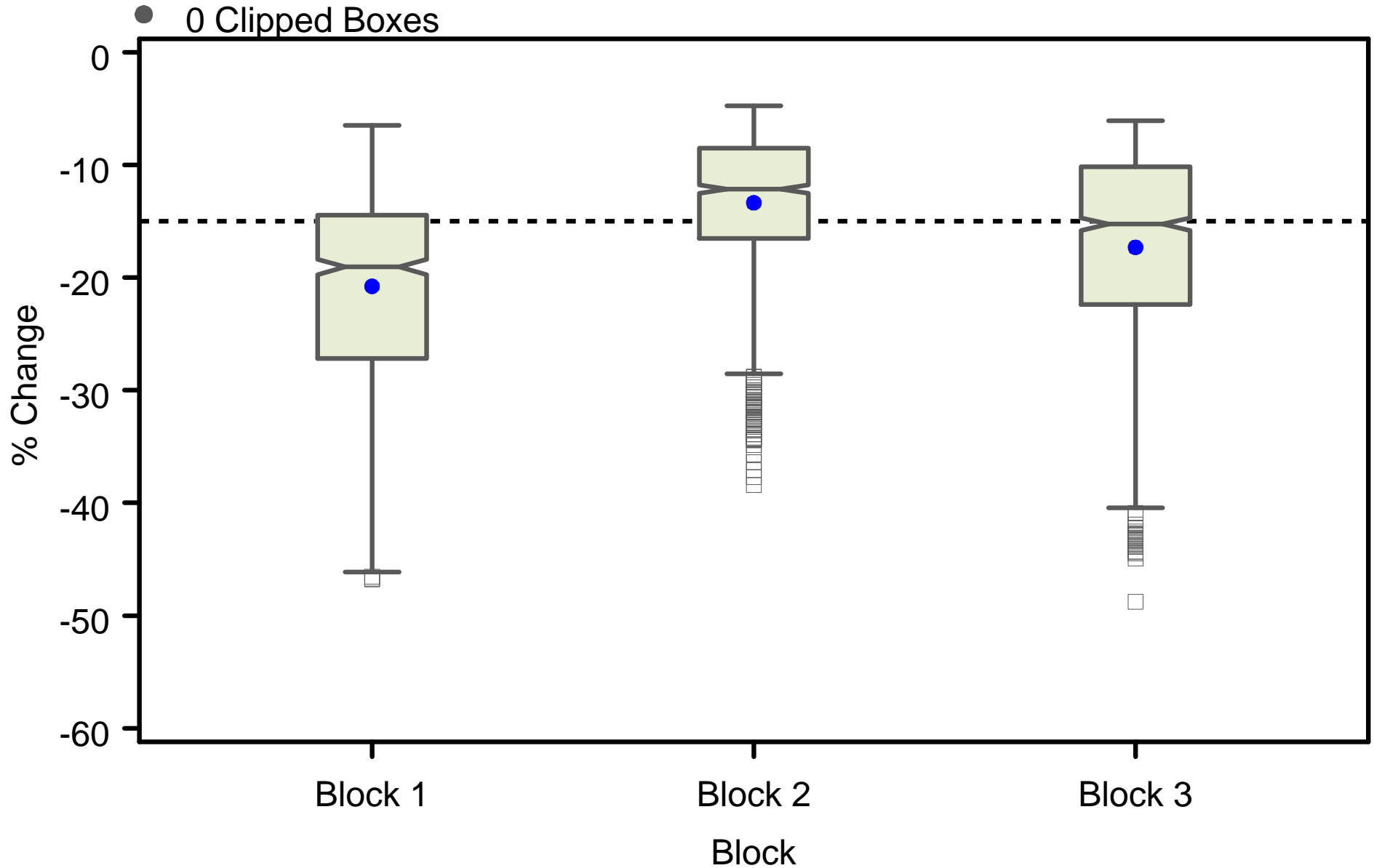

Period of Record: 1995-2004
Distribution of % Change in Abundance by Block
Species=Anchoa mitchilli adults Scenario=Total adjust - NP - 15%

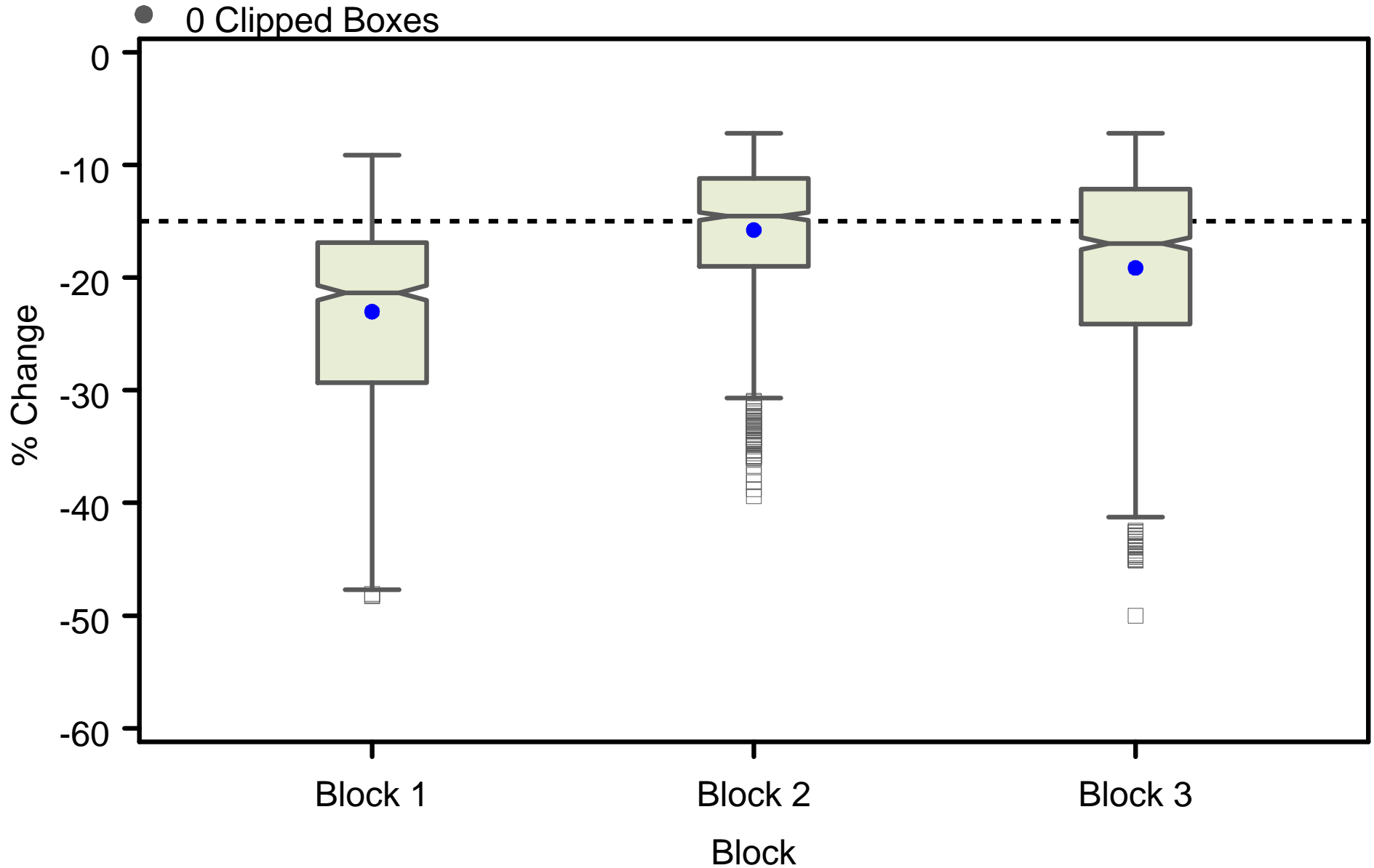

Period of Record: 1995-2004
Distribution of % Change in Abundance by Block
Species=Anchoa mitchilli adults Scenario=Total adjust - NP - 20%

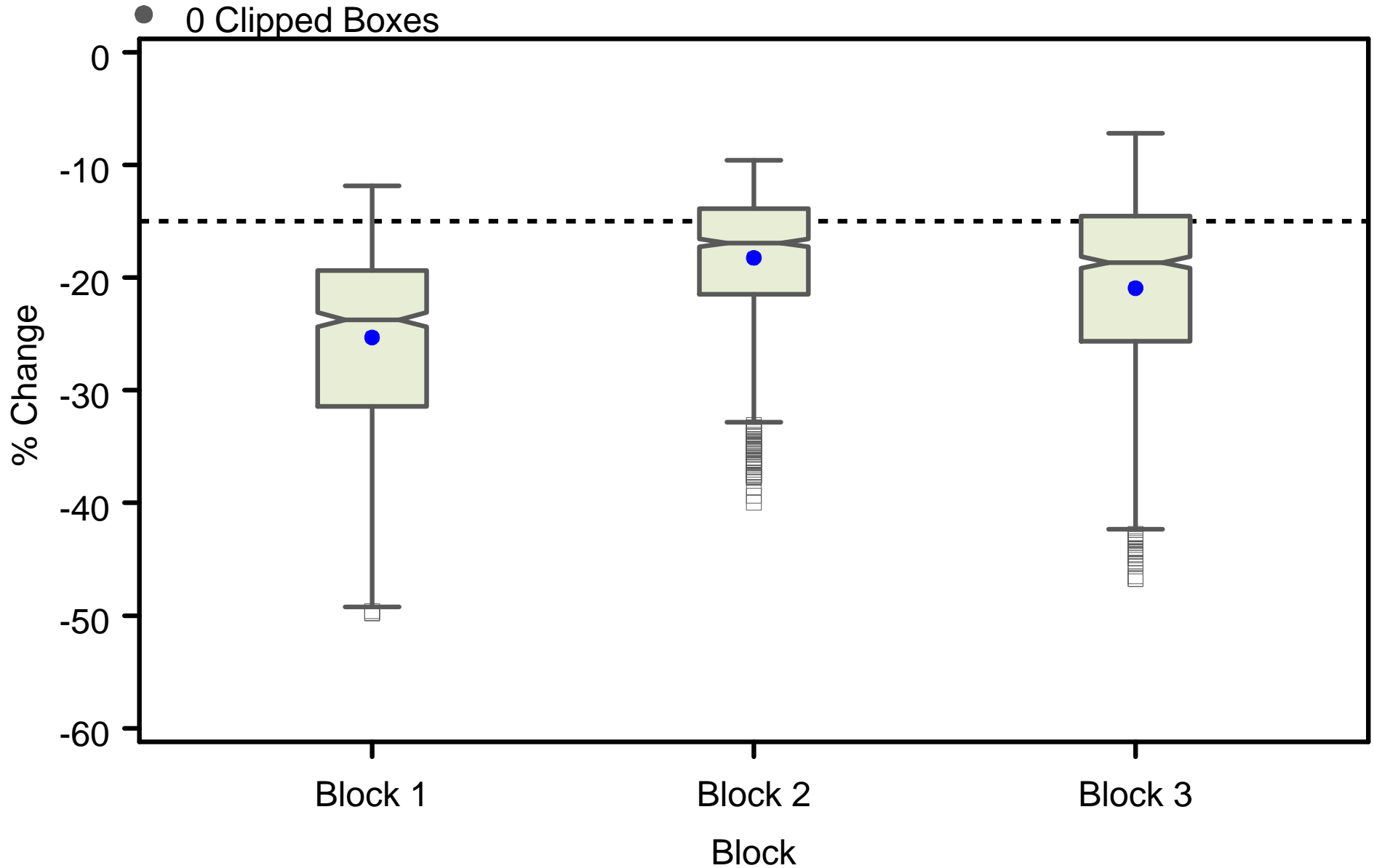

Period of Record: 1995-2004
Distribution of % Change in Abundance by Block
Species=Cyathura polita Scenario=Northport (NP)

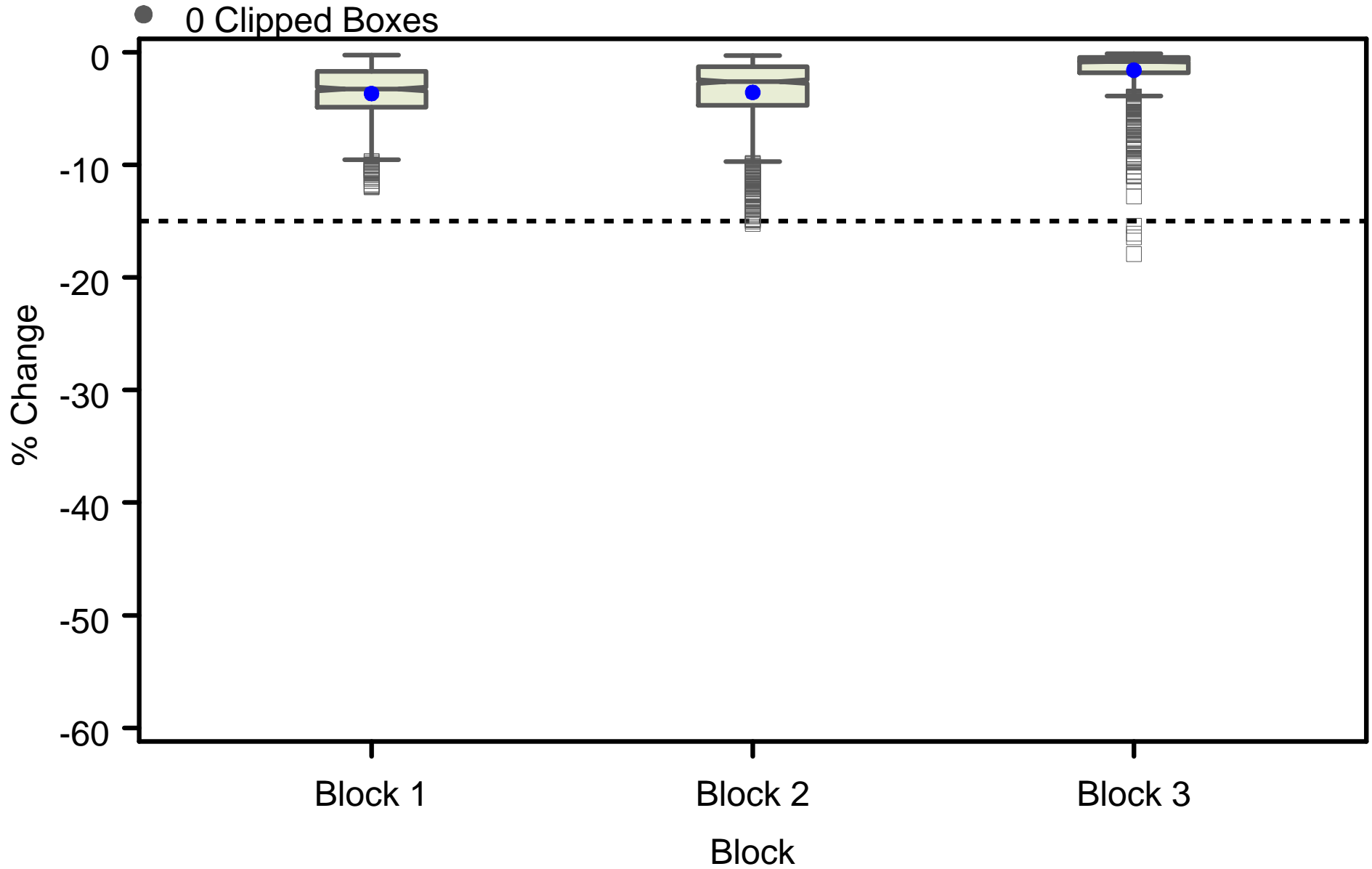

Period of Record: 1995-2004
Distribution of % Change in Abundance by Block
Species=Cyathura polita Scenario=Ag adjust

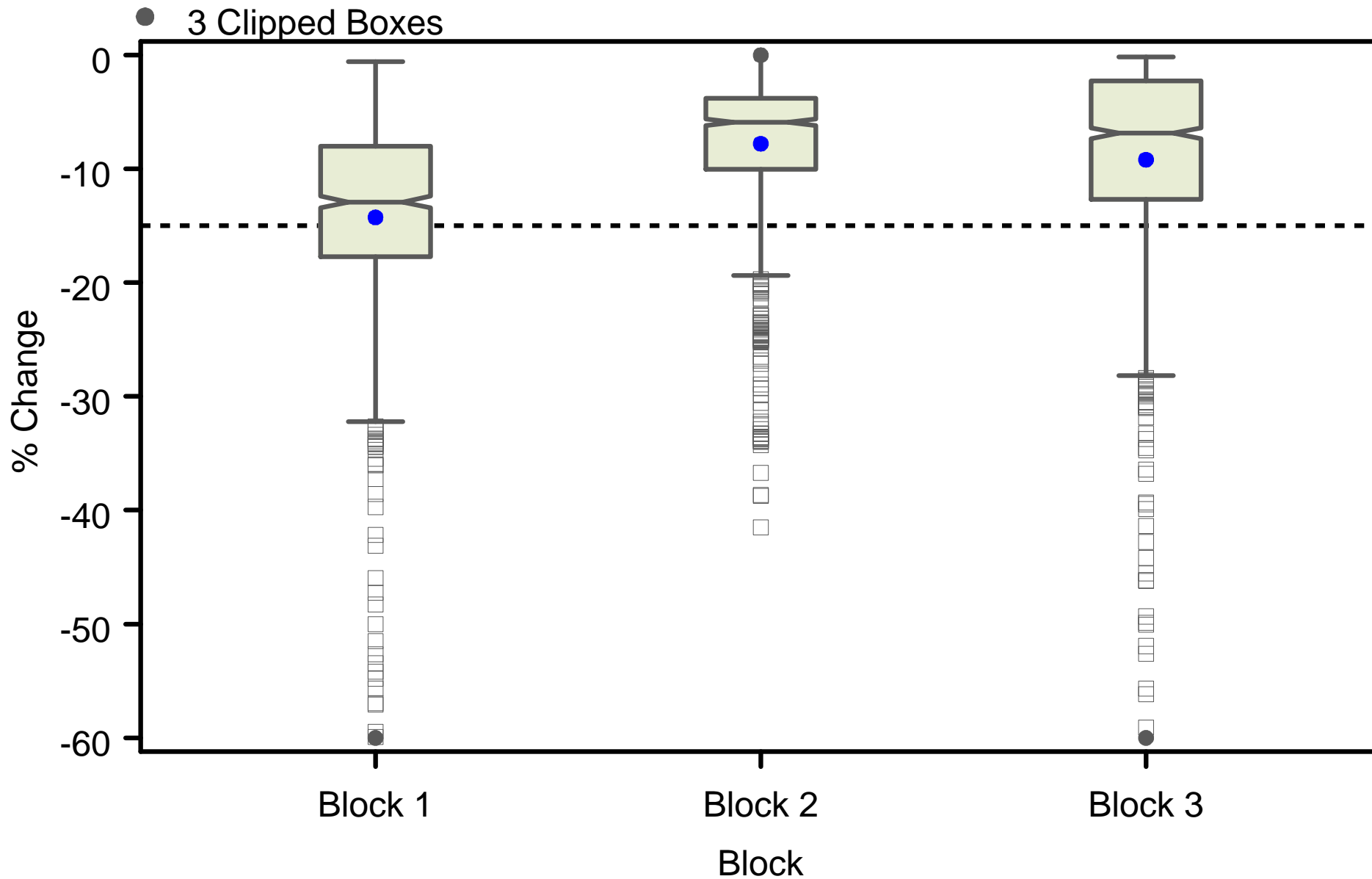

Period of Record: 1995-2004
Distribution of % Change in Abundance by Block
Species=Cyathura polita Scenario=Total adjust

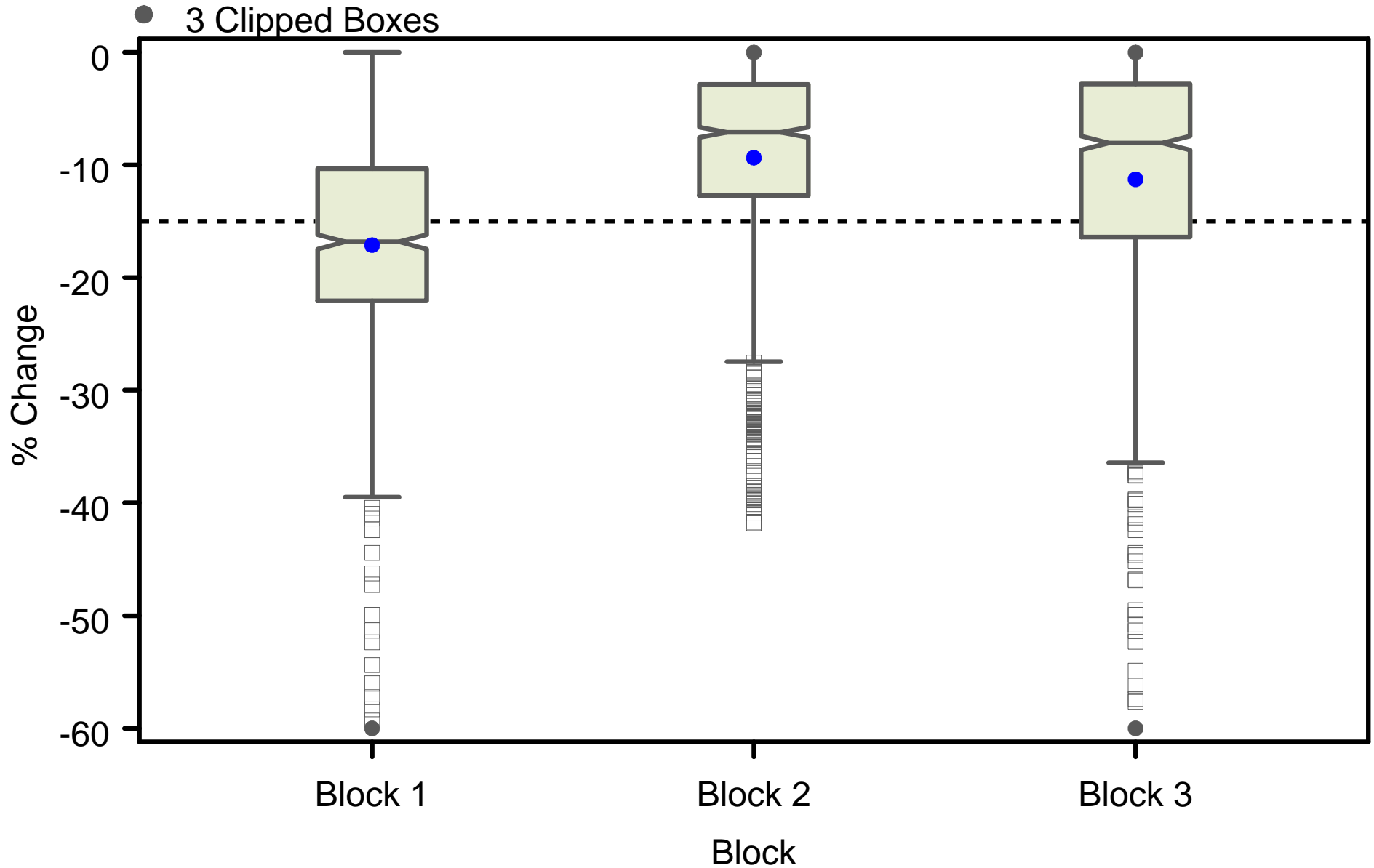

Period of Record: 1995-2004
Distribution of % Change in Abundance by Block
Species=Cyathura polita Scenario=Total adjust - NP

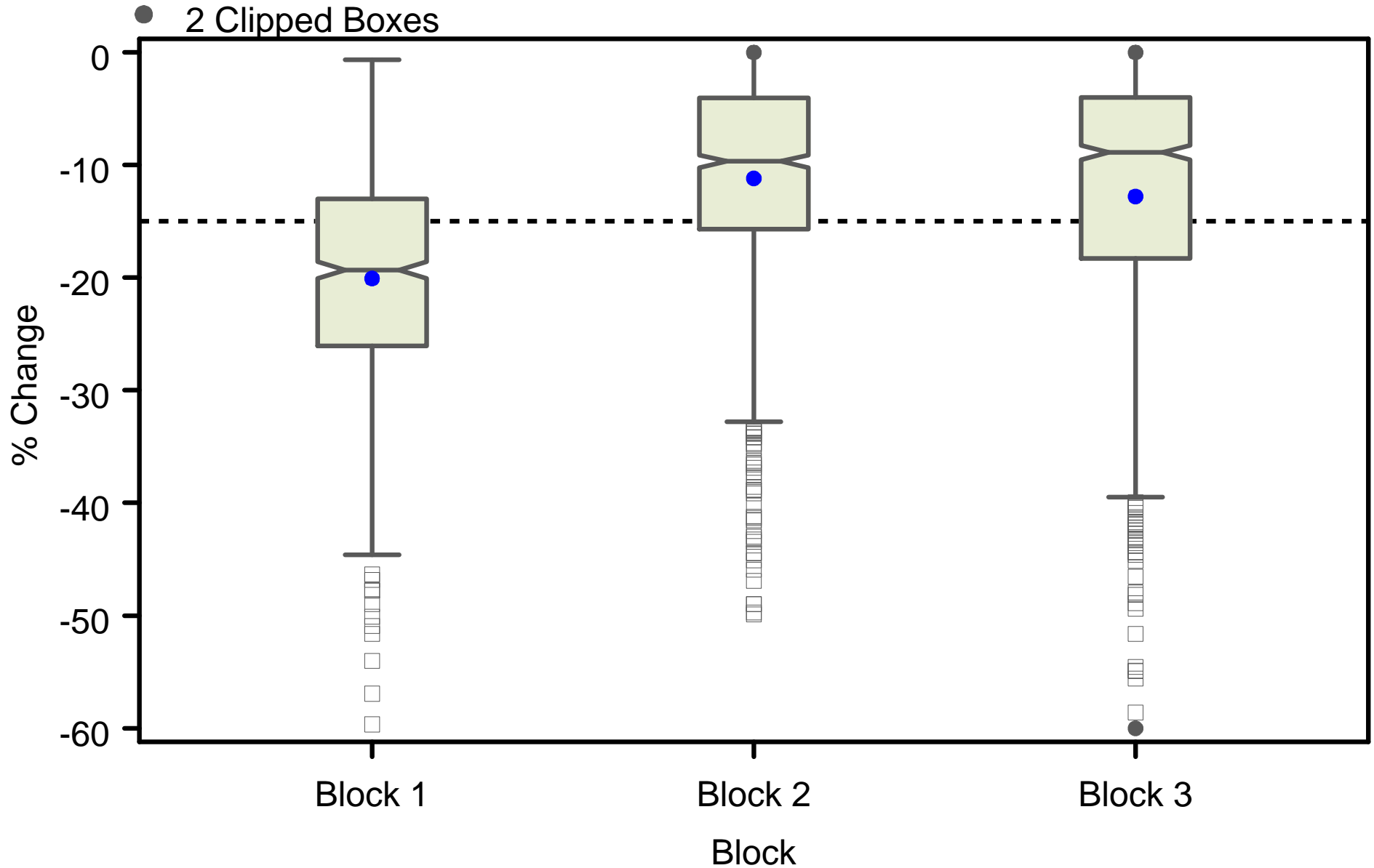

Period of Record: 1995-2004
Distribution of % Change in Abundance by Block
Species=Cyathura polita Scenario=Total adjust - NP - 10%

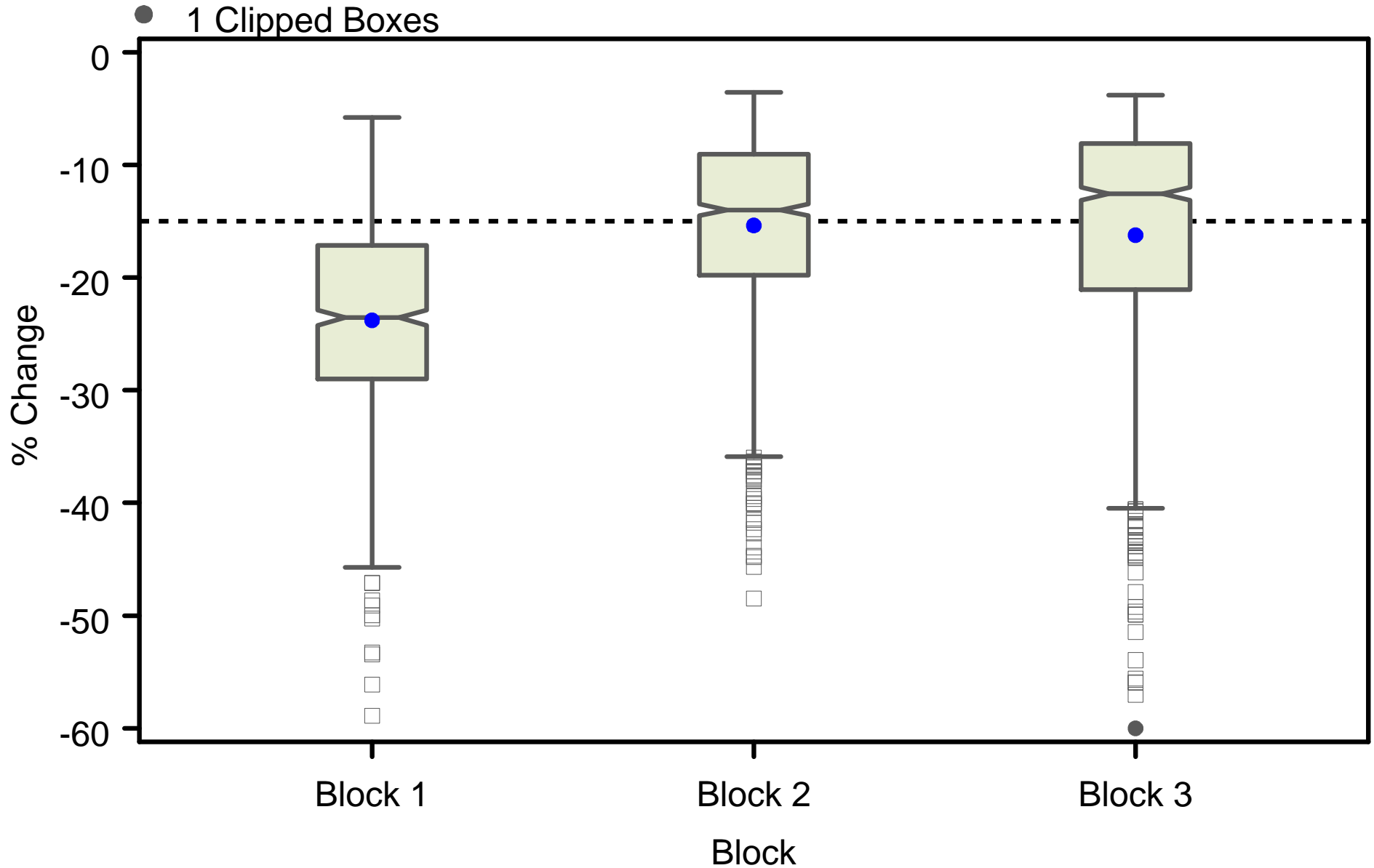

Period of Record: 1995-2004
Distribution of % Change in Abundance by Block
Species=Cyathura polita Scenario=Total adjust - NP - 15%

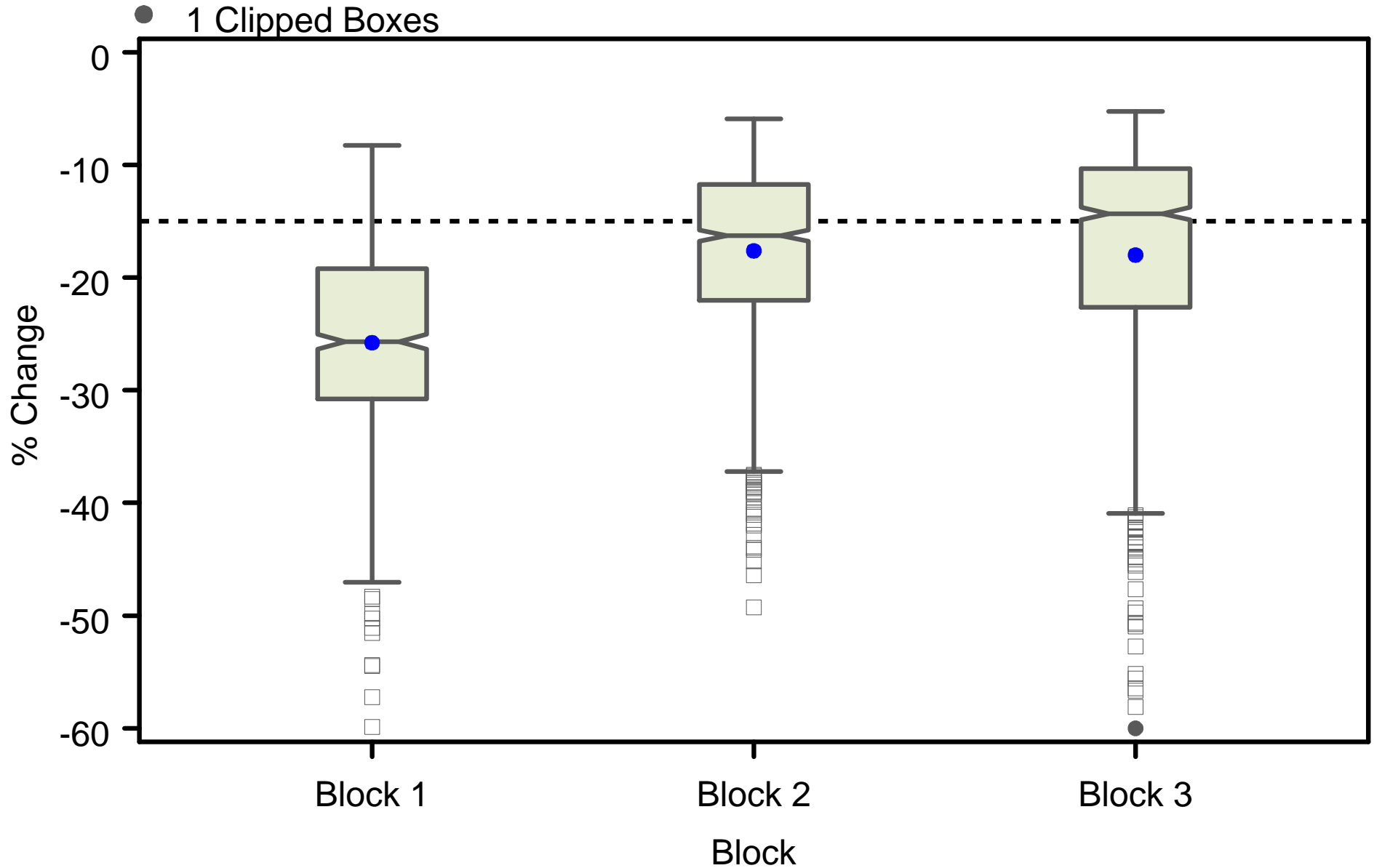

Period of Record: 1995-2004
Distribution of % Change in Abundance by Block
Species=Cyathura polita Scenario=Total adjust - NP - 20%

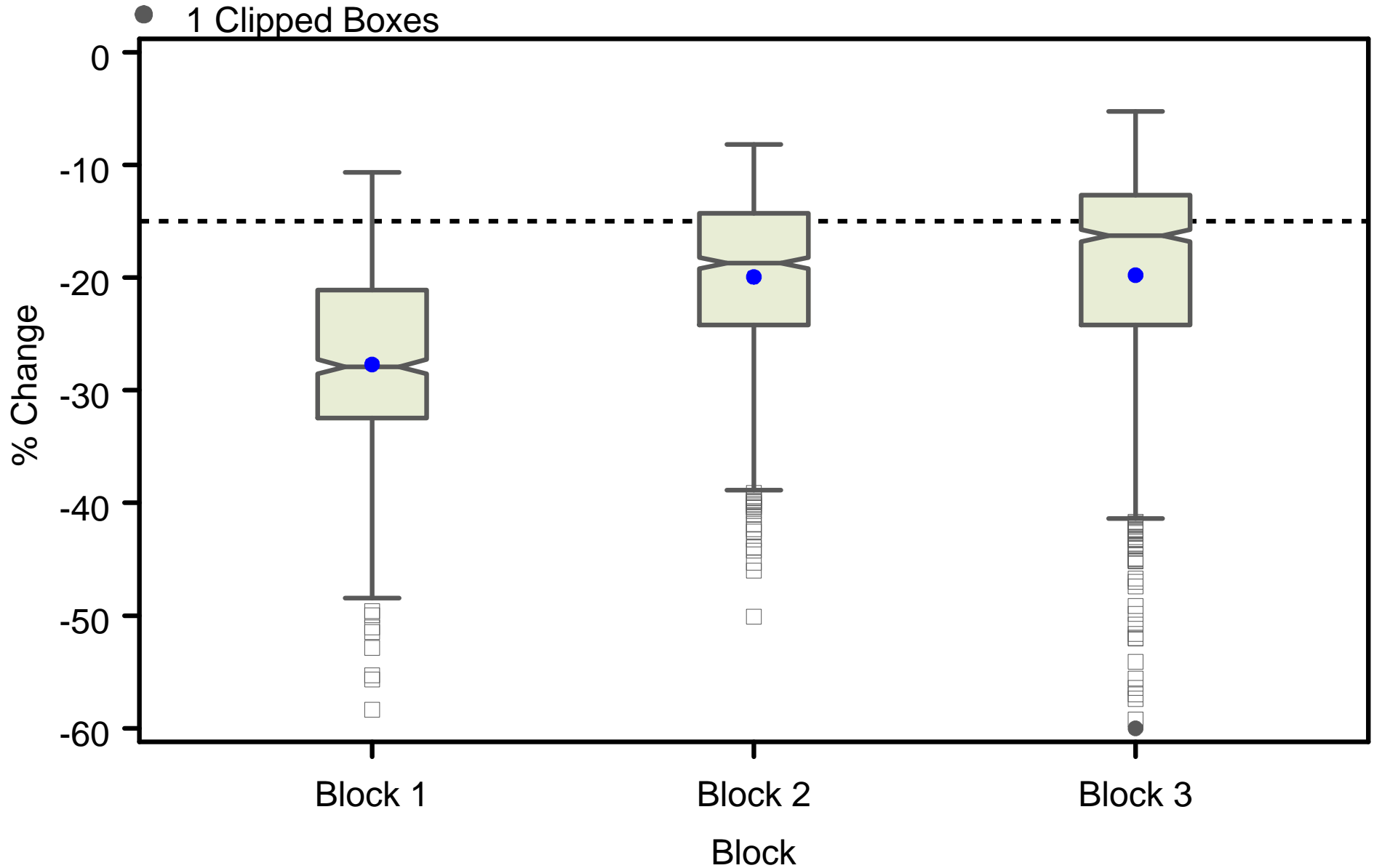

Period of Record: 1995-2004
Distribution of % Change in Abundance by Block
Species=*Gambusia holbrooki* <=25mm Scenario=Northport (NP)

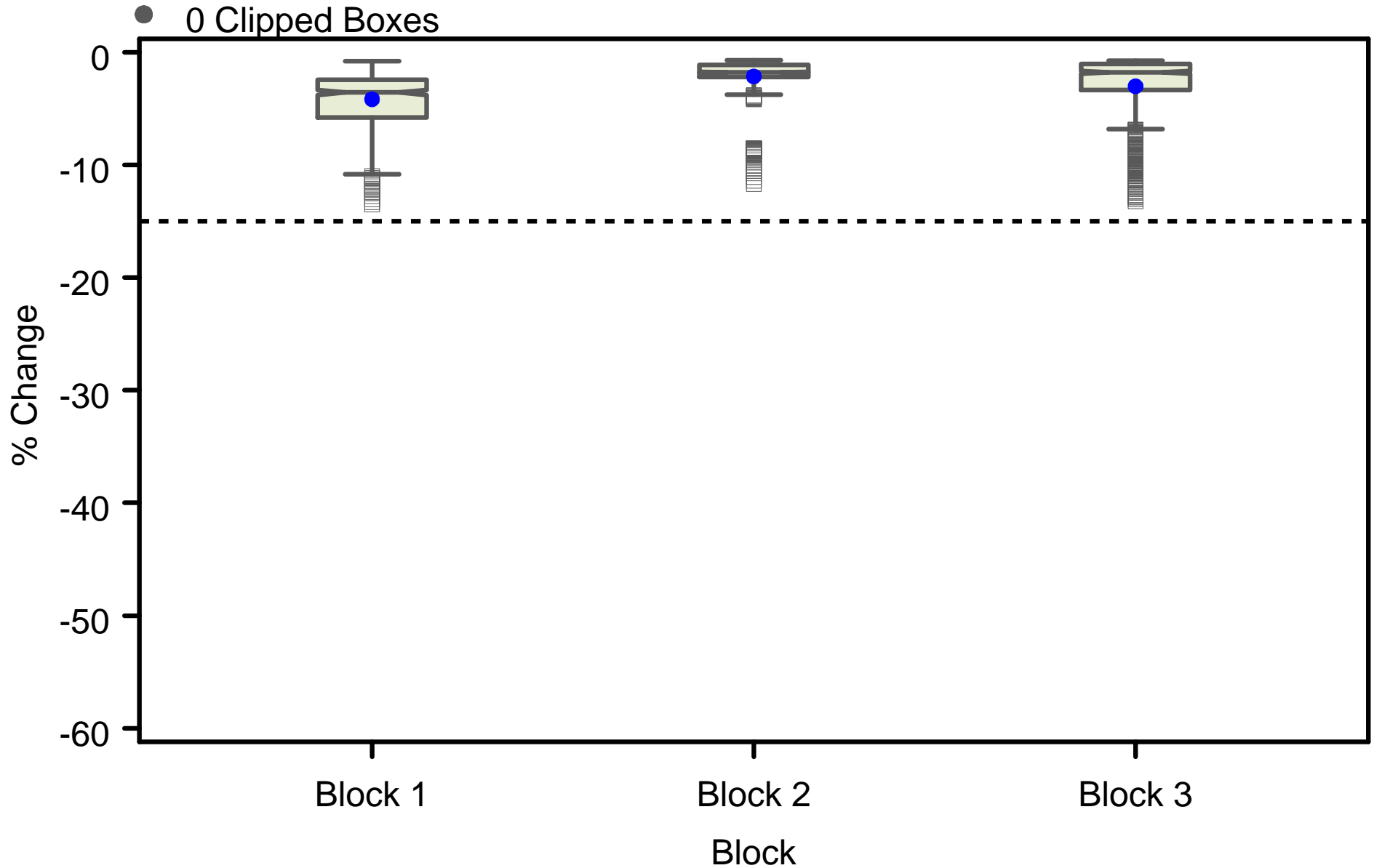

Period of Record: 1995-2004
Distribution of % Change in Abundance by Block
Species=Gambusia holbrooki <=25mm Scenario=Ag adjust

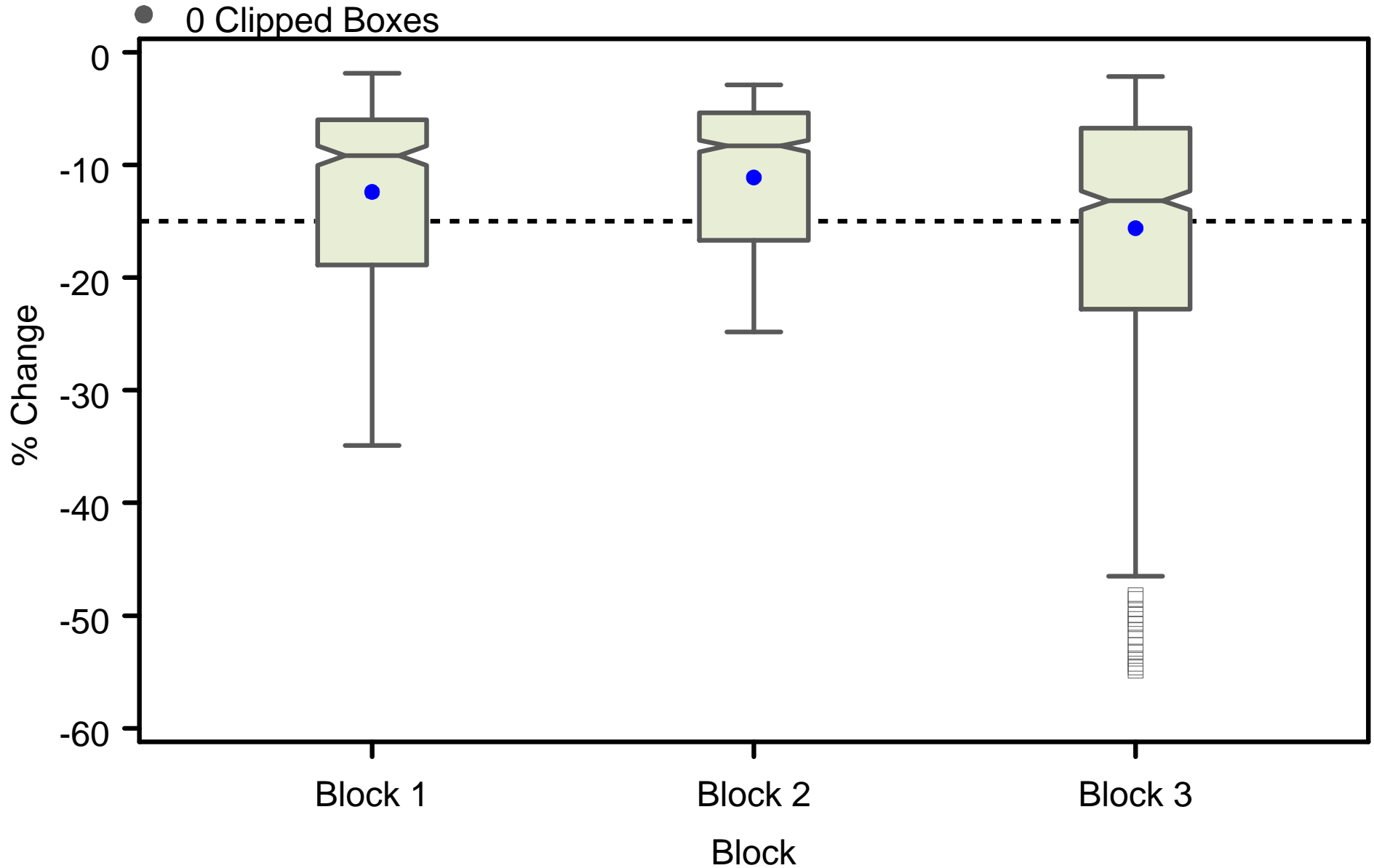

Period of Record: 1995-2004
Distribution of % Change in Abundance by Block
Species=Gambusia holbrooki <=25mm Scenario=Total adjust

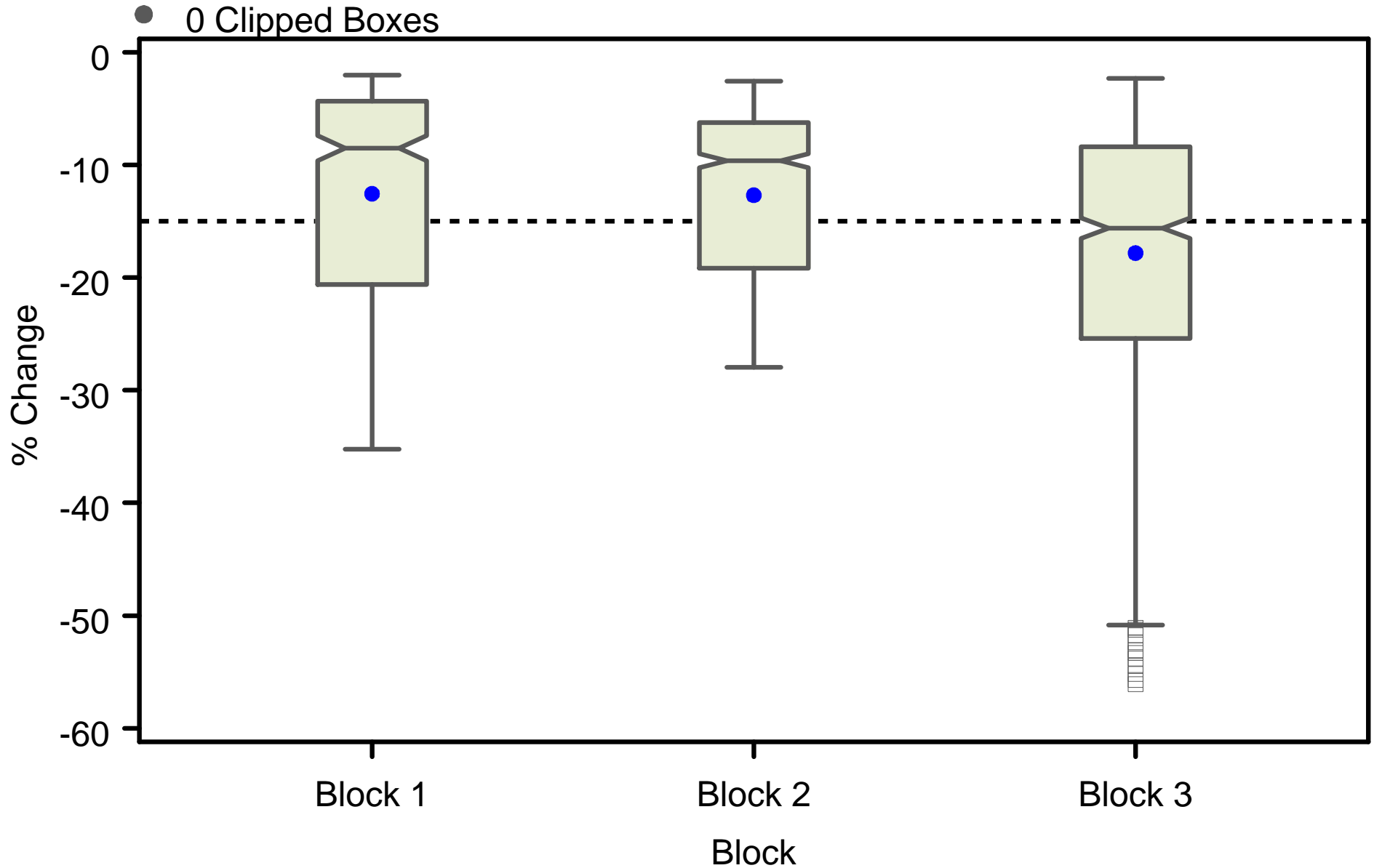

Period of Record: 1995-2004
Distribution of % Change in Abundance by Block
Species=*Gambusia holbrooki* <=25mm Scenario=Total adjust - NP

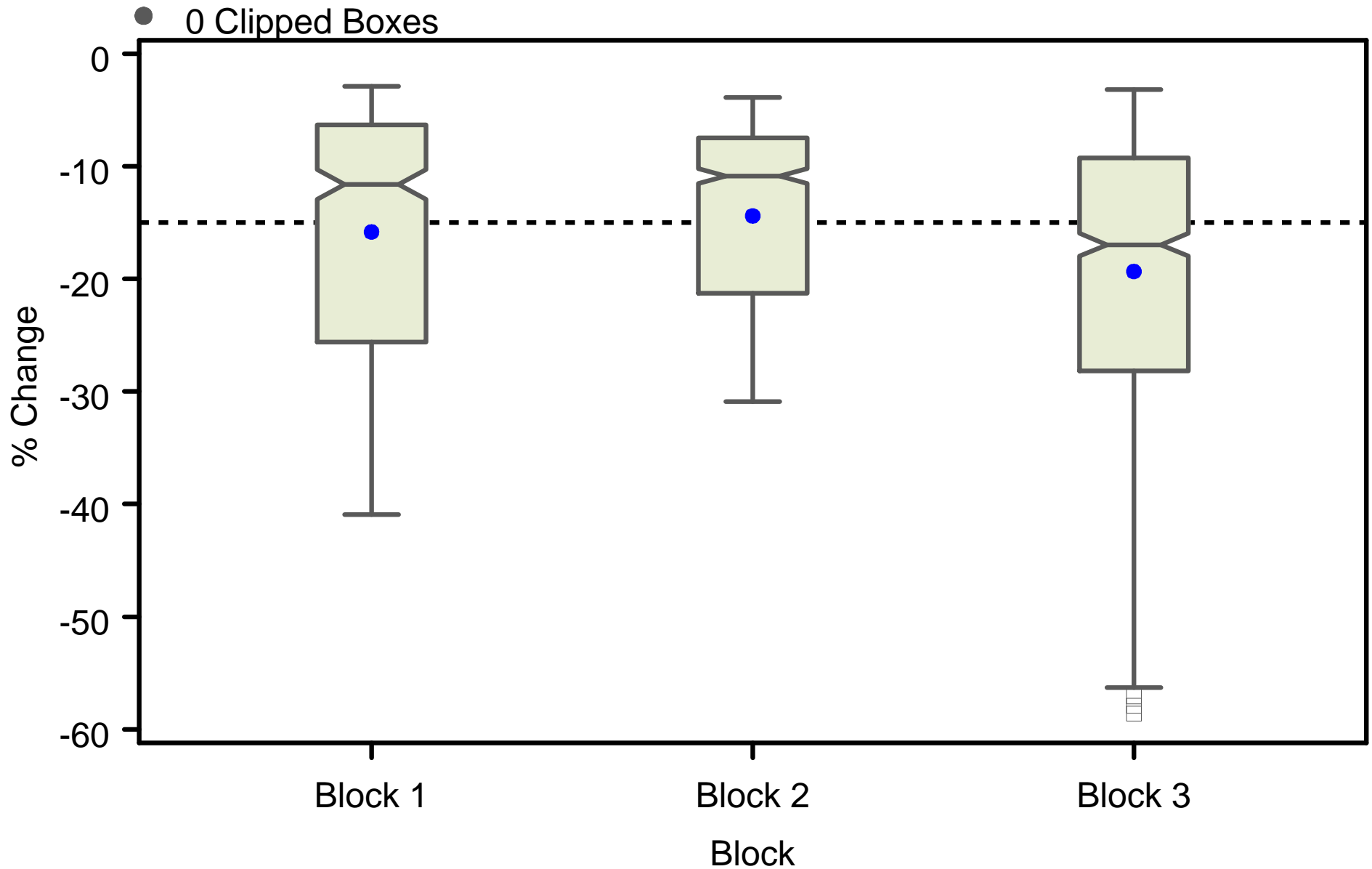

Period of Record: 1995-2004
Distribution of % Change in Abundance by Block
Species=Gambusia holbrooki <=25mm Scenario=Total adjust - NP - 10%

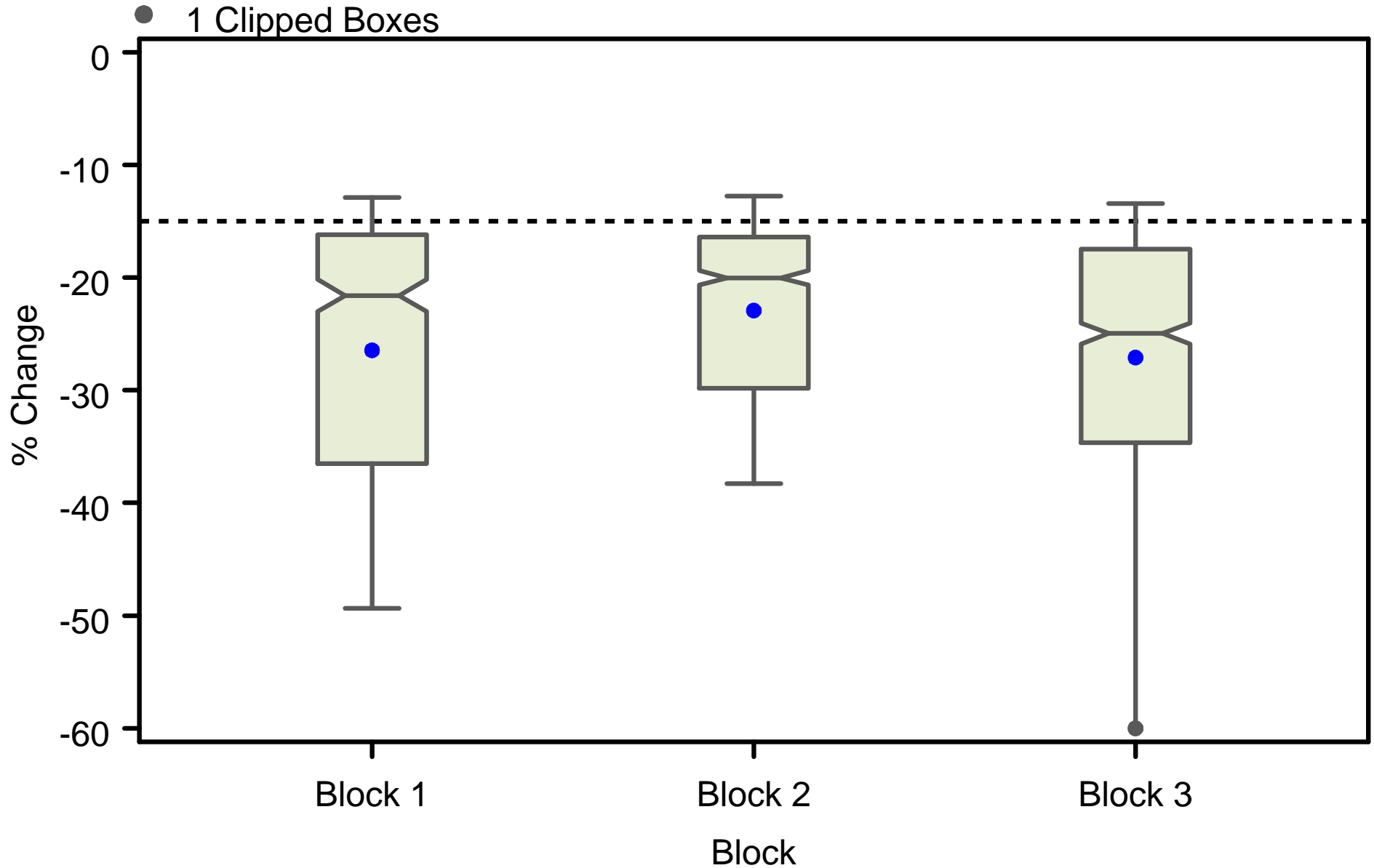

Period of Record: 1995-2004
Distribution of % Change in Abundance by Block
Species=Gambusia holbrooki <=25mm Scenario=Total adjust - NP - 15%

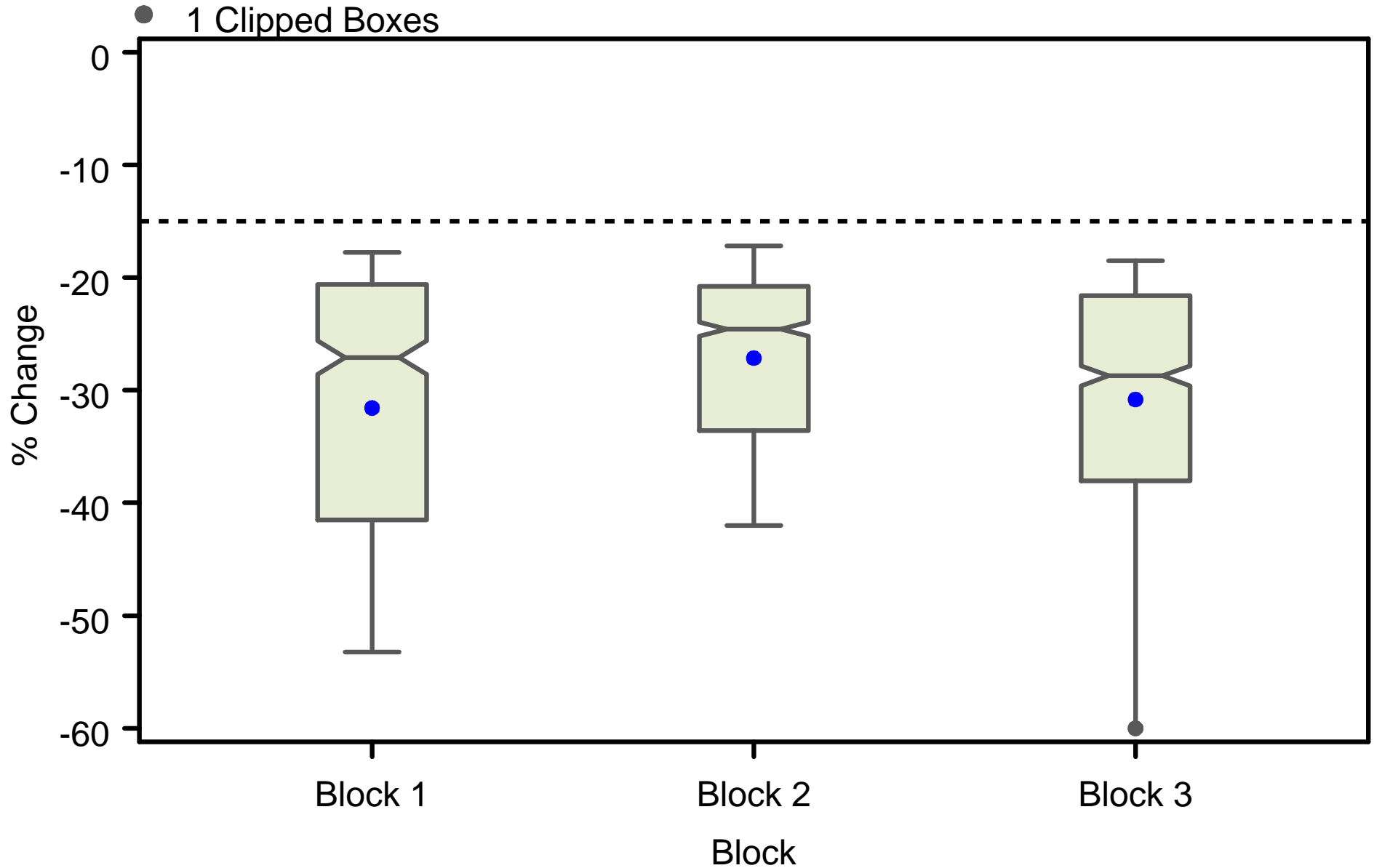

Period of Record: 1995-2004
Distribution of % Change in Abundance by Block
Species=Gambusia holbrooki <=25mm Scenario=Total adjust - NP - 20%

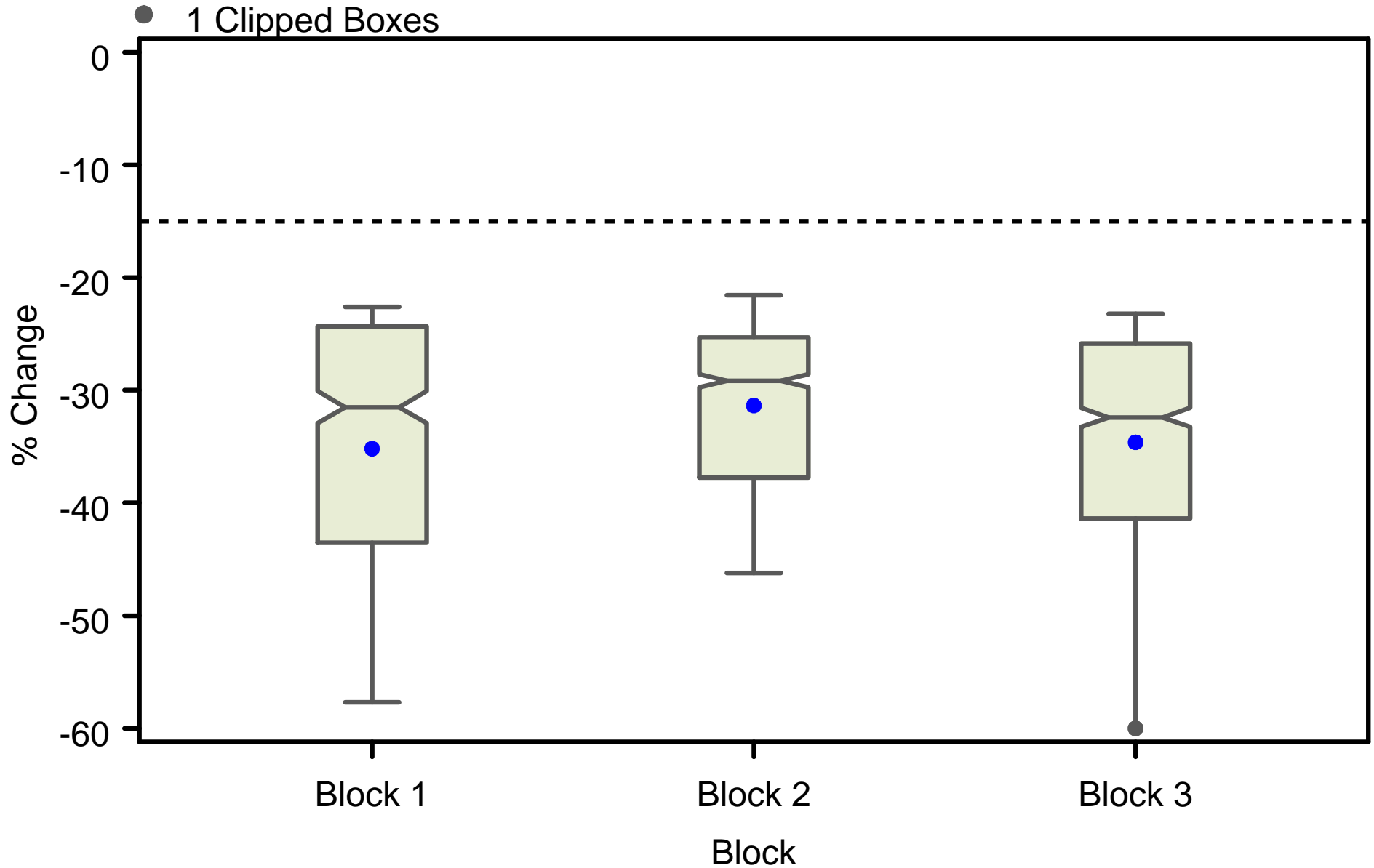

Period of Record: 1995-2004
Distribution of % Change in Abundance by Block
Species=*Gambusia holbrooki* >=26mm Scenario=Northport (NP)

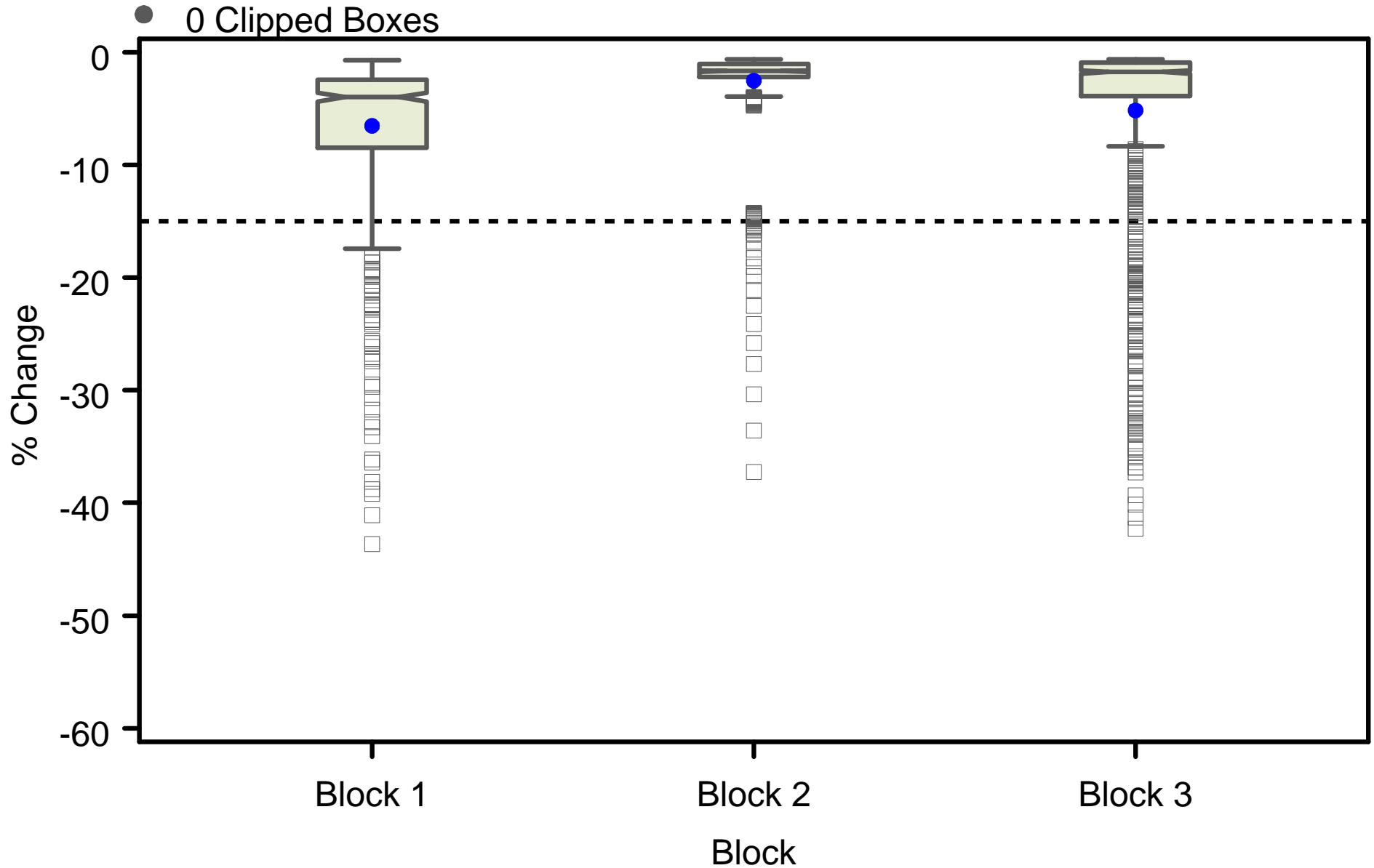

Period of Record: 1995-2004
Distribution of % Change in Abundance by Block
Species=*Gambusia holbrooki* $\geq 26\text{mm}$ Scenario=Ag adjust

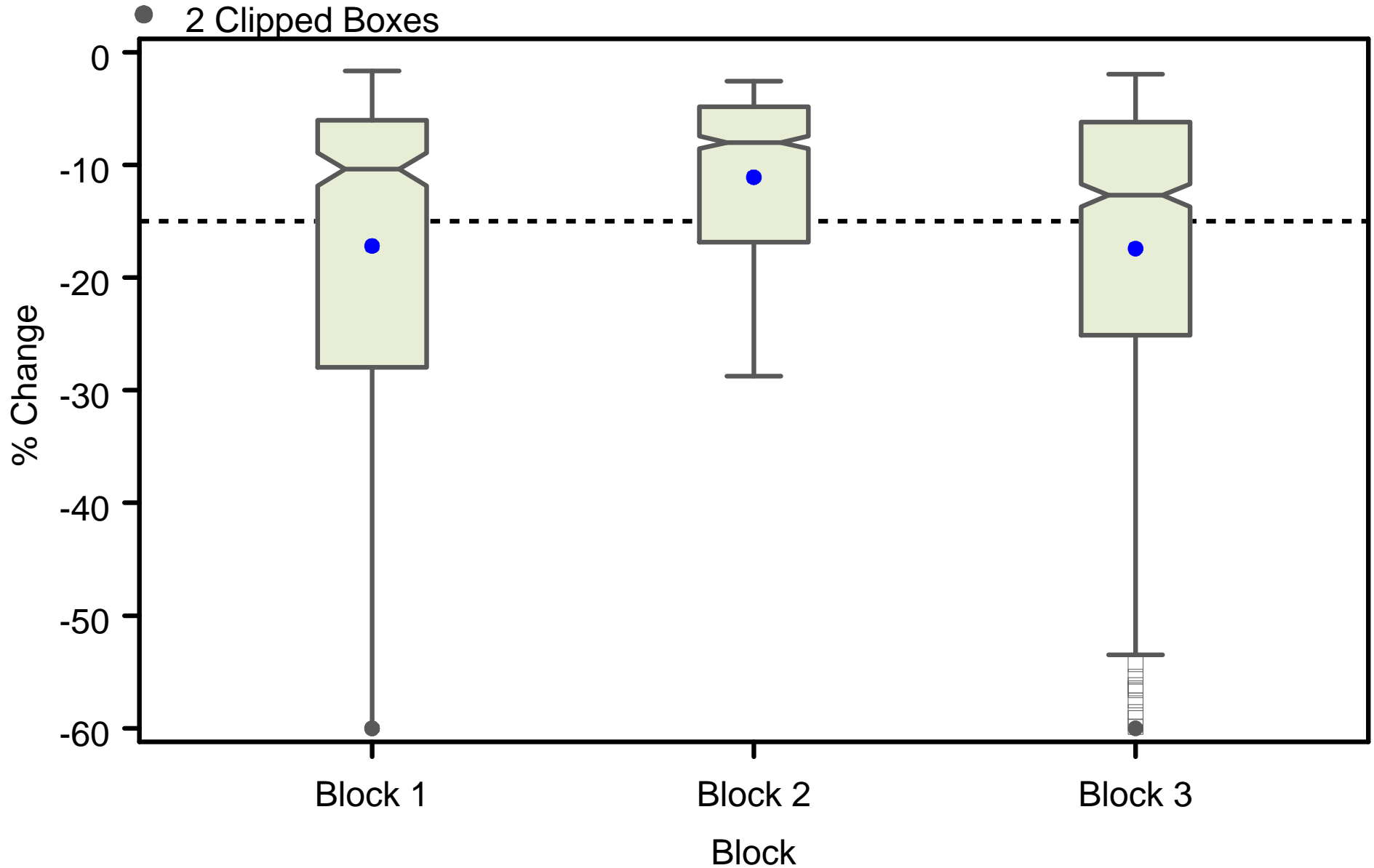

Period of Record: 1995-2004
Distribution of % Change in Abundance by Block
Species=*Gambusia holbrooki* ≥ 26 mm Scenario=Total adjust

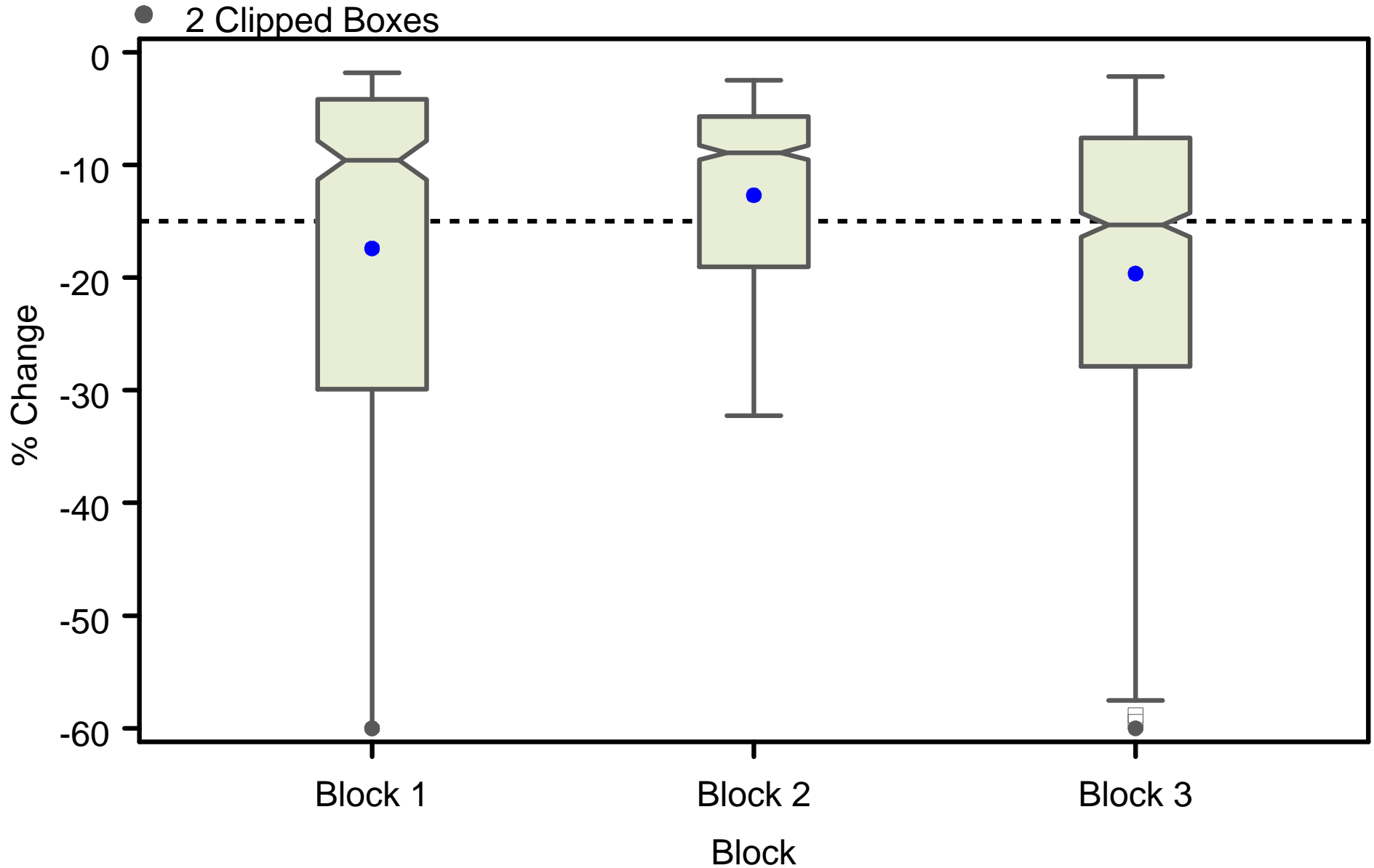

Period of Record: 1995-2004
Distribution of % Change in Abundance by Block
Species=*Gambusia holbrooki* >=26mm Scenario=Total adjust - NP

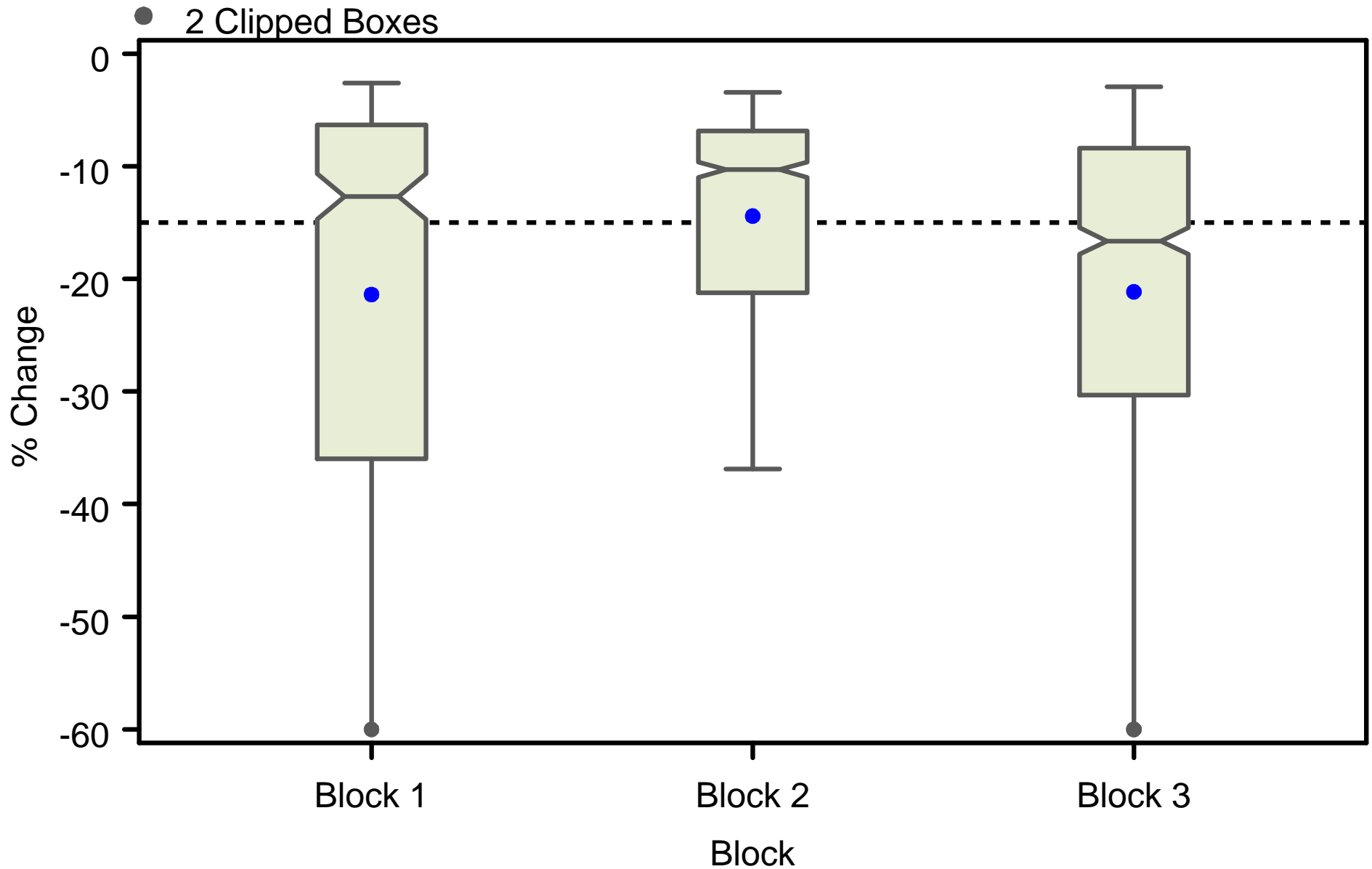

Period of Record: 1995-2004
Distribution of % Change in Abundance by Block
Species=*Gambusia holbrooki* $\geq 26\text{mm}$ Scenario=Total adjust - NP - 10%

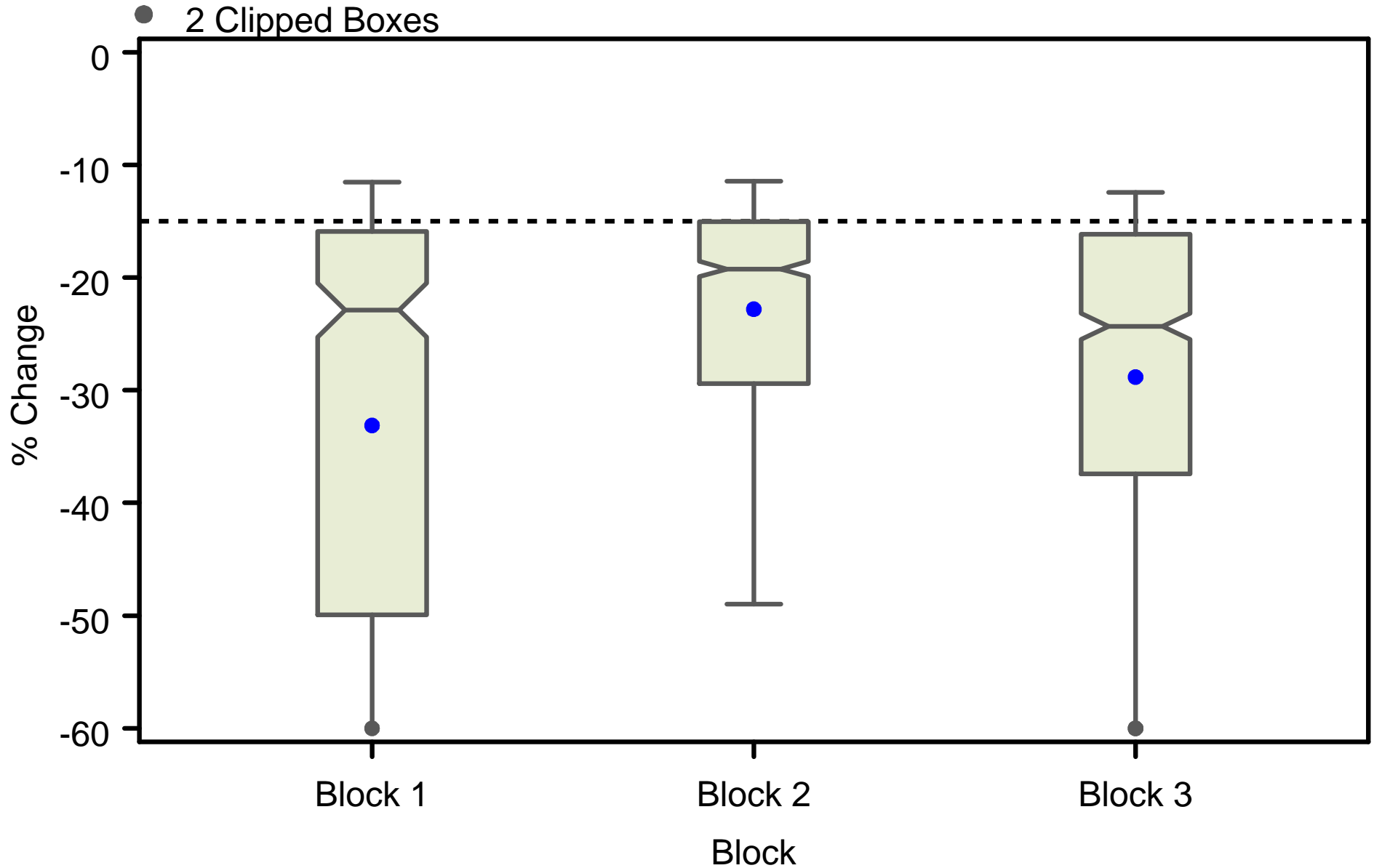

Period of Record: 1995-2004
Distribution of % Change in Abundance by Block
Species=*Gambusia holbrooki* $\geq 26\text{mm}$ Scenario=Total adjust - NP - 15%

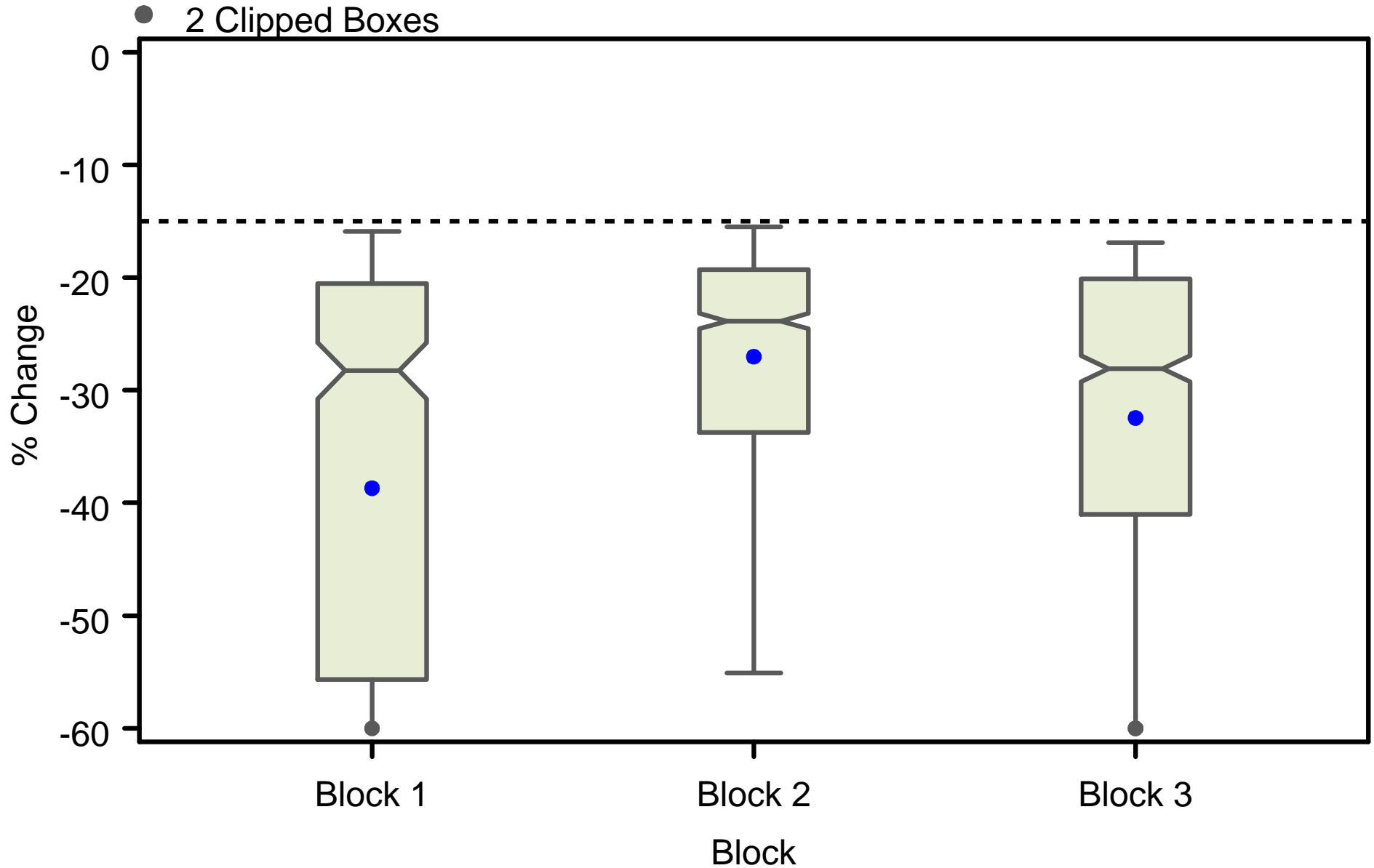

Period of Record: 1995-2004
Distribution of % Change in Abundance by Block
Species=*Gambusia holbrooki* $\geq 26\text{mm}$ Scenario=Total adjust - NP - 20%

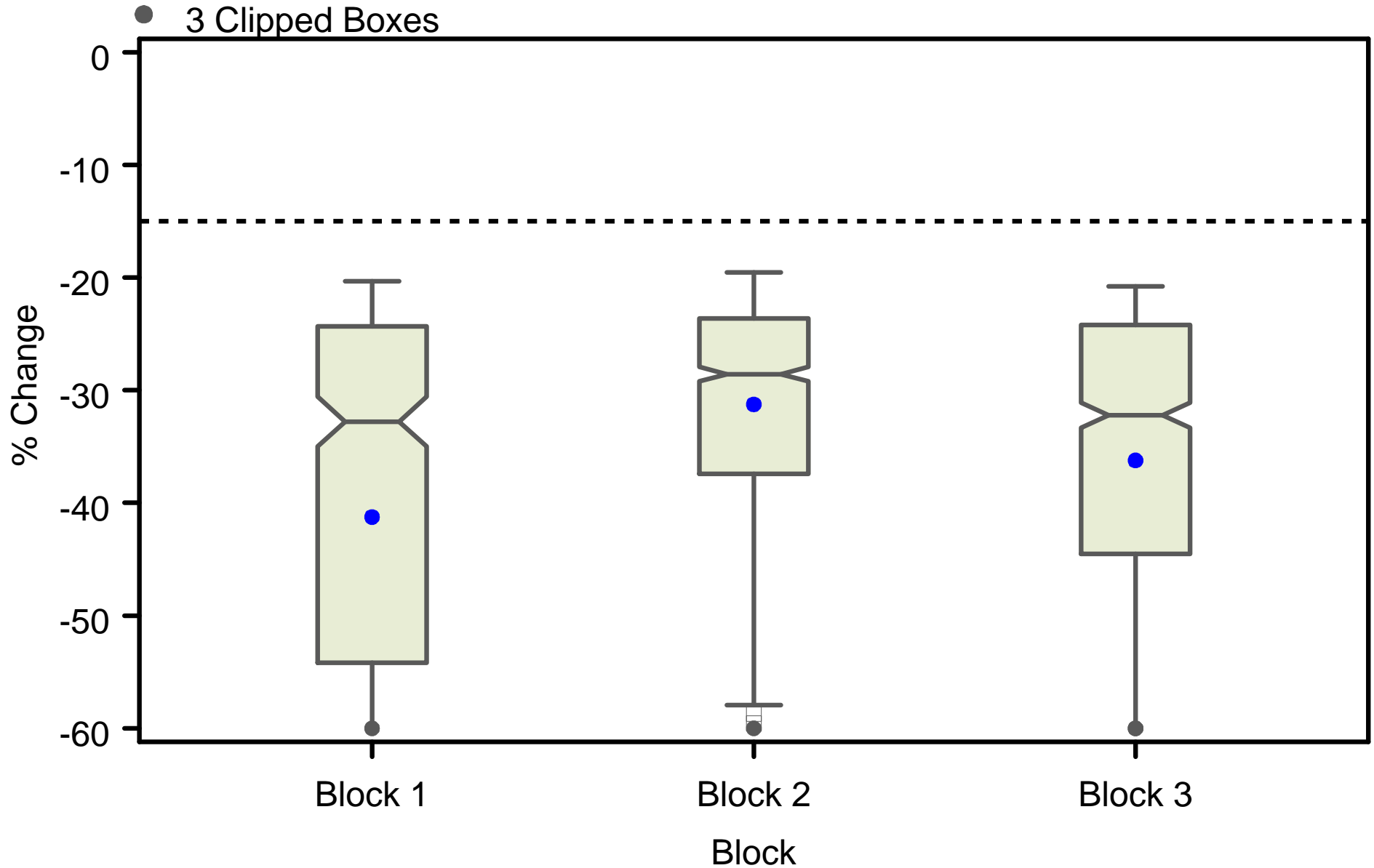

Period of Record: 1995-2004
Distribution of % Change in Abundance by Block
Species=*Palaemonetes intermedius* Scenario=Northport (NP)

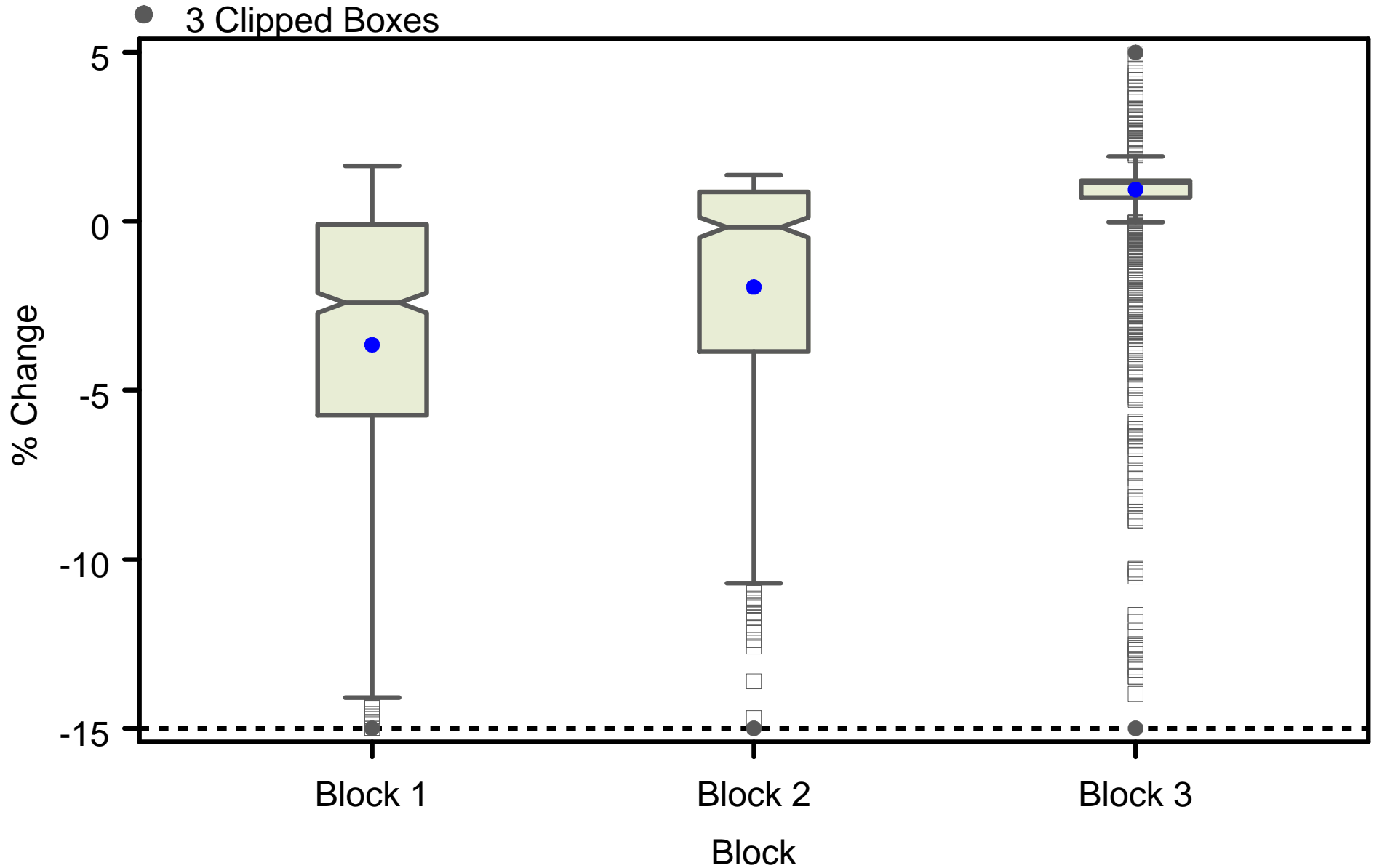

Period of Record: 1995-2004
Distribution of % Change in Abundance by Block
Species=*Palaemonetes intermedius* Scenario=Ag adjust

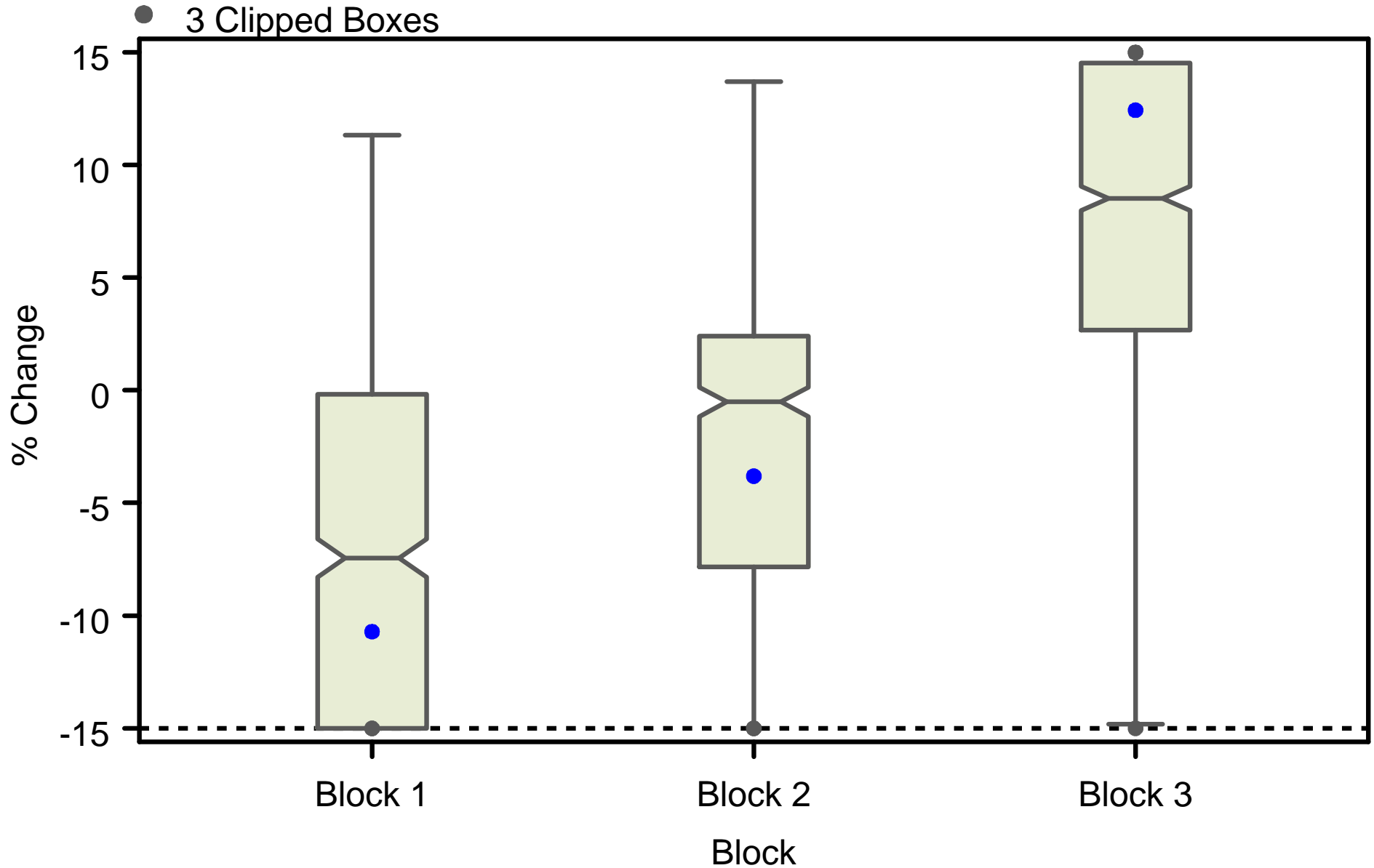

Period of Record: 1995-2004
Distribution of % Change in Abundance by Block
Species=*Palaemonetes intermedius* Scenario=Total adjust

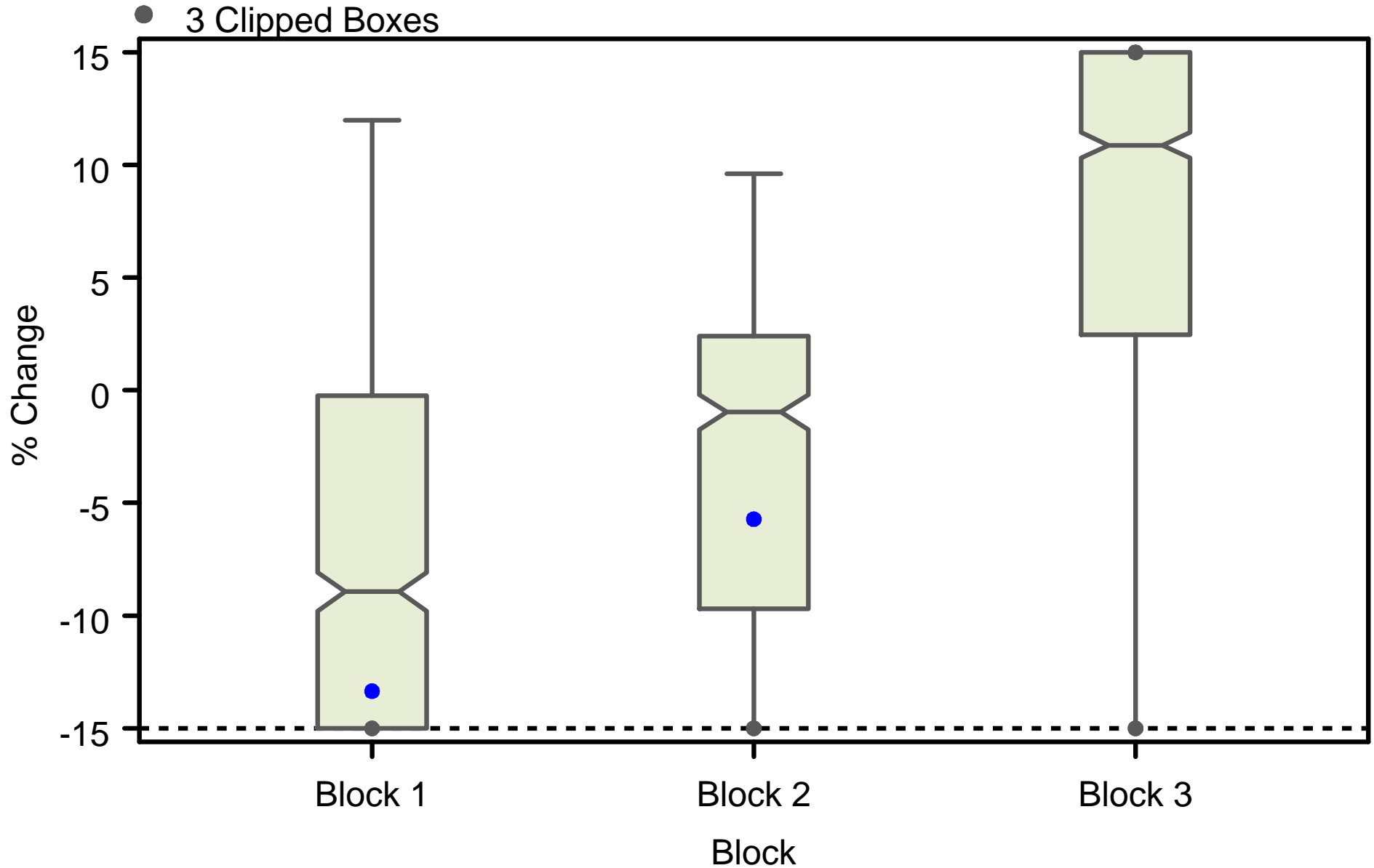

Period of Record: 1995-2004
Distribution of % Change in Abundance by Block
Species=*Palaemonetes intermedius* Scenario=Total adjust - NP

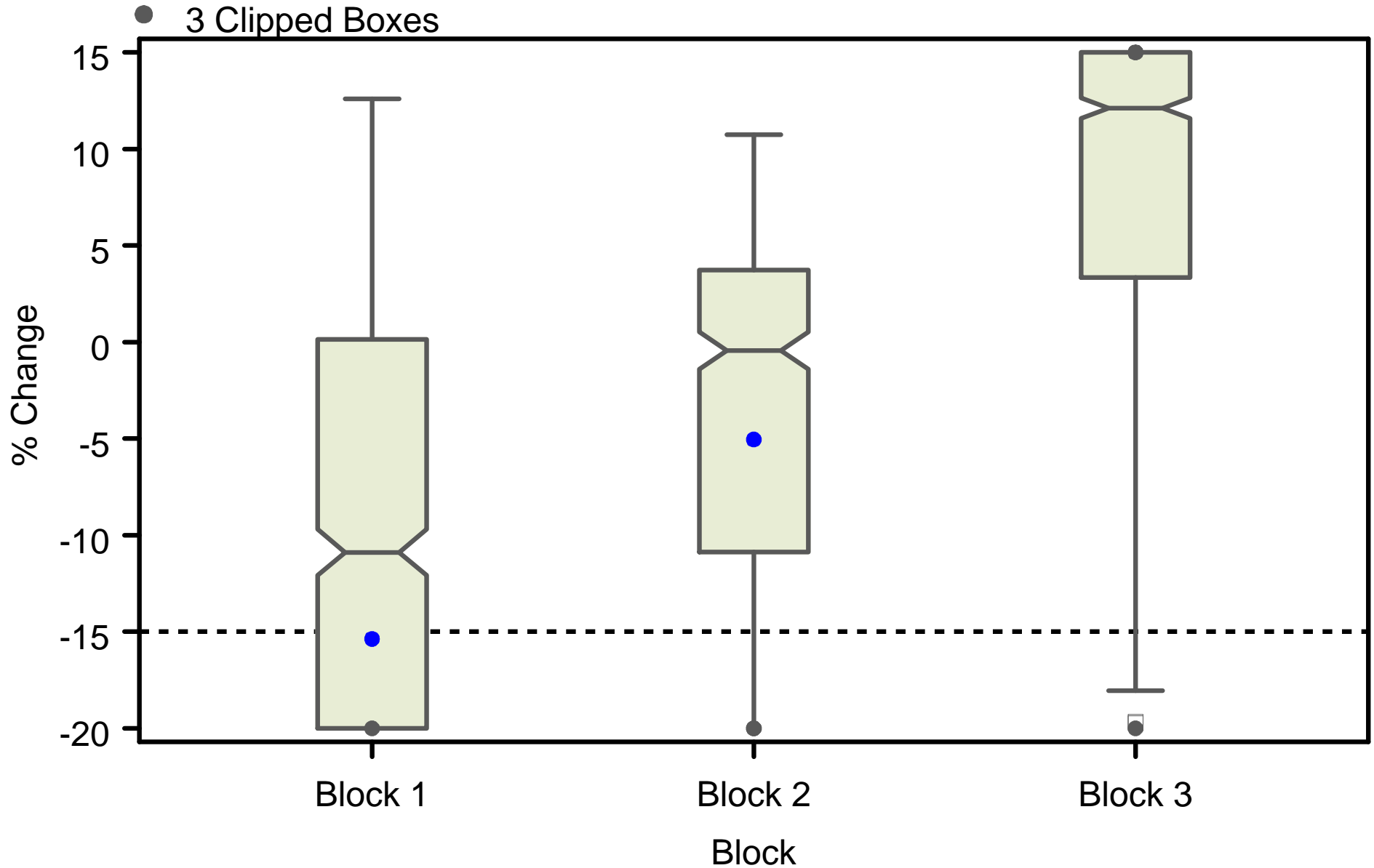

Period of Record: 1995-2004
Distribution of % Change in Abundance by Block
Species=*Palaemonetes intermedius* Scenario=Total adjust - NP - 10%

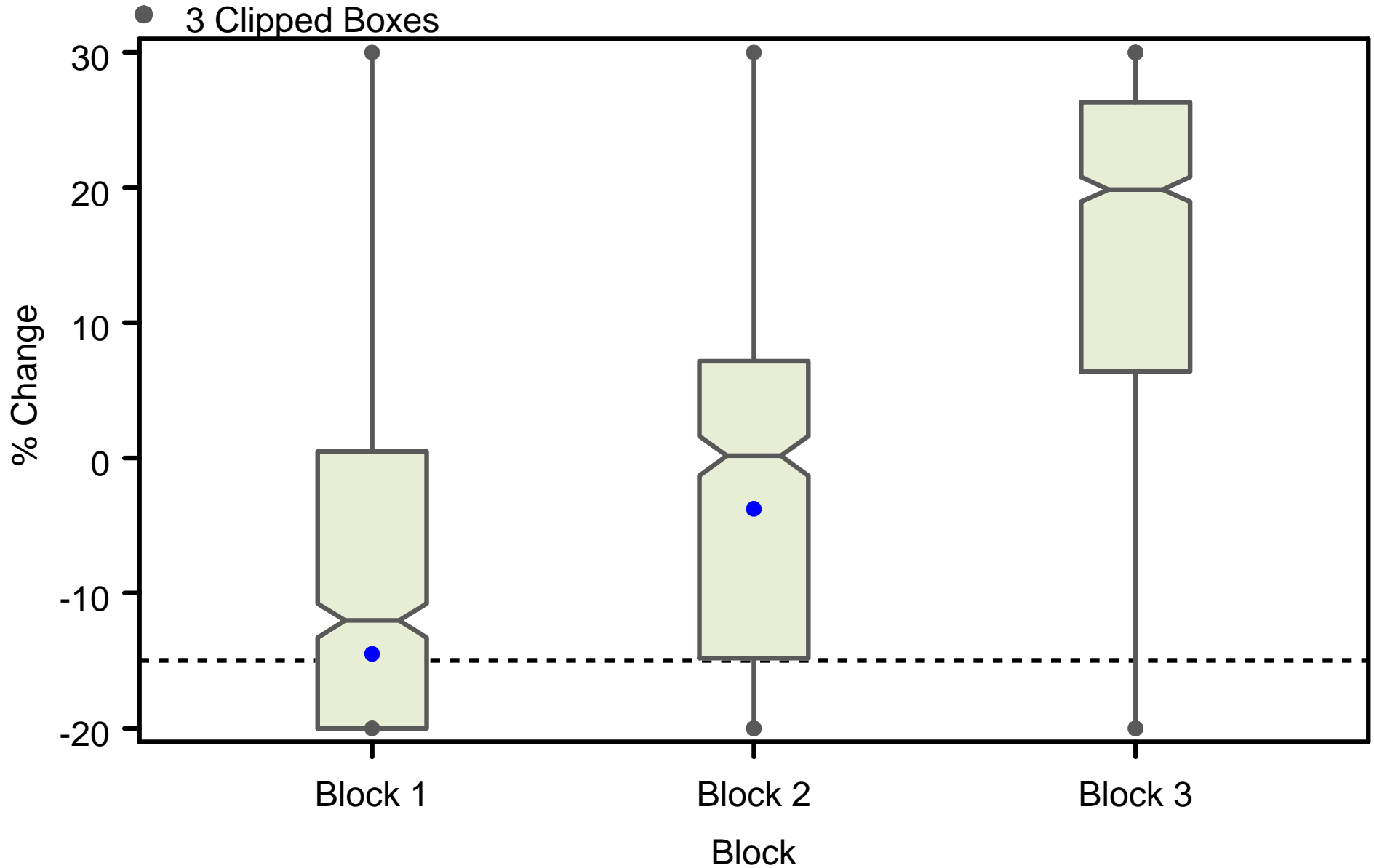

Period of Record: 1995-2004
Distribution of % Change in Abundance by Block
Species=*Palaemonetes intermedius* Scenario=Total adjust - NP - 15%

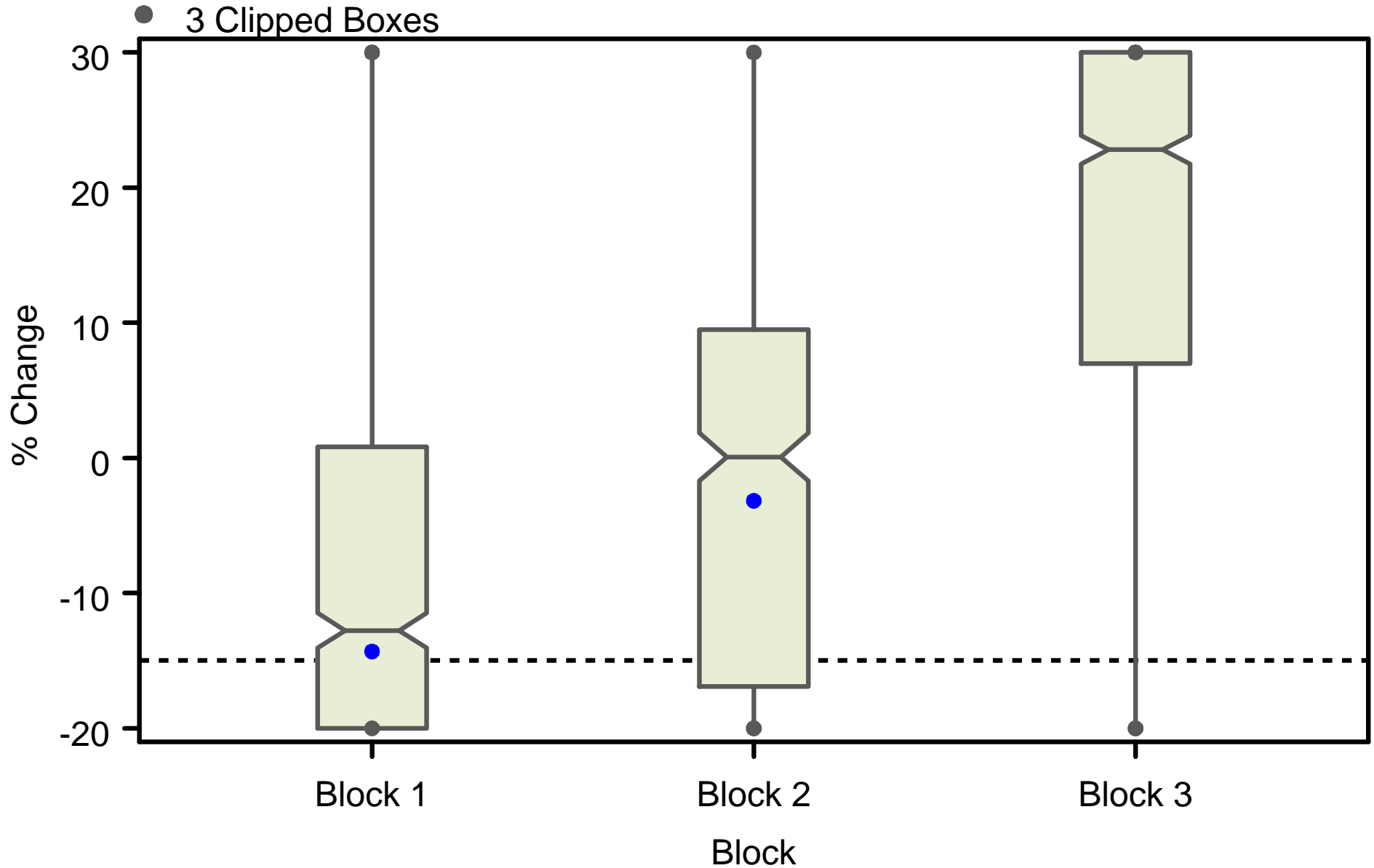

Period of Record: 1995-2004
Distribution of % Change in Abundance by Block
Species=*Palaemonetes intermedius* Scenario=Total adjust - NP - 20%

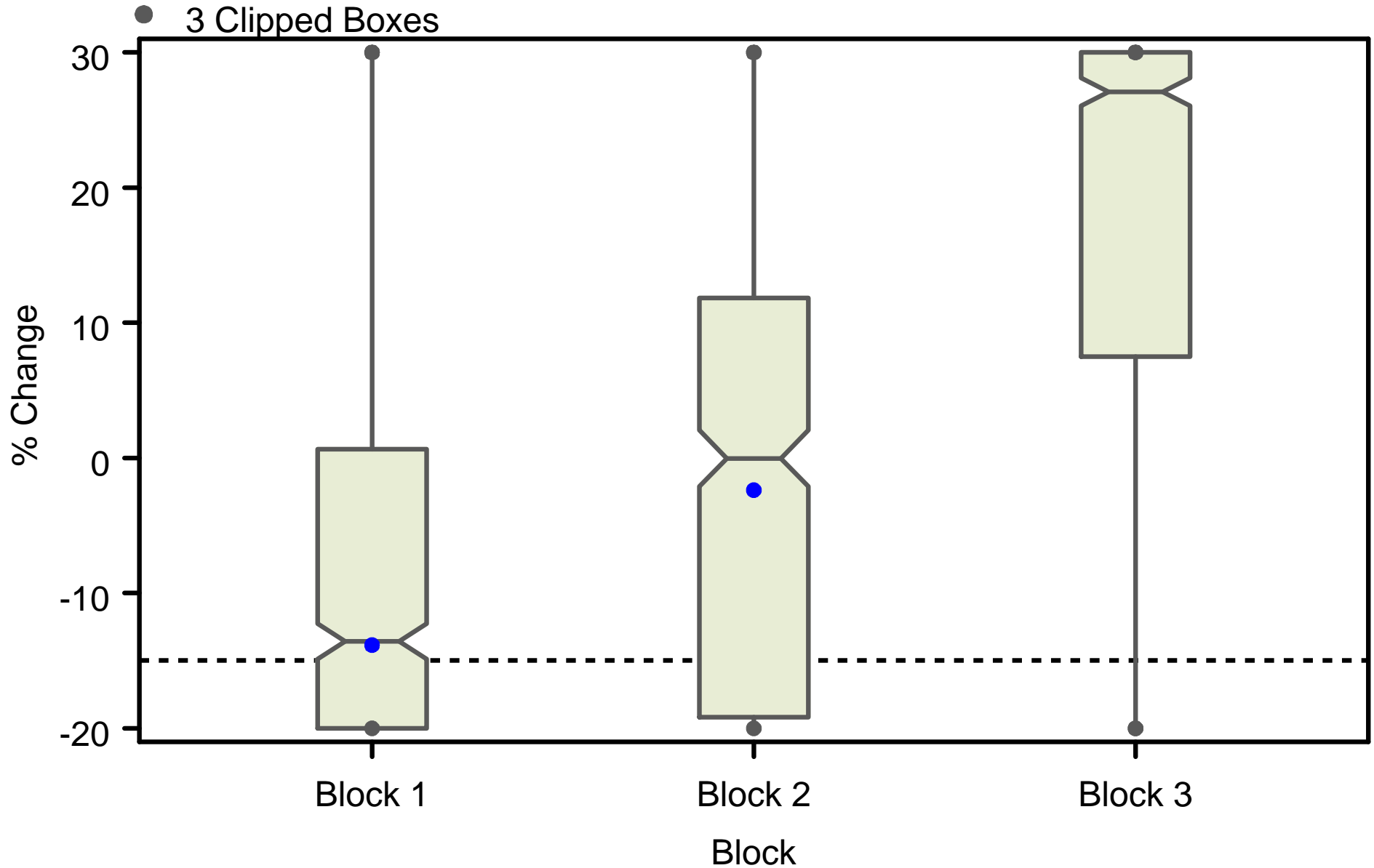

Period of Record: 1995-2004
Distribution of % Change in Abundance by Block
Species=Menidia spp. juveniles Scenario=Northport (NP)

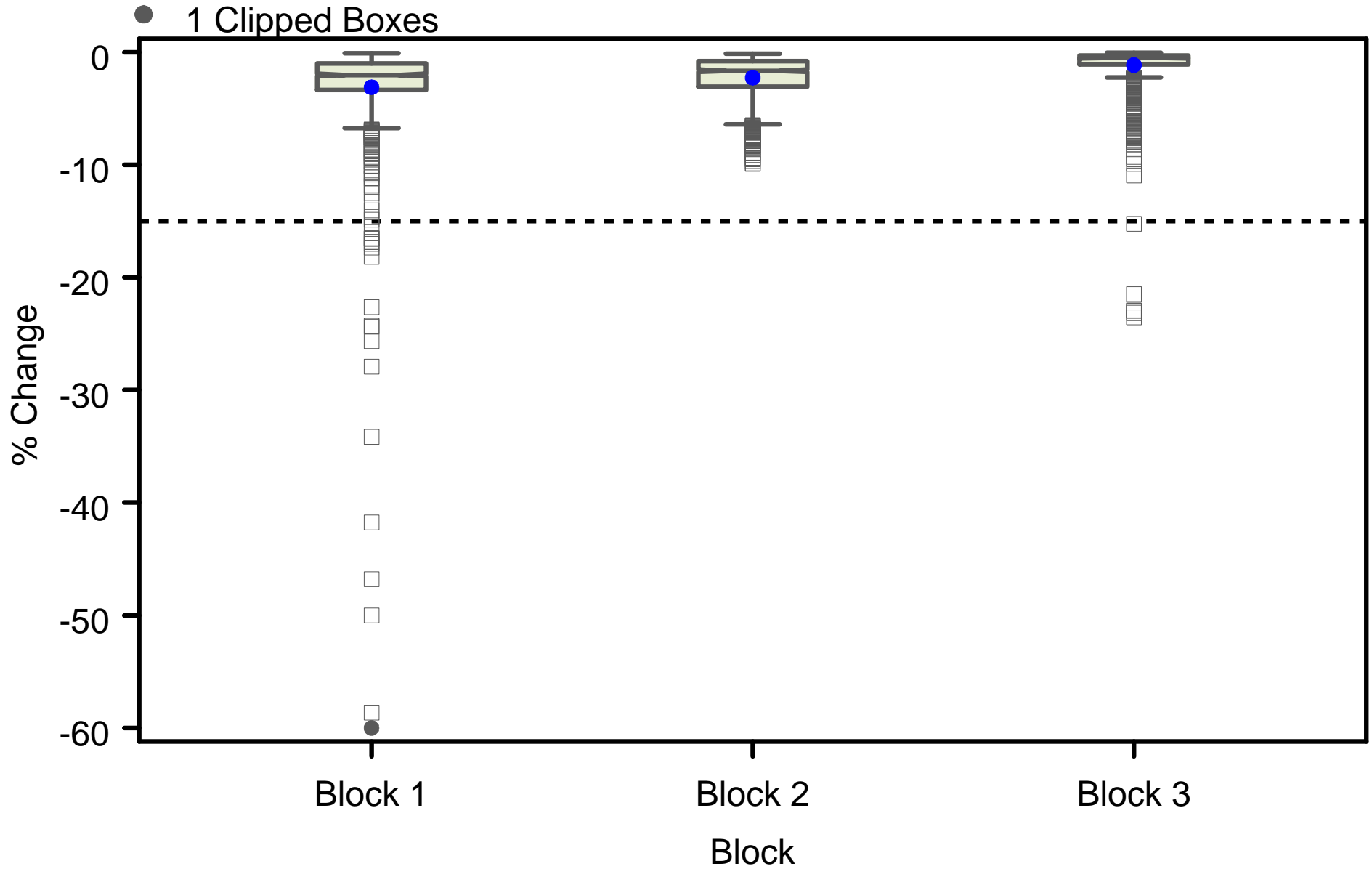

Period of Record: 1995-2004
Distribution of % Change in Abundance by Block
Species=Menidia spp. juveniles Scenario=Ag adjust

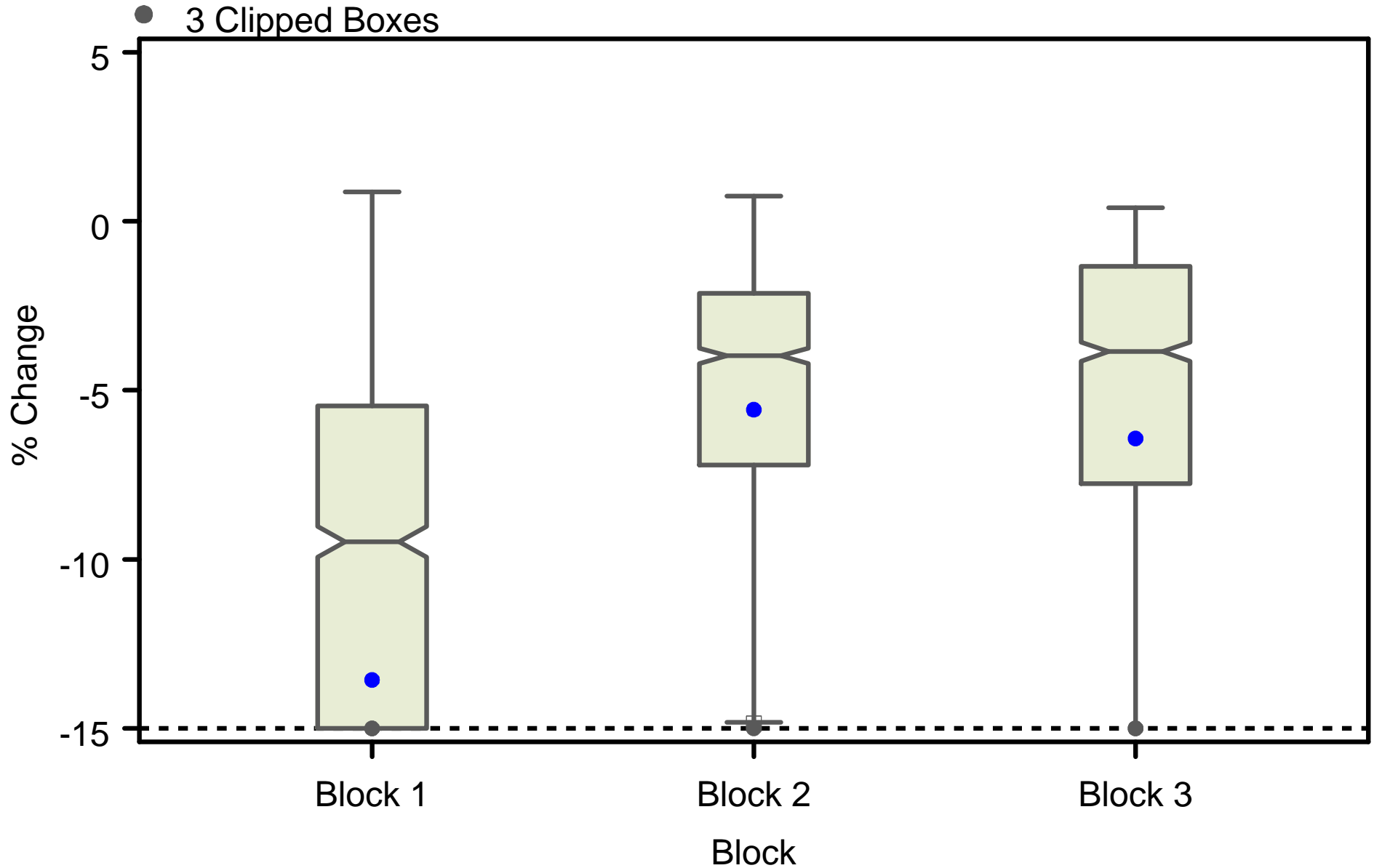

Period of Record: 1995-2004
Distribution of % Change in Abundance by Block
Species=Menidia spp. juveniles Scenario=Total adjust

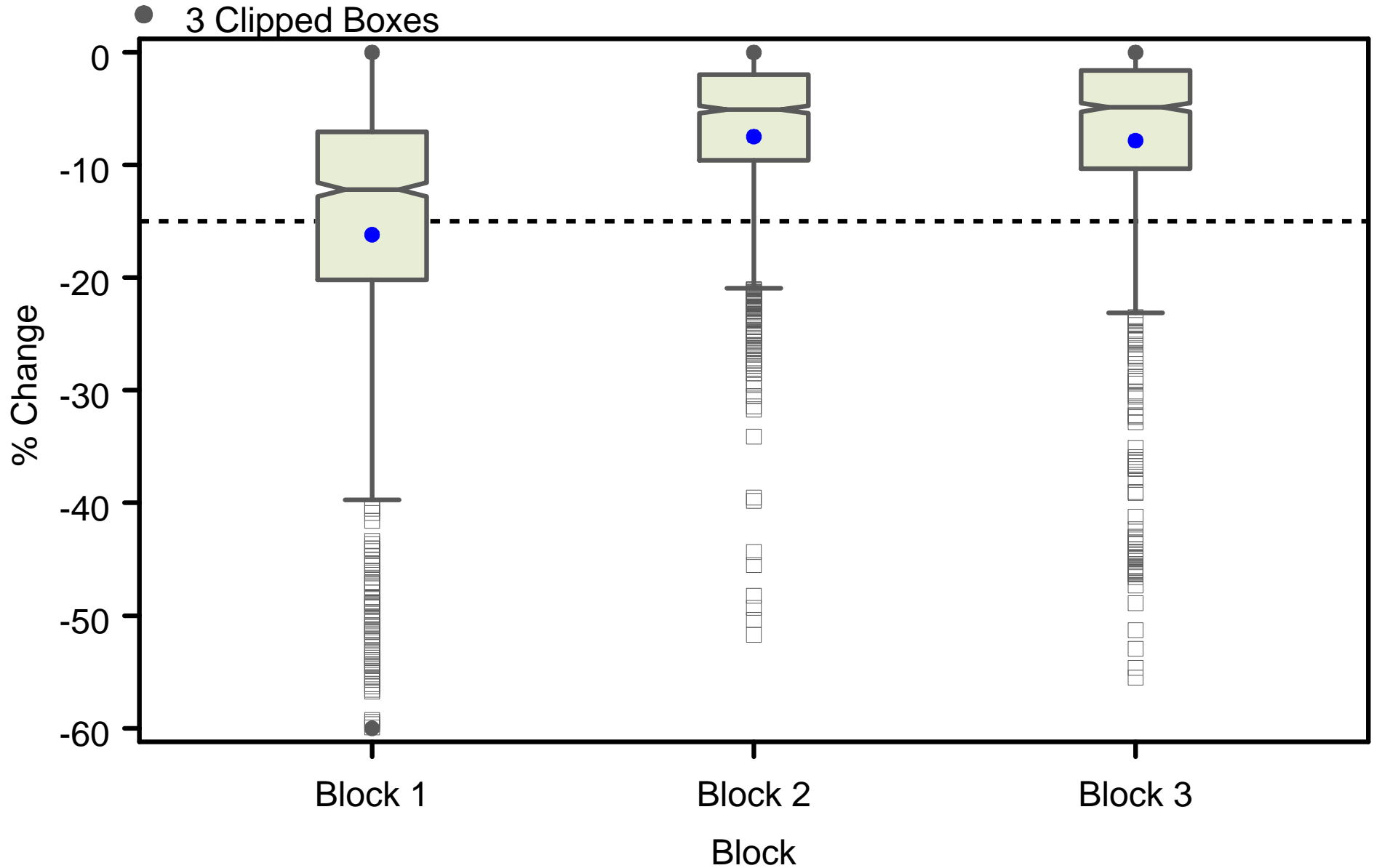

Period of Record: 1995-2004
Distribution of % Change in Abundance by Block
Species=Menidia spp. juveniles Scenario=Total adjust - NP

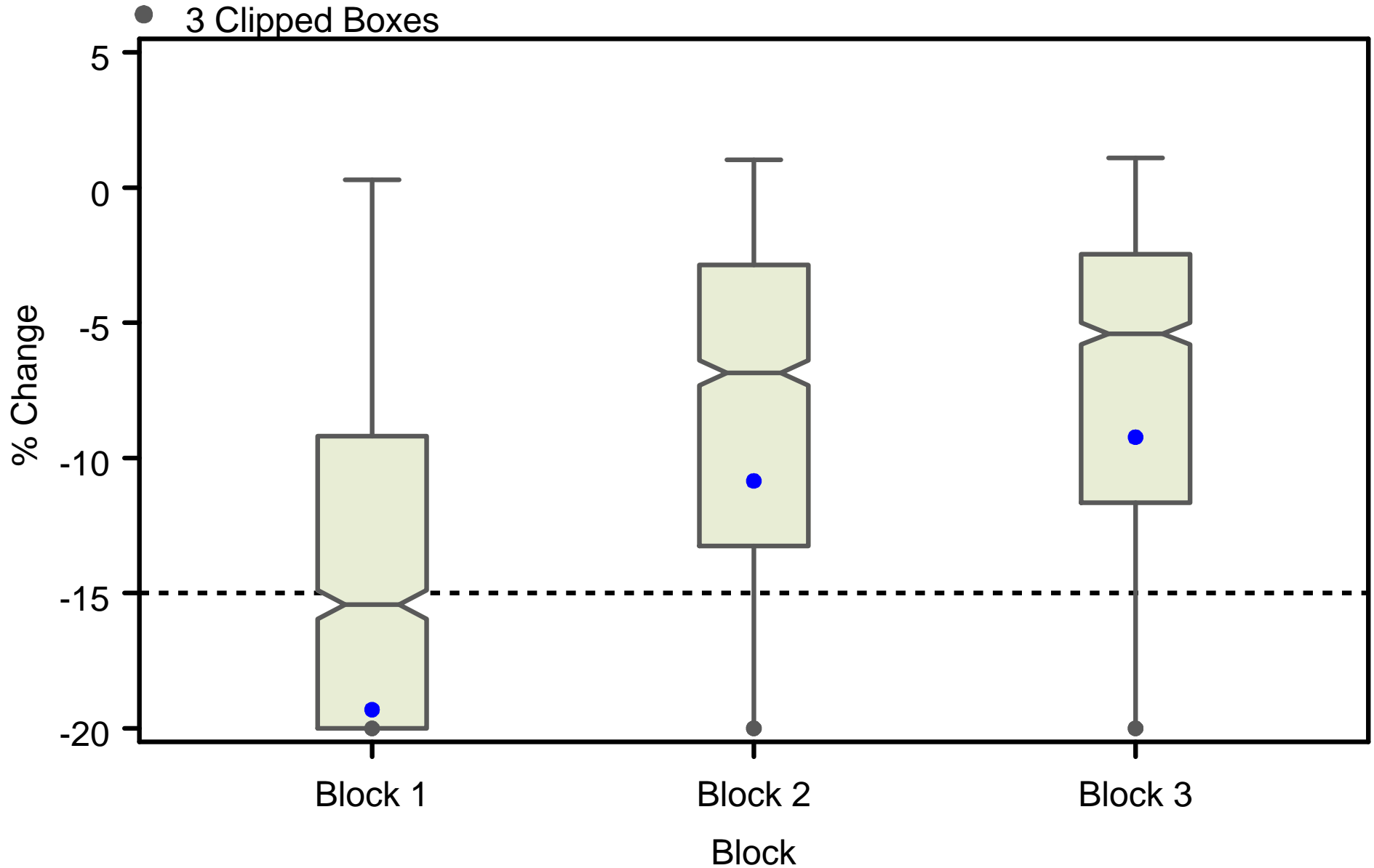

Period of Record: 1995-2004
Distribution of % Change in Abundance by Block
Species=Menidia spp. juveniles Scenario=Total adjust - NP - 10%

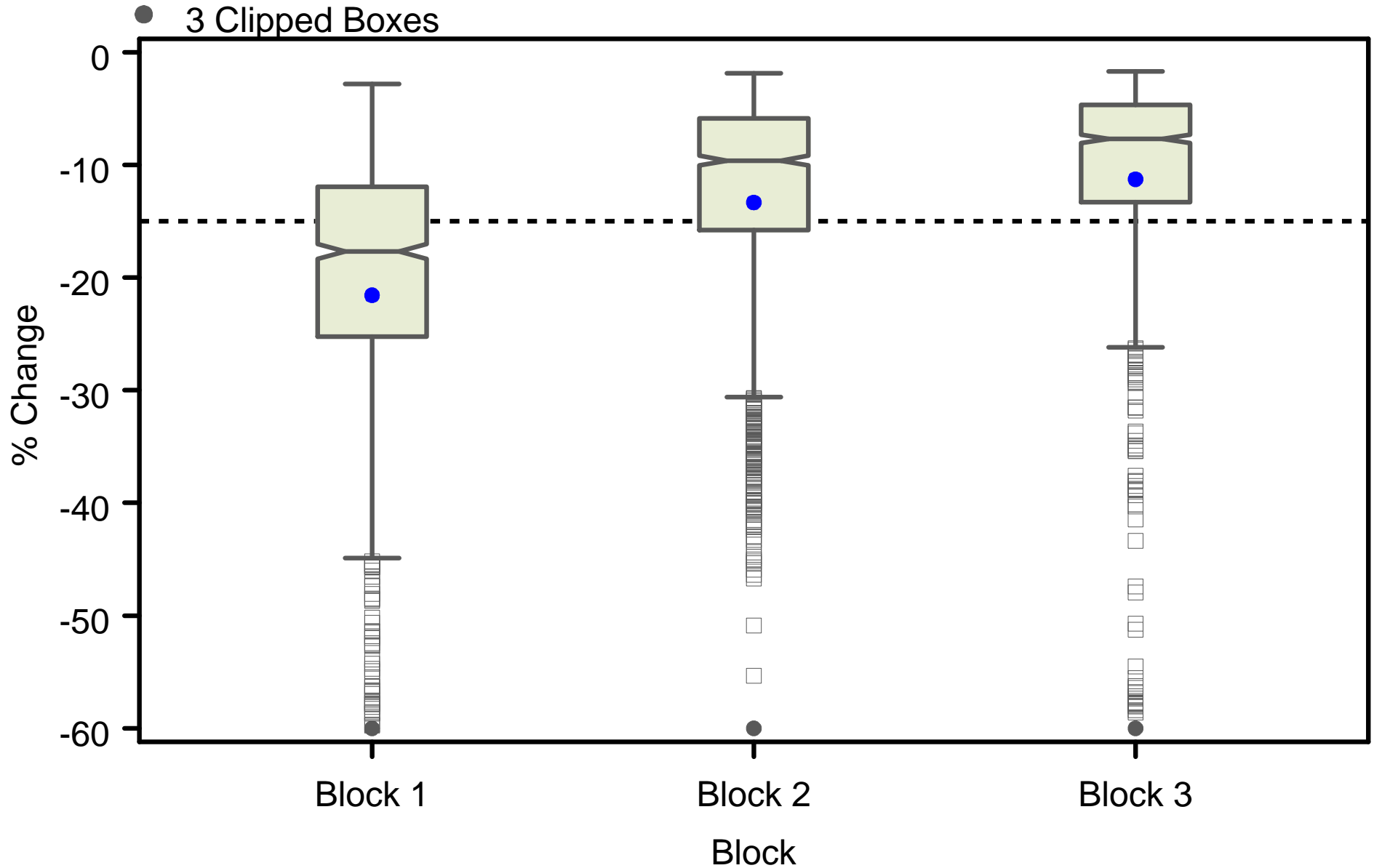

Period of Record: 1995-2004
Distribution of % Change in Abundance by Block
Species=Menidia spp. juveniles Scenario=Total adjust - NP - 15%

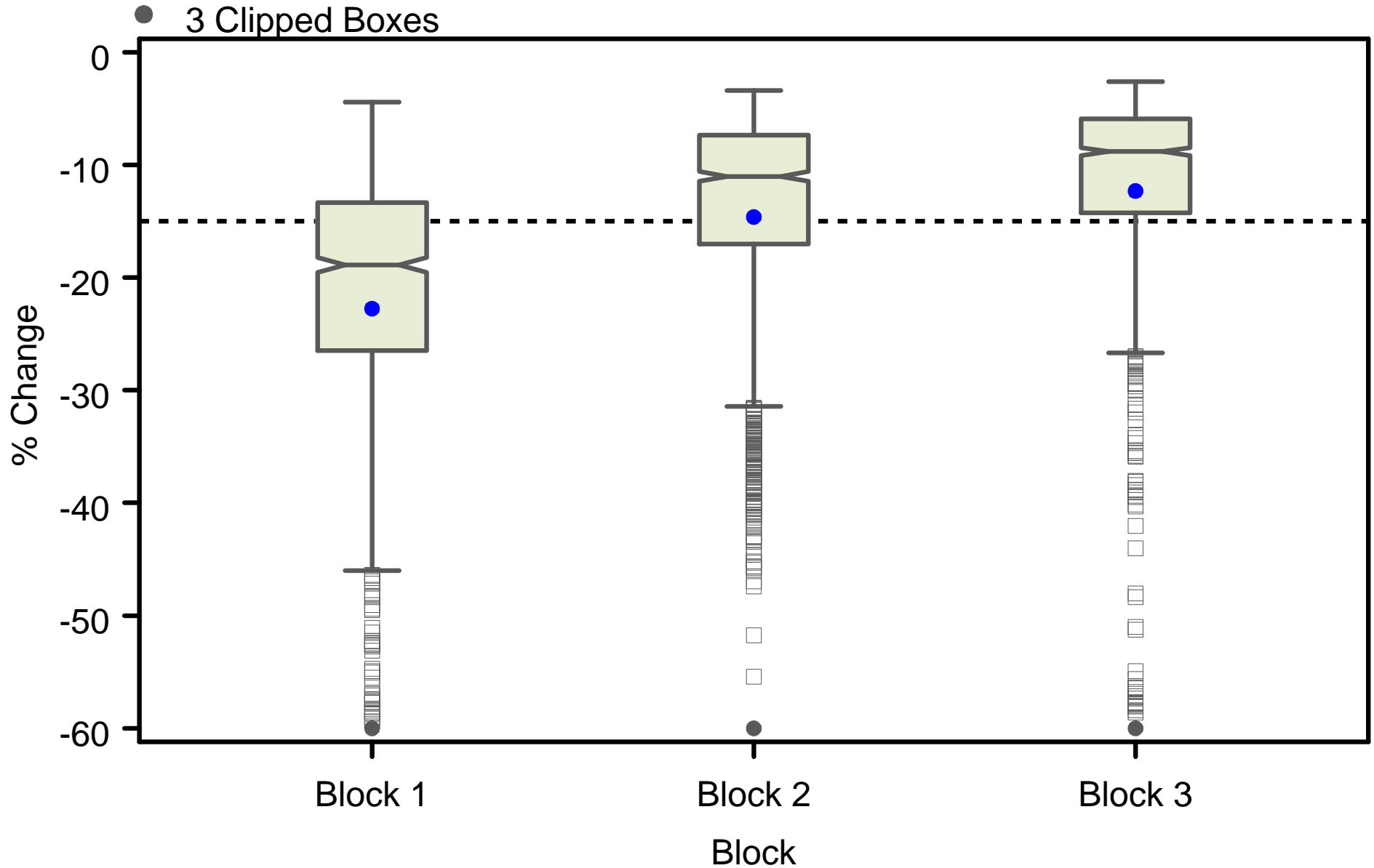

Period of Record: 1995-2004
Distribution of % Change in Abundance by Block
Species=Menidia spp. juveniles Scenario=Total adjust - NP - 20%

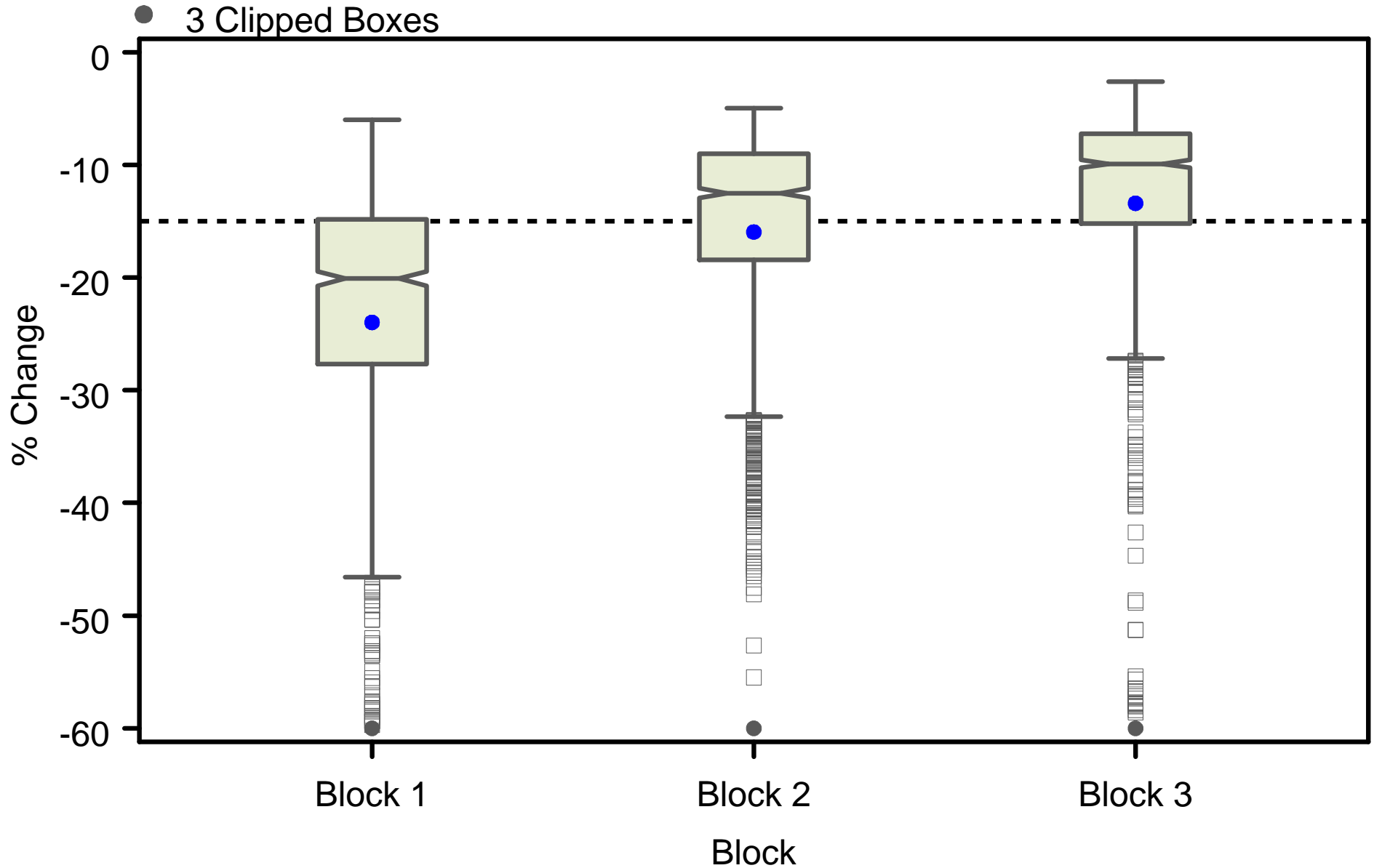

Period of Record: 1995-2004
Distribution of % Change in Abundance by Block
Species=Palaemonetes pugio Scenario=Northport (NP)

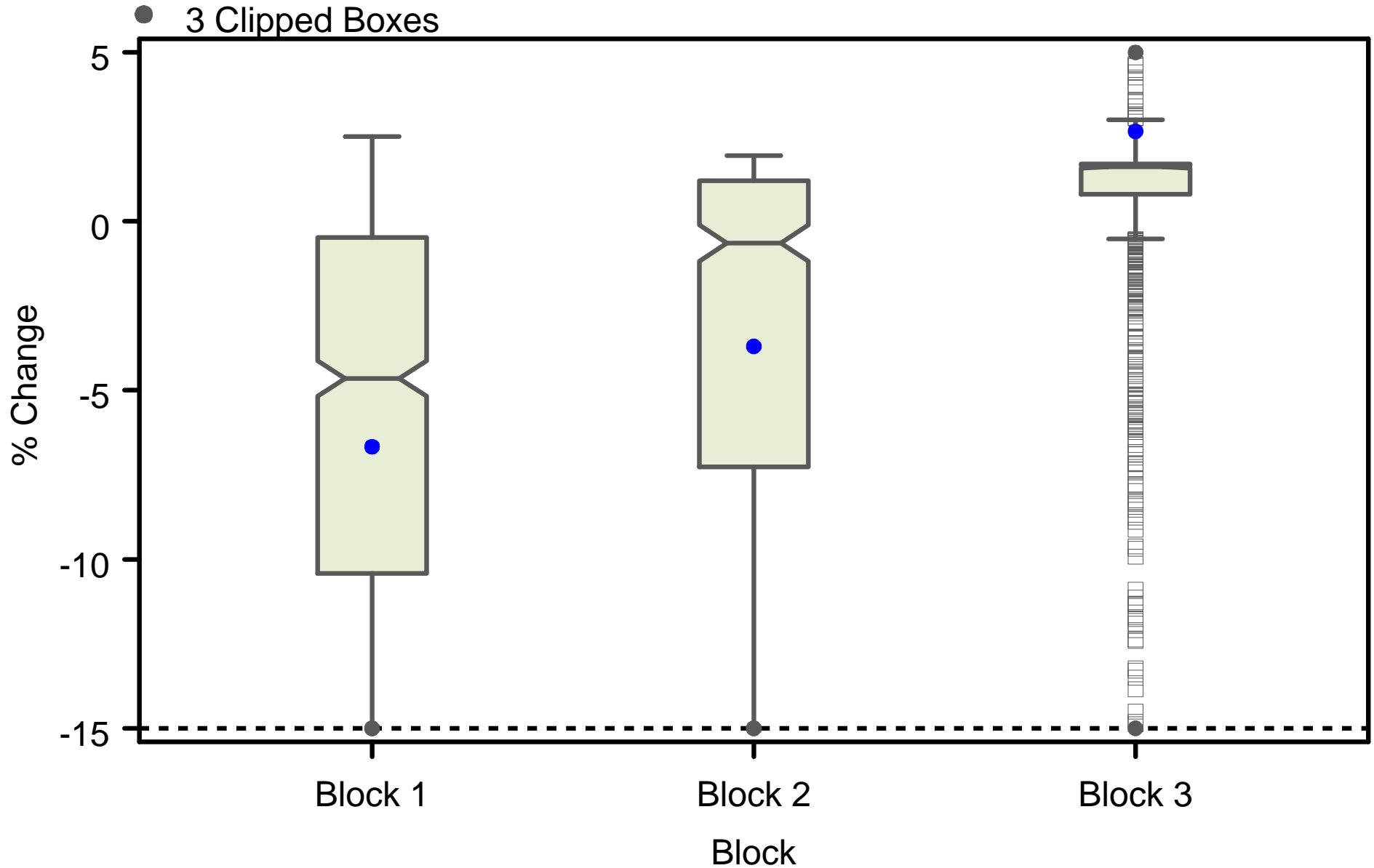

Period of Record: 1995-2004
Distribution of % Change in Abundance by Block
Species=*Palaemonetes pugio* Scenario=Ag adjust

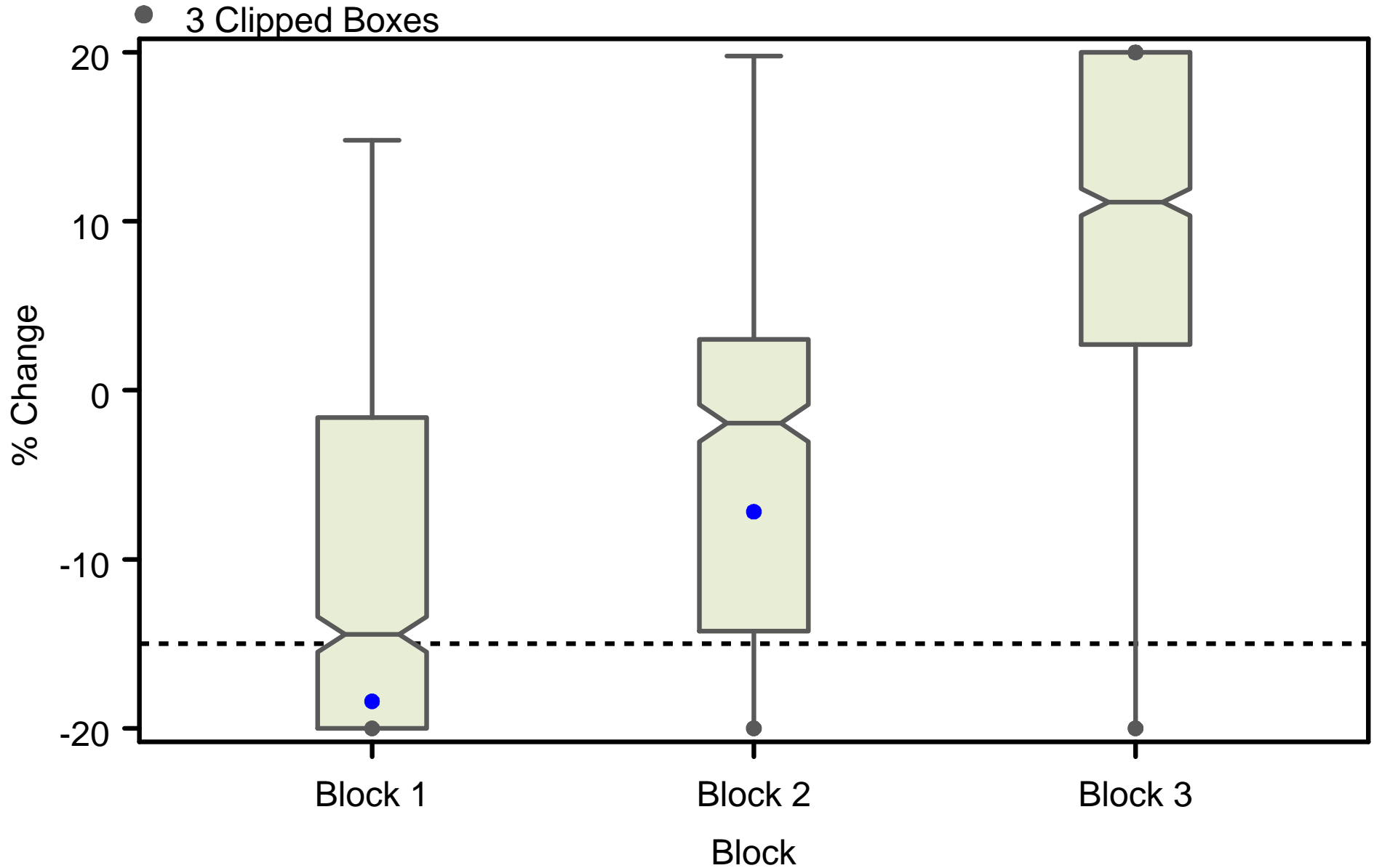

Period of Record: 1995-2004
Distribution of % Change in Abundance by Block
Species=Palaemonetes pugio Scenario=Total adjust

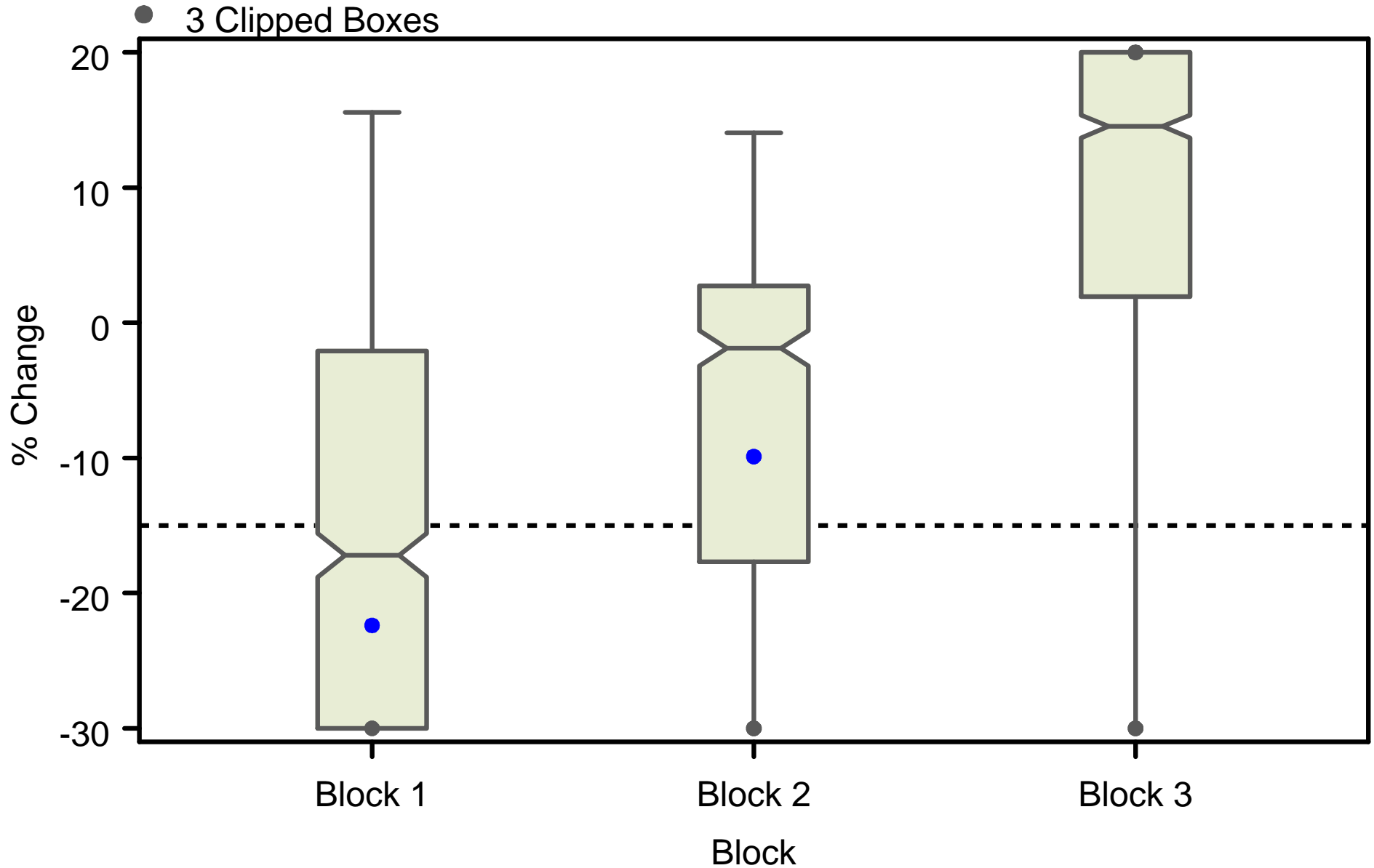

Period of Record: 1995-2004
Distribution of % Change in Abundance by Block
Species=Palaemonetes pugio Scenario=Total adjust - NP

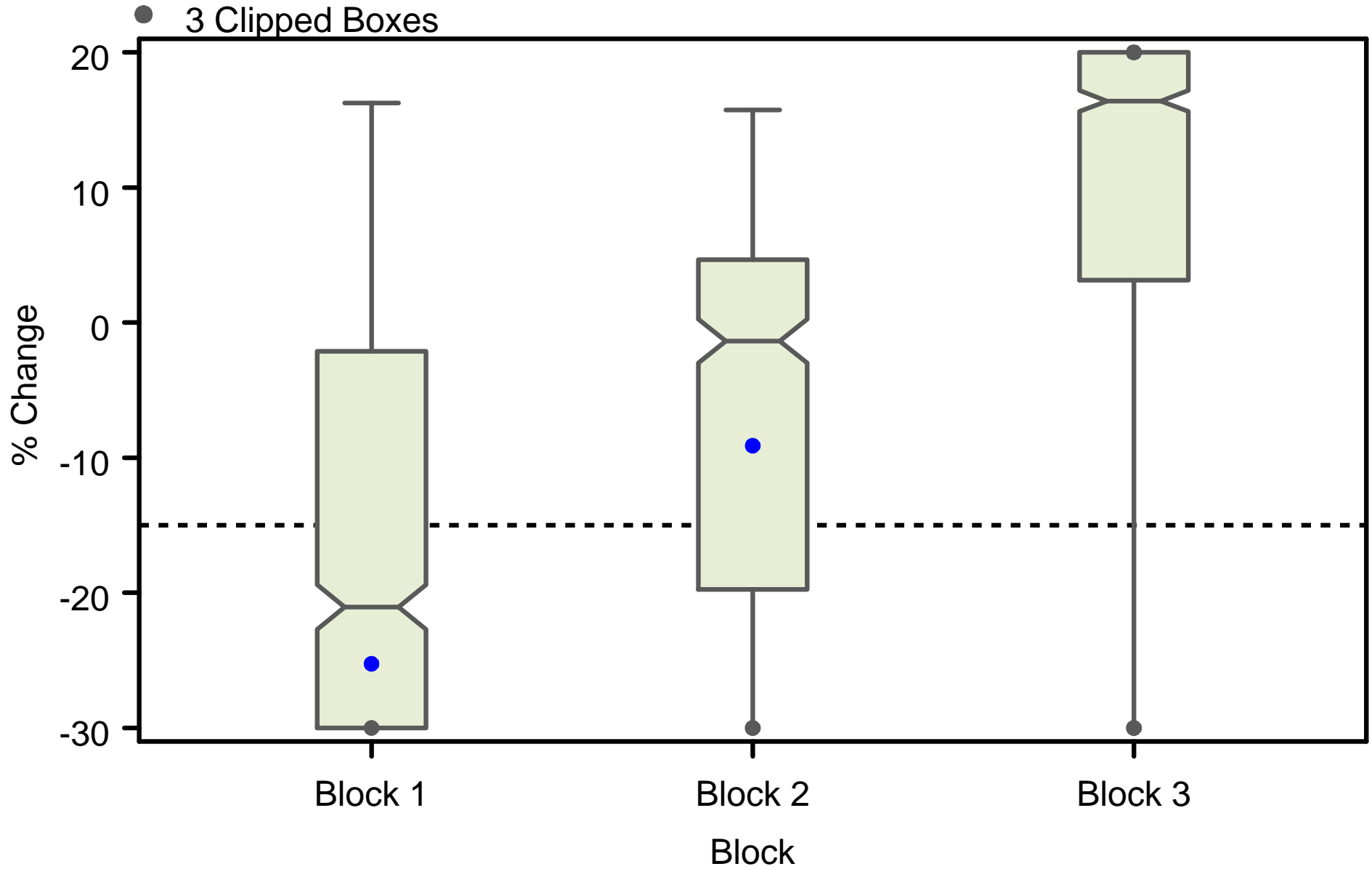

Period of Record: 1995-2004
Distribution of % Change in Abundance by Block
Species=*Palaemonetes pugio* Scenario=Total adjust - NP - 10%

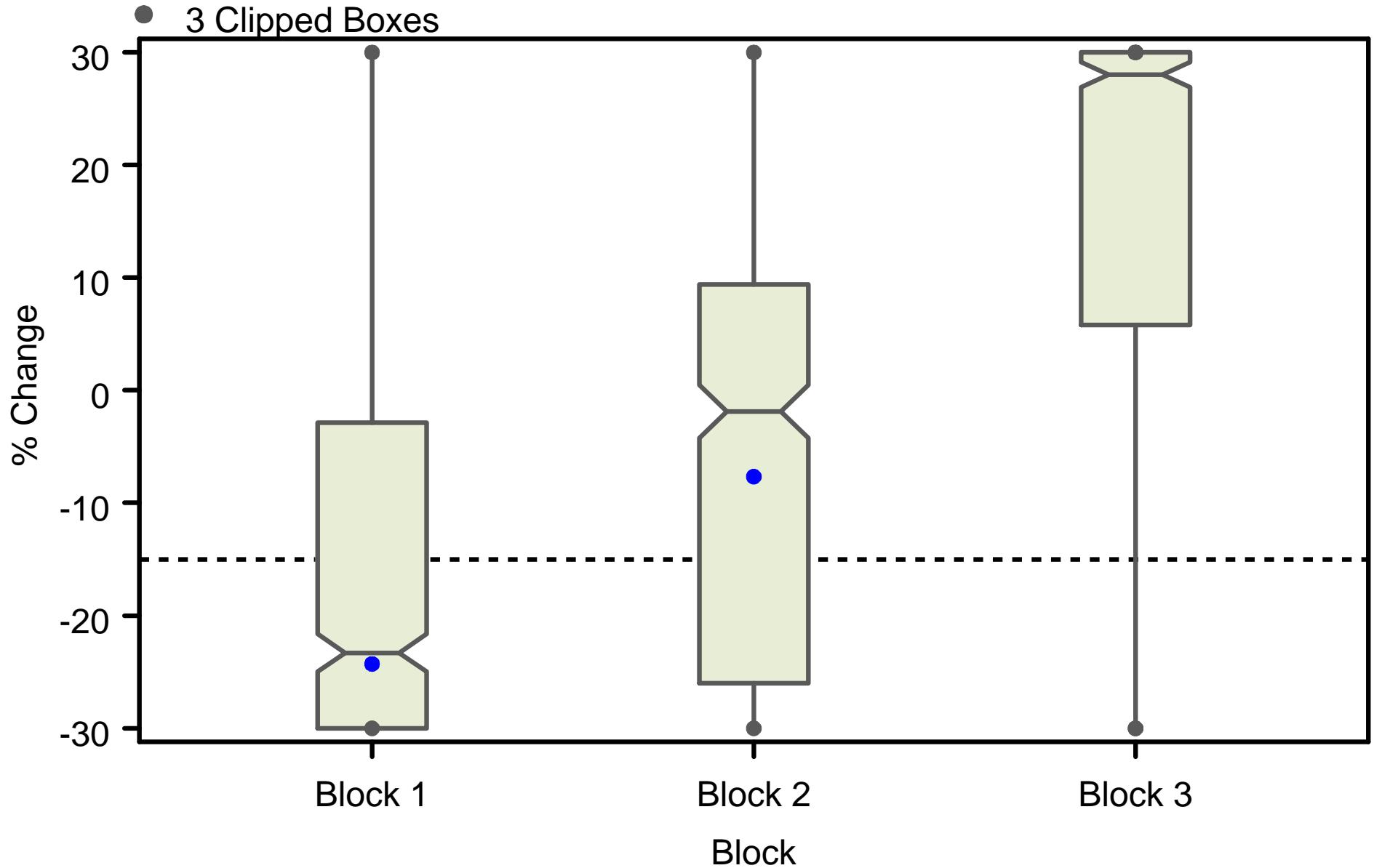

Period of Record: 1995-2004
Distribution of % Change in Abundance by Block
Species=*Palaemonetes pugio* Scenario=Total adjust - NP - 15%

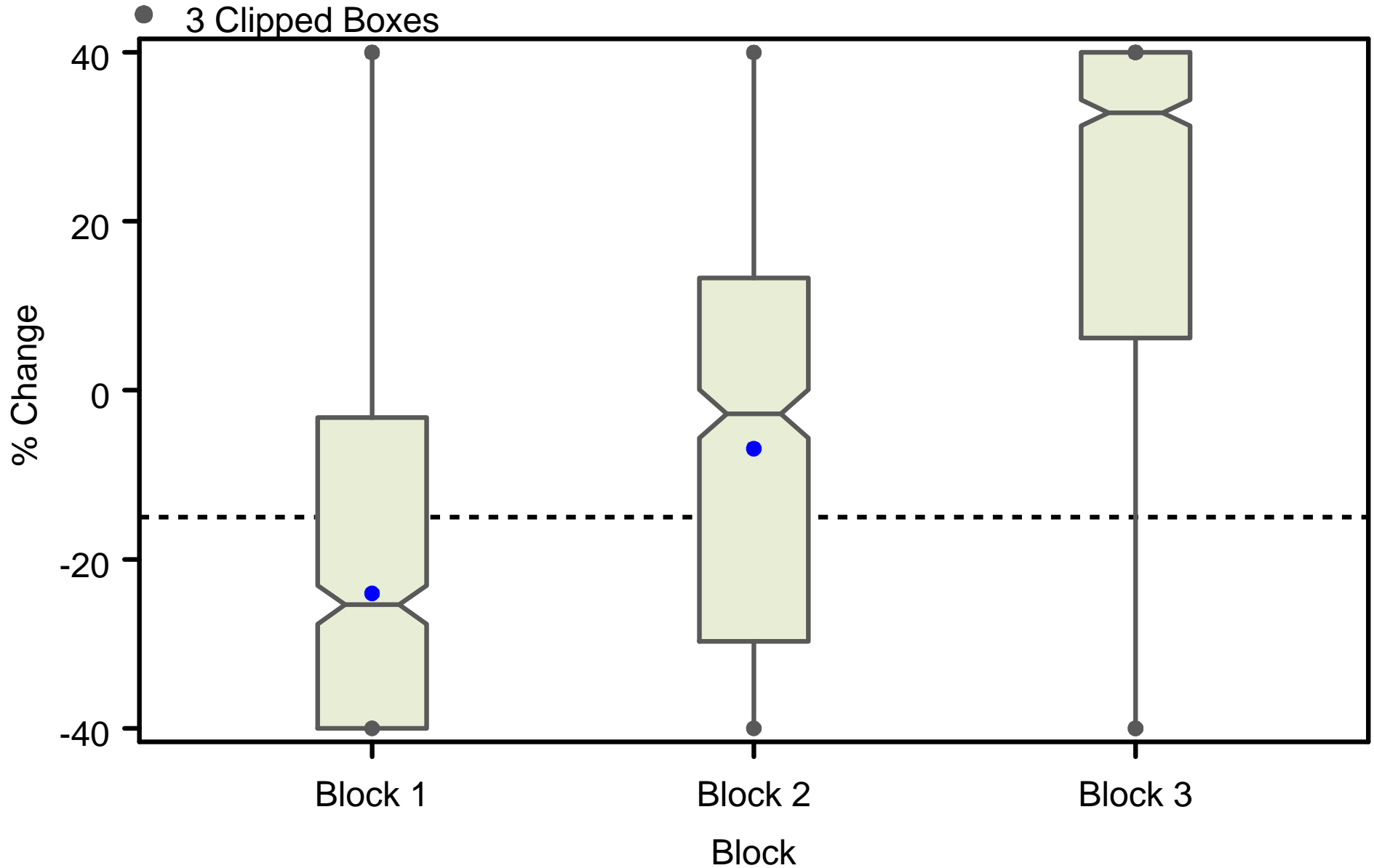

Period of Record: 1995-2004
Distribution of % Change in Abundance by Block
Species=*Palaemonetes pugio* Scenario=Total adjust - NP - 20%

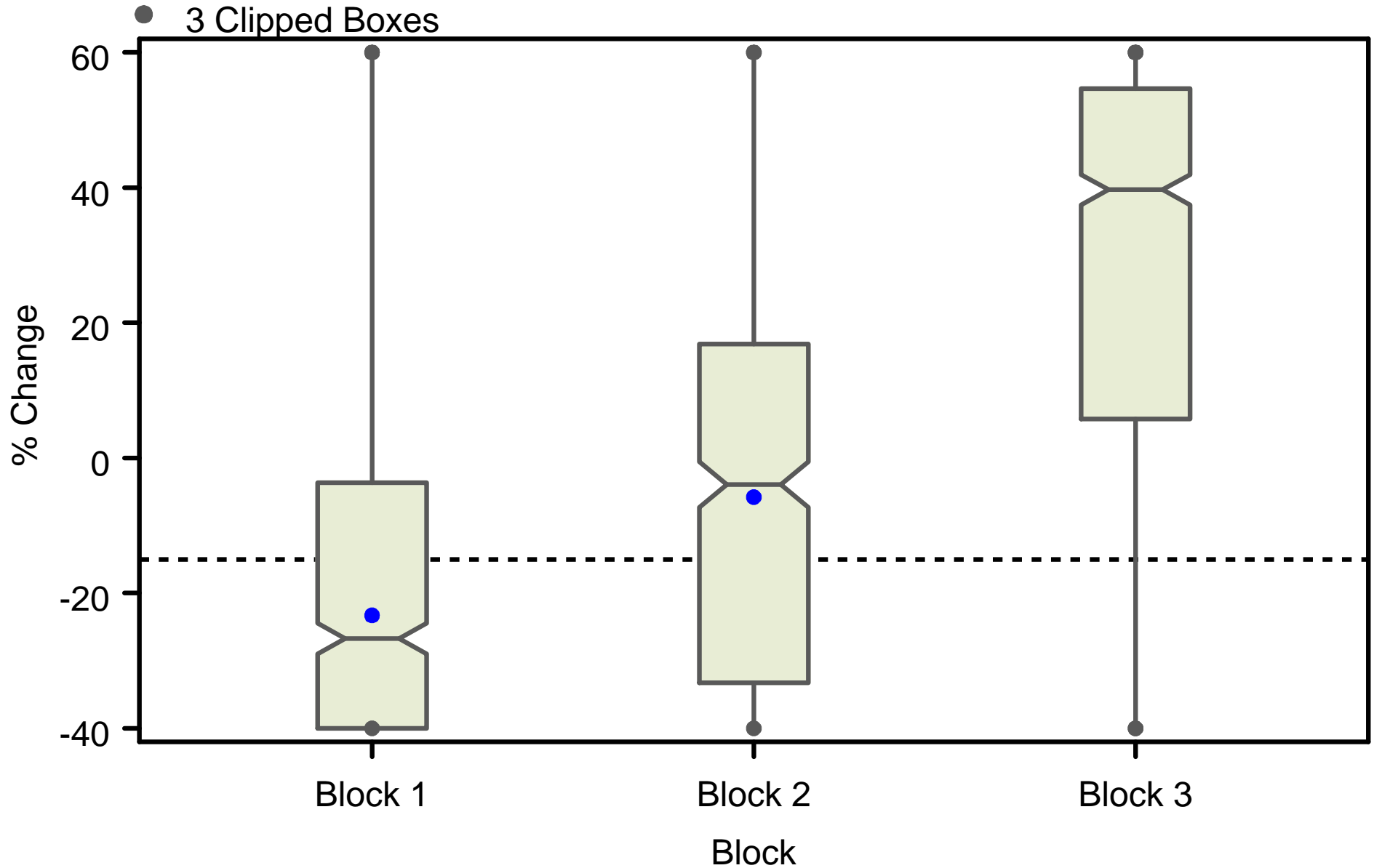

Period of Record: 1995-2004
Distribution of % Change in Abundance by Block
Species=*Tricnectes maculatus* juveniles Scenario=Northport (NP)

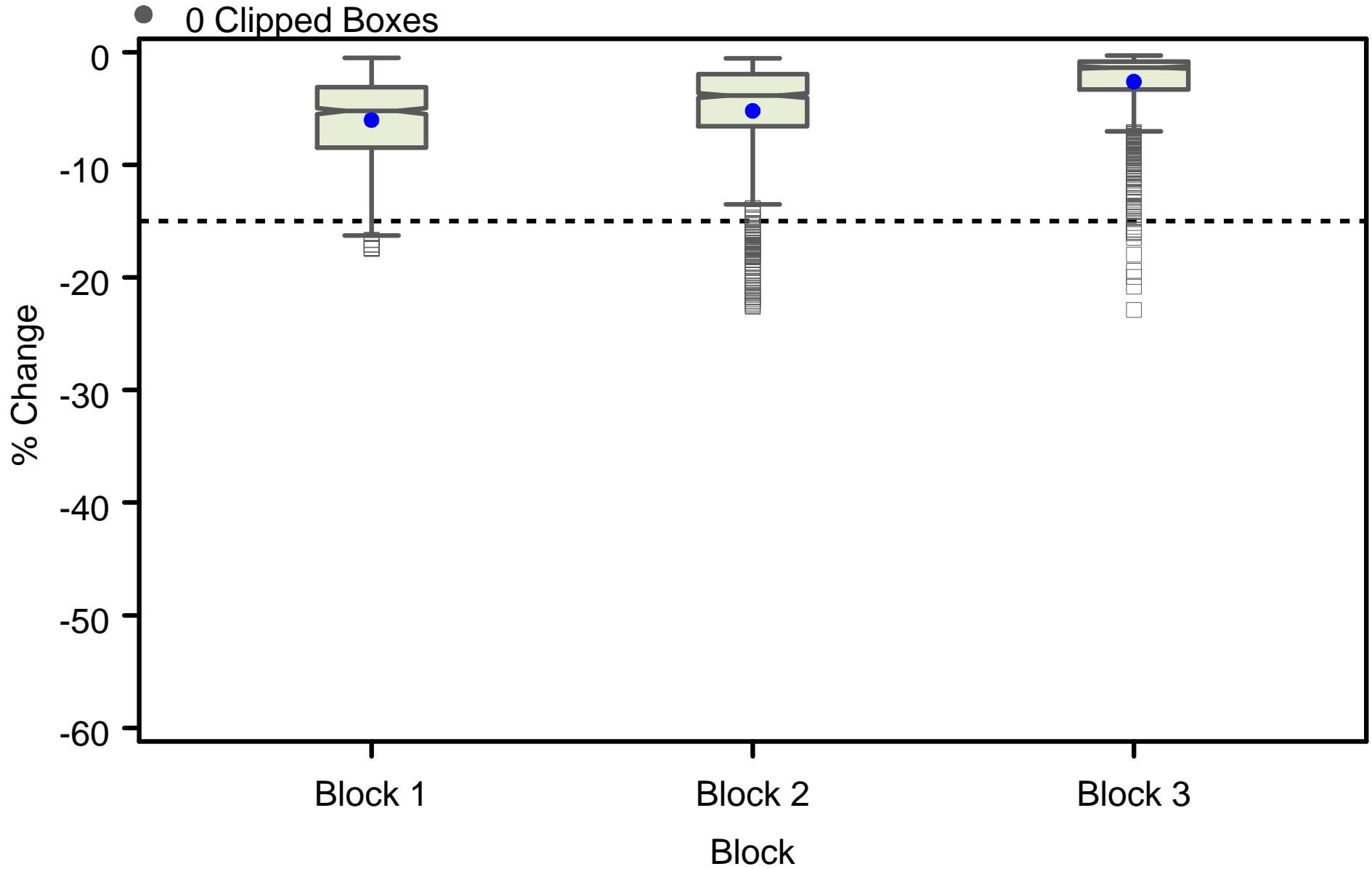

Period of Record: 1995-2004
Distribution of % Change in Abundance by Block
Species=Tricnectes maculatus juveniles Scenario=Ag adjust

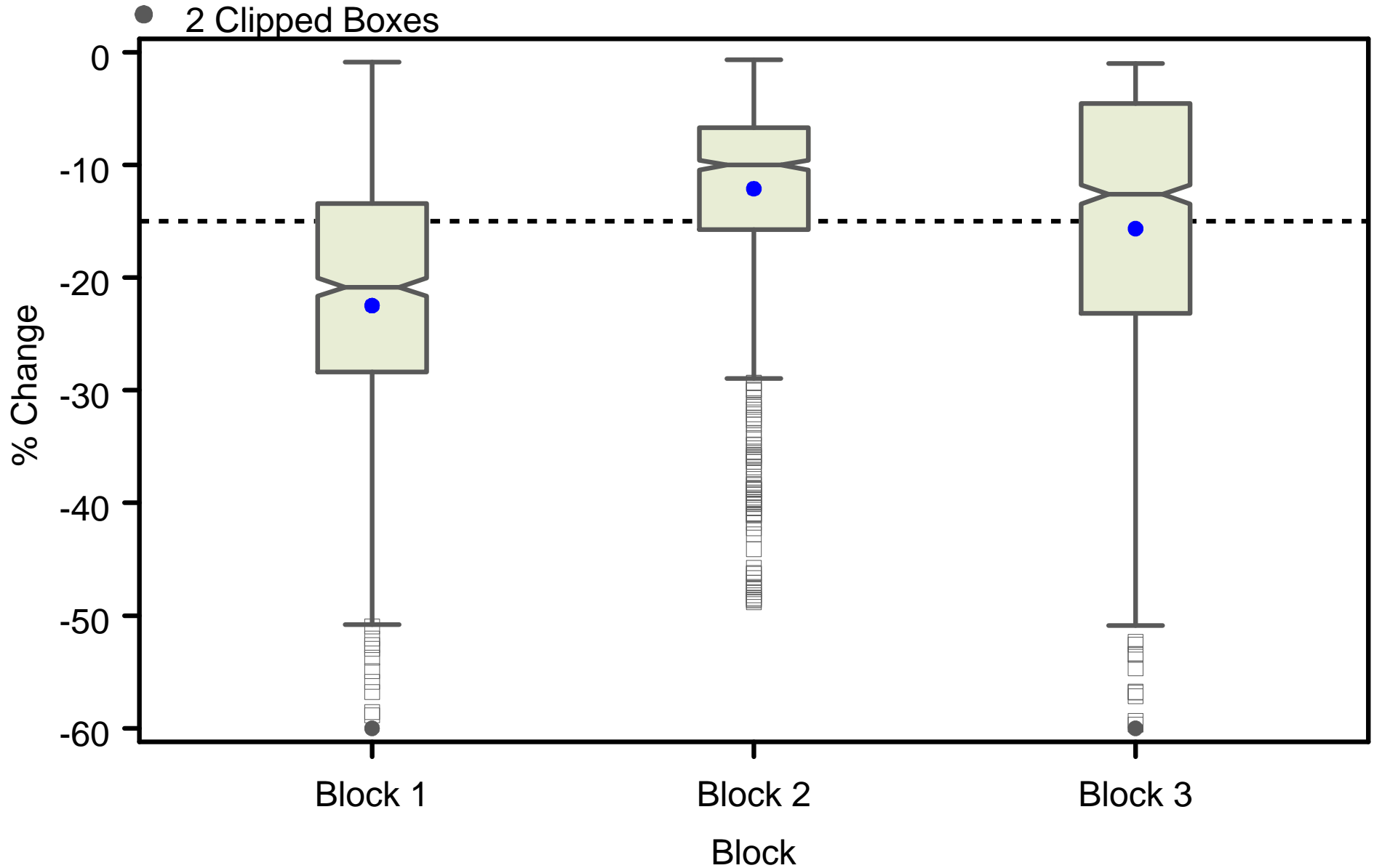

Period of Record: 1995-2004
Distribution of % Change in Abundance by Block
Species=*Tricnectes maculatus* juveniles Scenario=Total adjust

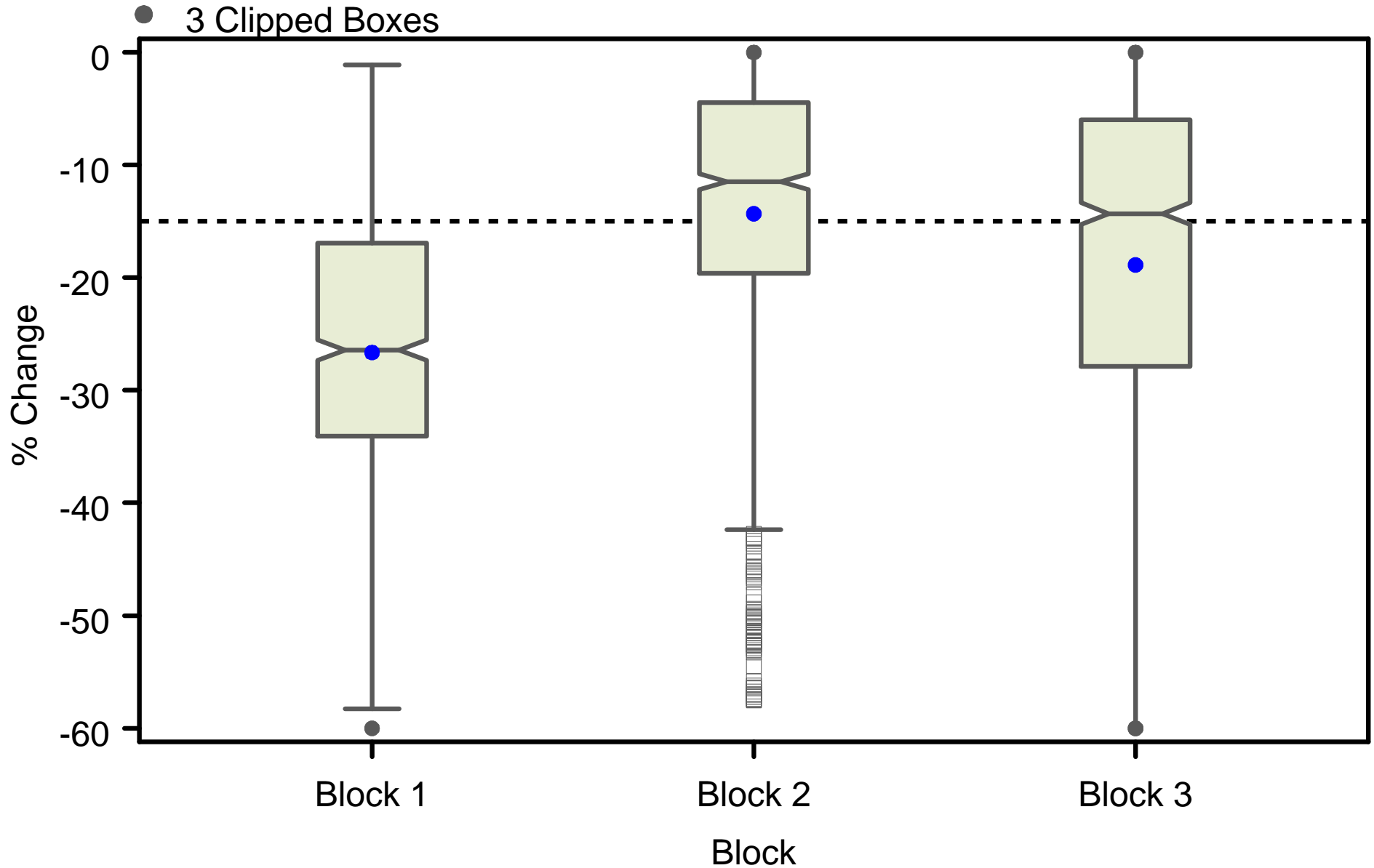

Period of Record: 1995-2004
Distribution of % Change in Abundance by Block
Species=Tricnectes maculatus juveniles Scenario=Total adjust - NP

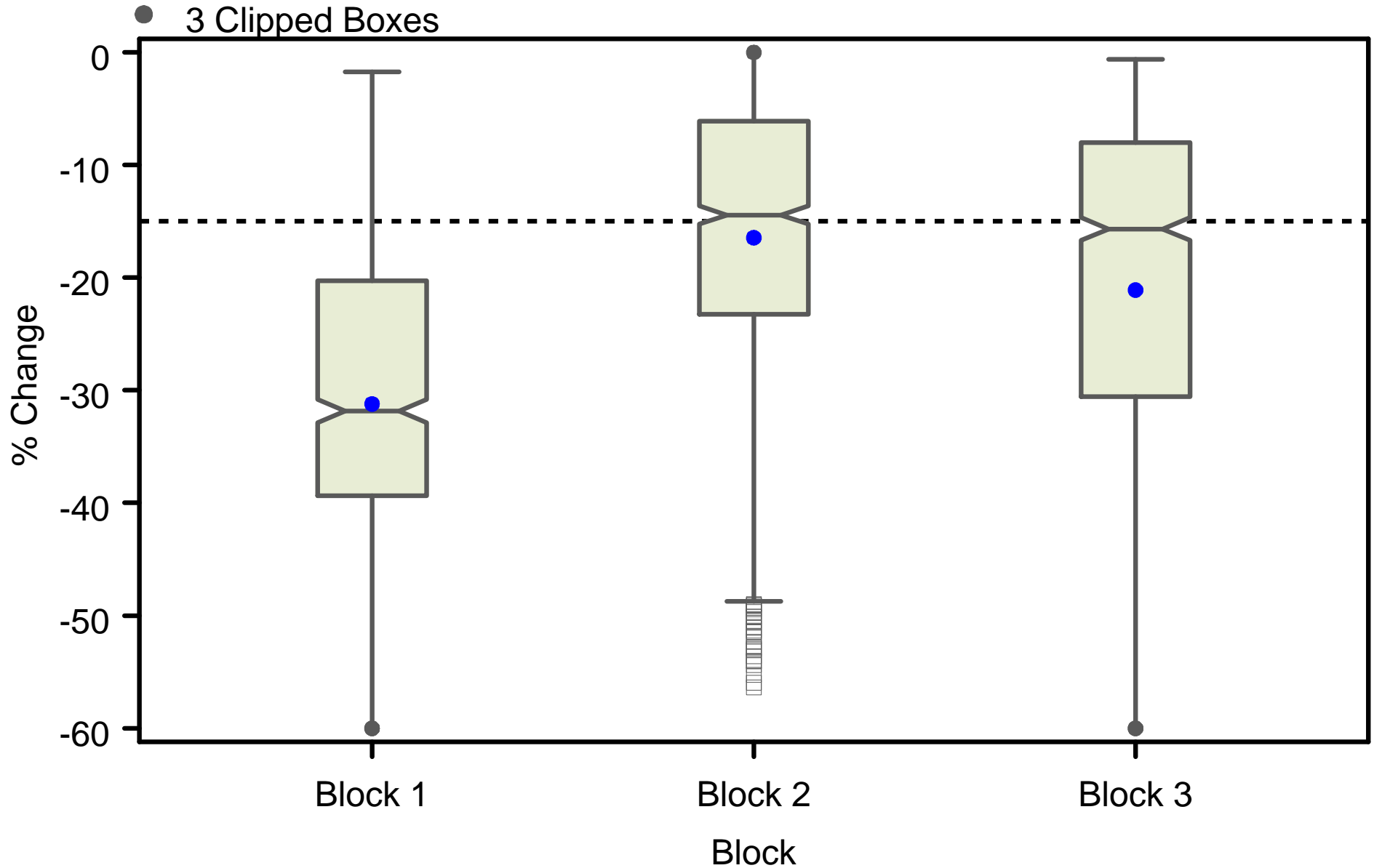

Period of Record: 1995-2004
Distribution of % Change in Abundance by Block
Species=Tricnectes maculatus juveniles Scenario=Total adjust - NP - 10%

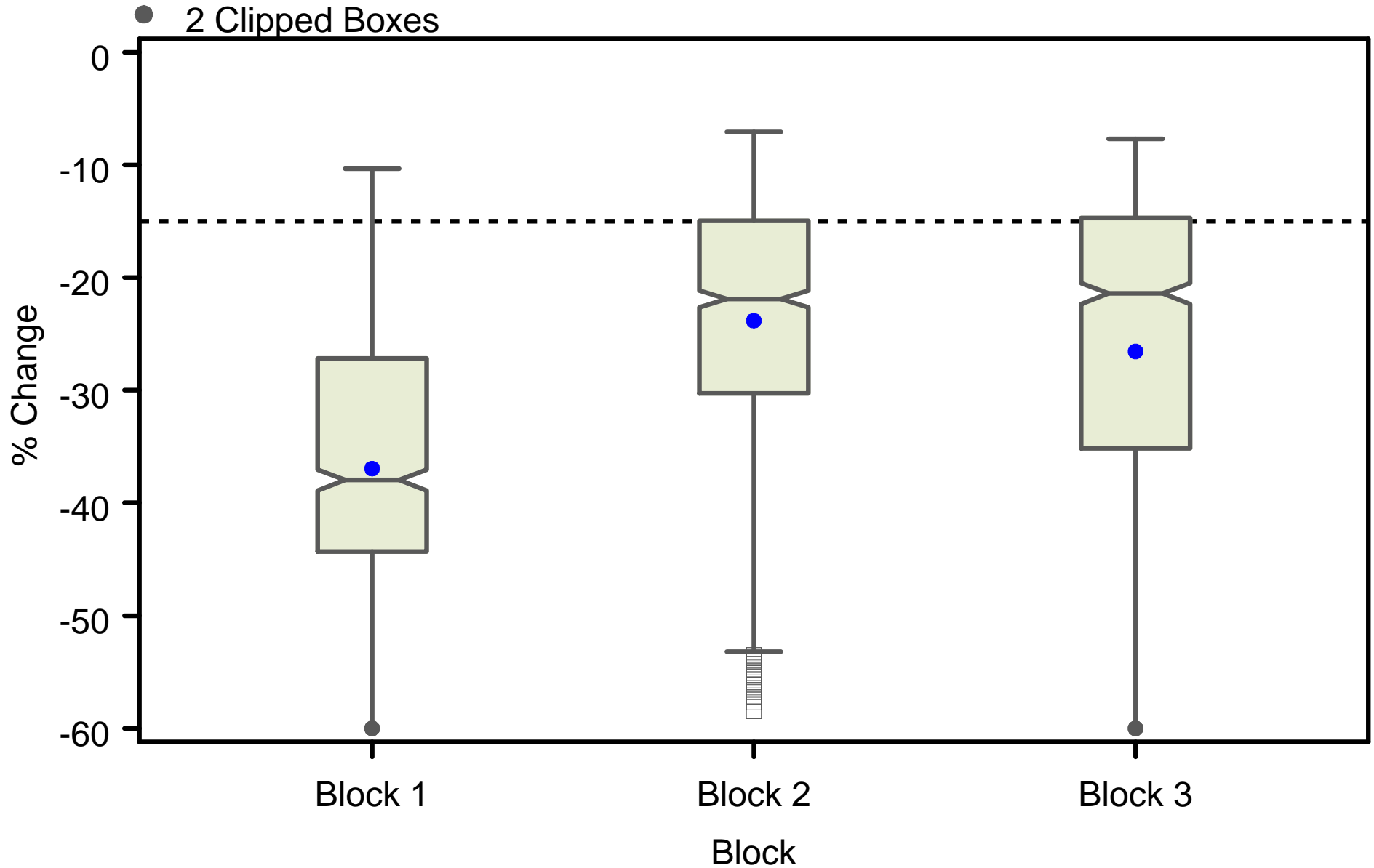

Period of Record: 1995-2004
Distribution of % Change in Abundance by Block

Species=Tricnectes maculatus juveniles Scenario=Total adjust - NP - 15%

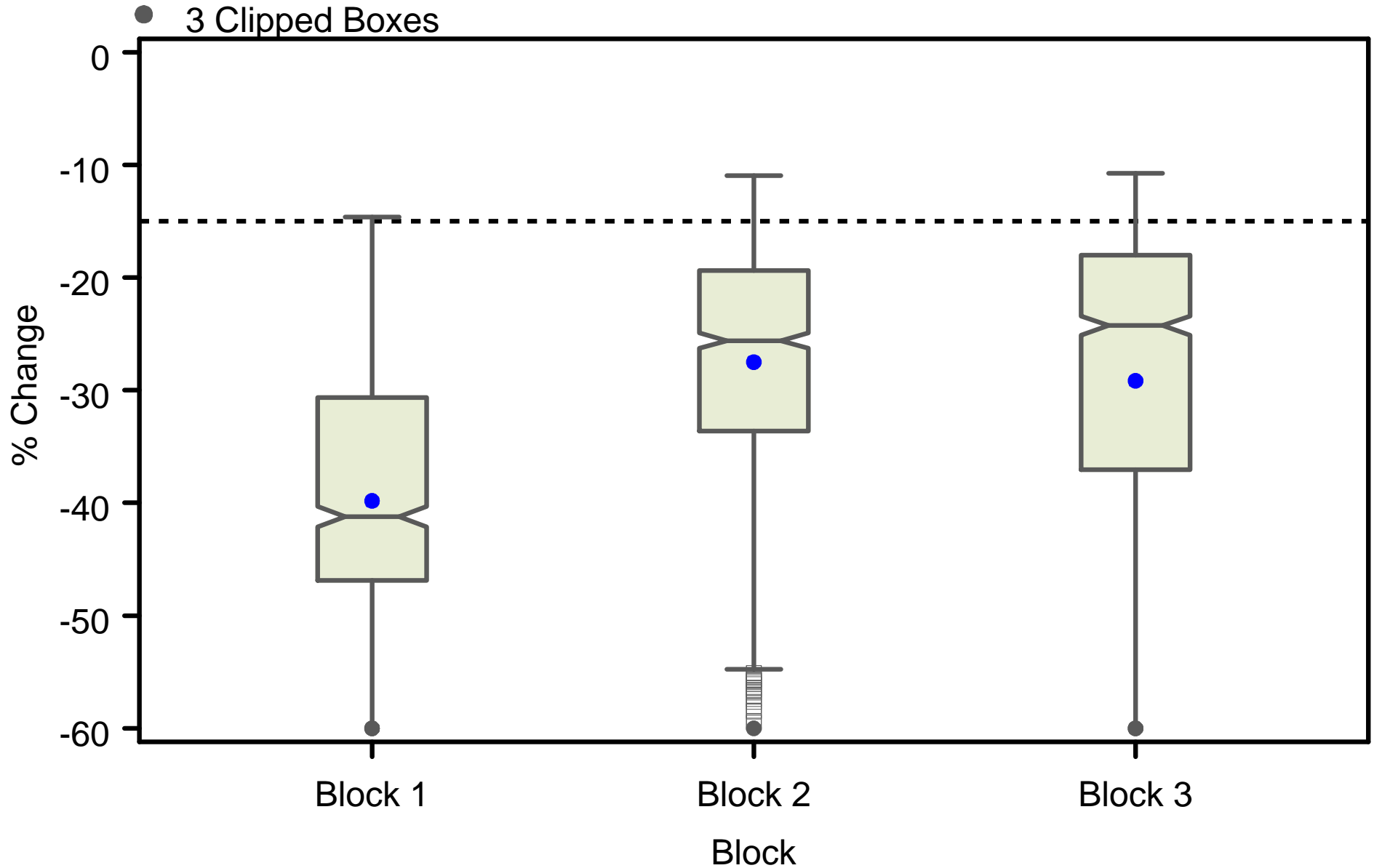

Period of Record: 1995-2004
Distribution of % Change in Abundance by Block
Species=Tricnectes maculatus juveniles Scenario=Total adjust - NP - 20%

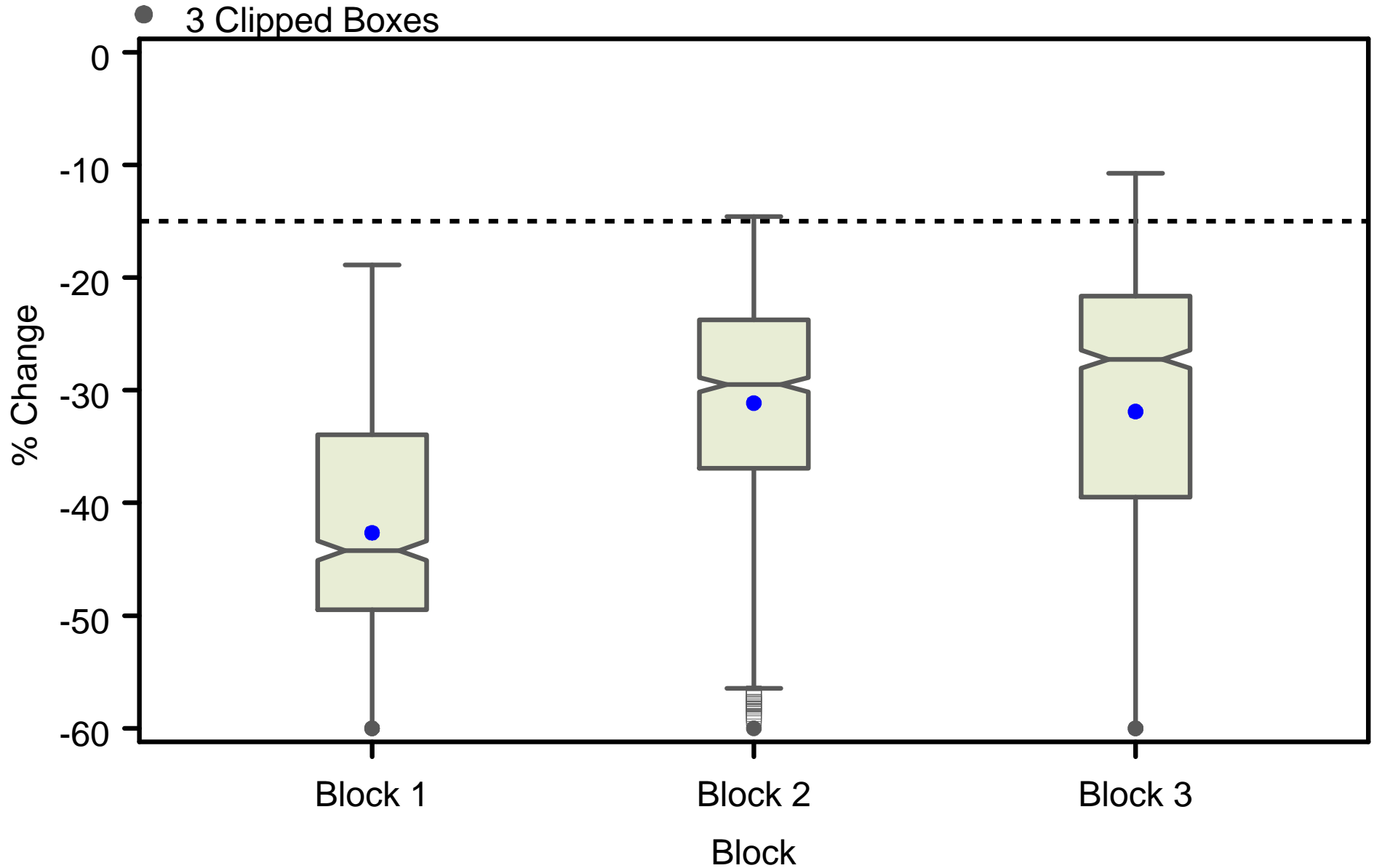

Period of Record: 1995-2004
Distribution of % Change in Abundance by Block
Species=Unid Americamysis juveniles Scenario=Northport (NP)

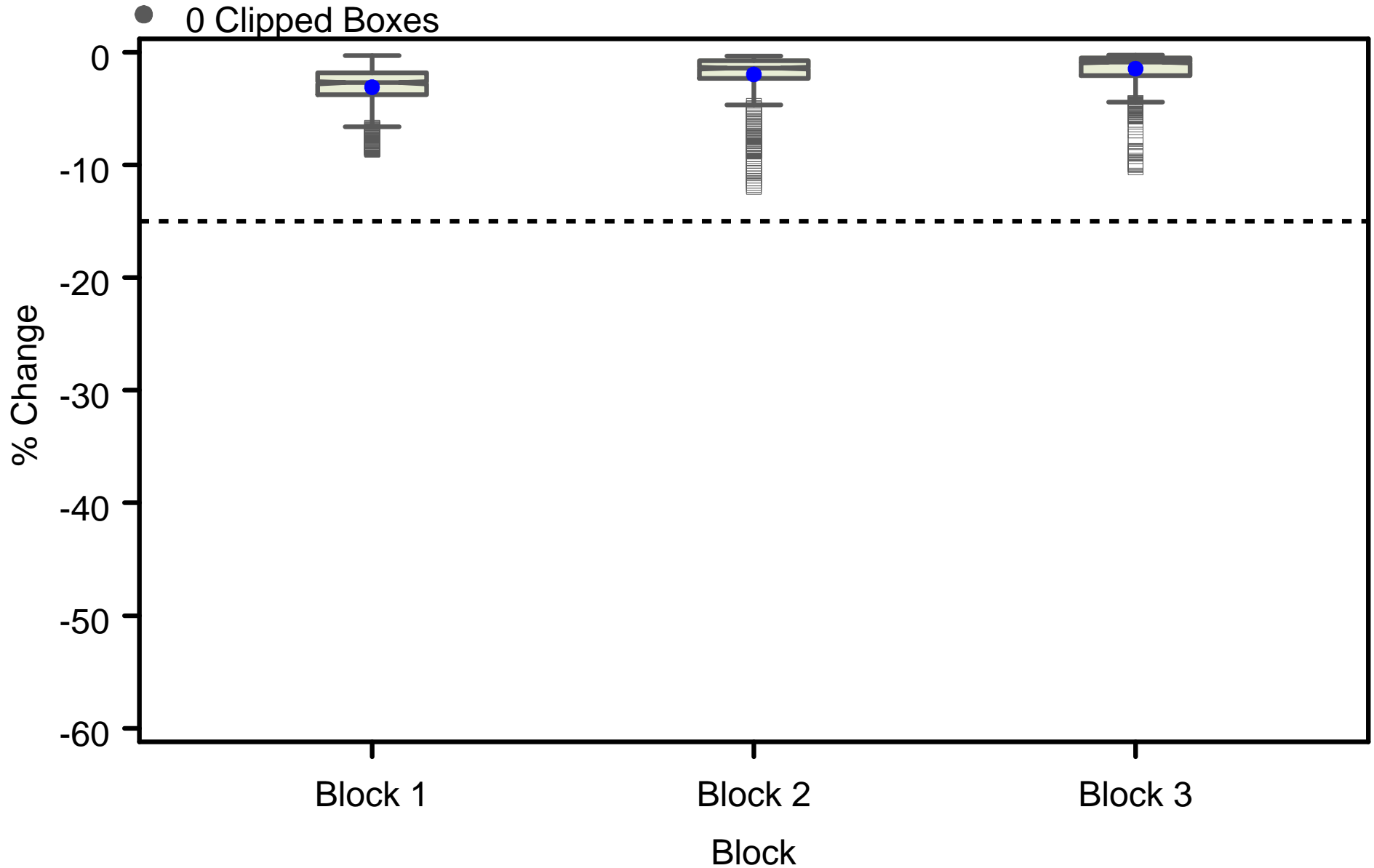

Period of Record: 1995-2004
Distribution of % Change in Abundance by Block
Species=Unid Americamysis juveniles Scenario=Ag adjust

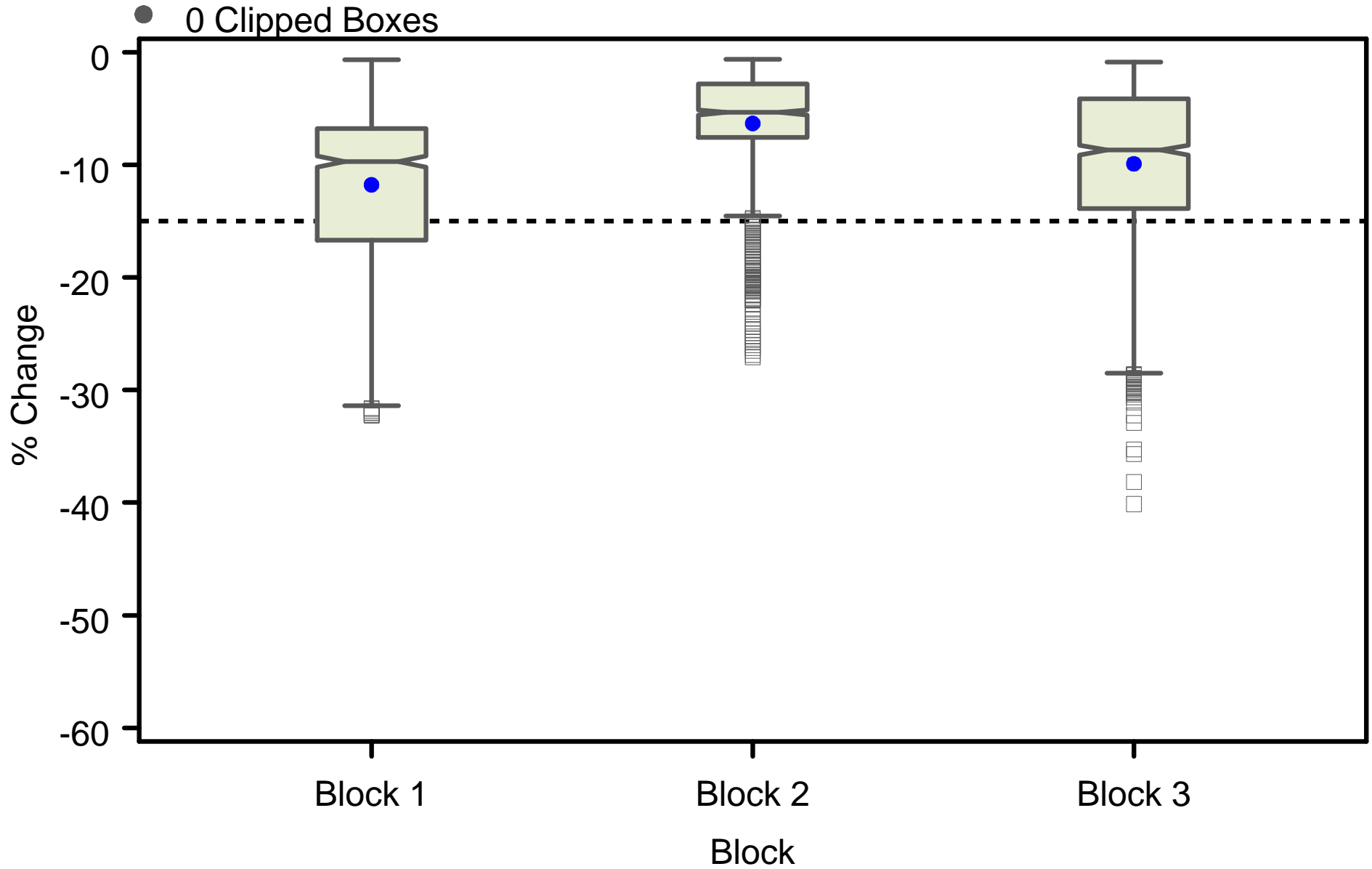

Period of Record: 1995-2004
Distribution of % Change in Abundance by Block
Species=Unid Americamysis juveniles Scenario=Total adjust

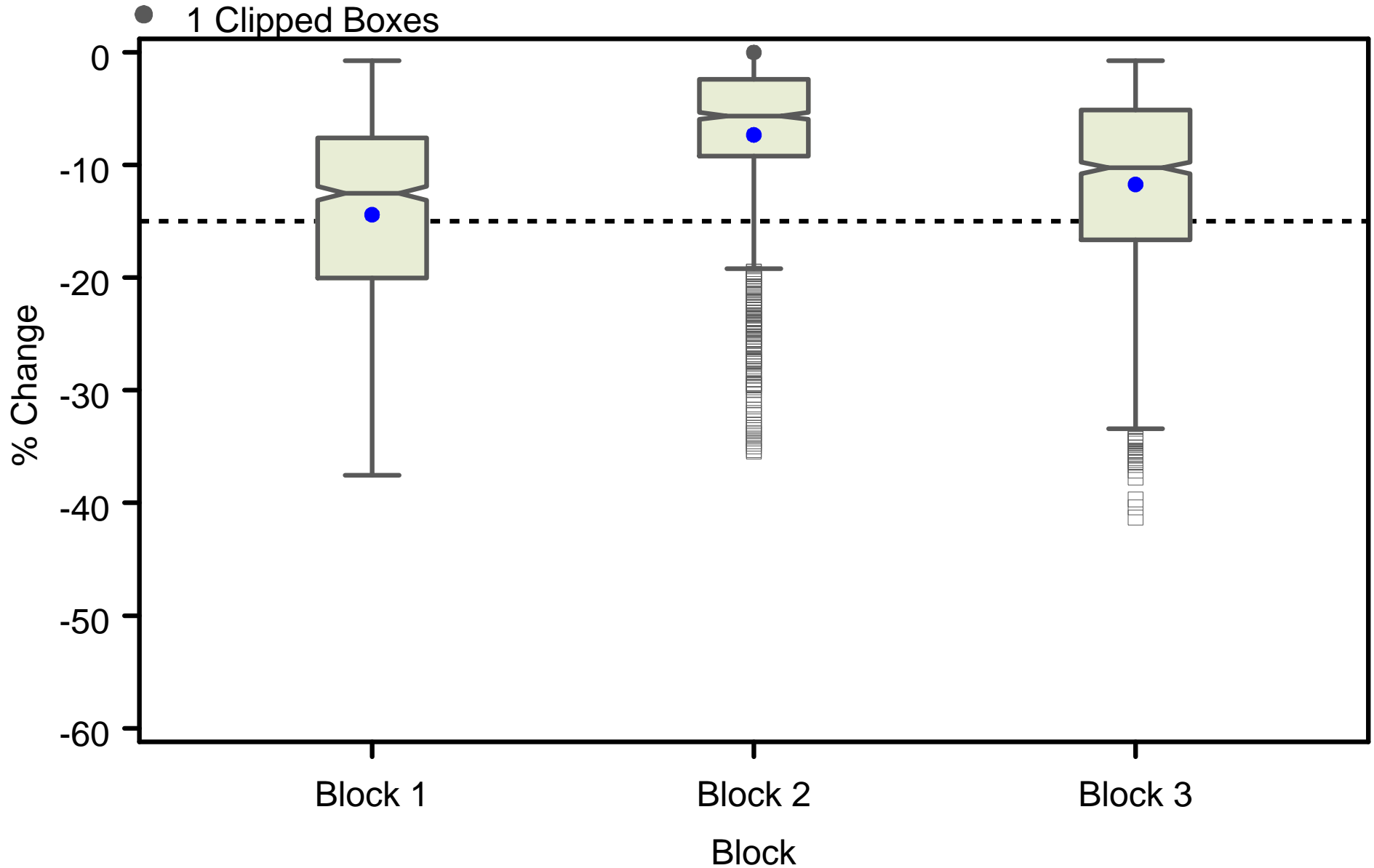

Period of Record: 1995-2004
Distribution of % Change in Abundance by Block
Species=Unid Americamysis juveniles Scenario=Total adjust - NP

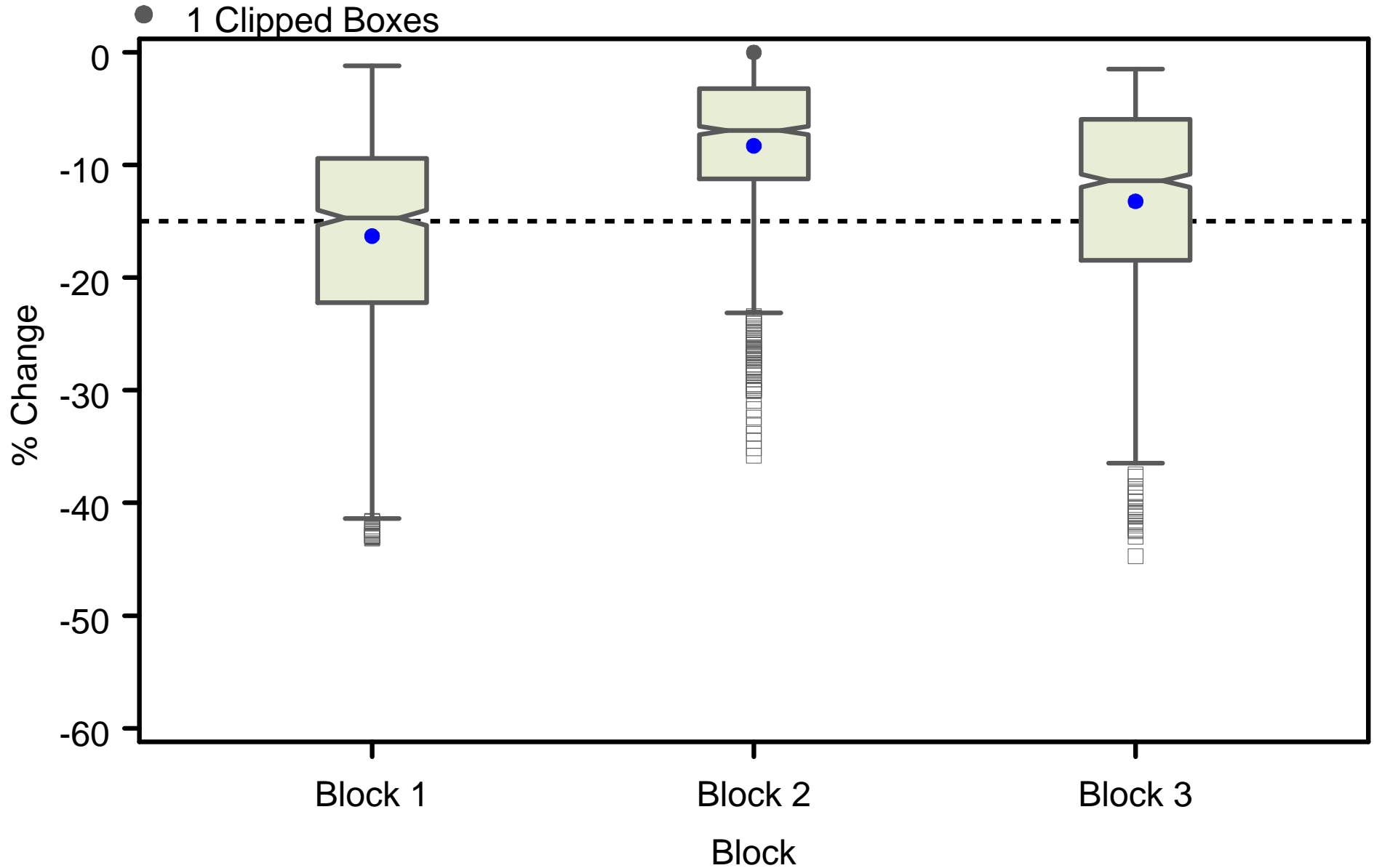

Period of Record: 1995-2004
Distribution of % Change in Abundance by Block
Species=Unid Americamysis juveniles Scenario=Total adjust - NP - 10%

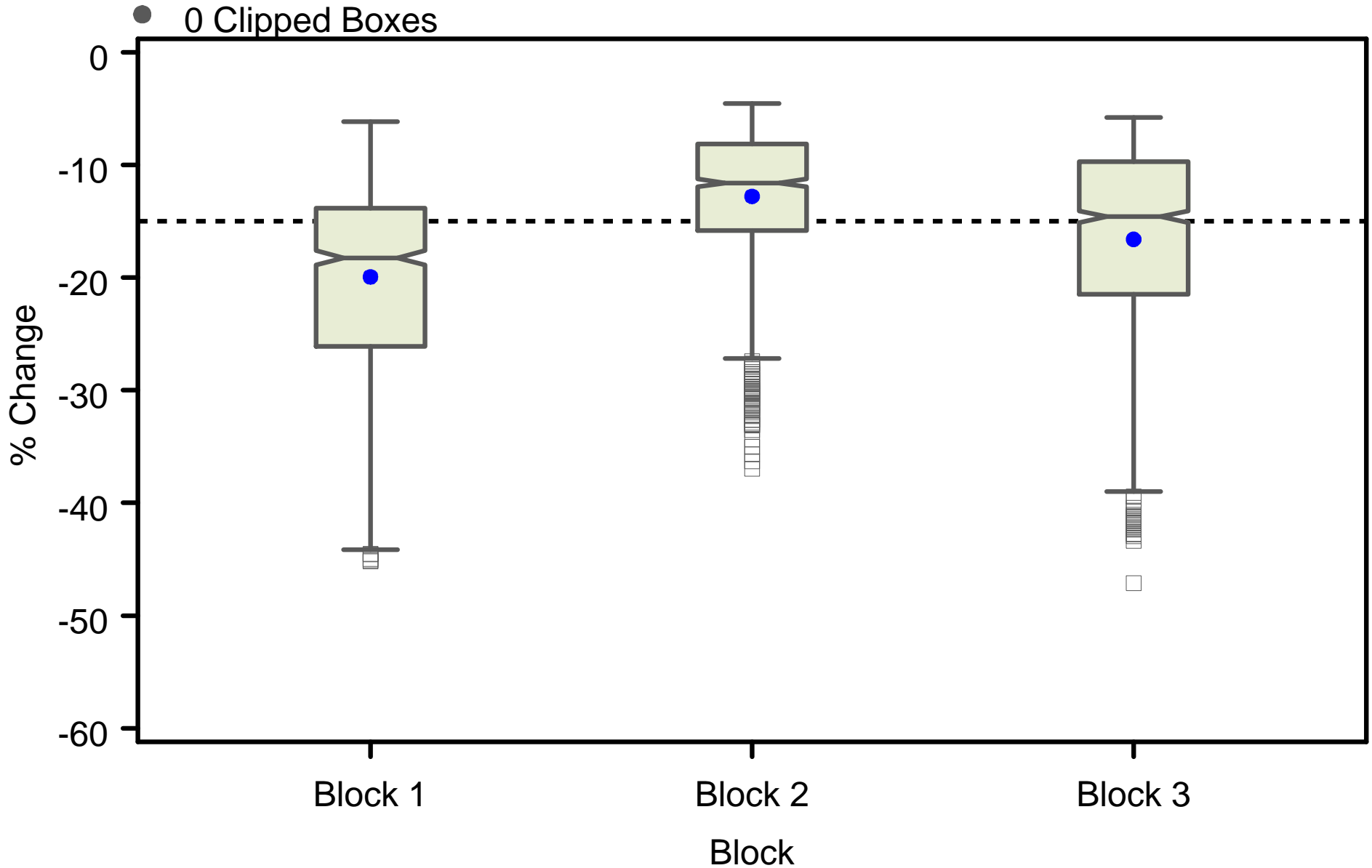

Period of Record: 1995-2004
Distribution of % Change in Abundance by Block
Species=Unid Americamysis juveniles Scenario=Total adjust - NP - 15%

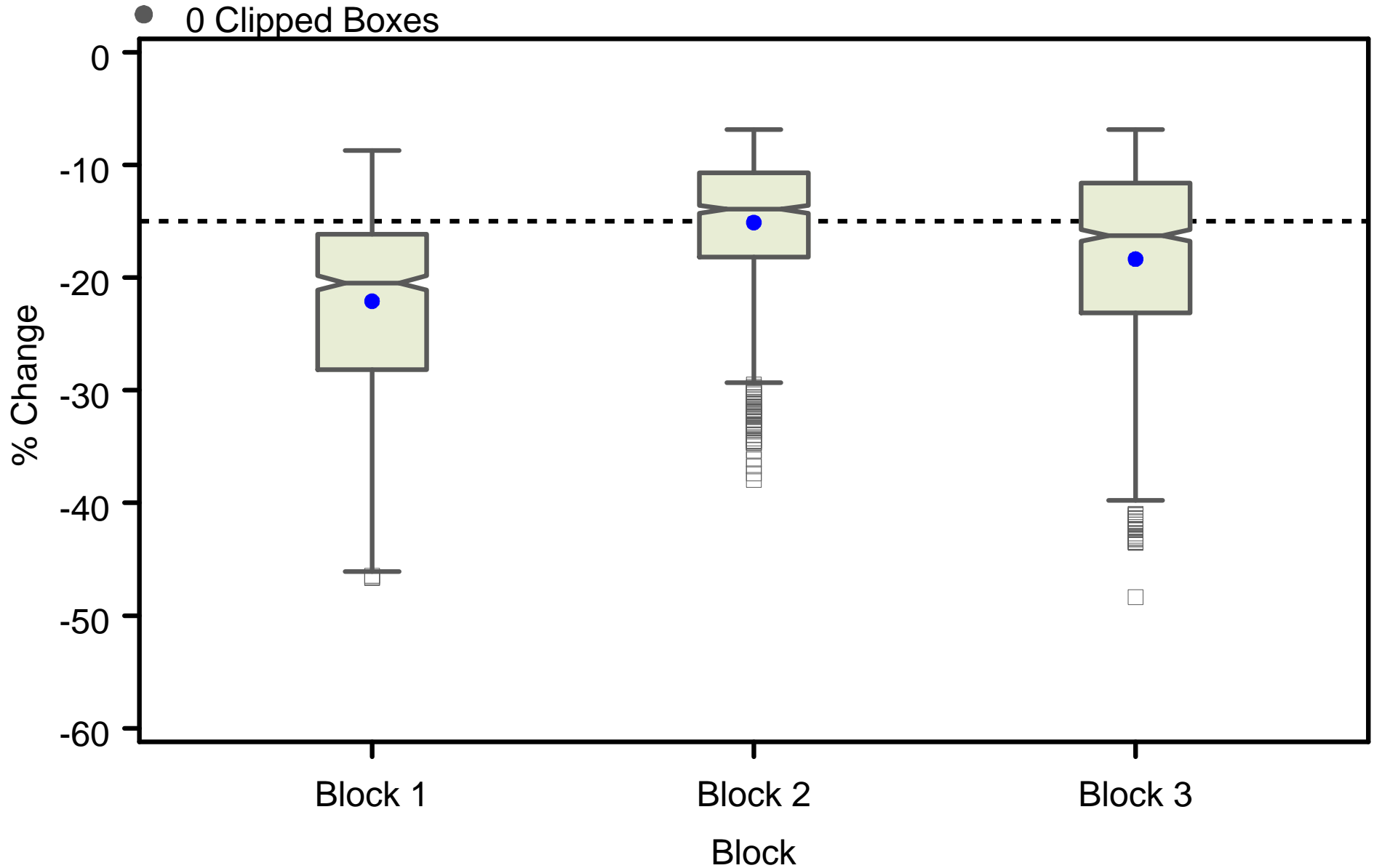

Period of Record: 1995-2004
Distribution of % Change in Abundance by Block
Species=Unid Americamysis juveniles Scenario=Total adjust - NP - 20%

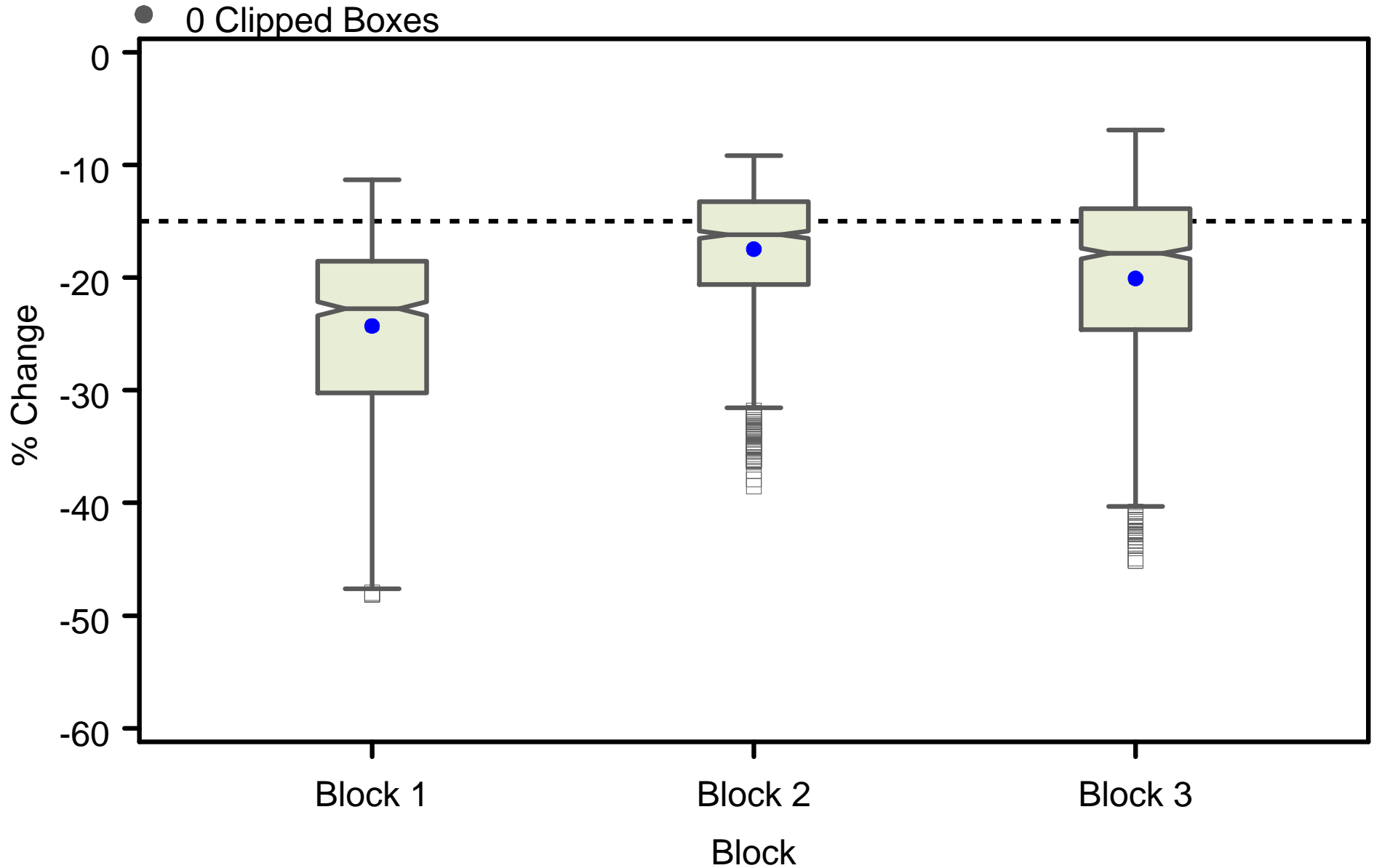

Hydrodynamic Model Period of Study:1999-2002

Distribution of % Change in Abundance by Block

Species=*Americamysis almyra* Scenario=Northport (NP)

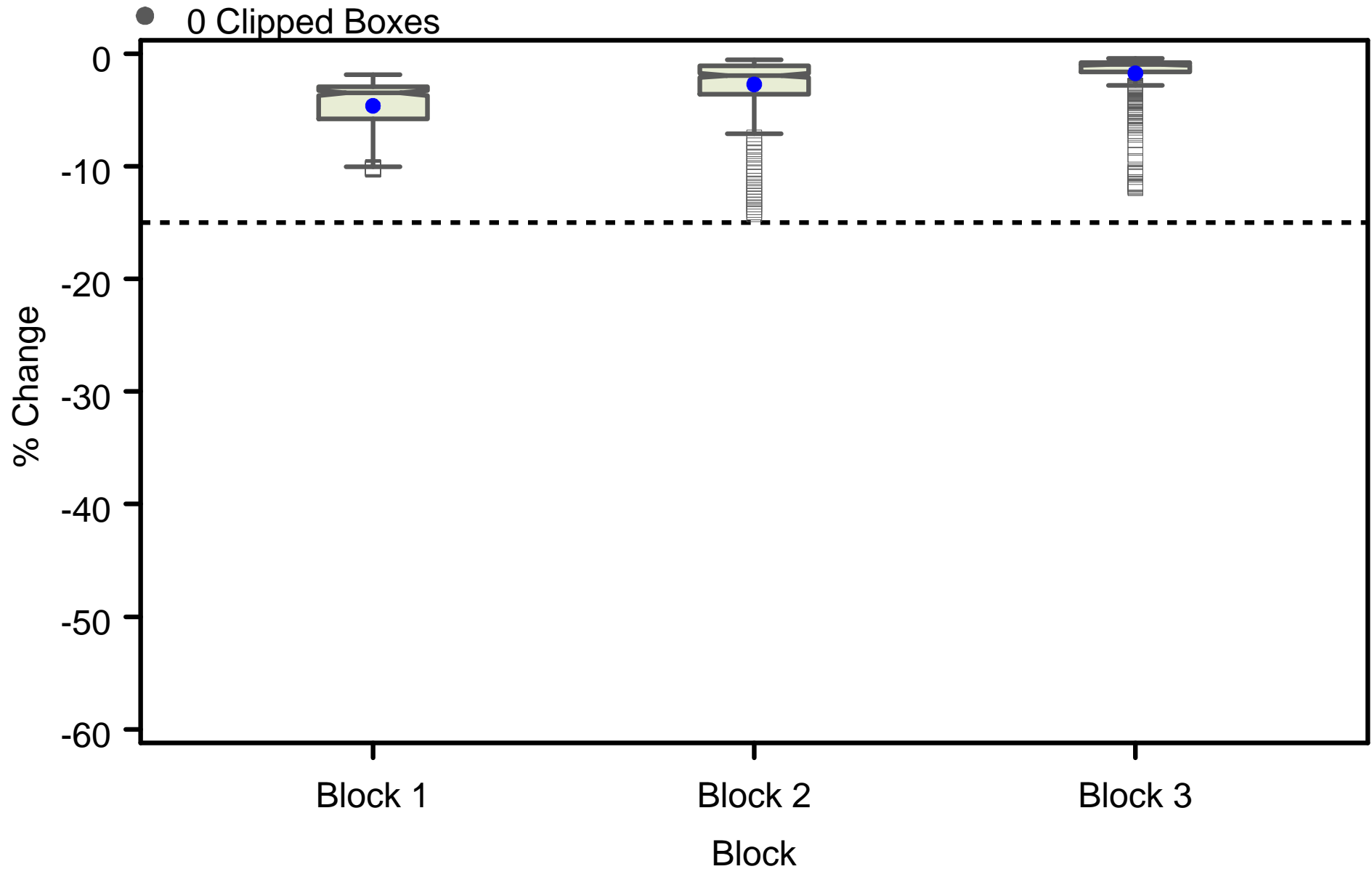

Appendix 8U

Median values for percent reductions in daily abundance for selected indicator taxa for seven flow reduction scenarios for three seasonal blocks. Values for plankton taxa are percent change in total abundance in the river, while values for seine and trawl taxa are for percent change in catch-per-unit-effort.

Table 8U-1. Median values of daily percentage changes in the abundance of selected fish and invertebrate tax age/size classes for seven flow reduction scenarios for **BLOCK 1 during 1999-2002**. Results presented separately for regressions using the sum of the Myakka River and Myakkahatchee Creek gages and regressions that use the Myakka River gage alone. Results for each scenario are listed for predictions limited to the flow domains of the regression (left of -) and predictions using all flows (right of -). Predictions involving City of North Port withdrawals were not generated for the one gage regressions. Cells that include percent changes 15 % and greater are highlighted in yellow and changes greater 25% and greater are highlighted in gray.

Block 1 - Sum gaged*	Percentage reductions from baseline (predictions limited to regression domain and all flows)									
	<i>Americamysis almyra</i> plankton	<i>Americamysis almyra</i> (2) plankton	<i>Cyathura polita</i> plankton	<i>Palaemonetes intermedius</i> seine	<i>Palaemonetes pugio</i> seine	<i>Menidia spp.</i> plankton - juveniles	<i>Trinectes maculatus</i> plankton - juveniles	<i>Gambusia holbrooki</i> seines <= 25 mm	<i>Gambusia holbrooki</i> seines >= 26 mm	
North Port Permitted	4 - 4	4 - 7	4 - 5	4 - 5	8 - 8	3 - 3	6 - 8	5 - 0	6 - 0	
Agricultural adjustment	13 - 13	17 - 27	14 - 17	16 - 20	28 - 33	11 - 11	23 - 27	15 - 0	20 - 0	
Total adjustment	20 - 21	28 - 34	18 - 22	22 - 27	36 - 42	14 - 14	29 - 34	17 - 0	23 - 0	
Total adjustment - North Port	25 - 27	33 - 38	21 - 31	26 - 38	42 - 53	19 - 19	34 - 42	22 - 0	29 - 0	
Total adjustment - North Port - 10%	29 - 31	39 - 45	25 - 34	30 - 45	48 - 62	21 - 21	40 - 47	34 - 0	43 - 0	
Total adjustment - North Port - 15%	31 - 34	42 - 49	27 - 36	33 - 48	52 - 66	22 - 22	43 - 49	39 - 0	49 - 0	
Total adjustment - North Port - 20%	34 - 36	46 - 52	29 - 37	35 - 52	54 - 71	24 - 24	46 - 52	45 - 0	55 - 0	

* regression using sum of flow at Myakka River near Sarasota and Big Slough Canal at Tropicaire Blvd.
** regressions using Myakka River near Sarasota flow only, not applicable to North Port permitted withdrawals

Block 1 - One gage **	<i>Ephemeropteran larvae</i> plankton	<i>Mesocyclops edax</i> plankton	<i>Gambusia holbrooki</i> plankton - juveniles	<i>Trinectes maculatus</i> plankton - juveniles
	Agricultural adjustment	28 - 32	14 - 28	14 - 19
Total adjustment	38 - 40	15 - 33	18 - 27	32 - 39
Total adjustment - 10%	44 - 47	30 - 39	21 - 31	39 - 46
Total adjustment - 15%	48 - 51	33 - 41	23 - 33	43 - 49
Total adjustment - 20%	51 - 54	35 - 44	25 - 35	46 - 52

Table 8U-2. Median values of daily percentage changes in the abundance of selected fish and invertebrate tax age/size classes for seven flow reduction scenarios for **BLOCK 2 during 1999-2002**. Results presented separately for regressions using the sum of the Myakka River and Myakkahatchee Creek gages and regressions that use the Myakka River gage alone. Results for each scenario are listed for predictions limited to the flow domains of the regression (left of -) and predictions using all flows (right of -). Predictions involving City of North Port withdrawals were not generated for the one gage regressions. Cells with percent changes greater than 15 % are highlighted in yellow and changes greater than 25% are highlighted in gray.

Block 2 - Sum gaged*	Percentage reductions from baseline (predctions limited to regression domain and all flows)									
	<i>Americamysis almyra</i> plankton	<i>Americamysis almyra</i> (2) plankton	<i>Cyathura polita</i> plankton	<i>Palaemonetes intermedius</i> seine	<i>Palaemonetes pugio</i> seine	<i>Menidia spp.</i> plankton - juveniles	<i>Trinectes maculatus</i> plankton - juveniles	<i>Gambusia holbrooki</i> seines <= 25 mm	<i>Gambusia holbrooki</i> seines >= 26 mm	
North Port Permitted	2 - 2	2 - 2	4 - 4	1 - 3	2 - 5	2 - 2	6 - 6	2 - 2	2 - 2	
Agricultural adjustment	7 - 8	7 - 7	7 - 8	2 - 5	4 - 10	5 - 5	12 - 13	15 - 15	15 - 15	
Total adjustment	8 - 8	7 - 8	9 - 10	1 - 7	3 - 14	7 - 7	15 - 16	18 - 17	18 - 18	
Total adjustment - North Port	10 - 10	8 - 9	13 - 15	2 - 11	6 - 21	10 - 10	20 - 22	20 - 20	20 - 20	
Total adjustment - North Port - 10%	15 - 15	13 - 14	17 - 19	3 - 16	9 - 28	12 - 12	28 - 29	29 - 29	28 - 28	
Total adjustment - North Port - 15%	17 - 18	15 - 17	20 - 22	5 - 18	11 - 32	14 - 14	31 - 33	33 - 33	32 - 32	
Total adjustment - North Port - 20%	20 - 21	18 - 20	22 - 24	7 - 21	14 - 35	15 - 15	35 - 36	37 - 37	36 - 36	

* regression using sum of flow at Myakka River near Sarasota and Big Slough Canal at Tropicaire Blvd.
** regressions using Myakka River near Sarasota flow only, not applicable to North Port permitted withdrawals

Block 2 - One gage **	<i>Ephemeropteran larvae</i> plankton	<i>Mesocyclops edax</i> plankton	<i>Gambusia holbrooki</i> plankton - juveniles	<i>Trinectes maculatus</i> plankton - juveniles
	Agricultural adjustment	13 - 16	11 - 14	7 - 9
Total adjustment	14 - 20	15 - 19	8 - 12	18 - 20
Total adjustment - 10%	28 - 30	23 - 25	15 - 17	26 - 28
Total adjustment - 15%	33 - 34	26 - 28	17 - 19	30 - 32
Total adjustment - 20%	37 - 39	29 - 32	20 - 22	35 - 36

Table 8U-3. Median values of daily percentage changes in the abundance of selected fish and invertebrate tax age/size classes for seven flow reduction scenarios for **BLOCK 3 during 1999-2002**. Results presented separately for regressions using the sum of the Myakka River and Myakkahatchee Creek gages and regressions that use the Myakka River gage alone. Results for each scenario are listed for predictions limited to the flow domains of the regression (left of -) and predictions using all flows (right of -). Predictions involving City of North Port withdrawals were not generated for the one gage regressions. Cells that include percent changes 15 % and greater are highlighted in yellow changes 25% and greater are highlighted in gray.

Block 3 - Sum gaged*	Percentage reductions from baseline (predictions limited to regression domain and all flows) + signs for <i>Palaemonetes</i> mean positive change									
	<i>Americamysis almyra</i> plankton	<i>Americamysis almyra</i> (2) plankton	<i>Cyathura polita</i> plankton	<i>Palaemonetes intermedius</i> seine	<i>Palaemonetes pugio</i> seine	<i>Menidia spp.</i> plankton - juveniles	<i>Trinectes maculatus</i> plankton - juveniles	<i>Gambusia holbrooki</i> seines <= 25 mm	<i>Gambusia holbrooki</i> seines >= 26 mm	
North Port Permitted	1 - 1	1 - 1	1 - 1	+ 1 + 1	+ 2 + 2	1 - 1	1 - 1	2 - 2	2 - 2	
Agricultural adjustment	10 - 10	8 - 8	7 - 7	+ 11 + 11	+ 16 + 16	4 - 4	13 - 12	18 - 18	20 - 14	
Total adjustment	11 - 11	9 - 9	8 - 8	+ 15 + 15	+ 22 + 22	5 - 5	14 - 14	21 - 21	22 - 17	
Total adjustment - North Port	12 - 13	10 - 10	9 - 9	+ 17 + 16	+ 24 + 24	5 - 5	16 - 16	23 - 23	24 - 18	
Total adjustment - North Port - 10%	16 - 16	13 - 13	13 - 13	+ 22 + 22	+ 33 + 32	8 - 8	21 - 21	31 - 31	31 - 26	
Total adjustment - North Port - 15%	18 - 18	14 - 14	14 - 15	+ 25 + 25	+ 38 + 37	9 - 9	24 - 24	34 - 35	35 - 30	
Total adjustment - North Port - 20%	20 - 20	16 - 16	16 - 16	+ 29 + 28	+ 43 + 42	10 - 10	27 - 27	38 - 39	38 - 34	
* regression using sum of flow at Myakka River near Sarasota and Big Slough Canal at Tropicaire Blvd.										
** regressions using Myakka River near Sarasota flow only, not applicable to North Port permitted withdrawals										
Block 3 - One gage **										
	Ephemeropteran larvae plankton	<i>Mesocyclops edax</i> plankton	<i>Gambusia holbrooki</i> plankton - juveniles	<i>Trinectes maculatus</i> plankton - juveniles						
Agricultural adjustment	18 - 24	10 - 12	7 - 9	18 - 20						
Total adjustment	27 - 24	12 - 16	9 - 11	20 - 21						
Total adjustment - 10%	32 - 33	23 - 22	16 - 16	28 - 30						
Total adjustment - 15%	36 - 38	26 - 26	18 - 18	33 - 34						
Total adjustment - 20%	41 - 42	29 - 29	20 - 21	37 - 38						

Appendix 8V

Cumulative distribution function plots of daily abundances of selected indicator taxa for seven flow reduction scenarios for three seasonal blocks. Values for plankton taxa are for total abundance in the river, while values for seine and trawl taxa are for catch-per-unit-effort.

Myakka River

Period of Record 1995-2004

Normalized Area Under Curve

Taxa=*Americamysis almyra*2 Block=Block 1

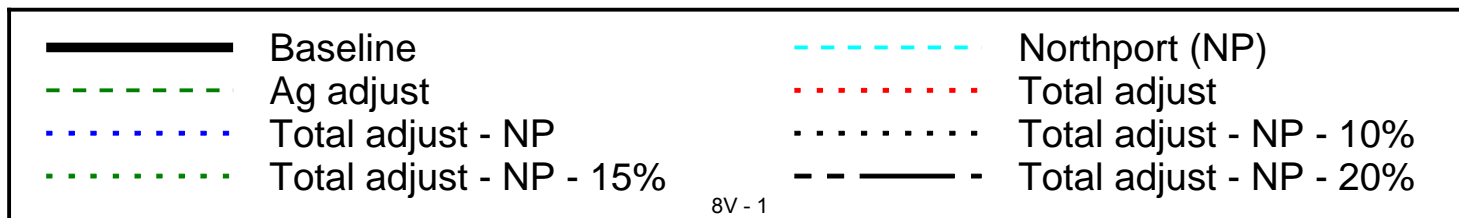
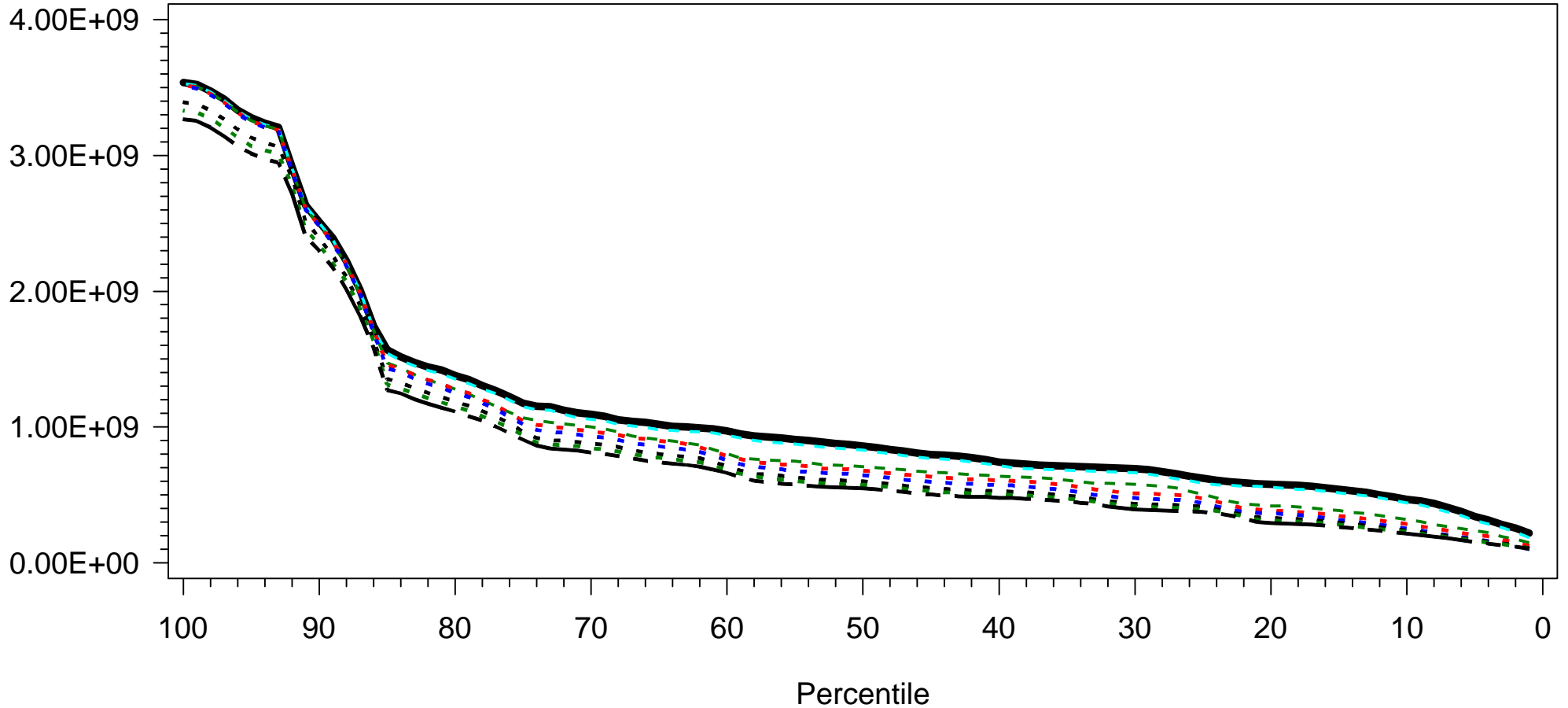

Myakka River

Period of Record 1995-2004

Normalized Area Under Curve

Taxa=*Americamysis almyra*2 Block=Block 2

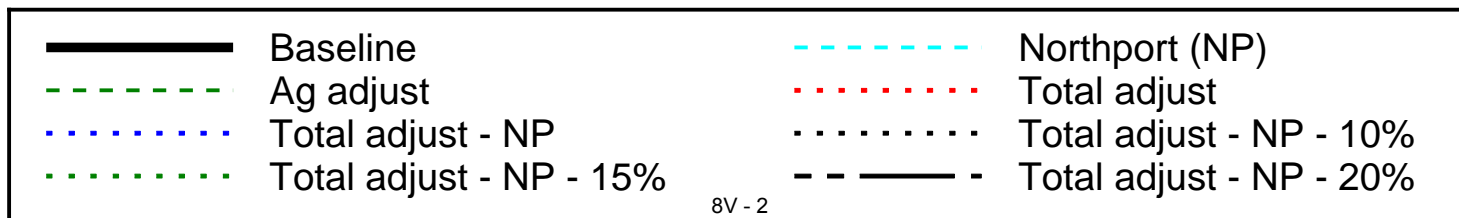
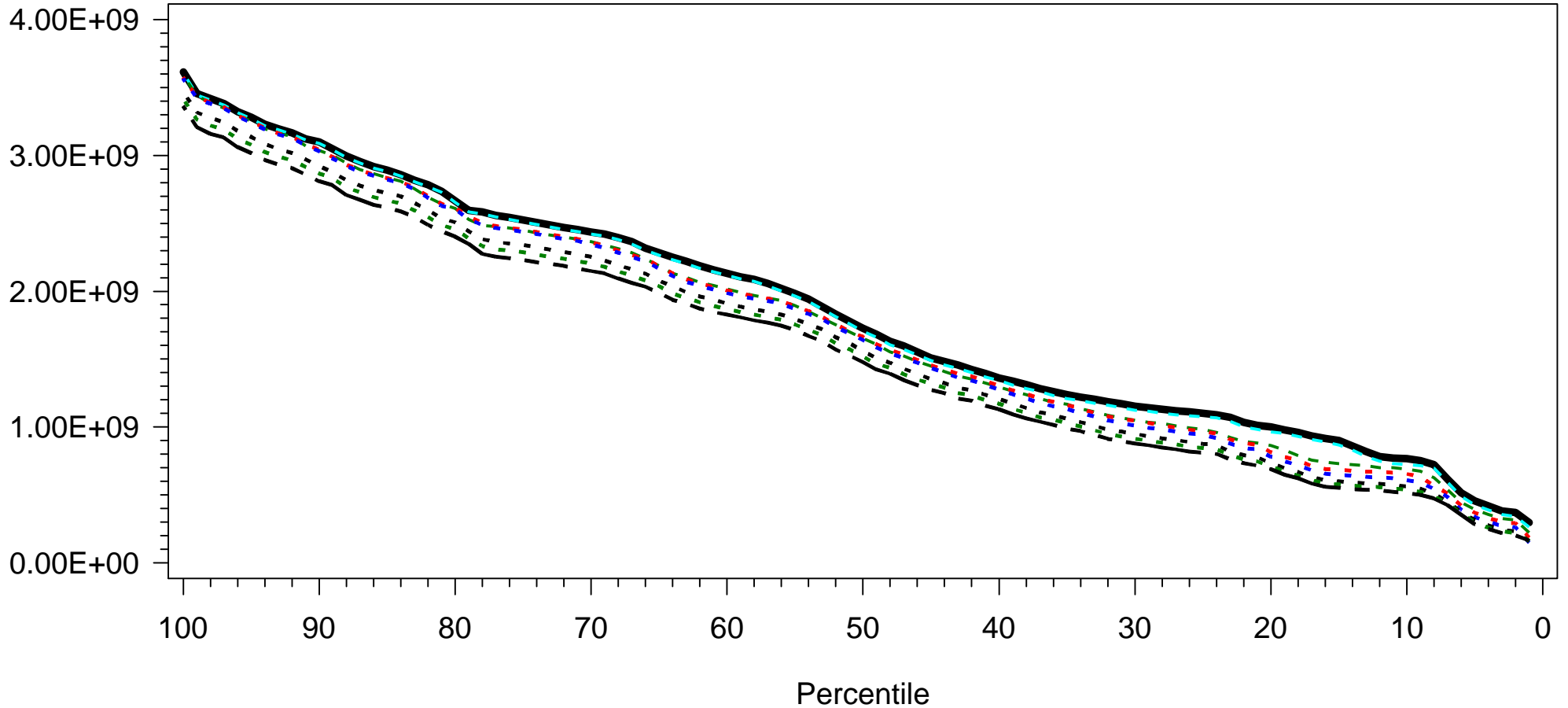

Myakka River

Period of Record 1995-2004

Normalized Area Under Curve

Taxa=*Americamysis almyra*2 Block=Block 3

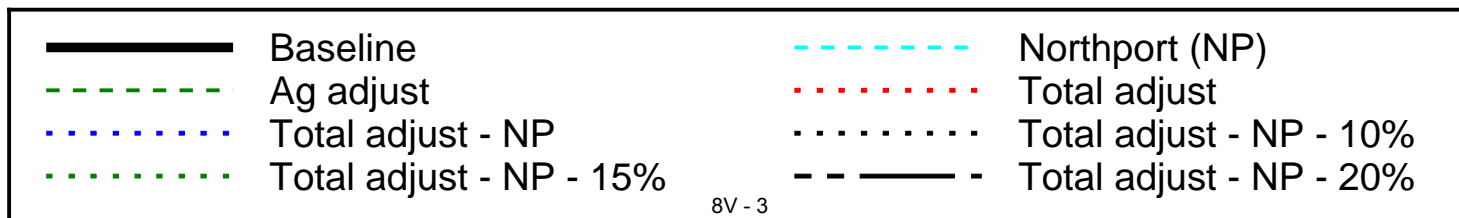
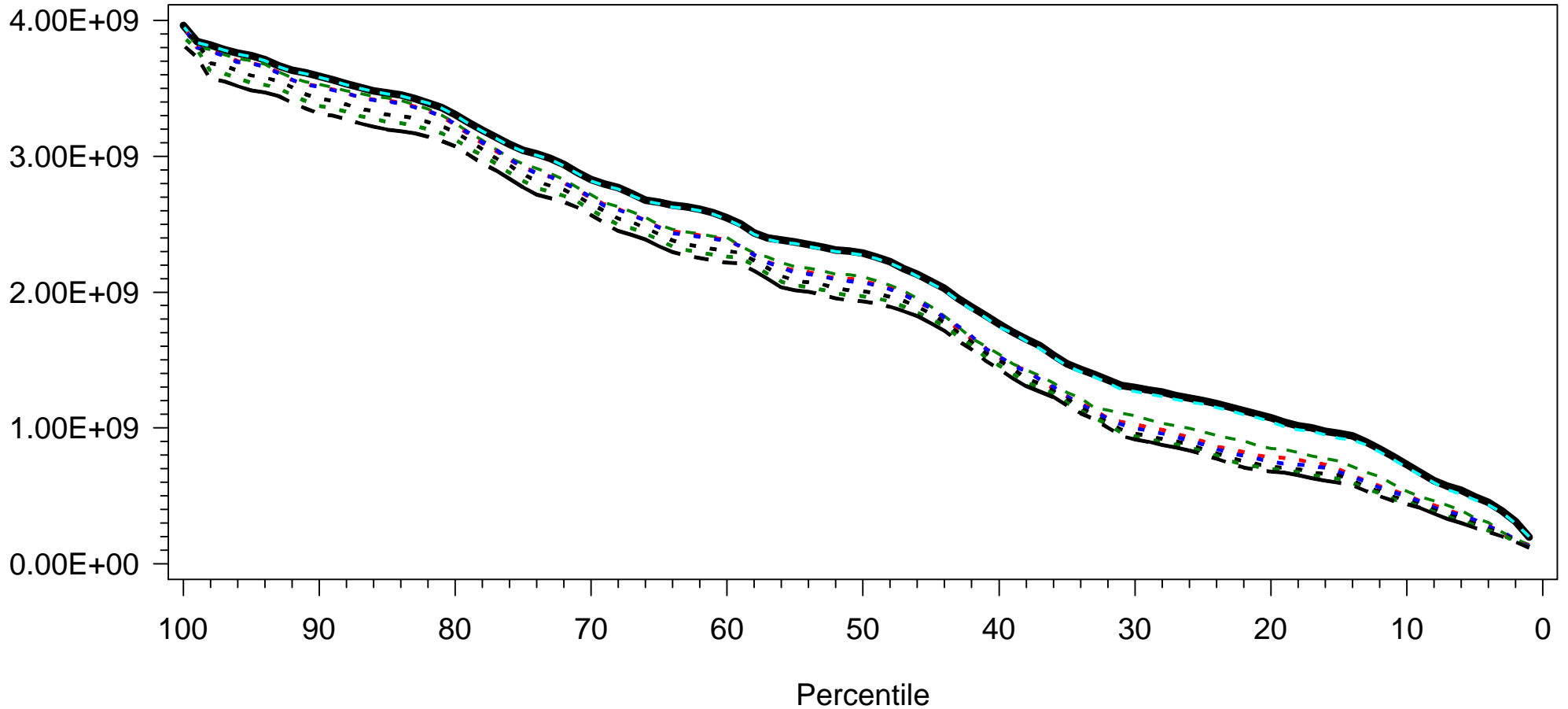

Myakka River

Period of Record 1995-2004

Normalized Area Under Curve

Taxa=*Americamysis almyra* Block=Block 1

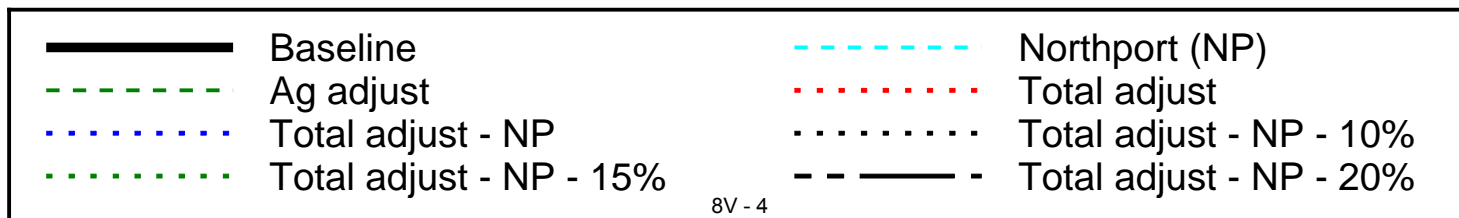
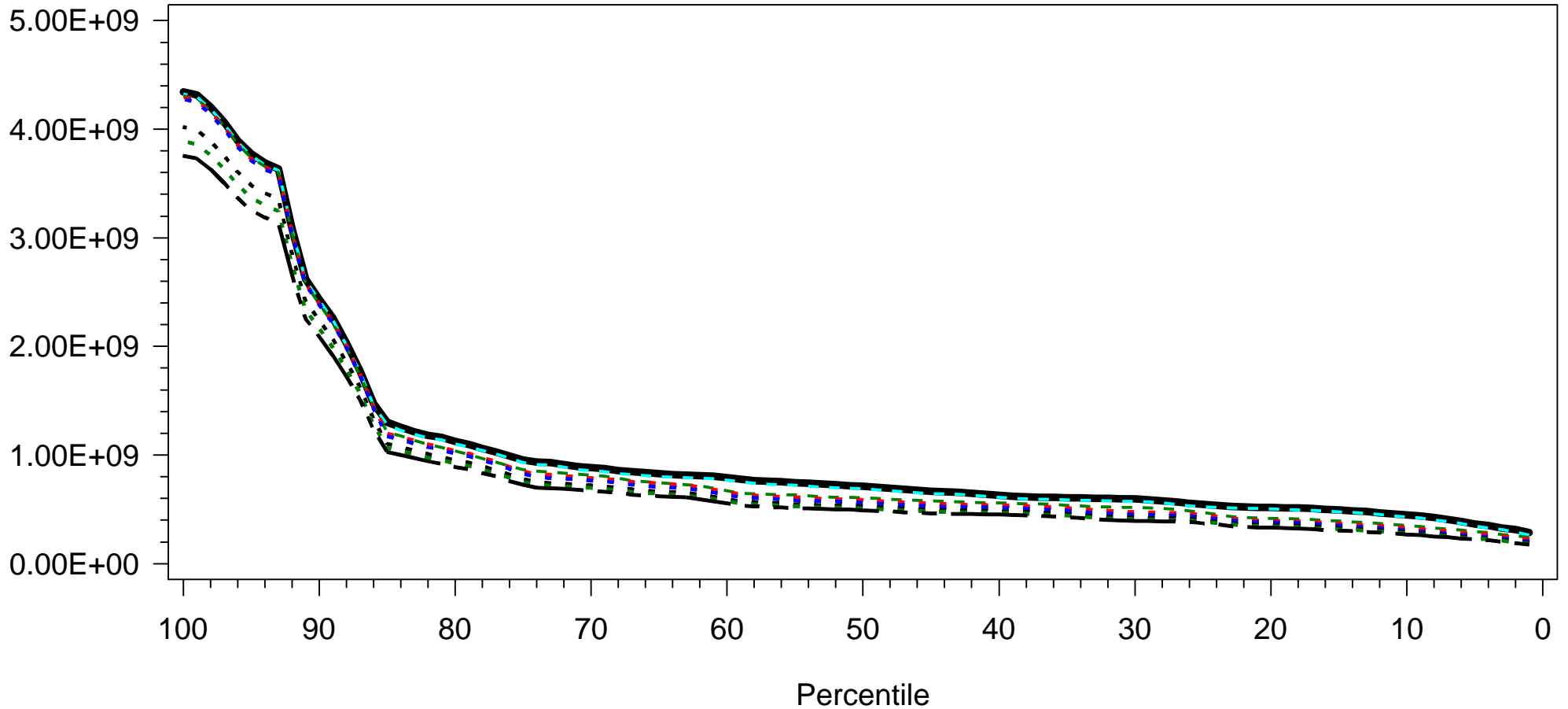

Myakka River

Period of Record 1995-2004

Normalized Area Under Curve

Taxa=*Americamysis almyra* Block=Block 2

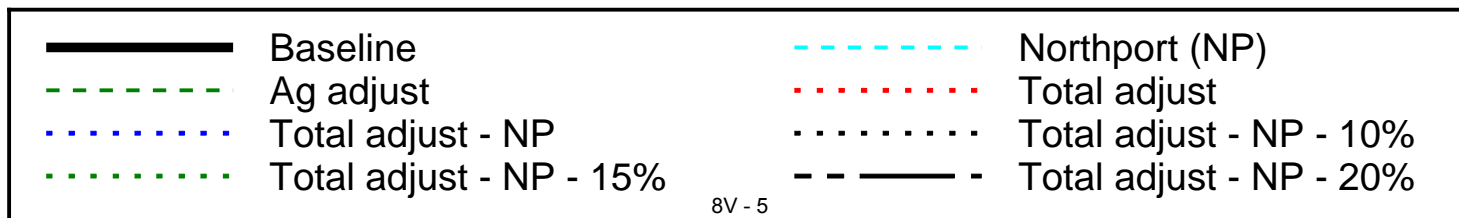
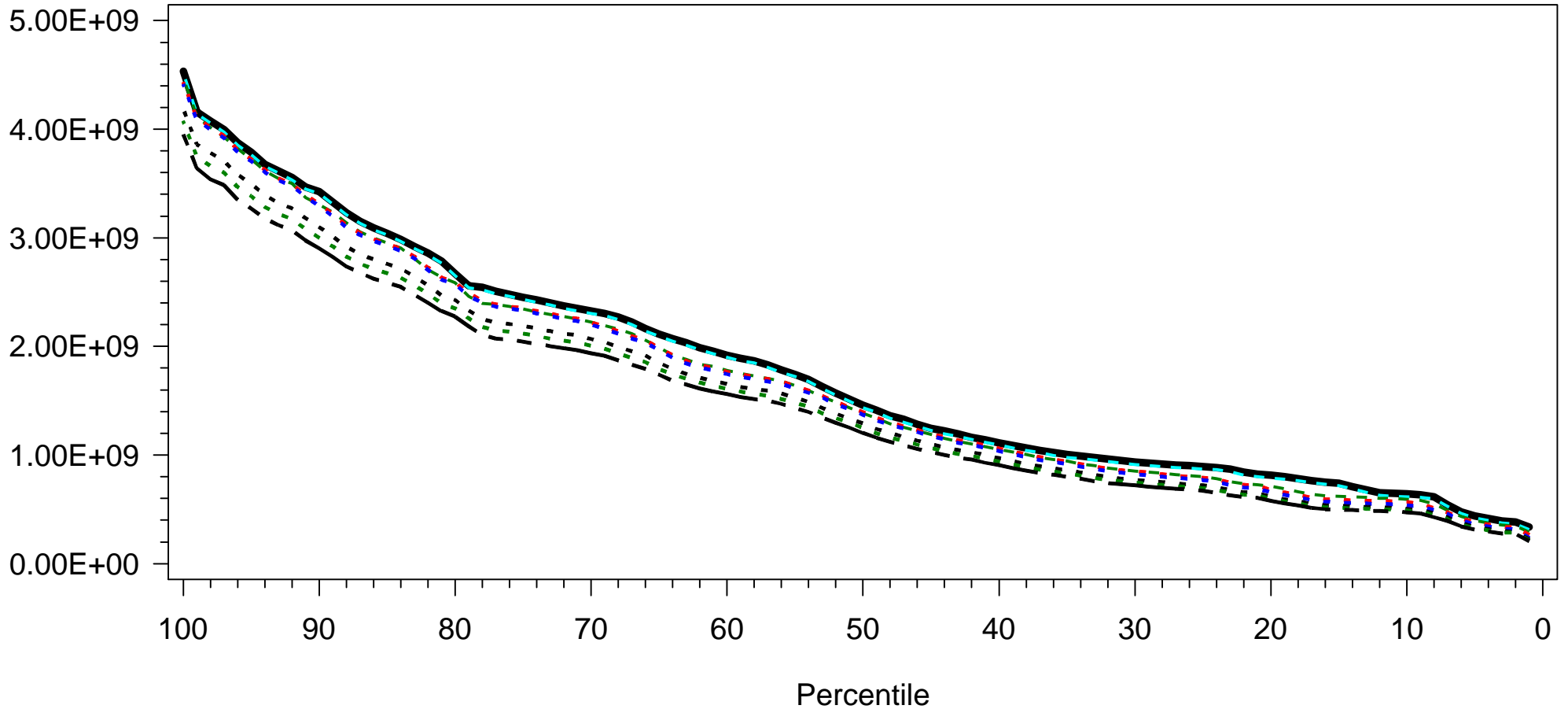

Myakka River

Period of Record 1995-2004

Normalized Area Under Curve

Taxa=*Americamysis almyra* Block=Block 3

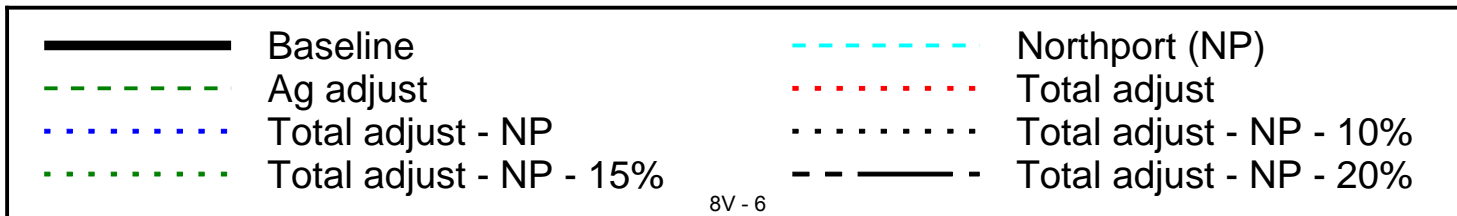
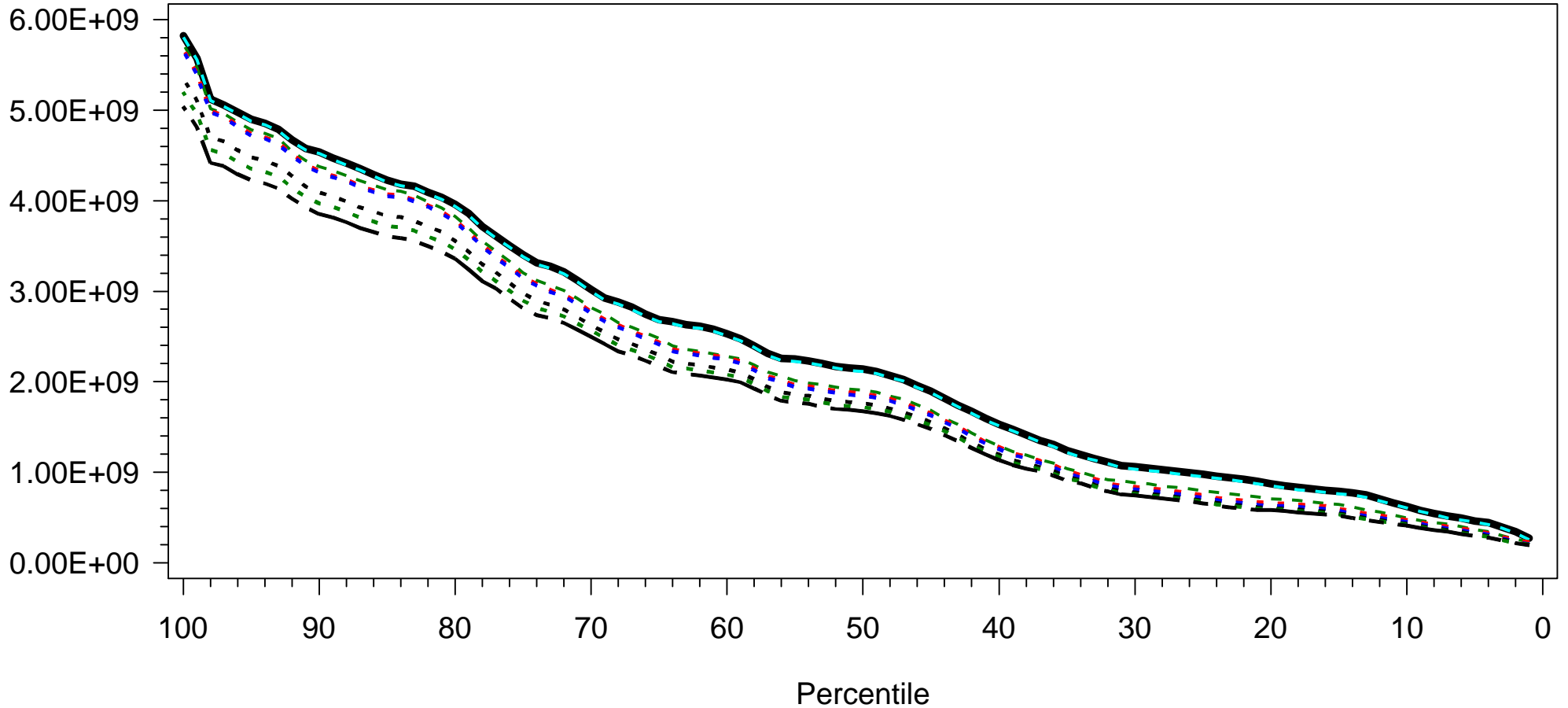

Myakka River

Period of Record 1995-2004

Normalized Area Under Curve

Taxa=Anchoa mitchilli Block=Block 1

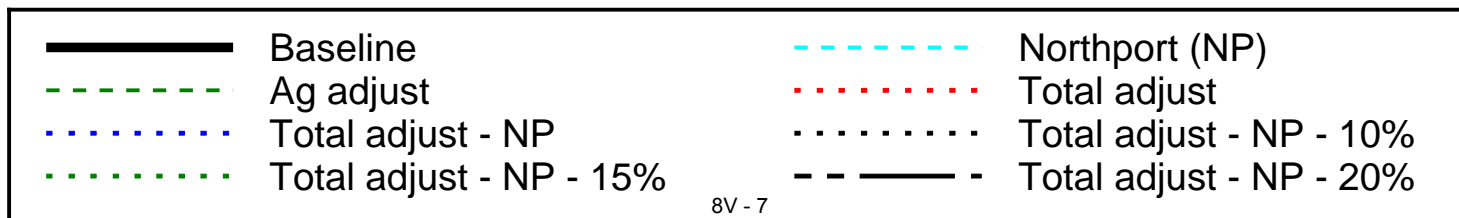
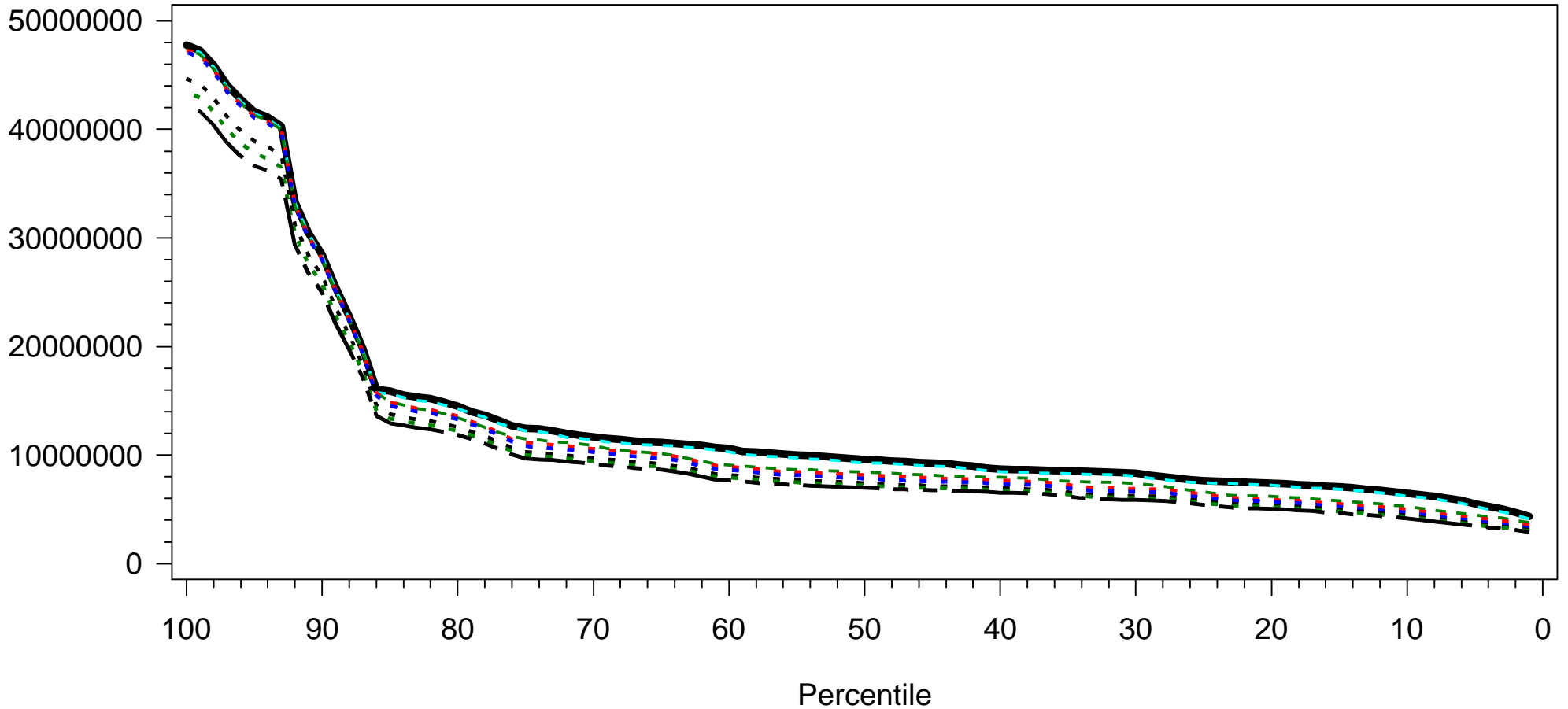

Myakka River

Period of Record 1995-2004

Normalized Area Under Curve

Taxa=Anchoa mitchilli Block=Block 2

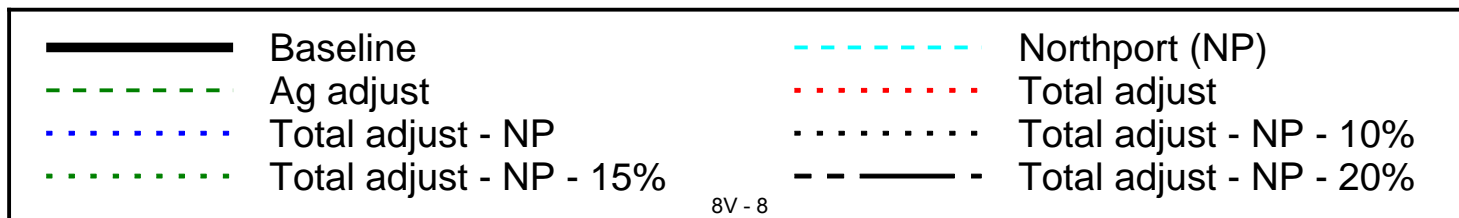
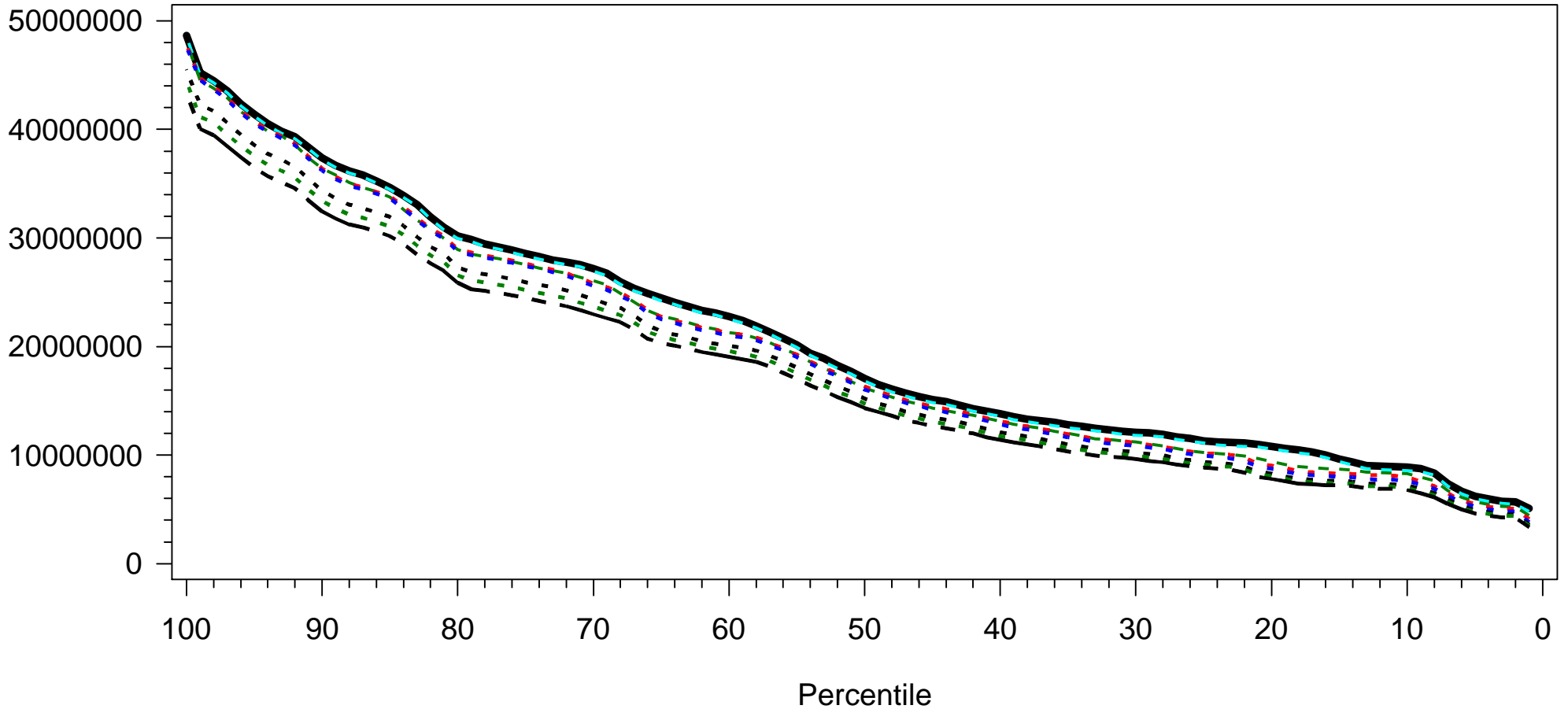

Myakka River

Period of Record 1995-2004

Normalized Area Under Curve

Taxa=Anchoa mitchilli Block=Block 3

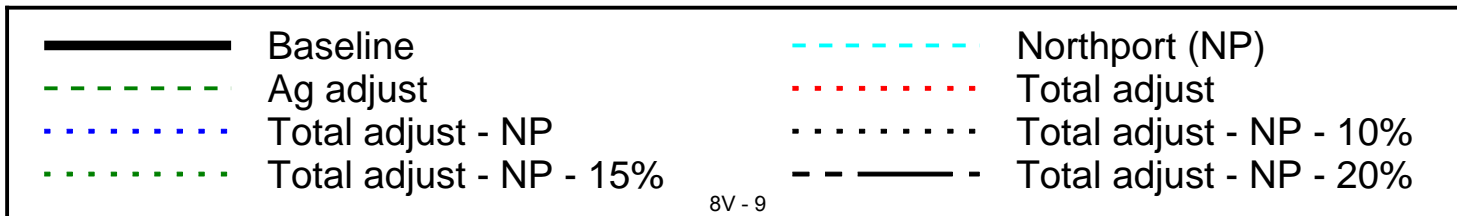
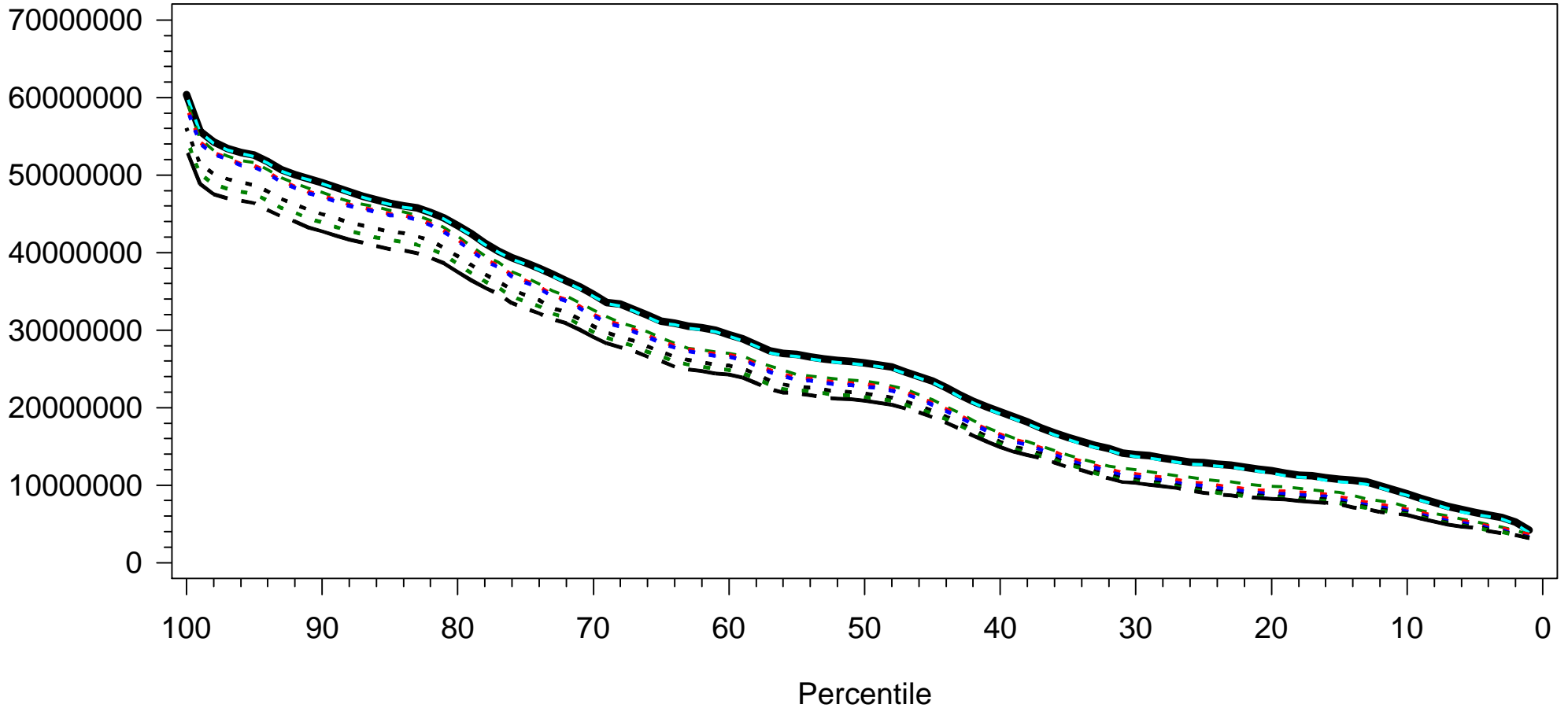

Myakka River

Period of Record 1995-2004

Normalized Area Under Curve

Taxa=Cyathura polita Block=Block 1

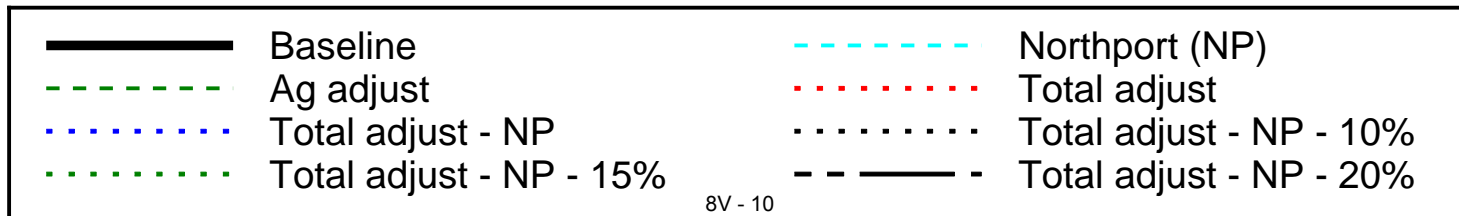
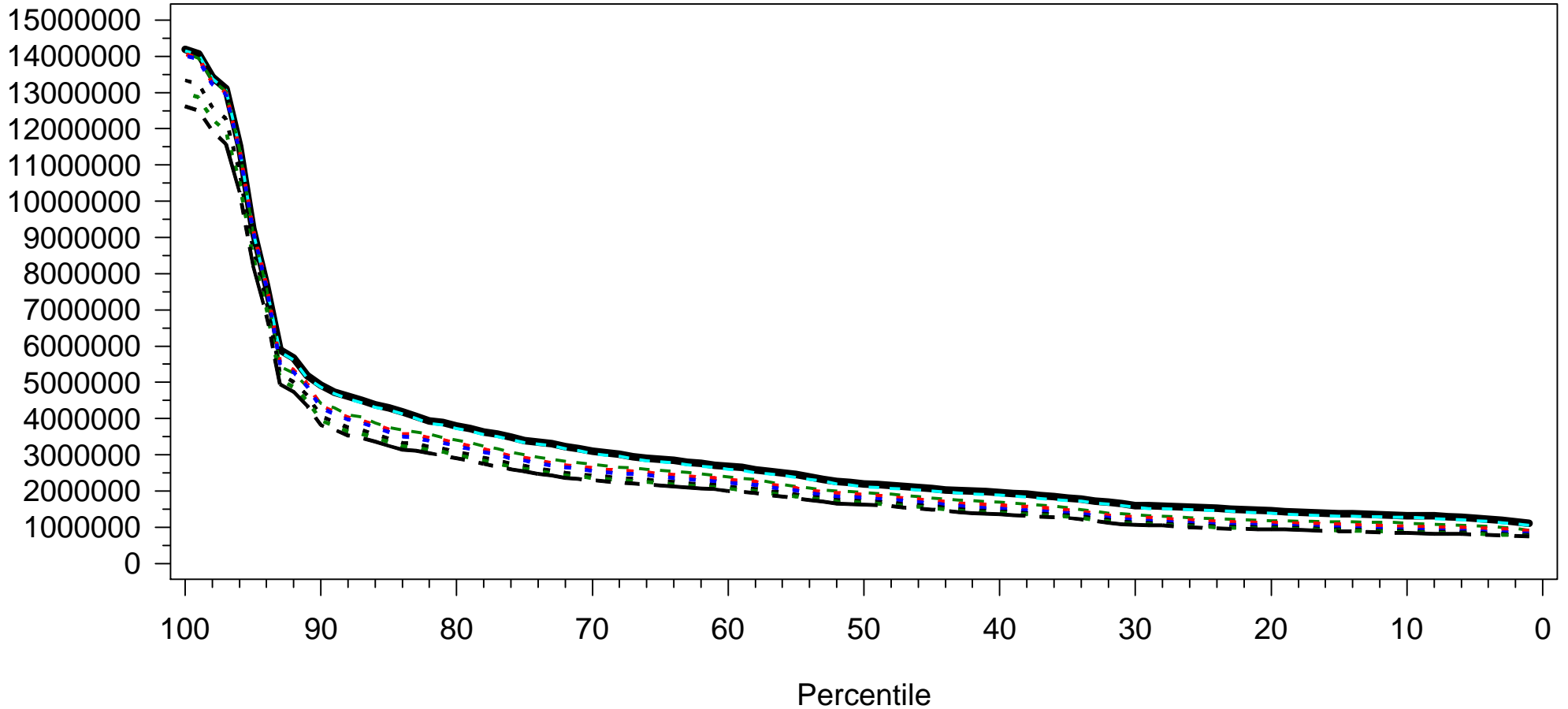

Myakka River

Period of Record 1995-2004

Normalized Area Under Curve

Taxa=Cyathura polita Block=Block 2

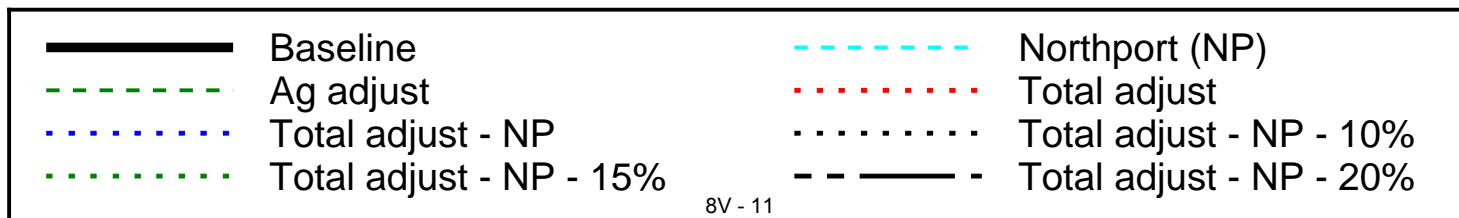
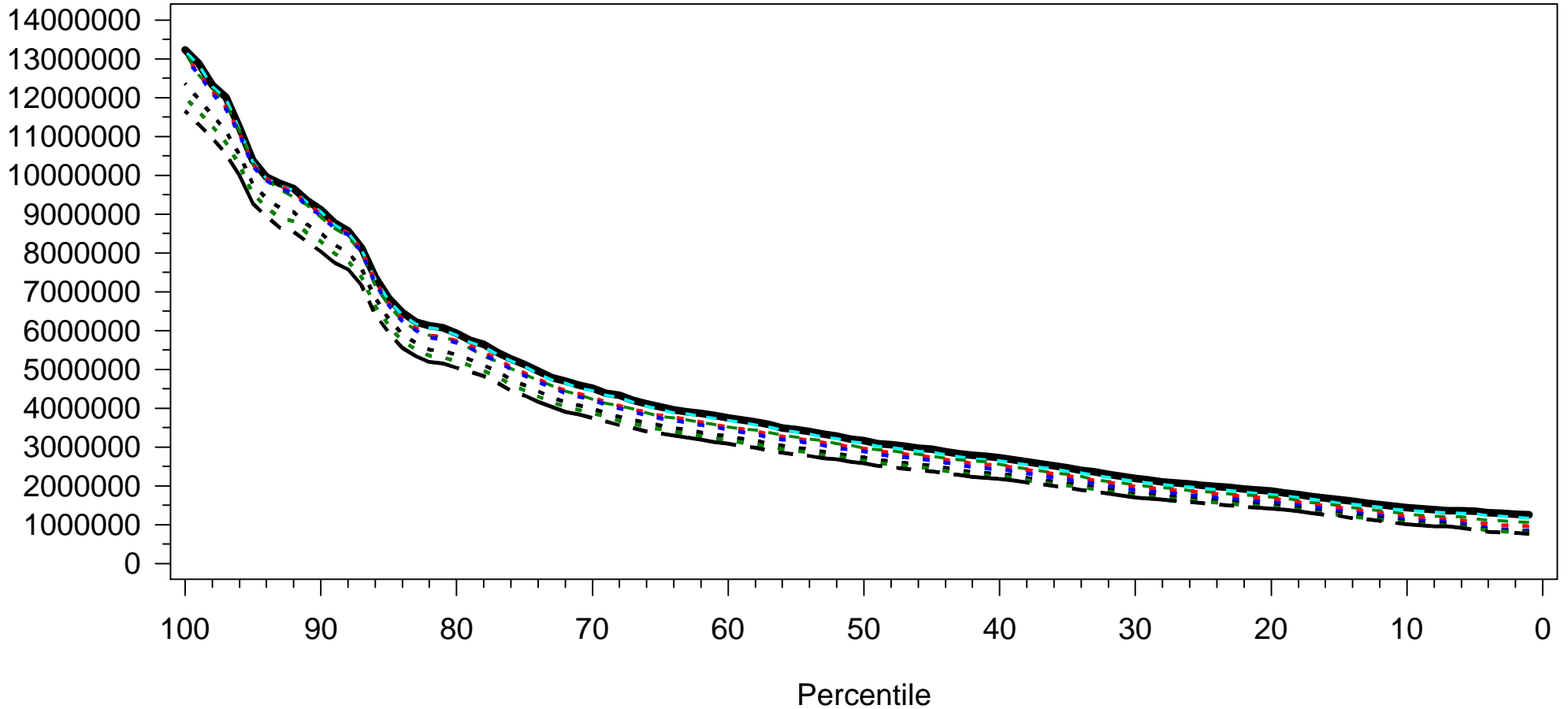

Myakka River

Period of Record 1995-2004

Normalized Area Under Curve

Taxa=Cyathura polita Block=Block 3

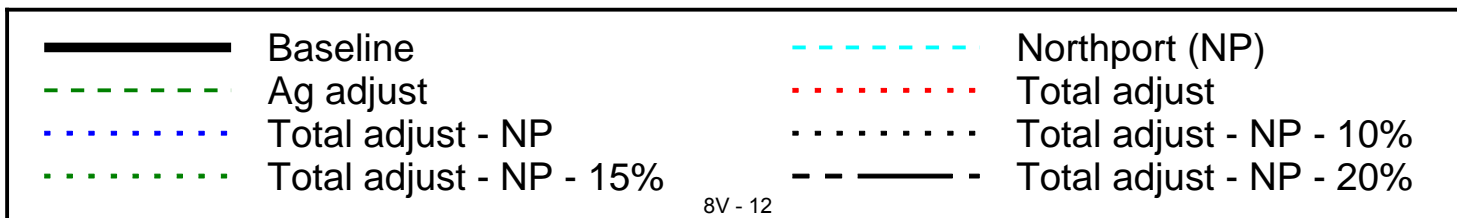
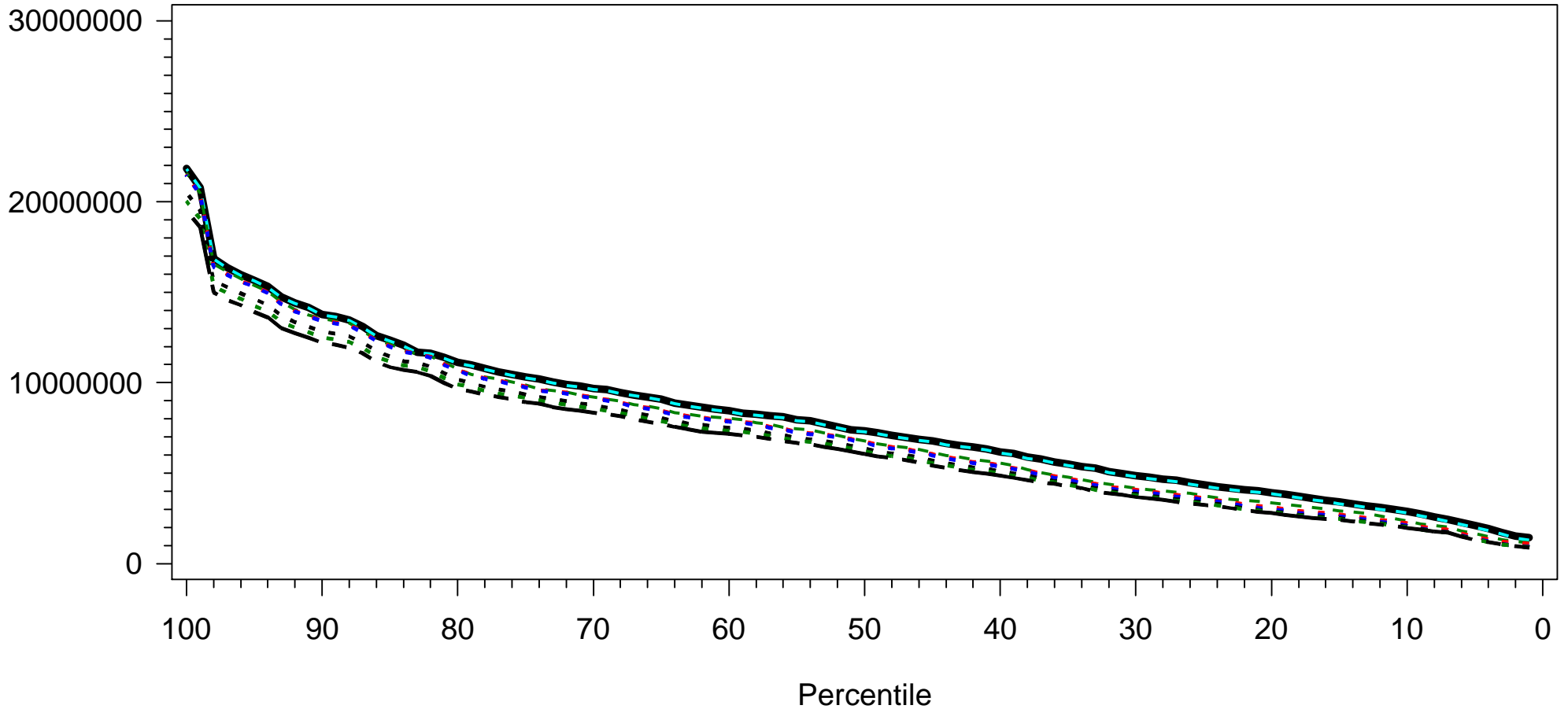

Myakka River

Period of Record 1995-2004

Normalized Area Under Curve

Taxa=*Gambusia holbrooki* <=25mm Block=Block 1

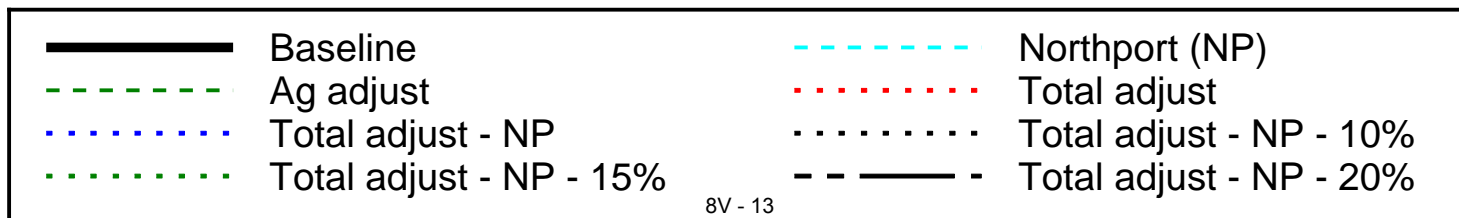
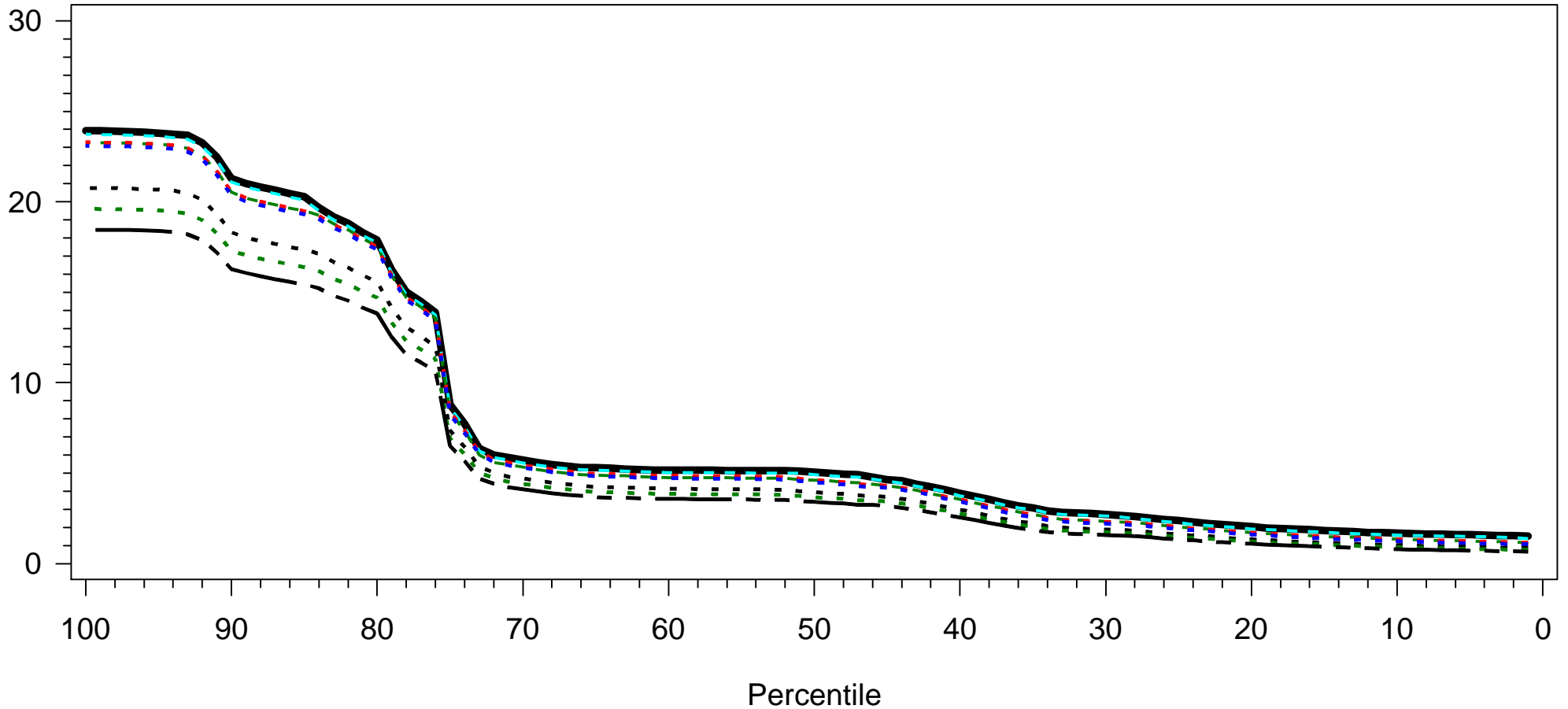

Myakka River

Period of Record 1995-2004

Normalized Area Under Curve

Taxa=*Gambusia holbrooki* <=25mm Block=Block 2

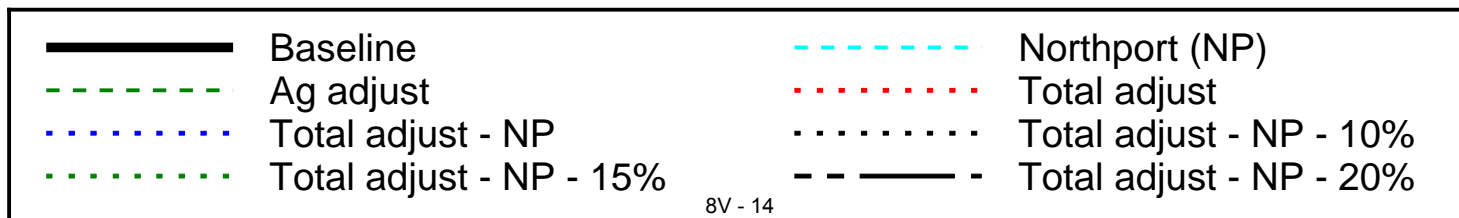
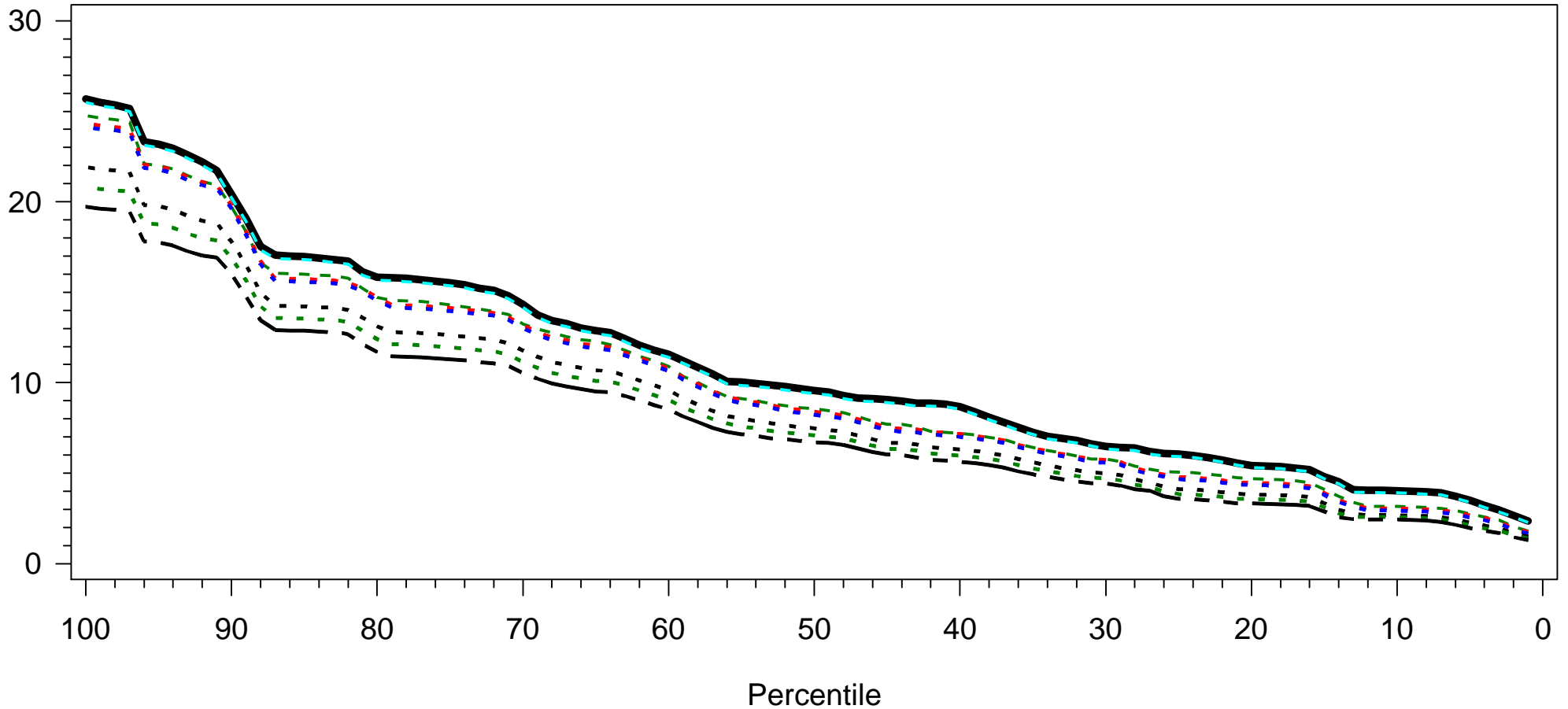

Myakka River

Period of Record 1995-2004

Normalized Area Under Curve

Taxa=*Gambusia holbrooki* <=25mm Block=Block 3

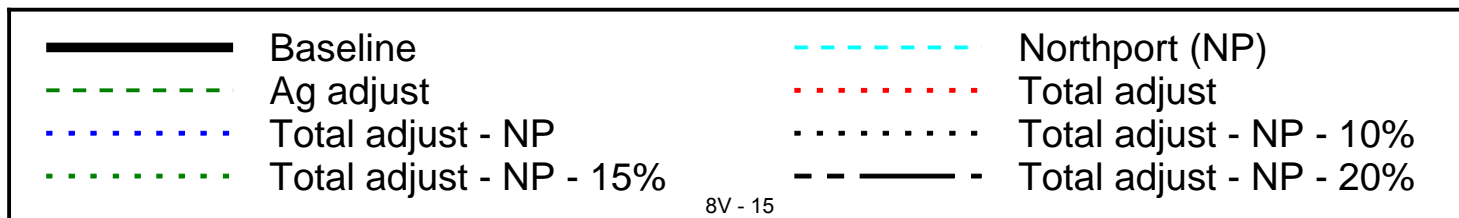
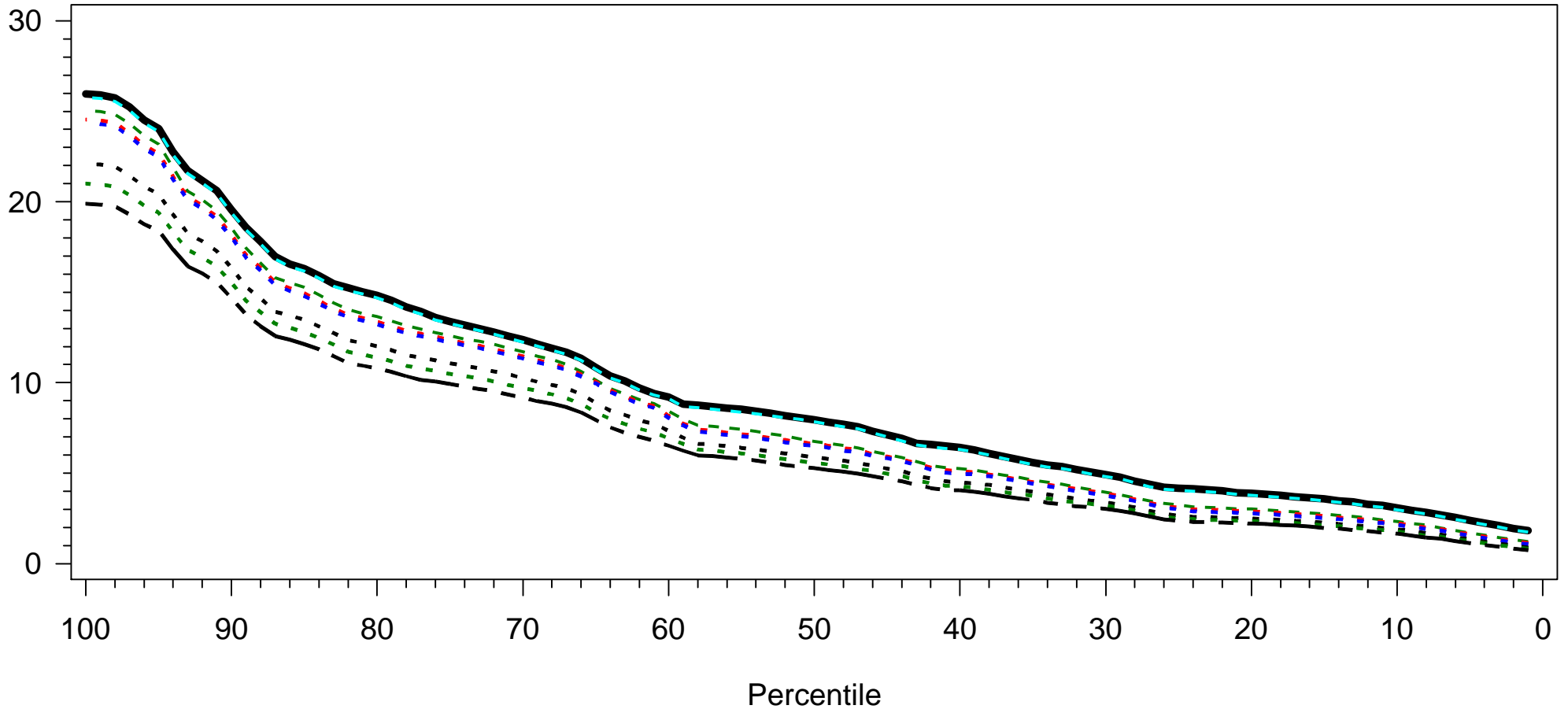

Myakka River

Period of Record 1995-2004

Normalized Area Under Curve

Taxa=*Gambusia holbrooki* >25mm Block=Block 1

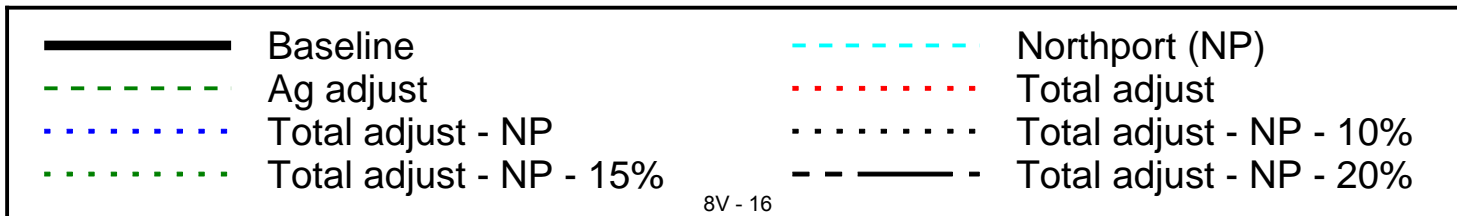
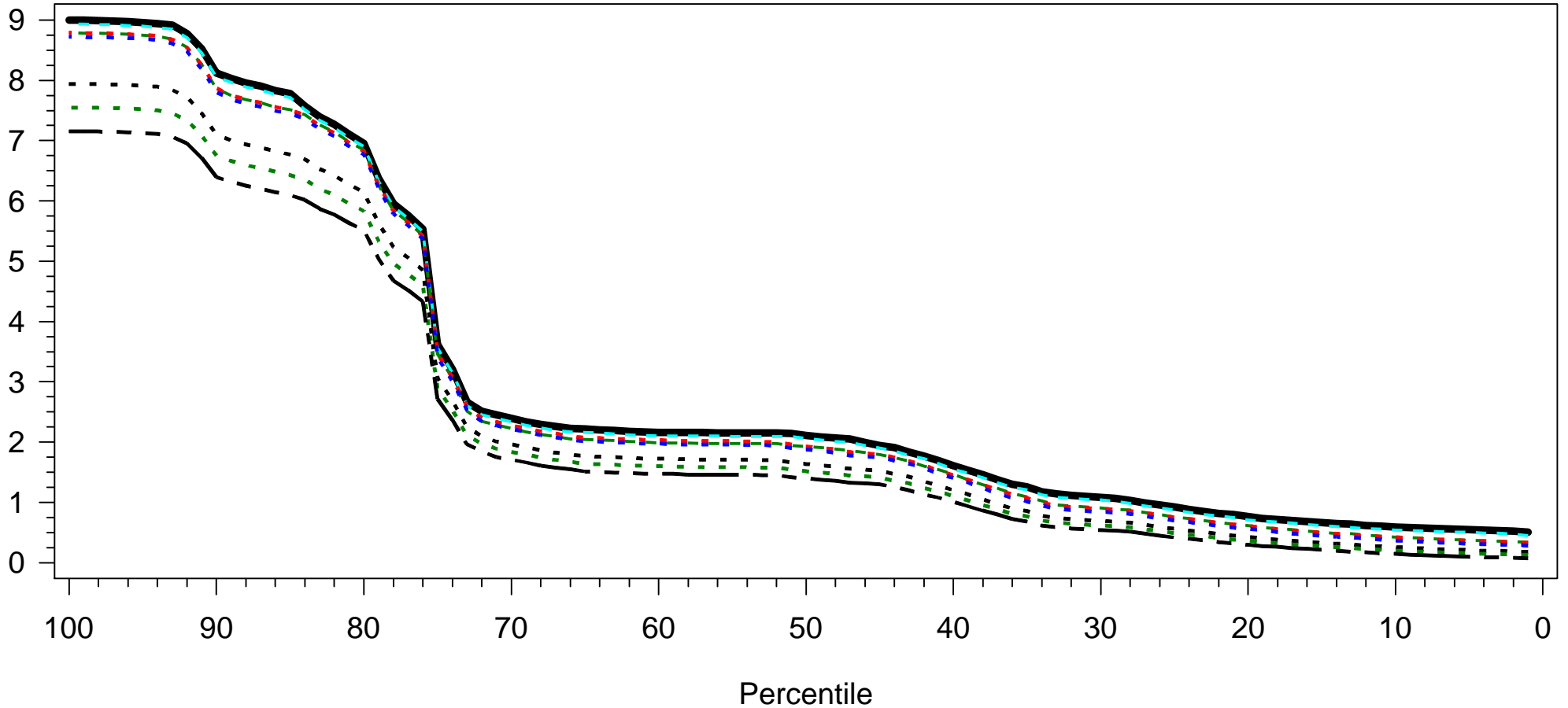

Myakka River

Period of Record 1995-2004

Normalized Area Under Curve

Taxa=*Gambusia holbrooki* >25mm Block=Block 2

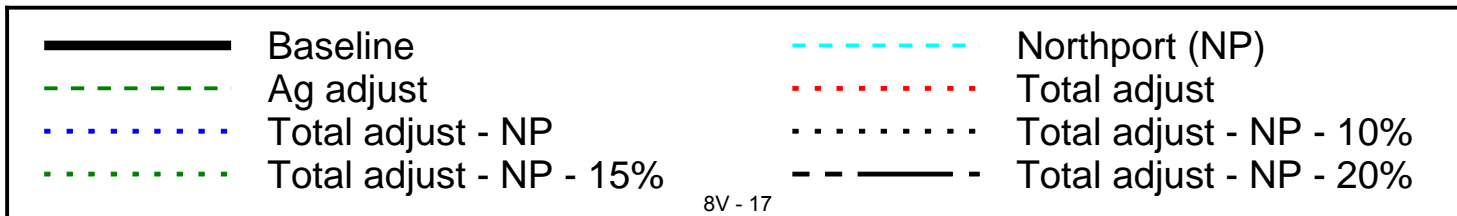
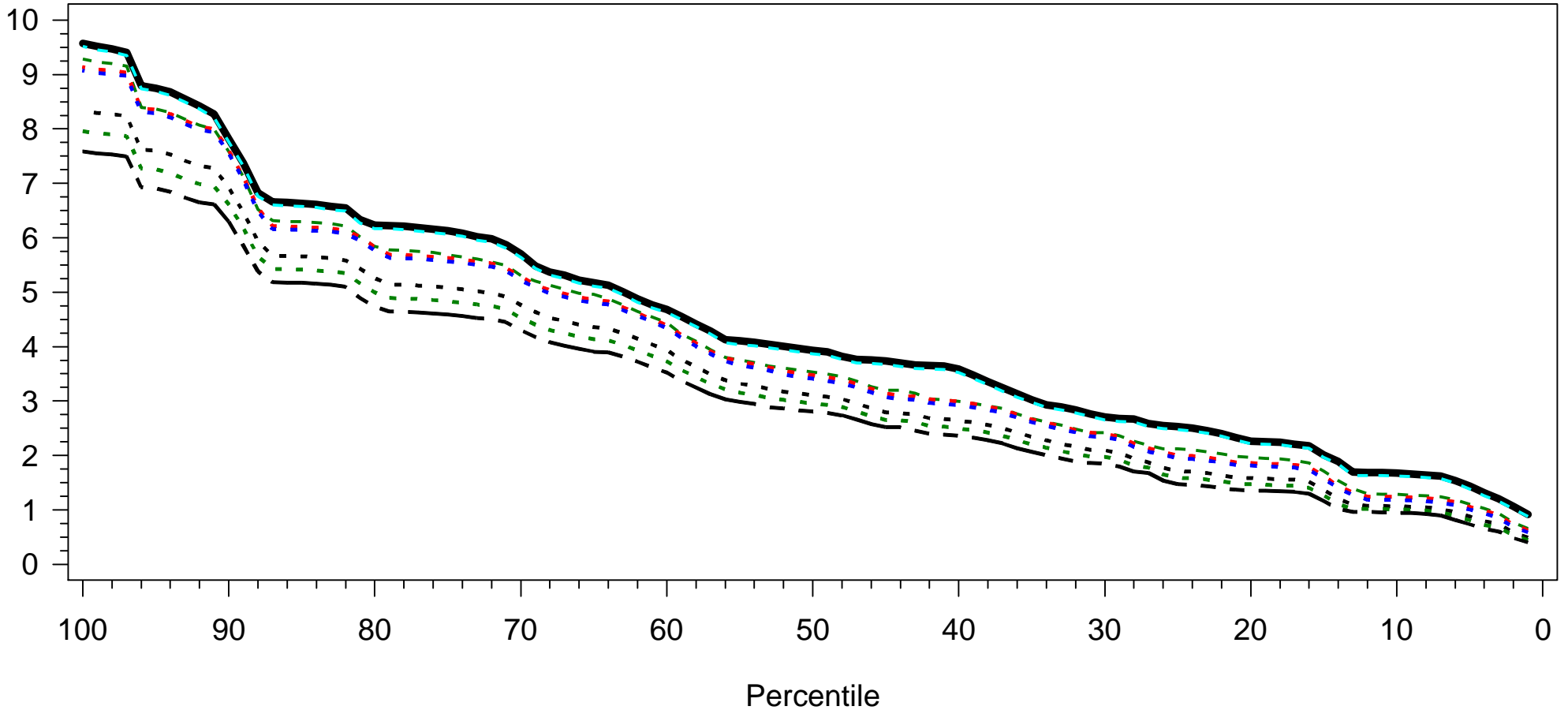

Myakka River

Period of Record 1995-2004

Normalized Area Under Curve

Taxa=*Gambusia holbrooki* >25mm Block=Block 3

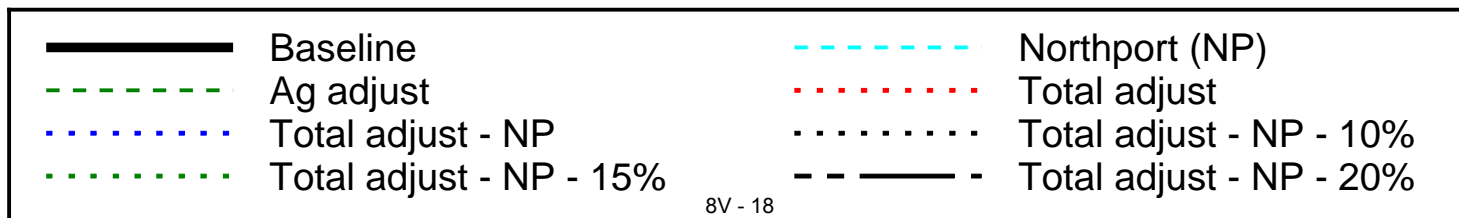
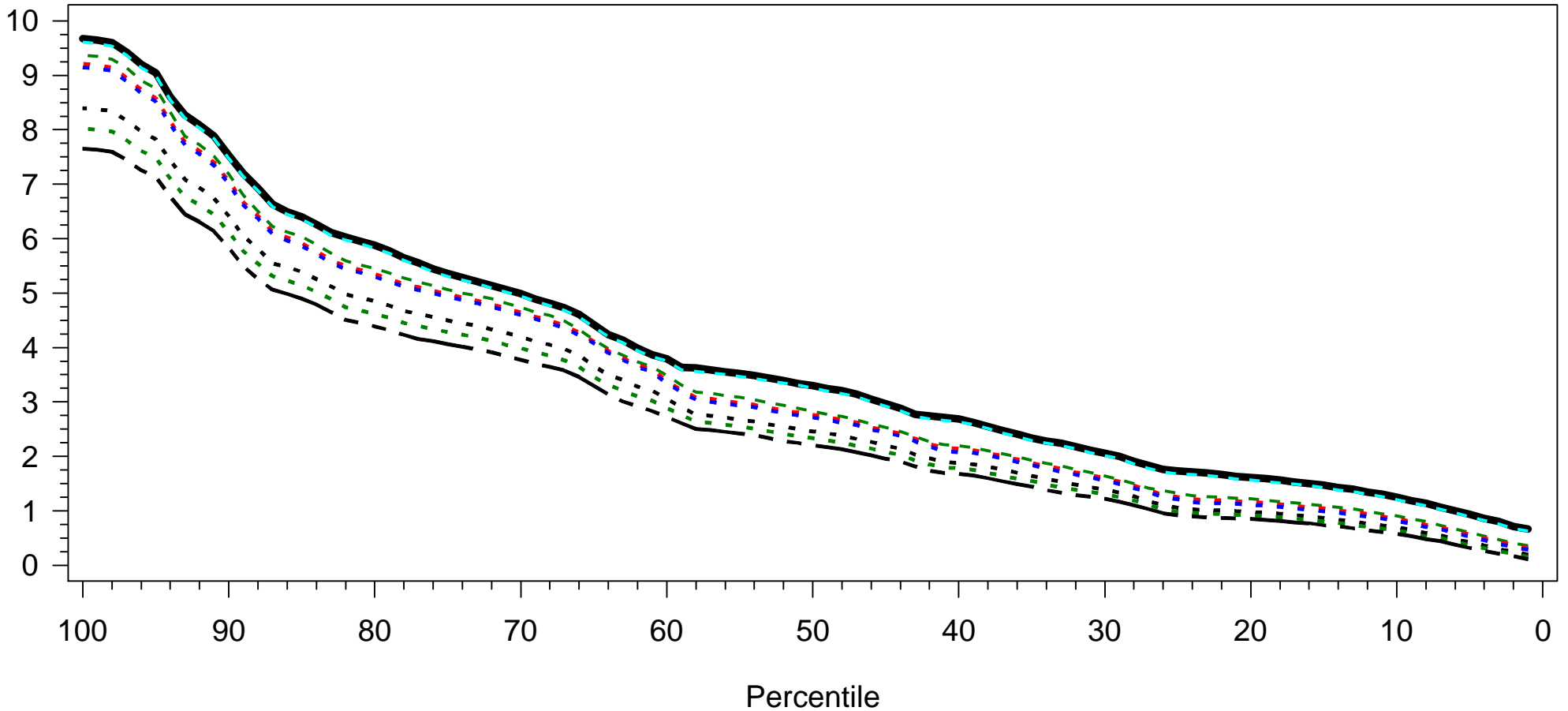

Myakka River

Period of Record 1995-2004

Normalized Area Under Curve

Taxa=*Palaemonetes intermedius* Block=Block 1

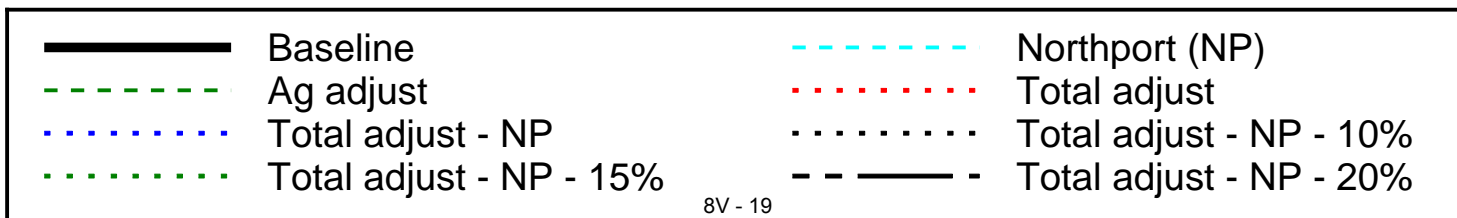
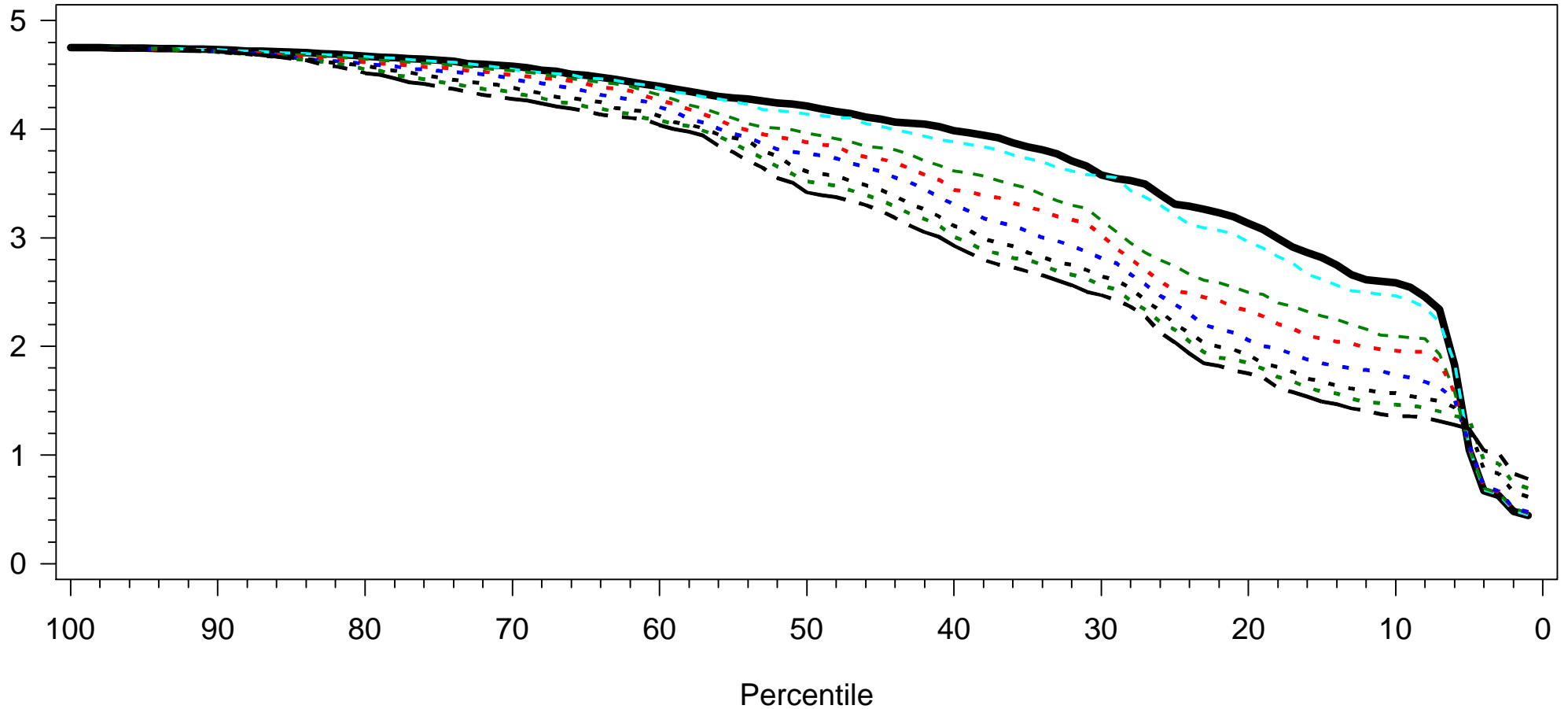

Myakka River

Period of Record 1995-2004

Normalized Area Under Curve

Taxa=*Palaemonetes intermedius* Block=Block 2

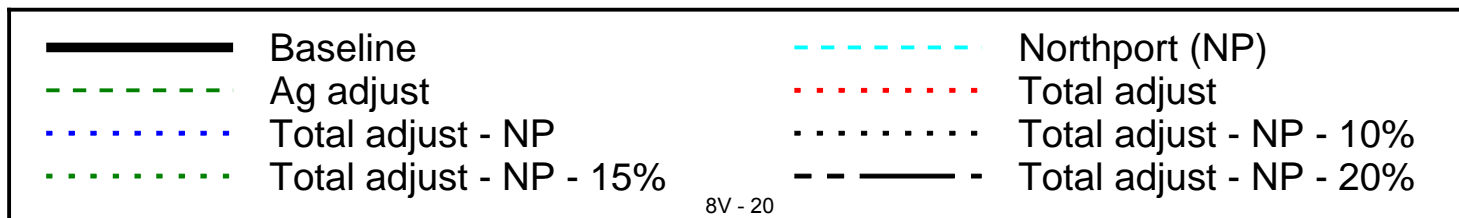
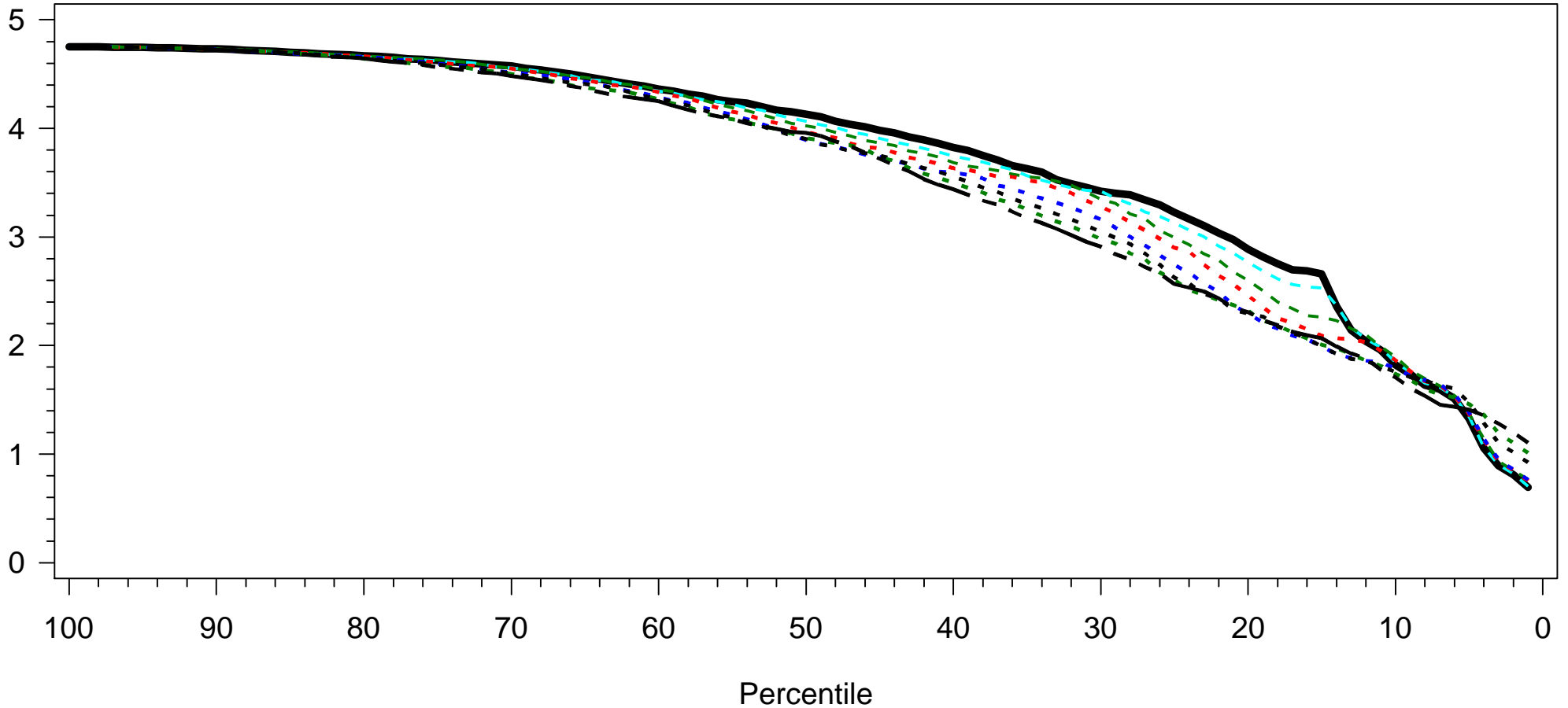

Myakka River

Period of Record 1995-2004

Normalized Area Under Curve

Taxa=*Palaemonetes intermedius* Block=Block 3

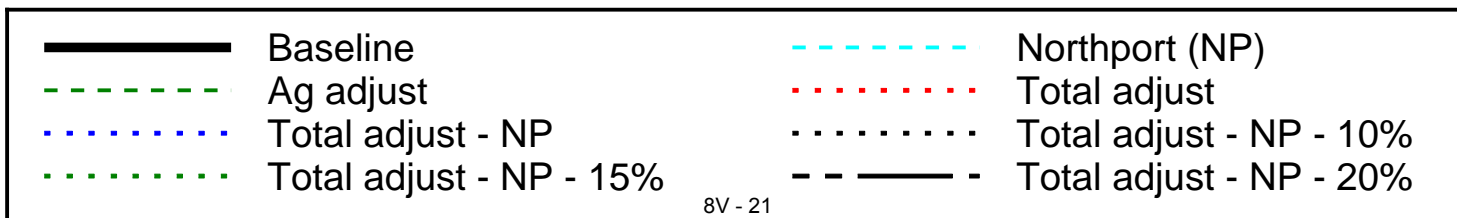
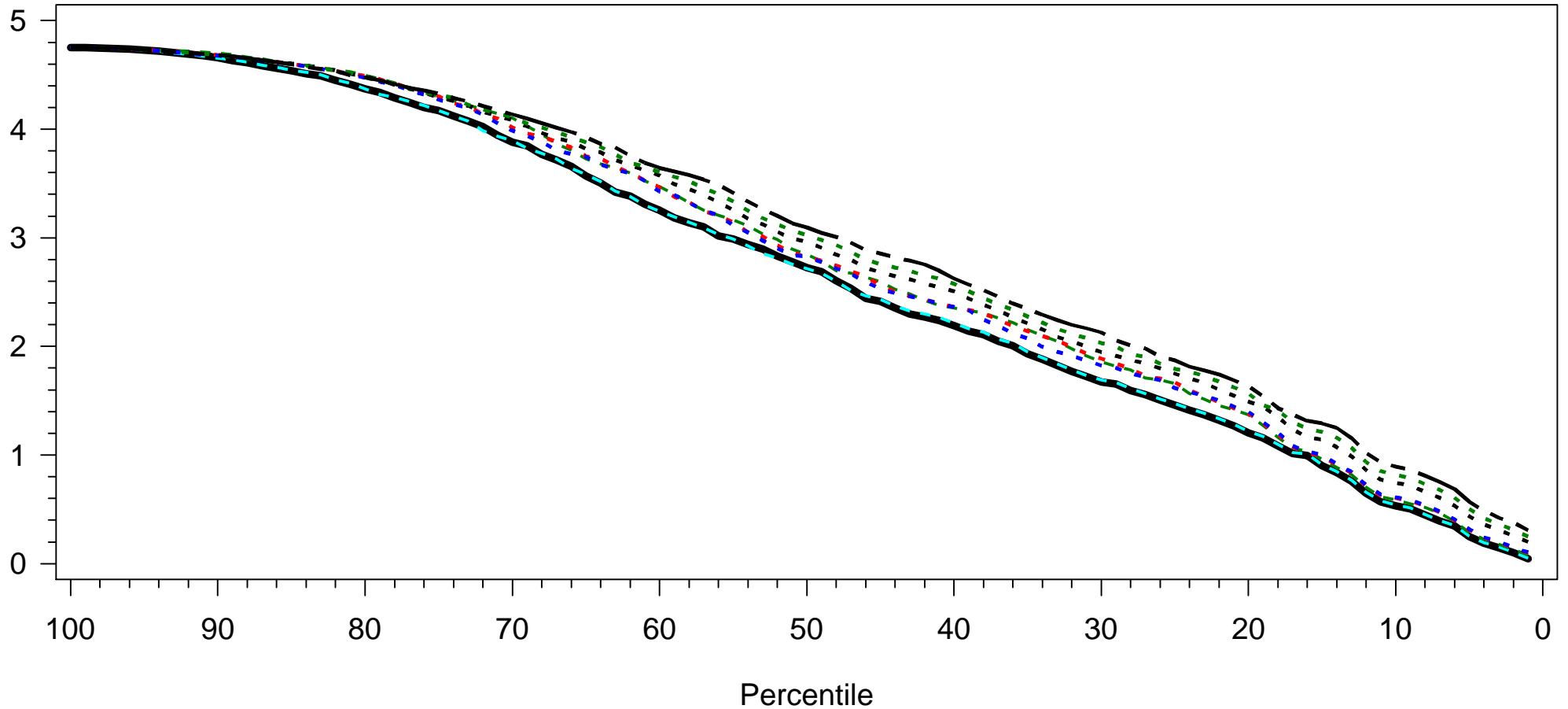

Myakka River

Period of Record 1995-2004

Normalized Area Under Curve

Taxa=Menidia spp. juveniles Block=Block 1

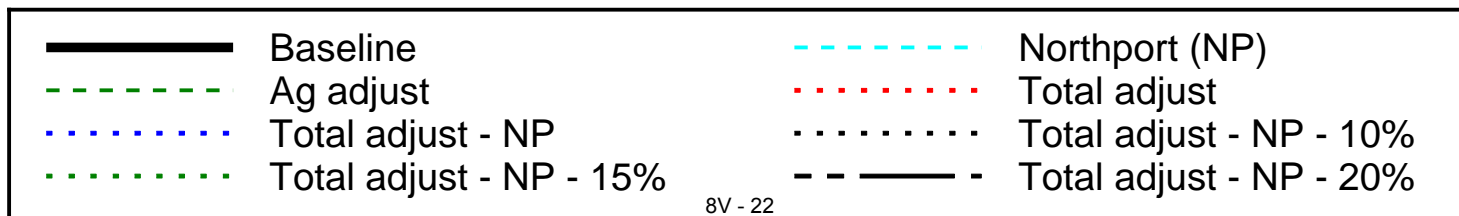
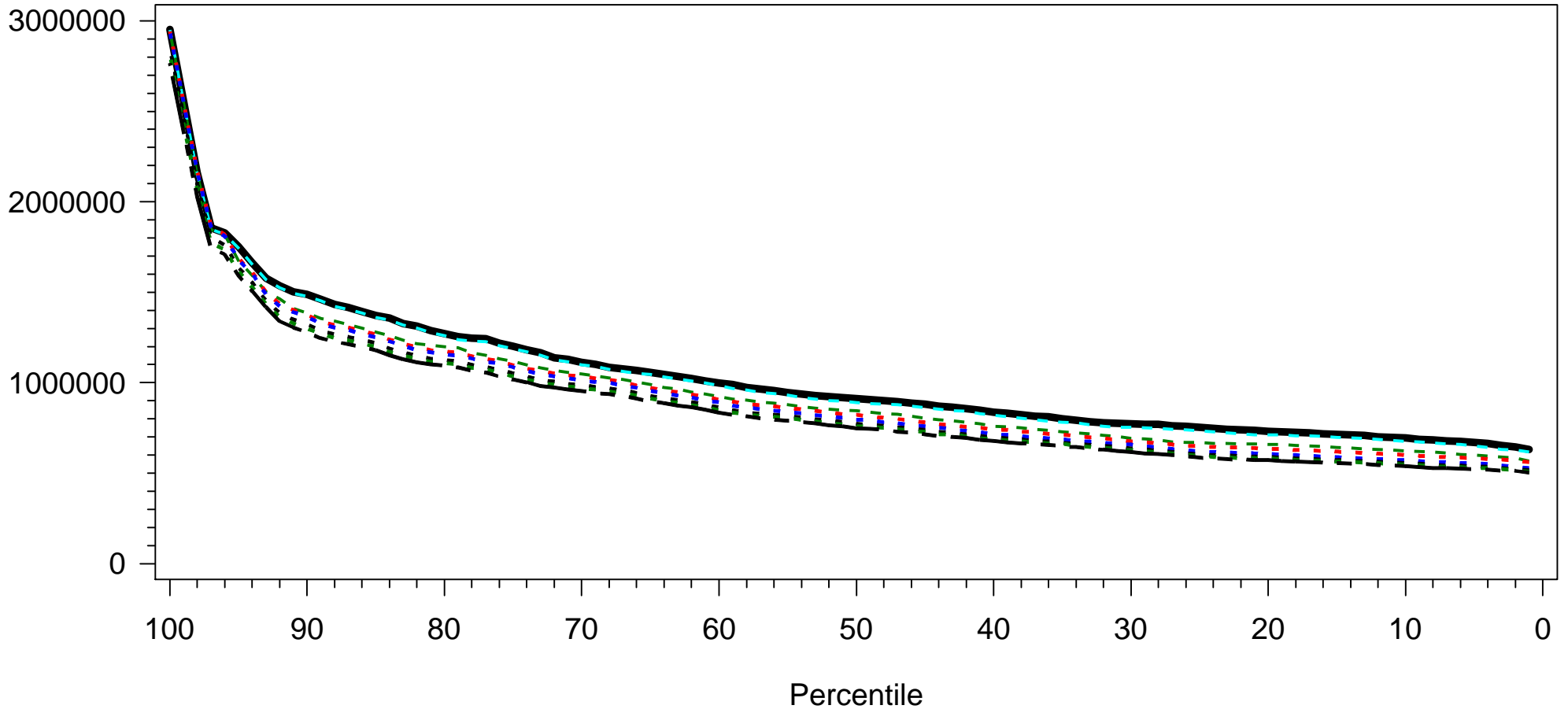

Myakka River

Period of Record 1995-2004

Normalized Area Under Curve

Taxa=Menidia spp. juveniles Block=Block 2

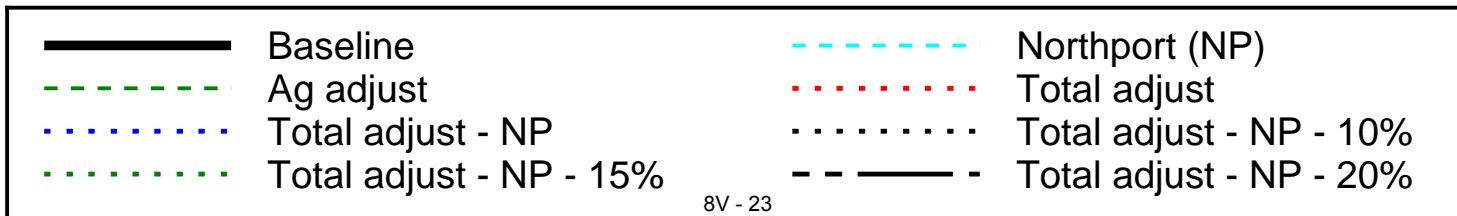
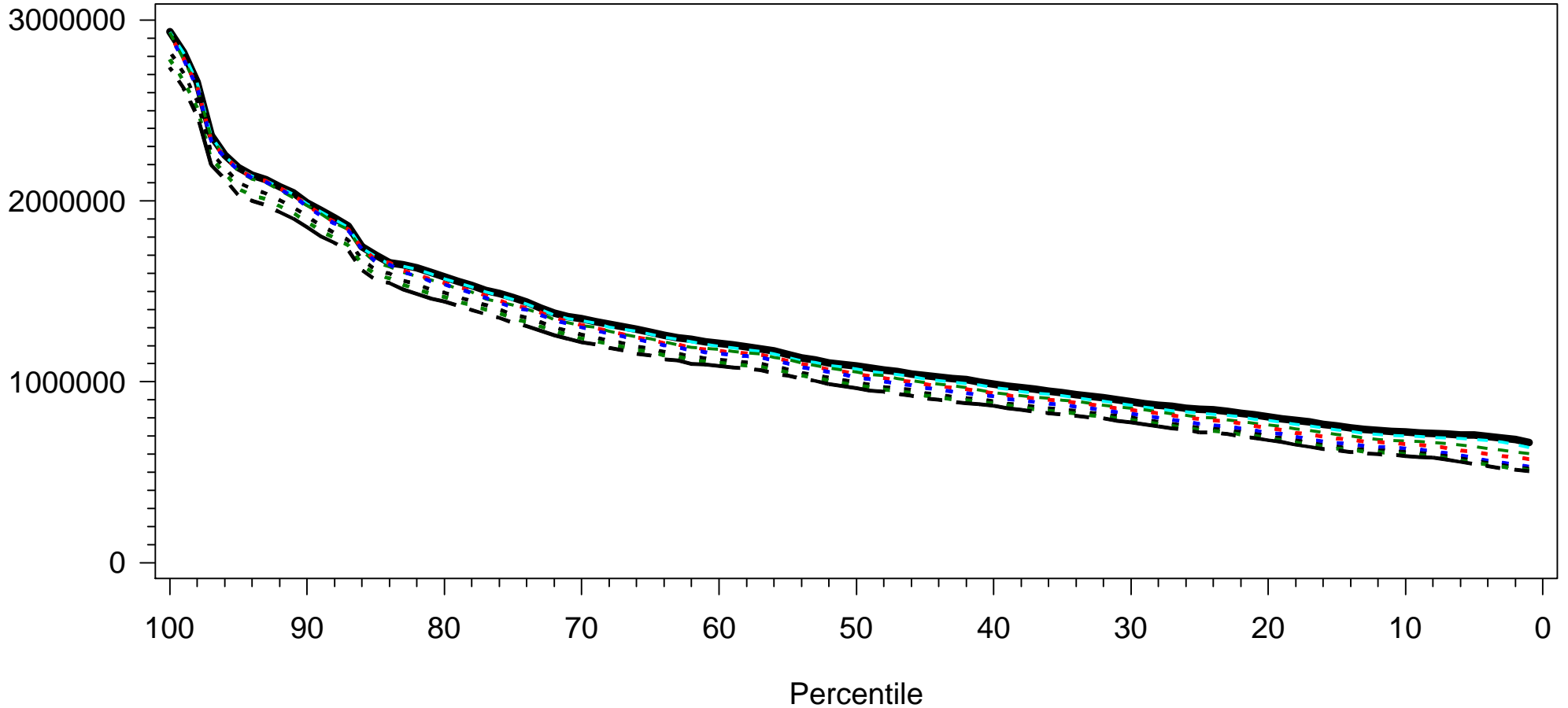

Myakka River

Period of Record 1995-2004

Normalized Area Under Curve

Taxa=Menidia spp. juveniles Block=Block 3

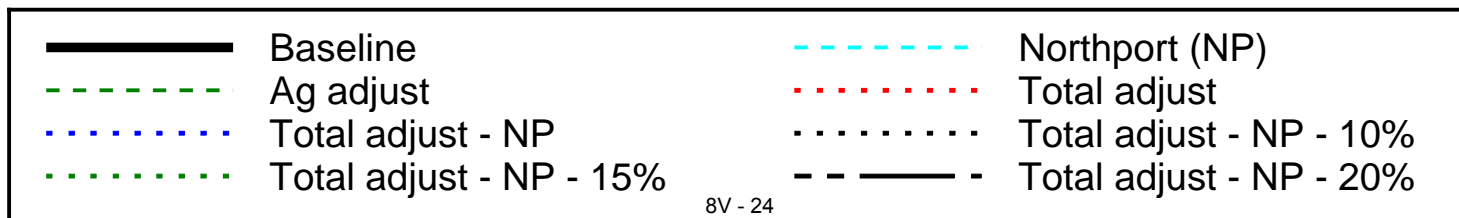
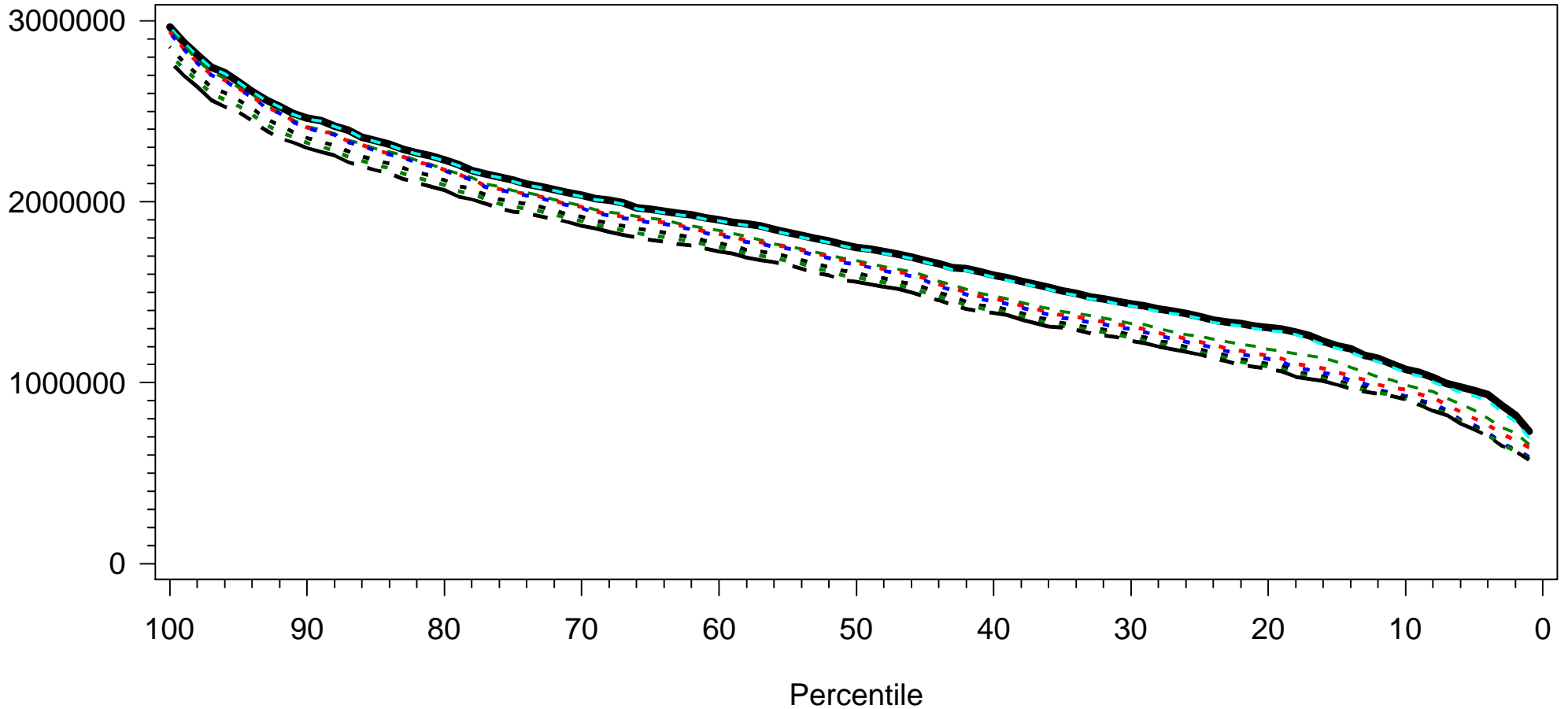

Myakka River

Period of Record 1995-2004

Normalized Area Under Curve

Taxa=Palaemonetes pugio Block=Block 1

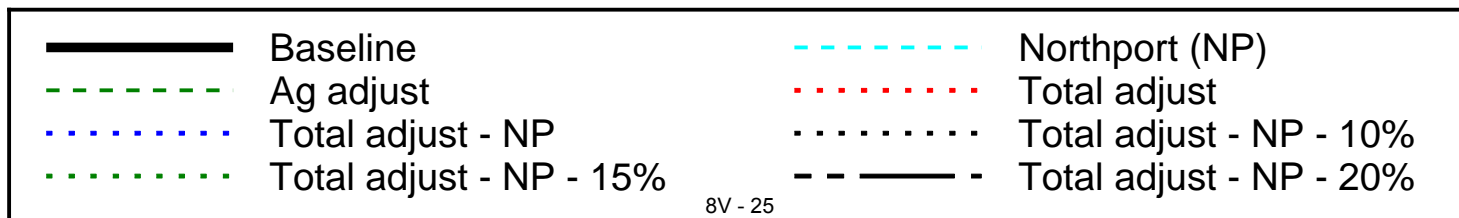
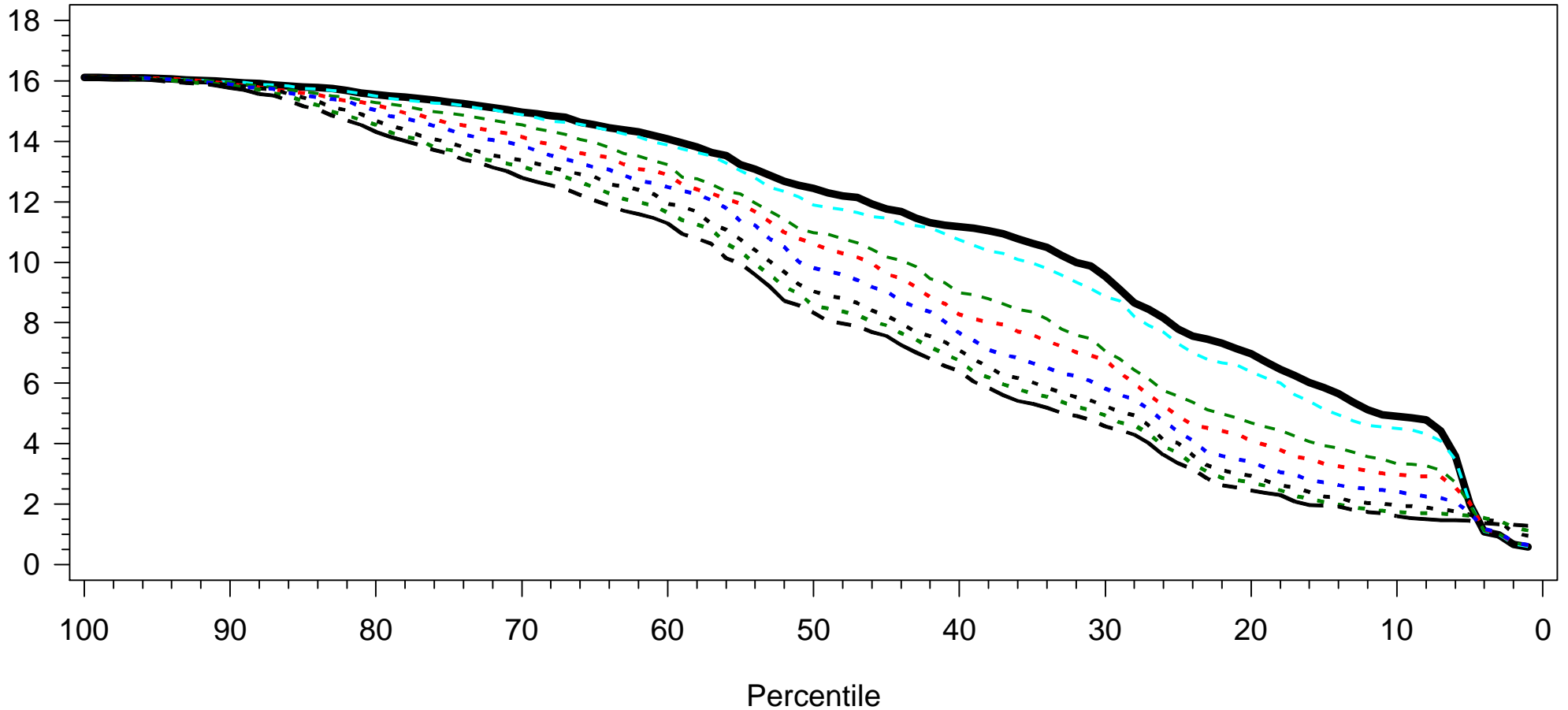

Myakka River

Period of Record 1995-2004

Normalized Area Under Curve

Taxa=Palaemonetes pugio Block=Block 2

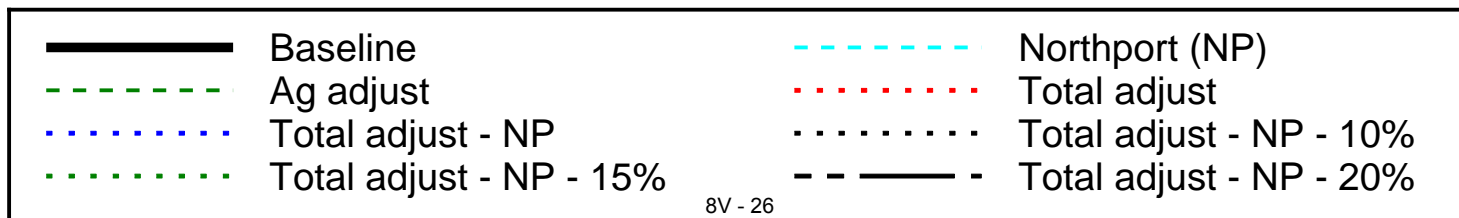
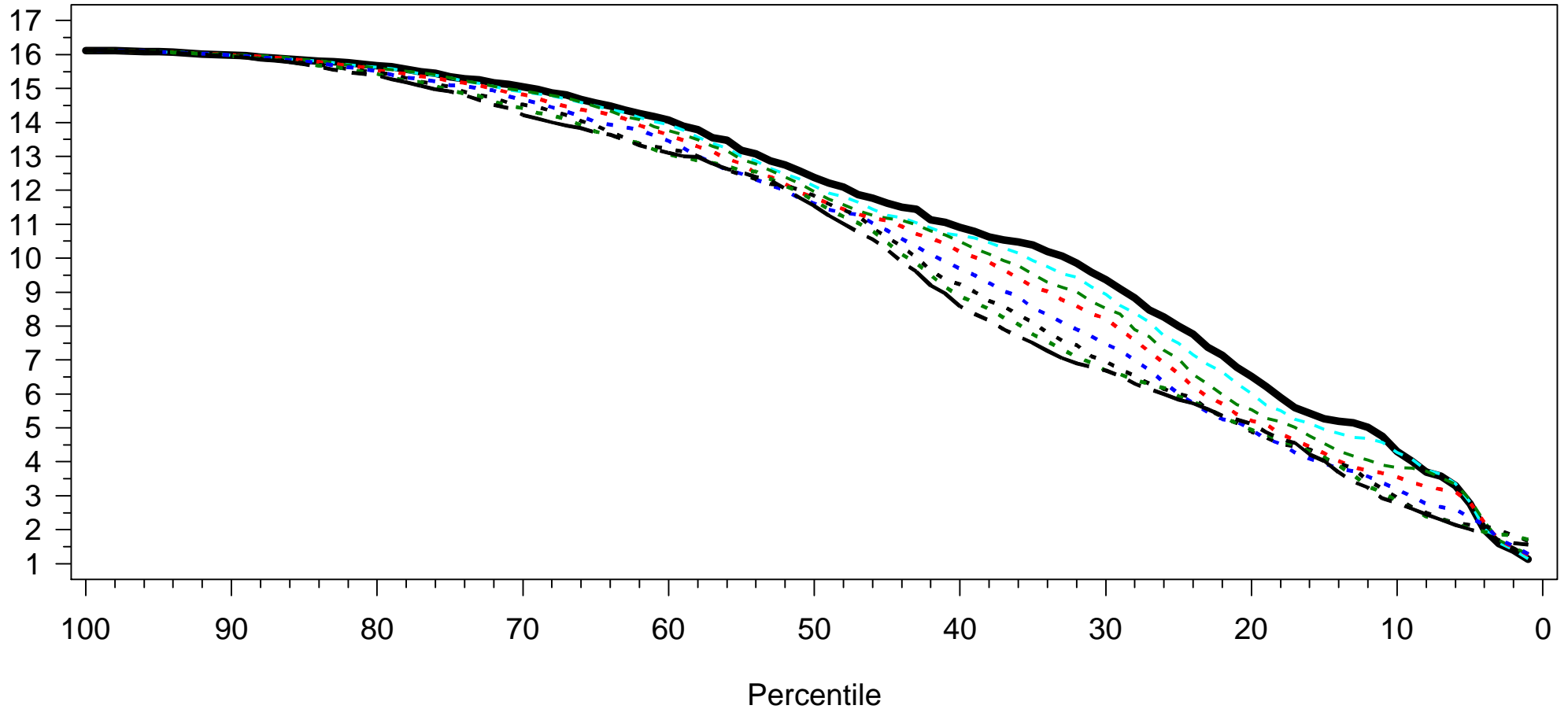

Myakka River

Period of Record 1995-2004

Normalized Area Under Curve

Taxa=Palaemonetes pugio Block=Block 3

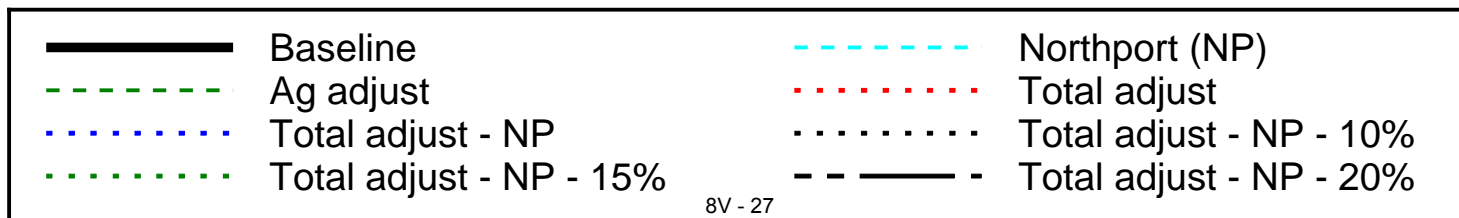
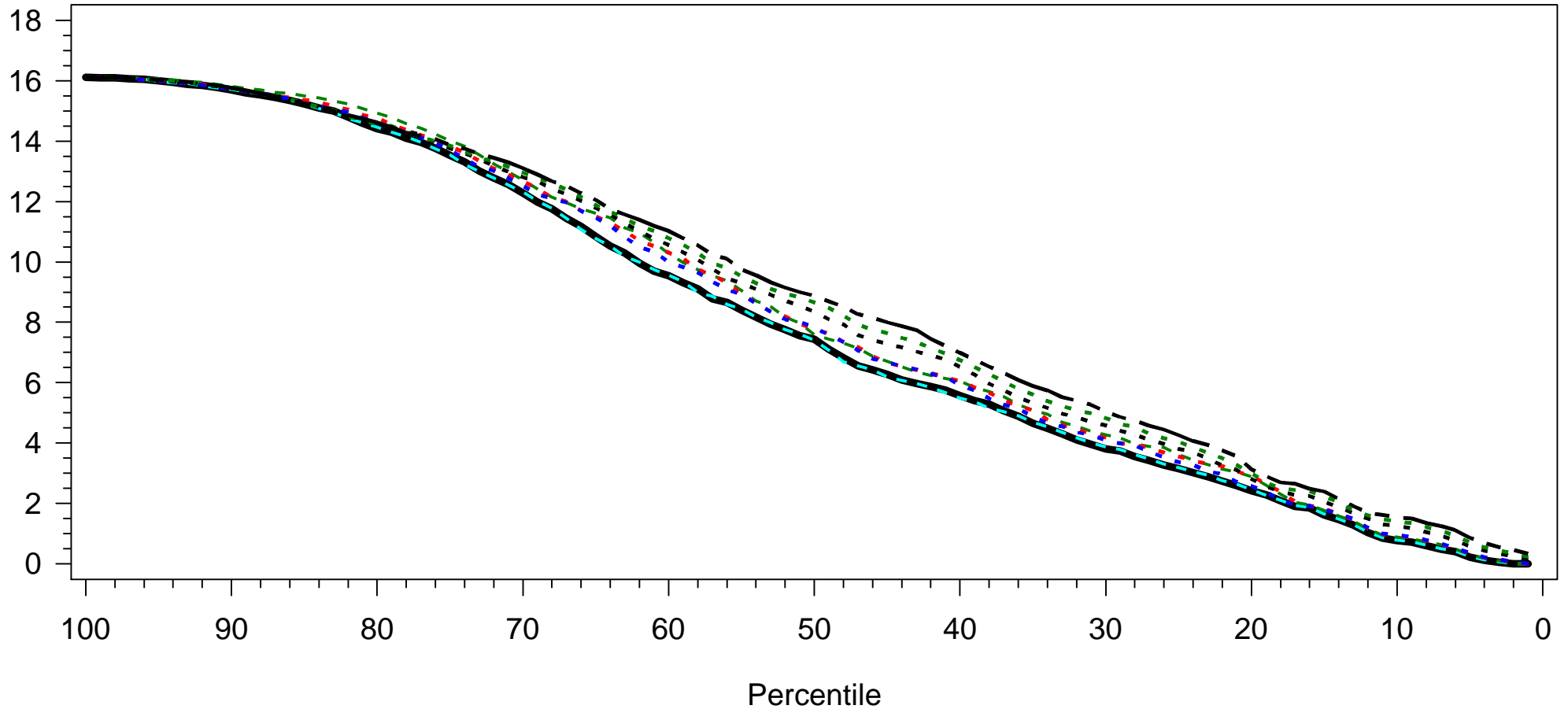

Myakka River

Period of Record 1995-2004

Normalized Area Under Curve

Taxa=Trinectes maculatus juveniles Block=Block 1

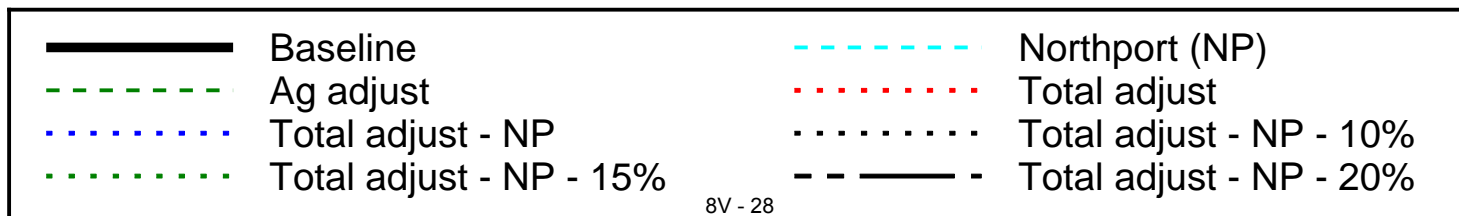
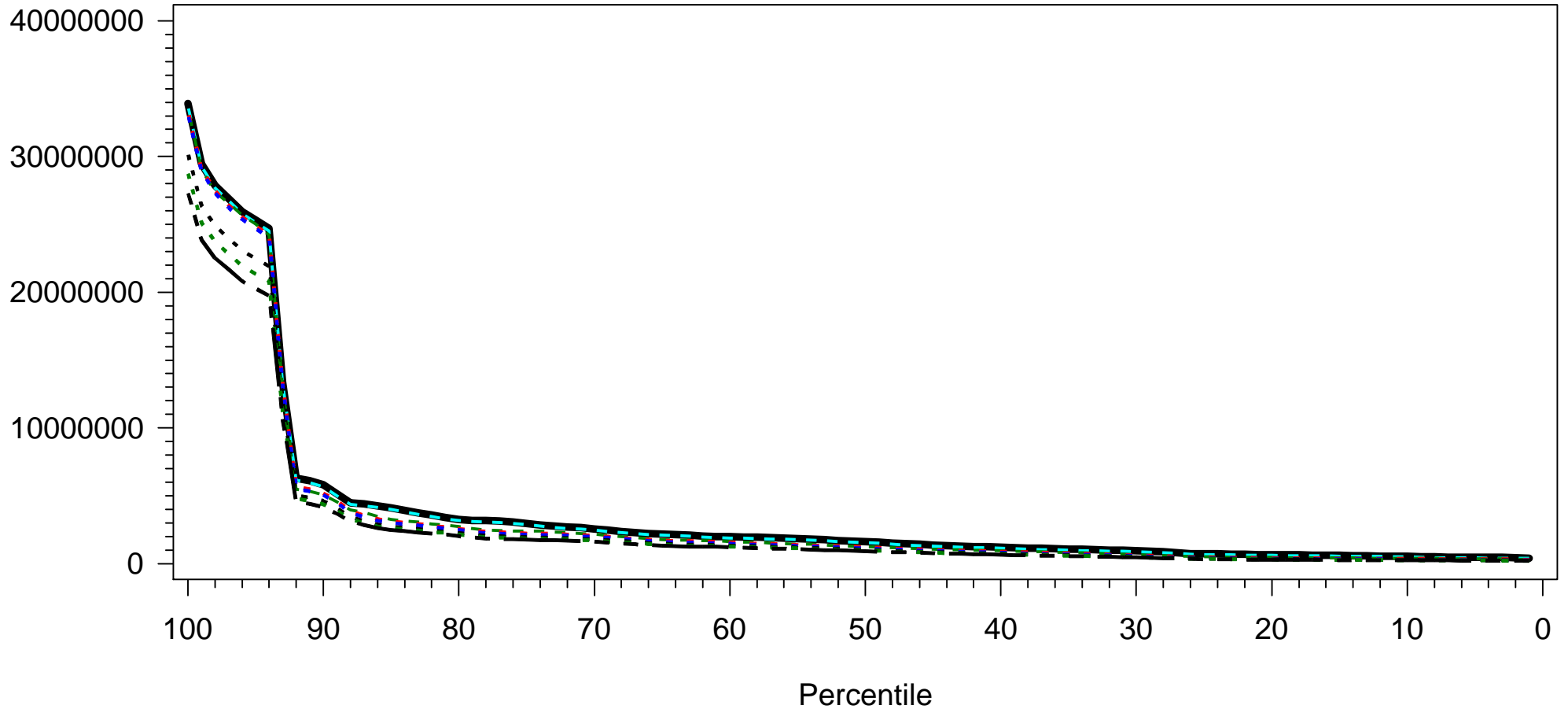

Myakka River

Period of Record 1995-2004

Normalized Area Under Curve

Taxa=Trinectes maculatus juveniles Block=Block 2

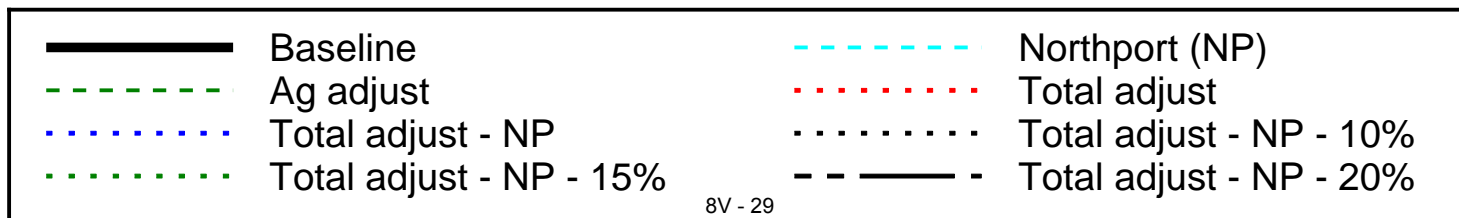
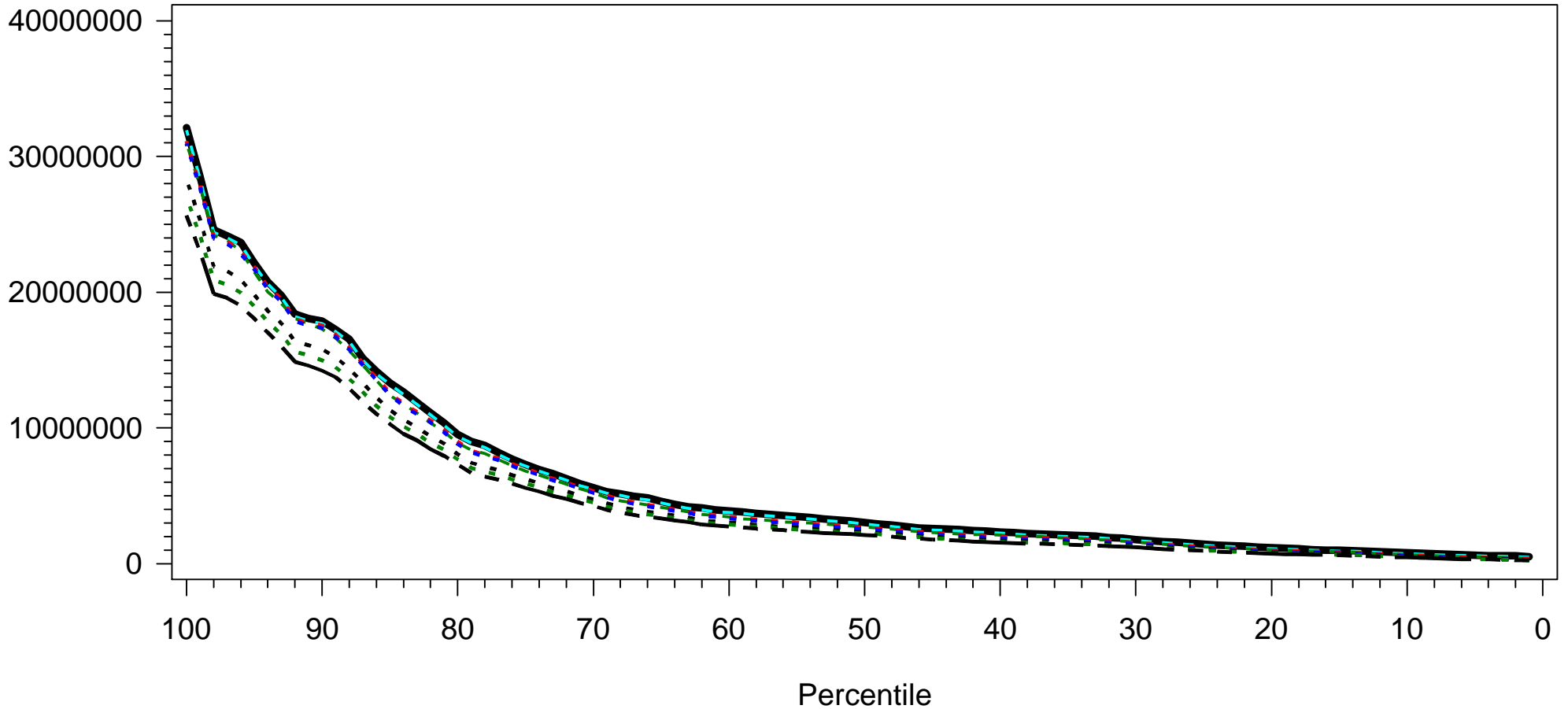

Myakka River

Period of Record 1995-2004

Normalized Area Under Curve

Taxa=Trinectes maculatus juveniles Block=Block 3

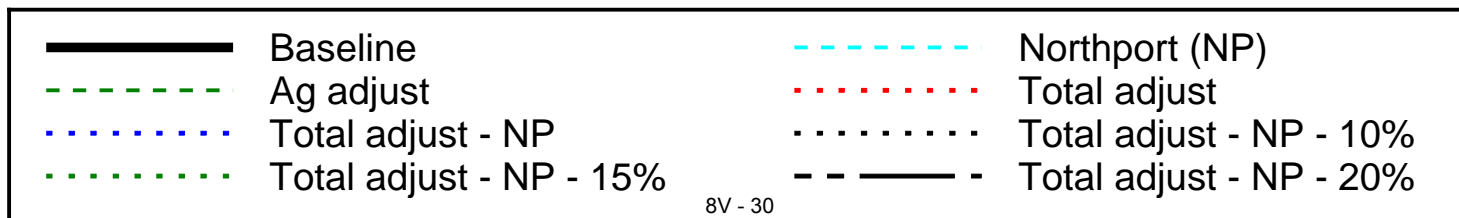
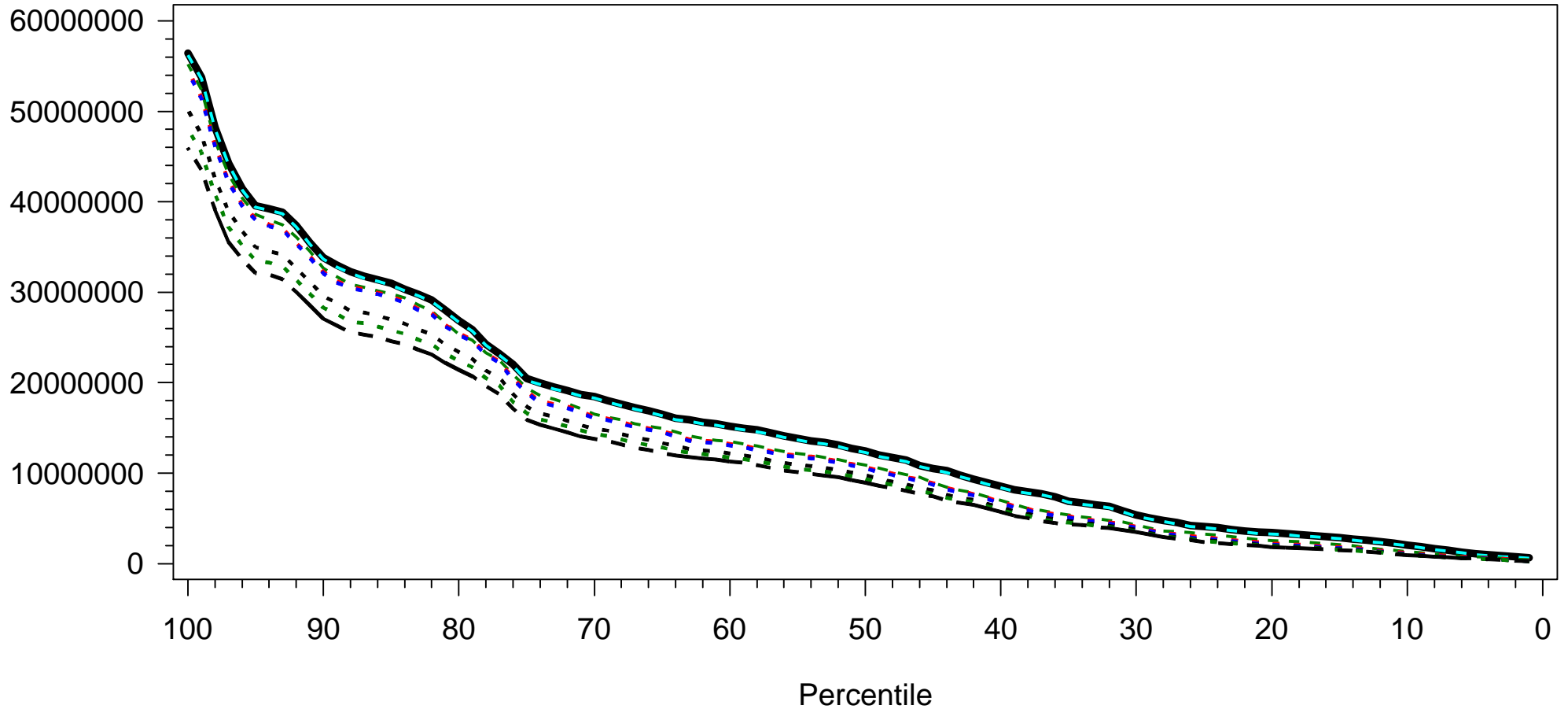

Myakka River

Period of Record 1995-2004

Normalized Area Under Curve

Taxa=Unid Americamysis juveniles Block=Block 1

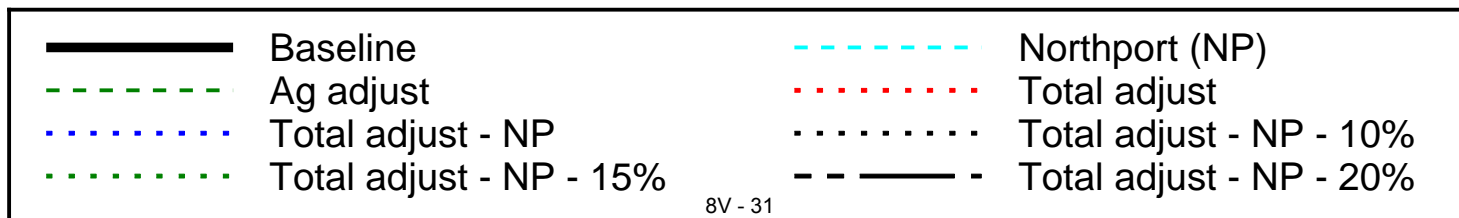
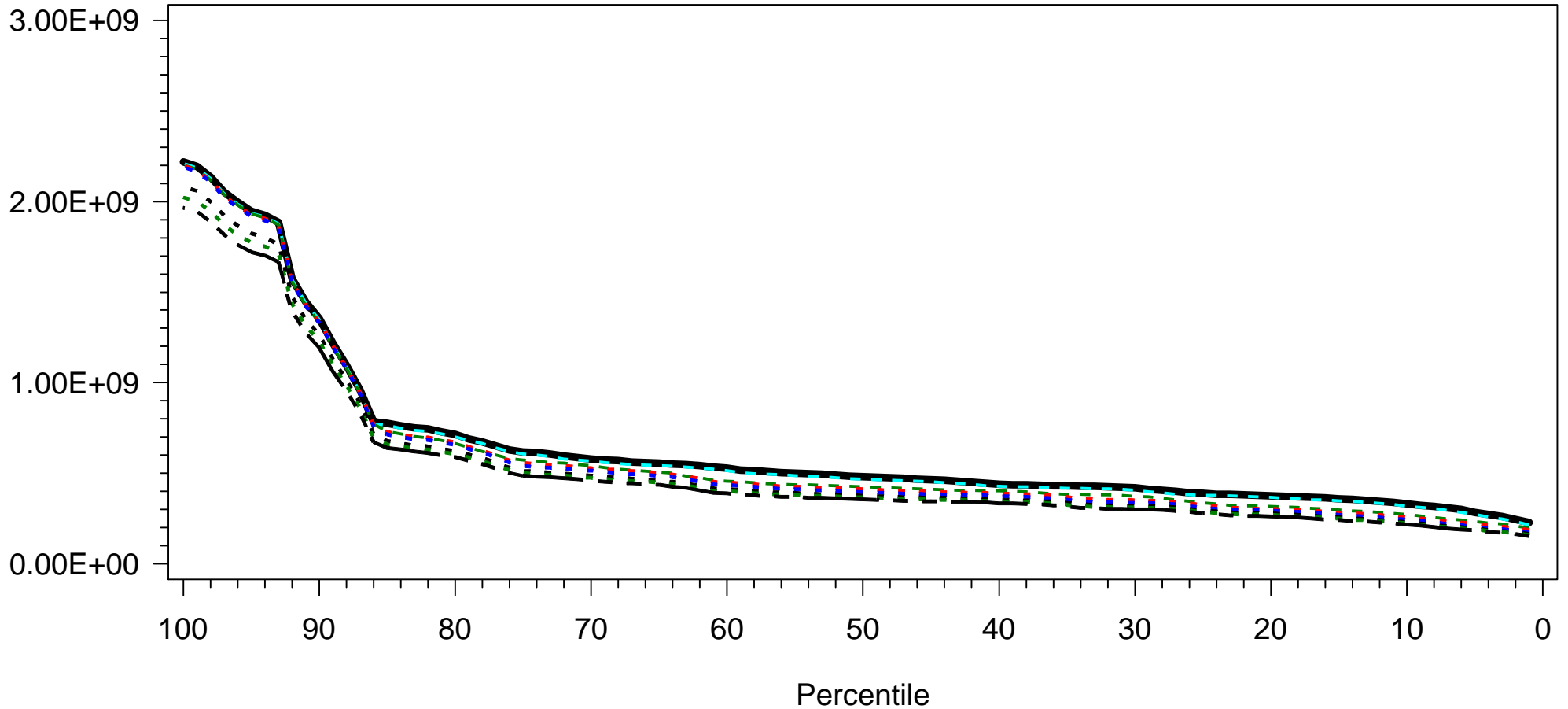

Myakka River

Period of Record 1995-2004

Normalized Area Under Curve

Taxa=Unid Americamysis juveniles Block=Block 2

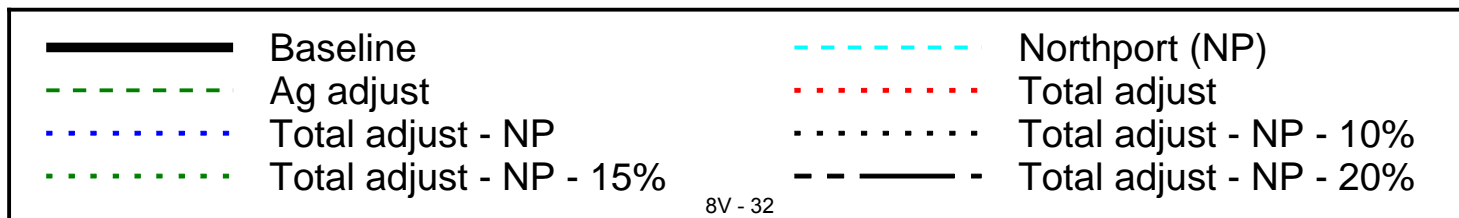
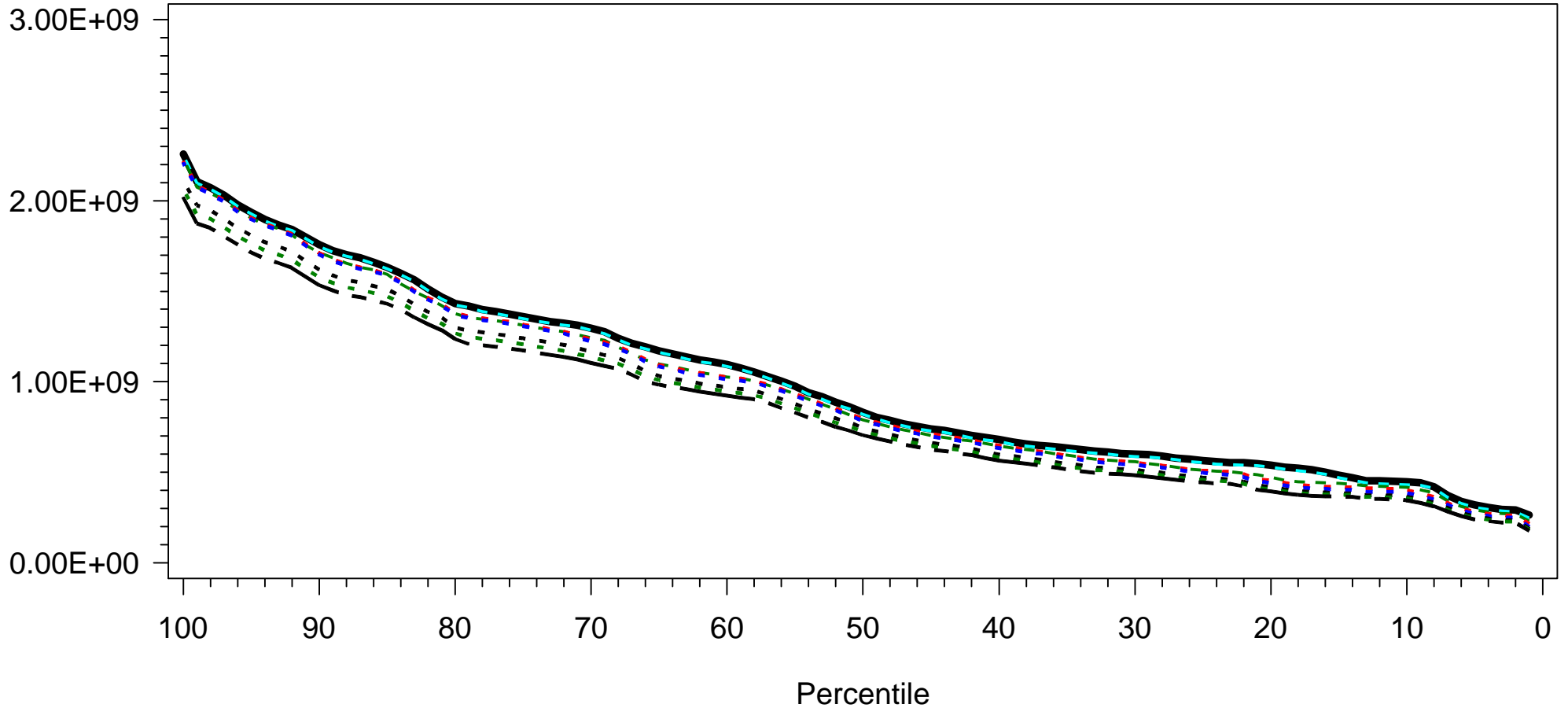

Myakka River

Period of Record 1995-2004

Normalized Area Under Curve

Taxa=Unid Americamysis juveniles Block=Block 3

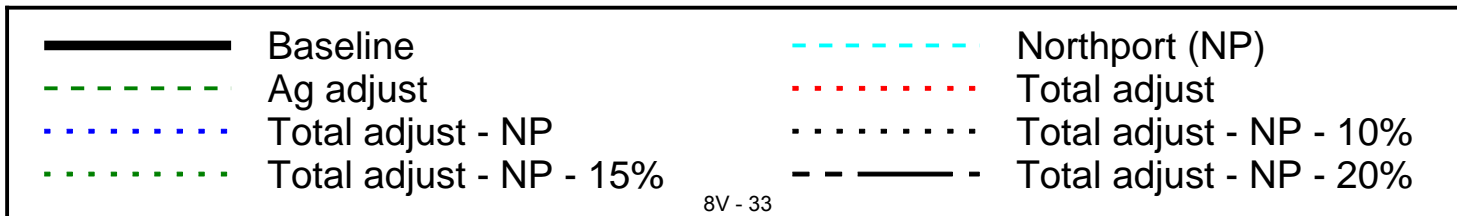
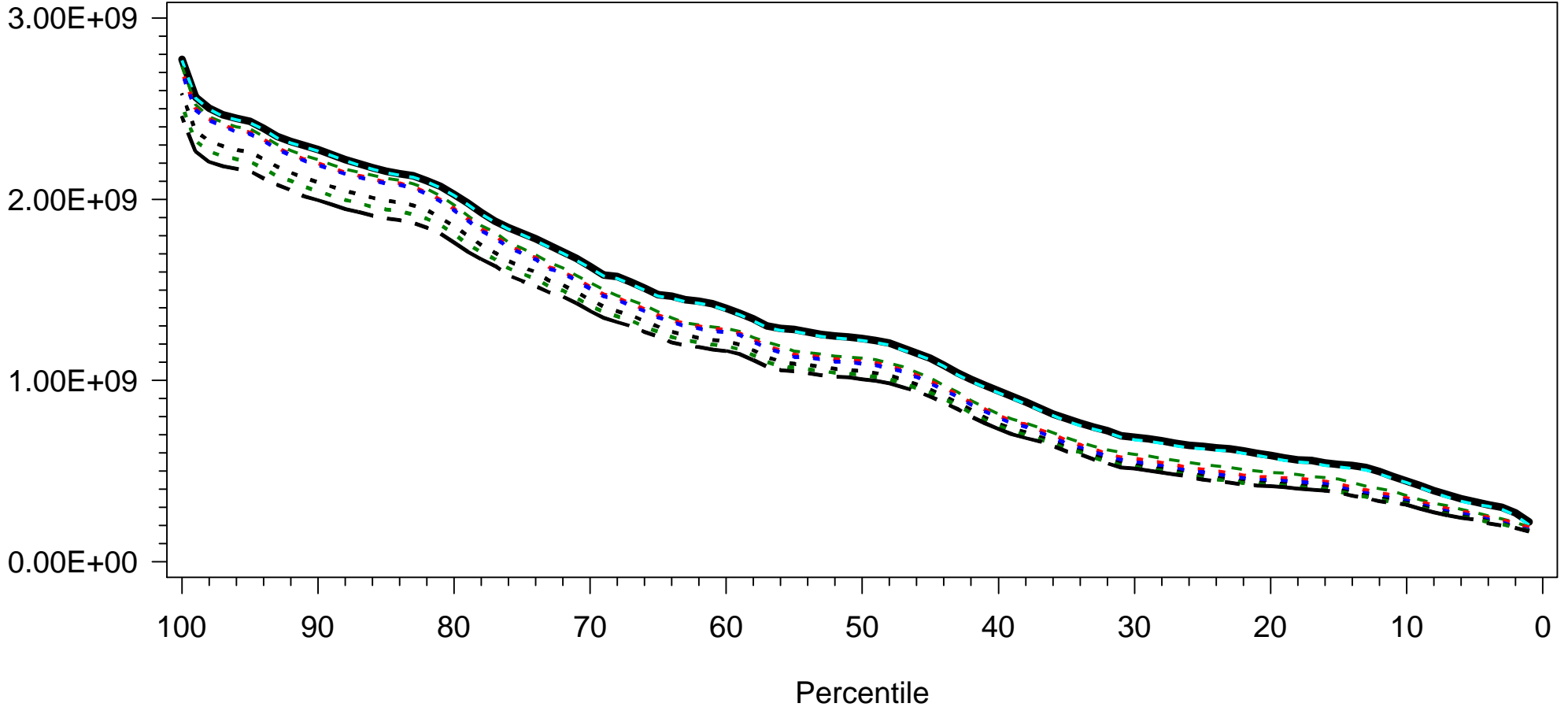

Myakka River

Period of Record 1995-2004

Normalized Area Under Curve

Taxa=Americamysis almyra2 Block=Block 1

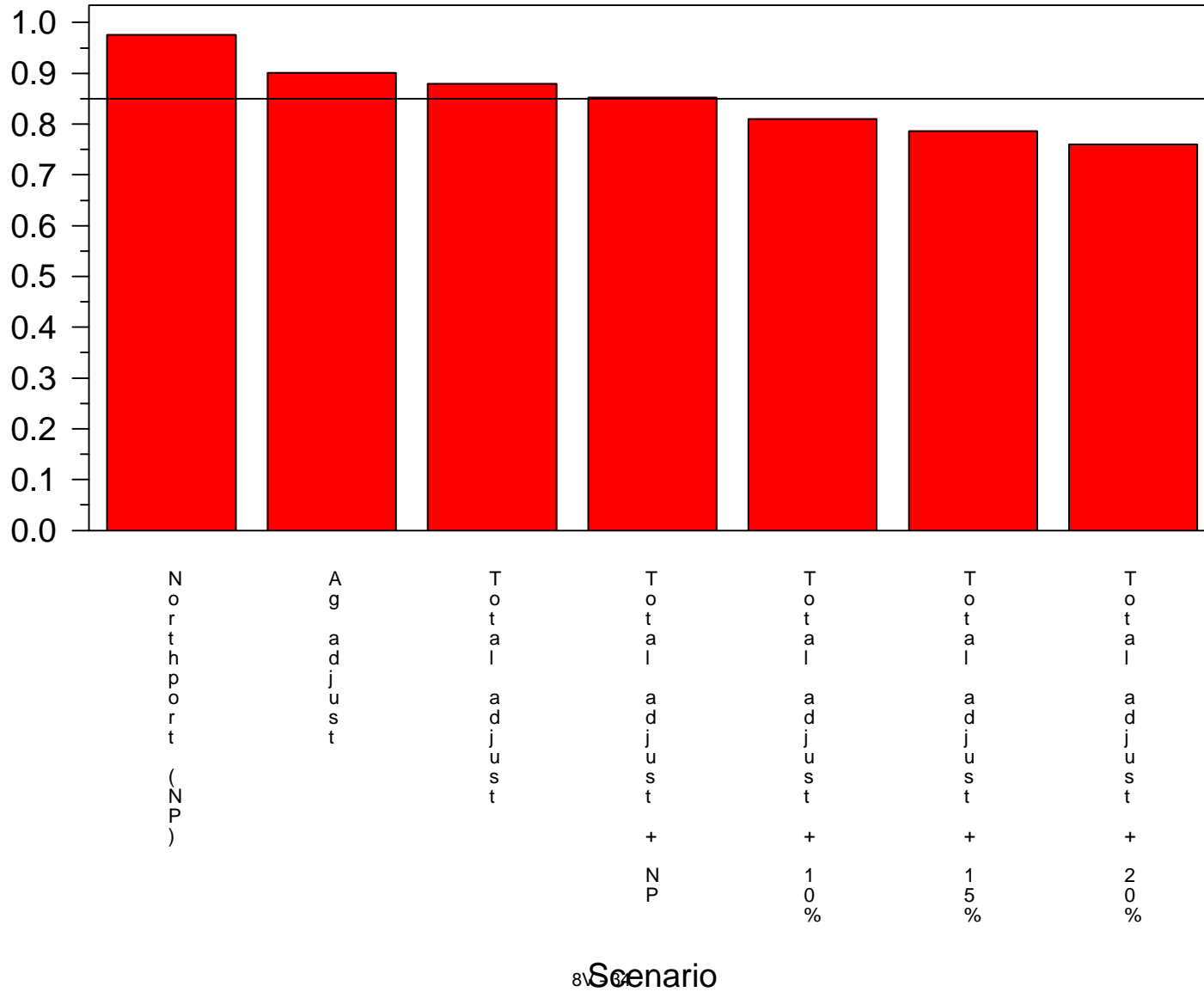

Myakka River

Period of Record 1995-2004

Normalized Area Under Curve

Taxa=Americamysis almyra2 Block=Block 2

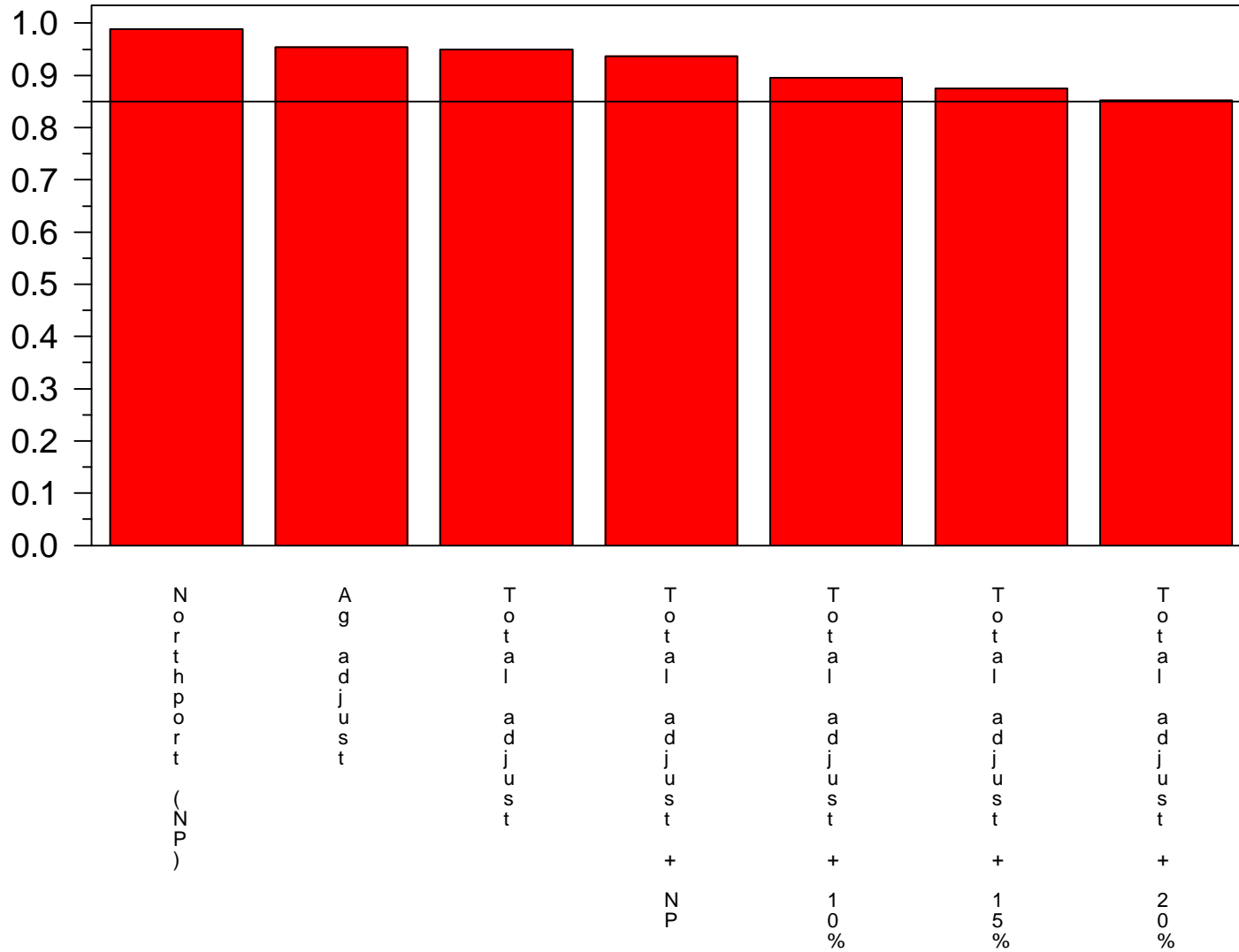

Myakka River

Period of Record 1995-2004

Normalized Area Under Curve

Taxa=Americamysis almyra2 Block=Block 3

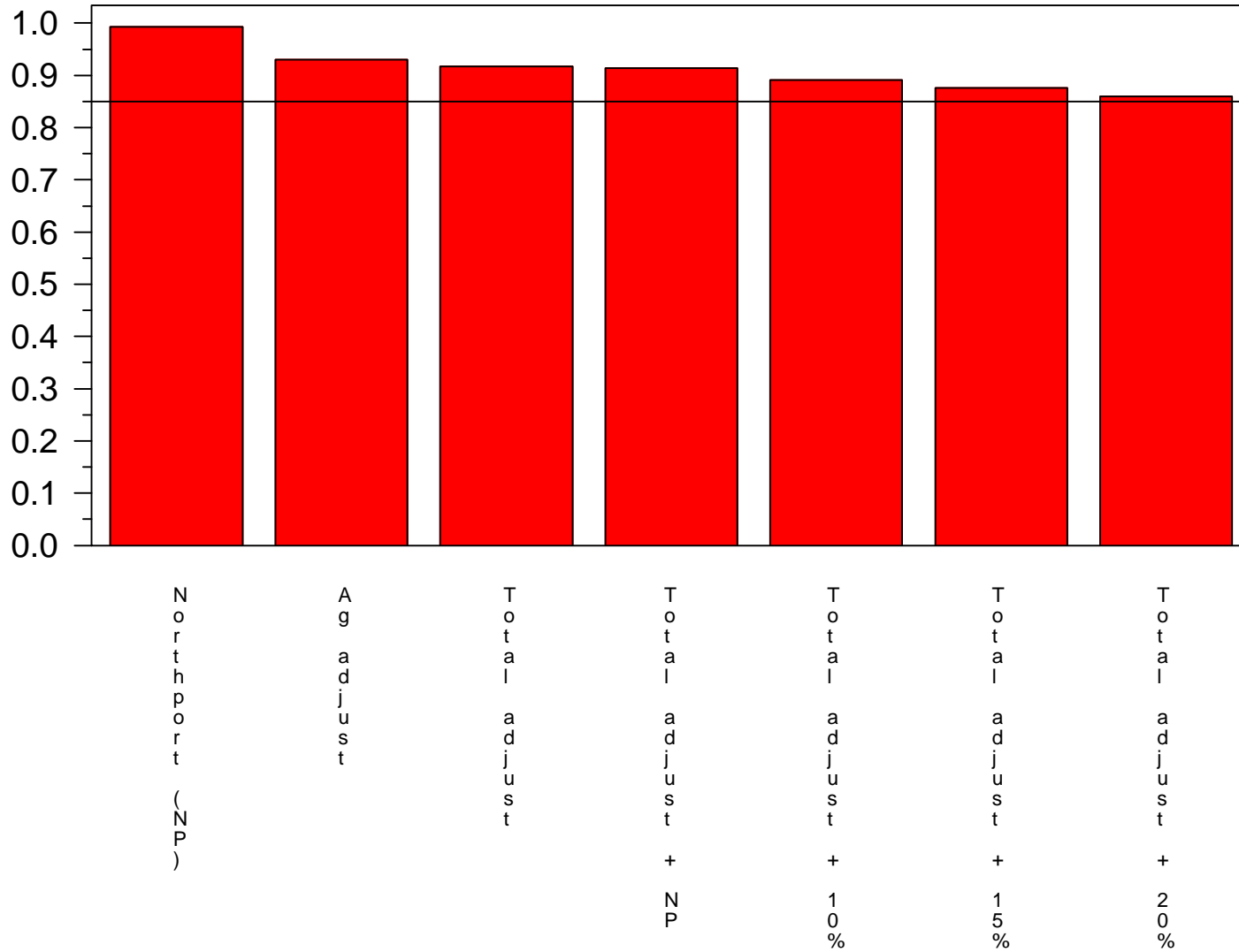

Myakka River

Period of Record 1995-2004

Normalized Area Under Curve

Taxa=*Americamysis almyra* Block=Block 1

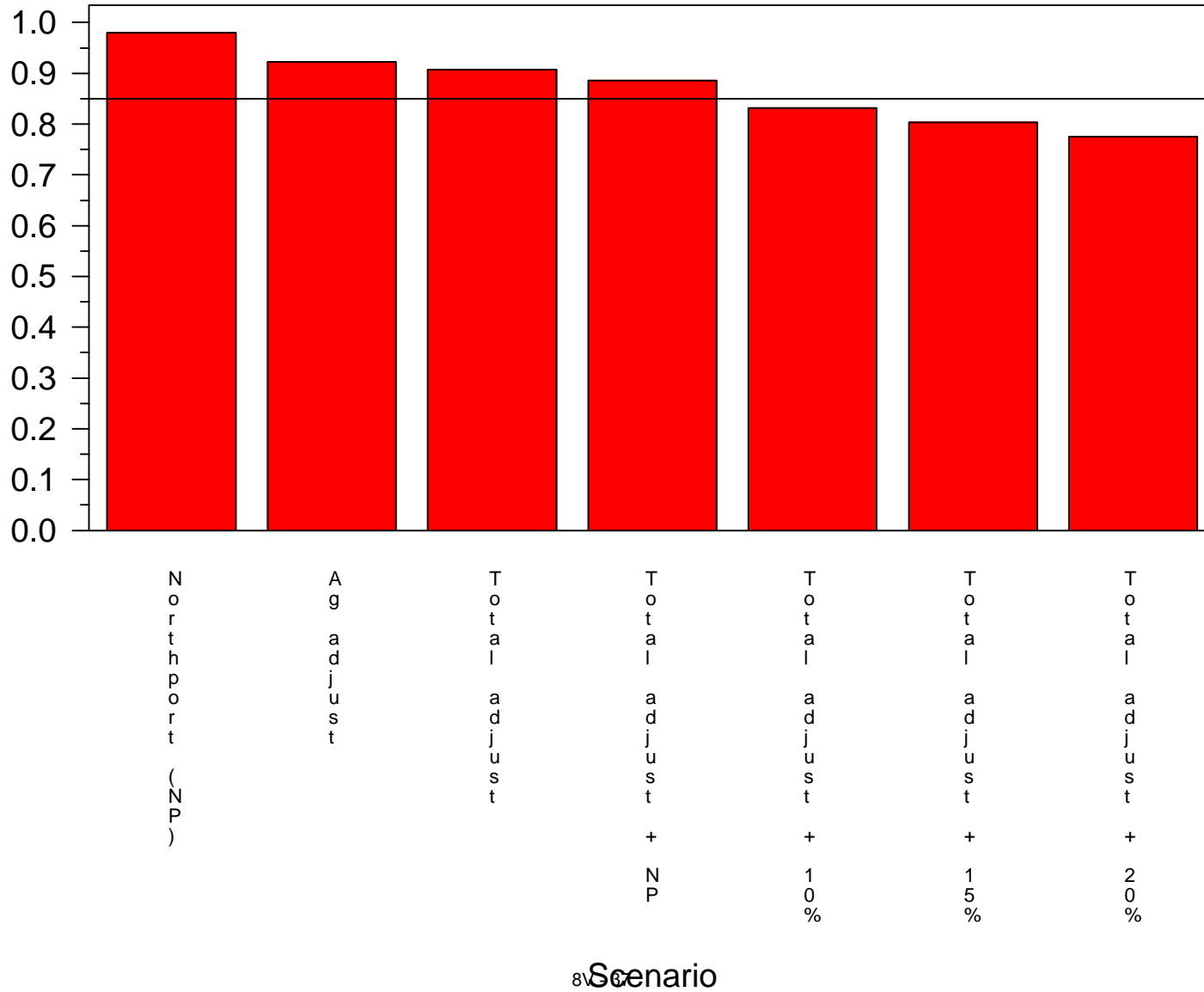

Myakka River

Period of Record 1995-2004

Normalized Area Under Curve

Taxa=*Americamysis almyra* Block=Block 2

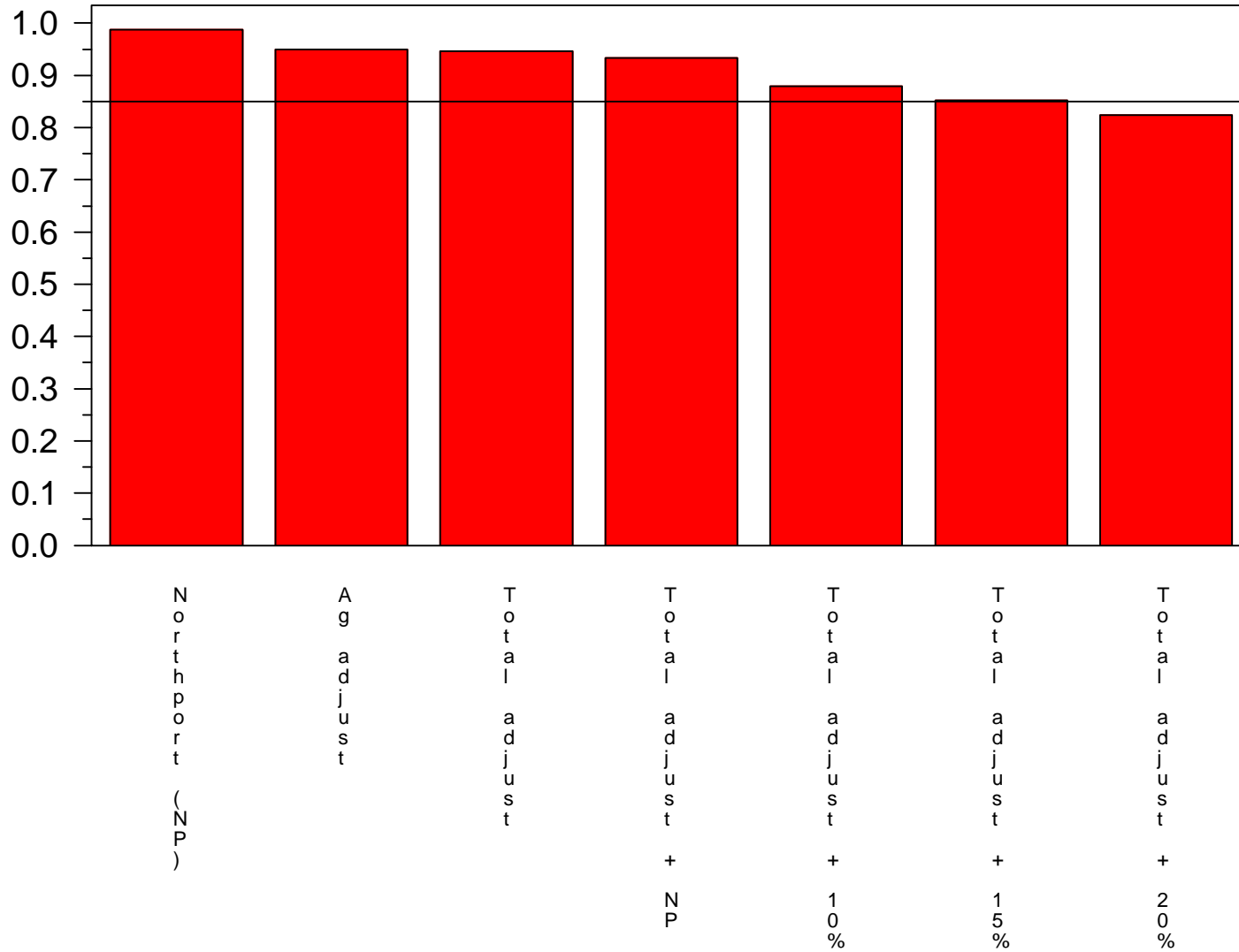

Myakka River

Period of Record 1995-2004

Normalized Area Under Curve

Taxa=*Americamysis almyra* Block=Block 3

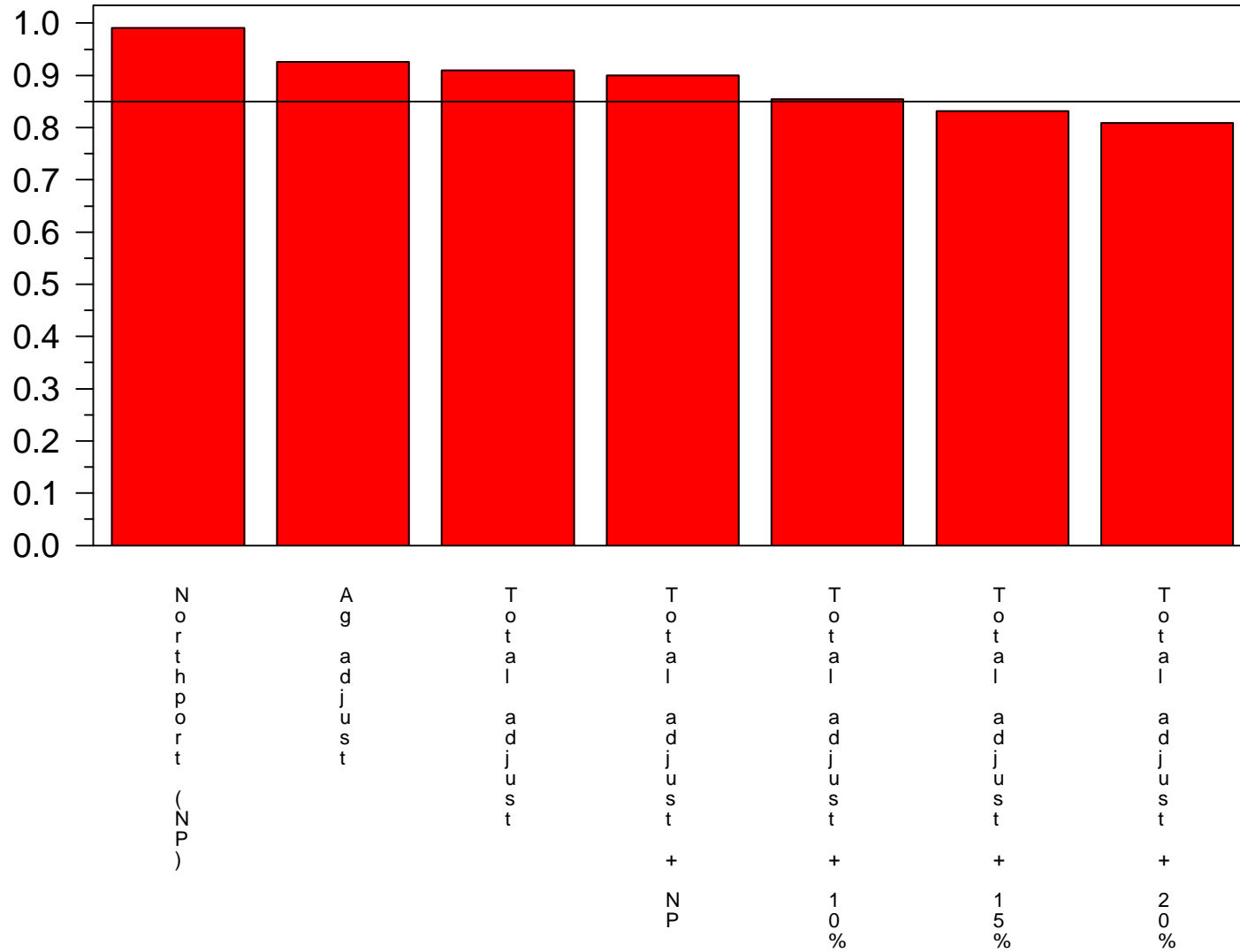

Myakka River

Period of Record 1995-2004

Normalized Area Under Curve

Taxa=Anchoa mitchilli Block=Block 1

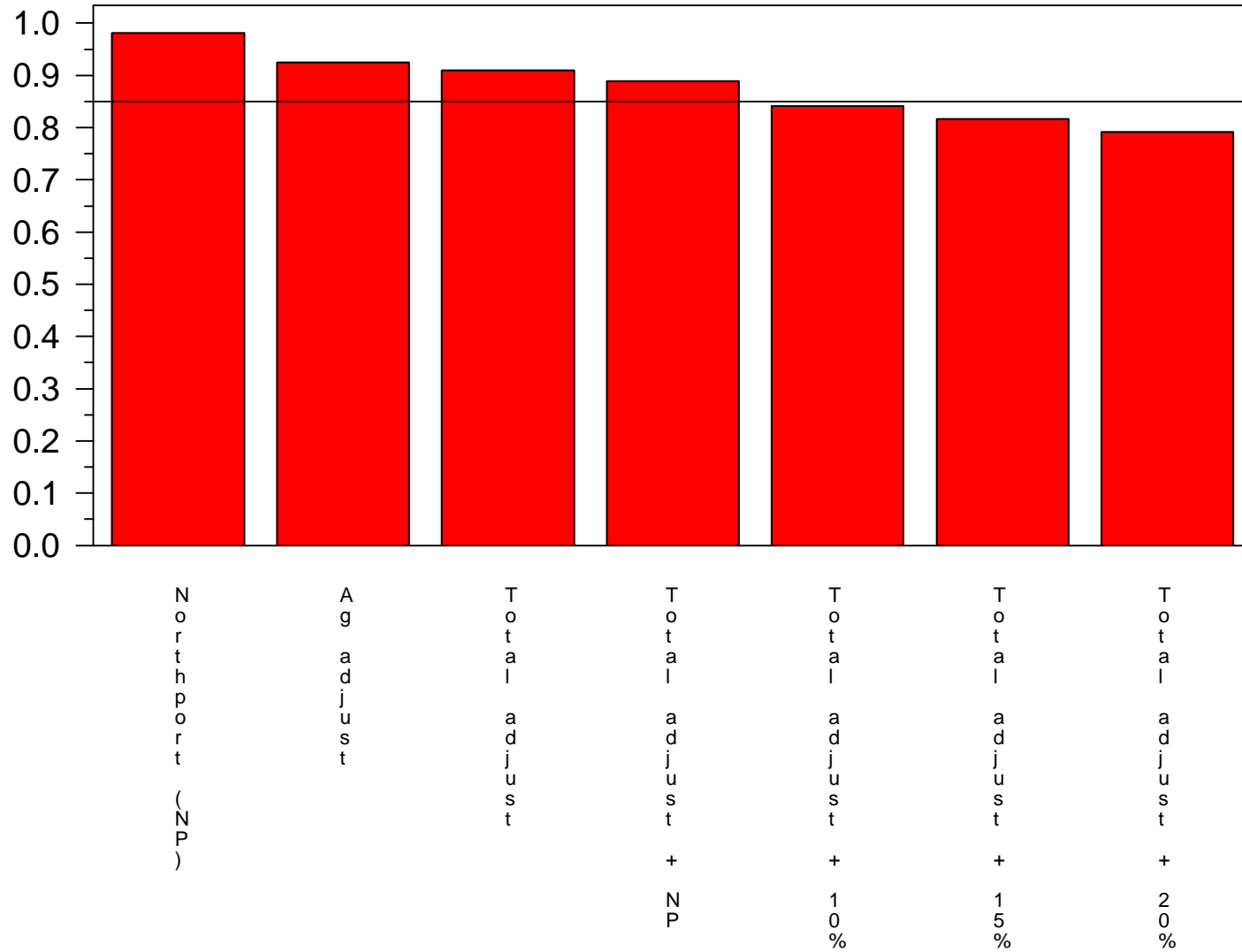

Myakka River

Period of Record 1995-2004

Normalized Area Under Curve

Taxa=Anchoa mitchilli Block=Block 2

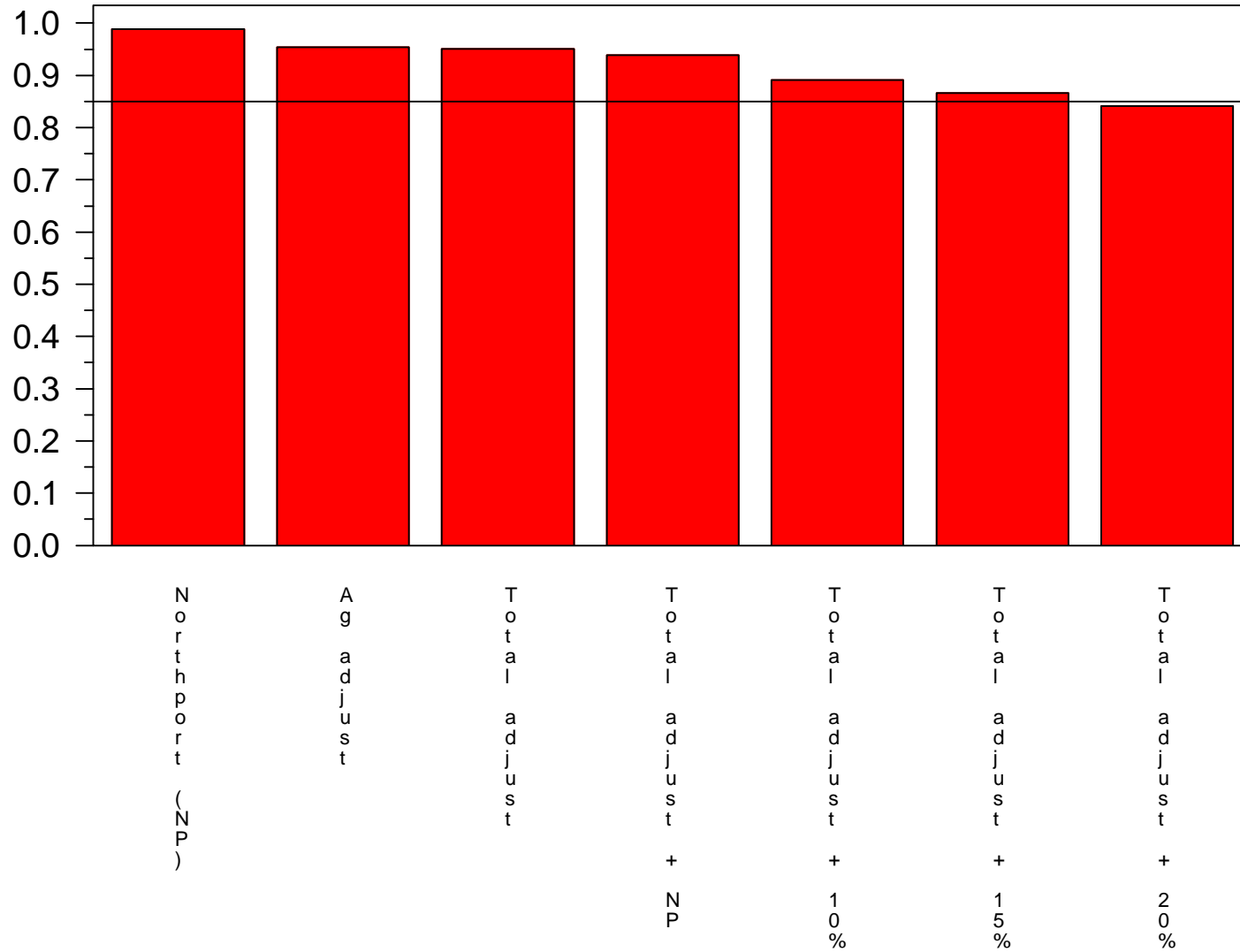

Scenario

Myakka River

Period of Record 1995-2004

Normalized Area Under Curve

Taxa=Anchoa mitchilli Block=Block 3

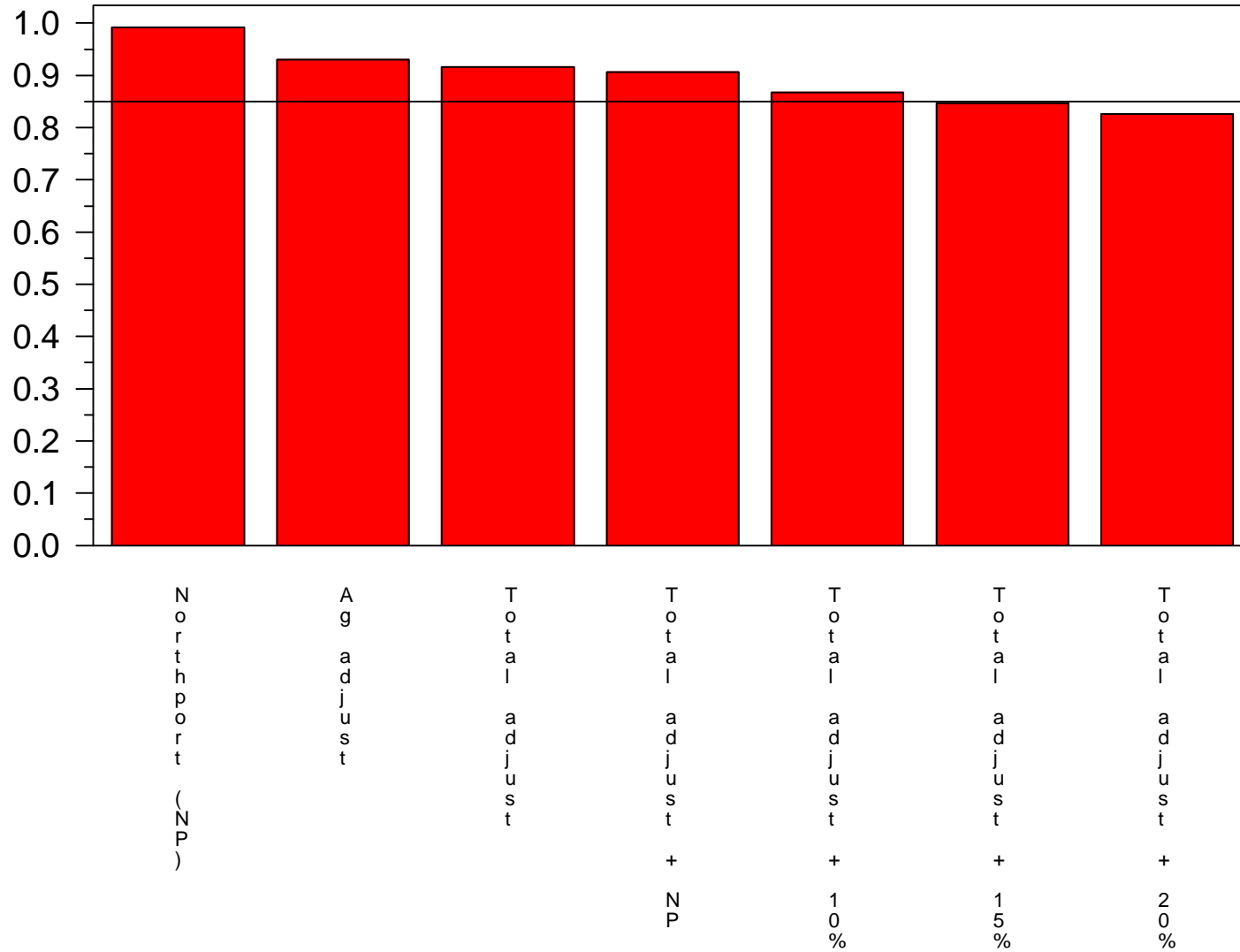

Scenario

Myakka River

Period of Record 1995-2004

Normalized Area Under Curve

Taxa=Cyathura polita Block=Block 1

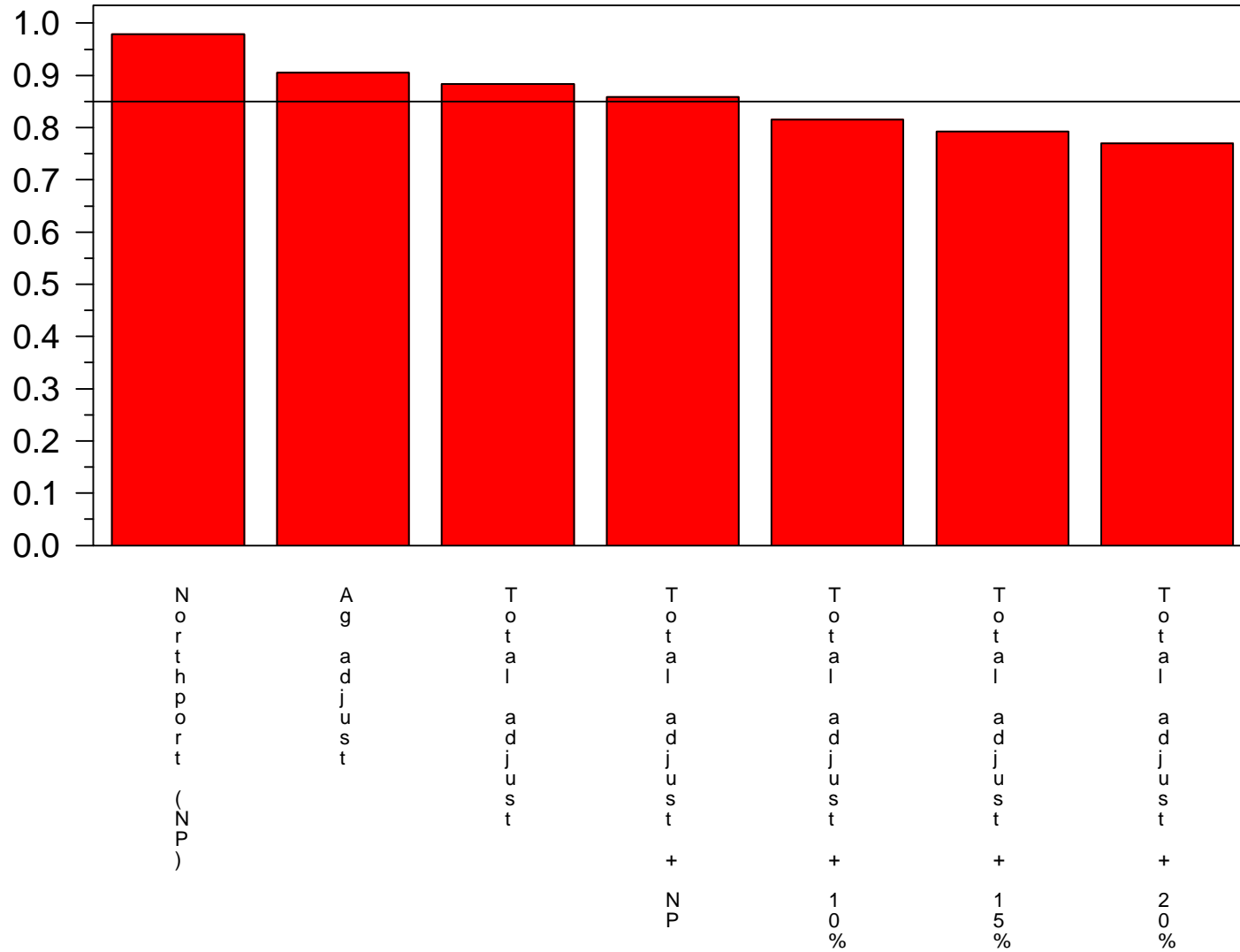

Scenario

Myakka River

Period of Record 1995-2004

Normalized Area Under Curve

Taxa=Cyathura polita Block=Block 2

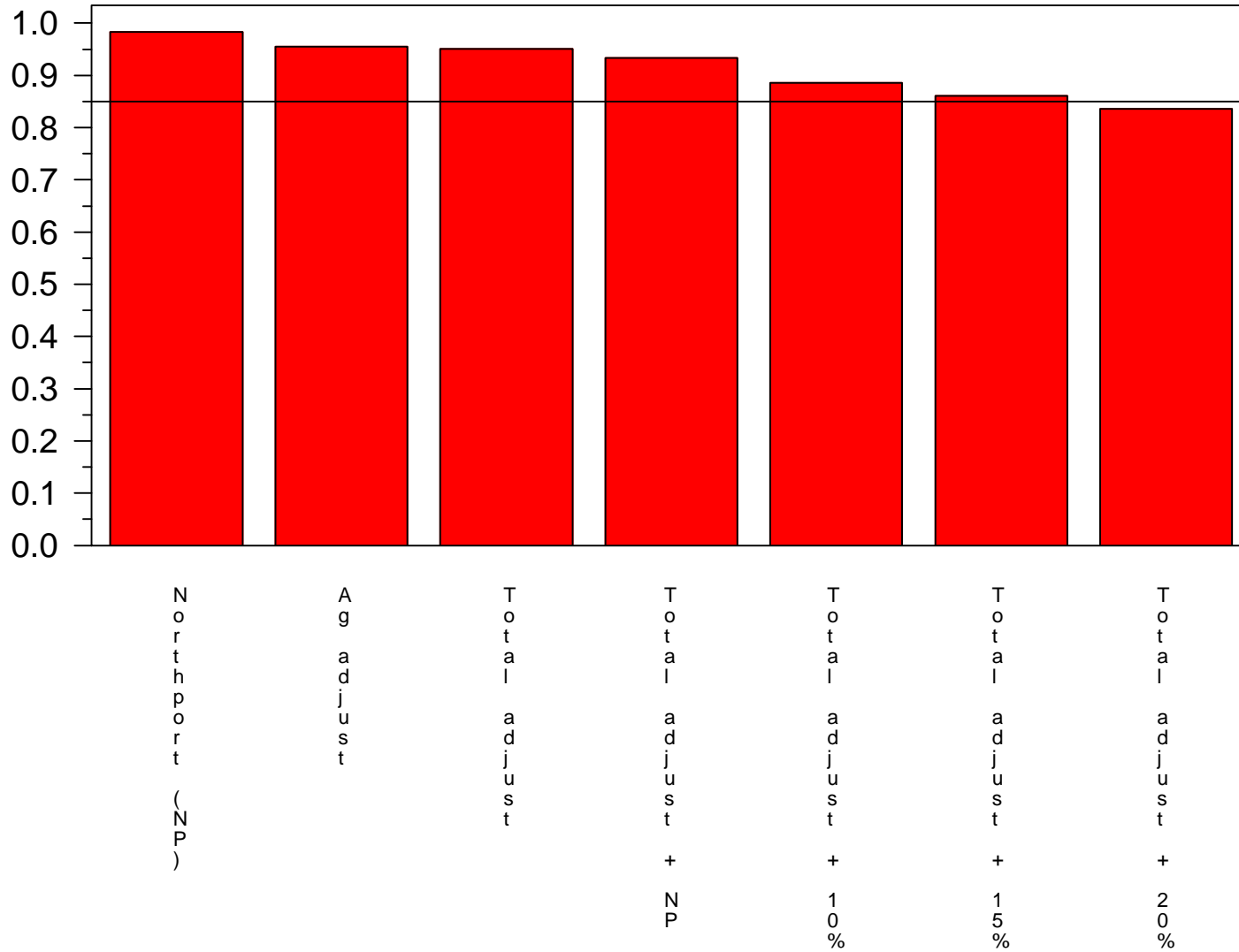

Scenario

Myakka River

Period of Record 1995-2004

Normalized Area Under Curve

Taxa=Cyathura polita Block=Block 3

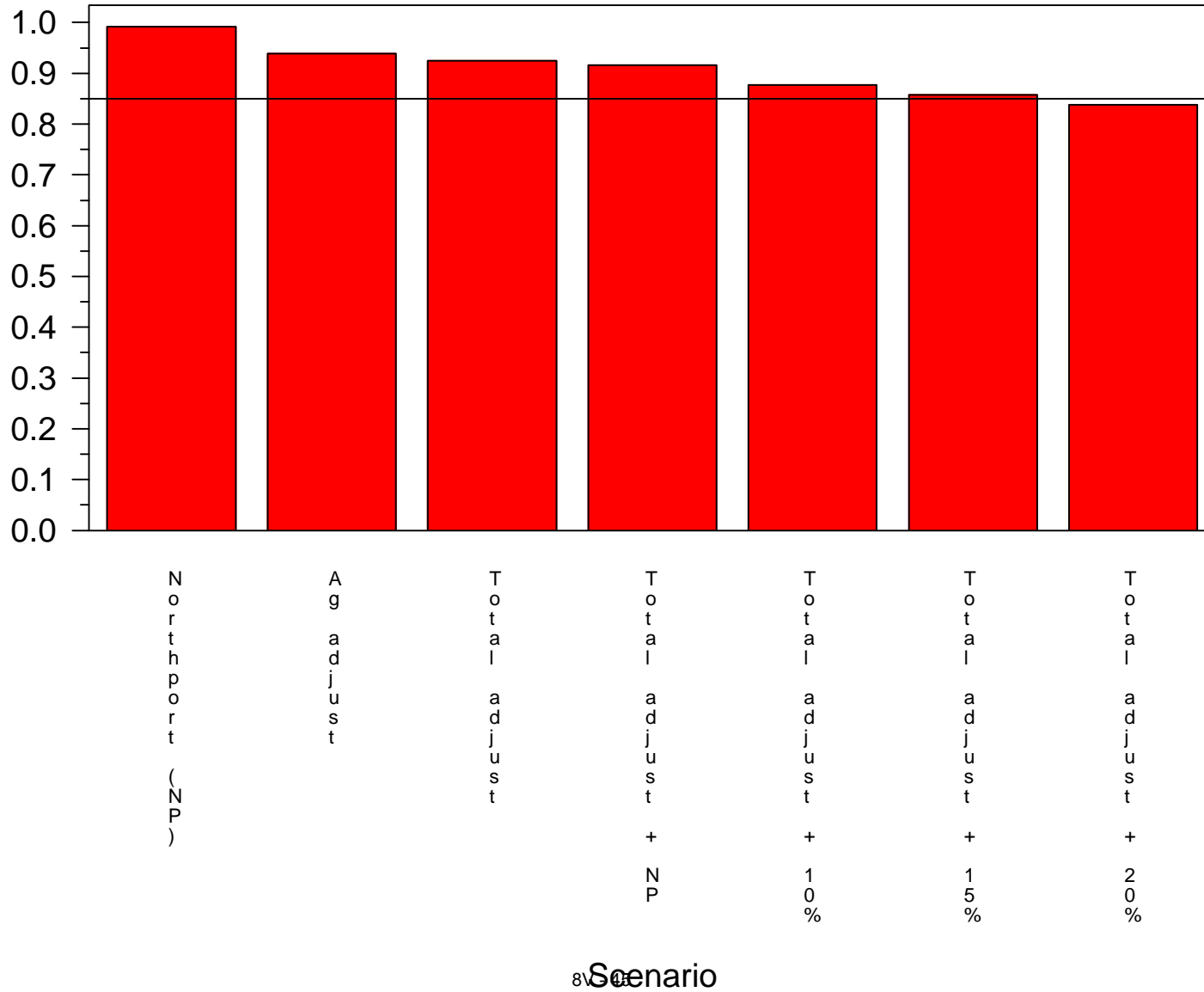

Myakka River

Period of Record 1995-2004

Normalized Area Under Curve

Taxa=*Gambusia holbrooki* <=25mm Block=Block 1

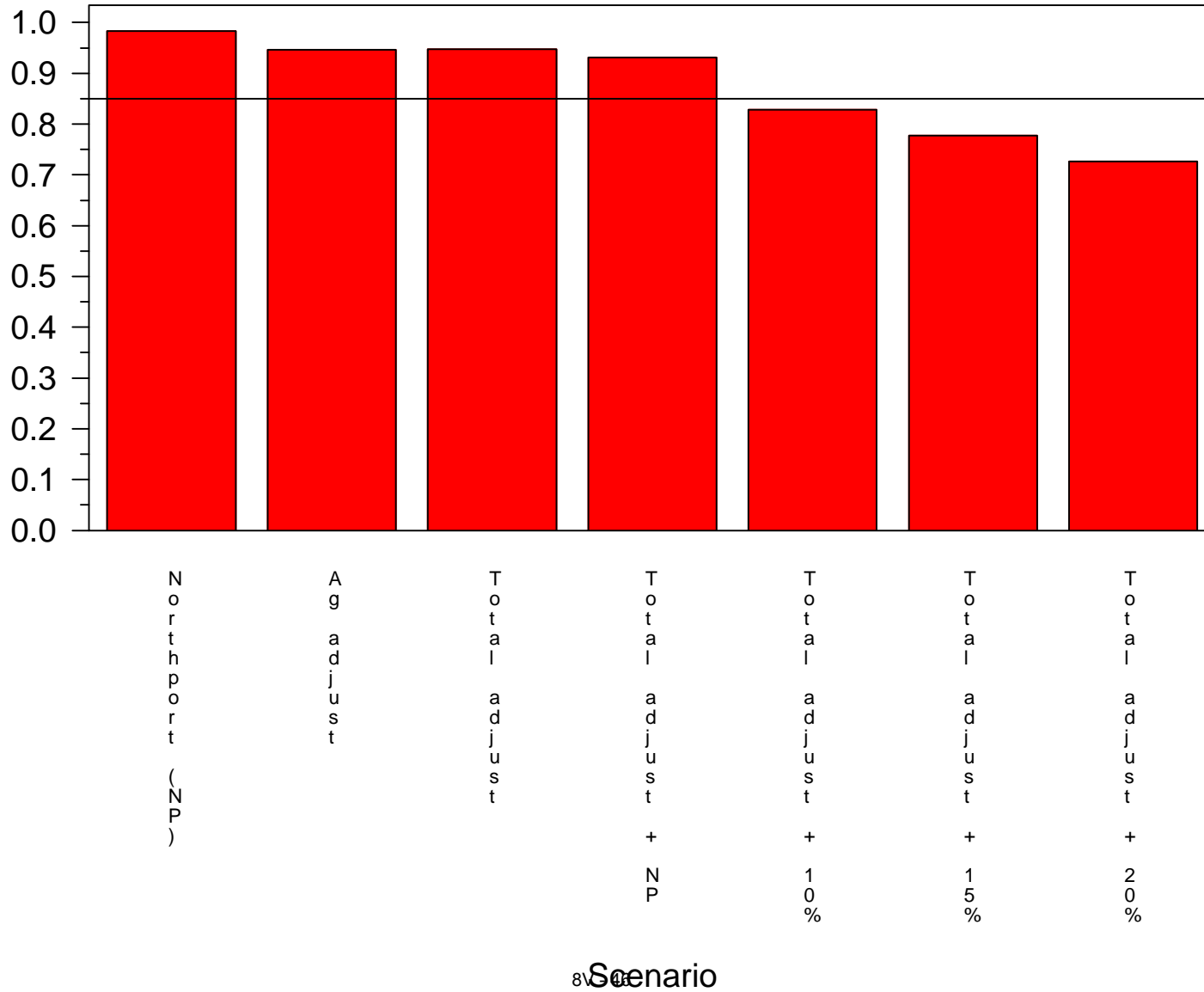

Myakka River

Period of Record 1995-2004

Normalized Area Under Curve

Taxa=*Gambusia holbrooki* <=25mm Block=Block 2

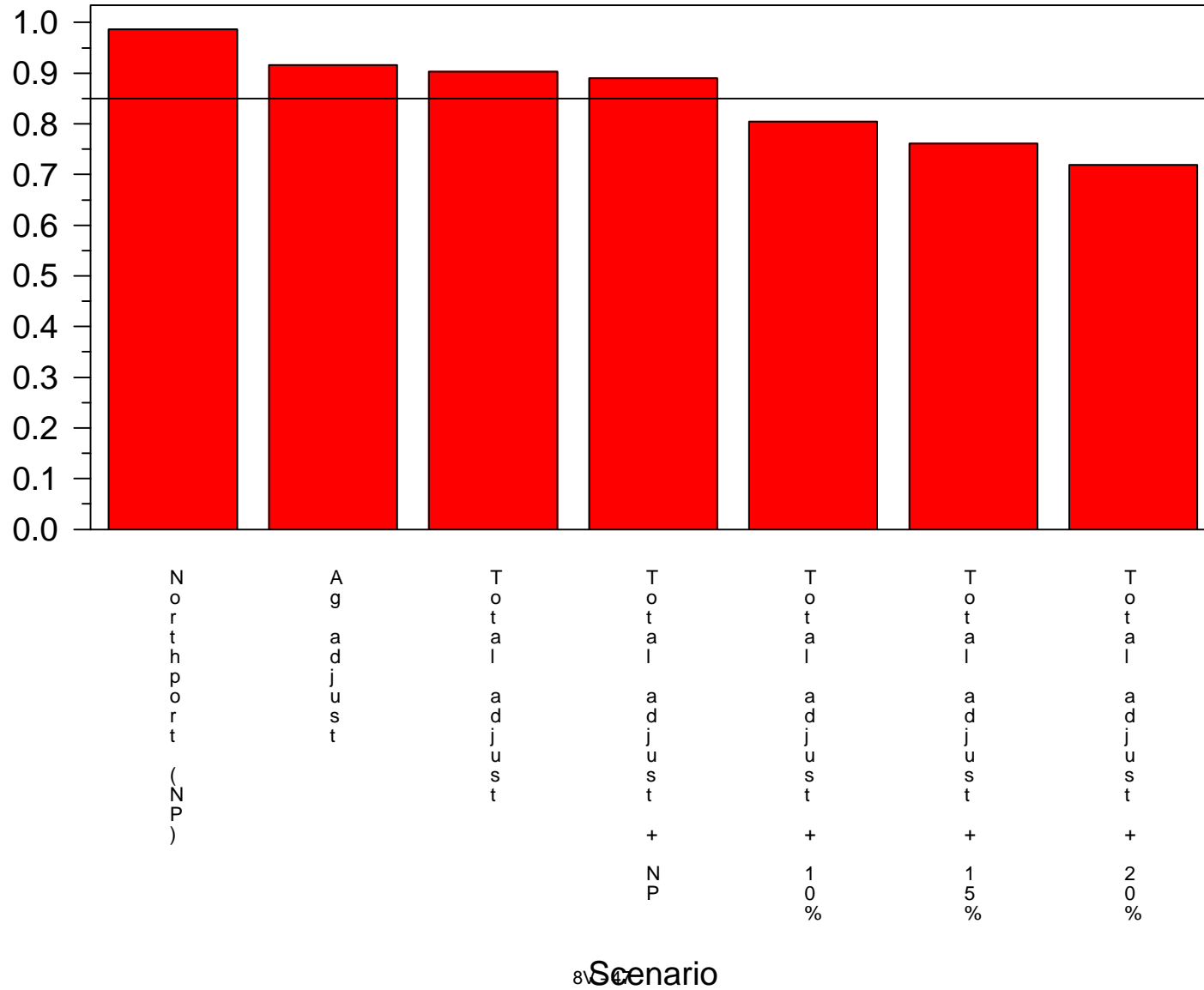

Myakka River

Period of Record 1995-2004

Normalized Area Under Curve

Taxa=*Gambusia holbrooki* <=25mm Block=Block 3

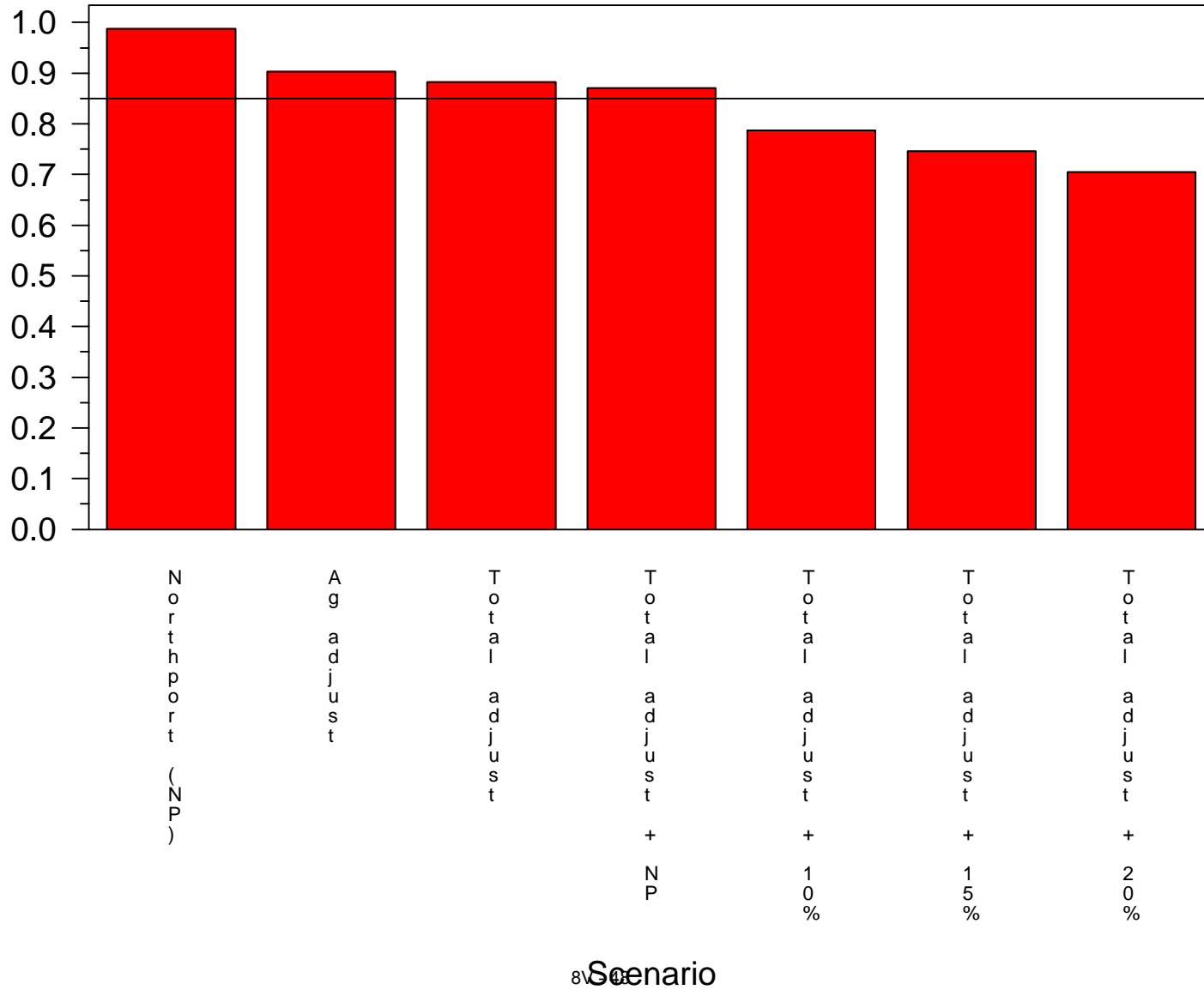

Myakka River

Period of Record 1995-2004

Normalized Area Under Curve

Taxa=*Gambusia holbrooki* >25mm Block=Block 1

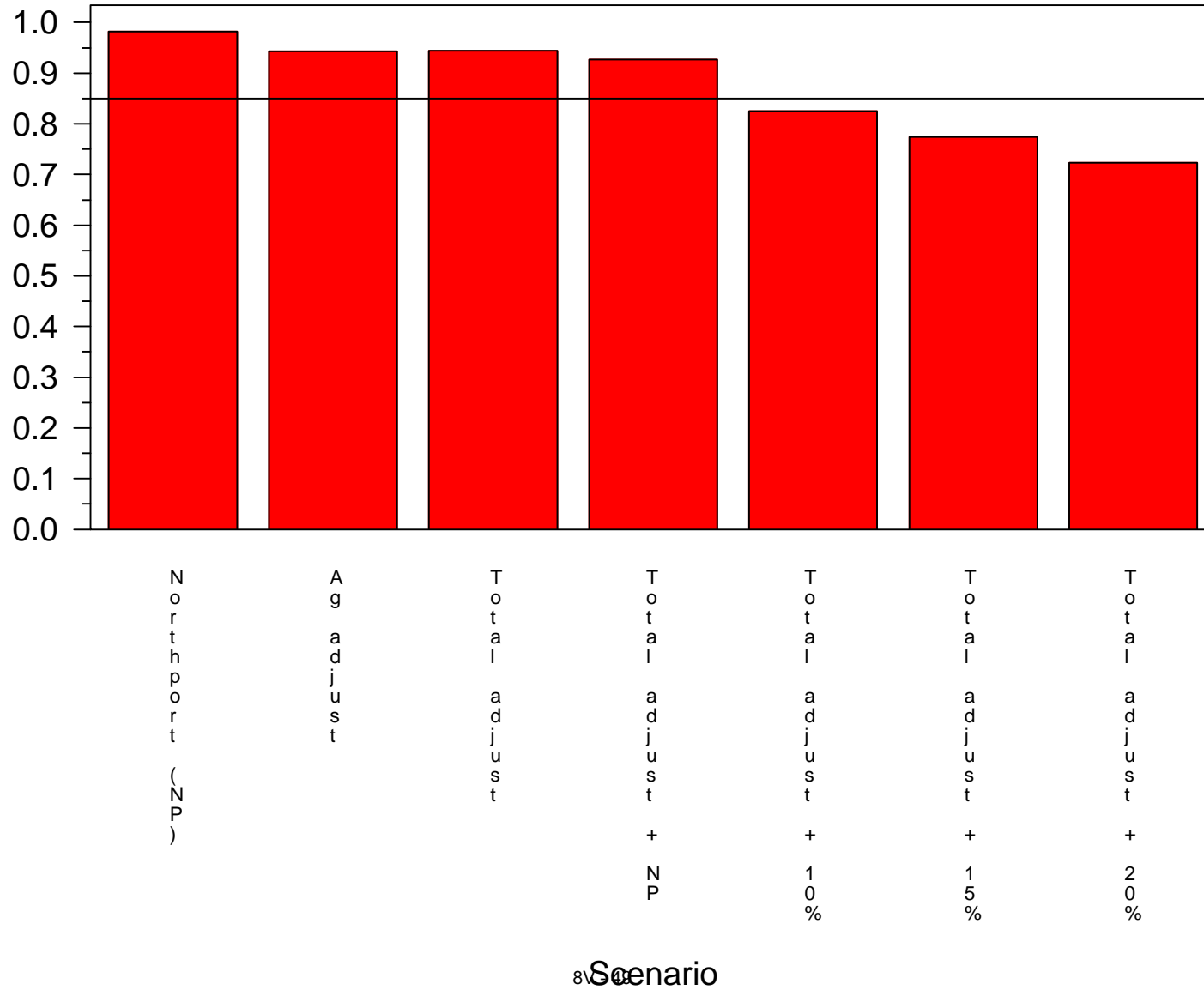

Myakka River

Period of Record 1995-2004

Normalized Area Under Curve

Taxa=*Gambusia holbrooki* >25mm Block=Block 2

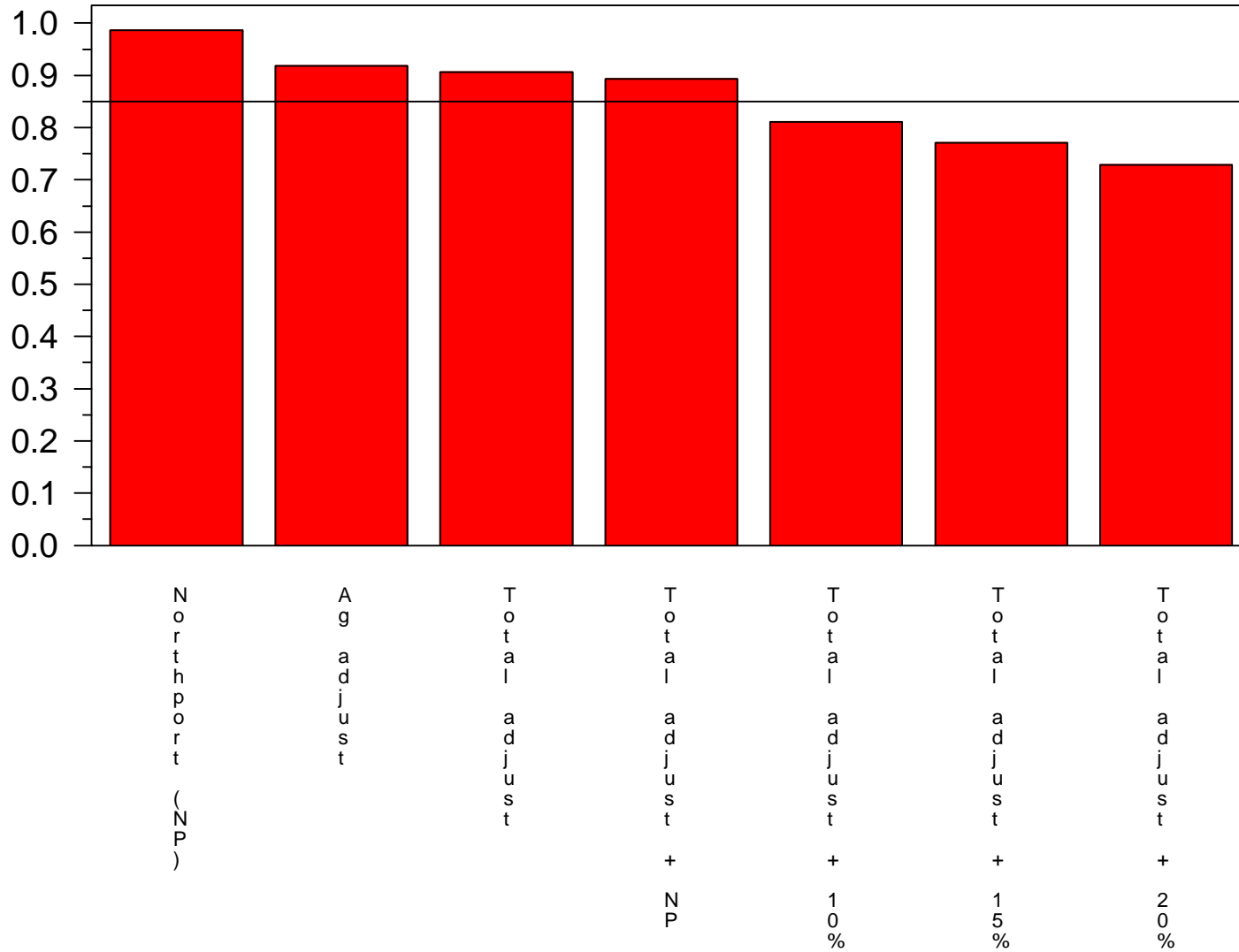

Myakka River

Period of Record 1995-2004

Normalized Area Under Curve

Taxa=*Gambusia holbrooki* >25mm Block=Block 3

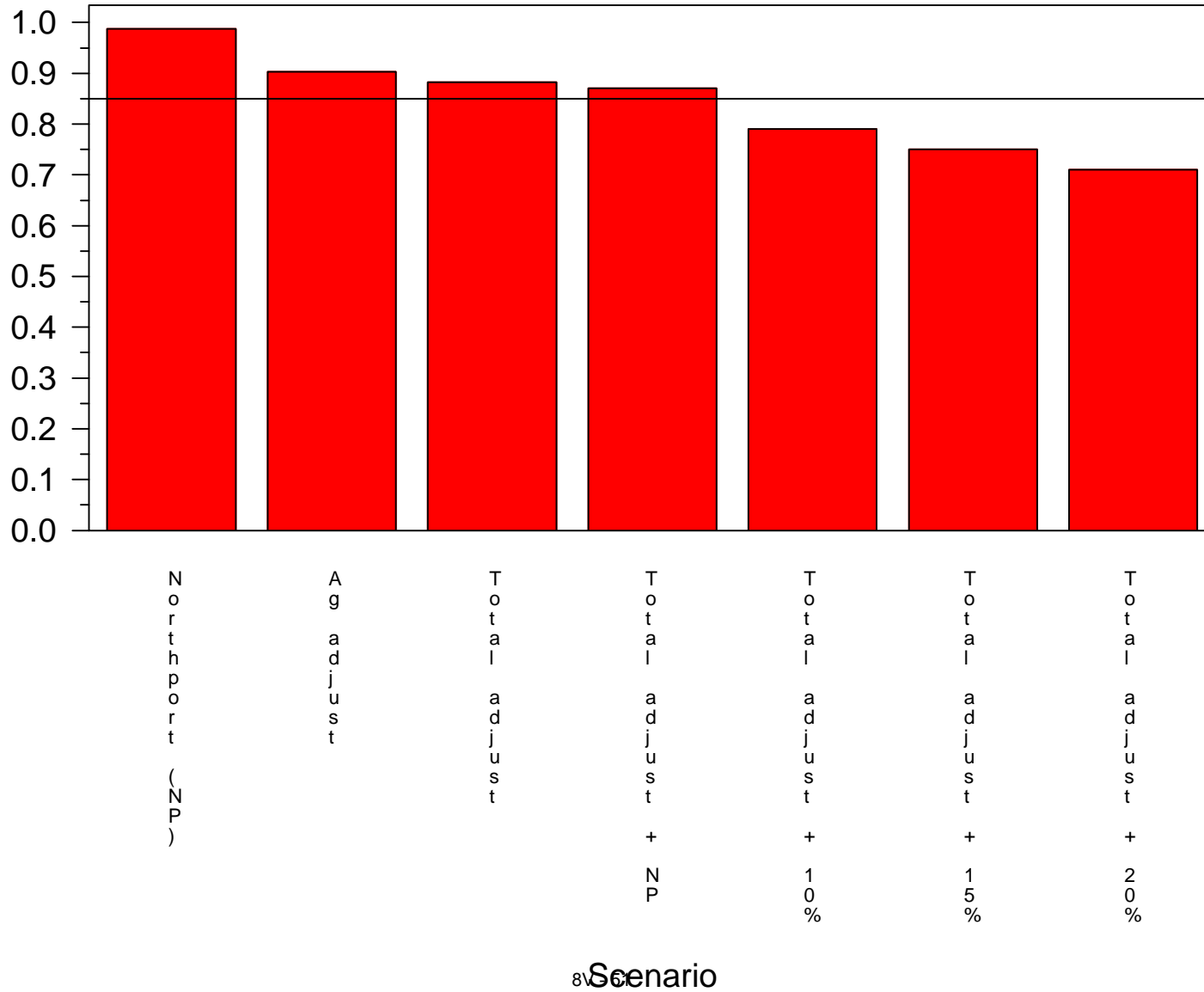

Myakka River

Period of Record 1995-2004

Normalized Area Under Curve

Taxa=*Palaemonetes intermedius* Block=Block 1

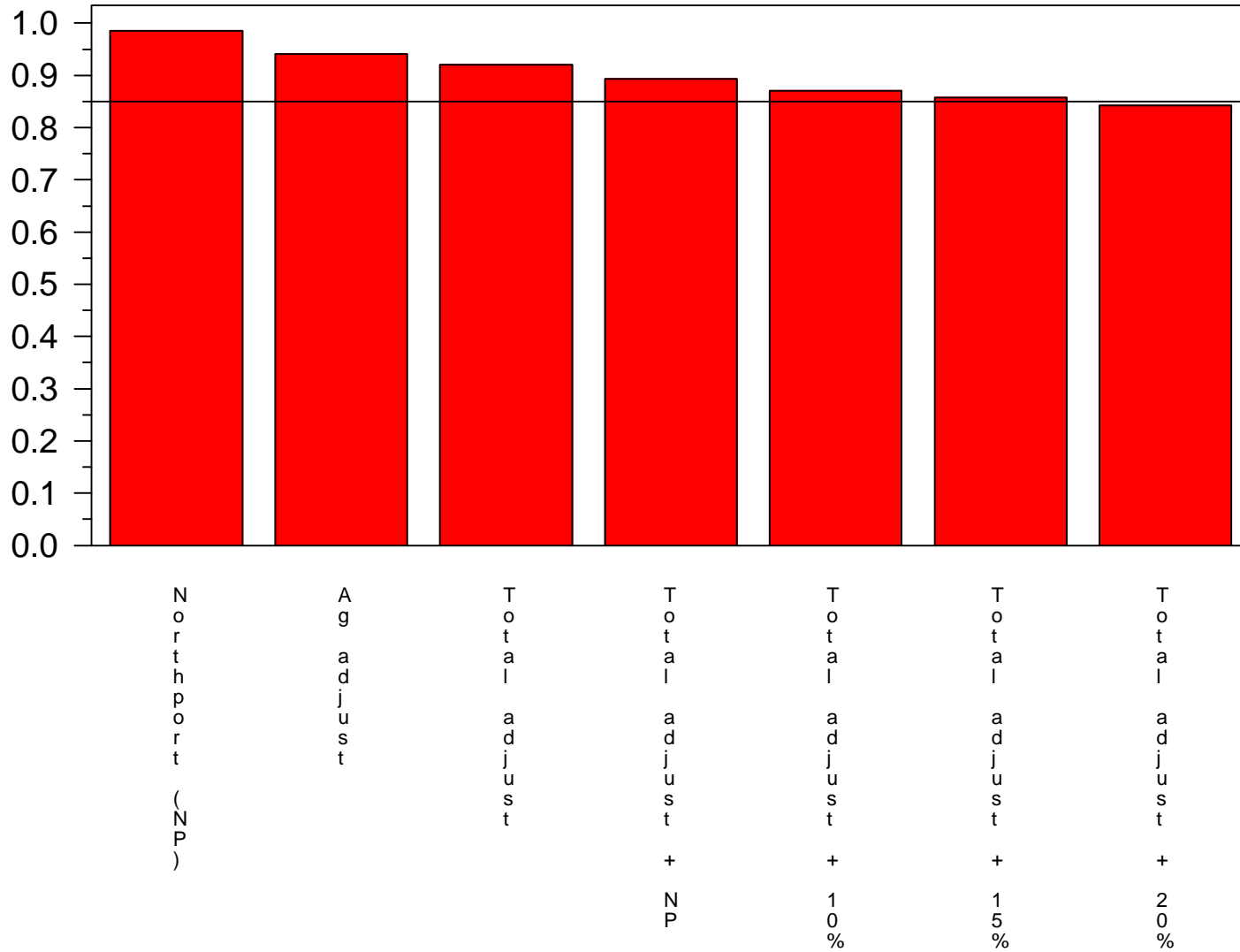

Scenario

Myakka River

Period of Record 1995-2004

Normalized Area Under Curve

Taxa=*Palaemonetes intermedius* Block=Block 2

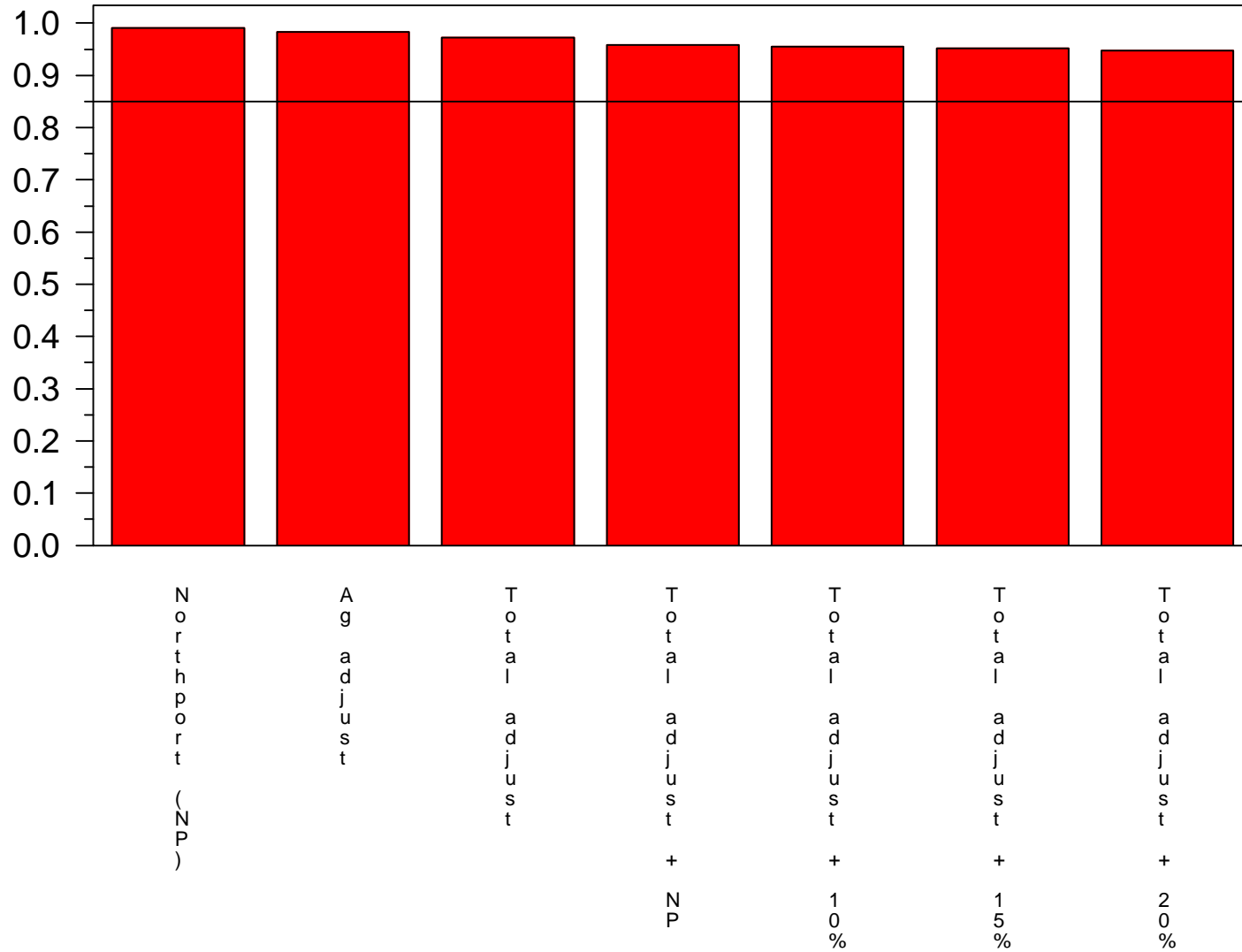

Myakka River

Period of Record 1995-2004

Normalized Area Under Curve

Taxa=*Palaemonetes intermedius* Block=Block 3

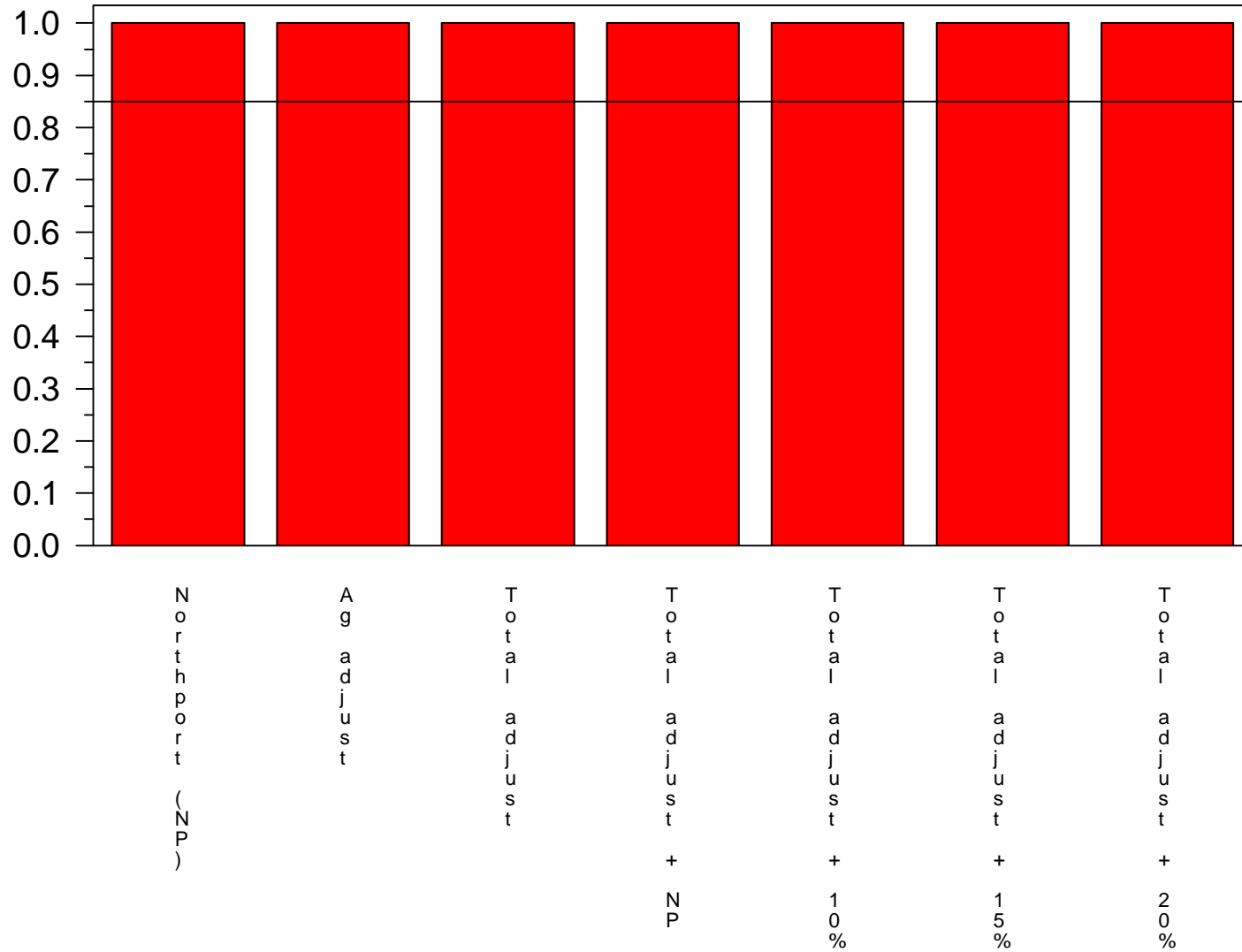

Myakka River

Period of Record 1995-2004

Normalized Area Under Curve

Taxa=Menidia spp. juveniles Block=Block 1

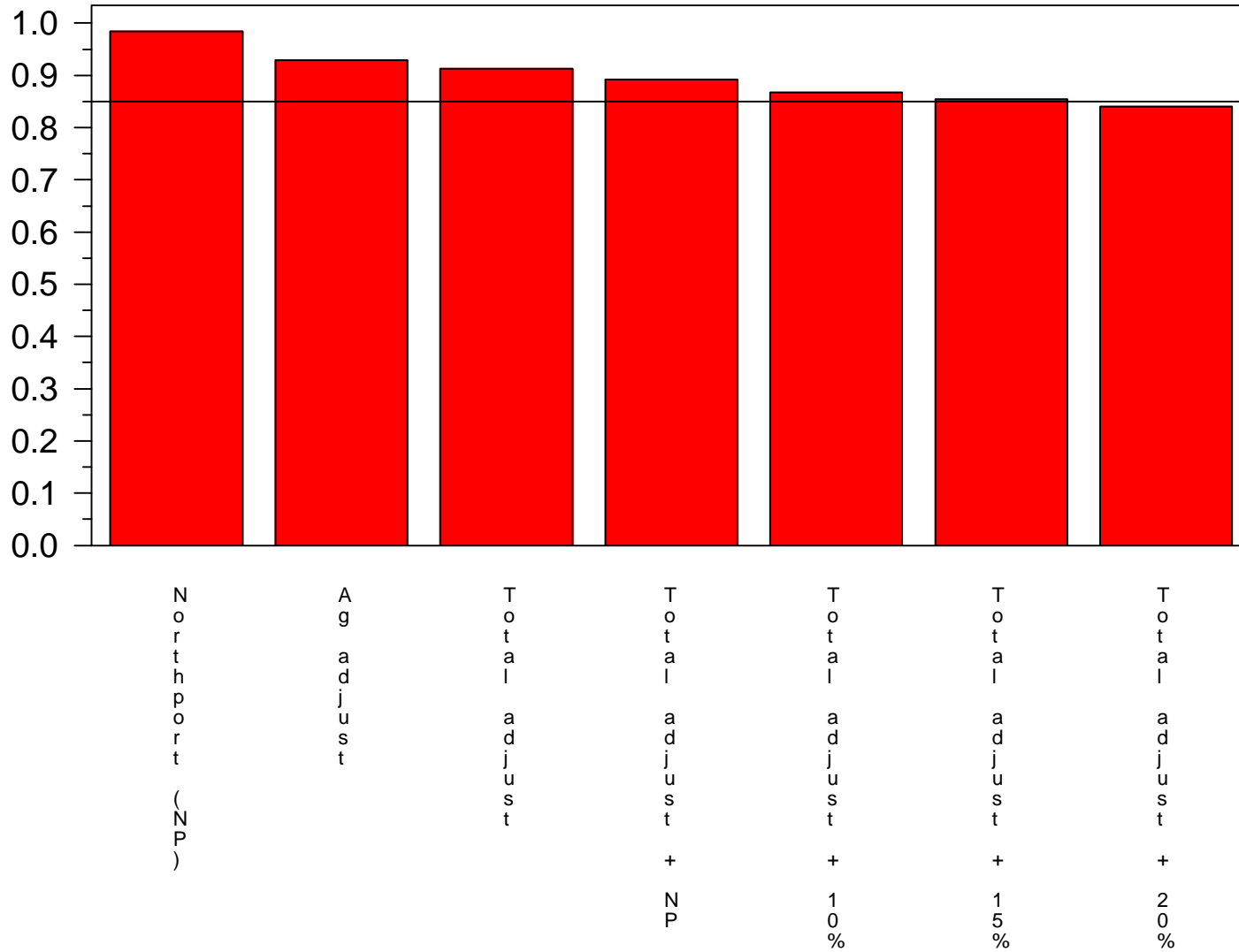

Myakka River

Period of Record 1995-2004

Normalized Area Under Curve

Taxa=Menidia spp. juveniles Block=Block 2

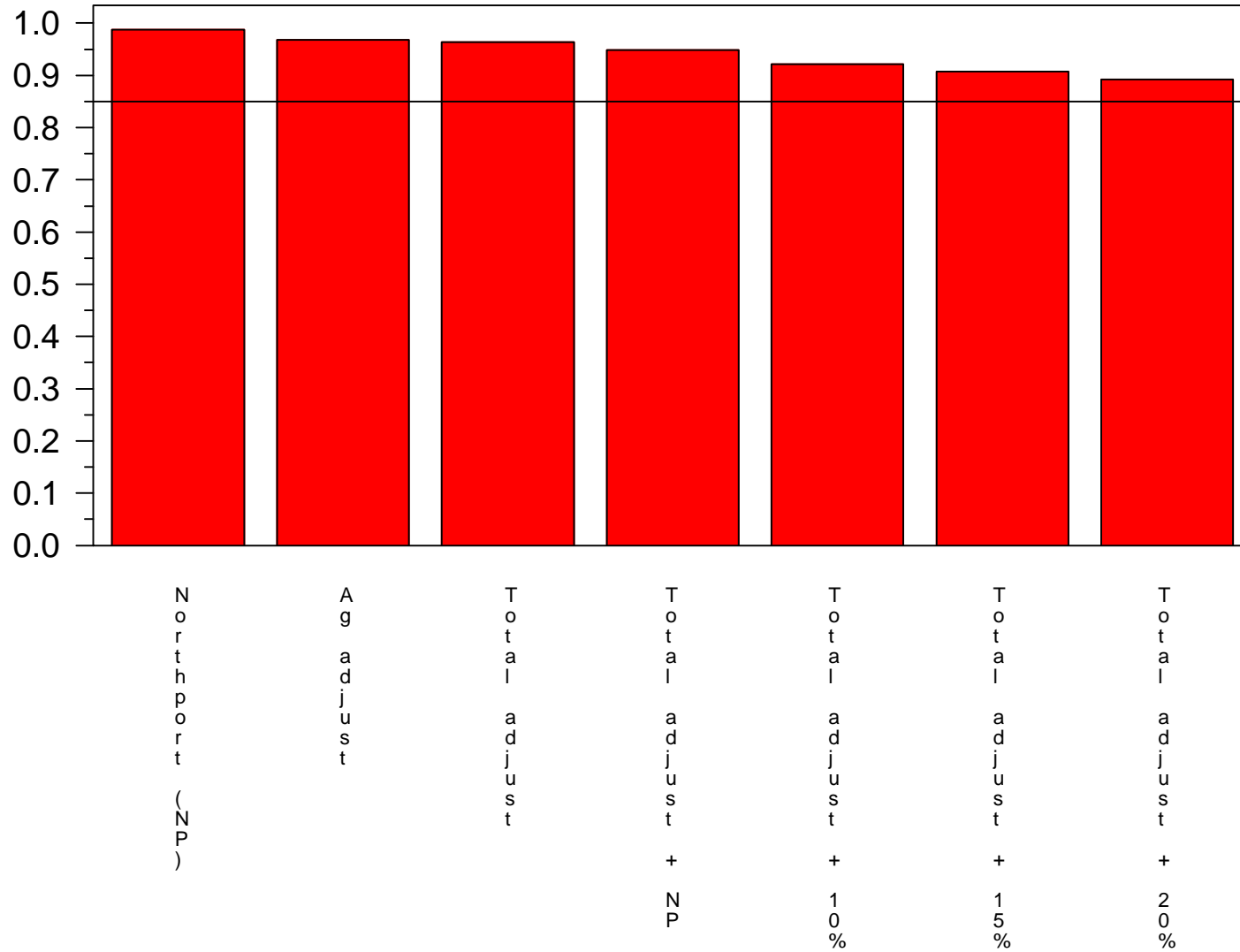

Myakka River

Period of Record 1995-2004

Normalized Area Under Curve

Taxa=Menidia spp. juveniles Block=Block 3

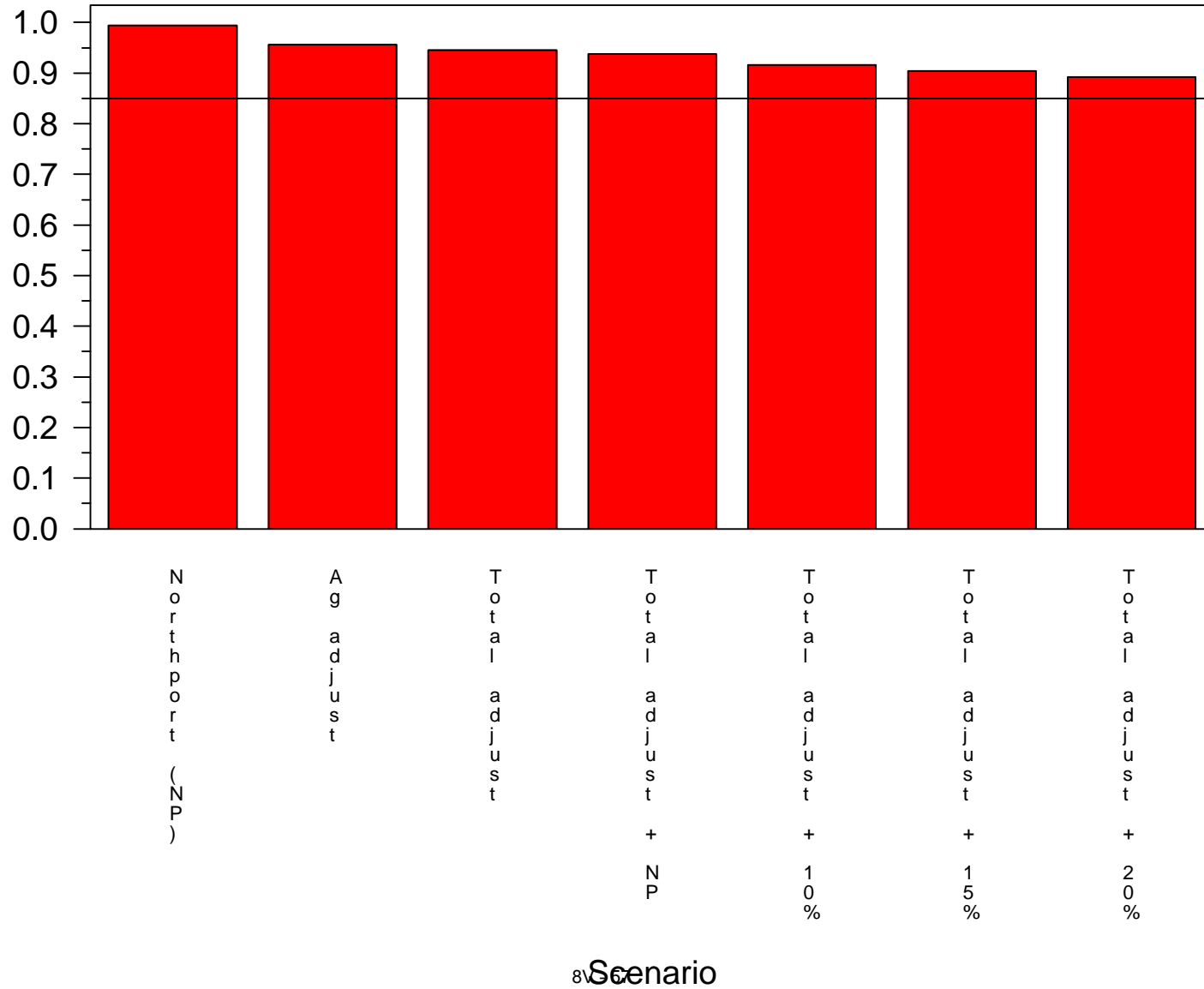

Myakka River

Period of Record 1995-2004

Normalized Area Under Curve

Taxa=Palaemonetes pugio Block=Block 1

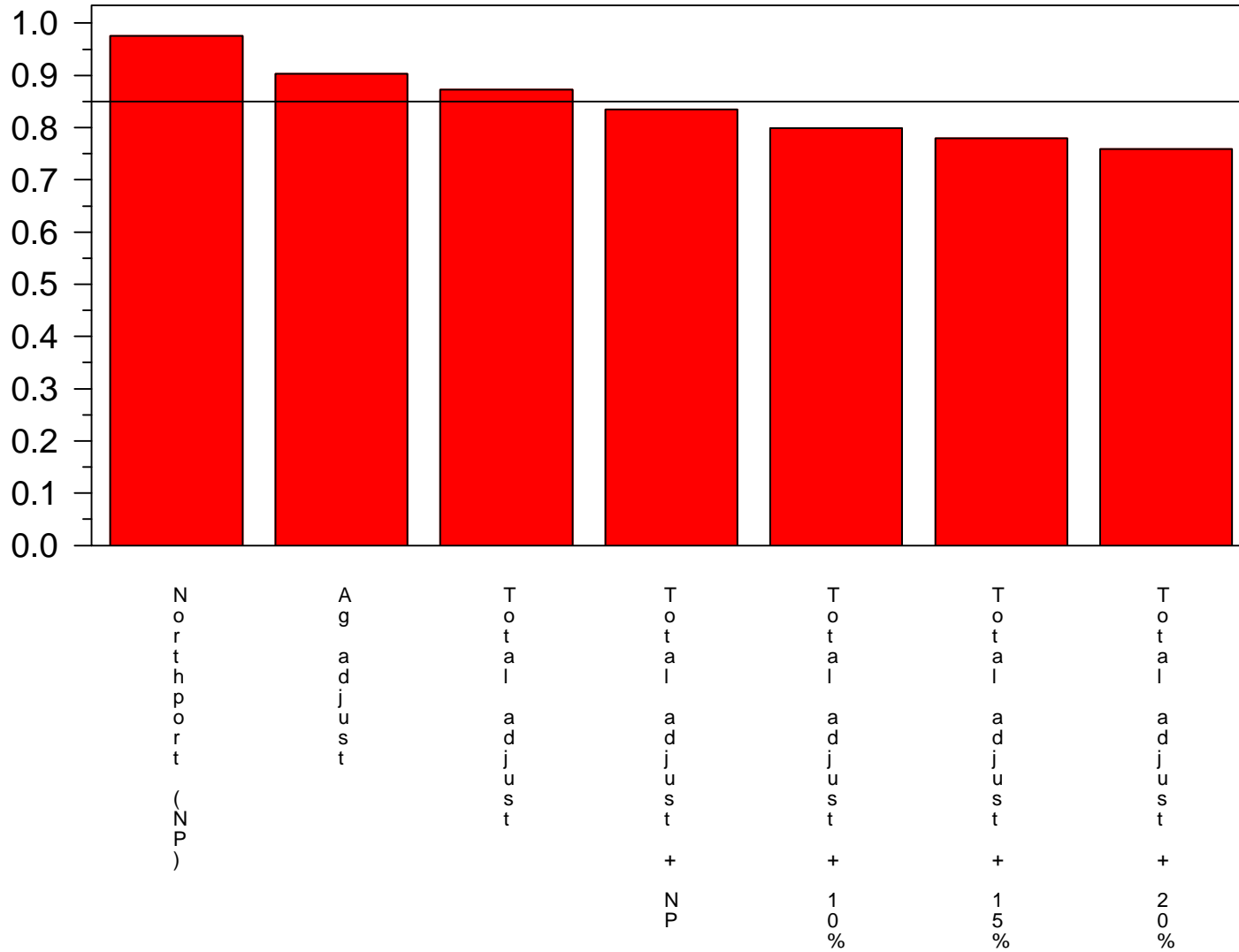

Myakka River

Period of Record 1995-2004

Normalized Area Under Curve

Taxa=Palaemonetes pugio Block=Block 2

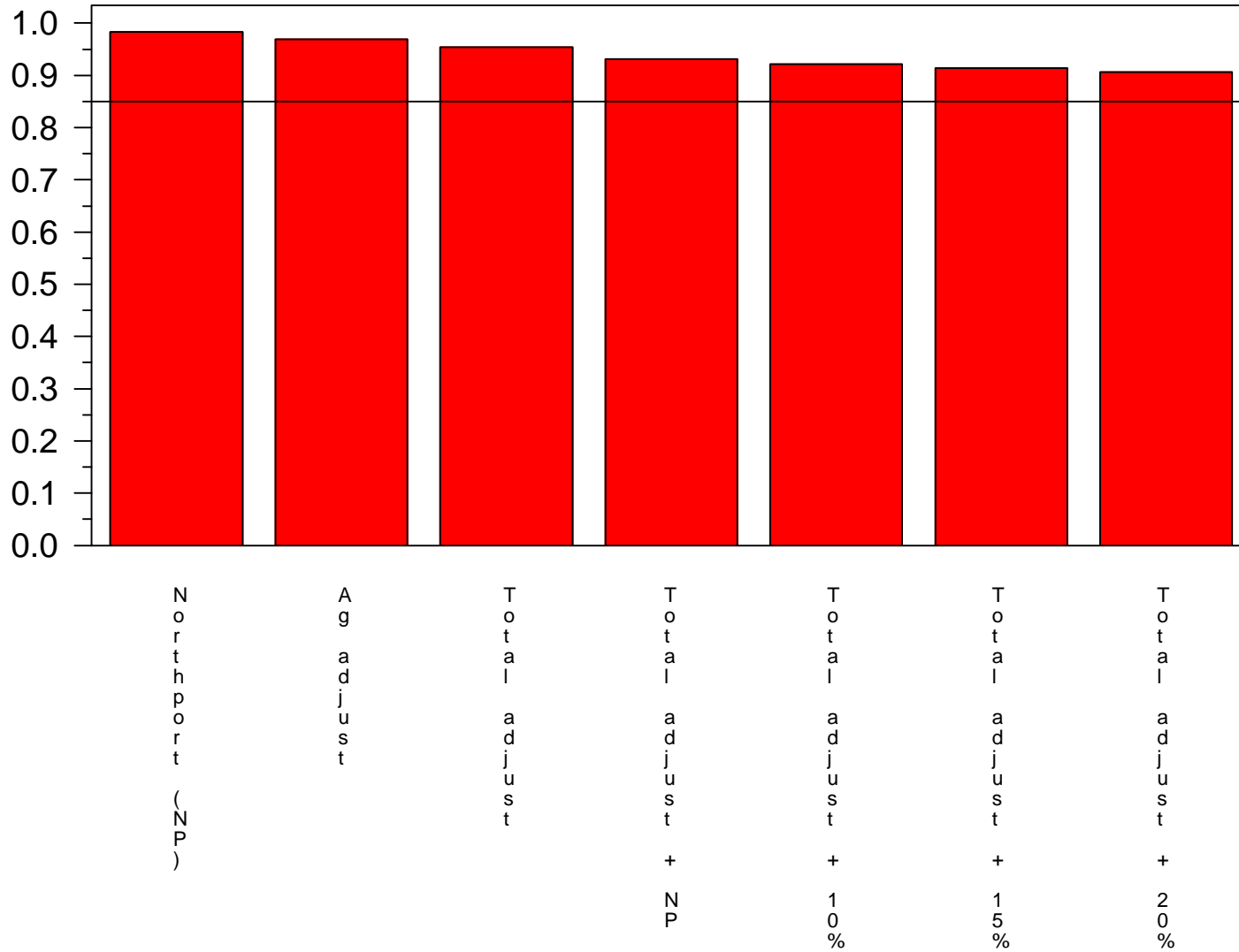

Myakka River

Period of Record 1995-2004

Normalized Area Under Curve

Taxa=Palaemonetes pugio Block=Block 3

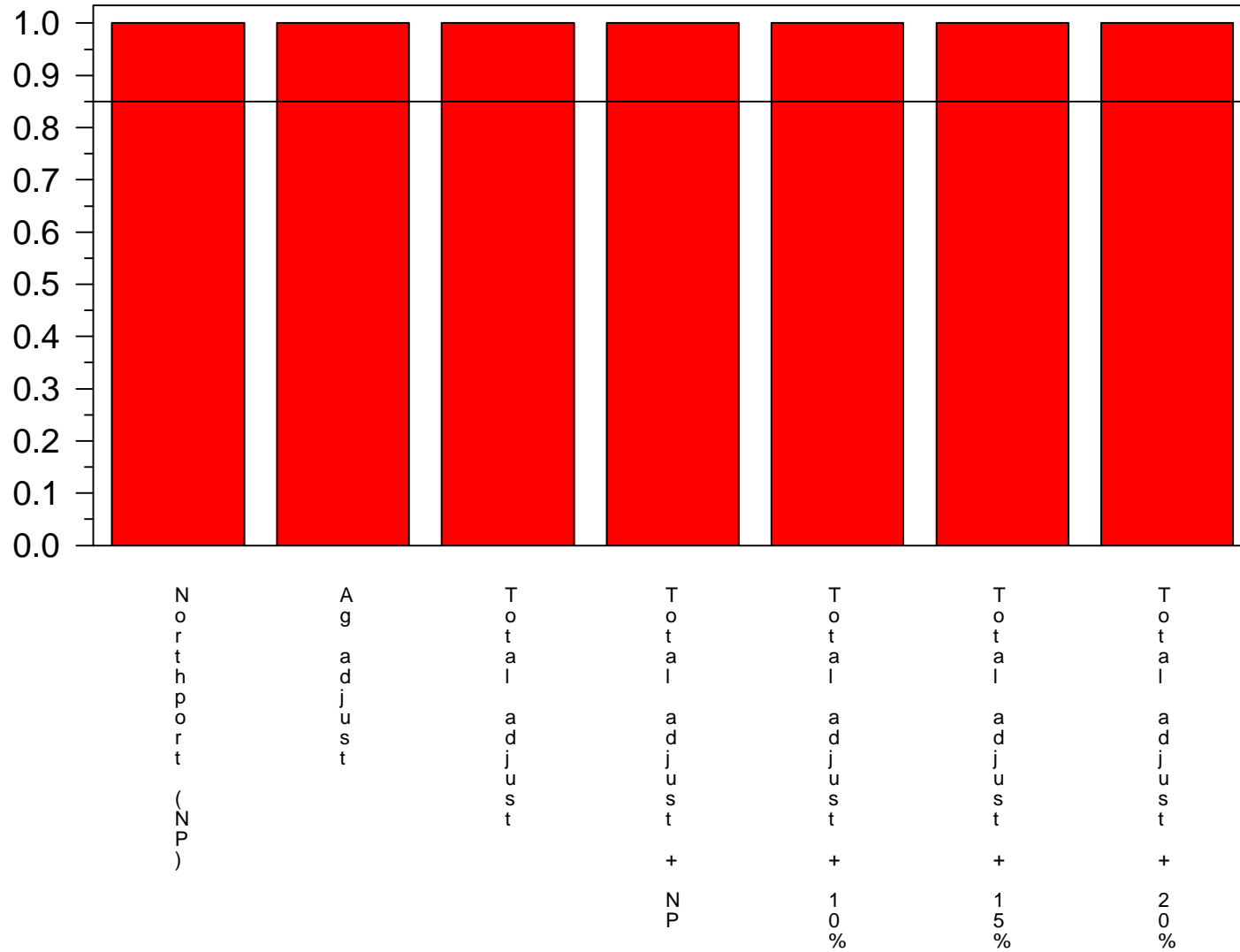

Myakka River

Period of Record 1995-2004

Normalized Area Under Curve

Taxa=Trinectes maculatus juveniles Block=Block 1

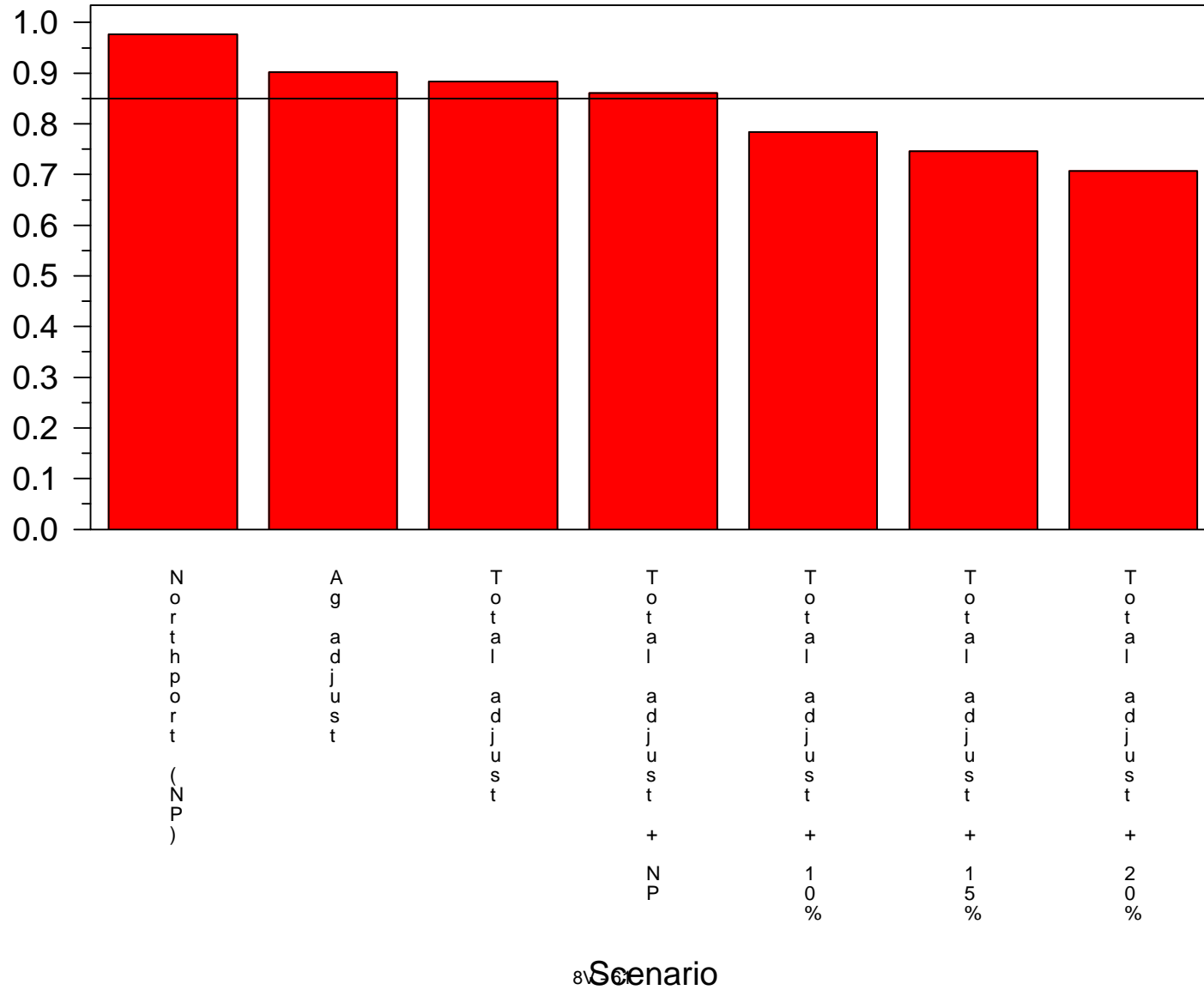

Myakka River

Period of Record 1995-2004

Normalized Area Under Curve

Taxa=Trinectes maculatus juveniles Block=Block 2

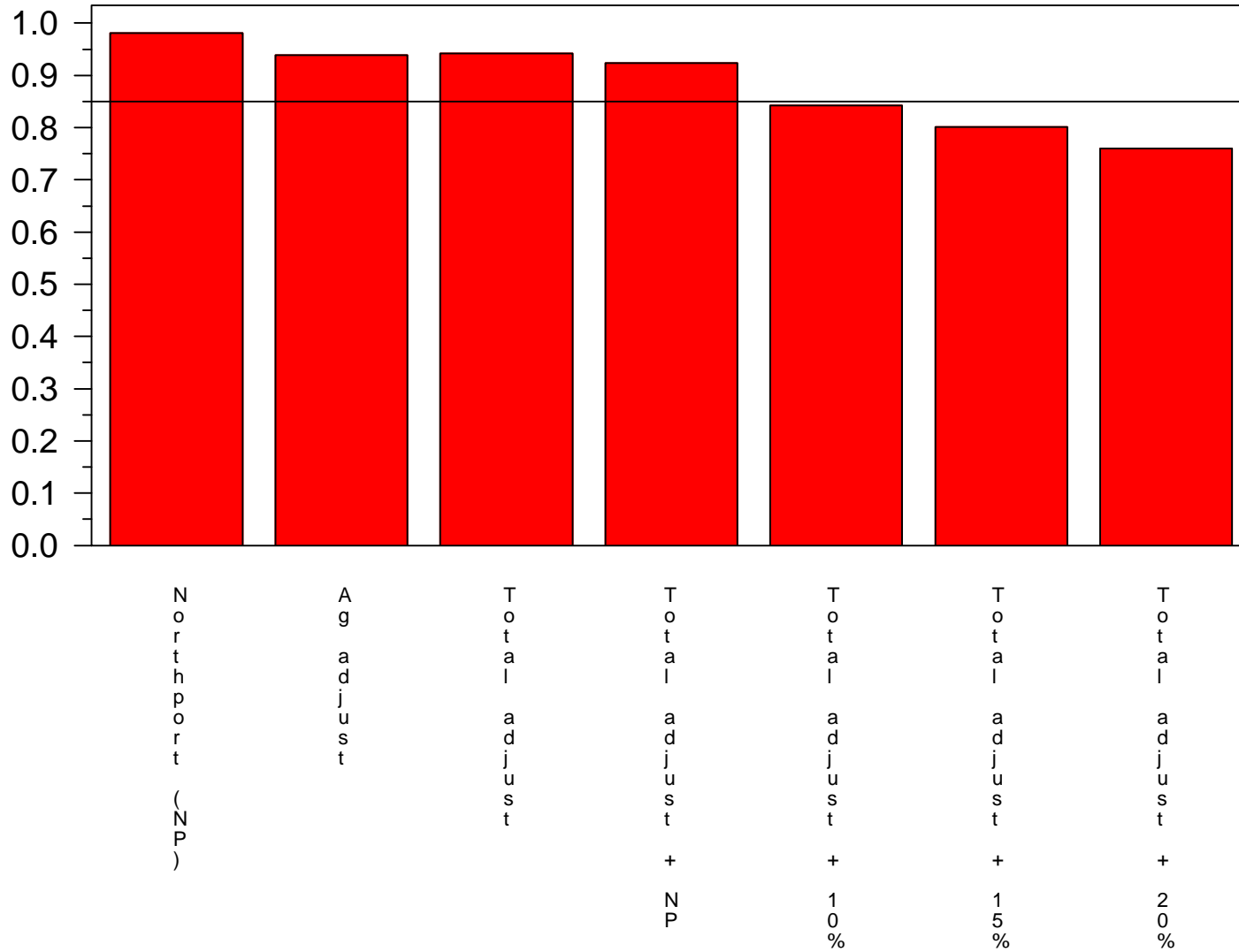

Myakka River

Period of Record 1995-2004

Normalized Area Under Curve

Taxa=Trinectes maculatus juveniles Block=Block 3

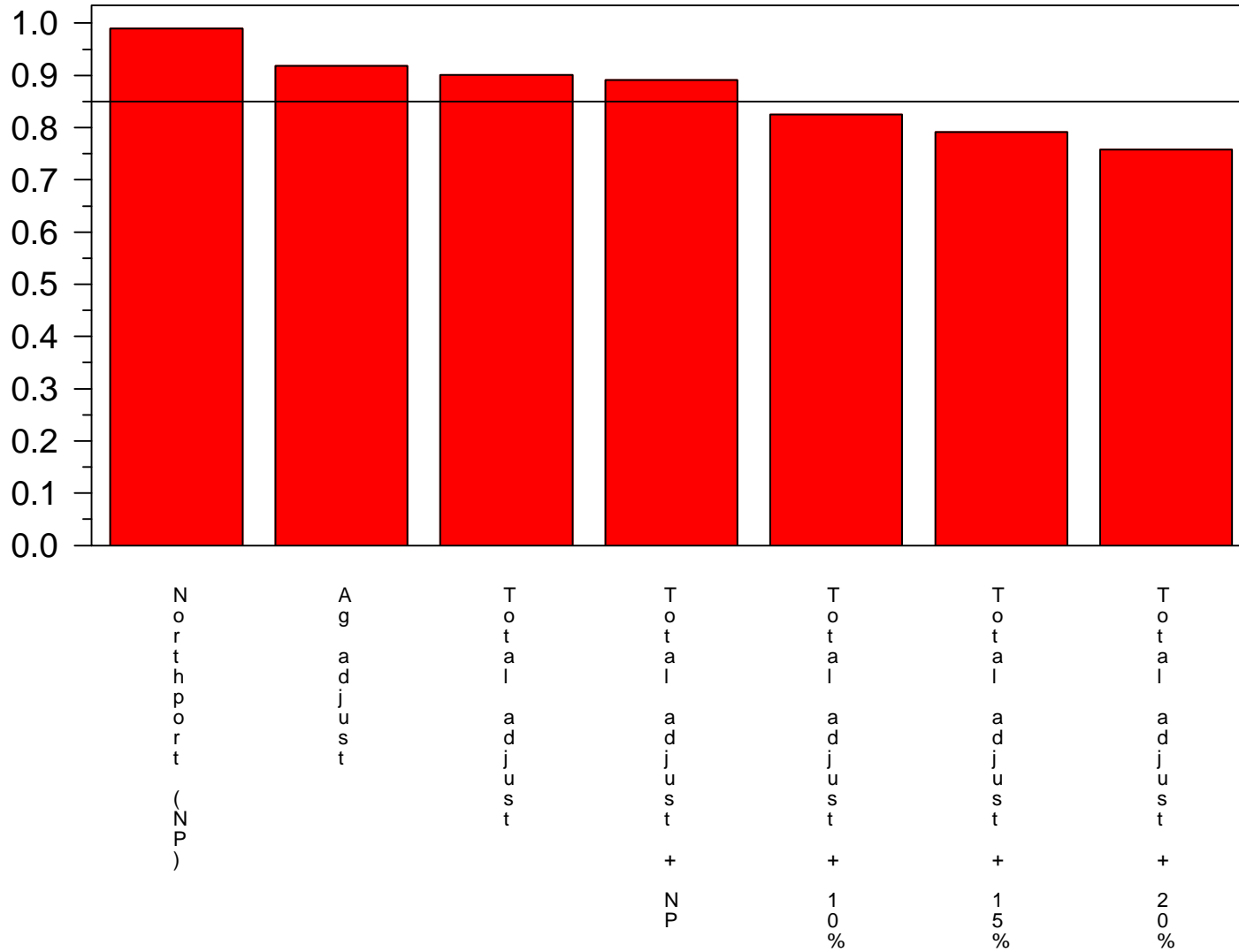

Myakka River

Period of Record 1995-2004

Normalized Area Under Curve

Taxa=Unid Americamysis juveniles Block=Block 1

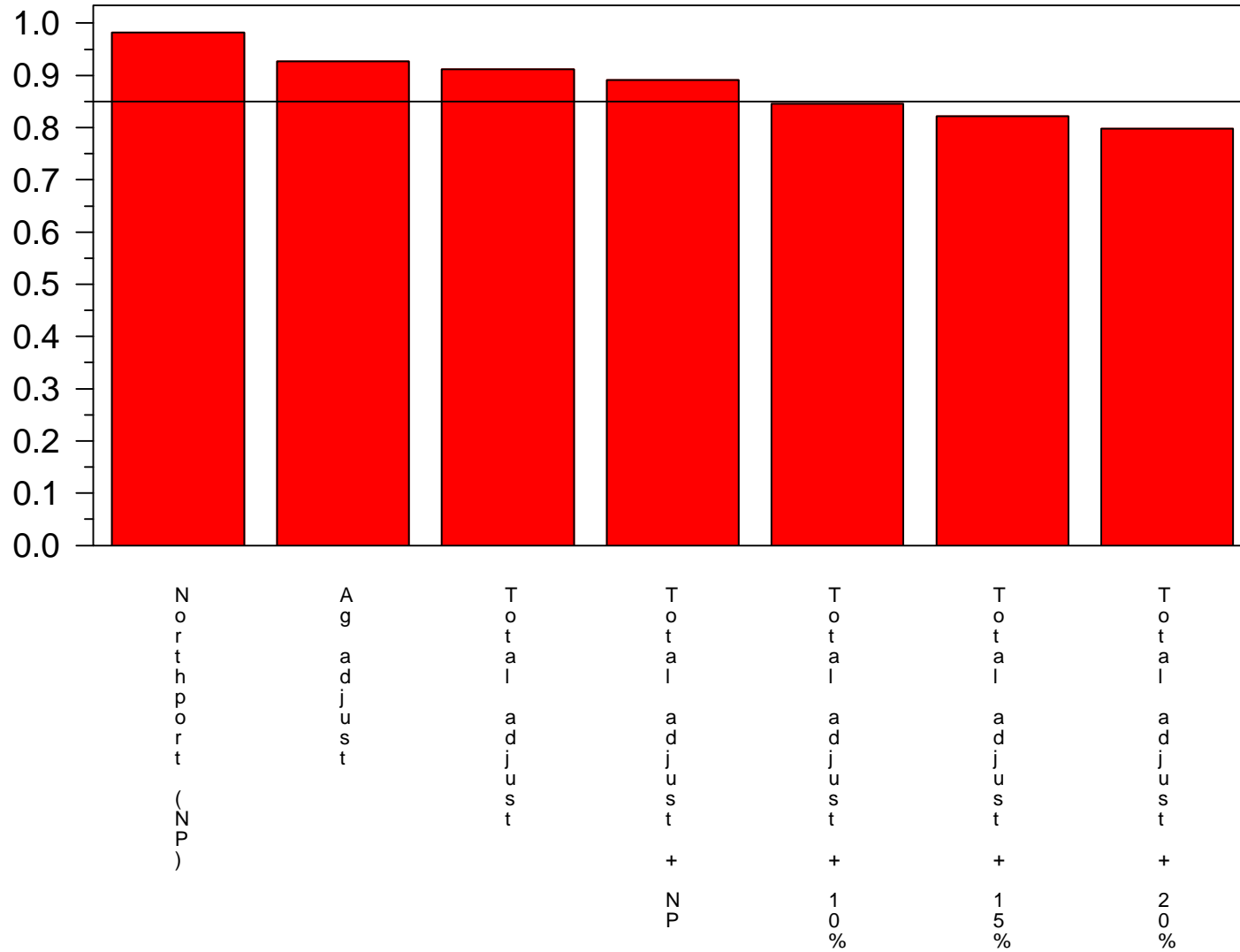

Myakka River

Period of Record 1995-2004

Normalized Area Under Curve

Taxa=Unid Americamysis juveniles Block=Block 2

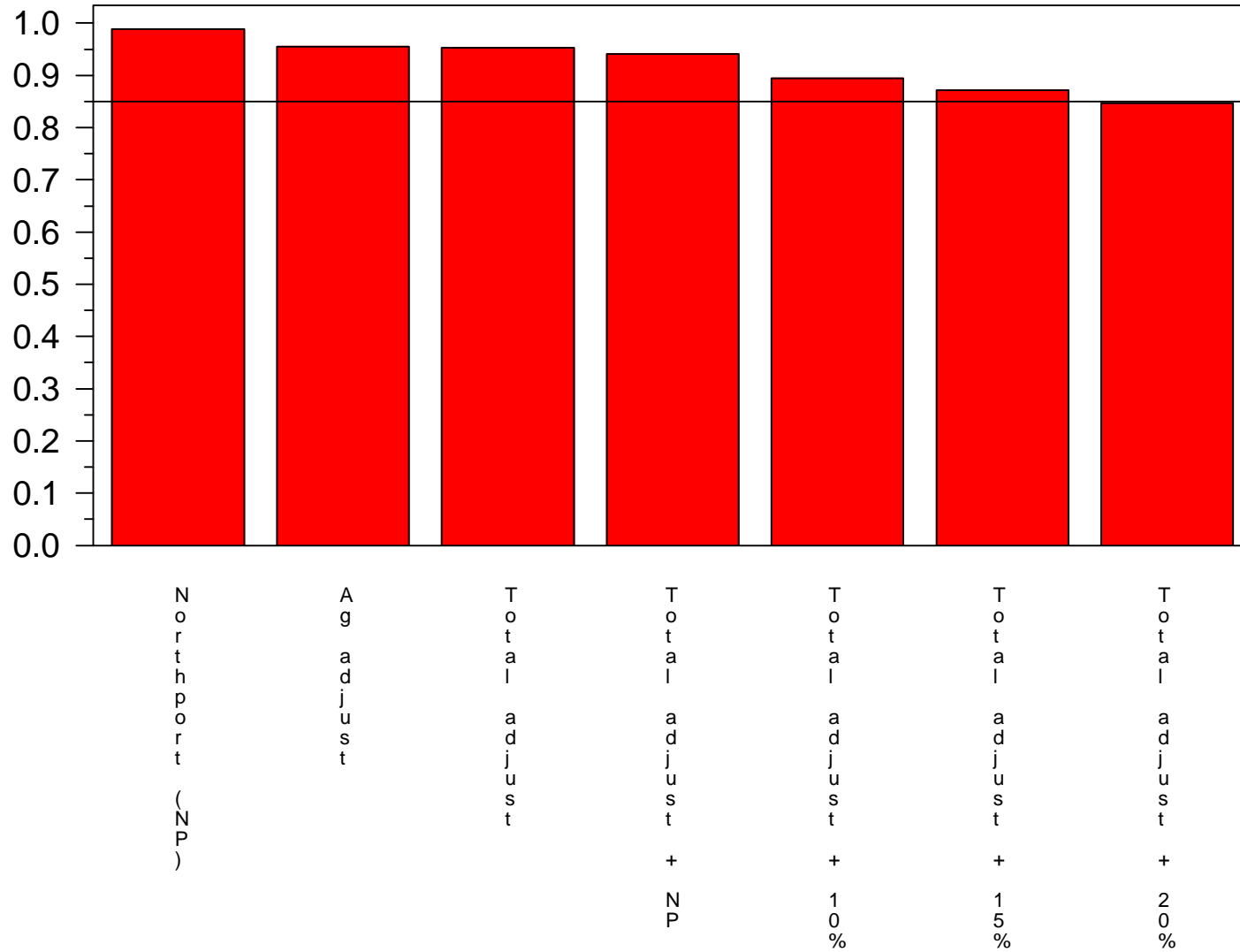

Myakka River

Period of Record 1995-2004

Normalized Area Under Curve

Taxa=Unid Americamysis juveniles Block=Block 3

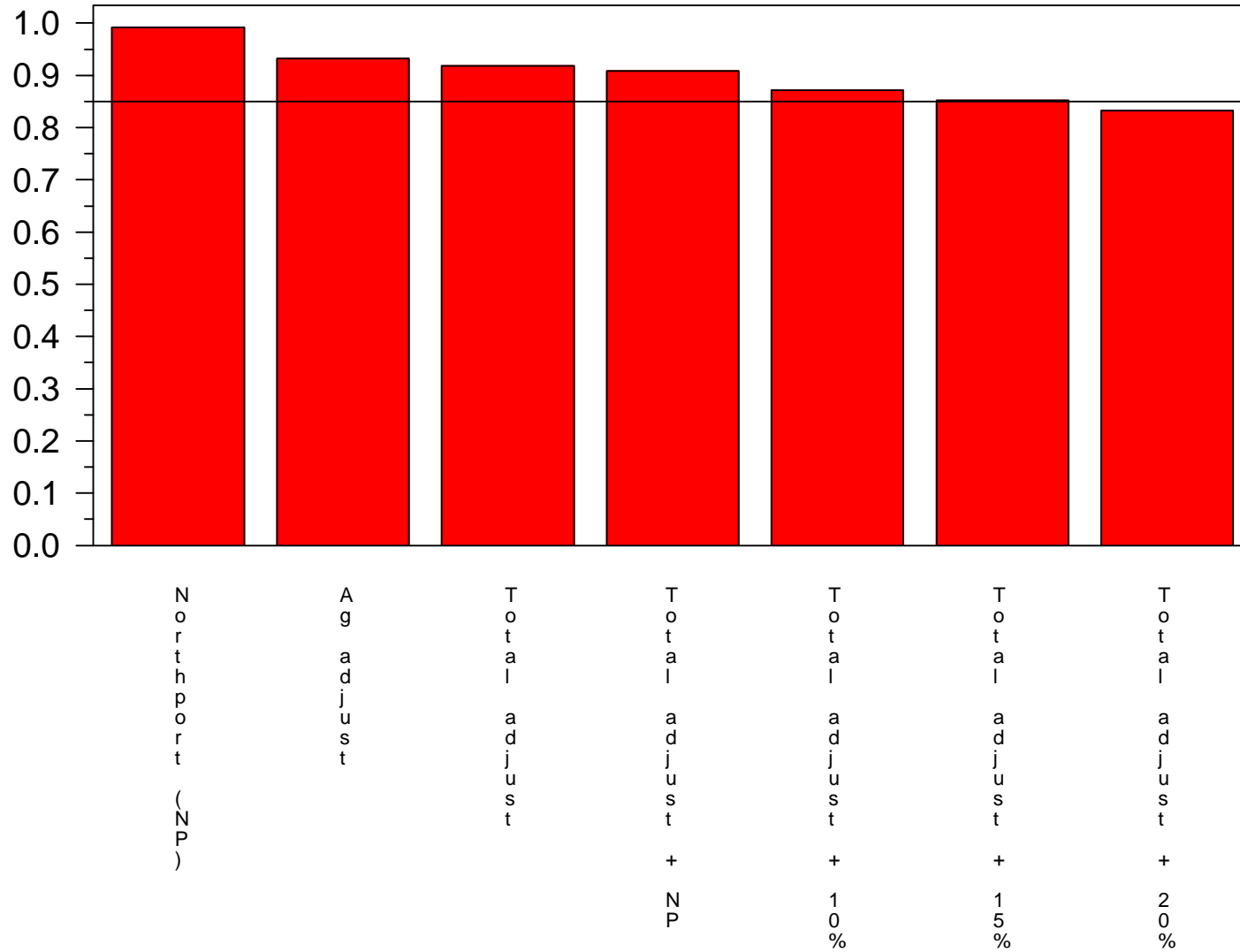

Appendix 8W

Percent reductions in daily abundances for selected indicator taxa for seven flow reduction scenarios for three seasonal blocks measured as differences in the normalized areas under cumulative distribution function curves. Values for plankton taxa are percent change in total abundance in the river, while values for seine and trawl taxa are for percent change in catch-per- unit-effort.

Table 8W-1. Percent changes in the abundance for selected fish and invertebrate taxa age/size classes for seven flow reduction scenarios for **BLOCK 1 during 1995-2004** calculated as the difference in the areas under the cumulative distribution function curves for the baseline and the flow reduction scenarios. Results presented only for regressions that used the sum of the Myakka River and Myakkahatchee Creek gages with the predicted values limited to the flow domains of the regression. Cells that include percent changes 15 % and greater are highlighted in yellow and changes 25% and greater are highlighted in gray.

Block 1 - Sum gaged*	Percentage reductions from baseline (predictions limited to regression domains)								
	<i>Americamysis</i>	<i>Americamysis</i>	<i>Cyathura</i>	<i>Palaemonetes</i>	<i>Palaemonetes</i>	<i>Menidia</i>	<i>Trinectes</i>	<i>Gambusia</i>	<i>Gambusia</i>
	<i>almyra</i>	<i>almyra (2)</i>	<i>polita</i>	<i>intermedius</i>	<i>pugio</i>	<i>spp.</i>	<i>maculatus</i>	<i>holbrooki</i>	<i>holbrooki</i>
	plankton	plankton	plankton	seine	seine	plankton - juveniles	plankton - juveniles	seines <= 25 mm	seines >= 26 mm
North Port Permitted	2	2	2	2	3	2	3	2	2
Agricultural adjustment	8	10	10	6	10	7	10	5	6
Total adjustment	9	12	12	8	13	9	12	5	6
Total adjustment - North Port	11	15	14	11	17	11	14	7	7
Total adjustment - North Port - 10%	17	19	19	13	20	13	22	17	18
Total adjustment - North Port - 15%	20	21	21	14	22	15	25	22	23
Total adjustment - North Port - 20%	23	24	23	16	24	16	29	27	28

* regression using sum of flow at Myakka River near Sarasota and Big Slough Canal at Tropicaire Blvd.

Table 8W-2. Percent changes in the abundance for selected fish and invertebrate taxa age/size classes for seven flow reduction scenarios for **BLOCK 2 during 1995-2004** calculated as the difference in the areas under the cumulative distribution function curves for the baseline and the flow reduction scenarios. Results presented only for regressions that used the sum of the Myakka River and Myakkahatchee Creek gages with the predicted values limited to the flow domains of the regression. Cells that include percent changes 15 % and greater are highlighted in yellow and changes 25% and greater are highlighted in gray.

Block 2 - Sum gaged*	Percentage reductions from baseline (predictions limited to regression domains)								
	<i>Americamysis</i>	<i>Americamysis</i>	<i>Cyathura</i>	<i>Palaemonetes</i>	<i>Palaemonetes</i>	<i>Menidia</i>	<i>Trinectes</i>	<i>Gambusia</i>	<i>Gambusia</i>
	<i>almyra</i>	<i>almyra (2)</i>	<i>polita</i>	<i>intermedius</i>	<i>pugio</i>	<i>spp.</i>	<i>maculatus</i>	<i>holbrooki</i>	<i>holbrooki</i>
	plankton	plankton	plankton	seine	seine	plankton - juveniles	plankton - juveniles	seines <= 25 mm	seines >= 26 mm
North Port Permitted	1	1	2	1	2	1	2	1	1
Agricultural adjustment	5	5	5	2	3	3	6	5	8
Total adjustment	5	5	5	3	5	4	6	10	9
Total adjustment - North Port	7	6	7	4	7	5	8	11	11
Total adjustment - North Port - 10%	12	10	11	5	8	8	16	20	19
Total adjustment - North Port - 15%	15	13	14	5	9	9	20	24	23
Total adjustment - North Port - 20%	18	15	16	5	9	11	24	28	27

* regression using sum of flow at Myakka River near Sarasota and Big Slough Canal at Tropicaire Blvd.

Table 8W-3. Percent changes in the abundance for selected fish and invertebrate taxa age/size classes for seven flow reduction scenarios for **BLOCK 3 during 1995-2004** calculated as the difference in the areas under the cumulative distribution function curves for the baseline and the flow reduction scenarios. Results presented only for regressions that used the sum of the Myakka River and Myakkahatchee Creek gages with the predicted values limited to the flow domains of the regression. Cells that include percent changes 15 % and greater are highlighted in yellow and changes 25% and greater are highlighted in gray.

Block 3 - Sum gaged*	Percentage reductions from baseline (predictions limited to regression domains) + signs for Palaemonetes mean positive change								
	<i>Americamysis</i>	<i>Americamysis</i>	<i>Cyathura</i>	<i>Palaemonetes</i>	<i>Palaemonetes</i>	<i>Menidia</i>	<i>Trinectes</i>	<i>Gambusia</i>	<i>Gambusia</i>
	<i>almyra</i>	<i>almyra (2)</i>	<i>polita</i>	<i>intermedius</i>	<i>pugio</i>	<i>spp.</i>	<i>maculatus</i>	<i>holbrookii</i>	<i>holbrookii</i>
	plankton	plankton	plankton	seine	seine	plankton - juveniles	plankton - juveniles	seines <= 25 mm	seines >= 26 mm
North Port Permitted	1	1	1	0	0	1	1	1	1
Agricultural adjustment	8	7	6	+ 5	+ 5	6	10	10	10
Total adjustment	9	8	8	+5	+4	6	10	12	12
Total adjustment - North Port	10	9	8	+4	+3	6	11	13	13
Total adjustment - North Port - 10%	15	11	12	+7	+7	8	18	21	21
Total adjustment - North Port - 15%	17	13	14	+9	+9	10	21	25	25
Total adjustment - North Port - 20%	19	14	16	+11	+11	11	24	29	29

* regression using sum of flow at Myakka River near Sarasota and Big Slough Canal at Tropicaire Blvd.

Table 8W-4. Percent changes in the abundance for selected fish and invertebrate taxa age/size classes for seven flow reduction scenarios for **BLOCK 1 during 1999-2002** calculated as the difference in the areas under the cumulative distribution function curves for the baseline and the flow reduction scenarios. Results presented only for regressions that used the sum of the Myakka River and Myakkahatchee Creek gages with the predicted values limited to the flow domains of the regression. Cells that include percent changes 15 % and greater are highlighted in yellow and changes 25% and greater are highlighted in gray.

Block 1 - Sum gaged*	Percentage reductions from baseline (predictions limited to regression domains)								
	<i>Americamysis</i>	<i>Americamysis</i>	<i>Cyathura</i>	<i>Palaemonetes</i>	<i>Palaemonetes</i>	<i>Menidia</i>	<i>Trinectes</i>	<i>Gambusia</i>	<i>Gambusia</i>
	<i>almyra</i>	<i>almyra (2)</i>	<i>polita</i>	<i>intermedius</i>	<i>pugio</i>	<i>spp.</i>	<i>maculatus</i>	<i>holbrookii</i>	<i>holbrookii</i>
	plankton	plankton	plankton	seine	seine	plankton - juveniles	plankton - juveniles	seines <= 25 mm	seines >= 26 mm
North Port Permitted	4	5	3	2	3	2	5	3	4
Agricultural adjustment	13	17	13	9	15	8	20	14	16
Total adjustment	17	24	17	13	19	11	26	16	19
Total adjustment - North Port	21	29	20	16	24	13	31	20	23
Total adjustment - North Port - 10%	26	34	24	20	29	16	37	31	36
Total adjustment - North Port - 15%	29	37	27	23	32	17	40	42	50
Total adjustment - North Port - 20%	31	40	29	25	35	18	43	42	50

* regression using sum of flow at Myakka River near Sarasota and Big Slough Canal at Tropicaire Blvd.

Table 8W-5. Percent changes in the abundance for selected fish and invertebrate taxa for seven flow reduction scenarios for **BLOCK 2 during 1999-2002** calculated as the difference in the areas under the cumulative distribution function curves for the baseline and the flow reduction scenarios. Results presented only for regressions that used the sum of the Myakka River and Myakkahatchee Creek gages with the predicted values limited to the flow domains of the regression. Cells that include percent changes 15 % and greater are highlighted in yellow and changes 25% and greater are highlighted in gray.

Block 2 - Sum gaged*	Percentage reductions from baseline (predictions limited to regression domains)								
	<i>Americamysis almyra</i>	<i>Americamysis almyra (2)</i>	<i>Cyathura polita</i>	<i>Palaemonetes intermedius</i>	<i>Palaemonetes pugio</i>	<i>Menidia spp.</i>	<i>Trinectes maculatus</i>	<i>Gambusia holbrooki</i>	<i>Gambusia holbrooki</i>
	plankton	plankton	plankton	seine	seine	plankton - juveniles	plankton - juveniles	seines <= 25 mm	seines >= 26 mm
North Port Permitted	2	2	3	2	3	2	3	2	2
Agricultural adjustment	7	6	6	3	5	4	10	13	13
Total adjustment	7	7	8	5	8	5	11	15	15
Total adjustment - North Port	9	8	10	8	12	7	14	17	17
Total adjustment - North Port - 10%	14	13	15	10	15	10	22	25	25
Total adjustment - North Port - 15%	17	15	17	11	17	11	26	29	29
Total adjustment - North Port - 20%	20	17	20	13	19	13	29	33	33

* regression using sum of flow at Myakka River near Sarasota and Big Slough Canal at Tropicaire Blvd.

Table 8W-6. Percent changes in the abundance for selected fish and invertebrate taxa age/size classes for seven flow reduction scenarios for **BLOCK 3 during 1999-2002** calculated as the difference in the areas under the cumulative distribution function curves for the baseline and the flow reduction scenarios. Results presented only for regressions that used the sum of the Myakka River and Myakkahatchee Creek gages with the predicted values limited to the flow domains of the regression. Cells that include percent changes 15 % and greater are highlighted in yellow and changes 25% and greater are highlighted in gray.

Block 3 - Sum gaged*	Percentage reductions from baseline (predictions limited to regression domains) + signs for <i>Palaemonetes</i> mean positive change								
	<i>Americamysis almyra</i>	<i>Americamysis almyra (2)</i>	<i>Cyathura polita</i>	<i>Palaemonetes intermedius</i>	<i>Palaemonetes pugio</i>	<i>Menidia spp.</i>	<i>Trinectes maculatus</i>	<i>Gambusia holbrooki</i>	<i>Gambusia holbrooki</i>
	plankton	plankton	plankton	seine	seine	plankton - juveniles	plankton - juveniles	seines <= 25 mm	seines >= 26 mm
North Port Permitted	1	0	1	0	0	1	1	2	2
Agricultural adjustment	9	8	8	+ 8	+ 10	5	12	16	16
Total adjustment	10	8	9	+ 9	+ 12	6	13	18	18
Total adjustment - North Port	12	8	10	+ 9	+ 12	6	14	19	19
Total adjustment - North Port - 10%	16	11	13	+ 13	+ 17	8	20	27	27
Total adjustment - North Port - 15%	18	13	15	+ 15	+ 20	10	24	31	31
Total adjustment - North Port - 20%	20	15	17	+ 17	+ 22	11	27	35	35

* regression using sum of flow at Myakka River near Sarasota and Big Slough Canal at Tropicaire Blvd.

Appendix 8X

Percent reductions in mean daily abundances for selected indicator taxa for seven flow reduction scenarios for three seasonal blocks. Values for plankton taxa are percent change in total abundance in the river, while values for seine and trawl taxa are for percent change in catch-per-unit-effort.

Table 8X-1. Percent changes from baseline for mean values of predicted daily abundances for selected fish and invertebrate taxa age/size classes for seven flow reduction scenarios for **BLOCK 1 during 1995-2004**. Results presented separately for regressions using the sum of the Myakka River and Myakkahatchee Creek gages and regressions that use the Myakka River gage alone. Results for each scenario are listed for predictions limited to the flow domains of the regression (left of -) and predictions using all flows (right of -). Predictions involving City of North Port withdrawals were not generated for the one gage regressions. Cells that include percent changes 15 % and greater are highlighted in yellow and changes 25% and greater are highlighted in gray.

Block 1 - Sum gaged*	Percentage reductions from baseline (predictions limited to regression domain and all flows)									
	<i>Americamysis almyra</i>	<i>Americamysis almyra</i> (2)	<i>Cyathura polita</i>	<i>Palaemonetes intermedius</i>	<i>Palaemonetes pugio</i>	<i>Menidia spp.</i>	<i>Trinectes maculatus</i>	<i>Gambusia holbrooki</i>	<i>Gambusia holbrooki</i>	
	plankton	plankton	plankton	seine	seine	plankton - juveniles	plankton - juveniles	seines <= 25 mm	seines >= 26 mm	
North Port Permitted	2 - 2	3 - 3	2 - 2	3 - 3	4 - 4	2 - 1	2 - 3	2 - 2	2 - 2	
Agricultural adjustment	8 - 9	11 - 11	11 - 13	9 - 17	13 - 19	11 - 11	10 - 11	6 - 7	7 - 7	
Total adjustment	10 - 11	13 - 14	13 - 15	12 - 21	17 - 23	13 - 13	12 - 13	7 - 7	7 - 7	
Total adjustment - North Port	12 - 13	15 - 17	15 - 16	14 - 26	20 - 27	16 - 11	14 - 15	8 - 9	8 - 9	
Total adjustment - North Port - 10%	17 - 19	20 - 22	19 - 20	14 - 28	22 - 31	18 - 13	22 - 22	18 - 20	18 - 20	
Total adjustment - North Port - 15%	20 - 21	22 - 25	21 - 22	15 - 30	23 - 33	19 - 15	26 - 25	23 - 25	23 - 25	
Total adjustment - North Port - 20%	22 - 24	25 - 27	23 - 24	16 - 32	24 - 35	20 - 16	29 - 30	28 - 30	28 - 30	

* regression using sum of flow at Myakka River near Sarasota and Big Slough Canal at Tropicaire Blvd.

** regressions using Myakka River near Sarasota flow only, not applicable to North Port permitted withdrawals

Block 1 - One gage **	Percentage reductions from baseline (predictions limited to regression domain and all flows)			
	Ephemeropteran larvae	<i>Mesocyclops edax</i>	<i>Gambusia holbrooki</i>	<i>Trinectes maculatus</i>
	plankton	plankton	plankton - juveniles	plankton - juveniles
Agricultural adjustment	10 - 11	14 - 5	11 - 11	11 - 11
Total adjustment	12 - 12	17 - 4	13 - 13	13 - 13
Total adjustment - 10%	22 - 22	23 - 12	18 - 18	22 - 22
Total adjustment - 15%	27 - 27	26 - 15	20 - 20	26 - 27
Total adjustment - 20%	32 - 32	29 - 19	22 - 22	31 - 31

Table 8X-2. Percent changes from baseline for mean values of predicted daily abundances for selected fish and invertebrate taxa age/size classes for seven flow reduction scenarios for **BLOCK 2 during 1995-2004**. Results presented separately for regressions using the sum of the Myakka River and Myakkahatchee Creek gages and regressions that use the Myakka River gage alone. Results for each scenario are listed for predictions limited to the flow domains of the regression (left of -) and predictions using all flows (right of -). Predictions involving City of North Port withdrawals were not generated for the one gage regressions. Cells that include percent changes 15 % and greater are highlighted in yellow and changes 25% and greater are highlighted in gray.

Block 2 - Sum gaged*	Percentage reductions from baseline (predictions limited to regression domain and all flows)									
	<i>Americamysis almyra</i>	<i>Americamysis almyra</i> (2)	<i>Cyathura polita</i>	<i>Palaemonetes intermedius</i>	<i>Palaemonetes pugio</i>	<i>Menidia spp.</i>	<i>Trinectes maculatus</i>	<i>Gambusia holbrooki</i>	<i>Gambusia holbrooki</i>	
	plankton	plankton	plankton	seine	seine	plankton - juveniles	plankton - juveniles	seines <= 25 mm	seines >= 26 mm	
North Port Permitted	1 - 1	1 - 1	2 - 2	2 - 3	3 - 3	2 - 2	2 - 2	1 - 1	1 - 1	
Agricultural adjustment	5 - 5	5 - 5	5 - 5	4 - 6	5 - 6	4 - 4	6 - 6	8 - 9	8 - 9	
Total adjustment	6 - 6	5 - 5	5 - 6	4 - 9	6 - 9	5 - 5	6 - 6	10 - 10	9 - 10	
Total adjustment - North Port	7 - 7	6 - 7	7 - 8	5 - 12	7 - 12	8 - 8	8 - 8	11 - 12	11 - 11	
Total adjustment - North Port - 10%	12 - 12	11 - 11	12 - 13	5 - 13	8 - 13	10 - 10	16 - 16	20 - 20	19 - 19	
Total adjustment - North Port - 15%	15 - 15	13 - 13	14 - 15	5 - 13	9 - 14	12 - 11	20 - 20	24 - 24	23 - 23	
Total adjustment - North Port - 20%	18 - 18	15 - 16	16 - 18	5 - 14	9 - 15	13 - 13	24 - 24	28 - 29	27 - 27	

* regression using sum of flow at Myakka River near Sarasota and Big Slough Canal at Tropicaire Blvd.

** regressions using Myakka River near Sarasota flow only, not applicable to North Port permitted withdrawals

Block 2 - One gage **	Percentage reductions from baseline (predictions limited to regression domain and all flows)			
	Ephemeropteran larvae	<i>Mesocyclops edax</i>	<i>Gambusia holbrooki</i>	<i>Trinectes maculatus</i>
	plankton	plankton	plankton - juveniles	plankton - juveniles
Agricultural adjustment	8 - 8	6 - 5	5 - 7	7 - 7
Total adjustment	8 - 8	7 - 3	6 - 7	7 - 7
Total adjustment - 10%	18 - 18	14 - 10	10 - 12	17 - 17
Total adjustment - 15%	24 - 24	18 - 14	13 - 14	21 - 22
Total adjustment - 20%	29 - 29	21 - 18	15 - 17	26 - 27

Table 8X-3. Percent changes from baseline for mean values of predicted daily abundances for selected fish and invertebrate taxa age/size classes for seven flow reduction scenarios for **BLOCK 3 during 1995-2004**. Results presented separately for regressions using the sum of the Myakka River and Myakkahatchee Creek gages and regressions that use the Myakka River gage alone. Results for each scenario are listed for predictions limited to the flow domains of the regression (left of -) and predictions using all flows (right of -). Predictions involving City of North Port withdrawals were not generated for the one gage regressions. Cells that include percent changes 15 % and greater are highlighted in yellow and changes 25% and greater are highlighted in gray.

Block 3 - Sum gaged*	Percentage reductions from baseline (predictions limited to regression domain and all flows) + signs for <i>Palaemonetes</i> mean positive change								
	<i>Americamysis almyra</i> plankton	<i>Americamysis almyra</i> (2) plankton	<i>Cyathura polita</i> plankton	<i>Palaemonetes intermedius</i> seine	<i>Palaemonetes pugio</i> seine	<i>Menidia spp.</i> plankton - juveniles	<i>Trinectes maculatus</i> plankton - juveniles	<i>Gambusia holbrooki</i> seines <= 25 mm	<i>Gambusia holbrooki</i> seines >= 26 mm
North Port Permitted	1 - 1	1 - 1	1 - 1	0 + 2	0 0	1 - 1	1 - 1	1 - 2	1 - 2
Agricultural adjustment	8 - 8	7 - 7	6 - 6	+ 4 + 2	+ 4 + 2	5 - 5	8 - 8	10 - 11	10 - 11
Total adjustment	9 - 9	9 - 9	8 - 8	+ 4 + 2	+ 3 + 1	6 - 6	10 - 10	12 - 14	12 - 13
Total adjustment - North Port	10 - 10	10 - 10	8 - 8	+ 4 + 1	+ 3 + 0	7 - 6	11 - 11	13 - 15	13 - 15
Total adjustment - North Port - 10%	15 - 15	13 - 13	12 - 12	+ 7 + 4	+ 6 + 3	9 - 8	18 - 18	21 - 23	21 - 22
Total adjustment - North Port - 15%	17 - 17	14 - 14	14 - 14	+ 9 + 5	+ 9 + 5	10 - 9	21 - 21	25 - 28	25 - 26
Total adjustment - North Port - 20%	19 - 19	16 - 16	16 - 16	+ 11 + 7	+ 10 + 7	11 - 10	24 - 24	30 - 32	29 - 30
* regression using sum of flow at Myakka River near Sarasota and Big Slough Canal at Tropicaire Blvd. ** regressions using Myakka River near Sarasota flow only, not applicable to North Port permitted withdrawals									
Block 3 - One gage **	Percentage reductions from baseline (predictions limited to regression domain and all flows)								
	Ephemeropteran larvae plankton	<i>Mesocyclops edax</i> plankton	<i>Gambusia holbrooki</i> plankton - juveniles	<i>Trinectes maculatus</i> plankton - juveniles					
Agricultural adjustment	11 - 11	9 - 2	8 - 6	11 - 11					
Total adjustment	14 - 14	11 - 2	9 - 6	13 - 13					
Total adjustment - 10%	24 - 24	18 - 10	14 - 11	22 - 22					
Total adjustment - 15%	29 - 29	21 - 14	16 - 13	27 - 27					
Total adjustment - 20%	34 - 34	25 - 18	19 - 16	31 - 31					

Table 8X-4. Percent changes from baseline for mean values of predicted daily abundances for selected fish and invertebrate taxa age/size classes for seven flow reduction scenarios for **BLOCK 1 during 1999-2002**. Results presented separately for regressions using the sum of the Myakka River and Myakkahatchee Creek gages and regressions that use the Myakka River gage alone. Results for each scenario are listed for predictions limited to the flow domains of the regression (left of -) and predictions using all flows (right of -). Predictions involving City of North Port withdrawals were not generated for the one gage regressions. Cells that include percent changes 15 % and greater are highlighted in yellow and changes 25% and greater are highlighted in gray.

Block 1 - Sum gaged*	Percentage reductions from baseline (predictions limited to regression domain and all flows)								
	<i>Americamysis almyra</i> plankton	<i>Americamysis almyra</i> (2) plankton	<i>Cyathura polita</i> plankton	<i>Palaemonetes intermedius</i> seine	<i>Palaemonetes pugio</i> seine	<i>Menidia spp.</i> plankton - juveniles	<i>Trinectes maculatus</i> plankton - juveniles	<i>Gambusia holbrooki</i> seines <= 25 mm	<i>Gambusia holbrooki</i> seines >= 26 mm
North Port Permitted	4 - 4	5 - 6	4 - 2	5 - 6	6 - 7	3 - 0	5 - 6	4 - 5	5 - 5
Agricultural adjustment	13 - 15	18 - 20	14 - 17	13 - 23	19 - 26	12 - 12	21 - 23	15 - 17	18 - 20
Total adjustment	18 - 20	24 - 27	18 - 22	18 - 30	25 - 33	15 - 15	26 - 29	17 - 21	21 - 23
Total adjustment - North Port	22 - 25	29 - 33	21 - 21	21 - 36	29 - 39	19 - 12	31 - 33	21 - 25	26 - 28
Total adjustment - North Port - 10%	26 - 29	35 - 40	25 - 25	22 - 41	31 - 44	21 - 14	37 - 39	32 - 38	38 - 43
Total adjustment - North Port - 15%	29 - 32	36 - 43	27 - 27	23 - 43	33 - 47	23 - 16	40 - 42	37 - 44	44 - 50
Total adjustment - North Port - 20%	31 - 34	42 - 46	29 - 29	25 - 46	35 - 50	24 - 17	43 - 45	42 - 50	50 - 56
* regression using sum of flow at Myakka River near Sarasota and Big Slough Canal at Tropicaire Blvd. ** regressions using Myakka River near Sarasota flow only, not applicable to North Port permitted withdrawals									
Block 1 - One gage **	Percentage reductions from baseline (predictions limited to regression domain and all flows)								
	Ephemeropteran larvae plankton	<i>Mesocyclops edax</i> plankton	<i>Gambusia holbrooki</i> plankton - juveniles	<i>Trinectes maculatus</i> plankton - juveniles					
Agricultural adjustment	25 - 27	20 - 14	13 - 12	24 - 24					
Total adjustment	33 - 34	25 - 18	17 - 17	30 - 31					
Total adjustment - 10%	40 - 42	31 - 25	21 - 21	37 - 38					
Total adjustment - 15%	44 - 46	33 - 28	24 - 24	41 - 41					
Total adjustment - 20%	48 - 49	36 - 31	26 - 26	44 - 45					

Table 8X-5. Percent changes from baseline for mean values of predicted daily abundances for selected fish and invertebrate taxa age/size classes for seven flow reduction scenarios for **BLOCK 2 during 1999-2002**. Results presented separately for regressions using the sum of the Myakka River and Myakkahatchee Creek gages and regressions that use the Myakka River gage alone. Results for each scenario are listed for predictions limited to the flow domains of the regression (left of -) and predictions using all flows (right of -). Predictions involving City of North Port withdrawals were not generated for the one gage regressions. Cells that include percent changes 15 % and greater are highlighted in yellow and changes 25% and greater are highlighted in gray.

Block 2 - Sum gaged*	Percentage reductions from baseline (predictions limited to regression domain and all flows)									
	<i>Americamysis</i>	<i>Americamysis</i>	<i>Cyathura</i>	<i>Palaemonetes</i>	<i>Palaemonetes</i>	<i>Menidia</i>	<i>Trinectes</i>	<i>Gambusia</i>	<i>Gambusia</i>	
	<i>almyra</i>	<i>almyra (2)</i>	<i>polita</i>	<i>intermedius</i>	<i>pugio</i>	<i>spp.</i>	<i>maculatus</i>	<i>holbrooki</i>	<i>holbrooki</i>	
	plankton	plankton	plankton	seine	seine	plankton - juveniles	plankton - juveniles	seines <= 25 mm	seines >= 26 mm	
North Port Permitted	2 - 2	2 - 2	2 - 3	2 - 4	3 - 4	2 - 2	4 - 4	2 - 2	2 - 2	
Agricultural adjustment	7 - 7	6 - 6	6 - 7	4 - 7	6 - 8	5 - 5	10 - 10	13 - 13	13 - 13	
Total adjustment	8 - 8	7 - 7	8 - 9	6 - 12	9 - 11	7 - 7	11 - 12	15 - 15	15 - 15	
Total adjustment - North Port	9 - 10	8 - 9	11 - 13	8 - 15	12 - 15	11 - 11	14 - 15	17 - 17	17 - 17	
Total adjustment - North Port - 10%	14 - 15	13 - 14	15 - 18	10 - 17	15 - 19	13 - 13	22 - 23	25 - 25	25 - 25	
Total adjustment - North Port - 15%	17 - 18	15 - 16	17 - 20	11 - 18	17 - 21	14 - 14	26 - 26	29 - 29	29 - 29	
Total adjustment - North Port - 20%	20 - 20	18 - 18	20 - 22	13 - 20	19 - 23	16 - 16	29 - 30	33 - 33	33 - 33	

* regression using sum of flow at Myakka River near Sarasota and Big Slough Canal at Tropicaire Blvd.
** regressions using Myakka River near Sarasota flow only, not applicable to North Port permitted withdrawals

Block 2 - One gage **	Percentage reductions from baseline (predictions limited to regression domain and all flows)			
	Ephemeropteran	<i>Mesocyclops</i>	<i>Gambusia</i>	<i>Trinectes</i>
	larvae	<i>edax</i>	<i>holbrooki</i>	<i>maculatus</i>
	plankton	plankton	plankton - juveniles	plankton - juveniles
Agricultural adjustment	12 - 12	10 - 10	7 - 9	12 - 12
Total adjustment	13 - 13	11 - 7	9 - 11	13 - 14
Total adjustment - 10%	23 - 23	18 - 14	13 - 15	22 - 23
Total adjustment - 15%	28 - 28	21 - 18	16 - 18	26 - 27
Total adjustment - 20%	33 - 33	25 - 22	18 - 20	31 - 32

Table 8X-6. Percent changes from baseline for mean values of predicted daily abundances for selected fish and invertebrate taxa age/size classes for seven flow reduction scenarios for **BLOCK 3 during 1999-2002**. Results presented separately for regressions using the sum of the Myakka River and Myakkahatchee Creek gages and regressions that use the Myakka River gage alone. Results for each scenario are listed for predictions limited to the flow domains of the regression (left of -) and predictions using all flows (right of -). Predictions involving City of North Port withdrawals were not generated for the one gage regressions. Cells that include percent changes 15 % and greater are highlighted in yellow and changes 25% and greater are highlighted in gray.

Block 3 - Sum gaged*	Percentage reductions from baseline (predictions limited to regression domain and all flows) + signs for <i>Palaemonetes</i> mean positive change									
	<i>Americamysis</i>	<i>Americamysis</i>	<i>Cyathura</i>	<i>Palaemonetes</i>	<i>Palaemonetes</i>	<i>Menidia</i>	<i>Trinectes</i>	<i>Gambusia</i>	<i>Gambusia</i>	
	<i>almyra</i>	<i>almyra (2)</i>	<i>polita</i>	<i>intermedius</i>	<i>pugio</i>	<i>spp.</i>	<i>maculatus</i>	<i>holbrooki</i>	<i>holbrooki</i>	
	plankton	plankton	plankton	seine	seine	plankton - juveniles	plankton - juveniles	seines <= 25 mm	seines >= 26 mm	
North Port Permitted	1 - 1	1 - 1	1 - 1	0 0	0 0	1 - 1	1 - 1	2 - 2	2 - 2	
Agricultural adjustment	9 - 9	8 - 8	8 - 8	+ 7 + 9	+ 10 + 9	5 - 5	12 - 12	16 - 17	16 - 17	
Total adjustment	10 - 11	8 - 8	9 - 9	+ 8 + 8	+ 11 + 11	5 - 5	13 - 13	18 - 19	18 - 19	
Total adjustment - North Port	12 - 12	9 - 9	10 - 10	+ 9 + 7	+ 12 + 10	6 - 6	14 - 14	20 - 21	20 - 21	
Total adjustment - North Port - 10%	16 - 16	12 - 13	13 - 13	+ 13 + 11	+ 17 + 15	8 - 8	20 - 20	27 - 29	28 - 29	
Total adjustment - North Port - 15%	18 - 18	14 - 14	15 - 15	+ 15 + 13	+ 20 + 18	9 - 9	24 - 24	31 - 33	31 - 33	
Total adjustment - North Port - 20%	20 - 20	16 - 16	17 - 17	+ 17 + 15	+ 22 + 21	11 - 11	27 - 27	35 - 36	35 - 37	

* regression using sum of flow at Myakka River near Sarasota and Big Slough Canal at Tropicaire Blvd.
** regressions using Myakka River near Sarasota flow only, not applicable to North Port permitted withdrawals

Block 3 - One gage **	Percentage reductions from baseline (predictions limited to regression domain and all flows)			
	Ephemeropteran	<i>Mesocyclops</i>	<i>Gambusia</i>	<i>Trinectes</i>
	larvae	<i>edax</i>	<i>holbrooki</i>	<i>maculatus</i>
	plankton	plankton	plankton - juveniles	plankton - juveniles
Agricultural adjustment	18 - 18	13 - 6	10 - 6	16 - 16
Total adjustment	20 - 20	14 - 7	11 - 7	18 - 18
Total adjustment - 10%	29 - 29	21 - 14	16 - 12	26 - 27
Total adjustment - 15%	34 - 34	24 - 18	18 - 14	31 - 31
Total adjustment - 20%	38 - 38	28 - 22	20 - 17	35 - 35

Appendix 8Y

Percent reductions in median daily abundances for selected indicator taxa for seven flow reduction scenarios for three seasonal blocks. Values for plankton taxa are percent change in total abundance in the river, while values for seine and trawl taxa are for percent change in catch-per-unit-effort.

Table 8Y-1. Percent changes from baseline for median values of predicted daily abundances for selected fish and invertebrate taxa age/size classes for seven flow reduction scenarios for **BLOCK 1 during 1995-2004**. Results presented separately for regressions using the sum of the Myakka River and Myakkahatchee Creek gages and regressions that use the Myakka River gage alone. Results for each scenario are listed for predictions limited to the flow domains of the regression (left of -) and predictions using all flows (right of -). Predictions involving City of North Port withdrawals were not generated for the one gage regressions. Cells that include percent changes 15 % and greater are highlighted in yellow and changes 25% and greater are highlighted in gray.

Block 1 - Sum gaged*	Percentage reductions from baseline (predictions limited to regression domain and all flows)									
	<i>Americamysis</i>	<i>Americamysis</i>	<i>Cyathura</i>	<i>Palaemonetes</i>	<i>Palaemonetes</i>	<i>Menidia</i>	<i>Trinectes</i>	<i>Gambusia</i>	<i>Gambusia</i>	
	<i>almyra</i>	<i>almyra (2)</i>	<i>polita</i>	<i>intermedius</i>	<i>pugio</i>	<i>spp.</i>	<i>maculatus</i>	<i>holbrooki</i>	<i>holbrooki</i>	
	plankton	plankton	plankton	seine	seine	plankton - juveniles	plankton - juveniles	seines <= 25 mm	seines >= 26 mm	
North Port Permitted	3 - 3	4 - 4	4 - 4	3 - 5	7 - 9	3 - 1	8 - 6	4 - 10	4 - 26	
Agricultural adjustment	13 - 10	16 - 13	13 - 21	9 - 28	20 - 46	12 - 12	22 - 31	9 - 30	10 - 77	
Total adjustment	17 - 14	21 - 18	16 - 25	13 - 35	24 - 54	15 - 15	26 - 36	10 - 33	11 - 85	
Total adjustment - North Port	21 - 18	25 - 23	19 - 26	13 - 42	25 - 63	17 - 14	31 - 39	11 - 43	12 - 100	
Total adjustment - North Port - 10%	26 - 23	31 - 29	22 - 30	15 - 48	28 - 70	20 - 17	38 - 44	21 - 60	22 - 100	
Total adjustment - North Port - 15%	28 - 25	34 - 33	24 - 32	17 - 51	31 - 73	21 - 18	40 - 47	26 - 68	27 - 100	
Total adjustment - North Port - 20%	31 - 28	37 - 36	26 - 33	19 - 55	33 - 75	22 - 19	44 - 50	33 - 77	34 - 100	

* regression using sum of flow at Myakka River near Sarasota and Big Slough Canal at Tropicaire Blvd.

** regressions using Myakka River near Sarasota flow only, not applicable to North Port permitted withdrawals

Block 1 - One gage **	Percentage reductions from baseline (predictions limited to regression domain and all flows)			
	Ephemeropteran	<i>Mesocyclops</i>	<i>Gambusia</i>	<i>Trinectes</i>
	larvae	<i>edax</i>	<i>holbrooki</i>	<i>maculatus</i>
	plankton	plankton	plankton - juveniles	plankton - juveniles
Agricultural adjustment	31 - 29	25 - 28	13 - 21	28 - 32
Total adjustment	34 - 36	25 - 32	17 - 25	32 - 38
Total adjustment - 10%	42 - 43	30 - 37	21 - 29	38 - 44
Total adjustment - 15%	45 - 47	33 - 40	24 - 31	40 - 47
Total adjustment - 20%	49 - 51	36 - 42	26 - 33	44 - 51

Table 8Y-2. Percent changes from baseline for median values of predicted daily abundances for selected fish and invertebrate taxa age/size classes for seven flow reduction scenarios for **BLOCK 2 during 1995-2004**. Results presented separately for regressions using the sum of the Myakka River and Myakkahatchee Creek gages and regressions that use the Myakka River gage alone. Results for each scenario are listed for predictions limited to the flow domains of the regression (left of -) and predictions using all flows (right of -). Predictions involving City of North Port withdrawals were not generated for the one gage regressions. Cells that include percent changes 15 % and greater are highlighted in yellow and changes 25% and greater are highlighted in gray.

Block 2 - Sum gaged*	Percentage reductions from baseline (predictions limited to regression domain and all flows)									
	<i>Americamysis</i>	<i>Americamysis</i>	<i>Cyathura</i>	<i>Palaemonetes</i>	<i>Palaemonetes</i>	<i>Menidia</i>	<i>Trinectes</i>	<i>Gambusia</i>	<i>Gambusia</i>	
	<i>almyra</i>	<i>almyra (2)</i>	<i>polita</i>	<i>intermedius</i>	<i>pugio</i>	<i>spp.</i>	<i>maculatus</i>	<i>holbrooki</i>	<i>holbrooki</i>	
	plankton	plankton	plankton	seine	seine	plankton - juveniles	plankton - juveniles	seines <= 25 mm	seines >= 26 mm	
North Port Permitted	1 - 2	1 - 1	3 - 3	2 - 2	3 - 2	2 - 2	4 - 4	2 - 2	2 - 2	
Agricultural adjustment	5 - 5	5 - 5	6 - 5	3 - 3	4 - 5	4 - 4	10 - 13	11 - 15	10 - 14	
Total adjustment	5 - 4	4 - 4	7 - 8	5 - 5	5 - 7	5 - 5	11 - 14	12 - 17	12 - 17	
Total adjustment - North Port	6 - 6	5 - 6	9 - 10	6 - 6	6 - 12	7 - 7	16 - 18	14 - 19	13 - 18	
Total adjustment - North Port - 10%	11 - 12	10 - 11	14 - 15	6 - 7	5 - 18	9 - 9	24 - 26	22 - 26	21 - 25	
Total adjustment - North Port - 15%	14 - 15	13 - 14	16 - 17	5 - 9	5 - 20	11 - 11	27 - 29	26 - 30	25 - 29	
Total adjustment - North Port - 20%	18 - 18	15 - 16	19 - 20	4 - 11	7 - 23	12 - 12	30 - 33	30 - 33	29 - 32	

* regression using sum of flow at Myakka River near Sarasota and Big Slough Canal at Tropicaire Blvd.

** regressions using Myakka River near Sarasota flow only, not applicable to North Port permitted withdrawals

Block 2 - One gage **	Percentage reductions from baseline (predictions limited to regression domain and all flows)			
	Ephemeropteran	<i>Mesocyclops</i>	<i>Gambusia</i>	<i>Trinectes</i>
	larvae	<i>edax</i>	<i>holbrooki</i>	<i>maculatus</i>
	plankton	plankton	plankton - juveniles	plankton - juveniles
Agricultural adjustment	15 - 17	11 - 8	5 - 7	14 - 15
Total adjustment	15 - 17	12 - 7	7 - 9	16 - 18
Total adjustment - 10%	24 - 27	18 - 14	11 - 13	25 - 27
Total adjustment - 15%	29 - 32	21 - 18	14 - 16	30 - 31
Total adjustment - 20%	34 - 36	25 - 22	16 - 18	34 - 35

Table 8Y-3. Percent changes from baseline for median values of predicted daily abundances for selected fish and invertebrate taxa age/size classes for seven flow reduction scenarios for **BLOCK 3 during 1995-2004**. Results presented separately for regressions using the sum of the Myakka River and Myakkahatchee Creek gages and regressions that use the Myakka River gage alone. Results for each scenario are listed for predictions limited to the flow domains of the regression (left of -) and predictions using all flows (right of -). Predictions involving City of North Port withdrawals were not generated for the one gage regressions. Cells that include percent changes 15 % and greater are highlighted in yellow and changes 25% and greater are highlighted in gray.

Block 3 - Sum gaged*	Percentage reductions from baseline (predictions limited to regression domain and all flows) + signs for <i>Palaemonetes</i> mean positive change									
	<i>Americamysis</i>	<i>Americamysis</i>	<i>Cyathura</i>	<i>Palaemonetes</i>	<i>Palaemonetes</i>	<i>Menidia</i>	<i>Trinectes</i>	<i>Gambusia</i>	<i>Gambusia</i>	
	<i>almyra</i>	<i>almyra (2)</i>	<i>polita</i>	<i>intermedius</i>	<i>pugio</i>	<i>spp.</i>	<i>maculatus</i>	<i>holbrooki</i>	<i>holbrooki</i>	
	plankton	plankton	plankton	seine	seine	plankton - juveniles	plankton - juveniles	seines <= 25 mm	seines >= 26 mm	
North Port Permitted	1 - 1	1 - 1	1 - 1	2 - 0	0 + 1	1 - 1	1 - 2	2 - 3	2 - 3	
Agricultural adjustment	11 - 11	8 - 8	8 - 8	+ 2 + 2	+ 1 + 3	5 - 5	13 - 13	15 - 24	14 - 26	
Total adjustment	12 - 12	9 - 9	9 - 9	+ 2 0	+ 4 + 2	5 - 5	15 - 15	17 - 27	17 - 29	
Total adjustment - North Port	14 - 14	10 - 10	9 - 10	+ 3 + 2	+ 6 + 1	6 - 6	15 - 17	19 - 30	18 - 32	
Total adjustment - North Port - 10%	18 - 18	13 - 13	13 - 14	+ 8 + 3	+ 12 + 10	8 - 8	22 - 23	26 - 37	25 - 40	
Total adjustment - North Port - 15%	20 - 20	15 - 15	15 - 16	+ 11 + 6	+ 16 + 15	10 - 10	25 - 26	30 - 40	29 - 44	
Total adjustment - North Port - 20%	22 - 22	16 - 17	17 - 17	+ 14 + 9	+ 19 + 21	11 - 11	28 - 29	34 - 44	33 - 48	

* regression using sum of flow at Myakka River near Sarasota and Big Slough Canal at Tropicaire Blvd.

** regressions using Myakka River near Sarasota flow only, not applicable to North Port permitted withdrawals

Block 3 - One gage **	Percentage reductions from baseline (predictions limited to regression domain and all flows)			
	Ephemeropteran	<i>Mesocyclops</i>	<i>Gambusia</i>	<i>Trinectes</i>
	larvae	<i>edax</i>	<i>holbrooki</i>	<i>maculatus</i>
	plankton	plankton	plankton - juveniles	plankton - juveniles
Agricultural adjustment	22 - 21	12 - 6	8 - 8	18 - 18
Total adjustment	24 - 23	14 - 8	9 - 9	21 - 20
Total adjustment - 10%	33 - 32	21 - 15	14 - 14	29 - 28
Total adjustment - 15%	37 - 36	24 - 19	16 - 17	33 - 33
Total adjustment - 20%	42 - 41	28 - 23	19 - 19	37 - 37

Table 8Y-4. Percent changes from baseline for median values of predicted daily abundances for selected fish and invertebrate taxa age/size classes for seven flow reduction scenarios for **BLOCK 1 during 1999-2002**. Results presented separately for regressions using the sum of the Myakka River and Myakkahatchee Creek gages and regressions that use the Myakka River gage alone. Results for each scenario are listed for predictions limited to the flow domains of the regression (left of -) and predictions using all flows (right of -). Predictions involving City of North Port withdrawals were not generated for the one gage regressions. Cells that include percent changes 15 % and greater are highlighted in yellow and changes 25% and greater are highlighted in gray.

Block 1 - Sum gaged*	Percentage reductions from baseline (predictions limited to regression domain and all flows)									
	<i>Americamysis</i>	<i>Americamysis</i>	<i>Cyathura</i>	<i>Palaemonetes</i>	<i>Palaemonetes</i>	<i>Menidia</i>	<i>Trinectes</i>	<i>Gambusia</i>	<i>Gambusia</i>	
	<i>almyra</i>	<i>almyra (2)</i>	<i>polita</i>	<i>intermedius</i>	<i>pugio</i>	<i>spp.</i>	<i>maculatus</i>	<i>holbrooki</i>	<i>holbrooki</i>	
	plankton	plankton	plankton	seine	seine	plankton - juveniles	plankton - juveniles	seines <= 25 mm	seines >= 26 mm	
North Port Permitted	3 - 4	3 - 6	3 - 4	7 - 10	12 - 18	3 - 1	7 - 12	6 - 0	7 - 0	
Agricultural adjustment	19 - 17	26 - 25	15 - 19	19 - 37	32 - 58	12 - 12	27 - 22	15 - 0	20 - 0	
Total adjustment	23 - 22	26 - 33	19 - 24	25 - 46	40 - 70	14 - 14	34 - 32	19 - 0	24 - 0	
Total adjustment - North Port	26 - 26	26 - 39	23 - 23	31 - 59	48 - 84	19 - 13	39 - 41	24 - 0	30 - 0	
Total adjustment - North Port - 10%	27 - 31	32 - 46	27 - 27	32 - 67	50 - 93	21 - 16	45 - 46	34 - 0	43 - 0	
Total adjustment - North Port - 15%	27 - 33	36 - 49	29 - 29	35 - 71	54 - 96	22 - 17	47 - 48	39 - 0	49 - 0	
Total adjustment - North Port - 20%	30 - 36	41 - 52	31 - 31	36 - 75	55 - 100	23 - 18	49 - 51	46 - 0	57 - 0	

* regression using sum of flow at Myakka River near Sarasota and Big Slough Canal at Tropicaire Blvd.

** regressions using Myakka River near Sarasota flow only, not applicable to North Port permitted withdrawals

Block 1 - One gage **	Percentage reductions from baseline (predictions limited to regression domain and all flows)			
	Ephemeropteran	<i>Mesocyclops</i>	<i>Gambusia</i>	<i>Trinectes</i>
	larvae	<i>edax</i>	<i>holbrooki</i>	<i>maculatus</i>
	plankton	plankton	plankton - juveniles	plankton - juveniles
Agricultural adjustment	29 - 35	24 - 15	15 - 13	29 - 25
Total adjustment	36 - 45	25 - 20	17 - 17	36 - 35
Total adjustment - 10%	43 - 51	30 - 26	21 - 21	41 - 41
Total adjustment - 15%	46 - 55	31 - 29	23 - 23	42 - 45
Total adjustment - 20%	50 - 58	35 - 32	25 - 26	47 - 48

Table 8Y-5. Percent changes from baseline for median values of predicted daily abundances for selected fish and invertebrate taxa age/size classes for seven flow reduction scenarios for **BLOCK 2 during 1999-2002**. Results presented separately for regressions using the sum of the Myakka River and Myakkahatchee Creek gages and regressions that use the Myakka River gage alone. Results for each scenario are listed for predictions limited to the flow domains of the regression (left of -) and predictions using all flows (right of -). Predictions involving City of North Port withdrawals were not generated for the one gage regressions. Cells that include percent changes 15 % and greater are highlighted in yellow and changes 25% and greater are highlighted in gray.

Block 2 - Sum gaged*	Percentage reductions from baseline (predictions limited to regression domain and all flows)									
	<i>Americamysis almyra</i>	<i>Americamysis almyra (2)</i>	<i>Cyathura polita</i>	<i>Palaemonetes intermedius</i>	<i>Palaemonetes pugio</i>	<i>Menidia spp.</i>	<i>Trinectes maculatus</i>	<i>Gambusia holbrooki</i>	<i>Gambusia holbrooki</i>	
	plankton	plankton	plankton	seine	seine	plankton - juveniles	plankton - juveniles	seines <= 25 mm	seines >= 26 mm	
North Port Permitted	2 - 2	2 - 2	4 - 5	2 - 3	3 - 5	3 - 3	6 - 7	2 - 2	2 - 2	
Agricultural adjustment	7 - 6	7 - 6	7 - 8	4 - 4	6 - 10	5 - 5	12 - 11	13 - 13	13 - 13	
Total adjustment	6 - 7	6 - 7	10 - 10	6 - 6	9 - 14	6 - 6	13 - 14	14 - 14	14 - 14	
Total adjustment - North Port	8 - 9	8 - 8	13 - 14	8 - 11	13 - 20	10 - 10	20 - 21	16 - 16	15 - 15	
Total adjustment - North Port - 10%	14 - 15	13 - 14	17 - 19	10 - 14	17 - 24	12 - 12	25 - 27	25 - 25	24 - 24	
Total adjustment - North Port - 15%	17 - 18	16 - 17	20 - 21	12 - 16	20 - 28	13 - 13	29 - 31	29 - 29	29 - 29	
Total adjustment - North Port - 20%	20 - 21	18 - 21	22 - 23	13 - 17	20 - 32	15 - 15	33 - 35	34 - 34	34 - 34	

* regression using sum of flow at Myakka River near Sarasota and Big Slough Canal at Tropicaire Blvd.
 ** regressions using Myakka River near Sarasota flow only, not applicable to North Port permitted withdrawals

Block 2 - One gage **	Percentage reductions from baseline (predictions limited to regression domain and all flows)			
	Ephemeropteran larvae	<i>Mesocyclops edax</i>	<i>Gambusia holbrooki</i>	<i>Trinectes maculatus</i>
	plankton	plankton	plankton - juveniles	plankton - juveniles
Agricultural adjustment	16 - 16	11 - 15	8 - 10	14 - 14
Total adjustment	22 - 22	14 - 15	10 - 12	17 - 19
Total adjustment - 10%	31 - 31	21 - 22	15 - 17	25 - 27
Total adjustment - 15%	35 - 36	25 - 25	17 - 19	29 - 32
Total adjustment - 20%	40 - 40	29 - 29	20 - 21	34 - 36

Table 8-V6. Percent changes from baseline for median values of predicted daily abundances for selected fish and invertebrate taxa age/size classes for seven flow reduction scenarios for **BLOCK 3 during 1999-2002**. Results presented separately for regressions using the sum of the Myakka River and Myakkahatchee Creek gages and regressions that use the Myakka River gage alone. Results for each scenario are listed for predictions limited to the flow domains of the regression (left of -) and predictions using all flows (right of -). Predictions involving City of North Port withdrawals were not generated for the one gage regressions. Percent changes in medians relative to baseline of 15 % and greater for the within flow domain results are highlighted in yellow and changes 25% and greater are highlighted in gray.

Block 3 - Sum gaged*	Percentage reductions from baseline (predictions limited to regression domain and all flows) + signs for <i>Palaemonetes</i> mean positive change									
	<i>Americamysis almyra</i>	<i>Americamysis almyra (2)</i>	<i>Cyathura polita</i>	<i>Palaemonetes intermedius</i>	<i>Palaemonetes pugio</i>	<i>Menidia spp.</i>	<i>Trinectes maculatus</i>	<i>Gambusia holbrooki</i>	<i>Gambusia holbrooki</i>	
	plankton	plankton	plankton	seine	seine	plankton - juveniles	plankton - juveniles	seines <= 25 mm	seines >= 26 mm	
North Port Permitted	1 - 1	1 - 1	1 - 1	0 0	+ 1 + 3	1 - 1	1 - 1	2 - 3	2 - 3	
Agricultural adjustment	11 - 11	8 - 8	10 - 10	+ 10 + 6	+ 9 + 6	6 - 6	13 - 13	21 - 22	21 - 25	
Total adjustment	13 - 12	9 - 9	11 - 11	+ 11 + 7	+ 11 + 9	6 - 6	15 - 15	22 - 25	22 - 27	
Total adjustment - North Port	14 - 13	10 - 10	12 - 12	+ 12 + 6	+ 15 + 10	7 - 7	16 - 17	24 - 28	24 - 31	
Total adjustment - North Port - 10%	17 - 17	13 - 13	16 - 15	+ 16 + 11	+ 22 + 19	9 - 9	23 - 23	31 - 34	31 - 38	
Total adjustment - North Port - 15%	19 - 19	14 - 14	18 - 17	+ 19 + 15	+ 25 + 23	11 - 11	26 - 26	35 - 38	35 - 43	
Total adjustment - North Port - 20%	21 - 21	16 - 16	19 - 19	+ 22 + 17	+ 28 + 27	12 - 12	29 - 30	38 - 41	38 - 46	

* regression using sum of flow at Myakka River near Sarasota and Big Slough Canal at Tropicaire Blvd.
 ** regressions using Myakka River near Sarasota flow only, not applicable to North Port permitted withdrawals

Block 3 - One gage **	Percentage reductions from baseline (predictions limited to regression domain and all flows)			
	Ephemeropteran larvae	<i>Mesocyclops edax</i>	<i>Gambusia holbrooki</i>	<i>Trinectes maculatus</i>
	plankton	plankton	plankton - juveniles	plankton - juveniles
Agricultural adjustment	21 - 25	14 - 11	9 - 10	18 - 19
Total adjustment	22 - 26	17 - 14	12 - 11	21 - 21
Total adjustment - 10%	31 - 35	23 - 21	17 - 16	29 - 29
Total adjustment - 15%	36 - 39	27 - 24	19 - 18	33 - 33
Total adjustment - 20%	40 - 43	30 - 27	21 - 21	37 - 38