

# Marine algae of the Jubail Marine Wildlife Sanctuary, Saudi Arabia

Olivier De Clerck and Eric Coppejans

**Abstract:** The intertidal zone of the Saudi Arabian Gulf coast is exposed to extreme climatic fluctuations and therefore is almost devoid of any macroalgal or seagrass growth, even in sites not affected by oil pollution. These plants are restricted to subtidal habitats which were not affected by the oil spill. Ninety taxa were recorded: one Xanthophyta, 20 Chlorophyta, 25 Phaeophyta and 44 Rhodophyta. Their diversity in the study area is about as high as in similar regions of the south-western coast of the Arabian Gulf, and their biomass can be very high locally, at least for part of the year. Forty-two of these species are new for the Saudi Arabian Gulf coast and 15 are new for the Arabian Gulf. Descriptions, illustrations and identification keys of the species collected are given. The various algal vegetation types are described and their distribution in the area is discussed.

## الطحالب البحرية في محمية الجبيل للأحياء البحرية في المملكة العربية السعودية

أوليفر دوكليرك وأيريك كوببيانس

خلاصة: تتعرض منطقة ما بين المد والجزر على شاطئ المملكة العربية السعودية في الخليج العربي باستمرار لتبدلات مناخية شديدة لذا فإنها تكون شبه خالية من الطحالب الكبيرة والاعشاب البحرية حتى في الاماكن غير الملوثة بالنفط. وعليه فإن وجود هذه النباتات ينحصر في مواطن ماتحت المد والجزر والتي لم تتأثر بالتلوث النفطي. وقد تم تسجيل ٩٠ نوعاً تشمل طحلب أصفر واحد (زائتوفيتا)، ٢٠ طحالب خضراء (كلوروفيتا)، ٢٥ طحالب بنية (فيوفيتا)، و ٤٤ (رودوفيتا). إن درجة التنوع في منطقة الدراسة تماثل درجة التنوع في أماكن مشابهة من الساحل الجنوبي الغربي للخليج العربي، وقد تكون كتلتها الحيوية عالية جداً في بعض الأماكن على الأقل في بعض أوقات السنة. وتشمل هذه الانواع ٤٢ نوعاً جديداً بالنسبة لشاطئ المملكة العربية السعودية على الخليج العربي و ١٥ نوعاً تسجل لأول مرة في منطقة الخليج العربي. وقد تم وصف ورسم وعمل مفاتيح لتصنيف الأنواع التي تم جمعها. كما تم وصف انماط الطحالب المختلفة ومناقشة مناطق أنتشارها.

## INTRODUCTION

The Jubail Marine Wildlife Sanctuary was established in 1992 in the area including the Dauhat ad-Dafi and Dauhat al-Musallamiya embayment complex. The major aim of this study was to provide a useful tool, enabling fellow researchers to identify the algae present in the area. Next to the identification keys, species descriptions and illustrations, a glossary of the most important technical terms used in those keys and descriptions has been added.

Previous phycological inventories in the Arabian Gulf were compiled by ENDLICHER & DIESING (1845), BØRGESEN (1939), NEWTON (1955 a, b), NIZAMUDDIN & GESSNER (1970), BASSON (1979 a, b), JONES (1986), AL-HASAN & JONES (1989) and BASSON et al. (1989). These results are

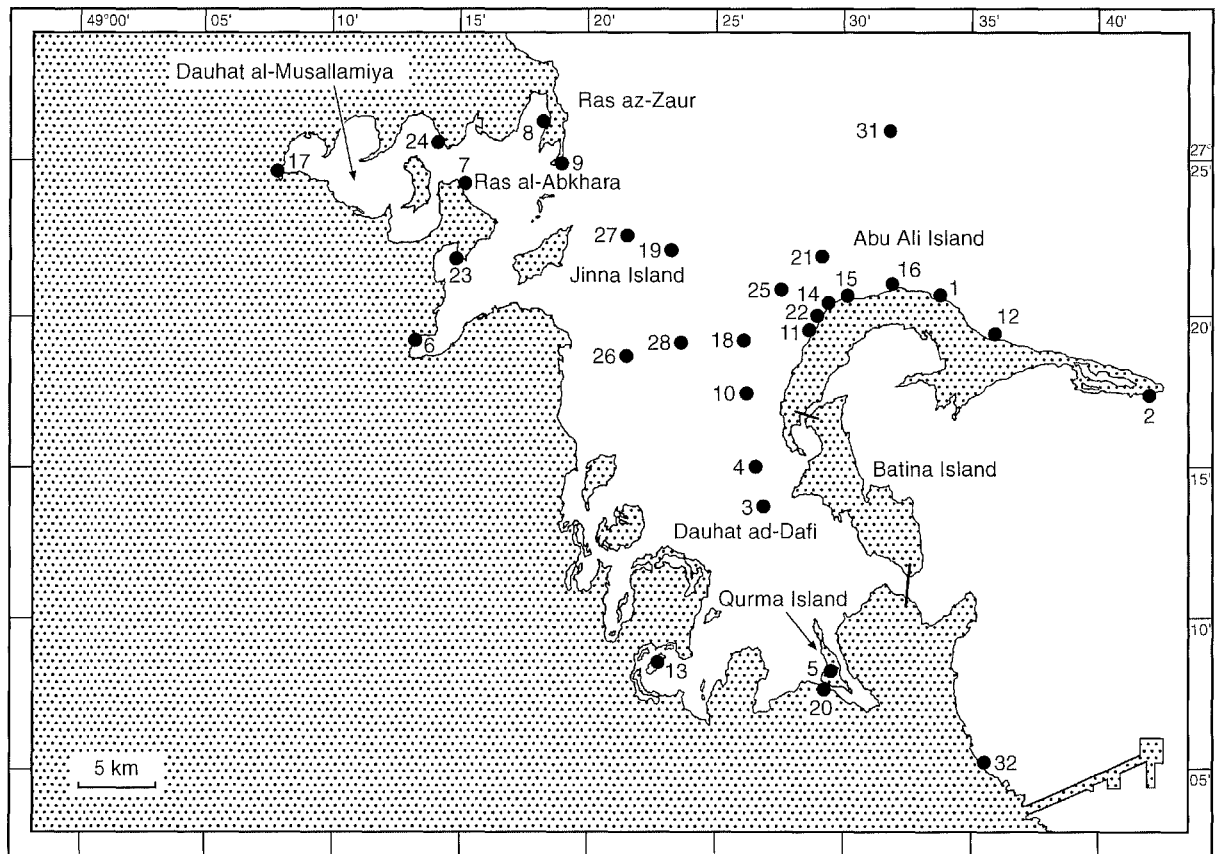

Fig. 1: Sites visited in the Sanctuary.

summarised in the checklist of BASSON (1992). More ecologically orientated research was conducted by BASSON et al. (1977), MCCAIN (1984), MCCAIN et al. (1984) and SHEPPARD et al. (1992).

The different biotopes and associated algal flora present in the Sanctuary are described. The impact of the 1991 Gulf War Oil Spill was discussed in a previous paper (DE CLERCK & COPPEJANS 1994: 18-21).

## MATERIALS AND METHODS

Fieldwork was carried out in different seasons: 18.01-05.02.1992, 13.05-28.05.1992, 17.07-20.08.1992, 30.10-14.11.1992, 19.02-05.03.1993. This gave us the opportunity to study the pronounced seasonal variation in algal development throughout the year.

Observations and collecting were restricted to the Jubail Marine Wildlife Sanctuary (Fig. 1). It soon became apparent that patch reefs and waters near Abu Ali Island supported the richest algal floras. For this reason our survey concentrated on these areas, combined with observations at some of the Permanent Transect Lines (PTLs, see JONES et al. this volume). Karan Island was visited only once (August 1992).

Surveys were conducted partly by wading in the intertidal zone at low tide and partly by snorkelling or SCUBA-diving in the subtidal zone. GPS Magellan readings of sampling sites were

taken. The following biotopes were studied from high water level to the sublittoral zone: mangrove stands, salt-marsh, bare intertidal sand- and mudflats, including tidal channels and shallow sand pools with stones and shell fragments, rocky shores, including intertidal pools; in the subtidal area the fringing reefs and patch reefs, seagrass beds and bare sandy areas were visited. Finally some collecting was also done around Karan and Harqus. Some of the collected material was prepared as herbarium specimens (as in DAWES 1981: 366-369), and the remainder was preserved in 4 % formalin in sea water. The dried specimens form a complete reference collection which has been deposited in the herbarium of the Universiteit Gent (GENT); a collection containing at least one specimen from each species is in the Saudi Arabian National Museum of Natural History, Riyadh (SNMNH). The preserved samples are used for anatomical analysis whereas the dried specimens are useful for studying the morphological variability of the species, due to ecological factors and to seasonal development. Both approaches are necessary for accurate identification, which was carried out in Gent.

Table 1: Description and location of collecting sites.

Site number	Site description	Coordinates
1	Abu Ali Island, slipway	27°21'08"N 49°32'04"E
2	Abu Ali Island, NE tip	27°18'53"N 49°38'04"E
3	Dauhat ad-Dafi, sand patch	27°12'55"N 49°26'24"E
4	Dauhat ad-Dafi, island west of Batina	27°14'32"N 49°25'30"E
5	Dauhat ad-Dafi, PTL 10	27°07'54"N 49°29'04"E
6	Dauhat ad-Dafi, Farraiya Bay	27°13'40"N 49°19'30"E
7	Dauhat ad-Dafi, Ras al-Abkhara (PTL 5)	27°24'09"N 49°13'53"E
8	Ras az-Zaur, coastal reef	27°26'37"N 49°18'14"E
9	Ras az-Zaur, seaward part	27°25'16"N 49°17'50"E
10	Dauhat al-Musallamiya, rock patch	27°16'53"N 49°25'30"E
11	Abu Ali Island, SW of big antenna	27°17'44"N 49°27'32"E
12	Abu Ali Island, near ARAMCO village	27°19'44"N 49°34'53"E
13	Dauhat ad-Dafi, PTL 2	27°08'48"N 49°23'24"E
14	Abu Ali Island, E of big antenna	27°20'00"N 49°29'00"E
15	Abu Ali Island, small antenna	27°20'54"N 49°29'51"E
16	Abu Ali Island, Fishermen's bay	ca 27°21'N 49°32'E
17	Dauhat al-Musallamiya, PTL 8	27°24'47"N 49°08'07"E
18	Dauhat ad-Dafi, southern patch reef	27°19'10"N 49°25'20"E
19	Dauhat ad-Dafi, cap reef	27°22'51"N; 49°23'08"E
20	Dauhat ad-Dafi, Qurma channel	27°07'49"N 49°27'32"E
21	Dauhat ad-Dafi, reef near antenna	27°21'51"N 49°27'58"E
22	Abu Ali Island, big antenna	27°19'22"N 49°28'14"E
23	Dauhat al-Musallamiya, PTL 4	27°24'30"N 49°12'32"E
24	Dauhat al-Musallamiya, PTL 9	27°27'00"N 49°13'14"E
25	Dauhat ad-Dafi, twin reef	27°20'17"N 49°26'02"E
26	Dauhat ad-Dafi, west reef	27°20'21"N 49°22'44"E
27	Dauhat ad-Dafi, big reef	27°23'28"N 49°21'29"E
28	Dauhat ad-Dafi, shallow reef	27°19'27"N 49°24'24"E
29	Harqus	27°56'15"N 49°41'00"E
30	Karan	27°42'45"N 49°49'30"E
31	Dauhat ad-Dafi, whip corals	ca 27°26'N 49°31'E
32	Field Research Centre	27°05'07"N 49°35'05"E
33	Tarut Bay	ca 26°38'N 50°05'E

## Glossary

### Technical terms used in the identification keys and the species descriptions

Remark: the definitions given here refer to their traditional use in phycology; they might be different from the use in other botanical disciplines. For a more complete glossary we refer to BOLD & WYNNE (1985: 646-661).

**abaxial:** away from the main axis

**acropetal:** towards the apex

**adaxial:** towards the main axis

**aerocyst** (= air bladder): gas-filled cavity used as a floating device

**akinetete:** thick-walled, non-motile spore

**anastomosing:** cells or filaments attaching to each other, resulting in a network

**articulated:** composed of segments and mobile articulations

**ascending:** with the basal part creeping, the apical part being erect

**basipetal:** towards the basis

**carpogonium:** the female reproductive cell in Rhodophyta, generally bearing an elongated, hair-like structure, the trichogyne

**cerebriform:** with the appearance of brains

**clavate:** club-shaped

**coenocytic:** composed of multinuclear segments (with transverse walls)

**columella:** central column of sterile tissue in a conceptacle

**complanate:** compressed

**conceptacle:** a cavity in the thallus, containing the reproductive structures

**cortex:** the outer layer of cells, surrounding the central medulla

**corticate:** covered by an outer layer of small cells (cortex)

**crustose:** forming a crust on the substrate

**cryptostoma** (pl.: cryptostomata): small invagination of the frond surface containing a group of hairs

**cuneate:** wedge-shaped

**cupula:** cup-shaped structure

**cystocarp:** reproductive structure in Rhodophyta, formed after fertilisation of the carpogonium, surrounded by a sterile cell layer (the pericarp)

**determinate branchlet:** a branch with limited growth

**diaphragm:** a thin transverse cell layer separating two segments

**dichotomous:** branching into two equal parts

**diffuse** (growth): not localised

**distal:** towards the apex

**distichous:** in two rows

**ecad:** a growth form (modification) due to environmental factors (not genetically fixed)

**ecorticate:** without a cortex

**emarginate:** with a small indentation at the apex

**endophytic:** growing in a host plant (generally in its external cell walls)

- epilithic:** growing on hard substrate (rocks, stones, etc.)
- epiphytic:** growing on a host plant (phorophyte)
- epithallus:** the upper tissue of crustose Corallinaceae (Rhodophyta), formed by the distal cells of the hypothallus (in simple forms), of the perithallus (in more complex thalli)
- false ramification (false branching):** branching not formed by a longitudinal section of an intercalary cell, but by repetitive transverse sections and the extrusion of a daughter cell row from the original filament
- flabellate:** fan-shaped
- flabellum:** blade-like part
- foliose:** blade-like
- forcipate:** like a pair of pincers
- frond:** the erect part of the seaweed
- fugacious:** disappearing quickly
- furcate:** divided into two equal parts
- gametocyst (gametangium):** a cell producing (a) gamete(s)
- gametophyte:** the (generally haploid) gamete-producing phase of the life history of a plant
- gonimoblast:** a group of diploid spores formed after the fertilisation of the female reproductive cell (carpogonium) within the red algae
- gregarious:** plants growing close together but not in mats or turfs
- haptera:** holdfast composed of fleshy, cylindrical, generally branched structures which form innumerable rhizoids that attach in microscopic crevices in the substratum and secrete adhesive mucilage, thus ensuring a strong attachment
- helicoidal:** as a stripe on a snail shell
- hypothallus:** basal prostrate cell layer(s) of crustose Corallinaceae (Rhodophyta)
- hirsute:** covered with long hairs
- hyaline:** colourless, transparent
- indusiate:** covered by a membranous structure
- infralittoral:** subtidal, below low water mark
- infralittoral fringe:** narrow zone  $\pm$  between mean low and spring low water mark
- intercalary:** between the base and the apex
- invaginate:** with a depression
- involucrum:** (*Liagora*): a group of sterile filaments around a reproductive structure
- lacerate:** torn or irregularly cleft
- lenticular:** with the shape of a double-convex lens
- lingulate:** tongue-shaped, broad and  $\pm$  parallel-sided
- medulla:** the central part of a thallus, surrounded by the cortex
- meristem:** active growing zone
- micrometre ( $\mu\text{m}$ ):** one thousandth of a millimetre
- moniliform:** arranged like a string of rounded beads
- monomerous:** a construction type in Corallinaceae in which the vegetative thallus is built up by a single system of filaments running  $\pm$  to the thallus surface
- monosporocysts (= monosporangium):** a cell containing a single spore (monospore)
- monostromatic:** composed of a single layer

- mucronate:** provided with a short spiny projection (mucro)
- multiaxial:** thallus composed of several to many axial filaments, all with (sub-)apical growth
- muricate:** covered with small spiny outgrowths
- obovoid:** like an inversed egg, broadest towards the apex
- ovoid:** egg-shaped, broadest towards the base
- pedicel:** a small stalk
- pedicellate:** provided with a small stalk
- peltate:** shield-like, with a stalk from the centre
- perennial:** lasting several years
- pericentral cell:** see polysiphonous
- phorophyte:** plant on which the epiphyte is growing
- phylloid:** leaf-like structure
- pinnate:** feather-like
- pinnule:** side branchlet
- plurilocular:** with several chambers (loculi)
- polychotomy:** numerous branches arising from a single point
- polysiphonous:** in a transverse section the axial (central) cell (or cells in *Sphacelaria*) is (are) surrounded by several pericentral (or cortical) cells
- proliferation:** irregularly placed offshoots (not belonging to the original branching pattern)
- propagule:** pluricellular structure for vegetative reproduction, with a characteristic morphology, formed directly by the thallus
- prostrate:** creeping (= repent)
- proximal:** towards the base
- pseudocortex:** a cortex-like structure, mostly formed by downgrowing rhizoids
- pseudohair:** terminal part of a uniseriate filament, formed by elongate cells poor in chloroplasts (sometimes even colourless), without a basal meristem
- pseudoparenchymatous:** with the appearance of parenchyme, but composed of laterally adherent filamentous structures
- pyrenoid:** a cell organelle within a plastid (but possibly extruding), forming a centre for carbohydrate synthesis
- rachis:** main axis of a pinnate structure
- radial:** in all directions
- ramuli:** small branchlets
- receptacle:** inflated part of a brown alga containing the reproductive structures
- reniform:** kidney-shaped
- repent:** creeping
- rhizine:** internal, thick-walled filamentous structure with small diameter
- rhizoid:** root-like structure
- rhodolith:** loose-lying, rounded, pebble-like thallus of a Corallinaceae
- secretory cell (gland cell):** a small, usually subspherical cell with highly refractive contents, which may function in secretion or storage
- siphonous:** tubular, multinuclear structure (without transverse walls)
- sorus (pl.: sori):** a group of reproductive cells or hairs

- spermatocyst:** a cell producing male reproductive cells (non-motile spermatia, or motile spermatozooids)
- sporocyst (= sporangium):** a cell producing one or several spores
- sporophyte:** the diploid, spore-producing phase of the life history of a plant
- stellate:** star-like
- stichidium** (pl.: stichidia): transformed branches, bearing or containing reproductive structures (mainly tetrasporocysts)
- stipe:** stem-like structure
- stipitate:** with a stem-like structure
- stolon(oid):** (resembling) a creeping, cylindrical axis
- supralittoral fringe:** narrow zone  $\pm$  between mean high and spring high water mark
- sympodial:** development of an axis by repeated replacement of the growing apex by a lateral growing point from below, generally resulting in a zigzag main axis
- tapering:** becoming narrower
- terete:** cylindrical
- tetrahedral:** arranged like the tips of a four-sided pyramid
- tetrasporocyst (tetrasporangium):** a cell containing four spores after meiosis
- thallus:** simple plant body of a non-vascular plant (without distinct roots, stems or leaves)
- tophule:** olive-shaped to subspherical branch swelling (*Sargassum*)
- torulose:** cylindrical, but with numerous rounded excrescences
- tribuliform:** obtriangular with rounded corners
- trichoblast:** a generally colourless, dichotomously branched hair (Ceramiales)
- trichocyte:** hair-bearing cell of some crustose Corallinaceae; generally larger and more rounded than the surrounding vegetative cells
- tristichous:** on three rows
- tuberculate:** covered with knobbly outgrowths
- uniaxial:** with a single central axis (in a transverse section)
- unilocular:** with a single chamber (loculus)
- uniseriate:** in a single row
- verrucose:** roughened, covered with wart-like outgrowths
- verticil:** a whorl
- zoidocyst (zoosporangium):** a structure producing a single or several motile reproductive cells
- zonate:** in a linear arrangement

## RESULTS

### Floristics: description of the collected taxa

In this study we describe Xanthophyta, Chlorophyta, Phaeophyta and Rhodophyta; we exclude the Cyanophyta as they were studied by L. HOFFMANN (this volume). Owing to the limited time available, only the most frequently occurring epiphytes have been included. Those that were observed sporadically are included in the identification keys and the species list, but they have been neither described nor illustrated; for these taxa we refer to previous publications. The identification

keys, descriptions and illustrations included here are original, based on material collected from the study area, and analysed and drawn by the first author in his M.Sc. thesis (DE CLERCK 1993). The identification keys only include the species observed during our research. We have used the most recent nomenclature available and added the basionym and recent synonyms; for complete synonymies we refer to different floras, publications and checklists which have also been used for species identification: TAYLOR (1960), ABBOTT & HOLLENBERG (1976), JAASUND (1976), GARBARY et al. (1980), WOMERSLEY (1984, 1987), LAWSON & JOHN (1987), SILVA et al. (1987), SCHNEIDER & SEARLES (1991), COPPEJANS & PRUD'HOMME VAN REINE (1992 a), VERHEIJ & PRUD'HOMME VAN REINE (1993). Classification within the different divisions sometimes varies from one author to another, depending on the weight given to discriminating characters. Our choice, therefore, mentioned at the heading of each division, is a subjective one. Within the divisions the lower taxonomic levels are given in alphabetical order. Some ecological data are included and previous collections along the west coast of the Gulf are mentioned. The citation of reference specimens permits future checking of their identification, along with the sites (see Fig. 1 and Table 1) and seasons in which the species were collected; HEC stands for Herbarium Eric Coppejans, ODC for Olivier De Clerck.

### Identification to the divisions

The first step in identifying marine algae is less obvious than it appears, as blue-green, green, brown and red algae are not always characterised by a blue, green, brown or red colour respectively. All algae contain green chlorophyll which is (partly) covered by other accessory pigments, depending on the division to which they belong. Blue-green and red algae, for example, contain both blue and red pigments in different quantities, resulting in different tinges from blue to red. Some of these algae lose these accessory pigments when they are exposed to strong insolation, resulting in greenish specimens of red algae (e.g. *Laurencia obtusa*). Decaying specimens (washed ashore) also lose the accessory pigments first, leaving green-coloured and, later on, discoloured thalli. On the other hand, the orangy to reddish-coloured carotenoids, frequently present in reproductive cells, can give an orangy colour to some fertile green algae. Finally, the presence of numerous microscopic epiphytic algae (e.g. diatoms) or cover by a layer of sediments can mask the real colour of the phorophyte.

In general, the pigmentation is most clearly observed in transmitted light or in a section under the microscope, where the colour of the individual plastids can be seen. If in doubt, the reader is referred to other identification keys for the different divisions. Below we present a key to the six marine algal divisions present in the study area.

### Key to divisions of marine algae in the study area

- |      |  |                   |
|------|--|-------------------|
| 1.a. | Absence of well-defined plastids in the cells; thalli generally bluish, but sometimes also blackish, greenish or even reddish, of limited size (a few millimetres), but able to form intricate mats; cells forming filaments or grouped in a mucilaginous matrix |                   |
|      |  | <b>Cyanophyta</b> |
| b.   | Presence of well-defined plastids . . . . .  | 2                 |
| 2.a. | Algae yellowish-green to dark green, filamentous, cylindrical and massive or hollow or forming blades . . . . .  | 3                 |
| b.   | Algae differently pigmented, at least some parts pinkish or brownish . . . . .   | 4                 |



- 3.a. Transverse walls absent in vegetative parts, thallus filamentous (individual filaments < 50 µm), irregularly branched **Xanthophyta**
- b. Transverse walls present or absent, if individual filaments < 50 µm then transverse walls present **Chlorophyta**
- 4.a. Thallus pinkish, red, violet or purplish, of very divergent morphology; fertile specimens with very characteristic tetrasporocysts, monosporocysts, gonimoblasts or spermatocysts **Rhodophyta**
- b. Thallus brown(ish) . . . . . 5
- 5.a. Unicellular algae, but sometimes grouped by a mucilaginous matrix, often golden brown (diatoms, not studied here) **Bacillariophyta**
- b. Thallus pluricellular, yellowish-brown to dark brown, of varying complexity; frequent presence of hairs or pseudohairs; fertile specimens in many species with characteristic plurilocular zoidocysts **Phaeophyta**

### Key to species of the division Chlorophyta

Classification follows WOMERSLEY (1984)

- 1.a. Thallus umbrella-shaped, calcified and whitish *Acetabularia calyculus*
- b. Thallus not umbrella-shaped . . . . . 2
- 2.a. Thallus hollow . . . . . 3
- b. Thallus not hollow . . . . . 5
- 3.a. Thallus a ± spherical, hollow, brittle structure, cells visible with the naked eye **Dictyosphaeria cavernosa**
- b. Thallus tubular, cells not visible with the naked eye . . . . . 4
- 4.a. Ultimate branches apically uniseriate *Enteromorpha clathrata*
- b. No uniseriate apical parts *Enteromorpha flexuosa*
- 5.a. Thallus composed of a repent stolon, bearing upwardly directed fronds and downwardly directed rhizoidal branches . . . . . 6
- b. Thallus filamentous . . . . . 7
- 6.a. Pinnules of the fronds di- or tristichous *Caulerpa sertularioides* ecad *sertularioides*
- b. Pinnules of the fronds radially placed *Caulerpa sertularioides* ecad *farlowii*
- 7.a. Thallus composed of filaments, but these intricate and forming a pseudoparenchymatous stipe and flabellum *Avrainvillea amadelpha*
- b. Filaments not intricate . . . . . 8
- 8.a. Filaments without transverse walls (siphonous structure) . . . . . 9
- b. Filaments with transverse walls (uninuclear or coenocytic structure) . . . . . 10
- 9.a. Thallus 3-10 cm high, ramuli richly branched *Bryopsis hypnoides*
- b. Thallus 1-3 cm high, ramuli unbranched *Trichosolen* sp.
- 10.a. Thallus hollow at the basis and composed of several cell rows, uniseriate towards the apices *Enteromorpha clathrata*
- b. Thallus completely uniseriate . . . . . 11
- 11.a. Thallus microscopic, composed of branched epi- or endophytic filaments . . . . . 12
- b. Thallus macroscopic or at least forming macroscopic tufts . . . . . 13
- 12.a. Individual cells long and slender, no hairs *Entocladia viridis*
- b. Individual cells rather rectangular, bearing undulated hairs *Phaeophila dendroides*

- |       |   |  |
|-------|---|--|
| 13.a. | Filaments unbranched  | 14   |
| b.    | Filaments branched  | 18   |
| 14.a. | Filaments 10-18 µm in diameter  | <i>Rhizoclonium tortuosum</i>                    |
| b.    | Filaments 60-160 µm in diameter   | 15   |
| 15.a. | Filaments basally attached, 120-160 µm in diameter                        | <i>Chaetomorpha aerea</i>                        |
| b.    | Filaments entangled between other algae, not fixed, 60-120 µm in diameter | 16   |
| 16.a. | Filaments 110-120 µm in diameter; cells 0.5-1 times as long as broad      | <i>Chaetomorpha linum</i> f. <i>brachyarthra</i> |
| b.    | Thallus up to 80 µm in diameter; cells 1-4 times as long as broad         | 17   |
| 17.a. | Cells 1-2 times as long as broad  | <i>Chaetomorpha mediterranea</i>                 |
| b.    | Cells 2-4 times as long as broad  | <i>Chaetomorpha gracilis</i>                     |
| 18.a. | Thallus as compact green cushions, 5 cm in diameter                       | <i>Cladophoropsis sundanensis</i>                |
| b.    | Thallus not cushion-like  | 19   |
| 19.a. | Thallus forming expanded mats, brownish-green                             | <i>Cladophora</i> cf. <i>coelothrix</i>          |
| b.    | Thallus as isolated tufts, green  | 20   |
| 20.a. | Tufts generally elongated, ramuli in groups of 3-5                        | <i>Cladophora koeiei</i>                         |
| b.    | Tufts generally not elongated, more woolly, ramuli single                 | <i>Cladophora nitellopsis</i>                    |

## Class Chlorophyceae

## Order Caulerpales

## Family Caulerpaceae

Genus *Caulerpa* Lamouroux*Caulerpa sertularioides* (S.G. Gmelin) Howe*Fucus sertularioides* S.G. Gmelin*Caulerpa plumaris* (Forsskål) C. Agardh

Different forms have been described within this species (four in TAYLOR 1960: 144). In the study area two of them occur: *C. sertularioides* f. *sertularioides* and *C. sertularioides* f. *farlowii* (Weber-van Bosse) Børgesen. As intermediate forms also occur, we follow COPPEJANS & PRUD'HOMME VAN REINE (1992 b: 672) and call them ecads (ecological phenotypes).

*Caulerpa sertularioides* ecad *sertularioides*

(Figs 2-3, 11)

Material: SNMNH/P/ALG: 1, Site 3, 20.I.1992; 2, Site 20, 20.V.1992. — HEC: 8912, Site 3, 20.I.1992; 8922, Site 5, 22.I.1992; 9120 b, Site 20, 20.V.1992. — ODC 84, Site 20, 06.XI.1992.

Thallus composed of prostrate stolonoids and erect branches up to 10 cm long. Stolonoids terete, irregularly and rather densely branched; downwardly growing rhizoid-bearing branches irregularly placed, 1-6 cm long, with a terminal tuft of numerous rhizoids; upright foliar branches also irregularly placed, 3-10 cm high, pinnate, composed of an unbranched rachis and distichous cylindrical pinnulae which are disposed in a single plane; pinnulae 200 µm in diameter, 0.5-1 cm long, slightly upwardly curved, with a pointed apex. Some specimens are tristichous, but intermediates occur with a distichous base and a tristichous apical part.

*Caulerpa sertularioides* ecad *farlowii*

(Figs 4, 12)

Material: SNMNH/P/ALG: 3, Site 20, 20.V.1992; 4, Site 8, 24.VII.1992; 5, Site 24, 28.VII.1992; 6, Site 8, 05.XI.1992. — HEC: 9092, Site 15, 17.V.1992; 9120 a, Site 20, 20.V.1992; 9147, Site 7, 24.V.1992; 9222, Site 8, 24.VII.1992; 9248, Site 7, 27.VII.1992; 9258, Site 24, 28.VII.1992. — ODC: 72, Site 8, 05.XI.1992; 83, Site 20, 06.XI.1992.

General morphology similar to *C. sertularioides* ecad *sertularioides* but the foliar branches are more compact, only 1-5 cm high, the pinnulae are placed radially and are more strongly curved.

Both ecads grow on sandy substrates of the infralittoral zone, but some parts of a thallus can also grow on hard substrates. Perennial species with no morphological variation throughout the year. Within the Sanctuary, the distribution of *C. sertularioides* ecad *sertularioides* is restricted to the area around Qurma Island. *Caulerpa sertularioides* ecad *farlowii* is more general and grows in sheltered biotopes (Dauhat al-Musallamiya) from 0.5 m depth downwards, whereas *C. sertularioides* ecad *sertularioides* only grows from 2 m depth downwards. The transition from one ecad to the other is very distinct around Qurma Island.

*Caulerpa sertularioides* has been reported by BASSON (1979 a: 51) from the Saudi Arabian Gulf coast; recorded by BASSON et al. (1989: 29) from Bahrain and by AL-HASAN & JONES (1989: 295) from Kuwait.

### Family Udoteaceae

#### Genus *Avrainvillea* Decaisne

#### *Avrainvillea amadelpha* (Montagne) Gepp & Gepp

(Figs 5-6, 13-15)

*Udotea amadelpha* Montagne

*Chloroplegma sordidum* Zanardini

*Avrainvillea lacerata* Harvey ex J. Agardh f. *robusta* Gepp & Gepp

Material: SNMNH/P/ALG: 7, Site 3, 20.I.1992; 8, Site 23, 27.VII.1992; 9, Site 7, 27.VII.1992; 10, Site 24, 28.VII.1992. — HEC: 8911, Site 3, 20.I.1992; 8918, Site 5, 22.I.1992; 8938, Site 7, 24.I.1992; 8944, Site 8 25.I.1992; 8987, Site 14, 31.I.1992; 9015, Site 16, 04.II.1992; 9078, Site 16, 15.V.1992; 9142, Site 7, 24.V.1992; 9186, Site 16, 20.VII.1992; 9224, Site 8, 24.VII.1992; 9238, Site 9, 27.VII.1992; 9241, Site 23, 27.VII.1992; 9246, Site 7, 27.VII.1992; 9266, Site 24, 28.VII.1992; 9317, Site 1, 01.VIII.1992. — ODC: 63, Site 11, 02.XI.1992; 85, Site 20, 06.XI.1992; 110, Site 16, 10.XI.1992.

In the study area *A. amadelpha* seems to be a very variable species: many intermediates occur between two extreme forms, each growing in a specific biotope.

A first typical form growing on soft substrate has a rhizomatous holdfast bearing several fronds; stipes branched 1-3 times, length varying between 3 and 8 cm, diameter 3-7 mm; flabellum cuneate to markedly flabellate, 2-4 cm in diameter, upper margin smooth (not lacerate), olive green, sometimes with a faint concentric zonation or containing a considerable amount of sediments.

The second typical form growing on coral boulders has a mat-like holdfast with numerous, densely packed fronds; stipes only 0.5-3 (to 5) cm long, 3-7 mm in diameter; flabellum cuneate to flabellate, 1-3 (to 6) cm long, 3-5.5 cm wide, upper margin eroded by the surf or eaten by fish, dark green to dirty brownish (which is not due to the presence of sediments) and sometimes with a faint concentric zonation.

There are also aberrant forms with subcylindrical flabella (HEC 8918), or reniform flabella and very short stipes (HEC 9142, 9242, the first one being very stiff, the second one supple).

The anatomy of the different forms is more homogeneous: fronds composed of numerous, dichotomous, siphonous filaments, 12-20 µm in diameter, gradually tapering apically, cylindrical to torulose with a rounded to slightly clavate apex; constriction at the branching shallow to deep; olive to hyaline.

A common species in the Sanctuary, along sheltered and surf-exposed coasts. Growth form one on sandy-silty substrate, frequently in seagrass beds, down to 10 m depth (Site 31), sometimes fixed on buried coral fragments. Growth form two in crevices of coral boulders, most frequently at

the seaward (surf-exposed) side of the reef, close to the low water mark down to 1 m depth, very common along Abu Ali Island. Perennial species without seasonal morphological variation.

*Avrainvillea amadelpa* is a very variable species morphologically. Our soft-substrate form is similar to the deep-water form of GEPP & GEPP (1911: 42-44), *A. amadelpa* f. *submersa* Gepp & Gepp, and to the descriptions of OLSEN-STOJKOVICH (1985: 37) and COPPEJANS & PRUD'HOMME VAN REINE (1989: 120-123). The reef form, on the other hand, is morphologically quite different from the descriptions of GEPP & GEPP (l.c.) and OLSEN-STOJKOVICH (l.c.): they describe very condensed thalli with narrow flabella whereas ours have mostly broad flabella. This might be due to the relative shelter that the Saudi Arabian specimens find in the crevices of the coral. Anatomical descriptions are very homogeneous, except for the presence of a well-developed pseudocortex reported by OLSEN-STOJKOVICH (l.c.). This character is not mentioned by GEPP & GEPP (l.c.) and was not observed by COPPEJANS & PRUD'HOMME VAN REINE (l.c.); it was also absent in our and BASSON's (1979 a: 51) material from the Saudi Arabian Gulf coast.

Reported from the Saudi Arabian Gulf coast by BASSON (l.c.); recorded from Bahrain by BASSON et al. (1989: 29) and from Kuwait by AL-HASAN & JONES (1989: 295).

## Order Chaetophorales Family Chaetophoraceae

Genus *Entocladia* Reinke

*Entocladia viridis* Reinke

*Acrochaete viridis* (Reinke) Nielsen

*Endoderma viridis* (Reinke) Wille

*Phaeophila viridis* (Reinke) Burrows

Morphology as in BØRGESEN (1939: 58). Occasionally observed as an endophyte in the external cell walls of some red algae (e.g. *Champia parvula*). Recorded by NEWTON from Kuwait (1955 a) and Bahrain (1955 b). New record for the Saudi Arabian Gulf coast.

Genus *Phaeophila* Hauck

*Phaeophila dendroides* (Crouan frat.) Batters

*Ochlochaete dendroides* Crouan frat.

Morphology as illustrated in COPPEJANS (1983: Plate 24, Fig. 1). Ecology as *Entocladia viridis*. Recorded by NEWTON (1955 b) from Bahrain. New record for the Saudi Arabian Gulf coast.

## Order Cladophorales Family Cladophoraceae

Genus *Chaetomorpha* Kützing

*Chaetomorpha aerea* (Dillwyn) Kützing

(Fig. 7)

*Conferva aerea* Dillwyn

Material: HEC: 8909 p.p., Site 2, 19.I.1992; 9098, Site 32, 17.V.1992.

Filaments gregarious, up to 30 cm long, unbranched, attached to the substrate, curly, frequently forming intricate clusters, light green. Filaments uniseriate, attached by an elongated basal cell (450-500 µm long) with short proximal rhizoids; cells constricted at the cross walls, with a diameter of 120-160 µm at the widest part, isodiametrical to twice as long as wide; cell wall 10-15 µm thick.

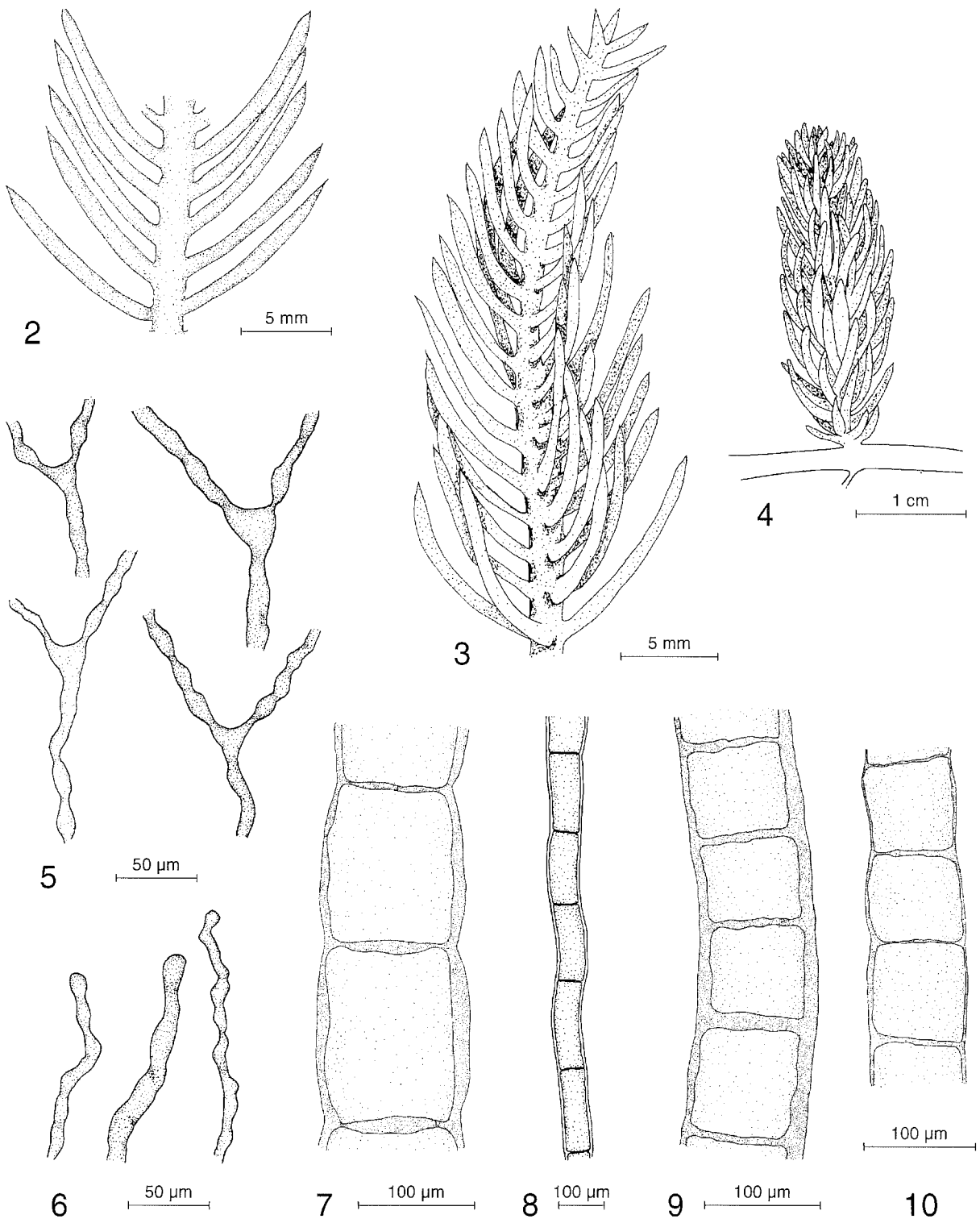

Figs 2-10: 2-3, *Caulerpa sertularioides* ecad *sertularioides*: 2, detail of an erect branch with a distichous branching pattern; 3, erect branch with a tristichous branching pattern; 4, *Caulerpa sertularioides* ecad *farlowii*, erect branch with a radial branching pattern; 5-6, *Avrainvillea amadelpha*: 5, dichotomies with constrictions; 6, filaments with rounded apices; 7, *Chaetomorpha aerea*, portion of a filament with barrel-shaped cells; 8, *Chaetomorpha gracilis*, portion of a filament with cylindrical cells; 9, *Chaetomorpha linum* f. *brachyarthra*, portion of a filament with cylindrical, thick-walled cells; 10, *Chaetomorpha mediterranea*, portion of a filament with cylindrical cells.

Collected on small shells or stones in the intertidal zone or the infralittoral fringe in the winter and spring (May); rare.

Some authors include this species in *C. linum*, others keep it separate (BURROWS 1991: 139). In this case *C. aerea* represents the attached form and *C. linum* the unattached one. Chromosome numbers clearly suggest their distinction. Additionally, the diameter mentioned by different authors for *C. aerea*, is rather variable: BØRGESEN (1940: 40): 100-120 µm, CHAPMAN (1961: 77): 125-400 µm, DURAIRATNAM (1961: 19-20): 200-250 µm. Morphologically our specimens look rather like *C. linum*; this is probably due to the fact that, although these thalli are attached to small hard substrates, they are moved around by tides and wave action.

Reported from the Saudi Arabian Gulf coast by BASSON (1979 a: 48-50); recorded by NEWTON (1955 b) and BASSON et al. (1989: 28) from Bahrain and by NEWTON (1955 a) and AL-HASAN & JONES (1989: 293) from Kuwait.

*Chaetomorpha gracilis* (Kützting) Kützting (Fig. 8)

*Conferva gracilis* Kützting

Material: SNMNH/P/ALG 11, Site 23, 27.VII.1992. — HEC 9242, Site 23, 27.VII.1992.

Unbranched, uniseriate filaments entangled with other filamentous algae, light green. Filaments 65-80 µm in diameter; cells cylindrical, 2-4 times longer than their diameter, not constricted at the transverse walls; cell wall thin: 1.5-2 µm.

A single sample was collected in July, mixed with *Centroceras clavulatum*, *Rhizoclonium tortuosum* and *Cladophora* cf. *coelothrix*, in a subtidal *Halodule uninervis* bed. Most probably overlooked because of its minute dimensions.

First record for the Gulf region.

*Chaetomorpha linum* (O.F. Müller) Kützting f. *brachyarthra* Kützting (Fig. 9)

Material: SNMNH/P/ALG 12, Site 16, 04.II.1992. — HEC 9008, Site 16, 04.II.1992.

Thallus composed of unbranched, unattached filaments, forming intertwined tufts, entangled around other plants; light green. Cells cylindrical, 110-120 µm in diameter, 0.5-1 times as long as the diameter, not constricted at the transverse walls; cell wall ± 10 µm thick and layered.

A single specimen was collected in a subtidal *Halodule* bed, close to low water mark, in February. The specimens collected by BASSON (1979 a: 50) from the Saudi Arabian Gulf coast have a slightly smaller diameter: 90-110 µm.

*Chaetomorpha mediterranea* (Kützting) Kützting (Fig. 10)

*Spongopsis mediterranea* Kützting

*Chaetomorpha capillaris* (Kützting) Børgesen

*Rhizoclonium capillaris* sensu Kützting

*Chaetomorpha tortuosa* (J. Agardh) Kützting

*Conferva tortuosa* J. Agardh non Dillwyn

*Chaetomorpha bottnica* Waern

Material: HEC 8909 p.p., Site 2, 19.I.1992.

---

Figs 11-17: 11, *Caulerpa sertularioides* ecad *sertularioides*, habit; 12, *Caulerpa sertularioides* ecad *farlowii*, habit; 13-15, *Araucaria amadelpha*: 13, habit of the typical soft-substrate form with rhizomatous holdfast; 14, habit of the typical reef form with a mat-like holdfast; 15, habit of an aberrant form with subcylindrical flabella; 16, *Cladophora koeiei*, habit; 17, *Cladophora nitellopsis*, habit.

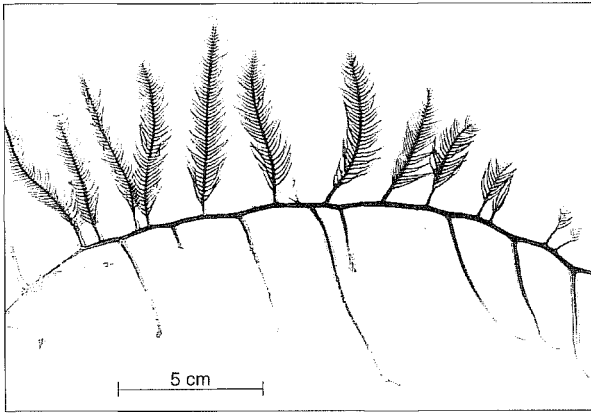

11

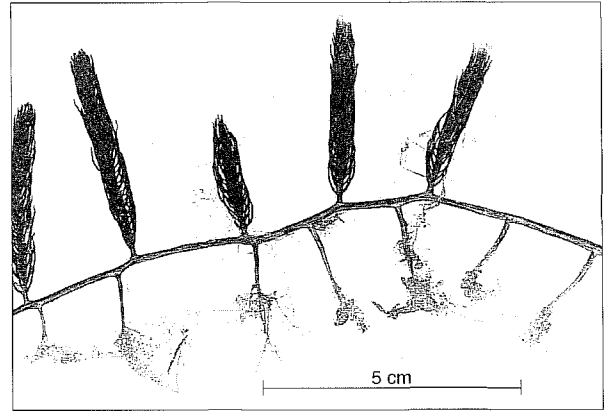

12

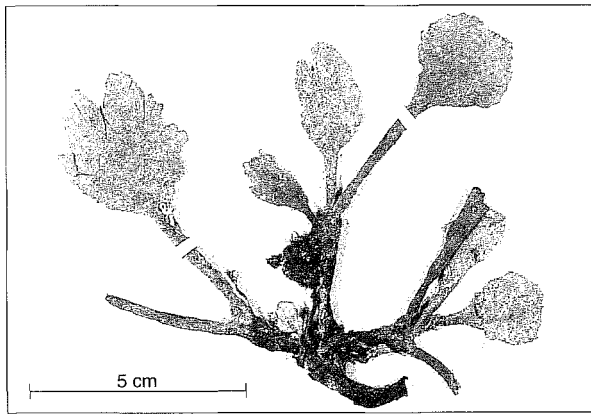

13

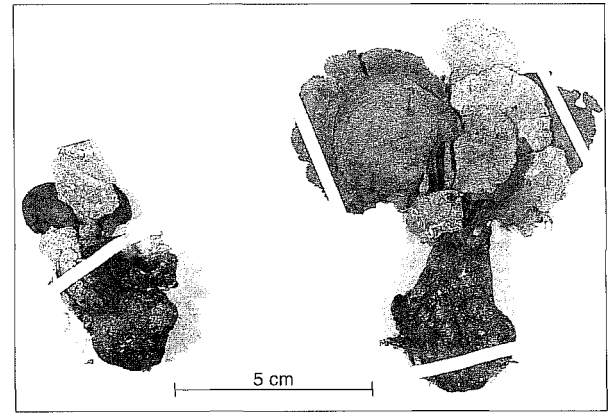

14

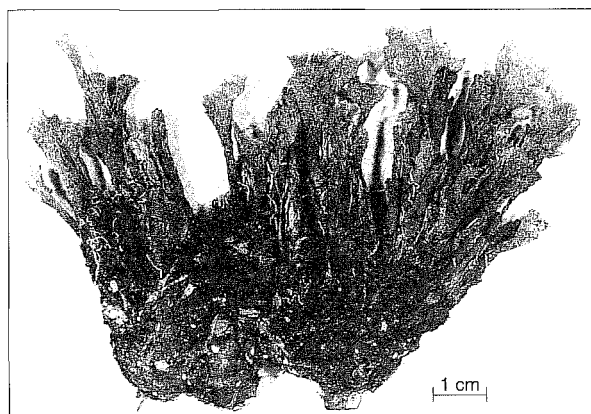

15

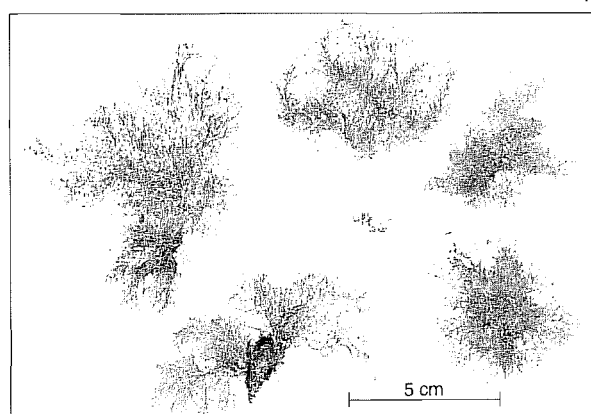

17

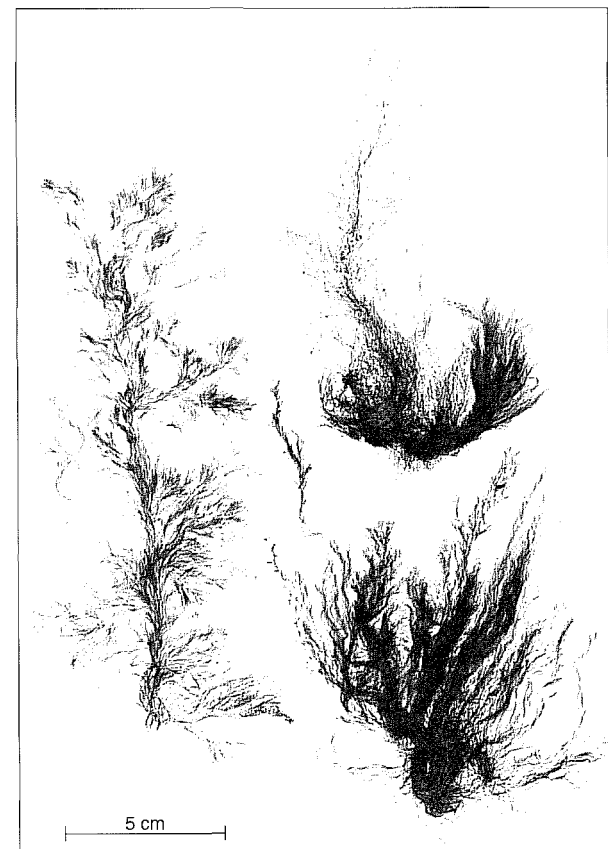

16

Thallus up to 20 cm, forming woolly tufts, entangled around other plants; filaments unbranched, strongly curled, light green. Filaments uniseriate, cylindrical cells 62-76  $\mu\text{m}$  in diameter, 1-2 times as long as wide; apical cell rounded; cell wall 4-7  $\mu\text{m}$  thick.

A single sample was collected, mixed with other *Chaetomorpha* and *Cladophora* species, forming rope-like strands, in January on the sandflats of Abu Ali Island.

This material is very similar to the description of HAMEL (1931: 120) and BØRGESEN (1939: 64). Taxonomy and synonyms follow BURROWS (1991: 140-141).

Recorded by BASSON et al. (1989: 28) from Bahrain and by AL-HASAN & JONES (1989: 293) (as *Chaetomorpha capillaris*) from Kuwait where it was also observed in the winter. New record for the Saudi Arabian Gulf coast.

### Genus *Cladophora* Kützing

#### *Cladophora* cf. *coelothrix* Kützing

(Fig. 18)

Material: SNMNH/P/ALG 13, p.p., Site 23, 27.VII.1992. — HEC 9242 p.p., Site 23, 27.VII.1992.

Individual thallus only a few millimetres long, irregularly branched, dark green in the field, becoming dark brownish upon drying. Branches uniseriate, cell division intercalary; side branches frequently placed on (sub-)vertical walls; cells markedly clavate, 150-250  $\mu\text{m}$  in diameter at the widest part, 600-800  $\mu\text{m}$  long; apical cells with a rounded to pointed top, the top cell wall being strongly thickened and layered, up to 45  $\mu\text{m}$  thick, resulting in a mucronate appearance. Main axes narrow abruptly at the base into a rhizoidal part, horizontally spread and forming new erect branches. Rhizoids on upper parts of the thallus are scarce.

A single sample was collected in the summer, in a sheltered bay, on silty sediment at 2-3 m depth among seagrasses.

The general appearance and some morphological characters are similar to VAN DEN HOEK'S description (1963: 41), but he mentions cylindrical cells with thin cell walls, many of which give off one rhizoid, each at their basal poles. Our material clearly belongs to the section *Repentes* and is very close to *C. coelothrix*, though differing from European material. BØRGESEN (1939: 72) questions his identification of *C. coelothrix* from this region.

Recorded by AL-HASAN & JONES (1989: 293) from Kuwait, but not mentioned by BASSON (1979 a, b) for the Saudi Arabian Gulf coast. New record for this coast.

#### *Cladophora koeiei* Børgesen

(Figs 16, 19-20)

Material: SNMNH/P/ALG 14, Site 8, 02.II.1992. — HEC: 8906, Site 2, 19.I.1992; 8907, Site 2, 19.I.1992; 8950, Site 8, 25.I.1992; 8996, Site 8, 02.II.1992; 9009, Site 16, 04.II.1992; 9010, Site 15, 04.II.1992; 9020, Site 16, 05.II.1992.

Thallus forming large, supple, elongated tufts; branching varies from sparse to dense, but always with isolated tufts of branchlets along the main axes; light green. Branches uniseriate, gradually tapering towards the apices; main axis dichotomous, but polychotomy also present because of the development of secondary branches; branching rather sparse in the basal part of the thallus. Cells cylindrical, 100-170  $\mu\text{m}$  in diameter at the base, tapering gradually towards the apices, up to 1 mm long in the main axes; ramuli in groups of three to five, forming small isolated dense clusters, more or less unilaterally branched; apical cells slightly clavate to cylindrical, 30-45  $\mu\text{m}$  in diameter, with rounded top. We also observed typical *Cladophoropsis*-like branching, where side branches are formed without a basal transverse wall, but these are formed later on.

Collected exclusively in the winter, intertidally and subtidally, down to 2 m depth, epilithic on beach rock, small stones or shells. A single sample was collected, epiphytic on *Halodule uninervis*. Restricted to the areas exposed to some surf: Ras az-Zaur and Abu Ali Island.



Our material is very similar to the description by BØRGESEN (1939: 66-67) who originally named it *C. kōiei*. According to the International Code of Botanical Nomenclature art. 73.6 (I.C.B.N. 1988: 72) the use of “ø” is not allowed in scientific names and must be changed into “oe”. Therefore *C. kōiei* should be *C. koeiei* and not *C. koiei* as given in BASSON (1979 a: 50).

Reported by BASSON (l.c.) for the Saudi Arabian Gulf coast; recorded by NEWTON (1955 b) and BASSON et al. (1989: 28) from Bahrain.

### *Cladophora nitellopsis* Børgesen

(Figs 17, 21)

Material: SNMNH/P/ALG: 15, Site 5, 22.I.1992; 16, Site 24, 28.VII.1992; 17, Site 8, 05.XI.1992. — HEC: 8919, Site 5, 22.I.1992; 8921, Site 5, 22.I.1992; 8923, Site 6, 23.I.1992; 8940, Site 7, 24.I.1992; 8950, Site 8, 25.I.1992; 8972, Site 18, 26.I.1992; 8977, Site 13, 30.I.1992; 9121, Site 20, 20.V.1992; 9265, Site 24, 28.VII.1992. — ODC: 2, Site 2, 31.X.1992; 70, Site 8, 05.XI.1992.

Thallus generally smaller than 5 cm, forming irregular, woolly tufts composed of uniseriate branches; light green, but sometimes brownish because of epiphytic diatoms or accumulated sediment. Main as well as secondary axes (sub-)dichotomous (occasionally trichotomous); no marked difference between them; *Cladophoropsis*-like branching locally present; cells of these axes 90-115 µm in diameter, up to 800 µm long. Ramuli single on the mother cells, basipetally reflexed, alternate to opposite in the major part of the thallus, unilateral towards the apices; branchlets of last order unicellular, occurring up to the apex; apical cell cylindrical, 20 µm in diameter, 250-450 µm long; top rounded.

Collected in all seasons, mainly along sheltered coasts, on small stones and shells in the intertidal, in the mangrove creeks and the subtidal area. Very similar to BØRGESEN's original description (1939: 69-71).

AL-HASAN & JONES (1989) recorded this species from Kuwait, NEWTON (1955 b) and BASSON et al. (1989: 28) from Bahrain. *Cladophora nitellopsis* is new for the Saudi Arabian Gulf coast.

### Genus *Cladophoropsis* Børgesen

#### *Cladophoropsis sundanensis* Reinbold

(Fig. 22)

Material: SNMNH/P/ALG: 18, Site 16, 20.VII.1992; 19, Site 8, 24.VII.1992; 20, Site 7, 27.VII.1992; 21, Site 16, 01.VIII.1992; 22, Site 1, 01.XI.1992. — HEC: 8929, Site 6, 23.I.1992; 9190, Site 16, 20.VII.1992; 9220, Site 8, 24.VII.1992; 9256, Site 7, 27.VII.1992; 9291, Site 16, 01.VIII.1992. — ODC: 21, Site 1, 01.XI.1992; 40, Site 1, 02.XI.1992; 125, Site 7, 11.XI.1992.

Thallus forming compact cushions 1-2 cm high, up to 5 cm in diameter, appressed to the substrate by the whole lower surface, composed of strongly interwoven filaments; light green. Filaments uniseriate; branching unilateral, very typical: the side branches have no transverse wall at their basis. Cells coenocytic, 80-135 µm in diameter, the length varying from 1 to 3.5 mm; apical parts, where the cells have not yet attained their full length, are markedly wider (up to 150-160 µm); cell wall thin (1.9 µm) and not layered. Rhizoids formed on the whole lower surface of the thallus.

Collected in all seasons, on hard substrate of the intertidal and from the infralittoral fringe, best developed along exposed coasts, but also present in sheltered bays. A single sample was collected from the shallow infralittoral in the winter, epiphytic on *Cystoseira trinodis*.

The division of the genus *Cladophoropsis* into species is based mainly on branching patterns and on the filament diameter. According to KOOISTRA (1993) culture experiments prove that these characters are variable. The diameters of our specimens are the same as the dimensions given by CRIBB (1960: 10) for *C. sundanensis*: 70-140 µm. Some of our specimens also contain broader filaments (180-210 µm), similar to the dimensions of *C. membranacea* (C. Agardh) Børgesen. On

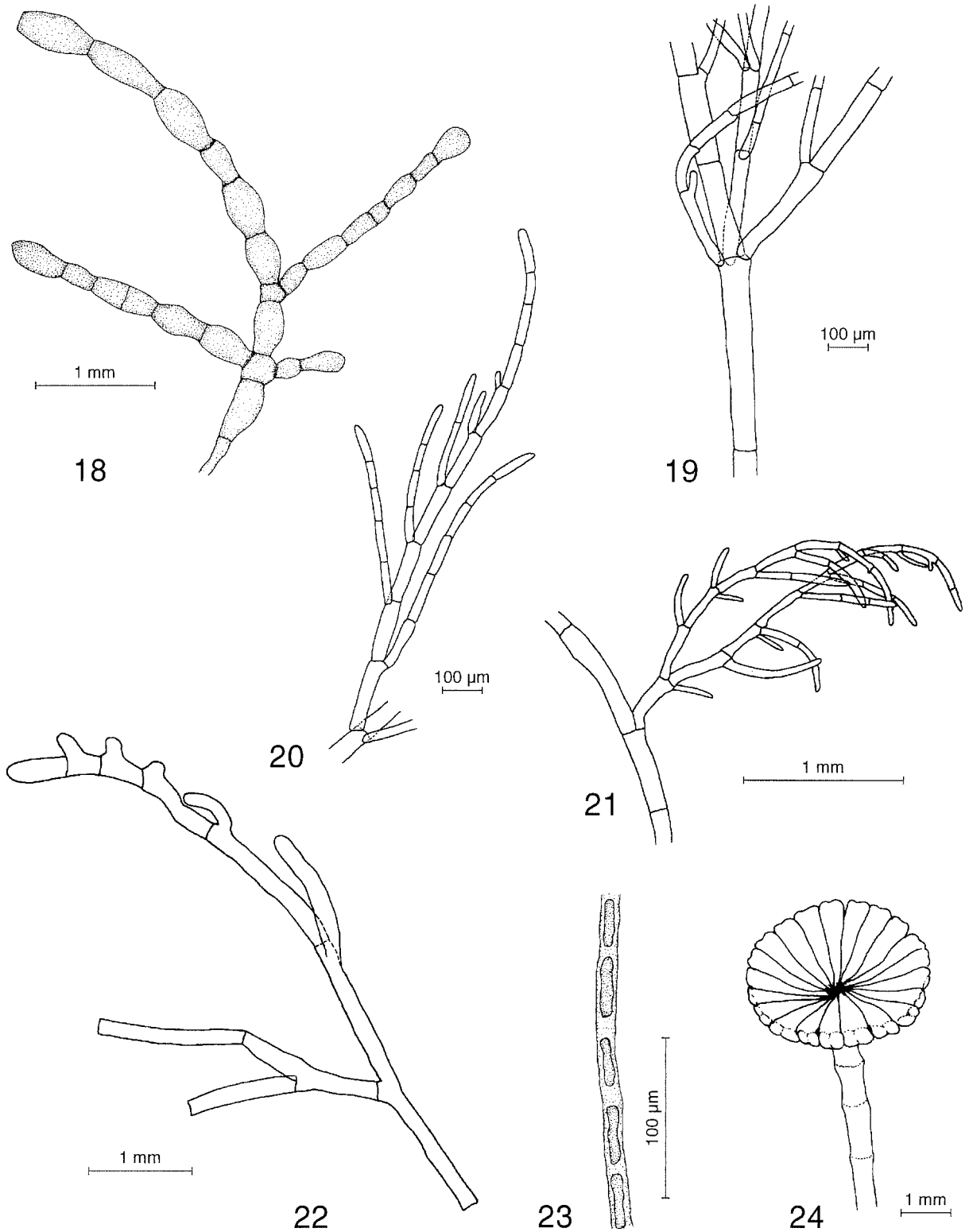

Figs 18-24: 18, *Cladophora* cf. *coelothrix*, portion of an apical part of a branch; 19-20, *Cladophora koeiei*: 19, detail of the main axis with several ramuli; 20, apical part of a ramulus; 21, *Cladophora nitellopsis*, detail of the main axis with a single ramulus; 22, *Cladophoropsis sundanensis*, detail of an apical branch with unilateral branching pattern; 23, *Rhizoclonium tortuosum*, portion of a filament with cylindrical, thick-walled cells; 24, *Acetabularia calyculus*, terminal portion of a plant with the stalk bearing a single cupula.

the other hand, BASSON (1979 a: 51) and AL-HASAN & JONES (1989: 294) recorded *C. zollingeri* (Kützinger) Børgesen from Kuwait and from the Saudi Arabian Gulf coast respectively. In his description however, BASSON (l.c.) gives a diameter of 300-390 µm which would suggest *C. macromeres* Taylor. WOMERSLEY & BAILEY (1970: 268) give a diameter of 180-250 µm for *C. zollingeri*. Only a world-wide revision of the genus will clarify the matter.

New record for the Gulf.

### Genus *Rhizoclonium* Kützinger

#### *Rhizoclonium tortuosum* (Dillwyn) Kützinger

(Fig. 23)

*Conferva tortuosa* Dillwyn

*Rhizoclonium juergensii* (Mertens) Kützinger

*Rhizoclonium riparium* (Roth) Harvey

*Rhizoclonium lacustre* Kützinger

*Rhizoclonium implexum* (Dillwyn) Kützinger

*Rhizoclonium affine* Kützinger

*Rhizoclonium kochianum* Kützinger

*Rhizoclonium biforme* Kützinger

*Rhizoclonium kernerii* Stockmayer

*Rhizoclonium interruptum* Kützinger

Material: SNMNH/P/ALG 23, p.p., Site 23, 27.VII.1992. — HEC 9242 p.p., Site 23, 27.VII.1992.

Thallus composed of thin, intertwined filaments, mixed with other algae. Filaments uniseriate, unbranched, without rhizoids at the transverse walls; cells cylindrical, 10-18 µm in diameter, 2-3 times as long as wide; cell wall markedly thick: 2-3 µm.

Mixed with *Chaetomorpha gracilis* and *Cladophora* cf. *coelothrix*, at 2-3 m depth, forming extensive mats over the sandy-silty substrate amongst seagrasses, in July.

BØRGESEN (1939: 63) recorded *R. kernerii* from the Iranian coast, but according to BURROWS (1991: 177) this is a synonym of *R. tortuosum*. Reported by BASSON (1979 a: 50) from Saudi Arabia and recorded from Bahrain by BASSON et al. (1989: 29) as *R. kochianum* and *R. kernerii*.

## Order Dasycladales

### Family Polyphysaceae

### Genus *Acetabularia* Lamouroux

#### *Acetabularia calyculus* Quoy & Gaimard

(Figs 24-26)

*Acetabularia subrii* Solms-Laubach

*Acetabularia caraibica* Okamura

Material: SNMNH/P/ALG: 24, Site 9, 24.VII.1992; 25, Site 24, 28.VII.1992. — HEC: 9090, Site 15, 16.V.1992; 9232, Site 9, 24.VII.1992; 9263, Site 24, 28.VII.1992; 9359, Site 27, 06.VIII.1992. — ODC: 52, Site 11, 02.XI.1992; 118, Site 16, 10.XI.1992.

Thallus 2.5-4 cm high, umbrella-like, calcified and whitish. Attached by basal rhizoids; stipe hollow, with 1-6 apical whorls of hairs; each hair generally composed of five segments; each branching point bears 1-5 (to 8) segments of a higher order. Fertile plants possess one (to two) apical cupulae: greenish funnel-like structures, 1-5 mm in diameter, composed of 18-28 contiguous and laterally adhering gametangial rays; they are triangular with an emarginate apex (rounded in young specimens), only slightly calcified and therefore not strongly adherent to each other; each of them contains numerous gametocysts. The corona inferior is present under the cupula and is composed of as many blunt warty outgrowths as gametangia; the corona superior, above the cupula, has the same number of outgrowths, but each of them forms 2-3 apical protuberances which grow out into sterile hairs and form a whorl around the blunt apex of the main axis.

Only fertile specimens, with cupula, can be observed with the naked eye; therefore data on seasonality only indicate the presence of fertile material: collected from May to November, but also observed in the winter, in the intertidal and infralittoral along both sheltered and rather exposed coasts, attached to small hard substrates (shells, worm tubes, small stones).

Reported by BASSON (1979 a: 53) from the Saudi Arabian Gulf coast (as *A. caliculus*); recorded from Bahrain by BASSON et al. (1989: 29) and from Kuwait by AL-HASAN & JONES (1989: 295).

### Order Derbesiales Family Bryopsidaceae

Genus *Bryopsis* Lamouroux

*Bryopsis hypnoides* Lamouroux

(Fig. 27)

Material: SNMNH/P/ALG 26, Site 18, 26.I.1992. — HEC: 8945, Site 8, 25.I.1992; 8965, Site 18, 26.I.1992; 9003, Site 15, 04.II.1992.

Thallus composed of several main axes starting from a common holdfast, densely branched radially, up to 5 cm high. Diameter at the basis 300-500 µm; side branches radially placed, constricted at the base, each branch being narrower than the previous one, the ultimate ones being 15-25 µm in diameter; the basal branches longer than the upper ones, resulting in a conoid appearance of the individual fronds, grouped in more or less hemispherical tufts; some specimens with a naked base of a few millimetres, resulting in a stipitate appearance; dark green. Siphonous structure; plastids oval, 7-8 µm long, each one containing a single pyrenoid.

Not common in the study area but locally abundant, collected exclusively in the winter, along surf-exposed coasts, epilithic on horizontal (more rarely vertical), shaded substrate, at the base of coral boulders at 1-2 m depth. A single sample was collected (HEC 9003 b) epiphytic on *Avrainvillea amadelpa*.

Recorded by AL-HASAN & JONES (1989: 294) from Kuwait in the winter. New record for the Saudi Arabian Gulf coast.

Genus *Trichosolen* Montagne

*Trichosolen* sp.

(Figs 31-32)

Material: SNMNH/P/ALG 27, Site 2, 22.VII.1992. — HEC 9213, Site 2, 22.VII.1992.

Thallus gregarious, forming a hairy cover on the substrate, 1-3 cm high; main axis well marked, terete, 100-200 µm in diameter at the basis, gradually tapering towards the apex; side branches radially arranged on the upper two thirds of the main axis, constricted at the basis, not ramified, 30-45 µm in diameter and 1-2 µm long; gametocysts in twos (seldom solitary), basal and adaxial on the ramuli, ovoid, mucronate, 60-65 µm wide, 135-270 µm long; light green. Siphonous structure.

A single sample was collected on a dead branch of *Acropora*, at 3 m depth in a sheltered area, in the summer. BASSON (1979 a: 51) described *T. mauritiana* (Børgesen) Taylor for the Saudi Arabian Gulf coast with reservation, because of the absence of reproductive structures. Our

---

Figs 25-30: 25-26, *Acetabularia caliculus*: 25, the outside of the cupula showing the corona inferior; 26, detail of a hair with the basal segment bearing eight new segments of higher order; 27, *Bryopsis hypnoides*, habit; 28, *Dictyosphaeria cavernosa*, habit; 29-30, *Enteromorpha flexuosa*: 29, habit of a fully grown specimen; 30, habit of young specimens.

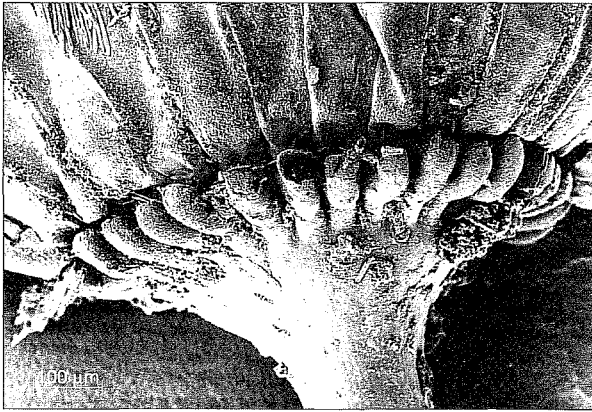

25

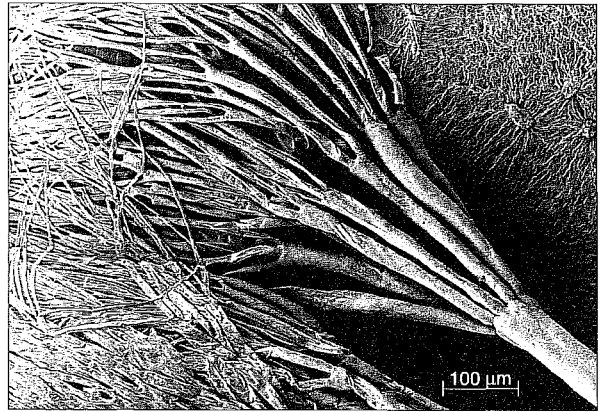

26

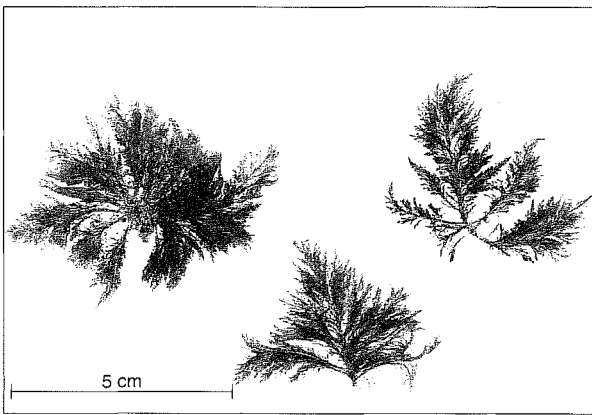

27

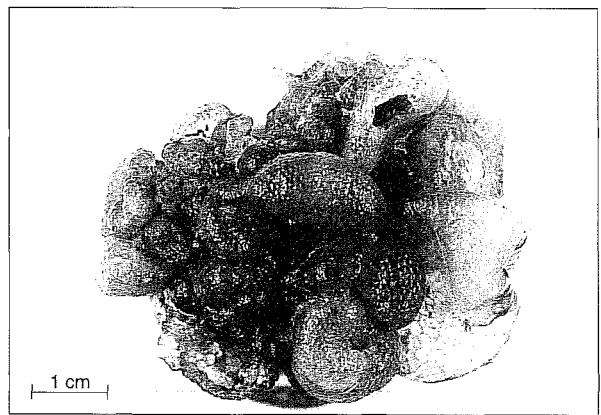

28

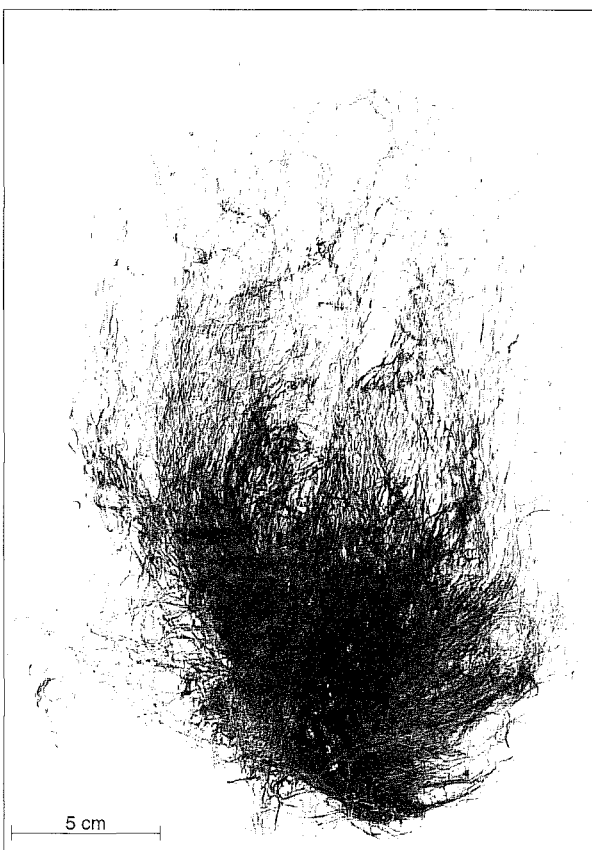

29

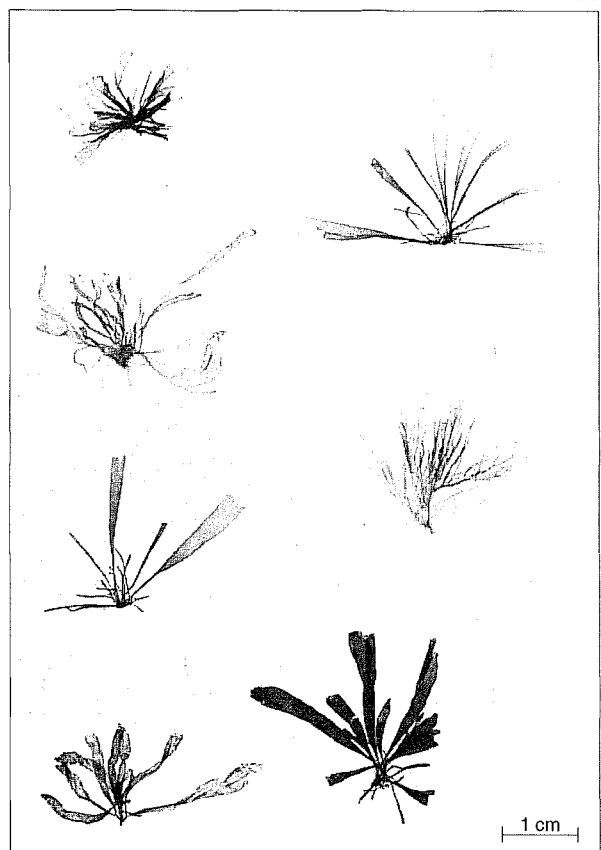

30

material clearly differs from this species because it has no apical gametocysts and the thallus is much more slender. There is some resemblance with *T. mucronata* (Børgesen) Taylor but this species has longer ramuli (up to 3 mm) and only one (rarely two) gametocyst(s) per ramulus, which is situated at some distance from the main axis. Our specimens therefore might belong to a new species, but further research is needed.

### Order Siphonocladales

#### Family Valoniaceae

Genus *Dictyosphaeria* Decaisne

*Dictyosphaeria cavernosa* (Forsskål) Børgesen

(Fig. 28)

*Ulva cavernosa* Forsskål

*Dictyosphaeria favulosa* (C. Agardh) Decaisne

Material: SNMNH/P/ALG: 28, Site 7, 24.V.1992; 29, Site 7, 27.VII.1992. — HEC: 8928, Site 6, 23.I.1992; 9141, Site 7, 24.V.1992; 9254, Site 7, 27.VII.1992. — ODC 126, Site 7, 11.XI.1992.

Thallus globular, up to 5 cm in diameter, isolated or gregarious, hollow, irregularly lobed, stiff and brittle, often apically eroded, resulting in hollow cup-like structures; transparent dark green, sometimes bleached. Composed of a single cell layer; cells strongly inflated, resulting in a warty thallus surface; cell diameter 1.5-2 mm, cell wall very thick.

Perennial species, with no seasonal fluctuations in abundance or appearance; epilithic in low intertidal pools, frequent in the infralittoral fringe and also present in the shallow infralittoral. A single sample was collected as an epiphyte on *Digenea simplex* (HEC 8928). Mainly present in the sheltered parts of Dauhat al-Musallamiya.

Reported by BASSON (1979 a: 50) from the Saudi Arabian Gulf coast; recorded by AL-HASAN & JONES (1989: 294) from Kuwait and by BASSON et al. (1989: 29) from Bahrain.

### Order Ulvales

#### Family Ulvaceae

Genus *Enteromorpha* Link

*Enteromorpha clathrata* (Roth) Greville

(Fig. 33)

*Conferva clathrata* Roth

Material: SNMNH/P/ALG 30, Site 18, 07.XI.1992. — HEC: 8973, Site 18, 26.I.1992; 9007, Site 16, 04.II.1992; 9361, Site 30, 11.VIII.1992. — ODC 89, Site 18, 07.XI.1992.

Thallus 0.2-10 cm high, forming intricate plants; branching irregular and dense, all along the thallus; all branches tubular, tapering towards the apices where they become uniseriate; grass green. Tubular parts with a diameter up to 400 µm at the basis, narrowing to 20-30 µm towards the apices, composed of a single cell layer; cells arranged in longitudinal rows, and towards the apices sometimes in transverse rows, isodiametrical, 20-30 µm in diameter; a single plastid per cell, with two or more pyrenoids.

Epilithic as well as epiphytic; from low water mark down to 2-3 m depth; the deep water forms have wider branches. General on hard substrate of the infralittoral fringe in the winter; a single sample was collected in the summer.

CHAPMAN (1961: 62-66) distinguished several varieties; our specimens are similar to *E. clathrata* var. *plumosa* Kützing, because the branches have small diameters. According to DAWSON (1954: 384) and BLIDING (1963: 109) they would belong to *E. clathrata* Typus II.

Collected in Kuwait by AL-HASAN & JONES (1989: 292); reported from the Saudi Arabian Gulf coast by BASSON (1979 a) and recorded from Bahrain by BASSON et al. (1989: 28).

*Enteromorpha flexuosa* (Wulfen ex Roth) J. Agardh (Figs 29-30, 34-35)

*Conferva flexuosa* Wulfen ex Roth

*Ulva flexuosa* Wulfen

*Enteromorpha intestinalis* (Linnaeus) Link var. *tubulosa* Kützing

*Enteromorpha tubulosa* (Kützing) Kützing

*Enteromorpha intestinalis* f. *tubulosa* (Kützing) Chapman

*Enteromorpha intermedia* Bliding

Material: SNMNH/P/ALG: 31, Site 2, 19.I.1992; 32, Site 2, 31.X.1992. — HEC 8905, Site 2, 19.I.1992. — ODC 1, Site 2, 31.X.1992.

Thallus 5-30 cm high, tubular, 0.5-3 mm in diameter; branching mainly in the basal part, sparse in the upper regions; no main axis visible because of the similarity of the side branches; much narrower proliferations. Tubular parts composed of a single cell layer; cells in longitudinal rows, especially in the upper parts: lower down new cells are formed by oblique cell walls, resulting in more irregularly positioned cells. Cells isodiametrical, 11-21 µm in diameter, containing a single plastid with two or more pyrenoids.

Observed exclusively on hard substrate (on dead coral and a fibre-glass boat), at or below the low water line; only found in the autumn and winter, at Abu Ali Island (Site 2).

Recorded by AL-HASAN & JONES (1989: 292) from Kuwait, by BASSON et al. (1989: 28) from Bahrain and reported by BASSON (1979 a: 48) from the Saudi Arabian Gulf coast.

#### Division Xanthophyta

Classification follows CHRISTENSEN (1987)

Class Xanthophyceae

Order Vaucheriales

Family Vaucheriaceae

Genus *Vaucheria* De Candolle

*Vaucheria piloboloides* Thuret

(Fig. 36)

*Vaucheria fuscescens* Kützing

Material: HEC 8947, Site 8, 25.I.1992.

Thallus composed of an intricate mass of thin filaments forming woolly tufts; green but, because of the accumulation of large amounts of sediments, hardly recognisable as such. Sterile filaments without transverse walls (siphonous), 29-51 µm in diameter, sparsely branched. Male and female reproductive structures on the same filament; spermatocysts (antheridia) longish conical with 1-2 lateral or a single terminal pore on the top of a small nozzle, isolated from the rest of the thallus by a single hyaline cell. Oocysts (oogonia) positioned under the spermatocysts, isolated from the thallus by a single transverse wall, clavate with a marked stipe-like basal part and a hemispherical apical part, 160-240 µm in diameter. The zygote lenticular, with a thickened cell wall, apically attached in the oocyst, only filling part of it and containing numerous oil droplets.

A single sample was collected, in winter at Ras az-Zaur in a shallow, sheltered area of the infralittoral zone with pronounced sedimentation. Our material is similar to the description given by CHRISTENSEN (1987: 23-25) after material from the British Isles.

Recorded by AL-HASAN & JONES (1989: 299) from Kuwait. New record for the Saudi Arabian Gulf coast.

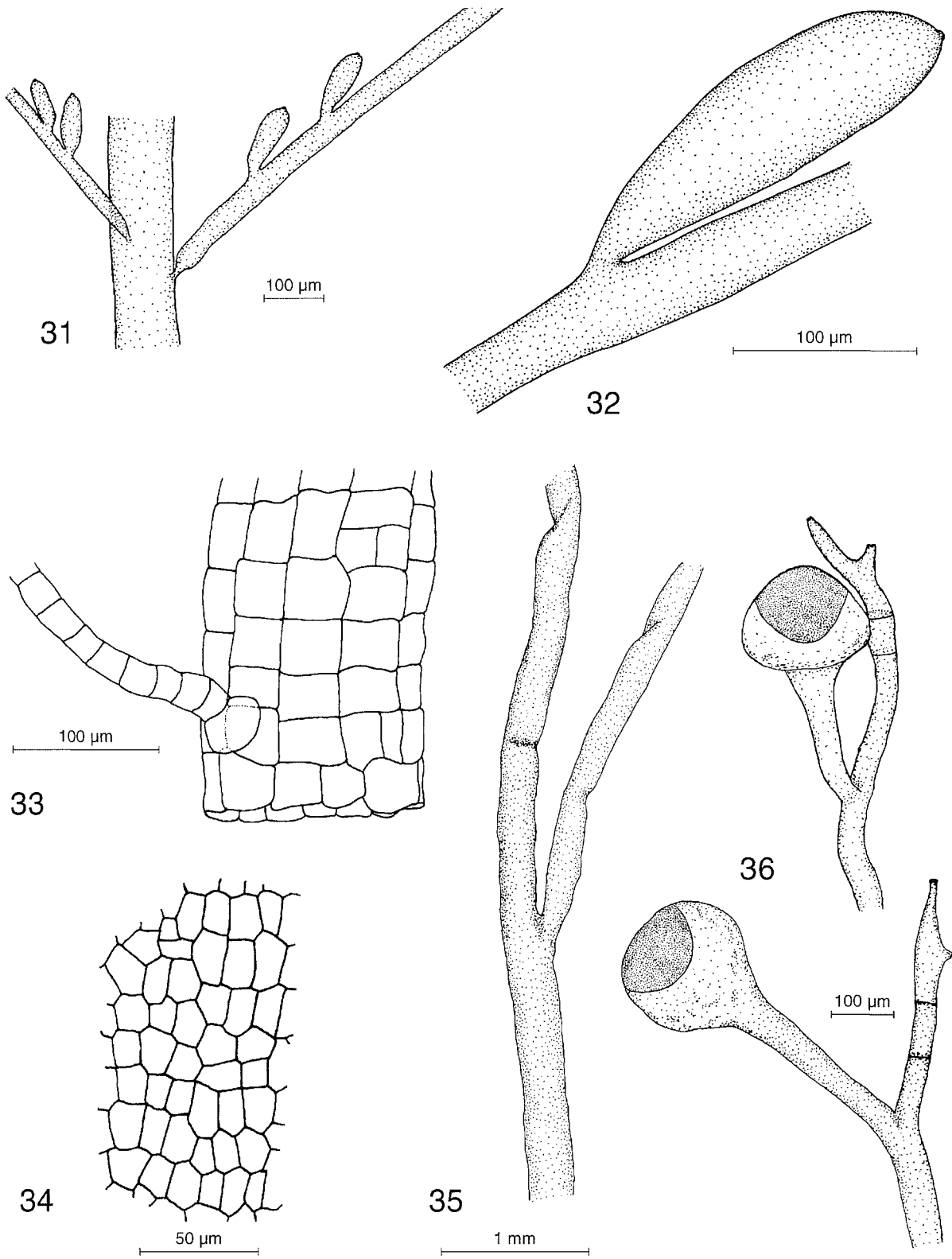

Figs 31-36: 31-32: *Trichosolen* sp., portion of the main axis and branchlets bearing two gametocysts each; 32, detail of a mucronate gametocyst; 33, *Enteromorpha clathrata*, detail of a branch showing the regular arrangement of the cells and a uniseriate branchlet; 34-35: *Enteromorpha flexuosa*: 34, surface view showing the arrangement of the cells; 35, detail of a branched axis; 36, *Vaucheria piloboloides*, terminal part of a filament showing sporocysts with 2-3 pores and thick-walled oocysts.



Division **Phaeophyta**

Classification follows SILVA et al. (1987)

Class **Phaeophyceae**Key to species of the class **Phaeophyta**

- |       |   |    |
|-------|---|----|
| 1.a.  | Thallus uniseriate, composed of microscopically thin, branched filaments . . . . .  | 2  |
| b.    | Thallus not uniseriate, composed of a more complex tissue . . . . .   | 4  |
| 2.a.  | Growth diffuse, no marked meristematic zones; axes branched over their whole length<br><i>Hincksia mitchelliae</i>  |    |
| b.    | Marked meristematic zones, branching rare, mainly basal . . . . .   | 3  |
| 3.a.  | Thallus epilithic; plurilocular zoidocysts spindle-shaped<br><i>Feldmannia indica</i>   |    |
| b.    | Thallus epiphytic (on <i>Sargassum</i> ); plurilocular zoidocysts conical to subcylindrical<br><i>Feldmannia irregularis</i>  |    |
| 4.a.  | Thallus forming large, irregularly lobed, hollow structures . . . . .   | 5  |
| b.    | Thallus not hollow . . . . .  | 6  |
| 5.a.  | Thallus perforated<br><i>Hydroclathrus clathratus</i>   |    |
| b.    | Thallus not perforated<br><i>Colpomenia sinuosa</i>   |    |
| 6.a.  | Thallus up to 0.5 cm high, forming stiff upright tufts, composed of multicellular segments, frequently bearing typical propagules . . . . .                         | 7  |
| b.    | Thallus larger and not composed of segments . . . . .   | 8  |
| 7.a.  | Propagules Y-shaped<br><i>Sphacelaria rigidula</i>  |    |
| b.    | Propagules tribuliform ( $\pm$ obtriangular)<br><i>Sphacelaria tribuloides</i>  |    |
| 8.a.  | Thallus terete, slimy and very supple; epiphytic on <i>Sargassum</i><br><i>Nemacystus erythraeus</i>  |    |
| b.    | Thallus not slimy; terete, three-winged or compressed . . . . .   | 9  |
| 9.a.  | Thallus strongly compressed, composed of dichotomous straps or flabellate lobes, generally smaller than 20 cm; reproductive structures not in receptacles . . . . . | 10 |
| b.    | Thallus cylindrical or somewhat compressed, not dichotomous, generally larger than 20 cm; reproductive structures in receptacles . . . . .                          | 16 |
| 10.a. | Thallus dichotomous . . . . .   | 11 |
| b.    | Thallus composed of flabellate lobes . . . . .  | 14 |
| 11.a. | Straps with a marked midrib<br><i>Dictyopteris membranacea</i>  |    |
| b.    | No midrib . . . . .   | 12 |
| 12.a. | Thallus repent, straps anastomosing<br><i>Dictyota friabilis</i>  |    |
| b.    | Thallus erect, straps not anastomosing . . . . .  | 13 |
| 13.a. | Straps 0.5-1 mm broad, no transverse darker bands<br><i>Dictyota indica</i>   |    |
| b.    | Straps 5-10 mm broad at the basis, 2-3 mm at the apices, with transverse darker bands<br><i>Dictyota</i> sp.  |    |
| 14.a. | Thallus prostrate, margin not incurved<br><i>Lobophora variegata</i>  |    |
| b.    | Thallus erect or ascending, funnel-shaped, margin incurved . . . . .  | 15 |
| 15.a. | Hair rows on both surfaces; sori of sporocysts above each hair row of the lower thallus surface<br><i>Padina boergesenii</i>  |    |
| b.    | Hair rows only on the lower thallus surface, sori of sporocysts above each hair row of the lower surface<br><i>Padina minor</i>                                     |    |

- 16.a. Thallus composed of prostrate stolonoid parts and erect axes with peltate branches  
*Turbinaria ornata* f. *evesiculosa*
- b. Thallus without prostrate stolonoids; phylloids present, but never peltate . . . . . 17
- 17.a. Thallus three-winged, aerocysts not distinct *Hormophysa cuneiformis*
- b. Thallus compressed or cylindrical, aerocysts (if present) obvious . . . . . 18
- 18.a. Thallus muricate, spiny (at least the basis of the main axes) . . . . . 19
- b. All axes smooth . . . . . 20
- 19.a. Thallus completely spiny, even the aerocysts muricate; aerocysts solitary, but sometimes very numerous  
*Cystoseira myrica*
- b. Only the main axes muricate, especially the basal parts; aerocysts smooth, frequently in series of 2-3  
*Cystoseira trinodis*
- 20.a. Branching pinnate, axes complanate, phylloids absent *Sargassum decurrens*
- b. Branching irregular (radial), phylloids present . . . . . 21
- 21.a. Margin of the phylloids smooth (not dentate), with cryptostomata; aerocysts spherical, 4-5 mm in diameter  
*Sargassum boveanum*
- b. Margin of the phylloids generally dentate; if smooth, then without cryptostomata; aerocysts spherical or spindle-shaped, 2 mm in diameter, up to 6 mm long . . . . . 22
- 22.a. Phylloids undulated, with rounded apices, cryptostomata rare *Sargassum binderi*
- b. Phylloids plane, with acute apices, cryptostomata frequent . . . . . 23
- 23.a. Aerocysts spindle-shaped, 2 mm in diameter, up to 6 mm long  
*Sargassum boveanum* var. *aterrimum*
- b. Aerocysts spherical to subspherical, 2-10 mm in diameter . . . . . 24
- 24.a. Phylloids 1-3 mm broad; aerocysts spherical, 2-4 mm in diameter  
*Sargassum angustifolium*
- b. Phylloids 5-10 mm broad; aerocysts subspherical, 5-10 mm broad  
*Sargassum latifolium*

### Order Chordariales

#### Family Spermatochnaceae

Genus *Nemacystus* Derbès & Solier

*Nemacystus erythraeus* (J. Agardh) Sauvageau

(Figs 37, 44)

*Cladosiphon erythraeus* J. Agardh

Material: SNMNH/P/ALG 174, Site 19, 19.V.1992. — HEC: 9073, Site 16, 15.V.1992; 9104, Site 18, 18.V.1992; 9110, Site 19, 19.V.1992.

Thallus 20-30 cm long, composed of cylindrical, very supple, slimy axes, 1-2 mm in diameter; branching dense and irregular; numerous short laterals, perpendicular on the main axes; dark brown. Medulla 100-150 µm in diameter, massive in young parts, hollow in older axes, composed of a small number (10-15) of hyaline cells, 45 µm in diameter (in transverse section), 200-300 µm long; cortex composed of unbranched pigmented filaments, 150-200 µm long, 11-15 cells long, of which the basal ones cylindrical, 7-8 µm in diameter, 15 µm long and the apical ones subspherical, 12 µm in diameter and 19 µm long; hyaline hairs 350 µm long, with cylindrical cells, 8-12 µm in diameter, 80-90 µm long. Unilocular zoidocysts at the basis of the assimilatory filaments, ovoid, 15-22 µm wide, 20-35 µm long; plurilocular zoidocysts not present.

Only present in the spring, epiphytic on *Sargassum* spp. at surf-exposed sites (Abu Ali Island and some patch reefs).

NEWTON (1955 b), BASSON (1979 a: 57) and BASSON et al. (1989: 31) recorded *N. decipiens* (Suringar) Kuckuck from the Saudi Arabian Gulf coast and Bahrain. According to DE JONG & PRUD'HOMME VAN REINE (in prep.) our specimens and those from NEWTON (1955 b) belong to *N. erythraeus*. Both species grow epiphytically and have an almost identical morphology. Anatomically however, they differ in the dimensions of the assimilatory filaments and in the fact that the central axis remains solid in *N. decipiens* or becomes hollow in *N. erythraeus*. AL-HASAN & JONES (1989: 296) recorded *Cladosiphon occidentale* Kylin from Kuwait. This brown alga is morphologically very similar but anatomically different; it also grows as an epiphyte on *Sargassum*.

Order Dictyotales  
Family Dictyotaceae

Genus *Dictyopteris* Lamouroux

*Dictyopteris membranacea* (Stackhouse) Batters

(Figs 38, 45)

*Fucus membranaceus* Stackhouse

*Dictyopteris polypodioides* (De Candolle) Lamouroux

Material: SNMNH/P/ALG 33, Site 1, 25.V.1992. — HEC 9151, Site 1, 25.V.1992.

Thallus erect, 15-20 cm high, strap-like, membranous, dichotomous (trichotomous), branch angles 45-60°; attachment by a rhizoidal holdfast bearing one or several erect fronds; straps 0.5-1 cm wide, midrib 1 mm wide (lateral veins absent); blade margin smooth, slightly undulated, sometimes eroded at the basis, resulting in a stipitate appearance; proliferations frequently present, originating from the midrib; orangy brown, turning to olive green or bluish upon drying. Blade 80 µm thick, composed of two cell layers; midrib lenticular in transverse section, 900 µm wide, 250 µm thick, composed of cells with strongly thickened walls. Unilocular sporocysts, 90-130 µm in diameter combined with hyaline cylindrical hairs, 20 µm in diameter, on both sides of the blade in irregularly placed sori along either side of the midrib.

Only collected once, a few hundred metres from the shore of Abu Ali Island, in the spring, at 7 m depth, epilithic on rocky substrate where it forms extended, dense populations on vertical substrate within the *Sargassum* beds.

New record for the Gulf. NIZAMUDDIN & GESSNER (1970: 6) described *D. australis* Sonder from the Gulf; this species has side veins.

Genus *Dictyota* Lamouroux

*Dictyota indica* Sonder

(Fig. 39)

Material: SNMNH/P/ALG: 34, Site 18, 26.I.1992; 35, Site 15, 18.VII.1992; 36, Site 9, 24.VII.1992; 37, Site 21, 30.VII.1992; 38, Site 18, 31.VII.1992; 39, Site 1, 01.VIII.1992; 40, Site 1, 01.XI.1992; 41, Site 11, 02.XI.1992; 42, Site 8, 05.XI.1992; 43, Site 25, 07.XI.1992. — HEC: 8897, Site 1, 19.I.1992; 8962, Site 18, 26.I.1992; 8994, Site 14, 31.I.1992; 9088, Site 15, 16.V.1992; 9108, Site 18, 18.V.1992; 9170, Site 15, 18.VII.1992; 9228, Site 8, 24.VII.1992; 9231, Site 9, 24.VII.1992; 9270, Site 21, 30.VII.1992; 9286, Site 18, 31.VII.1992; 9300, Site 1, 01.VIII.1992; 9332, Site 25, 06.VIII.1992; 9351, Site 26, 06.VIII.1992. — ODC: 14, Site 1, 01.XI.1992; 37, Site 11, 02.XI.1992; 74, Site 8, 05.XI.1992; 95, Site 25, 07.XI.1992; 113, Site 16, 30.XI.1992.

Thallus 5-20 cm high, forming elegant upright tufts composed of dichotomous straps; interdichotomies 0.5-2.5 cm long, branch angles 60°, sinuses rounded; straps generally spirally twisted, 0.5-1 mm wide, tapering very slightly towards the apices, with smooth margins; proliferations sometimes very numerous, merging from the thallus margin and surface; dark brown, without transverse bands. Thallus 90-100 µm thick in transverse section; a single medullary layer with large hyaline cells, 70 µm high, 100-110 µm broad and 200-250 µm long (in superficial

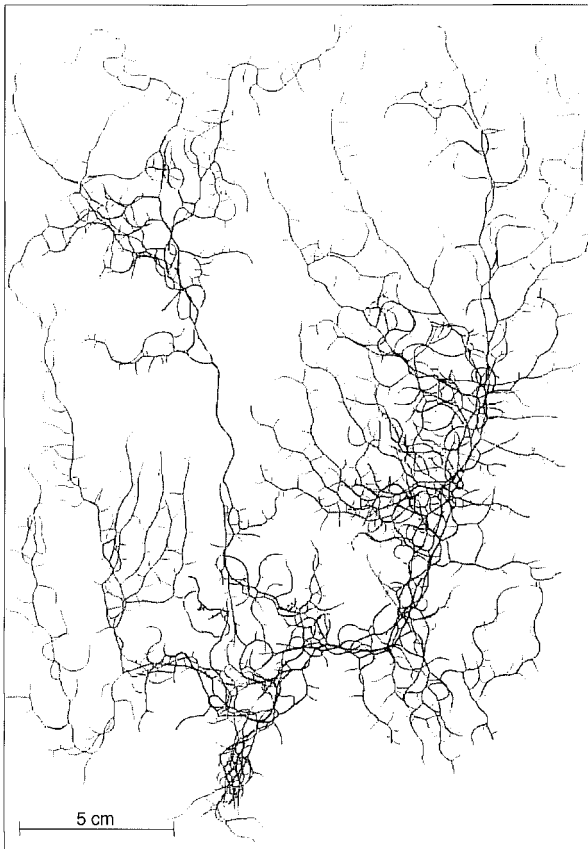

37

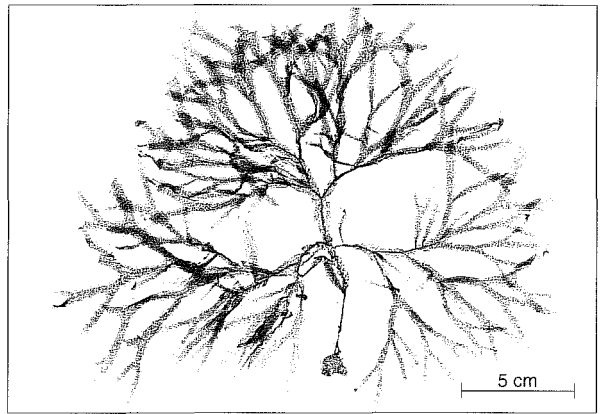

38

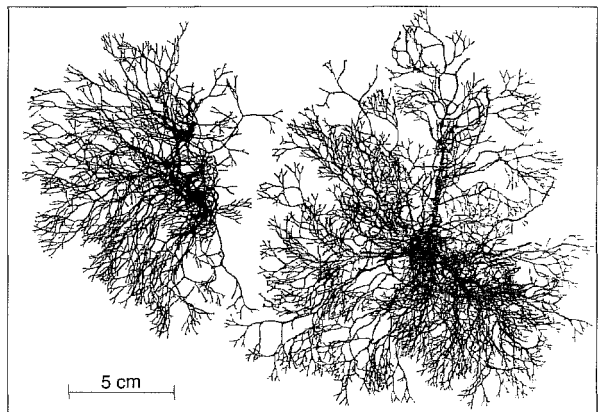

39

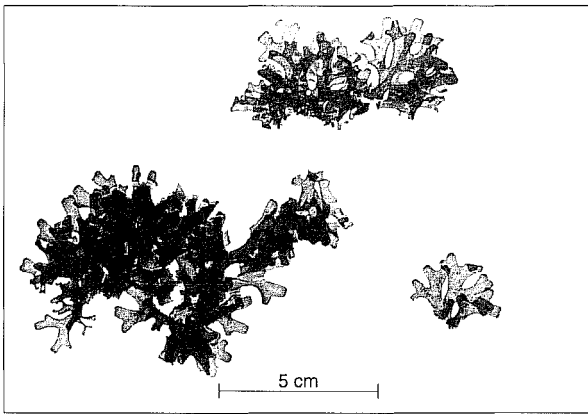

40

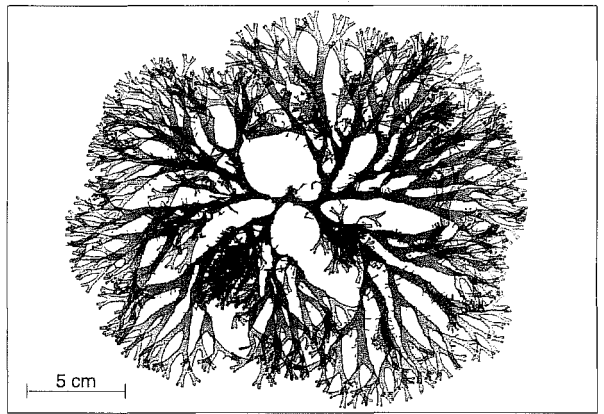

41

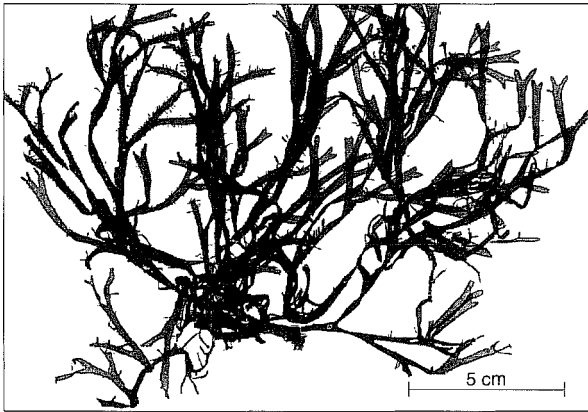

42

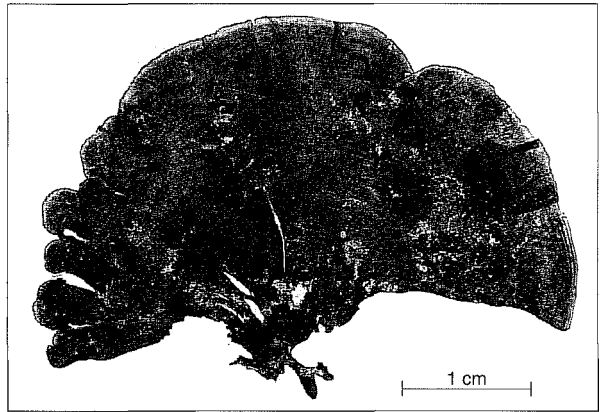

43

view); cortex also single-layered, cells 16 µm high, 20-25 µm broad and 50 µm long (in superficial view). Tetrasporocysts scattered, 45-50 µm in diameter, over both surfaces of the thallus, not grouped in sori, not surrounded by an involucrem.

Present all year round, epilithic (sometimes on hardened tar) as well as epiphytic, in the infralittoral zone along surf-exposed coasts.

According to culture experiments of HÖRNIG et al. (1992) on material from the Atlantic Ocean, there is continuous morphological variation within the *D. cervicornis-divaricata-indica-linearis*-group; they therefore synonymise a large number of species. Such a study has not been carried out for the Indian Ocean yet; meanwhile we follow the more traditional species concept.

*Dictyota indica* was reported for the Gulf by NIZAMUDDIN & GESSNER (1970: 5) and JONES (1986: 30). This is a first record for the Saudi Arabian Gulf coast.

*Dictyota friabilis* Setchell

(Figs 40, 46)

non *Dictyota friabilis* sensu Jaasund

Material: SNMNH/P/ALG 44, Site 30, 03.VIII.1992. — HEC 9323, Site 30, 03.VIII.1992.

Individual straps 3-5 mm wide, prostrate, with smooth margins, attached to each other by marginal, hyaline rhizoids; size of the thallus difficult to estimate because of this repeated anastomosing pattern resulting in a roof-tile-like cascading covering; branching dichotomous; interdichotomies 3-8 mm long, branch angles 60-80°; golden brown, no iridescence, no transverse stripes. Straps 115-125 µm thick in transverse section; single-layered medulla composed of large, hyaline cells, 70 µm high, 63 µm broad, 110 µm long (in superficial view); cortical layer composed of small coloured cells, arranged in longitudinal and transverse rows, 14 µm high, 23 µm broad, 24 µm long (in superficial view); apical cell lenticular, prominent. Sporocysts scattered, 65-70 µm in diameter, over the entire upper surface of the thallus, not grouped in sori, not surrounded by an involucrem.

This entity was only collected once, at Karan, during the summer at 9 m depth; it was locally abundant and covered vast areas of the *Acropora* reef together with *Lobophora*. Comparison with the type specimen (UC 261252, 19.IV.1922, Setchell & Parker) allows us to conclude that our specimen definitely belongs to *D. friabilis* Setchell. *Dictyota friabilis* sensu JAASUND (1970: 75) is a species with projections from the surface and involucre spores. These characters are not present on the type specimen. Jaasund himself questions the difference between *D. friabilis* and *D. bartayresiana* Lamouroux. According to us *D. friabilis* sensu Jaasund has to be considered as a growth form of *D. bartayresiana* Lamouroux. Reported from the Arabian Gulf coast by DE CLERCK & COPPEJANS (1994: 21 as *Dictyota* sp. 1).

*Dictyota* sp.

(Figs 41-42)

Material: SNMNH/P/ALG: 45, Site 15, 22.V.1992; 46, Site 15, 18.VII.1992; 47, Site 1, 01.VIII.1992. — HEC: 9099, Site 18, 18.V.1992; 9135, Site 15, 22.V.1992; 9165, Site 21, 26.V.1992; 9169, Site 15, 18.VII.1992; 9299, Site 1, 01.VIII.1992; 9340, Site 25, 06.VIII.1992.

Thallus up to 12 cm high, erect, ramified in a single plane, generally resulting in a fan-shaped appearance, in the spring, but sometimes also with a more irregular outline; branching dichotomous; interdichotomies 1-2.5 cm; straps 5-10 mm wide at the basis, 2-3 mm towards the apices,

---

Figs 37-43: 37, *Nemacystus erythraeus*, habit; 38, *Dictyopteris membranacea*, habit; 39, *Dictyota indica*, habit; 40, *Dictyota friabilis*, habit; 41-42, *Dictyota* sp.: 41, habit of a specimen collected in spring; 42, habit of a specimen collected in summer; 43, *Lobophora variegata*, habit.

sometimes spirally twisted; margin towards the apices dentate, these teeth forming lingulate proliferations towards the base of the thallus, especially in the summer when the specimens become very intricate because of these proliferations; locally marginal rhizoids occur; apex rounded; dark brown at the basis, golden brown higher up; sterile. Transverse section 230  $\mu\text{m}$  thick; medulla composed of large hyaline cells, 140-150  $\mu\text{m}$  broad, 180  $\mu\text{m}$  high, 220-280  $\mu\text{m}$  long (in superficial view); cortex layer composed of strongly pigmented cells: 21  $\mu\text{m}$  broad, 25  $\mu\text{m}$  high, 48-53  $\mu\text{m}$  long (in superficial view); plastids concentrated in transverse bands, in the spring and summer.

Epilithic in the infralittoral zone along surf-exposed coasts: Abu Ali Island, patch reefs.

Our specimens show considerable similarity with herbarium specimens from Leiden (L) named *D. ciliolata* Kützing. However, we are cautious in naming our specimens *D. ciliolata* as several poorly known species with dentate margins are reported from the Indian Ocean: *D. crenulata* J. Agardh, *D. hauckiana* Nizamuddin and *D. maxima* Zanardini. Further research is ongoing.

### Genus *Lobophora* J. Agardh

#### *Lobophora variegata* (Lamouroux) Womersley

(Figs 43, 47)

*Dictyota variegata* Lamouroux

*Zonaria variegata* (Lamouroux) C. Agardh

*Gymnosorus variegatus* (Lamouroux) J. Agardh

*Pocockiella variegata* (Lamouroux) Papenfuss

Material: SNMNH/P/ALG: 48, Site 14, 31.I.1992; 49, Site 15, 18.VII.1992; 50, Site 2, 22.VII.1992; 51, Site 2, 31.X.1992. — HEC: 8983, Site 14, 31.I.1992; 9167, Site 1, 25.V.1992; 9172, Site 15, 18.VII.1992; 9212, Site 2, 22.VII.1992; 9274, Site 21, 30.VII.1992; 9301, Site 1, 01.VIII.1992; 9322, Site 30, 03.VIII.1992. — ODC: 10, Site 2, 31.X.1992; 112, Site 16, 10.XI.1992.

Thallus composed of one or several fan-shaped lobes, 1-5 cm in diameter, prostrate or even crustose (never erect); orangy brown to brown; live material frequently with concentric blackish zigzag bands which mostly disappear upon drying; adhesion generally proximal, by branched, pluricellular rhizoids with cylindrical to moniliform cells. Cortex single-layered: cells on radial rows in superficial view, 12  $\mu\text{m}$  broad, 11  $\mu\text{m}$  high in transverse section, 21  $\mu\text{m}$  long (in superficial view); subcortex two-layered, composed of cells 25  $\mu\text{m}$  broad and 12  $\mu\text{m}$  high (transverse section); medulla single-layered, with large, hyaline cells, 25-30  $\mu\text{m}$  broad, 50  $\mu\text{m}$  high. Downward side with similar cortex and subcortex. Indusiate sori of sporocysts on both thallus surfaces, except for the crustose forms which only have them on the upper surface; unilocular sporocysts dark brown, pyriform, sessile, 60  $\mu\text{m}$  broad, 105  $\mu\text{m}$  high.

Perennial species which is very abundant in all seasons throughout the study area. Always epilithic on coral in the sublittoral and therefore absent in sheltered bays. *Lobophora variegata* seems to grow very well between the branches of *Acropora*, where it completely covers its basal parts; collected at the eastern tip of Abu Ali Island and around Karan. It never develops so extensively on the *Porites*-dominated reefs.

Most authors mention a double-layered cortex, but single-layered ones (as in our material) have been recorded by PAPPENFUSS (1943: 463-468) and TRONO (1969: 32-33). This species was reported by BASSON (1979 a: 57) from Saudi Arabia and recorded by BASSON et al. (1989: 31) from Bahrain (as *Pocockiella variegata*).

### Genus *Padina* Adanson

Remark: authors disagree upon the position of the upper side of fronds of *Padina*; we follow the terminology of TRONO (1969: 33-34), amongst others, who defined the upper side as that side

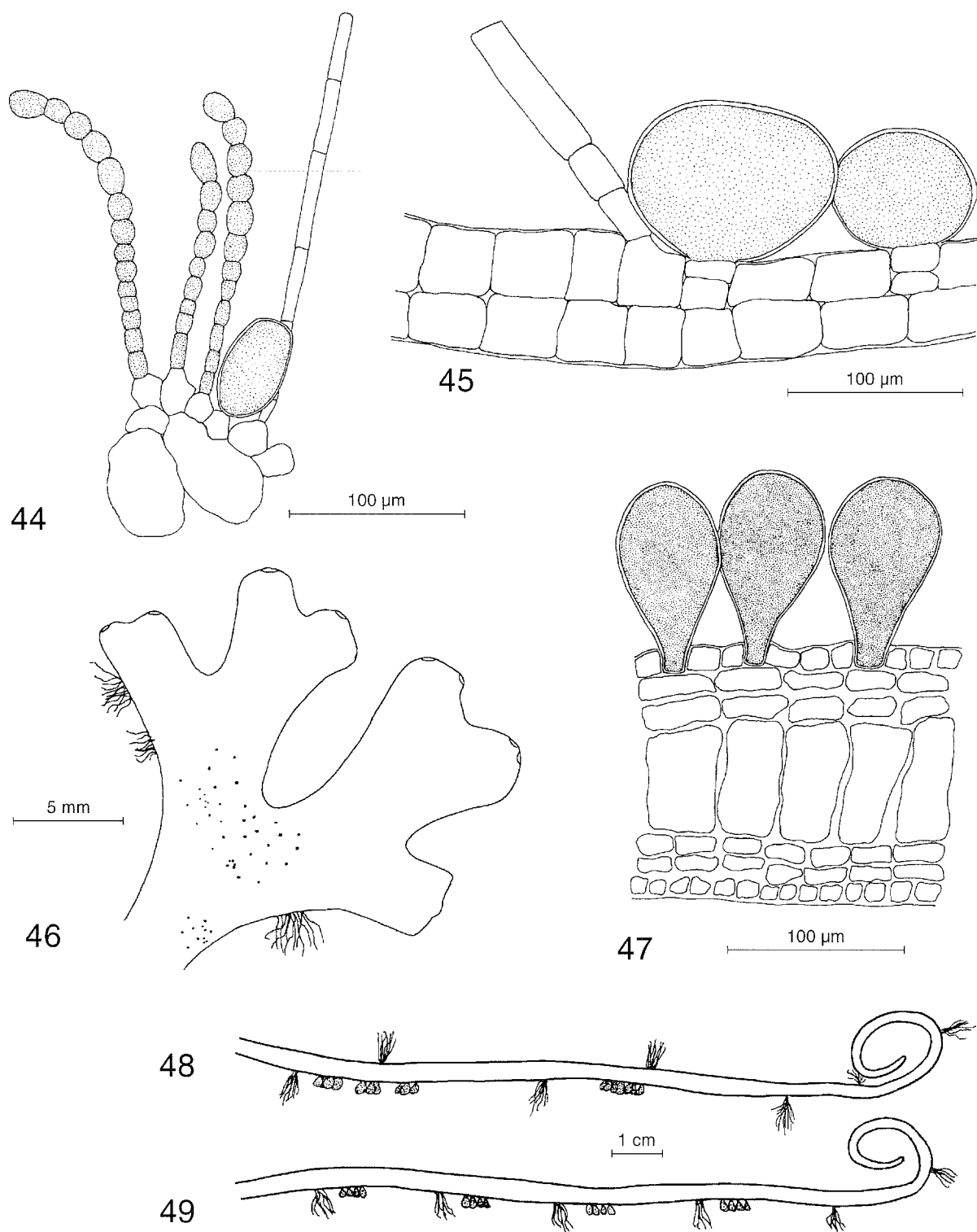

Figs 44-49: 44, *Nemacystus erythraeus*, part of a transverse section showing a few medullary cells, the cortex with assimilatory filaments a hyaline hair and a sporocyst; 45, *Dictyopteris membranacea*, transverse section of the lamina showing two unilocular sporocysts and a hyaline hair; 46, *Dictyota friabilis*, detail of the habit showing dichotomous branching, marginal rhizoids and dispersed tetrasporocysts; 47, *Lobophora variegata*, transverse section of the lamina showing three unilocular sporocysts, the cortex, the subcortex, and the central medullary layer; 48, *Padina boergesenii*, radial section of the lamina showing the distribution of hair rows and sori; 49, *Padina minor*, radial section of the lamina showing the distribution of hair rows and sori.

to which the incurved margin is directed; this generally is the surface facing the sun; reproductive structures are then situated on the lower side; the cells of the upper side are larger than those of the lower side.

*Padina boergesenii* Allender & Kraft

(Figs 48, 50-51)

Material: SNMNH/P/ALG: 52, Site 15, 16.V.1992; 53, Site 18, 18.V.1992; 54, Site 15, 18.VII.1992; 55, Site 16, 20.VII.1992; 56, 57, Site 8, 24.VII.1992; 58, Site 9, 24.VII.1992; 59, Site 21, 30.VII.1992; 60, Site 21, 30.VII.1992; 61, Site 1, 01.XI.1992; 62, Site 11, 02.XI.1992; 63, Site 18, 07.XI.1992; 64, Site 21, 07.XI.1992. — HEC: 9011, Site 16, 04.II.1992; 9087, Site 15, 16.V.1992; 9093, 9094, 9095, Site 15, 17.V.1992; 9100, Site 18, 18.V.1992; 9101, Site 18, 18.V.1992; 9114, Site 19, 19.V.1992; 9125, Site 2, 21.V.1992; 9164, Site 21, 26.V.1992; 9171 a, b, Site 15, 18.VII.1992; 9185, 9196, Site 16, 20.VII.1992; 9207, Site 2, 22.VII.1992; 9226, 9227, Site 8, 24.VII.1992; 9235, 9236, Site 9, 24.VII.1992; 9271, Site 21, 30.VII.1992; 9281, Site 21, 30.VII.1992; 9284, Site 18, 31.VII.1992; 9296, 9298, Site 1, 01.VIII.1992; 9330, 9335, Site 25, 06.VIII.1992; 9345, Site 26, 06.IX.1992; 9355, 9357, Site 27, 06.VIII.1992. — ODC: 13, Site 1, 01.XI.1992; 60, Site 11, 02.XI.1992; 81, Site 8, 05.XI.1992; 86, Site 18, 07.XI.1992; 99, Site 25, 07.XI.1992; 100, Site 21, 07.XI.1992; 107, Site 16, 10.XI.1992; 120, Site 15, 10.XI.1992.

Thallus composed of several supple, flabellate to funnel-shaped lobes, only slightly calcified on both sides, up to 15 cm wide; attachment by a small pluricellular disc, covered by rhizoids; frond with concentric hair rows on the upper and lower surface, separated from each other by smooth areas; hair rows of one side alternating with those of the other side; the distance from any hair row of the lower side to the following hair row of the upper side (only 1-2 mm) is always smaller than the distance from any row from the upper side to the following one from the lower side (being 2-5 mm); in cross-section, this results in an alternation of wider and narrower smooth zones; young hairs are orangy, fully grown hairs long and hyaline. Sporocysts grouped in long concentric sori, just above each hair row of the lower side, not always clearly delimited: in transverse sections it sometimes appears as if there are several soral bands in a single smooth zone. Thallus largely composed of two cell-layers of which the upper one (50 µm) is slightly larger than the lower one (35 µm); the thickness increases towards the basis (100-140 µm) as well as the number of cell layers (3-4). Sori 0.5-1.5 mm broad, not indusiate; sporocysts spherical, 110 µm in diameter, on a small pedicel.

*Padina boergesenii* develops in the spring and disappears in late autumn; growing on hard substrate in the infralittoral zone, along surf-exposed coasts. Depending on their habitat, two growth forms can be distinguished: specimens from reef surfaces are composed of narrower segments and are somewhat darker; thalli from more sheltered sites have larger lobes. Old specimens are frequently covered by numerous epiphytes: *Enteromorpha clathrata*, *Hydrolithon farinosum*, *Herposiphonia secunda* f. *tenella*, *Jania rubens*, *Polysiphonia* spp., *Sphacelaria rigidula*.

*Padina boergesenii* was already reported from the Gulf as *P. gymnospora* sensu Vickers: from the Saudi Arabian Gulf coast by BASSON (1979 a: 55) and DE CLERCK & COPPEJANS (1994: 21), recorded by BASSON et al. (1989: 31) from Bahrain and by NEWTON (1955 a) from Kuwait. AL-HASAN & JONES (1989: 297) reported *P. australis* Hauck from Kuwait. Some authors consider *P. australis* as a synonym of *P. boergesenii*.

*Padina minor* Yamada

(Figs 49, 52)

Material: SNMNH/P/ALG: 65, Site 16, 20.VII.1992; 66, Site 1, 01.VIII.1992. — HEC: 9096, Site 15, 17.V.1992; 9195, Site 16, 20.VII.1992; 9200, Site 27, 21.VII.1992; 9208, Site 2, 22.VII.1992; 9273, Site 21, 30.VII.1992; 9294, Site 1, 01.VIII.1992; 9336, Site 25, 06.VIII.1992.

Thalli up to 8 cm in diameter, composed of a single or several fan-shaped lobes; young specimens undivided, older ones split into numerous narrow, wedge-shaped lobes; upper side markedly more calcified and whitish than the lower side which is orangy-brown; attached by a



pluricellular disc covered by numerous rhizoids; concentric rows of hairs on the frond only well-developed on the lower side, absent or almost invisible on the upper side; width of the smooth zones between the hair rows of the lower side constant: 1-2 mm, depending on the specimen. Transverse section two-layered, 60 µm thick, the upper layer being slightly larger than the lower one. Concentric sori not indusiate, just above each of these hair rows; sporocysts 57-85 µm in diameter.

This species is much rarer in the study area than *P. boergesenii*. The material collected in the spring was very young, with undivided lobes, and sterile; the lobes of the summer material were lacerated into numerous narrow segments and were fertile. Generally occurring in the infralittoral fringe, on hard substrate (including hardened tar).

The distinction of *P. boergesenii* from *P. minor* is not always obvious in the field. Moreover *P. boryana* Thivy is also very similar to these species, but the thallus becomes three cells thick at the base.

New record for the Gulf.

### Order Ectocarpales Family Ectocarpaceae

Genus *Feldmannia* Hamel

*Feldmannia indica* (Sonder) Womersley & Bailey

(Figs 56-57)

*Ectocarpus indicus* Sonder

*Giffordia indica* (Sonder) Papenfuss & Chihara

*Ectocarpus duchassaingianus* Grunow

*Giffordia duchassaingiana* (Grunow) Taylor

Material: SNMNH/P/ALG 67, Site 30, 28.VII.1992. — HEC 9361, Site 30, 28.VII.1992.

Thallus forming small (a few millimetres), brown, woolly tufts of intricate, uniseriate filaments; attached by branched, pluricellular rhizoids; main upright filaments rarely branched, and if so then mostly in the basal region; meristematic zones well marked, darker, intercalary, 200 to 400 µm long, individual meristematic cells 10-25 µm long. Cells of non-meristematic parts generally cylindrical, barrel-shaped in some parts of the thallus, 20 µm in diameter, 55 µm long; plastids discoidal, a single pyrenoid per plastid. Subcylindrical plurilocular zoidocysts solitary, lateral, 32 µm in diameter, 55 µm long; unilocular zoidocysts not present.

A single sample was collected in the summer, on a buoy, just below the water line. Recorded by AL-HASAN & JONES (1989: 220) as *Giffordia indica* from Kuwait. First record for the Saudi Arabian Gulf coast.

*Feldmannia irregularis* (Kützing) Hamel

(Fig. 58)

*Ectocarpus irregularis* Kützing

*Giffordia irregularis* (Kützing) Joly

According to BØRGESEN (1941: 29) the following species are also synonyms:

*Ectocarpus coniger* Børgesen

*Ectocarpus cryptophilus* Børgesen

Material: SNMNH/P/ALG 68, Site 14, 31.I.1992. — HEC: 8991, Site 14, 31.I.1992; 9014, Site 16, 04.II.1992.

Thallus composed of uniseriate, branched, microscopic filaments, forming small hairy tufts 0.5-1 cm high. Branching of the erect filaments mainly basal, no well-marked distinction between main axes and side branches; diameter gradually tapering towards the apices; meristematic zones well-marked, darker near the thallus basis, individual meristematic cells 10-15 µm long. All

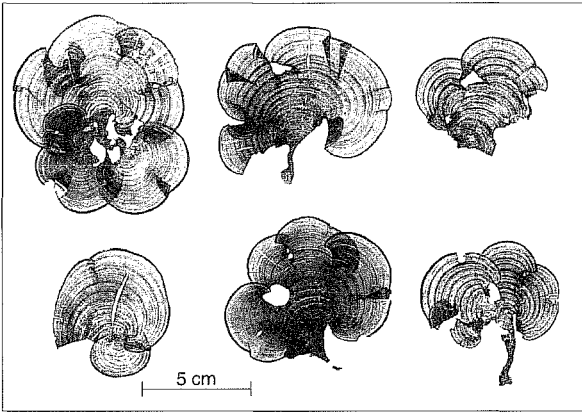

50

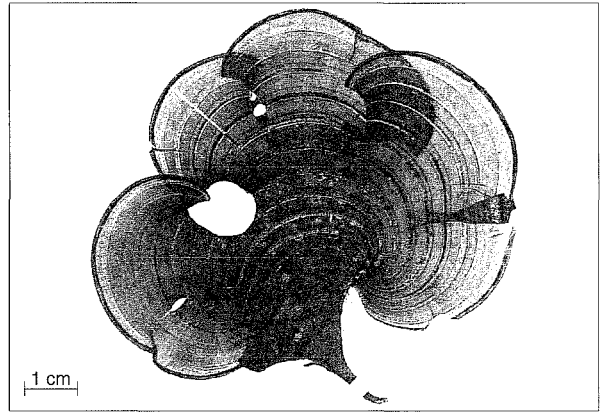

51

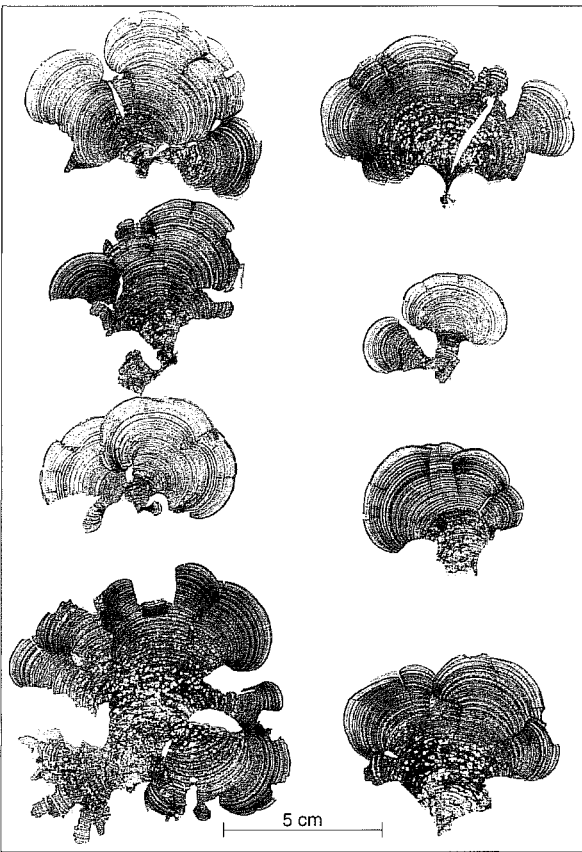

52

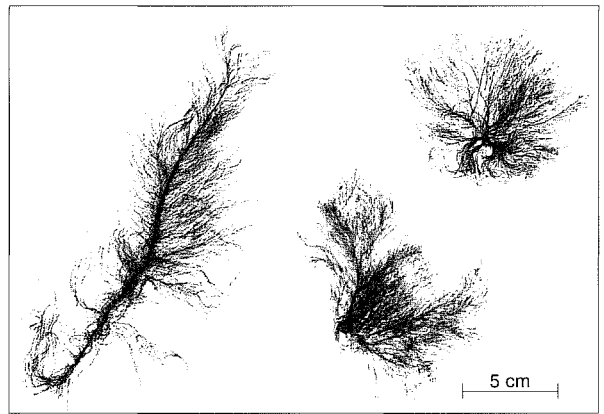

53

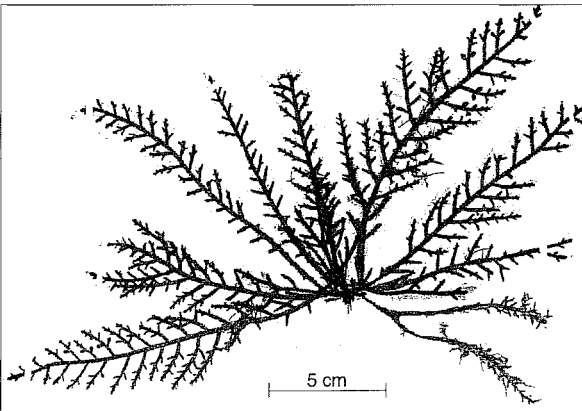

54

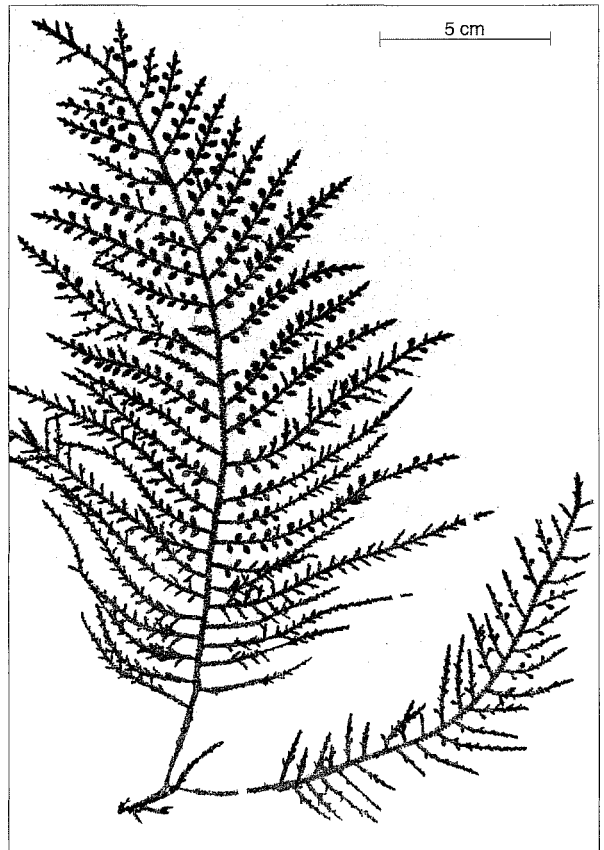

55

vegetative cells cylindrical, not constricted at the transverse walls, 20 µm in diameter, 80-100 µm long; plastids discoidal, each with a single pyrenoid. Plurilocular zoidocysts lateral, sessile, solitary or in series of 2-4, generally just under the meristematic zones, conical, 23-30 µm in diameter, 75-110 µm long; unilocular zoidocysts not observed.

Observed exclusively in the winter, at Abu Ali Island, epiphytic (hemi-endophytic) in the cryptostomata of *Sargassum* spp. and *Cystoseira trinodis*. Reported by BASSON (1979 a: 53) as *Ectocarpus irregularis* from the Saudi Arabian Gulf coast.

### Genus *Hincksia* Gray

*Hincksia mitchelliae* (Harvey) Silva

(Figs 53, 59-60)

*Ectocarpus mitchelliae* Harvey

*Giffordia mitchelliae* (Harvey) Hamel

Material: SNMNH/P/ALG: 69, Site 1, 19.I.1992; 70, Site 18, 26.I.1992; 71, Site 14, 31.I.1992; 72, Site 1, 01.VIII.1992. — HEC: 8894, 8896, Site 1, 19.I.1992; 8946, Site 8, 25.I.1992; 8964, Site 18, 26.I.1992; 8981, Site 14, 31.I.1992; 8982, Site 14, 31.I.1992; 9086, Site 15, 16.V.1992; 9105, 9107, Site 18, 18.V.1992; 9292, Site 1, 01.VIII.1992.

Thallus forming woolly tufts up to 20-30 cm high, composed of uniseriate, branched filaments which become intricate and can form rope-like structures; more rarely as isolated filaments. Branching irregular, with narrow angles (30-45°); young side branches with rather acute apices; main axis not recognisable; growth diffuse. Cells cylindrical, 35-40 µm in diameter at the basis, gradually tapering to 15-20 µm at the apices; cell length up to 85 µm; plastids discoidal, each of them with a single pyrenoid. Presence of apical hyaline pseudohairs, 10-15 µm in diameter. Plurilocular zoidocysts lateral, solitary, or if in series, then isolated from each other by 2-3 vegetative cells, sessile, subcylindrical, 15-20 µm in diameter, 60 µm long; unilocular zoidocysts on the same thallus as the plurilocular ones, lateral, sessile, ovoid, in series of 3-4, 35-55 µm broad.

During the cold season *H. mitchelliae* covers vast surfaces of the reefs, together with *Colpomenia sinuosa*. It also grows epiphytically (e.g. on *Sargassum*) and was found on plastic sheeting wrapped around coral. The species is also present in the summer but these specimens are much smaller. Its distribution is limited to surf-exposed sites: Abu Ali Island, patch reefs, Ras az-Zaur.

Recorded as *Giffordia mitchelliae* by BASSON (1979 a: 53) from the Saudi Arabian Gulf coast, by NEWTON (1955 a) and AL-HASAN & JONES (1989: 296) from Kuwait and by NEWTON (1955 b) from Bahrain.

## Order Fucales

### Family Cystoseiraceae

### Genus *Cystoseira* C. Agardh

*Cystoseira myrica* (S.G. Gmelin) J. Agardh

(Figs 54-55)

*Fucus myrica* S.G. Gmelin

Material: SNMNH/P/ALG: 73, Site 7, 24.I.1992; 74, Site 15, 22.V.1992; 75, Site 15, 18.VII.1992; 76, Site 16, 20.VII.1992; 77, Site 9, 24.VII.1992; 78, Site 24, 28.VII.1992; 79, Site 11, 02.XI.1992. — HEC: 8933, Site 7, 24.I.1992; 9022, Site 16, 05.II.1992; 9082, Site 16, 15.V.1992; 9113, Site 19, 19.V.1992; 9137, Site 15, 22.V.1992; 9178, Site 15, 18.VII.1992; 9191, Site 16, 20.VII.1992; 9234, Site 9, 24.VII.1992; 9267, Site 24, 28.VII.1992; 9297, Site 1, 01.VIII.1992; 9326, Site 25, 06.VIII.1992; 9356, Site 27, 06.VIII.1992. — ODC: 46, Site 11, 02.XI.1992; 73, Site 8, 05.XI.1992.

---

Figs 50-55: 50-51, *Padina boergesenii*: 50, habit; 51, detail of a thallus showing the alternation of narrow and wide smooth zones; 52, *Padina minor*, habit; 53, *Hincksia mitchelliae*, habit; 54-55, *Cystoseira myrica*: 54, habit of a specimen with young annual branches; 55, habit of a fully grown annual branch with numerous aerocysts.

Thallus 10-30 cm high, spiny, more or less resembling a *Picea*; branches usually alternate pinnate, sometimes more irregular towards the basis which is perennial; annual branches completely covered by numerous, small, spiny branchlets; side branches gradually shorter towards the apices of the main axes, resulting in an elongate triangular appearance; ramuli short, sometimes replaced by aerocysts; these are oval, 2 mm wide and 5 mm long, covered by small spines and bearing an apical longer spine, resulting in an apparently lateral air vesicle; sometimes the terminal spine continues to grow and branch, resulting in an intercalary aerocyst which is more characteristic for this genus. Blackish-brown. General appearance relatively variable: some are more slender and bear numerous aerocysts, others are more dense and bear few, if any, aerocysts.

In the winter some of the perennial bases still bear a few eroded erect branches; the annual branches develop in the spring; summer specimens are covered by sediment which is trapped between the spiny branchlets; in the autumn these annual branches are shed. *Cystoseira myrica* is epilithic and mainly develops along surf-exposed coasts, from the infralittoral fringe, where it can be locally abundant, down to the deeper infralittoral. Some specimens have also been collected at more sheltered sites or even in intertidal pools (Ras al-Abkhara); however, it is absent from very sheltered bays.

Reported by BASSON (1979 a: 57) from the Saudi Arabian Gulf coast; recorded by NEWTON (1955 b) and BASSON et al. (1989: 31) from Bahrain and by NEWTON (1955 a) and AL-HASAN & JONES (1989: 289) from Kuwait.

*Cystoseira trinodis* (Forsskål) C. Agardh

(Fig. 61)

*Fucus trinodis* Forsskål

*Cystophyllum trinode* (Forsskål) J. Agardh

*Cystoseira muricata* (Turner) C. Agardh

*Cystophyllum muricatum* (Turner) J. Agardh

Material: SNMNH/P/ALG: 80, Site 9, 25.I.1992; 81, Site 21, 30.VII.1992; 82, Site 1, 01.XI.1992; 83, Site 22, 02.XI.1992. — HEC: 8941, Site 9, 25.I.1992; 8951, Site 10, 26.I.1992; 9004, Site 15, 04.II.1992; 9021, Site 16, 05.II.1992; 9134, Site 2, 22.V.1992; 9161, Site 21, 26.V.1992; 9197, Site 27, 21.VII.1992; 9272, Site 21, 30.VII.1992; 9334, Site 25, 06.VIII.1992. — ODC: 15, Site 1, 01.XI.1992; 29, Site 22, 02.XI.1992; 45, Site 11, 02.XI.1992; 62, Site 14, 02.XI.1992; 96, Site 25, 07.XI.1992; 101, Site 21, 07.XI.1992.

Thallus 30-70 cm high, slender and supple; branching radial; basis perennial, clavate, densely covered by small spiny outgrowths and bearing some complanate, linear phylloid structures up to 4 cm long, 2 mm broad and with smooth margins. Annual branches cylindrical, 1-3 mm in diameter, generally slightly muricate, but sometimes almost smooth or rather densely covered by branched spines; side axes bearing short terete ramuli; aerocysts intercalary, solitary or in twos (or threes), spindle-shaped, 1 mm in diameter, 3-4 mm long, in the apical part of the branches, the terminal one with an apical spine; cryptostomata over the whole thallus surface; basal part dark brown, upright axes yellowish-brown. Receptacles lateral on side branches, frequently under the aerocysts, simple or irregularly branched, cylindrical, 0.5-1 cm long, approximately 1 mm in diameter.

Annual branches start growing in the autumn and are fully grown by the winter; they are shed in the summer. *Cystoseira trinodis* grows exclusively epilithically in the relatively deeper infralittoral zone (2-5 m depth) along surf-exposed coasts: Abu Ali Island, Ras az-Zaur and around the patch reefs, attached to coral fragments on sand, seaward of the reef or on sand-covered hard substrate, frequently associated with *Hormophysa cuneiformis* and *Sargassum decurrens*.

BASSON (1979 a: 59) suggested that the presence of only one or two (instead of two or three) aerocysts might be due to the extreme ecological conditions in the Gulf, causing more stress for

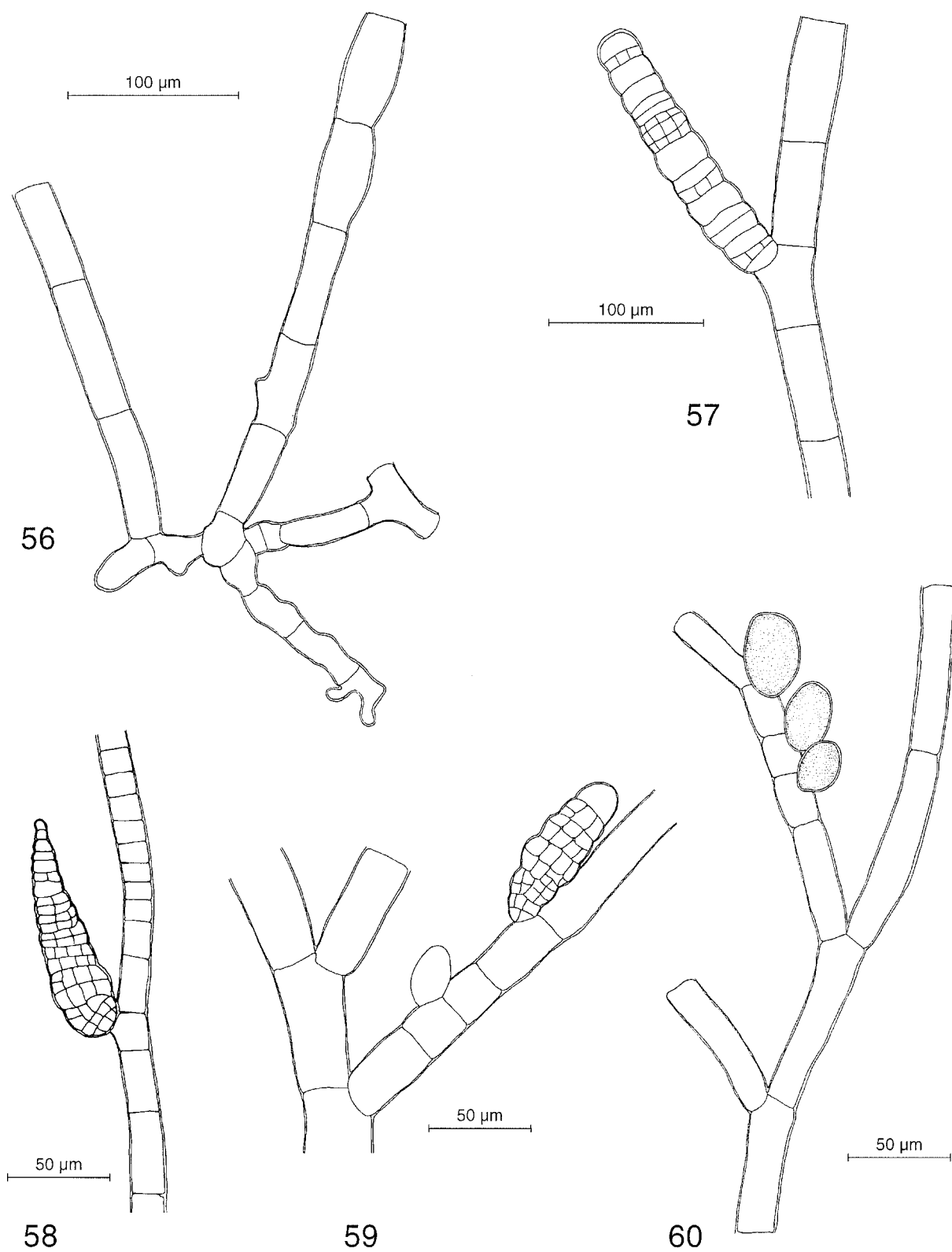

Figs 56-60: 56-57, *Feldmannia indica*: 56, portion of the rhizoidal holdfast; 57, portion of a filament bearing a single, sessile, cylindrical plurilocular zoidocyst; 58, *Feldmannia irregularis*, portion of a filament bearing a single, sessile, conical plurilocular zoidocyst; 59-60, *Hinckesia mitchelliae*: 59, portion of a filament bearing a single, sessile, subcylindrical plurilocular zoidocyst and a juvenile plurilocular zoidocyst; 60, portion of a filament bearing a series of three unilocular zoidocysts.

the organisms. The number of serial aerocysts in material from Kenya, for example, is also very variable and therefore does not confirm BASSON's (l.c.) hypothesis.

Reported by BASSON (l.c.) from the Saudi Arabian Gulf coast; recorded by NEWTON (1955 b) and BASSON et al. (1989: 32) from Bahrain and by NEWTON (1955 a) and AL-HASAN & JONES (1989: 298) from Kuwait.

### Genus *Hormophysa* Kützing

#### *Hormophysa cuneiformis* (J.F. Gmelin) Silva

(Fig. 62)

*Fucus cuneiformis* J.F. Gmelin

*Hormophysa triquetra* (C. Agardh) Kützing

Material: SNMNH/P/ALG: 84, Site 21, 26.V.1992; 85, Site 15, 18.VII.1992; 86, Site 1, 01.XI.1992; 87, Site 22, 02.XI.1992. — HEC: 8936, Site 7, 24.I.1992; 8957, Site 10, 26.I.1992; 9162, Site 21, 26.V.1992; 9174, Site 15, 18.VII.1992; 9353, Site 27, 06.VIII.1992. — ODC: 19, Site 1, 01.XI.1992; 30, Site 22, 02.XI.1992; 47, Site 11, 02.XI.1992; 104, Site 27, 07.XI.1992.

Thallus 20-50 cm high, erect, stiff; branching irregular, pinnate or in verticils; basis perennial, small; annual branches single or numerous on a small stipe, three-winged, more or less segmented and with markedly dentate margins; aerocysts intercalary, developed in the medulla, giving an articulated appearance to the axes because the axes are constricted between two aerocysts and the wing-like structures are interrupted; orangy brown.

*Hormophysa cuneiformis* is a perennial species with maximum development of the annual branches in the summer; in the autumn they are largely covered by epiphytes: *Hydrolithon farinosum*, *Herposiphonia secunda*, *Leveillea jungermannioides* etc. Most of the specimens lose their annual axes the winter. *Hormophysa cuneiformis* is a general species in the study area, occurring on hard substrate along surf-exposed coasts, but it has also been observed at the more sheltered Ras al-Abkhara. Like *Cystoseira trinodis*, this species does not occur on the coral reefs, but on coral fragments on sand just outside the reef or on sand-covered hard substrate of the infralittoral where, locally, it forms extended patches.

Reported by BASSON (1979 a: 59) from the Saudi Arabian Gulf coast; recorded by NEWTON (1955 b) and BASSON et al. (1989: 32) from Bahrain and by AL-HASAN & JONES (1989: 298) from Kuwait.

### Family Sargassaceae

#### Genus *Sargassum* C. Agardh

*Sargassum* species are morphologically very variable. On a world-wide scale 150-200 species have been described (WOMERSLEY 1987: 418); a large number of these are most probably growth forms (ecads) or even only growth stages of a single entity. The representatives of some regions from the south-east Asian Pacific have recently been restudied and redescribed (TSENG et al. 1985; ABBOTT et al. 1988; MAGRUDER 1988; TSENG & BAOREN 1988; TSUDA 1988; YOSHIDA 1988), but as yet no such study has been carried out in the Indian Ocean.

In the material from the Gulf some extreme forms are easily recognisable and identifiable, but aberrant or intermediate forms are numerous, especially between *S. angustifolium*, *S. boveanum*,



61

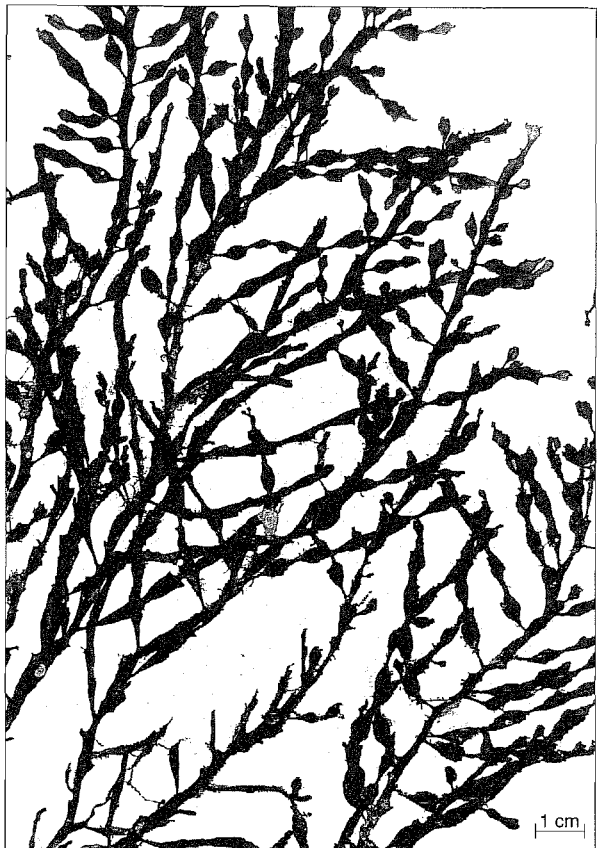

62

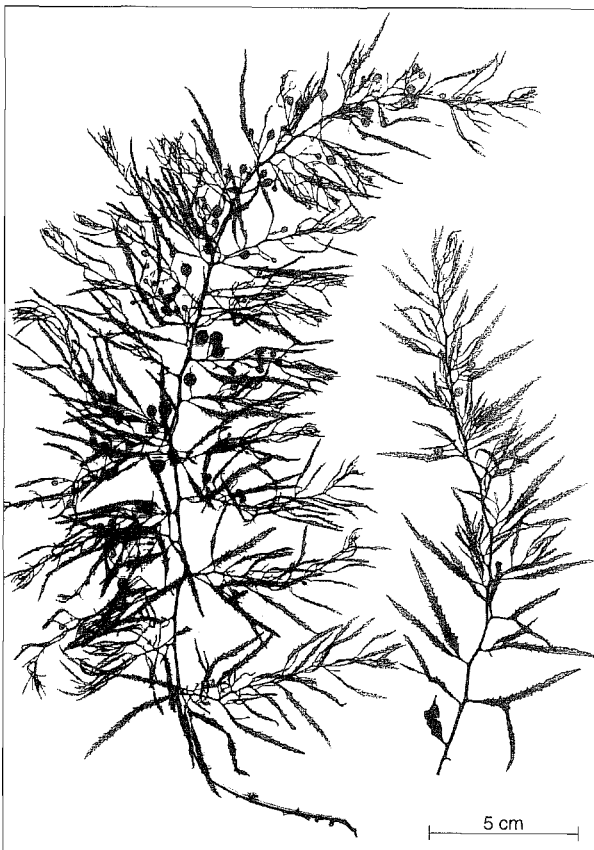

63

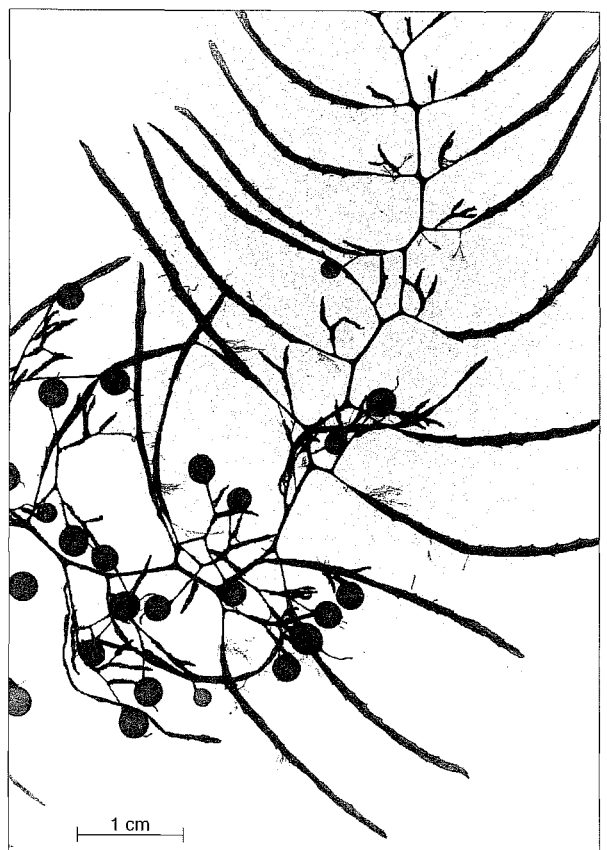

64

*S. boveanum* var. *aterrimum* and *S. latifolium*. Owing to the absence of taxonomic consensus we do not provide any synonymies.

Our herbarium specimens have been identified according to BASSON (1979 a: 59-60) and the morphologically most typical specimens have been indicated.

*Sargassum angustifolium* C. Agardh

(Figs 63-64)

Material: SNMNH/P/ALG: 88, Site 9, 25.I.1992; 89 (most typical), Site 10, 26.I.1992; 90, Site 14, 31.I.1992; 91, 92, Site 15, 22.V.1992; 93, Site 1, 01.XI.1992; 94, Site 18, 07.XI.1992. — HEC: 8900, Site 1, 19.I.1992; 8943, Site 9, 25.I.1992; 8954, 8955 (most typical), Site 10, 26.I.1992; 8992, Site 14, 31.I.1992; 9006, Site 15, 04.II.1992; 9138, 9140, Site 15, 22.V.1992; 9153, Site 1, 25.V.1992; 9311, Site 1, 01.VIII.1992. — ODC: 20, Site 1, 01.XI.1992; 90, Site 18, 07.XI.1992.

Thallus erect, up to 30-60 cm long, elegant and supple, attached by a small perennial, parenchymatous disc 1 cm in diameter; perennial stipe very short, hardly visible, bearing the annual branches; these terete, 1 mm in diameter. Branching distichous, alternate, sometimes somewhat sympodial; phylloids very narrow, simple, linear (rarely forked), 1-3 mm broad, 10-50 mm long, margin dentate, apex pointed, midrib slightly developed only in the broader phylloids; cryptostomata small and not conspicuous; aerocysts on the side branches, lateral, pedicellate, spherical, sometimes mucronate, 2-4 mm in diameter; light to dark brown. Receptacles in axillary clusters, simple or furcate, 0.3 mm broad, up to 8 mm long.

*Sargassum angustifolium* was observed frequently on the subtidal reef platforms, but only in the spring; it forms extended *Sargassum* beds up to 1 m high together with *S. boveanum* and *S. latifolium*. In the summer these impressive vegetation beds disappeared, except for a few locations at Abu Ali Island (Sites 2 and 16).

Reported by BASSON (1979 a: 59) from the Saudi Arabian Gulf coast; recorded by NEWTON (1955 b) from Bahrain and by NEWTON (1955 a) and AL-HASAN & JONES (1989: 298) from Kuwait.

*Sargassum binderi* Sonder

(Figs 65-66)

Material: SNMNH/P/ALG: 95 (most typical), Site 1, 25.V.1992; 96, 97, Site 2, 31.X.1992. — HEC: 9152 (most typical), Site 1, 25.V.1992; 9177, Site 15, 18.VII.1992; 9349, Site 26, 06.VIII.1992. — ODC 11, 12, Site 2, 31.X.1992.

Thallus up to 40 cm high, erect, tough, attached by a small perennial parenchymatous disc 1 cm in diameter. Branches erect, radially branched, phylloids broad, oval, 1-1.5 cm broad, 3-5 cm long, very crisp, with a midrib; margin smooth or dentate, apex blunt; cryptostomata absent; aerocysts pedicellate, spherical, not mucronate, 5 mm in diameter; light brown to yellowish, markedly lighter colour than the other *Sargassum* spp. Receptacles grouped in axillary clusters, dichotomously branched, 1-2 mm long.

*Sargassum binderi* was not observed frequently in situ in the area: in spring it forms patches locally on sand-covered hard substrate at 3-7 m depth a few hundred metres out from Abu Ali Island. In the summer large quantities of floating specimens were observed; locally it must be abundant.

Reported by BASSON (1979 a: 59) from the Saudi Arabian Gulf coast and recorded by AL-HASAN & JONES (1989: 298) from Kuwait.





65



66

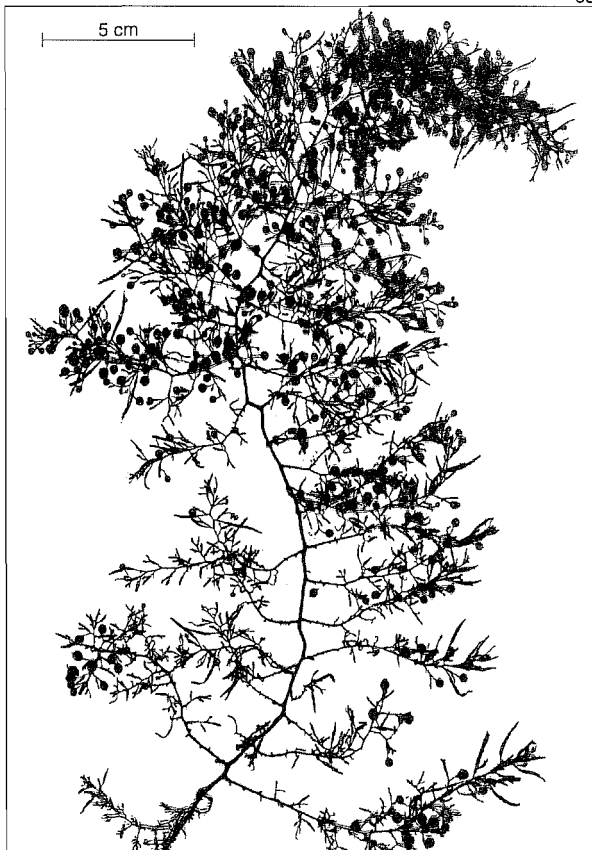

67

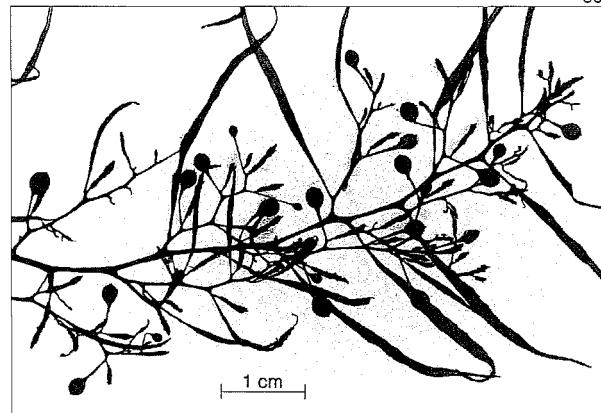

68

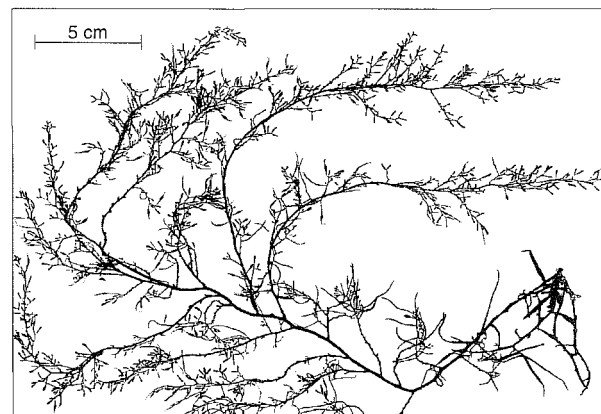

69

*Sargassum boveanum* J. Agardh (Figs 67-68)

Material: SNMNH/P/ALG 98 (most typical), Site 1, 25.V.1992. — HEC: 9154 (most typical), 9155, Site 1, 25.V.1992; 9158, 9159, 9160, Site 21, 26.V.1992. — ODC 127, Site 31, 12.XI.1992.

Thallus up to 60-70 cm high, erect, thin and elegant, attached by a small perennial parenchymatous disc 1 cm in diameter; perennial stipe 0.5 cm long, terete, sometimes bearing tophules (basal olive-shaped to subspherical branch swellings); axes cylindrical, 1 mm in diameter, slightly sympodial, side branches alternating, short, resulting in a well-marked main axis; phylloids linear, margin smooth or slightly undulated, 0.5-1 mm broad, 0.5-3.5 cm long, apex rounded; cryptostomata inconspicuous; aerocysts pedicellate, spherical, smooth or mucronate, 4-5 mm in diameter; thallus light to dark brown. Receptacles in axillary clusters, on side branchlets of higher order, simple, terete, with slightly verrucose surface, 5-10 mm long.

Same distribution and seasonality as *S. angustifolium*. Reported by BASSON (1979 a: 59) from the Saudi Arabian Gulf coast; recorded by NEWTON (1955 b) and BASSON et al. (1989: 32) from Bahrain and by NEWTON (1955 a) and AL-HASAN & JONES (1989: 298) from Kuwait.

*Sargassum boveanum* J. Agardh var. *aterrimum* Grunow (Fig. 69)

Material: SNMNH/P/ALG 99, Site 15, 22.V.1992. — HEC: 9139, Site 15, 22.V.1992; 9160 (most typical), Site 21, 26.V.1992.

Thallus up to 40 cm high, erect, supple and elegant, attached by a small perennial parenchymatous disc; perennial stipe 3 mm long; all branches terete, branching of the main axes distichous, alternating; side branches becoming long, obscuring the main axis; phylloids linear, 0.5-1 mm broad, 10-30 mm long, margins smooth; aerocysts subspherical to spindle-shaped, 2 mm wide, 3-6 mm long, with terminal mucron of up to 2 mm long. Receptacles in axillary clusters, simple, cylindrical, 5-10 mm long.

Same distribution and seasonality as *S. angustifolium*. Reported by BASSON (1979 a: 60) from the Saudi Arabian Gulf coast.

*Sargassum decurrens* (Brown ex Turner) C. Agardh (Figs 70-71)

*Fucus decurrens* Brown ex Turner

Material: SNMNH/P/ALG: 100, Site 9, 25.I.1992; 101, Site 2, 22.V.1992; 102, Site 22, 21.VII.1992; 103, Site 1, 01.XI.1992; 104, Site 11, 02.XI.1992; 105, Site 25, 07.XI.1992. — HEC: 8942, Site 9, 25.I.1992; 8993, Site 14, 31.I.1992; 9133, Site 2, 22.V.1992; 9156, 9157, Site 1, 25.V.1992; 9198, Site 22, 21.VII.1992; 9312, Site 1, 01.VIII.1992; 9325, Site 25, 06.VIII.1992; 9352, Site 27, 06.VIII.1992. — ODC: 18, Site 1, 01.XI.1992; 59, Site 11, 02.XI.1992; 92, Site 25, 07.XI.1992; 103, Site 27, 07.XI.1992.

Thallus 15-35 cm high, erect, markedly symmetrical, fern-like, stiff, attached by a small perennial disc 1 cm in diameter; perennial stipe terete, 0.5-5 cm long; annual branches terminal on the stipe, compressed, winged, with a more or less marked midrib, 5-7 mm wide at the basis, tapering towards the apex; lateral branches distichous, alternate, also complanate, becoming shorter towards the apex of the main axis, resulting in a long triangular appearance, branching 2-3 times, becoming gradually narrower; aerocysts not present on all specimens, axillary of the side branches spherical, pedicellate, sometimes mucronate, 3-5 mm in diameter; orangy brown to dark brown. Receptacles in irregular clusters, on the upper side of branchlets, simple or furcate, terete to clavate, 0.7-1 mm in diameter, 2-4 mm long.

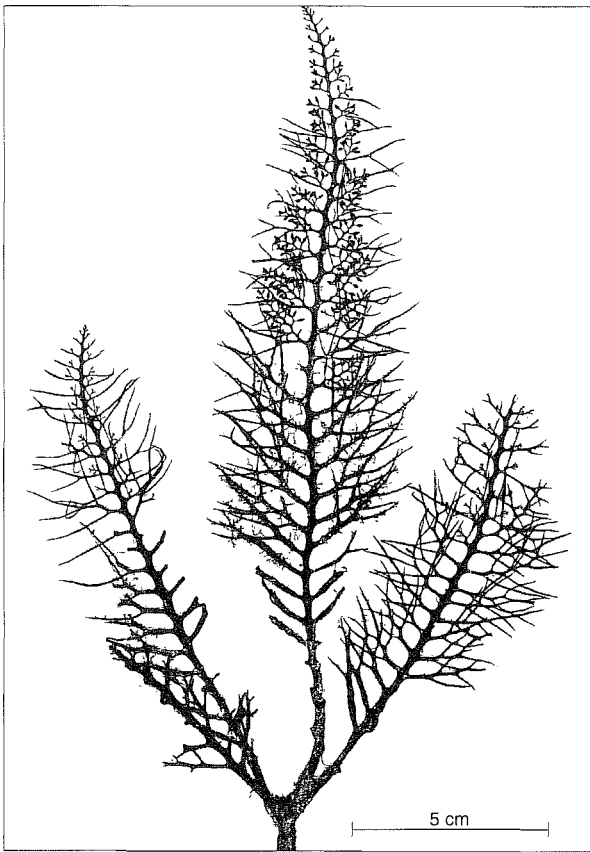

70

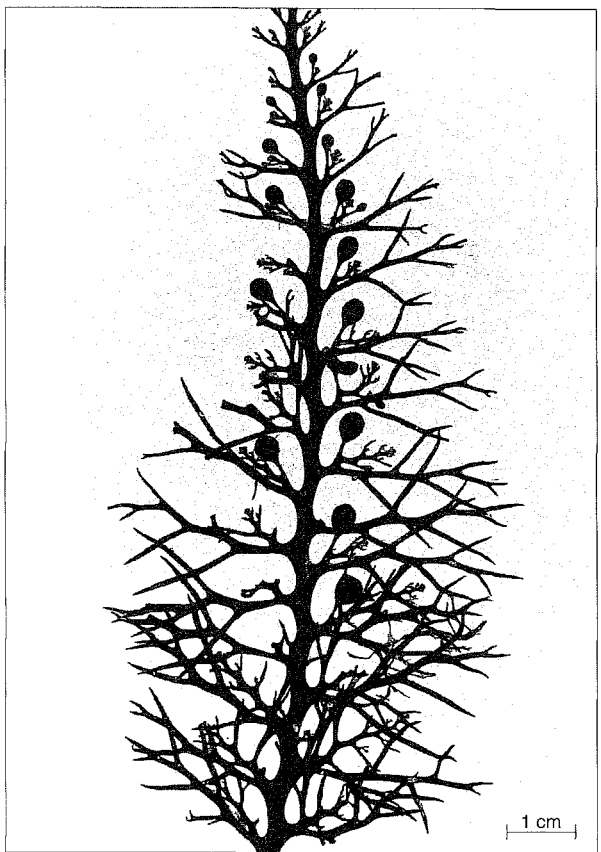

71

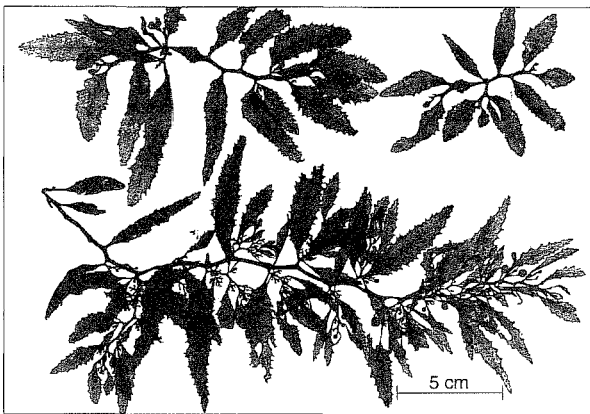

72



73

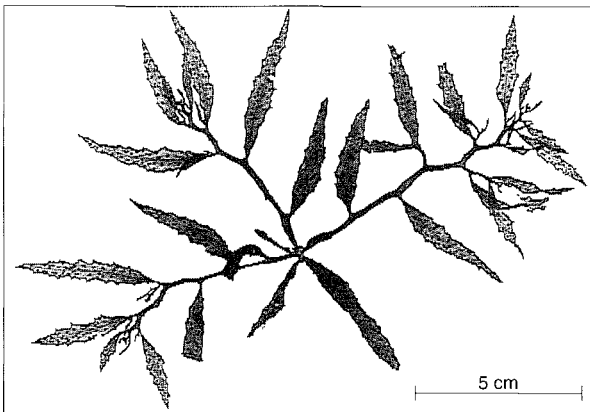

74

Sterile, fertile and eroded specimens were observed in all seasons, thus without well-defined seasonality. Mainly growing along surf-exposed coasts, on hard substrate in the infralittoral, frequently associated with *Hormophysa cuneiformis* and *Cystoseira trinodis*.

*Sargassum decurrens* has been recorded from the Gulf by NEWTON (1955 a). Most other authors (BASSON 1979 a: 60, AL-HASAN & JONES 1989: 299, BASSON et al. 1989: 32) describe it as *S. heteromorphum* J. Agardh. WOMERSLEY (1987: 419-422) suggests that the *S. heteromorphum* material from the Gulf most probably belongs to *S. decurrens*; we agree with him, according to his descriptions and illustrations of both species, after material from South Australia.

*Sargassum latifolium* (Turner) C. Agardh

(Figs 72-74)

*Fucus latifolius* Turner

Material: SNMNH/P/ALG: 106 (most typical), Site 10, 26.I.1992; 107, Site 2, 21.V.1992; 108, Site 15, 22.V.1992; 109, Site 15, 18.VII.1992; 110, 111, Site 1, 01.VIII.1992; 112, Site 2, 31.X.1992; 113, Site 2, 31.X.1992; 114, Site 11, 02.XI.1992; 115, Site 25, 07.XI.1992; 116, 117, Site 16, 10.XI.1992; 118, Site 15, 10.XI.1992. — HEC: 8899, Site 1, 19.I.1992; 8952 (most typical), 8956, Site 10, 26.I.1992; 8966, Site 18, 26.I.1992; 8990, Site 14, 31.I.1992; 9126, Site 2, 21.V.1992; 9138, Site 15, 22.V.1992; 9175, 9176, Site 15, 18.VII.1992; 9309, 9310, Site 1, 01.VIII.1992. — ODC: 11, Site 2, 31.X.1992; 12, Site 2, 31.X.1992; 20, Site 1, 01.XI.1992; 61, Site 11, 02.XI.1992; 97, Site 25, 07.XI.1992; 102, Site 21, 07.XI.1992; 108, 109, Site 16, 10.XI.1992; 121, Site 15, 10.XI.1992.

Thallus up to 70 cm high, erect, elegant, attached by a small perennial disc; perennial stipe short, simple, terete; annual branches strongly compressed to cylindrical, 2-4 mm broad, sympodially branched (marked zigzag-shaped main axis); phylloids rather fleshy, morphologically strongly variable, generally lanceolate, markedly dentate, apex pointed, 0.5-1 cm broad, 2-6 cm long; cryptostomata all over the thallus, 0.5-1 mm in diameter; aerocysts subspherical to spindle-shaped, 3-6 mm broad, 5-10 mm long, smooth, without a terminal mucron. Receptacles in axillary clusters, cylindrical, simple or furcate, 1-2 mm long.

*Sargassum latifolium* is the most common *Sargassum* species in the study area. It covers large areas of the infralittoral reef platform during late winter (from end of February onwards) and the spring, together with *S. angustifolium* and *S. boveanum*. During the summer and autumn it is the only *Sargassum* species which remains fully grown, especially along Abu Ali Island. During these seasons young, prostrate specimens are also frequent in this biotope.

Reported by BASSON (1979 a: 60) from the Saudi Arabian Gulf coast; recorded from Bahrain by NEWTON (1955 b) and BASSON et al. (1989: 32).

Genus *Turbinaria* Lamouroux

*Turbinaria ornata* (Turner) J. Agardh f. *evesiculosa* (Barton) Taylor

(Figs 75, 77)

*Turbinaria conoides* (J. Agardh) Kützting var. *evesiculosa* Barton

Material: SNMNH/P/ALG 119, Site 30, 03.VIII.1992. — HEC 9321, Site 30, 03.VIII.1992.

Thallus composed of a well-developed prostrate, stolonoidal part and some erect axes with peltate branchlets; the whole structure stiff and tough: stolonoids 1 mm in diameter, more or less dichotomous, forming an extended network; erect axes unbranched, 3-4 cm high, bearing rows of compactly placed peltate branchlets; these can be absent at the basal parts, leaving rows of scars and resulting in a stipitate appearance of the erect fronds; stipe of the phylloids 10 mm long, widening from the basis (2 mm) to the peltate top (3-4 mm); phylloids triangular in surface view, 10-12 mm in diameter, margin strongly dentate, generally with 2-3 intramarginal teeth or even a small intramarginal ridge; no aerocysts; dark brown. Receptacles in dense axillary clusters, 3 mm long, simple.

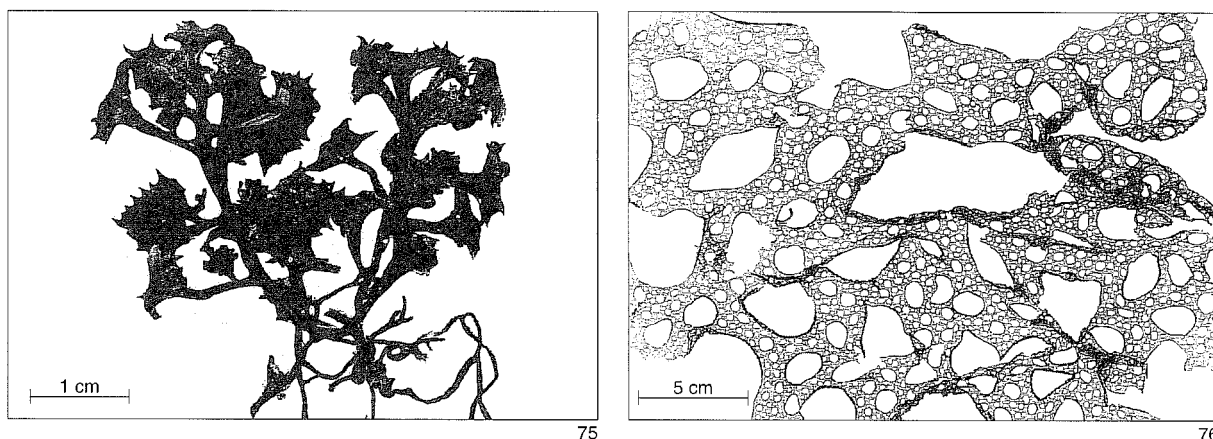

Figs 75-76: 75, *Turbinaria ornata* f. *evesiculosa*, habit; 76, *Hydroclathrus clathratus*, habit.

This species was only observed at Karan (Site 30), where the stolonoid stage covers vast areas of the reefs; the typical erect axes were only observed sporadically.

BASSON reported *T. conoides* (J. Agardh) Kützing from Karan. According to TAYLOR (1964: 476) and observations of Coppejans along the Kenyan coast, this species is much more slender, the erect axes being ramified, and the peltate branchlets contain an aerocyst.

New record for the Gulf.

#### Order Scytosiphonales Family Scytosiphonaceae

Genus *Colpomenia* (Endlicher) Derbès & Solier

*Colpomenia sinuosa* (Mertens ex Roth) Derbès & Solier

(Fig. 78)

*Ulva sinuosa* Mertens ex Roth

Material: SNMNH/P/ALG 120, Site 14, 31.I.1992. — HEC: 8895, Site 1, 19.I.1992; 8963, Site 18, 26.I.1992; 8979, Site 14, 31.I.1992; 9083, Site 15, 16.V.1992.

Thallus forming brittle, hollow structures, spherical when young, becoming irregularly lobed to cerebriform, up to 20 cm in diameter; yellowish-brown structure composed of 5-8 cell layers, with two cortical layers of thick-walled cells, 9-12  $\mu\text{m}$  in diameter, and thin-walled medulla cells, gradually becoming larger towards the centre of the thallus; surface covered by bundles of hyaline hairs; fertile specimens with numerous sori (diameter 200-400  $\mu\text{m}$ ) of uniseriate, plurilocular sporocysts with a central hair bundle.

*Colpomenia sinuosa* covers vast surfaces of sublittoral reef flats during the winter. In the spring these die off, leaving enormous amounts of loose-lying material in the lagoon where they are quickly broken down. By the summer they have disappeared completely. A single observation as epiphyte on *Halodule uninervis*. Distribution related to the coral reefs: Ras az-Zaur, Abu Ali Island and the patch reefs.

Reported by BASSON (1979 a: 57) from the Saudi Arabian Gulf coast; recorded by NEWTON (1955 b) and BASSON et al. (1989: 31) from Bahrain and by NEWTON (1955 a) and AL-HASAN & JONES (1989: 297) from Kuwait.

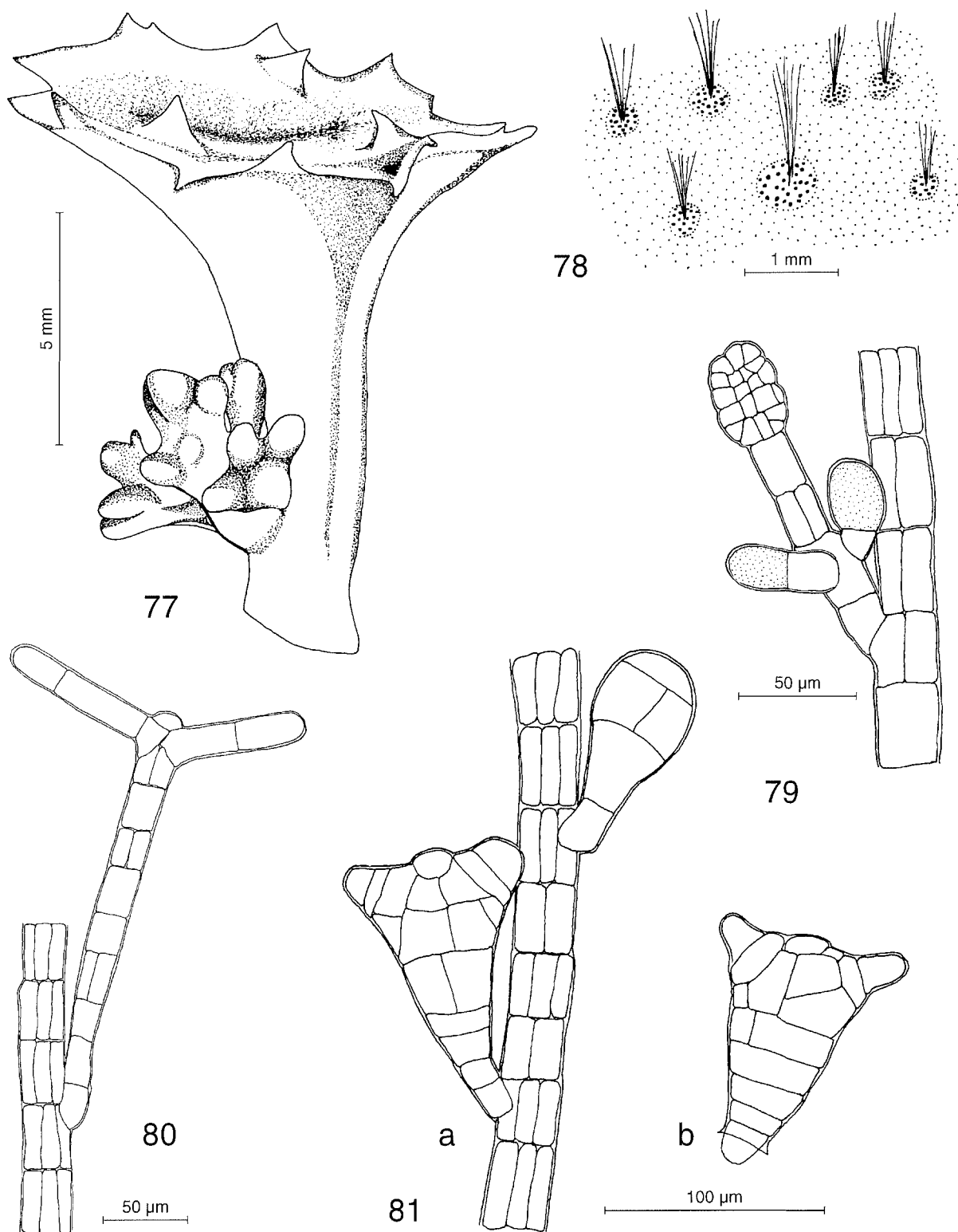

Figs 77-81: 77, *Turbinaria ornata* f. *evesiculosa*, branchlet of an erect axis with a terminal peltate phylloid and a juvenile receptacle; 78, *Colpomenia sinuosa*, surface pattern of punctate sori each with a central hair tuft; 79-80, *Sphacelaria rigidula*: 79, portion of an axis bearing three pedicellate plurilocular zoidocysts; 80, portion of an axis bearing a Y-shaped propagule; 81, *Sphacelaria tribuloides*: a, portion of an axis bearing a juvenile subspherical and a fully grown tribuliform propagule; b, a shed germinating propagule.

Genus *Hydroclathrus* Bory*Hydroclathrus clathratus* (C. Agardh) Howe

(Fig. 76)

*Encoelium clathratum* C. Agardh*Hydroclathrus cancellatus* Bory

Material: SNMNH/P/ALG 121, Site 2, 21.V.1992. — HEC 9122, Site 2, 21.V.1992.

Thallus forming brittle, hollow, perforated structures, up to 30 cm in diameter; perforations from circular to irregularly oval, 0.1-5 cm in diameter; orangy brown; sterile.

Observed exclusively at the eastern tip of Abu Ali Island, during late winter and early spring, on a rocky platform just below low water. Like *Colpomenia*, the entire *Hydroclathrus* population dies off in spring, forming enormous loose-lying masses in the lagoon and decaying quite quickly.

Reported by BASSON (1979 a: 57) from the Saudi Arabian Gulf coast; recorded by BASSON et al. (1989: 31) from Bahrain and by NEWTON (1955 a) from Kuwait.

## Order Sphacelariales

## Family Sphacelariaceae

Genus *Sphacelaria* Lyngbye*Sphacelaria rigidula* Kützinger

(Figs 79-80)

*Sphacelaria furcigera* Kützinger

Material: SNMNH/P/ALG: 122, Site 14, 31.I.1992; 123, Site 15, 22.V.1992. — HEC: 8898, Site 8, 02.II.1992; 8982, Site 14, 31.I.1992; 9012, 9013, 9016, Site 16, 04.II.1992; 9109, Site 15, 17.V.1992; 9136, Site 15, 22.V.1992; 9163, Site 21, 26.V.1992; 9275, Site 21, 30.VII.1992; 9342, Site 25, 06.VIII.1992.

Forming small, stiff, epiphytic tufts, 2-5 mm high. Attachment by small discs, forming stolonoidal branches developing new discs; upright filaments 50 µm in diameter at the base, gradually tapering towards the apices; hyaline hairs (15-20 µm in diameter) are frequent in the apical regions; branching irregular; main axis and side branches very similar; prominent apical cell cylindrical, rounded, 65-88 µm long, splitting transversely into a primary segment which is divided again by a transverse wall into two secondary segments (usually of equal size); these secondary segments then undergo longitudinal divisions, producing the mature polysiphonous filament (after PRUD'HOMME VAN REINE 1982: 7); segments 30-45 µm long, length/width: 1-1.5. Propagules Y-shaped, composed of a basal stipe-shaped part, 170-230 µm long, slightly tapering towards its basis and two upwardly directed similar branches (100-245 µm long); the apical cell of the stipe forming a well-marked papilla between the branches. Plurilocular zoidocysts stalked, generally in threes, 28 µm in diameter, 40 µm long.

Most frequent in the cold season, but present throughout the year, most frequently as an epiphyte on old *Sargassum* and *Cystoseira trinodis* specimens in the infralittoral zone along surf-exposed coasts.

Reported by BASSON (1979 a: 53) from the Saudi Arabian Gulf coast as *S. furcigera*; recorded by NEWTON (1955 b) and BASSON et al. (1989: 31) from Bahrain and by NEWTON (1955 a) and AL-HASAN & JONES (1989: 296) from Kuwait.

*Sphacelaria tribuloides* Meneghini

(Fig. 81)

*Sphacelaria rigida* Hering

Material: SNMNH/P/ALG 124, Site 18, 31.VII.1992. — HEC: 9290, Site 18, 31.VII.1992; 9293, Site 1, 01.VIII.1992.

Macroscopically very similar to *S. rigidula*, but epilithic. Filaments sparsely branched, angle of ramification very narrow (30°), all axes almost parallel; no difference in diameter between them;

axes 50 µm in diameter at the basis, gradually tapering towards the apices (25 µm); apical cell 100 µm long, cylindrical, with rounded top, with similar development as described for *S. rigidula*; segments 40-65 µm long, length/width: 1-2. Propagules tribuliform (obtriangular with rounded corners), stipitate, 100-120 µm long, 60-70 µm wide at the top; apical cell extruding; young propagules spherical. Pluri- and unilocular zoidocysts not observed.

Epilithic in the intertidal, the infralittoral fringe and the infralittoral zone, along surf-exposed coasts: Abu Ali Island, southern patch reef, collected in the summer, autumn and winter.

This species may be confused with *S. novae-hollandiae* Sonder which has similar propagules, but the length/width ratio of the segments is only 0.6-1. This species was recorded by AL-HASAN & JONES (1989: 296) from Kuwait, also as an epiphyte on other brown algae. *Sphacelaria tribuloides* was reported by BASSON (1979 a: 55) from the Saudi Arabian Gulf coast; recorded by BASSON et al. (1989: 31) from Bahrain and by AL-HASAN & JONES (l.c.) from Kuwait.

## Division Rhodophyta

### Key to species of the division Rhodophyta

- |       |  |                                  |
|-------|--|----------------------------------|
| 1.a.  | Thallus calcified (sometimes only slightly so and still supple) . . . . .  | 2                                |
| b.    | Thallus not calcified . . . . .  | 8                                |
| 2.a.  | Thallus erect . . . . .  | 3                                |
| b.    | Thallus encrusting . . . . .   | 5                                |
| 3.a.  | Branchlets in verticils; lime deposition mainly at the basis   | <i>Crouania attenuata</i>        |
| b.    | No verticillate branchlets, branching of main axes dichotomous; calcification all over   | 4                                |
| 4.a.  | Thallus supple, not articulated, up to 10 cm high  | <i>Liagora distenta</i>          |
| b.    | Thallus brittle, articulated, 1-5 cm high  | <i>Jania rubens</i>              |
| 5.a.  | Thallus epiphytic, up to a few mm in diameter  | <i>Hydrolithon farinosum</i>     |
| b.    | Thallus epilithic, up to several centimetres in diameter . . . . .   | 6                                |
| 6.a.  | Thallus tuberculate, sometimes branched  | <i>Sporolithon molle</i>         |
| b.    | Thallus forming smooth crusts . . . . .  | 7                                |
| 7.a.  | Calcification forming a crust on the lower surface of the thallus, frond leathery  | <i>Peyssonnelia simulans</i>     |
| b.    | Calcification intracellular, resulting in stony crusts   | <i>Lithophyllum kotschyianum</i> |
| 8.a.  | Thallus microscopic, mostly epiphytic; unbranched or false ramifications present and then cells blue-green and with a thick ± gelatinous cell wall . . . . . | 9                                |
| b.    | Thallus visible with the naked eye (although sometimes composed of microscopic filaments); always branched, no false ramifications . . . . .                 | 10                               |
| 9.a.  | Filaments unbranched; monospores formed by oblique walls   | <i>Erythrotrichia carnea</i>     |
| b.    | Filaments branched; reproduction by thick-walled akinetes  | <i>Chroodactylon ornatum</i>     |
| 10.a. | Thallus composed of separate filaments, not (pseudo-)parenchymatous, sometimes polysiphonous . . . . .   | 11                               |
| b.    | Thallus more complex, (pseudo-)parenchymatous or with a well-developed cortex . .  | 33                               |
| 11.a. | Thallus uniseriate throughout, no nodal belts . . . . .  | 12                               |
| b.    | Thallus not uniseriate throughout: with nodal belts or polysiphonous . . . . .   | 17                               |
| 12.a. | Branching at the proximal side of the cells; apices surrounded by verticils of trichoblasts  | <i>Anotrichium tenue</i>         |



- b. Branching at the distal end of the cells; no verticils of trichoblasts . . . . . 13
- 13.a. Branching verticillate . . . . . 14
- b. Branching not verticillate: opposite, alternate or radial . . . . . 15
- 14.a. Thallus gelatinous; up to 5-10 cm high; tetrasporocysts zonate *Dudresnaya* sp.
- b. Thallus slimy but not gelatinous; mostly as small epiphytes occasionally up to 5 cm; tetrasporocysts tetrahedral *Crouania attenuata*
- 15.a. Branching opposite *Antithamnion cruciatum*
- b. Branching alternate or radial . . . . . 16
- 16.a. Attached by rhizoids; monospores absent *Callithamnieae* sp.
- b. Attached by a pseudoparenchymatous disc; lateral monospores frequent *Acrochaetium savianum*
- 17.a. Thallus with nodal belts: alternation of uni- and pluricellular parts in at least a part of the thallus . . . . . 18
- b. Thallus polysiphonous (central axis and pericentral cells all over the thallus, no alternation of uni- and pluricellular parts) or completely covered by cortical cells . . . 21
- 18.a. Side branchlets with nodal belts (and a terminal spine), main axes completely corticate *Spyridia filamentosa*
- b. Whole thallus with nodal belts . . . . . 19
- 19.a. Nodal belts composed of several irregular transverse cell rows *Ceramium strictum*
- b. Nodal belts very short, 1-2 transverse cell rows . . . . . 20
- 20.a. Filaments very thin (less than 50  $\mu\text{m}$ ), with straight apices *Ceramium codii*
- b. Filaments more than 50  $\mu\text{m}$  in diameter, with forcipate apices *Ceramium fastigiatum* f. *flaccidum*
- 21.a. Thallus composed of dissimilar structures: main axes with a cover of pericentral cells or completely corticate and branchlets either with nodes and internodes, foliose or uniseriate . . . . . 22
- b. All parts of the thallus with a similar structure (except for the colourless trichoblasts, if present) . . . . . 26
- 22.a. Side branchlets with nodal belts and a terminal spine; main axes uniseriate, but completely corticate with alternation of short and long cortical cells *Spyridia filamentosa*
- b. Side branchlets foliose or uniseriate; main axes polysiphonous, cortex present or absent . . . . . 23
- 23.a. Side branchlets foliose, erect on the prostrate axes with seven pericentral cells *Leveillea jungermannioides*
- b. Side branchlets uniseriate, dichotomous . . . . . 24
- 24.a. Main axes with four pericentral cells, slight cortication limited to the basis *Dasya* cf. *corymbifera*
- b. Main axes with five pericentral cells, cortex absent or well-developed . . . . . 25
- 25.a. Cortex absent; uniseriate ramelli incurved,  $\pm$  stiff, on every second segment of the axis *Heterosiphonia crispella*
- b. Cortex well developed; uniseriate ramelli straight, very supple, on every segment of the axis *Dasya baillouvia*
- 26.a. All axes covered by small cortical cells arranged in longitudinal rows; presence of verticils of bicellular spines at the nodes *Centroceras clavulatum*
- b. All axes covered by long pericentral cells (as long as the axial cells) . . . . . 27

27.a.	(Ten to) 15 pericentral cells	<i>Polysiphonia opaca</i>	
b.	Nine or less pericentral cells . . . . .		28
28.a.	Nine pericentral cells	<i>Herposiphonia secunda</i>	
b.	Three or four pericentral cells . . . . .		29
29.a.	Three pericentral cells; no trichoblasts	<i>Falkenbergia</i> -phase	
b.	Four pericentral cells; trichoblasts present, sometimes rare . . . . .		30
30.a.	Attached by a disc, mostly epiphytic	<i>Polysiphonia crassicollis</i>	
b.	Attached by rhizoids . . . . .		31
31.a.	Thallus partly repent, partly erect; side branches relatively short and generally unbranched; open connection between pericentral cell and rhizoid	<i>Polysiphonia</i> cf. <i>scopulorum</i> var. <i>villum</i>	
b.	Thallus completely erect; side branches ramified; rhizoids not in open connection with the pericentral cell . . . . .		32
32.a.	Distinct main axis with helicoidally placed side branches	<i>Polysiphonia kampsaxii</i>	
b.	Branching ± dichotomous, no marked main axis; numerous adventitious branchlets	<i>Polysiphonia</i> sp.	
33.a.	Thallus crustose	<i>Peyssonnelia simulans</i>	
b.	Thallus not crustose . . . . .		34
34.a.	Cylindrical uniaxial structure recognisable in transverse section (central axis, pericentral cells and cortex) . . . . .		35
b.	No cylindrical uniaxial structure recognisable in transverse section . . . . .		39
35.a.	Three pericentral cells; axes of older specimens becoming hollow	<i>Asparagopsis taxiformis</i>	
b.	Five pericentral cells; thallus massive . . . . .		36
36.a.	Thallus brittle and ± spiny at the apices	<i>Acanthophora spicifera</i>	
b.	Thallus supple, not spiny . . . . .		37
37.a.	Axes covered by uniseriate ramelli resulting in a velutinous appearance	<i>Dasya baillouviana</i>	
b.	Axes smooth, slippery (only apical trichoblasts in the invaginate apices) . . . . .		38
38.a.	Thallus prostrate, epiphytic; small intercellular spaces (in TS); marked cell wall thickenings of some pericentral cells	<i>Chondria collinsiana</i>	
b.	Thallus erect, mostly epilithic; large intercellular spaces (in TS); no cell wall thickenings of pericentral cells	<i>Chondria dasyphylla</i>	
39.a.	Thallus blade-like, lanceolate, monostromatic, with a midrib	<i>Hypoglossum</i> sp.	
b.	Thallus not blade-like . . . . .		40
40.a.	Thallus hollow, at least partly . . . . .		41
b.	Thallus not hollow . . . . .		42
41.a.	Thallus segmented, with transverse diaphragms	<i>Champia parvula</i>	
b.	Thallus not segmented, uniaxial with three pericentral cells towards the apices	<i>Asparagopsis taxiformis</i>	
42.a.	Thallus hirsute, densely covered by bristle-like branchlets	<i>Digenea simplex</i>	
b.	Thallus surface smooth . . . . .		43
43.a.	Apices invaginate . . . . .		44
b.	Apices pointed or rounded, not invaginate . . . . .		46
44.a.	Thallus supple, greenish	<i>Laurencia obtusa</i>	
b.	Thallus stiff, red or brownish. . . . .		45

- |       |  |                               |    |
|-------|--|-------------------------------|----|
| 45.a. | Branchlets warty, very densely arranged  | <i>Laurencia papillosa</i>    |    |
| b.    | Branchlets clavate, not densely arranged   | <i>Laurencia patentiramea</i> |    |
| 46.a. | Thallus stiff, cartilaginous; attached securely to the substrate in different places; generally small (1-2 cm) . . . . . |                               | 47 |
| b.    | Thallus supple, only attached to the substrate by a single point; up to 20 cm long . .                                   |                               | 49 |
| 47.a. | Several apical cells present   | <i>Wurdemannia miniata</i>    |    |
| b.    | A single apical cell present . . . . .   |                               | 48 |
| 48.a. | Erect axes compressed; internal rhizines present   | <i>Gelidium pusillum</i>      |    |
| b.    | All axes terete; no internal rhizines  | <i>Gelidiella myriocladia</i> |    |
| 49.a. | Side branches smooth; stellate propagules present  | <i>Hypnea cornuta</i>         |    |
| b.    | Side branches with spiny outgrowths; no propagules   | <i>Hypnea cervicornis</i>     |    |

### Class Bangiophyceae

Classification follows GARBARY et al (1980) modified by WOMERSLEY (1994)

#### Order Compsopogonales

#### Family Erythrotrichiaceae

Genus *Erythrotrichia* Areschoug

*Erythrotrichia carnea* (Dillwyn) J. Agardh

(Fig. 82)

*Conferva carnea* Dillwyn

Material: SNMNH/P/ALG 125, Site 18, 07.XI.1992. — ODC 88 a, Site 18, 07.XI.1992.

Thallus composed of microscopic filaments, rarely 1.5 cm high, pinkish-red. Filaments uniseriate, not ramified, with a thick, gelatinous cell wall; attached by a small basal disc; cells cylindrical, 12-15 µm in diameter, 12-20 µm long; plastid stellate with a single axial pyrenoid. Monospores intercalary, formed by oblique cell divisions; released through a lateral pore, leaving a small nozzle-like structure.

*Erythrotrichia carnea* seems to be a general epiphyte on various macroalgae, but was usually only observed under the microscope, except for a single collection where it formed a pinkish-red covering on *Sargassum*. It appears to develop under any ecological conditions, throughout the study area and in all seasons.

Reported by BASSON (1979 b: 67) from the Saudi Arabian Gulf coast; recorded by BASSON et al. (1989: 35) from Bahrain and by AL-HASAN & JONES (1989: 300) from Kuwait.

### Order Porphyridiales

#### Family Porphyridiaceae

Genus *Chroodactylon* Hansgirg

*Chroodactylon ornatum* (C. Agardh) Basson

(Fig. 83)

*Conferva ornata* C. Agardh

*Asterocytis ornata* (C. Agardh) Hamel

Material: epiphytic on ODC 34 (*Dasya* cf. *corymbifera*), Site 11, 02.XI.1992.

Thallus composed of microscopic filaments; uniseriate, many false ramifications, with a thick, gelatinous cell wall; attached by a small basal disc; cells 5-10 µm broad, 8-12 µm long; blue-green. Akinetes oval, 7 µm broad, 10 µm long, surrounded by a supplementary cell wall. Epiphytic. More detailed data on its distribution and seasonality are not yet available.

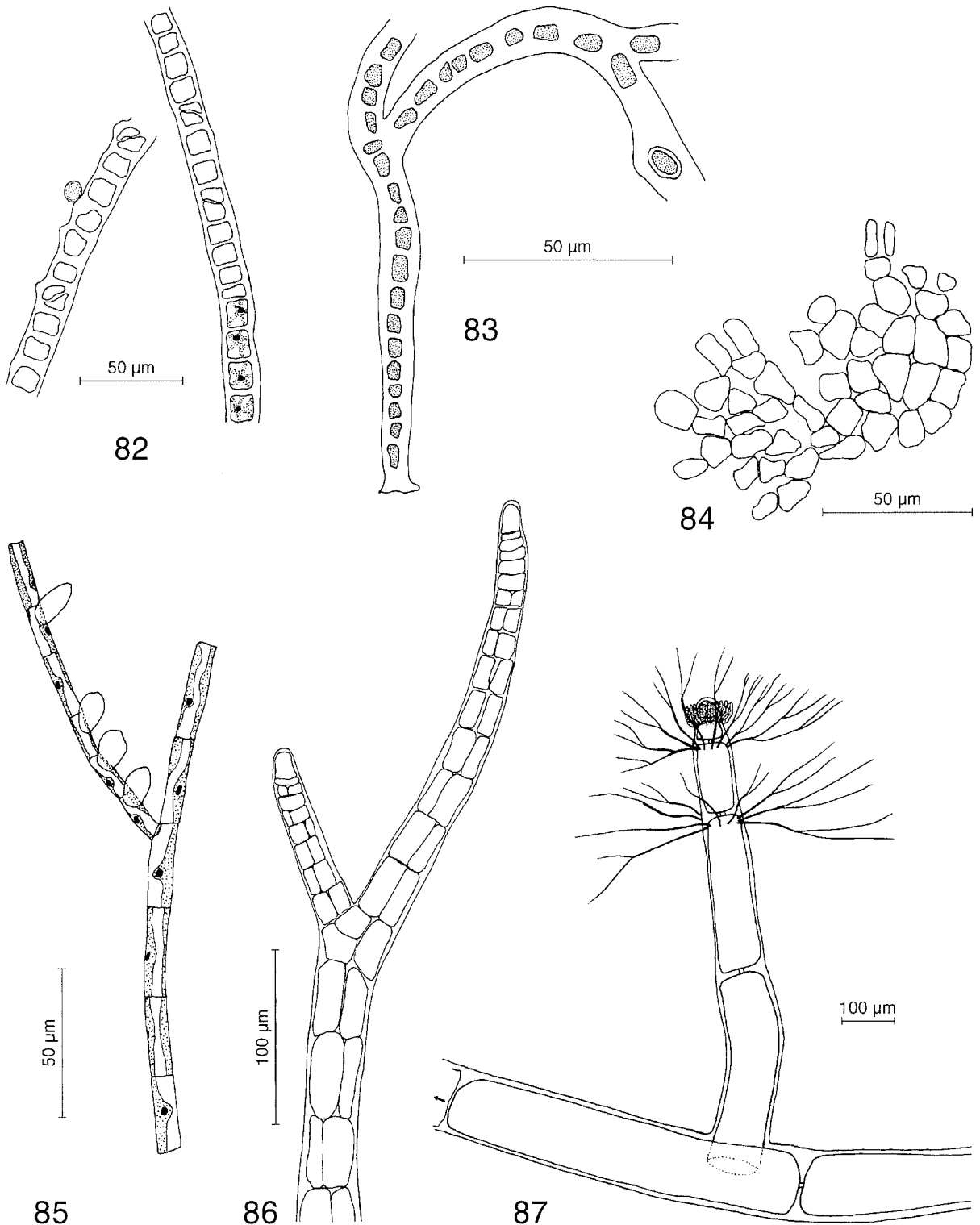

Figs 82-87: 82, *Erythrotrichia carnea*, portion of a filament showing monospores and cells with stellate plastids and a single pyrenoid; 83, *Chroodactylon ornatum*, portion of a filament showing false ramification and a single akinete; 84-85, *Acrochaetium savianum*: 84, detail of pseudoparenchymatous fixation disc; 85, detail of a branched filament showing a series of four monosporocysts; 86, *Asparagopsis taxiformis* (sporophyte, *Falkenbergia hillebrandii*), distal part of a branch with three pericentral cells surrounding an indistinct axial cell; 87, *Anotrichium tenue*, portion of a filament showing a young branch with subapical verticils of trichoblasts.

Reported by BASSON (1979 b: 67) from the Saudi Arabian Gulf coast; recorded by NEWTON (1955 b) and BASSON et al. (1989: 34) from Bahrain and by NEWTON (1955 a) and AL-HASAN & JONES (1989: 299) from Kuwait.

Class **Florideophyceae**

Classification follows GUIRY (1990: 349-350)

Order **Acrochaetales**

Family **Acrochaetiaceae**

Genus *Acrochaetium* Nägeli

*Acrochaetium savianum* (Meneghini) Nägeli

(Figs 84-85)

*Callithamnion savianum* Meneghini

Material: SNMNH/P/ALG 127, Site 18, 07.XI.1992. — ODC 88 b, Site 18, 07.XI.1992.

Thallus 2-3 mm high, erect, forming woolly tufts; red; composed of uniseriate, radially branched filaments; attached by a pseudoparenchymatous disc; cells cylindrical, tapering towards the apex, (5 to) 7 (to 10)  $\mu\text{m}$  in diameter, 20-40  $\mu\text{m}$  long; plastid parietal, with a single pyrenoid. Monospores lateral, sessile, in series of 3-4, on the adaxial side of the basis of a side branch, ovoid, 9-13  $\mu\text{m}$  in diameter, 14-18  $\mu\text{m}$  long; no tetrasporocysts observed.

Frequent epiphyte, but generally overlooked in the field because of its small size; a single sample collected on *Padina boergesenii* in the autumn where it formed a pinkish epiphytic cover. No further data on seasonality and distribution available. Reported by BASSON (1979 b: 69) from the Saudi Arabian Gulf coast.

Order **Bonnemaisoniales**

Family **Bonnemaisoniaceae**

Genus *Asparagopsis* Montagne

*Asparagopsis taxiformis* (Delile) Trevisan

(Fig. 88)

*Fucus taxiformis* Delile

Material: SNMNH/P/ALG: 128, Site 1, 19.I.1992; 129, Site 14, 31.I.1992; 130, Site 15, 16.V.1992; 131, Site 1, 01.VIII.1992. — HEC: 8901, Site 1, 19.I.1992; 8985, Site 14, 31.I.1992; 9084, Site 15, 16.V.1992; 9111, Site 19, 19.V.1992; 9303, Site 1, 01.VIII.1992.

Gametophyte: thallus 5-30 cm high, growing in patches, with repent and erect terete axes; stolonoidal part irregularly branched, 0.5-1.5 mm in diameter, attached by numerous rhizoids; erect axes 1-1.5 mm in diameter at the basis, basal area often bare; side branches 2-5 (to 9) cm long, in four rows, resulting in a four-ribbed outline and a four-sided pyramidal top; side branches repeatedly ramified, diameter gradually tapering, apical cells curved inward; bright pink, staining the paper blue upon drying. Cystocarps on the main axis as well as on the side branches, pedicellate, spherical, 700-800  $\mu\text{m}$  in diameter.

Sporophyte:

*Falkenbergia hillebrandii* (Bornet) Falkenberg

(Figs 86, 89)

*Polysiphonia hillebrandii* Bornet

Material: SNMNH/P/ALG: 132, Site 1, 19.I.1992; 133, Site 14, 31.I.1992; 134, Site 21, 30.VII.1992; 135, Site 1, 01.VIII.1992; 136, Site 1, 01.XI.1992. — HEC: 8902, Site 1, 19.I.1992; 8988, Site 14, 31.I.1992; 9173, Site 15, 18.VII.1992; 9276, Site 21, 30.VII.1992; 9302, Site 1, 01.VIII.1992. — ODC: 23, Site 1, 01.XI.1992; 111, Site 16, 10.XI.1992.

Thallus forming woolly tufts 2-7 cm in diameter, composed of microscopic, irregularly branched filaments with no distinct main axes, 30-65  $\mu\text{m}$  in diameter; all parts composed of three pericentral cells surrounding an inconspicuous central axis; pink to pinkish-red. No tetrasporocysts observed.

The distribution of the gametophyte and sporophyte is limited to the strongly surf-exposed sites (Abu Ali Island, patch reefs). The gametophyte develops exclusively on the seaward side of the coral boulders, mainly on inclined, vertical and overhanging walls. Frequently collected in the winter and the spring, rare in the other seasons. Sporophyte also on vertical coral walls, but not limited to the seaward side of the reef, collected all year round.

The sporophyte has been recorded from the Gulf previously: NIZAMUDDIN & GESSNER (1970: 12) and AL-HASAN & JONES (1989: 300), but this is the first record of the gametophyte from the Gulf.

Order Ceramiales  
Family Ceramiaceae

Genus *Anotrichium* Nägeli

*Anotrichium tenue* (C. Agardh) Nägeli

(Fig. 87)

*Griffithsia tenuis* C. Agardh

Material: SNMNH/P/ALG 137, Site 16, 20.VII.1992. — HEC 9179, Site 16, 20.VII.1992.

Thallus up to 10 cm long, repent; forming an intricate mass of thin filaments; attached by unbranched, unicellular rhizoids; branching irregular, no distinct main axis; pinkish-red. Structure uniseriate, side branches formed at the proximal part of the cells; cells from the median parts 120  $\mu\text{m}$  in diameter, 800  $\mu\text{m}$  long; apices surrounded by verticils of branched trichoblasts; sterile.

Collected only once, in the summer at Abu Ali Island (Fishermen's Bay), epiphytic on *Halodule uninervis*, at 1 m depth. Recorded from Kuwait by AL-HASAN & JONES (1989: 303, as *Griffithsia*) and by BASSON et al. (1989: 36, as *Griffithsia*) from Bahrain. New record for the Saudi Arabian Gulf coast.

Genus *Antithamnion* Nägeli

*Antithamnion cruciatum* (C. Agardh) Nägeli

*Callithamnion cruciatum* C. Agardh

Observed as a rare microscopic epiphyte. Description in NIZAMUDDIN & GESSNER (1970: 10); new record for the Saudi Arabian Gulf coast.

*Callithamnieae* sp.

(Fig. 94)

Material: HEC: 8904, Site 1, 19.I.1992; 9211, Site 2, 22.VII.1992.

Thallus 2-3 cm high, forming elegant, supple, woolly, spherical tufts; light pink; composed of uniseriate axes; attached by a network of rhizoids at the basis of the erect branches; branching of main axes and laterals radial; main axis clearly recognisable, cells 120  $\mu\text{m}$  in diameter and 250  $\mu\text{m}$  long at the basis, gradually tapering towards the apices to 20  $\mu\text{m}$  width and 30  $\mu\text{m}$  length, with

---

Figs 88-93: 88-89, *Asparagopsis taxiformis*: 88, habit of the gametophyte; 89, habit of the sporophyte (*Falkenbergia hillebrandii*); 90, *Centroceras clavulatum*, forming stiff tufts epiphytic on *Cystoseira myrica*; 91, *Ceramium strictum*, habit; 92, *Dasya baillouwiana*, habit; 93, *Dasya* cf. *corymbifera*, habit.



88

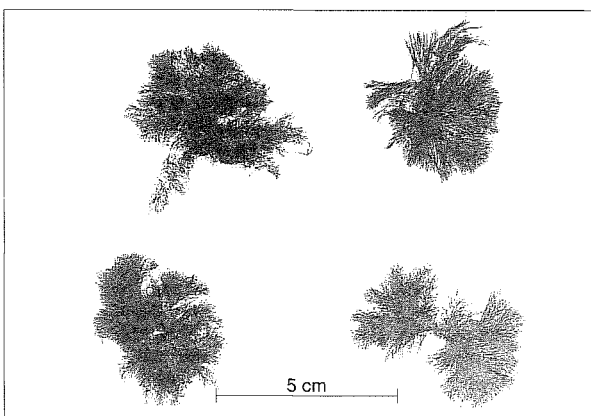

89

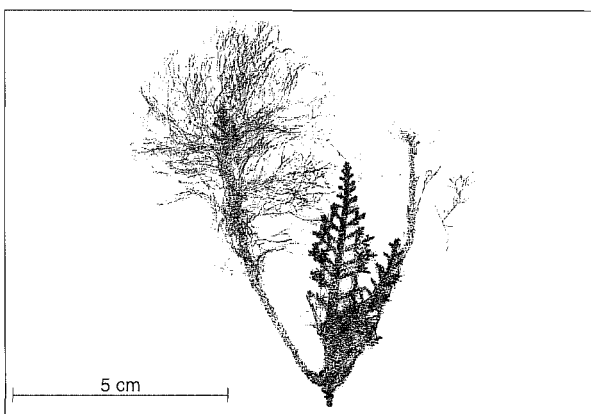

90

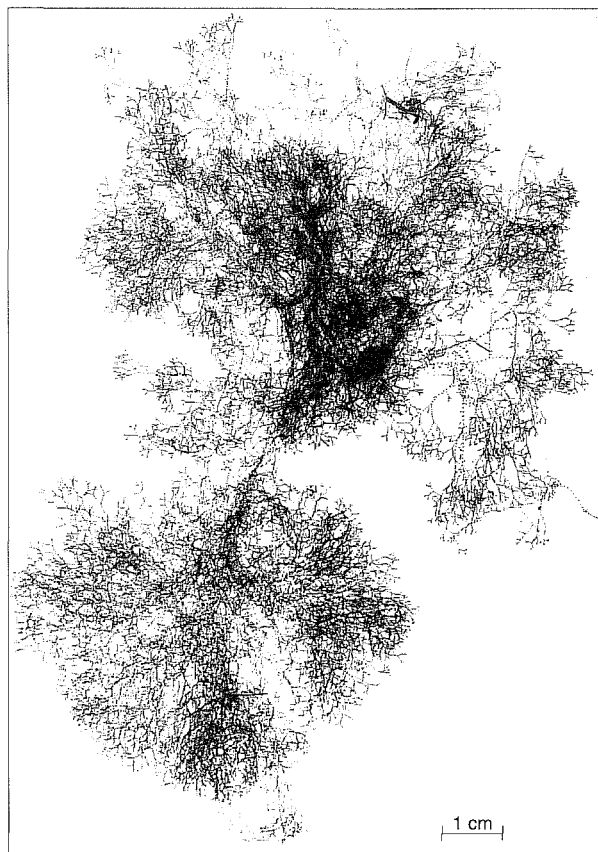

91

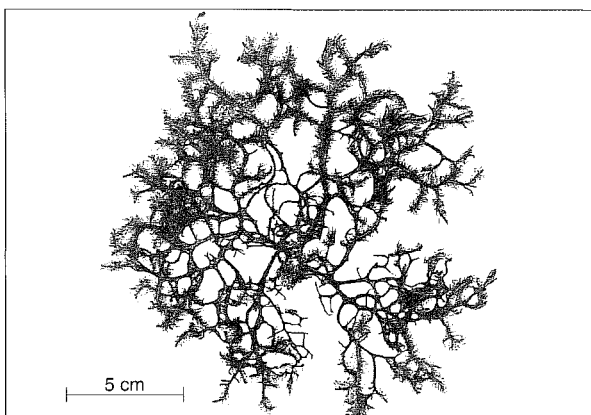

92

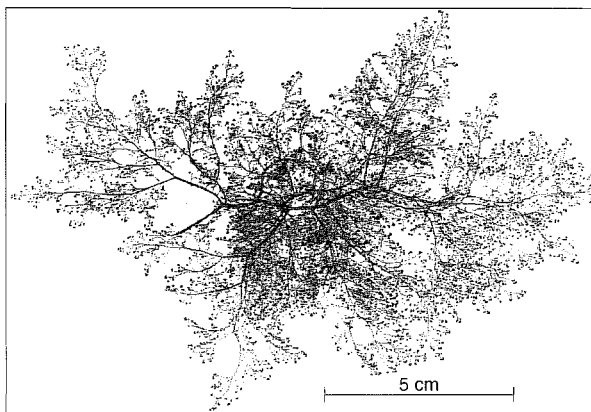

93

rounded top; no secretory cells; sterile and therefore not identifiable to genus level. A single sample was collected in the winter, epilithic on coral fragments, at 2 m depth, along Abu Ali Island.

Genus *Centroceras* Kützing

*Centroceras clavulatum* (C. Agardh) Montagne (Figs 90, 95)

*Ceramium clavulatum* C. Agardh

Material: SNMNH/P/ALG: 138, Site 7, 27.VII.1992; 139, Site 11, 02.XI.1992; 140, Site 8, 05.XI.1992. — HEC: 9252, Site 7, 27.VII.1992; 9264, Site 24, 28.VII.1992; 9339, Site 25, 06.VIII.1992. — ODC: 24, Site 1, 01.XI.1992; 51, Site 11, 02.XI.1992; 76, Site 8, 05.XI.1992.

Thallus composed of prostrate and ascending filaments or forming erect, stiff tufts up to 5 cm high; light brown to dark red. Filaments uniaxial, composed of long internodes, separated by short nodes; attached by pluricellular, unbranched rhizoids; branching dichotomous, axes 130-150 µm in diameter; axial cells 300-400 µm long, corticated over the whole length; cortical cells in longitudinal rows along the internodes, 11 µm broad, 66 µm long; irregularly placed, isodiametrical, 11-15 µm in diameter at the nodes; 2-5 bicellular spines on each node, 35 µm long; sterile.

*Centroceras clavulatum* was collected in all seasons, generally epiphytic on *Digenea simplex* and *Padina boergesenii*, more rarely epilithic, along sheltered and surf-exposed coasts.

Reported by BASSON (1979 b: 72) from the Saudi Arabian Gulf coast; recorded by NEWTON (1955 b) and BASSON et al. (1989: 36) from Bahrain and by NEWTON (1955 a) and AL-HASAN & JONES (1989: 303) from Kuwait.

Genus *Ceramium* Roth

*Ceramium codii* (Richards) Feldmann-Mazoyer

*Ceramothamnion codii* Richards

Observed as a rare microscopic epiphyte; characteristic short nodal belts. Morphology as illustrated in COPPEJANS (1983: Plate 156). Recorded from Bahrain by BASSON et al. (1989: 36). New record for the Saudi Arabian Gulf coast.

*Ceramium fastigiatum* (Wulfen ex Roth) Harvey f. *flaccidum* Petersen (Fig. 96)

*Conferva fastigiata* Wulfen ex Roth

Material: SNMNH/P/ALG 141, Site 2, 22.VII.1992. — HEC 9211, Site 2, 22.VII.1992.

Thallus forming erect tufts, up to 5 cm high, supple; marked nodes and internodes; pinkish-red. Structure uniaxial, composed of long internodes separated by short nodes; attached by unicellular, unbranched rhizoids; branching dichotomous, no adventitious branches; axes 80-120 µm in diameter; axial cells cylindrical to slightly barrel-shaped, almost hyaline, 180-500 µm long in median parts, ecorticate; nodes 40 µm high, as wide as the internodes, composed of two rows of isodiametrical cells of which the lower ones are slightly larger than the upper ones; apices slightly incurved; segments elongating more quickly than in *C. strictum*; nodes of the entire thallus with hyaline hairs (but this character has no taxonomic value); sterile.

A single sample of this taxon was collected at Abu Ali Island in the summer, at 1 m depth, epiphytic on *Acanthophora spicifera*. Reported by BASSON (1979 b: 72) from the Saudi Arabian Gulf coast; recorded from Bahrain by BASSON et al. (1989: 36).

*Ceramium strictum* (Kützing) Harvey (Figs 91, 97)

*Gongroceras strictum* Kützing

Material: SNMNH/P/ALG: 142, Site 2, 19.I.1992; 143, Site 16, 05.II.1992. — HEC: 8908, Site 2, 19.I.1992; 8998, Site 8, 02.II.1992; 9005, Site 15, 04.II.1992; 9023, Site 16, 05.II.1992; 9075, Site 16, 15.V.1992. — ODC: 7, Site 2, 31.X.1992; 80, Site 8, 05.XI.1992.



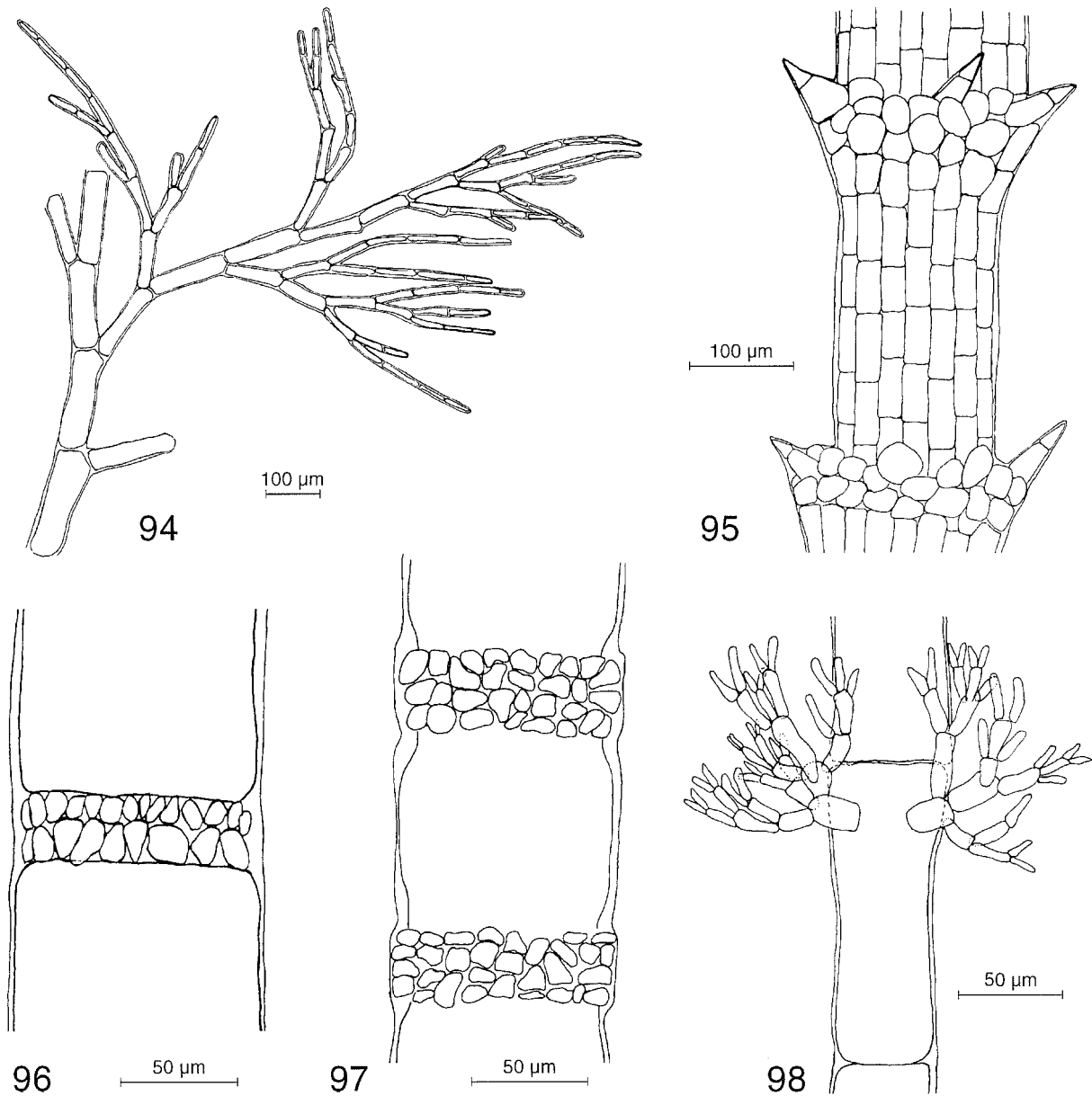

Figs 94-98: 94, *Callithamnieae* sp., portion of an axis bearing a single ramulus; 95, *Centroceras clavulatum*, portion of a filament with spiny outgrowths on the nodes; 96, *Ceramium fastigiatum* f. *flaccidum*, portion of a filament showing internodes and a node composed of two cell layers; 97, *Ceramium strictum*, portion of a filament showing internodes and nodes composed of several layers of isodiametrical cells; 98, *Crouania attenuata*, portion of a filament with a verticil of branchlets on the distal part of the axial cell.

Thallus forming erect, very supple tufts 2-10 cm high; nodes and internodes clearly marked; dark red to light pink. Filaments uniaxial, composed of long internodes, separated by short nodes; attached by numerous unicellular, unbranched rhizoids; internal rhizoids also present, formed by cortical cells, growing downwardly in an axial cell, not reaching the next node, unicellular, 10 µm in diameter (taxonomic value of this character doubtful); branching dichotomous, but adventitious branches frequent; filaments 170-210 µm in diameter in median parts, cortication restricted to the nodes; axial cells cylindrical to slightly barrel-shaped, almost hyaline, up to 570 µm long, ecorti-

cate; nodes up to 60  $\mu\text{m}$  high, as wide as the internodes, composed of several irregularly placed cell rows; cells isodiametrical to longitudinally elongated; apices strongly incurved; segments becoming gradually longer downwards; nodes covered with hyaline hairs (not a distinctive character); sterile.

Collected all year round at Abu Ali Island and at Ras az-Zaur, in intertidal pools down to 2 m depth, epiphytic on *Digenea simplex* and *Cystoseira trinodis*. Our material is very similar to the description of *C. leutzbergii* Schmidt by BASSON (1979 b: 72) but, according to WYNNE (cited in BASSON 1992: 226), this identification is doubtful because it is a Brazilian species. Moreover, according to TAYLOR (1960: 524) this is a prostrate species, whilst our material was erect.

New record for the Gulf.

### Genus *Crouania* J. Agardh

#### *Crouania attenuata* (C. Agardh) J. Agardh

(Fig. 98)

*Mesogloia attenuata* C. Agardh

Material: SNMNH/P/ALG 144, Site 8, 05.XI.1992. — ODC: 78, Site 8, 05.XI.1992; 119, Site 15, 10.XI.1992.

Thallus ascending or erect, mostly as a small epiphyte but occasionally up to 5 cm high, rather fragile, somewhat gelatinous, pink to whitish at the basis because of a slight deposit of lime, gradually tapering towards the apices. Structure uniseriate, composed of main and side axes, branching irregular; axial cells 150  $\mu\text{m}$  in diameter and 300  $\mu\text{m}$  long at the basis; ramuli in verticils (of threes or fours) at the distal end of each cell of the axes, upwardly curved, 3-5 times dichotomously branched, cells 20-25  $\mu\text{m}$  in diameter, 40-60  $\mu\text{m}$  long, with pointed apex; sterile.

The only macroscopic specimen (5 cm) was epilithic and collected at Ras az-Zaur in the autumn on the subtidal reef flat, but small specimens were observed as epiphytes in the infralittoral in all seasons. More detailed data on its distribution and seasonality are not yet available.

*Crouania attenuata* has been recorded from Bahrain by BASSON et al. (1989: 36). New record for the Saudi Arabian Gulf coast.

### Genus *Spyridia* Harvey

#### *Spyridia filamentosa* (Wulfen) Harvey

(Fig. 99)

*Fucus filamentosus* Wulfen

Material: SNMNH/P/ALG: 145, Site 8, 02.II.1992; 146, Site 27, 21.VII.1992; 147, Site 24, 28.VII.1992; 148, Site 11, 02.XI.1992. — HEC: 8997, Site 8, 02.II.1992; 9201, Site 27, 21.VII.1992; 9253, Site 7, 27.VII.1992; 9259, Site 24, 28.VII.1992; 9348, Site 26, 06.VIII.1992. — ODC 48, 57, Site 11, 02.XI.1992.

Thallus up to 10 cm high, prostrate to erect, with a rather woolly appearance; creamy to light yellowish. Structure uniaxial; attached by basal rhizoids; branching of the axes irregular, without well-marked main axis, bearing unramified branchlets with a completely different anatomy. Axes 1-1.5 mm in diameter at the basis, gradually tapering towards the apices; axial cells 150-200  $\mu\text{m}$  long, completely covered by a single-layered cortex; this is composed of 14 isodiametrical cells (25  $\mu\text{m}$  in diameter) on the transverse walls of the axial cells (the nodes) and 29 elongated cells (12  $\mu\text{m}$  broad) along the internodes (the pericentral cell, which bears the side branchlet, forms three lateral cells in a basipetal direction [STEGENGA 1986: 66]), alternating with the nodal cortical cells; branchlets unramified, 1 mm long, axial cells 30  $\mu\text{m}$  in diameter, 60-80  $\mu\text{m}$  long, cortication limited to the transverse walls of the axial cells resulting in a primitive *Ceramium*-like appearance, with a terminal bicellular spine; unicellular hairs present all over the thallus. Spermatocyst sori covering large parts of the ramuli at maturity, resulting in a spindle-shape with maximum diameter of 85  $\mu\text{m}$  and up to 200  $\mu\text{m}$  long; no cystocarps observed.

Present all year round, mainly collected in intertidal pools and channels and in the infralittoral fringe along sheltered coasts. Reported by BASSON (1979 b: 75) from the Saudi Arabian Gulf coast;

recorded by NEWTON (1955 b) and BASSON et al. (1989: 36) from Bahrain and by AL-HASAN & JONES (1989: 304) from Kuwait.

### Family Dasyaceae

Genus *Dasya* C. Agardh

*Dasya baillouviana* (S.G. Gmelin) Montagne

(Figs 92, 100)

*Fucus baillouviana* S.G. Gmelin

*Dasya pedicellata* (C. Agardh) C. Agardh

Material: SNMNH/P/ALG: 149, Site 8, 02.II.1992; 150, Site 18, 18.V.1992; 151, Site 16, 20.VII.1992; 152, Site 2, 22.VII.1992. — HEC: 8932, Site 6, 23.I.1992; 8999, Site 8, 02.II.1992; 9068, Site 16, 15.V.1992; 9102, Site 18, 18.V.1992; 9143, Site 7, 24.V.1992; 9184, Site 16, 20.VII.1992; 9199, Site 27, 21.VII.1992; 9206, Site 2, 22.VII.1992; 9233, Site 9, 24.VII.1992; 9247, Site 7, 27.VII.1992; 9307, Site 1, 01.VIII.1992; 9338, Site 25, 06.VIII.1992; 9346, Site 26, 06.VIII.1992. — ODC: 3, Site 2, 31.X.1992; 32, Site 11, 02.XI.1992.

Thallus 10-20 cm high, erect, very supple, slippery to the touch; attached by a small basal disc; axes irregularly branched, without distinct main axis, terete, 0.5-1.5 mm in diameter at the basis, gradually tapering towards the apices; ramelli radially placed, 3-10 mm long, elegant, giving a velutinous appearance to the thallus; dark red, pinkish to creamy. Structure of the axes uniaxial: axial cell and five pericentral cells distinct from the cortical cells: axial cell 120 µm in diameter, pericentral cells 250-300 µm wide and cortical cells isodiametrical, 20-40 µm wide in a transverse section of a median part of the thallus. Ramelli uniseriate, branching mainly basal, 2-3 times dichotomous, basal cells 15-20 µm broad, 30-50 µm long, apical cells 8-10 µm broad, 40-60 µm long. Cystocarps stipitate, but lateral and perpendicular on the pedicel that forms a papilla-like basal outgrowth of the cystocarp, spherical, 350 µm in diameter, with a long beak-like ostiole, 150 µm long, 100 µm wide.

Collected all year round but most frequent in the spring and the summer and mainly along surf-exposed coasts: Ras az-Zaur, Abu Ali Island and the patch reefs, but some specimens were collected along sheltered coasts at Ras al-Abkhara and Farraiya Bay; generally epilithic, more rarely epiphytic, in the infralittoral zone.

Reported by BASSON (1979 b: 78) from the Saudi Arabian Gulf coast, as *D. pedicellata*; recorded from Bahrain by BASSON et al. (1989: 38) and from Kuwait by AL-HASAN & JONES (1989: 304).

*Dasya* cf. *corymbifera* J. Agardh

(Figs 93, 101)

Material: SNMNH/P/ALG: 153, Site 14, 31.I.1992; 154, Site 19, 19.V.1992; 155, Site 11, 02.XI.1992. — HEC: 8949, Site 8, 25.I.1992; 8968, Site 18, 26.I.1992; 8995, Site 14, 31.I.1992; 9112, Site 19, 19.V.1992. — ODC 34, Site 11, 02.XI.1992.

Thallus up to 15 cm in diameter, erect, forming woolly, very supple, hemispherical tufts; attached by a small basal disc; branching irregular, radial, no distinct main axis, branches terete, 0.5-1 mm in diameter at the basis, gradually tapering towards the apices; ramelli radially on the axes, 0.5-1.5 mm long, straight, very supple, giving a woolly appearance to the thallus; pink to reddish-brown with darker tips. Structure of the axes uniaxial, polysiphonous, the axial cell and the four pericentral cells very distinct: axial cell 50 µm in diameter, 190 µm long, pericentral cells 150 µm wide in a transverse section of a median part of the thallus; rhizoids formed towards the basis of the axes, lying in the grooves between the pericentral cells and resulting in a pseudocortex; ramelli uniseriate, 4-5 times dichotomously branched, basal cells 20 µm broad and 80 µm long, apical cells 10 µm broad, 200 µm long; irregularly lobed tubercles (of unknown origin and/or function) present on the basal parts of the axes, up to 150 µm in diameter. Stichidia of tetrasporo-

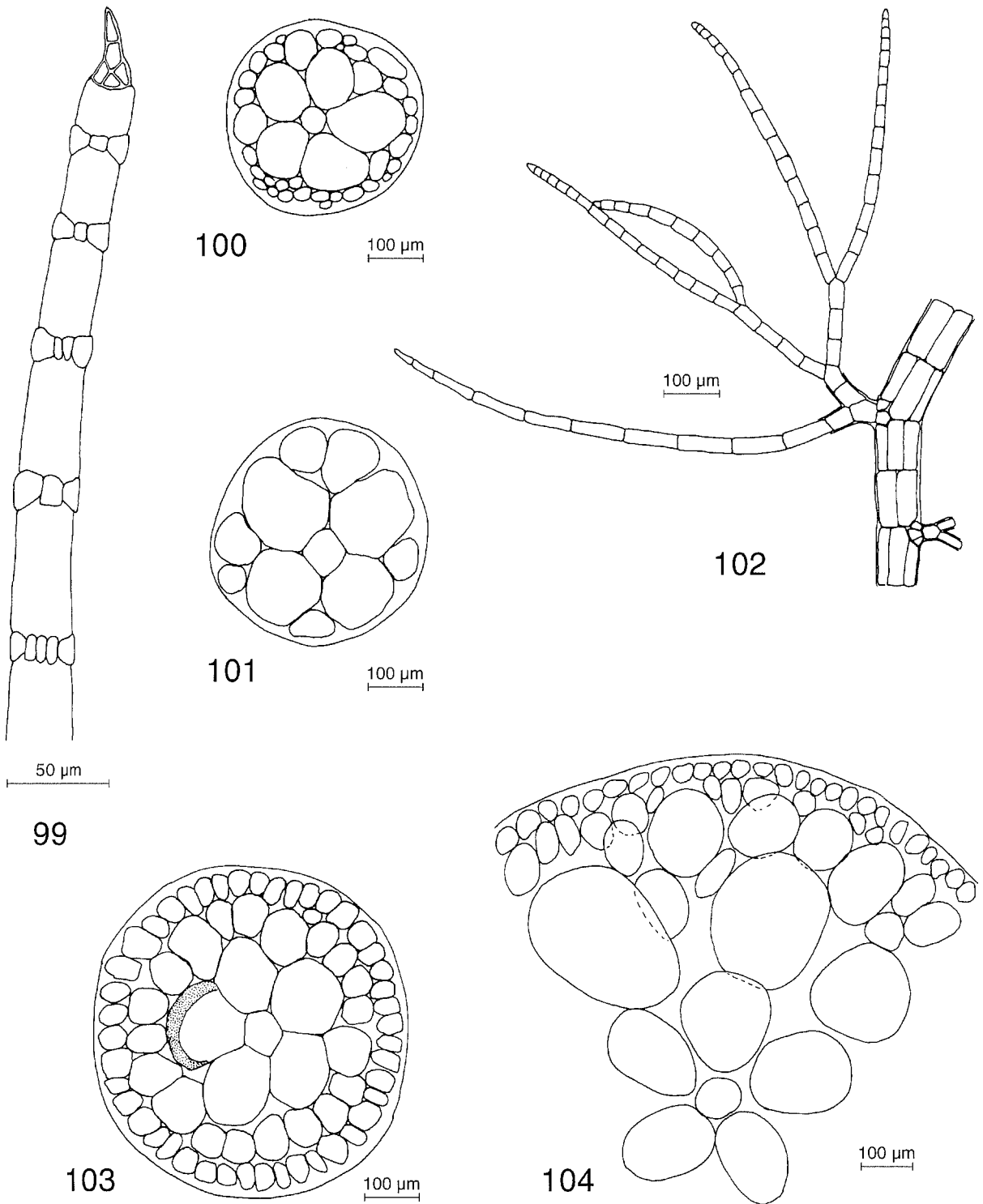

Figs 99-104: 99, *Spyridia filamentosa*, branchlet which is only corticated at the nodes; 100, *Dasya baillouviana*, transverse section of an axis showing a well-developed cortex and five distinct pericentral cells surrounding an axial cell; 101, *Dasya* cf. *corymbifera*, transverse section of an axis showing four pericentral cells surrounding an axial cell and pseudocortex cells lying in the grooves of the pericentral cells; 102, *Heterosiphonia crispella*, portion of a polysiphonous axis bearing a single uniseriate branchlet; 103, *Chondria collinsiana*, transverse section of an axis showing a cortex and five pericentral cells with a distinct abaxial wall thickening, surrounding the axial cell; 104, *Chondria dasyphylla*, part of a basal transverse section of an axis showing a cortex and five pericentral cells surrounding the axial cell.

cysts single on the basal part of the ramelli, on a bicellular pedicel, spindle-shaped and helicoidally twisted because of the extruding tetrasporocysts, 95 µm broad, 310 µm long; tetrasporocysts spherical, 70-85 µm in diameter.

Collected in the autumn, winter and spring along the surf-exposed coasts: Ras az-Zaur, Abu Ali Island and the patch reefs, epilithic as well as epiphytic on *Digenea simplex* and *Halodule uninervis* in the infralittoral zone. In the winter large numbers of loose-lying specimens are found in the shallow lagoon along Abu Ali Island.

BASSON (1979 b: 75) reported *D. ocellata* (Grateloup) Harvey from the Saudi Arabian Gulf coast. This species is characterised by strongly corticated axes and tetrasporocysts with a diameter of 30-40 µm. Our material is only slightly corticated and the tetrasporocysts are 70-80 µm in diameter; morphologically they are very similar to Mediterranean material in the Herbarium Gandavensis (GENT) and to the description of *D. corymbifera* by BØRGESEN (1919: 321).

This is a new record for the Gulf.

Genus *Heterosiphonia* Montagne

*Heterosiphonia crispella* (C. Agardh) Wynne

(Fig. 102)

*Callithamnion crispellum* C. Agardh

*Heterosiphonia wurdemannii* (Bailey ex Harvey) Falkenberg

Material: HEC 9211, Site 2, 22.VII.1992. — ODC 115, Site 16, 10.XI.1992.

Thallus 1.5 cm high, partly prostrate, partly erect, forming small pinkish-red tufts. Structure uniaxial, composed of axes and ramelli; attached by rhizoids; axes subdichotomous, without recognisable main axis, 140 µm in diameter at the basis, gradually tapering towards the apices (75 µm), polysiphonous; axial cell 140-170 µm long in median parts of the thallus, surrounded by five pericentral cells, as long as the axial cells, no cortex; ramelli at every second segment of the axes in a more or less distichous position, uniseriate except for the basal segment, ± 1 mm long, incurved, 1-3 times dichotomous, basal uniseriate cell 50 µm in diameter, 76 µm long, apical cell 15 µm wide, 13 µm long; sterile.

Samples collected in the summer and autumn at Abu Ali Island, epiphytic on *Leveillea jungermannioides* and *Halodule uninervis*, in the infralittoral. Recorded from Kuwait by AL-HASAN & JONES (1989: 304). A new record for the Saudi Arabian Gulf coast.

#### Family Delesseriaceae

Genus *Hypoglossum* Kützing

*Hypoglossum* sp.

Observed as a rare epiphyte. *Hypoglossum spathulatum* (Sonder) Kützing was recorded by NIZAMUDDIN & GESSNER (1970: 12) from the Iranian coast. New record for the Saudi Arabian Gulf coast.

#### Family Rhodomelaceae

Genus *Acanthophora* Lamouroux

*Acanthophora spicifera* (Vahl) Børgesen

(Fig. 105)

*Fucus spiciferus* Vahl

Material: SNMNH/P/ALG: 156, Site 16, 15.V.1992; 157, Site 19, 19.V.1992; 158, Site 16, 20.VII.1992; 159, Site 8, 24.VII.1992; 160, Site 22, 02.XI.1992. — HEC: 8961, Site 18, 26.I.1992; 9069, Site 16, 15.V.1992; 9117, Site 19, 19.V.1992; 9131, Site 2, 22.V.1992; 9183, Site 16, 20.VII.1992; 9221, Site 8, 24.VII.1992; 9230, Site 9, 24.VII.1992; 9268,

Site 24, 28.VII.1992; 9306, Site 1, 01.VIII.1992; 9329, Site 25, 06.VIII.1992; 9354, Site 27, 06.VIII.1992. — ODC: 6, Site 2, 31.X.1992; 36, Site 22, 02.XI.1992; 43, Site 11, 02.XI.1992; 58, Site 14, 02.XI.1992; 75, Site 8, 05.XI.1992.

Thallus 5-30 cm high, erect, bushy and stiff (even somewhat brittle) when young, older specimens becoming more elegant; attached by a parenchymatous, irregular disc, bearing one or several main axes; branching radial, in four rows; main axes terete, 1-2 mm in diameter at the basis, with scars of broken ramelli but without spines; side axes similar to the main axis, densely set with short determinate branchlets (0.5-2 mm long), covered by small spines (0.5 mm long), trichoblasts present at the apices but fugacious; light brown to pinkish, blackening upon drying; sterile.

Present all year round, but with optimum development during the spring and summer; in the autumn and winter we only observed old, eroded specimens with largely bare main axes. Most frequent along surf-exposed coasts: Abu Ali Island, Ras az-Zaur and patch reefs, from low water mark down to 3 m depth, generally epilithic but sometimes epiphytic (on *Cystoseira*, *Digenea*).

Reported from the Saudi Arabian Gulf coast by BASSON (1979 b: 78); recorded from Bahrain by BASSON et al. (1989: 38) and from Kuwait by AL-HASAN & JONES (1989: 304). These authors also mention *A. muscoides* (L.) Bory, which is a distinct species characterised by the presence of spines on the main axes.

#### Genus *Chondria* C. Agardh

##### *Chondria collinsiana* Howe

(Figs 103, 106)

Material: SNMNH/P/ALG 161, Site 20, 20.V.1992. — HEC 9118, Site 20, 20.V.1992.

Thallus up to 10 cm long, repent, supple, epiphytic; attached by pluricellular, unbranched rhizoids, 20-30  $\mu\text{m}$  in diameter, formed from any part in contact with the substrate; all parts terete, 400-600  $\mu\text{m}$  in diameter, with a segmented appearance (every 300  $\mu\text{m}$ ) because of the transverse walls of the central axis and the wall thickenings of some of the pericentral cells seen in transmitted light; branching irregular, frequent, without marked main axis; all side branches constricted at the basis, young branchlets clavate, apices obtuse, depressed; pink. Structure uniaxial; axial cells 68  $\mu\text{m}$  in diameter, 300  $\mu\text{m}$  long, surrounded by five pericentral cells, 144  $\mu\text{m}$  in diameter, abaxial walls strongly thickened, intercellular spaces small; cortex two-layered, internal cells 70  $\mu\text{m}$  in diameter, outer cells 35-45  $\mu\text{m}$  in cross-section and 150  $\mu\text{m}$  long in superficial view; trichoblasts subapical, in the apical invaginations; sterile.

A single specimen, in spring at Qurma, epiphytic on a *Halodule uninervis* leaf, in a channel. *Chondria collinsiana* has been recorded from the Gulf (Qatar) by Heiba et al. (1990; cited in BASSON 1992: 227). New record for the Saudi Arabian Gulf coast.

##### *Chondria dasyphylla* (Woodward) C. Agardh

(Figs 104, 107)

*Fucus dasyphyllus* Woodward

Material: SNMNH/P/ALG: 162, Site 7, 24.I.1992; 163, Site 18, 26.I.1992; 164, Site 14, 31.I.1992; 165, Site 16, 05.II.1992; 166, Site 2, 22.V.1992; 167, Site 2, 22.VII.1992; 168, Site 2, 31.X.1992. — HEC: 8910, Site 2, 19.I.1992; 8925, Site 6, 23.I.1992; 8937, Site 7, 24.I.1992; 8960, Site 18, 26.I.1992; 8980, Site 14, 31.I.1992; 9024, Site 16, 05.II.1992; 9071, 9077, Site 16, 15.V.1992; 9130, Site 2, 22.V.1992; 9181, Site 16, 20.VII.1992; 9203, Site 2, 22.VII.1992. — ODC: 4, Site 2, 31.X.1992; 27, Site 1, 01.XI.1992; 44, Site 11, 02.XI.1992; 130, Site 33, 21.II.1993.

Thallus 5-20 cm high, erect, bushy, growing as dense or open tufts, very supple; attached by a small basal parenchymatous disc; branching irregular, without well-marked main axis; all parts terete, 1-2 mm in diameter at the basis; young branches spindle-shaped, constricted at the basis; apex invaginate; light pink to light brown. Structure uniaxial; axial cells 90  $\mu\text{m}$  in diameter, surrounded by five pericentral cells, 170  $\mu\text{m}$  in diameter, without cell wall thickenings, intercellular spaces very big; cortex 3-4-layered, the internal cells 210  $\mu\text{m}$  in diameter, the outer ones 15-20  $\mu\text{m}$  in cross-section, 70-80  $\mu\text{m}$  long in superficial view.

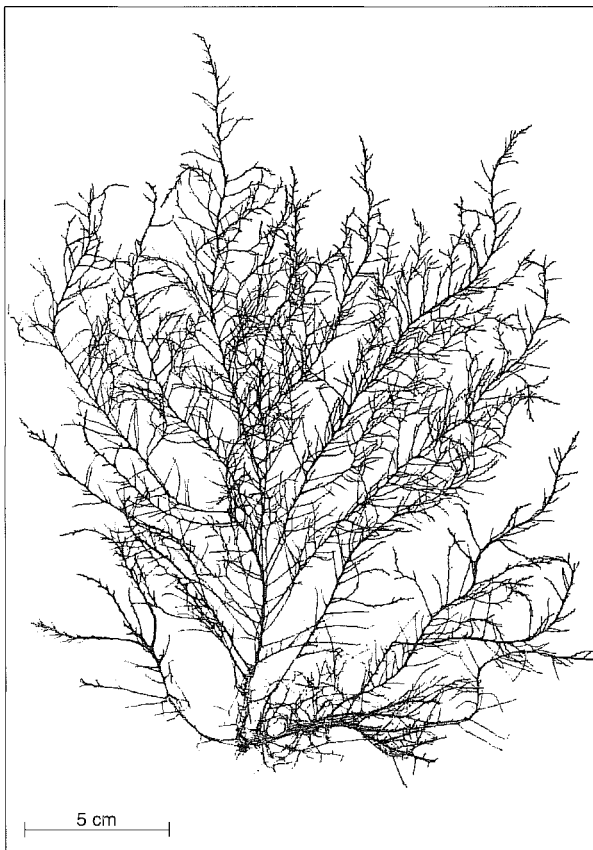

105

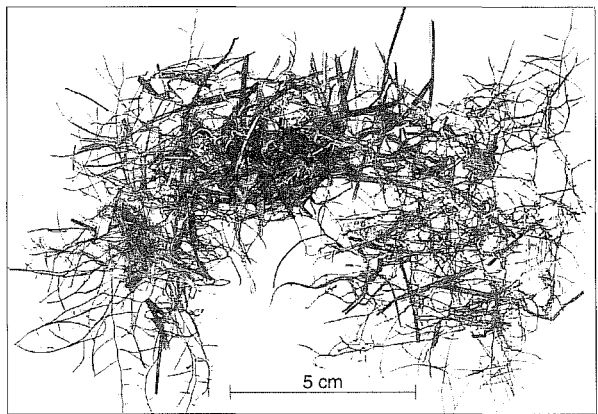

106

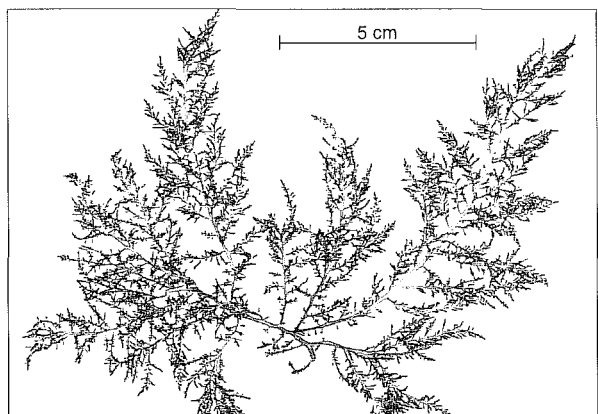

107

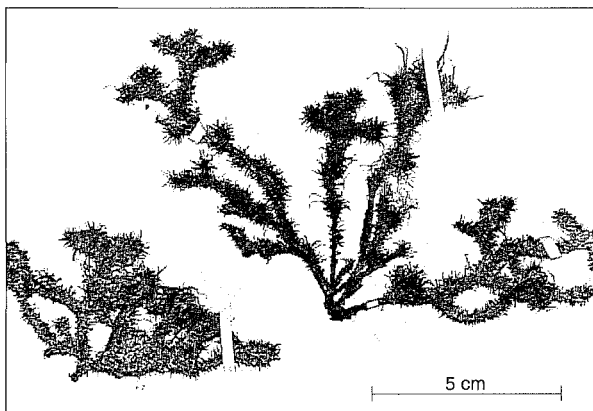

108

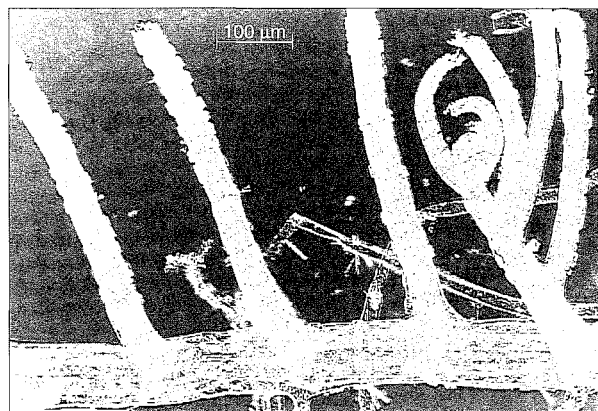

109

Figs 105-109: 105, *Acanthophora spicifera*, habit; 106, *Chondria collinsiana*, growing epiphytic on *Halodule uninervis*; 107, *Chondria dasyphylla*, habit; 108, *Digenea simplex*, habit; 109, *Herposiphonia secunda* f. *tenella*, detail of a prostrate axis bearing several upright axes with limited growth and a single side axis with unlimited growth showing an incurved apex.

Present all year round, but most frequent in the cold season when it also develops in intertidal pools and in the infralittoral fringe; the intertidal specimens disappear in the summer. Generally epilithic, but also epiphytic on *Digenea*, along surf-exposed and sheltered coasts.

Reported by BASSON (1979 b: 78) from the Saudi Arabian Gulf coast; recorded by NEWTON (1955 b) and BASSON et al. (1989: 38) from Bahrain and by NEWTON (1955 a) and AL-HASAN & JONES (1989: 304) from Kuwait.

Genus *Digenea* C. Agardh*Digenea simplex* (Wulfen) C. Agardh

(Fig. 108)

*Conferva simplex* Wulfen

Material: SNMNH/P/ALG: 169, Site 7, 24.I.1992; 170, Site 23, 27.VII.1992; 171, Site 18, 31.VII.1992; 172, Site 11, 02.XI.1992; 173, Site 11, 02.XI.1992. — HEC: 8914, Site 4, 02.I.1992; 8920, Site 5, 22.I.1992; 8934, Site 7, 24.I.1992; 9030, Site 16, 05.II.1992; 9081, Site 16, 15.V.1992; 9146, Site 7, 24.V.1992; 9225, Site 8, 24.VII.1992; 9245, Site 23, 27.VII.1992; 9257, Site 7, 27.VII.1992; 9287, Site 18, 31.VII.1992; 9316, Site 1, 01.VIII.1992; 9337, Site 25, 06.VIII.1992. — ODC: 17, Site 1, 01.XI.1992; 28, Site 11, 02.XI.1992; 39, Site 11, 02.XI.1992; 71, Site 8, 05.XI.1992; 98, Site 25, 07.XI.1992; 123, Site 7, 11.XI.1992.

Thallus 5-20 cm high, erect, bushy, solitary or gregarious, with a brush-like appearance when clean, but generally covered by silt and/or numerous epiphytes; axes cartilaginous, 1-1.5 mm in diameter, branching irregular, completely covered by simple, stiff, dense branchlets, 5 mm long, eventually eroded from the lower part of the thallus; dull brown to reddish. Uniaxial structure not recognisable in transverse section: main axes composed of a parenchyme with larger internal cells and smaller outer ones; branchlets with a central axis, 6-8 pericentral cells and a thin cortex, bearing deciduous trichoblasts at the tips. No reproductive structures observed.

Perennial species, its appearance not changing through the seasons, epilithic in the infralittoral zone along surf-exposed and sheltered coasts; forming extended, dense vegetation beds in the infralittoral fringe of subhorizontal coasts, then quite often heavily covered by silt and by various epiphytes such as: *Ceramium strictum*, *Jania rubens*, *Laurencia obtusa*, *Laurencia papillosa*, *Spyridia filamentosa*, but also *Acanthophora spicifera* and *Chondria dasyphylla*, sometimes completely obscuring the porophyte.

Recorded by NEWTON (1955 b) and BASSON et al. (1989: 38) from Bahrain and by AL-HASAN & JONES (1989: 305) from Kuwait between July and November. A new record for the Saudi Arabian Gulf coast.

Genus *Herposiphonia* Nägeli*Herposiphonia secunda* (C. Agardh) Ambronn f. *tenella* (C. Agardh) Wynne

(Fig. 109)

*Hutchinsia secunda* C. Agardh*Hutchinsia tenella* C. Agardh*Herposiphonia tenella* (C. Agardh) Ambronn

Material: HEC 9211, Site 2, 22.VII.1992. — ODC 50, Site 11, 02.XI.1992.

Thallus repent, 1-10 mm long, composed of prostrate axes bearing, alternately, series of three erect branchlets with limited growth and a prostrate lateral axis with similar morphology as the main axes, all of them terete; prostrate axes attached by unicellular rhizoids with a terminal adhesion disc, formed at the distal end of every second segment; diameter of prostrate axes 90-120 µm, segments 1.5-2 times as long as wide; apices of the prostrate axes incurved, erect branchlets up to 2 mm long, 50 µm in diameter, segments 1.5 times as long as broad. Structure uniaxial, polysiphonous; axial cell surrounded by nine pericentral cells, not corticated; trichoblasts only on the erect branchlets, 2-3, small, fugacious; sterile.

Mostly epiphytic, less frequently epilithic. Collection of this tiny alga is rather accidental; therefore data on distribution and seasonality are not yet available.

BASSON (1979 b: 78) reported *H. dendroidea* Hollenberg from the Saudi Arabian Gulf coast, and AL-HASAN & JONES recorded the same species from Kuwait. This species differs from *H. secunda* in that the segments are as long as they are broad. BØRGESEN (1939: 131) described *H. secunda* (as *H. tenella* which is now considered to be a synonym) from Iran. *Herposiphonia secunda* f. *tenella* is recorded for Bahrain by NEWTON (1955 b) and by BASSON et al. (1989: 38). A new record for the Saudi Arabian Gulf coast.



Genus *Laurencia* Lamouroux*Laurencia obtusa* (Hudson) Lamouroux

(Figs 110-112)

*Fucus obtusus* Hudson

Material: SNMNH/P/ALG: 175, 176, Site 16, 05.II.1992; 177, Site 16, 15.V.1992; 178, Site 8, 24.VII.1992; 179, Site 7, 27.VII.1992; 180, Site 11, 02.XI.1992. — HEC: 9026, 9027, Site 16, 05.II.1992; 9076, Site 16, 15.V.1992; 9091, Site 15, 16.V.1992; 9145, Site 7, 24.V.1992; 9193, Site 16, 20.VII.1992; 9218, Site 8, 24.VII.1992; 9249, 9250, Site 7, 27.VII.1992; 9328, Site 25, 06.VIII.1992. — ODC: 41, Site 11, 02.XI.1992; 55, Site 11, 02.XI.1992; 79, Site 8, 05.XI.1969; 91, Site 18, 07.XI.1992; 117, Site 16, 10.XI.1992; 139, Site 11, 24.II.1993.

Thallus 3-6 (to 20) cm high, forming supple, erect, bushy plants; large specimens conoidal; attached by a small disc bearing a single or several main axes, 1 mm in diameter throughout the thallus; all parts terete; branching radial, lateral axes obscuring the main axis, all of them relatively densely covered by short, radially placed branchlets; these frequently grouped in twos or threes, resulting in a subopposite or pseudoverticillate appearance, becoming shorter towards the apices of the axes, constricted at their basis, covered by short, truncate, ultimate branchlets with invaginate apex; green, to pinkish at the shaded basis and the growing tips. Uniaxial structure disappearing just under the apices and not visible in transverse sections lower down; medulla cells isodiametrical, 30-90 µm in diameter, without wall thickenings; pigmented cortex single-layered, cells not projecting, isodiametrical to slightly radially elongated in transverse section, 20-37 µm in diameter; sterile.

Collected in all seasons, along sheltered and surf-exposed coasts, epiphytic and epilithic in intertidal pools down to and including the infralittoral zone. Recorded from Bahrain by NEWTON (1955 b) and from Kuwait by AL-HASAN & JONES (1989: 305). New record for the Saudi Arabian Gulf coast.

*Laurencia papillosa* (C. Agardh) Greville

(Figs 113-114)

*Chondria papillosa* C. Agardh

Material: SNMNH/P/ALG: 181, Site 16, 15.V.1992; 182, Site 7, 24.V.1992; 183, Site 16, 20.VII.1992; 184, Site 2, 22.VII.1992; 185, Site 8, 24.VII.1992; 186, Site 9, 24.VII.1992; 187, Site 23, 27.VII.1992; 188, Site 7, 27.II.1992; 189, Site 24, 28.VII.1992; 190, Site 11, 02.XI.1992; 191, Site 11, 02.XI.1992. — HEC: 9080, Site 16, 15.V.1992; 9144, Site 7, 24.V.1992; 9182, Site 16, 20.VII.1992; 9204, Site 2, 22.VII.1992; 9223, Site 8, 24.VII.1992; 9229, Site 9, 24.VII.1992; 9243, Site 23, 27.VII.1992; 9255, Site 7, 27.II.1992; 9269, Site 24, 28.VII.1992; 9304, Site 1, 01.VIII.1992; 9327, Site 25, 06.VIII.1992. — ODC: 38, Site 11, 02.XI.1992; 42, Site 11, 02.XI.1992; 124, Site 7, 11.XI.1992.

Thallus up to 15 cm high, repent, ascending to erect, stiff cartilaginous, somewhat brittle; attached by a basal disc bearing several axes; branching radial, main axis not distinct from the side axes; all parts terete, 1-2 mm in diameter, gradually tapering towards the apices; ramuli short, all over the thallus, clearly placed in a helix towards the apices of the axes, papillose, 0.5-1 mm long, with invaginate apex; trichoblasts remaining rudimentary; brownish-red to cream-coloured. Structure uniaxial but only visible close to the growing apex; lower down a homogeneous medulla in transverse section, cells isodiametrical, without wall thickenings; cortex single-layered, cells not projecting, radially elongated, palisade-like, 15 µm broad, 30 µm high; sterile.

Collected all year round, as small specimens in the winter and reaching maximal development in the summer; in the autumn they start decaying. Occurring along sheltered and surf-exposed coasts, mostly epilithic but also epiphytic, from intertidal pools down to the infralittoral zone.

Recorded by BASSON et al. (1989: 38) from Bahrain and by NEWTON (1955 a) and AL-HASAN & JONES (1989: 305) from Kuwait. New record for the Saudi Arabian Gulf coast.

*Laurencia patentiramea* (Montagne) Kützling

(Figs 115-116)

*Chondria obtusa* (Hudson) C. Agardh var. *patentiramea* Montagne*Laurencia paniculata* (C. Agardh) J. Agardh

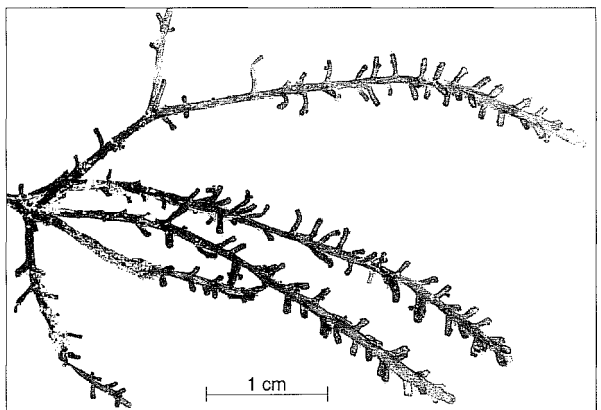
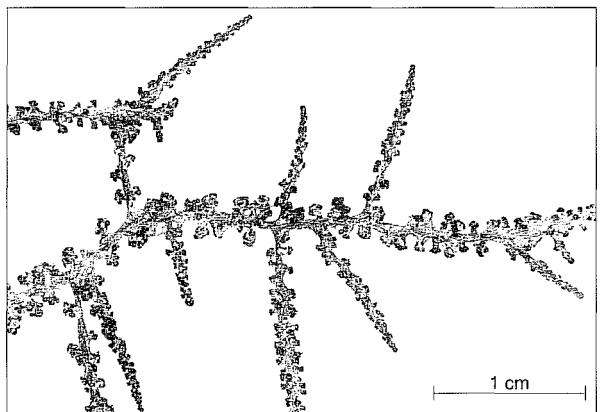
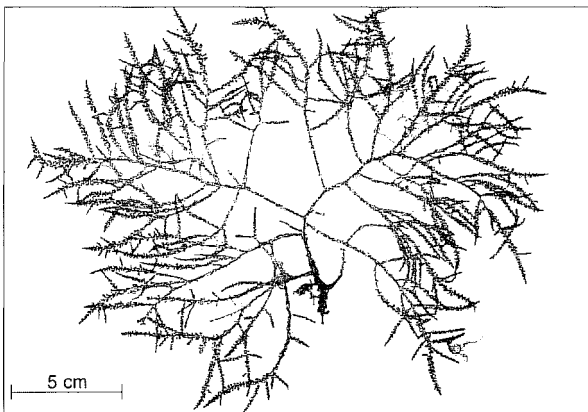
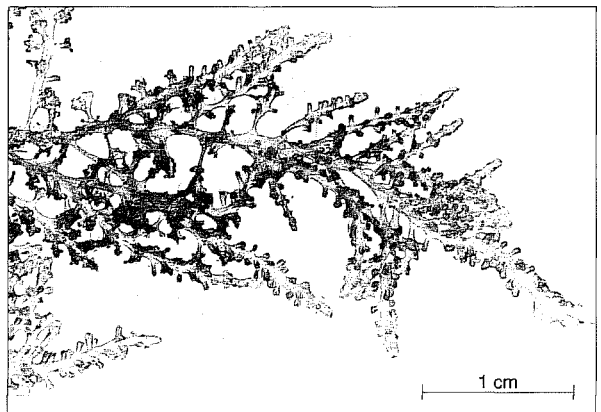
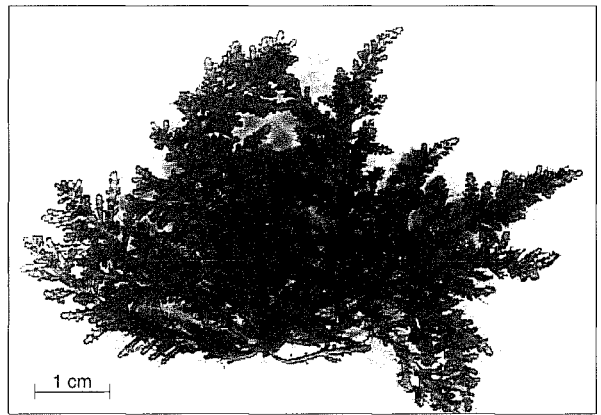
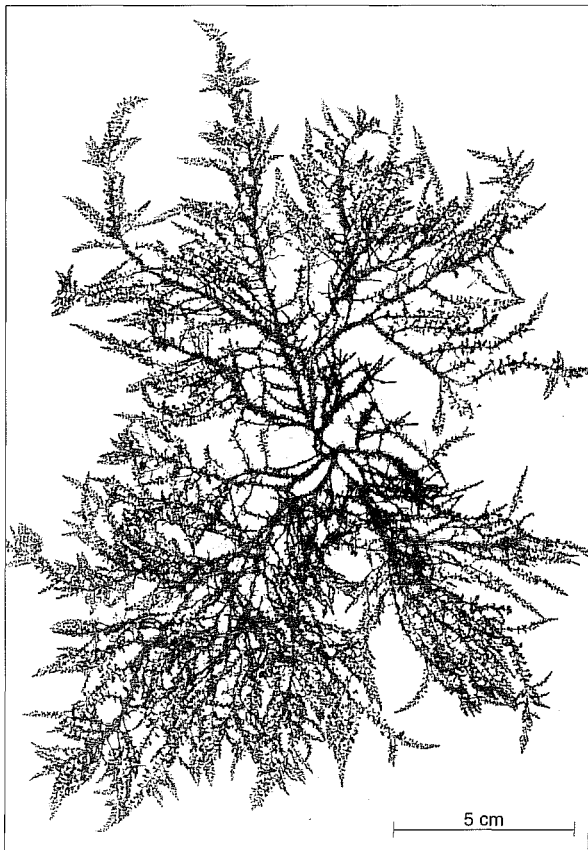

Material: SNMNH/P/ALG: 192, Site 16, 05.II.1992; 193, Site 16, 15.V.1992. — HEC: 8915, Site 4, 20.I.1992; 8926, 8927, Site 6, 23.I.1992; 8935, Site 7, 24.I.1992; 8959, Site 18, 26.I.1992; 9028, Site 16, 05.II.1992; 9079, Site 16, 15.V.1992; 9132, Site 2, 22.V.1992; 9192, Site 16, 20.VII.1992; 9305, Site 1, 01.VIII.1992. — ODC: 116, Site 16, 10.XI.1992; 135, Site 18, 22.II.1993.

Thallus up to 15 cm high, erect, very stiff cartilaginous; attached by a basal disc, bearing a single or several erect axes; well-marked main axis, with radially placed shorter side axes, all of these terete and 1-2 mm in diameter, bearing numerous branchlets, perpendicular on the axes, clavate with invaginate apex, 1-2.5 mm long (somewhat longer and less warty than in *L. papillosa*), with well-developed, conspicuous trichoblasts in the apical invaginations; dark purple to light brown. Structure uniaxial but central axis and pericentral cells not recognisable in transverse sections: medulla cells isodiametrical, 35-120 µm in diameter, without wall thickenings; cortex single-layered, cells not projecting, radially elongated, palisade-like, 15 µm broad, 30 µm ; sterile.

Collected all year round, along sheltered and exposed coasts, in the infralittoral zone, generally epilithic. According to YAMADA (1931: 191) *L. papillosa*, *L. intermedia* Yamada and *L. patentiramea* may be growth forms of the same species.

Reported by BASSON (1979 b: 78) from the Saudi Arabian Gulf coast (as *L. paniculata*); recorded from Bahrain by BASSON et al. (1989: 38).

#### Genus *Leveillea* Decaisne

##### *Leveillea jungermannioides* (Hering & Martens) Harvey

(Figs 127-128)

*Amansia jungermannioides* Hering & Martens

Material: SNMNH/P/ALG: 194, Site 2, 22.V.1992; 195, Site 1, 02.XI.1992. — HEC: 9019, Site 16, 04.II.1992; 9129, Site 2, 22.V.1992; 9205, Site 2, 22.VII.1992; 9331, Site 25, 06.VIII.1992. — ODC: 26, Site 1, 01.XI.1992; 35, Site 1, 02.XI.1992; 93, Site 25, 07.XI.1992; 114, Site 16, 10.XI.1992.

Thallus 1-5 cm long, repent, attached by unramified, polysiphonous rhizoids with a terminal disc; branching of the prostrate axes irregular; main axis not distinct; prostrate terete axes polysiphonous, with seven pericentral cells, no cortication; ramuli distichous, ascending, partly imbricate, foliose, 600 µm at their basis, 500 µm high, abruptly tapering at the apex, monostromatic, with a marked midrib; apex incurved; trichoblasts not observed, normally apical on the phylloids; dark red; sterile.

Collected all year round in the infralittoral zone, mainly epiphytic on *Cystoseira trinodis*, *Laurencia papillosa*, *Sargassum* spp., *Dasya* cf. *corymbifera*. Most of the specimens are relatively small, but some collections are composed of large clumps (especially populations growing on a plastic sheet wrapped around coral just below low water level).

Reported by BASSON (1979 b: 79) from the Saudi Arabian Gulf coast; recorded by BASSON et al. (1989: 38) from Bahrain.

#### Genus *Polysiphonia* Greville

##### *Polysiphonia crassicolis* Børgesen

(Figs 117-118)

Material: HEC: 9187, Site 16, 20.VII.1992; 9211, Site 2, 22.VII.1992.

Thallus 0.5-1.5 cm high, erect, forming small epiphytic supple tufts; brownish-red. Attached by a small basal disc, diameter 150 µm, forming one or more erect axes; ramification helicoidal;

---

Figs 110-116: 110-112, *Laurencia obtusa*: 110, habit of a dried specimen; 111, habit of a preserved specimen; 112, detail of an apex (apex pointing to the right); 113-114, *Laurencia papillosa*: 113, habit; 114, detail of an apex (apex pointing to the right); 115-116, *Laurencia patentiramea*: 115, habit; 116, detail of a young thallus (apex pointing to the right).

main axis distinct from the shorter side branches, 160 µm in diameter at the basis, gradually tapering towards the apices, to 70 µm; segments (0.5 to) 1-1.5 times as long as broad; adventitious branchlets present; trichoblasts rudimentary. Structure polysiphonous; each segment composed of an axial cell surrounded by four pericentral cells; diameter of pericentral cells in transverse section four times the diameter of the central axis; no cortication. Tetrasporocysts in the apical parts of the side branches, in short helicoidal series (in twos or threes), deforming the branch, spherical, 60 µm in diameter; cystocarps juvenile and therefore still atypical, shortly stipitate.

Observed, epiphytic on *Halodule uninervis*, at 1 m depth in the summer at Abu Ali Island. Reported by BASSON (1979 b: 79) from the Saudi Arabian Gulf Coast; recorded by NEWTON (1955 b) and BASSON et al. (1989: 39) from Bahrain and by NEWTON (1955 a) and AL-HASAN & JONES (1989: 305) from Kuwait.

*Polysiphonia kampsaxii* Børgesen

(Figs 119-120, 129-130)

Material: SNMNH/P/ALG: 196, Site 12, 26.I.1992; 197, Site 13, 30.I.492; 198, Site 9, 24.VII.1992. — HEC: 8930, 8931, Site 6, 23.I.1992; 8970, Site 12, 26.I.1992; 8978, Site 13, 30.I.492; 8998 b, Site 9, 02.II.1992; 9237, Site 9, 24.VII.1992. — ODC 49, Site 14, 02.XI.1992.

Thallus 1-4 cm high, erect, forming supple tufts; orangy to pinkish-red; attached by simple, unicellular rhizoids (diameter 30 µm) arising from the repent axis; erect parts with distinct main axis, 280 µm in diameter at the basis, gradually tapering to 70 µm towards the apices, helicoidally branched, adventitious branchlets inconspicuous; segments 0.5-1 times as long as broad; trichoblasts persistent. Structure polysiphonous; each segment composed of an axial cell and four hourglass-shaped pericentral cells; diameter of pericentral cells in transverse section four times the diameter of the central axis; no cortication. Tetrasporocysts in the apical parts of the lateral branches in short helicoidal rows (2-4), spherical, 70-80 µm in diameter, deforming the branches. Cystocarps 340 µm broad, 390 µm long.

Observed exclusively in the winter, epilithic or epiphytic on pneumatophores of *Avicennia marina*, close to low water mark or in intertidal pools; mainly distributed in sheltered areas: Dauhat al-Musallamiya and Dauhat ad-Dafi.

*Polysiphonia kampsaxii* mainly differs from *P. coacta* Tseng by its hourglass-shaped pericentral cells, used by Børgesen as a discriminative character. *Polysiphonia coacta* was recorded by AL-HASAN & JONES (1979: 305) from Kuwait; recorded by NEWTON (1955 b) and BASSON et al. (1989: 38) from Bahrain. New record for the Saudi Arabian Gulf coast.

*Polysiphonia opaca* C. Agardh

(Figs 121, 131)

Material: SNMNH/P/ALG 199, Site 6, 23.I.1992. — HEC: 8917, Site 4, 20.I.1992; 8924, Site 6, 23.I.1992; 8939, Site 7, 24.I.1992.

Thallus 1-2 cm high, erect; brownish-red; attached by unbranched unicellular rhizoids, diameter 30 µm, formed on a short repent axis; erect branches with radial ramification, main axis

---

Figs 117-126: 117-118, *Polysiphonia crassicolis*: 117, detail of the discoidal holdfast; 118, transverse section of an axis showing four pericentral cells surrounding an axial cell; 119-120, *Polysiphonia kampsaxii*: 119, detail of a cystocarp with carpospores; 120, transverse section of an axis showing four pericentral cells surrounding an axial cell; 121, *Polysiphonia opaca*, transverse section of an axis showing 15 pericentral cells surrounding an axial cell; 122, *Polysiphonia* cf. *scopulorum* var. *villum*, transverse section of an axis showing four pericentral cells surrounding an axial cell; 123-124, *Polysiphonia* sp.: 123, transverse section of an axis showing four pericentral cells surrounding an axial cell; 124, portion of an axis showing an adventitious branchlet with apical trichoblasts and a single rhizoid; 125, *Hydrolithon farinosum*, surface view showing hypothalial cells, a trichocyst and epithalial cells (dotted); 126, *Jania rubens*, portions of a thallus showing dichotomous branching.

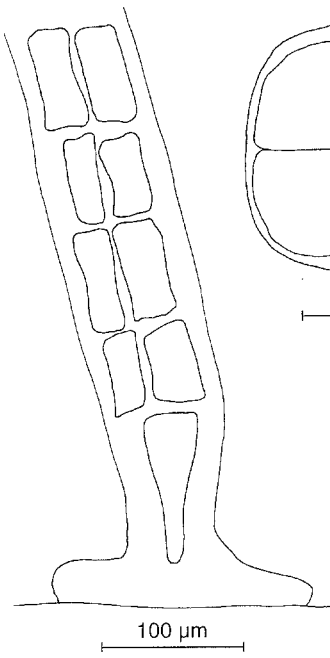

117

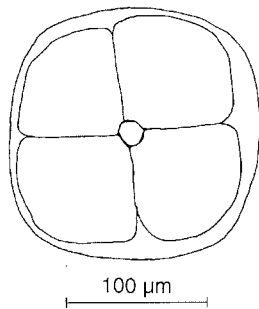

118

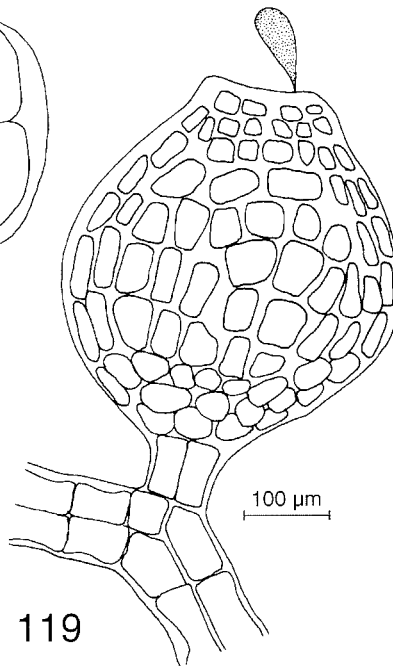

119

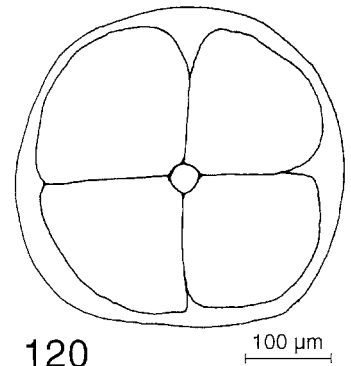

120

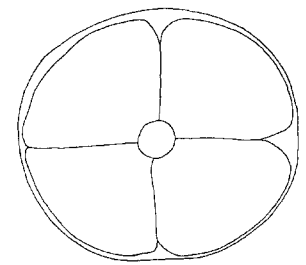

122

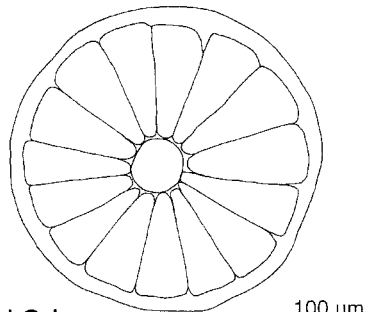

121

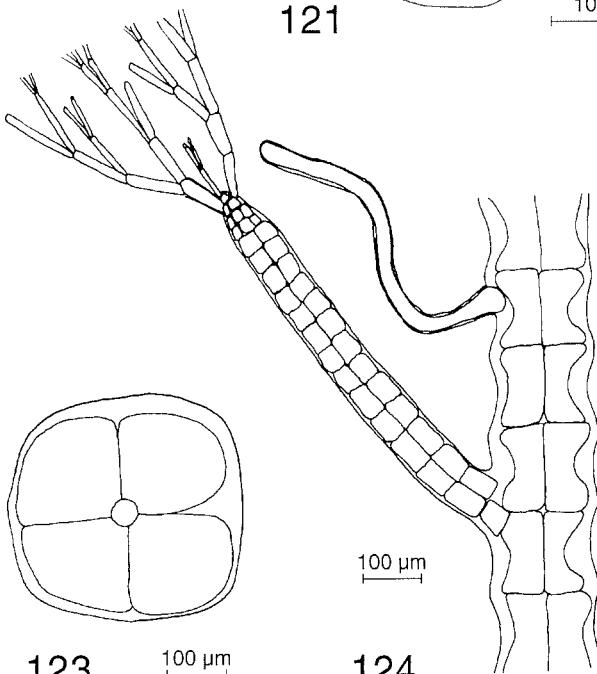

123

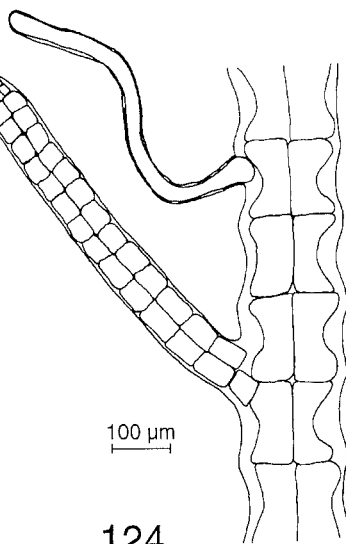

124

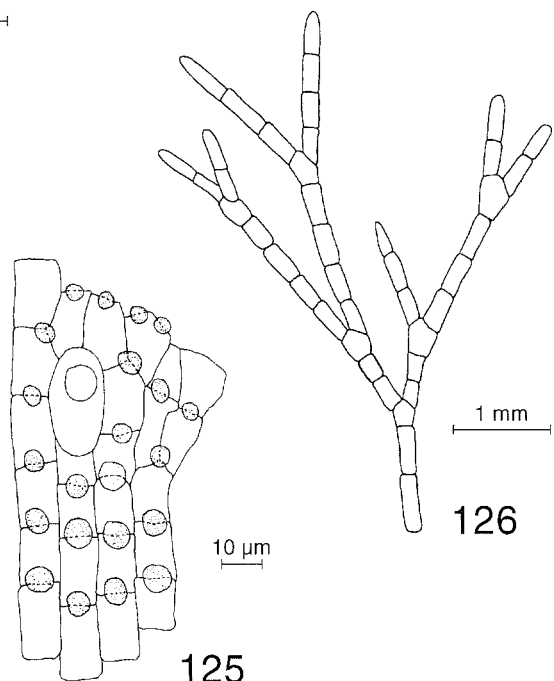

125

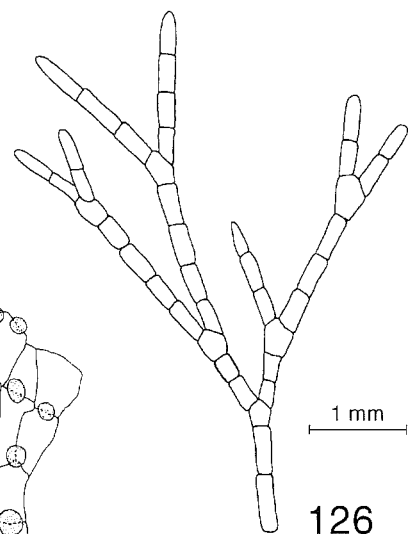

126

very distinct from the shorter laterals, 200  $\mu\text{m}$  in diameter at the basis, gradually tapering to 80  $\mu\text{m}$  towards the apices; segments 0.5-1 times as long as the diameter; trichoblasts numerous towards the apices, forming an apical tuft. Structure polysiphonous; each segment composed of an axial cell surrounded by (10 to) 15 pericentral cells; diameter of pericentral cells in transverse section twice the diameter of the central axis; no cortication. Tetrasporocysts in apical parts of the lateral branches, helicoidally placed, not deforming the axis, spherical, 50-60  $\mu\text{m}$  in diameter.

Collected exclusively in the winter, epilithic along the sheltered coasts of Dauhat ad-Dafi and Dauhat al-Musallamiya, in shallow low midlittoral pools and in the infralittoral fringe down to 2 m depth. New record for the Gulf.

*Polysiphonia* cf. *scopulorum* Harvey var. *villum* (J. Agardh) Hollenberg (Fig. 122)

*Polysiphonia villum* J. Agardh

*Lophosiphonia villum* (J. Agardh) Setchell & Gardner

Material: SNMNH/P/ALG 200, Site 23, 27.VII.1992. — HEC 9239, Site 23, 27.VII.1992.

Thallus 10 cm long, repent, forming extended mats, dark red; attached by unicellular, unbranched rhizoids, formed on the prostrate axes and remaining in open connection with the pericentral cell that formed it; prostrate axes irregularly branched, 200-230  $\mu\text{m}$  in diameter, forming erect axes every (1 to) 2-4 (to 8) segments; these perpendicularly placed, up to 6 mm long, only rarely branched, 40-80  $\mu\text{m}$  in diameter, with straight apices; segments 1-1.5 times as long as broad; trichoblasts rarely fully grown. Structure polysiphonous; each segment composed of an axial cell surrounded by four pericentral cells; diameter of pericentral cells in transverse section 3-4 times the diameter of the central axis; no cortication. Tetrasporocysts in the apical, median or basal parts of the erect branches, in longitudinal, straight rows or solitary, spherical, 70-80  $\mu\text{m}$  in diameter.

A single sample was collected in the summer, at Abu Ali Island, on silty-sandy substrate and decaying leaves of *Halodule uninervis*, in the infralittoral at 2 m depth. The morphological characters and ecology of our material are similar to former descriptions (HOLLENBERG 1968: 81, BASSON 1979 b: 79, SCHNEIDER & SEARLES 1991: 473) except for filament diameters, of 50-85  $\mu\text{m}$ , 60-100  $\mu\text{m}$  and 31-38  $\mu\text{m}$  respectively. Because of the markedly broader repent axes of our specimens (200-230  $\mu\text{m}$ ) we remain cautious with this identification.

Reported by BASSON (l.c.) as *Lophosiphonia villum* from the Saudi Arabian Gulf coast; recorded from Bahrain by BASSON et al. (1989: 39).

*Polysiphonia* sp. (Figs 123-124, 132)

Material: SNMNH/P/ALG 201, Site 20, 20.V.1992. — HEC 9119 a, Site 20, 20.V.1992.

Thallus ascending, up to 10 cm high, forming relatively stiff, dense, intricate tufts; pinkish-red; attached by unbranched, unicellular rhizoids, diameter 30  $\mu\text{m}$ , formed by pericentral cells of the repent part of the filaments; erect branches radially arranged, dichotomous, with no distinct main axis; diameter 500  $\mu\text{m}$  at the basis, gradually tapering to 70  $\mu\text{m}$  towards the apices; segments 0.5-1.5 times as long as broad; adventitious branchlets numerous; trichoblasts persistent. Structure polysiphonous; each segment composed of an axial cell surrounded by four pericentral cells;

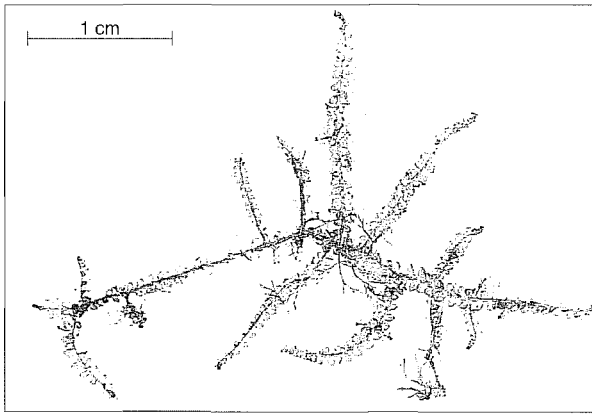

127

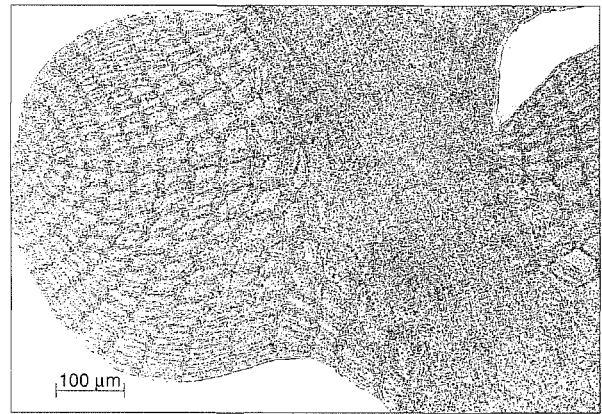

128

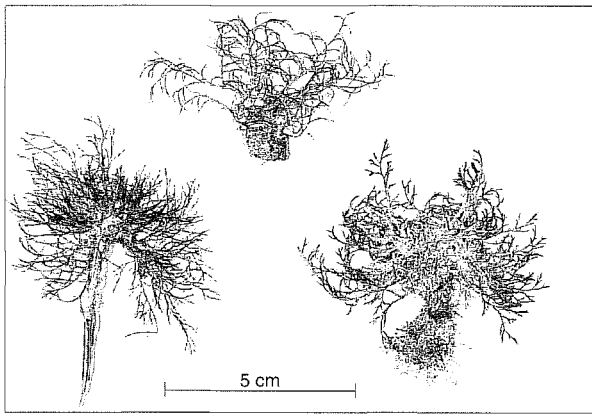

129

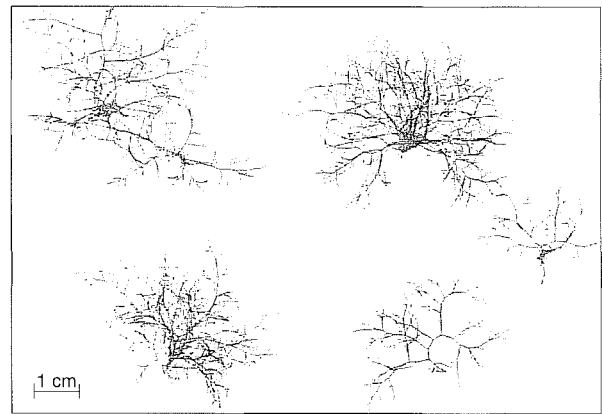

130

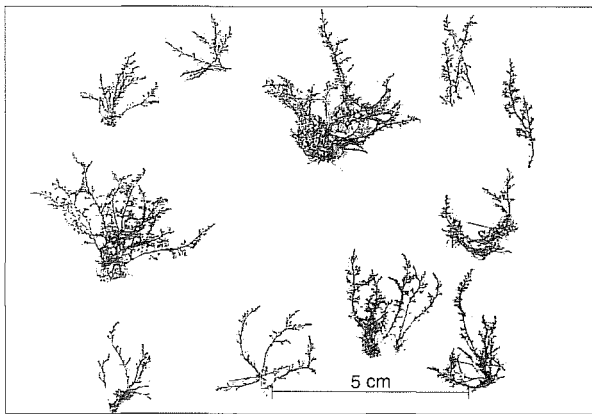

131

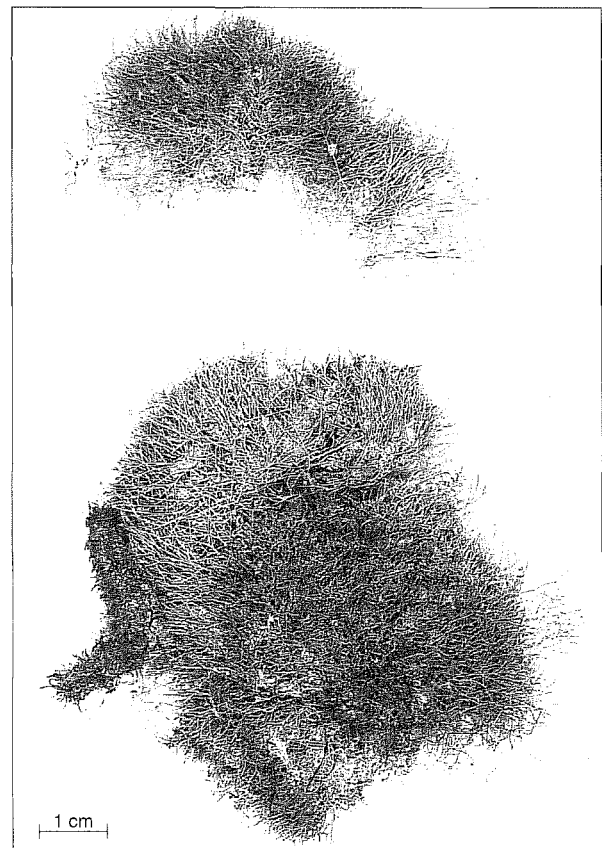

133

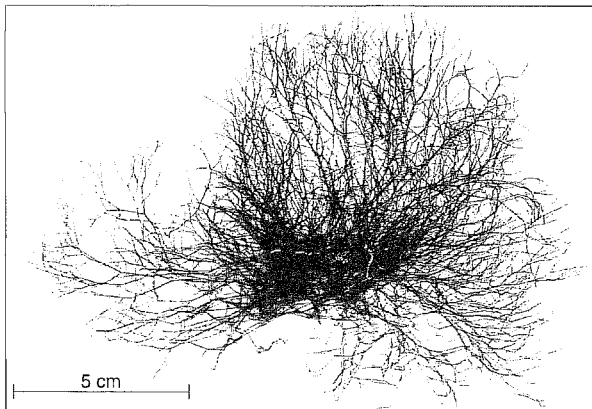

132

diameter of pericentral cells in transverse section four times the diameter of the central axis; no cortication; sterile.

A single sample was collected in the spring in the Qurma Channel, epipsammic, on shell debris and on dead *Halodule* leaves at 3 m depth. *Polysiphonia* species belonging to the section Oligosiphonia (with four pericentral cells) are numerous all over the world. They are mainly distinguished on the basis of characters of reproductive structures: morphology and dimensions of the cystocarp, position of the tetrasporocysts (solitary, in straight or helicoidal rows). This material was sterile and therefore not identifiable to species level.

### Order Corallinales Family Corallinaceae

Genus *Hydrolithon* Foslie

*Hydrolithon farinosum* (Lamouroux) Penrose & Chamberlain (Fig. 125)

*Melobesia farinosa* Lamouroux

*Fosliella farinosa* (Lamouroux) Howe

Material: SNMNH/P/ALG: 202, Site 14, 31.I.1992; 203, Site 16, 04.II.1992. — HEC: 8986 b, Site 14, 31.I.1992; 9018, Site 16, 04.II.1992; 9282, Site 21, 30.VII.1992.

Thallus 1-5 mm in diameter, crustose, nearly circular, slightly calcified, pinkish-white. The centrally placed spore divides twice and forms a single-layered hypothallus, composed of dichotomous, contiguous filaments; cells radially elongated, 9 µm broad, 16 µm long; trichocytes terminal on a filament, the neighbouring cell rows surrounding them and filling the gaps behind the trichocytes, obovate, 16 µm broad, 25 µm long, with markedly thickened cell wall and a hair scar at its distal end; epithallial cells on the tangential walls of two hypothallial cells, circular, 4.5-6 µm in diameter; conceptacles spherical, 170 µm in diameter, with a single central pore.

Very common epiphyte on *Anotrichium tenue*, *Hormophysa cuneiformis*, *Padina boergesenii*, *Halodule uninervis*. One sample collected on plastic sheeting wrapped around coral. Present all year round, along surf-exposed coasts, but possibly also present in sheltered biotopes.

DE CLERCK & COPPEJANS (1994: 21) originally recorded this species as *Fosliella farinosa*. PENROSE & CHAMBERLAIN (1994: 295-300) proved *Fosliella* Howe to be a heterotypic synonym of *Hydrolithon* Foslie. Therefore the correct name of this species is now *Hydrolithon farinosum* (Lamouroux) Penrose & Chamberlain.

Reported by BASSON (1979 b: 70) from the Saudi Arabian Gulf coast; recorded by NEWTON (1955 b) and BASSON et al. (1989: 35) from Bahrain and by NEWTON (1955 a) from Kuwait (as *Fosliella farinosa*). AL-HASAN & JONES (1989: 301) recorded *Pneophyllum lejolisii* (Rosanoff) Chamberlain which is morphologically very similar, but mainly differs in the position of the trichocytes and in the reproductive structures.

Genus *Jania* Lamouroux

*Jania rubens* (Linnaeus) Lamouroux (Figs 126, 133)

*Corallina rubens* Linnaeus

Material: SNMNH/P/ALG: 204, Site 14, 31.I.1992; 205, Site 7, 27.VII.1992; 206, Site 1, 01.XI.1992. — HEC: 8958, Site 10, 26.I.1992; 8986, Site 14, 31.I.1992; 9017, Site 16, 04.II.1992; 9251, Site 7, 27.VII.1992. — ODC 16, Site 1, 01.XI.1992.

Thallus 1-5 cm high, forming dense, erect, stiff tufts, attached by a small disc; branching dichotomous, angle of ramification 45-60°, interdichotomies 0.7-1.5 mm long; axes composed of



calcified segments, separated from each other by uncalcified articulations; segments without articulations 120-180  $\mu\text{m}$  in diameter, 500-1200  $\mu\text{m}$  long; branching segments cuneate, 180-250  $\mu\text{m}$  wide at the distal part, 500-1000  $\mu\text{m}$  long; apical segments cylindrical, not tapering or only slightly so, with rounded top; light pink to greyish.

*Jania rubens* is a perennial, mainly epiphytic species; very frequent in the region, in the infralittoral, along sheltered and surf-exposed coasts. Locally (Site 7) forming a distinct zone (with *Digenea simplex* being the phorophyte) in the infralittoral fringe.

*Jania pumila* Lamouroux, also reported from the Gulf by BØRGESEN (1939: 107-108), AL-HASAN & JONES (1989: 301) and BASSON et al. (1989: 35), differs because of the smaller diameter of the segments: 60-100 (to 150)  $\mu\text{m}$ . This species is not present in our collection. Reported by BASSON (1979 b: 70) from the Saudi Arabian Gulf coast; recorded from Bahrain by NEWTON (1955 b) and BASSON et al. (1989: 35).

### Genus *Lithophyllum* Philippi

#### *Lithophyllum kotschyianum* Unger

Material: HEC: 8975, Site 18, 26.I.1992; 9001, Site 1, 31.I.1992.

Young parts of plants encrusting, older parts branched, branches compressed to plate-like shape, not cylindrical; crustose parts attached to the substratum. Crustose parts 0.5-1.0 mm thick. Thallus pseudoparenchymatous; cells of adjacent filaments laterally connected by secondary pit connections. Crustose parts of thalli dorsiventral and monomerous; ventral region composed of filaments more or less paralleling the substratum and organised in a non-coaxial manner (cells 5-15  $\mu\text{m}$  in diameter and 10-30  $\mu\text{m}$  long); dorsal region composed of portions of filaments curving outwardly from the ventral region towards the surface (cells 5-12  $\mu\text{m}$  in diameter and 5-10  $\mu\text{m}$  long). Branched parts radial and monomerous; central core composed of filaments arising from the ventral region, organised in a non-axial manner (cells 5-10  $\mu\text{m}$  in diameter and 10-25  $\mu\text{m}$  long); peripheral region (cells 5-10  $\mu\text{m}$  in diameter and 5-12  $\mu\text{m}$  long) composed of portions of filaments curving outwardly from the central core towards the surface. Trichocytes not observed. Filaments terminated by a single, rounded epithallial cell (cells 5-10  $\mu\text{m}$  in diameter and 3-6  $\mu\text{m}$  long) and one subepithallial meristematic cell producing new epithallial cells outwardly or additional vegetative cells inwardly.

Tetrasporocyst development on the side of the plate-like branches not exposed to sunlight. Conceptacles 250-350  $\mu\text{m}$  internal diameter and 200-225  $\mu\text{m}$  internal height. Conceptacle floor more than 15 cells below thallus surface. Conceptacle roof 5-8 cells thick, arising from filaments surrounding the tetrasporocystical disc, less than 15 % of the conceptacle raised above the thallus surface. Old and empty conceptacles buried. Columella present, filaments of columella protruding into the pore. Conceptacles of gametocysts have not been found (VERHEIJ 1994: 100).

*Lithophyllum kotschyianum* is a perennial, epilithic species on coral and shells; very frequent in the region, in the infralittoral, along surf-exposed coasts. New record for the Gulf.

## Family Sporolithaceae

### Genus *Sporolithon* Heydrich

#### *Sporolithon molle* (Heydrich) Heydrich

(Fig. 139)

*Sporolithon ptychoides* Heydrich f. *mollis* Heydrich

Material: HEC: 8967, Site 18, 26.I.1992; 9000, Site 1, 31.I.1992.

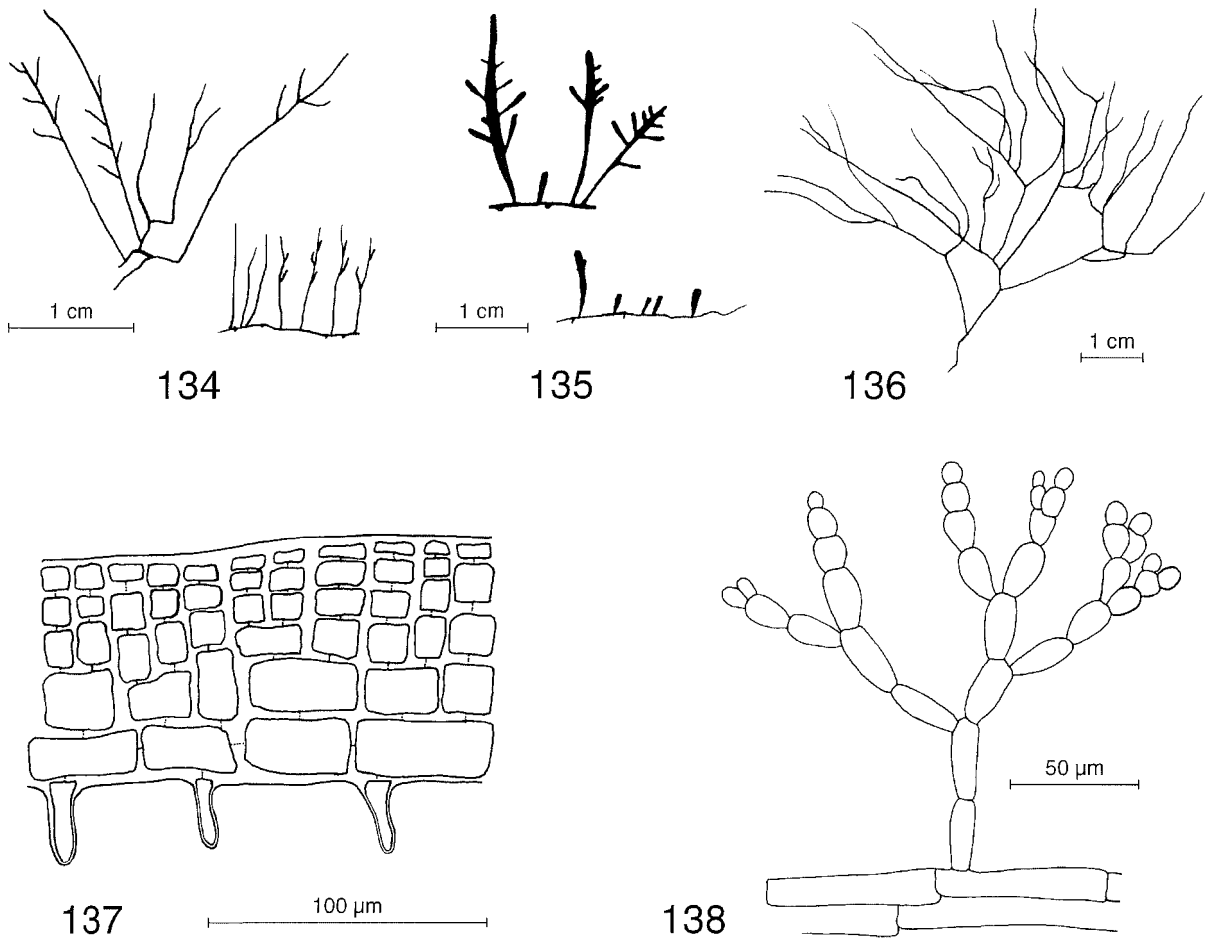

Figs 134-138: 134, *Gelidiella myriocladia*, habit; 135, *Gelidium pusillum*, habit; 136, *Wurdemannia miniata*, habit; 137, *Peyssonnelia simulans*, radial section showing a single layered hypothallus, perithallial filaments and unicellular rhizoids; 138, *Liagora distenta*, detail of a dichotomous assimilatory filament.

Plants flat to lumpy, usually attached but sometimes free-living and forming rhodoliths. Thallus pseudoparenchymatous; cells of adjacent filaments connected laterally by cell fusions and secondary pit-connections. Ratio of secondary pit-connections to lateral cell fusions 2:1 to 3:1. Crustose parts of thalli dorsiventral and monomeric; ventral region composed of filaments more or less parallel to the substratum (cells 5-10 µm in diameter and 10-25 µm long); dorsal region composed of portions of filaments curving outwardly from the ventral region towards the surface (cells 5-10 µm in diameter and 5-15 µm long). Lumpy parts radial and monomeric; central core composed of filaments arising from the ventral region (cells 5-10 µm in diameter and 10-25 µm long); peripheral region composed of portions of filaments curving outwardly from the central core towards the surface. Filaments each terminated by a single, flared epithallial cell and one subepithallial meristematic cell producing new epithallial cells outwardly or additional vegetative cells inwardly.

Tetrasporocysts 75-85 × 30-40 µm, solitary or loosely grouped but not formed on a basal layer of elongated cells. No additional layers of cells formed between the tetrasporocysts. Paraphyses 3-4 cells long. Old and empty tetrasporocysts becoming buried and sometimes infilled by vegetative growth. Gametophytes not observed (VERHEIJ 1993: 189).

*Sporolithon molle* is a perennial, epilithic species; very frequent in the region, in the infralittoral, along surf-exposed coasts. Often forming a distinct zone on the reef flat. Covering large parts of the upper part of the *Acropora* reef on the offshore island. Recorded for the Saudi Arabian Gulf coast by BASSON (1979 b: 70) as *Lithothamnion* sp.

Order Gelidiales  
Family Gelidiaceae

Genus *Gelidiella* Feldmann & Hamel

*Gelidiella myriocladia* (Børgesen) Feldmann & Hamel

(Fig. 134)

*Echinocaulon myriocladum* Børgesen

Material: SNMNH/P/ALG: 207, Site 8, 24.VII.1992; 208, Site 1, 01.XI.1992; 209, Site 8, 05.XI.1992. — HEC: 9202, Site 27, 21.VII.1992; 9219, Site 8, 24.VII.1992; 9277, Site 21, 30.VII.1992; 9289, Site 18, 31.VII.1992; 9333, Site 25, 06.VIII.1992. — ODC: 9, Site 2, 31.X.1992; 22, Site 1, 01.XI.1992; 54, Site 11, 02.XI.1992; 77, Site 8, 05.XI.1992.

Thallus 1-2 cm high, forming extended dense mats or small tufts, composed of repent stolonoids bearing numerous erect axes, all parts terete; very strongly attached by numerous wedge-shaped, irregularly placed haptera; erect axes 130-200 µm in diameter, not ramified, or irregularly to pinnately branched, with pointed apices; greenish, orange to dark brown. Structure uniaxial, but only recognisable because of the single apical cell; cortical cells in superficial view irregularly placed, rectangular with rounded corners, 9-10 µm long, 5-7 µm broad, in transverse section square, 5-7 µm in diameter; subcortex forming the transition to the medulla, composed of oval cells, 10-15 µm in diameter; no internal rhizines. Stichidia of tetrasporocysts terminal on the erect axes, 200 µm long, 60 µm broad.

Distribution limited to surf-exposed sites: Abu Ali Island, Ras az-Zaur and the patch reefs. Covering vast horizontal surfaces of the infralittoral hard substrates, especially in the summer, but also in the autumn. The thalli remain short because of intense grazing by sea urchins (*Echinometra mathaei*) and herbivorous fish. A single sample was collected, epiphytic on *Digenea simplex*. Reported from the Saudi Arabian Gulf coast by BASSON (1979 b: 69).

Genus *Gelidium* Lamouroux

*Gelidium pusillum* (Stackhouse) Le Jolis

(Fig. 135)

*Fucus pusillus* Stackhouse

Material: SNMNH/P/ALG: 210, Site 2, 22.VII.1992; 211, Site 2, 31.X.1992. — HEC: 9214, Site 2, 22.VII.1992; 9278, Site 21, 30.VII.1992; 9295, Site 1, 01.VIII.1992. — ODC 8, Site 2, 31.X.1992.

Thallus 0.5-2.5 cm high, forming open mats composed of repent, terete stolonoids and compressed erect axes; very strongly attached by numerous, irregularly placed, wedge-shaped haptera; tough erect axes terete at the basis, compressed higher up, up to 1000 µm broad, irregularly to pinnately branched, side branches constricted at their basis, also compressed, 2-5 mm long; reddish-brown. Structure uniaxial, but only recognisable because of the single apical cell; cortical cells in surface view irregularly placed, isodiametrical, 5-9 µm in diameter, radially arranged and, in transverse section, rectangular with rounded corners, subcortex forming a gradual transition to the medulla which is composed of rounded cells, 12 µm in diameter; internal rhizines present in the subcortex and the medulla; sterile.

Distribution and seasonality very similar to *Gelidiella myriocladia*, sharing the same biotope but being less frequent. Recorded from Kuwait by AL-HASAN & JONES (1989: 301). New record for the Saudi Arabian Gulf coast.

Genus *Wurdemannia* Harvey

*Wurdemannia miniata* (Sprengel) Feldmann & Hamel (Fig. 136)

*Sphaerococcus miniatus* Sprengel

Material: SNMNH/P/ALG 212, Site 2, 22.VII.1992. — HEC 9217, Site 2, 22.VII.1992.

Thallus 4-5 cm high, forming wiry clusters of terete axes; attached by irregularly placed, disciform haptera; branching irregular to unilateral; axes 200 µm in diameter, apically with short points; dark red. Structure multiaxial, with several apical cells; cortex cells in superficial view longitudinally elongated, angular, in transverse section square to rectangular, 10-15 µm broad, radially 10-17 µm long; medulla cells isodiametrical, 15-25 µm in diameter, central cells not smaller than the peripheral ones, no internal rhizines.

A single sample was collected in the summer, epilithic on vertical walls of the pier at the NE tip of Abu Ali Island, 1-3 m depth. Reported by NIZAMUDDIN & GESSNER (1970: 8) from the Iranian coast. New record for the Saudi Arabian Gulf coast.

### Order Gigartinales

#### Family Dumontiaceae

Genus *Dudresnaya* Crouan frat.

*Dudresnaya* sp. (Fig. 140)

Material: SNMNH/P/ALG: 213, Site 14, 31.I.1992; 214, Site 19, 19.V.1992. — HEC: 8971, Site 18, 26.I.1992; 8984, Site 14, 31.I.1992; 9127, Site 19, 19.V.1992. — ODC 134, Site 18, 22.II.1993.

Thallus 5-10 cm high, erect, gelatinous; attached by a basal disc; branching of main axes radial, no distinct main axis, cylindrical, 10 mm in diameter at the basis, gradually tapering towards the apices which are acute; bright red. Structure uniseriate, composed of axes and ramuli; axis clearly visible at the apex, composed of cells: 30 µm in diameter and 100 µm long in subapical parts, 80 µm in diameter and 280 µm long at the basis; cells covered by downwardly growing rhizoids towards the basis; ramuli verticillate (4), on the distal end of each axial cell, frequently dichotomously branched, cells 20 µm broad and 100 µm long at the basis, 4 µm broad and 20 µm long at the apices. Tetrasporocysts lateral on the apical parts of the ramuli, shortly stipitate, zonate, cylindrical, 10 µm in diameter, 30 µm long.

Observed exclusively in the cold season, on the (mostly seaward) vertical walls of coral boulders of surf-exposed coasts: along Abu Ali Island and on the patch reefs.

Dumontiaceae are characterised by the uniaxial structure having whorls of four ramuli; the thalli are frequently gelatinous and the tetrasporocysts zonate. Our specimens could not be identified to species level because female reproductive structures were absent (KYLIN 1956: 148-149, ROBINS & KRAFT 1985: 2). Morphologically, the specimens resemble the illustration of *Dudresnaya crassa* Howe in SCHNEIDER & SEARLES (1991: 260), but further research is needed. No such gelatinous alga has previously been recorded from the Gulf.

#### Family Hypneaceae

Genus *Hypnea* Kützting

*Hypnea cervicornis* J. Agardh (Figs 141-142)

*Hypnea spinella* Kützting

Material: SNMNH/P/ALG 215, Site 15, 16.V.1992. — HEC: 9085, Site 15, 16.V.1992; 9103, Site 18, 18.V.1992; 9341, Site 25, 06.VIII.1992; 9358, Site 27, 06.VIII.1992. — ODC 5, Site 2, 31.X.1992.

Thallus 10-20 cm high, erect, forming dense, relatively stiff tufts; attached by a small parenchymatous disc bearing several main axes; branching alternately distichous to irregular; main axes and side branches very similar, terete, 2 mm in diameter at the basis, gradually tapering towards the apices; ramuli radially placed, branched, spiny, 5-10 mm long; dark red to purplish. Structure uniaxial, but not recognisable in transverse section which is composed of medulla and cortex; all cells isodiametrical in transverse section, those of the central part of the medulla 200-250 µm in diameter, gradually smaller towards the periphery, to 35 µm in diameter, no cell wall thickenings; cortex single-layered, pigmented, 9-10 µm in diameter. No propagules; cystocarps on the basal parts of the thallus, on the median or distal part of the branched ramuli, subspherical, 630 µm wide, 450 µm high.

Collected in the spring and summer, epilithic in the infralittoral zone, around the patch reefs and along Abu Ali Island; a single, small, sterile specimen was found in the autumn.

BØRGESEN (1939: 112), BASSON (1979 b: 70) and BASSON et al. (1989: 35) recorded *H. valentiae* (Turner) Montagne from the Gulf. This species is characterised by the large number of perpendicularly placed ramuli, absent in our material. *Hypnea cervicornis* is a new record for the Gulf.

*Hypnea cornuta* (Kützinger) J. Agardh

(Figs 143-144)

*Chondroclonium cornutum* Kützinger

Material: SNMNH/P/ALG: 216, Site 15, 04.II.1992; 217, Site 16, 05.II.1992; 218, Site 2, 21.V.1992; 219, Site 16, 20.VII.1992; 220, Site 11, 02.XI.1992. — HEC: 8969, Site 18, 26.I.1992; 9002, Site 15, 04.II.1992; 9025, Site 16, 05.II.1992; 9070, 9074, Site 16, 15.V.1992; 9124, Site 2, 21.V.1992; 9180, Site 16, 20.VII.1992; 9314, Site 1, 01.VIII.1992. — ODC: 56, Site 11, 02.XI.1992; 133, Site 18, 22.II.1993.

Thallus 10-20 cm high, erect, forming thin to dense, supple tufts; attached by a small parenchymatous disc, bearing several main axes; branching of these alternately distichous to unilateral; main axis generally easily recognisable; all axes terete, 2 mm in diameter at the basis, pointed at the apices; ramuli radially and perpendicularly placed, generally unbranched, with spiny apex, upwardly curved, 150-300 µm in diameter, 1-5 (to 10) mm long; cream to light pink. Structure uniaxial, composed of medulla and cortex; all cells isodiametrical in transverse section, the axial cell 20 µm in diameter; medulla cells gradually smaller towards the periphery, without cell wall thickenings, 150 µm in diameter towards the centre, 40 µm in the periphery; cortex single-layered, composed of pigmented cells, 12 µm in diameter. Propagules stellate, with 3-5 branches, 0.5-1 mm in diameter, on axes and ramuli; tetrasporocysts grouped in stichidia on the distal part of the side branches; no cystocarps observed.

*Hypnea cornuta* is common in the winter and spring, on subtidal hard substrate along exposed coasts: coral fragments, slopes of patch and fringing reefs. Still present in the summer and autumn, but less common.

This species can be distinguished from other *Hypnea* species by the presence of the stellate propagules, a character restricted to this species. AL-HASAN & JONES (1989: 302) recorded *H. cornuta* from the coast of Kuwait during the warm season, BASSON et al. (1989: 35) from Bahrain; BASSON (1979 b: 70) reported this species from the Saudi Arabian Gulf coast.

Family Peyssonneliaceae

Genus *Peyssonnelia* Decaisne

*Peyssonnelia simulans* Weber-van Bosse

(Fig. 137)

Material: HEC: 8976, Site 18, 26.I.1992; 9279, Site 21, 30.VII.1992; 9308, Site 1, 01.VIII.1992.

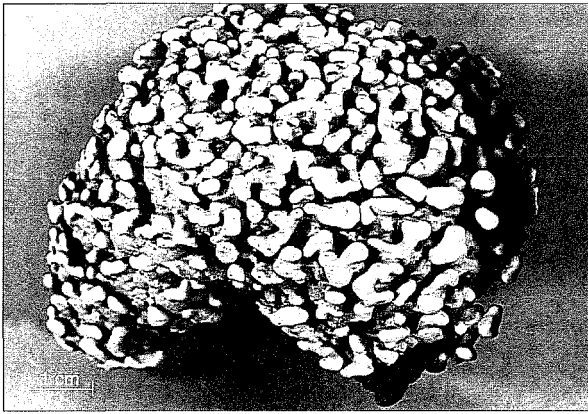

139

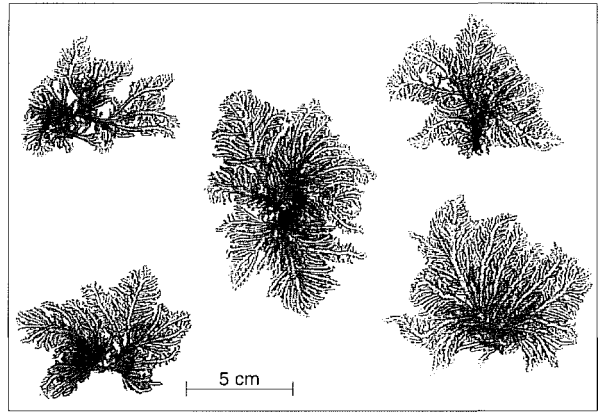

140

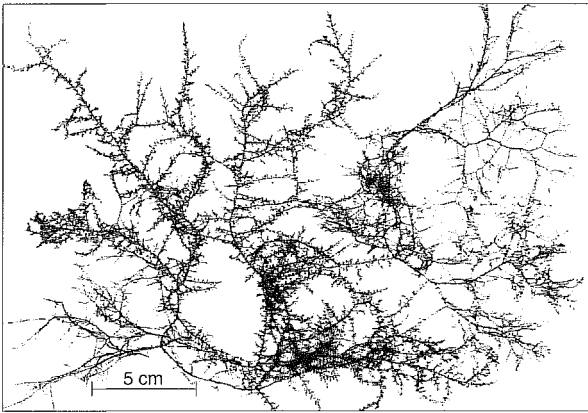

141

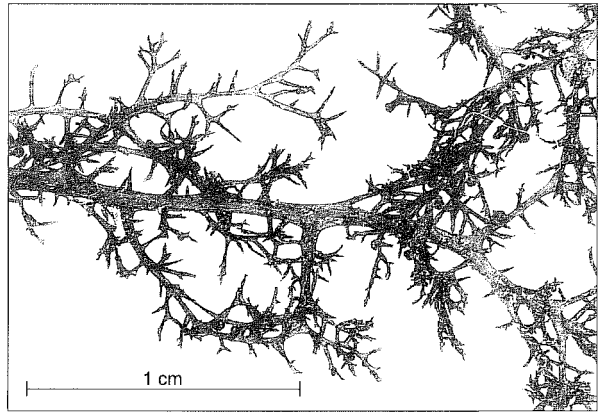

142

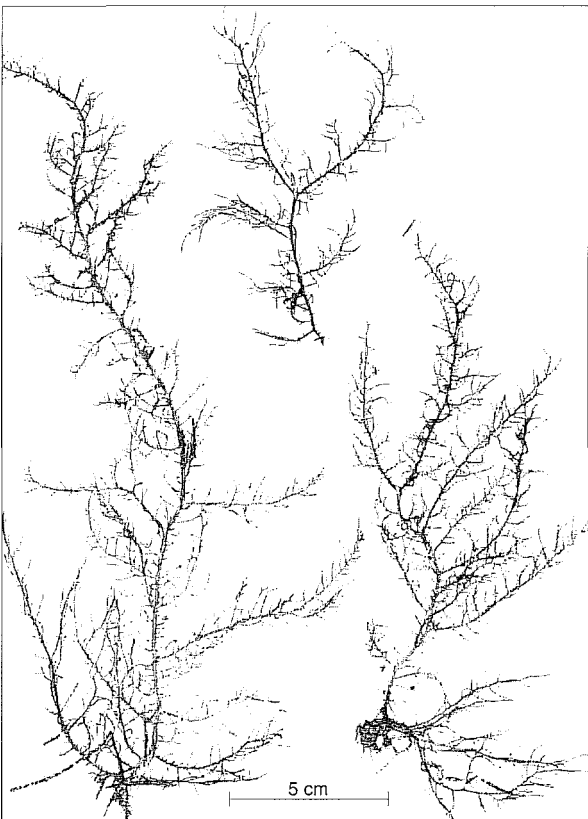

143

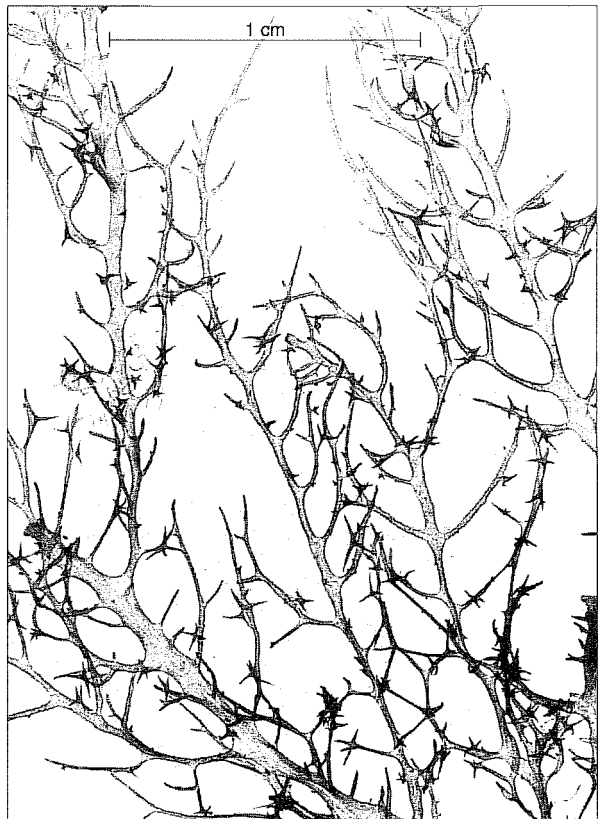

144

Thallus crustaceous, with irregular outline, 0.5-4 cm in diameter, leathery, calcification on the lower side of the thallus; easily removable from the substrate, bordeaux-red; 70-90  $\mu\text{m}$  thick in radial section, composed of a hypo- and a perithallus; attached by unbranched unicellular rhizoids, inserted on the distal end of the hypothallus cells, 10  $\mu\text{m}$  in diameter; hypothallus single-layered, composed of rectangular cells, 25-40  $\mu\text{m}$  long, 17-22  $\mu\text{m}$  high; perithallus 4-5 cells high, the lowermost one very similar to the hypothallus cells, giving rise to two short filaments forming an angle of 70° with the hypothallial cell row in radial section: cells 12-20  $\mu\text{m}$  wide and 10-15  $\mu\text{m}$  high, the apical cells being shorter; sterile.

*Peyssonnelia simulans* is an inconspicuous, perennial species, attached to coral fragments, shells and calcified red algae; detailed data on its distribution are not yet available. AL-HASAN & JONES (1989: 301) recorded this species from Kuwait. First record for the Saudi Arabian Gulf coast.

### Order Nemaliales Family Liagoraceae

Genus *Liagora* Lamouroux

*Liagora distenta* (Mertens) Lamouroux

(Figs 138, 145)

*Fucus distentus* Mertens

Material: SNMNH/P/ALG 221, Site 2, 22.V.1992. — HEC 9128, Site 2, 22.V.1992.

Thallus erect, 10 cm high, composed of supple terete branches, resulting in hemispherical fronds, attached by a small basal disc; branches slippery to the touch, 2 mm in diameter at the basis, 0.5 mm at the apices, dichotomous; angle of ramification 60-170°, interdichotomies 2-3 cm at the basis, 0.5 cm towards the apices; adventitious branchlets with similar, but more compact, morphology present all over the thallus but more frequent towards the basis, perpendicular on the main axes; calcification stronger at the basis, resulting in a whitish colour; upper parts pinkish. Medulla composed of numerous cylindrical, thin-walled cells, 12  $\mu\text{m}$  in diameter, 75  $\mu\text{m}$  long; assimilatory filaments up to 170  $\mu\text{m}$  long, 4-5 times dichotomously branched, basal cells cylindrical to barrel-shaped, 10  $\mu\text{m}$  in diameter, 28  $\mu\text{m}$  long, apical cells spherical or subspherical, 8  $\mu\text{m}$  in diameter. Cystocarps spherical, between the assimilatory filaments, 150  $\mu\text{m}$  in diameter, completely surrounded by an involucre.

A single sample was collected from a relatively extended, but isolated, population on a subtidal beach rock platform, just below low water mark at the eastern tip of Abu Ali Island in the spring.

NIZAMUDDIN & GESSNER (1970: 8) recorded *L. distenta* from the Gulf, but their specimens had an alternate branching pattern. According to ABBOTT (1990 a: 114-116) the branching of this species can vary from dichotomous to alternating, with a distinct main axis. BASSON et al. (1989: 35) describe *L. viscida* (Forsskål) C. Agardh from the Gulf; this species is more strongly calcified and the diameter of the branches is almost constant from the basis to the apices (ABBOTT 1990 b: 310-312). A new record for the Saudi Arabian Gulf coast.

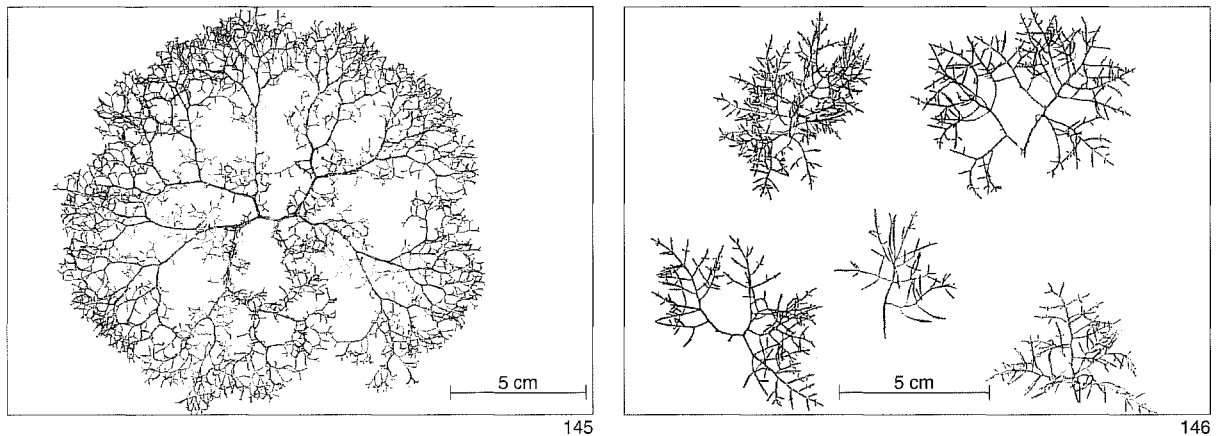

Figs 145-146: 145, *Liagora distenta*, habit; 146, *Champia parvula*, habit.

### Order Rhodymeniales Family Champiaceae

Genus *Champia* Desvaux

*Champia parvula* (C. Agardh) Harvey

(Fig. 146)

*Chondria parvula* C. Agardh

Material: SNMNH/P/ALG: 222, Site 16, 15.V.1992; 223, Site 2, 21.V.1992. — HEC: 9072, Site 16, 15.V.1992; 9097, Site 32, 17.V.1992; 9123, Site 2, 21.V.1992. — ODC: 132, Site 33, 21.II.1993; 138, Site 11, 24.II.1993.

Thallus (0.5 to) 5-10 cm high, ascending, supple, slippery to the touch; attached by a small disc bearing a single or several axes; branching alternate, opposite or verticillate; no well-marked distinction between main and side branches; axes hollow (mucilage-filled), 1 mm in diameter, divided into barrel-shaped segments by transverse diaphragms; young segments wider than long, fully grown ones as long as, or slightly longer than wide; pink to orangy. Structure tubular, single-layered, covered by a gelatinous cell wall; in superficial view composed of large polygonal cells (30-40  $\mu\text{m}$  in diameter) mixed with smaller ones (15  $\mu\text{m}$  in diameter), forming sparse cortex; regularly spaced longitudinal filaments along the cavity of the thallus, 60  $\mu\text{m}$  in diameter, bearing oval gland cells, 80  $\mu\text{m}$  broad, 100  $\mu\text{m}$  long; segments separated from each other by single-layered septa; sterile.

Fully grown specimens collected in the spring, epilithic in the infralittoral fringe and zone, along surf-exposed coasts. Winter specimens are markedly smaller. Collected in Kuwait by AL-HASAN & JONES (1989: 303). A new record for the Saudi Arabian Gulf coast.

#### Marine habitats and associated algal flora

Note: the letters and numbers used to indicate the different biotopes are those recorded in the next chapter to describe the distribution of the different vegetation types in the Sanctuary.

#### A. The supralittoral and intertidal zones

The intertidal zone (and even the supralittoral fringe) of tropical coasts is generally richly covered by a large number of seaweeds and seagrasses which form distinct superimposed zones. On the



contrary, the intertidal shoreline of the Saudi Arabian Gulf is almost devoid of algae and seagrasses, due to extreme annual fluctuations in temperature and salinity (BASSON et al. 1977: 42, JOHN et al. 1990: 273-281).

### A.1. Salt-marshes

Large areas of this habitat were heavily polluted by the oil spill, but even the non-polluted sites are devoid of algal growth (except for the extended, thick mats of Cyanophyta). This is confirmed by BASSON et al. (l.c.). In other tropical regions, algae such as *Vaucheria*, *Enteromorpha*, *Ulva*, etc. develop in this biotope.

### A.2. Mangroves

Vast areas of this shrubby vegetation were severely damaged by the oil spill. However, the absence of *Bostrychietum*, an algal association which is very characteristic on the pneumatophores of mangroves in most tropical areas (COPPEJANS & GALLIN 1989), was not caused by the pollution: *Bostrychia* and the associated species of this algal community have never been recorded in the Gulf area. Here the *Avicennia marina* pneumatophores are generally covered by a layer of blue-green algae, and some of the aerial roots growing in the tide channels support epiphytic *Chondria dasyphylla*, *Polysiphonia kampsaxii* and *Cladophora nitellopsis* during the cold season only.

### A.3. The bare areas (without macroscopic woody plants)

#### A.3.1. Sandy and muddy coasts

This is the zone where a well-marked zonation of different seagrasses, mixed with some algae (COPPEJANS et al. 1992), occurs in other regions of the Indian Ocean. In the Jubail area even the unpolluted zones appeared to be completely devoid of any macroscopic vegetation. This is the result of the scorching effect of the sun during the summer and of the cold temperatures in the winter. In the cold season, however, small stones or shell fragments were sometimes covered by *Cladophora nitellopsis* and *Acetabularia calyculus*, especially in the shallow tide pools or tide channels. Here some seagrass (*Halodule uninervis*) growth could occur, especially towards low water mark.

#### A.3.2. Rocky substrate

The upper and middle parts of the intertidal rocks were also almost completely devoid of macroscopic vegetation. In other parts of the Indian Ocean this habitat is characterised by a relatively dense cover of various macroalgae. Here, again, the extreme climatic conditions inhibit the development of this vegetation in the Gulf region. Deeper rock pools support some algal growth of which the brown algae *Cystoseira trinodis*, *Cystoseira myrica* and *Hormophysa cuneiformis* are the most characteristic species. Old specimens of these are frequently covered by several epiphytes: *Hincksia mitchelliae*, *Sphacelaria rigidula*, *Jania rubens*, *Hydrolython farinosum* etc. The lower part of the intertidal zone (in fact the infralittoral fringe, between mean and spring low water mark) along sheltered coasts is generally characterised by a dense vegetation of *Digenea simplex*. In shallow pools close to the extreme low water line a relatively rich algal flora may develop, especially during spring, with *Dictyosphaeria cavernosa*, *Cladophora* sp., *Chondria dasyphylla*, *Laurencia obtusa*, *L. papillosa*, *Polysiphonia opaca*, *Ceramium strictum*, *Hypnea cornuta* etc. Along exposed coasts (Abu Ali Island) *Cladophoropsis sundanensis* forms cushion-like growths in the infralittoral fringe.

## B. The subtidal zone

This habitat was not affected by the oil spill and therefore supports natural vegetation types.

### B.1. Sand and mud substrate

Sandy and muddy substrates dominate the subtidal zone. They are either bare or covered by seagrasses; *Halodule uninervis* (Forsskål) Ascherson is the dominant species, forming extensive beds from low water mark down to 3 m depth. Locally it may be replaced by *Halophila stipulacea* (Forsskål) Ascherson and *H. ovalis* (Brown) Hooker (see also RICHMOND this volume). Both of these generally develop close to the low water mark as colonising species (e.g. on shifting sand banks). In a few areas the green alga *Avrainvillea amadelpha* is mixed with *Halodule*. Below 3 m depth the seagrass cover declines rapidly and another Chlorophyte, *Caulerpa sertularioides*, colonises the available space in patches, down to 6 m depth.

### B.2. Hard substrate

#### B.2.1. The reefs

Fringing coral reefs are well developed along the NW coast of Abu Ali Island and along the E coast of Ras az-Zaur. Shallow patch reefs are distributed over the central area of Dauhat ad-Dafi. They each support a similar and diverse algal flora: their upper surface, close to the water surface, is frequently covered by *Sporolithon molle*. In the winter they are largely covered by the cerebriiform brown alga *Colpomenia sinuosa* and the filamentous *Hincksia mitchelliae*. These species die off in the spring; large quantities of loose-lying, decaying specimens of *Colpomenia* are then found in the lagoon of Abu Ali Island and in sheltered subtidal bays around the patch reefs. At the same time, the perennial bases of *Sargassum* start sprouting new annual branches, which grow quite quickly to form dense bushes up to 1 m in height and may completely cover parts of the reef. A characteristic epiphyte is the slimy *Nemacystus erythraeus* but numerous other epiphytic algae develop on this large phorophyte. In the summer the annual branches of *Sargassum* are shed, creating a new drifting habitat until they are washed ashore. Together with *Halodule* leaves, annual branches of *Cystoseira* and *Hormophysa*, drift wood and other organic material, they form a specific biotope at spring high water level with a typical associated fauna. Around Karan *Sargassum* was not observed, but the stolonoidal stage of *Turbinaria ornata* f. *evesiculosa* covers vast areas of the reefs. Vertical and overhanging walls generally have a very colourful and rich flora (especially in the spring) along the continental coast, with huge specimens of *Asparagopsis taxiformis*; Karan supports large populations of *Lobophora variegata*. The perennial green alga *Avrainvillea amadelpha* typically develops in the seaward crevices of the coral heads.

#### B.2.2. Subtidal rock substrate

On (sub)horizontal, partly sand-covered hard substrate between coral heads, an algal community develops which is generally dominated by *Hormophysa cuneiformis*, *Cystoseira trinodis* and *Sargassum decurrens*, locally mixed with large amounts of *Padina boergesenii*, *Dictyota indica* and *Dictyota* sp.

The different *Sargassum* species and *Cystoseira trinodis* die off towards the summer, leaving the hard substrate rather bare. Hence, observations in different seasons are essential in order to understand annual fluctuations in the biomass of the submerged vegetation.

A final, noteworthy, characteristic of the subtidal vegetation on hard substrate is the extreme patchiness of some species, e.g. *Liagora distenta*, *Hydroclathrus clathratus*, which were only observed

on a few square metres within the whole study area. Fieldwork must therefore be carried out in as many localities as possible to ensure that locally abundant species are not overlooked.

### B.2.3. Deep rock substrates

In the spring and early summer extensive *Sargassum binderi* beds are present on hard substrates between 4 and 6 m depth, N of Abu Ali Island. *Dictyopteris membranacea* (a new record for the Gulf) grows extensively on the vertical walls. This type of vegetation has rarely been observed but, judging by the amounts of drifting *S. binderi*, it should occur frequently in the area.

## Distribution of algae in the Sanctuary

Abu Ali Island is undoubtedly the richest part of the study area. Site 11, at the western side of the island, also has a large intertidal zone (A.3.1., A.3.2.). The subtidal zone lacks a fringing reef, but some rocky substrate occurs locally (B.2.2.). The fringing reef follows the coast from Site 22 to Site 1. Sites 22, 14, 15, 16 are the richest in the area. The very narrow intertidal zone consists mainly of sand (A.3.1.) but, locally, is composed of beach rock (A.3.2.). The subtidal is dominated by fringing reef with a shallow lagoon, a reef flat and a reef edge (B.2.1.). Site 2, the tip of Abu Ali Island, differs from the other sites by having an *Acropora* reef. Large parts are overgrown by *Lobophora variegata*. *Sargassum* does not grow on the reef itself but on the pier boulders. Vast areas of the soft substrate look like a crater landscape because of the activities of worms; they are devoid of any algal growth.

The patch reefs (B.2.1.), sites 18, 19, 21, 25, 26, 27 and 28, are all very similar and their vegetation is comparable to that along Abu Ali Island. Rock patches with a different vegetation (B.2.2.) also occur in the bay at sites 3, 4, 10 and 31.

At Ras az-Zaur, Site 8, a fringing reef (B.2.1.) has developed and most of the species occurring at Abu Ali Island are present here, although *Sargassum* spp., *Lobophora variegata* and *Colpomenia sinuosa* are absent. In the subtidal zone of Site 9, the seaward side of the peninsula, soft substrate (B.1.) is dominant. Where subtidal hard substrate is available a flora corresponding to B.2.2. is present.

Dauhat ad-Dafi and Dauhat al-Musallamiya are sheltered bays. At Qurma (Site 20), a mangrove and salt-marsh vegetation has developed (A.1., A.2.). Sites 13 and 17 are very similar to Site 20. Sites 6, 7, 23 and 24 are poor in species. Where hard substrate (B.2.2.) is available the algal biomass may be considerable (e.g. Site 7) but some species, such as *Cystoseira trinodis*, *Hormophysa cuneiformis* and *Sargassum* spp., remain very rare or absent. The lack of hard substrate is not the only factor to restrict their occurrence. The precise limiting factor is not yet known, but is probably a combination of salinity and temperature fluctuations.

The reefs of the offshore islands (B.2.1.) are completely different from all the other habitats. They contain only a few algal species, but these are almost all limited to the islands.

## CONCLUSIONS AND DISCUSSION

The inventory of the study area is not complete; most of the smaller epiphytes have been omitted from the analysis, Karan was visited only once and some samples await identification. However, from the available data, it already appears that the seaweed and seagrass vegetation of the area

between Ras az-Zaur and Abu Ali Island is very rich, compared to other regions in the Arabian Gulf: a total of 90 taxa (one Xanthophyta, 20 Chlorophyta, 25 Phaeophyta and 44 Rhodophyta) have been collected and identified within the study area. Forty-two are new for the Saudi Arabian Gulf coast of which 15 (marked with “\*”) are new for the Gulf: Chlorophyta: *Bryopsis hypnoides*, *Chaetomorpha mediterranea*, *C. gracilis* (\*), *Cladophora* cf. *coelothrix*, *C. nitellopsis*, *Cladophoropsis sundanensis* (\*), *Entocladia viridis*, *Phaeophila dendroides*, *Trichosolen* sp. (\*); Xanthophyta: *Vaucheria piloboloides*; Phaeophyta: *Dictyopteris membranacea* (\*), *Dictyota indica*, *Dictyota friabilis* (\*), *Feldmannia indica*, *Padina minor* (\*), *Sargassum decurrens*, *Turbinaria ornata* f. *evesiculosa* (\*); Rhodophyta: *Anotrichium tenue*, *Antithamnion cruciatum*, *Asparagopsis taxiformis* (gametophyte) (\*), *Ceramium codii*, *C. strictum* (\*), *Champia parvula*, *Chondria collinsiana*, *Crouania attenuata*, *Dasya* cf. *corymbifera* (\*), *Digenea simplex*, *Dudresnaya* sp. (\*), *Gelidium pusillum*, *Herposiphonia secunda* f. *tenella*, *Heterosiphonia crispella*, *Hypnea cervicornis* (\*), *Hypoglossum* sp., *Laurencia obtusa*, *L. papillosa*, *Liagora distenta*, *Lithophyllum kotschyannum* (\*), *Peyssonnelia simulans*, *Polysiphonia kampsaxii*, *P. opaca* (\*), *Sporolithon molle* (\*), *Wurdemannia miniata*. We would like to emphasise that we have not been able to see herbarium specimens of previous collections and therefore we cannot compare them with our samples. It is quite likely that *Sargassum heteromorphum* recorded by several authors is in fact *S. decurrens*; within other genera it is more difficult to state whether we actually found a new entity for the region or if we identified it differently (e.g. *Ceramium strictum* versus *C. leutzbergii*). Twenty species previously recorded from the Saudi Arabian Gulf coast have not been collected in the Sanctuary so far. Many of these are small epiphytes which we did not study in detail and others may have been present but identified differently: Chlorophyta: *Chaetomorpha linum*, *Cladophora sericioides*, *Cladophoropsis zollingeri*, *Trichosolen mauritiana*; Phaeophyta: *Dictyota dichotoma* var. *intricata*, *D. divaricata*, *Turbinaria conoides*; Rhodophyta: *Acrochaetium bahreinii*, *A. robustum*, *Amphiroa fragilissima*, *Ceramium cruciatum*, *C. flaccidum*, *C. maryae*, *C. subverticillatum*, *Dasya ocellata*, *Eupogodon pilosus*, *Herposiphonia dendroidea*, *Hypnea valentiae*, *Polysiphonia tuticorinensis*, *P. variegata*.

Finally, the absence of representatives of the genus *Ulva* and the very restricted amounts of *Enteromorpha* indicate a low eutrophication level, compared to Kuwait and Tarut Bay, for example, where they are luxuriant.

The climatic conditions of the supralittoral and intertidal zones are so extreme, especially in summer, that macroalgal and seagrass development is inhibited along the Gulf coast of Saudi Arabia. The oil spill of 1991 almost exclusively covered these areas and therefore did not really influence algal development. Moreover, some tar-covered rocks of the infralittoral fringe were completely colonised by *Padina minor* and *Dictyota indica*. As seaweeds do not have true roots but root-like or discoidal holdfasts, they can attach themselves to any hard substrate (rock, coral, shells, plants, buoys, ropes, boats, and also hardened oil) if the amount of toxic elements is not too high. Their respiration and nutrient uptake takes place over the entire thallus surface and therefore they are independent of the substrate quality. Finally, as most seaweeds are annual, recolonisation takes place very quickly with spores arriving from unpolluted areas.

As seaweeds generally depend on the presence of hard substrate for their development, vast surfaces of the study area are unsuitable and therefore devoid of algae. The few rocky and coral areas along the coast, including the patch reefs, show well-developed algal growth. In some seasons *Sargassum* forms dense bushy stands, completely covering the reefs locally and so forming a distinct biotope with a large biomass. The influence of this *Sargassum* canopy on the corals is as yet unknown (COLES 1988: 211), as is the impact of the large numbers of sea urchins on these same reefs in the warm season, when *Sargassum* has almost completely disappeared. The luxuriant algal

development on these coastal hard substrates could be due to the extreme environmental conditions prevailing in this littoral zone, subjecting the corals to more stress and optimising the seaweed growth. On the other hand, ecological conditions are more suitable for corals around the offshore islands, and seaweeds are outcompeted, except for the crustose Corallinaceae and a few species which develop on the dead bases of the coral boulders or between the *Acropora* branches. Large numbers of herbivorous fish are present around these islands, grazing heavily on the algae. These facts confirm the hypothesis of LITTLER & LITTLER (1984: 339, Fig. 7) on the relative-dominance paradigm emphasising four potentially predominant space-occupying groups of sessile reef organisms (corals, microfilamentous algae, frondose macroalgae, coralline algae).

The presence of mangrove stands, salt-marsh vegetation, seagrass beds, coral patches and associated algae confirms that the area of the Jubail Marine Wildlife Sanctuary is a good representative for of the marine flora and vegetation of the southern coast of the Saudi Arabian Gulf.

### ACKNOWLEDGEMENTS

We are greatly indebted to the EC and NCWCD who financed the work and we would like to thank F. Krupp for giving us the opportunity to join the research team. We are grateful to many of the other team members who helped us during the fieldwork, especially M. Richmond, B. Böer, I. Watt and T. Woodhouse. E. Verhey is acknowledged for identifying the crustose Corallinaceae. Thanks also to C. De Maire who mounted the herbarium specimens and prepared the herbarium labels and to R. Heynderickx for the photographic illustrations. H. Stegenga's remarks on the original manuscript were valuable; A. Newton, who corrected the English language, is also acknowledged.

### REFERENCES

- ABBOTT, I.A. 1990 a. A taxonomic and nomenclatural assessment of the species of *Liagora* (Rhodophyta, Nemaliales) in the herbarium of Lamouroux. *Cryptogamic, Algologique* 11: 111-136.
- ABBOTT, I.A. 1990 b. A taxonomic assessment of the species of *Liagora* (Nemaliales, Rhodophyta) recognized by J. Agardh, based upon studies of the Type specimens. *Cryptogamic Botany* 1: 308-322.
- ABBOTT, I.A. & HOLLENBERG, G. 1976. *Marine Algae of California*. 827 pp. Stanford, Stanford University Press.
- ABBOTT, I.A., TSENG, C. & LU BAOREN 1988. Clarification of some subgeneric nomenclature in *Sargassum* subgenus *Sargassum*. In: *Taxonomy of Economic Seaweeds*. Vol. 2. Abbott, I.A. (ed.): 55-58. La Jolla, California Sea Grant College Program.
- AL-HASAN, R.H. & JONES, W.E. 1989. Marine algal flora and sea grasses of the coast of Kuwait. *Journal of the University of Kuwait (Science)* 16: 289-340.
- BASSON, P.W. 1979 a. Marine algae of the Arabian Gulf coast of Saudi Arabia (first half). *Botanica Marina* 22: 47-64.
- BASSON, P.W. 1979 b. Marine algae of the Arabian Gulf coast of Saudi Arabia (second half). *Botanica Marina* 22: 65-82.
- BASSON, P.W. 1992. Checklist of marine algae of the Arabian Gulf. *Journal of the University of Kuwait (Science)* 19: 217-230.
- BASSON, P.W., MOHAMED, S.A. & ARORA, D.K. 1989. A survey of the benthic algae of Bahrain. *Botanica Marina* 32: 27-40.
- BASSON, P.W., BURCHARD, J.E., HARDY, J.T. & PRICE, A.R.G. 1977. *Biotores of the Western Arabian Gulf*. 284 pp. Dhahran, ARAMCO.
- BLIDING, C. 1963. *A Critical Survey of the European Taxa in the Ulvales*. Part 1. *Capsosiphon, Percursaria, Blidingia, Enteromorpha*. 160 pp. Stockholm, Opera Botanica.
- BOLD, H.C. & WYNNE, M.J. 1985. *Introduction to the algae. Structure and Reproduction*. 720 pp. Englewood Cliffs, Prentice Hall Inc.
- BØRGESEN, F. 1919. The marine algae of the Danish West Indies. Part 3. Rhodophyceae. *Dansk Botanisk Arkiv Udgivet Af Dansk Botanisk Forening* 1: 305-368.
- BØRGESEN, F. 1939. Marine algae from the Iranian Gulf. In: *Danish Scientific Investigations in Iran I*. Jessen, K. & Sparck, R. (eds): 47-141. Copenhagen, Einar Munksgaard.

- BØRGESSEN, F. 1940. Some marine algae from Mauritius. I. Chlorophyceae. *Kongelige Danske Videnskabernes Selskab, Biologiske Meddelelser* 15: 1-84.
- BØRGESSEN, F. 1941. Some marine algae from Mauritius. II. Phaeophyceae. *Kongelige Danske Videnskabernes Selskab, Biologiske Meddelelser* 16: 1-79.
- BURROWS, E. 1991. *Seaweeds of the British Isles. Vol. 2. Chlorophyta*. 238 pp. London, Natural History Museum.
- CHAPMAN, V.J. 1961. The marine algae of Jamaica. Part 1. Myxophyceae and Chlorophyceae. *Bulletin of the Institute of Jamaica, Science series* 12: 1-159.
- CHRISTENSEN, T. 1987. *Seaweeds of the British Isles. Vol. 4. Tribophyceae (Xanthophyceae)*. 36 pp. London, Natural History Museum.
- COLES, S.L. 1988. Limitations on reef coral development in the Arabian Gulf: temperature or algal competition? *Proceedings of the 6<sup>th</sup> International Coral Reef Symposium* 3: 211-216.
- COPPEJANS, E. 1983. Iconographie d'Algues Méditerranéennes. *Bibliotheca Phycologica* 63: 317 pl.
- COPPEJANS, E. & GALLIN, E. 1989. Macroalgae associated with the mangrove vegetation of Gazi Bay (Kenya). *Bulletin de la Société Royale de Botanique de Belgique* 122: 47-60.
- COPPEJANS, E. & PRUD'HOMME VAN REINE, W.F. 1989. Seaweeds of the Snellius-II Expedition. Chlorophyta: Caulerpales (except *Caulerpa* and *Halimeda*). *Blumea* 34: 119-142.
- COPPEJANS, E. & PRUD'HOMME VAN REINE, W.F. 1992 a. The oceanographic Snellius-II expedition. Botanical results. List of stations and collected plants. *Bulletin des Séances de l'Académie Royale des Sciences d'Outre-Mer* 37: 153-194.
- COPPEJANS, E. & PRUD'HOMME VAN REINE, W.F. 1992 b. Seaweeds of the Snellius-II expedition (E. Indonesia): the genus *Caulerpa*. (Chlorophyta-Caulerpales). *Bulletin des Séances de l'Académie Royale des Sciences d'Outre-Mer* 37: 667-712.
- COPPEJANS, E., BEECKMAN, H. & DE WIT, M. 1992. The seagrass and associated macroalgal vegetation of Gazi Bay (Kenya). In: The Ecology of Mangrove and Related Ecosystems. Jaccarini, V. & Martens, E. (eds). *Hydrobiologia* 247: 59-75.
- CRIBB, A.B. 1960. Records of marine algae from South-Eastern Queensland V. *Department of Botany: University of Queensland papers* 4: 1-31.
- DAWES, C. 1981. *Marine Botany*. 628 pp. New York, John Wiley & sons.
- DAWSON, Y. 1954. Marine plants in the vicinity of the Institut Océanographique de Nha Trang, Viêt Nam. *Pacific Science* 8: 373-481.
- DE CLERCK, O. 1993. *De Zeegryassen en Macrowieren van het reservaat ten noorden van Jubail*. Licentiaatsverhandeling Wetenschappen (groep Plantkunde). Universiteit Gent: 187 pp., 111 pl. Unpublished thesis.
- DE CLERCK, O. & COPPEJANS, E. 1994. Status of the macroalgae and seagrass vegetation after the 1991 Gulf War oil spill. *Courier Forschungsinstitut Senckenberg* 166: 18-21.
- DE JONG, Y. & PRUD'HOMME VAN REINE, W.F. (submitted for publication). A review of the genus *Nemacystus* (Spermatocnaceae, Phaeophyta), including a preliminary phylogenetic hypothesis.
- DURAIRATNAM, M. 1961. Contribution to the study of the marine algae of Ceylon. *Bulletin of the Fisheries Research Station of Ceylon* 10: 1-181.
- ENDLICHER, S.L. & DIESING, C.M. 1845. Enumeratio algarum, quas ad oram insulae Karek, sinus Persici, legit Theodorus Kotschy. *Botanische Zeitung* 3: 268-269.
- GARBARY, D., HANSEN, G. & SCAGEL, R. 1980. The marine algae of British Columbia and northern Washington: Division Rhodophyta (Red Algae), Class Bangiophyceae. *Syesis* 13: 137-195.
- GEPP, A. & GEPP, E.S. 1911. The Codiaceae of the Siboga Expedition including a monograph of Flabellariaceae and Udoteae. *Siboga-Expedition Monography* 62: 1-150 + 22 pl.
- GUIRY, M. 1990. Sporangia and spores. In: *Biology of the Red Algae*. Cole, K.M. & Sheath, R.G. (eds): 347-376. Cambridge, Cambridge University Press.
- HAMEL, G. 1931. *Chlorophycées des Côtes Françaises*. I. 168 pp. Rouen.
- HOFFMANN, L. 1994. Distribution, species composition and status of the intertidal blue-green algal mats. *Courier Forschungsinstitut Senckenberg* 166: 16-17.
- HOLLENBERG, G.J. 1968. An account of the species of *Polysiphonia* of the central and western tropical Pacific Ocean. I. *Oligosiphonia*. *Pacific Science* 22: 56-98.
- HÖRNIG, I., SCHNETTER, R. & PRUD'HOMME VAN REINE, W.F. 1992. The genus *Dictyota* (Phaeophyceae) in the North Atlantic. I. A new generic concept and new species. *Nova Hedwigia* 54: 45-62.
- International Code of Botanical Nomenclature 1988. Greuter, W. (ed.). 328 pp. Königstein, Koeltz.
- JAASUND, E. 1970. Marine algae in Tanzania IV. *Botanica Marina* 13: 71-79.
- JAASUND, E. 1976. *Intertidal seaweeds in Tanzania*. 160 pp. Tromsø, University of Tromsø.
- JOHN, V.C., COLES, S.L. & ABOZED, A.I. 1990. Seasonal cycles of temperature, salinity and water masses of the Western Arabian Gulf. *Oceanologica Acta* 13 (3): 273-281.
- JONES, D.A. 1986. *A Field Guide to the Sea Shores of Kuwait and the Arabian Gulf*. 160 pp. University of Kuwait, Blandford Press, U.K.

- KOOISTRA, W. 1993. *Historical biogeography in tropical Atlantic populations of Cladophoropsis membranacea and related species*. Ph.D. thesis, unpublished. 111 pp. Groningen, Van Denderen.
- KYLIN, H. 1956. *Die Gattungen der Rhodophyceen*. 673 pp. Lund, Gleerups Förlag.
- LAWSON, G. & JOHN, D. 1987. *The Marine Algae and Coastal Environment of Tropical West Africa*. (2<sup>nd</sup> ed.). 415 pp. Berlin, J. Cramer.
- LITTLER, M.M. & LITTLER, D.S. 1984. Models of tropical reef biogenesis: the contribution of algae. *Progress in Phycological Research* 3: 323-364.
- MAGRUDER, W. 1988. *Sargassum* (Phaeophyta, Fucales, Sargassaceae) in the Hawaiian Islands. In: *Taxonomy of Economic Seaweeds*. Vol. 2. Abbott, I.A. (ed.): 65-89. La Jolla, California Sea Grant College Program.
- MCCAIN, J.C. 1984. Marine ecology of Saudi Arabia. The nearshore, soft-bottom benthic communities of the northern area, Arabian Gulf, Saudi Arabia. *Fauna of Saudi Arabia* 6: 79-101.
- MCCAIN, J.C., TARR, A.B., CARPENTER, K.E. & COLES, S.L. 1984. Marine ecology of Saudi Arabia. A survey of coral reefs and reef fishes in the northern area, Arabian Gulf, Saudi Arabia. *Fauna of Saudi Arabia* 6: 102-126.
- NEWTON, L. 1955 a. The marine algae of Kuwait. In: *The Wild Flowers of Kuwait and Bahrain*. Dickson, V. (ed.): 100-102. London, Allen and Unwin.
- NEWTON, L. 1955 b. The marine algae of Bahrain. In: *The Wild Flowers of Kuwait and Bahrain*. Dickson, V. (ed.): 141-144. London, Allen and Unwin.
- NIZAMUDDIN, M. & GESSNER, F. 1970. The marine algae of the northern part of the Arabian Sea and of the Persian Gulf. "Meteor" *Forschungs-Ergebnisse*, Reihe D 6: 1-42.
- OLSEN-STOJKOVICH, J. 1985. A systematic study of the genus *Avrainvillea* Decaisne (Chlorophyta, Udoteaceae). *Nova Hedwigia* 41: 1-68.
- PAPENFUSS, G.F. 1943. Notes on algal nomenclature. II. *Gymnosorus* J. Agardh. *American Journal of Botany* 30: 463-468.
- PENROSE, D. & CHAMBERLAIN, Y.M. 1994. *Hydrolithon farinosum* (Lamouroux) comb. nov.: implications for generic concepts in the Mastophoroideae (Corallinaceae, Rhodophyta). *Phycologia* 32: 295-303.
- PRUD'HOMME VAN REINE, W.F. 1982. A taxonomic revision of the European Sphacelariaceae (Sphacelariales, Phaeophyceae). *Leiden Botanical Series* 6: 1-293.
- ROBINS, P.A. & KRAFT, G.T. 1985. Morphology of the type and Australian species of *Dudresnaya* (Dumontiaceae, Rhodophyta). *Phycologia* 24: 1-34.
- SCHNEIDER, C.W. & SEARLES, R.B. 1991. *Seaweeds of the southeastern United States. Cape Hatteras to Cape Canaveral*. 553 pp. Durham, Duke University Press.
- SHEPPARD, C.R.C., PRICE, A.R.G. & ROBERTS, C. 1992. *Marine Ecology of the Arabian Region. Patterns and Processes in Extreme Tropical Environments*. 359 pp. London, Academic Press.
- SILVA, P.C., MENEZ, E.G. & MOE, R.L. 1987. Catalog of the benthic marine algae of the Philippines. *Smithsonian Contributions to the Marine Sciences* 27: 1-179.
- STEGENGA, H. 1986. The Ceramiaceae (excl. *Ceramium*) (Rhodophyta) of the South West Cape Province, South Africa. *Bibliotheca Phycologica* 74: 1-149.
- TAYLOR, W.R. 1960. *Marine Algae of the Eastern Tropical and Subtropical Coasts of the Americas*. 870 pp. Ann Arbor, University of Michigan Press.
- TAYLOR, W.R. 1964. The genus *Turbinaria* in eastern seas. *Journal of the Linnean Society (Botany)* 58: 475-487.
- TRONO, G.C. 1969. The marine benthic algae of the Caroline Islands. II. Phaeophyta and Rhodophyta. *Micronesica* 5: 25-119.
- TSENG, C. & LU BAOREN. 1988. Studies on Chinese species of zygoecarpic *Sargassum*. In: *Taxonomy of Economic Seaweeds*. Vol. 2. Abbott, I.A. (ed.): 23-54. La Jolla, California Sea Grant College Program.
- TSENG, C., YOSHIDA, T. & MENG CHIANG, Y. 1985. East Asiatic species of *Sargassum* subgenus *Bactrophycus* J. Agardh (Sargassaceae, Fucales), with keys to the sections and species. In: *Taxonomy of Economic Seaweeds*. Vol. 1. Abbott, I.A. & Norris, J.N. (eds): 1-14. La Jolla, California Sea Grant College Program.
- TSUDA, R. 1988. *Sargassum* of Micronesia. In: *Taxonomy of Economic Seaweeds*. Vol. 2. Abbott, I.A. (ed.): 59-64. La Jolla, California Sea Grant College Program.
- VAN DEN HOEK, C. 1963. *Revision of the European species of Cladophora*. 248 pp. + 55 pl. Leiden, Brill.
- VERHEIJ, E. 1993. The genus *Sporolithon* (Sporolithaceae fam. nov., Corallinales, Rhodophyta) from the Spermonde Archipelago, Indonesia. *Phycologia* 32: 184-196.
- VERHEIJ, E. 1994. Nongeniculate Corallinaceae (Corallinales, Rhodophyta) from the Spermonde Archipelago, SW Sulawesi, Indonesia. *Blumea* 39: 95-138.
- VERHEIJ, E. & PRUD'HOMME VAN REINE, W.F. 1993. Seaweeds of the Spermonde Archipelago, SW Sulawesi, Indonesia. *Blumea* 37: 385-510.
- WOMERSLEY, H.B.S. 1984. *The Marine Benthic Flora of Southern Australia. Part I*. 329 pp. Government Printer Woolman.
- WOMERSLEY, H.B.S. 1987. *The Marine Benthic Flora of Southern Australia. Part II*. 484 pp. Adelaide. South Australian Government Printing Division.

- WOMERSLEY, H.B.S. 1994. *The Marine Benthic Flora of Southern Australia. Rhodophyta. Part III A*. 508 pp. Canberra, Australian Biological Resources Study.
- WOMERSLEY, H.B.S. & BAILEY, A. 1970. Marine algae of the Solomon Islands. *Philosophical Transactions of the Royal Society of London* 259: 257-352.
- YAMADA, Y. 1931. Notes on *Laurencia*, with special reference to the Japanese species. *University of California Publications in Botany* 16: 185-310.
- YOSHIDA, T. 1988. Japanese and Taiwanese species of *Sargassum* subgenus *Sargassum*. In: *Taxonomy of Economic Seaweeds*. Vol. 2. Abbott, I.A. (ed.): 5-22. La Jolla, California Sea Grant College Program.

Authors' addresses:

Olivier De Clerck and Prof. Dr. Eric Coppejans, Universiteit Gent, Vakgroep Morfologie, Systematiek & Ecologie, Laboratorium Plantkunde, K.L. Ledeganckstraat 35, 9000 Gent, Belgium.



## Index

All scientific names of divisions, classes, orders, families, genera, species, varieties, forms and ecads used in this publication are arranged alphabetically. Names of genera and species are in italics, higher taxonomic ranks are regular; currently valid names are bold, synonyms and basionyms (of both genera and species) are not; species names and synonyms are followed by the genus name where they are actually placed in this work. The generic synonymies only apply to the species included here and only concern recent changes.

<i>Acanthophora</i> .....	259	<i>Centroceras</i> .....	254
<i>Acetabularia</i> .....	217	<b>Ceramiales</b> .....	252
<i>Acrochaete</i> ( <i>Entocladia</i> ) .....	210	<b>Ceramiales</b> .....	252
<b>Acrochaetiaceae</b> .....	251	<i>Ceramium</i> .....	254
<b>Acrochaetiales</b> .....	251	<i>Ceramothamnion</i> ( <i>Ceramium</i> ) .....	254
<i>Acrochaetium</i> .....	251	<i>cervicornis</i> ( <i>Hypnea</i> ) .....	274
<i>aerea</i> ( <i>Chaetomorpha</i> ) .....	210	<i>Chaetomorpha</i> .....	210
<i>affine</i> ( <i>Rhizoclonium</i> ) .....	217	<b>Chaetophoraceae</b> .....	210
<i>amadelpa</i> ( <i>Avrainvillea</i> ) .....	209	<b>Chaetophorales</b> .....	210
<i>Amansia</i> ( <i>Leveillea</i> ) .....	265	<i>Champia</i> .....	278
<i>angustifolium</i> ( <i>Sargassum</i> ) .....	238	<b>Champiaceae</b> .....	278
<i>Anotrichium</i> .....	252	<b>Chlorophyceae</b> .....	208
<i>Antithamnion</i> .....	252	<b>Chlorophyta</b> .....	207
<i>Asparagopsis</i> .....	251	<i>Chloroplegma</i> ( <i>Avrainvillea</i> ) .....	209
<i>Asterocytis</i> ( <i>Chroodactylon</i> ) .....	249	<i>Chondria</i> .....	260
<i>aterrimum</i> (var. <i>Sargassum</i> ) .....	240	<i>Chondroclonium</i> ( <i>Hypnea</i> ) .....	275
<i>attenuata</i> ( <i>Crouania</i> ) .....	256	<b>Chordariales</b> .....	224
<i>australis</i> ( <i>Padina</i> ) .....	230	<i>Chroodactylon</i> .....	249
<i>Avrainvillea</i> .....	209	<i>Cladophora</i> .....	214
<i>baillouviana</i> ( <i>Dasya</i> ) .....	257	<b>Cladophoraceae</b> .....	210
<b>Bangiophyceae</b> .....	249	<b>Cladophorales</b> .....	210
<i>biforme</i> ( <i>Rhizoclonium</i> ) .....	217	<i>Cladophoropsis</i> .....	215
<i>binderi</i> ( <i>Sargassum</i> ) .....	238	<i>Cladosiphon</i> ( <i>Nemacystus</i> ) .....	224
<i>boergesenii</i> ( <i>Padina</i> ) .....	230	<i>clathrata</i> ( <i>Eutevomorpha</i> ) .....	220
<b>Bonnemaisoniaceae</b> .....	251	<i>clathratus</i> ( <i>Hydroclathrus</i> ) .....	245
<b>Bonnemaisoniales</b> .....	251	<i>clavulatum</i> ( <i>Centroceras</i> ) .....	254
<i>bottnica</i> ( <i>Chaetomorpha</i> ) .....	212	<i>codii</i> ( <i>Ceramium</i> ) .....	254
<i>boveanum</i> ( <i>Sargassum</i> ) .....	240	<i>coelothrix</i> ( <i>Cladophora</i> ) .....	214
<i>brachyarthra</i> (f. <i>Chaetomorpha</i> ) .....	212	<i>collinsiana</i> ( <i>Chondria</i> ) .....	260
<b>Bryopsidaceae</b> .....	218	<i>Colpomenia</i> .....	243
<i>Bryopsis</i> .....	218	<b>Compsopogonales</b> .....	249
<b>Callithamnieae</b> .....	252	<i>coniger</i> ( <i>Feldmannia</i> ) .....	231
<i>Callithamnion</i> ( <i>Acrochaetium</i> , <i>Antithamnion</i> , <i>Heterosiphonia</i> ) .....	251, 252, 259	<i>conoides</i> ( <i>Turbinaria</i> ) .....	242
<i>calyculus</i> ( <i>Acetabularia</i> ) .....	217	<i>Corallina</i> ( <i>Jania</i> ) .....	270
<i>cancellatus</i> ( <i>Hydroclathrus</i> ) .....	245	<b>Corallinaceae</b> .....	270
<i>capillaris</i> ( <i>Chaetomorpha</i> ) .....	212	<b>Corallinales</b> .....	270
<i>caraibica</i> ( <i>Acetabularia</i> ) .....	217	<i>cornuta</i> ( <i>Hypnea</i> ) .....	275
<i>carnea</i> ( <i>Erythrotrichia</i> ) .....	249	<i>corymbifera</i> ( <i>Dasya</i> ) .....	257
<i>Caulerpa</i> .....	208	<i>crassicollis</i> ( <i>Polysiphonia</i> ) .....	265
<b>Caulerpaeae</b> .....	208	<i>crispella</i> ( <i>Heterosiphonia</i> ) .....	259
<b>Caulerpales</b> .....	208	<i>Crouania</i> .....	256
<i>cavernosa</i> ( <i>Dictyosphaeria</i> ) .....	220	<i>cruciatum</i> ( <i>Antithamnion</i> ) .....	252
		<i>cryptophilus</i> ( <i>Feldmannia</i> ) .....	231

<i>cuneiformis</i> ( <i>Hormophysa</i> ) .....	236	<b>Gigartinales</b> .....	274
<i>Cystophyllum</i> ( <i>Cystoseira</i> ) .....	234	<i>Gongroceras</i> ( <i>Ceramium</i> ) .....	254
<i>Cystoseira</i> .....	233	<i>gracilis</i> ( <i>Chaetomorpha</i> ) .....	212
<b>Cystoseiraceae</b> .....	233	<i>Griffithsia</i> ( <i>Anotrichium</i> ) .....	252
<i>Dasya</i> .....	257	<i>Gymnosorus</i> ( <i>Lobophora</i> ) .....	228
<b>Dasyaceae</b> .....	257	<i>gymnospora</i> ( <i>Padina</i> ) .....	230
<b>Dasycladales</b> .....	217	<b><i>Herposiphonia</i></b> .....	262
<i>dasyphylla</i> ( <i>Chondria</i> ) .....	260	<b><i>Heterosiphonia</i></b> .....	259
<i>decurrens</i> ( <i>Sargassum</i> ) .....	240	<i>hillebrandii</i> ( <i>Falkenbergia</i> ) .....	251
<b>Delesseriaceae</b> .....	259	<b><i>Hincksia</i></b> .....	233
<i>dendroides</i> ( <i>Phaeophila</i> ) .....	210	<b><i>Hormophysa</i></b> .....	236
<b>Derbesiales</b> .....	218	<i>Hutchinsia</i> ( <i>Herposiphonia</i> ) .....	262
<i>Dictyopteris</i> .....	225	<b><i>Hydroclathrus</i></b> .....	245
<i>Dictyosphaeria</i> .....	220	<b><i>Hydrolithon</i></b> .....	270
<i>Dictyota</i> .....	225	<b><i>Hypnea</i></b> .....	274
<b>Dictyotaceae</b> .....	225	<b>Hypneaceae</b> .....	274
<b>Dictyotales</b> .....	225	<i>hypnoides</i> ( <i>Bryopsis</i> ) .....	218
<i>Digenea</i> .....	262	<b><i>Hypoglossum</i></b> .....	259
<i>distenta</i> ( <i>Liagora</i> ) .....	277	<i>implexum</i> ( <i>Rhizoclonium</i> ) .....	217
<i>duchassaingianus</i> ( <i>Feldmannia</i> ) .....	231	<i>indica</i> ( <i>Dictyota</i> ) .....	225
<i>Dudresnaya</i> .....	274	<i>indica</i> ( <i>Feldmannia</i> ) .....	231
<b>Dumontiaceae</b> .....	274	<i>intermedia</i> ( <i>Enteromorpha</i> ) .....	221
<i>Echinocaulon</i> ( <i>Gelidiella</i> ) .....	273	<i>interruptum</i> ( <i>Rhizoclonium</i> ) .....	217
<b>Ectocarpaceae</b> .....	231	<i>intestinalis</i> ( <i>Enteromorpha</i> ) .....	221
<b>Ectocarpales</b> .....	231	<i>irregularis</i> ( <i>Feldmannia</i> ) .....	231
<i>Ectocarpus</i> ( <i>Feldmannia</i> ) .....	231	<b><i>Jania</i></b> .....	270
<i>Encoelium</i> ( <i>Hydroclathrus</i> ) .....	245	<i>juergensii</i> ( <i>Rhizoclonium</i> ) .....	217
<i>Endoderma</i> ( <i>Entocladia</i> ) .....	210	<i>jungermannioides</i> ( <i>Leveillea</i> ) .....	265
<b><i>Enteromorpha</i></b> .....	220	<b><i>kampsaxii</i></b> ( <i>Polysiphonia</i> ) .....	266
<b><i>Entocladia</i></b> .....	210	<i>kernevi</i> ( <i>Rhizoclonium</i> ) .....	217
<i>erythraeus</i> ( <i>Nemacystus</i> ) .....	224	<i>kochianum</i> ( <i>Rhizoclonium</i> ) .....	217
<b><i>Erythrotrichia</i></b> .....	249	<b><i>koeiei</i></b> ( <i>Cladophora</i> ) .....	214
<b>Erythrotrichiaceae</b> .....	249	<b><i>kotschyanum</i></b> ( <i>Lithophyllum</i> ) .....	271
<i>evesiculosa</i> (f. <i>Turbinaria</i> ) .....	242	<i>lacerata</i> ( <i>Avrainvillea</i> ) .....	209
<b><i>Falkenbergia</i></b> .....	251	<i>lacustre</i> ( <i>Rhizoclonium</i> ) .....	217
<i>farinosum</i> ( <i>Hydrolithon</i> ) .....	270	<b><i>latifolium</i></b> ( <i>Sargassum</i> ) .....	242
<i>farlowii</i> (ecad <i>Caulerpa</i> ) .....	208	<b><i>Laurencia</i></b> .....	263
<i>fastigiatum</i> ( <i>Ceramium</i> ) .....	254	<b><i>Leveillea</i></b> .....	265
<i>favulosa</i> ( <i>Dictyosphaeria</i> ) .....	220	<b><i>Liagora</i></b> .....	277
<b><i>Feldmannia</i></b> .....	231	<b>Liagoraceae</b> .....	277
<i>filamentosa</i> ( <i>Spyridia</i> ) .....	256	<i>linum</i> ( <i>Chaetomorpha</i> ) .....	212
<i>flaccidum</i> (f. <i>Ceramium</i> ) .....	254	<b><i>Lithophyllum</i></b> .....	271
<i>flexuosa</i> ( <i>Enteromorpha</i> ) .....	221	<b><i>Lobophora</i></b> .....	228
<b>Flordeophyceae</b> .....	251	<i>Lophosiphonia</i> ( <i>Polysiphonia</i> ) .....	268
<i>Fostiella</i> ( <i>Hydrolithon</i> ) .....	270	<b><i>mediterranea</i></b> ( <i>Chaetomorpha</i> ) .....	212
<i>friabilis</i> ( <i>Dictyota</i> ) .....	227	<i>Melobesia</i> ( <i>Hydrolithon</i> ) .....	270
<b>Fucales</b> .....	233	<b><i>membranacea</i></b> ( <i>Dictyopteris</i> ) .....	225
<i>furcigera</i> ( <i>Sphacelaria</i> ) .....	245	<i>Mesogloia</i> ( <i>Crouania</i> ) .....	256
<i>fuscescens</i> ( <i>Vaucheria</i> ) .....	221	<b><i>miniata</i></b> ( <i>Wurdemannia</i> ) .....	274
<b>Gelidiaceae</b> .....	273	<i>minor</i> ( <i>Padina</i> ) .....	230
<b>Gelidiales</b> .....	273	<b><i>mittchelliae</i></b> ( <i>Hincksia</i> ) .....	233
<b><i>Gelidiella</i></b> .....	273	<b><i>molle</i></b> ( <i>Sporolithon</i> ) .....	271
<b><i>Gelidium</i></b> .....	273	<i>muricata</i> ( <i>Cystoseira</i> ) .....	234
<i>Giffordia</i> ( <i>Feldmannia</i> , <i>Hincksia</i> ) .....	231, 233	<b><i>myrica</i></b> ( <i>Cystoseira</i> ) .....	233

<i>myriocladia</i> ( <i>Gelidiella</i> ) .....	273	<i>simplex</i> ( <i>Digenea</i> ) .....	262
<i>Nemacystus</i> .....	224	<i>simulans</i> ( <i>Peyssonnelia</i> ) .....	275
<b>Nemaliales</b> .....	277	<i>sinuosa</i> ( <i>Colpomenia</i> ) .....	243
<i>nitellopsis</i> ( <i>Cladophora</i> ) .....	215	<b>Siphonocladales</b> .....	220
<i>obtusa</i> ( <i>Laurencia</i> ) .....	263	<i>sordidum</i> ( <i>Chloroplegma</i> ) .....	209
<i>Ochlochaete</i> ( <i>Phaeophila</i> ) .....	210	<b>Spermatochnaceae</b> .....	224
<i>opaca</i> ( <i>Polysiphonia</i> ) .....	266	<i>Sphacelaria</i> .....	245
<i>ornata</i> ( <i>Turbinaria</i> ) .....	242	<b>Sphacelariaceae</b> .....	245
<i>ornatum</i> ( <i>Chroodactylon</i> ) .....	249	<b>Sphacelariales</b> .....	245
<i>Padina</i> .....	228	<i>Sphaerococcus</i> ( <i>Wurdemannia</i> ) .....	274
<i>paniculata</i> ( <i>Laurencia</i> ) .....	263	<i>spicifera</i> ( <i>Acanthophora</i> ) .....	259
<i>papillosa</i> ( <i>Laurencia</i> ) .....	263	<i>spinella</i> ( <i>Hypnea</i> ) .....	274
<i>parvula</i> ( <i>Champia</i> ) .....	278	<i>Spongopsis</i> ( <i>Chaetomorpha</i> ) .....	212
<i>patentiramea</i> ( <i>Laurencia</i> ) .....	263	<b>Sporolithaceae</b> .....	271
<i>pedicellata</i> ( <i>Dasya</i> ) .....	257	<i>Sporolithon</i> .....	271
<i>Peyssonnelia</i> .....	275	<i>Spyridia</i> .....	256
<b>Peyssonneliaceae</b> .....	275	<i>strictum</i> ( <i>Ceramium</i> ) .....	254
<i>Phaeophila</i> .....	210	<i>subrii</i> ( <i>Acetabularia</i> ) .....	217
<b>Phaeophyceae</b> .....	223	<i>sundanensis</i> ( <i>Cladophoropsis</i> ) .....	215
<b>Phaeophyta</b> .....	223	<i>taxiformis</i> ( <i>Asparagopsis</i> ) .....	251
<i>piloboloides</i> ( <i>Vaucheria</i> ) .....	221	<i>tenella</i> (f. <i>Herposiphonia</i> ) .....	262
<i>plumaris</i> ( <i>Caulerpa</i> ) .....	208	<i>tenuis</i> ( <i>Anotrichium</i> ) .....	252
<i>Pocockiella</i> ( <i>Lobophora</i> ) .....	228	<i>tortuosa</i> ( <i>Chaetomorpha</i> ) .....	212
<b>Polyphysaceae</b> .....	217	<i>tortuosum</i> ( <i>Rhizoclonium</i> ) .....	217
<i>polypodioides</i> ( <i>Dictyopteris</i> ) .....	225	<i>tribuloides</i> ( <i>Sphacelaria</i> ) .....	245
<i>Polysiphonia</i> .....	265	<i>Trichosolen</i> .....	218
<b>Porphyridiaceae</b> .....	249	<i>trinodis</i> ( <i>Cystoseira</i> ) .....	234
<b>Porphyridiales</b> .....	249	<i>triquetra</i> ( <i>Hormophysa</i> ) .....	236
<i>ptychoides</i> ( <i>Sporolithon</i> ) .....	271	<i>tubulosa</i> (var., f. <i>Enteromorpha</i> ) .....	221
<i>pusillum</i> ( <i>Gelidium</i> ) .....	273	<i>Turbinaria</i> .....	242
<i>Rhizoclonium</i> .....	217	<i>Udotea</i> ( <i>Avrainvillea</i> ) .....	209
<b>Rhodomelaceae</b> .....	259	<b>Udoteaceae</b> .....	209
<b>Rhodophyta</b> .....	246	<b>Ulvaceae</b> .....	220
<b>Rhodymeniales</b> .....	278	<b>Ulvales</b> .....	220
<i>rigida</i> ( <i>Sphacelaria</i> ) .....	245	<b>Valoniaceae</b> .....	220
<i>rigidula</i> ( <i>Sphacelaria</i> ) .....	245	<i>variegata</i> ( <i>Lobophora</i> ) .....	228
<i>riparium</i> ( <i>Rhizoclonium</i> ) .....	217	<i>Vaucheria</i> .....	221
<i>robusta</i> (f. <i>Avrainvillea</i> ) .....	209	<b>Vaucheriaceae</b> .....	221
<i>rubens</i> ( <i>Jania</i> ) .....	270	<b>Vaucheriales</b> .....	221
<b>Sargassaceae</b> .....	236	<i>villum</i> (var. <i>Polysiphonia</i> ) .....	268
<i>Sargassum</i> .....	236	<i>viridis</i> ( <i>Entocladia</i> ) .....	210
<i>savianum</i> ( <i>Acrochaetium</i> ) .....	251	<i>Wurdemannia</i> .....	274
<i>scopulorum</i> ( <i>Polysiphonia</i> ) .....	268	<i>wurdemannii</i> ( <i>Heterosiphonia</i> ) .....	259
<b>Scytosiphonaceae</b> .....	243	<b>Xanthophyceae</b> .....	221
<b>Scytosiphonales</b> .....	243	<b>Xanthophyta</b> .....	221
<i>secunda</i> ( <i>Herposiphonia</i> ) .....	262	<i>Zonaria</i> ( <i>Lobophora</i> ) .....	228
<i>sertularioides</i> ( <i>Caulerpa</i> ) .....	208		