

The eco-geography of the brown shrimp  
*Crangon crangon* in Europe



Joana Costa Vilhena de Bessa Campos

The eco-geography of the brown shrimp *Crangon crangon* in Europe

Joana Campos

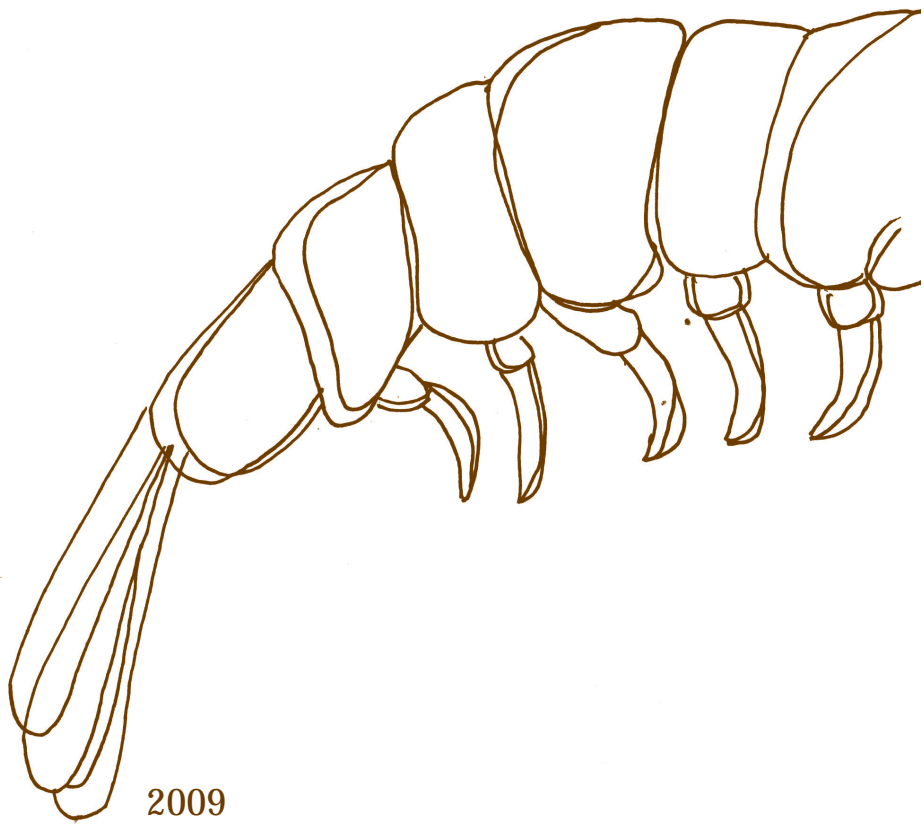

2009

The eco-geography of the brown shrimp  
*Crangon crangon* in Europe

The research reported in this thesis was carried out at the Laboratory of Ecophysiology of the Center of Marine and Environmental Research, Portugal (CIMAR/CIIMAR), at the Department of Marine Ecology and Evolution (MEE) of the Royal Netherlands Institute for Sea Research (NIOZ) and at the Fisheries Station of the Bodø University College, Norway (HIBO) and financially supported by the grant SFRH/BD/11321/2002 and the project POCI/CLI/61605/2004 from 'Fundação para a Ciência e a Tecnologia (FCT)', Portugal.

Cover design: Beatriz Alão

Figures: Beatriz Alão, Felipe Ribas and Henk Hobbelink

Printed by: Candeias Artes Gráficas – Braga – Portugal  
[www.candeiasag.com](http://www.candeiasag.com)

ISBN 978-90-865-9350-7

Depósito Legal: 296963/09

**VRIJE UNIVERSITEIT**

The eco-geography of the brown shrimp *Crangon crangon* in Europe

**ACADEMISCH PROEFSCHRIFT**

ter verkrijging van de graad Doctor aan  
de Vrije Universiteit Amsterdam,  
op gezag van de rector magnificus  
prof.dr. L.M. Bouter,  
in het openbaar te verdedigen  
ten overstaan van de promotiecommissie  
van de faculteit der Aard- en Levenswetenschappen  
op donderdag 10 september 2009 om 10.45 uur  
in de aula van de universiteit,  
De Boelelaan 1105

door

Joana Costa Vilhena de Bessa Campos

geboren te Porto, Portugal

promotor: prof.dr. S.A.L.M. Kooijman  
copromotor: dr. H. van der Veer

## **O organismo**

Medir um organismo – pensava o senhor Juarroz – é aceitar uma mentira, pois um organismo, por definição, não tem comprimento, tem fome.

Como medir algo que está a mudar? Como medir uma mudança? – pensava o senhor Juarroz.

*Gonçalo M. Tavares*

To my grandmother



## Contents

I	General introduction	9
II	Autecology of <i>Crangon crangon</i> (L.) with an emphasis on latitudinal trends Joana Campos & Henk W. van der Veer Oceanography and Marine Biology: An Annual Review 46, 65-104	15
III	Population zoogeography of brown shrimp <i>Crangon crangon</i> (L.) along its distributional range based on morphometric characters Joana Campos, Cindy Pedrosa, Joana Rodrigues, Sílvia Santos, Johanes IJ. Witte, Paulo Santos & Henk W. van der Veer Journal of Marine Biological Association of the UK 89, 499-507	51
IV	Phylogeography of the common shrimp, <i>Crangon crangon</i> (L.) across its distribution range Pieterella C. Luttikhuisen, Joana Campos, Judith van Bleijswijk, Katja T.C.A. Peijnenburg & Henk W. van der Veer Molecular Phylogenetics and Evolution 46, 1015–1030	65
V	Latitudinal variation in growth of <i>Crangon crangon</i> (L.): does counter-gradient growth compensation occur? Joana Campos, Vânia Freitas, Cindy Pedrosa, Rita Guillot & Henk W. van der Veer Journal of Sea Research, doi:10.1016/j.seares.2009.04.002	87
VI	Population fluctuations of the brown shrimp <i>Crangon crangon</i> (L.) in the western Dutch Wadden Sea, The Netherlands Joana Campos, Ana Bio, Joana F.M.F. Cardoso, Rob Dapper, Johannes IJ. Witte & Henk W. Van der Veer	105
VII	The estimation of the Dynamic Energy Budget parameters for the brown shrimp <i>Crangon crangon</i> (L.) Joana Campos, Sebastian A.L.M. Kooijman & Henk W. van der Veer	127
VIII	Synthesis: Recruitment of the brown shrimp <i>Crangon crangon</i> (L.) over a latitudinal gradient	141
	References	149



Summary	169
Samenvatting	177
Resumo	182
Acknowledgements	187
Curriculum vitae	189

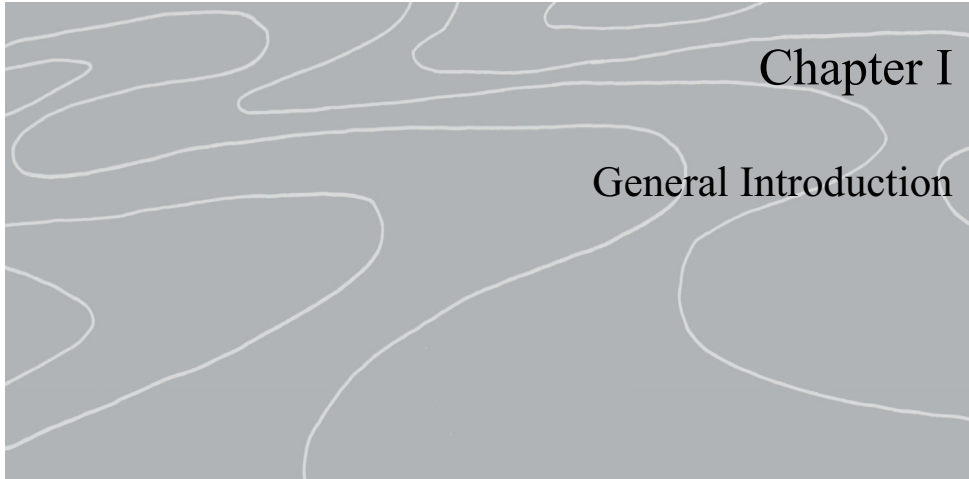

# Chapter I

## General Introduction

Shallow coastal and estuarine soft-bottom areas are complex and highly productive ecosystems, which constitute important feeding grounds for shore birds and nurseries for fish in their early stages of life. The nursery function is determined both by improved predation refuge and abundant food resources (Wolff 1983; McLusky & Elliot 2004), whereby estuarine benthic fauna represents a rich food supply (Day et al. 1989). Several estuarine epibenthic species are common to most European estuaries, from Norway in the north to Portugal in the south, covering a latitudinal range from about 70°LN to around 37°LN, respectively. Moreover in widely separated geographical areas as such, recurrent assemblages comprised of apparently functionally and taxonomically similar organisms are discernible (Woodin 1999).

Concerning the predators functional group, epibenthic species feeding on benthic invertebrates common to most European estuaries include two decapod crustaceans, brown shrimp (*Crangon crangon* L.) and green crab (*Carcinus maenas* L.), two goby species [*Pomatoschistus microps* (Kroyer) and *P. minutus* (Pallas)] and one flatfish species, flounder (*Platichthys flesus* L.), along with another flatfish, plaice (*Pleuronectes platessa* L.) northerly of Portugal. These epibenthic species form most of the abundance found in European shallow waters, from estuaries around UK (Henderson et al. 1987; Marshall & Elliot 1998; Attrill et al. 1999; Brian et al. 2005), the Wadden Sea (Beukema 1992; Klein Breteler 1975; Fonds 1978; Kuipers & Dapper 1981, 1984) and western Baltic Sea (Pihl & Rosenberg 1982; Evans 1983) in north-west Europe to estuaries in France (Mouny et al. 2000; Selleslagh et al. 2009), Spain (Cuesta et al. 2006; Drake et al. 2002; Munilla & San Vicente 2005; González-Ortegón et al. 2006) and Portugal (Neves et al. 2007; Sá et al. 2006; Salgado et al. 2004).

The brown shrimp, also known as common shrimp, *C. crangon*, is one of these common and highly abundant species in European estuaries. Hence, its recruitment must be successful in most years and locations. Additionally, since it is consistently abundant, it will play an important role in the ecosystem functioning. In fact, brown shrimp is both a prey of fish, crustaceans and shorebirds (Pihl 1985; Henderson et al. 1992; Del Norte-Campos & Temming 1994; Walter & Becker 1997) and predator of meiofauna and early stages of fish and bivalves (Pihl & Rosenberg 1984; Van der Veer et al. 1991, 1998; Ansell & Gibson 1993; Oh et al. 2001; Amara & Paul 2003).

Besides ecologically significant, it is also a valuable fisheries resource, especially in the North Sea where it has a market value between €50–70 million (Polet 2002; ICES 2006). Consequently, numerous studies illustrate its importance and try to clarify several aspects of its life history. The growth trajectory under natural environment towards recruitment to fisheries has received some attention in the past, especially in the Wadden Sea. Here reproduction occurs throughout the year with more intense settlement in spring/summer and autumn (Boddeke & Becker 1979; Boddeke et al. 1976; Feddersen 1993), while fisheries maximum is consistently observed in autumn (ICES 1996; Boddeke 1982). Hence a major discussion is still under debate: are spring settlers recruiting to fisheries in autumn? What is the contribution of the summer generation? This discussion was initiated by Boddeke (1976) who considered summer reproduction to yield the recruits to autumn commercial catches. In contrast, Kuipers & Dapper (1984) suggested that winter reproduction sustains autumn fisheries through heavy spring settlement. The different perspectives rely on different considerations about growth rates and predation pressure under field conditions.

The present thesis meant to contribute to Boddeke (1976) and Kuipers & Dapper (1984) discussion. Additionally to the question focusing on the Wadden Sea, a broader approach is made in this work: over the latitudinal range of the species when are shrimps recruiting to the adult population? To get an insight in this subject it is required the knowledge of brown shrimp's life history across its distributional area, namely on possible latitudinal trends in reproduction, settlement and recruitment patterns. Since temperature and food conditions vary along such wide latitudinal gradient, differences in growth are also to be expected.

The knowledge about *C. crangon* biology and fisheries has been compiled in the past by Tiews (1970), though almost 40 years have passed and no update has been made. Hence as a starting point, an update of the 1970 compilation is made in this thesis to identify gaps in knowledge of brown shrimp biology over its latitudinal range. Then, the population structure is studied using morphometry and genetic tools. Following, growth of two populations one from the north and the other from the south edges of brown shrimp geographic distribution is investigated to evaluate counter gradient growth compensation in latitude. Next, the long term trends of brown shrimp abundance at intermediate latitude are analyzed to access factors controlling or regulating the species recruitment. Finally, the species Dynamic Energy Budget

(DEB) parameters are estimated in order to use this tool in the analysis of the recruitment of *C. crangon* in coastal European estuaries over a latitudinal gradient.

## **Thesis outline**

This thesis is divided in six main components: [1] a review of brown shrimp publications with a latitudinal perspective presenting gaps in knowledge of brown shrimp biology (Chapter 2); [2] *Crangon crangon* zoo and phylogeography (Chapters 3 and 4); [3] species growth variation in latitude (Chapter 5); [4] factors affecting long term trends in brown shrimp recruitment at intermediate latitude (Chapter 6); [5] estimation of DEB parameters for *C. crangon* (Chapter 7); and [6] a synthesis on recruitment of brown shrimp over its latitudinal range applying the Dynamic Energy Budgets (DEB) model (Kooijman 2000) with a final discussion (Chapter 8).

### **II. Autecology of *Crangon crangon* (L.) with an emphasis on latitudinal trends**

This Chapter aims to update and extend the synopsis by Tiews (1970) on the biology and fisheries of brown shrimp *Crangon crangon* (L.) and to identify missing gaps in information. Additionally, a further purpose is to distinguish possible patterns with latitude in life history traits which most likely reflect trends in temperature conditions. The brown shrimp is distributed over a wide geographic area, in shallow ecosystems along the entire European coast, from the White Sea in the North till Morocco in the south, and into the Mediterranean until the Black Sea in the east. However, no information exists about the genetic population structure along the broad geographic area. Despite one of the most abundant species of coastal shallow ecosystems, and hence with a key functional role, it is still unclear whether the species' population dynamics is top down or bottom up controlled. Possible limiting factors at distribution edges are described. It is also uncertain if growth conditions are optimal and only determined by prevailing water temperatures, or if food limitation is a regulating mechanism.

### **III. Population zoogeography of brown shrimp *Crangon crangon* L. along its distributional range based on morphometric characters**

Morphometry has been proved to be applicable to identify subpopulation structure in the brown shrimp *Crangon crangon* L. at a local scale (100 km) around the UK. In this chapter, the same method is tested to evaluate its applicability to describe subpopulation structure at a much larger scale (1000 km). *C. crangon* populations were sampled in 25 locations over the whole distributional range from northern Norway to the Mediterranean and Black Sea to evaluate spatial variability. At four sites (Bodo, Norway; Wadden Sea, The Netherlands; Minho and Lima estuaries, Portugal), changes in morphometry were also followed in time. Results are discussed attending to brown shrimp life history traits.

#### **IV. Phylogeography of the common shrimp, *Crangon crangon* (L.) across its distribution range**

In this chapter the biogeographic history of brown shrimp is investigated and compared with the geographic history of its distribution area. Since morphometrics proved not to be a faultless method to establish the population structure of *Crangon crangon*, the species genetic structure was studied by sequencing a 388 base pairs fragment of the cytochrome-c-oxidase I gene for 140 individuals from 25 locations across its distribution range. Divergence times between main phylogeographic groups were estimated using net nucleotide divergence and applying a molecular clock. Gene flow across known oceanographic barriers (e.g., the Strait of Gibraltar and/or Oran-Almeria front, Sicilian Straits, and Turkish Straits) is discussed.

#### **V. Latitudinal variation in growth of *Crangon crangon*: does counter-gradient growth compensation occur?**

The distribution area of *Crangon crangon* covers a large latitudinal range from 34 to 67° north in European shallow waters. Since temperature is a major environmental factor determining growth, the thermal gradient across latitudes might be reflected in growth rate differences of brown shrimp from populations at different latitudes. In this chapter, growth in length in relation to water temperature is studied for *C. crangon* from two populations at the northern and southern edges of its distributional range to determine whether growth compensation, counter acting latitudinal thermal gradient, occur (counter-gradient growth compensation). Growth experiments were carried out at both distribution limits to determine maximum possible growth in relation to water temperature. Crustaceans do not grow continuously; instead they need to periodically shed the hard exoskeleton during moult or ecdysis. The rate of growth is then a function of the time between moulting events (intermoult period) and the size increase at a moult (moult increment). Hence, differences in growth rate are discussed analysing temperature and latitude effects on these two variables.

#### **VI. Fluctuations on the brown shrimp *Crangon crangon* (Crustacea: Caridea) abundance in the western Dutch Wadden Sea, The Netherlands**

A 34 years time series of *Crangon crangon* abundance in the Dutch Wadden Sea, located at intermediate latitude in relation to its distribution, is analyzed in this chapter. To understand possible reasons for inter-annual fluctuations in recruitment corresponding to autumn abundance and in over wintering stock size, i.e. adult *C. crangon* abundance in spring, a number of biotic and physical variables were tested. Several hypotheses were raised from the correlations and models for both seasons. A discussion on the relative importance of the environmental factors is presented in this chapter.

**VII. The estimation of DEB parameters for the brown shrimp *Crangon crangon* (L.)**

Dynamic Energy Budget (DEB) model has been successfully applied to describe the energy flow through individuals from food assimilation to its use in maintenance, growth, development and reproduction in various marine species (Van der Veer et al. 2001; Cardoso et al. 2006). Though the model involves only a few parameters (for a recent overview see Kooijman 2001), their estimation is not simple and requires the existence of data sets on various physiological features which in the case of brown shrimp are not available. In this chapter, a preliminary estimate of DEB parameters for *Crangon crangon* is obtained by a special protocol which allowed dealing with missing values and enabled consistency between parameters. Improvement of accuracy will require further laboratory experiments.

**VIII. Synthesis: Recruitment of brown shrimp over a latitudinal gradient**

In the synthesis, brown shrimp *Crangon crangon* recruitment to adult populations in coastal European estuaries is investigated for the East Atlantic subpopulation over a latitudinal gradient. The growth trajectory from settlement till recruitment to adult population is studied for three populations scattered over the species' distribution: Valosen estuary, Norway, in the north; Wadden Sea, The Netherlands, at intermediate latitude; and Minho estuary, Portugal, in the south. Simulations of brown shrimp growth at these areas are performed using the DEB model fed with the parameters estimates fro *C. crangon*, and seasonal variations on temperature at the respective areas. A contribution to Kuipers & Dapper (1984) and Boddeke (1976) debate on the growth trajectory from settlement to autumn fisheries/adult population is then presented, extending the focus on the Wadden Sea to the north east Atlantic area of the species' distribution.



## Chapter II

### Autecology of *Crangon crangon* (L.) with an emphasis on latitudinal trends

#### Abstract

This review aims to update and extend the synopsis by Tiews (1970) on the biology and fisheries of *Crangon crangon* (L.). Its wide distributional range along the European coast, from the White Sea to Morocco within the Atlantic, and throughout the Mediterranean and Black Seas reflects the capability of *C. crangon* to cope with a wide range of temperature and salinity conditions, and is further explained by its migratory capacity. Present knowledge suggests that the limiting factor at the northern cold water edge of its distribution is formed by egg and larval development, and at the southern warm water edge, by maintenance costs. No information is available about the genetic population structure, but patterns in isoenzymes and in morphometric characters indicate the existence of various subpopulations. Over its distributional range, especially along the North Atlantic coast clear trends in life history parameters are observed, most likely reflecting temperature conditions. Due to its generally high abundance, the common shrimp forms a key component in the functioning of coastal shallow ecosystems; however, it is unclear whether the population dynamics of the species is subject to top-down or bottom-up control. On the one hand, *C. crangon* is an opportunistic feeder with a wide prey spectrum. Yet it remains to be solved whether growth conditions are optimal and only determined by prevailing water temperatures, or whether food limitation is a regulating mechanism. On the other hand, top-down control by predation cannot be excluded, since *C. crangon* is also an important food item for a variety of predators, especially fish species. There are strong indications that predation by *C. crangon* might regulate some of their prey species. Topics for further research include [1] the analysis of the genetic population structure by means of molecular tools; [2] the study of growth and reproduction in relation to latitude; [3] the application of Dynamic Energy Budgets for the analysis in terms of energy of the various trade-offs, including growth versus reproduction; and [4] the analysis of the mechanisms determining recruitment, especially whether top-down or bottom-up control is occurring.



## Introduction

The brown shrimp *Crangon crangon* (L.) is a marine coastal decapod species with a wide distribution range along the European coast, from the White Sea in the North of Russia to the Mediterranean and Black Seas (Muus 1967; Tiews 1970; Gelin et al. 2000). It is present in Malta (Micaleff & Evans 1968) and Morocco (J. Campos, person. observation), within the latitude parallels of 34 and 67°N (Mediterranean, temperate and cold climatic zones). Within the Mediterranean, the distribution of *C. crangon* is not clear. Only in the Adriatic Sea, it is subjected to a small scale fishery (D. Tagliapietra, person. comm.). Expansion and contraction of the population range still seems to continue, since recently, the brown shrimp has been re-observed in Icelandic waters (B. Gunnarsson, person. comm.) after a first incidental observation in 1895 (Doflein 1900), though not listed among the Icelandic Decapoda species in 1939 (Holthuis 1980).

*Crangon crangon* inhabits mainly soft bottom (sandy, sandy-mud and muddy substrata) estuarine and marine shallow areas, including coastal lagoons, with preference for grain sizes between 125 and 710  $\mu\text{m}$  (Pinn & Ansell 1993), although it may occur at depths of 20 to 90 m (Al-Adhub & Naylor 1975), especially during winter (Hinz et al. 2004), and anecdotic information suggests even to 120 m depth as in the Brevik Fjord, Sweden (Wollebaek 1908).

*Crangon crangon* is a very abundant species in European estuaries and hence an important component of those ecosystems. Due to its high abundance, it forms an extensive food source for a large range of predators, including fish like gadoids and pleuronectiforms, crustaceans, and wading birds (Pihl 1985; Henderson et al. 1992; Del Norte-Campos & Temming 1994; Walter & Becker 1997). In turn it preys heavily upon several benthic species, such as bivalve spat and juvenile plaice (Pihl & Rosenberg 1984; Van der Veer et al. 1991, 1998; Ansell & Gibson 1993; Oh et al. 2001; Amara & Paul 2003).

In the nineteen-seventies, Tiews (1970) compiled all existing knowledge with respect to brown shrimp biology and fisheries at that time. Since then there have been numerous publications about the species. Thus, the main objective of this review is to update the compilation by Tiews (1970) with a broadened and partly changed scope. In this respect, the intention is to give more emphasis on the ecology of the species, especially on its role and function in the ecosystem in relation to its distributional range. The backbone of this review is the analysis of life history strategy of *C. crangon* over its latitudinal distribution range. The various life history traits are described from an ecophysiological point of view, whereby energy will be used as token for fitness with the aim to detect gaps in the knowledge of the species biology. This review is mainly based on published information. In addition, valuable information from grey literature references has also been incorporated.

## Taxonomic status and genetic population structure

### *Taxonomic status*

The precise classification of *Crangon crangon* (Linnaeus, 1758) seems to be unsettled. It belongs with other shrimps, prawns, lobsters, crayfish and crabs to the Order Decapoda, which derives its name from five pairs of ambulatory thoracopods called pereopods, posterior to three pairs of thoracopods termed maxillipeds, since they function as mouthparts. However, above and under order level there is still some debate. Decapoda belong to Arthropoda and within this taxon to Crustacea, which have been considered in the past as a Phylum and a Class – and still are according to some authors (Brusca & Brusca 2003) - and presently are defined as a Superphylum and a Subphylum, respectively, considering Arthropoda as a monophyletic group, which is not fully established (Martin & Davis 2001). Crustacea are also referred to as a Phylum, Superclass or Class by some authors (Martin & Davis 2001). Within Crustacea, the Suborder or Supersection Natantia, grouping together all known shrimp species, persists for some authors due to its simplicity. Nevertheless nowadays *C. crangon* is placed in the Class Malacostraca, Subclass Eumalacostraca and Superorder Eucarida, being Natantia no longer considered a valid taxon (Martin & Davis 2001). As Malacostraca it has a total of 20 segments: 5 segments make up the cephalon or head, 8 segments compose the thorax, and 7 segments make up the abdomen; as Eumalacostraca it possesses a carapace enclosing the thorax, stalked, movable eyes, biramous antennules, scalelike antennal exopod, telson and uropods forming a tailfan and biramous pleopods 1–5; as Eucarida *C. crangon* has a well-developed carapace that is fused to all the thoracic somites, a telson without a caudal furca, and typically metamorphic larval development. *C. crangon* belongs to the Infraorder Caridea which occurs within the Suborder Pleocyemata – since their fertilised eggs are incubated by the female, and remain stuck to the pleopods (swimming legs) until they are ready to hatch - and consists of species whereby the third pereopods do not terminate in chelae and the lateral edges of the second abdominal segment overlap those of the first and third segment. Within the Infraorder Caridea *C. crangon* belongs to the Superfamily Crangonoidea, due to its short rostrum, and to the Family Crangonidae (Haworth, 1825), which is characterized by the fact that the first pereopods are sub-chelate.

*Crangon crangon* is the type species of the Genus *Crangon*. Several synonyms occur in earlier literature, the common being *C. vulgaris*. In the past, Tiews (1970) listed the position of the species with regard to the closely related NE American *Crangon septemspinosa* Say, and NW American *C. alaskensis* Lookington, as not certain: they might be subspecies of a single species or even full synonyms of each other, but Tiews (1970) did not provide detailed taxonomic information. Also the south European form of the species inhabiting the Mediterranean and the Black Sea has in the past sometimes been considered to be a subspecies, though generally no subspecies are distinguished. In European waters, *C. crangon* and *C. allmanni* are closely related (Smaldon et al. 1993), whereby in North American waters

*C. dalli* Rathbun, 1902 strongly resembles *C. allmanni* (own morphological observations). For more detailed information see Zariquiey-Álvarez (1968), Zarenkov (1970), Tiews (1970), Smaldon et al. (1993), Butler (1980), Christoffersen (1988) and Hayashi & Kim (1999).

Though still under debate, the present status of the Genus *Crangon* includes 18 species and subspecies (Christoffersen 1988). Due to misidentifications in the past, present distribution patterns of the various species are difficult to determine. While in the NE Atlantic only two species seem to occur, *C. crangon* (Linnaeus, 1758) and *C. allmanni* Kinahan, 1857; and in the NW Atlantic only one species has been found, *C. septemspinosa* Say, 1818, in the SW Atlantic no *Crangon* species is registered. On the other hand, in the NE Pacific more (sub)species are found: *C. alaskensis* Lockington, 1877; *C. alba* Holmes, 1900; *C. franciscorum franciscorum* Stimpson, 1856; *C. franciscorum angustimana* Rathbun, 1902; *C. handi* Kuris & Carlton, 1977; *C. holmesi* Rathbun, 1902; *C. nigricauda* Stimpson, 1856; and *C. nigromaculata* Lockington, 1877. Finally, a recent revision of the NE Asian species has resulted in the following seven species being listed: *C. affinis* De Haan, 1849; *C. amurensis* Brashnikov, 1907; *C. cassiope* De Man, 1906; *C. dalli* Rathbun, 1902; *C. hakodatei* Rathbun, 1902; *C. propinquus* Stimpson, 1860; and *C. uritai* Hayashi & Kim, 1999, this last one being the most closely related with *C. crangon* (Hayashi & Kim 1999).

With respect to *C. crangon*, there is still serious doubt whether *C. septemspinosa* from the NE Atlantic is the same species or a different one, and the same applies for *C. affinis* from the NE Asia. A detailed genetic analysis of the various *Crangon* species is required to resolve the present uncertainties.

### *Population structure*

Analysis of the biogeographic and genetic associations in the green crab *Carcinus maenas* by Roman & Palumbi (2004), as well as investigations in other species, suggests a general biogeographical subdivision into the areas of the Mediterranean, Western Europe and Northern Europe.

For *Crangon crangon*, a study analyzing various isoenzymes on a large scale (1000 km) (Bulnheim & Schwenzer 1993) identified four regional groups namely the North Sea and Baltic Sea; the North Atlantic Ocean; Portugal and the Adriatic Sea. On a smaller scale (100 km), two analyses using the variability in morphometric characters even suggested the existence of a much more detailed population structure: Maucher (1961) suggested differences between North Sea and the Baltic Sea populations, and Henderson et al. (1990) distinguished six subpopulations in British waters alone. However, in both studies the results on spatial variability were based on a single sampling programme only. A recent analysis of the stock structure in UK populations by means of variability in morphology and genetics could not find support for a subpopulation structure on a small scale (Beaumont & Croucher 2006). Yet, so far, *C. crangon* genetic population structure has not been studied over its distributional range by molecular tools of DNA sequencing.

## Autecology of *Crangon crangon*

### Morphology

#### *Characteristics of the species*

This description of the distinctive morphology of *Crangon crangon* is based on Holthuis (1955), Zariquiey-Álvarez (1968) and Smaldon et al. (1993). The rostrum is unarmed with a triangular shape and a rounded apex, measuring half the length of the eye or slightly more. The carapace presents an anteriorly directed spine in the anterior quarter of the median line and three pairs of lateral spines: antennal, below the orbit; pterygostomian, on the antero-ventral corner; and hepatic spines, on the lateral border of the carapace. The stylocerite, which is a lateral expansion of first segment of the antenular peduncle, is acutely pointed with half the length of this peduncle. In the scaphocerite, which is the laterally expanded and flattened exopod of the antennae, the apical spine exceeds the lamellar portion. The third maxilliped is equal in length to the scaphocerite and possesses an exopod and an arthrobranch, small gills also associated to pereopods. The mandible has only a molar process and no incisor process nor mandibular palp, and the teeth are sharply pointed.

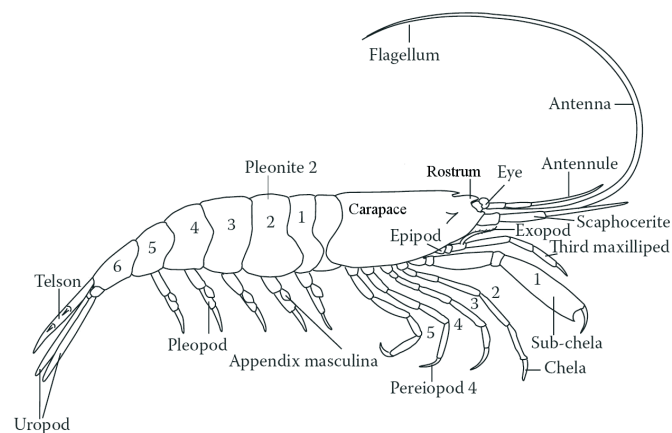

**Fig. 2.1.** Morphology of *Crangon crangon*.

The pereopod 1 is sub-chelate and stout and pereopod 2 extends to three quarters the length of propus (segment 6) of pereopod 1, while dactyl (segment 7) of pereopod 2 is about one quarter the length of the propus of pereopod 1. The sixth abdominal segment, pleonite 6, is smooth dorsally without groove or carinae, enabling to easily distinguish *C. crangon* from *C. allmani*. The endopods of pleopods 2-5 are two-segmented and do not present appendix interna. Finally, the telson has two pairs of small lateral spines.

Differences in form and dimension of various morphologically quantitative traits can be used to study patterns of geographic variation and differences among populations (Henderson et al. 1990), whereby especially the following characters are used after standardizing for total length: carapace length; telson length; inner uropod length; inner uropod width; maximum length of sub-chela; maximum width of sub-chela; length of segment 4 (merus) of first pereopod and maximum length of segments 4 (merus) and 5 (carpus) of pereopod 5 (Fig. 2.1).

#### *Differences between sexes*

Morphologically, differences between sexes are not immediately obvious, specially under 20 mm length (Meredith 1952). Three main morphological characteristics are described to distinguish sexes: the endopod of the first and second pairs of pleopods and the outer branch (olfactory) of the antennules (Fig. 2.2).

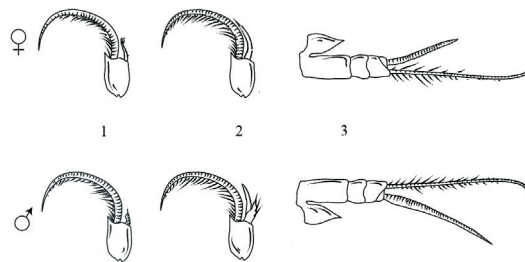

**Fig. 2.2.** The endopod of the first (1) and second (2) pairs of pleopods and the olfactory branch of the first antenna (3) in *Crangon crangon* females (upper panel) and males (bottom panel), after Meyer-Waarden & Tiews (1957).

The endopod of the first pair of pleopods is shorter in males than in females (Gelin et al. 2000) of all ages (Schockaert 1968). In females it is always clearly visible and look like narrow spoons (Meredith 1952), while in males it is spine-like and hardly visible (Tiews 1970) (Fig. 2.2). It is a useful character to distinguish sexes of smaller shrimps (Lloyd & Yonge 1947), although difficult to use in animals under 22 mm (Dalley 1980), or even under 25 to 30 mm (Gelin et al. 2000). In females above 27 mm, this endopod is visible by eye and may attain 6 mm (Meredith 1952).

In males, the endopod of the second pair of pleopods bears an appendix masculina used in copulation and sperm transfer (Fig. 2.2). It is spined on one side (Tiews 1970) and clearly visible in shrimps from 15-16 mm total length onwards (Muus 1967), although some authors found it only apparent over 20 to 30 mm length (Lloyd & Yonge 1947; Meredith 1952; Tiews 1970). Since the appendix masculina is absent in females, it can be useful to separate sexes when the first endopod is of doubtful size (Meredith 1952).

Finally, the outer or olfactory branch of the antennules is longer and has more segments and olfactory hairs in males than in females (Lloyd & Yonge 1947; Tiews 1954; Tiews 1970). The second antenna also presents some differences between sexes which have been described by Ehrenbaum (1890), Kemp (1908), Havinga (1930), Meredith (1952), and Tiews (1954, 1970). Namely, it is longer than body length in males, while in females it is shorter. Nevertheless, it is often not practical to separate sexes basing on this feature, because in preserved material the antennae often break (Tiews 1970).

#### *Differences in relation to growth*

Growth of shrimp seems to be isometric since various morphometric characters show linear relationships with total shrimp size (Table 2.1). With size, and hence during growth, the number of segments of the olfactory branch of the antennules increase after each moult by a definitive number which varies regularly between one and three according to the age and size of the shrimp and depends on prevailing temperature (Tiews 1954). However, the relationship between shrimp size and number of segments varies between males and females (Fig. 2.3). The increase in segment numbers is faster in males than in females, and with increasing shrimp size the differences between males and females become large enough to distinguish between sexes, though the morphology of endopods of the first and second pleopods are much more reliable characters for use in sex determination.

**Table 2.1.** Linear relationships between total length (mm) and respectively carapace length (CAR); telson length (TEL); maximum length of sub-chela (SUBLE); maximum width of sub-chela (SUBWI); length of segment 4 of first pereopod (PERI); inner uropod length (INNLE); inner uropod width (INNWI); and maximum length of segments 4 (MAX4) and 5 (MAX5) of pereopod 5 for *Crangon crangon* in the western Dutch Wadden Sea in September 2003.

	CAR	TEL	SUBLE	SUBWI	PERI	INNLE	INNWI	MAX4	MAX5
N	30	30	74	74	74	30	73	73	73
R <sup>2</sup>	0.996	0.994	0.992	0.988	0.994	0.998	0.982	0.991	0.997
Coefficient	0.206	0.148	0.101	0.032	0.092	0.135	0.033	0.080	0.057
95% CI Low.	0.201	0.144	0.099	0.032	0.090	0.133	0.032	0.078	0.056
95% CI Up.	0.210	0.153	0.103	0.033	0.094	0.137	0.034	0.081	0.058

N, number of cases; CI, confidence interval; Low., lower; Up., upper; Source: Campos et al. (2009)

#### *Life cycle*

In general, the life cycle of *Crangon crangon* is similar to that of many other species. Reproduction of brown shrimp occurs in deeper (10 to 20 m) and more saline waters offshore, usually in sandy or muddy areas (Tiews 1954; Henderson & Holmes 1987). During the egg stage, the eggs are not free-floating in the plankton but are carried by females. After hatching

of the eggs, a free-floating planktonic larval stage is followed by settlement and demersal juvenile and adult stages. Due to the rigid exoskeleton, growth of *C. crangon* is irregular and takes place by various moultings, whereby the exoskeleton is released, an increase in body volume occurs and a new soft skeleton is formed that hardens in a few days (Smaldon et al. 1993). After the first planktonic stages, shrimp larvae migrate to shallow nursery areas, such as estuaries, where they grow up (Tiews 1970; Heerebout 1974; Boddeke et al. 1976; Beukema 1992). With increasing size, adults move towards deeper water, where they reproduce.

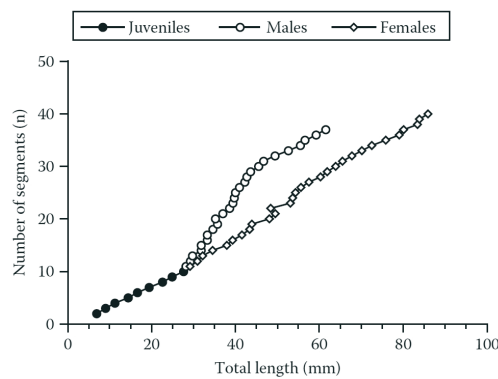

**Fig. 2.3.** Number of segments of the olfactory branch of the antennules (n) of *Crangon crangon* males and females in relation to shrimp size (mm). Data after Tiews (1954).

The onset of sexual maturity appears to be at a size of between 35 and 40 mm total length (Meredith 1952). There is some debate about whether *C. crangon* is a dioicous species with male and female reproductive organs in different individuals or a protandrous hermaphrodite, beginning its life as males and later on changing into females. For a long time only anecdotic information was present (Boddeke et al. 1988). Recently, Schatte & Saborowski (2006) observed in an eight-month-long laboratory experiment that one out of 70 males performed morphological sex reversal. They concluded that *C. crangon* may be capable of changing sex; however, the low frequency of occurrence suggests that the species is more a facultative than an obligate protandric hermaphrodite, and hence consequences at population level are most likely not relevant.

Brown shrimp is an euryhaline species (Broekema 1942; Lloyd & Yonge 1947; Muus 1967; Tiews 1970; Criales & Anger 1986) occurring at salinities between 0 and 35 (Mees 1994; Mouny et al. 2000) (salinity expressed in accordance with Practical Salinity Scale 1978) and commonly is found in waters of relatively low salinity (1-5) (Havinga 1930; Boddeke 1976). *C. crangon* can survive at temperatures between 6 and 30 °C (Lloyd & Yonge 1947; Abbott & Perkins 1977; Jeffery & Revill 2002). At lower temperatures, as during

severe winters, brown shrimp prefer high salinity and hence show a tendency to migrate to offshore waters (Broekema 1942).

### *Ecophysiological characteristics*

Combining information from various locations, in a description of the ecophysiological characteristics of brown shrimp, without knowing the possible existence of genetic subpopulations, may result in a misinterpretation of latitudinal variation. Therefore, and since most available information refers to Atlantic locations, in this review the description of Mediterranean shrimp ecophysiology is mentioned separately, whenever this information exists. Furthermore, the combination of knowledge from various shrimp stocks may introduce some bias because of adaptations of local stocks to environmental conditions, either occurring as phenotypic plasticity or as genetic selection.

### *Egg stage*

Fertilisation in brown shrimp is external (Tiews 1970). Brown shrimp has no copulatory organs, the spermatophores being applied to the ventral side of the female, usually close to the genital opening (Lloyd & Yonge 1947). Sperm may then be stored in the oviducts (Boddeke 1982). Copulation and spawning occur within 48 hours of mating (Abbott & Perkins 1977), and egg extrusion takes between 4 and 8 minutes. *Crangon crangon* has post-spawning parental care by carrying the eggs, which are attached to the pleopods with secretions from a cement gland after copulation, taking further 30 minutes (Lloyd & Yonge 1947). The newly attached egg is spherical but gradually enlarges almost exclusively in one dimension and becomes elliptical (Lloyd & Yonge 1947).

In early stages of development, the size distribution of the eggs is probably not homogenous, but as the ovary approaches to spawning, most ova attain a certain maximum size. Egg size depends on female size, whereby larger females tend to produce larger eggs (Marques & Costa 1983). The maximum egg diameter reported is in the range of 0.58 mm (Meredith 1952; Pandian 1967) to 0.61 mm, shortly before spawning (Lloyd & Yonge 1947). Eggs produced in winter are usually larger than summer ones (Havinga 1930), respectively with minimum diameter of 0.43 and 0.37 mm on the Dutch coast (Boddeke 1982) and maximum diameter of 0.86 and 0.76 mm at Port Erin Bay (Oh & Hartnoll 2004).

During incubation, different developmental stages can be distinguished (Table 2.2). The incubation period of the eggs is dependent on prevailing water temperature (Meredith 1952; Tiews 1954; Boddeke & Becker 1979), but only those eggs that develop between 6 and 21 °C are viable (Wear 1974). Different relationships for the incubation of the eggs (D, days) until hatch have been described by various authors (for summary see Temming & Damm (2002):

$$D = 1031.34T^{-1.354} \quad (\text{Belgian waters; Redant 1978}) \quad [1]$$

$$D = 20437(T+3.6)^{-2.3} \quad (\text{UK waters; Wear 1974}) \quad [2]$$



$$D = 1230.27T^{-1.43} \quad (\text{Dutch coastal waters, summer eggs; Boddeke 1982}) \quad [3]$$

$$D = 1548.82T^{-1.49} \quad (\text{Dutch coastal waters, winter eggs; Boddeke 1982}) \quad [4]$$

However, the differences between these relationships are small, and in general egg development might last from 2-3 weeks at 20 °C to up to more than 3 months at 6 °C (Fig. 2.4). With increasing temperature, egg development can occur at lower salinity, though at salinities below 15, eggs fail to develop and are lost by the females (Broekema 1942).

**Table 2.2.** Egg development stages in the brown shrimp *Crangon crangon*.

Stage	Colour	Description	Broekhuysen (1936)	Meredith (1952)	Oh et al. (1999)
1	greenish, transparent	Early spawned, small eggs, early blastoderm	I, II, III, IV	A, A+	A
2	white	Bigger eggs, large blastoderm, gastrulation	V, VI	B-	B
3	white to light brown	Eyes of larvae become visible	VII	B+	C
4	brownish	Large eyes visible, outline of carapace and abdomen	VIII	C-, C, C+	D
5	brown	Whole pre-larvae visible, abdomen separated from head, first empty egg capsules	IX	D	E
6		Larvae hatched, leaving only degenerated eggs and empty egg capsules	X, XI	E	F

Source: Adapted after Oh et al. (1999), based on Havinga (1930), Broekhuysen (1936), Meredith (1952), Tiews (1970) and own observations.

#### *Larval stage*

The larvae have been described by Du Cane (1839), Ehrebaum (1890), Havinga (1930), Lebour (1947), Williamson (1960), Dalley (1980), Gurney (1982) and Criales & Anger (1986), including five (Ehrenbaum 1890; Williamson 1960; Dalley 1980; Criales & Anger 1986) to six pelagic stages and an extra post-larval stage (Gurney 1982). These first planktonic stages occur in higher salinity locations (Marques 1982). The length at hatching is 2 mm increasing to 4.6 to 4.7 mm at the end of the last larval stage, when the animals settle (Lloyd & Yonge 1947). Larvae hatching from summer eggs are smaller than those from winter eggs: respectively, 2.14 and 2.44 mm (Boddeke 1982).

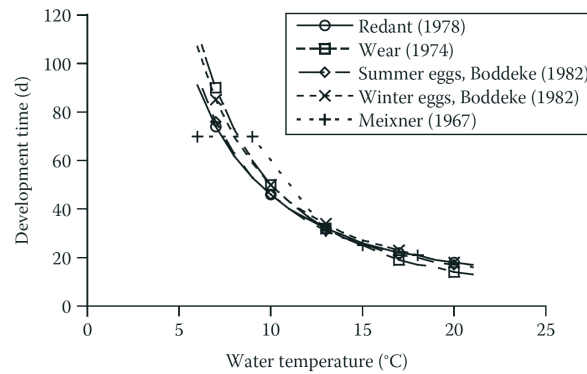

**Fig. 2.4.** Egg development time (d, days) of *Crangon crangon* in relation to water temperature (°C).

Larval development is only successful at a narrow temperature range of 9 to 18 °C and at a narrow salinity range, mainly in the polyhaline zone (salinity around 32), with mortality at salinities below 16 and slower development at a salinity of 25 (Criales & Anger 1986). Within this temperature range, the length of the pelagic larval period (D, days) depends on temperature (Lloyd & Yonge 1947), and various relationships have been published:

$$\begin{aligned}
 D &= 941.78T^{-1.347} && \text{(Wadden Sea area; Temming & Damm 2002)} && [5] \\
 D &= 952.09T^{-1.258} && \text{(Dutch coastal waters, summer larvae; Boddeke 1982)} && [6] \\
 D &= 1148.42T^{-1.405} && \text{(Dutch coastal waters, winter larvae; Boddeke 1982)} && [7]
 \end{aligned}$$

In addition, measurements in the laboratory at 12, 15 and 18 °C are available from Criales & Anger (1986). Overall, the length of the larval stage corresponds with that of the egg stage at the same temperature and, within a relatively small temperature range (9-18 °C), larval development varies from about 3 weeks at 18 °C to about 7 weeks at 9 °C (Fig. 2.5).

The number of larval moults at metamorphosis is mainly a reflection of development time, as is indicated by the relationship between the number of moults (M), larval development time (D, days) and water temperature (T, °C), after Criales & Anger (1986):

$$M = 0.00584 * D * T^{1.347} \quad [8]$$

This means that the number of moults increases from 5.9 on average at 12 °C, to 7 moults at 18 °C (Criales & Anger 1986).

### Settlement

Settlement occurs in the first or second post-larval stage at 4 to 6 mm body length. Kuipers & Dapper (1984) reported an average length at settlement of 4.7 mm total length, occurring after two to five months of development. The processes inducing settlement in *C. crangon* are unknown. In flatfish species, favourable food conditions are considered to be the clue triggering settlement on the sediment surface (Creutzberg et al. 1978). It is unclear whether settlement in larval shrimps is induced by a similar mechanism.

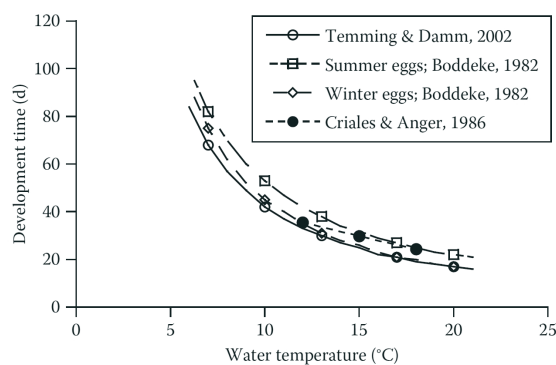

**Fig. 2.5.** Larval development time (d, days) of *Crangon crangon* in relation to water temperature (°C), summarized by Temming & Damm (2002).

It is also unclear whether the larvae are only being transported passively, by being swirled up in the water column by increasing tidal or wind induced currents and sinking down at low current velocities (Rijnsdorp et al. 1985; Bergman et al. 1989); or whether in addition larvae are able to affect this transport selectively by swimming up from the seabed during flood tides and remaining on the seabed during ebb tides, so called selective tidal transport, as observed in flatfish species (Rijnsdorp et al. 1985; Jager 1999).

Nevertheless, settlement is only possible when larvae reach the sediment surface. Once here, larvae have to maintain the position without being displaced. In this respect, active partial burying by the settling larvae like in fish larvae might be effective because it might reduce drag forces induced by currents close to the sea bed (Arnold & Weihs 1978). Such a mechanism in combination with the size of the larvae would imply that sediment conditions might be important. In general, shallow and silty estuarine areas are mentioned as suitable for settlement (Berghahn 1983; Kuipers & Dapper 1984; Boddeke et al. 1986; Henderson and Holmes 1987).

### Juvenile stage

Field information indicates that the habitat requirements of juvenile shrimp are rather broad including very fine to coarse sand (Kuipers & Dapper 1981, 1984).

Brown shrimp use an ambush strategy and rarely actively search or pursue their prey (Gibson et al. 1995). Juvenile shrimps eat mainly meiofauna and shift towards a diet on macrofauna-sized items when they reach a total length over 20 mm (Pihl & Rosenberg 1984; Gee 1987). Food items are taken approximately in relation to their relative occurrence (Pihl & Rosenberg 1984), and therefore the brown shrimp has been defined as a trophic generalist (Evans 1983; Pihl & Rosenberg 1984), omnivorous (Lloyd & Yonge 1947; Muus 1967; Tiewes 1970; Kuhl 1972) or a carnivorous opportunistic (Pihl & Rosenberg 1984) and even cannibalism is very common (Marchand 1981).

Feeding and growth of the brown shrimp occurs at least within a temperature range between 5 to 25 °C (M. Fonds, unpubl., cited in Van Lissa 1977 and in Kuipers & Dapper 1981). In the laboratory, maximum growth has a positive relationship with increasing temperature, and an inverse relationship with shrimp size (Fig. 2.6). From these growth experiments in aquaria the following growth equation could be determined between daily length growth ( $dL/dt$ ,  $\text{mm d}^{-1}$ ), water temperature ( $T$ , °C) and shrimp body size ( $L$ , mm):

$$dL/dt = 0.1625 + 0.01025 * T - 0.00403 * L \quad [9]$$

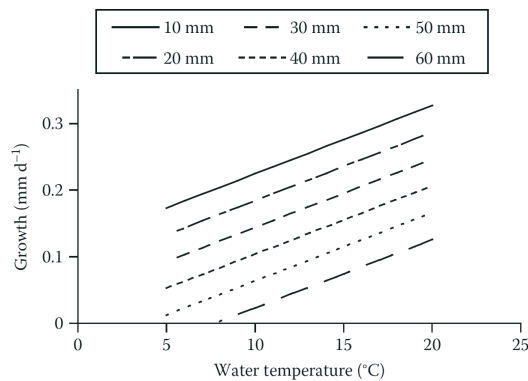

**Fig. 2.6.** Body size growth ( $\text{mm d}^{-1}$ ) of juvenile and adult shrimp *Crangon crangon* in relation to water temperature (°C) and shrimp size (mm) in the laboratory under optimal food conditions. Data after M. Fonds (unpubl. observations cited in Van Lissa 1977 and Kuipers & Dapper 1981).

Juvenile shrimps show maximum growth at about 25 °C (Van Lissa 1977). In relation to adults, juveniles show a faster growth and are more tolerant to high temperatures (Van Donk & De Wilde 1981). Young shrimps also seem to prefer lower salinities than adults (Marques 1982).

#### *Adult stage*

The maturity of females is easy to evaluate by the presence of eggs, while in males it can only be estimated, since no external feature reveal this status (Muus 1967; Schockaert 1968).

Therefore, there is more information on female maturation; it has been assumed that maturity of males occur at the same time as for females (Muus 1967), which might be incorrect.

The described variability in size and age at maturity in *C. crangon* suggests that they mature in a similar way to various fish species, such as plaice *Pleuronectes platessa* according to a trajectory in the length and hence age space (Rijnsdorp 1993). In fish, this window is a reflection of the result of becoming sexually mature when the animal has passed some fixed size-threshold (Roff 1991) in combination with a distinct spawning period of once a year. In *C. crangon* size at maturity seems to be more related to temperature than with age (Meredith 1952). The size-at-maturation threshold differs for males and females, whereby males become mature at a smaller size (22-43 mm total length) than females (30-55 mm total length) (Lloyd & Yonge 1947; Boddeke 1966; Muus 1967; Schockaert 1968; Meixner 1970; Marques and Costa 1983; Gelin et al. 2000; Oh & Hartnoll 2004).

No detailed information is available about maturation in males. In females, bigger individuals seem to start to have eggs earlier than smaller ones (Meredith 1952; Marques & Costa 1983). During the first stages of egg development there is a considerable increase in the number of eggs but in subsequent stages this increase tends gradually to cease (Spaargaren & Haefner 1998). The average number of eggs per female is positively correlated with body size but variability exists between areas and between summer and winter eggs (Fig. 2.7). There is a suggestion of a lower fecundity during winter as a result of the limited volume of eggs that female can held because winter eggs are larger (Henderson & Holmes 1987).

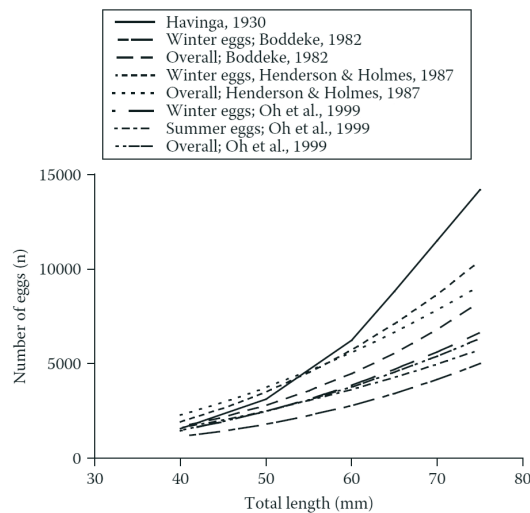

**Fig. 2.7.** Fecundity (number of eggs) in relation to female *Crangon crangon* total length (mm).

Feeding and growth of adult shrimps also occurs at least within a temperature range between 5 to 20 °C (M. Fonds, unpubl. in Kuipers & Dapper 1981). In the laboratory,

maximum growth is a positively related with increasing temperature, an inversely related with shrimp size (Fig. 2.6). The same relationship as found for juveniles, seem to apply for adults, whereby no differences were described between males and females (Van Lissa 1977; M. Fonds, unpubl. in Kuipers & Dapper 1981):

$$dL/dt = 0.1625 + 0.01025*T - 0.00403*L \quad [10]$$

where  $dL/dt$  is daily length growth ( $\text{mm d}^{-1}$ ),  $T$  is water temperature ( $^{\circ}\text{C}$ ) and  $L$  is shrimp body size (mm).

Adult shrimps can endure extremely low temperatures (Havinga 1930; Tiews 1970), but they seem to be less tolerant to high temperatures (Van Donk & De Wilde 1981), although they live in areas up to  $30^{\circ}\text{C}$  temperature (Havinga 1930; Tiews 1970). Actually, shrimps from all stages of development can tolerate a combination of temperature of  $-1.8^{\circ}\text{C}$  and salinity between 18 and 26 (Boddeke 1975). The salinity optimum at  $20-22^{\circ}\text{C}$  is around 28-29 for 2 year old shrimps, and 15-20 for 1 year old shrimps, while at  $3-5^{\circ}\text{C}$  the salinity optimum is 33. Therefore, with increasing temperature the salinity optimum shifts towards less salinity water, which means that brown shrimp can stand lower salinities better when the temperature is high. On the contrary, with increasing age the salinity optimum shifts towards a higher salinity (Broekema 1942). Therefore, young shrimps can endure lower salinities than older ones (Tiews 1970). Optimum salinity also differs between sexes, being higher for males than for females at least at  $15^{\circ}\text{C}$  (Lloyd & Yonge 1947). Despite brown shrimp can be found within a salinity range of 5-35 (Hagerman 1971), males cannot withstand such low salinities as females, and die at salinities below 10 (Lloyd & Yonge 1947). Females usually avoid salinities under 12.6. Finally, low salinity increases the duration of the ovarian cycle since it delays brown shrimp maturation (Broekema 1942; Spaargaren & Haefner 1998; Gelin et al. 2001a, b).

### *Food and role as predator*

#### *Food*

*Crangon crangon* is characterized as either a trophic generalist (Evans 1983; Pihl & Rosenberg 1984), or an omnivorous (Lloyd & Yonge 1947; Muus 1967; Tiews 1970; Kuhl 1972) or carnivorous opportunistic (Pihl & Rosenberg 1984).

The diet of brown shrimp includes both meiofauna and endobenthic macrofauna as evidenced by field studies (Pihl & Rosenberg 1984; Pihl 1985; Nilsson et al. 1993) and experiments (Hedqvist-Johnson & André 1991; Nilsson et al. 1993) and consists of three predominantly bottom-dwelling categories: infaunal organisms (bivalves, cumaceans, foraminifereans, harpacticoids, nematodes, oligochaetes) (Jensen & Jensen 1985; Oh et al. 2001), epifaunal organisms (amphipods, isopods, gastropods) and demersal organisms

(mysids, shrimps and fishes). As a consequence, cannibalism is also very common (Marchand 1981). Potential prey items change with increasing shrimp size and shift from juvenile shrimps eating mainly meiofauna towards a diet on macrofauna-sized items when they reach a total length over 20 mm (Pihl & Rosenberg 1984; Gee 1987). Part of the food consists of regenerating body parts such as by sublethal browsing of the siphon tips of bivalve species (Bonsdorff et al. 1995).

Shrimps use an ambush strategy to catch their prey and rarely actively search or pursue its prey (Gibson et al. 1995). Although Gibson et al. (1998) found that brown shrimp has higher activity during the light period, most authors state that it is more active (Nouvel-van Rysselberge 1937; Hagerman 1970; Al-Adhub & Naylor 1975; Dyer & Uglow 1978; Van Donk & De Wilde 1981; Gelin et al. 2001a, b) and predation rates are higher at dark (Lloyd & Yonge 1947; Dyer & Uglow 1978; Ansell & Gibson 1993; Norkko 1998), with feeding peaks at dawn and dusk coinciding with the period between low and high tide (Del Norte-Campos & Temming 1994). During day time, brown shrimp buries itself in the sand (Dyer & Uglow 1978; Gelin et al. 2001a, b) and may attack preys when they approach (Pinn & Ansell 1993).

Apart selecting preys according to its size (larger shrimps eat larger preys) (Gibson et al. 1995), food items are taken approximately in relation to their relative occurrence (Pihl & Rosenberg 1984). Hence seasonal changes in the diet are mainly caused by fluctuations in food availability (Plagmann 1939; Pihl & Rosenberg 1984).

#### *Role as predator*

Due to its high abundance, predation by *C. crangon* can have a significant effect on its prey populations (Evans 1984; Pihl & Rosenberg 1984; Pihl 1985; Norkko 1998) and hence it is considered an ecologically important benthic predator (Reise 1977; Kuipers & Dapper 1981; Kuipers et al. 1981; Jensen & Jensen 1985; Gee 1987; Matilla et al. 1990; Nilsson et al. 1993; Bonsdorff et al. 1995; Cattrijsse et al. 1997; Oh et al. 2001; Hiddink et al. 2002)

Predation processes are in general based on size-based predation relationships. For instance, based on stomach content analysis it seems that fish predators should be in general four times larger than their prey (Daan et al. 1990; Van der Veer et al. 1997). In the case of *C. crangon*, such relationships will also determine to a large extent its potential prey spectrum. Its relatively small maximum size of less than 9 cm total length in combination with its demersal way of life implies that predation is concentrated on demersal small prey items, small species or on the early and small life stages of larger species.

Predation on siphon tips of bivalves is an example of consumption of parts of prey species, the whole animal either being inaccessible or too large to tackle. Siphons are used by bivalves for feeding, defecation, reproduction and respiration and when they are extended near to or above the sediment surface, these unprotected parts become vulnerable to predation. Predation on siphon tips not only by shrimps but also by crabs and fishes is a general phenomenon in coastal areas (a.o. Macer 1967; Edwards & Steele 1968; De Vlas 1979).

Despite the fact that siphon tips are regenerated, this type of predation has several important consequences for bivalves, because regeneration of lost siphon tissue takes up energy at the cost of growth and reproduction and induces behavioural changes in bivalves (burying depth). Inhibit feeding and reduced growth has been observed as a consequence of sublethal browsing of siphon tips by shrimps (Kamermans & Huitema 1994; Bonsdorff et al. 1995).

Predation on small species includes meiofauna (Hedqvist-Johnson & André 1991) and oligochaetes (Reise 1977). Although shrimp predation can be substantial, there are no studies analysing whether this type of predation is responsible for a top-down control of these small species.

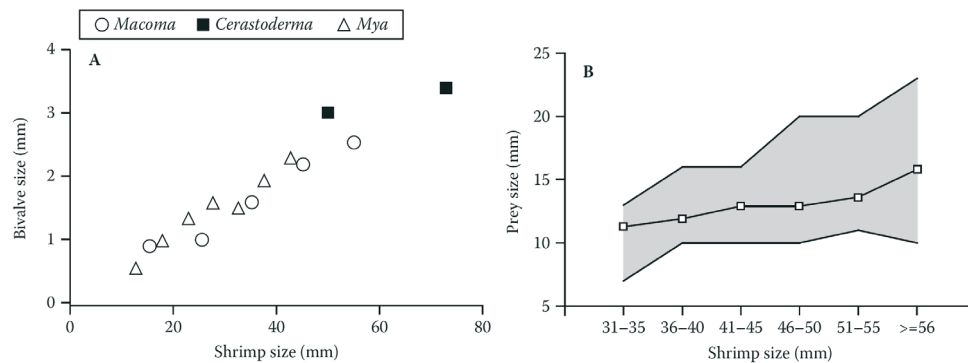

**Fig. 2.8.** Predator-prey size relationships in the field for *Crangon crangon* as predator and A: bivalve spat as prey (mean spat size of various bivalve species from Van der Veer et al. (1998) and B: flatfish larvae as prey (mean flatfish larvae size ( $\square$ ), together with range (grey) and minimum and maximum observed size, after Van der Veer & Bergman (1987).

Predation on infaunal macrofauna (Moller & Rosenberg 1983; Matilla et al. 1990; Beukema et al. 1998; Strasser 2002; Flach 2003) and on just settled flatfish larvae (Van der Veer 1986; Van der Veer & Bergman 1987; Pihl 1990; Van der Veer et al. 1990; Wennhage 2002; Amara & Paul 2003) before they become too large for shrimps to prey upon (Pihl & Rosenberg 1984; Nilsson et al. 1993) are examples of predation on early and small life stages of larger species. Shrimp can prey upon bivalve spat up to a size of a few mm (Fig. 2.8A) and inter-annual variation in this predation has been suggested to be controlling bivalve recruitment (Van der Veer et al. 1997; Phillippart et al. 2003). A similar size-based relationship is found for flatfish larvae as prey (Fig. 2.8B). In this case, predation by shrimps did not determine the recruitment of the flatfish, but acted as a fine control damping inter-annual variability (Van der Veer 1986). Cannibalism is the most extreme form of predation and it is suggested to be very common in shrimps (Marchand 1981). Stomach content analysis in the Dutch Wadden Sea shows that cannibalism on just settled shrimps of about 6 mm total



length occurs in shrimps in size over 30 mm (Derks 1980), which means a predator-prey size ratio of about 5:1. There is no information available about the importance of cannibalism in regulating and controlling recruitment.

So far it is obvious that the role of predation by shrimps must be substantial due to their high abundance. Top-down control has been suggested in some cases; however, this aspect has not been studied in detail up to now.

### *Recruitment*

Recruitment is defined as the process whereby juveniles survive to attain sexual maturity and join the reproductive population. Shrimps become mature at a size between 22-43 mm total length in males and 30-55 mm total length in females (Lloyd & Yonge 1947; Boddeke 1966; Muus 1967; Schockaert 1968; Meixner 1970; Marques & Costa 1983; Gelin et al. 2000; Oh & Hartnoll 2004) and this normally occur within the first year of life. Studies on the level and variability in recruitment in *C. crangon* must therefore focus on the early life stage of *C. crangon*, where densities of more than 100 individuals per m<sup>2</sup> are not uncommon (Berghahn 1983). So far such process-oriented studies are lacking partly due to its distribution patterns and extremely high abundance.

Recruitment seems to be successful in most areas and years, since over a wide latitudinal range, *C. crangon* is continuously abundant in shallow coastal systems (see for instance Tiews 1970; Pihl & Rosenberg 1982; Kuipers & Dapper 1984; Oh et al. 1999). At this stage, at least water temperature can be listed as an important abiotic factor: timing of immigration and settlement of shrimp larvae is strongly related to prevailing water temperature (Beukema 1992) and recruitment is positively related to temperature (Henderson et al. 2006). Besides temperature, the North Atlantic Oscillation and river flow influences recruitment, probably due to their effects on the productivity and growth of estuarine organisms (Henderson et al. 2006).

Whether just-settled juveniles suffer from growth limitation is unknown; however, there is no information suggesting that starvation-induced mortality occurs. Hence, predation and cannibalism might be an important source of mortality (Henderson & Homes 1989). Nevertheless, according to Henderson et al. (2006) predators' abundance in a 25-year data series varied considerably through time with no correspondence between the peaks and troughs in predators and *C. crangon* abundance. Therefore top-down control alone seems to be insufficient to explain the regulation of the brown shrimp population. The importance and impact of cannibalism should be studied in more detail, since Pihl & Rosenberg (1982) estimated that up to more than 20% of the annual food consumption of *C. crangon* in Swedish shallow waters might consist of young shrimps. Whether cannibalism was acting as a density-dependent source of mortality was not studied and it is unknown if cannibalism acts as a controlling factor (generating inter-annual variability in recruitment) or as a regulating factor (damping inter-annual variability in recruitment).

## Latitudinal gradients

### *Seawater temperature*

Seasonal patterns in sea water temperature are the result of complex interactions whereby especially air-sea interaction, hydrodynamic processes and local bathymetry play an important role. On a large scale, trends in sea surface temperature are to a large extent a reflection (with some time delay) of trends in air temperature. Over the distributional range of *C. crangon*, a general latitudinal trend in sea surface water temperature is observed along the European coast, with average temperatures decreasing with increasing latitude. In the Mediterranean, a weaker trend is present with increasing temperatures from east to west due to a combination of factors, i.e. increasing air temperatures, reduced influence of mixing by Atlantic oceanic water through the Strait of Gibraltar, etc. Finally, from Turkey into the Black Sea temperatures again decrease with increasing latitude. Along the European coast, mean sea water temperatures vary between around 25°C in summer and 14°C in winter in southern Europe, to about 15 °C in summer and 2 °C in winter in northern Denmark and in England (see for instance: <http://www.nodc.noaa.gov/OC5/indprod.html>).

Most long-term data sets are collected in subtidal areas and there is less detailed information available for surface waters and for intertidal regions (Fig. 2.9). Along the European Atlantic coast, the seasonal pattern in temperature shows maximum values in July-August and minimum in winter. Maximum summer temperatures vary from about 10°C at 70°N latitude in Norway to about 21°C at 41°N in Portugal. The seasonal fluctuation is lowest at highest latitude (about 8°C), highest at intermediate latitude (about 15°C) and intermediate at low latitude in Portugal (about 10°C). In addition to seasonal fluctuations, daily fluctuations of several degrees occur (Fig. 2.10). In the Mediterranean, a similar seasonal pattern is observed, although summer temperatures appear to be higher than along the European Atlantic coast with values above 20°C (Fig. 2.9).

### *Seasonal migration*

Changes in environmental factors, especially temperature (Boddeke 1976; Boddeke et al. 1976; Beukema 1979; Spaargaren 1980; Henderson & Holmes 1987), and to a lesser extent salinity (Broekema 1942; Lloyd & Yonge 1947; Tiews 1970; Labat 1977a, b; Marques 1982; Henderson & Holmes 1987; Gelin et al. 2001a, b), light intensity/day length (Spaargaren 2000) and food conditions (Broekema 1942; Lloyd & Yonge 1947; Tiews 1970; Boddeke 1976; Spaargaren 2000), affecting the physiological performance of shrimps are responsible for observed migration patterns, both tidally (Janssen & Kuipers 1980), daily (Hartsuyker 1966) and seasonally.

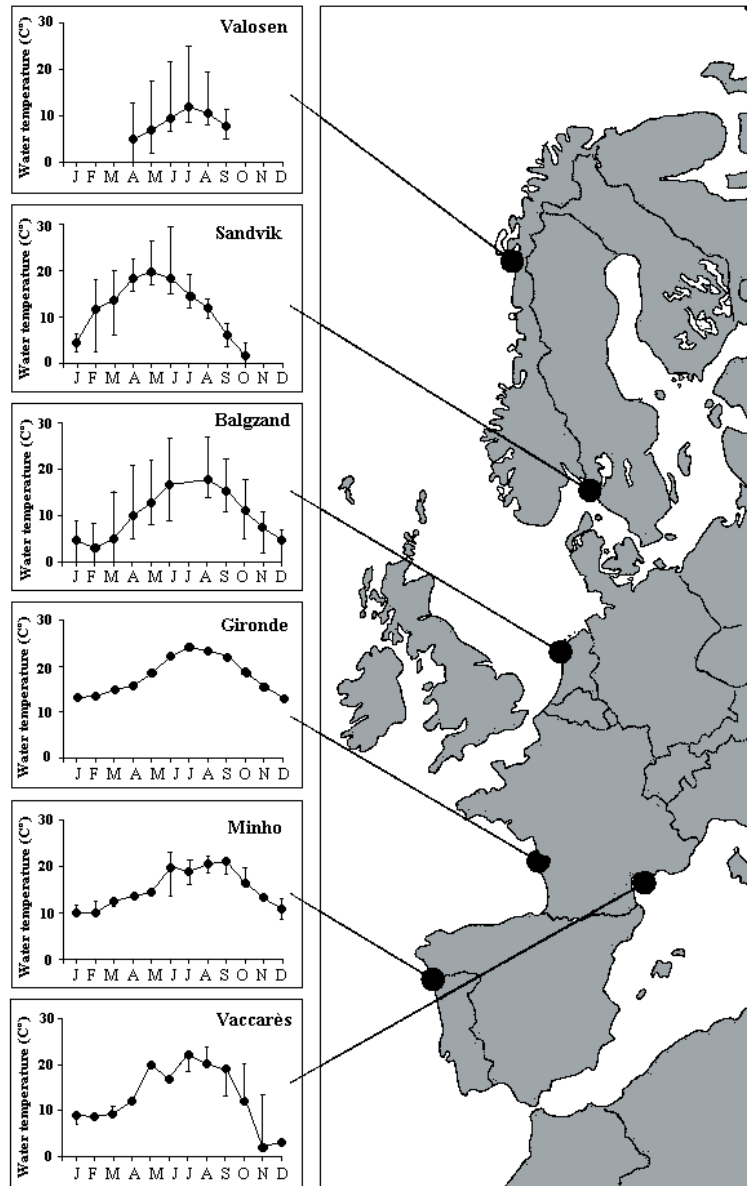

**Fig. 2.9.** Seasonal patterns in water temperature (°C) along the European Atlantic coast. Data source: Valosen, Norway (J. Campos & V. Freitas, unpubl. observations), Sandvik Sweden (Pihl & Rosenberg 1982), Balgzand The Netherlands (H. Van der Veer & H. Witte, unpubl. observations), Gironde France (Bachelet 1986), Minho Portugal (J. Campos & V. Freitas, unpubl. observations) and Vaccarès France (Gelin et al. 2000). Mean values are presented together with observed range (if available).

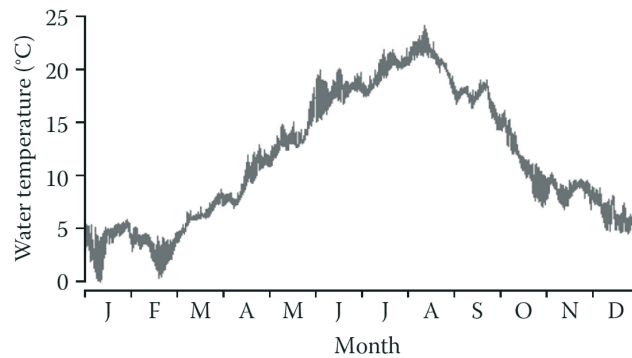

**Fig. 2.10.** Daily mean and daily fluctuations in water temperature (°C) in the surface water at Marsdiep near the southern part of the Isle of Texel, western Wadden Sea, The Netherlands. (Data after Van Aken 2008b)

The most pronounced patterns are seasonal migrations especially near lagoons and estuarine areas. The temperature tolerance of the various life stages of *C. crangon* (Fig. 2.11) suggests that suboptimal or even lethal temperature conditions are the main forcing reason for the observed seasonal migration patterns. Along the northern Atlantic coast, the migration during autumn/winter to deeper and often more saline waters can be considered as a refuge from the low winter temperatures. The return to shallow brackish areas during spring/summer (Broekema 1942; Lloyd & Yonge 1947; Tiews 1954; Muus 1967; Boddeke 1976; Boddeke et al. 1976; Marques 1982; Baden and Pihl 1984; Henderson & Holmes 1987; Beukema 1992; Attrill & Thomas 1996; Spaargaren 2000; Drake et al. 2002; Gibson et al. 2002) can be explained by a search for warmer temperatures (Spaargaren 1980). More southwards, in the Mediterranean, and in some years also along the Atlantic coast, migration movements in summer to deeper waters seem to be an escape from excessively high temperatures in search for colder waters (Labat 1977a). Above 27°C, an exodus of *C. crangon* from the intertidal towards deeper water occurs (Berghahn 1983, 1984).

Various other abiotic and biotic factors can complicate the seasonal migration patterns. First of all, salinity directly affects the temperature tolerance of shrimps: at low temperatures shrimps prefer high salinities, while at high temperatures, low salinities are preferred (Broekema 1942). Especially, the combination of low temperature and low salinity is avoided (Broekema 1942; Van der Baan 1975; Marques 1982). On the other hand, despite low temperatures in winter, when salinity is over 25 apparently it is unnecessary to migrate from the estuary (Meredith 1952). Also many shrimps remain in the open sea in Atlantic waters during summer, suggesting that there is no physiological necessity to live in lower salinities at higher temperatures (Spaargaren 1980).

Another factor is life stage. The young (and smaller) shrimps (Temming & Damm 2002) and ovigerous (berried) females (Lloyd & Yonge 1947; Van der Baan 1975) are the first

invading shallow areas in spring/summer, while the bigger ones are the first to leave this areas in winter (Muus 1967; Boddeke et al. 1976). Emigration to deeper waters is size-dependent, since shrimps tend to inhabit deeper zones as they grow (Spaargaren 2000), resulting in increasing average size with depth (Del Norte-Campos & Temming 1998). Furthermore, migration differs with age and sex groups (Boddeke 1976), which partly reflects also differences in reproductive cycle (Van der Baan 1975; Boddeke 1976; Kuipers & Dapper 1981; Henderson & Holmes 1987; Gelin et al. 2001a, b), whereby berried females and fertile males are more sensitive to temperature (Boddeke 1976; Boddeke et al. 1976) and prefer higher salinities, while young shrimps seem to prefer lower salinities (Marques 1982). As a consequence, a second migration seawards may occur in summer to reproduce (Henderson & Holmes 1987). In contrast, in the Mediterranean Sea, brown shrimp migrate seawards in spring/summer and return to shallow waters in autumn (Labat 1977a, b; Gelin et al. 2000), although juveniles enter Mediterranean lagoons in spring to grow and females leave these lagoons in winter to reproduce (Labat 1977b).

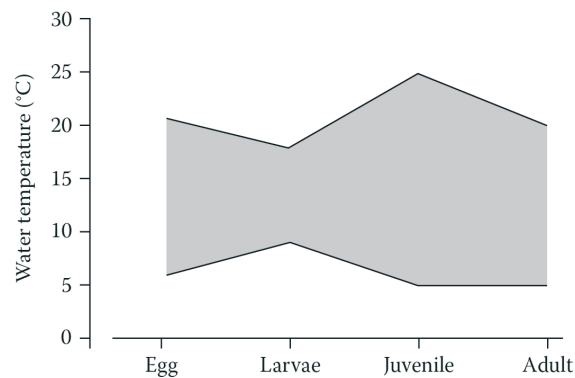

**Fig. 2.11.** Optimal temperature ranges (°C) of *Crangon crangon* in relation to life stage. For references see text.

### *Reproduction*

When referring to the reproduction period some authors mean the months/seasons of higher abundance of ovigerous females, others refer to the timing of egg hatching and others to the period of higher abundance of larvae. Taking this into account, the breeding seasons of brown shrimp seem to vary with location (Fig. 2.12). However, besides excluding mature males which are not clearly identifiable, these studies usually exclude non-ovigerous females that are clearly mature on the basis of ovarian condition or the form of their appendages (Oh & Hartnoll 2004).

At latitudes around 51-54°N, females with eggs are present all year (Meredith 1952; Kurc et al. 1965; Heerebout 1974; Boddeke 1982; Marques 1982; Moreira et al. 1992; Del Norte-

Campos & Temming 1994), although, in some cases, less abundantly in autumn, which may be considered to be a resting period (Lloyd & Yonge 1947; Meredith 1952; Tiews 1954; Boddeke et al. 1976; Boddeke & Becker 1979; Duran 1997; Oh & Hartnoll 2004).

In the Mediterranean and Baltic Seas, only one spawning season is reported corresponding respectively to the coldest months (Labat 1977a, b; Crivelli 1982; Gelin et al. 2000) and to summer (Henking 1927; Muus 1967). Along the Atlantic coast the number of spawning periods increases with latitude up to three per year and/or these periods are more extent sometimes overlapping each other (subsequent spawning periods start before the previous one has finished) (Lloyd & Yonge 1947), although to the south, in the Tagus estuary, brown shrimp reproduce throughout the year, but mainly during spring (Marques 1982).

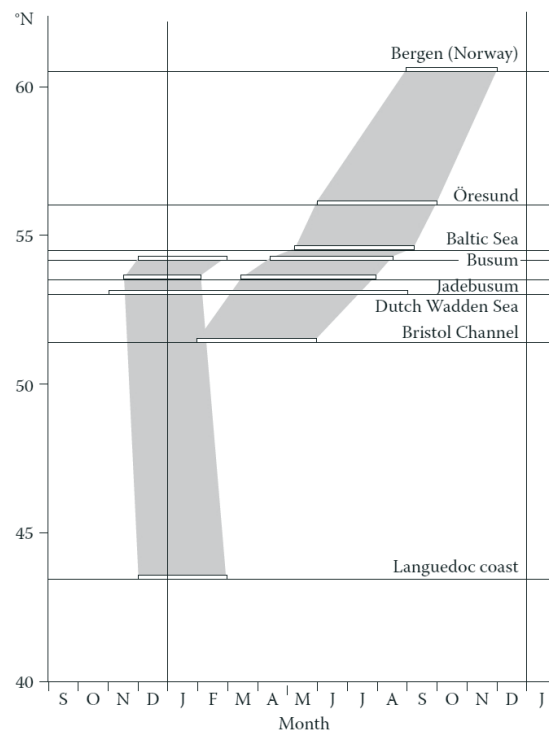

**Fig. 2.12.** Reproductive periods of *Crangon crangon* in relation to latitude. Data after Kuipers & Dapper (1984) based on Tiews (1970). Shaded areas represent fixed winter spawning season and the shifting summer spawning.

Fecundity of brown shrimp seems to be significantly higher at southern latitudes in the Mediterranean when compared with the fecundity along northern Atlantic coasts (Gelin et al. 2000; Gelin et al. 2001a, b), although this may reflect different genetic subpopulations and not latitudinal variation.

Overall, the reproductive period seems to shift from a restrictive period from summer/autumn in the northern part of the distribution via all-year-round to a winter period near the southern edge in the Mediterranean (Fig. 2.12). In areas where reproduction seems to occur throughout the year, spawning peaks seem to shift from north to south from summer in German and Danish coasts (Tiews 1970) to winter in the Dutch Wadden Sea.

According to Oh & Hartnoll (2004), differences between winter and summer brood are not the egg numbers but the mean egg volume and dry weight of the eggs. Consequently, the reproductive investment of *C. crangon* is higher in a winter brood than in a summer brood.

The migration of ovigerous females and fertile males to deeper and more saline areas may distort the conclusions of previous studies. Therefore, probably in some of the latitudes represented in Figure 2.12, the reproduction period may be more extent. Furthermore, the percentage of ovigerous females may not reflect quantitatively the reproduction cycle due to the great fluctuations in the size of the stock of mature females (Boddeke & Becker 1979).

### *Life history traits*

#### *Size at hatching*

The length at hatching is 2 mm increasing to 4.6 to 4.7 mm at the end of the last larval stage, when the animal settle (Lloyd & Yonge 1947). Larvae hatching from summer eggs are smaller than the ones from winter eggs: respectively, 2.14 and 2.44 mm (Boddeke 1982). There is no information of a latitudinal trend in size at hatch.

#### *Settlement*

In estuarine shallow areas settlement starts earlier than in marine sandy coastal places, coinciding with the annual bloom of pelagic copepods (Boddeke et al. 1985). In most places within the Atlantic settlement takes place during the warmer period. After cold winters, the moment of settlement and peak densities of settlers are delayed (Beukema 1992). There is no information about settlement period for the Mediterranean Sea.

Settlement occurs at 4 to 6 mm body length, in the first or second post-larval stage (Pihl & Rosenberg 1982), at an average length of 4.7 mm (Kuipers & Dapper 1984). Due to lower winter temperatures and consequently larger larval development time, in more northern areas the settlement of post-larval shrimp is expected to take place later than in southern areas (Beukema 1992).

#### *Growth*

The analyses of growth and age are complicated by the fact that there are no visible morphometric or other characters that are related to the age of *C. crangon*. In the past Tiews (1954) suggested a method to determine growth and age based on the fact that the number of segments of the outer antennules are directly related to the number of moults (Fig. 2.13A). In

combination with information on the relationship between the frequency of moulting and water temperature (Fig. 2.13B), the trends in the number of segments of the antennules together with that in the prevailing water temperature would in principle allow a reconstruction of growth patterns and hence age. This method has been applied in the past by Tiews (1970) and was re-introduced by Schockaert (1968) in Belgian waters and by Gelin et al. (2000) in the Mediterranean. Preferably, this method should be validated before it is applied to other areas. However, this was not done neither by Schockaert (1968) nor by Gelin et al. (2000); in both cases basic information from Tiews (1954) for the German Wadden Sea was taken. The relationship between shrimp size and the number of segments seems to be rather robust. For the western Dutch Wadden Sea a similar relationship was found (Fig. 2.13A); however, the observed variability was greater than described by Tiews (1954).

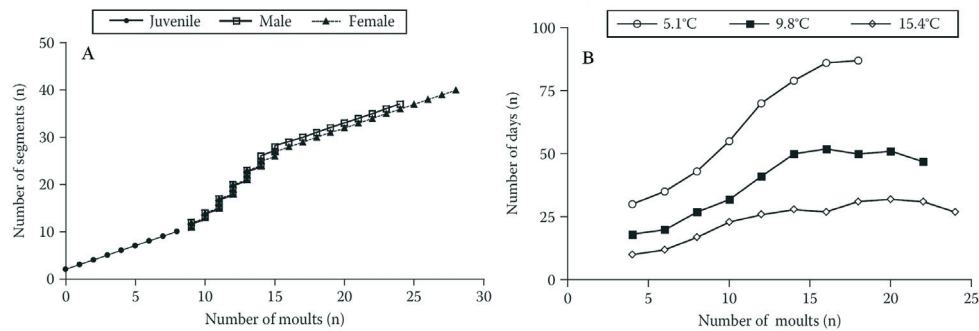
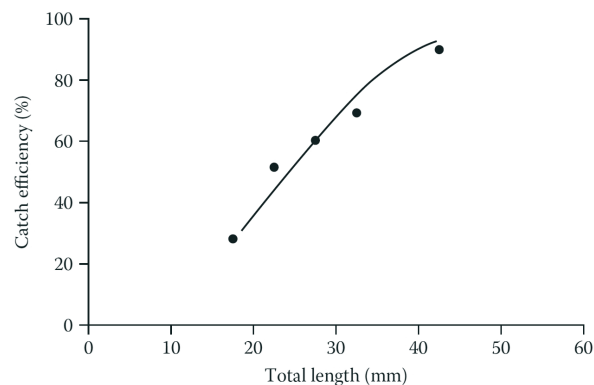

**Fig. 2.13.** Relationship between A: the number of segments (n) of the olfactory branch of the antennules and the number of moults (n); and B: the frequency of moulting (n) and water temperature (°C). After Tiews (1953).

With respect to the relationship between the frequency of moulting and water temperature, the data of Tiews (1954) are puzzling. Tiews (1954) provide information for three temperatures, respectively 5.1, 9.8 and 15.4°C. In combination with the relationship between shrimp size and the number of segments, growth rates can be calculated for the trajectory 18–45 mm (4–16 moults) and they are respectively 0.5, 1.0 and 1.5 mm d<sup>-1</sup>, which is far above maximum growth rates found by M. Fonds (unpubl., cited in Van Lissa 1977 and in Kuipers & Dapper 1981) and by Meixner (1969) in the laboratory. This means that the relationship between water temperature and frequency of moulting needs to be revalidated before the method of Tiews (1954) can be applied. Furthermore, since moulting is related to growth, food conditions also play a role. Neither Tiews (1954), nor Schockaert (1968) and Gelin et al. (2000) provide information on this aspect. Therefore, their results should be considered as preliminary and not yet validated.



With the introduction of more quantitative sampling designs, the analysis of growth based on shifts in size-frequency distributions over time became popular. However, the applicability of this method is limited. First, most sampling gears, especially trawls, have a very low efficiency for the smallest size-classes (Redant 1978). For a 2 m beam trawl with 5 mm mesh size, the brown shrimp catch efficiency increases from about 28% for shrimp of 15-20 mm total length to 100% from a size of 50 mm onwards (Fig. 2.14). Furthermore, migration movements and size-selective predation processes bias the growth patterns over time.



**Fig. 2.14.** Relationship between total length of *Crangon crangon* (mm) and the catch efficiency (%) of a 2-m beam trawl with 5 mm mesh size, based on a series of comparisons of beam trawl and seine catches. Dots represent measurements; line is polynomial function. Data after Van Lissa (1977).

Shifts in length-frequency distributions over time have been used for two different approaches. With the aid of software programs such as ELEFAN, modal size class progressions over time have been used to determine the Von Bertalanffy growth function (VBGF) parameters for each sex (Oh et al. 1999). By this method, no differences in growth between the German Bight and the Irish Sea could be found (Oh et al. 1999). As an alternative, Kuipers & Dapper (1984) assumed maximum growth rates of shrimps in the field. By combining experimentally established maximum growth rates in relation to temperature and shrimp size, with the modal progressions in size-frequency distributions, they calculated immigration and emigration patterns. However, Kuipers & Dapper (1984) did not provide evidence in support of their assumption of maximum growth rates of shrimps in the field.

This means that at present no reliable estimates of the growth rates of shrimps in the field are available. Therefore, the controversy about the origin of the exploitable stock in the German and Dutch Wadden Sea in autumn, whether it is based on summer (Boddeke 1982) or winter eggs (Kuipers & Dapper 1984), still exists, despite a recent study by Temming & Damm (2002) whose analysis was also based on the assumption of maximum growth in the field.

### *Size at maturity*

The onset of sexual maturity seems to be variable between 35 and 50 mm total length (Meredith 1952, summarized in Gelin et al. 2000 and in Oh & Hartnoll 2004). There is a weak suggestion of an increase in size with decreasing latitude; however, it is unclear whether this really reflects geographical variation or whether it is caused by differences in criteria used between studies or even a consequence of different genetic subpopulations instead of mere latitudinal variation.

### *Age*

Most published information about age should be considered with some caution, since so far reliable estimates of growth rates of males and females in the field are lacking. Therefore, aspects as number of spawnings in the life cycle, age-specific reproductive investments and mortality schedules and maximum life span cannot be analysed at present.

Published information shows that females attain a larger size than males (Meredith 1952). Maximum size reported for females is 95 mm (Tiews 1954, 1970; Heerebout 1974), while males may reach a maximum size of 75 mm (Tiews 1970) but both are rarely attained (Kuipers & Dapper 1981). Females live longer than males (Meredith 1952), up to 5 years for females and 4 years for males (Lloyd & Yonge 1947; Henderson & Holmes 1987), and older shrimps are extremely rare (Tiews 1954).

There seems to be a difference in both maximum length and longevity with latitude, with a tendency for greater longevity in intermediate latitudes (about 3 years) decreasing towards edges of distribution (1-2 years), although Gelin et al. (2000) stated that life span decreased with latitude. The reason for this difference may be related to reduced growth rate or to a shorter life-span or a combination of both (Muus 1967). Nevertheless, information from the edges of the distributional area is insufficient to substantiate this tendency.

## ***Crangon crangon* fisheries**

Since the synopsis of Tiews (1970), several studies on brown shrimp fisheries have been published, most being on the efficiency and selectivity of fishing gears (Polet 2000; Munro & Somerton 2002; Polet 2002; Polet et al. 2004; Revill and Holst 2004a; Polet et al. 2005a, b), impacts (Safran 1987; Robin 1992; Boddeke 1996; Walter & Becker 1997; Berghahn & Purps 1998; Vorberg 2000; Cabral et al. 2002; Lancaster & Frid 2002; Gamito & Cabral 2003), and measures to reduce by-catch (Berghahn et al. 1995; Graham 2003) and discards (Revill & Holst 2004b). The influence of several factors on *Crangon crangon* catchability includes population structure and sampling strategy (Polet & Redant 1999) and environmental variables such as temperature (Jeffery & Revill 2002), light level, sediment type and turbidity (Addison et al. 2003) have also been studied. Additional information can be obtained from the working group dedicated to the investigation of the brown shrimp fishery (WGCRAN) in the International Council for the Exploration of the Sea (ICES) which meets and reports annually.

### *Fisheries characteristics*

Because of its bottom-dwelling mode of life, *C. crangon* is caught with demersal fishing gear: for a long time the most common gear used has been a pair of beam trawls (Tiews 1970). Nowadays, the North Sea brown shrimp fishery is performed by about 620 vessels, with a maximum engine power of 221 kW (300 hp) (Polet 2000, 2002), using twin beam trawls with a minimum mesh size of 20 mm (inside mesh) due to small size of the target species (c.a. 35-80 mm) (Revill et al. 1999). Trawl design and sorting equipment vary considerably between countries and vessels (Lancaster 1999). The length of each beam varies from 6m in the Solway Firth fishery, UK (Lancaster 1999), to 7-9 m in Belgium (Polet & Redant 1999). The parts of the fishing gear that make contact with the sea bottom are mainly the shores and the rollers of the ground rope; tickler chains are not used (Vorberg 2000). Despite a considerable decrease in the number of vessels, the fishing effort (fished area per unit time) increased considerably in the 1980s (Berghahn & Vorberg 1997).

After hauling the catch is sorted on deck by means of a riddle (Lancaster 1999; Polet & Redant 1999; Graham 2003). This separates consumable size or 'consumption' shrimps (usually >45 mm total length) from non-commercial by-catch (a wide variety of benthic species mostly crustaceans, echinoderms and molluscs, fish and undersized shrimps) which is discarded into the sea. The catch is usually cooked on board the vessel. The consumption fraction is usually passed through the riddle once more after cooking to separate fish or any small shrimps which were not separated by the first riddling prior to cooking (Lancaster 1999).

At present, there is no minimum landing size for *C. crangon* in the European Union (EU). Traditionally it was determined by the limitations of hand picking, as the 'pickers' could not unshell very small individuals. However since the 1990s most of the shrimps are being landed rough (unpicked, i.e. with shell) and exported and hence the selection of larger shrimps for consumption has become less relevant, prompting fears that juvenile shrimps may be landed if the market conditions allow (Lancaster 1999).

### *Fishing areas*

The traditional fishing grounds (Tiews 1970) are still the most exploited areas: the brown shrimp fishery is performed commercially mainly in the coastal zone and estuaries surrounding the North Sea (Berghahn & Purps 1998; Polet 2000, 2002), along the German, Dutch, Belgian and Danish coasts and on the east and west coasts of UK. On a much smaller scale it is also performed on several areas of the French coast (Robin 1992), on Tagus estuary, Portugal (Cabral et al. 2002), on the Adriatic Sea (D. Taglapietra, person. comm.) and in Rumanian waters in the Black Sea (D. Micu, person. comm.). In Algeria and Tunis there was a shrimp fishery at least in the past (Holthuis 1980).

## *Landings*

### *Seasonal patterns*

Several environmental factors have been reported to affect the success of the *Crangon* fishery. Light levels and endogenous rhythms affect its emergence behaviour (Hagerman 1970; Al-Adhub & Naylor 1975) and influences brown shrimp catchability. Light intensity in turn covaries with turbidity and depth and hence these variables may also affect catchability (Berghahn et al. 1995; Addison et al. 2003). Also sediment type is reported to affect the success of the fisheries (Addison et al. 2003), due to the preference of *C. crangon* for muddy or sandy substrata (Pinn & Ansell 1993). Therefore, muddy and sandy deeper areas are the ones which provide higher catch rates specially when the water is turbid and the light levels are low (Addison et al. 2003). In some studies, especially in shallow waters, brown shrimp catch rates are dependent on the tidal phase (Al-Adhub & Naylor 1975; Henderson & Holmes 1987; Berghahn et al. 1995; Lancaster 1999), but in deeper waters, it was not considered to be the most relevant factor (Addison et al. 2003).

Seawater temperature clearly affects brown shrimp catchability, since it influences the vertical escape response of the shrimp to towed ground gear. However, small non-marketable shrimp (<50 mm) are captured irrespective of seawater temperature (Jeffery & Reville 2002). A description of vertical escape behaviour of the species is given in Jeffery & Reville (2002). Another factor affecting the success of brown shrimp fisheries might be predation. Predation pressure is dependent on both the abundance of the predators and the prevailing water temperature. Normally, predation pressure will covary with temperature and hence show a seasonal pattern. Gadoids are a main predator of *C. crangon*. Berghahn (1996) reports a mass invasion of juvenile whiting causing a considerable decrease in brown shrimp abundance which was reflected in a steep decline of North Frisian shrimp catches from June 1990 to July 1991 (Berghahn & Purps 1998).

As a consequence, indices of *C. crangon* abundance based on catch rates are biased by systematic effects of environmental factors on its catchability (Del Norte-Campos & Temming 1994; Lancaster 1999). To overcome this, Addison et al. (2003) proposed an adjusted index of catch rates, incorporating information on light level, sediment type, turbidity and temperature that more accurately describes trends in abundance.

Overall, fisheries for *C. crangon* show a quite stable seasonal pattern which is related to the local environmental conditions and the recruitment patterns of juvenile shrimps. The normal pattern consists of very low catches during winter, increasing catches in spring, a slight depression in catches in June/July and a strong autumn fishery. However, peak autumn landings in recent years extended to November/December and to September/November in German and Dutch fisheries respectively (ICES 1996), instead of September/October in previous years (Boddeke 1982). In some areas such as the Loire and the Tagus estuaries, brown shrimp fishing is only a summer activity (Robin 1992; Cabral et al. 2002).

*Annual catches*

The North Sea *C. crangon* fisheries are a valuable marine resource, with a market value between € 50–70 million (Polet 2002; ICES 2006). Total North Sea brown shrimp landings increased with oscillations from around 10,000 t in 1970 till almost 30,000 t in mid-1980s; then dropped to about 10,000 t again in late 1980s. Since 1990, landings have increased and Danish, German, Dutch and UK fleets attained a record catch of over 37,000 t in 2006 (Fig. 2.15). 87% of these shrimp were landed by Germany and The Netherlands alone, with around 16,000 t each, while Denmark accounted for 11%, with the remainder landed by the UK (ICES 2006). In 1999, the EU total allowable catch (TAC) was 26,000 t, valued at € 53 million, and the German and Dutch fleets account for 84% of the total landings (Revill et al. 1999). At the Tagus estuary, 35 vessels operate with an estimated annual catch of *ca* 1750 t, of which approximately 90% is discarded. However, although this fishery is targeting on brown shrimps (50% of the catches), due to a decrease in its commercial value, flatfish such as *Solea solea* and *S. senegalensis* have become the main target species in recent years (Cabral et al. 2002). For 2006 no EU TAC has been defined for brown shrimp landings. Although targeting brown shrimp, the landings of fishery also include valuable round- and flatfish species like cod *Gadus morhua*, whiting *Merlangius merlangus*, dab *Limanda limanda*, plaice *Pleuronectes platessa*, flounder *Platichthys flesus* and sole *Solea solea* (Polet 2000).

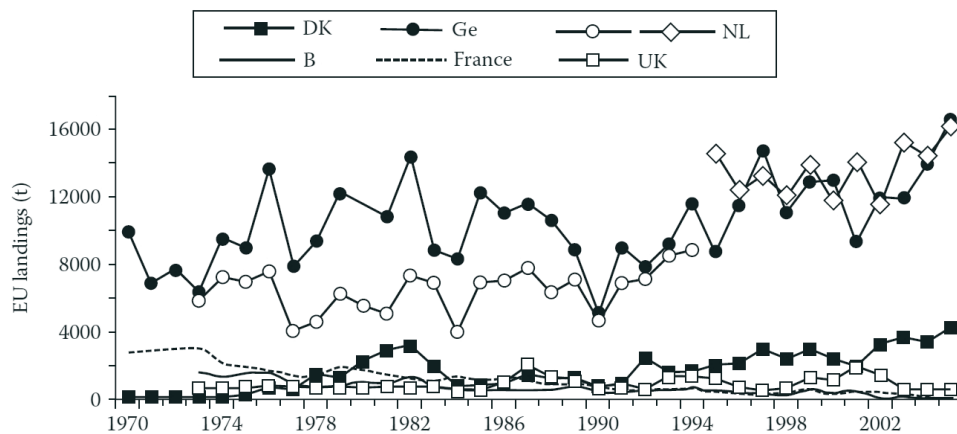

**Fig. 2.15.** Landings (t) of *Crangon crangon* by various countries. Data after ICES (2006). DK-Denmark; Ge = Germany; NL = Netherlands; B = Belgium; UK = United Kingdom.

Annual fluctuations are not only determined by market conditions but also affected by environmental variability. Relevant climatic factors are the winter NAO (North Atlantic Oscillation) index plus the sea surface temperature in winter, which enhance recruitment of *C.*

*crangon* and hence influence shrimp landings in the subsequent autumn and spring fishing seasons (ICES 1996). Still under debate is the potential impact of eutrophication. Eutrophication due to river run-off in coastal waters is assumed to improve densities of a major food resource for juvenile shrimps, the calanoid copepods (Boddeke et al. 1986) and as a consequence result in enhanced shrimp catches (Boddeke 1978, 1996). However, it is unclear whether it would act on stock size (enhanced recruitment) or biomass of individual shrimps (enhanced growth) and the underlying mechanisms of such a hypothesis are not presented. Any suggestions so far are anecdotal or based on correlations.

In recent years, a decline in UK landings has occurred which is consistent with the general trend of the North Sea *Crangon* fishery to 'slide' in a north-easterly direction, possibly caused by climatic factors (ICES 1996).

### *Impact of Crangon crangon fisheries*

#### *Impact on shrimp stocks*

Shrimp trawling has been claimed to be responsible for depleting shrimp stocks (Dahl et al. 1994). Between 30 and 60% of the weight of *C. crangon* caught are currently discarded (Graham 1997; Van Marlen et al. 1998). There is no legal minimum landing size for brown shrimps in the EU, but a minimum market size of 45 mm of total length (minimum carapace width of 6.5 mm), though shrimp as small as 20 mm (TL) are regularly caught in these fisheries (Van Marlen et al. 1998). The discarding of non-marketable *C. crangon* in the North Sea is substantial in magnitude representing around 27,000 t or 75 billion individuals annually (Revell & Host 2004b) and corresponding to around 50% (Lancaster & Frid 2002) to over two-thirds of the shrimp catch by number (Van Marlen et al. 1998). In the Lower Saxony fishery in Germany, marketable sized shrimps (over 50 mm total length, equivalent to 8 mm carapace length) make up only 11% (by weight) of the catch (Walter 1997). However, most undersized shrimps are separated from the catches by the riddling process and return to the sea alive (Lancaster & Frid 2002). Their survival rate seems to be high in the entire capture, hauling, riddling, discarding and bird predation processes: 75–80% survival is estimated for the Solway Firth (Lancaster & Frid 2002) and for the Belgian fishery (Mistakidis 1958). The majority of mortalities seem to occur in the trawl and not in the riddling process (Lancaster & Frid 2002). Moreover, it seems that natural mortality is much higher than mortality caused by fisheries (Anon. 1979), which can be on average three times higher than fishing mortality for shrimps over 30 mm total length (Tiews & Schumacher 1982).

#### *Impact on the benthic community*

Besides disturbing the sediment surface during hauls, the beam trawl fishery has a considerable impact on benthic communities and causes damage to both epifauna and infauna (e.g. Bergman & Hup 1992), reducing the diversity of benthic species. Other authors consider

shrimp trawls to be relatively light fishing gears with low impact on the sea bottom (Rumohr et al. 1994; Vorberg 1997) and basically non-destructive (Stock et al. 1996). This seems to be the case with respect to *Sabellaria spinulosa* reefs in the Wadden Sea, whose decline is not attributable to shrimping activities (Vorberg 2000).

Due to the small mesh size used and since fishing grounds are also densely inhabited by other species including juvenile fish, brown shrimp catches also include large amounts of by-catch, which consists of a wide variety of non-commercial fish, especially gobies *Pomatoschistus* spp., and benthic species (mostly crustaceans, echinoderms and molluscs) together with undersized brown shrimp and commercial fish species (Anon. 1973; Mohr & Rauck 1979; Symonds et al. 1985; Sankey 1987; Boddeke 1989; Rauck & Wienbeck 1990; Van Beek et al. 1990; Kaiser & Spencer 1995; Walter 1997; Berghahn & Purps 1998; Cabral et al. 2002; Polet 1998, 2002), namely some flatfish species, e.g. dab *Limanda limanda*, plaice *Platessa platessa*, flounder *Platichthys flesus* and sole *Solea solea* (Garthe et al. 1996) and round fish species like cod *Gadus morhua*, whiting *Merlangius merlangus* (Berghahn & Purps 1998; Polet 2000) and bib *Trisopterus luscus* (Safran 1987; Robin 1992). Other flatfish species are netted occasionally and in much lower quantity: *Psetta maxima*, *Scophthalmus rhombus*, *Bluglossidum luteum*, *Microstomus kitt* and *Glyptocephalus cynoglossus* (Berghahn & Purps 1998).

This by-catch is discarded immediately after sorting on board the vessels (Berghahn & Purps 1998; Polet 2000; Cabral et al. 2002). Part of the by-catch may survive, but several factors contribute to mortality of discarded animals, namely haul duration, tow depth, total volume of the catch, conditions on deck, sorting process, temperature and species and size of individuals (Kelle 1976; Van Beek et al. 1990; Berghahn & Røsner 1992; Berghahn et al. 1995; Kaiser & Spencer 1995; Cabral et al. 2002; Gamito & Cabral 2003). Despite the fact that total fish by-catch attains only around 10% by weight (annual average) (Tiews 1990), the brown shrimp fishing fleet has a significant negative effect on the stocks of several North Sea commercially important species (Revill et al. 1999), such as 0 and 1 age group plaice (Van Marlen et al. 1998), if the discard mortality due to the entire brown shrimp, sole and plaice fisheries are considered (Berghahn & Purps 1998). In contrast, the brown shrimp fishery has a relatively small impact on cod, whiting and sole. Annual landings lost due to current levels in the European *C. crangon* fisheries have been estimated to be around 7,000–19,000 t for plaice (Revill et al. 1999), valuing approximately € 20 million (Van Marlen et al. 1998). This is equivalent to 10–25% of the 1998 total allowable catch for plaice in the North Sea. Estimates for cod, whiting and sole are 2,000 t, 1,500 t and 600 t, respectively (Polet 2002). In the Irish Sea, the yield of sole and plaice was estimated to reduce 1.4 and 8.9% respectively, as a consequence of the English West coast brown shrimp fleet activities (Sankey 1987).

Fishery waste may be eaten by fish, marine mammals and scavenging seabirds of (e.g. Hudson & Furness 1988; Garthe et al. 1996; Walter & Becker 1997). Walter & Becker (1997) estimated that 6–14% (average 9.8%) of discarded shrimps by in the German *C. crangon*

fishery is eaten by gulls, mainly smaller ones like black headed gulls *Larus ridibundus* and herring gulls *Larus argentatus*, which presented an average swallowing rate of 1.3 and 0.4 shrimps per minute, respectively. Discards may also increase levels of particulate and dissolved organic matter which in turn may attract scavengers and decomposers (e.g. Berghahn 1990; Kaiser and Spencer 1994).

## Synthesis

### *Distributional range*

Along the European coast, the brown shrimp *Crangon crangon* is one of the most widely distributed species showing in general continuously high abundances of juveniles and adults (Havinga 1930; Boddeke & Bekker 1979; Fabbiani 1979; Pihl & Rosemberg 1982; Berghahn 1983; Henderson & Holmes 1987; Beukema 1992; Del Norte-Campos & Temming 1998; Beyst et al. 2001; Temming & Damm 2002; Amara & Paul 2003), reflecting the fact that annual recruitment must be successful under most conditions. Detailed information on the factors determining the species distributional limits are lacking, although it will include the prevailing temperature conditions.

Despite the fact that the temperature tolerance range varies between life stages, a minimum temperature for *C. crangon* seems to be about 5 °C. At such temperature egg and larval development is slow and last already a number of months. Low temperatures may even cause mortality to early larval stages (Criales & Anger 1986). A longer larval stage also means a longer period of exposure to predation. Hence, the limiting factor at the northern cold water edge of the distribution might be formed by the temperature-induced length of the egg and larval development. Since temperature conditions present annual fluctuations, also the distributional edge will show spatial variability, i.e. expansion and contraction of the population range. This might explain the description of the species in Icelandic waters in 1895 (Doflein 1900) and the subsequent absence until the recent re-observation by B.Gunnarson (person. comm.).

Each species can only tolerate increasing temperatures within a specific range. At first, various physiological rates increase exponentially with increasing temperature. Subsequently, metabolism shows a further increase while food intake rate slows down (see for instance Willmer et al. 2000) and hence the remaining scope for growth and reproduction decreases. At a certain temperature, energy uptake can no longer compensate the metabolic demands. Under these conditions, an individual cannot survive for long. Juvenile and adult stages are able to exhibit migration movements to escape from these unfavourable conditions. However, this is not the case for the more passive larval stages which even show a lower temperature tolerance compared with other life stages. With a decreasing scope for growth the energy available for reproductive investment will decrease. Warm water conditions may cause recruitment failure in spring due to starvation (Kattner et al. 1994). The warm-water



distributional limit is therefore most likely to be a reflection of a mixture of limiting factors, i.e. reproduction and survival of the larval stages.

Suboptimal temperature conditions occur more often at the edges of the distribution, both low temperatures towards the northern edge and high temperatures at the southern edge. Therefore, migration movements, both tidally, daily and/or seasonally will be more pronounced and often towards both distributional edges, explaining the disappearance of shrimps in shallow waters in winter in the northern part and in summer in the southern part of the distribution. There are also indications that especially at high temperatures in the Mediterranean, also salinity conditions might act as a trigger (Gelin et al. 2000, 2001a, b).

#### *Latitudinal trends*

Previous studies about latitudinal trends in other marine species' life histories indicate some trends. In exotherms, the physiological rates usually are higher with temperature. Thermal gradients would be expected to have similar effects but various metabolic processes show 'latitudinal compensation': individuals from colder high latitude environments may maintain physiological rates nearly as high as those from low latitude localities. This is observed in some fish species like *Menidia menidia*, *Morone saxatilis*, *Fundulus heteroclitus*, *Sebastes diploproa* in which individuals from northern populations have a higher inherited capacity for growth (Boehlert & Kappenman 1980; Isely et al. 1987; Conover & Present 1990; Nicieza et al. 1994; Schultz et al. 1996). The northern-derived copepod *Scottolana canadensis* also grow faster at high latitudes (Lonsdale & Levinton 1985, 1989); in contrast, the growth rates of the bivalve *Macoma balthica* become lower at increasing latitude (Drent 2002, 2004). Faster growth seems to be related not only to temperature but also to the length of the growing season. Later beginning (water warming up) and earlier ending (water cooling down) of seasons causes shorter growing periods at higher latitudes. The trend of later spawning and recruitment with latitude, such as the shift from winter to summer larval release in more northern regions reported for the crab *Carcinus maenas* by Sprung (2001) also contributes to shorten the growing season. However, other factors like food availability maybe as important as temperature in the structuring of latitudinal tendencies in life history events (Drent 2002, 2004). Overwinter mortality in northern fish populations is high and size-selective (Schultz et al. 1998), despite the larger energy storage in the north which prepares individuals for the colder season. The reserve accumulation rate of somatic storage has a genetic basis (Schultz & Conover 1997).

An analysis of trends in life history parameters pre-requires insight in the subpopulation structure of *C. crangon*. In this respect only limited information is available. In other species with a similar distributional pattern, molecular techniques have revealed some pattern of subpopulation structure at least between the Mediterranean and the Atlantic coast, but in some cases also demonstrated further grouping within these two areas (Gysels et al. 2004a, b; Roman & Palumbi 2004). Preliminary analysis in *C. crangon* based on morphometric

variability and isoenzymes patterns suggests that some form of subpopulation structure might be expected at least between the Mediterranean and the Atlantic coast (Maucher 1961; Bulnheim & Schwenzer 1993; Henderson et al. 1990). Therefore, the present analysis of latitudinal trends in life history parameters is restricted to patterns along the coastline, thereby excluding the Mediterranean.

Despite the wealth of information available about various aspects of the biology, ecology and life history of the species, it is amazing that there is still a lack of knowledge about essential aspects of its role and functioning in the ecosystem. Most striking is the lack of knowledge about the growth conditions for *C. crangon* in natural conditions. Recent studies on growth (Schockaert 1968; Gelin et al. 2000) either refer to the work of Tiews (1954) ignoring the fact differences in growth conditions might be present, or assume maximum growth and apply model predictions to analyse the life history in the field (Kuipers & Dapper 1984; Temming & Damm 2002). Conclusions about age at maturity and maximum age that are based on these assumptions about growth should be considered as preliminary, as long as the assumptions about growth conditions in the field have not yet been validated.

A starting point for the analysis of growth conditions in the field are laboratory observations on maximum possible growth on relation to food conditions and temperature. For *C. crangon* basic information is available from the work by M. Fonds and co-workers as referred to by Kuipers & Dapper (1984). However, the underlying experiments have never been documented except for an internal student's report (Van Lissa 1977), which means that at present the quality of the data cannot be evaluated. Therefore, for *C. crangon*, more experiments on growth in relation to abiotic (temperature, salinity) and biotic (food conditions, shrimp size) conditions need to be performed. Such experiments should include so-called common garden experiments with individuals from different populations over the range of the species, to analyse whether counter-gradient growth compensation does occur (c.f. Conover and Present 1990). Once such information is available, growth conditions in the field and in relation to the distribution of the species can be analysed. It is doubtful whether the standard methods applied so far, i.e. estimates based on shifts in length-frequency distributions over time are applicable. Due to the continuous immigration of just-settled juveniles in combination with size-selective predation and emigration movements, size frequency distributions often do not provide insight in or reflect population growth. An alternative might be the introduction of Dynamic Energy Budgets (DEB) (Kooijman 2000) for *C. crangon*. After estimation of only seven species-specific parameters according to standard procedures (Kooijman 2000; Van der Veer et al. 2006), the DEB model can be applied for the estimation of growth under prevailing temperature and food conditions. Recently, this approach has been applied successfully for the analysis of food and growth conditions in various bivalve species in the intertidal in the Dutch Wadden Sea (Cardoso et al. 2006). It seems therefore worth trying to implement this model for the analysis of growth in *C. crangon*.

Present preliminary information suggests that there seems to be some patterns in life history parameters with latitude, which most likely reflect trends in temperature conditions. Reproductive period shifts from a restrictive period in summer-autumn in the northern part via all-year reproduction to a winter period near the southern edge. This further suggests that reproductive investment is highest in the centre of the distribution. An analysis of latitudinal trends of various life history parameters such as size at hatching, maximum age, size and age at first maturation can only be performed after information about latitudinal trends in growth in the field becomes available.

More information on recruitment is also required. *C. crangon* is one of the most abundant epibenthic predators and more information becomes available that it might regulate some of their prey species, especially various bivalve species in temperate estuaries (Van der Veer et al. 1998; Philippart et al. 2003). On the other hand, due to its high abundance over a wide latitudinal range *C. crangon* is also an important food item for a variety of predators especially fish species (Pihl 1985). Nevertheless, there are no indications of top-down control by predators. Any insight in processes determining recruitment level and variability are lacking at the moment. In general, in marine species, recruitment is assumed to be determined in the early life stages when numbers are at a maximum (Leggett & DeBlois 1994). The fact that predators exploit more the juvenile shrimp while the fishery exploits more the adult shrimp after the predators have taken their toll, might explain why there are so far no suggestions of an impact of the shrimp fisheries on recruitment (Welleman & Daan 2001).

The above account indicates that there is an urgent need for various types of process-oriented studies on aspects of the life history in *C. crangon* over its latitudinal range.

#### *Future research*

Future studies should include a detailed genetic analysis of the various *Crangon* species to resolve the present uncertainties in this genus, followed by the analysis of the genetic population structure of *C. crangon* by means of molecular tools. A basic gap in knowledge is the lack of information regarding growth conditions in the field in relation to abiotic and biotic conditions, including the possibility of counter-gradient growth compensation. Such information would provide insight in the population structure and dynamics of *C. crangon* over its distributional range and form a starting point for recruitment studies. This would also finally result in an analysis of latitudinal gradients in life history parameters. It is questionable whether this can be based on existing knowledge since additional information from the northern part of distributional range seems to be required.

## Chapter III

### Population zoogeography of the brown shrimp *Crangon crangon* (L.) along its distributional range based on morphometric characters

#### **Abstract**

Morphometry has been used in the investigation of the common shrimp *Crangon crangon* L. subpopulation structure at a local scale (100 km) around the UK (Henderson & Holmes 1987). In the present study, *C. crangon* populations were sampled over the whole distributional range from northern Norway to the Mediterranean and Black Sea to test whether the same method could be applied to describe subpopulation structure at a much larger scale (1000 km). Spatial variability in morphometric characters was determined by sampling 25 locations across the distributional range. In addition, the temporal variability in morphology was studied at 4 sites (Bodø, Norway; Wadden Sea, The Netherlands; Minho and Lima estuaries, Portugal). Contrary to expectations, temporal variability was observed in three of those localities resulting in an inability to distinguish between populations at the local scale. However, the large scale subdivision of shrimp populations from Adriatic, Black Sea, Mediterranean and Atlantic were clearly identified. It is concluded that, while there are clear morphological differences between major zoogeographic zones, at a local scale, subpopulations frequently cannot be identified because of individual variability.

## Introduction

The common or brown shrimp *Crangon crangon* L. is an abundant epibenthic crustacean over its entire Atlantic coastal range, from Norway to Morocco and throughout the Mediterranean and Black Seas. It especially favours shallow coastal and estuarine waters with sandy or muddy bottoms (Tiews 1970). Because of its generally high abundance, the species plays an important functional role in coastal ecosystems as prey species for fish, crustaceans and birds (Pihl 1985; Henderson et al. 1992; Del Norte-Campos & Temming 1994; Walter & Becker 1997) and as predator on juvenile stages of epi- and infauna (Pihl & Rosenberg 1984; Van der Veer et al. 1991; Ansell & Gibson 1993; Van der Veer et al. 1998; Oh et al. 2001; Amara & Paul 2003). Its general biology is well known (Tiews 1970) and indicates geographic variability in the species life history. However, at present, no detailed information is available as to the extent to which this variability is caused by either genotypic and/or phenotypic plasticity in order to adapt to different environmental conditions.

Besides a key ecological role in shallow water ecosystems, brown shrimp is commercially exploited, especially in the North Sea. As for other fishery resources, successful stock management requires knowledge of the population structure (Cadurin 2000). Tools applied so far to investigate *C. crangon*'s population structure were the variability in morphometric characters (Maucher 1961; Henderson et al. 1990; Beaumont & Croucher 2006) and investigations on allozymes (Abdullah & Shukor 1993; Bulnheim & Schwenzer 1993; Beaumont & Croucher 2006) and Amplified Fragment Length Polymorphism's (AFLP) locus (Beaumont & Croucher 2006). All these studies were performed on a small scale (100 km), with the exception of Bulnheim & Schwenzer (1993). These authors were able to identify on a large scale (1000 km) four regional groups, [1] the North Sea and Baltic Sea; [2] the North Atlantic Ocean; [3] Portugal and [4] the Adriatic Sea. While Abdullah & Shukor (1993) found little genetic difference between two populations in the South of Wales, Beaumont & Croucher (2006) detected a population subdivision between east and west coast in the UK, both by allozyme and AFLPs variation. Two morphometric studies even suggested the existence of a much more detailed population structure on a smaller scale. Maucher (1961) suggested differences between North Sea and Baltic Sea populations and Henderson et al. (1990) distinguished already six subpopulations around British waters. However, in a third more recent study (Beaumont & Croucher 2006) from five sites around the UK only one was distinctively identified morphologically from the others, by possessing longer telsons and inner uropods. Nevertheless, all these conclusions on spatial variability were drawn from single sampling programs on a limited temporal extent.

To date, the studies by Maucher (1961) and Henderson et al. (1990) have never been expanded despite its promising results (high resolution). In this study, we applied the method of variability in morphometric characters to analyse subpopulation structure of brown shrimp *C. crangon* over its entire distributional range from Norway until the Black Sea including the Mediterranean Sea, especially in what concerns to its scale resolution at a larger scale (1000

km). In addition, to this single sampling programme, at four stations monthly sampling, was used to study temporal variability.

## Materials and methods

### *Data collection*

Samples were collected by beam-trawl or push-net at intertidal stations distributed over the whole geographic range of the species (Fig. 3.1). Table 3.1 presents a list of sampling locations, their GPS positions, date of sampling, number and length range of analysed shrimps by sex. All shrimps were checked individually for species identification according to Smaldon et al. (1993). Since sampling took place in different time periods, potential bias by temporal variability was also checked at four different locations spread over the distributional range: [1] Valosen estuary (Bodø, Norway); [2] Texel (Dutch Wadden Sea, The Netherlands); [3] Minho and [4] Lima estuaries (north of Portugal). At these locations, shrimps of different size and sex were collected and measured monthly (Table 3.1).

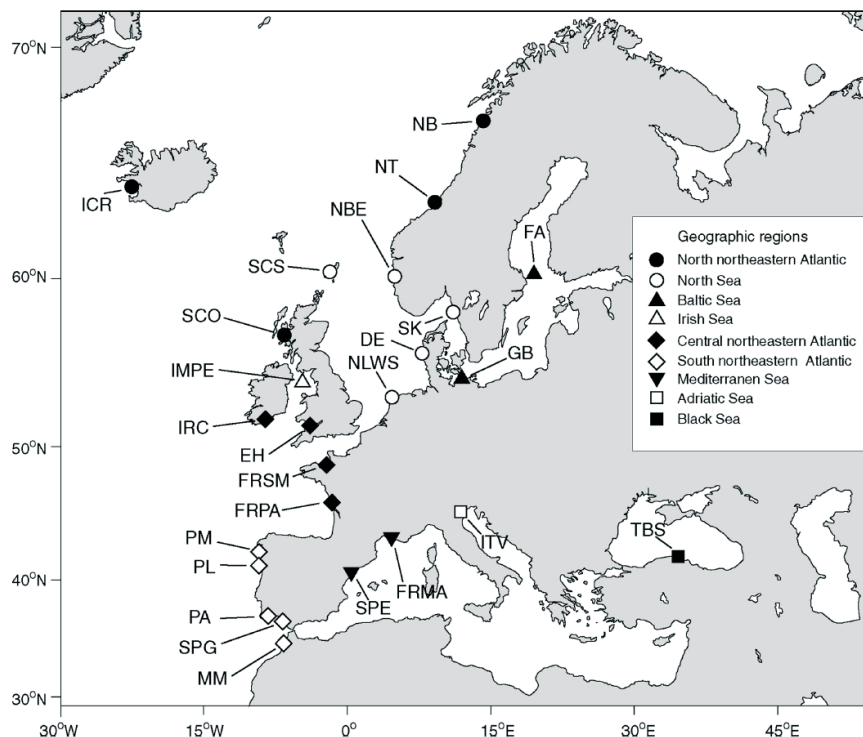

**Fig. 3.1.** Sample locations for *Crangon crangon* illustrating the geographic distribution. Sample codes correspond to those in Table 3.1.

**Table 3.1.** Sampling information: location, code, geographic region, GPS position, sampling date and length range of *Crangon crangon* and sample size (n) per sex. Samples chosen for local scale spatial variability analysis in italic.

Location	Country	Code	Geographic region	Latitude	Longitude	Sampling date	Length range (mm)						
							Males (n)	Females (n)					
Valosen, Bodo	Norway	NB4/05	N NE Atlantic	67°16'N	14°37'E	April 2005	14-47 (34)	14-65 (65)					
		NB5/05				May 2005	13-48 (44)	17-62 (43)					
		<i>NB6/05</i>				<i>June 2005</i>	11-45 (34)	13-66 (63)					
		NB7/05				July 2005	11-51 (34)	11-69 (68)					
		NB8/05				August 2005	12-47 (36)	12-53 (49)					
		NB9/05				September 2005	11-49 (36)	10-65 (55)					
		NB10/05				October 2005	11-52 (42)	11-70 (66)					
Reykjavik	Iceland	ICR	N NE Atlantic	64°09'N	21°56'W	June 2005	31-51 (9)	30-69 (14)					
Sletvik, Trondheim	Norway	NT	N NE Atlantic	63°25'N	10°22'E	October 2003	16-53 (29)	18-58 (42)					
Oban	Scotland	SCO	N NE Atlantic	56°25'N	05°28'W	October 2003	26-46 (33)	28-62 (44)					
Bergen	Norway	NBE	North Sea	60°19'N	05°19'E	September 2004	25-39 (5)	9-51 (9)					
Weisdale Voe	Scotland	SCS	North Sea	60°13'N	01°19'W	August 2004	22-38 (3)	18-51 (74)					
Kristineberg	Sweden	SK	North Sea	58°15'N	11°28'E	September 2003	26-49 (26)	25-60 (36)					
Esbjerg	Denmark	DE	North Sea	55°31'N	08°33'E	September 2003	26-55 (32)	15-73 (55)					
Texel, Wadden Sea	The Netherlands	NLWS9/03	North Sea	53°04'N	04°49'W	September 2003	24-45 (18)	25-61 (10)					
		NLWS10/03				October 2003	17-51 (14)	19-64 (19)					
		NLWS11/03				November 2003	14-54 (19)	12-63 (34)					
		NLWS12/03				December 2003	11-51 (17)	13-74 (25)					
		NLWS1/04				January 2004	9-51 (21)	6-65 (23)					
		NLWS2/04				February 2004	14-47 (24)	15-61 (32)					
		NLWS3/04				March 2004	14-54 (14)	22-70 (35)					
		NLWS4/04				April 2004	16-40 (9)	26-71 (21)					
		NLWS5/04				May 2004	27-47 (23)	23-66 (43)					
		NLWS6/04				June 2004	22-44 (25)	16-68 (53)					
		NLWS7/04				July 2004	19-46 (25)	11-69 (56)					
		<i>NLWS8/04</i>				<i>August 2004</i>	22-40 (22)	22-69 (47)					
		Ålund Islands				Finland	FA	Baltic Sea	60°20'N	19°88'E	September 2004	14-51 (39)	13-53 (27)
		Baltic Sea				Germany	GB	Baltic Sea	54°06'N	12°09'E	August 2004	29-43 (11)	29-58 (18)
Port Erin Bay	Isle of Man	IMPE	Irish Sea	54°05'N	04°46'W	July 2004	30.5-58 (16)	22-75.5 (42)					
Hinkley Point	England	EH	C NE Atlantic	52°07'N	01°08'W	November 2003	45-61 (16)	46-75 (34)					
Cork	Ireland	IRC	C NE Atlantic	51°51'N	08°29'W	May 2004	19-38 (16)	29-60 (28)					
Mt. St. Michel	France	FRSM	C NE Atlantic	48°40'N	01°40'W	January 2004	34-47 (9)	38-58 (41)					
Pertuis d'Antioche	France	FRPA	C NE Atlantic	46°04'N	01°12'W	October 2004	38-53 (9)	41-75 (41)					
Minho	Portugal	PM10/03	S NE Atlantic	41°52'N	08°49'W	October 2003	11-45 (26)	17-45 (30)					
		PM11/03				November 2003	15-40 (25)	14-47 (35)					
		PM12/03				December 2003	17-37 (27)	12-49 (33)					
		PM1/04				January 2004	15-37 (23)	17-46 (28)					
		PM2/04				February 2004	17-38 (22)	16-47 (33)					
		PM3/04				March 2004	19-36 (20)	19-49 (26)					
		PM4/04				April 2004	17-37 (23)	14-49 (37)					
		PM5/04				May 2004	14-43 (57)	18-51 (42)					
		<i>PM6/04</i>				<i>June 2004</i>	12-32 (24)	13-47 (39)					
		PM7/04				July 2004	12-32 (21)	9-43 (37)					
		PM8/04				August 2004	13-33 (25)	13-45 (69)					
		PM9/04				September 2004	9-37 (23)	13-45 (33)					
		PM10/04				October 2004	12-35 (23)	14-45 (32)					
		PM11/04				November 2004	11-38 (28)	13-48 (37)					
		Lima				Portugal	PL10/03	S NE Atlantic	41°41'N	08°47'W	October 2003	13-40 (37)	18-46 (19)
							PL11/03				November 2003	14-48 (33)	11-51 (37)
PL12/03	December 2003		14-47 (36)	18-59 (44)									
PL1/04	January 2004		17-38 (26)	15-59 (34)									
PL2/04	February 2004		16-42 (30)	17-58 (42)									
<i>PL3/04</i>	<i>March 2004</i>		16-42 (27)	12-60 (62)									
PL5/04	May 2004		16-35 (5)	15-57 (12)									
PL6/04	June 2004		14-36 (4)	12-52 (5)									
Guadalquivir	Spain	SPG	S NE Atlantic	37°25'N	04°58'W	March 2004	11-30 (22)	9-66 (159)					
Fuzeta, Algarve	Portugal	PA	S NE Atlantic	37°02'N	07°45'W	April 2004	18-32 (13)	20-42 (17)					
Merja-Zerga	Morocco	MM	S NE Atlantic	34°50'N	06°20'W	August 2004	10-32 (41)	12-40 (65)					
Ebro Delta	Spain	SPE	Mediterranean	40°43'N	00°44'W	February 2005	42 (2)	51-62 (14)					
Étang de Vaccarès	France	FRMA	Mediterranean	43°27'N	05°13'E	November 2003	42-59 (25)	58-70.5 (17)					
Venice	Italy	ITV	Adriatic Sea	45°30'N	12°15'E	May 2004	44-52 (11)	49-66 (89)					
Sinop	Turkey	TBS	Black Sea	42°01'N	35°09'E	March 2005	27-62 (18)	21-64 (75)					

### Data analysis

From each sample, several shrimps (Table 3.1), when possible regularly divided over sex and total size range (defined as the total length (TL), the distance between the end of folded uropods/telson and the tip of scaphocerites (Schockaert 1968; Schumacher & Tiews 1979), were examined for nine characters (Fig. 3.2), following Henderson et al. (1990): carapace length (CAR); telson length (TEL); inner uropod length (INNLE); maximum inner uropod width (INNWI); maximum sub-chelae length (SUBCLE); maximum sub-chelae width (SUBCWI); length of segment 4 (merus) of the first pereiopod (PERI); maximum length of segment 4 (merus) of pereiopod 5 (MAX4); maximum length of segment 5 (carpus) of pereiopod 5 (MAX5). Sex was determined as described by Tiews (1970): [1] measuring the length of the 2nd outer and inner antennules; and [2] observing endopodites' morphology on the 1st (bigger and spoon-like in females) and 2nd pleopods (biramous in males). All measurements were done to the nearest 0.001 mm TL on a computer screen with digital images from a binocular by means of Axio Vision 4.1 software or with Leica Qwin 500 software. Animals with regenerated appendages or missing some of the measured parts of the body were rejected.

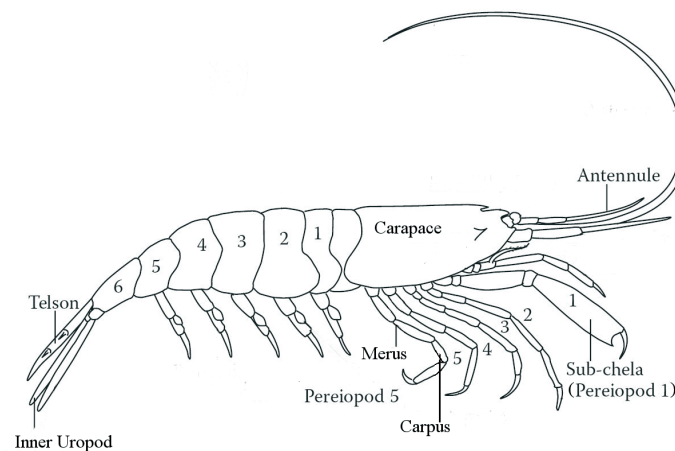

**Fig. 3.2.** Morphometric parameters measured on *Crangon crangon* specimens.

### Statistical analysis

Isometric growth was tested by determining the correlation between each morphometric variable and TL for each sex per location and sampling date using Pearson correlation coefficient and Bonferonni probability. General Linear Models (GLM) (without constant) were applied to investigate linear relationships between the morphometric parameters



(dependent variables) and TL (independent variable), per location and per sampling month for each sex, with location and date of sampling considered independent variables and defined as categories. No constant was used in GLM because at zero mm TL, all variables were assumed to be also zero in size.

Since most variables for each sex were normally distributed in each location and in each sampling date in the four main locations (Bodo, Texel, Minho and Lima) (Shapiro-Wilk test,  $0.05 < p\text{-value} < 0.000$ ), no transformation was performed. All morphometric variables were corrected for size by calculating allometric coefficients dividing each measurement by respective TL, which transformed the variables into the same order of magnitude and hence there was no need to normalise them.

To check for similarities between sexes, locations/regions and dates of sampling an analysis of similarities (ANOSIM) was applied to the morphometric measurements corrected for TL, using Euclidian distance because it can measure distances between any two points in space (Clarke & Warwick 2001). ANOSIM is a permutation test analogue of the standard ANOVA (analysis of variance), used to detect differences among groups, which calculates the probability of random occurrence of the observed groups. In ANOSIM the test statistic R is a comparative measure of the degree of separation of sites based on rank similarities between samples. Usually it falls between zero and one indicating some degree of discrimination between sites, which may be significant or not. Larger values are indicative of complete separation and values close to zero represent no differences between sites. However, when there are many replicates at each site R may be very small and yet significantly different from zero (Clarke & Warwick 2001).

Multivariate principal components analysis (PCA) was used to detect variation between the nine morphometric variables and among locations/regions. Additionally another multivariate technique, a linear discriminant analysis was performed to determine our ability to distinguish between locations/regions.

Sexual and temporal variability was evaluated per sampling date in the four main locations. Only mature individuals between 40 to 50mm TL were used in sexual variability analysis to avoid possible morphological differences associated to size class. However due to low numbers of females of 40-50mm TL in samples from other sites and after proving isometry, all mature females 40 to 60mm TL were used in temporal and spatial variability analysis.

Spatial variability was evaluated at two scales of resolution: large scale comparing samples collected in various locations pooled per main geographic region and local scale comparing samples from all locations, with only one sample chosen randomly from the four main sites (Table 3.1).

Pearson correlation, General Linear Models (GLM) and Linear Discriminant Analysis were done in Systat 11.0. PCA and ANOSIM analyses were performed with Primer 6 software (Primer-E, Plymouth Marine Laboratory UK).

## Results

### *General results: Isometry and sexual variability*

Morphometric variables were positively correlated with TL for both sexes ( $0.42 < \text{Pearson correlation coefficient} < 0.99$ ;  $p < 0.001$ ), with some exceptions due to insufficient data, suggesting linear relationships, which was confirmed by the GLM analysis (Table 3.2). Therefore there was no evidence of allometric growth for both females and males for the size range used in this study and hence no data transformation was performed.

**Table 3.2.** Maximum, minimum and average regression coefficients obtained by General Linear Model for each morphometric variable per sex of *Crangon crangon*. Variable abbreviations in the text.

sex		CAR	TEL	SUBLE	SUBWI	PERI	INNLE	INNWI	MAX4	MAX5
females	max	0.222	0.169	0.110	0.036	0.099	0.155	0.037	0.083	0.059
	min	0.189	0.138	0.086	0.027	0.082	0.124	0.023	0.065	0.047
	mean	0.206	0.151	0.099	0.032	0.091	0.137	0.032	0.076	0.053
males	max	0.215	0.183	0.104	0.034	0.100	0.160	0.035	0.083	0.057
	min	0.180	0.140	0.075	0.025	0.078	0.124	0.027	0.066	0.045
	mean	0.197	0.155	0.091	0.029	0.088	0.139	0.031	0.075	0.051

Except for Minho estuary where only three males 40 to 50mm were caught and hence differences between sexes wasn't possible to analyse, ANOSIM global tests for sexual variability resulted in a significant difference ( $p < 1\%$ ) but at a low value of R ( $R < 0.300$ ) (Table 3.3). Although this could suggest that overall both sexes were not distinguishable, when analysing each sampling date in the pairwise tests (Table 3.3) significant sexual variability ( $p < 5\%$ ) was observed in several months. Moreover in some of these cases (August and September in Bodo; January and May to August in Texel) R statistic was close to 1 ( $R > 0.650$ ) indicating that individuals of the same sex were more similar to each other than between sexes.

### *Spatial variability: large versus local scale resolution*

At the large scale, despite the low value of R, considering the enormous amount of information, the variability between main geographic regions (North, Central and South North-eastern Atlantic, North, Irish, Baltic, Mediterranean, Adriatic and Black Seas) was significant ( $R = 0.291$ ;  $p = 0.02\%$ ) (Table 3.4). In the pairwise tests, Adriatic, Black Seas and North NE Atlantic were significantly different from all other areas ( $R > 0.160$ ;  $p < 5\%$ ). The Mediterranean Sea differed significantly from all regions but North Sea and Central NE Atlantic ( $R = 0.130$ ;  $p = 6.10\%$  and  $R = -0.036$ ;  $p = 63.5\%$ , respectively). Yet, within the Atlantic area, shrimps from several regions were statistically indistinguishable: the North Sea population was similar to the Baltic and Irish Sea populations; further, the Baltic was similar

to the Irish Sea and the central and southern NE Atlantic; and the central NE Atlantic was also similar to the Irish Sea. At the local scale, comparing morphometrics between each of the 25 locations, the huge amount of data made interpretation very difficult and, although there was significant variability between locations ( $R=0.447$ ;  $p=0.02\%$ ), no clear pattern could be generated from the results: nearby locations could be distinguished from each other but were indistinguishable from distant localities.

**Table 3.3.** Results of ANOSIM analysis (R-statistic and significance level) between sexes of *Crangon crangon*: global and pairwise tests for each sampling date. Significant values shown in bold; \*non significant values; \*\* insufficient data (only one sex present in the sample).

Bodo			Texel			Minho		
Sampling date	R	p (%)	Sampling date	R	p (%)	Sampling date	R	p (%)
Global	<b>0.269</b>	<b>0.02</b>	Global	<b>0.299</b>	<b>0.02</b>	Global	<b>0.209</b>	<b>0.04</b>
April*	0.089	19.70	September**			October*	-0.309	85.70
May	<b>0.308</b>	<b>0.60</b>	October*	-0.031	60.00	November*	0.129	20.00
June	0.249	3.30	November*	-0.130	68.60	December	<b>0.327</b>	<b>0.10</b>
July	<b>0.385</b>	<b>0.30</b>	December*	-0.083	65.70	January**		
August	<b>0.772</b>	<b>0.02</b>	January	<b>0.771</b>	<b>2.90</b>	February*	0.081	24.80
September	<b>0.779</b>	<b>0.02</b>	February*	0.193	15.80	March	<b>0.434</b>	<b>0.30</b>
October	<b>0.295</b>	<b>0.06</b>	March*	0.480	5.50			
			April*	0.778	25.00			
			May	<b>0.651</b>	<b>0.02</b>			
			June	<b>0.766</b>	<b>0.06</b>			
			July	<b>0.850</b>	<b>0.10</b>			
			August	<b>0.794</b>	<b>0.30</b>			

**Table 3.4.** Results of ANOSIM analysis of *Crangon crangon* for each geographic region. R-statistic below diagonal and significance level above diagonal. Significant values shown in bold.

a) Global: **R = 0.291, p = 0.02%**

Geogr. Region	NNE Atlantic	North Sea	Baltic Sea	Irish Sea	CNE Atlantic	SNE Atlantic	Medit. Sea	Adriatic Sea	Black Sea
NNE Atlantic		<b>0.02</b>	<b>0.1</b>	<b>0.02</b>	<b>0.02</b>	<b>0.08</b>	<b>0.02</b>	<b>0.02</b>	<b>0.02</b>
North Sea	<b>0.257</b>		18.90	23.50	<b>0.02</b>	<b>0.02</b>	6.10	<b>0.02</b>	<b>0.02</b>
Baltic Sea	<b>0.168</b>	0.056		2.20	21.20	3.70	<b>0.04</b>	<b>0.02</b>	<b>0.02</b>
Irish Sea	<b>0.245</b>	0.039	0.069		40.20	<b>0.20</b>	<b>0.04</b>	<b>0.02</b>	<b>0.02</b>
CNE Atlantic	<b>0.348</b>	<b>0.129</b>	0.054	0.012		<b>0.02</b>	63.50	<b>0.02</b>	<b>1.3</b>
SNE Atlantic	<b>0.073</b>	<b>0.166</b>	0.095	<b>0.146</b>	<b>0.291</b>		<b>0.02</b>	<b>0.02</b>	<b>0.02</b>
Medit. Sea	<b>0.486</b>	0.130	<b>0.253</b>	<b>0.272</b>	-0.036	<b>0.332</b>		<b>3.60</b>	<b>0.02</b>
Adriatic Sea	<b>0.680</b>	<b>0.553</b>	<b>0.525</b>	<b>0.555</b>	<b>0.252</b>	<b>0.666</b>	<b>0.148</b>		<b>0.07</b>
Black Sea	<b>0.534</b>	<b>0.575</b>	<b>0.587</b>	<b>0.559</b>	<b>0.185</b>	<b>0.570</b>	<b>0.518</b>	<b>0.184</b>	

Due to the huge amount of data only the PCA centroids (PCA scores' average) per geographic region and per location are shown in a two-dimensional plot (Fig. 3.3). The first

two PCA axes were sufficient to explain 79% of total variance (Table 3.5). Negative loadings for PC1 were produced in all characters, with telson and carapace allometric coefficients presenting a stronger influence (-0.571 and -0.534, respectively). While 2-D PCA centroids plot per location were not obvious in respect to subpopulation structure (Fig. 3.3B), per geographic region the main subpopulations detected in ANOSIM (Adriatic, Black Sea, Mediterranean, North NE, Central and South NE Atlantic) are clearly apart (Fig. 3.3A). According to Discriminant Analysis results (Table 3.6) several locations had only 33% of data assigned correctly to the location, while at larger scale individuals from the regions mentioned above were assigned correctly at more than 50%.

**Table 3.5.** Cumulative percentage of variation explained by the first five principal components from the PCA performed on allometric coefficients of all *Crangon crangon* females 40 to 60 mm and eigenvectors for allometric coefficients of the morphometric variables. Variables abbreviations given in the text.

	PC1	PC2	PC3	PC4	PC5
Cum.%Variation	59.3	79.0	86.4	90.7	94.1
Variable					
CAR	-0.534	0.484	0.679	-0.091	-0.041
TEL	-0.571	-0.556	0.009	0.556	-0.23
SUBLE	-0.226	0.435	-0.472	0.242	-0.011
SUBWI	-0.046	0.158	-0.186	-0.007	-0.163
PERI	-0.254	0.181	-0.253	0.223	0.762
INNLE	-0.463	-0.341	-0.232	-0.742	0.151
INNWI	-0.095	-0.012	0.065	-0.045	0.147
MAX4	-0.191	0.261	-0.335	-0.137	-0.392
MAX5	-0.106	0.157	-0.217	-0.055	-0.374

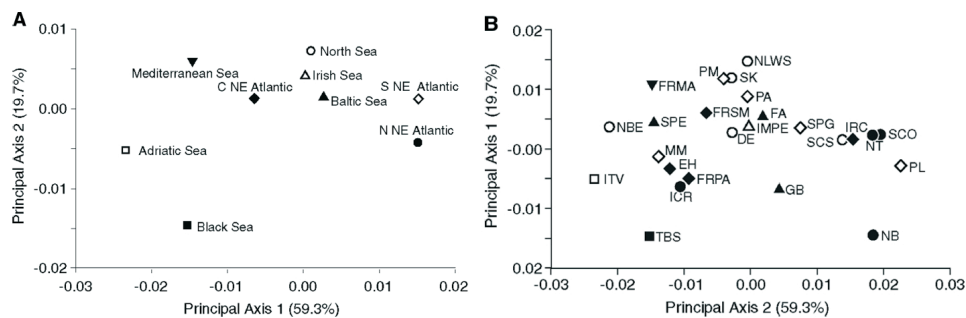

**Fig. 3.3.** Two-dimensional PCA centroids (scores average for the first two principle axis) plot performed on the allometric coefficients of all *Crangon crangon* females 40 to 60 mm A: from each geographic region and B: from each location. Locations codes on Table 3.1.

**Table 3.6.** Percentage of individuals of *Crangon crangon* correctively assigned to its original group: a) geographic region and b) location, according to Discriminant Analysis. Location codes on Table 3.1.

a) Geographic Region	%correct	b) Location	%correct	Location	% correct
Adriatic Sea	68	PA	1	MM	1
Baltic Sea	77	FA	53	PM6/04	20
Black Sea	78	GB	57	FRSM	13
C NE Atlantic	52	NBE	40	SCO	46
Irish Sea	63	NB6/05	87	FRPA	32
Mediterranean	86	IRC	29	IMPE	38
N NE Atlantic	53	SPE	55	ICR	42
North Sea	52	DE	58	SCS	36
S NE Atlantic	50	SPG	33	TBS	78
Total	58	EH	60	NT	27
		SK	33	ITV	59
		PL3/04	59	NLWS8/04	62
		FRMA	1	Total	47

### Temporal variability

Temporal variability was observed in three of the four main locations. ANOSIM global tests showed a significant level for temporal variability ( $p < 5\%$ ), except for Bodo due to the extremely low value of R ( $R=0.052$ ;  $p=0.06\%$ ). Despite the low value of R for Minho ( $R=0.261$ ;  $p=0.02\%$ ) and Lima ( $R=0.114$ ;  $p=0.50\%$ ), due to the large number of samples, the difference between sampling dates can still be considered significant. Whilst for Texel the mid-range value of R ( $R=0.323$ ;  $p=0.02\%$ ) indicated significant differences between sampling dates. Furthermore, the pairwise tests of ANOSIM analysis indicated several significantly different pairs of sampling dates by both their significant level ( $p < 5\%$ ) and their mid-range ( $0.300 < R < 0.650$ ) to high value of R ( $R > 0.650$ ).

### Discussion

Population structure of a species is usually referring to its genetic background, the members of an independent subpopulation sharing a common pool of genetic characteristics and being to some extent isolated from other populations. *C. crangon*'s population genetic structure has not yet been studied using molecular tools (DNA Sequencing). Analysis of the biogeography of a related species with an almost similar life cycle and native distributional range, the green crab *Carcinus maenas*, suggests a general subdivision into Mediterranean, Western Europe and Northern Europe populations (Roman & Palumbi 2004). A similar pattern might then be expected for *C. crangon*. At a local scale, Abdullah & Shukor (1993) identified variation at several allozyme loci but with little genetic difference between two locations in the South of Wales, while Bulnheim & Schwenzer (1993) found some differentiation in the NE Atlantic based on three polymorphic allozyme loci. Beaumont & Croucher (2006) detected higher

levels of polymorphism in two allozyme loci, suggesting a population subdivision between east and west coast in the UK, further confirmed by the analysis of three AFLP's loci. Weetman et al. (2007), also using AFLP's, draw the same conclusion of some Atlantic population differentiation among locations from around the British islands and from the Baltic Sea. Based on these studies broad-scale homogeneity of fishery stocks should not be assumed.

Phenotypical plasticity can also be expressed within a subpopulation. Both genetic and phenotypic characters can be reflected in shape and biometry of a subpopulation, two components of morphology which are expected to contain information about a biological group reflecting evolutionary processes responsible for diversity (Hammer 2002). Therefore morphometric analysis can be used to study patterns of geographic variation and differences among "populations" intended to define subpopulation structure as discriminate "phenotypic stocks" (Cadrin 2000), which is particularly important when dealing with a fisheries resource such as *C. crangon*. In the present study, we considered that each subpopulation would be defined by significant differences in a set of morphometric parameters. The question remains as to which morphological features will best explain the relationships, since the choice of descriptors can greatly affect the conclusions (Strauss 2001). One way to avoid possible bias is to measure as many variables as possible in a multivariate approach (Cadrin 2000).

We have measured the same nine morphometric parameters used by Henderson et al. (1990). Data were then analysed differently, because allometric growth was assumed in their work. We tested and confirmed isometry between morphological parameters and total length, as Beaumont & Croucher (2006) did with a similar dataset but from five locations around the UK, and hence data transformation would not change the observed trends. Only size standardization of the data was necessary to reduce it to the same order of magnitude and that was done by simply dividing each parameter by total length. Moreover, besides an ordination method, we used an Analysis of similarities (ANOSIM) and Discriminant Analysis to detect differences among groups, and hence strengthening the trends' reliability.

The conclusions of our study are in part similar to that of Henderson et al. (1990), since at local scale we can distinguish almost as many "subpopulations" as the number of sampled locations. However, despite environmental conditions like temperature, salinity and food availability affect body development and hence body morphology, it does not seem reasonable that each location corresponds to a different population defined by a particular morphotype. Given the mobility of *C. crangon* and the planktonic larval stage, when studying spatial variability at a large scale, grouping samples by main geographic region – North, Central and South NE Atlantic, North, Irish, Baltic, Mediterranean, Adriatic and Black Seas - allowed the analysis of larger subpopulation structures. Adriatic and Black Sea populations resulted very clearly recognizable. Remarkably, some Atlantic regions (Central NE Atlantic, North, Irish and Baltic Seas) were then morphometrically homogeneous, which suggests that the observed significant differences at local scale may actually be caused by high individual

variability within a single population. Although the Mediterranean could be distinguished from most regions, including the neighbour South NE Atlantic region, it was not distinguishable from the Central NE Atlantic and Irish Sea, possibly suggesting a clinal variation in the morphometric variables chosen. Therefore, those widely distant populations (Mediterranean and Central NE Atlantic and Irish Sea) seem to be similar considering only the nine morphological variables analysed, requiring the study of more variables to be more sensitive.

Within the Mediterranean, Adriatic and Black Seas, the homogeneous pattern observed in the central part of the vast Atlantic region would not be expected because the continental shelf is non continuous over these three regions. In contrast, the shelf is continuous along the European Atlantic coast. However, the variability of some locations within the Atlantic suggests the existence of discontinuity boundaries between subpopulations (neighbour locations from different subpopulations where morphometric variability is higher). This could be the case of several sites in the North Sea - Bergen and Kristineberg in relation to North NE Atlantic; Esbjerg in relation to Central NE Atlantic and to Baltic Sea; and Texel in relation to Central NE Atlantic -; GB in the Baltic in relation to the North Sea and Minho in South NE Atlantic in relation to Central NE Atlantic. However, the sampling programme was not designed with this perspective in mind and hence several locations should be analysed further to be conclusive. Furthermore, the separation between South NE Atlantic and the Mediterranean populations would require the morphometric analysis of a very relevant site between Gibraltar straight and Oran-Almeria Front, both already described as possible barriers between populations of marine species (Patarnello et al. 2007).

Morphometrics' resolution failed at local scale possibly due to the huge variability within locations. Brown shrimp dispersal potential is not easy to assess. On one hand, epibenthic adults and eggs, which are not free floating but carried by females, are not expected to be much influenced by currents; but on the other hand, the pelagic larval stage which lasts for 5 to 10 weeks according to temperature (Criales & Anger 1986), may be more susceptible to passive transport. Also, seasonal migrations may be expected to contribute to the species dispersal. Temporal variability in morphometrics had not been studied in those two previous works. We followed monthly the morphometrics at four local populations and detected variability between sampling dates, which might be related partly to seasonal migrations: Atlantic brown shrimp, especially males, are known to migrate into deeper areas when temperature cools down, returning to shallow waters in Spring/Summer (Lloyd & Yonge 1947; Henderson & Holmes 1987; Beukema 1992; Attrill & Thomas 1996; Drake et al. 2002; Gibson et al. 2002). The inverse migration pattern is observed in the Mediterranean (Labat 1977a). Sampling in different periods may then provide different morphometric information because available individuals may not include the entire population pool. Moreover food availability and predation pressure might also vary seasonally affecting the morphometry traits of the population. Finally, the fact that brown shrimp's reproduction takes place during a

large period with different cohorts experiencing diverse environmental conditions for development and growth may also contribute for morphometrics' temporal variation and 'irreversible non genetic adaptation' (Kinne 1962; Van der Veer et al. 2000) affecting its physiological performance and hence growth and maybe resulting in spatial morphometric variability. For example, populations in the Bristol Channel reproduce twice a year, in late winter and early summer. It is possible that individuals from each of these cohorts, which experience widely differing temperatures during early development, may differ appreciably in their morphometrics when adults.

In conclusion, conventional morphometrics is capable of resolving large-scale brown shrimp subpopulation structure and indicates the existence of Adriatic, Black Sea, Mediterranean and Atlantic *C. crangon* populations. But it is not useful at a small scale because of large between individual and temporal variabilities. The reason for this variability is not known, but it might be related to two particular features of the life cycle, seasonal migrations and the long reproductive period.

**Acknowledgements** Thanks are due to all who provided samples, namely A. Crivelli, A. Geffen, B. Mieske, B. Gunnarsson, D. Tagliapietra, E. Cicek, H. Taleb, J. Mork, J. Davenport, J. Strottrup, K. Aanio, L. Pihl, M. Cristo, P. Henderson, P. Drake, R. Nash, R. Gibson, S. Bilgin, S. Henderson and Y. Desaunay, and to those who helped in sampling, namely J.C. Antunes, E. Martins, J. Rodrigues, S. Ramos, L. Scott, S. Sjollem, S. Tavares, S. Mendes, S. Skreslet and V. Freitas. We are also grateful to M. Cusson, P. Henderson, A. Bio and E. Meesters for statistical advice and support and to G. Dumas and S.C. Dias for providing the figures.





## Chapter IV

### Phylogeography of the common shrimp, *Crangon crangon* (L.) across its distribution range

#### **Abstract**

The common or brown shrimp *Crangon crangon* (L.) is a highly abundant and important taxon, both ecologically and commercially, yet knowledge on its population structure and historical biogeography is limited. We studied population genetic structure across the distribution range of this species by sequencing a 388 bp fragment of the cytochrome-*c*-oxidase I gene for 140 individuals from 25 locations. Strong population structuring and high levels of genetic diversity were observed. Four main phylogroups were uncovered: NE Atlantic, western Mediterranean, Adriatic Sea and Black Sea. Gene flow of these shrimp across known oceanographical barriers (e.g., the Strait of Gibraltar and/or Oran-Almeria front, Sicilian Straits, and Turkish Straits) is severely restricted. The oldest and most variable populations currently inhabit the western Mediterranean. The observed absence of structure across the entire NE Atlantic shelf is proposed to be due to relatively recent colonization following the glacial cycles of the late Pleistocene. Black Sea shrimp are currently disconnected from the Mediterranean populations and colonization is inferred, on the basis of coalescent analysis, to have happened relatively recently, but possibly earlier than 7,000 years ago. We postulate the hypothesis that *C. crangon* survived the last brackish-water (<7‰) period inside the Black Sea and/or one of the adjacent inland seas. We conclude that [1] common shrimp populations from different basins are strongly differentiated, [2] gene flow across basins is probably very limited, and [3] the biogeographic history of the taxon is largely in accordance with the geographic history of its distribution range. This study provides further evidence that high population connectivity of marine species (e.g. by policy makers) should not be assumed.

## Introduction

Insight in current and past population genetic structure is necessary for taking management decisions in commercially exploited marine organisms (Awise 1998; Feral 2002), especially when such species play a key role in ecosystems. Dispersal potential and realized dispersal are important determinants of the fate of exploited populations, both in terms of recolonization potential and for predicting the potential for adaptation under shifting selective regimes (e.g., climate change, predation pressure, population collapse) (Moritz 1994; Crandall et al. 2000). Moreover, population genetic knowledge can help to identify localities with high levels of genetic diversity for selecting marine protected areas (MPA's) (Horwood 2000; Palumbi 2001).

The common or brown shrimp *Crangon crangon* (L.) is highly abundant and important from an ecological point of view and as a commercially fished resource, yet knowledge on its population structure and historical biogeography is limited. The goals of the present study are to assess the extent to which populations of *C. crangon* are differentiated across the species' distribution range and to compare inferred population histories with the geological history of the area.

As a highly abundant prey (e.g., Nehls & Tiedemann 1993; Hampel et al. 2005) as well as predator (e.g., Norkko 1998; Hiddink et al. 2002; Wennhage 2002), *C. crangon* plays a key role in near-shore ecosystems (Pihl & Rosenberg 1984; Van der Veer et al. 1998; Philippart et al. 2003; Beukema & Dekker 2005). It is distributed along NE Atlantic coasts from the White Sea and Iceland down to Morocco, in the Baltic Sea and the Mediterranean Sea, as well as the Black Sea (Holthuis 1980). The species is commercially exploited throughout most of its distribution range, with a total harvest for 2004 of 38,752 t; The Netherlands and Germany are responsible for the main part of catches (87% in 2004) (Garibaldi 2002). Total catches of the common shrimp have shown a pattern of decrease from the 1950s and 1960s (40,000-70,000 t per year) until 1990 (less than 16,000 t), after which catches have been increasing again (Garibaldi 2002). Points of concern have not only been the status of the target species itself (e.g., Reville & Holst 2004; Polet et al. 2005a, b), but also effects on population dynamics of species that suffer mortality as discarded bycatch or by being harmed during bottom trawling (e.g., Berghahn & Purps 1998; Vorberg 2000) and indirect effects of shifts in shrimp abundance on other taxa in the food web (e.g., Philippart et al. 2003; Beukema & Dekker 2005).

*Crangon crangon* is an epibenthic species inhabiting soft-sediment estuarine and coastal habitats, including coastal lagoons, at depths of 0-20 m, although records of up to 130 m exist (Holthuis 1980). Common shrimp mature at a size of at least 30-40 mm, depending on temperature conditions, and at an age of one year (Tiews 1970). Sexual reproduction consists of internal insemination of the females, who store sperm and carry their fertilized eggs until they hatch (Boddeke et al. 1991). Reproduction occur a number of times a year until the shrimp reach their maximum age of three to five years (Tiews 1970). *C. crangon* is capable of

changing sex but apparently at low frequency of occurrence, suggesting that the species is a facultative rather than an obligate protandric hermaphrodite (Boddeke et al. 1991; Schatte & Saborowski 2006). Egg development varies between 10 to 12 weeks at 6 °C and about 3 weeks at 18 °C (Tiews 1970; Wear 1974). After hatching, development of the pelagic larvae lasts about 3 to 7 weeks, again depending on temperature (Criales & Anger 1986). The post-larvae settle in shallow waters with sandy or muddy substrata. During their growth, shrimp gradually move to deeper waters (Kuipers & Dapper 1984). In autumn, decreasing temperatures initiate a migration of both juveniles and adults to more offshore waters, to return in early spring in Atlantic populations (Lloyd & Yonge 1947; Kuipers & Dapper 1981, 1984; Henderson & Holmes 1987; Beukema 1992). In Mediterranean populations, by contrast, the shrimp move towards brackish waters in autumn, returning to the sea in spring (Labat 1977a, b; Crivelli 1982; Gelin et al. 2001a, b).

The life history of the common shrimp does not allow easy *a priori* expectations of its dispersal potential and gene flow. While the adults are epibenthic and should therefore not be influenced much by currents, the pelagic larval stage may be more susceptible to dispersal. Also, the seasonal migration may be expected to increase gene flow. Three previous population genetic studies have shown that dispersal potential of the common shrimp is not pervasive. Bulnheim & Schwenzler (1993) concluded on the basis of three polymorphic allozyme loci for eight population samples that some differentiation in the NE Atlantic exists and that a sample from the Adriatic Sea was the most divergent. Beaumont & Croucher (2006) reported on population differentiation around Britain on the basis of two allozyme and three AFLP (Amplified Fragment Length Polymorphism) loci. Weetman et al. (2007) draw the same conclusion of some Atlantic population differentiation among samples from around the British islands and from the Baltic Sea, on the basis of 24 AFLP loci. The latter study also identified three loci potentially under the influence of selection. The authors conclude that broad-scale homogeneity of fishery stocks should not be assumed.

The geological history of salt and brackish water basins in the area inhabited by *C. crangon* today is a dynamic one. The Miocene (23-5.3 million years ago, MYA) was a warm epoch, though its final stage, the Messinian, already witnessed substantial cooling down, and formation of the Greenland glaciers began. Africa collided with Eurasia, forming the Mediterranean basin which dried up around 6 MYA when the land was raised in the west, isolating the basin from the Atlantic and leaving water inside the basin to evaporate to desiccation (Krijgsman et al. 1999). Virtually all marine flora and fauna in the basin went extinct during the latter episode, called the 'Messinian salinity crisis'. At the end of the Miocene, the Strait of Gibraltar broke and Atlantic water reflooded the Mediterranean basin. During the Pliocene (5.3-1.8 MYA) the climate cooled down to ranges comparable to present times. Around 3 MYA the Arctic ice cap was formed. The cold Pleistocene (1.8 million - 12,000 years ago) brought a series of ice ages ('glacials') to Europe, during which glaciers and sea ice extended southward to varying extents, compressing species' ranges both on land

and in the sea in more southern areas. Flora and fauna in Europe thus underwent repeated cycles of range compression and extension, signatures of which are often clear in patterns of genetic variation (Hewitt 2004). The most recent severe glaciation event dates back to around 18,000 years ago and is referred to as the Last Glacial Maximum (LGM). During the LGM, sea ice conditions were such that coastal fauna along Europe's coast were in all likelihood for the most part pushed as far south as the south of Britain and France or even the Iberian Peninsula (Dawson et al. 1992). However, there are indications that small northern refugia may have existed along the Scottish and Norwegian coasts (Sutherland 1984; Vorren et al. 1988).

The history of populations of coastal marine fauna in European seas are therefore expected to vary with basins: while the Mediterranean has an uninterrupted marine history of up to 5.3 MY, and this history is possibly even older for Iberian Atlantic coasts, the more northern Atlantic habitats should be much younger and may date back to after the LGM or to other Pleistocene interglacials. The Baltic and Black Seas are special cases and may be even younger; about 7,500 and 7,000 years, respectively.

The aims of the present study were to assess population genetic structure and to infer historical patterns of distribution and demography for the common shrimp's entire distribution area. The former will be used for inferring levels of gene flow, which will provide further insight into the extent to which present-day populations are connected by dispersal. The latter will provide background information about the environmental circumstances and selection regimes to which the ancestors of present-day shrimp were exposed in the past, which can help to better understand shifts in species abundances in coastal communities in recent decades (Philippart et al. 2003; Beukema & Dekker 2005; Henderson et al. 2006). We collected sequence data for a portion of the mitochondrial cytochrome-*c*-oxidase I gene for a total of 140 individuals originating from 25 locations spanning almost the entire distribution range (only the White Sea is not represented). In addition, *C. crangon* is compared to sequence data for four congeneric species to get a first idea of relationships within the genus.

## Materials and methods

### *Sampling*

*Crangon crangon* samples were collected from 25 locations spanning the species' distribution during 2003-2005 (Table 4.1 and Fig. 4.1). Sampling was done in shallow water (<2 m) by small beam trawl or push nets, with the exception of the samples from Turkey and Italy, which were taken from the subtidal by beam trawl. In addition, samples from other *Crangon* species were kindly sent to us by colleagues (see Acknowledgements) for outgroup comparison: *C. alaskensis* from the coast of Washington State, USA, and Kodiak Island, Alaska, USA; *C. septemspinosa* from Tuckerton, New Jersey, USA; *C. cassiope* from Wakasa Bay, Japan; and *C. amurensis* from Tedai Bay, Japan. All shrimps were identified to species

level according to Smaldon et al. (1993) and individually stored in 96% ethanol at 4 °C. DNA was extracted from a tissue sample taken from under the third pleonite.

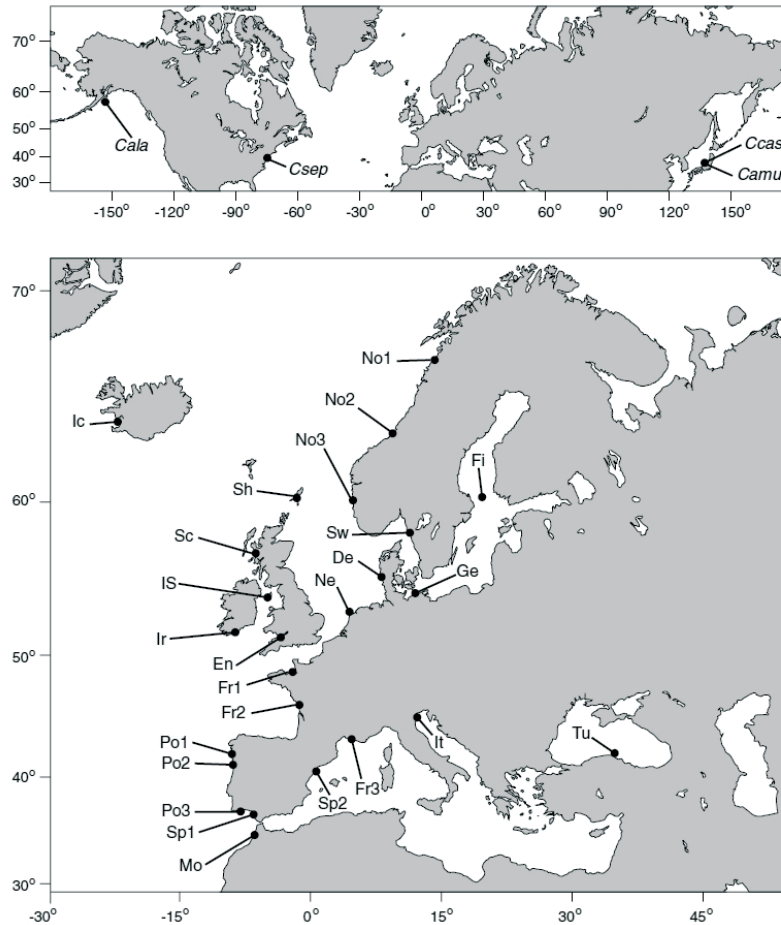

**Fig. 4.1.** Sample localities for *Crangon crangon* (black dots in bottom panel) and other *Crangon* species used for outgroup comparisons (black dots in top panel; ‘Csep’ = *C. septemspinosa*; ‘Cala’ = *C. alaskensis*; ‘Ccas’ = *C. cassiope*; ‘Camu’ = *C. amurensis*). Sample codes correspond to those in Table 4.1.

#### *DNA extraction, amplification and sequencing*

DNA was extracted using the GenElute™ Mammalian Genomic DNA Miniprep Kit (Sigma®) according to the Mammalian Tissue protocol (partB), provided by the manufacturer. The elution step was done with 100 µl instead of 200 µl elution buffer. Extracted DNA was visualized on 1% TBE agarose gels.

**Table 4.1.** *Crangon* species and sampling information, including geographic region, GPS position and date, population code and sample size (*n*). Sampling localities are also indicated on the map in Fig. 4.1.

Species	Geographic region	Location	Country	Latitude	Longitude	Date	Code	<i>n</i>
<i>C. crangon</i>	NE Atlantic	Reykjavik	Iceland	64°09'N	21°56'W	Jun 2005	Ic	6
<i>C. crangon</i>	NE Atlantic	Valosen	Norway	67°16'N	14°37'E	Apr 2005	No1	2
<i>C. crangon</i>	NE Atlantic	Sletvik	Norway	63°25'N	10°22'E	Oct 2003	No2	2
<i>C. crangon</i>	NE Atlantic	Bergen	Norway	60°19'N	05°19'E	Sep 2004	No3	4
<i>C. crangon</i>	NE Atlantic	Weisdale Voe	Shetland Islands	60°13'N	01°19'W	Aug 2004	Sh	1
<i>C. crangon</i>	NE Atlantic	Fiskebäckskil	Sweden	58°15'N	11°28'E	Sep 2003	Sw	1
<i>C. crangon</i>	NE Atlantic	Oban	Scotland	56°25'N	05°28'W	Oct 2003	Sc	5
<i>C. crangon</i>	NE Atlantic	Esbjerg	Denmark	55°31'N	08°33'E	Sep 2003	De	4
<i>C. crangon</i>	NE Atlantic	Port Erin Bay	Isle of Man	54°05'N	04°46'W	Jul 2004	IS	6
<i>C. crangon</i>	NE Atlantic	Mok	The Netherlands	53°04'N	04°49'W	Sep 2003	Ne	4
<i>C. crangon</i>	NE Atlantic	Hensley Point	England	52°07'N	01°08'W	Nov 2003	En	6
<i>C. crangon</i>	NE Atlantic	Cork	Ireland	51°51'N	08°29'W	May 2004	Ir	5
<i>C. crangon</i>	NE Atlantic	Mont St. Michel	France	48°40'N	01°40'W	Jan 2004	Fr1	6
<i>C. crangon</i>	NE Atlantic	Minho	Portugal	41°52'N	08°49'W	Sep 2003	Po1	2
<i>C. crangon</i>	NE Atlantic	Lima	Portugal	41°41'N	08°47'W	Sep 2003	Po2	4
<i>C. crangon</i>	NE Atlantic	Fuzeta	Portugal	37°02'N	07°45'W	Apr 2004	Po3	1
<i>C. crangon</i>	NE Atlantic	Merja-Zerga	Morocco	34°50'N	06°20'W	Aug 2004	Ma	5
<i>C. crangon</i>	NE Atlantic	Pertuis d'Antioche	France	46°04'N	01°12'W	Oct 2004	Fr2	2
<i>C. crangon</i>	NE Atlantic	Guadalquivir	Spain	37°25'N	04°58'W	Mar 2004	Sp1	1
<i>C. crangon</i>	NE Atlantic	Ålund Islands	Finland	60°20'N	19°88'E	Sep 2004	Fi	7
<i>C. crangon</i>	NE Atlantic	Mecklenburger Bucht	Germany	54°06'N	12°09'E	Augt 2004	Ge	4
<i>C. crangon</i>	Mediterranean Sea	Ebro Delta	Spain	40°43'N	00°44'W	Feb 2005	Sp2	9
<i>C. crangon</i>	Mediterranean Sea	Étang de Vaccarès	France	43°27'N	05°13'E	Nov 2003	Fr3	30
<i>C. crangon</i>	Adriatic Sea	Venice	Italy	45°30'N	12°15'E	May 2004	It	13
<i>C. crangon</i>	Black Sea	Sinop	Turkey	42°01'N	35°09'E	Mar 2005	Tu	10
<i>C. alaskensis</i>	NE Pacific	Gulf of Alaska	U.S.A.	57°00'N	152°00'W	Jul 2004	<i>Cala</i>	2
<i>C. septemspinosa</i>	NW Atlantic	Cape May	U.S.A	39°00'N	74°50'W	Nov 2003	<i>Csep</i>	1
<i>C. amurensis</i>	NW Pacific	Wakasa bay	Japan	35°21'N	134°22'E	Sep 2004	<i>Camu</i>	1
<i>C. cassiopa</i>	NW Pacific	Wakasa bay	Japan	35°21'N	134°22'E	Sep 2004	<i>Ccas</i>	1

The primers COIp3 and COIp4 (Tong et al. 2000) were used to amplify an approximately 525 basepairs (bp) section of the mitochondrial cytochrome-*c*-oxidase subunit I (COI) gene. Polymerase chain reactions were run in 50 µl volumes [16 mM (NH<sub>4</sub>)<sub>2</sub>SO<sub>4</sub>, 67 mM Tris-HCl

pH 8.8, 4 mM MgCl<sub>2</sub>, 0.01% Tween20, 0.25 mM of each dNTP, 0.5 μM of each primer; 1 μl of template DNA (using a 1:5 dilution of the original DNA solution) and 1 unit Taq DNA polymerase (Biotherm)]. Temperature cycles consisted of a 5 min initial denaturation step at 94°C, 40 cycles of 30 s denaturation at 94°C, 30 s annealing at 47°C and 30 s extension at 72°C, followed by a final extension step of 7 min at 72°C.

Amplification results were confirmed by 1.5% TBE agarose gel electrophoresis. The fragment of interest was either purified directly (using QIAquick purification kit, Qiagen), or, when additional bands were visible, cut out of the gel and purified (QIAquick gel extraction kit, Qiagen). Cycle sequencing reactions were carried out for both directions using the Bigdye Terminator v1.1 kit (Applied Biosystems) and run on an automated sequencer (ABI Prism™ 310 Genetic Analyzer).

### *Sequence analysis*

Forward and reverse sequences were edited manually with the software Sequencing Analysis (Applied Biosystems) and assembled into consensus sequences using the program AutoAssembler (Applied Biosystems). Sequences were aligned using the program 'ARB' (Ludwig et al. 2004) to a sequence of *Drosophila yakuba* obtained from GenBank (accession number X03240; the amplified fragment is found in *D. yakuba* from positions 2235–2759), trimmed to a final alignment of 388 bp and deposited in Genbank (Accession Nos. EU191086–EU191225 and EU219848–EU219853).

Double peaks at specific nucleotide positions were encountered in the sequencing electropherograms. Repeated amplifications and sequencing from the same individual, as well as comparing forward and reverse sequencing runs, yielded the same double peaks consistently, indicating the presence of more than one sequence in the template DNA. Triple or quadruple peaks were never seen. Ambiguous sites were scored conservatively using IUPAC ambiguity codes, by including double peaks only when the lower peak was at least 60% of the height of the higher peak. The data set containing the IUPAC codes contained 140 sequences and is hereafter referred to as the 'heteroplasmic data set'. The haplotypes were separated using the method initially developed by Clark (1990) and implemented statistically in the program PHASE version 2.1 (Stephens et al. 2001; Stephens & Scheet 2005). Separation was done per sample and all haplotypes could be recovered with a probability of 1.00, apart from the single individual sampled from the Shetland Islands, which produced two double peaks. The data set with inferred haplotypes consisted of 191 sequences and is hereafter referred to as the 'phased data set'.

### *Phylogenetic analysis*

Evolutionary relationships among haplotypes were estimated using a Maximum Likelihood (ML) approach (Felsenstein 1981) in PAUP\* 4.0b10 (Swofford 2003). An appropriate model of sequence evolution was estimated for each data set using Modeltest 3.6 (Posada & Crandall



1998) based on a neighbour-joining (NJ) tree and Jukes Cantor distances. All ML analyses employed heuristic searches with NJ starting trees, TBR branch swapping, multrees option in effect and all parameters of the model of sequence evolution fixed as estimated in Modeltest. Nonparametric ML bootstrap analyses were performed using the same models of evolution, 500 heuristic replicates, NJ starting trees with NNI branch swapping and multrees option off.

COI DNA sequences of three representatives of the *C. crangon* group analysed here were compared to four other *Crangon* species (*C. septemspinosa*, *C. alaskensis*, *C. amurensis* and *C. cassiope*) to provide a preliminary phylogenetic perspective of relationships within the genus. This was done using a similar ML approach as outlined above, but with all parameters of the model of sequence evolution estimated in PAUP\*, multrees option in effect and a bootstrap analysis employing 500 replicates with TBR branch swapping.

#### *Demographic and divergence inference*

Estimates of genetic variation in samples pooled per main geographic area were obtained as haplotype diversities  $h$  (Nei 1987) and nucleotide diversities  $\pi$  (Tajima 1983; Nei 1987) using Arlequin version 3.1 (Excoffier et al. 2005) as well as percentage of adenine and thymidine (%AT). Tajima's tests of selective neutrality (Tajima 1989) were also carried out in Arlequin to compare the observed numbers of pairwise nucleotide differences between haplotypes in a sample with expectations under an infinite-sites model of sequence evolution and under assumptions of selective neutrality and stable population size. The significance of Tajima's  $D$  was tested by generating 10,000 random permutations.

Mismatch distributions were used in Arlequin v.3.1 (Excoffier et al. 2005) to estimate demographic parameters and coalescence times for the four major phylogeographic groups from a model of sequence polymorphism developing under rapid population expansion. A least squares approach is used in this model to test for deviation from population size expansion and it produces a maximum likelihood estimate for coalescence time ( $\tau = 2ut$ , where  $u$  equals the per-haplotype mutation rate and  $t$  equals the number of generations) of the haplotypes. Generation time was assumed to be one year. A molecular clock of 1.4 to 2.2% sequence divergence per million years was used, which was estimated for the shrimp genus *Alpheus* for the same portion of the mitochondrial COI gene and a well-dated geological barrier, the Isthmus of Panama (Knowlton & Weigt 1998).

Divergence times between main phylogeographic groups were estimated using net nucleotide divergence  $D_n$  (Nei & Li 1979) calculated from maximum likelihood distances between all pairwise sequence comparisons from PAUP\*. Net nucleotide divergence corrects for discrepancies between gene divergence and population divergence due to ancestral polymorphism in populations (Edwards & Beerli 2000), since it subtracts the average within-group divergence from the observed between-group estimate:  $d_{xy} - 0.5(d_x + d_y)$ . This method is unbiased if ancestral and descendent populations are of the same size, at mutation-drift equilibrium, and panmictic (Arbogast et al. 2002). For estimating times of divergence in years

from relative divergence times, a molecular clock of 1.4 to 2.2% sequence divergence per million years was used, as introduced above.

## Results

### *Sequence variation: double sequences*

Of 140 sequences obtained 79 were unique haplotypes, indicating a high level of genetic diversity. The total of 140 individual *C. crangon* sequences split into 191 phased haplotypes. The phased data set contained 60 polymorphic sites, of which five were replacement mutations and the other 55 silent substitutions. Three of the replacement mutations occurred in a single individual (It11: L replaced by Q, Y by F and F by L). The only other two replacement mutations were observed in Sp22 (W replaced by S) and in Tu6 (L replaced by W).

The fraction of individuals yielding double sequences, i.e., one or more double peaks at certain positions in electropherograms, differed strongly between samples (Table 4.2). The two samples from the western Mediterranean yielded more than 95% double sequences: 29 out of 30 individuals for sample location Fr3 and nine out of nine for sample location Sp2. In contrast, the Atlantic samples contained few double sequences: a total of six out of 78 individuals. The nucleotide divergence between haplotypes within the individuals producing double sequences varied accordingly with population: in samples with many double sequences also nucleotide and haplotype diversities were high (Table 4.2).

**Table 4.2.** Descriptive statistics for *Crangon crangon* cytochrome-*c*-oxidase I mitochondrial DNA sequences. Haplotype diversity (h), nucleotide diversity ( $\pi$ ), percentage adenine and thymine (%AT), average ML distance, Tajima's D (D), number of sequences ( $n_{seq}$ ), number of haplotypes ( $n_{hap}$ , number unique haplotypes in brackets), are shown for each of four main phylogeographic groups. NE-ATL = northeastern Atlantic Ocean; ADR = Adriatic Sea; BS = Black Sea; W-MED = western Mediterranean; het = heteroplasmic data set; ph = phased data set.

	h		$\pi \cdot 10^{-2}$		%AT	D	$n_{seq}$		$n_{hap}$	
	het	ph	het	ph	ph	ph	het	ph	het	ph
NE-ATL	0.760	0.753	0.198	0.215	66.7	-2.18**	78	83	31(25)	32(25)
ADR	0.949	0.967	0.345	0.608	65.4	-0.13 (n.s.)	13	18	10(8)	14(11)
BS	0.933	0.859	0.113	0.174	66.6	-1.78*	10	13	8(7)	8(6)
W-MED	1.000	1.000	1.060	2.065	67.2	1.60 (n.s.)	39	77	39(39)	76(75)

\*)  $P < 0.05$ ; \*\*)  $P < 0.01$ ; n.s.=not significant

Among the possible origins of the double amplification products are [1] one of the templates represents a nuclear copy of the mitochondrial sequence (NUMT), [2]

contamination during laboratory procedures, [3] DNA from two individuals was extracted, [4] gene duplication within the mtDNA, [5] heteroplasmy, or the presence of two mitochondrial lines in a single individual. [1] The possibility of a NUMT can in our view reasonably be ruled out for several reasons. First, in spite of the high level of polymorphism, no frame-shift mutations and very few replacement substitutions were observed, which are frequent in NUMTs because of the relaxed selection regime they experience (Williams & Knowlton 2001). Second, the population-specific heteroplasmy (see below) would imply that new NUMTs had arisen repeatedly since the origin of this species and there are no reports of recent NUMT formation in animals (Kmiec et al. 2006; but see Williams & Knowlton 2001). Third, cells contain many mitochondria, especially in muscle tissue such as used here, which is generally thought to result in 'swamping' of the single nuclear genome copy during PCR. Fourth, no evidence was seen of three haplotypes in one amplicon, which is to be expected in case of individuals heterozygous for a NUMT. Fifth and finally, nuclear DNA is characterized by much lower ratios of transitions to transversions than we encountered; transition rates were about ten times higher than transversion rates. [2] Contamination is highly unlikely because negative controls were run alongside all PCRs. [3] The possibility that tissue from two individuals was extracted is possible if females should carry stored sperm and/or fertilized eggs containing paternal mitochondria. The region of the abdomen where a tissue sample was taken (under the third pleonite) consists mainly of muscle tissue, but it is also the most anterior part to where the ovaries may reach (Lloyd & Yonge 1947; Boddeke et al. 1991). It is believed that fertilization is internal in *C. crangon* (Boddeke et al. 1991), implying that eggs inside the ovaries may contain paternal DNA. Boddeke et al. (1991) concluded from the observation of large numbers of sperm cells in the oviducts of wild-caught females that sperm storage takes place, but the oviducts themselves are located entirely in the cephalothorax. The eggs are most likely not fertilized until they leave the ovaries through the oviduct onto the outside of the female. The evidence is thus not conclusive, and empirical data on internal fertilization of *C. crangon* are limited, so that this possible origin of the double sequences remains open. [4] DNA duplication is infrequently observed within animal mitochondria and is believed to be evolutionarily ephemeral (e.g., Moritz & Brown 1987; Gach & Brown 1997; Burzynski 2007). Short life span of duplications would be in accordance with their population-specific occurrence in *C. crangon*. The high level of intra-individual variation present in our data, however, is not, because much time would be needed to accrue so much divergence between copies. Frequent recombination would need to be invoked, but the evidence for recombination in animal mitochondria is still under debate (see Barr et al. 2005 for a review). [5] Extensive heteroplasmy with highly diverged mitochondrial lineages has only been observed in some bivalves to date, where it is called 'DUI' (doubly uniparental inheritance of a male and a female line of mitochondria) (Zouros et al. 1994; Liu et al. 1996). However, milder forms of heteroplasmy have been reported for, e.g., anchovy *Engraulis encrasicolus* (Magoulas & Zouros 1993) and the flatfish *Platichthys flesus* (Hoarau et al.

2002). Joint occurrence of DNA duplication and heteroplasmy was described for brook sticklebacks *Culaea inconstans* (Gach & Brown 1997). Pending further research on finding the origins of the double amplification products (which we are currently undertaking using cDNA analysis and laboratory reared families), the double sequences will be assumed to represent independent functional haplotypes. However, all analyses will be presented for both the phased data set and the original data set, indicating whenever conclusions are dependent upon this assumption.

### *Phylogeography*

For the heteroplasmic data set (140 sequences, 88 unique haplotypes) the most appropriate model of sequence evolution as estimated in Modeltest was HKY+I+gamma rates and heuristic searches resulted in a single ML tree (see Appendix). For the phased data set (191 sequences, 130 unique haplotypes) the most appropriate model of sequence evolution was TrN+I+gamma rates and heuristic searches resulted in four ML trees with very similar topologies and of which one is shown in Fig. 4.2 with bootstrap support of >50% indicated. Outgroup analysis of these data sets including the species *C. alaskensis*, *C. septemspinosa*, *C. amurensis*, and *C. cassiope* resulted in similar topologies, with the Western Mediterranean clade as the most basal grouping, but bootstrap support for major branches was much lower. This is probably because the outgroups were too divergent and we had limited data to resolve interspecific relationships.

A very clear phylogeographic structure emerged from the phylogenetic trees, irrespective of whether the heteroplasmic (see Appendix) or the phased (Fig. 4.2) data set was used, with four groups corresponding to well defined geographic areas: [1] the NE Atlantic (NE-ATL); [2] the Adriatic Sea (ADR); [3] the Black Sea (BS); and [4] the Western Mediterranean (W-MED). The Baltic Sea did not constitute a separate group. Each of the four groups thus identified represented a monophyletic clade with moderate to strong bootstrap support, meaning that lineage sorting has been complete at this geographic scale.

All samples were very diverse, as is demonstrated by the high haplotype diversities ( $h$ ) that ranged from 0.760 (0.753 in the phased data set) for the northeastern Atlantic to 1.000 for the Western Mediterranean (Table 4.2). The highest level of nucleotide diversity ( $\pi$ ) was also found in the Western Mediterranean and was substantially higher than in the other three phylogeographic groups (Table 4.2). While in the Western Mediterranean all (or all apart from two in the phased data set) sequences were unique, in the samples from the NE Atlantic region, 53 (56 in the phased data set) individuals shared a haplotype with one or more other individuals, despite belonging to samples as distant as, for example, Iceland and Morocco. No haplotype was shared between the four groups, underlining the strong phylogeographic structure. However, four Adriatic Sea sequences appeared from the phylogenetic analyses to be basal with respect to the Black Sea clade (Fig. 4.2, Appendix).

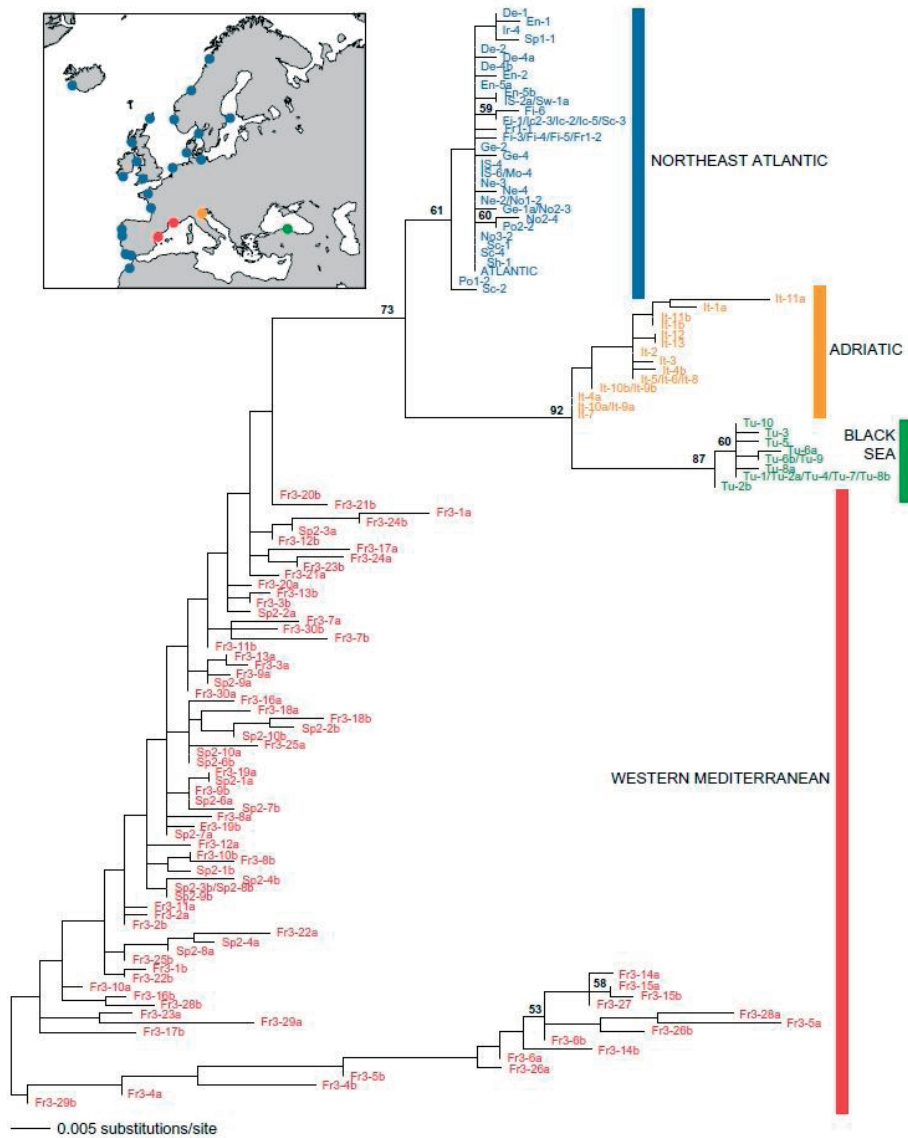

**Fig. 4.2.** Midpoint-rooted Maximum Likelihood phylogeny of 191 phased cytochrome-c-oxidase I haplotypes obtained from 140 *Crangon crangon* individuals sampled across its distribution range. Taxon labels correspond to those in Table 4.1 and Figure 4.1 and are composed of: (1) sample code, (2) individual number and (3) a or b when two haplotypes were present in a single shrimp (see text for details). The taxon label ‘ATLANTIC’ refers to a single NE Atlantic haplotype shared among 41 individuals from samples across the NE Atlantic: De, En, Fi, Fr1, Fr2, Ge, IS, Ic, Ir, Ma, Ne, No1, No2, No3, Po1, Po2, Po3, Sc, Sh1, and Sw. Numbers above major branches indicate percentage bootstrap support (all values higher than 50% shown).

Mismatch distributions were clearly unimodal for the NE Atlantic and Black Sea groups (Fig. 4.3), typical of populations that have undergone a recent bottleneck in population size followed by rapid population expansion (Slatkin & Hudson 1991; Rogers & Harpending 1992). This pattern was confirmed by Tajima's  $D$  statistic, which for the NE Atlantic and the Black Sea was negative and differed significantly from expectations under a neutral model of evolution assuming constant population size (Table 4.2). By contrast, the Western Mediterranean displayed a multimodal mismatch distribution (Fig. 4.3) and a positive Tajima's  $D$  that did not significantly deviate from a neutral equilibrium model (Table 4.2). The Adriatic took up an intermediate position with a unimodal mismatch distribution, suggesting a population expansion, and a negative but non-significant Tajima's  $D$ . The fact that the mean number of pairwise differences among the Adriatic sequences is higher, indicates that the population bottleneck may have happened longer ago there than in the NE Atlantic and Black Sea (Fig. 4.4).

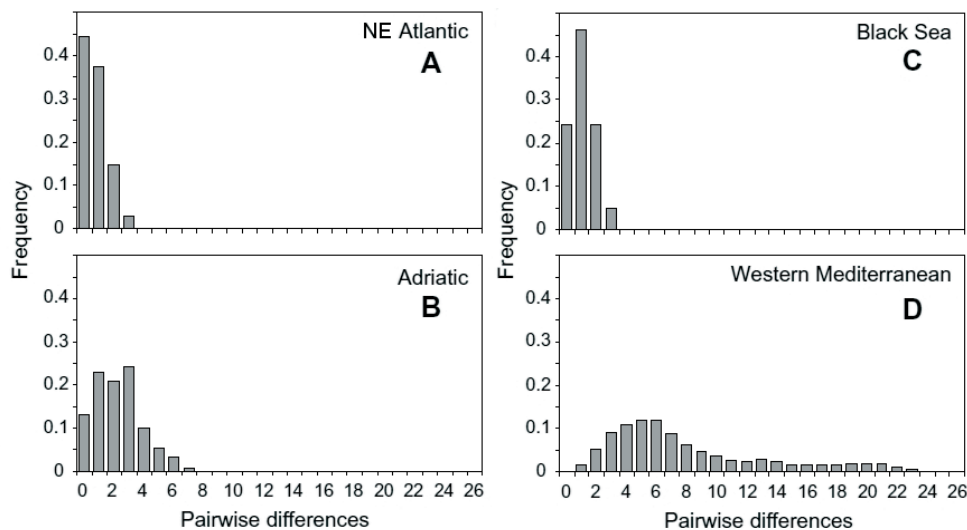

**Fig. 4.3.** Mismatch distributions of pairwise sequence differences for *Crangon crangon* from the NE Atlantic (A), Adriatic Sea (B), Black Sea (C) and Western Mediterranean (D).

Coalescent analyses from the mismatch distributions suggested that the youngest phylogeographic groups are the NE Atlantic and the Black Sea, for which the haplotypes coalescence an estimated 23 to 38 thousand and 22 to 35 thousand generations ago, respectively (Table 4.3). The Western Mediterranean is the oldest with an estimated age of 70 thousand to 1.1 million generations, while the Adriatic Sea is intermediate with 51 to 79 thousand generations estimated coalescence time (Table 4.3). Testing demographic

parameters on the basis of the mismatch distributions does not significantly reject population expansion for any of the four phylogeographic groups (10,000 random permutations,  $P > 0.05$ ).

**Table 4.3.** Mismatch analysis for *Crangon crangon*.

	mean	var.	$\tau$	years ago
NE-ATL	0.774	0.685	0.814	23800-37500
ADR	1.673	1.366	1.723	50500-79300
BS	0.615	0.396	0.766	22400-35300
W-MED	5.948	16.533	2.377	69600-109400

#### *Population divergence*

All estimated divergence times between the four major phylogeographic groups suggested population splits dating back to the early and middle Pleistocene, or even late Pliocene (Table 4.4). The most recent split was between the Adriatic and the Black Sea: 1.2 to 1.9 MYA, and the oldest divergence was between the NE Atlantic and the Black Sea (2.8 to 4.4 MYA), which are also geographically the most distant. The order of population splitting suggested from the latter analysis is not consistent with the phylogenetic trees, which suggest that the NE Atlantic, Adriatic and Black Sea samples share a more recent common ancestor together than any of these populations do with the Western Mediterranean samples (bootstrap support 73% in the phased analysis, Fig. 4.2; bootstrap support 87% in the heteroplasmic analysis, Appendix).

**Table 4.4.** Divergence time analysis on the basis of net nucleotide divergence between four major phylogeographic groups of *Crangon crangon*.

comparison			net divergence	years
ADR	vs.	BS	2.62	$1.2-1.9 \cdot 10^6$
NE-ATL	vs.	ADR	4.09	$1.9-2.9 \cdot 10^6$
NE-ATL	vs.	BS	6.19	$2.8-4.4 \cdot 10^6$
NE-ATL	vs.	W-MED	3.54	$1.6-2.5 \cdot 10^6$
ADR	vs.	W-MED	5.98	$2.7-4.3 \cdot 10^6$
BS	vs.	W-MED	5.56	$2.5-4.0 \cdot 10^6$

### *Preliminary phylogenetic analysis*

Preliminary analysis of relationships among five species within the *Crangon* genus suggested that the taxa most closely related to *C. crangon* are *C. septemspinosa* and *C. alaskensis*. However, bootstrap support for all interspecific groupings are negligible - very low (44% and 56%) and therefore do not allow definite conclusions. It is noteworthy that *C. crangon*, although placed in a monophyletic group with respect to the other four species, had a bootstrap support of only 55%. Probably the fragment analysed did not contain enough information to reliably uncover these genus-level relationships.

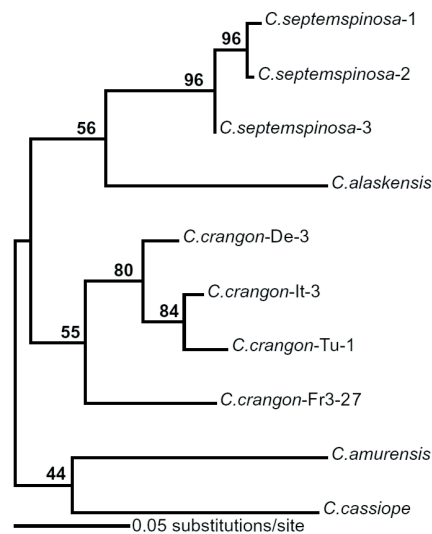

**Fig. 4.4.** Preliminary midpoint-rooted Maximum Likelihood phylogeny of ten cytochrome-c-oxidase I haplotypes obtained from *Crangon septemspinosa* (5 individuals, 3 haplotypes), *C. alaskensis* (2 individuals, 1 haplotype), *C. crangon* (4 individuals, 4 haplotypes representing the four main phylogeographic groups), *C. amurensis* (1 individual, 1 haplotype) and *C. cassiope* (1 individual, 1 haplotype; see Table 4.1 and Fig. 4.1 for sampling details). Bootstrap support is given above branches.

### **Discussion**

The COI fragment analysed here for the common shrimp *Crangon crangon* yielded high levels of intraspecific variation, suitable for studying phylogeographic patterns. Several individuals hosted two copies of the fragment, resulting in double amplification products. The frequency of individuals producing double sequences varied between populations, as did the divergence between sequences encountered within individuals. On the basis of the present data we cannot distinguish between internal fertilization, DNA duplication and heteroplasmy as possible origins of the double sequences. For the inferences made and discussed below, we assume both copies are functional and independent. This is correct if they originate from



internal fertilization (if mating is random with respect to mtDNA), because they would then represent two individuals from the same population. However, the assumption of independence may cause bias in inferences in case of DNA duplication or heteroplasmy. If either of these is the case, the copies may not inherit independently and/or not accumulate sequence variation at the same rate, which would not be in accordance with assumptions underlying models of evolution of mtDNA. These considerations add to other, more general limitations of inferring gene flow or divergence times from a single (mitochondrial) marker (e.g., Ballard & Whitlock 2004) and should be kept in mind when interpreting the inferences made in this paper.

#### *Current population structure*

Current population structure of the common shrimp *Crangon crangon* is strongly subdivided over its distribution range. In spite of the observed strong structuring, a remarkable homogeneity was observed for its Atlantic range, with haplotypes shared from Morocco to Iceland and the Baltic Sea. The latter observation is in contrast to Bulnheim & Schwenzer (1993), Beaumont & Croucher (2006), and Weetman et al. (2007), who report some population differentiation between northeastern Atlantic populations of *C. crangon* on the basis of allozymes and AFLP, respectively. The absence of population structure in the Atlantic range of *C. crangon* might be explained either by [1] the region is connected by levels of gene flow sufficient to prevent population genetic structure from building up, or [2] current gene flow is restricted but populations have not yet diverged because colonization has happened too recently. Studying additional independent loci may help to distinguish between these alternatives. The only available alternative loci are in the nuclear genome (nDNA), which, being diploid and biparentally inherited, have a four times slower rate of lineage sorting than mitochondrial DNA (mtDNA) (Birky et al. 1989; Palumbi et al. 2001). Therefore, mtDNA should show evidence of reduced gene flow sooner after population subdivision than nDNA, although the power of nDNA is stronger when multiple loci are studied, which is not possible for the essentially single-locus mitochondrial genome. The higher power of multi-locus studies could be the reason for the contrasting results on intra-Atlantic population subdivision between this study and previous ones (Bulnheim & Schwenzer 1993; Beaumont & Croucher 2006; Weetman et al. 2007). Therefore, results from these latter studies may indicate that mtDNA homogeneity is the result of recent recolonization rather than high levels of gene flow. Indeed, the Atlantic range was likely colonized recently by *C. crangon* because the area was severely affected by the Pleistocene ice ages and suitable marine coastal habitat may have been largely reduced to the Portuguese coast and southward during the last glacial maximum 18,000 - 10,000 years ago (see below for a more extensive discussion of historical inferences). Additionally, the fact that populations are strongly structured within the Mediterranean basin may suggest that the Atlantic range is not strongly connected by gene flow either. Hydrographic properties of the Mediterranean, however, differ severely from

those in the NE Atlantic, confounding this comparison. While the Mediterranean consists of a number of semi-enclosed circulation systems and shelf areas (Agostini & Bakun 2002) and has small tidal currents, the Atlantic continental shelf is characterized by a residual surface current in northeastward direction, called the North Atlantic Current, and moderate to strong tidal currents. Atlantic *C. crangon* populations may therefore be more prone to effective migration than those in the Mediterranean.

Baltic Sea common shrimp seem to form a direct Atlantic extension, as no genetic break was observed between Baltic and Atlantic *C. crangon*, confirming the allozyme data of Bulnheim & Schwenzler (1993). This is a general and expected pattern for Baltic marine taxa (Johannesson & André 2006), which have colonized the basin no earlier than 7,500 years ago (Ignatius et al. 1981). Two marked exceptions to this general pattern are the bivalves *Macoma* spp. (Väinölä & Varvio 1989; Luttkhuizen et al. 2003; Väinölä 2003) and *Mytilus* spp. (reviewed in Riginos & Cunningham 2005) but apparently the common shrimp shows the common pattern. Although our shrimp sample sizes are too small to draw definite conclusions, the data show no evidence for lowered genetic variation within the Baltic (average ML genetic distance 0.00322, seven haplotypes, three of which unique, found among 12 sequences) compared to the Atlantic (average ML genetic distance 0.00220, 29 haplotypes, 22 of which unique, found among 71 sequences), in contrast to what is generally observed for marine taxa in the Baltic (Johannesson & André 2006).

Reciprocal monophyly of shrimp sequences from the Atlantic and Mediterranean basins (Fig. 4.2) is evidence of severely restricted (or even a complete absence of) present-day gene flow across the Strait of Gibraltar and/or the Alboran Sea. This is a pattern that is commonly observed for marine taxa (e.g., Quesada et al. 1995a, b; Borsa et al. 1997; Naciri et al. 1999; Zane et al. 2000; Perez-Losada et al. 2002; Bargelloni et al. 2003, 2005; Peijnenburg et al. 2004, 2006; Chevolut et al. 2006; Remerie et al. 2006), although some taxa do not show it (e.g., Bargelloni et al. 2003, 2005; Duran et al. 2004a, b; Stamatis et al. 2004, 2006). Because shrimp from the Alboran Sea were not included in this study, we cannot at present tell whether the Strait of Gibraltar itself or the Oran-Almeria front is the main point of genetic subdivision. However, it has been argued that the Oran-Almeria front is the more likely present-day barrier to gene flow (Quesada et al. 1995a, b; Naciri et al. 1999; Zane et al. 2000). Water that flows in from the Atlantic moves in anticyclonic gyres inside the Alboran Sea and forms an oceanographical front on the eastern side, which runs from Oran in Morocco to Almeria in Spain (Milot 1999), restricting passive and active migration of organisms between water masses on either side of the front.

Barriers to gene flow of *C. crangon* within the Mediterranean Sea/Black Sea are also evident from our analyses. Present-day gene flow of *C. crangon* across the Turkish Straits or the Aegean Sea is absent or severely limited, as is gene flow between the eastern and western basins of the Mediterranean Sea. The former is evidenced by the monophyly of the sequences obtained from the Black Sea (Fig. 4.2, Appendix), a pattern which is in accordance with

several other taxa (e.g., anchovy: Magoulas et al. 1996, 2006; chaetognaths: Peijnenburg et al. 2004, 2006; copepods: Papadopoulos et al. 2005; Unal et al. 2006; mussels: Ladoukakis et al. 2002). The restricted exchange of water between the Black Sea and the Mediterranean across the Bosphorus is likely to form the most important physical barrier to effective migration, in addition to selection effects due to the vastly different habitats in terms of salinity and temperature (Mediterranean: 14-23 °C and 36-39‰; Black Sea: 7-14 °C and 36-39‰; from Peijnenburg et al. 2004). The data do not support gene flow between the western Mediterranean and the Adriatic Sea (in the eastern Mediterranean basin) either, which is in accordance with observations for a number of other taxa (fish: Borsa et al. 1997; Bahri-Sfar et al. 2000; Stefanni & Thorley et al. 2003; bivalves: Mariani et al. 2002; copepods: Papadopoulos et al. 2005; chaetognaths: Peijnenburg et al. 2004, 2006). Analogous to the Turkish Straits, the narrowness of the Sicilian Straits may underlie the restricted gene flow between western and eastern Mediterranean basins.

### *Biogeographic history*

Our preliminary phylogenetic analysis suggests that the most recent divergence between Atlantic and Pacific *Crangon* is between *C. septemspinosa* and *C. alaskensis* and that they split a minimum of 6.6 MYA, which is consistent with a scenario of trans-Arctic immigration after the opening of the Bering Strait in the Pliocene (see also Vermeij 1991). Furthermore, the common ancestor to NW Atlantic *C. septemspinosa* and NE Atlantic *C. crangon* is also estimated to have lived a minimum of 6.6 MYA, which suggests that the two species invaded opposite sides of the Atlantic right after the opening of the Bering Strait and have not been in contact since that time. However, this preliminary conclusion must be regarded with much caution until tested further by analysis of more sequence data and a wider range of population samples of *C. septemspinosa*. In addition, the trans-Atlantic divergence dates may become smaller as more taxa are added to the phylogenetic analysis. Finally, the taxonomy of the genus is by no means without controversies. For example, it is still debated whether *C. septemspinosa*, *C. crangon* and Pacific *C. affinis* are actually the same species (Holthuis 1980; C. Franssen, Naturalis Museum of Natural History, Leiden, The Netherlands, person. comm.).

The patterns of genetic variation for *C. crangon* COI are largely congruent with the geological history of the marine basins the species currently inhabits (outlined in the Introduction). The NE Atlantic and Baltic Sea were probably colonized from a single refugium, which is consistent with a southern range compression during the LGM. The start of population expansion is estimated at roughly 30,000 years ago (Table 4.3), which predates the LGM, and this may be the result of our pooling of all Atlantic samples if in fact there is slight population structuring with possibly higher variability in the south. Alternatively, it may result from the general tendency of an upward bias in estimates of recent divergence times, as detailed by Ho et al. (2005) and Ho & Larson (2006).

The Black Sea was probably colonized by a *C. crangon* population ancestral to the one currently found in the Adriatic Sea as well. However, the estimated timing of colonization (some 30,000 years ago) predates the short saltwater history of the Black Sea, which is about 7,000 years (Ryan et al. 1997; Svitoch et al. 2000). Before that, from about 23,000 years ago onwards, it was an isolated low-salinity basin of approximately 6.4‰ (Emory & Hunt 1974). In the case of *C. crangon*, which is tolerant of a wide range of salinities and is found deep into the Baltic Sea where salinities drop below 7‰, it is possible that it survived the low-salinity era inside the Black Sea or in the adjacent Azov Sea or Caspian Sea. Magoulas et al. (1996, 2006; but see Grant 2005) postulate a similar hypothesis for anchovy *Engraulis encrasicolus*, which can tolerate salinities as low as 5‰ (Demir 1963). For further evaluation of this hypothesis a more thorough analysis in terms of other DNA loci and other taxa is needed.

The timing of population division between the Adriatic Sea and the Black Sea arrives, however, at a much earlier date (1.2-1.9 MYA, see Table 4.4). Comparing this to the 22-35 thousand years from the mismatch analysis (Table 4.3), it must be concluded that a population or populations ancestral to the present-day Black Sea population was already isolated from the Mediterranean ancestors long before the Black Sea was colonized. A similar pattern was reported for Black Sea copepods *Calanus* spp. (Papadopoulos et al. 2005) and chaetognaths (Peijnenburg et al. 2004).

The western Mediterranean presently harbours the oldest and demographically most stable *C. crangon* populations that exist within the species (Fig. 4.3, Table 4.3). This is consistent with the geographical history of the area, which indicates that suitable habitat for *C. crangon* may have been available for several million years. It has been suggested that taxa of colder waters colonized the Mediterranean later than tropical ones, i.e. not until about 2 MYA, because of the shifting distribution of thermoclines in the adjacent Atlantic (Angel 1979; Ekman 1968). Mismatch analysis of our data indeed suggests that shrimp populations presently inhabiting the western Mediterranean have a history of up to one million years (Table 4.3).

A remarkable result of our phylogenetic analyses is that Adriatic and Black Sea *C. crangon* appear not to derive directly from the western Mediterranean ancestral population but instead to share a common ancestor with present-day Atlantic *C. crangon* (Fig. 4.2, Appendix). Estimated dates of population divergence for all comparisons, i.e., between NE Atlantic, western Mediterranean, Adriatic Sea and Black Sea, are more than a million years ago (Table 4.4). It is possible that the grouping of the NE Atlantic, Adriatic and Black Sea clades (Fig. 4.2) is an artifact resulting from too little data (only one locus of 388 bp analysed), although variability in the studied fragment is large and bootstrap values are reasonable (73% and 87% in the phased and heteroplasmic analyses, respectively; see Fig. 4.2, Appendix). If we rule out such an artifact, we can distinguish two haplotype groups: one in the western Mediterranean with a long history of population size stability (group A) and another in the Atlantic, Adriatic Sea and Black Sea with a similarly long history (deep

population splits) but which is characterized by several population bottlenecks (group B). Because, ultimately, Mediterranean shrimp must have originated in the Atlantic, and both group A and B are present in the Mediterranean, the data suggest two separate colonization events of *C. crangon* across the Atlantic-Mediterranean divide. The order of events, which should explain the absence of group A from the Atlantic samples, can at present not be determined. Analysis of additional (Atlantic) samples of *C. crangon* and, in particular, of its closest relatives may shed more light on this issue.

Similar cases of multiple colonizations of the Mediterranean basin have been described for flounder (Borsa et al. 1997), Atlantic bonito (Viñas et al. 2004) and anchovy (Magoulas et al. 1996, 2006; Grant 2005). In the case of flounder, in contrast to *C. crangon*, the western Mediterranean contains descendents of the most recent colonization event. In the case of anchovy, two diverged mitochondrial clades occur which have a heterogeneous geographic distribution: in some areas, the clades co-occur and in others their frequencies show steep clines. The anchovy data are interpreted as evidence of secondary contact after evolution in isolation (Magoulas et al. 1996). More specifically, since one of the clades is older than the other, a history of two colonization events of the Mediterranean is inferred, one of which was accompanied by a severe bottleneck (Grant 2005). Atlantic bonito in the Mediterranean is strikingly similar to anchovy in that it contains two distinct clades, one old and stable and one with a bottlenecked history; as in anchovy, the two clades overlap in distribution to form areas of secondary contact (Viñas et al. 2004). The main difference between the latter two examples and shrimp *C. crangon* is that the data presented here for shrimp do not show secondary contact but, instead, populations that have remained isolated since their origin.

### *Conclusions*

Four major phylogeographic groups have been identified for the common shrimp *C. crangon*: the NE Atlantic (including the Baltic Sea), the western Mediterranean, the Adriatic Sea and the Black Sea. Gene flow between these groups appears to be virtually absent. The implication for marine conservation genetics is that populations of *C. crangon* are probably hardly connected by effective dispersal. Physical barriers to gene flow are likely to include the Strait of Gibraltar and/or Oran-Almeria front, the Sicilian Straits and the Turkish Straits. The overall high level of variation is most pronounced in the western Mediterranean, which is interpreted as evidence of a long and stable population history.

Inferred population histories are largely congruent with the known biogeographic history of the distribution area. The Atlantic and Black Sea shrimp, and to a lesser extent Adriatic shrimp as well, have probably undergone repeated population size bottlenecks, resulting from the cyclical changes in temperature, sea level, and associated salinity changes during the Pleistocene.

**Acknowledgements** We thank A. Bol, S. Sjollema, M. Puister, H. Witte, S. Santos, C. Wuchter and J. Cardoso for assistance in the lab, and H. Witte for species identification. We are grateful to R. Glas and C. Franssen for helpful suggestions and discussions. Thanks are also due to the following people that contributed shrimps: K.W. Able (USA), J. Mork (Norway), A. Geffen (Norway), L. Pihl (Sweden), J. Strøttrup (Denmark), R. Gibson (Scotland), R. Nash (Isle of Man), J. Davenport (Ireland), P. Henderson (England), A. Crivelli (France), Y. Desaunay (France), K. Aanio (Alund Islands), B. Gunnarsson (Iceland), K. Bailey (USA), M. Reichert (USA), U. Damm (Germany), B. Mieske (Germany), D. Tagliapietra (Italy), E. Cicek and S. Bilgin (Turkey), H. Taleb (Morocco), M. Cristo (Portugal), P. Drake (Spain), S. Henderson (Shetland Islands), Y. Yamashita (Japan) and those who helped in sampling, namely E. Martins, L. Scott, J.C. Antunes, P.T. Santos, S. Sjollema, S. Tavares, S. Mendes, S. Skreslet and V. Freitas. H. Malschaert was Linux and ARB helpdesk.

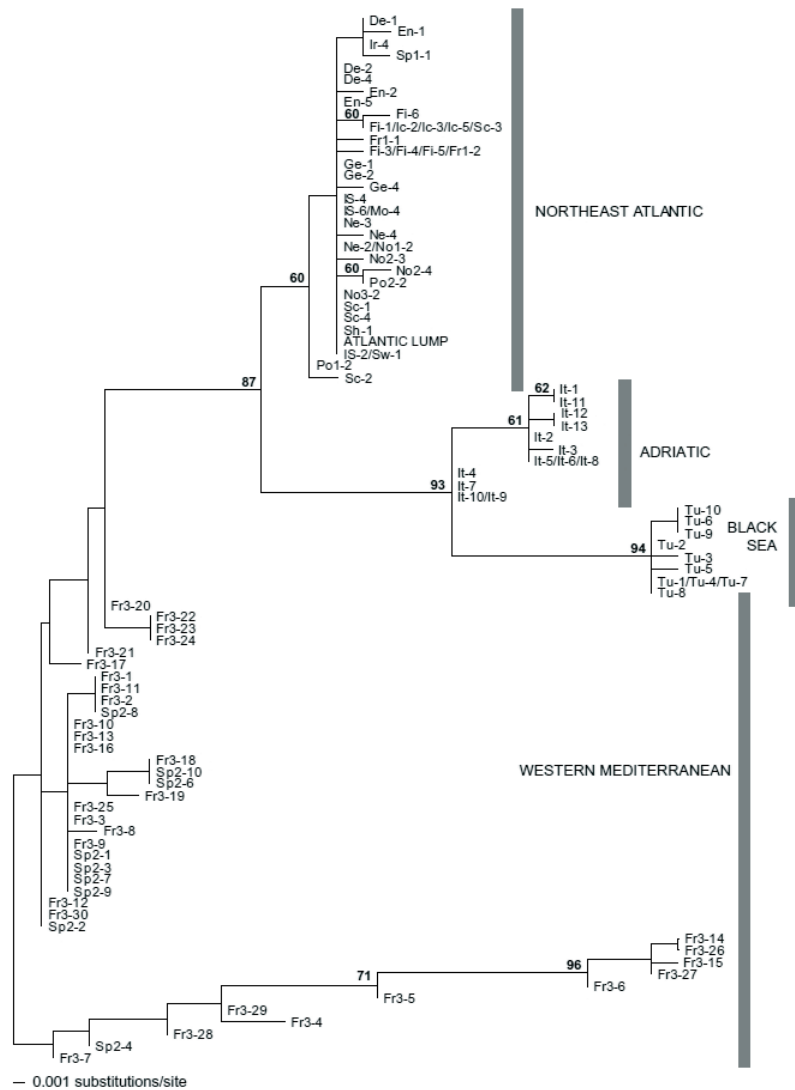

**Appendix** Midpoint-rooted Maximum Likelihood phylogeny of 88 cytochrome-*c*-oxidase I haplotypes of which 51 sequences contained one or more heteroplasmic sites (coded with ambiguity letters) obtained from 140 *Crangon crangon* individuals sampled across its distribution range. The taxon label ‘Atlantic Lump’ refers to a single NE Atlantic haplotype shared among 38 individuals from samples across the NE Atlantic: De, En, Fi, Fr1, Fr2, Ge, IS, Ic, Ir, Ma, Ne, No1, No2, No3, Po1, Po2, Po3, Sc2, Sh1, and Sw. Numbers above major branches indicate percentage bootstrap support (all values of >50% are shown). Outgroup analysis including the species *C. alaskensis*, *C. septemspinosa*, *C. amurensis*, and *C. cassiope* resulted in a similar topology with the Western Mediterranean clade as the most basal grouping.

## Chapter V

### Latitudinal variation in growth of *Crangon crangon*: does counter-gradient growth compensation occur?

#### Abstract

Length growth in relation to water temperature was studied for *Crangon crangon* (L.) from two populations at the northern and southern edges of its distributional range to determine whether counter-gradient growth compensation occurs. In crustaceans, growth rate depends on the time between moulting events (intermoult period) and the size increase at moult (moult increment). In this study, the period between moults was shorter at higher temperature, ranging respectively from about 11 days at 25 °C to 27 days at 10 °C at southern edge, and from 10 to 24 days at the same temperatures at the northern edge. Moult increment showed a large variability, from 1.5 to 2.7 mm with no clear trend with temperature at the northern edge; and decreasing from about 2.7 mm at 10 °C to about 1.5 mm at 25 °C at the southern edge. As a result, the temperature effect on the overall growth rate differed between shrimps from the north and those from the south, suggesting counter-gradient growth compensation. At the northern edge, mean growth increased from about 0.12 mm d<sup>-1</sup> at 10 °C to about 0.23 mm d<sup>-1</sup> at 25 °C, while at the southern edge, growth was lower, about 0.08 mm d<sup>-1</sup> at 10 °C and increased to about 0.16 mm d<sup>-1</sup> at 25 °C. Maximum observed growth rates of shrimps from the north were also higher and ranged from 0.17 mm d<sup>-1</sup> at 10 °C to 0.89 mm d<sup>-1</sup> at 25 °C, while shrimps from the south grew at a maximum of 0.08 to 0.75 mm d<sup>-1</sup> respectively at 15 and 20 °C. Sex and size differences were also found, with males growing slower than females and at a decreasing growth rate with increasing size. Implications for the brown shrimp's life cycle are discussed.



## Introduction

The brown shrimp *Crangon crangon* (L.) inhabits a very wide distributional area along the European coast, from the White Sea in the North of Russia to Morocco, within the NE Atlantic and throughout the Mediterranean and Black Seas (Tiews 1970; Campos & Van der Veer 2008). Over this range, strong population structuring occurs with four major phylogeographic groups: the NE Atlantic, the western Mediterranean, the Adriatic Sea and the Black Sea (Luttikhuizen et al. 2008). Though its migratory capacity might partly explain the wide geographic distribution, it also reflects the capability of *C. crangon* to endure a wide range of environmental conditions.

Environmental factors which vary with latitude can potentially result in intraspecific differences in successful phenotypes over an extensive latitudinal range (c.f. Kinne 1962, 1964). Since lower temperatures generally reduce metabolism of poikilotherms, the latitudinal thermal gradient would be expected to cause a similar effect, i.e., at high latitudes the organisms' metabolism is reduced in comparison to low latitudes. In contrast, several studies revealed a 'latitudinal compensation' (i.e., metabolism is as high or even higher at high latitudes compared to low latitudes) in features such as vertebral number, growth rate, food conversion efficiency, spawning season and energy storage in a number of species (Dehnel 1955; Ament 1979; Levinton 1983; Conover 1990; Conover & Present 1990; Schultz et al. 1996; Billerbeck et al. 1997, 2000; Conover et al. 1997; Schultz & Conover 1997; Purchase & Brown 2000; Lapolla 2001). However, to date, information about *C. crangon* is absent.

Crustaceans such as *C. crangon* do not grow continuously but by periodically shedding the hard exoskeleton in a process called moult or ecdysis. Between consecutive moults, size increase is very constrained (Meixner 1966), therefore the growth rate is a function of the frequency of moults and depends on two factors: the size increase at moult (moult increment) and time between moulting periods (intermoult period).

Despite extensive studies, there is still a lack of information on the growth of *C. crangon* under natural conditions (ICES 2007; Campos & Van der Veer 2008). Any analysis of growth conditions in the field requires laboratory observations on growth under controlled food and temperature conditions. To date, only some unpublished information is available from M. Fonds and co-workers (Van Lissa 1977), referred to by Kuipers & Dapper (1984). Field studies on growth (Schockaert 1968; Gelin et al. 2000) either still refer to the work of Tiews (1954), ignoring the fact that in their study differences in growth conditions might be present, or assume maximum growth and apply model predictions to analyse the life history in the field (Kuipers & Dapper 1984; Temming & Damm 2002). Other field studies on a local scale, based their growth estimation on cohort analysis (Marchand 1981; Boddeke et al. 1985; Henderson & Holmes 1987; Beukema 1992; Del Norte Campos & Temming 1998; Oh et al. 1999; Burrows et al. 2001; Viegas et al. 2007), which in the case of brown shrimp is complicated due to almost continuous spawning throughout the year and to migration with increasing size.

In this study, experiments on *C. crangon* growth in relation to abiotic (temperature) and biotic (shrimp size and sex) conditions are presented. To account for 'latitudinal compensation' and analyse whether counter-gradient growth compensation does occur (c.f. Conover & Present, 1990), laboratory experiments were carried out with individuals from two different locations spread over the latitudinal range of *C. crangon* distribution: Minho estuary, Portugal, near the southern limit of distribution and Valosen estuary, Norway, at the northern limit of distribution. Individual growth was analyzed at a range of controlled temperatures under optimal food conditions (excess of food). The size increase at moult (moult increment) and the time between successive moulting events (intermoult period) in relation to temperature were followed separately for males and females.

## Material and methods

### *Sampling areas*

Shrimps for the growth experiments were caught at two locations respectively near the southern and at the northern edge of the distribution: [1] Minho estuary, 41°N latitude, Portugal; and [2] Valosen estuary, 67°N latitude, Bodø, Norway in May 2006 (Fig. 5.1). Temperature conditions were measured with a temperature probe at Minho estuary, and with a temperature logger at Valosen from April to September 2005 and from April to October 2006, except July.

### *Growth experiments*

All experiments were run in indoor facilities, at CIIMAR (Porto, Portugal) and at HIBO (Bodø, Norway). To minimize variability due to conducting the experiments at different sites, water temperature, salinity, light and food were controlled. Additionally, the same procedure for sampling, acclimatization and experimental set up was applied at both locations.

Shrimps were collected 10 to 15 days before the start of the experiment. Animals were caught with a 1 m beam trawl with 5 mm mesh size. The smaller animals were selected and transferred randomly to four aerated seawater containers 100x30x35 cm. In Portugal, seawater was initially assigned at 15 °C and 32 usp salinity and in Norway at 7 °C and 29 usp, corresponding to the field conditions found at the sampling location at the time of the collection. During three days, conditions at each container were gradually set at the levels of the trials, namely salinity was assigned to 29-32 usp in all four containers and water temperature was set at 10, 15, 20 and 25 °C ( $\pm 1$  °C) respectively in each of the four containers. After this three-day period, the shrimps were allowed to acclimatize to the experimental conditions, including temperature, for one week.

Seawater was re-circulated and changed two to three times a week to remove metabolic wastes. The bottom of the aquaria was covered with a 5 cm deep layer of sediment taken from each location, washed with seawater, dried for 5 days at 60 °C and sieved through a 0.5 mm

sieve. Photoperiod was set to 12h light and 12h darkness. Room temperature was kept at 15 °C in Portugal and at 10 °C in Norway. In each basin, temperature and salinity were controlled independently and checked daily. A cooler was used to maintain a constant 10 °C water temperature in Portugal, while no device was necessary in Norway; the same way no device was used in the 15 °C treatment in Portugal. The other water temperature levels were maintained with water resistances.

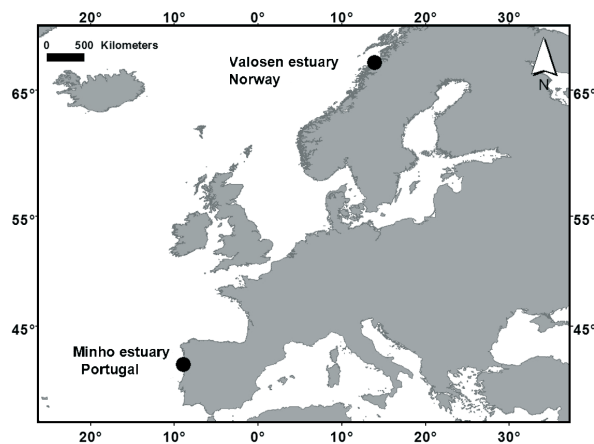

**Fig. 5.1.** Location of the sampling stations at the northern edge (Valosen estuary; 67°N; Bodø Norway) and at the southern edge (Minho estuary; 41°N; Caminha, Portugal) of *Crangon crangon* distribution.

After acclimatization, from each container five sets of five females and five males per 10 mm length class (Lk) were taken randomly. Shrimps were measured for initial total length (TL, from the tip of scophocerites till the end of folded uropods/telson) and an individual code was attributed to each animal before returning to the original container. During the trials, each shrimp was kept individually within the container, separated from the others by perforated plastic cages. Mean size at the beginning of the experiment varied from 25.6±0.18 mm for Lk2 size class (20 to 29 mm) to 33.6±0.24 mm for Lk3 (30 to 39 mm) at Minho and from 26.8±0.26 mm for Lk2 to 34.5±0.15 mm for Lk3 at Valosen. Mean initial size did not differ between sexes (ANOVA:  $F=3.161$ ,  $p=0.08$  and  $F=2.645$ ,  $p=0.104$ , respectively for Minho and Valosen) nor between temperature treatments (ANOVA:  $F=1.391$ ,  $p=0.24$  and  $F=1.028$ ,  $p=0.380$ , respectively for Minho and Valosen). Among latitudes, differences between mean initial size were also not significant (ANOVA:  $F=0.006$ ,  $p=0.94$ ).

During the experiment, all animals were provided with excess food on a daily basis, six to seven days a week, and checked individually for exuvium. The food consisted of frozen or fresh mussel (*Mytilus edulis*) meat for human consumption, in this way preventing an eventual presence of toxic algae, and was stored in a cooler. A number of mussels were cut in

small pieces and one to two pieces of meat were given to each shrimp on a daily basis. In Portugal, mussel meat was obtained in groceries; in Norway it was obtained directly at a local depuration centre. Before feeding, the remainders of the previous day were removed with a pincet.

Whenever a moult occurred, the shrimp's total length was measured in the two following days, the duration of the intermoult period was registered and the mean length after moulting was estimated. Every time a shrimp died it was substituted by another one from a replacement pool to allow compensating for mortality due to handling. Table 5.1 presents the duration, mean temperature and salinity, number of shrimps of each sex and size class for each group that survived at least one month and mortality rate after 30 days of running the experiment. At the end of the experiment (November 2006 and December 2006, respectively in Norway and in Portugal), and whenever a shrimp died, all individuals were measured for the final total length. Intermoult growth rate in length for each individual was calculated from the difference between total length after and before moulting divided by the number of days of the intermoult period.

**Table 5.1.** Experimental conditions: mean daily temperature and salinity, duration of each treatment, number of *Crangon crangon* individuals of each sex per 10 mm length class (Lk) which survived more than 30 days in the experiment and mortality rate (%) after 30 days of experiment for both studied populations.

Temperature (°C)	Salinity	Duration (days)	Number of shrimps				Mortality rate (%)
			Lk2		Lk3		
			females	males	females	males	
<b>Valosen</b>							
10.6±0.37	30.5±0.40	176	11	8	13	15	10
15.3±0.51	30.4±1.12	157	10	6	10	19	12
19.9±1.70	31.1±1.37	154	13	6	15	25	30
25.2±1.26	30.7±1.59	148	7	5	20	21	0
<b>Minho</b>							
10.6±0.87	29.1±1.18	150	16	16	17	7	45
15.8±0.46	28.4±0.37	86	13	3	20	1	0
20.2±1.18	29.6±1.45	188	16	21	23	20	39
24.7±0.95	30.3±1.17	155	28	20	27	17	48

### *Statistical analysis*

Since mortality was high at the beginning of the trials in three treatment levels (Table 5.1), only information from shrimps which survived at least 30 days in the trials was used in the data analysis. After this period, the survival rate was at least 50%. Shrimps from Minho estuary presented higher mortality rate after 30 days than shrimps from Valosen, though it

was null at the 15 °C treatment. All northern shrimps subjected to the warmest treatment (25 °C) also survived for at least 30 days.

Heteroscedasticity, i.e. whether the variance of the error terms differed across observations, was evaluated applying Levene's test, and the data was found to be homoscedastic ( $0.05 < p < 0.830$ ). All values of intermoult period, moult increment and daily growth rate at moult of each shrimp were pooled together in the statistical treatment, meaning that shrimps which moulted several times contributed with the same number of values for each variable as the number of moults. Since several individuals only moulted once during the experiment, a high number of missing values for subsequent moults was generated. Therefore, mixed linear model of analysis of variance, with 'individuals' nested within location as random factor, was applied to test the null hypothesis of no difference between variables at different temperatures and from different latitudes. Besides accounting for individual differences (correlation between measures on the same animal at different times), this method avoids needless loss of power due to missing values (Hopkins 2000).

First, for each population, temperature, sex and initial length class (10 mm Lk) were considered as fixed factors. Then, the effect of latitude as fixed factor was tested separately for each temperature treatment, because the random matrix was too large for the model to test all factors simultaneously. Interactions between factors were only tested when main terms were significant and only significant interactions were considered in the statistical analysis. Subsequently, Bonferroni's a posteriori multiple range tests were performed to determine which levels of temperature differed ( $p < 0.05$ ). The first moult was excluded from all calculations because the intermoult period was probably underestimated. Additionally, following Kuipers & Dapper (1984), a non-linear regression was performed considering daily growth rate (GR, mm d<sup>-1</sup>) as dependent variable and temperature (T, °C) and initial length (L, mm) as regressors. The resultant model follows the equation

$$GR = a + bT - cL$$

where a, b and c are constants. All tests were run using Systat 12.0.

## Results

For both areas, field temperature data was transformed to mean monthly water temperature after excluding values corresponding to emersion periods during low-water (Fig. 5.2). Temperature did not differ between years at both sites (ANOVA:  $F=0.365$ ,  $p=0.547$  and  $F=0.900$ ,  $p=0.344$ , respectively for Minho and Valosen data), even when restricting to the sampling period common for both locations (ANOVA:  $F=0.044$ ,  $p=0.833$ ). In contrast, water temperature was significantly higher at the southern site (ANOVA:  $F=49.912$ ,  $p < 0.001$ ) averaging during the common sampling period  $17.0 \pm 1.67$  and  $8.8 \pm 2.25$  °C, respectively at Minho and Valosen estuaries.

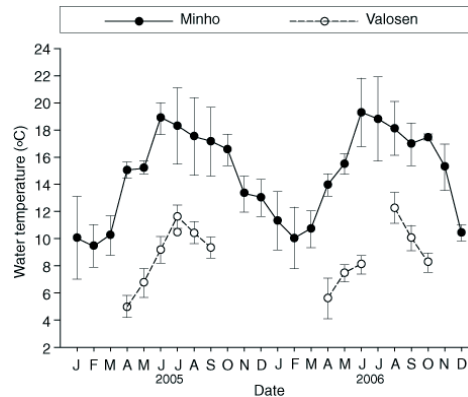

**Fig. 5.2.** Mean monthly water temperature (°C) and standard deviation at Minho and Valosen estuaries for the years 2005 and 2006. Data source: J. Campos & V. Freitas, unpubl.

### *Intermoult period*

The intermoult period was significantly different ‘within individuals’ at both locations (Table 5.2). In both areas, intermoult period was significantly shorter for females than for males (Table 5.2). Size only significantly affected the intermoult duration at Valosen (Table 5.2), with shorter intermoult periods for smaller shrimps (Fig. 5.3a).

Analysing fixed effects, the time between consecutive moults decreased significantly with increasing water temperature both at the northern and southern edge (Table 5.2). However, the impact of temperature differed (Fig. 5.3a, Table 5.3): at the northern edge the decrease was strongest between 10 and 15 °C (significant differences only between 15 and 20 °C, Table 5.3); while at the southern edge, the strongest effect occurred between 15 and 20 °C.

Intermoult period averaged from  $11.0 \pm 0.46$  days at 25 °C to  $26.7 \pm 0.63$  days at 10 °C for southern individuals and from  $10.3 \pm 0.77$  days to  $24.1 \pm 0.87$  for northern individuals (Fig. 5.3a). Although no significant difference was found at the two highest temperature treatments, at the other two levels (10 and 15 °C), shrimps from Minho showed significantly longer intermoult periods than shrimps from Valosen (Table 5.4). This difference was especially pronounced at 15 °C:  $24.5 \pm 0.79$  days for Minho shrimps and  $14.4 \pm 0.85$  days for Valosen’s.

### *Moult increment*

The size increment between moults was significantly different ‘within individuals’ from each location (Table 5.2) and showed a large variability at both locations (Fig. 5.3b). In general, size increment between moults was significantly smaller in males (Table 5.2), though smaller males presented higher increments than bigger ones while smaller females presented shorter increments than bigger ones at both locations but only at the two lowest temperatures (Fig. 5.3b).

**Table 5.2.** ANOVA results on the effects of temperature (T), sex and initial size class (Lk), individuals within location (ID(L)) and significant interaction terms on intermoult period (IP), moult increment (MI) and growth rate (GR) of *Crangon crangon* from Valosen and Minho populations.

Source	df	SS	F	p	df	SS	F	p
<b>Valosen</b>				<b>Minho</b>				
IP				IP				
T	3	28.605	56.63	<b>&lt;0.001</b>	3	110.238	141.73	<b>&lt;0.001</b>
Sex	1	13.060	4.61	<b>0.033</b>	1	145.746	5.52	<b>0.020</b>
Lk	1	95.643	9.09	<b>0.003</b>	1	277.208	3.05	0.081
T x Lk					3	24.152	4.43	<b>0.004</b>
ID(L)	155	71.739	4.10	<b>&lt;0.001</b>	173	63.423	3.55	<b>&lt;0.001</b>
Error	524	17.498			860	17.855		
MI				MI				
T	3	0.348	0.36	0.782	3	10.553	8.69	<b>&lt;0.001</b>
Sex	1	0.794	29.52	<b>&lt;0.001</b>	1	25.827	33.88	<b>&lt;0.001</b>
Lk	1	0.740	4.85	<b>0.028</b>	1	0.751	6.26	<b>0.013</b>
T x Lk	3	5.085	3.33	<b>0.019</b>	3	2.629	8.79	<b>&lt;0.001</b>
Sex x Lk	1	6.825	10.87	<b>0.001</b>	1	6.798	12.58	<b>&lt;0.001</b>
ID(L)	155	3.993	3.92	<b>&lt;0.001</b>	173	2.944	3.40	<b>&lt;0.001</b>
Error	524	1.018			860	0.866		
GR				GR				
T	3	0.005	8.89	<b>&lt;0.001</b>	3	0.049	8.21	<b>&lt;0.001</b>
Sex	1	0.016	38.97	<b>&lt;0.001</b>	1	0.360	33.12	<b>&lt;0.001</b>
Lk	1	0.036	21.64	<b>&lt;0.001</b>	1	0.116	22.85	<b>&lt;0.001</b>
T x Lk	3	0.022	3.76	<b>0.011</b>	3	0.032	7.62	<b>&lt;0.001</b>
Sex x Lk	1	0.030	11.67	<b>0.001</b>	1	0.079	11.67	<b>0.001</b>
ID(L)	155	0.023	4.05	<b>&lt;0.001</b>	173	0.023	2.59	<b>&lt;0.001</b>
Error	524	0.006			860	0.009		

At the northern edge, no clear trend between moult increment and temperature was found (Table 5.2), while at the southern edge, the picture was more complicated. Here, water temperature significantly affected moult increments (Table 5.2) and a slightly decreasing trend in increment size with increasing water temperature was found (Fig. 5.3b). Comparing both sites, moult increment was significantly larger at the northern location except at 15 °C (Table 5.3, Fig. 5.3b) and varied on average between 2.46±0.21 at 10 °C and 2.72±0.22 mm at 15 °C, and between 1.48±0.11 at 25 °C and 2.65±0.14 mm at 10 °C, respectively for shrimps from Valosen and Minho.

**Table 5.3.** Results of Bonferroni test between temperature levels on intermoult period (IP) and on growth rate (GR) of *Crangon crangon* from Valosen (upper half of each matrix) and from Minho estuary (bottom half of each matrix).

	IP	10°C	15°C	20°C	25°C	GR	10°C	15°C	20°C	25°C
10°C			<b>&lt;0,001</b>	<b>&lt;0,001</b>	<b>&lt;0,001</b>	10°C		<b>0,001</b>	<b>0,041</b>	<b>&lt;0,001</b>
15°C	0,160			1,000	<b>0,002</b>	15°C	1,000		0,934	1,000
20°C	<b>&lt;0,001</b>	<b>&lt;0,001</b>			<b>0,020</b>	20°C	<b>&lt;0,001</b>	<b>&lt;0,001</b>		<b>0,043</b>
25°C	<b>&lt;0,001</b>	<b>&lt;0,001</b>	0,059			25°C	<b>&lt;0,001</b>	<b>&lt;0,001</b>	1,000	

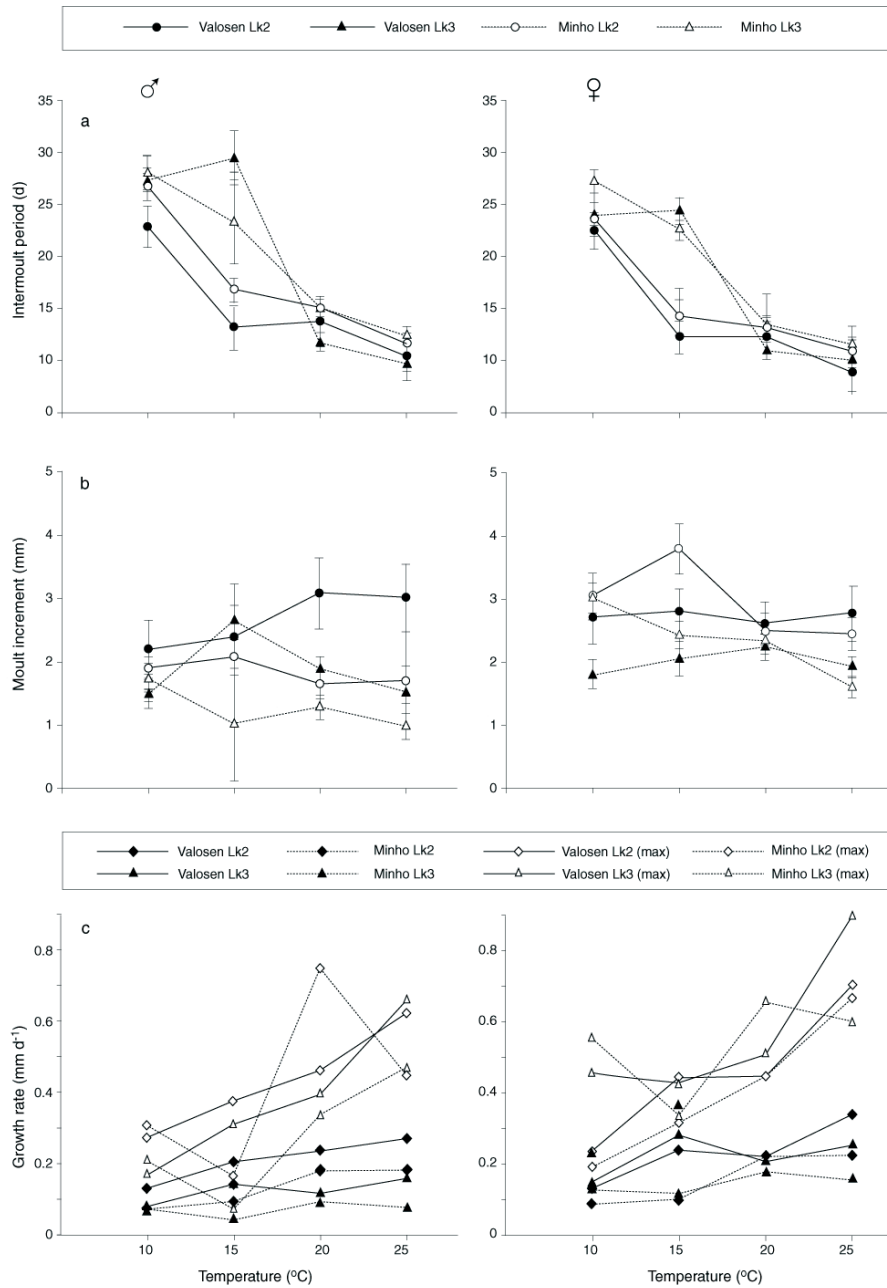

**Fig. 5.3.** (a) Mean intermoult period (days), (b) mean moult increment (mm) and (c) mean and maximum growth rates (mm d<sup>-1</sup>) of male (right panel) and female (left panel) *Crangon crangon* of Lk2 (20-29 mm) and Lk3 (30-39 mm) size classes in relation to water temperature (°C) for Valosen and Minho estuaries.



**Table 5.4.** ANOVA results for each temperature level on the effects of latitude (L), sex and initial size class (Lk), individuals within latitude (ID(L)) and significant interaction terms on intermoult period (IP), moult increment (MI) and growth rate (GR) of *Crangon crangon*.

source	df	SS	F	p	SS	F	p	SS	F	p
<b>IP</b>										
10°C										
L	1	530.775	5.33	<b>0.023</b>	22.615	7.87	<b>0.006</b>	0.075	10.88	<b>0.001</b>
Sex	1	64.533	0.47	0.496	4.219	1.06	0.306	0.009	1.02	0.316
Lk	1	360.739	11.97	<b>0.001</b>	0.008	0.01	0.937	0.020	7.17	<b>0.008</b>
Sex x Lk	1				1.801	1.38	0.242			
ID(L)	82	138.408	4.59	<b>&lt;0.001</b>	3.961	3.03	<b>&lt;0.001</b>	0.009	3.21	<b>&lt;0.001</b>
Error	208	30.132			1.308			0.003		
15°C										
L	1	4787.049	56.23	<b>&lt;0.001</b>	9.050	3.42	0.069	0.462	35.35	<b>&lt;0.001</b>
Sex	1	1473.150	25.28	<b>&lt;0.001</b>	14.446	8.26	<b>0.005</b>	0.000	0.04	0.844
Lk	1	62.528	2.23	0.137	8.287	11.28	<b>0.001</b>	0.012	4.20	<b>0.042</b>
ID(L)	62	95.685	3.41	<b>&lt;0.001</b>	3.004	4.09	<b>&lt;0.001</b>	0.015	5.03	<b>&lt;0.001</b>
Error	189	28.090			0.735			0.003		
20°C										
L	1	9.499	0.39	0.536	20.521	8.53	<b>0.004</b>	0.057	3.65	0.058
Sex	1	41.222	1.19	0.279	3.077	0.76	0.388	0.031	1.18	0.281
Lk	1	322.477	21.23	<b>&lt;0.001</b>	0.164	0.19	0.662	0.040	6.27	<b>0.013</b>
Sex x Lk	1				7.793	9.05	<b>0.003</b>	0.052	8.21	<b>0.004</b>
ID(L)	90	30.391	2.00	<b>&lt;0.001</b>	3.455	4.01	<b>&lt;0.001</b>	0.022	3.47	<b>&lt;0.001</b>
Error	442	15.193			0.861			0.006		
25°C										
L	1	4.651	0.24	0.625	54.519	23.07	<b>&lt;0.001</b>	0.511	17.42	<b>&lt;0.001</b>
Sex	1	143.271	4.17	0.045	20.442	4.00	<b>0.049</b>	0.291	4.68	<b>0.034</b>
Lk	1	289.975	25.36	<b>&lt;0.001</b>	20.263	22.21	<b>&lt;0.001</b>	0.660	54.84	<b>&lt;0.001</b>
ID(L)	92	25.327	2.22	<b>&lt;0.001</b>	3.462	3.79	<b>&lt;0.001</b>	0.042	3.52	<b>&lt;0.001</b>
Error	545	11436.000			0.912			0.012		

*Mean and maximum growth rates*

The overall average growth rate differed significantly ‘within individuals’ (Table 5.2). Significant differences between sexes were found, with males growing slower than females, as well as between size classes (Table 5.2). Yet, size interaction with sex and size interaction with temperature were also significant (Table 5.2): bigger females grew faster than smaller ones at the lowest temperature levels, but the smallest grew faster at the two highest temperature treatments; and smaller males grew faster than bigger ones (Fig. 5.3c).

The different effect of temperature on the size increment between moults in combination with the observed impact on the intermoult period resulted in significant differences in the temperature dependence of overall growth (Table 5.2). In general, daily growth rate at moult increased significantly with increasing temperature for shrimps from both areas (Table 5.2, Fig. 5.3c), but the impact of temperature on growth rate varied with latitude, inversely following the intermoult period trend. At Minho, the strongest temperature influence was observed between 15 and 20 °C (Fig. 5.3c), while at the northern location, despite a weaker trend, the increase in growth rate was the strongest between the two lower temperatures, 10 and 15 °C.

Boferroni's test (Table 5.3) revealed that for Valosen, growth rate increased significantly with temperature, though stabilizing between 15 °C and 20 °C. For Minho estuary, growth rate did not differ significantly between the two lowest temperatures and between the two highest temperatures. Thus, growth was stable between 10 and 15 °C, decreasing then significantly with increasing temperature, though being stable again between 20 and 25 °C.

**Table 5.5.** Percentage of moults which resulted in null and in negative growth rate of *Crangon crangon* from Valosen and Minho populations at each temperature level.

Population	Temperature (°C)	Null growth (%)			Negative growth (%)		
		males	females	both	males	females	both
<b>Valosen</b>	10	4.0	6.1	10.1			
	15	4.5	0.6	5.1			
	20	13.2	3.6	16.8			
	25	5.0	2.0	7.0			
	Total			10.1			
<b>Minho</b>	10	8.6	9.3	17.9	0.0	0.6	0.6
	15	0.0	2.4	2.4	0.0	1.2	1.2
	20	4.9	6.0	10.9	0.0	0.0	0.0
	25	2.9	6.1	9.0	0.8	0.6	1.4
	Total			10.4			1.2

The mean growth rate differed significantly between latitudes (Table 5.4). Shrimps from Valosen grew faster than shrimps from the Minho estuary at all temperature levels except females at 20 °C (Fig. 5.3c). Maximum growth rates were also higher for northern shrimps ranging from 0.17 for males Lk3 at 10 °C to 0.89 mm d<sup>-1</sup> for females Lk3 at 25 °C, while maximum growth rates of southern shrimps ranged from 0.08 for males Lk3 at 15 °C to 0.75 mm d<sup>-1</sup> for males Lk2 at 20 °C (Fig. 5.3c).

Though experimental conditions were designed for maximum growth, namely excess food was provided daily, remarkably in both populations at all temperature treatments up to 17.9% of the moults in a total of 1839 observed moults did not result in a size increase, i.e., size after moulting was exactly the same as before. Consequently, individual growth rate at

moult was null. Zero growth occurred in around 10% of the moults for both populations more frequently in males (Table 5.5). For Minho population negative values of growth rate were also observed in up to 1.4% of the total number of moults, though mainly in females (Table 5.5), due to a reduction in size after moulting.

**Table 5.6.** Parameters estimates, 95% confidence intervals (CI) and  $R^2$  values of the non-linear regressions with growth rate of *Crangon crangon* from Valosen and Minho populations as function of temperature and initial length.

Population/sex	Parameter	Estimate	Lower 95% CI	Upper 95% CI	$R^2$
<b>Valosen</b>					
males	a	0.296	0.223	0.369	0.656
	b	0.004	0.002	0.006	
	c	0.007	0.005	0.009	
females	a	0.257	0.166	0.348	0.693
	b	0.006	0.003	0.009	
	c	0.005	0.003	0.007	
<b>Minho</b>					
males	a	0.134	0.065	0.202	0.533
	b	0.005	0.002	0.007	
	c	0.004	0.002	0.006	
females	a	0.056	0.010	0.101	0.639
	b	0.006	0.004	0.007	
	c	0.001	0.000	0.002	

### *Growth function*

Since sex differences in growth rate were significant, the non-linear regression models were applied to males and females from each location separately. Therefore, it resulted in four growth functions, whose parameters and  $R^2$  are presented in Table 5.6. For both sexes, northern shrimps present higher initial growth rate ( $a$  parameter) than the ones from the southern population: initial growth rate of northern males is about twice as much and that of northern females is five times greater. For each location, males' initial growth rate was higher than that of females. In contrast, increase in growth rate with temperature ( $b$  parameter) was higher for females than for males from both locations, while males' growth rate was more dependent on initial length ( $c$  parameter) than females, resulting in a less steep rise of growth rate for males.

## **Discussion**

### *Factors determining growth*

*Crangon crangon* is very abundant along its wide distributional range between of 34 till 67°N within the NE Atlantic (Campos & Van der Veer 2008). Despite the distance separating the

populations of north Norway from those in Portugal, and though brown shrimp can and do migrate short distances avoiding unfavourable circumstances, its occurrence in such remote areas is a sign of a high capability to live under very different environmental conditions. Over such a latitudinal range, temperature might be the most relevant environmental factor affecting the species' life cycle. In fact, average water temperature in north Norway is almost half of the temperature in Portugal, respectively 8.8 °C at Valosen estuary, and 17.0 °C at Minho estuary for the period from April to September (Freitas et al. 2007; Campos & Van der Veer 2008).

Crustaceans such as *Crangon crangon* must discard their hard exoskeleton to be able to increase in size. During this short and sensitive period of moult or ecdysis, an increase in body size occurs as a consequence of water absorption (Nouvel-van Rysselberge 1937; Hagerman 1976). Later, during one to three days of a postmoult phase, the new exoskeleton hardens and water is replaced by body tissue. During intermoult period, next ecdysis is prepared by accumulating energy storage and forming a new exoskeleton, which may take around 13 to 30 days (Tiews 1970), and up to 60-70 days at temperature lower than 12 °C (Lloyd & Yonge 1947). Therefore, high growth rates in the brown shrimp can only be achieved by [1] an increase in size after moulting, [2] a decrease in the intermoult period duration, i.e. an increase in moult frequency, or [3] a combination of both.

In the present study, temperature mainly affected the duration of the intermoult period. Size increment after ecdysis was very variable especially for northern shrimps, while the time between moult events was consistently shorter with increasing temperature for shrimps from both studied areas. Nevertheless, trends in intermoult period were sufficient to cause a change in growth rate with temperature. A decreasing trend in the intermoult period with increasing temperature, as well as the inconsistent effect of temperature on size increments, has been observed previously in brown shrimp (Tiews 1954; Evans 1984) and in other crustaceans (Hartnoll 2001).

Temperature has a great effect on brown shrimps' growth rate, as in other crustaceans (Hartnoll 2001). Both juvenile and adult *C. crangon* are able to grow at least between 5 and 25 °C (M. Fonds, unpubl., cited in Van Lissa 1977). In general, growth becomes faster with increasing temperature (Meixner 1966; Tiews 1954; Duran 1997), but at highest temperatures growth may decline where it is associated with higher mortality (Hartnoll 2001). Such a decline at high temperature was not observed in the present study, and this fits with the estimation that the optimal temperature for *C. crangon* appears to be around 25 °C with a temperature tolerance limit as high as about 30 °C (Freitas et al. 2007).

Besides temperature, other abiotic factors such as the presence of sediment (Regnault 1976), light conditions (Plankemann 1935; Nouvel-van Rysselberge 1937) and salinity (Broekema 1942) might affect growth of *C. crangon*. In the present study, sediment was used and light conditions were controlled, but the impact of salinity was not incorporated, although controlled between 29 and 32 usp. The combination of small shrimps and relatively high

salinity might have interfered to some extent with present results since the salinity optimum seems to vary with shrimps' age and with temperature: *C. crangon* prefer more saline water as they grow (Broekema 1942).

Additionally, biotic factors, including shrimp's life stage, size/age and sex (Nouvel-van Rysselberge 1937; Lloyd & Yonge 1947; Meredith 1952; Tiews 1954; Meixner 1966; Evans 1984; Henderson & Holmes 1987; Duran 1997; Oh et al. 1999; Oh & Hartnoll 2000) and food conditions (Plagmann 1939; Meixner 1966; Evans 1984; Oh & Hartnoll 2000) might also interfere with growth. In the present study, females from both areas grew faster than males but differences with size were dependent on temperature and sex. Although excess of food was provided to allow maximum growth, a small percentage of individuals did not show any growth or even grew negatively, i.e. shortening after moult, suggesting suboptimal conditions. In the experiments, the diet was not varied to prevent an additional source of variability between the trials at the two locations. Hence, food quality might have been not adequate to promote maximum growth. In fact, the main food sources of *C. crangon* are small Crustaceans and Polychaets (Plagmann 1939; Evans 1984), though the naturally available species at the two locations are different. However, maximum growth rates obtained in this study (0.75 and 0.89 mm d<sup>-1</sup>, respectively for shrimps from Minho and Valosen estuaries) were higher than any other estimate reported in previous studies. In field works, lowest estimates, under 0.10 mm d<sup>-1</sup>, were found on the Isle of Man, 0.01 mm d<sup>-1</sup> (Oh et al. 1999), in the UK, 0.02 mm d<sup>-1</sup> (Duran, 1997), in the Baltic and in Germany, 0.03 mm d<sup>-1</sup> (Meyer 1936; Dornheim 1939); highest estimates, over 0.35 mm d<sup>-1</sup>, were determined in The Netherlands, 0.35-0.49 mm d<sup>-1</sup> (Boddeke et al. 1986; Kuipers & Dapper 1981, 1984; Cattrijsse et al. 1997). In laboratory, minimum estimates were found with shrimps from the Dutch Wadden Sea, 0.01 mm d<sup>-1</sup> (2 °C) (M. Fonds, person. comm.), from Scotland 0.02 mm d<sup>-1</sup> (10 °C) (Edwards 1978) and the Isle of Man, 0.0157 to 0.0267 mm d<sup>-1</sup> (15 °C), respectively for males and females (Oh et al. 1999; Oh & Hartnoll 2004); highest estimates were obtained with shrimps from the Isle of Man, 0.57 mm d<sup>-1</sup> (20 °C) (Dalley 1980), and with shrimps from the Dutch Wadden Sea and from Germany, 0.50 mm d<sup>-1</sup> (22 °C) (M. Fonds, person. comm.; Meixner 1969). The great variability found in growth rates estimates is related to the variable conditions in these works (temperature, food, size/age of shrimps). Yet, one major problem common to all studies, including the present one, which might explain such variability, is that no generation control was made: none of the works were performed with a strain from a laboratory stock, reared in a common environment for some generations. This condition would account for environmental effects on the progeny prior to undertake the experiments (Conover & Present 1990; Conover & Schultz 1995) and certainly would decrease variability in growth estimates under the same conditions. Also growth studies under ad libitum food conditions are required for comparisons with field observations.

*Does counter-gradient growth compensation occur?*

Counter-gradient growth compensation refers to adaptation to latitudinal or altitudinal gradients in the length of reproductive or growing seasons or in temperature (e.g. Berven et al. 1979; Conover & Present 1990; Kokita 2004).

*Compensation in length of season*

Information on latitudinal trends in *C. crangon* reproductive seasons is scarce, because only few studies were conducted at the edges of its distribution. In a latitudinal approach, Kuipers & Dapper (1984) suggested a shift from winter spawning season (the period of egg-bearing females occurrence) in the south towards winter to summer reproduction, at intermediate latitude, and autumn spawning in the north of brown shrimps' distribution. However, the information from low latitude referred to a Mediterranean population, and hence belonging to a distinct phylogeographic group (Luttikhuisen et al. 2008). In fact, in Mondego estuary (40°NL), Portugal, near the southern limit of the species distribution in the NE Atlantic, *C. crangon* reproduction occurs almost continuously throughout the year, with main spawning seasons in spring/summer besides winter (Viegas et al. 2007). Southerly, in Tagus estuary, reproduction also takes place all over the year, with main spawning in spring/summer (Marques 1982; Marques & Costa 1983). The autumn spawning of northern populations referred by Kuipers & Dapper (1984) is also incorrect. These authors based their description on Tiews (1970) who cited Woelleback (1908) imprecisely. In fact, Woelleback (1908) sampling took place from the 28<sup>th</sup> of November till the 8<sup>th</sup> of December 1898 at Brevik Fjord (59°NL), south of Oslo, Norway, and only one egg-bearing female was caught in the last day out of 20 individuals caught in the entire period. Woelleback (1908) also caught a single female with eggs on the 3<sup>rd</sup> of August 1898 off Jaederen (59°NL, south of Bergen). Hence, no clear information was obtained on reproduction period at northern latitudes, though it might correspond to early winter and summer at least. At Valosen estuary, egg-bearing females are present from April to August with maximum numbers in July (J. Campos, person. observation). Therefore, though a late autumn/early winter spawning is possible at deeper waters both in the northern and in the southern limits of the distributional range, reproduction occurs mainly in the same time period, during spring/summer, at both edges. Additionally, at intermediate latitude, winter and summer eggs can be distinguished based on size whereby winter eggs and larvae are larger (Boddeke 1982). No information exists to support a possible latitudinal trend on egg size.

With respect to length of the growing season, the experiments do not provide conclusive results, since they were restricted only to the temperature range above 10 °C. At 10 °C, growth of northern shrimps was higher than that of southern shrimps. Compensation in the length of the growing season would be possible if this pattern would prove to be consistent also at lower temperatures. However, this requires additional experiments at lower temperatures.

Moreover, water temperature and length of the growing season co-vary across the same environmental gradient, making it difficult to disentangle their unique effect.

*Compensation in growth rate*

Northern shrimps can also compensate for the shorter 'growing season' by growing very fast during the brief period of the year when relatively higher temperatures occur in their habitat. Despite the lower water temperature at north Norway, northern shrimps indeed grew at a faster rate than southern ones at most temperature levels tested. This suggests compensation in growth rate counteracting the latitudinal thermal gradient. Moreover, both at the lower and at the higher temperatures tested, 10 and 25 °C respectively, northern shrimps mean growth rate was also superior suggesting greater capacity for growth both at low and at high temperatures for the population from high latitude. The results are consistent with adaptation to length of the growing season: the highest growth capacity of high latitude individuals counteracting a decreasing gradient of the growing season duration.

However, with respect to the maximum growth rates observed, that of southern shrimps approached the values observed for shrimps from the north, but with differences in sex and size. Maximum growth of southern shrimps was even superior to northern shrimps' growth maximum at 10 and 20 °C. This raises some questions on the conclusions regarding counter-gradient growth compensation in brown shrimp based only on mean growth rates. Other aspects may also limit the conclusions. First, despite the effort to apply the same experimental procedures at both locations, the different laboratory set up might have partly influenced the results. Second, the scenario for egg and larval stages at different temperatures for populations from different latitudes should also be taken into account (Broekema 1942; Criales & Anger 1986). Euryplastic organisms such as brown shrimp tend to attain their highest 'non-genetic irreversible adaptation' to temperature during early life, decreasing thereafter (Kinne 1964) – the variability induced by abiotic conditions at a certain life stage still expresses itself on a functional level later on (Kinne 1962), as has been shown for growth and mortality in juvenile plaice (Van der Veer et al. 2000). Growth rate later in life might be more dependent on temperature conditions experienced during early life rather than during subsequent stages. Hence, 'maximum' acclimatation of a given latitudinal population might only be achieved in individuals born and raised in the test environment (Kinne 1964).

It is questionable whether compensation in growth may be an adaptation to cope with size-selective winter mortality, since the lowest temperature tolerance limit is at about 0°C (Freitas et al. 2007). Starvation may be one cause of size-selective winter mortality, and hence large size may provide more reserves to survive high latitude severe winters. Smaller shrimps have lower energy stores (c.f. Kooijman 2000), and may be more susceptible to mortality by exposure to low temperature than larger shrimps. Due to their higher capacity for growth, if northern shrimps were placed at a low latitude environment they would be expected to grow larger at the end of the growing season than the southern shrimps. Despite the more

favourable winter temperatures, southern shrimps do not grow faster. Though puzzling, some cost of rapid growth must limit southern individuals' growth capacity. In environments where food levels are low and temperature is high, especially during egg and larval periods, higher maintenance energy is required reducing the energy left for growth and reproduction. One option to cope with such a situation is a shift in energy flux between reproduction and growth (Kooijman 2000), explaining growth capacity reduction at least partly. Hence experiments with adult females should be conducted to clarify possible reductions in reproductive investment at lower latitude. Additionally, a more conservative response of growth rate to temperature could provide a better match between food requirements and the patterns of food availability at low latitude. In the case of Atlantic silverside (*Menidia menidia*), while northern faster growing fishes present higher food consumption and food conversion efficiencies, allocating a smaller portion of energy to maintenance and activity, slower growth of southern fishes seem to have evolved due to a reduction in maximum swimming capacity (Billerbeck et al. 2000).

In conclusion, despite experiencing a shorter growing season and a lower average temperature in their natural environment, northern shrimps grew faster than southern ones, which live in areas of longer growing periods and higher and consequently more favourable temperatures for growth. Therefore the capacity for growth increases with latitude, counteracting the decline temperature effect, and hence counter-gradient growth compensation seems to occur. The difference in performance of northern shrimps is greatest at the higher temperatures that enable growth. This means that the phenotypic plasticity of growth in relation to temperature seems to increase with latitude. However, it is unclear whether this is at the cost of the reproduction capacity. Moreover, despite the low-temperature adaptation of northern shrimps, shrimps' growth capacity does not seem to be adapted to the temperatures more frequently encountered in their environment, since northern shrimps grew faster at higher temperatures, levels at which southern shrimps would be expected to grow more rapidly if better adapted. Therefore, counter-gradient growth compensation was probably achieved by growing faster at higher latitudes within the short period of favourable temperatures and by expanding the growing season to periods of lower temperature.

**Acknowledgements** The authors would like to thank the staff from HIBO, NIOZ and CIIMAR who provided the means to accomplish this study namely to S. Skreslet, H. Witte, M. Krostad, E. Tryggestad, T. Skålsvik, H. Santos, J.C. Antunes, E. Martins and L. Guilhermino; and to the students who collaborated in rearing the shrimps especially to E. Dias, S. Santos, C. Mendes and M.J. Almeida. Thanks are also due to I. Tulp, A. Rijnsdorp and one anonymous referee for valuable comments on earlier versions of this paper. A. Marhadour revised the English. This work was partly funded by the EU RECLAIM project (REsolving CLimAtic IMPacts on fish stocks); EC Contract Number 044133.





## Chapter VI

# Population fluctuations of the brown shrimp *Crangon crangon* (L.) in the western Dutch Wadden Sea, The Netherlands

### Abstract

Long-term trends in the brown shrimp *Crangon crangon* population were studied near the entrance of the western Dutch Wadden Sea using a 34-year time series of fyke net catches. Over the years a general increasing trend in the catch was observed. During autumn, the abundance of the brown shrimp was on average five times greater, and interannual fluctuations were more pronounced as compared to spring. Time lag effects of up to one year were found, which are consistent with the species longevity and life cycle. The population seemed to respond rapidly to changes in environmental conditions: abrupt declines after exposure to adverse conditions, as in spring 1999, were followed by steep recoveries, already in the autumn of the same year. Two hypotheses were tested and discussed: [1] recruits in autumn are related to predator abundance and temperature during previous warmer seasons, and [2] overwintering adults' abundance is determined by predation pressure and abiotic conditions in winter. In general, predator abundance was the main factor related to brown shrimp abundance, especially for autumn catches. Multiple linear regression modelling even showed that predators altogether accounted for up to 55% of the explained variance in the spring and up to 85% of the explained variance in the autumn. Previous winter conditions such as sunshine duration, salinity and fresh water discharge from Lake IJssel into the Wadden Sea and NOAI were also related to autumn abundance. Yet, temperature conditions during previous growing season did not determine the autumn size stock. Winter sunshine duration and WNAOI were related to spring size stock. Additionally, temperature and salinity were relevant factors affecting this season abundance. A significant positive relationship between spring and autumn abundance and annual commercial landings was also found.

## Introduction

The brown or common shrimp *Crangon crangon* (L.) is one of the most abundant benthic species in shallow soft bottom areas along the European coast (Tiews 1970; Campos & Van der Veer 2008) with a clear population structure (Luttikhuisen et al. 2008). Due to its high abundance, *C. crangon* forms a key component of the trophic web: it is an extensive food source for several predators including fish, crustaceans and shorebirds (Pihl 1985; Henderson et al. 1992; Del Norte-Campos & Temming 1994; Walter & Becker 1997) and in turn it preys heavily upon numerous benthic species, such as bivalve spat and juvenile flatfish (Pihl & Rosenberg 1984; Van der Veer et al. 1991, 1998; Ansell & Gibson 1993; Oh et al. 2001; Amara & Paul 2003). Besides a relevant ecological role, brown shrimp is a valuable fisheries resource, especially in the North Sea (Polet 2002; ICES 2008).

In the Dutch Wadden Sea, situated at intermediate latitude within the brown shrimp distribution, egg bearing females can be found all year around, although mainly in summer and winter (Boddeke & Becker 1979; Boddeke 1982; Kuipers & Dapper 1984). The summer generation might be subjected to heavy predation pressure, resulting in high mortality and low contribution to the fisheries standing stock (Kuipers & Dapper 1984). In contrast, the larvae originating from winter eggs migrate into shallow nursery grounds where they settle in spring/summer (Boddeke & Becker 1976; Boddeke et al. 1976; Feddersen 1993), and grow and increase in mass until autumn (Boddeke 1976; Kuipers & Dapper 1984; Beukema 1992; Cattrijsse et al. 1997). Most shrimps reach maturity in the first autumn of life, and then migrate to overwintering grounds and are recruited into the commercial fishery. Part of the winter generation survives their first winter, returning to the nurseries the following spring when they become available to the fishery. At this time, the new winter generation also appears (Kuipers & Dapper 1984).

Despite these seasonal fluctuations, *C. crangon* is consistently highly abundant (Kuipers & Dapper 1984; Beukema 1992), and hence recruitment, measured as the number of juveniles joining the reproductive population, must be highly successful almost every year. However, the processes underlying recruitment of *C. crangon* juveniles to the adult stock are not clearly understood. Food availability (Broekema 1942; Lloyd & Yonge 1947; Beukema 1992), predation pressure (Cattrijsse et al. 1997) and environmental conditions, such as water temperature (Ehrenbaum 1890; Havinga 1930; Boddeke 1975; Boddeke et al. 1976; Kuipers & Dapper 1984; Del Norte-Campos & Temming 1998), salinity (Broekema 1942; Henderson & Holmes 1987; Spaargaren 2000), light intensity or day length (Spaargaren 2000) and dissolved oxygen (Attrill et al. 1999) have been related to the species recruitment.

A number of studies on the abundance of brown shrimp at intermediate latitude of distribution based on extensive time series of respectively 12 (Attrill et al. 1999), 30 (Boddeke 1968; Driver 1976; Welleman & Daan 2001) and 40 years (Spaargaren 2000) suggest that predation pressure might be the most important source of mortality (Henderson & Holmes 1989), though top-down control alone seems insufficient to explain recruitment

regulation. In German waters, a 30-year study showed recently that the abundance of *C. crangon* in autumn was mainly influenced by river in-flow, winter water temperature and Winter North Atlantic Oscillation Index (WNAOI) (Siegel et al. 2005). Nevertheless, none of these factors was found to influence brown shrimp's abundance in spring (Siegel et al. 2005). In contrast, in the Bristol Channel, the number of recruits was found to negatively correlate with WNAOI in autumn, and positively relate with river runoff and water temperature from January to August (Henderson et al. 2006). The severity of the winter and hence, winter temperature, has also been pointed out as determinant for interannual oscillations in brown shrimp's abundance: after severe winters, the brown shrimp is absent or scarce at places where it has been numerous previously. This is probably due to emigration to deeper (Beukema 1979) offshore waters (Boddeke 1975, 1976), causing later arrival of the new generation (Beukema 1992).

Only a few studies provide reliable information on juvenile abundance due to their presence over large areas and their continuous emigration to deeper waters as they grow (Del-Norte Campos & Temming 1998; Spaargaren 2000). To understand the key processes determining recruitment, we must rely on long-term data sets on adults. In the western Dutch Wadden Sea, near the island of Texel, a long-term fishing programme started in 1960. Fyke catches from this still ongoing project provide information on the abundance of adult brown shrimp and several of its predators. Seasonality in adult *C. crangon*'s abundance in this area is known to peak in spring and autumn (Spaargaren 2000), whereby autumn abundance represents emigration of mature shrimps towards overwintering grounds, and spring abundance corresponds to the overwintering immigration of adult shrimps returning to shallow waters. In the present paper, we have analysed which physical and biotic factors influence *C. crangon*'s abundance and its seasonal and interannual fluctuations in the Dutch Wadden Sea. The following hypotheses were defined:

1)  $H_0$ : The abundance of adults in autumn is determined by the abundance of predators and prevailing water temperature during the growing season;

2)  $H_0$ : The abundance of overwintering adults in spring is determined by predation pressure and environmental conditions during the winter.

The parameters used to test these hypotheses included predator abundance (as an indicator of predation pressure) and environmental variables which might reflect the seasonal conditions, such as water temperature, North Atlantic Oscillation index (NAOI), salinity, sunshine duration, daily precipitation, and fresh water flow into the Wadden Sea. Additionally, the relationship between brown shrimp's autumn and spring abundances and its commercial landings was analysed.

## Material and methods

### *Biological time series*

Monitoring started in 1960 near the southern part of Texel, de Hors, in the Marsdiep, at the entrance of the Dutch Wadden Sea (Fig. 6.1) and has been continued ever since. Fishing takes place using a passive trap belonging to the fyke nets (Nédélec 1982). This so-called 'fyke-kom' or 'kom-fyke' is a combination of a pound net and a fyke supported by wooden poles. It has a leader of 200 m running from above the high water mark into the subtidal region where two terminal chambers collect and catch fish and crustaceans (see Fig. 1 in Van der Veer et al. 1992). The mesh-size of the leader and the two chambers is 10 \* 10 mm. The tide in the area is dominated by the semidiurnal lunar tide, and the tidal range varies between 1 and 2 m depending on conditions (neap versus spring tide; day versus night, weather conditions). Normally, tidal current velocities in the fishing area do not exceed  $1 \text{ m s}^{-1}$ , except for periods with strong wind stress. Apart from wind and tidal influence, catching effort can be considered constant. Therefore, fyke catches were assumed to reflect the species abundance.

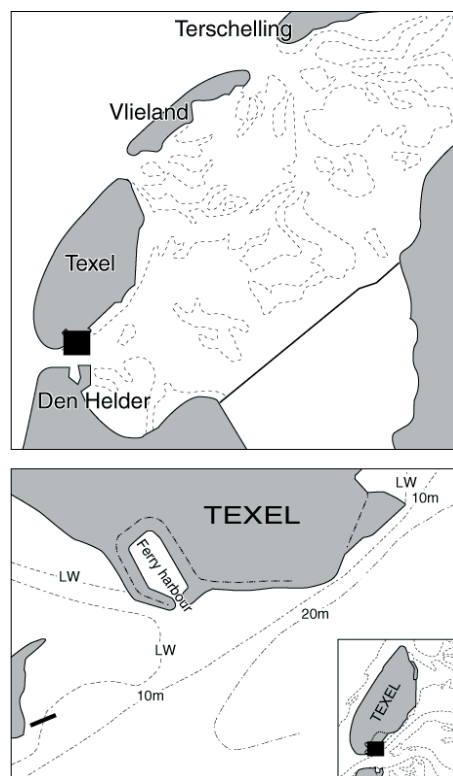

**Fig. 6.1.** Sampling location on the Texel island, Dutch Wadden Sea.

During winter, the kom-fyke is removed to avoid possible damage by ice floes. In summer, large amounts of jellyfish or macroalgae sometimes clog the net, rendering fishing impossible. Normally, the kom-fyke was emptied every morning from Monday to Friday irrespective of the tidal phase, except in case of bad weather conditions. When catches were low, the net was emptied every other morning. Only samples representing fishing periods of less than 48h were considered for the present analysis following Van der Meer et al. (1995), since longer periods may have resulted in net clogging or in losses due to decay or consumption (predation and cannibalism).

All fyke net catches were sorted immediately and identified to species. For each species, individuals were counted. However, when numbers were large, total wet mass was determined by species. Before data analysis, masses were transformed into counts, using a fixed ratio, i.e. a fixed mean individual mass based on actual measurements. All information was stored in a database for further analysis. Information on daily abundance (ind. d<sup>-1</sup>) of brown shrimp (CRANG) and potential predators grouped at Order level were then extracted from the database and mean daily abundances were determined for each season (see below). The potential predators included Clupeiforms (CLUP), Gadiforms (GAD), Perciforms (PERC), Scorpaeniforms (SCORP), Pleuronectiforms (FLAT) and Decapods (CRAB) (Tiews 1970; Vlas 1979; Pihl 1985; Henderson & Holmes 1989; Henderson et al. 1992; Hamerlynk & Hostens 1993; Berghahn 1996; Cattrijsse et al. 1997).

The present study was based on the data collected between 1974 and 2008, a period with consistent brown shrimp observations. To test the two hypotheses stated above, the respective response variables were defined as the brown shrimp abundance in autumn (representing emigrating adults), which was considered as the mean catches from September to November; and the abundance in spring (representing immigrating adults), which was considered as the mean catches of April to June. The mean catches of July and August (summer abundance) and the mean of the catches from December to March of the following year (winter abundance) were used as parameters to evaluate possible effects of past shrimp's abundances on these two response variables. Winter data were only available for 18 of the 34 years.

### *Environmental variables*

Spring and summer were considered as the growing seasons. The environmental variables chosen reflect to some extent the season's conditions and included water temperature, NAO index (NAOI), salinity, sunshine duration, daily precipitation and lake IJssel fresh water discharge. Time series of water temperature (°C) (Van Aken 2008b) and salinity (Van Aken 2008a) at the Marsdiep area, Texel, were available for the entire monitoring period. Seasonal temperature and salinity were determined by averaging respective monthly means, over the same seasons as for the biological data. NAOI data, which reflects the large-scale pattern of climate variability in the North Atlantic Ocean, is determined by the difference between the normalized sea level air pressure between the Azores and Iceland (Jones et al. 1997) and was

taken from NOAA/National Weather Service via <http://www.cpc.noaa.gov/index.php>. Winter NAO index (WNAOI) and extended WNAOI were determined as the average of NAOI from January to March and December to March, respectively. An average spring and autumn NAOI was also calculated with data from April to June and September to November, respectively. Meteorological information which included sunshine duration (SUN, 0.1 hour) and total daily precipitation (DAYPREC, 0.1 mm) was obtained from the Royal Netherlands Meteorological Institute. Data on the lake IJssel fresh water out-flow (DEBIET,  $\text{m}^3 \text{s}^{-1}$ ) into the western Wadden Sea at the Afsluitdijk area was obtained from Van der Hoeven (1982) for the period 1960-1975 and from the Rijkswaterstaat for the period 1976-2007.

For the period 1973-1994, annual commercial brown shrimp landings (LANDINGS, t) from the North Sea were obtained from producer organisations, and for the period 1995-2007, the information was taken from VIRIS log book data, which until 2003 also included landings in foreign harbours.

#### *Data analysis*

Data were log-transformed, if necessary, to achieve approximate normal distributions. General trend, seasonal trend and serial correlation in the spring and autumn shrimp catch data were analysed by means of an auto-regressive moving average, ARMA ( $p, q$ ) time series model (Brockwell & Davis 1996). To fit the ARMA noise model the sequence of observations has to constitute a weakly stationary process, i.e. a process with constant mean and variance. If necessary, data have to be transformed first in order to achieve stationarity. The noise model was chosen examining the sample and residual autocorrelation functions (ACF) and partial autocorrelation functions (PACF), and model parameters were estimated. The best of a series of alternative model complexities was selected based on the minimum biased-corrected Akaike information criterion AICC (Hurvich & Tsai 1989). For a detailed description of the ARMA modelling steps see Chapter 5 of Brockwell & Davis (1996).

A possible effect of previous brown shrimp abundances on seasonal observations was studied for the spring and autumn data sets separately. Analysing series of data from the same season, only long-term temporal relationships (yearly lags) could be examined. To assess medium-term seasonal effects, correlations with variables from previous seasons were also computed. Therefore, spring and autumn shrimp abundances were also correlated to biotic and abiotic data from previous seasons, allowing assessment of past population's (previous seasons' shrimp data) and predator or environmental conditions' effects.

Cross-correlations were computed between the seasonal shrimp abundances and abundances in the preceding spring and autumn seasons. Cross-correlations were also computed for the seasonal shrimp abundances and other biological (predators' abundances) and environmental variables. Cross-correlation analysis not only provided correlation values for time series but also showed possible temporal delay in correlation. A list of biological and environmental variables and their main statistics can be found in Appendix.

The influence of one or more different biotic and abiotic variables on brown shrimp abundances in spring and autumn was studied through multiple linear regression modelling (McCullagh & Nelder 1983). The functions relate spring or autumn shrimp abundances as response variable with seasonal predator abundances and seasonal environmental conditions. To test the hypotheses mentioned above including possible delayed responses of shrimp abundances to the predictor variables, the latter were taken from the response period and from previous seasons. Analysis for shrimp spring abundances considered: (1) shrimp data from the previous autumn and the previous spring; (2) and predator and (3) environmental data from the same period as the response variable, from the previous winter (when available) and the previous autumn (see Appendix). Analysis for shrimp autumn abundances considered: (1) shrimp data from the previous spring and the previous autumn, as well as (2) predator and (3) environmental data from the same period as the response variable, from the previous winter (when available), the previous summer and previous spring. Since biological winter data were scarce (only available for 18 years) two subsets were considered for each season: one considering only data available for the whole sampling period and a second including shrimp and predators winter data but consequently with less observations.

To avoid stepwise-model-selection pitfalls, we performed an all-subsets regression (Miller 2002) calculating models with all possible combinations of a given size (i.e including one predictor, 2 predictors, etc.). Considering sample sizes, we tested models with up to ten predictors for the first dataset ( $n=34$ ) and with up to seven predictors for the second ( $n=18$ ). The best two models of each size were submitted to leave-one-out cross-validation to aid model choice. Final models were chosen aiming at maximum parsimony and minimum cross-validation error, as well as inclusion of consistently chosen predictor variables. The relative importance of each predictor variable was determined by the averaging sequential sums of squares over all orderings of regressors (Lindeman et al. 1980). Residuals were tested for normality and for autocorrelation.

Time series analysis was undertaken in ITSM (Hyndman 1994) and all other statistical analyses were performed using R (R Dev. Core Team 2005).

## Results

### *Seasonal and inter-annual variability in shrimp abundance*

Brown shrimp abundance in the Wadden Sea showed approximately five times higher mean abundances and three times higher median abundances in autumn than in spring (Fig. 6.2, Appendix). Maximum abundance in spring occurred in 2000 (25 ind. d<sup>-1</sup>), with peaks in 1986, 1987, 1998, 2001 and 2006. The highest catch in autumn was observed in 1999, reaching 220 ind. d<sup>-1</sup> on average. Other peak abundances were observed in 1987, 1991, 1998 and 2003. Minimum spring abundance occurred in 1984 when no brown shrimp was captured. However, spring abundance was in general very low (6.1 ind. d<sup>-1</sup> on average) and average values of < 4



ind.  $d^{-1}$  were detected in several years (1976, 1977, 1980 to 1983, 1989, 1990, 1994, 1995, 1999, 2004 and 2005). The lowest autumn abundance recorded to date was also in 1984 with low values continuing for the following two years.

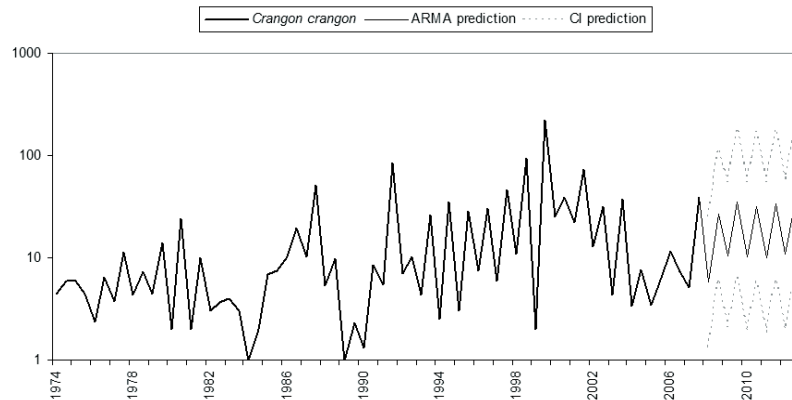
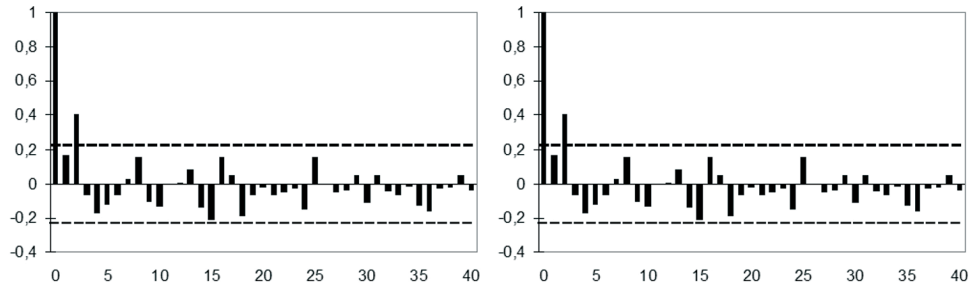

**Fig. 6.2.** Observed mean spring and autumn catch rate (ind.  $d^{-1}$ ) of *Crangon crangon* and ARMA forecast (logarithmic y-axis).

The shrimp abundance data series showed an increasing trend up to the early 2000's and a seasonal component reflecting the differences between spring and autumn. Linear trend and seasonal component were fitted to the transformed data using ordinary least-squares. The resulting linear trend for the log-abundances  $S(t) = 0.0196 t + 1.4864$  ( $t$ , time in half year periods), reveals an average increase of 1.02 per year for untransformed abundances. The seasonal components were  $-0.58277$  and  $0.58277$  for spring and autumn, respectively. The residual ACF and PACF (Fig. 6.3) obtained after the linear trend and the seasonal signal were subtracted from the data and showed that an ARMA (2, 2) model fitted the data well. This means that only data from the previous year (one spring and one autumn season) had a significant correlation with each observation. The obtained residual ARMA model was:

$X(t) = 0.6176 X(t-1) - 0.3665 X(t-2) + Z(t) - 0.5617 Z(t-1) + 0.8028 Z(t-2)$ , with a white-noise variance of 0.5586 and an accuracy parameter of 0.0012. A forecast for the five years following the sample period is shown in Figure 6.2, showing the increasing trend and forecast uncertainty.

The positive correlation between shrimp abundances and those observed during the previous year found in the time series analysis was also found in the correlation analyses (Table 6.1). Autumn abundance was significantly positively correlated to that of the previous autumn and to a lesser degree to that of the previous spring. Spring abundance was significantly positively correlated to that of the previous autumn. Note that all analyses were performed on log-transformed shrimp abundances.



**Fig. 6.3.** ACF (left) and PACF (right) with half-year lags, after subtracting the linear trend and the seasonal signal from the brown shrimp abundance data.

#### *Relationship between shrimp abundance, predators and environmental variables*

The natural logarithm was taken for all biological data (shrimp and predators abundance), since this transformation normalized these data adequately. Environmental data did not need to be transformed. Cross-correlations relating (log-transformed) shrimp data to (log-transformed) predator data and (non-transformed) environmental variables are presented in Table 6.1, including significant correlations for non-zero lags. In terms of predators, spring shrimp abundances were significantly positively correlated with Clupeiforms and negatively correlated with Decapods. Autumn shrimp abundances were also significantly positively correlated with the seasons Clupeiforms and Perciforms abundances, next to the Clupeiforms in the previous spring.

There was further a significant negative correlation with Scorpaeniforms and Pleuronectiforms abundances measured two years before. Both spring and autumn shrimp data were positively correlated to landings and to sunshine duration of the previous winter. Spring data were furthermore positively correlated with autumn water temperature, whereas autumn showed a negative correlation with the winter out-flow from lake IJssel. Cross-correlation functions (CCF) could not be calculated for winter biotic data due to the incomplete time series. Time series of the spring, autumn and winter (when available) data of the most relevant variables are shown in Figure 6.4.

#### *Regression models*

The two best models for each subset of predictor variables for the brown shrimp spring and autumn abundances are presented in Tables 6.2 and 6.3, respectively. Based on the sample size and the cross-validation error and its evolution with increasing model complexity, the following five-predictor model for the spring data was chosen:

$$\log(\text{CRANG}) = 1.465 + 0.313 \log(\text{CRANGa}) + 0.878 \log(\text{PERC}) - 0.386 \text{TEMP} - 0.611 \log(\text{GADa}) + 0.312 \text{TEMPa}$$

Population fluctuations

Table 6.1. Cross-correlation (CC) results (Pearson correlation) of spring and autumn *Crangon crangon* abundances to environmental variables from the current season (no subscript), and to predators and environmental variables from previous autumn (a), spring (s), summer (sm) and winter (w) seasons; codes according to Appendix. Whenever correlation was highest and significant for a non-zero lag, this lag and its correlation is also mentioned (Maximum lag, CC). Significant correlations are printed in bold; variables selected in the final multiple linear regression models (LM) are given (1 = model considering variables available for the whole time series, 34 samples; 2 = model including biotic winter variables, restricted to 18 samples).

Variable	Spring		Variable	Autumn		
	Zero-lag CC	LM		Zero-lag CC	Maximum lag	LM
CRANGa	<b>0.400</b>	1	CRANGs	<b>0.439</b>		
CRANGs	0.249		CRANGa	<b>0.582</b>		
CLUP	<b>0.390</b>		CLUP	<b>0.368</b>		
GAD	-0.181		GAD	-0.334		
PERC	0.222	1	PERC	<b>0.512</b>		1,2
SCORP	-0.218		SCORP	-0.230		
FLAT	-0.111		FLAT	-0.180	1	-0.326
CRAB	<b>-0.432</b>		CRAB	0.080		
TEMP	0.048	1	TEMP	0.002		
SAL	-0.232		SAL	-0.251		
SUN	-0.011		SUN	0.222		
DAYPREC	0.038		DAYPREC	0.013		
DEBIET	0.221		DEBIET	0.065		
CLUPa	-0.555		CLUPs	<b>0.499</b>		1
GADa	-0.297	1	GADs	-0.214		
PERCa	0.229	2	PERCs	0.040		
SCORPa	-0.234	2	SCORPs	<b>-0.334</b>		
FLATa	-0.201		FLATs	-0.234		
CRABa	-0.086		CRABs	-0.241	2	<b>-0.578</b>
TEMPa	<b>0.419</b>	1	TEMPs	0.276		
SALa	0.091	2	SALs	-0.061		
SUNa	0.129		SUNs	0.108		
DAYPRECa	0.025		DAYPRECs	0.142		
DEBIETa	-0.035		DEBIETs	0.055		
TEMPw	-0.039		TEMPW	0.002		
SALw	-0.073		SALw	0.105		1
SUNw	<b>0.392</b>		SUNw	<b>0.418</b>		
DAYPRECw	-0.045		DAYPRECw	-0.074		
DEBIETw	-0.130		DEBIETw	<b>-0.373</b>		1
			CLUPsm	0.205		1,2
			GADsm	-0.099		
			PERCsm	-0.070		
			SCORPsm	-0.103		
			FLATsm	-0.057		
			CRABsm	0.142	1	<b>0.458</b>
			TEMPsm	0.223		
			SALsm	-0.184		
			SUNsm	0.084		
			DAYPRECsm	0.015		
			DEBIETsm	0.031		
LANDINGS	<b>0.398</b>		LANDINGS	<b>0.465</b>		
NAOI	-0.051		NAOI	-0.173		2
WNAOI	-0.039	2	WNAOI	0.218		
exWNAOI	-0.046		exWNAOI	0.017		

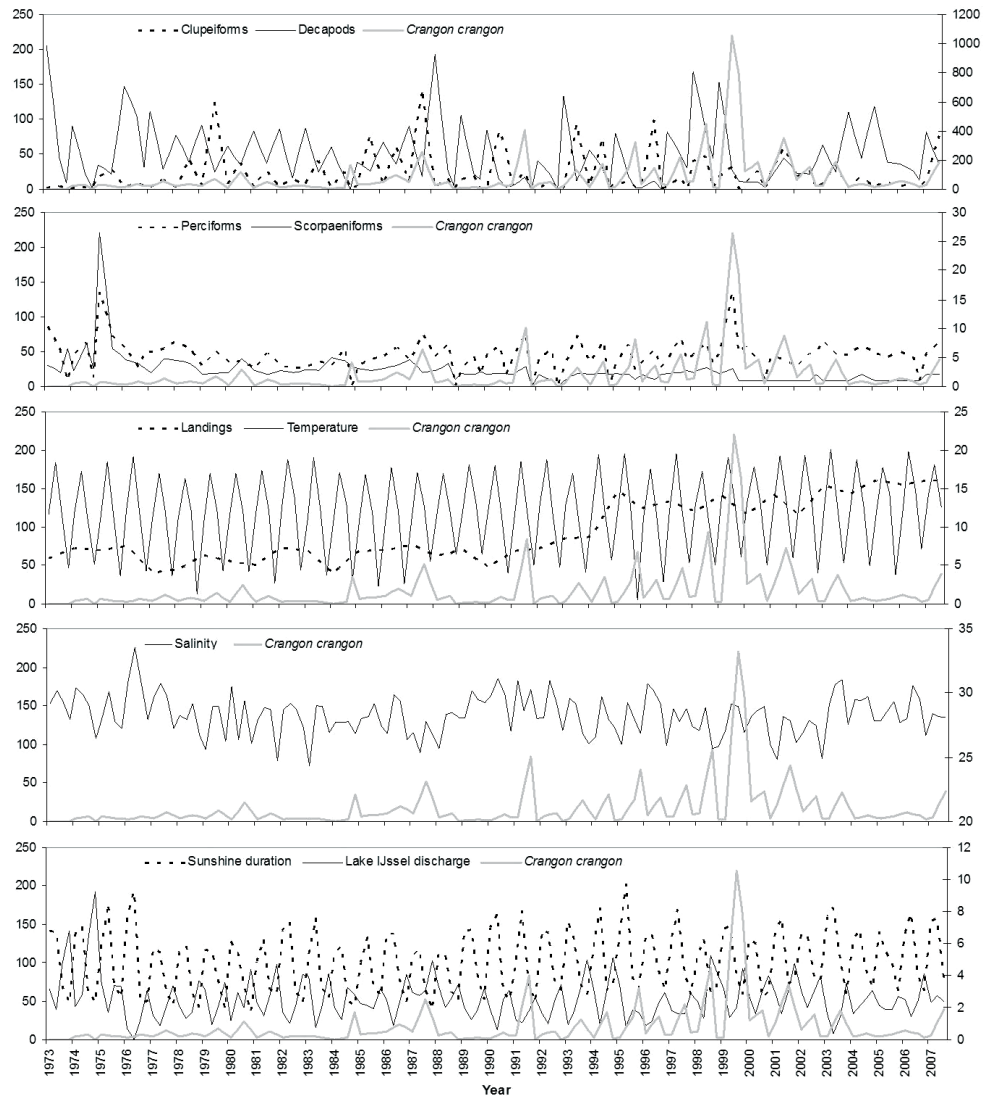

**Fig. 6.4.** Time series of the spring, autumn and winter (when available) abundance of *Crangon crangon* (left axis), Clupeiforms, Decapods, Perciforms and Scorpaeniforms, and annual commercial landings (1000 t), water temperature ( $^{\circ}\text{C}$ ), salinity, sunshine duration (d) and fresh water discharge from the Lake IJssel into the Wadden Sea ( $100 \text{ m}^3 \text{ s}^{-1}$ ).

with CRANG and CRANGa representing *C. crangon* abundance in spring and in the previous autumn, respectively, PERC the abundance of Perciforms, TEMP spring water temperature, GADa the abundance of Gadiforms in the previous autumn and TEMPa water temperature in

the previous autumn. All model terms were significant ( $\alpha = 0.05$ ). The model explains 56.9% of the variance, with CRANGa accounting for 32%, TEMPa for 27%, GADa for 15%, PERC for 14% and TEMP for 12% of the explained variance.

Table 6.2. The two best regression models with 1 to 10 model parameters (df) for the spring data excluding biotic winter-variables (n=34), their model terms, multiple  $R^2$  and leave-one-out cross-validation error (CV); selected model is printed in bold; codes according to Appendix.

df	Model terms	$R^2$	CV
1	TEMPa	0.175	0.407
	CRAB	0.186	0.415
2	CRAB+SAL	0.299	0.361
	CRANGa+TEMPa	0.323	0.359
3	CRANGa+TEMPa+WNAOI	0.407	0.335
	CRANGa+TEMP+TEMPa	0.408	0.335
4	CRANGa+TEMP+CLUPa+TEMPa	0.479	0.305
	CLUP+PERCa+TEMPa+exWNAOI	0.479	0.327
5	<b>CRANGa+PERC+TEMP+GADa+TEMPa</b>	<b>0.569</b>	<b>0.270</b>
	CLUP+GAD+ PERCa+TEMPa+exWNAOI	0.570	0.279
7	CRAB+SAL+ GADa+ PERCa+SALa+exWNAOI	0.618	0.281
	CRAB+DEBIET+ GADa+ PERCa+SALa+exWNAOI	0.620	0.283
6	CRAB+DEBIET+SUNw+GADa+ PERCa+SALa+exWNAOI	0.674	0.261
	CRANGs+CRAB+DEBIET+ GADa+ PERCa+SALa+exWNAOI	0.683	0.258
8	FLAT+CRAB+DEBIET+SUNw+ GADa+ PERCa+SALa+exWNAOI	0.714	0.239
	CLUP+CRAB+SAL+DAYPREC+ GADa+ PERCa+SALa+exWNAOI	0.715	0.247
9	CLUP+CRAB+SAL+DAYPREC+ SUNw+GADa+ PERCa+SALa+exWNAOI	0.742	0.241
	FLAT+CRAB+DEBIET+SUNw+ GADa+ PERCa+SALa+LANDINGS+exWNAOI	0.743	0.230
10	CRANGa+CLUP+DAYPREC+DEBIET+DAYPRECw+GADa+ PERCa+TEMPa+SALa+exWNAOI	0.767	0.225
	FLAT+CRAB+DEBIET+SUNw+DEBIETw+ GADa+ PERCa+SALa+LANDINGS+exWNAOI	0.768	0.219

For the autumn data the following model was selected:

$$\log(\text{CRANG}) = 9.588 + 2.265 \log(\text{PERC}) + 0.321 \log(\text{CLUPs}) + 0.172 \log(\text{CLUPsm}) - 0.438 \text{SALw} - 0.003 \text{DEBIETw}$$

with CRANG representing *C. crangon* abundance in the current autumn, PERC the abundance of Perciforms, CLUPs and CLUPsm the abundance of Clupeiforms in the previous spring and summer, respectively, SALw and DEBIETw salinity and discharge from the Lake IJssel into the Wadden Sea in the previous winter. All model terms were significant ( $\alpha = 0.05$ ). The model explains 79.0% of the variance, with PERC accounting for 39%, CLUPs and CLUPsm for 17% each, SALw for 16% and DEBIETw for 11% of the explained variance.

Table 6.3. The two best regression models with 1 to 10 model parameters (df) for the autumn data excluding biotic winter-variables (n=34), their model terms, multiple  $R^2$  and leave-one-out cross-validation error (CV); selected model is printed in bold; codes according to Appendix.

df	Model terms	$R^2$	CV
1	PERC	0.262	0.902
	CRANGa	0.339	0.806
2	PERC+CLUPsm	0.495	0.707
	CRANGa+PERC	0.513	0.613
3	PERC+SALw+DEBIETw	0.538	0.618
	PERC+CLUPs+SCORPs	0.643	0.507
4	PERC+CLUPsm+SALw+DEBIETw	0.735	0.405
	PERC+CLUPs+SALw+DEBIETw	0.686	0.501
5	CRANGs+PERC+CLUPs+SALw+DEBIETw	0.770	0.425
	<b>PERC+CLUPs+ CLUPsm+SALw+DEBIETw</b>	<b>0.790</b>	<b>0.370</b>
6	CRANGs+PERC+SUNsm+SALw+DAYPRECw+DEBIETw	0.819	0.320
	PERC+CLUPs+FLATs+CLUPsm+SALw+DEBIETw	0.831	0.302
7	CRANGs+PERC+DEBIETs+SUNsm+SALw+DAYPRECw+DEBIETw	0.859	0.265
	CRANGs+PERC+SUN+CLUPs+SCORPs+DEBIETs+SALw	0.863	0.283
8	CRANGa+PERC+FLATs+DAYPRECs+DEBIETs+CLUPsm+SUNsm+TEMPw	0.897	0.206
	CRANGs+PERC+SUN+DEBIET+CLUPs+SCORPs+DEBIETs+SALw	0.902	0.202
9	CRANGs+PERC+SUN+DEBIET+CLUPs+SCORPs+DEBIETs+SALw+NAOI	0.914	0.185
	CRANGa+PERC+CLUPs+FLATs+DAYPRECs+DEBIETs+CLUPsm+SUNsm+TEMPw	0.918	0.187
10	CRANGs+PERC+CLUPs+GADs+DEBIETs+GADsm+SUNsm+SALw+DAYPRECw+DEBIETw	0.930	0.165
	CRANGa+PERC+CLUPs+FLATs+DAYPRECs+DEBIETs+CLUPsm+SUNsm+TEMPw+NAOI	0.934	0.163

Model residuals were approximately normally distributed and did not present significant temporal autocorrelation (Fig. 6.5), suggesting that model parameters account for the autocorrelation found in the seasonal brown shrimp abundance data. Regression model predictions correlated closely with the measured abundances (Fig. 6.6).

Considering also winter shrimp and fish data as candidate predictor variables, and therefore only 18 sample years, the selected spring model was:

$$\log(\text{CRANG}) = -6.766 + 2.253 \log(\text{PERCa}) - 1.068 \log(\text{SCORPa}) + 0.199 \text{SALa} - 0.913 \text{WNAOI}$$

with CRANG representing spring *C. crangon* abundance, PERCa and SCORPa the densities of Perciforms and Scorpaeniforms of the previous autumn, SALa the salinity of the previous autumn and WNAOI the NAOI of the previous winter. All model terms were significant ( $\alpha = 0.05$ ). The model explains 79.5% of the variance, with PERCa accounting for 39%, WNAOI for 38%, SCORPa for 16% and SALa for 7% of the explained variance.

The autumn model was:

$$\log(\text{CRANG}) = -5.746 + 2.920 \log(\text{PERC}) + 0.542 \log(\text{CLUPsm}) + 0.433 \log(\text{PERCw}) - 1.060 \text{NAOI}$$

with CRANG representing autumn *C. crangon* abundances, PERC and PERw autumn and previous winter Perciforms abundance, respectively, CLUPsm abundances of Clupeiforms in

the previous summer and NAOI autumn NAOI. All model terms were significant ( $\alpha = 0.01$ ). The model explains 90.9% of the variance, with CLUPsm accounting for 36%, PERC for 33%, PERCW for 16% and NAOI for 15% of the explained variance.

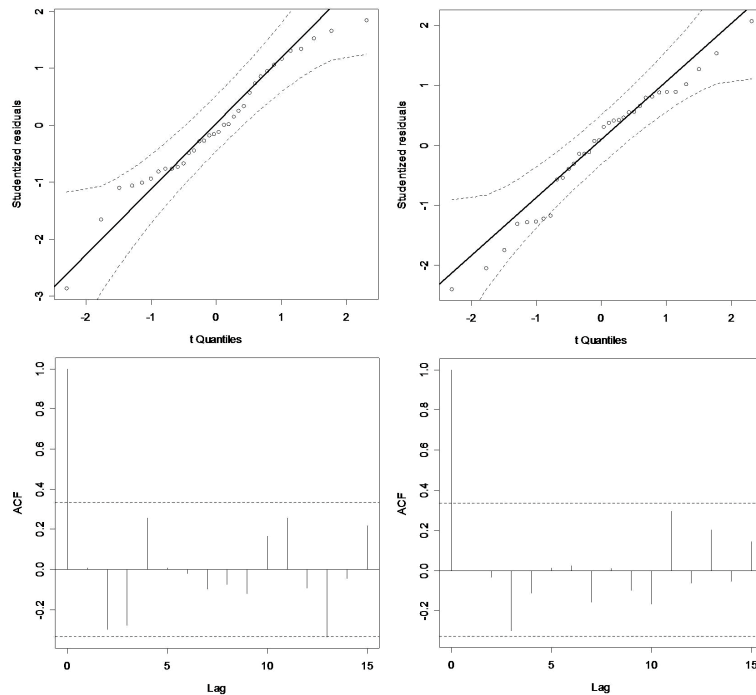

**Fig. 6.5.** QQ-plot of regression model residuals (upper graphs) and residual autocorrelation functions (lower graphs) for the selected spring (left) and autumn (right) regression models.

## Discussion

### *Long-term trends in annual abundance*

For the last 34 years, despite large fluctuations, the abundance of *Crangon crangon* in the Dutch Wadden Sea presented an overall increasing trend. ARMA prediction therefore showed a stable seasonal trend for the next five years. However, there seems to be a decreasing trend in the stock size after 2000, which was not analysed separately, as the available time series is presently too short for a sound time-series analysis on the divided data. Future monitoring shall reveal if and when brown shrimp abundance will recover from the recent downward trend. In the Bristol Channel, a general increasing trend was also found till 2005 (Henderson et al. 2006), while in the German Wadden Sea, no trend was found in brown shrimp densities between 1974 and 2002 (Siegel et al. 2005). Brown shrimp fishery in the North Sea has also

been increasing since the 1970s, despite a considerable decline from mid to late 1980s of about one third of previous landings, and reached a maximum of 16,000 t in 2006 (Dutch landings) (ICES. 2008). However, it should be kept in mind that this increase in landings is also partly due to an increase in fishing effort.

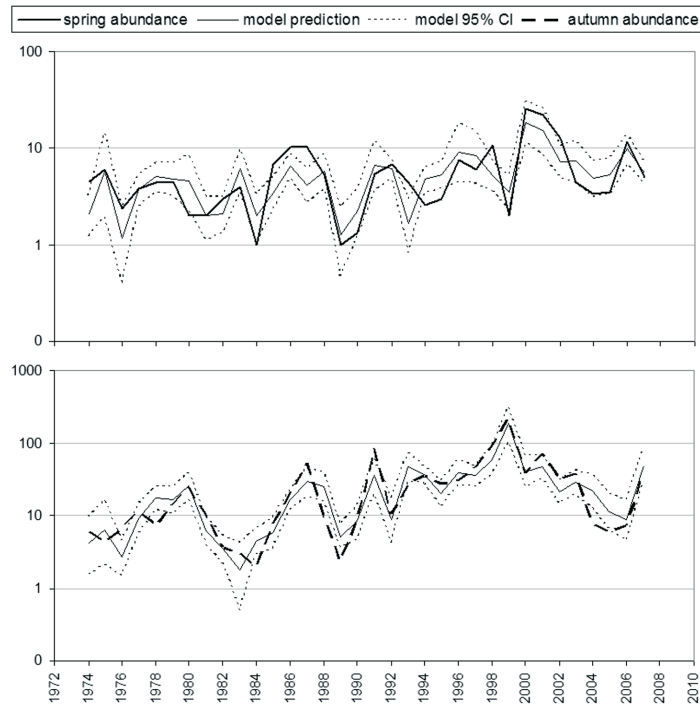

**Fig. 6.6.** Spring and autumn *Crangon crangon* abundances, regression model predictions and their 95% confidence intervals (CI).

In addition to the long-term increasing trend, seasonality in brown shrimp abundance was observed with considerably lower (five times) abundances in spring compared to autumn. This is a common observation (Siegel et al. 2005; Henderson et al. 2006), reflecting shrimp production in the coastal zone (Kuipers & Dapper 1984). Also commercial landings are greatest in autumn and lowest in spring (ICES 2006). Since the fyke mesh size (10 \* 10 mm) was too large to capture the small juveniles entering the Wadden Sea, the observed low spring abundance represents the adult shrimps which have overwintered offshore (Temming & Damm 2002) and survived winter mortality; while the large autumn abundance represents mature shrimps leaving the nurseries to the overwintering areas in the coastal zone. The variability of spring abundance was also lower than that of autumn, as revealed by the



deviation in relation to the mean (see Appendix); spring abundance was consistently low, while autumn fluctuations were more pronounced. This is the opposite of what was found in the German area, with more relatively stable autumn densities in comparison to spring densities (Siegel et al. 2005).

Some peaks and lows in brown shrimp abundance in the Dutch Wadden Sea coincided with or occurred close to those observed in time series from other sites. The 1987 autumn peak of the present study preceded the 1988 maximum observed in the Bristol Channel and followed the 1986 peak in the German Bight; the 2003 peak in the Dutch Wadden Sea followed the 2002 autumn maximum in the Bristol Channel; and the 1998 spring peak coincided in the Dutch and the German Wadden Sea. From 1976 to 1978 spring minima were registered both in the German and in the Dutch Wadden Sea; the 1983 and 1989/90 spring minima of the present study preceded respectively the 1984 and the 1991 minima in the German area. Other fluctuations did not correspond with the dynamics observed at the other two locations and might be related to local conditions. Regional variability has been detected in three areas of the German Bight, with occasional opposing trends in abundance for the same year (Siegel et al. 2005).

#### *Seasonal trends in abundance*

Brown shrimp life cycle follows a seasonal pattern. At intermediate latitude of distribution (around 45-55° north), reproduction occurs in more saline waters throughout the entire year with spawning peaks in spring-summer and winter (Boddeke 1982; Kuipers & Dapper 1984; Henderson & Holmes 1987; Oh & Hartnoll 2004). Pelagic larvae are found over almost the entire year (Lebour 1947; Kuhl & Mann 1963; Van der Baan 1975), though mostly from May to September (Plett 1965; Feddersen 1993), migrating into shallow nurseries often situated in estuaries. Hence, the bulk of larval settlement takes place in the warmer seasons (Kuipers & Dapper 1981) and might contribute for the high autumn recruitment to fisheries (Kuipers & Dapper 1984). Remarkably, over the period of scientific observation, *C. crangon* recruitment has been very successful. The same way, in most years and across its geographic distribution *C. crangon* is continuously highly abundant in shallow coastal areas (Campos & Van der Veer 2008).

Time-series and cross-correlation analysis revealed population effects with lags of up to 1 year (i.e. one spring and one autumn season), which is consistent with *Crangon crangon*'s life history, namely with its longevity of 1-3 years (Campos & Van der Veer 2008). Given the short life span of the species, rapid seasonal changes in abundance could be expected, with abrupt drops due to adverse environmental conditions, and steep recoveries under favourable circumstances. Such rapid changes of abundance were observed in the present study in 1999: a spring minimum was followed by an autumn maximum in the same year. This was the maximum for the entire time-series.

### *Factors affecting autumn abundance*

Apart from previous shrimp abundances (representing temporal autocorrelation), other variables were related with the size of autumn recruits' stock. As hypothesized, predator abundance was observed to consistently influence brown shrimp autumn abundance, explaining up to 85% of the variance in autumn models when considered altogether, reflecting their high importance. Predation and even cannibalism, which represents about 20% of the species annual food consumption (Pihl & Rosenberg 1982), are known to be important causes of brown shrimp natural mortality (Henderson & Holmes 1989), though fluctuations in predators' abundance might be difficult to relate with *C. crangon* stock fluctuations (Henderson et al. 2006).

Concerning the predators groups, Clupeiforms, Perciforms, Scorpaeniforms, Pleuronectiforms and Decapods were the groups with the greatest influence in autumn, though the last two with one and two years lag, respectively. Autumn *C. crangon* abundance was positively cross-correlated with the Clupeiforms, which comprised mostly herring, *Clupea harengus*, but included also twaite shad, *Alosa fallax*, and was further related to the abundance of this group in the previous spring. Clupeiforms are planktivorous (Dalpadado et al. 2000) and, hence, do not feed on adult shrimps. The positive correlation between *C. crangon* and Clupeiforms abundances suggests that they share environmental resources but do not compete. However, Clupeiforms might feed on *C. crangon* planktonic larvae, which would explain the time lag between autumn abundance and spring fish abundance. Perciforms were also positively cross-correlated with autumn abundance and a selected term in the models. In contrast, shrimp abundance was negatively related to Scorpaeniforms and Decapods probably due to mortality losses by predation. The Decapods group included only the crab *Carcinus maenas* and was the second most abundant group in the entire time-series, following the Clupeiforms, while the Scorpaeniforms group was the least abundant predators group on average.

The environmental variables which were related to autumn brown shrimp abundances were (1) sunshine duration, (2) salinity, (3) out-flow from the Lake IJssel into the Wadden Sea, and (4) NAOI, the first three during winter. However, temperature conditions during the growing season (spring and summer) were not related with the autumn stock, contradicting hypothesis 1. Autumn abundances were more closely related to previous winter conditions. Winter sunshine duration was positively correlated with autumn abundance, while salinity and out-flow from the Lake IJssel, both from the previous winter, were negatively related to autumn stock. Therefore, winters with more saline conditions, probably associated with lower precipitation and out-flow from the Lake IJssel, favour autumn recruitment. Salinity directly affects brown shrimp ecophysiology and influences its migration; it also indirectly influences the stock through changes in productivity and hence food availability. River discharge also affected the autumn recruitment in the Bristol Channel (Henderson et al. 2006) and in the

German Bight (Siegel et al. 2005). Finally, NAOI was only a relevant factor in the model when including the winter variables.

### *Factors affecting spring abundance*

*C. crangon* adult stock in spring (recruits) was positively related with the previous autumn recruitment, but not with the adult stock in spring one year earlier. This was expected since spring population represents overwintering adults and hence belongs to the same generation as previous autumn population. In addition, the abundance of predators was also very relevant determining shrimp stock, though with less importance than in autumn, explaining up to 55% of the spring models' variance. This supports the hypothesis that shrimp abundance depends mainly on predator abundance, especially in autumn. Although the research hypothesis considered predation impact during winter, the fyke catch in this season might not correspond to the predators affecting shrimps in the overwintering areas since they migrate offshore.

Apart from Pleuronectiforms, the same groups which were related to autumn abundance also affected the stock in spring, but Clupeiforms were more important in spring and Perciforms in autumn. During spring, Clupeiforms were positively, whereas Scorpaeniforms and Decapods were negatively related to shrimp abundance. Finally, Gadiforms abundance in autumn was included in the spring model and negatively related to shrimp abundance. Despite including whiting *Merlangius merlangus*, a very abundant and important potential predator of brown shrimp (Henderson & Holmes 1989; Henderson et al. 1992; Hamerlynk & Hostens 1993; Singh-Renton & Bromley 1999), Gadiforms did not show a significant cross-correlation with the Dutch Wadden Sea shrimp stock, contradicting the observations in the German area (Siegel et al. 2005) and in the Bristol Channel (Henderson et al. 2006). However, the abundance of Gadiforms was correlated with the abundance of other predators, especially Scorpaeniforms. Therefore, the effect of Gadiforms might have been expressed in the models by a confounding variable.

Environmental conditions correlated to brown shrimp spring abundances included (1) winter sunshine duration, (2) temperature, (3) autumn salinity and (4) winter NAOI. While winter sunshine duration, temperature and salinity, both in autumn, were positively related with spring abundance, spring temperature and WNAOI were negatively related. However, as in autumn, WNAOI which was previously considered important in the Bristol Channel (Henderson et al. 2006), only revealed to be relevant when including the winter variables, accounting for 38% of the explained variance in the spring model.

The hypothesis established for the spring season considered only winter conditions. Yet, only sunshine duration in winter was determinant. Its positive relationship with brown shrimp size stock in spring and also in autumn suggests that mild winters with more clear days favours the increase of the stock later in the year, which might be related with an overall increase in the productivity of the area. On the contrary, after severe winters with lower mean sunshine duration, brown shrimp abundance decline and the species might even be practically

absent, as has been observed previously on the Wadden Sea tidal flats (Beukema 1992). This confirms the hypothesis that spring abundance is determined by the severity of winter conditions. Nevertheless, in the present study, winter sunshine duration was not correlated with any other winter environmental variable, such as temperature.

In conclusion, over the last 34 years, a general increasing trend in the abundance of *Crangon crangon* in the western Dutch Wadden Sea was observed which is consistent with trends observed in other areas and reported by fisheries. Autumn abundance was five times higher than spring abundance and presented more pronounced variability, which conforms to brown shrimp life cycle. The abundance of adults in autumn was positively related to predator abundance, while the abundance of overwintering adults in spring was related to the severity of winter conditions besides predation pressure. The chosen multiple regression models for the spring and autumn time-series fitted the data very well, especially the autumn models which explained up to 90.9% of the variance. Less or more complex models could have been chosen, and also different models of the same complexity, as some of the biotic and abiotic variables available for regression modelling are correlated and may produce similar results in a multiple regression model. It will be interesting to validate the selected and alternative models on future brown shrimp data, which is still being sampled. More data will allow a better insight into the effects of climate variables and predation pressure on brown shrimp abundances and confirm or refute the recent downward trend in shrimp population.

**Acknowledgments** The authors would like to thank M. Boos, P. Henderson, I. Tulp and A. Rijnsdorp for critical comments on a previous version of this manuscript. P. Henderson revised the English and I. Tulp provided data on shrimp commercial landings. This work was partly funded by Fundação para a Ciência e a Tecnologia (Portugal) through a grant attributed to J. Cardoso (SFRH/BPD/34773/2007).

**Appendix** Variables codes, description, minimum, maximum, median, mean and standard deviation (sd) for spring and autumn datasets. (abundance in ind d<sup>-1</sup>, temperature in °C, sun duration in 0.1 h, precipitation in 0.1 mm, Isssel Lake flow in m<sup>3</sup> s<sup>-1</sup>, landings in t)

Code	Description	Spring				Autumn					
		max	min	median	mean	sd	max	min	median	mean	sd
CRANG	<i>Crangon crangon</i> daily abundance of current season	25.38	0.00	4.43	6.14	5.49	220.14	2.00	12.71	29.61	41.06
CRANGs	<i>Crangon crangon</i> daily abundance of previous spring	25.38	0.00	4.34	5.99	5.59	25.38	0.00	4.43	6.14	5.49
CRANGa	<i>Crangon crangon</i> daily abundance of previous autumn	220.14	0.10	10.78	28.48	41.33	220.14	0.00	10.78	28.48	41.33
CLUP	Clupeiforms daily abundance of current season	188.78	3.24	20.88	35.48	39.25	686.39	12.52	127.11	200.50	170.06
CLUPs	Clupeiforms daily abundance of previous spring						188.78	3.24	20.88	35.48	39.25
CLUPsm	Clupeiforms daily abundance of previous summer						2623.98	3.25	72.66	189.03	472.56
CLUPa	Clupeiforms daily abundance of previous autumn	686.39	12.52	124.66	190.39	170.15					
CLUPw	Clupeiforms daily abundance of previous winter	294.23	0.00	2.47	20.24	68.69	294.23	0.00	2.47	20.24	68.69
GAD	Gadiforms daily abundance of current season	19.64	4.49	8.01	9.09	4.06	34.10	3.34	8.29	10.26	6.25
GADs	Gadiforms daily abundance of previous spring						19.64	4.49	8.01	9.09	4.06
GADsm	Gadiforms daily abundance of previous summer						31.92	1.00	6.44	8.86	7.72
GADa	Gadiforms daily abundance of previous autumn	34.10	3.34	8.29	10.23	6.28					
GADw	Gadiforms daily abundance of previous winter	13.77	0.00	3.49	4.54	4.03	13.77	0.00	3.49	4.54	4.03
PERC	Perciforms daily abundance of current season	16.31	3.00	5.05	5.23	2.34	16.31	3.22	6.46	6.60	2.32
PERCs	Perciforms daily abundance of previous spring						16.31	2.20	4.01	4.48	2.34
PERCsm	Perciforms daily abundance of previous summer						13.07	1.00	4.47	4.93	2.44
PERCa	Perciforms daily abundance of previous autumn	16.31	3.22	6.37	6.56	2.32					
PERCw	Perciforms daily abundance of previous winter	6.00	0.00	1.79	2.30	2.18	6.00	0.00	1.79	2.30	2.18
SCORP	Scorpaeniforms daily abundance of current season	26.52	1.00	2.17	3.07	4.29	7.42	1.00	2.33	2.76	1.56
SCORPs	Scorpaeniforms daily abundance of previous spring						26.52	1.00	2.17	3.07	4.29
SCORPsm	Scorpaeniforms daily abundance of previous summer						7.03	0.00	1.00	1.19	1.59
SCORPa	Scorpaeniforms daily abundance of previous autumn	7.42	1.00	2.38	2.77	1.55					
SCORPw	Scorpaeniforms daily abundance of previous winter	6.50	0.00	2.11	2.11	1.50	6.50	0.00	2.11	2.11	1.50
FLAT	Pleuronectiforms daily abundance of current season	39.02	7.62	11.70	14.84	7.74	20.70	5.17	9.01	10.01	3.53
FLATs	Pleuronectiforms daily abundance of previous spring						39.02	7.62	11.70	14.84	7.74
FLATsm	Pleuronectiforms daily abundance of previous summer						29.71	3.78	12.27	12.97	5.88
FLATa	Pleuronectiforms daily abundance of previous autumn	20.70	5.17	9.15	10.07	3.51					
FLATw	Pleuronectiforms daily abundance of previous winter	101.50	0.00	5.06	12.84	23.52	101.50	0.00	5.06	12.84	23.52
CRAB	Decapods daily abundance of current season	926.96	8.29	391.62	379.12	222.15	495.14	49.92	118.76	144.31	90.54
CRABs	Decapods daily abundance of previous spring						926.96	8.29	391.62	379.12	222.15
CRABsm	Decapods daily abundance of previous summer						1999.41	16.62	202.91	353.51	432.93

Appendix (Cont.)

Code	Description	Spring					Autumn				
		max	min	median	mean	sd	max	min	median	mean	sd
CRABw	Decapods daily abundance of previous winter	211.33	0.00	20.25	55.17	68.62	211.33	0.00	20.25	55.17	68.62
TEMP	Water temperature of current season	14.24	10.60	11.91	11.96	0.95	14.77	10.70	12.17	12.45	0.91
TEMPs	Water temperature of previous spring						14.24	10.60	11.91	11.96	0.95
TEMPsm	Water temperature of previous summer						20.07	16.30	18.05	18.14	1.04
TEMPa	Water temperature of previous autumn	14.77	10.70	12.17	12.44	0.91					
TEMPw	Water temperature of previous winter	6.48	0.51	4.35	4.30	1.37	6.48	0.51	4.35	4.30	1.37
SAL	Salinity of current season	30.93	24.33	28.04	28.08	1.69	31.04	25.68	28.95	28.82	1.09
SALs	Salinity of previous spring						30.93	24.33	28.04	28.08	1.69
SALsm	Salinity of previous summer						33.50	25.40	29.10	29.14	1.47
SALa	Salinity of previous autumn	31.04	25.68	29.00	28.86	1.08					
SALw	Salinity of previous winter	29.25	24.74	26.99	26.95	0.94	29.25	24.74	26.99	26.95	0.94
SUN	Sun duration of current season	7.69	4.79	6.41	6.25	0.81	5.07	2.41	3.36	3.47	0.61
SUNs	Sun duration of previous spring						7.69	4.79	6.41	6.25	0.81
SUNsm	Sun duration of previous summer						9.78	5.35	6.77	6.94	1.15
SUNa	Sun duration of previous autumn	5.07	2.41	3.35	3.46	0.61					
SUNw	Sun duration of previous winter	3.74	1.73	2.59	2.66	0.50	3.74	1.73	2.59	2.66	0.50
DAYPREC	Total daily precipitation of current season	2.42	0.49	1.63	1.53	0.42	5.33	1.67	2.86	2.92	0.83
DAYPRECs	Total daily precipitation of previous spring						2.42	0.49	1.63	1.53	0.42
DAYPRECSm	Total daily precipitation of previous summer						4.50	0.37	1.85	2.10	1.07
DAYPRECa	Total daily precipitation of previous autumn	5.33	1.67	2.92	2.94	0.81					
DAYPRECw	Total daily precipitation of previous winter	3.01	0.94	1.93	1.91	0.55	3.01	0.94	1.93	1.91	0.55
DEBIET	Lake IJssel flow into the Wadden Sea of current season	390.74	65.78	220.23	224.57	81.52	630.00	119.38	237.20	255.46	100.74
DEBIETs	Lake IJssel flow into the Wadden Sea of previous spring						390.74	65.78	220.23	224.57	81.52
DEBIETsm	Lake IJssel flow into the Wadden Sea of previous summer						292.45	0.00	134.10	144.78	70.07
DEBIETa	Lake IJssel flow into the Wadden Sea of previous autumn	630.00	119.38	239.00	262.43	107.64					
DEBIETw	Lake IJssel flow into the Wadden Sea of previous winter	926.75	168.19	364.12	394.35	134.04	926.75	168.19	364.12	394.35	134.04
LANDINGS	Annual landings of previous year	16141.65	3998.90	7252.44	9036.12	3809.45					
LANDINGS	Annual landings of current year						16141.65	3998.90	7394.07	9335.57	3955.15
NAOI	North Atlantic Oscillation Index of current season	1.39	-0.96	0.02	0.08	0.52	1.81	-1.14	-0.09	-0.05	0.64
WNAOI	Winter North Atlantic Oscillation Index	1.67	-0.78	0.41	0.34	0.58	1.67	-0.78	0.41	0.34	0.58
exWNAOI	Extended Winter North Atlantic Oscillation Index	1.41	-0.99	0.35	0.29	0.56	1.41	-0.99	0.35	0.29	0.56



## Chapter VII

### The estimation of the Dynamic Energy Budget parameters for the brown shrimp *Crangon crangon*

#### **Abstract**

This paper presents estimates for the parameters of the standard Dynamic Energy Budget (DEB) model for the brown shrimp *Crangon crangon* L. Available data sets were insufficient to allow the estimation of all parameters directly. Consistency between parameter values could only be achieved by applying a protocol. As a consequence, the estimated set of parameters should be considered as preliminary and additional laboratory experiments are required to improve the accuracy of the estimates. In the present study, growth of shrimps is assumed to be continuous, neglecting the process of moulting whereby periodically the hard exoskeleton is shed. Males and females differ in their maximum size, respectively 7.5 and 9.5 cm total length and these differences are expressed in differences in  $\kappa$  (the fraction of utilized energy spent on somatic maintenance plus growth), respectively 0.95 and 0.80, and in  $\{\dot{p}_{Am}\}$  (the maximum surface area specific assimilation rate), respectively 25.2 and 37.9 J cm<sup>-2</sup> d<sup>-1</sup> at 10°C.



## Introduction

The brown shrimp *Crangon crangon* (L.) is an epibenthic decapod species widely distributed along European coast between 34 and 67°N latitude parallels, including the Mediterranean and Black Seas (Campos & Van der Veer 2008) with preference for shallow coastal and estuarine waters with sandy or muddy bottoms (Tiews 1970). Across its distribution it presents a strong population structuring with four major phylogeographic groups: the NE Atlantic, the western Mediterranean, the Adriatic Sea and the Black Sea (Luttikhuisen et al. 2008).

*C. crangon* frequently dominates estuarine communities reaching high densities, and hence represents an important functional component of the ecosystem: on the one hand it preys upon juvenile stages of epi- and infauna (Pihl & Rosenberg 1984; Van der Veer et al. 1991; Ansell & Gibson 1993; Van der Veer et al. 1998; Oh et al. 2001; Amara & Paul 2003); and on the other hand it is a prey species for fish, crustaceans and birds (Pihl 1985; Henderson et al. 1992; Del Norte-Campos & Temming 1994; Walter & Becker 1997). At the moment its role in the ecosystem functioning is not entirely clear and requires further attention. Despite extensive studies, there is still a lack of information on energy flow through reproduction and growth of *C. crangon* under natural conditions (Campos & Van der Veer 2008).

Dynamic energy budgets (DEB) can be used to describe the energy flow through individual organisms from the assimilation of food to the utilization for maintenance, growth, development and reproduction. In the late 1980-ties Kooijman (1986) published a theory that was later called DEB theory, and has been successfully applied in describing the energy allocation to growth and reproduction in a number of marine species (Van Haren & Kooijman 1993; Van der Veer et al. 2001; Cardoso et al. 2006). Powerful aspects of DEB theory are that intra- and interspecific differences between species are captured in the same model using only a different set of parameter values and that only 6 parameters are required for predictions on growth and reproduction (for a recent overview see Kooijman 2001). However, the estimation of the parameters is complicated and uses several types of data simultaneously. A systematic methodology is described in Kooijman et al. (2008).

For *C. crangon* no estimates of DEB parameters are available at present. The optimal approach to estimate the various parameters would be an experiment designed in such a way that simultaneously, growth and reproduction are determined preferably under several food conditions (Kooijman 1993, 2000). However, in this paper an attempt is made to estimate the various DEB parameters based on published information whereby the protocol described in Van der Veer et al. (2006) is used to get consistency between the various parameter estimates.

A complication factor is that the brown shrimp does not grow continuously in a gradual way, but by periodically shedding the hard exoskeleton in a process called moult or ecdysis (Campos et al. 2009). Consequently, individual growth is a function of the frequency of moults and depends on size increase at a moult (moult increment) and time between moulting

periods (intermoult period). To deal with this, detail adjustments in auxiliary theory for shrimps would be required. However, in this study growth is assumed to be continuous.

## Material and methods

The estimation of the various DEB parameters followed the procedure of Van der Veer et al. (2006) and consisted of two steps:

[1] Based on available data sources from literature, as many parameters were estimated individually;

[2] Subsequently, a standard protocol was applied to correct for inconsistency between parameters and to achieve a consistent set.

### *Data sets required for parameter estimation*

In addition to the primary DEB parameters, temperature sensitivity and tolerance range and the conversion from physical to volumetric length (shape coefficient) were determined.

*Temperature sensitivity* can be estimated from rates at various temperatures, whereby especially oxygen consumption rates are suited.

The *shape coefficient* determines how a specific length measurement (total length, body width etc.) relates to structural volumetric length and can be determined from data on length and somatic body mass. In case only data on total mass are available, data directly after spawning should be taken.

The *maximum surface area-specific ingestion and assimilation rates* can be calculated from experiments on maximum food intake in relation to body volume or size, within the temperature preference range and preferably at a temperature around the optimal temperature of the species.

The *volume-specific maintenance costs per unit of time* cannot be determined directly. The change over time in energy content during starvation is a rough indication of the order of magnitude.

*Maximum storage density* can be estimated in an indirect way as the difference in energy content between a well fed and an individual after starvation just before mortality occurs. This requires starvation experiments in which the individuals are well fed before the experiment starts.

So far, the *volume-specific costs for growth* cannot be estimated in a direct way. The approach is by determining the energy content of the structural body mass of an individual multiplied by a conversion factor reflecting growth efficiency.

$\kappa$  (*Kappa*), the fraction of storage energy which is allocated to somatic maintenance plus growth versus maturity maintenance plus maturation or reproduction, can only be estimated on the basis of observations on growth and reproduction simultaneously; here it was obtained from the gonado-somatic index.

*Protocol to get consistency between parameter*

The procedure for calibrating the DEB parameters includes the following three steps:

[1] First of all determining the value for volume-specific costs for growth [ $E_G$ ], maximum storage density [ $E_m$ ] and volume-specific maintenance costs [ $\dot{p}_M$ ];

[2] Next, simulation runs in Stella with the values determined in [1] to determine the value of  $\kappa$ , whereby the ratio between somatic mass and gonad mass just before spawning corresponds with field observations, and

[3] Applying the formula for maximum volumetric length under optimal food conditions ( $f=1$ ) to get an estimate of maximum surface area-specific assimilation rate  $\{\dot{p}_{Am}\}$ .

**Parameter estimation**

Table 7.1 summarizes information on energy content of various life stages or components in *Crangon crangon* and the conversion factors used.

**Table 7.1.** Energy content of *Crangon crangon* based on literature information.

	Sex	Energy content	Reference
Individual shrimp	Unknown	17.6 kJ g <sup>-1</sup> dry weight	Evans (1984)
Eggs	Unknown	25.1 kJ g <sup>-1</sup> dry weight	Edwards (1978)
Eggs stage I	Unknown	5915 cal g <sup>-1</sup> dry weight	Edwards (1978)
Eggs stage II	Unknown	5602 cal g <sup>-1</sup> dry weight	Edwards (1978)
Eggs stage III	Unknown	5165 cal g <sup>-1</sup> dry weight	Edwards (1978)
Freshly hatched protozoa	Unknown	5287 cal g <sup>-1</sup> dry weight	Pandian (1967)

*Shape coefficient*

The estimates of the shape parameters for the various species were based on length-ash free dry mass data (AFDM) and on length-wet mass data from the western Dutch Wadden Sea, 1976 (Van Lissa 1977), whereby no differentiation was made between males, females and egg carrying females nor between somatic and reproductive mass. Assuming that reproductive mass was negligible, the estimate by means of weighted regression was significant (Fig. 7.1) and resulted in a shape coefficient of  $0.116 \pm 0.028$  for dry mass and  $0.213 \pm 0.053$  for wet mass. This means that the conversion factor from AFDM to wet mass is 6.1843.

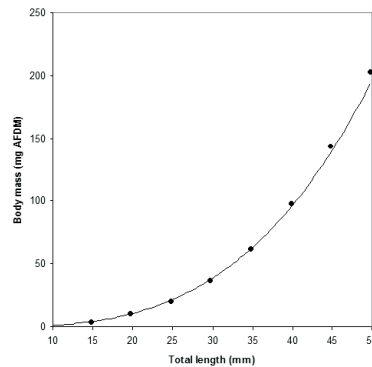
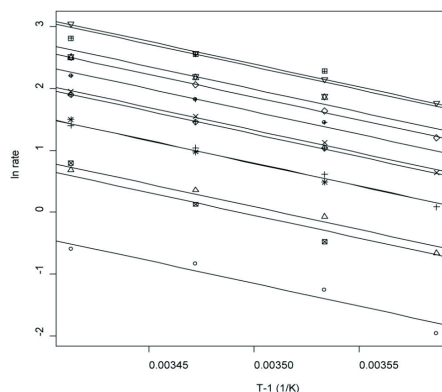

**Fig. 7.1.** Total length (mm) – somatic mass [mg ash free dry mass (AFDM)] relationship for *Crangon crangon* based on data for the western Dutch Wadden Sea (Van Lissa 1977). Shape coefficient for dry weight (mg):  $0.116 \pm 0.028$ ; and for wet weight (mg):  $0.213 \pm 0.052$  ( $n=9$ ;  $r^2 \text{ adj}=0.98$ ).

### *Arrhenius temperature*

Information on optimal temperature, temperature performance breadth and temperature tolerance range for the species were summarized by Freitas et al. (2007). The temperature tolerance range, i.e. the area of above-zero performance (c.f. Huey & Kingsolver, 1989) for *C. crangon* varied from as low as 273 K (0 °C) to about 303 K (30 °C), whereby the optimal temperature was at 296 K (23 °C).

The temperature sensitivity was estimated from experiments on oxygen consumption as function of temperature over the range 5.8 to 25 °C (Van Donk & De Wilde, 1981) and resulted in an estimate of the Arrhenius temperature,  $T_A$ , ( $\pm$  s.e.) of  $7351 \pm 266$  K (Fig. 7.2).



**Fig. 7.2.** Arrhenius plot (ln rate versus  $1/T$ ) for the oxygen consumption data for *Crangon crangon* based on Van Donk & De Wilde (1981). Arrhenius temperature ( $\pm$  s.e.):  $7351 \pm 266$  K.

At both the low and high temperatures, rates are reduced and for this the quantitative formulation by Sharpe & De Michele (1977) was followed. This formulation is based on the idea that the rate is controlled by an enzyme that has an inactive configuration at low and high temperatures, respectively below and above the optimum temperature. This means that the reaction rate has to be multiplied by the enzyme fraction that is in its active state. For formulas see Kooijman (2000) page 57. In this way four parameters are generated,  $T_L$  and  $T_H$  which relate to respectively the lower and upper boundary of the tolerance range where 69% (=  $\ln 2$  %) of the enzymes are active, and  $T_{AL}$  and  $T_{AH}$  which are the Arrhenius temperatures for the rate of decrease at both boundaries.

### *Maximum storage density*

Seasonal changes in energy content of *C. crangon* have been described for the Baltic, Gdansk Bay by Szaniawska (1983). Caloric values were lowest in the period November-March and highest in August. For a 42 mm female shrimp, maximum values were 25.18 J mg<sup>-1</sup> AFDM and lowest values were 16.07 J mg<sup>-1</sup> AFDM. The difference 9.11 J mg<sup>-1</sup> AFDM can be considered as storage. Converted into wet mass according to the conversion factor obtained from Figure 7.1 (1 mg AFDM = 6.1843 mg wet mass) this would mean 1.473 kJ g<sup>-1</sup> or cm<sup>-3</sup> wet mass. However, it is unlikely that the minimum energy content represents a situation without any storage at all. Therefore, the value should be considered as an underestimation of the maximum storage density.

A starvation experiment was carried out with sets of shrimps with mean size of 27 mm (LK 5, 5 mm length class) by M. Fonds and co-workers (unpubl.) in 1997 (Experiment I). At the beginning and end of a 24 days period, the AFDM was determined. Temperature conditions were not listed but were most likely in the order of 15 °C. Shrimps lost respectively 54 and 61% of their AFDM, while their wet mass remained roughly the same. This corresponded to a loss of respectively 14.4 and 16.2 mg AFDM or 252.7 and 285.5 J, assuming that 1 mg AFDM = 17.6 J (Evans 1984). Shrimps of 27 mm have a body volume of about 164.4 mg wet, which means a maximum storage of respectively 1.54 – 1.74 kJ cm<sup>-3</sup>. The AFDM of shrimps in size of 50 mm amounts 202 mg AFDM (energy content 202\*17.6=3.555 kJ), corresponding to 1.25 g wet mass or cm<sup>3</sup>. Converted into energy content, this means an energy content of 3.6 kJ cm<sup>-3</sup>. Maximum storage is in the order of 1.75 -2.00 kJ cm<sup>-3</sup>. Under the assumption that the shrimps were well fed, this would mean a structural energy content [ $E_v$ ] of about 1.5 – 1.85 kJ cm<sup>-3</sup>.

The estimate of the maximum storage of 1.5 – 1.85 kJ cm<sup>-3</sup> is in the same order but, as expected, higher than the value determined from seasonal pattern in energy content in the field. Therefore, a maximum storage of 1.75 kJ cm<sup>-3</sup> seems in the correct order of magnitude.

*Volume specific maintenance costs per unit of time*

In 1997, two groups of shrimps in size respectively 32-36 mm and 42-46 mm, were starved at various temperatures (10, 15 and 20 °C) for 18 days by M. Fonds and coworkers (unpubl.) (Experiment II). Body wet mass remained the same over the period of starvation and from the differences in body dry mass, the daily losses could be calculated and converted into  $\text{J cm}^{-3} \text{ mass d}^{-1}$ . These values overestimate the maintenance rate because in the beginning of the period of starvation growth also occurred. Estimates varied from about 25 at 10 °C to about 41  $\text{J cm}^{-3} \text{ d}^{-1}$  at 20 °C (Table 7.2).

**Table 7.2.** Starvation experiment on *Crangon crangon* in October 1997 during 18 days. For conversion of AFDM into J a factor of 17.6  $\text{J g}^{-1}$  AFDM was used.

Temp. (°C)	Mean TL (mm)	Wet mass (mg)	Initial (mg)	End (mg)	AFDM		$\text{J d}^{-1}$	$\text{J cm}^{-3} \text{ d}^{-1}$
					Difference (mg)	% ( $\text{mg d}^{-1}$ )		
10	32.5	239	62	56	6	0.10	5.87	24.5
15	32.5	234	60	49	11	0.18	10.76	46.0
20	32.5	241	62	52	10	0.16	9.78	40.6
10	42.5	494	128	113	15	0.12	14.67	29.7
15	42.5	516	137	120	17	0.12	16.62	32.2
20	42.5	519	136	117	19	0.14	18.58	35.8

Experiments on the sand shrimp *C. septemspinosa*, which is sometimes considered as the same species but occurring along the eastern North American coast (Campos & Van der Veer 2008) are described by Taylor & Peck (2004). Routine oxygen consumption for unfed shrimps at 10 °C amounted 0.10  $\text{mg O}_2 \text{ h}^{-1}$  for shrimps with a wet mass of 0.5 g (see Fig. 2B in Taylor & Peck 2004). Assuming a conversion factor of 14 J per  $\text{mg O}_2$  (Fonds et al. 1992), this would correspond to 33.6  $\text{J cm}^{-3} \text{ d}^{-1}$  at 10°C.

*Reproductive output*

The monthly change in reproductive investment expressed as gonad index (100\*gonad dry mass/body dry mass) has been described for Irish Sea shrimp (Oh & Hartnoll 2004). Reproductive investment was maximum in January-March with mean values of up to 10. For the Dutch Wadden Sea, no seasonal pattern is available; however, reproductive investment appeared to be higher with a mean gonad index of 13 (maximum 17) in July (J. Campos & H. Van der Veer, unpubl.).

## Parameter calibration

### *Determining the values for $[E_G]$ , $[E_M]$ and $[\dot{p}_M]$*

Both the experimental data by M. Fonds and co-workers and the experiments on *C. septemspinosus* by Taylor & Peck (2004) suggested a  $[\dot{p}_M]$  of about  $30 \text{ J cm}^{-3} \text{ d}^{-1}$  at  $10^\circ\text{C}$ . However, the data are biased because they include a growth and reproduction component and also the data at respectively 15 and  $20^\circ\text{C}$  are not in line with expectations according to an Arrhenius temperature of about 7000 K. The value is about twice as high as those estimated for various bivalve species (Van der Veer et al. 2006) and even higher than that of a flatfish species, plaice *Pleuronectes paltessa* (Van der Veer et al. 2001, 2009a). Taken into account the bias, the value for  $[\dot{p}_M]$  might be in the order of  $20 - 25 \text{ J cm}^{-3} \text{ d}^{-1}$  at  $10^\circ\text{C}$  or  $45 - 58 \text{ J cm}^{-3} \text{ d}^{-1}$  at  $20^\circ\text{C}$ . Therefore, a value of  $24 \text{ J cm}^{-3} \text{ d}^{-1}$  at  $10^\circ\text{C}$  was taken.

There is no direct estimate of the volume-specific costs for growth  $[E_G]$ . The cell complexity of an invertebrate such as brown shrimp is considered to be intermediate to that of bivalves and vertebrates (fishes). This would mean that  $[E_G]$  would be in between 1.9 and  $5.6 \text{ kJ cm}^{-3}$ . Therefore, a value of  $3 \text{ kJ cm}^{-3}$  has been selected for the simulation.

The only estimate of maximum storage density  $[E_m]$ , based on shrimps of 27 mm suggested a maximum storage of about  $1.5 - 1.75 \text{ kJ cm}^{-3}$ . However, this estimate was based on only a few observations and is also most likely an underestimation. Therefore, a value of  $2050 \text{ J cm}^{-3}$  has been taken in line with the estimates for various bivalve species as well as for plaice (Cardoso et al. 2006; Van der Veer et al. 2001, 2009a).

### *Determination of the value of $\kappa$*

The relationship between  $\kappa$  and the gonad index based on simulation runs in Stella is shown in Figure 7.3. Field data suggested a gonad index of about 13 with a maximum of 17. However, shrimps are thought to produce a number of egg batches, meaning that for comparison, the gonad index should be multiplied by the number of egg batches. The assumption of 2 egg batches a year would mean a GSI of 34 and this result in a  $\kappa$  of 0.85. Three egg batches per year would imply a  $\kappa$  in the order of 0.80.

### *Determining $\{\dot{p}_{x_m}\}$ from maximum volumetric length*

The maximum size reported is 9.5 cm for *C. crangon* females (Tiews 1954, 1970; Heerebout, 1974) and 7.5 cm for males (Tiews 1970). With a shape coefficient for wet mass of 0.213, a  $\kappa$  of 0.80 and a  $[\dot{p}_M]$  of  $24 \text{ J cm}^{-3} \text{ d}^{-1}$  at  $10^\circ\text{C}$ , it would result in a  $\{\dot{p}_{Am}\}$  of  $60.7 \text{ J cm}^{-2} \text{ d}^{-1}$  for female shrimps. For males, gonadal output is much lower and hence  $\kappa$  will be much higher, at least in the order of 0.95. This would mean a  $\{\dot{p}_{Am}\}$  of  $40.4 \text{ J cm}^{-2} \text{ d}^{-1}$  at  $10^\circ\text{C}$

for males. Losses due to digestion are unknown, but shrimps in general are considered as ‘sloppy’ feeders. Therefore, 0.33 was taken for losses due to digestion. The consequence would be a maximum surface area-specific ingestion rate  $\{\dot{p}_{Xm}\}$  for females and males of respectively  $90.7$  and  $60.3 \text{ J cm}^{-3} \text{ d}^{-1}$ .

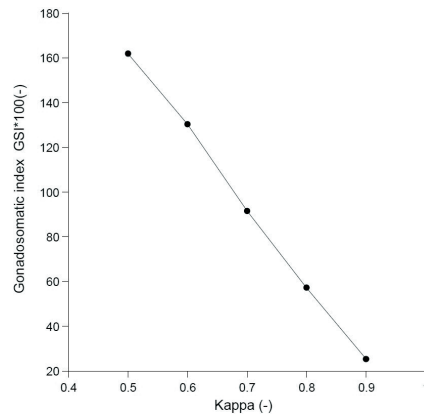

**Fig. 7.3.** Relationship between Kappa (-) and gonad index ( $100 \times$  gonadal mass/somatic mass) just before spawning for *Crangon crangon* based on simulations of the DEB model with species-specific parameter values. For values see Table 7.2.

Van Lissa (1977) conducted some experiments on the daily ration of shrimps. Since sex was not mentioned, most likely in his experiment it has been a mixture of both males and females. At  $10 \text{ }^\circ\text{C}$  a shrimp of  $60 \text{ mm TL}$  consumes  $13.42 \text{ mg AFDM d}^{-1}$  (Van Lissa 1977; Fig. 7.1), which corresponds to  $236 \text{ J d}^{-1}$ . A  $60 \text{ mm TL}$  shrimp has a body mass of respectively  $338 \text{ mg AFDM}$  or  $2.08 \text{ g wet mass}$ . This would correspond to a daily ration of  $113 \text{ J cm}^{-3} \text{ d}^{-1}$ . Compared with an assimilation rate of respectively  $40.4$  and  $60.7 \text{ J cm}^{-2} \text{ d}^{-1}$  for males and females, this would mean that assimilation rate is 2 – 3 times the ingestion rate. Van Lissa (1977) indicates that the experimental results should be taken with some precaution and although shrimps are known to be ‘sloppy’ feeders (Van Lissa 1977; M. Fonds, person. comm.), indeed this value seems to be too high.

### Parameter validation

The DEB parameters for *C. crangon* were validated by determining the maximum possible growth in length for small shrimps applying the DEB model and then comparing it with published experimental growth data (Campos et al. 2009). Since growth in females is larger than in males, simulated maximum growth for females was taken and compared with the laboratory data.



The comparison of DEB model simulations with laboratory observations of growth under optimal food conditions is presented in Figure 7.4. The difference in slope suggests that the estimate of the Arrhenius temperature (7000 K) might be too low and would be in the order of  $T_A=9000$  K. Since the estimated volume-specific maintenance rate was higher than that of more complex organisms (fishes) and that of the related species *Carcinus maenas* ( $15.9 \text{ J cm}^{-3} \text{ d}^{-1}$ ) (Van der Veer et al. 2009b), the volume-specific maintenance rate was reduced to  $15.9 \text{ J cm}^{-3} \text{ d}^{-1}$  and as a consequence  $\{\dot{p}_{Am}\}$  and  $\{\dot{p}_{Xm}\}$  were adopted to respectively 37.9 and  $58.9 \text{ J cm}^{-2} \text{ d}^{-1}$ . This parameter set resulted in growth estimates closer to the range of maximum growth observed (Fig. 7.4).

In line with the corrections for the female shrimp DEB parameter set, this would mean for the male shrimp also an Arrhenius temperature of 9000 K, a volume-specific maintenance rate of  $15.9 \text{ J cm}^{-3} \text{ d}^{-1}$  and hence a  $\{\dot{p}_{Am}\}$  and  $\{\dot{p}_{Xm}\}$  of respectively 25.2 and  $37.8 \text{ J cm}^{-2} \text{ d}^{-1}$ , and for  $[E_m]$  this means a value of  $851 \text{ J cm}^{-3}$ .

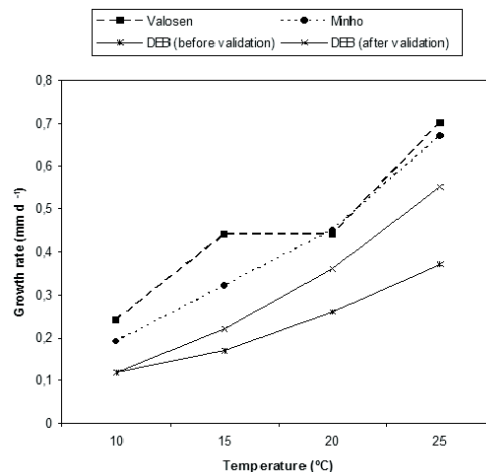

**Fig. 7.4.** *Crangon crangon* maximum growth rate in relation to temperature (°C) determined under laboratory with shrimps from Valosen (Norway) and from Minho (Portugal) estuaries, and from DEB simulations with the parameter set prior to validation and after validation. Data after Campos et al. (2009).

Based on the set of primary parameters, the various compound parameters could be estimated. This resulted in a maintenance rate constant  $\dot{k}_M$  of  $0.006 \text{ d}^{-1}$  for both males and females. Both the energy conductance  $\dot{v}$  and the investment ratio  $g$  differed between male and female shrimp due to differences in primary parameters. This also holds true for the Von Bertalanffy growth constant. The complete set of DEB parameters is listed in Table 7.3.

**Table 7.3.** Primary and compound parameters of the DEB model for male and female *Crangon crangon* together with the parameter estimates at 10 °C. Notation after Kooijman (2000). For more information see text.

Symbol	Dimension	Interpretation	Males	Females
$T_A$	K	Arrhenius temperature	9000	9000
$T_{OPT}$	K	Optimum temperature	296	296
$T_L$	K	Lower boundary of tolerance range	273	273
$T_H$	K	Upper boundary of tolerance range	303	303
$T_{AL}$	K	Rate of decrease at lower boundary	6700000	6700000
$T_{AH}$	K	Rate of decrease at upper boundary	49368	49368
$\{\dot{p}_{Xm}\}$	W.m <sup>-2</sup> (J cm <sup>-2</sup> d <sup>-1</sup> )	Maximum surface area-specific ingestion rate	37.8	58.9
	-	Losses due to digestion	0.33	0.33
$\{\dot{p}_{Am}\}$	W.m <sup>-2</sup> (J cm <sup>-2</sup> d <sup>-1</sup> )	Maximum surface area specific assimilation rate	25.2	37.9
$[\dot{p}_M]$	W.m <sup>-3</sup> (J cm <sup>-3</sup> d <sup>-1</sup> )	Volume specific maintenance costs	15.9	15.9
$[E_m]$	(J cm <sup>-3</sup> )	Maximum storage density	851	851
$[E_G]$	(J cm <sup>-3</sup> )	Volume-specific costs of growth	2500	2500
$[E_V]$	(J cm <sup>-3</sup> )	Volume-specific structural energy content	1750	1750
$\kappa$	-	Fraction of utilized energy spent on maintenance plus growth	0.95	0.80
$\delta_m$	-	Shape coefficient	0.213	0.213
$L_{MAX}$	(cm)	Maximum observed length	7.5	9.5
$VL_{MAX}$	(cm)	Maximum observed volumetric length	4.077	8.285
$V_P$	(cm <sup>3</sup> )	Volume at start of reproductive stage	0.103	0.261
	( $\mu$ m)	Egg diameter	430	430
	(J egg <sup>-1</sup> )	Egg energy content	0.413	0.413
$\dot{v}$	(cm d <sup>-1</sup> )	Energy conductance	0.0296	0.0445
$\dot{k}_M$	(d <sup>-1</sup> )	Maintenance rate constant	0.006	0.006
$g$	(-)	Investment ratio	3.092	3.672
$K$	(y <sup>-1</sup> )	Von Bertalanffy growth constant	0.0016	0.0017

## Discussion

Despite the relatively low number of species-specific parameters that are required to be able to apply the DEB model, parameter estimation is not that easy. Although Kooijman (2000) clearly describes the type of experiments that should be performed, so far they have not been

executed for shrimps and hence parameter estimation needs to rely on combining fragmentary and sometimes contradictory data sources (Van Haren & Kooijman 1993; Van der Meer 2006; Van der Veer et al. 2001, 2006, 2009a).

At present there are various options for parameter estimation. Preferably well-designed laboratory experiments should be performed; however they are labor intensive and so far lacking. Most species resist culturing under carefully controlled conditions. A second best option is the application of software package DEBtool to determine parameter values based on high quality data sets (Kooijman et al. 2008). The software package DEBtool can directly be downloaded from <http://www.bio.vu.nl/thb/deb/deblab/debtool>. Recently, parameter estimation has been split up in a natural sequence of 10 steps, whereby compound parameters are determined first, next the primary parameters, then the composition parameters and finally the thermodynamic parameters (Kooijman et al. 2008). The elegance of these 10 steps is that the sequence matches a sequence of required data of increasing complexity (Kooijman et al. 2008). In reality, most often data sets are not extensive enough for all 10 steps, but the parameters that can be obtained with less steps are already very useful. For these situations Van der Veer et al. (2006) has suggested a protocol to guarantee the estimation of a complete and consistent parameter set. Due to the lack of basic information for *Crangon crangon*, this procedure has been adopted in this study.

DEB parameters are individual-specific to allow for evolutionary change across generations by variation and selection. The diversity of environmental conditions over the distributional range of the species can potentially generate individual differences. In the case of brown shrimp the latitudinal range of distribution covers an extensive area from 34 to almost 70°NL (Campos & Van der Veer 2008). Over such a wide latitudinal range, temperature is a main environmental factor varying and affecting brown shrimp's energy budget. The fraction of utilized energy spent in maintenance and growth, the volume-specific costs for growth and the maximum storage density are temperature-independent and will remain the same across the species distribution area. In contrast, food intake and maintenance are temperature-dependent but if these processes vary in a similar way the organism functioning will remain the same from an energetic perspective. However, different individuals of the same species differ little in parameters values and hence mean DEB parameters values should be used as species-specific. In the present paper, DEB parameters were mainly estimated with data obtained with brown shrimp populations from intermediate latitudes of the species distribution, especially from the Dutch Wadden Sea, but also Gdansk bay and from the Irish Sea. Some differences might have then been generated.

Another source of intraspecific differences in DEB parameters is gender. Although, sex can be determined externally in the brown shrimp relatively easily (Tiews 1970; Campos & Van der Veer 2008), it is relatively time consuming and hence in most field studies, males and females are not distinguished (c.f. Kuipers & Dapper 1984; Pihl 1985). This means that although DEB parameters have been determined for males and females separately, for field

comparison with previous studies this does not make sense. Similar with many other species, male and female shrimp differ in their maximum size, respectively 7.5 and 9.5 cm (Tiews 1954). These differences are expressed in differences in especially  $\kappa$  (the fraction of utilized energy spent on maintenance plus growth) and hence in  $\{\dot{p}_{Am}\}$  (the maximum surface area specific assimilation rate). Another complicating factor is the fact that crustaceans grow discontinuously by periodically shedding the hard exoskeleton in a process called moult or ecdysis (see for instance Tiews 1970). This makes individual growth a function of the frequency of moults that depends on size increase at a moult (moult increment) and time between moulting periods (intermoult period). However, field population studies deal with growth as if it is continuous (c.f. Kuipers & Dapper 1981, 1984). This further complicates the application of the DEB model for *C. crangon*, though requiring adjustments only at auxiliary theory level for the species but not to the core theory

In conclusion, the estimates of the DEB parameters for male and female shrimp should be considered with some precaution. It cannot be excluded that some of the parameter values need some more fine-tuning, however this would require additional laboratory experiments.

**Acknowledgments** The authors would like to thank M. Fonds for providing unpublished information and V. Freitas and J.F.M.F. Cardoso for valuable comments on early versions of this manuscript.



## Chapter VIII

### Synthesis: Recruitment of the brown shrimp *Crangon crangon* (L.) over a latitudinal gradient

In all European shallow coastal waters, crustaceans such as brown shrimp *Crangon crangon* and green crab *Carcinus maenas* are consistently very abundant. They thus play a relevant role in the functioning of local ecosystem as both preys of fish and shorebirds and predators of meiofauna and early stages of fish and bivalves. For that reason, a large amount of important studies on these species have been carried out in the past. The first studies were rather descriptive and also focused at the individual level. Good examples are the various papers by Tiews and the 1970 FAO synopsis on brown shrimp life history and fisheries as his 'magnus opus'. The following two decades, the 70-ties and 80-ties were characterized by a shift to more quantitative studies, as a result of the introduction of (semi)-quantitative sampling designs such as beam trawls and drop traps. Also the focus on ecosystem modeling and hence energy flow webs have pushed it.

Despite this huge amount of studies, basic questions about recruitment, population dynamics, growth and reproduction still remained unanswered. In this respect the vivid debate about growth potential of *C. crangon* in Dutch waters is striking. Despite reproduction in this area takes place almost all year around with two distinct generations, summer and winter, North Sea shrimp fisheries are constantly greatest in autumn. Kuipers & Dapper (1984) suggested that autumn fisheries are sustained by winter reproduction through heavy spring settlement; while Boddeke (1976, 1982) and Boddeke & Becker (1979) argued that autumn catches are the result of summer reproduction. Each perspective relies on different arguments especially on predation pressure and on the growth trajectory from settlement to fisheries recruitment. For Kuipers & Dapper, summer generation is under a huge predation pressure and hence their contribution for autumn fisheries is scarce, whilst winter brood settles in mass during spring and recruits to fisheries in the following autumn. In contrast, for Boddeke,

summer brood growth rates are so fast that by the following season, within 3-4 months, shrimps attained the commercial size. This controversy was and still is unsolved mainly because of the continuous influx of settling larvae (recruitment to adult stock) and the outflow of maturing shrimps (migration) that make any study on population dynamics almost impossible with the methods available at that time.

This was the situation at the start of this PhD thesis. The reason for focusing on *C. crangon* biology was the feeling that recent new development especially the innovative Dynamic Energy Budgets (DEB) model of Kooijman (2000) would offer an opportunity to crack at least a few of the remaining riddles about its recruitment and growth. Despite the controversy, some aspects were certain: females account for the bulk of commercial fisheries and commercial catches are consistently greater in autumn. Curiously, despite during the period preceding Tiews synopsis, both sexes were mainly investigated separately and sex differences in growth were described (Havinga 1930; Lloyd & Younge 1947; Meredith 1952; Tiews 1954; Meixner 1966), after this review several population researches on brown shrimp focused both sexes combined. This includes Kuipers & Dapper (1984) and Boddeke (1982) works, when referring to recruitment to fisheries. To contribute for their debate, in this thesis special attention is devoted to two aspects: timing (summer or winter shrimps generation) and sex differences in growth. Comparisons with previous works are then hampered by the fact that, in the past, no distinguishing between sexes was made.

At a first stage, however, as since Tiews 1970 no overview of existing knowledge about the species biology had been published, it was felt then as essential to summarize recent information and identify remaining gaps first. The review which made up the second Chapter of the present thesis did confirm our renewed interest to focus on *C. crangon*. Yet, it became clear that before any progress could be made with respect to recruitment, population dynamics, growth and reproduction in the Dutch Wadden Sea in order to contribute to solve the Kuipers-Boddeke debate, first of all the population structure of the species should be identified.

Previous studies basing on *C. crangon* morphometry already suggested some form of subpopulation structure around the British islands (Henderson et al. 1990) and between North Sea and Baltic Sea populations (Maucher 1961). This is a very restricted area compared to the wide geographic distribution of the species which ranges from the latitude parallels of 34 to 67°N. However, the length of the pelagic larvae stage suggested that exchange between neighboring populations even over large distances would be guaranteed. Both extensive morphometric studies (Chapter 3) and present DNA techniques (Chapter 4) falsified this hypothesis: instead a clear subpopulation structure could be identified with four major phylogeographic groups. Remarkably, with the present techniques, the entire NE Atlantic population belongs to a single large subpopulation, separated from the western Mediterranean, the Adriatic Sea and the Black Sea (Fig. 8.1). Therefore, all further studies were restricted to NE Atlantic subpopulation.

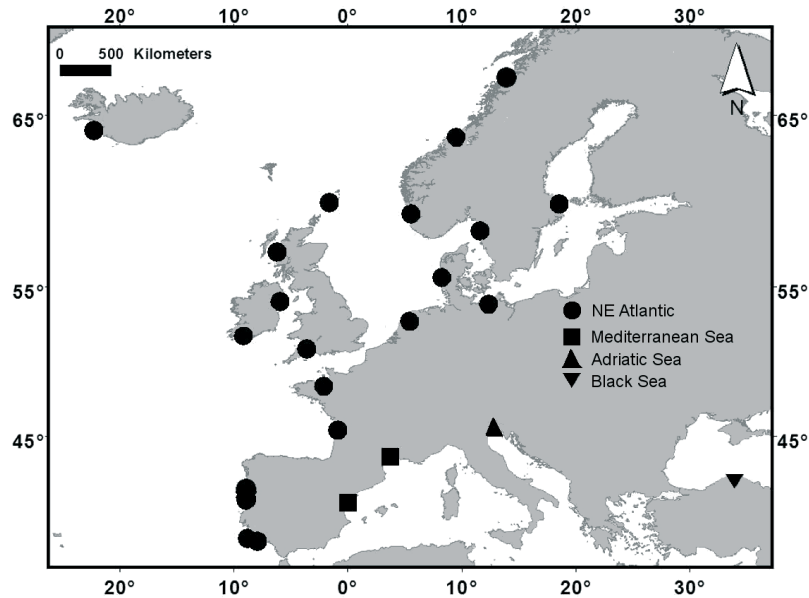

Fig. 8.1. *Crangon crangon* sub-population structure based on genetics.

Following, the problem of growth and its impact on recruitment in the Dutch Wadden Sea was tackled. One of the main reasons for the disagreement was the lack of accurate growth data. Only some information on groups of individuals was available, despite the fact that within a population, differences in growth with shrimp size, as well as between males and females were expected. Moreover, phenotypical plasticity in the form of irreversible non-genetic adaptation, as well as counter gradient growth compensation, could further complicate this picture. In this thesis, an experimental approach on individual growth was implemented, where a special attention on sex differences was addressed. Two different populations were taken, one from the northern and the other from the southern edge of the species geographic distribution, to tackle the question whether counter gradient growth compensation did seem to occur (Chapter 5). In addition, for the Dutch Wadden Sea population, long term trends in population fluctuations, and hence in recruitment were analyzed (Chapter 6). Results were clear namely in relation to differences between males and females and to seasonal trends in abundance, but partly puzzling and at least not enough to unambiguously settle the growth debate. Also the observed trends should not be extrapolated for shrimp sizes beyond the range of length used in the estimations from the growth experiments, especially for small juveniles and larger adults. For this reason, an alternative approach was also followed: applying the DEB theory to brown shrimp. Once the DEB parameters for *C. crangon* would be available



(Chapter 7) applying the DEB model would allow the prediction of maximum possible growth in relation to prevailing water temperatures and this would set an upper limit to possible growth in field conditions. The only handicap is that comparisons with previous works are hampered by the fact that in the past studies were based on both sexes combined.

Although the accuracy of the DEB parameters can still be improved, the DEB simulations are promising and convincing. First of all, clear differences between males and females do occur whereby fastest growth rates are observed in females. DEB model simulations of maximum growth under optimal food conditions in relation to prevailing water temperature conditions in the Wadden Sea better fitted with the predictions of slower growth rates by Kuipers & Dapper (Fig. 8.2): it would take about 1.5 years for male and 1 year for female shrimps from settlement to 5 cm commercial size. Males settling in spring and hence from winter generation would be available to fisheries in autumn not of the current year, as postulated by Kuipers & Dapper, but of the following year. In contrast, females, which make up the bulk of commercial catches, when settling in autumn in the Wadden Sea would grow to a maximum of 5 cm in the following autumn and becoming then available to the fisheries. However, autumn settlers probably arose from summer generation. This means that it is not the summer brood from the current year as Boddeke claimed, nor the previous winter generation as Kuipers & Dapper suggested, but the summer generation from previous year which contributes to the bulk of the fisheries recruits in autumn. Therefore, the resultant population growth rate must be much smaller than the one Boddeke purposed and only slightly smaller than the one Kuipers & Dapper estimated. Curiously the heavy spring settlement must then be under intense predation pressure (or other source of mortality) because common spring commercial catches (after one year of female growth) are not in line with expectations. In contrast, autumn settlement, which is not as intense as spring one, is much more successful in terms of recruitment to fisheries due to lower mortality (maybe due to lower predation pressure) since commercial catches consistently show a maximum after one year. Consequences for population structure and recruitment are straightforward: not only conditions within a year but also of the preceding year and winter are critical in determining recruitment to the fisheries in the Wadden Sea.

These results stress the need of analyzing sex's trends separately. Kuipers & Dapper (1984) conclusions were based on information for both sexes combined. However, it is known that females grow much faster than males and attain larger size. Therefore, two sets of DEB parameters were estimated for males and females separately and hence different trends were found in growth simulations of shrimps from the Wadden Sea population. It is possible that if those authors analyzed the growth of each sex separately they would draw conclusions similar to the present ones. Another suggestion from present results is that, if commercial catches mainly consist on females larger than 5 cm, males mortality might be larger than that of females or only few males live long enough to attain this size (around 1.5 years).

Commercial fisheries on brown shrimp are insignificant, if even existent, at high and low latitudes of the species geographic distribution. Yet, applying DEB simulations under optimal food conditions at the prevailing temperatures observed at the northern and southern edges of brown shrimp distribution, latitudinal trends on the growth trajectory from settlement to fisheries size, 5 cm, can be analyzed. Overall, the simulations (Fig. 8.2) showed a general increasing trend with latitude in the time required to grow from settlement to fisheries size, starting at any time of the year; in this growth trajectory, females take almost half the time of males. For establishing latitudinal trends in this growth trajectory it would be required the knowledge on settlement and reproduction periods at the distribution edges. Yet, this information is scarce since only few studies were conducted in the past at high and low latitude of the species distributional range.

Though at intermediate latitude, larvae settlement peaks in spring/summer and to a lesser extent also in autumn (Boddeke & Becker 1979; Boddeke et al. 1976; Feddersen 1993), no information is still available for the edges of the species distribution. The same way, information on latitudinal trends in brown shrimp reproduction periods is scarce. In a latitudinal approach, Kuipers & Dapper (1984) suggested a shift from winter reproduction (when egg-bearing females were more abundant) in the south towards winter and summer reproduction in the Wadden Sea, at intermediate latitude, and autumn spawning in the north of brown shrimp's distribution. However, these authors based on erroneous information: to infer on trends for low latitude populations, they referred to a Mediterranean population, belonging to a distinct phylogeographic group (Fig. 8.1), when in Portugal *C. crangon* spawning is almost continuous throughout the year with a peak in spring/summer (Marques 1982; Marques & Costa 1983; Viegas et al. 2007); and to depict northern trends, they based their description on an imprecise citation of Woelleback (1908) work by Tiews (1970). At Valosen estuary (67°NL), Norway, egg-bearing females are present in spring/summer, from April to August with maximum numbers in July (pers. observation). Therefore, though a late autumn/early winter spawning is possible at deeper waters in northern areas, reproduction seems to occur in the same time period at both distribution edges: spring/summer.

Considering as main reproduction period at all latitudes the spring and summer seasons, subsequent settlement occurs probably during late summer and autumn/winter. In the north of the species geographic distribution, females would then reach fisheries size in the following autumn/winter after 1.5 years. In the south, female settlement in autumn/winter would lead to an earlier recruitment to fisheries size in summer, after a shorter growth period of only 7 to 11 months. Hence, for females the time required from settlement to fisheries size increases with latitude from 7-11 months in the south, to 1 year at intermediate latitude and 1.5 years in the north. The same way, for males an increasing latitudinal trend is found in the time needed to reach 5 cm. Yet, the difference is much more pronounced: southern males take 14-15 months to reach fisheries size, while males from intermediate latitude take up to almost 2 years (16-22 months) and those from northern populations may take about 3 years (up to 34 months).

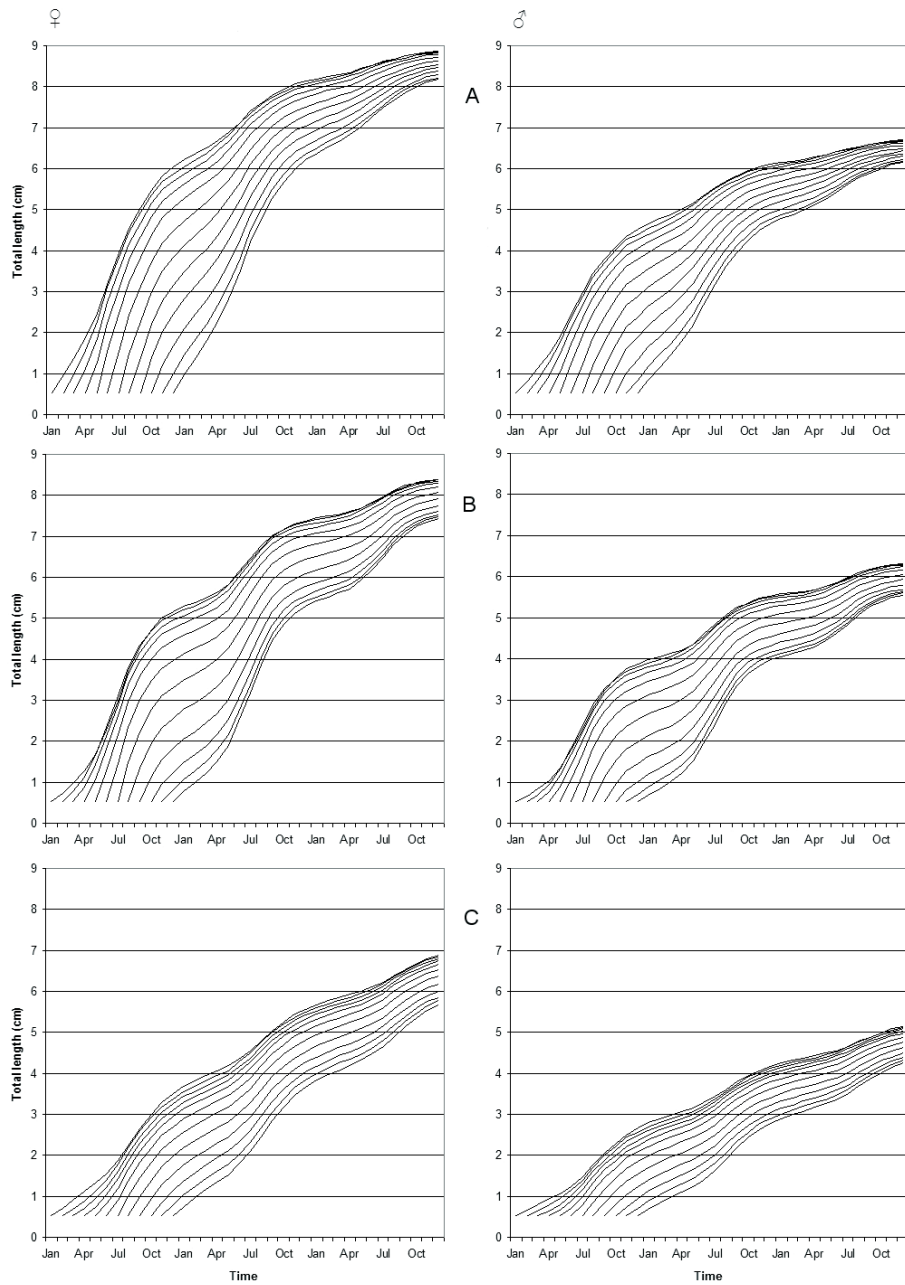

**Fig. 8.2.** *Crangon crangon* growth simulations applying DEB models with individuals from Minho estuary, Portugal (A), the Wadden Sea, The Netherlands (B) and Valosen estuary, Norway (C), for each sex separately (females on upper panel and males on bottom panel).

In conclusion, DEB simulations favour the smaller growth rates of Kuipers & Dapper (1984) argument. However, the resultant growth rate is inferior to that reported by these authors, and suggests that it is the summer generation from previous year which contributes to the bulk of the fisheries recruits in autumn. Yet, on one hand, settlement in autumn (originate from the summer generation) is not reported to occur as heavily as in spring (originate from the winter generation); and, on the other hand, spring commercial catches are not in line with an expected peak from the DEB simulations, which can be due to heavy predation pressure upon spring settlers resulting in high mortality. Therefore, even though DEB simulations were successful, several aspects require further attention. First of all, DEB parameters estimation requires accuracy improvement through laboratory experiments especially designed for this purpose. This is especially relevant because, with the present DEB parameters, growth simulations under optimal food conditions at constant temperature result inferior to maximum observed growth rates from experimental approaches (see Chapter 6). Differences in parameter estimates between individuals from different populations are possible due to environmental variations; ideally, in the future, the comparisons should be made with a parameter set for each population. Additionally, information on reproduction and settlement periods at the edges of brown shrimp distributional range is necessary to confirm the trends observed in DEB simulations for northern and southern populations.

**Acknowledgments** The authors would like to thank S.A.L.M. Kooijman, V. Freitas and J.F.M.F. Cardoso for valuable comments on early versions of this chapter.





## References

- Abbott, O.J. & Perkins, E.J. 1977. The biology of the brown shrimp *Crangon crangon* in the Solway Firth. Scientific Report Cumbria Sea Fisheries Committee 77, 1-34.
- Abdullah, R. & Shukor, N.A., 1993. Isozyme variation between two closely related species *Crangon crangon* and *Crangon almanni* Kinahan (Decapoda, Caridea). *Crustaceana* 64, 114-121.
- Addison, J.T., Lawler, A.R. & Nicholson, M.D. 2003. Adjusting for variable catchability of brown shrimps (*Crangon crangon*) in research surveys. *Fish. Res.* 65, 285-294.
- Agostini, V.N. & Bakun, A. 2002. 'Ocean triads' in the Mediterranean Sea: physical mechanisms potentially structuring reproductive habitat suitability (with example application to European anchovy, *Engraulis encrasicolus*). *Fish. Oceanogr.* 11, 129-142.
- Al-Adhub, A.H.Y. & Naylor, E. 1975. Emergence rhythms and tidal migrations in the brown shrimp *Crangon crangon* (L.). *J. Mar. Biol. Assoc. UK* 55, 801-810.
- Amara, R. & Paul, C. 2003. Seasonal patterns in the fish and epibenthic crustaceans community of an intertidal zone with particular reference to the population dynamics of plaice and brown shrimp. *Est. Coast. Shelf Sci.* 56, 807-818.
- Ament, A. 1979. Geographic variation in relation to life history in three species of the marine gastropod genus *Crepidula*: growth rates of newly hatched larvae and juveniles. In Stancyk SE (ed) *Reproductive ecology of marine invertebrates*. University of South Carolina Press, Columbia, pp. 61-76.
- Angel, M.V. 1979. Zoogeography of the Atlantic Ocean. In: Van der Spoel, S., Pierrot-Bults, A.C. (Eds.), *Zoogeography and diversity of plankton*. Bunge, Utrecht, The Netherlands, pp. 168-190.
- Anonymous 1973. Expert consultation on selective shrimp trawls. FAO Fish. Rep. IJmuiden, The Netherlands, 139pp.
- Anonymous 1979. Report of the working group on crangonid shrimps. ICES, CM 1979/K:7, 1-31.
- Ansell, A.D. & Gibson, R.N. 1993. The effect of sand and light on predation of juvenile plaice (*Pleuronectes platessa*) by fishes and crustaceans. *J. Fish Biol.* 43, 837-845.
- Arbogast, B.S., Edwards, S.V., Wakeley, J., Beerli, P. & Slowinski, J.B. 2002. Estimating divergence times from molecular data on phylogenetic and population genetic timescales. *Annu. Rev. Ecol. Syst.* 33, 707-740.

## References

---

- Arnold, G.P. & Weihs, D. 1978. Hydrodynamics of rheotaxis in plaice (*Pleuronectes platessa* L.). J. Exp. Mar. Biol. Ecol. 75, 147-169.
- Attrill, M. J. & Thomas, R. M. 1996. Long-term distribution patterns of mobile estuarine invertebrates (Ctenophora, Cnidaria, Crustacea: Decapoda) in relation to hydrological parameters. Mar. Ecol. Prog. Ser. 143, 25-36.
- Attrill, M.J., Power, M., Myles Thomas, R. 1999. Modelling estuarine Crustacea population fluctuations in response to physico-chemical trends. Mar. Ecol. Prog. Ser. 178: 89-99.
- Avise, J.C. 1998. Conservation genetics in the marine realm. J. Hered. 89, 377-382.
- Bachelet, G. 1986. Recruitment and year-to-year variability in a population of *Macoma balthica* (L.). Hydrobiologia 142: 233-248.
- Baden, S.P. & Pihl, L. 1984. Abundance, biomass and production of mobile epibenthic fauna in *Zostera marina* (L.) meadows, western Sweden. Ophelia 23, 65-90.
- Bahri-Sfar, L., Lemaire, C., Ben Hassine, O.K. & Bonhomme, F. 2000. Fragmentation of sea bass populations in the western and eastern Mediterranean as revealed by microsatellite polymorphism. Proc. R. Soc. Lond., B 267, 929-935.
- Ballard, J.W.O. & Whitlock, M.C. 2004. The incomplete natural history of mitochondria. Mol. Ecol. 13, 729-744.
- Bargelloni, L., Alarcon, J.A., Alvarez, M.C., Penzo, E., Magoulas, A., Reis, C. & Patarnello, T. 2003. Discord in the family Sparidae (Teleostei): divergent phylogeographical patterns across the Atlantic-Mediterranean divide. J. Evolution. Biol. 16, 1149-1158.
- Bargelloni, L., Alarcon, J.A., Alvarez, M.C., Penzo, E., Magoulas, A., Palma, J. & Patarnello, T. 2005. The Atlantic-Mediterranean transition: Discordant genetic patterns in two seabream species, *Diplodus puntazzo* (Cetti) and *Diplodus sargus* (L.). Mol. Phylogenet. Evol. 36, 523-535.
- Barr, C.M., Neiman, M. & Taylor, D.R. 2005. Inheritance and recombination of mitochondrial genomes in plants, fungi and animals. New Phytol. 168, 39-50.
- Beaumont, A.R. & Croucher, T. 2006. Limited stock structure in UK populations of the brown shrimp, *Crangon crangon*, identified by morphology and genetics. J. Mar. Biol. Assoc. UK 86, 1107-1112.
- Berghahn, R. 1983. Untersuchungen an Plattfischen und Nordseegarnelen (*Crangon crangon*) im Eulitoral des Wattenmeeres nach dem Übergang zum Bodenleben. Helgoländer Meeresun. 36, 163-181.
- Berghahn, R. 1984. Zeitliche und räumliche Koexistenz ausgewählter Fisch- und Krebsarten im Wattenmeer unter Berücksichtigung von Räuber-Beute-Beziehungen und Nahrungskonkurrenz. PhD thesis, University of Hamburg.
- Berghahn, R. 1990. On the potential impact of shrimping on trophic relationships in the Wadden Sea. In Trophic Relationships in the Marine Environment, M. Barnes & R. N. Gibson (eds.), Aberdeen, UK: Aberdeen University Press, 130-140.
- Berghahn, R. 1996. Episodic mass invasions of juvenile gadoids into the Wadden Sea and their consequences for the population dynamics of brown shrimp (*Crangon crangon*). Mar. Ecol. 17, 251-260.
- Berghahn, R. & Purps, M. 1998. Impact of discard mortality in *Crangon* fisheries on year-class strength of North Sea flatfish species. J. Sea Res. 40, 83-91.
- Berghahn, R. & Rösner, H.U. 1992. A method to quantify feeding of seabirds on discard from the shrimp fishery in the North Sea. Neth. J. Sea Res. 28, 347-350.
- Berghahn, R. & Vorberg, R. 1997. Shrimp fisheries and nature conservation in the National Park Wadden Sea of Schleswig-Holstein. UBA-Texte 82/97, 197pp.
- Berghahn, R., Wiese, K. & Lüdemann, K. 1995. Physical and physiological aspects of gear efficiency in North Sea brown shrimp fisheries. Helgoländer Meeresun. 49, 507-518.
- Bergman, M.J.N. & Hup, M. 1992. Direct effects of beamtrawling on macrofauna in a sandy sediment in the southern North Sea. ICES J. Mar. Sci. 49, 5-11.

- Bergman, M.J.N., Van der Veer, H.W., Stam, A. & Zuidema, D. 1989. Transport mechanisms of larval plaice (*Pleuronectes platessa* L.) from the coastal zone into the Wadden Sea nursery area. Rapp. P.-v. Réun. Cons. Int. Explor. Mer 191, 43-49.
- Berven, K.A., Gill, D.E. & Smith-Gill, S.J. 1979. Countergradient selection in the green frog, *Rana clamitans*. Evolution 33, 609-623.
- Beukema, J.J. 1979. Biomass and species richness of the macrobenthic animals living on a tidal flat area in the Dutch Wadden Sea: effects of a severe winter. Neth. J. Sea Res. 13, 203-223.
- Beukema, J.J. 1992. Dynamics of juvenile shrimp *Crangon crangon* in a tidal-flat nursery of the Wadden Sea after mild and cold winters. Mar. Ecol. Prog. Ser. 83, 157-165.
- Beukema, J.J. & Dekker, R. 2005. Decline of recruitment success in cockles and other bivalves in the Wadden Sea: possible role of climate change, predation on postlarvae and fisheries. Mar. Ecol. Prog. Ser. 287, 149-167.
- Beukema, J.J., Honkoop, P.J.C. & Dekker, R. 1998. Recruitment in *Macoma balthica* after mild and cold winters and its possible control by egg production and shrimp predation. Hydrobiologia 375/376, 23-34.
- Beyst, B., Hostens, K. & Mees, J. 2001. Factors influencing fish and macrocrustacean communities in the surf zone of sandy beaches in Belgium: temporal variation. J. Sea Res. 46, 281-294.
- Billerbeck, J.M., Orti, G. & Conover, D.O. 1997. Latitudinal variation in the number of vertebral number as a genetic basis in the Atlantic silverside, *Menidia menidia*. Can. J. Fish. Aquat. Sci. 54, 1796-1801.
- Billerbeck, J.M., Schultz, E.T. & Conover, D.O. 2000. Adaptive variation in energy acquisition and allocation among latitudinal populations of Atlantic silverside. Oecologia 122, 210-219.
- Birky, C.W., Fuerst, P. & Maruyama, T. 1989. Organelle gene diversity under migration, mutation, and drift-equilibrium expectations, approach to equilibrium, effects of heteroplasmic cells, and comparison to nuclear genes. Genetics 121, 613-627.
- Boddeke, R. 1966. Sexual cycle and growth of brown shrimp (*Crangon crangon*). ICES, CM 1966/M:6.
- Boddeke, R. 1968. Forecasting the landings of brown shrimp (*Crangon crangon*) in The Netherlands. ICES, CM, Shelfish and Benthos Committee 1968/K:8.
- Boddeke, R. 1975. Autumn migration and vertical distribution of the brown shrimp *Crangon crangon* L. in relation to environmental conditions. Proc. 9<sup>th</sup> Europ. Mar. Biol. Symp., H. Barnes (ed.), Aberdeen: Aberdeen University Press, 483-494.
- Boddeke, R. 1976. The seasonal migration of the brown shrimp *Crangon crangon*. Neth. J. Sea Res. 10, 103-130.
- Boddeke, R. 1978. Changes in the stock of brown shrimp (*Crangon crangon* L.) in the coastal area of the Netherlands. Rapp. P.-v. Réun. Cons. Int. Explor. Mer 172, 239-249.
- Boddeke, R. 1982. The occurrence of winter and summer eggs in the brown shrimp (*Crangon crangon*) and the pattern of recruitment. Neth. J. Sea Res. 16, 151-162.
- Boddeke, R. 1989. Management of the brown shrimp (*Crangon crangon*) stock in the Dutch Coastal waters. In Marine Invertebrate Fisheries: Their Assessment and Management, J. F. Caddy (ed.), New York, 35-62.
- Boddeke, R. 1996. Changes in the brown shrimp (*Crangon crangon* L.) population off the Dutch coast in relation to fisheries and phosphate discharge. ICES J. Mar. Sci. 53, 995-1002.
- Boddeke, R. & Becker, H.B. 1979. A quantitative study of the fluctuations of the stock of brown shrimp (*Crangon crangon*) along the coast of The Netherlands. Rapp. P.-v. Réun. Cons. Int. Explor. Mer 175, 253-258.
- Boddeke, R., Bosschieter, J.R. & Goudswaard, P.C. 1988. Mating, sperm transfer and sex change in *Crangon crangon* (Decapoda, Natantia). Am. Zool. 28 A109.
- Boddeke, R., Bosschieter, J.R. & Goudswaard, P.C. 1991. Sex change, mating, and sperm transfer in *Crangon crangon* (L.). In: Bauer, R.T., Martin, J.W. (Eds.), Crustacean sexual biology. Columbia University Press, New York, USA, pp. 164-182.



## References

---

- Boddeke, R., Dijkema, R. & Siemelink, M.E. 1976. The patterned migration of shrimp populations: a comparative study of *Crangon crangon* and *Penaeus brasiliensis*. FAO Fish. Rep. 200, 31-49.
- Boddeke, R., Driessen, G., Doesburg, W. & Ramaekers, G. 1985. Settlement and growth of brown shrimp (*Crangon crangon*) in a coastal area. ICES, CM 1985/K 16: 8.
- Boddeke, R., Driessen, G., Doesburg, W. & Ramaekers, G. 1986. Food availability and predator presence in a coastal nursery area of the brown shrimp (*Crangon crangon*). Ophelia 26, 77-90.
- Boehlert, G.W. & Kappenman, R.F. 1980. Variation of growth with latitude in two species of rockfish (*Sebastes pinniger* and *Sebastes diploproa*) from the Northeast Pacific. Mar. Ecol. Prog. Ser. 3, 1-10.
- Bonsdorff, E., Norkko, A. & Sandberg, E. 1995. Structuring zoobenthos: the importance of predation, siphon cropping and physical disturbance. J. Exp. Mar. Biol. Ecol. 192, 125-144.
- Borsa, P., Blanquer, A. & Berrebi, P. 1997. Genetic structure of the flounders *Platichthys flesus* and *P. stellatus* at different geographic scales. Mar. Biol. 129, 233-246.
- Brian, J.V., Fernandes, T., Ladle, R.J. & Todd, P.A. 2005. Patterns of morphological and genetic variability in UK populations of the shore crab, *Carcinus maenas* Linnaeus, 1758 (Crustacea : Decapoda : Brachyura). J. Exp. Mar. Biol. Ecol. 329: 47-54
- Brockwell, P.J. & Davis, R.A. 1996. Introduction to time series and forecasting. Springer, U.S.A.
- Broekema, M.M.M. 1942. Seasonal movements and the osmotic behaviour of the shrimp *Crangon crangon* L. Archs Neerl. Zool. 6, 1-100.
- Broekhuysen, G.J. 1936. On development, growth, and distribution of *Carcinus maenas* (L.). Archs Neerl. Zool. 2, 257-339.
- Brusca, R.C. & Brusca, G.J. 2003. Invertebrates. Sinauer Associates, Sunderland, MA.
- Bulnheim, H.P. & Schwenzer, D.E. 1993. Population genetic studies on *Crangon crangon* and *C. allmanni* (Crustacea, Decapoda) from European coastal areas. Zool. Jahrb. 97, 327-347.
- Burrows, M.T., Gontarek, S.J., Nash, R.D.M. & Gibson, R.N. 2001. Shrimp predation on 0-group plaice: contrasts between field data and predictions of an individual-based model. J. Sea Res. 45, 243-254.
- Burzynski, A. 2007. Two events are responsible for an insertion in a paternally inherited mitochondrial genome of the mussel *Mytilus galloprovincialis*. Genetics 175, 959-962.
- Butler, T.H. 1980. Shrimps of the Pacific coast of Canada. Can. B. Fish. Aquat. Sci. 202, 280 pp.
- Cabral, H.N., Teixeira, C.M., Gamito, R. & Costa, M.J. 2002. Importance of discards of a beam trawl fishery as input of organic matter into nurseries within Tagus estuary. Hydrobiologia 475/476, 449-455.
- Cadrin, S.X., 2000. Advances in morphometric identification of fishery stocks. Reviews in Fish Biology and Fisheries 10, 91-112.
- Campos, J., Freitas, V., Pedrosa, C. & Van der Veer, H.W. 2009. Latitudinal variation in growth of *Crangon crangon* (L.): does counter-gradient growth compensation occur? J. Sea Res., doi: 10.1016/j.seares.2009.04.002
- Campos, J. & Van der Veer, H.W. 2008. Autecology of *Crangon crangon* (L.) with an emphasis on latitudinal trends. Oceanogr. Mar. Biol., Annu. Rev. 46, 65-104.
- Cardoso, J.F.M.F., Witte, J.I.J. & Van der Veer, H.W. 2006. Intra- and interspecies comparison of energy flow in bivalve species in Dutch coastal waters by means of Dynamic Energy Budgets (DEB theory). J. Sea Res. 56, 182-197.
- Catrijsse, A., Dankwa, H.R. & Mees, J. 1997. Nursery function of an tidal marsh for the brown shrimp *Crangon crangon*. J. Sea Res. 38, 109-121.
- Chevolot, M., Hoarau, G., Rijnsdorp, A.D., Stam, W.T. & Olsen J.L. 2006. Phylogeography and population structure of thornback rays (*Raja clavata* L., Rajidae). Mol. Ecol. 15, 3693-3705.
- Christoffersen, M.L. 1988. Genealogy and phylogenetic classification of the world Crangonidae (Crustacea, Caridae), with a new species and new records for the South Western Atlantic. Rev. Nordestina Biol. 6, 43-59.

- Clark, A.G. 1990. Inference of haplotypes from PCR-amplified samples of diploid populations. *Mol. Biol. Evol.* 7, 111-122.
- Clarke, K.D. & Warwick, R.M., 2001. Change in marine communities: an approach to statistical analysis and interpretation. 2<sup>nd</sup> edition. PRIMER-E Plymouth.
- Conover, D.O. 1990. The relationship between capacity for growth and length of the growing season: evidence for and implications of countergradient variation. *T. Am. Fish. Soc.* 119, 416-430.
- Conover, D.O., Brown, J.J. & Ehtisham, A. 1997. Countergradient variation in growth of young striped bass (*Morone saxatilis*) from different latitudes. *Can. J. Fish. Aquat. Sci.* 54, 2401-2409.
- Conover, D.A. & Present, T.M.C. 1990. Counter-gradient variation in growth rate: compensation for length of the growing season among Atlantic silverside from different latitudes. *Oecologia* 83, 316-324.
- Conover, D.O. & Schultz, E.T., 1995. Phenotypic similarity and the evolutionary significance of countergradient variation. *Trends Ecol. Evol.* 10, 248-252.
- Crandall, K.A., Bininda-Emonds, O.R.P., Mace, G.M. & Wayne, R.K. 2000. Considering evolutionary processes in conservation biology. *Trends Ecol. Evol.* 15, 290-295.
- Creutzberg, F., Eltink, A.T.G.W. & Van Noort, G.J. 1978. The migration of plaice larvae *Pleuronectes platessa* into the western Wadden Sea. *Proc. 12<sup>th</sup> Europ. Mar. Biol. Symp.*, D.S. McLusky & A.J. Berry (eds.), Oxford, New York: Pergamon Press, 243-251.
- Criales, M.M. & Anger, K. 1986. Experimental studies on the larval development of the shrimps *Crangon crangon* and *C. almanii*. *Helgoländer Meeresun.* 40, 241-265.
- Crivelli, A.J. 1982. Biology of three Malacostraca (Decapoda) in a Mediterranean lagoon with particular emphasis on the effect of rapid environmental changes on the activity (catchability) of the species. *Est. Coast. Shelf Sci.* 15, 591-604.
- Cuesta, J. A., Gonzalez-Ortegon, E., Rodriguez, A., Baldo, F., Vilas, C. & Drake, P. 2006. The decapod crustacean community of the Guadalquivir Estuary (SW Spain): seasonal and inter-year changes in community structure. *Hydrobiologia* 557, 85-95
- Daan, N., Bromley, P.J., Hislop, J.R.G. & Nielsen, N.A. 1990. Ecology of North Sea fish. *Neth. J. Sea Res.* 26, 343-386.
- Dahl, K., Borchardt, T., Dankers, N. & Farke, H. 1994. Status, trends, regulations and ecological effects of the Wadden Sea fishery. *Ophelia* 6, 87-97.
- Dalley, R. 1980. The survival and development of the shrimp *Crangon crangon* (L.) reared in the laboratory under non-circadian light-dark cycles. *J. Exp. Mar. Biol. Ecol.* 47, 101-112.
- Dalpadado, P., Ellertsen, B., Melle, W. & Dommasnes, A. 2000. Food and feeding conditions of Norwegian spring-spawning herring (*Clupea harengus*) through its feeding migrations. *ICES J. Mar. Sci.* 57, 843-857.
- Dawson, A.G. 1992. Ice age earth. Late quaternary geology and climate. Routledge, London.
- Day, J. W., Hall, A. S., Kemp, W. M. & Yanez-Arancibia, A. 1989. Estuarine ecology. New York: Wiley, 558pp.
- Dehnel, P.H. 1955. Rates of growth of gastropods as a function of latitude. *Physiol. Zool.* 28, 115-144.
- Demir, N. 1963. Synopsis of biological data on anchovy *Engraulis encrasicolus* (Linnaeus) 1758 (Mediterranean and adjacent sea). *FAO Fish. Synop.* 26, Rome.
- Del Norte-Campos, A.G.C. & Temming, A. 1994. Daily activity, feeding and rations in gobies and brown shrimp in the northern Wadden Sea. *Mar. Ecol. Prog. Ser.* 115, 41-53.
- Del Norte-Campos, A.G.C. & Temming, A. 1998. Population dynamics of the brown shrimp *Crangon crangon* L., in shallow areas of the German Wadden Sea. *Fish. Manage. Ecol.* 5, 303-322.
- Derks, P. 1980. Kwantitatieve bepaling van de dagelijksr voedselopname van garnalen, *Crangon crangon* (L.), volgens het Bajkov-principe met een schatting van de jaarlijkse consumptie en produktie van de populatie op het Balgzand, een droogvallend getijdengebied, en enige gegevens omtrent het voedselzoeken en de voedselsamenstelling. *Int. Rep. Neth. Inst. Sea Res.* (unpub.), 31 pp.

## References

---

- De Vlas, J. 1979. Annual food intake by plaice and flounder in a tidal flat area in the Dutch Wadden Sea, with special reference to consumption of regenerating parts of macrobenthic prey. *Neth. J. Sea Res.* 13, 117-153.
- Doflein, F. 1900. Die decapoden Krebse der arktischen Meere. *Fauna Arctica I Abh.* X.
- Dornheim, H. 1969. Beiträge zur Biologie der Garnele *Crangon crangon* (L.) in der Kieler Bucht. *Ber. Dt. Wiss. Kom. für Meeresforsch.* 20, 179-215.
- Drake, P., Arias, A.M., Baldó, F., Cuesta, J. A., Rodríguez, A., Silva-Garcia, A., Sobrino, I., Garcia-Gonzalez, D. & Fernandez-Delgado, C. 2002. Spatial and temporal variation of the nekton and hyperbenthos from a temperate European estuary with regulated freshwater inflow. *Estuaries* 25, 451-468.
- Drent, J. 2002. Temperature responses in larvae of *Macoma balthica* from a northerly and a southerly population of the European distribution range. *J. Exp. Mar. Biol. Ecol.* 275, 117-129.
- Drent, J. 2004. Live history variation of a marine bivalve (*Macoma balthica*) in a changing world. PhD Thesis, University of Groningen, The Netherlands.
- Driver, P.A. 1976. Prediction of fluctuations in the landings of brown shrimp (*Crangon crangon*) in the Lancashire and Western Sea Fisheries District. *Est. Coast. Shelf Sci.* 4, 567-573.
- Du Cane, C. 1839. Metamorphosis of Crustacea. *Annals and Magazine of Natural History* 2, 178-181.
- Duran, M. 1997. The ecology of brown shrimp *Crangon crangon* (L.) in the Wash. PhD Thesis, University of East Anglia, School of Biological Sciences, Norwich, UK, unpublished.
- Duran, S., Pascual, M., Estoup, A. & Turon, X. 2004a. Strong population structure in the marine sponge *Crambe crambe* (Poecilosclerida) as revealed by microsatellite markers. *Mol. Ecol.* 13, 511-522.
- Duran, S., Pascual, M. & Turon, X. 2004b. Low levels of genetic variation in mtDNA sequences over the western Mediterranean and Atlantic range of the sponge *Crambe crambe* (Poecilosclerida). *Mar. Biol.* 144, 31-35.
- Dyer, M.F. & Uglow, R.F. 1978. Heart and scaphognathite beat behaviour in laboratory-held *Crangon crangon* (L.). *J. Exp. Mar. Biol. Ecol.* 32, 209-218.
- Edwards, R. & Steele, J.H. 1968. The ecology of 0-group plaice and common dabs at Loch Ewe. I. Population and food. *J. Exp. Mar. Biol. Ecol.* 2, 215-238.
- Edwards, R.R.C. 1978. Effects of water-soluble oil fractions on metabolism, growth and carbon budget of the shrimp *Crangon crangon*. *Mar. Biol.* 46, 259-265.
- Edwards, S.V. & Beerli, P. 2000. Perspective: Gene divergence, population divergence, and the variance in coalescence time in phylogeographic studies. *Evolution* 54, 1839-1854.
- Ehrenbaum, E. 1890. Zur Naturgeschichte von *Crangon vulgaris* Fabr. Berlin, Dt. Seefisch.-Verein, Mittl. Sekt. Küsten Hochseefisch., Sonderbeilage, 9-124.
- Ekman, S. 1968. Zoogeography of the sea. Sidgwick and Jackson, London, UK.
- Emory, K.O. & Hunt, J.M. 1974. Summary of the Black Sea investigations. In: Degens, E.T., Ross, D.A. (Eds.), *The Black Sea - geology, chemistry and biology*. The American Association of Petroleum Geologists, Tulsa, Oklahoma, USA, 575-590.
- Evans, S. 1983. Production, predation and food niche segregation in a marine shallow soft-bottom community. *Mar. Ecol. Prog. Ser.* 10, 147-157.
- Evans, S. 1984. Energy budgets and predation impact of dominant epibenthic carnivores on a shallow soft bottom community at the Swedish west coast. *Est. Coast. Shelf Sci.* 18, 651-672.
- Excoffier, L., Laval, G. & Schneider, S. 2005. Arlequin ver. 3.0: An integrated software package for population genetics data analysis. *Evol. Bioinform. Online* 1, 47-50.
- Fabbiani, F. 1979. Biologie et écologie de deux caridés (Crustacea, Decapoda) d'une lagune camarguaise: *Crangon crangon* et *Palaemon squilla* de l'étang du grau de Piémanson. Thèse de 3ème cycle, Université des Sciences et Techniques du Languedoc, Montpellier, France.
- Fedderson, U. 1993. Eine vergleichende studie uber zooplantonvorkommen in Nordfriesischen wattenmeer. Diplomarbeit, Universität Hamburg, pp. 49.

- Felsenstein, J. 1981. Evolutionary trees from DNA sequences: a maximum likelihood approach. *J. Mol. Evol.* 17, 368-376.
- Feral, J.P. 2002. How useful are the genetic markers in attempts to understand and manage marine biodiversity? *J. Exp. Mar. Biol. Ecol.* 268, 121-145.
- Flach, E.C. 2003. The separate and combined effects of epibenthic predation and presence of macro-infauna on the recruitment success of bivalves in shallow soft-bottom areas on the Swedish west coast. *J. Sea Res.* 49, 59-67.
- Fonds, M. 1978. The seasonal distribution of some fish species in the western Dutch Wadden Sea. In: Dankers, Wolff and Zijlstra (ed.) *Fishes and fisheries of the Wadden Sea*. Report 5 of the Wadden Sea working group: 42-77.
- Fonds, M., Cronie, R., Vethaak, A.D. & Van der Puyl, P. 1992. Metabolism, food consumption and growth of plaice (*Pleuronectes platessa*) and flounder (*Platichthys flesus*) in relation to fish size and temperature. *Neth. J. Sea Res.* 29, 127-143.
- Freitas, V., Campos, J., Fonds, M. & Van der Veer, H.W. 2007. Potential impact of temperature change on epibenthic predator-bivalve prey interactions in temperate estuaries. *J. Therm. Biol.* 32, 328-340.
- Gach, M.H. & Brown, W.M. 1997. Characteristics and distribution of large tandem duplications in brook stickleback (*Culaea inconstans*) mitochondrial DNA. *Genetics* 145, 383-394.
- Gamito, R. & Cabral, H. 2003. Mortality of brown-shrimp discards from the beam trawl fishery in the Tagus estuary, Portugal. *Fish. Res.* 63, 423-427.
- Garibaldi, L. 2002. *FAO Fishery Information, Data and Statistics (FIDI)*.
- Garthe, S., Camphuysen, K. & Furness, R.W. 1996. Amounts of discards by commercial fisheries and their significance as food for seabirds in the North Sea. *Mar. Ecol. Prog. Ser.* 136, 1-11.
- Gee, J.M. 1987. Impact of epibenthic predation on estuarine intertidal harpacticoid copepod populations. *Mar. Biol.* 96, 497-510.
- Gelin, A., Crivelli, A.J., Rosecchi, E., Kerambrun, P. 2000. Is the brown shrimp *Crangon crangon* (L.) population of the Vaccarès lagoon (Camargue, France, Rhône delta) an annual population? *CR Acad. Sci. III-Vie* 323, 741-748.
- Gelin, A., Crivelli, A.J., Rosecchi, E. & Kerambrun, P. 2001a. Can salinity affect reproductive success in the brown shrimp *Crangon crangon*? *J. Crustacean Biol.* 21, 905-911.
- Gelin, A., Crivelli, A.J., Rosecchi, E. & Kerambrun, P. 2001b. The effect of salinity changes on the population structure and reproductive traits of *Crangon crangon* L. populations in the Camargue (Rhône Delta, France). *Ecoscience* 8, 8-17.
- Gibson, R.N., Pihl, L., Burrows, M.T., Modin, J., Wennhage, H. & Nickell, L.A. 1998. Diel movements of juvenile plaice *Pleuronectes platessa* in relation to predators, competitors, food availability and abiotic factors on a microtidal nursery ground. *Mar. Ecol. Prog. Ser.* 165, 145-159.
- Gibson, R.N., Robb, L., Wennhage, H. & Burrows, M.T. 2002. Ontogenetic changes in depth distribution of juvenile flatfishes in relation to predation risk and temperature on a shallow-water nursery ground. *Mar. Ecol. Prog. Ser.* 229, 233-244.
- Gibson, R.N., Yin, M.C. & Robb, L. 1995. The behavioural basis of predator-prey size relationships between shrimp (*Crangon crangon*) and juvenile plaice (*Pleuronectes platessa*). *J. Mar. Biol. Assoc. UK* 75, 337-349.
- González-Ortegón, E., Pascual, E., Cuesta, J.A. & Drake, P. 2006. Field distribution and osmoregulatory capacity of shrimps in a temperate European estuary (SW Spain). *Est. Coast. Shelf Sci.* 67, 293-302.
- Graham, N. 1997. Reduction of by-catch in the brown shrimp, *Crangon crangon*, fisheries of the Wash and Humber estuaries. PhD Thesis, University of Lincolnshire and Humberside, UK.
- Graham, N. 2003. By-catch reduction in the brown shrimp, *Crangon crangon*, fisheries using a rigid separation Nordmore grid (grate). *Fish. Res.* 59, 393-407.

## References

---

- Grant, W.S. 2005. A second look at mitochondrial DNA variability in European anchovy (*Engraulis encrasicolus*): assessing models of population structure and the Black Sea isolation hypothesis. *Genetica* 125, 293-309.
- Gurney, A.R. 1982. The larval development of *Crangon crangon* (Fabr. 1795) (Crustacea: Decapoda). *Bull. Brit. Mus. Nat. Hist. (Zool.)* 42, 247-262.
- Gysels, E. S., Hellemans, B., Pampoulie, C. & Volckaert, F.A.M. 2004a. Phylogeography of the common goby, *Pomatoschistus microps*, with particular emphasis on the colonization of the Mediterranean and the North Sea. *Mol. Ecol.* 13, 403-417.
- Gysels, E. S., Hellemans, B., Patarnello, T. & Volckaert, F.A.M. 2004b. Current and historic gene flow of the sand goby *Pomatoschistus minutus* on the European Continental Shelf and in the Mediterranean Sea. *Biol. J. Linn. Soc.* 83, 561-576.
- Hagerman, L. 1970. Locomotory activity patterns of *Crangon vulgaris* (Fabricius) (Crustacea, Natantia). *Ophelia* 8, 255-266.
- Hagerman, L. 1971. Osmoregulation and sodium balance in *Crangon vulgaris* (Fabricius) (Crustacea, Natantia) in varying salinities. *Ophelia* 9, 21-30.
- Hagerman, L. 1976. The respiration during the moult cycle of *Crangon vulgaris* (Fabr.) (Crustacea, Natantia). *Ophelia* 15, 15-21.
- Hamerlynk, O. & Hostens, K. 1993. Growth, feeding, production, and consumption in 0-group bib (*Trisopterus luscus* L.) and whiting (*Merlangius merlangus* L.) in a shallow coastal area of the south-west Netherlands. *ICES J. Mar. Sci.* 50, 81-91.
- Hammer, O. 2002. *Morphometrics – brief notes*. Zurich. [on-line] <http://folk.uio.no/ohammer/past/morphometry.pdf>
- Hampel, H., Cattrijsse, A., Elliott, M., 2005. Feeding habits of young predatory fishes in marsh creeks situated along the salinity gradient of the Schelde estuary, Belgium and The Netherlands. *Helgoland Mar. Res.* 59, 151-162.
- Hartnoll, R.G. 2001. Growth in Crustacea – twenty years on. *Hydrobiologia* 449, 111–122.
- Hartsuyker, L. 1966. Daily tidal migrations on the shrimp *Crangon crangon*. *Neth. J. Sea Res.* 3, 52-67.
- Havinga, B. 1930. Der granat (*Crangon vulgaris* Fabr.) in den holländischen Gewässern. *J. Cons. Int. Explor. Mer* 5, 57-87.
- Hayashi, K.-I. & Kim, J.N. 1999. Revision of the East Asian species of *Crangon* (Decapoda: Caridea: Crangonidae). *Crustac. Res.* 28, 62-103.
- Hedqvist-Johnson, K. & André, C. 1991. The impact of the brown shrimp *Crangon crangon* on soft bottom meiofauna: an experimental approach. *Ophelia* 34, 41-49.
- Heerebout, G.R. 1974. Distribution and ecology of the Decapoda-Natantia in the estuarine region of the rivers Rhine, Meuse and Sheldt. *Neth. J. Sea Res.* 8, 73-93.
- Henderson, P.A. & Holmes, R.H.A. 1987. On the population biology of the common shrimp *Crangon crangon* (L.) (Crustacea: Caridea) in the Severn Estuary and Bristol Channel. *J. Mar. Biol. Assoc. UK* 67, 825-847.
- Henderson P.A. & Holmes R.H.A. 1989. Whiting migration in the Bristol Channel: a predator-prey relationship. *J. Fish Biol.* 34, 409-416.
- Henderson, P.A., James, D. & Holmes, R.H.A. 1992. Trophic structure within the Bristol Channel: seasonality and stability in Bridgewater Bay. *J. Mar. Biol. Assoc. UK* 72, 675-690.
- Henderson, P.A., Seaby, R.M. & Marsh, S.J. 1990. The population zoogeography of the common shrimp (*Crangon crangon*) in British waters. *J. Mar. Biol. Assoc. UK* 70, 89-97.
- Henderson, P.A., Seaby, R.M. & Somes, J.R. 2006. A 25-year study of climatic and density-dependent population regulation of common shrimp *Crangon crangon* (Crustacea: Caridea) in the Bristol Channel. *J. Mar. Biol. Assoc. UK* 86, 287-298.

- Henking, H. 1927. Der Fang der Nordsee-Garnalen (*Crangon vulgaris* L.) in der Ostsee. Mitteil. Dt. Seefisch.-Vereins 43, 1-14.
- Hewitt, G.M., 2004. Genetic consequences of climatic oscillations in the Quaternary. Philos. Philos. T. Roy. Soc. B 359, 183-195.
- Hiddink J.G., Marijnissen S.A.E., Troost, K., Wolff, W.J. 2002. Predation on 0-group and older year-classes of the bivalve *Macoma balthica*: interaction of size selection and intertidal distribution of epibenthic predators. J. Exp. Mar. Biol. Ecol. 269, 223-248.
- Hinz, H., Kroncke, I. & Ehrich, S. 2004. Seasonal and annual variability in an epifaunal community in the German Bight. Mar. Biol. 144, 735-745.
- Ho, S.Y.W. & Larson, G. 2006. Molecular clocks: when times are a-changin'. Trends Genet. 22, 79-83.
- Ho, S.Y.W., Phillips, M.J., Cooper, A. & Drummond, A.J. 2005. Time dependency of molecular rate estimates and systematic overestimation of recent divergence times. Mol. Biol. Evol. 22, 1561-1568.
- Hoarau, G., Holla, S., Lescasse, R., Stam, W.T. & Olsen, J.L. 2002. Heteroplasmy and evidence for recombination in the mitochondrial control region of the flatfish *Platichthys flesus*. Mol. Biol. Evol. 19, 2261-2264.
- Holthuis, L.B. 1955. The recent genera of Caridean and Stenopodidean shrimps (Class Crustacea, Order Decapoda, Supersection Natantia) with keys for their determination. Zool. Verh., Leiden 26, 1-157.
- Holthuis, L.B. 1980. FAO species catalogue. Shrimps and prawns of the world. An annotated catalogue of species of interest to fisheries. FAO Fish. Synop. (125) 1.
- Hopkins, W.G. 2000. A new view of statistics. Internet Society for Sport Science: <http://www.sportsci.org/resource/stats/>
- Horwood, J.W. 2000. *No-take zones: a management perspective*. In: Kaiser, M.J., Groot, S.J.d. (Eds.), Effects of fishing on non-target species and habitats. Biological, conservation and socio-economic issues. Blackwell Science, Oxford, pp. 302-311.
- Hudson, A.V. & Furness, R.W. 1988. Utilisation of discarded fish by scavenging seabirds behind whitefish trawlers in Shetland. J. Zool. 215, 151-166.
- Huey, R.B. & Kingsolver, J.G. 1989. Evolution of the thermal sensitivity of ectotherm performance. Trends Ecol. Evol. 4, 131-135.
- Hurvich, C.M. & Tsai, C.-L. 1989. Regression and time series model selection in small samples. Biometrika 76, 297-307.
- Hyndman, R.J. 1994. *ITSM for Windows*. Springer, USA.
- ICES 1996. Report of the working group on Crangon fisheries and life history. ICES CM 1996/K:4.
- ICES 2006. Report of the working Group on *Crangon* fisheries and life history (WGCRAN). ICES CM 2006/LRC 10, pp. 35.
- ICES 2007. Report of the working Group on *Crangon* fisheries and life history (WGCRAN). ICES CM 2007/LRC 08, pp. 40.
- Ignatius, H., Axberg, S., Niemistö, L. & Winterhalter, B., 1981. Quaternary geology of the Baltic Sea. In: Voipio, A.V. (Ed.), The Baltic Sea. Elsevier, Amsterdam, pp. 54-104.
- Isely, J.J., Noble, R.L., Koppelman, J.B., & Philipp, D.P. 1987. Spawning period and first-year growth of northern, Florida, and intergrade stocks of largemouth bass. T. Am. Fish. Soc. 116, 757-762.
- Jager, Z. 1999. Selective tidal stream transport of flounder larvae (*Platichthys flesus* L.) in the Dollard (Ems estuary). Est. Coast. Shelf Sci. 49, 347-362.
- Janssen G.M. & Kuipers B.R. 1980. On tidal migration in the shrimp *Crangon crangon* (Balgzand, Wadden Sea). Neth. J. Sea Res. 14, 339-348.
- Jensen, K.T. & Jensen, J.N. 1985. The importance of some epibenthic predators on the density of juvenile benthic macrofauna in the Danish Wadden Sea. J. Exp. Mar. Biol. Ecol. 89, 157-174.

## References

---

- Jeffery, S. & Reville, A. 2002. The vertical distribution of southern North Sea *Crangon crangon* (brown shrimp) in relation to towed fishing gears as influenced by water temperature. *Fish. Res.* 55, 319-323.
- Johannesson, K. & André, C. 2006. Life on the margin: genetic isolation and diversity loss in a peripheral marine ecosystem, the Baltic Sea. *Mol. Ecol.* 15, 2013-2029.
- Jones, P.D., Jonsson, T. & Wheeler, D. 1997. Extension to the North Atlantic Oscillation using instrumental pressure observations from Gibraltar and South-West Iceland. *Int. J. Climatol.* 17, 1433-1450.
- Kaiser, M.J. & Spencer, B.E. 1995. Survival of by-catch from a beam trawl. *Mar. Ecol. Prog. Ser.* 126, 31-38.
- Kamermans, P. & Huitema, H.J. 1994. Shrimp (*Crangon crangon* L.) browsing upon siphon tips inhibits feeding and growth in the bivalve *Macoma balthica* (L.). *J. Exp. Mar. Biol. Ecol.* 175, 59-75.
- Kattner, G., Wehrmann, I.S. & Merck, T. 1994. Interannual variations of lipids and fatty acids during larval development of *Crangon* spp. in the German Bight, North Sea. *Comp. Biochem. Phys. B* 107, 103-110.
- Kelle, W. 1976. Sterblichkeit untermasziger Plattfische im Beifang der Garnelenfischerei. *Meeresforschung* 25, 77-89.
- Kemp, S.W. 1908. The Decapoda Natantia of the coasts of Ireland. *Sci. Invest. Fish. Branch, Ireland* 1, 1-190.
- Kinne, O., 1962. Irreversible nongenetic adaptation. *Comp. Biochem. Physiol.* 5, 265-282.
- Kinne, O., 1964. Non-genetic adaptation to temperature and salinity. *Helgoland Mar. Res.* 9, 433-458.
- Klein Breteler, W.C.M. 1975. Food consumption, growth and energy metabolism of juvenile shore crabs, *Carcinus maenas*. *Neth. J. Sea Res.* 9, 255-272.
- Kmiec, B., Woloszynska, M. & Janska, H. 2006. Heteroplasmy as a common state of mitochondrial genetic information in plants and animals. *Curr. Genet.* 50, 149-159.
- Knowlton, N. & Weigt, L.A. 1998. New dates and new rates for divergence across the Isthmus of Panama. *Proc. R. Soc. Lond., B* 265, 2257-2263.
- Kokita, T. 2004. Latitudinal compensation in female reproductive rate of a geographically widespread reef fish. *Environ. Biol. Fish.* 71, 213-222.
- Kooijman, S.A.L.M. 1986. Energy budgets can explain body size relations. *J. Theor. Biol.* 121, 269-282.
- Kooijman, S.A.L.M. 1993. *Dynamic Energy Budgets in Biological Systems*. Cambridge Univ. Press, Cambridge.
- Kooijman, S.A.L.M. 2000. *Dynamic and energy mass budgets in biological systems*. Cambridge: Cambridge University Press.
- Kooijman, S.A.L.M. 2001. Quantitative aspects of metabolic organization: a discussion of concepts. *Philos. T. Roy. Soc. B* 356, 331-349.
- Kooijman, S.A.L.M., Sousa, T., Pecquerie, L., Van der Meer, J. & Jager, T. 2008. From food-dependent statistics to metabolic parameters, a practical guide to the use of dynamic energy budget theory. *Biological Reviews* 83, 533-552.
- Krijgsman, W., Hilgen, F.J., Raffi, I., Sierro, F.J. & Wilson, D.S. 1999. Chronology, causes and progression of the Messinian salinity crisis. *Nature* 400, 652-655.
- Kuhl, H. 1972. Hydrography and biology of the Elbe estuary. *Oceanogr. Mar. Biol., Annu. Rev.* 10, 225-309.
- Kuhl, H. & Mann, H. 1963. On the distribution of shrimp larvae (*Crangon crangon* L.) in the estuary of the Elbe. *Veröff. Inst. Küst. Binnenfisch.* 27, 50-52.
- Kuipers, B.R. & Dapper, R. 1981. Production of *Crangon crangon* in the tidal zone of the Dutch Wadden Sea. *Neth. J. Sea Res.* 15, 33-53.
- Kuipers, B.R. & Dapper, R. 1984. Nursery function of Wadden Sea tidal flats for the brown shrimp *Crangon crangon*. *Mar. Ecol. Prog. Ser.* 17, 171-181.
- Kuipers, B.R., De Wilde, P.A.W.J. & Creutzberg, F. 1981. Energy flow in a tidal flat ecosystem. *Mar. Ecol. Prog. Ser.* 5, 215-221.
- Kurc, G., Faure, L. & Laurent, T. 1965. La pêche des crevettes au chalut et les problèmes de sélectivité. *Rev. Trav. Inst. Pech. Marit.* 29, 137-161.

- Labat, J.-P. 1977a. Ecologie de *Crangon crangon* (L.) (Decapoda, Caridea) dans un étang de la côte Languedocienne I. - Croissance, reproduction, migrations mer/étang. *Vie Milieu* 27, 273-292.
- Labat, J.-P. 1977b. Ecologie de *Crangon crangon* (L.) (Decapoda, Caridea) dans un étang de la côte languedocienne. II. - Mouvements et répartition intralagunaires. *Vie Milieu* 27, 359-367.
- Ladoukakis, E.D., Saavedra, C., Magoulas, A. & Zouros, E. 2002. Mitochondrial DNA variation in a species with two mitochondrial genomes: the case of *Mytilus galloprovincialis* from the Atlantic, the Mediterranean and the Black Sea. *Mol. Ecol.* 11, 755-769.
- Lancaster, J. 1999. Ecological studies on the brown shrimp (*Crangon crangon*) fishery in the Solway Firth. PhD Thesis, University of Newcastle Upon Tyne, United Kingdom.
- Lancaster, J. & Frid, C.L.J. 2002. The fate of discarded juvenile brown shrimps (*Crangon crangon*) in the Solway Firth UK fishery. *Fish. Res.* 58, 95-107.
- Lapolla, A.E. 2001. Bay anchovy *Anchoa mitchilli* in Naragansett Bay, Rhode Island. II. Spawning season, hatch date distribution and young-of-the-year growth. *Mar. Ecol. Prog. Ser.* 217, 103-109.
- Lebour, M.V. 1947. Notes on the inshore plankton of Plymouth. *J. Mar. Biol. Assoc. UK* 26, 527-547.
- Leggett, W.C. & DeBlois, E.M. 1994. Recruitment in marine fishes: is it regulated by starvation and regulation in the egg and larval stages? *Neth. J. Sea Res.* 32, 119-134.
- Levinton, J.S. 1983. The latitudinal compensation hypothesis: growth data and a model of latitudinal growth differentiation based upon energy budgets. I. Interspecific comparison of *Ophryotrocha* (Polychaeta: Dorvilleidae). *Biol. Bull.* 165, 686-698.
- Lindeman, R.H., Merenda, P.F. & Gold, R.Z. 1980. Introduction to Bivariate and Multivariate Analysis. Scott, Foresman, Glenview, IL, USA.
- Liu, H., Mitton, J.B. & Wu, S.-K. 1996. Paternal mitochondrial DNA differentiation far exceeds maternal mitochondrial DNA and allozyme differentiation in the freshwater mussel, *Anodonta grandis grandis*. *Evolution* 50, 952-957.
- Lloyd, A.J. & Yonge, C.M. (1947). The biology of *Crangon vulgaris* L. in the Bristol Channel and the Severn estuary. *J. Mar. Biol. Assoc. UK* 26, 626-661.
- Lonsdale, D.J. & Levinton, J.S. 1985. Latitudinal differentiation in copepod growth: an adaptation to temperature. *Ecology* 65, 1397-1407.
- Lonsdale, D.J. & Levinton, J.S. 1989. Energy budgets of latitudinally separated *Scottlana canadensis* (Copepoda: Harpacticoida). *Limnol. Oceanogr.* 34, 324-331.
- Ludwig, W., Strunk, O., Westram, R., Richter, L., Meier, H., Yadhukumar, Buchner, A., Lai, T., Steppi, S., Jobb, G., Forster, W., Brettske, I., Gerber, S., Ginhart, A.W., Gross, O., Grumann, S., Hermann, S., Jost, R., König, A., Liss, T., Lussmann, R., May, M., Nonhoff, B., Reichel, B., Strehlow, R., Stamatakis, A., Stuckmann, N., Vilbig, A., Lenke, M., Ludwig, T., Bode, A. & Schleifer, K.H. 2004. ARB: a software environment for sequence data. *Nucleic Acids Res.* 32, 1363-1371.
- Luttikhuizen, P.C., Campos, J., Bleijswijk, J., Peijnenburg, K.T.C.A. & Van der Veer, H.W., 2008. Phylogeography of the common shrimp, *Crangon crangon* (L.) in European waters. *Mol. Phylogenet. Evol.* 46, 1015-1030.
- Luttikhuizen, P.C., Drent, J. & Baker, A.J. 2003. Disjunct distribution of highly diverged mitochondrial lineage clade and population subdivision in a marine bivalve with pelagic larval dispersal. *Mol. Ecol.* 12, 2215-2229.
- Macer, C.T. 1967. The food web in Red Wharf Bay (North Wales) with particular reference to young plaice (*Pleuronectes platessa*). *Helgoländer Meeresun.* 15, 560-572.
- Magoulas, A., Castilho, R., Caetano, S., Marcato, S. & Patarnello, T. 2006. Mitochondrial DNA reveals a mosaic pattern of phylogeographical structure in Atlantic and Mediterranean populations of anchovy (*Engraulis encrasicolus*). *Mol. Phylogenet. Evol.* 39, 734-746.



## References

---

- Magoulas, A., Tsimenides, N. & Zouros, E. 1996. Mitochondrial DNA phylogeny and the reconstruction of the population history of a species: The case of the European anchovy (*Engraulis encrasicolus*). *Mol. Biol. Evol.* 13, 178-190.
- Magoulas, A. & Zouros, E. 1993. Restriction-site heteroplasmy in anchovy (*Engraulis encrasicolus*) indicates incidental biparental inheritance of mitochondrial DNA. *Mol. Biol. Evol.* 10, 319-325.
- Marchand, J. 1981. Observations sur l'écologie de *Crangon crangon* (Linné) et *Palaemon longirostris* (H. Milne Edward) (Crustacea, Decapoda, Natantia). Estuaire interne de la Loire (France). *Vie Milieu* 31, 83-92.
- Mariani, S., Ketmaier, V. & de Mattheis, E. 2002. Genetic structuring and gene flow in *Cerastoderma glaucum* (Bivalvia: Cardiidae): evidence from allozyme variation at different geographic scales. *Mar. Biol.* 140, 687-697.
- Marques, J.C. 1982. Estudo ambiental do estuário do Tejo - Decápodes do estuário do Tejo: distribuição das espécies e estudo da variação sazonal e ciclo reprodutivo das populações de *Carcinus maenas* (Decapoda, Brachyura), *Crangon crangon*, *Palaemon longirostris* e *Palaemon serratus* (Decapoda, Caridea). Laboratório Marítimo da Guia, Lisboa, Portugal.
- Marques, J.C. & Costa, M.J. 1983. Estudo ambiental do estuário do Tejo - Decápodes do estuário do Tejo: distribuição das espécies e estudo da biologia das populações de *Carcinus maenas* (Decapoda, Brachyura), *Crangon crangon*, *Palaemon longirostris* e *Palaemon serratus* (Decapoda, Caridea). Laboratório Marítimo da Guia, Lisboa, Portugal.
- Marshall, S. & Elliot, M. 1998. Environmental influences on the fish assemblage of the Humber Estuary, UK. *Est. Coast. Shelf Sci.* 46, 175-184.
- Matilla, J., Olafsson E.B. & Johannsson A. 1990. Predation effects of *Crangon crangon* on benthic infauna on shallow sandy bottoms - an experimental study from southern Sweden. *Proc. 24th Europ. Mar. Biol. Symp.*, Aberdeen: Aberdeen University Press, 503-516.
- Martin, W. & Davis, G.E. 2001. An Updated Classification of the Recent Crustacea. *Natural History Museum of Los Angeles County, Science Series* 39, 1-124.
- Maucher, W.D. 1961. Statistische Untersuchungen über Unterschiede in den Körperproportionen zwischen der Nord und Ostseeform von *Crangon crangon* L. *Kieler Meeresforsch.* 17, 219-227.
- McCullagh, P. & Nelder, J.A. 1983. *Generalized linear models*. Chapman and Hall, London.
- McLusky, D.S. & Elliott, M. 2004. *The Estuarine Ecosystem. Ecology, Threats and Management*. 3<sup>rd</sup> ed. Oxford University Press, 214 pp.
- Mees, J. 1994. The hyperbenthos of shallow coast waters and estuaries: community structure and biology of dominant species. PhD Thesis, University of Gent, Belgium.
- Meixner, R. 1966. The effects of food supply on moulting, growth and spawning of the shrimp *Crangon crangon* (L.). *ICES CM* 1966/M 5, 1-7.
- Meixner, R. 1967. *Experimentelle Untersuchungen zur Biologie der Nordsee garnele*. Dissertation. University of Hamburg.
- Meixner, R. 1969. Wachstum, Hautung und Fortpflanzung von *Crangon crangon* (L.) bei Einzelaufzucht. *Ber. Dt. Wiss. Kom. für Meeresforsch.* 20, 93-111.
- Meixner, R. 1970. Reproduction of the sand shrimp, *Crangon crangon* (L.). *FAO Fish. Rep.* 57, 259-264.
- Meredith, S.S. 1952. A study of *Crangon vulgaris* in the Liverpool Bay area. *Proc. Trans. Liverpool Biol. Soc.* 58, 75-109.
- Meyer, P.-F. 1936. Die Nordseekrabbe (Granat, Garnele) *Crangon vulgaris* Fabr. im Jadebusen. *Z. Fisch., Neudamm* 34, 319-358.
- Meyer-Waarden, P.F. & Tiews, K. 1957. Krebs- und Muscheliere I. Teil. *Krebstierre by Tiews. Arb. Dt. Fisch. Verb.* 8: 1-56.
- Micaleff, H. & Evans, F. 1968. *The marine fauna of Malta*. Royal University of Malta, Biology Department, Malta University Press, 1-26.

- Miller, A. 2002. Subset selection in regression. 2<sup>nd</sup> Edition. Chapman and Hall/CRC, Florida, USA.
- Millot, C. 1999. Circulation in the Western Mediterranean Sea. *J. Marine Syst.* 20, 423-442.
- Mistakidis, M.N. 1958. Comparative fishing trials with shrimp nets. *Fish. Invest.*, II XXII(1).
- Mohr, H. & Rauck, G. 1979. First results of German experiments with a selective trawl. *ICES, CM 1979/B:7*, 1-7.
- Moller, P. & Rosenberg, R. 1983. Recruitment, abundance and production of *Mya arenaria* and *Cardium edule* in marine shallow waters, western Sweden. *Ophelia* 22, 33-55.
- Moreira, F., Assis, C.A., Almeida, P.R., Costa, J.L. & Costa, M.J. 1992. Trophic relationships in the community of the upper Tagus Estuary (Portugal): a preliminary approach. *Est. Coast. Shelf Sci.* 34, 617-623.
- Moritz, C. & Brown, W.M. 1987. Tandem duplications in animal mitochondrial DNAs: Variation in incidence and gene content among lizards. *Proc. Natl. Acad. Sci. USA* 84, 7183-7187.
- Moritz, C.S. 1994. Defining 'Evolutionary Significant Units' for conservation. *Trends Ecol. Evol.* 9, 373-375.
- Mouny, P., Dauvin, J.-C. & Zouhiri, S. 2000. Benthic boundary layer fauna from the Seine estuary (eastern English Channel, France): spatial distribution and seasonal changes. *J. Mar. Biol. Assoc. UK* 80, 959-968.
- Munilla, T. & San Vicente, C. 2005. Suprabenthic biodiversity of Catalan beaches (NW Mediterranean). *Acta Oecol.* 27, 81-91.
- Munro, P. T. & Somerton, D. A. (2002). Estimating net efficiency of a survey trawl for flatfishes. *Fish. Res.* 55, 267-279.
- Muus, B.J. 1967. The fauna of Danish estuaries and lagoons. Distribution and ecology of dominating species in the shallow reaches of the mesohaline zone. *Medd. Kom. Dan. Fisk. Havunders.*, Fisk 5, 1-316.
- Naciri, M., Lemaire, C., Borsa, P. & Bonhomme, F. 1999. Genetic study of the Atlantic/Mediterranean transition in sea bass (*Dicentrarchus labrax*). *J. Hered.* 90, 591-596.
- Nédélec, C. 1982. Definition and classification of fishing gear categories. *FAO Fish. Tech. Pap.* 222, pp. 51.
- Nehls, G. & Tiedemann, R. 1993. What determines the densities of feeding birds on tidal flats - a case-study on dunlin, *Calidris alpina*, in the Wadden Sea. *Neth. J. Sea Res.* 31, 375-384.
- Nei, M. 1987. *Molecular evolutionary genetics*. Columbia University Press, New York.
- Nei, M. & Li, W.-H., 1979. Mathematical model for studying genetic variation in terms of restriction endonucleases. *Proc. Natl. Acad. Sci. USA* 76, 5269-5273.
- Neves, A., Cabral, H.N. & Gordo, L.S. 2007. Distribution and abundance patterns of decapod crustaceans in the Sado estuary, Portugal. *Crustaceana* 80, 97-112.
- Nicieza, A.G., Reyesgavilan, F.G. & Brana, F. 1994. Differentiation in juvenile growth and bimodality patterns between northern and southern populations of Atlantic salmon (*Salmo salar* L.). *Can. J. Zool.* 72, 1603-1610.
- Nilsson, P., Sundback, K. & Jonsson, B. 1993. Effect of the brown shrimp *Crangon crangon* L. on endobenthic macrofauna, meiofauna and meiofaunal grazing rates. *Neth. J. Sea Res.* 31, 95-106.
- Norkko, A. 1998. The impact of loose-lying algal mats and predation by the brown shrimp *Crangon crangon* (L.) on infaunal prey dispersal and survival. *J. Exp. Mar. Biol. Ecol.* 221, 99-116.
- Nouvel-van Rysselberge, L. 1937. Contribution à l'étude de la mue, de la croissance et de la régénération chez les Crustacés Natantia. *Rec. Inst. Zool. Torley-Rousseau* 6, 5-161.
- Oh, C.-W. & Hartnoll, R.G. 2000. Effects of food supply on the growth and survival of the common shrimp, *Crangon crangon* (L.) (Decapoda: Caridea). *Crustaceana* 73, 83-99.
- Oh, C.-W. & Hartnoll, R.G. 2004. Reproductive biology of the common shrimp *Crangon crangon* (Decapoda: Crangonidae) in the central Irish Sea. *Mar. Biol.* 144, 303-316.
- Oh, C.-W., Hartnoll, R.G. & Nash, R.D.M. 1999. Population dynamics of the common shrimp, *Crangon crangon* (L.), in Port Erin Bay, Isle of Man, Irish Sea. *ICES J. Mar. Sci.* 56, 718-733.
- Oh, C.-W., Hartnoll, R.G. & Nash, R.D.M. 2001. Feeding ecology of the common shrimp *Crangon crangon* in Port Erin Bay, Isle of Man, Irish Sea. *Mar. Ecol. Prog. Ser.* 214, 211-223.

## References

---

- Palumbi, S.R. 2001. The ecology of marine protected areas. In: Bertness, M.D., Gaines, S.D., Hay, M.E. (Eds.), *Marine community ecology*. Sinauer Associates, Sunderland, USA, pp. 509-530.
- Palumbi, S.R., Cipriano, F. & Hare, M.P. 2001. Predicting nuclear gene coalescence from mitochondrial data: The three-times rule. *Evolution* 55, 859-868.
- Pandian, T.J. 1967. Change in the chemical composition and calorific relate of developing eggs of the shrimp *Crangon crangon*. *Helgoländer Meeresun.* 16, 216-224.
- Papadopoulos, L.N., Peijnenburg, K.T.C.A. & Luttikhuisen, P.C. 2005. Phylogeography of the calanoid copepods *Calanus helgolandicus* and *C. euxinus* suggests Pleistocene divergences between Atlantic, Mediterranean, and Black Sea populations. *Mar. Biol.* 147, 1353-1365.
- Patarnello, T., Volckaert, F.A.M. & Castilho, R. 2007. Pillars of Hercules: is the Atlantic-Mediterranean transition a phylogeographical break? *Mol. Biol.* 16, 4426-4444.
- Peijnenburg, K.T.C.A., Breeuwer, J.A.J., Pierrot-Bults, A.C. & Menken, S.B.J. 2004. Phylogeography of the planktonic chaetognath *Sagitta setosa* reveals isolation in European seas. *Evolution* 58, 1472-1487.
- Peijnenburg, K.T.C.A., Fauvelot, C., Breeuwer, J.A.J. & Menken, S.B.J. 2006. Spatial and temporal genetic structure of the planktonic *Sagitta setosa* (Chaetognatha) in European seas as revealed by mitochondrial and nuclear DNA markers. *Mol. Ecol.* 15, 3319-3338.
- Perez-Losada, M., Guerra, A., Carvalho, G.R., Sanjuan, A. & Shaw, P.W. 2002. Extensive population subdivision of the cuttlefish *Sepia officinalis* (Mollusca: Cephalopoda) around the Iberian Peninsula indicated by microsatellite DNA variation. *Heredity* 89, 417-424.
- Philippart, C.J.M., Van Aken, H.M., Beukema, J.J., Bos, O.G., Cadee, G.C. & Dekker, R. 2003. Climate-related changes in recruitment of the bivalve *Macoma balthica*. *Limnol. Oceanogr.* 48, 2171-2185.
- Pihl, L. 1985. Food selection and consumption of mobile epibenthic fauna in shallow marine areas. *Mar. Ecol. Prog. Ser.* 22, 169-179.
- Pihl, L. 1990. Year-class strength regulation in plaice (*Pleuronectes platessa* L.) on the Swedish west coast. *Hydrobiologia* 195, 79-88.
- Pihl, L. & Rosenberg, R. 1982. Production, abundance and biomass of mobile epibenthic marine fauna in shallow waters, western Sweden. *J. Exp. Mar. Biol. Ecol.* 57, 273-301.
- Pihl, L. & Rosenberg, R. 1984. Food selection and consumption of the shrimp *Crangon crangon* in some shallow marine areas in western Sweden. *Mar. Ecol. Prog. Ser.* 15, 159-168.
- Pinn, E. H. & Ansell, A.D. 1993. The effect of particle size on the burying ability of the brown shrimp *Crangon crangon*. *J. Mar. Biol. Assoc. UK* 73, 365-377.
- Plagmann, J. 1939. Ernährungsbiologie der Garnele (*Crangon vulgaris* Fabr.). *Helgoländer Meeresun.* 2, 113-162.
- Plankemann, H. 1935. Beiträge zur Physiologie der garnelenhautung. *Schr. Nat. Wiss. Ver. Schlesw.-Holst.* 21, 195-216.
- Plett, A. 1965. Über das Vorkommen von Garnelenlarven (*Crangon crangon* L.) vor der deutschen Küste in den Jahren 1963 und 1964. *Arch. Fischereiwiss.* 16, 54-67.
- Polet, H. 1998. Experiments with sorting grids in the Belgian brown shrimp (*Crangon crangon*) fishery. ICES Fish. Behav. Work. Group Meeting, La Coruña, Spain.
- Polet, H. 2000. Codend and whole trawl selectivity of shrimp beam trawl used in the North Sea. *Fish. Res.* 48, 167-183.
- Polet, H. 2002. Selectivity experiments with sorting grids in the North Sea brown shrimp (*Crangon crangon*) fishery. *Fish. Res.* 54, 217-233.
- Polet, H., Coenjaerts, J. & Verschoore, R. 2004. Evaluation of the sieve net as a selectivity-improving device in the Belgian brown shrimp (*Crangon crangon*) fishery. *Fish. Res.* 69, 35-48.
- Polet H., Delanghe F. & Verschoore R. 2005a. On electrical fishing for brown shrimp (*Crangon crangon*) I. Laboratory experiments. *Fish. Res.* 72, 1-12.

- Polet, H., Delanghe, F. & Verschoore, R. 2005b. On electrical fishing for brown shrimp (*Crangon crangon*) - II. Sea trials. *Fish. Res.* 72, 13-27.
- Polet, H. & Redant, F. 1999. Effect of population structure, sampling strategy and sample size on the estimates of selection parameters for shrimp (*Crangon crangon*) trawls. *Fish. Res.* 40, 213-225.
- Posada, D. & Crandall, K.A. 1998. MODELTEST: testing the model of DNA substitution. *Bioinformatics* 14, 817-818.
- Purchase, C.F. & Brown, J.A. 2000. Interpopulation differences in growth rates and food conversion efficiencies of young Grand Banks and Gulf of Maine Atlantic cod (*Gadus morhua*). *Can. J. Fish. Aquat. Sci.* 57, 2223-2229.
- Quesada, H., Beynon, C.M. & Skibinski, D.O.F. 1995a. A mitochondrial-DNA discontinuity in the mussel *Mytilus galloprovincialis* Lmk - Pleistocene vicariance biogeography and secondary intergradation. *Mol. Biol. Evol.* 12, 521-524.
- Quesada, H., Zapata, C. & Alvarez, G. 1995b. A multilocus allozyme discontinuity in the mussel *Mytilus galloprovincialis* - the interaction of ecological and life-history factors. *Mar. Ecol. Prog. Ser.* 116, 99-115.
- R Development Core Team 2005. R: A language and environment for statistical computing. R Foundation for Statistical Computing, Vienna, Austria.
- Rauck, G. & Wienbeck, H. 1990. Square meshes in shrimp fisheries - a possible means to reduce meshing of young soles. *Inf. Fischwirtsch.* 39, 17-21.
- Redant, F. 1978. Komsumptie en produktie van post-larvale Crangon crangon in de Belgische kustwateren. PhD Thesis, Vrije Universiteit, Brussels, Belgium.
- Regnault, M. 1976. Influence du substrat sur la mortalité et la croissance de la crevette *Crangon crangon* (L.) en élevage. *Cah. Biol. Mar.* 17, 347-357.
- Reise, K. 1977. Predator exclusion experiments in an intertidal mud flat. *Helgoländer Meeresun.* 30, 263-271.
- Remerie, T., Bourgois, T., Peelaers, D., Vierstraete, A., Vanfleteren, J. & Vanreusel, A. 2006. Phylogeographic patterns of the mysid *Mesopodopsis slabberi* (Crustacea, Mysida) in Western Europe: evidence for high molecular diversity and cryptic speciation. *Mar. Biol.* 149, 465-481.
- Revill, A. & Holst, R. 2004a. The selective properties of some sieve nets. *Fish. Res.* 66, 171-183.
- Revill, A.S. & Holst, R. 2004b. Reducing discards of North Sea brown shrimp (*Crangon crangon*) by trawl modification. *Fish. Res.* 68, 113-122.
- Revill, A., Pascoe, S., Radcliffe, C., Riemann, S., Redant, F., Polet, H., Damm, U., Neudecker, T., Kristensen, P. & Jensen, D. 1999. The economic and biological consequences of discarding in the European *Crangon* fisheries. Final Report to the European Commission, Contract No. 97/SE/025.
- Riginos, C. & Cunningham, C.W. 2005. Local adaptation and species segregation in two mussel (*Mytilus edulis* x *Mytilus trossulus*) hybrid zones. *Mol. Ecol.* 14, 381-400.
- Rijnsdorp, A.D., Van Stralen, M. & Van der Veer, H.W. 1985. Selective tidal transport of North Sea plaice *Pleuronectes platessa* in coastal nursery areas. *T. Am. Fish. Soc.* 114, 461-470.
- Rijnsdorp, A.D. 1993. Relationship between juvenile growth and the onset of sexual maturity of female North sea plaice, *Pleuronectes platessa*. *Can. B. Fish. Aquat. Sci.* 50, 1617-1631.
- Robin, J.-P. 1992. The brown shrimp fishery of the Loire Estuary: production and by-catch of juvenile fish. *Fish. Res.* 13, 153-172.
- Roff, D.A. 1991. The evolution of life histories. Theory and analysis. Chapman and Hall, New York.
- Rogers, A.R. & Harpending, H. 1992. Population growth makes waves in the distribution of pairwise genetic differences. *Mol. Biol. Evol.* 9, 552-569.
- Roman, J. & Palumbi, R. 2004. A global invader at home: population structure of the green crab, *Carcinus maenas*, in Europe. *Mol. Ecol.* 13, 2891-2898.
- Rumohr, H., Schomann, H. & Kujawski, T. 1994. Environmental impact of bottom gears on benthic fauna in the German Bight. In: Environmental impact of bottom gears on benthic fauna in relation to natural resources

## References

---

- management and protection of the North Sea. S. J. de Groot and H. J. Lindeboom (eds.). NIOZ-Rapport 1994-11, RIVO-DLO Report CO26/94,75–86.
- Ryan, W.B.F., Pitman, W.C., Major, C.O., Shimkus, K., Moskalenko, V., Jones, G.A., Dimitrov, P., Gorur, N., Sakinc, M. & Yuce, H. 1997. An abrupt drowning of the Black Sea shelf. *Mar. Geol.* 138, 119-126.
- Sá, R., Bexiga, B., Veiga, P., Vieira, L. & Erzini, K. 2006. Feeding ecology and trophic relationships of fish species in the lower Guadiana River Estuary and Castro Marim e Vila Real de Santo António Salt Marsh. *Est. Coast. Shelf Sci.* 70, 19-26.
- Safran, P. 1987. Étude d'une nurserie littorale à partir des pêches accessoires d'une pêche artisanale de crevettes grises (*Crangon crangon* L.). *Oceanol. Acta* 10, 239-248.
- Salgado, J.P., Cabral, H.N., Costa, M.J. & Deegan, L. 2004. Nekton use of salt marsh creeks in the upper Tejo estuary. *Estuaries* 27, 818-825.
- Saunoy, S.A. 1987. The shrimp fishery and its by-catch in north western and North Wales fisheries district. North Western and North Wales Sea Fisheries Committee, Lancaster, UK.
- Schatte, J. & Saborowski, R. 2006. Change of external sexual characteristics during consecutive moults in *Crangon crangon* L. *Helgoland Mar. Res.* 60, 70-73.
- Schockaert, E. 1968. Contribution à l'étude de la croissance et de la reproduction de la crevette grise (*Crangon crangon* L.) au large de la côte belge. *Biol. Jaarboek* 36, 169-179.
- Schultz, E.T., Conover, D.O., Ehtisham, A. 1998. The dead of winter: size dependent variation and genetic differences in seasonal mortality among Atlantic silverside (Atherinidae : *Menidia menidia*) from different latitudes. *Can. J. Fish. Aquat. Sci.* 55, 1149-1157.
- Schultz, E.T. & Conover, D.O. 1997. Latitudinal differences in somatic energy storage: adaptive responses to seasonality in estuarine fish (Atherinidae: *Menidia menidia*). *Oecologia* 109, 516-529.
- Schultz, E. T., Reynolds, K. E. & Conover, D.O. 1996. Countergradient variation in growth among newly hatched *Fundulus heteroclitus*: geographic differences revealed by common-environment experiments. *Funct. Ecol.* 10, 366-374.
- Schumacher, A. & Tiews, K. 1979. On the population dynamics of the brown shrimp (*Crangon crangon* L.) off the German coast. *Rapp. P.-v. Réun. Cons. Int. Explor. Mer* 175, 280-286.
- Selleslagh, J., Amara, R., Laffargue, P., Lesourd, S., Lepage, M. & Girardin, M. 2009. Fish composition and assemblage structure in three Eastern English Channel macrotidal estuaries: A comparison with other French estuaries. *Est. Coast. Shelf Sci.* 81, 149-159.
- Sharpe, P.J.H. & De Michele, D.W. 1977. Reaction kinetics of poikilotherm development. *J. Theor. Biol.* 64, 649–670.
- Siegel, V., Gröger, J., Neudecker, T., Damm, U. & Jansen, S. 2005. Long-term variation in the abundance of the brown shrimp *Crangon crangon* (L.) population of the German Bight and possible causes for its interannual variability. *Fish. Oceanogr.* 14, 1-16.
- Singh-Renton, S. & Bromley, P.J. 1999. Feeding of smelt whiting (*Merlangius merlangus*) in the central and southern North Sea. *J. Mar. Biol. Assoc. UK* 79, 957-960.
- Slatkin, M. & Hudson, R.R. 1991. Pairwise comparisons of mitochondrial DNA sequences in stable and exponentially growing populations. *Genetics* 129, 555-562.
- Smaldon, G., L.B. Holthuis & Fransen, C.H.J.M. 1993. Coastal Shrimps and prawns. Second edition. *Synopses of British Fauna* 15, pp. 142.
- Spaargaren, D.H. 1980. The significance of seawater viscosity for the tidal transport of common shrimps, *Crangon crangon* (L.). *Ophelia* 19, 145-153.
- Spaargaren, D.H. 2000. Seasonal and annual variations in the catches of *Crangon crangon* (L., 1758) (Decapoda, Natantia) near the coast of Texel, The Netherlands. *Crustaceana* 73, 547-563.
- Spaargaren, D.H. & Haefner, P.A. 1998. Quantitative changes during ovarian development in the brown shrimp *Crangon crangon* (L., 1758) (Decapoda, Natantia). *Crustaceana* 71, 247-257.

- Sprung, M. 2001. Larval abundance and recruitment of *Carcinus maenas* L. close to its southern geographic limit: a case of match and mismatch. *Hydrobiologia* 449, 153–158.
- Stamatis, C., Triantafyllidis, A., Moutou, K.A. & Mamuris, Z. 2004. Mitochondrial DNA variation in northeast atlantic and mediterranean populations of norway lobster, *Nephrops norvegicus*. *Mol. Ecol.* 13, 1377-1390.
- Stamatis, C., Triantafyllidis, A., Moutou, K.A. & Mamuris, Z. 2006. Allozymic variation in Northeast Atlantic and Mediterranean populations of Norway lobster, *Nephrops norvegicus*. *ICES J. Mar. Sci.* 63, 875-882.
- Stefanni, S. & Thorley, J.L. 2003. Mitochondrial DNA phylogeography reveals the existence of an Evolutionarily Significant Unit of the sand goby *Pomatoschistus minutus* in the Adriatic (Eastern Mediterranean). *Mol. Phylogenet. Evol.* 28, 601-609.
- Stephens, M.N., Smith, N.J. & Donnelly, P. 2001. A new statistical method for haplotype reconstruction from population data. *Hum. Genet.* 68, 978-989.
- Stephens, M.N. & Scheet, P. 2005. Accounting for decay of linkage disequilibrium in haplotype inference and missing data imputation. *Am. J. Hum. Genet.* 76, 449-462.
- Stock, M., Schrey, E., Kellermann, A., Gätje, C., Eskildsen, K., Feige, M., Fischer, G., Hartmann, F., Knoke, V., Möller, A., Ruth, M., Thiessen, A. & Vorberg, R. 1996. Ökosystemforschung Wattenmeer – Synthesebericht: Grundlagen für einen Nationalparkplan. Schriftenreihe des Nationalparks Schleswig-Holsteinsches Wattenmeer, Heft 8, 784 pp.
- Strasser, M. 2002. Reduced epibenthic predation on intertidal bivalves after a severe winter in the European Wadden Sea. *Mar. Ecol. Prog. Ser.* 241, 113-123.
- Strauss, R.E. 2001. [on-line] [http://www.faculty.biol.ttu.edu/Strauss/Morphometrics/LectureNotes/01\\_Intro.PDF](http://www.faculty.biol.ttu.edu/Strauss/Morphometrics/LectureNotes/01_Intro.PDF)
- Sutherland, D.G. 1984. The quaternary deposits and landforms of Scotland and the neighbouring shelves: a review. *Quaternary Sci. Rev.* 3, 157-254.
- Svitoch, A.A., Selivanov, A.O. & Yanina, T.A. 2000. The Pont-Caspian and Mediterranean Basins in the Pleistocene (Paleogeography and correlation). *Oceanology* 40, 868-881.
- Swofford, D.L. 2003. Phylogenetic analysis using parsimony (\*and other methods). Sinauer Associates, Sunderland, Massachusetts.
- Symonds, D.J., Davies I.L. & Brander K.M. 1985. Effect of a small meshed fishery on the stocks of pre-recruit plaice and sole. *ICES CM* 1985/G:28.
- Szaniawska, A. 1983. Seasonal changes in energy content of *Crangon crangon* L. (Cristacea, Decapoda). *Pol. Arch. Hydrobiol.* 30, 45-56.
- Tajima, F. 1983. Evolutionary relationship of DNA sequences in finite populations. *Genetics* 105, 437-460.
- Tajima, F. 1989. Statistical method for testing the neutral mutation hypothesis by DNA polymorphism. *Genetics* 123, 585-595.
- Taylor, D.L. & Peck, M.A. 2004. Daily energy requirements and trophic positioning of the sand shrimp *Crangon septemspinosa*. *Mar. Biol.* 145, 167-177.
- Temming, A. & Damm, U. 2002. Life cycle of *Crangon crangon* in the North Sea: a simulation of the timing of recruitment as a function of the seasonal temperature signal. *Fish. Oceanogr.* 11, 45-58.
- Tiews K. 1953. Studien zu der Büsumer Garnelenfischerei, ihren biologischen Grundlagen und ihrer wirtschaftlichen Struktur. PhD thesis, Christian Albrechts Universität, Kiel.
- Tiews, K. 1954. Die biologischen Grundlagen der Büsumer Garnelenfischerei. *Ber. Dt. Wiss. Kom. für Meeresforsch.* 13, 235-269.
- Tiews, K. 1970. Synopsis of biological data on the common shrimp *Crangon crangon* (Linnaeus, 1758). *FAO Fish. Synop.* 57, 1167-1224.
- Tiews, K. 1990. 35-Jahres-Trend (1954-1988) der Häufigkeit von 25 Fisch- und Krebstieren an der deutschen Nordseeküste. *Arch. Fischereiwiss.* 40, 39-48.
- Tiews, K. & Schumacher, A. 1982. Assessment of brown shrimp stocks (*Crangon crangon* L.) off the German coast for the period 1965-1978. *Arch. Fischereiwiss.* 32(1/3), 1-11.

## References

---

- Unal, E., Frost, B.W., Armbrust, V. & Kideys, A.E. 2006. Phylogeography of *Calanus helgolandicus* and the Black Sea copepod *Calanus euxinus*, with notes on *Pseudocalanus elongatus* (Copepoda, Calanoida). *Deep-Sea Res. II* 53, 1961-1975.
- Van Aken, H.M. 2008a. Variability of the salinity in the western Wadden Sea on tidal to centennial time scales. *J. Sea Res.* 59, 121-132.
- Van Aken, H.M. 2008b. Variability of the water temperature in the western Wadden Sea on tidal to centennial time scales. *J. Sea Res.* 60, 227-234.
- Väinölä, R. 2003. Repeated trans-Arctic invasions in littoral bivalves: molecular zoogeography of the *Macoma balthica* complex. *Mar. Biol.* 143, 935-946.
- Väinölä, R. & Varvio, S.-L. 1989. Biosystematics of *Macoma balthica* in northwestern Europe. *Proc. 23rd Europ. Mar. Biol. Symp.*, 309-316.
- Van Beek, F.A., Van Leeuwen, P.I. & Rijnsdorp, A.D. 1990. On the survival of plaice and sole discards in the otter-trawl and beam-trawl fisheries in the North Sea. *Neth. J. Sea Res.* 26, 151-160.
- Van der Baan, S.M. 1975. Migration of *Crangon crangon* in surface waters near the "Texel" lightship. *Neth. J. Sea Res.* 9, 287-296.
- Van der Hoeven, P.C.T. 1982. Observations of surface water temperature and salinity, State Office of Fishery Research (RIVO): 1860-1981. KNMI Scientific Report WR 82-8. KNMI, De Bilt.
- Van der Meer, J. 2006. An introduction to Dynamic Energy Budget (DEB) models with special emphasis on parameter estimation. *J. Sea Res.* 56, 85-102.
- Van der Meer, J., Witte, I.I.J. & Van der Veer, H.W. 1995. The suitability of a single intertidal fish trap for the assessment of long-term trends in fish and epibenthic invertebrate populations. *Environ. Monit. Assess.* 36, 139-148.
- Van der Veer, H.W. 1986. Immigration, settlement and diversity-dependent mortality of a larval and early post-larval 0-group plaice *Pleuronectes platessa* population in the western Wadden Sea. *Mar. Ecol. Prog. Ser.* 29, 223-236.
- Van der Veer, H.W., Bies, B. & Witte, J.I.J. 2000. Selective growth and mortality of juvenile 0-group plaice *Pleuronectes platessa* L. in the Dutch Wadden Sea: a consequence of irreversible non-genetic adaptation during early pelagic life. *Mar. Ecol. Prog. Ser.* 197, 273-283.
- Van der Veer, H.W. & Bergman, M.J.N. 1987. Predation by crustaceans on a newly settled 0-group plaice (*Pleuronectes platessa* L.) population in the western Wadden Sea. *Mar. Ecol. Prog. Ser.* 35, 203-215.
- Van der Veer, H.W., Bergman, M.J.N., Dapper, R. & Witte, J.I.J. 1991. Population dynamics of an intertidal 0-group flounder *Platichthys flesus* population in the western Dutch Wadden Sea. *Mar. Ecol. Prog. Ser.* 73, 141-148.
- Van der Veer, H.W., Cardoso, J.F.M.F. & Van der Meer, J. 2006. The estimation of DEB parameters for various North Atlantic bivalve species. *J. Sea Res.* 56, 107-124.
- Van der Veer, H.W., Ellis, T., Miller, J.M., Pihl, L. & Rijnsdorp, A.D. 1997. Size-selective predation on juvenile North Sea flatfish and possible implications for recruitment. In *Early life history and recruitment in fish populations*, R.C. Chambers & Trippel E.A. (Eds.): Chapman Hall, London, 279-303.
- Van der Veer, H.W., Feller, R.J., Weber, A. & Witte, J.I.J. 1998. Importance of predation by crustaceans upon bivalve spat in the intertidal zone of the Dutch Wadden Sea as revealed by immunological assays of gut contents. *J. Exp. Mar. Biol. Ecol.* 231, 139-157.
- Van der Veer, H.W., Kooijman, S.A.L.M. & Van der Meer, J. 2001. Intra- and interspecies comparison of energy flow in North Atlantic flatfish species by means of dynamic energy budgets. *J. Sea Res.* 45, 303-320.
- Van der Veer, H.W., Pihl, L. & Bergman, M.J.N. 1990. Recruitment mechanisms in the North Sea plaice *Pleuronectes platessa*. *Mar. Ecol. Prog. Ser.* 64, 1-12.

- Van der Veer, H.W., Witte, J.I.J., Beumkes, H.A., Dapper, R., Jongejan, W.P. & Van der Meer, J. 1992. Intertidal fish traps as a tool to study long-term trends in juvenile flatfish populations. *Neth. J. Sea Res.* 29, 119-126.
- Van der Veer, H.W., Cardoso, J.F.M.F., Peck, M.A., Kooijman, S.A.L.M., 2009a. Physiological performance of plaice *Pleuronectes platessa* (L.): a comparison of Static and Dynamic Energy Budgets. *J. Sea Res.* (in press).
- Van der Veer, H.W., Cardoso, J.F.M.F., Freitas, V., Carvalho, C., Peck, M.A., Kooijman, S.A.L.M., 2009b. Analysis of physiological performance of North Atlantic marine organisms by means of interspecies differences in DEB parameters (in prep)
- Van Donk, E. & De Wilde, P.A.W.J. 1981. Oxygen consumption and motile activity of the brown shrimp *Crangon crangon* related to temperature and body size. *Neth. J. Sea Res.* 15, 54-64.
- Van Haren, R.J.F. & Kooijman, S.A.L.M., 1993. Application of a dynamic energy budget model to *Mytilus edulis* (L.). *Neth. J. Sea Res.* 31, 119-133.
- Van Lissa, J.H.L. 1977. Aantallen, voedselopname, groei en produktie van de garnaal (*Crangon crangon* L.) in een getijdengebied, alsmede de voedselopname en groei onder laboratoriumomstandigheden. *Int. Rep. Neth. Inst. Sea Res.* 1977-10, pp. 101.
- Van Marlen, B., Redant, F., Polet, H., Radcliffe, C., Reville, A., Kristensen, P.S., Hansen, K.E., Kuhlmann, H.J., Riemann, S., Neudecker, T. & Brabant, J.C. 1998. Research into *Crangon* Fisheries Unerring Effect, RESCUE - EU-study 94/044, RIVO Report C054/97.
- Vermeij, G.J. 1991. Anatomy of an invasion: the trans-arctic interchange. *Paleobiology* 17, 281-307.
- Viegas, I., Martinho, F., Neto, J. & Pardal, M. 2007. Population dynamics, distribution and secondary production of the brown shrimp *Crangon crangon* (L.) in a southern European estuary. Latitudinal variations. *Sci. Mar.* 71, 451-460.
- Viñas, J., Bremer, J.A. & Pla, C. 2004. Phylogeography of the Atlantic bonito (*Sarda sarda*) in the northern Mediterranean: the combined effects of historical vicariance, population expansion, secondary invasion, and isolation by distance. *Mol. Phylogenet. Evol.* 33, 32-42.
- Vorberg, R. 1997. Auswirkungen der Garnelenfischerei auf den Meeresboden und die Bodenfauna des Wattenmeeres. Verlag Kovac, Hamburg.
- Vorberg, R. 2000. Effects of shrimp fisheries on reefs of *Sabellaria spinulosa* (Polychaeta). *ICES J. Mar. Sci.* 57, 1416-1420.
- Vorren, T.O., Vorren, K.D., Torbjorn, A., Gulliksen, S. & Lovlie, R. 1988. The last deglaciation (20,000 to 11,000 BP) on Andoya, northern Norway. *Boreas* 17, 41-77.
- Walter, U. 1997. Quantitative analysis of discards from brown shrimp trawlers in the coastal area of the East Frisian island. *Aust. J. Mar. Fresh. Res.* 45, 61-76.
- Walter, U. & Becker, P.H. 1997. Occurrence and consumption of seabirds scavenging on shrimp trawler discards in the Wadden Sea. *ICES J. Mar. Sci.* 54, 684-694.
- Wear, R.G. 1974. Incubation in British decapod crustacea, and the effects of temperature on the rate and success of embryonic development. *J. Mar. Biol. Assoc. UK* 54, 745-762.
- Weetman, D., Ruggiero, A., Mariani, S., Shaw, P.W., Lawler, A.R. & Hauser, L. 2007. Hierarchical population genetic structure in the commercially exploited shrimp *Crangon crangon* identified by AFLP analysis. *Mar. Biol.* 151, 565-575.
- Welleman, H.C. & Daan, N. 2001. Is the Dutch shrimp fishery sustainable? *Senckenb. Marit.* 31, 321-328
- Wennhage, H. 2002. Vulnerability of newly settled plaice (*Pleuronectes platessa* L.) to predation: effects of habitat structure and predator functional response. *Mar. Ecol. Prog. Ser.* 269, 129-145.
- Williams, S.T. & Knowlton, N. 2001. Mitochondrial pseudogenes are pervasive and often insidious in the snapping shrimp genus *Alpheus*. *Mol. Biol. Evol.* 18, 1484-1493.
- Williamson, D.I. 1960. Crustacea, Decapoda: larvae. VII. Caridea, Fam. Crangonidae and Stenopodidae. *Fich. Ident. Zooplancton* 90, 1-5.



## References

---

- Willmer, P., Stone, G. & Johnston, I. 2000. Environmental physiology of animals. Blackwell Science Ltd, Oxford.
- Wolff, W.J. 1983. Estuarine benthos. In: Estuaries and Enclosed Seas (ed. B. H. Ketchum), Elsevier, Amsterdam. pp. 151–182.
- Wollebaek, A. 1908. Remarks on decapod crustaceans of the North Atlantic on the Norwegian fjords I and II. Bergens Museum 12, 1-74.
- Woodin, S.A. 1999. Shallow water benthic ecology: A North American perspective of sedimentary habitats. Aust. J. Ecol. 24, 291–301.
- Zane, L., Ostellari, L., Maccatrozzo, L., Bargelloni, L., Cuzin-Roudy, J., Buchholz, F. & Patarnello, T. 2000. Genetic differentiation in a pelagic crustacean (*Meganyctiphanes norvegica*: Euphausiacea) from the North East Atlantic and the Mediterranean Sea. Mar. Biol. 136, 191-199.
- Zarenkov, N.A. 1970. Revision of the genera *Crangon* Fabricius and *Sclerocrangon* G.O. Sars (Decapoda, Crustacea). Zool. Zh. 44, 1761-1775. Translated from Russian by Fish. Res. Board Canada Translation Series 1465.
- Zariquiey-Álvarez, R. 1968. Crustáceos decápodos ibéricos. Invest. Pesq. 32, 1-510.
- Zouros, E., Ball, A.O., Saavedra, C. & Freeman, K.R. 1994. An unusual type of mitochondrial DNA inheritance in the blue mussel *Mytilus*. Proc. Natl. Acad. Sci. USA 91, 7463-7467.



## Summary

### Summary

#### *The eco-geography of the brown shrimp Crangon crangon in Europe*

All along the European coast, a few species account for most of the numbers and biomass observed in shallow waters. One of them is the brown or common shrimp *Crangon crangon*. The distribution of this small crustacean ranges as far north as the White Sea, in Russia, till Morocco in the south of NE Atlantic and also into the Mediterranean and Black Seas. This wide region differs greatly in environmental characteristics. Brown shrimp must then be able to cope with an extensive variety of ecological conditions especially of temperature, salinity, food quality and quantity observed in such vast geographic area.

Besides ecologically important, the species is a very valuable fisheries resource in the North Sea and various other areas (Adriatic Sea, Black Sea). In the past, commercial interest has motivated, and still, does numerous studies at several levels, from the species physiology to ecological population dynamics and commercial fisheries. Yet, it is amazing that despite being so abundant and so extensively studied, still basic life history features like growth conditions and population regulating mechanisms are still unclear.

The aim of this project was to identify the remaining gaps in knowledge and to try to fill in some of them. As a starting point, the synopsis of Tiews (1970) was taken. This overview on brown shrimp biology and fisheries was published almost four decades ago. Since then many other relevant investigations were available and the need for an update was felt. Starting from a life cycle perspective, an extensive literature review was made in Chapter 2.

Additionally, a latitudinal perspective was adopted because the species geographic distribution covers a wide area, from 34 to 67°LN in Europe.



Distribution of the brown shrimp *Crangon crangon* (in black); presence not confirmed (dark grey).  
De verspreiding van de gewone garnaal *Crangon crangon* (in swart); aanwezigheid niet bevestigd (in donker grijs).  
Distribuição geográfica do camarão-mouro *Crangon crangon* (a preto); presença não confirmada (a cinza escuro).

Surprisingly, in several fields almost any progress had been made. Since Tiews (1970), still the taxonomic status of *Crangon crangon* is unclear. Also, the existence of genetically different European populations could not be excluded and should be clarified by means of molecular tools. Another basic gap in knowledge is the lack of information regarding growth conditions in the field in relation to abiotic and biotic conditions, including the possibility of counter-gradient growth compensation. Although sexes can be identified morphologically, in field studies growth differences between males and females has been neglected so far. Detailed information on growth would provide insight into the population structure and dynamics of *C. crangon* over its distributional range and form a starting point for recruitment studies. This would also finally permit an analysis of latitudinal gradients in life-history parameters.

To contribute for clarifying the species sub-population structure two approaches were applied: [1] a classic morphometry study, based on the size of certain morphological traits, and [2] a genetic analysis. The same brown shrimp samples were used in both approaches. These were collected at 25 locations across the entire species geographic distribution area; only the White Sea was not cover in these studies.

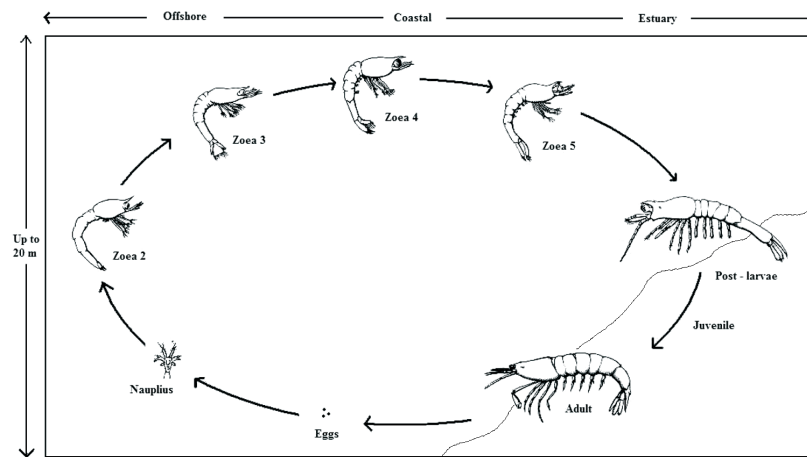

The life cycle of the brown shrimp *Crangon crangon*.  
 De levenscyclus van de gewone garnaal *Crangon crangon*.  
 Ciclo de vida do camarão-mouro *Crangon crangon*.

Previous work in British waters suggested the existence of subpopulation structure already at a small local scale (100 km) based on morphometry. In Chapter 3, the study was extended to cover the whole geographic range of *Crangon crangon* and test whether the same method could be applied to describe subpopulation structure at a much larger scale (1000 km). The 25 brown shrimp samples provided information on spatial variability in morphometric characters. In addition, at four sites (Bodø, Norway; Wadden Sea, The Netherlands; Minho and Lima estuaries, Portugal) we assessed the temporal variability in morphology. Morphological differences between major zoogeographical zones enable to clearly distinguish between populations from the Adriatic Sea, Black Sea, Mediterranean Sea and NE Atlantic. However, opposing expectations, at a local scale, subpopulations frequently cannot be identified due to individual variability, reflected in temporal variability. Hence the morphometric approach is inappropriate to distinguish between populations at small scale.

The taxonomic status and the genetic population structure was studied in Chapter 4 by sequencing a 388 bp fragment of the cytochrome-c-oxidase I gene of *Crangon crangon* for 140 individuals from the same 25 locations across the distribution range of the morphometric study. Also some other *Crangon* species were analysed: *C. alaskensis* from the coast of

Washington State, USA, and Kodiak Island, Alaska, USA; *C.septemspinosa* from Tuckerton, New Jersey, USA; *C. cassiope* from Wakasa Bay, Japan and *C. amurensis* from Tedai Bay, Japan.

Genetic tools provided clear evidences on brown shrimp's strong population structure. Surprisingly, across the entire geographic distribution area, only four major phylogeographic groups could be distinguished: the NE Atlantic, the western Mediterranean, the Adriatic Sea and the Black Sea. These groups also correspond to well define geographic regions, the same distinguished in the morphometry study, suggesting that gene flow between basins is very restricted. The biogeographic history of the taxon is largely in accordance with the geographic history of its distribution range. The western Mediterranean populations are the oldest and most variable of the four groups. Black Sea and Mediterranean populations are currently disconnected, though colonization of the first happened relatively recently, possibly earlier than 7000 years ago. Remarkably, within the NE Atlantic, genetic homogeneity was found from Morocco to Iceland and Baltic Sea which might be resultant from recent colonization, following the glacial cycles of the late Pleistocene, despite restricted gene flow.

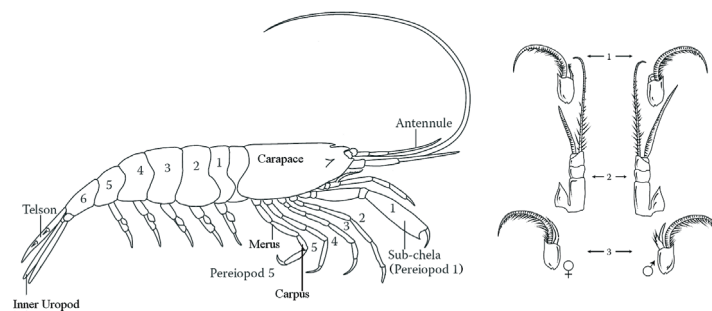

Morphometric variables and sex differences of brown shrimp *Crangon crangon*.

Morfologische kenmerken die onderzocht zijn en morfologische verschillen tussen mannelijke en vrouwelijke garnaal *Crangon crangon*.

Variáveis morfológicas e diferenças entre os sexos de camarão-mouro *Crangon crangon*.

The observed genetic subpopulation structure let to the decision to focus the further studies on the NE Atlantic population; populations from Mediterranean, Adriatic and Black Seas were considered to be genetically apart. From the review (Chapter 2), the lack of information regarding growth conditions in relation to abiotic and biotic conditions was identified as a second unclear question. In Chapter 5, extensive laboratory experiments were performed on small brown shrimp to study the length growth in relation to water temperature. These experiments were carried out under similar conditions for three populations respectively at the northern (Bodø, Norway), intermediate latitude (Wadden Sea, The Netherlands) and southern edge (Minho, Portugal) of the species distributional range to

determine whether counter-gradient growth compensation occurred. Crustaceans such as *C. crangon* do not grow continuously but by periodically shedding the hard exoskeleton in a process called moult or ecdysis. Between consecutive moults size increase is very constrained, therefore the rate of growth is a function of the frequency of moults and depends on two factors: the size increase at a moult (moult increment) and time between moulting periods (intermoult period). Individual growth was followed in order to analyze both components.

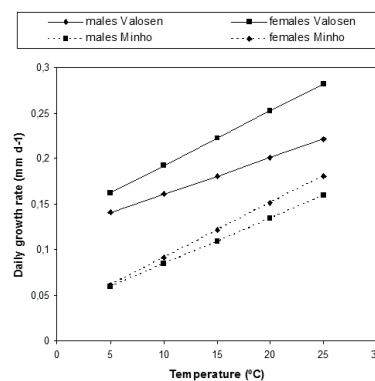

Impact of water temperature on the growth of the brown shrimp *Crangon crangon*.  
 De invloed van de watertemperatuur op de groei van de garnaal *Crangon crangon*.  
 Impacto da temperatura no crescimento do camarão-mouro *Crangon crangon*.

Unfortunately, for the Wadden Sea no reliable data could be obtained. As expected, animals from both other populations grew faster at higher temperature. The intermoult period was inversely related to water temperature, while moult increment was a largely variable. Sex and size differences were also found, with males growing slower than females and at a decreasing growth rate with size. However, at the same temperature level, northern shrimps grew faster than southern shrimps, contrasting the thermal gradient expected for the original populations – growth would be expected to be slower for the population living at lower temperatures. Therefore, this experimental investigation also suggested compensation in growth counter acting latitudinal thermal gradient.

Population dynamics of *Crangon crangon* is difficult to assess because reproduction occurs over longer time periods and juveniles emigrate continuously to deeper waters as they grow. To understand the key processes determining recruitment, we must rely on long-term data sets on adults. In Chapter 6, factors influencing fluctuations in *C. crangon* abundance in the Dutch Wadden Sea were analysed using a long-term dataset from a fyke fishing programme started in 1960. This provided information on adult brown shrimp and several of its predators. *C. crangon* abundance follows a seasonal pattern with peaks in spring and

autumn. Autumn abundance, representing emigration of mature shrimps towards overwintering grounds, is consistently larger (around five times) than spring abundance, which corresponds to the overwintering immigration of adult shrimps returning to shallow waters. Two hypotheses were tested and discussed: [1] recruits in autumn are related to predator abundance and temperature during previous warmer seasons, and [2] overwintering adults' abundance is determined by predation pressure and abiotic conditions in winter. In fact, the predator abundance was the factor most consistently related with shrimp abundance especially in autumn. Autumn abundance was further related to previous winter conditions, while temperature and salinity were relevant factors affecting spring abundance. A significant positive relationship between spring and autumn abundance and annual commercial landings was also found.

The relation between spring and autumn abundance and commercial catches in the Dutch Wadden Sea reflects the ongoing debate on when these landings originate from. In other words, since reproduction occurs throughout the year, which shrimp generation is the most contributing one to the autumn fisheries peak? On one hand, the position defended by R. Boddeke and colleagues since 1976 was that brown shrimp growth would be fast enough to enable the summer generation to attain commercial size (50 mm) already in the first autumn of life. On the other hand, the argument suggested by B.R. Kuipers and R. Dapper in 1984 was that it is the winter generation the one that sustains the autumn landings by intense settlement during spring. Both arguments are based on different considerations on the species growth: for Boddeke brown shrimp growth should be amazingly fast to enable to reach the commercial size in large numbers within about four months, from summer to autumn; in contrast, for Kuipers and Dapper the species would require at least about nine months till recruiting to fisheries. Therefore, to bring this dispute one step further would require clarification on the growth timeframe from settlement to commercial size. Unfortunately, still no reliable growth data from shrimps in the Wadden Sea are available. Therefore, an alternative was required and for this Dynamic Energy Budgets (DEB) were selected.

Dynamic Energy Budgets can be used to describe the energy flow through individual organisms from the assimilation of food to the utilization for maintenance, growth, development and reproduction. Powerful aspects of DEB theory are that intra- and interspecific differences between species are captured in the same model using only a different set of parameter values and that only ten parameters are required for predictions on growth and reproduction.

In Chapter 7, the various DEB parameters were estimated based on available information, whereby growth was assumed to be continuous and therefore more or less representing the situation of (continuous) population growth instead of (discontinuous) individual growth. Differences between males and females (maximum size, respectively 7.5 and 9.5 cm total length) were reflected in differences in the fraction of utilized energy spent on somatic maintenance plus growth and the maximum surface area specific assimilation rate.

With the parameters for male and female *C. crangon* being available, in Chapter 8, the DEB theory was applied to predict maximum possible growth in relation to the prevailing water temperature conditions. An upper limit for growth under natural conditions would then be evident. Besides applying the DEB model for the Dutch Wadden Sea population, an extension was made to depict latitudinal trends in the growth timeframe from settlement to commercial size by simulating growth at water temperature conditions at the northern and southern edges of the species distribution.

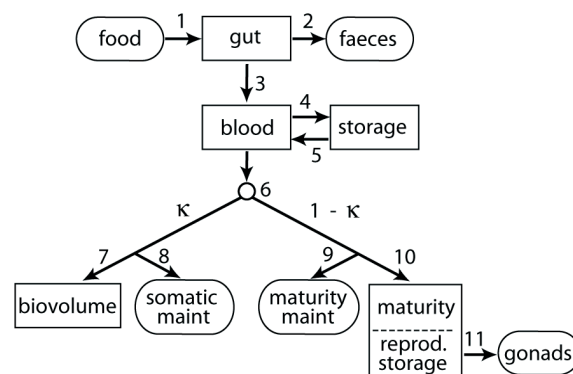

Energy flow in the Dynamic Energy Budget theory.

Energie stroom in een organisme volgens de Dynamic Energy Budget theorie.

Fluxo energético na teoria Dynamic Energy Budget.

In the growth trajectory from settlement (around 0.47 cm) to fisheries size (around 5.00 cm), females do grow faster than males stressing the need of studying sex's trends separately. Maximum growth simulations under optimal food conditions at the Wadden Sea temperature conditions revealed that males would take 1.5 years and females just 1 year from settlement to fisheries size. Therefore, females, which make up the bulk of commercial landings, to become available to the fisheries in autumn, must have settled in the Wadden Sea during the previous autumn, one year before, and hence probably arose from summer generation. Consequently, it is not the summer brood from the current year as Boddeke claimed, nor the previous winter generation as Kuipers and Dapper suggested, but the summer generation from previous year which represents the major contribution to autumn peak in fisheries. The resultant population growth rate must then be much smaller than the one Boddeke purposed and only slightly smaller than the one Kuipers and Dapper estimated. The time required to grow from settlement to fisheries size tends to increase with latitude, with females, taking almost half the time of males. For establishing reliable latitudinal trends in this growth trajectory it would be required the knowledge on settlement and reproduction periods at the distribution edges. Yet,



this information is scarce since only few studies were conducted in the past at high and low latitudes of the species distributional range.

Finally, did we make any progress? From the genetics point of view, we did clarify the population structure but it is unknown to what extent new genetic markers can change this perspective. Growth information can be more accurate: we still need field validation and information on maximum growth of brown shrimp from intermediate latitude populations. Also DEB parameters can be more accurate: estimates rely on available datasets on the species biology, and improvement of accuracy demands laboratory experiments especially designed for this purpose. In fact, actual simulations with DEB underestimated the growth trajectory at optimal food conditions. Since differences in parameters estimates between individuals from different populations are possible due to environmental variations, ideally separate parameter sets should be estimated for each population.

The role of the species in the ecosystem functioning requires further studies, namely to clarify how important is *C. crangon* to control their preys populations and to what extent is the brown shrimp dynamics dependent on predation pressure and food availability. DEB model can be used to reconstruct food conditions in the field. In this case, an accurate age estimation of *C. crangon* is required. An attempt has been made in the past to estimate brown shrimp age counting segments in the outer antennule and relating with water temperature (Tiews 1970). This methodology should be tested and validated. Other methodologies such as marking experiments could also be used.

This thesis also stresses the need for distinguishing sexes in studies on brown shrimp: faster growth, longer maximum size and maximum age of females, suggest higher mortality of males. This should be further clarified under natural and controlled conditions. Additionally, information on reproduction and settlement periods at the edges of brown shrimp geographic range is necessary to confirm the trends observed in DEB simulations for northern and southern populations. Finally, growth simulations applying the DEB model at different temperature scenarios might be an important tool to assess the impact of global climate change on brown shrimp dynamics.

## Samenvatting

### *De eco-geografie van de gewone garnaal Crangon crangon in Europa*

Langs de gehele Europese kust bepalen slechts een paar soorten het merendeel van het aantal en biomassa a organismen. Een van de talrijke soorten is de bruine of gewone garnaal *Crangon crangon*. Deze kleine kreeftachtige komt voor vanaf de Witte Zee in het hoge noorden in Rusland, tot in het zuiden aan de Atlantische kust van Marokko, en verder in de Middellandse en de Zwarte Zee. Al deze gebieden verschillen sterk van elkaar en de garnaal moet daarom in staat zijn zich te passen aan uiterst verschillende ecologische omstandigheden, in het bijzonder wat betreft temperatuur, zoutgehalte en voedselomstandigheden.

Naast van ecologisch belang is de garnaal erg waardevol voor de visserij in de Noordzee en verscheidene andere gebieden (Lagune van Venetië, Zwarte Zee). In het verleden was, en tot op heden nog steeds is, het commerciële belang de drijfveer van een groot aantal studies op verschillende niveaus, variërend van de fysiologische prestaties van een enkele garnaal tot de populatiedynamika van de commerciële visserij. Het is daarom verbazingwekkend dat ondanks de overvloed aan studies basale aspecten van de garnaal, zoals groei en de mechanismen die de populatie bepalen, nog steeds onduidelijk zijn.

Het doel van dit onderzoek was het identificeren wat kennishiaten wat betreft de garnaal en vervolgens deze trachten althans gedeeltelijk in te vullen. De samenvatting van Tiews (1970) werd gebruikt als basis, al hoewel dit overzicht van de biologie van de gewone garnaal en van de visserij al bijna 40 jaar oud is. Sindsdien is er veel onderzoek over dit onderwerp gepubliceerd en dit maakte een actualisatie noodzakelijk. Hoofdstuk 2 bevat daarom een uitgebreide literatuur studie met de levenscyclus als uitgangspunt, en opgesplitst naar gebied van voorkomen. Dit laatste vanwege het feit dat de garnaal over een groot gebied in de ondiepe Europese kust wateren onder zeer verschillende omstandigheden voorkomt, vanaf de 34ste tot 67ste noorderbreedte.

Het is verrassend dat in verscheidene onderzoeksgebieden bijna geen voortgang is geboekt. Sinds de publicatie van Tiews (1970) is nog steeds de taxonomie van de *Crangon crangon* onduidelijk. Verder kan er ook niet worden uitgesloten dat er langs de Europese kust meerdere genetisch verschillende populaties bestaan. Dit zou met behulp van moleculaire onderzoeksmethoden moeten worden uitgezocht. Hiernaast ontbreekt ook basale kennis omtrent de condities voor de groei in relatie tot biotische en abiotische factoren, inclusief de mogelijke zogeheten 'countergradient growth compensation' (het vermogen om in koudere streken harder te groeien bij dezelfde temperaturen). Verder vond Tiews (1970) al een verschil in groei tussen mannelijke en vrouwelijke garnalen. Alhoewel beide geslachten kunnen worden geïdentificeerd met behulp van uitwendige kenmerken, werd dit in veldstudies tot nu toe niet gedaan. Gedetailleerde informatie over de groei zou inzicht verschaffen over de structuur en dynamiek van de *C. crangon* populatie over zijn verspreidingsgebied en gedetailleerde studies aan recruitering mogelijk maken. Uiteindelijk zou dit kunnen leiden tot inzicht in hoeverre 'life history' parameters variëren over het verspreidingsgebied.

Om na te gaan in hoeverre er verschillende sub populaties onderscheiden kunnen worden, werden twee methoden toegepast: [1] een klassiek morfologisch onderzoek, gebaseerd op de grootte van een aantal morfologische kenmerken, en [2] een genetische analyse waarbij dezelfde monsters werden

gebruikt. Deze monsters waren genomen op een 25-tal locaties verspreid over de gehele geografische verdeling van deze soort; alleen de Witte Zee ontbrak.

Eerder onderzoek in de Engelse wateren suggereerde, gebaseerd op morfologische kenmerken, het bestaan van sub-populatie structuur op een kleine lokale schaal (100 km). In Hoofdstuk 3 is dit onderzoek uitgebreid naar alle gebieden waar de *Crangon crangon* voorkomt en is onderzocht of dezelfde methode kon worden toegepast om de sub-populatie structuur te beschrijven op een veel grotere schaal (1000 km). De 25 gewone garnaal monsters verschaften informatie over de ruimtelijke variaties in morfologische eigenschappen. Daarnaast zijn voor vier locaties (Bodø, Noorwegen; de Wadden Zee, Nederland; Minho and Lima estuaria, Portugal) de variaties van morfologische kenmerken in de tijd bepaald.

Morfologische verschillen tussen belangrijke zoogeografische gebieden maken het mogelijk om duidelijk onderscheid te maken tussen de populaties van de Adriatische Zee, de Zwarte Zee, de Middellandse Zee en het Noord-Oosten van de Atlantische Oceaan. Tegen de verwachting in kunnen, op een lokale schaal, sub-populaties vaak niet worden geïdentificeerd door de grote variaties tussen de individuele garnalen zelf, wat verward kan worden met variaties over de tijd. De morfologische methode kan daarom niet gebruikt worden om verschillende populaties te onderscheiden op een kleine ruimtelijke schaal.

Taxonomie en de genetische structuur werd onderzocht in Hoofdstuk 4 door de volgorde te bepalen van een 388 bp fragment van de Cytochrome-c-oxidase I gen voor 140 exemplaren verzameld over dezelfde 25 locaties als voor de morfologische studie. Tegelijkertijd werden ook enkele andere *Crangon* soorten geanalyseerd: *C. alaskensis* van de kust van de staat Washington, USA en van Kodiak eiland in de staat Alaska; *C. septemspinosa* uit Tuckerton, New Jersey; *C. cassiope* uit de baai van Wakasa en *C. amurensis* uit de baai van Tedai, Japan.

Het genetisch onderzoek toonde een duidelijke populatie structuur aan. Verrassend genoeg, werden er slechts vier grote phylogeografische groepen gevonden: het Noord-Oosten van de Atlantische Oceaan, het westen van de Middellandse Zee, de Adriatische Zee en de Zwarte Zee. Deze groepen komen duidelijk overeen met verschillende geografische gebieden, identiek als die van de morfologische studie. Dit suggereert dat er weinig uitwisseling is van genen tussen de verschillende gebieden. De biogeografische historie van het taxon *Crangon* komt goed overeen met hoe de garnaal zich heeft verspreid gedurende de laatste millennia. De populaties in het westen van de Middellandse Zee zijn de oudsten en het meest gevarieerd van alle vier de groepen. De groepen in de Zwarte en Middellandse Zee staan momenteel niet in contact met elkaar alhoewel de kolonisatie van de Zwarte Zee vrij recentelijk heeft plaatsgevonden, waarschijnlijk 7000 jaar geleden of eerder. Het was opvallend dat in het Noord-Oosten van de Atlantische Oceaan een enkele homogene populatie werd gevonden vanaf Marokko tot IJsland en de Baltische Zee. Dit kan misschien het resultaat zijn van een recente kolonisatie na de laatste ijstijd in het late Pleistoceen, ondanks de eerder genoemde beperkte *gene flow* tussen de gebieden.

Naar aanleiding van de waargenomen genetische populatiestructuur werd besloten om de verdere aandacht te richten op de populatie langs de Noordoostelijke Atlantische oceaan. De Middellandse, Adriatische en Zwarte Zee werden beschouwd als genetisch aparte groepen. Uit de literatuur studie (Hoofdstuk 2) kwam verder naar voren het ontbreken van kennis omtrent de biotische en abiotische factoren die de groei bepalen. In Hoofdstuk 5 worden uitvoerige laboratorium proeven beschreven met jonge garnalen waarbij groeisnelheid als functie van watertemperatuur bepaald werd. De proeven

werden onder vergelijkbare omstandigheden uitgevoerd met drie populaties respectievelijk uit Bodø, Noorwegen, in het noorden, uit de Wadden Zee, Nederland en uit Minho, Portugal, in het zuiden. Op deze manier kon de groei voor verschillende breedtegraden worden onderzocht. Kreeftachtigen zoals Crangon groeien niet continue maar door het periodieke vervangen van hun harde uitwendige skelet in een proces dat vervelling of ecdysis wordt genoemd. De toename in grootte van het uitwendige skelet na vervelling is klein. De groeisnelheid hangt daarom af van hoe vaak vervelling plaatsvindt en hoe groot het uitwendige skelet groeit na iedere vervelling. Om deze twee factoren te analyseren werd de groei aan de hand van individuele garnalen bestudeerd.

Helaas kon voor de Wadden Zee geen betrouwbare data worden verkregen. Zoal verwacht groeien de jonge garnalen in beide andere populaties sneller bij hogere temperatuur. De tijd tussen het verwisselen van het exoskelet was negatief gerelateerd aan de watertemperatuur terwijl de mate van groei van ieder nieuw exoskelet een grote variatie vertoonde. Hiernaast werden er ook verschillen tussen geslacht en tussen verschillend grote garnalen gevonden. Mannelijke garnalen blijken langzamer te groeien dan vrouwelijke garnalen met een groeisnelheid die afneemt naarmate de garnaal groter wordt. Daarentegen groeien noordelijke garnalen bij dezelfde temperatuur sneller dan de zuidelijke garnalen. Dit suggereert het bestaan van een zogeheten *counter gradient* compensatie, die afhankelijk is van de breedtegraad.

De populatiedynamika van *Crangon crangon* is moeilijk te bestuderen door de lange voortplantingsperiode en de continue migratie van jonge garnalen tijdens de groei naar diepere wateren. Hierdoor moeten we ons baseren op lange termijn registraties van aantallen volwassen garnalen. In Hoofdstuk 6 worden de factoren die de dichtheid van volwassen *Crangon crangon* in de Wadden Zee bepalen geanalyseerd, gebruik makend van lange termijn series van het NIOZ fuiken programma dat van start ging in 1960. Dit programma verschaft informatie over de aantallen van volwassen garnalen en van verscheidene van hun predatoren. De dichtheid van de gevangen *Crangon crangon* volgt een jaarlijks patroon met pieken in de lente en herfst. De dichtheid in de herfst, veroorzaakt door de passerende emigratie van volwassen garnalen naar hun overwinteringsgebieden voor de kust, is consequent groter (ongeveer 5 keer) dan de dichtheid van de naar de Waddenzee terugkerende volwassen garnalen in de lente. Twee hypothesen werden getest: [1] het aantal wegtrekkende garnalen in de herfst is gerelateerd aan de dichtheid predatoren en de temperatuur gedurende de voorgaande zomermaanden, en [2] de dichtheid van volwassen garnalen die overwinteren wordt bepaald door de druk van de predatoren en de abiotische omstandigheden in de winter. Uit het onderzoek bleek dat de dichtheid van de predatoren het sterkst gerelateerd was aan de dichtheid garnalen, vooral in de herfst. De dichtheid wegtrekkende garnalen in de herfst was verder gerelateerd aan de condities in de voorgaande winter. Temperatuur en zoutgehalte waren relevante factoren die de dichtheid in de lente beïnvloedden. Een significante positieve relatie werd ook vastgesteld tussen de dichtheid wegtrekkende garnalen in de herfst en de vangst van de commerciële visserij.

De relatie tussen de dichtheid garnalen in de lente en herfst in de NIOZ fuik en met de vangst van de commerciële visserij in de Wadden Zee (zie Hoofdstuk 6) roept de vraag op waar de vangst vandaan komt. Aangezien de garnalen zich min of meer gedurende het hele jaar voortplanten, is de vraag welke generatie het meest bijdraagt aan de piek in de vangst in de herfst. Aan de ene kant werd door R. Boddeke en zijn collega's in 1976 de stelling geponeerd dat voor de in de zomer geboren generatie de groei snel genoeg zou zijn om in de herfst al een commerciële grootte te bereiken. Aan de

andere kant suggereerden B.R. Kuipers and R. Dapper in 1984 dat het de overlevende winter generatie was die de piek in de visvangst in de volgende herfst bepaalde. Beide argumenten verschillen door verschillende aannamen omtrent de mogelijke groei van jonge garnalen. Boddeke veronderstelt een verbazingwekkend hoge groeisnelheid vanaf de zomer tot de herfst om in slechts 4 maanden een commerciële grootte te bereiken. Daar tegenover hebben volgens Kuipers and Dapper de jonge garnalen 9 maanden nodig om volwassen te worden. Om deze discussie een stap dichterbij een oplossing te brengen vereist inzicht in de tijd tussen het moment dat de jonge garnaal zich vestigt op de bodem en het moment dat zij volwassen en gevangen wordt. Helaas bestaat er nog steeds geen betrouwbare informatie over de groei van de garnalen in de Wadden Zee. Daarom moest een alternatieve methode worden gebruikt waarbij de keus viel op de zogeheten Dynamic Energy Budgets (DEB theorie).

DEB theorie beschrijven de energie stromen door een organisme, van voedselopname tot het verbruiken van energie voor onderhoud, groei, ontwikkeling and voortplanting. Sterke punten van de DEB theorie zijn dat verschillen tussen en binnen de soorten gemakkelijk in hetzelfde model gemodelleerd kunnen worden, door verschil in parameterwaarden, en dat slechts 6 parameters nodig zijn om de groei en voortplanting van een soort te voorspellen.

In Hoofdstuk 7 zijn de verschillende DEB parameters geschat voor *Crangon crangon* gebaseerd op aanwezige literatuurinformatie. Hierbij werd uitgegaan van continue groei, wat dus meer populatiegroei weergeeft dan individuele groei. Het verschil in grootte tussen mannelijke en vrouwelijke garnalen (maximale totale lengte van 7.5 en 9.5 cm respectievelijk) werd weerspiegeld in verschillende waarden voor een tweetal parameters: de fractie energie die gebruikt wordt voor lichaamsonderhoud en groei en de maximale oppervlakte afhankelijke voedselopname.

Met de beschikbare parameters voor zowel mannelijke als vrouwelijke *C. crangon* werd in Hoofdstuk 8 de 'Dynamic Energy Budget' theorie toegepast om de maximaal mogelijke groei na te gaan onder verschillende water temperaturen. Dit zou dan de bovengrens bepalen voor de groei onder natuurlijke omstandigheden. Naast het toepassen van de DEB theorie voor de Wadden Zee populatie werden ook groeischattingen gemaakt voor de meest noordelijke en zuidelijke gebieden waar de gewone garnaal voorkomt. Hoewel de nauwkeurigheid van de geschatte waarden van de DEB parameters verder verbeterd kan worden kon over het geheel het DEB model met succes worden toegepast.

De periode die de garnaal nodig heeft om te groeien vanaf het moment dat ze zich installeert op de bodem (ongeveer 0.47 cm) tot het moment dat ze groot genoeg is voor de visserij (5 cm) is korter voor vrouwelijke garnalen dan voor mannelijke garnalen. Dit geeft aan dat beide geslachten apart moeten worden bestudeerd. Maximale groei voorspellingen toonden aan dat mannelijke garnalen ongeveer 1.5 jaar nodig hebben voor de eerder genoemde groeiperiode terwijl dat voor de vrouwelijke garnalen slechts 1 jaar is. De vrouwelijke garnalen, die het grootste deel uitmaken van de commerciële visvangst in de herfst, moeten zich daarom al een jaar eerder hebben gevestigd in de Wadden Zee en komen dus waarschijnlijk voort uit de zomer generatie van dat jaar. Dit betekent dat de visvangst in de herfst niet bepaald wordt door de zomer vestiging in het huidige jaar, zoals wordt beweerd door Boddeke, noch door de winter generatie zoals Kuipers en Dappers suggereerden maar door de zomer generatie van het jaar daarvoor. Hieruit volgt dat de groei van de populatie veel kleiner moet zijn dan wordt voorgesteld door Boddeke en iets kleiner dan de door Kuipers en Dapper geschatte snelheid. De tijd die nodig is om te groeien van het moment van vestigen tot het bereiken van een grootte voor de

visserij neemt toe met de breedtegraad, waarbij de vrouwelijke garnalen de helft van de tijd nodig hebben in vergelijking met de mannelijke garnalen. Inzicht in de groeiperiode voor verschillende breedtegraden vereist informatie over de perioden van vestiging en voortplanting aan de uiterste grenzen waar de garnaal voorkomt. Helaas bestaat hierover maar weinig informatie. Slechts een paar studies zijn in het verleden verricht op hoge en lage breedtegraden.

Tenslotte rest de vraag of we enige vooruitgang hebben geboekt. We hebben een beter inzicht in de genetische populatiestructuur maar het is onbekend hoe nieuwe genetische markers dit resultaat in de toekomst nog kunnen veranderen. Verder is nog steeds nauwkeuriger groei informatie gewenst: we hebben nog verificatie nodig met veld studies en informatie over de maximale mogelijke groei van populaties op andere breedtegraden. Ook kunnen de schattingen van de DEB parameters verbeterd worden: de huidige waarden zijn gebaseerd op een combinatie van diverse gegevens. Voor de verbetering van de nauwkeurigheid zijn speciaal voor dit doel toegesneden laboratorium proeven noodzakelijk. Aangezien omgevingsfactoren van invloed kunnen zijn, zou het ideaal zijn als in de toekomst een aparte set met parameters gebruikt zou worden voor iedere populatie. Tevens kan het DEB model ook gebruikt worden om voedsel condities in het veld te reconstrueren. Hiervoor is een nauwkeurige schatting van de leeftijd van de *Crangon crangon* noodzakelijk. In het verleden heeft men dit geprobeerd door het aantal segmenten te tellen in de buitenste antenulles en dit te relateren aan de watertemperatuur. Deze methode moet verder getest en geverifieerd worden. Andere technieken zoals proeven met markeringen zouden ook mogelijk gebruikt kunnen worden.

Dit proefschrift benadrukt de noodzaak om onderscheid te maken tussen de geslachten: de snellere groei, de grote maximale lengte en maximale leeftijd van vrouwelijke garnalen suggereert een hogere mortaliteit van mannelijke garnalen. Dit dient verder uitgezocht te worden onder natuurlijke en gecontroleerde omstandigheden. Daarnaast is informatie over de voortplanting en periode van vestiging nodig voor populaties aan de randen van het verspreidingsgebied om te in de DED simulaties waargenomen trends te verifiëren voor de noordelijke en zuidelijke populaties. Meer studies zijn nodig om te bepalen welke rol de soort speelt in het ecosysteem, met name moet worden uitgezocht in welke mate de dynamiek van de gewone garnaal afhankelijk is van de predator druk en hoeveel invloed *Crangon crangon* heeft op zijn prooi populaties. Tenslotte kunnen groei simulaties met het DEB model voor verschillende temperatuur scenario's een belangrijk instrument zijn in het bepalen van de invloed van klimaat verandering op de productiviteit van de gewone garnaal.

*Dankwoord* - Ik will graag Machiel Bos, Henk van der Veer, Bas Kooijman, Ana Bio en Ben Abbas bedanken voor hun nuttige suggesties wat betreft Nederlands-Engels vertaling.

## Resumo

### *Eco-geografia do camarão-mouro Crangon crangon na Europa*

Ao longo de toda a costa europeia, apenas um pequeno número de espécies contribui para a biomassa total dos estuários, entre elas o camarão-mouro *Crangon crangon*. A distribuição deste pequeno crustáceo estende-se desde o Mar Branco, Rússia, no Norte, até Marrocos no Sul do Atlântico Nordeste, incluindo ainda o Mediterrâneo e o Mar Negro. *C. crangon* é então capaz de viver em condições muito diversas de temperatura, salinidade, disponibilidade e qualidade de alimento observadas nesta área geográfica tão vasta.

Para além de ecologicamente importante, este camarão é um recurso pesqueiro valioso, principalmente no Mar do Norte, mas também noutras áreas (Mar Adriático, Mar Negro). O interesse comercial da espécie motiva numerosos estudos a diversos níveis, desde a fisiologia, a nível individual, até à dinâmica populacional e à biologia pesqueira, a nível ecológico. Contudo, é surpreendente que, sendo uma espécie tão abundante e tão extensivamente estudada, características básicas como crescimento e mecanismos reguladores das populações, estejam ainda por esclarecer.

O objectivo deste estudo é identificar falhas no conhecimento da biologia do camarão-mouro e colmatar algumas delas. Como base de partida usou-se a sinopse de Tiews (1970) sobre a biologia e pescas da espécie. No entanto, esta síntese foi publicada há quase quatro décadas e, desde então, foram escritos muitos trabalhos. Tornou-se, pois, imperativa uma actualização. Assim, no Capítulo 2, fez-se uma extensa revisão da literatura, adoptando-se uma perspectiva latitudinal, pois a distribuição geográfica da espécie abrange uma extensa área na Europa, desde 34 até 67° de latitude Norte.

Curiosamente, constatou-se pouco progresso em várias áreas. Desde Tiews (1970), o estatuto taxonómico da espécie carece de clarificação. A existência de populações geneticamente distintas não deve ser descurada e deve ser esclarecida. Outras falhas básicas no conhecimento incluem falta de informação sobre condições de crescimento em relação às condições bióticas e abióticas, incluindo a possibilidade de 'compensação contra-gradiente'.

Embora Tiews (1970) descrevesse diferenças no crescimento entre machos e fêmeas, e apesar dos sexos serem morfologicamente diferenciáveis, esta distinção tem sido negligenciada nos estudos em meio natural. Informação detalhada sobre o crescimento permitiria analisar a estrutura e dinâmica populacional da espécie ao longo da sua distribuição e serviria como ponto de partida para estudos de recrutamento. Permitiria ainda avaliar a existência de gradientes em latitude nas características do ciclo de vida.

De forma a contribuir para esclarecer a estrutura da população da espécie, duas abordagens foram implementadas: [1] um estudo de morfometria clássica, baseado nas dimensões de determinados caracteres morfológicos, e [2] uma análise genética. Foram usadas em ambos os estudos as mesmas amostras de camarão, obtidas em 25 locais ao longo de toda a distribuição geográfica da espécie; apenas o Mar Branco não foi amostrado.

Em águas britânicas, tinha sido já sugerida a existência de uma estrutura da população à escala local (100 km) com base em morfometria. No Capítulo 3, este método foi alargado a toda a distribuição geográfica da espécie para testar a sua aplicação a larga escala (1000 km). Em quatro locais (Bodø, Noruega; Mar de Wadden, Holanda; estuários do Minho e Lima, Portugal) avaliou-se ainda a variabilidade ao longo do tempo na morfologia. Conseguiu-se distinguir claramente as

populações das principais zonas zoogeográficas: Mar Adriático, Mar Negro, Mar Mediterrâneo e Atlântico Nordeste, através das diferenças morfológicas. Contudo, contrariamente ao esperado, à escala local, não foi possível identificar as subpopulações devido à variabilidade individual, reflectida na variabilidade temporal. Assim, a abordagem morfométrica revelou-se inapropriada para a distinção entre subpopulações a pequena escala.

No Capítulo 4, estudou-se o estatuto taxonómico e a estrutura genética da população do camarão-mouro pela sequenciação de um fragmento do gene citocromo oxidase I com 388 pares de bases, de 140 indivíduos provenientes dos mesmos 25 locais analisados no estudo morfométrico. Algumas outras espécies do mesmo género foram igualmente analisadas: *C. alaskensis* obtido na costa de Washington e na ilha de Kodiak, Alasca, USA; *C. septemspinosa* obtido em Tuckerton, Nova Jersey, USA; *C. cassiope* obtido na Baía de Wasaka; e *C. amurensis* da Baía de Tedai, ambas no Japão.

O estudo genético evidenciou a forte estruturação da população de camarão-mouro. Curiosamente, em toda a área geográfica de distribuição apenas se distinguem quatro grupos filogeográficos principais: o Atlântico Nordeste, o Mediterrâneo Oeste, o Mar Adriático e o Mar Negro. Estes grupos correspondem a regiões geográficas bem definidas, as mesmas observadas na abordagem morfométrica, o que sugere que o fluxo genético entre regiões é restrito. A história biogeográfica do taxon é também concordante com a história geográfica da sua área de distribuição. A população do Mediterrâneo é a mais antiga e mais variável das quatro. Actualmente encontra-se separada da população do Mar Negro, embora a colonização deste ter ocorrido recentemente, possivelmente há menos de 7000 anos. Curiosamente, observou-se homogeneidade genética ao longo de todo o Atlântico Nordeste, de Marrocos à Islândia e Mar Báltico, o que pode ser resultante de uma colonização recente, após os ciclos glaciares do final do Pleistoceno, apesar de fluxo genético restrito. Os estudos que se seguiram nesta tese, restringiram-se então à população do Atlântico Nordeste; as populações dos Mares Mediterrâneo, Adriático e Negro foram consideradas geneticamente separadas.

Na revisão da literatura (Capítulo 2), detectou-se um deficiente conhecimento das condições de crescimento da espécie em relação a factores ambientais. Numa primeira abordagem, no Capítulo 5, desenvolveram-se experiências de crescimento em laboratório a temperatura controlada. Para permitir avaliar a existência de ‘compensação contra gradiente’ no crescimento, estas experiências foram executadas em condições semelhantes com animais provenientes de três populações, respectivamente no Norte (Bodø, Noruega), a latitude intermédia (Mar de Wadden, Holanda) e no Sul (estuário do Minho, Portugal) da distribuição geográfica da espécie. Os Crustáceos como o camarão-mouro, não crescem de forma contínua, pois necessitam libertar-se do exoesqueleto num processo denominado de muda ou ecdysis. O crescimento é muito limitado no período entre mudas, pelo que a taxa de crescimento é função da frequência de muda e depende de dois factores: do incremento em tamanho após a muda e do intervalo entre mudas. Para analisar ambos os componentes, nas experiências seguiu-se o crescimento individual dos camarões.

Infelizmente para o Mar de Wadden não se obtiveram dados de confiança. Conforme esperado, os animais das outras duas populações cresceram mais rapidamente a temperatura mais elevada. O período entre mudas foi inversamente relacionado com a temperatura, enquanto que o incremento após a muda apresentou uma grande variabilidade. Detectaram-se ainda diferenças entre sexos, com os machos a crescer mais lentamente. Contudo, para um mesmo nível de temperatura, os camarões do Norte cresceram mais rapidamente do que os camarões do Sul, contrastando com o gradiente térmico esperado para as populações de origem – seria de esperar que o crescimento fosse mais lento para a



população do Norte, onde a temperatura média é mais baixa. Deste modo, esta abordagem experimental sugere a existência de uma compensação no crescimento, contrariando o gradiente térmico em latitude.

A análise de séries de dados temporais é uma ferramenta útil para a compreensão dos processos chave que determinam o recrutamento. No caso do camarão-mouro, estas séries facilitam bastante, pois a sua dinâmica populacional é de difícil estudo, já que se reproduz ao longo de quase todo o ano e os juvenis migram continuamente para maiores profundidades à medida que crescem. No Capítulo 6, aproveitou-se uma série temporal de um programa iniciado em 1960, para estudar os factores que influenciam as flutuações na abundância de *C. crangon* no Mar de Wadden holandês. Para além de informação sobre abundância de camarão-mouro, esta série de dados inclui informação sobre a abundância dos seus principais predadores. A abundância de *C. crangon* segue um padrão sazonal com picos na Primavera e Outono. A abundância no Outono representa a emigração de camarões adultos em direcção às zonas de inverneio, e é consistentemente maior (cerca de cinco vezes) do que a abundância na Primavera. Esta corresponde à parte da população adulta que regressa às zonas menos profundas após o Inverno. Testaram-se e discutiram-se duas hipóteses: [1] o recrutamento no Outono está relacionado com a abundância de predadores e com a temperatura durante as estações precedentes mais quentes, e [2] a abundância de adultos que regressam após o Inverno é determinada pela pressão de predação e pelas condições abióticas de Inverno. De facto, a pressão de predação foi o factor mais consistentemente relacionado com a abundância de camarão, principalmente no Outono. Nesta estação a abundância foi também relacionada com as condições do Inverno anterior, enquanto que a temperatura e a salinidade foram relevantes na Primavera. Foi ainda observada uma relação positiva entre a abundância de camarão e as descargas comerciais da espécie no Mar do Norte.

A relação positiva entre a abundância no Outono e Primavera e a pesca comercial reflecte o debate em curso sobre a origem das descargas no Mar do Norte. Uma vez que o camarão-mouro se reproduz ao longo de quase todo o ano, qual a geração que mais contribui para o pico de Outono observado anualmente nas pescas comerciais? Por um lado, R. Boddeke e colegas defendem desde 1976 que o crescimento de *C. crangon* é suficientemente rápido para permitir que a geração de Verão atinja o tamanho comercial (50 mm) já no primeiro Outono de vida. Por outro lado B.R. Kuipers e R. Dapper, 1984, sugerem que é a geração de Inverno a que sustém as descargas comerciais de Outono, através de intenso 'settlement' na Primavera. Ambos os argumentos pressupõem diferentes considerações sobre o crescimento da espécie: para Boddeke, o crescimento deverá ser incrivelmente rápido para permitir a um elevado número de animais, atingir o tamanho comercial em apenas quatro meses, do Verão para o Outono; pelo contrário, para Kuipers e Dapper, são necessários pelo menos cerca de nove meses para o camarão-mouro recrutar à pesca. Deste modo, para clarificar esta questão seria necessário esclarecer o período de tempo desde o 'settlement' até ao tamanho comercial. Infelizmente, as experiências de crescimento com camarões provenientes do Mar de Wadden falharam. Assim, recorreu-se a uma abordagem alternativa, o modelo 'Dynamic Energy Budgets' (DEB).

O modelo DEB pode ser usado para descrever o fluxo energético através dos indivíduos desde a alimentação até à utilização do alimento para manutenção, crescimento, desenvolvimento e reprodução. Uma das vantagens da teoria DEB consiste no relativamente reduzido número de parâmetros necessário para estabelecer previsões sobre crescimento e reprodução. No Capítulo 7, os vários parâmetros DEB foram estimados considerando o crescimento como contínuo e, como tal,

representando o crescimento contínuo da população, em vez do crescimento individual, descontínuo. As diferenças entre machos e fêmeas, como o tamanho máximo (respectivamente 7,5 e 9,5 cm de comprimento total), reflectiram-se em diferenças na fracção de energia utilizada na manutenção e no crescimento, e na taxa de assimilação máxima.

No Capítulo 8, aplicou-se a teoria DEB usando os parâmetros para machos e fêmeas de camarão-mouro para prever o crescimento máximo possível em relação aos níveis habituais de temperatura da água. Estabeleceu-se assim um limite superior para o crescimento em condições naturais. Para além de aplicar o modelo DEB nas condições de temperatura do Mar de Wadden, estenderam-se as simulações para detectar tendências em latitude na duração do período de crescimento desde o 'settlement' até ao tamanho comercial, usando as condições de temperatura observadas nos limites Norte e Sul de distribuição da espécie. Apesar de ser necessário melhorar a exactidão dos parâmetros, o modelo DEB foi aplicado com sucesso.

Na trajectória de crescimento desde o 'settlement' com cerca de 0,47 cm até ao tamanho comercial, cerca de 5,0 cm, as fêmeas crescem mais rapidamente do que os machos, enfatizando a necessidade de estudar ambos os sexos separadamente. As simulações de crescimento máximo nas condições habituais de temperatura do Mar de Wadden, demonstraram que, enquanto os machos precisam de 1 ano e meio, as fêmeas demoram apenas um ano a atingir o tamanho comercial. Assim, para estarem disponíveis para a pesca no Outono, o período de 'settlement' das fêmeas no Mar de Wadden deverá ter ocorrido um ano antes, também no Outono. Estas fêmeas provêm provavelmente da geração do Verão anterior. Uma vez que a maioria das capturas comerciais é constituída por fêmeas de camarão-mouro, deverá ser, não a geração de Verão do ano em curso, como Boddeke sugeria, nem a geração de Inverno como Kuipers e Dapper proponham, mas sim a geração do Verão do ano anterior, a que mais contribui para o pico de Outono nas pescas. A resultante taxa de crescimento da população deve ser então muito inferior à proposta por Boddeke e apenas ligeiramente inferior à que Kuipers e Dapper estimaram. A duração do período de crescimento desde o 'settlement' até ao tamanho comercial tende a aumentar com a latitude, com as fêmeas a demorarem quase metade do tempo dos machos. Contudo, para estabelecer tendências latitudinais realistas nesta trajectória de crescimento seria necessário conhecer os períodos de 'settlement' e reprodução nos limites de distribuição.

Finalmente, houve progresso no conhecimento da biologia de camarão-mouro? Do ponto de vista da genética, sendo dúvida que a estrutura da população ficou mais clara, mas desconhece-se até que ponto novos marcadores genéticos poderão alterar esta situação. A informação sobre o crescimento ainda requer validação das simulações em meio natural e investigação em populações de latitude intermédia. De facto, as presentes simulações subestimam o crescimento em condições óptimas. Os parâmetros do DEB foram estimados com base em dados já disponíveis; para obter parâmetros mais exactos seriam necessárias experiências desenhadas especialmente para este fim. Idealmente, dever-se-ia estimar um conjunto de parâmetros para cada população, pois as estimativas podem diferir devido a variações ambientais.

O papel da espécie no funcionamento do ecossistema requer investigação, nomeadamente para esclarecer quão importante é o camarão-mouro no controlo das suas presas e até que ponto a dinâmica da espécie depende da pressão de predação e da disponibilidade em alimento. O modelo DEB pode ser usado para reconstruir as condições ambientais de alimento. Para tal, é necessária uma estimativa da idade dos indivíduos que poderá ser obtida com experiências de marcação ou relacionando o número

de segmentos das anténulas com a idade, sabendo a temperatura da água. Esta metodologia deverá ser testada e validada.

Esta tese reforça ainda a necessidade de distinção dos sexos em estudos de camarão-mouro: o crescimento mais rápido, o tamanho máximo mais longo e a maior longevidade das fêmeas sugerem elevada mortalidade dos machos. Este aspecto deveria ser clarificado em meio natural e em laboratório. É ainda necessária informação sobre períodos de reprodução e 'settlement' nos limites de distribuição da espécie para confirmar as tendências observadas nas simulações do DEB. Por fim, simulações aplicando o modelo DEB a diferentes cenários de temperatura, poderão ser uma ferramenta para avaliar impactos de alterações climáticas na dinâmica do camarão-mouro.



## Acknowledgements

Every project has to come to an end, even if the answer is not found. And a PhD is not an exception. This long journey is only possible with the collaboration of a number of persons. Here is a tribute to those who somehow contributed to my long PhD journey...

From the very start of this thesis I have been very fortunate. With no previous announcement, Henk van der Veer received me, accepted to supervise my work and prepared a proposal I could not refuse, though departing for holidays. Despite 2000 km apart, I have been in very good hands, both in the most inspired moments and in the difficult ones. Yet, I would probably never contact my supervisor, if Prof. dr. Paulo Santos did not encourage me, and hence my gratitude to him.

Joana Cardoso has been my link to NIOZ from the beginning of this thesis. I only met her at Texel but I could always count on her. Not only Joana gave me valuable scientific suggestions, but also took care of my welfare during my stays at the island. More than once, Joana was abroad and even so I stayed at her place. Well, in the exchange of “cat sitting”.

One of the first valuable advises Henk gave me was to find students who could collaborate with me. Thanks to this recommendation, I had the pleasure of working with numerous young students, who were especially helpful assisting in the intensive field work, laboratory analysis and experiments. The list is very extensive. Even so, I would like to thank my first two students, Cindy Pedrosa and Joana Rodrigues, and also Cristiane Mendes, Ester Dias, Maria João Almeida, Marisa Silva, Rita Guillot, Sasha Sjollem, among others, who were tireless and have all contributed valuably to accomplish this thesis. I will always be thankful to them.

I am proud that two of my earlier students followed their ambitions and are now independently undertaking their own PhD studies, Vânia Freitas and Sílvia Santos. My PhD was very enriched by our teamwork, especially during the intense periods in the distant northern Norway. Thank you also for your kind patience in my hard moments...

Two relevant chapters of my thesis depended on sampling along the entire European coast. That was only possible with the valuable collaboration of several researchers who gently provided samples

## Acknowledgements

---

or the means for sampling. Again the list is very extensive which makes me pleased, since no revenue was expected for them. All are named in the respective chapters but I would like to thank especially some of them. Sampling at Minho estuary was facilitated by José Carlos Antunes who provided the means, and by Eduardo Martins, the tireless fisherman. Both are also good friends. Faraway, in northern Norway, above the Polar Artic Circle, I was fortunate to have the kind support of Stig Skreslet and of the HIBO fisheries station staff. Among them especially Erik Tryggestad and Tormod Skålsvik were also important to the success of the laboratory experiments. An especial thank you to Hans Witte is also due to his assistance and advice, besides his very good mood. I am further grateful to Erdogan Cicek and Sabri Bilgin, who assisted sampling in the Black Sea and received me as an honourable guest.

I would like to thank my promoter Prof. dr. S.A.L.M. Kooijman for his prompt assistance commenting the thesis, clarifying doubts and pushing me further. I even owe him the inspiration for the thesis title!

Prof. dr. Paulo Santos offered me the initial opportunity to work at CIIMAR, while Prof. dr. João Coimbra strongly motivated and supported my work, especially during the final writing period. In this period, Ana Bio and Mónica Maia-Mendes were also very encouraging. My work at CIIMAR further benefited from the advices of Hugo Santos, namely on the experiments' design and maintenance, and from the teamwork and friendship of Sérgio Costa Dias, who is always available for a relaxing talk.

The intriguing issues on genetics gave me the opportunity to greatly learn working with Pieterella Luttikhuisen and Katja Peijnenburg. Several researchers including Adriian Rijsdorp, Ingrid Tulp and Peter Henderson gave me further important suggestions to improve some of the chapters. I could also count with statistical advice from Erik Meesters, Mathieu Cusson, Ana Bio and Peter Henderson. Felipe Ribas, Gonçalo Dumas, Henk Hobbelink, Sérgio Costa Dias and Sónia Mendes helped with the figures and my daughter Beatriz Alão was responsible for the final arrangements, including the thesis cover and layout. My brother João Campos solved all kinds of informatics troubles.

Friends deserve a tribute too for their support, patience and moments of rest. In the several visits to Texel and Bodø, I had the pleasure of meeting a nice group of people. An especial thank you is due to the kind Ramsahai family, namely Rekha and Shanti, from Utrecht, who provided me a strategic cosy 'hotel' for visiting the country. Northly, I could enjoy the amusing company of the Bodø 'journalists team', namely Bjørn Vang and Bent-Are. Thank you for your pleasant fish dinners and for the fishing trips. I would like to thank also my long term friends Sónia Mendes, Joana Matos and Marta Assunção, who are very precious to me. More recently and intensively, David and Margarida's friendship has been very refreshing: thank you for the long dinners, the long talks and long walks in the nature, for the concerts and theatre plays we have been together, sharing experiences...

My family deserves a very special thank you for their unconditional patience, confidence and encouragement. In my frequent travelling I could count especially with my husband and my mother, but also with my father, brother, uncles and parents-in-law, who replaced me in taking care of my children. No words can express my gratitude. So, simply thank you very much. Muito obrigada Hugo, pela confiança nos meus propósitos, por todo o apoio e carinho; muito obrigada Beatriz, Raúl e Lua, pelo significado que têm para mim; muito obrigada mãe, pela constante disponibilidade e paciência para me ouvires. E eu tenho sempre muito que dizer...

## Curriculum vitae

Joana Campos was born on the 10th of January 1972 in Porto, Portugal. In 1990 she began studying Aquatic Sciences (Biology) at the Institute of Biomedical Sciences Abel Salazar from Porto University. In 1996 she started working as co-ordinator of environmental education projects at the Estação Litoral da Aguda, Portugal, for a 4-year period. In 1997 she obtained her Licentiate degree in Aquatic Sciences. From 1999 to 2002, she worked at IPIMAR on the project “Improving sampling of Western and Southern European Atlantic Fisheries – SAMFISH”. She obtained her Masters degree in Applied Ecology at the Faculty of Science from Porto University in 2002, with a thesis on the feeding ecology and growth of the sea robin *Trigla lucerna* in the Mondego estuary. In January 2003 she was granted with a 4-year scholarship from the Portuguese Science Foundation to do her PhD at CIIMAR and at NIOZ. Her PhD working project was further funded with a grant from the same institution. Results from these studies are documented in this thesis. Since 2007, she is working at CIIMAR on the project “Managing Effects of Global Climate on Estuarine Biodiversity and Productivity” supported by a grant from Iceland, Liechtenstein and Norway through the EEA Financial Mechanism and the Norwegian Financial Mechanism. In this project which also involves the NIOZ and the Bergen University, she co-ordinates the work of seven PhD students.

### Publications

- Cabral, H.N., Vasconcelos, R., Vinagre, C., França, S., Fonseca, V., Maia, A., Reis-Santos, P., Lopes, M., Ruano, M., Campos, J., Freitas, V., Santos, P.T. & Costa, M.J. 2006. Relative importance of estuarine flatfish nurseries along the Portuguese coast. *J. Sea Res.* 57, 209-217.
- Campos, J., Freitas, V., Pedrosa, C., Guillot, R. & Van der Veer, H.W. 2009. Latitudinal variation in growth of *Crangon crangon* (L.): does counter-gradient growth compensation occur? *J. Sea Res.*, Doi: 10.1016/j.seares.2009.04.002
- Campos, J., Pedrosa, C., Rodrigues, J., Santos, S., Witte, J.IJ., Santos, P. & Van der Veer, H.W. 2009. Population zoogeography of brown shrimp *Crangon crangon* along its distributional range based on morphometric characters. *J. Mar. Biol. Assoc. UK* 89, 499-507.
- Campos, J. & Van der Veer, H.W. 2008. Autecology of *Crangon crangon* (L.) with an emphasis on latitudinal trends. *Oceanogr. Mar. Biol., Annu. Rev.* 46, 65-104.
- Freitas, V., Campos, J., Fonds, M. & Van der Veer, H.W. 2007. Potential impact of temperature change on epibenthic predator–bivalve prey interactions in temperate estuaries. *J. Therm. Biol.* 32, 328–340.
- Freitas, V., Costa-Dias, S., Campos, J., Bio, A., Santos, P. & Antunes, C. 2009. Patterns in abundance and distribution of juvenile flounder, *Platichthys flesus*, in Minho estuary (NW Iberian Peninsula). *Aquat. Ecol.*, Doi: 10.1007/s10452-009-9237-8.
- Luttikhuisen, P., Campos, J., Bleijswijk, J., Peijnenburg, K.T.C.A. & Van der Veer, H.W. 2008. Phylogeography of the common shrimp, *Crangon crangon* (L.) across its distribution range. *Mol. Phylogenet. Evol.* 46, 1015-1030.
- Rodrigues, P., Reis-Henriques, M.A., Campos, J. & Santos, M.M. 2006. Urogenital papilla feminization in male *Pomatoschistus minutus* from two estuaries in NW Iberian Peninsula. *Mar. Environ. Res.* 62, S258-S262.

